

OFFICIAL REPORTS



Q R P :::::

:::::::::: OF THE

RESEARCH GROUP

ISSUE FOR

NOV 1950.

EDITED BY: J. Whitehead  
6, Abbot's Tilt, Hersham  
Walton-on-Thames, Surrey

Dedicated to the  
advancement  
of Low Power Radio

**QRP**

# Q, R, P

No: 14.

November 1950.

.....

For some months now the "Q R P" mail-bag has averaged thirty letters a week. One lies before me now. "It seems a very long time since I heard from you, OM," the writer complains, "Infact I've been wondering if I have offended you in some way."

He had done nothing of the sort, of course, I had always found his letters interesting and informative and had made good use of them in the mag from time to time. I wrote and told him so by return, but it left me with an unhappy feeling that others of you might be feeling the same way -- and saying nothing!

There are nearly two hundred of you now -- and still only one of me! My job (which, to my sorrow, has no connection with radio) leaves me, perhaps, rather less than the average of spare time, and the preparation of "Q R P" from the first rough notes to the final wrapping up occupies the whole of that time during the second half of each month. There are other essential duties such as producing leaflets, application forms, data sheets and so on, and, of course, accounts and membership files to keep. And thirty correspondents a week, all hoping for personal answers!

OMs -- if you don't get that personal answer to every letter please don't think that you have offended me! ALL your letters are carefully read and all relevant data noted and carefully filed for use at the appropriate time. And all letters that require immediate

answers get them. But if I answered every letter personally there would be no "Q R P". Believe me it is anything but lack of interest.

Another point -- if your circuit or the bit of data you sent in does not appear in the following issue of the mag, please do not think that your effort has not been appreciated. In order to keep the cost of the mag within the revenue provided by your 5/- subs I can only use a certain quantity of paper, thus restricting the amount of gen I can include. Every bit of data that has come to hand however small has been filed and indexed and will be brought forward as space permits.

Finally -- don't stop writing. "Q R P" depends on your letters. You see, although it has my name at the top, it is you who write the mag really -- I only string it together.

Yrs, Sincerely,

*John Whitehead*

THANKS.

A.E. Stonestreet asks us to pass on his sincere thanks to G5GG for the prompt answer to a letter enquiring for certain data the receipt of which has enabled him to continue his experimental work.

"It is this co-operation", says A.E.S, "and the spirit with which it is given that makes our hobby worth while."

A.E.S. also thanks us for a small part which we gladly played in effecting an introduction between a friend of his, now resident in Pakistan, and AF2K.

Let us know if your friend does get his AF call, OK -- we shall be particularly interested.

A SPECIAL O-V-1 by R.J. BROOKER.

Although this receiver is intended to be used for portable operation as well as fixed station, ordinary two-volt valves were used instead of the 1.5 volt types, the reason being that they have been found to give a much better account of themselves than the smaller ones.

The RF stage is a W21 which, although it is a variable mu valve, (super control pentode in Americanese) is run flat out, that is with no bias. With 150 volts on the anode and about 70 on the screen this gives plenty of gain, which is very desirable in an RF stage. Even under these conditions current is only 5 mA. RF and detector stages are separately tuned and this causes no inconvenience whatever as the greater part of the tuning can be done without touching the RF control, and the desired signal, when found, can be peaked up considerably more with the separate control than with a ganged drive.

Note the co-ax type lead from the HT line to the top cap of V1 on the detector side of the interstage screen. This is shown in Fig 3 but, for clarity, has been omitted from the circuit diagram, Fig 1.

The resistance, R5, may be found necessary in some cases and should certainly be included if there is any tendency to instability.

The detector is a PM2HL and reaction is controlled by means of varying the anode current (R3), a coarse control being provided by the 100 pF condenser, VC4. The detector is transformer coupled to the output stage. This may seem a little old fashioned to some, but look at it this way -- the main reason for using RC coupling instead of transformers, back in the early days, was that transformers then were very inefficient and caused all sorts of undesirable things like threshold howl and so on. Modern transformers do not do this and, furthermore, one can obtain correct matching.

The output stage is an LP2 triode. By applying 9 volts grid bias

Fig 7

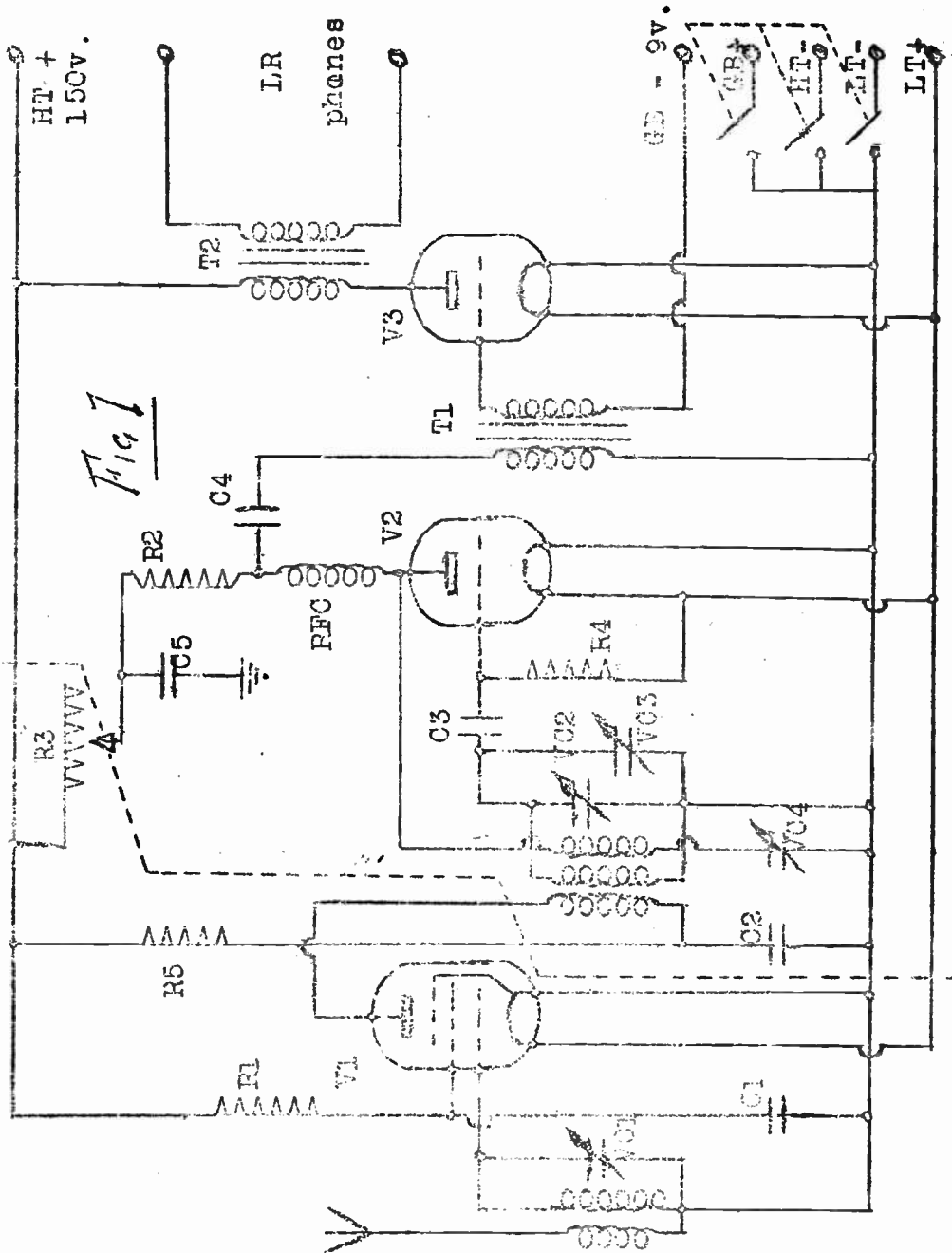

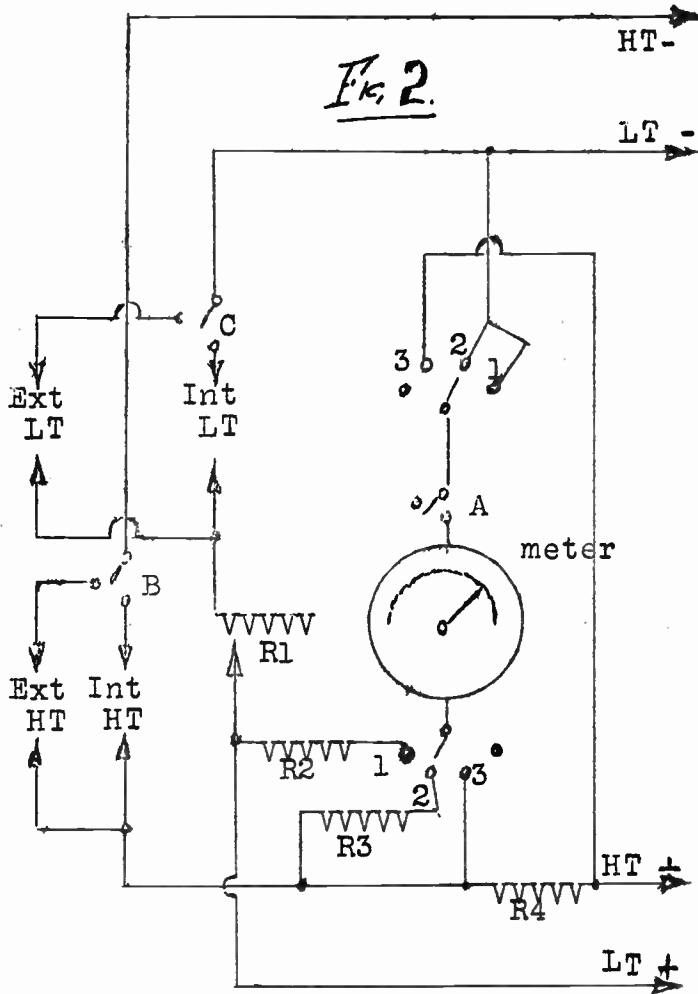

to this valve it draws a little under one mA. It has been found that this causes no loss in signal strength and, though it gives slight distortion on strong signals anyone really interested in Dx will not be seeking strong signals as a rule.

An ordinary microphone transformer feeds a pair of low resistance headphones. Plug-in coils are used, those installed at the moment being Denco range 5, which, with 200 pF max tuning capacity, cover 22 to 14 Mc/s.

There is no trace of hand capacity whatever with this receiver, but the old adage must be remembered, that it is essential to take all wiring as directly as possible and make no unnecessary connections.

As will be seen from Fig 4, the power pack is actually a separate unit from the Rx, although housed in the same cabinet. The

meter is used primarily to check that the LT supply is exactly two volts. It can be switched to measure the HT voltage and current. The meter used gives ranges of 3v, 250v, and 12 mA. The HT and LT block in the original set came from a 58 set and measures approximately 6" x 5" x 3".

Component values for the main diagram (Fig 1) are:--  
 VC1, VC2: 200 pF. VC3: 10 pF. VC4: 100 pF. C1,2,4,5: 0.1 uF.  
 C3: 100 pF (ceramic). R1: 50 K. R2: 60 K. R3: 10 K. R4: 3.6 meg.  
 R5: optional. T1: ratio 4:1. T2: microphone transformer.  
 RFC: Eddystone. Coils: Denco, Range 5. V1: W21. V2: PM2HL.  
 V3: LP2.

Component values for the Power Supply (Fig 2):--  
 R1: 10 ohms, wire wound. R2: 6.7 K. R3: 500 K. R4: 12 ohms.  
 Switch A: Meter in/out. Switch B: HT int/ext. Switch C: LT int/ext.  
 Ranges of the ganged four-way switches: "1", 3 volt FSD.  
 "2", 250 volt FSD. "3", 12 mA FSD. The meter is a Weston model 506,  
 500 uA FSD, and the negative meter connection is made through the Rx  
 on/off switch to HT -.

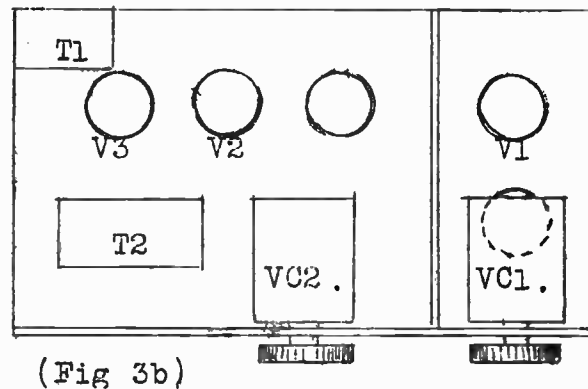
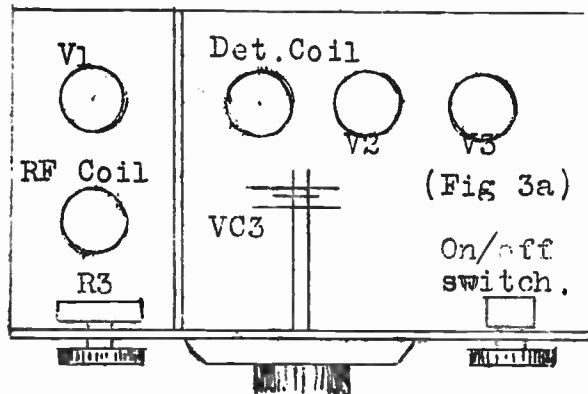

Fig 3a shows a plan of the chassis layout and Fig 3b is the "under-chassis" plan. The chassis measurements are 9" x 5" x 2½". Fig 4 shows the front panel with the power supply unit in position.

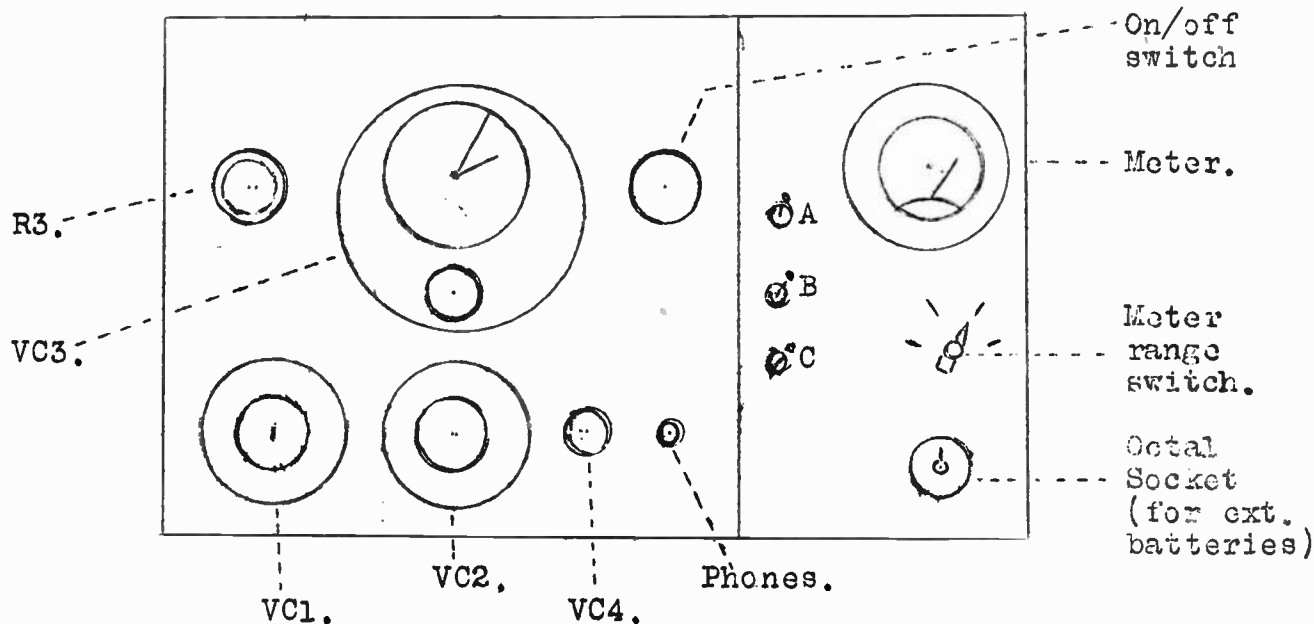

FIG 4.

The receiver described above is the nearest approach to perfection in the 1-V-1 class which has come to our notice since the inauguration of "Q R P". It is well worth the attention of all serious QRP Dx enthusiasts and, in order to retain the full excellence of the original model, all copies should be laid out on exactly similar lines. The same applies, of course, to component values.



TOP BAND RECEPTION NOTES, by BILL IBALL, Wigan TR.

(Ed:-- Bill uses a C-V-1 with a 210HF and a PM22A by Mullard, and his antenna is 15 ft high, W - E, 40 ft long. The following notes are the result of a close watch on the band from March 1949 to May 1950.)

One of the outstanding drawbacks of most QRP receivers is the inability to receive many phone stations, and unless one has a really good antenna much apparent Dx is missed. To compensate this loss, the QRP receiver is ideal for CW operation because of it's quiet background and simplicity of operation; and simplisity of operation is an essential factor with this type of Dxing.

My personal experience on the Top Band proves that it is a real experimental band and much useful information can be gleaned from the "conversations" of the amateurs. Apart from that, the main interest appears to be reception distance of low powered, or semi low powered transmissions, and usually a QRP amateur will readily confirm a comprehensive report of a SWL. I have been struck with displays of the real "Ham" spirit which exists on the Top Band. Usually one doesnot get the greedy Dx hound ruining the Dx contact of another "Ham". I have known them to queue up in order to work a Dx call with no persistent calling of the contact during actual "working period". And there doesn't seem to be any of that "handing him over to my old pal GØXYZ." The fact that this band is truly experimental, with a code of honour superior to conditions on the other regular bands (not VHF), is, in my opinion, the reason it is not too popular with both fraternities. This statement may appear to be very "uppish" to say the least, but I have no doubt that the band will be overrun by the Dx smatchers during the coming Trans-Atlantic contests. I shall be very much surprised if I am proved wrong. Fortun-

ately the rules governing the contest are reasonably good and may help to minimise the effect I fear.

In an attempt to bear out my contention concerning Dx hours, is it not surprising that the only times the Top Band are crowded occurs during field days and contests? On the average week night there is plenty of room to spare on this band, although, under normal conditions, there is excellent weekend activity. In comparison, I know that usually 3.5 Mc/s gets pretty busy most nights, infact one evening last month the band was just a jumble of calls pounding away at the key or "spitting into the mike". The potentialities of the Top Band appear to be sadly overlooked or underated, and to the best of my knowledge no one has attempted to explain why it should be so.

Generally speaking the best Dx comes in on CW and with that in view I paid particular attention to the "key pounders", and more especially to weak signals and to those suffering from a large dose of QSB. It is not at all strange that some of the weak sigs should be comparatively near to this QTH, and not necessarily QRP Tx's at that. That is one of the reasons why the Top Band is so interesting to me. Here is another. On 2/3/50, at 2250 GMT, I logged GW5AB at an estimated RST 459 with QSB down to zero. I sent him a report and he informed me that his antenna was "just a lot of wire running round the shack, then hung out of the fanlight onto a line post -- just over thirty feet in all." His Tx was "a small self contained rig" though he didn't state his power. GW5AB is near Cardiff.

Another interesting Veri comes from G3EKP/P for a report on June 24th at 1909 GMT. I estimated him at RST 559, peaking S6. He says that he was using 2 watts, QTH Darwin. GI3CVH of Co Armagh verified a report of 18/3/50 at 2314 GMT when his input was but 4 watts. My estimation was RST 569 at peak, QSBing to S3.

G8HI/P of Wiltshire confirmed my reception of his signals

(11/6/49) at 1854 GMT when using 5 watts. I gave him 549, and at 2155 GMT the same day he was peaking S7. Another interesting "case" was GM8FM of MidLothian. He constantly put in a good CW signal but was heard very poorly on speech. There are many more interesting instances, but perhaps the above will be sufficient to stimulate a little Top Band enthusiasm among those SWLs who have not ventured there before. Let me add that only on two occasions has my listening continued after midnight. Anyone with the normal amount of patience with a simple O-V-O or O-V-1 can obtain a good return in pleasure when studying the Top Band.

(Ed:-- The following extracts from Bill's Top Band logs will show the doubters that there is plenty to hear on the QRP band. G2AFV (Barnsley), ATW, BUR, BXS, CPT (Poole); G3AMG, ANM, DSE, DUW, EKX, ERH, EZZ, FCQ, FKV (Falkirk), FSH, FVH, GIE; G4GA (London), GT (Herts); G6HD (Kent, 4.5w); G8LN (London); GI2HML (Belfast); GM3ATV; GM4JQ (Falkirk).

Now come on, OMs, let's have some regular 1.7 Mc/s reports).

#### Q R P GROUP S W L CARDS.

Support for the suggested production of a QRP Research Group QSL card has been quite strong enough to go ahead with plans.

In the mean time, has anyone any bright ideas on matters of design? It should be simple (for, as with women's dress, simplicity is the main ingredient of "effect") and yet distinctive. I suggest, too, that we want to get right away from the now hackneyed emblems of lattice masts and lightning flashes, and also to forget the increasing array of globes and spheres.

There is a year's free subscription to "Q R P" waiting for the member who sends in the best design before December 1st, 1950.

DUG UP BY :--

George Partridge,  
G3CED,  
"Brent House",  
17, Ethel Road,  
Broadstairs.

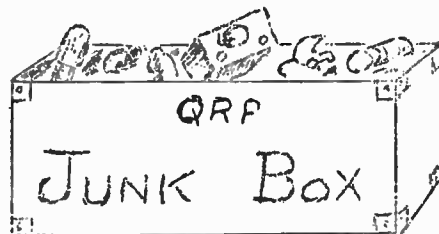

WHAT OFFERS!  
VERY CHEAP!!  
MUST BE CLEARED!!!

That bloodthirsty old Brigand of Broadstairs has done it again! He has dug up another treasure chest full of amazing bargains. Drop him a line direct, OMs, for any of these really useful items:--

(1): Assembled on a rack type chassis -- 12" CRT, slightly burnt but suitable for experimental work; scanning coils, home made to Wireless World specification; focus coil pot (coil burnt out); black rubber mask for above CRT; time base complete; EHT unit complete; power unit, 240v, 450v, 6v, 4v.

(2): T V set, vision and sound, with VCR 97. EHT unit requires reassembling but is otherwise complete. This set gives excellent results in Bromley from a dipole in the roof. BEST OFFER OVER £5.

(3): Large quantity of components including many transformers, chokes and valves of numerous types.

(4):  $\frac{1}{4}$  HP 240v 50 cycle Induction Motor (self starting).

(5): CRYSTALS: Exchange 1960 and 1968.5 for any two between 1720 and 1800.

MODULATION SYSTEMS. by GW2DDX, Part 3.

SUPPRESSOR GRID MODULATION:-

Let us take a look at some of the Efficiency Modulation Systems. Should anyone be under a misapprehension about the word "efficiency", let me say at once that the meaning of "efficiency modulation" is modulation that is obtained at the expense of the efficiency of the stage being modulated. This simply means that to obtain modulation we have to reduce the output efficiency of our power amplifier.

In the case of a pentode PA, operating under Class "C" conditions, the pentode has a screen and suppressor-grid in addition to the control grid, and we can apply modulation to any one of these. The smallest amount of audio will do this, five watts being sufficient to modulate a 100 watt PA stage

How is it that so small an amount of audio can modulate such high power when we have just seen that 50 per cent of the input to the PA is needed for anode (or plate) modulation? Well, in the anode system we have to swing the PA anode voltage, which is considerable, and to do this a large amount of audio voltage is required to get reasonably deep, or full modulation.

Where the valve has a suppressor-grid this is where, normally, the audio is injected. We only require to swing the bias voltage, which is very small compared with the anode voltage. The plate current is varied in sympathy with the bias voltage -- hence the PA efficiency is varied also.

The adjustments for grid, or suppressor-grid modulation are very much the same. A small pentode will give ample output to modulate our PA suppressor-grid. To adjust for modulation, keep the drive to the PA constant, then increase the negative bias until the plate current drops to the proper operating value. Generally it should be the current corresponding to the rated plate dissipation

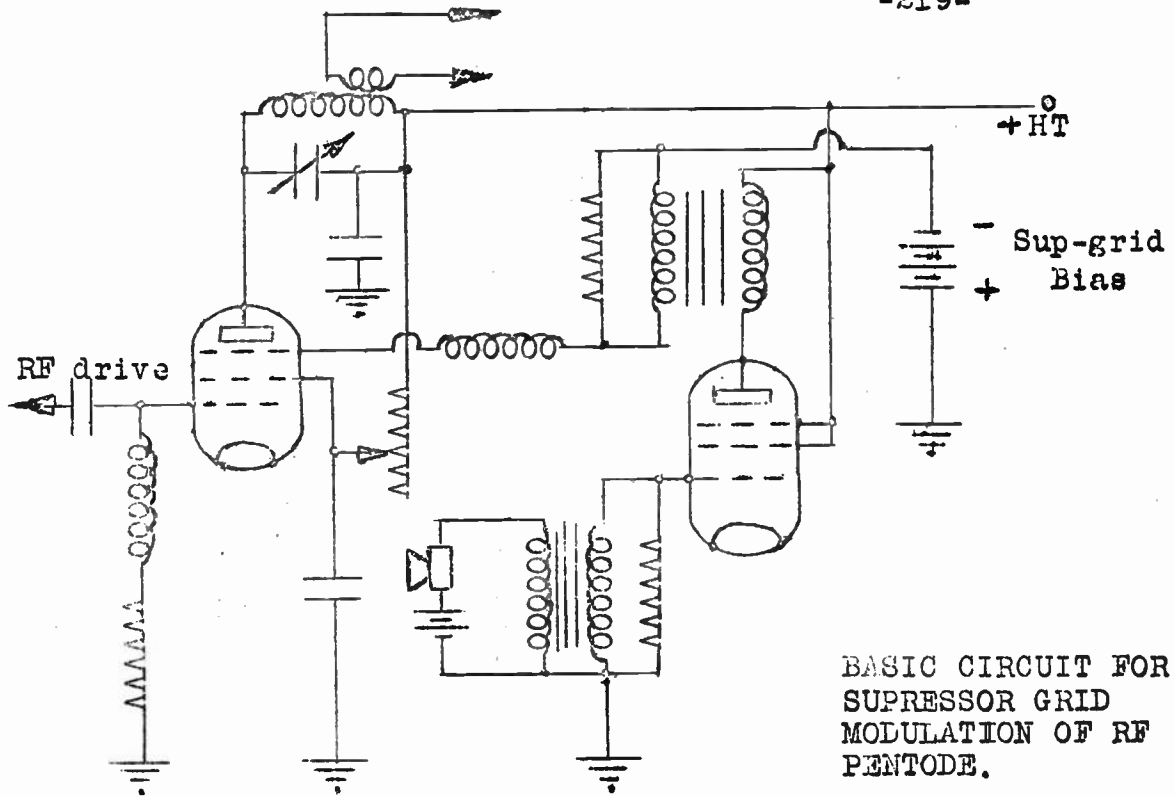

BASIC CIRCUIT FOR  
SUPPRESSOR GRID  
MODULATION OF RF  
PENTODE.

of the amplifier, at the particular plate voltage used. When the modulation is applied it should be possible to cause the antenna current to rise, and the plate current to dip simultaneously. In practice the bias and modulating voltage are adjusted so that the valve is operating most efficiently during modulation peaks in a positive direction. The output from the modulated stage just drops to zero during negative modulation peaks. This condition corresponds to 100 per cent modulation.

The valve can operate at maximum efficiency only during positive modulation peaks, and must work at lower efficiencies at all other times. The efficiency is in the region of 38 % and the modulated output from such a state is about a third of the CW output. So you see we have to give quite a bit of available RF away in order to use telephony.

These little articles are written to aid the newcomer and the QRP CW man. They are not intended to be conclusive. For a more detailed and mathematical explanation of modulation the reader is referred to one of the many good text books dealing with the subject.

Next month we will discuss CATHODE BIAS MODULATION, together with a practical QRP Tx that has been successfully modulated by this system.

#### NOTES AND NEWS by R. J. Brooker.

Comments received this month on conditions agree fairly closely in the observation that 14 Mc/s has been suffering from "short skip". Occasionally, however, there has been plenty of Dx for the lucky ones listening at night. There is little doubt that, as things are at the moment, the CW fans score heavily over the phone boys.

Mike Wassell sends some interesting comments on 14 Mc/s:--

VR6AA was heard on phone, Oct 2nd, 0300 to 0330, operating on 14150 Kc/s, the QTH being Pitcairn Island.

W20XE/MM, the schooner "Bowdoin" of the Macmillan Arctic Expedition, came over on Aug 17th at 1640 to 1700 on 14300 Kc/s.

YA3B at 1721 to 1738 on the same day on 14029 Kc/s had a T1 note!

ZM6AK was heard calling CQDx at 0740 on Oct 2nd on 14040 Kc/s but no reply came up.

TA3GVU was overheard expounding the interesting theory that the recent bad condx were due to the planet Jupiter being closer to the Earth than it has been for 75 years! Any more ideas on this?

Bob Iball of Workshop wonders if anyone can give him any gen on the Swedish shore telephony on Top Band. He is also curious as to why the QRK of ham stations is usually weaker around 1.7 Mc/s than between 1.8 and 1.9 Mc/s (I should check your Rx alignment, OM).

Many hams do prefer to use the lower end of the band in order to try and avoid interference from other services which share it, especially "Loran" up at the high end. As Bob Iball points out Loran is "nowt but a darned nuisance" from the amateur point of view, but it is infact a very valuable navigational aid. Pulses transmitted from the main station trigger a "slave" station which also transmitts pulses after a suitable time interval; both signals are picked up by a receiver on board any ship at sea, the time intervals can be measured and, using the figures thus obtained, in conjunction with specially prepared charts, the ship's position can be established. At the moment a quarter of the Earth's surface is covered by these stations and it is a great pity that a different frequency could not have been chosen.



Finally, here are some usefull Dx QTHs supplied by Mike Wassell:--

- ET8AB; Ivan Pastre, Base Aviation, Douala, French Camerouns.
- FO8AA; Radio Club Oceania, Papeete, Tahiti.
- HK1DZ; PO Box 59, Barranquilla, Colombia.
- KG4AK; D.Constantino, Navy 115, Box 18 c/o FPO, NY, NY, USA.
- VE7HC; 2075 Nelson St., Vancouver, BC, Canada.
- VK5KO; 25 Farrell St., Glenelg, South Australia.
- VR5PL; Noel Mortensen, Box 26, Nukualofa.
- VP8AP; c/o FIDS, Port Stanley, Falkland Islands.

Well, that's the lot for this month, chaps. Let's have plenty of news by the 15th of next month which is the dead-line if I am to get it sorted out in time for John to include in the next issue.

73 es gud Dx,

R. J. B.

(Ed:-- And don't forget, OMs, that all the above was recorded on strictly QRP receivers. Don't leave it all to Mike. With a little concerted effort this could be a really "hot" column, especially in view of the fact that there is less time lag in the publication of it than there is with ANY of the other journals. News received here on the 17th--and even on the 20th of the month in some cases--can be in print in the issue reaching you on the first of the next month. And DO please remember that any news you have for this column should go straight to: R.J.Brooker, 77 The Cottages, Rosendale Rd, Herne Hill, SE24. Your logs and any other gen should of course come to me as in the past.)

.....  
NEXT MONTH'S FEATURES:-- An unique O-V-O with variable grid capacity (by Les Waine). An experimental circuit for Automatic Reaction Control (by Ray Coley). "With a QRP Tx on Top Band", by G2AJU. And a FULL REPORT OF THE R S G B EXHIBITION.

"Q R P" C - 2 PANEL.  
(1950 calls only)

SECTION 1 :- Unverified List.

	MEGACYCLES				TOTAL	
	3.5	7	14	28	C	Z
Bob Brocker	12	12	131	54	146	38
Bert Glass	14	19	137	32	140	37
D. Gordon	12	16	75	88	119	31
P.Huntsman	18	22	97	--	98	33
Mike Wassell	18	23	80	--	80	32
Peter Short	9	8	79	--	79	31
H. G. Wells	--	--	77	--	77	27
F. Herridge	15	38	59	33	76	23
Bob Murray	5	16	71	--	73	24
Arthur Looney	--	--	60	--	60	19
R. Nixon	3	19	60	2	60	19
David White	5	3	29	--	33	12
Ian Glenn	5	4	28	--	33	11

SECTION 2 :- QSL Verified List.

Bob Brooker	3	2	15	19	38	19
Bert Glass	--	--	27	4	-?-	14
Arthur Looney	--	--	16	--	16	6
Bob Murray	--	3	13	--	15	8
Peter Short	--	--	10	--	10	8
D. Gordon					8	8
P.Huntsman	--	--	4	--	4	2
F.Herridge					1	1
Ian Glenn					1	1

SEPTEMBER RECEPTION REPORTS.

---

INDEX TO OPERATORS:--

- "RI": - Robert Iball, Worksop, O-V-0.  
"AG": - A.L.Glass, 2597, Plymouth, O-V-1 (0.5 watt).  
"RB": - R.J.Brooker, 3457, Herne Hill, 1-V-1 (0.8 watt).  
"HW": - H.G.Wells, 3894, Waltham Cross, O-V-1 (1 watt).  
"MW": - Mike Wassell, 3982, Birmingham, SH4 (1.2 watts).  
"AL": - Arthur Looney, 2959, Liverpool, 1-V-1 (1.06 watts).  
"SB": - S.Beharrell, 321, York, 1-V-2 (1.2 watts).

TIME INDEX:--

- (1) 0001/0300, (2) 0301/0600, (3) 0601/0900, (4) 0901/1200,  
(5) 1201/1500, (6) 1501/1800, (7) 1801/2100, (8) 2101/2400.
- 

1.7 Mc/s LOG:-

- 1.9.50 (RI7&8): - G2JF, OG; G3CXG, DKZ, GGH, GKQ, NL, ZP, ZY; G5JU; G8DHX, TD  
2.9.50 (RI6&8): - G2AASH, AJK, EGL, JF; G3GKQ, GSY, FAB, FQT, HR; G6WD.  
3.9.50 (RI8): - G2AJK, JF, FS; G3AMT, BWR, DFU, DKO, EGE, ETN, FRF, GLS, HR;  
G13KV.  
5.9.50 (RI8): - G2AOP, BON; G3CYY, DKO, EES, FYT, GGN, GLV, GSV; G4GJ, OK;  
G5AY; G6GO, LB.  
6.9.50 (RI7): - G2BKC, JT, QX; G3AKY, CEM, ENN, EQ, JSP, FEX, GDA, GGN, GIO,  
GKQ, GWY, HVG, OV; G5RZ; G13KV; GM3LHI, FXL; GW3BJZ.  
7.9.50 (RI6&7): - G2AOP, LU, LZ, UQ; G3ANT, ATO, AWD, BQF, CYY, DBZ, EVW, EDT,  
GKQ, GLV, GMI, GTB, GY; G4KO; G6KR, KS, QC, VC; G8HF; GM3FXL;  
GW3BJZ; DL1UJ; DL6PU; PAØLJ, LY.  
12.9.50 (AG7): - G2FID, HW/A, JF; G3LAW, DHE, DTG; G5RZ.

(The above sample of Top Band activity shows that there is plenty there. Drop in and have a look round sometimes, OMs.-- ED.)

14 Mc/s LOGS:-

1.9.50 (SB3) :- TI2FG. (AL3) :- CP5EL.  
2.9.50 (AL3) :- CE3CZ; CS3AA.  
3.9.50 (RB4) :- KL7GG; VK7JB. (SB8) :- CX2CO.  
5.9.50 (HW7) :- HZ1KE; VP6SD; VQ4AQ, RF. (HW3) :- CX2CO.  
6.9.50 (HW7) :- SVØWZ; VQ4RF.  
7.9.50 (HW7) :- SU1MR.  
8.9.50 (HW7) :- VP6SD; VQ4RF.  
10.9.50 (SB3) :- VQ4RF; YV5VP.  
11.9.50 (HW8) :- CS3AA; KP4EE; VP6FA.  
12.9.50 (RB6) :- CS3AA, VS1AY. (SB3) :- HI6EC (HW8) :- CS3AA; HI6EC  
(AG3) :- K2BU; KL7GG; OX3BD; W6TXL; W7KWA; WØYXC.  
13.9.50 (AG3) :- HZ1JE; KV4AC; VK2YZ; VK3GA, YL; VK4EL.  
(RB3) :- TI2TG; VK2AT. (RB6) :- CS3AA; VU2JP; ZS1BK, 1GX, 5W,  
14.9.50 (AG3) :- KH6EK, ES, IJ. (RB3) :- VK2CP; VK3HG. (6IX,  
(MW6) :- FT4AT; UG6KAA; VS1AY; VS9AH  
(AG7) :- ZS1BK; ZS3X; ZS6UR.  
(MW8) :- FF8AH; VP4LS, TH; ZD1ISS; ZD4AD.  
15.9.50 (MW6) :- HZ1KE; OX3BD; SU1MR; UA9CL; VU2BH.  
16.9.50 (RB3) :- Many VK1, 2, 3, 4, 5 and VK7AJ; ZL4CL  
(MW3) :- VE6DG; VE7VO; ZL3FV.  
17.9.50 (MW3) :- KL7GG; VE7HC; VK1AD, 2AGH, 2AGT, 2AIL, 3ALQ, 5KO.  
20.9.50 (MW3) :- CR6AI; VP3CW, 5AK, 9BA; ZC4DZ.  
21.9.50 (MW2) :- FG8AB; HR1MB; KZ4EL; VE6PM; VP8AP; VR5PL.  
23.9.50 (MW3) :- FE8AB; TG9JK; UI8KAA; VE8MI, 8OH; VP1IH, 4TH.  
(HW7) :- KP4AW. (HW3) :- VP4TI, 6FO.  
24.9.50 (RB4) :- EQ3UU; OX3BD. (HW6) :- VQ4AQ. (HW7) :- VP9G; YV1AA.  
(RB7) :- VQ4BC.  
27.9.50 (HW6) :- SU1MR. (HW7) :- VP4TI.  
28.9.50 (MW6) :- FB4AB; FI3ZZ; OQ5CF; ST2AM; VQ9CL; VU2BH; WØLYC.  
29.9.50 (RB3) :- Many VKs. (RB5) :- KG6USA. (HW7) :- P11LC; YV5BQ.  
30.9.50 (HW3) :- VK4LN, 5RM; ZL4AW. (HW5) :- HZ1AB.  
(HW6) :- UG6KAA; VE8TC.

"TWO - WATT" Tx PANEL.

STATION	1.7		3.5	7	14	20
	Countries	Counties	Countries			
G3EDW	4	11	3	12	--	--
G5QI	--	--	14	13	--	--

Input: G3EDW, all QSOs worked at 1 watt.  
 G5QI, " " " " 0.5 to 2 watts.

THE MONTHS BEST QSOs FROM G3EDW.

Call	QTH	approx Dx.	Band	Watts input
GD3UB,	Nr Ramsey, IOM,	290	1.7	1.0
DL2QI,	Detmold	360	"	"
GC2EMV,	Jersey, CI	200	"	"
DL3GL,	Bonn,	310	3.5	"
DL3LK,	Alfeld,	400	"	"
GW3ZV	Nr Aberdare, S Wales	130	"	"
GC2CNC,	Jersey, CI	200	"	"
GC5OU,	" "	"	"	0.5

.....

GROUP CALLS now include the following Full Members:--

G2AJU	G2DHV	G2HKQ	G3CED	G3TAZ	G3EDW	G3FKI
G3TSX	G3FAU	G3FJW	G3FVE	G4QW	G5GG	G5QI
						GW2DDX

.....: GEAR CHANGE. .....

EXCHANGE: Two Mazda HL23 for set of plug-in coil formers or coils to cover 30 Mc/s to 1.5 Mc/s.

D.White, 31 St James Rd, Kingston-on-Thames, Surrey

---

FREE: Two Hivac XP triodes and one Hivac XY output pentode All new and unused (2,0 volt heaters).

Miss Verna Stent, 34 Laleham Rd, Staines, Middx.

---

.....

DO REMEMBER to visit STAND 4 at the RSGB Exhibition. I am looking forward to a personal QSO with you and shall be on the stand from approx 1900 hrs to closing time Wed, Thurs and Fri, and from opening time onwards on Saturday.

If you can't make it during those times you'll still find plenty to interest you including our latest leaflets AND THE CARTER SHIELD.

.....