

The **TALKING**
MACHINE
WORLD

*For the
 makers &
 sellers of
 talking
 machines*

Published Each Month by Edward Lyman Bill, Inc., at 373 Fourth Ave., New York, September 15, 1922

Victrola

REG. U. S. PAT. OFF.

The word "Victrola" as well as the picture "His Master's Voice" is an exclusive trademark of the Victor Talking Machine Company. Being registered trademarks they cannot lawfully be applied to other than Victor products.



REG. U. S.
PAT. OFF.

"HIS MASTER'S VOICE"

Victor Talking Machine Company, Camden, N. J.

"The Best Record is Better on a Sonora"



Marquette
\$125



Lafayette
\$165



Canterbury
\$200



Queen Anne
\$250

Here They Are! Sonora's New Popular-Priced Periods

They represent an opportunity to you, Mr. Dealer, such as you have never had put up to you before.

Why?

Because the sheer quality of these instruments is astonishing even to phonograph experts.

Because more popular-priced periods are going to be bought this season than ever—the hunger for periods is everywhere.

Because these instruments produce the most exquisite refinement of tone possible to a phonograph today.

Because, in spite of their sterling value, they are low priced. Yes, low—we mean it and the public realizes it. Finally

Because Sonora is being advertised this year to one-half the population of the country.

These are decisive reasons. Act while you can get an adequate stock. Write us today for information

A Few Facts that will sell the New SONORA Models for you

Substantial Construction — a thorough examination by customers of all Sonora's visible parts is a powerful sales argument in itself.

Motors — Sonora motors are marvelously perfected for long-running and durability.

Tone—the present-day Sonora tone quality is an almost unbelievable improvement along the logical lines of Sonora tone mastery.

Beauty of Cabinets—Sonora's fame for exquisite, artistic cabinet work, in the best taste of the times, has taken even greater strides in the new models.

Sonora Phonograph Company, Inc.

George E. Brightson, President

New York, 279 Broadway

Canadian Distributors: Sonora Phonograph, Ltd., Toronto



The Highest Class Talking Machine in the World

The Talking Machine World

Vol. 18. No. 9

New York, September 15, 1922

Price Twenty-five Cents

HOW MUSICAL CENSUS OF THE COMMUNITY HELPS SALES

Experiment Made by Donahoe & Donahoe, Victor Dealers of Fort Dodge, Ia., to Increase Prospect List and Augment Sales Points Way for Others to Utilize This Plan of Operation

"We took a musical census of our community a short time ago and found it very profitable and successful in every way," says J. M. Donahoe, of Donahoe & Donahoe, Victor dealers, Fort Dodge, Ia., describing the sales producing plan recently used by that concern in the house organ of Mickel Bros. Co., Victor distributors, of Omaha, Neb. "The results obtained therefrom were far beyond our expectations. It was profitable from many angles, but to explain it all thoroughly would take too much time and space. I will outline it briefly.

"We first advertised for sales people. Then, after a careful selection of the required number and quality, we gave each of them plenty of instructions along all lines of the game; also their marked territory, one late player roll and six records. They were instructed to use as the opening talk that they were making a complete musical census of our city for us and our object was to find out exactly the different makes of pianos, players and talking machines which were in use at the present time, so we could properly equip our service department more completely for their requirements, as we have always given our service department special attention in the way of giving expert repair service when needed.

"The explanation went over big in most places. Where they had an instrument the solicitor had an opportunity to get us a monthly roll or record customer by playing these over in their parlor and, seven times out of ten, got a nice order, also a new name for the mailing list, or, best of all, if they had no instrument

here is where the salesman got a new name to call on the following day. In the few places that would not grant an audience from this framed-up excuse the salesman invariably got the desired information next door.

"The sales people were paid \$1 per day, 10 cents per item on each sale and three cents per card for all fully and correctly filled out. We made it plain to them that the telephone would be used to verify their work and any plugged cards would cause an immediate 'canning.' We also paid from \$1 to \$5, according to size, for each machine sold to prospects turned in by them within five days; \$5 on new pianos and from \$7.50 to \$10 on player-pianos.

"This, all in all, gave the workers a great incentive to hustle and get the prospects promptly, as there was a five-day limit attached to it, so the live prospects were promptly reported and the territory thoroughly combed. The solicitors made money and we made a number of immediate sales and got plenty of cards to work on for a long time, besides the great saving of time calling on people who were equipped in the musical way.

"I would suggest to any and all who have not taken the census of their town or city to do so at the very earliest convenience. Be sure and lay the foundation right and frame it well, as so many of those good schemes can be spoiled by not being properly organized, or by going at it "wild." The old saying, "A poor start is a good finish," doesn't apply in this case. Be sure to get a good start and in the finish the results will be gratifying."

KIMBERLEY CO. REORGANIZED

Change Name to Kimberley Phonograph Co. of New Jersey—To Increase Production

PERTH AMBOY, N. J., September 8.—The Kimberley Phonograph Co., Inc., which has been operating successfully for some time past, under the direction of Leo Jacobson, has been reorganized and will increase production in the near future. The reorganized concern will be known as the Kimberley Phonograph Co. of New Jersey and Mr. Jacobson will remain as the head of the new organization. The officers are: Leo Jacobson, president; David Isenberg, secretary, and Adolph Greenbaum, treasurer. The company has about completed the purchase of the property in Fayette street, where the plant is located, from Joseph Polkowitz, Inc., and it was said to-day that the title to the land will be taken within a few days.

NEW CONNECTION FOR GEO. T. BEAN

George T. Bean, for a number of years connected with the legal staff of the Victor Talking Machine Co., Camden, has become a member of the law firm of Prindle, Wright & Small, New York, which firm in the future will be known as Prindle, Wright, Neal & Bean.

TO HANDLE PARAMOUNT IN SOUTH

Dewey D. Prater, well-known songwriter, of Millport, Ala., has been appointed Southern representative for the New York Recording Laboratories, Inc., of New York City and Port Washington, Wis., manufacturers of Paramount records.

A Grafonola shop has been opened at 132 North Fifth street, Lafayette, Ind., by C. L. Beisel. It is attractively arranged.

TAKES ON BRUNSWICK LINE

Mather Bros. Co., New Castle, Pa., Installs Complete Line of Machines and Records

The Mather Bros. Co., jewelry and talking machine dealer at New Castle, Pa., has taken on the Brunswick line of phonographs and records, in addition to the Victor line, which the company has handled for some time past. The talking machine department of the store, at 213 East Washington street, has been remodeled, and there is now available a battery of ten demonstration booths.

Featuring the Odd, Unusual Records With Which Buyers Are Unacquainted

How best to insure a great development of record sales is one of the questions of the hour. Dealers are not doing their duty to themselves if they fail to consider every possible way and means of concentrating public attention on the very remarkable records which are being placed on the market to-day—remarkable because of their perfection and the fact that they are veritable photographs of the voices of the great singers and the skill of all the great instrumentalists of the world.

We doubt very much, however, whether dealers have brought to the attention of the customers the many unusual and unique recordings which are to be found in the catalogs of the leading companies. Music lovers never fail to have in their collections a well-assorted selection of operatic, orchestral, and even the better-class jazz numbers, but there are still to be found in the record lists some very remarkable records of string orchestras, the harp, the cembalom, the organ, the harmonica, that odd potato-like instrument, called the ocarina, and other musical in-

APPOINTED GRANBY SALES MANAGER

Thomas McCreedy, Well-Known Talking Machine Man, Takes Important Post With That Concern—Has Had Valuable Experience

Thomas McCreedy, well known throughout the talking machine trade, has been appointed sales manager of the Granby Phonograph Corp., of Newport News, Va. Mr. McCreedy's former connection as Eastern sales manager of the Unit Construction Co. and previous to that metropolitan district representative of the Victor Talking Machine Co., of Camden, N.



Thomas McCreedy

J., has built up for him a wide circle of acquaintances throughout the talking machine trade in the Eastern territory.

His wide knowledge of the talking machine business, combined with his affiliation in the past with publishing houses and advertising agencies, well fits him for the sales and advertising work which will be included in his new duties with the Granby Co.

Mr. McCreedy will make his headquarters at the main office of the company at Newport News and operate from that point. He has well-defined plans for progressive development of Granby sales which he expects shortly to put into operation.

struments which invite and merit consideration.

The unusualness of these recordings and the very remarkable effects secured in the laboratory are well worth particular attention. It would be an excellent idea were these records grouped for a window display and special cards used emphasizing the uniqueness of this display and the merits of each individual record. This would not only demonstrate enterprise on the part of the dealer, but it would unquestionably help sales, for there are plenty of talking machine owners who are not acquainted with the many novel records which are procurable. And, mark you, these records are not freaks or novelties, but artistic recordings that deserve special consideration from owners of talking machines on this account.

Where dealers send out bulletins of new records to their customers they ought to include a special folder bearing upon whatever unusual records they have in stock and which help so much to add a pleasing touch or change to the musical programs given in the home.

Profitable Plan for Keeping in Touch With Earning Power of Salesmen :: :: By A. M. Burroughs, Burroughs Adding Machine Co.

Consider these two facts. They are vital in retail music store merchandising. And no dealer can ignore them long and continue to make fair profits in his business.

1. A clerk's salary should represent no more than a fixed "sales expense" percentage of the total merchandise he sells.

2. Merchandise yields the biggest profit when it is sold the day it is put on the shelf.

Let us illustrate the first. A music store proprietor has a clerk to whom he is paying \$25 a week. The proprietor knows from his records that he can allow, say, five cents out of every dollar's worth of goods sold for the salary part of selling expense.

If the clerk sells \$500 worth of goods a week he is just barely earning his wages. If he is selling less than that he is losing money for you. Keeping him on, under such circumstances, is neither fair to you nor to the clerk.

As to Fact No. 2.

A unit of merchandise is unpacked and placed on display. After the first day it begins to eat up possible profits as viciously as a rat destroys cheese. Suppose that it occupies four square feet of floor room. You are paying \$40 a month for 400 square feet. Then you are paying approximately 10 cents a week rent on that unit.

Besides that, you possibly have money at 6 per cent invested in it. You are paying insurance on it. All the time it is on the floor it is getting shop worn, it is lowering its original finish or its style—in short, its salability.

What is the solution?

How is a dealer to know whether a clerk is earning his salary? How is he to know what goods are moving and what are not?

Perhaps we can borrow from the experience of a music dealer in the mid-West. He has worked out a system that answers those questions for him satisfactorily.

There are two simple records in his system. They are headed up "Sales by Clerks" and "Sales by Departments."

The first thing each morning the proprietor, or his stenographer-bookkeeper, sorts the sales slips by clerks. He happens to have seven clerks. The illustration would be just as good if he had one or two.

The clerks' sales for the previous day are

listed and totaled in the proper columns on the "Sales by Clerks" form. The bookkeeper then finds the total sales for each clerk for the month to date.

In his desk are records of this sort for several months. Thus the proprietor has, at his fingers' tips, complete information about the usefulness of every clerk in his employ. He pays every man a fair wage and every one of

Every one of the clerks was working at top speed. Over the hum I could hear such urgings as these: "Have you ever heard this record, Mr. Wilkins? Customers tell us it's fine." Or, "You'll find this machine will just suit your purpose, Mrs. Hopkins. It is put out by a good, reliable house. The XYZ Co., you know. You've seen their attractive advertisements in all the national magazines, of course."

This mid-West dealer watches his departments just as closely as he does his clerks. Each one has got to earn its share of profits or furnish a good reason for not doing so.

After figuring the total sales by clerks the bookkeeper figures them by departments. Each one has a certain quota. This quota is based on a certain number of turnovers a year. The proprietor knows that a department that falls below this quota is losing him money as surely

Sales by Departments								
Date Aug 5, 1922								
A	B	C	D	E	F	G	H	TOTAL
1500	400	355	1500	125	100	25	465	75065
2500	275	195	245	100	125	25	575	5435
2500	450	245	395	100	69	25	750	10189
2750	825	245	490	200	75	25	825	11140
2800								
2900								
3000								
3100								
3200								
3300								
3400								
3500								
3600								
3700								
3800								
3900								
4000								
4100								
4200								
4300								
4400								
4500								
4600								
4700								
4800								
4900								
5000								

Sales by Clerks								
Date Aug 5, 1922								
Blair	Beall	McCLean	Rayne	Wills	Powers	McIsaac	Proprietor	Total
1050	125	125	220	125	76	675	1020	63143
2200	675	145	125	220	123	320	450	14669
2500	456	145	125	220	123	320	450	14669
1850	3500	546	147	430	330	500	335	14167
4800	4500	546	147	430	330	500	335	10491
395	4500	675	678	240	320	90	50	4436
2400	11250	3350	765	345	75	540	90	5110
2400	1250	1200	450	225	420	225	640	5110
2750	149	145	345	470	250	300	150	5110
375	6750	847	632	335	500	40	500	5110
2750	675	696	145	445	620	240	320	6548
4500	6750	754	432	3500	1225	240	400	230
6750	6750	454	1030	645	645	52	400	430
675	5800	205	125	460	223	837	75	38
2820	205	504	223	500	225	225	125	125
2350	5000	100	325	490	348	260	125	125
169	65	425	268	490	360	120	420	225
2375	604	225	462	348	500	80	225	400
2300	143	240	500	30	148	400		
3500								
4500								

Two simple forms for keeping track of daily sales by clerks and by departments and finding daily sales totals.

them knows that he is rated on results alone.

In addition to keeping each clerk's sales for the month to date some merchants also figure out the salary part of the selling expense within the limits which have been fixed and what clerks need immediate attention.

When the time comes to adjust salaries these merchants consider their records of "Sales by Clerks." Every adjustment is made fairly and without jeopardizing the margin of profits that is due them.

Last week I called on the mid-West merchant. The store was full of customers.

as though a thief were sneaking it out of the cash register.

With accurate sales facts always at hand he can buy with greater assurance. He can jack up in lines that are slack—in fact, he knows exactly where he stands.

What he can and does do every music store proprietor can do. It isn't a case of wonderful personality, advertising or sales stunts or peculiar methods.

It is simply a case of getting the facts and using them intelligently.

But, first of all, get the facts.

THE TALKING MACHINE'S HELPMATE



EQUIPPED WITH NYACCO ALBUMS

NYACCO Albums Aid Fall Business

Right Price, Service, Increased Sales, Quality, Strength and Durability—all are found in NYACCO albums.

These qualities mean dollars and cents to you. Plan now for your fall business. Plan to sell NYACCO albums this fall. NYACCO albums make satisfied customers and develop reorders.

Write us for quotations and prices—To-day.

Dealers, a beautiful colored display card, 11 in. by 14 in., mailed upon request.

JOBBERs and DISTRIBUTORs—How many do you want?



The Only Loose-Leaf Record Album on the Market

New York Album & Card Co., Inc.

NEW YORK
23-25 Lispenard St.

A. W. CHAMBERLAIN
New England Factory Representative
174 Tremont St., Boston, Mass.

CHICAGO
415-417 S. Jefferson St.

Western Coast Factory Representative, E. R. DARVILL—Munson Raynor Corp., 315 S. Broadway, Los Angeles, Cal.

Victor supremacy is the supremacy of performance

Wherever music is known, the Victrola is known—and its superiority recognized. That is a consideration of vital importance to every dealer in Victor products.



Victrola IV, \$25
Oak



Victrola VIII, \$50
Oak



Victrola No. 90
\$125
Mahogany, oak or walnut



Victrola No. 120
\$275
Victrola No. 120, electric, \$315.00
Mahogany or oak

Victor Wholesalers

- Atlanta, Ga.....Elyea Talking Machine Co.
Phillips & Crew Piano Co.
- Baltimore, Md.....Cohen & Hughes
E. F. Droop & Sons Co.
H. R. Eisenbrandt Sons, Inc.
- Birmingham, Ala...Talking Machine Co.
- Boston, Mass.....Oliver Ditson Co.
The Eastern Talking Machine Co.
The M. Steinert & Sons Co.
- Brooklyn, N. Y.....American Talking Mach. Co.
G. T. Williams Co., Inc.
- Buffalo, N. Y.....Curtis N. Andrews
Buffalo Talking Machine Co., Inc.
- Burlington, Vt.....American Phonograph Co.
- Chicago, Ill.....Lyon & Healy
The Rudolph Wurlitzer Co.
Chicago Talking Machine Co.
- Cincinnati, O.....Ohio Talking Machine Co.
The Rudolph Wurlitzer Co.
- Cleveland, O.....Cleveland Talking Machine Co.
The Eclipse Musical Co.
- Columbus, O.....The Perry B. Whitsit Co.
- Dallas, Tex.....Sanger Bros.
- Denver, Colo.....The Knight-Campbell Music Co.
- Des Moines, Ia.....Mickel Bros. Co.
- Detroit, Mich.....Grinnell Bros.
- Elmira, N. Y.....Elmira Arms Co.
- El Paso, Tex.....W. G. Walz Co.
- Honolulu, T. H.....Bergstrom Music Co., Ltd.
- Houston, Tex.....The Talking Machine Co. of Texas
- Jacksonville, Fla..The French Nestor Co.
- Kansas City, Mo....J. W. Jenkins Sons Music Co.
The Schmelzer Co.
- Los Angeles, Cal...Sherman, Clay & Co.
- Memphis, Tenn.....O. K. Houck Piano Co.

- Milwaukee, Wis.....Badger Talking Machine Co
- Minneapolis, Minn..Beckwith, O'Neill Co.
- Mobile, Ala.....Wm. H. Reynolds
- Newark, N. J.....Collings & Co.
- New Haven, Conn...The Horton-Gallo-Creamer Co.
- New Orleans, La....Philip Werlein, Ltd.
- New York, N. Y.....Blackman Talking Mach. Co.
Emanuel Blout.
C. Bruno & Son, Inc.
Charles H. Ditson & Co.
Knickerbocker Talking Machine Co., Inc.
Musical Instrument Sales Co.
New York Talking Mach. Co.
Ormes, Inc.
Silas E. Pearsall Co.
- Oklahoma City, Okla.....Oklahoma Talking Machine Co.
- Omaha, Nebr.....Ross P. Curtice Co.
Mickel Bros. Co.
- Peoria, Ill.....Putnam-Page Co., Inc.
- Philadelphia, Pa....Louis Buehn Co., Inc.
C. J. Heppe & Son.
Penn Phonograph Co., Inc.
The Talking Machine Co.
H. A. Weymann & Son, Inc.
- Pittsburgh, Pa.....W. F. Frederick Piano Co.
C. C. Mellor Co., Ltd.
Standard Talking Mach. Co.
- Portland, Me.....Cressey & Allen, Inc.
- Portland, Ore.....Sherman, Clay & Co.
- Richmond, Va.....The Corley Co., Inc.
- Rochester, N. Y.....E. J. Chapman Co.
- Salt Lake City, U...The John Elliott Clark Co.
- San Francisco, Cal..Sherman, Clay & Co.
- Seattle, Wash.....Sherman, Clay & Co.
- Spokane, Wash.....Sherman, Clay & Co.
- St. Louis, Mo.....Koerber-Brenner Music Co.
- St. Paul, Minn.....W. J. Dyer & Bro.
- Syracuse, N. Y.....W. D. Andrews Co.
- Toledo, O.....The Toledo Talking Machine Co.
- Washington, D. C...Cohen & Hughes
E. F. Droop & Sons Co.
Rogers & Fischer



"HIS MASTER'S VOICE"

Victrola

REG. U. S. PAT. OFF.

Important: Look for these trade-marks. Under the lid. On the label.

Victor Talking Machine Company
Camden, New Jersey

How Pessimism Kills Business as Well as the Morale of the Sales Force :: :: By Alonzo K. Foster

Upon the outlook of the members of the retail staff of a business depends in a great measure the success of the merchant. No salesman or staff of men can accomplish the best results of which they are capable unless their outlook on life and business in general is clear, courageous and optimistic. A pessimistic attitude, no matter how hard the salesman tries to keep it under cover, is bound to be noticed by customers, and an unfavorable impression is created, which may mean the loss of a sale, or perhaps of a customer, with a consequent loss of profits to the dealer. Furthermore, it has been found through observation that if one member of the staff loses his optimism the poison gradually permeates the entire force unless measures are taken to stop its growth and eliminate it entirely.

A case in point was brought to the attention of the writer in a recent conversation with the Eastern manager of a large music concern, who has charge of a number of retail stores in the metropolitan district. This manager said in part:

"One of my stores recently suffered a serious slump in business in comparison to the amount of business transacted by our other stores in less lucrative territories. I finally sent for the branch manager to discuss the situation and to see if there was any way of overcoming this difficulty.

"He came, and from the time he started to talk until he stopped his story was one of pessimism. I asked him how he accounted for his poor showing in the way of sales and he lost no time in pointing out to me that it was almost impossible to make sales due to the fact that there were so many out of work; conditions were unsettled; many people were without adequate homes; there

existed a buyers' strike, etc. I let him finish and then I asked him if he had made any attempt to figure out how many people in his territory had good jobs, comfortable homes and money to spend. He replied that he had not thought of that.

"During the week following our interview I personally investigated conditions in that territory. I also dropped in to chat with the mana-

Poisonous Influence of Pessimism of One Member of Staff Often Affects the Entire Sales Organization

ger and some of the sales staff and I discovered that the attitude of the manager had poisoned the whole organization.

"To make a long story short, this manager is now producing excellent results in the territory immediately adjoining his old stand and the store which had been made non-productive through his pessimism is now, under new management, reporting normal sales.

"The first-named manager has learned his lesson. When I transferred him I impressed on

his mind that he was getting one of the most profitable territories in our organization and pointed out the possibilities for sales. He went to work with enthusiasm and is getting results. The fact that sales in his old territory immediately picked up following the change of managers is ample proof that the men composing that branch were affected by his 'blue' viewpoint and that this accounted for the poor showing made.

"To be optimistic does not mean that a man must try to convince himself that business is good when it is not, but if he desires to remain in business he must face the facts squarely and try to discover just what is retarding his development and then set all his energies to work in overcoming the obstacles."

COLUMBIA RECORD MUSIC FOR DANCE

E. R. Berry in Columbia, Miss., Gets Some Good Publicity Through Free Dances

COLUMBIA, MISS., September 7.—E. R. Berry, proprietor of Berry's Pharmacy, gave a surprise to the music-loving public in this city recently by hiring the American Legion Hall and sending out general invitations for a free dance. The music for the occasion was furnished by exclusive Columbia artists, represented through the medium of Columbia records. E. L. Estes, field representative of the New Orleans branch of the Columbia Graphophone Co., operated an electric Magnavox in connection with the Columbia Grafonola, by which means the records were amplified sufficiently to fill the entire hall with perfect dance music.

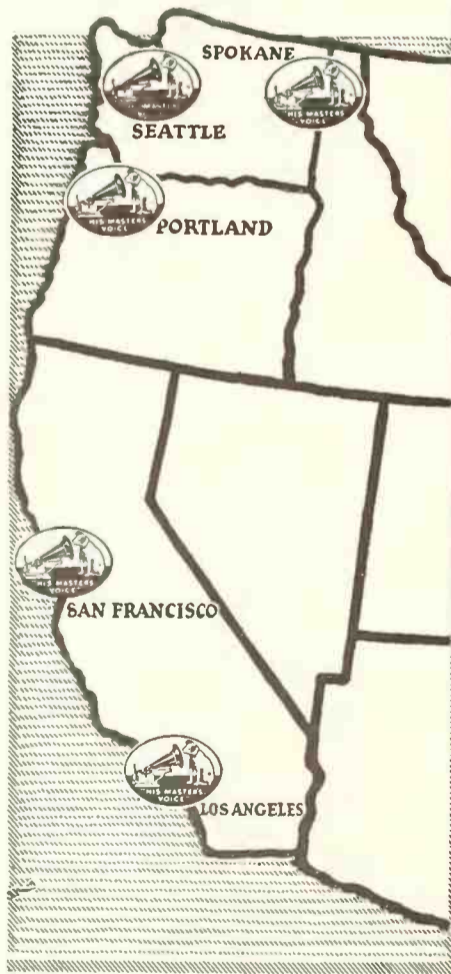

Sherman, Clay & Co.

Victor Distributors on the Pacific Coast

Victrolas Victor Records
Victor Accessories

Main Wholesale Depot:
741 Mission Street, San Francisco, Cal.

Branch Wholesale Depots:
10th and Santee Streets, Los Angeles, Cal.
N. W. Corner 13th and Glison Streets,
Portland, Oregon
Oceanic Bldg., Cor. University and Post Streets,
Seattle, Washington
330 West Sprague Ave., Spokane, Washington

5 DISTRIBUTING DEPOTS for YOUR CONVENIENCE

Victor supremacy is the supremacy of performance



Victrola VI, \$35
Mahogany or oak



Victrola IX, \$75
Mahogany or oak



Victrola No. 110
\$225
Mahogany, oak or walnut



Victrola No. 130
\$350
Victrola No. 130, electric, \$390
Mahogany or oak

It proves an unparalleled understanding of the sound-reproducing art—of music and mechanics and all the kindred sciences that make for success in the talking-machine industry.



Victrola No. 300
\$250
Victrola No. 300 electric, \$290
Mahogany, oak or walnut



Victrola No. 330
\$350
Victrola No. 330, electric, \$390
Mahogany



"HIS MASTER'S VOICE"

Victrola

REG. U. S. PAT. OFF.

Important: Look for these trade-marks. Under the lid. On the label.

Victor Talking Machine Company
Camden, New Jersey



(Registered in the U. S. Patent Office)

PUBLISHED BY EDWARD LYMAN BILL, Inc.

President and Treasurer, C. L. Bill, 373 Fourth Ave., New York; Vice-President, J. B. Spillane, 373 Fourth Ave., New York; Second Vice-President, Raymond Bill, 373 Fourth Ave., New York; Secretary, E. L. Bill; Assistant Treasurer, Wm. A. Low.

J. B. SPILLANE, Editor

RAY BILL, B. B. WILSON, BRAID WHITE, Associate Editors

L. M. ROBINSON, Advertising Manager

L. E. BOWERS, Circulation Manager

Trade Representatives: A. F. CARTER, WILSON D. BUSH, C. CHACE, EDWARD LYMAN BILL, V. D. WALSH, E. B. MUNCH, C. R. TIGHE, SCOTT KINGWILL, A. J. NICKLIN

Western Division: Republic Building, 209 So. State Street, Chicago, Ill. Telephone, Wabash 5242

Boston: JOHN H. WILSON, 324 Washington Street

London, Eng., Office: 2 Gresham Building, Basinghall St. W. LIONEL STURDY, Mgr.

The Talking Machine World has regular correspondents located in all of the principal cities throughout America.

Published the 15th of every month at 373 Fourth Ave., New York.

SUBSCRIPTION (including postage): United States, Mexico, \$2.00 per year; Canada, \$3.00; all other countries, \$4.00. Single copies, 25 cents.

ADVERTISEMENTS: \$5.50 per inch, single column, per insertion. On quarterly or yearly contracts a special discount is allowed. Advertising pages, \$150.00.

REMITTANCES should be made payable to Edward Lyman Bill, Inc., by check or Post Office Money Order.

NOTICE TO ADVERTISERS—Advertising copy should reach this office before the first of each month. By following this rule clients will greatly facilitate work at the publication headquarters.

Long Distance Telephones—Numbers 5982-5983 Madison Sq.
Cable Address: "Elbill," New York

NEW YORK, SEPTEMBER 15, 1922

THE BUSINESS SITUATION REVIEWED

TALKING machine manufacturers who regulate the production of their plants according to a strict schedule that is calculated to take care of the needs of the trade on a more or less definite basis declare that the manufacturing schedules from now until the first of the year call for a volume of output that comes close to touching some records along that line.

The schedules for the most part are based upon actual advance orders in hand or definitely in prospect and are to be accepted as an indication of the better feeling that pervades the talking machine trade generally, a feeling that business is going to be better after the passing of Summer and that a full measure of sales cannot be realized unless retailers are assured of sufficient stock on hand to meet all demands.

In the face of the existing situation, as it has developed out of the rail and coal strikes, it would seem that those members of the trade who have had sufficient confidence to order liberally and for early delivery have accomplished more for their own protection than they perhaps realize. The transportation problem of itself is going to be a serious one for months to come, while readjustments are being made, and the problem is further complicated by the fact that even should the coal strike be completely settled before this is published the demands for coal movement will serve to interfere seriously with the transportation of merchandise of less vital importance.

Despite all this there is evidence of increased industrial activity and agricultural prosperity, based on bumper crops in most sections, that promises a volume of demand that will tax retailing facilities. The period of liquidation in the retail talking machine trade is practically at an end, and there should be nothing to interfere with a very substantial Fall business that will measure up to the most optimistic expectations. In fact, the question promises to be not that of getting business but rather that of getting sufficient stock to handle it promptly and to the best advantage.

There have been some mighty good years in the talking machine business, as some thousands of wholesalers and dealers can testify, and the lean years have been few. It is safe to assume, therefore, that the chance for a substantial comeback in the near future is excellent.

AN EFFECTIVE MEANS OF REACHING BUYERS

THE season of fairs of the State and County variety is again approaching and members of the talking machine trade in various sections of the country have already made known their intention of having more or less elaborate displays at these different shows, particularly at the State fairs such as those held in Michigan, New York and other States and recognized as annual institutions. Even under ordinary circumstances, with business running along smoothly, the average retailer is acting wisely when he arranges for some form of exhibit at a recognized fair in his vicinity where his line may be seen and inspected by thousands who under ordinary circumstances might never go near his place of business.

With business conditions as they are now and promise to develop during the Fall months, it is imperative that the retailer take advantage of every opportunity for displaying his wares and demonstrating them to the public outside his store as well as inside.

The talking machine with its accompanying records represents an ideal exhibit feature, for it can be kept going almost constantly and its music proves an irresistible attraction to the thousands of fair visitors. It has been proven on numerous occasions that a good talking machine exhibit holds the crowds as few other displays can, and, whether actual sales result during the fair or not, the fact remains that the name of the exhibitor and the name of the products he is showing have been strongly stamped on the minds of those who have taken occasion to stop, look and listen.

Not only has the talking machine dealer attention-compelling music makers as a foundation for his exhibit, but he has also at hand very generous supplies of display material, particularly that featuring records, which is calculated to add to the attractiveness of the booth, while at the same time representing advertising of the best sort.

With the need for more business generally recognized, as is likewise recognized the need for more aggressive sales tactics, the retailer will find in the Fall fair a welcome opportunity for placing his wares before a maximum number of people with a minimum amount of effort.

WHY THE FARMER IS A GOOD PROSPECT

THERE came to New York recently a salesman who had won the trip to the metropolis as first prize in a salesmanship contest conducted by a Middle West music house. It was the second time the same man had won the big prize for selling more goods than his fellows and he ascribes his success to the fact that while the majority of the salesmen kept pretty close to city trade he did his business with the farmers.

One point made by this salesman which should be of particular interest to talking machine men was that the farmer makes the best kind of a prospect for musical instruments providing he is treated "like a human being" and not differently from the ordinary city prospect. He declared that some salesmen had a certain attitude for the city prospect and quite another of a patronizing sort for the rural man and this attitude was resented by the latter.

The points made by the salesman on farmer trade were that their credit was good and that the check in full was generally ready when the instrument was delivered; that they had more appreciation of the home because they spent more time in it, and that the average farmer is pretty well fixed and does not suffer from industrial fluctuations as does his city brother.

"There are ten farmers in a financial position to buy pianos and talking machines for cash for every one or two city men who are able to buy those instruments on instalments," he said.

It is an argument that should appeal to those who confine their sales efforts to the crowded districts instead of going out into the highways and byways and getting close to nature.

A NATIONAL LIBRARY OF RECORDS

REPORTS from Berlin to the effect that arrangements have been made for building up a library of records of all known languages and dialects as a permanent branch of the National Library of Berlin are of general interest not only to those who recognize the desirability of preserving such historical records, but to those in the talking machine trade who have had a part in making possible the recording of the actual voices.

For a number of years there have been offered suggestions for the development of a record library in Washington in which could be filed records of the voices of the great men of this day and days to come. It has been realized that such a library would be of tremendous historical value in the future.

In France there has been more or less organized effort to collect records of the voices of noted artists and statesmen, in fact, government officials in Paris were among the first to suggest the value of having records of noted artists filed for the benefit of posterity.

In England, particularly in the early days of the phonograph, records were made by Gladstone and noted personalities of that era, which were filed for historical use. There is no question as to the tremendous value of a national library of records of leading statesmen and prominent men in all lines of art and commerce.

Prof. Wilhelm Doegen, who has charge of the work for the Berlin Library, has mapped out a systematic campaign and is having special records made of languages and dialects not already recorded, as well as of the voices of noted personages. The master records themselves, of metal, are to be preserved in the library, and it is maintained that in that form the records will last for thousands of years.

A particular feature of interest is that the work of building up a record library has at last been started in the right way and the Berlin move should stimulate similar activities in other countries. We have heard much of the value of recording and preserving the actual voices of the great artists and statesmen, but that fact means very little unless there is some organized attempt made to preserve copies of such records in a way that will make them available to future generations for the purpose of study.

It might be well for the trade itself to organize and support some propaganda to that end in this country.

placed, it is probable that the music industry will be more largely represented at the next National Merchandise Fair, which, it is now decided, will be not only an annual, but, very probably, a semi-annual event.

The music trade has, on several occasions, tried the experiment of holding expositions or shows with the object of bringing the buyer and seller together under conditions calculated to enable each to cover more ground at less expense, but as far as this industry is concerned the results were, for the most part, unsatisfactory.

The enlarged scope of the National Merchandise Fair, taking in all the leading industries of America, has made a wide appeal and attracted thousands of buyers of recognized standing who have placed orders in sufficient volume to make the venture pay for the individual exhibitors. It is true that most of the products shown were those for which orders are placed at definite seasons of the year; whereas talking machines and other musical instruments do not rank as seasonal products. But there is no question as to the advantage of having musical instruments shown with other goods handled by the average mercantile establishment, if only for the purpose of emphasizing the fact that talking machines and musical instruments generally are really an important part of home equipment and not things apart.

The managers of the National Merchandise Fair are entitled to congratulations on the success achieved and it is gratifying that the support vouchsafed warrants the holding of future fairs on a much larger scale.

UNIFORM CONDITIONAL SALES ACT IN FORCE

THE movement for the adoption of a Uniform Conditional Sales Act in all the various States, which has been under way for some time past, and has already been put over successfully in several States, including New York, where such a law became effective on September 1, deserves the support of talking machine dealers as well as all others selling on instalments, for the law is calculated to simplify that procedure for both buyer and seller while, at the same time, affording adequate protection for both.

The main features of the law as passed in New York have been analyzed for The World by a well-known attorney who has pointed out the changes from the present statute. The uniform measure is of particular importance in that, should it be adopted by a majority of the States, retailers engaging in inter-State commerce, that is, doing business in several States, will avoid the trouble incident to drawing up sales contracts conforming to the several State laws.

The practice of selling on instalments has done much to develop modern business, and anything calculated to simplify the procedure and encourage that type of business means a greater volume of sales. Cash, of course, is most desirable, but there would be many idle factories in the music industry if talking machines and pianos were sold only for cash.

NATIONAL MERCHANDISE FAIR SCORES

THE National Merchandise Fair, which recently held forth in New York, excited considerable interest in the music industry, as, indeed, in all other lines of trade. The aim of the fair was to simplify buying and selling problems with the subsequent economy in time and money, and it was designed along the general lines of the great fairs or messes held in Leipzig and other centers in Germany which are attended by business men from all parts of the world.

The fair scored a greater success than anticipated and thousands of buyers from all sections of the country were in attendance. The displays at the Grand Central Palace and the Seventy-first Regiment Armory were of a character to arouse keen interest.

The first show included exhibits by several manufacturers of talking machines, records and talking machine supplies and accessories and, judging from the interest manifested and the orders



Follow the Black Line

Who's your Victor jobber?

ORMES, Inc.

'PHONE FITZROY 3271-2-3

15 West 37th Street

New York

Vital Importance of Service Demonstrated in Retail Trade Development :: By A. L. Parsons

In the talking machine business, as in other lines of merchandising, the impression which the customer has of the store and the human elements who run it determine in a great measure whether or not sales are made. In this connection it is safe to say that first impressions are the strongest. Whether they are good or bad depends entirely on the reception the customer or prospective buyer receives when the store is visited. A bad first impression is one way of curtailing sales and minimizing the best efforts of the salesman afterward. In either case an impression is hard to eradicate. If it is good it will stick and only laxity on the part of members of the sales staff who come in contact with the customer will cause a reversal of favor. The bad impression will stick with equal tenacity and is even harder to overcome because suspicion of the integrity of the establishment has been raised in the mind of the prospect.

The writer recently was in conversation with a friend on this subject. It seems that he had entered a certain store with the object of purchasing certain records which he had seen advertised the night before. From the tone and quality of the advertising he was led to believe that he would receive service of the highest order. When he entered the store he walked over to the service counter behind which two salesmen were holding an animated conversation. He waited a few moments and as neither of the so-called salesmen appeared to pay any attention to him he walked over to the end of the counter where they were talking and asked if there was any one in the place who would wait on him. One of the clerks ungraciously asked him what he wanted and my friend, incensed, sarcastically apologized

for interrupting his conversation and walked out of the place.

Right here it is only fair to say that in the talking machine field, generally speaking, salesmen are of a high order and a case of this character is rare. This incident is related merely to emphasize the point brought out in the first paragraph of this article. Of course, this is an extreme case, but it takes far less than this to

Upon the Good or Bad First Impression of the Customer Depends Future Patronage and Business Development

create an unfavorable impression and antagonize a customer or prospect and thus make an enemy.

Another incident which bears on the subject of creating an impression was related to the writer by a salesman who swung the balance of favor in his direction by a trifle, slight in itself, but important, inasmuch as it not only made a sale, but made a firm friend of two people, a recently married couple. The story follows:

"A young couple came into the store one afternoon and asked to see a certain model machine of

the line we carry. Unfortunately, we did not have that particular machine in stock at the time. I was attending these prospects and told them that I would make a special effort to obtain the type of machine they asked for and let them know as soon as it arrived. I also tried to get them to look at our other models; however, they were in a hurry and departed, but not before I had the name and address.

"I immediately got in touch with our jobber and put in a rush order for a machine. It arrived the next day and I made quick contact with my prospect on the phone. I told him that I had secured the machine he had wanted to see and, to make a long story short, he and his wife came to the store and not only purchased that machine but a number of records. They have been purchasing records ever since.

"When I had finished with the young man he told me that he had decided in favor of my line because he was convinced that a house which took the trouble to render such a quality of service must handle an equally high-class quality of merchandise. He stated that in no other store which he and his wife had visited previously had any of the salesmen taken enough interest in him as a prospective buyer to even secure his name and address. In short, they did not seem to care whether he became a customer or not."

This is only another of those little things which spell success or failure for a business. It is quite evident, even to a layman in the matter of the art of salesmanship, that the average person who is considering the expenditure of a considerable amount of money expects to receive adequate service. And it is also evident that if this service is not rendered, even though the prospect makes one purchase, he will not go out of his way to make another.

When a prospective customer enters a store and a cheerful salesman immediately comes forward with a sincere desire to be of service the visitor feels it instinctively and a foundation of confidence in that salesman and store is started which will in all probability mean a sale at that time and many future sales if the proper methods of follow-up are employed.

NEW COMBINATION IN KNOXVILLE

Clark-Jones-Sheely Co. Organized With Capital Stock of \$100,000 to Take Over Several Groups of Music Stores in That Territory

KNOXVILLE, TENN., August 31.—The Clark-Jones-Sheely Co., a new concern, capitalized at \$100,000, has filed its application for a charter at the County Clerk's office. The new corporation merges the three stores of the Lynn-Sheely Co. in Johnson City, Morristown and Bristol; the two stores of Clark & Jones, in Knoxville and Chattanooga, together with the Knoxville Music Co. and the Victrola Shop. An organization meeting was held on August 14 and the corporation started operation formally on August 15.

The local branch of the firm is located in the old Board of Commerce Building, 422 South Gay street. The building was occupied about September 1. Earl Worsham and Frank Clark, who hold a lease on the building from the Nellie C. Ross estate, have subleased to the Clark-Jones-Sheely Co.

The store at 422 South Gay street will deal in pianos, players, talking machines and records. The Clark & Jones store, at 514 South Gay street, will continue in operation under Leslie E. Miller, its manager.

Paul J. Albright, enterprising Victor dealer, of David City, Neb., is using billboard advertising to good effect.

SEND FOR YOUR SAMPLE TO-DAY

This is the New Design



Mr. Victor Retailer—

Would you spend 15c to bring a customer into your store and keep your name constantly before a Victrola owner?

We'll say you will! That is why we will send you a free sample on request of our Advertising Sales-Building Record Brush. *YOUR ad inserted without extra charge.*

KNICKERBOCKER TALKING MACHINE CO.

Victor Wholesalers

138 West 124th St.

New York City

TIMELY ANTICIPATION IS REALIZATION OF PROFITS

The Fall Season

Statements from twelve dealers in different sections of the country show that sales for the first six months of 1922 were almost identical with figures for the corresponding months in 1916.

On this basis, the last half of 1922, and particularly the Holiday Season, will develop a similarly sensational increase in record and machine business everywhere.

In the raw products market, shortages have already begun to appear and there is every likelihood that the last months of this year will find dealers hard put for various stocks.

Peerless is anticipating an unusually heavy demand for albums by timely purchases of essential materials and will, therefore, be in a position to meet extraordinary dealer requirements.

But, as a definite protection to yourselves, we invite you to place tentative orders at once for delivery in November and December, thereby obviating the element of uncertainty and possible loss when the season opens—as it did in 1916.

Phil Ravis

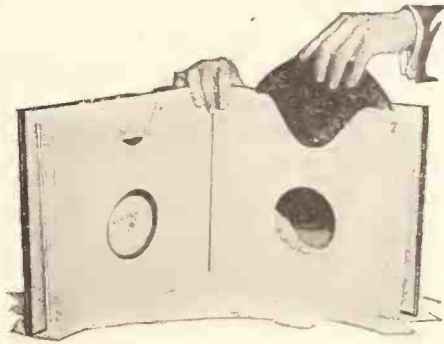

Showing how 10-inch records fit into Peerless Big Ten

Preparation, in the matter of a more than adequate record album stock, is sales insurance that no talking machine dealer should neglect.

The comparatively small investment in a gross of albums will prove a source of endless satisfaction and actual profit when the busy season begins.

Particularly, when you carry and advertise

PEERLESS

—the Album

there is an added gratification and additional income by reason of meeting a popular demand for quality at a price.

In placing your Winter machine order, give a thought to this important accessory, albums, assure your supply now and—specify Peerless.

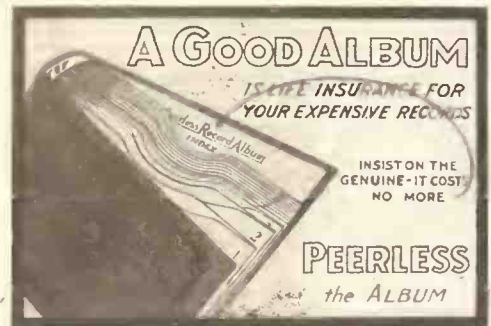

Display This Sign—It Will Sell Peerless Albums for You—Send for Yours at Once.

ALBUMS SUPPLIED IN LETTERED SETS
FOR ALL MODEL MACHINES

It Does Make A Difference What Albums You Sell

PEERLESS ALBUM COMPANY

PHIL. RAVIS, President

WALTER S. GRAY
San Francisco
942 Market St.

636-638 BROADWAY
NEW YORK

L. W. HOUGH
Boston
20 Sudbury St.

Standardization of Sales Presentation as an Aid to Greater Efficiency :: :: By W. Braid White

The talking machine business has reached a position which fairly entitles it to any public esteem it may commonly receive. As the talking machine and its music become more and more firmly established in public affection it becomes more and more necessary to consider all problems of salesmanship in the broadest possible position. In the history of every industry there comes always one moment when novelty ceases to be its prime characteristic and when the necessity arises of building up for its exploitation some standard method of merchandising. That moment has already come in our business.

It is time, that is to say, for us to think about standardizing our sales presentations in respect of the talking machine and its records.

By the term "sales presentation" I mean the statements made and the things done by the salesman in urging the merits of that which he has to sell. By the term "standard sales presentation" I mean to signify a method so scientifically correct and so adaptable that it can be applied, in principle, to every case which may arise. Before going on to discuss such a standard presentation, to be used by talking machine salesmen, it may be well, however, to say a few words in defense of the scheme.

Need of Standards

Some will always believe, no doubt, that the salesman's impromptu inspiration is the best of guides and that there is little, if any, advantage gained in evolving a standard sales talk. With this belief, although it is held by some eminent business men, I venture to disagree. For it should be obvious that any sale of a specialized article like the talking machine, which depends almost entirely upon demonstration, can always be done in one best way only, no matter how many possible ways of doing it may be found to exist. In other words, it must be possible to find one best way, based upon the best knowledge as to the ideas which are to be impressed upon the purchaser and upon that purchaser's reactions to them. For the solution of most of the many selling problems which are based on the factor of demonstration a standard way of presenting the sales argument has been worked out and is in more or less universal use. There is no

reason for believing that it cannot be equally well worked out successfully for the talking machine industry.

The Prospect's Previous Ideas

The prospective purchaser of a talking machine comes to the store with certain predilections and previously formed notions. Most of these are usually rather hazy and would scarcely bear much analysis. Nevertheless, it is no longer possible to imagine any ordinary person coming into a store without some notion of what a talking machine is. The automobile itself is not better known. How then are such preconceived ideas as the visitor or prospective purchaser of a talking machine certainly possesses imprinted upon his consciousness?

In the first place, he receives some ideas from seeing talking machines in the homes of his friends. In the second place, he reads the advertising of the great national advertisers. In the third place, the first two considerations operate to produce a general idea of the desirability of music in the home. Very likely no one of the three converging causes will be consciously felt, although the prospect may be sufficiently interested to mention the third one. Generally speaking, however, we may be quite sure that the prospect is nearly always motivated by the three considerations adverted to.

Outline of a Presentation

Plainly, then, any presentation must be based upon the fact that the prospect does not need to be persuaded as to the advisability of music in the home. Of that much we may be sure. He is already convinced. The need then is (1) to show him that the machine offered actually gives him what he wants; (2) that it is worth the price asked for it; (3) that the records are genuinely worth-while reproductions of music, and (4) that they in turn are worth what is asked for them.

These four points can best be proved and pressed home, surely, by a sales presentation which involves the smallest amount of talking and the largest amount of showing. In other words, if this foregoing statement be based on fact the sales talk should be divided into the following phases:

1. A very short introduction, leading almost instantly to the appearance of actual music.

Salesman makes prospect comfortable in demonstration booth and talks briefly about variety of music available for his or her hearing at this very moment. He tries to find out what the prospect likes and, above all, does not venture to make up the prospect's mind for him in advance. Blunders here are inexcusable. The true music lover must not be insulted with jazz and the dance fiend must not be bored with grand opera.

2. Demonstration of the machine's musical quality by means of records, chosen as above.

This phase shall be brief in duration and be cut off as soon as prospect shows that he is convinced that the machine really gives good music. The next step is to show

3. Special reasons for the machine's ability to reproduce music well.

This involves explanation and demonstration of machine's special mechanical and acoustical features. Remember, however, that statements made in a positive tone about highly dubious acoustical points should be avoided, as they are likely at any time to provoke argument and spoil the sale. In this category of controversial topics should be included everything relating to the actual method of reproduction, for in these respects little of positive knowledge actually exists. Leave alone all details about diaphragms and tone chambers, for most of what you are likely to say will be nonsense. Let the musical values be demonstrated by test; that is to say, let the records do the talking. It is then a simple matter to

4. Demonstrate that good music is worth a fair price.

The only need here is to point out, when the question of price comes up, as it will now, that the reproduction of fine music comprises an art based on experience, great skill, fine workmanship and fine material. These cost money. The fact that a customer may not at first sight "see where the money comes in" is really not to the point. The price of a Rolls-Royce is taken for granted as being fair, because its performance can instantly be appreciated by every one who has a chance to experience this. The reliability of the house which sells, the celebrity of the name of the machine, and the maker's and seller's consequent ability to guarantee performance unreservedly afford the only security needed. Moreover, it is not a matter of figures, but a matter of service. "Not what it costs, but what it will do."

Normally, the deal should now be ready to close, which in this case means that it should actually now be closed, save for the formalities of signing and delivery.

Nevertheless the important question of music remains and this must always be handled carefully. It may be laid down as a principle that the aim of all sales talk at this point should be, not so much to sell the customer a lot of music at the start when already a purchase of a machine has been made involving from one to five hundred dollars, as to get the customer into the habit of coming each month to make additional purchases of records. A dozen well-selected records should make a good beginning for most purchasers. After that it is a question of follow-up and sales service. These matters do not strictly come within the province of this article.

These outlines for a standard presentation are submitted to sales managers in the hope that they may stimulate some thought and discussion.

The North Shore Talking Machine Co., Evanston, Ill., has opened the Victrola Service Store at 554 Center street, Winnetka, Ill., where the Victor line of machines and records will be handled exclusively.

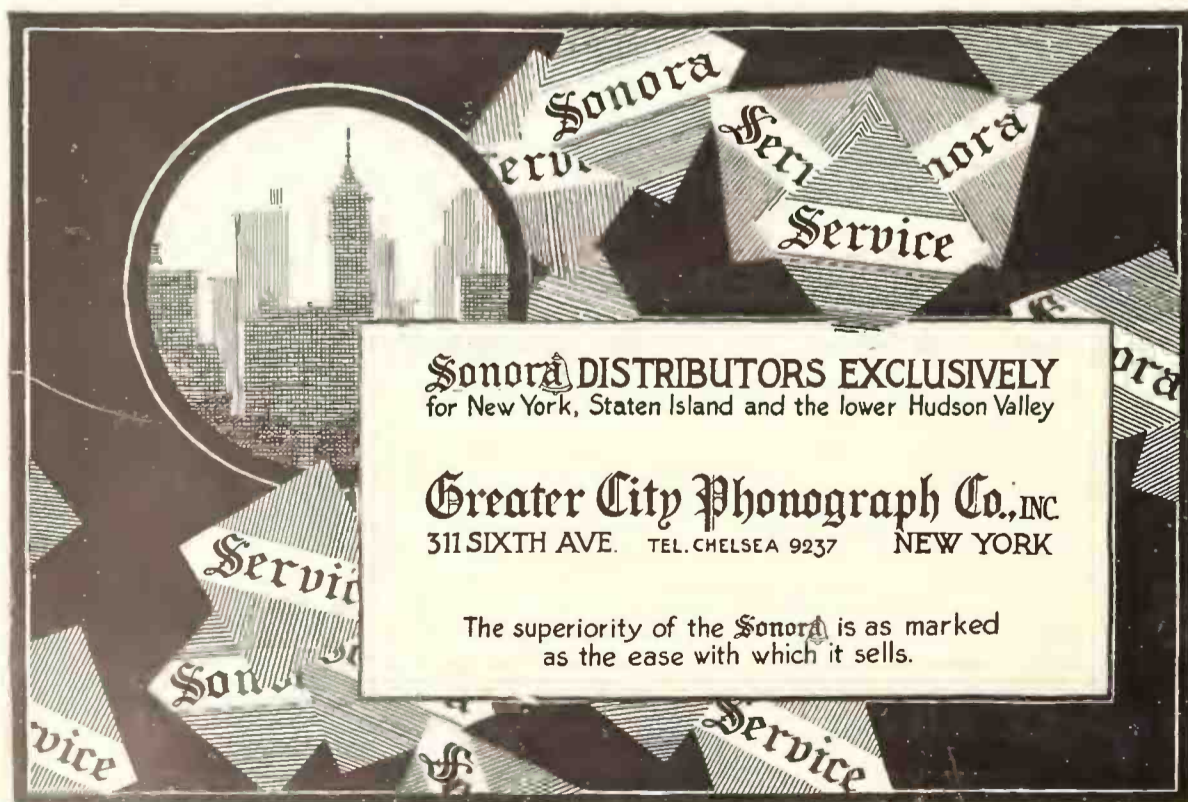

Sonora DISTRIBUTORS EXCLUSIVELY
for New York, Staten Island and the lower Hudson Valley

Greater City Phonograph Co., INC
311 SIXTH AVE. TEL. CHELSEA 9237 NEW YORK

The superiority of the **Sonora** is as marked
as the ease with which it sells.



To Protect the Dealer and the Public

A new trademark, a symbol of quality, has been adopted by the Radio Corporation of America. It appears at the top of this page, and soon it will be affixed to all Radiolas, Radiotrons and other products.

The new symbol is more than a trademark. It is the dealer's and the purchaser's guarantee that the apparatus to which it is applied is the result of research conducted by the foremost scientists and engineers; is the product of the most reliable and well equipped manufacturing organization in the country; and is marketed in accordance with methods approved by experienced business men.

Like the R C A apparatus still on sale, bearing the old symbol—the letters R C in a circle—the newly marked R C A apparatus will embody the highest standard of quality and will be backed by the same protection which R C apparatus has enjoyed during the past.

The new monogram has been adopted to render apparent, instantly and unmistakably, the products of the Radio Corporation of America. Henceforth, this symbol R C A will appear on all apparatus and Radiolas—from the simplest crystal receiver to the Cabinet type. It testifies to the constant striving of the R C A organization—research engineers, factories and sales force—to produce and sell only the best, and to develop types of Radiolas which will keep pace with

the advancement of broadcast reception and which will apply the new discoveries made in the R C A research laboratories.

Teaching the Public What R C A Means Through Advertising

The new symbol R C A will be widely advertised throughout the country. In an art which is so rapidly developing and which offers so many opportunities for the marketing of unreliable apparatus, it becomes more and more necessary to drive home the importance of the highest engineering and manufacturing standards. The symbol R C A is a guarantee that these standards have been insisted upon in the manufacture of Radiolas.

Write for Display Cards

R C A dealers will be supplied with R C A symbols for store display. By writing to us and stating whether a decalcomania window sign or a wall card is desired, we shall be glad to meet their wishes.

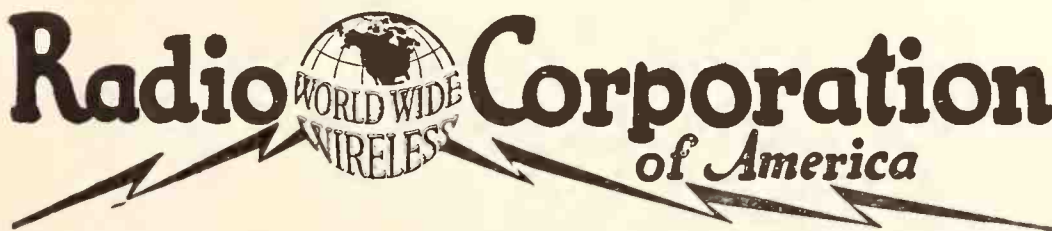

Sales Department, Suite 2076
233 Broadway, New York, N. Y.

District Office
10 South La Salle St., Chicago, Ill.

Among R C A distributors are the following famous music houses:

ALBANY RADIO CORPORATION, Albany, N. Y.
LANDAY BROS., Inc., New York City

W. F. FREDERICK PIANO COMPANY, Uniontown, Pa.
LYON & HEALY, Chicago, Ill.

Methods of Modern Business Management-- Value of Quick Stock Turnover :: By G. W. Hafner

Manager of G. W. Hafner, Inc., Chicago.

The interest of every business man is, naturally, to make his capital do as much work for him as possible. That means letting a given dollar rest in a given lot of material for as short a time as possible. And doing this means moving stock as rapidly as possible. And the one word that covers all this is "turnover."

Definition of Turnover

It is never possible to make money on dollars that are tied up in commodities that will not move. And when prices are falling it is easy to lose a great deal of money by holding onto merchandise or materials that move slowly, while the price for which they can be sold becomes constantly less and less. Because of this

every manufacturer and merchant ought to have information on the movement of goods in and out. It is this movement in and out, not only of the merchandise itself, but also of that which the merchandise represents, money, to which the term "turnover" has been applied.

In any business there are two things that are disposed of, replaced and disposed of again; or, in other words, "turned over." These are:

1. The stock of merchandise.
2. The money invested in such merchandise.

And the turnover of these items has a very definite effect upon the profits which the business makes during a given period. Hence, an analysis of this effect is necessary in order to plan

properly and conduct the business so as to:

1. Secure the maximum profit with a given capital, or
2. Secure a given profit with a minimum capital.

Quick Versus Slow Turnover

Perhaps the easiest way to state the case for a rapid rate of turnover in business is as follows:

A certain business, we will say, has annual sales of \$50,000 and makes a gross profit of \$17,500 (or 35 per cent of the sales). If we take off \$12,500 for expenses (25 per cent of the sales) the net profit would be \$5,000 (or 10 per cent of the sales). But if the annual sales of that business are increased to \$100,000 and a gross profit of 35 per cent is still realized, the amount of gross profit would be \$35,000. Suppose expenses of the business are doubled because of this increased business—a very liberal margin—there would then be \$25,000 in expenses to deduct from the gross profit of \$35,000, leaving a net profit of \$10,000.

Now, it is at once evident that, having increased the sales to such an extent, the same percentage of profit is not required. The tendency in any business should be to increase the turnover and thereby decrease the percentage of profit. Under these circumstances the nation as a whole would benefit, and the individual engaged in the business would certainly not suffer.

Another illustration: Two men are engaged in building construction. John Smith, the first contractor, finishes twelve jobs a year, making \$1,000 net profit on each job. He earns a total of \$12,000. Jim Jones, the second contractor, finishes eighteen jobs a year, making \$750 on each job. He earns a total of \$13,500. Moreover, he gets business away from Smith because his price is more attractive. When there are none too many jobs to go around at best this last consideration is of great importance.

Making Your Dollar Active

If a dollar earns ten profits for its owner in a year the owner can afford to take a smaller profit each time than on another dollar which earns him, say, only five profits during the same length of time. And yet the dollar which returns the smaller rate of profit will bring in the larger volume of profit, simply because it is so much more active.

Now, this is precisely the point that most business men seem not to understand. They do not seem to be able to grasp the fundamental principle that even though the percentage of profit on merchandise or service be but, say, 5 per cent, if it is earned often enough, say, ten times in a year, the annual turnover on money or rate of profit on investment will be 50 per cent.

Too many merchants overlook the fact that their cost of doing business of, say, 25 per cent, cannot correctly be used to demand a 15 per cent margin of profit on each and every kind of merchandise sold, because it is the percentage of profit on one sale and not on the year's investment. A larger margin of profit needs to be added to the slow-moving materials and a smaller margin to the quick-moving.

The vital point of comparison is how much profit can you make a dollar earn selling a given article. Any business man can get rich earning a 5 per cent margin of profit on one certain commodity if he sells it often enough; on the other hand, he may go bankrupt on merchandise offering 100 per cent profit if he rarely makes a sale. Quantity selling is the greatest modern profit policy. The profit on any one article or commodity is not much, but when this profit is multiplied by 1,000 or 5,000 or 10,000 the profit on the volume becomes considerable.

Lazy dollars, unnecessarily high profits and sluggish business all tend to go together. The

(Copyright, 1922, by G. W. Hafner)

Is There a MYSTERY in Your Mind?

GRANBY EDITORIAL LETTER

Number Eight

From Granby Phonograph Corporation, Newport News, Va.

CERTAIN pleasant rumors are floating around about the Granby Phonograph proposition. Have you caught any of them? By "any," two rumors, in particular, are meant.



RUMOR NO. 1. Granby Profits are higher by generous greenback fistful than on other standard machines. Exactly how much higher they are can not be told here in this space, but CAN be told promptly, the minute you write or telegraph the factory for information.

RUMOR NO. 2 Constitutes the MYSTERY. We can't describe the mystery in this space. It is not good business practice to do so except to interested dealers. But we'll tell you, the minute you ask and thereby show your interest. (You are not obligated in any way.) This mystery is about

to affect EVERY GRANBY OWNER IN THE UNITED STATES, and it will AFFECT EVERY GRANBY PROSPECT WHO IS TO BUY IN THE PRODUCTIVE MONTHS JUST AHEAD.

There is no rumor, of course, in the fact that the Granby Machines are now sold on LIBERAL TERMS. Every dealer who knows *what* those terms are concedes that fact. Granby terms are LIBERAL, because the Granby Phonograph Corporation is capitalized for \$2,500,000, which in turn is secured and backed by the entire \$4,500,000 of the American Home Furnishers Corporation of Norfolk, Virginia. Granby can afford to be LIBERAL.

Are the following statements right? You expect profits as a reward for your industry in making many sales. You expect profits as a reward for your ability to keep expenses down. You expect profits as a reward for your wisdom in picking merchandise that SELLS and STAYS SOLD. You expect profits for every penny you invest; good-sized, generous profits. If that is your point of view, Granby thinks you are right. And because we think that you are in business for PROFIT, we offer big PROFITS to you now.

That MYSTERY, which we called "Rumor No. 2," above, has a great deal to do with your profits, whether you become a Granby Dealer or not.

You can listen for yourself to the "Mellow as Southern Moonlight" Granby tone, you can examine the authentic Period Cabinets done in genuine piano-finish 5-ply: we welcome you to give your expert attention to these points. They constitute the final PROFIT element. The Granby Phonograph as a PRODUCT delivers the goods. Let the machine prove it.

Your business sense will tell you what PROFITS you can make out of the Granby line, as soon as you examine the machine from an expert point-of-view, as soon as you get the full facts of the Granby proposition. Will you write us a letter today, and say, "I accept your offer to inform me without obligation on the opportunities for PROFIT in the Granby line. And by the way, what is that MYSTERY?" Use different words, if you like. But shoot along your letter.

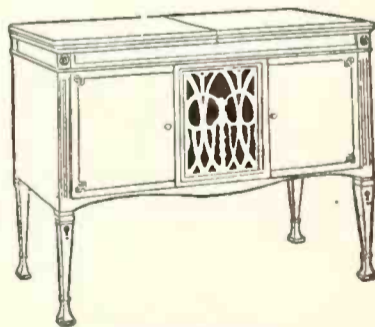

ADAM CONSOLE
Lifetime Construction
GRANBY No. 60

OR TELEGRAPH!

GRANBY Phonograph CORPORATION

Capital \$2,500,000.00

Offices and Factory

Newport News,

Virginia

business man who makes money in spite of conditions—and there are many such—are those who go out aggressively to make their dollars active.

How to Find the Rate of Turnover

The rate of turnover for a given time depends on just two things:

1. The average amount of money invested in the merchandise.

2. The sales of the merchandise in the period.

Both amounts must be stated in the same terms in order to get a correct result. That is, the average amount invested must be figured both at the cost price and at the selling price. It does not matter much which way they are figured, so far as the accuracy of the result goes, but it does make a decided difference if one of the elements is figured at one price and the other at the other price. The result in that case is a figure that means precisely nothing.

It is obvious, then, that, since these two elements only are involved, the problem of increasing the rate of turnover depends on these two and no others. Hence, one or both of two things must be done:

1. The average amount of money invested in merchandise must be decreased, relative to the volume of sales; or

2. The sales must be increased in a greater ratio than the increase in the merchandise investment.

The rate of turnover may be found by dividing the yearly net sales by the equivalent merchandise investment.

By "equivalent merchandise investment" is meant a constant yearly investment in merchandise which is equivalent to the actual merchandise investment over a period of one year.

This means that the "equivalent merchandise investment" must be expressed in terms of time as well as of money. The fundamental unit in which equivalent investment is expressed is the dollar-year. It may also be expressed in some related unit which is reducible to dollar-years, such as dollar-months or dollar-weeks.

In explanation of this, one dollar invested for one year is a dollar-year. Two dollars invested

for six months, or three dollars invested for four months, or fifty cents for two years are all exact equivalents of a dollar-year.

Thus, if you invest \$500 in a certain article or commodity twice a year you have an equivalent investment in that particular article of \$250. Suppose your sales of this article for the year to be \$1,000. By dividing the equivalent investment of \$250 into your sales of \$1,000 you find that your rate of turnover is four. If you invest \$500 in a given article every three months you have an equivalent investment of \$125. If your sales of that article for the year amount to \$2,000 your rate of turnover is sixteen.

Relation Between Turnover and Profit

A business man pays a certain amount for the goods he sells and he sells them for a certain other amount usually greater than the first. It is the difference between these that determines the success or failure of a business. The merchandise itself is only a means to an end.

For certain reasons a merchant may want to invest as little money as possible in stock. The turnover of this investment, then, becomes of great importance, for he must get his original investment back before he can invest it again. This turnover is dependent largely upon the movement of the goods, but the unit profit and the extension of credit also play an important part. An analysis of the turnover will largely determine the advisability of extending more or less credit and the amount of unit profit necessary with the given investment and the probable sales.

A knowledge of stock turnover by lines enables the business man to segregate the fast-moving lines from those that move slowly. It indicates the commodities for which there is a ready demand, and those for which a demand must be created. This shows him where to concentrate his advertising and sales effort. It enables him to apply different sales methods particularly adapted to the conditions. He can, perhaps, increase the percentage of profit on the slow-moving lines to compensate for the slowness of movement, or possibly by decreasing his margin of

profit the movement can be speeded up. His buying can be scheduled so that his stock is always kept at the minimum.

In the final analysis it must be remembered that turnover is not an end in and of itself, but merely a means to an end, namely, yearly net profits. The banker can pay his overhead expenses and declare dividends only by daily turnover of cash on hand. The same problem confronts any business man. His stock must turn a given number of times a year in order to yield a profit.

To exemplify further the close relations between turnover and profit it is necessary only to refer to the ordinary vegetable and fruit market. The proprietor of such a market must turn his stocks daily or they become unsalable. His stocks must sell and sell quickly, for therein lie his profits. Adopt the fruit vendor's methods, make them applicable to your business and then watch the result.

V. T. STEVENS WITH STONE CO.

Well-Known Talking Machine Man Joins Staff of Vocalion Distributor in Northwest

MINNEAPOLIS, MINN., September 5.—The Stone Piano Co., of this city, Northwestern distributor for Vocalion phonographs and Vocalion Red records, announces the addition of Vernon T. Stevens to the selling organization in the capacity of Northwestern manager.

Mr. Stevens is well known in the talking machine trade, particularly through his successful methods in popularizing records by means of "plugging" along the same lines as are followed in the sheet music business. He worked on the idea of hooking up records with prominent professional people in the theatrical field, and the result was a substantial increase in business.

The Brunswick Shop, Alhambra, Cal., has moved from 210 West Main street to larger quarters at 409 West Main street, that city.



Vacation Daze

Snap out of it and investigate our claims for Dealers' Service.

Ask any Pearsall dealer—he will tell you.

"Desire to Serve—Plus Ability"

10 EAST 39th ST.



NEW YORK CITY

SILAS E. PEARSALL COMPANY
DISTRIBUTORS

It is easy to sell what you believe in!

THE great success of the phonograph business rests on the fact that in practically every human being is a lively hunger for *good* music. In the exact degree to which you can satisfy that hunger your sales will increase—no more, no less.

As a phonograph and record merchant are you fully aware of the musical beauty of Columbia Records?

In selling Columbia Records do you know you can truthfully say, "In all the realm of music there is nothing finer than the selections which bear the Columbia mark."

If you can say this with solid conviction and prove it, can't you see how Columbia Records will sell themselves? You can easily prove this fact to yourself so completely that nothing can unsell you. You can prove it to your customers in the same way.

For instance—"A Dream," by Bartlett, Columbia Record A-79287, is one of the most beautiful lyric ballads ever written. As sung by Charles Hackett, it is one of the most beautiful records ever made. Other artists

have sung this song for other record makers, giving their interpretations. They are excellent. But Hackett has given it a touch of tender sweetness and sympathy beyond compare. His voice, his way of

singing it are exquisitely perfect. When the song is ended and the listener rouses from his reverie he wants that little chunk of rapture for his own.

Do you know this Columbia Record? Have you ever compared it closely with the same selection in any other make? Do it and you'll be absolutely convinced that "A Dream" as Columbia has made it has never been equaled. Make the same comparison for any customer and he will prefer the Columbia rendition to any other. Don't take our word for this. Test it out on yourself or your customers.

Another example—Columbia Record 49666 is a tenor and baritone selection by Hackett and Stracciari of the "Solenne in quest ora" duet from Verdi's opera, "La Forza del Destino." If one is familiar with this song, as made by other record manufacturers, one knows the song to expect. But when one listens to these two magnificent voices as they blend and burst into the enchanting harmonies of this operatic gem he listens fascinated. It is a thrill of complete musical satisfaction that is as rare as it is wonderful.

If you haven't heard this Columbia Record you have a treat ahead. Get it! Let its beauty sink into you. Then get records of the same selection as made by others. They are great, too, but any one with or without a trained ear will say the Columbia recording and the beautiful balance of the voices in the Columbia Record are infinitely better. Play these competing records, one after the other, to any customer, don't tell him which is which, and he will tell you to wrap up the Columbia.



Columbia



Are you aware of the veritable gold mine of fine music which Columbia Records offer you as customer winners and profit makers?

Are you able right now to play for your customers a programme that will give them a fair idea of the excellence of Columbia music?

If you want to stamp Columbia quality into the minds of your customers so they will never forget it, we suggest you order the following Columbia Records, then get their competitors and make a demonstration. Play them incognito and you'll be more than surprised at the result.

"A Dream." Tenor Solo. Charles Hackett. 79287. "Souvenir." Violin Solo. Kerekjarto. 79708.

"La Forza del Destino" "Fiddle and I." Soprano (Solenne in quest ora). Solo. Hulda Lashanska. Hackett and Stracciari. 78391. 49666.

"Pirate Dreams." Soprano Solo. Rosa Ponselle. 49571. "One Fine Day." Soprano Solo. Hulda Lashanska. 77878.

After all, you and Columbia are not selling records. We are in the wonderful business of selling happiness, pleasure, amusement. The name Columbia on the record, the name of the selection, the name of the artist are so many handles by which the buyer grasps identification.



Records

Columbia Graphophone Co.
New York



The ALBUM method EXCELS all other RECORD FILING systems EVER TRIED



SELECTING THEIR FAVORITES

To the Trade:

Our Record Album factory—all or any part of it—is at your command. Hundreds of customers can and will gladly testify as to the good quality of our production.

Our large and growing business is due to satisfied customers and repeat orders.

Imprint (firm name or trade mark) stamped on covers if desired when orders are sufficiently large to justify it.

OUR ALBUMS ARE MADE TO CONTAIN VICTOR, COLUMBIA, EDISON, PATHE, VOCALION AND ALL OTHER DISC RECORDS

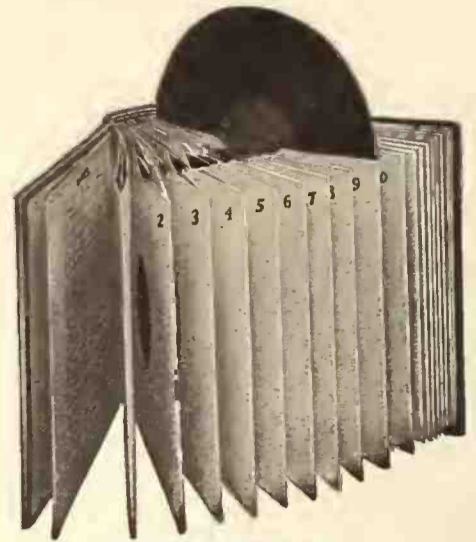

THE PERFECT PLAN

NATIONAL PUBLISHING CO., 239 S. American St., PHILADELPHIA, PA.

New York Office, 54 Franklin Street, Telephone, Franklin 1227, James E. Maguire, Representative

A. H. CURRY MAKES 2,000-MILE BUSINESS TRIP BY AIR

Vice-president of Thos. A. Edison, Inc., Journeys From San Antonio, Tex., to St. Louis by Airplane—Returns Home Pleased With General Conditions and Prospects

A. H. Curry, vice-president of Thos. A. Edison, Inc., is credited with introducing an innovation in the matter of transportation while making a tour of the country recently for the



A. H. and N. C. Curry Ready to Start

purpose of visiting various Edison jobbers when he traveled 2,000 miles through the West by airplane.

Mr. Curry started his air journey from Stinson Field, San Antonio, accompanied by his brother, Capt. N. C. Curry, of Dallas, and with Gene Willard as pilot. The first stop was Dallas, which was reached in three hours from San Antonio, the plane traveling at an average speed of 100 miles per hour. Then, in order, Mr. Curry traveled by air from Dallas to Denver, Des Moines, Iowa; Kansas City, and finally to St. Louis, from which point he returned to New York by rail. In all the airplane covered approximately 2,000 miles of territory.

"My trip was just an exemplification of the age's swiftness," declared Mr. Curry. "I was

on an inspection trip that required hurry, therefore the airplane. Our company may use this mode of travel more extensively in the future, for it certainly has every advantage over the train for distance travel."

Mr. Curry is a Texan, and while in Dallas visited a number of his relatives and acquaintances.

One of the accompanying photographs shows Mr. Curry and his brother ready to



The End of the Journey

"take off" from San Antonio. The other shows Mr. Curry and his brother being welcomed by J. K. Patterson, of the Texas-Oklahoma Phonograph Co., and A. F. Beyer, of San Antonio.

Upon his return to the headquarters of Thos.

A. Edison, Inc., in Orange, Mr. Curry expressed his enthusiasm regarding the results of his trip. He reported the conditions improving steadily throughout the West, particularly in the agricultural sections, where bumper crops are the rule, and stated that both jobbers and dealers in Edison phonographs and Re-Creations were of one mind regarding the prospects for a most substantial Fall trade.

He found stocks to be in fair shape, with the dealers inclined to order very liberally in anticipation of future requirements, and offered the opinion that the problem for the next few months would likely be one of getting sufficient goods, rather than one of selling.

FIRE DAMAGES FREEMAN CO.

Talking Machine Cabinets and Metal Accessories Damaged and Destroyed

NASHVILLE, TENN., August 30.—The Freeman Talking Machine Co., of this city, and another concern in the same building were considerably damaged by fire recently.

The fire was confined to the cabinet and furnishing room, where the fire started, and where many of the cabinets and metal parts of talking machines were either destroyed by fire or ruined by water.

On the second floor was stored a lot of cypress wood used in the manufacture of cabinets, which was partially destroyed. The fire was the second one in the same building in the last few years. Damage to the two concerns was estimated at \$25,000. Partial insurance was carried on the premises.

F. F. Christine, proprietor of the Stroudsburg Music Co., Stroudsburg, Pa., recently tendered a picnic to his employes at North Water Gap. An elaborate dinner was one of the features.

Patented
1914

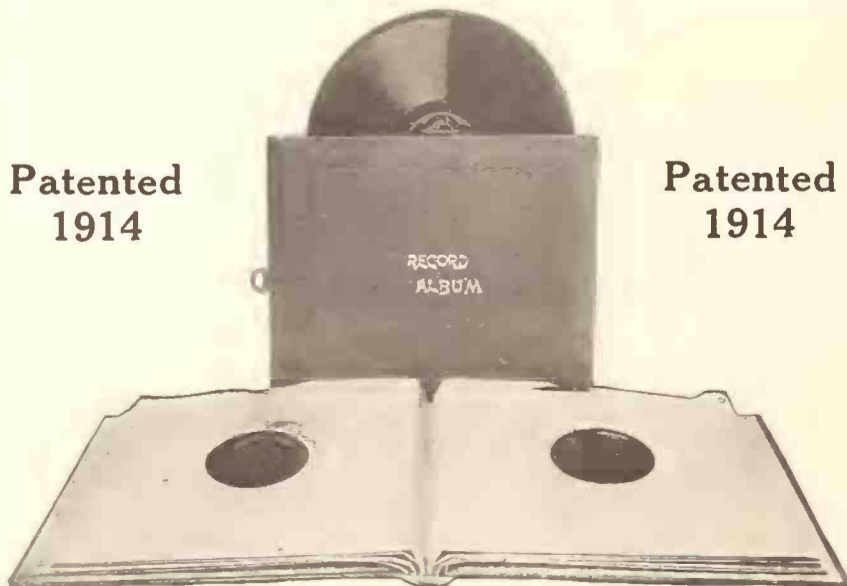

Patented
1914

Quality and Price = Satisfaction

The Reputation of Boston albums has been built upon Quality and Price. The quality is of the highest possible kind and the price is the fairest.

When two factors such as these stated above are combined there is only one result—Absolute Satisfaction.

Absolute Satisfaction to one's self and his customers means a steady influx of good business.

Boston albums are conducive to good business. Do you handle them?

BOSTON BOOK COMPANY

501-509 PLYMOUTH COURT CHICAGO, ILL.



Splendid Recordings of
Leading European Orchestras
 Exclusively on

Okéh
 and
ODEON

For real beauty and irresistible appeal try our imported European Recordings. Your customers are shopping nowadays for specialties of the kind we are offering below.

DAJOS BELA and His Orchestra
 12 inch—\$1.25
 3008 { Bummel Petrus (Jolly Peter), Intermezzo
 { The Wedding of Sleeping Beauty
 The one unsurpassed masterpiece of
 delightful melodies.

MAREK WEBER from the Esplanade Hotel, Berlin

plays famous Strauss Waltzes and up-to-date drawing room music
 12 inch—\$1.25

- | | | | | | |
|--------|--|---------|---|---------|-----------------------------------|
| 3017 { | Blue Danube Waltz
(Johann Strauss) | 85019 { | Greetings of Love
Under the Lindentree | 85023 { | Dreaming, Waltz
Please, Waltz |
| | Southern Roses Waltz
(Johann Strauss) | | 85022 { | | London Fox
Erato, Boston Waltz |

MELODIOUS POPULAR CLASSICS

- | | | | |
|--------|--|--------|--|
| 3016 { | La Boheme, Part 1, European Symphony Orchestra
La Boheme, Part 2, European Symphony Orchestra | 3005 { | Raymond Overture, Part 1, European Symphony Orchestra
Raymond Overture, Part 11, European Symphony Orchestra |
| | 3015 { | | Fifth Symphony (Beethoven), First Movement: Allegro con Brio, Part 1
Fifth Symphony (Beethoven), First Movement: Allegro con Brio, Part 2 |
| 3094 { | Hungarian Rhapsody, No. 2, Part 1, European Symphony Orchestra
Hungarian Rhapsody, No. 2, Part 2, European Symphony Orchestra | 3009 { | Rigoletto—Fantasia, Part 1, European Concert Band
Rigoletto—Fantasia, Part 2, European Concert Band |

FOREIGN LANGUAGE ODEON RECORDS

Our foreign language records have a quality of tone and genuine reproduction which makes them the favorite in their class among foreign record buyers.

Ask for our new catalogues in the following languages:

- | | | | | | |
|----------|--------|---------------|---------|--------------|---------|
| Bohemian | German | Hebrew—Jewish | Italian | Polish | Serbian |
| French | Greek | Hungarian | Mexican | Scandinavian | Turkish |



General Phonograph Corporation

OTTO HEINEMAN, PRESIDENT

25 West 45th Street, New York City





RADIO ATTRACTS PUBLIC TO STORE

Brunswick Phonograph Shop, San Antonio, Tex., Installs Receiving Apparatus for Benefit of Patrons—Other Effective Ideas Used by This Concern Help to Build Prestige.

SAN ANTONIO, TEX., September 6.—A radio set installed in a talking machine record demonstration room is attracting many customers to the Brunswick Phonograph Shop, according to Charles A. Meyer, proprietor. Following the recent installation of a radio department at this establishment a radio receiving set was installed and every provision for the comfort of patrons who drop in to hear the concerts is made.

The members of the sales force of this live-wire organization are all musicians of considerable ability and they have formed a stringed instrument orchestra of their own. If the plans of Mr. Meyer for the installation of a broadcasting station in his establishment materialize this orchestra will be conspicuous on the musical programs which will be sent out by radio.

The Brunswick Phonograph Shop is also the headquarters of the Lone Star Radio Club, composed of the radio amateurs of the city. A workroom is being fitted up in the store for the use of the fans. All of these things have been instrumental in building the good will and prestige which the Brunswick Shop enjoys in this city.

GRUBBS' MUSIC SHOPPE BANKRUPT

Toledo Music Concern Files Petition—Liabilities Set at \$6,000, Assets \$2,000

TOLEDO, O., August 30.—Grubbs' Music Shoppe, 411 St. Clair street, W. A. Grubbs, proprietor, filed a petition in bankruptcy with Fordyce Belford, referee in bankruptcy in the United States District Court for the Northern District of Ohio.

Liabilities are given as approximately \$6,000, with assets of perhaps \$2,000. The heaviest creditors are the E. H. Close Realty Co., Columbia Graphophone Co. and several sheet music publishers.

Grubbs' Music Shoppe dealt in music rolls, sheet music and talking machines.

DEATH OF MRS. EISENBRANDT

Wife of W. D. Eisenbrandt, Victor Wholesaler, of Baltimore, Passed Away Recently

BALTIMORE, MD., September 4.—Mrs. Elise S. A. Eisenbrandt, wife of W. D. Eisenbrandt, local Victor wholesaler, died August 20 at her home at Mt. Washington after a brief illness. Mrs. Eisenbrandt, who was a daughter of the late A. H. and Anna Marie Schulz, was well known in musical circles in Baltimore and vicinity, and her charming personality had won for her a host of warm friends. Besides her husband, she is survived by her two daughters.

GOOD GRAFONOLA SALES

Connecticut Columbia Dealers Doing Exceedingly Well With This Line

NEW BRITAIN, CONN., September 7.—Last December John A. Andrews & Co., Columbia dealers, installed a complete Grafonola department and through the use of energetic sales methods and aggressive publicity have sold hundreds of Grafonolas in this section. In connection with a recent newspaper advertising campaign Manager Rheinhold, of the Grafonola department, states that thirty-one Grafonolas were sold. Mr. Rheinhold is not only enthusiastic regarding this showing, but believes that the outlook for Fall and Winter trade is unusually promising.

Gus Haenschen and J. O'Keefe, of the Brunswick Recording Laboratory, New York City, have been enjoying a cruise of the St. Lawrence River and the Great Lakes in their new yacht, Brunswick.

PREPARING FOR CONVENTION OF OHIO ASSOCIATION

Committees Appointed to Look After Various Details of Forthcoming Annual Gathering of the Music Merchants' Association of Ohio—Prominent Trade Members on Program

TOLEDO, OHIO, August 31.—At a special meeting of the Toledo Music Merchants' Association, held here recently, for the purpose of shaping matters for the forthcoming convention at the Hotel Secor, September 26 and 27, of the Music Merchants' Association of Ohio, President Fred N. Goosman named the following committees: Entertainment, Henry C. Wilderimuth, Henry F. Stucke, Paul Hayes and Frank Frazelle; Reception, W. W. Smith, Preston P. Brown, David Blaine and Carl Rule. These groups will co-operate with State officials in every way in order to make the convention of direct benefit to every delegate.

Assurance has been given that many visitors from outside the State of Ohio will attend the gathering of business men. A goodly number of hotel reservations have already been made. Chicago is planning to send a special car of delegates under the leadership of Matt Kennedy, of the Chicago Piano Club.

That all visitors will be amply repaid for their time and efforts is assured beyond a doubt. There will be plenty of entertainment for those seeking diversion and a large quantity of substantial business-building material for the merchant in search of helps and plans which he can apply to his own problems. The roster of speakers is a noteworthy one and gives assurance of the high caliber of the convention topics.

The principal address of the convention will be delivered by George W. Pound, general counsel of the Music Industries Chamber of Commerce, New York. Other widely known leaders who have accepted invitations to address the convention are: Richard W. Lawrence, president of the Music Industries Chamber of Commerce; Edwin R. Butler, president of National Association of Music Merchants; C. C. Adams, president of the Illinois Music

Merchants' Association; C. M. Tremaine, director of the National Bureau for the Advancement of Music; Bradford Mills, Toledo, president of the Federated Music Teachers' Association; A. C. Grinnell, vice-president of the Music Industries Chamber of Commerce and past president of the National Association of Music Merchants.

Rex Hyre, Cleveland, secretary of the Music Merchants' Association of Ohio, was among those who attended the Toledo meeting.

Exhibitors will be afforded every opportunity for displaying their products. No doubt a large number of manufacturers will avail themselves of this chance to get in touch with a goodly number of customers and prospects. Already several have reserved space, among them Hallet & Davis Piano Co., Bush & Lane Piano Co., Auto Pneumatic Action Co., Steger & Sons and Cable-Nelson.

The golf tournament will be played at the widely known links of the Inverness Club. Carl Landgraf, secretary of the J. W. Greene Co., has this contest in charge. All contestants must register before the day of the convention.

On Tuesday noon, September 26, convention delegates will be the guests of the local Exchange Club. Fred N. Goosman was recently installed as president of the club.

The Toledo Music Merchants' Association, through its president, Henry F. Stucke, of Grinnell Bros., is co-operating in a large way to make the convention a success. They have chartered the "City of Toledo," one of the large lake steamers, for a moonlight ride on Lake Eric. They also have other plans under development which they will announce shortly.

E. R. Laughead, Hallet & Davis Piano Co., was in conference recently with President Fred N. Goosman relative to convention matters.



THE SATISFIED CUSTOMER IS THE DEALER'S GREATEST ASSET

RADIO INSTRUMENTS

ARE MOST SATISFACTORY
In Design, Finish, Simplicity of Operation and GENERAL RESULTS

We Manufacture a Complete Line of RADIO Instruments and Parts, all of which typify FEDERAL QUALITY and TRADITION.



FEDERAL CRYSTAL RECEIVER FEDERAL JUNIOR AMPLIFIER



TO THE DEALER

You may be assured of SATISFIED CUSTOMERS if you sell FEDERAL apparatus. Write for DEALER'S discounts.

Federal Telephone and Telegraph Company
BUFFALO, NEW YORK

Just compare any record of any make with the needle cut Pathe Actuelle and then you will know why the Pathe Actuelle is—

The Best Record in the World

Play on any phonograph with steel needles

For Example, try

- Dancing Fool..... No. 020802
- Three o'Clock In The Morning..... No. 020791
- Parade of the Wooden Soldiers..... No. 020780
- Romany Love..... No. 020777
- "Stumbling"..... No. 020746
- Say It While Dancing..... No. 020799



2 for \$1.00 - 55c each

(59c in Rocky Mountain States)

Partial List of Famous Artists—

- Tito Schipa
- Yvonne Gall
- Adamo Didur
- Margarethe Matzenauer
- Rudolph Ganz
- Anna Fitziu
- Eleonora de Cisneros
- Claudia Muzio
- Luigi Montesanto
- Kathleen Howard
- David Bispham
- Grace Hoffman
- Alexander Debruille
- Helen Yorke
- Roberto Rotondo

DEALERS—

If you don't act quick your neighbor will be selling Actuelle Records. Write to us at once for information regarding the Blue Ribbon Order.

PATHÉ FRÈRES PHONOGRAPH CO.

20 Grand Avenue

Brooklyn, New York

Why Not Stage a "Keep-the-Children-Home-Nights" Exposition in Your Store? :: By F. H. Williams

With the approach of Fall and the resumption of school activities the same old problem presents itself to the parents of young people who are in school, namely, how to keep the children home at nights.

In the Summertime, when there are band concerts in the parks, picnics to claim attention and week-ends at nearby lake and river resorts, it is not to be expected that the young people will stay home. But when Fall comes and school begins it is up to the young people to get busy and study at night and not waste all their time at poolrooms and dance halls.

Because this is a very real problem, which troubles a big percentage of all the parents, and because the remedy is to be found at the store of the talking machine dealer it does seem as though he should cash in on this situation this year to the utmost extent possible.

The remedy, of course, is for parents to buy talking machines and records and by their use not only keep the young people at home, but get them to bring their friends to the house where the parents can see just who and what sort of friends they are. Young people will stay home when there is music in the house—this fact has been proved time and again—and parents who realize that talking machines will do this are not slow in purchasing machines. So it is evident that the dealer who brings all this home to the parents most forcefully through advertising or by personal letters is certain to get some good business.

Why don't YOU plan to do this, Mr. Talking Machine Dealer?

Here are some of the ways in which you can bring this proposition to the attention of the

parents and some of the ways in which you can make it a profitable business proposition.

A very effective and quite unusual method of getting this subject before the parents of the city, so that it would create a lot of comment and thereby enjoy a tremendous lot of highly valuable word-of-mouth advertising, would be that of devoting a week to a "Keep-Children-at-Home-Nights" Exposition in your store.

The object of the exposition would be, of

Various Means of Emphasizing the Value of the Talking Machines as a Power for Good in the Community

course, to show how a talking machine keeps children at home some, if not all, the nights during the Fall and Winter, and how much benefit the children derive from staying home.

In starting the exposition it would be a good plan to secure a lot of short interviews from parents who have purchased "talkers" from your store, using their actual experiences with machines in making home so pleasant for the youngsters that they didn't want to go out in

the evenings. These interviews need not carry the names of the people giving them—they should be brief and placed on placards which could be placed at prominent positions about the store.

The next thing to do would be to arrange an attractive display of the same styles of talking machines used by the people giving the interviews. This would give pith and point to the display. It would be also a good plan to have a display of the records which have been found most successful by parents in arousing the interest of the young people. Such records would, very probably, be dance records, popular vocal selections and popular music of all sorts.

The third thing to do in perfecting plans for an exposition would be to get data from school authorities as to the effect on school work of children staying home nights, in contrast with those in the habit of going nightly to poolrooms and dance halls. School authorities could quickly show how much more efficient the home-keeping students are than the other kind and these facts could be presented in short, snappy paragraphs on placards placed close together near the display of talking machines for the home. A great many parents would find this information most interesting. It would be an entirely new slant on the results to be secured by keeping the young people at home nights.

Another good idea would be to prepare some sample programs for the evenings to be spent at home, on which there could be apportioned time for the young people to spend in study, time for dancing, time for hearing vocal selec-

(Continued on page 22)

The Recent Chicago Radio Show

Resulted in quantity orders from concerns ranging from Florida to California on—

THE RADIO BUILDER SET



Shipped to customer in "knock-down" form and requiring only a screwdriver and a few moments to complete its assembly.

When finished it provides a vacuum tube set which is very selective, giving extremely loud and undistorted signals.

Price - \$25.00

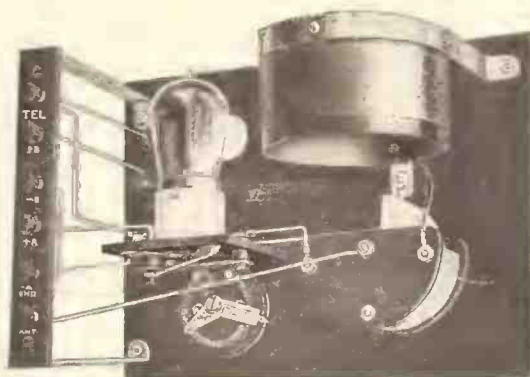

SOME DEALER PROPOSITIONS STILL OPEN

The above type set is available in one, two and three tube form.

RAYMOND RADIO CORPORATION

Manufacturers to the Radio Industry

Offices: 309 Lafayette Street, N. Y.

Works: Farmingdale, L. I.

STAGE A "HOME NIGHTS" EXPOSITION

(Continued from page 21)

tions and the better class of music, time for games and time for a final dance. Different programs for each night could be outlined and they should be played up strongly on signs which could be used on the walls and windows of the store. While it is altogether likely that few, if any, people would follow out the programs exactly outlined, still every one who came into the store would be interested in looking them over and they might get ideas out of the programs which they could use to good advantage in their own homes—this means stimulating record sales.

To let people know about your "Keep-Children-at-Home-Nights" Exposition use newspaper advertising for the event and also play up the affair by means of interesting and attractive cards in your window displays. Such advertising should tell frankly just what the exposition is designed to do—help parents in their efforts to keep their children at home on

schools nights. Each person in the city who is interested in this problem should be invited to attend regardless of whether or not he or she is interested in the purchase of a talking machine.

If you have a mailing list of prospects send a letter to the names on this list telling about the exposition. Also it would be a good idea to obtain from the principal of your local high school a list of the parents of the children in the school and to phone to these parents an invitation to attend the exposition. If you frankly explain to the high school principal just why you want the list of names of parents of high school pupils he would be very glad to cooperate with you as, of course, it would help the school officials greatly to have the children devote their evenings to studying at home. Then why not get in touch with the presidents of the local women's clubs and extend to these clubs an invitation to attend the exposition. It might even be possible to get some of the women's club presidents, the principal of the local high school, the superintendent of public

schools and some of the other civic leaders to give endorsements of the exposition which you could incorporate in your advertising for the affair.

Get the local newspapers to run some news stories about the proposition. The object is constructive and interests a big percentage of all the population in the city and would be considered as real news by readers.

To start off the Fall season with an exposition of this kind would give the dealer a talking point with parents of young people and so would be a constant, all-year business booster. Hence, arrange to stage a "Keep-the-Children-Home-Nights Exposition" in your store. And do it NOW!

ALTERATIONS AT LONG MUSIC HOUSE

Prominent Pasadena Music Concern Making Extensive Changes to Establishment

PASADENA, CAL., September 2.—Extensive alterations are now being made at the Long Music House, 15 West Colorado street, this city. When completed the Long Music Store will be one of the most modern institutions of its kind to be found in any city on the Pacific Coast. The work will consume about a month's time and when completed it is probable that a formal opening, to which the public will be invited, will be held.

The whole interior of the store is to be changed and modern built-in glass display cases will be a feature. The front also will be remodeled and will be one of the most attractive on Colorado street. A large balcony is to be constructed, upon which will be located booths for reproducing pianos and talking machines. On the main floor will be located ten or more booths for record demonstrations. One of the features will be the inviting lobby and another will be a large auditorium in the rear. An expensive ventilating system is to be installed and cool air will be circulated throughout the store and the booths.

UNIQUE PUBLICITY STUNT

Clown Rolling Giant Columbia Record Attracts Much Attention

SAVANNAH, GA., August 31.—J. E. Baxley, manager of the Grafonola department of Haverty's Furniture Co., recently conceived a unique ad-



Columbia Clown and His Giant Record advertising stunt which is shown in the accompanying illustration. Mr. Baxley sent this clown all over town rolling a giant Columbia record, featuring one of the latest hits. The stunt produced excellent results.

OPEN NEW VICTOR STORE

T. S. Crosby & Son, furniture dealers, of Coshocton, N. Y., have opened a new talking machine department, in which the Victor line is featured.

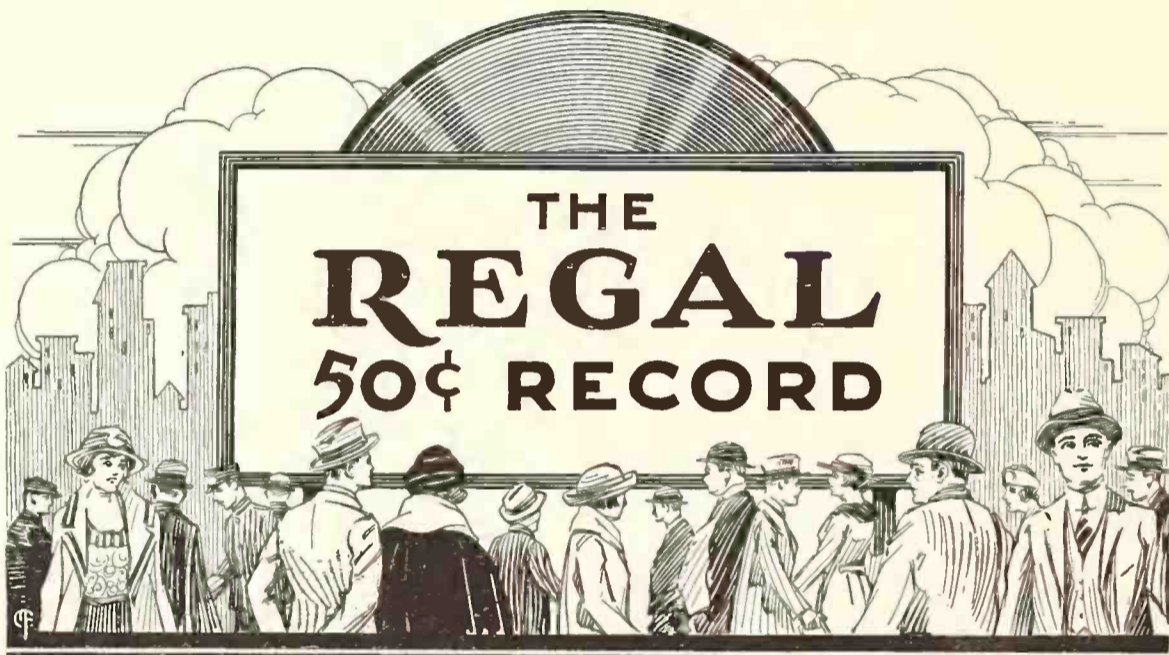

This Fall they will buy Regal 50c Records

These people are record buyers. They are looking for value.

Each day thousands of them discover Regal's exceptional quality.

They buy. They pass the word to their friends and their friends buy. Eventually they will all buy.

They shift their preference to Regal because Regal serves their purpose and saves their money. Regal gives them the quality they want at the price they are willing to pay—75c worth of record value for 50c—in every way.

That value is the secret of Regal's splendid success and Regal dealers everywhere are satisfied with the results—profitable results.

The way is open for you too. Write for an exclusive territorial arrangement.

REGAL RECORD CO., Inc.

20 West 20th Street

New York

See record index for current Regal list



HONEST QUAKER

(Reg. U. S. Pat. Office)

MAIN SPRINGS



Write for a copy of our HONEST QUAKER Main Springs and QUAKER Mica Diaphragms chart!

—a size for every motor.

—packed in individual dust-proof, rust-proof containers, neatly labeled, with complete information for your convenience.

—unconditionally guaranteed to be perfect in every respect.

“And they cost no more than ordinary springs”

Everybody's
TALKING MACHINE CO. INC.

Makers of-

Honest Quaker Main Springs

Umantone Needles

A Complete Line of Talking Machine
Repair Materials

810 Arch Street, PHILADELPHIA

Canadian Distributors:

H. A. BEMISTER, Montreal

GEO. L. LAING & CO., Toronto



The Opportunities for the Sale of Talking Machines Throughout Cuba :: By Russell R. Voorhees

What are the chances of increasing the sale of American-made phonographs in Cuba? That question has most likely been asked often by American phonograph manufacturers because of the closeness of the island and also because of the ease with which merchandise can be shipped there. It can be quickly answered by saying that the chances for increasing the sale of American-made phonographs in Cuba are at this writing both good and bad. That seems strange, to say the least, but it is nevertheless true, as a little thought will prove.

In the first place the sale of merchandise in any country is dependent to a great degree on the amount of wealth which that country produces. To this can be added the amount of wealth that the tourist leaves in the country as he passes through. From this viewpoint Cuba is not a very good market for phonographs at this time because her chief source of wealth, sugar, is more or less upset both as to price and as to demand. Her other big crop, tobacco, is showing an improvement, but at the same time it is not what it should be. An insight into the situation can be obtained from the fact that men who cut the sugar cane in the field now get 40 cents a day, in comparison to \$2 a day a year or two back. From this it can be seen that the wealth now being produced in Cuba is not very great. Economic conditions in Cuba are very much upset, although they are to-day better than they were a year ago or even six months ago. But at that Cuba is not producing wealth enough to put it in the class of merchandise purchasers to any extent.

The tourist is visiting Cuba and leaving money, to be sure, but no country the size of Cuba can develop itself on the tourist business alone. The money the tourist is spending is helping the situation, but that is about all that can be said.

And so it is not hard to see why Cuba is not much of a market for American-made talking machines at this writing. But, while the present situation is not very pleasant as far as in-

creased business is concerned, it is not hard to see a bright future for increased business.

The population of the island of Cuba is about 3,000,000. Outside of Havana and Santiago there are few, if any, cities that amount to a great deal. True, there are so-called cities of 25,000 population, but a Cuban city of that size is far from being like a city in the United States of the same size. It can truly be said that the mass of the Cuban population lives outside of the cities and is of the peon type, which means that they are poor. Their hovels or huts do not contain the rudiments of comfort such as we in the States know them to be. They represent the great purchasing

Cuba Offers Opportunities, Now Latent, Well Worth Watching so as to Be in Readiness When They Break

power of Cuba that has never been developed, and it is to this that I am looking more than to the people concentrated in Havana and the other cities.

Cuba is bound to progress, and as she progresses, which means as she produces more wealth, she will be a better customer for American-made talking machines. The peon or peasant will not be satisfied with his hovel and improvised home furnishings when he begins to earn more and have more. Then he will want better things and more of them. And not only that, but he will begin to look for

some recreation, which has been so long denied to him because of poverty. Talking machines fall naturally in this class, and someone will get the business of the island when it reaches the point where it can buy them. The American talking machine manufacturer might as well get in and get this business. That class of Cuban represents half of the population of the island, so the value of cultivating it can easily be seen.

The balance of the population, very largely concentrated in Havana and the other cities, and which knows something of the comforts of modern living, are also possible customers. While they already know what phonographs are and have them in many instances, still there are many who have not, but who are possible customers. As business improves in the island and as greater and greater wealth is produced their demands will increase accordingly.

The one thing that is a happy feature is that the Cuban is a spender. Money goes about as fast as it comes, regardless of how slow or fast it comes, and not only does he spend, but he likes to spend. So it is just a question of catching him when he has money and selling him then.

From this it can be seen that Cuba offers opportunities that, while they do not exist today, are well worth watching for, so as to be ready when they do break. It is just a question of waiting until conditions in general improve and until Cuba produces a greater wealth, when it will be possible to sell more "talkers" there.

But there is still another field for the sale of machines in Cuba. It would be a difficult matter to find a country with more eating places than are in Cuba. Havana appears to be overstocked with cafes and eating places, but they all appear to be doing a fair business, to say the least. Some of them have talking machines, but many have not, and here is a market for cheap machines. I noticed that many of the cafes had small phonographs that sold for around \$10 to \$15. For the most part they use Spanish records, although a good lively American number is occasionally heard. Without a doubt, many of the cafes that do not have a talking machine could be induced to buy one, especially if some sort of a time payment proposition could be arranged, such as is the practice in the United States. It seems that a "talker" in the cafes is a great attraction, especially during its early life, and so there appears to be some worth-while reason why the proprietors should buy one.

It is well to remember that the Cuban is a lover of music, and some of the finest bands in the world are to be found in Havana. They rank, unquestionably, with the best. The interest that is taken in the Sunday afternoon concerts in the public parks in Havana and other cities is enough to prove that the Cuban likes music. And the phonograph will give him just what he wants in his home.

But in the selling of phonographs there is a trick. Cuba is a country that appears to be run for the benefit of Cubans. It is next to impossible to do business with them direct, so American manufacturers of talking machines seeking to enter that field or to extend their sales there should seek some connection that is Cuban. There seems to be little if any dislike for American goods; it is just a question of doing business with Americans, that's all. And so it would be well while conditions are somewhat unsettled and upset to look into the possibilities that the island offers and thus be ready when they are ready.

Shipments to Cuba are a very easy matter.

(Continued on page 26)



**BRUNS
MADERITE**

MADERITE
WATERPROOF
PHONOGRAPH MOVING COVERS

Cover, Straps Attached



A cover that will fully protect against damage in delivery and against the ravages of inclement weather.

Why be troubled with packing and unpacking? Why not just slip a MADERITE Padded Delivery Cover over the machine? No fuss, no dirt and positive insurance against damage incident to delivery.

The use of the BRUNS MADERITE Covers, made of highest grade waterproof fabric, heavily padded, is not only serviceable but profitable. This cover is highly recommended.

Consult your regular jobber or write us for sample of cloth and prices.

A. BRUNS & SONS
50 Ralph Ave., Brooklyn, N. Y.
Manufacturers of Everything Made of Canvas

A. BRUNS & SONS
50 RALPH AVE.
BROOKLYN
N. Y.

"Genius is but the infinite capacity for taking pains"

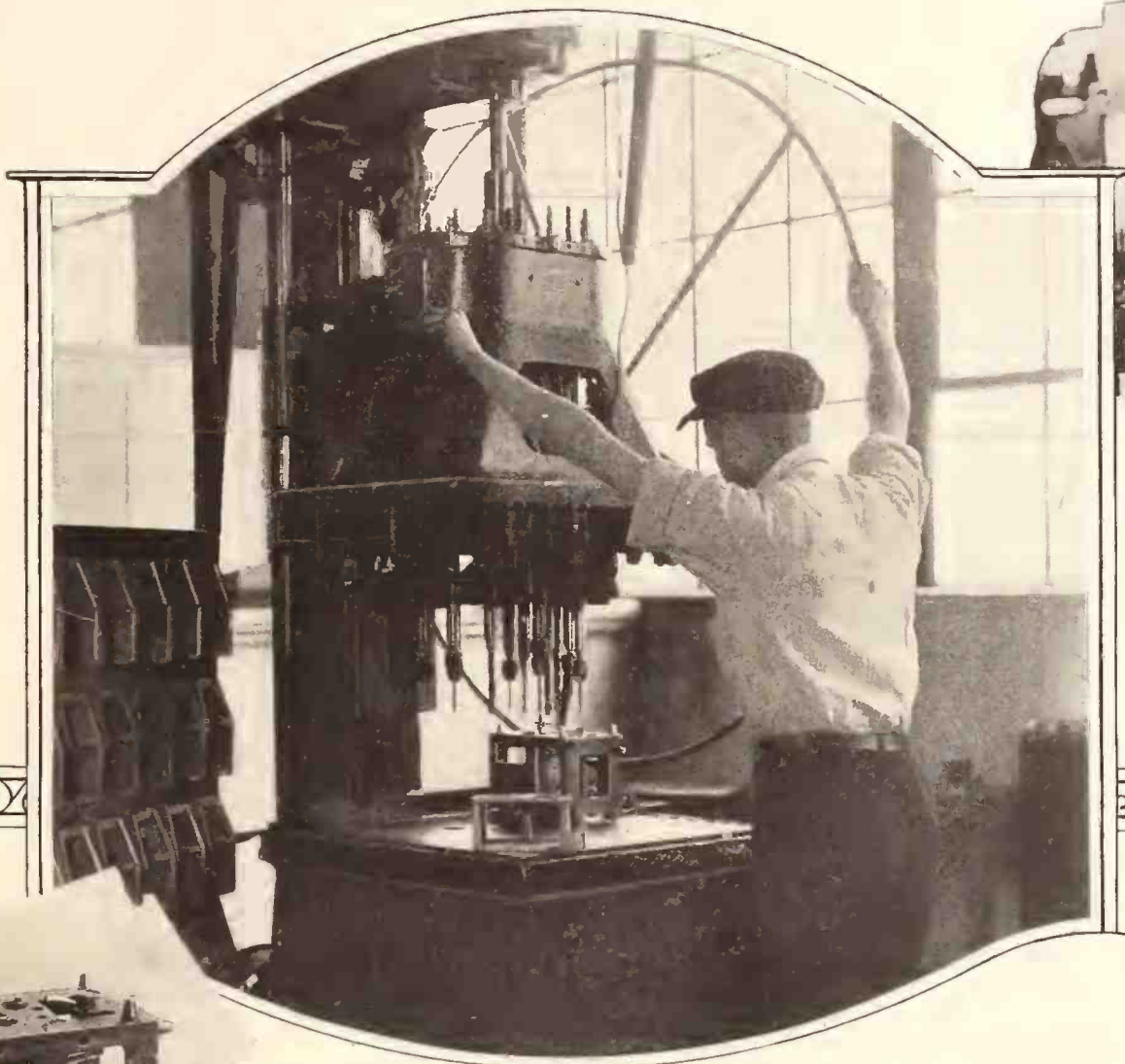

In assembling The Cheney motor the holes drilled and reamed in The Cheney motor frame become the bearing points for spindles and gears. The assembly of The Cheney motor is a very delicate and exacting operation.

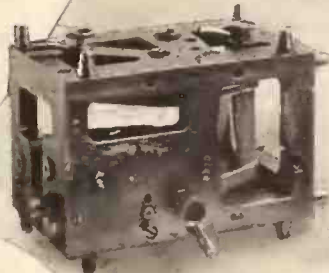
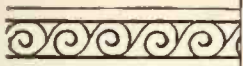

This is the drill jig which makes it possible for the operator of the multiple spindle drill to work so quickly and accurately. It is made from seasoned grey iron and bushed with hardened tool steel and ground bushings, which play the important part of keeping the holes accurately spaced during the multiple drilling and reaming operations.

Through these little holes the drills pass and bore their way into the motor frame housing, combining speed and utmost accuracy.

How 15 Holes of Different Sizes are Drilled in less than a minute in a Cheney Motor Frame

It is a cardinal principle in The Cheney motor factory that accuracy must never be sacrificed for speed. That does not preclude the use of the most modern inventions for cutting down production costs.

Illustrated above is a multiple spindle drill which makes it possible for an operator to drill fifteen holes of different sizes in a Cheney motor frame in less time than it takes to tell it. Every hole

is absolutely accurate to the thousandth of an inch, not only in diameter but in spacing as well.

It is through the use of such efficient methods as this that The Cheney Talking Machine Company has been able to produce instruments with a reputation for highest quality, and yet to keep prices at a level no higher than that of the ordinary phonograph.

THE CHENEY TALKING MACHINE COMPANY • CHICAGO

The CHENEY

THE MASTER INSTRUMENT

"The Longer You Play It, the Sweeter It Grows"



BUSINESS OPPORTUNITIES IN CUBA

(Continued from page 24)

Talking machines can be loaded into freight cars at the factory in America and run to Key West, where they are run onto special boats that take them direct to Havana, a matter of only seven hours. From Havana they can be run to any part of the island, arriving at their destination just as they were packed at the factory in America. Of course, they can be shipped by water as well, but that means extra handling.

As far as the railroads in Cuba are concerned it is safe to say that they are as efficient as many roads in the States and will give excellent service. Many words of commendation are heard in Cuba and elsewhere about the Cuban railroads.

In conclusion it is safe to say that Cuba offers a market for American talking machines, if not to-day, then to-morrow. They like music and are willing to spend money to have it in their homes. Just now money is none too plentiful, but when conditions improve, and that is the case right now, money will be more plentiful. And when money becomes more plentiful the buying season will start. Talking machines of all prices can then be sold in Cuba. Someone will get this business. Will it be American manufacturers? That remains to be seen. As for Cuba, it is not a manufacturing country, and so must buy from someone.

NEW VOCALION RECORD DISTRIBUTORS

Strevell-Paterson Hardware Co. to Handle Line in Salt Lake City

The Strevell-Paterson Hardware Co., the prominent concern in Salt Lake City, Utah, has been appointed distributor in that territory for the Vocalion Red Records manufactured by the Aeolian Co. This and other additions to the list of distributors serve to complete a chain of wholesale representatives that covers the country very thoroughly.

BECOMES COLUMBIA DEALER

NEW ORLEANS, LA., September 6.—D. A. Barre, at one time connected with the bookkeeping department of the local branch of the Columbia Graphophone Co. and more recently field representative, resigned his position recently to become an exclusive Columbia dealer. Mr. Barre is opening up an attractive store at 1509 Dryades, under the name of the Barre Music Shop, and his thorough knowledge of Columbia product should enable him to attain unusual success in his new venture.

MAIL AS AN AID TO RURAL TRADE

Dealers Can Obtain Much Business From Farmers Now Going to Mail Order Houses by Utilizing Mails to Establish Contact

An almost entirely undeveloped opportunity for the talking machine dealer lies in the rural districts surrounding his community which he finds impossible to make personal contact with. The great mail-order houses of the country are capturing much business from the farmers which should go to the dealer in the nearest city with the expenditure of a little effort. If the mail-order houses can get the talking machine and record business of the farmers it is logical to assume that the talking machine dealer is in a better position to do so.

In going after this trade the merchant has the distinct advantage of being much closer to the farmer. He can advertise in the papers which reach the farmers in his community and when he has worked up his prospect list he can make a much closer contact with the rural dweller because of the fact that, while the mail-order houses handle a large variety of goods, the talking machine dealer is, in a manner of speaking, a specialist.

He can keep the farmer supplied with the latest record supplements and can make more direct appeals by letter, whereas the mail-order house depends for sales mainly upon catalogs issued at stated intervals. This plan is at least worth trying and if put into effect intelligently new customers and increased sales should result.

WHITEMAN NAILS FALSE RUMORS

Orchestra Leader Denies Emphatically Making Records for Any Company Other Than the Victor Talking Machine Co.

In a recent statement Paul Whiteman, famous orchestra leader, denied most emphatically rumors to the effect that he and members of his orchestra had made records for concerns other than the Victor Co. In his statement Mr. Whiteman said:

"Within the past several weeks there have been many rumors to the effect that members of my orchestra and myself are making records for companies other than the Victor Talking Machine Co.

"It is insinuated that either individually or collectively we are recording under assumed names. It would be greatly appreciated by me, as well as members of my orchestra, if you would publish an absolute denial of the rumor.

"Paul Whiteman and His Orchestra is an ex-

IN THE
HANDY
CAN



NYOIL

FOR YOUR
PHONOGRAPH

Made in Our Watch Oil DEPARTMENT

which for half a century
has made 80% of all the
watch, clock and chronom-
eter oil used in America.

The Best Oil For Any Talking Machine

In refining, Nyoil is given the same care as our famous watch oil receives. All gums and impurities are removed, leaving it

Colorless, Odorless and Stainless.

Housekeepers say they would not be without Nyoil because it is best for phonographs and sewing machines—for polishing furniture and woodwork and is odorless and will not stain. It is free from acid and will not gum, or become rancid. Sportsmen find it best for guns because it prevents rust.

NYOIL is put up in 1-oz., 3-oz. and 8-oz. Bottles and in Quart and Gallon Cans.

For Sale by all Talking Machine Supplies Dealers
WILLIAM F. NYE, New Bedford, Mass., U.S.A.

clusive Victor organization and will remain exclusively Victor. I have been approached with other propositions, but in every instance I have made my position very clear and have stated definitely that I am not interested."

LARGER QUARTERS IN EL PASO

EL PASO, TEX., September 2.—The Del Norte Talking Machine Co. has moved from San Francisco street to new and larger quarters at 331 South El Paso street. The new quarters have been remodeled at considerable expense and provide practically double the facilities of the old store.

The stockholders of the Del Norte Talking Machine Co. are: Alberto Solis, L. G. Fernandez and W. J. Geck. Mr. Solis was for over ten years with W. G. Walz & Co., Victor, wholesalers in this city.

BROOKS CO. CREDITORS MEET

SAGINAW, MICH., September 2.—The first meeting of the creditors of the Brooks Mfg. Co., talking machine manufacturer, which was adjudicated bankrupt on August 18, was held in the offices of Cook & Cook, 205 Eddy Building, this city, on Tuesday, August 29, at 9 o'clock, when creditors proved their claims, appointed a trustee and examined the bankrupt.

THE NEW PHILLIPS OCTAGON THROW BACK ARM No. 5

Deep Full Tone

Also equipped with our regular
No. 3 Reproducer if desired

Tone Arm measures 8½ in., and
9 in. from centre to centre

Tone Arms and Sound Boxes
complete from \$2.00 up

For Portables 6½ to 8 inches

CAN BE EQUIPPED WITH AUTOMATIC STOP

Quantity Prices on Request

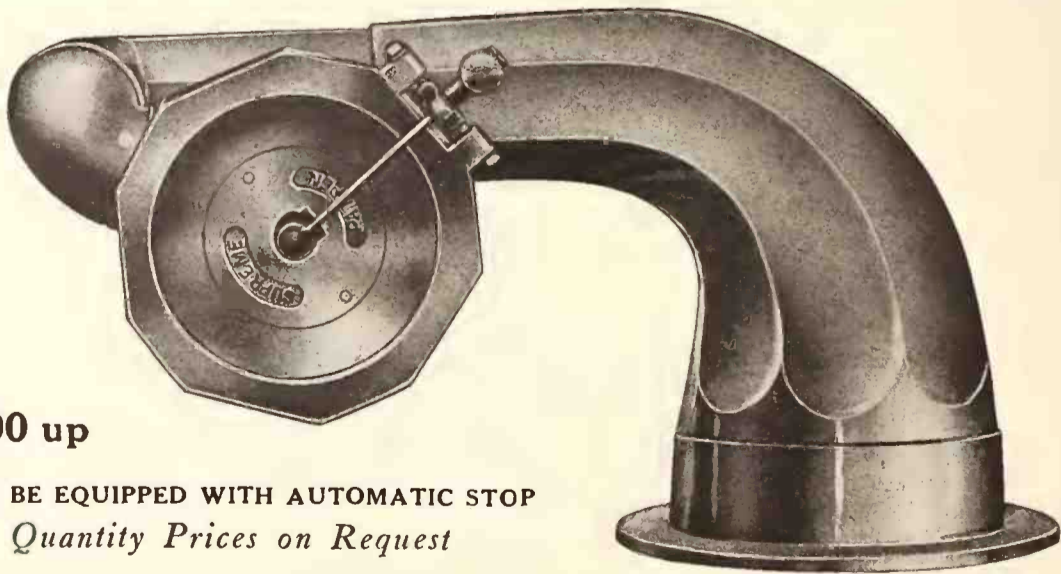

The William Phillips Phono Parts Corp.

Manufacturers of Tone Arms for Portable, Medium and High Grade Machines

145 West Forty-fifth Street

New York City



THE DANGER AHEAD

and

HOW TO MEET IT

The Danger Ahead is in the supply of Victor goods not meeting the demand. Dealers' stocks of Victrolas are more depleted than ever at this time of year. Over-confidence on the part of Victor Dealers in the ability of Victor Distributors to supply them with goods as wanted, with the uncertainty as to new type Victrolas, has contributed to a "hand-to-mouth" buying attitude.

The recent announcement of the new flat-top Victrolas and the assurance of no further change in price or styles between now and January 1st has resulted in a sudden demand, and a shortage of Victrolas for the holidays seems inevitable. Never before was the Victor line so well prepared to meet competition. The necessity of Victor Dealers being prepared is most apparent. The Danger Ahead is an extreme shortage. How to meet it is the problem.

Supplementing the largest and most complete stock of Victrolas that we have ever had at this time of year, we have placed additional orders with the factory for the largest quantity of goods ever ordered by us for the Fall and holiday season. Blackman Dealers are going to be in an enviable position if they will co-operate with us.

Place an order NOW for estimated requirements of all Victrolas for delivery during September, October, November and December.

It has always been the Blackman policy to respect the wishes of our dealers in permitting them to rearrange advance orders according to current needs.

Continued business relations under the Blackman policy have always been on a basis of mutual satisfaction, so, while we do not guarantee delivery and therefore permit cancellations, the moral obligation on our part is always highly respected, and dealers who co-operate with us by placing advance orders are entitled to first consideration.

Concentrate with us as your Victor Distributor and make us feel obligated to take care of you, not only in the supply of goods, but with an ample extension of credit.

If you are a Blackman Dealer, stick closer than ever. If you are not, now is the time for us to get together. Concentrate on the Victor line this year through Blackman, and you will successfully meet the Danger Ahead. We are going to be prepared, and Blackman Dealers will benefit accordingly.

Blackman

TALKING MACHINE Co.

28-30 W. 23RD ST. NEW YORK N.Y.

VICTOR WHOLESALE DISTRIBUTORS





Music Lovers Are Not All Millionaires

The wise music dealer knows how much of his business comes from the purchaser of inexpensive instruments, and he is carrying out this same knowledge in his marketing of the new big line of radio equipment.

De Forest offers particularly good co-operation in this respect to the music dealer, because although there are De Forest sets which are very elaborate and most beautifully finished there are also inexpensive De Forest sets such as the Radiohome and the Everyman illustrated on this page—very efficient for short distance receiving from 30 to 100 miles, beautifully finished in their smallest detail, but at the same time moderate in price.

When you represent De Forest you give your patrons a real service—not only the service of the famous De Forest quality, but also the satisfaction which comes of offering the complete line from the simplest to the most elaborate sets.

DE FOREST RADIO TEL. & TEL. CO.
JERSEY CITY, N. J.



GOOD WORK FOR MUSIC IN MOBILE

Reynolds Music House Sponsors Most Successful Music Memory Contest in That City, Donating All the Prizes—Plans Now Under Way for Citywide Contest During Fall

MOBILE, ALA., September 2.—In local musical trade circles there is still being felt the effect of Mobile's first music memory contest, which was brought to a close recently at Lyons Park, where over 3,000 men, women and children attended to witness the hotly contested finish. The contest was started in June, being sponsored by W. H. Reynolds, of the Reynolds Music House, local Victor wholesalers, and under the personal direction of Mrs. Carl Klinge, prominent in local musical circles, and Miss Hazel Council, in charge of the Victrola department of the Reynolds Music House.

A feature of the contest was the giving over of four play centers for an hour daily to the contest work. For that period the children gathered around the Victrola for the purpose of studying the various compositions included in the contest. One good composition was featured daily, and the instructor impressed the members of the audience with its title, the composer and other features connected with it. Twenty-five selections were included in the contest, fifteen of them being used in the final test.

In addition to the music memory work Victrola concerts were held daily in the parks, the Reynolds Music House furnishing the records. Children were taught folk dances by means of Victor records, a children's chorus was organized among the smaller children, who were taught songs from records, and the older girls formed glee clubs, singing with the Victrola. There were also many other musical activities.

There were 150 entries in the final event and the local newspapers devoted over 300 inches of reading matter to the contest. The prizes were donated by the Reynolds Music House, the first prize being a Victrola, the second \$10 worth of Victor records and the third \$5 worth of records.

The finale of the contest was made the occasion of an elaborate concert, at which a number of prominent artists appeared and which was attended by Mayor Geo. Crawford, who made the address of welcome. At the conclusion of the concert awards were announced, Miss Cora Cook winning first prize with a perfect score; Miss Eileen Sutton, second prize, with one error, and Miss Alvira Thierry third prize, with two errors. The winner of the second prize is totally blind and wrote her answers on the typewriter by the touch system.

As a result of the success of the first contest plans are now under way for the holding of a city-wide music memory contest in public schools of the city during the Fall, the contest to be brought to a climax with a big Community Music Week in the Spring.

VALUE OF A COMPLETE STOCK

Failing to Meet the Requirements of Customers Results in Loss of Customers

The installation of a complete record stock cannot be too strongly urged on the talking machine dealer. Many concerns have lost and are continuing to lose profitable customers because of the fact that they are unable to supply the demands of these people. Whenever a dealer is forced to say, "I am sorry, but we haven't that record in stock," a prospective customer registers disappointment, and when this happens to the same customer several times she loses faith in the establishment and is very likely to visit some other store in the future where she can obtain the exact record which she requires.

Ray Higgins has been made manager of the talking machine department of the Home Furniture Co., Bennington, Vt.

COURTESY IN BUSINESS

By EDWARD FRASER CARSON

When I went to school there was a story in one of the readers that I have never forgotten. It was about General George Washington.



Edward Fraser Carson

It seems that George and a friend were walking down the street one day when they met an old negro woman carrying a basket of wash. When she saw the Father of His Country she put down her basket and curtsied.

"Mawnin', Gin'ral," she exclaimed.

Washington, according to the story, lifted his hat and responded to the greeting, when his friend expressed surprise that he should do so to a negro slave.

"And why not," replied the general. "Do you think I am going to let that negro be more polite than I am?"

Whether the story is true or not is neither here nor there. It points a moral and teaches a lesson that surely is needed these days.

Courtesy costs nothing and in business you will find that it pays real big dividends. Courtesy will fill your store with customers, empty your shelves of stock and roll up your bank account.

If you are an employe courtesy will raise your salary, win you promotion.

"He who rides with Courtesy will never lack cheerful company," wrote a philosopher of other days, while another said, "Who rides the nag called Courtesy will sleep nights in comfort, and his journey will be pleasant and joyous."

There are a lot of young chaps—and old chaps, too, I am sorry to say—who have the foolish idea that to be courteous is to be effeminate. How or where they get that idea Heaven only knows. A lot of them are working as clerks. And they are of the breed who are ever grumbling that "a feller doesn't get a chance."

They never seek to wake up to the fact that they themselves are to blame, that they are standing in their own light.

When a customer asks for some special attention these chaps seem to take it as a personal affront. They are indifferent—uninterested. They seem to think that to be courteous to a customer implies inferiority on their part.

Know then, young man, that when I enter a store to buy phonographs or furs, sugar or tea, those things are for the moment the things that interest me most. If you will show that YOU, too, are interested, if you make an effort to satisfy me, I simply cannot help taking an interest in you. And the sum total of the interest of all customers in a clerk is the measure by which he is valued by the boss.

Of course, there are employers who themselves are unappreciative. If you find yours to be afflicted that way the best thing to do is

to seek a new one. You are in the wrong job.

But speaking generally, it is true that the chap who is cheerful in his efforts, who takes an interest in his customers, who bears with their peculiarities—he is the chap who will win out.

Suppose your customer IS cranky and impatient and finicky. Suppose you DO have to show him half a dozen records or two dozen neckties, or whatever it is you are selling. Suppose he—or she—DOESN'T find what they seek and go out without making a purchase—you certainly will not induce them to come back the next time they are in the market by being discourteous.

Remember that is what you are being paid for—to PLEASE the customer. To make the customer WANT to come back.

Far from implying that you are INFERIOR, to be courteous PROVES that you are just the opposite just as the customer's impatience or discourtesy shows HIS lack of those qualities which go to make up the true gentleman.

I think that if I had to make a choice between dishonesty and discourtesy in a clerk I should prefer dishonesty. A dishonest clerk may steal the profits of a few sales, but a discourteous clerk will drive customers away until there are no profits at all.

JOIN STEWART BROS. CO. STAFF

COLUMBUS, O., September 2.—Burt Tullar, for the past twenty-one years a well-known talking machine salesman in Columbus, having been identified with the W. E. Heskett Co., Bope-Hayes Co. and the Pathé Shop, and Roy D. Layman, formerly with the Stewart Bros. Co. and the Alward Co., of Newark, O., have become associated with the talking machine section of the Stewart Bros. Co., of Columbus. The department, a comparatively new one, is one of the most complete in the downtown section, and will, no doubt, prove most successful under the charge of these enterprising men.



Showing Reproducer of Jewel Needle Equipment Turned Up to Change Needle; Also Position When Not in Use



Showing Reproducer of Jewel Needle Equipment in Position for Playing Vertical Cut Records on Edison Phonograph



For The New Edison

NOT
Just Another Equipment
BUT

a distinct improvement in Tone Reproduction as well as in Mechanical Construction and Finish.

Send for descriptive circular which contains "HINTS REGARDING THE CARE OF A PHONOGRAPH."

If your jobber does not handle, write us.

Price the same. Liberal discount to dealers.

GUARANTEED IN EVERY WAY.

MONEY BACK IF NOT SATISFIED.

We handle highest grade Jewel Point Needles.



Showing Reproducer of Jewel Needle Equipment in Position for Playing Lateral Cut Records on Edison Phonograph



Showing Back View of Jewel Needle Equipment in Position for Playing Lateral Cut Records on Edison Phonograph

Plays all types of records. Operates the same as the "EDISON" with the LEVER.

No adjustments necessary when changing from lateral to vertical cut records. Stop prevents swinging to the right.

Needle scratch almost entirely removed.

Turning back of Reproducer permits of easy access to needle socket and saves records from unnecessary scratching.

Is the ONLY equipment that plays vertical cut records in the proper "EDISON" position with the Reproducer turned FACE DOWN to the record, giving it a floating action.

Needle CENTERS on all records.

Straight air-tight construction and absence of movable joints insure perfect reproduction and great volume.

Pivoted ball-joint insures perfect reproduction and freedom of movement both vertically and horizontally.

Weight is the lightest that can produce perfect results, thus saving the record, and permitting a freedom and sweetness of tone considered impossible.

Indestructible NCM-Y-KA diaphragms do not blast, crack, split or warp, and are the greatest development in phonographic sound reproduction in years.

JEWEL PHONOPARTS COMPANY

154 W. Whiting St., Chicago

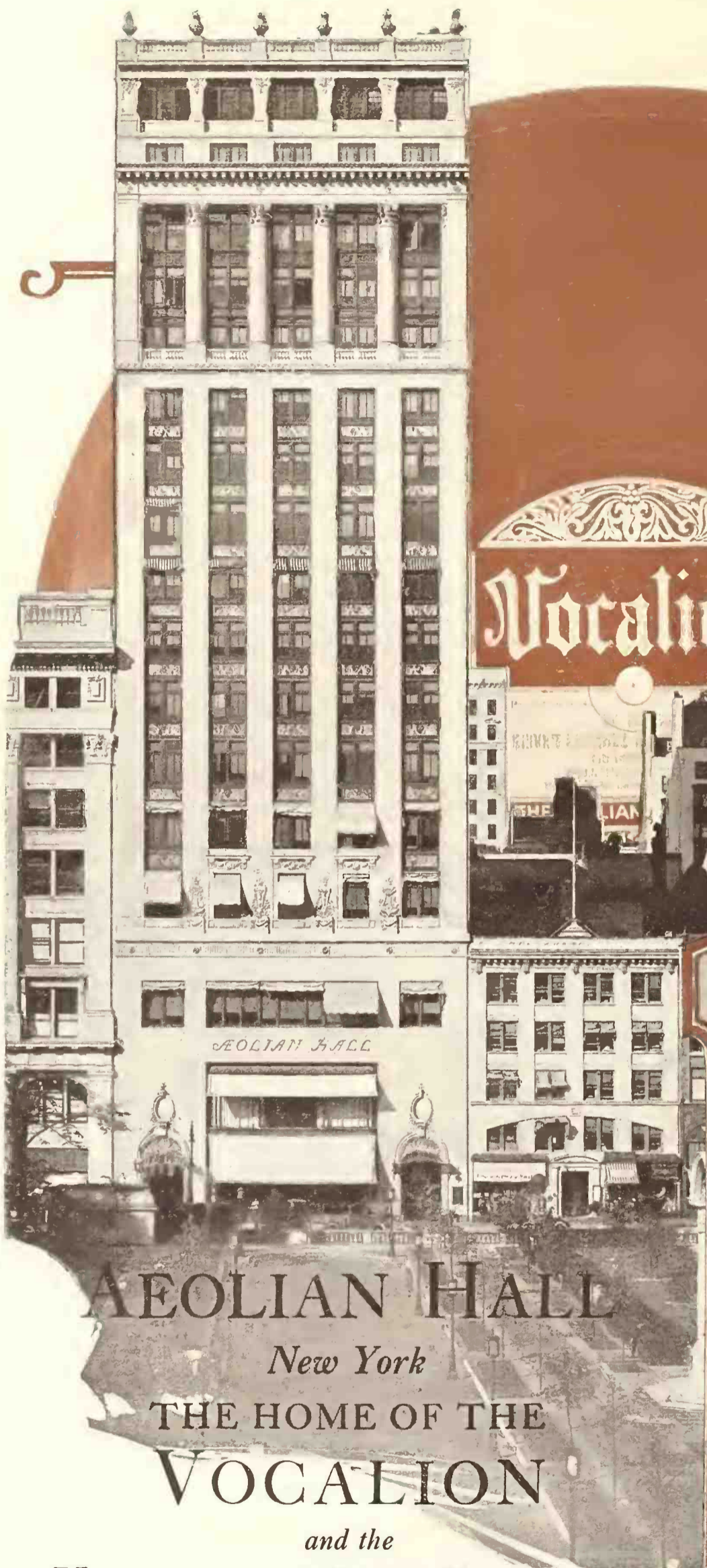

Style 720—Conventional Model

VOCALION

PHONOGRAPHS—RED RECORDS

A SURE-FIRE PROPOSITION for Fall—*the Vocalion Line of Phonographs and Red Records.* Aeolian-made products are a guarantee of *substantial quality.* The Vocalion, individualized by the Graduola Tone-Control, is the highest development of the phonograph. Vocalion Red Records are leaders for brilliancy and timeliness.

*We Invite Your Correspondence on The Vocalion Line
in Connection With Your Fall Business Campaign.*

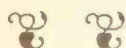

THE DISTRIBUTORS OF THE VOCALION AND VOCALION RED RECORD

MUSICAL PRODUCTS DIS. CO.,
37 E. 18th St., New York City
A. C. ERISMAN CO., 174 Tremont St., Boston, Mass.
Vocalion Record Distributors
WOODSIDE VOCALION CO., 154 High St., Portland, Me.
LINCOLN BUSINESS BUREAU,
1011 Race St., Philadelphia, Pa.
GIBSON SNOW CO., 306 West Willow St., Syracuse, N. Y.
Vocalion Record Distributors
CLARK MUSICAL SALES CO.,
324 N. Howard St., Baltimore, Md.
SONORA DISTR. CO., 505 Liberty Ave., Pittsburgh, Pa.
Vocalion Record Distributors
PENN-VOCALION CO., 16 W. King St., Lancaster, Pa.
O. J. DE MOLL & CO., 12th and G Sts., Washington, D. C.
VOCALION CO. of OHIO,
328 W. Superior St., Cleveland, Ohio

VOCALION CO. of OHIO, 420 W. 4th St., Cincinnati, Ohio
LIND & MARKS CO., 530 Bates St., Detroit, Mich.
THE AEOLIAN COMPANY,
529 S. Wabash Ave., Chicago, Ill.
LOUISVILLE MUSIC CO., 529 S. 4th St., Louisville, Ky.
HESSIG ELLIS DRUG CO.,
Memphis, Tenn.
Vocalion Record Distributors
THE AEOLIAN CO., 1004 Olive St., St. Louis, Mo.
GUEST PIANO CO., Burlington, Iowa
D. H. HOLMES CO., New Orleans, La.
STONE PIANO CO., Fargo, N. D.
STONE PIANO CO., 826 Nicollet Ave., Minneapolis, Minn.
STREVELL-PATERSON HARDWARE CO.,
Salt Lake City, Utah
MUNSON-RAYNER CORP.,
315 Broadway, Los Angeles, Cal.
THE MAGNAVOX CO., 616 Mission St., San Francisco, Cal.
Vocalion Record Distributors

THE AEOLIAN COMPANY

NEW YORK

CHICAGO

ST. LOUIS



The Criterion Quartet has filled over 250 engagements during the past twelve months. That's popularity with a big P. Through Columbia Records they will now fill unlimited engagements. Their first Columbia recording is "My Cradle Melody," A-3667. Paired with this is a Hart and Shaw duet, "Down Old Virginia Way." This record will take like a case of measles in a Kindergarten.

Columbia Graphophone Co.
NEW YORK

COLUMBUS

Trade Outlook Bright—Expert Salesmen Needed, Says Leslie I. King—Month's News Budget

COLUMBUS, O., September 4.—Talking machine dealers generally in this section declare that business is showing a distinctly upward trend and that, barring unexpected complications, there is every reason to expect a most substantial Fall business. Both machine and record sales are keeping up and the cash receipts are very satisfactory.

What the talking machine industry needs most at the present time, in the opinion of Leslie I. King, manager of the talking machine department of the Morchouse-Martens Co., High near Town street, is master salesmanship. "Never in all the time since I have been in the business, and that is sixteen years, was this particular qualification so necessary as at the present time," said Mr. King.

"In our firm we have emphasized this point to the extent that we can now see the results. Practically 90 per cent of our machines were sold by our salesmen away from the store. Many of these sales required a number of approaches, some of which from the first were discouraging. But, by proper procedure and concentrated effort, our sales for the month of

July were 8 per cent in excess of what they were during the same month a year ago. This to me proved the fact that what we need at the present time to carry on our business on the scale that we have been doing is master salesmanship."

An attractive way of advertising records and music rolls has been devised by Mrs. C. C. Baker, of the C. C. Baker Co. Mrs. Baker finds it advantageous to feature in window displays the music that is played in the moving picture shows. Frequently passers-by who happen to come from the motion picture shows stop to view the windows and, in finding the music displayed which they have just heard, are pleasantly surprised. Featuring the numbers that are offered in the motion picture shows enables this firm to sell records, although the day when those particular numbers were popular has passed. When it comes to trimming windows Mrs. Baker is an artist. She arranged and designed windows that have been commented upon by a number of local artists.

Harry Patton, manager of the Elite Music Store, is advertising in Jewish publications some of the well-known Hebrew songs. Mr. Patton has a large Jewish trade and believes it will stimulate his record sales if he informs the Jewish people through the Jewish press of the number of Hebrew records he has to offer them.

More than usual interest has been shown in the record entitled "Nobody Lied," which is one of the records in the August Victor re-

lease. This is due, no doubt, to the fact that this number was written by a young man who attended Ohio State University and was sung in this city for the first time early last Winter, when the musical comedy "Scarlet Mask" was presented by students from the university at the Elks Club. Hyatt Berry is the composer of both score and words.

E. M. Levy, of Heaton's Music Store, stated that the machine business in the past month was unusually good. Although various models were selling well, still models No. 80, 100 and 90 were the best sellers. The cash receipts from the sale of records was practically as good as during holiday seasons. The types of records that are in demand, according to Mr. Levy, are the dance and popular song records.

F. J. Connor, manager of the Z. L. White Co., Victor dealer, reported a like condition with reference to the volume of business, although a good deal of his record business was in the Red Seal line. "The orchestral numbers of 'Tannhauser' by the Philadelphia Orchestra have been a big seller for us," said Mr. Connor. A few weeks ago Mr. Connor planned to take a short vacation during the early part of September, but, owing to the increase of business, Mr. Connor feels that it would be hazardous for him to go away for even a short length of time.

Foreign records and sets of the health-building records which were recently issued by the Victor Co. have been good sellers in the Elite Music Store, according to Harry Patton, manager.

Three more Victor artists have been added to the list of artists that are scheduled to appear in Columbus during the Fall and Winter months, they being: Geraldine Farrar, who sings on December 1; Rachmaninoff, who plays on March 19, and Fritz Kreisler on February 22. Paderewski is another possibility for the coming season.

F. L. Fritchey, special representative of the Perry B. Whitsit Co., Victor wholesaler, reports that business is picking up in the rural sections in the State of Ohio. He anticipates a busy Fall season in the talking machine industry.

W. H. Eichenlaub, manager of the People's Furniture Co., Victrola dealer, is spending his vacation at a number of points on the Great Lakes.

REMODELING IN LOS ANGELES

Parmelee Dohrmann Co. Installing Full Unico Equipment in Talking Machine Department

LOS ANGELES, CAL., September 2.—The Unico system for demonstration booths and fixtures is being installed by the Parmelee Dohrmann Co. for its new music department on the main floor. The Unit Construction Co. is represented on the Coast by the Walter S. Gray Co. and J. J. Grimsey, manager of the Los Angeles branch office of the latter company, is overseeing the work.

VELVET COVERED TURNTABLES

ADD TO THE QUALITY OF MACHINES



A.W.B.

Boulevard
VELVETS

THE BEST TALKING MACHINES ARE EQUIPPED WITH

A. W. B. BOULEVARD VELVETS

GRAND PRIZE—GOLD MEDAL, ST. LOUIS EXHIBITION

WRITE FOR SAMPLES AND PRICES

A. WIMPFHEIMER & BRO., Inc.
450-460 Fourth Avenue, New York

ESTABLISHED 1845

Four-Minute Conference on Business Topics

No. 5—Your Desire to Do Business

[This is the fifth of a series of four-minute conferences on topics of direct interest to business men in the talking machine trade which have been prepared for this publication by Lester G. Herbert.—EDITOR.]

It is a perfectly normal desire of those who are anxious to succeed to increase the volume of business done. Increased volume means lower overhead and larger profits, and this is a desirable end to achieve.

But there is such a thing as an eagerness to do business running away with one's judgment. Unless business can be done right it is better left undone.

The farmer who was so anxious to keep his men busy that he drew in load after load of fine hay before it was properly cured learned his lesson in the Wintertime, when he found that the whole mass had mildewed and spoiled.

The man who killed his fat hogs and put the choice, carefully fed meat into the refrigerator before the animal heat had left the carcass learned his lesson when he found that the whole had to be discarded.

The automobile salesman who parted with a fine car and took notes from an unknown stranger was a sadder and wiser man in a short time.

Bankers and keen business men generally are glad to do business—when they can do it right—but they go slowly enough to be sure of their ground and, as is perfectly right, they protect themselves in all legitimate ways from possible loss.

For business to be profitable it must be satisfactory to both parties. Any business which invites a flareback or renders a complication liable is to be avoided. To buy a piece of property at a bargain makes a man feel good, but he wants to be sure that his title is clear or his good feelings will not last very long. To sell a nice bill of goods is very pleasing, but if the money is not forthcoming, or one has to resort to a great deal of trouble to get the payment, the goods are better kept in stock.

Business which really counts is that which is done right from start to finish and which is not hurried or misrepresented or concluded on terms which are ill-advised. It is just as easy—and in the end much easier—to do business right than to do it wrong, for any practice which is open to question undermines confidence and prevents all possibility of real progress.

TALKING MACHINES RUINED BY FIRE

350 Machines Practically Destroyed by Fire in Warehouse in Oneida, N. Y.

SYRACUSE, N. Y., September 1.—Fire practically ruined 350 talking machines recently in a storehouse in Oneida, causing a loss estimated at \$15,000. Three hundred of the machines were owned by Mrs. Fred Wyker, of Liverpool, N. Y., and the other fifty were the property of Benjamin Ferrara, a talking machine cabinet manufacturer. Most of the loss was covered by insurance.

BIG RESULTS IN A SMALL TOWN

MORGAN CITY, LA., September 5.—J. J. Goldman, Columbia dealer in this city, recently ran the selected dealers' advertising campaign, which produced results far beyond any expectations. Although this city has a population of only 5,000, Mr. Goldman felt that he had not closed all the possible sales in his territory through this campaign, and four weeks later put over another sale that netted him twenty-one Grafonolas, besides a large quantity of Columbia records.

E. E. HOHMANN ON SOUTHERN TRIP

JOHNSTOWN, PA., September 1.—E. E. Hohmann, manager of sales of the Modernola Co., of this city, manufacturer of the Modernola talking machine and the Modernolette portable, left on August 17 for a trip of about one month's duration. Mr. Hohmann plans to cover West Virginia, Ohio and Michigan in the interest of Modernola products.

S. M. Watson, who handles Sonora phonographs and Vocalion Red records in Vallejo, Cal., has moved to new quarters at 618 Marin street, that city.

THE VOCALION IN WASHINGTON

Vocalion Phonographs and Red Records Get Strong Foothold in National Capital and Environs Under Auspices of O. J. DeMoll & Co.

WASHINGTON, D. C., September 7.—O. J. DeMoll & Co., distributors in this territory for Vocalion phonographs and Red records, have been exceptionally successful in placing that line with over a score of live representatives, both in Washington proper and in neighboring towns and cities. The company has been rendering the sort of service that appeals to retailers and the Vocalion line is being strongly featured. Among the concerns handling the Vocalion line through the medium of DeMoll & Co. are:

William C. Bean, Rockville, Md.; Blustein, 2010 Fourteenth street N. W.; T. P. Culley & Son, 1327 G street N. W.; C. L. Datnov, 1233 Seventh street N. W.; A. Durso, 1225 H street N. E.; H. A. Garren, 907 H street N. E.; Globe Furniture Co., 1023 Seventh street N. W.; The Gibson Co., Inc., 917 G street N. W.; Harry C. Grove, Inc., 1210 G street N. W.; I. K. Hunter, 718 Ninth street N. W.; Keller & Schwinger, 3653 Georgia avenue N. W.; Knickerbocker Music Shop, 1788 Columbia road N. W.; Lansburgh & Bro., 420 Seventh street N. W.; Philip Levy & Co., Div., 735 Seventh street N. W.; McHugh & Lawson, 1222 G street N. W.; The Music Shop, 419 Ninth street N. W.; The Quality Shop, Fourteenth and F streets N. W.; George H. Railing, 818 King street, Alexandria, Va.; R. H. Reamy, 623 Pennsylvania avenue S. E.; Robinson's Music Store, 1306 G street N. W.; Charles Schwartz & Son, 3123 M street N. W.; Charles Schwartz & Son, 708 Seventh street N. W.; J. M. Sokolove, 1804 Seventh street N. W.; Southwest Music Store, 409 Seventh street S. W.; Studio Shop, 1725 L street N. W., and Swan's Variety Store, 3201 Fourteenth street N. W.



Recorded in Italy
by the best
known Italian Singers

POPULAR ITALIAN RECORDS LATEST RELEASES

10 Inch Records \$.75 Each

- 1007 Pulcinella Ad Una Festa Da Ballo. Scena Comica. Un Balbuziente in Tribunale. Scena Comica.
- 0991x L'Altalena. Song.....Cav. G. Godono
- E L'Ammore. Song.....Cav. G. Godono
- 1000 'O Guarracino. Part 1. Song, P. Mazzone
- 'O Guarracino. Part 2. Song, P. Mazzone
- 0957x Luntano 'A Te, Mari'. Song, Cav. G. Godono
- L'Acquaiola. Song....Cav. D. Giannini
- 0997x Serenatona. Song.....R. Ciaramella
- Vipera. Song.....Jole Baroni
- 0955x Tic-Ti-Tic-Ta. Song.....R. Ciaramella
- Piererotta. Song.....R. Ciaramella
- 0993x Venerdi'. Song.....F. Rondinella
- 'E Ssignurine D' 'O Palazzo. Song, R. Ciaramella
- 0989x Mia Dolce Amica...Cav. Uff. G. Godono
- Voce D'Amor.....Cav. Uff. G. Godono
- 0995x Totonno 'E Quagliarella....Ciaramella
- Niru TeLangella
- 1001x Signora Mia (Duetto), Donnarumma-Ciaramella
- 'A Cura 'E Mamma' (Duetto), Donnarumma-Ciaramella
- 1003x Canzone AmericanaDonnarumma
- Donna Fifi'Ciaramella
- 1005x Mo Esce Achille. Scena Comica. Il Cavamachia. Scena Comica.
- 1019x Momenti Giolosi. Orchestra. Al Bosforo. Polka.
- 1021x Carmen (Selection). Bells. Nozze D'Oro. March.
- 1033x Abat-Jour (Salome), Ciaramella-Rondinella
- Ninnolo....Cav. Uff. G. Godono, Tenore

We Are Also Manufacturers & Distributors of



New Hits Released the 15th of Each Month

JUST OUT

- 225—Napule E Maria. Versi di L. Bovio. Musica di G. Lama. (Word Roll). \$1.25
- 047—Si Me Scurdass' 'E Te! Versi di F. Pennino. Musica di D. Ietti. (Word Roll) 1.25
- 194—La Chiamavano Cosetta. Versi e Musica di A. Bixio. (Word Roll). 1.25
- 234—Non T'Amo Piu (Romanza). By F. P. Tosti. (Word Roll)..... 1.00
- 211—Tu Me Vulive Bene. Versi di L. Criscuolo. Musica di M. Cosentino. (Word Roll)..... 1.25
- 231—Ideale (Romanza). By F. P. Tosti. (Word Roll) 1.00
- 217—Giovinezza Giovinezza. Versi di M. Manni. Musica di G. Castoldo. (Word Roll) 1.00
- 206—Giro Di Nozze. Polka. C. E. Bevilacqua. Instrumental90
- 207—Foglia Di Rosa. Mazurka. A. A. Egidi. Instrumental90

ITALIAN BOOK CO.

Music Dep't

145-47 Mulberry St.
New York City

DISCOUNT TO DEALERS—ASK FOR CATALOGUES

PHONOGRAPH CASES RADIO CASES

Reinforced 3-ply Veneer

The Standard Case for Talking
Machines and Radio Sets

Let us figure on your requirements

MADE BY
PLYWOOD CORPORATION, Goldsboro, N. C.

Mills in Va., N. C. and S. C.



BRINGING DEAD ACCOUNTS TO LIFE

H. J. Buckley Writes on the Need of Co-ordination and Co-operation in Business—Points Out That There Is a Gold Mine of Sales Possibilities in Inactive Accounts on the Books

In every business house—manufacturer as well as dealer—there is a gold mine of sales possibilities in the inactive accounts on the ledgers, says Homer J. Buckley, president of Buckley, Dement & Co., Chicago, in a recent article in *Printers' Ink* on "Bringing Dead Accounts Back to Life." Have you, Mr. Proprietor, ever had your credit man or bookkeeper come to you and say: "Mr. Jones, we are transferring our ledger sheets to-day to our transfer ledger and opening up new ledgers for this six-month or this year period and find more than 200 names of customers among our ledger sheets that we have not had any business from in a year or more. Don't you think the sales department ought to get after them?"

No, Mr. Proprietor, unfortunately, credit men and bookkeepers are not as a rule constituted that way—and the process of transferring inactive accounts is going on in every business house in the country without any notice on the part of the heads of the business.

Seventy-five per cent of the people who discontinue buying never complain—they just quit cold. Only 25 per cent who have a grievance or a complaint or adjustment tell you about it. These 25 per cent are really your friends—they are giving you a chance to square yourself. But you don't always treat them that way.

The 75 per cent that quit cold without complaining may do so for any one of a hundred reasons—usually service—very seldom price. Here are a few of the reasons: 1, a cold-blooded letter from your collection department; 2, discourtesy on the part of sales people; 3, errors; 4, delayed shipments; 5, promises that are not kept; 6, refusal to correct mistakes; 7, making an adjustment with a grudge or a sting in it. Treatment like this

causes many a customer to say: "I'm through with that outfit!"

If a name goes into the inactive list a letter or a series of letters should go right out to that customer. If the matter is handled right he can be brought back into the fold, usually stronger than before, because your efforts will have shown the customer the spirit of the house and its appreciation of the value of his good will and your desire for his patronage.

How often does something like this happen in your business? Investigate! You may get some surprises, and I repeat—the bigger the business the greater the evil.

All the above is related to show the need of co-ordination and co-operation in a business, and especially in a big business. The reason the average dealer is not making more than a living is because of his own inefficiency and not because of competition or ungrateful people. If it costs \$10 to get a new customer it's worth \$10 to hold an old customer.

FEATURES BRUNSWICK THRIFT BANK

Brunswick Dealer Using Publicity That Is Producing Results—Thrift Bank Proves Valuable Sales Stimulant

COLUMBUS, O., September 5.—The Morehouse-Martens Co., of this city, Brunswick dealer, recently used effective publicity featuring the Brunswick "Thrift Bank," which is meeting with considerable success throughout the country. This enterprising dealer carried newspaper advertising that illustrated a popular Brunswick model, and the heading of the advertisement read as follows: "If You Intend to Own a Talking Machine You Are Entitled to a Brunswick Thrift Bank."

The text of the advertisement was timely and straight to the point, pointing out that less than twenty cents a day deposited in the bank would provide enough to purchase the model illustrated. This "Thrift Bank," which is shaped like a Brunswick phonograph, will be featured extensively by Brunswick dealers this Fall and, judging from the results already secured, the bank will prove a valuable sales stimulant.

RECEIVER FOR A. B. TAGGART CO.

Jas. Harbauer Takes Charge of Affairs of Retail Music House in Toledo

TOLEDO, O., August 31.—James Harbauer has been appointed receiver to take charge of the affairs of the A. B. Taggart Co., 618 Madison avenue, dealer in string and band instruments, Brunswick phonographs and sheet music.

Something over a year ago this concern succeeded the Ignaz Fischer Music House, which was then conducted by Carl and Alpha Fischer, son and daughter of Ignaz Fischer, deceased. The original enterprise did a large business in church and sacred music for over thirty-five years and reached every quarter of the country with its wares.

Liabilities are placed at \$30,000 and assets not exceeding \$10,000. Funds of the business being used to develop certain improvements, it is stated, made the assignment for the benefit of creditors necessary.

SELL SONORA TO TEACHERS

The sales department of the Sonora Phonograph Co., New York, was advised this week by Streger Bros., Portchester, N. Y., Sonora dealers, that they had sold a Sonora to the teachers of a Portchester school as a gift to their principal. Streger Bros. are following up this sale among the parents of the children in the school and expect shortly to report additional sales as a direct result of it.

The Hassler Drug Co., of Osceola, Neb., recently remodeled its store, and the Victor department now occupies a prominent portion of the establishment.

If all the Manhattan Radio Headsets that have been manufactured and sold since the first one was produced on March 20th, 1922, were placed side by side, they would stretch in an unbroken line eleven miles long.

This means quantity production—and quantity production assures you of four things:

1: Uniform quality of product. Quantity production demands absolute uniform quality of raw materials. Only the very best materials are uniform in quality.

2: Rigidly tested product. Quantity production necessitates rigid tests at every stage of manufacture. Rejection of a finished headset is costly.

3: A Correctly Designed Product. The proper design of the Manhattan headset and the use of special tools—only possible in quantity production, enable us to add refinements and extra features at no increased manufacturing cost.

4: A Quality Product at a Quantity Price. Quantity production cuts labor costs. This enables us to offer Quality Headsets at Quantity Price.



No. 2500—2000 Ohms
\$6.00

No. 2501—3000 Ohms
\$7.00

Radio is coming back stronger than ever. Get ready—place your order with your jobber NOW for Manhattan Radio Headsets.

MANHATTAN
ELECTRICAL SUPPLY CO., INC.
Makers of the famous Red Seal Dry Batteries

NEW YORK
17 Park Place

CHICAGO, ILL.
114 So. Wells St.

ST. LOUIS, MO.
1106 Pine St.

SAN FRANCISCO
604 Mission St.

VINCENT LOPEZ

AND HIS HOTEL PENNSYLVANIA ORCHESTRA



NOW STARRING ON BROADWAY

VINCENT LOPEZ has assumed his rightful place as the foremost director of dance music. At Keith's Palace Theatre, America's greatest vaudeville house, Lopez and His Hotel Pennsylvania Orchestra were originally engaged for one week. The very first night he received an ovation—the second night the storm of applause was so great that Lopez had to make a curtain speech and beg the audience to allow the rest of the performance to continue.

Lopez has arrived! Keith's have engaged him as a headliner for four weeks more at the Palace, making a total of

eight weeks—the season's greatest run.

Lopez records are selling like hot cakes! Broadway has gone wild over his enticingly new and novel dance music. Those who have been privileged to hear Lopez at the Palace pronounce him a genius, not only as a conductor of dance music, but as a showman as well. Lopez plans an extensive tour of the important cities. Every Okeh dealer will have an opportunity to cash in on the nation-wide popularity resulting from this tour.

We point with pride to the fact that Vincent Lopez and His Hotel Pennsylvania Orchestra now record only for

Okeh Records

The Records of Quality

Here are the Fast Selling Lopez Hits—Price 75c each

- | | |
|---|--|
| 4647 { I'm Just Wild About Harry
Deedle Deedle Dum | 4625 { Lovable Eyes
Happy Days |
| 4660 { 'Neath the South Sea Moon
Just Because You're You (That's Why I Love You) | 4612 { Some Sunny Day
Stumbling |
| 4591 { Kiss Me by Wireless
Teasin' | 4605 { California
Mo-Na-Lu |
| 4654 { Sweet Indiana Home
The Yankee Doodle Blues | 4579 { Rosy Posy
Nola |
| 4662 { Dancing Fool
Dixie Highway | 4664 { Aida
Anitra's Dance |
| 4638 { Parade of the Wooden Soldiers
O Gee! O Gosh! | (Special Dance Arrangements by
J. Bodewalt Lampe) |



General Phonograph Corporation

OTTO HEINEMAN, President

25 West 45th Street, New York City





Just Joy-yous—that's what Van and Schenck are. Fun Fomenters. Gloom Lifters. Their two latest songs, "I'm the Black Sheep of Dear Old Dixieland" and "Yankee Doodle Blues," reduce Mr. Grouch to an ectoplasm. The two in one. A-3668.

**Columbia Graphophone Co.
NEW YORK**



ANALYSIS OF NEW UNIFORM CONDITIONAL SALES LAW

Henry H. Harkavy, Prominent New York Attorney, at Request of The World, Makes a Special Analysis of the New Conditional Sales Law, Effective in New York State on September 1

[There was recently passed by the Legislature of the State of New York a Uniform Conditional Sales Law, which went into effect on September 1 of this year, and which embodies a number of features of particular interest to talking machine merchants and others who make a practice of selling on instalments.

At the request of The World Henry H. Harkavy, the well-known New York attorney, has prepared the following analysis of the new law for the benefit of the trade. —EDITOR'S NOTE.]

Observing and intelligent persons must surely have noticed from reports in the public prints the wise policy of the law toward uniformity throughout the various States in such laws as vitally affect the conduct of business and business affairs. In keeping with this policy of progress in the law the Legislature of the State of New York at its last session enacted what is to be known as the "Uniform Conditional Sales Law." This goes into effect September, 1922, at which time the old law (Article IV, Personal Property Law) governing conditional sales of goods becomes inoperative, except, of course, in so far as it is necessary to preserve rights accrued under it. This new "Uniform Conditional Sales Law" will, in due course, undoubtedly be enacted by the various States, with a view that the law of conditional sales of goods and chattels throughout the United States shall be uniform.

The outstanding points of difference between the new and the old are six in number.

First—The duration of the lien created by filing the instrument of conditional sale is lengthened from one year to three years (Section 71, U. C. S. L.).

Second—The sale of the property retaken by the vendor at present required by Section 65 of the Personal Property Law, which was a source of great inconvenience and often hardship to the vendor, will now be dispensed with in the majority of cases.

The new law provides:

"If the buyer has not paid at least Fifty (50 p.c.) per centum of the purchase price at the time of the retaking, the seller shall not be under a duty to resell the goods, as prescribed in Section 79, unless the buyer serves upon the seller within ten days after the retaking a written notice demanding a resale, delivered personally or by registered mail (Section 80, U. C. S. L.)."

Third—Where there is no resale pursuant to the notice served upon the vendor by the vendee, or at the voluntary election of the vendor, the seller may retain the goods as his own property, and the buyer shall be discharged of all obligations incurred by the contract (Section 80-c, U. C. S. L.).

Fourth—Upon default of the buyer the seller may retake the goods without legal process, if this can be done without a breach of the peace (Section 76, U. C. S. L.). Or, at his election, he may give notice to the buyer of not less than

twenty, nor more than forty, days of intention to retake the goods, because of the buyer's default. If notice is so served and the buyer does not perform before the day set for retaking the seller may retake the goods and hold them subject to the provisions above stated (Section 77, U. C. S. L.).

Fifth—If the seller does not give notice of intention to retake the goods above mentioned he shall retain the goods for ten days after the retaking, during which period the buyer, upon payment or tender of the amount due, with interest, at the time of retaking, or upon performance or tender of performance of the conditions in which default has been made up to the time of the retaking, may redeem the goods and take possession of them, and continue in the per-

ALL YEAR USE FOR PORTABLES

Many Opportunities for Using Small Machines, Both Indoors and Outdoors, Through All the Months of the Year

Some of the manufacturers of portable talking machines refuse to take kindly to the belief that such machines have only a seasonal sale. They point out that there are many uses for a portable machine other than for outing purposes, such as in camps, on boats, etc., as well as, for instance, their use in connection with health and physical exercise records. A portable machine also comes in handy for the playing of "kiddie records" at night, and thus it is made use of in several parts of the house and in no wise infringes upon the use of the distinctly musical instrument in the drawing or living room.

Such manufacturers also point out that while it is true that the strictly portable machine has a seasonal use, the fact that most manufacturers operate on a national scale gives them distribution in parts of the country where there is much camping and automobiling in other than summer months.

Among those who hold the above belief is the Plaza Music Co., 18 West Twentieth street,

formance of the contract, as if no default had occurred (Section 78 U. C. S. L.).

"If the buyer does not redeem the goods within ten days after the seller has retaken possession, and the buyer has paid at least Fifty (50 p.c.) per centum of the purchase price at the time of the retaking, the seller shall sell them at public auction in the State where they were at the time of the retaking, such sale to be held not more than thirty days after the retaking. The seller shall give to the buyer not less than ten days' written notice of the sale, either personally or by registered mail (Section 79, U. C. S. L.)."

Sixth—If the seller fails to comply with the provisions above stated after retaking the goods the buyer may recover from the seller his actual damages, if any, and in no event less than one-fourth of the sum of all payments which have been made under the contract, with interest. (Section 80-e, U. C. S. L.).

New York, manufacturer of the "Pal" portable phonograph. Early in September this company still reported an excellent demand for the portable for both immediate and future delivery and points out that the quality portable machine has proved of value to the flat-dweller on the space-economizing idea. It also found an excellent field among college men and women, who, it seems, require just such a machine. The company plans a very active Fall and Winter sales and advertising campaign as a means of co-operating with dealers throughout the country.

PLAN EXTENSIVE ALTERATIONS

Flory-Williamson Co. Holds Sale to Make Room for Alterations

BINGHAMTON, N. Y., September 2.—Extensive rebuilding and remodeling activities which are contemplated by the Flory-Williamson Co., 132-134 State street, are being preceded by a rebuilding sale of pianos, players, talking machines and all kinds of musical instruments which are handled by this company.

A. C. Fay, the manager, states that the stock of musical instruments must be greatly reduced before carpenters and builders take possession of the upper floors of the store.

Okéh Records



OUTING PORTABLES
GRANBY
PHONOGRAPHS
MASTER TONE
TALKING MACHINES
NEEDLES
Okéh — Truetone — Wall-Kane
Tonofone — Gilt Edge
Delivery Bags, Accessories, etc.
Complete Stocks—Prompt Service



IROQUOIS SALES CORPORATION
Wholesale Distributors
210 Franklin St. BUFFALO, N. Y.

The New EDISON Baby Console

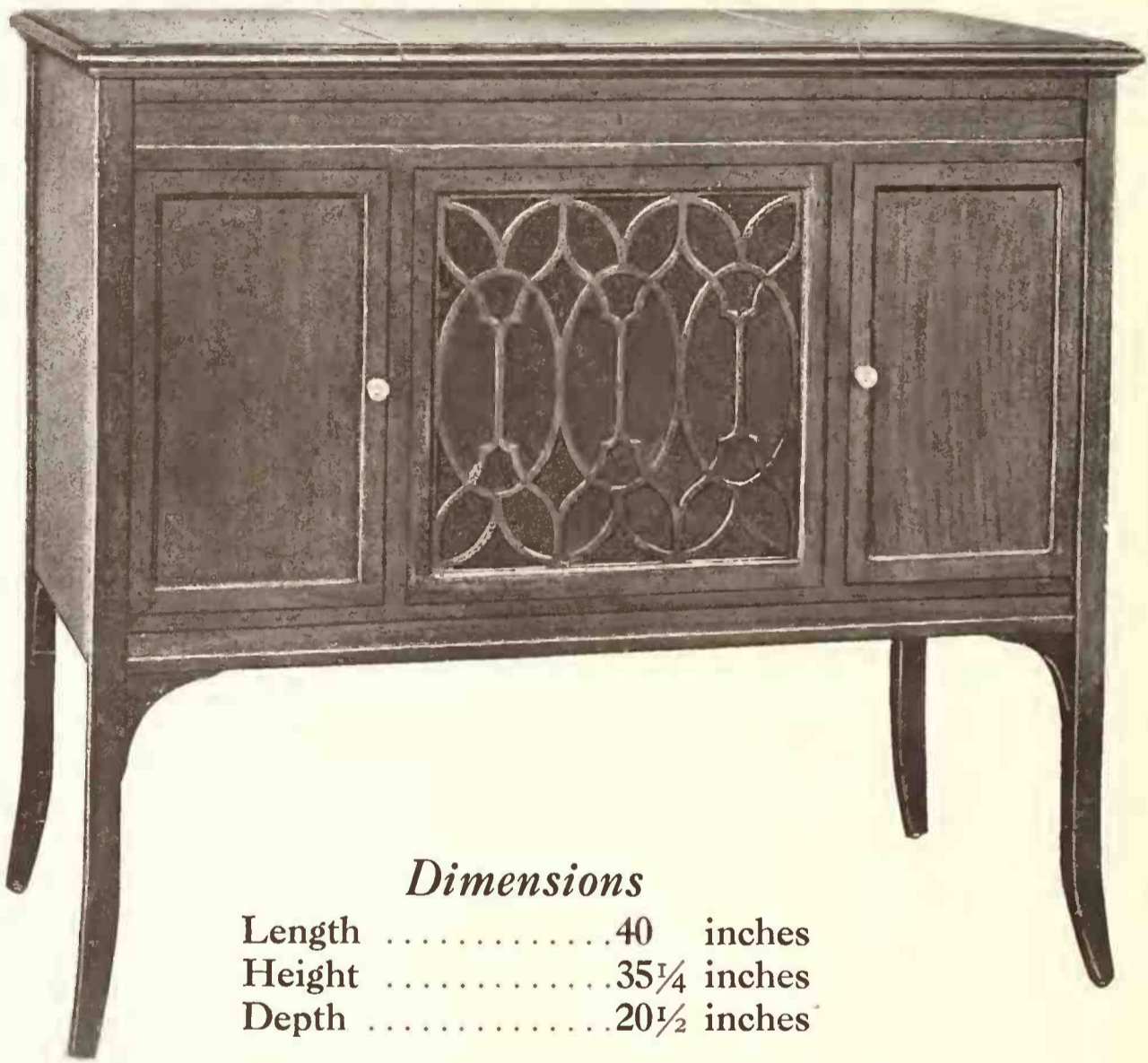

Dimensions

Length	40	inches
Height	35 $\frac{1}{4}$	inches
Depth	20 $\frac{1}{2}$	inches

(See page facing this)

The New EDISON Baby Console

\$175.00

THE new Baby Console joins the famous Edison group in response to a wide demand.

Music-lovers everywhere will welcome the conservative, artistic design and the attractive price of the Baby Console. Its mechanical fitness is assured by Mr. Edison's recent laboratory tests, resulting in the perfection of this model.

THOMAS A. EDISON, Inc.
Orange, New Jersey

Overwhelming Value of a Consistent, Continuous Advertising Program Demonstrated

Advertising is regarded, and rightly so, as the open sesame to success in business when rightly used. Given an honest product, meeting a well-defined need, plus the proper kind of advertising, and success is certain to follow. So much has been written concerning the value of advertising that there is nothing new to be said on the subject, although one point that is, perhaps, not as well understood as it should be is the fact that advertising must be continuous to produce maximum results.

The talking machine industry, in common with all other industries in the country, during the past decade has depended upon advertising to a large degree for its success. A comparison of present-day advertising in this field with the publicity which was used ten or twelve years ago will show a distinct improvement in design, subject matter, effectiveness and logical sales-producing appeal. The trade has learned these lessons, but there is one lesson which many factors in the trade have yet to comprehend—and that is the power and value of continuous advertising.

While it is true that some of the more successful companies have proven firm believers in the policy of continuous advertising, and have been inclined to expand their publicity campaigns when other factors, in the face of existing conditions, were contemplating retrenchment, there are still many in the industry who seem to be inclined to advertise without any fixed system or at least to confine their advertising to those seasons of the year when it is believed the best results are possible.

When business was in excellent shape, and the supply of machines and records was not equal to the demand, some manufacturers and dealers appeared to feel that they should spend some of their money for advertising, working possibly on the theory that because business was good and they were making money they could afford to spend a little of it for printer's ink. Those who have pursued this policy have curtailed their advertising when times became hard—when money was not so plentiful and when accounts collectible commenced to freeze up—arguing in defense of their policy that they could not afford to spend any money for publicity. Just when they should advertise!

One of the most convincing proofs of the value of continuous advertising is to be found in the chart which accompanies this article. This chart was prepared by the economic research department of the Curtis Pub. Co., and shows graphically the varying volumes of business done by three classes of merchants—those who do no advertising, those who do seasonal advertising and those who advertise throughout the entire

year. An analysis of the chart shows that the merchant or manufacturer who does not advertise starts the year with very little business. His business then gradually increases, reaching an apex in the month of May and then dropping sharply to a very low level until the end of August, when the volume gradually rises again, reaches its peak early in December and then

December, when the Fall campaign is on, the volume of business is somewhat greater than is that of the non-advertiser, but during the months when no advertising is carried the seasonal advertiser finds his business about on a par with the man who does no advertising at all.

The last diagram shows effectively the value

of continuous, all-the-year-round advertising. The continuous advertiser begins his year with a volume of business that is practically equivalent to the May peak enjoyed by the non-advertiser. The volume rises in February to a point above the May peak of the non-advertiser and continues to keep above that peak until the end of June. During July and August there is a natural decrease in business, but even the low level is only slightly below the same May peak of the non-advertiser. By the end of September the volume of sales again shows a steady increase, reaching its apex in December and continuing at its highest level until almost the end of the month, when there is a natural decrease shown, the decrease being caused by the Christmas and New Year holidays.

A further analysis will show that the total volume of sales for the year produced by continuous advertising is nearly 40 per cent greater than the volume enjoyed by the seasonal advertiser, the seasonal advertiser in turn doing perhaps 25 per cent more business than the non-advertiser. This analysis shows conclusively that the continuous advertiser is the man who really gets the greatest value for the money he spends in

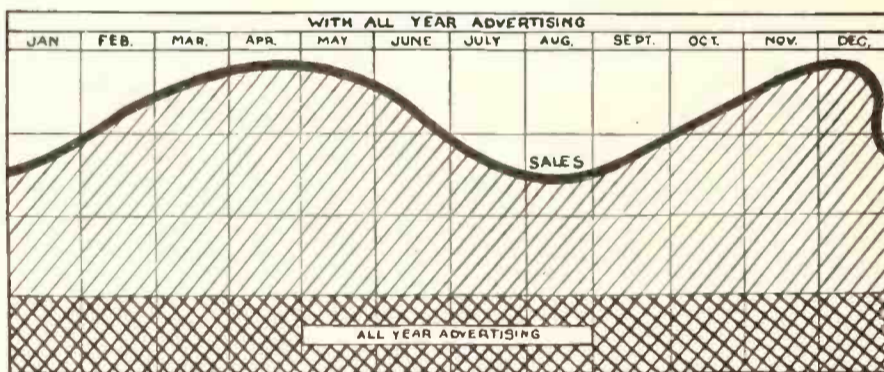
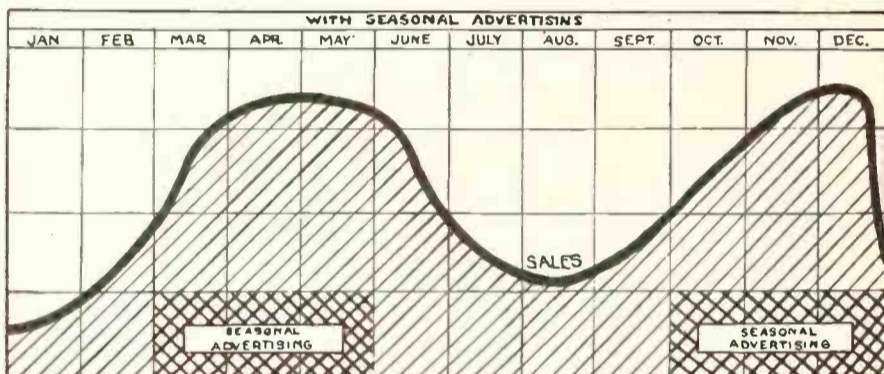
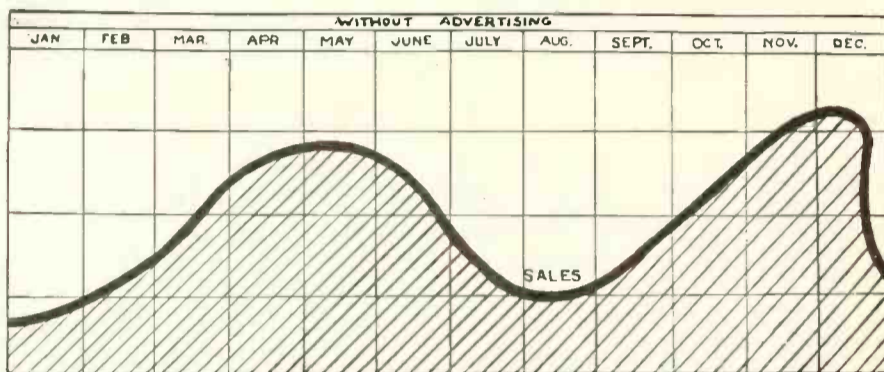

Chart Showing Effect of Continuous Advertising

drops abruptly to the low level experienced during August. The merchant who endeavors to increase his business through seasonal advertising is in somewhat better position than the merchant who does no advertising, for the chart shows that during the months of March, April and May, when the Spring advertising campaign is in effect, and during October, November and

Profit by the Demand for Okeh Records

Write or Phone

BRISTOL AND BARBER CO., Inc.

For Particulars

Distributors for Manhattan and Vicinity

3 EAST 14th STREET

Stuyvesant 1724

NEW YORK

publicity and shows further that the advertiser who is committed to the seasonal policy does not get full value for what money he does spend, because he allows the cumulative effect of his publicity to be lost almost entirely during the periods when he does not advertise.

The old adage concerning the stone worn away by the continuous dropping of water applies forcefully to the theory of advertising. Hogsheads of water can be splashed on a rock and do no more than wash away the grit, but the same volume of water, if allowed to fall, drop by drop, on a given point, will start an erosion that eventually will wear away the entire stone. So it is with advertising. Spasmodic splashes of publicity will produce only a temporary effect, but continuous, consistent, all-the-year-round advertising, because of its cumulative effect, will produce a volume of profitable business that will practically insure the wise advertiser against hard times, lack of demand, seasonal slumps and all the other evils which come to the man or the industry which does not rightly use the greatest of all modern business-producing forces—consistent advertising.

"VISION" IN ADVERTISING

My good friend Herbert H. Longfellow was telling me the other day, says Thos. Dreier, that he believes there is a vision in advertising that illumines common things; that dignifies common needs; that is a herald of light. There is an aim in advertising that is beyond the plea of a business for profit or the desire of a man for gain. There is an ideal in advertising that is not selfish; that is a revealer of beauty; that is the servant of life and its joys. The word is for the mind at its best and its voice is for the hearts of its peers.

If you want knowledge, you must toil for it. Toil is the law. Pleasure comes through toil and not by self-indulgence and indolence. When one gets to love work his life is a happy one.—Ruskin.

FIFTEENTH TRADE ANNIVERSARY

Abram Davega Completes Another Year in Victor Distributing Service—Has Had an Active Trade Career Since August, 1907

Although still a young man, Abram Davega, president of the Knickerbocker Talking Machine Co., Victor wholesaler, New York City, has completed fifteen years in the Victor business.



Abram Davega

In August, 1907, upon graduating from a Summer course at the School of Commerce at New York University, Abram Davega joined his father, the late Isaac Davega, in the old firm of I. Davega, Jr., Inc. He rapidly took hold of the management of the business and in a very short time afterward became vice-president of the corporation. Mr. Davega was then probably the youngest officer of a Victor distributing firm in the country.

Upon the death of his father last year, Mr. Davega was elected chief executive of the company and in that important position has admirably directed the destinies of the company in its successful career.

Coincident with Mr. Davega's fifteenth anniversary of his entering in the talking machine business is the occurrence of the Knickerbocker Talking Machine Co.'s twentieth anniversary.

OPENS STORE IN BURLINGTON

C. W. Ross, formerly connected with the College Music Rooms, Burlington, Vt., has opened an attractive music studio in the Y. M. C. A. Building, that city. Talking machines, radio outfits and pianos are handled.

TARIFF CHANGES IN NORWAY

Ad Valorem Tax Levied on Importations of Talking Machines, Etc., in New Bill—Advance Over Old Rates Is Registered

WASHINGTON, D. C., September 1.—The Norwegian Storting, at a special meeting, recently passed a bill for increased import duties on all articles considered luxuries, to be calculated on an ad valorem basis, according to information received by the Bureau of Foreign and Domestic Commerce here from Consul General A. G. Snyder, stationed at Christiania, Norway. These duties were previously levied at specific rates, according to the weight of the goods. The new duties, which represent a considerable advance, affect the importation of talking machines of various kinds. An article in the bill provides that "talking machines, such as gramophones, phonographs, and the like, with flat or cylindrical records and other accessories, including record-making apparatus; also parts thereof," must pay an ad valorem duty of 20 per cent. The former duty, by weight, was 1.50 crowns per kilo.

APPOINT PACIFIC COAST AGENT

Max Willinger, president of the New York Album & Card Co., New York City, reports that both the Chicago and New York factories are busy on Fall orders. The demand for Nyacco albums is reported to be steadily increasing and good Fall business is expected.

Max Willinger, the energetic president of the company, continues to divide his time between the Chicago and New York headquarters of the business and was in Chicago the early part of the month.

The Pacific Coast talking machine trade will be interested in the announcement of the appointment of a Western Coast factory representative. This important post will be held by E. R. Darvil, of the Munson-Raynor Corp., 315 South Broadway, Los Angeles, Cal.

DO YOU KNOW

That Wide-awake Dealers are increasing their profits thru the sales of De Luxe Needles

Before you place your next order don't fail to write us for samples and full particulars about

DE LUXE NEEDLES

DUO-TONE COMPANY, INCORPORATED

Sole Manufacturers of De Luxe Needles
ANSONIA, CONN.



Full Tone

DON'T FORGET THESE FACTS
Perfect Reproduction of Tone No Scratchy Surface Noise
PLAYS 100-200 RECORDS



Medium Tone

Three for 30 cents (40 cents in Canada)

Radio Developments During the Past Year

By E. E. BUCHER, Sales Manager, Radio Corporation of America

[The talking machine industry as a whole will undoubtedly be keenly interested in this message to the trade from E. E. Bucher, sales manager of the Radio Corporation of America. Mr. Bucher is recognized as one of the foremost authorities of the radio field, and his thorough knowledge of merchandising is certain to be an important factor in the progress and activities of this company. In the very near future Mr. Bucher will have another message of interest to our trade, relating particularly to the merchandising of RCA products in the talking machine industry.—Editor's note.]

A real and rapidly growing utility which throbs vigorously with nation-wide public interest usually imposes abnormal demands upon the industry concerned. Over a year ago, the Radio Corporation of America was face to face with a stupendous undertaking—that of supply-



E. E. Bucher at His Desk

ing the highest grade radio apparatus to thousands of people situated everywhere in the United States, at a moment's notice. This situation, which "developed overnight," commanded the immediate action of every department of the company. Many problems were slated for almost immediate solution—a physical engagement against time began.

To meet the demand of this new branch of the radio industry it was necessary first to develop and design apparatus suitably simple, complete and efficient to fulfill the demands of the public. Second, to expand the manufacturing,

warehouse and delivery facilities of the organization so as to satisfactorily cope with business which had already been characterized as overwhelming. Third, to create and firmly establish an administrative staff to educate the public on this new subject and to sell apparatus and promote sales through advertising and publicity peculiar only to this new branch of the communication field.

Fully aware of what the future had in store, once the bonds of full public acceptance were released, the Radio Corporation of America spared no efforts in mobilizing its forces and plunged into the field with the ultimate view to creating a nation-wide radio sales-service. Supported by the manufacturing and engineering facilities of the Westinghouse Electric and Manufacturing Co., the General Electric Co. and the Wireless Specialty Apparatus Co. all labored strenuously.

Pioneering immediately followed, for who was in a position to venture future predictions and advance methods of procedure? The problem which required first thought was: What will be the nature of the apparatus required to meet this particular demand? Having unlimited development resources, the Radio Corporation and its associates studied the various existing radio circuits and appliances, and shortly afterwards placed on the market a series of compact receiving sets, devised simplified instructions for their installation, and released the instruments through a selected group of responsible electrical distributors throughout the country.

Considerable time is always required to pilot a large organization into the trend of a new and rapidly flowing activity; human inertia is an important factor, and flexibility varies in proportion to the magnitude of the interests involved.

In spite of the difficulties represented by the then existing situation, the products of the Radio Corporation were warmly welcomed by the mass of the enthusiasts. These products are now being used by thousands of satisfied owners whose aerial installations can be seen almost anywhere in the United States.

A year has now passed and it is gratifying

to review the activities during that period which provide very valuable foundations for drawing inferences and developing future policies. A basis for calculations is now available. A year's experience is an intangible, valuable asset.

The supply of Radio Corporation apparatus at the present is abreast of the demand. The organization is prepared for emergencies and it is very certain that the situation is now well within control.

To furnish apparatus to meet a standard, not an emergency, is the very essence of R C A service. The reputation which the Radio Corporation of America and its associates have won during the past year is their guarantee for the future.

ATTRACTIVE COLUMBIA FLOAT

King Furniture Co. Arranges Artistic Float Featuring the Grafonola

SAN ANTONIO, TEX., September 5.—The King Furniture Co., of this city, Columbia dealer, created considerable comment recently through the use



Columbia Float Designed by King Furniture Co. of a handsome float, which was entered in a local parade. This float, besides carrying large Columbia banners artistically painted, represented a grape arbor scene furnished comfortably with a divan table and an L-2 Grafonola. In front of the grape arbor was an amplifier which was used to excellent advantage during the parade.

RECEIVES FOREIGN INQUIRIES

Sherburne Mfg. Co. Reports Increased Sales Activity Abroad—Working on New Radio Product—Important Announcement Soon

DETROIT, MICH., September 5.—The Sherburne Mfg. Co., of this city, manufacturer of automatic stops and balance lid supports, states that it has been receiving numerous inquiries from foreign countries, indicating that the manufacturers abroad are resuming general activities. Within a period of a week half a dozen inquiries were received from well-known concerns in foreign countries asking for quotations on various accessories in large quantities. Incidentally, these inquiries refer to the company's advertising in The Talking Machine World.

The executives of the company also state that the radio field is showing exceptional activity, and in all probability the Sherburne Mfg. Co. will have an interesting announcement to make to the trade regarding its activity in this field. It is likely that a small radio set will be manufactured by the company, and a comprehensive sales campaign is now being prepared.

FRENCH NESTOR VISITS GOTHAM

French Nestor, president of the French Nestor Co., Victor wholesaler at Jacksonville, Fla., was a recent visitor to New York City. He spent August 31 with his mother in West Virginia, that day being her birthday. While in the North he made a brief visit to the Victor plant in Camden, N. J.

A new talking machine establishment, to be known as the Music Shoppe, has been opened in Provo, Utah.



LOOKING INTO THE FUTURE

For Victor retailers the future is unusually bright, as the recent additions to the Victor line, including the new Victor horizontal types and the Victor Health Exercise records, provide unlimited opportunities for profitable sales activities.

For future service to Victor dealers, Mickel Bros. Co. have strengthened every department of their organization and are splendidly equipped to render invaluable service to the Victor dealers in this territory.

MICKEL BROS. &

**411 COURT AVENUE
DES MOINES, IOWA**



BRUNO

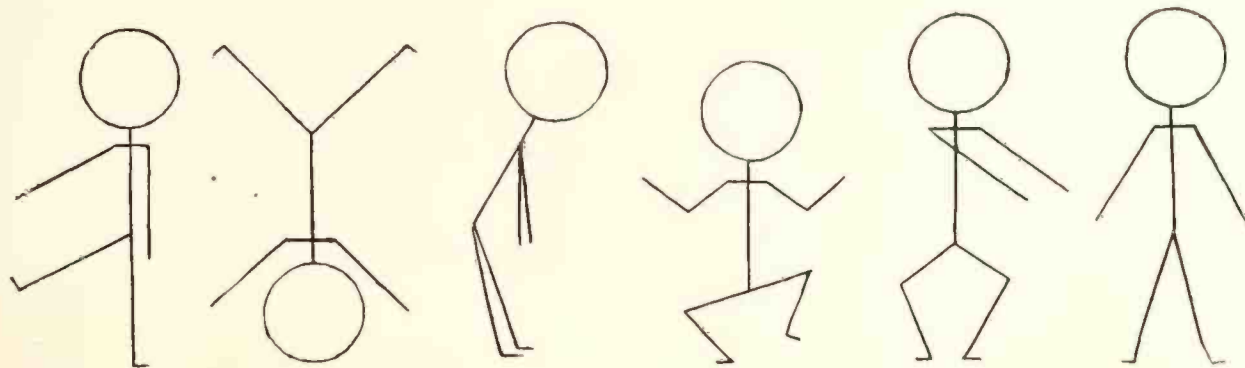

New Life In Your Business!

Whatever business we may be engaged in the uppermost question in our minds is "What can be done to stimulate new and greater buying power?" At times a single but simple thought properly "put over" has resulted in almost unbelievable profits. Anything, therefore, that arouses curiosity, that creates interest, and which at the same time may serve a practical purpose—that "something" will invariably prove to be a most substantial profit-maker.

And now, Victor Dealers, here is just such an item—a set of Victor Records for Health Exercises. These records, three of them to a set, begin a new era of profits for you. They will be the means of bringing to your store entirely new clientele—people you have never seen—people who heretofore have never displayed any interest in the Talking Machine.

Here certainly is a new avenue of approach, and with a bit of vim and vigor behind your efforts the "development" of your bank-roll is a certainty.

Think of it, Mr. Victor Dealer, every man, woman and child is now **your** logical prospect. What are you going to do to "build up" the nation and incidentally the scope of your business?

A rare opportunity awaits you, Mr. Victor Dealer!

C. BRUNO & SON, Inc.
351-353 Fourth Ave., New York
Victor Wholesalers to the Dealer Only

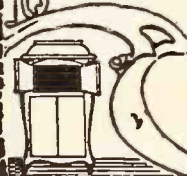

INVENTS BREATHING GRAMOPHONE

London Inventor Produces Something New as Basis of Synchronization of Motion Pictures and the Talking Machine

A gramophone invention by E. H. Verity, who has been carrying on extended experiments in the synchronization of motion pictures with the talking machine, is being exhibited in London, Eng. The invention consists of a gramophone that "breathes" like a human being and is shown as a basis for synchronization of motion pictures with the talking machine.

Mr. Verity, in discussing his invention, says: "After experiments lasting over fifteen months I realized that the gramophone must breathe in order to get the proper effect. I employ an ordinary sound box which is attached to a tone arm at the end of which is fitted an amplifying chamber or throat. In this throat is fitted an electric element and a suitable arrangement of holes induces a draft which is so placed that the entire apparatus works under conditions similar to the human throat while speech is in progress."



No. IX

Dear Bill:

To-day more than ever before scientific merchandising is receiving the attention of keen business men everywhere, who realize that if they are to make a go of merchandising they must operate with a complete knowledge of the people with whom they desire to do business, their goods, costs of operation and, in short, the hundred and one things which a merchant should be thoroughly versed in if he is to get out of the "storekeeper" class and rise above his more unprogressive competitors. In every community there are leading merchants engaged in various lines of business. These men and the enterprises they operate stand head and shoulders above everyone else, and they get the bulk of the worth-while business. The reason is simple. They have discarded the methods of twenty years ago, and you may be sure that they do not operate on a haphazard basis. You can employ your time to no better advantage than to investigate and make a study of the methods of the leading merchants of your community. In this manner you no doubt will learn much which will prove of benefit to you in the conduct of your business.

This study of business methods does not necessarily apply exclusively to music houses, but to every leading merchandising business in your town. After all, when the thing is brought right down to the last analysis, merchandising, to be successful, is conducted on practically the same principles, whether it be the selling of hardware or musical instruments. The merchant buys a certain product and seeks to sell it at a profit. This sounds simple, but it involves many considerations, such as overhead, stock turnover, collections, etc. Of course, in the musical instrument business, as well as in any other enterprise, there are certain particular problems which will not be found in any other line of endeavor.

Take for example the leading furniture houses in your community. Their selling methods are peculiarly similar to yours, with the exception that they do not take into consideration the music factor unless they handle this line. Now, undoubtedly these concerns sell on the time payment plan, and, therefore, I would suggest that you make an effort to find out the methods used by them to stimulate collections, the letters they use which have brought about the best results and the views of their credit men on risks, etc. A sidelight on their selling principles might also suggest some changes in your own policies which may prove of benefit from the standpoint of increased efficiency. The automobile agencies and other enterprises which make use of large prospect lists may prove a valuable source of information as to the best manner of securing prospective customers and the means used to approach or make contact with these people. These concerns may be using effective plans which could easily apply to your line, and, anyway, such a study is bound to return dividends in the broadened knowledge of merchandising which will inevitably result. No merchant who has made a success of his business will refuse the desired information in view of the fact that your business will not conflict with his and on your promise to reciprocate.

Hoping you make use of these suggestions and profit by them, I am As ever,

Jim.

FABRICS FOR WINDOW DISPLAYS

Chas. H. Ditson & Co. Offering Elaborate Assortment of Plushes and Velours Particularly Suitable for Use in Window Displays

Chas. H. Ditson & Co., New York Victor wholesalers, have arranged to supply their dealers with an attractive assortment of plushes and velours of high quality and rich coloring and design for use in window trimming. The company has been able to get hold of a large quantity of such material, especially suitable for setting off talking machine displays to advantage, and is offering it to dealers practically at cost and at a price below wholesale cost.

That retailers appreciate the opportunity of getting material is evident by the quantity already purchased, some retailers taking several yards each of different designs and coloring in order to provide for a variety of window trims. The idea of supplying the plushes and velours is credited to Paul Carlton, manager of the wholesale Victor department.

THE PORTABLOOP



Size 24 x 27 inches over, all

You Will Carry It This Fall

Why Not Stock It Now?

We Can Make Prompt Deliveries

List Price \$10.00



210 Central Avenue

Mr. Edison Man:—

Don't Say

"KAN'T," say "KENT"

Write for catalog of complete line

The KENT No. 1

With "S" Sound Box

Has given complete satisfaction for years

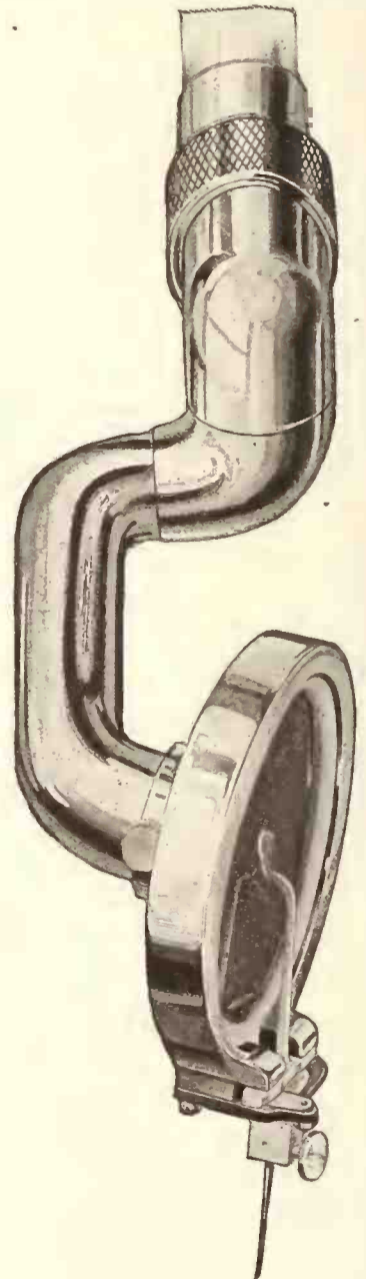

Reg. U. S. Pat. Off.

F. C. KENT CO.

Irvington, N. J.

TO EXHIBIT DR. DE FOREST'S "PHONOFILM" NEXT MONTH

New York Representative of Dr. De Forest Tells of the Great Possibilities of This Invention for Synchronizing Speaking Movies—New Talking Film Photographs Voice

Strips of the Dr. Lee de Forest talking film or "phonofilm" have been received by his representatives in New York City and will be exhibited here by Dr. de Forest next month, when he returns from Germany.

It appears like an ordinary strip of film with almost invisible razor lines running vertically on the extreme right. The razor lines are the effects of minute points of light which play upon the edge of the strip under the control of the vibrations of the human voice. From this record the voice is reconstructed with the help of selenium photoelectric cells and the audion amplifier invented by Dr. de Forest for use in radio.

This invention, it is suggested, may be capable of use as an automatic interviewer or mechanical stenographer and may become a competitor of the talking machine for general use, in addition to its primary purpose of introducing the spoken word into the motion picture drama.

It is asserted, also, that the apparatus for registered sounds with pictures costs but little and may be made an annex to any motion picture camera, so that when a public man or a personage in the news is being filmed his words may be recorded at the same time. The possibility of developing the film photograph record as a substitute for the present type of record also is put forward by representatives of Mr. de Forest in this city.

The path of light on the film which registers the sound waves is so narrow that an ordinary inch-wide film has room for a hundred voice photographs side by side. The compactness of the film makes it possible, it was said, to carry about a sound-recording machine charged with enough film to register a day's proceedings in Congress.

The New York Telephone Co. has been experimenting for several years on a radio printing machine. This prints by radio, just as tickers and other telegraph machines typewrite by wire at the present time in up-to-date newspaper offices. The radio printing machine makes it possible, for instance, for a man in an airplane to batter away at a typewriter while his radio connections automatically beat a "mill" on the ground and turn out copies of what is being written in the air.

The Lee de Forest talking film, as it exists to-day, can be hitched, after the film is developed, on to broadcasting instruments, it is claimed, so that the voice pictures can be wireless great distances and then turned back again into sound waves. So far the problem of running a typewriter or a linotype by sound waves has not been mastered, but close approaches to it have been made.

By the use of light similar to the photography of sound waves by Mr. de Forest the printed word has been turned into sound, so that the blind can read by ear. The arrangement of black and white in the ordinary letter causes such varying effects when the letters are intensely lighted and passed over selenium photoelectric cells that the electric current can be controlled by them so as to produce sounds which the blind can interpret into letters.

In both the de Forest invention and the machine which renders the printed word into sound for the blind the key is the peculiar property of selenium. In darkness this substance is resistant to electricity. In light it conducts electricity. In varying light it modifies the current of electricity passing through it.

In the de Forest invention the aperture for the admission of light for the sound-wave photography is said to be in some way controlled by the vibration of the sound. This produces the variations in the sound pictures on the film. When reproduced these variations modify the light which passes through. The modifications of light keep the electrical resistance of the

selenium cells in constant variation. The electrical current is thus controlled by the pictures of the sound waves. The current is magnified by the audion tubes and in turn it controls a diaphragm or microphone like that of the ordinary telephone receiver, finishing up the process of reconstructing the sound.

The process is outlined in general terms as follows in a letter by Mr. de Forest to his representative here:

"Taking the picture: 1. Sound waves (voice of the actor) translated into electrical waves. 2. Electrical waves translated into light waves. 3. Light waves recorded on the edge of the film.

"Reproducing the picture: 1. Light waves translated back into electrical waves. 2. Electrical waves translated back into sound waves. 3. Sound waves amplified with loud-speakers placed near the screen for the audience."

The stumbling block which has impeded other efforts to perfect the talking film has been the difficulty in exactly synchronizing the voice and the picture. This is important, since sound travels at 1,090 feet a second and light at 186,000 miles a second. Unless the word and action correspond exactly in time, as rendered by the talking-picture machine, the effect is spoiled. With the picture and the sound-wave on the same film, the time unity is preserved to the thousandth part of a second.

BECKER MUSIC CO. OPEN IN CAIRO

CAIRO, NEB., September 2.—The Gaston Music Co., one of the oldest concerns engaged in the musical instrument business in this part of the State, has been succeeded by the Becker Music Co. Victor talking machines, Edison phonographs, pianos and player-pianos are handled.

A little egotism is a good thing. It gives a man a feeling of confidence in his ability. But egotism, like other things, is often overworked.

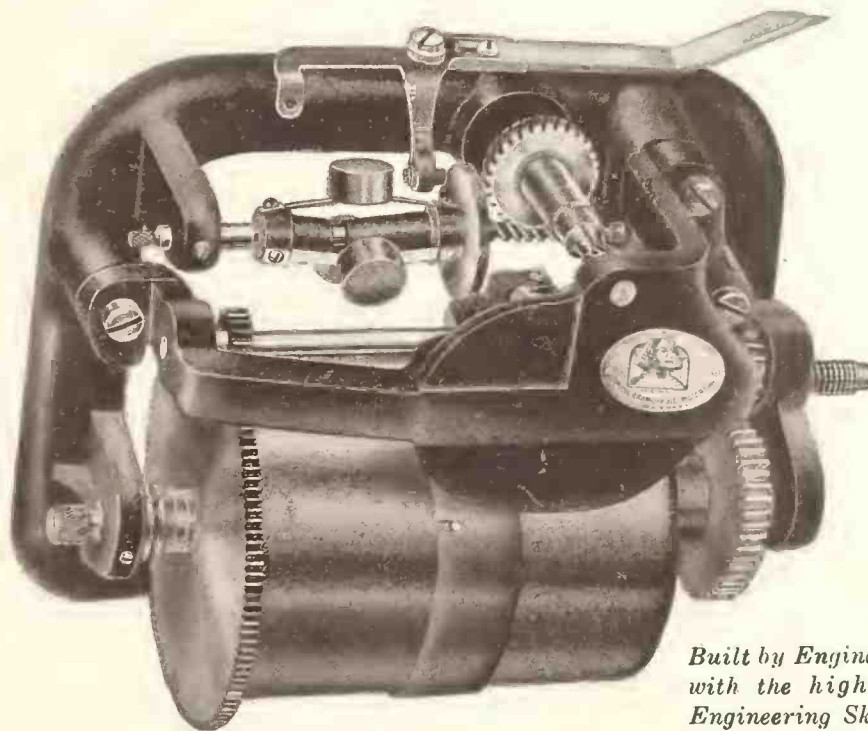

Built by Engineers with the highest Engineering Skill.

DESIGNED to stand the shocks of hard usage.

BUILT to run smoothly and noiselessly under varying conditions.

OPERATED with uniformity, and constant in speed.

Write for prices



Sphinx Gramophone Motors Inc.

21 East 40th St.
NEW YORK CITY

Band or Orchestra FULL STRENGTH!



*And into the moonlit night poured
the full resounding dance music of
a military band — as if the band
were there, in reality*

Without a Magnavox Tele-phonograph in constant service for demonstrating records, the music store of today is operating on less than 50% of its real efficiency.

There are many competitive phonographs—but only *one* Magnavox Tele-phonograph. By increasing the tone volume of any phonograph three or four times, the Magnavox also increases correspondingly the *use* and thus the *sale* of phonographs and records.

Write today for full information about the marvelous Magnavox Tele-phonograph and its importance in the sale of phonographs and records.

THE MAGNAVOX COMPANY, Oakland, California
New York Office, 370 Seventh Avenue

MAGNAVOX

Tele-phonograph

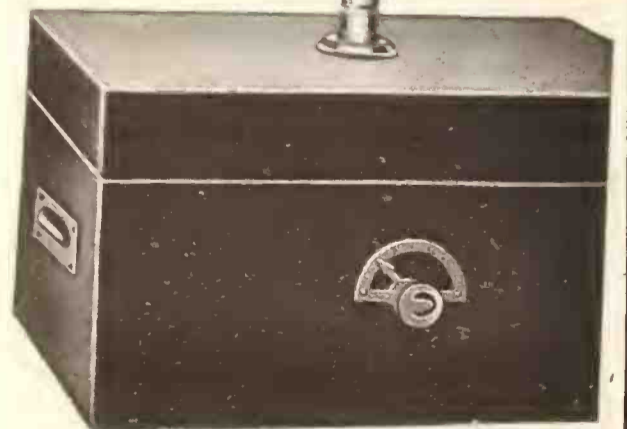

The Magnavox Tele-phonograph is an attachment to the phonograph as important as the phonograph itself.

Demonstrated in your store, the Magnavox Tele-phonograph makes an ordinary record clearly audible along the street. Nothing helps to sell records and phonographs like a Magnavox—and people who already own a phonograph want the Magnavox Tele-phonograph to make their instrument really complete.

IDICO—A disinfecting deodorant to keep hearing rooms sweet in summer. Can be provided by your Dealer Service man.

**Columbia Graphophone Co.
NEW YORK**



EMERSON POPULAR RECORDS AGAIN

Emerson Phonograph Co. Announces Revival of Popular Record Catalog, With Records Listed at Seventy-five Cents—To Market a New Phonograph Under Name of "Emerson"

The Emerson Phonograph Co., New York, which since its reorganization has confined its activities to the manufacture of standard records of which it has a most comprehensive catalog, has announced the arrival of a popular catalog.



B. Abrams

B. Abrams, president of the company, in commenting upon its new popular catalog, said: "There have been no releases of Emerson popular records since last May and Emerson dealers in all parts of the country have felt the need of

continuing their activities in that direction, which resulted in our receiving hundreds of requests for Emerson popular records.

"We have made such progress in our plans and policies as to now justify us in issuing a monthly list of current selections in song and instrumental form. These, however, will be only the active hits, those for which there is a demand, and which when placed upon the dealers' shelves will assure a quick turnover.

"In our standard record catalog, which is most complete, we have been revising and cutting the list, eliminating all dead titles and leaving only the active issues, which include standard, sacred, classical, secular and foreign records of all kinds.

"The Emerson popular record will be retailed at seventy-five cents, the price at which it became so popular, assuring the dealer a substantial profit and allowing the manufacturer, if possible, to give better quality and the highest class product throughout. At this retail price also it is possible to plan the high standard merchandising policies, methods for protection of the dealer, and co-operation to both dealer and jobber."

The Emerson Phonograph Co. has a list of over 10,000 retailers in the various parts of the country who have at one time or other handled Emerson products. In appointing jobbers the company announces that the names of the dealers, orders, etc., in the given jobbers' territory will be turned over at once.

The Emerson Co.'s shipping department has been moved from its downtown location to 105 West Twentieth street, New York City, a centrally located point with ideal shipping facilities. The whole shipping department has been reorganized and both the standard records and the new popular numbers will, under the new arrangement, get prompt attention and allow for high-class service.

In commenting upon the position which the Emerson record has attained the officers of the company point out that the Emerson Phonograph Co. was for several years the third largest record manufacturer in the United States and that over 100,000,000 records have been produced by the company, some millions of which are now in American homes.

The Emerson Phonograph Co. will shortly announce the details for marketing a new popular-priced phonograph under the trade name "Emerson." These products will consist of a complete line of machines including upright and period models. The workmanship and woods, etc., as well as the various metal parts and other equipment, will be of a type that will merit the appreciation of the large number of dealers acquainted with the Emerson product.

The officers of the Emerson Phonograph Co. are B. Abrams, president, and Rudolph Kanarek, treasurer. Mr. Abrams is also president of the Grand Talking Machine Co., of Brooklyn, N. Y., which, in addition to operating a retail establishment, carries on a jobbing business of talking machines, needles, records and music rolls.

OPERATING SUCCESSFUL BUSINESS

Keers Music Shop, of New Rochelle, N. Y., Owned by Juliet Keers—Handles Victor Talking Machines and Okeh Records

NEW ROCHELLE, N. Y., September 3.—One of the most recently established music stores in this city is the Keers Music Shop, at 767 Main street, which is owned and managed by Juliet Keers. Miss Keers, who in private life is known as Mrs. A. E. Berry, handles the Victor line of talking machines, Okeh records, pianos, musical instruments, etc., and is making extensive plans for increasing the size of the business in the Fall.

Miss Keers is well known to the trade in the metropolitan district, having at various times been connected with the Baumer Piano Co., the Rice Music Co., of New Rochelle, and the S. B. Davega Co., New York City.

W. G. Waltz, president of the W. G. Waltz Co., Victor distributor, of El Paso, Tex., is planning a visit to the Victor Talking Machine Co.'s plant in Camden, N. J., early in October.

Newest Model

Latest Improvements



The Modernola

Most Modern of Phonographs

Something Different.
A Special-Feature Machine.
Solid Woods—No Veneers.
As Good as the Best.
Better Than Many.

WANTED. A few more live dealers.
 Exclusive territory given.

Write Department H.
MODERNOLA CO., JOHNSTOWN, PA.
 The Modernola Sales Co., Inc.
 929 Broadway, New York, N. Y.



"A Good House to Represent"

The biggest drive for Sales in SONORA'S History

NOW is the time to sell only the best! Buying power is coming back. Hundreds of thousands of out-of-date and inferior phonographs will be discarded. More people will want *quality*—the quality always associated with the famous Sonora.

The new Sonora instruments, built to meet this enormous and exacting demand—although wonderfully improved and refined—are lower priced than ever.

156,000,000 readers, as circulation is computed, will have these facts driven home to them through our unprecedented newspaper campaign, which will blanket the country this fall.

Thousands of dollars will be made in the coming season by those who have sold Sonoras and those who decide to sell them now. The tireless sales assistance of the great Sonora organization will stand behind these dealers.

With this gigantic harvest ahead it is poor foresight and a losing policy not to have an adequate stock of Sonoras. Sonora discounts are liberal.

**Why wait until the demand forces you to act?
Sell the Sonora now.**

Sonora Phonograph Company, Inc.

GEORGE E. BRIGHTSON, President

NEW YORK : 279 BROADWAY

Canadian Distributors: Sonora Phonograph, Ltd., Toronto

THE INSTRUMENT OF QUALITY
Sonora
CLEAR AS A BELL 

The Highest Class Talking Machine in the World



The distributor named below who covers the territory in which you are located will be glad to answer all inquiries regarding a Sonora agency on receipt of a letter from you.

Gibson-Snow Co.,

Syracuse, N. Y.
State of New York with the exception of towns on Hudson River below Poughkeepsie and excepting Greater New York.

Sonora Company of N. J.,

605 Broad St., Newark, N. J.
State of New Jersey.

Hessig-Ellis Drug Co.,

Memphis, Tenn.
Arkansas, Louisiana, Tennessee, Mississippi.

Kiefer-Stewart Co.,

Indianapolis, Ind.
State of Indiana.

Lee-Coit-Andreesen Hardware Co.,

Omaha, Nebr.
State of Nebraska.

M. S. & E.,

221 Columbus Ave., Boston, Mass.
Connecticut, Rhode Island, Massachusetts, Maine, New Hampshire and Vermont.

C. L. Marshall Co., Inc.,

514 Griswold St., Detroit, Mich.
Michigan, Ohio and Kentucky.

The Magnavox Co.,

616 Mission St., San Francisco, Cal.
Washington, California, Oregon, Arizona, Nevada, Hawaiian Islands, northern Idaho.

Southern Drug Company,

Houston, Texas.
Southeastern part of Texas.

Southern Sonora Company,

310-314 Marietta St., Atlanta, Ga.
Alabama, Georgia, Florida and North and South Carolina.

Southwestern Drug Co.,

Wichita, Kans.
Southern part of Kansas, Oklahoma (except 5 N.E. counties) and Texas Panhandle.

Doerr-Andrews-Doerr,

Minneapolis, Minn.
States of Montana, North Dakota, South Dakota, Minnesota.

C. D. Smith Drug Co.,

613 Arcade Bldg., St. Louis, Mo.
St. Joseph, Mo.
Missouri, northern and eastern part of Kansas and 5 counties of N.E. Oklahoma.

Moore-Bird & Co.,

1751 California St., Denver, Colo.
States of Colorado, New Mexico and Wyoming east of Rock Springs.

Strevell-Patterson Hardware Co.,

Salt Lake City, Utah.
Utah, western Wyoming and southern Idaho.

C. J. Van Houten & Zoon,

Marquette Bldg., Chicago, Ill.
Illinois and Iowa.

Yahr & Lange Drug Co.,

Milwaukee, Wis.
Wisconsin, Upper Michigan.

Sonora Dist. Co. of Pittsburgh,

1214 Arch St., Philadelphia, Pa.
Eastern Pennsylvania, Maryland, Delaware, District of Columbia and Virginia.

Sonora Co. of Phila., Inc.,

2002 Jenkins Arcade Bldg., Pittsburgh, Pa.
Western Pennsylvania and West Virginia.

Long Island Phonograph Co.,

150 Montague St., Brooklyn, N. Y.
All of Brooklyn and Long Island.

Greater City Phonograph Co., Inc.

311 Sixth Avenue, New York.
Counties of Westchester, Putnam and Dutchess; all Hudson River towns and cities on the west bank of the river, south of Highland; all territory south of Poughkeepsie, including Greater New York, with the exception of Brooklyn and Long Island.

MAKING EXTENDED SALES TRIP

R. W. Moon, of Swanson Sales Co., Visiting Twenty-five Trade Centers—Many Inquiries Received From Jobbers and Dealers

LOS ANGELES, CAL., September 5.—R. W. Moon, general manager of the Swanson Sales Co., of this city, distributor of the Swanson portable phonograph, is at present away on an extended sales trip, and according to his present plans will visit twenty-five of the leading trade centers throughout the country. Mr. Moon will spend a few days at the Chicago office of the company, and will then proceed to New York, where the company has also established offices.

During the past few months the Swanson Sales Co. has received inquiries from many of the leading cities and territories asking for jobber and dealer franchises for the Swanson phonograph. Mr. Moon is planning to call upon the majority of these inquirers, and judging from the success already achieved by the Swanson phonograph, he will have a number of important announcements to make upon his return to Los Angeles.

PHONOGRAPHS TO SOOTHE INSANE

Six Machines Purchased by County Supervisor for Jersey City Insane Asylum

JERSEY CITY, N. J., September 4.—Six phonographs have been ordered by County Supervisor John F. O'Neill, one for each ward in the County Insane Asylum at Laurel Hill. This was prompted by observation that the mental patients at Laurel Hill have appeared to be greatly soothed by the weekly concerts given there every Wednesday night under the same auspices. Under the seating arrangements at these concerts the insane have the "front rows" on the lawn, with the tubercular patients seated above on the first terrace and the almshouse inmates on the second terrace, and after every concert this year the insane have been much more quiet, those who are naturally noisy, than before the concert began; hence the idea of supplying music right in the wards by means of phonographs. Freeholder Frank Boland is chairman of the County Insane Asylum Committee.

Alwin Wild, of Hobart, Ind., has added a very fine line of talking machines and records to his regular business.

NEW SERIES OF SONORA POSTERS

Plan to Issue Two Posters a Month With the Series Probably Going Through Entire Year

L. C. Lincoln, advertising manager of the Sonora Phonograph Co., New York, announced recently that the company had just prepared a striking new series of posters which he believed would be received enthusiastically by Sonora dealers everywhere. It is planned to issue two posters a month, the series probably going through an entire year. Each poster will illus-

ceptionally striking, following the most successful and popular foreign poster styles. The accompanying illustration, showing the first two posters, hardly does justice to their distinctiveness and originality, as the color scheme of each poster is one of its most important features.

HELP MAKE THE NATION MUSICAL

Under the caption, "Helping to Make Nation Musical," the editor of the Vancouver, B. C., Sunday Sun says:

"Just as scholarships have been given by men



Two New and Very Attractive Posters Issued by Sonora Phonograph Co., New York

trate a scene from a popular opera and the whole series will form a de luxe catalog of Sonora product, as each poster will display a different Sonora model in the natural colors of the wood.

Mr. Lincoln, who is a firm believer in the publicity value of posters that are attractively designed, devoted considerable time and attention to the preparation of the new series, and he has already made plans for practically the entire year's campaign. The first poster in the series is called "The Spirit of Music," and the second one is a scene from the opera "The Love of Three Kings." The color designs are ex-

to stimulate interest in trade and in technical education, just as schools and libraries have been erected for the poor to enable them to be better fitted to gain material wealth, so also there should be funds for the poor to secure a musical education.

"The talking machine can do much to stimulate and prepare the way for such an education. What better outlet could be found for the surplus funds of philanthropists than the placing of musical machines in the homes of the needy? By such philanthropy the poor in Canada could have the opportunity of hearing the best in music produced by the finest musicians in the world. Phonographs could be purchased or rented on the time payment plan, such as most retail music houses now use, and by means of a controlled free library of worthwhile records of all companies all the musical literature of the world could be placed at their disposal.

"Music would thus become a part of the daily life of the people. This would help Canada to become a truly great musical nation, and she would, moreover, develop spiritually as she has attained material progress."

CLEVER STUNT AIDS NEEDLE SALES

ROCKFORD, ILL., September 2.—The Sandeen Music House, Columbia dealer of this city, has evolved a clever plan to stimulate the sale of needles and impress on the minds of the customers the necessity of frequent changes of needles for the best results from talking machines. In each record demonstration booth a cardboard disk which bears the following message has been placed in a conspicuous place: "Observe—Change needles for each record played. Use steel needles only once and save records."

When you think you have reached the limit try to beat that record. Even if you do not succeed in doing so you will at least have the satisfaction of having tried and undoubtedly you will have accomplished more than would have been the case otherwise.

Ward's Khaki Moving Covers



Grade "D" Cover with No. 3 Straps

Distributors

BRISTOL & BARBER, INC.,
3 E. 14th St., New York City

C. L. MARSHALL CO., INC.,
Butler Bldg., Detroit, Mich.

W. D. & C. N. ANDREWS,
Buffalo, N. Y.

SHERMAN, CLAY & CO.,
741 Mission St., San Francisco, Cal.

Prices of Covers

For table or small machines, without straps	Net \$3.65
For cabinet or large machines, without straps:	
Grade D, medium size	5.35
Grade D, large size	5.65
Grade K, medium size	6.65
Grade K, large size	7.35

Grade K has double-weight padding and each upright corner is reinforced with a 9-inch strip of quilting of same materials as body.

The medium cover for any make of machine corresponds in size to the Victrola Nos. 10 and 11, Edison Nos. 100 and 150, Columbia Nos. 75 and 100, Sonora, Baby Grand, Imperial and Troubadour. The large cover is for all larger cabinet machines of any make.

Ward's Detroit Cover With Straps Attached
The only cover on the market with this special feature. It eliminates all possibility of straps becoming misplaced or lost.

Medium size	\$6.65
Large size	7.00

Slip-on Dust Covers, for wareroom and home, medium size \$1.70. Large size \$2.00.

Also complete line of Covers for Console Model Machine. Prices on application.

THE C. E. WARD CO.
(Well-Known Lodge Regalia House)
101 William Street New London, Ohio
Also Manufacturers of Rubberized Covers and Dust Covers for the Wareroom

GOLDMAN BAND RECORDS FOR VICTOR

Famous New York Organization, Under Baton of Edwin Franko Goldman, Makes Records of Two of His Popular Marches—Organization Has Been Acclaimed by More Than a Million New Yorkers During the Summer

The admirers of Edwin Franko Goldman, director of the Goldman Band, which delighted hundreds of thousands during the Summer months with its concerts on Columbia Green, New York, will be greatly pleased to learn that he has closed a contract with the Victor Talking Machine Co. whereby this organization will make records for the Victor Co. The Goldman Band made its first recordings early this month in the Victor laboratories when two of Mr. Goldman's very popular and stirring marches, the "Chimes of Liberty" and "The Sagamore," were recorded. These two compositions will appear on a double disc and will be ready for the trade probably in November. Other recordings of Mr. Goldman's compositions, as well as interpretations by this band of the works of other composers, will appear in the Victor catalog in due course.

The Goldman Band has won a most unique place in the hearts of New Yorkers. It is a splendid body of artists, and has brought the best in the domain of classical music as well as the choicest of popular music to the people of the city practically without cost, for, thanks to a number of public-spirited citizens, Mr. Goldman has been able to finance this organization for several seasons. It seems to us the Goldman Band should now win a larger measure of support from the public at large who can appreciate the tremendous cultural value of good music in the community. A small yearly appropriation from each attendant at the concert would be the most substantial mark of appreciation of the great work which Mr. Goldman and his band have accomplished for the development of musical taste and appreciation in our great city.

During the season of twelve weeks which ended September 8 more than sixty concerts were given by Goldman's Band in New York City, and it is estimated that nearly a million people heard its music during the Summer. The success of Goldman's Band and its popular conductor has been so marked that arrangements for 1923 will include a longer season and possibly a tour of the country.

Through the Victor records of the Goldman Band, the merits of this organization will now be brought to the attention of a wider clientele of music-lovers throughout the nation.

P. S. KANTNER A VISITOR

San Francisco Columbia Co. Manager Optimistic Over Fall Outlook

P. S. Kantner, manager of the San Francisco branch of the Columbia Graphophone Co., arrived in New York recently for a visit to the executive offices. Mr. Kantner, who was only recently appointed to the important post he now occupies, attained phenomenal success as acting manager of the San Francisco branch, and, under his capable direction, Columbia product has advanced steadily in popularity throughout northern California.

Mr. Kantner states that northern California is carrying on an extensive advertising campaign at the present time, and that through the activities of the various Chambers of Commerce in that section of the country a fund of \$1,000,000 has been subscribed for advertising its resources. Mr. Kantner reports that merchants and manufacturers are looking forward to the biggest Fall business in years and that outside of the months of April and May California has felt the business depression only slightly.

The brilliant and speedy worker who occasionally sleeps by the wayside as exemplified in the fable of the Hare and the Tortoise is very often passed by the persistent plodder even as the tortoise passed the hare.

PATHE REORGANIZATION NEAR

Only Matter of Weeks Before Receivers-in-Equity Will Be Discharged and Pathé Sound Wave Corp. Take Over the Business

The last barrier in the process of reorganization of the Pathé Frères Phonograph Co., Brooklyn, N. Y., has been passed and it is now only a matter of weeks before it is expected that the receivers-in-equity will be discharged and the newly organized Pathé Sound Wave Corp. will take over the business of the Pathé Frères Phonograph Co. The consent of the creditors was practically unanimous to the plans submitted by the reorganization committee and it only awaited the approval of the banks holding the mortgage on the large Pathé plant in Brooklyn. This was recently secured and immediately plans for the completion of the reorganization were put into execution.

The record end of the business has been phenomenal. Although daily production during the Summer months has reached a large figure,

the demands now being received are increasing daily and it is expected that Fall business will exceed former records. The popular price at which Pathé Actuelle needle-cut records have been placed continues to stimulate the sales of these records and the market for Pathé sapphire-cut records is keeping up in a satisfactory manner.

HANDY RECORD CO. INCORPORATED

Papers were filed with the Secretary of State at Albany, on August 30, for the incorporation of the Handy Record Co., New York City, with a capital of \$25,000. The incorporators are: W. C. and L. M. Handy.

TO ENLARGE DEPARTMENT

Plans for enlarging its talking machine department are under consideration by The Browning Bros. Co., Ogden, Utah. The concern has enjoyed a steady increase in its talking machine sales.

HARPONOLA



The Phonograph with the Golden Voice

The new models are ready,—ready to help you make big profits on the Fall and Holiday trade.

Ready to build a greater good will for the sweet, rich and full Harponola tone.

Ready to prove that the mechanical excellence, always a feature of Harponola Machines, has a fitting resting place in the superb and graceful new Harponola cabinets.

Write for the Harponola Proposition

It's among the most liberal in the trade. It's been a huge profit maker for hundreds of dealers and jobbers,—AND CAN BE FOR YOU. Write, right now.

THE HARPONOLA COMPANY

101 MERCELINA PARK
CELINA, OHIO

Edmund Brandts, President



GRAFONOLA OIL and GRAFONOLA POLISH
 —To "limber up" the Grafonola after re-
 turning from summer vacation. See your
 Dealer Service man. He can provide both.

Columbia Graphophone Co.
 NEW YORK

SALT LAKE CITY

*Marked Improvement in Trade Despite Labor Troubles—Music Week
 in October—The Radio Situation—News Happenings of the Month*

SALT LAKE CITY, UTAH, September 6.—The talking machine business is rather good, dealers report, with a very fair demand for instruments as well as records. The portable models are in demand for school purposes, though many of these instruments have been sold for outing purposes. The strikes are hurting business somewhat.

It is expected that Music Week—the first ever held here—will be staged during the Mormon Conference and the State Fair, which are held the first week in October. Just what form the festival will take is not known at this writing. President Norberg, of the Utah Association of Music Industries, told your correspondent that the music trade interests were very anxious to keep in the background as far as possible, as they did not wish to convey the impression that they were the only persons back of the movement and were in it for selfish reasons. It is likely that the school children will take a prominent part in the festivities and President Norberg said that was one reason why the week was postponed till October, as

it would give the children time to get their bearings after the Summer holidays.

Oscar W. Ray, manager of the wholesale Vocalion record department of the Aeolian Co., was a recent local visitor.

The Ogden store of the Glen Bros.-Roberts Piano Co. has a novel way of distributing its free literature. The big Victor dog belonging to the store is placed on the sidewalk near the curb and in his mouth is placed a little basket, which holds the literature. A written invitation to "Take One" is attached to the dog.

Frank Madsen, of the talking machine department, Lyric Music Co., Ogden, is home after a month's trip to the East, which was spent on business.

The talking machine department of the Browning Bros. Co., Ogden, is to be enlarged in the near future, according to R. G. Thomas, in charge. Mr. Thomas said new booths, among other things, would be added.

George S. Glen, president of the Glen Bros.-Roberts Piano Co., and in charge of the company's business at Ogden, reports a brisk de-

mand for the new console models, especially Edisons and Victors. Mr. Glen said he anticipated a good Fall business, provided the strikes have not done too much damage.

Henry Gardner, manager of the phonograph department of the Daynes-Beebe Music Co., says business is improving. Mr. Gardner was in charge of the musical program at the Mormon Temple Excursion at Saltair during the earlier part of the month. He leads the Temple Choir.

The Thatcher Music Co., of Logan City, gave a silver loving cup for the winner of the music memory contest in Cache Valley recently. This contest helped the sales of machines and records considerably, a member of the firm said.

John Elliot Clark, local Victor agent, his mother, Mrs. Frances Elliot Clark, and son have gone to Yellowstone National Park on a vacation, making the trip by auto. Mrs. Clark is a brilliant woman and is head of the educational department of the Victor Talking Machine Co.

Spencer Eccles, president of the Thatcher Music Co., of Logan, was a visitor to the factory of the Victor company some time ago and says he was much impressed with what he saw.

Radio is not proving quite so successful in the mountain country as was at first thought. The head of a local radio company says the mountains are a hindrance to the transmission of sound waves. It is hoped, however, that this may be overcome. Recently a crowd of 2,000 persons, about half the population of a certain country town, assembled to hear a concert that was being given in Salt Lake City, but not one word or note was conveyed to them and the affair was a dismal failure.

William Berry, of New Orleans, has been made manager of the talking machine department of the Glen Bros.-Roberts Piano Co., succeeding George A. Bolduc, who resigned some weeks ago to accept a position in the Middle West. It is not expected, however, that Mr. Berry will be able to assume his new duties till October 1 or later.

The Utah Phonograph Co. has moved from Main street to a location on East Third South street or Broadway near the Municipal Market.

STRONG AUGUST RECORD DEMAND

Dance Numbers Have a Particularly Strong Appeal, Reports Regal Record Co.

The Regal Record Co., 18 West Twentieth street, New York, states that the August demand for records was most brisk. This was particularly true of dance numbers, and the sales department reports that "Three O'Clock in the Morning," the popular waltz, had one of the largest sales ever known.

The Regal Co. makes it a special point of issuing monthly lists which feature the better sellers and include all the active current numbers, as well as some carefully selected titles that are just coming into popularity.



HENRY BURR



ALBERT CAMPBELL



JOHN MEYERS

EIGHT FAMOUS VICTOR ARTISTS

In Concert and Entertainment

Personal Appearance of

Eight Popular Victor Favorites on One Program

A live attraction for live dealers and jobbers

Bookings now for season 1922-1923
 Sample program and particulars upon request

P. W. SIMON, Manager

1658 Broadway

New York City



FRANK CROXTON



MONROE SILVER



BILLY MURRAY



FRED VAN EPS



FRANK BANTA

Famous Ensembles including

Campbell & Burr - Sterling Trio - Peerless Quartet

WARNING! This Melody is Contagious!
Once you get it you can't forget it!

COAL BLACK MAMMY

Europe's Latest and Biggest Fox Trot Tune

"You can't go wrong With any FEIST song"

Cause I'm goin', yes, I'm goin' with a love that's ever growin' to that Coal Black Mammy o' mine—

ARTISTIC BRUNSWICK DISPLAY ROOMS

New York Offices Handsomely Rearranged—
New Equipment Throughout—Model Brunswick Retail Shop for Use of Dealers Is Shown
—Various Brunswick Models on Display

The offices of the phonograph division of the Brunswick-Balke-Collender Co., New York, now present a very striking and attractive appearance after a complete renovation and the installation of new equipment and fixtures. The entire offices have been rearranged and a large display room has been equipped with every modern convenience known for the retail selling of Brunswick phonographs and records.

As one enters the main door of the office a splendid display of all models of Brunswick phonographs, artistically grouped in the center

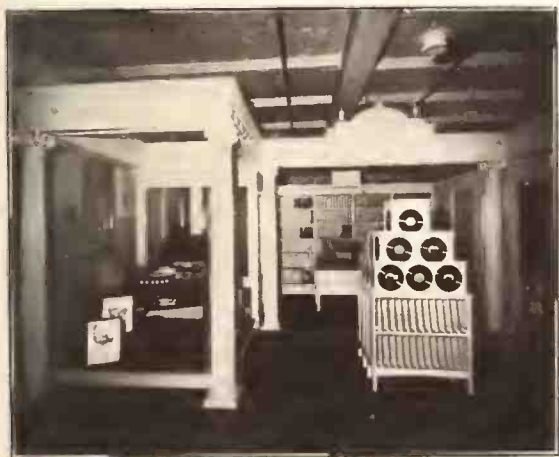

The Model Brunswick Retail Shop

of the showroom, is on view. The grouping of these models is impressive, creating an effect of beauty, and showing to advantage Brunswick designs and Brunswick craftsmanship. On ivory panels throughout the room framed pictures of Brunswick artists are shown, adding a pleasing touch of color.

In the rear of the display room is shown a model Brunswick retail shop, equipped with a complete equipment for the retail dealer, such as artistically trimmed windows, private hearing rooms, modern record racks and record counters, and also a showcase containing phonograph accessories. This model shop is finished in glazed ivory and equipped with florentine lights, all of which typify the ideal Brunswick retail store.

This entire exhibit will remain a permanent feature of the Brunswick offices and it is expected that Brunswick dealers all over the East can come here and get pointers in arranging their own stores. It is a service which the Brunswick offices in New York have to offer dealers that will be appreciated and demonstrates the co-operation which the Brunswick Co. is continually striving to give to its dealers. This progressive move is one of many which the New York offices are planning for the Fall and Winter business, and it is expected that with this new move Brunswick sales totals this Fall and Winter will show a decided increase.

A Means of Time-Saving and Customer-Saving

By ROBERT N. STANNARD

"We're out of that record," replied the saleslady, fingering her memorandum pad and pencil, "but if you'll give me your name and address we'll get it and send it to you."

It is difficult for a customer to refuse such a request, for it serves to impress on him that his trade is wished for and that the store's being out of that number was an exceptional occurrence rather than a general condition.

Any shop that lets a customer get out without offering such service is overlooking what ought to be an obvious principle: that a satisfied customer comes again.

In nine cases out of ten, unless the customer is in a great hurry for the record, such a request is complied with.

The salesgirl, in addition to having a memo of an "out-of-stock" record, has a prospect's name and address, which is valuable in itself. When the record is finally delivered to the customer a monthly catalog of current records or other advertising literature of the store may be mailed. It would serve not only the usual purpose of such literature, but might further impress the customer with the fact that your store wishes his trade in particular, inasmuch as he was compelled once to wait or go without.

Consider the opposite course of action and it will show the value of the above. If the customer sees no memo made of the record that is not stocked he will think the store is not up to date or fully equipped, and he may feel that his custom is not especially desired. Having no memorandum, the clerk is likely to forget to order the number. Perhaps the customer calls again for the record and finds it is not in stock yet. His original impression is intensified.

So there are three ways in which such memo-

randa are of value to the phonograph shop. First—It reminds you to order it. Second—It gives you a prospect's name and address. Third—It favorably impresses the customer if made before his eyes.

Out-of-stock memoranda may be made to serve in other ways just as sales records are for the purpose of classifying customers' wants and re-orders. If it is not thought wise to stock on one call for some particular number, when a sufficient number of calls come for it it would be wise to stock it. The "out" memo gives you an exact record without guesswork.

WHERE PHONOGRAPH IS BARRED

Court in Massachusetts Issues Injunction Against Use of Phonograph in Public Where It Annoys Neighboring Merchants

The use of a phonograph at the entrance to a store for advertising purposes may be the subject for an injunction and damages if the noise produced by it constitutes a public nuisance, according to the decision of Judge De Courcy in sustaining a previous equity decision in Suffolk County, Mass., recently.

Owners of nearby stores brought the suit, and were awarded damages for the "gradual wear on their nervous systems, in some instances producing headaches," and an injunction to prevent overloud tones being played to attract attention to the store's wares was obtained and upheld in spite of the defendant's demurrer.

Remember, no band leader can produce faultless music if even the humblest player doesn't play in the right key. Are you playing in the right key?

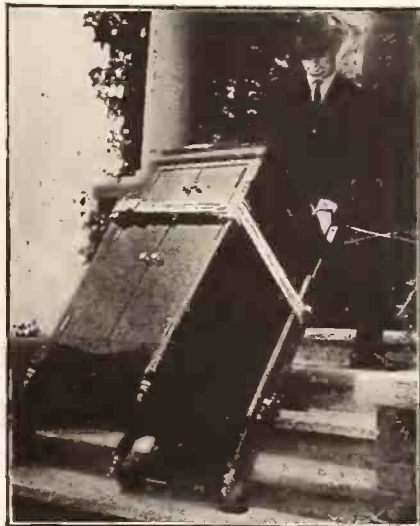

TRUCKS

The Lea Phonograph and Talking Machine Truck must be used to be appreciated.

With it one man can handle the Edison Chippendale, Victor No. XVII, Cheney No. 6 Queen Anne and other large models. This truck also fits the smaller sizes.

It is only a one-man job to deliver your instrument from the showroom to any apartment floor.

Piano trucks, hoists, covers, straps, movers' supplies. May we send you a circular and prices?

Made only by

Self Lifting Piano Truck Co.
FINDLAY, OHIO



Okeh Records



AND

CONSOLIDATED SERVICE

Signify

Profits
Rapid Turnover
Promptness
Co-operation

Okeh Records give the dealer greatest satisfaction and profit. We carry a large stock at all times. Consolidated service insures quick delivery of the latest releases, prompt attention to all orders and the closest co-operation.

Are you receiving your share of profits from the increasing demand for Okeh Records?

Write us for full information about an Okeh Agency.

Consolidated Talking Machine Co.

227 W. Washington Street, Chicago, Ill.

Detroit Branch: 2957 Gratiot Avenue



MARION HARRIS

Announcing

MARION HARRIS

Exclusive Brunswick Artist

A brand new star in the Brunswick constellation! Another celebrity already well known to the millions! A famous singer with a personal following on two continents. Whose very name would sell almost any record.

Reigning Queen of Popular Songdom and World-Wide Vaudeville favorite signs exclusive contract with Brunswick.

Her first two Brunswick Records are brilliant examples of her charming voice and personality as well as the fidelity of Brunswick recording.

No. 2309—I'm Just Wild About Harry
(Song Hit from "Shuffle Along")

My Cradle Melody (Darky Croon Lullaby)

Accompaniment by Isham Jones' Orchestra

No. 2310—Sweet Indiana Home

Blue

Accompaniment by Isham Jones' Orchestra

More Marion Harris Records soon

Brunswick Records can be played on any phonograph

THE BRUNSWICK-BALKE-COLLENDER CO.

Established 1845

CHICAGO NEW YORK CINCINNATI TORONTO



BRUNSWICK

PHONOGRAPHS AND RECORDS



EVERYBODY'S T. M. CO. IN NEW HOME

Makers of Well-known Honest Quaker Main Springs in Attractive Quarters at 810 Arch Street, Philadelphia—Increased Distribution of Product at Home and Abroad—Fall Campaign Will Be Vigorously Conducted

PHILADELPHIA, PA., September 8.—Arch street, which seems to have become the headquarters for talking machine wholesale houses in this city, has added a new neighbor in Everybody's Talking Machine Co., which has recently moved to attractive quarters at No. 810. The entire street floor and basement have been secured, thereby affording the maximum facilities for the conduct of the business. Efficient stock filing equipment has been installed and the new quarters greatly exceed the old in floor space. It was stated by an official of the company that this move was made imperative by the remarkable growth of its business. This company hitherto conducted its business in a successful manner at 38 North Eighth street, and has built up an enviable reputation as the maker of Honest Quaker main springs. It is also the manufacturer of motors, tone arms, sound boxes and other talking machine accessories. The executives of the company are strong believers in quality product and have closely adhered to this policy in the lines which the company makes.

The distribution of the products of this company has been greatly increased and Honest Quaker main springs and other products of Everybody's Talking Machine Co. can now be purchased from coast to coast in the United States and in Canada, Mexico and Porto Rico as well. Agents have also been appointed for foreign distribution. Much care has been exercised in the selection of proper distribution and many well-known wholesalers who have established a reputation for first quality merchandise have been appointed. S. Fingrudt, secretary of the company, states that with the co-operation of these distributors the sales of Honest Quaker main springs during the past six months have eclipsed any like period in the history of the organization.

With the distribution well taken care of, an extensive Fall campaign has been inaugurated. Mr. Fingrudt stated: "We have selected The Talking Machine World to bring our message to the general trade in the United States and we plan to publish monthly interesting educational information regarding the importance of the phonograph mainspring and mica diaphragm."

The various sales representatives of the company, Philip E. Grabuski, William Braiterman and Paul Susselman, are energetically calling upon the trade and have already secured excellent Fall business.

The reason happiness never hatches for some people is because they keep chasing the hen off the nest.—Toledo Blade.

W. C. FUHRI'S IMPORTANT POST

Well-known Talking Machine Executive Now General Manager of Okeh Record Division—Ideally Qualified for Important New Duties

Otto Heineman, president of the General Phonograph Corp., New York, announced this week the appointment of W. C. Fuhri as general manager of the company's Okeh record division. Mr. Fuhri, who is one of the best-known talking machine men in the country, has been associated with the General Phonograph Corp. for the past three years as general sales manager of the Okeh record department, and in



W. C. Fuhri

this capacity has attained exceptional success.

W. C. Fuhri numbers among his personal friends dealers from one end of the country to the other, as for over twenty years he has been identified with talking machine activities. For many years Mr. Fuhri was associated with the Columbia Graphophone Co., occupying important executive and administrative positions that brought him in close touch with the dealers throughout the country. His lengthy experience has given him a thorough knowledge of every phase of record merchandising, and, moreover, has enabled him to thoroughly appreciate the dealers' requirements and co-operate with the retailers accordingly.

During the past year Okeh records have advanced steadily in prestige and popularity throughout the country, and this success may be attributed to the quality of the record plus the intensive co-operation afforded Okeh jobbers and dealers. Mr. Fuhri spends very lit-

tle time in New York, preferring to visit the jobbers and dealers in their respective territories, and this policy has been an important factor in the development of the Okeh sales organization.

DOUBLING GENNETT RECORD OUTPUT

Half of New Presses to Be in Operation on September 15 and Balance Ready in December

RICHMOND, IND., September 7.—The Starr Piano Co. makes the important announcement that work has started on the proposed doubling of the output of Gennett records in an effort to meet the steadily increasing demand for those records. The first additional battery of presses for that purpose is now in transit to the factory and it is hoped to have them set up and in operation by September 15. Sufficient equipment to double the present record output is scheduled to be ready for operation by December 1. When all the new presses are in operation at capacity the output will be 30,000 Gennett records per day.

Despite the increased facilities the company expects to have some difficulty in meeting the record demand in full during the Fall and Winter months inasmuch as the record business of the company has increased almost 300 per cent over that of last year, with an even larger percentage on phonographs.

E. L. BROWN SUCCEEDS E. L. GARLAND

Edw. Strauss Announces Mr. Brown's Appointment As Brunswick Representative for New Jersey—Well Equipped for This Position

Edward Strauss, manager of the New York offices of the phonograph division of the Brunswick-Balke-Collender Co., recently announced that E. L. Brown, well known in talking machine circles in New York City, has been appointed Brunswick representative for the State of New Jersey, taking over the territory left vacant by E. L. Garland, who has resigned. Mr. Brown is well versed in talking machine selling and comes to the Brunswick Co. well equipped to take over this active territory, and already he has shown that he can offer the Brunswick dealers a service that is bound to win for him many fast friends.

ANOTHER POST FOR IRWIN KURTZ

Irwin Kurtz, well known in the metropolitan district as a live talking machine dealer, and president of the Talking Machine Men, Inc., has been appointed by Judge Mack to act as receiver for a men's furnishing concern at 237 Sixth avenue, New York, which has filed a bankruptcy petition. Mr. Kurtz is also a lawyer.

Life is not so short but that there is always time for courtesy.—Emerson.

ZENDA FOX TROT

THE COAST TO COAST SENSATION

from Rex Ingram's

"PRISONER OF ZENDA"

Published by BELWIN, Inc., 701 Seventh Avenue, New York, N. Y.

MAIN SPRING and PARTS FOR ALL MOTORS and MACHINES

COMPONENT PARTS FOR COLUMBIA MOTORS

COLUMBIA

No.	Description	Price each
2951	Columbia main springs.....	\$0.33
3451	Columbia spring barrel head..	Complete 0.75
5008	Spring barrel winding gear, old style..	0.75
3834	Spring barrel winding gear, new style..	0.75
604	Needle cups.....	Per 100 2.00
606	Needle cup covers.....	Per 100 1.00
5106	First intermediate gears.....	Complete 0.40
5107	Second intermediate gears.....	Complete 0.40
12337	Worm gear for single-spring motor.....	0.40
12336	Bevel pinion single-spring motor.....	0.35
12333	Bevel pinion, regular style.....	0.75
12334	Bevel pinion, latest style.....	0.75
12235	Bevel pinion for old-style double spring.....	0.50
12332	Bevel pinion disk shaft.....	Complete 1.00
13496	Male winding pinion.....	0.30
12496	Female winding pinion.....	0.30
3004	Governor shaft.....	0.40
11778	Driving shaft.....	Complete 0.50
13796	Governor balls.....	Complete 0.08
3570	Governor springs.....	Per 100 1.00
6739	Stylus bar.....	Complete 0.35
5010	Universal attachment.....	0.35
13228	Winding crank, 3 sizes.....	0.35
	Columbia Governor Screws.....	Per 100 1.00
	Columbia Barrel Screws, No. 2621.....	Per 100 1.00
	Columbia Sound Box Thumb Screws.....	Per 100 1.50

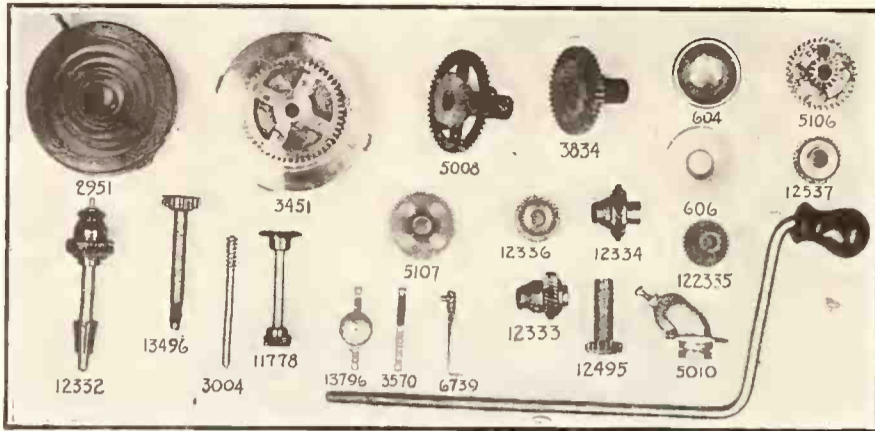

COMPONENT PARTS FOR MEISELBACH MOTORS

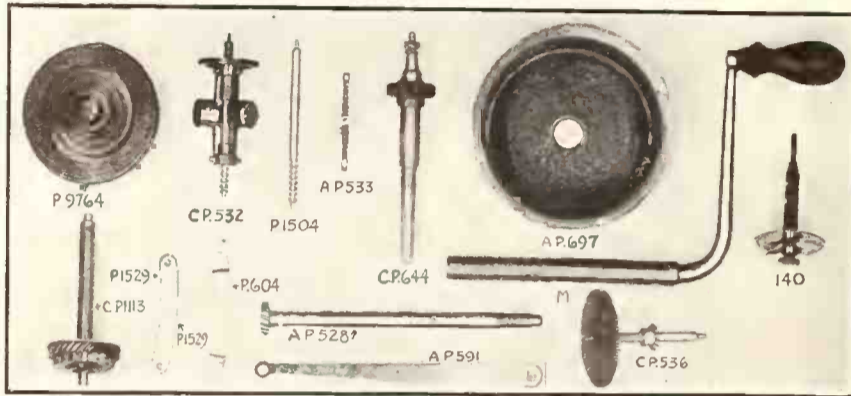

COMPONENT PARTS FOR HEINEMAN MOTORS

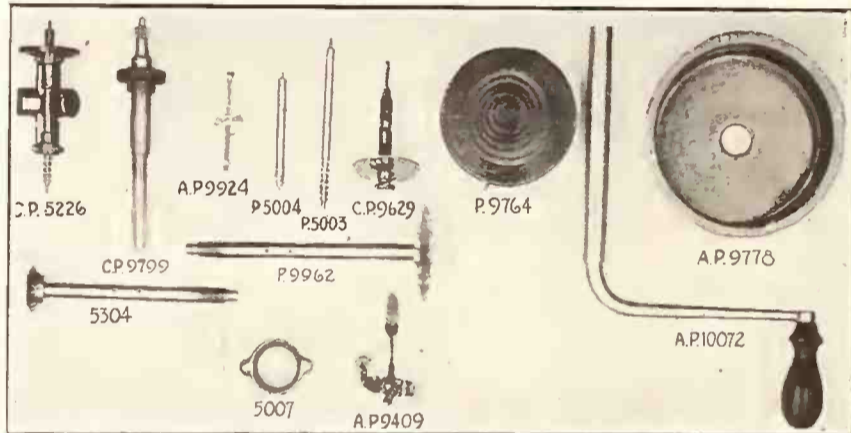

COMPONENT PARTS FOR VICTOR MOTORS

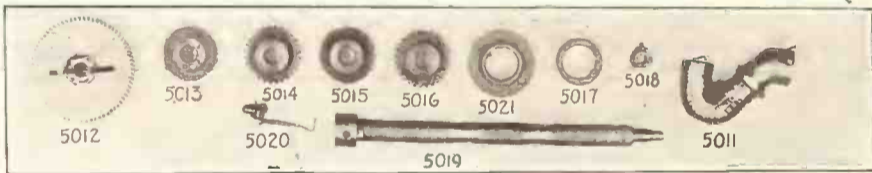

PARTS FOR VARIOUS MAKES

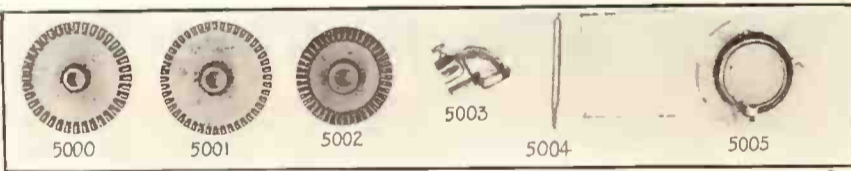

SILENT WINDING SILENT RUNNING

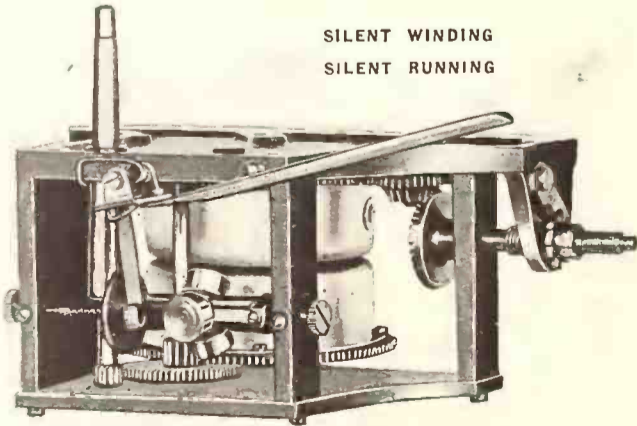

M No. 4

SPECIFICATIONS FOR M 4—Double Spring, Motor Playing Four 10-inch Records. Cast Iron Frame. Worm Drive. Beveled Gear Winding. Ratchet device that prevents clicking furnished complete, with graduated regulator, winding key of desired size, turntable stop working under turntable, fibre-back escutcheon, washers, screws, felts; also 12-inch turntable, covered with all-wool felt. Built especially for high-grade machines.

Monthly Price List Big Reductions on Main Springs

Description	Price each
2 in. x 0.22 x 16 ft., Meisselbach No. 18.....	\$1.25
2 in. x 0.25 x 16 ft., for Edison.....	1.25
1 1/2 in. x 0.22 x 17 ft., reg. for Victor.....	0.60
1 1/2 in. x 0.22 x 17 ft., Victor bent arbor.....	0.60
1 3/16 in. x 0.25 x 16 ft., Heineman No. 44.....	0.60
1 1/2 in. for Edison Disc.....	1.25
1 in. x 0.25 x 12 ft., Heineman No. 33 and 77.....	0.33
1 in. x 0.25 x 16 ft., oblong hole, for Meisselbach, Sonora and Krasberg.....	0.50
1 in. x 0.28 x 10 ft., for Columbia.....	0.33
1 in. x 0.22 x 10 ft., for Columbia.....	0.30
1 in. x 0.20 x 13 ft., for Victor.....	0.33
1 in. x 0.23 x 10 ft., for Victor, bent arbor.....	0.33
3/4 in. x 0.23 x 10 ft., for Blick motor.....	0.30
3/4 in. x 0.25 x 10 ft., oval hole.....	0.28
3/4 in. x 0.22 x 8 ft., German motor.....	0.25
3/4 in. x 0.22 x 8 ft., for Swiss motor.....	0.22
3/4 in. x 0.25 x 11 ft., for Edison.....	0.22
1 in. x 0.25 x 19 ft., for Brunswick.....	0.60
1 in. x 0.22 x 9 ft., for Meisselbach No. 12.....	0.30

MICA DIAPHRAGMS

Description	Price each
1 23-32 in. Victor Ex. Box, first grade.....	\$0.12
1 1/2 in., new Victor No. 2 very best.....	0.18
1 31-32 in., for Sonora.....	0.20
2 1-16 in., for Meisselbach box.....	0.22
2 3/8 in., for Pathé new style.....	0.35
2 3-16 in., for Columbia No. 6.....	0.25
2 9-16 in., for Pathé or Brunswick.....	0.45

SAPPHIRES

Description	Price each
Pathé, very best, loud tone, genuine.....	\$0.12
Pathé, soft tone, ivory setting.....	0.18
Pathé, soft tone, steel setting.....	0.10
Edison, very best, medium tone.....	0.18
Edison, very best, loud tone.....	0.15
Edison, genuine diamond.....	1.25

STEEL NEEDLES

Description	Price each
Brilliantone, all tones.....	Per 1000 \$0.45
Blue Steel Reflexo, per package.....	0.07 1/2
Gilt-edged Needles, per package.....	0.05
Wall Kane Needles, per package.....	0.05

ATTACHMENTS

Description	Price each
Kent, for Victor arm.....	\$0.25
Kent, for Edison with C box.....	2.50
Kent, without box for Edison.....	1.00
Universal old style, for Victor tone-arm.....	1.15
For Columbia, plays Vertical records.....	0.25

MOTORS

Description	Price each
No. M, complete with 12-in. turntable.....	\$4.50
No. 36, complete with 12-in. turntable.....	7.50
No. 33, complete with 12-in. turntable.....	6.50
Imported single-spring, 10-in. turntable.....	2.25

STONE ARMS

Description	Price each
No. K, with sound box.....	\$1.25
No. P, nickel-plated without sound box.....	2.75
No. P, gold-plated.....	4.50
No. M, ton arm, Meisselbach sound box.....	4.75
No. M, gold-plated.....	7.50

SOUND BOXES

Description	Price each
No. B-1 Bliss Sound Box, fit Victor.....	\$1.25
No. B Balance, fit Victor.....	0.75
No. F Favorite, fit Victor.....	1.75
No. I Nickel-plated, loud and clear.....	3.00
No. I Gold-plated, loud and clear, for Victor.....	4.50
No. M Nickel-plated, mellow tone, for Victor.....	1.75
No. M Gold-plated, mellow tone, for Victor.....	2.25
No. G Nickel or gold-plated, fit Victor.....	1.00
No. P Gloria patent, extra loud.....	3.00
No. P Gloria, gold-plated.....	4.00
No. H Imported nickel-plated.....	1.25

ILSLEY LUBRICANT

5-lb. Can.....	\$1.75
1-lb. Can.....	0.40
4-oz. Can.....	0.15

DELIVERY ENVELOPES

40-lb. Brown Kraft 10-in. per 1,000.....	\$7.50
40-lb. Brown Kraft 12-in. per 1,000.....	9.50

GENUINE

Hohner Harmonicas

Description	Price each
1896 Marine Band, any key, per doz.....	\$4.50
1896 Full Concert, per doz.....	10.00
214 1/2 Vestpocket Harp, per doz.....	3.60
151 Marine Band Tremolo, per doz.....	8.00
606 Echo (double-sided), per doz.....	10.00
34B The Old Standby, per doz.....	4.00
132 Hohner Band, per doz.....	4.25
Complete revolving stand with 3 doz. Harmonicas, 32 inches high, mahogany.....	26.50

PARTS—HARDWARE

No.	Description	Price each
5000	Crown gear for Blick motor.....	\$0.25
5001	Crown gear for Melophone motor.....	0.25
5002	Crown gear for Heineman No. 0.....	0.25
5003	Tone-arm goose neck for Independent arm.....	0.25
5004	Governor pinion for imported motor.....	0.25
5005	Tone-arm base for Independent arm.....	0.25
	Automatic nickel-plated lid supports.....	0.22
	Automatic gold-plated lid supports.....	0.45
	Piano hinges, nickel-plated, 15 1/2 in. long.....	0.22
	Highly nickel-plated needle cups.....	Per 100 2.00
	Covers for cups.....	Per 100 1.00
	Highly gold-plated cups.....	Per 100 7.00
	Needle cup covers, gold-plated.....	Per 100 5.00
	Turntable felts, 10-in., round or square.....	0.15
	Turntable felts, 12-in., round or square.....	0.18
	Motor bottom gear for Triton motor.....	0.20

FAVORITE MFG. CO.
105 East 12th St., New York
Tel. 1666 Stuyvesant

FAVORITE MFG. CO.
105 East 12th St., New York
Tel. 1666 Stuyvesant

ANNOUNCE NEW LONG CONSOLES

Two New Cabinets With Wood-paneled Doors Now Ready for Trade—New Prices Announced on Other Long Consoles

H. C. Naill, of the Geo. A. Long Cabinet Co., Hanover, Pa., manufacturer of Long consoles and record cabinets, was a recent visitor to New York. While here he introduced to the trade two new Long consoles which will be known as Nos. 608 and 610. These new cabinets are equipped with wood-paneled doors and provide a splendid housing for the Victrola VI, with shelves for albums.

These recent additions to the Long console line have been received enthusiastically by all of the dealers who have had an opportunity of seeing them, and Mr. Naill is making arrangements whereby the factory capacity of the Long plant will be enlarged in order to give the trade maximum service and co-operation during the Fall and holiday season.

The widely known Long consoles Nos. 601 (Colonial), 602 (Louis XV) and 603 (Chipendale) are still retained in the Long line at prices lower than heretofore. Mr. Naill expects that there will be a tremendous demand for these cabinets during the next few months, and factory facilities have been provided accordingly.

The Geo. A. Long Cabinet Co. was the pioneer in the introduction of console cabinets to accommodate the Victrola VI and Victrola IV, placing these cabinets on the market some two years ago. The cabinets met with immediate success and are now being merchandised by dealers throughout the country.

There is no truer test of a man's qualities for permanent success than the way he takes criticism. The little-minded man can't stand it. It pricks his egotism. He "crawfishes." He makes excuses. Then, when he finds that excuses won't take the place of results, he sulks and pouts. It never occurs to him that he might profit from the experience.—Thomas A. Edison.

H. N. McMenimen
Consulting Engineer

Consultation by appointment on every phase of the phonograph industry, including:

Recording, Plating and Pressing

Motor, Tone-Arm and Reproducer Design

Patent and Model Development

Sales Promotion and Advertising Plans

Laboratory:

Scotch Plains, N. J.
Tel. Fanwood 1438

Offices:

2 Rector Street, New York
Tel. Rector 1484

HAWAIIAN MUSIC AGAIN POPULAR

L. L. Leverich, Columbia Advertising Manager, Gives Interesting Views on Timely Subject—Popularity of Hawaiian Music Is Increasing

The Columbia Graphophone Co. will include in its October list an interesting record by Ferera's Hawaiian Instrumental Quartet, representing something new and different in the way of Hawaiian music. Two Hawaiian guitars, a violin and a flute make up the quartet, and the combination is ideally suited to satisfy the requirements of admirers of Hawaiian music.

Commenting upon the recent demand for music of the Hawaiian type, Lester L. Leverich, advertising manager of the Columbia Graphophone Co., stated as follows in a recent chat with *The World*:

"The keen observer will note that such things as advertising, art, modes and music travel in cycles. There are styles in music just as there are styles in gowns. These styles come into vogue, flourish for a time, then pass on—but only temporarily. Sooner or later they make their complete swing around the circle and come back to the attention of Mr. and Mrs. Public Demand. They may be cut a trifle differently here and shaped somewhat differently there, but fundamentally they are the same styles that flourished months or years before.

"Looking back a few years we come to the period in which Hawaiian music set the style. What started it is difficult to say. The consensus of opinion seems to be that it was borne in on the tidal wave of desire for things Hawaiian created by Laurette Taylor when she presented 'The Bird of Paradise.'

"Columbia was among the first of the record manufacturers to list Hawaiian numbers in anticipation for the demand for the mysterious, weirdly wistful South Sea melodies brought to our shores on the singing wires of the Hawaiian guitar and the ukulele. Then, for a time, the minds of the people passed on to other musical styles—styles too numerous to mention, for the public taste is a fickle one.

"Slowly, but surely, however, the long pendulum is swinging back. The strong breezes are starting to blow in again off the Pacific carrying with them this message from the land of perpetual sunshine—'Hawaiian music is coming back.' Many signs point out the truth of this message. The outstanding hit of 'Good Morning, Dearie,' which just closed after a phenomenal run on Broadway, was a Hawaiian air. You all know it—'Ka-Lu-A.' One of the most-talked-of numbers of this year's 'Follies' is a Hawaiian number, 'Neath a South Sea Moon.' Everyone hums it or whistles it coming out of the theatre and for days afterwards.

"At the beaches, every group of bathers has its little bobbed-haired flapper with her ukulele. Sitting in the middle of her circle of admirers, she strums away while everyone joins in the chorus. No matter what they sing, they always end up with 'Aloha Oe.' Again the Hawaiian atmosphere. Does the flapper keep up-to-date? We'll say she does."

L. A. JACOBI RESIGNS

L. A. Jacobi, for the past two years manager of the Newark, N. J., store of Landay Bros., resigned early this month and announced his intention of taking a much-needed rest and vacation. Mr. Jacobi, who is well known in the retail and wholesale field, has not definitely decided on his plans for the future, but is giving deep consideration to going into the retail business for himself.

ENLARGE VICTOR DEPARTMENT

The B. S. Porter Son Co., Lima, O., has rearranged its entire store and enlarged the Victrola department to take care of the growing business. Wm. M. Snyder, in charge of the section, states a fine increase is recorded in both city and country sales.

\$350,000 DEAL IN LIMA, O.

Rowlands Bros. Buy Business of Harmon Furniture Co., Including Large Talking Machine Department—Will Be Made Part of Chain

LIMA, O., September 2.—A Lima transaction of more than ordinary importance was the sale of the F. E. Harmon Furniture Co. to Rowlands Bros. The deal embraced the store building and the entire stock, including the Victrola and Edison talking machine and record stocks.

The new owners, Chas. H. Rowlands, of Columbus, O., and Alfred R. Rowlands, Mansfield, O., are two of the foremost and largest owners of chain stores in the country. They now control thirty stores. The approximate cost of the building and business is said to be \$350,000. The structure, which is five stories, will be improved and a complete new stock installed.

The Paulin Music Co., Santa Barbara, Cal., has filed articles of incorporation. The concern is capitalized at \$100,000.

KODISK

A Metal Disk for Home Recording

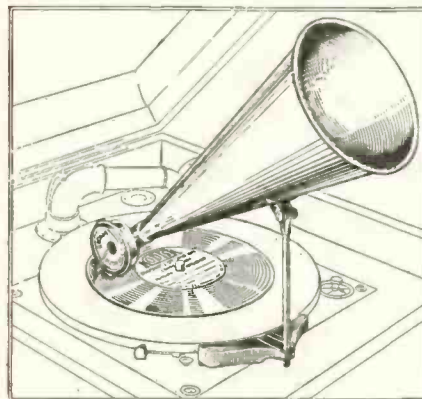

Kodisk Recorder fits all phonographs. Kodisk Recorder uses a steel needle to record and reproduce. Kodisk Recorder is simply constructed. Kodisk Records play on any phonograph the same as regular records. Send for a sample set. List price of Kodisk Recorder and twelve 8 inch double Kodisk Records, \$13.20. Regular trade discount.

Write for our 100-page encyclopedia containing illustrations and prices of

Outing, Swanson, Plymouth, Standard, Orpheus and Stewart Portables

- Radio Apparatus
- Jones Motrola
- Recordola
- Attachments for Edison, Victor and Columbia
- Albums and Album Sets
- Bubble Bocks
- Cabinets, Record and Roll
- Record Carrying Cases
- Corrugated Boards
- Moving Covers
- Dust Covers
- Dancing Toy
- Envelopes, Record Delivery
- Stock and Supplement
- Geer and Gold Seal Repeaters
- Needles, Steel and Tungsten
- Fibre Needle Cutter
- Display Fixtures
- Record Lights
- Lubricants
- Motors
- Nameplates
- Piano and Duet Benches
- Player-Piano Cleaner
- Polishes
- Record Cleaners
- Tonearms and Sound Boxes
- Springs
- Strings

The Cabinet and Accessories Co.

Incorporated
OTTO GOLDSMITH, Pres.

145 East 34th St. New York

Our new headquarters after October 1st will be
3 WEST 16th ST., near Fifth Ave., New York

Announcing EMERSON OCTOBER RECORDS

Shipments Begin September 15th

POPULAR DANCE RECORDS

- 10538 { DANCING FOOL (Fox-trot).....Emerson Dance Orchestra
SOOTHING (Fox-trot).....Sydney Kleefeld Orchestra
- 10539 { NOBODY LIED (Fox-trot).....Strand Dance Orchestra
COO COO (Fox-trot).....Empire State Dance Orchestra
- 10540 { THE SNEAK (Fox-trot).....Globe Music Masters
SAY IT WHILE DANCING (Fox-trot).....Globe Music Masters
- 10541 { JUST BECAUSE YOU'RE YOU (Fox-trot).....Globe Music Masters
FASCINATION (Fox-trot).....Emerson Dance Orchestra
- 10542 { GEORGETTE (Fox-trot).....Sydney Kleefeld Orchestra
PARADE OF THE WOODEN SOLDIERS
(Fox-trot).....Strand Dance Orchestra
- 10543 { CALL ME BACK, PAL O' MINE (Waltz).....Lauer's Orchestra
SWANEE RIVER MOON (Waltz).....Empire State Dance Orchestra

POPULAR VOCAL RECORDS

- 10544 { OLD KENTUCKY MOONLIGHT,
Sung by.....Lewis James & Elliott Shaw
MY CRADLE MELODY. Sung by.....Crescent Trio

POPULAR VOCAL RECORDS

- 10515 { MARY, DEAR. Sung by.....Charles Harrison
SWEET INDIANA HOME. Sung by Lewis James & Elliott Shaw

STANDARD RECORDS

- 10514 { AMERICA. Male Quartet.....Criterion Male Quartet
STAR SPANGLED BANNER. Male Quartet.....Criterion Male Quartet

NOVELTY AND COMEDY RECORDS

- 10291 { THE MOCKING BIRD. Monolog.....Billy Golden
UNCLE JOSH'S BIRTHDAY. Monolog.....Billy Golden

IRISH RECORDS

- 10394 { MEDLEY OF IRISH JIGS. Irish Hornpipe.....Tom Ennis
MEDLEY OF IRISH REELS. Irish Hornpipe.....Tom Ennis

- 10344 { COUNTY KERRY MARY. Tenor Solo.....Hugh Donovan
WRAP THE GREEN FLAG 'ROUND ME,
BOYS. Tenor Solo.....Hugh Donovan

OTHERS FOR RAPID FUTURE RELEASES



EMERSON

For years the third largest record manufacturer in the World.

Serving thousands of prosperous dealers, large and small, from the Atlantic to the Pacific Coast.

Over 100,000,000 Emerson Records are in hundreds of thousands of American homes.

Over \$2,000,000 has been spent in Emerson public and trade advertising, making this line one of the most prominent on the market.

Today Emerson Records Constitute a Bigger and Better Proposition Than Ever.

JOBBER'S CORRESPONDENCE INVITED

Dealers: Write for New Releases and Terms

EMERSON PHONOGRAPH CO.

206 FIFTH AVENUE

NEW YORK, N. Y.

A song by Nora Bayes is always like a beam of good, old, healthy sunshine. Her two latest, "Just Like a Violin" and "Good Mornin'" (It's mighty good to be home), will push the clouds away.

Stock this record and demonstrate it and your digits will put a fresh polish on the cash register keys. A-3669.

Columbia Graphophone Co.
NEW YORK



THE NEW FLAT TOP VICTROLAS

Two New Horizontal Models With Flat Tops, Numbers 210 and 230, Are Announced

The Victor Talking Machine Co. has just announced to the trade two new horizontal model Victrolas both with flat top and designed to meet an apparent demand for instruments of that type. Much interest attaches to the new



Victrola No. 210

styles from the fact that they are the first flat-top models to be put on the market by the Victor Co., although the previous styles in horizontal models marketed by the company some time ago have met with unusual success.

The new models are known as Victrola No. 210, furnished in mahogany or walnut and listed



Victrola No. 230, Louis XV Design at \$100, and Victrola No. 230, Louis XV, furnished in mahogany and listed at \$375, with electric motor at \$415.

No. 230, most attractive in design, follows something along the lines of preceding horizontal Victrola models, to the extent of having the amplifying chamber and its doors in the center, with record filing space at the side. No. 210, however, follows along entirely new lines, the amplifying chamber occupying one-half of the cabinet, while the other half is given over to records. Both sides are fitted with doors.

No. 210 is fitted with a record rack which may be removed if it is desired to install record albums, while No. 230 comes equipped with record albums.

Deliveries of the two new models to wholesalers and through them to dealers will begin very shortly, and it is the opinion of the trade that the two new models will prove important factors in Fall and Winter business to an extent that will create a shortage in the new styles.

GRETSCH LINES-IN DEMAND

E. E. Strong, general sales and advertising manager of the Fred. Gretsch Mfg. Co., Brooklyn, N. Y., reports a good demand well apportioned throughout the entire Gretsch line. Ukuleles are still selling very big and banjos are a close second. The market for good quality violins is also reported large. The Fred. Gretsch Mfg. Co. reports a number of new dealers have taken on the line and predicts good business for the Fall season.

INSPIRATION FROM HIGHER UP

Civically, socially and commercially we get our inspiration from the man higher up. An executive, no matter how small the business, should remember that. The optimism, the energy, the cheerfulness displayed by a head sets an example to every man and woman in the department.

NEW VOCALION RECORD DISTRIBUTOR

Munson, Rayner Corp., Los Angeles, to Handle Vocalion Red Records at Wholesale

LOS ANGELES, CAL., September 2.—The Munson, Rayner Corp., of this city, has been appointed distributor for the Vocalion Red Records, and arrangements have been made for installing a large department with a full stock of such records to facilitate prompt deliveries to dealers.

The arrangements with the new distributor were completed recently by Oscar W. Ray, manager of the wholesale Vocalion Record Division of the Aeolian Co., while on a business visit recently to this city.

REMODELING IN FT. WAYNE

Duessler Phonograph Shop Providing Enlarged Facilities for Handling Business

FORT WAYNE, IND., August 28.—The Duessler Phonograph Shop, 208 West Berry street, this city, is remodeling the interior of its store to provide additional facilities for the display and sale of Columbia and Brunswick phonographs and records.

The plans call for a special demonstration room for the Gulbransen reproducing piano, as well as several artistic booths for phonograph demonstrations. The interior will be finished entirely in white enamel with furnishings and equipment to match.

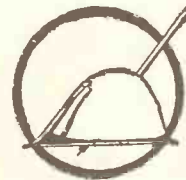
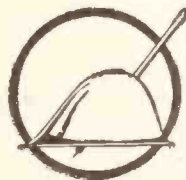
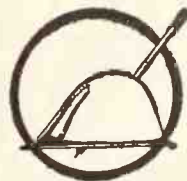
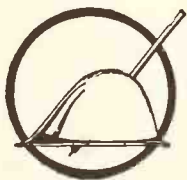
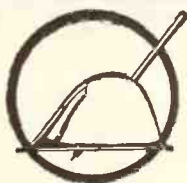

Superior Tone Quality

Bell Hood Needle

does it

Most natural tone reproductions

Try your favorite record with a Bell Hood Needle

Plays Many Times Without Changing

Now selling at 15 cents per package

BELL HOOD NEEDLE COMPANY

183 Church Street, New Haven, Conn., U. S. A.

C. R. JOHNSTONE
VICE-PRES., GEN. MGR.

THE BELL RECORDING CORP.,

Associated With National Metals Depositing Corporation

9 East 47th Street, New York City

BEST RECORDING

EXPERIENCED SPECIALISTS

LOUD AND CLEAR

LAST WORD IN QUALITY

We Specialize in Private Recording

and

General Recording for the Phonograph Trade



IMPORTANT ANNOUNCEMENTS FOR VOCALION DEALERS

Substantial Downward Revision of Prices Made on Fourteen Conventional and Period Models of Vocalions—Ten New Console Period Styles Now Ready for Trade

The Vocalion dealers, under date of August 30, received a most important double announcement from the Aeolian Co., one section calling attention to an interesting downward revision of prices on two conventional styles and on practically all current upright period styles of

\$315, now \$275; Style 1633 was \$375, now \$300; Style 1617, was \$365, now \$325; Style 1623 was \$400, now \$350; Style 1627 was \$425, now \$375; Style 1629 was \$495, now \$395; Style 1615 was \$425, now \$395; Style 1625 was \$475, now \$425; Style 1631 was \$525, now \$465, and Style 1614, formerly \$495, now \$475.

In announcing the price reductions the company states that dealers will be rebated in full on all stock of the above-mentioned Vocalions which they have on hand as of September 1,



New Period Vocalion No. 1624

Vocalion machines, and the other to a new series of styles furnished in console period Vocalions.

It is expected that the reduction in prices of the various styles will prove of distinct advantage to retailers during the Fall in stimulating demand. The price changes are as follows:

Style 450, formerly listed at \$150, now listed at \$125; Style 650, formerly \$185, now \$160; Style 1635, period, formerly \$325, now \$250; Style 1619, formerly \$285, now \$265; Style 1621 was



New Period Vocalion No. 1632



New Period Vocalion No. 1626



New Period Vocalion No. 1618

1922, and purchased at the present prevailing wholesale prices.

The new console period models just announced, which are companion pieces to the upright period models that have proven very successful, are: Style 1620, listed at \$285; style 1636, \$300; Style 1634, \$325; Style 1622, \$350; Style 1618, \$365; Style 1624, \$385; Style 1628, \$415; Style 1630, \$450; Style 1626, \$465, and Style 1632, \$495. The various styles, four of which are reproduced herewith, are most attractive in every particular.

NATIONAL METALS DEPOSITING CORPORATION

FACTORY
34 East Sidney Ave., Mt. Vernon, N.Y.
Telephone: Oakwood 8845

MOUNT VERNON — NEW YORK
MANUFACTURERS OF

LABORATORY
415 Fourth Ave., New York, N.Y.
Tel. Madison Square 6635



WE DEPOSIT THE
FINEST COPPER
IN THE WORLD

FOR YOUR CONVENIENCE
DELIVER RECORDED WAX
TO OUR LABORATORY



OUR
IMPROVEMENT
ALL STAMPERS
HAVE
HIGHLY POLISHED
MACHINED BACKS

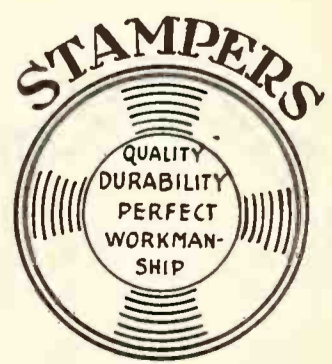

EACH SALE OF
WALTER CAMP'S
"DAILY DOZEN"
 NETS YOU A WORTH-WHILE PROFIT

List Price

Now

\$10.00

*Usual Dealers'
Discount*

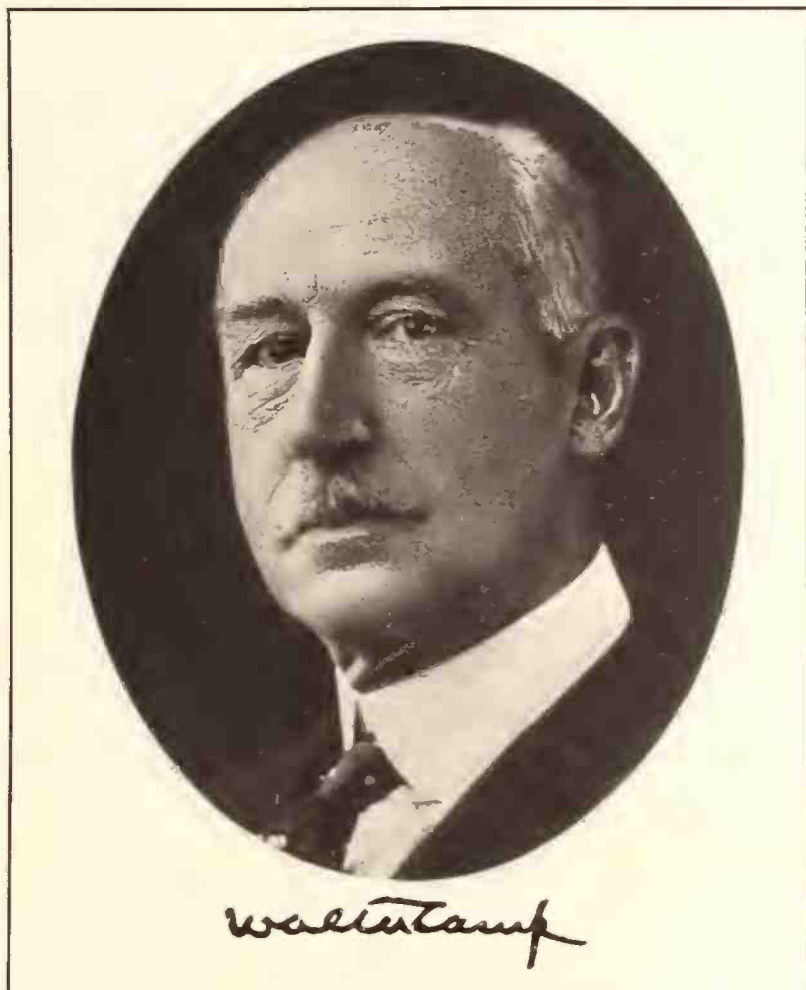

List Price

Now

\$10.00

*Usual Dealers'
Discount*

An imitation "twelve" can never equal the "DAILY DOZEN," because any system of health exercise records cannot possibly be any greater than the man who conceives or directs them.

Walter Camp is recognized internationally as America's foremost athletic authority. His system, known as the "DAILY DOZEN," has been universally accepted as the acme of perfection in health exercise.

Dealers handling Walter Camp's "DAILY DOZEN" on HEALTH BUILDERS records have the satisfaction of knowing that they represent the original and best system of health records on the market.

HEALTH BUILDERS' national advertising has educated the public to look for Walter Camp's signature before buying physical exercise records.

None genuine without this signature: *walcamp*

WE INVITE YOU TO BE JUDGE AND JURY

Send to-day for a set of the "Daily Dozen" at the regular dealer discount. If after demonstration and comparison you wish to return it—do so—at our expense.

HEALTH BUILDERS

DEPARTMENT W9

334 FIFTH AVENUE

NEW YORK, N. Y.

DIAMOND JUVENILE CONSOLE

—a 3-way profit proposition

The reason we have been over-sold on this practical little machine almost from the start is not just because of its individual profit and quick sales possibilities. While six machines cost \$90 and sell for \$150, giving you a profit of \$60, this is only the first feature.

The big point is that the Diamond Juvenile Console gives you a greatly increased buying audience for juvenile records and through children brings parents into the store more frequently. This always results in the sale of more regular records!

Your problem is to get more people into your store more frequently. This is what the Diamond Console has been accomplishing for the hundreds of dealers who have installed it as a basis for a real children's department.

A Real Musical Instrument for Children

Cabinet—Durable Diamond construction throughout. Made from selected veneers and hardwoods. Built with infinite care by experienced cabinet makers. Height, 24 inches; width, 14 inches; length, 28 inches.

Finish—Enameled in Gray, Blue and Ivory. Washable Finish. Blue or old rose silk grille.

Motor—Heineman motor — cut gears — cast frame — fully guaranteed — removable motor board.

Tonearm — Die Cast — nickel-plated—Artois reproducer.

Turntable — Special 9-inch felt faced—plays all records, 10 inch or smaller. Particularly adapted to all children's records—including Bubble Books.

List Price, \$25.00 each
Six Machines or over \$15.00 each
Less than six machines \$16.50 each

Diamond Juvenile Furniture

Six pieces—4 chairs, table and costumer. Juvenile proportions. Durably made. Beautifully enameled and decorated. Makes perfect juvenile booth when installed with the Diamond Console.

Fine for window display.

Six Pieces—\$17.50
F. O. B. Oswego, N. Y.

DISTRIBUTORS:

A. C. Erisman & Co.
174 Tremont Street, Boston, Mass.
Consolidated Talking Machine Co.
227-229 N. Washington St., Chicago, Ill.
The Rudolph Wurlitzer Co.
121 East 4th Street, Cincinnati, Ohio
Cabinet & Accessories Co.
145 East 34th Street, New York City
Walter S. Gray Co.
942 Market Street, San Francisco, Cal.
Munson, Rayner Corporation
315 So. Broadway, Los Angeles, Cal.



Diamond No. 1 Rack 27½ inches high by 9½ inches deep by 16 inches wide. Finished in Ivory or Gray—\$5.00 each. Finished in Mahogany—\$6.00 each.

The Diamond Record Service Rack

TESTED and proved one of the greatest little sales boosters ever developed for the talking machine dealer. Made with two sections—one for *selected* records and one for rejected records. Automatically speeds up customers' decisions—sells more records in less time. Actually demonstrated that it creates more

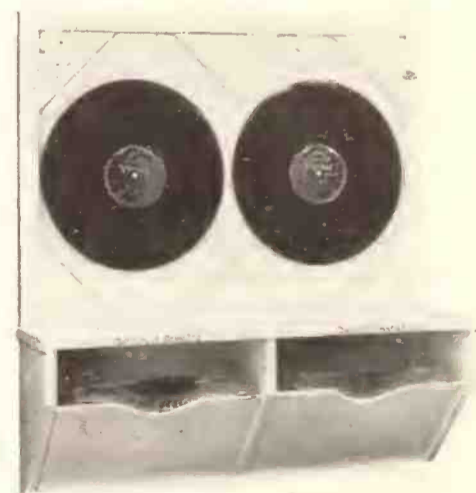

Diamond No. 2 Rack 27½ inches high by 9½ inches deep by 28 inches wide. Finished in Ivory or Gray—\$7.50 each; Finished in Mahogany—\$9.00 each.

decisions for *selected* records than any method ever used. Eliminates breakage by customers. Has special background arrangement for display of whichever record you want to feature. Takes the place of the usual cluttered up table. Takes little room on the booth wall. Substantially made and nicely finished in enamel, the Diamond Record Service Rack will prove the biggest little investment you ever made.

The Diamond Products Corporation

Executive Offices and Showrooms:

25 West 43rd Street, New York Factories: Oswego, N. Y.

TOLEDO

Sales Continue Climbing—Fall Outlook Good Despite Industrial Troubles—Month's News Budget

TOLEDO, O., September 6.—Talking machine merchants have experienced a substantial climb in sales the past month. While the increase was not as large as the previous month it was nevertheless of a favorable character—and this in spite of adverse conditions.

The railroad strike is being felt by music merchants rather acutely. Shipments are delayed and goods which customers are waiting for are lost in the railroad yard jams.

Music merchants in the Michigan resort territory and in the Lake resort regions have experienced a good Summer run of trade and feel that with the bumper crops harvested Fall trade will resume the normal seasonal trend. Moreover, the small-town merchant is back in the race and is adding to his store force and outside workers. He is going after business now because he is convinced there is a real opportunity to land a good percentage of his farmer customers, as well as others.

On the whole reports indicate that the undercurrent is moving strongly in the direction of complete industrial recovery. The settlement of the coal strike will drive the rumor hound to cover. He has brought about much unrest and his reports that large factories would soon close were indeed far-reaching and caused patrons to defer buying musical instruments.

Dealers Seeking Salesmen

According to Chas. H. Womeldorff, manager of the Toledo Talking Machine Co., one of the encouraging signs of the return to normal conditions is that dealers are seeking additional help for their talking machine departments. A number of requests have come from local and outside retailers asking for assistance in locating desirable workers.

A direct campaign exploiting the three Victor special releases to go on sale Friday, September 15, is under way. These are: "Struttin' at the Strutters' Ball," Zee Confrey and his orchestra; "The French Trot," All-Star Trio and Orchestra; "Why Should I Cry Over You?" Blues, The Virginians; "Say It While Dancing," Benson Orchestra, and "I'm Just Wild About Harry," Whiteman's Orchestra. These records will be featured; they will also appear in the October supplement. A great deal of interest is also being manifested in the two new flat-top Victrolas which will be offered shortly to the trade.

Meeting of Brunswick Dealers

A meeting of importance to Brunswick retailers was that held at the Hotel Secor recently. The group consisting of dealers and their workers was addressed by A. L. Fram, director of sales promotion for the Brunswick-Balke-Collender Co. Sales and advertising plans as well as helps for the dealer were discussed. Much enthusiasm was manifested by those in attendance and the plans outlined were adopted. Luncheon was served and the meeting voted a highly helpful one.

100 Per Cent Business Growth

At the LaSalle & Koch Co. Victrola Shop the biggest increase for a single month experienced in a long period was recorded recently when a 100 per cent growth was marked up, according to R. O. Danforth, manager of the department. The store, with its dozens of departments, frequently holds contests destined to keep department heads on edge. A motor speedway was constructed with autos labeled 10 per cent, 25 per cent, 50 per cent, 100 per cent occupying places on the track. The Victrola Shop races with its 100 per cent label was up in the front practically from the start of the month. This unusual showing was so pleasing to the store interests that a coveted front window on Adams street was awarded for displaying the wares of the shop for one week.

The fine showing was accomplished through co-operating with store sales events, advertising and by getting a fair percentage of the talking machine owners who visit the large store daily to buy records and supplies there instead of merely purchasing the usual items and going elsewhere for talking machine merchandise.

On the day of the semi-annual remnant sale over 500 records were sold, also a number of talking machines. The theory that such a section cannot couple its efforts with sales going on in the store is all wrong. Timely combinations which were featured did much to add to the sales volume. Talking machine business for five days was equal to more than half the total recorded during an entire month in 1921.

Two New Salesmen for Greene Co.

At the J. W. Greene Co. sales are above those of last year at this time, E. A. Kopf states. A brisk Fall sales campaign is about to be launched. Two salesmen have been added to the force, Kenneth Frederick, formerly with the Cable Company, and Ralph J. Fisher. A feature which is adding to volume is a Victrola and Console mirror combination known as No. 260. This outfit, in conjunction with a dozen selections, moved rapidly. It is found that many folks prefer to buy an assortment such as this instead of being compelled to purchase each piece separately.

Miss Pulliver Speaks on Music Appreciation

At the Lucas County Teacher Institute, which convened in Toledo the last week in August, Miss Grazele Pulliver, of Cleveland, addressed the group under the auspices of the J. W. Greene Co. Her topic was "Music Appreciation in the Schools," a subject uppermost in the minds of instructors at this season.

Selling Victrolas From Trucks

At Grinnell Bros. the Ford truck Victrola service, which was inaugurated recently and which goes direct to the consumer with machines, is proving a real asset to the department, R. C. Elwell states. As many Victrolas are sold in this manner on occasion as are sold in the store. However, the coupling of store ef-

forts with outside work is responsible for the showing, it is said.

Manager A. J. Pete, of the Lion Store Victrola rooms, made a trip to the Merchandise Fair in New York, and to the Victor factory the latter part of August. This concern is making an investigation of radio possibilities and the part it will play in merchandising. Should events warrant, the radiophone will receive special attention in future store plans.

A Campaign on Advertising

The Da-Lite Electric Display Co. will renew its Fall advertising and sales campaign in September. A drive will be made to secure new users of its monthly Victor panel service. The sales force has been enlarged by the addition of two men, who will solicit the trade in the interest of Victor jobbers. One of these men will cover the Pacific Coast by way of the Southern route and it is expected Western headquarters will eventually be established in Los Angeles.

Buys W. B. Duck Co. Stock

Whitney, Blaine & Wildermuth Co., who acquired the Victrola stock of the W. B. Duck Co. recently, report a very favorable volume of sales. Fall plans include a drive to acquaint customers with the many features of the new upstairs store. One of these is that demonstration booths are supplied with washed air drawn into the building by means of fans. Among the late hits "Hot Lips," "Send Back My Honeyman" and "My Rambler Rose" are favored, Henry C. Wildermuth states.

Increased Call for Machines

Rae & Maxwell report a marked improvement in the demand for machines. A number of important contracts have been closed lately. Aeolian, Columbia and Jewett are dealt in.

Call for Foreign Records

Frank Fleightner, Columbia, Jewett and Vocalion dealer, is receiving a large number of calls for foreign selections, particularly Italian and Spanish. The demand for this type of music improves when the workers have plenty of cash. Their buying power is greater at this time than for months.

MANY INQUIRIES FROM DEALERS

M. S. Davis, president of the Encore Sales Co., New York City, general factory distributor for the Encore record re-player, reports that the initial announcement of the company last month resulted in inquiries from interested dealers in all sections of the country. Additional dealer helps in the way of literature, counter and window cards are being planned.

Main-Springs

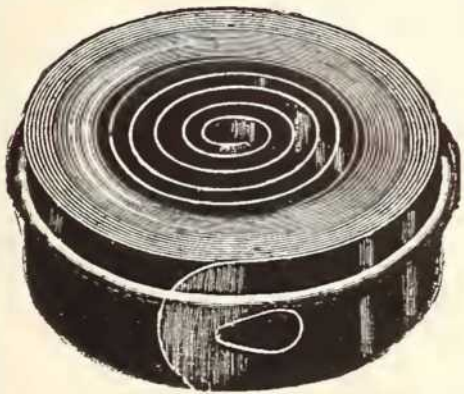

For any Phonograph Motor
Best Tempered Steel

Size	Material	Each
3/8 inch x 10 feet	for all small motors	\$.30
1/2 " x 10 "	Pathe, Columbia, Heineman	.35
1 " " " "	Columbia	.40
1 " " " "	Columbia with hooks	.50
1 " " " "	Victor, old style	.45
1 " " " "	Victor, new style	.50
1 1/4 " " " "	Victor, new or old style	.70
1 " " " "	Heineman and Pathe	.45
1 " " " "	Saal, Silvertone, Krasberg	.45
1 " " " "	Saal, Silvertone, Brunswick	.50
1 " " " "	Sonora, Brunswick, Saal	.60
1 3/16 " " " "	Heineman and Pathe	.75
1 1/2 " " " "	Edison Disc	1.50

SAPPHIRES—GENUINE

Pathe, very loud tone, each 15c, 100 lots \$11.00.
Edison Loud-tone, each 15c; in 100 lots, \$11.50.

TONE-ARMS

The very best, loud and clear, throw-back.....\$4.50
With large reproducer, very loud, Universal.....4.00
With smaller reproducer, but loud and clear.....2.50

PHONOGRAPH NEEDLES

We can give you best price on Brillantones, Magnedo, Wall-Kane, Tonofone, Nupoint, Gilt Edge, Incoas and Velvotone Needles.

ORDER RIGHT FROM THIS AD

Send for price list of other repair parts and motors.
Terms—F. O. B. St. Louis, Mo. Send enough to cover postage or goods will be shipped by express.

The Val's Accessory House
1000-1002 Pine St. St. Louis, Mo.

Victor Wholesalers



The House
of
Mellor
in
Pittsburgh
since
1831

The
Player-Tone
 IT'S SIMPLY GREAT

No Better Tone Instrument
 In the World

—PRICE—

Will Sell Phonographs Today
 And We Have It

Every Player-Tone phonograph is exceptionally good, with the house back of it for years.

Player-Tone phonographs are masterful in their perfection of high grade cabinet work, exquisitely finished by skilled workmen, and when you sell one of these perfect tone producing instruments, you prepare the way for another Player-Tone sale.

The more closely you analyze our high grade construction, combined with perfect tone quality, the more fully will you realize its unqualified value.

We have liberal discounts for dealers with catalogue. Write for it today.

Player-Tone Talking Machine Co.

Office and Salesrooms

967 Liberty Avenue Pittsburgh, Pa.



\$65.00
 Model 551
 Mahogany Only



\$75.00
 Model 601
 Mahogany Only



\$85.00
 Model 701
 Mahogany Only



\$100.00
 Model 801
 Mahogany Only



EMERSON
 Model 40
 All gold equipment,
 with 5 record filing
 albums. \$150.00



\$150.00
 Model 901
 All Gold Equipment



\$75.00
 Model 310
 Oak or Mahogany



\$90.00
 Model 311
 Oak or Mahogany



\$110.00
 Model 314
 Oak, Mahogany or Walnut



\$125.00
 Model 316
 Oak or Mahogany

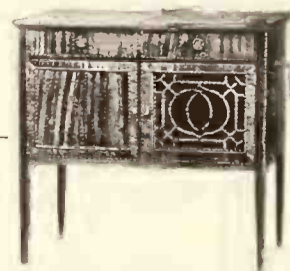

EMERSON
 Model 30
 All gold equipment,
 with 5 record filing
 albums. \$135.00

MILWAUKEE

Trade Conditions Reviewed—Sonora Dealers Meet—Goldsmith Optimistic—Victor Dealers Discuss Situation—The Month's News

MILWAUKEE, Wis., September 10.—Industrial trade conditions, employment problems, crop reports and general economic market reviews of Wisconsin and the upper peninsula of Michigan are reflected in the wholesale talking machine market of this city. Agricultural districts are in a sound financial condition as bumper harvests are drawing to a close. Consequently the small-town dealer in phonographs and records is confidently laying in a large stock of machines and making general preparations for a good Fall business. All of this is directly attributed to the certain prospect of large food crops.

A corn and wheat crop equal to last year's excellent average and a hay crop that sets a record for preceding years are the reports of the crop survey for Wisconsin. With rural trade in an optimistic frame of mind, attention turns to that of the big city dealer.

During the Summer months sales of talking machines have been mounting steadily. There was no falling off in sales from the comparatively low June sales records to those of August. Most of the leading wholesalers and jobbers in Milwaukee, which is the center of trade for Wisconsin, Michigan peninsula and the northern Mississippi valley, found that trade was improving monthly. This has set a precedent over preceding years, for during the warm months a seasonal slump is generally experienced. With this excellent record behind them dealers and wholesalers are not as confident of future markets as they might be. The effect of the coal and railroad strikes on business is now their chief concern. Shipments of talking machines on Fall orders have been seriously hampered, wholesalers state. The railroads will be severely taxed even after the strike is settled. They will have to move an amount of coal in a few weeks which is usually spread over many months and the season of crop-moving has arrived. Fall orders are being filled as rapidly as possible, as dealers throughout the State send in requests for immediate shipments that they may have the stock on hand for display during the inception of their early advertising campaigns. Many of the State and county fairs scattered throughout the State find a sizable exhibit of local talking machine dealers on display.

Talking Machines at Household Exhibition

Milwaukee wholesalers are making extensive plans for their entrance in the Household Exhibition at the Auditorium in October. The Yahr & Lange Co., distributor of the Sonora; the Badger Talking Machine Co., Victor distributor; the J. B. Bradford Co., Brunswick representative, and other leading Milwaukee houses

will be represented. The machines will be demonstrated before approximately 100,000 persons during Exposition Week.

Outing of Milwaukee Dealers

Music dealers of Milwaukee and Chicago met at Ravinia Park, Chicago, last month for the first annual intercity outing of merchants. Approximately five hundred merchants with their wives and families attended the outing. One hundred of the Milwaukee dealers chartered a special train for the trip to Chicago. Henry M. Steussy, sales manager in charge of Edison lines and Victrolas at the Kesselman-O'Driscoll Music House, was in charge of the Milwaukee delegation. At the intercity baseball game Sam Goldsmith, Badger Talking Machine Co., was the star of the invading nine. Hugh Holmes, of the J. B. Bradford Co., newly appointed Brunswick representative; Harry A. Goldsmith, secretary of the Badger Talking Machine Co.; S. R. Christopherson, sales manager of Yahr & Lange Co., wholesaler of the Sonora and Okeh lines; Florian Flanner, of the Flanner-Hafsoos Music House, Edison representative, were the leaders of the Milwaukee visitors. Next year the Milwaukee Music Industries will be the hosts to the Chicago dealers and wholesalers in a joint picnic at a popular Wisconsin resort, said Mr. Christopherson, secretary of the Milwaukee organization.

At the regular meeting of the Milwaukee Association of Music Industries, which was held in the Colonial room of the Wisconsin Hotel, routine business and plans for an active social and business campaign for Fall were discussed. Another meeting will be held later in September.

Yahr & Lange Co. Entertains Dealers

Prominent Sonora dealers of Wisconsin and the upper peninsula of Michigan held a sales conference and educational meeting in Milwaukee the closing days of August under the patronage of S. R. Christopherson, sales manager of the music merchandise division of the Yahr & Lange Co., distributor of the Sonora phonograph in Wisconsin, Michigan, Minnesota and Iowa. Fred E. Yahr, president of the Yahr & Lange Co., delivered the address of welcome to the visitors assembled in the display rooms of the company, said to be the most elaborate and best furnished display rooms of any wholesaler in the Northwest. President Yahr conducted a personal tour through the large six-storied plant of the company prior to the opening meeting.

"Beautifying Your Store and Making Sales" was the title of the address made by President Howers, of the Adjustable Fixture Co., at the afternoon conference of the dealers. He spoke of the importance of atmosphere in the store,

the returns that invariably came from the proper investments in furnishings and the proper fixtures for the console display of talking machines. Attractive stores furnished throughout the country were displayed on a screen for the benefit of the talking machine dealers. New ideas in window decoration and reception room furnishing were given.

Jack Carr, advertising prodigy, addressed the dealers on the "Use of Direct-by-Mail Advertising in Building Your Business." This subject was gone into in detail and the live discussion that followed showed the paramount position it occupied in the dealers' minds.

H. J. O'Connor, field representative of the Sonora Phonograph Co., New York, spoke on "The Sonora, the Highest Class Talking Machine in the World."

The possibilities of film advertising for producing business were pointed out by George F. May, of the Milwaukee Film Advertising Service, who used illustrated slides and moving pictures in his lecture. General discussion of music business and industry by the dealers and wholesalers followed the education conference. Sales problems and announcement of an intensive Fall advertising campaign to be launched in the middle of September occupied the remainder of the day.

A banquet, dance and entertainment was held in the Republican House in the evening. Marion Yahr, daughter of Fred E. Yahr, danced. A vaudeville sketch and other features were given. The evening was principally a social gathering to which the wives of the visiting delegates were invited. No formal speeches were given at the dinner.

S. R. Christopherson announced that active plans are under way for the completion of a Wisconsin Sonora Dealers' Association and another conference will be held in Milwaukee to perfect the plans, exchange new ideas, etc.

George F. Ruez Honored

George F. Ruez, president and treasurer of the Badger Talking Machine Co., has been elected trustee of the village of Shorewood, a suburb of Milwaukee. Shorewood property has an assessed valuation of \$12,000,000, he stated. Mr. Ruez was good-naturedly distributing cigars at the Badger offices, celebrating the recent arrival of a baby daughter, when he was informed of his trustee appointment.

Goldsmith Looks for Big Demand

Harry A. Goldsmith, secretary of the Badger Talking Machine Co., Victor distributor in this territory, reviewing current trade conditions, stated: "We are preparing to enter one of the best Fall seasons in our history. A large number of advance orders has been received and our territory is in a specially good condition. Advertising campaigns recently launched are beginning to bear fruit. Trade gained materially each month during the Summer and is now making rapid strides as the Fall season gets under way.

"The biggest demand is for high-grade instru-

(Continued on page 66)



New Model "E"

The General Phonograph Mfg. Co.
Model "E"
TABLE PHONOGRAPH
The Greatest Value on the Market
 IMMEDIATE DELIVERIES IN ANY QUANTITY
 Plays All Makes of Records
 Superior Tone Quality

Write for our Proposition
The General Phonograph Mfg. Co.
 ELYRIA, OHIO

BAGSHAW

The Oldest and Largest
Manufacturers of Steel
Talking Machine
Needles in the World

NEEDLES

Best By Comparison

By actual comparison, BAGSHAW NEEDLES are the finest steel talking machine needles manufactured today. Each BAGSHAW needle is backed by the reputation of the pioneers in the talking machine needle industry. They are guaranteed by the manufacturer, the jobber and the dealer alike.

Whether you desire needles packed in cans, envelopes or in bulk—or under your own trade-mark—W. H. BAGSHAW CO. can best satisfy your requirements.

*Samples and Prices
Upon Request*

The famous BRILLIANTONE and genuine PETMECKY brands are manufactured by BAGSHAW. The world over, BAGSHAW steel talking machine needles are renowned for their uniform length, uniform points and uniform hardness.

W.H. BAGSHAW CO.

FACTORIES: LOWELL, MASS.

SELLING AGENTS

BRILLIANTONE STEEL NEEDLE CO. OF AMERICA
INCORPORATED

347 FIFTH AVENUE

AT 34th STREET

NEW YORK

SUITE 610



Regarding Our Limited Introductory Offer

Phonograph dealers everywhere have rallied to the Brilliantone idea of selling needles in individually imprinted containers. They appreciate the effective advertising value of the Brilliantone container. They are availing themselves of our special introductory offer to imprint the firm name on orders for as little as 1,750 cans. Are your customers seeing your name every time they play a phonograph?

BRILLIANTONE NEEDLES

In Tin Boxes
Imprinted With Your Name
On Orders for 1750 Boxes

Three Tones: Extra Loud, Loud, Medium

Tie up with the largest makers of phonograph needles in America. Send for prices and samples. And tell us to whom you desire shipment billed.

BRILLIANTONE STEEL NEEDLE CO. OF AMERICA, INC.

Selling Agent for W. H. Bagshaw & Co.
Factory: Lowell, Mass.

347 FIFTH AVENUE NEW YORK

Canadian Agents: The Musical Merchandise Sales Co.
79 Wellington Street West Toronto, Canada

Let
us put
Your
name
here

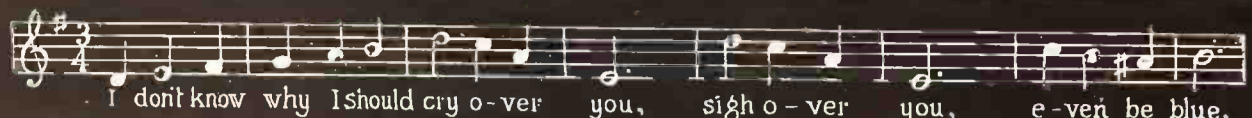

I don't know why I should cry o-ver you, sigh o-ver you, e-ven be blue,

The Big Waltz Ballad Hit

Why Should I Cry Over You

It's Another "I'm Sorry I Made You Cry"

"You can't go wrong With any FEIST song"

HEAR IT NOW!

TRADE HAPPENINGS IN MILWAUKEE
(Continued from page 63)

ments. The only styles of the lower classes selling during the Summer months were the portable machines and as demand for these has fallen off most of the trade now is confined to console and period models of the high-class type. Even the farmers in the rural districts are asking for these models, our country dealers tell us. We look forward to a good Fall and Winter season."

Increased operations and enlargement of the field of the company have resulted in an increase in the stock to 60,000 preferred, with 1,000 shares of common stock of no par value, a recent amendment stated. The Badger Talking Machine Co. is Victor representative for Wisconsin and upper Michigan territory.

Broadcasts Victor and Edison Records

The Kesselman-O'Driscoll Music House, representing the Edison and Victor lines, recently

gave a special Masonic lecture from their music house which was heard at the annual Masonic picnic at Delafield, Wis. The Victor and Edison records were broadcasted in the entertainment program furnished after the lecture. L. J. Monroe, head of the radio department of the music house, said the company station, the first in any American music house, has a range of one thousand miles. It is officially licensed and has the call, WCAY.

Victor Dealers of Fox River Valley Meet

Twenty Victor dealers from as many different cities attended the monthly meeting of the Victor dealers of the Fox River Valley at the Hotel Calumet, Fond du Lac, Wis. At 6 o'clock a dinner was served, followed by a business session. L. S. Morgan, representative of the Victor Talking Machine Co. for the State of Wisconsin, addressed the dealers on the outlook for Fall and Winter business. The factories, he said, were working to capacity to take care of new business and were ready to

give the dealers better service than ever. The meeting was brought to Fond du Lac through the efforts of J. A. Santee, of the Badger Music Shop. Dealers from New Holstein, Ripon, Berlin, Manitowoc, Plymouth, Waupun and Two Rivers, as well as Valley cities, attended. It is planned to include dealers from northeastern Wisconsin, as well as upper Michigan, in a proposed State association. The next meeting of the dealers will be held in Green Bay. D. N. Grouix, of that city, will preside, W. J. Augustine declared.

New Concern in Eau Claire

C. F. Funk, A. Y. Anderson, A. M. Anderson and P. L. Peterson, of Eau Claire, have organized a new company in that city that manufactures a machine without incorporating a metallic horn in its make. It plays all kinds of records.

Famous Victor Artists to Appear

The Eight Victor Artists, whose fame is nation-wide, will appear in Appleton, Wis., the first week in October at the Lawrence Memorial Chapel, dealers in that city have been informed, and they are preparing to conduct simultaneously an advertising campaign.

Talking Machine Men Help Out

Hugh W. Randall, president of the J. B. Bradford Co., representative and distributor of the Brunswick in Wisconsin territory, together with a number of other prominent talking machine men of Milwaukee, members of the Wisconsin Club, was in charge of the entertainment program at "A Night in Madrid" party on August 30. Talking machine men take a prominent part in the club's musical activities.

Dealers Tie Up With Isham Jones Orchestra

Brunswick dealers in this city linked up their advertisements with the appearance of the famous Isham Jones Orchestra in Milwaukee last week. The orchestra appeared at the Mari-gold Gardens. It has been very popular with Milwaukee music lovers and at its recent appearance a large number of Brunswick records were sold featuring the orchestra. Dealers advertised extensively the presence of the musicians and profited by the large sales of records on their departure. The J. B. Bradford Co. had charge of the advance sale of tickets and was instrumental in booking the orchestra.

Means of Augmenting Sales

Albert E. Smith, well-known Victor house in Madison, Wis., is offering a special cut-out puzzle free to all boys and girls in its sale of August and September Victor records. The novel plan was used to introduce the children's records of the store and also augment the sale of the larger new releases. It proved to be successful in that more records were sold under the puzzle plan than in the preceding month, officials reported.

The most stupendous epigram since La Rochefoucauld wrote his maxims: "Pain is the rent that the soul pays for living in the house of flesh." Benjamin De Casseres is the author.

AUTOMATIC STOPS

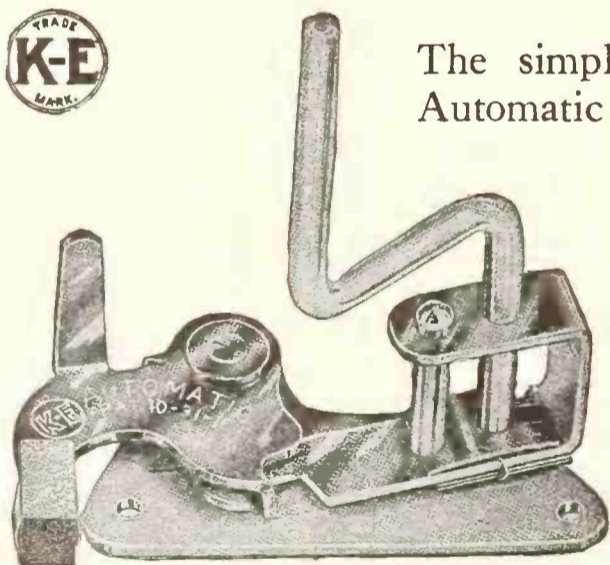

The simplest and most efficient Automatic Stop on the market. They give excellent service, are easily installed and are absolutely guaranteed.

Send 50c. for Sample Stop

SWEETEN THE TONE

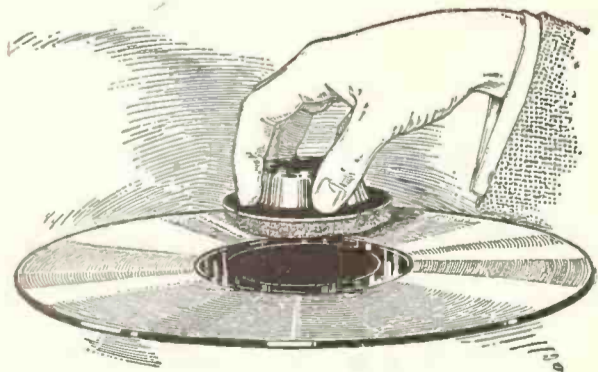

with K-E and Simplex Circular Record Cleaners

Reduced Prices Big Profits Write for Particulars NOW

KIRKMAN ENGINEERING CORPORATION
484-90 Broome Street New York

Truetone

TRADE MARK

The WORLD'S BEST
PHONOGRAPH NEEDLES

**NONE
BETTER
MADE**

DEAN

**UNIFORM
POINTS**

**UNIFORM
LENGTHS**

**PERFECT
REPRODUCTION**

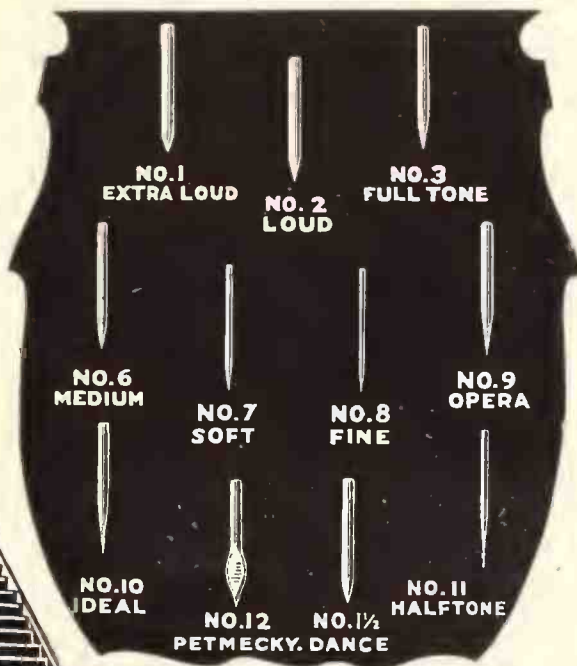
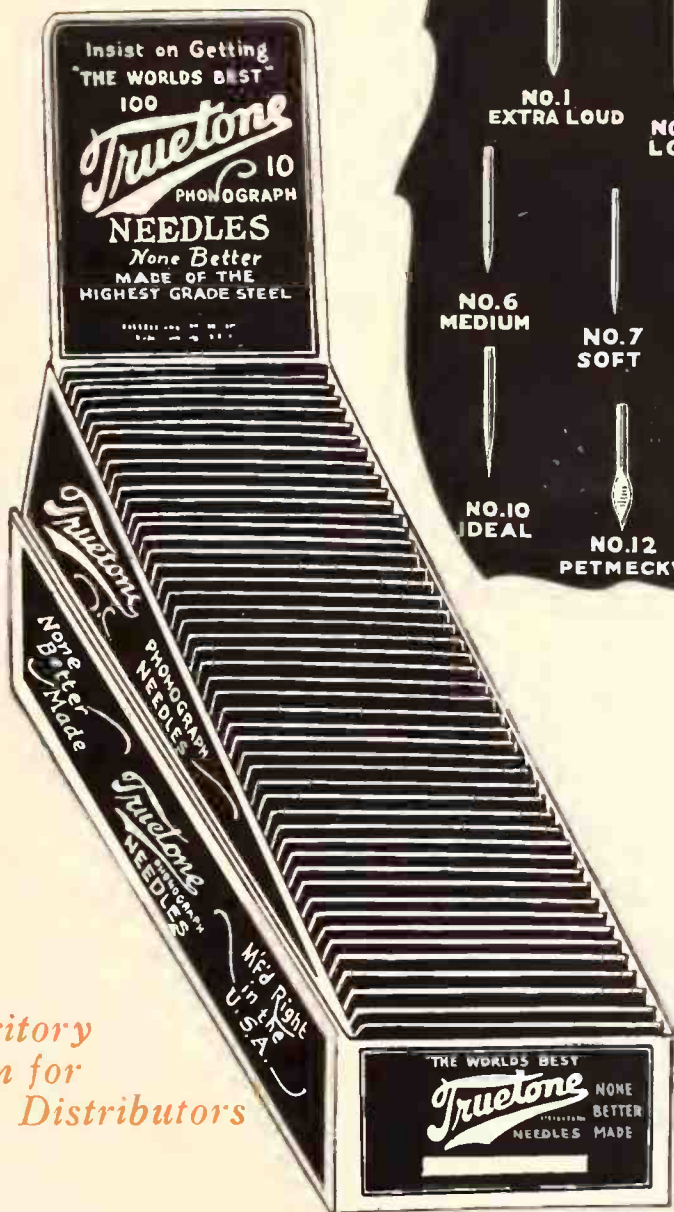

*Territory
Open for
Live Distributors*

*Write for
Our Current
Prices*

Manufactured by
GENERAL PHONOGRAPH CORPORATION
 OTTO HEINEMAN, President
 25 West 45th Street, New York



The Trade in **BOSTON** *and* **NEW ENGLAND**
 JOHN H. WILSON, Manager
 324 WASHINGTON ST., BOSTON, MASS.

BOSTON, Mass., September 8.—When this correspondence is read the coal strike will have been entirely settled if one can get the right angle as this is penned; for it is now a matter of twenty-four hours, so it is stated, though one recalls that we have been on the eve of settlement of this and the railroad strike several times in the past few weeks. New England has felt the strain of both strikes rather severely, but it is unquestionably the railroad strike that has most affected the talking machine industry locally, for it has badly held up the delivery of goods. Not a few dealers will tell you that machines and supplies long since ordered are not yet received. One wholesaler told your correspondent the other day that he had had to go to the railroad sheds almost daily to look for his goods and that it had been no uncommon thing to find consignments that had been several weeks in transit. Should it happen by any chance that the railroad strike is much longer continued it will work great harm to the talking machine industry, for the business is on the eve of big things; large orders for the Fall trade are being placed and dealers, on the other hand, are getting in close touch with customers to the point of receiving orders, not for cheap outfits, but for the more expensive ones. Should the goods for which the orders are piling up be much delayed it will be most unfortunate for everyone concerned. The past few weeks have seen a decided change in sentiment hereabouts. Those who have been traveling through the New England field report that dealers in Maine, New Hampshire and Vermont, these States being the farthest removed from large trade centers, are feeling especially optimistic over the Fall prospects. In fact, the indications are for big and healthy business.

Vacations are now a thing of the past and this means that everyone is buckling down to business determined to do his share in helping to create better conditions. Saturday closing, too, is at an end, which means a longer business week for the stores.

Many Unfilled Orders for Edisons

Frederic C. Silliman, New England head of the Pardee-Ellenberger Co., reports that there are more unfilled orders on the books than he has seen in a long time and this is pretty good indication of a big September business. Lately the company has been holding an ex-

hibit in its handsome showrooms of the New Edison models, these ranging from \$60 to \$135. The many dealers who looked them over were so pleased with them that large advance orders were the result. The baby console, in particular, proved highly attractive to the trade and it is likely that this type will be carried by many Edison dealers throughout New England within the next two months.

Frank S. Horning Sells Out

On August 31 Frank S. Horning terminated his connection with the Frank S. Horning Co., Inc., at 22 Boylston street, having sold his interest to the F. C. Henderson Co. By the time this is read he will be more or less settled in St. Louis, whither he has gone to take charge of the talking machine and piano department of the Stix-Baer Fuller Co., one of the largest department stores of that city. There is general regret among the talking machine trade at his departure, for while here Mr. Horning became exceedingly popular, not only with dealers, but with the public. Regret at his leaving also comes from another source, the music trade in general, that is, the membership of the New England Music Trade Association, of which he was unanimously elected president at the last annual meeting. Mr. Horning opened his store about three years ago and in that interim he was able to build up quite a good trade in Victor goods, which this store carried exclusively.

Widener Gets Houghton & Dutton Department

Beginning September 1 the talking machine department at the Houghton & Dutton store, corner of Tremont and Beacon streets, which heretofore was leased by the F. C. Henderson Co., came into the possession of J. G. Widener, who will hereafter operate it. Mr. Widener is well known in this city and has conducted several talking machine departments here during the past several years.

Second Victor Salesmanship Class

The second class in Victor salesmanship for the especial benefit of those who were unable to attend the other one held so successfully a fortnight ago started to-day, September 5, to continue through the following three days. The sessions as before are being held in Steinert Hall, which the M. Steinert Co. has generously donated to the class for the purpose. Since the last one F. C. Delano, who conducts these

classes, has been enjoying a vacation at Portland, Me., and came down from there for the new session. Mr. Delano has engagements for classes for a whole year ahead.

John Cotter Visiting Pacific Coast

By the time this issue of The World is out John Cotter, vice-president and treasurer of the Hallet & Davis Co., will be well on his way to the Pacific Coast. He left "The Hub" on September 6 and was accompanied by Mrs. Cotter. They will make a stay of a single day in Chicago and then continue West, taking in the Grand Canyon en route. Their ultimate destination will be San Francisco, where a visit will be paid Mrs. Cotter's family, who resides on the Coast, and to Riverside, where they will be the guests of J. A. Stitt, Pacific Coast road man for the Hallet & Davis Co. From Riverside it is planned to take a motor trip to San Diego. Before returning East Mr. Cotter will pay a visit to Seattle and the return trip East will be by way of Butte, Mont., and Salt Lake City, Utah, in which city a week will be spent. Mr. Cotter plans to be away about six weeks and in that time he will probably come in touch with a good many Hallet & Davis dealers.

The Hallet & Davis Salesman

The fourth number of the Hallet & Davis Salesman has been issued. It has a wealth of good reading, which the dealers of this company ought to thoroughly digest. The talking machine proposition of this house is given due attention and considerable mention is made of the value of publicity when properly handled by dealers. One special article under the title of "National Publicity Increases Turnover" should get a wide reading, for there is much meat in it for dealers to ponder over.

Vocalion Hall News

Manager Birdsall, of Vocalion Hall, in Boylston street, spent the Labor Day holiday on a trip into the country and this several days' week-end holiday helped prepare him for the brisk business which is looked for with the beginning of the September season, a business which Mr. Birdsall believes should continue right along to the holidays. All of Manager Birdsall's retail staff will have returned from their vacations following Labor Day and decks will then be cleared for promising prospects, which already are on the way. The large show

(Continued on page 68)

**DITSON
VICTOR**



SERVICE

**"The Coming Fall" Is Here
Make It a Victor Fall**

There is little time for putting record and machine stocks in perfect form to meet the coming post-summer demand. Fill in the gaps now. Arrange for future requirements.

Ditson Service will lighten the task for you

**CHARLES H. DITSON & CO.
NEW YORK**

**OLIVER DITSON CO.
BOSTON**

A NEW DANCE CRAZE

STUMBLING

A FOX TROT ODDITY

"You can't go wrong
With any FEIST song"

HEAR IT NOW

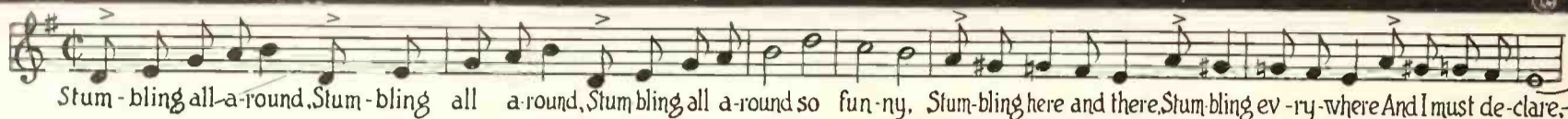

Stum - bling all-a-round, Stum - bling all a-round, Stum bling all a-round so fun-ny, Stum-bling here and there, Stum-bling ev - ry-where And I must de-clare-

THE TRADE IN BOSTON AND NEW ENGLAND—(Continued from page 67)

window of Vocalion Hall has lately had some very attractive displays, such as have caused many a passer-by to halt and take further notice.

Bright Outlook for the Sonora

J. O. Morris, president of the Musical Supply & Equipment Co., was in town last week conferring with Joseph Burke, New England manager of the company, relative to the Fall business and arranging about the supply of Sonora machines, for which Manager Burke is having a wide demand from dealers carrying this line. He says that he has a lot of business booked up for September. A new house of importance to take on the Sonora is N. F. Joslin & Co., of Malden, which is one of the largest, if not the largest store in that city. The company's initial order was a very large one. Mr. Burke was only able to get a ten days' vacation toward the middle of August, when he motored up with Mrs. Burke to North Woodstock, N. H.

Victor Co. Officials Stop Off

J. S. Macdonald, sales manager of the Victor Co., paid a flying visit to Boston the latter part of August while en route to Wells Beach, Me. He had his golfing outfit with him, but could not be induced to stay here long enough to play with some of the local experts. Ralph L. Freeman, director of distribution at the Victor factory, was also here, as he was on his way to Nova Scotia. Harry McClaskey, better known as Henry Burr to the friends of the Victor, came to Boston during August to visit his

brother, who makes his home in the neighboring town of Brookline.

Reports Better Conditions in South

R. O. Ainslie, of the Hallet & Davis Co., is expected back in a few days from his extended but hurried trip South in the interests of the talking machine product of this house, as well as the other lines that are carried. His trip began at Atlanta, and thence he visited Birmingham, New Orleans, Houston, San Antonio, Dallas, Little Rock and St. Louis. From letters he sent back to the office he found a decided improvement in business conditions at every point visited. Meanwhile, the traveling staff, which is devoting its attention to pushing the Hallet & Davis phonograph, is finding business considerably better than it was and everyone is most sanguine for a good Fall trade.

W. A. Batchelder to Re-enter Trade

Warren A. Batchelder, widely known in talking machine circles throughout the New England States, and for the past several years manager of the former Tremont Talking Machine Co., now the Iver Johnson Co., Tremont street, will re-enter the trade following a brief, but well-merited, vacation.

Mrs. E. H. Lansing in Spain

Mrs. Lizzie Lansing, widow of the late E. H. Lansing, local manufacturer of talking machine and piano moving covers, who was widely known to the trade, is touring Spain, accompanied by her daughter, a teacher of economics

in Smith College. Mr. Lansing, who died several years ago during the National Music Show in New York, was the originator of the Lansing khaki cover, now made and sold by the Lansing Sales Co., 170 Harrison avenue, this city, of which Henry Smith is president and general manager.

Sees Distinct Change for Better

That radiant smile which usually wreathes the face of Fred E. Mann, the New England manager of the Columbia Co., is more radiant than ever these days and there's a reason: he sees a distinct change for the better in the trend of business. He says the rush began to be plainly manifest the end of July; that all of August there was a distinct improvement in trade, and his fear now is that dealers who neglect to lay in adequate stocks are going to get left when the rush sets in, for the holiday impetus usually gets pretty well under way late in October. Mr. Mann says that the call for machines has been much larger than in some time, but it is in the record business that the greatest improvement has been seen, and this particular line he describes as actually booming.

Fine New Store in Norwich, Conn.

Manager Mann a few days ago entertained at his office Abner Schwartz, head of Schwartz Bros., of Norwich, Conn., who told Mr. Mann about the new building which his house, one of the largest furniture concerns in New England, is having erected, and which is to contain an exclusive Columbia department, to be in charge of L. H. Webber. The formal opening of the new store is scheduled for September 15, and it is not unlikely that Mr. Mann will go down to Norwich for the event, for he will be in New London about that time for a conference of Rotary Clubs, of which he is an officer here in town. Mr. Mann has been enjoying several week-ends this Summer in motor trips to Lake Winnepesaukee, New Hampshire, where friends of his have a beautiful Summer home.

Some Interesting Personals

O. F. Benz, Columbia record sales manager, and E. O. Rockwood, general record manager for the same company, were Boston visitors the latter part of August.

R. F. Bolton, of the recording department of the Columbia Co., spent a part of August at Falmouth Heights and made a few visits while there with Manager Mann at the Boston offices.

KRAFT-BATES AND SPENCER INC.
NEW ENGLAND DISTRIBUTORS

Brunswick
PHONOGRAPHS AND RECORDS

The Brunswick Finance Plan, about which you have doubtless heard a great deal during the past year, has now been in operation long enough to prove its great money-making value for dealers under any and all conditions.

We will be glad to mail you the full details in the form of a booklet, or to discuss them personally.

KRAFT, BATES & SPENCER, Inc.

1265 Boylston St.

Boston, Mass

New England Distributors

Steel Needles Motrolas Record Brushes Khaki Covers



"LONG QUALITY" CABINETS
"PEERLESS" ALBUMS

Both of these well-known accessories help to make

GOOD FALL BUSINESS

for the Talking Machine retailer.

Let Hough tell how.

L. W. HOUGH

New England Representative

20 SUDBURY STREET BOSTON, MASS.

Mr. Bolton up to four years ago was Columbia district manager for New England and New York State.

Billy Fitzgerald, whose Victor shop in Cornhill continues to be discovered by his out-of-town friends as they journey Bostonward, says he has had a very good Summer. He has not as yet been able to get away, but is planning a few days' respite at Mason, N. H.

George Krunscheid, who is well known in the trade, is now allied with the Independent Talking Machine Co., which is operated by Halperin Bros. at 128 Summer street.

Two new additions to the staff of F. C. Henderson's Brunswick shop at 152 Boylston street are Miss G. C. Swift and Miss Eva O'Brien, both experienced women in the talking machine business. A new man at this same place is Thomas H. Wallace, who comes here from Quincy, and who will solicit on the outside for the talking machine business of this house.

A. J. Jackson, head of the Boylston street Victor warerooms bearing his name, spent part of his vacation the latter part of August on a motor trip to the Provinces.

Winthrop M. Harvey, head of the C. C. Harvey Co., spent a part of August on a motor trip with Mrs. Harvey and a party of friends to the Province of Quebec. Ernest A. Cressey, of the company, is back from a three weeks' vacation with Mrs. Cressey at Jackson, N. H., and Wallace W. Flagg, the dean of the sales force of the Harvey house, also has returned from his vacation, also spent in the White Mountains, to which place he goes every year.

Columbia Men to Visit North

George P. Donnelly, assistant manager of the Columbia Co.'s New England department, is starting away on September 18 for a couple of

EASTERN SERVICE

NEW ENGLAND SERVICE FOR NEW ENGLAND DEALERS



Join the Eastern Family

and enjoy the exceptional service which our efficient organization is rendering to New England dealers.

Victor Wholesalers Exclusively

85
ESSEX
ST.

THE EASTERN TALKING MACHINE CO.

BOSTON
MASS.

VICTOR DISTRIBUTORS

weeks' trip, which will take him through Maine and Canada. He will be accompanied by W. R. Ingalls, the Columbia's traveling representative for Maine and New Hampshire.

some of the problems which face them from time to time.

The grand wind-up of the session was in the nature of a testimonial to those attending the class and members of their families. This outing, dinner and dance took place at Pemberton, which was reached by a delightful sail down Boston Harbor. Attending this outing were 361 men and women, and the three jobbers already mentioned were the hosts, with such men as George A. Dodge, Herbert Shoemaker, Kenneth E. Reed and Henry Winkelman especially in the forefront to see that everybody had a good time. On leaving the boat at Pemberton the first thing in order was a group picture taken in front of Hotel Pemberton, then everybody repaired to the splendid salt water swimming tank, where there was a most enjoyable program of swimming and diving and other forms of aquatic sports, and where some of the Victor people showed themselves as much at home in the water as on land. In

(Continued on page 70)

FIRST VICTOR SALESMANSHIP CLASS SCORES IN BOSTON

Under the Auspices of the Three Local Jobbers One Hundred and Seven People Attend Opening Class Held by F. A. Delano—Event Closed With Outing, Dinner and Dance at Pemberton

BOSTON, MASS., August 30.—The first Victor salesmanship class in this city is a thing of the past and the three jobbers, the Eastern Talking Machine Co., the Oliver Ditson Co. and the M. Steinert & Sons Co., may well take pride in the success which attended the class from start to finish. Despite the fact that there were many Victor people on vacations the attendance at the class numbered 107, which is the largest single class ever held since F. A. Delano has been conducting them, which work he has been engaged in now for some months in the interests of better Victor business. It is of special interest that the success of this

class has been such as to warrant the three local jobbers in seriously considering another class for the benefit of those unable to attend and who have evinced a keen interest in the idea. For this possible second class there already are forty-eight enrolled. There is little that is new to say regarding the class, for the trade press has had a good deal of late touching Mr. Delano's success and the methods which he pursues in attaining his altogether praiseworthy results. There are lectures, sales debates, arguments presented by imaginary buyers as well as by sellers, a recital of the experiences of those in the class, including

**"Perfection" Edison Attachments
and
"Perfection" Reproducers**

The "Perfection" Flexi-Tone Edison Attachment (No. 4 and No. 7) as illustrated, attached to all types of Edison Disc Machines, makes the most perfect attachment available for playing all makes of lateral cut records requiring steel, tungstone or fibre needles. Only first quality mica diaphragms used in "Perfection" reproducers, giving clear, natural tone. The horizontal ball-joint and direct uplift construction give freedom of movement so that attachment may be used with or without lever, giving excellent results.

Retail price \$9.00 Gold. \$8.00 Nickel.

The "Perfection" Pur-I-Tone Edison Attachment (No. 6 Universal) plays All makes of records on New Edison Disc Machine.

Retail price \$10.00 Gold. \$9.00 Nickel.

The "Perfection" Edison Attachment (No. 4 and No. 2) plays all makes lateral cut records on New Edison Disc Machine.

Retail price \$7.00 Gold or Nickel.

The "Perfection" Pur-I-Tone Reproducers to play all makes hill and dale records on Victor Machines.

Retail Price \$6.00 Gold. \$5.00 Nickel.

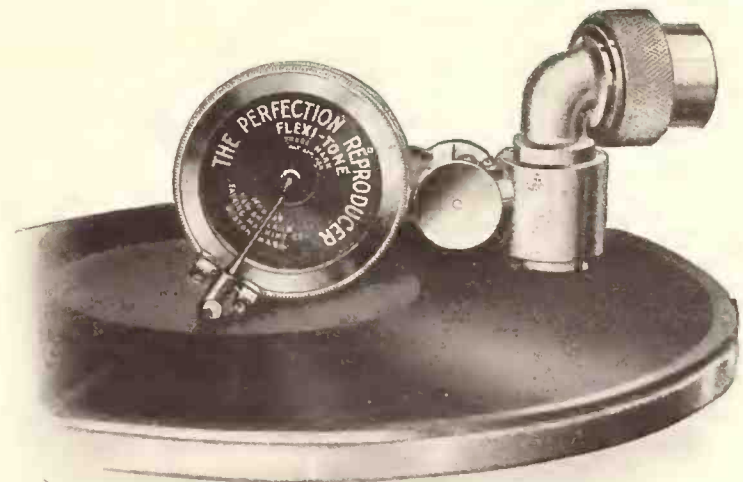

The "Perfection" Flexi-Tone Reproducers to play all makes lateral cut records on Victor and Columbia Machines.

Retail Price \$6.00 Gold. \$5.00 Nickel.

The "Perfection" Pur-I-Tone Reproducers to play all makes hill and dale records on Columbia Machines.

Retail price \$6.50 Gold. \$5.00 Nickel.

NOTE—Special Discounts to Dealers, also Quantity Prices on Request

New England Talking Machine Co. 16-18 Beach St., Boston, Mass.

THE TRADE IN BOSTON AND NEW ENGLAND—(Continued from page 69)

the swimming contest Miss Frances E. Bahr, of Bahr's Music Store, at Quincy, was the winner over seven male contestants, and in the greased pillow contest John Mahoney, of Steinert's, and Roddy A. McInnes, of Houghton & Dutton's; Chris Gormley, of Henderson's, and John Baldelli, of Steinert's, provided great amusement. In the tub race the contestants were Mahoney, Gormley, Miss Bahr, Baldelli and Harris G. Monroe, of Monroe's Music Store, at Orange. Monroe was the only one to paddle the course. Some of the finest diving of the afternoon was that by Miss Bahr, who is an especially graceful figure in all sorts of water sports, and Charlie Von Euw, of Steinert's. In the tug-of-war, captained on the one side by Baldelli, with Mahoney as anchor, and by McInnes as captain, with Jack Elliott, of Shepard's, as anchor on the other team, the former won. The ball game was between the boys at Steinert's, captained by Von Euw, and the Eastern, captained by Waldron, and might have been a longer one if Dodge and Reed hadn't got tired of umpiring. As it was, the Eastern team was the winner. Never mind the score.

Then came the dinner, served in Pemberton Inn. It was one of the best that could be provided and was a shore one in every sense. There was one large table, at which the heads of the three jobbing houses entertained Mr. Delano, who, upon his appearance, was greeted with a round of applause. For the dancing Bert Lowe's Orchestra furnished the music and it is of more than ordinary interest that many of the dealers who heard this orchestra for the first time declared it to be of such quality as to warrant it being included in a Victor catalog, that its members should be counted among Victor artists.

Toward the end of the dinner Mr. Delano was called upon for a few words. He thanked the class for their constant interest during the sessions and expressed his gratification at being able to conduct so intelligent a body of men and women. Subsequently Walter Gillis, a Victor dealer, proposed a vote of thanks to Mr. Delano for what he had done for the dealers here in New England and to the several local Victor jobbers for providing so enjoyable an entertainment. At the final session of the class Mr. Delano was presented with a handsome gold pocket knife and a platinum chain. Those attending the class who came from a distance and who could not go

back and forth daily were housed at the Hotel Bellevue, where everything was done to make their stay in town a pleasant one. There was a special word of appreciation to the Steinert house for its courtesy in opening Steinert Hall for the sessions of the class. Mr. Reed, as chairman of the general committee, had a very busy week, but there was seemingly nothing overlooked to make the whole affair a splendid success.

Members of the Salesmanship Class

Mrs. Grace E. Stiles, Apollo Music Co., Boston; Ralph M. Avery, Avery Furniture Co., Framingham, Mass.; Mildred Emerson, W. H. Avery, Concord, N. H.; Beatrice B. Bahr, Frances E. Bahr, Helen S. Bahr, Bahr Music Co., Quincy, Mass.; Cora Barite, Barite Talking Machine Co., Boston; Helen Egan, Barney's Music Store, Newport, R. I.; Anna Quinn, Barton Co., Manchester, N. H.; Philip Lewis, H. W. Berry Co., Cambridge, Mass.; Marguerite Kimball, Leola Handley, Bon Marche Co., Lowell, Mass.; Maude Marion Jackson, J. E. Bostock Co., Taunton, Mass.; Chester E. Clarkson, Clarkson Furniture Co., Waltham, Mass.; Gertrude Hazen, Stephen S. Bruin, Oliver Ditson Co., Boston; E. Gertrude Briggs, Flint Adaskin Co., Providence, R. I.; Catherine Walsh, Walter J. Gillis Co., Boston; F. T. White, C. C. Harvey Co., Boston; Claire Leduke, J. Heidner & Son, Springfield, Mass.; Edna Neumann, J. Heidner & Son, Holyoke, Mass.; Christopher A. Gormley, Henderson's, Boston; Roy L. Hunt, Roy L. Hunt, Medfield, Mass.; Gertrude Swift, Henderson's, Boston; Philip Cohen, A. Hirshberg & Sons, E. Boston; Paul E. Humez, M. L. Howard, Cambridge, Mass.; Emma G. Purinton, Frank B. Howard, Rutland, Vt.; Alice Gray, Mrs. B. H. MacIntosh, A. M. Hume Co., Boston; Frederick D. McGinn, Iver-Johnson Co., Boston; G. W. S. Ide, G. W. S. Ide, Reading, Mass.; Harriette A. Knowles, Jordan Marsh Co., Boston; Charles Dolinsky, Kaplan Brothers, Fall River, Mass.; Adelaide I. Chesley, John Z. Kelley, Lynn, Mass.; Doris G. Steady, George L. Kerr, Elmira DeGabbis, George L. Kerr, Franklin, Mass.; Amelia Silvia, Kahn's Music Co., Middleboro, Mass.; Ellen Hortense Hubbard, Lefavour's Music House, Salem, Mass.; D. Levenson, Jr., D. Levenson, E. Boston; Mildred Gertrude Galligan, Lilly Co., Stoughton, Mass.; Daisy M. Pirie, Littlefield Piano Co., Barre, Vt.; Mr. Manganaro, G. DeBizzozera, Paul Bouchard, Manganaro Music Co., Quincy,



Attendants at the First Victor Salesmanship Class Held Recently in Boston, Under Auspices of Local Victor Jobbers

PHONOGRAPH AND PIANO ACCESSORIES

Manufacturers

LANSING KHAKI COVERS

The Pioneer Moving Cover

SLIP AND RUBBER COVERS FOR PHONOGRAPHS AND PIANOS

Distributors

Bradley and Plymouth Portable Machines	Piano Benches
All-in-One Reproducers	Piano Stools
Nyacco Record Albums	Piano Chairs
Universal Fixtures	Piano Scarfs
Victrolene Polish	Player Benches
Jones Motrolas	Music Cabinets
Hall Fiber Needles	Lesley's Patching
Steel Needles	Outfits
Sapphires	

The Electora for the Player Piano

TRY OUR SERVICE!

Lansing
SALES CO.

170 Harrison Avenue

BOSTON, 11, MASS.

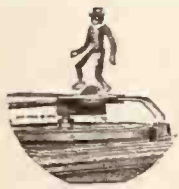

Ragtime Rastus
Price \$1.35

MAGNETIC THE DANCERS

PATENTED AUG-1922



Shimandy
Price \$1.65

A
Great
Attraction
for
Your Window

Retail
Price \$1.00



Simple
to Adjust
on Any
Phonograph
No
Attachments

Retail
Price \$1.00

INTRODUCING OUR LATEST ITEM

This fascinating little couple will waltz, one-step or fox-trot to the music of the record in a most realistic manner. Captivating in appearance and dainty in movement, they appeal at once to the most discriminating purchaser.

NATIONAL COMPANY, Cambridge 39, BOSTON, MASS.

We also announce reduced prices on our original line.



Boxing Darkies
Price \$1.50



Fighting Roosters
Price \$1.65

Mass.; Elizabeth Murphy, A. McArthur Co., Boston; Harris G. Monroe, Monroe Music Store, Orange, Mass.; Marion W. Balcom, H. F. Morse, Wareham, Mass.; Oscar Carlson, Nichols & Atkins, Harwich, Mass.; Mr. and Mrs. Harry Russell, Outlet Co., Providence, R. I.; Phyllis A. Barry, F. W. Peabody, Amesbury, Mass.; Wm. L. Persons, Wm. L. Persons, Hudson, Mass.; William J. Brown, J. J. Piotti, J. J. Piotti, Dorchester, Mass.; Frederic A. Flint, Madeline Storer, Grace Galt, E. A. Robart & Son, Brookline, Mass.; Stephen H. Reynolds, M. J. Reynolds, Milford, Mass.; Mr. Rheinherz, Byron Auer, Rheinherz Music Store, Roxbury, Mass.; Olga E. Mitchell, Marguerite K. Woods, Herbert W. Roper, Marcellus Roper Co., Worcester, Mass.; Mr. Grogan,

M. Lubababine, Rosen Talking Machine Co., Boston, Mass.; Louis M. Fincke, Harry Rosen, Miss White, Saul A. Rouffa, E. Cambridge, Mass.; Paul D. Wood, C. H. Seavey, Saco, Me.; George E. Seavey, G. S. Snow, George E. Seavey, Haverhill, Mass.; Alice Preston, Shepard Co., Providence, R. I.; Miss Sprague, United Talking Machine Co., Brockton, Mass.; Marie Jeanne Boisvert, Warren Upham, Mrs. Warren Upham, Mrs. Charmard, H. W. Upham, Malden, Mass.; Richard Loring, Wakefield Music Store, Wakefield, Mass.; Mrs. E. F. Welch, Irene E. Welch, E. F. Welch, Westboro, Mass.; Clayton L. Caswell, Wheeler's Pharmacy, Springfield, Vt.; Mr. Edwards, Wheeler's Pharmacy, Claremont, N. H.—truly a very representative assemblage.

grown from a very small business to a very substantial manufacturing plant."

Mr. Douglass' death was a distinct shock to Mr. Ready. However, the manner in which he quickly took up the management of the business and carried it on portends the success with which the company will, undoubtedly, meet under Mr. Ready's direction.

DEMAND FOR "RADAK" RADIO SETS

CAMBRIDGE, MASS., September 5.—The Clapp-Eastham Co., of this city, reports an exceptional demand for its radio sets. This company, founded in 1906 and incorporated in 1908, was one of the first companies in the field. From the small space occupied by this concern in 1906 the business has grown so that it now occupies not only its main fourteen-story factory building at Cambridge, but has several other factories where parts are made.

Last month the announcement was made of the adoption of the name "Radak" as the distinguishing name for Clapp-Eastham products and an extensive advertising campaign was placed through the Churchill Hall Advertising Agency, New York City, in national publications, featuring this new name in connection with Clapp-Eastham sets. An extensive Fall campaign has been started and attractive literature prepared for the jobber and dealer.

There are three ways in which to find the value of a dollar; one is to find out what you have to give in order to get a dollar; the second is to spend it and see what you can get for a dollar; the third is to save it and see what you can do without and keep the dollar.

APPOINTED CHIEF EXECUTIVE

W. A. Ready Advanced to Important Position in National Co., of Boston—Well Qualified by Experience for New Duties

CAMBRIDGE, MASS., September 8.—Announcement has been made by the National Co., of this city, of the appointment of W. A. Ready as chief executive of the company. Mr. Ready has been associated with the National Co. for the past seven years and was closely associated with R. L. Douglass, the former head of the company, in his executive duties, thus qualifying him admirably to occupy the place recently left vacant through the death of Mr. Douglass.

Mr. Ready greatly admired his former co-worker and briefly outlined to a representative of The World the remarkable career of Mr. Douglass. He said, in part: "Mr. Douglass was born in Plymouth, Mass., November 14, 1879. His father, Roswell S. Douglass, was one of the owners of the Plymouth Woolen Co., which later became a part of the American Woolen Co. He attended the public schools of Plymouth and then graduated at the

East Greenwich Academy, at East Greenwich, R. I., at the age of fifteen years. He later entered Wesleyan at Middletown, Conn.

"His first business experience was with the Judson L. Thomson Rivet Co., of Waltham. Later he was employed by the F. S. Webster Co., of Boston, and with it advanced very rapidly, until he became head of its Philadelphia office. He later resigned his position and joined the advertising department of Collier's Weekly. His next business was as sales and advertising manager of the B. F. Sturtevant Co., of Hyde Park, Mass., where he remained for five years. He resigned in 1914 with the intention of traveling in Europe, but the war broke out and Ragtime Rastus had just been patented, so Mr. Douglass and his associates formed a company for the sale of the talking machine toys. During the past seven years, through his efforts in the National Co., it has

COTTON FLOCKS for UNIFORM QUALITY RECORD MANUFACTURE GUARANTEED

Write for Trial Samples—Supplied Without Charge

CLAREMONT WASTE MFG. CO., Claremont, N. H.

ASK TO HEAR IT



THREE O'CLOCK in THE MORNING

Tempo di Valse Lente



It's three o'clock in the morn - ing.

"You can't go wrong with any 'Feist' song"



The WORLD FAMOUS CHIMES WALTZ THAT IS MOVING A MILLION FEET

BUFFALO

*Unexpected Increase in Sales
Volume Raises Spirits of Merchants — Activities of Month*

BUFFALO, N. Y., September 7.—From wholesalers and retailers come reports of a business improvement that exceeds anything which the trade had hoped for at this season of the year. Sales of machines and records increased in unexpected volume during the last half of August and the first week of September. There is every indication that the improvement will not only continue but will increase when the busy season for the trade is reached. Many firms report August showing a very large increase over July in the amount of business transacted and also a big gain over the corresponding month of 1921. Inquiries as well as sales have shown a splendid gain and throughout the trade there is a pronounced feeling that the end of the depression has been reached and that the talking machine merchant is due to have a Fall and Winter of real prosperity.

Victor dealers are greatly interested in the announcement of the new flat top models, which have been followed by the placing of

many orders by retailers. Both C. N. Andrews and the Buffalo Talking Machine Co. report dealers placing orders for large numbers of the new machines, and predict that they will become very popular additions to the Victor line. It is expected Model 210 will develop into a real Victor leader.

Meetings of the Victor Talking Machine Dealers' Association of Western New York will be resumed in September, it is expected.

Frank E. Bolway & Son, Inc., of Syracuse, distributors of the Edison line in western New York, recently completed a most successful week's showing of the line which they represent. Parlors were engaged in the Lafayette Hotel and letters were mailed inviting 1,000 dealers to visit the displays. Every Edison machine ranging in value up to \$375 was shown and all were demonstrated to the score of dealers who called each day to see the exhibit, which included the new junior models. Delight was expressed by the trade generally at the first showing of the new junior models and also at the quality revealed by some of the new records which were played. The exhibit was in personal charge of C. L. Eddy, general sales manager of the Syracuse company and some important agencies were closed.

The Utley Piano Co., Edison dealer, will be forced to seek a new location, as the property which it occupies in Main street has been

sold to a jewelry company and will be taken over by them when the present lease expires on November 1.

William F. Froehley, for many years musical instrument and record dealer in Hamburg, a suburb of Buffalo, died recently at his home in that village, at the age of 63 years. He was postmaster of the village for 17 years.

G. D. Lynch has opened an up-to-date music store in Main street, Medina, and is devoting a large portion of his establishment to talking machines and records. The store will be a unit of the chain operated by Goold Bros., of this city. Mr. Lynch was formerly with the J. N. Adam & Co. music store here.

The Sonora has a fine new home in Buffalo, the store of the John G. Schuler Co. at Main and West Utica streets having recently expanded. An additional adjoining store room has been taken over by the company and is now being used. New departments and display windows have been installed in the increased space.

Charles H. Hutchens, founder of the Hutchens Music House in Lockport, died at his home in that city after an illness of two months. He was formerly proprietor of music stores in Ridgeway and Olean. His son, Henry W. Hutchens, took over active management of the Lockport store some time ago.

Stephen Butler has resigned as manager of the new music store of J. N. Adam & Co., one of the largest and finest in western New York. The store recently moved into the building which it now occupies in Washington street. Mr. Butler's successor to this position has not been named.

Victor & Co. have remodeled their talking machine department and have installed five new booths for demonstration purposes. This firm recently took over the stock and Victor franchise of C. E. Siegesmund. President Arthur Victor is giving a large share of his time and attention to the new department.

A Pathé Actuelle was featured in the act of Rasso, European juggler, which was recently presented at Shea's Theatre.

ANNOUNCE NEW POPULAR PRICE MOTOR

The Favorite Mfg. Co., 105 East Twelfth street, New York City, is introducing a new motor for talking machines which is available in quantity lots at a very popular price. The product is of original design with double spring and playing four ten-inch records. It has a cast-iron frame, is worm-driven and of the beveled gear winding type. A ratchet device prevents clicking and it has other points of merit.

The Favorite Mfg. Co. is also making a special sales campaign on graphite lubricant, the manufacturers of which are Ilsey, Doubleday & Co. It is taking particular pains also to introduce to the talking machine trade Hohner harmonicas.

Sherburne Automatic Stop

Stops When You Want It to Stop

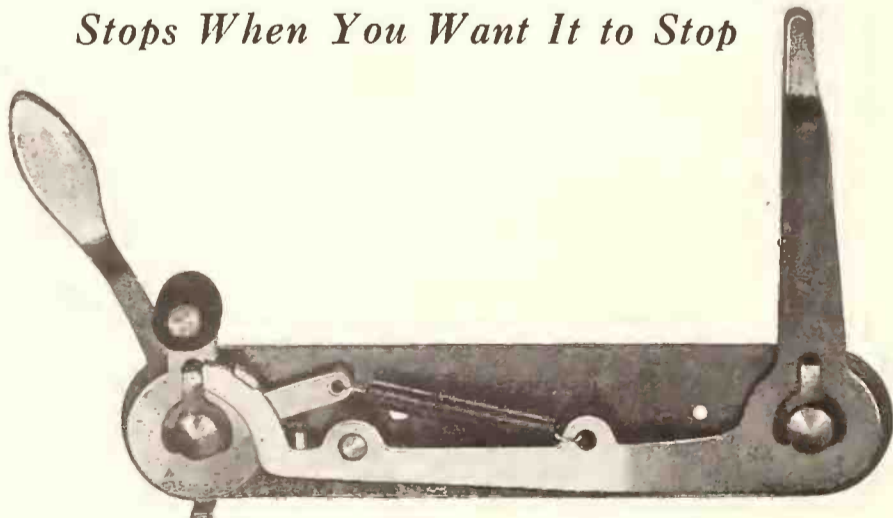

Manufacturers: Has *your* automatic stop ever helped your dealers make a sale?

Investigate the Sherburne

Sample sent upon request

SHERBURNE MANUFACTURING COMPANY
948 Penobscot Building

Detroit, Mich.

THE BIGGEST MONEY MAKING HIT OF THE TALKING MACHINE WORLD



KODISK

TRADE MARK
"SNAPSHOTS OF YOUR VOICE"

You see it everywhere—in hundreds of stores, in thousands of homes—the new wonder that you can sell to everyone who owns a talking machine and is a buyer of records.

KODISK

TRADE MARK
"SNAPSHOTS OF YOUR VOICE"

WHAT IT IS

Kodisk is a silvery metal disk on which you make your own phonograph records—by using your own phonograph to record and then playing it on the same machine like any ordinary record with a steel needle.

WHAT IT DOES

It records songs, voices, etc.—even baby's laugh and prattle is perfectly reproduced.

WHO BUYS IT

Every man or woman who owns a phonograph wants it, the minute you show it and explain its wonderful possibilities for fun and entertainment.

HOW THE RECORDS ARE MADE

Use an ordinary paper megaphone as an amplifier to sing into the horn of any phonograph—or for still more perfect and professional results, use the SPECIAL KODISK RECORDER (retail price \$6.00)

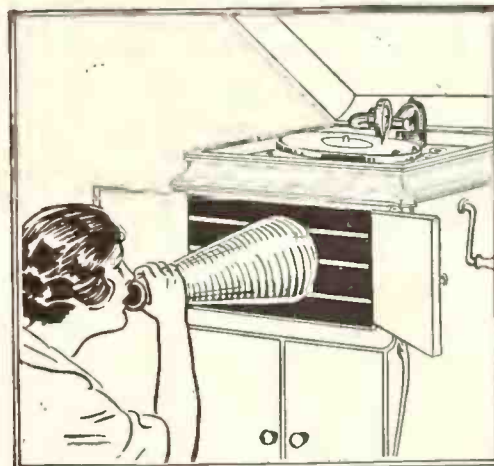

Eight-inch KODISK RECORDS—ready to record, RETAIL for 60c. (double-sided)

WARNING! KODISK Records are manufactured under United States Patent No. 1421045, issued June 27, 1922. Our patent protection extends not only to all kinds of sound records made in metal tablets with any type of groove, but also covers broadly the process of recording in metallic substances, including the grooved blanks intended for home use on ordinary phonograph machines.

We accordingly advise the trade that only the blanks sold under the KODISK trade-mark and manufactured by the Metal Recording Disc Company are authorized to be made, sold or used.

The METAL RECORDING DISK CO., Inc.
MANUFACTURERS

Fisk Building, 57th St. and Broadway, N. Y.

M. & M. DISTRIBUTING CORP., Room 1308 Mallers Bldg.,
5 So. Wabash Ave., Chicago, Ill., Illinois Distributors

PHONO-VATIONS CO., INC., 37 E. 18th St., N. Y.
Distributors for New York State

FOX PHILADELPHIA CO., 723 N. 26th St., Phila., Pa.
Distributors for Pennsylvania

JOHN M. FOSTER CO., 6 King St., W., Toronto
Canadian Distributors

NOTE the special article in Popular Mechanics, August issue, featuring KODISK editorially.

CLEVELAND

Opening of New Knabe Warerooms a Great Event—Handles the Victor—Clever Columbia Stunt—New Brunswick Dealers—The News

CLEVELAND, O., September 8.—Monday, August 28, was a big day in Cleveland's musical circles, for on that day what may well be considered the last word in a music establishment catering to the ultra made its bow to Clevelanders with the opening of the Knabe Warerooms. The event marks another step in the retail talking machine industry here, in that it is the only independent exclusive Victor establishment on the avenue.

The Knabe establishment consists of three floors located in the Bulkley Building. The first floor comprises a window, in which only one instrument at one time will be displayed; a lobby graced with Oriental rugs and furniture in keeping with the same, a broad aisle flanked on one side by nine Victor demonstration rooms, and on the other by a series of grand pianos, representing the last word in the product of the Knabe, the Fisher and the Franklin.

The main room on the second floor will be given over to Victrola display and sale. This second floor is one of the few unique shops in the upper story of the Bulkley Building.

M. O. Mattlin, who has opened this establishment, points out that the new store opens with a new policy in music merchandising circles here. While, of course, the policy of one price will be maintained and rigidly adhered to, it will also have the distinction of being one of the most exclusive music merchandising enterprises in the country.

It was with this idea in mind, Mr. Mattlin explains, that after negotiating with Edward B. Lyons, general manager, the Eclipse Musical Co., Victor wholesaler, he determined to put in the Victor line to be the exclusive talking machine sold in the new warerooms. Ralph Rolan,

well known in local talking machine circles, is in charge of the Victor department here.

Brunswick Chippendale Admired

A shipment of the new Brunswick Chippendale models was received here last week, and a display of these machines made at the Halle Bros. Co. and the May Co. was much admired.

Great Columbia Publicity Stunt

The Cleveland branch of the Columbia Graphophone Co., working with Wm. Taylor, Son & Co., put on one of the biggest publicity "stunts" last week ever staged by any talking machine company in Cleveland. A display fea-



Columbia Models in Lobby of State Theatre

turing the Columbia period Grafonolas was exhibited in the lobby of Loew's State Theatre, and in connection was an exhibit showing the various processes necessary in manufacturing the Columbia record. This theatre is reported to have the largest lobby of any theatre in America, and over 60,000 people are in attendance at the theatre during the course of the week.

The display was attractively arranged and re-

ceived widespread interest and comment. George Krauslick, Dealer Service manager of the Cleveland branch, recorded the first sale of the exhibit by disposing of an electric model, P-27, Grafonola to Kenneth Reid, manager of Loew's State Theatre.

Featuring Victor Health Records

The newest additions to the health records which have arrived in Cleveland are those put out by the Victor people, and from all reports they are proving big sellers. The Buescher Co. is introducing these new records to the public in a novel way. An advertisement is being run in the dailies and on one side of it is an acrobat dressed in black tights juggling three big records on his feet. In heavy print at the top of the article is the announcement, "Keep Fit to Victor Music," under which is the following explanation, "Good health—the prized possession of those who exercise—is easily maintained by regular daily exercise, made attractive by cheering, rhythmic music. Twelve new complete exercises planned and supervised by Professor Chas. Collins. You'll be astonished by the invigorated feeling that follows their use. Hear them to-day!"

The May Co. is also promoting the Victor health records. A health room is now established in this store in which the Victor Health Records, the Walter Camp Health Builders and the Wallace Reducing Records are all displayed.

Baby Console Edison Model in Demand

The Phonograph Co. announced the fact last week that the "Baby Console" model of the Edison, retailing at \$175, is now available for dealers. This phonograph, like the higher-priced console types, is equipped with a "reproducer-locating device." It is expected to prove a big seller, as the Edison phonograph is a well-known make, and other console types are not being received in large enough numbers to supply the demand.

Advertising the Ohio Convention

As a means of advertising the convention at Toledo this September the Music Merchants' Association of Ohio is sending all retail music

HALL FIBRE NEEDLES

A Necessary Accessory—Made in America

represent years of experience in tonal development. Personal inspection of each needle produced in our factory assures perfect reproduction and

GUARANTEES SATISFACTION

Every Talking Machine Owner a Customer

HALL MANUFACTURING CO.

Successors to B & H FIBRE MFG. CO.

33-35 W. Kinzie St.

Chicago, Ill.



Date.....

Jobber's Name

Address

Gentlemen:—Please forward via

..... CARTONS COMBINATION HALL FIBRE NEEDLES
25 pkg. No. 1—50 pkg. No. 5.

..... CARTONS NO. 5 PACKAGES HALL FIBRE NEEDLES
100 pkg. in carton.

..... CARTONS NO. 1 PACKAGES HALL FIBRE NEEDLES
50 pkg. in carton.

DEALER'S NAME

ADDRESS

Marion Harris is blue-belle of the Blues. When you hear her sing "Send Back My Honeyman" you'll hand her the blue ribbon. To top this she's in again with "Away Down South." This record should pay your electric light bill. A-3659.

**Columbia Graphophone Co.
NEW YORK**



dealers what is known as a "Joy Bond." Two coupons are attached to the bond, one an application for membership to the Music Merchants' Association of Ohio, and the other for reservations at the convention. The bond is signed by F. N. Goosman, president, and Rexford C. Hyre, secretary.

Mr. Hyre recently announced that a golf tournament will be held at the annual convention and that Henry Dreher, of the B. Dreher's Sons Co., Cleveland, will present a golf cup to the winner.

New Brunswick Accounts

J. L. Du Breuil, district manager for the Brunswick-Balke-Collender Co., tells of four new accounts which have recently been closed. With the opening of E. W. Edward & Sons, a department store in Buffalo, N. Y., another dealer will be added to the already long list of exclusive handlers of the Brunswick records. D. D. Rupert, of Currensville, Pa., and the M. Huff Piano Co., of Clarion, Pa., will also handle Brunswick goods exclusively. A piano store is soon to be opened by J. W. Green & Co., of Toledo, at Fremont, O., and in addition to the piano stock it is to be an exclusive dealer for the Brunswick records and machines.

Columbia Activities and New Agents

George Krauslick, the wide-awake service manager of the Columbia Graphophone Co., is attending the State Fair in Columbus. He is well able to handle exhibitions and should be a great help to W. S. Minek, of Columbus, who is having an exhibit of Columbia machines at the fair.

The right to sell Columbia records and machines has been given the Ackerman Piano Co., of Marion, it was announced by S. S. Larmon, branch manager of the Columbia Co. Other new Columbia accounts opened during the month include: A. D. Baumhart, Vermillion, O.; Chas. F. Finck, Fredericktown, O.; F. M. Le Page, Sycamore, O.; Joseph C. Fister, Monroeville, O.; C. W. Sipe, Shelby, O., and the Collins Furniture Co., Spencerville, O.

Doing Well With Strand Line

The new Strand line is being featured by the Fischer Co., distributor for this territory, in a series of displays which have already resulted in the opening of a number of new accounts, according to R. J. Jamieson, sales manager. Displays were held in Columbus and Toledo, resulting in the opening of nine accounts.

HUNT MUSIC HOUSE CHANGES

Leonard E. Teed Becomes Secretary and Treasurer of White Plains Concern—Jas. A. Stafford Heads Talking Machine Department—Many Improvements Made in Store

WHITE PLAINS, N. Y., Sept. 5.—A change has been brought about in the official organization of Hunt's Leading Music House here through the election of Leonard E. Teed, Deputy County Treasurer of Westchester County, as secretary and treasurer of the company, succeeding L. R. Yeager, resigned. John H. Hunt continues as president of the company, with N. D. Hunt as vice-president.

An important recent addition to the staff of the store is James A. Stafford, a well-known and experienced talking machine man, and formerly connected with the advertising department of the Victor Co. in Camden, who has taken charge of the Victor department of the Hunt store and has already accomplished much in that capacity.

John H. Hunt, president of the company, reports a very satisfactory volume of business, which is increasing steadily with the growth of White Plains as a business and residence center. The company has placed Victrolas in practically all the public schools of the city and recently sold a Krakauer grand and a Victrola to the new Pelhamhurst Country Club.

The store has recently been remodeled to provide more space, the improvements including a mezzanine floor to house the offices and the newly equipped sheet music department. The grand piano department has been moved to elaborate quarters in the basement.

At the present time Hunt's Leading Music House handles Estey, Krakauer, Leins and Kohler & Campbell pianos and players, Victor talking machines and records, Q R S music rolls, sheet music and musical merchandise.

Mr. and Mrs. Hunt and Mr. and Mrs. Teed returned recently from an automobile trip through the Adirondacks and Canada, coming back by way of the Green Mountains.

The Del Norte Talking Machine Co., San Francisco street, El Paso, Tex., recently doubled its floor space to take care of increased business.

O. J. DEMOLL VISITS GOTHAM

Washington Music Merchant Says Prospects Are Bright in the National Capital

Otto J. DeMoll, head of O. J. DeMoll & Co., Washington, D. C., representative for the Aeolian Co. line of pianos, Pianolas and Duo-Art pianos, as well as wholesale representative for Vocalion phonographs and records, was a visitor to New York recently, he having brought his daughter from a Summer camp in Vermont to Atlantic City, where Mrs. DeMoll and two other daughters have been spending the Summer.

Mr. DeMoll stated that business prospects in the National Capital were for the most part very encouraging. The Government had discharged thousands of clerks who had been engaged in war work, but there were still left many thousands who are excellent prospects for piano and talking machine sales. An interesting feature of the Washington trade is that it is not subject to industrial changes to any degree, the bulk of the population being on the Government payroll regularly.

BECKER MUSIC CO. OPENS IN CAIRO

CAIRO, NEB., Sept. 5.—The Gaston Music Co. one of the oldest concerns engaged in the musical instrument business in this part of the State, has been succeeded by the Becker Music Co. Pianos, player-pianos, Victor talking machines and Edison phonographs are handled.

H. C. Sebiri, connected with the sales department of the Self Service Phonograph Co., is planning a pleasure and business trip through New York State.

**FACTS ABOUT
The PHONO-TONER**

TRADE MARK
(Registered in U. S. Patent Office)

It takes a lot of the harshness out of the reproduction of records.

Dealers featuring it have found that they could deliver better phonograph music.

They had more pleased customers too. These considerations should make it worth while for the progressive merchant to try out a sample—sent no charge.

The Phono-Toner displaces nothing, injures nothing; helps phonographs and records.

Retails 35c and 50c. Write Today

The Phono-Toner (actual size)



**The Phono-Tone Co.
310 Lincoln Building
PHILADELPHIA, PA.**

Forms handle for needle set-screw.



**The "VICSONIA"
REPRODUCER**

For Perfect interpretation of Edison Disc Records on Victrolas and Grafonolas.

Fitted with permanent jewel point. No loose parts.

Meet the demand—Serve your customers

Sample Model "A" or "B" Vicsonia, nickel plated, will be sent on receipt of \$4.50. Retail price \$7.50.

Note: Model "B" Vicsonia plays both Edison and Pathé records.

VICSONIA MFG. CO., Inc.

313 E. 134th STREET NEW YORK, N. Y.



New Gennetts Every Week!

In the Blue Label Gennett Records are released the latest popular songs and dance hits and standard numbers. Their timeliness, wide range and quality have given them tremendous popularity.

Gennett Records released under the Green Label represent the highest attainment in the art of sound recording. The best standard numbers come under this label, which assures variety in selection, perfect reproduction and the real musicianship of the artist.

"First and Best on Gennetts" is the slogan today. There is an opportunity for you in selling Gennetts. Get acquainted with them.

GENNETT RECORDS

Manufactured by
THE STARR PIANO COMPANY
 Richmond, Indiana

New York—Chicago—Los Angeles—Birmingham—Detroit—Cincinnati—Cleveland—Indianapolis
 Boston—Jacksonville—London, Canada

SAN FRANCISCO

Sales Volume Increases—New Victor Styles Interest—To Hold Music Week in November—New Managers and Other News of Month

SAN FRANCISCO, CAL., September 4.—Buying on the impulse of the moment is no longer an important factor in the music business on the Coast, say the leading dealers of San Francisco, yet for all that the sales volume is steadily increasing. Talking machine sales have increased as well as piano sales and the buyers seem largely to weigh and consider most deliberately before purchasing. The increased sales are not due to the special prosperity of any one class, though the employed class has shown greater purchasing power of late, probably on account of the activity in the many California seasonal industries. The railway strikes have caused prices of agricultural products to drop somewhat in the local markets, but the general condition of the growers is perhaps normal. Most crops are reasonably heavy, and some are unusually so.

Interested in New Flat-top Victor Consoles

The trade is showing much interest in the new flat-top console type machines announced by the Victor Co., and the announcement of another record exchange, the second for the year thus far, is welcome news to the talking machine dealers. B. R. Scott, assistant wholesale manager of the Victor department of Sherman, Clay & Co., says September records may be a little late in arriving on the Coast on account of the railroad troubles.

Mr. Hamilton, traveling representative for the Victor Co., is back on the Coast after a trip to the factory at Camden. He was in San Francisco a few days and then left for Los Angeles. He will be in the South for about a month and then spend most of his time in northern California for several months to come.

Master Syncopationist Buys Brunswick

Paul Ash, the popular pianist and musical director of the Grand Theatre Orchestra, recently purchased a Brunswick phonograph at the Sterling Furniture Co., which company has one of the most active Brunswick departments on the Coast. Paul Ash is a master syncopationist whose jazz programs have excited the wonder of modern music-lovers.

New Manager at Hauschildt's

Clarence Moran, manager of the talking machine department of the Hauschildt Music Co., has resigned his position to accept one in the piano department of the Wurlitzer store, in this city. Mr. Myers, the assistant manager of the Hauschildt department, has been promoted to the post of manager.

Apollo of the Sales Game Tells Secret

Billy Morton, manager of the retail Victor department of Sherman, Clay & Co., in this city, is generally considered an Apollo in the

local talking machine fraternity. "My wonderful physical development," says Billy proudly, "is due entirely to the Victor Health records. I demonstrate these records so often that I have become the living apotheosis of the doctrine they promulgate—the doctrine of physical health and beauty."

Outlook Is for Lively Fall Trade

Raymond E. Wolfinger, manager of the talking machine department of the Wiley B. Allen Co., has returned from a vacation trip to Lake Tahoe and the Yosemite Valley. He says the local business of the company is very good and that the outlook is for a lively Fall trade.

James J. Black, treasurer of the Wiley B. Allen Co., is shortly to become a benedict, so Dame Rumor has it. At least he has been seen out with the same girl twice lately.

A Progressive Columbia Manager

The most successful business record of the San Francisco branch of the Columbia Graphophone Co. in the last year is due largely to the progressive and energetic activities of P. S. Kantner, who has been the acting manager. Mr. Kantner's success has been recognized by the company and his appointment as manager of the branch has been confirmed in a letter from G. W. Hopkins, the general sales manager. Mr. Kantner has lined up the California Columbia dealers in his district so that they now work with great effectiveness in the various co-operative advertising campaigns. The Eastern Outfitting Co., San Francisco, one of the largest Columbia dealers in the district, sold 509 Columbia machines during the last three advertising campaigns. Mr. Kantner is at present on a trip to New York.

November 5 to 12 Will Be Music Week

The time has been definitely decided for Music Week in San Francisco. The week from November 5 to 12 is the time chosen as being the best to suit all those musical interests which will line up to make the week a success. The co-operation of all sorts of clubs and societies is assured and no doubt the week this year will make a decided stir. The talking machine dealers will see to it that the phonograph is given due prominence in many of the musical programs being planned.

Install Talking Machine Department

E. M. Loveland, of Ferndale, Cal., has installed a talking machine department in his store, but as yet is handling records exclusively. He has the Okeh line.

Broadcasting Conditions in Radio Field

Radio interest in the interior districts of California is not growing as fast as it should by reason of the inadequate broadcasting. The

average radio set cannot receive at long enough distances to make the Coast broadcasting available, and the local broadcasting is usually none too attractive. Interest in the large cities continues to increase steadily. Vocal and instrumental selections by the artists themselves produce the best results through the ether, though the record broadcasting is sometimes very satisfactory. J. J. Black, of the Wiley B. Allen Co., who is a splendid singer, sang for the radio at the Hale Bros. station this month.

Takes on Music Rolls

The California Phonograph Corp. in this city, has departed from its time-honored policy of dealing exclusively in talking machine merchandise and now has taken on the Q R S music roll line distributed in this territory by A. L. Quinn, the Pacific Coast manager of the Q R S Music Co., of Chicago.

PHYSICAL CULTURE RECORD SET

Dr. Royal S. Copeland Author of Series of Exercises Set to Music Issued by Bridgeport Die & Machine Co.—Opportunity to Keep Fit

BRIDGEPORT, CONN., September 6.—A new physical culture record set has been placed upon the market by the Bridgeport Die & Machine Co., record manufacturer of this city. Dr. Royal S. Copeland, well-known health commissioner of New York City, is the author of the various exercises and also gives a series of talks on health. The set consists of five ten-inch records in an album. On the A side of each record are contained the various physical culture exercises and on the B side a health talk. The exercises are to musical accompaniment and charts are supplied. It has been stated that Dr. Copeland will answer without cost health inquiries in connection with this record set which may be mailed him by owners of these sets at any time.

Both James W. Ogden, president, and W. A. Macfarlane, secretary and treasurer of the organization, are giving much of their attention to this new end of the business and are making a number of trips throughout the country in the interest of the physical culture set and the Puritan records, which this concern also produces.

ELKHART'S NEW STORE

Stewart & Schultz to Handle Pianos, Talking Machines and Band Instruments

ELKHART, IND., September 5.—Stewart & Schultz is the name of the new music firm which has just opened a fine store in this city. Members of the firm were formerly with the Boyer Music House and are experienced men. The lines they are carrying are Kimball pianos and phonographs and the complete Kimball line, including the Hinze and Whitney, also the Hobbart M. Cable line, Pierion phonographs and Martin band instruments and the Pedler family of wood-wind instruments.

BLUE BELLE
100 EXTRA LOUD 100
100 EXTRA LOUD 100
THE ONLY PHONOGRAPH NEEDLE TAPERED LIKE AN ARTIST'S FINGERS

THE NEWEST IN NEEDLES BLUE BELLE

THE NEEDLE THAT LENDS BEAUTY TO YOUR RECORD AND REPRODUCES A PERFECT TONE
IT MINIMIZES SURFACE NOISE
THE NEEDLE GIVING DEALERS A HANDSOME PROFIT—YOUR TRADE WILL BE ASKING FOR IT
BE READY TO SERVE THEM

Packed 100 Needles to a Package. 100 Packages to a Carton
Extra Loud, Loud, Medium and Half Tones—Price, \$4.50 per Carton

SAMUEL ESHBORN
65 FIFTH AVENUE NEW YORK
The Service House for Talking Machine Repair Parts and Supplies



But those good old days,—have passd and gone, ————— Good old days,— I had my hab-its on, —

STATE STREET BLUES

A Fox Trot Blues

HEAR IT NOW!

"You can't go wrong
With any FEIST's song"

CABINET & ACCESSORIES NEW HOME

Growth of Business Compels Removal to Larger and Well-equipped Quarters at 3 West Sixteenth Street, New York

Growing business has again made a move to larger quarters by the Cabinet & Accessories Co. imperative. This company, under the whole-hearted leadership of Otto Goldsmith, president, started several years ago with a small beginning and the representation of a very few lines of merchandise. At the present time, however, the Cabinet & Accessories Co. distributes practically everything in the talking machine accessory line and also has many articles of interest for the piano and radio dealer.

Attractive quarters have been secured at 3 West Sixteenth street. Occupation of the new building will be accomplished between September 15 and 20 and is so planned as to eliminate any interference with the regular business

of the company. Over 3,000 square feet have been secured and the company will occupy the entire second floor of the building, which is modern in every respect. The floor will be attractively arranged and an excellently planned showroom will enable a proper display of the many lines distributed.

VALUABLE ARTICLES AVAILABLE

National Bureau for Advancement of Music Issues List of Nearly 400 Articles of Special Interest to Members of Trade

The National Bureau for the Advancement of Music has just compiled a list of nearly 400 newspaper articles on musical subjects of special interest to the trade and the public with the suggestion that dealers get copies of the articles of direct interest to them either for publication in their local newspapers or for use in connection with their own publicity.

The Bureau sends to the newspapers of the country four articles each week, the articles covering a surprising range of subjects along musical lines. The articles are of a character that make them useful in many ways and it will be well for members of the trade to get in touch with the Bureau and secure copies of the articles of special value to them.

The fact that the 400 articles listed have been sent out by the Bureau in about a two-year period affords some idea of the work of that organization in only one of its phases. The list is too lengthy to print here, but copies can be secured from the National Bureau for the Advancement of Music, 105 West Fortieth street, New York.

An attractive music studio has been opened in the Y. M. C. A. building, Burlington, Vt., by C. W. Ross, formerly connected with the College Music Rooms. Mr. Ross will specialize in pianos, talking machines and radio outfits.

An Addition to the MUTUAL LINE

The New No. 1 A Tone Arm

Designed for both PORTABLE and UPRIGHT machines. Superiority in tone and appearance combined with low price make this one of the best values obtainable. It will make your business grow.

If you manufacture portable or small upright machines you will be interested in this combination. A trial order will convince you.

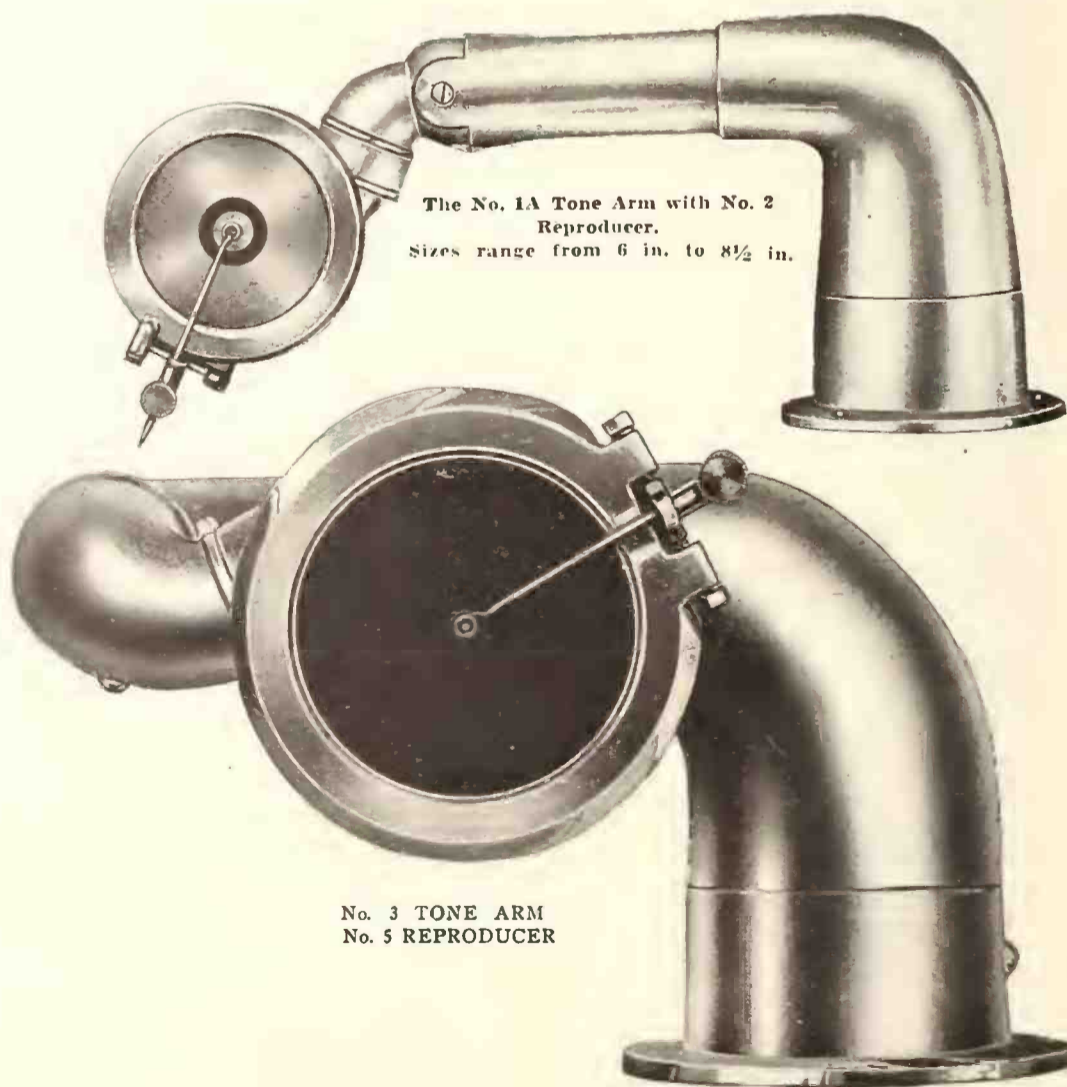

The No. 1A Tone Arm with No. 2 Reproducer. Sizes range from 6 in. to 8½ in.

No. 3 TONE ARM
No. 5 REPRODUCER

Mutual Phono Parts Manufacturing Corp.,

149-151 Lafayette Street
New York City

The Russell Gear & Machine Co., Ltd., 1209 King St., West, TORONTO, CAN., Exclusive Distributors for Canada and All Other British Possessions



Absolutely true to its period, with inlay at both front and ends, and with ¼-inch, 5-ply panels, this William and Mary Console combines both quality and compactness. It is 34¼ inches high, 32¼ inches wide, and 20 inches deep. Finish is in burl walnut or highly figured mahogany. There is not a single nail in its entire construction. Though priced at only \$135, this Jewett model competes successfully with any phonograph in the \$300 class.

❖ The Lions Roared ❖

The Lions of musical instrument merchandising heard our call and they've been roaring ever since. As a result, we are closing new contracts all over the country, in rapid succession, for the Jewett Line—the Line for Lions—Phonographs, Radiophonographs and Radio.

For, with such a line, the Lion of every community sees that he can get the Lion's share of the business.

On the sound foundation of his phonograph goodwill, he will also sell Radio. And the additional trade, thus built up,

will bring him more phonograph sales.

Leadership and Permanence are the rewards which each Lion is going to wrest from his competitors during the selling season now beginning.

Are you still hiding your head like the Ostrich, when Radio is forced on your attention? Or have you the courage and foresight to be a Lion and get the Lion's share of the business of your community, Phonograph and Radio combined?

If you're really a Lion, cut loose with that roar!

THE JEWETT RADIO AND PHONOGRAPH CO.
DETROIT, MICHIGAN



The Stewart Sales Co., 18 W. Georgia Street, Indianapolis, Ind.
Distributors for Indiana and Kentucky

JEWETT

RADIO AND PHONOGRAPHS



Columbia Record A-3665 is such a record as comes along only just about once in so often. It's Guido Deiro, the incomparable accordion player in two dreamy waltz selections. It's a record that every cake eater and finale hopper will welcome as a change from jazz.

Columbia Graphophone Co.
NEW YORK

USING ADVERTISING TO STABILIZE A NEW INDUSTRY

Waldemar Kaempffert, of Thos. F. Logan & Co., Gives Interesting Résumé of the Radio Corporation's Activities and Progress in the Radio Field in a Recent Issue of Printers' Ink

The feature article in the August 31 issue of Printers' Ink is entitled "How the Radio Corporation Is Using Advertising to Stabilize a New Industry," and under this heading Waldemar Kaempffert, of Thos. F. Logan & Co., gives an interesting résumé of the Radio Corporation's activities and progress in the radio field. Thos. F. Logan & Co. are handling the advertising of the Radio Corporation of America, and Mr. Kaempffert is therefore in a position to give authoritative data on the tremendous publicity campaign sponsored by this well-known company.

Mr. Kaempffert points out that, in co-operation with other manufacturers, the Radio Corporation is endeavoring to establish radio as a permanent influence in American homes, and in his article he traces briefly, but most interestingly, the phenomenal growth of the radio industry during the past year.

Practically every form of successful publicity is being used by the Radio Corporation of America in behalf of the industry as a whole and R C A products in particular. Mr. Kaempffert, in his article, reproduces some of the advertising that the Radio Corporation is using in national periodicals, trade papers and newspapers, emphasizing the fact that in order to protect the dealer trade-marks and trade names

were adopted. The name "Radiola" was given to all receiving sets, the name "Radiotron" was given to vacuum tubes and the letters R C A, distinctively drawn and enclosed in a circle, were adopted as the official trade-mark. Dealers displayed this trade-mark either in the form of decalcomanie window designs or in the form of wall cards. It is to be found in every advertisement, whether addressed to the public in magazines and newspapers or to the dealer and trade papers, and, of course, is found on every piece of apparatus supplied by the Radio Corporation of America.

Mr. Kaempffert, in his article, points out the motive and policy influencing each and every piece of advertising used in the Radio Corporation's campaign. Some of the advertisements do little more than classify the different types of Radiolas and explain very simply what may be expected of each. Other advertisements are devoted almost in their entirety to an explanation of the Radio Corporation's relation to the public, to the dealer and to radio itself, thereby constituting an expression of policy.

Last Spring, when it was impossible to meet the demand for radio apparatus, the Radio Corporation of America took the public into its confidence, showing the public that men and women were working day and night in its factories in

an effort to meet the demand for apparatus and accessories. Production figures were given and definite pledges were made that the output would be increased by named months. When these named months were at hand advertisements again informed the public of the fact that the pledges had been fulfilled.

Referring to the trade paper advertising used by the Radio Corporation of America, Mr. Kaempffert in this article states in part as follows:

"In the trade paper advertising which is aimed at the dealer the selling assistance that the Radio Corporation of America is willing to render is stressed as much as the character of its apparatus. In addition, the policies set forth in the popular magazines and newspapers are outlined for his benefit. Dealer helps, now widely used by all good merchandisers, are even more necessary in successfully selling radio products than shaving soaps and automobiles because radio is still a mystery to the man behind the counter. The salesmanship displayed by many dealers in handling radio supplies has rarely been brilliant.

"Last Winter the retailer had little to do but take orders. Next Winter he must be prepared to talk interestingly and convincingly about the radiolas and the radiotrons which he must not only display in his window and on his shelves, but also advertise in his local newspaper. He must be prepared to meet his customer again and again after a sale has been made, because that customer is sure to return for an interpretation of instructions that he cannot understand, despite all the care that has been taken to make them simple and clear. Hence the Radio Corporation's dealer helps constitute a special course in radio merchandising, which supplement its educational advertising in national mediums and newspapers."

WHY BUSINESS FASCINATES

Business is the greatest game ever developed. Like every other sport, the man who shows the best form, who keeps fit and does not permit himself to grow stale, is the winner of the competitive tournaments ever going on.



No. 3533-Twelve Flowering Plants, including pots in a box, complete \$5.00; larger size No. 3534 six plants to a box, per box \$3.60.
Write for ILLUSTRATED CATALOGUE NO. 35. Mailed FREE FOR THE ASKING.

FRANK NETSCHERT, Inc.
61 BARCLAY ST. NEW YORK, N. Y.

Order Your Supply of the New Encore Record Replayer Now

THE MOST EFFICIENT DEVICE OF ITS KIND EVER PRODUCED

The
Record
Replayer
Without
a
Fault



Made of
Steel.
Nickel-
Plated.
Celluloid
Adjuster

Retails at \$1.00

Discount to Dealers 40%

ORDER NOW AND WATCH YOUR SALES INCREASE

Some Territory Still Open for Jobbers

ENCORE SALES CORPORATION

Sole Manufacturers' Representative

6 CHURCH STREET

NEW YORK, N. Y.



STEGER

*the finest reproducing
Phonograph in the World*



Model
506
\$250



Model
502
\$125



Model
503
\$165



Model
509
\$225

THE most convincing proof of the Steger's wonderful powers of perfect tone reproduction is your complete forgetfulness of the phonograph's presence when it plays.

So clear, resonant, lifelike is all music reproduced by the artistic Steger that you seem to hear the actual notes of the human voice, piano or violin, band or orchestra as vividly as if the performers were present.

You will find the reasons for this perfection in the exclusive Steger features—the patented adjustable tone arm, which plays all disc records correctly without change of parts, the unique Steger tone reproducer and the vibrant Steger tone chamber of even grained spruce.

The Steger Sells Readily

The more you study this incomparable phonograph, the more easily will you recognize its sales advantages. The Steger is backed by a profitable merchandising plan that adds immeasurably to the value of Steger representation.

Desirable territory open. Write for the Steger proposition today!

Phonograph Division
STEGER & SONS
Piano Manufacturing Company
 Established by John V. Steger, 1879

Steger Building, . . . CHICAGO, ILL.
 Factories: Steger, Illinois, where the "Lincoln" and "Dixie" Highways meet.

"If it's a Steger—it's the most valuable Piano in the world."



Model
505
\$200



Model
504
\$150



Model
501
\$100



Model
510
\$250



Model
500
\$65

PAUL SPECHT SIGNS WITH COLUMBIA

Paul Specht's Famous Orchestra Arranges to Record Exclusively for Columbia Co.

The Columbia Graphophone Co. announced last week that arrangements had been completed whereby Paul Specht and his orchestra, known as Paul Specht's Society Serenaders, would record exclusively for the Columbia library. The first records of this well-known organization will be issued in the October list and will consist of "Silver Stars" and "In Rose Time."

This announcement by the Columbia Co. will

Paul Specht is an accomplished musician, and studied music under the capable guidance of his father, Prof. Chas. G. Specht, a well-known violinist, and one of the best-known organists and band leaders of his day. He also studied piano, violin and counterpoint at Coomb's Conservatory at Philadelphia, thereby gaining an invaluable musical education.

Paul Specht organized the "American Collegians" orchestra that toured the entire West with remarkable success, and shortly afterward appeared with his orchestra at the Alamac Hotel in Atlantic City. His success at this well-known hostelry was instantaneous and he was next engaged to supply the dance music for the

Hotel Addison at Detroit. In that city his orchestra soon became a by-word for the best dance music obtainable, and when he severed his connections at the Hotel Addison Mr. Specht was the guest of honor at a banquet which was attended by practically all of the leading musicians in Detroit.

After leaving Detroit Paul Specht's Society Serenaders were engaged for the Hotel

Astor roof dances, where the orchestra is now appearing. Under his capable direction his orchestra has attained a foremost position in New York's amusement circles, and the Hotel Astor roof is crowded nightly with dance enthusiasts who appreciate and recognize the distinctive playing of Paul Specht's Orchestra.

According to his present plans, Paul Specht will soon send three orchestras to London, and his Metropolitan orchestra, under the direction of J. Denny, is now playing Keith vaudeville in the Middle West. It is understood that Paul Specht's Society Serenaders will also be booked



Paul Specht's Famous Orchestra Now Recording for Columbia Co.

undoubtedly be received with enthusiasm by Columbia dealers from coast to coast, as Paul Specht and his orchestra represent one of the most successful and popular dance organizations in the country. Paul Specht has attained national renown as a leader in the individual interpretation of modern dance music and is the originator of the expression "Rhythimized Symphonic Syncopation." His organization has made a specialty of providing the popular dance hits with a unique and distinctive tone shading that has been a paramount factor in the success of the orchestra.

ILSLEY'S GRAPHITE PHONO SPRING LUBRICANT

Ilsley's Lubricant makes the Motor make good. Is prepared in the proper consistency, will not run out, dry up, or become sticky or rancid. Remains in its original form indefinitely.

Put up in 1, 5, 10, 25 and 50-pound cans for dealers. This lubricant is also put up in 4-ounce cans to retail at 25 cents each under the trade name of

EUREKA NOISELESS TALKING MACHINE LUBRICANT

Write for special proposition to jobbers

ILSLEY-DOUBLEDAY & CO., 229-231 Front St., New York

shortly for another tour of the Keith circuit, this organization having already appeared as a headliner on the big-time circuit, and winning an ovation at every performance.

FINAL EXCISE TAX REPORT

Music Industry Paid Nearly \$5,000,000 During Last Half Year That Tax Was in Force

WASHINGTON, D. C., September 5.—Although in force only during the first half of the fiscal year, which ended June 30 last, nearly \$5,000,000 were collected from the tax on pianos, organs and other musical instruments, according to figures which have just been made public by Commissioner of Internal Revenue David H. Blair. Collections for the period from July 1 to December 31, 1921, totaled \$4,951,752, it is stated, while for the entire fiscal year 1921 they had amounted to \$11,568,034, indicating that the musical instrument business had held up wonderfully during the months of general trade depression.

NEW STORE AT ATLANTIC CITY

Luigi A. Ferrari, the well-known musician of Atlantic City, N. J., has opened a new music store at 3902 Ventnor avenue, that city, where he handles a complete line of pianos, player-pianos, Victrolas and small musical instruments.

The Platt Music Co., of Los Angeles, Cal., has purchased the music business formerly conducted by the Whightman Music Co., 334 Fine avenue, Long Beach, Cal.

Do You Know What a Flexlume Sign Will Do?

A Flexlume Electric Sign will give you forceful advertising at a cost of only a few cents a day. It will work for you day and night, for Flexlumes are day signs as well as night signs. It will give your storefront a quality atmosphere, it will carry your message to the thousands who pass, all of which means that a Flexlume will increase your business.

Let us send you a sketch showing a Flexlume to meet your particular needs.

FLEXLUME CORPORATION
36 KAIL STREET BUFFALO, N. Y.

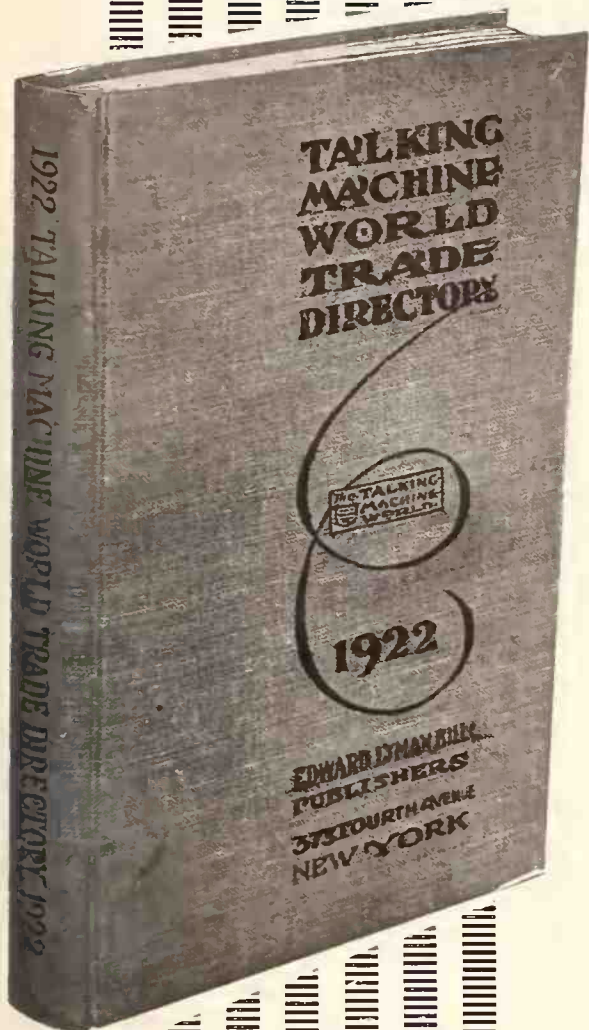

Only 50 Cents

THE most convincing evidence that THE TALKING MACHINE WORLD TRADE DIRECTORY is successfully filling the role for which it is intended lies in the great number of repeat orders we are daily receiving from those who purchase one copy to start.



One of our satisfied users writes: "There has never been a trade directory got up that has been so accurate as regards firms listed, and that has covered the field so thoroughly."



That means this book can and will serve you, whatever your connection with the industry may be, in a manner you can't afford to miss—especially in view of the nominal investment required. Better order your copy now!

**USE THIS
COUPON NOW**

Send Stamps or Check



EDWARD LYMAN BILL, Inc.,
373 Fourth Ave., New York City.

Gentlemen:

Please send me postage prepaid a copy of the 1922 edition of The Talking Machine World Trade Directory, in payment for which I enclose 50 cents.

Name

Firm

Street

City and State.....

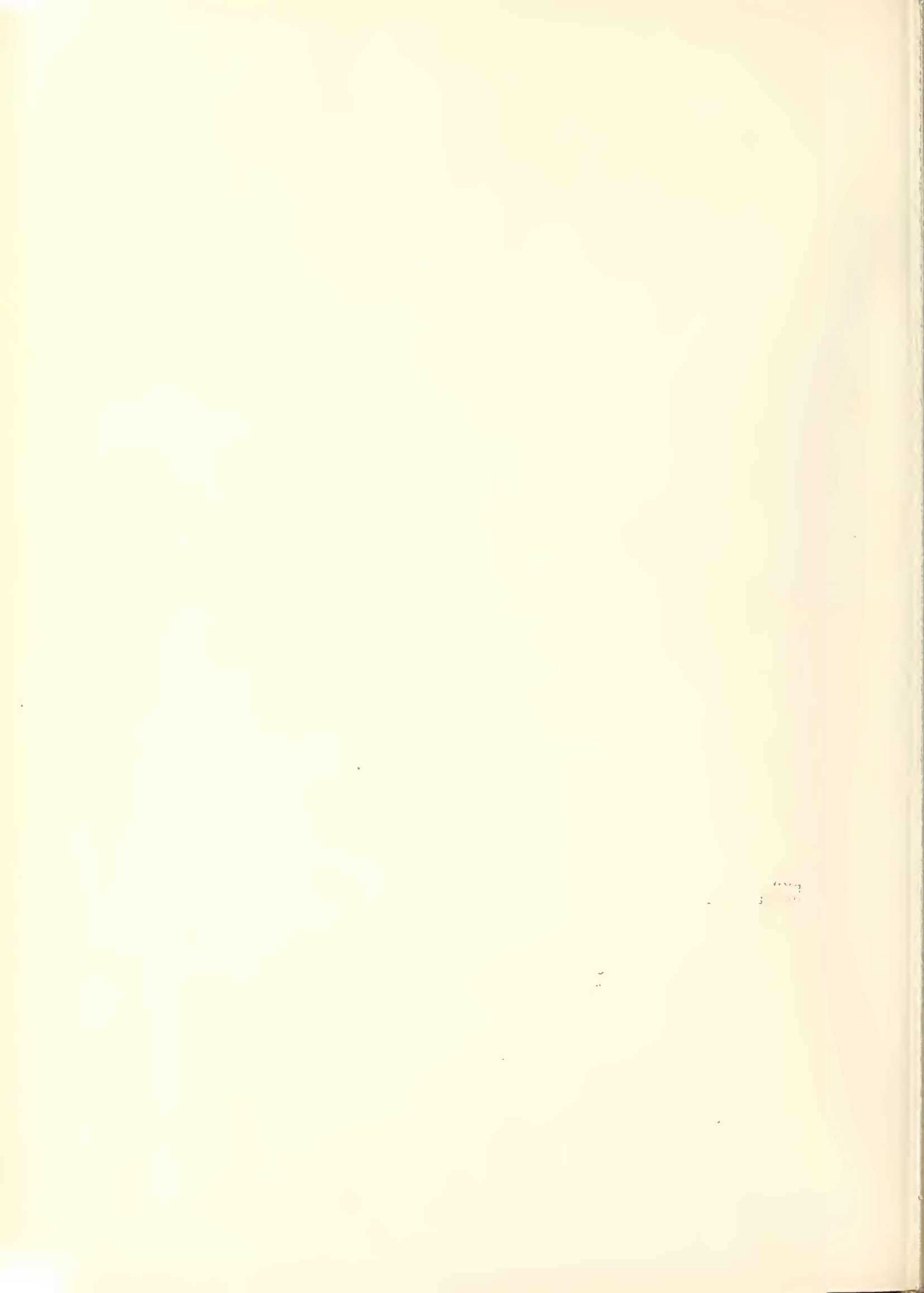

The Trade in PHILADELPHIA and LOCALITY

PHILADELPHIA, PA., September 6.—While many of the talking machine dealers of the Quaker City declare that their Fall business has started out in fine shape, nevertheless, the talking machine distributors feel that the complete adjustment of the rail strike as quickly as possible is necessary to ensure Fall business reaching, or even approximating, the usual figures for this time of the year.

Although Philadelphia does not lie in the heart of the coal regions, nevertheless, talking machine distributors were affected by the walk-out of miners to a considerable extent. They point out that many people not even connected with the coal industry have delayed making purchases of talking machines and records until the trouble was readjusted, as their natural conservative instinct warned them not to spend recklessly when conditions are not wholly normal. This attitude on the part of the public naturally caused the dealers to refrain from sending in their orders for new stock for the Fall and, therefore, the entire industry is more or less affected.

Talking machine dealers who are dependent solely upon Philadelphians and residents of the surrounding cities and towns for their business assert that their sales are improving rapidly and most encouragingly, but even this class of dealers say that they are confident that their sales would be increased to an even greater amount if normal industrial conditions prevailed.

Health Records Popular

There have been few innovations in the talking machine record business that have swept over Philadelphia with such success as have

the Victor Health Records recently issued and recorded under the direction of Professor Charles Collins, head of the Collins Physical Training Institute, of this city.

An unusually interesting demonstration of the Victor Health Records was held at the Bellevue-Stratford Hotel last month, following a luncheon of the Kiwanis Club. The demonstration was arranged by H. Royer Smith, well-known local Victor dealer, and Prof. Collins himself spoke. After the lecture and demonstration the club members went through the various exercises.

This exhibition was witnessed and, in fact participated in, by a number of the leading Victor distributors of Philadelphia who were present at the Kiwanis luncheon as the guests of Mr. Smith. These leaders in the talking machine trade of this city included G. W. Hoover, the president of the Victor Dealers' Association; A. C. Weymann, of H. A. Weymann & Sons; T. W. Barnhill, of the Penn Phonograph Co.; Louis Buehn, head of the firm that bears his name, and E. J. Dingley, assistant sales manager of the Victor Co.

H. Royer Smith was also the first Victor dealer in this city to give exhibitions of these health records in the show windows of his store, and the number of sales that he made during these demonstrations as well as that before the Kiwanis Club serve to indicate the popularity these records have attained in such a short time.

Tone Tests at Atlantic City

The Girard Phonograph Co., jobber of the New Edison, is planning to make a series of tone tests during the coming week at Atlantic

City, on Young's Million Dollar Pier, during the progress of the annual pageant. Among the artists who will assist during these tests, so that the audience can try to distinguish between their actual singing tones and those recorded by the New Edison, are Helen Davis, the mezzo-soprano; Victor Young, pianist, and Walter Chapman, the violinist. The Girard Phonograph Co. has recently fitted out a large number of dealers and is expecting a record-breaking business during the coming Fall months, according to Arthur W. Rhinow, one of the officials of the company.

"We have been opening several new accounts every week for the last six weeks and we are looking for the biggest year, as far as business is concerned, that the Edison has ever had," he said. "With the adjustment of the coal and rail strikes there is nothing that can stop the onward sweep of the Edison, I am sure. We are planning to give quite a number of tone-tests during the Fall months, as we have during past years, only this year the demands for these tests have assumed such large proportions that we have been obliged to sign up two troupes of tone-test artists instead of the single troupe that has done this work in the past. We have arranged for the services of Helen Davis, Victor Young and Walter Chapman, as the members of one of these troupes, while Marie Morrissey and Jacques Glockner will make up the other troupe.

"We are also preparing to place on the market the four new junior models of the Edison that will sell at lower prices than those charged for other Edison models, so that the Edison

(Continued on Page 84)

A STATEMENT OF FACT

Every indication points to this Fall being a Victor Selling and a Victor Buying Season.

Fundamental business conditions are better. This means increased buying power for the people. In our line it should be strongly reflected in greatly increased Victor Sales.

Victor Sales because people now demand a quality product of known value. Big sales of bankrupt stocks are apparently at an end, but not the effort to get rid of bad buys. This means selling hundreds of Victrolas to people who are dissatisfied, even to the extent of sacrificing their odd make.

You will be protected in sharing in this Victor Demand by purchasing NOW.

The Louis Buehn Company
The Victor Wholesalers
 of Philadelphia



Wake up lit-tle girl you're just dream-ing pret-ty dreams, Dream-ing the hours a-way,

WAKE UP LITTLE GIRL YOU'RE JUST DREAMING

HEAR IT NOW

"You can't go wrong
With any FEIST song"

THE TRADE IN PHILADELPHIA AND LOCALITY—(Continued from page 83)

will now be within the reach of every home. More than eighty per cent of our dealers have already visited our showrooms here in order to view these new models, and in every case the dealer's enthusiasm for these new models has far exceeded our expectations."

Grafonola Dealers Meet

Members of the Philadelphia Grafonola Dealers' Association held their usual monthly meeting last Tuesday, August 29, at the Adelphia Hotel. J. G. Oldwurtle, the president of the Association, presided and general trade conditions and prospects for Fall business were discussed.

Helping Dealers to Demonstrate

George A. Tatem, of the Talking Machine Co., has been arranging for a number of demonstrations of the Victor Health Records in the show windows of the dealers' stores. He has secured the services of Miss Dorothy Settler, who has been most successful in the demonstrations which she has given during the last three or four weeks under Mr. Tatem's direction. These demonstrations are being furnished free of charge to the dealers of the Talking Machine Co. and have been held recently in Trenton, Wilmington, Camden, Millville and Reading, while Mr. Tatem has just completed arrangements for further exhibitions in Harris-

burg, Lancaster, Lebanon and several other surrounding cities.

Some Recent Visitors

Among the recent visitors seen by Mr. Tatem was Dan Egan, manager of E. S. Applegate Co., of Trenton, who is conceded to be one of the most progressive dealers in the Victor business. Another of Mr. Tatem's recent visitors was John Huff, of Shenandoah, who is expecting a large business during the coming months, with the coal strike adjusted, as Mr. Huff says that he has found that the residents of that vicinity are well supplied with money, but are reluctant to spend it for anything but the necessities of life until the strike is settled and conditions return to normal again.

Opens Handsome New Store

H. Housel, of William H. Housel & Co., of Williamsport, was a recent visitor to the Louis Buehn Co. showrooms. Both F. B. Reineck, secretary, and C. W. Miller, the vice-president of the company, attended the opening of the handsome, newly renovated store of Joseph Heim Co., at 3800 North Broad street. The formal opening of the new store, which was attended by a number of the officials of the Victor Talking Machine Co. and fellow dealers and friends of Mr. Heim, was held on Friday, September 1. Mr. Heim was warmly congrat-

ulated upon the handsome appearance of his new store, which has been enlarged to include the buildings 3800-2-4-6-8 North Broad street. A new front has been completed and the entire interior has been beautifully decorated and refurnished and a number of booths have been installed for the comfort of customers listening to Victor records.

Remick's Remarkable Musical Emporium

The retail branch warerooms of Jerome H. Remick & Co., at 125 South Broad street, which were recently completed, are said to comprise an absolutely complete musical merchandise department store. A place has been provided for



Interior View of Remick Warerooms

everything in the music line with no detail overlooked.

Much attention has been given to the selection of the proper fixture equipment throughout. Dust-proof glass wall cases have been provided for such merchandise that is affected by exposure, such as musical instruments, strings, etc. Sheet music and talking machine records are well provided for in an efficient rack system arranged for ready and quick selling, and well displayed for the attention of the customer. A series of spacious hearing rooms has also been provided for the convenience of the patrons. Van Veen & Co., New York City, the builders of the equipment, state that the Remick establishment is a model one in every detail and after which all the branch stores of Jerome H. Remick & Co. are patterned.

Ability to Size Up a Prospect

"The ability to properly size up a prospect and sell a machine within that prospect's means is a quality of much value to the talking machine retailer," stated H. W. Weymann, wholesale manager of H. A. Weymann & Son, Inc., Victor wholesaler. "If a \$200 machine is sold to a \$100 prospect a repossession is likely, or

H. A. WEYMANN & SON, Inc.

1108 Chestnut Street

Philadelphia, Pa.

VICTOR WHOLESALERS

Q. R. S. PLAYER ROLLS

WEYMANN 'KEYSTONE STATE' STRING INSTRUMENTS

YOUR BUSINESS and OUR BUSINESS

are very much the same, Mr. Victor Retailer. We have the common purpose of increasing Victor merchandise sales. Getting together will prove mutually advantageous



Italian Music Rolls

Largest collection of Italian and other foreign music rolls in the United States. Catalogs and discounts on application.

UNITED MUSIC STORES

619 Cherry Street
225 W. Mulberry St.

Philadelphia, Pa.
Baltimore, Md.

CABLE ADDRESS REG'D
"FILASSE-PHILA."

Send for Samples and Special Quantity Quotations

LONG DISTANCE 'PHONE
BARING 635

IMICO INDIA RUBY MICA DIAPHRAGMS INTERNATIONAL MICA COMPANY

GENERAL OFFICES AND FACTORY: 37th and BRANDYWINE STS., WEST PHILADELPHIA, PA.

PHILADELPHIA, PA.
YOKOHAMA, JAPAN
CHICAGO, ILL.

THE TRADE IN PHILADELPHIA AND LOCALITY—(Continued from page 84)

even if there is no repossession the heavy payments on the higher-priced machine, which ought to be paid off in the same time as a lower-priced machine, will preclude the regular monthly purchase of records. It is a generally accepted fact that the regular purchase of records keeps up interest, which is greatly to be desired, and I feel sure that it is much wiser for a dealer to sell a machine the payments for which will not be beyond the purchaser's means and will allow a balance for the purchase of new records."

In referring to local conditions Mr. Weymann stated that the employment and building situations in Philadelphia were exceptionally good. New homes are being erected in all sections of the city. "Philadelphia," said Mr. Weymann, "is strongly Victor. It considers the Victrola as a home industry and it is safe to predict that 80 per cent of these new homes will be equipped with Victrolas."

General Radio Corp. Proves a Success

The phenomenal success of the General Radio Corp., of this city, in the few months of its existence, is a tribute to the untiring effort of Walter L. Eckhardt, the head of the organization. Through his former connection with local Pathé affairs Mr. Eckhardt is well known to every dealer in the entire city. Mr. Eckhardt's acquaintanceship also extends to all large centers throughout the country.

When the General Radio Corp. was originally formed it distributed radio sets and the Strand line of talking machines. At the present time the General Radio Corp. distributes, in addition to Strand talking machines, Okeh records and the products of the Radio Corporation of America. In addition to the lines distributed the General Radio Corp. also manufactures a wide line of quality radio products under the brand of "Geraco," and the Music Master Amplifier, a sound magnifying radio horn.

Mr. Eckhardt has hinted of other items now in the laboratory stage which are expected to be added to the line before the Winter is over.

Cheery Report Ament Business Expansion

The Fall season is bringing with it renewed efforts on the part of the talking machine dealer for increasing his business. T. W. Barnhill, president of the Penn Phonograph Co., Victor distributor, reports that business is increasing regularly and that many dealers are sending in orders for the Penn-Victor miniature dogs to increase their business.

G. D. Shewell Ends Canadian Tour

G. D. Shewell, Eastern sales representative for the Cheney phonograph, has returned to his headquarters here from an automobile tour of Canada. The party, which included Mrs. Shewell, stopped at a number of points including Montreal and Lake Placid in the Adirondack Mountains. G. D. Shewell, Jr., associated with

his father in the management of the business, left for a trip through Maine immediately following the return of Mr. Shewell.

Popularity of "Little" Songs

The popularity of "little" songs has been pointed out by B. H. Rogers, head of the Lincoln Business Bureau, distributor of the Vocalion phonograph and records. "The vogue of these 'little' songs is still with us," he said. "It started with such favorites as 'The Little Grey Home in the West,' 'Little Mother of Mine' and others using the endearing diminutive. Colin O'More, the Irish tenor, sings the newest of all these songs, 'I Love a Little Cottage,' for the new Vocalion record that tells a simple and likable little musical tale.

"One gets the habit of looking to the Ziegfeld Follies each year," he continued, "for the last word in beauty, fashion and up-to-date music. True to its reputation for the latter, this year's show has both the South Sea and the radio craze as subjects for big hits; namely, 'The South Sea Moon' and 'Listening on Some Radio,' double-headed Vocalion fox-trots performed by the Bar Harbor Society Orchestra."

H. W. Weymann on Motor Trip

Increasing sales were recently reported by H. W. Weymann, head of H. A. Weymann & Sons, who has returned from a well-deserved vacation in motoring through the New England States and Canada with a party of friends. He had a most enjoyable time.

AVOID "WOTINELL" ATTITUDE

The average individual dislikes to go into an establishment and wander around trying to discover where he can quickly be served or obtain the information he may be seeking. If he has, added to this, the feeling created by the familiar "wotinell" attitude so many persons delight in assuming toward an inquirer he is quite likely to go away with an unfavorable impression of those with whom he has been forced to transact his business.—Electrical World.

TWO NEW VICTOR RECORD RELEASES

"Three O'Clock in the Morning," by Whiteman, and "Mister Gallagher and Mister Shean," by the Originators, Just Announced

The Victor Talking Machine Co. has just announced special release of two new records of unusual interest, the first bearing on one side the waltz success, "Three O'Clock in the Morning," and on the other "Oriental," fox-trot, both played by Paul Whiteman and His Orchestra, and the second, a record of "Mister Gallagher and Mister Shean," recorded by Gallagher and Shean themselves and including a number of new verses. The new records will be placed on sale on September 22 and will appear also in the regular November supplement.

The Victor Co. has also announced a special release of three foreign records, including one German and two Neopolitan, which are offered in response to popular demand.

EXPORT TRADE RECOVERING

Analysis by First Federal Foreign Banking Association Shows Expansion

The export business of the manufacturing industries of the United States has shown a remarkable gain since the low point reached in February, and there seems reason for believing that it has started upon a period of recovery, according to an analysis of the situation published in a bulletin of the First Federal Foreign Banking Association. The article points out that the United States is selling a bigger dollar-volume month by month, selling more kinds of manufactured goods and expanding the area of distribution.

Form in business is knowledge of the job. When that is mastered you become runner-up for the opening just a little higher up. But before you can climb there must be a foundation upon which to get a toe-hold.

On Guard



Penn-Victor Dogs are the best watchmen of Victor Welfare in the Home.

Sold by most Victor Distributors.
Write them or us for prices.

Penn Phonograph Company

913 Arch Street Philadelphia, Pa.

Victor Wholesale Only

DECALCOMANIA

Name Plates for Talking
Machines, Pianos, etc.

High Class Workmanship

Write us for further information

National Decalcomania Co.
220-230 N. 60th St., Philadelphia, Pa.

INDIANAPOLIS

*Optimism Permeates Trade as Sales Climb to Record for Month—
Fall Business-building Plans Under Way—Month's News Budget*

INDIANAPOLIS, IND., September 7.—August was an extraordinarily good month with Indianapolis talking machine dealers. Almost without exception they report business far ahead of August, 1921. Plans are under way for Fall campaigns which are expected to firmly establish the trade on a normal basis.

"Buyers' Week," promoted the last week in August by the Indianapolis Chamber of Commerce and local wholesalers, brought a large influx of buyers to the city. Railroad fare was paid for every buyer who visited the city that week and registered with some wholesale house. The amount of actual buying done by the visitors far exceeded expectations, according to reports from all the leading houses.

Dealers Welcome New Edison Models

H. G. Anderson, general sales manager of the Kipp Phonograph Co., Edison distributor, says the company's agents are very enthusiastic over the prospect of handling new models being placed on the market by the Edison Co., especially as they will be in a position thereby to offer a machine at a price as low as \$100.

The sales force of the Kipp Co. was busy the latter part of August taking the semi-annual inventory. "Just as soon as we have finished this job," Mr. Anderson said, "we will plunge right into the liveliest and, we expect, the most productive Fall campaign we have ever put on. Business is to be had and the dealers are all very enthusiastic over prospects."

J. R. Jones a Visitor

J. R. Jones, Indiana representative of the Ohio Talking Machine Co., of Cincinnati, recently visited the Indianapolis Talking Machine Co., the Pearson Piano Co. and the Pettis Dry Goods Co. All of them report a rapidly increasing improvement in business.

"I have been in the talking machine game twenty years," Mr. Jones said, "and I am frank to say that this Summer has been the hardest I ever experienced. We are back, now, to the 1912 basis and we have to work for every sale. Fall orders, however, are showing a marked increase of confidence. There is a decided improvement in city accounts, while business in the country is very much more stable. I am

having exceptionally good results in the sale of the new Victor console No. 210. My prediction is that the Victor line will be going as strong as ever during the coming holidays."

Good Victor Business

Ira Williams, manager of the Victor department of the Pettis Dry Goods Co., reports that his August business was the best for that month in the history of the store. Record sales, he says, were chiefly responsible for the month's good showing.

Manager A. C. Hawkins, of the Indianapolis Talking Machine Co., says that the Victor business for the month of August was very satisfactory, considering the extremely hot weather which prevailed through most of the month.

Sonora Sales Increase

Edward L. Mayer, manager of the Sonora department of the Kiefer-Stewart Co., reports that the past month developed numerous sales in all new models of the Sonora. "This looks like a big year for period models," he said. "Dealers from the small towns have been particularly active in buying and they all say that the farmers are in a decidedly more receptive mood than they have been for many months. As a matter of fact, reports show farmers' spending power to have increased 50 per cent in this territory and that means just so much new money thrown into business channels."

Pearson Piano Co.'s Display at State Fair

H. A. Brown, manager of the talking machine department of the Pearson Piano Co., says his record business during August increased about 35 per cent over August of last year and that his machine business increased about 25 per cent. He has planned as a feature of the State Fair exhibit the giving away of a \$325 Style 6 Cheney machine to the holder of a lucky ticket. All visitors at the booth will be given an opportunity to win the machine. He will have nine machines on display throughout the week.

Features Golf Records

Walter J. Baker, manager of the Brunswick Shop, featured the new Chick Evans golf records in his window display during the last week of August. The records are in a set of five.

**MICA
DIAPHRAGMS**

Absolutely Guaranteed Perfect
We get the best India Mica directly.
We supply the largest Phonograph Manufacturers.

Ask for our quotations and samples before placing your order.

American Mica Works
47 West St. New York

The sales of Brunswick machines and records during the month represented a decided increase over the corresponding month of last year, Mr. Baker said.

News Gleanings

The sales of Edison machines and records during August aggregated more than during the month of October, 1921, according to W. O. Hopkins, manager of the Edison Shop.

H. G. Power, general manager of the furniture and Victrola departments of the Taylor Carpet Co., has left that company and become associated with the Foster Furniture Co., of this city. He is succeeded by K. T. Chapman, former advertising manager. Miss Minnie Springer, buyer for the Victrola department, spent the latter part of August with relatives at New Orleans, La., and Gulfport, Miss.

Expressions of Optimism

After having struggled successfully against the inclination of store executives to reduce his advertising appropriations, F. R. Follis, manager of the Victor department of L. S. Ayres & Co., was able to show for August the best business he ever had in that month. Mr. Follis plans to use a Victrola at the L. S. Ayres & Co. booth at the State Fair to furnish music for the promenade of fourteen living models who will display costumes each day during the fair.

"Our machine business in August increased close to 40 per cent over the business of August, last year," says C. P. Herdman, talking machine manager of the Baldwin Piano Co.

"Our business in August was about the same as usual," reports W. G. Wilson, of Widener's Grafonola Shop. "The Granby machine continues to sell well. We are enjoying our best business just now, however, with a new \$110 console model, which we are only distributing locally at the present time."

Competition on the part of off brands of talking machines is apparently less than it has been for several years, according to H. E. Whitman, of the Circle Talking Machine Shop. Victor sales are rapidly coming back to normal, he says, and there is a more hearty response to newspaper advertising.

Stewart Co. Distributes Jewett

The Stewart Sales Co., formerly the Stewart Talking Machine Co., has announced to the trade that it is the distributor for Indiana and Kentucky of the Jewett line. The company is taking advantage of the State Fair to place on display its first showing of the Jewett machines.

Lillard-Getmen-Hughes, Columbia dealers in Champaign, Ill., had an extensive display at the recent Champaign County Fair. I. S. Leon, Illinois representative of the Columbia Graphophone Co., spent two days at the fair in the dealer's exhibit booth.

THE PHONOMOTOR CO.

W. F. HITCHCOCK, Proprietor

121 WEST AVENUE
ROCHESTER, N. Y.

5 years of success everywhere



THE PHONOSTOP

100%
Efficient

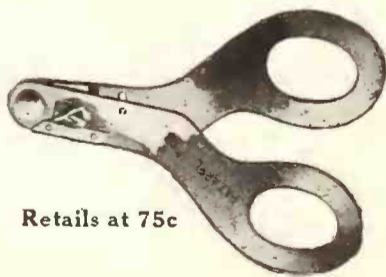

THE NEED-A-CLIP

Retails at 75c

Two Well-known Phonograph Accessories Needed in Every Instrument of Class. Satisfaction Guaranteed in Every Case

Once adapted becomes permanent.

A WHOLE PAGE of references if desired.

DON'T DALLY with inferiors, get THE BEST.

PHONOSTOPS are universal, STANDARD, and finished in nickel and gold.

NEED-A-CLIPS in nickel only.

Get Our Printed Price List Immediately

Samples sent by parcels post C. O. D.; money back if unsatisfactory, but you'll want more.

MOTORS

Double spring, plays three 10-inch records without rewinding. Nickel plated, worm drive. Complete with all accessories. Sample \$3.25. Special prices in quantity lots. Motor suitable for portable machine.

Pleasing Sound Phonograph Co.

Manufacturers—Jobbers
204 East 113th St., New York City
Jobbing Territory Open

ONE OUT OF MANY!

We have received many letters from jobbers and dealers telling us that the SWANSON Portable is the best portable on the market. We knew it all along, and the trade has emphasized its approval in a substantial, practical way.

The SWANSON has a wooden tone arm, double-spring motor, speed regulator and needle containers.

MUNSON, RAYNER CORPORATION
WESTERN DISTRIBUTORS

CHENEY TALKING MACHINE COMPANY
(MARSHALL FIELD & COMPANY)
SAN FRANCISCO LOS ANGELES

315 SOUTH BROADWAY
LOS ANGELES

MARSHALL FIELD
BUILDING
CHICAGO

FACTORY
GRAND RAPIDS
MICHIGAN

August 21, 1922.

Swanson Sales Company,
Merchants National Bank Building,
Los Angeles, California.

Gentlemen:

Attention: Mr. R. W. Moon

As the Western Distributors of the SWANSON Portable Phonograph, we are glad to write you that as a successful article of merchandise we believe the SWANSON stands among the very best of the small portable machines.

We are able to place the SWANSON with the dealers with the minimum of sales effort and from the number of repeat orders received we know that the retailers must be doing their part.

It is with pleasure that we write this and wishing you every success, we beg to remain,

Yours very truly,

MUNSON-RAYNER CORPORATION

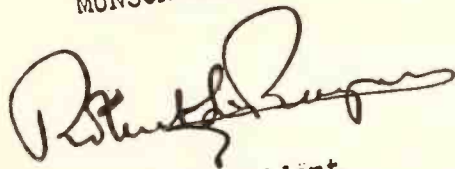

Vice-President

Unusually liberal discounts to live jobbers and dealers. Write our nearest sales office for details.



Swanson Sales Company

R. W. MOON, General Manager

1133 Broadway
New York, N. Y.

308 West Ontario Street
Chicago, Ill.

536 Merchants Nat'l Bank Bldg.
Los Angeles, Cal.

D E N V E R

Strikes Retard Business—Window Displays Win Praise—Consoles in Favor—News of Month

DENVER, COL., September 6.—Denver music dealers are almost agreed on the fact that not a great volume of business is to be expected in the early Fall, but they do expect a fair business and are not at all discouraged over the prospects. The two strikes still have a tendency to retard business. The slow delivery of new models of talking machines that have been put out by several of the leading manufacturers make it impossible to show customers new models nationally advertised and in some cases new models have been sold as quickly as placed on the floor. There is a decided increase in the sales of consoles, one firm, handling four makes of talking machines, claiming 60 per cent of

the sales this Summer have been in the console models.

The Laman-Johnson Music Co., at 35 Broadway, recently took an option on a building at 60-64 Broadway. The lease on its present store does not expire until May, but an effort will be made to sell the lease and get into its own building by October. The new store will give the company much larger quarters. G. A. Laman says the store's record sales have been much increased within the last few months.

A. E. Emrick, who recently gave up his position as traveling salesman for the Denver Dry Goods Co., Edison distributor, to go into business for himself, has gone back with the Denver people. His business at 1624 Tremont street goes on, however, the Emrick-Nadler Music Co. being conducted by Mr. Emrick's daughter and an assistant.

Workmen will begin, shortly, on the remodeling of the basement of the Charles E. Wells Music Co. store. Roy E. Thompson, head of the talking machine department, says his department will then be moved from the first

floor to the basement, where much larger quarters will be arranged. Business was excellent during August and many machines were sold during this period.

An attractive window was arranged under the direction of H. V. Huntoon, manager of the Victrola department of the Knight-Campbell Music Co., the first week in September. The background typified a section of a wall done in gray, in the center of which was placed a wall mirror and on either side fancy side lights. In front of this wall stood a console model Victrola, showing how nicely this type of musical instrument fitted this particular wall space. So many calls were made for the wall mirror that the department put in a stock and handled them along with the sale of talking machines. The mirror also served to bring people into the department. The balance of the window was a typical living-room setting. Business for August went ahead of the same month a year ago. Mr. Huntoon said he looked for good business with the two new Victor flat-top models, Nos. 210 and 230.

The McKannon Piano Co. has sold every console type Edison that has come in and regrets the inability to get these machines more rapidly. The company has just stocked up on radio merchandise and is showing how it can be connected up successfully for parlor use with the Edison phonograph. Mr. McKannon believes that radio and music must go together.

J. H. Blinn, manager of the talking machine department of the Baldwin Piano Co., says that, despite the two strikes, if business keeps up as it has done all Summer he will have no complaint to make.

The sale of Edison re-creations is keeping up well, says Norman D. Tharp, buyer of the Edison department, wholesale and retail, Denver Dry Goods Co. The popularity of Hawaiian music and piano numbers continues. Charles L. Clark, an Edison dealer from Laramie, Wyo., was a caller on the Edison distributors last week and reported he expected a pretty good business this Fall. He and his son had a booth at the fair held in Laramie during September, in which Edisons and pianos were displayed. Another caller was Wiley H. Clements, Edison dealer, of Canon City, Col. He reported a large fruit crop, with indications that a good business in Edisons would result this Fall.

Oscar Frazier, of the talking machine department of the Darrow Music Co., says that talking machines have sold better than records and efforts will be made to build up the sale of records.

An attractive Edison window was featured early in September by the Arvidson Piano Co., at 523 Sixteenth street.

R. B. Johnson, business manager of the wholesale and retail end of the Aeolian Co.'s branch house at St. Louis, has returned, after spending two months with the talking machine department of the Charles E. Wells Music Co.

T. P. Pattison, of the Pattison Music Co., has returned from his vacation, spent at Wagon Wheel Gap, Col.

INTRODUCE THE "BLUE BELLE" NEEDLE

Samuel Eshborn, well known as a distributor of talking machine parts and accessories, at 65 Fifth avenue, New York City, is introducing a new steel needle under the trade name "Blue Belle." This needle is a specially designed product of blue steel, non-rustable and made in various tones. The product has been given preliminary trials in many homes in Eastern territory and the result has been that Mr. Eshborn acquired the sales rights.

LIQUIDATING ITS BUSINESS

The Music Shop, Inc., Helena, Ark., handling Victor machines and records exclusively, is liquidating its business and expects to have its affairs wound up shortly after September 15. H. S. Blackwood is president of the company, H. C. Porter vice-president and I. A. Metz, secretary-treasurer.

There's a Brand New BUBBLE BOOK Audience for You—Every Year

Did you ever stop to consider this big advantage Bubble Books have over most other kinds of merchandise?

Think it over.

Every year there's a brand new crop of little folks just waiting to get acquainted with the books that sing. And their parents are just as eager as the children to find some new amusement for them.

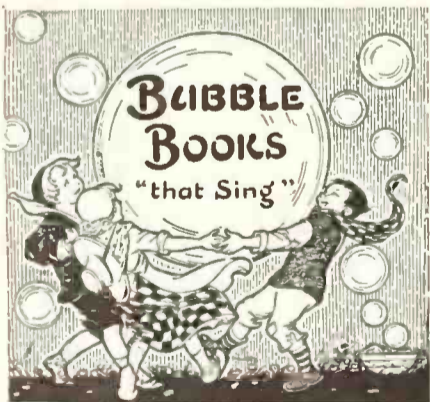

Get after this new audience! And get after the old customers, too, for remember that every Bubble Book sale means a chance to sell the other thirteen!

When you sell one you sell a habit and when you sell a habit, you're building business.

HARPER & BROTHERS, BUBBLE BOOK DIVISION

Established 1817

Franklin Square

New York, N.Y.

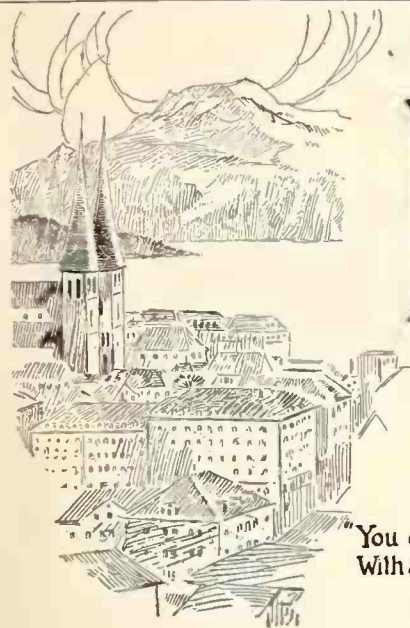

LONDON'S NEWEST WALTZ HIT! LOVELY LUCERNE

As Beautiful as "Valse Septembre" and by the same Writer



When falls the calm of e-ven-tide, There comes a vis-ion glow-ing.

"You can't go wrong
With any FEIST songs"

THE TWIN CITIES

Optimistic Outlook in Northwest—Dealers' Stocks Are Low and They Are Now Ordering Heavily—New Agencies—News of Month

MINNEAPOLIS and ST. PAUL, MINN., September 7.—Everything is almost all right in the Northwest—meaning that if the constituted authorities will settle the coal and railway strikes one way or another the Northwest will resume business in the good old Western style. The farmers are ready both to sell and buy, but there must be cars for moving grain, potatoes and other farm products and to bring fuel and other necessities. The farmer is beginning to think that he is something on the order of the "goat." After he has been working desperately hard ever since the Spring thaws, with the hope of recuperating from the heavy losses sustained during the past two years, he finds the grain prices sliding down so rapidly that he cannot figure out a profit, not to speak of recoupment for past losses. But, as he always has done, he will make the best of the situation and if he can't get the prices that he thinks he should have he will take the best he can get and proceed to put the country on an even keel again.

The coal strikes are supposed to be settled, but very little coal has come to the Northwest and, unless the Washington authorities get freight cars in motion, numerous Northwestern industries will have to close for a time.

Stocks Low Throughout the Northwest

Local dealers are anticipating their Fall wants on the basis of a return of prosperity and are placing orders accordingly, says Eugene F. O'Neill, of Beckwith-O'Neill Co., distributor of Victrolas and Victor records. Rad J. Sabra, formerly with Foster & Waldo and later manager of the Victrola department of Davis & Rubin, has joined the Beckwith-O'Neill Co.'s road staff and will cover Minnesota and Wisconsin.

Business Tripled in August

Manager Sharar, of the phonograph department of G. Sommers & Co., distributors of Pathé machines and records, informs The Talking Machine World that business in August was triple that of the July comparative volume and is far ahead of the August, 1921, totals—all of which is satisfactory to a comparatively new manager.

New Brunswick Agency

"Phonograph dealers with whom I have talked tell me that the talking machine business virtually has resolved itself into the handling of one or two standard machines," remarked E. L. Kern, director of the Brunswick-Balke-Collender Co. "I think that they are about right. There are many machines in the field, but we believe that the Brunswicks are coming to the fore. We are opening new accounts constantly and the record demand is increasing very rapidly. The new Giliusen-Raudenbush Co. store in Duluth will handle Brun-

wick phonographs exclusively and, by its style, will give our machine a great vogue in that territory."

Columbia Line With Friedman Store

Progress is reported by the Northwestern headquarters of the Columbia Graphophone Co. Collections are much better, but no great increase in sales is expected until the farmers can market their grain and other farm products. The harvest still is on the farms, as the railroads are unable to move it and rural traffic is seriously impeded in consequence. The Friedman Department Store, in Superior, Wis., recently opened a phonograph department, which will

be devoted exclusively to Columbia Grafonolas. Manager W. L. Sprague spent the tail end of August in New York in conference with officials of the company.

Edison Display at Minnesota State Fair

Laurence H. Lucker, Edison jobber in this territory and head of the Minnesota Phonograph Co., has made preparations for a general display of Edison wares at the Minnesota State Fair. Several salesmen were added last week to the St. Paul and Minneapolis retail stores and to the traveling road force. The retail totals for August show far greater than for July and also greater than August, 1921.

Vocalions and Red Records in Favor

Vocalion machines and the "Red" records are public favorites, as a result of the steady publicity and active work of the Stone Piano Co., Northwestern distributor. Manager Munson states that everything is in excellent position for fine Fall trade and this reflects the attitude of all dealers.



*Wall-Kane Needles
Protect the Record*

WALL-KANE NEEDLES

Used by 80% of the population, sold by the leading jobbers throughout the world.

A nationally advertised article that has been in ever-increasing demand since it was established in 1913

WALL-KANE needles are packed in metal display stands holding 60 packages, 24 loud, 24 extra loud and 12 medium.

They are also packed in cartons of 100 packages of a single tone, either loud, extra loud or medium.

**JOBBERS ONLY—APPLY FOR
SPECIAL PROPOSITION**

WALL-KANE NEEDLE MANUFACTURING CO.

Successors to

The Greater New York Novelty Co.

Sole Manufacturers of

WALL-KANE NEEDLES

3922 Fourteenth Avenue

Brooklyn, N. Y.



Those who like innovations will buy this record, for it's a novelty. Those who love real music will buy it for its genuine charm—A-3658. Ferera's Hawaiian Instrumental Quartet playing "Drowsy Waters" and "Ua Like—Noa Like"—two Hawaiian guitars, a violin and a flute.

Columbia Graphophone Co.
NEW YORK

C I N C I N N A T I

Consoles Have the Call—Trade Steadily Bettering—Edison Activities—Shortage of Machines Probable—Live News of Month

CINCINNATI, O., September 6.—The call of the console! That's the factor that has been keeping the local talking machine trade on its legs. The popularity of this style of machine has grown steadily and proves that it is no early blooming and rapidly fading affair. Most dealers report that the console type is selling far in excess of any other type at the same price, and jobbers note that the retailers, in new orders, are giving more and more attention to these machines. The only explanation of this popularity seems to be that the console can be made to fit in less obtrusively and more like a piece of furniture than can the upright type, and so far the fact that it undoubtedly requires much more room has been of little detriment to success in selling it.

Business in upright styles has not been bad; however, August trade was far in advance of July trade and was also better than business of August last year. This encouraging report is had from everyone in the business. Retailers are stocking up more completely with comprehensive stocks than has been the case for many months, and all indications point to the fact that Autumn business is going to be good. Jobbers are already anticipating a probable shortage of machines, especially of certain types much in demand, and are crowding manufacturers to send these needed machines. Jobbers also are warning retailers, in a way not to be misconstrued as selfish policy, that the demand is likely to exceed the supply.

Business in records this month picked up all around the trade in this city, and dealers declare it is only a foretaste of the real increase to come as soon as the weather is cool enough for chokers and felt hats.

Consoles Lead, Says A. H. Bates

A. H. Bates, of the Ohio Talking Machine Co., is one of the more enthusiastic of the jobbers. He said: "The prospects are that trade in September and October, with cool weather and evenings indoors, will be brisk. I truly believe there will be a shortage in machines this

Fall. We are cautioning our retailers to that effect, and are stocking up to our capacity ourselves. We expect to do an excellent business in the two new Victor models, No. 210 and No. 230, which will be ready for general trade in October. These are console models and, with the prevailing popularity of these models, a good business is sure to be had."

Mr. Thimele, manager of Ray C. Dilgard Co., Auburn, Ind., and Howard A. Brown, Pierson Piano Co., Indianapolis, Ind., visited Cincinnati and were entertained by Mr. Jones, Indiana representative of the Ohio Talking Machine Co. Mr. Brown and Mr. Thimele are Victrola dealers and report improving business.

Alterations at Adams Music Co.

The Adams Music Co., Covington, Ky., of which Mrs. Taylor is manager, has made extensive improvements in its Covington store. New record racks, new display windows and a new display room on the second floor have been added, making facilities for adding to an already large trade.

New Edison Consoles Attract Attention

The New Edison Co., P. H. Oelman, manager, is another house to have been favored by the advance in trade as compared with that of previous months and the same period of last year. Business, both in machines and records, has been excellent, according to Mr. Oelman, who said: "Our trade this month has been really encouraging and I think that the next two months will see us out of the woods. Console types have been selling exceptionally well. The new Edison consoles, especially the baby console, a moderately priced machine, have made a deep impression upon our dealers and very likely will be in great demand."

Several Edison dealers visited the local office at various times during the month. Among these were: R. A. McKee, Charleston, W. Va.; C. H. Hutchison, Ripley, O.; E. Sensenbrenner, Circleville, O.; Warren Spring, Eaton, O.; A. G. Krebs, Hamilton, O.; M. E. Radebough, Columbus, O. These dealers came to Cincin-

nati primarily to inspect the new baby console, and all were very much pleased with it.

Interesting News Brieflets

According to J. F. Van Court, of the Otto Grau Piano Co., which sells Victor and Brunswick products, the talking machine business has been very good. The extensive advertising of the company is bearing fruit.

The Victrola department of the Baldwin Piano Co. is busy. The record stock is showing a gratifying regularity in turnover and machines are in demand. The plan of having two salesmen tour surrounding country in a truck, with machines and supplies of records ready for instant sale to homes along the way, is working out with considerable success.

Morris Fantel, manager of the Widener Shop, remarked that business for August has been much better than any month in a very long time. "You may ride in Summer, but, after all, there's nothing like good music in Winter. The indoor days are almost here. Then we'll have our innings," he said.

Howard L. Chubb, of the Chubb-Steinberg Music Shop, also reports an excellent business in machines, records and radio equipment, a separate department which the Shop has established. Mr. Chubb's clever window displays continue to draw large crowds to his windows.

WALKING DOLL WELL RECEIVED

The advertising department of the Sonora Phonograph Co. has just produced as a part of its Fall publicity campaign a Sonora walk-



Some Clever Sonora Publicity
ing doll designed in four colors. Sonora dealers are ordering these dolls in large quantities with the idea in mind of distributing them among school children and for use by canvassers going after house-to-house business.



THE SHELTON Electric Motor

The "Simplicity" electrifies Victor, Edison and Columbia phonographs by simply taking off winding handle and placing motor against turntable. Automatic switch in motor operated when the turntable is started or stopped. Operating on AC or DC current of 110 volts. Specify type of current when ordering.

SHELTON ELECTRIC CO., 16 East 42nd Street, New York



THE ORSENIKO PERIOD PHONOGRAPH

BELMONT

One of our latest models, made in walnut; carvings by hand.



Every possible detail is embodied in the construction of this cabinet to make its appeal to the customer who is exacting in the furnishings for the home.

THE ORSENIKO COMPANY, Inc.

Showroom: 112 West 42nd Street
New York City, N. Y.

Factory: Skillman Ave. and Rawson St.
Long Island City, N. Y.



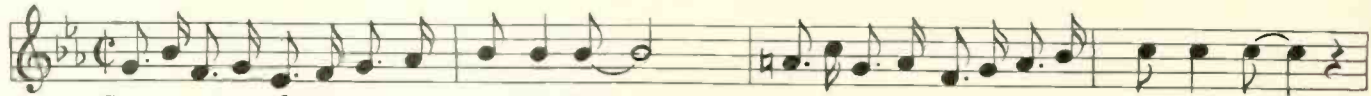

Syn-co-pate your feet you dog-gone strut-tin' hound,

No-one can com-pete when you are strut-tin' 'round.

Struttin' at the Strutter's Ball

"You can't go wrong
With any FEIST song"

A Creole Fox Trot
HEAR IT NOW!

EARLE E. CONWAY DISCUSSES CONDITIONS IN EUROPE

President of Hallet & Davis Piano Co., Boston, Returns From an Extended Visit Abroad and Makes Interesting Comments on Conditions As He Found Them in France and England

BOSTON, MASS., September 2.—President Earle E. Conway, of the Hallet & Davis Piano Co., is home from his European trip. He was greeted at the wharf, as the "Olympic" docked in New York, and there also was a splendid home-coming for Mrs. Conway and their two daughters, Miss Janet and Miss Virginia Conway. Mr. Conway and his family came immediately to Boston, and when it came to interviewing this leader in the industry it was evident that the thing that most impressed him was the gigantic restoration work that is going on in France and Belgium and which is bound to get its true recognition from all the countries that had a part in the recent international struggle. Mr. Conway also expressed himself as impressed with the serious aspect which the reparation question in both France and Germany is assuming.

Arriving in England, Mr. Conway said, he and his family toured that country and Scotland, and then went over to Paris, which they made their headquarters as they toured over France and Belgium, spending days on the battlefields. As to general conditions, President Conway said:

"It is almost unbelievable the way in which the people of France and Belgium, from the

well-to-do down to the peasants, have put their shoulder to the wheel and cleaned up the domestic and industrial chaos in the war-torn areas. Class barriers are forgotten for the time; a common end prompts men and women to work from six in the morning until dark, rebuilding, replanting, reclaiming. What this spirit of love of home means is shown by the fact that in Belgium, of 70,000 building units destroyed, 56,000 have already been restored.

"The living costs in Paris and London about parallel the living costs in New York. In Vienna, however, a \$30,000 house can be bought for \$700 in American money.

"Business conditions are fair in France and England, but the piano trade is quiet in both countries. France is now making about 2,000 pianos a year and England 60,000, probably fifty per cent of normal capacity. A high tariff fence has been built about this industry in both England and France. In the latter country a tariff of thirty-five per cent is imposed and that is based on the cost of manufacture of equal grade of product in France. It is expected that the tariff will soon obtain in the Colonies also, and this is a situation which holds little hope for importations at present.

"The political aspect is uneasy. The great

problem in France to-day is that of war reparation. I did not meet one man in France who was not unalterably firm in his belief that France should collect reparation, as laid out by



E. E. Conway, President, Hallet & Davis Co. the war-reparation board, even if she has to play a lone hand. The French patience is being sorely tried. On the other hand the Germans had led themselves to believe that they are being prodded, without rhythm or reason, to pay their debts. This vicious condition tends in no way to soften the antagonism in Europe and, indeed, there is open talk of another war in fifteen years; time enough, let us hope, for the Peace Tribunal to work out its anti-war plans."

Like all keen executive minds that have visited Europe and made a close study of the way law is meted out over there, Mr. Conway was profoundly impressed with Continental judiciary systems. He was loud in his commendation of the justice of the English courts, which exercised the element of common sense in handling cases, and the privilege of appeal, which is so overdone and abused in this country, gets very little encouragement over there, he said.

On reaching his office in this city Mr. Conway was made to feel that he was among friends, by the receipt of a handsome silver cigarette container bearing this inscription: "From the factory, the roadmen and office force of the Hallet & Davis Piano Co."

Gentile Bros., 857 Market street, Kenosha, Wis., have taken over the Columbia agency from Joseph Cardinal. Gentile Bros. are installing new hearing rooms and fixtures and will have a beautiful department for showing and selling Grafonolas and Columbia records. This store will pay special attention to merchandising Italian records.

Buy At the Source!

We are manufacturers and direct importers of Musical Instruments and their Accessories.

Much of our line is made right in our own Brooklyn Factory and comes to you direct.

But some merchandise can be made better and cheaper abroad than in America.

These lines we buy abroad from the largest and most famous factories, and bring in to this country in such large quantities as to give you every advantage of choice and price that only large-scale operation can make possible.

Take the subject of choice, for instance:

3,000 Instruments and Accessories Listed in Our New Catalog

That means an adequate selection in every line—a selection that gives you ample latitude both as to price and style—

—A selection that helps you to maintain a complete, well-balanced stock, and also enables you to offer those rarer and less-called-for instruments that some of your trade will want.

This wide latitude of choice is just one advantage of many that you enjoy when you buy right At The Source.

Two Free Books That Every Music Dealer Needs

Send today for our new Illustrated Catalog (quoting retail prices only) and also for Confidential Trade Price List No. 5. These books put the whole world of Musical Merchandise within your easy reach. Whether you are a customer of ours or not you need these books. And they are yours for the asking.

The FRED. GRETSCH MFG. CO.

Musical Instrument Makers Since 1883

60 BROADWAY

BROOKLYN, N. Y.

MAGNAVOX AND "RADIO"

J. A. Goldstein Entertains Kiwanis Club With Elaborate "Radio" Concert

J. A. Goldstein, proprietor of "The Music Shop," Columbia dealer, at Niagara Falls, was recently elected vice-president of the local Kiwanis Club. At one of their luncheons he was called on to furnish the entertainment for a dinner to be given the following week and decided to surprise the members with a "supposed" radio concert.

With a rather elaborate radio outfit, which he stocks, and the assistance of a concealed Magnavox, Columbia records and an accomplice, he proceeded to give a lengthy talk on the technicalities of radio, then announced he would "tune up" with Pittsburgh, whereupon strains of "Stumbling" came trickling from an unknown source.

After having played several other Columbia records the climax was reached by announcing the members would now hear the voice of an absent brother who had been called to Pittsburgh and had been asked by himself to go to the broadcasting station there and address the club at this time. After considerable delay in fake tuning came the absent one's voice from afar (in next room) "with many apologies for being so far from the beautiful Niagara" and, removing the voice attachment

from the Magnavox with hanging cords and plug, the "absent one" walked into the room, leaving many in dismay and wondering, until Mr. Goldstein explained everything to the satisfaction of all, and got some mighty fine advertising and orders for some of the popular records.

S. A. COLAHAN TAKES A BRIDE

Cheney Manager in New England Marries Marguerite K. Taylor, of Hallet & Davis Co. Staff

BOSTON, MASS., September 4.—This was the wedding day of Miss Marguerite K. Taylor, for some time private secretary to R. O. Ainslie, of the Hallet & Davis Co., and Stephen A. Colahan, the New England manager for the Cheney talking machine, the two having first met when Mr. Colahan came to Boston to take care of the retail business of the Pathé at the Hallet & Davis headquarters. The ceremony was performed this morning at St. Rose's Roman Catholic Church, Chelsea, in which city the bride resided, and the officiating clergyman was M. J. Scanlan, pastor of the church.

Following the wedding a breakfast and reception were held at Fraternity Hall, and for this and the ceremony there were a large number of friends of the bride and bridegroom from the Hallet & Davis offices and other music houses in the city. After a honeymoon trip by automobile to Maine Mr. and Mrs. Colahan will make their home at 112 Boston avenue, West Somerville.

"TALKER" HELPS GOOD ENGLISH

Dr. Vizetelly, Discussing the Charms of English Speech, Pays Tribute to Work of Talking Machine Companies for Their Timely Aid

"There are very few of us who realize the great debt we owe to the telephone companies for the vigorous campaigns they have been, and are still, conducting on behalf of standardized speech, and to secure the standardization of human voice sounds," says Dr. Frank H. Vizetelly, editor of the Practical Standard Dictionary, in an article in which he emphasizes the proper pronunciation of vowels and their value in bringing out the beauty of our language. "To them and to the phonograph companies, whose vociculturists have aided in the work, we are under an obligation that none of us can ever repay, for it is owing almost as much to their efforts as it is to the increased facilities of travel that standard English has spread, and that we are rapidly marching toward that uniformity of vocal sounds which will ultimately bring English into the same class as Italian as the language of song. But before we attain this distinction we must learn to give our vowels their full force, and to use our consonants with proper discretion. Then, wherever the English language is used in accordance with its best traditions, there standardized English will be found, no matter in what quarter of the globe this may be."

EDISON WAS GUEST OF HONOR

Thos. A. Edison was the guest of honor at a dinner given by the Edison Co., at the Hotel Commodore, on the evening of Monday, September 11, in connection with the fortieth anniversary of the first electric illumination of the downtown buildings in New York and the operation of the first central power house. The invitations state that the dinner was "in commemoration of forty years of Edison service in the city of New York." One guest at the dinner who was with Mr. Edison that September forty years ago was Samuel Insull, now president of the Edison Co., Chicago, and another was John W. Lieb, vice-president of the Edison Co., a resident of New Rochelle.

Thomas H. Fletcher, general retail manager of the Aeolian Co., New York, is at present spending his vacation at his farm near Nyack, N. Y., building up strength for a strenuous Fall.

SELL



Semi-Permanent NEEDLES

To Every New Phonograph and Record Buyer this Fall

Start your customers right!

A nice point in your relations with new buyers—and old!—is to recommend Sonora Semi-Permanent needles. They will appreciate it as a time-saving, trouble-saving—and RECORD SAVING suggestion.

The demonstration illustrated below is enough to show the superiority of these long-lived needles on sight.

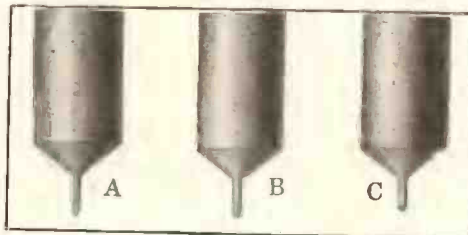

(A)—New Sonora Semi-Permanent Needle. Note that the parallel sides (which are not tapered) always fit the record groove perfectly.

(B)—Sonora needle after playing one record. No perceptible wear.

(C)—Sonora needle after playing over 50 records—needle is worn down but it is in perfect playing condition.

Sonora Phonograph Company, Inc.

GEORGE E. BRIGHTSON
President

279 Broadway New York

Canadian Distributors:
Sonora Phonograph, Ltd., Toronto

FOUR 20¢ PROFITS VERSUS ONE 30¢ PROFIT DIFFERENCE 50¢

The 75c record leaves you 30c profit. Banner 50c records leave you 20c profit (on 100 record lots)

But bona fide reports indicate that Banner sells four times faster than the 75c record. **FOUR TIMES FASTER!**

For one thing more people will buy a good 50c record than they will a similarly good 75c record. For another thing, people will buy more 50c records than they will 75c records.

That's a fact you should consider thoroughly in making your arrangements this Fall.

Write us for complete details and samples **TODAY!**

BANNER 50c RECORDS

PLAZA MUSIC CO.
18 WEST 20th Street NEW YORK

BROOKLYN DEALERS ARE READY FOR BIG TRADE

Distributors and Dealers Have Perfected Plans to Meet Demands—Radio Grows More in Favor—New Sonora Agencies—Stores Change Hands—Long Island Phonograph Co. Activities—Demonstrating Victor Health Records—Splendid Spirit of Optimism Prevails

Brooklyn and Long Island talking machine dealers are ready for an active Fall and Winter business. Carefully laid plans prepared during the last three months have equipped these dealers with an organization and a stock of talking machines and records to meet any demand which it is expected they will be called upon to supply the coming months. The sales personnel have been reorganized in some cases and special pains have been taken to train sales people and, no doubt, they will be able to give their clientele a superior service in every way, resulting in sales being better handled and correspondingly increased. In the case of those dealers who have been in fear of over-ordering their stock there will be the usual amount of complaining when business actually begins to come, but fortunately most dealers in this section are not in this class, as most of them have been far-sighted enough to order a plentiful stock. However, there must be some in any district who will not order in advance and these few will be sadly disappointed and consequently lose a lot of business which they would get, provided they had the stock to sell. Wholesalers and manufacturers have been urging the necessity of placing early orders to meet the expected Fall business and the wise dealer has followed this advice and he will be the one to reap the harvest.

Look Favorably on Radio

A general survey of the retail trade here seems to show that talking machine dealers are looking upon radio as a favorable asset to their business and without question many of them will carry radio stock this Winter. It seems that this radio equipment will consist of complete receiving units, which seems to be the vogue, and, no doubt, many of these will be sold by Brooklyn talking machine dealers during the coming Winter months. Already some dealers have a representative stock in their stores, while others have placed orders for early Fall delivery and are devoting a space in their

HELP YOURSELF

YOU WILL HELP YOURSELF MATERIALLY
BY MAKING SURE THAT YOUR ORDER
FOR VICTROLAS FOR YOUR FALL
NEEDS HAS BEEN PLACED.

IF YOU HAVE NOT ALREADY DONE SO,
OUR ADVICE IS TO

PLACE IT AT ONCE

AMERICAN

TALKING MACHINE CO.

BROOKLYN, N.Y.
VICTOR WHOLESALERS



store exclusively to the radio product, in charge of experienced radio men.

All in all, the situation is very encouraging and everyone is confident that the business done this Fall and Winter will show a decided increase over last year and if plans of these dealers are carried out there will be no doubt as to the outcome of this prophecy, for they offer every indication of fulfilling every plan in a highly satisfactory manner.

American Talking Machine Co. Activities

The American Talking Machine Co., Victor wholesaler, reports that the outlook for Fall and Winter trade is very encouraging and that its dealers will be prepared for an active Fall business. The carefully developed plans and strenuous work done by this wholesaler during the Summer months are now bearing fruit and orders for machines and records are being filled

to capacity. R. H. Morris, general manager of the company, is very much pleased with the situation generally and he remarked to The World that this Fall and Winter promises to be one of the most active seasons experienced by talking machine dealers since the war.

Chas. Offerman, popular representative of this company for Long Island, spent the last two weeks of August on a well-earned vacation in New England. He started in his automobile with the intention of visiting the leading resorts, returning by a different route. He reported back prepared to do valiant work for the talking machine dealer this Fall and Winter.

H. A. Heinemann, assistant to Mr. Morris, spent his two weeks' vacation in Northern New York State, where he goes each year to enjoy his pet hobby of catching real fish and taking many thousand pictures with his various kodaks.

Fred Oldehoff, who handles record orders of talking machine dealers for this company, is back at his desk "full of pep" after two weeks spent on a most enjoyable vacation.

Demonstrated Victor Health Records

To demonstrate that Long Island dealers are progressive, the Woodhaven Music Shop recently created considerable interest with the new Health records, recently issued by the Victor Talking Machine Co. David Feiner, proprietor of this shop, engaged three attractive young ladies, who demonstrated these records in the spacious show window of the store. The girls were dressed in bathing costume and to the music of these records went through the calisthenic exercises at periods of fifteen minutes throughout an entire day and evening. Mr. Feiner was the first dealer in Long Island to take advantage of this scheme, with the result that the new Health records were given a decided boost and also attracted hundreds of people into the store who not only purchased Health records, but other selections from the Victor catalog as well. The publicity alone derived from this opportune and clever advertising was well worth the time and money spent and, no doubt, will be emulated by many other dealers shortly. Mr. Feiner intends to repeat this again in a short time and it is his intention to resort to it many times during the Winter, for, as he stated, "it not only boosts the sales of the Health records, but increases materially sales of machines and other records as well."

Josep Buys Interests of Goebel Bros.

This month sees the passing into retirement

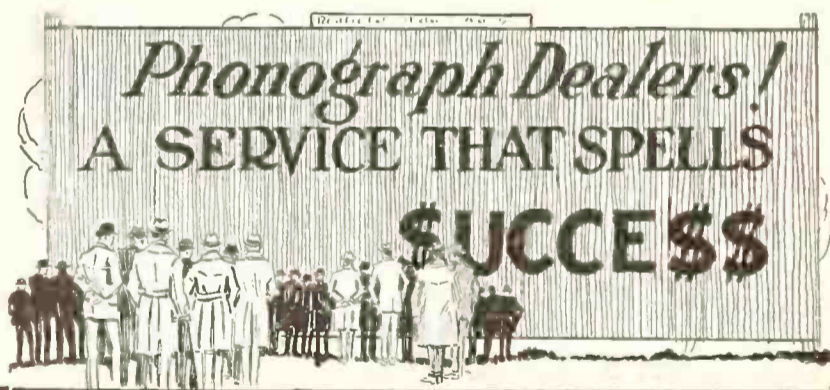

THE service we offer our dealers is a material factor in the service they can offer their customers.



Consult with us regarding plans for increasing business during the fall season.

Any communication from you will have our prompt and careful attention.

Long Island Phonograph Co., Inc.

Sonora Distributors for Brooklyn and Long Island

150 Montague Street, Brooklyn, N. Y.

Telephone Main 4186

of one of the oldest dealers on Long Island after many years of catering to the talking machine trade in Oyster Bay. Groebl Bros. were pioneers in the talking machine field and had established in their long years of service a business of large proportions. The proprietors of this talking machine shop are retiring and will locate in California and enjoy the fruits of their labors and a well-earned rest. The store, stock and fixtures have been purchased by Theodore Jospe, who conducts a talking machine store at Glen Cove. Mr. Jospe intends to rearrange this new store and it is expected he will make as large a success of his activities there as he did in his Glen Cove establishment.

Progressive Plans of L. I. Phonograph Co.

The Long Island Phonograph Co., wholesaler of the Sonora phonograph, reports that dealers are now beginning to place real orders for machines and that every indication points to a prosperous Fall season. New dealers have been added and this Fall and Winter will see an increase in this dealer list—larger than the company has ever had before. E. E. Schratweiser, sales manager of the company, has been co-operating with the dealers in helping them get their stores in shape for Fall business. He states that Sonora dealers in this section are well prepared and have stocked a large number of machines.

This month the company is sending out a very timely letter, bearing on the Fall campaign, and is also distributing among dealers the new Sonora machine catalog, which has just come off the press.

A special feature of the service which this company is offering its dealers during the month of September is the service of a special representative direct from Sonora headquarters in the person of Forrest P. Conklin, who is calling on Sonora dealers with the Long Island Phonograph Co.'s representative and doing timely work in offering dealers ideas and suggestions and helping them plan intelligently their Fall campaigns.

Lee Coupe, Long Island representative of this company, is back again at work after an enjoyable vacation spent at a Long Island Summer resort. Miss May McWalters, assistant to Mr. Schratweiser, also returned from a vacation spent in and around New York resorts, all ready to take up her active duties again.

Big Call for Bruns Maderite Cover

A. Bruns & Sons, manufacturers of the Bruns Maderite cover for talking machines, report that they are extremely busy filling orders from dealers all over the country for their now well-known product. These covers have met with considerable favor with the trade everywhere and during the past year many new features have been added to the line with the result that dealers have ordered in considerable quantities. Officials of the company stated that from the way dealers were writing in for covers it seemed a sure indication that business this Fall would be a very prosperous one and that the company is expected to be kept busy as never before.

Park Music Co. Has Sonora Line

The latest addition to the large list of Sonora dealers, established by the Long Island Phonograph Co., is the Park Music Co., at Floral Park, L. I. A. E. Swenson is the proprietor of this live store, which will feature the complete Sonora line the coming season. To properly introduce the Sonora to his clientele, Mr. Swenson recently carried a very fine window display showing these models, which created considerable interest, and followed up this display with an appropriate sales letter, which he sent to several hundred people in his vicinity. One entire day was devoted to the Sonora line and

VICTROLAS

A MESSAGE to Victor Retailers

Thought should be given now to arranging for ample Fall stock, and special consideration should be accorded to the sales possibilities of the new Victrola flat top models. In fact, the complete Victrola line and Victor record catalog.

We will be glad to aid the Victor retailer in arranging his Fall sales plans and to this end we offer our services.

VICTOR RECORDS

G. T. WILLIAMS CO. Inc.

272 Flatbush Avenue Extension Brooklyn, N. Y.

people who visited this store during that day were given souvenirs and little remembrances in the way of a large Sonora fan. Another feature of this day was the presence of a Sonora representative, who co-operated with the dealer in meeting his clientele and who boosted Sonora prestige with this dealer in a considerable degree. This account was secured through the efforts of E. E. Schratweiser, sales manager of the Long Island Phonograph Co.

George M. Millard's New Store

George M. Millard, 1803 Myrtle avenue, one of the most progressive dealers in Brooklyn, has just taken on in conjunction with his other line the complete Sonora line of phonograph models. He intends to feature this well-known phonograph and in order to give it right representation is planning to enlarge his store to more than double its present capacity. He plans to take over the entire building at this address and is to devote the first and second floors to his large talking machine business. Complete new equipment, such as sound-proof hearing rooms, up-to-date record racks and record counters and new fixtures are installed. A feature of these alterations will be one of the finest show windows in all Brooklyn. Mr. Millard expects to occupy these new quarters and have them entirely finished by October 1 and will announce the opening of this modern store at that time in an appropriate manner.

Jacob Corp. Buys A. H. Taylor Interests

Jacob Piano & Phonograph Corp., at 997 Broadway, which conducts one of the most attractive talking machine shops in this section, has recently purchased the entire stock and fixtures and good will of the store conducted by A. H. Taylor at 316 Fulton street, Jamaica. Mr. Taylor has conducted this store for many years past and is one of the pioneers in the Brooklyn talking machine field and is retiring from business after many years of catering to the talking machine public. He intends to have a long vacation, but it is rumored that he may after a time take up active duties again in connection with another talking machine shop in another section of the city.

The Jacob Corp. is planning to devote much of its time to the rearrangement of its new store, which will be in charge of a competent man. When alterations are completed this section of Brooklyn will have a talking machine purchasing center of the very finest type, and, no doubt, this store will become as well known as their thriving establishment at 997 Broadway.

Kept Business at Top Notch

M. Chale, manager of the Prospect Talking

Machine Shop at 357 Saratoga avenue, Sonora dealer, reported back for duty this week after a very pleasant vacation spent in northern New York State. Mr. Chale is considered one of the best-equipped talking machine men in Greater New York and through his efforts this establishment has grown into one of the most prosperous retail stores in Brooklyn. Mr. Chale stated that business during July and August had not slumped materially, simply because considerable time was spent calling on new and old customers and interesting them in the latest records by playing them in their homes. Also the repair man was sent out to many old customers and in that way much additional revenue was obtained through oiling and general overhauling of their talking machine motors. He seemed very confident that this coming Fall would be a prosperous one in every way.

Completes Renovation of Store

S. Leider, who conducts a talking machine shop at 216 New Lots Road, in the Canarsie section of Brooklyn, has just completed the renovation of his store and has added a very attractive display window. Mr. Leider is a Sonora dealer and recently displayed to advantage in his newly arranged windows several Sonora models, which aroused much interest and resulted in good sales. Record business Mr. Leider reports as very satisfactory, with all indications pointing to a very fine machine business for the Fall and Winter. With his new equipment he is well prepared to take care of this expected increase and results will more than warrant the expenditure entailed.

G. T. Williams Co.'s New Quarters

G. T. Williams Co., Inc., Victor distributor, is being congratulated on its new model distributing plant, 272 Flatbush avenue extension. The executive offices, shipping and other departments are all well arranged. The location of the quarters is most accessible.

COTTON FLOCKS

.. FOR ..

Record Manufacturing

THE PECKHAM MFG. CO., 238 South Street NEWARK, N. J.

ACME-DIE

CASTINGS

ALUMINUM-ZINC-TIN & LEAD ALL TYPES
Acme Die-Casting Corp.
Boston Rochester Brooklyn, N.Y. Detroit Chicago

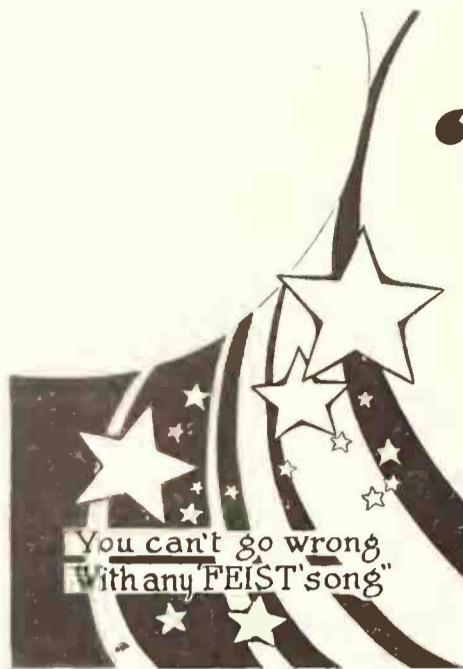

Your Feet Won't Keep Still When You Hear—
“SILVER STARS”

Percy Wenrich's New Fox Trot Hit—Hear It Once - Remember It Always



Sil - ver stars a - bove, ———— Tell me of your love, ————

CANTON

Betterment in Business—Exhibitors at Annual Fair—Recent Store Changes and Other News

CANTON, O., September 6.—The talking machine business in this section showed a distinct improvement during August and there is every indication that, with the settlement of the coal strike practically accomplished, trade during September will show a substantial improvement. More machines of the better class are being sold and dealers report that collections are keeping up in excellent shape.

The store of William R. Zollinger & Co. will continue to operate on its former policy and there will be no change of merchandising methods with the assumption of the business by Charles W. and Harry R. Zollinger, sons of the late William R. Zollinger. This announcement was made this week. Manager Pyle declared that the store was going in heavy on its county fair exhibit this year and that he expected the Zollinger booth to be one of the handsomest at the fair.

George Wille, head of the George C. Wille

Music Co., with stores in Canton and Massillon, proved a pleasing host Wednesday, August 30, to employes of his two stores. He entertained some forty employes and their families at his cottage at Turkeyfoot Lake, where a most pleasant afternoon was spent. At six o'clock he served a picnic supper on the lawn of his home. Business with this house shows steady betterment.

C. M. Alford, of the Alford & Fryar Piano Co., announced this week he would attend the annual meeting of the Ohio Music Merchants' Association, to be held September 26 and 27 at Toledo, O.

One Store Less in Canton

With the closing of the store of the J. W. Brown Piano Co. another Sonora agency passes from this district. It is understood that the Van-Fossen Smiley Piano Co. will now give much attention to the Sonora machine, which it has been selling for some time past.

The general store of the Garver Bros. Co., at Strasburg, O., known as the largest country store in the world, is making ready for its anniversary sales. It is expected that several piano and talking machine houses will have representatives at the store during the sales.

More than the usual number of music dealers have booths at the annual Stark County Fair, which opened Monday. Their displays in the new exhibition hall are attracting much attention. Dealers are displaying all kinds of musical instruments and sheet music and novel stunts are being used to attract patrons.

Invite Canton Dealers to Participate

The annual Fall exposition and sales week, to be held by the retail merchants' division of the Chamber of Commerce, is announced to open Monday, September 11, and for three days merchants will offer special window displays. Music dealers have been invited this year to join with other merchants in this promotion and have accepted. They, too, will dress up their windows and offer some sort of a special trade-pulling stunt. It will be the first year that the music dealers have taken part.

NEW VICTOR DEALER IN MEXICO

W. M. Cox, formerly connected with Coa. Fonografica de Ventas S. A., of Mexico City, as manager, has resigned and organized the firm of Buena & Cox, S. en C., in Guadalajara, Jal., handling the Victor line exclusively. It is the first talking machine shop in that section of Mexico.

During a recent visit to New York of F. K. Dolbeer, manager of the traveling department of the Victor Talking Machine Co., he was the guest of William J. Haussler, vice-president and general manager, and Jerome Harris, secretary of C. Bruno & Son, Victor distributors, and Fred P. Oliver, vice-president and general manager of the Blackman Talking Machine Co., Victor distributor, at an informal theatre party.

NOW OPERATING AS LANDAY BROS.

Max Landay, president of Landay Bros., Inc., announced early this month that the title of the Sonnenberg Music Co., of Bridgeport and New Haven, Conn., of which Landay Bros. have been the chief factors for some time, has been changed to Landay Bros.

Only one-third of so-called salesmanship is done outside the plant. The other two-thirds is done inside—by accurate order clerks and shipping clerks, by well-trained, efficient workmen, and by careful, conscientious, on-the-job department managers. It is the outside man's job to get the business, but those inside must keep it.



Should be on Every



Phonograph and Player Piano

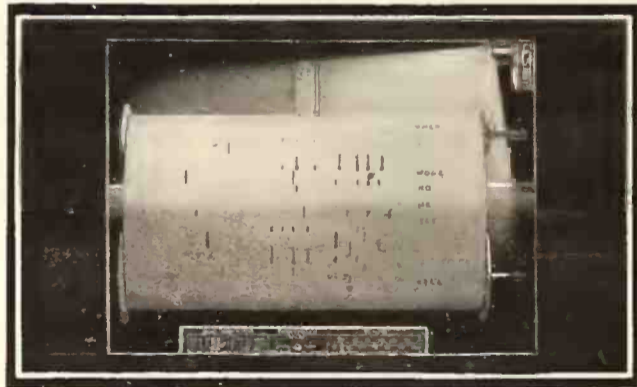

Beautifully finished in Nickel or Gold

It applies perfectly to every phonograph and player piano, no instrument is complete without it.

For phonographs this light makes cumbersome operations easy and simple in darkest corners where phonographs are usually placed. It prevents scratching of records and makes setting of automatic stop positive and simple.

For player pianos it is indispensable, gives an abundance of illumination for singing or inserting music rolls.

Easily and quickly attached, comes complete ready for use, no electricity or wiring necessary.

RECORD FLASHERS last indefinitely and are fully guaranteed. Batteries last from 6 to 12 months in service. Renewals can be had at 75 cents.

Prices { Nickel Plated with Battery - - \$3.00
 Gold " " " - - 3.75

*Special Discounts to Dealers and Manufacturers
 Write for descriptive circular*

Standard Accessory Corporation
 Sole Manufacturers and Patentees
 1015 Third St. Milwaukee, Wis.

Sharpen the Fibre Needle

Without removing it from the
Tone Arm of the Phonograph

It's 5 years ahead of the times

CONVENIENT

FAST SELLER



GOOD PROFITS

MECHANICALLY RIGHT

Very Simple

**LIDSEEN
 FIBRE NEEDLE
 CUTTER**

LIDSEEN PRODUCTS
 832-840 So. Central Ave. CHICAGO



CHICAGO
TALKING MACHINE CO
12 North Michigan Ave.

NEW YORK
TALKING MACHINE CO
521 West 57th Street

A.D. Geissler
President

New Victrola
No.230 "Louis XV"

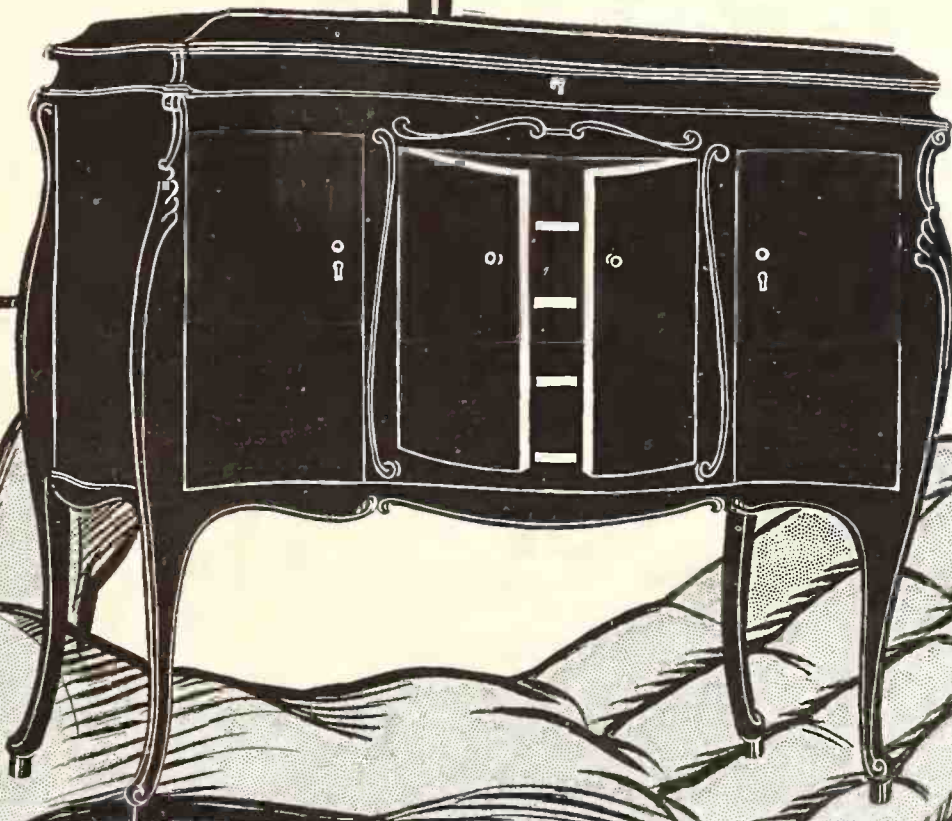

Victor Wholesalers Exclusively

Mid-West Point of View

WESTERN DIVISION OF THE WORLD, CHICAGO, ILL., SEPT. 10, 1922.

THE opinion is being expressed by various persons in this territory that the people of the Mid-West have no money to spend. But

Look
at the
"Liberties"

the slightest consideration is sufficient to show the absurdity of such a claim. For the banks are well known to be filled with savings account money and the prices of Liberty Bonds are high. Now, when any one talks about the people not having money, let him be politely but firmly led to the bulletin board and invited to inspect the figures which show what "Liberties" and savings bank deposits are doing. He will find plenty to astonish and excite him in the process. For when the people have no money they throw their bonds on the market. They do not try to buy, but to sell till the prices of "Liberties" have gone down, down and again down. The same, of course, is true of savings bank deposits. But, on the other hand, when prices of bonds and totals of deposits continue to rise, whilst at the same time business men say that things are not moving fast, the conclusion is also obvious. The people are holding their money. When people hold their money it is for two reasons always. One is the belief that prices are fictitious. The other is that some exciting disturbance will pass away shortly and that there will be general loosening up and spending when this occurs. People who are not even remotely touched by anything going on in the way of industrial disturbance nevertheless feel just that way about it and act accordingly. Well, that is just what is the matter at this moment. The railroad strike situation has been annoying and irritating everybody, but the outlook is better. The coal situation has only just been mended and, of course, the beneficial effects are partly neutralized by the shortage of cars on the railroads. There is the explanation of the whole present slackness. Money is plentiful, employment is not bad, but the people are uncertain and disinclined to make a start until there is something in the nature of a general settlement. That this is imminent we do not doubt, for a variety of reasons which need not be discussed here. Then look out for speed!

THIS railroad car question, by the way, should be heeded by merchants everywhere. It must be remembered that when the shop-

Cars
and
Orders

men's strike shall have been settled, there will be on hand a vast quantity of bad-order locomotives and cars. Of course, the statements made by the union officials about the condition of the rolling-stock at this moment have been exaggerated for technical reasons. Yet it is certain that the freight car shortage already exists and that in consequence there will be of a surety much delay in shipping goods during the early Fall. It is, therefore, highly advisable to place orders as early as possible. This sounds like rather familiar advice, yet it is highly important and should just now be kept in mind. In offering it we are thinking quite as much of the merchants as of the manufacturers. Of course, no manufacturing organization can hold its personnel together during an indefinitely long period of hand-to-mouth ordering by merchants too much frightened to be able to go out and dig up business. Personnel rapidly disintegrates, and there follow delay and consequent deterioration in output before the leaks can be patched again. But there are still more important reasons—important, that is, to the merchant—than these. The merchant, in other words, should realize that he cannot even put himself in position to care for prospects whom he does dig up if he has no stock on his floors. Now, it is a well-known fact that machine stocks are low, lower than record stocks in most cases. To allow them to degenerate still further is rank folly; nor is there anything at all in the present or prospective business situation to suggest that one ought to hesitate in building them up to a respectable position just as quickly as the factories can supply the goods.

THE story of the Milwaukee-Chicago music trade picnic would be wholly incomplete if we did not point out that a very large part of

Our
Intercity
Blowout

its success was due to the presence and active interest of the talking machine contingent. There are many talking machine men in the Chicago Piano Club and in the Milwaukee Music Trade Association. Moreover, when these two decided to have their annual outings together, the Columbia Graphophone Co.'s Chicago branch decided to join the merry throng, the more so because Manager John McKenna is secretary of the Piano Club, of Chicago. So the Columbia branch closed up the office and all the boys and girls went out to Ravinia to swell the crowd. One result, naturally, was that a great many Columbia dealers came along, got acquainted with the Piano Club members and went away impressed with the value of intra-trade social work. Of course, and the facts lead one to ask why the idea of co-operative outings should not be carried still further? We assert that if the whole trade closed down for a day and went off together in one huge picnic once a year, the results would be altogether to the good. It is worth trying and the result of one trial would, undoubtedly, justify a repetition. And while that notion is sinking in, permit us to remark that in our opinion the Milwaukee Music Trade Association comprises one fine bunch of live boys. Yes, sir!

WITH the beginning of the Fall there will be a recrudescence of activity in the radio field, and we may expect to hear of numerous

Radio
and
Phone

novelties in equipment and service. Meanwhile the air is filled with rumors of new radio-phonograph combination outfits. But with this cheerful news must go a warning, if many of our good readers among the merchants are not to be disappointed, as some of them have been disappointed already. We must again warn merchants, in fact, to keep an eye on that feature of the radio game to which Otto Schulz, president of Magnolia Talking Machine Co., drew attention last month. That is, that the reproduction of music via radio telephony must on no account be compared with the reproduction common to high-class talking machines to its manifest disadvantages if misunderstanding and many complaints are to be avoided. The fact is that those who buy these combination outfits must be carefully educated to understand that the two systems are totally different and that radio telephony is in its infancy, especially as respects receiving. With all due admiration for the remarkable achievements of physical discovery which have led to the present developments of radio telephony, it has to be acknowledged that the sort of reproduction which is commonly obtained with the best outfits would be justly considered intolerable if it came from the diaphragm of a talking machine. Radio telephony is in its infancy and merchants should, therefore, be careful to realize the facts about it before they start selling. With the customer rightly understanding what to expect there can be no trouble.

THERE is a great deal of uneasy, though hardly as yet perceptible, talk among business men and in business circles about the present

Wanted:
Some
Thinkers

strike situation in the basic industry of transportation. A word of cold analysis may not be out of order. In the first place let it be plainly said that, whether rightly or wrongly, ninety-nine in every hundred dwellers in the United States haven't the slightest desire to see any institution torn down or any violent change of any kind made in forms or systems of government. The one in every hundred who does desire all or part of a program of violence to be put into operation usually has very little analytical understanding of what he really expects to achieve, and his only value lies in the fact that he does know why he wants what he wants. There is a great need for education, a great need for serious thinking among the rank and file of the people of the United States when industrial or economic questions are to be considered. We unfortunately have a lot of citizens who will not think, will not act, will not even vote. If the pillars of the Temple fell in on them whose fault would it be?

From our **CHICAGO** HEADQUARTERS

REPUBLIC BLDG., 209 SOUTH STATE ST TELEPHONE WABASH 5242

EDWARD VAN HARLINGEN

WILLIAM BRAID WHITE

EUGENE F. CAREY

ARTHUR E. NEALY

A. SNYDER

CHICAGO, ILL., September 8.—From all indications we can look forward to an exceptionally busy Fall trade in all kinds of musical instruments. This is the belief of all men in the wholesale and retail trades here. The retail men believe that there will be keen competition this year and that it will tend to expand business to elaborate proportions. The wholesale men believe likewise.

There are, also, indications throughout the Chicago territory that many of the manufacturers will spring surprises in the line of talking machines which are out of the ordinary. At any rate we are sure of innumerable new designs and added features. Radio combinations will, in all probability, become important factors in the coming season's business. On every hand we see new companies coming out with radio receiving sets, often in combination with the regular talking machine. Just how strong these instruments will be on the market is as yet a matter of conjecture, but, at any rate, it is almost certain that we shall see many of them.

The retail business for the past month has been truly trying. During the first week in August retail business was going along fairly well throughout Chicago, but during the next three weeks the city was in the grip of the hottest spell of its existence. The thermometer seemingly was on a rampage, and only the parks and bathing beaches really did any business; retail trade, not only in music, but in everything else, got more or less of a setback and for a few days retail business was practically at a standstill. However, Chicago gets a

real hot wave once every year, whether it likes it or not, and when this time it actually slowed down the wheels of industry part of the retail trade was alarmed. The men in this end of the game are old-timers and know from past experience that they have to expect a few weeks, at least, of real sweltering weather that puts a crimp in every business. Knowing this, they made preparations accordingly and most of their vacations were taken during this particular time.

Another event that slowed up business was the car strike, which lasted a week. This, for a while, brought about a chaotic condition in all lines of industry in Chicago, but, owing to the efficiency of the traffic regulations put into effect by the police department, the workers and shoppers got to and from their homes in fairly good time, with little added expense.

The railway shop strikes centered in and about the shops in Chicago territory, particularly at Pullman, Hegewish and other car-repairing and building centers, have slackened up business considerably in those territories. This controversy has been protracted to such an extent that many of the former shop workers have gone into other lines of activity and, in all probability, there will be quite a shortage of help when the car shops and other places affected by the strike have settled their grievances.

The mining situation in the strip and other soft coal mines, upon which Chicago greatly depends for its coal supply, is easing up somewhat and the daily papers report that in certain sections the miners have resumed their

work. Of course, this resumption of work by the miners will not stimulate business in those sections to any great extent for the time being, but it is hoped that ere long the good effects of this resumption of activity will begin to assert themselves.

The farmers of Illinois, Indiana, Michigan and other surrounding States were up against a difficult proposition for a while during the latter part of August. The continued heat and the lack of rain came near destroying the bumper crops in these sections, but, somehow or other, with the help of a little shower once in a while, the crops as a whole have survived the drought.

Kimball Announces Improvement in Orders

The W. W. Kimball Co. reports that there has been a real improvement in phonograph orders within the last thirty days. This activity is especially noticeable in the farm communities and might be attributed to three things. One of them is the exhibits and county fairs that are now being staged at this time, the second is low stocks now prevailing and the third is that many of the dealers are putting on the special sales and starting the advertising campaigns which are customary with the opening of the Fall season.

Among Department Stores

Retailers are joining in with the wholesalers in declaring that business has shown a noticeable increase during the past month. Although it might be well to mention that there is a good deal of irritation prevailing at this writing, due to the strikes which are holding things back,

(Continued on page 100)

Announcement

“The Jewel Phonoparts Co., 154 Whiting St., Chicago, Ill. have added many refinements and improvements to their line of Jewel Tone Arms and Reproducers, and from Sept. 15th will be in production and will be pleased to furnish the Manufacturing Trade, on request, with illustrations, samples and prices on the highest grade Tone Arms and Reproducers that long knowledge of the business, money, skill and carefulness in manufacture, assembling and inspection can produce at the lowest possible cost consistent with the quality.”

FROM OUR CHICAGO HEADQUARTERS—(Continued from page 99)

nevertheless, conditions have shown a big improvement. Everybody asserts that as soon as the strike situation is relieved a "grand and glorious feeling" will be produced and buying will be noticeable on the part of all. While on the subject of strikes we might comment on the recent street-car strike that hit Chicago the first of August. After a strike of this kind there naturally would be expected quite a rush of orders, due to the fact that many buyers were handicapped during this period, and the reports are that business far surpassed expectations. Not only did prospects of long standing make a rush for talking machines, but there seemed to be a different spirit among those who had heretofore merely been lookers-on. Rothschild & Co., who handle various makes of the standard lines of talking machines, noticed this in particular. W. B. Papineau, manager of the talking machine department of The Fair, also reports that this condition was very noticeable, not only in talking machines and records, but also in small goods. There has

been an unusual demand for ukuleles during the past month. A novel idea was presented to the attention of The World man at this department in the way of a record booster. Along the sides of the demonstration booths the latest hits and popular records are placed. These are mounted on attractive backgrounds with a cut-out of the title page to catch the eye.

New Cheney Distributor in Cleveland

The Cheney Talking Machine Co. announces that the large music house of W. H. Buescher & Sons Co., of Cleveland, O., has taken on the Cheney. This connection gives the Cheney Talking Machine Co. splendid representation in the Cleveland territory and is decidedly complimentary to the manufacturers. In fact, the connection is advantageous to both companies, as it not only gives the Cheney Talking Machine Co. excellent representation, but also affords the Cleveland house a splendid new line with which to develop increased sales.

Chicago Travelers Back on the Job

When those important cogs of the industry,

the travelers, return to their respective territories after vacation full of pep and enthusiasm and begin to send in the orders we realize that the Fall season is close upon us. The Chicago Talking Machine Co. is keeping abreast of the situation and making plans for the volume of business that is expected within the near future. A. D. Geissler, president of the Chicago Talking Machine Co., recently paid a visit to the local office to prepare for the Fall trade. H. A. Diehl, traveling representative, has returned to his territory after a vacation. R. E. Kane, who travels Illinois and part of Iowa, is again back with his dealers and T. W. Williams is calling on the Chicago dealers once more. Everyone is settled for the Fall.

Lakeside Supply Co. Active

We are hearing a great deal about business betterment, and in some cases it is just optimistic talk, but when optimism is backed up by facts we really know that business is good. W. A. Fricke, of the Lakeside Supply Co., is very optimistic and says that business is picking up, both in the radio and phonograph fields. "From present indications we are going to have a bumper crop of business," says Mr. Fricke. "We have just finished a new loud speaker device for our radio which is now ready for the market. We have also opened up a retail department for the sale of Aeolian records. Miss Dawson, who has charge of this department, had previously been associated with a large concern in this capacity and is getting good results from the campaign she is putting on." Mr. Fricke further states that the Crossley radio equipment, because of its low price and wonderful reproducing powers, is appealing strongly to the music dealers. In fact, every music dealer ought to be interested in this line because of its marked appeal to public taste and quick turnover.

Columbia Men on the Job

Messrs. Sebok and Wichhorst, representatives of the Chicago branch of the Columbia Co., were aboard the S. S. South American on their way to call on G. H. Wickman, Columbia dealer, Mackinac Island, Mich. On board they met Charles Jiran, son of Joseph Jiran, Chicago Columbia dealer, and his bride, who were on their way to Buffalo, N. Y. Messrs. Sebok and Wichhorst realized that it is every young couple's desire to have a beautiful and cozy little home. Immediately Mr. Wichhorst placed Columbia Console Grafonola broadsides in every conspicuous spot on the ship, while Mr. Sebok related the happiness and pleasure that a Columbia Console Grafonola would give to the bride and groom. The result was that a Queen Anne design Grafonola will grace the choicest spot in the living room of their new apartment.

Paul S. Kantner, manager of the San Francisco branch of the Columbia Co., paid a visit to the Chicago office the early part of the week and reported that business conditions on the Coast are improving immensely and that a big Fall business is anticipated.

Miss Gerlach, of the Chicago office of the Columbia Co., is spending a two weeks' vacation in New York. While there she paid a visit to the New York executive offices and had the pleasure of watching Cyrena Van Gordon, Chicago, opera star, make records.

Oriola Scores Big at Edgewater

One of the biggest musical sensations that have hit these parts in many a day is the Oriola Terrace Orchestra, which is now playing at the Edgewater Beach Hotel. This is a Detroit organization which has lately come to the front with rapid strides. The present engagement at the Edgewater Beach Hotel, Chicago, will terminate October 31, when the musicians will entrain for New York for a week's recording at the Brunswick Recording Laboratories. The orchestra will move to Detroit for the opening of the big new Oriola Terrace on September 15. The Oriola Terrace Orchestra is composed of twelve pieces, with Ted Fiorito,

BEAU BRUMMEL In Squeaky Shoes!!

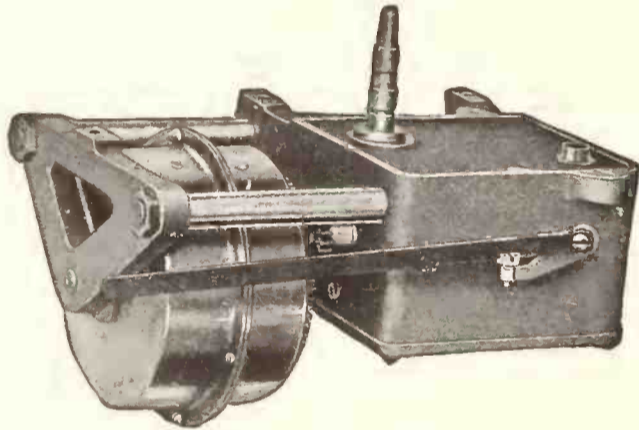

A thing may be durable and yet most objectionable.

Not so long ago, all motors were noisy. The coffee-mill-like winding sounds and the mechanical sounds of the motor were the accustomed though annoying prelude to an operatic air.

Today, instruments equipped with our enclosed, automatically lubricated motors avoid this objectionable defect. Not a sound—No intrusion of mechanics into the artist's offering, they are musical instruments—not machines.

Also, manufacturers were accustomed to bear a certain amount of bother and expense due to motor troubles after their instruments were sold.

Most of the makers of fine Phonographs now use our equipment, their motor troubles are forgotten, their costs as well as their overhead expense are reduced, and their cabinet work, no matter how exquisite, is matched in refinement and quality by the mechanism inside.

Let us send samples for trial at our expense to your Mechanical Department. See for yourself just what we offer at less money than you are doubtless now paying.

Let Us Furnish You Samples

United Manufacturing and Distributing Company

536 Lake Shore Drive

CHICAGO

FROM OUR CHICAGO HEADQUARTERS—(Continued from page 100)

the well-known writer of "Just Like a Rainbow" and other popular numbers, at the piano. Dan Russo is musical director.

Steger Scores at Progress Pageant

The Steger display at the Chicago Pageant of Progress, July 29-August 20, included a player-piano, a small grand, two phonographs

office, is the latest victim of the ever-prevalent disease known as nuptials, and from now on Jack will divide the "give and take" game of giving orders and will probably be satisfied to do the latter. Mr. MacNichols made the speech at the ceremonies held by the local office, at which Mr. and Mrs. Kapp were presented with

the past two weeks and will remain over another by popular request. Norman is the author of the big song hit "Nobody Lied." Dealers have found this tie-up a most profitable one, as the song sung by Marion Harris is a knockout.

Columbia dealers all over the Chicago branch territory are tying up to the new picture by Vitagraph, titled "My Wild Irish Rose." The Vitagraph Co. is furnishing splendid advertising material for window displays and wide-awake Columbia dealers have lost no time in taking advantage of this wonderful opportunity to stimulate the sale of Columbia record A1852 of the same name by the Columbia Stellar Quartet.

The Famous Players are putting out a Paramount picture, titled "Nice People," which made its initial appearance in Chicago at the Chicago Theatre on August 20. This is another big scoop for Columbia dealers in Chicago and many dealers are tying up to this picture with Columbia record A3445, the same selection by Furman and Nash, stellar Columbia artists.

Novel Exploitation

Marvin Lee, Western sales manager for Waterson, Berlin & Snyder, has been engaged for several days planning a coast-wise trip. In this connection he decided that it would be a good idea to announce his coming beforehand by some quite unique plan. So he secured a quantity of blank talking machine records, placed them on a dictating machine and then dictated the announcement relative to date of his arrival in each important town. It was necessary to dictate an individual record for each and every dealer he had scheduled on his trip. For many years Mr. Lee has adopted something new and unusual for the purpose of exploiting his firm's specials, but this time he feels he has hit upon an idea which will make

(Continued on page 102)

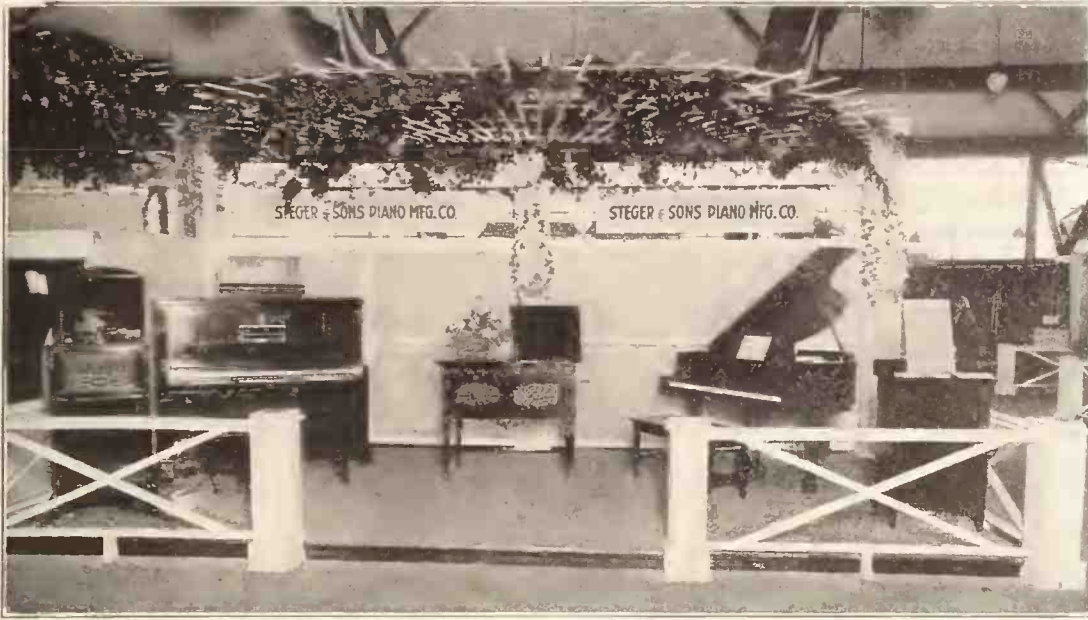

Exhibit Made by the Steger Co. at the Chicago Pageant of Progress

and a selection of benches and music cabinets, all products of the Steger factories.

One of the features of the exhibit was the new "Adam Model" Steger phonograph, distinctive because of the beauty of its design. The artistic hand-carvings which embellish it are all hand work. A style 506 Steger phonograph was used for demonstrating, and its wonderful tone reproducing qualities evoked many favorable comments from visitors.

Send-off for Jack Kapp

As reported in last month's World, Jack Kapp, record supervisor of the local Columbia

a handsome writing desk and chair and desk set by his fellow workers. After the wedding the bride and groom left on their honeymoon trip to the Coast. While on the Coast Mr. Kapp expects to call on several Columbia dealers and pay a visit to the San Francisco, Los Angeles, Denver and Kansas City branches of the company.

Tying Up With the Movies

The Chicago office of the Columbia Co. is at present tying up its dealers with Karyl Norman, the Creole fashion plate, who has been the big headliner at the Majestic Theatre for



"Built by tone specialists"

IN ITS SEVENTH YEAR OF STEADY SUCCESS

4 Cabinet Styles:

Mahogany, Walnut and Oak Finishes.

Patented Tone-Deflecting System:

Unsurpassed Workmanship.

Vertical Record Filing:

Mechanical and Acoustic Equipment Beyond Criticism.

Write for our *Revised Wholesale Prices*

Magnola Talking Machine Company

OTTO SCHULZ, President

711 Milwaukee Avenue

Chicago



Magnola Style Louis XVI

FROM OUR CHICAGO HEADQUARTERS—(Continued from page 101)

the trade sit up and take particular notice.

Frank Clark, Chicago manager of Waterson, Berlin & Snyder, is spending a vacation at Manitowish, Wisconsin.

Ray Reilly Married

Ray Reilly, Loop representative of the Columbia Graphophone Co., was wed to Irma Fisher, of this city, on Saturday, August 19. The ceremony took place at the home of the bride and among those invited were several prominent men of the local talking machine industry. Mr. and Mrs. Reilly spent their honeymoon in the East, traveling to Washington, Philadelphia, Atlantic City and New York, arriving home on Labor Day. After September 10 they will be at home at 4903 Monticello avenue.

A. J. Kendrick Was Marooned

The newspapers of the country have been publishing accounts of the now famous railroad train which was marooned with all its passengers in the desert recently. Among those aboard this train was A. J. Kendrick, sales manager of the phonograph division of the Brunswick-Balke-Collender Co. Mr. Kendrick left Chicago about the middle of August for a trip through the Southwest and coast sections of the country and, while aboard the train at Albuquerque, N. M., the train crew deserted and left the passengers all by their lonesomes. For this reason Mr. Kendrick was delayed for ten days, as he had intended to return to Chicago on or about September 5. It was his intention, originally, to follow the coast north to Vancouver, then hit the large States in the Northwest and return to Chicago by way of Minneapolis.

Annual Picnic of Columbia Forces

Wednesday, August 9, the Chicago office of the Columbia Co. held its annual picnic, which was a big success in every respect, it being held in conjunction with the picnic given by the Piano Club of Chicago at Ravinia Park. Several of the Columbians were prize-winners in

the contests held. A nail-driving contest for mothers and daughters, one of the features of the picnic, was won by Miss Sullivan and her mother. Twelve late records was the prize given. In the peanut race Miss McCarthy won the honors. It was obviously a "nutty" affair. A beautiful pair of silk hose was the prize for this affair. Ed Blimke, one of the greatest catchers around Chicago years ago, participated in the baseball game between Chicago and Milwaukee, which the former won by the small score of 22 to 3. Bauer, of Columbia, also played and enjoyed himself by hitting a home run. Blimke also carried off first honors in the horseshoe match, which he won handily and for which he was awarded a handsome pair of cuff links. After a good picnic supper the crowd took in the opera, "The Love of Three Kings." This picnic is considered by the Columbia family to be the best one to date.

New Melody Radio Set

The Melody National Sales Co. is just placing on the market a new three-step audio-frequency-radio-frequency receiving set. This radio set comes in combination with a handsome Melody console type talking machine, and has a range of 1,500 miles. The wave length ranges from 150 to 600 meters. The list price of this handsome new radio talking machine console is \$350. C. C. Slack, head of the Melody Co., also announces that a Melody portable long-range receiving set will be offered to the trade within a few weeks.

Vacationists and Travelers

Walter Deissler, of the Chicago Talking Machine Co., has just returned to his desk, after spending a delightful motoring vacation. He was accompanied by Mrs. Deissler, and spent all of the time touring through near-by States. Mr. and Mrs. Deissler spent a few days in Evansville, Ind., visiting relatives.

Ned Wilson, of New Orleans, La., is spending a few weeks in Chicago, calling on old friends.

L. C. Wiswell, manager of Lyon & Healy's wholesale and retail Victor departments, returned the first part of the week from South Haven, Mich., where he and his family spent a month's vacation. Mr. Wiswell motored from his home in Chicago to South Haven, and on the way to Michigan City he was passed by a flivver sedan, driven by a certain Talking Machine World representative. It was indeed a very, very hard thing to be out on a country road and have a flivver pass you; nevertheless, it happened.

A Center of Brisk Business

The Geo. H. Bent Music Shop, located at 3135 Logan boulevard, in the heart of Logan Square, has been the center of some brisk business this Summer. With special sales, attractive window displays and additional departments—namely, sheet music and small goods—this shop has enjoyed an unusual Summer business. For five years the Logan Square music-lover's shop handled only Victor talking machines and records. But it was seen that there was a big demand for sheet music, so a sheet music department was added during the month of July and the sales have passed expectations. A complete line of Martin band instruments was also taken on the first of August.

Lyon & Healy Radio Department

The radio department of Lyon & Healy, under the supervision of Charles P. Hindringer, has for the past two or three weeks been developing a scheme which has made a tremendous hit with radio fans and music lovers in and about Chicago. It is worked as follows:

The concert hall of Lyon & Healy is known all over this part of the country for its concerts, and during the season is kept packed by people who come to hear the latest Victor records, well-known artists, etc. When Mr. Hindringer was placed in charge of the radio department he thought it would be a good idea to broadcast these concerts. Accordingly he made ar-

(Continued on page 104)



RADIO — PHONOGRAPH



A COMBINATION CABINET

Made so you can install

Radio Panel or Panels

**In One Side and Phonograph
in the Other**

This cabinet is Flexible to the wants of your trade—can even be sold by the dealer to the Radio Enthusiast who wishes to install his own Radio Set.

Made in Quantities and Carried in Stock by Us—so can give you Prompt Service on "Hurry-Up" Orders, Large or Small.

WRITE TODAY To THE WOLF MANUFACTURING INDUSTRIES

Sales Offices
123 WEST MADISON STREET
Chicago, Ill.

Factory and General Office
110-126 3rd STREET
Quincy, Ill.



The
**FLETCHER UNIVERSAL
 TONE ARM and REPRODUCER**

Gives Proper Playing Weights for All Records. No Adjustment Screws or Springs
 SAMPLES \$8.00 Specify 8½" or 9½" arm

FLETCHER-WICKES CO., 6 East Lake Street, Chicago, Illinois

THE McLAGAN PHONOGRAPH CORPORATION, LIMITED, STRATFORD, ONTARIO, EXCLUSIVE CANADIAN AGENTS

FLETCHER REPRODUCER

Scientifically

Constructed



Gives Perfect
 Reproduction
 of Voice
 or Instrument

Volume and
 Perfect Detail

Dealers, Send for
 Prices and Terms



Reproducer
 and Connection
 for
NEW EDISON
 Plays all Records

ACTUAL SIZE

Carried in Stock for Victor and Columbia

THE FLETCHER "STRAIGHT"

Design Patented November 29th, 1921



**STRAIGHT INSIDE—Taper Outside
 BALL BEARINGS THROUGHOUT
 NEW DESIGN NEW CONSTRUCTION**

It is universal and equipped with the Regular Fletcher Reproducer, giving the same natural tone quality as heretofore
 Made in two lengths, 8½" and 9½" SEND FOR PRICES AND TERMS

FLETCHER-WICKES COMPANY
 6 EAST LAKE ST. CHICAGO

THE McLAGAN PHONOGRAPH CORPORATION, LIMITED, STRATFORD, ONTARIO, EXCLUSIVE CANADIAN AGENTS

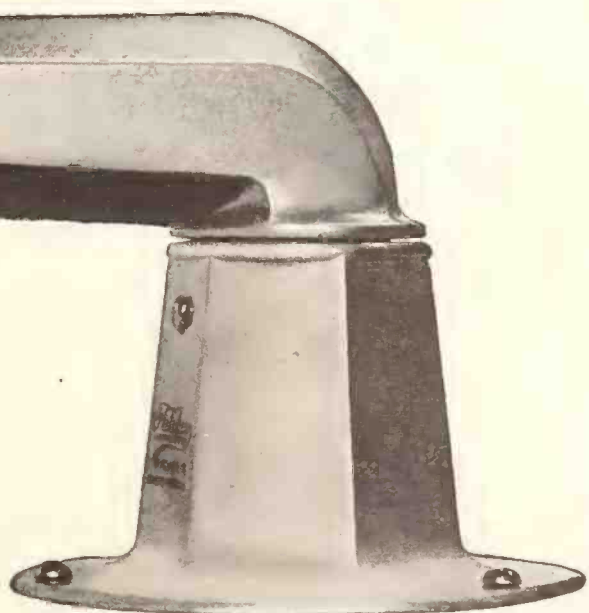

FROM OUR CHICAGO HEADQUARTERS—(Continued from page 102)

rangements with the management of station KYW, the Westinghouse Company's broadcasting station at Chicago, for a special wire, to be run direct into the concert hall. The necessary apparatus for transmitting the concerts from this broadcasting apparatus was then installed. Since then every concert that has been given at the Lyon & Healy hall has not only been heard by those in the hall, but for hundreds of miles around, by the radio enthusiasts who tune in on a 360 meter wave length.

Another feature in connection with radio, which was recently installed in Lyon & Healy's big store under Mr. Hindringer's direction, is the Arlington time announcer. This equipment has been set up in the retail radio department and picks up the Arlington, Md., time signals. This method of announcing time has been taken advantage of by nearly everyone who passes by the radio department, and it has proved its worth by the curiosity it has aroused.

Three Victor Specials

Victor dealers around the Chicago territory are preparing themselves for the special Victor record numbers, scheduled for release September 15. The records are: "Struttin' at the Strutter's Ball" and "The French Trot"; "Why Should I Cry Over You?" and "Blue"; "Say It While Dancing" and "I'm Just Wild About Harry." Owing to the increasing popularity of these selections the Victor Co. made an advance release from the October supplement dance records. The Victor jobbers of Chicago furnished a special window card featuring these specials.

Teaches Music Via Record

An educational talking machine record has made its appearance on the Chicago market. The purpose of this new record is to teach people who cannot read a note of music nor play a violin, mandolin, or mandolin banjo, to become proficient musicians, in their homes, with the aid of the talking machine.

F. M. Schneider, the originator of the record, has been teaching the above-named instruments in Chicago for many years and has been working on the teaching-by-record plan for several years. In connection with his records is a 64-page instruction book. The records and book cover a musical course equivalent to two years of instruction. Mr. Schneider states that he conceived the idea after close observation of hundreds of students. There are certain types of students who are slow to catch on, and always feel humiliated when they get up

in their classes. With the new records a student can play his lesson over and over again, as often as he desires, and in a short while cover a two years' course at the very minimum expense. The records are so arranged that they answer every question the student may ask as he goes over the instruction book.

Mr. Schneider announces that in a short time he will place these records on the market. In fact he is already casting about for distributors.

Brunswick-Balke-Collender Cartoon

The advertising department of the Brunswick-Balke-Collender Co. is using in its general publicity work a very interesting cartoon that combines a selling story with a humorous appeal. This cartoon is illustrated above, and, while the humorous angle is uppermost, it also serves the purpose of linking up the various Brunswick products.



MRS. JOCKO: WHAT'S THE MATTER WITH THAT FOOL-ACTING ELEPHANT?
MR. " OH HE'S JUST HEARD THAT THOSE Brunswick-Balke-Collender-Co HUNTERS ARE GATHERING SHELLAC FOR PHONOGRAPH RECORDS AND NOT IVORY FOR BILLIARD BALLS

Good Roads Encourage Business

E. A. Fern, of the Consolidated Talking Machine Co., has returned to Chicago from a month's business trip throughout the Lake States. In all he traveled something over 1,700 miles by auto. He stated that it was really remarkable to see what the good roads are doing for the small towns, especially in Michigan. The good roads are bringing the tourists from all over, and the business men of the small towns are reaping the profits. The benefits are being divided among all kinds of business and the talking machine men are getting their share of this business. Mr. Fern was accompanied on the trip by A. Thallmayer, of the Foreign Record Department of the General Phonograph Corp. Both Mr. Fern and Mr. Thallmayer called on Okeh dealers throughout their entire

(Continued on page 106)

VITANOLA

The Phonograph of Marvelous Tone

News of Importance



No. 43—List \$125.00

Write us for DEALER'S price

We are now opening new agencies, and if YOU are a live dealer who appreciates merchandise of the highest quality, carrying a dealer profit, too, that makes it a line far "above par," please write.

We need some dealers to join the hundreds of OLD Vitonola dealers who continue to handle and make a success of what one of them characterizes as "the one line we never had a kick on."

When you get our proposition we think you will be glad you wrote, so at least investigate—and "do it now."

We now have in process an entirely new line of uprights and consoles, at prices that will make them predominate in the customer's eye and attention. You may have descriptions and prices NOW, if you drop us a line.

"IT IS EASIER TO SELL THE VITANOLA THAN TO COMPETE WITH IT"

Good Salesmen Wanted to Represent Us in Territory Not Already Closed

Vitonola Talking Machine Co.

1920 So. 52nd Avenue

Cicero, Ill.



The Hall Mark of *Dependability Service and Quality*

The NAME
"KRASCO"

on a Talking Machine Motor means that you are assured of the best possible quality of high grade material and workmanship.

"KRASCO"—

A REVELATION
in SMOOTHNESS
and QUIETNESS

KRASCO No. 33

A very reliable Four Spring Motor, simple in design, compact, sturdy, mechanically right. Built to meet the most exacting demands for long distance playing on one winding.

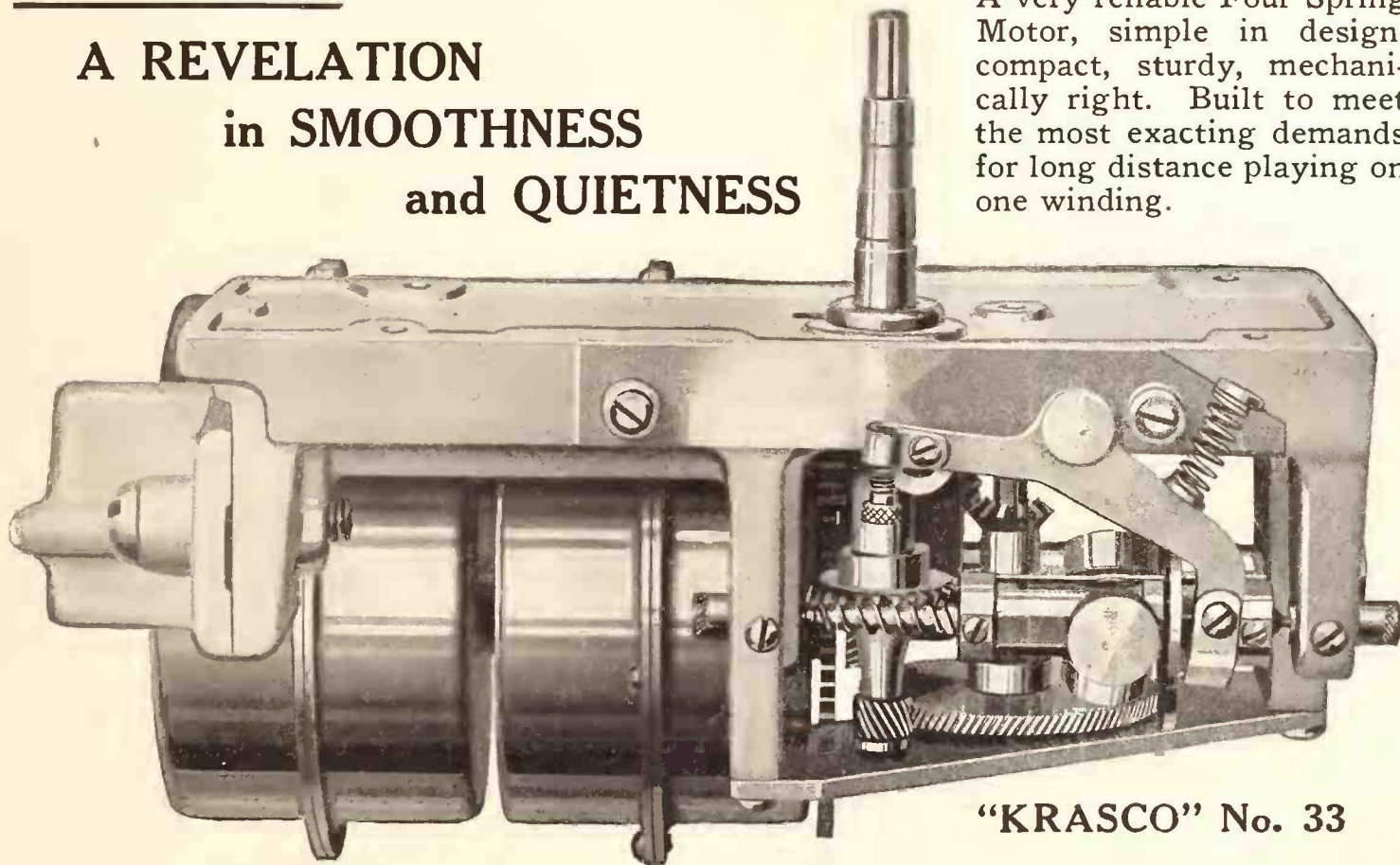

"KRASCO" No. 33

The Krasco Co. has reorganized on a larger and sounder financial basis than ever before. Krasco now has unparalleled facilities for the production of the celebrated Krasco Motor in any quantity and at *Greatly Reduced Prices*. Confer with Krasco on your requirements for two, three or four spring motors. Playing 4 to 10 records on one winding.

Note—Each and every part used in the building of Krasco Motors is produced by the Krasco Manufacturing Co. Krasco is built—not made or assembled.

Krasco Manufacturing Company

451 East Ohio Street

CHICAGO, ILL.



"You can't go wrong
With any FEIST's song"

The Tune That Sticks

TRICKS

The New Fox Trot Surprise by "Zez" Confrey Writer of **STUMBLING**



Very cute tricks, very cute tricks, very cute tricks they played, Wonderful tricks, quite a lot of wonderful tricks,

FROM OUR CHICAGO HEADQUARTERS—(Continued from page 104)

trip and both gentlemen, upon their return to Chicago, reported that Okeh records are very popular in the territories they visited.

Features "Romany Love" in Window

The Brunswick Shop, at 225 South Wabash avenue, created a splendid demand for the Brunswick record "Romany Love" through the



An Artistic Window Display

medium of an unusually appealing window, as may be seen from the accompanying illustration. The display not only attracted the attention of passers-by, but it was directly responsible for the sale of many of the "Romany Love" records.

Keep It Up

Walter Roche, assistant to Manager Wiswell,

was one of the Chicago trade to spend a happy two weeks' vacation at Wilson Beach, Ill.

Magnola Activities

Fred P. Bassett, vice-president of the Magnola Talking Machine Co., has returned to his desk, after spending a very pleasant vacation with his family, in their automobile.

F. J. Sheldon, office manager of the Magnola Talking Machine Co., is enjoying a two weeks' vacation with his family in Wisconsin.

Otto Schulz, Jr., son of Otto Schulz, president of the Magnola Talking Machine Co., is visiting friends in Tulsa, Okla., prior to his return to Princeton University for the beginning of his senior year. Mr. Schulz spent much of his vacation period working in and about the Magnola plant, in order to familiarize himself with the varied details of manufacturing.

One Thousand at Lyon & Healy Outing

Members of the Chicago Piano Club are not the only ones who are boasting of a successful picnic this Summer, for the annual outing held at Delwood Park by Lyon & Healy was equally successful. C.H. Anderson, chairman of the committee, with a host of assistants, put over one of the best picnics ever held by Lyon & Healy. With music furnished by Sweet's Band, of Joliet, as a special feature, mingled with an exciting baseball game between the single and married men; Henry S. Roethig, magician and trickster, to entertain, and dancing in the eve-

ning, there was something doing every minute of the day. The early arrivals participated in an indoor baseball game and horseshoe contest. The baseball game started the afternoon session, the married men beating the single men seven to one. Captains, Agnew and Buchal. Umpires, M. A. Healy and C. R. Fuller. Coaches, Collins and Roche. More than one thousand men, women and children attended the big event. The palatable supper was furnished by Lyon & Healy and was served in cafeteria style. The program concluded with dancing, which lasted from 6:30 to 9:30 and completed one of the most enjoyable reunions ever held by this house.

"It Pays to Advertise"

James Davin, alias "Jimmy," went swimming one afternoon recently at Edgewater Beach, and after the swim discovered he had lost the watch and chain which were presented to him some time ago by some talking machine men in the East. He reported the loss to the authorities and also inserted an ad in one of the Chicago dailies, whereupon the party who found the watch returned it promptly to Jim. "This proves," says Jimmy, "that it pays to advertise."

Statement From Krasco Mfg. Co.

The Krasco Mfg. Co., of Chicago, desires to point out what it says is an error of statement in an advertisement which was published on page 149 of the August issue of The Talking Machine World by James X. Galbaugh, of 1204 Consumers Building, Chicago. In this advertisement Mr. Galbaugh offered for sale what were described as "all tools, dies, machinery, patents, etc., necessary for the manufacture of the famous Krasco enclosed motor." The Krasco Mfg. Co. now states that the motor referred to by Mr. Galbaugh was invented by L. P. Valiquet and that although the old Krasberg Engineering Co. expended many thousands of dollars for experimental work on this motor it was never placed in production and was never sold under the name of Krasco. When the Krasberg Co. was dissolved Mr. Balbaugh came into possession of certain parcels of property, among which was this Valiquet enclosed motor. It seems that Mr. Galbaugh has had this in his possession for some time, but recently decided to offer it for sale. Not being familiar with the details concerning the older company he used the Krasco name in error, according to the Krasco Mfg. Co.

Make Serious Charges

The recent scandals in the Board of Education of Chicago have culminated in the finding of several indictments against members of the Board of Education and officers of various business concerns who have sold supplies to the school authorities. Among the concerns implicated is the Hiawatha Phonograph Co., which is charged by the Grand Jury with selling phonographs at excessively high prices for use in the

(Continued on page 108)

**THE TALKING MACHINE WORLD'S SALES PULMOTOR
"ABILITY" AT LAST**

1. Access-ABILITY
2. Dur-ABILITY
3. Find-ABILITY
4. Index-ABILITY
5. Label-ABILITY
6. Place-ABILITY
7. Port-ABILITY
8. Profit-ABILITY
9. Replace-ABILITY
10. Sale-ABILITY
11. Vis-ABILITY
12. Work-ABILITY

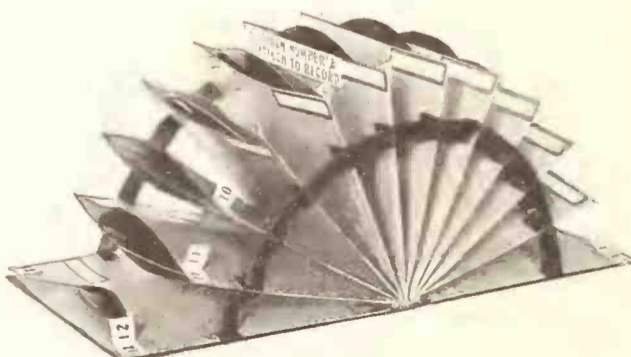

Not for one—but—for *all*—all 12—automatically, instantly, all the time—anywhere. The three-fingered—one-handed—miracle.

Anywhere—much more accessible, safe and convenient in but one-half the area. Infinitely more accessible, closed, than any "album"—open—anywhere.

THE AUTOMATIC-ALBUM

Just as marvelous an automatic cabinet fixture, as it is a transportable album, Optional at will.

UNYVERSAL UTYLYTY UNYTS CO.

6111 Winthrop Avenue

CHICAGO, U. S. A.

IMPORTANT Announcement

The GEER REPEATER—Now \$1.50



Advantages of the GEER REPEATER

- No. 1 It is adjustable, will play either vocal or instrumental records to the end.
- No. 2 It repeats instantly, thereby making the music continuous.
- No. 3 This repeater will last a lifetime. It will not wear out after a few weeks or months of using.
- No. 4 It fits any phonograph.
- No. 5 It is as easy to put on and take off as a record.
- No. 6 When dancing, dining, entertaining or working, the GEER REPEATER doubles the joy of owning a phonograph.
- No. 7 Full directions for use inside the beautiful box container.

A GREATER volume of sales and the desire to bring the retail price of the GEER REPEATER within the reach of every owner of a phonograph, so that dealers will find their repeater sales many times increased—these are the reasons why the retail price of the GEER REPEATER has been reduced to \$1.50.

We ask cooperation of every dealer in bringing the GEER REPEATER prominently to the attention of every phonograph owner. This repeater has been endorsed by many of the highest authorities in the phonograph field. Tens of thousands of users have expressed their delight in its possession. With its exclusive adjustable feature, the GEER REPEATER is an extreme bargain at the present price.

If you do not have a stock of GEER REPEATERS on hand, use the convenient coupon below and send us your order direct or through your jobber. Our Special Window Demonstration Record, which plays through in eighteen minutes without music, is given free with orders of 20 or more GEER REPEATERS.

Please send immediately 20 GEER REPEATERS and enclose one of the special Window Demonstrating Records. It is understood that the retail price is to be \$1.50. Enclosed* find \$18.00, payment in full.

*Credit extended to rated concerns.

Name

Street and No.

City State

WALBERT MANUFACTURING CO.
925-41 Wrightwood Ave. CHICAGO, ILL.

FROM OUR CHICAGO HEADQUARTERS—(Continued from page 106)

schools through undue influence with the political powers in the City Hall.

All efforts so far made to obtain a statement from officers of the Hiawatha Phonograph Co. have, however, been unsuccessful. Newspaper reports of the testimony before the Grand Jury quote Wm. H. Wade, of the Wade-Twichell Co., as stating that he had drawn up specifications for school phonographs which had been afterward changed by someone else. The Hiawatha Co. then obtained the contract for 300 machines at \$157 each.

Geer Repeater Now Listed at \$1.50

W. H. Huth, head of the Walbert Mfg. Co., of this city, manufacturer of the Geer record repeater, announced this week that the company had reduced the price of this repeater to \$1.50. Jobbers and dealers throughout the country have already been advised of this new price, and they have responded enthusiastically by forwarding large orders for immediate delivery.

For some time past Mr. Huth has been devoting a considerable part of his time and energies to a study of the manufacturing details incidental to the production of the Geer repeater, with the idea in mind of giving the trade the full benefit of any possible increase in factory facilities and efficiency. Mr. Huth finally decided upon certain important manufacturing policies, which, coupled with the tremendous demand for the Geer repeater, enabled the Walbert Mfg. Co. to reduce the retail price of the Geer repeater from \$2.50 to \$1.50.

The Geer repeater is now being handled by dealers from coast to coast, and is one of the most popular accessories on the market to-day. As a pioneer in the repeater industry the Geer record repeater has won the general approval of the industry, and its new retail price will undoubtedly act as a powerful stimulant to increased sales. An intensive merchandising and publicity campaign is now being prepared by the Walbert Mfg. Co. and will be announced in detail in the near future.

Krasco Re-enters

The Krasberg Engineering Co., which a few years ago placed the famous Krasberg motor on the market, has been reorganized as the Krasco Mfg. Co. and is on a bigger and stronger financial basis than ever before. The Krasco motor gained much popularity and favor with the trade during the war period and the old company grew to great proportions, but during the great slump that hit the industry shortly after the war reverses were met with and the

STERLING ^{No. 82} THROW BACK TONE ARM

A New Member of the Sterling Family

In response to a demand for a Throw Back Tone Arm, we have designed the No. 82 which embodies all the advantages of Sterling construction with the addition of the Throw Back feature. When in its normal operating position the Sterling Reproducer maintains perfect alignment under all conditions.



Showing how the No. 82 clears when in the Throw Back position.

STERLING DEVICES COMPANY

Manufacturers of the No. 11 Sterling Non-infringing Tone Arm, the Sterling No. 31 Tone Arm with Non-set Automatic Stop and the Sterling No. 41 Non-tapering Tone Arm

1819-21 CARROLL AVENUE CHICAGO, ILLINOIS

When in its Throw Back position the reproducer, even when adjusted for Edison or hill and dale records, "clears" the tone arm.

A new and improved needle holder is another added feature.

company was forced to discontinue business.

All the patents, together with manufacturing rights, have now been taken over by a new organization, which will continue manufacturing the Krasco motors under the name of the Krasco Mfg. Co. This company has been for the past two months steadily manufacturing the Krasco motor and is now in a position to supply the trade in any quantity. To-day the company is unhampered by indebtedness of any kind and has tangible net assets exceeding \$100,000. Many changes and additions have been made during the last year or so to the Krasco motor, due to the incessant work of Walter E. Lent, production manager of the company. Mr. Lent is a man of wide experience in the production of motors and is himself an expert of no mean ability. His efforts in perfecting the new Krasco motor have resulted in bringing it up to a state of high efficiency.

Other officers of the new company include D. S. Root, manager, who has had a wide experience in the commercial field and has been connected with some of the biggest manufacturing establishments in the country as director. He is assisted in his work by A. Wozny. Mr. Wozny has been closely associated for many years with many of the enterprises with which Mr. Root has been connected. He will act in the capacity of assistant manager for the Krasco Co. with complete charge of all Krasco sales. He is very familiar with all parts of the Krasco motor and states that he is glad at any time to give all the assistance or information he can regarding the motor. The Krasco Co. is furnishing its motors with complete equipment, such as turntable, turntable brake, winding crank, etc. The motors it is placing on the market are of the two, three and four-spring variety, which have a range from four to eight ten-inch records on one winding.

It Pays to Advertise

Wyman, Babb & Co., who have warerooms in the Republic Building in this city, report that the months of July and August were the biggest months in their history with the exception of the months preceding the holidays of the booming years of 1918 and 1919. It is also the first Summer during which they advertised consistently, as in all previous Summers they had reduced their advertising copy to a minimum with the approach of warm weather.

Cheney Activities

Prof. Forest Cheney, of the Cheney Talking Machine Co., who has been traveling all over the country in his famous Packard, "Blue Gull," making an educational tour among Cheney dealers, is getting ready for another trip to New England and the Atlantic Coast States. The professor's twin-six has run 8,000 miles this season and is going better than ever. Professor Cheney will leave Chicago on September 11 and make Buffalo his first stop.

These trips are being made by Professor Cheney to keep in touch with Cheney dealers and he intends to call on all Cheney distributors throughout the East, giving personal talks to them on selling methods and the meritorious points of the Cheney product. Professor Cheney is an exceptionally good talker and lecturer, who thoroughly knows his product and its points of merit. Members of the Chicago Piano Club had an opportunity a few weeks ago to hear this gentleman, when he gave a

Write for Information on

SCHNEIDER'S MUSIC INSTRUCTIONS

A Two Year Course on
Violin, Banjo and Banjo Ukulele
SIMPLE - EFFICIENT



SCHNEIDER'S SIMPLEX SYSTEM
PAT. PEND.
OF
MUSICAL INSTRUCTION ON RECORDS





LAKESIDE No. 776 TONE ARM

Has stood the test. The best small Arm on the market. Get ready for the Fall business.

Sample \$2.75

TWO LEAF PARALLEL RADIO CONDENSER



Accurate and well constructed, has same capacity as large types. Orders solicited for immediate delivery.

List \$1.50

LAKESIDE SUPPLY COMPANY, 339 So. Wabash Avenue, Chicago, Illinois
PHONE HARRISON 3840

FROM OUR CHICAGO HEADQUARTERS—(Continued from page 108)

short but excellent talk on salesmanship. Professor Cheney will be in New York at the end of this month, at which time a banquet will be given at the Commodore Hotel in his honor by the Eastern distributors.

Speaking of the Cheney factories at Grand Rapids, Professor Cheney says: "Our shipments are practically double what we had anticipated and figured on. The months of June, July and August showed that business was very healthy and is building up very rapidly. It seems that there is a larger demand for the more expensive models and that public taste jumps from the smaller models in the uprights right up to consoles, which jointly occupy the post of best sellers."

Opens Office in Indianapolis

B. V. Van Korn, of the Van Korn-Shower Co., with headquarters in Detroit and Grand Rapids, has recently opened an office in Indianapolis. The Van Korn-Shower people are Michigan distributors for the Cheney line and are very enthusiastic over the product. They are now taking over Indiana also.

O. F. Benz a Visitor

O. F. Benz, of the executive office of the Columbia Co., was a recent visitor to the Chicago office of the company. He took the evening train for St. Paul, Minn., where he will call on the local branch and will then call on the Kansas City and Omaha branches. Mr. Benz was highly elated over the sales of records in the mid-West.

An Asset to Accessory Lines

The Oro-Tone Co. has offered to the trade a new needle case and container for the well-known Orotone Edison reproducer. The new cases comprise a receptacle for the purpose of retaining the Oro-Tone Edison reproducer when not in use. At the side of this receptacle are three needle cups, one of which is reserved for discarded needles. They are finished with substantial and durable mahogany color leatherette.

These needle cups are of fine gun-metal finish.

The Oro-Tone Edison attachments are now being sent out ready-packed in these new Oro-Tone needle cases. The trade may also obtain empty needle cases for customers who already own Edison attachments and who will appreciate the advantages this little case offers.

Made Great Showing in Parade

One of the most attractive floats in the entire Pageant of Progress parade, held here recently, was that of the H. Reichardt Talking Machine Shop, live Victor dealer, at 6421 South Halsted



A Pageant of Progress Float

street, whose float graced the Englewood division. Prominent features of the float were a console and upright model of the Victrola and several Victor dogs.

All Set for Radio Show

The business office of the Chicago Radio Show gives out the information this week that everything is in readiness for the opening at the Coliseum on October 14. The show will last until the 21st. An immense amount of publicity has been given to this coming show by the local press, as well as by the largest trade papers throughout the country, and the



MELODY CONSOLE

Height 36½, Width 36, Depth 20½. Helman No. 77 Motor, Improved Blood Tone Arm and Reproducer. Genuine Mahogany. List Price \$125.00. Dealers' Price, \$60.00.

MELODY NATIONAL SALES CO.

190 N. State Street, Chicago, Ill.

Manufacturer

MELODY PORTABLE PHONOGRAPH

radio trade here in the West is most enthusiastic regarding its success.

Not only will many radio men be present as exhibitors, but quite a number of music men have already asserted their willingness to show combined talking machine and radio instruments.

Practically the entire exhibition space has already been signed up and it is now certain that the gate receipts will be tremendous. Those who are responsible for bringing about the show are U. J. Herrmann, managing director, and James F. Kerr, manager. To Mr. Kerr goes

(Continued on page 110)



GRL Products

Every business has back of it an ideal—the principle on which it is founded. The General Radio Laboratories have endeavored to pick out from amongst the many varied and often not too reliable radio equipment items which, after thorough laboratory and practical tests, it feels it can offer to jobbers, dealers and manufacturers with every assurance that the item is all that its manufacturers claim it to be.

We offer for immediate shipment the following reliable and practical equipment, at attractive discounts. Write for catalog.

Red Star Radio Telephone Receivers Non-Leak Variable Air Condensers Uradiola Receiving Sets Uradiogrand Receiving Sets	Variable Condensers, "S" type Radio Plugs and Jacks Amplitone Wire French (Ray-o-Vac) "B" Batteries GRL V. T. Sockets	GRL Variometers, Variocouplers and Potentiometers Dials and Knobs Binding Posts Magnet Wire
---	---	--

1740 Tribune Building



CHICAGO ILL.

General Radio Laboratories

INCORPORATED

FROM OUR CHICAGO HEADQUARTERS—(Continued from page 109)

much credit for the efficient manner in which he guided the project since its official endorsement and approval by the Chicago executive radio council on March 31. Mr. Kerr has produced many of the country's biggest exhibi-

tions and theatrical events. Mr. Herrmann is also a man with a wide range of experience in the theatrical business and has been a man behind the gun in many large exhibitions which have had outstanding successes.

miles away to the Milwaukee bunch. We must not fail to mention Jimmie Bristol's hurling, nor the heavy hitting of Ed Blinke, Jimmie Bristol again, Percy Tonk, A. M. Koch and Goldsmith. Hank Steussy, of Milwaukee, was knocked out of the box, Herzog replacing him in the fourth. Here is a complete report of the first inning, which is a good example of the five innings played:

Goldsmith grounded to Lufkin behind first. Lufkin made a pretty pickup on the run and then beat out Goldsmith in the race to first. Przylysky struck out and the Chicago fans applauded Bristol. Paul Netzow hit a bouncer

OUTING OF CHICAGO-MILWAUKEE CLUBS A HUGE SUCCESS

Many Talking Machine Men Present at Combined Picnic of Chicago Piano Club and the Milwaukee Association of Music Industries at Ravinia Park—Most Successful Event of Its Kind

CHICAGO, ILL., September 7.—Talking machine men were well in evidence at the recent outing of the Chicago Piano Club and the Milwaukee

for seeing that Chicago's reputation as a baseball center was upheld in a 25 to 2 victory, and to E. H. Grimm for successfully handling



Panoramic View of Those in Attendance at Chicago-Milwaukee Music Trade Outing

Association of Music Industries. The participation of the local Columbia forces, who held their outing at the same time, gave quite a talking machine coloring to the meet. The outing was such a decided success that the greatest possible credit is due to those actively interested in the affair, such as H. D. Hewitt, chairman of the outing committee, for his ability in securing the co-operation of his various sub-committees; to Sid Sachs for effectively discharging the duties of master of ceremonies; to Axel Christiansen for keeping things moving when the crowd had arrived; to Percy Tonk

the finances—in fact there was such a unanimous and enthusiastic support of the affair that it would be invidious to go on naming others.

The baseball game was the most exciting feature of the day, and of course there were other events which held the attention of the assemblage. Judging from the score of 25 to 2, one would not imagine that the game was worth while, but it was, all the same. Milwaukee came out on the short end of the count, yet the Cream City boys sure did hit the ball. It was the star fielding of the Chicago aggregation that made third base seem so many

to third. Hoppe picked it up neatly and nailed Netzow at first with a perfect toss to Lufkin. No runs.

Harry Schoenwald hit up a high fly back of third. Netzow got it and he was out. Blinke singled to short right for the first hit of the game and the Chicago outfit let out a wild yell. Jimmy Bristol smashed out a terrific liner to deepest left-center for a home run, scoring Blinke ahead of him, while the Chicago fans cheered and applauded uproariously. Hoppe hit a grounder to Herzog, who fumbled, and on that error Hoppe reached first. Lufkin laid

MADE ONLY BY THE "BLOOD TONE ARM COMPANY"

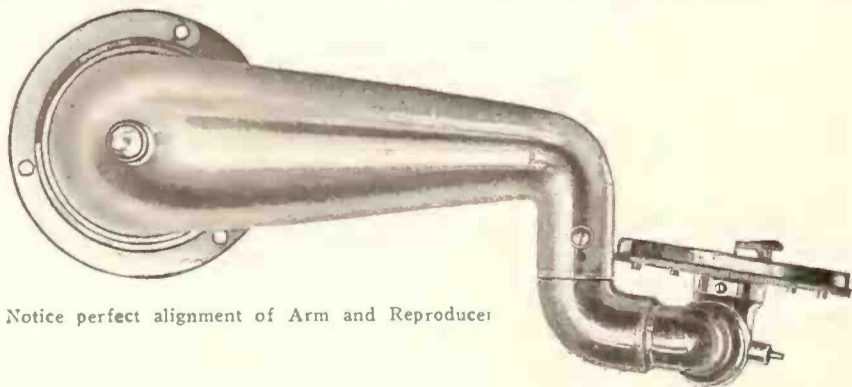

Notice perfect alignment of Arm and Reproducer

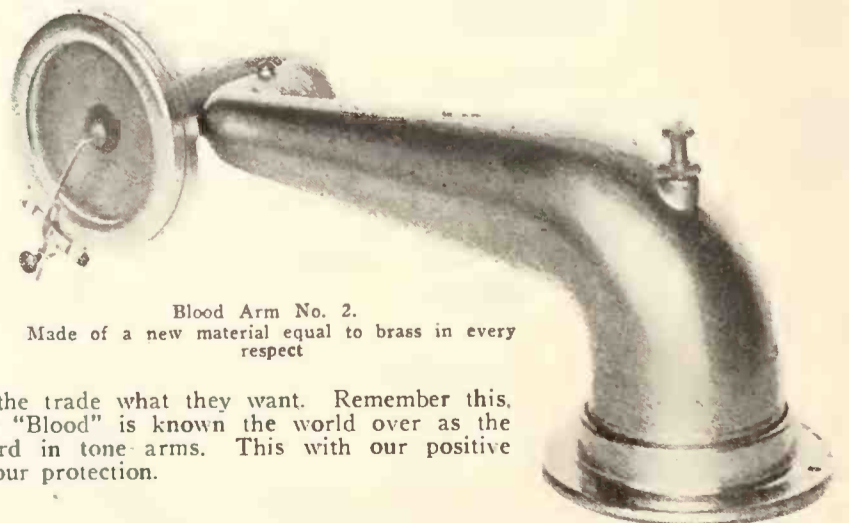

Blood Arm No. 2. Made of a new material equal to brass in every respect

MANUFACTURERS—It will pay you to use standard equipment on your phonographs. There is no higher standard than the Blood. Why experiment when you can buy Blood arms at the prices we offer them to you? By using Blood arms you are obtaining salable merchandise, because

you can give the trade what they want. Remember this, that the name "Blood" is known the world over as the highest standard in tone arms. This with our positive guarantee is your protection.

BLOOD TONE ARM COMPANY

326 River Street, CHICAGO

FROM OUR CHICAGO HEADQUARTERS—(Continued from page 110)

down a pretty bunt for a single and Hoppe advanced to second. Bauer cracked a screeching liner to deep center for a home run, scoring Hoppe and Lufkin ahead of him, and the Chicago rooters went wild again. Percy Tonk caught a fast one on the nose and cracked it into right for three bases. More noise. Al Koch drove a single to center and Tonk romped home. Michaels worked Steussy for a base on balls. Steussy was wild. Schoenwald fanned. Blimke ended the inning by going out on a high fly to Warner in right. Six runs.

The line-up of the two baseball teams follows:
Piano Club of Chicago: Schoenwald, 2b; Blimpke, ss; Bristol, p; Hoppe, 3b-c; Lufkin, 1b; Bauer, lf; Tonk, cf; Koch, c-3b, and Michaels, rf.

Milwaukee Association: Goldsmith, 2b; Przylysky, c; Netzow, 3b; Herzog, ss-p; Steussy, p-ss; Zimmers, lf; Scheft, cf; Pugh, 1b; Warner, rf, and Christophersen, x.

The other sports included races for boys, races for girls, fat men's race, fat women's race, four-footed race, peanut race for ladies, potato race for ladies, Cheney sales talk contest, nail-driving contest between mothers and daughters, sword swallowing contest for men, horseshoe pitching contest for men, chewing the string contest for married couples, kite-flying contest and a tug of war between Milwaukee and Chicago.

The prizes were well worth while and were as follows: Boys' race, won by Edward Blimke, Jr., a drum donated by Ludwig & Ludwig; girls' race, won by Margaret Whitsit, a ukulele donated by W. B. Papineau; fat men's race, won by H. D. Hewitt, set of Wallace reducing records, donated by Mr. Eckert, of Wallace Co.; fat women's race, won by Alice Haase, another set of Wallace reducing records, donated by Wallace Co.; peanut race for ladies, won by Irene McCarthy, pair of silk hose, donated by Matt Kennedy; potato race for ladies, won by Alice Lovkin, a pair of silk stockings, donated by Jimmie Bristol; nail-driving contest, won by Miss Sullivan and her mother, twelve late Okeh records, donated by Harry Schoenwald; champion sword swallower, won by Mr. Price, a box of cigars, donated by R. W. Berry; horseshoe pitching contest, won by Ed Blimke, a pair of cuff buttons, donated by Percy Tonk, and string-chewing contest, won by Mr. and Mrs. Grosvenor, set candlesticks, donated by Walter Jenkins.

INTERNATIONAL AND ANNUAL

CHICAGO RADIO SHOW

AT THE COLISEUM CHICAGO ILLINOIS

SATURDAY TO SATURDAY
OCT. 14TH TO OCT. 21ST

THE PUBLIC WILL MEET THE MANUFACTURER WILL MEET THE PUBLIC

IN THE LARGEST STREET-FLOOR EXPOSITION BUILDING IN THE UNITED STATES

A Show of Benefit to the Jobber and Dealer and the Buying Public

BUSINESS OFFICE
549 McCORMICK BLDG.
PHONE WABASH 1844

Tom Hindley, who won the \$5.00 prize donated by Professor Cheney, of the Cheney Talking Machine Co., for giving the best two-minute salesmanship talk, handed the money to the club to be used for charitable purposes.

To every contestant who came in second in the various contests and races a tiny toy piano was donated by Sid Sachs. Needless to say, there were many seconds.

HINDLEY TALKS ON SALESMANSHIP

Tom Hindley, of Mandel Brothers, Wins Cheney Prize for a Two-minute Selling Talk at the Chicago Piano Club Picnic

One of the events at the picnic of the Chicago Piano Club and Milwaukee Music Trades Association was the contest for a cash prize donated

by Professor Forest Cheney, of the Cheney Talking Machine Co., for the best two-minute talk on "How to Sell a Musical Instrument."

No notice was given to the five contestants who were invited to participate, and the talks were therefore entirely impromptu. The contest was won by Tom Hindley, manager of the Aeolian Vocalion Salons of Mandel Bros., Chicago. He spoke as follows:

"I shall not attempt to give you an absolutely 'cut and dried' formula for salesmanship, because, like the fourth dimension, such a thing does not exist. Where an element so variable as human nature enters in no rule can be laid down which will fit every case. There are, however, certain self-evident prerequisites which every salesperson ambitious to succeed should strive to acquire. Foremost among these are a personality that quickly inspires confidence, a cheerful disposition, patience, a fund of common sense and just enough knowledge of psychology to understand the peculiar characteristics of different types of customers.

"It always helps to greet your customer cordially—by name if you know it, thus breaking down that first cold barrier of hesitation. Assume that the customer has really come in to buy. The continued propaganda of your house, comprising, as it does, advertising, window display, service and the recommendation of satisfied customers, has already paved the way and served to instill the desire to possess a musical instrument. Endeavor to size up your customer's station in life and sell him the grade of instrument that it is really fitting he should install in his home.

"Proceed to describe the features and merits of your instrument in language that can be understood by the layman. Avoid technicalities and argument. Don't try to awe, but rather flatter and encourage what may be, as yet, only an embryonic musical taste. Don't do all the talking; give your customer a chance at least to commit himself on the particular instrument he considers within his means. From this point on actually begin to sell and work up to the close.

"There is liable to be one real obstacle loom up—especially if your store is located in a large city. The customer combats you with—"I have no time"—you can usually bank on this being said purely in self-defense and as an excuse to get away. So don't just let this go in one ear

(Continued on page 112)



Repair Parts

For All and Every Motor That Was Ever Manufactured

We can supply any part. The largest and most complete assortment of repair parts—in the United States—on hand, for old, obsolete and present-day motors. If your order cannot be filled from stock, we will make it up special.

Special prices on main springs, governor springs, micras, repair parts, motors, tone arms, steel needles, etc., in quantity lots.

Expert repairing on all makes of phonographs and motors.





INCORPORATED UNDER THE LAWS OF ILLINOIS

SUCCESSORS TO
Standard Talking Machine Co.
4-sided Talking Machine Co.
Harmony Talking Machine Co.
O'Neill-James Co.
Arzine Co.

High Grade Talking Machines, Disc Records,
Talking Machine Supplies, Etc

227-229 W. WASHINGTON ST., CHICAGO, ILL.
Branch: 2957 Gratiot Ave., Detroit, Mich.



TRADE MARK
"CONSOLA"
CABLE ADDRESS
"CONSOLA"

FROM OUR CHICAGO HEADQUARTERS—(Continued from page 111)

and out the other. Don't even let it go into one ear.

"Beware of the moment when the customer gets restless and asks if you have any descriptive literature. Consider that sale lost unless you can promptly get your 'back to the wall' and muster up sufficient courage to start off on a different and more successful tack. There is no time like the present for, unfortunately, prospects are not like Madame Bernhardt or Mr. Thomas' cat—they don't always come back!

"Don't knock the other fellow's goods—this might turn out to be a boomerang for you and a boost for him.

"Sell your instrument clean—always remembering that honesty is the best policy. Try not to undersell or oversell.

"Don't promise the impossible or you will surely come to grief.

"Be kind and courteous.

"Wear a smile and sell with enthusiasm.

"Finally—let all of us be proud of the fact that we are in the music business—helping to convey happiness into homes that would otherwise be dull and sordid."

STREGER BROS. SELL STORE

PORT CHESTER, N. Y., September 7.—The music store on 4 King street, formerly conducted by Streger Bros., is now being operated by W. F. Miller and J. G. Scavetta. In addition to musical instruments of all kinds and a complete stock of sheet music the concern has the agency for Vocalion and Sonora machines.

EDISON TAKES OVER KIPP BUSINESS

Prominent Indianapolis Edison Jobber Forced to Retire Because of Ill Health—Edison Interests to Operate Business Under the Management of John M. Vandervoort

A. H. Curry, vice-president and manager of Thomas A. Edison, Inc., announces that the Edison interests have purchased the jobbing business of Walter E. Kipp at Indianapolis, Ind. The new organization will have for its name Phonograph Corp. of Indiana. The headquarters will be in Indianapolis and the territory covered will be that tributary to this city. John M. Vandervoort, who assumed his duties the early part of September, is manager of this jobbing organization.

Mr. Kipp, who has been an Edison jobber for more than twenty years, has lately suffered from extremely poor health. He was told by his physicians that he could avoid serious consequences only by completely severing his connection with active business.

Apart from their regret at losing Mr. Kipp's valuable and energetic services, the Edison interests immediately decided that his business was of too much importance to be entrusted to strangers. They accordingly decided to form a new corporation to take over the Indianapolis jobbing business. This new corporation has purchased the Kipp interests outright.

"Walter is really one of the family," said Mr. Curry, when interviewed recently at West Orange. "He would have been as discontented at

allowing new people to succeed to his business as would we. We're going to try to carry on the fine establishment he has built up with the least possible number of changes."

Mr. Curry planned to make a trip to Indianapolis for the purpose of witnessing the inauguration of the regime.

PHONOGRAPH FACTORY FOR CHINA

Massachusetts Man Leaves to Take Charge of Selling End of New Enterprise

NORTH ADAMS, MASS., September 8.—Harold Bradley, of this city, who spent nearly five years opening up sales agencies for the Standard Oil Co. in China, is shortly to return to that country as sales manager for the first phonograph factory to be established in the Celestial Republic, of which he is one of the promoters.

The company, organized by men of long and intimate experience in Oriental commercial enterprises, has just been incorporated under the laws of Canada, and Mr. Bradley will leave for Montreal in about two weeks to take part in the completion of the organization. He expects to be ready to sail for China in about two months.

The factory for the manufacture of both phonographs and records will be erected in Shanghai, and will be under the supervision of a man who for more than twenty years has been prominently identified with both the experimental and manufacturing business in this country.

At the outset the recording will be confined entirely to the reproduction of Chinese music, of which there is said to be an almost universal appreciation among all classes of Chinese.

B. R. FORSTER BOUND FOR COAST

President of Brilliantone Steel Needle Co. Starts on Extended Business Trip—Increasing Demand for American Needles Reported

Byron R. Forster, president of the Brilliantone Steel Needle Co., New York City, left around the first of the month for a Western trip, embracing the principal cities in that territory and extending as far as the Coast.

The Brilliantone Co. has found business exceptionally good and a heavy demand is reported for this needle. Harry W. Acton, secretary of the company, pointed out that the supremacy of the American-made needle is well realized throughout the trade, as indicated by the fact that the demand for Brilliantone needles is exceeding former records. This despite the competition of needles of German manufacture being packed in this country and sold under American names.

Mr. Acton is the originator of a decided novelty in needle boxes which will shortly be produced. These new boxes are a combination record cleaner and needle box, holding 500 needles.

LARGER DEMAND FOR "DAILY DOZEN"

Coming of Fall Brings Increased Demand for Walter Camp's Health Records

R. B. Wheelan, president of Health Builders, Inc., New York City, producer of Walter Camp's "Daily Dozen" health-building records, reports that business picked up remarkably during August and continues to increase steadily.

"Competition is the life of trade," stated Mr. Wheelan, "and has had an effect in increasing our business, I believe. It all helps to educate the public upon the necessity of having health-building exercises in their homes and that Walter Camp's 'Daily Dozen' is specified is to be found in the large volume of orders we receive."

SOJOURNING IN NEW YORK STATE

N. B. Smith, assistant manager of the Chicago branch of the Columbia Graphophone Co., and family are spending their vacation in New York State.

THE NEW ORO-TONE CONCERT EDISON EQUIPMENT

No. 2-E. C.

MAY WE SEND SAMPLE ON APPROVAL?



You and Your Customers will be Delighted with the Deep, Powerful Tone Quality

Operated with the raising and lowering lever the same as the regular Edison reproducer. Retail price—Highest grade nickel plate..... \$7.25 Retail price—Highest grade gold plate..... 9.25

Usual Discount to Dealers

The above prices include this very essential and attractive needle cup case. Substantial and durable mahogany color leatherette. Fitted with gun metal finish needle cups as shown. Just what every Edison phonograph requires for needles and to hold either reproducer when the same is not in use. These cases will be supplied separately at 25c. each, less the usual discount.

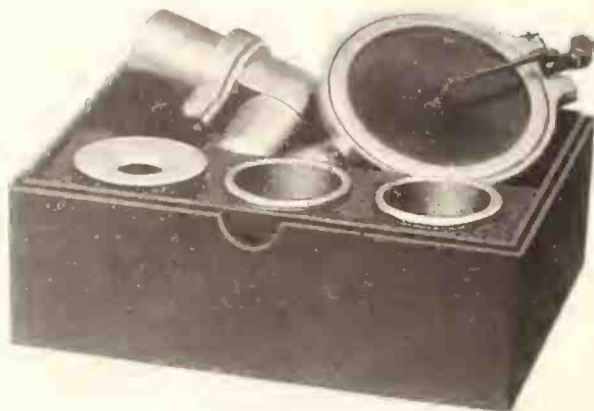

Order Your Sample To-day—It Will Be Sent on Approval
Send for Folder Showing Wireless Equipment

THE ORO-TONE CO.

Manufacturers of Highest Grade Phonograph and Wireless Equipment

1000 to 1010 George Street, Chicago, Ills.



The Music Box, Charleston, W. Va.

Frank Naese, Chicago, Ill.

THE UNICO SYSTEM IS SPEEDING 1922 TRADE REVIVAL

The three Unico Installations illustrated above are typical of the improvements recently made by hundreds of progressive Dealers from Coast to Coast.

PREPARE NOW THRU UNICO SERVICE FOR FALL AND HOLIDAY ACTIVITY

BECAUSE—Bumper crops are being harvested
 Industry's wheels are humming
 Normal conditions prevail in most districts
 Economic conditions—abnormal since April 1st—are now adjusted.

INSTALL UNICO PATENTED EQUIPMENT AND ACCEPT NO OTHER

BECAUSE—Unico Efficiency is proven by over 3,000 installations
 Unico Quality adds greatly to your prestige
 Unico Service is expert, unfailing and guaranteed
 Unico Prices are no higher than ordinary equipment of uncertain value.

Unico Service will transform your establishment into the Musical Headquarters of your community—and do it over night.



Unico Model Shop Outfit No. 1
 Price \$345.96, F. O. B. Phila.

Includes: One Audition Room, 6'0x6'0
 Two Record Racks (3,000 Capacity)
 One Record Counter, 6'0 long



Unico Model Shop Outfit No. 10
 Price \$575.29, F. O. B. Phila.

Includes: Two Audition Rooms, 6'0x9'0
 Two Record Racks (3,000 Capacity)
 One Record Counter, 6'0 long

*Unico Equipment Is Your Wisest—Safest—Most Profitable Investment
 Shipment from Stock—Expedited Delivery—Prompt Installation
 Ten Unico Service Branches Offer You Immediate Expert Service*

Consult our nearest branch today.

Unit Construction Company

RAYBURN CLARK SMITH, *President*

58th Street and Grays Avenue, Philadelphia, Pa.

NEW YORK, N. Y.
 299 Madison Ave.

ATLANTA, GA.
 49 Auburn Ave.

SAN FRANCISCO, CAL.
 942 Market St.

DALLAS, TEX.
 209 Dallas Bank Bldg.

NEW ORLEANS, LA.
 506 Marine Bank Bldg.

CHICAGO, ILL.
 30 N. Michigan Blvd.

SALT LAKE CITY, UTAH
 150 Main St.

DENVER, COLO.
 1642 Arapahoe St.

H. A. MOORE & CO., LTD. (Sales Agents)
 Premier House, London (W.C.I.), England



Marvelous execution in which dazzling technique is submerged in entrancing melody marks the playing of "Muineira" by Duci de Kerekjarto, violin virtuoso. Every resource of Kerekjarto's wonderful skill is commandeered, but through all the maze of subtle intricacies he journeys delicately bold, boldly delicate. It is a gem. Any order should include 49931.

Columbia Graphophone Co.
NEW YORK

ATLANTA

Resume of Situation in Southeast—Fair Prices for Bumper Crops Augur Well for the Trade

ATLANTA, GA., September 8.—The Atlanta National Bank is responsible for the following forecast regarding the business outlook in Georgia: If Georgia raises the same size cotton crop this year as she did last, at the prices now quoted, Georgia farmers are promised a return of \$90,000,000, or \$30,000,000 more than last year. And there is every indication the crop will be larger.

This increase, coupled with the fact that the crop this year has been raised much more cheaply than last year's crop, will greatly increase the paying and purchasing power of the Georgia farmer and this is bound to be reflected in every line of business. Other crops have added to the stability of the rural sections.

In the cities of the State labor is well employed and building permits show that the shortage of homes and business houses is being overcome. In Atlanta alone building permits have been issued calling for an expenditure of nearly \$12,000,000 since January 1. The Atlanta bond issue of \$8,000,000 will soon be flowing into all channels of trade.

The one disturbing feature is the freight situation. Unless the railroad strike is soon settled many merchants will find themselves short of goods at the very time when buyers are plentiful. It is necessary to anticipate requirements to a greater extent than usual and to place re-orders before stocks are exhausted. This can be more safely done this Fall, because of the business outlook as quoted above, than has been the case for several seasons past.

"Hot Lips" and "Georgette" are special releases by all of the prominent record companies and in consequence head the list as the two best sellers of the month.

The Atlanta Phonograph Co., in anticipation of an active Fall business, is erecting two new

record booths. It reports that machine sales have been excellent and that buyers of instruments at \$100 and upwards invariably choose the flat-top console design, which is steadily gaining popularity.

Chamberlain-Johnson-DuBose Co., the large department store, which has maintained an exclusive Victor department for many years, is retiring from the talking machine business. The space will be used for other lines.

The J. K. Polk Furniture Co. has become the distributor in this territory for "Honest Quaker" products. A complete line of main-springs, repair parts and accessories has been stocked.

M. O. Giles, special Okeh representative from New York headquarters, has just spent several days here.

The Columbia Graphophone Co. will be without the services of its assistant manager, John Mohl, during the month of September. Mr. Mohl is convalescing from an operation performed early in the month.

Manly Robison, manager, Phillips & Crew Piano Co., has returned to his duties after an illness of more than a week.

The Phillips & Crew Piano Co., Victor dealer, was well pleased with the results of its special advertising featuring the consolette Queen Anne design. Although it was mid-August, the Atlanta public quickly bought out the entire stock. In addition, a large number of sales of regular Victor products were made to prospects brought in by the special consolette offering.

The trade outlook in the Birmingham district is most promising. The twenty per cent increase in wages in the steel industry and the similar increase in the pay of the coal miners is responsible for greatly increased demand in all lines, so that merchants have been forced to order liberal stocks.

Okeh records of the "Lonesome Mama Blues" and "Nobody Lied" continue to outsell all other recent offerings.

Paul Byrum, who for a number of years was assistant to J. P. Riley, of the Atlanta Phonograph Co., left about the first of the month to accept a position with a local firm of coffee roasters.

The J. K. Polk Furniture Co. is actively working its territory in behalf of Okeh records, outfitting portables and its line of talking machine accessories. Manager P. C. Brockman is using an automobile for the purpose of intensively covering this field and plans to keep in continuous contact with it, either personally, or through his sales force.

R. M. BIRD WITH SHERMAN, CLAY & CO.

Victor Man Leaves for Pacific Coast—Friends Tender Dinner and Present Watch

CAMDEN, N. J., September 8.—R. M. Bird, associated with the Victor Talking Machine Co. as assistant manager of the record order department, resigned on September 1 to join the forces of Sherman, Clay & Co. in San Francisco, Cal., in the talking machine department. Mr. Bird had been associated with the Victor Co. for a number of years, with the exception of a short period, during which he was with Sherman, Clay & Co.

Before his departure for the Coast a number of his friends in the Victor Co. tendered a farewell dinner to him and Mrs. Bird at the Bala Country Club. Gus T. Wielage, head of the record order department, acted as toastmaster and presented him with a gold watch inscribed with the sentiments of the donors.

BUSINESS-BUILDING SUGGESTIONS

Knickerbocker Talking Machine Co. Presents Some Timely and Valuable Data for Dealers

The proper adaptation of general selling ideas to individual businesses has had noticeable effects in many instances of increasing business. Realizing this, it has long been the policy of the Knickerbocker Talking Machine Co., Victor wholesaler, New York City, to place before Victor retailers, from month to month, many excellent ideas in selling. Abram Davega, president of the company, has devoted much of his personal attention to this end of the business. The latest effort in this respect covers five closely typewritten pages and presents two alternative plans, together with suggested letters, a questionnaire for the proper classification of prospects, an optimistic quotation from Babson's statistical report and general suggestions on business building, advertising, etc. Dealers are taking full advantage of these suggestions.

Meyer Price has been appointed manager of the Newark, N. J., warerooms of Landay Bros., Victor dealers, according to a recent announcement by the company. Mr. Price succeeds L. H. Jacobi, who has resigned.

SECOND YEAR SUCCESSFUL LEADER

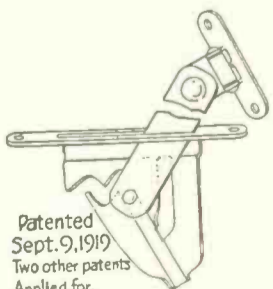

The Most Dependable and Inexpensive Lid Support on the Market

Patented Sept. 9, 1919
Two other patents Applied for.
The bottom plate is constructed of one piece of metal and it works automatically perfect. No parts to go out of order. The hinges are made in two styles—flexible and bent. Samples on request.

STAR MACHINE & NOVELTY CO.
81 MILL STREET BLOOMFIELD, N. J.

MOTORS

(Swiss)

DOUBLE SPRING

Suitable for Portable Phonographs

Stock On Hand, Ready For Delivery

Sample \$3.75—Write for One

MERMOD & CO., 874 Broadway N. Y.

OSLAND, Inc.

122 Fifth Avenue, New York City

Alpha Reproducer

Pivot stylus with spring tension

Radio products
Variocouplers
Variometers
Variable condensers

MANUFACTURED TO SPECIFICATIONS

A bull's eye for Columbia—a new orchestra—Paul Specht's Hotel Astor Organization with a new and captivating style of rendering dance music—"Rhythmized symphonic syncopation." Their first Columbia recording is "Silver Stars" and "In Rose Time." These are distinctly dance music innovations. Your customers will welcome them. A-3672.

Columbia Graphophone Co.
NEW YORK



AKRON, O.

Ford Shut-down Threat Hurts Trade—Sales Reach Fair Total

AKRON, O., September 5.—Sales results for August with the talking machine dealers in this section were very satisfactory, registering a substantial increase over June and July totals. There was every prospect of a very active September until reports came of the proposed shutting down of the Ford motor plants in Detroit and the immediate effect the announcement had on certain tire manufacturers and others engaged in supplying parts and material for the Ford Co. Business men generally, including music merchants, are living in the hope that the Ford people will reconsider the matter and remain in operation.

Business Better at O'Neil's

Miss Elsie Baer, head of the talking machine section of the M. O'Neil Co., stated that her sales slips for August were far ahead of those of the previous months and that in the face of existing conditions she expected her depart-

ment to show a gain in September over the corresponding month of a year ago. Records, she said, are still quiet with a noticeable pick-up the last part of the month.

F. W. Van Scoyoc, of the F. W. Van Scoyoc Piano Co., reports his talking machine section the past month experienced a good business, in spite of the fact it is a newcomer.

Better for Dales

The talking machine business at the store of the George S. Dales Co. during August was double that of July, according to Charles A. Savage, the new manager of the talking machine section of the store. The record service booth, opened on the main street level, reports very substantial sales of records. Victor and Cheney machines have also been in demand.

Busy With Concert Series

Earle Poling, of the Windsor-Poling Co., Victor dealer, reports his famous artists' series of concerts is meeting with hearty appreciation and that the advance ticket sale is very heavy. Jascha Heifetz, violinist, opens the course on November 1. All concerts will be in the armory. This music house has fostered popular artists' concerts here for several years.

"Moon River" and "The Little Red School House" have been featured records for the

Windsor-Poling Co. This firm has but 200 out of an order of 1,000 of the former number left on its shelves. "This is an example of what featuring a record with a snappy window trim will do," said Mr. Poling.

Radio Supplies Selling

Radio supplies in talking machine shops of Akron are enjoying an excellent business and dealers are well pleased with the success of their new lines. Most of the stores maintain separate departments for radio accessories and say that demand for this class of merchandise is very much on the increase at this season of the year. The majority of the dealers say there is absolutely nothing to the rumor that it is hurting the talking machine business; in fact, they say it is helping it.

Wants Merchants Protected

Retail music dealers of Akron have joined with other merchants of the Rubber City in an effort to have the city council pass legislation preventing any person from holding an auction sale within the city of Akron unless he has been in business at least one year. Merchants claim the "fly-by-night" merchant comes into Akron a few weeks before Christmas, opens a temporary store and unloads thousands of dollars' worth of inferior merchandise on the public, to the disadvantage of local merchants.

A. Gourse has opened a new shop at 38 South Howard street and has, in connection with many other lines, installed a musical merchandise section. The shop is modern in every respect.

EDISON OCTOBER WINDOW IS DEVOTED TO RE-CREATIONS



October Display Carries Message of "Music for Every Need and Mood" and "Flash-like Service on Hits"

SELLS SONORAS TO SCHOOLS

LANSING, MICH., September 5.—The Sonora Shop, of this city, owned by W. W. Cummings, recently delivered nine Sonora phonographs to a number of the schools in this city, where they will be utilized by the department of music for instruction purposes. The Sonora Shop also furnished the department of music with 200 records, which were selected by the music departments of the various schools. Mr. Cummings is delighted with the order for Sonora phonographs, as there was keen competition for this sale and a number of the leading makes were investigated before the Sonora was selected.

CONGRATULATIONS

George Seiffert, president of the Modernola Sales Co., Eastern distributor of the Modernola talking machine, is receiving the congratulations of his many friends in the trade upon the arrival, a week or so ago, of a young son. Mr. Seiffert bears the honors well, as this is the fourth time he has received similar congratulations. Mr. Seiffert's family now numbers two boys and two girls.

ADDS GOLD SEAL REPEATER

BOSTON, MASS., September 6.—It has been announced that the Gold Seal Repeater has been added to the many talking machine accessories distributed by the Lansing Sales Co. here.

MERIT—BUILT IN

The merit of *Van Veen* equipment is built in. Surface decoration may beautify, but cannot make a real hearing room. Even a fence may be painted to look pleasing to the eye; don't make the error of buying highly decorated fence to serve as sound-proof hearing rooms.



Interior of Remick Philadelphia Store

Van Veen patented double construction hearing rooms combine structural superiority with beauty and dignity of design. Their efficiency goes below the surface.

The moderate cost of *Van Veen* equipment places it within the reach of the most economical dealer.

*Complete equipment on hand ready to ship will give you a month's business
in the time it takes others to build the job*

VAN VEEN & COMPANY, Inc. 413-417 E. 109th St., New York City
Phone 7758 Harlem

Offices and Warerooms

LOS ANGELES

*Busy Fall Expected to Follow Excellent Summer Trade—John Steel
Guest of Music Men—Platt Music Co. Remodels—The News*

LOS ANGELES, CAL., September 5.—Vacations are over and members of the trade are settling down to the approaching Fall business, which is traditionally supposed to be far more active than the Summer. However, Summer sales have been so excellent that it will take a good deal to overshadow their totals. Several improvements and enlargements of talking machine departments have been made or are being made in several stores, in order that better service can be given and the increase of customers taken care of.

John Steel Guest of Association

The well-known tenor and Victor artist, John Steel, was the specially invited guest of the Music Trades Association of Southern California at the August meeting and banquet, and he gave them great pleasure by singing a number of songs. The fact that Mr. Steel sang to the members was especially appreciated, on account of the fact that he was due later at the Orpheum Theatre, where he was filling a three weeks' engagement and where he had met with an extraordinary popular reception, night after night.

Platt Music Co. Alterations

The front and main floor of the Platt Music Co. is all torn up through extensive alterations. The store adjoining the Platt Music Co., and until recently occupied by a tailoring concern, has been taken over and thereby the main floor will be increased to twice its former size. This will make very handsome quarters and double the window display space. The Victrola and musical departments will occupy the entire space which has been secured.

New Manager at Bullock's

Don C. Pcyton has been appointed Victrola sales manager at the music department of Bullock's, to succeed W. Ray, who recently resigned. Mr. Pcyton was formerly manager of the phonograph department of Meier & Frank, Portland, Ore., and previous to that was for some time with the Aeolian Co. in New York and Chicago. He was also connected with the

sales department of Silas E. Pearsall Co., Victor distributor in New York City.

New Victor Styles Please Dealers

The announcement by the Victor Co. of the new flat-top, horizontal models has been received with great satisfaction by Victor dealers throughout the southern California district.

Brunswick Sales Manager in Los Angeles

A. J. Kendrick, sales manager of the phonograph division of the Brunswick-Balke-Collender Co., was a visitor to Los Angeles during the latter part of August. He expressed himself as very well pleased with the phenomenal business and fine representation in this territory and extended congratulations to Local Manager Howard Brown.

Starr Manager Enjoys Vacation

F. L. Valentine returned recently from a much-enjoyed vacation at Warner's Hot Springs. This particular location is well off the beaten track, Mr. Valentine declares, and resembles the California of early days. Its adobe buildings, vast cattle ranges and Indian inhabitants are pleasing in the extreme to anyone who delights in exploring places which are not known to the ordinary vacation hunter.

Vocalion Record Sales Manager Here

Oscar W. Ray, sales manager of the Vocalion wholesale record department of the Aeolian Co., visited Los Angeles early last month and completed arrangements with the Munson-Rayner Corp., whereby the latter becomes distributor of the Vocalion records for southern California.

Cheney Distributor Moves

The Munson-Rayner Corp. has found it necessary to move to larger quarters. Although it has been in business as Cheney phonograph distributor three or four months only, business has already assumed such large proportions that it has been found impossible to conduct it satisfactorily in its large suite of offices and warerooms in the Homer Laughlin Building and it is now moving to the Knickerbocker Building, on Seventh and Grand streets. The Munson-

Rayner Corp. is also jobbing phonograph accessories and has recently acquired the distribution of Vocalion records for this territory. E. R. Darvill, sales manager, reports business as gratifying in the extreme.

Association Receives Banner

The banner awarded by the National Association of Music Merchants at the National Jubilee Convention, held in New York in June, to the Music Trades Association of Southern California for "organized effort" was formally presented at the August meeting. The banner is a handsome blue satin affair, suitably inscribed with gold lettering.

So. California Music Co. Installs Brunswick

The Southern California Music Co. has added the Brunswick line to its Victrola and Edison departments. This is one of the oldest music houses in Los Angeles and was one of the first to operate a phonograph department. The company will, in the near future, open a new additional store on Broadway in a seven-story building, now under construction, between Eighth and Ninth streets.

Parmelee Dohrmann Co.'s New Department

The new phonograph department of the Parmelee Dohrmann Co. on the main floor is now completed and ranks as one of the best in town. The new department was installed by the Unit Construction Co. and the work was supervised by J. J. Grimsey, southern California manager of the Walter S. Gray Co., Pacific Coast agent for the Unico System. Mrs. H. P. Howard is manager of the phonograph department.

Columbia Gleanings

The E. E. Long Piano Co., Columbia dealer, which purchased the fixtures of the Jerome H. Remick Co., has entirely remodeled its store at San Luis Obispo and the interior of the store now presents a most pleasing appearance. Mr. Long is planning to institute an aggressive sales and publicity campaign, which he feels certain will produce desired results.

C. W. Austin, exclusive Columbia dealer at Anaheim, Cal., recently purchased a 1922 Haynes automobile and has embarked on a vacation, to be in the nature of an automobile trip through the entire Pacific Northwest.

A recent visitor to the Los Angeles branch of the Columbia Graphophone Co. was Jack Kapp, of the Chicago branch, who visited this city in the course of his honeymoon trip. Another recent visitor was J. W. Joachim, star salesman for Summerfield & Hecht, Columbia dealers at Detroit, who stopped several days in Los Angeles while on an overland camping trip from Detroit, through the Northwest, down the Pacific Coast and back through the Middle Western States.

"SUPERB" SEMI-PERMANENT NEEDLES

SELL because they EXCEL

Play 100 to 200 Records :: Retail 4 for 30 cents

Send for Samples and Discounts

MELLOWTONE NEEDLE CO.

ANSONIA, CONN.

SIMPLEX

Electric Phonograph Motors

The SIMPLEX Electric Phonograph Motor Represents a New Phase in the Development of Sound Reproducing Instruments.

NOISELESS

ELIMINATES WINDING

TROUBLEPROOF

Make This Your
LEADING
Line for the
Coming Season

Sample
Price **\$19.50**



GUARANTEE
The SIMPLEX Electric Phonograph Motor is guaranteed Trouble-proof throughout and any parts or part thereof that should prove defective at any time, we will repair or replace same by a new motor, free of charge.

Particulars,
Quantity Prices, etc.,
on Application.

TRADE

MARK

The Mission of the SIMPLEX Electric Phonograph Motor is to reproduce music just as it was originally rendered. For its perfect and faithful reproductions of all disc records the SIMPLEX Electric Phonograph Motor will play any record you wish to hear and play it as it should be played.

It has an absolute constant speed under variations of voltages and frequency and records may be set at any speed desired—and it is built absolutely without a governor.

BETTER BUILT

BETTER DESIGNED

The SIMPLEX Electric Phonograph Motor has no competition because it is the only electric phonograph motor of its kind in the world. There are many features by which one can determine the efficiency of the SIMPLEX Electric Phonograph Motor. The essential features are:

- | | | | |
|----------------|----------------|------------|--------------|
| No Gears | No Commutator | No Springs | No Oiling |
| No Governor | No Brushes | No Winding | Noiseless |
| No Adjustments | No Transformer | No Belts | Troubleproof |

Record Stops Automatically on Last Note

It represents the very best of inventions and improvements and we therefore confidently say that the SIMPLEX Electric Phonograph Motor is combined with the highest precision of workmanship and select material.

TEST A SIMPLEX ELECTRIC MOTOR ON OUR 30-DAY TRIAL OFFER

When a Simplex Electric Motor is sent out, it is not sold until the motor has demonstrated in your own shop, in your own cabinet, during a 30-day test, that it will do all we claim. An extremely fair proposition in which the Simplex Motor is judged by its performance in your cabinet under your inspection. No strings to this offer. Your decision is final.

Manufactured in United States and Canada by the

Simplex Electric Phonograph Motor Co.

104 NEW WILDER BUILDING, 321 BLEURY ST., MONTREAL, CAN.

NEW ORLEANS

Dealers Prepare for Big Fall and Winter Trade Because of Fine Crops—Aggressive Merchants Get the Business—Month's News

NEW ORLEANS, LA., September 7.—While August has been a much better month than July with the retail dealers, and statistics show much larger returns than for the previous month, and even last August, still it remains for the wholesalers to tell the story of what has been done during the Summer and what the outlook is for the Fall.

It was worth a great deal to sit and listen to R. R. Sparrow at the Columbia Co.'s branch and John A. Hofheinz, of Philip Werlein, Ltd., the Victor wholesalers, as they recounted the encouraging stories coming in from the surrounding territory and from the local retail trade. Rivaling closely in optimism these stories are the reports from the local Edison and Brunswick dealers.

With the present prices of cotton, sugar and rice as good as they have been, even before the war, the chances for the Southern farmer paying off his debts and making a profit are better this year than they have been in some years. Upon this basis the country and city music dealers have been preparing for a big Winter and are boosting all lines of stock.

Value of Energetic Methods

As for the past Summer, a number of the retail dealers have complained that the season just passed has been an exceptionally dull one, but those who have dug to the bottom and scratched have gotten results. Mr. Hofheinz cites an instance of a dealer in the Southern part of the State who has made use of all of the campaigns and sales ideas offered by the Victor Co. and, during the past six weeks, he did more business than the entire seven months prior to that time.

Another instance of what advertising has

done comes in a story from Jesse French & Sons, agents for the Columbia line in Mobile, Ala.

T. B. Parsons, the manager, is a firm believer in attractive window displays. The last one cost him just \$9.50 and the day following this new display one salesman alone sold seven machines for cash. The window was called "Sunshine Alley," after the record which was being



Window Display on "Sunshine Alley"

featured at that time. At another time, when "My Wild Irish Rose" was being featured in a picture show just across the street, Mr. Parsons had a window to suit the occasion, bedecked with bright green ribbons and colored lights, which increased both his sales and the popularity of his store. Mr. Parsons reports: "Sales for August larger than last December, and cash sales the highest in the history of the store."

Ordering Machines by Wire

Max Schilling, the El Dorado dealer who made such an excellent showing last month with Grafonolas, comes back this month and

orders twelve machines by wire to be shipped by express. J. J. Goldman, from Morgan City, wired Mr. Sparrow at headquarters for twenty-two machines.

New Columbia Agencies

A new Columbia agency has just been established in Jackson, Miss., with the Hidelbing Furniture Co., in the territory of Salesman W. R. Richardson.

H. H. Irving has taken over the Columbia territory formerly covered by W. W. Twigg, who is now with the wholesale department of the Edison Co. Mr. Irving was formerly specialty salesman for the Firestone Tire Co. His headquarters will be Alexandria.

Talking Machine Man Is Mayor

An instance of the popularity of the music man in the community is seen in this item. L. I. Lefeaux, exclusive Columbia dealer for the city of Port Allen, La., was recently elected mayor of the town. Mr. Lefeaux is one of the many enthusiastic "sell-by-truck" Columbia dealers. This has given him first-hand information as to the condition of the roads.

One of his first official acts was to take steps to improve the streets and roads in and about the city, and now they are in a condition that causes the residents to loudly boost their mayor. A recent newspaper item states that, since his election, the town has taken on new life. He has put co-operation and enthusiasm in every department of the city works and is making signal progress in much-needed improvement. Mr. Lefeaux stated that one of the planks of his platform was "more congenial homes," which is another way of saying "more homes with music."

New Manager in Baton Rouge

Frank Allen, assistant to J. D. Moore, of the talking machine department of Maison Blanche, will, on September 15, assume the duties of manager of the Columbia department of the Globe Furniture Store, of Baton Rouge. This department of the Globe firm has just been reorganized under the supervision of E. L. Estes,

THE EMPIRE UNIVERSAL TONE ARMS

Will Give Your Product Individuality That Will Greatly Strengthen Its Selling Force

Send for sample of our new
Tone Arm for Portable
Machines.

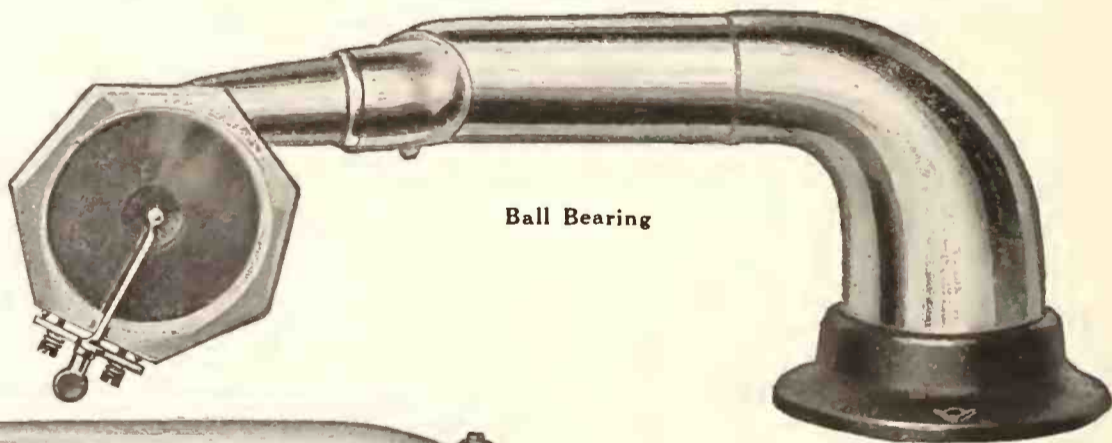

Ball Bearing

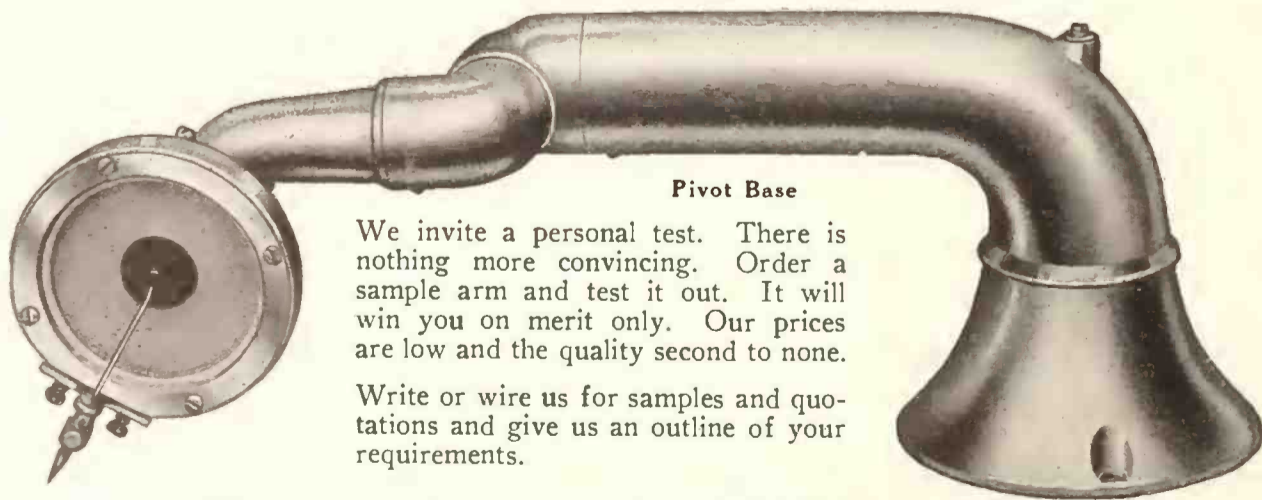

Pivot Base

We invite a personal test. There is nothing more convincing. Order a sample arm and test it out. It will win you on merit only. Our prices are low and the quality second to none.

Write or wire us for samples and quotations and give us an outline of your requirements.

THE EMPIRE PHONO PARTS COMPANY, 1362 East Third Street, Cleveland, O.

Established in 1914

Manufacturers of High-Grade Tone Arms and Reproducers

W. J. McNAMARA, President

general manager of the New Orleans office.

Nor have the country dealers been grabbing all the business. Listen to this!—The Barnett Furniture Co. here, as the result of one full-page ad in the New Orleans Item, sold twenty-seven machines in one day and, it is said, fifteen machines the second day.

The Levy Furniture Co. has been conducting a special drive during the past month on Grafnolas and has done more business in that line during August than the entire seven months previous to that time.

R. R. Sparrow, manager of the Southern district of the Columbia Co., has just returned from a two weeks' business trip to New York, where he has been preparing for the Fall business, and has been arranging the details for moving into the new home here on October 1.

Helping the Dealer to Sell

The substance of the talk which the correspondent had with John Hofheinz, manager of the Victor wholesale department at Werlein's, Ltd., is this: that the Victor people are leaving no stone unturned to help the dealer; they are going the limit in planning attractive "go-getter" campaigns and selling plans for them to follow. The dealer is encouraged and is welcoming the aid from headquarters. This attitude, plus the general outlook on the outside, in the industrial and agricultural world, is the best indication of a big revival of business.

Among the features planned for the dealers this Fall are: A drive on the Club Plan for Style 80 and a Caruso Record Sales Plan. Again, the two flat-topped console models, due out in the early Fall, are expected to increase the sales of the respective dealers. Horizontal type Victrolas have been very popular all the Summer and it is expected that their popularity will even pass the demand for the vertical types during the last half of 1922.

Dealers Placing Good Orders

As for the Fall orders and Winter stocks the local dealers have all pretty well anticipated their needs and have sent in pretty big orders, as have a large number of the country dealers. "Some, however," said Mr. Hofheinz, "have failed to heed the warning and if, as it is possible, there will be a shortage in some types these dealers will find it a hard matter to get the number of machines they would like."

Increased Demand for Re-creations

Over at the Diamond Disc Shop they reported an increase in business during August of 75 per cent over July in machine sales, while record sales increased approximately 50 per cent. A new plan of the Edison people has been to put out a new crew of two men with a truck, starting a house-to-house canvass placing machines in homes on the approval plan. According to the estimate of Mr. Billiet 60 to 75 per cent of the business is done on the approval plan and he has backed up his opinion by putting it into practice, and he attributes his increased business largely to this new plan.

Reports from the local retailers as a whole have been much better than last month. About three-fourths of the sales managers, however, of the talking machine departments at the different stores are away on their vacations and detailed news from these stores has been almost unobtainable.

Personals

J. D. Moore, manager of the talking machine department of Maison Blanche, is away on his vacation. With his family he is motoring to Brown Wells and expects to be gone about two weeks.

Edgar Newman, of the Maison Blanche music department, is motoring in New York State with his family. Ralph Young, manager of the Grunewald Victrola department, is off on his vacation. J. L. Billiet, manager of the Diamond Disc Shop, has just returned from an extensive trip through California State.

Miss Emma Delery, of the wholesale department of Philip Werlein, Ltd., who has been ill for some time, has just returned from a month's stay at Dawson Springs, Ky., where she has been recuperating.

CLOSES IMPORTANT MACHINE DEAL

Player-Tone T. M. Co. Purchases Entire Stock of Emerson Model 20—I. Goldsmith Returns From Buying Trip—Business Showing Substantial Increase—Fall Outlook Is Good

PITTSBURGH, PA., September 5.—I. Goldsmith, president of the Player-Tone Talking Machine Co., of this city, returned a few days ago from Grand Rapids, where he closed an important deal, whereby his company takes over the entire stock of the instrument formerly known as the Emerson upright model No. 20. This model is one of the most popular in the Emerson line of phonographs, having achieved considerable success because of its attractive cabinet design and the fact that it is equipped with a No. 44 Heineman motor, music master horn, Emerson tone arm and a record filing album device.

In a chat with The World Mr. Goldsmith stated that he is planning to feature the Emerson Model 20 through the medium of an intensive sales campaign, as he believes that the time

is now ripe to introduce an instrument of this type to the dealers throughout the country. He states that the phonograph factories in general seem to be on a sounder basis and that the outlook for Fall and Winter is excellent.

Mr. Goldsmith believes that the larger purchasers of talking machines are becoming tired of buying merchandise that does not build for the future, and that hereafter they will depend on standard, reliable merchandise as the backbone of their business.

The Player-Tone Talking Machine Co. is closing an excellent business, the sales totals for the year showing a substantial increase over 1921. Inquiries are being received from dealers in the leading trade centers and, judging from all indications, the 1922 Fall trade will compare very favorably with banner seasons of previous years.

Spaulding's Music Store, Exeter, N. H., W. C. Spaulding, proprietor, is now located in larger and more attractive quarters. Victrolas and Victor records are handled.

**Study the
SILENT Motor**

Its Advantages for Your Line of Talking Machines Are Self-Evident

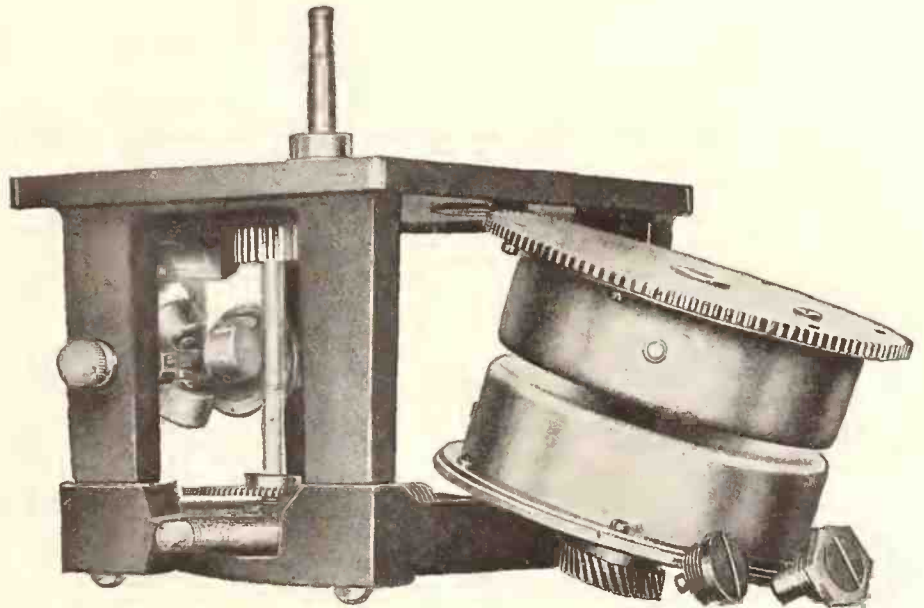

The Silent Motor With Spring Barrels Demounted. Note the Sturdy and Simple Construction.

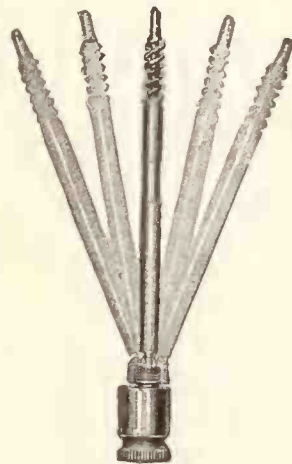

An Exclusive
SILENT MOTOR Feature.

Self-aligning governor shaft, mounted on universal ball-and-socket bearing. Eliminates governor trouble forever.

Send for Sample and Prices

THE SILENT MOTOR CORPORATION

CHARLES A. O'MALLEY, *President*

321-323-325 Dean Street,

BROOKLYN, N. Y.



Geor - gia! Geor - gia! My home sweet home

GEORGIA

Irresistible Fox Trot - Full of Rhythm and Snap - It's a Hit

"You can't go wrong with any 'Feist' song"

Proved Instantly Popular in Vaudeville
—A Great Favorite with Dancers.

HEAR IT NOW!

SUMMARY OF NEW TARIFF BILL SHOWS MANY CHANGES

Washington Bureau of The World Prepares Synopsis of the Important Changes Made in Former Tariff Rulings by Present Tariff Bill Which Directly Affect the Music Industry

WASHINGTON, D. C., Sept. 5.—For the benefit of its readers the Washington bureau of The World has prepared the following summary of the tariff bill, as passed by the Senate on August 19, showing changes made by that body:

A rate of 40 per cent ad valorem is provided in Paragraph 1441 for musical instruments and parts thereof, not specially provided for, pianoforte or player actions and parts thereof, pieces for musical instruments, pitch pipes, tuning forks, tuning hammers and metronomes, strings for musical instruments composed wholly or in part of metal; \$1 per thousand and 35 per cent ad valorem for tuning pins; 45 per cent ad valorem for violins, violas, violoncellos and double basses, of all sizes, wholly or partly manufactured or assembled; 40 per cent ad valorem for unassembled parts of the foregoing instruments.

Paragraph 1442 provides that phonographs, gramophones, graphophones and similar articles and parts thereof, not specially provided for, shall carry a rate of 30 per cent ad valorem; needles for phonographs, gramophones, and similar articles, will be dutiable at 45 per cent ad valorem.

Chamois skin, pianoforte, pianoforte action and player action leathers will be dutiable at 20 per cent ad valorem. Catgut, whipgut, Oriental gut, and manufactures thereof, not specially provided for, and manufactures of worm

gut, will be dutiable at 50 per cent ad valorem. Ivory tusks in their natural state or cut vertically across the grain only, with the bark left intact, are on the free list, but manufactures of ivory or vegetable ivory will be dutiable at 35 per cent ad valorem. All animal, vegetable or mineral wax not specially provided for is on the free list. Wood is also on the free list, as well as unmanufactured worm gut.

The ad valorem duties in the Senate bill are to be based upon the foreign valuation, while the House provided for the assessment of such duties upon the American valuation. It is believed that, after considerable discussion, the foreign valuation basis will eventually be adopted.

The Senate bill provides authority for the President to deal with dumping and unfair practices in importation by increasing or decreasing rates to an extent not to exceed 50 per cent of the rates fixed in the bill, after due investigations and hearings by the Tariff Board. He is empowered to take steps, either by changing rates or by prohibiting importation in extreme cases, to meet dumping or unfair practices in the importation or sale in this country of foreign goods, and is authorized to take retaliatory action against foreign governments attempting to restrict exportations to the United States by means of export duties or otherwise.

The bill is now being considered by a joint committee of the Senate and the House with a view to ironing out the differences in the measure as adopted by the two bodies and preparing the bill for final adoption. It is hoped that a final report will be made shortly so that the complete bill may be signed by the President.

ABILITY TO PICK ACTIVE SELLERS

Sol Kronberg, of the Banner record division of the Plaza Music Co., 18 West Twentieth street, New York City, in a recent chat with a representative of The Talking Machine World, was quite optimistic regarding Fall conditions. He said: "It is quite true that there is always a falling off of sales during the Summer months. This year, however, a marked improvement in activity has been seen. There was a stronger and more consistent demand, and as far as Banner records are concerned, we attribute this to the merits as well as the favorable retail price of the product."

Mr. Kronberg stated that his company was very fortunate in its selection of fast-selling numbers, and the ability to pick the active sellers was accredited to the fact that it is an extensive operator in the sheet music field, having a national distribution among sheet music dealers in all parts of the country.

VICTORS USED IN BROADCASTING

Victor records are used exclusively in the weekly radio concerts given by the Edmonton Journal, of Edmonton, Alta. The records are loaned by Mason & Risch, Ltd., of that city.

Model 17, Mahogany, Golden Oak or Fumed Oak, 75-record file. Emerson Music Master horn and Thrush Throat tone arm. Heine-man No. 44 motor. All exposed metal parts gold-plated. A beautiful machine worth many dollars more than we ask. We have also a number of Emerson Model 20's.



Emerson Phonographs

at startling low prices

WHAT would it mean to you to be able to offer your customers a beautiful, nationally known, high-grade Emerson Phonograph at a price so low that it seems ridiculously impossible—and yet be able to make a fine profit on them? You can do so. We have a number of Emersons, fine, new machines, which we made up for the Emerson Co., which we can sell you at a price you will scarcely believe possible. We want to break even and that's all. You and your customers get the benefit. You know the Emerson—how really high grade it is—and what a splendid reputation it has. Cash in on this real buying opportunity!

Write for full information

The UDELL WORKS :: Indianapolis

28th Street and Barnes Avenue

Announcing Reduced Prices and New Models LONG CONSOLES

Due to heavy demand, necessitating large cuttings, we have been able to reduce our manufacturing costs. We pass this saving to our customers—more than 10 per cent below former prices:

Please note that while Consoles 601, 602, 603, 608 and 610 are regularly fitted to take care of Victrola VI, these same cabinets can be fitted to take care of Victrola IV, and, when taking the reduction in price of Consoles into consideration, it enables the dealer to sell an up-to-the-minute standard outfit at a very moderate price.

Long Consoles are broadly covered by patents.
 Long Consoles are distinctive in design and have the divided top.
 Long Cabinets are regarded by the trade as the Standard of Quality.
 Deliveries can be made at once.
 Order now for Fall and Holiday requirements.
 Write to-day for catalog of full line.



Style 601
\$27.00



Style 602
\$30.00



Style 603
\$29.00

Announcing The New Long Consoles



Style 608
\$30.00

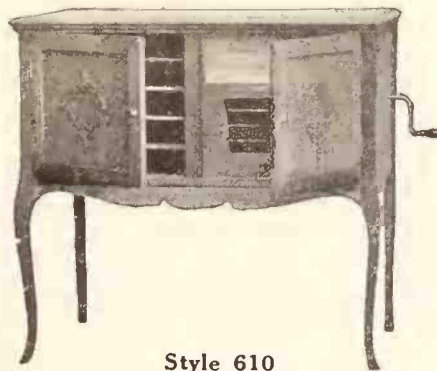

Style 610
Open doors showing arrangement of interior as used in 608 and 610

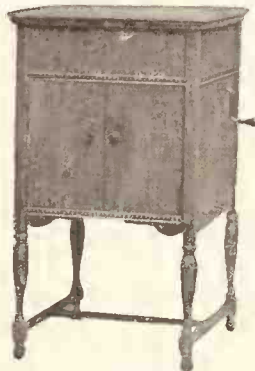

Style 606
For Victrola IV only
\$20.00



Style 610
\$28.00

The Geo. A. Long Cabinet Company
 HANOVER, PA.

Featured by Paul Whiteman and His Orchestra in George White's "Scandals."

HOT LIPS

The New "Wang Wang Blues" by the same Writer.

You can't go wrong With any FEIST song

HEAR IT NOW!

He's got hot lips — When he plays Jazz, — He draws out Steps, —

FOUR VERY ATTRACTIVE MODELS OF THE NEW EDISON

These New Designs, Which Range in Price From \$60 to \$135, Have Made a Great Impression On the Trade and Public and Orders Have Been Coming in From Distributors in a Lively Way

ORANGE, N. J., September 9.—Thomas A. Edison, Inc., recently announced four new models of the New Edison, which are of a revolutionary character insofar as price is concerned. Hitherto the New Edison instruments have comprised what the trade regarded as a high-priced line and at one time the lowest-priced model

have been demonstrating their enthusiasm for the new models brought out earlier in the year in a most convincing manner. The announcements of the further additions to the line have amplified this enthusiasm to a great extent, as it is the unanimous feeling of the Edison trade that the new models broaden the market and

width, 17½ inches; height, 42½ inches; depth, 18½; Re-Creation capacity, 33; price, \$100.

London Console, mahogany finish (brown); length, 35 inches; height, 35 inches; depth, 20½ inches; Re-Creation capacity, 34; 2-piece top; price, \$135.

DINNER FOR SALESMANSHIP CLASS

Those Attending Second Class of Victor Salesmanship School in Boston Guests of Local Jobbers at Dinner and Theatre Party

BOSTON, MASS., September 8.—The second class of the Victor Salesmanship School, which attracted a most satisfactory number of entrants, was brought to a close last night with a dinner party at the Hotel Brunswick, followed by a theatre party at the Colonial Theatre to see "Sally," when the sixty-one students were the guests of the local Victor jobbers, the Eastern Talking Machine Co., Oliver Ditson Co. and M. Steinert & Sons Co.

JOIN BRISTOL & BARBER STAFF

Bristol & Barber, distributors of talking machines and accessories, New York City, have enlarged their organization through the addition of four new members to the sales staff, consisting of: Alfred Friedman, formerly with the Plaza Music Co., who will cover New Jersey, part of New England and New York State south of Albany; Harry J. Steinberg, formerly with the Emerson Phonograph Co., covering Brooklyn; S. J. Palmer, formerly with the General Phonograph Corp., covering New York City in the interest of Okeh records, and Arthur J. O'Neill, at one time with the Pathé Frères Phonograph Co., who will cover New York City on Q R S music rolls. All four of these new members of the staff have had a wide experience in the talking machine field.

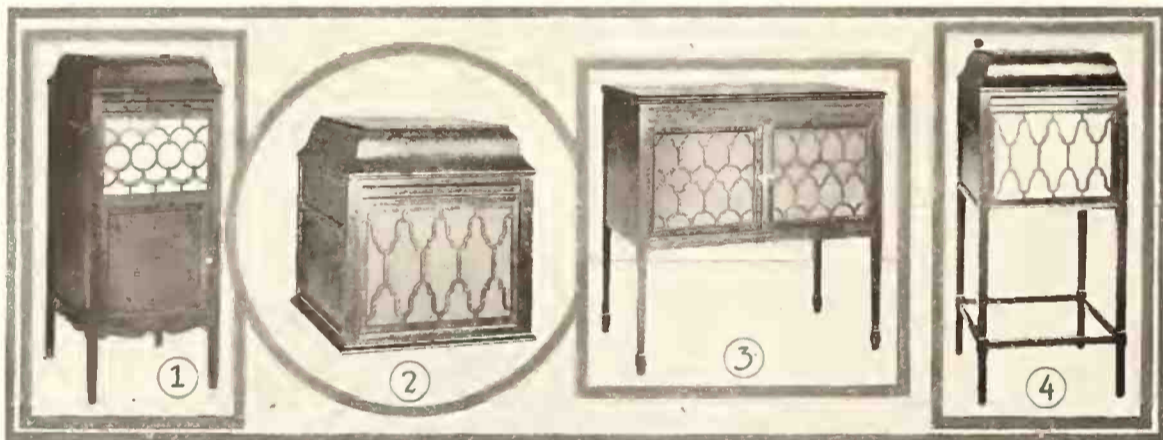

1. London Upright. 2. London No. 1. 3. London Console. 4. London No. 2.

was \$167. The new machines are all priced to cater to a demand for instruments selling around \$100 and less. Certain economies have been effected in the casework in order to make possible the low prices on these models, but in every instance the mechanical features of the New Edison are similar to the more expensive models.

The new instruments were announced to the trade a short time ago and already orders have been placed for an extremely large quantity of each model—a quantity which will keep the Edison plants and assembling centers busy to capacity throughout the balance of the year. For some time past the Edison jobbers and retailers

turnover volume of the Edison trade by about 100 per cent.

Deliveries throughout the country will be made on these new models in plenty of time to cater to the Fall trade. In the words of a prominent Edison official, these models bring the New Edison "within the reach of all." The new models include:

The London No. 1, mahogany finish (brown); width, 17½ inches; height, 19½ inches; depth, 18½ inches; price, \$60.

London No. 2, mahogany finish (brown); width, 17½ inches; height, 40 inches; depth, 18½ inches; price, \$75.

London Upright, mahogany finish (brown);

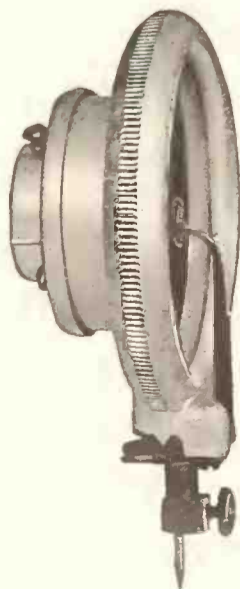

A QUALITY SOUND BOX

Here is a sound box that has won a reputation for its quality features of design, construction and tone.

It reproduces a full, mellow, resonant tone of unrivalled volume and clearness.

Good enough for the highest-class phonographs and cheap enough for the lowest-priced machines.

Get acquainted with the superior qualities of the Presto rubber-hub sound box and you will realize why it has been adopted by the leading independent manufacturers.

PRESTO PHONO PARTS CORPORATION

124-132 Pearl Street

Brooklyn, N. Y.



SAINT LOUIS

Settlement of Miners' Grievance Felt in Local Trade Circles— Appearance of Prominent Record Artists Helps Trade—The News

St. Louis, Mo., September 8.—With the beginning of September there was an improvement in the demand for the higher-priced talking machines, particularly consoles, which, it was felt, would have been more pronounced if it had not been for the unsettling effect of the railroad strike. The improvement in the local trade territory was helped by the settlement of the coal strike, particularly in Illinois, where the effects of that strike were most directly felt. However, the railroad strike was more disastrous than the coal strike in disturbing public confidence and interfering with industrial revival. The record business, however, was not seriously affected by either strike and held up very well during August and the first week of this month. The feeling is that, with the ending of the railroad strike, an immediate and active improvement in the demand for machines will be felt and there will be very good business through the Fall and early Winter, culminating in a record holiday business.

Public Favors Brunswick Artists

There never was anything like the success of the first appearance of Gene Rodemich and his celebrated orchestra in a free performance at the Vandervoort Auditorium of the new September Brunswick records. It is estimated that, after the auditorium had been filled to its capacity of 700, there were between 4,000 and 5,000 turned away. The congestion in the store became so great that traffic cops had to be called in from Olive street to clear the aisles. The stage was arranged with a handsome setting of palms and ferns. After the first number by the orchestra the lights were turned off and a Brunswick machine, in an upper box, took up the strain and was given full spotlight honors. The entire program was received by the audience with marked favor. Manager Hosier is vastly pleased with the success of the event, which will be repeated each month on Brunswick release dates.

F. L. Horning Arrives

Frank L. Horning, of Boston, has arrived to take the management of the Stix, Baer & Fuller talking machine department, succeeding F. J. Ennis, who recently, on account of ill health, went East and has concluded to remain there. During the interim the department was efficiently handled by Miss Helen Hatfield.

G. C. Friend, formerly with the Columbia Co.

at Kansas City, Mo., and Thomas Murphy, formerly with the Rudolph Wurlitzer Co. at Memphis, Tenn., are now with the Widener Shop as outside men.

"The Merely Ornamental Victrola" is the subject of a disquisition in the Koerber-Brenner advance list of records for October. The merely ornamental Victrola, it is explained, "is one that sits in a corner of the living room—and just sits there. It's a beautiful piece of furniture—it fits its corner nicely—it harmonizes with and balances off the rest of the living-room furnishings—but, like the well-trained small child, it's seen and not heard.

"It's really surprising what a lot of Victrola owners there are who allow their machines to become 'merely ornamental.' Do you know how many Victrola owners like that there are in your town? You can find out. Just go over your books and make a list of those customers who haven't bought any records during the past six months or so. It's a ten-to-one bet that, in the homes of those people who have quit buying records, the Victrola isn't played one-half hour a week. * * *

"Why not make a determined effort to bring those who haven't bought records for some time into the fold of regular buyers? A telephone call will get some of them. A letter, enclosing a well-chosen list of records, will get others. A personal call may be necessary to get the more reluctant. But whatever effort it takes to get them, that effort is worth while. Not only every Victrola but every talking machine in your town ought to be a source of month-after-month record sales for you. You can't afford to allow many of them to be 'merely ornamental'."

Class in Musical Appreciation

The School Board of Lebanon, Ill., granted the use of the school hall to Miss Estelle Heuman, of the Victor department of Daumueller's, and on each Tuesday morning a class in music appreciation is held. Thirty-five children attended the first class and the attendance promises to grow.

Victor Artists Play to Large Audience

Another striking success was the opening concert given by Dave Silverman's Orchestra in the talking machine department of the Famous & Barr Co. on the Victor release date. The orchestra played the same arrangements

as the records and a large audience was keenly appreciative. The orchestra has been engaged by Manager J. F. Ditzell to appear on all Victor release dates.

Artistic Float Attracts Attention

The DeMerville Piano & Music Co. entered an attractive float in a recent competitive parade of South St. Louis merchants. The float consisted of platforms built on the auto delivery body and draped in white with red Victor pennants. A dog and reproduction of the Victor trade-mark were part of the display as well as a horizontal Victrola. Mr. DeMerville distributed Victor puzzles to the children along the line of march and his was voted the most popular float in the parade.

An interesting contrast is shown in pictures received by Koerber-Brenner from Marion, Ill. The one shows the first Saturday morning children's class conducted by the Cline-Vick stores and has but nine children. The second shows the class a month later, held in a public park and numbering nearly fifty.

Paul Whiteman's Club Royal Orchestra

Paul Whiteman's Club Royal Orchestra, of New York, appeared recently for a week at the Grand Central Theatre, under an arrangement made by Manager J. F. Ditzell, of the Famous & Barr Co. talking machine department. During the orchestra's stay its Victor records were effectively exploited in Mr. Ditzell's section.

The talking machine sections of the department stores are again open six days a week.

Columbia News Items

A few weeks ago the Arkansas Light & Power Co.'s radio broadcasting station at Pine Bluff, Ark., arranged a program entitled "An Evening with Columbia Artists," and this was broadcasted. Operatic, symphony, popular dance and comedy music were included in the program, which was reproduced on the Grafonola and both records and Grafonola were supplied by the Knox-Walker Furniture Co.

Rolens & Millikan, of Murphysboro, Ill., used a Magnavox in connection with the County Fair held in that city recently. This enterprising dealer occupied the judges' stand immediately across the ampitheatre, and displayed a large sign advertising new Columbia records. Each time a record was played on the Magnavox the name of the record was shown on the sign, and this unique publicity was well received.

George Ermantraut, of Ermantraut & Sons, of this city, Columbia dealers, was married recently, and is now receiving the congratulations of his many friends in the trade.

Mr. and Mrs. Phil Dallmeyer, of Jefferson City, Mo., were recent visitors at the St. Louis branch of the Columbia Co. They stated that conditions in their home town were excellent.

There's Lots of Money Around

this broad land of ours.

For example: June and July were the biggest months of production and sales in the automobile industry, not even excepting the profligate years of '19 and '20.

And of the sales made a large percentage were first-time buyers.

These people had gone along economically and quietly and had been saving their money.

The automobile season is dropping off.

The talking machine season is just beginning—and there's lots of money around the country.

Our plans are all made. Are yours?

ECLIPSE MUSICAL CO.

Victor Wholesalers

CLEVELAND, OHIO.



Made of High Grade
Hardened Steel
Specially Treated
to Give
Frictionless Surface

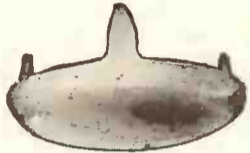

Extra Heavy
Size—1 1/8 in.



3/8 in.



1/4 in.



3/8 in.



1/2 in.



3/8 in.

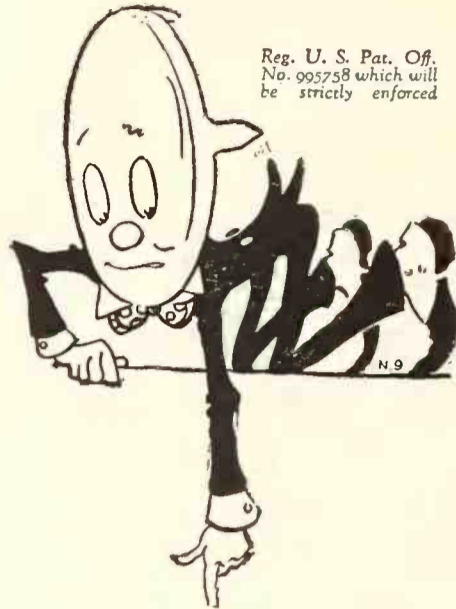

Reg. U. S. Pat. Off.
No. 995758 which will
be strictly enforced

Furniture Footwear *Invisibility*

A piece of furniture equipped with a form of footwear that raises it considerably above the floor goes far to spoil the lines of that particular piece or suite.

It is desirable that furniture footwear be invisible.

DOMES of SILENCE

once applied cannot be seen. Added to this great point "DOMES OF SILENCE" have these additional important qualities, which ordinary devices do not possess:

Economy
Simplicity
Silence

Adaptability—Suitable for covered and uncovered floors alike.

Service— Long wear.

Protection to furniture, floors and rugs.

The perfect footwear for furniture—

DOMES of SILENCE

"Better than Casters"

Henry W. Peabody & Co.

DOMES OF SILENCE DIVISION

17 State Street, New York City

In All Your Talking Machine Orders,

Specify **DOMES of SILENCE**

F 68

*What we say above about Furniture applies also
to Phonographs*

KANSAS CITY

Bad Effects of Coal and Rail Strikes Minimized by Aggressive Tactics of Dealers—Workers Help—Optimism for Fall Prevails

KANSAS CITY, Mo., September 5.—Talking machine jobbers and dealers in this territory differ somewhat as to existing business conditions and future prospects, although the majority are in an optimistic frame of mind and look for a very substantial Fall trade.

The coal and railroad strikes have had a rather bad effect on business in this territory for the reason that there are a number of communities which depend chiefly upon the patronage of miners and railroad workers.

Farmers also have been hit to a certain degree, being unable to move their crops freely and suffering in some sections from the effects of drought. However, there is still enough money in circulation to keep the trade moving more or less satisfactorily.

In spite of these discouraging conditions, or maybe because of them, certain dealers are more active in their preparations for going after the business than usual. They argue that if the business is hard to obtain, then it is all the more reason that they should use every possible means to secure it. Therefore, they are doing out-of-the-ordinary stunts.

One of the interesting plans is connected up with the Western Amateur Golf Tournament, in which "Chick" Evans successfully defended his title as champion. The Brunswick people are pushing the records which give the "Chick" Evans directions for playing golf. These records are displayed with a life-size picture of "Chick" and with an attractive assortment of golf paraphernalia. The golf fans are interested, further, in the statement that the profits on the sales of these records are to be devoted to establishing the "Chick Evans Foundation," which is to be devoted to carrying on the work of the National Caddies' Championship.

Sales Manager Schoenley, of the wholesale Victor department of the Schmelzer Co., is working out a campaign for the Tungstone needle, which is meeting with an enthusiastic reception from the dealers. He has several needles, duplicates of the real needle, but 110 times as large, which are to be sent from dealer to dealer and used in window displays. The actual size of the gigantic needles is six feet long and seven inches in diameter.

The campaign on Victor Health Records, which has been put on also by the Schmelzer Co., has met with good co-operation by the dealers, but it is generally agreed that the real results from this campaign will not be secured until after the hot weather.

Dealers in this territory are looking forward to the coming of the factory representatives of the Victor Co., F. A. Delano and his corps of assistants, who will hold a school of salesmanship in Kansas City during the Fall. The dates have not yet been arranged, but preliminary announcement has been made. The school will last five days and will be held in the Victor wholesale department of the Schmelzer Co. The course will be similar to that followed in other cities. Indications are that the attendance will be large.

G. W. Collins & Sons, exclusive Columbia dealers at Belleville, Kan., are staging a great sale on the occasion of their thirtieth anniversary. The drawing card of the sale was a voting contest of the most popular local resident.

Samples of the new line of Edison consoles have arrived here and Manager Blackman, of the Phonograph Co., states that they have been received with great interest and enthusiasm by the dealers. It is considered a step toward popularizing the Edison that the factory is now able to announce a genuine Edison at a price as low as \$60. Other machines of the line sell at \$75, \$100 and \$135. The baby console is receiving a hearty welcome in this market.

The Chappell Music Co., of Salina, Kans., exclusive Edison dealer, has determined to enlarge its business and add a line of pianos, player-pianos and other musical instruments. The first addition will be the Packard line. The company is moving into beautiful new quarters and reports a nice Summer's business. Herbert Bailey, who has been associated with Mr. Blackman in this city, will have charge of the enlarged business at Salina.

The appearance of Miss Florence E. Hazlett, educational representative of the Columbia Co., working out of the Kansas City branch, at Lexington, Mo., received much favorable comment. Miss Hazlett was on the program of the Lafayette County Teachers' Meeting at the high school building of Lexington, appearing in the afternoon of the first day's session to demonstrate the use of the Grafonolas in the public schools. Her appearance was well received and B. R. Young, the local Columbia dealer, reported that the sale of Columbia school records was greatly stimulated by the appearance.

Louis Deitsch, proprietor of Scanlan's Hardware & Furniture Co., St. Joseph, Mo., is using a novel scheme to secure replies to his letters to Grafonola and Columbia record prospects. He encloses a bright new penny to cover the post-

age of the return reply. The plan has been unusually successful in securing replies.

The Sweeney Automobile School, which has one of the most complete broadcasting stations in the country, has a special broadcasting room fitted up artistically with period design furniture, including a P-7 Charles II period design Grafonola.

R. H. Brown, for years connected with the teaching of music in Kansas City public schools, has moved to Manhattan, Kans., having purchased the music business of Harry Smethurst, of the Smethurst Music Co. The concern will be known as the R. H. Brown Music Co. Columbia Grafonolas, records, pianos and small musical instruments will be handled.

The Allen Phonograph Parlor, Columbia dealer, at Independence, Mo., has just started a Grafonola campaign and, to support this campaign, is running a series of full-page newspaper advertisements and it has distributed throughout the territory adjacent to Independence, Mo., 5,000 circulars featuring Grafonolas and the sale which it is now conducting.

Reports on the sales of the new style horizontal-topped Victor consoles indicate that the public has been waiting for them. One dealer has ordered at one time as many as twenty-five of them from the Schmelzer Co.

Victor dealers are combining to connect up in an advertising and selling campaign in connection with the visit to Kansas City of John Steel, who appears at the Orpheum. The Paul Talking Machine Co. will display, together with his records, a Victrola in the lobby of the theatre in which Mr. Steel will appear.

Cash in on the Wireless Demand

Our specially equipped Cabinets, with horn and all apparatus out of the way, sell themselves. Also in stock as complete Phonographs or Cabinets for assemblers. Write for Prices

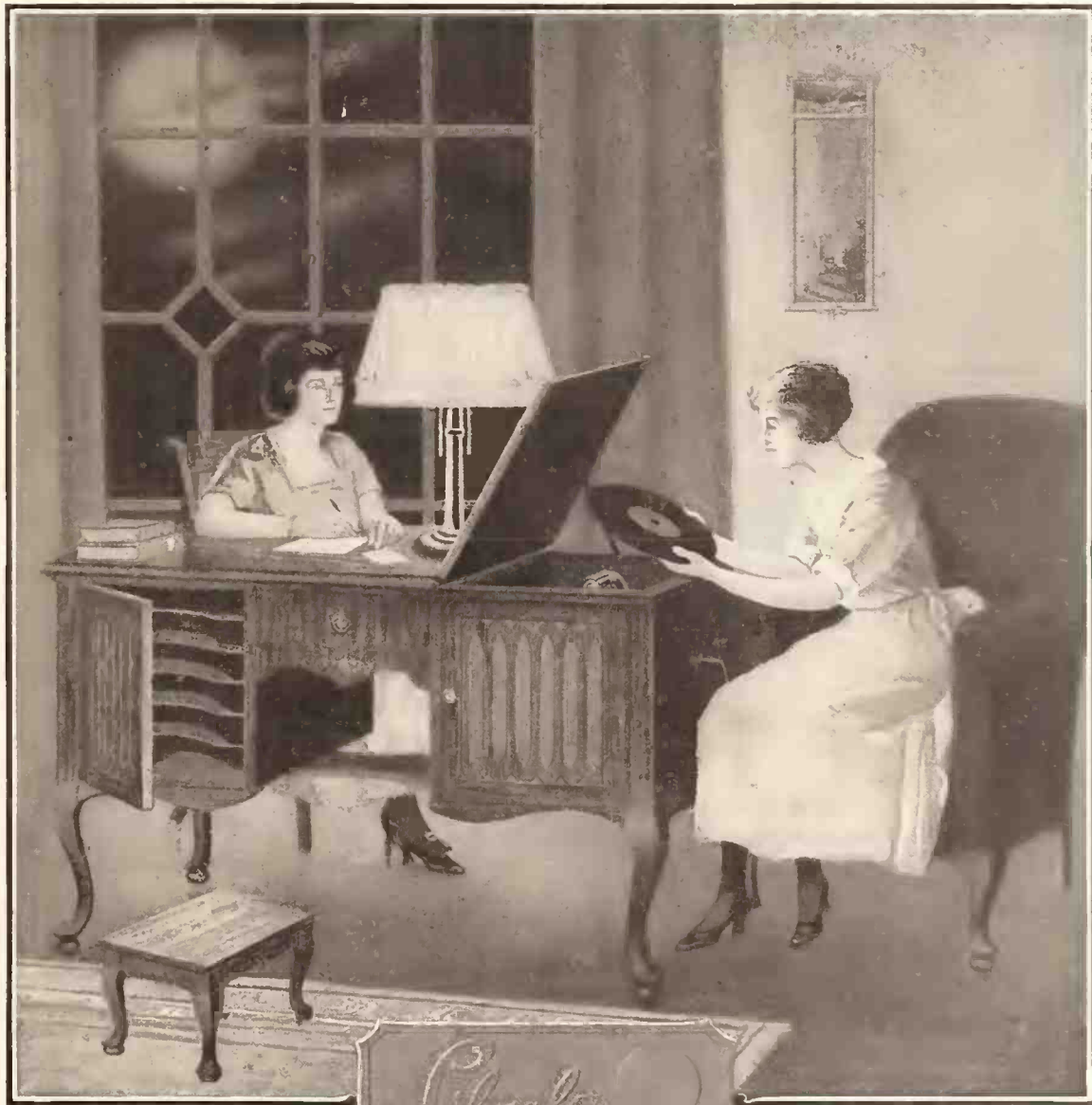

Seaburg Mfg. Co.
Jamestown, N. Y.

The Biggest Value on the Market. A Trial Order Will Convince

No. 250T, List Price \$195.00
Usual discounts to dealers
48"x28"x31" high. Finished all around

Genuine Mahogany, Walnut or Oak

THE 19TH HOLE

**Get HIM a copy today
It's funny - of course**

IF HE GOLFS — HE will enjoy this NEW "Sportsong"

*"You can't go wrong
With any FEIST song"*

SING OLD HYMNS FOR BRUNSWICK

Chorus of Sacred Harp Singers Recording Exclusively for Brunswick Co.—Perpetuating Hymns of the Pilgrim Fathers

A recent addition to the artists recording for the Brunswick-Balke-Collender Co. are the Sacred Harp Singers, chosen the official chorus of the United Sacred Harp Musical Association, which numbers over 5,000,000 persons in the United States and dates back to the beginning of American history, according to an announcement emanating from the Brunswick Co.

The Singers, who are now recording exclusively for the Brunswick Co., were selected from a delegation which came to New York from Texas early in July to fire the opening gun in a nation-wide campaign to bring about a revival of the old-fashioned choir singing of the Pilgrim Fathers. Typical hymns sung by

Among the recordings which have already been made and which appear on the Brunswick Purple Label list are the following: 5150—New Britain, C. M., Canaan's Land, C. M. D., Mixed Choir of the Original Sacred Harp Singers; 5151—Soft Music, Pleyel's Hymn, C. M., Mixed Choir of the Original Sacred Harp Singers; 5146—Penick, C. M., The Christian Warfare, Mixed Choir of the Original Sacred Harp Singers, and 5147—Easter Anthem, Antioch, L. M., Mixed Choir of the Original Sacred Harp Singers.

NOW MANUFACTURING RADIO HORNS

Standard Metal Mfg. Co., Newark, N. J., Enters New Field of Activity—Is Widely Known

The Standard Metal Mfg. Co., Newark, N. J., which for over twenty years has manufactured metal amplifying horns for the talking machine trade, is now manufacturing radio horns in addition to its other products.

The radio horns are in several designs and sizes. A particularly popular amplifying radio horn is that made of rubberoid, black enamel finish, designed to be used with all makes of radio receivers. It is of heavy material in order to avoid blast in amplification. The Standard Co. also manufactures a radio horn similar to the flower-shaped bell found on the old Edison phonograph. This is produced in rubberoid black enamel finish and also in grained mahogany.

Horns for the interior of cabinets are made upon specification and of every

design and dimension.

W. A. Lawrence, president of the Standard Metal Mfg. Co., is well known throughout the talking machine industry. In addition to the large volume of work for talking machine manufacturers, which includes horns for the interior of cabinets, the Standard Co. also had for many years close connection with the retail field through the manufacture of the old style exterior horns for talking machines.

In speaking of the demands for its earlier type of talking machine horn Mr. Lawrence said: "Although there is only a small retail demand for the machines with exposed horns in this country, and those particularly for school use, we are still delivering to the larger manufacturers many such horns for foreign consumption, particularly for South American and India trade, many orders coming direct.

NEW SONORA ELECTRIC SIGN

Day and Night Sign Announced by Sonora Advertising Department in Demand

A new "Da-Nite" sign has just been announced by the Sonora advertising department. The accompanying illustration shows the daytime effect of this sign and at night it is il-

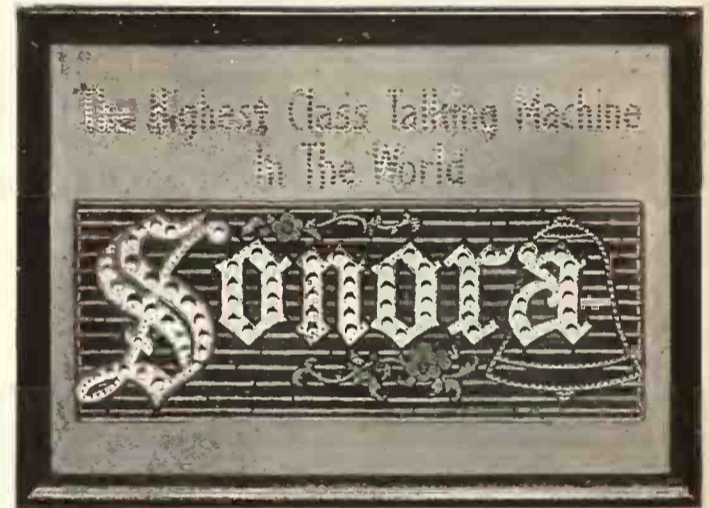

luminated by an electric bulb flashing on and off at regular intervals, giving an appearance as though the letters were composed of myriads of small electric bulbs. The color scheme of the background is blue and black, with white letters, and the size of the sign, 14½ inches by 20¼ inches, should make a distinct appeal to the Sonora dealer who aims to give his store 100 per cent publicity day and night.

We Have It!

A HIGH-CLASS TABLE MACHINE AT A PRICE THAT SELLS



Mahogany, 16x16x10, Double Spring, Universal T. A. Back Casting and Metal Horn
Sample Price to Dealers Now—\$12.50
Send for Sample To-day
Phonographs and Accessories, Repair Parts for All Makes.
Best Steel Needles of American Manufacture at 30c. per M.

FULTON TALKING MACHINE CO.
253-255 Third Ave., New York City
Between 20th and 21st Streets



The Sacred Harp Singers

the Sacred Harp Singers include such old-time favorites as "Promised Land," "Wondrous Love," "Amazing Grace" and "How Firm a Foundation." The Singers render their songs without musical accompaniment of any kind.

RECORDING FOR THE TRADE

We have a modern well-equipped laboratory with facilities for producing the highest grade recordings. We Solicit Your Business

Manhattan Recording Laboratories
48 West 39th St. New York

NEW ERA OF PROSPERITY FOR THE TRADE, DECLARES RAY

General Manager of Vocalion Record Division of Aeolian Co. Brings Back Satisfying Report Regarding Conditions and Prospects on Return from Transcontinental Trip

O. W. Ray, general manager of the Vocalion record division of the Aeolian Co., recently returned from a six weeks' trip to the Coast and to the Canadian Rockies and reports that the phonograph dealers and distributors, both in the Central West and on the Coast, express great faith in the new era of prosperity.

"This new era of prosperity in phonographs and records means far more for the permanency of the industry than the wave of prosperity that swept the phonograph industry during 1917, 1918 and 1919," said Mr. Ray upon his return. "To-day we find the dealers and distributors trained merchandisers in financing, banking and credits as well as on sales. In the period beginning 1917 manufacturers, dealers and distributors were all optimistic and paying a great deal of attention to sales and this attitude made a very dangerous factor for the industry. To-day every dealer is a banker, financier and credit man, as well as a sales expert, and it has made a factor of safety for the manufacturer that makes the phonograph industry more permanent than ever before and assures the dealer and distributor of making money.

"Reports show, in Indiana and Kansas, the greatest corn crop in the history of these States and offers the farmer the opportunity of paying his debts and having some money left over to spend on articles for his home. In Denver, Col., the mines are opening and crops are very large and the return of a permanent business is reported by all dealers.

"In Salt Lake City the Strevell-Paterson Hardware Co., which we have just appointed as distributor for Vocalion records, and the Consolidated Music Co., who is a dealer for Vocalion instruments and records, expresses a feeling of great confidence in the return of the phonograph business in this territory and the opening of the large copper and silver mines assures them of a very prosperous business this season.

"In Los Angeles one finds John Boothe, manager of the music department of Barker Bros., doing a Christmas business the year round. Houses in Los Angeles are going up on Monday, the decorators are in on Tuesday and the phonograph is sent out on Wednesday. The Munson-Rayner Corp., 315 South Broadway, Los Angeles, has just been appointed distributor for Vocalion Red Records, with Mr. Darville in charge. This concern is being stamped with Vocalion record business and promises to be one of our largest distributors.

"One of the most impressive things that I saw on my trip was the amphitheatre at Hollywood. It brought a message to me and I would like to carry this to the music industry as one of the many things that are being done on the Coast for the development of music. This amphitheatre seats 25,000 people, with a natural stage backed with mountains that rise one thousand feet high, and to step into it on the ever-starlight night of the California climate with a city of people sitting there as quiet as the night and to hear the symphony concerts conducted by Hertz, formerly of the Metropolitan, gave one a new realization of the power of music.

"At San Francisco I was royally entertained by Mr. Steers and Mr. Travers, of the Magnavox Co., and during my stay had the very pleasant opportunity of meeting our dealers in the San Francisco territory and talking to them. The spirit and enthusiasm and the following that the Vocalion Red Records have attained with our distributors were expressed by the fact that the dealers were present in 100 per cent attendance.

"Business conditions in both Portland and Spokane are improving and the prospects for a big lumber business and the tremendous wealth of the great Northwest in mines gives one a feeling that some day this territory will be one of the wealthiest in the United States. Meier Frank, in Portland, expresses his confi-

dence in the future of the phonograph industry by greatly increasing the size of his department, and the Simon Piano Co., who is a Vocalion instrument and record dealer in Spokane, has a large business this Summer and expects a very large business this Fall.

"One of the largest crops of wheat in the history of Montana, North Dakota and Minnesota promises this section a large business for the Fall and the Stone Piano Co., of Minneapolis, has already felt the effects of this optimism.

"My return visit to Chicago found H. B. Levy, the manager of our Chicago branch, with one hundred dealers in Chicago, demanding more Vocalion records and August was the biggest month in the history of Mr. Levy's business.

"My short time in New York since my return leads me to believe that New York City is one of the starting points of this new era of prosperity for our industry and I believe that all

members of the talking machine industry should be proud of their association and the future that this well-established industry offers."

HENDERSON OPENS IN ALBANY

ALBANY, N. Y., September 6.—An attractive Victrola shop has been opened in the heart of the business section of this city by the F. C. Henderson Co. The store, which is located at 23 Steuben street, has been completely stocked with a large assortment of the various Victrola models, and a large library of records has been installed. E. J. Yerick is manager.

HECHT CO. OPENS NEW MUSIC STORE

WASHINGTON, D. C., September 7.—An attractively appointed new music shop has just been opened at 628 F street, N. W., this city, by the Hecht Co., a large department store here. With the opening of the music shop the department conducted in the main store has been discontinued. Columbia Grafonolas and pianos are featured in the new establishment.



Patent Pending
Size: 8 in. x 14 in.
x 15 in.
Weight: Complete,
including album,
22 lbs.

"One handle handles it"

Outing

TALKING MACHINE

Perfection in a Portable Phonograph

Made in Mahogany and Fumed Oak Finishes

THE OUTING is the most complete and up-to-date portable phonograph ever made.

It is unique and attractive in design. Superior tone quality. Built to give years of satisfactory service.

JOBBERS:

- | | | | |
|--|--|--|---|
| <p>GENERAL PHONOGRAPH CORP.
New York Distributing Division
15 West 18th Street
New York, N. Y.</p> <p>CABINET & ACCESSORIES CO.,
145 East 34th St.,
New York, N. Y.</p> <p>BRISTOL & BARBER
3 East 14th St.
New York, N. Y.</p> <p>A. C. ERISMAN CO.,
174 Tremont St.,
Boston, Mass.</p> | <p>GEO. C. ULRICH & CO.
56 Estey Bldg.,
Philadelphia, Pa.</p> <p>ART EMBROIDERY CO.
Louisville, Ky.</p> <p>IROQUOIS SALES CO.
210 Franklin St.,
Buffalo, N. Y.</p> <p>UTICA'S GIFT & JEWELRY SHOP
Utica, N. Y.</p> <p>DAVENPORT PHONO. & ACCESS. CO.,
217 Brady St.,
Davenport, Ia.</p> | <p>VOCALION CO. OF OHIO
Cincinnati, O.</p> <p>VOCALION CO. OF OHIO
Cleveland, O.</p> <p>BURNHAM, STOEPEL & CO.
101 East Larned St.,
Detroit, Mich.</p> <p>WALTER S. GRAY CO.
942 Market St.,
San Francisco, Cal.</p> | <p>J. K. POLK FURN. CO.
294 Decatur St.,
Atlanta, Ga.</p> <p>CANDIOTO PIANO CO.
120 S. Limestone St.,
Lexington, Ky.</p> <p>WM. ANDERSON PIANO CO.
79 Eighth St., S.,
Minneapolis, Minn.</p> <p>RICHMOND SPORT & SPECIALTY SHOP
(Newton Corp.)
616 E. Broad St.
Richmond, Va.</p> |
|--|--|--|---|

There are still several good States and large Cities open. Full details or samples will be furnished responsible jobbers on application.

Outing

TALKING MACHINE CO., Inc.

A. J. COTE, President
MT. KISCO, N. Y.

Dealers in Mexico and Cuba should send orders and inquiries to
R. C. ACKERMAN
291 East 162nd Street New York, N. Y.

Foreign Export—CHIPMAN LIMITED
8-10 Bridge Street New York City
Cable Address, CHIPMUNK, New York



Featuring the **MUSICAL** POSSIBILITIES of the **TALKING MACHINE**

[EDITOR'S NOTE.—This is the twenty-third of a series of articles by William Braid White, devoted to the various interesting opportunities which prevail in the domain of education for the retailer of talking machines. The subject is one of great interest and we commend these articles to the consideration of all who are devoting attention to the featuring and developing of the musical possibilities of the talking machine.]

5—THE CROWN OF MUSICAL FORM

If what I said last month has been comprehended, the reader will now be ready to take another step along the delectable road of musical discovery. How fortunate he is in being able to take that journey in the magic vehicle of the talking machine! How happy is the fate of those who can have all music at their disposal and choose what they shall hear, when and how they want it!

The great classic masters of the late seventeenth and the early eighteenth centuries did not, of course, realize that they were doing revolutionary work. Telemann, Hasse, Buxtehude and Sebastian Bach were simple and humble men, who sometimes enjoyed court favor and the security of a small official position, who were always obscurely and quietly working for the sole purpose and to the sole end of giving rein to their own emotions and ideas. They wrote music because they could write music better than they could do anything else. They wrote without the slightest thought of the future; nor was their posterior fame even remotely anticipated by them. Now, it was they who worked out the art of Fugue until it stood complete as a Gothic cathedral in its marvelous co-ordination of detail into unitary design. In thus virtually exhausting the art of Fugue the masters of the Bach-Handel period set the stage for the next move in the ever-advancing development of the art of music.

It was Carl Philip Emanuel Bach, son of the great Sebastian, who perceived the desirability of breaking away from the strict art of Fugue, and of Contrapuntal form in general, and of turning to a music more artless and delicate, more elegant, if less majestic. His small pieces for the keyboard instruments of his day, harpsichord, spinet and clavichord, are drawn from a boundless imagination, warmly interested in the slowly opening mind of the new age of free thought and free inquiry. His work opened the way, through a train of followers and co-workers, for Josef Haydn, father of the symphony and spiritual parent of Beethoven, Mendelssohn, Schumann, Wagner and Brahms. It is with him that we must begin if we are to understand something of the crown of modern music, the symphony.

"Papa Haydn"

Haydn, born in 1732, was twenty-four years old when Mozart came into the world, and outlived his famous contemporary by no less than eighteen years. A Croatian by birth, he showed his Slavic warmth and geniality throughout a career which was extraordinarily well shaped to give him the opportunity he needed to develop his genius. Comparatively early in his course

he found himself directing the private orchestra maintained by the head of the great house of Esterhazy in Austria, and he remained in this position for more than twenty years. By virtue of his position he was able to experiment with the make-up and arrangement of the orchestra, to compose music suitable for the ideas he desired to test, and, in general, to do a wonderful preparatory work whereby his successors were able to step into a region of tone already explored and partly subdued, by the force of Haydn's genius.

Haydn was, of course, in a position that no musician would care to occupy, or indeed could occupy, to-day. The great Esterhazy family ruled its Hungarian estates with all the primitive suzerainty of a feudal lordship. A private court was maintained. The country house was a palace, while the town mansion in Vienna was only less elaborate and formal in its arrangements. Haydn, as Kapellmeister, was simply a sort of upper servant, coming after the major-domo and chief cook, but before the second butler. His instructions included a daily appearance, in white wig and white stockings, before the Prince, to receive orders about the dinner music and the various entertainments to which he was obliged to contribute. Shocking as the situation of this remarkable man now seems to us, however, we must remember that he was better off than poor Mozart, whose independent spirit led him to death at a premature age, by what was not very far removed from starvation. It remained for Beethoven to prove that a musician might remain independent of the patrons and the great, and yet earn his daily bread.

What Haydn Achieved

Now what exactly did Haydn achieve for the development of musical art? In the first place, having before him as good an orchestra (from 20 to 35 pieces) as the day could afford, he set to work where his predecessors had left off, and began to develop a more flexible vehicle for his ideas than the strict contrapuntal art of Bach could afford. He had, for background, the work of Carl Philip Emanuel Bach, who had discovered in the dance forms and popular songs of the day much material which could be worked up into effective shape. Bach had set many of his orchestral pieces in the forms of the older dances, gavotte, minuet, bourrée, sarabande. These, indeed, are still most charming, as the student will find by getting out the Victor records of the Suite in D major and listening carefully to them. But this listening will also show that Bach conceived the orchestra merely as a set of abstract parts, about as much distinguished from each other as are the various voices of a mixed choir, but not even thought of as possessing color values of their own to be used for their own sake. It remained for Haydn to follow up an idea which Carl Philip Emanuel Bach had partly worked out in his so-called Sonatas for the keyboard instruments, and to apply this to the orchestra along

with his own rapidly deepening belief that the orchestral instruments have each its own vocal color, which should be utilized accordingly, and not as mere abstract fillers-in of parts.

C. P. E. Bach's Idea

This idea of C. P. E. Bach was that an adequate form for a piece which is to be played but not sung, that is, for an instrumental piece. [Sonata is Italian for "sounded." A "Sonata" was therefore originally simply a piece for an instrument and not for the voice.] He thought that two contrasting themes could be worked out separately and gradually brought to an harmonious close, without any need for strict counterpoint. He was not entirely alone in this idea, of course, but his work was perhaps the most critical. Haydn had this idea before him in the shape of some little "Sonatas," by C. P. E. Bach and his contemporaries, and with his fine orchestra at his disposal was able to work out the form which crystallized as the Symphony, under his able hand.

What Is a Symphony?

The word "Symphony" was used, of course, long before Haydn's time, as, for instance, by Sebastian Bach, and then meant simply any ensemble of music, any concert of two or more instruments or voices. Haydn attached the name to his finest compositions in the form developed from C. P. E. Bach, and it has since been reserved for a particular style of writing for the grand orchestra, a style of which Haydn is the founder and his best works of the kind are still excellent examples.

Let me suggest to the student that he look up the record catalogs and discover for himself some of the symphonic works there available. He will find examples by Haydn, Mozart, Beethoven and Mendelssohn (to take the results of a hasty glance through the Victor, Columbia, Edison and Okeh catalogs). At the right moment, we shall select from these a certain symphony by Haydn, the famous Surprise Symphony, which may be found recorded by the Victor Orchestra in the Victor catalog, among the educational records.

The Quartet Form

Before taking this, however, let me make a needed observation. I am going to ask my reader to become acquainted with what I am calling the "crown of musical form," that is to say, with the most perfect and beautiful of all musical structures, the orchestral symphony. But it is necessary to say that the form on



PERRY B. WHITSITT & CO.

Records Make Ideal Gifts

Every Victor dealer should teach his community to accept this fact.

It will sell records the year around as well as in the holidays and it will sell Victrolas as well.



COLUMBUS ~ OHIO

VICTOR DISTRIBUTORS



**TALKING MACHINES COMPLETE
TALKING MACHINE CABINETS
RADIO CABINETS**

Golden Oak, Fumed Oak, Red and Brown Mahogany

Cabinets that will satisfy your customers—
Cabinets at prices that will make big profits

Send us your inquiries at once—Order Now.

THE H. LAUTER COMPANY
INDIANAPOLIS, INDIANA

which the Symphony is constructed may be applied also to music intended for a single instrument, for two instruments, or for a quartet, or quintet of instruments. When designed for a single instrument it is called a Sonata, as, for example, we have sonatas for piano and for violin and piano, or 'cello and piano, since the violin or 'cello is not able to carry the harmonies and the needed number of parts by itself. When, again, the music is written in this symphonic form, or for a stringed quartet, two violins, viola and 'cello, it is called a "Quartet." And so on.

We may, therefore, say that a sonata is a symphony for a solo instrument, or for two instruments, that a quartet is a symphony for a set of four instruments (nearly always the four stringed instruments of the violin family mentioned above); and that, conversely, a symphony is a sonata for orchestra. In each case, of course, the elaboration of the treatment and the richness of the whole structure are dependent upon the magnitude and complexity of the instrumental means. An orchestra can do work enormously surpassing the possibilities of a quartet in power, richness, variety and complexity. Hence, the writing must be differentiated, according to the nature of each case.

Haydn and Mozart both experimented so much with the quartet of stringed instruments that an introduction to the mysteries of symphonic form can hardly be had more perfectly than by comparing with each other some of the recordings of quartets by Mozart and Haydn, which are to be found in the catalogs, especially the Victor. As an introduction to what shall follow in the way of orchestral symphonies, we shall discuss some of the Flonzaley Quartet's recordings of some Haydn and Mozart quartets, and thus prepare ourselves for the Haydn symphony which is to follow, and which will then be much clearer to us.

Some Preliminaries to Hearing

As preparation for the actual hearing, let me

remind the reader that the sonata or symphony form commonly includes four movements, distinct and separate from each other. The first is the most important. It is usually marked Allegro (lively), but is sometimes preceded by a slow introduction of a few measures' length. The Allegro opens with a sharp, decided theme or tune, usually very crisp and snappy. This is repeated and then more or less "developed," that is to say, expanded out and put into varied instrumental dress, until the composer is satisfied that his hearers are familiar with it. Then is introduced a second theme, usually feminine, gentle and appealing in character. Then comes what is called the "development section," in which either or both are worked in all sorts of different ways, being subjected to rhythmic, and harmonic changes, as the learning and fancy of the composer dictate. The first theme is usually chosen for this development. The second theme then comes in again, usually, and there is a recapitulation of the first theme in something like its original form. Then comes a Coda or tail-piece, pulling the threads of the musical thought together and ending the movement. A quartet example is the allegro moderato from the Haydn quartet in D, recorded by the Flonzaley Quartet.

The second movement (usually marked Andante or Adagio, moderate speed or really slow, but in either case gentle) consists of a song-like melody, developed graciously and beautifully, aiming to charm more by its grace than by its power. A good example is the Andante from the Quartet in D, by Mozart, recorded by the Flonzaley Quartet.

The third movement was, with Haydn and in all his quartets, a minuet, or dance movement, based thereon. The minuet was a dance in 3-4 time, graceful, stately, and in every way charming. Beethoven worked it out into the more violent and energetic Scherzo, of which we shall speak later. An excellent quartet example is the Minuet from Mozart's Quartet, in

D major, admirably played by the Flonzaleys.

The finale or fourth movement is usually built much like the first movement. An actual example is not to be had at present, so far as known, in quartet recordings, but a good substitute is the Finale from Mozart's Symphony or orchestra, in E flat, as done by the Philadelphia Symphony Orchestra. This is clear, lightly orchestrated, and easy to grasp.

Now, as a preparation for next month's article, please get down the record of the Allegro from the Haydn quartet in D, and start it going. Listen carefully to it and see if you can distinguish the first and second themes, the development and the coda. Listen carefully to the separate work of the fourth instrument, the first violin playing the highest part, the second violin playing a little lower, the viola playing the alto parts, and the 'cello the tenor and bass.

I shall talk further about this and other quartet movements next month, and then get down to the symphonies, beginning with Haydn's Surprise Symphony, as said before.

(To be continued)

THOMAS SCORES IN EUROPE

Noted Singer and Vocalion Record Artist Attracts Great Audiences Abroad

John Charles Thomas, noted American singer, light opera star and Vocalion record artist, who has been in Europe for some months, is reported to have taken the European capitals by storm and at his recitals has attracted audiences that have packed to capacity the various halls. In London only Albert Hall, seating 12,000, was able to accommodate his English following.

Mr. Thomas will return to the United States in October and arrangements are being made for a transcontinental recital tour.

Dealers and salesmen should arouse new interest in records this Fall and Winter.

Puritan  Records

Puritan 50-cent Records Provide Quick Turnover

The great indoor season now at hand means increased playing of talking machines. This in turn greatly increases the turnover of record stocks.

You will profit by this demand if you carry the Puritan line of 50-cent records. A large catalogue of both standard and popular numbers appeals to every taste and through our weekly release system you get the new hits first.

Puritan records make pleased customers and provide quick turnover.

If you are located in territory East of the Ohio and North of the Potomac it will pay you to write today for full details.

The BRIDGEPORT DIE & MACHINE Co.
170 ELM ST. BRIDGEPORT, CONN.



PHONOGRAPHS

For beauty, for tone, for price

The dealer who makes money
 this Fall and Winter will be
the dealer who sells STRANDS

The policy that has succeeded:

- 1. Quality and Design**
To build none but first class instruments and to concentrate on correct flat-top consoles, every instrument guaranteed.
- 2. Low List**
So that you may offer better values, make sales easier and oftener and increase your rate of turnover.
- 3. Long Discounts**
To give you a liberal profit on each sale and make it doubly attractive to handle Strand Consoles.
- 4. Trouble-proof Shipping**
Prompt, safe deliveries assured by an ample output and a trouble-proof shipping system.
- 5. Protection**
Exclusive territory; you are protected against dividing your trade with nearby competitors.

"It's the Dealer's Turn Now"

These Direct Strand Representatives Are Ready to Serve You:

RICHARD H. ARNAULT, 95 Madison Avenue, New York City
 W. O. CARDELL, P. O. Box 1271, Tulsa, Okla.
 A. H. DANKMAN, 327 Adams Street, Buffalo, N. Y.
 CONSOLIDATED TALKING MACHINE CO., 227 W. Washington Street, Chicago, Ill.
 A. C. ERISMAN, 174 Tremont Street, Boston, Mass.
 W. S. GRAY, 942 Market Street, San Francisco, Cal.
 STERLING ROLL & RECORD CO., 137 West Fourth Street, Cincinnati, Ohio
 ARTOPHONE CORPORATION, 1103 Olive Street, St. Louis, Mo.
 H. KALISKI, Hotel Monteleone, New Orleans, La.
 G. C. SILZER, 1019 Walnut Street, Des Moines, Ia.
 WALTER L. ECKHARDT, 624 Market St., Philadelphia, Pa.
 RICKEN, SEEGER & WIRTS, Globe Bldg., Detroit, Mich.
 W. F. STANDKE, 1120 Grand Avenue, Kansas City, Mo.
 MERVIN E. LYLE, 214 Peachtree Arcade, Atlanta, Ga.
 R. J. JAMIESON, 25 Taylor Arcade, Cleveland, Ohio
 H. J. IVEY, General Delivery, Dallas, Texas
 L. D. HEATER, 614 East 28th Street, Portland, Ore.
 OTIS C. DORIAN, 11 Bloor Street, E. Toronto, Ont.
 R. L. CHILVERS, 49 Lincoln Avenue, Montreal, Que.

For Example:
 Strand Queen Anne
 Period Console
 Lists at \$125



To responsible dealers we offer a profitable franchise in localities not being yet covered. *Write or wire.*

MANUFACTURERS PHONOGRAPH CO., Inc.

95 Madison Avenue

New York

GEO. W. LYLE, *President*

DETROIT

Dealers Jubilant Over Excellent Business—Local Exhibits at State Fair—Review of Trade

DETROIT, MICH., September 11.—The past month was an exceptionally good month for the talking machine dealers of Detroit. From all sides one hears only jubilation over the volume of business transacted during that time. R. B. Alling, of the Phonograph Co. of Detroit, operating also the Edison Shop, said: "We have just closed one of the best months in the history of our concern—bar none. I am particularly pleased over our showing, not only for the past month, but for the entire Summer as well."

Cheering Reports on Business

H. S. Porter, of Grinnell Bros., is another to report a very pleasing business. As early as the sixteenth of August they had disposed of two-thirds of their quota for that month and, while figures are not available at this writing, it was confidently expected that the month would exceed that of 1921. Mr. Porter attributes a great deal of their brisk trade to the fact that they are out working for it all the time, instead of being content to let the public come to them. A new truck has recently been added to their sales force, to cover the outlying portions of the city. This makes three trucks which are manned by expert salesmen, who take a phonograph directly into the home of the prospect and there let him hear the machine under the same conditions that occur after purchase. Mr. Porter is very careful in the selection of the men he sends out to represent Grinnell Bros. and has managed to gather about him a group of high-powered salesmen who have literally "brought home the bacon." As a result of their success with this method, they are convinced that the usual Summer slump is but a fallacy and that it is folly to encourage this idea. H. W. Fish, manager of the Kimball Piano Co., reports that sales of Kimball phonographs and Okeh records have been highly pleasing. Mr. Fish is of the opinion that the local music dealers are headed for one of the biggest Fall seasons it has been their lot to experience in a long time. The ten branch stores of the firm are also doing a very brisk business in records and phonographs.

Exhibitors at State Fair

The Starr Piano Co., in company with J. L. Hudson Co. and Grinnell Bros., maintained an exhibit at the Michigan State Fair, which ran from September 1 to September 10. Business for the first half of the fair was very promising and it looks, at this writing, as if the exhibit at the fair will bring in more business than has been the custom for a number of years. E. P. Andrews, of the J. L. Hudson Music Store, said: "We are mightily encouraged over results of the display at the fair. It looks quite like the old times, when the fair could be counted on to boost our sales considerably."

Pleased With New Model

W. H. Huttie, district manager of the Starr Piano Co., is very pleased over the reception accorded the new small console model Starr phonograph and the new cabinet model. These two machines are on display for the first time in Detroit or vicinity, at the fair, and from the interest they are evoking will, undoubtedly, be one of the biggest selling lines of the Starr phonographs. Mr. Huttie recently had a very narrow escape from death while traveling from Flint to Detroit via automobile bus, when the car was ditched while turning out for a road hog. The machine went down an embankment and turned turtle twice. Aside from several severe bruises and minor cuts on his body, Mr. Huttie was unhurt and able to make the journey home in the company of friends who drove upon the scene shortly afterwards.

Music Memory Contest Coming to Close

The city-wide music memory contest examinations to determine the district prize winners

KIMBALL Phonographs

Invite good customers and Ready Sales

Because the line is attractive from a business-getting standpoint and is thoroughly *reliable* the Kimball is the phonograph for the dealer who is building wisely and well.





Style R
Equipped with Albums
37 in. High 40½ in. Wide
 23½ in. Deep

Write for Agency terms and the Kimball direct co-operative plan for financing sales.

Variety of Models in Console and Upright types.

W. W. KIMBALL CO.

306 So. Wabash Ave. Kimball Bldg.
CHICAGO

Manufacturers of Phonographs, Pianos, Player-Pianos, Pipe Organs, Distributors of Okeh Records.

are now under way and are expected to be completed by the twelfth, after which the finals to determine the grand prize winners will be conducted. The Edison Shop was the scene of one examination on the evening of September 7, when contestants from several districts were given an opportunity to display their knowledge of the masterpieces of music. Between 72,000 and 75,000 persons from the different districts and classes are entered in the contest, making the judging of the winners a difficult task. The contest as conducted by the Detroit News and the contributing music dealers has been most successful and has elicited a vast number of inquiries as to the manner of launching such an affair. This contest is the most stupendous one ever attempted in the United States and as a result the eyes of music dealers and organizations throughout the country have been fastened upon Detroit, eagerly watching results and absorbing information concerning it. Both the News and the dealers have been very generous in supplying information to all interested parties. August 31 saw the third and last of the famous music memory balls, put on by the Gardner-White Co. and the White Furniture Co. in collaboration with the contest. Only a limited number of tickets were given out, as the second dance was so heavily patronized as to necessitate the calling out of police reserves to handle the crowds. Prizes were awarded for the best dancers and the crowd thoroughly enjoyed themselves, although they regretted the passing of these dances. Themes used in the music memory contest were played by the orchestras at the Palais de Danse for these three affairs and did much to convince the dancers that the so-called classics could be utilized very favorably for dance purposes. These complimentary dances have been found to be one of the best means to promote interest in the contest itself and were the direct outgrowth of an idea of Percy Keen, of the Gardner-White Co.

In speaking of the tremendous amount of interest in the contest, Peter C. Sweeney, chairman of the contributing music dealers' committee, said: "We are very gratified over the large number of contestants enrolled in the contest, which involves the awarding of over \$16,000 worth of prizes. While it is impossible to estimate the educational value of the contest in actual dollars and cents, every dealer in the campaign feels that the time and effort he has expended have brought him very good returns and that the influence of the campaign will not easily wear off, but can be counted upon to

bring in more business for him in the future." Practically every make of phonograph sold in the city is represented in the list of awards, in addition to the grand prizes and the competition has been and still is keen.

Business Situation Reviewed

Reports for the first four working days of September show that the month has gotten away to a very good start, which, if maintained, will make the present month rank as one of the best of the year 1922. The outlook for the balance of the year is very bright, provided shut-downs of the large industrial plants can be averted, and the general opinion is to the effect that nothing of this nature will occur. However, many heavy advertising campaigns, slated for September, by the leading dealers are being held in abeyance, pending future developments among the motor car plants. If the Ford plant does not shut down on September 16, causing many smaller and affiliated concerns to close, then the dealers are planning on "knocking the public cold" with some heavy advertising, sustained throughout the balance of the season and so devised as to appeal particularly to and bring in a lot of the good trade they are convinced is in wait for them this Fall.



Artistic Decorating On Phonographs

Dealers and manufacturers, send your phonographs to us for decorations and special finishes. We maintain a high-class studio devoted entirely to this work. We will decorate your phonographs from our large selection of designs or from designs you may particularly specify.

Let us show you our work and submit estimate

MOHAWK WORKS OF ART

Mohawk Building
160 Fifth Avenue New York

SEPTEMBER SALES EXCELLENT

New York Talking Machine Co. Gives Favorable Business Report—Chas. B. Mason Back at Desk—R. E. Drake a Visitor

Chas. B. Mason, sales manager of the New York Talking Machine Co., Victor wholesaler, returned to his desk last week after spending about ten days trying to turn in a card of 100 or less at nearby New Jersey golf links. Mr. Mason has set 104 as his mark, but has not yet reached that figure.

In a chat with The World he stated that September sales for the first two weeks had been excellent, the increase being particularly noticeable in the demand for Victrolas of all types and descriptions. Mr. Mason stated that the most encouraging feature of this activity was the fact that practically all of the company's dealers reported a general buying movement on the part of the public. This included both Victrolas and Victor records and, judging from all reports received at the company's offices, Victor

dealers in metropolitan territory are preparing for a banner Fall season.

R. E. Drake, traveling representative for the Victor talking machine in New York State, was a recent visitor at the offices of the New York Talking Machine Co., bringing with him optimistic reports of business conditions up-State.

OLD FAVORITES REVIVED

Leo Feist, Inc., is the publisher of the new song series in book form under the title, "Good Old Timers." This is a collection of seventy-five songs arranged for singing and dancing and described as numbers "you can't forget." The songs have been compiled and edited by Lee Olean Smith and Theodore Morse. The contents include such numbers as "And Her Golden Hair Was Hanging Down Her Back," "Anona," "The Cat Came Back," "Curse of an Aching Heart," "Farmer in the Dell," "Picture No Artist Can Paint," "Where Did You Get That Hat?" and many other well-known titles. The publication will retail for fifty cents.

WINS PRIZE CUP FOR SINGING

Jack Harris Carries Off Honors at Annual Singing Contest at Asbury Park Casino

Jack Harris, who has represented Jack Snyder, Inc., the publisher and writer of "Meet Me Next Sunday," "In Maytime" and other successes, has spent the Summer in Asbury Park, N. J., where he was one of the features at the Casino on the boardwalk.

Each year William Whittel, manager of the Casino, gives a silver cup to the winning singer of the most popular song of the season, the judges being the audience and the contestants going through an elimination test. This year's cup was won by Jack Harris for the singing of the song, "Meet Me Next Sunday."

J. F. Ulery, prominent jewelry dealer at Eagle Lake, Tex., has added a talking machine department to his store. This department is modernly equipped and is a feature of the establishment which is planning to push the "Talker" line.

**JOHN STEEL'S
TELEGRAM ON
"NOVEMBER ROSE"
AND
"IN MAYTIME"**

<table border="1" style="width: 100%; border-collapse: collapse;"> <tr><th style="font-size: small;">CLASS OF SERVICE</th><th style="font-size: small;">SYMBOL</th></tr> <tr><td>Telegram</td><td></td></tr> <tr><td>Day Letter</td><td>Blue</td></tr> <tr><td>Night Message</td><td>Nite</td></tr> <tr><td>Night Letter</td><td>N L</td></tr> </table> <p style="font-size: x-small;">If none of these three symbols appears after the check (number of words) this is a telegram. Otherwise its character is indicated by the symbol appearing after the check.</p>	CLASS OF SERVICE	SYMBOL	Telegram		Day Letter	Blue	Night Message	Nite	Night Letter	N L	<div style="display: flex; justify-content: center; align-items: center;"> <div style="text-align: center;"> <p>WESTERN UNION</p> <p>TELEGRAM</p> </div> <div style="margin: 0 20px;"> <p>Form 12</p> </div> <div style="text-align: center;"> <table border="1" style="width: 100%; border-collapse: collapse;"> <tr><th style="font-size: small;">CLASS OF SERVICE</th><th style="font-size: small;">SYMBOL</th></tr> <tr><td>Telegram</td><td></td></tr> <tr><td>Day Letter</td><td>Blue</td></tr> <tr><td>Night Message</td><td>Nite</td></tr> <tr><td>Night Letter</td><td>N L</td></tr> </table> <p style="font-size: x-small;">If none of these three symbols appears after the check (number of words) this is a telegram. Otherwise its character is indicated by the symbol appearing after the check.</p> </div> </div> <p style="font-size: x-small; margin-top: 5px;">NEWCOMB CARLTON, PRESIDENT GEORGE W. E. ATKINS, FIRST VICE-PRESIDENT</p>	CLASS OF SERVICE	SYMBOL	Telegram		Day Letter	Blue	Night Message	Nite	Night Letter	N L
CLASS OF SERVICE	SYMBOL																				
Telegram																					
Day Letter	Blue																				
Night Message	Nite																				
Night Letter	N L																				
CLASS OF SERVICE	SYMBOL																				
Telegram																					
Day Letter	Blue																				
Night Message	Nite																				
Night Letter	N L																				

RECEIVED AT 225 WEST 52D STREET, NEW YORK CITY
207FY FAZ 80 BLUE

KANSASCITY MO 1148A SEPT 7 1922

JACK SNYDER

JACK SNYDER PUB CO NEWYTRK NY

CONGRATULATIONS ON YOUR NEW SONG NOVEMBER ROSE IT IS ONE OF THE BIGGEST SUCCESSES I HAVE EVER HAD SURPASSED ALL MY EXPECTATIONS IT SHOULD SWEEP THE COUNTRY BE ONE OF THE OUTSTANDING SONG HITS OF THE SEASON I WILL CONTINUE SINGING IT ON MY TOUR YOUR OTHER SONG IN MAYTIME I LEARNED TO LOVE CONTINUES TO BE ONE OF THE BIGGEST HITS OF MY ENTIRE PROGRAM YOU HAVE IN THESE TWO SONGS TWO OF THE BEST ON THE MARKET
REGARDS

JOHN STEEL

203P

"IN MAYTIME"

Is the Most POPULAR BALLAD in Vaudeville today

JACK SNYDER

"NOVEMBER ROSE"

Will be heard frequently in Vaudeville and Orchestra Circles

Music Publisher, **Inc.**, 1658 Broadway
NEW YORK CITY

GLEANINGS *from the* WORLD *of* MUSIC

EXPLOITATION THE BIGGEST FACTOR OF EXPENSE IN THE POPULAR MUSIC PUBLISHING BUSINESS

The Cost of Making a Song "Popular" and Therefore a Good Seller Is So Great That Music Publishers Cannot Issue Music to Retail at 10 or 15 Cents and Remain in Business

The most important factor in making popular music "popular" is undoubtedly the exploitation of the song. If all the expense a big publisher has in connection with a song were the cost of printing and the royalties paid to the writers he could sell music at 7 or 8 cents a copy and make money. A sheet of music is the most difficult kind of merchandising proposition, because the intrinsic value of the paper and printing amounts to only a few cents, but you must make this article so desirable that a customer will willingly pay 30 cents for it.

Now, what makes a song worth 30 cents? Simply the exploitation put behind it by the big publisher. Probably not oftener than once in a year will a publisher get what is called a "natural" hit—by that is meant a song that catches on immediately without any great effort or expense on the part of the publisher. All the other song "hits" have to be "made." Now, take into consideration the cost of "making." In an article some months ago we pointed out that a publisher has to do the following things before he publishes his song in marketable form: Make the piano arrangement, calling for the services of an expert arranger, usually a very high-priced man, as manuscripts are rarely if ever handed in to the publisher in a form that can be published—usually all they get is a "lead sheet and lyric." The arranger must put it in a suitable key and score it in a manner to come within the range of the ability of the average buyer of sheet music.

Then come the "professional" copies, vocal orchestrations in three or four different keys, the special versions for singles, doubles, quartets, extra catch lines, extra choruses, slides, dance orchestrations, etc., etc.—all this work for the

purpose of trying it out with vaudeville performers and dance orchestra leaders to see if the public likes it. If it shows signs of being popular then it is published as a "regular" copy in the form in which the public buys it. But—and here's the rub—if the performers and public do not take to it all of this work and material is discarded. This costs money. It costs money for the publisher to find out if he has a song worth publishing. The very small percentage of songs tried out in this manner that ever see the light of day, or, in other words, ever get published in "regular copy" form is really surprising. Actually dozens of them are worked on and discarded in the course of a year as not being "commercial" songs; that is, songs that will sell.

Now, assuming that the preliminary work has been encouraging and it has been decided to "go after" the song and work on it to make it a hit, what happens?

What the Professional Department Does

Additional quantities of professional copies, vocal orchestrations, dance orchestrations, band arrangements, slides and "special material," consisting of extra choruses, patter, catch lines, etc., to interest the performers, are then printed and supplied to the various offices of the publishers throughout the country. A word about these branch professional offices is not amiss here, because they add to the expense of "making" songs popular. The big publishers maintain them in the principal cities from coast to coast, starting in the East at Boston, then New York, Philadelphia, Baltimore, Atlanta, New Orleans, Pittsburgh, Cleveland, Cincinnati, Buffalo, Detroit, Chicago, Minneapolis, St. Louis, Kansas City, Denver, Los Angeles, San Francisco, Seattle, etc.

These offices employ from three to twenty men, according to locations, and their purposes are twofold, the first being to rehearse acts and get them "up" in the songs being exploited. They not only call upon and solicit acts playing their respective cities, but they also "follow up" acts that have been interested in the songs by the home office, usually in New York or Chicago.

Secondly, these branch office men, having covered the acts each week in the several theatres of their cities, must not overlook the possibilities of local "plugs"; that is, placing their singers in the picture houses, cabarets, band concerts, or any public gathering where it is possible to have the songs sung or played. Many of these men are paid \$75 or \$100 a week, besides the expenses they incur in traveling and entertaining. But this is all necessary if the song is to be "made"—songs are not going to make themselves—somebody must go out and work and spend money to get the tune in the air.

The Question of Advertising

Another item of expense is theatrical and trade paper advertising. Those performers who cannot be personally solicited must know about the new songs and the only way they can be reached is through the theatrical papers. The correspondence of this end of the business is a tremendous item in itself. For the small performer must get service by mail and get it quickly with the proper material so that he can put the song on without the aid of a professional rehearsal. A man handling this department must know what to write, and act, give the artist the proper "interpretation" of the songs by mail as well as possible; see that he gets the version best suited to him or her and an orchestration in the proper key. One of our big publishers retains a staff of six or seven arrangers just for the purpose of giving acts an orchestration suitable to their voice qualifications, or voice limitations. They are high-priced people, too. They get paid by the page, not by the day.

(Continued on page 134)

OH! WHAT A HIT!

The Brilliant Novelty Fox Trot ~

LONESOME MAMA BLUES

The fascinating melody that is keeping the feet of the entire country moving

**THE TERRIFIC SALE OF THIS RECORD IS
UNPRECEDENTED ABSOLUTELY THE
BIGGEST SELLING RECORD *of* THE SEASON!**

PUBLISHED BY **J.W. JENKINS SONS MUSIC CO.** KANSAS CITY, MO.

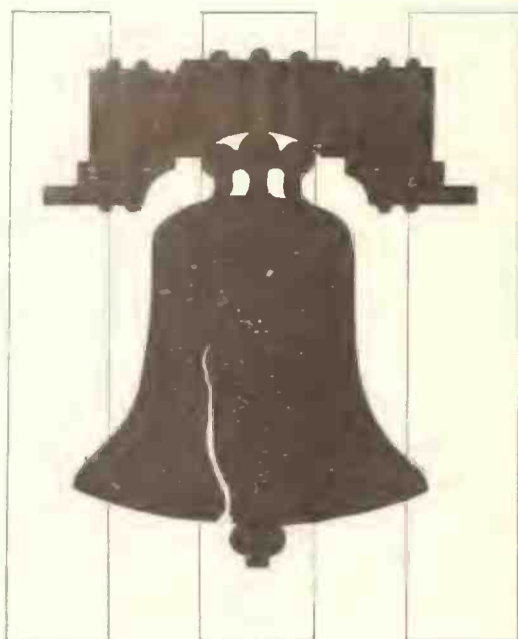

Edwin Franko Goldman's Inspirational Success

The Chimes of Liberty

As Triumphantly Played by
"THE GOLDMAN BAND"

"You can't go wrong
With any FEIST song"

HEAR
IT NOW!

EXPLOITATION OF SONGS EXPENSIVE

(Continued from page 133)

Every big publisher retains an expert arranger just to make special arrangements for quartets. He is another high-priced man. There are special departments maintained by every big publisher to keep the orchestra leaders all over the United States informed as to what's what in New York and Chicago. There are as many as 30,000 orchestra leaders on the lists of these big publishers and it is safe to say that each of them receives a special letter once or twice a month.

Super-salesmen Needed

The men on the professional department staffs of the big publishers are super-salesmen in their own field. On Monday afternoons you find them in the theatres of all the vaudeville circuits. If Brown and Jones are singing a ballad, or a comedy song, or a novelty song, and it is not one published by the house they represent, you'll find them back-stage immediately after the act is off presenting their "sales-talk" and trying to convince the act that it would be a bigger hit if it would sing their song.

Many New York publishers have fifteen sound-proof piano rooms for rehearsals, besides larger rooms for rehearsals of big acts and new orchestras just being formed. Duplicate this in the several cities mentioned above and there is shown a nice "overhead" investment in pianos alone. It all costs money, but it is needed to "make" songs. Eliminate the professional department, the orchestra department, cut out all advertising, discharge the staffs of highly trained professional office men, leave nothing but the printing presses and the dealer would not pay 2 cents a copy for the songs—songs the record manufacturers and roll manufacturers would not issue because there would be no "demand."

Creating the Demand

"Demand" is a powerful word and the only way to make a demand is to spend money—barrels of it—in "exploitation." That's where the real "cost" is in a song, not in paper, ink and

fancy covers, but without exploitation there would not be any hits and without hits there would not be any popular music business.

Hits cannot be made on printing presses—it is that tremendous amount of work between the printing press and the ultimate consumer that makes a piece of paper with notes on it salable merchandise.

The above are the outstanding factors involved in the cost of presenting and exploiting present-day song successes. These are the activities that are not discernible off-hand, but are influences that are most valuable and can hardly be dispensed with. They are not, however, all of the factors that add to costs. Popular publishers have, in addition, other activities, and expensive ones, which the trade, at least, is familiar with, such as "dealer helps," specific and general advertising, cut-outs, hangers, window strips and streamers and other material for display purposes, animated electric signs and advertising mats. That about completes the expensive activities; there are other minor factors and it may also be said that each song being an entity creates some particular need which cannot be included in a general summing up.

Nothing has been said of the cost of interesting and the expense involved in co-operating with the mechanical reproducers of songs and instrumental numbers.

The time and effort that are often required to put over a song can hardly be realized by those not actively engaged in the work. Take the case of the current waltz success, "Three o'Clock in the Morning." The publishers, Leo Feist, Inc., started work on this number in September, 1921, just a year ago, and worked for six months before any real results were noted. The waltz is only now at the height of its popularity, which indicates that persistence wins.

The early Fall weeks have shown a decided revival in sales of sheet music. This, naturally, is of interest to talking machine dealers, for sales of sheet music are reflected in the demand for talking machine records and player rolls.

"SCANDALS" HAS PREMIERE

George White's New Production Contains Several Song Hits

The annual George White "Scandals" opened in New York the last week in August and apparently it is to have its usual popularity. The music in the present production is of particular importance and it can be said that there is at least one song of hit caliber; that is, "I Found a Four-Leaf Clover." The book of the new "Scandals" is by Andy Rice and George White and the production is staged by Mr. White. The lyrics, however, are by the well-known B. G. DeSylva, and the music is from the pen of the equally well-known George Gershwin and includes such titles as "Argentine," "Cinderelatives," "She Hangs Out in Our Alley," "Where Is the Man of My Dreams?" and "I'll Build a Stairway to Paradise." Harms, Inc., is the publisher of the above numbers.

"CRY" NUMBER A HIT

Song by Cohn and Miller, Published by Feist, Proving Very Popular

CHICAGO, ILL., Sept. 5.—The new Leo Feist number, "Why Should I Cry Over You," written by Chester Cohn and Ned Miller, is declared to be one of the biggest hits in this part of the country. The words were written by Chester Cohn, while Ned Miller composed the lyric. Messrs. Cohn and Miller have originated several other popular hits, but their latest number has proved to be the biggest sensation. Hundreds of acts are taking on this hit and the large talking machine companies are recording this number. Mr. Cohn has been assistant professional manager of Leo Feist's Chicago office for a number of years, but it is only recently that this gentleman has been counted in the ranks of the popular songwriters.

"Why Should I Cry Over You," "Stumbling" and "Three o'Clock in the Morning" now lead the Leo Feist catalog as the three popular hits.

THE GREAT NEW FOX TROT SUCCESS

SAY IT WHILE DANCING

BY THE WRITERS OF

BENNY DAVIS *ANGEL CHILD* SILVER ABNER

M. WITMARK & SONS - Publishers - Witmark Building - NEW YORK

FIVE RECORD-BREAKING SONG HITS

HOMESICK

A Real Irving Berlin Song Hit

Yankee Doodle Blues

The Sensational Song Hit we took over from Harms, Inc.

While the Years Roll By

We stake our reputation on this one

Way Down South

The Masterpiece of all Southern Songs by the Writer of "Tucky Home"

TRULY

Whispering came from the West—
So did this one—Watch It

IRVING BERLIN, Inc., 1607 Broadway, New York

PUBLISHER HELPS RECORD SALES

Some Excellent Advertising Material Issued in Connection With the "Dancing Fool"

One of the Summer successes in both record and sheet music form is the Waterson, Berlin



Window Display of Landay Bros.

& Snyder issue, "Dancing Fool." The number, both in song and instrumental form, rose to popularity in a very short space of time and it has for some time been one of the main fea-

tures of many dance programs. The publishers issued some excellent advertising material which adapted itself particularly for window displays. This was in the form of almost life-size cut-outs of a dancing girl arranged on a dark cardboard background, giving the figure a spirit of animation. Herewith is shown a reproduction of the window display of the Fifth avenue, New York, store of Landay Bros., who operate a series of remarkably attractive retail shops in the metropolitan district.

BELWIN PUBLISHING "ZENDA"

New Fox-trot Featured in Conjunction With Photoplay of That Name

Belwin, Inc., is the publisher of the song and fox-trot "Zenda," which is being exploited in conjunction with Rex Ingram's production of the "Prisoner of Zenda," now being shown at the Astor Theatre, New York.

This photoplay, from all indications, ranks with the super films and bids fair to play an extended run at the Astor Theatre. Of importance to the musical world is the fact that the accompanying music has been arranged with great care. A novel ten-minute prologue, conceived by Ernst Luz, musical director of Loew, Inc., is one of the musical treats of the program. Miss Eva Clark, late of the Ziegfeld "Midnight Frolic," has the role of Princess Flavia in the prologue and sings the Belwin, Inc., number "Zenda." Miss Clark is noted for:

her perfect diction and a clear, bell-like tone.

During the showing of the picture "Zenda" is played nearly a dozen times in various tempos and at the finish of the last scene many in the audience are whistling the tune.

"Zenda" is by that successful young composer, Louis Breau, who is responsible for "Humming" and a series of waltzes. It is understood that "Zenda" will shortly be released by all the mechanical reproduction companies.

The number is assured of nation-wide popularity through the fact that the exhibition of the "Prisoner of Zenda," together with the special musical prologue, is to be shown at such theatres as Loew's State, Los Angeles Cal.; Loew's Warfield, San Francisco; Eastman Theatre, Rochester, and Massey Hall, Toronto.

"ORANGE BLOSSOMS" OPENS

New Musical Comedy Has Premiere—Harms, Inc., Publishing the Score

"Orange Blossoms," a new musical comedy presented by Edward Royce, with a book by Fred De Gresac and music by Victor Herbert, together with lyrics by B. G. de Sylva, opened recently in Philadelphia, Pa., and will shortly have its New York premiere. The prominent songs are "Way Out West in Jersey," "Legend of the Glowworm," "Then Comes the Dawning," "This Time It's Love," "A Kiss in the Dark" and "The Lonely Nest." Harms, Inc., publish the above numbers.

HEAR IT NOW!

"You can't go wrong
With any FEIST song"

TOOT, TOOT, TOOTSIE

(GOO' BYE)

A Fox Trot With a Tootsie Wootsie Rhythm



"Toot, toot, Toot-sie, Goo' Bye!

Toot, toot, Toot-sie, don't cry.



FLOAT FOR PAGEANT OF PROGRESS

Broadway Brunswick Shop, Chicago, Features Sam Fox Hits on Special Float

The music dealers in Chicago took quite an active part in the Pageant of Progress Parade held



Brunswick Shop Float in Pageant of Progress Parade in that city. A particularly attractive float was that of the Broadway Brunswick Shop, 4752 Broadway, that city.

Herewith is shown a reproduction of the decorated car. Besides advertising the shop itself two songs in the current catalog of Brunswick records are given publicity, "Romany Love," a record in fox-trot form, and "Nola," a novelty.

HARMS PUBLISHING THE SCORE

Music of "The Gingham Girl" Proving Very Popular

Schwab & Kussell are the producers of the new musical comedy entitled "The Gingham Girl," which recently opened up in New York City, the lyrics of which are by Neville Flesson and the music by Albert Von Tilzer, both of whom have been contributors to musical successes in the past. Harms, Inc., is the publisher.

NEW COHAN SHOW A BIG HIT

"Little Nelly Kelly" on the Way to a Long Run —Witmark Publishing the Score

George M. Cohan's new show, "Little Nelly Kelly," opened at the Tremont Theatre, Boston, Mass., and from indications the show will have a run well into the Fall season in that city. The offices of George M. Cohan look forward to this new offering being a worthy successor to his late productions, "Mary" and "The O'Brien Girl."

Mr. Cohan has a novelty in his book, a satire on the present-day mystery plays woven in musical comedy form. He is responsible for the book, lyrics and music, including a dozen individual numbers. Of particular importance are: "You Remind Me of My Mother," "Nelly Kelly, I Love You," "When You Do the Hinky Dee," "The Voice in My Heart," "Til My Luck Comes Rolling Along" and "The Name of Kelly." M. Witmark & Sons publishes the score.

NEW "GREENWICH FOLLIES"

Victoria Pub. Co. Issuing Numbers Heard in New Revue

The "Greenwich Village Follies," which is scheduled for an early New York premiere, opened recently in New Haven, Conn. The production is by John Murray Anderson, with a book by George V. Hobart and lyrics by Irving Caesar and John Murray Anderson, with music by Louis A. Hirsch. The song of particular importance, which should be heard frequently during the Fall months, is "Sweetheart Lane." Other numbers in the show are "Sixty Seconds Ev'ry Minute, I Think of You," "Jenny Lind" and "You Are My Rain-Beau." The above numbers are published by the Victoria Pub. Co.

THE SENSATIONAL NOVELTY
FOX-TROT
THE FRENCH TROT
SHEET RECORDS ROLLS
JOE MITTENTHAL · INC · NEWYORK

SECURES "YANKEE DOODLE BLUES"

Irving Berlin, Inc., Takes Over Publication Rights of Song and Instrumental Selection From Harms, Inc.—The First Berlin Purchase

It was announced late last week by Irving Berlin, Inc., that that company had closed negotiations with Harms, Inc., whereby the Berlin organization will take over the publication of the current success "Yankee Doodle Blues." This song and instrumental selection from the pens of Bud de Sylva, Irving Caesar and George Gershwin has, in a very short space of time, leaped into unusual popularity. It caused so much comment throughout trade and professional circles as to induce the Berlin company to make overtures for the publication rights.

"Yankee Doodle Blues" is considered more than a mere popular song. It has many other merits that commend it, some even going so far as to say it is a typical national song, bordering on the anthem type.

The announcement from the Berlin offices created more than a little comment. The fact that this publishing company has on its staff such well-known writers as Irving Berlin, Joe Young, Sam Lewis and George Meyers makes it unnecessary for it to acquire outside publications. Aside from this, however, the fact that the purchase was made from such a well-known and successful publishing house as Harms, Inc., gives the move added news value.

The sales department of Irving Berlin, Inc., states that this is the first time in the company's history that it has purchased a song from another publisher and justifies the move by saying "Yankee Doodle Blues" is one of the greatest songs ever issued.

The various branch offices of the Berlin organization, the band and orchestra department and the professional department have arranged an intensive publicity drive on the number.

PUBLISHING UKULELE SCORES

Fred Fisher, Inc., New York, First Publisher to Adopt Suggestion Made by Jerome Harris

The plan recently outlined in The World for publishing ukulele arrangements of popular numbers on sheet-music was put into operation recently. Fred Fisher, Inc., New York, was probably the first publishing house to publish the ukulele score and chose "Ji Ji Bo" as the first selection. This plan was originated by Jerome Harris, secretary of C. Bruno & Son, Inc., Victor wholesalers, and also wholesalers and importers of musical merchandise, New York City, and received the hearty commendation of many of the publishers.

GROWING IN POPULARITY

Joe Mittenenthal, Inc., recently released a new song and fox-trot entitled "The French Trot," which is scoring quite a success.

Swanee Smiles
A Sunny Southern Fox Trot

ELEANOR
The Latest Fox Trot Hit

FOX POPULAR HITS
Stock Them in RECORDS PLAYER ROLLS and SHEET MUSIC
"Swanee Smiles," "Eleanor" "Nola" and "Romany Love"
SAM FOX PUB. CO.
CLEVELAND, O. NEW YORK CITY

ROMANY LOVE
The New Gypsy Fox Trot Hit

NOLA
The Dance Sensation

Our A A A Quality
India Ruby Mica
DIAPHRAGMS

Are, without doubt, the finest Diaphragms
 manufactured.

Samples and Prices on Request

WILLIAM BRAND & CO.
 27 East 22nd Street New York City

MAMMOTH SONORA CAMPAIGN

Four-page Broadside Gives Details of Gigantic Newspaper Campaign—Series of Important Sales Helps Now Ready for Sonora Dealers

Sonora dealers throughout the country received this week a copy of a four-page broadside issued by the advertising department of the Sonora Phonograph Co., giving them full details regarding the mammoth Sonora publicity campaign started this month. In this broadside there were reproduced copies of four of the advertisements that will be used by the Sonora Phonograph Co. every week during September, October, November and December in sixty-six of the leading trade centers. The combined circulation of these newspapers is over 12,000,000 and L. C. Lincoln, advertising manager of the company, states that this is only a portion of the Sonora publicity campaign for the Fall of 1922.

Among the cities represented in this newspaper campaign are the following: New York (five papers), Chicago (three papers), Philadelphia (two papers), Cleveland (two papers), Boston (two papers), Pittsburgh (two papers), Detroit, St. Louis, Baltimore, Los Angeles, San Francisco, Buffalo, Milwaukee, Washington, Cincinnati, New Orleans (two papers), Minneapolis, Kansas City, Seattle, Indianapolis, Rochester, Portland, Ore.; Denver, Toledo, Providence, Columbus, Louisville, New Haven, Reading, St. Paul, Akron, Atlanta, Omaha, Des Moines (two papers), Worcester, Birmingham, Syracuse, Memphis, Richmond, San Antonio, Dallas, Dayton, Bridgeport, Houston, Hartford, Scranton, Grand Rapids, Youngstown, Springfield, Mass.; Fort Worth, Trenton, Nashville, Salt Lake City, Norfolk, Albany and Wilmington, Del.

This broadside also calls attention to Sonora's widespread outdoor advertising, together with the new series of posters that were recently issued. On the fourth page of the broadside there are reproduced a number of the other Sonora sales helps, including descriptive window signs, period screen lithographs, price cards, moving picture slides, display cards, walking doll, etc. All impressive evidences of constructive work for the dealers' benefit.

In a chat with The World Mr. Lincoln stated that this broadside emphasizes the Sonora Co.'s confidence in the business outlook for the 1922 Fall and holiday season, and also indicates the exceptional co-operation that is planned for Sonora dealers this Fall. The Sonora advertising department is leaving nothing undone to assist the dealers in making 1922 a banner year and this four-page broadside substantiates the company's faith in the future of the industry as a whole.

COLUMBIA DEALER ELECTED MAYOR

L. I. Lefeaux, exclusive Columbia dealer, at Port Allen, La., was recently elected Mayor of the town. Mr. Lefeaux is one of the most enthusiastic "sell-by-truck" Columbia dealers in the South and he has used this method of merchandising extensively in his sales work. Incidentally, it is stated that, since his election, the town of Port Allen has taken on new life and every department in the city administration is showing a general improvement. This shows the influence of music.

NEW PHOTOGRAPHIC RECORDING PLAN

Inventors Demonstrate in New York New Simplified Method for Recording and Reproducing Sound Through Means of Light on Film

One of the many new mediums being invented and developed for the purpose of recording and reproducing sound, particularly that of the human voice and of music, is what is known as "Fototone," invented for the recording of sound waves by photographic means on a film similar to that used for motion pictures. The device is the invention of Prof. E. I. Wenger, in association with Louis Brinkman, and has been demonstrated in New York recently.

The recording box is very similar to a motion picture camera, with the usual film storage and take-up magazines. By talking into a sensitive telephone transmitter the volume of light, reaching the film from a tiny lamp through a specially constructed slit, is regulated perfectly.

When reproducing, the film is run under a special electric lamp and the various photographic shadings upon the film regulate in turn the volume of light that reaches a sensitized and specially treated coil wound on soapstone. The coil is hooked up with a telephone receiver and regulates the volume and quality of sound.

Through the use of various forms of amplifiers it is possible to hear clearly and at some distance the sounds as reproduced from the film. The process is still in an experimental stage, but the Fototone laboratories are being established in Rochester, N. Y., to manufacture the device on a commercial basis.

The inventors claim that, through the use of their method when perfected, it will be possible to record complete operas and symphonies on one film record, reproducing the music through machines designed for home use.

W. L. Branson, of Sebree, Ky., is opening an up-to-date music store at Providence, Ky.



MUSIC MASTER
Radio
AMPLIFIER

"Superb Timbre"

That's the Voice of the Music Master. The correctness of tone and accurate reproduction along with a greatly increased sound volume, made perfect by the total absence of that unpleasant metallic screeching, appeals to exacting radio enthusiasts.

The basic principle of this instrument has been used for years in the construction of talking machine amplifiers and has now established its supremacy in the radio field. It is fully covered by patents.

The Music Master Radio Amplifier fits any radio set—no extra batteries required—operates best on low plate voltage (not over 100 volts).

A handsomely grained mahogany horn, fitting snugly into a black enameled cast aluminum gooseneck, is held in place by a nickel-plated ring of special alloy. This assembly is supported by an art metal base, which contains the powerful amplifying device.

Made in two sizes—14 inch for general use in the home \$35; 21 inch for concert work \$45

The Geraco Line now includes the Super Variometer and Variocoupler

Matched units—that will improve the appearance and efficiency of your outfit. Insure the most delicate tuning. Enclosed rotor—entire assembly of special hard-rubber compound—no metal parts. Dimensions 3 1/2" x 5 1/4" x 5". Shafts 1/4" diameter. Price \$6.00 each.

Descriptive matter on entire Geraco Line on request. Manufacturers, Jobbers and Dealers: Write at once for complete schedule of discounts.

General Radio Corporation

WALTER L. ECKHARDT, Pres.
 Manufacturers and Distributors of
 High Grade Radio Apparatus
 624-628 MARKET STREET, PHILADELPHIA

Distributors for
**OKEH RECORDS—STRAND PHONOGRAPHS
 AND GOLD SEAL RECORD REPEATERS**
 In Pennsylvania, Southern New Jersey, Maryland,
 Delaware, District of Columbia, Virginia, West Virginia.



GERACO
 PROVEN RADIO PRODUCTS



"I gave up Jim-my Rog-ers, Who owns two ga-rag-es, All for the love of Mike,—

The Love of Mike

A Comic Waltz Song With a Contagious Laugh

HEAR IT NOW!

"You can't go wrong With any FEIST songs"

BELIEVES IN WINDOW DISPLAYS

Phillips & Crew Co. Keep Tab of Public Interest in Their Specially Prepared Windows

ATLANTA, GA., September 6.—The Phillips & Crew Piano Co., the oldest music house in Georgia, and exclusive representative in this city of the Steinway and the Duo-Art pianos, and also



Phillips & Crew Co.'s Striking Window one of the oldest Victor representatives, is a great believer in window display as a means of interesting the public in its products. We are illustrating herewith a window prepared by this company in which "Lonesome Mama Blues" was featured.

The Phillips & Crew Co. kept careful check of the number of passers-by who were attracted

to the various window displays, and it is said that this window held the attention of more than one in three of those passing during the hours when the count was made. This window display was so successful that another special window, again using carefully prepared figures, was designed to feature the special releases, "Hot Lips" and "The Dancing Fool."

EXCELLENT EDISON PUBLICITY

Thomas A. Edison, Inc., Makes Reprints of Story of Edison Phonograph Achievements in New York World for Dealers' Use

ORANGE, N. J., September 10.—A very imposing story, occupying nearly half of a front page and devoted to a story of Thomas A. Edison and his prophecy of the phonograph, appeared in the New York World in one of its morning editions this Summer. The story included a large illustration and a complete description of the evolution of the phonograph in the light of Edison's personal experience and inventive work.

The advertising department of Thomas A. Edison, Inc., was quick to capitalize this unusual publicity in an effective manner. Full-size reprints were made of the front page of the New York World containing the Edison story and were supplied to Edison dealers throughout the country for display in their windows. A large number of Edison dealers inserted these reprints in their windows, with good results.

OGDEN CABINET CO. EXPANSION

Growing Popularity of Products Results in Expansion—Arrangements Completed to Make Everything in Store Equipment

LYNCHBURG, VA., September 6.—The Ogden Sectional Cabinet Co., of this city, has widened its line of manufacture to include everything in the equipment of talking machine warerooms. For many years the Ogden Co. has produced record cabinets, sectional and otherwise, for both store and home. More recently this company produced the "You-Nit" service table for the demonstration room and also to accommodate various table model machines. There have lately



OGDEN'S SECTIONAL STORE EQUIPMENT.

been added demonstration rooms and counters. In the demonstration rooms the Ogden Sectional Cabinet Co. uses the sectional feature, providing standardized sections simply and accurately made in three-foot widths. It is claimed that one of these rooms may be erected within an hour by a person without any experience. It is further claimed by the company that they are so constructed that they cannot be put up wrong and are subject to any arrangement and rearrangement which may be desired at a later date. Clamps are already set and only need to be tightened. The same system applies to the sectional record rack, and each complete roll or section is finished with a detachable panel end.

The record counter is six feet in width and is supplied with gliders or casters, as preferred, without variation in price. It is supplied with sectional compartment drawers for card files or accessories; also three upright compartments and two shelves.

J. B. Ogden, president of the company, has announced price reductions on the regular line of the company, effective September 15.

OPENS REPAIR DEPARTMENT

A repair department has been opened by the New England Talking Machine Co. at its factory, 16-18 Beach street, Boston, Mass., where repair work of all kinds is being solicited from the local phonograph trade.

EMPIRE PACKING CASES



3-Ply Veneer cross-banded and reinforced with clear pine cleats. Adopted as the standard case for the shipment of phonographs.

Quotations Made Upon Request.

Empire Manufacturing Co.
GOLDSBORO, N. C.

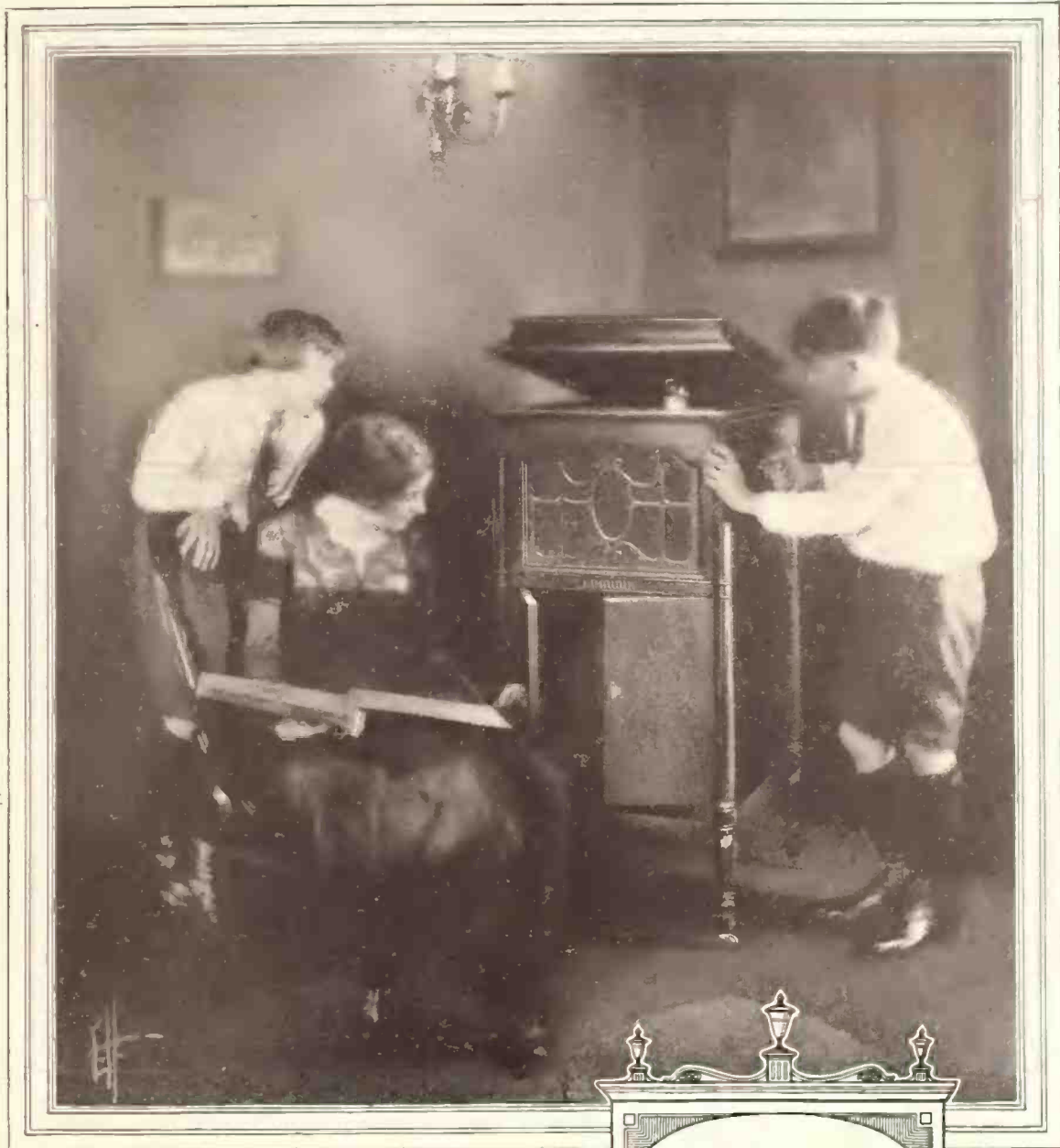

The Widdicomb Sheraton model illustrated is finished in Red or Antique Mahogany, or Walnut, and is equipped with albums for records, automatic stop and patented tone control. Widdicomb Phonographs play all records. Prices range from \$90 to \$260.

SHERATON
MODEL 8

Widdicomb phonographs reproduce recorded music—whether vocal or instrumental—with a surpassing faithfulness which is a revelation to music lovers. The artistic period designs of the Widdicomb are modern interpretations of the best work of the old masters of the art of wood fashioning. Naturally the merchant with the Widdicomb franchise gains and holds the esteem and patronage of the best class of buyers. Write today for complete catalog and full particulars regarding the Widdicomb franchise. Learn for yourself the unusual advantage it offers you.

THE WIDDICOMB FURNITURE COMPANY

Grand Rapids, Michigan

Fine Furniture Designers Since 1865

Widdicomb
PHONOGRAPH
The Aristocrat of Phonographs

PORTLAND, ORE.

Value of Advertising and Display of Merchandise Demonstrated in Concrete Manner—W. Hodecker in New Post—Review of Trade

PORTLAND, ORE., September 6.—That it pays to advertise and put your goods on display whenever the opportunity affords has been demonstrated to a marked degree by the phonograph department of the Reed, French Piano Co. This department had a most attractive booth at the Multnomah County Fair, held at Gresham, Ore., in August, and many good results were obtained by the demonstrations given of its Edison and Victor machines, according to M. C. Collins and Allen E. McLean, who were in charge of the exhibit.

The big Edison Chippendale proved the big seller for the week and one sale that especially pleased the firm was made to Mrs. Y. Smith, wife of the Superintendent of Agriculture at the Multnomah County farm and who was in charge of the art booth, right next to the phonographs.

E. B. Hyatt, president of the Oregon Music Trades Association, announces that activities will soon be resumed in full force, as the Association members, after a rest during the Summer months, are now ready for good Fall sessions of the Association. A "get-together" meeting has been called for September 8, when the campaign for the coming season will be the big question of the day. Some interesting announcements will soon be made by the various committees and a busy season is anticipated.

W. H. Beach, treasurer and general manager of the Bush & Lane Piano Co., was a Portland visitor from Holland, Mich., and spent a week looking over the situation with J. C. Gallagher, local manager. Charles T. Corbin, general manager of the Pacific Northwest, with headquarters in Seattle, was also here during the week. Mr. Gallagher reports business for August excellent in Bush & Lane machines and Victrolas.

Wm. Hodecker, for many years manager of the Victrola department of the Seiberling-Lucas Music Co., resigned his position to accept the management of the Meier & Frank phonograph department, where extensive improvements are under way. Mr. Hodecker succeeds Harry Andrews, who resigned on September 1. No successor has been appointed in Mr. Hodecker's place.

W. Graham, of San Francisco, representative of the Sonora Phonograph Co., was a visitor at the Sonora department of Lipman, Wolfe & Co. and paid his respects to Roy Feldenheimer, owner and manager of the department.

Jack Carney has been appointed district manager for the Columbia Graphophone Co., to fill the vacancy made by the resignation of Wm. Smith. Wm. Lawton, manager for the Pacific Northwest, with headquarters in Seattle, was a recent Portland visitor and acquainted Mr. Carney with his duties and introduced him to the various dealers.

L. D. Heater has returned to Portland after spending a month in California, visiting San Francisco, Los Angeles, Sacramento, Santa Monica and various cities in the interest of his lines. Mr. Heater, who is a jobber in phonograph accessories and agent for the Portophone, reports excellent business all through California. Mr. Heater put his brother, A. A. Heater, in charge of his San Francisco business.

J. D. Fleming, formerly with the phonograph department of the Bush & Lane Piano Co., has been made assistant manager of the Remick Song & Gift Shop and will have charge of the Columbia Grafonola department. Paula Kuhl, who was with Remick's, has affiliated with the Bush & Lane Co. in the piano department.

Miss Lois Wesson has been appointed cashier of the Sherman, Clay & Co. store, in place of Margie Tucker, who severed her connection with the company to become Mrs. Elrod Malory. In appreciation of her faithful service the firm presented Miss Tucker with a handsome silver electric percolator, silver tray, sugar and creamer, and her friends in the Victrola department presented her with a set of beautifully etched drinking and sherbet glasses.

Mrs. "Billy" Watts has returned from her operation for appendicitis and is being welcomed back by her many friends to her post in the record department of the Wiley B. Allen Co.

August was an exceptionally good record month and the Red Seal list contained many things that were welcomed by the real musicians. Most popular among the dance records, according to Leita Hayes, of the G. F. Johnson Piano Co.; Erma Ewart, of Wiley B. Allen's, and Emma Reynolds, of the Hyatt Talking Machine Co., were, first, "The Sneak," which all say is the most popular number since "Whispering"; "Three o'Clock in the Morning," "Stumbling," "Nobody Lied," "Indiana Home."

TOM GRIFFITH PLAYS GOOD GOLF

Sales Manager of Udell Works Comes Close to Winning Amateur Golf Championship

Tom Griffith, sales manager of the Udell Works, Indianapolis, Ind., was an important contender at the Indiana State Golf Amateur Championship Tournament held at French Lick Springs last month. Mr. Griffith was runner-up to the high man and has since challenged him to a special match, which will be played off somewhere in the East. This tournament naturally brings out each year the cream of golf talent in the State of Indiana, and Mr. Griffith's performance was therefore of an exceptional character.

Edward Barr has succeeded to the talking machine record business of Ira J. Knight, Ely, Nev.

**Tone Tells
Sound Sells**



Reg. U. S. Pat. Office

THE Oranola

PATENTS-PENDING

No AERIAL USED

LOOP ANTENNA self-contained in artistic piano-finished cabinet eliminates any wiring by purchaser.

COMBINATION RADIO AND PHONOGRAPH

RADIO ENGINEERS universally agree that radio and audio frequency transformation of energy received is best for receiving broadcasting.

That is why we use the radio and audio frequency amplification.

NO EXPENSE has been spared to make our product the best in every detail. Having passed through the experimental stage, we are prepared to stand behind each instrument with our unqualified guarantee.

OUR TALKING MACHINE (well known as THE PERFECT TALKING MACHINE), combined with our radio instrument, provides a universal means of sound reproduction without equal. Purity of tone in ample volume without distortion makes the ORANOLA almost human.

OUR KEYNOTE is simplicity of operation. No knowledge of electricity or wireless is required.

SEVERAL MODELS listing from \$150 to \$450. Descriptive circulars and discounts on application. WIRE OR WRITE for exclusive territory proposition. DEMONSTRATIONS at our office during broadcasting periods.

ORANOLA RADIO CORPORATION

228 Seventh Avenue

New York City

Ogden's Sectional Phonograph Store Equipment

As Simple as A. B. C.—Construction and Finish the Best

THE MYSTERY AND HIGH PRICES for Sound-Proof Booths are all "Bunk." Booths were used for various purposes before the Phonograph or Talking Machine was invented. For the Talking Machine Dealer they are Service Items, very important for increasing sales and necessary to Up-to-Date Merchandising.

OGDEN'S SECTIONAL EQUIPMENT comes to you at the lowest possible cost, sold direct from the Factory to you at a manufacturer's profit only and without branch office or salesman's expense added.



OGDEN'S SECTIONAL STORE EQUIPMENT.

The complete Store Equipment (as illustrated) consists of RECORD RACKS, for 2,500 10-inch and 12-inch Records —SALES COUNTER with every Dealer convenience for Card Files, Accessory Stock, Bags and Wrapping.

SOUND-PROOF BOOTH, 6 x 9 ft., is made by assembling the Units or Parts illustrated below.

ANY MAN AND A BOY for helper without carpentry experience can assemble this room in one hour. There is nothing to do but place Wall or Door Sections in the Pilaster and turn down the clamps. Place Ceiling units in position and Base Rail or Floor Shoe around the bottom and the job is complete, as tight as a drum, at a fraction of the usual cost.

Price of Ogden's Sectional Units

Record rack, No. 1-S, each	\$40.00
Paneled ends, each	5.00
Record sales counter, No. 1-S, each	80.00
Record sales counter, No. 2, each	60.00

Sound-Proof Booths No. 1-S

6 x 6 room for corner of store, each	\$105.00
6 x 9 room for corner of store, each	140.00
6 x 6 room for side wall of store	135.00
6 x 9 room for side wall of store	165.00
6 x 6 room for center of floor	165.00
6 x 9 room for center of floor	215.00

FINISHES:—GENUINE ENAMEL
White, Old Ivory and Gray

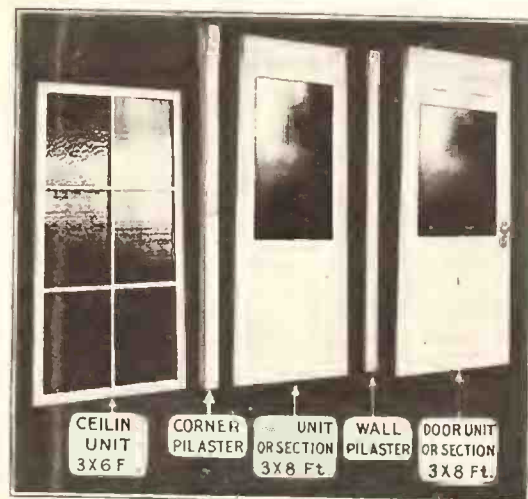

Room Units made to fit sound tight.

1. CEILING SECTION, 3 x 6 ft., with prism glass.
2. CORNER PILASTER, Clamps Wall Section.
3. WALL SECTION and Pilaster, make a 3-ft. Unit or Section.
4. SIDE WALL PILASTER.
5. DOOR UNIT OR SECTION.



FRONT VIEW OF RECORD SALES COUNTER #1
TOP 30" X 60" 32" WITH CASTORS

BACK VIEW OF RECORD COUNTER #1
SHOWS 3 DRAWERS WITH ADJUSTABLE COMPARTMENT DIVIDERS, ALSO 3 UPRIGHT COMPARTMENTS AND 2 SHELVES

FRONT AND BACK VIEW OF RECORD COUNTER, showing 3 compartment drawers for Card Files, also 3 Upright Compartments and 2 Shelves, which fill every Dealer requirement.

NOW IS THE TIME TO IMPROVE YOUR SERVICE

And increase your sales by using Ogden's Patented

MODERN STORE EQUIPMENT

RECORD CABINETS TO FIT YOUR REQUIREMENTS
A FILING SYSTEM WHICH DELIVERS THE GOODS
PRIVATE SALESROOMS WHICH "SELL"

Ogden's Complete Modern Store

Costs less than carpenter work. Everything ready for business the day you get it—Sectional—Unpack and "Set it up Yourself."

Send us a pencil Sketch of your Store, Showing where you want Record Racks, Customers' Counters and Private Salesrooms and we will quote you a delivery price on Sectional Equipment which you can install any evening and be "Up to Date" next day.

OGDEN SECTIONAL CABINET CO., Lynchburg, Va.

IN PITTSBURGH

End of Long Mine War Brightens Outlook—Optimism Permeates Trade—Unusual Sales in August—Radio Booms Record Sales

PITTSBURGH, Pa., September 11.—Keen satisfaction is expressed by the talking machine trade here over the ending of the bituminous coal miners' strike, which lasted over five months. As a result of the signing of the wage scale agreement more than 50,000 miners have returned to the mines, and the general outlook for improved industrial conditions is excellent.

Talking machine dealers here, as a rule, are quite optimistic concerning the coming Fall season and are confident that there will be some extra good business handled. One of the outstanding features of the trade here the past month have been the unusual sales for August. As a rule the talking machine trade is "off" during the Summer months, especially August, and little or no effort is made to attract business until after Labor Day.

At the offices of the Columbia Graphophone Co. Assistant Manager J. J. McGeehan stated that August sales showed a marked improvement over the same month a year ago. Mr. McGeehan stated that all indications pointed to a satisfactory Fall season. He declared that the demand for Columbia records was brisk.

At the Buehn Phonograph Co. Assistant General Manager H. M. Swartz vouchsafed the information that "our Edison business is good and we have no complaint to make as far as business is concerned." Mr. Swartz is of the opinion that there will be a busy season ahead for the Edison dealers in the Pittsburgh zone.

At the Standard Talking Machine Co., Victor distributor, Wallace Russell stated that the demand for popular Victrola models was good and he was of the opinion that there would be a shortage of these models if the demand is

maintained for any time at the present-day rate. Mr. Russell was rather optimistic relative to trade conditions for the talking machine trade as a whole.

Broadcasting the New Records

One of the features of the KDKA radio broadcasting station of the Westinghouse Co., at East Pittsburgh, was the broadcasting of the September Victor records. The records broadcasted were: "My Rambling Rose," Whiteman's Orchestra; "Dancing Fool," Club Royal Orchestra; "Hot Lips," Whiteman's Orchestra; "Send Back My Honey Man," The Virginians; "Oogie Oogie Wa Wa," Benson Orchestra; "Deedle Deedle Dum," Benson Orchestra. These records were loaned through the courtesy of the S. Hamilton Co.'s Wilksburg store and were reproduced on a Brunswick phonograph loaned by Gray & Martin, of Pittsburgh. The latter firm also has arranged for a Brunswick record concert to be given with the release of new Brunswick records. Edison records and an Edison phonograph were furnished through the courtesy of J. E. Bumbera, Edison dealer, of Swissvale, Pa.

An interesting fact is the large number of sales of records that are made just after some new records have been "sent out over the wireless." Frequently the dealers who loan the records are given mail orders that come from localities as far as 200 to 300 miles distant. These letters are from live-wire "radio lovers," who express in their letters keen appreciation of the records played and ask that they be sent them.

Favor National Record Week

The suggestion made in the editorial in The Talking Machine World for August relative to

a National Record Week has met with a cordial reception among the trade in Pittsburgh. The World representative, when querying some of the downtown dealers concerning the proposition, was told that the plan was "a good one." John Henk, the well-known manager of the Columbia Music Co., Columbia and Edison dealer, in referring to the National Record Week, said: "It is a very excellent idea and one that the talking machine dealers should boost to the limit. A National Record Week will be a stimulus to the trade as a whole that will bring about very pleasing results to the dealers. It is a plan that should be started soon—that is, plans made for the week—so that ample time can be given to dealers to prepare for such advertising and other publicity methods they may wish to utilize to bring about the principal goal—selling more records. I believe the week can be put over with but little expense or trouble and I am more than convinced that it will prove a paying proposition to those who engage in it in a whole-hearted and public-spirited manner."

Plan Big Fall and Winter Campaign

Thomas T. Evans, the well-known manager of the wholesale Victor department of the C. C. Mellor Co., is preparing for what he terms is a "big Fall and Winter business ahead." Mr. Evans is reviewing the field that the firm covers and, after meeting with some of the principal Victor dealers that he serves, is of the opinion that a very satisfactory season for the Victor line is approaching.

Some Columbia News

J. G. Heckinan's Music Shop, Meadville, Pa., Columbia dealer, recently completed a new Columbia record sales plan, in which prizes were offered to youthful contestants for the sale of Columbia records, and reports sales to date at 800. Excellent publicity was also received as the result of this plan and the dealer is enthusiastic regarding the results of the campaign.

Chauncey Parsons, manager of the music department of the Rosenbaum Store, Columbia dealer, returned recently from his vacation, a

RADIO HORNS Fit All Makes of Receivers

Rubberoid black enamel finish will take all makes of receivers. No air pocket. Designed for proper amplification and heavy material to avoid blast.

Horn Manufacturers for 20 Years.

For over 20 years the Standard Metal Manufacturing Co. has manufactured horns of all descriptions for leading talking machine manufacturers.

Special Horns

Amplifying horns of every description. Send your specifications and ask for prices. Particularly for all types and sizes of cabinets.

Gem Standard Radio Horn
11" Bell, 16" high, 14" wide, price \$7.50. Made in rubberoid black enamel finish; also in grained mahogany.

We also furnish additional (on specification) a loud speaking high grade phone with cord which can be attached to any of these horns. List price \$7.50.



"GEM"

STYLE 114
No. 114—14" Bell, 23" High
Price, \$12.00

The Above Style in Other Sizes
No. 17—7" Bell, 19" High; Price, \$7.50
No. 15—5" Bell, 14" High; Price, \$5.00
Rubberoid black enamel finish only.
Will take all makes of receivers. No air pocket. Designed to give proper amplification. Heavy material to avoid blast.



Standard Metal Mfg. Co.

Newark, N. J., U. S. A.

Faultlessly, flawlessly, Florence Macbeth sings the *Mignon Polonaise (I am Titania)*, the brilliant coloratura aria that is the despair of all but the elect among sopranos.

Her singing of the Shadow Song from *Dinorah* is a vocal accomplishment of the first magnitude. These two remarkable exhibitions of her art on one record make one of Columbia's choicest offerings. A-6219.

**Columbia Graphophone Co.
NEW YORK**



portion of which he spent in New York. Mr. Parsons visited the Columbia recording laboratory and it is possible that he will make some records, provided the excellent quality of his voice is of a recording character.

Enthusiasm among Columbia dealers in Youngstown, O., is running high, due to the announcement of the appearance of Al Jolson in "Bombo" in that city on September 15 and 16. Among the dealers who are planning to use effective tie-ups during Mr. Jolson's appearance are: the L. H. Cahn Co., L. M. Ress Co., Oster Bros. and the Ress Music Store.

The Rothert Co., Johnstown, Pa., one of Pennsylvania's leading musical houses, is featuring a line of Columbia period design Grafonolas in the Johnstown Furniture Store. Mr. Rothert has attained considerable success with the Columbia line, and the period model display cannot fail to add to his prestige as a leading Columbia dealer.

T. E. Shortell, manager of the Victor department of the S. Hamilton Co., reports an increase in business for August and is of the opinion that, with industrial conditions improved here, there is bound to be a reflection in better sales of the Victor line.

News of the Vacationists

A. A. Buehn, treasurer of the Buehn Phonograph Co., spent several days at the Edison factory the past week.

Wm. C. Hamilton, president of S. Hamilton Co., Victor dealer, has left for a vacation trip to the East.

S. H. Nichols, the well-known manager of the Pittsburgh offices of the Columbia Graphophone Co., is spending his vacation at Battle Creek, Mich.

J. C. Roush, president of the Standard Talking Machine Co., was a business visitor to the East and also paid a visit to the Victor Talking Machine Co. plant at Camden, N. J., the past week.

Wallace Russell, of the Standard Talking Machine Co., spent his Summer week ends with his family at Lake Chautauqua.

EUGENE A. WIDMANN IN EUROPE

Eugene A. Widmann, of the Pathé Frères Phonograph Co., Brooklyn, N. Y., is now in Paris, where he will spend several weeks at the headquarters of Pathé Frères, which is termed the parent house of the American concern. Mr. Widmann sailed during the latter part of August on the "Aquitania" and while in Europe will make a thorough study of conditions in that country and will make arrangements for new Pathé offerings in this country. He will also give much attention to radio interests which the Brooklyn organization is developing.

The Wonder Talking Machine Co., a New York corporation, which was succeeded by the Wonder Phonograph Corp., a Delaware corporation, early this year, has been dissolved. The Wonder Phonograph Corp. is continuing the manufacture of talking machines at its South Norwalk, Conn., plant, and in addition is manufacturing radio parts.

KIDDIE REKORD CO. ORGANIZED

New Company, With Capital of \$30,000, to Make Records Especially for Children

BRIDGEPORT, CONN., September 6.—Announcement was recently made of the incorporation of the Kiddie Rekord Co., of New York and this city, with a capitalization of \$30,000. It is stated that the new company will take over the business already commenced in the manufacture and sale of Kiddie Rekords, which are seven-inch, single-faced discs, with attractive pictures on the reverse side, and contain children's songs and verses. Much attention has been given to the selection of the matter and the recording artists. The discs themselves are well recorded and are said to have excellent wearing properties. The officers of the company are: Victor H. Emerson, president; J. F. Lounsberry, secretary, and James W. Ogden, treasurer. Both Mr. Emerson and Mr. Ogden are well known in the talking machine record industry. Mr.

Ogden is also president of the Bridgeport Die & Machine Co., manufacturer of the product, with headquarters at Bridgeport. The following distributors of Kiddie Rekords have been announced: Musical Products Distributing Co., New York, and the Fox Philadelphia Co., Philadelphia, Pa.

C. L. PRICE ENJOYS REST

Clarence L. Price, vice-president and general manager of Ormes, Inc., Victor wholesaler, returned to his desk last Friday, after a well-deserved ten days' rest. Mr. Price, accompanied by his family, motored to Mt. Holly, N. J., where relatives reside, and, realizing that the 1922 Fall season would be exceptionally active, he decided to take a "real" vacation. For a period of ten days Mr. Price forgot all about Victrolas, Victor records and possible shortages, devoting all of his time to the thorough enjoyment of his vacation. His appearance indicates that he was benefited by his rest.

To Dealers

Phonograph owners are buying Violin Spruce Reproducers.

Dealers' sales of Violin Spruce Reproducers are increasing daily.

Dealers are beginning to appreciate that the Violin Spruce Reproducer commands the serious interest of every phonograph owner; that every phonograph owner is a prospective purchaser.

Many dealers have sent us their orders and are already making profits from the sales of Violin Spruce Reproducers. Each day is adding new dealers to our ranks.

Are you acquainted with the Violin Spruce Reproducer? If not, write us to-day for detailed information and discounts.

Violin Spruce Reproducers are retailed only through dealers in phonographs and records.

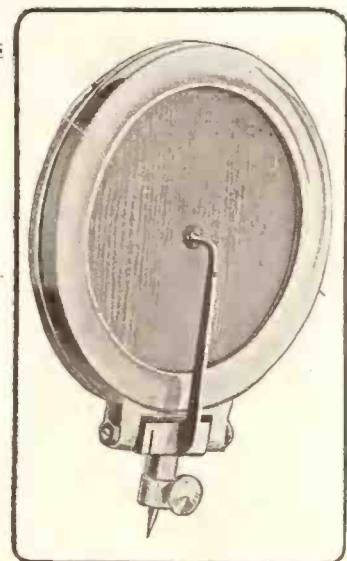

VIOLIN SPRUCE REPRODUCER

Eliminates all metallic sounds. Clarifies reproduction of the voice. Individualizes every instrument. Improves with use—like a violin. Not affected by atmospheric conditions.

Retails for \$7.50

THE DIAPHRAGM COMPANY
5005 Euclid Avenue, CLEVELAND, OHIO

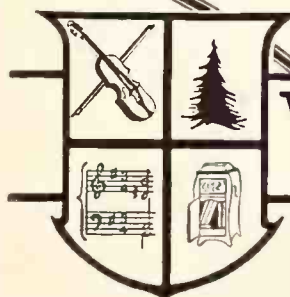

Violin Spruce Diaphragm

COLUMBIA NEWS ITEMS OF MONTH

O. F. Benz Visits Chicago and Toronto—L. L. Leverich Takes Brief Vacation—R. F. Bolton Again at Helm—Other Timely News

Lester L. Leverich, advertising manager of the Columbia Graphophone Co., accompanied by Mrs. Leverich, spent the Labor Day week-end at Atlantic City. Mr. Leverich did not indulge in a Summer vacation this year, so that his Labor Day vacation was in the nature of a well-deserved rest.

O. F. Benz, record sales manager, visited the Columbia Co.'s Chicago branch recently and while there represented the recording department in connection with several new numbers made by Frank Westphal and His Rainbo Orchestra. Immediately upon his return to New York Mr. Benz visited the Canadian branch at Toronto, accompanied by Robert F. Porter, field sales manager of the company.

Among the recent visitors at the Columbia executive offices were: W. L. Sprague, man-

DIRECT FACTORY PRICE—JUST MENTION THE QUANTITY

<p>MOTORS CASTINGS Grey Iron and Brass for</p>	<p>TURNTABLES MOTOR FRAMES TONE ARMS HORNS and THROATS</p>	<p>Stylus Bars Screw Machine Parts Talking Machine Hardware</p>
--	--	--

Direct Quantity Importations On { **JEWEL and STEEL (Bulk or Packed)**
PHONOGRAPH NEEDLES
GENUINE RUBY BENGAL MICA

D. R. DOCTOROW

Vanderbilt Ave. Bldg.
51 East 42nd Street, New York
Tel. Vanderbilt 5462
Murray Hill 800

ager of the Minneapolis branch, and A. B. Creal, manager of the New Orleans branch. Both of these visitors brought with them splendid reports of the business outlook in their respective territories.

Another welcome caller at the Columbia offices recently was Frank K. Pennington, formerly assistant general sales manager of the company and now general sales manager of the

A. B. Dick Co., of Chicago. Mr. Pennington was in splendid health and spirits and was keenly interested in the optimistic business reports that he received from all of the Columbia executives.

R. W. Reilly, "Loop" salesman for the Chicago branch of the Columbia Co., was a caller at the executive offices in New York a few weeks ago. Mr. Reilly was accompanied by his bride of a few weeks, and both he and Mrs. Reilly were given a royal reception by the members of the various departments in New York.

R. F. Bolton, general manager of the recording laboratories, returned to his desk last week, after taking a two weeks' rest. Mr. Bolton has a number of important plans in process of completion, and full details regarding the proposed activities of his department during the Fall will be announced in the near future.

H. L. Pratt, branch service manager of the company, is back at his desk after a fortnight's vacation and C. H. Woodbridge, sales manager of the Dictaphone division, is again at the helm, after a much-needed two weeks' rest.

NEW MODEL DETECTOR AND TUNER

Atlantic Instrument Co., Whose Receiving Sets Are So Popular, Announces Further Contributions That Appeal to the Radio Amateur

The Atlantic Instrument Co., New York, N. Y., manufacturer of the Atlantic Junior Radio Receiving Set, reports that the demand for this set has been far beyond expectations and that dealers throughout the country are now sending in repeat orders. These "repeats" are very gratifying, as officials of the company feel that the test of the genuine performance of the product is reflected by these orders, which, they state, has given satisfaction to hundreds of users.

The company this month is announcing to the trade a new model detector and tuner set, designed by its engineers, which contains several new and interesting features in radio units which, it is expected, will make a strong appeal to the amateur. Simplicity in design and operation is the keynote of this set. It is designed in such a way that, although simple and compact, it will not lose any of its efficiency, but will receive radio messages in a highly satisfactory manner. All necessary adjustments to this instrument are confined to two dials, one control being used for tuning and the other for the audion filament. All connections except that for the telephone are made through the rear of the instrument, eliminating annoying, unsightly connections in front of the cabinet. Another feature of this small instrument is a mounted colored jewel sunk into the panel directly in front of the audion which serves as a signal light and allows the operator to immediately assure himself that the audion lamps are lighted.

Officials of the company have been hard at work all Summer planning the Fall and Winter campaign, which consists of advertising and the distribution of attractive literature. It has already shown results, and it is expected that Fall and Winter business will be larger than last year.

The Dallas (Tex.) Music Industries Association held its first meeting of the Fall season at the Oriental Hotel, Dallas, on September 4.

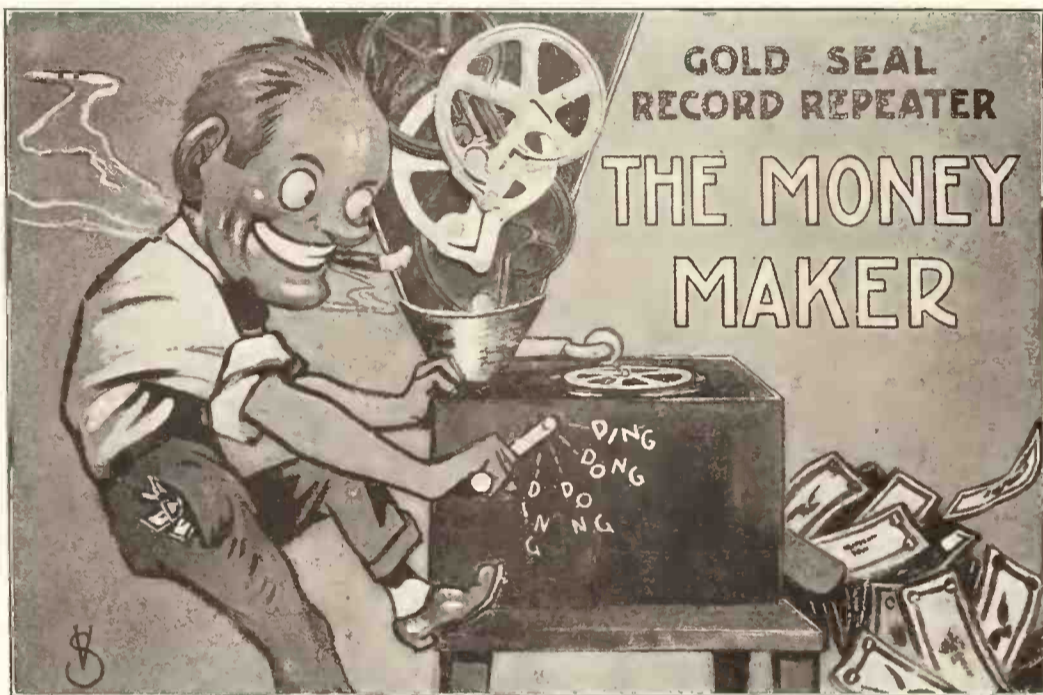

GOLD SEAL IS A MONEY MAKER

Wherever the Gold Seal Record Repeater is shown in a window—crowds congregate, and, in New York and Chicago, block the thoroughfare.

Wherever People Dance, Gold Seal Sells on Sight

Whenever the Gold Seal Record Repeater is demonstrated in a store there is an immediate jump in record sales, in sales of needles and accessories, and good salesmanship frequently steers this buying interest into consideration of new phonographs.

Gold Seal is the Great "Feeder" for General Sales

Get the public to stand in front of your window—show stock and sell the Gold Seal Record Repeater.

If they watch your demonstration they will come in and buy. With your store crowded with buyers of Gold Seal Repeaters you need have no worry over strikes, bad times, tight money or commercial depression.

Your salesmanship, the power of music, the novel appeal and the great utility of the Gold Seal Repeater, all will turn a sluggish business into a bright, active money-making institution.

Why Wait?—Your Jobber Can Deliver Gold Seals NOW

Get the jump on the Fall trade. Phonographs are beginning to sell fast. They can never be superseded in the home by any other instrument—their market is fixed, permanent and growing.

Gold Seal Will Give You Your Share

The crowds tell you what to sell. Gold Seal attracts a crowd. The crowds tell the public where to buy. Attract the crowds to your store with the Gold Seal Record Repeater—the fastest-moving, most useful accessory ever devised for a phonograph.

Sells for a Dollar—And Gives You a GOOD Profit

Gold Seal Needles are best for good phonographs—last longer, playing perfectly fifteen times. Gold-plated and non-corrosive.

THE GOLD SEAL CO., 105 West 40th Street, NEW YORK



We Are Featuring for October the Following Dance Records

Released September 15th

No. 18933—"Why Should I Cry Over You"

No. 18938 { "I'm Just Wild About Harry"
"Say It While Dancing"

Released September 22d

No. 18940—"Oriental Fox Trot"

Released September 30th

No. 18939—"Coal Black Mammy"

The "Da-Lite" Electric Display Service

Was started one year ago advertising VICTOR RECORDS Exclusively

IN THE PAST YEAR OVER THREE HUNDRED VICTOR DEALERS HAVE PROFITED BY ITS USE

If you want to cash in on the NEW VICTOR RECORD HITS, "while they are hot," why not subscribe for this service? We furnish you four artistic display panels each month at a cost of only \$6.00. The Display Sign costs you \$15.00. Your Jobber has a sample for your inspection. Ask him what he thinks of it or write us direct for descriptive folder and a sample display panel; also list of fifty panels we carry in stock for selling your old records.

**"DA-LITE" ELECTRIC DISPLAY CO., 116 North Erie Street
TOLEDO, OHIO**

TALKING MACHINE MEN MEET

Many Interesting Features Mark the First Fall Meeting of the Local Organization

The first Fall meeting of The Talking Machine Men, Inc., the organization of talking machine dealers of New York, New Jersey and Connecticut, was held at the Café Boulevard on Wednesday, September 13, in connection with the usual luncheon, and proved a decided success. Dealers, for the most part, were in an optimistic frame of mind and full of the energy that makes for business.

There were a number of interesting features scheduled for the meeting, including a talk by Otto Heineman, head of the General Phonograph Co., on the future of the phonograph industry and another talk by Edward Strauss, of the Brunswick Co., along the same lines.

Goodman & Rose, Inc., had several representatives present who demonstrated the latest songs put on the market by this company, and the Fairway Co. staged a demonstration of the new Victor Exercise Records.

A special committee reported on the radio situation and it was evident that the interest in this new development on the part of the dealers was very keen.

The entertainment committee reported that plans were being completed rapidly for the dance to be held on October 30 under the auspices of the Association.

ANNOUNCE THE TRIANGLE RECORD

BRIDGEPORT, CONN., September 6.—The Bridgeport Die & Machine Co., of this city, widely experienced and favorably known in the 50-cent record field, has announced the production of a new 50-cent record, to be known as the "Triangle" record. The Bridgeport Die & Machine Co. has always paid much attention to quality production and the early release of the popular record hits.

FILLING AN ARTISTIC WANT

The Mohawk Works of Art, New York City, reports that its initial announcement of the establishment of a study for the artistic redecoration of talking machines has evidently filled a long-felt want, judging from the number of inquiries that have been received. Department



The York—One of the New Brunswick Models

and wareroom managers report that there is a decided demand on the part of the buying public for specially finished talking machines and the Mohawk Works of Art has been very busy on this class of work.

Making promises is a harmful practice unless the intention is to live up to them. Many a customer has been lost because a dealer or salesman promised to secure an article or make a delivery on a certain date and did not do so.

NEW BRUNSWICK MODEL—THE YORK

Attractive New Instrument Designed for Use Where the Space Is Limited

The Brunswick-Balke-Collender Co., Chicago, has just introduced to the trade and public the latest style of Brunswick phonograph, an attractive flat-top console known as The York.

The new model is thirty-five inches wide, twenty-one and a half inches deep and thirty-three and a half inches high, and is obtainable in mahogany, Adam brown mahogany or American walnut. The list price is \$150. This latest style is equipped with all the standard Brunswick features, including the Ultona reproducer, the new all-wood oval tone amplifier, the tone modifier and other special equipment.

In announcing the new model the company states that it is specially designed to meet the popular demand for an instrument of that type which occupies but a limited floor space. The first of the new styles has already been placed in the hands of dealers.

FAMILIARITY BREEDS CONTEMPT

Courtesy is one of the basic principles of successful selling. Reserve is another. Many salesmen make the mistake of too much familiarity with customers. People enter a store to make a purchase, not to listen to levity and "breezy" remarks. These things breed contempt.

The Last Word in Electric Phonograph Motors

Make this *your*
leading line for
the coming
s e a s o n

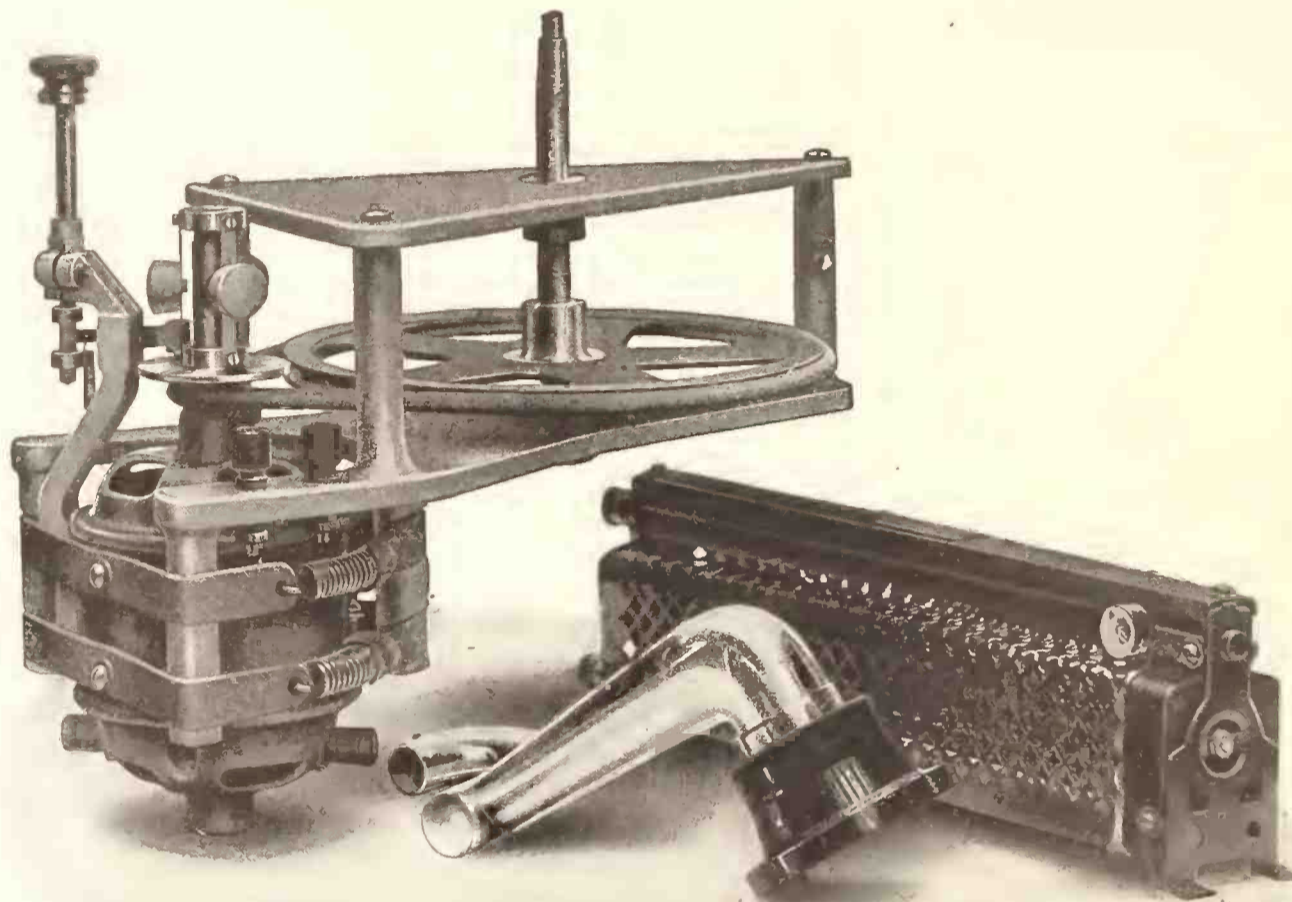

The Electromophone

Absolutely Silent

Adjustable to any voltage. Tone arm equipped with electrical stopping device, which operates in conjunction with the Electromophone—Record stops automatically on last note—Never fails!!

The Sole Selling Rights of This Unique Mechanism Are in the Hands of

THE STERNO MANUFACTURING CO.

19 CITY ROAD

LONDON, E. C., ENGLAND

ADDING TO STORE ATTRACTIVENESS

Zimmerman-Bitter Construction Co. Has Several Important Contracts Under Way Which Indicate Business Activity

The Zimmerman-Bitter Construction Co., New York, N. Y., manufacturer of all types of talking machine store equipment, reports that business in its line has been on the increase since the company started a few months ago. Several stores have been completely equipped with its product and many others are now in the process of construction. The company has just finished two very attractive jobs, one in Newark, N. J., at Broad and Market streets, and the Grenler Bros. store, at Ninety-sixth street and Broadway, New York, N. Y. Plans have been completed and some of the construction has already been started for the complete installation in the new store recently opened by Bucci Bros., at 163rd street and Third avenue, of seven private sound-proof hearing rooms, record racks and counters and a modern show window. When completed it will represent one of the finest and most attractive equipments manufactured by this company. Officials of the company stated that one of the largest contracts yet secured by them has just recently been signed, which will be announced at a later date. This contract is for one of the leading retail establishments in New York City and was secured after a thorough investigation and inspection of the creditable work already done by the company.

The Zimmerman-Bitter Construction Co. has also just secured a contract for the complete installation of store equipment for Szivos Bros., who recently purchased the entire block at Third street and First avenue, New York, which will be renovated throughout, the first floor of 120 East Third street being devoted to their talking machine business. This company will not only install show windows along the entire front of the building and record booths, racks and counters in the talking machine store, but it will install interior equipment throughout the entire building. This is one of the largest contracts yet secured by this company, the officials of which are much gratified because it was closed after a thorough inspection by Szivos Bros. of the work done by this company in other sections of the city.

LEO LANDAU SUCCUMBS TO CUPID

WILKES-BARRE, PA., September 11.—Leo Landau, of Landau's Music Store, this city, was married yesterday to Miss Anna Weisberger, of Nanticoke, Pa. The rites took place at 6 o'clock in the Y. M. H. A. auditorium here and a host of friends of both the bride and groom were present. Among the guests of the groom who were present was a large representation from Victor wholesale houses in New York and Philadelphia.

SPANIARD DESIRES AGENCY

WASHINGTON, D. C., September 9.—The owner of a retail establishment in Spain desires to secure an agency for talking machines, typewriters, etc., according to a request received by the Bureau of Foreign and Domestic Commerce. Complete information can be secured by communicating with the Department of Commerce and referring to File No. 3342.

THOS. F. GREEN BACK AT DESK

Popular Victor Executive Recovers From Recent Illness—Pearsall Sales for Month Very Satisfactory—Outlook Most Encouraging

The many friends in the trade of Thos. F. Green, president of the Silas E. Pearsall Co., New York, Victor wholesaler, will be sorry to learn that this popular Victor man was confined to his home for over two weeks recently through illness. Mr. and Mrs. Green had planned to spend some time at the home of W. T. Haddon, president of the Ohio Talking Machine Co., Haddonfield, N. J., but shortly after reaching Haddonfield Mr. Green became ill and was obliged to return to his home at Great Neck. He returned to his desk a few days ago, although not entirely recovered.

Lloyd L. Spencer, sales manager of the Silas E. Pearsall Co., in a recent chat with The World, commented upon the fact that August sales had been very satisfactory; in fact, well beyond expectations. September business for

the first two weeks was splendid and Mr. Spencer believes that Victor dealers as a whole will experience one of the most active Fall seasons of recent years.

LaRoe Bros., Victor dealers at Woonsocket, R. I., were recent visitors at the Pearsall offices, stopping in New York for a day or two, en route to their home, after spending several weeks at Atlantic City.

LAURENCE WALSH A BENEDICT

Laurence Walsh, of the sales staff of the New York Talking Machine Co., Victor wholesaler, was married a few weeks ago to Mrs. Grace Weir, a daughter of Mrs. Leila L. Weir, of Hartford, Conn., and well known in musical and theatrical circles. Mr. Walsh, who is covering New England territory for the New York Talking Machine Co., has attained pleasing success and has won the esteem of Victor dealers throughout his territory.

Have you noted that the diligent says "To-day," the sluggard says "To-morrow"?

**Complete Service
for the
Phonograph Trade**

You will now be able to rely on perfect service for **OKeh Records and Strand Phonographs**, for which we are now the recognized distributors in the territory embracing Pennsylvania, Southern New Jersey, Delaware, Maryland, the District of Columbia, Virginia and West Virginia.

At all seasons you can count on our warehouse having ready for instant shipment complete stock of these excellent records and all models of Strand phonographs.

Experts, and only men who deserve that title, constitute the service staff of the General Radio Corporation; and they will look after your needs as only experts can.

Your request will bring fullest information and latest price-lists and discount-sheets.

Let us answer your Radio Problems. We guarantee our merchandise and service.

The General Radio Corporation

Walter L. Eckhardt, President

Manufacturers and Distributors of High-Grade Radio Apparatus—The Geraco Line. Distributors for OKeh Records, Strand Phonographs and Gold Seal Record Repeaters.

624-626-628 Market Street, PHILADELPHIA

STYLUS BARS

(Any Style)

Stylus Bar and Mfg. Co.

Clague Rd.

Bay Village

OHIO



The arrogance, pride and splendor of a barbaric Eastern court, its voluptuous raw colors, mysticism and magnetic sense appeal is the picture that frames itself for you as you listen to "Prince Igor" by the Metropolitan Opera House Orchestra. The Columbia recording of this selection is a masterpiece of phonetics. The Zampa Overture on the reverse is an equally brilliant recording of one of this orchestra's greatest presentations. A-6218.

Columbia Graphophone Co.
NEW YORK

EXHIBIT NEW ORANOLA MODELS

Three New and Interesting Types of Oranola Receiving Instruments Shown and Demonstrated at Recent Merchandise Fair

One of the exhibits that attracted unusual attention at the National Merchandise Fair, held in the Grand Central Palace, New York City, during the early part of August was that of the Oranola Radio Corp., whose executive offices are at 228 Seventh avenue, New York City. This company displayed three new models of the Oranola radio receiving instruments, which have just been perfected and are now being introduced to the trade.

Radio sets of the upright cabinet and console style seem to be finding particular favor with the public and of the three models manufactured by the Oranola Co. two are uprights and one is of the console table type. This instrument is the invention of men who have been long connected with the talking machine industry and who have had wide experience in sound-reproducing machines.

They are Edward B. Jordan, Jr., president, and Edward B. Jordan, treasurer. The latter is well and favorably known to the people of Philadelphia, where he founded the Lulu Temple. At the demonstration Edward B. Jordan, Jr., said: "The Oranola sets include radio and audio frequency transformation of the energy received from the transmitting station, so proportioned that the volume of sound is

obtained without any annoying distortions which so frequently occur.

"Despite the fact that in the warm months there is plenty of static in the air, the pure tones of song and speech are heard and all the enunciation of words is clear and natural when received through our machines.

"The current supplied to the vacuum tubes is controlled by a single push-button switch and the tuning is accomplished by a single adjustment. The signal strength is regulated by a potentiometer gradually to a maximum with detector and filament current controlled by rheostats. The wave length adjustment is from 200 to 500 meters. In the console type and in one of the uprights the instrument is equipped to operate without outdoor or indoor aerial. The antenna is placed within the cabinet in such a manner that directional effects in receiving are avoided as far as possible. However, there are binding posts and connections provided for outdoor aerial and the latter can be used where the receiving set is made to function over a long range. In design, workmanship and from any engineering standpoint the product is of the best."

ROYAL T. M. CORP. BANKRUPT

A petition in bankruptcy has been filed by creditors against the Royal Talking Machine Corp., of 3945 North Western avenue. The concern is the manufacturer of the De Luxe and the Superb talking machines.

SONORA EXECUTIVES VERY ACTIVE

S. O. Martin and Jos. Wolff Visit Saginaw Factory—Frank J. Coupe Calls on Sonora Jobbers—H. C. Valeur Visits the Trade in Canada

S. O. Martin, vice-president and general manager of the Sonora Phonograph Co., New York, spent a few days last week visiting the Sonora factories at Saginaw. At the present time the Sonora factories are working to capacity in order to keep pace with the requirements of the jobbers and dealers.

Frank J. Coupe, vice-president and general sales manager of the company, made a trip recently to several of the leading trade centers en route to Chicago, spending a few days at Buffalo and Cleveland and visiting Sonora jobbers and dealers in those cities.

Joseph Wolff, vice-president and manager of production, returned recently from a visit to the factories at Saginaw and was delighted to find that, during his brief absence from New York, the business situation had shown a decided improvement all along the line.

H. C. Valeur, secretary and treasurer of the Sonora Phonograph Co., spent a few days at Toronto last week, conferring with the Sonora jobbers in that city and visiting some of the dealers.

CAROLA CO. MAKING PROGRESS

Cleveland Manufacturer Making Plans for Active Fall—New Equipment Added to Factory Facilities to Meet Growing Demand

CLEVELAND, OHIO, September 7.—The Carola Co., of this city, is now swinging into full production upon its talking machines, and recent installations of equipment are making it possible to take care of all comers this year. Such was the statement of N. I. Schwartz, general manager of the company, when interviewed today. "We expect to do an excellent business this Fall," continued Mr. Schwartz, "not only because of the general upward trend of business but because we have made certain refinements and improvements in our products which our friends say remove the last criticism. The trade is beginning to realize that our product is not a toy, but a real machine, capable of good music in volume. Of course, it is true that our machine is wonderfully suited to the younger generation and some of the department stores are doing an immense business on that basis, but our machine is a real machine and must be regarded as such."

D. K. M. SALES CO. CHARTERED

The D. K. M. Sales Co., 108 South La Salle street, Chicago, Ill., was recently incorporated by A. N. Dutton, P. B. Kuykendall, D. W. Martin and Charles Madden, with a capital of \$50,000. The concern has a factory at Vincennes, Ind., and will market a device for starting and stopping talking machines.



For A QUICK SALE

We Recommend



14117	{ JAZZIN' BABIES BLUES KIND LOVING BLUES	}	By ETHEL WATERS
14118	{ EARLY EVERY MORN LONESOME MONDAY MORNING BLUES	}	By ETTA MOONEY
14120	{ THAT DA DA STRAIN GEORGIA BLUES	}	By ETHEL WATERS
14122	{ THAT COOTIE CRAWL JA DA BLUES	}	By JULIA MOODY

EVERYBODY LIKES THEM — YOU CAN SELL THEM

PACE PHONOGRAPH CORP.

2289 Seventh Avenue
New York, N. Y.

Southern Trade Taken Care of by

SOUTHERN SONORA CO., 310 Marietta Street, ATLANTA, GA.

SELVIN'S ORCHESTRA TO RECORD ONLY FOR VOCALION

Prominent and Successful Organization Put Under Exclusive Contract by the Aeolian Co.—Enjoys a Wide Reputation for Producing Dance Music

The Aeolian Co. has just announced that a contract has been signed with Selvin's Orchestra, one of the most popular dance orchestras in New York, to record exclusively for Vocalion records. The organization has already made a number of Vocalion records which have proven very popu-

sons and is at present playing at the Boardwalk Restaurant which was opened for the new season on September 11 and promises to be among the popular rendezvous during the Fall and Winter.

Vocalion dance records have won a wide repu-



Selvin's Popular Dance Orchestra, Which Will Make Vocalion Records

lar. Under the new exclusive arrangement the Selvin Orchestra will be featured frequently in future Vocalion record lists.

Selvin's Orchestra has played in prominent Broadway resorts in New York for several sea-

sons and is at present playing at the Boardwalk Restaurant which was opened for the new season on September 11 and promises to be among the popular rendezvous during the Fall and Winter. Vocalion dance records have won a wide reputation and the addition of Selvin's Orchestra to the list of exclusive Vocalion recording organizations will have the effect of increasing this reputation to a very material degree throughout the country.

NEW RCA DEALER DISCOUNT

Radio Corp. of America Announces New Discount Schedule—Increased Dealer Discount Enthusiastically Received by Trade.

The Radio Corporation of America, New York manufacturer of RCA radio products, sent out recently an important announcement to its wholesale distributors advising them of new distributors' and dealers' discounts. This new schedule calls for increased discounts for the dealers, and the talking machine trade will undoubtedly welcome this new list.

For several months the sales department of the Radio Corporation of America had been working on a new discount schedule, especially in view of the fact that the company had appointed five

well-known distributors in the talking machine field. These distributors were advised by talking machine dealers that if it were possible to secure discounts approximating the average talking machine discount, radio business would be more profitable and more productive of results. The new discount schedule reflects the intention of the Radio Corporation of America to co-operate with its jobbers and dealers in every possible way and the company has been congratulated upon its move in this direction.

In its announcement to the trade the Radio Corporation of America suggests that distributors request their dealers to place orders for the Fall trade as quickly as possible, as the increased demand which has already materialized may find the dealers unable to make prompt deliveries.

TEXAS-SERVICE

OKeh Records

The Records of Quality

The Records your customer wants. Our stock is complete and the haul from DALLAS to your store is short, hence less expensive. We have the new hits while they are new and the old favorites and classics all the time.

Write us about the agency for this record in your town

MARTIN WEISS CO.
903 Elm Street DALLAS, TEXAS

J. H. TROUP MUSIC HOUSE EXPANDS

Adds Two Floors to Quarters—Large Space for Talking Machine Department—Victor and Edison Machines Featured by This House

HARRISBURG, PA., September 11.—The J. H. Troup Music House, 15 South Market Square, this city, is planning to enlarge its business to include two additional floors of the building which it occupies, making four floors in all, according to an announcement by J. H. Troup, head of the concern. Extensive plans for the remodeling of the quarters are under consideration. These include the construction of booths on the first floor, which will be devoted to the sale of records. The second floor will be turned over to the display of the Victor and Edison lines and the remaining space will be used for the display of pianos and musical instruments.

The Hancock Music Co., Brunswick dealer, of Pasadena, Cal., is greatly enlarging its floor space.

Radio and phonograph combined in the LYRADION—your customers will prefer this line

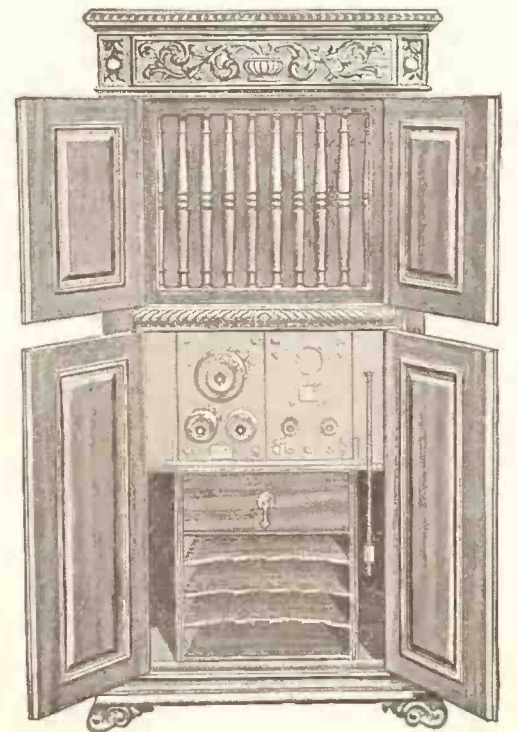

Lyradion Italian Renaissance

Combination radio and phonograph. A beautiful hand-carved cabinet in polychrome finish for large homes and clubs. Wired for Westinghouse "set" or complete with Lyradion 5 stage non-regenerative set. All instruments and batteries completely housed.

Radio enthusiasts are expressing their preference for the Lyradion line of attractively housed radio sets in no uncertain terms. While the lady of the house has tolerated the old method of placing batteries and sets on the library table and floors as a matter of necessity in the past, she is now demanding the attractive Lyradion combination radio and phonograph completely housing instruments and batteries and offering dual and perpetual entertainment features. Besides these attractive cabinets harmonize with the furnishings of the modest as well as the most luxurious home surroundings.

The wonderful Seabrook amplifying horn used on all models is responsible for the remarkable reproducing qualities of Lyradion instruments. This horn employs entirely new principles of sound reproduction which are fully protected by basic U. S. patents.

Lyradion cabinets can be furnished wired complete for Westinghouse two-stage R. C. sets or with Lyradion five-stage non-regenerative receiving sets.

Territory is being rapidly allotted—dealers or jobbers should write or wire immediately for proposition.

Lyradion Sales & Engineering Company

Mishawaka, Indiana KENYON W. MIX, Director

HAPPENINGS IN THE DOMINION OF CANADA

MANY FINE DISPLAYS AT CANADIAN NATIONAL EXHIBITION

Interest of Trade and Public Turned Toward Music Building of Exhibition Housing Exceptionally Fine Displays Showing Development of Talking Machine Industry—Other News

TORONTO, ONT., September 8.—The rapid growth and importance of the talking machine industry is being forcibly demonstrated here in the splendid display in the new Music Building at the Canadian National Exhibition. One of the largest exhibitors at the fair has as many as twenty-two or twenty-three different models. Averaged among the makers, it is estimated that fifteen models of each make are being manufactured. They comprise a complete list of types designed to harmonize with furniture of all periods. In the display, which has been prepared by a dozen or more manufacturers, in the Music Building an infinite variety of sizes and shapes are shown.

A music building is something new to the exhibition, although musical exhibits have been there as long as the fair has been held. This year there is a real music building in what was, a year ago, the Dairy Building. The interior of this structure has been remodeled. Phonograph booths abound on every side and its walls have been paneled and decorated. The granting of this space to the music trades is one of the many indications of the growing importance of the industry in Canada. Many thousands of visitors throng the aisles of the new building.

The fair runs from August 26 to September 9. One million, two hundred and forty-two thousand was the total attendance at the Canadian National Exhibition in 1921, which means that over one million people viewed the talking machine exhibits in the east wing of the Horticultural Building. To date the attendance is 119,000. The new music building is devoted entirely to phonograph displays, with the exception of the amphitheatre in the center of the building, which has a seating capacity of 88,800 persons. Nearly ten thousand square feet of floor space are actually devoted to the displays. Individual exhibits were maintained by the Columbia Graphophone Co., this city; Gerhard Heintzman, Ltd.; McLagan Phonograph Corp., I. Montagnes & Co., Sonora phonographs and needles; Musical Merchandise Sales Co., Brunswick phonographs and Brunswick records; Scythes Vocalion Co., Ltd., Aeolian-Vocalion and Vocalion records; Sun Co. of Canada, Ltd.; Starr Co. of Canada, Ltd., Starr phonographs and Starr records; the Sun record, Apex phonographs and Apex records; the R. S. Williams & Sons Co., Ltd., Edison phonographs and Edison Re-creations; Simplex Electric Phonograph Motor Co., Ltd., Montreal.

Selections by Canadian artists who have attained fame in the musical field through recordings of their specialties on records form a feature of the exhibits.

At the request of the Canadian Phonograph Manufacturers' Association, which has fathered the musical competitions for the past three years, and also at the request of the Exhibition management, the competitions this year are being conducted by the Canadian Bureau for the Advancement of Music. The following constituted the trade committee, which was known as Music Day Committee: F. A. Trestrail (convenor), John A. Fullerton, G. B. Heintzman, E. C. Scythes, W. B. Puckett, convenor of the Canadian Phonograph Manufacturers' Association's Exhibition Committee, and J. S. Atkinson, secretary of the Bureau. G. B. Heintzman was appointed to secure the co-operation of the piano exhibitors. Gordon Thompson, representing the sheet music men, in charge of publicity; E. C. Scythes in charge of open-air music, and W. B. Puckett in charge of attractions in the amphitheatre of the Music Building.

T. Nash, manager of the Sun Record Co., distributor of Apex records, recently visited the principal points between Toronto and Kingston in connection with Apex records and machines.

G. M. Browning, of the Gold Seal Co., Inc., New York, was a recent trade visitor here, the purpose of his mission being to arrange for the promotion of the sale of the Gold Seal record repeater in Canada. This repeater has won mer-

itorious approval throughout the United States market, over half a million, it is said, having been sold since its appearance only a few months ago. It can be made to retail in Canada at \$1.35. Mr. Browning intimated that it was the intention of his firm to open a Canadian branch for the manufacture of Gold Seal repeaters, Gold Seal needles and other Gold Seal products as soon as arrangements can be effected.

New local incorporations include the Purdy Radio Phonograph Co., Ltd., Toronto, and the Sonora Phonograph Co., Ltd. The latter concern is capitalized at \$40,000, according to an announcement just made.

BERLINER GRAMOPHONE EMPLOYEES HOLD ANNUAL PICNIC

River Sail and Numerous Athletic Events Mark Day of Jollity at Picnic of Employees of Berliner Gramophone Co., Ltd.—Continued Improvement in Sales Indicates Busy Fall

MONTREAL, CAN., September 8.—Employees of the Berliner Gramophone Co., Ltd., together with friends, held their annual picnic at Lavaltrie recently. Luncheon was served on board the steamer "Three Rivers" and various games and contests were held during the day at the picnic ground. On the return trip a dance was held on board. E. Berliner, vice-president of the company, with J. S. Shield, a director, officiated at the baseball game.

At a recent radio concert, broadcasted from Station C. FCF Montreal, Miss Joan Zafaro, the celebrated soprano, entertained the radio fans with a medley of classical airs. Leo Feist's popular Montreal representative, Gus Hill, also rendered the following numbers: "Why Should I Cry Over You?" "Stumbling" and "Georgia."

The Starr Co., of Quebec (Montreal), L. R. Beaudry, manager, is elated over the popularity of the Starr records in French. It is only two years ago that a few of these recordings were introduced. To-day they total over 125 listings with new numbers coming through every month.

The first prominent concert of the season will be given in the St. Denis Theatre on October 2 by Madame Galli-Curci, the great coloratura soprano and His Master's Voice artist.

In the big parade of St. Jean Baptiste, held in St. Hyacinthe, Que., lately, J. Bouchard, the well-known dealer of 19-21 Laframboise street, won second prize for his "float," which was twenty-three feet long, fifteen feet high and seven feet wide. The inside of the float, where an orchestra was placed, measured eighty-four square feet. In the front appeared two Victrolas—one a No. 50 portable and the other a No. 240 Console model. A big forty-two-inch reproduction of "Nipper," the famous His Master's Voice trade-mark, appeared on the top. On each side was a cut-out of a record thirty-four inches in diameter. The orchestra was composed of six players—three violins, piano, cornet and drums. All the selections played were directly advertising the recent issues of His Master's Voice records.

During the past month Creatore and his famous band attracted huge crowds to Dominion Park. Needless to say, Columbia dealers took advantage of his appearance and ran large-sized newspaper copy featuring this artist's extensive repertoire.

"The splendid classical and operatic selections being rendered weekly by the orchestras of the Capitol and Allen Motion Picture Theatres are creating quite an inroad on our stock of Victor Red Seal records," said Mr. Brown, of Brown's Talking Machine Shop.

Brunswick record sales with J. W. Shaw & Co. and Layton Bros., Ltd., continue to climb steadily every month and particularly in the call for Isham Jones Orchestra hits, which are becoming steadily more popular.

A noticeable improvement in sales of Edison phonographs and records is cited by Layton Bros., Ltd. This house is now busy formulating extensive sales plans for Fall and Winter business.

"While it is between Summer and Fall our sales of Sonora and Columbia Grafonolas have kept up wonderfully well," said C. W. Lindsay, Ltd., "and Columbia records are also in good demand."

Goodwin's, Ltd., Norman F. Rowell, manager, is most optimistic as to Fall business and has in sight the closing of a number of deals for Brunswick phonographs and is stocking up heavily in His Master's Voice records in anticipation of a good Winter and holiday selling season.

THOS. A. EDISON'S CONTRIBUTION

A despatch from Alexandropol, Armenia, states that sixty carloads of foodstuffs which the school children of New Jersey contributed to the American Orphan City, where the Near East Relief is maintaining 20,000 Armenian children, have arrived there. Among the interesting items were seventy-seven cases of phonographs, the personal gift of Thos. A. Edison.

Talking Machine Springs and Repair Parts

NONE BETTER IN QUALITY NONE LOWER IN PRICE

THE RENÉ MANUFACTURING CO.
MONTVALE, NEW JERSEY



MORRIS MUSIC SHOP, 130 Fordham Road, N. Y. City



GRINLER CO., 2554 Broadway, N. Y. City

BIGGER
BETTER
CHEAPER

WHAT WE ARE DOING FOR OTHERS WE CAN DO FOR YOU

Particulars on Request

HEARING ROOMS

RECORD RACKS

SERVICE COUNTERS

ZIMMERMAN-BITTER CONSTRUCTION CO.

325-27 East 94th Street, N. Y. City

DISPLAY CASES

MUSICAL INSTRUMENT

CASES, Etc.

SALES SCHOOL HELD IN PITTSBURGH

Splendid Representation at Salesmanship School Held by Mr. Delano Under the Auspices of Pittsburgh Victor Distributors

PITTSBURGH, PA., September 11.—The Victor School of Salesmanship conducted by the Victor Talking Machine Co., under the auspices of the Pittsburgh distributors, W. F. Frederick Piano Co.; C. C. Mellor Co. and the Standard Talking Machine Co., opened today in the Moose Temple, with F. A. Delano of the Victor Co. in charge. The school will continue until September 14 and will close with an informal dinner and theatre party tendered by the three Pittsburgh distributors to the students.

The list of students enrolled is as follows: Miss Irene Curtis, Aaron Furniture Co., Greensburg, Pa.; Jos. S. Amster and Agnes M. Bradley, Jos. S. Amster, Clairton, Pa.; F. M. Carpenter, Acme Book Store, Buckhannon, W. Va.; Mrs. W. G. Anderson and Miss Helen Perrier, W. G. Anderson, Midland, Pa.; Mr. and Mrs. G. B. Bennett, Wilkinsburg, Pa.; W. J. Benjamin, W. J. Benjamin, Vandergrift, Pa.; C. Russell Cooper and Miss Alda G. Anderson, Cooper Bros., New Kensington, Pa.; John E. Dinsmore, Cameron Drug Store, Cameron, W. Va.; W. N. Templeton, Clymer Furniture Co., Inc., Clymer, Pa.; Miss Katherine M. Slawik, Cassaday Drug Co., Alliance, O.; Miss Mae Belle Hall and L. W. Bell, Davis, Burkham & Tyler Co., Wheeling, W. Va.; Harry Diamond, Diamond Drug Co., Natrona, Pa.; O. T. Lytle, Dils Brothers Co., Parkersburg, W. Va.; H. I. Ellis, A. I. Ellis & Sons, Uniontown, Pa.; C. L. Ohle, The W. W. Espy Drug Co., Ben Avon, Pa.; Miss Olive Fawcett, L. J. Koster and James Larkin, "The Famous"—Katz & Goldsmith, Braddock, Pa.; Miss Anna Simpson, W. F. Frederick Piano Co., Pittsburgh; Miss Maude Collier, W. L. Frederick Piano Co., Cannonsburg, Pa.; Miss Margaret C. Cortea, W. F. Frederick Piano Co., Connellsville, Pa.; Miss Gladys Parker, W. F. Frederick Piano Co., Duquesne, Pa.; Arthur R. Prettyman, W. F. Frederick Piano Co., Morgantown, W. Va.; Guy Hammond, Jr., W. F. Frederick Piano Co., Grafton, W. Va.; Miss Sophie Easer, Half Brothers, Homestead, Pa.; H. R. McHendry, Mrs. Edna Reich, H. S. Schohe, T. E. Shortell, Miss Helen Ritchey and Miss Martha Maeder, S. Hamilton Co., Pittsburgh; Frank L. Hill, Jr., Frank L. Hill, Jr., Cannonsburg, Pa.; W. Roy James, James Pharmacy, Aspinwall, Pa.; Miss Esther Fielding and Miss Alice Brown, Kaufmann & Baer Co., Pittsburgh; Miss Mabel Spahn, Kaufmann's Dept.

Store, Pittsburgh; Dave Krasik, D. Krasik, Monessen, Pa.; Samuel Sandomire, W. A. Kulp, Braddock, Pa.; John C. Haggerty, Lechner & Schoenberger Co., Pittsburgh; Walter H. Leedom, Leedom's Drug Store, Hollidaysburg, Pa.; Miss Grace Smith, Lewis Bros. Co., East Liverpool, O.; Miss Dora Curtis, J. K. Lovett, Ambridge, Pa.; C. L. Repman, C. C. Mellor Co., Pittsburgh; C. E. Melleman and W. F. Lante, The Milleman Co., Zelienople, Pa.; W. J. Mullan, W. J. Mullan, Sewickley, Pa.; J. H. Colflesh, Mrs. O. F. McKee, Confluence, Pa.; Mrs. F. A. Johnson, Johnson Music Co., Pittsburgh; Mrs. W. F. McLay, W. F. McLay, Carnegie, Pa.; K. R. McMahon and Miss Mildred Miles, The McMahon Co., Youngstown, O.; Daniel G. Jones, W. L. Noble, Martins Ferry, O.; Miss Betty Kennedy, F. A. North & Co., Johnstown, Pa.; Leo E. Egan and Miss Sadie Mahon, J. H. Phillips, Pittsburgh; Ray Posner, Myer Posner, Mt. Pleasant, Pa.; Miss Simpson and Miss Edna M. Walker, Pioneer Music House, Inc., Indiana, Pa.; John F. Pentland, John F. Pentland, Toronto, O.; Joseph Asiano and J. Howard Riley, Robinson Music Co., Steubenville, O.; Miss M. Mervis, Rosen-

baum Co., Pittsburgh; Robt. Rainsberger, C. B. Rainsberger, East Palestine, O.; Miss Marie Schellhase, E. E. Schellhase, Waynesburg, Pa.; Miss Pearl Allen, P. W. Simon, Uniontown, Pa.; Miss Stell Meyers, Miss Minnie Kusterman and Miss Mae Harnett, Spear & Co., Pittsburgh.; W. A. Steadman, W. A. Steadman, Butler, Pa.; Miss Eleanor Rouczka, Steele Furniture Co., Pittsburgh; Mr. and Mrs. J. E. Slingluff, Cambridge, O.; J. W. Schell and Miss E. Mulvaney, South Hills Music Shop, Pittsburgh; Clark Wright and Isaac Skelton, Valley Furniture Co., East Pittsburgh, Pa.; T. I. Veiock, Veiock Music Co., New Brighton, Pa.; W. P. Wampler and Miss Jane Harris, F. C. Wampler & Son, Inc., McKeesport, Pa.; Miss Lenora Eitel and Miss Elma Westerman, Windsor Music Co., Tarentum, Pa.; Mrs. Leonore E. Tobin, F. A. Winter & Son, Altoona, Pa.; C. M. Wilson, C. M. Wilson Co., Salem, O.; Miss Eva M. Kays and Mrs. L. L. Moats, I. B. Wilson, Moundsville, W. Va.; Robt. Winter and Miss May Winter, Robt. Winter Music Co., Irwin, Pa.; G. B. Hellman, Miss Dorothy Hellman and Miss Laverne Evans, Yahrling-Rayner Music Co., Youngstown, O.

Atlantic Jewel

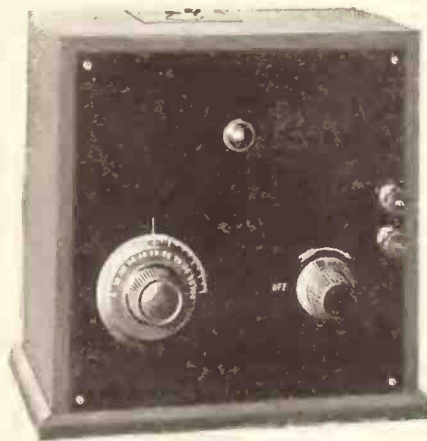

Without Accessories

LIST PRICE \$20.00

A single tube detector and tuner of handsome appearance and unrivaled excellence.

It is an achievement in simplicity without sacrifice of efficiency.

Atlantic, Jr.

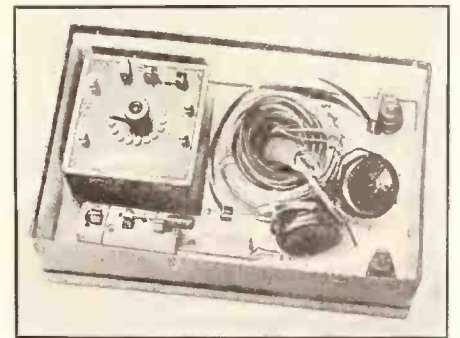

Complete

LIST PRICE \$18.00

An efficient and good-looking crystal set equipped with high-grade accessories. It comes in an attractive display case, ready to carry home and install.

RIGHT merchandise prices profits

Write for Catalogue

ATLANTIC INSTRUMENT COMPANY, Inc.

13-21 Park Row

Radio Mfrs.

New York City



SUPREME CONSOLE MODEL No. 200

This beautiful instrument is not only the best and most durable piece of merchandise offered the trade today, but it also carries the fairest and lowest price of any other instrument manufactured in America.

Every live jobber and wholesaler who has definite requirements for the coming season will surely benefit himself by getting in touch with us immediately. Your needs will be taken care of in a most satisfactory manner. And last, but not least, we are able to assure you of prompt deliveries.

We also manufacture three beautiful upright models, which, together with our SUPREME Console Model No. 200, make up the most remarkable offer ever made to the talking machine trade.

Quantity and Quality guaranteed with all orders. Write at once.

SUPERIOR PHONOGRAPH CO.
2331 Ogden Avenue Chicago, Ill.

OUR EXPORTS OF TALKING MACHINES

Exports and Imports of Talking Machines and Records Show a Decreasing Tendency as Compared With Last Year—Our Buyers Abroad

WASHINGTON, D. C., September 10.—In the summary of exports and imports of the commerce of the United States for the month of June, 1922 (the latest period for which it has been compiled), which has just been issued, the following figures on talking machines and records are presented:

The dutiable imports of talking machines and parts during June, 1922, amounted in value to \$35,901, as compared with \$37,636 worth which were imported during the same month of 1921. The twelve months' total ending June, 1922, showed importations valued at \$528,203, as compared with \$771,156 worth of talking machines and parts during the same period of 1921.

Talking machines to the number of 5,460 valued at \$168,503, were exported in June, 1922, as compared with 2,567 talking machines, valued at \$120,474, sent abroad in the same period of 1921. The twelve months' total showed that we exported 39,147 talking machines, valued at \$1,561,064, as against 67,897 talking machines, valued at \$3,071,757 in 1921.

The total exports of records and supplies for June, 1922, were valued at \$86,374, as compared with \$148,480 in May, 1921. The twelve months ending June, 1922, show records and accessories exported valued at \$1,471,853, in 1921, \$2,965,614.

The countries to which exports were made in June and the values thereof are as follows: United Kingdom, \$5,320; Canada, \$73,020; Central America, \$2,777; Mexico, \$15,155; Cuba, \$2,063; Argentina, \$2,798; Chile, \$837; Other South America, \$10,777; China, \$1,628; Japan, \$20,473; Philippine Islands, \$966; Australia, \$7,948; Other Countries, \$24,741.

K. C. Sexton, well-known Victor dealer of Washington, D. C., with headquarters at 631 Pennsylvania avenue, S. E., has opened a branch store at Seventh and C streets, S. E.

ELECTS TWO VICE-PRESIDENTS

David Sarnoff and William Brown Honored by Radio Corp. of America—Promotions Well Deserved—Both Well Known to Trade

Edward J. Nally, president of the Radio Corporation of America, New York, manufacturer of RCA products, announced a few days ago that the directors of the company had voted the rank of vice-president to two officials of the company. David Sarnoff, who is general manager of the company, was also elected vice-president. William Brown was elected vice-president and general attorney in recognition of his services in the legal department.

Mr. Sarnoff, who is only thirty-two years old, has been identified with the Radio Corporation of America and its predecessors for nearly sixteen years. He is recognized as one of the foremost radio authorities in the country, and at the recent music conventions in New York was one of the speakers at the noonday luncheons. His address was enthusiastically received by the music merchants in attendance, as it gave them a practical idea of the plans of the Radio Corporation of America in so far as they related to the music industries.

OTTO HEINEMAN VISITS CANADA

Otto Heineman, president of the General Phonograph Corp., spent a few days recently visiting the company's factory at Kitchener, Ont., Can., and the Canadian branch of the General Phonograph Corp. at Toronto. Mr. Heineman found business conditions in Canada very satisfactory, with every indication that the 1922 Fall season will be one of the most active periods of recent years.

A. Frangipane, secretary of the Mutual Talking Machine Co., reports a noticeable increase in business. Orders received during the first ten days of September were already in excess of the total amount for August. The volume of export business this month has exceeded any month in the history of the organization.

POST-VACATION TIME IN CAMDEN

Victor Co. Executives Now Actively Engaged in Carrying Out Large Production Schedule

CAMDEN, N. J., September 11.—The various executives and department heads of the Victor Talking Machine Co. have now returned to their desks in the executive offices after the vacation period and all forces are working hard in the carrying out of the ambitious production laid out for the factory from now until the first of the year.

Ralph L. Freeman, director of distribution, returned to-day from a three weeks' vacation with his family, most of which was spent in Canada, where some good fishing served to take Mr. Freeman's mind off of business matters.

OPENS FINE VICTOR DEPARTMENT

Boston House, of Washington, D. C., Makes Feature of New Department

WASHINGTON, D. C., September 9.—The Boston House, one of the leading local department stores here, has opened what is considered one of the finest Victor departments in this vicinity. The talking machine department is located on the fourth floor of the building and covers part of the floor space, extending an entire block. Twenty handsomely appointed record demonstration rooms in the architecture of various countries are a feature. R. H. Keller, one of the best known of successful talking machine men in the capital, is in charge.

NEW INVENTION

An inventor and engineer of long experience and established reputation in the phonograph industry has perfected an indestructible record and apparatus for producing same at a low cost, and seeks a high class business man or firm with sufficient capital to start manufacturing. The inventions are revolutionary in their character. Address "Box 1206," care The Talking Machine World, 373 Fourth Ave., New York, N. Y.

THE TALKING MACHINE WORLD'S CLASSIFIED ADVERTISING

FOR SALE

Recording machine, recording wax, shaving machine and recording tools, for professional use. No amateur. Address "Box 1204," care of The Talking Machine World, 373 Fourth Ave., New York, N. Y.

CARVED LEGS

Eight designs in gum, oak and mahogany. Prices reduced. Send for circular. Klise Mfg. Co., Grand Rapids, Mich.

MUSIC STORE FOR SALE

Columbia agency, pianos and small goods. Located in Detroit, Mich., and catering principally to foreign trade. Business profitable, owner wishes to go East. Will stand close investigation. Address "Box 1197," care The Talking Machine World, 373 Fourth Ave., New York, N. Y.

FOR SALE

Genuine Pathé sapphire needles. 12 cents each for cash. The Pathé Shop, 228 West Grand River Ave., Detroit, Mich.

FOR SALE

Several thousand standard make records, late numbers, also sacred, instrumental standard numbers, etc., at thirty-five cents each. Send for catalog. Central Phonograph Co., 127 N. 11th St., Philadelphia, Pa.

FOR SALE

Victor agency in town in Pennsylvania. Population 26,000, also six nearby towns to draw from. Store is well equipped and centrally located. Must sell on account of ill health. Answer "Box 1205," care The Talking Machine World, 373 Fourth Ave., New York, N. Y.

WORLD'S CLASSIFIED ADVERTISING

Any member of the trade may forward to this office a "Situation" advertisement intended for this Department to occupy a space of four lines, agate measure, and it will be inserted free. Replies will also be forwarded without cost. Additional space will be at the rate of 25c. per line. If bold faced type is desired the cost of same will be 25c. per line. Rates for all other classes of advertising on application.

POSITION WANTED—Retail store manager, having eight years' experience handling Victor and Columbia merchandise and musical instruments, possesses executive ability, resourcefulness and broad business experience, married, can furnish unquestionable reference. City or country preferred. Address "Box 1191," care The Talking Machine World, 373 Fourth Ave., New York, N. Y.

POSITION WANTED—Recording Engineer wishes to connect with company that is striving to excel whatever record you are putting out. I can help you to improve it. This statement is backed by experience. Address "Box 1193," care The Talking Machine World, 373 Fourth Ave., New York, N. Y.

WANTED—Young man to work in music store. Bright enough to take full charge in a few months. Send photograph and reference and salary desired in first letter. Address Feraud Brothers, Granite City, Ill.

WANTED—Associate to finance manufacture and marketing of novel recording attachment for all phonographs. Makes and reproduces loud, clear lateral records, from which permanent records of usual type are made. Address "Box 1202," care The Talking Machine World, 373 Fourth Ave., New York, N. Y.

POSITION WANTED—Recording engineer of broad technical experience open for engagement. Complete equipment. Consultation on problems relating to the industry. Address "Box 1203," care The Talking Machine World, 373 Fourth Ave., New York, N. Y.

POSITION WANTED—Many years as technical phonograph laboratory expert, can work and capable of superintending work from start to finish. Recordings, plating and matrix making. Use finest methods, wishes interview. Address "Box 1180," care of The Talking Machine World, 373 Fourth Ave., New York, N. Y.

POSITION WANTED—Assistant for recording laboratory, tool maker by trade. Four years' experience with recorder. Understand making of all recording instruments and detail work of laboratory. 39 years old. Address "Box 1188," care The Talking Machine World, 373 Fourth Ave., New York, N. Y.

POSITION WANTED—At liberty, experienced foreign and domestic shipping clerk, Victor products, executive ability. Address "Box 1189," care The Talking Machine World, 373 Fourth Ave., New York, N. Y.

POSITION WANTED—Young man, age 23, wishes to connect himself with Baltimore phonograph house, as salesman. Address "Box 1190," care The Talking Machine World, 373 Fourth Ave., New York, N. Y.

POSITION WANTED—Man, age 31, thoroughly experienced in selling phonographs and pianos, desires position as manager of department or floor salesman. College education. Best of references. Address "Box 1196," care The Talking Machine World, 373 Fourth Ave., New York, N. Y.

FOR SALE

Completely Equipped Record Factory

All machinery of latest type, built in many cases from exclusive designs. Entire plant laid out by competent engineers to operate at highest possible efficiency. Address "Box 1181," care The Talking Machine World, 373 Fourth Ave., New York.

SPRINGS

VICTOR		
1 1/4"x.022x18' 6" marine ends.....	No. 3014	\$.58
1 1/4"x.022x17' marine ends.....	No. 3014	\$.55
1 1/4"x.022x17' bent arbor.....	No. 5362	\$.57
1 1/4"x.022x13' bent arbor.....	No. 5423	\$.50
1 1/4"x.022x9' bent arbor.....	No. 5427	\$.42
1 1/4"x.022x9', bent each end.....	No. 6546	\$.42
1"x.020x13' 6" marine ends.....	No. 2141	\$.32
1"x.020x15' marine ends.....	No. 3335	\$.35
1"x.020x15' bent arbor.....	No. 5394	\$.38
1"x.020x15', bent each end.....	No. 6546	\$.43
3/8"x.020x9' marine ends.....	No. 988	\$.29
COLUMBIA		
1"x.028x10' Universal.....	No. 2951	\$.33
1"x.028x11' Universal.....	No. 2951	\$.35
1"x.030x11' hook ends.....		\$.45
1"x11' for motor No. 1.....		\$.35
HEINEMAN		
1"x.025x12' motors.....	No. 33 & 77	\$.33
1 3/16"x.026x19', also Pathé.....		\$.75
1 3/16"x.026x17'.....	No. 4	\$.59
MEISSELBACH		
3/8"x10' motors.....	No. 9 & 10	\$.29
1"x9' motors.....	No. 11 & 12	\$.29
1"x16' motors.....	No. 16, 17 & 19	\$.40
SAAL-SILVERTONE		
1"x.027x10', rectangular hole.....	No. 144	\$.42
1"x.027x13', rectangular hole.....	No. 145	\$.48
1"x.027x16', rectangular hole.....	No. 146	\$.58
BRUNSWICK		
1"x.025x12', rect'glar hole, regular....	No. 201	\$.45
1"x.025x18', rect'glar hole, regular....	No. 401	\$.65
1"x.025x16', rect'glar hole.....		\$.58
KRASBERG		
1"x12' motor 2A, pear-shape and rect. holes.		\$.49
1"x16' motor 3 and 4 on outer end.....		\$.60
EDISON DISC		
1 1/2"x.028x25', regular size disc motors....		1.47
1"x.032x11', Standard.....		\$.55
1 5/16", Home.....		\$.70
1 5/16"x18' type A 150, old style disc.....		1.28
1" Amberola 30-50-75.....		\$.56
SMALL MOTORS		
3/8"x.023x10', marine ends, Hein. Col., etc....		\$.29
3/8"x.025x10', marine ends, Hein. Col., etc....		\$.27
5/8"x.020x9', marine ends.....		\$.21
1/2"x.020x9', marine ends.....		\$.18
Victor Gov. springs, No. 1729.....	per 100	\$.95
Victor Gov. spring screws, No. 3304.....	per 100	\$.92
Victor Gov. halls, n/style, No. 3302.....	each	\$.07
Victor Gov. spring screw washer.....	per 100	\$.72
Columbia Gov. springs, No. 3510.....	per 100	\$.95
Columbia Gov. spring screws, No. 439.....	per 100	\$.92
Columbia Gov. spring screw washers.....	per 100	\$.72
Columbia Gov. ball, lead, flat and spring....		\$.08
Columbia Gov. ball, new style & spring....		\$.08
Turntable felts, all wool, green, 10", round.		\$.15
Turntable felts, all wool, green, 12", round.		\$.18
Terms, 2% cash with order.		

TALKING MACHINE SUPPLY CO., PARK RIDGE, N.J.

MACHINERY WANTED

Valabhdas Runchordas & Co., export, import and manufacturers' agents, located at 70 Apollo Street, Bombay, India, desire to get in touch with manufacturers of machinery listed below. Catalogs should be forwarded together with lowest export prices. Payment is cash in New York.

Complete machinery for manufacturing of Gramophone horns of tin, about 500 a month.

Spraying machinery for painting Gramophone horns and toys.

Machinery for manufacturing Gramophone and sewing needles, on small scale.

Machinery for making Gramophone needle boxes and other such articles from tin.

Printing machinery for above tin boxes.

Complete machinery for manufacturing Gramophone records, about 1,000 a day.

Machinery for cutting mica from 1" to 3" dia.

Wood-working machinery for manufacturing Gramophone cabinets, about 400 to 500 a month.

Paper and Book-Binders' requirements for manufacturing Gramophone record albums.

Clips for albums and handles, locks and all kinds of fittings required in manufacturing Gramophone record albums, record cases, suit cases and such other articles, made of wood, leather, fibre, cardboard, etc.

Prices with samples of Gramophone needles, springs and cabinet fittings of all kinds, required in the manufacture of Gramophone cabinets. Valabhdas Runchordas & Co., 70 Apollo Street, Bombay, Ind.

FOR SALE

Talking machine needles. Extra loud, loud and half tone. Lots of 100M or more 30cM. Lots of less than 100M 33cM. Address The Outlet Co., Victrola Store, Providence, R. I.

FOR SALE

General music and stationery store in good Wisconsin city of 5,000; main street corner; \$5,300 stock of pianos, phonographs, music rolls, records, violins, etc.; exclusive Victor agency; doing good business and prospects still better. Address "Box 1192," care The Talking Machine World, 373 Fourth Ave., New York.

To Close Out

900 CABINETS AND COMPLETE PHONOGRAPHS

Many styles and sizes
Large or small lots

Linerphone Talking Machine Co.

316 Union Pk. Ct., Chicago, Ill.

I WILL BUY

Recording Equipment for recording and making records. Recording machine, plating outfit, presses, etc. State full particulars, price, where material may be seen.

MEN

Also want to hear from men experienced in all branches of recording and record manufacture.

IDEAS

Particularly want to hear from those who have new ideas, process, or methods, provided you can produce results. Address "Box 1198," care The Talking Machine World, 373 Fourth Ave., New York, N. Y.

SALESMEN WANTED

We are seeking high grade and capable salesmen on a substantial commission basis to carry a non-competitive phonograph item that sells without difficulty. Men covering New York, Eastern Pennsylvania, New Jersey and Maryland will find it to their interest to communicate with us giving detailed information and connections. Address "Box 1187," care The Talking Machine World, 373 Fourth Ave., New York, N. Y.

PORTABLE PHONOGRAPH

An opportunity to acquire a going manufacturing concern making one of the best Portable talking machines. Address "Box 1200," care The Talking Machine World, 373 Fourth Ave., New York, N. Y.

FOR SALE

Magnavox with battery, conductor wire, rectified, complete. Will increase your record sales volume 100%. Cost \$200.00. Will sell half price. Address City Furniture Co., 6156 S. Halsted St., Chicago, Ill.

FOR SALE

Lateral cut recording machine, latest design with all tools and accessories. Address "Box 1201," care The Talking Machine World, 373 Fourth Ave., New York, N. Y.

FOR SALE

Music House, well established, prominently located in prosperous, substantial Eastern Pennsylvania city. Agency popular makes phonographs and pianos. Modern equipment of best quality. Price reasonable. Address "Box 1194," care The Talking Machine World, 373 Fourth Ave., New York, N. Y.

MOTORS FOR SALE

100 cast iron motors complete with 12" turntables, one piece handles, graduated regulators, under brake, fibre back escutcheon and screws and washers. This motor will play 5-10" records. Address "Box 1195," care The Talking Machine World, 373 Fourth Ave., New York, N. Y.

POSITION WANTED—Young man expert mechanic and salesman on all makes of phonographs and also radio wishes steady position anywhere. Address "Box 1199," care The Talking Machine World, 373 Fourth Ave., New York, N. Y.

(See opposite page for other classified ads)



EUROPEAN HEADQUARTERS

2 GRESHAM BLDG., BASINGHALL ST., E.C. LONDON.

W. LIONEL STURDY, MANAGER

Economic Conditions Show a Continuous Betterment Toward the Goal of Trade Prosperity—Review of Radio Conditions in Great Britain—Freight Decision on Records—Wireless Club to Organize—Billings Long-playing Record—"His Master's Voice" Salesmanship Course—Interesting Patent News—Origin of Goods Must Hereafter Be Certified—New Gramophone Needle—News of Month

LONDON, ENGLAND, September 7.—Economic conditions continue to show a slight improvement and each month is registered an advance towards that goal of trade prosperity which is the inspiration of human endeavor. Recovery to something like normalcy may be a slow process and it is possible the much-predicted golden boom in trade will this season pass us by. That trade will buck up considerably, however, is a foregone conclusion. Far-seeing men are not looking to be rushed off their feet, so to speak, but their expectations rightly incline to the belief in a steady progress that will react favorably on the semi-luxury industries, of which the gramophone is a typical example. Around the trade, it is true, opinions vary somewhat. Certain members' views, I think, are to an extent colored by the present quietness. But this is generic to all industries, more or less, and is appropriate to this period when so much business is held up owing to holiday making. That passing phase begets inactivity. It is about over now and we shall see a big leap forward within the next few weeks. As a fact I know that manufacturers have placed substantial orders with supply houses whose present

output capacity is being pushed to its utmost. The record trade, too, shows good signs of a forward movement. Dealers, perhaps, are ordering a little slowly as yet, but though not overlarge in bulk calls are more frequent—a sign that the public has commenced to buy. That is the foundation movement upon which rests the satisfaction of dealer, factor and manufacturer. Let us all do our best by every means possible to keep it going.

The Gramophone Dealer "Listens In"

Without a doubt the retailer of gramophones means to handle a fair share of the new radio business. And in this he is encouraged by the wireless manufacturers, who, I think, fully realize the importance of utilizing the well-established distributing channel represented by the great army of music dealers throughout the country. Gramophone factors and manufacturers in increasing numbers are planning to feature wireless receiving sets; already about a dozen such firms have actually marketed either crystal or valve, or both types. The whole business, however, is in a state of suspended animation pending the equipment of broadcasting stations (there are only two or three private ones in occasional use at present) and completion of arrangements for the issue of licenses to manufacture. Foreign instruments are barred for two years. A license to manufacture will only be issued after inquiry as to the bona fides of applicants who must guarantee their goods as of British manufacture throughout. Taking a leaf out of the American book of experience, our government means to control service and output through the medium of a so-called com-

mittee of the chief manufacturers. Herein, of course, is scope for abuse of privileges and already there is an outcry suggestive of the establishment of monopoly. As to that, we shall see when the control plans are published. Nobody knows how things stand at the moment except that the whole development of radio is in the air. I write this at a time when there is every anticipation of an early official statement upon the subject. The postmaster-general is ready to approve and authorize plans upon receipt of the memoranda and articles of association of the new Broadcasting Co. And it is almost certain that by the time these lines are published the firms included or interested in the Broadcasting Co. will have agreed on a complete scheme and probably started their service. The Marconi people have already fixed up with some of the leading artists.

Freighting of Gramophone Records

The judgment given by the Railway Rates Tribunal applicable to the carriage of gramophone discs restores the conditions prevalent in 1916. The evidence showed that parcels of records average about twenty-five pounds and travel up to 200 miles for 3s. 10d. under the full parcels scale rate. On owner's risk conditions the rate would be 2s. 1d. The 1916 conditions which now apply provide that when "properly" packed records will be carried at the full parcels scale, company's risk; when not properly packed, they will be carried at owner's risk. Packing to be proper must conform to certain reasonable regulations laid down.

An Industries Fair at Utrecht

In the permanent Fair Building at Vreden-



"His Master's Voice"

Copyright

This intensely human picture stands for all that is best in music

—it is the "His Master's Voice" trade-mark, and it brings to you, no matter where you are, the very best music of every kind, sung and played by the world's greatest artists—the greatest singers, pianists, violinists, orchestras and bands—all enshrined in the unequalled "His Master's Voice" records

'His Master's Voice'

—the trade-mark that is recognized throughout the world as the

HALL-MARK OF QUALITY

DENMARK: Skandinavisk Grammophon-Aktielselskab, Frihavnen, Copenhagen.

FRANCE: Cie. Française du Gramophone, 115 Boulevard Richard Lenoir, Place de la République, Paris.

SPAIN: Compañía del Gramófono, 56-58 Balmes, Barcelona.

SWEDEN: Skandinaviska Grammophon-Aktiebolaget, Drottning Gatan No. 47, Stockholm.

RUSSIA: The Gramophone Co., Ltd., 45, Nevsky Prospect, Petrograd (Petersburg); No. 1 Solyanka, Solyanoi Dvor, Moscow; 9, Golovinsky Prospect, Tiflis; Nowy-Swiat 30, Warsaw; 11 Michailovskaya Ulitsa, Baku.

INDIA: The Gramophone Co., Ltd., 139, Bal-
lughatta Road, Calcutta; 7, Bell Lane, Fort,
Bombay.

Great Britain:

The Gramophone Company, Ltd.

HAYES - MIDDLESEX - ENGLAND

AUSTRALIA: S. Hoffnung & Co., Ltd., Sole Concessionaries of The Gramophone Company, Limited, 163, Pitt Street, Sydney.

NEW ZEALAND: Gramophonium, Ltd., 118-120 Victoria Street, Wellington.

SOUTH AFRICA: Darter & Sons, Post Box 174, Capetown; Mackay Bros., Post Box 251, Johannesburg; Mackay Bros. & McMahon, Post Box 419, Durban; Ivan H. Haarburger, Post Box 105, Bloemfontein; Frans Moeller, Post Box 108, East London; B. J. Ewins & Co., Post Box 86, Queens-town; Handel House, Kimberley; Laurence & Cope, Post Box 182, Bulawayo; The Argus Co., Salisbury.

EAST AFRICA: Bayley & Co., Lourenço Marques.

HOLLAND: American Import Co., 22a, Amsterd-
veerkade, The Hague.

ITALY: A. Bossi & Co., Via Orfèci 2, Milan.

EGYPT (Also for the Sudan, Greece and the Ottoman Empire): K. Fr. Vogel, Post Box 414, Alexandria.

FROM OUR LONDON HEADQUARTERS—(Continued from page 154)

burg square, Utrecht, the seventh annual exhibition of goods of all descriptions and nationality will open September 4. There is to be a musical instrument section and, though a good attempt has been made to interest British manufacturers, the response so far has proved very disappointing to the London agents of the Fair promoters.

Wireless Clubs for Amateurs

With the completion of broadcasting arrangements near at hand a great speeding up of interest in wireless science is bound to follow. Amateurs all over the country will want to get together and discuss problems and initiate schemes for local experiments. Already about a hundred clubs or societies are at work in different parts of the country and by all reports an amazing development of this movement is under way.

When the private gramophone societies began to get busy people were astounded that there could be found so many enthusiasts willing to devote an evening per week listening to or criticizing records. As the movement spread a development of the original idea naturally followed, until to-day we find these societies are of real technical value in the advancement of the science of sound and its reproduction. At first regarded as of no importance, gramophone manufacturers are now only too glad to demonstrate their instruments or records before such critical audiences as the societies and to invite judgment.

Broadcasting opens up another useful avenue of self-seeking enlightenment and pleasure for gramophone societies. Existing clubs are therefore making arrangements to devote part time at present for discussion and interchange of opinions anent radiophony in general and its application to the gramophone. In one case brought to my notice the question has been raised for consideration that the title of the society be revised to incorporate the word wireless or broadcasting. This practical interest is all to the good of the new science of wireless.

Pemberton Billing's Long-playing Record

World Record, Ltd., is the name of the company formed to exploit the remarkable invention of Pemberton Billing, who is managing director of the new concern. Those who have seen and heard this wonderful long-playing record, with the device for speed control, are enthusiastic as to the prospects of the company's undertaking. I am informed that a factory at Mortlake has been equipped and a start made in the recording of a first batch of records comprising about 150 titles covering all phases of vocal and instrumental music. All the records will be of twelve-inch size, single-sided. If occasion necessitates the company is prepared to issue double-sided disks, but it is not anticipated that the need will arise as up to twenty minutes of music can be recorded on one side of these records.

Queried as to price, Mr. Hughes, sales man-

ager, informed me that three grades of records will be marketed. Prices will figure at 5s., 7s. 6d. and 10s. 6d. each retail, being determined according to class and reputation of the artist or instrumental organization. Plans are under way for a big sales campaign early in October.

The controller device by means of which the turntable is regulated to run at an even but sufficiently slow speed to play these records will retail at £1 19s. 6d. This controller operates on any kind of gramophone.

Brief Trade Paragraphs of Interest

The "Oranola" gramophone, which is now before the American public, has been revived here by the Musical Instruments Development Co. Capt. Bailey, the inventor, tells me that he has evolved several new models of unique design ranging in price from 10 to 75 guineas. Within the near future, I understand, Capt. Bailey will revisit New York.

The popular advertising manager of "His Master's Voice," V. S. Homewood, has entered the realm of matrimony. He first met his charming bride, Miss Lilian Bowers, at the Hayes office of the company. The marriage took place on July 22 and a big reception was afterwards held at the Hayes Council school. Hearty congratulations!

Tungs-tone needles eliminate a deal of trouble. Judging by the big demand for "His Master's Voice" brand the public appreciates this. The recently introduced loud-tone needle has met with a wonderfully good reception.

The Federation of British Music Industries draws attention to Iceland as a likely market for British musical goods. The present demand is mainly for gramophones and small musical instruments. British manufacturers may be expected to revise their guarantees "to withstand hot climates" to "hot, medium or cold."

The Board of Trade Journal contains particulars of a ruling of the Fiji Commissioners of Customs that the rates of duty on gramophone records are 15 per cent ad valorem British Preferential tariff and 27½ per cent general tariff.

On July 24 the registered unemployed numbered 1,362,300, nearly 7,000 less than the preceding week and over 461,000 less than at January last. All good for trade!

Australia now takes German goods. A consignment of musical instruments was unloaded at Sydney in July.

The "His Master's Voice" Salesmanship Course

In connection with the above, it is stated that classes are filling up well ahead. There is an opportunity now for dealers to take a course before the busy season commences. It is part of the company's free service to their agents and those who have attended the school—the number runs well into three figures—speak appreciatively of the knowledge gained and its sales value. These dealers can actually trace results. One big London dealer whom I always

thought of as a highly successful salesman told me that he attended "His Master's Voice" class somewhat out of curiosity. He quickly realized that he had a lot to learn and having completed the course can now speak in terms of unqualified praise of its sales value. The Gramophone Co. stands alone as a pioneer of this unique scheme and the more who take advantage of it the more will its sales influence be felt during the coming season.

Origin of Goods Now to Be Certified

In exercise of the powers conferred by the Safeguarding of Industries Act, the Board of Trade now directs that certificates of origin be required, so far as concerns the classes of goods covered by the act, in the case of goods consigned from all foreign countries in Europe. The necessary instructions have been issued to H. M. consular officers abroad and the form of certificate of origin prescribed by the Board of Trade can be seen on application to any customs and excise office.

Important Report Anent Empire Patents

Of considerable interest to gramophone traders and inventors is the report of a conference of representatives of the Patent Offices of the British Dominions. It was held to consider the practicability of instituting a system of granting patents which should be valid throughout the British Empire. The conference agreed as desirable the granting of patents which would be operative throughout the Empire, provided that it in no way affected the autonomy of the Dominions and India, or the rights and facilities which an inventor at present enjoys in those countries. With this object they decided on a scheme for the establishment of a central office for the reception and examination of applications for, and the granting of, patents. Until it should be possible to introduce the full scheme decided upon, a simply worked provisional scheme was adopted. Copies of the full report may be obtained from H. M. Stationery Office, London, at the price of one shilling and a penny.

Record Reviews by Post

In connection with the Federation's newspaper propaganda "the committee adopted the organizing director's proposal to offer regular reviews of new gramophone records to newspapers not already publishing such reviews." This very important statement is conveyed through the medium of the Federation Journal, August issue. The value of the idea lies in the fact that quite a large number of provincial newspapers are run by hard-worked men who could find little or no time adequately to review records, given that they had the opportunity so to do. As a matter of fact it is obviously out of the question to supply sets of records to every paper, unless done by enterprising local dealers. All things considered, therefore, it is highly probable that editors of the smaller class of newspapers, of which there

(Continued on page 156)

EDISON BELL



WINNER

GRAMOPHONE RECORDS

CABLE
 "PHONOKINO,
 LONDON"

ARE THE GREATEST VALUE FOR MONEY PRODUCED IN GREAT BRITAIN

TEN INCH DOUBLE SIDED NEEDLE CUT

PLAY ON ALL GRAMOPHONES

Catalogue contains 4000 Titles by the Premier Artistes, Instrumentalists, Orchestras and Bands of the British Empire

DEALERS PREPARED TO DO BUSINESS ARE INVITED TO COMMUNICATE WITH

Proprietors and Manufacturers, J. E. HOUGH, Ltd., 62 Glengall Road, London, S. E. 15, England

FROM OUR LONDON HEADQUARTERS—(Continued from page 154)

**Horn, Hornless and Table-Grand
GRAMOPHONES**
FOR
EXPORT
Please State Your Requirements
**REX GRAMOPHONE CO. 2 Elizabeth Place
Rivington Street, LONDON, E.C. 2, England**
Cable Address "Lyreodisc, London"

are about one thousand, would welcome the offer as representing a popular musical news service, just as they do the cut-and-dried political and other news services (for which a charge is made) from the various news associations. While the proposed record review service will doubtless interest a number of newspapers, it is as well to face the probability that the more influential journals, who employ their own musical critics, would scarcely accept reviews representing an outside opinion. They must be approached in another way. Some of these newspapers already give occasional space to the review of records, and in these instances the reviews are the work of the journal's musical

IMPORTANT RADIO INSTALLATIONS

Radio Corp. of America Equips Central America Station—Also Secures Important Order From the Government of Sweden

The Radio Corp. of America announced recently that it has received orders from the United Fruit Co. and the Tropical Radio Telegraph Co. for five radio sets; three for Central America and two for the United States, each one having a sending radius of more than 2,000 miles. The three Central America stations will be located on the corners of the triangle embracing Honduras, Nicaragua and Panama. The United States terminals of this communicating system will be at New Orleans, La., where the present station of the Tropical Radio Telegraph Co. will be enlarged, and at a new station which this company will erect near Miami, Fla.

Competing with English, French and Germans, the Americans were successful, according to a message received recently from E. F. W. Alexanderson, chief engineer of the Radio Corp. of America, in securing a contract with the Swedish Government for furnishing apparatus for a nine-power radio station to handle two wireless communications between the United States and Sweden. The total cost of the station erected will probably be over \$2,000,000.

The Sampaio Correia seaplane, which hopped off from New York August 16 on its attempted flight to Brazil, was equipped with a radio receiving set by the Radio Corp. of America. This set was capable of picking up stations within a radius of 500 miles and Lieut. Walter Hinton, pilot, who understands the radio code, used the receiving set to splendid advantage during the course of the trip.

critic, who receives the records direct from the manufacturing firm. Dealers will doubtless know how to profit by the scheme when it is in full swing.

Trade Treaty Between Britain and Spain

It is officially stated that arrangements are under sanction whereby all goods of United Kingdom origin will be entitled to the preferential rates of the Spanish customs tariff which might be granted by Spain to the goods of any other country.

A Wooden Gramophone Needle

From a Liverpool firm comes news of the manufacture and marketing of a new shape wooden or fiber needle which is said to give excellent results. I have tried the natural thorn and found it highly successful as a means of reproduction. The Puratone needle, as it is called, reminds one somewhat of a thorn and, though shorter, it is similar in its fine taper. Each needle is good for about twenty times, given careful handling. A special holder is necessary and this with two dozen needles retails at thirty pence. Fiber or wooden needles find an increasing appreciation with the British public.

HAS HAD AN INTERESTING CAREER

Simon H. Galperin, Music Dealer, of Charleston, W. Va., an Energetic Business Man

A recent issue of the Weekly Roar, the official organ of the Lions Club, of Charleston, W. Va., contained a very interesting story regarding the career of Simon H. Galperin, head of the Galperin Music Shop, 21 Capital street, Charleston.

Mr. Galperin was born in Russia in 1894 and came to Charleston in 1907, where he received his public school education, later going to a commercial college and finally to a technical school. Up to the time of the war he was engaged in the jewelry business with his brother. He enlisted in the army for service during the World War and, upon his discharge, opened his music shop, carrying pianos, Columbia Grafonolas, musical merchandise and practically all musical goods.

Mr. Galperin has met with much success in his business interests and also takes an active interest in the social and civic happenings of the growing city in which he resides.

G. D. SHEWELL AS A COMPOSER

PHILADELPHIA, Pa., September 6.—G. D. Shewell, president of the Cheney Sales Corp., of this city, has, in addition to his powers as executive and salesman, an accomplishment as a musician. Among recent releases of the Ampico music roll, produced by the American Piano Co., is a selection entitled "The Dance of the Popinjays," a classical piano solo composed by G. D. Shewell. It is a masterly composition which will win favor.

NEW CERTIFICATE

The accompanying illustration shows the new certificate which is now furnished to all authorized Sonora dealers. The size of this certificate, 11 inches by 15 inches, is suitable for framing, and Sonora dealers throughout the country will undoubtedly display this certificate prominently, as it is handsomely engraved. A new certificate is issued each year, and Sonora dealers have found that these certificates are important factors in building up customer confidence.

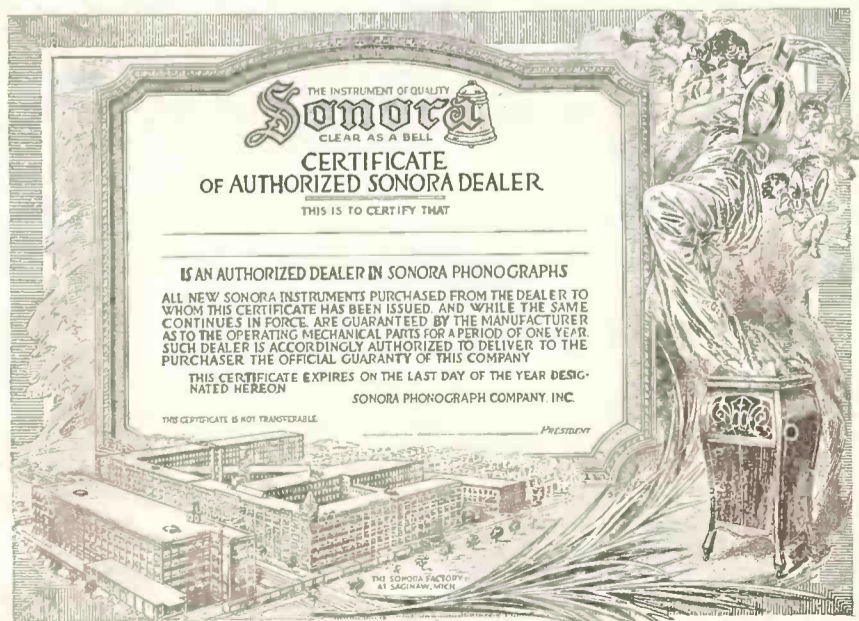

MANY ORDERS FOR UNITED MOTORS

CHICAGO, Ill., September 9.—The demand for talking machine motors manufactured by the United Mfg. & Distributing Co., Lake Shore Building, this city, has increased to such an extent that the company's factory is running to capacity. The demand for these motors is nation-wide and many large orders are being received, including a carload order from a concern in Saginaw, Mich.

JUST CAUSE FOR OPTIMISM

Thomas Kirkman, president of the Kirkman Engineering Corp., reports that orders received during the past month give just cause for optimism regarding Fall business. Increased orders are being received for both the K-E stop and record cleaners in substantial quantities.



**Where Dealers May Secure
COLUMBIA
Product**

Ready, Full Stocks, and Prompt Deliveries from Convenient Shipping Centers all over the United States.

Distributors

- Atlanta, Ga., Columbia Graphophone Co., 561-563 Whitehall St.
 - Baltimore, Md., Columbia Graphophone Co., 16 South Howard St.
 - Boston, Columbia Graphophone Co., 1000 Washington St.
 - Buffalo, N. Y., Columbia Graphophone Co., 737 Main St.
 - Chicago, Ill., Columbia Graphophone Co., 325 W. Jackson Blvd.
 - Cincinnati, O., Columbia Graphophone Co., 317-321 East 8th Street.
 - Cleveland, O., Columbia Graphophone Co., 1812 East 30th St.
 - Dallas, Tex., Columbia Graphophone Co., 816 North Preston St.
 - Denver, Colo., Columbia Stores Co., 1608 Glenarm Ave.
 - Detroit, Mich., Columbia Graphophone Co., 115 State St.
 - Kansas City, Mo., Columbia Graphophone Co., 2006 Wyandotte St.
 - Los Angeles, Cal., Columbia Graphophone Co., 809 S. Los Angeles St.
 - Minneapolis, Minn., Columbia Graphophone Co., 18 N. 3rd St.
 - New Orleans, La., Columbia Graphophone Co., 517-525 Canal St.
 - New York City, Columbia Graphophone Co., 121 West 20th St.
 - Omaha, Neb., Columbia Graphophone Co., Eighth and Jackson Sts.
 - Philadelphia, Pa., Columbia Graphophone Co., 40 N. 6th St.
 - Pittsburgh, Columbia Graphophone Co., 632-640 Duquesne Way.
 - Salt Lake City, Utah, Columbia Stores Co., 221 South West Temple.
 - San Francisco, Cal., Columbia Graphophone Co., 345 Bryant St.
 - Seattle, Wash., Columbia Graphophone Co., 911 Western Ave.
 - Spokane, Wash., Columbia Stores Co., 161 South Post St.
 - St. Louis, Mo., Columbia Graphophone Co., 1127 Pine St.
 - Tampa, Fla., Tampa Hardware Co.
- Headquarters for Canada:
 Toronto, Ont., Columbia Graphophone Co., 347 West Adelaide St.
 Montreal, Que., Columbia Graphophone Co., 824 St. Denis St.

Executive Office
COLUMBIA GRAPHOPHONE CO.
 Gotham National Bank Building New York

LATEST PATENTS RELATING TO TALKING MACHINES AND RECORDS

WASHINGTON, D. C., September 8.—Phonograph. Carl J. Pearson and Sigrid L. M. Pearson, Chicago, Ill. Patent No. 1,419,514.

This invention relates to sound-producing instruments, particularly to those which are used for musical purposes, and it has for its object the improvement of the tones produced by the talking machine. One of the methods by which the tone is improved, provided by the invention, is by the use of means for cleaning the groove of the record as the instrument is in use, and at the same time for lubricating the groove in a suitable manner, so as to reduce to a minimum the roughness of the groove and the friction of the needle therein.

Another object of the invention is to provide a horn or trumpet on each side of the sound box, so that the sound may not only be passed downwardly into the casing of the phonograph in an ordinary manner, but may also be passed directly cut from the sound box. A further object of the invention is to improve the horn by means of its shape, by suitable shutters and otherwise, and particularly by the introduction in an improved manner of suitable framework supporting properly tuned strings or wires. Other objects of the invention will be apparent from a consideration of the accompanying drawings and the following description thereof.

Of the drawings Figure 1 is a vertical sectional view of a phonograph embodying the features of the invention. Fig. 2 is a fragmental elevation of

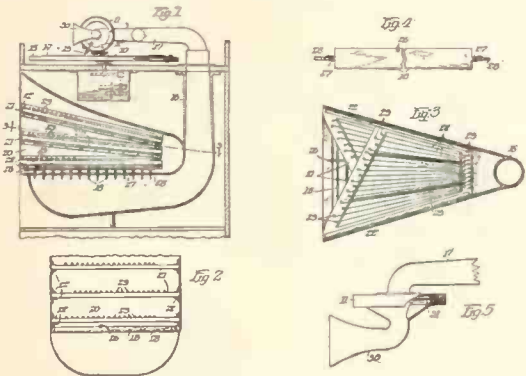

the front portion of the horn. Fig. 3 is a sectional view along the line 3—3 of Fig. 1. Fig. 4 is an elevation of a shutter used in connection with the horn, and Fig. 5 is a plan view of an additional trumpet which we provide.

Phonographic Sound Box. Wesley E. C. Lau, Klemme, Iowa. Patent No. 1,419,505. The general object of the invention is to provide a sound box wherein the stylus arm is not pivotally mounted upon the sound box, but is itself mounted upon a somewhat flexible support, which has a central opening, through which one end of the stylus-carrying arm projects, this end or extremity of the stylus-carrying arm being attached to the diaphragm to thus provide a mount for a stylus-carrying arm in which there are no bearings to wear, thus transmitting the record

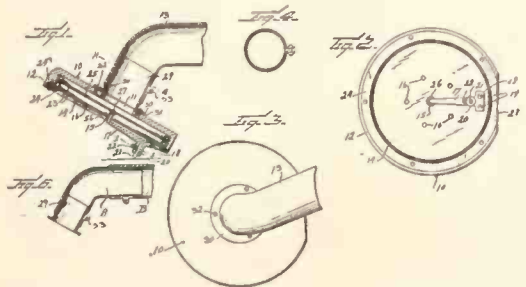

groove impulse directly to the diaphragm without its being transmitted through a bearing.

And a further object of the invention is to so mount the stylus-carrying arm or member that it is fully insulated from the body of the sound box, so as not to transmit vibrations thereto.

Figure 1 is a diametrical section through a sound box constructed in accordance with the invention, and through the tone arm connected therewith; Fig. 2 is a face view of the sound

box; Fig. 3 is a rear elevation thereof; Fig. 4 is a section on the line 4—4 of Fig. 1; Fig. 5 is a section on the line 5—5 of Fig. 1; Fig. 6 is a longitudinal sectional view through the joint between the tone arm proper and the neck of the sound box.

Sound Box for Talking Machines. James C. Drake, Rochester, Minn., assignor to Sears, Roebuck & Co., New York. Patent No. 1,419,238.

This invention relates to sound boxes for talking machines. It has for its objects to enable the parts to be assembled from the back instead of from the front, as in present practice, thus gaining certain advantages in manufacture without sacrificing tone quality; to enable the outside rim to be made of a metal that will take plating better than the die-cast material heretofore employed in practice.

These objects are attained by making the back of the box of solid metal carrying the coupling member to attach it to the tone arm, with a groove on its inner face to receive the rubber tubular gasket usually employed, and the front of the box of a ring having a similar groove on its inner face to receive a second rubber gasket, the diaphragm lying between these gaskets when the back and face are placed together. Both the back and the front around the grooves referred to have internal projections which alternate around the peripherics, so that they intermesh and interlock when the parts are assembled, and during assembling retain the rubber gaskets in position, thus curing a trouble now existent of falling out of a percentage of gaskets. By this device alone the number of boxes assembled by one person is increased approximately 25 per cent, or from 100 to 125 per day.

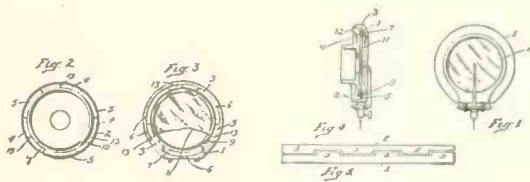
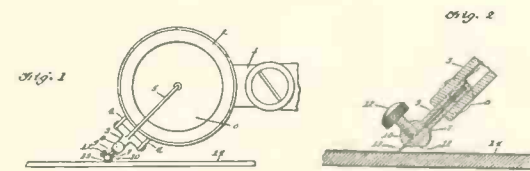

Figure 1 is a front view of the box assembled; Fig. 2 is an inside view of the back ready for assembling; Fig. 3 is a similar view of the front, and Fig. 4 is a sectional view on a vertical line approximately diametral. Fig. 5 is a diagram showing the development in a plane surface of the ring of intermeshing segments 3—3—3, 5—5—5.

Phonograph Needle and Holder Structure. Malvern W. Severance, Cleveland, O. Patent No. 1,418,478.

This invention relates to the needle and needle holder for phonographs. More specifically, the invention relates to those types or makes of phonographs the sound box mechanism of which includes a sound box secured to the tone arm, a needle receiving member or socket connected to said sound box, and a lever arm connecting said needle socket with the diaphragm of the sound box.

In the drawings Figure 1 is a side elevation showing the sound reproducer of an ordinary



phonograph, with the needle and holder secured thereto, the needle being in playing position upon a record, and Fig. 2 is an enlarged longitudinal section of the needle and holder.

Phonograph Record Holder. Philip Morgan, Lindsay, Ontario, Canada. Patent No. 1,409,392.

The principal objects of this invention are: to facilitate the handling of phonograph records

and to provide a form of holder which will keep the records in good condition and enable their being handled with ease and without danger of marring same.

A still further object is to devise a holder which will have an extraordinary storage capacity for records.

The principal feature of the invention consists in the arrangement of a plurality of arms upon a

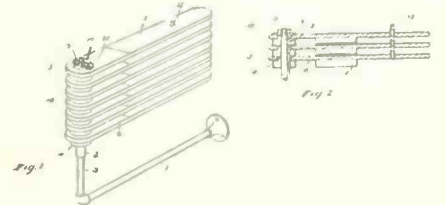

pivotal support, said arms being adapted to carry the records and to be swung upon the support independently the one of the other.

In the drawings, Figure 1 is a perspective view of the improved record holder; Fig. 2 is an enlarged vertical elevational sectional view through a portion of the device.

Phonograph.—Ray H. Manson, Elyria, O., assignor to the General Phonograph Mfg. Co., same place. Patent No. 1,419,938.

This invention relates to phonographs and more particularly to sound boxes and sound-conducting arms, the objects of the invention being to increase the efficiency of such devices and to provide devices which can be more conveniently and cheaply made than those at present in use.

Other objects of the invention and the invention itself will probably be better under-

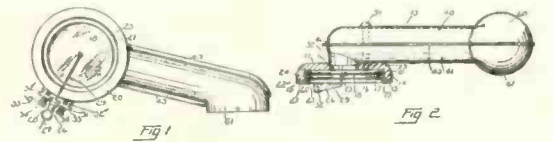

stood from a description of an embodiment of the invention.

Figure 1 is a front elevation of an embodiment of the invention; Fig. 2 is a plan view showing the sound box in section.

Sound Recording Process.—Aloysius J. Cawley, Pittston, Pa. Patent No. 1,420,304.

This invention relates generally to sound recording; more particularly it involves a process whereby sound is recorded upon a celluloid or similar film mechanically. A sound record groove may be impressed in a moving picture film as it passes through the camera, thus rendering it possible to record motion and sound, including articulate speech, simultaneously on the same medium.

By this process the film is for all intents and purposes a wax-like substance only during the actual time of recording and only at the precise place on the film where the sound is to be recorded. Just as soon as the record is impressed in the medium the latter immediately becomes hard and tough, precluding any possibility of damage to it. A master record can thus be produced directly on the margin of a motion picture film, from which a metallic or other matrix may be made.

Figure 1 is a view of the heating device in contact with a celluloid film, together with the sound recorder; Fig. 2 is an elevational view of a plurality of such devices, each independently heated; Fig. 3 is an elevational view of a heating device combined with an auxiliary temperature controller; Fig. 4 is a sectional view of three different types of heating device; Fig. 5a is a sectional view of a heating device in contact with the film on its sprocket wheel; Fig. 5b is a plan view of the heating strip in contact with the margin of the film; Fig. 5c is a plan view of a modified form of the heating

(Continued on page 158)

PATENTS RELATING TO TALKING MACHINES AND RECORDS—(Continued from page 157)

strip; Fig. 6 is an elevation view of a liquid heating device; Fig. 7a is an elevational view of a device intended to remove the film from con-

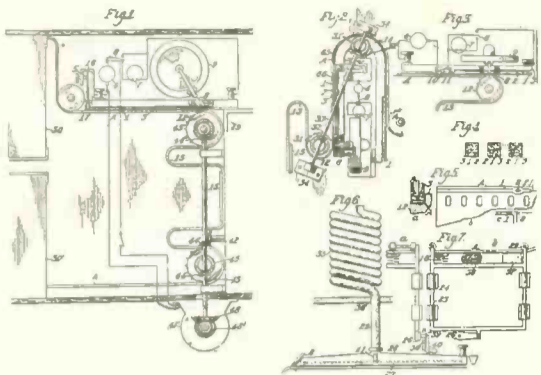

tact with heat strip; Fig. 7b is a side elevational view of the same device.

Device for Raising and Supporting Covers.—Frank A. Spencer, West Orange, N. J. Patent No. 1,420,347.

This invention relates to an improved device for lifting and supporting in lifted position a cover on receptacles, and is particularly adapted for the covers of phonographs.

The invention is designed to provide a device of this kind in which the cover, when released in its closed position, will be raised without shock, the lifting mechanism being so arranged that the initial movement of the cover, which is the hardest to perform, gives way to a less pressure as the cover rises, so that it stops gently and without shock.

The invention is illustrated in the accompanying drawing, in which Figure 1 is a section of a portion of a phonograph case with

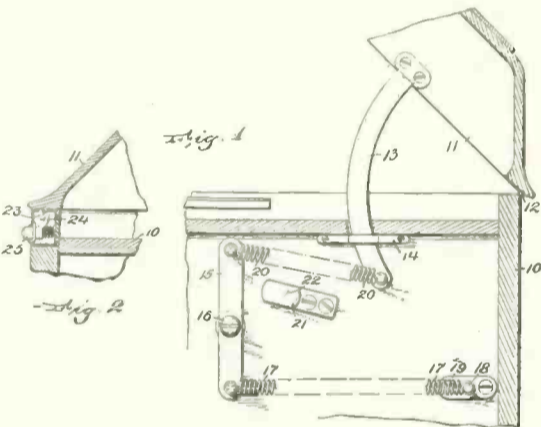

the raising and supporting device shown in elevation, and Fig. 2 is a sectional view showing a means for holding the cover down.

Phonograph Reproducer.—Burr B. Blood, Chicago, Ill., assignor to the Jewel Phonoparts Co., same place. Patent No. 1,419,913.

This invention relates to sound reproducers for phonographs and has for its object the provision of a construction wherein the stylus-bar is provided with a cross-head so formed that a proper pivotal mounting of the stylus-bar on the shell or casing may be provided, which enables all vibrations encountered by the stylus or needle to be thoroughly imparted to the flexible or mica diaphragm of the reproducer, without, however, permitting undue or improper vibration of the stylus-bar, the construction enabling a reproduction of sounds in greater volume and without loss in the tone quality.

The object of the invention, as well as its advantages, will be more fully comprehended

from the following detailed description of the drawing, wherein:

Figure 1 is a front elevation of the improved reproducer with a portion of the tone arm to which it is secured; Fig. 2 is a side elevation of

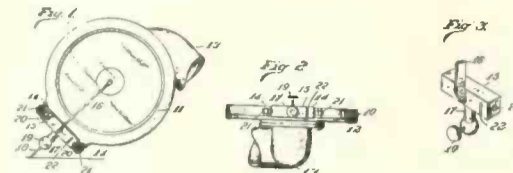

the reproducer, looking at the stylus receiving socket of the stylus-bar; Fig. 3 is a detail perspective view of the cross-head of the improved stylus-bar.

Process for Recording Sound Records.—Henry L. Wadsworth, Lexington, Mass., assignor to the Metal Recording Disc Co., Inc., New York. Patent No. 1,421,045.

This invention relates to talking machine records or tablets, and its object is to provide a novel and improved tablet and process of making the same. The invention has particular reference to a record having the laterally cut groove, so called, but is not confined to that type.

Picture - display Attachment for Phonographs.—Thomas D. Jones and John H. Barr, Kansas City, Mo. Patent No. 1,420,928.

This invention relates to electrical time mechanism for picture-display attachment for phonographs, and has for its object to produce mechanisms for infallibly synchronizing the display of pictures illustrative of particular words of a phonograph record, with the reproduction of such words by the phonograph. A further object is to produce attachments of the character referred to, which can be applied to any of the approved types of phonographs at small expense, so as to be within the means of private users as well as exhibitors catering to the public in theatres and the like.

A still further object is to provide mechanism for enabling the owner of a phonograph and electrically operated picture-projecting mechanism or apparatus to produce an electric switch for any record, which will make and break the electric circuit controlling the operation of the picture-projecting apparatus at the exact moment desired for flashing a picture on a screen illustrative of particular words reproduced from the record.

In order that this invention may be fully understood reference is to be had to the accompanying drawings in which:

Figure 1 is a fragmentary plan view of a phonograph provided with electric time mechanism embodying the invention; Fig. 2 is a sec-

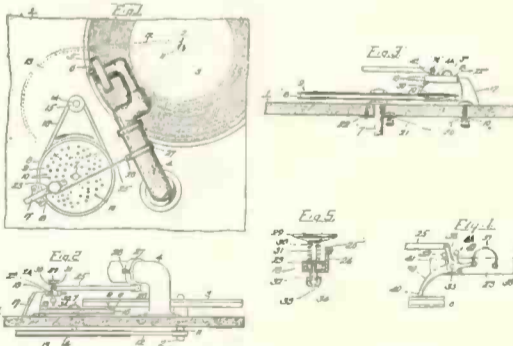

tion taken through the tone arm support to disclose the tone arm, the phonograph record and the timing mechanism in elevation; Fig. 3 is a section taken through the support for the tone arm, in the vertical plane of the axis of the rotary element of the timing mechanism; Fig. 4 is an enlarged detail illustrating certain features of construction of the timing mechanism, and Fig. 5 is an enlarged vertical section of part of the timing mechanism.

Sound Amplifier.—Walter F. Luhnnow, Oak Park, Ill. Patent No. 1,420,719.

This invention relates to means for modulating and amplifying sound, as, for instance, in sound-recording devices and especially in phonographs. It follows in a large measure the lines of co-pending applications, Serial No. 349,-

444, filed January 5, 1920, and Serial No. 357,300, filed February 9, 1920, but is distinct therefrom, particularly respecting the structure of the amplifying chamber or horn.

The main objects of the invention are to provide for enriching the tones to be recorded or reproduced; to provide amplifying means of improved form in connection with sound recorders and reproducers to selectively pick up and amplify the tones and qualities desired, and to provide such a device adapted for use in various forms in combination with a recorder or reproducer, either in a cabinet or, if so desired, apart therefrom.

In the accompanying drawings Figure 1 is a view of a complete phonograph partly in side elevation with the upper part in vertical section through the center from front to back. Fig. 2 is substantially a horizontal section through the branched end of the amplifying chamber on the line 2—2 of Fig. 1. Fig. 3 is an underside view of a modified form of branched amplifying chamber. Fig. 4 is similar to Fig. 3, except as to the form and arrangement of the branches. Fig. 5 is an axial section through a modified

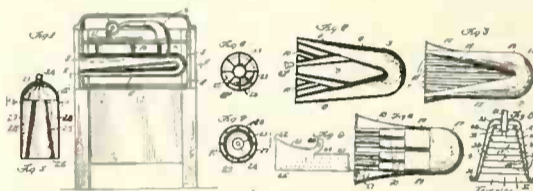

form of amplifying chamber or circular cross-section, with branches distributed about the main axis, and the sound admission tube being connected directly opposite the end of the inner part of the chamber. Fig. 6 is a section on the line 6—6 of Fig. 5. Fig. 7 is a front elevation of the sound discharge end of the amplifying chamber. Fig. 8 is an axial section of a bell-shaped chamber having a stepped inner wall. Fig. 9 is a side elevation of a horn with a medial sound inlet and with open-ended amplifying branches shown in dotted lines.

Phonograph. Peter J. Landin, Denver, Colo. Patent No. 1,422,453.

The object of this invention is to provide a phonograph which has superior means for transmitting the sound vibrations and which is so constructed as to almost entirely eliminate scratching and vibrations from the motor.

In the drawings: Figure 1 is a perspective view showing the complete instrument; Fig. 2 is a vertical section from front to rear through the instrument; Fig. 3 is a side elevation showing the hood and cover lifted. Fig. 4 is a plan with the hood and cover removed; Fig. 5 is an elevation of the amplifier and its tone arm; Fig. 6 is a vertical section through the amplifier and tone arm; Fig. 7 is a plan thereof; Fig. 7a shows

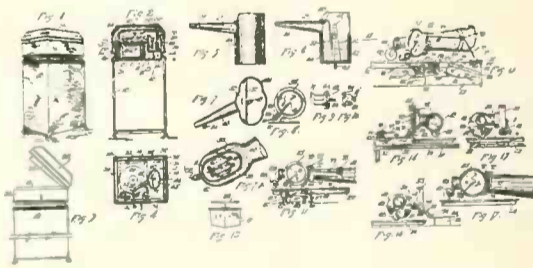

a modified form of tone arm and sound box; Fig. 8 is an elevation of the usual sound box provided with a specific needle holder of the present invention; Fig. 9 is an elevation of said needle holder; Fig. 10 is an end view thereof; Fig. 11 is a fragmentary elevation showing the releasing means for the sound box and the stopping means for the turntable; Fig. 12 is a detail of the motor unit; Fig. 13 is a perspective showing the tone arm, sound box, stopping means and resetting means; Fig. 14 is a view looking in the direction of the arrow 14 of Fig. 13; Fig. 15 is a view looking in the direction of arrow 15 of Fig. 13; Fig. 16 is a view similar to that of Fig. 15, showing said sound box as it is about to engage the resetting means; Fig. 17 is a detail elevation of the releasing means for the sound box.

REPAIRS

All Makes of Talking Machines Repaired Promptly and Efficiently

REPAIR PARTS FOR ALL MACHINES

ANDREW H. DODIN

28 Sixth Avenue

New York

TELEPHONE, SPRING 1194

Advance RECORD BULLETINS for October, 1922

VICTOR TALKING MACHINE CO.

- POPULAR SONGS
18930 My Buddy... Henry Burr
18934 Only a Smile... John Steel
18935 The Dixie Highway... Aileen Stanley
DANCE RECORDS
18931 Don't Bring Me Posies... Benson Orchestra of Chicago
18932 Struttin' at the Strutters' Ball... Zee Conroy and His Orchestra
18933 Why Should I Cry Over You?... The Virginians
18936 Two Little Wooden Shoes... Club Royal Orchestra
VOCAL AND INSTRUMENTAL RECORDS
45325 Little Coon's Prayer... Olive Kline
45323 Becky Is Back in the Ballet... Fanny Brice
I Dream of Jeanie With the Light Brown Hair... Lambert Murphy
RED SEAL RECORDS
88638 Salvator Rosa... Mia Picciarella
GIUSEPPE DE LUCA, Baritone
74744 Hérodiade... Vision Fugitive
MISCHA ELMAN, Violinist
74771 Symphonie Espagnole... Andante (4th Movement)
AMELITA GALLI-CURCI, Soprano
66092 Old Folks at Home... Stephen C. Foster
HANS KINDLER, Violoncellist
66049 Rêverie... Emile Dunkler
ERIKA MORINI, Violinist
66086 Valse Sentimentale... Schubert-Franko
SERGEI RACHMANINOFF, Pianist
66085 Minuet... Bizet-Rachmaninoff
TITTA RUFFO, Baritone
88660 Ernani... O de' verd' anni miei
OLGA SAMAROFF, Pianist
74772 Walküre... Ride of the Valkyries
TITO SCHIPA, Tenor
66077 Manon... Il Sogno
REINALD WERRENATH, Baritone
66087 The Little Shawl of Blue...

COLUMBIA GRAPHOPHONE CO.

- SYMPHONY RECORDS
49931 Muineira... Sarasate
80158 Salut D'Amour... Elgar
A3656 Melody... Dawes
A6218 Prince Igor... Borodin
80351 A Song of the Hills... Jacobs-Bond
A6219 Mignon-Polonoise... Ioson Titania
A3663 Dinorah... Ombra Leggera
A3663 Carry Your Cross With a Smile... Gabriel
A3657 Calvary... Sweney
A3658 Browsy Waters... Waltz
A3671 Come Along... I'm Through With Worryin'
A3672 Silver Stars... Wenrich
Romany Love... Zamecnik
Clover Blossom Blues... Keyes, Erdman, Meinken
A3672 Silver Stars... Wenrich
In Rosetime... Earl

- A3670 Truly... Rose
A3665 Lights and Shadows... Deiro
A3669 Just Like a Violin... Hopper
A3668 I'm the Black Sheep... Morgan
A3667 My Cradle Melody... Meyer
A3659 Away Down South... Akst
A3674 What Do You Care... Bradford
A3660 Say It While Dancing... Silver
A3662 Georgette... Henderson
A3661 Flapper Walk... Westphal
A3666 In My Home Town... Kalmar-Ruby
A3664 Lonesome Longin' Blues... Roberts
4597 Sweet Indiana Home... Intro.: "Bamboo Bay"
4598 Happy Lil' Sal... Margaret Hellar
4599 Everybody Calls Her Sunshine... George Wilton Ballard and Chorus
4600 Fireflies... Reed Orchestra
4601 The Larsen Kids Go Bathing... Norwegian-English Monologue
4602 Something Whispers... Metropolitan Quartet
4603 Becky, the Spanish Dancer... Vaudeville Specialty
4604 I'm Just Wild About Harry... Intro.: "Bandana Days"
4605 Rock Me in My Swanee Cradle... Vernon Dalhart and Chorus
4606 Serenade... Creator and His Band
4607 All Over Nothing at All... Fox-trot
4608 When You and I Were Young... Maggie, Blues
4609 Loveland Is Calling... Harvey Hindermeyer and Chorus
11233 Uchar Kupetz... Russkaya narodnaya piesnia
11234 Oi ya neschastay... Unhappy Cossack
4628 If Winter Comes... Fox-trot
4629 The Yankee Doodle Blues... Fox-trot
4630 We'll Build a Dear Little... Cute Little Love Nest
4631 Lovable Eyes... Intro.: "Hootch Rhythm"
4632 Georgette... Fox-trot

EDISON AMBEROL RECORDS

- 4628 If Winter Comes... Fox-trot
4629 The Yankee Doodle Blues... Fox-trot
4630 We'll Build a Dear Little... Cute Little Love Nest
4631 Lovable Eyes... Intro.: "Hootch Rhythm"
4632 Georgette... Fox-trot

EDISON DISC RE-CREATIONS

- 50945 True to the Flag March... United States Marine Band
50946 Happy Lil' Sal... Margaret Hellar
50947 A Broken Doll... Manuel Romain
50948 Mountain Maid... George McFadden
50949 Do You Sometimes Think of Me?... Marion Evelyn Cox-John Young
51001 A Country Fiddler at Home... Charles Ross Taggart
51002 Where the Silvery Colorado Wends Its Way... Walter Van Brunt and Chorus
50952 Sadie's Birthday Party... Vaudeville Specialty
80723 Something Whispers... Metropolitan Quartet
80724 Torn'a Surriento... Fernando Guaneri
32266 Sextet... Chi mi frena
32265 Les Filles de Cadix... The Maids of Cadiz

- Doute de la lumiere... "Hamlet"
51016 Just Because You're You... That's Why I Love You
51020 Say It While Dancing... Fox-trot
51021 With His Umpah Umpah... On the Umpah Isle
51026 Red Moon Waltz... Ernest L. Stevens' Trio
51022 Two Little Wooden Shoes... From "Spice of 1922"
51028 I'll Stand Beneath Your Window... To-night and Whistle
51032 Cow Bells... Fox-trot
51033 My Old Hawaiian Home... Palakiko's Hawaiian Orch.
51029 Blue... Fox-trot
51030 Believe Me if All Those Endearing Young Charms... Cornet Solo
80737 Long, Long Ago... Apollo Quartet of Boston
51031 Mary, Dear... Some Day We Will Meet Again
51035 Bells of the Sea... Palakiko's Hawaiian Orch.
Wistful Waltz... Imperial Marimba Band

BRUNSWICK RECORDS

- THIRTIETH RELEASE
50015 Polonaise Militaire... A Major
13052 Bonnie Wee Thing... Burns-Lehman
13053 Ol' Carolina... Cooke
20004 Blue Danube Waltz... Strauss
2307 Jolly Coppersmith... Peters
2308 Crazy Jo... Reser
2299 Nobody Loves Me Now... Tracey-Arndt
2300 Serenade... Sissie-Blake
2302 Away Down South... Lewis-Young-Akst
2303 Struttin' at the Strutters' Ball... Williams
2304 My Cradle Melody... Lewis-Young-Meyer
2305 Away Down South... Lewis-Young-Akst
5143 Neath the South Sea Moon... Ziegfeld
2306 Hurry Along... Liza, With Me
2310 Sweet Indiana Home... Donaldson
2301 Nobody Lied... Norman-Berry-Weher
2309 My Cradle Melody... Lewis-Young-Meyer

AEOLIAN CO.

- STANDARD SELECTIONS
30159 Love's Old Sweet Song... Bingham-Molloy
30160 Kalinka... Russian Folksong
20007 Oh, Dry Those Tears... Teresa del Riego

ADVANCE RECORD BULLETINS FOR OCTOBER—(Continued from page 159)

- 24030 The Low Back'd Car (Samuel Lover)—Tenor, Orch. Accomp. Colin O'More 10
- The Dear Little Shamrock (Cherry)—Tenor, Orch. Accomp. Colin O'More 10
- 14392 Sally in Our Alley (Carey-Smith), Criterion Male Quartet Darling Nellie Gray (Hanby-Shattuck), Criterion Male Quartet 10
- 14398 My Wild Irish Rose (Chauncey Olcott)—Tenor, Orch. Accomp. Chas. Harrison 10
- Off to Philadelphia in the Morning (Old Irish Melody)—Tenor, Orch. Accomp. Chas. Harrison 10
- 14399 Smilin' Through (Penn)—Baritone, Orch. Accomp. George Reardon 10
- Little Coon's Prayer (D'Arcy-Hope)—Tenor, Orch. Accomp. Vernon Dalhart 10
- 14401 Coming Home (Eardley-Wilmet-Willeby)—Soprano, Orch. Accomp. Claire Lillian Peteler 10
- Lullaby (Erminie) (Jakobowski)—Mezzo-Soprano, Orch. Accomp. Nanette Flack 10
- 14405 Honolulu Honeymoon (De Witt-Bowers), Ferrera-Franchini Hawaiian Rainbow (Gravelle-Haring), Ferrera-Franchini 10
- 14403 Mother Machree (Olcott-Ball)—Hand-saw, Guitar Sam Moore-Horace Davis 10
- Mighty Lak' a Rose (Nevin)—Guitar Duet, Sam Moore-Horace Davis 10
- SACRED SELECTIONS**
- 14398 One Sweetly Solemn Thought (Carey-Ambrose)—Baritone, Orch. Accomp. Elliott Shaw 10
- Crossing the Bar (Tennyson-Willsby)—Orch. Accomp. Aeolian Shannon Quartet 10
- 14402 Carry Your Cross With a Smile (Ogden-Gabriel)—Baritone, Orch. Accomp. Homer Rodeheaver 10
- A Heart Like Thine (J. W. Van Deventer)—Baritone, Orch. Accomp. Homer Rodeheaver 10
- INSTRUMENTAL SELECTIONS**
- 14400 Bonnie Brier Bush (Sousa).... Played by Lieut. Francis Sutherland and His 7th Reg. Band The Thunderer (Sousa).... Played by Lieut. Francis Sutherland and His 7th Reg. Band
- SOME FOREIGN AND OTHER SELECTIONS**
- 14396 Yom Kippur (Cry of Atonement) (In Hebrew) (Silberstein-Silberta)—Tenor, Orch. Accomp. Leonard Braun 10
- Israel (Burkhart-Fisher)—Tenor, Orch. Accomp. Leonard Braun 10
- 14397 Meyerke mein suhn (Ravel-Bowers) (In Hebrew)—Soprano, Orch. Accomp. Jean Alfred Geh ich mir Schapzieren (Traditional) (In Hebrew)—Soprano, Orch. Accomp. Jean Alfred 10
- 14404 Wenn du einmal eine Braut hast (Heye-Von Hirsch) (In German)—Tenor, Orch. Accomp. Ivan Frank 10
- Schmett Seiner Frau (Balle) (In German)—Orch. Accomp. Ernest Ball and Quartet 10
- 14406 Nofrio alla Banca (Humorous Talking) (In Sicilian).... Giovanni De Rosalia e Compagnia Nofrio Barbieri (Humorous Talking) (In Sicilian).... Giovanni De Rosalia e Compagnia
- POPULAR SELECTIONS**
- 14407 Sweet Indiana Home (Walter Donaldson)—Orch. Accomp. Sung by Honey Hurst Dixie Highway (Walter Donaldson)—Baritone, Orch. Accomp. Ernest Hare 10
- 14408 Oh! Is She Dumb (Clarke-Leslie-Gottler)—Tenor, Orch. Accomp. Billy Jones 10
- In My Home Town (Kalmar-Ruby)—Tenor, Orch. Accomp. Arthur Fields
- DANCE SELECTIONS**
- 14394 Dancing Fool (Ted Snyder)—Fox-trot, Piano Chorus by Hess and Banta, The Bar Harbor Society Orchestra
- Are You Playing Fair? (Siegrist-Cohen)—Fox-trot.... The Bar Harbor Society Orchestra 10
- 14395 Truly (Vincent Rose)—Fox-trot, Selvin's Orchestra
- Chanson (Rudolph Friml)—Fox-trot, Selvin's Orchestra 10
- 14410 Coal Black Mammy (St. Helier-Cliff)—Fox-trot, Yerkes' S. S. Flotilla Orchestra
- Two Little Wooden Shoes (Stanley-Hanley) (From "The Spice of 1922")—Fox-trot, Yerkes' S. S. Flotilla Orchestra 10
- 14411 Stuttering (Sidney D. Mitchell)—Fox-trot, The California Ramblers
- I Wish I Knew (You Really Loved Me) (Robert E. Spencer)—Fox-trot, The California Ramblers 10
- 14412 Ji-Ji-Boo (Willy White)—Fox-trot, The Bar Harbor Society Orchestra
- Chicago (That Toddling Town) (Fred Fisher)—Fox-trot.... The Bar Harbor Society Orchestra 10
- 14409 Tricks (Zez Confrey)—Fox-trot, Emil Coleman and His Montmartre Orchestra
- Come Along (I'm Through With Worryin') (From Ziegfeld "Follies of 1922") (Creamer-Layton)—Fox-trot, Emil Coleman and His Montmartre Orchestra 10

PATHE FRERES PHONOGRAPH CO.

- (ACTUELLE RECORDS—VOCAL)
- 020792 Honey, I Wants Yer Now—Hudson Male Quartet 'Tis But a Little Faded Flower, Arthur Wilson-Reed Rankin
- 020793 The Owl and the Pussy Cat.... Big City Four The Old Oaken Bucket.... Peerless Quartet
- NOVELTY**
- 020795 Satisfied Jack Claire-Frank Mann Hurry Along, Liza, With Me, Jack Claire-Frank Mann
- INSTRUMENTAL**
- 020794 Teasin' the Frets—Guitar Solo.... Nick Lucas Picking the Guitar—Guitar Solo.... Nick Lucas
- 022182 Humoresque—Accordion.... Boudini Brothers Danube Waves—Accordion.... Boudini Brothers
- POPULAR VOCAL**
- 020808 My Buddy Robert Bruce Underneath the Japanese Moon.... George Anderson
- DANCE**
- 020809 Who'll Take My Place?—Fox-trot. Will Carroll Trio Silver Stars—Fox-trot.... Will Carroll Trio
- 020813 Two Little Wooden Shoes—Fox-trot, Actuelle Dance Orch.
- Way Down Yonder in New Orleans—Fox-trot, Majestic Dance Orch.
- 020806 Call Me Back, Pal o' Mine—Waltz, Actuelle Dance Orch.
- Don't Bring Me Posies—Fox-trot, Actuelle Dance Orch.
- Pathé and Actuelle Records**
- POPULAR VOCAL**
- 20807 Oh, Is She Dumb?.... Vaughan De Leath Cow Bells.... Vaughan De Leath
- 20808 My Buddy Underneath the Japanese Moon.... Elliott Shaw
- DANCE**
- 20809 Who'll Take My Place?—Fox-trot. Don Parker Trio Silver Stars—Fox-trot.... Don Parker Trio
- 20810 Truly—Fox-trot.... Max Terr and Orch. Murmuring—Fox-trot.... Max Terr and Orch.

- 20811 Susie—Fox-trot Max Terr and Orch. Southern Moon—Waltz.... Max Terr and Orch.
- 20812 Clover Blossom Blues—Fox-trot.... Synco Jazz Band Chicago—Fox-trot.... Synco Jazz Band
- 20813 Two Little Wooden Shoes—Fox-trot. Sodero's Orch. Way Down Yonder in New Orleans—Fox-trot, N. Glantz and His Orch.
- 20814 Blue—Fox-trot California Ramblers I Wish I Knew—Fox-trot.... Samuels' Orch.
- 20806 Call Me Back, Pal o' Mine—Waltz, Sodero's Orch. Don't Bring Me Posies—Fox-trot.... Sodero's Orch.
- 20820 Tricks—Fox-trot N. Glantz and His Orch. Coal-black Mammy—Fox-trot. N. Glantz and His Orch.
- Records 20807 to 20820 may be obtained in both Pathé (sapphire) and Actuelle (needle-cut). Other numbers shown are Pathé numbers. The Actuelle number is the same as the Pathé but prefixed with a cipher, as 020807.

OKEH RECORDS

ODEON RECORDS

- 53103 Invitation to the Waltz (Weber)—Piano Solo, Eugene D'Albert 12
- Recorded in Europe by the International Talk. Machine Co.
- 50601 Mignon—Kennst du das land? (Knowest Thou the Land?) (Thomas)—Soprano with Orchestra (Sung in German).... Marie Jeritza 12
- Recorded in Europe by the International Talk. Machine Co.
- FONOTIPIA RECORD**
- 72306 La Ronde Des Lutins (Dance of the Goblins) (Bazzini)—Violin Solo, Piano Accomp., Jan Kubelik 10 3/4

OKEH ORCHESTRAS

- 4645 Eili-Eili—Orchestra, Sandor Joszi and His Orchestra 10
- Recorded in Europe
- Kol Nidrei (Max Bruch)—Orchestra, Sandor Joszi and His Orchestra 10
- Recorded in Europe
- 3017 Blue Danube Waltz (Johann Strauss)—Waltz, Marek Weber and His Orchestra 12
- Recorded in Europe
- Southern Roses Waltz (Johann Strauss)—Waltz, Marek Weber and His Orchestra 12
- Recorded in Europe
- VOCAL RECORDS**
- 4643 Georgia (H. Johnson-W. Donaldson)—Male Trio, with Orchestra.... Crescent Trio
- Plantation Lullaby (V. T. Stevens-G. Gillett-A. Holmer)—Male Quartet, with Orchestra, Shannon Four 10
- 4646 Sun of My Soul (J. Keble-W. H. Monk)—Baritone, with Orchestra.... Elliott Shaw
- Holy, Holy, Holy (R. Heber-J. B. Dykes)—Male Quartet and Contralto, with Orchestra, Shannon Four-Virginia Burt 10
- DANCE RECORDS**
- 4642 Ku Ku (The Klucking of the Ku Klux Klan) (E. R.-B. G.-B. F.)—Baritone Solo, Piano Accomp., Billy Frisch (With "A Trip to Hitland" Co.)
- Ku Ku (The Klucking of the Ku Klux Klan) (E. R.-B. G.-B. F.)—Fox-trot, Markel's Orchestra 10
- 4641 My Honey's Lovin' Arms (Joe Meyer-Herman Ruby)—Fox-trot.... Markel's Orchestra
- Whenever You're Lonesome (Just Telephone Me) (P. Wendling-M. Kortlander)—Fox-trot, Markel's Orchestra 10
- 4648 Nobody Lied (Edwin J. Weber)—Fox-trot, Markel's Orchestra 10
- The Sneak (N. H. Brown)—Fox-trot, Markel's Orchestra 10
- 4649 Wake Up, Little Girl (You're Just Dreaming) (L. Herscher-Joe Burke)—Fox-trot, Markel's Orchestra 10
- Soothing (Ted Fiorito-Eddie Storman)—Fox-trot, Markel's Orchestra 10
- 4650 It's Up to You (Maurice Yvain)—Fox-trot, Markel's Orchestra 10
- Kicky-Koo, You for Me—Me for You (Geo. W. Meyer)—Fox-trot.... Markel's Orchestra
- 4644 Blue Jeans (Lou Traveller)—Fox-trot, Okeh Marimba Band
- Just Another Kiss (J. and N. Hilbert)—Waltz, Okeh Marimba Band 10
- 4639 Keep on Building Castles in the Air (Percy Wenrich)—Fox-trot, Natzy's Biltmore Orch. (Jack Green, Director)
- Blushes (Ed. Raymond)—Fox-trot, Glantz and His Orchestra 10
- 4640 Coo Coo (From the Musical Comedy "Bombo") (Al Jolson-B. G. De Sylva)—Fox-trot, The Original Six (Geo. F. Kelly, Director)
- Building Love Castles (Ray Sherwood)—Fox-trot, The Original Six (Geo. F. Kelly, Director) 10
- 4647 I'm Just Wild About Harry (From the Musical Comedy "Shuffle Along") (Noble Sissle-Eubie Blake)—Fox-trot, V. Lopez and His Hotel Pennsylvania Orch.
- Deedle Deedle Dum (A. Sherman-S. Coslow-I. Mills)—Fox-trot, V. Lopez and His Hotel Pennsylvania Orch. 10

GENNETT LATERAL RECORDS

- 4896 If Your Heart Keeps Right (DeArmond-Ackley)—Baritone.... Homer Rodeheaver
- Brighten the Corner Where You Are (Ogden-Gabriel).... Homer Rodeheaver and Chorus
- 4897 Transformed (Burroughs-Ackley)—Baritone, Homer Rodeheaver
- Mother's Prayers Have Followed Me (DeArmond-Ackley)—Baritone.... Homer Rodeheaver
- 4913 The Rainbow—Fox-trot. Nathan Glantz and His Orch. The Graceful Swan.... Nathan Glantz and His Orch.
- 4919 Jolly Peter (Bummel Petrus) (Werner-Kersten)—Fox-trot.... Lanin's Famous Players
- Parade of the Wooden Soldiers (Die Parade Der Holzsoldaten) (Jessel)—Fox-trot, Lanin's Famous Players
- 4920 Bummel Petrus (Jolly Peter) (Werner-Kersten)—Fox-trot.... Lanin's Famous Players
- Die Parade der Holzsoldaten (Parade of the Wooden Soldiers) (Jessel)—Fox-trot, Lanin's Famous Players
- 4921 Clover Blossom Blues (Keys-Erdman-Meinken)—Fox-trot, "Husk" O'Hare's Super Orch. of Chicago
- Night (Davis-Simons)—Fox-trot, "Husk" O'Hare's Super Orch. of Chicago
- 4922 'Neath the South Sea Moon (Hirsch-Buck-Stamper)—Fox-trot.... Bailey's Lucky Seven
- I Wish I Knew (Spencer-Anderson-Bryant)—Fox-trot.... Joe Samuels and His Master Players
- 10063 Du Du Liegst Mir Im Herzen (Pax)—Tenor and Soprano.... Mr. and Mrs. Charles Hart
- Abschied Der Vogel—Tenor and Soprano, Mr. and Mrs. Charles Hart
- 10064 Absent (Glen-Metalf)—Tenor.... Lewis James
- Until (Teshmacher-Sanderson)—Tenor.... Lewis James
- 4923 Southland Medley (1) Swanee River, (2) Old Black Joe, (3) Turkey in the Straw, (4) My

- Old Kentucky Home, Rio Trio—Banjo, Saxophone and Piano
- Send Back My Honeyman (Creamer-Handman) Fox-trot.... Rio Trio—Banjo, Saxophone and Piano
- 4924 Snyder (Does Your Mother Know You're Out?), George P. Watson, Yodler
- Sauerkraut Is Bully.... George P. Watson, Yodler
- 4925 Old Folks at Home (Foster)—Soprano, Estelle Carey
- My Old Kentucky Home (Foster)—Soprano, Estelle Carey
- S4926 Mi Noche Trieste—Tango, Cantado por E. F. Gregorio
- Mister Gallagher and Mister Shean—Fox-trot, Nathan Glantz y su orquesta
- S4927 Olimpica (Vals).... Nathan Glantz y su orquesta
- Alma Gitana (Alfonso Esparaza Oteo)—Fox-trot, Nathan Glantz y su orquesta
- 4928 Olympic (Gallardo)—Waltz, Nathan Glantz and His Orch.
- Gypsy Soul (Alfonso Esparaza Oteo)—Fox-trot, Nathan Glantz and His Orch.
- 4929 Mary, Dear (DeCosta-Jerome)—Fox-trot, Bailey's Lucky Seven—Featuring Lillian Robbins
- Who'll Take My Place? (When I'm Gone) (Klages-Fazioli)—Fox-trot.... Bailey's Lucky Seven
- 4930 My Cradle Melody (Lewis-Young-Meyer), Strand Theatre Quartet
- Mary, Dear (Some Day We Will Meet Again) (DeCosta-Jerome)—Tenor.... Lewis James
- 4931 Evening Chimes, Venetian Ensemble—Lew Raderman, Director
- Love's Old Sweet Song (Molloy), Venetian Ensemble—Lew Raderman, Director

EMERSON PHONOGRAPH CO.

- POPULAR DANCE RECORDS**
- 10538 Dancing Fool—Fox-trot.... Emerson Dance Orch.
- Soothing—Fox-trot.... Sydney Kleefeld Orch.
- 10539 Nobody Lied—Fox-trot.... Strand Dance Orch.
- Coo Coo—Fox-trot.... Empire State Dance Orch.
- 10540 The Sneak—Fox-trot.... Globe Music Masters
- Say It While Dancing—Fox-trot. Globe Music Masters
- 10541 Just Because You're You—Fox-trot, Globe Music Masters
- Fascination—Fox-trot.... Emerson Dance Orch.
- Georgette—Fox-trot.... Sydney Kleefeld Orch.
- Parade of the Wooden Soldiers—Fox-trot, Strand Dance Orch.
- 10543 Call Me Back, Pal o' Mine—Waltz.... Lauer's Orch.
- Swanee River Moon—Waltz, Empire State Dance Orch.
- POPULAR VOCAL RECORDS**
- 10544 Old Kentucky Moonlight.... Lewis James-Elliott Shaw
- My Cradle Melody.... Crescent Trio
- 10545 Mary, Dear.... Charles Harrison
- Sweet Indiana Home.... Lewis James-Elliott Shaw
- STANDARD RECORDS**
- 10514 America—Male Quartet.... Criterion Male Quartet
- Star-Spangled Banner—Male Quartet, Criterion Male Quartet
- NOVELTY AND COMEDY RECORDS**
- 10291 The Mocking Bird—Monolog.... Billy Golden
- Uncle Josh's Birthday—Monolog.... Billy Golden
- IRISH RECORDS**
- 10394 Medley of Irish Jigs—Irish Hornpipe.... Tom Ennis
- Medley of Irish Reels—Irish Hornpipe.... Tom Ennis
- 10344 Count Kerry Mary—Tenor Solo.... Hugh Donovan
- Wrap the Green Flag 'Round Me, Boys—Tenor Solo.... Hugh Donovan

BANNER RECORDS

- DANCE RECORDS**
- 1094 Count the Days—Fox-trot.... Roy Collin's Orchestra
- Say It While Dancing—Fox-trot, Knecht's Dance Orchestra
- 1095 Swanee Bluebird—Fox-trot, Metropolitan Dance Players
- Love Days—Fox-trot.... Knecht's Dance Orchestra
- 1096 Soothing—Fox-trot.... Metropolitan Dance Players
- Keep on Building Castles—Fox-trot, Moulin Rouge Orchestra
- 1097 Truly—Fox-trot.... Roy Collin's Orchestra
- Sunshine Alley—Fox-trot.... Roy Collin's Orchestra
- 1098 I Wish I Knew—Fox-trot.... Banner Dance Orchestra
- Rosa—Fox-trot.... Banner Dance Orchestra
- 1099 Coal Black Mammy—Fox-trot, Moulin Rouge Orchestra
- Tricks—Fox-trot.... Moulin Rouge Orchestra
- 1100 Good Mornin'—Fox-trot. Lanin's Southern Serenaders
- I'm Just Wild About Harry—Fox-trot, Lanin's Southern Serenaders
- 1101 Old Virginia Way—Waltz, Metropolitan Dance Players
- Love Dreams—Waltz.... Knecht's Dance Orchestra
- VOCAL RECORDS**
- 1102 Old Kentucky Moonlight—Tenor Solo, Orch. Accomp. Hugh Donovan
- Call Me Back, Pal o' Mine—Tenor Solo, Orch. Accomp. Bert Trevor
- 1103 In Rosetime (When We Said Good-bye)—Tenor Solo, Orch. Accomp. Sam Ash
- Just Because You're You—Tenor Solo, Orch. Accomp. Bert Trevor
- STANDARD RECORDS**
- 2051 Cohen on Prohibition—Comic Monologue, Monroe Silver
- Cohen's New Auto—Comic Monologue. Monroe Silver
- 2056 La donna e mobile (Rigoletto)—Tenor Solo, Stanislaw Berini
- Che gelinda mamma (La Boheme)—Tenor Solo, Stanislaw Berini
- 2057 Meditation from Thais (Massenet)—Violin Solo, Milan Lusk
- Humoresque (Dvorak)—Violin Solo.... Milan Lusk
- 2059 Greenwich Witch—Piano Solo.... Vi Palmer
- You Tell 'em, Ivories—Piano Solo.... Vi Palmer

REGAL RECORDS

- DANCE RECORDS**
- 9350 Say It While Dancing—Fox-trot, Knecht's Dance Orch.
- Count the Days—Fox-trot.... Majestic Dance Orch.
- 9351 Soothing—Fox-trot.... Metropolitan Dance Players
- Love Days—Fox-trot.... Knecht's Dance Orch.
- 9352 Truly—Fox-trot.... Moulin Rouge Orch.
- Rosa—Fox-trot.... Majestic Dance Orch.
- 9353 Tricks—Fox-trot.... Hollywood Dance Orch.
- Coal-black Mammy—Fox-trot. Hollywood Dance Orch.
- 9354 Swanee Bluebird—Fox-trot, Metropolitan Dance Players
- Keep on Building Castles—Fox-trot, Moulin Rouge Orch.
- 9355 I'm Just Wild About Harry—Fox-trot, Lanin's Southern Serenaders
- Good Mornin'—Fox-trot, Lanin's Southern Serenaders
- 9356 Ole Virginia Way—Waltz, Metropolitan Dance Players
- Love Dreams—Waltz.... Knecht's Dance Orch.
- 9357 I Wish I Knew—Fox-trot.... Roy Collin's Orch.
- A Little Love—Fox-trot.... Roy Collin's Orch.
- VOCAL RECORDS**
- 9358 Call Me Back, Pal o' Mine—Tenor Solo, Orch. Accomp. Lewis James

Some Leading Jobbers of Talking Machines in America

TEST IT.

OUR VICTOR



Record Service

has a reputation for efficiency.

Suppose you try it.

E. F. DROOP & SONS CO.

1300 G. STREET, WASHINGTON, D. C.
231 N. HOWARD STREET, BALTIMORE, MD

RECORD BULLETINS FOR OCTOBER
(Continued from page 160)

- Old Kentucky Moonlight—Tenor Solo, Orch. Accomp. Lewis James
- 9359 Just Because You're You—Tenor Solo—Orch. Accomp. Bert Trevor
- In Rosetime (When We Said Goodbye)—Tenor Solo—Orch. Accomp. Sam Ash
- STANDARD RECORDS**
- 9360 Sunshine of Your Smile—Tenor Solo, Orch. Accomp. Walter Scanlan
- Little Grey Home in the West—Tenor Solo, Orch. Accomp. Walter Scanlan
- 9361 Operatic Potpourri (Carmen-Lucia-Gioconda), Bolognese Band
- Waltz of the Waves—With Cornet Obligato, Bolognese Band
- 9362 Repasz Band—March Regal Military Band
- Gee-Whiz—March Regal Military Band
- 9363 Monastery Garden—Incidental Singing by the New Stellar Quartet, Metropolitan Symphony Orch.
- Garden of Love—Caprice, Metropolitan Symphony Orch.

LATEST PURITAN RECORDS

DANCE RECORDS

- 11143 Georgette—Fox-trot Eddie Davis' Orch.
- My Cradle Melody—Fox-trot Eddie Davis' Orch.
- 11144 Who'll Take My Place When I'm Gone?—Fox-trot Frisco Syncopators
- J'en Ai Marre (It's Up to You)—Fox-trot, Majestic Dance Orch.
- 11145 Hot Lips—Fox-trot Specht's Society Syncopators
- You Can Have Him, I Don't Want Him—Fox-trot Specht's Society Syncopators
- 11146 Listening on the Radio (Intro.: "Rambler Rose," From the "Ziegfeld Follies, 1922")—Fox-trot, Frisco Syncopators
- Blue-eyed Blues—Fox-trot Frisco Syncopators
- 11147 Dancing Fool—Fox-trot Eddie Davis' Orch.
- The Sneak—Fox-trot Moulin Rouge Orch.
- 11148 Don't Bring Me Posies—Fox-trot, Majestic Dance Orch.
- Soothing—Fox-trot Metropolitan Dance Players
- 11143 Georgette (Ray Henderson)—Fox-trot, Eddie Davis' Orch.
- My Cradle Melody (Geo. W. Meyer)—Fox-trot, Eddie Davis' Orch.
- 11149 Tricks (Zez Confrey)—Fox-trot, Majestic Dance Orch.
- Rosa (Lew Brown-Jack Egau)—Fox-trot, Majestic Dance Orch.
- 11150 Count Those Days (Jack Tilson-Harry Bason)—Fox-trot Majestic Dance Orch.
- Swanee Bluebird (Cliff Friend-Con Conrad)—Fox-trot Broadway Melody Players
- 11151 A Little Love (Nathan Glantz-Frank Washauer)—Fox-trot Majestic Dance Orch.
- Mary Ellen (Jolson-Simon-Berg)—Fox-trot, Yerkes' S.S. Flotilla Orch.
- 11152 Love Days (Williams-Jones)—Fox-trot, Knecht's Dance Orch.
- Love Dreams (Ernest Golden)—Waltz, Knecht's Dance Orch.
- 11153 Truly (Davis-Rose)—Fox-trot Frisco Syncopators
- Say It While Dancing (Benny Davis-Arner Silver)—Fox-trot Knecht's Dance Orch.
- 11154 Down Old Virginia Way (Abe Olman-Gladys Gillette)—Waltz, Yerkes' Metropolitan Dance Players
- Coal-black Mammy (Laddy Cliff-Ivy St. Heller)—Fox-trot Frisco Syncopators
- 11155 Stuttering (Marceo Pinkard)—Fox-trot, Moulin Rouge Orch.
- I Wish I Knew (Spencer-Anderson-Bryant)—Fox-trot Earl Randolph's Orch.
- 11156 Call Me Back, Pal o' Mine (Perricone Dixon)—Tenor Solo, Orch. Accomp. Arthur Fields
- Old Kentucky Moonlight (Gillespie-VanAlstyne)—Tenor Solo, Orch. Accomp. Arthur Fields
- VOCAL RECORDS**
- 9121 Sweet Indiana Home—Baritone Solo Bob Thomas
- Mary, Dear—Tenor Solo Lewis James
- 9123 I've Got to Cool My Puppies Now—Comedy Solo, Orch. Accomp., Lucille Hegamin and Her Blue Flame Syncopators
- Send Back My Honey Man—Comedy Solo, Orch. Accomp., Lucille Hegamin and Her Blue Flame Syncopators
- GERMAN SELECTION**
- 9124 Bummel Petrus Blasorchester mit Gesang
- Marichen Sass Weinend im Garten, Blasorchester mit Gesang

NEW PLANT FOR LOS ANGELES

LOS ANGELES, CAL., September 8.—Plans for the location in this city of the National Phonograph & Motor Co. have just been announced. Options on several industrial sites have been obtained and a definite selection will be made within the next two weeks. The first unit of the factory will be finished and in operation by the first of the year.

W. J. DYER & BRO.

DYER B'LD'G, ST. PAUL, MINN.
NORTHWESTERN DISTRIBUTORS
OF THE



VICTOR

Machines, Records and Supplies

Shipped Promptly to all Points in the Northwest

Sherman, Clay & Co.

San Francisco, Los Angeles, Portland, Seattle, Spokane
PACIFIC COAST DISTRIBUTORS OF
VICTOR PRODUCTS

**SOUTHERN
VICTOR WHOLESALE**

The Corley Company

RICHMOND VIRGINIA

Mickel Bros. Co.

Omaha, Nebraska

Des Moines, Iowa

Victor Distributors

The
Toledo Talking Machine Co.

Toledo, Ohio

*Wholesale Victor
Exclusively*

CONSTRUCTIVE ARTICLES IN THIS ISSUE OF THE WORLD

Ready Reference for Salesmen, Dealers and Department Heads

How a Musical Census of the Community Helps Sales	3	Overwhelming Value of a Consistent, Continuous Advertising Program Demonstrated	38
Featuring the Odd, Unusual Records With Which Buyers Are Unacquainted	3	Radio Developments During the Past Year	40
Profitable Plan for Keeping in Touch With the Earning Power of Salesmen	4	Letter of a Veteran Salesman to a Friend	42
How Pessimism Kills Business as Well as the Morale of the Sales Force	6	Dr. Lee DeForest's "Photofilm" to be Exhibited Next Month	43
An Effective Means of Reaching Buyers	8	A Means of Time-Saving and Customer-Saving	51
Why the Farmer Is a Good Prospect	8	Review of Trade Conditions in New England	67-71
The Business Situation Reviewed	8	Using Advertising to Stabilize a New Industry	80
Vital Importance of Service Demonstrated in Building Retail Trade	10	Trade Happenings in the Quaker City and Pennsylvania	83-85
Standardization of Sales Presentation as an Aid to Greater Efficiency	12	Earle E. Conway Discusses Conditions in Europe	92
Methods of Modern Business Management—the Value of Quick Stock Turnover	14-15	How the Talking Machine Helps the Use of Good English	93
Why Not Stage a "Keep-the-Children-Home-Nights" Exposition in Your Store?	21-22	The Mid-West Point of View and General Western Trade News	98-112
The Opportunities for the Sales of Talking Machines Throughout Cuba	24	Summary of New Tariff Bill Shows Many Changes in Music Trade Field	120
The Mail as an Aid in Developing Rural Trade	26	New Era of Prosperity for the Talking Machine Trade, Declares O. W. Ray	127
The Importance of Courtesy in Business	29	Featuring the Musical Possibilities of the Talking Machine	128-129
Four-Minute Conferences on Business Topics	33	Gleanings From the World of Music	133-136
Bringing Dead Accounts to Life	34	Interesting Budget of News from the Dominion of Canada	150
Analysis of New Uniform Conditional Sales Law	35	Late Patents of Trade Interest to the Talking Machine Trade	157-158
		Advance Lists of October Bulletins of Talking Machine Records	159-161

A C Z A C D F H K L N P O S U A X V B D F G I J L N P O S U V X Z V C E F H J K W O P R T A C E M O N
 G E F I P Q R S T
INDEX TO ADVERTISERS
 T S R P O M K V H F E C V B C E F H J K W O P R T U V W X Y Z B D F G I J L M J O P S T V M Y A B A D

A
 Acme Die Casting Corp. 86
 Aeolian Co. 30, 31
 American Mica Works 95
 American Talking Machine Co. 94
 Atlantic Instrument Co. 151

B
 Bagshaw Co., W. H. 64
 Barnhart Bros. & Spindler Inside back cover
 Bell Hood Needle Co. 57
 Bell Recording Co. 58
 Belwin, Inc. 53
 Berlin, Inc., Irving 135
 Blackman Talking Machine Co. 27
 Blood Tone Arm Co. 110
 Boston Book Co. 18
 Brand, William 137
 Bridgeport Die & Machine Co. 129
 Brilliantone Steel Needle Co. 65
 Bristol & Barber 38
 Bruno & Son, Inc., C. 41
 Bruns & Sons, A. 24
 Brunswick-Balke-Collender Co. Insert following page 34
 Buehn Co., Louis 83

C
 Cabinet & Accessories Co. 55
 Cheney Talking Machine Co. 25
 Chicago Talking Machine Co. 97
 Chicago Radio Show 111
 Claremont Waste Mfg. Co. 71
 Classified Want Ads 152, 153
 Columbia Graphophone Co. 16, 17, 32, 35, 45, 50, 57, 75, 80, 90, 114, 115, 143, 148
 Consolidated Talking Machine Co. 52, 111
 Corley Co. 161

D
 Da-Lite Elec. Display Co. 145
 De Forest Radio Telephone & Telegraph Co. 28
 Diamond Products Co. 60
 Diapragm Co. 143
 Ditson & Co., Chas. H. 67
 Ditson Co., Oliver 67
 Doctorow, D. R. 144
 Dodge Mfg. Co. 149
 Dodin, Andrew H. 158
 Droop & Sons Co., E. F. 161
 Duo-Tone Co. 39
 Dyer & Co., W. J. 161

E
 Eagle Radio Co. 42
 Eastern Talking Machine Co. 69
 Eclipse Musical Co. 123
 Edison, Inc., Thos. A. 36, 37, Back cover
 Eight Famous Victor Artists 50
 Emerson Pbono. Co. 56
 Empire Mfg. Co. 138
 Empire Phono. Parts Co. 118
 Encore Sales Co. 80
 Eshborn, Samuel 77
 Everybody's T. M. Co. 23

F
 Favorite Mfg. Co. 54
 Federal Tel. & Tel. Co. 19
 Feist, Leo. 51, 66, 68, 72, 75, 78, 84, 89, 92, 96, 106, 120, 122, 126, 134, 135, 138
 Fletcher-Wickes Co. 103
 Flexlume Sign Co. 82
 Fox Pub. Co., Sam 136
 Fox-Vliet Drug Co. 47
 Fulton T. M. Co. 126

G
 General Phonograph Corp. Inserts following pages 18, 50 and 66
 General Phonograph Mfg. Co. 63
 General Radio Corp. 137, 147
 General Radio Laboratories 109
 Gibson-Snow Co. 47
 Gold Seal Co. 145

Gramophone Co., Ltd. 154
 Granby Phono. Corp. 14
 Greater City Phono. Co. 12
 Gretsck Mfg. Co., Fred 92
 Griffith Piano Co. 47

H
 Hall Mfg. Co. 74
 Harper & Bros. 88
 Harponola Co. 49
 Health Builders 59
 Hessig-Ellis Drug Co. 47
 Hough, J. E., Ltd. 155
 Hough, L. W. 68

I
 Ilsley, Doubleday & Co. 82
 International Mica Co. 85
 Iroquois Sales Co. 35
 Italian Book Co. 33

J
 Jenkins' Sons Co., J. W. 133
 Jewel Phonoparts Co. 29, 99
 Jewett Phono. Co. 79

K
 Kent Co., F. C. 42
 Kiefer-Stewart Co. 47
 Kimball Co., W. W. 131
 Kirkman Engg. Co. 66
 Knickerbocker T. M. Co. 10
 Kraft, Bates & Spencer, Inc. 68
 Krasco Mfg. Co. 105

L
 Lakeside Supply Co. 108
 Lausing Sales Co. 70
 Lauter Co., II. 128
 Lee-Coit-Andresen Hdw. Co. 47
 Lidseen Products 96
 Long Cabinet Co., Geo. A. 121
 Long Island Phono. Co. 94
 Lyradion Sales & Engg. Co. 149

M
 Magnavox Co. 44
 Magnola T. M. Co. 101
 Manhattan Elec. Supply Co. 34
 Manhattan Recording Laboratories 126
 Manufacturers' Phono. Co. 130
 Marshall Co., Inc., C. L. 47
 McMenimen, H. N. 55
 Mellor Co., C. C. 61
 Mellowtone Needle Co. 116
 Melody National Sales Co. 109
 Mermod & Co. 114
 Metal Recording Disc Co. 73
 Mickel Bros. Co. 40
 Minneapolis Drug Co. 47
 Mittenenthal, Inc., Jos. 136
 Modernola Co. 45
 Mohawk Works of Art 131
 Montagnes, I. & Co. 47
 Moore-Bird & Co. 47
 M. S. & E. 47
 Mutual Phono. Parts Co. 78

N
 National Co. 71
 National Decalcomania Co. 85
 National Metals Depositing Corp. 58
 National Publishing Co. 18
 Netschert, Frank 80
 New England Talking Machine Co. 69
 New York Album & Card Co. 4
 New York T. M. Co. 97
 Nye & Co., Wm. F. 26

O
 Ogden Sectional Cabinet Co., Inc. 141
 Oranola Radio Co. 140
 Ormes, Inc. 9
 Oro-Tone Co. 112
 Orsenigo Co. 91
 Osland, Inc. 114
 Outing T. M. Co. 127

P
 Pace Phono. Co. 148
 Pathé Frères Phono. Co. 20
 Peabody & Co., Henry W. 124
 Pearsall Co., Silas E. 15
 Peckham Mfg. Co. 95
 Peerless Album Co. 11
 Penn Phonograph Co. 85
 Phillips Phono. Parts Co., Wm. 26
 Phonomotor Co. 86
 Phonotone Co. 75
 Playertone T. M. Co. 62
 Plaza Music Co. 93
 Pleasing Sound Phono. Co. 86
 Plywood Corp. 33
 Presto Phono. Parts Corp. 122

R
 Radio Corporation of America 13
 Raymond Radio Co. 21
 Regal Record Co. 22
 Rene Manufacturing Co. 150
 Rex Gramophone Co. 156

S
 Seaburg Mfg. Co. 125
 Self-Lifting Piano Truck Co. 51
 Sbelton Elec. Co. 90
 Sherburne Mfg. Co. 72
 Sherman, Clay & Co. 6
 Silent Motor Corp. 119
 Simplex Elec. Phono. Motor Co. 117
 Smith Drug Co., C. D. 47
 Snyder, Inc., Jack 132
 Sonora Co. of Philadelphia 47
 Sonora Phonograph Co., Inc. Inside front cover, 46, 47, 93
 Sonora Phonograph Co. of Pittsburgh 47
 Southern Drug Co. 47
 Southern Sonora Co. 47
 Sphinx Gramophone Motors 43
 Standard Accessory Corp. 96
 Standard Metal Mfg. Co. 142
 Star Mach. & Nov. Co. 114
 Starr Piano Co. 76
 Steger & Sons Piano Mfg. Co. 51
 Sterling Devices Co. 108
 Sterno Manufacturing Co. 146
 Strevell-Patterson Hardware Co. 47
 Stylus Bar & Mfg. Co. 147
 Superior Phono. Co. 152
 Swanson Sales Co. 87

T
 Talking Machine Supply Co. 153
 Talking Machine World Trade Directory Insert following page 82
 Toledo Talking Machine Co. 161

U
 Udell Works 120
 Unit Construction Co. 113
 United Mfg. & Distr. Co. 100
 United Music Stores 84
 Unyversal Utylyty Unyts Co. 106

V
 Val's Accessory House 61
 Van Houten, C. J., & Zoon 47
 Van Veen & Co. 116
 Vicsonia Mfg. Co. 75
 Victor Talking Machine Co. Front cover, 5, 7
 Vitanola T. M. Co. 104

W
 Walbert Mfg. Co. 107
 Wall Kane Mfg. Co. 89
 Walthall Music Co. 47
 Ward Co., C. E. 48
 Weiss Co., Martin 149
 Weymann & Son, H. A. 84
 Whitsit Co., Perry B. 128
 Widdicomb Furniture Co. 139
 Williams Co., G. T. 95
 Wimpfheimer & Bro., A. 32
 Witmark & Sons, M. 134
 Wolf Mfg. Industries 102

Y
 Yahr & Lange Drug Co. 47

Z
 Zimmerman-Bitter Constr. Co. 151

The NEW Scotford Tonearm and Superior Reproducer



A new external shape of grace and beauty—without changing the internal design:



That same angle turn with the solid inclined plane deflecting the sound waves straight downward into amplifying chamber. That same famous Scotford tone—the tone of refinement—genuinely musical. Now in a tonearm of accepted, conventional, popular design. WRITE FOR SAMPLES.

NEW CONSTRUCTION



The long straight tube is of drawn Yellow Brass. Tonearm Base, Main Elbow and Connection Elbow and the Reproducer Frame, Face Ring and Back Plate are cast of TENSO White Brass Alloy—an alloy more than double the tensile strength of cast iron—much stronger, harder and lighter in weight than ordinary white metal alloys. New dies have been produced for casting all parts. The new parts are solidly cast, and are very substantial and durable.



STYLE NO. 1 FINISH
A combination of Nickel or Gold Plate and Black Rubber Japan



STYLE NO. 2 FINISH
A different combination of Nickel or Gold Plate and Black Rubber Japan



STYLE NO. 3 FINISH
All parts Plated in Nickel or Gold

In ordering specify whether Reproducer should have Plain Gilt Plate or "Superior" Name Plate. To obtain Individual Name Plate, customer must furnish Decalcomania Transfer

Samples Will be Submitted on Approval

Style 1 Tonearm long tube and main elbow, Reproducer face ring and back Black Japanned; other parts Plated.	Style 2 Tonearm long tube and main elbow Plated, base Black Japanned; Reproducer back Black Japanned, the face ring and frame Plated.	Style 3 All parts of Tonearm and Reproducer are Plated.
No. 1 New Scotford Tonearm and Superior Reproducer .	Nickel \$7.00	Gold \$ 9.00
No. 2 New Scotford Tonearm and Superior Reproducer .	Nickel 7.75	Gold 10.00
No. 3 New Scotford Tonearm and Superior Reproducer .	Nickel 8.50	Gold 11.00

Samples Prepaid at the Above Prices

Write for Our
Specification Sheet and Quantity Price List

BARNHART BROTHERS & SPINDLER

Monroe and Throop Streets

CHICAGO, ILLINOIS

*The latest addition to the
Edison line of consoles*

The Baby Console



See Pages 36, 37 inside

**JOBBER OF THE NEW EDISON, EDISON RE-CREATION, THE NEW EDISON DIAMOND AMBEROLA
AND BLUE AMBEROL RECORDS**

CALIFORNIA
Los Angeles—Edison Phonographs,
Ltd.
San Francisco—Edison Phonographs,
Ltd.

COLORADO
Denver—Denver Dry Goods Co.

GEORGIA
Atlanta—Phonographs, Inc.

ILLINOIS
Chicago—The Phonograph Co.
Wm. H. Lyons (Amberola only).

INDIANA
Indianapolis—Kipp Phonograph Co.

IOWA
Des Moines—Harger & Blish.

LOUISIANA
New Orleans—Diamond Music Co.,
Inc.

MASSACHUSETTS
Boston—Pardee-Ellenberger Co.
Iver Johnson Sporting Goods Co.
(Amberola only).

MICHIGAN
Detroit—Phonograph Co. of Detroit.

MINNESOTA
Minneapolis—Laurence H. Lucker.

MISSOURI
Kansas City—The Phonograph Co.
of Kansas City.
St. Louis—Silverstone Music Co.

MONTANA
Helena—Montana Phonograph Co.

NEBRASKA
Omaha—Shultz Bros.

NEW JERSEY
Orange—The Phonograph Corp. of
Manhattan.

NEW YORK
Albany—American Phonograph Co.
Syracuse—Frank E. Bolway & Son,
Inc., W. D. Andrews Co.
(Amberola only).

OHIO
Cincinnati—The Phonograph Co.
Cleveland—The Phonograph Co.

OREGON
Portland—Edison Phonographs, Ltd.

PENNSYLVANIA
Philadelphia—Girard Phonograph
Co.
Pittsburgh—Buehn Phonograph Co.
Williamsport—W. A. Myers.

RHODE ISLAND
Providence—J. A. Foster Co.
(Amberola only).

TEXAS
Dallas—Texas-Oklahoma Phono-
graph Co.

UTAH
Ogden—Proudfit Sporting Goods Co.

VIRGINIA
Richmond—The C. B. Haynes Co.,
Inc.

WISCONSIN
Milwaukee—The Phonograph Co. of
Milwaukee.

CANADA
Montreal—R. S. Williams & Sons
Co., Ltd.
St. John—W. H. Thorne & Co., Ltd.
Toronto—R. S. Williams & Sons
Co., Ltd.
Vancouver—Kent Piano Co., Ltd.
Winnipeg—R. S. Williams & Sons
Co., Ltd.
Babson Bros. (Amberola only).