

The TALKING MACHINE WORLD

AND
NOVELTY
NEWS

Published Each Month by Edward Lyman Bill at 1 Madison Avenue, New York, August 15, 1907



1907		AUGUST					1907	
SUN	MON	TUE	WED	THU	FRI	SAT		
	.	.	.	1	2	3		
4	5	6	7	8	9	10		
11	12	13	14	15	16	17		
18	19	20	21	22	23	24		
25	26	27	28	29	30	31		

Time says: "Your move."

IN accord with the policy of the Talking Machine World not to permit the use of the front cover to any one advertiser for a longer continuous period than one year, we take our place on the inside next month.

We wish to extend our hearty appreciation of the interest shown in our cover announcements in the past, and our every effort shall be to warrant this interest in the future.

Meanwhile, you can depend upon The Tea Tray Company working hand in hand with its friends, and our constant aim, both in methods and manufacture, shall be—progress.

We intend to keep our patrons fully informed, and our policy of acting in perfect accord with the best interests of all our customers shall be maintained.

THE TEA TRAY COMPANY OF NEWARK, N. J.

FOUNDED 1867

The Age of Combinations

The present time has been characterized by many as the age of combinations and certainly there are all kinds of combinations which affect directly the conditions in the various industries.

The best kind of combination however that we can name is the combination of the **Regina music box and the up-to-date talking machine.** It is the kind of a combination that will help you make dollars Mr. Talking Machine Dealer—easy dollars, too.

Don't you think that your customers would be interested in buying this music box, which of course is the Regina together with a talking machine attachment of the highest grade, particularly when the combination can be sold at an advance of only \$25.00 above the price of the Regina music box?

Of course you believe that you can find customers—plenty of them—as most progressive talking machine men do, and the part that is specially attractive about this is that you can make your usual percentage of profit. You have with the **REGINAPHONE**, and that is the name of this combination, the quality standard. You have the best mechanism that can be created. You can't surpass the talking machine in its equipment throughout, with any hundred dollar outfit on the market. We might go further and say any talking machine costing more than one hundred dollars, for we have special points of excellence among which we might mention the long running Regina motor. We have all the improvements including the tapering tone arm and perfect mechanism, all encased in a most attractive cabinet. We make them in several case styles to please a variety of tastes, but we use one grade talking machine attachment in all of them and that is the best.

Get ready for your fall trade by investigating the **REGINAPHONE.** Investigate now—the quicker you do, the sooner the dollars will be coming your way.

THE **REGINA** CO.

Main Office and Factory, Rahway, N. J.

BRANCHES:

Broadway & 17th Street, New York

259 Wabash Avenue, Chicago

Manufacturers of Regina Music Boxes, Reginaphones, Reginapianos,
Regina Chime Clocks and Regina Sublima Pianos.

Distributors of Victor Talking Machines
and Edison Phonographs.



The Talking Machine World

Vol. 3. No. 8.

New York, August 15, 1907.

Price Ten Cents

GETTING A "FORWARD MARCH" ON THINGS.

There Is No Profit in the Past—The Age Is a Progressive One and the Talking Machine Men Are Moving to the Front of the Procession—The Spirit of Getting Close to Your People—The Value of Co-operation—Let the Public Know You Are in Business and Keep Up-to-Date.

Now, right about face and try to get a "forward march" on things! Let the dead past bury its dead. Forget it! Ancient history is a good name for the by-gones, and just let it go at that. Don't stop to chew over old occurrences of the last six months and hem and haw over what might have been accomplished if this fellow had done his share, or grumble and growl and get yourself into a stew over the dead and unprofitable past.

That's it. There is no profit in the past. You cannot make money on what has been, except as a guide to what must be in the future. Recognize the mistakes or successes of the past and utilize them to the best advantage in the coming days. But right here let us tell you that it is a good thing in business not to do a thing twice over. Something new every time is the story—not wild, woolly and unreasonable, but simply different, progressive, more up to date, higher and beyond what you have done before, but always within the reach of your pocketbook and the appreciation of your customers. The procession is moving. It's marching onward. The world stands not still for a moment. The mercantile world is getting up higher-pressure steam for a swifter spurt, and every sense is keenly alert to the necessities and possibilities of the future, not of the past.

Now, talking about things is all right. It is a good thing to have counsel on all matters. What is that old story? "One to originate, many to cogitate and only one to execute." There you have it. Take the suggestion of one, call your forces together and talk about it, and then give it to one man to put into execution, placing the others under him. Now, we do not know what this thing is that you ought to do in your business. You ought to know that. Every man ought to know his own business best. But do not make a mistake. Every man does not think about the brightest things that his business is capable of by himself. Don't you ever think it. None of the big merchants made their successes by their own wit and intelligence, but they were smart enough to appreciate and put into execution the ideas of the numerous people whom they drew into co-operation with them. Get on to that,

please. Don't get stuck on yourself and think you know it all, even if fortune did favor you by leaving you a business or putting you in a big town in a good spot where trade could not be kept out of your doors except by planting a gatling gun inside of it. No man ever got rich on his own effort. That goes without saying—that is, in business. He might do it in literature, but even then he had to have a publishing concern behind him. But in the talking machine business the money is made by an accumulation of energies—doing things, and not talking about them.

Mr. Dealer, do you know that the greatest and best advertisement in the world is the spirit emanating from yourself, passing through your salespeople to the customer, that bids them welcome and makes them come again? It costs little, it earns a return at once and makes business a pleasure instead of a trial. Your best education comes from your customers. Do you know that? Your salespeople, awakening their interest, immediately draw from the customers suggestions, criticisms and expressions of interest which, when conveyed promptly to yourself, can be turned to profit and to enormous advantage in the year's accumulation. If you are not on good terms with your salespeople and your salespeople are indifferent to your customers, it is easy to understand that you hear nothing of all this, and that your education in business is consequently suffering serious and vital interference. The source of supply of the true knowledge of affairs is cut off from you. You shut off the light which would lead you to success. You cut away the leading strings that would guide you safely into prosperity and profit.

Every store and shop, however small and wherever situated, can be harmoniously conducted. All elements that clash had best be gotten rid of. In the end the business must suffer unless these things are removed. The wrong kind of goods, the wrong kind of people, the wrong kind of store, the wrong kind of anything must be changed, and can be changed. Have nothing which clashes. Put nothing in the way of calm, pleasant relationship. From the top of the sources of supply—the producer—through your own hands into those of the customer, everything should move

tions may be inserted at will. This is made possible by the simplicity of the obliterating magnet, which will erase one word while another is being substituted. Of course, what is true of one word is true of the whole of the disc.

There is a force of thirty-one men working on the perfecting and construction of these machines. One is impressed with the class of men employed; there is little doubt but that they are all experts in their respective lines, or men of the Carnegie type that almost do the impossible.

Morgan O. Hart, who was instrumental in the writer's visit to his company's works, demonstrated very clearly that those in charge of the production are bound to obliterate all the great weaknesses as well as a great many of the minor ones before the public is asked to pass opinion on the new talker. It looks as though the day is not far distant when one may hear an entire opera without a single break, or perchance we will see on a screen a great actor in his masterpiece while his lines are being reproduced from a thread of wire, that if needs be, may be almost unmeasurable. Who can tell?

Advertising is not a condiment to add spice to the business body, but a wholesome food to nourish it.

smoothly and cheerfully. Long faces are ill faces in the mercantile world. The martyr, the growler, the kicker, the hot-tempered, quarrelsome, nagging natures will find themselves in the rear rank or left out of the procession entirely. If it be the leader himself, woe betide him. Bad enough for the subsidiary ones to be out of tune, but when the man who is supposed to give the keynote bright and clear for the work of his institution is off the key, what sort of a tune do you think the band will play?

It is not enough nowadays to tell people you are handling talking machines, records and accessories; you must keep your goods before the public, and window display is one of the best ways to do this. Let the public know you are in business and what kind of goods you carry. They do not all know it. Even if they do, they sometimes forget it. One of the main things in dressing a window is simplicity. This is necessary, especially in small towns or in small stores. The main thing is to get the people into the store, and how to do this is the question. It is often best to divide your window in three or four parts and have it appear distinctive. Do not put too many goods of the same kind in a window, for a few machines well displayed is better than a lot of them crowded or thrown in. Your location has a great deal to do with window display. If you are on the main street, then you have a good start, but if you are not well located then you must do something to bring the people to you. Plan out to this end. Try and fix it so they will come; that is the main thing. If you are on the main street, it is very simple. After you get the people to the store you must have something in the window that will hold their attention, and the next thing is to get them into the store. It is no trouble to sell them after you get them inside. If you want to test the worth of your window, go outside. Count the exact number of people who pass in a certain time, say for ten minutes; notice the number that glance at the window, the number that stop and look at the window, and the number who go into the store. Many dealers pay too much attention to the buying part of the business and not enough to the selling. Don't forget people like to read prices. Keep your store up to date. If anything new comes out, get them and see how they take. Put new things in the window and show them off. Even a weather bulletin or something of the kind in the window is a good thing. Many things can be used in a window to attract people that are inexpensive.

TELEGRAPHONE PROGRESS.

World Correspondent Much Impressed With Latest Developments Toward Perfection.

(Special to The Talking Machine World.)

Wheeling, W. Va., Aug. 4, 1907.

The writer had the pleasure of visiting the laboratory and factory of the American Telegraphone Co. the other day, and it was a most enlightening experience, especially to one interested in the future of the talking machine business.

As most of the readers know, the Telegraphone differs in the fundamental principles from all other sound-recording devices. While many of the expert talking machine men of the country have seen the original machine and have claimed that it could never be made a commercial possibility, yet the men who are now working on it have done many of those things that were put down as being impossible. The fact is that the last machines that have come through the factory are marvels when compared with the machines that were shown to the public about two years ago. The machine that will be offered for sale within a short time is a spring-driven, metallic disc machine, intended mainly for office use. The recording is done with an electric magnet and correc-

WHERE GENEROSITY PAYS.

Willingness to Donate Machine and Services to Charitable Affairs Make Friends for the Dealer or Jobber—Publicity That Is Helpful in a Mutual Way.

Few persons outside the dealers directly interested pause to think of the vast amount of charitable work in which the talking machine has been engaged. Hardly any church fair or concert but owes a considerable portion of its entertainment to the offices of a talker in many instances supplied and manipulated by the local dealer free of charge.

Both the organization giving the entertainment and dealer profit by this plan. The former because a larger crowd is attracted and they are saved the expense of fitting up or hiring considerable extra talent, and the latter because many customers are won at such affairs who under ordinary circumstances would not hear the perfect work of the machine or be sufficiently interested to investigate. Many dealers realizing the benefits arising from this form of publicity take pains to make known their willingness to lend their machine and services to such enterprises gratis.

TELEPHONY WITHOUT WIRES.

Dr. Lee De Forest Gives Practical Test of His New Scheme Across the North River—Marvelous Possibilities of the Future—Music Transmitted by Wireless 'Phone.

Wireless telephony has taken its premier hop, skip and a jump across the North River, for Dr. Lee De Forest is now completing the installation of a plant in the Delaware & Lackawanna terminal at Hoboken, which will have communication with a station to be established in the new West street building at the foot of Cedar street.

This distance of two miles, Dr. De Forest does not hesitate to say, will be an easy matter, for sounds that he produced in his laboratory at Fourth avenue and 19th street in April, and referred to in *The Talking Machine World*, were heard aboard the steamship "Bermudian" in the Narrows, a distance of twelve miles. The music of a graphophone played in the laboratory was not only heard at the Brooklyn Navy Yard,



DR. DE FOREST SENDING A MESSAGE.

where a receiver has been installed, but it was so loud that it drowned out the wireless telegraph signals. The purely experimental stage was passed some time ago, and the definite operations now under way are important as recognizing the feasibility and value of wireless telephony for practical use.

The next move will be to equip North River ferryboats with the system, and by proving its efficiency to extend it in time to the general marine service. The fact that no operator is needed, thus eliminating a large item of expense, leads Dr. De Forest to believe that vessels equipped with wireless telephony will ultimately outnumber ships with wireless telegraphy ten to one.

"TALK ACROSS ATLANTIC."

"I consider wireless telephony more valuable as a commercial proposition than wireless telegraphy," says Dr. De Forest. "Although the distance between the first stations on opposite sides of the Hudson is only two miles, I believe it would be possible even now to talk with Sandy Hook. Before the end of the year we will be able to talk fifty miles, in five years' time 500 miles, and in ten or fifteen years across the Atlantic."

Dr. De Forest, who doesn't look a bit like his name, by the way, is keen, quick, as practical as he is thin, and thirty-four years of age. Convinced that wireless electricity was "the coming thing," he gave the subject special study while at Yale, and in 1902 applied for the first patent on his inventions, but did not begin experimenting with wireless telephony until last December. He has already made a name for himself with wireless telegraphy, but he dropped this some time ago to devote himself entirely to the perfection of his later inventions. It is interesting to note in this connection that the wireless telephone receiver is just the same as the receiver used at a wireless telegraph station.

"In the transmitter," said Dr. De Forest, "I employ an ordinary carbon microphone, such as is on every telephone in the city, and connect it with the wires which conduct the electric currents from the transmitter and antenna wires to earth. Thus every change in resistance between the carbon granules affects the strength of the high-frequency currents going into the earth, and in this way also the strength of the electric waves which are radiated outwardly from the antenna wires.

THEORY OF THE SYSTEM.

"The fundamental laws are the same as those which hold in radio-telegraphy, only it is necessary, in order to have the ether waves reproduce the sound waves of the voice, that the number of sparks generated per second shall be so great that the sound of the spark itself becomes inaudible. Each spark produces an impulse at the receiver exactly like itself in nature, only greatly reduced in strength. Now, if these impulses follow each other too rapidly to be heard, the listening ear at the receiver hears no individual impulse, but it can through the telephone detect changes in the local current which are caused by changes in the intensity of the spark impulses at the transmitting station. And if the strength of the spark impulses is directly governed by the voice of one speaking into the transmitter, it is clear that the listener will be made aware of every inflection or shade of sound at the transmitter.

"The minute currents which represent human speech pass through the heated gases of a delicate little receiver called the 'audion,' and are translated into regular telephone currents which, acting upon an ordinary telephone receiver, will give rise to the sound pulsations of the air. Every inflection of the voice, every little peculiarity of sound, each note of a piano, the timbre of each instrument of an orchestra, will be instantly transported and reproduced with perfect fidelity. The ether waves which represent the sound vibrations may have passed over miles of city or wastes of sea, or through the walls of hundreds of buildings. Nothing will retard or obstruct them.

MECHANISM IS SIMPLE.

"And yet the mechanism which makes this possible is very small and simple. It is but a step from the wireless telegraph transmitter with its noisy, irregular spark and Morse sending key to the radio-telephone transmitter with its regular spark and its telephone-microphone, into which any one, however unskilled, may talk. The 'audion,' with its incandescent gaseous medium, has a keener ear for electric sounds and trans-

lates them with a finer exactness than any other form of wireless responder known to the world."

To "keep the line open," as it were, the person speaking must press a button in the instrument and then take the finger from the button to hear the reply. In this respect the De Forest invention is similar to the telephone used in London.

"Is the voice distorted?" was asked.

"Not in the least," said Dr. De Forest. "There may be a frying sound if communication is imperfect, such as is heard in any telephone when

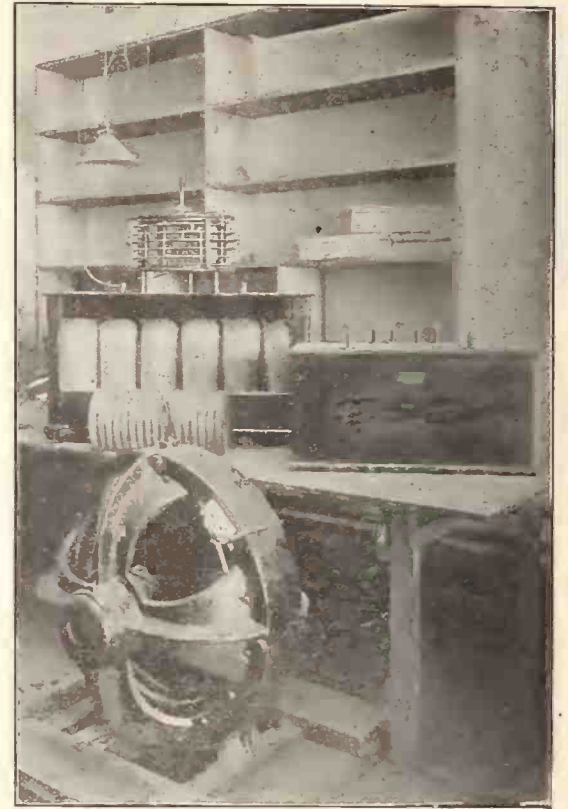

GENERATING PLANT FOR THE WIRELESS TELEPHONE.

it is not working properly, but the tone of the voice is never changed."

Connection between one instrument and another is secured by moving a key on the receiver. This is called "tuning," and the moment an instrument is properly "tuned" the little incandescent lamp begins to burn. One must know where to turn, just as it is necessary with the ordinary telephone to give "central" the number desired. Because of the "tuning," wireless telephones would not be practicable for a large city, for the reason that general interference would cause them to get out of "tune." Dr. De Forest said that the system could be operated successfully in rural communities, however, and that it

ATTENTION! NEW ENGLAND DEALERS

If you handle both EDISON and VICTOR, we can offer you an advantage no other New England jobbing house can—One Source of Supply for both

**EDISON PHONOGRAPHS
AND VICTOR MACHINES**

ONE SHIPMENT—ONE EXPRESSAGE

THERE'S AN ADVANTAGE! Try the Eastern's Policy of Service.

THE EASTERN TALKING MACHINE CO.

177 TREMONT ST., BOSTON, MASS.

Distributors of EDISON and VICTOR MACHINES, Records and all Supplies

Eastern Agents for HERZOG DISK and CYLINDER RECORD CABINETS

\$500

\$500



The Victor Auxetophone is contained in a handsome mahogany cabinet (Louis XV. style). It is simple, finely made, and a beautiful piece of furniture.



A special type of air compressor, run by a silent electric motor, applies the pneumatic power at a point where it magnifies only the musical sound-waves. All mechanical sounds are submerged and disappear.



Right Now

is the time for you to make big money on the

Victor Auxetophone

Everything is ripe and ready for quick and profitable sales

Summer homes, country clubs, lawn parties, public parks, excursions, hotels, large restaurants, pleasure resorts—they all need a Victor Auxetophone and need it now.

Right in your territory to-day you can sell a Victor Auxetophone easier and quicker than any other instrument of half the price.

Nothing else you can offer wakes up such instant enthusiasm. This splendid instrument combines the perfect Victor tone-quality with the big, rich, powerful sound-volume of the grandest pipe-organ, and plays any Victor record loud enough to fill any hall, church or theatre, or "all outdoors," if desired.

The Victor Auxetophone sells itself at a hearing.

And the sale is followed by a large sale of high-

Push the Victor Auxetophone. Take our word that it will pay you big. Push it hard. Push it now.

Victor Talking Machine Company, - Camden, N. J., U. S. A.

Full information and prices can be obtained of any of the Victor Distributors as follows:

Altoona, Pa.....W. H. & L. C. Wolfe.
 Atlanta, Ga.....Alexander-Elyea Co.
 Phillips & Crew Co.
 Baltimore, Md.....Cohen & Hughes.
 E. F. Droop & Sons Co.
 H. R. Eisenbrandt Sons.
 Wm. McCallister.
 Birmingham, Ala.....E. E. Forbes Piano Co.
 Boston, Mass.....Oliver Ditson Co.
 Eastern Talking Machine Co.
 M. Steinert & Sons Co.
 Brooklyn, N. Y.....American Talking Machine Co.
 Buffalo, N. Y.....W. D. Andrews.
 Canton, O.....The Klein & Heffelman Co.
 Charlotte, N. C.....Stone & Barringer Co.
 Chicago, Ill.....Lyon & Healy.
 The Talking Machine Co.
 The Rudolph Wurlitzer Co.
 Cincinnati, O.....The Rudolph Wurlitzer Co.
 Cleveland, O.....W. H. Buescher & Sons.
 Collister & Sayle.
 Eclipse Musical Co.
 Columbus, O.....The Perry B. Whitsit Co.
 Dallas, Tex.....Thos. Goggan & Bro.
 Dayton, O.....The John A. Fetterly Co.
 Denver, Colo.....Knight-Campbell Music Co.
 Hext Music Co.
 Des Moines, Iowa.....Edward H. Jones & Son.
 Detroit, Mich.....Grinnell Bros.
 Dubuque, Iowa.....Harger & Blish.
 Duluth, Minn.....French & Bassett.
 El Paso, Texas.....W. G. Walz Co.
 Galveston, Tex.....Thos. Goggan & Bro.
 Grand Rapids, Mich.....J. A. J. Friedrich.
 Harrisburg, Pa.....S. A. Floyd.

Honolulu, T. H.....Bergstrom Music Co.
 Indianapolis, Ind.....C. Koehring & Bro.
 Jacksonville, Fla.....Metropolitan Talking Machine Co.
 Kansas City, Mo.....J. W. Jenkins Sons Music Co.
 J. F. Schmelzer & Sons Arms Co.
 Little Rock, Ark.....O. K. Houck Piano Co.
 Lincoln, Neb.....Ross P. Curtice Co.
 Los Angeles, Cal.....Sherman, Clay & Co.
 Memphis, Tenn.....O. K. Houck Piano Co.
 E. E. Forbes Piano Co.
 Milwaukee, Wis.....McGreal Bros.
 The Boston Store.
 Minneapolis, Minn.....Minnesota Phonograph Co.
 Mobile, Ala.....Wm. H. Reynolds.
 Montreal, Canada.....Berliner Gramophone Co., Ltd.
 Nashville, Tenn.....O. K. Houck Piano Co.
 Newark, N. J.....Price Phono. Co.
 Newark, O.....Ball-Fintze Co.
 New Haven, Conn.....Henry Horton.
 New Orleans, La.....Nat'l Auto. Fire Alarm Co.
 Philip Werlein, Ltd.
 New York, N. Y.....Bettini Phonograph Co., Ltd.
 Blackman Talking Machine Co.
 Sol. Bloom.
 C. Bruno & Son.
 I. Davega, Jr.
 S. B. Davega.
 Chas. H. Ditson & Co.
 The Jacot Music Box Co.
 Landay Brothers.
 The Regina Music Box Co.
 Stanley & Pearsall.
 Benj. Switky.
 Victor Distributing & Export Co.
 Omaha, Neb.....A. Hospe Co.
 Nebraska Cycle Co.
 Piano Player Co.

Peoria Ill.....Chas. C. Adams & Co.
 Philadelphia, Pa.....C. J. Heppe & Son.
 Musical Echo Company.
 Penn Phonograph Co., Inc.
 Louis Buehn & Brother.
 Western Talking Machine Co.
 H. A. Weymann & Son.
 Pittsburgh, Pa.....Pittsburg Phonograph Co.
 Powers & Henry Co.
 Standard Talking Machine Co.
 Portland, Me.....Cressey & Allen.
 Portland Talking Machine Co.
 Portland, Ore.....Sherman, Clay & Co.
 Providence, R. I.....J. Samuels & Bro.
 Richmond, Va.....The Cable Co.
 W. D. Moses & Co.
 Rochester, N. Y.....The Talking Machine Co.
 Rock Island, Ill.....Totten's Music House.
 Salt Lake City, Utah.....Carstensen & Anson Music Co.
 San Antonio, Tex.....Thos. Goggan & Bro.
 San Francisco, Cal.....Sherman, Clay & Co.
 Savannah, Ga.....Youmans & Leete.
 Seattle, Wash.....Sherman, Clay & Co.
 Sioux Falls, S. D.....Sioux Falls Talking Mach. Exchange.
 Spokane, Wash.....Eiler's Piano House.
 St. Louis, Mo.....O. K. Houck Piano Co.
 Koerber-Brenner Music Co.
 St. Louis Talking Machine Co.
 St. Paul, Minn.....W. J. Dyer & Bro.
 Koehler & Hinrichs.
 Syracuse, N. Y.....W. D. Andrews.
 Toledo, O.....The Hayes Music Co.
 A. J. Rummel Arms Co.
 Whitney & Currier Co.
 Washington, D. C.....John F. Ellis & Co.
 S. Kann & Sons Co.

might not be impossible for small towns. "But it will be best of all," he adds, "for communication from ship to ship, from shore to shore, and between islands."

The inventor has in mind one use for wireless telephony in New York that will appeal to music lovers. With the permission of the management of an opera house he could carry an opera performance up through the roof, he said, and send it hot off the griddle to people with wireless receivers in their homes. In this way a person could hear all the operas for the trifling expense of \$2 a month. But Dr. De Forest hasn't mentioned this to Conried or Hammerstein as yet.

TALKING MACHINES IN SAMOA.

In a report upon the music trade in Samoa Consul George Heimrod, of Apia, states that there are six talking machines in that section imported by H. J. Moors, an American merchant. The Consul's report is as follows:

"Importations of pianos for the last ten years have not exceeded fifty, and of these perhaps six, expressly built for the tropics, are in condition to form accordant musical sounds. The manufacture, with the exception of two American pianos, is of German and English origin. The instruments were either imported directly or through an agent from the colonies, who makes regular yearly visits to the islands of Tonga, Samoa and Fiji with the view of tuning and selling pianos. Of other musical instruments I find two organs, one piano player and six phonographs. The latter have been introduced by H. J. Moore, an American merchant in Apia."

PERMISSION TO BUILD SHOW WINDOWS.

After several weeks of experience with the red tape of city government, Lawrence McGreal, the well-known Edison and Victor jobber of Milwaukee, Wis., finally obtained permission from the Common Council in an ordinance taking up several typewritten sheets, to build show windows in the new building, 172-176 Third street. The new windows will afford the firm excellent opportunities for displaying their extensive line to advantage.

DOUGLAS CO.'S NEWARK HEADQUARTERS.

The Douglas Phonograph Co. have removed their Newark, N. J., store to the new quarters at the corner of New and Halsey streets, and things are being rapidly straightened out after the mix-up due to the moving.

The new quarters are well located, nicely decorated and well-lighted, both naturally and arti-

ficially, over 150 incandescent lamps being placed in the ceiling of the main floor. The first floor is devoted to the Edison machines and records, and the second floor to the Victor line. The building is well equipped in every respect.

VICTOR TRADE-MARK.

Time and time again the origin of the Victor trade-mark, "His Master's Voice," has been discussed in these columns, but the subject is again reopened through the daily press by H. S. Berliner, who recently wrote a Washington paper as follows:

"Mr. William Barry Owen, the veteran manager of the company in England, which purchased the picture, writes as follows concerning 'His Master's Voice':

"A man (Mr. Francis Bearaud) came into my office in London and said he had made a picture with a sentimental idea attached to it—of his own dog listening to a phonograph—and that as he needed to sell it he would offer it to the company. "How much?" I asked. "Two hundred and fifty pounds," he said. "Too much; I will give you fifty pounds for catalog work, and if I decide in thirty days to take the world copyright and all your interest I will pay you another fifty pounds." This occurred on a Thursday, and on Saturday I paid him the second fifty pounds and sent him to my attorneys to make out papers. This is the entire history."

THE TALKING MACHINE IN CARTOON.



culo mail order house, who use three hundred graphophones in handling their correspondence. This is an instance of how large business houses can profit by the use of the commercial talking machine system.

Charles Eabold, for some time manager of the talking machine department for George W. Clark, Syracuse, N. Y., now holds a similar position with the Andrew J. Speich Co., of that city, who handle the Victor line.

C. L. Reimer, the talking machine dealer of Asbury Park, N. J., has added Columbia graphophones to his other lines, and reports a steadily increasing business.

BIG ORDER FOR BLANK RECORDS.

An order for 10,000 blank records monthly was recently received by the Columbia Phonograph Co. from Sears, Roebuck & Co., the great Chi-

SPECIAL NOTICE TO JOBBERS

Our "Tulip" and "Morning Glory" Horn PROPOSITION the BEST you ever heard of. GET OUR PRICES AND SAMPLE ORDER.

EVERY HORN
A WORK OF
ART :: :: ::



OUR PATENTED "TULIP."

ALL COLORS AND
DECORATIONS

Don't wait until you get
rushed for business and then
order. **NOW** is the time.

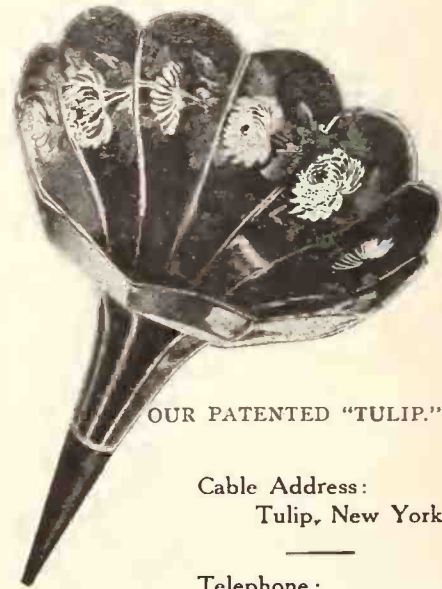

OUR PATENTED "TULIP."

Cable Address:
Tulip, New York

Telephone:
350 Cortlandt

Address all correspondence to

The New Jersey Horn Mfg. Co.
45-47-49 Monmouth Street - Newark, N. J.

B. Schuyler Morris, Gen'l Sales Agent
271 Broadway, cor. Chambers St., New York City



September List of New Victor Records

Get the complete list. Be in position to give every customer what he wants when he wants it. Don't make it necessary for a single customer to go to your competitor's for a record that you ought to have.

8-inch size 35 cents each

- Arthur Pryor's Band**
 No. 5192 Ship Ahoy March.....Lusk
Victor Orchestra, Walter B. Rogers, Conductor
 5193 The Banner March.....Von Blon
Yodel Song, by George P. Watson
 5129 Sour Krout is Bully.
Duet by Miss Jones and Mr. Murray
 5137 It's Nice to Have a Sweetheart—From the TouristsKerker
Descriptive Specialty by Collins and Harlan
 1727 Two Rubes in a Tavern.....Stanley
Yankee Talk by Cal Stewart
 1640 Uncle Josh On a Street Car.....Stewart
Two Teddy Bear Records
 Issued especially for the children.
 5202 Frolic of the Teddy Bears.
 Adapted from Bratton's "Teddy Bears Picnic."
 (Played by Victor Orchestra.)
 5191 The Teddy Bear's Lullaby.
 Sung by Mr. Macdonough, with orchestra.

10-inch size 60 cents each; 12-inch size \$1.00 each

- Arthur Pryor's Band**
 5203 Comedian's March—10 inch.....Smetana
 From Bartered Bride.
 5205 Austrian Army Bugle Calls Waltz—10 inch.
 Plusty
 5206 On the Belvedere—Two Step (Na Belvederu Pochod)—10 inch.....Faster
 31650 Daughter of the Regiment Overture—12 inch.
 Donizetti
 31651 The Death of Custer—12 inch.
 (The Battle of Little Big Horn.)
 31652 Red Mill Selection—12 inch.....Herbert
Victor Orchestra, Walter B. Rogers, Conductor
 5185 The Minute Men (March and Two-Step)—10 inchWinburn
 5208 Merry Widow Waltz—10 inch.....Lehar

Victor Dance Orchestra

- 31655 Merry Widow Waltz (Ballsirenen)—12 inch.
 Lehar
Bell Solo by Chris Chapman
 5188 Medley Dance—10 inch.....Kamman
Mezzo-Soprano Solo by Miss Pearl Benham
 5187 In May Time—10 inch.....Speaks
Tenor Solo by Henri Leonl
 5201 I Love You, Ma Cherie—10 inch.
Tenor Solo by Harry Macdonough
 5189 Dreaming—10 inch.....Dailey
Comie Song by Miss Ada Jones
 31654 I'm in Love With the Slide Trombone—12 inchFurth
Tenor Solo by Frederic C. Freemantel
 5194 Over the Line—10 inch.....Phelps
Bass Solo by Frank C. Stanley
 31653 Chorus, Gentlemen—12 inch.....Lohr
Songs by Billy Murray
 5195 I Think I Oughtn't Auto Any More—10 inch.
 5196 In the Land of the Buffalo—10 inch.
 Williams-Van Alstyne
 5197 Harrigan (from Fifty Miles From Boston)—10 inch.....Cohan
"Coon" Song by Arthur Collins
 5204 Brother Noah Gave Out Checks for Rain—10 inchLongbrake
Duet by Stanley and Macdonough
 5200 When Johnny Comes Marching Home—10 inchLambert
Four Records by Vesta Victoria
 5181 The Next Horse I Ride On—10 inch.....Everhard
 5182 Waiting at the Church—10 inch.....Pether
 5183 Poor John—10 inch.....Pether
 5184 Billy Green—10 inch.....Gifford
Laughing Specialty by Famous Comedians
 52000 Laughs You Have Met—10 inch.
 (Illustrated by five famous funmakers.)
German Specialty by Jones and Spencer
 5186 Minnie and Herman—10 inch.

Male Quartet by the Haydu Quartet

- 5167 The Last Rose of Summer Is the Sweetest Song of All—10 inch.....Sidney
Comie Duet by Collins and Harlan
 5190 There's Room for Us All on the Trolley—10 inchBennet
Lyric Quartet
 5199 Rock of Ages—10 inch.....Buck

Red Seal Records

- Five New Nielsen-Constantino Records, Alice Nielsen, Soprano**
 Twelve inch, with orchestra, \$1.50 each, in Italian.
 74074 Barbieri—Uno Voce Poco Fa.....Rossini
 (A Little Voice I Hear.)
Florenco Constantino, Tenor
 10 inch, with orchestra, \$1.00 each. Italian.
 64072 Rigoletto—La Donna e Mobile (Woman Is Fickle)Verdi
 12 inch, with orchestra, \$1.50 each. Italian.
 74073 Barbieri—Ecco RidenteRossini
 (Dawn, With Her Rosy Mantle.)
Duets by Nielsen and Constantino
 12 inch, with orchestra, \$1.50 each. Italian.
 74075 Traviata—Parigi o Cara (Far From Gay Paris)Verdi
 74076 Faust—Dammi Ancor (Duet from Garden Scene)Gounod
 (Let Me Gaze on Thy Beauty.)
Two Ballads by Ancona, Mario Ancona, Baritone
 10 inch, with Orchestra, \$2.00 each. In Italian.
 87010 Mattinata (Morning Serenade).....Tosti
 87011 Invano—Serenata (In Vain).....Tosti
Two New Witherspoon Records, Herbert Witherspoon, Bass
 12 inch, with Orchestra, \$1.50 each. In English.
 74071 Meet Me By Moonlight Alone.....Wade
 74072 Messiah—Why Do the Nations.....Handel
An Oratorio Number by de Gogorza, Emilio de Gogorza, Baritone
 12 inch, with Orchestra, \$1.50. In English.
 74069 God, My Father.....Dubois
 From "Seven Last Words of Christ."

A splendid list! And every record with that remarkable musical tone-quality that distinguishes Victor Records from all others, and makes them the easiest sellers and the best money-makers.

We help along the demand for these new records by advertising a complete descriptive list in the daily newspapers throughout the country around the end of August.

Stock up and get the full benefit.

Victor Talking Machine Company

Camden, N. J., U. S. A.

SPECIAL DESIGNS WILL HAVE CALL.

How the Change in the Equipment of Edison Phonographs Will Affect the Horn and Crane Business—The Situation Analyzed.

The announcement recently made by the National Phonograph Co., whereby they intend to equip all phonographs with large horns, has made many figure how such a move would affect the sale of these articles as independent transactions. Chatting with a leading member of the industry a few days ago on this subject, he said:

"At first glance it would seem that the market for independent sales would be very materially affected, and that giving a customer a large horn with a machine would make such transactions impossible. A close study of the situation, however, will undoubtedly warrant a different conclusion. People purchasing talking machines have for a number of years past been accustomed to employing their own fancy as to the style horn they will use, and the various horn manufacturers have largely catered to this fancy in producing endless varieties and styles of horns, many of which possessing distinct virtues, so as to please any and all purchasers. One manufacturer alone claims to produce over two hundred different styles and sizes of horns for talking machines.

"The horn is the most conspicuous part of a talking machine, the eye naturally centers on it, and whereas dealers and jobbers have frequently felt it was a hardship to be obliged to carry so many different style horns, at the same time they must not forget the fact that through having these different styles the fancy of each individual has been catered to, with the result of largely increasing machine sales.

"Up to the present time it has been found impossible to make one style, size, and finish of horn that would suit all purchasers, and these same conditions are bound to exist under the

new equipment. Undoubtedly the sale of cheaply constructed horns will be largely affected, but the market for high priced and artistic looking horns should if anything be larger. The public will be educated to the advantages derived from the large size horns when they purchase their machines, and the opportunity to sell a high priced, better appearing or better tone horn will certainly be increased. It is my opinion that progressive jobbers and dealers will still find a good market for their high grade horns, and that public demand will undoubtedly require the sale as a separate transaction of horns different from those furnished with the original outfit. Again, the opportunity to make the stock more attractive would be entirely lost with the dealer if he fails to vary his stock with different horns and cranes."

PAYS TO BE ATTENTIVE.

An Illustration in This Connection That Should be Noted by Talking Machine Men.

There is a lesson in this story related by Hayward Cleveland, of the Columbia Phonograph Co., for every dealer and salesman in the talking machine business, and the moral should be noted:

"One day some years ago, at our uptown store, a postal card was received from a small town in upper New York, asking for 'catalogs of your machines and records,' no other word except the inquirer's name. The mailing clerk sent the matter asked for in an unsealed envelope, postage one cent. No letter accompanied. In a few days there came by registered mail twelve crisp five-dollar bills, four ones and 50 cents in postage, \$64.50 in all, and an order for an AB graphophone, records and supplies! No merit attached to us. We did not neglect, nor did we cultivate. The lesson was not lost. The moral was: 'Pay heed to the most trivial inquiry or request.'

"The other day a besmeared envelope, with an illegible misspelled superscription was received. Inside was a single sheet of plain paper, on which was scrawled the following: 'Will you Send To Blaks To W. A. Stonefaller, Greenwich, Conn.?' That was all. The whole almost deserved being ignored. A note was dispatched, politely asking for 25 cents payment in advance. By return mail there came that amount in postage, accompanied by the engraved visiting card of a Madison avenue customer of ours (same surname) with this written thereon: 'Two blank cylinders for the little \$10 graphophone.' It developed that the first note had been sent by the infant son of a millionaire capitalist, whose country address we did not know.

"Moral—Pay heed, for 'you never can tell' who is at the other end of the line!"

CLEVER WINDOW DISPLAY

Made by the Regina Company in New York
—Reginaphones and Sublimas Featured.

The Regina Co., 17th street and Union Square, have arranged a most pleasing window exhibit which is attracting most favorable attention. In the foreground is a sprinkling of Reginaphones which are adapted to any size music boxes on the market and a number of cabinet instruments in mahogany, Vernis Martin and dainty decorated floral panels. In the second window is a "Sublima," which tells on the revolving perforated roll an interesting story of how it was perfected, facts relative to its mechanism and tone, the number of times it played, the number of instruments of its kind that had been sold, etc., etc., all of which invites and holds the attention of passers-by. The company are very busy at the Rahway factory, and the orders received by mail and from road salesmen would indicate that dealers are placing orders early with the anticipation that fall trade is to be good.

AT LAST!

A New Reproducer For Cylinder Machines Three Times As Loud As Any In Existence

**LOUD ENOUGH FOR CONCERT HALLS OR FOR DANCING,
OR CAN BE MODIFIED TO A WHISPER IF DESIRED**

The only reproducer in the world having an adjustable weight tension by which the pressure on the record can be increased or decreased instantly, thus enabling the operator to play the old wax records or the new moulded kind with equal safety to the record in regard to wear. The most natural tone reproducer on the market. Makes any old record good and a good record perfect. Will sell twice more records for the dealer than the regular reproducer and will not wear the record half as much.

An Entirely New Principle Sold with the distinct understanding that if not exactly as represented can be returned and money will be cheerfully refunded. Indorsed by all who have heard it, including several of the leading Edison jobbers, as the very best reproducer on the market. Gives a volume of sound hitherto unheard of in any detachable reproducer.

Guaranteed For One Year We absolutely guarantee this Reproducer to be much louder, more natural in tone, less liable to get out of order than any other Reproducer on the market to-day, besides having our patent system of weight pressure adjustability. Failing which the money will be cheerfully refunded and the Reproducer will cost you nothing. Patents applied for in U. S. and all Foreign Countries.

REFERENCES: First National Bank, Lincoln, Neb.; Columbia National Bank,
Lincoln, Neb.; First Trust & Savings Bank, Lincoln, Neb.

Price (\$10.00) Ten Dollars

Special Offer This Month Only To All Interested Upon receipt of five dollars in cash, Postal or Express money order or Draft and one old Edison Model C, or one old Columbia Spring Contact Reproducer and this ad., we will ship sample reproducer to any part of the World with the distinct understanding that if not entirely satisfactory money will be immediately refunded. If no old reproducer is sent, send \$8.00 instead of \$5.00, an allowance of \$3.00 being made on old reproducer. No order will be noticed unless accompanied by full amount of order. Please specify if EDISON or COLUMBIA reproducer is desired.

**Undoubtedly a Record Breaker, but will not wear the Record. A Decade
In Advance of Anything Known for the Reproduction of Sound.**

Usual discount to jobbers and dealers on initial order of not less than six and three respectively.

Make all orders payable to

THE MAESTROPHONE PHONOGRAPH CO., Lincoln, Nebraska, U. S. A.

TEXAS ANTI-TRUST LAWS

Are Causing Consternation Among All Classes of Merchants—Will Talking Machine Contracts be Effected?—Drastic Amendments.

(Special to The Talking Machine World.)

Austin, Texas, August 10, 1907.

The several amendments to the previously stringent Texas anti-trust laws enacted by the Legislature recently closed, has created consternation among all classes of merchants, as its provisions absolutely prohibit any one from acting as agent, jobber or retailing any goods manufactured by a trust, or entering into any agreement to reduce, advance or alter a price on any article or commodity. The minimum penalty is two years' imprisonment in the State penitentiary.

Several legal authorities consulted have stated that hardly a merchant in the State is exempt from some violation of the law as it now stands, and when effective every one will be in jeopardy, as county attorneys and district attorneys are given a bonus of \$100 for every suit won under its provisions, and many prosecutions are anticipated. The Legislature may be called into special session to modify some of its terms. For instance, one section imposes as a special tax of 50 per cent. on gross sales of pistols and firearms, and all hardware dealers are closing out their stock at less than cost.

Whether or not it affects the talking machine contracts is not known, but the attorneys of at least one factory have taken up the matter, and their attorney is now collecting the best legal opinions in the State. It is thought the paragraph relation to restraint of trade will require the elimination of any contract in writing not to sell to dealers who may be suspended or undesirable on account of price cutting or other violation of the patent provisions and license under which the goods are sold.

Doubtless the intent of the law was to curb the larger trusts, and already a fine of over \$1,000,000 has been assessed against the Waters-

Pierce Oil Co. necessitating a receiver, and it is rumored action will be next begun against agents and jobbers of the American Tobacco Co. In the meantime, every county attorney in the State is "sitting up and taking notice" of the available cases where he can obtain bonuses. One of the provisions of the law is that all cases must be brought in the Travis County Court, in which Austin, the capital, is located, and it will cause endless trouble to merchants cited to appear as witnesses or defendants.

Another bill enacted imposes a 2 per cent. gross tax on most all commercial houses, in addition to the already heavy taxes in Texas. At least one phonograph jobbing house has been seeking a location just beyond the Texas line from which point they could supply their Texas customers, but attorneys say this will not avoid the law, as each retail dealer will then be equally guilty, and there would be a chance for some enterprising county attorney to bring a wholesale indictment against, say, two hundred dealers, and if convicted would receive a hundred dollars each bonus, a fee not to be scorned or tried for.

There is no talking machine jobber in this city, but they are located at nearly all other larger cities in Texas, and representatives of two of them with their attorneys have been here consulting the general attorney of the State as to his construction of the act, but they were not interviewed by your correspondent, and this information is gathered from newspaper reports that have gone forth from here by correspondents of large dailies who are in close touch with these matters.

DOT FONOGRAF.

Der oder tay ven I come der house in I dake down my gonsertena fon der shelf und dink I blay me sum music yet, ven my vife git mad und say, Chake:

I'ud avay dot gonsertena on der shelf und led it stay, Id chust nerey drifes me krazy und der tog he ruus avay.
Dot old ding vass all ridt sum dlme manny, manny years ago,
Ven der musicg vas nod blendy und der peobles dey vas schlow,
Took der monie from der kuppert und go down to Schneider's store
Vere dey sell dem musiek boxes vot blays bieees by der score,
Pring along some blendy Reckerds, ve vill make der neibers laf
Ven dey heir der musiek blayen from der Edison Fonograf.

Vell, I vos der poss uv der hous, bud ven Lena say, "Go, Chake" den I go, und dot vas all about it. I puy me a fonograf und about tu dotzen reckerds und ven I kum der house in und pud him on der dable und make him blay, Lena she say:

Did yu effer here such blaying here, ver'e Kummen Dru der Rie,
Dixey, Duly und Magludy, Sauerkraut und Dond Yu Gry,
Der pirds is singen, pands is blayen, dares Lena Schmitt und Chust my Sthile,
Panjos, bells und violenas is blayen musiek all der vile,
Home Sweed Home und Good I'y Mudder, my! I told yu dot vas fine
Chake, now dell me vot's Id blayen? Hlmmel, dot's der Wacht um Rhine.
Good by now old gonsertena, von now vas a big skiddu,
Ve vill pud yu in der kubbert, it vas dwenty-dree fur yu.
—Harry George Bauman, in The New Phonogram.

HANDLING TALKING MACHINES SOLELY.

Frank J. McArdle, proprietor of the Omaha Piano Player Co., Omaha, Neb., who was obliged to give up his quarters in the department store of O'Donohue-Redmond-Norwich Co., owing to the failure of that company, has decided to discontinue his piano and player business, and will devote his entire attention to talking machines. He will carry a full stock of Victor machines and about 12,000 records on the second floor of the old Boston store.

INCORPORATED THIS WEEK.

The Ideal Fastener Co., 143 Liberty street, New York, was incorporated with the Secretary of State at Albany on July 27 for the purpose of manufacturing horn supports for talking machines; capital, \$15,000. Directors: Charles Newman, L. M. Walstein and Otto Crane, New York.



- ☞ Do you like this issue of the World?
- ☞ Is it not worth something to you in your business?
- ☞ Do you receive it regularly?
- ☞ If not, why not?
- ☞ The fault is your own, for we've done our part in supplying you with a sample copy.
- ☞ Subscribe for it.
- ☞ That's the only way to get it.
- ☞ It is worth ten times the annual cost to you, whether your store is in Houston, Hong Kong or Hindoostan. We have subscribers in all these places, and they say "Yes."
- ☞ Be progressive and read the World. Your competitor takes it and he knows its value.
- ☞ It costs one dollar yearly in the United States and Mexico; all other countries, one dollar and twenty-five cents.
- ☞ Don't delay sending in your order; not soon, but NOW! We can handle anything in checks, postal orders, stamps, and, of course, cash.

THE
Talking Machine World
SUBSCRIPTION DEPARTMENT
1 Madison Avenue, New York

PETMECKY

Multitone, Self-Sharpening Talking Machine Needles

are guaranteed to play any disc record with less or no harm to the record than any other metal needle ever made. Moreover, they will produce a purer, sweeter tone than any other needle. A dealer writes: "Samples received; my first order for 10,000 needles tells you what I think of them. I wonder how anyone will use any but the Petmecky on his finest records." We have hundreds of just such unsolicited testimonials—yours, too, if you will but try them. Kindly write us for samples, booklet, prices, etc.

PETMECKY COMPANY

506 New York Life Building
KANSAS CITY, MO.



EDWARD LYMAN BILL, - Editor and Proprietor

J. B. SPILLANE, Managing Editor.

Trade Representatives: GEO. B. KELLER, F. H. THOMPSON, W. H. DYKES, L. E. BOWERS, B. BRITAIN WILSON, A. J. NICKLIN.

Boston Office: ERNEST L. WAITT, 278A Tremont St.

Chicago Office: E. P. VAN HARLINGEN, 195-197 Wabash Ave.

TELEPHONES: Central, 414; Automatic, 8643.

Philadelphia Office: Minneapolis and St. Paul: H. P. THOMPSON. ADOLF EDSTEN.

St. Louis Office: San Francisco Office: CHAS. N. VAN BUREN. S. H. GRAY, 240 Sacramento St.

Cleveland Office: G. F. PRESCOTT.

London, England, Office:

69 Basinghall St., E. C. W. LIONEL STURDY, Manager.
Berlin, Germany, CHAS. ROBINSON, Breitstrasse 5.

Published the 15th of every month at 1 Madison Ave. N.Y.

SUBSCRIPTION (including postage), United States, Mexico, One Dollar per year; all other countries, \$1.25. England and her colonies, five shillings.

ADVERTISEMENTS, \$2.00 per inch, single column, per insertion. On quarterly or yearly contracts a special discount is allowed. Advertising Pages, \$60.00; special position, \$75.00.

REMITTANCES, in other than currency form, should be made payable to Edward Lyman Bill.

IMPORTANT.—Advertisements or changes should reach this office by the first of each month. Advertisements arriving too late for insertion in the current issue will, in the absence of instructions, be inserted in the succeeding issue.

Long Distance Telephones—Numbers 1745 and 1761 Gramercy. Cable Address: "Elbill," New York.

NEW YORK, AUGUST 15, 1907.

THE meeting of the Eastern Talking Machine Jobbers' Association in New York last month, which is reported extensively elsewhere in this issue, was an event of great importance to the talking machine trade. It surprised the promoters. In fact, the officers of the association did not believe that the meeting would be such a pronounced success. There were many things discussed in a business way which certainly will have an effect in shaping the future of the industry. The social functions were pleasing and made a most delightful feature of the meeting. The talking machine men are active. There will be another meeting in Buffalo next month, which will be practically a joint session with the Central States Jobbers' Association, following their meeting held in Chicago in June. Now the result of all the gatherings of the talking machine men, to our minds, will mean a national organization rather than two or three sectional ones. It was informally discussed at the recent gathering. Why not, gentlemen of the talking machine trade, form a national talking machine association? You could have committees appointed of gentlemen who reside in the East and West, and through them any special information could be reported to a central body, so that the workings of the association would be in complete harmony, and yet there would be a greater strength in the whole than if the talking machine trade were split into factions East, West, North and South. By uniting the interests the trade can be best served, and there are many things which are constantly coming up which demand action on the part of those directly interested in maintaining the welfare of the trade. We recommend to the talking machine men who meet in Buffalo next month to immediately start the wheels in motion for the formation of a national association.

OUR readers should understand that this publication, which is devoted solely to the interests of the talking machine trade, will strive

earnestly for the establishment of a national association, and we shall be pleased to work hand in hand with the talking machine men to promote its growth. The interests of this trade are steadily growing, and with an expanding industry it is but natural that there are problems constantly developing, all of which may not be of easy solution. A national talking machine jobbers' association will undoubtedly make for the advancement of trade interests, and can accomplish much more than the isolated individual. Local lines are being steadily eliminated, and the interests of the talking machine men in all sections of the country are identical.

NO matter whether a man may be doing business in Maine or California, it is necessary that trade conditions surrounding him be of the same uniform character and should be guarded with the same caution.

The editor of this publication called the piano manufacturers together in 1888 and presided at the first national gathering of piano men in this country. That meeting was the origin of the association movement in the music trades. He next advocated the formation of a piano dealers' association, and this was formed at precisely the time and place suggested by him. This organization has now hundreds of members, and has been instrumental in helping to eliminate from the music trade certain evils which had crept in. The talking machine business is in its infancy, as far as development goes, so before any evils have developed it may be well to guard against them. By all means, let us have a talking machine jobbers' national association, and let the inceptive move be made in the early fall.

THERE is no denying the fact that the condition of the horn market has been, and is even to-day, somewhat unsettled. For weeks, before the Edison move was definitely announced, there was a marked feeling of unrest, for it was conceded that if such a great producing concern as the National Phonograph Co., with its extensive business ramifications, should enter into the manufacture of horns, it would have an immediate effect upon the market. Edison men would, of course, be compelled to buy the Edison outfits, and that would cut out just that much outside horn business. The affiliations of the National Co. are so close to their factors in various sections of the country that their entree into the horn field was looked upon as being a move which would unsettle trade conditions as applied to horns for some time. Then again it was stated upon excellent authority that this company had secured options on a number of plants, and this also caused a good deal of speculation as to the outcome of the proposed move.

THE announcement, however, has been made, and the National Phonograph Co. will have a complete horn equipment ready by the 15th of next month. Some of the manufacturers and some of the big jobbers are hit heavily by this move. There is no reason, however, to suppose that the horn business is going to the demerit bowwows simply because the National Co. adds another department to its present extensive line, and enters the arena as horn manufacturers. Horns will be made and sold in larger quantities than ever, and there is no particular occasion for any one to lose their heads over the present condition. Special horns will be created to reach a select trade, as seen by

special announcements in this issue of The World. Then there are many people who already own machines and will desire new horns for them. We shall all be doing business, gentlemen, we hope, for some time to come.

A SUBSCRIBER asks us: "What do you consider the greatest essential in the selling of talking machines at retail?" We should say tactfulness, for without that the salesman is lost. It is a mistake sometimes to tire customers by running records which do not in the slightest interest them. A salesman should use sufficient tact to size up his customer, so that he would know just what kind of music would appeal to him. We have seen some salesmen put on rag-time music for some men whose tastes did not run in that line; we have also seen them show off high-class operatic music to people who had no more conception of the beauties of musical orchestration than they had of the mysteries hidden in the monuments of Egypt. It is easy to find out from the dress, the appearance, or the language of each individual caller what music appeals to him without seeming to put the question direct, and then give him something which he likes, but not enough to tire. Don't let a record run until its close, but just a little, enough to whet the appetite, and then put on something more and show the variety. Then the customer begins to be interested in a talking machine; he begins to realize something of its development. Tactfulness by all means as a salesmanship essential. Study it and salesmen will learn how to handle their trade more successfully, and in the end they, too, will be making bigger salaries.

A NUMBER of World readers have asked us for an opinion as to the final result of the suits brought against the National Phonograph Co. by the New York Phonograph Co. It seems as if we should not be called upon to again explain the attitude of this paper, and that is, our absolute refusal to be dragged into any of the legal complications which seems to be inseparable from the talking machine business. The courts presumably are fairly able to handle matters which may be legally brought before them, and it is not within the province of a trade newspaper to try cases in its columns. The officers of the National Phonograph Co. do not seem in the slightest disconcerted over the recent developments, and our acquaintance with them teaches us that they are quite competent to conduct their affairs in the future as in the past without any special admonition from us. The World could republish a lot of the matter which has been circulated through the columns of the daily papers, which is well calculated to arouse fear on the part of some of the Edison New York agents, but we do not propose to express an opinion as to the ultimate outcome of this long-fought series of legal battles and expound our beliefs as to what effect it may have upon the business of the Edison agents within the borders of the Empire State. We assume that the Edison people know their business, and we are sure of one thing, and that is that we shall attend as nearly as possible to our own affairs and not meddle with that which belongs exclusively to the courts.

IN a few weeks it will be time to buckle on the armor for the battle for fall trade. Are you ready?

THE SEARCHLIGHT FOLDING HORN



Patent No. 771441
Oct. 4, 1904

Patent No. 12442
Jan. 30, 1906

THE ONLY PRACTICAL,
COLLAPSIBLE HORN IN THE WORLD

Style—Gun Metal Finish—Gold Striped.

For all Edison and Victor Machines except Victor 1.

Size, 23 x 28 Cylinder; 23 x 21 Disc. Boxed, 3½ x 7 x 20 Inches.

“A Startling Novelty”

THE SEARCHLIGHT FOLDING HORN

The Searchlight Folding Horn
A masterpiece in every respect.
Opened it resembles a solid flower horn,
Folded you can carry it in your pocket.



THE Bell is self-sustaining and *one piece*, ready for use in ten seconds by unfolding the bell and attaching the funnel.

No clamps, rods or braces. Never out of order.
No experience required to fold or unfold it. A child can work it.

Small enough to send with the box containing the talking machine. No expense in packing.

Light enough to be sent by mail as merchandise.

AN EPOCH-MAKING HORN!

Send to Your Jobbers for Samples

Send Now

MANUFACTURED BY THE
SEARCHLIGHT HORN COMPANY

753-755 Lexington Avenue

Borough of Brooklyn, New York

VALUE OF ANSWERING LETTERS.

Prompt Attention to Communications Makes Friends for the House and Acts as a Stimulator to Your Business.

Talking machine men need hardly be told that the first requisite to success in business is promptness in answering inquiries of all kinds, even though not seemingly important. The dereliction of some concerns on this point is appalling. Rarely a week passes but we hear tales of people who have written firms on business matters and failed to receive any sort of acknowledgment.

People come to know us through our letters and we are forced to rest under the judgment our letters have evoked. If we have occasion to write but once, great care should be taken as there will be no opportunity to remove any unfortunate impression it gives. If there are letters to follow them, a wrong impression created by the first letter may be eradicated by later editions.

A business man wants a customer to know and believe he is being treated fairly and with courtesy; that his continued business is valuable, and that a strong desire to retain it is evidenced by the writer.

One of the strongest points in favor of writing polite, thoughtful and considerate letters is that it develops into a habit and the writer becomes thoroughly imbued with the spirit that pervades them and soon finds as great satisfaction in writing them as the other does in receiving them.

Subordinates take their cue from the one "higher up," and they can do much to make or mar the fortunes of the man they serve, and because of that great care should be taken to keep harmony and courtesy at the helm.

WILL DISPLACE THE "BARKER."

The Officials of the Iowa State Fair Adopt a New Idea That Will be Welcomed.

It is the intention of the officials of the Iowa State Fair to use a number of talking machines in connection with the Bureau of Information to displace the usual barker. Machines will be placed at various points on the grounds to direct visitors to cars, the various special exhibitions and other general features.

Visitors to the fair will hear such speeches issuing from the talkers, as—

"Take the fair grounds cars for the big fair at the south door to the courthouse. Beware of the bunco man!"

"The airship goes up on the south side to-day. Don't buy tickets; it is a free exhibition."

"Beware of pickpockets!"

Of course the talking machines will be in charge of men who can give more detailed information when desired.

DISCOVERS A PAYING BUSINESS.

Elwood Ayres, a wandering piano dealer of Missouri, who creates interest in his instruments by concerts given in country school houses, some time ago discovered that a moving picture show would largely increase his audiences, and forthwith purchased an outfit, accompanying the pictures with appropriate piano or organ selections. One of the films portrayed a Chicago slaughter house where pigs were being killed, and music suitable for the scene, was not to be produced on either of his two instruments in an effective manner. Mr. Ayres, however, was not balked at that, but immediately installed a talking machine, which reproduced the voices of the pigs squealing in frightened

STEWART

You can handle banjos easily and add to your income. Talking machine men will find them big sellers.



THE BAUER CO., 726-730 Girard Avenue Philadelphia, Pa.

and gruesome tones in a very natural manner. Increased audiences quickly testified to the success of his scheme.

TRADE NOTES FROM BELFAST.

Strikes of Dock Laborers and Carters Have Disturbed Business—Delay in Getting American and English Shipments—Some Comments on Reduction in Price of Records—Other News.

(Special to The Talking Machine World.)

Belfast, Ireland, July 24, 1907.

All departments of trade in Belfast have been seriously affected for several weeks past by the combined strikes of dock laborers and carters, and business has accordingly been quite paralyzed. For example, the largest jobber here has not yet obtained delivery of a big consignment of Edison records despatched to him on July 6 by the National Phonograph Co., Ltd., London.

Three of the large shipping companies have been under the necessity of engaging several hundreds of laborers from England to load and discharge cross-channel cargoes. After the day's work is over these men embark on three special steamers which lie each night in Belfast Lough, about five miles from the port. With commendable consideration, two of the said companies hired, some weeks ago from Mr. Osborne, Monarch Senior gramophones, and purchased almost 100 records, with which the laborers are entertained while the boats are at anchor, thus distracting their thoughts, minimizing homesickness and dispelling ennui. Needless to say the men appreciate heartily the thoughtfulness of their employers.

The somewhat drastic reduction in price of Edison gold moulded records from 1s. 6d. to 1s., which will come into operation on August 8, has given rise to adverse criticism and newspaper correspondence, much of which is inane if not scurrilous. In the case of one trade journal an article appeared in which it was actually suggested that the National Phonograph Co. should be "punished" for what the writer described as a "hardship," although he confessed he had not read the company's agreements and was not only reasoning without data but endeavoring to extinguish an "ignis fatuus" of his own creation. Your humble Belfast scribe considers that both jobbers and dealers should be grateful to the National Phonograph Co. (1) for making the reduction during the dull or "off" season when stocks are low, (2) for allowing a rebate of 1d. per record on all purchases from March 1 till June 8, (3) for agreeing to supply jobbers with the records from June 10 till August 8 at the reduced trade price, thus enabling said jobbers to acquire an abnormal profit during term of notice (60 days), and (4) for reducing retail price, which should result in an immense output of the goods during ensuing winter.

The Gramophone Co. deserve the thanks of all their dealers for having, at the request of Mme. Melba, agreed to reduce the price of 12-in. records by that famous prima donna from 21s. to 12s. 6d. Other expensive gramophone records have also been reduced, but dealers will not suffer in the slightest from said reductions, as the Gramophone Co. have very generously agreed to supply records free of charge against the difference in price of those held in stock by their customers on July 18. In doing so they are acting in harmony with their usual thoughtful policy, which for many years has not only kept them in close touch with their dealers but created for them an enviable reputation in the talking machine industry.

Owing to the connection of Marconi with the talking machine trade it is interesting to note that an official of the Marconi company is quoted as saying that a radiograph service will be begun between Ireland and Canada in September. The commercial rate will be 10 cents and the press rate 5 cents a word between Clifton and Glace Bay. Immediately after this service is started, the power at the wireless station at Cape Cod will be increased and a service will be opened thence to Poldhn.

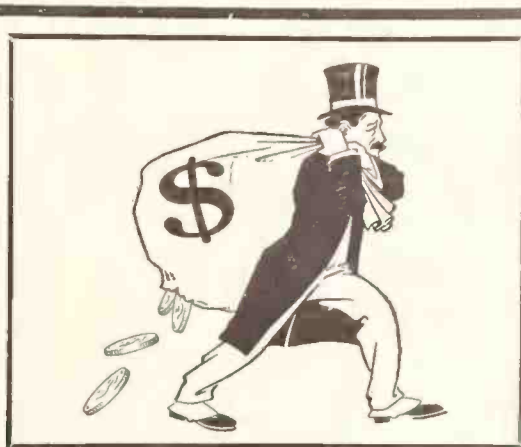

How we save you money without cutting prices

We can't sell you Victor goods at a less price than any other jobber—we're all on the same basis there, and must all maintain the regular Victor prices. But we can save you money in lots of other ways. All brought about by the promptness of our service.

We ship all orders the same day they are received. That saves money for you all around. Saves the money you usually spend in telegraphing to your jobber to hurry your order. Saves the money you lose because customers get tired of waiting for their goods. Saves shipping charges, because having the goods in stock we can send them by freight so that you'll get them in plenty of time, where another jobber would have to hustle around for the goods first and then send them by express.

You save not only money, but time, trouble and worry by ordering from us your Victor talking machines and records, record cabinets, trumpet horns, fiber cases, English needles, and accessories and specialties of every sort.

Save time by writing now for our catalogue. Then you'll have it when you get ready for your next order.

The Victor Distributing and Export Company

77 Chambers Street New York



100,000 RECORDS ALWAYS IN STOCK

JOBBER'S

EDISON
PHONOGRAPHS
RECORDS, ETC.

GENERAL SUPPLIES
FOR
CYLINDER MACHINES

Douglas Phonograph Company

MANUFACTURERS "PERFECTION" SUPPLIES, ETC.
RETAIL—WHOLESALE—EXPORT

Salesroom, 89 Chambers Street
Cable Address, Doughphone, N. Y.

New York

Largest Exclusive Talking Machine Jobbers in the World.

DISTRIBUTORS

VICTOR
TALKING MACHINES
RECORDS, ETC.

GENERAL SUPPLIES
FOR
DISC MACHINES

RECORD CABINETS

No Change in Price—No Change in Quality

Compare our prices and goods with those of any other Jobber and you will find that

We Save You From 10% To 33 1-3%

All other manufacturers have increased their prices, due to the advance of Labor and Material. The prices we fixed two (2) years ago, still prevail and in some instances we have made marked reductions.

Don't purchase Record Cabinets before obtaining our prices and illustrations.

PRACTICAL SUGGESTIONS AND COMMENTS.

REPRODUCER FOR CYLINDER MACHINES.

A new reproducer for cylinder machines has just been placed on the market by the Maestro-Phone Phonograph Co., of Lincoln, Neb. This reproducer is something decidedly new, and the results obtained are said to be marvelous. A special feature involved is an adjustable weight tension by which the pressure on the record can be increased or diminished, thus enabling the operator to play the old wax records or the new moulded kind with equal safety to the record in regard to wear.

A. C. Mestraud, the inventor of this reproducer, is an old talking machine expert, well and favorably known in this trade, having for years been connected with it in various capacities. For some months The World has known of several important patents granted this gentleman, and that the only thing he needed was capital to push them. This came from an unexpected quarter—in the form of a legacy, and we congratulate not only Mr. Mestraud, but the talking machine trade in general, inasmuch as they will shortly benefit largely from these various inventions, which we can safely state will win no small share of attention and consideration.

PLAYING RECORDS BACKWARD.

The Ocala (Fla.) Banner of recent date contained the following story: "Dr. J. Van Hood, of Ocala, has just brought into successful operation an experiment that should be of considerable interest to the scientific world. For some time the doctor has wondered how words would sound if uttered backward. By experimenting with his own voice and others, he realized the utter impossibility of any one pronouncing backward. Some people, to whom he mentioned the matter, confused it with spelling backward, but it takes little reflection to see that it is a very different thing.

"Dr. Hood finally decided that if he could have a phonographic record run through a phonograph backward he would attain his desired result. This seemed impossible, owing to the records being larger at one end than another, but a jeweler of Ocala, after some experiments, bored out a record so it could be put on a cylinder last end first, and to Dr. Hood's greatest satisfaction and every one else's surprise, the apparatus worked successfully. A great many people have heard this record work in the last few days. The sounds it makes are utterly strange, not to say ludicrous, yet can be recognized closely enough to be understood. The experiment is causing great interest here, and seems well worth the notice of the scientific as well as the curious."

PACETTI EXPLAINS ANTIQUITY OF IDEA.

The foregoing having caught the eye of G. J. Pacetti, the well-known talking machine dealer of St. Augustine, Fla., when reproduced in his local paper, he wrote the editor as follows: "An article in yesterday's Record taken from the Ocala Banner says that an Ocala man has just discovered that the human voice can be reproduced on the phonograph backward. It seems to me that the gentleman is a little late with his discovery as the playing of phonograph records backward is as old, almost, as the playing of the phonograph itself. Nine years ago I reproduced phonograph records backward. Any one, with the help of a pocket knife, can in five minutes adjust a cylinder record to the phonograph and play it backward. A vocal record in English will, when reproduced backward, sound as though it was recorded in a foreign language. There are hundreds of phonograph owners who have among their collections of records a few that they can play backward for their own amusement."

IMPROVED REPRODUCER.

John White, the talking machine expert, of London, has favored The World with the following contribution on reproducers, which will doubtless interest our American as well as our English and colonial subscribers. He says:

"That there is a reproducer on the market that

will play any or every record to perfection will be denied on all sides by experts and experimenters alike. The type I illustrate I have used for some time and hesitated before claiming what I now do for it. That it will play any make of record and better still give an extremely full volume, without the slightest overtone or sign of a blast, is certain. The machine is or was a Lambertphone. The type is the Excelsior. The reproducer is of the usual floating type, measuring in diameter 2 1/4 inches. It had originally a weight of 3 or more ounces, and a heavy screw-ring to jam the gaskets on either side of the diaphragm. That ring I took out, also the plain rubber gaskets, and then ma-

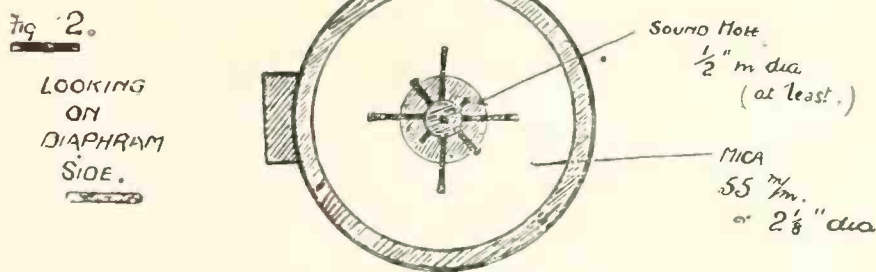
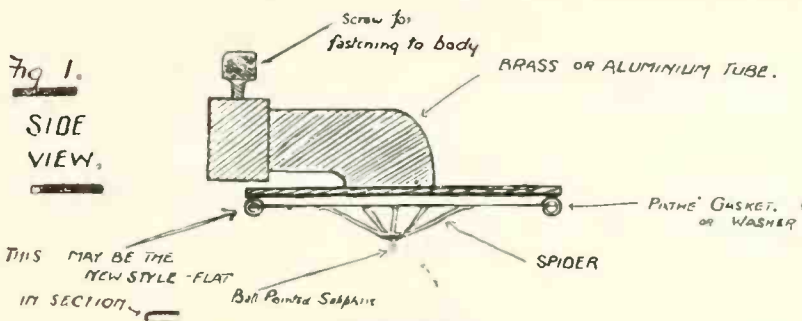

chined and filed away the outer portion with the screw-threads for the ring, leaving the surface as plain and flat as the diaphragm itself.

"This reduced the weight to two and half ounces and rendered necessary a gasket of the Pathe type, namely, the split tubular ring. Having secured a fine piece of mica 2 1/8 inches in diameter, I slipped the gasket on to it, not without some trouble, as the gasket was so tight, measuring 1 inch diameter without stretching any. However, I managed it by getting it on to a piece of tough cardboard the same diameter and then transferring it by taking the mica and plucking the rubber ring over the edge of same a bit at a time. Then withdrawing the card-

board I smoothed the edges into a snug fit. This ring and mica diaphragm I cemented to the surface of the lightened reproducer and let it dry carefully, then tested for air spaces round the edge. These spaces I cemented up by running the cement round it and giving it an assured hold. I next hunted up all the best types of domes and "spiders" that I had in my possession. I found the 3/8-inch ordinary dome had a muffled effect on playing a record. After boring four holes, 1-16 of an inch in size round the dome, I found it improved, though not quite so much of an improvement as I wanted.

"Smaller domes I tried and gave up as they were useless to distribute the vibrations. The actual spider I use now measures 1 inch in diameter across the outside claws (four in number), and two claws 1/2 inch across, with the remaining two 1/4 inch between their feet. This spider I fitted with a ball pointed sapphire of good quality, and as I said before I am astonished at the results. There is nothing extraordinary about the reproducer, which is of the Matthews type, and one can easily make their own as good by following these instructions given beforehand. One point about the Matthews reproducer makes me glad. The vibrations, or sound waves, to be more correct, pass through a parallel tube into the trumpet through a hole of the same diameter as the

tube, i. e., half an inch. In other sound-boxes or reproducers this point is neglected, and I say emphatically they are wrong as this one proves. The giant tone it gives out is not from the diaphragm alone. It comes from the combination of all the parts and lets the user of the phonograph enjoy his records as he ought. In the Edison Model C the hole is too small, and when enlarged even slightly the difference can be noticed when playing a record.

"This idea can be adapted to other reproducers by taking the old shell to pieces, that is to say, taking out the diaphragm and stripping the surface off with a file. A better way is to purchase the Matthews reproducer or make one out of a

NO SIR-E-E

We are not hustling to sell Horns and Cranes—not trying to "load up" our trade with these goods—though we've too many in stock.

We're Stuck with Horns and Cranes—but we're taking our medicine ourselves—not trying to pass it on to the trade.

September 16th next, every Phonograph will be equipped with Horn and Crane, so don't load up with Horns and Cranes at any price—but make every effort to close out what you have on hand.

We want your *continued* business—we're not after a trifling temporary profit—we try to deserve your trade by working for your interest—keeping you posted.

Send us your orders, for you can depend on fair treatment and prompt attention every time.

American Phonograph Co.

106 WOODWARD AVENUE, DETROIT, MICH.

square of brass and a brass tube, as can easily be done. A piece of brass 3 inches square by 1-16 inch thick can be bought for 15 cents or thereabouts. Then brass tubing is not dear for the quantity required, about 3 inches, say, of 1/2 inch tube, will be ample. Cut the brass into a circle 2 1/4 inches in diameter, and bore a hole in the center, measuring the same as the outside diameter of your brass tube, say, 1/2 inch. The next step is to cut the tube at an angle of 45 degs. so as to get a bend on the reproducer tube when completed.

"Some of the model engineers who are also readers of the paper will be able to bend a tube into the right angle and cut off what they require, though others may not find this easy. In that case it will be best to apply to a house making a specialty of supplies.

"Those who make it themselves will require to cut and solder the parts together, making a shell when completed like Fig. 4. The means of connecting reproducer to machine can be either a short rubber tube or the connector off the original reproducer for the time being. In conjunction with a large brass or flower horn this will be found to give the most surprising volume.

ELECTRIC AUTOMOBILE "TALKER" HORN.

A new English electric automobile horn is made of a combination of an electric buzzer, with the ordinary automobile horn. The Talking Machine News describes it as follows:

"A brass cylindrical case contains a steel vi-

brating disc, held at its periphery by two flanges and two electro-magnets, and the rapid vibration of the disc caused by the magnetization and demagnetization of the magnets yields a sound which is magnified in volume and effectiveness by the horn. The current is provided by an eight-volt accumulator. The signal can be maintained as long as is necessary or desired, the blast louder and more continuous than that of the ordinary wind horn, and with the switch on the steering wheel the driver can give his warning without removing his hand from the wheel."

A RECORD CLEANER AND PRESERVATIVE.

The Record Food Co., Kansas City, Mo., have recently placed upon the market their new record cleaner and preservative, suitable for all styles of records which have proven very successful.

Besides cleaning, Record Food also lubricates and enables one needle to play from two to six of the largest disc records, doing away with scratching, and producing the highest quality of tone. It is put up in 16-oz. jars and tins, sufficient for from 400 to 500 records.

Record Food is the result of extensive experimenting by members of the company, all of whom are talking machine enthusiasts and have used the preparation in its various forms for several years until it was brought to perfection.

A number of surprises in an inventive way are "on the stocks." More anon.

GOGGAN & BRO. IN NEW QUARTERS.

Thomas Goggan & Bro., Dallas, Tex., have removed to their new three story building on Elm street, which has been fitted up in a handsome manner. The main floor is devoted exclusively to Victor talking machine parlors, the firm being distributors for that line. A complete cooling system is a feature of the new quarters and aids business in the hot weather.

PROGRESSIVE DETROIT JOBBERS.

The American Phonograph Co., 106 Woodward avenue, Detroit, Mich., are said to be among the oldest talking machine retailers in the country, having been in the business for over ten years. They have very handsome quarters for displaying both the Edison and Victor lines, with a number of soundproof booths for demonstrating purposes.

SOL BLOOM OPENS ON 34TH STREET.

Sol Bloom has leased the premises at 40 West 34th street and is making alterations to the property that will make it one of the finest stores of its class in the city.

The Victor Distributing & Export Co. have placed a new disc record case on the market, which is made of heavy jute manila paper and fully protects the records.

THE PHONOMETER

(PATENT APPLIED FOR)

The Only Talking Machine Speed Meter

Instantaneous in Action. Permanently Effective. Absolutely Accurate.

FOR USE ON ALL DISC MACHINES

REASONS WHY ALL DISTRIBUTORS AND DEALERS SHOULD HANDLE THIS NEW AND BIG SELLING NOVELTY

- I. BECAUSE it is **absolutely accurate.**
- II. BECAUSE it indicates the speed of all disc machines **instantly.**
- III. BECAUSE by its use each and every record can be reproduced at the correct speed, and all musical records (vocal or instrumental) **reproduced in the same musical key (or pitch)** that the artists originally sang or played the selections.

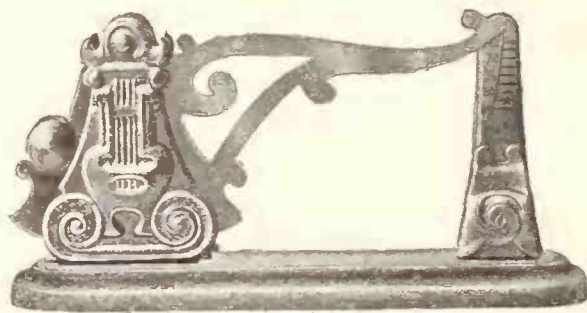

RETAIL, ONE DOLLAR.

- IV. BECAUSE the voices of Caruso, Melba and all the other vocal artists, speaking records of celebrities, the tone qualities of solo instruments, etc., **cannot be faithfully reproduced** from records and thus bring forth the individuality of the artists or instruments, the tone quality and life-like realism required, **if the machine is not accurately and properly regulated.**
- V. BECAUSE you can sell a **Phonometer** to every machine or record customer upon demonstration.
- VI. BECAUSE it becomes an **absolute necessity!**

VII. BECAUSE **the Phonometer** is for sale by and receiving the highest endorsements of the following Distributors of Disc Machines:

BLACKMAN TALKING MACHINE CO.,
97 Chambers St., New York.
DOUGLAS PHONOGRAPH CO.,
89 Chambers St., New York.
S. B. DAVEGA, 32 East 14th St., New York.
I. DAVEGA, JR., 125 West 125th St., New York.
JACOT MUSIC BOX CO.,
39 Union Square, New York.
LANDAY BROS., 400 Fifth Ave., New York.
VICTOR H. RAPKE,
1601 Second Ave., New York.

REGINA CO., 41 Union Square, New York.
STANLEY & PEARSALL,
541 Fifth Ave., New York.
ALFRED WEISS, 1525 First Ave., New York.
C. KOEHRING & BRO.,
578 Virginia Ave., Indianapolis, Ind.
POWERS & HENRY,
Sixth St. and Duquesne Way, Pittsburg, Pa.
METROPOLITAN TALKING MACHINE CO.,
Jacksonville, Fla.

VICTOR DISTRIBUTING AND EXPORT CO.,
77 Chambers St., New York.
LYON & HEALY,
Chicago, Ill.
FRIEDRICH'S MUSIC HOUSE,
30-32 Canal St., Grand Rapids, Mich.
STONE & BARRINGER CO., Charlotte, N. C.
CRESSEY & ALLEN,
Portland, Me.
SOL. BLOOM, 3 East 42d St., New York.
MARITIME PHONOGRAPH CO.,
32 Dock St., St. John, N. B.
LOUIS BUEHN & BRO.,
43 North 9th St., Philadelphia, Pa.

DEALERS—Write your distributor immediately for sample and attractive advertising matter, etc.

MANUFACTURED BY

PHONOGRAPHIC MUSIC CO.

39 South Ninth Street

= =

Brooklyn, N. Y.

BIRDS AS MUSICIANS.

Also a Chat on the Subject of Recording Aboriginal Music by Means of the Talking Machine—Some Interesting Points.

There was a very readable article published in Harper's Monthly Magazine for April, 1907, entitled "Music of Man and Bird," in which the author, Mr. Henry Oldys, explains most interestingly that birds are musicians.

For instance, he declares that he has heard a fragment from the Toreador's Song in Carmen flung across the fields to his ears by a meadow-lark.

MEADOWLARK



The wood pewee and song sparrow are also composers of legitimate music, according to Mr.

WOOD PEWEE



SONG SPARROW

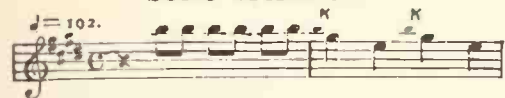

Oldys, and the fact that this important discovery has been made opens up a vista of rare enjoyment to talking machine enthusiasts.

Why not delve deeper into this absorbing subject and perhaps add other feathered vocalists to the musical fraternity?

Is there not a sunny window in your home where a bird may be enticed to warble out his thanks for the crumbs spread upon the sill so lavishly? Most assuredly there must be, and to record the melody that swells from his throbbing throat is not nearly so difficult as you think.

Move your talking machine to the window and use a horn with a flaring bell of large circumference in order that the recording zone may extend over as great an area as possible. That done, you have only to adjust a recorder, the diaphragm of which has been chosen with care to give best results in recording whistling. Then insert a blank upon the mandrel, attach a cord to the starting lever, and slipping back out of sight, await the coming of the "talent." When the concert is under way, pull gently on the cord, and the talking machine will do the rest.

Mr. Oldys was forced to write down the music as fast as it came to him from the trees and thickets, and there is, therefore, a slight suspicion of doubt as to accuracy, but the talking machine stands ready to eliminate that doubt, and to prove conclusively whether or not birds are real musicians.

My phonograph is going to engage in this fascinating game this summer, and I will be glad to report as to my success or failure. In the meantime, Mr. Dealer, ask your customers to enter the field while on their vacations. It will mean the sale of blanks and recording horns, etc., for you, and at the same time will add a zest to your patrons' phonographic appetites.

There is another point brought out in Mr. Oldys' article that should be of vital interest to the talking machine trade because it establishes the fact that the "talker" is of priceless value to scientists in procuring exact examples of pure aboriginal music.

He says in part: "It is gratifying to know that the French are at present systematically obtaining phonographic records of aboriginal music—a method originally employed by Dr. J. Walter Fewkes, of our own country, in his ethnological study of the Zuni Indians. This means, although not absolutely faultless, is in many respects more satisfactory than one dependent on the accuracy of the observer. Were both methods used as independent checks on each other, the resultant records, if agreeing, would have the highest degree of scientific value.

The element of doubt in the case of phonographic records arises mainly from the mechanical imperfections of the instrument, the more or less constrained poise of the performer, and, when a song is recorded the singer's lack of experience necessary to insure a faithful reproduction. I have listened to phonographic records, secured by Dr. Fewkes, of songs sung by Hopi (popularly known as Moki) Indians which were practically impossible of transcription because of the almost constant blare of the instrument due to the singer's mouth being too close to the mouthpiece. On the other hand, however, a song by a Winnebago Indian girl, recorded at the same time, came out very clearly:

This is not the whole song, but enough is quoted to show the general character of the music, which is quite comparable with ours. It is possible that it derives resemblance from influences due to the singer's having received her education among the whites.

Finally I may add that I have frequently lis-

WINNEBAGO INDIAN LOVE-SONG

From phonograph record taken by Dr. J. WALTER FEWKES.

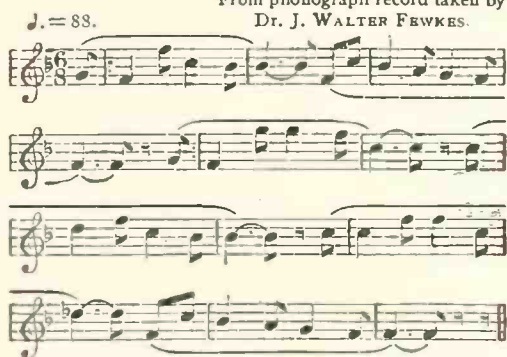

tened to a cylinder record of the singing of a native song by an Eskimo. This record was made on one of Lieutenant Peary's expeditions,

and is now in the possession of Mr. R. J. Meigs, of Washington, D. C."

As the mechanical imperfections spoken of



above are now extinct, we may expect even greater strides on the part of the talking machine through the intricate paths of science.

HOWARD TAYLOR MIDDLETON.

WEEKLY TALKING MACHINE RECITALS.

The Olney Music Co., St. Joseph, Mo., have arranged for weekly talking machine concerts in connection with the settlement work of the Free Kindergarten and Day Nursery of that city. At the first concert held a fortnight ago a large crowd listened with evident pleasure to the music.

A deaf and dumb mendicant in Berlin recently discarded the signs and pathetic letter for the much more up-to-date "talker." He has the list of his afflictions and the woes of his family recorded on a cylinder, and when the lady of the house opens the door in response to his knock she is greeted with a burst of eloquence from the talking machine. It is said the results pay handsomely.

THE *Playrite* DIAPHRAGM

TRADE MARK

"The Name Tells What They Do"

RECORDS PLAY RIGHT

WITH THIS DIAPHRAGM

PRODUCES
FULL
VOLUME

THE TONE
IS
NATURAL

A NEEDED IMPROVEMENT.

Great improvements have been made in Talking Machine Records, resulting in more volume and better tone.

You cannot get the full benefit of these improvements unless the Throat of your Talking Machine is perfect. It is therefore important to improve the Throat of the Talking Machine as much as possible. The Throat is the Diaphragm.

THE IMPROVEMENT ACCOMPLISHED.

After careful experiments a specially prepared Fibre Diaphragm has been produced that gives the desired Volume and Tone combined.

THE "PLAYRITE" DIAPHRAGM.

Records Play Right when this fibre diaphragm is fitted in the speaker, and it is therefore known as the "Playrite" diaphragm for "The Name Tells What They Do."

The *Playrite* Diaphragm Plays Right, for it produces a Loud, Clear, Natural Tone without blasting or smothering the lighter tones. Vocal Records sound like the natural voice, and Instrumental Records have that round, mellow tone that has been sought.

To hear a Record played with the "Playrite" diaphragm means you will want one in your speaker, and that you will get all the music on the Record hereafter.

ANY DEALER CAN SUPPLY IT.

Any competent dealer can fit the "Playrite" Diaphragm in a speaker, and satisfaction is guaranteed or money refunded.

Each "Playrite" Diaphragm has a crosshead riveted to it, and therefore does away with loose crossheads. "Playrite" Diaphragm complete with crosshead, 25c. each.

The "**PLAYRITE**" Diaphragm is made in two sizes to fit Phonograph Reproducers and Victor Exhibition Sound Boxes. State which size is wanted. Other sizes will be ready soon.

PRICES ARE RESTRICTED. 25c. each with crosshead attached.

FREE SAMPLE

To Dealers or Jobbers who write on business letter head and specify what machines they handle.

MANUFACTURED BY

BLACKMAN TALKING MACHINE CO.

J. NEWCOMB BLACKMAN, Prop'r.

97 Chambers Street

NEW YORK

TRADE NOTES FROM INDIANAPOLIS.

Horn Question Discussed—Kipp-Lisk Co.'s New Home—Talkers for Concerts and Lawn Parties—Penny Arcades Doing a Good Business—Increasing Call for Commercial Graphophones—Talker Concerts a Success.

(Special to The Talking Machine World.)

Indianapolis, Ind., Aug. 1, 1907.

The announcement of the National Phonograph Co. that all their machines will in future be supplied with horns is causing a good deal of discussion among the Edison dealers of this city. The fact that the company will supply machines in this way means that all horns now on hand will be in the nature of a white elephant to be disposed of by the jobbers. It is known that some of the Edison dealers here now have a good supply of horns on hand. Others, however, are not so heavily stocked.

The new order also, it is said, will cause a great deal of extra work in the way of crating. Every time a machine goes out a horn will have to go with it, and this will mean much extra work. A. B. Wahl said that he canceled his order for horns in good time and was not caught by the new methods of the company. It is not known here yet whether or not the company will make any further arrangements for the convenience of the jobbers.

The Kipp-Link Co., extensive dealers in all kinds of talking machines, will soon be ready to move into their new home on Washington street. The building is now undergoing a thorough remodeling and will be ready within a few days. When completed this will be one of the best locations for a talking machine house in the city. The stock of the Kipp-Link Co. will be greatly increased, and both the jobbing and retail business will be carefully looked after.

Charles Craig, of the Indiana Phonograph Co., an extensive jobber in the Edison line, has been away from his place of business several days on account of illness. His sickness is said, however, not to be serious. It was reported at Mr. Craig's store that the retail business has increased rapidly during the last few weeks and has grown ahead of the jobbing business.

One way of accounting for the increase in the retail business is the great number of talking machines that are being used on canoes this season. Talking machines on canoes are something new in Indianapolis, but the resorters are taking to the custom readily, and almost every canoe on the river about Broad Ripple will soon be supplied with music it seems.

The Columbia Phonograph Co. are having a great run on furnishing machines for lawn fete entertainments. The Star, an Indianapolis paper, conducts a summer mission for sick children near Fairview park. Hundreds of lawn fetes

are given for this enterprise each summer by the best people of the city, and the Columbia machine has come to be greatly in demand for such entertainments. A Columbia machine is shipped out to be used at these entertainments four or five times a week.

George Hall, who lives on North Pennsylvania street, has a Twentieth Century Columbia machine which he has allowed to be used at a number of lawn fetes. Mr. Hall is a great favorite with the young people, and when they ask him for the use of his machine it is forthcoming.

Mr. Williams, manager of the Columbia Phonograph branch at Terre Haute, was in the city on a business visit a few days last week. He said that business is unusually good at Terre Haute considering the season.

The Columbia Co. are having a good demand for their commercial graphophones. The custom of using them in business establishments is growing by leaps and bounds, and the trade of the Columbia Co. is greatly increased along this line. The branch here sells all of the office machines that it can get in stock.

The mayor of Noblesville, a city a few miles from Indianapolis, has caused consternation among the people of his city by closing up all places of amusement on Sunday. The mayor's orders are iron bound, and he will not even allow the most harmless amusement resort to remain open on that day. Meanwhile the amusement seeking people of the city are going to other cities on Sunday and the traction cars are crowded.

Never before in the history of Indianapolis has the business of penny arcades and five-cent vaudevilles been so good during the summer season as it is at present. Every place in the city is having a good business. One five-cent vaudeville man estimates that the summer season this year is cutting the business down only about 20 per cent. This is regarded as an unusually small cut, considering the great number of people who flock to the parks and summer gardens in the heated season.

The Bijou Dream Theatre is making a hit now with two sets of pictures, "Genevieve of Barbant," and "Chasing a Motorist." The house is drawing good crowds daily.

The Dreamland Amusement Co. is having a good business here, and reports that the outlook at Terre Haute is encouraging. O. L. Burton, manager of the company here, says that Terre Haute is one of the best amusement cities for its size in the Middle West. He was located at Terre Haute for several weeks after the arcade and vaudeville was started there by his company.

Frank Zepp, of the Vaudette, is planning to take a two weeks' vacation soon. He has not decided just yet how he will spend the time.

The talker concerts that are being given at

Fairview by C. Koehring & Bros. are proving to be a great hit. These concerts are given with an auxetophone. This is a talking machine which is arranged in such a way that it gives out a great volume of sound. The music may be heard all over the park, and the concerts are drawing immense crowds to this pleasure resort, which is one of the most popular in the city.

MME. MELBA ENTHUSIASTIC OVER "TALKER."

Referring to her interview with Mme. Melba, Miss Mabel Wagnalls, the eminent pianist, author and musical critic, daughter of the publisher of The Literary Digest, The Circle and the Standard Dictionary, in her interesting book, "Stars of the Opera," writes as follows: "When asked her opinion of the new and wonderful records of her voice, Mme. Melba spoke with enthusiasm, 'They are, indeed, a remarkable achievement. I am looking, however, for still greater improvements, and am keenly interested in every new development.' A matter of 'keen interest' it must indeed be to every prima donna of to-day, this amazing magic trumpet that can record the subtle individual quality of a singer's voice and give it gloriously forth again when desired. By means of this weird invention the present vintage of fine voices can be bottled up like rare wine and poured out in future years. More wonderful still, like the 'widow's cruse,' this trumpet never grows empty; from its uptilted mouth the flow of song will stream on continuously, if so desired and directed. It is enough to make poor Jenny Lind and other long silent singers turn restlessly in their graves; they died too soon to profit by the powers of this recording trumpet, which surely has no rival save the one that Gabriel blows."

HERE'S AN ORCHESTRA THAT WON'T BOOSE.

H. C. Burrell, a Cleveland, O., shipowner who was much troubled by the orchestras on his boats, the members of which would get drunk and strike at frequent intervals, has tried the experiment of placing a large talking machine on one of his steamers, the Frontenac, plying between Cleveland, Lorain, Sandusky and Detroit. The \$150 Columbia outfit, in charge of a cabin boy, gives better results than any orchestra he has previously had in his employ.

The extent of the talking machine system of language instruction may be realized when it is stated that among the many leading educational institutions using this system are the United States Military Academy at West Point, the Naval Academy at Annapolis and Yale University.

NORTHWESTERN DEALERS

TRY US

WE ARE

JOBBER AND DISTRIBUTERS

EXCLUSIVELY OF

EDISON

Phonographs

VICTOR

Talking Machines

and Supplies

MINNESOTA PHONOGRAPH CO.

LAURENCE H. LUCKER

505-7-9-11 Washington Avenue, So.
MINNEAPOLIS :: MINN.

THE
IKONOGRAPH

A Perfect
Moving Picture Machine

FOR THE
HOME

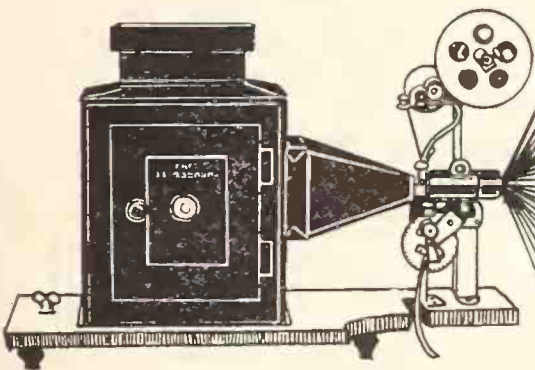

**ENOUGH
SAID!!**

IKONOGRAPH COMMERCIAL COMPANY

36 East 23d Street, New York, N. Y.

**DISTRIBUTORS
OF THE
IKONOGRAPH**

- ALBANY, N. Y. FINCH & HAHN.
- BALTIMORE, MD. .. E. F. DROOP & SONS Co.,
231 N. Howard St.
- BOSTON, MASS..... BOSTON CYCLE AND SUNDRY Co.,
48 Hanover St.
IVER JOHNSON SPORTING GOODS
Co., 163 Washington St.
- BUFFALO, N. Y. THE TALKING MACHINE Co.,
13 Genesee St.
- CANTON, O. KLEIN & HEFFELMAN,
216 N. Market St.
- CHICAGO, ILL. RUDOLPH WURLITZER Co.,
266 Wabash Ave.
- CINCINNATI, O. RUDOLPH WURLITZER Co.,
10 W. Fourth St.
- COLUMBUS, O. PERRY WHITSIT Co.,
213 South High St.
- DAYTON, O. NIEHAUS & DOHSE,
35 E. 5th St.
- EASTON, PA. WILLIAM WERNER,
432 Northampton St.
- HOBOKEN, N. J. ECLIPSE PHONOGRAPH Co.,
203 Washington St.
- NEWARK, N. J. EDISONIA Co.,
57 Halsey St.
- NEW HAVEN, CONN. PARDEE-ELLENBERGER Co.,
96-104 State St.
- NEW YORK, N. Y. .. DOUGLAS PHONOGRAPH Co.,
89 Chambers St.
BENJ. SWITKY,
27 East 14th St.
- PHILADELPHIA, PA. LOUIS BUEHN & BRO.,
45 North 9th St.
PENN PHONOGRAPH Co.
17 South 9th St.
- PITTSBURG, PA. POWERS & HENRY Co.,
6th and Duquesne Sts.
- PORTLAND, ME. PORTLAND TALKING MACHINE Co.
- PROVIDENCE, R. I. J. A. FOSTER COMPANY
Weybosset and Dorrance Sts.
- ROCHESTER, N. Y. .. THE TALKING MACHINE Co.,
97 Main St.
- SCHENECTADY, N. Y. FINCH & HAHN,
506 State St.
- TROY, N. Y. FINCH & HAHN,
3 Third St.
- UTICA, N. Y. WILLIAM HARRISON,
41 Columbia St.
- WASHINGTON, D. C. E. F. DROOP & SONS Co.,
925 Pennsylvania Ave., N. W.

Why not have your name in the limelight?

WILL SPEND \$150,000 MORE.

Victor Talking Machine Co. Announce Big Increase in Advertising Appropriation—Most Vigorous Campaign to Carry on the Victor Development in a Most Emphatic Way.

Under date of July 26 the Victor Talking Machine Co. have issued a circular letter to Victor dealers announcing that "another additional and special advertising appropriation, has just been made by our board of directors, of \$150,000 in addition to our already huge advertising appropriations for this season. We believe that our Victor dealers throughout America will hail with joy the inauguration of this new idea of advertising so broadly over the entire country monthly the 'New Victor Records' and the 'Simultaneous Opening Day' feature.

"We have studied the newspaper situation throughout America thoroughly, and feel that we have selected the leading newspapers in every city where a Victor distributor is located, and that these newspapers, with their enormous general and out-of-town circulation will reach, with their influence for business, practically every hamlet in America. The combined daily readers of these papers, we are informed, is about 10,000,000 people.

"We hand you herewith the advertisement exactly as it will appear—design, size and wording—on the 29th day of this month (the 28th, this month, being Sunday) in all of the newspapers mentioned on the enclosed list.

"We would, were it possible, cheerfully insert in this advertisement the names of our various distributors and dealers in these cities, but on consideration you will agree that this is not practical, there being in some cities altogether too many dealers to permit of this. It would not be fair to insert distributors' names and omit dealers, or vice versa.

"We have secured the very best space in all these papers, and will not permit the insertion of other talking machine ads. on our page or surrounding our ad., but have no objection to any enterprising Victor dealers placing an exclusive Victor advertisement on that page on the 28th day of each month if they choose, but the advertisement cannot contain any reference to other talking machines or other talking machine goods.

"Wise and enterprising advertisers will take advantage of this hint—that is one of the best ways of getting the full benefit of this advertising. We are spending all this money, and making all this effort, to send Victor business right to your store, and the more enterprising Victor dealers are entitled to their greater share.

"On or about the 20th of each month the copy of the advertisement as it will appear in these newspapers on the 28th will be mailed to all Victor dealers throughout America as a reminder for them to arrange for their supplemental advertising if they so choose.

The next new advertising idea and decision is the most far-reaching and influential that could be selected in any of the periodicals of the country.

"We have contracted for an entire page in each issue of the Ladies' Home Journal. An inside page in the Ladies' Home Journal costs \$4,000 per insertion. Our outside pages in this same Journal cost \$6,000 per insertion. The Ladies' Home Journal, according to the investigations of our own advertising department, has over 1,250,000 subscribers. According to investigations made at a great expense, and for its own information, the Ladies' Home Journal people discovered that they have at present about five readers for each Journal printed. This means that our monthly ad. cannot help but be seen by 7,250,000 of the best class of buyers.

"This page ad. will be devoted to a monthly 'selected list of Victor records,' our idea being to rejuvenate and keep going the trade on truly excellent records, which perhaps have fallen off in their sale somewhat on account of inattention. A copy of this ad. will also be sent you each month, quite in advance of the appearance of

the Journal, so as to give you time to order any of these records that you may not have in stock from your distributor.

"In addition to the above two new ideas, we also call your attention to the fact that we are spending an enormous sum this year in excess of any other year for regular magazine advertising. Furthermore, we are using many more back covers and colors in the principal monthly and weekly publications, like the Ladies' Home Journal, Saturday Evening Post and Collier's Weekly.

"We are also developing more trade in the farming districts. We have begun a strong advertising campaign in the agricultural papers throughout the country. This space will be largely increased, beginning with the September issues. This campaign in the farming districts, through the agricultural papers, is aimed especially to develop instalment sales for Victor dealers. Within a few weeks you will receive from our advertising department the first advertisements or numbers of our educational campaign, for the instalment plan among dealers. We trust that all Victor dealers will find these instalment articles of great interest.

"Every Victor dealer throughout America should appreciate, by the above statements, the enormous confidence the Victor Co. feels in the continued growth and prosperity of the talking machine business. Without a full and strong belief that these huge fortunes that are expended continuously in advertising will return again in the shape of largely increased business for us all, they would have better been expended in dividends to the present stockholders.

"Go after the Victor business in your neighborhood. Let your neighbors know that you sell Victors. If you were exclusive agent for 'Royal Baking Powder' or 'Worcestershire Sauce' you would have to hang out a sign announcing the fact to sell much of it."

Is it any wonder talking machines are attracting widespread attention when there is such a propelling power behind them?

THE PATENT SYSTEM

Discussed by Thomas A. Edison—Says He Has Made Money Not by Inventions But by Manufacturing—His Advice to Young Inventors Worthy of Consideration.

Thomas A. Edison is not a great admirer of our patent system. He says that he has lost money on every one of his inventions, considering them purely as inventions, and has made his fortune by manufacturing. Mr. Edison advises the young inventor not to attempt to get a patent, but to keep his invention a secret and manufacture it himself. In this connection he said in a talk some time ago: "No sooner does an inventor make known some important mechanical discovery by applying for a patent than a pirate comes along and steals it. Years pass before the case comes to trial, and in the meantime the practice of the courts gives the pirate the benefit of the doubt. Many patents are decided in the inventor's favor only when the patent is about to expire, and has therefore become almost worthless. This is all wrong. The courts should give the man who first secures a patent or first makes application for it the benefit of the doubt until the question of priority has been finally passed upon and settled. As it is now the pirate staves off the trial from year to year and the poor inventor is robbed of his due, but if the change I mention was made, patent cases would be speedily brought to trial, and in most instances justice done to all. When it is made, as it is sure to be sooner or later, there will be a rush of invention and discovery in this country such

as we have never seen. Under the present conditions, however, not the big but the small inventions, a new toy for children, an improved lamp-burner, and the like, are the ones that are making the most money. Their insignificance protects them against the pirate, who fails to discover that there is money to be made by stealing them. Still, my advice to a young inventor would be to study the expensive operations of all large factories—every operation, you know is expensive in proportion to the number of men required—and try to devise a machine with which fewer men could do the work. The wealth of the modern world has been made by labor-saving machinery. The end has not yet been reached in this field, and it is still possible for a young inventor to devise a machine for some operation essential to the manufacture of steel which would save the labor of a number of men. Then if he went into the manufacture of that one product on his own account, he could hold his own with all the other manufacturers and undersell them as long as he kept his machine a secret. There is no better method by which the inventor in these days can get the full benefit of his invention."

MAGNIFYING CHOIR LEADER'S VOICE.

In the old village of Braybrook in Northamptonshire is a monster trumpet 5 feet 6 inches in length, and having a bell-shaped end 2 feet 1 inch in diameter.

The trumpet is made up of ten rings, which in turn are made up of smaller parts. The use of this trumpet—only four of the kind are known to exist at the present day—was to magnify the voice of the leader in the choir and to summon the people to the church service.

At the present time neither the choir nor the service is in need of this extraordinary "musical instrument," but the vicar of the church takes care of the ancient relic and is fond of showing it to all visitors.

HOW PROF. DUTTON MANAGED IT.

Recently Prof. Edward C. Dutton, professor of criminal law at the Washington College of Law, Washington, D. C., had an invitation to deliver an address at two different points on the same evening. One of these addresses was a response to a toast by the freshman class of his college, and being unable to be in two places at the same time, he called at the Columbia Phonograph Co.'s store and dictated his response to a half-foot cylinder. A "Twentieth Century" graphophone was sent to the banquet held by the freshman class and Professor Dutton's toast was given just as though he were present. The machine was concealed by a large American flag, in one corner of the room, and when the toastmaster called upon Professor Dutton for his response, everyone looked greatly surprised, for he was not present in person. Immediately, however, his voice spoke out from behind the flag, just as naturally as life. The astonishment was greater, however, at the end of the toast, when the American flag was withdrawn and instead of Professor Dutton being revealed, there stood the machine. The enthusiasm aroused by this was intense, and the "doubting Thomases" were amazed.

John Scott, salesman in the string instrument department of C. H. Ditson & Co., 8-10-12 East 34th street, is enjoying life at Atlantic City, N. J. He will remain there three weeks and expects to return in fine fettle for a stirring fall business campaign. Louis Fricke, in the talking machine department of the same house, is spending his vacation at Easton, Pa. He claims to be an expert fisherman. His friends state that they are from Missouri and insist that they be shown sworn evidence.



MELLO-TONE

Attachment makes a *Perfect Musical Instrument* of a *Talking Machine* or *Phonograph*. Produces tones natural. Eliminates all metallic sounds and blasts. Regulates and mellows the tone. Can be adjusted while sample is playing. Is quite ornamental.

Prices and Samples sent to Dealers

MELLO-TONE CO., SPRINGFIELD, MASS.

“THE IDEAL”

A SELF SUPPORTING HORN FOR ALL EDISON AND COLUMBIA MACHINES

20 INCH BELL
PERFECT TONE
HANDSOME FINISH

NO CRANE · NO STAND · NO SUPPORT
WEIGHS ONLY A FEW OUNCES

ALL ALUMINUM

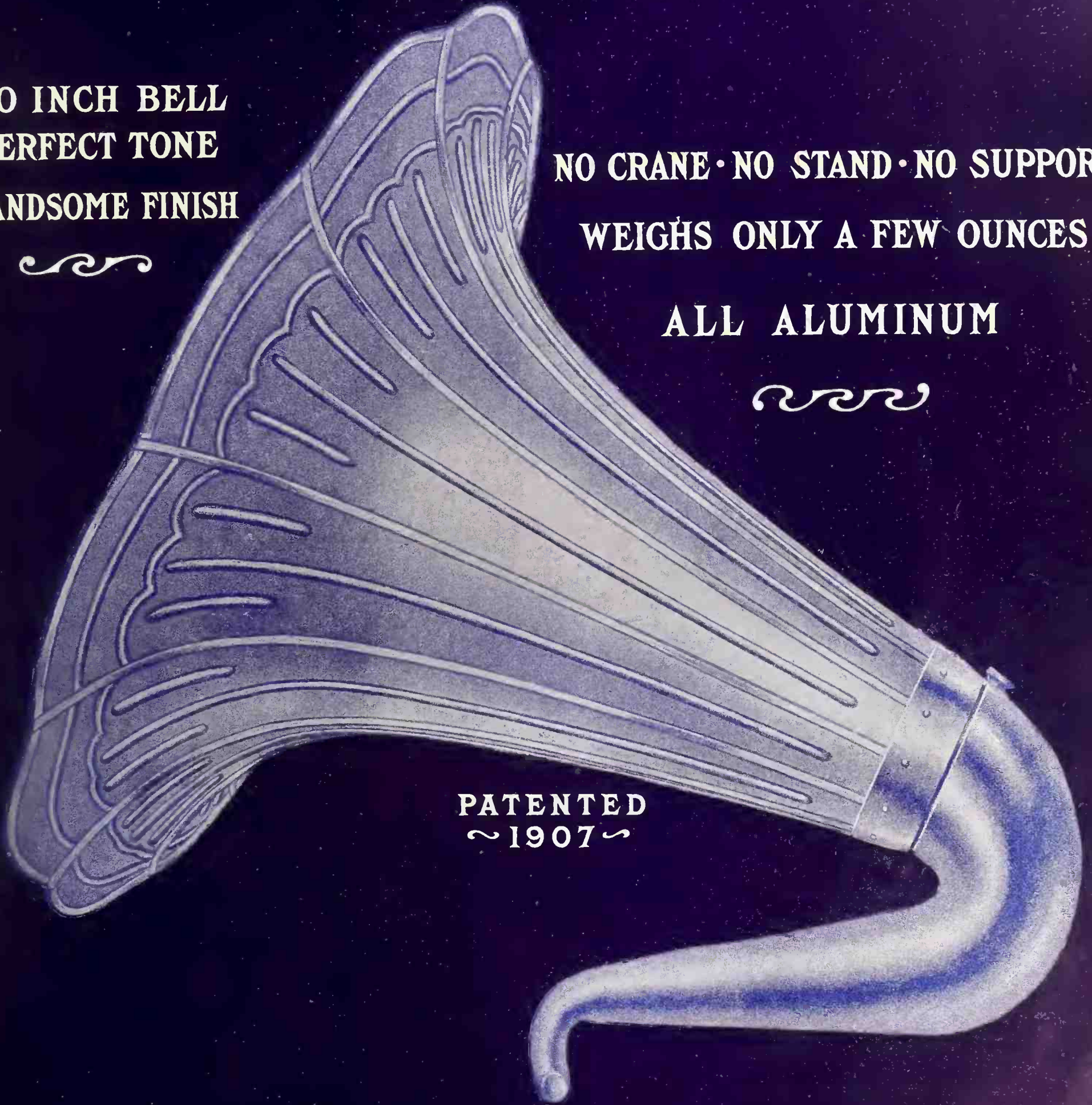

PATENTED
~ 1907 ~

TELEPHONE

DEVINEAU

NEW YORK
36 E. 23RD ST.



MANUFACTURING CO

CLEVELAND, O.
2095 E. 36TH ST.

New York August 13, 1907.

Mr. Dealer,
Everywhere, U. S. A.
Dear Mr. Dealer,

Replying to your favor of the 12th inst. we take great pleasure in giving you herewith the desired information concerning our new patented horn "The Ideal". It can be instantly attached to the reproducer of any Edison or Columbia machine without the aid of crane, support or similar device for it is absolutely self supporting.

The balancing point of the horn being directly above the axis of the mandrel causes the friction to be reduced to a minimum. The weight of the horn (only a few ounces) is equally divided, thus eliminating the heavy pressure on the feeder of the machine. "The Ideal" is made entirely of aluminum with a twenty inch bell; all superfluous weight is removed bringing the total down to only a few ounces. Though extremely wholesome, loud and distinct. Made in one size, one style and one shade which overcomes the necessity of carrying in stock large quantities of various styles, sizes, etc.

The inner and outer surfaces are satin finished which imparts a beautiful, dull, silvery shade. The horn comprises two parts, the elbow and the bell, a feature that makes it easy to ship.

As we anticipate a tremendous demand for "The Ideal" we urgently request you to place your order at the earliest possible date to insure its delivery by Sept. 15th.

Yours respectfully,

Devineau Manufacturing Co.

"The Ideal" not being sold by us directly to dealers, kindly ask member for a copy of our Retail Dealers' agreement for price list, amount, terms, etc.

TRADE HAPPENINGS IN CLEVELAND.

Business Termed Phenomenal for This Season of the Year—Italians Among Best Patrons of Talking Machine Houses—Orders for Wurlitzer—Improvements in Devineau Biophone—Auxetophone for Theatre—Multigraph Co. Increase Capital—Neff to Represent National Co.—H. E. Jones Chats on the Growing Appreciation of the Commercial Graphophone in Business.

(Special to The Talking Machine World.)

Cleveland, O., August 10, 1907.

Trade in talking machine circles is considered somewhat phenomenal in this usually acclaimed "dull season." While business quieted down a little in July it was hardly noticeable by most dealers, and with some a notable increase over previous months is reported. Generally speaking, talking machine dealers have no reason to complain of present conditions.

The dealers are all well stocked, covering the entire field of talking machines and supplies, and are preparing for an expected good fall trade. Dealers are doing more advertising locally, and it is evident they intend to secure all the benefit they can from the extended publicity of the manufacturers in their efforts to interest people in their products.

The Italian population of Cleveland is large and constantly increasing, and comprises among its number some of the leading business men. They are among the best patrons talking machine dealers have, some of whom specially cater for their patronage, which is considered very desirable. They are liberal purchasers of the best in records.

W. C. Broadwell, representative of the Rudolph Wurlitzer Co., Cincinnati, whose territory takes in Michigan and the northern parts of Ohio and Indiana, is spending a few days in the city, and has taken a number of orders. He says he found business very good for this season of the year in all the localities he has visited. He recently sold two piano orchestrions to the Cedar Point Amusement Co., costing \$7,000. The company use them in the dancing pavilion. He also made a sale of one to Drake & Wallis proprietors of the resort at St. Joseph, Mich.

Mr. Devineau states that he has been delayed in placing his Biophone on the market from the fact that he had to make some important changes. A new tone arm has been added, which wonderfully improves the sound, and the attachment has been so fixed that the Devineau self-supporting horn, the "Ideal," can also be placed on the biophone attachment. Mr. Devineau is giving the finishing touches to the "Ideal," which can be adjusted to all Edison and Columbia cylinder, and all Victor and Columbia disc ma-

chines, thus the biophone attachment making the "Ideal" a universal horn.

Mr. H. B. McNutty, of the Eclipse Musical Co., just returned from a brief trip as far east as Buffalo, says he found the talking machine business good all along the line, and returned with several good sized orders. Since embarking in the exclusive wholesale trade, Mr. McNutty states their business has increased by leaps and bounds, surpassing their most sanguine expectations.

W. J. Roberts, Jr., reports trade exceptionally good, his business during June and July being larger than in the same months a year ago. Besides sales of a good many of the various grades of machines he has sold a number of Victrolas, and could have disposed of a number more if it were possible to obtain them from the manufactory.

W. H. Buescher & Son recently sold an Auxetophone to the Family Theater, where it is doing duty as an entire orchestra, giving satisfaction to the management and audiences. "Trade," said Mr. Buescher, Jr., "is good—fine! There is a general demand for machines, especially Victrolas. The August records, both of Victor and Edison, are selling well. We are having no dull season this year."

The Bailey Co. report the talking machine trade is good and that they are doing a fine business. Sales of machines are made daily, and they have sold several Victrolas, and are having inquiries for Auxetophones. The management stated they were doing well with Tonophones, and having a large and constant demand for records. The company have the Star machine on sale, and claim it is a fine instrument. The company anticipate a good fall trade.

"Business," said Mr. Bourgeois, assistant manager of the Columbia Phonograph Co., "has picked up wonderfully within the last two weeks, both in sales of machines and records. We sold six high priced machines last Saturday, and a large number of August records." Mr. Probeck has returned from his vacation trip West, much rested and in improved health.

"With the exception of last December, I did the best month's business in July of any since I started in business," said Hugh Gulley.

"My sales were of high priced machines and Red Seal records. I am having inquiries right along for the best grades of machines and records, and August has opened up in the most encouraging manner, and gives promise of the most satisfactory results."

At the music store of H. E. McMillen trade in the talking machine line was reported grand and improving. The manager stated they were daily making sales of machines, and the demand for records excellent.

The Gottdiner & Wicht Co., Nos. 645-649 Pearl street, dealers in Victor and Edison machines, report the usual midsummer dulness. "We are selling some machines," said Mr. Gottdiner, "and are having a very good call for records. Business is just about as usual at this season."

L. Hartwell, of the West Side Phonograph and Talking Machine Store, said business was very good, that he was selling some machines and a good many records. The great majority of Mr. Hartwell's trade is German and Hungarian, and is very reliable. Mr. Hartwell is desirous of going West and is offering his store for sale.

The American Multigraph Co. have raised its capital stock from \$250,000 to \$5,000,000. For each share the stockholders have, twenty have been apportioned.

E. A. Neff, who for some time has been with the well-known firm of Ball-Fintze, Newark, O., large jobbers of talking machines, has left their employ, and will hereafter represent the National Phonograph Co., of Orange, N. J. Mr. Neff has an extended acquaintance throughout this section, and is well liked by the fraternity of talking machine men. The National have secured a valuable acquisition to their force of representatives and a number of dealers here expressed the hope that Mr. Neff would be assigned to his old stamping ground.

W. W. Young, representative of the "Mellotone" Co., of Springfield, Mass., was a recent visitor to Cleveland, and secured several orders for the attachment. Dealers say it is a valuable improvement, as it eliminates some objectionable features.

"Like everything new," said H. E. Jones, manager of the commercial graphophone department of the Columbia Phonograph Co., "which has to be actually tried before it is possible to demonstrate its superiority over older methods, business men are more or less reluctant to install the machines in their offices, even on a trial basis, fearing, through lack of knowledge of the ease and convenience with which the machines are operated by beginners, that the installation of the graphophone will interfere with the regular progress of their office affairs. In most cases where this feeling of reluctance withholds the concerns from trying out the machines, and they are, unlike the Roman emperor, fully and finally persuaded, to the point of installing them, they swing to the opposite extreme, and more enthusiastically approve the system than those others who are in a more receptive mood when approached by the salesman. It is a very agreeable fact also that the opposition, almost universal upon the part of the typist, to the primary introduction of the machines, is very soon changed by use of them to the most thorough satisfaction. It often occurs that the typist, who is sometimes almost hysterical at the idea of having to use the machines, will, after a few weeks' use, decide that it is much easier and more comfortable for her than to transcribe from notes. It is difficult to say just what brings this about, but it is undoubtedly due to the fact that they discover that the machine eliminates entirely the serious eyestrain incident to transcribing from notes, caused by the constant shifting of the eye from the notebook to the typewriter; and also that the graphophone saves so much time for them as to enable them to avoid entirely the necessity for overtime work, such as is almost universal in a busy office where stenography only is used."

"Are there are other uses to which the graphophone may be put, Mr. Jones, other than office work and letter writing?"

"Yes; one of the most unique uses to which it

JOBBER!—DEALER!

If you are overstocked on perfect goods which you think will not sell readily and want to unload quickly—write us—No quantity too large.

POWERS & HENRY CO.

101 Sixth Street

PITTSBURG, PA.

has been put in this city was mentioned in the April issue of the Talking Machine World, although the practical results of this use of the machine were not then known. One of the concerns using the commercial graphophone has utilized one of their recording machines to make a series of records of a most unbearable racket occasioned by some machinery in an adjoining building. This unusual, unnecessary noise was such as to seriously interfere with the dispatch of business where the graphophone was in use. Well, the records made of this disturbance have been submitted to the firm's attorney, with the result that it is his opinion they will form adequate grounds upon which to bring suit for an abatement of the nuisance. This adds one more to the manifold advantages of having the commercial graphophone in the office. The little machine has demonstrated its ability to be about everything else heretofore, and now in this queer case adds the additional accomplishment of being a truthful, reliable and forcible witness in court."

THREE ORACLES OF SUCCESS.

Expressions of Opinion from Men in Three Different Branches of the "Talker" Industry.

The World man buttonholed three talking machine men in his trade rounds the past week, and got them on the subject of success in life. No. 1 was a manufacturer who said:

"One should learn to do the best he can when at work, and lay aside all worry as to results, when that work is faithfully done. A man soon learns another thing. That is, to first find a want, and then provide something to fill the same; and then to open your hand and show the people what you have—to advertise it. I have also learned that it pays to make an article first class in all respects. To hold the thing up in all lights and points of examination, and to ask: 'How can that be improved?' When you see where, go on and improve it. Spend money generously in labor-saving machinery and tools to produce it."

No. 2, a dealer, said: "I have been a talking machine dealer for many years now, and nothing else. Such success as I have gained I hold due to the fact that I have done the one thing, and have tried to do it as well as my limitations would allow."

No. 3 was a jobber, who has made his mark in the talking machine field. He expressed himself as follows: "A young man to be successful in business must possess a certain ability for that business, and we will also take it for granted that he has a fair amount of industry. But the thing that will give him the best service and insure continuous success is an unswerving honesty and a record for truthfulness that can never be doubted. Prosperity based upon dishonesty is uncertain, and this fact applies with special force in the mercantile world. Without these characteristics a man may succeed to a certain extent, but it will be something that adds neither to his credit nor his happiness."

WANTS NATIONAL ASSOCIATION.

Walter L. Eckhardt Chats Interestingly on the Growth of the Central and Eastern Jobbers Associations—Many Callers at Columbia Offices—Some Interesting Statistics.

In a chat with The World recently Walter L. Eckhardt, manager of the wholesale department of the Columbia Phonograph Co. made some interesting remarks, in which he said:

"After participating in the festivities of the two recent meetings of the Central States Jobbers' Association and the Eastern Talking Machine and Jobbers' Association, the former held in Chicago on June 17 and 18 and the latter in New York on July 22 and 23, I feel that the talking machine and graphophone merchants, jobbers, dealers and manufacturers are to be congratulated for bringing about the promising condition in which the industry is at present. On all sides there is a definite indication of prosperity due to the one priced system upon which graphophones and other talking machines are to-day sold.

"It has been announced that the two associations are to assemble in a joint meeting on September 11 and 12, and I sincerely trust that this meeting will result in the formation of a national association, which will no doubt promote the organization of a Southern and Western association. Four independent organizations governed by the national association would result, I feel confident, in the promotion of the best interests of all concerned in the talking machine industry.

"During the recent New York meeting it was a genuine pleasure to note the good fellowship and friendly spirit existing between competitive jobbers, which is, in my opinion, the best possible indication of fair and broad competition.

"Many members of the Eastern Talking Machine and Jobbers' Association visited our offices and were very much interested in the new Columbia products, the new Symphony grand graphophone, the upright grand graphophone and the new tapering arm cylinder machines. It was freely prophesied that these would obtain great popular favor.

"The orders now on hand and the arrears are both exceedingly large for this season of the year, and I would suggest to all intending buyers to anticipate their wants as far as possible in advance, as it is quite evident that the supply during the coming season will be oversold before the season is actually upon us."

In the course of Mr. Eckhardt's many years' experiences he has gathered some interesting statistics. He states that 75 per cent. of the talking machine men are under thirty-five years of age, 10 per cent. are below forty-five years of age, thus leaving but 15 per cent. for the "Oslerized" class.

The Milner Music Co., who have started in business in Cincinnati, O., will handle both the Victor and Edison lines. They are occupying the former Ilsen & Co. store on Sixth street. Raymond Strief, formerly with the Rudolph Wurlitzer Co., is secretary and treasurer of the new concern.

Talking Machine Repair Parts

are necessary in your business. It is possible that so far you have been unable to obtain satisfactory results in your repair work due to cheap and inferior parts.

Every Talking Machine Jobber in the United States knows that our parts are the Very Best Made.

Belts of superior quality.

Sapphires, ground and polished to the thousandth part of an inch.

Needles—we are Sole Agents for the **Schwabacher Needle Factory, Germany**. All needles made of the finest **English Steel**. Needles are put up in envelopes and handsomely decorated tin boxes.

Partes de refaccion para maquinas parlantes

Son necesarias en sus negocios probablemente no ha podido Ud. obtener resultados satisfactorios en su trabajo de reparacion, debido a sus partes o accesorios baratos y de inferior cualidad.

Todos los comerciantes en fonografos en los Estados Unidos.

Saben que nuestras partes de refaccion son las mejores manufacturadas.

Bandas de cualidad superior.

Safiros acabados con brillo y afinados a la milésima parte de una polgada.

Agujas Solo nosotros somos los unicos agentes de la gran fabrica de Alemania de agujas, marca "Schwabacher" las cuales son hechas del acero mas fino de Inglaterra.

Las agujas se empaican en sobres, puestas en cajas de lata, elegantemente decoradas.

THE TALKING MACHINE SUPPLY CO.

A. P. PETIT, General Manager.

400 Fifth Avenue, New York, U. S. A.

ANNUAL MEETING OF THE EASTERN TALKING MACHINE JOBBERS ASSOCIATION

The Most Successful Meeting Ever Held Was That at the Hotel Astor on July 22d and 23d—New Officers Elected—Many Matters of Importance Transacted—Banquet Tendered by the Greater New York Members Greatly Enjoyed—Members Later Guests of the Tea Tray Co. at Luncheon and of the Herzog Art Furniture Co. at a Delightful Outing to Coney Island.

The annual meeting of the Eastern Talking Machine Jobbers' Association, which took place at the Hotel Astor, New York, July 22d and 23d, was one of the most successful yet, held, es-

pecially from the point of attendance and the many important matters discussed and acted upon that is sure to redound to the best interest of the trade at large.

bership roll during the year, and thanked the members for their co-operation on this score.

Directors and Officers Elected.

The nominating committee appointed at the last meeting submitted the following for directors as provided by the by-laws from which four officers were to be elected. W. D. Andrews, J. Newcomb Blackman, Louis B. Buehn, A. H. Jacot and E. F. Taft.

A resolution was hereupon offered: That the by-laws be amended giving the nominating committee power to select names for offices to be filled, which was adopted. The committee then retired, and later submitted the following nominations: President, W. D. Andrews; vice-president, J. N. Blackman; secretary, A. H. Jacot; treasurer, Louis Buehn. For directors: W. D. Andrews, J. N. Blackman, A. H. Jacot, Louis Buehn and E. F. Taft (five in all). The ticket was elected unanimously. S. B. Davega and W. O. Pardee, the retiring officers, were tendered a vote of thanks for their excellent service.

Reports of special committees were then read,

the time that jobbers are to extend dealers a cash discount of two per cent., were then read by the secretary, but no definite action was taken. It was deemed wise to take the matter up at the



W. D. ANDREWS, PRESIDENT.

Monday's Session.

The first session was held Monday afternoon at 2 o'clock, President W. D. Andrews presiding: After roll call, to which 35 members responded, the minutes of the previous meeting were read and approved. J. F. Bowers, as a representative of the Central States Talking Machine Jobbers' Association, was hereupon extended the courtesy of temporary membership, and took an active part in the discussions.

Reports of the Officers.

Addresses were then made by all the officers of the association, who referred to the hearty co-operation of the members, all of which worked for the upbuilding of the organization. Treasurer Davega's report was most gratifying, for it showed that the association had only spent one-half of the amount received during the fiscal year, leaving a good balance in the treasury.

Secretary Jacot urged that the members send in their credit reports more promptly, and pointed out their importance as a help to all the members in extending credits. He also asked that each member act as a committee of one in securing new members. He added that over thirty new members had been added to the mem-



LOUIS BUEHN, TREASURER.

but action on certain far-reaching matters was deferred until the joint meeting, which is to be held September 9 and 10.

Letters from the Manufacturers.

Letters received from the Victor, Edison and Columbia companies relative to the difference in price of instruments sold for cash or on the instalment plan; the issue of the number of new records each month, the number of records catalogs should contain, and number to be cut out during the year, also the matter of regulating



J. NEWCOMB BLACKMAN, VICE-PRESIDENT.

joint meeting to be held at Buffalo. Meanwhile the committees appointed will have received full reports from the manufacturers, and the members will be able to discuss the matter more fully.

Messrs. C. V. Henkel, Benjamin Switky and S. B. Davega were appointed a committee to wait upon the manufacturers and submit reports to the members at the earliest possible moment. After receiving these reports the members will be in a better position to handle the subjects in-



A. H. JACOT, SECRETARY.

telligently, and take such action as they deem wise in the premises.

The following were elected to membership, making a total of 64: Cressey & Allen, Portland, Me., and Arthur F. Ferriss, of Utica, N. Y.

Next Meeting to be Held in Buffalo.

It was voted to hold the next meeting at Buffalo, N. Y., September 9 and 10, and C. N. Andrews, of Buffalo; C. L. Neal, of Neal, Clark & Neal, of Buffalo, and C. V. Henkel, of New York, were appointed a committee to complete all necessary arrangements as to hotel accommodations, etc.

Resolution Regarding Entertainment. Vice-President Blackman offered the following

GET THE BEST



IT HAS STOOD THE TEST

RECORD FOOD

Improves, preserves and sells Records. No catch-penny fad or fancy to sell once and cast aside, but an item of merit and practical use based on a natural law of mechanics. Nothing like it. No complicated mixing or problematical quantity. The customer sees what he gets and common sense shows him it will do the work.

One jar, ready for use, covers 500 Records.

**A Steady, Sure Seller
It Sells Itself and Records Too
Others Sell It, Do You?**

Put up in large opal (white), screw-top jars. Write us for terms and get it for fall trade.

**RECORD FOOD CO.
KANSAS CITY, MO.**

resolution, which was adopted unanimously:

"Whereas, Members in cities where meetings of this association have been held have provided entertainment for the visiting members at considerable expense, and,

"Whereas, The expense of such entertainment has been distributed among a number of members; and,

"Whereas, A continuance of this practice would establish a precedent and be an expensive burden to be shouldered by members where meetings are held, and only a few could contribute; therefore, be it

"Resolved, That the best interests of the association will be served by discontinuing this practice and requesting all members to refrain from furnishing entertainment, unless the expense is borne pro rata by each one participating."

This was unanimously adopted.

Other Matters of Interest Discussed.

Several important resolutions offered were tabled for final action at the Buffalo meeting. Meanwhile the members are requested to weigh them carefully and offer suggestions, which will be incorporated in resolutions which are to be drafted by the committee specially appointed for this work. The committee appointed follows: J. N. Blackman, C. V. Henkel and A. H. Jacot.

In connection with the appointment of this committee it is suggested that members who may be diffident about expressing their views before the meetings, write them out and send them to J. Newcomb Blackman, 97 Chambers street, New York, the chairman. The committee will gladly welcome ideas in this form, and if they embody anything of practical value, it will be embodied in a formal resolution for the action of the Buffalo convention. Members are requested to jot down ideas as they occur to them from time to time, and give the committee the benefit of their consideration in concrete form.

Vice-President Blackman made a motion that as the secretary was obliged to expend certain sums which could not be incorporated in an incidental expense account that he be allowed \$100 per annum to meet same. Adopted.

Regarding Special Business.

A member asked if the Victor Talking Machine Co. had taken any action relative to the grievance filed regarding their providing special envelopes to obviate breakage of records. It was pointed out that the jobbers had lost considerable through the breakage of records, and that the company had had ample time to rectify same.

Secretary Jacot explained that the Victor people had taken the matter under advisement, and had promised to give the subject early attention, but to date nothing had been done.

Secretary Jacot was instructed to communicate with the company again, and draw their attention to the great loss sustained, also to the patience displayed, a year having elapsed since the association made its request for reforms noted.

Issuing Sample Records in Advance.

The matter of issuing sample records two months in advance was next discussed. Many of the jobbers complained that the dealers would not place orders for October records in July. It was pointed out that the National Phonograph Co. claimed it was necessary to submit samples two months in advance in order to manufacture the records and make prompt shipments. No action was taken. The meeting then adjourned to Tuesday morning.

THE BANQUET MONDAY NIGHT.

After the meeting was adjourned the members and guests repaired to the yacht room adjoining the banquet hall, where refreshments were served. During this interval the members were introduced to the guests of the evening. At the appointed hour, 7.30 o'clock, President Andrews and the other officers led the way to the Nimrod room, where the banquet, tendered by the Greater New York members, was served. The following sat around the festive board:

W. D. Andrews, Syracuse, N. Y.; C. N. Andrews, Buffalo, N. Y.; S. B. Davega, L. Kaiser; J. N.



The Banquet of the Eastern Talking-Machine Jobbers' Association at the Hotel Astor, Monday Evening.

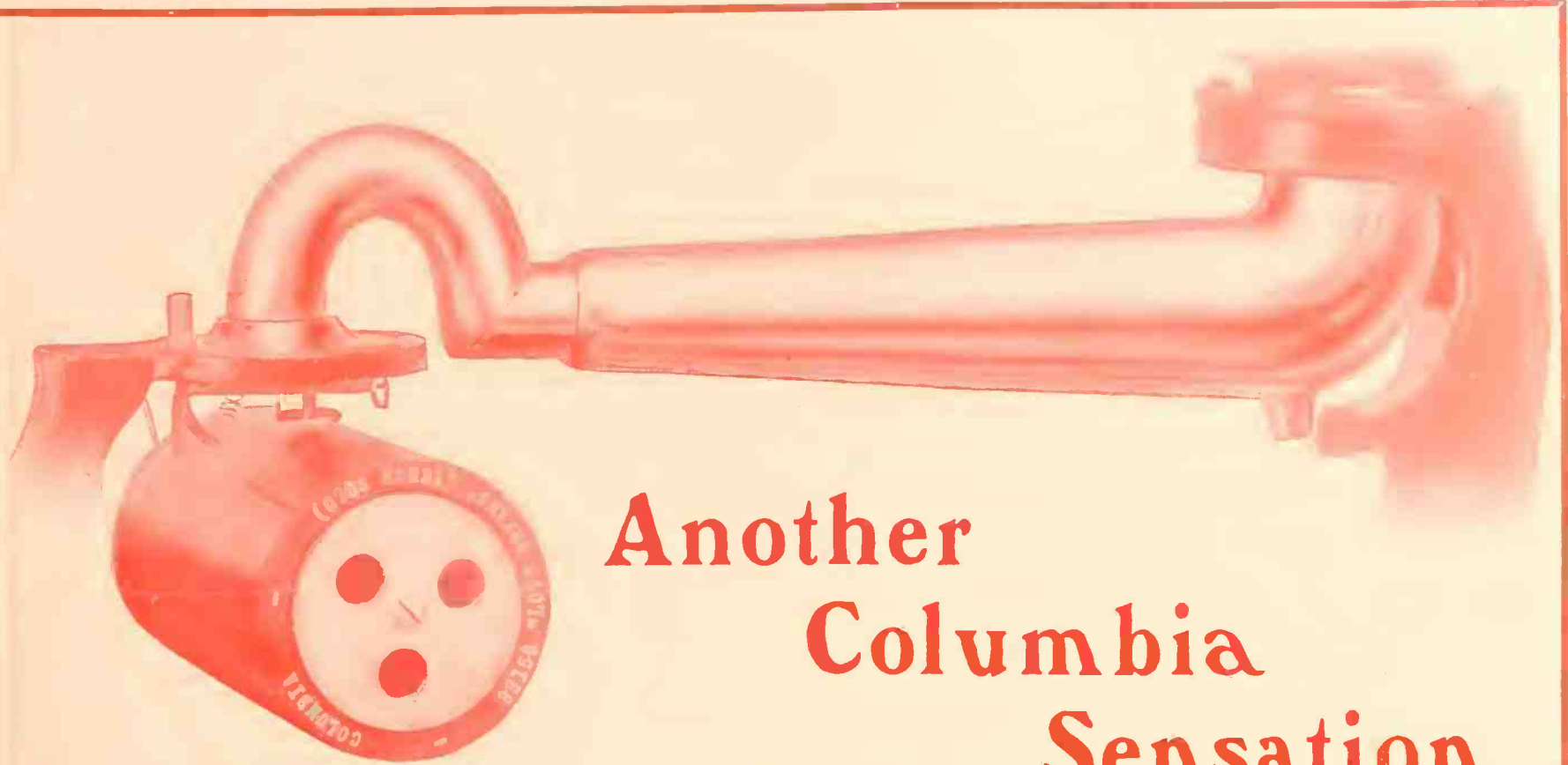

Another Columbia Sensation

This is decidedly the greatest improvement in the evolution of cylinder "talking machines."

The musical world remembers the instant success that came to the Columbia *Disc* Graphophone when first equipped with our Aluminum Tone Arm.

We have now adapted it to the Columbia Cylinder Graphophone.

It is a scientific fact that aluminum metal has the remarkable quality, when used as a sound conveyer, of wholly eliminating all false vibrations and producing a soft, full, perfectly natural tone, impossible to obtain from any other metal. The Aluminum Tone Arm on this new model does away entirely with any of the hollow horn-tone

that is unavoidable in the ordinary construction.

This model BQ machine is very compact, and very similar in general appearance to the Columbia Disc Graphophones, the horn swinging *over*, rather than away from the cabinet, occupying hardly more space than the cabinet itself, and wholly dispensing with the awkward, unsightly horn crane, horn stand, and rubber tube connection.

The motors are noiseless in operation, and the cabinets are beautifully designed, made of the finest selected oak and hand polished.

Every machine is equipped with the Lyric Tone Reproducer.

**Model BQ.—A New
Cylinder Graphophone
selling at \$30 retail,
equipped with the
famous Columbia Alu-
minum Tone Arm and
Handsome Flower Horn.**



COLUMBIA PHONOGRAPH CO., Gen'l

Tribune Building, New York

Stores in Principal Cities.

Dealers Wanted Wherever We Are Not Now Represented.



Blackman, G. G. Blackman, R. B. Caldwell, Blackman Talking Machine Co.; A. H. Jacot, Jacot Music Box Co.; J. F. Blackman, William Bohn, J. F. Blackman & Son; I. Davega, Jr.; C. V. Henkel, John Helm, John Kaiser, Douglas Phonograph Co.; Victor H. Rapke; J. B. Furber, A. E. Villard, the Regina Co.; Alfred Weiss; James Landay, Landay Bros.; A. P. Petit, Talking Machine Supply Co.; E. H. Leng, John S. Leng's Sons & Co.; George A. Stanley, Stanley & Pearsall; C. B. Warner, Kirtland Bros.; Benjamin Switky, Sol Bloom; W. L. Eckhardt, Columbia Phonograph Co., all of New York; Albert S. Marten, J. H. B. Conger, Howard G. Hull, Tea Tray Co., Newark, N. J.; John Rose, Astoria, L. I.; Clinton G. Price, H. S. Price, Price Phonograph Co., Newark, N. J.; N. D. Griffin, American Phonograph Co., Gloversville, N. Y.; Chas. B. Bailey, John F. Ellis Co., Washington, D. C.; J. F. Bowers, Lyon & Healy, Chicago, Ill.; William C. Finch, Finch & Hahn, Schenectady, N. Y.; W. O. Pardee, H. L. Ellenberger, F. H. Silliman, Pardee-Ellenberger Co., New Haven, Conn.; W. D. Wilmott, Fall River, Mass.; A. O. Petit, Edisionia Co., Newark, N. J.; Louis J. Gerson, Henry E. Marschalk, Musical Echo Co., Philadelphia, Pa.; Adolph Weiss, Western Talking Machine Co., Philadelphia, Pa.; Louis W. Fickett, Cressey & Allen, Portland, Me.; Herbert Lewis, Lewis Talking Machine Co., Philadelphia, Pa.; H. W. Weymann, H. A. Weymann & Son, Philadelphia, Pa.; C. L. Neal, Neal, Clark & Neal Co., Buffalo, N. Y.; Pat. Powers, Buffalo, N. Y.; Powers & Henry Co., Pittsburg, Pa.; R. H. Morris, American Talking Machine Co., Brooklyn, N. Y.; Louis Buehn, A. Buehn, Louis Buehn & Bro., Philadelphia, Pa.; John Herzog, M. A. Carpell, Herzog Art Furniture Co., Saginaw, Mich.; Theo. F. Bentel, Theodore F. Bentel & Co., Pittsburg, Pa.; William M. Davis, Forsyth & Davis, Kingston, N. Y.; E. F. Taft, Eastern Talking Machine Co., Boston, Mass.; John Miller, Penn Phonograph Co., Philadelphia, Pa.; C. B. Haynes, C. B. Haynes & Co., Richmond, Va.; Mr. Wonderlick, J. Samuels & Bro., Providence, R. I.

The tables were gaily decked with mounds of Jack roses and trailing fern, and withal made a pleasing picture. At each plate was also a boutonniere of lilies of the valley for each diner. The menu was as follows:

- Lucines de Little Neck
- Coupes de Gombo Froid
- Olives: Radis Amandes Salées
- Traites de Rivière de Long Island, Meunière
- Pommes de Terre Persillade
- Fillets Miguons de Boeuf aux Champignons Frais
- Petits Pois Nouveaux
- Asperges, Sauce Hollandaise
- Sorbet Yvette
- Poussins de Philadelphie Rôtis sur Canapé
- Salade de Coeurs de Laitnes et Tomates
- Glace de Fantaisie
- Petits Fours Fruits Assortis
- Café Noir
- Chateau Doisy Barsac, 1895.
- Pontet Canet, 1898.

President and Guests Toasted.

After cigars C. H. Wilson, sales manager of the National Phonograph Co., proposed a toast to the visiting guests, which was drunk standing. This was followed by a toast to the new president, who, in acknowledging it, emphasized his need of the co-operation of every member in furthering the interests of the association. He next called upon Albert S. Marten, president of the Tea Tray Co.

Mr. Marten's Remarks.

Mr. Marten spoke most appreciatively of the honor bestowed on him as guest of the association, and added: "I see about me the most prominent men identified with the talking machine business and its allied industries, and feel that the work you are doing through co-operation must surely be for the best interest of all concerned; in fact it is remarkable what your association has accomplished through concerted action, and I feel that every manufacturer must surely appreciate it and cannot fail to work hand in hand with you, for the upbuilding and strengthening of the business in which we are all so vitally interested. As I look about me I

note many who have worked their way up from the foot of the ladder and have become a power in their several lines. For instance, there is Vice-President Blackman, who I well remember carried a horn in one hand and a standard machine in the other, and from a very small beginning has become one of the leaders in his line. The growth of our industry is marvelous and I know your association has done much to bring the business to such a high standard. Thanking you again for the honor conferred and hoping to be present at the next banquet I will close by inviting you all to be our guests at luncheon here Tuesday."

Vice-President Blackman Heard From.

Vice-President Blackman, who was next called upon, said in part: "What Mr. Marten said is

tion is growing, and the trade now realizes that through its good offices we have corrected many trade evils and abuses. We aim to promote the interest of every manufacturer, jobber and dealer, and last and most important to elevate the business to the highest standard."

C. H. Wilson's Remarks.

C. H. Wilson, sales manager of the National Phonograph Co., on being called upon, said he was more than pleased to come in touch with so many representative men in the talking machine world, and added that W. E. Gilmore, president of the National Phonograph Co., who had arrived from Europe on Saturday, would have been delighted to attend the banquet and given a little talk on trade topics, had not pressure of business kept him away.



JOBBER SNAPPED WHILE ON THE BOAT TO CONEY ISLAND.

true, for I did go around with a machine and a few records, and that was the beginning of my success in this special line and calling. I naturally had to overcome many obstacles, but success rewarded my efforts. As to association work we need the co-operation of every jobber in the country, for in unity there is strength. We want competent and fair jobbers. We want the manufacturers to be fair with us and co-operate with us to elevate the business in every point, and that means fair competition. We aim as an association to bring the jobber and manufacturer in closer touch with each other, to meet on these festive occasions as good fellows, and in every instance to work in unison for the success of every branch of the industry. Our organiza-

"I assure you," continued Mr. Wilson, "that whatever steps your association takes, we believe is for the best interests of the trade at large. The jobbers and manufacturers should meet every issue squarely, and leave no stone unturned to have the business reach the highest standard possible in the mercantile world. The holding of these meetings and the discussion of the many problems of the trade is, I believe, conducive of much good, as they bring about harmony, which is a most important factor in every line of business. One important issue, I think, that should be taken up by your organization is the amalgamation of interests—to combine all the jobbers' associations under one separate head in a national association. By concerted ac-

To the Talking Machine Trade of Western New York

BUFFALO, N. Y., July 31, 1907.

I wish to inform you that I have just purchased the Edison jobbing stock and good will of Mr. Robert L. Loud, of this city. Having formerly purchased of him the Victor line, it removes Mr. Loud from the wholesale Talking Machine business entirely.

I only take from Mr. Loud's stock such goods as are in their original packages, and of the very latest pattern and style. He keeping the retail stock.

As I will continue in the future as in the past to cater to the wholesale trade exclusively, I ask for a continuance of your trade.

Mr. E. Burley who has represented this house in the past, is no longer in my employ. But a representative will call on you as usual.

Thanking you for all past as well as future favors, I remain,

Yours truly,

W. D. ANDREWS

TALKING MACHINES AND SUPPLIES

Seneca Street, Corner of Wells
Opposite Broezel Hotel

BUFFALO, N. Y.

tion you would be in the position to outline policies that would surely redound to the interest of every jobber and dealer in the country and accomplish much good."

J. F. Bowers of Lyon & Healy Speaks.

President Andrews then introduced J. F. Bowers, of Lyon & Healy, Chicago, and representative of the Central States Talking Machine Jobbers' Association, with some very happy remarks. Mr. Bowers, who spoke in a humorous vein, kept his auditors interested by citing stories that had a direct bearing on every point he wished to emphasize. He said in part: "I am a rank outsider, but, nevertheless, am pleased to be present at this sumptuous feast and listen to the various arguments which were presented by the previous speakers. This gathering brings to my mind a similar banquet held in this city some time ago when we took up the subject of the copyright law. Around the festive board were John Kendrick Bangs (a second Mark Twain), Bronson Howard, Victor Herbert, T. P. O'Connor, a member of Parliament, and other brilliant minds, none, of course, more brilliant than the toastmaster, for I was the toastmaster. (Laughter.) We discussed the subject of the copyright law pro and con, complimented Mr. O'Connor on his achievements in England, and by co-operation secured national recognition. The Music Publishers' Association has accomplished great good by banding together for one common end. Mr. Wilson's remark on amalgamation rings true. We need co-operation. There is a lack of affiliation between the Central and Eastern associations. A national association is what is needed. Let us get together and I know we will become a great power for good. I am a great believer in organization. Lyon & Healy are members of a number of local associations, and have been greatly benefited thereby. There should be a national association, and I think the hour is near at hand for its consummation. Let us get together and work to this end."

C. V. Henkel on Association Growth.

C. V. Henkel, of the Douglas Phonograph Co., outlined the growth of the association, and what good had been accomplished in a little over a year. He also argued strenuously for amalgamation, and spoke of the increase in membership and how it proved conclusively that

he added, "but to work hand in hand for the best interests of all concerned."

Other Gentlemen Who Spoke.

Other speakers were William Pelzer, of the legal department of the National Phonograph Co., who spoke on the one-price system and the laws affecting contracts in various States; W.



TALKING MACHINE JOBBERS IN THE ORIENT (CONEY ISLAND).

the jobbers were being won over one by one by simply "being shown" what could be done and, above all, that they were studying their best interests by becoming affiliated and not attempting to fight the battle single handed. "We are not organized to intimidate the manufacturers,"

A. Lawrence, of the Standard Metal Co.; J. A. MacNabb, of the Zonophone Co.; John Herzog and M. A. Carpell, of the Herzog Art Furniture Co.; J. B. Furber, of the Regina Co.; Pat. Powers, of Buffalo, and Walter L. Eckhardt, of the wholesale department of the Columbia Phonograph Co.

President Andrews asked for a rising vote of thanks to the jobbers of Greater New York for their sumptuous banquet and entertainment. Mr. Wilson also asked for a vote of thanks from the guests to the local association for being so ably entertained.

The members and guests then repaired to the roof garden, where a delightful hour was spent.

TUESDAY'S SESSION.

There was a goodly attendance at Tuesday morning's session when the following members were elected as a nominating committee for next year: John Miller, of the Penn Phonograph Co., Philadelphia; C. G. Andrews, of the Boston Cycle & Sundry Co., of Boston; C. V. Henkel, of New York; S. B. Davega, of New York, and A. O. Petit, of the Edisonia Co., Newark, N. J.

Protection in the Selling of Supplies.

Vice-President Blackman offered the following resolution:

"Whereas, The practice of most talking machine companies of selling their product through jobbers and affording the jobber protection has been approved by the trade in general and resulted in a healthy growth; and,

"Whereas, Horns and horn cranes have been sold by many manufacturers direct to dealers and without any protection to the jobber, and it has resulted in supplies being sold and made a part of the talking machine outfits, which were not up to the standard of quality maintained by representative manufacturers of machines, and has tended to cheapen and lower the standard of talking machine outfits in general, thus injuring a great industry; therefore, be it

"Resolved, That the members of this association are requested to support only such manufacturers of horns or other supplies, whose product is of standard quality and whose policy is that of following the talking machine manufacturers in protecting the jobber; and be it further

"Resolved, That the secretary send a copy of this resolution to manufacturers of horns and supplies, obtaining, if possible, their reply and their co-operation." It was unanimously adopted.

Subsequently Mr. Blackman suggested that



**Recommended as Best
By those Who Know Best**

Every dealer who would like to add to his business a feature that will increase it from 10 to 30 per cent. should give his consideration to the following recommendation.

"The undersigned E. E. and Minister Plenipotentiary of His Majesty, the King of Spain, to the United States, has much pleasure in stating that the words for the study of the Spanish language as prepared by the International Correspondence Schools, of Scranton, Pa., which I have carefully listened to, are the most perfect rendering of the pure Castilian pronunciation. I consider them invaluable to the student of our language, and cannot too much praise their efficiency and convenience."
EMILIO DE OJEDA.

This official endorsement is the highest possible recommendation for the efficiency and accuracy of the I. C. S. Spanish Course, and plainly tells the characteristics of

I.C.S. LANGUAGE SYSTEM
WITH
Thomas A. Edison
PHONOGRAPH

This system of language instruction is in use at the U. S. Government War College at Washington, and the phonograph system has been lately adopted by the University of Chicago, and everywhere it is being recognized as the coming method of language instruction. Phonograph dealers all over the country have been very successful in handling the language feature in connection with their other business. There is no reason why *you* cannot do the same—there is no reason why *you* should not do it next month, only because of your own indifference and negligence to write *now* asking for further particulars. Don't you think it worth while to find out more about such a feasible means of increasing your business?

Write us a postal to-day.

INTERNATIONAL CORRESPONDENCE SCHOOLS, SCRANTON, PA.

any member send in the name of such manufacturers whom they desired to have a copy of the above resolutions, and it would be promptly forwarded. He would also impress upon the members to report the names of the manufacturers who are not supporting the association, so that proper, suitable steps be taken to have the party fully understand the situation.

Keeping Tabs on Credits.

Vice-President Blackman submitted a most excellent card system for keeping tab on credits, and the majority of the members will adopt same forthwith.

Secretary Jacot Thanked.

C. V. Henkel offered a resolution which is to be engrossed and framed, and finally presented to Secretary Jacot, embodying the thanks of the

Phonograph Co., the next speaker outlined why his company had adopted a new horn and stand. He incidentally explained that they had learned that the cutting of prices could be traced direct to the handling of miscellaneous horns, and that the dealers were complaining bitterly on this score. He also noted that the jobbers were obliged to carry a large stock, and if his company supplied them it would eliminate price cutting to no small degree, and, moreover, the jobbers and dealers would make a greater percentage of profit. He also stated that his company wished to go on record as being in hearty sympathy with the aims and objects of the association, and willing to do all in their power to advance its interests.

National Co.'s New Agreement.
Mr. Wilson was then asked several questions



ANOTHER GROUP TAKEN ON THE PIER IN CONEY ISLAND.

association for his efficient work and good offices. It was pointed out that Secretary Jacot had worked most arduously and was deserving of the highest praise for work admirably performed.

Albert S. Marten Speaks.

After an executive session, several manufacturers and their representatives were asked to address the meeting. Albert S. Marten, president of the Tea Tray Co., spoke upon several topics of interest, and assured the association of the hearty co-operation of his concern in all matters affecting their interests.

Topham Complains of Trade Abuses.

A communication was received from James F. Topham, of Washington, D. C., calling attention to certain trade abuses; in fact, complained on the very score embraced in the foregoing resolution. Secretary Jacot was instructed to send Mr. Topham a copy of the resolution, and advise him of the association's action.

C. H. Wilson's Remarks.

C. H. Wilson, representing the National

relative to the company's new agreement, which is to be issued Sept. 16 next. It was pointed out that the jobbers were in favor of a differential price schedule, which would allow a cash discount. This would cut off ruinous competition and protect the small dealer to no small degree.

The following members spoke on this important subject at considerable length: President Andrews, J. B. Furber, Secretary Jacot, Vice-President Blackman, S. B. Davega, Pat Powers and I. Davega.

The following committee was appointed to take the matter up at once with the manufacturers: Messrs. Furber, Buehn, Henkel, Pardee and Blackman.

Differential Price Discussed.

Tuesday's session was in great part devoted to the discussion of the differential price on goods sold for cash or on instalments. It was the consensus of opinion that the manufacturing companies should allow a proper discount as between the two sales, in conformity with the general practice in every line of business. The fact was pointed out that as it now stands that when a customer finds he cannot obtain better terms in buying for cash or on eight months' time, he will invariably take advantage of the latter, to the detriment and perhaps damage of the transaction. Further, it was held the one-price system placed the jobber and dealer on the same footing, but the present method of selling was driving jobbers into the retail business. This would be remedied were a differential schedule adopted by the companies and embodied in their agreements, a concession the trade were clearly entitled to by all known mercantile rules and usages. Many telling points were made by Messrs. Andrews, Blackman and others. On August 7 the committee conferred on this question with President Gilmore, at the New York offices of the National Phonograph Co., when their views were presented in detail. Mr. Gilmore listened attentively, asked a number of questions, and said he would take the matter under advisement, and promised an early reply. C. H. Wilson, manager of sales; F. K.

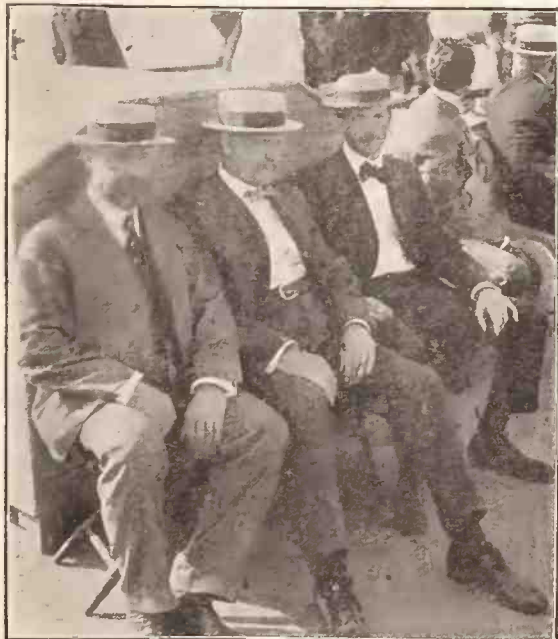

MESSRS. JACOT, ANDREWS AND BLACKMAN "DEAD TO RIGHTS."



Get Ready For Fall Trade

This will be the biggest Record year you have ever known — so, get ready. If you mean to get your share of the business, you must have your stock kept in the most convenient shape. That means you must have

THE "HEISE" SYSTEM OF WIRE RECORD RACKS

Made for Cylinder or Disc Records to fit any given space in your store or in revolving forms.

- Hold most records —
- Keep records clean —
- Prevent damage —
- Save much space —

- Keep stock for you —
- Tell you if stock is low —
- Save clerk's time —
- Save customer's time —

THEIR CONVENIENCE ENABLES YOU TO DO TWICE THE BUSINESS

Sold by Jobbers everywhere
Get a complete Catalog

"MADE IN SYRACUSE" BY THE
SYRACUSE WIRE WORKS
Syracuse, N. Y.

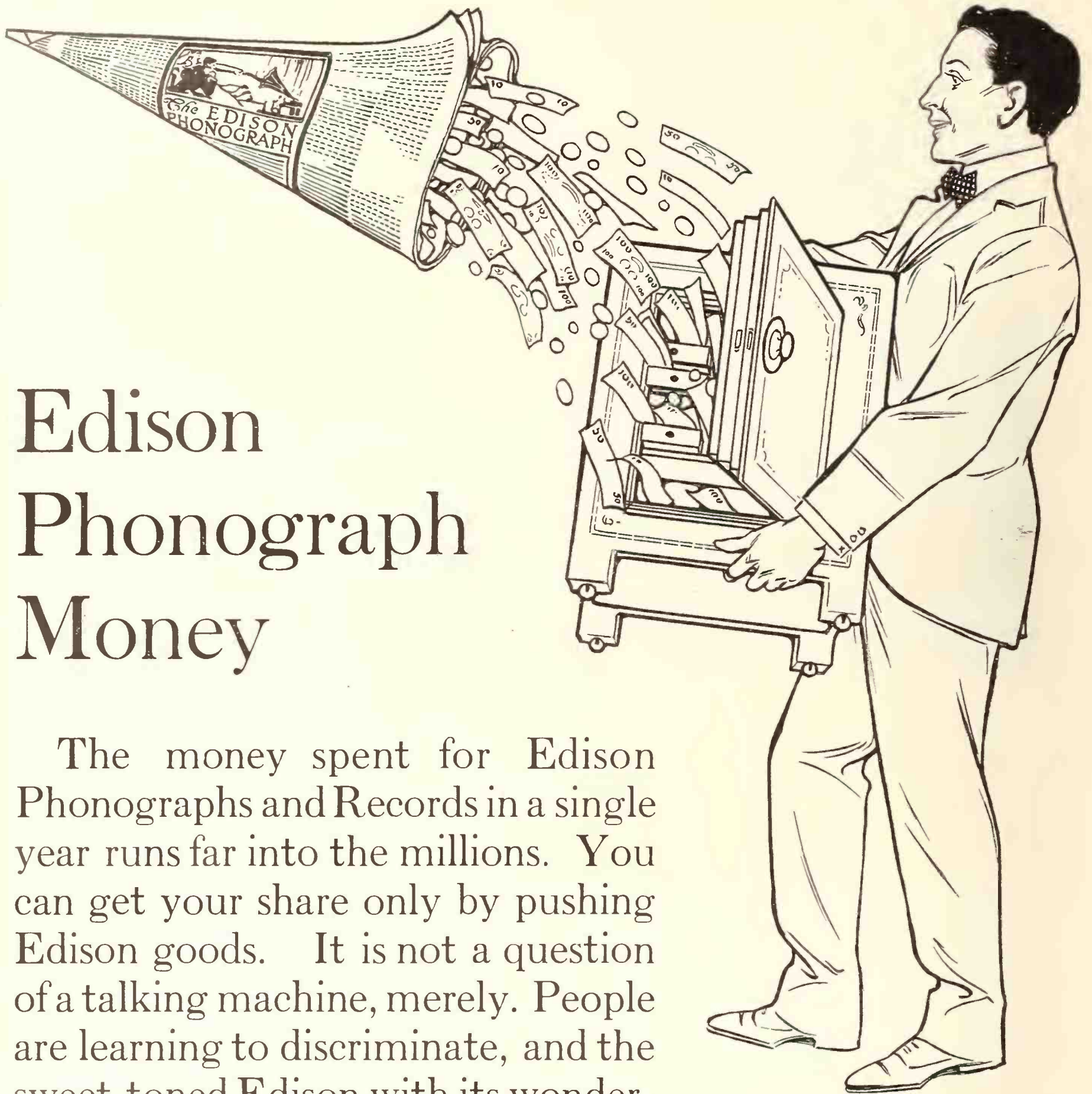

Edison Phonograph Money

The money spent for Edison Phonographs and Records in a single year runs far into the millions. You can get your share only by pushing Edison goods. It is not a question of a talking machine, merely. People are learning to discriminate, and the sweet-toned Edison with its wonderful powers of perfect reproduction makes the strongest bid for popular favor.

The demand for Edison Phonographs and Records is now the greatest in its history and is increasing, as our advertising prompts more people to investigate and the Edison itself influences them to buy.

If you carry Edison goods, put your best selling machinery behind them. It will pay you. If you are without Edison goods, write us for terms and the name of a nearby jobber who can supply you.

NATIONAL PHONOGRAPH CO., 59 Lakeside Ave., Orange, N. J.

concerned. I believe that this industry will move on to greater and grander accomplishments. The talking machine has ceased to be regarded as a toy, and it is playing its part as a great educational force on the world's stage. It is not only used as an entertainer, but it is used in educational institutions, and it is found as a companion of the business man in his office. I believe that its future is assured, and I know that with the men whom we have behind the guns greater victories will be accomplished. It is an industry which should be maintained on a high plane, and I believe that you gentlemen will all be interested in keeping it there, and I assure

the chutes had been shot, and the various shows had been carefully examined, and the dark corners of Dreamland explored Mr. Carpell invited the delegates to a sumptuous repast, and behind mountains of steamed clams and other appetizing accessories a couple of delightful hours were passed as a finale to the talking machine men's gathering in this city.

At the head of the table sat John Herzog, treasurer and general manager of the Herzog Co. Mr. Herzog contributed greatly to the evening's entertainment by some very clever and witty remarks at the close of the dinner. He spoke of his pleasant experiences in the talking

Talking Machine Jobbers' Association and other bodies in different lines I do business with is marked; in fact, it is striking. The questions they have handled were treated in such an open and broad way, that such an association must be beneficial, conducted as it is in such an admirable manner. As regards the members, I could not help but observe that they are high-minded and act accordingly; their heart and soul is in their business and it is conducted on live lines. In our dealings with the talking machine trade we have found more satisfaction than with many of the furniture people I could name. In brief, we were all greatly pleased and delighted."

FRED G. LOEFFLER'S GOOD BUSINESS.

Fred G. Loeffler, the talking machine dealer of 260 Bergenline avenue, Union, N. J., and who also conducts a store in Jersey City, is doing an excellent business in both popular and operatic selections. He caters especially to a large mailing list, and he says his chief trouble does not consist in getting orders but in getting enough of the popular records to fill orders. He claims to have lost several sales of the "Rigoletto" quartet, the most expensive record he carries, through his inability to get a sufficient supply from the jobbers.

AUXETOPHONE CONCERTS IN THE PARKS.

With the object of advertising his business, E. R. Kern, of the Kern Music Co., Jersey City, N. J., offered to give free Auxetophone concerts in the parks during the balance of the summer on the evenings upon which there is no concert by the municipal band. The electric light company, however, wanted \$100 for furnishing light during concert evenings, which somewhat delayed the acceptance of Mr. Kern's offer by the city. The Kern Music Co. do a great deal of newspaper and street car and other forms of advertising and always keep before the public.

It is now about time to get in line for the fall campaign.



There is some difference of opinion as to which of the four machines is the best, but the opinion is unanimous regarding Herzog Cabinets.

SOUVENIR GIVEN OUT BY THE HERZOG ART FURNITURE CO.

you, to the utmost of my ability, that my trade paper organization shall be pledged to its advance. Everything which we can do consistently shall be done to promote the legitimate interests of this trade, and I say confidently that its future advance will be just as miraculous as its development within the past half dozen years."

THE TRIP TO CONEY ISLAND.

Immediately after the conclusion of the luncheon, given by the Tea Tray Co. to the visiting talking machine delegates, M. A. Carpell, New York representative of the Herzog Art Furniture Co., Saginaw, Mich., took the entire delegates in charge, acting in the capacity of host. Mr. Carpell proved himself a pastmaster in the art of entertaining, and from the time that the seventy-five delegates boarded the steamer for Coney Island until the close of the dinner, his effervescing good nature was everywhere manifest in making Tuesday afternoon and evening a red letter period in the memory of the talking machine men.

Mr. Carpell bought up a large portion of Coney



M. A. CARPELL.

Island, which he presented to the visiting delegates, who took temporary possession of the seashore domain of Manhattan. In his purchase Mr. Carpell included all of the shows at Coney Island, and in order to acquaint the delegates with the beauty and variety of his possessions he piloted them personally through every show known to Coney Island habitués. Mr. Carpell owned Dreamland on Tuesday afternoon and evening, and none disputed his authority. After

machine trade, and gave an enjoyable and reminiscent talk. He said among other things that he regretted that the president of his company, John L. Jackson, was unable to be present, but that he took great delight in meeting the talking machine men of the East.

In response to a call from the chair, James F. Bowers, of Lyon & Healy, Chicago, gave an interesting and entertaining address, which was enthusiastically received by the banqueters. Among those present were: John H. B. Conger, W. A. Laurence, J. F. Bowers, F. H. Silliman, W. O. Pardee, W. D. Griffen, V. H. Rapke, W. L. Eckhardt, C. V. Henkel, A. H. Jacot, C. N. Andrews, William Bohn, John W. Blackmau, Lipman Kaiser, A. W. Barklow, Alfred Weiss, Adolf Weiss, W. D. Wilmot, A. P. Petit, E. C. Plume, William C. Finch, Benjamin Switky, R. H. Morris, John Kaiser, Ed. E. Buehn, F. B. Werner, G. T. Williams, J. D. Beekman, A. O. Petit, O. C. Neal, L. H. Stewart, L. Rose, C. G. Price, H. S. Price, J. Rose, S. B. Davega, J. Newcomb Blackman, John Herzog, Carl E. Ackerman, W. D. Andrews, Fred H. Thompson, Thos. Frost, M. A. Carpell, Louis Jay Gerson, Henry E. Marschalk, H. L. Ellenberger, T. F. Murray, Herbert T. Lewis, R. B. Caldwell, J. B. Furber, J. A. MacNabb, A. Hanz, P. A. Powers, I. Davega, Jr.

Thus closed one of the most enjoyable reunions of the talking machine jobbers ever held. Indeed, it would be hard to speak of any former occasion, excepting the Edison entertainment, given by the National Phonograph Co., July last, to which it could be compared, according to the statements of a number of the participants. That event—never to be forgotten—was more elaborate and on a greater scale, but it was generally believed no more cordial feeling of good fellowship could have prevailed.

A Chat With Mr. Carpell.

Later when Mr. Carpell, the sales manager of the Herzog Art Furniture Co., was asked about his impressions of the association, he said: "The difference between the personnel of the Eastern

Some Facts Worth Considering

THE talking machine man frequently asks, "How can I increase my business?" The answer is easy. Place on a side line which takes but little space, which is attractive, and a standard in its particular line. Take the **Black Diamond Strings**, for instance. Steel and wound. New process. They are the finest manufactured. They are used by all of the prominent artists, and you will have a trade coming your way when it is known that you handle the "Black Diamond." Music dealers all over America, and all over the world for that matter, know full well the value of this product.

National Musical String Co.
New Brunswick, N. J.

BEKA RECORD

THE BEST and CHEAPEST DISC

IN THE WORLD

*The largest and most Comprehensive Repertoire which has
ever been compiled, in*

**GERMAN
ENGLISH
FRENCH
ITALIAN
PORTUGUESE
RUSSIAN
AUSTRIAN
HUNGARIAN
DANISH
SWISS
DUTCH
SPANISH
SERVIAN
CROATIAN
BOSNIAN
POLISH
HEBREW**

CHINESE :

**SWATOW
GUAKAU
PEKINESE
SHANSINESE
KIANGNESE
CANTONESE**

**ARABIAN
TURKISH
EGYPTIAN
SYRIAN
PERSIAN**

HINDUSTANEE :

**AFGHANISTA
URDU
MARATHI
CUJARATHI
HINDI
TARSI
BENGALIE
CANARESE
TELAGU**

**TAMIL
MALAYIAN
STAMBOUL
GAMBALANG**

INTERNATIONAL CATALOGUE (224 Pages) GRATIS

UP-TO-DATE SUPPLEMENTS

CORRESPONDENCE INVITED

Beka Record, G. m. b. H. Berlin, Heidelberger Str. 75-76

***Breslau, Bombay, Colombo, Madras, Calcutta, Rangoon, Singapore, Batavia, Soerabaya,
Saigon, Hong Kong, Shanghai, Tokio, Kobe, Yokohama***

SOLE AGENT FOR GREAT BRITAIN AND COLONIES

O. RUHL, KIMBERLEY HOUSE, 6 and 7 REDCROSS ST., LONDON, E. C.

FROM OUR EUROPEAN HEADQUARTERS

69 BASINGHALL STREET, LONDON, E. C., W. LIONEL STURDY, MANAGER.

TRADE HAPPENINGS IN ENGLAND.

Local Trade Is Quiet, But Manufacturers Are Kept Busy Supplying Colonial Demands—American Houses Planning to Capture Foreign Trade—Victor Men Abroad—Dictating Virtually to the Type—Ruhl's Good Report—Factory Quarters for National Phonograph Co.—President Easton's Impressions—Chappell Watching Pirates—Reducing Record Prices—A New Record Box—British Sonogram Co.'s New Records—Barnett Samuel News—Columbia Outing—New Factors—Some Postage Points—Some Clever Bonci Publicity—Favorite Co. to Make Records—Dictaphone at the Business Exhibition—Sheffield Choir Records—Some Odeon Items—International Neophone Co. to Start Company in the United States—Interesting Budget of News Items.

(Special to The Talking Machine World.)
World Office, 69 Basinghall Street,
London, E. C., Eng., August 6, 1907.

One can summarize business conditions during the last few weeks from many standpoints. The "man in the street" would say it was distinctly bad as far as sales are concerned, while from the manufacturer's point of view the talking machine industry is most prosperous. This may read rather illogical, but the answer is supplied by the dealer who says: "It is not us who are doing the business, as the home trade is distinctly quiet all round with everybody outside the factors and manufacturers, whose factories are kept busily engaged supplying the wants of our colonies and other countries, where, of course, business is in full swing," and from my own observation this is the general state of things today.

The weather fortunately keeps pretty fine, but owing to the sudden changes we do not see as many machines on the lawns or up the river as we would wish, still this summer shows a distinct advance in the number and variety of machines in evidence on the punts and houseboats. Holiday making is in full swing during July and August, particularly, and with so many leading men in the trade and others now on their vacation it is not surprising that business must and does suffer to an appreciable extent.

Then, again, one must not lose sight of the

adverse influence of the railway men's agitation, and threatened strikes in other quarters, while the bad weather we experienced up to a few weeks ago has had a most disastrous effect upon the crops throughout the land. Thus the feeling of insecurity these things engender, makes the spending class hold on tight to what little surplus they are able to save from their earnings, which, under better conditions, they would spend. There are, however, good prospects for an excellent fall trade. The leading firms are preparing for it in many ways, and when home orders come along they will all be ready to handle them with promptness and efficiency.

Hawthorne & Sheble Co. in London.

The Hawthorne & Sheble Manufacturing Co., of Philadelphia, are represented in London in the person of William McArdle, who is located at 10 Christopher street, Finsbury, one of the most convenient centers for talking machine men to get at. I found him in a spacious room surrounded by a variety of horns, machines, records and accessories, which, upon inspection, proved to be equal if not better than the best upon this market. I have not the space to enter into a detailed description, but Mr. McArdle will be pleased to convey particulars, or, better still, will give practical demonstration to such as are interested enough to make an appointment with him. He will fix up an agency with a good wholesale distributing firm in London, and also in the principal continental centers, which will be worked from this city. Mac is in splendid trim, and has requested me to convey his respects to the "boys" across the water.

Mr. Beecroft Also a Visitor.

Clement Beecroft, of the Tea Tray Co., is also over here on business for his house.

President Johnson Returns in September.

Another visitor is Eldridge R. Johnson, president of the Victor Talking Machine Co., who has been here for some time. He expects to return about September, but the date is not definitely decided upon. It may not be generally known that just previous to his sailing Mr. Johnson met with a very nasty accident. Out driving one day the horse bolted, with the result that the occupants of the trap were precipitated into the roadway. "At the time," said Mr. Johnson, "I thought it had only resulted in a sprained ankle, but on arrival here I sought medical advice, and under

the X rays it was discovered that several bones of the foot were dislocated, while the leg bone was broken." I am glad to say that Mr. Johnson is now well on the road to recovery, and is able to transact business as usual. Mr. Johnson is not here on business. He makes it a practice to spend the summer in England, chiefly because the climate is more beneficial to his wife's health. This is only possible since he has brought his business to such a system as to be able to conduct it equally as well from London. "I have found trade generally good," continued Mr. Johnson, "but it lacks the stability prevalent in American circles."

Mr. Geissler, general manager of the selling department of the Victor Co., is yet another visitor this month, but he does not stop long this time.

From the Mouth Direct to the Type.

A novel experiment in journalism is being conducted by the editor of the Automobile Owner. He dictates his descriptive articles, news items and other matter to the Columbia Phonograph Co.'s "Dictaphone," and sends the cylinders direct to the composing room, where they reproduce his spoken words to the compositors. These clever "graduates of the case" set up type, not from copy, but from dictation. In describing this new method, the editor says: "A great part of the editorial portion of this paper has been produced without a word having been put on paper. Our innovation has been brought about by the use of the 'Dictaphone.' For some time past we have been using these machines in connection with the typewriter, the matter being dictated directly into the wax cylinders at odd moments, and then handed on to the typist to transcribe. In this way it is found we can keep our typist continually employed, and save the time occupied in dictation. This saving is approximately about two hours in three.

"This success suggested to us the possibility of applying the 'Dictaphone' to the linotype machine, and we approached the Columbia Phonograph Co. to co-operate with us in carrying out the undertaking. There was some difficulty at first in accustoming the lino operators to the sound of the voice, but it soon passed, and during the last month we have had Columbia 'Dictaphones' connected to three of the linotype machines at the works of our printers. These

THE NEW REX RECORD CO., LONDON

Offer a British made Record at a price which will command trade. It secures preferential tariff in all British Colonies. Get into touch with this line for future trade.

PARTICULARS FROM

THE NEW REX CO., 261 Liverpool Road, LONDON, ENGLAND

GEO. DYER, Sec.

PATHE FRÈRES—LONDON
PATHE FRÈRES—LONDON

PATHE'S DISC

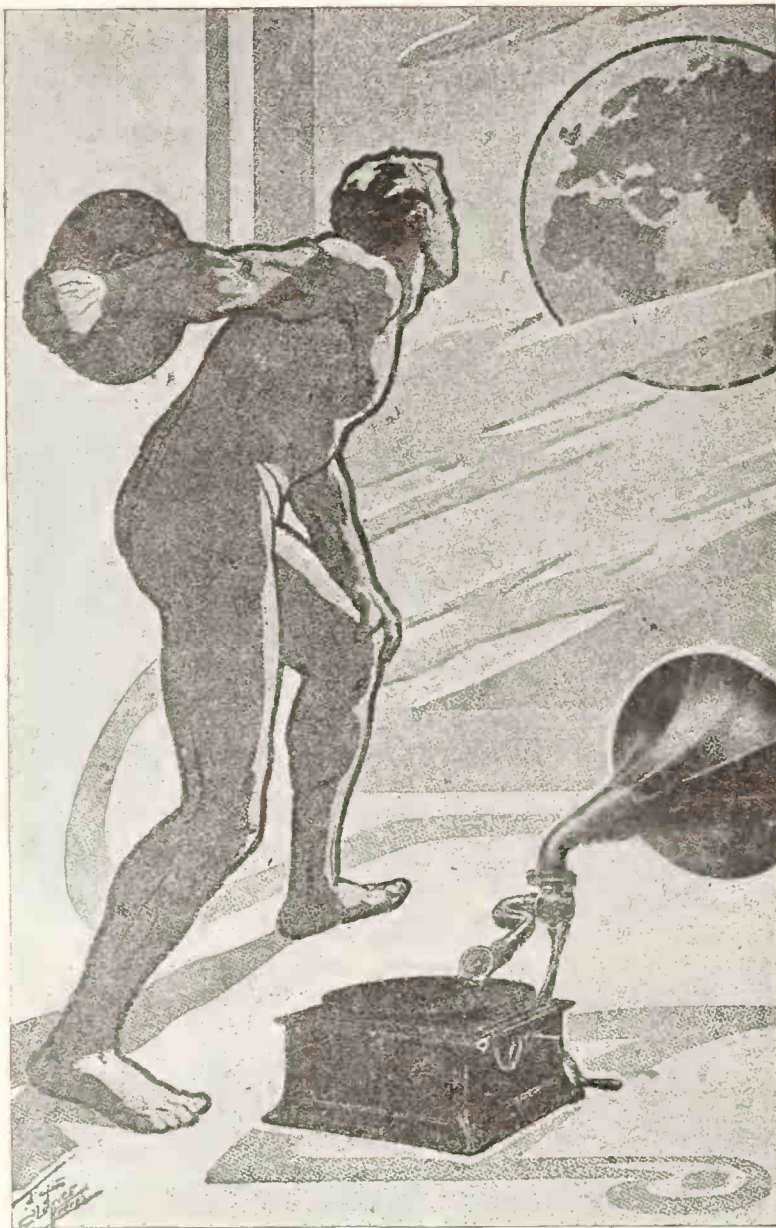

ONCE YOU HAVE HEARD
PATHE'S DISC YOU WILL
 NEVER BUY OTHERS.

PATHE'S DISCS ARE PLAYED
 WITHOUT A NEEDLE, HENCE THEIR
 GREAT SUPERIORITY.

THE TIME FOR FANCY PRICES
 FOR DISCS IS PAST WE GIVE YOU THE
 GREATEST STAR ARTISTES AT ONE
 UNIFORM PRICE, **3/-** PER DISC.

THE GREAT SUPERIORITY OF THE
PATHE DISC IS OBTAINED BY
 USING A SAPHIRE POINT, THERE
 IS NO CHANGING THE NEEDLE,
 GIVES THE NATURAL VOICE.

PATHE'S RÉPERTOIRE
 CONTAINS OVER **20.000**
 SELECTIONS DRAWN FROM
 ALL PARTS OF THE WORLD.

PATHE'S PHONOS

LONDON WAREHOUSE, 14, 16, 18, LAMBS CONDUIT STREET (W.C.)
 LONDON RETAIL SHOWROOMS, 64, REGENT STREET, LONDON (W.)

PATHE FRÈRES—LONDON
PATHE FRÈRES—LONDON

FROM OUR LONDON HEADQUARTERS—(Continued.)

notes and certain other portions of the paper are the result."

Conscience in Business.

Shut out conscience from your methods, and you may make money; but you will certainly make enemies and lose friends, and possibly look around some day for a hand to shake and a heart to sympathize with you in some difficulty or other. Go straight to your creditors when in difficulty, explain your situation and possibilities. Do not fear to "face the music," for the open course is the best always.

Trade Satisfactory With Ruhl.

"Trade this month," said Mr. O. Ruhl, "has been most satisfactory. So far we show a 50 per cent. advance over sales in July last year for the Lindstrom machines, while the Beka record business is expanding all the time. Mr. Ruhl recently paid a visit to Newcastle, which, he says, was of a most satisfactory nature, and business generally up north was excellent.

Factory Quarters for National Phonograph Co.

The rumor announced in our June issue as to the probability of the National Phonograph Co. opening factories in London, is now a rumor no longer, for I am informed by Mr. Lemoine that commodious premises have been secured at Willesden for the purpose of manufacturing records, and which, it is expected, will be in full working order in a month or so. Edison factors and dealers will join us in congratulating the National Co. upon this, their latest, acquisition, which means that the trade may calculate upon a much improved service and quicker delivery facilities. In connection with the above, we hope it will enlighten our contemporary, who sits in a glass house and throws stones!

Interesting Interview With President Easton.

Just before his departure from these shores I was fortunate enough to secure a short chat with E. D. Easton, the Columbia Phonograph Co.'s courteous and strenuous president, who sailed

with his family on July 31 for New York after a visit to all the branches of the company at Berlin, St. Petersburg, Vienna, Milan, Paris, and, of course, London. It has been Mr. Easton's custom for a number of years to combine with his annual holiday a tour of inspection of the continental branches. Not only does this give him the opportunity of keeping closely in touch with the needs and condition of each office, but his presence is a decided inspiration and encouragement to the managers. Mr. Easton was much



PRESIDENT E. D. EASTON.

impressed with the handsome appearance of the new Paris shop on the boulevard and its splendid prospects for retail business and while he did not reach London in time to visit the Business Exhibition at Olympia, he was naturally much pleased with the splendid results achieved by his company at the commercial stand there,

and I was glad to learn that this branch of the business had made very great strides in America. While on this side of the Atlantic word came to him that the company's business for June had exceeded the previous June very considerably. Mr. Easton said that he expected it, for the business was never better than at present, and their manufacturing facilities were strained to the utmost—unfulfilled orders being more than double even this time last year. Asked as to the comparative volume of trade at the various centers, Mr. Easton stated that he had found the growth of business fairly uniform, the only difference being in the continuity of progress all the year round. "The talking machine trade is only in its infancy; yet, at least in America, we have reached that stage of stability which means business—and good business, too—each month throughout the twelve. As an instance, I may say our June sales this year were much greater than January, which is a state of things, I think, we should all like to see more universal." With this agreement I made my adieu, but not before I had been regaled with the following amusing story, which very forcibly illustrates a contrast, and at the same time shows a lesson in consideration:

"The police regulations in America are anything but pleasant to motorists who transgress the laws of the country, and it is no uncommon thing for a chauffeur to be placed under arrest on some petty charge and detained for a whole day before being released on recognizances. I am thankful to say," continued President Easton, "that I have so far escaped such an unpleasant experience, although I have been an ardent motorist for years, but in face of these expectations a little adventure I had in Switzerland was in the nature of an agreeable contrast—if amusing. It came about in this way: You know that I combine business with pleasure while upon my annual tour, and this time we spent ten days in beautiful Switzerland. Hiring an automobile, we

NEOPHONE DISC PHONOGRAPH

(SYSTEM DR. MICHAELIS)

NEOPHONE DISC RECORDS

NEOPHONES
NEED
NO
NEEDLES

The First and Original Sapphire Discs
No Needles to Change
Plays With Permanent Sapphire Point

It is proposed to form subsidiary companies and establish agencies in all parts of America and all foreign countries, for the purpose of meeting local requirements.

For particulars apply to

The International Neophone Company, Ltd.

2 TABERNACLE STREET, LONDON, E. C.

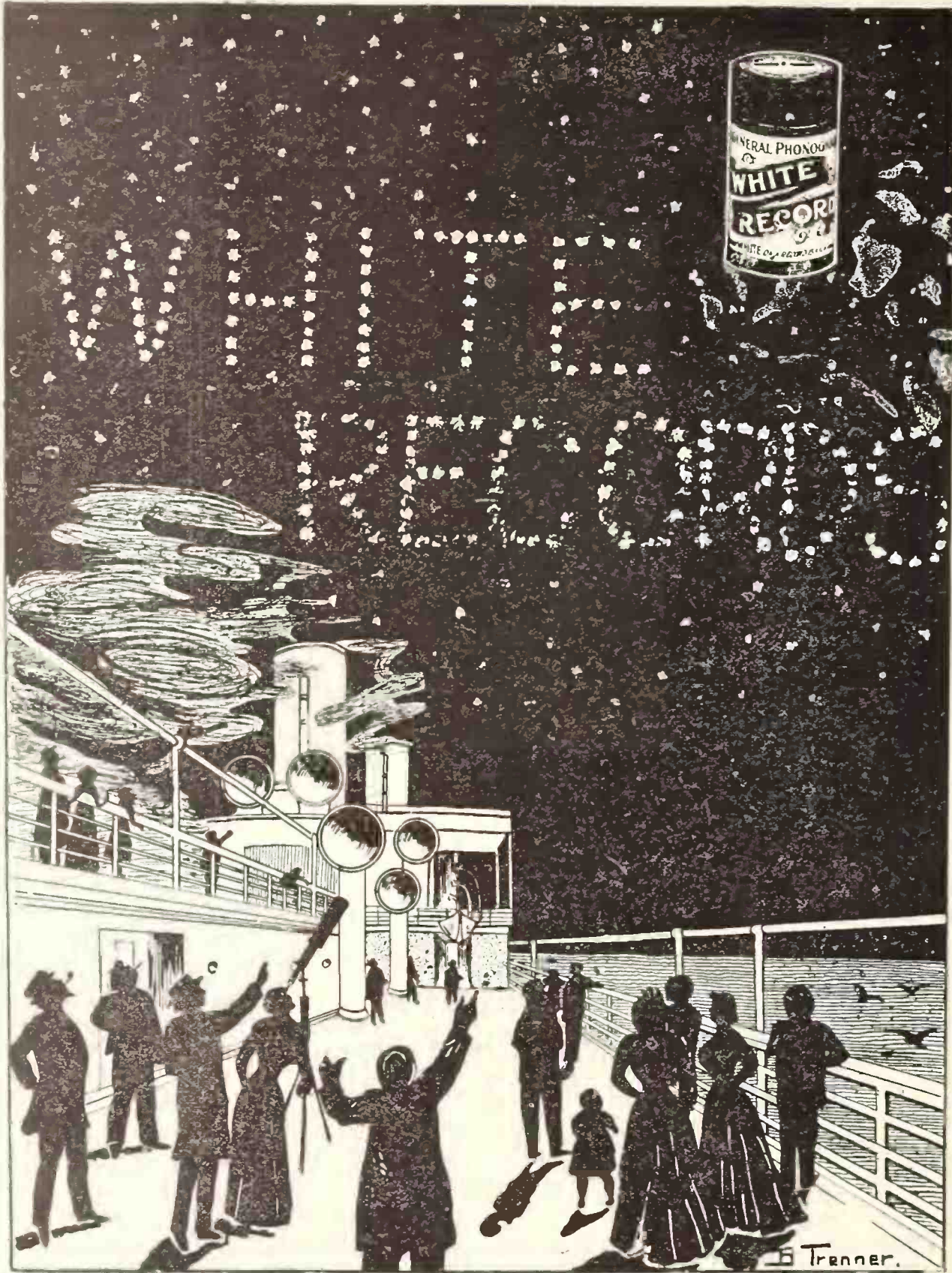

HAVE THE BEST

Canadian dealers and jobbers should bear in mind,

The "WHITE" Record is BRITISH MADE

and by purchasing this record they benefit by the preferential tariff. Stock this record and increase your sales. The "White" Record has merit, and the large sales are the best evidence of this.

JAS. ANDERSON

255-257-259 Clarendon St., SO. MELBOURNE

SOLE SELLING AGENT FOR AUSTRALIA

RETAIL PRICE, 1/- EACH

LATEST TITLES—ALL GOOD SELLERS

INSTRUMENTAL

By the IMPERIAL TROMBONE QUARTETTE.

202 Cujus Animum (Stabat Mater).

203 Intermezzo ("Cavalleria Rusticana").

By H. LYELL TAYLER (harp and violin).

206 Ave Maria.

By the EMPIRE MILITARY BAND.

207 The Khaki Carbineer (march).

211 The Merry Widow (waltz).

VOCAL

By WILFRED PLATT.

200 The Storm Fiend.

201 Asleep in the Deep.

By JOHNNY WAKEFIELD.

204 The Little Shirt My Mother Made for Me.

208 What Did I Do?

By ARTHUR GILBERT.

205 Too-ral-i-oo-ral-i-ay.

By MISS FRANCES GROVES.

209 Poor John.

210 She Hasn't Done Her Hair Up Yet.

Supplementary List for August.

By the EMPIRE MILITARY BAND.

212 Morning, Noon and Night (overture).

By H. LYELL TAYLER (harp and violin).

213 Intermezzo ("Cavalleria Rusticana").

By HECTOR GRANT.

214 By the Banks of Allan Water (Scotch comic).

By PETER DAWSON.

215 The Bells of Aberdovey.

218 Jolly Good Luck to the Girl who Loves a Soldier.

By the IMPERIAL TROMBONE QUARTETTE.

216 In Cellar Cool.

219 A Coon Band Contest.

By WILL DANBY.

217 Potted Poetry.

The following selections are from one of our foreign departments, and are all made by the Imperial Band of Berlin:

220 Army March.

221 Sansouci March.

222 Maxime March.

223 Carmen.

Ask your Jobbers for them; up-to-date Jobbers carry them in stock. Send for List and samples of our "Neophone" Disc Records, made by the latest gold moulding process, "White System."

THE GENERAL PHONOGRAPH COMPANY, Ltd., 1 Worship Street, City Road, LONDON, E. C., ENGLAND

FROM OUR LONDON HEADQUARTERS—(Continued.)

one day found ourselves in a high part of the country where it appears motor cars were not allowed during certain hours. I can hardly say we were arrested, but any way, we found ourselves in the care of the law, and were treated most courteously. The trouble now was how to get away. We were told it would be necessary to hire a team of horses to draw the car away, deposit 100 francs, and last, but not least, walk ahead in front of the horses out of the restricted area. And this is how we eventually met the obligations of the Swiss law." Said I, "It would have been a grand illustration to present to The World readers." "Yes," answered Mr. Easton, "but as cameras were scarce, you will have to do your best with the pen."

A Point for Salesmen.

Cultivate a cheerful manner. A cheery smile and bright speech is half-way toward making a sale; a sullen look and a surly tongue are sure guides to failure. Optimism is ever the ace of trumps in business and out of it.

Chappell & Co. After Pirates.

Outside all the police stations, and on the principal boardings in and around London are notices announcing a reward of £50 which will be paid by Messrs. Chappell & Co. for information leading to the conviction of persons guilty of printing pirated copies of the "Merry Widow" waltz.

Russell Hunting's Discovery.

I am authorized to announce that Russell Hunting, of Michael Casey fame, recently made a most important discovery bearing upon the recording art. It would, of course, be premature to say more at present, as the matter has only just got beyond the experimental stage, but suffice it to say that it will bring the reproduction of voice and music more nearer natural perfection than at present.

Walter P. Thompson Back from Canada.

Walter P. Thompson, representing Pathe Freres, has returned from his extensive Canadian trip, where he reports having done a large business. Messrs. Pathe Freres are now offering an 11-inch double-sided disc at four shillings.

Red Label Record Prices Reduced.

The Gramophone & Typewriter Co., Ltd., announce a reduction in the price of their Red Label records. As the reduction amounts in some cases to more than 33 per cent., dealers handling these products will certainly not be the losers, since the sales and the profits must increase proportionately. Mme. Melba herself requested the company to sell her records at 12s. 6d. instead of one guinea, as so many unknown friends could not afford the latter price. A further list of records by Mme. Melba is now ready.

"Paris in London" Syndicate Plans.

The "Paris in London" syndicate, who have secured the long vacant Aldwych-Strand site, have in view the erection of a building costing £500,000, and which will contain a theatre, a concert hall, a restaurant, and, among other departments, galleries in which there will be a permanent exhibition of arts and manufactures. This means a series of industrial exhibitions which will encircle the interior of the building. Other notable features include the establishment of a French club and the running of a purely French theatre, wherein French plays in the lighter vein will be staged exclusively.

Melograph Record Co. Incorporated.

With a capital of £5,000, in £1 shares, the Melograph Record Co. was registered without articles on July 11 to adopt an agreement with Ernest Hesse & Co., of Berlin, to carry on the business of phonograph record manufacturers. Registered office, Lyceum Chambers, 97 Hanover street, Liverpool.

Duty on Australian Catalogs.

The duty on catalogs sent to Australia may now be prepaid in London at the rate of 3d. per pound. Duty stamps are issued from the Commonwealth office, 72 Victoria street, London, S. W.

An Improved Record Box.

The Russell Hunting Record Co. have issued an improved record box. The old label which has proved so popular, and which it would be hard to equal for effectiveness, has been retained, but the change consists in deeper caps, top and bottom, firmly gummed, flush with the body of the box. Thus there are no cap edges protruding, which in the case of the old boxes was so often the cause of records being broken by falling through. "The 'Merry Widow' opera has been so much in demand," said Mr. Manson, "that we have included no less than four more selections in our August list." And, by the way, the first one I notice is "The Vilja Song," sung (under the title "Miss") by Mabel Manson, the wife of the genial manager of this company. Their new premises are giving much satisfaction, but it has been found necessary to take additional floor space in the building adjoining.

Reduction in Price of Edison Records.

The forthcoming reduction in price of the Edison gold-moulded record from 1s. 6d. to 1s. naturally caused somewhat of a sensation in the trade, but we think it a move of good policy on the part of the National company, and feel sure all dealers will recognize it in the same light, as it means more trade and consequently better returns in the future. The company recognize that a certain amount of inconvenience will ensue, and have therefore made a generous pro-

vision for rebate on purchases between March 1 and June 8, inclusive. Those who have not received particulars of this should write to the National Company in London. Chatting with Mr. Lemoine upon the matter, I am told that the reduction has met with general approval.

A Test Case.

Application was made at Bow street, under the Musical Copyright Act, 1902, and a summons was granted against a hawkers to show cause why a talking machine disc and a perforated music roll, which he had offered for sale, should not be destroyed.

Music Trades Exhibition in Manchester.

A musical instrument trades exhibition is to be held at Manchester. It opens September 9 at the St. James Hall.

Edison Bell's Comprehensive List.

The Edison Bell August list of records contains a most comprehensive variety of selections, and is one of the finest issued this year.

American Talking Machine Co. Notes.

Business was going apace at the American Talking Machine Co. and at the time of my call there were distinct preparations for increased trade during this next season. A new catalog with buyers' index or trade tally will be issued in good time.

Cook's Athletic Co. Changes.

We have received a communication to the effect that Cook's Athletic Co. (1907), Ltd., has acquired the business of Cook's Athletic Co., Ltd., and is continuing same at the old address under entirely new management.

General Phonograph Co. Plans.

Last month I made reference to the fact that the General Phonograph Co. had taken over the business of Neophone, Ltd. All business, including that of the "White" gold-moulded cylinder record, will in future be carried on from No. 1 Worship street, City Road. Here it was that I found Mr. White with his staff of experts around him, all doing their share in producing what is claimed will be one of the best phonograph cut discs now on the market. It is intended to apply the gold-moulded process—White's system—to the well-established Neophone product, and it will be manifest to all that this combination means a record of excellence, and one that all enterprising dealers everywhere should handle. Terms and particulars will be supplied on application to the General Phonograph Co. at above address.

Fr. Rauth's Northern Trip.

Fr. Rauth recently made a round trip up north, and reports things as fairly satisfactory for the time of year. His very adaptable needle box is again offered in this month's advertisement.

CARL LINDSTRÖM, G. m. b. H.
BERLIN

LARGEST Continental Manufacturer of All Kinds of

TALKING MACHINES

Best Quality

Best Workmanship

Best Value

Agent for England and Colonies:

O. RÜHL, 6 and 7 Red Cross St.
London, E. C., England

To whom all inquiries should be addressed

FROM OUR LONDON HEADQUARTERS—(Continued).

Homophone Double-Sided Discs.

The August issue of Homophone double-sided discs contains the first new English repertoire.

New Series of Flower Horns.

Felix Heilbronn, of Willibold, Twier & Co., showed me a fine new series of Frankonia flower horns, brass and steel embossed, and in all colors. They report good business both in these and disc machines.

British Sonogram Co. Make Records.

By the courtesy of Mr. Mellerio I was enabled to hear about a dozen new titles comprising sentimental and coon songs, violin and pianoforte solos, just recorded under their improved system. One can speak very highly of these records on account of their natural musical qualities, apart from their distinct pronunciation; the violin solos are exceptionally sweet. These issues will comprise No. 2 list, which will be forwarded to dealers upon request.

Pathe Freres New Machine Catalog.

Pathe Freres state that they are well satisfied with the reception accorded their new 8½-inch double sided disc at 1s. 6d. I may say that these records are every bit as well recorded as the larger discs, while the tone volume and purity is excellent. A new machine catalog is in course of preparation, and will be ready shortly, as also a larger catalog covering over 2,000 selections on the 8½-inch and 11-inch records.

Recent Odeon Agencies.

We are informed that several important

agencies have been arranged by the Odeon Co. Messrs. Ashton & Mitchell's Royal Agency have opened a showroom at 33 Old Bond street, W., devoted exclusively to Odeon and Fonotopia records. They are also arranging to open showrooms at their branches at 35 Sloane street, and 16 Gloucester road, S. W. Another important agency appointed is that of the Musetta Piano Player Co., 83 New Oxford street, W. C.

Records of Herr Kandt's Band.

During July a special issue of Odeon records was made, the series, consisting of six double-sized records by Herr Kandt's Band, under the direction of Herr Julian Kandt. Kandt's Band is one of the most famous and popular organizations of its kind. Among the numerous engagements it has fulfilled have been "Command Performances" before the King and Queen, His Majesty having on several occasions complimented Herr Kandt upon the perfect ensemble and refinement of his band. The band has also performed before the King and Queen of Spain, the Prince and Princess of Wales, etc., etc.

Barnett Samuel & Sons Offer.

In their advertisement (elsewhere in this issue) Barnett Samuel & Sons offer to send absolutely free to all tradesmen a (reduced size) sample of their record album, which is the only British-made album on this market. They are made in no less than six sizes and styles, and are very strongly put together, as the sample will demonstrate. Another new line issued by this firm is a patent divided needle box, to hold

Words Fraught With Meaning

TO YOU

Our catalogue is not the most expensive, but it is the most **COMPREHENSIVE**, and therefore the one of most use to you.

It contains illustrations and full particulars of every machine, record and accessory of merit now on the British market.

Our buying facilities place us in a position to quote rock-bottom prices.

Specify your exact requirements with quantities.

FREE—Export Catalogue on receipt of Trade Card.

AMERICAN TALKING MACHINE CO.
31 Tabernacle St., London, Eng.

WORTH A GUINEA A BOX

Registered in many countries

GREAT ADVERTISING LINE

Sapphires
Guaranteed
Genuine



Record
Albums

Flexible Nickel End Connections

Flower Horn Rubber Connections

WRITE FOR SPECIALTIES

FR. RAUTH, 9 Christopher St., London, E. C.

See my previous advertisements

10 & 12 inch FLOWER HORNS

THE BRITISH BOOM OF THE YEAR!

THE RECORD
THAT'S
HALF AN INCH
LONGER!

"STERLING" RECORDS

The Best Cylinder Record and the Best Selling Record on the British Market. Every record made under the supervision of Mr. Russell Hunting, the original "Michael Casey." Every record a masterpiece of its kind. Send for our list. It is full of novelties.

PRICE 1s.

Liberal Discount for Export

25 CENTS

MANUFACTURED By

THE RUSSELL HUNTING RECORD CO., Ltd.

13, 15, 17 City Road

LONDON, E. C., ENGLAND

Australasian Representative: H. A. PARKER, 19 Hunter Street, SYDNEY

200, put up in fancy tins printed in colors. It is a very neat little box, and contains a needle and waste receptacle all in one. Mr. Balcombe states that a new illustrated catalog is now in course of preparation, and is expected to be published early in September.

Columbia Co. Hold Their Outing.

On Saturday, July 6, the employees of the London factory, of the Columbia Phonograph Co., held their first outing at Halliford-on-Thames. The party enjoyed a delightful ride by brakes through the beautiful Thames Valley, and on arrival at their destination spent the time in boating and sports. After dinner various members of the party contributed to the program of songs and instrumental music. Mr. A. Gladden occupied the chair. The toasts were "Our Manager" and "Success to the Firm."

Latest Addition to List of Factors.

Constantine Craies & Co. are a new firm to enter the rapidly swelling list of factors. Those principally interested are Mr. C. Craies, late managing director of Neophone, Ltd., and Mr. Sidney T. Aldridge, late assistant manager of the same company, and also of the Gramophone and Zonophone companies, as export manager. I was permitted a view of the premises which were then being fitted up to carry large stocks of records and machines. There is ample accommodation, and I was informed by Mr. Aldridge of their intention to factor and carry a representative stock of all classes of machines, accessories and records, apart from which they are themselves manufacturing a splendid series of disc

PHILIP NEALE,
PHONO. EXPERT,
5 Chalk Farm Rd. LONDON, N. W.

Talking Machines of every description repaired. Special terms to the trade. City address and price list on receipt of postal. No job too small—no job too large.

FROM OUR LONDON HEADQUARTERS—(Continued).

machines with inlaid Sheraton cases, and carrying a patent tone arm, which, with slight adjustment, will allow of both the phonograph cut and Berliner type of records being played.

New Columbia Catalog Coming.

The Columbia Co. state that a new catalog, covering all their machines and records, will be ready in the near future.

Enlightenment Still Necessary.

Every now and then one is astonished at the amount of misapprehension that exists with reference to the talking machine, even on the part of those who are supposed to know better. A recent incident of this kind occurred to one of the travelers of the Cardiff branch of the Columbia Co. he went to answer in person a letter received from a customer and happened to meet the lady at the lodge gates as she was coming out of her park for a drive in her motor car. She was exceedingly affable to the salesman, but the thing which made him stare with astonishment was her request, as she handed him a disc record to whistle the tune for her. Apparently she had a hazy notion that by looking at the engraving of the sound lines the salesman could read off the music as one does the printed sheet.

Lyon & Co. Preparing for Coming Season.

A. Lyon & Co., the city road factors, are busily preparing for the coming season, which they mean shall be a good one. Business was said to be satisfactory for the time of year.

Latest Imperial Records.

The August list of Imperial records includes a splendid variety of selections. At least one new artist, Albert Campbell, is listed, while I notice also the return of an old supporter.

Wilfred Samuel's Trip to Berlin.

Wilfred Samuel, of Barnett Samuel & Sons, paid a business visit to Berlin last month, which, it is understood, was of a satisfactory nature.

Received Highest Award.

At the talking machine contest at Epsom on

July 17 the Odeon Co. received the highest award in the trade class for their needle disc records. The records which carried off the honors, were the "Tancredi Overture" (grand opera, 13 3/4 in., Cat. No. 7201), and Mr. Lloyd Chandos' "Nirvana" (Cat. No. 606). Great surprise was evinced by these members of the trade present at the purity and volume of these delightful records and the honor was unanimously voted as fair and equitable. The instrument used was the "Exhibition" Discodeon.

Increased Postage to New Zealand.

On and after July 25 there will be an increase in the postage charged on parcels for New Zealand exceeding four feet in length and girth combined. The postage on parcels not exceeding that size will remain unaltered. A copy of the new regulations may be seen at any British post office.

The "Talker" in Morocco.

Did Kaid Maclean have a presentiment of his capture? He is said to have ordered only recently before he fell into Raisuli's hands a Columbia graphophone which had been sent out to him from London. The imagination pictures captor and captive dancing a merry fling to the waltz from "The Merry Widow," for if this music charms the continent, and takes all London by storm, may it not be expected to prove equally seductive in the wild hill country of Morocco? Still, if Raisuli continues to exhibit the storm qualities of a lion heart, there is some satisfaction in the thought that the Kaid may be deriving solace from the graphophone's companionship, forgetting his discomforts and minimizing the dreariness of confinement, while the barbarian amuses himself perplexing the Powers.

To Make Records in a Few Weeks Time.

I am informed by Mr. Fischer, of the Favorite Record Co., that he expects recording to commence in London in a few weeks' time.

British Sonogram Co.'s Announcement.

The British Sonogram Co. announce that No. 2

list of records will be ready about the first week in August, and a few days after they will have on the market ten or twelve new up to date "Sovereign" records made under an improved system. Recording was in full swing at the time of my call, "and while, said Mr. Mellerio, "machine deliveries are a little behindhand, we have excellent prospects for the season in sight.

Bonci Appearance With Melba.

The appearance of Signor Bonci with Mme. Melba at Covent Garden goes to show what strides the talking machine is making, and the manner in which the makers of high-class records are raising the level of this type of musical instrument. Signor Bonci is under contract with the Fonotipia Co. to make Fonotipia records, and it is interesting to note that Victorian Sardou, the famous dramatist, was recently persuaded to make records of extracts from his own works after hearing Bonci's record of "La Donna e Mobile." Messrs. Sterling & Hunting state that Signor Bonci's appearance has led to an enormous demand for his Fonotipia records, notably that of the famous "Rigoletto" quartet ("Bella figlia dell amore"), with Bonci as the Duke, as he played at Covent Garden. This record is a 13 3/4-inch size, and sells at 25 shillings.

Some Clever Advertising Work.

By the way, a brilliant piece of advertising work was achieved in connection with Signor Bonci's first appearance at Covent Garden on Saturday, July 13. Spaces were booked in three important dailies for the following Monday, and special arrangements made therewith for the receipt of "copy" at a very late hour. Accordingly Mr. Louis Sterling and a member of the staff of Sterling & Hunting, Ltd., witnessed the performance at Covent Garden, jumped into a waiting motor and were driven rapidly to the offices of the Daily Mail. Here the "copy," describing Bonci's reception, was prepared and handed in. The other two offices have arranged for the copy to be delivered on Sunday, and this was done.

THE POPULAR RECORD
is now the

"SOVEREIGN"

Double-sided, Unbreakable
Disc Record

(WILL NOT WEAR OUT)

THE BEST RECORD FOR THE SUMMER TRADE

THE BEST RECORD FOR THE SHIPPING TRADE

THE BEST RECORD FOR THE MILLION

LIST No. 2. (50 Records = 100
Titles, mostly
Bands and Instrumental Titles) is now ready.

LIST No. 3 of about 10 or 12
Double Sided Re-
cords (making 20
or 24 Titles) from
The Sonogram's
own new and up-
to-date recording
process, is in
course of prepara-
tion and will be
ready about Au-
gust 15.



THE "SONOGRAM"
Standard Machine

RETAIL PRICE, £5

SPECIFICATION:—Sound-tight Ball and Socket Joint, 10-in. Turntable, Silent Side-wind, Silent Movement, Double Spring, "Sovereign" Sound Box, Handsome Oak Cabinet (our own design), Flower Horn (22-in. x 22-in.)

The "Sovereign" is the Record most suitable for use in Tropical countries, as the process of manufacture enables it to withstand the heat better than any other record in existence.

Retail Price, 2/-

THE POPULAR 30s.
THE DE LUXE £10

SONOGRAMS

Are also
coming on the market shortly

ALL SONOGRAM
GOODS ARE
BRITISH MADE

WRITE FOR LISTS AND FULL PARTICULARS TO
The BRITISH SONOGRAM CO., Ltd.

Cable Address: EBNOLOID, LONDON

77, City Road, LONDON, E. C.



DEUTSCHE TELEPHONWERKE



G. M. B. H.

Talking Machine Department

BERLIN S. O. 33, ZEUGHOFSTRASSE 6 8

OUR NEW

ORTHOPHONE

LUXUS TALKING MACHINES



are up to date
at all points
and represent
a very high
class manufacture
besides being
of the
most modern
construction



FROM OUR LONDON HEADQUARTERS—(Continued).

The result was that almost side by side with the press criticisms of "Rigoletto" on the Monday there appeared in the advertisements of "Fonotopia" records an account of Bonci's debut, and a list of his records from that opera. Thus was an advertisement treated as news and advantage taken of the interest in Bonci's appearance.

Graphophone for the "White City."

At Manchester's new pleasure ground, the "White City," a Columbia sound-magnifying Premier graphophone has been supplied to provide the mysterious music of mermaids, etc., on the "Mystic River."

Zonophone Stand Much Admired.

The Zonophone stand was the center of attraction for talking machine men and others at the Ironmongers' Exhibition held last month at the Agricultural Hall. The "boom" was felt even there, for good business was reported every day.

Talker Popular in Every Walk of Life.

Where is the talking machine not to be found? A correspondent points out that it is in evidence at the hospital, in the prison, the home, fetes, bazaars, churches, at political meetings, on yachts, in schools, at places of amusement, on the lawn; in fact, everywhere, and under many other circumstances, not the least of which is the street corner nuisance who endeavors to get music from worn-out records, and extract coppers from the pockets of the unwary as the perambulating policeman disappears from view.

Provides Music for the Soldiers.

In addition to the twenty-five guineas subscribed to the building fund of the Union Jack Club, the Gramophone & Typewriter Co. generously presented gramophones and records to provide music, which will enable the soldiers to pass away many pleasant hours.

Business Exhibition a Success.

The Business Exhibition held at Olympia, July 4-13, was the first of its kind to be held in this country. Its purpose was to bring together for the benefit of business men all those devices and inventions which have for their end efficiency and economy. It afforded opportunities to investigate those things calculated to make the conduct of business simpler, safer and more expeditious. Thousands visited the exhibition, some solely for the purpose of reporting on one particular invention only, and needless to say the large number of orders booked will keep the exhibitors busy for many a day to come. It was altogether an undoubted success, and should be held at least once a year.

The Dictaphone the Central Interest.

The only firm in the talking machine trade who secured a stall was the Columbia Phonograph Co., and their report is given hereunder:

One of the most interesting exhibits at the business show was the Columbia Phonograph Co.'s "Dictaphone." There were usually more people about this stand than any other in the big

building. Its position was very prominent in the main aisle, close to the entrance. It occupied an entire block in the ground plan, so that it was surrounded on all four sides by aisles. Counters were built along the sides, covered with red upholstery, leaving the center for comfortable chairs, tables and the manager's desk. Along the counters were placed Dictaphones, both electrically driven and the spring motor varieties, and interspersed were the transcribing machines and typewriters for the typists' use.

A large force of experienced salesmen was on hand to demonstrate the advantages of the Dictaphone. They would dictate letters into the machine before their audience, pass the cylinder over to the typist, who transcribed the matter right away, and then show the letter to those interested. It was this public practical demonstration of the convenience and time-saving features of the instrument that attracted and fascinated the crowds and made it difficult at times for some of the people to get near enough to see and hear all that was going on.

A lot of educational work was necessary. A great majority of those who saw the Dictaphone at work had crude or wholly erroneous notions about it. Not once nor twice, but several times the demonstrators were asked if the dictated letter came out typewritten at the other end, indicating that the questioners thought that without any human intervention matter spoken into the cylinders could be reproduced at once to the eye in typewritten form. Other questioners inquired whether if a foreign language were spoken into the machine it would reproduce it. Still others had the idea that the dictator was speaking through a speaking tube directly to the typist who was writing down all he said at the very moment he said it.

Yet it was evident from the outset that the Dictaphone was attracting a great deal of serious attention from keen business men. The saving of all the time in taking down stenographic notes was at once apparent to them, and the economy this effected. Other advantages, its convenience and the saving of the high-priced men's time were appreciated after a little consideration and explanation. The daily papers, both in London and the provinces, gave generous notices to the Dictaphone, which were responsible for the visits of heads of firms from all over the country to Olympia, with the sole object of seeing it in operation and examining into its merits. The secretary of a huge manufacturing enterprise in Loughboro spent over an hour at the stand. He went into every detail of this new method of correspondence, and was immensely impressed. He stated that he had been sent to London by his firm to examine and report on the Dictaphone. He came direct to Olympia from the train, immediately hunted up the Columbia stand, and without visiting any

other exhibit in the building, left for the Midlands as soon as he had become acquainted with the advantages of the machine. His was not an isolated case. Several other visitors stated that they had come to the exhibition from Hull, or Durham, or Liverpool, or Hunstanton, particularly to see the Dictaphone. Several heads of London firms made appointments for their typists to visit the stand and try their hands at transcribing. Not only was there this interest on the part of visitors, but many of the exhibitors themselves stated that the Dictaphone stand was the drawing card of the show.

Sales of several outfits were made during the exhibition, trial orders for many more were obtained, while the introduction secured to large commercial and manufacturing enterprises, business offices and professional and literary men are sufficient to keep the Dictaphone department busy for several months to come. It is, therefore, almost superfluous to add that the Columbia Phonograph Co. are highly gratified with the results of their exhibit.

British Mail Boats Fastest in Future.

The Government returns issued recently show the number of days, hours and minutes occupied in the transit of the mails between Great Britain and New York. In the matter of speed the German boats are ahead of the British, as the following figures of the last four voyages from New York made in 1906 by the *Lucania*, the *Campania* and the *Kronprinz Wilhelm*, exemplify:

Lucania.			Campania.			Kronprinz Wilhelm.		
d.	h.	m.	d.	h.	m.	d.	h.	m.
6	2	58	6	1	0	5	16	15
5	18	23	6	2	15	5	16	40
5	20	27	5	23	32	5	19	32
5	20	23	5	25	0	5	15	23

The German boats land their mails at Plymouth, whereas the Cunarders land at Queens-town. The new Cunarders, the *Lusitania* and *Mauretania*, are, however, expected to cover the distance between Sandy Hook and Queenstown in four days, sixteen hours, and the journey to Liverpool in about five days, so that the restoration of British supremacy is assured.

The Sheffield Choir in a New Role.

The world-famous Sheffield Choir, having achieved practically all that is humanly possible in the way of proving what a trained body of choristers can do, and having demonstrated that ability alike in London, Leeds and numerous other English musical centers, and in Dusseldorf, Cologne, Frankfurt and other Rhineland cities during their last year's triumphal tour of Germany, are now essaying a somewhat more difficult role. Their series of triumphs recently brought them under the notice of one of the largest firms in the talking machine industry, and the suggestion was made that the Choir

FREE
SAMPLE (reduced size) of our

Dulcephone

ALBUM

Sent to Traders on application.

Barnett Samuel & Sons
LIMITED

ALBUM MAKERS
Manufacturers and Wholesalers
of Phonograph Merchandise

WORSHIP ST., LONDON, ENGLAND

- No. I...For 10-inch Discs...Single sided.
- No. II...For 10-inch Discs...Double sided.
- No. III...For 10½-inch Discs...Double sided.
- No. IV...For 12-inch Discs...Single sided.
- No. V...For 12-inch Discs...Double sided.
- No. VI...EDITION DE LUXE...For 10-inch Discs.

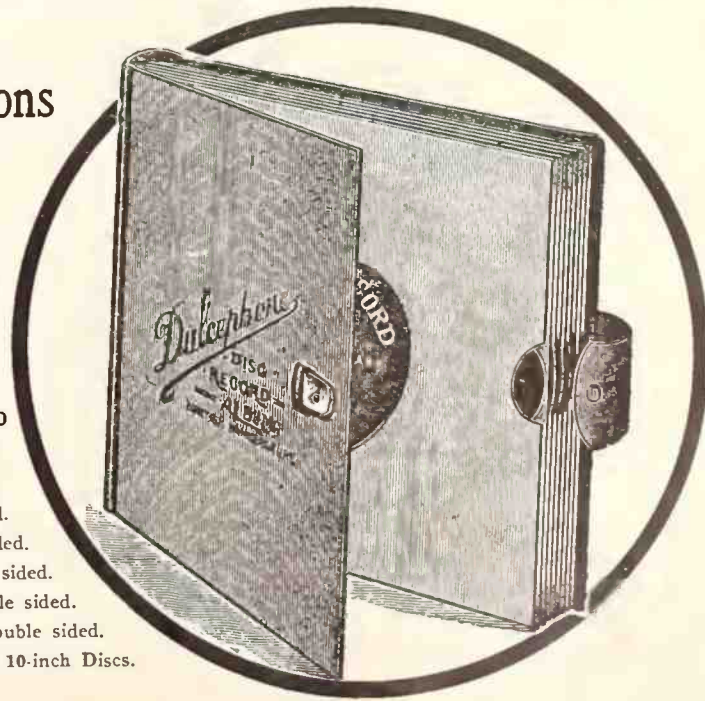

FROM OUR LONDON AND BERLIN HEADQUARTERS.

should make a series of disc records with the company in question. Dr. Coward, the popular conductor of the Sheffield Choir, fell in with the idea, once he was convinced that the scheme was practicable and that there was a greater chance of success with this particular company than had been evidenced by the efforts of record making companies previously. This was not a matter of great difficulty, for certain improvements had been effected of late which had a bearing upon the previous difficulty of making successful chorus records, and this, together with the fact that such artists as Mesdames Destinn and Hempel, of Covent Garden; Mr. Watkin Mills, Mr. Lloyd Chandos, Mr. Harry Dearth and the like had associated themselves with these records, proved in a convincing manner to Dr. Coward that the reputation of his fine chorus would be perfectly safe in being connected with Odeon records.

Accordingly the Odeon Co. sent down a special recording staff, equipped with the necessary apparatus, and supervised by its recording engineer, Mr. Arthur H. Brooks, to make, with the Sheffield Choir, a series of oratorio and other records. A hall at Messrs. Wilson, Peck & Co.'s Beethoven House, was specially arranged for the purpose, and here on Saturday (July 13) the selected members of the Choir, chosen among themselves by popular vote, and under the baton of their gifted conductor, Dr. Coward, assembled to give of their best for the delight of those musical people who, perhaps unable to gratify their love by performing their own vocal or instrumental music, rely upon the talking machine to supply their need.

The records made on Saturday include selections from the "Messiah," "Elijah" and "John Gilpin," as well as a number of unaccompanied part songs. When the operations (conducted in semi-privacy, of course, for there are numerous secrets jealously guarded by the experts) were

concluded, the recording chief stated that the records from his point of view were very successful, though the necessary tests could only be made in London.

The Odeon Co. have been the recipients of flattering letters from the M.P.'s for the Sheffield divisions concerning this stroke of enterprise.

They also ask us to state that in addition to the splendid work which Dr. Coward has done toward making the records a success, they desire to acknowledge the indefatigable efforts of the secretary of the Sheffield Choir, A. S. Burrows, by whom most of the arrangements on behalf of the Choir were made. The Choir will visit Canada in the near future.

Revising Their List of Dealers.

Messrs. Sterling & Hunting, Ltd., state that they are revising their list of the dealers who stock "Odeon" records with a view to referring to dealers' inquiries from their localities. Dealers who are willing to execute such business when it is handed to them in this way should get their names on this list, and should send a postcard marked "Register of Dealers" to the company at 14 Hamsell street, E. C.

Odeon Records for August.

The complete catalog of Odeon records dated August has several points of interest. In the first place it is one of the most artistic productions it has ever been our pleasure to see. The cover is printed in two colors, black superimposed upon a dainty blue, and the design used is a fine piece of pen and ink work by Penryn Stanlaws. We congratulate the Odeon Co. upon securing this fine picture. Another feature of the catalog is the inclusion of an index, with numerous cross references to titles and instrumental solos, etc., which is a distinct innovation and one sure to be appreciated. Last of all we notice that the list of "Standard" (7½ inch) Odeon records has been eliminated, with a

view, we understand, to publication in a separate form.

Neophone Co. Expansion.

I have had a further interview with Dr. Michaelis, the inventor of the sapphire disc records, and he informed me that (as I pointed out in my last letter) the General Phonograph Co., Ltd., had purchased the business and rights of Neophone, Ltd., and that they are actively preparing a comprehensive catalog of new gold-rimmed Neophone records to be ready in time for the coming season, and, as a matter of fact the first issue has already taken place, and we have listened with much pleasure and enjoyment to the perfect orchestration of their latest products. The whole of the foreign business in Neophone will continue to be effected as heretofore by the International Neophone Co., Ltd., whose general manager is Dr. Michaelis. This company is dividing into districts the countries under their jurisdiction, viz., all foreign countries (except Germany), and are appointing a sole agent for each division. Their product is now so well-known and appreciated that American dealers will, no doubt, quickly put themselves into communication with the International Neophone Co., Ltd., whose offices are No. 2 Tabernacle street, but before long the International Neophone Co., Ltd., propose to complete their arrangements for the formation of an American Neophone Co. Dr. Michaelis, with Mr. O. H. Waetzig, technical manager and head recording expert, is preparing to go over and commence his propaganda of the original sapphire disc talker, the Neophone.

TRADE NEWS FROM GERMANY.

Talking Machine Business Expanding—Foreign Trade Is Especially Active—Beka Records for the World—Tone Arm Action—Dr. Moskowski's Visit—Some Figures Regarding Export of Disc Records and Machines—New Factory in Hanover—Dealers to Establish Fixed Prices—Exhibitors at Leipzig Fair.

(Special to The Talking Machine World.)

Berlin, Germany, August 2, 1907.

Business in this country is very brisk, the season considered, and there is a steady increase in the output of talking machines and records to meet domestic and export demands. The foreign trade is proving to be an important feature of the business of talking machine manufacturers, and exports are now being made to all parts of the world. Another pleasant development worth noting is the steady betterment noticeable in machines and records. It is true we have plenty of poor stuff—in fact, too much of it—but purchasers are evidently becoming more critical, and this is reflected in the demands by factors and dealers for a better grade of goods.

There is an enormous demand for Beka records made in this city, and the manufacturers are now putting out a catalog, both international and domestic, that must prove amazing to those who have not kept closely in touch with the growth of this enterprise. This concern now control master records of practically every country "under the sun," and their excellence is paid tribute to by the large purchases in the great cosmopolitan centers of the world. In fact, the Beka people now control the largest and most comprehensive repertoire which has ever been compiled. Members of the trade desiring something very special should look up their advertisement in the London department and keep in touch with this great institution.

The tone arm action of the Carl Lindstrom and the Odeon Co. against the German Gramophone Co., Ltd., has been decided in favor of the plaintiffs, and the German company's patent cancelled. The German Gramophone Co., Ltd., are going to take the case to the higher courts.

The immense strides Germany has taken in the manufacture of disc talking machine rec-

The Best and Most Beautiful
Talking Machine of the World is

Holzweissig's Talking Machine

HYMNOPHONE

20 Patterns Superiorly Finished

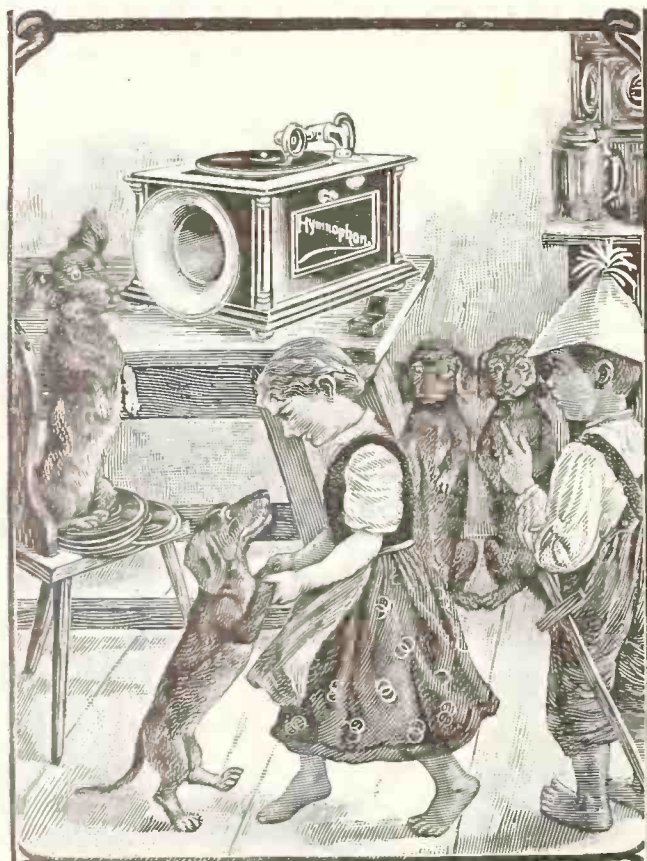

Only the
Hymnophone
is the ideal
of
talking
machines

The exclusive
privilege for
the United
States is to be
conferred

U. S. Patent No. 825725

Ernst Holzweissig Nachf., Leipzig (Germany)

ords may be realized when it is stated that though only about four years have elapsed since disc records were made in this country in marketable quantities, the following is the amount of export business from January to May, 1907, from German disc factories. The figures given are per 100 kilos (220.46 pounds): Belgium, 188; France, 727; Great Britain, 3,702; Holland, 186; Austria-Hungary, 565; European Russia, 339; Switzerland, 271; European Turkey, 94; Egypt, 282; British India, 632.

In the matter of machines the following figures are given by the German press as being the amount of export business in that line from January to May of this year: Belgium, 18,800 kilos; Denmark, 15,200 kilos; France, 43,000 kilos; Great Britain, 87,000 kilos; Italy, 14,800 kilos; Holland, 10,200 kilos; Austria-Hungary, 69,800 kilos; Roumania, 9,300 kilos; Russia, 113,600 kilos; Sweden, 12,000 kilos; Switzerland, 5,900 kilos; Turkey, 6,500 kilos; Egypt, 3,100 kilos; Argentina, 9,500 kilos; Brazil, 7,000 kilos; United States, 38,400 kilos. It will be seen that Russia offers the best market for German talking machines, with England second and Austria-Hungary third, though the latter country is Germany's political ally.

A new factory has been established in Hanover, Germany, for the manufacture of disc records under the title of the International Gramophone Co., m. b. H. It is stated that the Deutsche Grammophon, A. G., have applied for an injunction against the new company to restrain them from continuing to use the name first adopted.

The Society of German Dealers of Talking Machines has commenced its task of undertaking to establish fixed retail prices for all German talking machine articles. Despite strenuous opposition it is believed the society will succeed.

The Deutsche Telephon Werke of this city will not exhibit at the Leipzig autumn fair this time, but they invite all customers and visitors to call at their showrooms at Berlin Zeughofstrasse, where the company will exhibit their latest types of machines, which include many novelties that most prove of world-wide interest.

American manufacturers and jobbers cannot fail to be interested in the Hymnophone, Ernst Holzweissig's talking machine, an announcement regarding which appears elsewhere. It contains many individual features that must command consideration.

HORN SITUATION DISCUSSED

By Horace Sheble, of the Hawthorne & Sheble Mfg. Co.—Change in Edison Equipment Will Help Demand for Better Grade Horns.

(Special to The Talking Machine World.)
Philadelphia, Pa., August 9, 1907.

In a recent interview with Horace Sheble, of the Hawthorne & Sheble Manufacturing Co., he was asked the question as to how their company figured the change in equipment proposed by the National Phonograph Co. would affect the sale of horns and cranes as independent transactions, and he replied:

"In the old days talking machines were all equipped with hearing tubes, and their sale was extremely limited. With the advent of the small

horn the sale increased, the public realizing the benefit to be derived from dispensing with the objectionable hearing tubes. Many customers, however, desired to secure a better reproduction than could be obtained through using the small horn, which demand started experimenting in all quarters to produce a more effective article, the results of which experimenting evolved the present numerous styles on the market.

"The varieties thus secured have undoubtedly assisted very materially in the development of the talking machine industry, as the public differ in their ideas as to appearances as well as to results obtained, and by catering to this fancy as well as varying the equipment, the progressive dealer has been able to affect many sales that were otherwise impossible.

"Undoubtedly the change in equipment as proposed will affect the sale of certain style horns, but it will by no means usurp the horn market as applied to Edison phonographs. The public to-day is just as discriminating as it was last year, and what will suit one customer will not appeal to another, so that the progressive dealer will always find a good market for horns different from what is furnished with the original outfit. The move to sell large horns on machines as part of the equipment is not a new one, as it has already been employed by several machine manufacturers, but we have found a steadily increasing demand for horns of different design to be used on such machines.

"During the past two years we have noticed a much larger market for better grade horns, which fact has been demonstrated to our satisfaction by the enormous sale on our line of "Artistic" flower horns. We look for this demand to increase. The crane situation is in somewhat the same condition. Cheaply constructed cranes for Edison phonographs will be forced off the market, but cranes of different designs, which are equally as good or better than those furnished with the machine, will undoubtedly meet with a ready sale.

"We welcome the change of equipment as an assistance in educating the public to the advantages of using a large horn. The sale of horns other than similar styles to those originally furnished we believe will increase."

At the request of a large number of distributors, the Victor Talking Machine Co. have decided to mail two hangers and advance copies of the regular and folder supplements from Camden on such a date as will insure there being in the hands of Victor dealers on the 28th of each month.

PACIFIC COAST HAPPENINGS.

Star Talking Machine in Great Favor—W. S. Gray's Good Columbia Work—Splendid Outlook for Good Fall Business—Some Recent Victor Visitors—Other Live News.

(Special to The Talking Machine World.)
San Francisco, Cal., August 6, 1907.

Kohler & Chase are now distributing pamphlets, issued by the Hawthorne & Sheble Manufacturing Co., makers of the Star talking machine, giving a full description of all parts of the machine, and the various models. There is a good Star business at the Oakland store now. Bernard S. Goldsmith, of the talking machine department, says that Edison goods are also doing well there, as the tapering arm attachment, which does away with the horn projecting in front, and produces a much fuller and sweeter tone, makes the Edison machine more attractive than ever. The scratchless Star records are also attracting a lot of business. Mr. Goldsmith, speaking of the outlook of the talking machine trade, says he believes that it will be the greatest part of the music trade on the Coast in a few years.

The Columbia Phonograph Co. have another new display this week. One of the windows is filled with little tents, over each of which is displayed the flag of some nation, in which, according to the inscription, the Columbia graphophone is admired. W. S. Gray, of the Columbia Co., has been sending out letters to many families in San Francisco, calling their attention to the Columbia Sterling disc graphophone, and inviting everybody to the daily free concerts given at the Van Ness avenue store.

Clark Wise is holding a bargain sale of talking machines this week, offering \$25 machines, which were somewhat damaged by rough handling on the cars, for \$9.85 each.

The Eilers Music Co.'s Fillmore street store has now a full stock of Victor goods on hand, and sales are starting off very satisfactorily.

Mr. Ornstein, manager of the sales department of the Victor Talking Machine Co., left for the North last week. Arthur Geissler, of the same company, was in San Francisco on a visit last week.

KELSEY WITH RAPKE.

J. P. Kelsey, well known in the talking machine trade, has been engaged as manager by Victor H. Rapke, and will locate at the Victor H. Rapke Co.'s factory, 530 East 72d street.

TALKING MACHINE DEALERS
SHOULD BE FAMILIAR WITH THE BEST
DRUMS
MADE—WRITE TO-DAY FOR CATALOG
EXCELSIOR DRUM WORKS
A. G. SOISTMANN, Manager
1109-1111 Locust Street Philadelphia, Pa.

The Latest Invention!



THE KEEN Attachment
CAN BE USED ON ALL CYLINDER MACHINES

It improves the sound, softens the reproductions. The attachment enables the user to turn horn in any direction. Saves much annoyance and produces better results than the old way. Every talking machine man will see the advantage of this new invention. Don't delay investigation, you can increase your sales with it.

Invented by a pioneer talking machine man, whose practical experience has taught him the value of this attachment. **RETAIL PRICE, \$7.50.** Liberal discount to the legitimate trade.

Keen Phonograph Co., Manufacturers
2413 Kensington Avenue - - - Philadelphia, Pa.

STAR TALKING MACHINES RECORDS

Star Talking Machines

Brilliant tone

Superior wearing
qualities

Handsome
appearance

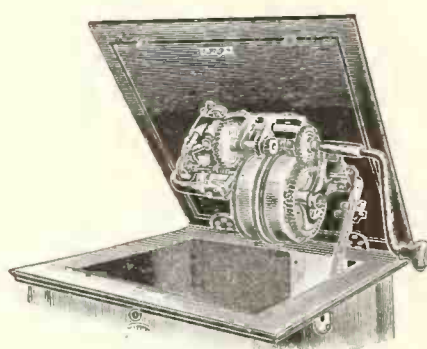

Star Records

Natural reproduc-
tion

Musical perfection

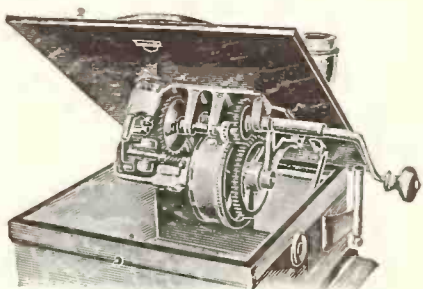

Write for Catalogue

HAWTHORNE & SHEBLE MANUFACTURING CO.

PHILADELPHIA, PA., U. S. A.

FROM OUR CHICAGO HEADQUARTERS

195-197 WABASH AVENUE, E. P. VAN HARLINGEN, MANAGER.

Business Shows a Healthy Increase Over Last Year—The Victor Co. Help Dealers—Henry Babson Married—C. W. Noyes' Successful Trip—C. E. Goodwin Visiting Yellowstone Park—Chicago Case Co. Increase Capacity—J. W. Mills Spreading Out—Edison Men Gather at Grand Rapids—The Columbia Boost Club—Arthur D. Geissler Returns from Vacation Spent on Pacific Coast—Reports Progress in This Territory—Movements of Regina Men—Improvements in Local Establishment of National Phonograph Co.—All the News of the Month.

(Special to The Talking Machine World.)

Chicago, Ill., July 9, 1907.

Both jobbers and retailers report business as keeping up remarkably well. July, as a whole, is generally reported as having been quite up to June, and in some cases a moderate increase in sales is reported. In most cases business is reported as showing a healthy increase over last year.

The remarkable efforts of the Victor Co. to assist dealers through the medium of advertisements in local dailies are the subject of favorable comment in the trade. The big 600-line advertisement announcements of the August bulletin which appeared in the Tribune, Record, Herald, News and American on Monday, July 29, are said by dealers to have had a distinct effect on sales. When one considers that these and similar announcements appeared in the leading papers of all the principal cities of the country, and that similar advertising will be done each month, in addition to greatly extended magazine publicity and a vigorous campaign in agricultural papers for the benefit of the country dealers, the finish

of that extra \$150,000 advertising appropriation can be readily seen.

Quietly and with no announcement of his going, but with quickened step and a new light gleaming in his eyes, did Henry Babson hie himself westward the latter part of July. His destination, though he breathed it not, was Seward, Neb., the old Babson home, and where all of the Babson boys spent the early part of their lives. It was to claim one of the fairest daughters of Seward that Mr. Babson turned homeward, and on the morning of August 2 he was married to Miss Laura Davis. They are spending their honeymoon in the mountains of Colorado and will return and be at home to their friends in Chicago's beautiful suburb of Riverside about September 1. To none of his friends, even those who entertained "suspicions," would Mr. Babson admit the object of his visit to Nebraska, and even his brothers insisted that he only owned up at the last moment when the fact that his absence would be so prolonged seemed to make explanations necessary. Both Frederick K. and Gus Babson have beautiful homes at Riverside, and another Babson residence will be erected there in the near future.

C. W. Noyes, secretary and Western representative of the Hawthorne & Sheble Mfg. Co., returned the latter part of last month from a trip among Central Western jobbers and will leave about the middle of August for the Pacific coast. "During the past month," said Mr. Noyes, "I have seen most of the jobbers from the Missouri river east to Pittsburg, and in all but one or two instances they report themselves as highly pleased with the volume of trade this summer. July equaled, and in the majority of cases exceeded, that of a year ago.

No one looks for anything but an excellent business this fall, and the number of concerns who are arranging for larger quarters and are making extensive improvements to their premises speaks eloquently of the general prosperity." While in Detroit, Mr. Noyes spent Sunday with Charles M. Daniel (Niel Morret), composer of "Hiawatha," "Silver Heels," "Moonlight," "Cherry," etc. In speaking of the new copyright bill, which failed to pass the last session of Congress, Mr. Noyes stated that the failure was due to the fact that the fight for the bill was made by the publishers instead of by the composers, who were more vitally interested in its passage and whose arguments would have the most weight with the lawmakers. Mr. Daniels claimed to speak by the book when he said that the case would be reopened and that the composers would have a full hearing and would see that their claims were strongly and fully presented.

E. E. Forbes, of the E. E. Forbes Piano Co., Birmingham, Ala., and Memphis, Tenn., was a Chicago visitor last month.

E. C. Plume, Western wholesale manager for the Columbia Phonograph Co., returned the first of the month from New York, where he attended the various festivities attendant upon the Eastern Talking Machine Jobbers' Association. Incidentally he closed a deal with a local house which will not only do an immense mail order business in Columbia graphophones from Chicago but will also handle the company's full line exclusively at its numerous retail stores throughout the Central West and East. The contract involves something like a quarter of a million dollars, it is understood, and the initial order indicates that the company mean business with a big B.

Special Notice to Dealers

We spend **Ten Times** as much in Advertising Edison Phonographs and Records as any other Jobber.

As a Result **WE HAVE** Inquiries to refer and **WE DO** refer them **DAILY** to dealers **WHO BUY OF US.**

GET IN LINE

Remember that Jobbers who do not advertise cannot have many inquiries to refer.

BABSON BROTHERS

"THE PEOPLE WITH THE GOODS"

G. M. NISBETT, Mgr. Wholesale

19th St., Marshall Boul. & California Ave., Chicago, Ills.

Mr. Young, representing the Mello-Tone Co., Springfield, Mass., was a recent visitor to Chicago and secured a nice volume of business from local jobbers on the Mello-tone horn attachment.

C. E. Goodwin, manager of the talking machine department of Lyon & Healy, left the middle of last month for the Yellowstone. After thoroughly exploring and enjoying the wonders of Uncle Sam's wonderful little corner on Nature's wonders, he proceeded to Portland, where he is now visiting his parents. He is expected back about the middle of August. Assistant Manager L. C. Wiswell is in charge in Mr. Goodwin's absence. "We are having a good healthy summer business," he said, "and July ran considerably ahead of last year." The department has just issued revised lists of the best selling Victor and Edison records, the Victor list including 300 names and the Edison 250. These lists have proved of real value to dealers, and they are carefully revised from time to time.

George M. Nisbett, wholesale manager for Babson Bros., left on the 4th, accompanied by his wife and a party of friends for Minocqua for a stay of several weeks. Mr. Nisbett is a mighty fisherman, and also is a camera fiend of high degree. He has been experimenting this summer with a special trick camera of his own devising, and if he doesn't convince his friends on his return that he broke all Waltonian records at Minocqua the pictures will not be to blame.

Gus Babsou, of Babson Bros., is spending his vacation at Mackinac Island.

The Chicago Case Co. have greatly increased capacity in their new factory at 241 South Jefferson street, and have taken advantage of the comparatively dull months to accumulate a big stock of record cases wrapped and ready for shipment, so as to be prepared for instant satisfaction of the demands of the fall trade. They make five styles of cylinder and six styles of disc record cases of varying capacities and of superior and durable construction.

James W. Mill, the enterprising talking machine dealer of Elgin, Ill., is spreading out. On July 22 he moved from his former store, which he had made famous in Elgin as the "Mill on Spring street," to a new and more central location at 166 Chicago street. This store was formerly occupied by the W. W. Kimball Co., the agency for whose pianos Mr. Mill has taken. The store has been remodeled throughout, and has an excellent show window which Mr. Mill will know how to take advantage of. Mr. Mill carries the Edison, Victor and Columbia lines, and is preparing to add the Zonophone in the fall. In addition to talking machines and pianos, a specialty will be made of small goods, and the sheet music stock will be increased.

Two of the retail stores of James I. Lyons have been moved to larger quarters in anticipation of an increased fall trade. The Lincoln Avenue Phonograph Exchange, Chicago, managed by Elmer A. Fearn, is now at 1049 Lincoln avenue, while the Aurora Phonograph Exchange, at Aurora, Ill., now occupies a fine store at 113 Fox street, in charge of Walter A. Stephens.

E. H. Uhl, manager of the Chicago house of

Rudolph Wurlitzer Co., reports an excellent business this summer in their automatic instrument department. They are just setting up on the third floor of the Wurlitzer building one of their latest band organs, an immense instrument especially adapted for roller skating rinks and all places where an unusual volume of sound is necessitated. The instrument sells at \$5,500. They are also showing the Wurlitzer orchestrians, which are becoming exceedingly popular for high-grade restaurant use. Mr. Uhl, by the way, is building himself a handsome home on the North Side.

That was quite a gathering of Edison missionaries over at Grand Rapids last month. For a fortnight they lingered in the Michigan town, talked over matters pertaining to the furtherance of the company's interests, and mingled with the visiting furniture dealers. There were present J. W. Scott, who represents the National Phonograph Co. in New England, and the western traveling contingent, consisting of W. P. Hope, M. G. Kreusch, F. L. Fritschie, A. H. Kloehr, A. V. Chandler, H. A. Turner, and George A. Ranner. A. C. Ireton, superintendent of salesmen, came from the factory to meet the men. The object of the gathering was two-fold. Heretofore the western men have all gone East each year, before taking their vacations, for a chat at headquarters. This year it was decided to have the meeting, so far as the western travelers were concerned, in the West, and gathering at Grand Rapids at the time of the midsummer furniture exposition enabled the boys to meet the furniture dealers from all over the country, familiarize themselves with the opportunities for selling phonographs in furniture stores, and avail themselves of the experience of dealers who are successfully conducting talking machine departments. A fine exhibit of Edison goods was made in the Klingman building, where the furniture exposition was held. From Grand Rapids the men all went on their vacations, and are now again in their respective territories.

C. W. Barues, manager of the commercial department of the National Co., who looks after the interests of the business phonograph in Chicago, has returned from a trip to the factory at Orange.

A. V. Chandler, Chicago city representative for the National Phonograph Co., is fitting up a model phonograph store on the sixth floor of 304 Wabash avenue. It is separated from the commercial department by sound-proof partitions. Here a complete line of Edison phonographs will be carried, together with a record stock arranged on modern shelving, with the latest type trays equipped with Rapke labels, the whole arrangement being devised to show the visiting dealers how to handle phonographs and records to the best advantage.

F. J. McArdle, proprietor of the Piano Player Co. and the American Talking Machine Co., at Omaha, Neb., has discontinued the player business and will devote his entire attention to the talking machine business in the future.

W. W. Parsou, manager of the commercial department of the Columbia Phonograph Co.'s local

branch, is having a busy summer. He says that they are having difficulty in getting machines from the factory to supply the demand from Chicago's great commercial institutions for commercial dictation graphophones.

The Columbia Graphophone Club was duly launched the latter part of July, with a charter membership of fifty, a fine list of officers, and an ambitious program. That inveterate organizer, O. W. Eckland, of the instalment department, started it under the guise of the Columbia Boost Club a few weeks ago, with the intention of confining it to the instalment salesmen, but the idea grew and grew, and is still growing. The membership of the club is to be open to anyone connected in any way with the sale of graphophones. It is hoped eventually to have branch organizations in every city that boasts a Columbia store and where ten or more members can be secured, the officers of the various clubs to form a national executive body. Ultimately it is expected that some sort of a sick benefit will be established by the club. The Chicago organization will hold its meetings on the first Monday of each month, the meetings being devoted to the discussion of topics dear to the heart of every graphophoneite and to planning social events calculated to promote good-fellowship among the members, and at the same time do a little legitimate Columbia boosting. Among the events already planned for the near future are a trolley ride to one of the municipal parks and a moonlight excursion on the lake. The officers for the first year are: President, O. W. Eckland; vice-president, C. F. Baer; treasurer, O. M. Kiess; secretary, James Flanigan; executive committee, W. W. Parsons, chairman; E. C. Fuhri, T. F. McCarty, George Riemenschneider, Frank Cass.

Victor E. Green, one of the hustling Columbia crew managers, won the prize of a round-trip ticket offered to crew or store manager securing the largest business during June and July. A. Libben, manager of the Ashland avenue store, and A. Weiss, manager of the Halstead street store, were both close seconds.

George Ornstein, manager of the traveling department of the Victor Talking Machine Co., was in Chicago for a few days early in the month on his return to the factory from a trip to the coast. He reported business on the coast as unusually excellent this summer, and that far western Victor distributors are looking for an unusually good fall and holiday trade.

B. Feuberg, of Dillbahrer & Feinberg, proprietors of the Western Talking Machine & Supply Co., returned the first of the month from a three weeks' sojourn at St. Joseph, Mich., where he took the baths. After Mr. Dillbahrer has returned from a week's wrangle with the wriggly denizens of the Michigan lakes, Mr. Feinberg will start on a trip among the central western jobbers singing the "everything in the supply line, f. o. b. Chicago" slogan.

Arthur D. Geissler, manager of the Talking Machine Co., returned to-day from a six weeks' trip to the coast, bronzed, healthy and happy, notwithstanding the fact that a log which turned

JOBBER:



BEFORE PLACING YOUR ORDERS for Horns, Cranes, Cabinets, Needles, Main Springs, Disc Record Envelopes, Horn Connections, Oil Cans, and in fact anything in the supply line.

GET OUR PRICES

We can save you money, and make prompt shipment from our Chicago warehouse. Write for prices and samples of "Standard" needles. Have you received our new illustrated catalog and price list? If not, write for it to-day.

WESTERN TALKING MACHINE AND SUPPLY COMPANY
DILLBAHRER & FEINBERG, Proprietors - - - - **6 East Madison Street, CHICAGO**

up at the other end of a long dive from the wharf at Santa Barbara caused various and sundry injuries to the Geissler countenance, which barely escaped leaving their record forever. A photograph taken some days afterward on the beach would hardly be recognized by friends of the popular talking machine man, but thanks to skilled care the classic features have again assumed their classic repose and beauty. "Barring the log, I had a delightful trip," said Mr. Geissler. "Frisco is still having a fine talking machine trade, and the dealers all look for a big business the balance of the year. Of course, I

JAMES I. LYONS
J O B B E R
EDISON AND ZONOPHONE
MACHINES AND RECORDS



SPECIALLY
 PREPARED
**PHONOGRAPH
 OIL**

ASK FOR OUR PRICES

NEW STYLE
**RECORD
 CABINETS**

SPRINGS IN STOCK FOR ALL MAKES OF
 TALKING MACHINES

192-194 VAN BUREN STREET
 CHICAGO

called on all my old friends—Peter Bacigalupi, Byron Mauzy, Clark Wise & Co., Benjamin Curtaz & Sons, and others, and found them, as usual and in spite of everything, doing a fine business in their old-time, aggressive way, calculated to make eastern dealers who know nothing of the liberal buying policy of the public out on the coast open their eyes with astonishment. I spent a good deal of time at Santa Barbara and Santa Catalina with an old college chum of mine, and dropped in on the Los Angeles trade, of course. The George J. Birkel Co., the Bartlett Music Co., and the Southern California Music Co. are all going after the trade vigorously, and are getting it. The way the latter concern advertises its talking machine business is a caution. Their advertising bills must be something enormous, but they find it pays to go after things in a large way. Reverting to 'Frisco and environs, there are a couple of news items I might give you. Mr. Smith, formerly manager of Wiley B. Allen's Oakland business, is putting in a large branch department at Kohler & Chase's Seattle store. The Oakland Graphophone Co., at Oakland, and one of the most active concerns across the bay, have grown wonderfully with the impetus given to Oakland the last year, and ranks right up with their brethren in 'Frisco in volume of business.

"On the way home I stopped at Denver—a big Victor town, by the way. The Knight-Locke Piano Co. is whooping things up along large lines, and genial John Pass of the John Pass Music Co., is certainly making things hum as usual. Colorado Springs is a great Victor town. The wealthy retired miners there are devotees of the talking machine, and the Knight-Locke branch have a great trade on Victor 5s and 6s, on Victor Victrolas, and the entire line of Red Seal Records. Salt Lake City is another western town that is distinctly in line. I saw Carstenson & Anson and the Clayton Music Co., who are having a fine Victor business and pushing it for all they are worth.

"I find things have been moving along nicely in my absence. From all the reports I got while away regarding conditions in the West leads me to think that we are going to have a business of fine, large proportions this fall. There certainly are no indications of any let-up in the talking machine business.

W. F. Standke, manager of the Memphis, Tenn., branch of the Columbia Phonograph Co., was in the city the other day on his way to the wilds of northern Michigan for a brief vacation.

H. W. Wheeler, in charge of the St. Paul office of the Columbia Phonograph Co., and F. J. Weyel, manager of the commercial graphophone department for both Minneapolis and St. Paul, were in the city the other day. They were on their return from a visit to the factories, various of the eastern Columbia branches, and the Jamestown Exposition. While East they met O. J. Junge, formerly with the Columbia's Chicago office, but who is now in business for himself at Lincoln, Neb., as a jobber of Columbia goods.

George Cass, assistant manager of the Chicago office of the Columbia Phonograph Co., has just returned from his vacation, spent among the Michigan lakes.

John Otto, retail talking machine manager at Rudolph Wurlitzer Co., has become a suburbanite, having bought himself a home in Irving Park. The retail department is doing some effective work in the way of circulars describing the best of the Victor records each month, the work of L. Keau Cameron.

W. A. Lawrence, representing the Staudard Metal Mfg. Co., Newark, N. J., was a recent Chicago visitor.

L. C. Wiswell, assistant manager of the talking machine department of Lyon & Healy's, is delighted. It's a boy, and a ten and a half pounder.

W. H. Bagshaw and brother, of the great talking machine needle manufacturing house of W. H. Bagshaw, Lowell, Mass., were in the city recently on a general western trip.

J. Blumberg, western manager for the Regina Company, is spending his vacation with his family at Ottawa Beach. Secretary L. T. Gibson,

**The Victor Deal-
 ers' Warehouse**

That's what we are. We are entirely at your disposal—as much so as if we were your employees.

We are in business wholly to serve you. We do no retail business, but we do the largest Victor business in the country.

Devoting every energy to an EXCLUSIVE WHOLESALE BUSINESS enables us to give the quickest and most complete service.

REMEMBER, we depend on your business, not the consumer; we must please you.



72-74 Wabash Avenue.
 CHICAGO, ILL.



IT'S ALL IN
 THE BALL

PAT. PENDING
"TIZ-IT"

THE NEW ALL METAL

HORN CONNECTION

THE MISSING LINK BETWEEN
 THE HORN AND MACHINE

RETAILS AT 50 CENTS

NEW MODEL HAS TAPERED
 BENT TUBE THAT FITS ALL HORNS

Can be used on all Edison
 Phonographs and new style cylinder
 Graphophones.

IMPROVES ANY MACHINE 100 PER CENT.
 Send for Descriptive Circulars and Discounts to the Trade
SPECIAL INTRODUCTORY OFFER TO
 DEALERS—Write for it To-Day

KREILING & COMPANY
 INVENTORS AND SOLE MANUFACTURERS
 853 North 40th Ave., CHICAGO, ILL., U. S. A.

The "WURLITZER HARP"

A Refined Musical Instrument, operated by Electricity and Perforated Paper Rolls

A Few Points for
DEALERS
to Remember

- 1st. It is the most refined of all Musical Instruments.
- 2nd. It is no trouble to sell the "Wurlitzer Harp" if you can show and demonstrate it to your customers.
- 3rd. It is the only Instrument of its kind; being thoroughly protected by patents, it is impossible to imitate it.
- 4th. The soft, sweet music of the "Wurlitzer Harp" makes it especially desirable for high class, refined public places.
- 5th. The Harp automatically rewinds itself and therefore requires no attention.

PRICES:

Including Direct Current Motor and one Roll of Music, \$500.

Furnished with Alternating Current Motor and one Roll of Music, \$550.

Sold for cash or on the Easy Payment Plan.

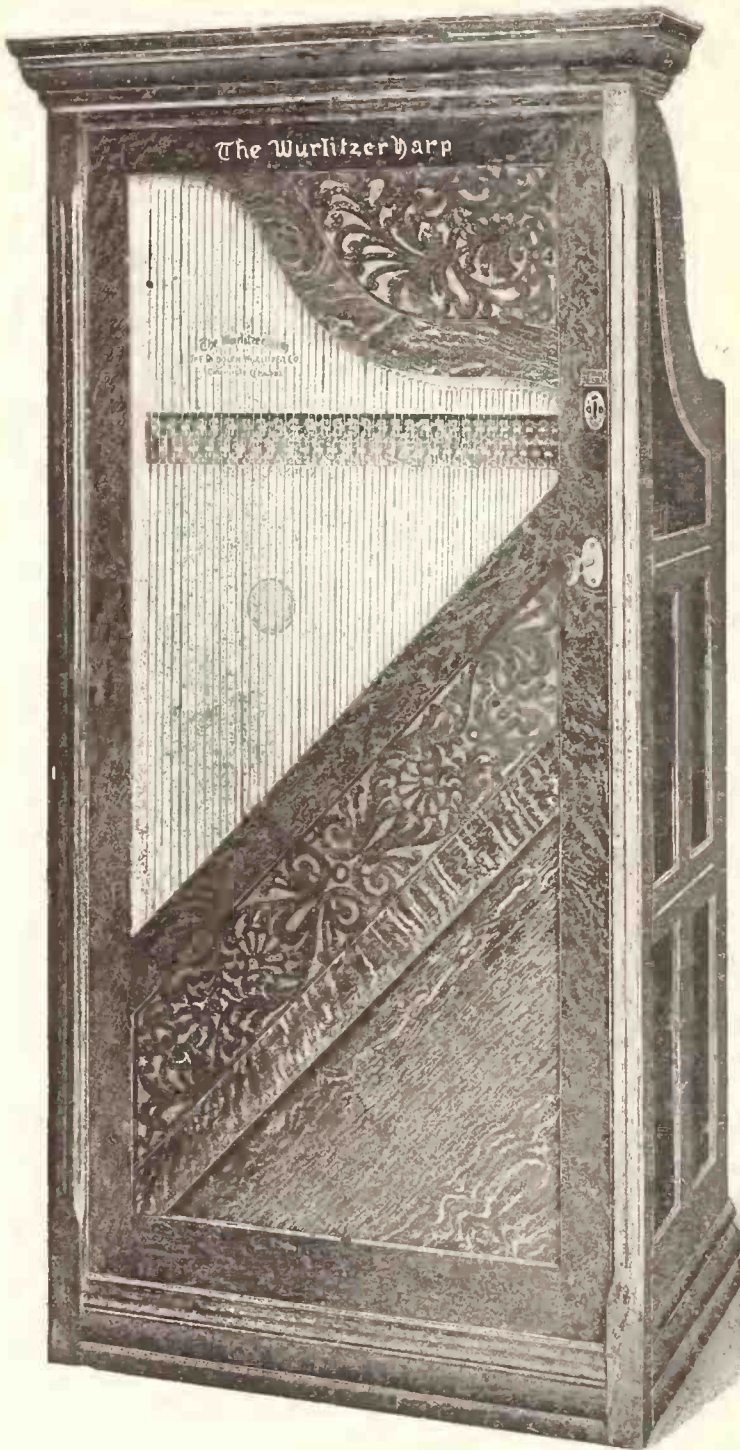

THE
Wurlitzer Harp

This beautiful instrument is conceded by every one who has seen and heard it to be the most wonderful as well as the sweetest musical instrument ever produced.

The Harp contains sixty strings which are picked by automatic fingers (almost human in their operation), and produces a volume of soft, sweet music equal to several Italian Harps picked by hand. The face of the instrument is covered by a large harp-shaped plate glass, showing the interior lit up by electric lights and the wonderful little fingers picking the strings. This feature gives the instrument an exceedingly attractive appearance.

Like all of our automatic instruments, the Harp is operated by electricity and perforated paper music rolls; it is simple in construction and requires little more attention than the ordinary electric piano. The music rolls contain six selections each, and are operated by our automatic rewinding device, the same as in the Pianino. It also has a coin-detector slot which prevents the use of spurious coins to operate it. Yale locks are used throughout.

The case is beautifully figured quarter-sawn or weathered oak, with rich moulding, panels and scroll work, finished in every detail to conform with the beautiful instrument it incloses and will prove an ornament in any place.

As a money maker in fine hotels, cafés, restaurants, cigar and drug stores the harp has proven itself to be the King of them all; its soft, sweet music making it exceptionally popular in places where other instruments would be too loud.

THE PIAN-ORCHESTRA

Has established the fact that perfect music can be rendered by mechanical means. The Pianorchestra is certainly a wonderful instrument.

16 Styles.

Prices, \$1,200 to \$5,000.



MILITARY BAND ORGAN

Operated by pinned cylinders and intended for carousels, tent shows, etc.

Prices, \$200 up.

GREATEST LINE OF AUTOMATIC MUSICAL INSTRUMENTS IN THE WORLD

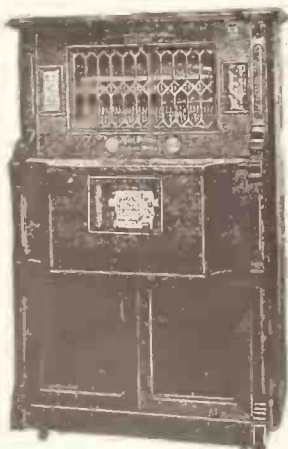

THE "PIANINO"

The latest edition to our line of Electric Pianos. This is a 44-Note Piano with Nickel-in-slot attachment. A great money-maker.



THE TONOPHONE

King of Electric Pianos. Operated by Electricity. All the latest music.

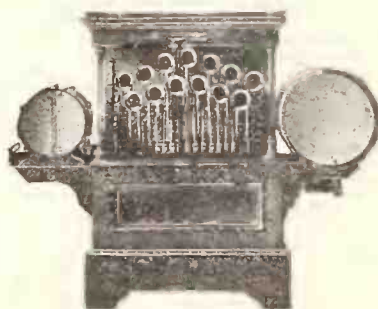

MILITARY BAND ORGAN

Operated with perforated Paper Rolls, and designed for Amusement Parks, Roller Skating Rinks and Dancing Pavilions.



THE WURLITZER PLAYER-PIANO

The only Perfect Player-Piano playing the entire keyboard. Can be played by hand or by Electricity with Perforated Paper Rolls.



THE MANDOLIN QUARTETTE

The most fascinating musical instrument on the market. This is a combination instrument, producing the wonderful music of four mandolins with piano accompaniment.

LIBERAL INDUCEMENTS

and exclusive agency in unoccupied territory. Beautiful Illustrated Catalog free upon request.

THE RUDOLPH WURLITZER CO.

CINCINNATI

MANUFACTURERS

CHICAGO

of the company, is here in his absence, and has no particular complaint to make of Chicago as a summer resort. Business is keeping up remarkably well on our entire line this summer, said Mr. Gibson. The new Reginalphones have met with exceptional favor with the trade. The Sublimas pianos are taxing our factory capacity to the utmost.



BABSON BROS. BASE BALL TEAM.

Among the talking machine dealers who called on Babson Bros. the last week or two and inspected their new building out at Douglass Park were W. H. Jennish, Waterloo, Ia.; Otis Bigelow, Dowagiac, Mich.; Tom Bonfield, Hammond, Ind.

TRADE NOTES FROM BOSTON.

Look for Good Fall Business—Old Home Week Not Helpful to Business—C. J. Sylvester Manager of the Osgood Store—Leading Firms Make Encouraging Reports.

(Special to The Talking Machine World.)

Boston, Mass., August 10, 1907.

Summer business with the talking machine dealers has not been any better than they hoped for. Everybody is looking for a spurt as soon as the September records come. The recent issue of grand opera records has acted as an impetus on high class trade, but most of the "common people" regard the price as too high.

A good example for retail dealers to follow is seen at the warerooms of the Columbia Phonograph Co. here, where Manager Blakeborough has placed on a convenient counter by themselves all of the slow moving records, with placards calling attention to them as bargains at slightly reduced prices. This acts as an incentive to buyers to at least look them over, and as there are a great number of really good things that move slowly they are secured at a bargain.

Old Home Week here was very unsatisfactory from a business point of view, for none of the talking machine warerooms did any business at all. Most of them had kept their salesmen away from their vacation for the week, when they might just as well have let them all go away for a rest and shut up shop.

C. J. Sylvester, who has until recently been with the Leland store at Worcester, has been appointed manager of the talking machine department of the C. S. Osgood Co., vice Herbert Royer, who resigned to go on the road for the Victor Co. The Osgood Co. have recently taken the jobbing agency for the Columbia goods, and have rearranged their warerooms.

At the Eastern Talking Machine Co. everybody is waiting for the new Edison equipments to arrive. Business is reported fairly good here. Wholesale Manager Chamberlain is about to take a two weeks' vacation. His new idea in a record carrying case has proven to be a good thing, and he is selling a lot of them.

The Boston Cycle & Sundry Co. are booming the sale of their patented carrying cases for disc and tubular records, and also their trays for the keeping of records on the shelves in warerooms.

"We are waiting, only waiting," is the refrain at the Oliver Ditson Co., where Manager Winkelman is planning for moving his talking machine department down three floors, and having the entire second floor of the Ditson building for it. Workmen are still hustling, getting the floor into shape, but it will be another fortnight before the department is in its new quarters.

GOOD REPORTS FROM BALTIMORE.

Summer Trade Makes Good Showing—Call Is for Expensive Machines and Records—Excellent Month With Edison Goods—Columbia Co. Also Make Encouraging Reports—All the Leading Houses Most Optimistic Regarding the Outlook for Fall Business.

(Special to The Talking Machine World.)

Baltimore, Md., August 10, 1907.

The popularity of the talking machine in this city is becoming more pronounced each month, judging from the manner in which business keeps up during the warm weather. The sales, according to the statements of those engaged in the business, were exceedingly large during the month of July, and the business, as a whole, during that month, was larger than any recorded for the same month of preceding years. The dealers are inclined to believe that the popularity of these machines at summer resorts, both at the seaside and in the mountains, was responsible for the heavy run of business during July on account of so many people going away to these places to spend the hot days. From the showing in the trade during the first week of August the dealers feel confident that there will be no let up in the sales, but are rather inclined to predict that the business will even surpass that of July.

While the sales of machines have been numerous, the demand for high grade and operatic records has been the greatest reason for the excellent condition of the summer business. These records have been more in demand than the ordinary ones, although the desire of owners of talking machines to have the latest popular airs to play on their instruments has been such as to make the sale of these records quite large. The operatic records, however, are the ones that took the premium for the largest sales during the past month, the demand for these being way above the average for other months.

George A. Gustin, manager of the Columbia Phonograph Co., West Lexington street, was one of those who announced that the business of his company has kept up in great shape, especially in the jobbing department. A large number of the Columbia phonographs were sold during the month, and the indications are that the good business will continue all during the warm weather. Records of popular selections were sold right along, and there seems to be no abatement in the demand.

The E. F. Droop & Sons Co. on North Howard street also experienced an excellent month with

the Edison machine, while the sale of high-grade records by the company was up to the top notch. The members of the company look for the trade to continue good during the remainder of the summer, while they are making preparations for a heavy fall trade, when they expect business to take a big boom after vacation days are over.

The same encouraging reports in regard to the trade come from members of the firm of H. R. Eisenbrandt & Sons, Charles and Lexington streets. One of the members of the firm stated recently that "the demand for the Victors becomes greater each week, while the sale of high grade records is always on the increase." Their business was excellent during July, and like the heads of the other houses, the statement is made that the operatic records take the lead in the number of sales. Business in the jobbing department is also fine.

DEVINEAU'S IDEAL HORN.

An All Aluminum Product Which Weighs Only a Few Ounces and Requires No Support.

Talking machine jobbers and dealers will be interested in the "Ideal" horn, which is shown in another portion of this paper. This new invention possesses many individual characteristics, which will appeal at once in a favorable way to users of talking machines. The "Ideal" is handsomely finished, made of aluminum, requires no stand or support, and can be used with all Columbia and Edison machines.

It is interesting to note in this connection that there are many inventive minds which are working along the development of horns, and as a result new and original ideas along these lines will be constantly appearing. It is the "special" horn which to-day will attract attention.

This item, taken from the Capitol of Des Moines, Ia., shows how the good work is going on: "W. H. Jayne has installed in his office at the court house the most complete set of electrical phonographic appliances to be found in the county. Mr. Jayne is court reporter for Judge Howe, and he is kept so busy that he has decided to do transcript and court reporting at the same time, and thus save many hours. In leisure moments he will now dictate testimony for transcripts into the phonographs, start it going into the ear of his typewriter and hie himself back to the courtroom, there to resume the arduous labors of taking the evidence of witnesses right off the bat. The new machinery is very expensive, and is attracting great interest among the court house attendants.

Record and Machine Cases

We manufacture a full line of cases for Cylinder and Disc Records, Machine Cases and Horn Cases. Carrying goods in stock, we can make prompt shipment. Our quality is the best, and prices right. Ask for our catalogue.

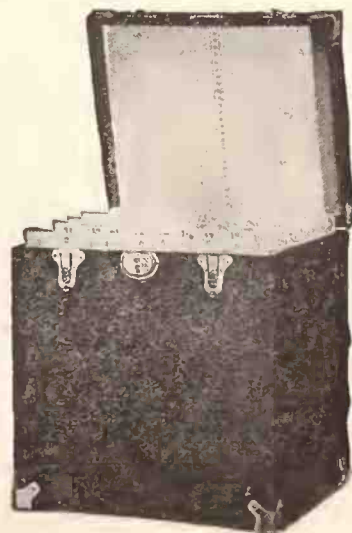

CHICAGO CASE MFG. CO.

241-247 S. JEFFERSON ST.

CHICAGO, ILL.

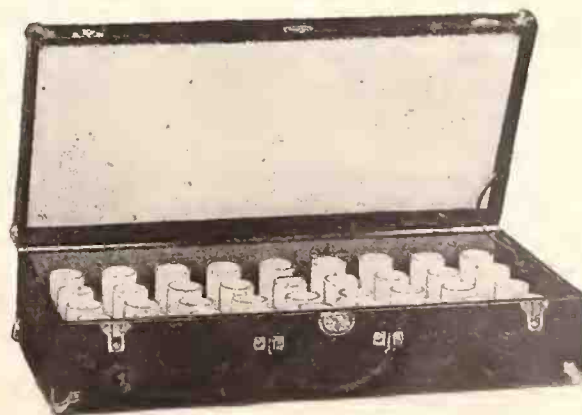

IMPROVED
PETMECKY

Multi-Tone Needles

Ultra in quality

Supreme in universal esteem

Beyond question the best

EXPORT TRADE SOLICITED

SAMPLES, TESTIMONIALS, ETC.

SENT ANYWHERE UPON REQUEST

PATENTEE

SOLE MANUFACTURER

PETMECKY

346 Broadway

NEW YORK

NEWS OF THE MONTH FROM THE SAINTLY CITY.

Trade for Summer Good With Healthy Outlook for the Fall—St. Louis Talking Machine Co.'s Report—Conroy's Big Edison Trade—Knight's Record Club a Success—Silverstone's Good Trip—Jobbers and Dealers Should Get Together—Columbia Co.'s Summer Business—Star Disc Machine Handled by Silverstone Co.—Some Recent Visitors—Invention of Some Moment by a Member of the Trade—Other News of General Trade Interest.

(Special to The Talking Machine World.)

St. Louis, Mo., August 6, 1907.

The jobbing trade for the past month has been very good, and gives promise of a large fall business. The retail trade is reported to have furnished a clever surprise by being much better than expected. High class outfits are in good demand, and the demand for records has been very satisfactory.

C. W. Long, manager of the St. Louis Talking Machine Co., reports the jobbing trade to be very satisfactory, and that their record sales have been very heavy. Manager Owens, manager of this company's retail department, reports an excellent trade, and that their record trade is of the best.

Manager T. P. Clancy, of the Columbia Phonograph Co., states that their summer's business is furnishing a great surprise in its large volume, and that the outlook for the fall trade could not be better. Mr. Clancy recently purchased the famous local horse Red Leaf, who is supposed to be one of the finest runabout horses in the West.

W. C. Fuhri, department manager of the Columbia Phonograph Co., with headquarters in Chicago, spent two days here recently.

Eug. Ketterer, manager of the talking machine department of the Conroy Piano Co., states that their jobbing trade on Edisons has been away beyond expectations, and that their retail trade for July furnished a very pleasant surprise.

D. K. Myers, jobber of Zonophones, reports trade very good, and extremely satisfactory for this season of the year.

The West End Talking Machine Co. is the name of a newly organized concern, who opened for business at 3839 Finney avenue, August 1. They will handle Zonophone and Edison machines and records.

John Magner, formerly assistant manager of the Boston, Mass., office of the Columbia Phonograph Co., has accepted a position with the local office of the same concern as manager of the commercial department.

A. A. Knight, the well-known jobber, reports trade good. He recently organized a record club for which he charges \$1 for a membership, and with the return of one dozen records and the payment of 50 cents he furnishes another dozen records. He states that the club is quite a success.

Mr. Knight states that some time ago an individual called on him, and during the conversation stated that his wife had left him, and being quite lonesome he wanted to buy a talking machine and a supply of records. Mr. Knight sold him an outfit, and for some time after that this party proved to be an excellent customer for records. After a while he was missed, and Mr.

Knight looked him up. When he found him he told Mr. Knight that his wife had returned to him, and that he had sold his talking machine and outfit.

By the closing of the O. K. Houck Piano Co.'s store here on September 1 they will also go out of the talking machine business. J. P. Booker, who has been the manager of their talking machine department, is no longer with them.

Marks Silverstone, president of the Silverstone Talking Machine Co., returned recently from an extensive trip through southwest Missouri. He reports that the section through which he traveled appeared to be very prosperous, particularly the mining section, of which Joplin, Mo., is the principal city.

A prominent jobber and dealer who is in the habit of making trips through this territory now and then, tells me that he thinks the jobbers should meet the dealers personally, and that he is making these trips for the sole desire of getting in touch with them. He states that it promotes good feeling, and gives the jobber an opportunity of giving the dealer the benefit of his experience by advising them how to increase their business. He also stated that upon his advice two dealers who handled the talking machine business as a side line, have decided to go in the business exclusively.

One of this jobber's suggestions to all dealers is to have the number and name of record together. He says it will be the means of selling more goods, particularly where the dealer carries only a limited stock.

The customer glancing over the stock will invariably select some records on account of the title being prominent.

The Silverstone Talking Machine Co. have been recently appointed jobbers for the Star disc machine.

Charles A. Tate, Flora, Ill., and W. S. Bell, of the Bell Bros. Music Co., Lawrence, Kan., talking machine dealers, were recent visitors at the St. Louis Talking Machine Co.

The St. Louis Talking Machine Co. are just putting on the market a handsome new cypress rack 7 feet 3 inches high and 6 feet long. It is for the purpose of holding disc records, and it promises to be a very valuable feature for all dealers. It will hold 2,500 records and is built in a most staple manner. The shelves are braced by a method that absolutely prevents them from warping or collapsing. The rack was patented by C. W. Long, local manager of the St. Louis Talking Machine Co., who sold the rights to the St. Louis Talking Machine Co. The patent was applied for on May 10, 1907, and granted on July 8, 1907.

Wm. S. Byrd, traveler for the Columbia Phonograph Co., is home from a successful ten days' trip through Illinois.



Reg. U. S. Pat. Off.

PATENTED JULY 8th, 1907

"The St. Louis Record Rack"

Built of wood, with iron rods, every shelf braced, smooth finish, ready to paint or stain to match your fixtures, and shipped knocked down.



Made in Sections

of 6 feet long by 7 feet 3 inches high, each section holding 245 to 2,500 records.

Cleanest, strongest, and best appearing rack on the market.

Made in three styles—All 10 inch; 10 and 12 inch; or 8, 10 and 12 inch.

Price, \$18 per Section

Quotations made on special sizes.

St. Louis Talking Machine Co.

MILLS BUILDING

7th & St. Charles Streets

ST. LOUIS, MO.

The Only Exclusive Victor Distributors in Missouri

QUICK SHIPMENTS FROM ST. LOUIS TO THE SOUTHWEST.

OF

Edison Machines, Records

AND GENERAL TALKING MACHINE SUPPLIES

We carry the largest stock west of New York and we invite your orders, which will receive immediate attention and quick delivery.

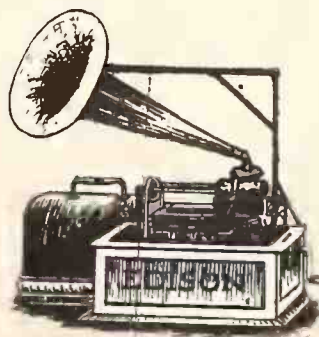

CONROY PIANO CO.

1100 Olive Street

ST. LOUIS, MO.

TIMELY TALKS ON TIMELY TOPICS.

Fortunately for the trade the courts are in recess during the summer, and they are therefore spared the trouble of speculating "what will be done next" when a decision from somewhere is handed down. The past year has been particularly fruitful of litigation either over talking machine patents or agreements or contracts, neither of which have conduced to the comfort of those immediately or prospectively affected. Some curious situations have been created, but it is safe to say these will be pretty well cleaned up before another year rolls around.

It should be remembered that a few cases, over which a great hullabaloo has been created, do not affect the trade the slightest. The daily newspapers note these suits involve millions, so to speak, and that is sufficient for the majority of them to go off on a tangent, publishing sensational and highly colored stories which the jobbers and dealers should take cum grano salis. The trade may rest assured that if any legal proceedings are under way in the courts The World will keep them fully informed as to their meaning and intent when a judicial opinion is delivered. To prejudge cases is purely idle speculation, and is neither profitable or satisfactory.

The export business of American manufacturers of not only machines and records is growing with amazing rapidity, but makers of horns, cranes, cabinets and the general line of requisites and the minor devices classified as general improvements are also feeling the impetus of a strong demand from foreign countries. It is universally conceded that American-made goods "have the call," as it were, wherever talking machines are known, and their supremacy is not likely to be superseded. In referring to this question not long ago the manager of the foreign department of a prominent concern said to The World: "While the trade here is extremely interesting in its development, it cannot compare with that of the foreign business, in which something new is constantly coming up. New countries, new people and new conditions present entirely fresh phases at every turn. Of the magnitude of this trade, as an illustration, I may say that in the Argentine Republic alone the Victor Talking Machine Co. and the Columbia Phonograph Co. have yearly sales totaling fully \$300,000 each, and this has been secured in a comparatively short time. The buyers

place orders on a most liberal scale, and one of them will purchase more goods at one time than a half dozen of the largest jobbers in the United States. This may sound like boasting, but it is true, nevertheless."

"An important factor in the foreign trade," continued the expert, "is the record repertory. You must have the native records, or you might as well retire from the field. It is not all skittles and beer recording abroad, and in my experience it does not pay to send recorders from this country. I would rather pay \$10,000 to bring talent to the United States than spend \$5,000 in any foreign country. Recorders who work at home, with every facility ready at hand, obtaining splendid results day in and day out, when they go abroad and have to contend with wholly different conditions most always fail. Our company have had skilled men in China for a year and a half, and we have got no records yet. It is purely a gamble, evidently."

"Attention must also be given to the character and tone of the records. In warm climates, where the houses are open—in fact, many with no roofs to mention—the loud, brilliant record only will command a sale. What would be eminently satisfactory here would be neglected there. Then the disc record, which is not affected by climatic conditions, is the one that can be carried in stock without injury or deterioration, on account of the composition or material used. For example, I have known that of 100,000 cylinder records in Cuba 40,000 were useless inside of a year. This drawback, however, has now been largely overcome, and cylinder records are gaining ground right along."

The annual meeting of the Eastern Talking Machine Jobbers' Association, the proceedings of which are reported elsewhere, was a notable gathering from more than one point of view. The charge that this body was not representative must be revised, in face of the number and standing of firms who were in attendance or have qualified as members. While the sessions were executive it is known that the discussions were on subjects of direct and lasting import to every jobber who desires to see the business placed on a profitable basis, in which a high standard of mercantile probity will be maintained. The exchange of credit information has

proven invaluable to every member, and the contention that the manufacturing companies should differentiate between cash and instalment sales as to price will doubtless bear good fruit.

Efforts were also made, in a suggestive form to be sure, that a difference should be drawn between jobbers who actually sell the dealer and those who are listed as such because they comply with the placing of the minimum initial order, but are exclusive retailers nevertheless. The association would like to persuade the manufacturers this practice is neither fair nor equitable, and should like them to define a jobber as one who has at least one traveling salesman out in the trade. Perhaps their views in this respect may prevail eventually, but the manufacturers are not disposed to make the concession just at present.

The Eastern Association, however, is on a high plane of efficiency, and the energetic spirits who rescued the organization from its former moribund condition, into which it lapsed through errors of judgment, are to be congratulated. The Central States Jobbers' Association have also been greatly strengthened, and the joint meeting of the two bodies in Buffalo, N. Y., next month is looked forward to as marking a new era in the history of the trade. Whether the organizations will become amalgamated as a national association, or the present status be maintained, with representatives possessing delegated powers from each, also remains to be determined. The opinions of several well-known figures in the trade are printed in this issue of The World, and they are worthy careful reading.

Within a day after William E. Gilmore, president of the National Phonograph Co., met the special committee of the Eastern Talking Machine Jobbers' Association, he addressed every Edison jobber in the country requesting their individual opinion concerning a concession of a 5 per cent. discount on cash sales on phonographs only, the part payment or instalment transactions to remain in statu quo. President Gilmore stated in his circular letter of the 8th inst. that he, with other officers of the company and the chiefs of departments, had conferred with the committee, and therefore he was desirous of having a consensus of views irrespective of the association. Replies are requested to be returned by August 19, with a possible plan of embodying the results of the canvass in the forthcoming new agreement about due from the company. The jobbers on receipt of the communication immediately commenced to get their dealers interested by personal visits and through special letters, explaining the situation, at the same time requesting their prompt acceptance and co-operation. It is now plain that if the Edison jobbers and dealers are sincere in seeking this advantage they should not neglect to file their indorsement or otherwise at once. The National Phonograph Co. have been the first of the manufacturers to take up this momentous question for settlement, and they are therefore entitled to a free, full and candid expression of opinion regarding it from all in interest.

Owing to the enormous mail received by the Columbia Phonograph Co., sometimes reaching the total of 180,000 letters daily, a special room has been built onto the postoffice at Bridgeport, Conn., for the sole purpose of handling the mail of that concern.

H. C. Grove, manager of the Washington, D. C., branch of the Columbia Phonograph Co., has been elected a member of the Washington Chamber of Commerce.

The Jersey City, N. J., stores of the Columbia Phonograph Co., under Manager R. H. Hicks, have built up a very fine business, June being a record month in the matter of sales. Sixteen canvassers are kept in the field in that city.

Better to have fifty things down in your "want book" and decide not to order them, than to fail to put down one that you really need.

WE FILL OUR ORDERS COMPLETE

ONLY EXCLUSIVE JOBBER IN THE UNITED STATES
OF

Zon-o-phone Machines and Records

ALWAYS FULL STOCK — NO SUBSTITUTION

WE DO NOT RETAIL

Hence records come to you without marks of needle. Orders filled same day they are received.

Full Line Record Cases and Needles

Give me a trial order and you will not regret it.

WRITE FOR CATALOGUES, MACHINES AND RECORDS

D. K. MYERS

712 North Second Street - - - - - ST. LOUIS, MO.

The ZON-O-PHONE RECORD is the BEST RECORD MADE

TRADE HAPPENINGS IN PHILADELPHIA.

Business for the Month a Pleasant Surprise—The Horn Situation Comes in for Much Discussion—Opinion Is That It Will Put an End to Price Cutting—Victor Co. Publicity Highly Praised for Its Help to Dealers—Jobbers Reunion Still Discussed—New Columbia Jobbers—Additional Factories for Victor Co. at Camden—Musical Echo Co. News—Disc Talking Machine Co.'s Advertising Campaign—Other Items Worth Recording.

(Special to The Talking Machine World.)

Philadelphia, Pa., August 10, 1907.

Business in "talkers" for the month of July in this city proved to be a pleasant surprise, the only poor week being that of the Elks' convention, when, except for some possible publicity from concerts, etc., the men in this business might as well have closed shop (at least the retail end). There was such an improvement in trade the latter part of the month it brought accounts considerably ahead of last year's booking. August came in with a swing, as far as the retail end of the business is concerned, and nearly all the jobbers are most optimistic in regard to the outlook. Wholesale trade is, of course, quiet, and will probably continue so until at least the first of September. Collections for some reason or another continue below the satisfactory mark, though not dangerously so.

Just at present there are a number of subjects that are occupying a good deal of the attention of the jobbers here, one of the most important being the new move of the National Phonograph Co. in adopting a standard horn and crane to be sold with each machine of their manufacture, in regard to which the feeling is varied as it is uncertain. This, however, is the natural result of any sudden change of policy, everyone being vitally interested in the pros and cons of the case. A member of the trade, in speaking of the situation, said: "On the whole I believe it to be a good thing. Of course, it has come very suddenly—too much so, I believe, for the public to swallow easily—especially to the tune of \$5. You see, the horn manufacturers have

educated the public's taste to the fancy, bright-colored articles, and if the Edison people are going to restrict themselves and us to the common black horn, I think there will be trouble, at least at first. One thing I'm glad of, however—it will eliminate price-cutting and drive out the shysters."

Another remarked: "It wholly depends on how the thing is handled whether or not it will be viewed with entire favor. Just at present it has some of the dealers—I might say, many of them—worried as to how they will be able to dispose of their present stock of flower horns; others, especially in the poorer sections, kick on the increase in price. Personally, I am glad of the move, but think that the National Co. should crate each horn separately, instead of nesting them, as has been the custom of the horn manufacturers. In their case, with so many different styles, it was impracticable, but with the National Co. it would be a great saving in time and labor, and would insure the dealer or customer a bright, clean article, free from dust and scratches that are liable where horns are kept in stock. Then, again, in the matter of actual expense, to recrate each horn separately would cost the jobber at least 25 cents, and when this, with the time and labor considered, amounts to a good slice of what little profit there is in it, I think that if the National Co. would adopt this method of shipping, they would be fully repaid for their extra outlay."

"Mighty glad of it," was the verdict of a third. "It's going to stop all this cutting that has been the ruination of the supply business

and put out of business all those cheap manufacturers who turned out their stuff in some attic and then peddled it around among the dealers—horns poorly made, that never gave any satisfaction, and only caused a lot of bad blood between customers who got stung and the dealers, and what is more, it will cut out the necessity of carrying such an enormous stock of all kinds of horns. Of course things may be a little unsettled at first, but after all, it's a little thing, and I don't think it will affect us much one way or another, only it will change the manner of sales somewhat, though a good many outside horns will continue to be sold, notwithstanding."

Not a jobber in this city who is handling the Victor Co.'s line but is congratulating that company on their latest flyer in the advertising field. As referred to elsewhere in The World, the Victor Talking Machine Co. have started to use each month a liberal amount of space in the leading daily papers in all the large cities throughout the country, and on Monday, July 29, the Inquirer, North American, Record and Bulletin came out with a 600-line advertisement in the form of the new August list of records. No names were given, but the North American's man saw a good chance for extra business, and before the paper went to press he had every Victor jobber in the city occupying space of some kind below the ad. From reports given out this one move of the Camden company has increased business marvelously. To quote Mr. Marschalk, of the Musical Echo Co.: "It has made the retail end of the business resemble December rather than August." At any rate, there is no question but that its effect on the trade in general will be decidedly stimulating and it will force many to advertise and adopt advanced methods that would have set back and let well enough alone.

Notwithstanding the fact that several weeks have now passed since the meeting of the Eastern Jobbers' Association in New York, one of the chief topics of conversation is the royal good time given the jobbers of this city on that trip, and many of the amusing incidents that hap-

Mr. Talking Machine Dealer

If you are located in New England—

We Can Save You Money.

Our facilities permit us to ship goods on first Express after order is received. We **wholesale exclusively**—consequently everything is shipped in original packages as received from the factory—no played-out records, no second-hand machines.

We **manufacture** a number of talking machine accessories among which are our famous Tray Outfits. (If you are not using this system for carrying records in stock it will pay you to write us.)

The **Lynn Record Cases and Peg Boxes** are another of our products.

We also manufacture the **Wentworth and No. 10 Horn Stands**.

Special Lines and Special Prices on Flower Horns.

==== We solicit a trial order. ====

Boston Cycle & Sundry Co.,

J. M. Linscott, Manager

48 Hanover Street, Boston, Mass.

pened either at the banquet or while guests of the Tea Tray Co., or that prince of hosts, Mr. Carpell, of the Herzog Furniture Co., are retold over and over again. All are now looking forward to the big meeting which is to be held at Buffalo next month, and all are much in favor of the proposed plan for a national association. Many of the jobbers will add a social feature to the trip by taking their wives along to enjoy the beauties of Niagara.

Business during the month of July was very satisfactory with the Columbia Co., both wholesale and retail departments doing well. This company are enjoying an immense demand for Bonci records. During the Elks' convention here a special record was brought out that took wonderfully, namely, "Hello, Willie," a take-off on the famous "Hello, Bill" of this society. The words were written by a local member and put to the tune of "Arrah Wanna." It was sung by the well-known baritone, J. W. Myers, who also being an Elk, put his whole heart and soul into the rendition. The Columbia Co. are pushing the wholesale end of their business for all it is worth and the following list of new dealers will prove that little grass is allowed to grow under their feet: Wm. Groff, Millheim, Pa.; W. C. Jones, Hamonton, N. J.; McCurdy Bros., Philadelphia, Pa.; Moon & Miller, Hazelton, Pa.; Ernst B. Spring, Philadelphia, Pa.; George L. Anderson, Avondale, Pa.; Bennage Bros., Louisburg, Pa.; D. K. Bishop, Millroy, Pa.; Howard C. Bullock, Canton, Pa.; A. C. Beeman, Elkland, Pa.; Alex. Demacock, Bethlehem, Pa.; R. H. English, Wellsbro, Pa.; Gettysburg Department Store, Gettysburg, Pa.; Philip Gould, Olive Beach, N. J.

Plans have been completed and bids received for the erection of two additional factories and a power plant for the Victor Talking Machine Co. in Camden at a cost of \$200,000.

The two additional factories will be erected at Second and Cooper streets, and the power plant to be installed will have a capacity of 4,000 horsepower. One of the new buildings will measure

92 by 174 feet, with one story and basement and provisions for five additional stories to be erected later. The other new building will be six stories high and will measure 80 by 173 feet. Both buildings will be built of brick with stone trimmings to match the present building. The column, floor and roof construction will be of reinforced concrete with slag roof covering. A triple window construction will be employed for obtaining the maximum amount of light. The power house will have a 4,000-horse-power plant installed.

The Musical Echo Co. report increased business for July and so far for August, as compared with last year. In fact, the retail business has taken a remarkable spurt, much of which Mr. Marschalk attributes to the extensive daily paper advertising now being carried on by the Victor Co. Louis J. Gerson has been away for some days on account of the serious illness of his wife, who has just undergone an operation for appendicitis, but is now thought out of danger.

Louis Buehn & Bro. report business very fair for this time of year. This company are as usual pushing the wholesale end of their business and devote their whole time to their dealers' wants, in consequence of which their list is not only a live one, but a growing one.

C. J. Heppe & Son are doing a thriving business at the old stand and report trade extremely good in Edison goods.

C. P. Bartholomes, chief inspector of the Columbia Phonograph Co., was a recent visitor in this city.

H. W. Weyman has now taken on his shoulders the troubles of a commuter and runs down to Atlantic City every evening for a dip in the briny. Mr. W. reports everything moving smoothly.

H. B. Herr, a dealer of Lancaster, Pa., was entirely burned out July 4. He has secured new quarters and will be open for business on or before August 15. The loss was covered by insurance.

The Penn Phonograph Co. report that orders have been booked away ahead for phonographs and films.

Herbert T. Lewis, of the Lewis Talking Machine Co., spoke very optimistically of the outlook in Columbia lines for this month and the fall, and said: "Yes, business is picking up fast with us this month, and the only trouble I'm having just at present is getting any Marconi stuff. While in New York recently I saw the new Columbia taper arm cylinder machine, and you can quote me as saying that I think without a doubt that it is the coming thing in this end of the business and will make a big hit." Chas. A. Swain, Cape May, N. J.; John Kirschneck, Media, Pa., and Samuel Brown Co., Philadelphia, Pa., have just been appointed Columbia dealers by this company.

F. H. Reiff, the enterprising Edison, Victor and Zonophone dealer of York, Pa., was a recent visitor and left several nice orders with some of the jobbers before leaving town.

The Disc Talking Machine Co., jobbers in Zonophone machines and records, located at 13 North 9th street, report a pronounced increase in business during the past four weeks. H. N. McMenimen, lately sales manager for the Universal Talking Machine Co., holds the position of general manager with Harry K. Smith, formerly connected with the Berliner Gramophone Co., as an able assistant. This company are carrying on an extensive advertising campaign in the dailies, and a new follow-up system inaugurated by Mr. M. is showing excellent results in the wholesale department.

THE REGISTER RECORD HOLDER.

A Very Clever Device for Holding and Finding Record—A Time Saver to the Busy Man.

It is seldom that we find a long-felt want so admirably filled as in the case of the Register Record Holder. It is about to be put on the market here, and we understand it has already

No More "Time Lost" in Finding "What's Wanted"



Any Disc INSTANTLY FOUND and INSTANTLY REPLACED Where it Belongs !!

PRACTICAL! COMPACT! CHEAP!

This device consists of a number of thin keys, each one numbered or labeled with the title of the disc it holds.

You have but to *press the key* and the mechanism rolls it slowly out and into your hand. The particular key remains depressed and open till disc is replaced.

No Talking Machine outfit is *now complete* without a cabinet or pedestal fitted with the

Automatic Disc Holder

Very few people *had* any use for cabinets, but



Now There's a Reason. Holders Fit Any Cabinet! Any Discs Fit Holders!

FOR PARTICULARS AND PRICE, ADDRESS

AUTOMATIC DISC HOLDER CO. - - 332 BROADWAY, N. Y.

been taken up by the Gramophone & Typewriter, Ltd., Pathe Freres, in London, and all the principal jobbers in Europe.

The device consists of a number of thin keys, each one numbered or labeled with the title of the disc it holds, and pivoted at about its center in a small grooved block. In use the disc is placed in the front of groove and given a slight push. It rolls in and its weight depresses the back and correspondingly raises the front of the numbered finger, as shown in cut. It will thus be seen that on depressing the desired key in the front the disc will roll forward gently and out into the hand—but this is not all. The key of the empty groove will naturally remain depressed until the disc is replaced, thus insuring at all times that each record is put into its proper space. The facility with which any disc may be selected prevents the tendency, so general in other devices, of taking out three or four discs at a time to avoid the trouble of again searching for the ones that may be subsequently wanted. The whole arrangement is compact, neat and admirably carried out.

A cabinet as shown in cut (holding eight dozen records) will, we think, when generally known, be considered an almost essential part of a talking machine outfit.

The patentee, who is temporarily in New York, and whose office is 332 Broadway, is, we understand, desirous of making arrangements with manufacturers, jobbers and dealers for the sale of this device. It is sold by the yard, each yard holding eight dozen records in sections of six keys each. The Register record holder fits discs of any diameter, and can be used with any size cabinet or pedestal.

This matter is well worth the attention of every live dealer. It is inexpensive and undoubtedly one of the most practical devices of its kind that has yet appeared.

The Victor Talking Machine Co. will soon have ready a number of Mexican records, including numbers by noted bands and vocalists.

A NEW COLLAPSIBLE HORN.

Which Will Interest the Trade, Can be Reduced to Almost Pocket Size Quickly—Has Splendid Reproductive Powers.

The illustrations which are shown on a neighboring page, and which are reproduced here in

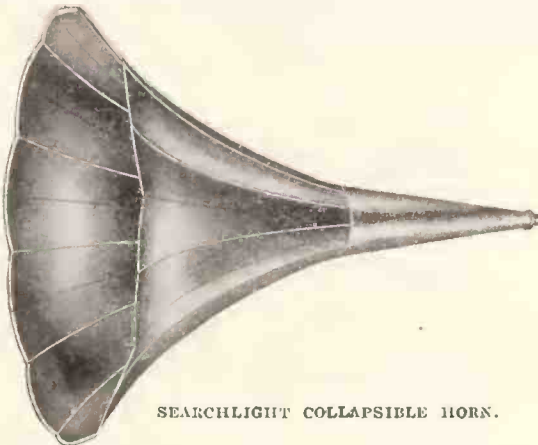

SEARCHLIGHT COLLAPSIBLE HORN.

smaller form, of the new horn recently placed upon the market, will be of interest to talking machine men everywhere. We refer to the new collapsible horn put forth by the Searchlight Horn Co.

The fact that this horn can be so quickly reduced to occupy but a small space makes it at once a desirable product for talking machine



SEARCHLIGHT COLLAPSIBLE HORN CLOSED.

dealers. Recently this new Searchlight product was subjected to rigid tests, and experts who

were present did not hesitate to pronounce it a most admirable horn, not only from the fact that its novel form permitted it to be reduced in so short a time to almost pocket size, but the fact that it possesses marvelous reproductive powers. The tonal quality of this new folding horn elicited the warmest admiration and approval from those present. Some of the gentlemen had claimed that it was impossible to have a collapsible horn which was a good reproducer of sound, but those gentlemen who were skeptical at first admitted later when the tests were applied that this new claimant for horn patronage was a wonderful creation in every respect.

While the illustrations shown give a fair idea of this new collapsible horn, yet it should be seen and heard to be fully appreciated.

One feature of this horn that appeals to seller and user is that the bell is self-sustaining and in one piece and can be made into a solid flower horn and ready for use, or collapsed for packing, within 10 seconds. It is made entirely of metal.

NEW VICTOR VICTROLA DESIGN

The Victor Talking Machine Co., Camden, N. J., have their new cabinet working plant now finished, and in excellent running order. One of the first products of this department of the great factory is a new model of the Victor Victrola, the first sample of which was received in New York by the Regina Co. The design differs materially in point of elegance and finish from the first of these notable machines, which has proven one of the best instruments of the Victor line ever manufactured by the Victor Talking Machine Co., of Camden, N. J.

Eddie Merritt, the Douglas Phonograph Co.'s only "ambassador of commerce" at present, leaves for his vacation next Saturday, the 17th. Mr. Merritt is one of the road cracks, and has rolled up a record in sales for the past year. The Douglas Co.'s interests are always in good hands when Eddie is on the job.

Announcement Extraordinary

On September 1st we will move our wholesale Edison and Victor Talking Machine Department to our new building at

126 UNIVERSITY PLACE

connecting with our present establishment, 32 E. 14th St., in rear. We will then be the only jobbers in the Metropolitan district devoting a building exclusively to wholesale interests.

S. B. DAVEGA

TELEPHONE { 985 } STUYVESANT
{ 984 }

L. KAISER

Director Wholesale Department

32 EAST 14th STREET
126 UNIVERSITY PLACE
NEW YORK CITY

Indestructible Records

WIN ON THEIR OWN MERITS

WHY ?

Their musical tone surpasses all others

They will not become scratchy or unmusical

Constant handling does not wear them

They are suitable to all climates

Heat or cold does not affect them

100%
VALUE



100%
VALUE

YOU GET 100% VALUE WITH EACH SHIPMENT

SEND FOR CATALOGUE

35c. each

Regular Discount to the Trade

35c. each

The Indestructible Phonographic Record Co.

ALBANY, NEW YORK, U. S. A.

COLUMBIA PHONOGRAPH CO.'S BOOTH AT THE JAMESTOWN EXPOSITION.



One of the handsomest displays made by any manufacturer at the Jamestown Exposition is that of the Columbia Phonograph Co., who are located at the northeast corner of the Manufacturers' and Liberal Arts Building. As may be seen from the illustration herewith, the structure is a most imposing one, and is attracting unusual attention from all who visit the Exposition grounds. In this handsome booth are displayed all the latest Columbia products, including the improved commercial graphophone, which is so much in vogue with the great corporations, and the latest improved records, as well as many

KEEPING SHOP BY MACHINE.

Showing How the Talking Machine Idea Has Been Adopted Into Commerce.

Near Amsterdam a tourist who does not know a word of Dutch recently saw in a shop window the announcement, "English spoken." He entered the shop. "English, sir?" asked a youth behind the counter.

Then he picked up a cylinder, placed it in a graphophone and the instrument duly sung out—but in German: "Sir (or madam), the pro-

novelties which are now being introduced by the Columbia Phonograph Co. At the St. Louis and Portland expositions their display attracted considerable attention, and it is safe to say that this interest is being more than duplicated at Jamestown, where the gentlemen in charge are most attentive and courteous to all who call. The increasing interest in the exposition will bring lots of people to Jamestown the coming fall, and it is safe to say that no exhibit will win or deserve more consideration than that made by the Columbia Phonograph Co.

prietor, who speaks German, will be telephoned for and will return to the establishment in less than five minutes. Will you please be seated?"

Being familiar with German, the tourist seated himself. In came the proprietor, who, it turned out, spoke excellent English. The stranger asked why the graphophone did not talk English. The explanation was: "It's my stupid assistant! I have a cylinder on which is recorded the message in English; he used the wrong one.

"There is no excuse for him," continued the annoyed proprietor. "My English cylinder is

tinted red at the ends and the German one blue. Lucky for me, sir, that you know German, else I might have lost an esteemed patron."

COMING SEASON WILL BREAK RECORD.

The most conservative minded man in the trade cannot but admit that the coming season is going to break the record set up last year. He has only to note the always increasing growth to reflect that the orders he placed with his jobber last year at this time will not meet the demand which is at hand. We on our part, says the National Phonograph Co., are receiving orders from the longest headed men in the business far in advance of last season. Taking these as typical of what are to come, we feel that despite the great extension of our factories, the increased staff of workers and the high pressure kept up during the summer, we shall yet have to work overtime.

ADVANTAGES OF KEEN ATTACHMENT.

In another part of The World will be found an interesting announcement from the Keen Phonograph Co., of Philadelphia in which they are exploiting the Keen attachment, which is described as "the missing link to the phonograph." The manufacturers sum up these advantages as follows: (1) A clearer sound is secured. (2) The horn doesn't rest its weight on the sound reproducer (which nine times out of ten is the trouble experienced by phonograph users). (3) The horn can be turned to any angle. (4) Everything is more compact. (5) The improvement in appearance is marked. It is only necessary to study the points of this invention to appreciate its great advantages.

COLUMBIA RECORD IN NEW DRESS.

The "Columbia Record" for August appears in an entirely new form—quarto size, with an illustrated cover in colors, in keeping with the magazine idea of the day. Under the editorship of George P. Metzger, chief of the advertising department, the new "Record" supersedes the monthly publication so long identified with the interests of the Columbia Phonograph Co., General. In sending forth the revised and greatly altered edition, the manager adds these few pointed and pertinent words:

"Yes, the 'Columbia Record' has put on a new uniform, and its aims and purposes have been chirped up a bit, too. Hereafter the 'Columbia Record' will be devoted to the interests of Columbia dealers exclusively. It is not meant for the consumer. Consider this issue merely as a fair start—and then every month look for improvement, and take hold and help. If you see a knothole, stick a plug in it and sing out good and plenty. We'll take your suggestions with thanks and your kicks with meekness."

TRANSACT BIG HORN BUSINESS.

B. Schuyler Morris, general sales manager for the New Jersey Horn Mfg. Co., 271 Broadway, New York, is well pleased with the reception that is being accorded to their "Tulip" horns. At the factory in Newark, N. J., they have a capacity of 3,000 horns a week, and report that at the present time orders are being received from every point of the United States. The factory is in charge of Mr. Maurer, a practical man, who has been connected with the horn manufacturing business for the past fifteen years, and who makes a specialty of designing new styles. This company also manufacture a full line of Morning Glory horns of all sizes, suitable for the trade. Mr. Morris has inaugurated a very lively campaign in the interest of his house, and the claims made for his horns as to tonal excellence, durability and workmanship are worth investigation.

On August 1 William McArdle, the minister abroad for the Hawthorne & Sheble Manufacturing Co., Philadelphia, Pa., went to Paris, France, from London, England. He briefly writes: "H. & S. on top."

Quality Horns Count

and every Standard horn that is put forth has passed the most rigid examination, and purchasers will have the satisfaction of knowing that the grade of the STANDARD is unsurpassed in finish, and in quality.

Our horns are exquisitely designed and made so that they will meet every requirement of the horn trade. The styles are original and there is an individuality about the Standard which commands trade.



STANDARD METAL MFG. CO.

Factory address, Jefferson, Chestnut and Melbourne Sts. - NEWARK, N. J.
Offices and Salesrooms, 10 Warren Street - NEW YORK, N. Y.

A CHAT WITH C. V. HENKEL

On the Future of the Jobbers Association—
The Formation of a National Association In-
terestingly Discussed by This Gentleman.

Following the late meeting of the Eastern Talking Machine Jobbers' Association in New York more or less talk was heard of the object and purpose of the national organization, proposed to be consummated at Buffalo, N. Y., September 9-10. Among others deeply interested in this project is C. V. Henkel, president and general manager of the Douglas Phonograph Co., and one of the committeemen appointed to complete the arrangements for the convention, who talked with *The World* as follows:

"When one gets right down to formulating a plan for organizing a National Association of Talking Machine Jobbers it is more or less of a problem. The question as it presents itself to me is: First, shall the national body supersede the sectional associations altogether? or, second, shall the present organizations be preserved? Better still, should still other associations—west, north, south and east—be formed, with each sending delegates to the national gatherings. As it now stands there may be strictly local associations, in Philadelphia for example, that in no way interfere with the Eastern Talking Machine Jobbers' Association.

"At present a lot of time is lost," continued Mr. Henkel, "in passing on questions of the utmost importance to the entire jobbing trade. Personally, I would prefer one body at present, as the local associations are not strong enough to send enough delegations, in point of members, to take up and dispose of questions to the satisfaction of the trade at large. It may be that not only city, but State associations may follow in the course of time. You know there is always more or less criticism where business of this kind is left in the hands of a few. Another thing, it has been said that our association is not representative, and a national organization would remove this objection effectually. Besides the value of the exchange of credit information is greatly enhanced when a wider scope is given its operation, as it would be with a national association. In fact, a national association properly organized could afford to establish a separate and distinct bureau for this purpose, and place at its head a competent man who could conduct its affairs expertly and along up-to-date lines.

"One of the greatest helps created by these associations is the fraternal spirit that has been developed by the social functions incidental to the meetings. To my mind this does as much practical good as is accomplished by the business meetings. Just what will be done at Buffalo I

am unable to say just now, but the trade may rest assured that the greatest good to the greatest number will be the guiding policy of the committee in charge of the arrangements, of which I have the honor to be a member."

GOOD REPORTS FROM CINCINNATI.

Summer Trade Shows Increase Over Last Year
—Wurlitzer Co. Secure More Room—Reginaphone to Ireland—McGreal's Good Business
—Expansion With Columbia Co.

(Special to *The Talking Machine World*.)

Cincinnati, O., August 8, 1907.

The trade in this vicinity, in the main, did not finish the month of July at the remarkable pace set in the early part of the month. Although everybody reports a good healthy increase over the same period of last year, the increase is not in proportion with that of May and June over the same months of last year. There is nothing to indicate, however, that a single condition stands in the way of making the fall and winter business of 1907 the greatest by far in the history of the industry.

The house of Wurlitzer has again found it necessary to reach out for more room. They have secured 15,000 feet of floor space in the large building located at 126 East Fourth street, directly opposite the main store, where the wholesale end of the talking machine department will have added facilities and advantages heretofore impossible, as this department had outgrown its former quarters. One of the floors will be devoted to Victor, Edison and Zonophone machines, while another will be used for records. An up-to-date shipping room and a salesroom conveniently arranged and equipped, are the result of the acquisition of this much-needed floor space, and incidentally, a source of great satisfaction to Mr. Dietrich, of the house of Wurlitzer, as well as its patrons.

Mr. Bruce, of the Smith & Nixon Piano Co., who has charge of the sales department of the Reginaphone, reports good business in machines and records. They have just filled an order for a large Reginaphone for the Rev. Father Powers, of Queenstown, County Cork, Ireland.

Lawrence McGreal, 29 East Fifth street, reports a very satisfactory run of business for the month just past. The sale of high-class records is exceptionally good, the Edison leading in machine sales. Altogether, there is nothing to indicate that Mr. McGreal has been in Cincinnati but two months except the calendar. The present and the outlook are rosy.

The Columbia Phonograph Co. report the best July business they have ever experienced; the sales showing great increase, both in their retail and wholesale departments over any previous

July. The "Symphony Grand Graphophone" was put on exhibition recently, and it is creating the greatest interest among the better class of trade, who simply stand in admiring amazement at its wonderful tones and beautiful construction. It is put up in the style of an upright mahogany grand piano, is made to hold a large number of ten and twelve-inch disc records, and the horn is hidden from view. The sales promise to be beyond the supply.

The Van Phonograph Co., Mr. Salm says, has no fault to find with July's business, as it was in excess of the July of '06, both in record and machine sales.

John Arnold, of the Arnold Music & Phonograph Co., says they are having a wonderfully good trade in Victor records, especially.

SYMPHONY GRAND GRAPHOPHONE

Recently Placed on the Market Is Being Caught Up by Purchasers—Mrs. Gates Selects One and Her Friends Order More—Will be a Big Seller the Coming Fall and Winter.

The symphony grand graphophone is the latest high grade product of the Columbia Phonograph Co., General. The first machine coming through the factory was placed in the window of the company's 23d street store, New York, last week, and was snapped up by Mrs. John W. Gates, wife of the Western financial magnate, who bets a million at a clip, within fifteen minutes of its first appearance on the floor. On removing the machine to the Waldorf-Astoria Hotel in less than an hour after delivery a couple of ladies from the famous hostelry came in the store and each wanted a symphony grand also, and immediately, they were so pleased with the one sent Mrs. Gates. This instrument stands about as high as the ordinary upright piano, is hornless, of beautiful design and finish, comes in mahogany and sells for \$200. The company believe they have one of the handsomest machines ever put on the market, and are arranging to push its manufacture as rapidly as possible, as the symphony grand graphophone has been put down as one of the biggest sellers ever.

GEN. BRESLER'S GOOD WORK.

Among the guests of the Long Beach Hotel at the time of the recent fire that destroyed that resort was Gen. A. L. Bresler, export manager for Caille Bros., the large manufacturers of slot machines, with offices at 32 Union Square, East, New York. By hard work Gen. Bresler saved about one-third of his baggage, and after the fire had charge of a temporary police force, formed by swearing in a number of deputies, who preserved order and prevented the looting of the property of the guests.

Central States Edison Dealers

I AM ready to look after your Phonograph needs from my Cincinnati wholesale place. My stock from beginning to end is new and fresh and my aim shall be to give dealers not only good service, but aid them in every way to make money with the line by giving them every assistance possible, and ten years' experience, first as road salesman for the National Phonograph Co., and four years of jobbing Edison goods exclusively in Milwaukee, should fit me for the successful work of middleman.

I MOST RESPECTFULLY SOLICIT YOUR VALUED
PATRONAGE :: WRITE FOR CONTRACTS

LAWRENCE MCGREAL, Cincinnati, Ohio

29 East 5th Street

ANENT DIFFERENTIAL PRICES.

Henry E. Marschalk Says That the Trade Is on the Threshold of a Solution of One of the Greatest Trouble-Breeders With Which the Talking Machine Business Is Afflicted—Lack of Differentiation as Between Cash and Instalment Sales.

(Special to The Talking Machine World.)

Philadelphia, Pa., August 12, 1907.

Henry E. Marschalk, of the Musical Echo Co., the prominent talking machine jobbers, at 1217 Chestnut street, this city, in a chat this week with The World he said:

"'Necessity is the mother of invention.' This old familiar phrase may be appropriately applied to the present-day talking machine situation, more especially as it relates to the instalment bugaboo. At last our brains have begun to gyrate, and it would appear that we are upon the threshold of a solution of one of the greatest trouble-breeders with which the talking machine business is afflicted, namely, the lack of differentiation as between cash and instalment sales. The element of rascality is sometimes present, as it may seem; but more failures may be traced directly to the instalment business than to any other source.

"Long and assiduously have manufacturers and jobbers flaunted the slogan, 'Go after the instalment business; increase your retail sales,' and the sentiment found fruitful echo in the dealer—large and small. It looked dazzling at the start, and the 10 per cent. above list prices, which everybody charged, added the necessary rose-colored hue to these boomerang sales to induce redoubled effort to 'get more.' Everybody made remarkable strides (especially the manufacturers); business increased with wonderful rapidity, and when our sales sheets (not our cash sheets) were gone over and showed gains of from 50 to 200 and 300 per cent., certainly we had good cause to sing praises of our phenomenal prosperity; but we reckoned without our host. The big fellow had not then begun to lop off that extra 10 per cent., and the little fellow had not then lost his inducement for cash. The big fellow did lop it off, and the little fellow did lose his inducement, and then—trouble. That is where we stand to-day—face to face with trouble, and lots of it. The little dealer who had been 'going right along with the gang,' making great leaps and bounds in his sales and, at the start, getting a fair share of cash business—enough to bolster up the instalment end—began to realize that the big fellow was rapidly killing his chance for cash sales, and that the alternative confronted him either to quit the job or meet competition. The average American is not a quitter and, above all, is an optimist, so it was in order to figure that either Providence or good luck, or perhaps even hard work, would make this instalment business self-supporting. Then began a race for more instalment sales with the prospect for cash business practically eliminated. Some of them, miraculous as it may seem, have held together in one way or another; but the great majority are, to use the vernacular of the day, 'up against it.' They have either failed already

AMERICAN TEN INCH RECORDS

We have about 5,000 new ten-inch American Records. Chicago selections, 18c. each in thousand lots. Address, "Blue Records" Talking Machine World, 1 Madison Ave., New York.

WILL SELL BUSINESS.

FOR SALE.—Thriving piano, phonograph, bicycle and sporting goods business, established 30 years, in live town, 50 miles from New York. Valuable agencies. One side line pays rent and clerk hire without any investment. Full investigation. Fine store, fresh stock, inventory about \$5,000. Half cash; balance secured. Address "PIANOS," care Talking Machine World, 1 Madison Avenue, New York.

FOR SALE.

200 brass and black and gold regular and flower horns at 25 per cent. off jobbers' cost; new wholesale stock. List of sizes on application. Robert L. Loud, Buffalo, N. Y.

and ruined their credit standing by a trip through the bankruptcy court, or some poor jobber is nursing them along, hoping against hope.

"Who stands under this burden? Is it the manufacturer? Emphatically no! It is the poor jobber. He is the fellow, alas! who has been supplying the small dealer, while the latter has been wrecking himself on the instalment shoals, perhaps unconsciously, but with a degree of certainty which is appalling. He it is who hustles his check off to the manufacturers on the 10th and 15th of each month. He it is who paralyzes his profit and loss account with these bad debts—debts directly due to an incorrect condition of trade—i. e., lack of differentiability in prices, above referred to. He it is who sucks the lemon, while the more luscious and palatable fruit goes in another direction.

"So we have 'necessity' as the 'mother of invention.' We must needs rejuvenate the cash business, for under present conditions who but an ass or a rich man would buy for cash when he can make one of these 'unfeeling' weekly or monthly investments at no added cost? Thus, also, we have our brain gyrations—a hash of intellect in some wise head—and, behold! a result—a suggestion that we allow 5 per cent. discount for spot cash! How simple, yet how effective! May blessings be upon this head, may blessings be upon the other heads which gave impetus to the thought, and may blessings be upon the heads of the manufacturers for quickly grasping the thought and embodying it in their contracts, for surely they will do so."

S. B. DAVEGA EXPANSION.

Lease 126 University Place Which Will be Connected With 32 E. 14th Street—New Quarters Will be Devoted to Wholesale.

S. B. Davega, the enterprising talking machine jobber at 32 East 14th street, this city, has leased spacious quarters at 126 University Place, which will be occupied on September 1. These premises will be connected with his present establishment and will be devoted exclusively to the wholesale trade. This will give Mr. Davega one of the most central establishments in the city, as well as facilities that will enable him to cater to the demands of his growing trade.

NEW EDISON CATALOGS.

Copies of the numerical and alphabetical catalog of records, form No. 1,120, have been mailed the trade. This includes in one cover the catalogs which have heretofore appeared separately, and supersedes numerical catalog No. 1,020, and alphabetical catalog No. 1,025. It contains all domestic and foreign records listed to and including July, 1907, and will be current for six months. The domestic, grand opera and foreign lists are first given in numerical order, followed by the domestic list in alphabetical form. This combined form will be a permanent feature. Jobbers will please bear in mind that copies have been mailed to all dealers and that it will not be necessary to supply them with other copies except upon request.

Copies of a new edition of the machine catalog, form No. 1,135, were mailed to the trade during July. Although this catalog is bound in a new cover, it is only intended for use until the new equipment becomes effective on September 16. At that time an entirely new catalog will be printed, covering all the changes in equipment and prices.

W. D. ANDREWS BIG PURCHASE.

W. D. Andrews, the prominent talking machine jobber of western New York, and president of the Eastern Talking Machine Jobbers' Association, recently purchased the entire stock of Edison machines carried by Robt. L. Loud, of Buffalo. Having purchased the stock of Victor machines from the same party a month ago, this gives Mr. Andrews a magnificent line of machines, which are being shown to advantage at his warerooms on Seneca street, corner of Wells, where he is splendidly located to carry on a great jobbing trade.

**Turn Waste Into Profit**

That waste space in your store is rich soil. A good side line will make it yield big profits.

Musical Instruments is the logical side line for talking machine dealers.

There's more money to be made out of musical instruments than any other line you could add to your talking machine business.

And they pull well together—that's the beauty of it!

Musical instruments require little space and less time. Odd corners in store and windows, tops of show cases and counters are excellent places to display them.

**Durro Violins
Lester & Monarch Accordeons
Duss Band Harmonicas
and Durro Strings**

in fact all our specialties are the best known instruments and admittedly the best sellers on the market.

Our prices are just as unique as our goods—none so attractive. That means you can make business *come to you* instead of you going after it.

Musical instruments will bring you a class of individuals with musical ideals who still have the notion that talking machines are mere mechanical play-toys. You thus can have within earshot people you could not reach otherwise and convince them to the contrary.

This is the best proposition ever made to you. Grasp it! Write for Catalog and special prices. But act quickly, because your competitor around the corner may be reading this.

**Buegeleisen
& Jacobson**

113-115 University Place
NEW YORK

Sole Importers of the Famous DURRO VIOLIN

"TALKERS" GREATLY IN VOGUE

In the Twin Cities—The Leading Jobbers and Dealers Well Pleased With General Conditions—Latest Trade Happenings.

(Special to The Talking Machine World.)

Minneapolis and St. Paul, Aug. 5, 1907.

Talking machines are in greater vogue in the Twin Cities than ever before in the history of these devices in Minnesota. Notwithstanding the dulness that comes with the heated period all the houses are doing an exceptional business. Particularly flattering reports are given by the Victor dealers, but all report a trade far in excess of what was done a year ago.

A. M. Magoon, who handles the talking machine department for the New England Furniture Co., says that the trade is unusually strong for this season of the year. The Edison trade continues to hold its own very nicely and is a considerable factor. There has been a very decided increase in the demand for grand opera records.

J. H. Wheeler, a jobber in the Columbia goods, says that the country trade is unusually strong for this season of the year.

T. C. Hough, the pioneer talking machine man in the Twin Cities, finds himself and his office force unusually busy for this time of the year. The machines have found a field, and the trade appears to be as well established as any other line of business in the country.

The Minnesota Phonograph Co., of which L. H. Lucker is proprietor, with headquarters in Minneapolis, is steadily enlarging their trade in Victor and Edison machines and records, and they are well pleased with the business outlook.

EDISON MONTHLY'S NEW DRESS.

With the new form of the Edison Phonograph Monthly for August, Editor McChesney says: "At the age of four and a half years the Edison Phonograph Monthly has assumed a new and more becoming dress. The new cover, with its colored stock and two colors of ink, will be

A PLAN WORTH \$\$\$\$

MR. RETAIL DEALER: Get the business coming your way early this fall. Plan No. 14 will do it. IT'S ORIGINAL. Making BIG MONEY for all that are using it.

SELLS standard makes of MACHINES at FULL PRICE. Equally successful in large cities or small towns. No extra stock required. Dealers in other lines of business, interest their customers in this plan. It's their gain and COSTS you NOTHING. EACH CUSTOMER they send to you means a PROFIT TO YOU OF \$19.20. 8-page Folder describes it. Price \$1.00 in currency. FREE—30 Days. Copy for TWO-BUSINESS-GETTING-ADS. with each folder ordered prior to September 15.

Advertising has made us successful retailers of Talking Machines. We can help you.

BARD BROS. ADV. DEPT. WHEELING, W. VA.

Best Phonograph CYLINDER RECORD CABINET

Patent Horn Holder

Out of Sight when not in use, In Place when wanted

For particulars write

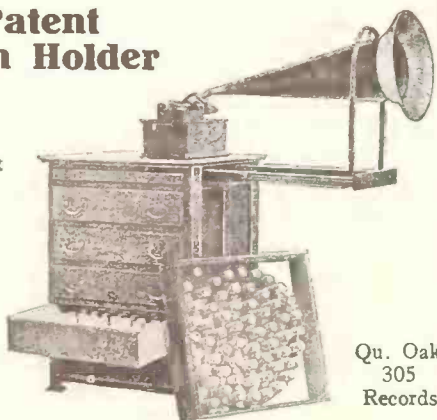

Qu. Oak
305
Records

SYRACUSE CABINET CO., Syracuse, N.Y.

changed each month, and it is hoped that its attractive appearance will be appreciated by the trade. It will be noticed that the advance list and comments are combined, and that the publishers' names are incorporated with them, instead of occupying a separate space, as heretofore." This last announcement should be particularly pleasing to the music publishers who have long contended that if their names only were connected with their publication the cup of happiness would be overflowing and they would rest content, despite the lack of royalty fees.

COLUMBIA'S NEW HOME.

Their Great Retail Headquarters Out of the Hands of the Decorators at Last—Handsomely Fitted Up—Attractive Window Displays That Merit Special Praise.

After weeks of unavoidable delay the Columbia Phonograph Co.'s new establishment at 35-37 West 23d street, New York, is practically to rights, and we may add that it is one of the handsomest and best equipped in Greater New York. The color scheme throughout is forest green, with light green side walls decorated with silver, bronze and gold panels and medallions, the latter having the monogram C. P. emblazoned in their center.

The display windows are in quarter-sawn green-tinted oak, with leaded glass and prism panels above a paneled wainscoting, and matches the general interior decoration to a nicety. The mezzanine floor, which forms a crescent in the rear of the store, is of quartered oak and of the same tint as the display windows and sound-proof booths erected underneath. The floors are also to be covered with dark green linoleum to harmonize with the decorations as noted. Leading up to the mezzanine floor is a stairway with a mirrored background, which, together with mirrored doors which lead to the rear private offices, telephone exchange booth, stock room, etc., and situated directly underneath the balcony, gives an exaggerated depth to the main or store floor. Two electroliers in bronze on each side of the balustrade, and many electric light globes distributed every few feet along the balcony railing, sheds a subdued light and gives a touch that is most pleasing to the eye. The mezzanine floor is set apart to the bookkeeping and minor departments, and this gives the entire store floor for the display of machines, cabinets, horns and miscellaneous stock.

Since the display windows were completed, H. P. Godwin, the display advertising manager, has arranged several most attractive exhibits, and they are attracting much favorable attention. This week the arrangement is most effective. In the west window is a graphophone suspended from a birch standard, and the sign post reads, "A strong guarantee holds your machine up to the mark and insures free repairs for one year." The certificate printed from an engraved plate seemingly holds the links of the suspended chains together and literally carries out the argument so tersely told. A sprinkling of graphophones makes a pleasing background. In the east window, and at right angles, are two large machines with notes issuing from the horns. The notes are caught up with black thread, and a close inspection is necessary to solve the optical illusion. The sign between the instruments reads, "There is music in the air; also in our records." A choice display of disc and cylinder cabinets in all the popular woods and finishes completes the picture.

DEALERS ON SUSPENDED LIST.

The following dealers have been placed on the suspended list since July by the National Phonograph Co.: George Swinehart & Son, Cooksville, Ill.; Bullock & Lyman, Cushing, and John J. Carpenter, Medeville, Ia.; C. H. Cobb, Gardner, and H. M. Burnham, Oldtown, Mass.; H. C. Ingalls & Co., Dover, N. H.; Italo-Americano Phono. Co. (R. Guard & Co.), New York City; Ben Hart, Fargo, N. D.; Clarence D. Baird Mu-

sic Concern, Alexandria, Tenn.; Daynes Romney Music Co., Salt Lake City, Utah; W. Reichenstein, Norfolk, Va.; G. H. Stewart, Walworth, Wis.

WITHDREW APPLICATION FOR COMMISSION.

Before Justice Mills, in the special term of the Supreme Court held August 3 in the chambers in Mount Vernon, N. Y., an application on behalf of the New York Phonograph Co. was made for an open commission to take evidence from witnesses outside of the State. The application was later withdrawn. It was reported that the real purpose of the appointment of the commission was to obtain Thomas A. Edison as a witness.

INVESTIGATORS WERE DISTURBED.

During the recent telephone investigation in Boston, Mass., a morning session of the hearing was broken up by the antics of a talking machine in the neighborhood, which butted in with all too appropriate songs at the critical points in the testimony. While the investigators were inquiring just what a certain high salaried "advisor" did for the telephone company, the strains of "He Walked Right in, Then Turned Around and Walked Right Out Again" issued from the horn of the machine. After this personal thrust, officers suppressed the talker for the balance of the hearing.

H. M. Holleman, president of the Texas Phonograph Co., Houston, Tex., expects to attend the joint meeting of the talking machine jobbers to be held in Buffalo next month, and from there will visit the New York markets for the purpose of buying stock. This company now operate three stores in Houston and supply over two hundred dealers.

The Schmelzer Arms Co., Kansas City, are sending out an attractive series of advertising postals calling attention to special records in the Victor list for August, made by May Irwin and Alice Lloyd, the former making four and the latter three records each out of the list. The matter is printed on the back of a regular post card.



NYOIL FOR PHONOGRAPHS

We have for 40 years been producers of Delicate Oils for Watches, Clocks and Chronometers, and we offer NYOIL as the most delicate and effective article ever produced for the use of Phonographs.

W. F. NYE
New Bedford, Mass., U. S. A.

SPECIAL TO THE TRADE!

FOR 30 DAYS ONLY—These 1907 Song Hits at 10c. per copy, or \$10.00 per hundred:

"Every One Is In Slumberland But You and Me"
"Twinkling Star"
"Sweethearts May Come and Sweethearts May Go"
"Where The Jessamine Is Blooming, Far Away"
Instrumental—Paula Valse Caprice

It will pay you to keep in touch with us. Write to-day!

THIEBES-STIERLIN MUSIC CO.
ST. LOUIS, MO.

UNIQUE GERMAN IDEA.

How the Talking Machine May be Utilized in Military Circles for Drilling or Cheering the Men on to Victory.

The ever useful talking machine has been suggested to fill still another sphere in German military circles, with what definite object has not been stated. According to the suggestion, the regulation talking machine is carried on top of the knapsack as shown in the accompanying illus-

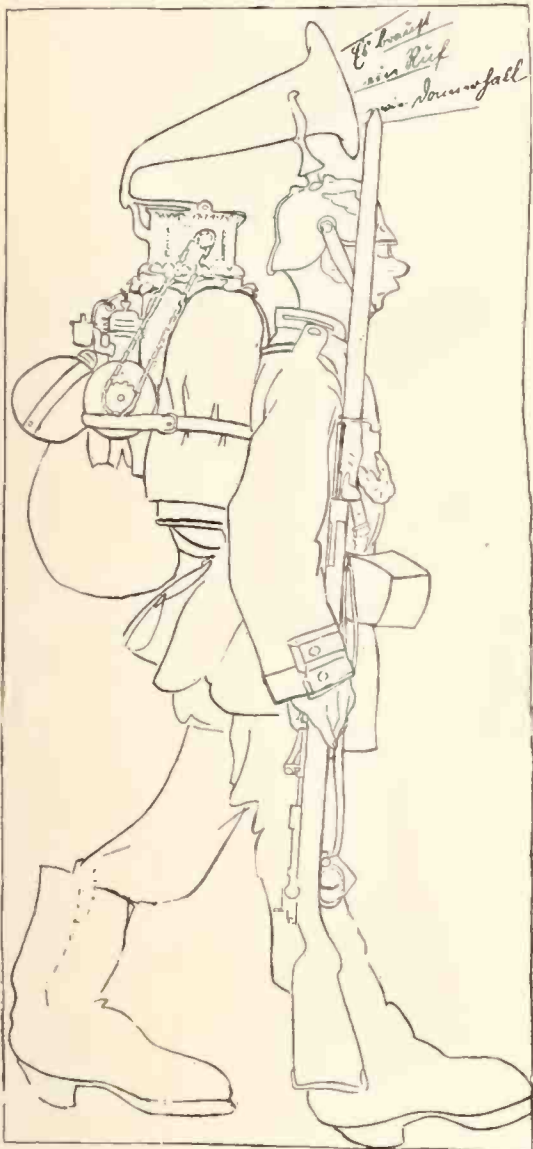

tration taken from a German paper, the horn being carried forward over the soldier's head.

Whether the device is intended to lighten the march despite the additional weight of the machine, to enable the infantrymen to raise the cry, "Hoch der Kaiser" automatically, or to raise the yells of conflict while still saving the soldiers' breath is not stated. An army corps all equipped with talkers spouting out the German battle hymn or the music of Wagner should strike terror into the heart of even the bravest enemy, especially those who have attended an amateur saengerfest in times of peace.

WM. E. GILMORE AT THE HELM.

On July 19, William E. Gilmore, president of the National Phonograph Co., got in from his European trip aboard the "Celtic" of the White Star line. He had been away since May 8. Mrs. Gilmore and J. R. Schermerhorn, assistant general manager, and his wife, returned with Mr. Gilmore.

TALKERS ON THE MISSISSIPPI.

What would the old-time pilots of the romantic days of the Mississippi think if they could return to earth, take their places in the pilot houses and hear the strains of a talking machine issue from the cabin. The steamer New Camelia, of the river fleet plying between New Orleans and Lake Pontchartrain, is the latest vessel to be equipped with a Victor machine and a bountiful supply of grand opera records, and it is said the passengers express themselves as being delighted with the voices of the grand opera stars which go to fill the leisure hours of the trip.

HERE AND THERE IN THE TRADE.

On August 10 George P. Metzger, manager advertising department of the Columbia Phonograph Co., General, started on a week's vacation, which he enjoyed aboard his yacht in Long Island Sound waters, with headquarters at Port Jefferson, N. Y.

During the past month the following jobbers registered at the New York offices of the National Phonograph Co.: J. F. Bowers, of Lyon & Healy, Chicago; C. B. Haynes, of C. B. Haynes & Co., Richmond, Va.; C. Davidson, of Perry B. Whit-sit & Co., Columbus, O.; C. N. Andrews, Syracuse, N. Y.; E. Percy Ashton, of the American Phonograph Co., Detroit, Mich.; W. E. Henry, of the Powers & Henry Co., Pittsburg, Pa.; T. H. Towell, Eclipse Music Co., Cleveland, O.; H. Shields, of the Denver Dry Goods Co., Denver, Col.; John N. Willys, of the Elmira Arms Co., Elmira, N. Y.; T. Lamaze, of the I. C. S., Scranton, Pa.

Frederick D. Wood has been appointed music director of the Leeds & Catlin Co. He was formerly a band and orchestra leader in London, Eng., and has been identified with recording work for a number of years. Recently he held the same position with the now defunct American Record Co. The Leeds & Catlin Co. have now completed samples of their new mechanical feed machines, and on Tuesday an order was placed for the first consignment. It is a popular price machine, with complete horn equipment.

On the 12th R. E. Caldwell, manager of sales of the Blackman Talking Machine Co., New York, returned from his annual fortnightly vacation, the charms of Saratoga Springs claiming his attention.

George McGrath, at one time a well-known traveling salesman in the shipping department of the Douglas Phonograph Co., New York, died on the 11th inst. at Rahway, N. J., of pneumonia, after a brief illness. The company sent a handsome floral tribute in memory of a faithful employe.

Robert L. Loud, of Buffalo, who recently closed out his talking machine business, announces elsewhere the sale of his horn stock at a discount that is worth considering.

The striking popularity of the commercial graphophone with corporations having much correspondence is well illustrated by the order just received from Sears, Roebuck & Co., Chicago, call-

ing for 1,000 blank records to be delivered every month for the use of the 300 graphophones employed by the company. When you realize that each record has a capacity of eight average letters and that it can be shaved at least 100 times, thus in reality giving each record a capacity of 360 letters, some idea can be gathered as to the immense amount of correspondence handled by that firm.

J. T. Williams, general manager of the Victor Distributing & Export Co., 77 Chambers street, New York, who has been spending the past fortnight with his family at Asbury Park, N. J., returns to business Monday.

Edward N. Burns, third vice-president of the American Graphophone Co. and manager of the Columbia Phonograph Co.'s export department, returned Monday from a special trip to Cuba.

Miss Gertrude Gannon has been made manager of the new Cincinnati, O., branch of Lawrence McGreal. She has been employed by McGreal Bros. for a number of years and has a thorough knowledge of the business.

PRESIDENT EASTON BACK FROM EUROPE.

Edward D. Easton, president of the Columbia Phonograph Co., General, returned from Europe on the "Adriatic," of the White Star line, August 7. Paul H. Cromelin, vice-president of the company, who had preceded Mr. Easton abroad, came back on the same vessel. They were accompanied by their wives and others.

J. A. BERST RETURNS FROM EUROPE.

J. A. Berst, manager of the American branch of Pathe Freres, the famous French manufacturers of talking machines, records, the cinematograph system of moving pictures, etc., 42 East 23d street, New York, returned from his six weeks' trip to Paris last month. Mr. Berst reports business in his special line in the French capital unusually strong, the capacity of the great factories being pushed to the utmost.

The Blackman Talking Machine Co. have recently put on the market a new concealed horn cabinet suitable for any tapering arm disc machine. The bell of the horn is against a perforated panel in the side of the cabinet, and the sound issues from it in full volume.

In the July issue of "The Voice of the Victor" there is a very interesting article on Caruso, which is humorously illustrated. There are a number of other valuable pointers of interest.

Mr. Dealer!

Now is the proper time to order for your fall and winter trade.

RAPKE'S SPECIALTIES

are indispensable in any Talking Machine store.

THE RAPKE COLLAPSIBLE HORN AND CRANE

sells at sight.

THE RAPKE TRAY AND LABEL SYSTEM

for Disc and Cylinder Records is Standard. Order from your Jobber.

VICTOR H. RAPKE CO., Mrs.

1661 Second Avenue

NEW YORK CITY

Leading Jobbers of Talking Machines in America

OLIVER DITSON COMPANY

Are the largest Eastern Distributors of
**Victor Talking Machines
and Records**

Orders from Dealers are filled more promptly, are packed better, are delivered in better condition, and filled more completely by this house than any other house in the Talking Machine business, so our customers tell us.

150 Tremont St., BOSTON, MASS.

C. Koehring & Bro.

INDIANAPOLIS, IND.

VICTOR DISTRIBUTORS

Our stock is complete. Orders filled the same day as received.

KNIGHT MERCANTILE CO.

Zonophone Jobbers

Get prices on needles, cases, cabinets; new 10-in. records 20c.

211 No. 12th St. ST. LOUIS, MO.

Peter Bacigalupi & Sons

SAN FRANCISCO, CAL.

WHOLESALE 1021-23 Golden Gate Ave. RETAIL 1113-15 Fillmore St.

JOBBERS Edison, Zonophone

DEALER Victor

All Kinds of Automatic Musical Instruments and Slot Machines.

Chas. H. Ditson & Co.

Have the most completely appointed and best equipped

VICTOR TALKING MACHINE Department

IN NEW YORK CITY

to-day, and solicit orders from dealers, with the assurance that they will be filled more promptly, and delivered in better condition than they can be from any other source.

Nos. 8-10-12 East 34th St., NEW YORK CITY

HARGER & BISH

Western Distributors for the

VICTOR COMPANY.

It's worth while knowing, we never substitute a record.

If it's in the catalog we've got it.

DUBUQUE, IOWA.

BABSON BROS.

19th St. and Marshall Boulevard

CHICAGO, ILL.

Special attention given DEALERS only, by G. M. NISBETT, Manager, Wholesale Department.

LARGEST STOCK OF EDISON PHONOGRAPHS AND RECORDS in the U. S.

You Can Get Goods Here

EDISON VICTOR JOBBERS DISTRIBUTORS

Our wholesale depot is a mile from our retail store. Records are not mailed over for retail customers and then shipped out to dealers. Dealers buying from us get brand new goods just as they come from the factory.

LAWRENCE MCGREAL, Milwaukee, Wis.

PITTSBURG PHONOGRAPH CO.

VICTOR and EDISON
JOBBERS

Largest and most complete stock of Talking Machines and Records in Western Pennsylvania.

Southern California Music Co.

EVERYTHING FOR TALKING MACHINES

Edison and Zon-o-Phone Jobbers

LOS ANGELES, CAL.

NEW ENGLAND JOBBER HEADQUARTERS EDISON AND VICTOR

Machines, Records and Supplies.

THE EASTERN TALKING MACHINE CO.
177 Tremont Street BOSTON, MASS.

BENJ. SWITKY

Victor and Zonophone Distributor

Phone 665 Gramercy 27 E. 14th St., New York City

KLEIN & HEFFELMAN CO.

Canton, OHIO.

Edison & Victor

MACHINES, RECORDS AND SUPPLIES

Quickest service and most complete stock in Ohio

Eclipse Phonograph Co.,

Hoboken, N. J.

Jobbers of Edison Phonographs and Records.

Best deliveries and largest stock in New Jersey

THE ECLIPSE MUSICAL COMPANY

JOBBERS OF EDISON PHONOGRAPHS,

VICTOR TALKING MACHINES,
RECORDS AND SUPPLIES.

LARGEST STOCK, QUICKEST SERVICE. 714 Prospect Ave., Cleveland, O.

Jacot Music Box Co.,

39 Union Sq., New York.

Mira and Stella Music Boxes.

Edison and Victor Machines
and Records.

JOHN F. ELLIS & CO.

WASHINGTON, D. C.

Distributor

VICTOR Talking
Machines
and RECORDS Wholesale and Retail
Largest Stock in the South

E. F. DROOP & SONS CO.

925 Pa. Avenue
WASHINGTON, D. C.

109 N. Charles St.
BALTIMORE, Md.

Wholesale and Retail
Distributors

Edison Phonographs
Victor Talking Machines

Southern Representatives for

Topham's Carrying Cases; Herzog's Record Cabinets; Searchlight, H. & S. Tea Tray and Standard Metal Co.'s Horns and Supplies.

PACIFIC COAST DISTRIBUTORS OF

Victor Talking Machines and RECORDS

STEINWAY PIANOS—LYON & HEALY
"OWN MAKE" BAND INSTRUMENTS

Sherman, Clay & Co. San Francisco Portland
Oakland Los Angeles

PERRY B. WHITSIT CO.,

213 South High Street, Columbus, Ohio.

Edison Phonographs and Records **JOBBERS** Victor Talking Machines and Records

S. B. DAVEGA,

EDISON JOBBER
VICTOR DISTRIBUTOR

Kaiser's Illuminated Signs for Edison, Victor and Columbia Records.

32 East 14th St. New York City.

WEYMANN & SON

WHOLESALE DISTRIBUTORS

EDISON Talking Machines VICTOR
Records & Supplies

Place your name on our mailing list.
We can interest you.

923 Market St., Philadelphia, Pa.

KOHLER & CHASE

Oakland, Cal. Seattle, Wash.

JOBBERS OF ZONOPHONES

—AND—
EDISON PHONOGRAPHS

WE claim Largest Stock and Best Service, and are willing to "SHOW YOU."

NEAL, CLARK & NEAL CO.,

BUFFALO, N. Y.

Jobbers of Edison, Columbia, Zonophone and American machines and records.
Largest Talking Machine house between New York and Chicago.

IF YOU'RE IN WESTERN MICHIGAN it will be money in your pocket to order

Victor Machines and Records

JULIUS A. J. FRIEDRICH
30-32 Canal Street, Grand Rapids, Michigan

Our Motto: Quick Service and a Saving in Transportation Charges

Every Jobber in this country should be represented in this department. The cost is slight and the advantage is great. Be sure and have your firm in the September list.

Leading Jobbers of Talking Machines in America

THE NEW TWENTIETH CENTURY TALKING MACHINE CO.

L. MAZOR, Proprietor
 Baltimore Headquarters Zonophone Jobber
 Talking Machines and Records. The Biggest Assortment of Hebrew Records.
 1423-25 E. Pratt Street, BALTIMORE, MD.

FINCH & HAHN,

Albany, Troy, Schenectady.
 Jobbers of Edison
Phonographs and Records
 100,000 Records
 Complete Stock Quick Service

Lewis Talking Machine Co.
 33 South 9th Street, Philadelphia, Pa.

Columbia Jobbers
 SUPPLIES OF EVERY DESCRIPTION
 Give us a trial on your next month's Record order.

SPALDING & CO.

109-113 W. Jefferson St., Syracuse, N. Y.
 JOBBERS
COLUMBIA MACHINES and RECORDS
 Also Athletic Goods, Fishing Tackle and Cutlery

THE OLDEST TALKING MACHINE HOUSE IN PENNSYLVANIA

C. J. HEPPE & SON
 1115-1117 Chestnut St. PHILADELPHIA, PA.
EDISON and VICTOR A Stock that is always Complete
GOODS and ALL ACCESSORIES

C. B. Haynes W. V. Youmans

C. B. HAYNES & CO.
 Wholesale Distributors
Edison Phonographs and Records
 All Supplies
 602-604 E. Main St. RICHMOND, VA.

Paste This Where You Can Always See It!

MR. DEALER:

We refer all Talking Machine inquiries coming from towns where we are represented by dealers to the dealer or dealers in that town.

VICTOR and EDISON JOBBERS

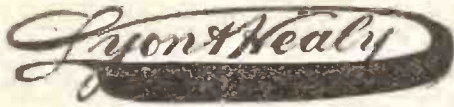

CHICAGO

F. M. ATWOOD

160 N. MAIN STREET
 MEMPHIS, TENN.
EDISON JOBBER

Have you a meritorious article you want "pushed" in Mexico? We are Edison jobbers; twenty years' experience in the country. Address

The WARNER DRUG CO.
 Torreon, Coah., Mex.
 Apartado 163

We Help the Dealer Sell
ZONOPHONES
 WE FURNISH YOU NEW IDEAS
DISC TALKING MACHINE CO.
 13 No. 9th St., PHILADELPHIA, PA.
 H. N. McMENIMEN, GEN'L MGR.

Every Jobber in this country should be represented in this department. The cost is slight and the advantage is great. Be sure and have your firm in the September list.

OUR FOREIGN CUSTOMERS.

Amount and Value of Talking Machines Shipped Abroad from the Port of New York.

(Special to The Talking Machine World.)

Washington, D. C., August 5, 1907.

Manufacturers and dealers in talking machines will doubtless be interested in the figures showing the exports of talking machines for the past four weeks from the port of New York:

JULY 15.

Bombay, 14 pkgs., \$337; 7 pkgs., \$100; 4 pkgs., \$197; Buenos Ayres, 16 pkgs., \$2,212; 43 pkgs., \$4,589; Callao, 8 pkgs., \$280; Cardenas, 4 pkgs., \$188; Cristobal, 5 pkgs., \$411; Hamburg, 2 pkgs., \$28; Havana, 15 pkgs., \$1,927; 13 pkgs., \$374; Havre, 25 pkgs., \$938; La Guaira, 9 pkgs., \$634; Lanchezbe, 10 pkgs., \$434; London, 169 pkgs., \$4,378; 25 pkgs., \$1,675; Melbourne, 14 pkgs., \$552; Milan, 30 pkgs., \$580; Para, 16 pkgs., \$892;

St. Petersburg, 8 pkgs., \$493; Singapore, 9 pkgs., \$229; Vera Cruz, 103 pkgs., \$4,123.

JULY 22.

Alexandria, 2 pkgs., \$107; Antwerp, 1 pkg., \$100; Bombay, 35 pkgs., \$830; Buenos Ayres, 2 pkgs., \$111; Cartagena, 3 pkgs., \$1,332; Ceara, 12 pkgs., \$488; Delagoa Bay, 3 pkgs., \$207; Glasgow, 5 pkgs., \$118; Guayaquil, 14 pkgs., \$666; Havana, 23 pkgs., \$1,292; 22 pkgs., \$456; Havre, 4 pkgs., \$100; Limon, 1 pkg., \$118; La Paz, 20 pkgs., \$1,232; London, 8 pkgs., \$706; 10 pkgs., \$484; 178 pkgs., \$3,590; Manila, 12 pkgs., \$1,187; Oporto, 3 pkgs., \$185; Port Au Prince, 2 pkgs., \$140; Rio de Janeiro, 11 pkgs., \$272; Southampton, 37 pkgs., \$16,280; Smyrna, 3 pkgs., \$242; 2 pkgs., \$138; Trinidad, 11 pkgs., \$203; Valparaiso, 1 pkg., \$294; 3 pkgs., \$328; Vera Cruz, 11 pkgs., \$575; Yokohama, 29 pkgs., \$857.

JULY 29.

Berlin, 102 pkgs., \$1,062; Buenos Ayres, 17 pkgs., \$1,379; Calcutta, 10 pkgs., \$306; Hamburg,

2 pkgs., \$150; Havana, 52 pkgs., \$1,253; 34 pkgs., \$397; Havre, 14 pkgs., \$500; Liverpool, 1 pkg., \$200; London, 163 pkgs., \$3,460; 1 pkg., \$100; Manila, 2 pkgs., \$216; Milan, 6 pkgs., \$190; Rio de Janeiro, 3 pkgs., \$302; St. Kitts, 9 pkgs., \$130; St. Petersburg, 9 pkgs., \$461; 7 pkgs., \$536; Vera Cruz, 37 pkgs., \$1,877; Wellington, 7 pkgs., \$139; Yokohama, 150 pkgs., \$4,639.

AUGUST 5.

Antwerp, 3 pkgs., \$400; Buenos Ayres, 8 pkgs., \$423; Colon, 3 pkgs., \$309; 13 pkgs., \$128; Corinto, 6 pkgs., \$112; Guayaquil, 6 pkgs., \$229; Hamburg, 1 pkg., \$155; Havana, 8 pkgs., \$297; Havre, 25 pkgs., \$784; Iquitos, 2 pkgs., \$125; Iquique, 2 pkgs., \$184; Liverpool, 181 pkgs., \$5,118; Savanilla, 3 pkgs., \$443; Sydney, \$2,608 pkgs., \$29,649; Valparaiso, 7 pkgs., \$160; 7 pkgs., \$359; Vera Cruz, 65 pkgs., \$1,561.

Edwin Walker, of the Walker Talker Co., Erie, Pa., was a recent World visitor.

There Is Unmistakably A Growing Demand



for a better grade of Horns, especially accentuated in decorated styles. We have just brought out a new line of Artistically Decorated

Morning Glory Horns

Jobbers! If you are looking for a line of quick sellers drop us a postal.

The following are a few of our new decorations: White, Yellow or American Beauty Roses, Water Lilies, Tulips, Golden Rod and Daisies, Black Berries, Gold Leaf, landscape and special designs in striping. Write for prices on our regular line of flower horns.

Dealers order through your jobber

NEWARK TINWARE AND METAL WORKS, 28-32 DIVISION PLACE, NEWARK, N. J.

LATEST PATENTS RELATING TO TALKING MACHINES AND RECORDS

(Specially prepared for The Talking Machine World.)
Washington, D. C., August 6, 1907.

PHONOGRAPHIC HORN. Louis Devineau, Cleveland, O. Patent No. 861,206.

This invention has for its object to provide a horn which shall be of such size as to sufficiently amplify the sounds produced in the operation of phonographs and at the same time so construct and proportion the parts of said horn as

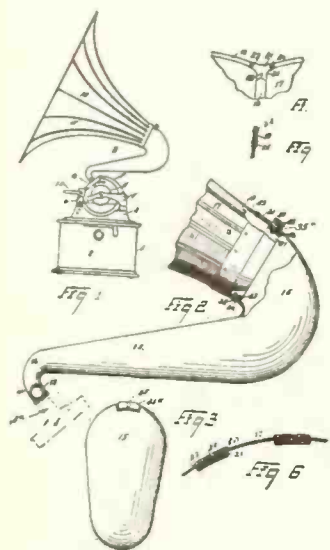

to dispense with the necessity of using a special support therefor, the horn being carried and supported entirely by the tubular portion of the reproducer. A further object of the invention is to relieve the bearings on which the carriage traverses from undue friction. A still further object of the invention is to produce a horn of this type which is extremely light and attractive

in appearance, and which may be conveniently assembled and disassembled. Fig. 1 represents a side elevation of a phonograph of standard construction having the horn applied thereto; Fig. 2 represents an enlarged detail, partly in elevation and partly in section, of the horn, a portion of the reproducer being shown in dotted lines; Fig. 3 represents an end elevation of the elbow of the horn, and Figs. 4, 5 and 6 represent details of the bell of the horn.

SOUND-REPRODUCING MACHINE. Frederick Myers, London, England. Patent No. 860,878.

This invention is for improvements in or relating to sound-reproducing machines and has particular reference to those in which disc records are employed. According to this invention, the record, instead of being carried upon a table rotated by the motor, as heretofore, is supported upon a stationary table, while the sound-box travels in a circular path over the face of the record. One advantage of a machine constructed in this manner is that it is found to operate efficiently even when tilted considerably out of the normal level, whereas machines having a rotating record are rendered irregular in action or even inoperative under similar conditions. The sound-box is driven by the motor but is also free to move laterally in a straight line and preferably in a path strictly radial to the record for the

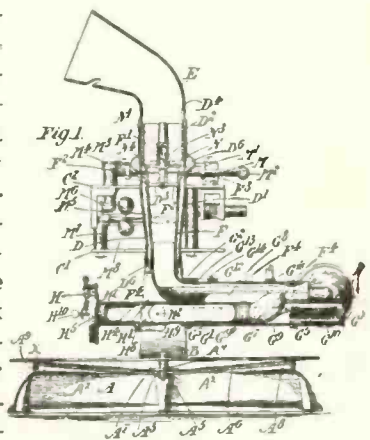

purpose of following the spiral groove therein in the well-known manner. In disc machines at present on the market, the sound-box is carried on a pivoted arm and therefore cannot move in a straight line whether such line be radial or otherwise, but traverses a path constituting an arc struck from the pivot of the arm. A further

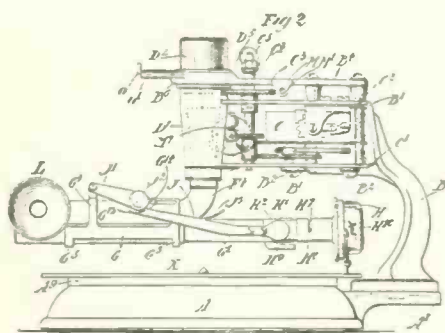

feature of this invention consists in utilizing the movement of the sound-box to provide a forced draft through the intake of the trumpet

whereby the volume of the sound is increased and the quality improved.

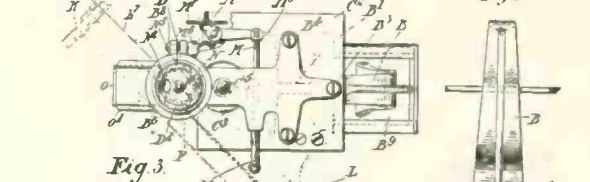

In the accompanying drawings Fig. 1 is a central vertical section of the machine viewed from the front; Fig. 2 is a side elevation of the same viewed from the right of Fig. 1; Fig. 3 is a plan of the machine; Fig. 4 is a perspective view of a detail; Fig. 5 is a rear elevation of the support-

ing bracket, and Fig. 6 is a perspective view of the sound-box and adjacent parts.

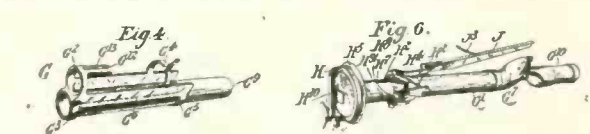

AUTOMATIC PHONOGRAPH. William W. Rosenfield, New York. Patent No. 859,114.

This invention relates to automatically operated phonographs, and more particularly to means for raising the reproducer from the record and for returning the parts to normal or starting position.

In accordance with the present invention, the return mechanism of the phonograph is actuated by a motor other than that by which the phonograph is given its reproducing movements, such additional motor being preferably an electric motor. By providing such additional motor for operating the return mechanism, the motor by which the phonograph is given its reproducing movements is relieved of the work of actuating the return mechanism and a much quicker return may be obtained than would otherwise be possible with such motors as are ordinarily used for operating the phonograph.

The invention has been made in connection with and in some of its features is especially adapted for use with phonographs provided with means for automatically rewinding the motor by which the phonograph is given its reproducing movements, and more particularly phonographs

of this class in which the phonograph is actuated by a spring motor which is automatically rewound by an electric motor. When the present invention is applied to such phonograph the automatic return mechanism may be actuated by the electric rewinding motor, the spring motor being thus relieved of the work of actuating the return mechanism. The invention is not, however, to be limited in all its features to a construction in which the return mechanism is actuated by the rewinding motor, since obviously

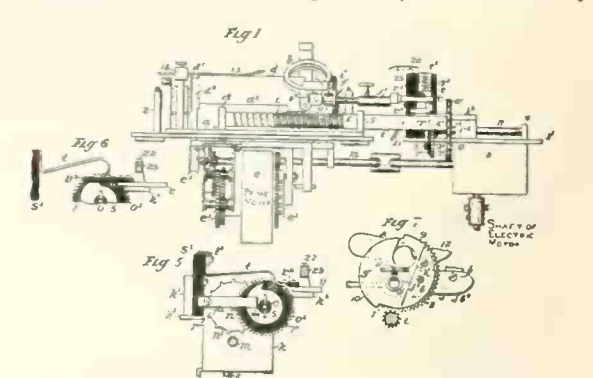

a special motor might be provided for actuating the return mechanism, and when such special motor is provided the invention might be applied to a phonograph not having a rewinding motor as well as to one having a rewinding motor.

A full understanding of the invention can best

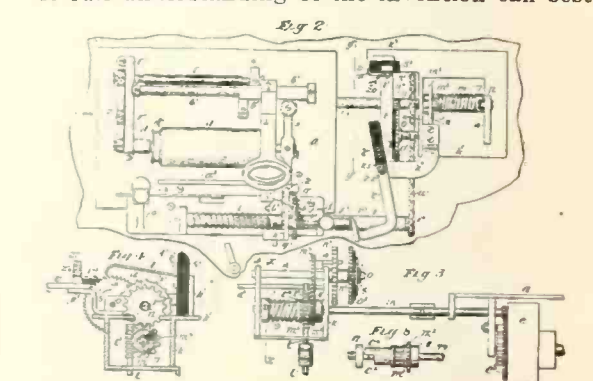

be given by a detailed description of a preferred construction embodying the various features thereof, and such a description will now be given in connection with the accompanying drawings which show the invention as applied to a spring motor actuated phonograph.

In said drawings, Fig. 1 is an elevation. Fig. 2 is a plan of a spring motor actuated phonograph of known construction provided with an automatic return mechanism and with rewinding means constructed in accordance with the present invention. Fig. 3 is a view of parts of the operating mechanism looking from the back of Figs. 1 and 2. Fig. 4 is a view, partly in section

Mr. Dealer.

Have you ever been caught short on your Edison Records and found that your Jobber could not help you out?

Have you ever lost a sale in consequence? Then you can appreciate the value of doing business with a Jobber who can fill your orders promptly.

We are the largest exclusive Edison Jobbers in the East, and carry the most extensive line of Edison Machines, Records and Supplies.

We guarantee immediate shipment of all orders.

ECLIPSE PHONOGRAPH CO.
203 Washington Street
HOBOKEN, N. J.

on line x-x of Fig. 3. Fig. 5 is a view, partly in section on line y-y of Fig. 2, looking toward the right. Fig. 6 is a view of parts shown in Fig. 5, but in a different position. Fig. 7 is an enlarged view of parts of the automatic return mechanism, looking toward the left in Figs. 1 and 2. Fig. 8 is a detail view of the friction coupling interposed between the electric motor and the spring motor, the friction spring of such coupling being removed.

GRAPHOPHONE SOUND-BOX. John F. Murray, Lindsay, O. Patent No. 860,604.

This invention relates in a reproducer or sound-box having a peculiar shape, and having a double armed stylus lever, and needle adapted for use

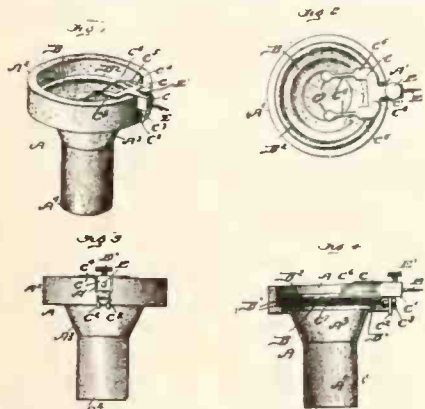

with the hard disc records. The object of the invention is to obtain a clear, distinct and natural tone. Fig. 1 is a perspective view of the improved attachment. Fig. 2 is a plan view. Fig. 3 is a side elevation. Fig. 4 is a vertical or longitudinal section.

PHONOGRAPH HORN. Henry B. Seaman, New Brighton, N. Y. Patent No. 858,763.

This invention has for its object the provision of a horn which shall be free from the raucous noises characteristic of many horns constructed at the present day. Many efforts have been made to do away with the detrimental quality above mentioned, the most recent attempt to accomplish this being what is known as the "Morning Glory" horn, but it has been discovered that the raucous quality proceeds not so much from the shape of the horn as from the uninterrupted reflection of the sounds from the sides of the horn, which in the human throat is prevented by tonsils, teeth, etc.

Accordingly baffling means have been devised to interrupt the sound waves in their progress from the reproducing device through a phonograph horn, and these means may take, conveniently, the form of a plate or gate of which it is preferable to provide several within the horn, arranging them also preferably so that they will

be adjustable at the will of the operator. By this means a tortuous passage is provided for the sound waves, considerably modifying the quality of the tone transmitted by the horn, and also enabling its volume to be controlled by the operator readily.

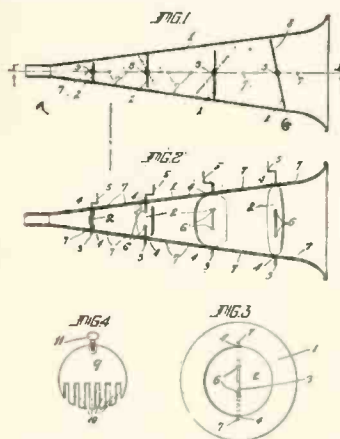

In the drawings, Fig. 1 is a longitudinal sectional view of a phonograph horn, in the construction of which the improvements have been embodied; Fig. 2 is a vertical longitudinal section on the line x-x, Fig. 1; Fig. 3 is a front elevation looking from right to left on Fig. 2, and Fig. 4 shows a modified form of baffle member.

STARTING AND STOPPING MECHANISM FOR PHONOGRAPHS. Clarence H. Wilkes and Howard Lyle, Little Falls, N. Y. Patent No. 860,110.

This invention relates to starting and stopping mechanisms for phonographs. It has for an object to provide a means connected to the starting lever and operated automatically either by

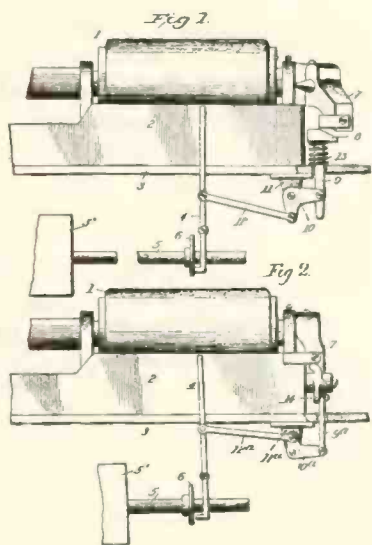

the closing and the opening of the gate or by the shifting of the lock for the gate. In the drawings Fig. 1 is a front elevation of one embodiment of the invention, and Fig. 2 is a front elevation of another embodiment of this invention.

TALKING MACHINE. William Rabe and Carl Kamrath, of New York, N. Y., assignors to Landay Bros., New York. Patent No. 859,180.

This invention relates particularly to machines of the flat record type and consists in means for adapting such machines to the making and reproducing of "home" records, and to that end they are here shown, and are preferably constructed so as to be applicable to the ordinary machines now in use, and intended for use only in reproducing commercially made records.

The object has been to produce a mechanism simple and cheap in construction, convenient and certain to operate, of great amplitude of movement so as to be applicable to records of various

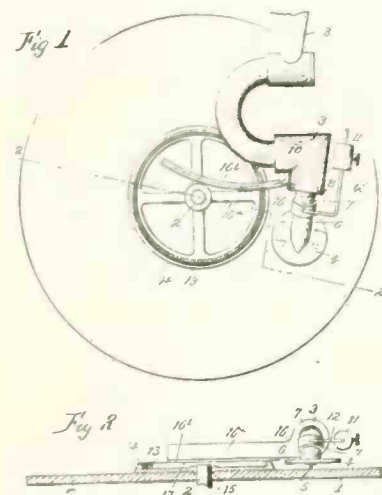

sizes, accurately adjustable to the work to be done and smooth and noiseless in action.

In the accompanying drawings, the mechanism is shown arranged for the production of records of the graphophone type, wherein the sound waves are recorded and reproduced by vertical movements of the stylus, but it is not intended to limit the scope of the invention to that use.

In said drawings, Fig. 1 is a plan view of the improved mechanism with so much of the parts of an ordinary talking machine as is necessary to an understanding of the same. Fig. 2 is a vertical, sectional elevation thereof taken on the planes indicated by the dotted lines 2-2, Fig. 1.

SOUND-CONVEYING TUBE FOR TALKING MACHINES. Robert A. Boswell, Washington, D. C. Patent No. 859,165.

This invention relates to sound-conveying tubes for talking machines, particularly talking machines of the disc type, and has for its object

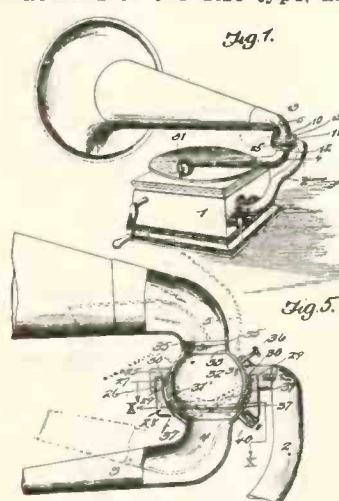

to provide a simple, inexpensive and efficient construction of the joint or connection between the reproducer arm and the delivery or amplifying horn of such sound conveying tubes, by which the necessary movements of both the reproducer arm and the horn, both

horizontal and vertical, may all be effected from substantially the same point of center. A further object of the invention is to provide a construction of joint or connection

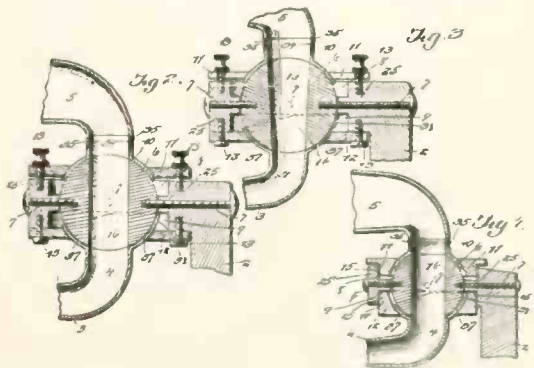

between the reproducer arm and the horn by which these parts may have freedom of movement independent of each other, so that whatever may be the position of the horn the free end of the reproducer arm may move freely as may be required to permit the stylus to follow the record

The O. K. and UNIVERSAL Horn Cranes

for Edison and Columbia Machines.

Wait for

THE IDEAL FOLDING HORN

the greatest novelty of the year.

The Ideal Fastener Co.

143 Liberty Street,
New York City.

groove. A further object of the invention is to provide means by which the horn may be held in any position in which it may be placed so as to direct the sound in any desired direction and to provide means by which the free end of the reproducer arm may be held in raised position when it is desired to lift it from the record to permit the record to be removed and a new one placed in position. A further object of the invention is to provide means by which the free end of the reproducer arm will be prevented from sagging if swung to one side of the record.

Referring to the drawings, Fig. 1 is a perspective view of a talking machine having the invention applied thereto; Fig. 2 is a vertical sectional view through the joint between the reproducer arm and the horn; Fig. 3 is a view similar

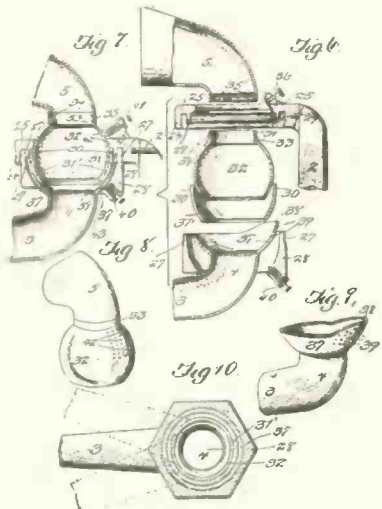

to Fig. 2, but showing a slightly modified form of joint; Fig. 4 is a view similar to Fig. 2, but showing a further modification; Fig. 5 is a view similar to Fig. 2, showing a further modification; Fig. 6 is a detail sectional view of the construction shown in Fig. 5, but showing the parts in position to be assembled; Fig. 7 is a view similar to Fig. 2, showing a construction similar to that shown in Figs. 5 and 6, but with slight modifications; Fig. 8 is a detail perspective view of the joint end of the horn shown in Fig. 7; Fig. 9 is a detail perspective view of joint end of the reproducer arm shown in Figs. 5, 6 and 7, and Fig. 10 is a horizontal sectional view on line x-x of Fig. 5.

ADJUSTABLE REPRODUCER ARM FOR TALKING MACHINES. Walter C. Runge, Camden, N. J., assignor to International Royal Phone Co., Boston, Mass. Patent No. 860,332.

This invention relates to reproducer arms for talking machines using different mandrels of various diameters on a mandrel shaft having

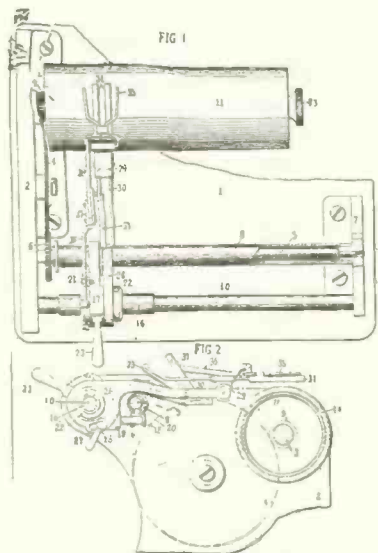

a fixed position and in which the reproducer is shifted with respect to the sound record by adjusting the arm instead of shifting the mandrel shaft as in previous machines. One of the objects is to provide mechanism by means of which the reproducer can be shifted with respect to the mandrel shaft so that records and mandrels of different diameters may be used on the same machine. Another object is to provide means whereby the reproducer stylus will be automatically placed in proper position on records of various diameters. Another object is to provide means for placing the reproducer into or out of operative engagement with the record regardless of the diameter of the latter or the posi-

tion of the arm. Another object is to provide means for guiding a reproducing trumpet along the record in such manner that it will be free to move universally under irregularities in the record, but will hold the stylus firmly in the sound groove.

Fig. 1 is a top view of a graphophone provided with this improved adjustable reproducer arm; Fig. 2 a side view of a portion of the structure of Fig. 1; Fig. 3 a side view of a portion of the structure of Fig. 1; with the raising and lowering device down; Fig. 4 a corresponding view with the raising and lowering device up; Fig. 5 a side view of the arm in conjunction with a record of large diameter; Fig. 6 a top view of a slight modification of the arm in conjunction with a record of small diameter; Fig. 7 a side view of the structure of Fig. 6; Fig. 8 a side view of the structure of Figs. 6 and 7 in conjunction with a record of large diameter; Figs. 9 and 10 detail views of a form of manually operated lever system; Fig. 11 a detail view of a sound-box holder mounted on the arm in place of the trumpet yoke.

SOUND-BOX FOR TALKING MACHINES. Minard A. Possons, Cleveland, O. Patent No. 857,483.

This invention relates to improvements in sound boxes for talking machines, and is for use in connection with that class of machines in which a disc record is used and a metal stylus. It is well known that in the machines which use a disc record and a metal stylus, that are now so generally used, that the needles or stylus are intended to be used but once, and that after such

use the needle is removed and another unused one substituted therefor.

One object of the present invention is to avoid the necessity of removing the stylus from its support as is required in the machines now in use, by providing an improved stylus formed from sheet metal and having a plurality of closely arranged reproducing points which can be cheaply constructed, and a new reproducing point brought into operative position by a slight rotary movement of the disc.

Another object is to so construct the stylus that it is rigid in the lateral direction of the sound waves formed upon the disc record to prevent any possible loss in the transference of the delicate variations thereof to the sounder disc, but which is flexible in a direction at right angles to these sound waves so that it will yield to the roughness and unevenness of the bottom of the sound wave groove, which is found, in practice, to very materially soften the tone and to avoid the well-known grinding and grating sound very common to these instruments.

Another object of the present invention is to support this disc-like stylus with its plurality of reproducing points with the plane of its flat surface extending across the disc record, or radial thereto, and the axis thereof at right angles to said direction, which causes the lateral irregularities of the sound waves to act upon the stylus in a direction parallel with the flat plane or surface of the disc, and therefore offering a rigid unyielding stylus in that direction, but which will yield in the direction at right angles thereto for the purpose stated in the preceding paragraph.

Another object of the present invention relates to an improved oscillatable support for the stylus and in the manner of connecting the stylus bar with the sound disc, as well as other details of specific construction of the stylus itself.

In the accompanying drawings Fig. 1 is an end view of the improved sound box, Fig. 2 is an edge elevation of Fig. 1 partly shown in section; Fig. 3 is an enlarged sectional view taken longitudinal the oscillating support for the stylus. Fig. 4 is an enlarged detached view in perspective of the stylus carrying member.

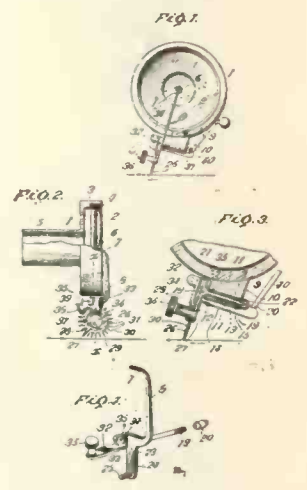
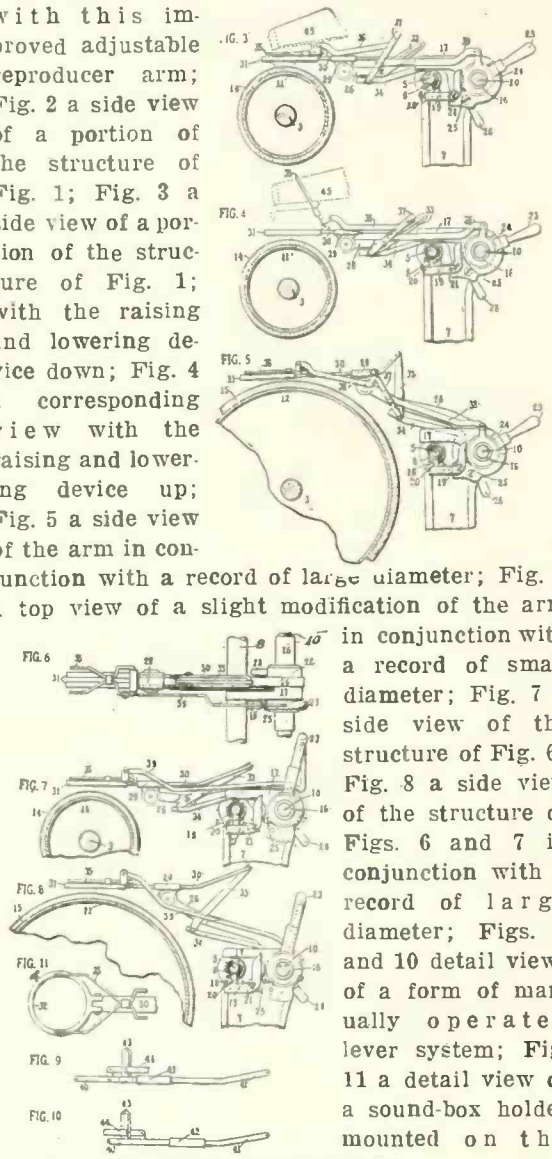



Mr. Dealer:
If you want always to get the goods, send your orders to a house of exclusive **Victor Jobbers.**
STANLEY & PEARSALL
541 Fifth Avenue, N. Y.

DEALERS — Be Up to Date

Stop clinging to traditions and buying inferior **RECORDS** because they have a name.

Order the **IMPERIAL** and get the latest and best on the market at most advantageous prices to yourself.

SEND FOR LISTS AND PRICES

LEEDS & CATLIN COMPANY - - **New York**

RECORD BULLETINS FOR SEPTEMBER, 1907.

NEW EDISON GOLD MOULDED RECORDS.

Edison Gold Moulded Records are made only in Standard Size. Both Standard and Concert Records may be ordered from this list. Order by number, not title. If Concert Records are wanted, give the number and letter C.

- 9626 Comin' Thro' the Rye—Humoresque (Bellstedt) Edison Concert Band
- 9627 Jack and Jill (Cohan) Ada Jones
- 9628 When the Bluebirds Nest Again, Sweet Nellie Gray (Helf) Manuel Romain
- 9629 Hungarian Dance—No. 2 (Brahms) Edison Hungarian Orchestra
- 9630 Theodore (Bryan) Edward M. Favor
- 9631 Many's the Time (Rose & Fischer) Collins and Harlan
- 9632 When Someone Really Cares (Cahill) Irving Gillette
- 9633 To Your Health (Gesundheit) Waltz (Helf) Edison Military Band
- 9634 I'd Rather Two-Step than Waltz, Bill (Burt) Billy Murray
- 9635 An Amateur Minstrel Rehearsal (Original) Edison Vaudeville Co.
- 9636 Just Because I Loved You So (Harris) Harry Anthony
- 9637 Chopin's Nocturne (Chopin) Hans Kronold
- 9638 I Think I Oughtn't Ought to any More (Bryan) Edward Meeker
- 9639 Tell Mother I'll Be There (Fillmore) Edison Mixed Quartet
- 9640 Your Lips, Your Eyes, Your Golden Hair (Sturges) Reinald Werrenrath
- 9641 The Magpie and the Parrot (Bendix) Edison Symphony Orchestra
- 9642 Brother Noah Gave Out Checks for Rain (Longbrake) Arthur Collins
- 9643 Herman and Minnie (Original) Ada Jones and Len Spencer
- 9644 A Little Suit of Blue (Chattaway) Byron G. Harlan
- 9645 Red Wing Medley (Original) Albert Benzier
- 9646 Everloving Spooony Sam (Fischer) Bob Roberts
- 9647 Flanagan at the Barber's (Original) Steve Porter
- 9648 The Blue Jay and the Thrush (Fulton) Harlan and Belmont
- 9649 The 74th Regiment March (Losey) Edison Military Band

COLUMBIA 10-INCH DISC RECORDS.

- 3672 March of the Powhatan Guard (Wm. Wall Whiddit). Official March of the Jamestown Tri-Centennial Exposition. Prince's Military Band
- 3673 Jamestown Dixie or Dixie Patrol (A. Patricolo) Prince's Military Band
- 3674 Since You Called Me Dearie (Durand). Tenor Solo, Orch. Acc. Byron G. Harlan
- 3675 You Splash Me and I'll Splash You (Solman). Soprano Solo, Orch. Acc. Miss Ada Jones
- 3676 I'm Happy When the Band Plays Dixie (Vanderveer). Whistling Solo, Accomp. by Prince's Military Band. Edward Ables
- 3677 When the Bluebirds Nest Again, Sweet Nellie Gray (Costello and Helf). Vocal Quartet, Male Voices, Piano Acc. Columbia Quartet
- 3678 Every Little Bit, Added to What You've Got, Makes Just a Little Bit More (J. Fred Helf). Baritone and Tenor Duet, Orch. Acc. Collins and Harlan
- 3679 Many's the Time—Coon Song (Rose and Fischer). Baritone and Tenor Duet, Orch. Acc. Collins and Harlan
- 3680 Little Black Lamb (Theo. Morse). Baritone and Tenor Duet, Orch. Acc. Stanley and Burr
- 3681 Red Wing—An Indian Fable (Kerry Mills). Baritone and Tenor Duet, Orch. Acc. Stanley and Burr
- 3682 Won't You Be My Honey (Theo. Morse). Soprano and Tenor Duet, Orch. Acc. Ada Jones and Billy Murray
- 3683 Everloving Spooony Sam—Coon Song (Rice and Fischer). Baritone Solo, Orch. Acc. Arthur Collins
- 3684 Face to Face—Sacred (Herbert Johnson). Tenor Solo, Orch. Acc. Henry Burr
- 3685 Saved by Grace—Sacred (Crosby and Stebbins). Tenor Solo, Orch. Acc. Henry Burr
- 3686 A Little Suit of Blue (Chattaway). Tenor Solo, Orch. Acc. Byron G. Harlan
- 3687 Die Wacht am Rhein. Tenor Solo in German, Orch. Acc. Emil Muench
- 3688 Die Welt ist Meschige. Contralto Solo in Hebrew. Piano Acc. Frau Pepi Littman
- 3689 Schulem Elelchem. Contralto Solo in Hebrew, Piano Acc. Frau Pepi Littman
- 3690 Herman and Minnie (introducing the song "Herman"). Vaudeville Specialty, Orch. Acc. Ada Jones and Len Spencer
- 3691 Flanagan at the Barber's (Steve Porter). Vaudeville Specialty, Orch. Acc. Steve Porter
- 5605 Presidente Quintana—Marcha (Ricardo Herold) Banda Espanola
- 5655 Lejos Del Dien Amado—4 Vals Boston (Gerardo Metallo) Banda Espanola

COLUMBIA 12-INCH DISC RECORDS.

- 5700 Royal Italian March. Banda Espanola, Senor C. A. Prince, Director
- 5708 Selection from "Madame Butterfly" (Puccini) Banda Espanola, Senor C. A. Prince, Director
- 5710 Selection from "Traviata" (Verdi) Banda Espanola, Senor C. A. Prince, Director
- 5711 Overture "Magic Flute"—Die Zauberflote (Mozart) Banda Espanola, Senor C. A. Prince, Director
- 9000 Gems of Bohemia—Smes Ceskyeh Pismi (F. V. Sasfrank) Prince's Military Band
- 30079 Selection from "Martha" (Flotow) Prince's Military Band
- 30080 From Greenland's Icy Mountains—Sacred (Dr. Lowell Mason). Baritone Solo, Orch. Acc. Charles Gordon

NEW COLUMBIA X.P. (CYL.) RECORDS.

- 33159 Since You Called Me Dearie (Durand). Tenor Solo, Orch. Acc. Byron G. Harlan

- 33160 You Splash Me and I'll Splash You (Solman). Soprano Solo, Orch. Acc. Miss Ada Jones
- 33161 I Know That I'll Be Happy 'Till I Die—Solo by Arthur Collins. Minstrel, Orch. Acc. Rambler Minstrel Company
- 33162 When the Bluebirds Nest Again, Sweet Nellie Gray (Costello and Helf). Vocal Quartet, Male Voices, Orch. Acc. Columbia Quartet
- 33163 Red Wing—An Indian Fable (Kerry Mills). Baritone and Tenor Duet, Orch. Acc. Stanley and Burr
- 33164 Won't You Be My Honey (Theo. Morse). Soprano and Tenor Duet, Orch. Acc. Ada Jones and Billy Murray
- 33165 Everloving Spooony Sam—Coon song (Rice and Fischer). Baritone Solo, Orch. Acc. Arthur Collins
- 33166 Where the Silvery Colorado Wends Its Way (Charles Avril). Baritone Solo, Orch. Acc. J. W. Myers
- 33167 Saved by Grace—Sacred (Crosby and Stebbins). Tenor Solo, Orch. Acc. Henry Burr
- 33168 A Little Suit of Blue (Chattaway). Tenor Solo, Orch. Acc. Byron G. Harlan
- 33169 Herman and Minnie (introducing the song "Herman"). Vaudeville Specialty, Orch. Acc. Ada Jones and Len Spencer
- 33170 Flanagan at the Barber's (Steve Porter). Vaudeville Specialty, Orch. Acc. Steve Porter
- 40543 Glorias Nacionales—Paso Doble Militar (Rafael Gascon) Banda Espanola
- 40548 Tarde Otonal—Vals (Juan G. Evans) Banda Espanola
- 40551 De Flor en Flor—Schottische (Juan G. Evans) Banda Espanola

NEW COLUMBIA B. C. (CYL.) RECORDS.

- 85132 Medley Two-step (Arr. by R. L. Halle)... Prince's Orchestra—Dance Music
- 85133 Adoree—Valse Lente (F. Legrand)... Prince's Orchestra—Dance Music
- 85134 Medley Waltz (Arr. by C. A. Prince)... Prince's Orchestra—Dance Music
- 85135 Waltzes from "The Red Mill" (Victor Herbert)... Prince's Orchestra—Dance Music
- 85136 Many's the Time—Coon Song (Rose and Fischer). Baritone and Tenor Duet, Orch. Acc. Collins and Harlan
- 85137 Little Black Lamb (Theo. Morse). Baritone and Tenor Duet, Orch. Acc. Stanley and Burr
- 85138 Face to Face—Sacred (Herbert Johnson). Tenor Solo, Orch. Acc. Henry Burr
- 85139 Chimmy and Maggie in Nickel Land—Tough Dialect (Len Spencer). Vaudeville Specialty, Orch. Acc. Ada Jones and Len Spencer
- 85140 Uncle Josh in Society (Cal Stewart). Uncle Josh Weathersby's Laughing Story. Cal Stewart

ZON-O-PHONE 10-INCH RECORDS.

- ZON-O-PHONE CONCERT BAND.
- 834 Gallant Fifth March
- 835 Grand Mogul—March and Two-step
- 836 I'd Like to Know Your Address and Your Name—Medley Waltz
- 837 I'd Rather Two-step than Waltz, Bill—Medley Two-step
- 838 Marching Home Thro' Dixie Land—March
- 839 Pickles and Peppers—March
- HAGER'S ORCHESTRA.
- 840 Brookfield—Two-step
- 841 Dark Eyes—A Mexican Dance
- 842 Gibson Girl—Waltz
- ACCORDION SOLO BY J. J. KIMMEL.
- 843 Straight Jigs—Medley
- CLARINET SOLO, PLAYED BY THEO. PUSSINELLI, WITH ORCH. ACC.
- 844 Little Nell
- VOCAL SELECTIONS WITH ORCH. ACC.

- 826 Chimmy and Maggie in Nickel Land—Descriptive Scenc... Ada Jones and Len Spencer
- 845 Dinner Time... Arthur Collins
- 846 Every Little Bit, Added to What You've Got, Makes Just a Little Bit More... Collins and Harlan
- 827 Harrigan... Billy Murray
- 828 Holy, Holy, Holy... Mendelssohn Mixed Quartet
- 829 I'm in Love with the Slide Trombone... Miss Ada Jones
- 830 Mammy's Little Curly Head... Miss Ada Jones
- 847 Mighty Lak' a Rose... Henry Burr
- 831 Oh, That Will Be Glory... Peerless Quartet
- 848 Reed-Bird (The Indian's Bride)... Collins and Harlan
- 849 Rescue the Perishing... Frank C. Stanley and Henry Burr
- 832 Take Me Where There's a Big Brass Band... Billy Murray
- 850 Theodore... Edward M. Favor
- 833 Where Are You Going to, My Pretty Maid?... Mendelssohn Mixed Quartet

NEW VICTOR RECORDS FOR SEPTEMBER.

- ARTHUR PRYOR'S BAND.
- 5203 Comedian's March—From Bartered Bride. Smetana 10
- 5205 Austrian Army Bugle-Calls—Waltz... Tlusty 10
- 5206 On the Belvidere—Two-step (Na Belvederu Pochod) ... Fester 10
- 31650 Daughter of the Regiment Overture, Donizetti 12
- 31651 The Death of Custer—The Battle of Little Big Horn... Herbert 12
- 31652 Red Mill Selection... Herbert 12
- VICTOR ORCHESTRA, WALTER B. ROGERS, CON.
- 5185 The Minute Men—March and Two-step... Winburn 10
- 5208 Merry Widow Waltz... Lehar 10
- VICTOR DANCE ORCHESTRA.
- 31655 Merry Widow Waltz (Ballsirenen)... Lehar 12
- BELL SOLO BY CHRIS. CHAPMAN, WITH ORCH.
- 5188 Medley Dance... Kamman 10
- MEZZO-SOPRANO SOLO BY MISS PEARL BENHAM WITH ORCH.
- 5187 In May Time... Speaks 10
- TENOR SOLO BY HENRI LEONI WITH ORCH.
- 5201 I Love You, Ma Cherie... 10
- TENOR SOLO BY HARRY MACDONOUGH WITH ORCH.
- 5189 Dreaming... Dailey 10
- COMIC SONG BY MISS ADA JONES WITH ORCH.
- 31654 I'm in Love with the Slide Trombone... Furth 12
- TENOR SOLO BY FREDERIC C. FREEMANTEL WITH ORCH.
- 5194 Over the Line... Phelps 10
- BASS SOLO BY FRANK C. STANLEY WITH ORCH.
- 31653 Chorus, Gentlemen!... Lohr 12
- SONGS BY BILLY MURRAY WITH ORCH.
- 5195 I Think I Oughtn't Auto Any More... 10
- 5196 In the Land of the Buffalo... Williams-Van Alstyne 10
- 5197 Harrigan—From Fifty Miles from Boston... Cohan 10
- "COON" SONG BY ARTHUR COLLINS WITH ORCH.
- 5204 Brother Noah Gave Out Checks for Rain... Longbrake 10
- DUET BY STANLEY AND MACDONOUGH WITH ORCH.
- 5200 When Johnny Comes Marching Home, Lambert 10
- FOUR RECORDS BY VESTA VICTORIA.
- 5181 The Next Horse I Ride On... Murray-Everhard 10
- 5182 Waiting at the Church... Leigh-Pether 10
- 5183 Poor John... Pether 10
- 5184 Billy Green... Lawrence-Gifford 10
- LAUGHING SPECIALTY BY FAMOUS COMEDIANS.
- 52000 Laughs You Have Met.—Illustrated by five famous fun-makers... 10
- GERMAN SPECIALTY BY JONES AND SPENCER WITH ORCH.
- 5186 Minnie and Herman... 10
- MALE QUARTET BY THE HAYDN QUARTET ORCH. ACCOM.
- 5167 The Last Rose of Summer is the Sweetest Song of All... Sidney 10
- COMIC DUETS BY COLLINS AND HARLAN WITH ORCH.
- 5190 There's Room for Us All on the Trolley... Bennet 10
- LYRIC QUARTET ORCH. ACCOM.
- 5199 Rock of Ages... Buck 10
- ARTHUR PRYOR'S BAND.
- 5192 Ship Ahoy, March... Lusk 8
- VICTOR ORCHESTRA.
- 5193 The Banner March... Von Blon 8
- YODEL SONG BY GEORGE P. WATSON WITH ORCH.
- 5129 Sour Krout is Bully... 8
- DUET BY MISS JONES AND MR. MURRAY WITH ORCH.
- 5137 It's Nice to Have a Sweetheart—From The Tourists... Kerker 8

SATISFIED

customers are the best asset you can have. You must handle the best if you want your trade to come again and send others. Our Cabinets will do their share to make your business a paying proposition.

CABINETS FOR DISC AND CYLINDER RECORDS

Let us send you booklets

THE UDELL WORKS INDIANAPOLIS, INDIANA, U.S.A.



No. 505. CYLINDER RECORD CABINET Holds 125 Cylinder Records.

DESCRIPTIVE SPECIALTY BY COLLINS AND HARLAN.	
1727 Two Rubes in a Tavern	Stanley 8
YANKEE TALK BY CAL STEWART.	
1640 Uncle Josh on a Street Car	Stewart 8
TWO "TEDDY BEAR" RECORDS.	
Issued especially for the children.	
5202 Frolic of the 'Teddy Bears—Adapted from Bratton's "Teddy Bear's Picnic" (played by Victor Orchestra).	
5191 The Teddy Bear's Lullaby—Sung by Mr. Macdonough, with orchestra.	8
NEW RED SEAL RECORDS.	
ALICE NIELSEN, SOPRANO, IN ITALIAN.	
74074 Barbieri—Una voce poco fa—(A Little Voice I Hear)	Rossini 12
FLORENCIO CONSTANTINO, TENOR.	
34072 Rigoletto—La donna è mobile (Woman is Fickle)	Verdi 10
74074 Barbieri—Ecco ridente (Dawn, with her Rosy Mantle)	Rossini 12
DUETS BY NIELSEN AND CONSTANTINO IN ITALIAN.	
74075 Traviata—Parigi o cara—(Far from Gay Paris)	Verdi 12
74076 Faust—Dammi ancor—(Duet from Garden Scene) (Let Me Gaze on Thy Beauty)	Gounod 12
MARIO ANCONA, BARITONE (IN ITALIAN).	
87010 Mattinata—Morning Serenade	Tosti 10
87011 Ivano—Serenata—In Vain	Tosti 10
HERRBERT WITHERSPOON, BASS.	
74071 Meet Me by Moonlight Alone	Wade 12
74072 Messiah—Why Do the Nations	Handel 12
AN ORATORIO NUMBER BY DE GOGORZA.	
EMILIO DE GOGORZA, BARITONE, IN ENGLISH.	
74069 God, My Father—From "Seven Last Words of Christ"	DuBois 12

EDISON CIRCULAR TO THE TRADE.

Notice of Change in Horn Equipment and List Prices of Edison Phonographs, to Take Effect September 16, 1907.

The following communication was sent out to the talking machine trade on July 22 by the National Phonograph Co.:

"Beginning September 16, 1907, all Edison phonographs will be equipped with a horn support and solid metal polygonal shaped horn, somewhat different from any now on the market. The horns will be finished in black, with gilded decoration, and present a very neat, as well as attractive appearance. They will also produce better and more satisfactory results phonographically. The sizes of horns for different machines follow: Gem, 19 inches long, 11-inch bell; Standard, 30 inches long, 19-inch bell; Home, 32 inches long, 21½-inch bell; Triumph, Balmoral, Conqueror and Alva, 33 inches long, 24-inch bell.

"It is a well-known and established fact that for several years the price of all material, as well as labor, used in the construction of mechanical and musical instruments has constantly increased, and although we have heretofore considered raising the prices of phonographs to meet this increase in cost of manufacture, we have withheld doing so up to the present time. Now, however, that we are going to supply, at a further increase in cost, a larger horn and horn support, we are compelled to do so, and, beginning September 16, 1907, list prices of the different types of Edison phonographs, including horn and horn support, will be as follows: Gem, \$12.50; Standard, \$25; Home, \$35;

Triumph, \$55; Balmoral, \$70; Conqueror, \$85; Alva, \$85. Discounts to jobbers and dealers will remain the same as at present. No changes will be made in equipment or prices of slot machines of any style.

"Jobbers and dealers having a stock of machines on hand September 16 must equip them with the new horn and horn support, and sell them at the increased prices. To enable them to do this we will supply the horn and horn support separately from machines, at the increase made in price of outfits, these prices being subject to regular machine discounts, i. e., horn and horn support for Gem machine, at \$2.50 each, list; horn and horn support for Standard, Home, Triumph, Balmoral, Conqueror or Alva, at \$5 each, list. Dealers should order from their jobbers, and the jobbers from us.

"It is impossible to tell just when we will be able to begin shipping machines with the new equipment, but whenever it is, it must be distinctly understood that such outfits must not be sold to users until on or after September 16. There will be no objection, however, to a jobber supplying them to dealers prior to that time, provided it is understood and agreed to that they cannot be put on sale until that time. To take care of requirements up to September 16 we will continue filling orders with the present equipment, unless instructed otherwise.

"Within the next two or three weeks we hope to be in position to supply sample outfits complete, to such jobbers as may desire them, or to show them what the new horn and crane will be. If you desire samples sent you, please place your order immediately, plainly specifying thereon: 'One each Gem, Standard, Home and Triumph machines equipped with new style horn and horn support, or should you not want all of these different styles, specify just which particular types you do want.

"In order to include the foregoing changes, and to embody other minor changes, a new agreement will also be issued to take effect September 16, 1907. Jobbers' copies of these agreements will be forwarded to jobbers at the earliest possible date, and they should be signed and returned to us not later than September 16. New agreements will also be forwarded to dealers, either direct or through their jobbers, and should be signed and returned immediately to either the jobber or us direct, as the case may require.

"To provide against delay in supplying extra horns and supports for machines on hand, we would thank dealers to notify their jobbers, and jobbers to notify us on August 15, as to the approximate number of each style they will require on September 16, and would suggest your placing orders for them as soon after August 15 as possible.

TALKING MACHINE SAVES LIVES

Of a Picnic Party During a Recent Outing—Honored as a "Hero."

A large talking machine equipped with a very loud reproducer and big brass horn was the means of saving the lives of a picnic party of ten on a recent holiday. Five young couples had started early in the day for a launch trip on Long Island Sound, and in addition to a generous supply of edibles and drinkables had brought along the "talker" and a number of choice records to enliven the idle hours.

All went well until, while returning at sunset, a heavy and sudden fog blotted out everything except within a few yards of the boat and rendered the shore line and passing craft invisible. The situation was especially dangerous owing to the fact that one of the many sound steamers leaving the city late in the afternoon might bear down and run into them before a move could be made toward safety. Those in the launch who realized the danger and their helplessness had resigned themselves to the worst, when one bright mind suggested the use of a talker as a fog horn. A record of a full band selection was placed on the mandrel and hardly had the machine started to play when shouts and the tinkling of engine-room bells were heard and a big passenger steamer swept by not ten yards away, with propellers churning up great seas in an effort to arrest her progress with full speed astern, and the rail lined with anxious faces. Only the sound of the talking machine had given the pilot warning of the proximity of the launch and enabled him to sheer off in time to avoid a collision. As it was, the steamer's wash almost swamped the little craft.

The picnic party reached shore safely, although the hour was late and all suffered from a bad case of nerves, but the talker was hailed as a guardian angel and holds a place in the heart of the owner that could not be filled with the possession of a half dozen automobiles.

WALZ'S BIG TALKER TRADE.

The El Paso Dealer Says Sales Are Running Away Ahead of Last Year.

W. G. Walz, of the W. G. Walz Co., dealers in pianos, organs and talking machines, El Paso, Texas, was among recent trade visitors. Mr. Walz incidentally called at the National Phonograph Co.'s headquarters in Union Square and talked shop with several heads of departments. He stated that his sales of talkers ran away ahead of last year, and that he looked for a rousing business this fall, as prosperity was in full swing throughout the entire State, and that every industry was booming.

This Show Case and 50 per cent. Cash Profits are yours

Hohner Harmonica Display

SHOW CASE and HARMONICA ASSORTMENT

This offer consists of an excellent assortment of the best selling HOHNER Harmonicas, to retail at prices ranging from 25c. to \$1.00, and a first-class show case, made of the best material and perfect in every respect. The assortment is made up of seventeen different styles, with not a dead seller among them. Each style comes in a separate package which is labeled to show at what price its contents can be retailed for and contains an assortment of keys. The case is made of solid quarter-sawn oak, plate glass, and is specially designed for displaying Harmonicas. The instruments appear on an elevated platform, under which there is room to store a small stock. With every case a number of price-tickets are given which can be placed on each instrument to display its retail value.

THIS IS WHAT YOU RECEIVE:

4 dozen Assorted Harmonicas, to retail at 25c. each	\$12.00
2½ dozen Assorted Harmonicas, to retail at 35c. each	10.50
2 dozen Assorted Harmonicas, to retail at 50c. each	12.00
½ dozen Assorted Harmonicas, to retail at 75c. each	4.50
½ dozen Assorted Harmonicas, to retail at \$1.00 each	6.00

Total retail value of Harmonicas.....\$45.00
Value of Show Case, at least..... 12.00

Total Value.....\$57.00

Your Gain A Show Case which will last indefinitely
50 per cent. Cash Profit on your investment.
Size of case: 20¾ inches wide, 24¾ inches long, 14 inches high.

Ask Your Jobber

M. HOHNE

475 Broadway, NEW YORK
Canadian Office, 76 York St., Toronto

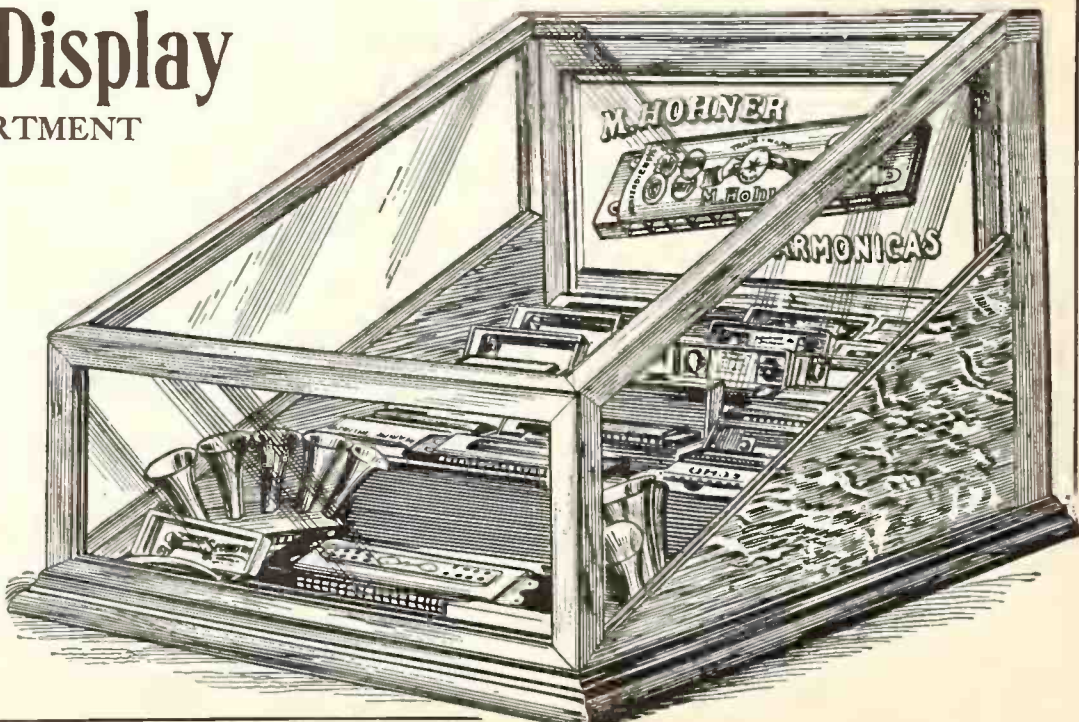

MOVING PICTURE AND AUTOMATIC MACHINES

WHAT HAS BEEN ACCOMPLISHED

In Bringing the Moving Picture and Its Commercial Possibilities to the Attention of the Talking Machine Trade—Facts in This Connection That Are Well Worth Thinking Over.

Nearly a year has passed since The Talking Machine World first brought the moving picture machine to the attention of this trade as an article of great commercial possibilities. At that time it was only its use in the 5-cent theaters that we referred to. We saw these places of amusement spring up one after another until not a prominent thoroughfare in our city was left unoccupied. At first it was supposed that this was but another craze which had taken hold of the American public, and which would soon die out, but one only has to visit the Nickelodian of to-day to realize that these places are here to stay. Most important of all, however, they awakened the brains of inventors to the immense field open to the man who could invent a motion machine suitable for home use. This, as our readers know, is no longer a dream, a longed-for attainment, but a settled question. Like in every other phase of life when necessity calls human brains respond, if not to the letter at least with a practicable substitute.

With our large facilities for gathering news from all parts of the globe we have been keeping our finger on the pulse of this trade, and on the appearance of this new aspirant for trade favor were promptly on the ground in the interests of the talking machine trade, for we realized the importance of pushing the motion picture machine along with the "talker." Hence we have opened this department in the interest of these devices, and to keep the manufacturer, jobber and dealer acquainted with the condition of affairs. To-day, at least a score of the largest jobbers in this country have taken up the moving picture machine, and are pushing them in their territory, with the aid of their road men, with such good results that when asked by The World what he thought of the possibilities one jobber said: "Why, I have already sold my entire first order and have not received the first shipment yet."

This certainly is an encouraging start, but one must remember that this is but the beginning, for after the sale of the machines come films, an endless list, with fresh subjects coming out each month. In many ways there are advantages in this business over the talker; for instance, in shipping films to dealers or customers, the saving in freight charges will be enormous. Dealers won't have to worry, either, about how large a percentage of broken records the month's report will show, for films are put up in little round fireproof metal boxes, which eliminate all chances of damage. The supply end of this new business is very large, and an endless number of lights, lenses, rewinds, tanks for gas, wire, etc., etc., for all of which there will be a goodly demand, which means an extra profit for jobber and dealer.

Like in every phase of business any radically

new invention is looked upon skeptically at the start. This in most cases arises from ignorance of the article or subject involved. One of the first points to be brought to light was the exorbitant cost of films. This was a perfectly natural conclusion to arrive at when it is remembered that the only pictures which came under their notice were those used by professionals and manufactured by the old-established houses in this line. Films of this character, of course, are beyond the purse of private parties, costing, as they do, from 14 to 16 cents a foot, many of the subjects running up to the 1,000 foot mark. The new companies knew that to give an exact reproduction of these large pictures and market them at a reasonable figure was impossible, so they began to study the problem before them with the following results: Firstly, for home use, it was unnecessary to throw a picture more than a half or third the size used in theaters. It was therefore decided that a smaller film would be desirable, for the saving in cost would be material. Secondly, by reducing the picture the flicker so noticeable in many of the larger would be reduced, if not wholly eliminated, and, thirdly, by just so much as the film picture was reduced the number of pictures to the foot would increase. For example, a 50-foot film, with pictures measuring one-half inch, would do the same work that a hundred-foot film picture measuring one inch.

Of course, it would only be possible to carry this proportion out to a limited point, for if the picture was too small you would lose both scope and much detail. Our readers must not think, however, that because a film happens to be half the size of a regular it can be retailed at 7 or 8 cents a foot instead of 14 or 16, for this is not the case. It is true that there is a good deal saved on the raw material, but one must take into consideration that each picture is retouched separately, and if the number is doubled to the foot the cost of this process is in proportion increased, therefore, when the new companies turn out a subject to retail at 10 cents a foot, with a liberal discount to jobbers and dealers, they have performed what not so long ago was thought impossible. Of course, as this business progresses it is certain that a process will be found whereby the cost will be still more reduced. Even at the 10-cent rate, however, the manufacturers had to turn out subjects that would not exceed \$1.50 for the benefit of those who could not afford a longer film. But 10 or 15 feet are run off too quickly to give any satisfaction, so these pictures are joined together into what is called an endless film, and as the subjects for the most part are such that one cannot tell just where each begins or finishes, such as a bathing scene, railroad trains, a prize fight, etc., very good results are obtained.

As time goes on and the "talker" trade becomes more familiar with this business, many ideas now in embryo will be developed to push the film business. The same thing is true in this as in that of the phonograph field. The money will be made mostly from the pictures. One thing undoubtedly will be brought about, namely, an exchange system, whereby owners of machines buying a certain number of films outright will be allowed to exchange them for a nominal charge—enough to cover wear and give a fair margin of profit to the dealer. Dealers should also get their customers to form clubs if possible, thereby lessening the individual expenditure. This will also spread the craze, for members will invite outsiders to their entertainments, and these in turn are likely to club in or buy an outfit for their own use. These social gatherings will do much toward arousing new interest in talkers, for the two go hand in hand and the re-

tailer who has his eyes open ought certainly to reap a harvest.

WILL IT BE AN "ARCADE" MERGER?

A. L. Erlanger Who Recently Completed a Great Vaudeville Combine Sees Big Money in the Nickel Moving Picture Theatres—Makes Friends With His Doughty Antagonist Impresario Hammerstein.

Oscar Hammerstein was sitting on the steps of the Victoria Theater recently talking about some of the things he was going to do in opera this year. Most of the people who came along stared at him, for the fame of the new impresario has gone far, but he did not pay any attention, except to say: "I guess they wonder why I have so little dignity."

Down the street came another man at whom all the wise ones stared as he came along. His name is often upon the lips of theatrical people, and it had figured in the newspapers of the day as the head of a great world merger of theaters. This other man was Abraham L. Erlanger.

Now, among the traditions of the Rialto are several which deal with the feuds of Oscar Hammerstein and Abraham Erlanger, and at present the Hammerstein vaudeville interests and the Erlanger vaudeville interests are clashing in serious fashion. It has been a long time since the two had met and talked. But for all that Mr. Erlanger walked across to the stoop where Mr. Hammerstein was sitting. He held out his hand and Mr. Hammerstein shook it.

"Tell me about that merger," said Mr. Hammerstein.

Mr. Erlanger just smiled.

"Tell me, honestly, is there anything you are going to keep your fingers out of?" persisted Mr. Hammerstein.

"Well, I might have some fun with a circus," said Mr. Erlanger.

"How about the five-cent phonograph places?" asked Mr. Hammerstein.

"There's money in them," smiled the head of the theatrical syndicate. "I've talked that over."

"I suppose you'll have a string of opera houses next," said Mr. Hammerstein.

"No, I guess I'll keep out of that," reflected Mr. Erlanger. Then he smiled.

"But, say, you seem to have got in pretty well on that, didn't you? Saw the country was coming that way. There's money in it."

Mr. Hammerstein started to retort, but Mr. Erlanger stopped him. "Now, don't you try to tell me you are in it for art or I'll go away," he said. "What's your subscription? And, by the way, how would you like us to do your booking? You needn't come over to our office at all. I'd come over here and we'd sit out on the front stoop and fix the whole thing up."

"There, didn't I tell you," said Mr. Hammerstein. "You can't keep out of it. You'll be merging grand opera yet. When you take that, will you let me keep this theater a while?"

"Oh, I'm thinking of selling seats good for

The Card Printer

Prints your name on five cards for one cent. It is the best slot machine ever produced.

MANUFACTURED BY

The Card Printer Co.

79 East 130th Street

NEW YORK

MOTION PICTURE Machines, Films and General Supplies

Sole Agents for

**POWER'S CAMERAGRAPH
EDISON'S KINETOSCOPES**

The largest and only exclusive store of its kind in the city.

THE SWAAB CO.

330 Spruce Street

PHILADELPHIA, PA.

We Make Pennies Grow

If you deposit your savings in a bank, you may earn 3 per cent. or possibly 4 per cent. Invest them in a Penny Arcade and

your investment will net you 150 per cent. to 300 per cent. per annum.

LET US PROVE IT TO YOU.

Let us show you how you can gain an independent income by an investment of \$600 and upward.

We will start you, assist you in every way in making your establishment a profitable one, and give you the benefit of our 20 years' experience both as operators and manufacturers.

WE WILL SEE THAT YOU MAKE A SUCCESS, for *your success* will mean *our success*.

Given a fair location, and that is easily found in any town with a population of upward of 5,000, your investment will be returned to you in four or five months, after which all receipts are CLEAR PROFIT.

Just now is the *time to start* and take advantage of the spring and summer season.

Your town certainly should have an ARCADE. If there already is one in operation, YOU start another better one and show that you are up to the minute and a hustler.

If you are now operating an ARCADE, improve the same by adding CAILLE MACHINES and CUT DOWN REPAIR BILLS.

No machines like CAILLE MACHINES for showing big receipts!!

The public prefer Caille Machines, as they always work and always work correctly. They never are out of order.

No scales like CAILLE SCALES, and we make 5 different styles, all of them absolute leaders.

But we also make the famous CAILOSCOPE and have recently patented the CAILOPHONE, both of which machines outdistance anything on the market.

In fact we make *257 Varieties*, all of them "*Caille Quality*," which means excellence in every detail of construction, mechanism and appearance.

A postal Card will bring you our handsomely illustrated Catalogue for 1907, showing the largest line of coin controlled machines manufactured in the largest plant in the World devoted exclusively to the construction of automatic devices.

WRITE TO-DAY and be
First on the Ground.

The Caille Bros. Co.
DETROIT, MICH.

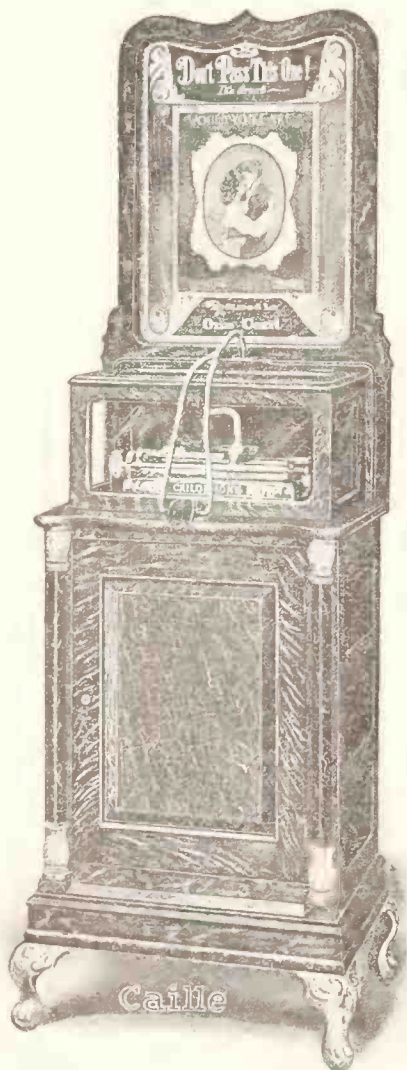

Eastern and Export Office:
32 Union Square, N. Y. City

Western Office:
902 Republic Bldg., Chicago

both the New York and Victoria," smiled Mr. Erlanger. "Want to go in on it?"

"Don't look at me in that money-making way," protested Mr. Hammerstein.

"Well, I haven't done any business for five minutes, and I'm lonesome," said Mr. Erlanger. "You'd better think over that opera and vaudeville business. By the way, that's a fine tie you have on."

"Got it in Paris," said Mr. Hammerstein.

Then they talked of Paris, and Mr. Erlanger went away smiling. The wise theatrical people began speculating what new combination was in the air, but this was just what they had said.

CINEMATOGRAPHS IN SPAIN.

Demand for Films Is Quite Active—Orders Placed Largely With France, England and Germany—Chances for American Firms.

(Special to The Talking Machine World.)

Washington, D. C., Aug. 4, 1907.

Consul-General B. H. Ridgely reports to the Department of Commerce and Labor that Barcelona is becoming a center for cinematographic shows and a thriving business is being done in films, which are principally imported from France and England, some also coming from Germany, with occasional purchases from American firms. He adds: "It is impossible to state the number of films sold here, but Barcelona is the best market for them in Spain, Madrid being the next best. All the leading French and English makers have local agents. The length of the films sold varies from 44 to 110 yards. They are delivered at 2 pesetas (38 cents) per meter (39.37 inches). The subjects preferred depend somewhat on the class of entertainment for which they are required. The cinematograph, which claims to have the most select patronage, prefers scenes from nature. There are 30 or 40 cinematographic shows in and around Barcelona. All sorts of moving pictures representing life in America would be popular in Spain. Any American firm furnishing films of this sort would probably find it profitable to send an agent to Barcelona."

THE AUTOMATON WAS HUMAN.

C. W. Solomon Tells How He Had Been Duped Into Becoming Part Owner of Automatic Checker Player.

Chagrined because he had been duped into becoming part owner of an automatic checker player, which he afterward found contained a small boy, Charles W. Saloman, of New York, recently told some more interesting details of his negotiations with one Morris J. Mansfield, "inventor" of the apparatus, who was charged with swindling and arrested.

In bewailing the fact that he had been cleverly duped, Saloman told how he had been approached by the owner of the wonderful piece of mechanism, and had taken the bait. The "machine" worked to perfection, and a fortune seemed in store for the purchaser until the boy was discovered in the interior.

"Why, I was ready to form a stock company, with \$1,000,000 capital, to show the figure all over the country," said Saloman. "I had scores of friends who were crazy to buy the stock. Mansfield told me the figure was an exact duplicate of the famous one in the Eden Musee, and it looked so to me when I investigated.

"The contrivance was a wonder even without the boy in it, but it was useless without Mansfield to operate it. It ran by clockwork, not electricity, as Mansfield alleged. The batteries shown to the public connect with wires that did not run anywhere. The clockwork simply bent the automaton forward every time it said 'check' in playing chess or checkers.

"That fifteen-year-old son of Mansfield who was in the machine was a marvel at playing chess or checkers when he is outside of the figure. His father, I have since learned, has taught all of his four children, almost from infancy, to play the games.

"Why, the night before the figure was placed on exhibition, my brother-in-law opened \$150 worth of wine—real champagne, too—and christened the figure Hassan Paska, saying we would get back the money for the wine the next week. Oh, I don't hesitate to say we thought we had a good thing with millions in it. Even after I exposed Mansfield's trick he wanted me to stand for it and allow him to take it around country fairs, where he said he could win \$5 a game betting on checkers. The 'fake' cost me \$150, but think what it cost Leopold!"

TRADE ITEMS.

The average life of a moving picture film is between 1,000 and 1,200 times exhibited. Of course, care in handling and the machine, whether good or bad, prolongs or lessens its wearing quality.

At a meeting of the directors of the American Mutoscope & Biograph Co., held July 17, the position of general manager (held so long by Mr. George Van Guysling, the vice-president of the company) was abolished. Mr. Van Guysling, who has but recently recovered from a severe attack of nervous prostration, has been granted a two months' vacation, and has gone South.

Edward E. Warren, an usher in the Hathaway Theater, New Bedford, Mass., was arraigned before Justice Stetson on July 16, for having violated the laws of that State, by operating a moving picture machine in the theater without having a license. The fine in such cases is not less than \$5 and not more than \$500, but at the suggestion of his counsel the court allowed the case to be "put on file," as the proceedings were sufficient to warn the management of all theaters that the laws of the State must be respected.

We learn that rigid laws to decrease the fire risk now said to be caused by conditions around the various moving picture shows in Birmingham, Ala., will most probably be adopted by the city council at an early date.

Mayor W. P. Ball, of New Orleans, La., is carrying on a strenuous campaign to stamp out the use of suggestive or criminal pictures in the nickelodians in this city. He has been joined in this work by the Protestant Ministers.

The slot machine business has been quiet. The export business alone has kept up to the mark, and large shipments to foreign countries go out on every steamer. The American manufacturer still holds his own at the top of the list abroad, and our machines are always given the preference. Much of the slackness in the States is credited to the widespread craze for moving pictures, and there is little doubt that a good deal of coin is being sidetracked by these nickelodians.

The Giant Bean Shoot is one of the newest slot machines on the market. This device is 7 feet 6 inches high, made of hardwood, oak finish, with a red background, which makes it a very attractive ornament. When in use a ball is discharged from a gun, throwing out while ascending from one to five signals, and when blown to the limit (600) will ring the bell at the top. It retails for \$25, and is a money maker.

The Marvelous Automatic Palm Reader continues to hold the public interested, and is conceded one of the greatest money makers ever produced in this country.

GRINDS OUT HARD COIN.

Easy Money Found in the Coin Operating Machines and Moving Picture Business—The Picture Business Should be Kept Clean—Talking Machine Men Should be Alive to the Dollar Making Power of the New Device.

The value of coin-operating machines should be apparent to every dealer, and there are plenty who are making modest fortunes annually out of these automatically operated devices. They are silent, tireless workers. Chatting with one of the leading men in the trade the other day he said:

"I have been much pleased with the coin-in-the-slot devices which I have handled. We have been doing a big jobbing business all over this country, and in some others as well, and it seems to me that talking machine men are not alive to the opportunities of this business, for they overlook its possibilities.

"I was interested in an article which appeared in The World of last month relating to moving picture developments, and I agree with the sentiment expressed in that article that moving pictures have won a splendid position, and like the talking machine business it is only in its infancy as far as development is concerned. Of course, there have been a few men in the business who helped to degrade it, and in some of the leading towns there has been a lot of obscene and impure scenes depicted which should be kept away from the young, for they have a tendency to drag down the business. Any man who presents immoral pictures to the public ought to be kicked out of the moving picture trade. The business should be kept clean, and it can be maintained there if only decent men take up the business. It is a charming business in many ways and if run properly it can be made into a big paying enterprise."

When one stops to think of films, moving pictures, etc., a big business vista is opened, and if we investigate, to the extent of obtaining statistics as to the amount of money which is spent annually in supporting the various moving picture theaters over the land, it would be surprising; and when we look into the automatic machine business we will find that results there are just as astonishing. Mechanical instruments of all kinds have leaped into popularity, and are now producing big business for dealers in all parts of the country. This line embraces almost everything from pianos down to the smallest known product. With the countless parks and places of amusement which are open during the summer months it should be extremely easy for every man to secure a fair amount of business. If the pages of this publication are consulted it will be found that there are a number of money making devices which are exploited in our columns.

LEWIS M. SWAAB'S SUCCESS.

Lewis M. Swaab, of 338 Spruce street, Philadelphia, Pa., who is sole agent for Power's Cameragraph and also handles the Edison kinetoscope in that city, started business in the back parlor of his residence only three years ago, devoting himself exclusively to the motion picture business. The business has prospered until at the present time he occupies the entire floor, together with an extension in the rear, one of the largest moving picture stores in the city, and is looking for larger quarters nearer the heart of the city. He has discontinued his second-hand

USE OUR FILMS THEY ARE THE ACME OF PERFECTION

You expect maximum results from your show, don't you? Then let us supply your Film service. Our prices are right. Our subjects always the best (we don't handle any other kind). Adopting our service means increased profits. Does away with all worry about repeaters or poor service. Courtesy and honest treatment alike to one and all has placed us in the lead of Film Renters of America.

All standard machines and accessories in stock. Can make prompt deliveries. Better order now before the rush of the season commences. We have the best shipping facilities in the country. Our motto: Orders filled in a minute. STRIP TICKETS, 20 CENTS PER 1000 IN 5000 LOTS. PATHE'S LIFE OF CHRIST—rented reasonable. TRY IT!

Write for our list of subjects, songs, prices, etc., to-day.

O. T. CRAWFORD FILM EXCHANGE COMPANY.

Gaiety Theatre Building, ST. LOUIS, MO.

business, and handles only new goods, though he does a large renting business. He credits honest dealing as being the basis of his success. Mr. Swaab states that he contemplates engaging in the manufacture of machines and films in order to supply his trade.

TRADE NEWS FROM CLEVELAND.

Owing to the Commendable Efforts of the Proprietors Picture Shows Are More Popular—Automatic Vending Co. the Latest—Recent News.

(Special to The Talking Machine World.)

Cleveland, O., August 8, 1907.

As a result of recent agitation against alleged objectionable moving picture shows in Cleveland there has been a marked improvement in the character of the films now shown. The change is due to the commendable efforts of the proprietors themselves. At the time objection was made to some of the exhibits, they formed an organization and appointed a committee. Mr. C. M. Christian, chairman, to have supervision and visit all moving picture shows regularly, and report any infringements of propriety. "We can't afford to get the women, the churches, the Y. M. C. A. and the City Hall down on us," said the proprietor of one of the popular resorts, "so we're going to be good."

The Automatic Vending Co. of Cleveland was recently incorporated in this state for the purpose of operating the "Universal Salesman or Penny Department Store." It is a penny slot machine exhibiting in a dust and waterproof show case samples of the goods, enabling the purchaser to select from a large number and variety such articles as he wishes. The machines are furnished by the Universal Salesman Co. of Detroit.

A firm at Massillon, O., are offering for rent a film of the Elks' parade at Philadelphia, 720 feet in length. It has not yet been put on exhibition in Cleveland.

"The American," claimed to be the first motion picture theatre in Cleveland, and the largest between New York and San Francisco, is a popular resort, and doing a good business. The company have been using films of their own make for some time, and are now installing a plant to increase the capacity and produce all kinds of films on a more extended scale. Mr. Wm. Bullock, the manager, says they antedate the Gaumont chronophone by two years, having given a demonstration at that time called "Retribution." The American use a Columbia electric disc machine with Marconi records.

Summer resorts are attracting the crowds and

has had the effect of decreasing the patronage of the moving picture theatres and penny arcades, although they are all doing a paying business. "The Marlo," adjoining the talking machine store of W. H. Buescher & Son, is popular and well patronized. Tony's electric theatre, at 410 Lorain street, was the first moving picture show established on the West Side and has been doing well. The manager stated business was a little quiet at present, owing to the numerous summer resort attractions. Mr. Long uses a twentieth century machine, and gives six changes a week.

I. R. B. Arnold, proprietor of the Stereopticon Exchange, 45 Sheriff street, reports business fairly good in stereopticons, slides, acetylene and calcium light, electric outfit and films. Mr. Arnold says trade will be fine next fall and winter.

The Great Penny Arcade, 2043 W. 25th street, was put out of business the other day. One would suppose such a place would be the last a burglar would have designs on, but when Elmer Masetacs, the proprietor, opened the place he discovered thieves had broken in during the night and robbed him of the entire outfit, entailing a loss of \$500.

OMAHA AUTHORITIES' RADICAL STEP.

(Special to The Talking Machine World.)

Omaha, Neb., Aug. 6, 1907.

It is probable that slot machine players of all kinds in use in public places in the city will be put out of business by the action of the Fire and Police Commissioners of Omaha. Ordinances of the City Council require a license for each machine which vends music or merchandise, but no attempt has ever been made to force payment so long as the machines did not become a nuisance. Now, however, as the result of a crusade against slot machines in cigar stores, saloons and other places for gambling and other purposes, the ban has to be put on anything provided with a slot for the reception of coins or checks by enforcing the ordinance, its provisions requiring a license rather too high to be paid with profit. It is hoped, however, that a distinction will be made between these places and well-conducted amusement resorts.

NEW PLACES JUST OPENED.

Nicolet—Harry Metz, 187 Passaic street, Passaic, N. J.

Opera House—Manager McDonald, Chicago, Ill.

Mr. Lawler, South Ohio street, between Main and Second, Sedalia, Mo.

C. H. Lucas, Black Block, Plain City, O.

Nickelodian—Cary Block, Plain City, O.

Spokane, Wash., has a new moving picture theater which opened last month. It is termed "The Scenic." This company has exclusive right to use the viascope. W. H. Bell, of Chicago, has charge of the moving picture machine department.

The Westminster Theater, of Providence, R. I., is open for the summer season. The views shown will be strictly up to date.

The new theater is open at Muscatine, Ia., at 112 West Second street. This will be managed by John Gordon, of Sioux City, Ia., who calls his new theater The Unique. Illustrated songs will be one of Mr. Gordon's specialties.

Charleston (S. C.) proposes to give the best of fire protection to all of the moving picture patrons in that city. A new ordinance has recently been passed which makes an offender liable to a fine of \$100 and imprisonment for violating the ordinance.

George Behrens and Clinton Spencer, of Muskegon, Mich., have opened a Nickelodeon at Big Rapids, Mich.

Fred E. Fink and H. H. Niemeyer are managing a new moving picture theater at Portage, Wis.

MARVELS OF SOUND REPRODUCTION.

Harry Burgess, under the auspices of the Victor Co., recently delivered a most interesting lecture in London upon the "Marvels of Sound Reproduction; or Romance of Sound." To an audience of nearly eight hundred, Mr. Burgess described the first talking machine and its development up to the time the present marvelous instruments were produced. Selections played upon the different machines did much to illustrate the real progress made in the field, as where the first records when reproduced or the early machines were devoid of expression and enabled the listener to hear only about one word in three, the latest Caruso record rivaled the great tenor himself in perfect rendition. Stereopticon views also tended to better acquaint the audience with the subject of the lecture.

The first coin in the slot machine dates back to Egypt's halcyon days. It was an automatic receptacle which sold holy water and was placed at the doors of the temples in which the Egyptians worshipped daily. A tiny coin was dropped into the basin and immediately a certain amount of water was ejected.

An entire building, at 1012 Chestnut street, Philadelphia, Pa., has been leased by H. A. Weymann & Sons, who has removed from 925 Market street, which has proven too small for their growing business. They are Victor and Edison distributors.

The Lavery Phrenologist is making a great sensation in this city. It is proving itself not only a mystifier, but a money maker.

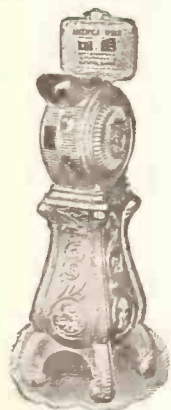

THE MUTOSCOPE

For Summer Parks, Penny Arcades, etc., has proved itself to be the greatest money earner of all coin-operated machines. In fact it has made the "Penny Vaudeville" what it is to-day. The privilege of free exchange of pictures keeping them fresh and up-to-date, make it always attractive. Our New Type E Mutoscope, besides being handsomer in design, possesses many improvements in mechanism over former models.

Write for Particulars

AMERICAN MUTOSCOPE & BIOGRAPH CO., 11 East 14th Street
NEW YORK CITY

PACIFIC COAST BRANCH, 116 North Broadway, LOS ANGELES, CAL.

THE PIANOVA COMPANY,

Manufacturers of

44 AND 65 NOTE ELECTRIC PLAYERS

with or without nickel in the slot attachment

SECURE THE AGENCY NOW.

117-125 Cypress Avenue,

New York.

60 YEARS' EXPERIENCE

PATENTS

TRADE MARKS
DESIGNS
COPYRIGHTS & C.

Anyone sending a sketch and description may quickly ascertain our opinion free whether an invention is probably patentable. Communications strictly confidential. HANDBOOK on Patents sent free. Oldest agency for securing patents. Patents taken through Munn & Co. receive special notice, without charge, in the

Scientific American.

A handsomely illustrated weekly. Largest circulation of any scientific journal. Terms, \$3 a year; four months, \$1. Sold by all newsdealers.
MUNN & Co. 361 Broadway, New York
Branch Office, 625 F St., Washington, D. C.

FROM **EASY MONEY** GET ONE

(Easy Money Catalogue, Copyrighted)



COUNTING THE MONEY

is the greatest hardship in paying for a Peerless Coin Operated Piano. We sell the piano to the dealer and he pays for it with the money received from his customer—he is satisfied. The customer pays for it with the money taken from the cash-box of the Piano—he is satisfied. The man who puts the nickel in the Piano hears it play—he is satisfied. Everyone has made a good thing on his investment, is satisfied, and it has been so easy to get the money. You can't find any other line of business where the profits are so large and sure to all concerned, and where no one has to worry over anything more serious than

COUNTING THE MONEY

ROTH & ENGELHARDT

Props. PEERLESS PIANO PLAYER CO.

Windsor Arcade, Fifth Avenue, New York.

Factories, St. Johnsville, N. Y.



Good Money in Columbia Records

If you were located close enough to the Tribune Building to see how the jobbers are coming in without solicitation and going out well equipped with delivery dates, you would begin to see why our statements and predictions are so cheerful.

You wouldn't wait long before getting a line on certain signs of the times that mean as much to you as they do to us—and they mean doubled orders, and doubled output, and steadily increasing success to us.

If there ever was a time when time meant money to you and every other man in the business, it's right now—and if you're keen you won't lose any of it before getting stocked up with Columbia Records.



Columbia Phonograph Co., Gen'l
Tribune Building, New York

GRAND PRIX, PARIS, 1900. GRAND PRIZE, MILAN, 1906.
DOUBLE GRAND PRIZE, ST. LOUIS, 1904

Stores in all Principal Cities

Dealers wanted wherever we are not now represented

And Sales Are Climbing Every Day

