

For Reference

NOT TO BE TAKEN FROM THIS ROOM

FIELD STRENGTH SURVEY

OF STATION C.K.U.A.

Ex LIBRIS
UNIVERSITATIS
ALBERTAENSIS



The undersigned hereby certify that they have read and recommended to the Committee on Graduate Studies for acceptance a dissertation on a "Field Strength Survey of Station C.K.U.A.", submitted by David G. Williams in partial fulfilment of the requirements for the degree of Master of Science.

.....*L.H. Nichols*.....

.....*W. E. Bourns*.....

.....*H. M. ...*.....

FIELD STRENGTH SURVEY
OF STATION C.K.U.A.

BY

DAVID G. WILLIAMS B.Sc.(E.E.)

An investigation carried out under
the direction of Dr. H. J. MacLeod.

Presented to the Committee on Graduate
Studies, University of Alberta, as a
partial requirement for the degree of
Master of Science.

UNIVERSITY OF ALBERTA
DEPARTMENT OF ELECTRICAL ENGINEERING
EDMONTON
APRIL 13, 1935.

Introduction.

In order to understand what is meant by the term field strength and how it is measured, it is first necessary to have a clear idea of the process by which speech and music are conveyed from the transmitting aerial to the receiving aerial.

The energy radiated from a transmitting antenna¹ exists in the form of electric and magnetic fields, propagated outwards from the antenna with a velocity equal to that of light. These two fields are in phase with each other, have equal magnitudes or strengths when expressed in absolute units, and are at right angles to each other and to their direction of propagation. The direction of the electric component is usually vertical and that of the magnetic component therefore horizontal for waves of broad cast or lower frequency, and such a wave is said to be vertically polarized. In passing it may be mentioned that short waves often exhibit remarkable rotation of their plane of polarization, especially after reflection from the Heaviside layer or after passing through some object such as a building.

The effect of these waves, or radiation fields, on the receiving antenna may be considered as being due to either the electric field or the magnetic field, but not due to both, since they are two aspects of the same thing².

1. F.E.Terman, Radio Engineering, Chapter I.

2. E.B.Moullin, Radio Frequency Measurements, p 425.

Thus the voltage induced in the antenna may be ascribed to the separation of charges in the conductor by the electric field, or to the cutting action of the conductor on the magnetic field travelling past with the velocity of light.

Near to the transmitting antenna there exists also another set of fields, the induction electrostatic and magnetic fields, which are responsible for the capacity and inductance of the antenna system respectively.

The radiation fields, electric and magnetic, are in phase with each other but are in phase quadrature with the antenna current, and their intensity varies inversely as the first power of the distance from the antenna. Insofar as the induction fields are concerned, the magnetic field is in phase with the antenna current but the electric field is in phase with the radiation fields, and therefore lags the antenna current by 90° . The strength of these induction fields varies inversely as the square of the distance from the antenna, and so they die out much more rapidly than the radiation fields do. At a distance of $\frac{\lambda}{2\pi}$ (λ = wave length) from the transmitter the strengths of the induction and radiation fields are equal, closer in, the induction fields predominate, further away, the radiation fields are the stronger.

Thus it is evident that measurements of the strength of the radiated fields should begin at distances of several wavelengths from the transmitter. It should be noted also that the value as measured is the effective value of the field strength, and is equal to $\frac{1}{\sqrt{2}}$ x the maximum value.

Field strengths are measured in volts, millivolts or microvolts per meter. This voltage may be considered as that which would be generated by the radiation magnetic field sweeping across a conductor one meter long, the conductor being placed in the plane of polarization of the wave and parallel to the wave front.

The measurement is made by picking up the transmitted signal with a suitable aerial, usually a loop, and then measuring the voltage developed in the aerial by the signal. The measurement of this voltage may be made directly with a calibrated vacuum tube voltmeter or indirectly by comparing it by means of an uncalibrated vacuum tube voltmeter with a locally produced and accurately known voltage of the same frequency. It is the latter system that is used in this investigation.

The relation between the strength of the signal and the voltage developed in the antenna is given by the equation,

$$E = eh$$

where E = voltage developed in the antenna in volts,

e = field strength in volts/meter,

h = effective height of the antenna in meters.

The effective height of an antenna is a function of its physical dimensions and can be easily calculated from them. The modification of the above equation that is necessary when the antenna is tuned to the transmitter frequency will be considered later.

Propagation and Attenuation of Radio Waves.¹

The radiation from a transmitter may be considered as being made up of two components, the sky wave and the ground wave. The ground wave follows the surface of the earth as it travels outwards from the transmitter and is vertically polarized since the electrostatic flux of a horizontally polarized wave would be short circuited by the semi-conducting earth. The ground wave is attenuated as it passes over the earth's surface, the amount of attenuation depending on the character of the surface and the frequency of the transmitter, but remaining practically constant as between night and day or from season to season.

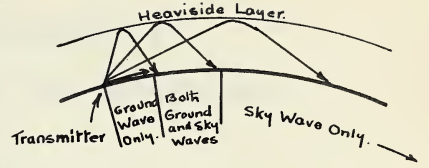

The sky wave travels upwards from the surface of the earth and is reflected down by the Heaviside layer. The field strength of the wave at a point so distant from the transmitter that only the sky wave reaches it is extremely variable and depends on many factors.

The reception in the intermediate region where both sky and ground waves have appreciable magnitudes may be very poor at times due to interference phenomena.

In this investigation only the ground wave will be considered.

The inverse distance law (neglecting attenuation) for

1. Terman, Radio Engineering, Chap. 15.

obtaining values of field strength at various distances from the transmitter is, (ground wave only),

$$E = \frac{188 h I}{\lambda r} \quad \text{millivolts/meter.}$$

where h = effective height of transmitting antenna in meters,

I = antenna current in amperes,

λ = wavelength in meters,

r = distance in kilometers.

This equation is also written occasionally in the form,

$$E = \frac{377 h f I}{c d} \quad \text{volts/meter.}$$

where h = effective height of antenna in cms.,

f = frequency in cycles/second,

I = antenna current in amperes,

c = velocity of light in cms/second,

d = distance from antenna in cms..

The effect of attenuation is introduced into the above equations by multiplying by an attenuation factor, and there have been many attempts made to find a formula to fit all conditions that may be encountered. The Austin-Cohen formula published in 1911 was derived from transmission measurements made over sea water, but was therefore not valid for overland transmission. Sommerfeld's analysis for the latter case was published in 1909, but was too complicated for practical use. Recently, Rolf¹ has prepared graphs to simplify the application of Sommerfeld's theory. This theory dealt with transmission over a semi-conducting plane and therefore at large distances had to be corrected

1. Bruno Rolf, Proc.I.R.E. 1930, Page 391.

for the diffraction effect caused by the curvature of the earth.

Watson¹ has derived a formula for transmission over a semi-conducting sphere, but his formula is inaccurate if applied near to the transmitter.

There is no need to give here a detailed discussion of the attenuation of the ground wave as there are numerous articles in the literature on the subject. Two or three equations will be given however for purposes of comparison with the simple formula given above.

The formula²

$$E = \frac{377 h I}{\lambda d} e^{-\frac{\alpha d}{x \lambda}} \mu v/m,$$

where α and x are constants, is of the type derived by Sommerfeld, Austin-Cohen and Fuller.

Whittemore³ gives a formula for the ground wave

$$E = 19.42 \times 10^4 \frac{\sqrt{p}}{d} e^{-\frac{101.5 \alpha d}{\lambda^{0.6}}} \mu v/m.$$

where p = radiated power in kilowatts,

d = distance in miles,

α = 0.0246 for the northeastern U.S.A.

Van-der-Pol's ground wave formula is⁴

$$E = 300 \frac{\sqrt{p}}{d} \times \frac{2 + 0.3p}{2 + p + 0.6p^2} \mu v/m, \text{ where } p = \frac{\pi D}{6.1 \delta \lambda^2}$$

The following are the chief reasons for making field strength measurements,

1. Analyses of antenna systems. This includes the determination of the effective height, radiation resistance, radiated power and any directional properties of the antenna.

1. Kirby and Norton, Proc.I.R.E., 1932, Page 841
 A.D.Ring, " " " 611
 T.L.Eckersley " " " 1555
2. Epenscheid, Anderson and Bailey, Proc.I.R.E., 1926, Page 20.
3. Whittemore, Proc.I.R.E., 1929, Page 1347.
4. A.D.Ring. loc. cit.

2. Investigation of the attenuation of the waves as they travel outwards from the transmitter.

3. Estimations of the service areas of the station.

4. Interference measurements on two or more stations on the same frequency or on adjacent frequencies.

The determination of the effective height, radiation resistance and radiated power is made by taking a series of field strength readings on a circle around the station at a sufficiently close distance (5 or 6 wavelengths) to eliminate the effect of attenuation and averaging the results. Then by substitution in the equation for transmission without attenuation the effective height, etc, can be calculated.

Investigation of the attenuation of the waves is made by plotting curves of field strength against distance for various directions around the transmitter and making comparisons between the observed results and theoretical curves.

The service area of a transmitter is defined as the area lying within a given field strength contour line, the value of the contour being the minimum field strength that produces satisfactory reception. Following are listed a few of the recommendations found in published articles on the subject.

In 1926 Goldsmith¹ gave the following classification,

<u>Signal Field Strength.</u>	<u>Nature of Service.</u>
0.1 mv/meter	Poor service
1.0 "	Fair "
10 "	Very good "
100 " and up	Excellent "

1. A.N.Goldsmith, Proc.I.R.E., 1926, P582.

He also stated that the outer limit of the service area usually lay just under the 10 mv/meter level.

Edwards and Brown¹ in 1928 stated that at least 5 mv/meter was necessary for continuous high quality reception, and in another paper published in the same year Jansky² said that for rural areas 100 microvolts/meter provided good service and 50 microvolts/meter fair service, but that values much larger than these were necessary for city areas.

Ring³ in 1932 gave the following recommendations for good quality service,

<u>Type of District.</u>	<u>Signal Strength.</u>
Business area	10 mv/meter
Residential "	2 "
Rural "	0.5 "

For fair service the strengths were one-half of the above and for poor service they were one-quarter.

It is quite probable that with the modern super-heterodyne receivers with high sensitivity and automatic volume control, good results are being obtained with signal strengths of less than 50 microvolts/meter in localities that are free from bad interference.

1. S.W.Edwards and J.E.Brown, Proc.I.R.E., 1928, P 1177.
2. C.M.Jansky, Proc.I.R.E., 1928, pl356.
3. A.D.Ring, loc. cit.

Historical Note.

The first field strength measurements appear to have been made by Duddell and Taylor¹ in the year 1905 by means of the direct measurement of the current in the receiving antenna with a sensitive thermal ammeter. In 1906 Pickard¹ introduced the method of comparing the received signal with a locally produced signal of the same frequency. These measurements were made by aural comparison as the three electrode vacuum tube had not yet come into general use. In 1921 Pickard developed this comparison method into the modern system, an example of which is excellently described in a paper by A.Jensen.² This system is the one which was finally adopted for this investigation after considerable experimentation with other methods.

The particular advantage of Jensen's method is that as the local measuring voltage is introduced into the loop instead of being applied directly to the input terminals of the receiver, both the signal from the transmitter and the comparison signal are resonated in the loop so that the loop resistance, which varies considerably from time to time and place to place, does not have to be known.

1. G.W.Kenrick and G.W.Pickard, Proc.I.R.E., 1930, p 649.
2. Axel Jensen, Proc.I.R.E., 1926, p 333.

Apparatus.

1. Loop aerial.

The loop aerial is constructed as a square coil, the length of the side being considerably greater than the axial length. The side dimension is approximately 70 cms. and the axial length 18 cms.. It is wound with 16 turns of #21 enamelled single cotton covered wire, the turns spaced 1 cm. apart, with a space of 3.5 cms. allowed between the middle turns to leave room for the supporting pole.

The diagonal supports are made of 3/8" oak board with strips of bakelite inserted in the ends and slotted to hold the wires. These diagonals are braced at the center with a square piece of oak veneer on each side and an oak block is set in the bottom angle to carry the supporting rod.

The chief difficulty involved in the construction of the loop is the problem of obtaining as large an effective height as possible so as to feed a large signal voltage to the fairly insensitive receiver used, while at the same time keeping the distributed capacity small so that the loop can be tuned over the broadcast band with a 350 micro-microfarad variable condenser.

The effective height of a loop¹ in meters is the factor by which the field strength in volts/meter must be multiplied ~~by~~ to give the voltage generated in the loop by the passing electromagnetic wave. It is thus a measure of the effectiveness of the loop as an aerial.

ELEVATION AND SIDE VIEW OF LOOP.

SCALE 1" = 20 mm.

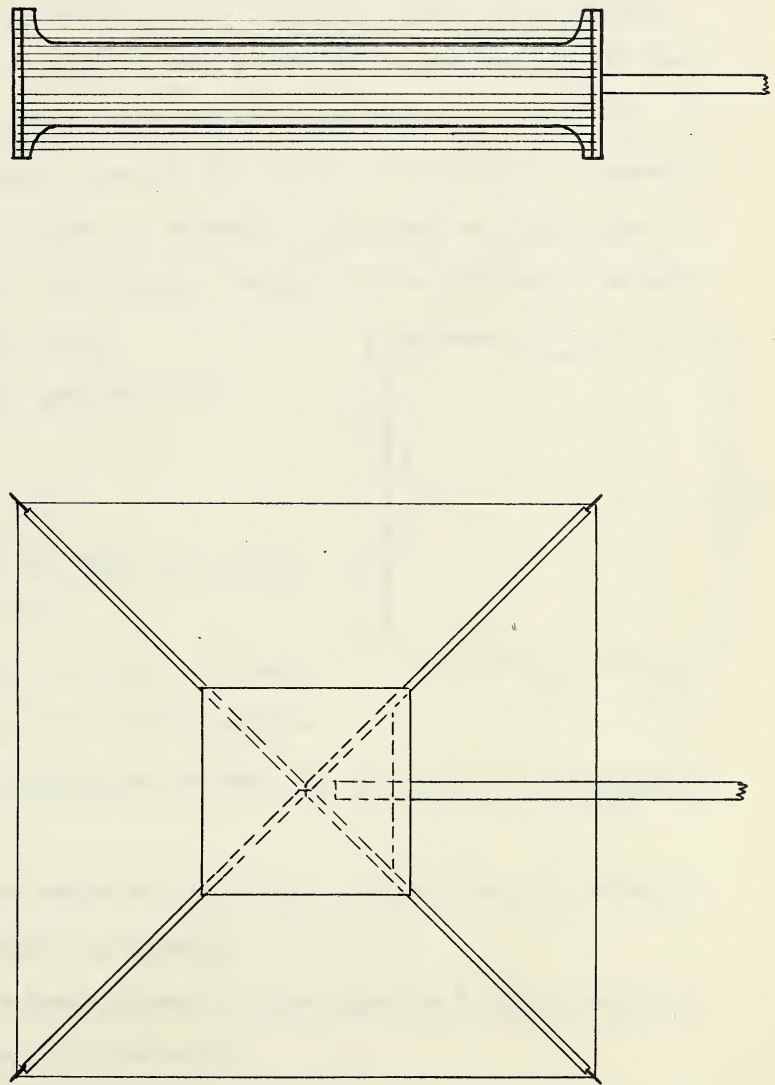

When the plane of the loop is directed at the transmitter, the electromagnetic wave induces no voltages in the horizontal top and bottom wires of the loop as they do not "cut" the wave, being perpendicular to the wave front. However, voltages are generated in the vertical wires forming the sides of the loop as they are parallel to the wave front and to the plane of polarization of the wave. These voltages have equal magnitudes and act in opposite directions around the loop and so tend to cancel each other, but there is a small resultant voltage due to the slight phase difference caused by the distance between the sides of the loop.

The voltage generated in each side is

$$E_1 = E_2 = eNl \text{ volts}$$

where e = field strength in volts per meter,

N = number of turns in loop,

l = length of side in meters.

The phase difference between E_1 and E_2 is $\frac{2\pi d \cos \theta}{\lambda}$ radians, where

d = distance between the sides of the loop in meters,

λ = wavelength in meters,

θ = angle between plane of the loop and the direction of travel of the wave.

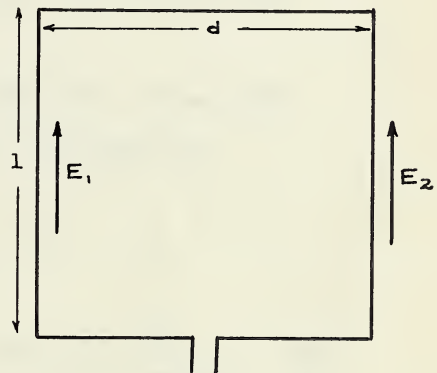

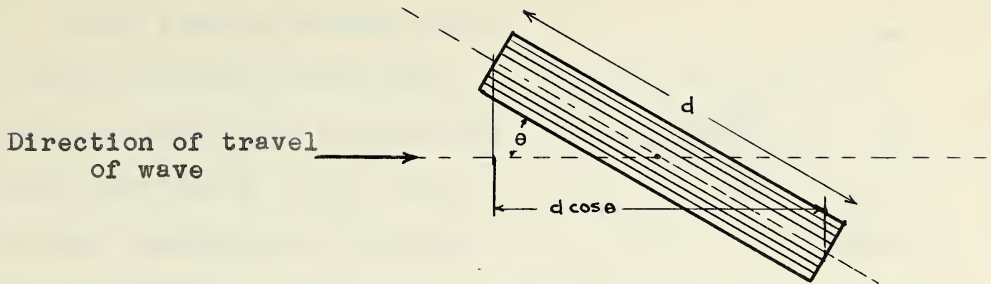

The phase difference between two points one wavelength apart is 2π radians, and thus the phase difference between two points $d \cos \theta$ meters apart is $\frac{d \cos \theta}{\lambda} \cdot 2\pi$ radians. If the loop is placed at an angle θ as shown, voltages of magnitude $eNd \sin \theta$ are generated in the top and bottom wires, but as there is no phase difference they exactly cancel each other.

The voltages generated in the vertical wires must be added vectorially to obtain their resultant, E .

$$\begin{aligned} \text{Thus } E &= 2E_1 \cos(90 - \phi/2) \\ &= 2eNl \sin\left(\frac{\pi d \cos \theta}{\lambda}\right) \end{aligned}$$

and since $d \ll \lambda$, in this case,

$$\sin\left(\frac{\pi d \cos \theta}{\lambda}\right) = \frac{\pi d \cos \theta}{\lambda}.$$

$$\text{Then } E = \frac{2\pi eNld \cos \theta}{\lambda}$$

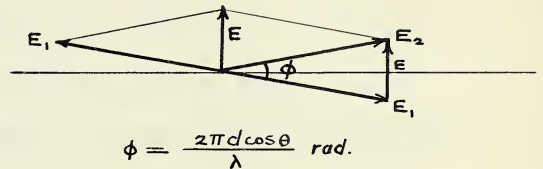

and the effective height of the loop, h , is

$$h = \frac{E}{e} = \frac{2\pi Nld \cos \theta}{\lambda} \text{ meters}$$

$$= \frac{2\pi AN \cos \theta}{\lambda} \text{ meters.}$$

where A is the area of the loop in square meters.

This formula explains the "figure of eight" reception characteristic of a loop aerial since when $\cos \theta = 0$, the voltage generated in the loop by the wave is zero.

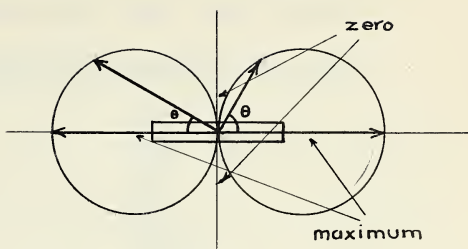

The effective height of a loop of ordinary size is usually small since l and d are small compared with the wavelength.

For the loop constructed in this investigation the effective height is calculated as follows,

$$\text{Number of turns } N = 16$$

$$\text{Horizontal length } d = .705 \text{ meters}$$

$$\text{Vertical length } l = .703 \text{ "}$$

$$\text{Wavelength } \lambda = 517 \text{ "}$$

$$\text{Thus } h = \frac{2\pi ldN}{\lambda} = \frac{2 \times .705 \times .703 \times 16}{517} = .096 \text{ meters or } 9.6 \text{ cms.}$$

The inductance of the loop as calculated from its dimensions and the number of turns according to the formula given in Terman's Radio Engineering is 327 microhenries. This value was checked experimentally by tuning the loop to various frequencies with a precision condenser, noting the capacity required for each frequency.

The formula for resonance

$$\text{is then } f = \frac{1}{2\pi\sqrt{L(C+C_0)}}$$

where f = frequency,

L = inductance of loop

C = tuning capacity,

C_0 = distributed capacity of loop.

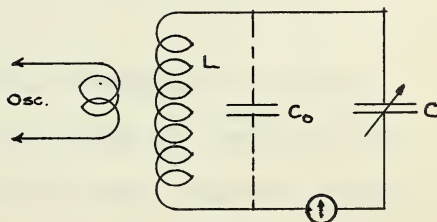

The following table gives the readings that were taken,

Frequency in kilocycles. Tuning capacity in $\mu\mu\text{f.}$

315	736
378	498
488	277
573	186
585	177.4
648	134.5

By substituting these values in the equation given above and making simultaneous solutions of different pairs of equations for L and C_0 , the following results were obtained,

Loop inductance in h. Distributed capy. in $\mu\mu\text{f.}$

323	56
322	56
321	55
325	53
321	55

Taking the best values as 321 microhenries and 55 micromicrofarads, the maximum frequency at which the loop will resonate is then

$$f = \frac{10^{-3}}{2\pi\sqrt{321 \times 10^{-6} \times 55 \times 10^{-12}}} = 1200 \text{ K.C.}$$

These measurements were taken without the transposed wires threaded in canvas strips that are used to connect the loop to the receiver. These will also add some inductance and capacity to the above values, so that the maximum frequency at which measurements can be taken will be somewhat less than 1200 K.C..

The distributed capacity could be reduced by using a smaller loop, wider spacing of the turns or smaller wire. However a smaller loop would result in less induced voltage

for the same field strength, wider spacing of turns would increase the inductance as well as making the loop too bulky, and the use of smaller wire would increase its resistance and so decrease the Q . The ideal wire for use in winding loops for broadcast frequencies is litzendraht wire, commonly called "litz". It is composed of a large number of very fine wires insulated from each other by enamelling and interwoven to form a wire of ordinary size. This wire has a particularly low radio frequency resistance due to its small "skin effect".

An important electrical property of the loop is its "Q". The Q of a circuit is defined as the ratio $\frac{\omega L}{R}$, where $\omega = 2\pi \times f$,

L = inductance of the circuit,

R = resistance of the circuit at the frequency f .

If an alternating voltage of the correct frequency is impressed on a resonant circuit having a certain Q , then at resonance a voltage of $Q \times E$ will exist across both the coil and the

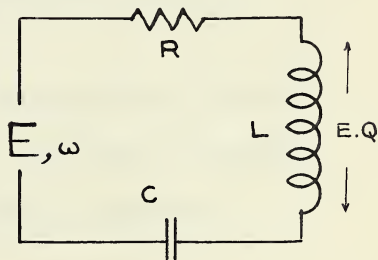

condenser. The loop, being tuned to the transmitter frequency acts as such a circuit and since the voltage generated in the loop by the signal is $e \times h$, the voltage that appears across the loop is $e \times h \times Q$.

It is possible, however, to use only one half of this voltage. The loop tends to act as an ordinary

antenna, in addition to its function as a loop, due to its height above the ground, and in order to prevent the unwanted voltage that results from adding to the voltage already across the loop it is necessary to connect the

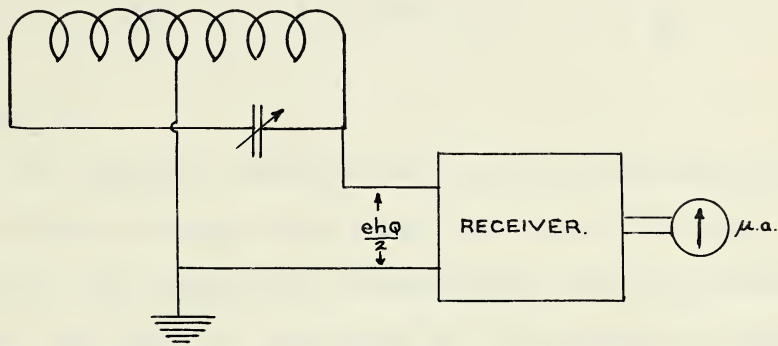

center of the loop to ground. This balances both halves of the loop with respect to ground and thereby eliminates the so-called "antenna effect" of the loop. The ordinary loop voltage is unaffected by this arrangement except that its useful value is reduced to one half of what it otherwise would be.

In order to effect the comparison between the received signal and the locally generated signal, the loop is opened at the center and a resistance of one ohm is inserted.

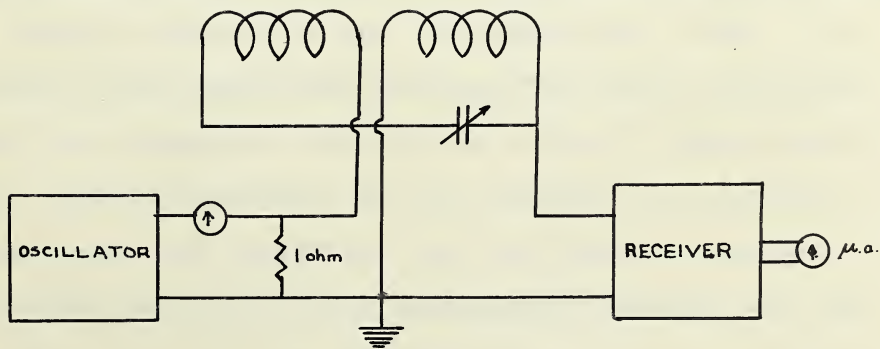

Thus when a known oscillating current is passed through this one ohm, a known voltage is generated in the loop,

and when this voltage is adjusted to produce an effect on the receiver equal to that caused by the electromagnetic wave, it is then a simple matter to calculate the field strength, since

$$I \times l \times Q/2 = e \times h \times Q/2 \quad \text{or} \quad e = \frac{I}{h}$$

2. Receiver.

As the primary considerations in the construction of this field strength measurement set were economy, portability and simplicity, commensurate with reasonable accuracy, the receiver was built as a two tube set with one stage of radio frequency amplification preceding a biased detector.

The voltage developed across one half of the loop is applied to the grid of the radio frequency amplifier, and the output voltage of the amplifier is applied to the grid of the detector. The indication of the received signal is given on a 30-microampere d.c. meter in the plate circuit of the detector. On account of the necessity for portability and hence the use of batteries, the choice of tubes is limited to the "30" series of 2 volt, low current tubes especially designed for battery operation. The radio frequency amplifier is a type 34 super control R.F. amplifier pentode, and the detector is a type 32 screen-grid R.F. amplifier used as a biased detector. A pentode amplifier and a screen-grid detector are used as they both give high amplification, for as much amplification as possible is necessary owing to the small

number of tubes used and the resultant lack of sensitivity. The use of a microammeter as the indicating meter gives the set additional sensitivity. The actual reading of the microammeter is not used in the measurement except for the purpose of making the locally generated signal equal to the received signal.

A variable gain control is incorporated into the grid bias circuit of the radio frequency amplifier in order that both large and small signal strengths may be measured. The maximum signal strength that can be accommodated is limited by the maximum output voltage of the oscillator and attenuator, while the minimum strength is limited by the deflection of the microammeter becoming too small to be accurately reproduced.

A variable grid bias control on the detector tube is provided in case of need, but ordinarily this control does not have to be altered.

A headphone jack is placed in the plate circuit of the detector to assist the operator in tuning the local oscillator to the frequency of the transmitter by means of the heterodyne beat note, the frequency of this note being the difference between the oscillator and transmitter frequencies.

All high voltage leads to the receiver and oscillator have 80 millihenry radio frequency chokes in them and are bypassed to ground with .01 microfarad condensers.

The filament, grid bias, plate and screen batteries

for the receiver are all turned on simultaneously with a triple pole switch. The filament rheostat, however has an open position so that the filaments may remain off while the plate and grid voltages are still applied.

The sensitive microammeter has a 1 milliampere fuse in series with it as a precaution against a burnout if the plate current of the detector should exceed 1 milliampere. This meter also has a variable resistor shunting it in order to increase its range whenever necessary and the resistor has an open position so that the maximum sensitivity of the meter may be used. The meter is kept shorted during transportation to prevent the needle from oscillating and thus becoming bent by hitting the ends of the scale.

The receiver is merely used as an uncalibrated radio frequency vacuum tube voltmeter for the purpose of establishing the equality of two voltages; one induced in the loop by the passing electromagnetic wave, and the other injected into the loop by the local oscillator. The gain control, as stated above, serves to extend the range of voltages that can be compared.

CIRCUIT DIAGRAM
OF
FIELD STRENGTH MEASUREMENT SET

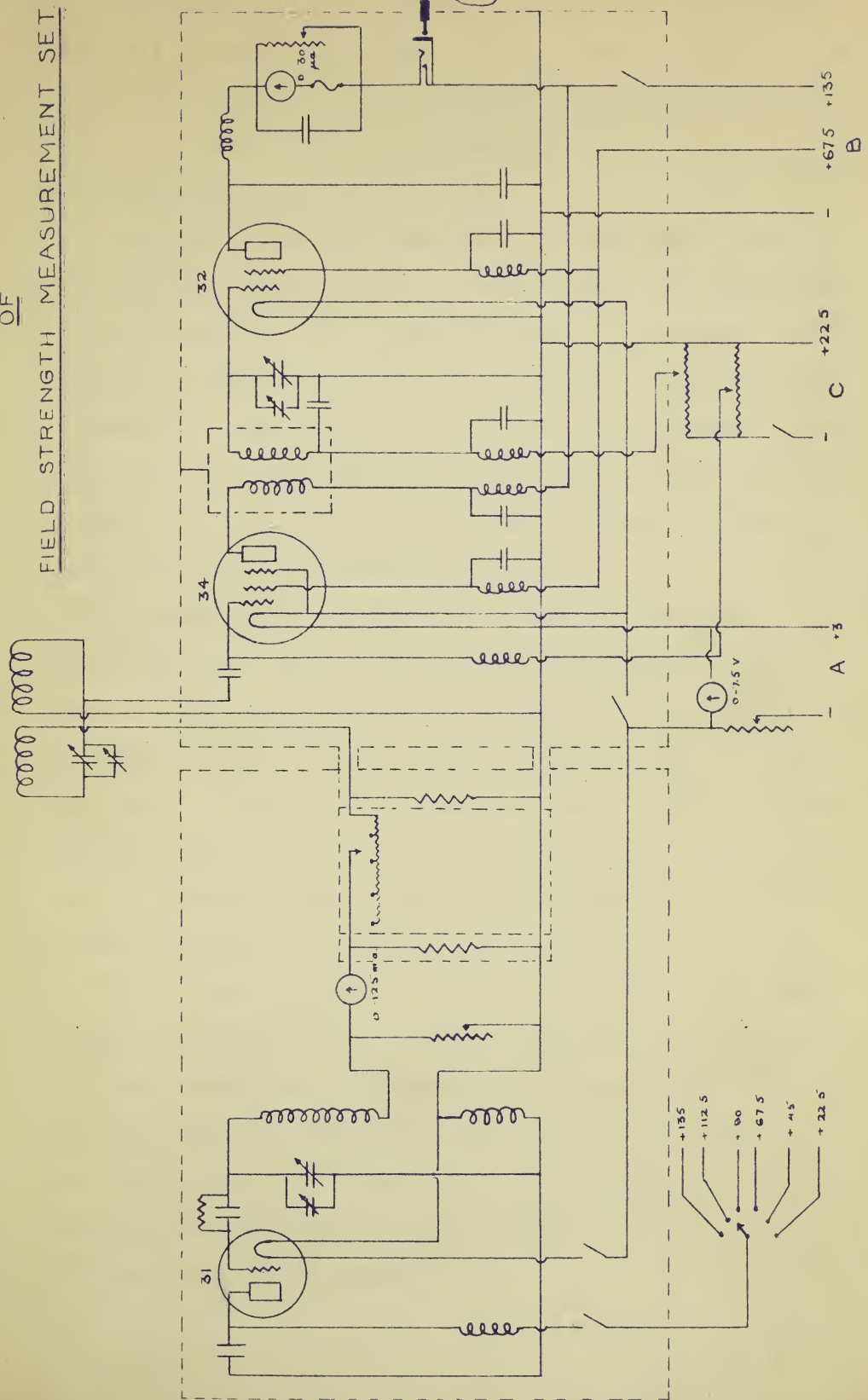

DOTTED LINES INDICATE SHIELDING.

3. The apparatus that is used to provide a known radio-frequency voltage in the loop equal to the voltage induced by the radiation from the transmitter can be divided into two parts, oscillator and attenuator.

(a) Oscillator.

The oscillator is of the conventional shunt feed Hartley type, using a type 31 power triode for economical battery operation. The important point to be noted in the design and construction of the oscillator is that it must be extremely well shielded to prevent the existence of any stray fields outside the oscillator box, as they would be picked up by the loop and the known voltage from the attenuator would be interfered with.

To assist in the reduction of stray fields, the oscillator tank coil is wound as a rectangular toroid, since theoretically a toroidal coil has no external field. Actually there is a small field produced, but it is very much smaller than if an ordinary solenoidal coil were used. The cross-section of the coil is rectangular since the coil form is therefore much easier to construct than in the case of the conventional doughnut type of coil.

The toroid is built to fit in the rather small space in the oscillator box originally provided for a solenoidal coil, and therefore its dimensions are somewhat restricted for the required inductance. The coil is 6.1" across and 2.8" thick with a 2" hole in the center and has 120 turns.

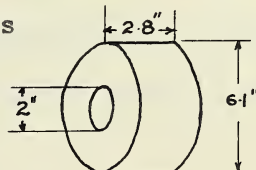

From the formula in Appendix A of

Terman's Radio Engineering the inductance is 228 microhenries, and it is tuned over the broadcast band with a 0.00035 microfarad variable condenser.

To obtain the oscillating current which is used to provide the known output voltage, the tank coil is opened at the neutral or grounded point, the current is measured with a 0-125 milliampere thermocouple meter and then passed through an attenuating network. The value of the oscillating current is altered when necessary by a non-shortening tap switch arrangement which varies the plate voltage of the oscillator tube in steps of 22.5 volts up to a maximum of 135 volts. A fine adjustment of the current is obtained with the variable resistor shunting the meter and attenuator. This resistor is of the carbon compression type (non-inductive) in order that adjustments of it may not affect the frequency of the oscillator.

A single rotary switch turns on both the plate and filament voltages of the oscillator simultaneously, but the plate voltage circuit may be controlled independantly by the tap switch mentioned above.

Both the oscillator tuning condenser and its vernier are mounted well behind the front panel and the condenser shafts are extended through the panel for tuning purposes by means of steel couplings and short lengths of bakelite rod. This arrangement is necessary to eliminate the stray fields that would be present if the condenser shafts were allowed to protrude through the panel.

(b) Attenuator.

The purpose of the attenuator is to introduce a small yet accurately known voltage into the loop. To accomplish this, as was previously explained, a 1 ohm resistor is inserted in the center of the loop and the current through this ohm is measured. The difficulty here lies in the accurate measurement of very small radio frequency currents. The best system is to start with a large current that can be conveniently measured with a thermocouple type milliammeter, and then to divide the current up with a network of resistances in such a manner that only a known fraction of it, which can be calculated from the values of the resistances forming the network, passes through the ohm in the loop.

The most sensitive thermocouple milliammeter that can be obtained at a reasonable cost is the 0-125 range meter. This instrument unfortunately has a square law scale so that readings below 30 or 40 milliamperes tend to be inaccurate.

The range of field strengths that this measurement set is designed to cover is approximately 1 to 60 millivolts per meter. This range is divided up into four sections, each section being covered by variation of the current in the attenuator between 40 and 120 milliamps.

The arrangement of the oscillator and attenuator is shown in the diagram on the next page.

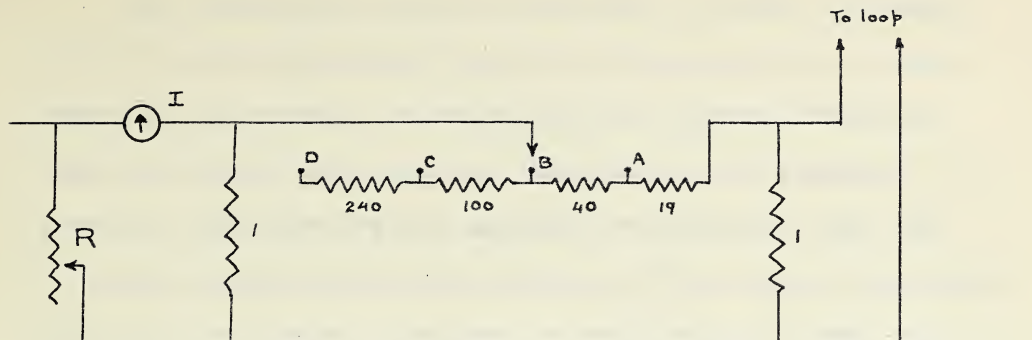

The Variable resistor R is the non-inductive carbon compression resistor mentioned above. The 1 ohm on the right is the output ohm or the ohm in the center of the loop, and the fraction of the current I that passes through this ohm is varied by the tapped 399 ohm resistor. The balance of I of course passes through the input ohm on the left. Thus when the tap A is used the current through the output ohm is $1/21 I$, and the voltage injected into the loop is $\frac{I}{21}$ millivolts, I being expressed in milliamperes.

Similarly when B is used the fraction of the current is $1/61$, with C it is $1/161$ and with D it is $1/401$.

These fractions were originally intended to be $1/20$, $1/60$, $1/160$ and $1/400$ respectively, but an error in the calculation of the sizes of the series resistors caused the denominators to be increased by one in each case. Fortunately the difference is not large enough to warrant the construction of new resistors.

The attenuation ratios necessary to cover the range of 1-60 millivolts/meter in four sections and the corresponding resistances are calculated as follows. One ohm shunt resistors are used as they seem to be standard practice and they are the smallest resistances that can be easily constructed while using as fine wire as possible. Since the resistance inserted in the loop is 1 ohm, the value of the current I required to give a voltage across this ohm equal to the voltage produced in the loop by a field strength e is readily found from the equation

$$I \times \frac{1}{a} \times l = e \times h ,$$

where l/a is the fraction of I that flows through the 1 ohm, and h is the effective height of the loop.

The useful range of the thermocouple milliammeter is 40-120 m.a. or a 1-3 ratio, and since h is very nearly 0.1 meter, to measure a field strength of 60 m.v./meter using 120 m.a. oscillating current,

$$120 \times \frac{1}{a} \times l = 60 \times 0.1 \quad \text{or} \quad a = 20.$$

Thus the first attenuation factor is 1/20. Now when I is reduced to 40 m.a., the corresponding field strength is 1/3 of 60 or 20 m.v./meter. For continuity, the maximum field strength measurable on the next tap with 120 m.a. again must be then 20 m.v./meter, so that

$$120 \times \frac{1}{a} \times l = 20 \times 0.1 \quad \text{or} \quad a = 60,$$

and when I is reduced to 40 m.a. the corresponding field strength is similarly 1/3 of 20 or $6 \frac{2}{3}$ millivolts/meter.

By proceeding in this manner it is easily found that the range 7.5 to 2.5 m.v./meter is covered when $a = 160$ and when $a = 400$ the range is 3 to 1 m.v./meter, the current I in each case being varied between 40 and 120 m.a. by means of the shunting resistor R .

The construction of this attenuating network presents no small problem, since the resistances have to have certain accurately known values at radio frequencies. The difficulties of constructing a resistor that will be accurate at radio frequencies are concerned with the elimination of "skin-effect" and inductance. At high frequencies the current tends to travel on the surface of the wire, so that the effective or useful area of the conductor is decreased, and its resistance thereby increased. This is the so-called "skin-effect". Also an appreciable amount of inductance in a resistor will introduce an inductive reactance in addition to the resistance present, so that the resistor will have an impedance greater than its resistance. However, since the resistance and reactance add at right angles to give the impedance, a small amount of inductance in a resistor has a negligible effect.

The skin-effect can be considerably reduced by the use of very fine wires, but the use of fine wire is limited by the current the wire has to carry, for if the wire becomes heated, its resistance will increase. The inductive effect also can be practically eliminated by arranging the wire in a narrow loop or bifilar winding, since a small loop

has small inductance.

Thus if the foregoing precautions are observed, it is possible to construct resistors whose radio frequency resistances will not differ from their d.c. values by more than a very small amount, the calibration on d.c. being made with a Wheatstone bridge and a sensitive galvanometer.

All the resistances in this attenuator are wound with fine manganin wire in the non-inductive manner mentioned above. The maximum size of wire used is #30, with which the 1 ohm shunt resistors are wound. The 19 and 40 ohm series units are made with #36 wire, and the 100 and 240 ohm units are wound with very fine wire, probably #42 or #44.

Moullin¹ states that if no manganin wire larger than #22 is used for standard resistors, they may be considered to have a resistance that is independent of frequency to the accuracy of measurement ordinarily possible at high frequencies.

Also Zenneck² gives a table which shows that if the resistance of manganin wire is not to exceed the d.c. value by more than 0.1% at a frequency of 500 KC, its maximum diameter should be .135 mm.. For an increase of 1%, the maximum diameter can be .75 mm.. The largest wire used here, #30, has a diameter of .25 mm., so that an increase in resistance of less than 1% is to be expected from all the units used in this attenuator.

1. E.B.Moullin, Radio Frequency Measurements, p 240.

2. J.Zenneck, Wireless Telegraphy, p 398.

In Jensen's description¹ of his field strength set he states that the impedance at radio frequency of a bifilar winding of #36 wire 3.5 cm. long is only 1/5 of 1% greater than its resistance. On the basis of this fact, all the units in this attenuator are assumed to have negligible inductance.

The following are the actual sizes of the different units used ; measured on direct current.

	<u>Nominal Resistance.</u>	<u>Measured Resistance.</u>
Input ohm	1 ohm	1.002 ohms
Output ohm	1 "	1.002 "
	19 "	18.98 "
	40 "	40.04 "
	100 "	100.3 "
	240 "	240.5 "

The series resistances are wound on a bakelite toroid, the ends being soldered to brass bolts running through the toroid, all connections made on the rear side. The front ends of the bolts are soldered to lugs on a ten-point rotary switch, the bolts being spaced around the toroid to correspond with the lugs. As only half of the switch points and lugs are needed, every other one is removed.

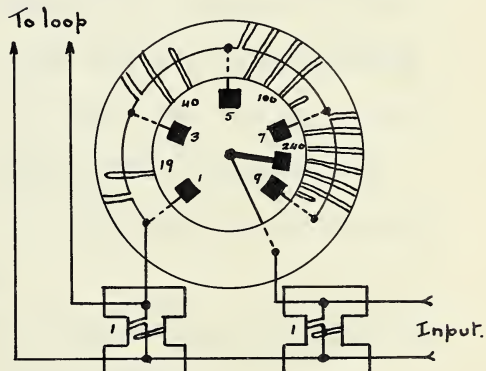

The connection from the rotating selector arm of the switch is soldered to another bolt through the toroid. By this means the toroid is firmly fixed to the switch

1. Axel Jensen, loc.cit.

and the whole assembly is fixed to the panel by the single hole mounting system of the switch. A copper box completely encloses both toroid and switch, and the one ohm shunt units are mounted on small pieces of bakelite in shielded partitions in the back bottom corners of the box.

The output ohm is connected to the loop circuit by two heavy copper wires running through a rectangular shielding tube made of galvanized iron, the wires being supported by transverse strips of bakelite. This tube passes from the attenuator box through the oscillator shield box into the receiver shield box, where the wires are connected to a 3-way jack and so to the loop by means of a 3-way plug and wires threaded in strips of canvas.

The knob of the selector switch has an arrow inscribed on it, and fastened to the panel behind the knob is a plate with numbers from 1 to 10 on it, each number corresponding to a tap on the ten point switch. As half the switch points are removed, the even numbers on this dial indicate open positions of the attenuator, and the odd numbers correspond as shown in the previous diagram.

The following table shows the attenuation for each tap;

<u>Switch Position.</u>	<u>Attenuation.</u>
7	1/21
5	1/61
3	1/161
1	1/401

When the switch arm is on tap 9, the attenuation is $\frac{1}{2}$. This ratio was not originally provided for but it may be useful at times for the measurement of extremely large field strengths.

This attenuator is the outcome of several experiments on the production of small known radio frequency voltages.

The first system tried was a high resistance potentiometer across a one ohm as shown, but this was found to be impractical as it was essential that the output circuit should draw no current through the

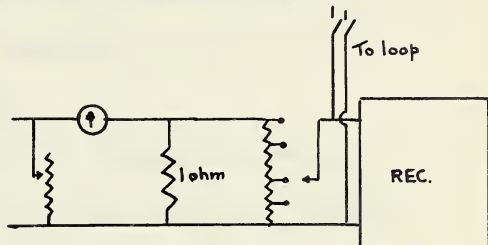

potentiometer. The next arrangement tried was simply a tapped low resistance forming the

output resistance through which the known current flowed. The variable resistance was a General

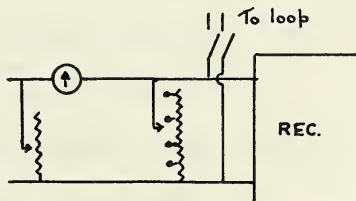

Radio decade box, and a considerable amount of time was spent in calibrating this box at radio frequency with a special type of vacuum tube voltmeter using a screen-grid tube. The decade box, however, was found to have too much inductance, so that it was discarded and a series of small resistors with low inductance was constructed to take its place.

However, at this point it was realized that even if these resistors functioned properly, the system was not very good because the locally produced voltage was not

injected into the loop but was applied directly to the receiver. This meant that the Q of the loop entered into the calculation of the field strength, and as this quantity is hard to determine besides being subject to considerable variation, it was finally decided to adopt the system described by Jensen,¹ but with considerable simplification in the interests of economy.

Operation of the field strength set.

The following is the procedure for taking a reading. The loop is taken from its box and is placed on the support which is fastened to the left side of the car at the rear window. The plugs on the ends of the wires from the loop are inserted in the jacks in the loop tuning condenser box and the 3-way plug on the end of the lead from this box is inserted in the jack in the panel of the receiver. The loop tuning condenser box is arranged to hang on the window near the loop support while the measurement set itself is placed in the back seat of the car.

With the oscillator plate voltage tap switch in an open position, both filament switches are turned on and the filament rheostat is turned up until the voltmeter indicates 2 volts.

The microammeter shunting resistor is then increased until the meter shows a small deflection. The best place for this resistor is just before the open position is reached. At this point the shunting resistance is about

1. Axel Jensen, loc. cit.

equal to the meter resistance so that the range of the meter is about twice the full scale deflection.

The headphones are plugged in and the receiver gain control is turned up. The loop is then rotated and the loop and receiver tuning dials are adjusted until the station is brought in and the microammeter deflection is a maximum. If the signal is modulated, the headphones assist materially in locating and tuning in the station.

The microammeter deflection is then adjusted to a suitable value by means of the gain control and the reading is noted.

Next the attenuator switch is set on a low tap, 1 or 3, and the oscillator plate voltage switch is set on a low voltage point, about 45 volts. The oscillator is tuned to the transmitter frequency until a very low beat note is heard in the headphones. When the beat note is very low it may be seen with the swing of the microammeter needle.

At this point the loop is rotated through 90° until the reception from the transmitter is zero. The oscillator plate voltage is increased, and the carbon resistor and attenuator tap switch are varied until the deflection of the microammeter is the same as it was for the reception from the transmitter, with a convenient current shown on the thermal milliammeter.

If the frequency of the oscillator varies while these adjustments are being made, it is readjusted with the vernier condenser.

No dials or knobs associated with the loop or the receiver are touched after the microammeter deflection is once set with the receiver gain control.

The measurement is then finished except for the calculation of the field strength from the equation

$$e = \frac{l}{a} \cdot \frac{I}{h}$$

where e = field strength in millivolts/meter,

$\frac{l}{a}$ = attenuation factor,

I = oscillating current in milliamperes,

h = effective height of loop in meters.

In turning off the set after a reading has been taken, the microammeter is shorted and the oscillator plate voltage switch placed in an open position. The filament rheostat is turned off before either filament switch, otherwise if one circuit were opened first the voltage on the other filament would increase immediately to a dangerous value.

The usual system of making a field strength survey is to take several series of readings in radial directions about the transmitter. About eight equally spaced radials are used and curves are plotted on semi-logarithmic paper showing the variation in signal strength as the distance from the transmitter is increased.

From these curves contour lines of equal field strength can be plotted on a map of the country around the transmitter for comparison of the intensity of the radiation in various directions.

Readings are also taken on a circle around the transmitter at a distance of about 5 wavelengths in order to obtain a value of the effective height of the antenna. A distance of 5 wavelengths is used in order that the readings may not be affected by either the induction fields that exist near the transmitter or by attenuation of the waves as they travel over the surface of the ground.

Observations and Results.

The following are the readings taken on a circle of radius 1.69 miles around the transmitter in order to determine the effective height of the antenna.

<u>Location.</u>	<u>Field Strength.</u>
West entrance to University Farm	29.8 mv/m.
Corner 109 St. and 66 Ave.	28.8
S.E. corner South Side Athletic Grounds	28.8
81 Ave and 100 St.	30.3
83 Ave. and 99 St.	27.8
86 Ave. and 99 St.	29.0
89 Ave. and 99 St.	30.0
Cor. Sask. Drive and 99 St.	38.2
Scenic drive just north of flagpole.	34.8
100 A St. and 98 Ave.	29.3
Bottom of McDougall Hill.	31.3
Beside McDougall Church.	32.3
103 Ave. and 105 St.	28.8
104 Ave. and 108 St.	30.3
Ave. south of Cemetary, about 118 St.	30.8
Cor. 127 St. and Stony Plain Road.	30.8
102 Ave about 136 St.	32.8
142 St and 95 Ave, Road to Country Club.	30.8

POLAR CURVE OF FIELD
STRENGTH OF C.K.U.A. AT A
DISTANCE OF 5 WAVELENGTHS.

N
↑

MILLIVOLTS PER METER.

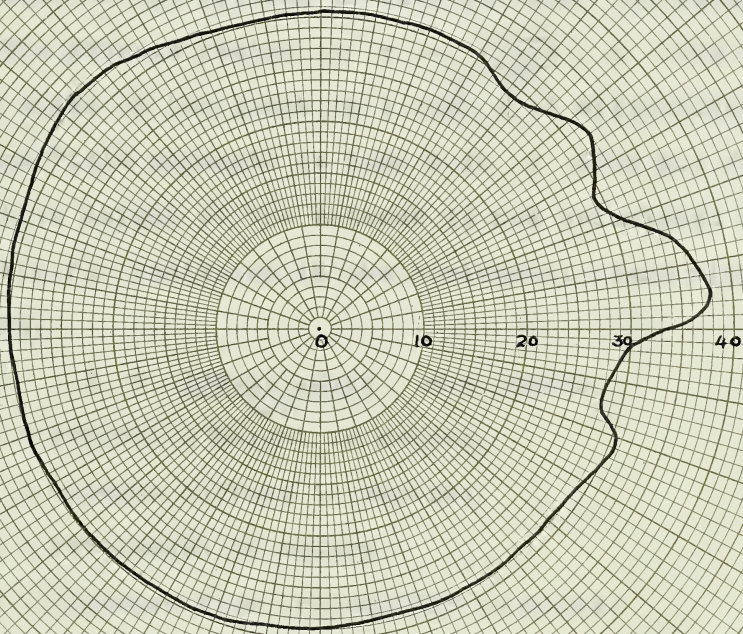

These readings were then plotted on polar paper, (see preceding page) so that the distance from the origin to any point on the curve represents the field strength in that direction at a point 1.69 miles from the transmitter. The curve in the southwest quadrant is estimated since at the time the readings were taken the roads in that area were impassible and observations could not be made on that portion of the circle.

The area of the diagram is 11.5 sq. ins. by planimeter and thus the average radius is $r = \sqrt{\frac{11.5}{\pi}} = 1.92$ ins. Since the scale of the graph is 1 inch = 16 millivolts/meter, the average field strength is $1.92 \times 16 = 30.6$ m.v./meter. The effective height of the antenna is now calculated from the equation for radiation in the horizontal plane without attenuation,

$$E = \frac{188 \times h \times I \times 0.62}{\lambda \times r} \quad \text{m.v./meter,}$$

where h = effective height in meters,

I = antenna current in amperes,

λ = wavelength in meters,

r = distance from transmitter in miles,

0.62 = factor converting kilometers to miles.

Throughout this whole investigation the antenna current was kept constant at 9 amperes.

$$\text{Then } h = \frac{30.6 \times 517 \times 1.69}{0.62 \times 188 \times 9} = 25.5 \text{ meters.}$$

This value agrees quite well with the figure 24.4 obtained by Mr. Sinclair from the physical dimensions of the antenna.

1. Thesis by G. Sinclair, Determination of the Constants of an Ungrounded Antenna System.

The transmitter is unfortunately rather badly situated for this investigation of its effective height as it is closely surrounded by the University buildings, particularly the residences and the Plant Pathology lab, and the river valley and the built-up areas of the city are bound to have some effects. This last fact is seen in the irregularity of the curve towards the east. As there are not many big buildings directly on the south bank of the river valley, this irregularity is probably due to either the topography of the valley or to the proximity of the campus buildings. However, sufficient work has not yet been done in this area to determine the exact cause.

If it is due to the valley, then it is to be expected that a similar irregularity ~~will~~ be found to occur in the south-west portion of the curve when it can be investigated.

The following readings were taken to obtain the curves of field strength against distance for several directions around the transmitter.

South along the Calgary Highway.

S.E. corner South Side Athletic Grounds.	26 m.v./m.
0.3 miles south.	22
School house at railroad crossing.	8.7
Ellerslie.	5.4
2 miles south	3.8
2 miles south	2.7

South East along Cooking Lake Road.

Corner 99 St. and 83 Ave.	28
Corner Whyte Ave. and 93 St.	17
Whyte Ave at City Limits.	12
1 mile east and $\frac{1}{2}$ mile south.	8.1
3 miles east.	5.3
2 miles south.	4.7

East along Clover Bar Road.

Scenic Drive north of flagpole.	35
Top of Dawson Hill.	15
2 miles east of city limits.	6.3
2 miles north at Clover Bar.	3.4
3 miles east.	2.5

North East along Road to Fort Saskatchewan.

Corner 108 St. and 104 Ave.	30
Corner 96 St. and 105a Ave.	19
Corner 86 St. and 112 Ave.	13
Fort Trail at Railway Bridge.	7
$\frac{1}{2}$ mile south of Mental Institute.	2.6

North along Road to Namao.

Ave south of Cemetary about 118 St.	31
Portage Ave opposite Prince of Wales Armouries.	18
Corner 118 Ave and Namao road.	13
2 miles north of City Limits.	7

North West along St. Albert Road.

Corner 127 St. and Stony Plain Road.	31
Corner 127 St. and 111 Ave.	13
200 yards past sawmill.	6.5
300 yards past City Limits.	2.2

West along Jasper Highway.

Corner 142 St. and 95 Ave.	31 m.v./m.
At City Limits.	19
2½ miles west.	7
Winterburn.	4

The curves are plotted on semi-logarithmic paper and comprise pages 42, 43, and 44. On each sheet is plotted also the theoretical inverse distance curve for no attenuation for purposes of comparison. An effective height of 24.4 meters was used in the calculations for this curve.

The chief use of these curves in this investigation is for the construction of a field strength contour map. However they can also be used to make a comparison with curves predicted from attenuation theory. The formula used here is that of Sommerfeld as given by Eckersley¹, as it is simple in form and easy to apply.

In this formula the theoretical field strength values (from the inverse distance law) are multiplied by a reduction factor S. This factor is obtained from a graph showing S as a function of Sommerfeld's "numerical distance", called d_n , which is in turn a function of the earth conductivity σ , the wavelength λ , and the distance from the transmitter x . The equation for finding d_n is as follows,

$$d_n = \frac{\pi x}{2\sigma \lambda^2 c},$$

where c is the velocity of light in cms/sec, x and λ are

1. P.P.Eckersley, Calculation of the Service Area of Broadcast Stations, Proc.I.R.E. 1930, p 1160.

GRAPH SHOWING VARIATION
OF FIELD STRENGTH WITH
DISTANCE.

— SOUTH - CALGARY HIGHWAY
— SOUTH-EAST - COOKING LAKE ROAD.

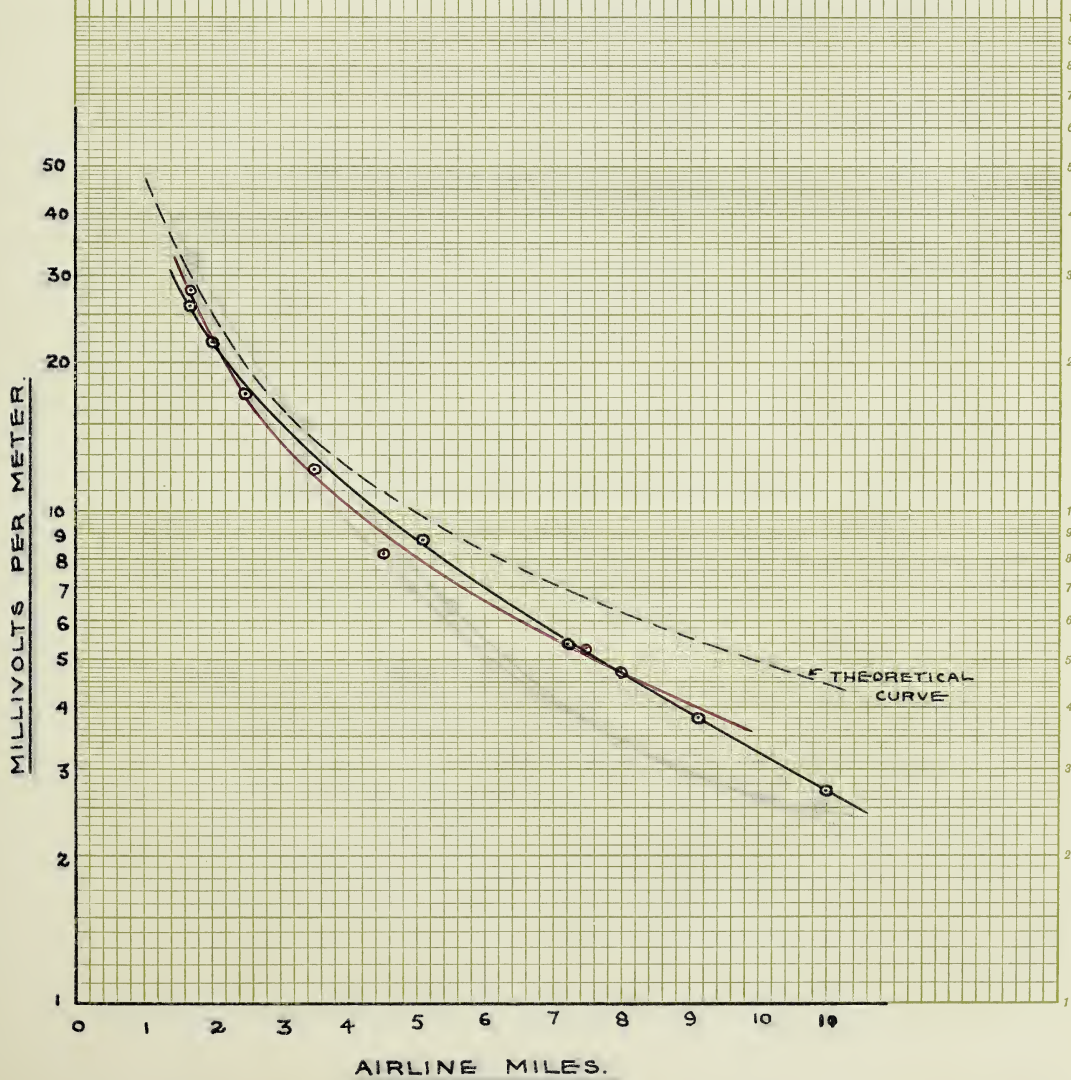

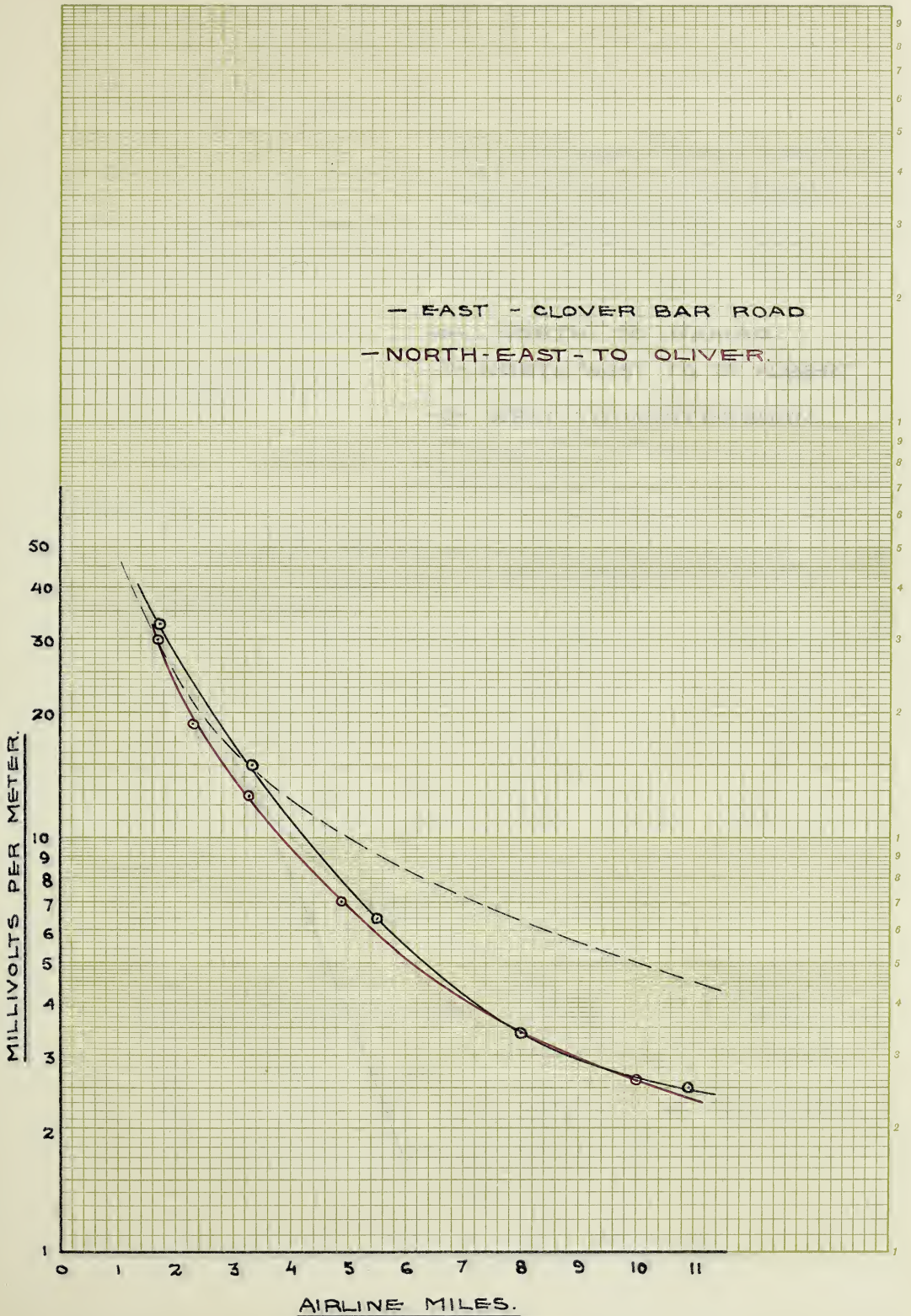

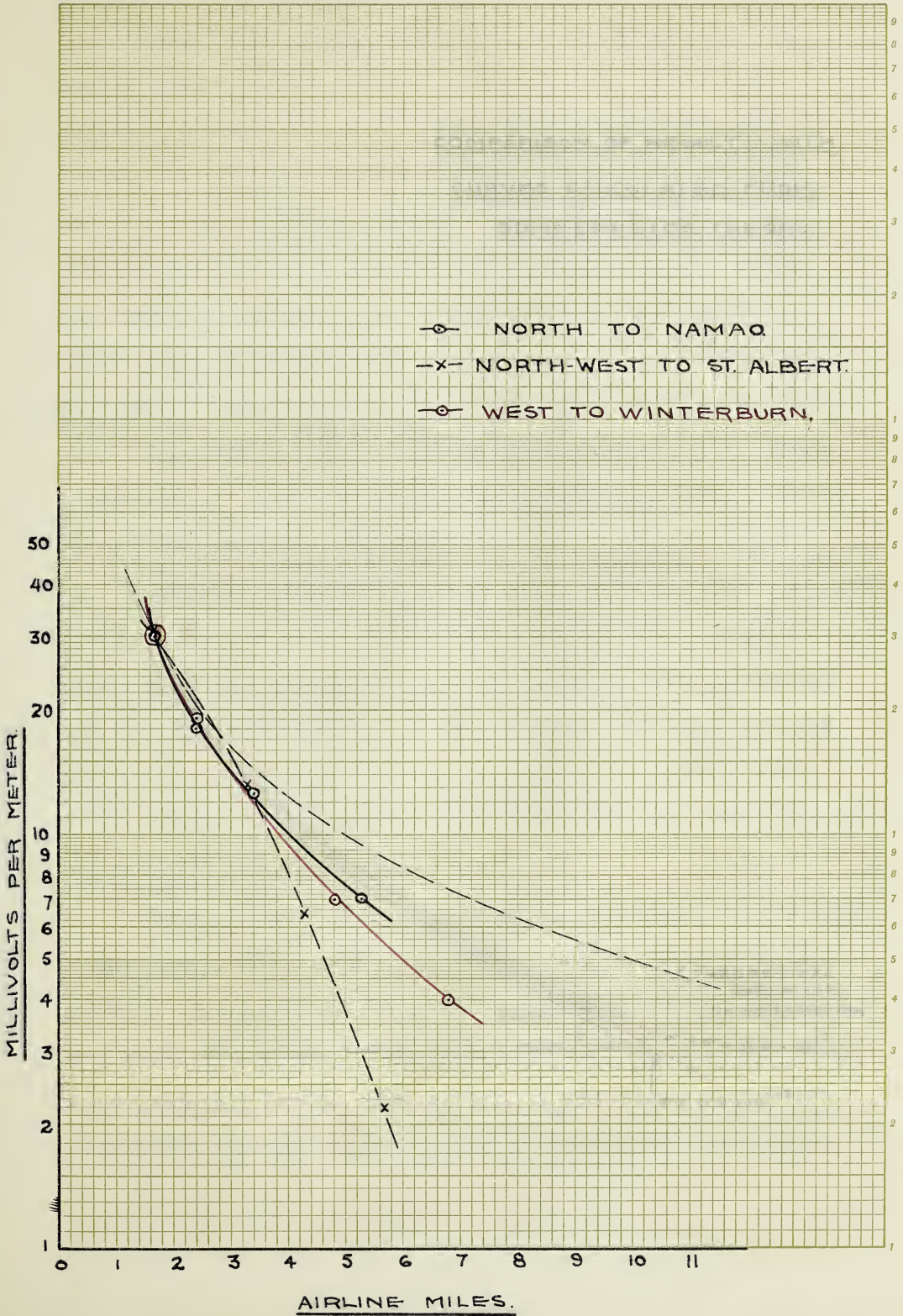

COMPARISON OF RESULTS WITH
CURVES CALCULATED FROM
SOMMERFELO'S THEORY

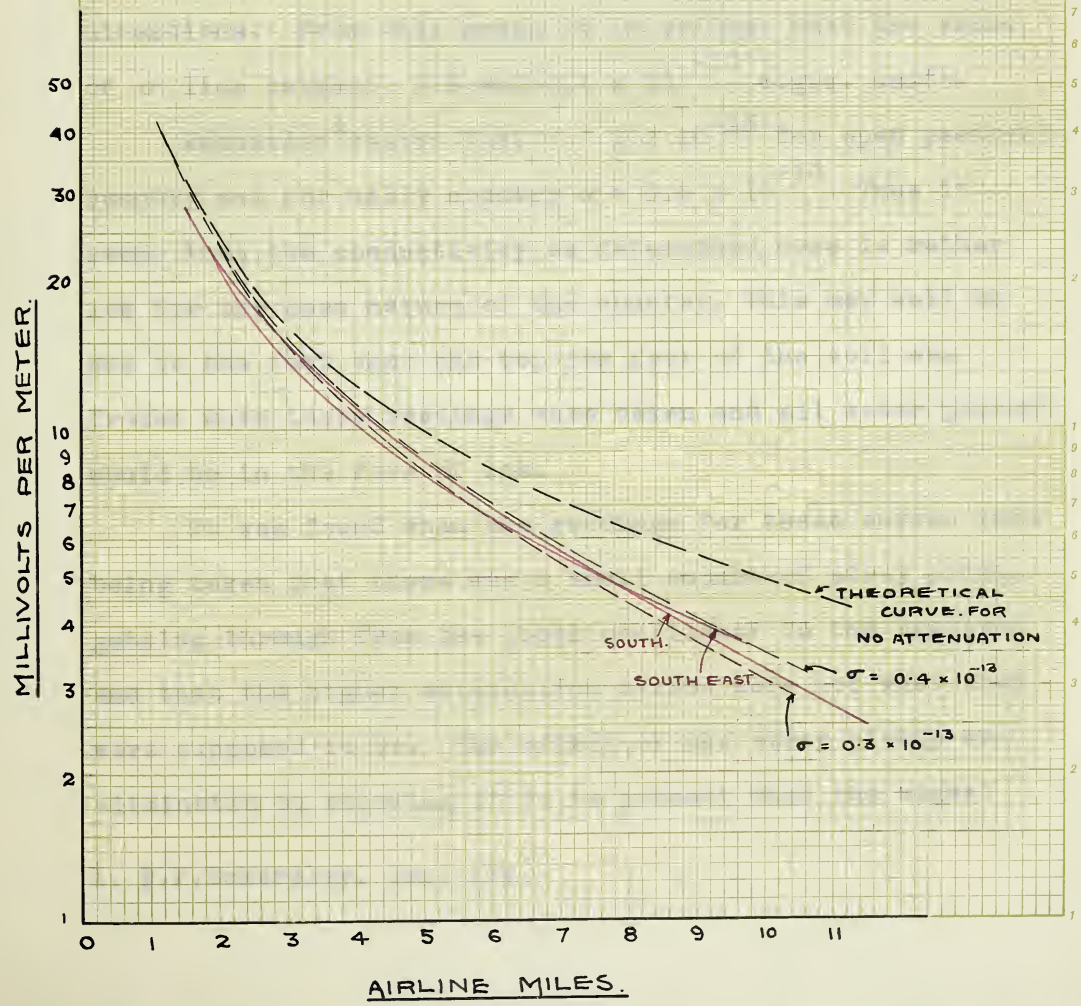

in cms and σ is expressed in c.g.s. units.

Using a few normal values of σ reduction factors were calculated for several points on the theoretical inverse distance field strength curve until two new curves were obtained which fitted closely the observed results, one slightly high and the other slightly low. On page 45 are shown the observed curves for the south and south-east directions together with the theoretical curves for no attenuation, for $\sigma = 0.3 \times 10^{-13}$ and also 0.4×10^{-13} c.g.s. units. The south and south-east curves were taken since there is more even topography in these directions. From this graph it is evident that the value of σ lies between 0.3 and 0.4×10^{-13} c.g.s. units.

Eckersley¹ states that $\sigma = 1 \times 10^{-13}$ for open pastoral country and for hilly country $\sigma = 0.5 \times 10^{-13}$. Thus it seems that the conductivity as determined here is rather low for the open nature of the country. This may well be due to the fact that the top few feet of the soil was frozen when these readings were taken and all water present would be in the form of ice.

It was found when the readings for these curves were being taken that there was a small amount of stray pickup getting through from the local oscillator to the receiver and that the higher attenuation ratios were not what they were supposed to be. The effect of the stray pickup was eliminated by allowing it to be present when the signal

1. B.P.Eckersley, loc. cit.

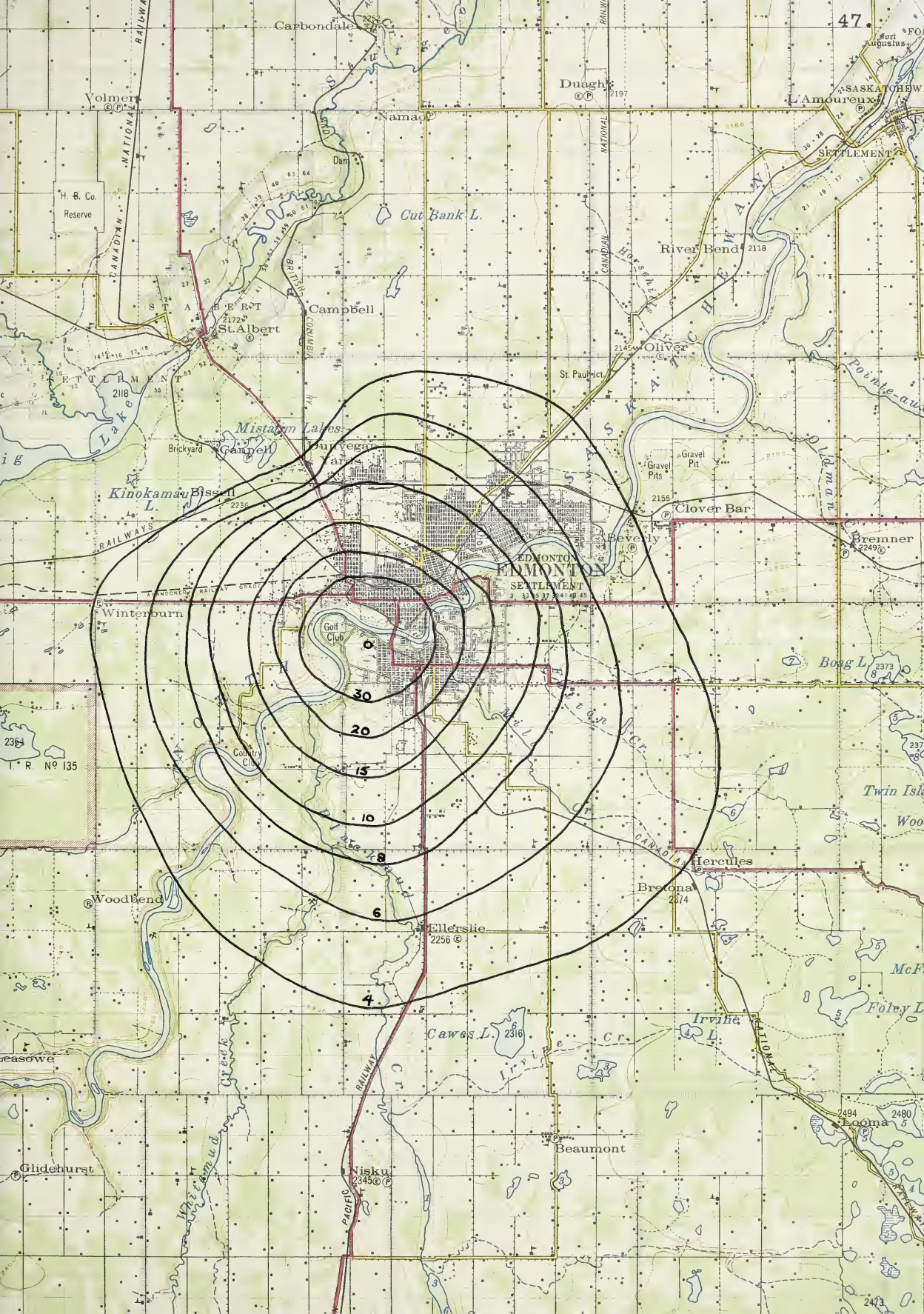

Carbondale

Duagh

L'Amoureux

Volmer

Namadji

SETTLEMENT

H. B. Co. Reserve

Cut Bank L.

River Bend

ST. ALBERT

Campbell

St. Paulin

Oliver

Kinokama Bissell L.

Mistagan Lakes

Gravel Pits

Clover Bar

EDMONTON SETTLEMENT

Bremner

Winterburn

30

20

15

10

8

6

4

Boag L.

Twin Island

Wood

Hercules

Bretona

Ellerslie

McF

Foley L.

Cawes L.

Irvin L.

Measowe

Nisku

Beaumont

Cooma

Glidehurst

from the transmitter was being received and new attenuation ratios were found by a calibration process using the 1/21 tap as a starting point. The ratios as used for taking these readings are 1/21, 1/54, 1/105, and 1/151. The exact cause of this discrepancy has not yet been determined but it is probably due to unforeseen capacities in the attenuator system.

From the curves showing the field strength as a function of the distance from the transmitter, points of equal field strength in the various directions are taken and plotted as contours on a map of the locality, page 47. Owing to the fact that all side roads were blocked with snow at the time readings were taken, it was possible to make measurements along only the main highways. To this extent the contours in the in-between areas may be slightly inaccurate, especially in the south-west.

When this investigation was started it was desired to find whether or not the new L-type antenna recently erected was directional. As the effect for this antenna should be an increase in strength towards the north, there does not appear to be any marked directivity in this case. To make certain of this, however readings should be taken out to the limit of the ground wave to get rid of any local effects caused by the city or the river valley.

There is a considerable increase in strength towards the south and south-west, and a marked diminution exists towards the north-west. It is noticeable, however, that the diminution does not start until some distance from the

transmitter is reached. This effect may therefore be due to some strictly local cause along the St Albert road. Unfortunately owing to the condition of the side roads this explanation could not be tested.

On the whole it may be said that with the new antenna the general shape of the contours is reasonably satisfactory.

The increase in strength towards the south and south-east cannot be attributed to any reflecting or directing action of the buildings near to the transmitter as none of them have a height that is a sufficiently large fraction of one wavelength. From the value of the earth conductivity obtained for this direction, is it probable that this strength is normal and that there is more attenuation in the other directions.

In conclusion the author wishes to thank Dr. MacLeod for his supervision and assistance during the course of the investigation, also Mr. Cornish for his help and the use of his car for the fieldwork, and Mr. Sinclair for the operation of the transmitter.

BIBLIOGRAPHY.

Only articles marked with an asterisk are of special interest in connection with this investigation.

1. Vallauri, G. Measurement of Electric and Magnetic Fields Received During Trans-Oceanic Radio Transmission. Proc.I.R.E. 1920. p 286.
2. Englund, C.R. Notes on Measurements of Radio Signals. Proc.I.R.E. Feb. 1923.
3. Brown, W.W., Englund, C.R. and Friis, H.T., Radio Transmission Measurements. Proc.I.R.E. April, 1923.
4. Bown, R. and Gillett, Distribution of Radio Waves over City Districts. Proc.I.R.E. Aug. 1924.
5. Investigations on the Propagation of Electromagnetic Waves. Proc. I.R.E. 1925.
6. Dye, D.W., Current Transformer Methods of Producing Small Voltages at Radio Frequencies. Jour.I.E.E. 1925, p 597.
7. Round,H.J., Eckersley,T.L., Tremellen,K., and Lunnon,F.C. Measurements of Signal Strengths at Large Distances. Jour.I.E.E. 1925,p 933.
8. Epenscheid,L., Anderson,C.N. and Bailey,A. Transatlantic Radio Telephone Transmission. Proc.I.R.E. 1926. p 7.
9. Bown,R., Martin,K., and Potter,R.K., Some Studies in Radio Broadcast Transmission. Proc.I.R.E., 1926, p 57.
10. Lindenblad,N. and Brown,W.W. Main Considerations in Antenna Design. Proc.I.R.E. 1926, p 291.
- * 11. Jensen,A.G. Portable Receiving Sets for Measuring Field Strengths at Broadcasting Frequencies. Proc. I.R.E. 1926, p 333.
12. Friis,H.T. and Bruce,E. A Radio Field Strength Measuring System for Frequencies up to Forty Megacycles. Proc.I.R.E. 1926, p 507.
13. Goldsmith,A.N. Reduction of Interference in Broadcast Reception. Proc.I.R.E. 1926, p 575.
14. Austin,L.W. and Wymore,I.J. Radio Signal Strength and Temperature. Proc.I.R.E. 1926, p 781.
- * 15. Smith-Rose,R.L. and Barfield,H. Attenuation of Wireless Waves due to the Surface of the Earth. Jour.I.E.E. 1926, p 766.

16. Hollingworth, J. Propagation of Radio Waves. Jour. I.E.E. 1926, p 579.
- * 17. Englund, C.R. and Friis, H.T. Methods for the Measurement of Radio Field Strengths. Trans. A.I.E.E. May, 1927.
18. Epenscheid, L. Radio Broadcast Coverage of City Areas. Jour. A.I.E.E. Jan, 1927.
- * 19. McIlwain, K. and Thompson, W.S. A Radio Field Strength Survey of Philadelphia. Proc. I.R.E. 1928, p 181.
20. Pickard, G.W. Some Correlations of Radio Reception with Atmospheric Temperature and Pressure. Proc. I.R.E. 1928, p 765.
21. O'Neill, H.M. Characteristics of Certain Broadcasting Antennas. Proc. I.R.E. 1928, p 872.
22. Edwards, S.W. and Brown, J.E. The Use of Radio Field Intensities as a Means of Rating the Outputs of Radio Transmitters. Proc. I.R.E. 1928, p 1173.
23. Jansky, C.M. Some Studies of Radio Broadcast Coverage in the Middle West. Proc. I.R.E. 1928, p 1356.
- * 24. Barfield, R.H. Attenuation of Wireless Waves over Land. Jour. I.E.E. 1928, p 204.
25. Eckersley, P.P. Design and Distribution of Wireless Broadcasting Stations for a National Service. Jour. I.E.E. 1928, p 501.
26. Kenrick, G.W. Radio Transmission Formulae. Phil. Mag., Aug, 1928.
27. Meissner, A. Transmitting Antennas for Broadcasting. Proc. I.R.E. 1929, p 1178.
28. Whittemore, L.E. Some Principles of Broadcast Frequency Allocation. Proc. I.R.E. 1929, p 1343.
- * 29. Edwards, S.W. and Brown, J.E. The Problems Centering about the Measurement of Field Intensity. Proc. I.R.E. 1929, p 1377.
30. Barfield, R.H. and Munro, G.H. Attenuation of Wireless Waves over Towns. Jour. I.E.E. 1929, p 253.
- * 31. Eckersley, P.P., Eckersley, T.L. and Kirke, H.L. Design of Aerials for Broadcasting Stations. Jour. I.E.E. 1929, p 507.
32. Hollingworth, J. and Naismith, R. High Frequency Field Intensity Measuring Apparatus. Jour. I.E.E. 1929, p 1033.

33. Rolf, B. Graphs to Prof. Sommerfeld's Attenuation Formula for Radio Waves. Proc.I.R.E. 1930, p391.
34. Kenrick, G.W. and Pickard, G.W. Summary of Progress in the Study of Radio Wave Propagation Phenomena. Proc.I.R.E. 1930, p 649.
- * 35. Eckersley, P.P. The Calculation of the Service Area of Broadcast Stations. Proc.I.R.E. 1930, p 1160.
36. Reyner, J.H. Measurements of Signal Strength in Cornwall. Jour.I.E.E. 1930, p 181.
37. Bird, J.R. The Design of Radio-Frequency Signal Generators. Proc.I.R.E. 1931, p 438.
38. Fassbender, H., Eisner, F. and Kurlbaum, G. Investigation of the Attenuation of Electromagnetic Waves. Proc.I.R.E. 1931, p 1446.
39. Jansky, C.M. and Bailey, S.L. On the use of Field Intensity Measurements for the Determination of Broadcast Station Coverage. Proc.I.R.E. 1932, p 62.
- * 40. Ring, A.D. Empirical Standards for Broadcast Allocation. Proc.I.R.E. 1932, p 611.
41. Kirby, S.S. and Norton, K.A. Field Intensity Measurements at Frequencies from 285 to 5400 Kilocycles per Second. Proc.I.R.E. 1932, p 841.
- * 42. Eckersley, T.L. Direct Ray Broadcast Transmission. Proc.I.R.E. 1932, p 1555.
43. Mutch, W.W. A Note on an Automatic Field Strength and Static Recorder. Proc.I.R.E. 1932, p 1914.
44. Rakshit, H. A Radio Field Strength Survey of Calcutta and Suburbs. Phil. Mag., 1931, p 174.
- * 45. Report of Committee on Radio Propagation Data. Proc.I.R.E. 1933, p 1419.
46. Anderson, C.N. Attenuation of Overland Radio Transmission in the Frequency Range 1.5 to 3.5 Megacycles per Second. Proc.I.R.E. 1933, p 1447.
47. Taylor, P.B. A Compact Radio Field Strength Meter. Proc.I.R.E. 1934, p 191.