

DATABOOK

Price

25 cents



**POCKET
DATABOOK**

RAYTHEON

**RADIO
RECEIVING
TUBES**

**RAYTHEON
PRODUCTION
CORPORATION**

55 Chapel Street Newton, Mass.

420 Lexington Ave. New York, N. Y.

445 Lake Shore Drive Chicago, Ill.

555 Howard St. San Francisco, Cal.

415 Peachtree St., NE Atlanta, Ga.

Copyright 1957
by
RAYTHEON PRODUCTION CORPORATION
Newton, Mass.

It is the responsibility of the user to determine whether any commercial use of the data or circuits presented in this booklet constitutes infringement of any patent, and no liability or obligation of any kind is assumed by Raytheon with respect to such use.

Each tube sold by Raytheon is licensed only to the extent of the notice which appears on the carton containing the tube.

FIRST EDITION
Third Printing
June, 1958
Form R-632A

FOREWORD

This DATA BOOK has been prepared by the Raytheon Production Corporation to furnish in compact form the chief technical data on the complete line of radio broadcast receiving tubes. In addition to the maximum ratings and values of essential characteristics there are given in this booklet the more important characteristic and operating curves for each active tube. The information given by these curves may well be even more valuable and useful than the ratings and nominal characteristics. This information has not heretofore been generally available in convenient and readily accessible form. Much of it has previously been obtainable only by a limited number of receiver design engineers. Data are given on all tubes that have been at all widely used in the past in receivers and amplifiers that are still handled in the trade as replacements; also on all types that are being used in new receivers including all new types announced up to the end of 1937.

To make this booklet of maximum usefulness an introductory section has been included which gives brief descriptions of the various classes of tubes and how they operate; definitions of the various tube characteristics and terms and explanations of how these quantities may be determined from the characteristic curves; simple circuit diagrams showing the essentials of the various sections of a modern radio receiver, including the newer features, and convenient charts for determining the proper values of certain tube circuit constants and operating voltages.

For completeness there have been included the essential data on Raytheon resistor tubes and panel lamps for radio receivers.

This booklet has been designed for the use of design engineers, radio dealers, servicemen and members and customers of the radio industry generally. Much thought and labor has been devoted to its preparation. It is our hope that it will prove really useful and at the same time acquaint you with Raytheon tubes and Raytheon Engineering Service.

TABLE OF CONTENTS

	PAGE
TUBE ELEMENTS	5
TUBE CLASSIFICATION BY STRUCTURE	5
TUBE CLASSIFICATION BY FUNCTION	6
FUNDAMENTAL CHARACTERISTICS OF RADIO TUBES	7
TUBE APPLICATION AND CIRCUITS	9
RECOMMENDED OPERATING PRACTICES	19
CONVERSION CURVES	22
RESISTANCE COUPLED AMPLIFIER DESIGN CURVES	23
TUBE TESTING	26
RAYTHEON RECEIVING TUBE LIST	28
RAYTHEON SPECIAL RECEIVING TUBES	31
INTERCHANGEABLE TUBE TYPES	32
RAYTHEON RESISTANCE TUBES	33
RAYTHEON PANEL LAMPS	34
RATINGS AND CHARACTERISTICS OF RAYTHEON RECEIVING TUBES (FOLLOWING PAGE 34)	

TUBE ELEMENTS

A radio tube, or vacuum tube, is a vacuum device in which electric current flows, as a stream of electrons, through the evacuated space from one electrode to another. A HIGH VACUUM TUBE is one in which the degree of vacuum is so high that the characteristics of the tube are not affected by gas ionization. Most radio receiving tubes are of this class. A GAS TUBE is one which has a gas filling, usually at relatively low pressure, and in which gas ionization is essential to the normal operation of the tube. Types 82 and 0Z4G are examples of this class.

CATHODE The cathode is the electrode which supplies the electrons necessary for the operation of the tube. In general the cathode must be heated to obtain sufficient emission of electrons. A FILAMENTARY CATHODE is in the form of a wire or ribbon through which heating current flows and is sometimes called a "directly heated" cathode. In some of the earlier receiving tubes, such as the 199 and the 201A, the cathode is a filament of thoriated tungsten and is normally operated at a temperature of approximately 1700°C. In more recent types, such as the 26, 45, and 1A4, the cathode is a wire or ribbon of nickel or nickel alloy coated with the oxides of barium and strontium and is normally operated at 600° to 800°C. A UNI-POTENTIAL, or "indirectly heated", cathode consists of a metal sleeve, usually nickel, which encloses an insulated filament, or heater, through which heating current flows. The cathode sleeve is generally coated with the oxides of barium and strontium and is operated normally at 600° to 800°C.

PLATE The plate, or anode, is the electron collector element of a tube and is normally the one to which the main portion of the electron stream flows. It is usually in the form of a cylinder of thin metal and may be circular, oval or rectangular in cross-section. In some tubes the plate is carbonized to increase its heat radiating ability.

GRID A grid is an auxiliary electrode placed between the cathode and the plate. It usually consists of a spiral of wire fastened at each turn to one or more, usually two, longitudinal support wires. In cross-section, the outline of a grid may be circular, oval or rectangular. The grid spiral is usually of uniform pitch, but some tubes employ VARIABLE MU GRIDS in which the turns are not uniformly spaced. In a few cases the grid consists merely of two vertical wires or strips of metal. The grids in a multi-grid tube are commonly referred to by numbers indicating their position radially with respect to the cathode, number 1 grid being adjacent to the cathode. Grids are also referred to by names indicating their function. A CONTROL GRID, or input grid, is one to which an input signal voltage is applied and which modulates the main electron stream in accordance with the input signal. A SPACE CHARGE GRID is a grid placed in the electron stream and positively charged to partially neutralize the space charge effect caused by the cloud of electrons surrounding the cathode. A SCREEN GRID is an auxiliary grid placed between the control grid and the plate and operated at a positive d-c voltage with respect to the cathode. Besides accelerating the electrons toward the plate, a screen grid acts as an electrostatic shield and reduces the capacity between the plate and the control grid. A SUPPRESSOR GRID is a grid placed between the screen grid and the plate and connected to a point of low d-c potential to prevent the passage of low velocity secondary electrons originating either at the plate or at the screen grid. In some tubes it is connected internally to the cathode and in others it is connected to a separate base pin. In some pentagrid tubes, such as the type 6A7, the number two grid, which serves as the anode for the oscillator section, is called the ANODE GRID. The term ALIGNED GRIDS refers to a pair of adjacent grids having the same number of turns per inch and placed so that each turn of one grid lies in the same horizontal plane with the corresponding turn of the adjacent grid. The grids usually aligned are the control grid and the screen grid in some tetrode and pentode power amplifier tubes. This arrangement causes the electrons to flow in flat beams between successive turns of the aligned grids. Since the screen grid wires are out of the direct path of the electrons, fewer electrons reach the screen grid and the screen grid current is lower than that of similar tubes without aligned grids.

TUBE CLASSIFICATION BY STRUCTURE

Radio tubes may be classified according to the number of elements or electrodes they contain.

A DIODE is the simplest form of tube and contains two elements, a cathode and a plate. Types 01 and 12Z3 are examples of this class.

A TRIODE or three element tube, contains a cathode, a grid and a plate, as for example, types 27 and 2A3.

A TETRODE is a four element tube having a cathode, two grids and a plate. The name SCREEN GRID TUBE is sometimes used for a tetrode, such as the type 24A, in which the outer grid is operated as a screen grid. One type of tetrode is a BEAM POWER TUBE in which the electrodes are so spaced that the electron stream is confined to relatively narrow paths, or beams, and sufficient space charge is built up between the screen grid and the plate to prevent any appreciable flow of secondary electrons between them. The electron beams are produced by the use of aligned grids and deflector plates partially surrounding the screen grid support rods and connected electrically to the cathode. The 6L6 and 6V6G are beam power tubes.

A PENTODE is a five element tube which contains a cathode, three grids and a plate, types 70 and 42, for example.

- A **HEXODE** is a six element tube containing a cathode, a plate and four other electrodes.
- A **HEPTODE** is a seven element tube having a cathode, a plate and five other electrodes, usually grids. **PENTAGRID** is another term applied to this type of tube. Types 6A7 and 6L7 are in this classification.
- A **MULTIPLE UNIT TUBE** is one containing two or more sets of electrodes, or units, in the same envelope. In some types a single cathode, common to both units, is used; in others separate cathodes are used. Each unit can usually be operated as if it were a separate tube in its own envelope. A two unit tube is often referred to as a **DUO-or DUPLEX- TUBE**.
- A **DUO-DIODE** is a duplex tube containing two diode units, as a type 80 or a 6H6.
- A **DUO-DIODE TRIODE** is a duplex tube containing a duo-diode unit and a triode unit, as a type 75.
- A **DUO-DIODE PENTODE** is a duplex tube containing a duo-diode unit and a pentode unit, as a type 6B7.
- A **DIODE-PENTODE** is a duplex tube containing a diode unit and a pentode unit, as a type 12A7 or a 25A7G.
- A **TRIODE-PENTODE** is a duplex tube containing a triode unit, and a pentode unit, as a type 6F7.
- A **TRIODE-HEPTODE** is a duplex tube containing a triode unit and a heptode unit.
- A **TWIN TUBE** is a duplex tube containing duplicate units, types 6A6 and 1E7G, for example.

TUBE CLASSIFICATION BY FUNCTION

Tubes may be further classified according to their uses or functions in a circuit.

- A **RECTIFIER TUBE** usually a diode or a twin diode, is one used in obtaining a direct current or voltage from an alternating current supply.
- A **HALF-WAVE RECTIFIER TUBE** is one used in a half-wave rectifier circuit and in which current flows only during alternate half-cycles of the a-c supply voltage. A half-wave rectifier tube is usually a diode such as a type 81 or a 12Z3. However, a triode like the type 37 or other multi-electrode tube may be used by connecting the grid or grids to the plate to form a diode.
- A **FULL-WAVE RECTIFIER TUBE** is a twin diode used in a full-wave rectifier circuit in which the two diodes are so connected that current flows through one diode during one half-cycle and through the other diode on the alternate half-cycle of the a-c supply voltage. Two separate diodes may be used instead of a twin diode in a full-wave circuit.
- A **VOLTAGE DOUBLER TUBE** is a twin diode tube having separate cathodes insulated from each other so that the two sections may be connected in series in a voltage doubler circuit. Although a twin diode tube is usually used in this circuit, two separate diodes may be used to accomplish the same result.
- AN **AMPLIFIER TUBE** is one used to amplify a voltage applied by the input circuit between two electrodes, a control grid and the cathode. An amplified voltage appears in the output circuit, usually the plate circuit and a portion of this voltage is developed across the load impedance.
- A **VOLTAGE AMPLIFIER TUBE** is an amplifier tube used to supply an amplified voltage to another tube which may be another voltage amplifier tube, a power amplifier tube or a detector tube.
- A **POWER AMPLIFIER TUBE** is an amplifier tube used to develop a relatively large amount of power, as contrasted to voltage, in the output circuit and may be a triode, a tetrode, or a pentode.
- A **REMOTE CUTOFF AMPLIFIER TUBE** is one that requires a relatively high negative bias on the control grid to reduce the plate current and transconductance to zero or to very low values. Relatively large signal voltages may be applied to tubes of this class without producing serious cross modulation or modulation distortion. Most remote cutoff tubes are made with a variable- μ control grid.
- A **DETECTOR TUBE** is one used to separate the low frequency component of a modulated signal from the high frequency carrier of radio or intermediate frequency. Various types of tubes, diodes, triodes, tetrodes and pentodes may be employed as detectors.
- AN **OSCILLATOR TUBE** is an amplifier tube operated in a suitable circuit to produce a-c power when supplied with d-c power. Triodes such as types 76 and 6J5G, are commonly used as oscillators in superheterodyne receivers.

A MIXER TUBE is one in which two applied voltages of different frequency are combined, or mixed, to produce beat frequency voltages which are equal to the sum and difference of the applied frequencies, in the output circuit.

A CONVERTER TUBE is a special form of mixer tube in which one of the two combining voltages is produced by self-oscillations in the tube itself. The 6A7 is one of the tubes designed specially for converter service but other multi-grid types, such as the type 77, have been used.

AN ELECTRON RAY TUNING INDICATOR TUBE is a tube in which an electron beam causes a luminous area to appear on a fluorescent screen, or target. The shape and size of this luminous area vary in accordance with the voltage applied to the control grid of the tube, giving a visual indication of the changes in the control grid voltage. Usually this tube is a duo-triode, one section functioning as a d-c amplifier and supplying an amplified d-c voltage to the control electrode of the target section. The 6E5 is an example of a tuning indicator tube.

FUNDAMENTAL CHARACTERISTICS OF RADIO TUBES

A radio tube, as a circuit element, exhibits some electrical characteristics, such as resistance and capacitance, which are similar to those of other circuit elements and, in addition, it has other characteristics which are unique. Since the current-voltage relations of a tube usually are not linear, the d-c current flowing between two electrodes is not directly proportional to the d-c voltage between them. For this reason, the a-c or variational characteristics depend on the d-c voltages applied between the elements and are not the same for large amplitudes as for small. Therefore, the characteristics of a tube, as a circuit element, are commonly expressed in terms of their values for a-c current and voltage of very small amplitudes, and with specified values of d-c voltage applied to the various electrodes. It is necessary to distinguish between the d-c voltages applied to the various electrodes, which determine only the operating conditions, and the a-c voltages which are being amplified. The cathode is usually considered as the zero or reference point of voltage and the voltage between the cathode and any other electrode is designated as the voltage of that electrode, as for example, PLATE VOLTAGE, SCREEN-GRID VOLTAGE, and GRID VOLTAGE. The d-c voltage on the control grid is commonly called the GRID BIAS.

RECTIFIERS In a radio tube, the electrons originating at the cathode are attracted to any electrode which is at a positive potential with respect to the cathode and repelled from any electrode which is at a negative potential. Diode rectifier tubes depend on this fact for their operation, as plate current can flow only during the half-cycle when the plate is positive. The important characteristic of a rectifier tube is the STATIC PLATE CHARACTERISTIC, a curve showing the relation between the d-c plate voltage and current. Typical diode plate characteristic curves may be found in the rating and characteristic data section under any rectifier tube type, for instance, the type 81. At low plate voltages the plate current increases approximately as the $3/2$ power of the plate voltage. At higher plate voltages the plate current approaches the total electron emission of the cathode, which is the maximum value of plate current obtainable at a certain cathode temperature. A derived characteristic is the relation between the d-c output current and voltage in a typical rectifier circuit. Typical curves may be found in the rating and characteristic data section under any rectifier types, such as the type 80. Since the values shown by the curves are dependent on the circuit constants, transformer resistance and reactance and smoothing filter characteristics, they should be used only to indicate the tube performance under certain arbitrary, but usually typical, operating conditions.

AMPLIFIERS In amplifier tubes, the amplification depends on the fact that a small voltage applied to the control grid has the same effect on the plate current as a much larger voltage applied to the plate. A measure of this amplifying effect is the AMPLIFICATION FACTOR, μ or μ_m , which indicates the relative effectiveness of the grid voltage versus the plate voltage in controlling the plate current. It is equal to the quotient of a small change in plate voltage divided by the compensating change in grid voltage necessary to maintain the plate current constant. THE TRANSCONDUCTANCE or MUTUAL CONDUCTANCE, G_m , of a tube is a factor indicating the magnitude of the controlling effect of the control grid voltage on the plate current, and is expressed in micromhos which are equivalent to microamperes per volt. It is equal to the quotient of a small change in plate current divided by the change in grid voltage producing it, when all other elements voltages are constant and there is no external impedance in the plate circuit. The PLATE RESISTANCE, R_p , of a tube is the effective internal a-c resistance between the plate and cathode. It is expressed in ohms and is equal to the quotient of a small change in plate voltage divided by the accompanying change in plate current, with constant voltages on the other elements and no external impedance in the plate circuit. Amplification factor, transconductance and plate resistance are connected by the relation $G_m = \mu / R_p$, hence any one of these quantities may be found if the other two are known. In multi-grid tubes there may be several values of amplification factor and transconductance, depending on which element is used as the control grid and which element as the plate, as for example, grid #1 to grid #2 transconductance or grid #1 to plate transconductance, or grid #3 to plate transconductance.

An amplifier tube may be considered as an a-c generator whose generated e.m.f., or open-circuit voltage is the product of the amplification factor, μ , and the a-c grid voltage, E_g . The voltage, μE_g , appears in the plate circuit in series with the plate resistance, R_p , which corresponds to the internal resistance of the generator. The transconductance is the short-circuit a-c current per unit of a-c grid voltage.

The VOLTAGE AMPLIFICATION or VOLTAGE GAIN is the amplification obtained from a tube in connection with its associated circuit, and is equal to the quotient of the a-c voltage, E_r , developed across the load resistance, R_L , divided by the a-c grid voltage, E_g . Since the a-c voltage generated in the output circuit of a tube is in series with the plate resistance, the a-c voltage developed across the load resistance depends on the relative values of R_p and R_L . The voltage amplification is given by the following formulas:

$$\text{VOLTAGE GAIN} = \frac{\mu R_L}{R_p + R_L} = \frac{G_m R_p R_L}{R_p + R_L} \quad (1)$$

TRIODES The static plate characteristic curves of a triode are similar to those of a diode, except that a family of curves is usually given, each curve corresponding to some arbitrarily chosen value of grid bias. Typical triode plate characteristic curves may be found in the rating and characteristic data section, for instance, under the types 6F5, 76, or 6Q7. The other family of curves under the types 6F5 and 6Q7 shows the same information in another form, the relation between the d-c grid voltage, or bias and the d-c plate current for several values of d-c plate voltage. The amplification factor may be determined from the plate family of curves by finding the plate voltage, at constant plate current, corresponding to two values of grid bias. The amplification factor is then equal to the quotient of the change in plate voltage divided by the change in grid voltage. The transconductance is equal to the slope of the plate current vs. grid voltage curve at any point where its value is desired. The transconductance may also be determined from the plate family of curves by finding the change in plate current, at constant plate voltage, corresponding to a change in grid bias. The transconductance, in micromhos, is then equal to the change in plate current in microamperes divided by the change in grid voltage. The plate resistance equals the slope of the plate current vs. plate voltage curve at any point where its value is desired. Thus, the three fundamental characteristics of a tube may be determined approximately from the static characteristic curves. In determining amplification factor, transconductance and plate resistance from the static characteristic curves, greater accuracy will be obtained if the increments read from the curves are as small as can be read conveniently.

TETRODES The plate current vs. control grid voltage curves of a tetrode are similar to those of a triode, but the plate current vs. plate voltage curves are quite different, as may be seen by referring to the plate characteristic curves of a typical tetrode, such as the type 2A. At values of plate voltage higher than the screen grid voltage, where a tetrode is usually operated, the plate current curves are relatively flat, indicating high values of plate resistance and amplification factor. In this region the value of plate current depends more on the value of d-c screen grid voltage than on the value of d-c plate voltage. At plate voltages lower than the screen grid voltage the values of plate current are unstable due to the effects of SECONDARY EMISSION. When the plate, or any other electrode, is more than about 12 volts positive the electrons which strike it cause it to emit secondary electrons. These electrons may be pulled back to the plate, or, if there is another electrode nearby at a higher d-c potential, they may be drawn away from the plate to the higher potential electrode. In the region of the plate current characteristics where the plate is at a low d-c potential, the secondary electrons are drawn to the screen grid, decreasing the plate current and increasing the screen current correspondingly. In the operating region where the plate is at a higher potential than the screen grid, the plate current is increased and screen current decreased by secondary electrons from the screen grid. The amount of secondary emission is largely dependent on the surface condition of the electrodes and usually varies widely in different tubes. Tetrodes are ordinarily not operated under conditions which permit the plate voltage to fall below the screen grid voltage unless the design of the electrodes is such that secondary emission is largely eliminated. In beam power output tubes, which are tetrodes, the effects of secondary emission are largely eliminated and the characteristics resemble those of pentodes.

Because of the electrostatic shielding effect of the screen grid, the control grid to plate capacitance of tetrodes is very much lower than that of triodes. Tetrodes designed for use in high frequency stages usually contain additional shields placed outside of the electron stream in such a way that the grid to plate capacitance is still further reduced. This feature makes tetrodes more suitable than triodes for use in amplifying r-f or i-f frequencies where large grid to plate capacitances would tend to cause oscillation or instability. The high amplification factor and plate resistance of tetrodes permit high gain and selectivity with the tuned circuits ordinarily used at high frequencies. The high amplification factor also permits high gain in resistance coupled audio frequency amplifiers.

PENTODES The plate current vs. plate voltage curves of a pentode resemble those of a tetrode with the important exception that there is no abrupt dip in the curves at the point where the plate voltage equals the screen grid voltage. Refer to the plate characteristic curves of types 606, 42, etc., in the rating and characteristic data section for typical pentode curves. This improvement in characteristics results from the effect of the suppressor grid, #3 grid, which prevents the passage of secondary electrons between the plate and the screen grid. The plate current curves are flatter than in corresponding types of tetrodes, hence the plate resistance and amplification factor are correspondingly higher. Pentodes may be used for the same service as tetrodes and have the same advantages of low grid to plate capacitance and high amplification factor and plate resistance. In addition, since the plate current curves are smooth over a wide range of plate voltage, pentodes can be operated as power amplifiers at large amplitudes of a-c voltage and current.

MIXER OR CONVERTER TUBES An important characteristic of a mixer or converter stage is the **CONVERSION TRANSCONDUCTANCE** which is equal to the quotient of the beat frequency, or 1-f, component of the plate current divided by the r-f signal voltage on the control grid, with no impedance in the plate circuit and constant d-c voltages on all the electrodes. In converter circuit calculations, conversion transconductance corresponds to transconductance in single frequency amplifier circuits. The **TRANSLATION GAIN** of a mixer stage is analogous to the voltage gain of an amplifier stage, and is the ratio of the 1-f output voltage appearing across the plate load impedance, to the r-f signal voltage applied to the control grid. Its value depends on the circuit constants as well as on the mixer tube characteristics and operating conditions. The **CONVERSION PLATE RESISTANCE** of a mixer tube is the effective plate resistance to the beat frequency, or 1-f, component of the plate current and corresponds to the plate resistance of an amplifier tube. A pentagrid converter tube is ordinarily operated as if it consisted of two sections, each having its own control grid, both grids simultaneously controlling the plate current in accordance with the separate grid voltages. The curves in Fig. 1 and Fig. 2 show the effect of the inner number 1 and the outer number 4 control grid voltages respectively on the plate current and on the current to grid number 2 which serves as the anode of the inner section. The negative relation between the voltage on the outer control grid and the anode current of the inner section, shown in Fig. 2, is typical of pentagrid tubes. Each section has the characteristics of amplification factor, plate resistance and transconductance, the values depending on the d-c voltages applied to the electrodes of both sections.

TUNING INDICATORS For typical tuning indicator characteristic curves refer to the type 6E5 in the rating and characteristic data section. The curve of shadow angle vs. grid bias is the most important as it shows the range of grid voltage necessary to completely control the pattern on the fluorescent target.

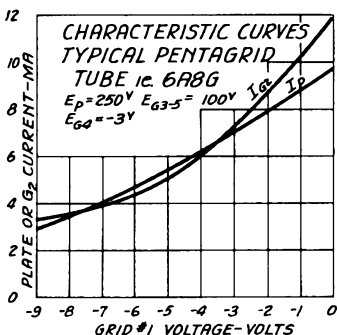

FIG. 1

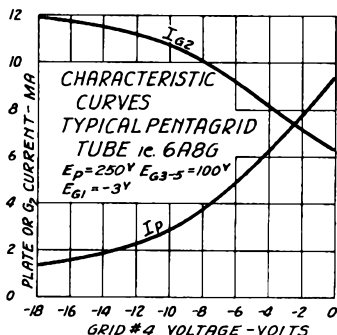

FIG. 2

TUBE APPLICATION AND CIRCUITS

RECTIFIERS In the application of rectifier tubes care should be taken that the published maximum ratings are not exceeded. Rectifier tubes are rated for **MAXIMUM A-C PLATE VOLTAGE**, the maximum RMS value of a-c voltage that should be applied to the plate of the tube and for **MAXIMUM D-C OUTPUT CURRENT**, the highest value of d-c plate current, averaged over one a-c cycle, at which the tube should be operated. They are also rated for **MAXIMUM PEAK PLATE CURRENT**, the maximum instantaneous peak value of plate current that should be permitted to flow through the tube and for **MAXIMUM INVERSE PEAK VOLTAGE** which is the maximum instantaneous peak value of plate voltage that should be applied to the tube during the half-cycle when the plate is negative and no current is flowing to the plate. **THE VOLTAGE DROP** is the d-c plate voltage corresponding to some specified value of d-c plate current, usually equal to the maximum d-c output current per plate.

A typical half-wave rectifier circuit is shown in Fig. 3 and a typical full-wave rectifier circuit in Fig. 4. A condenser input filter is shown in each circuit. If C_1 were omitted the filter would be a choke input filter. With condenser input the d-c output voltage will be higher and the regulation over the working range poorer than with choke input. Increasing the capacity of C_1 will increase the d-c output voltage, but will also increase the peak plate current and the inverse peak voltage applied to the tube. Some filter circuits employ two chokes in series, as shown in Fig. 4, to further reduce the hum voltage. In some cases the plate supply for the output stage is taken from the first choke and the rest of the tubes supplied through both chokes. This allows a smaller choke with a lower current rating to be used for L_2 , and improves the regulation of the output voltage.

TYPICAL HALF WAVE RECTIFIER CIRCUIT

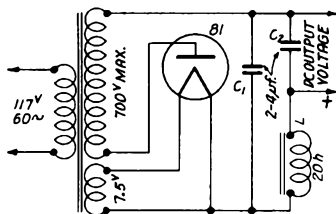

FIG. 3

TYPICAL FULL WAVE RECTIFIER CIRCUIT

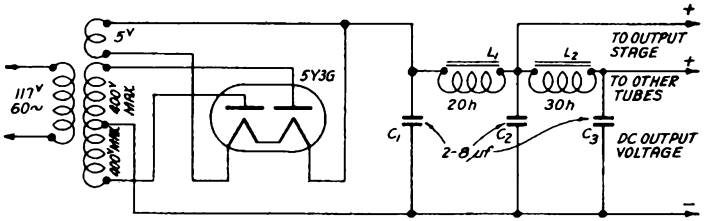

FIG. 4

Fig. 5 shows a voltage doubler circuit such as is sometimes used in receivers operating directly from the a-c line without a power transformer. The d-c output voltage will be somewhat less than twice the value which would be obtained with a half-wave rectifier. Its value depends on the capacity of condensers, C_1 , and on the d-c output current, as shown by the curves for the 25Z5 tube.

TYPICAL VOLTAGE DOUBLER CIRCUIT

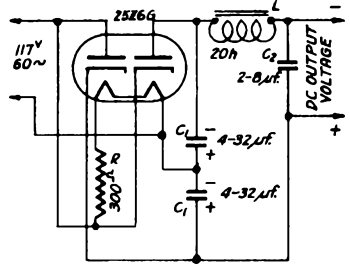

FIG. 5

AMPLIFIERS Two general types of amplifiers are used in radio receivers, high frequency amplifiers for radio and intermediate frequencies and low frequency amplifiers for audio frequencies. High frequency amplifiers are usually transformer coupled and may be used over a range of frequencies as in a tuned r-f receiver, or at a single frequency as in the i-f amplifier of a superheterodyne receiver. Pentode or tetrode tubes are commonly used in high frequency amplifiers because of their low grid to plate capacitance and high values of transconductance and plate resistance. Fig. 6 and Fig. 7 show typical high frequency amplifier circuits such as are used in a tuned r-f receiver and in a superheterodyne receiver.

TYPICAL TUNED R-F AMPLIFIER AND DETECTOR CIRCUIT

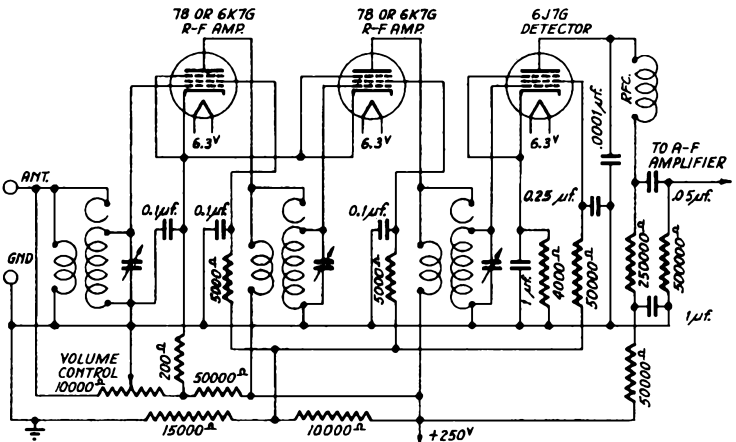

FIG. 6

TYPICAL PUSH-PULL POWER AMPLIFIER—CLASS AB₂

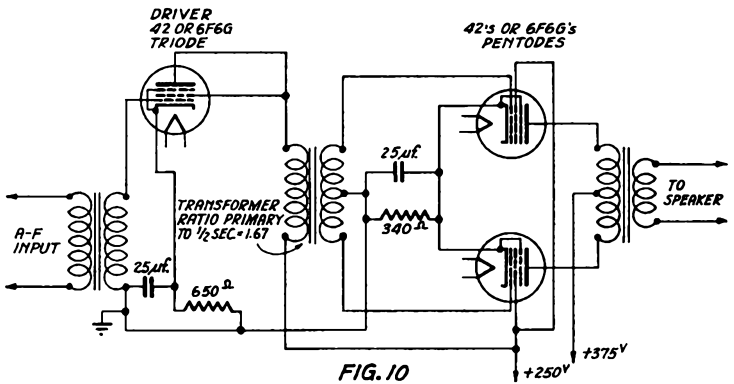

FIG. 10

A PHASE INVERTER circuit is shown in Fig. 11. The signal voltage for triode R is obtained from the tap, P, on the resistor, R_g, in the output circuit of the other triode. This tap should be adjusted so that the signal voltage applied to triode R is equal to the input signal on the grid of triode L. For example, if the voltage gain of triode L is 25, the tap, P, should be adjusted to supply 1/25 of the voltage across R_g to the grid of triode R.

TWIN TRIODE PHASE INVERTER

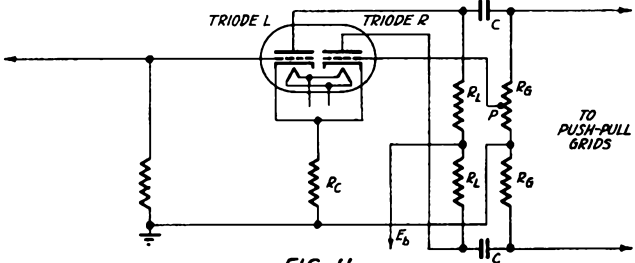

FIG. 11

Amplifier stages are classified with respect to the tube operating conditions and the relation between the grid bias and the maximum normal value of a-c signal voltage, which determine the fraction of the a-c cycle during which plate current flows. In a CLASS A amplifier stage, the plate current flows during the complete a-c cycle, the grid bias usually being fixed at approximately one-half of the cutoff bias (the grid bias necessary to reduce the plate current to practically zero). Ordinarily, the maximum normal peak value of the a-c voltage is approximately equal to the grid bias and no grid current flows during any portion of the cycle but this is not a necessary condition for Class A operation. The subscript 1, as in Class A₁, is sometimes used to indicate that no grid current flows during any part of the input cycle.

Fig. 12 shows the section of the plate current vs. plate voltage family of a triode operated as a CLASS A amplifier. The LOAD LINE represents the relation between the instantaneous values of grid voltage, plate voltage and plate current during a cycle at full rated signal level. Its slope is numerically equal to the reciprocal of the effective a-c impedance in the external plate circuit. Since this impedance is chiefly resistive, it is commonly referred to as the LOAD RESISTANCE, R_L. The operating point, O, indicates the static values of plate voltage, E₀, and current, I₀, with no signal. The load line terminates at plate current curves corresponding to the maximum and minimum instantaneous values of grid voltage at full rated signal, the swing in grid voltage being the same in either direction from the operating point, O. The difference between the plate voltage at the operating point and at either end of the load line equals approximately the peak value of the a-c output voltage developed across the load resistance. The RMS value of the a-c output voltage will be 0.707 times the peak voltage obtained from the curves. The power output may then be calculated approximately from the relation:

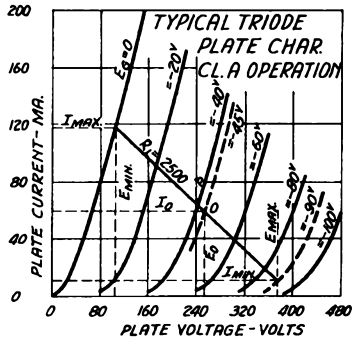

FIG. 12

$$\text{POWER OUTPUT} = \frac{(E_{\text{RMS}})^2}{R_L} = \frac{[0.707(E_{\text{max}} - E_0)]^2}{R_L} = \frac{[0.707(E_0 - E_{\text{min}})]^2}{R_L} \quad (2)$$

A more accurate formula which includes both halves of the cycle is:

$$POWER OUTPUT = \frac{(E_{max} - E_{min})(I_{max} - I_{min})}{8} \quad (3)$$

The values of E_{max} , E_{min} , I_{max} , and I_{min} , are read from the curves as shown in Fig. 12. If the values of E_{max} , and E_{min} are expressed in volts, the values of I_{max} , and I_{min} should be expressed in amperes to give the power output in watts.

The second harmonic distortion, expressed in percent, may be calculated from the formula:

$$2ND HARMONIC = \frac{\frac{I_{max} + I_{min}}{2} - I_0}{I_{max} - I_{min}} \times 100 \quad (4)$$

I_0 is the value of d-c plate current at the operating point and is read from the curves. All the values of current in equation (4) should be expressed in the same units, milliamperes or amperes. Fig. 13 shows typical variations of power output, plate current and harmonic distortion with signal input voltage for a triode operated as a Class A amplifier. The power output varies approximately as the square of the input voltage and the distortion is low and is chiefly second harmonic.

The PLATE EFFICIENCY is the percentage ratio of the power output to the product of the average d-c plate voltage and d-c plate current at full signal.

$$PLATE EFFICIENCY (\%) = \frac{PO}{E_p I_p} \times 100 \quad (5)$$

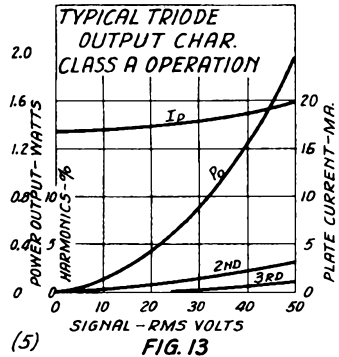

In a Class A triode amplifier the plate efficiency is relatively low, 15% to 25%.

The POWER SENSITIVITY is the ratio of the power output to the square of the input signal voltage, E_p .

$$POWER SENSITIVITY = \frac{PO}{E_p^2} \quad (6)$$

The power sensitivity of a Class A triode amplifier is also relatively low.

The method of calculating the approximate power output and distortion for a pentode or a tetrode, operated as a Class A amplifier, is similar to that for triodes. Fig. 14 shows a family of plate characteristic curves for a typical pentode Class A amplifier. The power output may be calculated approximately from the formula:

$$PO = \frac{[I_{max} - I_{min} + 1.41(I_x - I_y)]^2 \frac{E_{max} - E_{min}}{I_{max} - I_{min}}}{32} \quad (7)$$

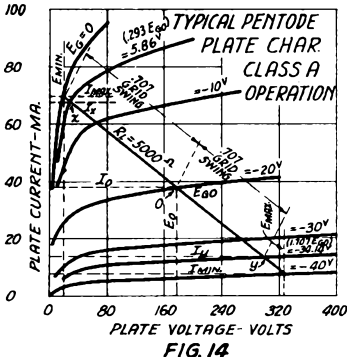

The values are read from the curves at the points indicated in Fig. 14. The values of I_x and I_y are determined by the intersections of the load line with the plate current curves corresponding to grid biases of $0.293 E_0$ and $1.707 E_0$ respectively, where E_0 is the value of the grid bias at the operating point, 0.

The second harmonic distortion, expressed in percent, may be calculated from the formula:

$$2ND HARMONIC = \frac{I_{max} + I_{min} - 2I_0}{I_{max} - I_{min} + 1.41(I_x - I_y)} \times 100 \quad (8)$$

The third harmonic distortion, in percent, is given by the formula:

$$3RD HARMONIC = \frac{I_{max} - I_{min} - 1.41(I_x - I_y)}{I_{max} - I_{min} + 1.41(I_x - I_y)} \times 100 \quad (9)$$

Fig. 15 shows the variation of power output, plate current, screen current and distortion with signal input voltage and Fig. 16 shows the variation of the same quantities with load resistance for a typical pentode Class A Amplifier. A pentode is normally operated with a load resistance of approximately the value at which the second harmonic is a minimum. In some cases, the load resistance is adjusted for a lower value of third harmonic and the second harmonic is balanced out by using two tubes in push-pull or by introducing a balancing amount of second harmonic in a preceding stage. Beam power tubes are frequently operated with lower values of load resistance than are pentodes to reduce the odd harmonic distortion. A Class A pentode amplifier generally has higher plate efficiency, 35% to 45%, and higher power sensitivity than a Class A triode. The distortion is also generally higher and consists mostly of third and higher odd order harmonics.

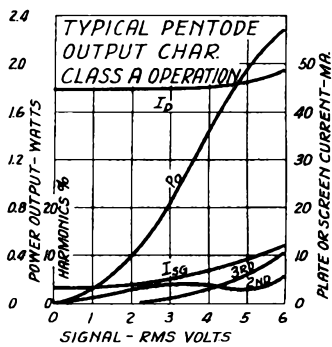

FIG. 15

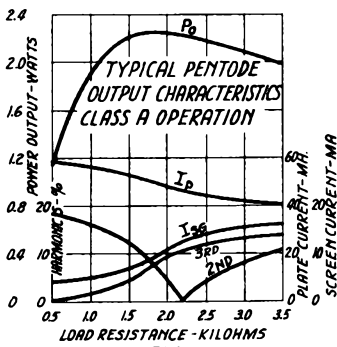

FIG. 16

In a CLASS B amplifier stage two tubes or the two sections of a twin tube are used in a push-pull circuit. The grid bias is fixed at approximately the cutoff value and plate current flows in each plate circuit on alternate half-cycles of signal voltage when the grid is positive. Since the grid of a Class B tube is swinging positive during a considerable portion of the cycle, grid current usually flows for part of the cycle. This grid voltage and current represent power which must be supplied by the preceding tube called the DRIVER TUBE. The power output of the driver tube is often the limiting factor in determining the power output of a Class B stage. Since the average value of the plate current of a Class B stage varies considerably with signal voltage, the plate voltage supply should have good regulation to prevent excessive decrease in d-c plate voltage and limitation of output as the signal voltage is raised.

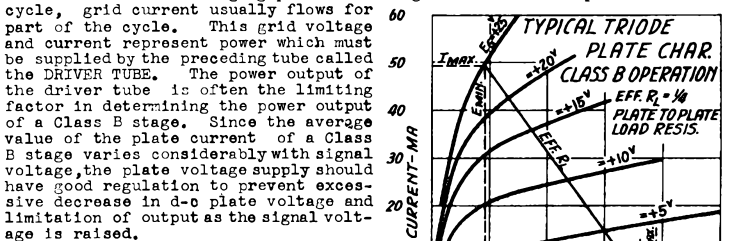

FIG. 17

Fig. 17 shows the section of the plate current vs. plate voltage family of a triode used as a Class B amplifier. In Class B operation the plate current of one tube is practically cutoff during each alternate half-cycle and contributes very little to the power output. The power output from the two tubes may be calculated approximately from the plate family of one tube and is equal to the sum of the power outputs represented by the extensions of the load line on either side of the operating point, O.

$$PO = \frac{(E_o - E_{min})(I_{max} - I_o)}{2} + \frac{(E_{max} - E_o)(I_o - I_{min})}{2} \quad (10)$$

Since the plate current of one tube is practically cutoff during each alternate half-cycle, formula (10) may be reduced to a further approximation:

$$PO = \frac{(E_o - E_{min}) I_{max}}{2} \quad (11)$$

The actual power output is somewhat higher than that shown by these relations because of the effects of the third and other odd harmonics. Fig. 18 shows typical variations of power output, plate current and distortion with signal input voltage for a Class B Amplifier. The distortion is chiefly third and other odd harmonics. The plate efficiency, 50% to 65%, and the power sensitivity at full power output are both relatively high.

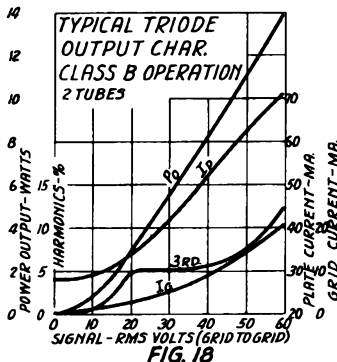

FIG. 18

A CLASS AB amplifier stage is one which operates under conditions intermediate between Class A and Class B. The grid bias is fixed at a value between that for Class A operation and cutoff and plate current flows in each plate circuit for less than one complete cycle but for more than one half-cycle of the signal voltage. If the normal maximum peak value of the signal voltage does not exceed the grid bias and no grid current flows during any part of the input cycle, the amplifier may be designated as Class AB₁. If grid current flows during any portion of the input cycle the amplifier may be designated as Class AB₂. Fig. 19 shows the section of the plate voltage plate current family of a triode used as a Class AB₂ Amplifier. The power output from two tubes may be computed approximately from the plate family of one tube in the same manner as for Class B operation. The characteristics of power output, plate current, plate efficiency and plate current fluctuations with signal and driving power are intermediate between those of Class A and Class B operation.

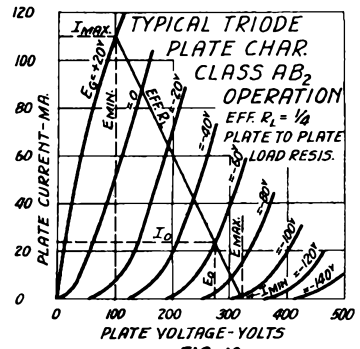

FIG. 19

Power output pentodes or tetrodes may be used as Class B or Class AB Amplifiers, and the approximate power output may be computed from the plate current vs. plate voltage curves in the same way as in the case of triodes.

In a CLASS C amplifier the grid bias is fixed at a value greater than the cutoff value and the plate current flows during less than one half-cycle. Class C amplifiers are not used in radio receivers, although an OSCILLATOR may be considered as a special type of Class C amplifier in which the input voltage is derived from the output voltage by means of circuit coupling.

A CLASS BC amplifier stage is one which operates under conditions intermediate between Class B and Class C and is not used in radio receivers.

DETECTOR AND AUTOMATIC VOLUME CONTROL CIRCUITS

Detectors are used in radio receivers to separate the audio frequency component of the modulated signal from the high frequency carrier or to change the carrier frequency. In superheterodyne receivers, the first detector is used to obtain an intermediate frequency from the r-f input frequency. The important characteristic of a detector tube is the relation between the r-f signal input voltage and the resultant a-f or i-f output voltage. This relation is shown for a typical diode in Fig. 20, for a triode operated as a grid leak detector in Fig. 21 and for a biased triode detector in Fig. 22.

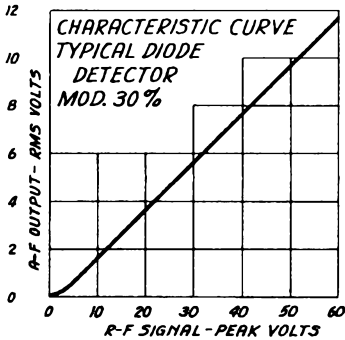

FIG. 20

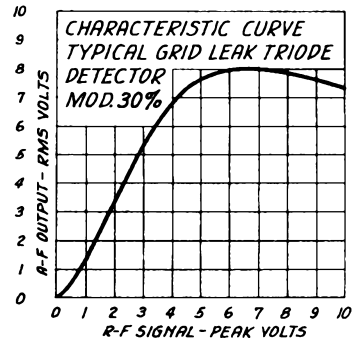

FIG. 21

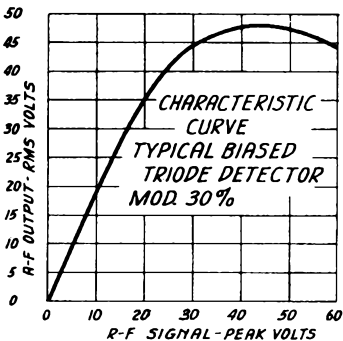

FIG. 22

TYPICAL GRID LEAK DETECTOR

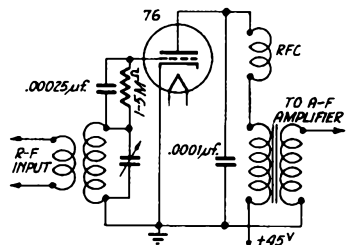

FIG. 23

In a grid leak detector circuit, Fig. 23, the r-f signal is rectified in the grid-cathode circuit which acts as a diode detector. The a-f voltage across the grid leak and condenser is amplified by the tube and the amplified voltage appears in the plate circuit. The r-f signal is also amplified by the tube and an r-f filter should be inserted in the output circuit to prevent the high frequency from reaching the a-f amplifier. Increasing the resistance of the grid leak increases the sensitivity to weak signals, but tends to introduce instability and distortion with large signals.

In a biased detector circuit, Fig. 24, a high negative bias is applied to the grid and the no-signal plate current is practically zero. The rectification takes place in the plate circuit due to the fact that more plate current flows on the positive half-cycles of the signal voltage than on the negative half-cycles. Both a-f and r-f voltages appear in the plate circuit and an r-f filter should be used to by-pass the r-f component. A biased detector normally draws no grid current and therefore does not decrease the sensitivity and selectivity of the input circuit.

TYPICAL BIASED DETECTOR

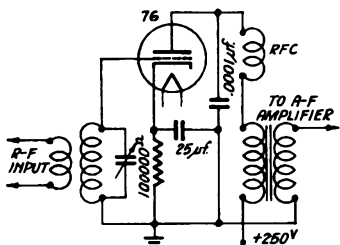

FIG. 24

Diode detectors are commonly used because of their ready adaptation to detection and control circuits. A diode detector circuit, shown in Fig. 25, functions as a half-wave rectifier and the a-f voltage appears across the load resistor, R_1 , which is by-passed for r-f by condenser C_1 . The by-pass condenser C_1 charges up to a voltage approximately equal to the peak voltage of the signal and maintains a d-c voltage proportional to the carrier amplitude across the load resistor, R_1 . Since diode detectors are operated at very small currents, the operating characteristics of all types are practically the same.

TYPICAL DIODE DETECTOR CIRCUIT

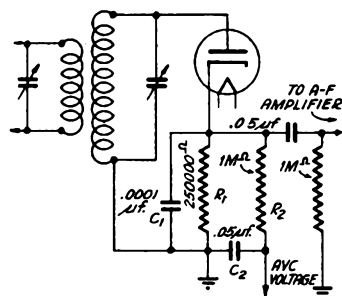

FIG. 25

Automatic volume control, AVC, may be obtained by applying the d-c voltage developed across the diode load resistor, as a negative bias, to the control grids of the r-f and i-f amplifier tubes in the receiver so that their gain increases or decreases as the r-f signal decreases or increases. A typical circuit is shown in Fig. 25. The filter $R_2 - C_2$ is introduced to prevent the AVC voltage from varying at audio frequencies and to prevent high frequency voltage from being fed back to the r-f or i-f amplifier tubes.

In diode detector circuits certain precautions should be taken to insure linearity and low distortion with high percentage modulation. The r-f signal voltage applied to the diode should be approximately 10 volts, and the ratio of the a-c impedance to the d-c resistance in the diode circuit should be as high as possible. The a-c impedance is usually less than the d-c resistance in the diode circuit due to the shunting effect of the AVC network and the grid leak of the following audio amplifier tube. Therefore, the grid leak and AVC filter resistors should be as high as allowable in the grid circuits of the a-f and r-f amplifier tubes, and the diode load resistor should not be too high. The a-c/d-c impedance ratio may be improved by feeding the a-f amplifier and the AVC network from a tap on the diode load resistor, as shown in Fig. 7. While this connection reduces the sensitivity, it increases the a-c/d-c impedance ratio appreciably. The r-f by-pass condenser across the diode load resistor should not be too large as this will cause loss of gain and distortion at the higher audio frequencies.

TYPICAL DIODE DETECTOR CIRCUIT WITH DELAYED AVC

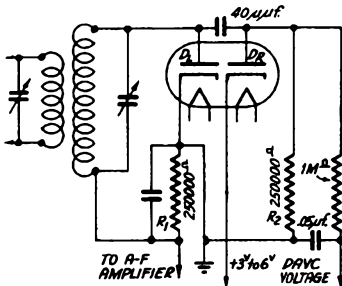
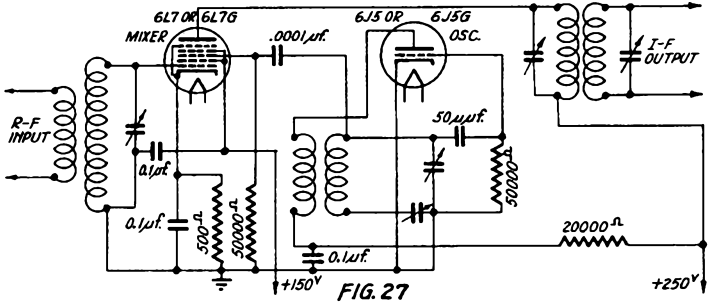

FIG. 26

In some cases it is desirable for the AVC action to be delayed until the signal reaches a certain predetermined strength, in order that the receiver may receive weak signals with maximum sensitivity. A circuit which accomplishes this is called a delayed AVC, or DAVC circuit and is shown in Fig. 26. Diode, D_1 , is used as a detector to supply a-r voltage to the a-f amplifier and diode, D_2 , is used to supply delayed AVC voltage. The amount of delay depends on the voltage on the cathode of D_2 . For example, if the cathode of D_2 is returned to a point 3 volts above ground, no current can flow through D_2 until the signal strength increases sufficiently to cause more than 3 volts to be developed across R_2 , and the AVC action is delayed until the signal reaches approximately 3 volts peak.

In a superheterodyne receiver, a frequency converter stage is used to convert the incoming r-f signal to the i-f frequency. Two tubes may be used, one as the oscillator and the other as the mixer, or first detector, or both functions may be combined in a single converter tube such as a type 6A7 or a 6AGG. Fig. 27 shows a typical frequency converter circuit using a pentagrid mixer tube and a separate oscillator. A typical pentagrid converter circuit using a single tube is shown in the circuit of Fig. 7.

TYPICAL FREQUENCY CONVERTER CIRCUIT USING SEPARATE OSCILLATOR



VOLUME EXPANDER CIRCUIT

In the recording of phonograph records or in broadcasting, particularly of music having a large volume range such as symphony orchestra selections, the volume range is compressed so that the soft passages are louder and the loud passages are softer than in the original music. This compression is necessary to keep the soft passages above the background noise level of the equipment and to prevent the loud passages from overcutting the grooves on the record or overmodulating the carrier. More natural reproduction of such music may be obtained by the use of a volume expander amplifier which amplifies the loud passages more than the soft passages and thus increases the volume range. Fig. 28 shows a circuit for a volume expander amplifier using a type 6L7 or 6L7G pentagrid tube.

VOLUME EXPANDER CIRCUIT

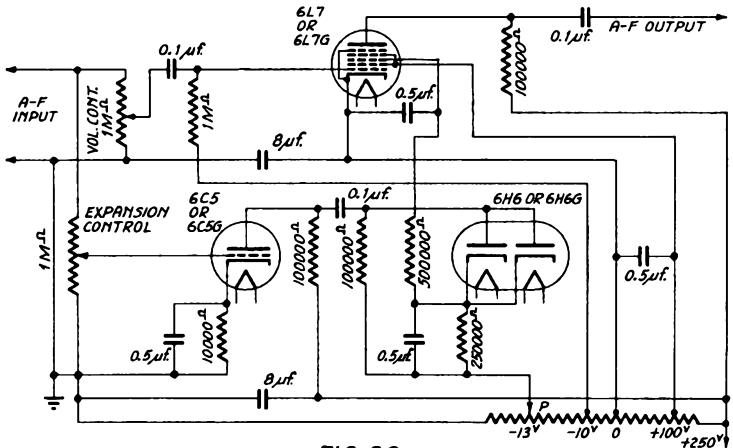

The operation of the circuit is as follows: The gain of the 6L7 audio amplifier depends on the bias on number 3 grid. The input signal is applied to the number 1 grid of the 6L7 and also to the grid of the 6C5. The amplified signal from the 6C5 is rectified by the 6H6 or 6H6G and the d-c output voltage applied, as a positive bias, to the number 3 grid of the 6L7 so that the gain increases and decreases with the amplitude of the signal. The position of tap, P, determines the initial bias on grid number 3 of the 6L7 and should be adjusted so that the no-signal plate current of the 6L7 is 0.15 milliamperes. The input signal on the grid of the 6L7 should not exceed one volt peak in order to prevent excessive distortion. If it is desired to delay the expander action until the input signal reaches a certain level, a negative bias may be applied to the plates of the 6H6 or 6H6G rectifier tubes.

AUTOMATIC FREQUENCY CONTROL CIRCUITS

An automatic frequency control circuit, as applied to a superheterodyne receiver, is one which automatically controls the oscillator frequency in such a manner that the intermediate frequency is maintained at the frequency to which the i-f amplifier is tuned. Thus, a receiver equipped with AFC automatically corrects inaccuracies in manual tuning and compensates for oscillator drift. An AFC circuit consists of a frequency discriminator circuit and a control circuit. The discriminator detects changes in intermediate frequency and supplies a d-c voltage, the polarity of which depends on the direction of the frequency change, to the control circuit which changes the oscillator frequency and returns the intermediate frequency to the proper value.

FREQUENCY DISCRIMINATOR CIRCUIT FOR AFC.

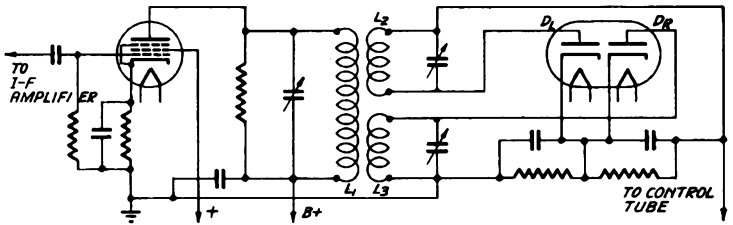

FIG. 29

Fig. 29 shows a frequency discriminator circuit. The primary, L_1 , is tuned to the intermediate frequency of the receiver and loosely coupled to the secondaries, L_2 and L_3 , which are tuned to frequencies spaced equally above and below the intermediate frequency. The voltages across L_2 and L_3 are applied to a duo-diode rectifier as shown. The d-c output voltage of this rectifier is the AFC voltage and is equal to the difference between the voltages developed by each diode. When the i-f signal is on the center frequency the voltages applied to the diodes are equal, the d-c output voltages are equal and no resultant AFC voltage is developed. If the i-f frequency changes toward the resonant frequency of L_2 , more voltage will be applied to diode, D_L , than to the other diode, D_R , will develop more d-c voltage than D_R , and the resultant AFC voltage will be negative with respect to ground. In like manner, if the i-f frequency changes toward the resonant frequency of L_3 , the resultant AFC voltage will be positive with respect to ground.

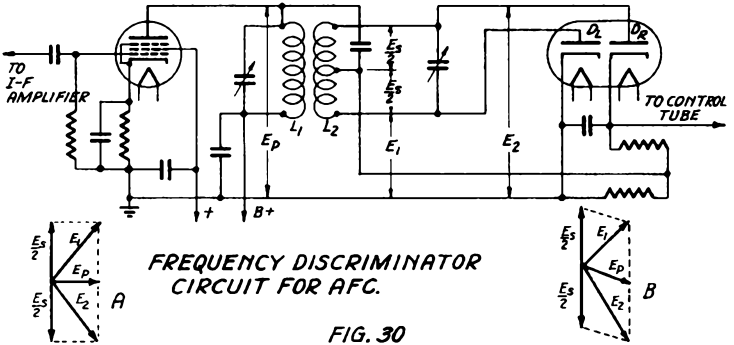

FIG. 30

Another discriminator circuit which does not depend on side circuits, tuned above and below the intermediate frequency, for its operation is shown in Fig. 30. In this circuit the primary L_1 , and the secondary, L_2 are both tuned to the intermediate frequency of the receiver and are loosely coupled. The operation of the circuit depends on the fact that at the resonant frequency the primary voltage, E_p , and the secondary voltage, E_s , are 90° out of phase and on the fact that the phase angle varies as the frequency changes. The circuit is arranged so that the voltage, E_1 , applied to one diode is the vector sum of the primary voltage and one-half of the secondary voltage, and the voltage, E_2 , applied to the other diode is the vector sum of the primary voltage and the other half of the secondary voltage. As in Fig. 29, the resultant AFC voltage is the difference between the d-c voltages developed by each diode. Vector diagram, A, in Fig. 30 shows the phase relations of the several voltages when the applied voltage is at the resonant frequency. Since the voltages, E_1 and E_2 , which are applied to the diodes are equal, no resultant AFC voltage is developed. If the applied voltage changes in frequency, the phase relations may be as shown in vector diagram, B. The voltage, E_2 , applied to diode D_R , will be greater than the voltage, E_1 , applied to the other diode. D_R will develop more d-c voltage than D_L and the resultant AFC voltage will be positive with respect to ground. If the frequency changes in the opposite direction, E_1 will be greater than E_2 and the resultant AFC voltage will be negative with respect to ground.

CONTROL CIRCUIT FOR AFC

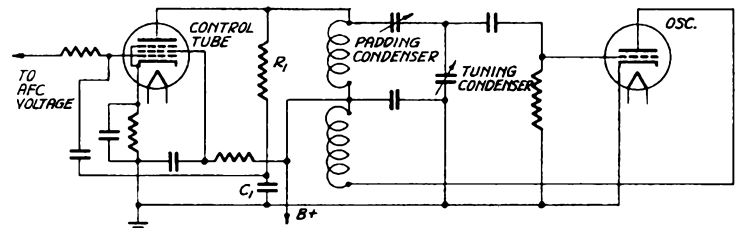

FIG. 31

Fig. 31 shows a control circuit which controls the oscillator frequency in accordance with the d-c voltage developed by the discriminator. The plate of the control tube is coupled to the oscillator tank coil and a voltage approximately 90° out of phase with the voltage across the tank coil is applied to the grid. In Fig. 31 this out of phase voltage is obtained from condenser, C_1 , which is in series with resistor, R_1 , across the tank coil. In practice the resistance of R_1 is made much greater than the reactance of C_1 and the current through C_1 is practically in phase with the voltage across the tank coil. The voltage across C_1 is therefore practically 90° out of phase with the tank coil voltage. The plate circuit of the control tube then acts like an inductance across the tank coil. The value of this effective inductance depends on the bias on the grid of the control tube. As the bias of the control tube is determined by the AFC voltage generated by the discriminator, the control tube tends to maintain the oscillator at the proper frequency.

RECOMMENDED OPERATING PRACTICES

FILAMENT AND HEATER VOLTAGE Radio receiving tubes are designed to operate satisfactorily with moderate variations in heater or filament voltage from the rated values. However, for best performance and life the rated values should be maintained as closely as possible. At excessively high values of heater or filament voltage there is danger of heating the first grid to the point where it emits a sufficient number of electrons to interfere with the proper functioning of the tube and in a-c operated receivers the hum introduced from the a-c heater supply is likely to be greatly increased. Furthermore, the rate of evaporation of active material from the cathode is greatly accelerated with corresponding reduction in tube life. At excessively low heater or filament voltages the electron emission from the cathode may be reduced to the point where the tube characteristics and the receiver performance are seriously affected. In the case of tubes in which a relatively large current is drawn from the cathode, particularly power amplifier and rectifier tubes, operation under such conditions is apt to result in serious damage to the tube and early failure.

It is now standard practice to design a-c operated receivers for a line voltage of 117 volts and the filament and heater transformers should be designed to supply exactly the rated voltages to the heaters and filaments with this line voltage. If this is the case, the performance and life of the tubes will not be seriously affected by the normal fluctuations in line voltage, if these are not more than ten percent. The best practice is to have the receiver power transformer supplied with taps so that the voltages may be held within 5% of the normal value. When the filaments or heaters are operated in series the total voltage does not divide exactly equally among the various tube filaments or heaters due to small variations in heater resistance. In this case the bad effects of large variations in line voltage are exaggerated. It is important that receivers having the heaters connected in series be designed to supply exactly the rated value of current to the heaters or filaments at the standard line voltage of 117 volts.

The tubes used in automobile receivers are designed to give satisfactory life and performance with the heater voltage fluctuating between 5.5 and 8.0 volts as in normal automobile operation and the connections should be arranged to maintain the heater voltage at all times within this range.

In home receivers where the heater or filament current is supplied directly from two-volt or six-volt storage batteries the variation in filament voltage will normally not be excessive. However, precautions should be taken against excessive voltage drop in the filament supply connections and against abnormal battery voltages such as might occur during battery charging or when the battery is discharged.

For best results, the filament voltage applied to two-volt tubes should be within the range of 1.8 to 2.2 volts. Operation at a voltage of 2.3 volts for a short period is permissible. The tubes are generally operative at voltages as low as 1.7 volts but with reduced sensitivity and output.

The two-volt-tube receivers designed for use with aircells are equipped with the proper series resistor for maintaining the filament voltage within a suitable range during the life of the battery. With many two-volt-tube receivers for use with three-volt dry batteries or dry packs there are provided ballast tubes which tend to hold the filament current at the proper value. It is essential that these ballast tubes be rated for the same value of current as the total filament current of the receivers with which they are used. As the characteristics of the ballast tube are apt to undergo a permanent change during life, it is advisable to replace it whenever the filament battery is replaced.

Some two-volt-tube receivers now employ a type of resistor tube which may be used with a storage battery, aircell or drycell supply. (See "RB" resistor tubes at end of rating and characteristic data section).

Some two-volt-tube receivers are designed to operate with the filament voltage supplied directly from a 4.5 volt dry battery or dry pack, the two-volt tubes being used in pairs with the filaments in series. The range of filament voltage is somewhat greater in this case than in the preceding cases but better battery economy is obtained.

TUBE MOUNTING The common and safest practice is to mount tubes in a vertical position. However, it is also generally permissible to mount them in a horizontal position. When filament type tubes are mounted horizontally they should be turned so that the plane of the filament is vertical, to avoid the chance of the filament sagging sufficiently to touch the grid or the plate.

Provision should be made for free circulation of air around the tubes. This applies particularly to the rectifier and power output tubes which must dissipate considerable power. Too close confinement increases the chance of grid emission or loss of vacuum due to electrolysis of the glass between the sealed in leads at high glass temperatures.

Modern tubes, particularly those of the heater type, are capable of withstanding relatively severe vibration for short periods without damage. If they are subjected to severe vibration continuously a gradual wearing away of the insulated heater coating or of the mica spacer is liable to occur and premature failure of the tube may result. Where the receiver is likely to be subjected to severe vibration a cushioned mounting should be provided for the receiver chassis and means should be employed to prevent or damp out resonant vibrations of the chassis and tubes.

MICROPHONICS Microphonic howling, when due to a tube, is caused by mechanical feedback from the speaker to the tube either through the air or through the chassis. Tubes which are followed by high audio frequency gain are most susceptible. Heater type tubes are much less microphonic than filament types and ordinarily give no trouble except under extreme conditions. In filament types, particularly the two-volt types, the filament may be set into vibration at its resonant frequency by extremely small impulses of the same frequency. In present day tubes improved methods of filament support are used to reduce this tendency and to damp out oscillations of the filament, but if the audio frequency gain in the receiver is high, special precautions must be taken in the receiver to reduce mechanical feedback. The most sensitive tube should not be mounted close to the speaker; the speaker should not be rigidly connected to cabinet or chassis; the chassis should have a cushioned mounting in the cabinet and resonant vibrations in the chassis should be avoided or damped out.

Ordinary precautions against tube microphonics are usually sufficient for audio frequency gains up to about 100 db. with heater type tubes and up to about 50 db. with two-volt tubes. Gains exceeding these values usually require special precautions against tube microphonics and hum. Microphonic troubles may originate in the converter or even in the i-f amplifier tubes through audio frequency modulation of the carrier or of the i-f frequency, even when the gain in the audio frequency stages is not especially high. Similar precautions should be used to avoid this type of microphonic effect.

HUM In modern a-c operated receivers filament type tubes are used only as plate-supply rectifiers or as output tubes. Filters are provided to eliminate the hum voltage developed in the rectifier section by the a-c supply. The voltage gain in the output stage is usually low and the hum is not noticeable if the simple precautions are taken of connecting the grid and plate return leads to the mid-point of the filament transformer secondary and of having this point well by-passed to the chassis. The heater type tubes used in all the other positions are so designed that, under favorable circuit conditions, only very small hum voltages are introduced into the audio and radio frequency circuits by the a-c heater voltage and current. For minimum hum the ground connection to the heaters should be made to the center point of the heater winding. If hum is present, it is usually caused by improper filtering or is introduced by some circuit element other than the tubes.

However, under some conditions, a troublesome amount of hum may originate in the tubes. The second detector tube or the first audio amplifier tube is most likely to give trouble because it is followed by the maximum audio gain. Hum may also originate in the mixer or in the i-f amplifier tubes, due to 60 cycle modulation of the r-f or i-f carrier.

The most common cause of hum in a tube is a minute leakage current between the heater and the cathode, which by flowing through some high resistance circuit element, such as the cathode resistor, develops a small voltage which is amplified by the succeeding audio frequency stages. To reduce hum from this source the cathode resistor should be by-passed and the cathode should be made negative with respect to the heater.

Other circuit precautions include the proper shielding of the tubes and component parts to prevent both electrostatic and electromagnetic coupling between them, and the arrangement of the wiring in such a way that leads followed by high audio frequency gains are not looped around the filament supply wires and are kept as far as possible from any leads carrying alternating currents.

Hum is sometimes introduced by the direct action of a strong 60 cycle magnetic field on the tubes. This occurs when the tubes are placed too close to the power transformer or the filter choke and the chassis should be laid out to avoid this possibility.

GRID CIRCUIT RESISTORS In present day receivers grid circuit resistors of relatively high values are commonly used, for instance, in resistance coupled amplifier stages, in the diode detector stage and in automatic volume control and other automatic control networks. As a result, a grid current of as little as a few microamperes may cause serious reduction in the grid bias due to the voltage drop in these resistors. This condition may lead to reduced sensitivity, instability or even to serious overheating and damage to the tubes or other circuit elements. Circuits in which a common resistor is inserted in the grid return lead of two or more tubes are particularly susceptible to loss of bias due to grid current.

The tubes are always checked for grid current during final testing in the factory and are held to a limit of not more than one or two microamperes. The average value is a small fraction of a microampere. However, when a tube is operated in a receiver, a higher value of grid current may appear due to a minute evolution of gas from the parts or to a minute amount of erratic electrical leakage across an insulator or to a small amount of thermal electron emission from the grid. The grid current due to gas usually tends to decrease rapidly as the receiver is operated. The current due to grid emission appears only after the tube has become heated to its maximum operating temperature and is aggravated by any conditions tending to overheat the tube, such as insufficient provision for air circulation, high line voltage, excessive plate voltage or insufficient grid bias.

The best precaution against trouble from this source is the avoidance of circuits which depend for their operation on extremely high values of grid resistors. A second precaution is to obtain the grid bias by means of the voltage drop in a cathode, or self-bias, resistor rather than to use a fixed bias. With self-bias any tendency toward the loss of bias due to grid current is partially compensated for by an increase in the self-bias because of the resultant increase in plate current. A further precaution is the avoidance of excessive plate and screen grid voltages and currents by making sure that the tubes are operated well within their maximum ratings even at the highest line voltages. A fair amount of regulation in the screen and plate voltage supplies is also helpful in this respect.

As a general rule, the grid resistor for a single tube, exclusive of the output tube, should not exceed three megohms and a maximum of one megohm would be preferable. Where a resistor is common to the grid circuit of two or more tubes the value of the resistor should not exceed these values divided by the number of tubes whose grid current flows through it. The above rule applies in the case of self-bias.

In the case of fixed-bias, the maximum value of the grid resistor should never exceed one megohm and this value should be reduced in inverse proportion to the number of tubes for whose grid current it forms a path. In applying these rules it should be noted that they refer to the total resistance in the grid circuit including the sum of all series resistors such as are used in some control circuits.

In the case of output tubes, a maximum value for the grid resistor is commonly given with the tube rating. In general, a value of one megohm is the maximum safe value for tubes of low output ratings up to 3 or 4 watts and 1/10 to 1/4 megohm for tubes of higher output ratings.

PRECAUTIONS AGAINST BLOCKING DUE TO SECONDARY EMISSION When a sufficiently high positive voltage is applied momentarily to a control grid there is an emission of secondary electrons from this grid to the screen grid or to the plate. Under some conditions this current may exceed the flow of electrons from the cathode to the control grid so that there is a net flow of electrons into the grid through the external grid circuit. If this circuit includes a very high resistance the resultant voltage drop may be sufficient to maintain the grid at a positive potential in spite of an externally applied negative grid bias. When the grid becomes "locked" positive in this manner the tube is blocked and inoperative and may be permanently damaged by overheating due to the resultant excessive plate current.

In most tubes the secondary emission characteristic of the control grid is low enough so that this trouble will occur only under abnormal conditions. A frequent cause of trouble is a defective wave change switch that applies a high positive d-c voltage to the grid momentarily during switching. Surges sufficiently high may reach the r-f amplifier tubes or the converter tube to cause blocking under certain circuit conditions. Sufficient surge is also sometimes developed in the output tube, when the set is turned on, to cause blocking under bad circuit conditions.

To avoid trouble of this kind it is advisable to use as low values of resistance as is possible in the grid circuits of the tubes that may be subjected to surge, particularly the tubes mentioned above. The switches should be designed and adjusted to reduce grid current surges to a minimum. The circuits should be arranged to provide high damping for surges. This can frequently be accomplished by taking advantage of the damping effect of the grid current flow when a grid is thrown slightly positive. This alone will protect a tube against small surges.

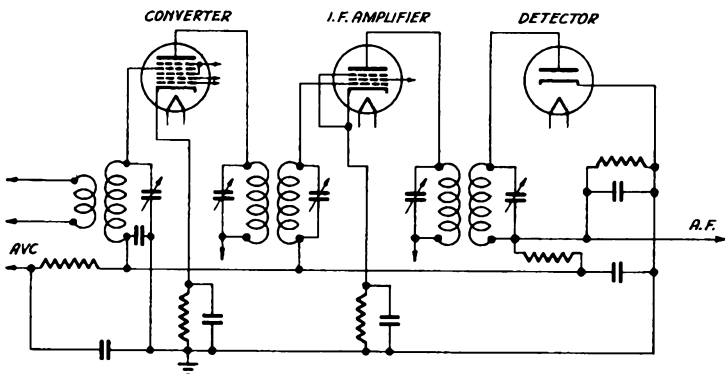

FIG. 32

Added damping for an r-f amplifier or a converter tube may be obtained by coupling its grid circuit to the grid circuit of an i-f amplifier tube, as shown in Fig. 32, so that a surge reaching the grid of the r-f amplifier or the converter tube is partially dissipated by causing grid current to flow in the i-f amplifier tube.

It is also possible to connect a diode to the r-f amplifier or converter tube grid circuit in such a way that a surge will be dissipated by causing current to flow through the diode. Fig. 33 shows a diode connected to the grid circuit of a converter tube to prevent blocking due to secondary emission.

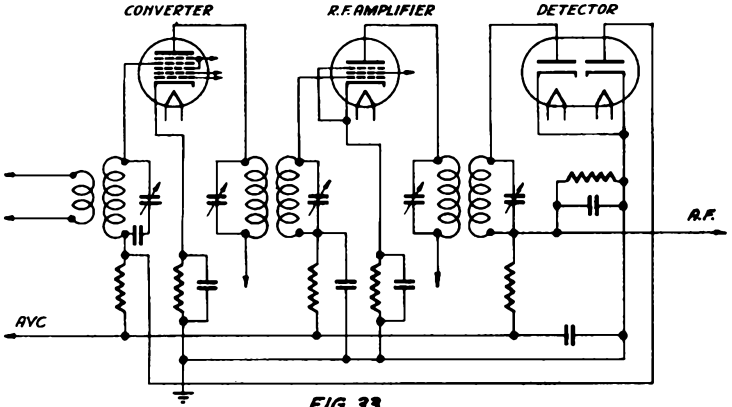

FIG. 33

CONVERSION CURVES

The following curves, Figs. 34, 35 and 36, may be used to find the approximate operating conditions for power amplifier triodes, tetrodes and pentodes at other than the published operating conditions.

Fig. 34 should be used for triodes operated at other than the published plate voltage and for tetrodes and pentodes operated at other than the published plate and screen voltages. For example, suppose it is desired to operate a pentode power amplifier at a plate and screen voltage 20% lower than the published values. The percent change from the published operating conditions may be read at the intersections of the curves with the -20% ordinate. Thus, for a 20% decrease in plate and screen voltages, the grid bias should be decreased 20% or the bias resistor increased 12%, the load resistance should be increased 12%, the plate and screen current will be decreased 27% and the power output will decrease 48%. Values for triodes may be determined from the curves in the same manner.

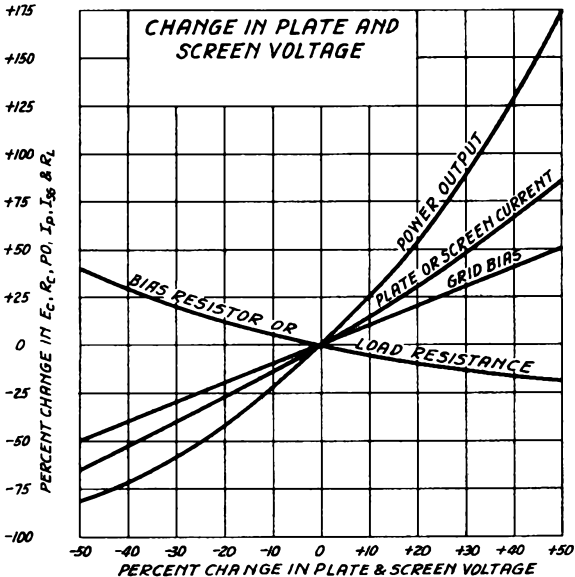

FIG. 34

Fig. 35 should be used for tetrodes and pentodes where only the plate voltage is changed and the values are read from the curves in the same way as in Fig. 34.

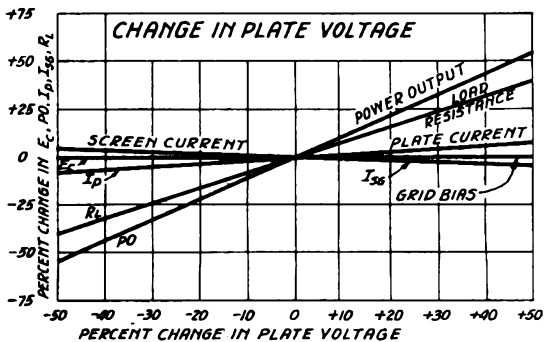

FIG. 35

Fig. 36 should be used for tetrodes and pentodes where only the screen voltage is changed and the values are read from the curves as in the previous figures. Tetrodes and pentodes should not be operated with the screen voltage appreciably higher than the plate voltage.

When choosing new operating conditions for any tube the published maximum ratings should not be exceeded.

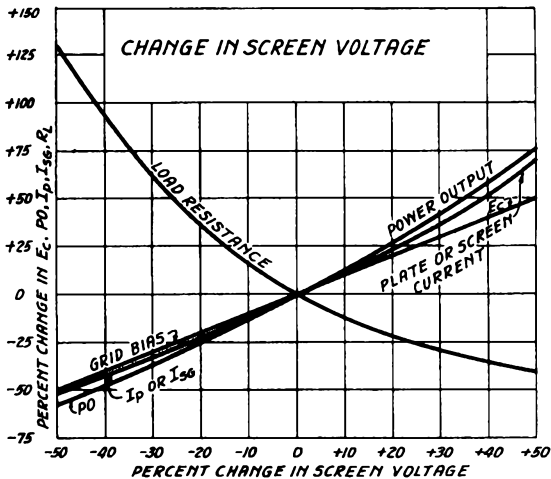

FIG. 36

RESISTANCE-COUPLED AMPLIFIER DESIGN CURVES

The curves in Figs. 38 to 43 give circuit design data for use with the heater type tubes commonly used in resistance-coupled amplifiers. The curves show the proper value of cathode resistor, R_c , for use with several values of plate resistor, R_L , at plate supply voltages from 90 to 300 volts. The values of output voltage, E_o , (peak volts) at maximum signal and the voltage gain, V_G , are also shown by the curves.

Typical circuit diagrams for triode and pentode resistance coupled amplifiers may be found on page 11.

The value of the coupling condenser, C , depends on the value of R_g , the grid resistor for the following tube and for approximately 75 percent of the high frequency response at 60 cycles the value will be:

$$C = \frac{0.003}{R_g} \quad C = \mu f \quad R_g = \text{MEG OHMS}$$

The curves were plotted using a value of $R_g = 2 R_L$ in all cases.

For the condition, $R_g = R_L$, the value of R_0 from the curves should be decreased 15%.

For the condition, $R_g = 4 R_L$, the value of R_0 from the curves should be increased 10%.

The value of R_0 should not exceed the maximum value allowable in the grid circuit of the following tube.

The proper value for the cathode by-pass condenser, C_0 , may be found from the relation:

$$C_0 = \frac{7000}{R_0}$$

$$C_0 = \mu F$$

$$R_0 = \text{OHMS}$$

The value of the screen by-pass condenser should be at least 0.05 to 0.1 μF .

In phase inverter circuits, such as the one shown in Fig. 11 on page 12, where a common cathode resistor is used the value of the resistor should be one-half that read from the curves for a single tube and the cathode by-pass condenser should be omitted.

The curves in Figs. 44, 45 and 46 apply to two-volt tubes and are similar to those in the previous figures, except that values of grid bias instead of cathode resistor are shown.

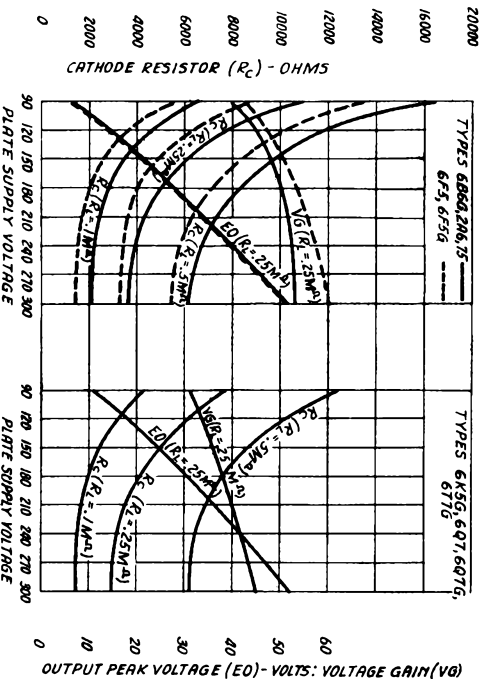

FIG. 37

FIG. 38

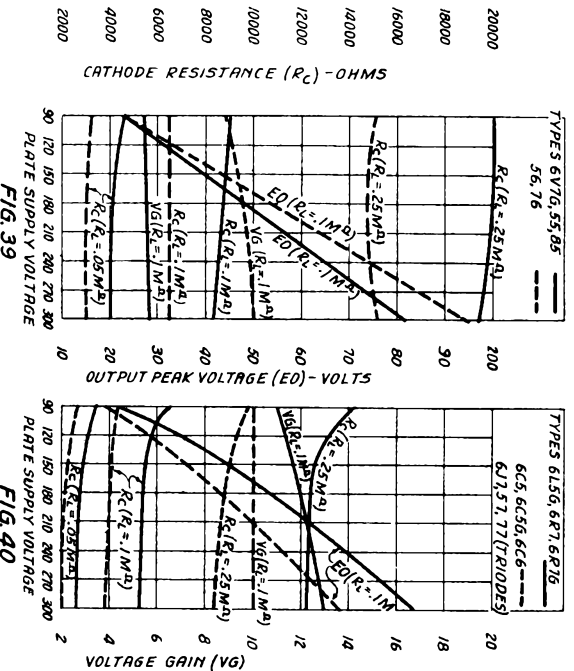

FIG. 39

FIG. 40

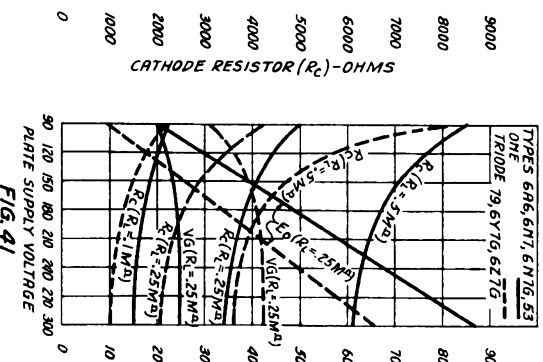

FIG. 41

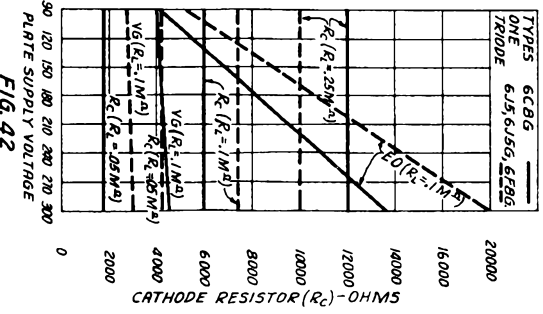

FIG. 42

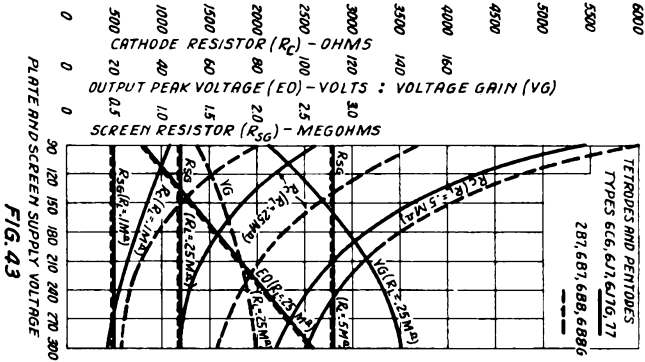

FIG. 43

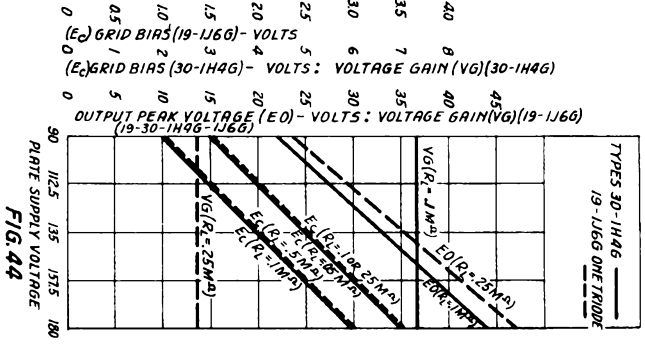

FIG. 44

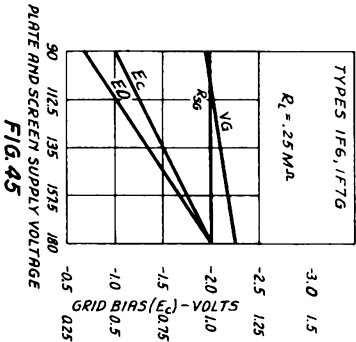

FIG. 45

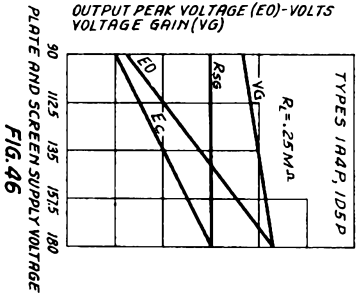

FIG. 46

All tubes are put through a mechanical and electrical test in the factory as one of the last operations. They are individually checked for such items as short circuits, open circuits, grid current, electron emission from the cathode, tube noise and certain operating characteristics such as plate current, transconductance or power output. The original design has previously been completely tested for all important operating characteristics. The individual factory tests insure that each tube is of good quality so far as factory processing is concerned and that it conforms to the original design within standard tolerances, as indicated by one or more key characteristics. At frequent, regular intervals sample tubes are selected at random from the production and are tested in the laboratory for all important characteristics. Random samples of regular production tubes are also life tested at approximately maximum rated voltages and the characteristics are measured after various periods of operation to determine the quality and the degree of constancy of the characteristics during life.

The test equipment required for this factory and laboratory testing is elaborate and expensive and one test set can readily accommodate only a few tube types out of the two hundred that are now on the market. Obviously, it is neither practical nor necessary, for the tube dealer or even for the set manufacturer to make as complete a test of tubes as is done by the tube manufacturer. However, a small percentage of defects develop during shipment and handling and most dealers find it advantageous to check each tube, when sold, as an insurance that it is operative and to check the condition of tubes that have been in service. Various types of relatively simple tube testing equipment have been developed for the dealer's use. In most cases this simple equipment will not give an accurate measurement of a tube's operating characteristics or of its ability to perform satisfactorily in any particular receiver. The simplest will at least tell whether or not a tube is operative, and the more elaborate will give an approximate indication of the value of some major characteristic.

Since a radio tube cannot perform properly without a copious supply of electrons from the cathode, a test that will measure or at least give a comparative indication of the electron emission can be used as a rough check on the operating condition of a tube and of its ability to perform up to the normal standard for its type. In the common form of emission type tube checker a fixed value of a-c voltage is applied between the cathode and the nearest grid (usually with the other elements connected to this grid) through a fixed resistor and a d-c current indicating meter. Provisions are, of course, made for applying rated heater or filament voltage to the tube and for making the proper electrode connections for each tube type. In addition, facilities are often included for testing for short circuits, open filaments and often for electrical leakage between the elements.

The Radio Manufacturer's Association has recommended, in the interests of standardization, certain values of circuit constants that should be used in this type of tube checking equipment. The RMA recommends that tubes be tested under the following conditions:

1. Rated Filament or Heater Voltage
2. Fixed Emission Voltage of 30 volts RMS
3. Total effective series impedance of testing circuits should be varied as follows:
 - (a) High value for diodes, exclusive of power rectifiers
5000 ohms
 - (b) Medium value for battery tubes of limited emission-1000 ohms
 - (c) Low value for remaining types
200 ohms
4. A pointer type of indicating meter is recommended as the most reliable device for indicating tube characteristics.
5. The regulation of the system should not exceed $\pm 5\%$ with the range of loads for which the tester is designed.
6. The short circuit or leakage test circuit should not respond to a resistance greater than 250,000 ohms.
7. The RMA recommended circuit is shown in Fig. 47.

To establish limits for an emission type tube tester it is necessary to read a number of tubes of each type to be tested, and determine the average readings for good tubes of each type. Due to minor differences in design, tubes of the same type but of different manufacture may give different readings in tube testers, and still perform equally well in a receiver. In general, the end of the useful life of power amplifier tubes is indicated by a reading 50% below the average for good tubes of the same type, and of voltage amplifier tubes and rectifier tubes by readings 35% and 20% below average respectively.

Other types of tube checkers are designed to give a rough check on some other tube operating characteristic, such as plate current, transconductance or power output. Accurate measurement of these characteristics requires sensitive measuring equipment and accurately measured element voltages for a large range and variety of test conditions and tube connections. All of these items are increasingly expensive to obtain as the degree of accuracy is increased.

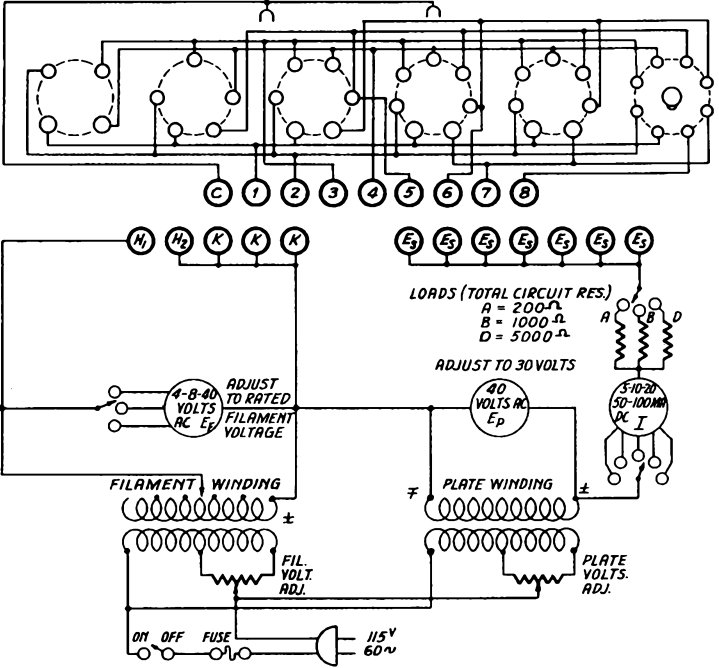

R.M.A. STANDARD EMISSION TESTER
FIG. 47

RAYTHEON RECEIVING TUBES

TYPE NO.	STRUCTURE	CATHODE	USE
00A	Triode	5.0 volt Filament	Detector
01A	Triode	5.0 volt Filament	Detector or Amplifier
024	Twin Diode	Cold	Full Wave Rectifier
024G	Twin Diode	Cold	Full Wave Rectifier
1A4	Tetrode	2.0 volt Filament	Remote Cutoff Amplifier
1A6	Heptode	2.0 volt Filament	Frequency Converter
1B4/951	Pentode	2.0 volt Filament	Detector or Amplifier
1B5/25S	Duo-Diode Triode	2.0 volt Filament	Detector Amplifier
1C6	Heptode	2.0 volt Filament	Frequency Converter
1C7G	Heptode	2.0 volt Filament	Frequency Converter
1D5G	Pentode	2.0 volt Filament	Remote Cutoff Amplifier
1D7G	Heptode	2.0 volt Filament	Frequency Converter
1E5G	Pentode	2.0 volt Filament	Detector or Amplifier
1E7G	Twin Pentode	2.0 volt Filament	Power Amplifier
1F4	Pentode	2.0 volt Filament	Power Amplifier
1F5G	Pentode	2.0 volt Filament	Power Amplifier
1F6	Duo-Diode Pentode	2.0 volt Filament	Detector Amplifier
1F7G	Duo-Diode Pentode	2.0 volt Filament	Detector Amplifier
1G5G	Pentode	2.0 volt Filament	Power Amplifier
1H4G	Triode	2.0 volt Filament	Detector or Amplifier
1H6G	Duo-Diode Triode	2.0 volt Filament	Detector Amplifier
1J5G	Pentode	2.0 volt Filament	Power Amplifier
1J6G	Twin Triode	2.0 volt Filament	Power Amplifier
1-V	Diode	6.3 volt Heater	Half Wave Rectifier
2A3	Triode	2.5 volt Filament	Power Amplifier
2A3H	Triode	2.5 volt Heater	Power Amplifier
2A5	Pentode	2.5 volt Heater	Power Amplifier
2A6	Duo-Diode Triode	2.5 volt Heater	Detector Amplifier
2A7	Heptode	2.5 volt Heater	Frequency Converter
2B7	Duo-Diode Pentode	2.5 volt Heater	Detector Amplifier
5T4	Twin Diode	5.0 volt Filament	Full Wave Rectifier
5U4G	Twin Diode	5.0 volt Filament	Full Wave Rectifier
5V4G	Twin Diode	5.0 volt Heater	Full Wave Rectifier
5W4	Twin Diode	5.0 volt Filament	Full Wave Rectifier
5W4G	Twin Diode	5.0 volt Filament	Full Wave Rectifier
5X4G	Twin Diode	5.0 volt Filament	Full Wave Rectifier
5Y3G	Twin Diode	5.0 volt Filament	Full Wave Rectifier
5Y4G	Twin Diode	5.0 volt Filament	Full Wave Rectifier
5Z3	Twin Diode	5.0 volt Filament	Full Wave Rectifier
5Z4	Twin Diode	5.0 volt Heater	Full Wave Rectifier
6A3	Triode	6.3 volt Filament	Power Amplifier
6A4/LA	Pentode	6.3 volt Filament	Power Amplifier
6A5G	Triode	6.3 volt Heater	Power Amplifier
6A6	Twin Triode	6.3 volt Heater	Power Amplifier
6A7	Heptode	6.3 volt Heater	Frequency Converter
6A8	Heptode	6.3 volt Heater	Frequency Converter
6A8G	Heptode	6.3 volt Heater	Frequency Converter
6AB5	Cathode Ray	6.3 volt Heater	Tuning Indicator
6AC5G	Triode	6.3 volt Heater	Power Amplifier
6B4G	Triode	6.3 volt Filament	Power Amplifier
6B5	Duo-Triode	6.3 volt Heater	Power Amplifier
6B6G	Duo-Diode Triode	6.3 volt Heater	Detector Amplifier
6B7	Duo-Diode Pentode	6.3 volt Heater	Detector Amplifier
6B8	Duo-Diode Pentode	6.3 volt Heater	Detector Amplifier
6B8G	Duo-Diode Pentode	6.3 volt Heater	Detector Amplifier
6C5	Triode	6.3 volt Heater	Detector or Amplifier
6C5G	Triode	6.3 volt Heater	Detector or Amplifier
6C6	Pentode	6.3 volt Heater	Detector or Amplifier
6C8G	Twin Triode	6.3 volt Heater	Amplifier or Phase Inverter
6D6	Pentode	6.3 volt Heater	Remote Cutoff Amplifier
6D8G	Heptode	6.3 volt Heater	Frequency Converter
6E5	Cathode Ray	6.3 volt Heater	Tuning Indicator
6E6	Twin Triode	6.3 volt Heater	Power Amplifier
6F5	Triode	6.3 volt Heater	Amplifier
6F5G	Triode	6.3 volt Heater	Amplifier
6F6	Pentode	6.3 volt Heater	Power Amplifier
6F6G	Pentode	6.3 volt Heater	Power Amplifier
6F7	Triode Pentode	6.3 volt Heater	Amplifier or Converter
6F8G	Twin Triode	6.3 volt Heater	Amplifier
6G5/6H5	Cathode Ray	6.3 volt Heater	Tuning Indicator
6G6G	Pentode	6.3 volt Heater	Power Amplifier
6H6	Twin Diode	6.3 volt Heater	Detector
6H6G	Twin Diode	6.3 volt Heater	Detector
6J5	Triode	6.3 volt Heater	Amplifier
6J5G	Triode	6.3 volt Heater	Amplifier
6J7	Pentode	6.3 volt Heater	Detector or Amplifier
6J7G	Pentode	6.3 volt Heater	Detector or Amplifier
6J8G	Triode Heptode	6.3 volt Heater	Frequency Converter
6K5G	Triode	6.3 volt Heater	Amplifier
6K6G	Pentode	6.3 volt Heater	Power Amplifier
6K7	Pentode	6.3 volt Heater	Remote Cutoff Amplifier
6K7G	Pentode	6.3 volt Heater	Remote Cutoff Amplifier
6L5G	Triode	6.3 volt Heater	Detector or Amplifier
6L6	Tetrode	6.3 volt Heater	Power Amplifier
6L6G	Tetrode	6.3 volt Heater	Power Amplifier
6L7	Heptode	6.3 volt Heater	Mixer or Amplifier
6L7G	Heptode	6.3 volt Heater	Mixer or Amplifier

TYPE NO.	STRUCTURE	CATHODE	USE
6N5	Cathode Ray	6.3 volt Heater	Tuning Indicator
6N6G	Duo-Triode	6.3 volt Heater	Power Amplifier
6N6MG	Duo-Triode	6.3 volt Heater	Power Amplifier
6N7	Twin Triode	6.3 volt Heater	Power Amplifier
6N7G	Twin Triode	6.3 volt Heater	Power Amplifier
6P7G	Triode Pentode	6.3 volt Heater	Amplifier or Converter
6Q7	Duo-Diode Triode	6.3 volt Heater	Detector Amplifier
6Q7G	Duo-Diode Triode	6.3 volt Heater	Detector Amplifier
6R7	Duo-Diode Triode	6.3 volt Heater	Detector Amplifier
6R7G	Duo-Diode Triode	6.3 volt Heater	Detector Amplifier
6S7G	Pentode	6.3 volt Heater	Remote Cutoff Amplifier
6T5	Cathode Ray	6.3 volt Heater	Tuning Indicator
6T7G/6Q6G	Duo-Diode Triode	6.3 volt Heater	Detector Amplifier
6U5	Cathode Ray	6.3 volt Heater	Tuning Indicator
6U7G	Pentode	6.3 volt Heater	Remote Cutoff Amplifier
6V6	Tetrode	6.3 volt Heater	Power Amplifier
6V6G	Tetrode	6.3 volt Heater	Power Amplifier
6V7G	Duo-Diode Triode	6.3 volt Heater	Detector Amplifier
6W5G	Twin Diode	6.3 volt Heater	Full Wave Rectifier
6X5	Twin Diode	6.3 volt Heater	Full Wave Rectifier
6X5G	Twin Diode	6.3 volt Heater	Full Wave Rectifier
6Y6G	Pentode	6.3 volt Heater	Power Amplifier
6Y7G	Twin Triode	6.3 volt Heater	Power Amplifier
6Z7G	Twin Triode	6.3 volt Heater	Power Amplifier
6ZY5G	Twin Diode	6.3 volt Heater	Full Wave Rectifier
10	Triode	7.5 volt Filament	Power Amplifier
12A	Triode	5.0 volt Filament	Detector or Amplifier
12A5	Pentode	12.6/6.3 v. Heater	Power Amplifier
12A7	Diode Pentode	12.6 volt Heater	Rectifier Power Amplifier
12Z3	Diode	12.6 volt Heater	Half Wave Rectifier
15	Pentode	2.0 volt Heater	Amplifier
19	Twin Triode	2.0 volt Filament	Power Amplifier
20	Triode	3.3 volt Filament	Power Amplifier
22	Tetrode	3.3 volt Filament	Amplifier
24A	Tetrode	2.5 volt Heater	Detector or Amplifier
25A6	Pentode	25 volt Heater	Power Amplifier
25A6G	Pentode	25 volt Heater	Power Amplifier
25A7G	Diode Pentode	25 volt Heater	Rectifier Power Amplifier
25B6G	Pentode	25 volt Heater	Power Amplifier
25L6	Tetrode	25 volt Heater	Power Amplifier
25L6G	Tetrode	25 volt Heater	Power Amplifier
25Z5	Twin Diode	25 volt Heater	Rectifier Voltage Doubler
25Z6	Twin Diode	25 volt Heater	Rectifier Voltage Doubler
25Z6G	Twin Diode	25 volt Heater	Rectifier Voltage Doubler
26	Triode	1.5 volt Filament	Amplifier
27	Triode	2.5 volt Heater	Detector or Amplifier
30	Triode	2.0 volt Filament	Detector or Amplifier
31	Triode	2.0 volt Filament	Power Amplifier
32	Tetrode	2.0 volt Filament	Detector or Amplifier
33	Pentode	2.0 volt Filament	Power Amplifier
34	Pentode	2.0 volt Filament	Remote Cutoff Amplifier
35/51	Tetrode	2.5 volt Heater	Remote Cutoff Amplifier
36	Tetrode	6.3 volt Heater	Detector or Amplifier
37	Triode	6.3 volt Heater	Detector or Amplifier
38	Pentode	6.3 volt Heater	Power Amplifier
39/44	Pentode	6.3 volt Heater	Remote Cutoff Amplifier
40	Triode	5.0 volt Filament	Amplifier
41	Pentode	6.3 volt Heater	Power Amplifier
42	Pentode	6.3 volt Heater	Power Amplifier
43	Pentode	25 volt Heater	Power Amplifier
45	Triode	2.5 volt Filament	Power Amplifier
46	Dual Grid Triode	2.5 volt Filament	Power Amplifier
47	Pentode	2.5 volt Filament	Power Amplifier
48	Pentode	30 volt Heater	Power Amplifier
49	Dual Grid Triode	2.0 volt Filament	Power Amplifier
50	Triode	7.5 volt Filament	Power Amplifier
52	Dual Grid Triode	6.3 volt Filament	Power Amplifier
53	Twin Triode	2.5 volt Heater	Power Amplifier
55	Duo-Diode Triode	2.5 volt Heater	Detector Amplifier
56	Triode	2.5 volt Heater	Detector or Amplifier
57	Pentode	2.5 volt Heater	Detector or Amplifier
58	Pentode	2.5 volt Heater	Remote Cutoff Amplifier
59	Pentode	2.5 volt Heater	Triple Grid Power Amplifier
71A	Triode	5.0 volt Filament	Power Amplifier
75	Duo-Diode Triode	6.3 volt Heater	Detector Amplifier
76	Triode	6.3 volt Heater	Detector or Amplifier
77	Pentode	6.3 volt Heater	Detector or Amplifier
78	Pentode	6.3 volt Heater	Remote Cutoff Amplifier
79	Twin Triode	6.3 volt Heater	Power Amplifier
80	Twin Diode	5.0 volt Filament	Full Wave Rectifier
81	Diode	7.5 volt Filament	Half Wave Rectifier
82	Twin Diode	2.5 volt Filament	Full Wave Rectifier
83	Twin Diode	5.0 volt Filament	Full Wave Rectifier
83V	Twin Diode	5.0 volt Heater	Full Wave Rectifier
84/6Z4	Twin Diode	6.3 volt Heater	Full Wave Rectifier
85	Duo-Diode Triode	6.3 volt Heater	Detector Amplifier
89	Pentode	6.3 volt Heater	Triple Grid Power Amplifier

TYPE NO.	STRUCTURE	CATHODE	USE
950	Pentode	2.0 volt Filament	Power Amplifier
BA	Twin Diode	Cold	Full Wave Rectifier
BH	Twin Diode	Cold	Full Wave Rectifier
BR	Diode	Cold	Half Wave Rectifier
WD-11	Triode	1.1 volt Filament	Detector or Amplifier
WX-12	Triode	1.1 volt Filament	Detector or Amplifier
V-99	Triode	3.3 volt Filament	Detector or Amplifier
X-99	Triode	3.3 volt Filament	Detector or Amplifier

Individual tube data sheets are arranged in the same numerical order as in the above listing.

RAYTHEON SPECIAL RECEIVING TUBES
(Supplied for Replacement Use Only)

TYPE NO.	FILAMENT VOLTS AMP		BASING	SHIELD CONNECTED TO	CHARACTERISTICS USE & DIMENSIONS
2A7S	2.5	1.0	Same as 2A7	Cathode Pin	Same as 2A7
2E5	2.5	0.8	Same as 6E5	No Shield	Same as 6E5 Except Filament Rating
2S/4S	2.5	1.35	Same as 84/6Z4	Cathode Pin	Approx. 40 ma per plate at 50 volts d-c. Duo-Diode Detector, 4 3/16" x 1 9/16"
2Z2/084	2.5	1.5	Same as 81	No Shield	Similar to 1-V
6A7S	6.3	0.3	Same as 6A7	Cathode Pin	Same as 6A7
6B7S	6.3	0.3	Same as 6B7	Cathode Pin	Same as 6B7
6C7	6.3	0.3	See Below	Separate Pin	Same as 85AS
6D7	6.3	0.3	See Below	Separate Pin	Same as 6C6
6E7	6.3	0.3	See Below	Separate Pin	Same as 6D6
6F7S	6.3	0.3	Same as 6F7	Cathode Pin	Same as 6F7
6Y5	6.3	0.8	See Below	Separate Pin	Similar to 84/6Z4
6Z5	$\frac{12.6}{6.3}$	$\frac{0.4}{0.8}$	See Below	No Shield	Similar to 84/6Z4
24S	2.5	1.75	Same as 24A	Cathode Pin	Same as 24A
27S	2.5	1.75	Same as 27	Cathode Pin	Same as 27
35S/51S	2.5	1.75	Same as 35/51	Cathode Pin	Same as 35/51
55S	2.5	1.0	Same as 55	Cathode Pin	Same as 55
56S	2.5	1.0	Same as 56	Cathode Pin	Same as 56
56-AS	6.3	0.3	Same as 76	Cathode Pin	Same as 76
57S	2.5	1.0	Same as 57	Cathode Pin	Same as 57
57-AS	6.3	0.4	Same as 6C6	Cathode Pin	Same as 6C6 Except Heater Amps.
58S	2.5	1.0	Same as 58	Cathode Pin	Same as 58
58-AS	6.3	0.4	Same as 6D6	Cathode Pin	Same as 6D6 Except Heater Amps.
75S	6.3	0.3	Same as 75	Cathode Pin	Same as 75
85-AS	6.3	0.3	Same as 85	Heater Pin Adjacent to Cathode Pin	Similar to 85 Except $\mu=20$; $G_m=1250$; $I_p=5.5$ ma; $E_p=250$ v. $E_g = -9$ v.
<u>182B</u> 482B	5.0	1.25	Same as 45	No Shield	Similar to 45 Except Filament Rating; $\mu=5$; $G_m=1500$; $I_p=18$ ma; $E_p=250$ v; $E_g = -35$ v.
<u>185</u> 485	5.0	1.25	Same as 45	No Shield	Similar to 45 Except Filament Rating; $\mu=3$; $G_m=1500$; $I_p=20$ ma; $E_p=250$ v; $E_g = -58$ v.
486	3.0	1.25	Same as 27	No Shield	Similar to 27 Except Heater Rating; $\mu=12.8$; $G_m=1300$; $I_p=5.2$ ma; $E_p=180$ v; $E_g = -10$ v.

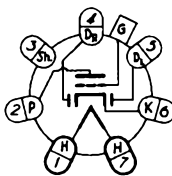

6C7

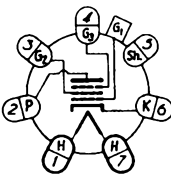

6D7
6E7

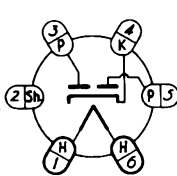

6Y5

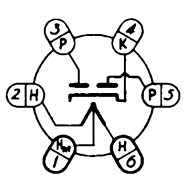

6Z5

BOTTOM VIEWS OF SOCKETS

INTERCHANGEABLE TUBE TYPES

Raytheon tubes can be used as replacements for tubes of other manufacturers as follows:

- A Tube types having the same RMA type numbers (with a letter, or two letters, between two numbers, as 6A7 or 6ZY5G) are interchangeable.
- B On standard tube types with two or three figure type numbers, the last two figures form the significant type numbers regardless of letter prefixes. For example, the Raytheon 45 will replace the UX-245, CX-345, or SX-245 tubes.
- C Types differing in number by the suffix letters "A", "G", "H", "MG" or "V" are interchangeable in general regardless of this letter. For example, the 12A may replace a 112 or 112A, the 2A3 may replace a 2A3H, and a 6A8G may replace a 6A8 or 6A8MG.
- D Tubes with octal bases and standard size glass bulbs are designated by the suffix, "G" on the type number, as 6A8G. Tubes with octal bases, glass bulbs and attached metal shields are designated by the suffix "MG" on the type number, as 6A8MG. Tubes with octal bases and metal bulbs have no suffix on the type number, as 6A8. "G" type tubes having type numbers corresponding to metal tube or "MG" type numbers have, in general the same electrical characteristics excepting capacitances, and are usually interchangeable with the corresponding metal or "MG" types except for space requirements and the possible requirement of external tube shields.
- E Shielded types distinguished by the added letter "S" may or may not be interchangeable with types without this letter suffix.
- F Exceptions to the above tubes are types, D-1, DE-1, RE-1, SO-1, RE-2, SO-2, KR-20, KR-22, KR-28, 43MG, HZ-50, 59B, G-84, 182B, 183, Kellogg 40L, 482A, 482B, 484, 484A, and 25Z5MG, which do not correspond with types 1-V, 20, 22, etc. The 01A (201A) is not interchangeable with the 1-V, or 1, and the WX-12 is not interchangeable with the 12A (112A). Types 57AS, 58AS, 485 and 950 may be replaced only by Raytheon tubes bearing the same full type number.
- G The following table lists the obsolete and non-standard tube types with the Raytheon types which normally may be used for replacement.

TYPE NO.	NORMALLY REPLACEABLE BY RAYTHEON TYPE	TYPE NO.	NORMALLY REPLACEABLE BY RAYTHEON TYPE	TYPE NO.	NORMALLY REPLACEABLE BY RAYTHEON TYPE
00	00A	25Z5MG	25Z6G	210	10
01	01A	25Z6MG	25Z6G	213	80
01AA	01A	27-HM	56	216	81
D-1/2	81	KR-28	84/6Z4	216B	81
1	1-V	35	35/51	220	20
D-1	80	35S	35S/51S	222	22
DE-1	27	36A	36	224	24A
KR-1	1-V	37A	37	224A	24A
RE-1	80	38A	38	226	26
2A3H	2A3	39	39/44	227	27
G-2	2S/4S	39A	39/44	230	30
G-2S	2S/4S	43MG	25A6G	231	31
RE-2	81	44	39/44	232	32
SO-2	50	HZ-50	12Z3	233	33
G-4	2S/4S	51	35/51	234	34
G-4S	2S/4S	51S	35S/51S	235	35/51
5Y3	5Y3G	56-A	76 *	236	36
5Z4MG	5Z4, 5V4G	57-A	57-AS	237	37
KR-5	6A4/LA	58-A	58-AS	238	38
6A8MG	6A8G	64	36 *	239	39/44
6B6	6B6G	64A	36	240	40
6B6MG	6B6G	65	39/44 *	245	45
6C5MG	6C5G	65A	39/44	247	47
6F5MG	6F5G	67	37 *	250	50
6F6MG	6F6G	67A	37	280	80
6G5	6G5/6H5	68	38 *	280H	83V
6H5	6G5/6H5	68A	38	281	81
6H6MG	6H6G	80M	83 †	288	83V
6J7MG	6J7G	81M	81	C-299	V-99
6K7MG	6K7G	84	84/6Z4	X-299	X-99
6L7MG	6L7G	G-84	222/G84		
6N6	6N6G	88	83 †	482A	71A
6N6MG	6N6G	95	2A5	482B	182B/482B
6P7	6P7G	96	1-V	482B	183/483 †
6Q7MG	6Q7G	98	84/6Z4	483	183/483
6R7MG	6R7G			585	50
6X5MG	6X5G	112	12A	586	50
6Y5V	6Y5	112A	12A	P-861	6Z4/84
6Z3	1-V	120	20	951	1B4/951
6Z4/84	04/6Z4	171	71A	986	83 †
6Z5/12Z5	6Z5	171A	71A		
C-11	WD-11	171AC	71A	AD	1-V
C-12	WX-12	171B	71A	AF	82
WD-12	WX-12	182-A	71A	AG	83 †
14Z3	12Z3	182-B	183 †	AX	01A
22AC	24A	V-199	V-99	B	V-99
24	24A	X-199	X-99	E	20
25A6MG	25A6G			G	40
25A7	25A7G	200	00A	H	00A
25A8	25A7G	201	01A	LA	6A4/LA
25S	1B5/25S	201A	01A	PZ	47
25/25S	1B5/25S	202	10	PZH	2A5

† When the filament supply will stand one ampere additional drain.

* In automobile receivers only.

‡ When both power tubes are changed together.

RAYTHEON RESISTOR TUBES

FOR

A-C - D-C RECEIVERS

Type No.	No. of Tubes	No. of 25 V Tubes	Volts Drop at 300ma	No. of Dial Lamps	Dial Lamp Type	Circuit	Base Pin Numbers				Inter-change-able with
							R	R ⁰	T ¹	T ²	

(see next page)

SMALL METAL SHELL TYPES

36A	5	2	36.0	None		A	3	7			
K36B	5	2	36.0	1	#40	B	3	7	8		
K36C	5	2	36.0	2	#40	C	3	7	8		
K36D	5	2	36.0	2	#40	D	3	7	8	2	
L36B	5	2	36.0	1	#46	B	3	7	8		
L36C	5	2	36.0	2	#46	C	3	7	8		
L36D	5	2	36.0	2	#46	D	3	7	8	2	
42A	4	2	42.3	None		A	3	7			
K42B	4	2	42.3	1	#40	B	3	7	8		
K42C	4	2	42.3	2	#40	C	3	7	8		
K42D	4	2	42.3	2	#40	D	3	7	8	2	
K42E	4	2	42.3	3	#40	E	3	7	8		
L42B	4	2	42.3	1	#46	B	3	7	8		
L42C	4	2	42.3	2	#46	C	3	7	8		
L42D	4	2	42.3	2	#46	D	3	7	8	2	
49A	3	2	48.6	None		A	3	7			
K49B	3	2	48.6	1	#40	B	3	7	8		
K49C	3	2	48.6	2	#40	C	3	7	8		
K49CB											
K49D	3	2	48.6	2	#40	D	3	7	8	2	
L49B	3	2	48.6	1	#46	B	3	7	8		
L49C	3	2	48.6	2	#46	C	3	7	8		
L49D	3	2	48.6	2	#46	D	3	7	8	2	
55A	2	2	54.9	None		A	3	7			
K55B	2	2	54.9	1	#40	B	3	7	8		
K55C	2	2	54.9	2	#40	C	3	7	8		
K55D	2	2	54.9	2	#40	D	3	7	8	2	
L55B	2	2	54.9	1	#46	B	3	7	8		
L55C	2	2	54.9	2	#46	C	3	7	8		
L55D	2	2	54.9	2	#46	D	3	7	8	2	

See Data Sheet at end of Characteristic Data Section

GLASS BULB TYPES

140L4	4	2	42.3	1	#46	B	1	4	3		
140L8	4	2	42.3	2	#46	C	1	4	3		
140L44	4	2	42.3	2	#46	D	1	4	3	2	
140R	4	2	42.3	None		A	1	4			
140R4	4	2	42.3	1	#40	B	1	4	3		40B2
140R8	4	2	42.3	2	#40	C	1	4	3		40A2
140R44	4	2	42.3	2	#40	D	1	4	3	2	
165L4	3	2	48.6	1	#46	B	1	4	3		
165L8	3	2	48.6	2	#46	C	1	4	3		
165L44	3	2	48.6	2	#46	D	1	4	3	2	
165R	3	2	48.6	None		A	1	4			
165R4	3	2	48.6	1	#40	B	1	4	3		50B2
165R8	3	2	48.6	2	#40	C	1	4	3		50A2
165R44	3	2	48.6	2	#40	D	1	4	3	2	
185L4	2	2	54.9	1	#46	B	1	4	3		
185L8	2	2	54.9	2	#46	C	1	4	3		
185L44	2	2	54.9	2	#46	D	1	4	3	2	
185R	2	2	54.9	None		A	1	4			50X3
185R4	2	2	54.9	1	#40	B	1	4	3		
185R8	2	2	54.9	2	#40	C	1	4	3		50X3T
185R44	2	2	54.9	2	#40	D	1	4	3	2	
60R30G		Special	18.6	1	#40	B	1	4	3		
878R48	7	2	23.6	1	#40	See Special	See Special	Circuit			
340		Special	46.5	None		A	1	4			

LARGE PERFORATED METAL SHELL TYPES

42A1	4	2	42.3	None		A	4	8			
42A2	4	2	42.3	1	#40	B	4	8	1		
42B2	4	2	42.3	2	#40	C	4	8	1		
49A1	3	2	48.6	None		A	4	8			
49A2	3	2	48.6	1	#40	B	4	8	1		
49B2	3	2	48.6	2	#40	C	4	8	1		
55A1	2	2	54.9	None		A	4	8			
55A2	2	2	54.9	1	#40	B	4	8	1		
55B2	2	2	54.9	2	#40	C	4	8	1		
2LR212		Special	39	2	#40	D	4	8	1	2	

Voltage drops are computed to supply filament current of 300 ma. with line voltage of 117.5 volts.

Continued on next page

RAYTHEON RESISTOR TUBE CIRCUITS

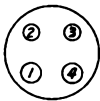
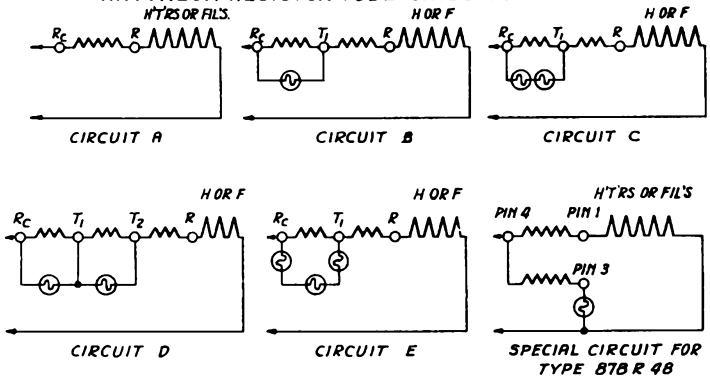

**BOTTOM VIEW OF
GLASS TUBE STANDARD
BASE PIN LOCATION**

TUBE OUTLINE DIMENSIONS

	GLASS	SMALL METAL	LARGE METAL
MAX. DIA.	1 ¹³ / ₁₆ "	1 ¹ / ₁₆ "	1 ⁵ / ₁₆ "
MAX. HT. ABOVE SOCKET	4 ¹ / ₁₆ "	2 ⁴ / ₁₆ "	4 ⁹ / ₁₆ "

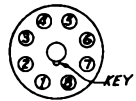

**BOTTOM VIEW OF
METAL TUBE OCTAL
BASE PIN LOCATION**

For data on RAYTHEON RESISTOR TUBES FOR BATTERY OPERATED RECEIVERS refer to the TYPES NB-1 to NB-8 at the end of the rating and characteristic data section.

RAYTHEON MINATURE LAMPS

RADIO PANEL TYPES

Type No.	Volts	Amps.	C.P.	Bulb	Base	Bead Color	L.C.L. Inches	M.O.L. Inches
R40	6-8	0.15	0.5	T-3 1/4	Min. Screw	Brown	29/32	1 1/8
R40-A	6-8	0.15	0.5	T-3 1/4	Min. Bayonet	Brown	23/32	1 1/8
R41	2.5	0.5	0.5	T-3 1/4	Min. Screw	White	29/32	1 1/8
R42	3.2	0.5	0.75	T-3 1/4	Min. Screw	Green	29/32	1 1/8
R43	2.5	0.5	0.5	T-3 1/4	Min. Bayonet	White	23/32	1 1/8
R44	6-8	0.25	0.8	T-3 1/4	Min. Bayonet	Blue	23/32	1 1/8
R45	3.2	0.5	0.75	T-3 1/4	Min. Bayonet	Green	23/32	1 1/8
R46	6-8	0.25	0.8	T-3 1/4	Min. Screw	Blue	29/32	1 1/8
R48	2.0	0.06	0.03	T-3 1/4	Min. Screw	Pink	29/32	1 1/8
R49	2.0	0.06	0.03	T-3 1/4	Min. Bayonet	Pink	23/32	1 1/8
R49-A	2.1	0.12	0.07	T-3 1/4	Min. Bayonet	White	23/32	1 1/8
R50	6-8	0.2	1.0	G-3 1/2	Min. Screw	White	23/32	15/16
R292	2.9	0.17	0.3	T-3 1/4	Min. Screw	White	29/32	1 1/8
R292A	2.9	0.17	0.3	T-3 1/4	Min. Bayonet	White	23/32	1 1/8

AUTOMOTIVE TYPES

R51	6-8	0.2	1.0	G-3 1/2	Min. Bayonet	White	1/2	15/16
R55	6-8	0.4	1.5	G-4 1/2	Min. Bayonet	White	1/2	1 1/16

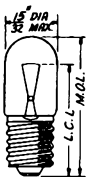

R 40
R 41
R 42
R 46
R 48
R 292

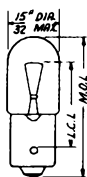

R 40A
R 43
R 44
R 45
R 49
R 49A
R 292A



R 50

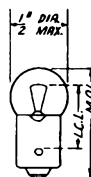

R 51

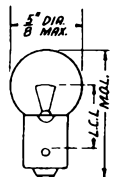

R 55

00A

RAYTHEON

00A

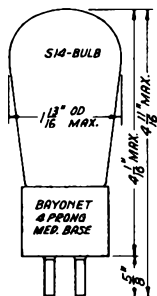

TRIODE
VAPOR TYPE DETECTOR
Filament Type Glass Bulb

The 00-A is a vapor type triode tube designed for service as a detector in storage battery operated receivers.

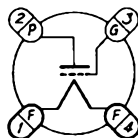

BOTTOM VIEW OF SOCKET

RATINGS

Filament Voltage	5 d-c	volts
Filament Current	0.25	amp
Max. Plate Voltage	45	volts

CHARACTERISTICS

Plate Voltage	45	volts
Grid Bias	0	volts
Amplification Factor	20	
Plate Resistance	30000	ohms
Transconductance	666	umhos
Plate Current (approximate)	1.5	ma

DETECTOR - GRID LEAK TYPE

Plate Voltage	45	volts
Grid	Return to negative filament	
Grid Leak Resistance	2 to 3	megohms
Grid Condenser	0.00025	uf

DIRECT INTERELECTRODE CAPACITANCES

Grid to Plate	8.5	uf
Input	3.2	uf
Output	2.0	uf

01A

RAYTHEON

01A

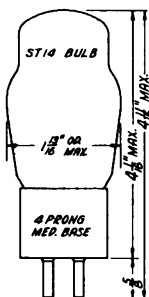

TRIODE
DETECTOR OR AMPLIFIER
Filament Type Glass Bulb

The 01-A is a triode type amplifier tube designed for service as a detector or amplifier in storage battery operated receivers.

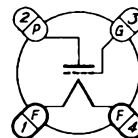

BOTTOM VIEW OF SOCKET

RATINGS

Filament Voltage	5 d-c	volts
Filament Current	0.25	amp
Max. Plate Voltage	135	volts

DIRECT INTERELECTRODE CAPACITANCES

Grid to Plate	8.1	uf
Input	3.1	uf
Output	2.2	uf

AMPLIFIER - CLASS A

Plate Voltage	90	135	volts
Grid Bias	-4.5	-9	volts
Amplification Factor	8	8	
Plate Resistance	11000	10000	ohms
Transconductance	725	800	umhos
Plate Current	2.5	3	ma

DETECTOR - BIASED TYPE

Plate Voltage	90	135	volts
Grid Bias (approximate)	-7.5	-13.5	volts
Plate Current	Adjusted to 0.2 ma with no signal		

DETECTOR - GRID LEAK TYPE

Plate Voltage	45	volts
Grid	Returned to positive filament	
Grid Leak Resistance	0.25 to 5	megohms
Grid Condenser	250	uf

OZ4 OZ4G

RAYTHEON

OZ4 OZ4G

TWIN DIODE
FULL WAVE GAS FILLED RECTIFIER
Ionic Heated Cathode Type
Metal Bulb-OZ4 Glass Bulb-OZ4G

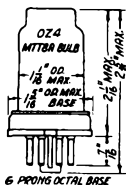

The OZ4 is a full wave gas filled type rectifier tube with an ionic heated cathode requiring no heater supply voltage. It is designed particularly for service where high overall efficiency is desired.

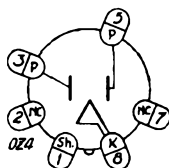

BOTTOM VIEW OF SOCKET
OZ4G - #1 PIN - NO CONN.
- #2 PIN - OMITTED

FULL WAVE RECTIFIER

No Heater Supply Required
Maximum D-C Output Voltage
Minimum D-C Output Current
Maximum D-C Output Current
Maximum Peak Plate Current
Minimum Starting Peak Voltage
Average Dynamic Voltage Drop

300	volts
30	ma
75	ma
200	ma
300	volts
24	volts

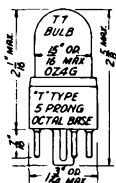

The OZ4 was developed primarily for use in vibrator type B supply units for automobile receivers. It has the typical characteristics of all gas-filled rectifiers as regards a constant drop and ability to handle high peak currents. Any tendency of the tube to generate r-f noise may be eliminated by proper filtering and by connecting the metal shell to the point giving the best shielding. The shielding and filtering commonly used to eliminate vibrator noise will usually be sufficient.

The OZ4 is filled with a permanent gas rather than a vapor filling. The tube characteristics are independent of the surrounding temperature.

The OZ4 has the same external form and dimensions as other tubes of the metal line. However, in this tube the metal shell serves chiefly as container and electrostatic shield for the glass bulb, which is required to insulate the contained gas from the grounded shell.

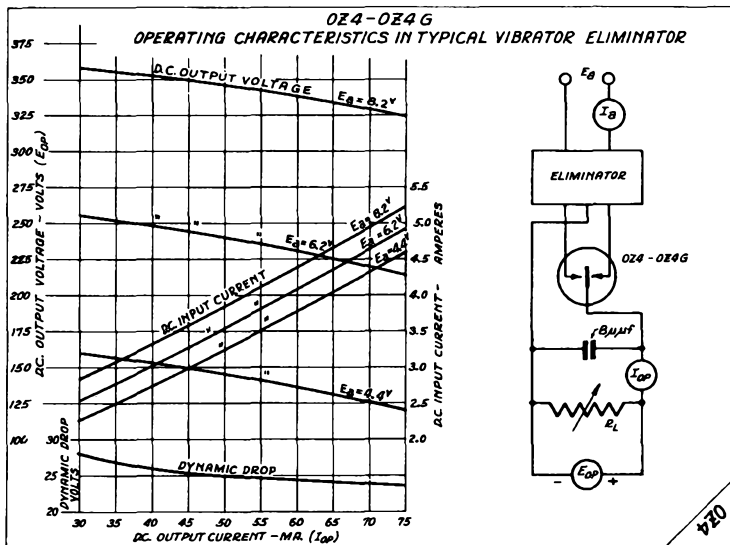

TETRODE
REMOTE CUTOFF AMPLIFIER
Filament Type Glass Bulb

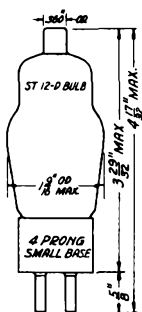

The 1A4T is a tetrode type amplifier tube with remote cutoff characteristics designed for service as a high frequency amplifier in battery operated receivers. The ratings and electrical characteristics are identical with those of the type 1D5GT. For characteristics of the pentode type, 1A4P, refer to the type 1D5GP.

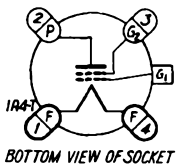

BOTTOM VIEW OF SOCKET
1A4-P, G₂ CONNECTED TO #4 PIN (-F)

RATINGS

Filament Voltage	2.0	d-c volts
Filament Current	0.060	amp
Maximum Plate Voltage	180	volts
Maximum Screen Voltage	67.5	volts

DIRECT INTERELECTRODE CAPACITANCES

Grid to Plate	0.012 max.*	μmf
Input	4.6	μmf
Output	11	μmf

AMPLIFIER - CLASS A

Plate Voltage	180	volts
Screen Voltage	67.5	volts
Grid Bias	-3	volts
Amplification Factor	720	
Plate Resistance	0.96	megohm
Transconductance	750	μmhos
Plate Current	2.3	ma
Screen Current	0.7	ma
Transconductance at -15 volts bias	15	μmhos

*With tube shield.

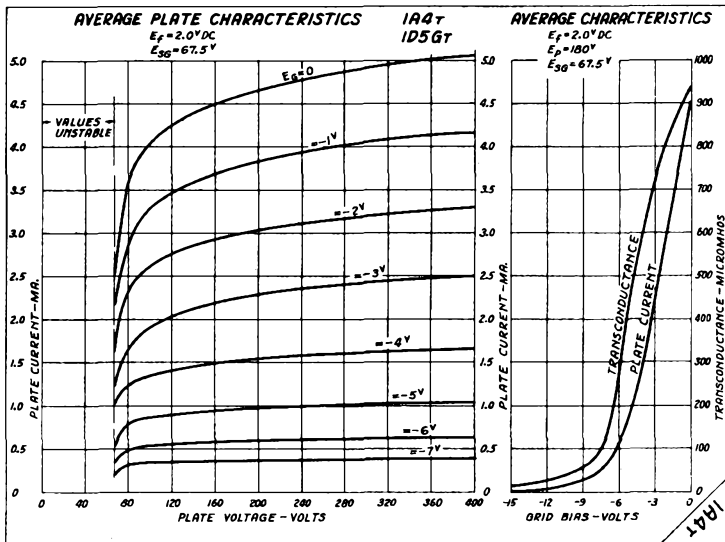

HEPTODE
PENTAGRID CONVERTER

Filament Type Glass Bulb

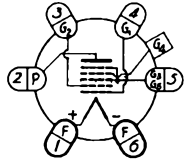
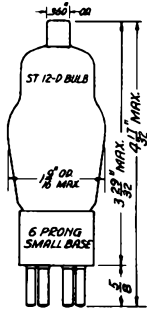

BOTTOM VIEW OF SOCKET

The 1A6 is a pentagrid type converter tube designed for service as a combined mixer and oscillator in battery operated superheterodyne receivers. The ratings and electrical characteristics are identical with those of the type 1D7G.

RATINGS

Filament Voltage	2.0 d-c volts
Filament Current	0.060 amp
Maximum Plate Voltage	180 volts
Maximum Screen Voltage	67.5 volts
Maximum Grid #2 Voltage	135 volts
Maximum Grid #2 Supply	180† volts
Minimum Grid #4 Bias	-3 volts
Maximum Cathode Current	9 ma

DIRECT INTERELECTRODE CAPACITANCES (approximate)

Grid #4 to Plate	0.25*	μf
Grid #4 to Grid #2	0.2 *	μf
Grid #4 to Grid #1	0.1 *	μf
Grid #1 to Grid #2	0.8	μf
Grid #4 to all other Elements (r-f input)	10.5	μf
Grid #1 to all other Elements (osc. input)	5	μf
Grid #2 to all other Elements (osc. output)	6	μf
Plate to all other Elements (mixer output)	9	μf

FREQUENCY CONVERTER - SUPERHETERODYNE CIRCUIT

Plate Voltage	135	180	volts
Screen (Grids #3 and #5) Voltage	67.5	67.5	volts
Anode Grid (#2) Voltage	135	135	volts
Anode Grid Supply Voltage		180 †	volts
Control Grid (#4) Bias	-3	-3	volts
Oscillator Grid (#1) Resistor	50000	50000	ohms
Plate Resistance	0.4	0.5	megohm
Conversion Transconductance	275	300	μmhos
Plate Current	1.2	1.3	ma
Screen Current	2.5	2.4	ma
Anode Grid Current	2.3	2.3	ma
Oscillator Grid Current	0.2	0.2	ma
Total Cathode Current	6.2	6.2	ma
Control Grid Bias	-22.5	-22.5	volts

(For Conversion Transconductance = 4 μmhos)

With plate voltage = 135 to 180 volts, screen voltage = 67.5 volts, anode grid voltage = 135 volts (no series resistor), control grid bias = -3 volts and oscillator grid voltage = 0 volts, the transconductance of the oscillator section (not oscillating) is 425 μmhos and the anode grid current is 2.3 ma.

†Applied through a 20000 ohm series resistor, by-passed by a 0.1 μf. condenser.
*With tube shield.

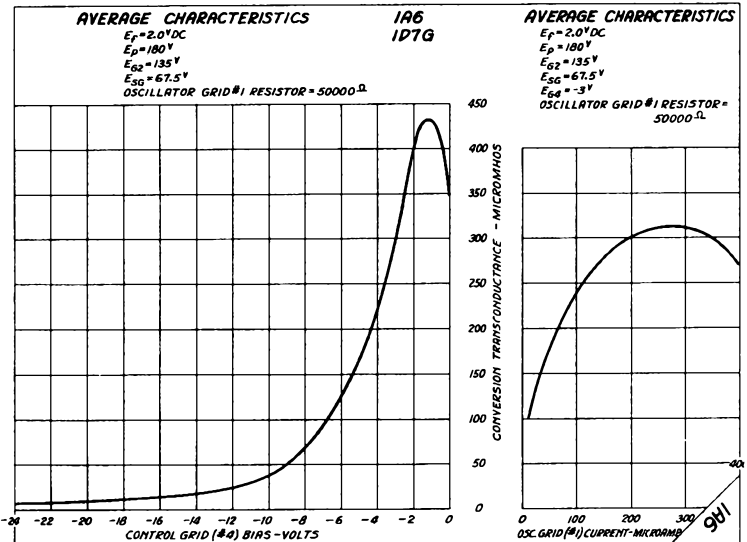

PENTODE
AMPLIFIER

Filament Type Glass Bulb

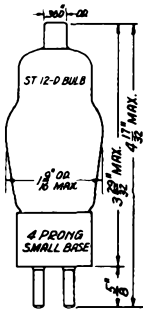

The 1B4/951 is a pentode type amplifier tube designed for service as a high frequency amplifier in battery operated receivers. The ratings and electrical characteristics are identical with those of the type 1E5GP.

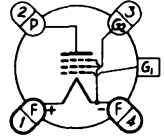

BOTTOM VIEW OF SOCKET

RATINGS

Filament Voltage	2.0	d-c	volts
Filament Current	0.060		amp
Maximum Plate Voltage	180		volts
Maximum Screen Voltage	67.5		volts

DIRECT INTERELECTRODE CAPACITANCES

Grid to Plate	0.007	max.*	μ f
Input	5		μ f
Output	11		μ f

AMPLIFIER - CLASS A

Plate Voltage	90	180	volts
Screen Voltage	67.5	67.5	volts
Grid Bias	-3	-3	volts
Amplification Factor	600	975	
Plate Resistance	1	1.5	megohm
Transconductance	600	650	μ hos
Plate Current	1.6	1.7	ma
Screen Current	0.7	0.6	ma
Grid Bias for Plate Current Cutoff	-8	-8	volts

*With tube shield.

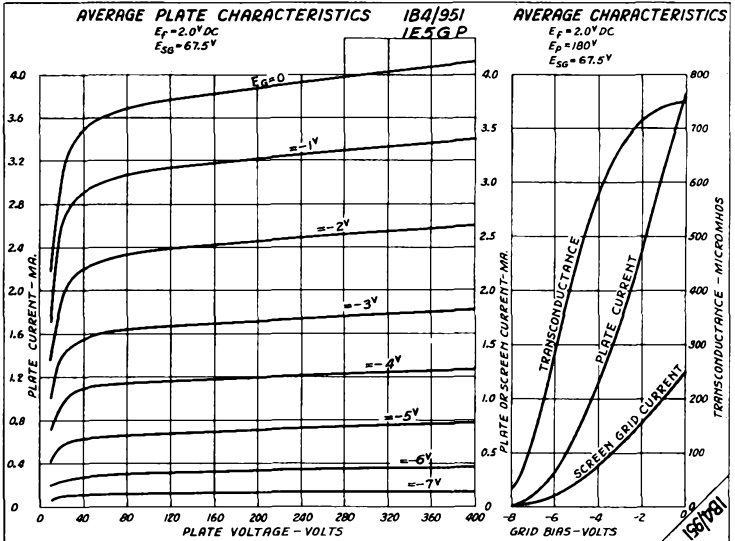

DUO-DIODE TRIODE
DETECTOR AMPLIFIER
Filament Type Glass Bulb

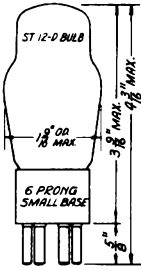

The 1B5/25S is a duo-diode triode type amplifier tube designed for service as a combined diode detector, AVC rectifier and audio frequency amplifier in battery operated receivers. The ratings and electrical characteristics are identical with those of the type 1H6G.

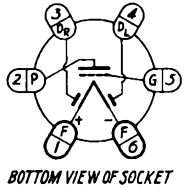

RATINGS

Filament Voltage	2.0 d-c	volts
Filament Current	0.060	amp
Maximum Plate Voltage	135	volts

DIRECT INTERELECTRODE CAPACITANCES - TRIODE SECTION

Grid to Plate	3.6	μ f
Input	2.0	μ f
Output	3	μ f

AMPLIFIER - CLASS A - TRIODE SECTION

Plate Voltage	135	volts
Grid Bias	-3	volts
Amplification Factor	20	
Plate Resistance	35000	ohms
Transconductance	575	μ mhos
Plate Current	0.8	ma

DIODE SECTION

The two diode units are independent of each other and of the triode section except for the common filament. The diodes may be used as a half-wave or as a full-wave rectifier; or one diode may be used as a half-wave rectifier for detection, and the other diode used as a rectifier to obtain delayed AVO voltage.

If only one diode plate is used as an audio rectifier, DL on pin 4 should be used because DL is near the negative end of the filament and current will flow to this plate with zero signal when returned to the negative end of the filament.

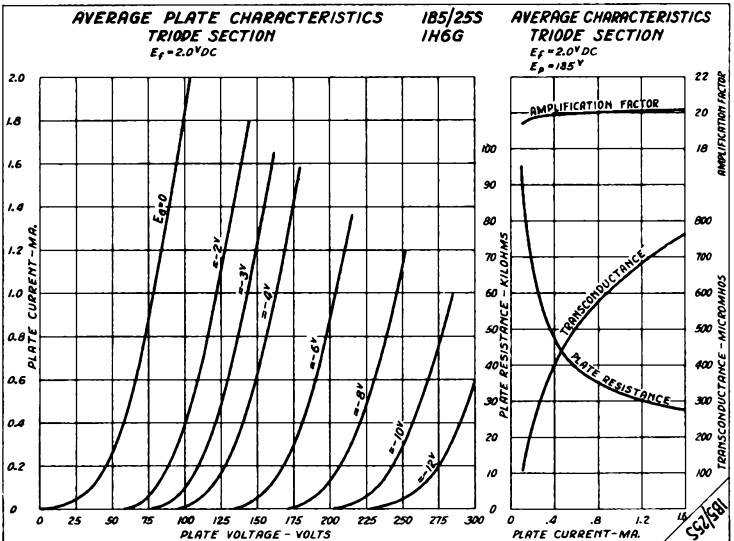

HEPTODE
PENTAGRID CONVERTER

Filament Type Glass Bulb

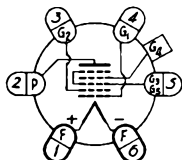
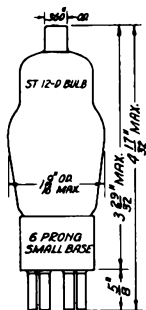

BOTTOM VIEW OF SOCKET

The 1C6 is a pentagrid type converter tube designed for service as a combined mixer and oscillator in battery operated superheterodyne receivers. The ratings and electrical characteristics are identical with those of the type 1C7G.

RATINGS

Filament Voltage	2.0 d-c volts
Filament Current	0.12 amp
Maximum Plate Voltage	180 volts
Maximum Screen Voltage	67.5 volts
Maximum Grid #2 Voltage	135 volts
Maximum Grid #2 Supply	180† volts
Minimum Grid #4 Bias	-3 volts
Maximum Cathode Current	9 ma

DIRECT INTERELECTRODE CAPACITANCES (approximate)

Grid #4 to Plate	0.3 *	μμf
Grid #4 to Grid #2	0.3 *	μμf
Grid #4 to Grid #1	0.15*	μμf
Grid #1 to Grid #2	1.5	μμf
Grid #4 to all other Elements (r-f input)	10	μμf
Grid #1 to all other Elements (osc. input)	6	μμf
Grid #2 to all other Elements (osc. output)	6	μμf
Plate to all other Elements (mixer output)	10	μμf

FREQUENCY CONVERTER - SUPERHETERODYNE CIRCUIT

Plate Voltage	135	180	volts
Screen(Grids #3 and #5) Voltage	67.5	67.5	volts
Anode Grid (#2) Supply Voltage	135 †	180 †	volts
Control Grid (#4) Bias	-3	-3	volts
Oscillator Grid (#1) Resistor	50000	50000	ohms
Plate Resistance	0.55	0.75	megohm
Conversion Conductance	300	325	μmhos
Plate Current	1.3	1.5	ma
Screen Current (approximate)	2	2	ma
Anode Grid Current	2.6	3.3	ma
Oscillator Grid Current	0.2	0.2	ma
Total Cathode Current (approximate)	6.5	7	ma
Control Grid Bias	-14	-14	volts

(For conversion conductance = 4 μmhos)

With plate voltage = 135 to 180 volts, screen voltage = 67.5 volts, anode grid voltage = 135 volts (no series resistor), control grid bias = -3 volts, and oscillator grid voltage = 0 volts, the transconductance of the oscillator section (not oscillating) is 1000 μmhos, and the anode grid current is 4.9 ma.

†Applied through a 20000 ohm series resistor, bypassed by a 0.1 μf. condenser.

*With tube shield.

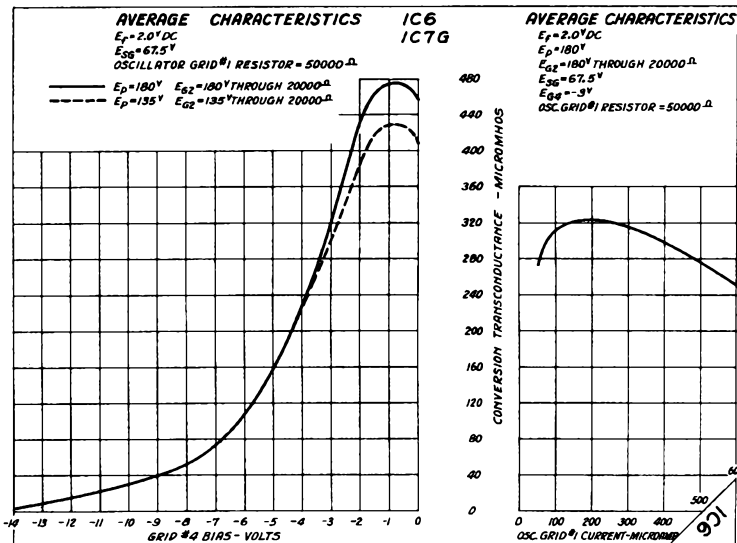

HEPTODE
PENTAGRID CONVERTER
Filament Type Glass Bulb



The 1C7G is a pentagrid type converter tube designed for service as a combined mixer and oscillator in battery operated superheterodyne receivers. The ratings and electrical characteristics are identical with those of the type 1C6.

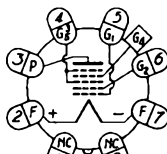

RATINGS

Filament Voltage	
Filament Current	
Maximum Plate Voltage	
Maximum Screen Voltage	
Maximum Grid #2 Voltage	
Maximum Grid #2 Supply	
Minimum Grid #4 Bias	
Maximum Cathode Current	

BOTTOM VIEW OF SOCKET

2.0 d-c volts
0.12 amp
180 volts
67.5 volts
135 volts
180 † volts
-3 volts
9 ma

DIRECT INTERELECTRODE CAPACITANCES*

Grid #4 to Plate	0.3	µuf
Grid #4 to Grid #2	0.3	µuf
Grid #4 to Grid #1	0.1	µuf
Grid #1 to Grid #2	1.5	µuf
Grid #4 to all other Elements (r-f input)	11	µuf
Grid #1 to all other Elements (osc. input)	7	µuf
Grid #2 to all other Elements (osc. output)	7	µuf
Plate to all other Elements (mixer output)	14	µuf

FREQUENCY CONVERTER - SUPERHETERODYNE CIRCUIT

Plate Voltage	135	180	volts
Screen(Grids #3 and #5) Voltage	67.5	67.5	volts
Anode Grid (#2) Supply Voltage	135 †	180 †	volts
Control Grid (#4) Bias	-3	-3	volts
Oscillator Grid (#1) Resistor	50000	50000	ohms
Plate Resistance		0.75	megohm
Conversion Transconductance	300	325	µmhos
Plate Current	1.3	1.5	ma
Screen Current (approximate)	2	2	ma
Anode Grid Current	2.6	3.3	ma
Oscillator Grid Current	0.2	0.2	ma
Total Cathode Current (approximate)	6.5	7	ma
Control Grid Bias	-14	-14	volts

(For Conversion Transconductance = 4 µmhos)

With plate voltage = 135 to 180 volts, screen voltage = 67.5 volts, anode grid voltage = 135 volts (no series resistor), control grid bias = -3 volts and oscillator grid voltage = 0 volts, the transconductance of the oscillator section (not oscillating) is 1000 µmhos, and the anode grid current is 4.9 ma.

*With tube shield connected to cathode.

†Applied through a 20000 ohm series resistor, bypassed by a 0.1 µf condenser.

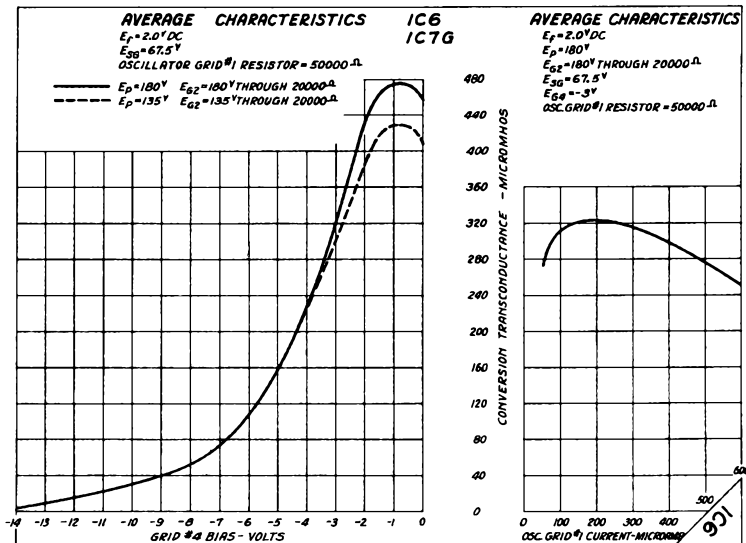

1D5G-P

RAYTHEON

1D5G-P

PENTODE
REMOTE CUTOFF AMPLIFIER
Filament Type Glass Bulb

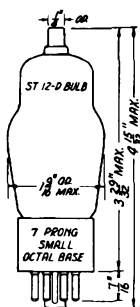

The 1D5GP is a pentode type amplifier tube with remote cutoff characteristics designed for service as a high frequency amplifier in battery operated receivers. The ratings and electrical characteristics are identical with those of the type 1A4P. For characteristics of the tetrode type, 1D5GT, refer to the type 1A4T.

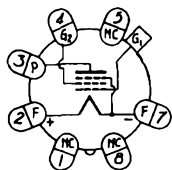

BOTTOM VIEW OF SOCKET

RATINGS

Filament Voltage	2.0 d-c	volts
Filament Current	0.060	amp
Maximum Plate Voltage	180	volts
Maximum Screen Voltage	67.5	volts

DIRECT INTERELECTRODE CAPACITANCES

Grid to Plate	0.007 max.*	μμf
Input	6.2	μμf
Output	12	μμf

AMPLIFIER - CLASS A

Plate Voltage	90	180	volts
Screen Voltage	67.5	67.5	volts
Grid Bias	-3	-3	volts
Amplification Factor	425	750	megohm
Plate Resistance	0.6	1	megohm
Transconductance	720	750	μmhos
Plate Current	2.2	2.3	ma
Screen Current	0.9	0.8	ma
Transconductance at -15 volts bias	15	15	μmhos

*With tube shield.

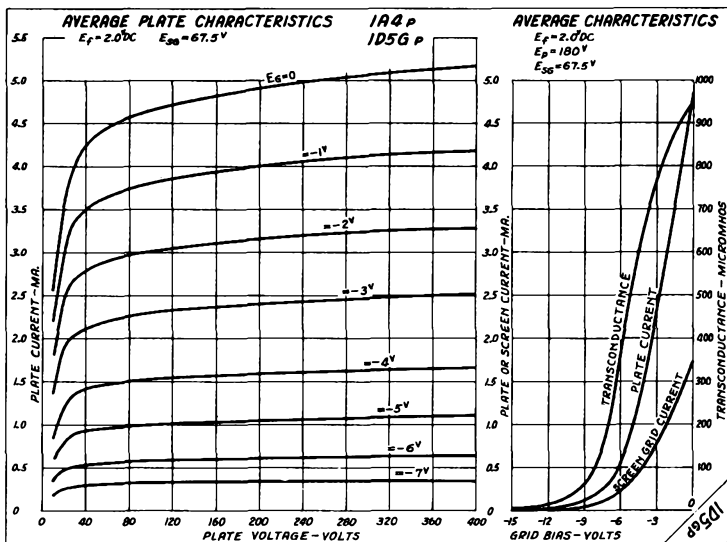



HEPTODE
PENTAGRID CONVERTER
Filament Type Glass Bulb

The 1D7G is a pentagrid type converter tube designed for service as a combined mixer and oscillator in battery operated superheterodyne receivers. The ratings and electrical characteristics are identical with those of the type 1A6.



RATINGS

Filament Voltage	
Filament Current	
Maximum Plate Voltage	
Maximum Screen Voltage	
Maximum Grid #2 Voltage	
Maximum Grid #2 Supply	
Minimum Grid #4 Bias	
Maximum Cathode Current	

BOTTOM VIEW OF SOCKET

2,0 d-c	volts
0,060	amp
180	volts
67.5	volts
135	volts
180†	volts
-3	volts
9	ma

DIRECT INTERELECTRODE CAPACITANCES*

Grid #4 to Plate	0.3	μf
Grid #4 to Grid #2	0.3	μf
Grid #4 to Grid #1	0.1	μf
Grid #1 to Grid #2	1.5	μf
Grid #4 to all other elements (r-f input)	11	μf
Grid #1 to all other elements (osc. input)	7	μf
Grid #2 to all other elements (osc. output)	7	μf
Plate to all other elements (mixer output)	14	μf

FREQUENCY CONVERTER - SUPERHETERODYNE CIRCUIT

Plate Voltage	135	180	volts
Screen (Grids #3 and #5) Voltage	67.5	67.5	volts
Anode Grid (#2) Voltage	135	135	volts
Anode Grid Supply Voltage		180†	volts
Control Grid (#4) Bias	-3	-3	volts
Oscillator Grid (#1) Resistor	50000	50000	ohms
Plate Resistance	0.4	0.5	megohm
Conversion Transconductance	275	300	μmhos
Plate Current	1.2	1.3	ma
Screen Current	2.5	2.4	ma
Anode Grid Current	2.3	2.3	ma
Oscillator Grid Current	0.2	0.2	ma
Total Cathode current	6.2	6.2	ma
Control Grid Bias	-22.5	-22.5	volts

(For Conversion Transconductance = 4 μmhos)

With plate voltage = 135 to 180 volts, screen voltage = 67.5 volts, anode grid voltage = 135 volts (no series resistor), control grid bias = -3 volts and oscillator grid voltage = 0 volts, the transconductance of the oscillator section (not oscillating) is 425 μmhos and the anode grid current is 2.3 ma.

*With tube shield connected to cathode.

†Applied through a 20000 ohm series resistor, bypassed by a 0.1 uf condenser.

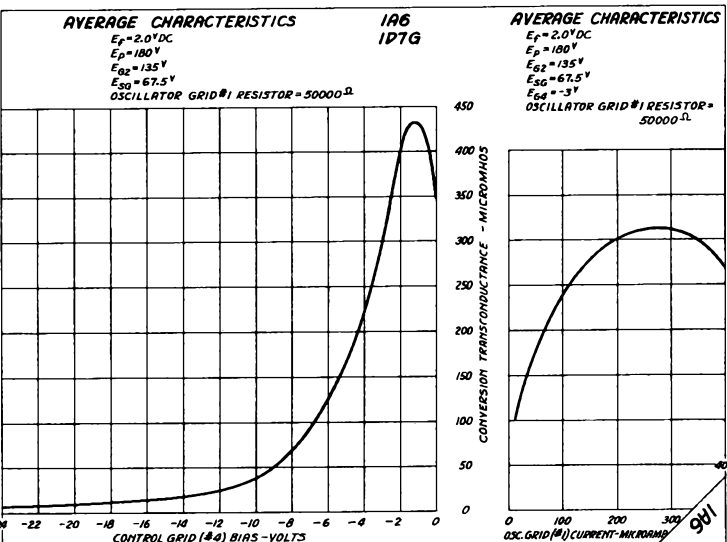

PENTODE
AMPLIFIER

Filament Type Glass Bulb



The 1E5GP is a pentode type amplifier tube designed for service as a high frequency amplifier in battery operated receivers. The ratings and electrical characteristics are identical with those of the type 1B4/951.

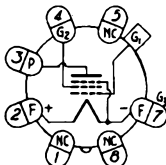

BOTTOM VIEW OF SOCKET

RATINGS

Filament Voltage	2.0	d-c	volts
Filament Current	0.060		amp
Maximum Plate Voltage	180		volts
Maximum Screen Voltage	67.5		volts

DIRECT INTERELECTRODE CAPACITANCES

Grid to Plate	0.007	max.*	μ f
Input	6.2		μ f
Output	12		μ f

AMPLIFIER - CLASS A

Plate Voltage	90	180	volts
Screen Voltage	67.5	67.5	volts
Grid Bias	-3	-3	volts
Amplification Factor	600	975	
Plate Resistance	1	1.5	megohms
Transconductance	600	650	μ mhos
Plate Current	1.6	1.7	ma
Screen Current	0.7	0.6	ma
Grid Bias for Plate Current Cutoff	-8	-8	volts

*With tube shield.

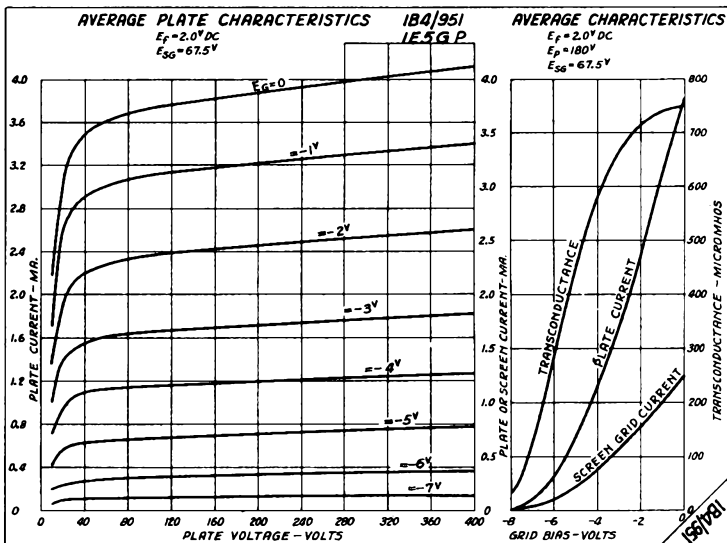

1E7G

RAYTHEON

1E7G

TWIN PENTODE
POWER AMPLIFIER
Filament Type Glass Bulb

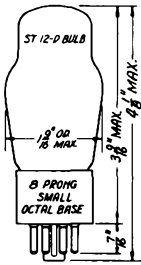

The 1E7G is a twin pentode type amplifier tube designed for service as a push-pull amplifier in the output stage of battery operated receivers.

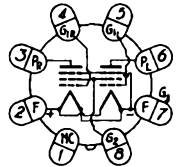

BOTTOM VIEW OF SOCKET

RATINGS

Filament Voltage	2.0 d-c	volts
Filament Current	0.24	amp
Maximum Plate Voltage	135	volts
Maximum Screen Voltage	135	volts

AMPLIFIER - CLASS A - EACH PENTODE

Plate Voltage	135	volts
Screen Voltage	135	volts
Grid Bias*	-4.5	volts
Amplification Factor	350	
Plate Resistance	0.22	megohm
Transconductance	1600	μmhos
Plate Current	7.5	ma
Screen Current	2.1	ma

AMPLIFIER - CLASS A - PUSH-PULL

Plate Voltage	135	volts
Screen Voltage	135	volts
Grid Bias*	-7.5	volts
No-Signal Plate Current (total)	6.5	ma
No-Signal Screen Current (total)	2	ma
Load Resistance	24000	ohms
Total Harmonic Distortion	5	percent
Power Output	0.65	watt

(With signal = 12 volts RMS grid to grid)

*Grid return to negative filament.

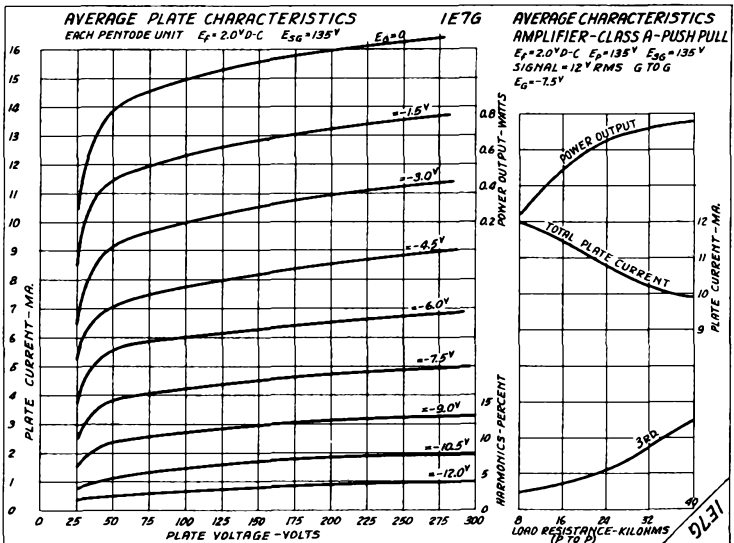

PENTODE
POWER AMPLIFIER
Filament Type Glass Bulb

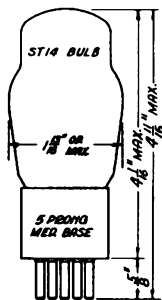

The 1F4 is a pentode type power amplifier tube designed for service in the output stage of battery operated receivers. The ratings and electrical characteristics are identical with those of the type 1F5G.

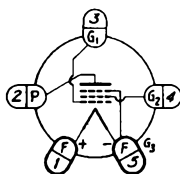

BOTTOM VIEW OF SOCKET

RATINGS

Filament Voltage	2.0 d-c volts
Filament Current	0.12 amp
Maximum Plate Voltage	135 volts
Maximum Screen Voltage	135 volts

AMPLIFIER - CLASS A

Plate Voltage	90	135	volts
Screen Voltage	90	135	volts
Grid Bias	-3	-4.5	volts
Amplification Factor	340	340	
Plate Resistance	0.24	0.2	megohm
Transconductance	1400	1700	umhos
Plate Current	4	8	ma
Screen Current	1.3	2.6	ma
Load Resistance	20000	16000	ohms
Total Harmonic Distortion	5	5	percent
Power Output	120	340	mw

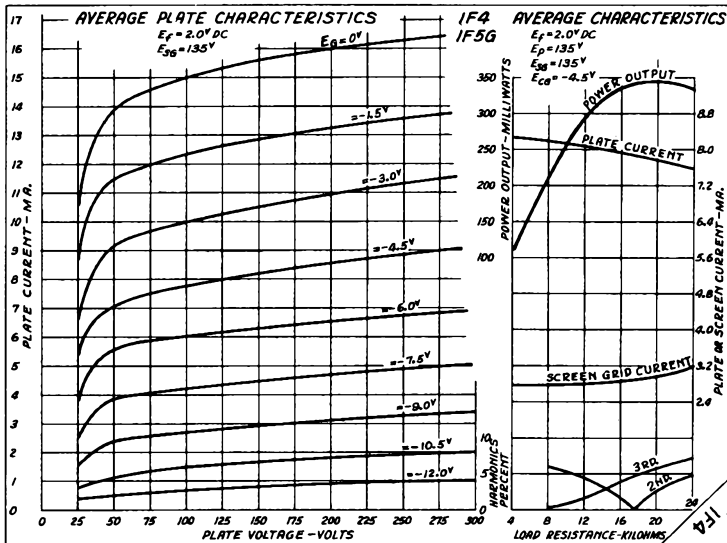

1F5G

RAYTHEON

1F5G

PENTODE
POWER AMPLIFIER
Filament Type Glass Bulb

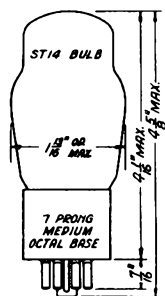

The 1F5G is a pentode type power amplifier tube designed for service in the output stage of battery operated receivers. The ratings and electrical characteristics are identical with those of the type 1F4.

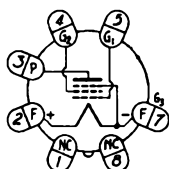

BOTTOM VIEW OF SOCKET

RATINGS

Filament Voltage	2.0	d-c	volts
Filament Current	0.12		amp
Maximum Plate Voltage	135		volts
Maximum Screen Voltage	135		volts

AMPLIFIER - CLASS A

Plate Voltage	90	135	volts
Screen Voltage	90	135	volts
Grid Bias	-3	-4.5	volts
Amplification Factor	340	340	
Plate Resistance	0.24	0.2	megohm
Transconductance	1400	1700	μmhos
Plate Current	4	8	ma
Screen Current	1.3	2.6	ma
Load Resistance	20000	16000	ohms
Total Harmonic Distortion	5	5	percent
Power Output	120	340	mW

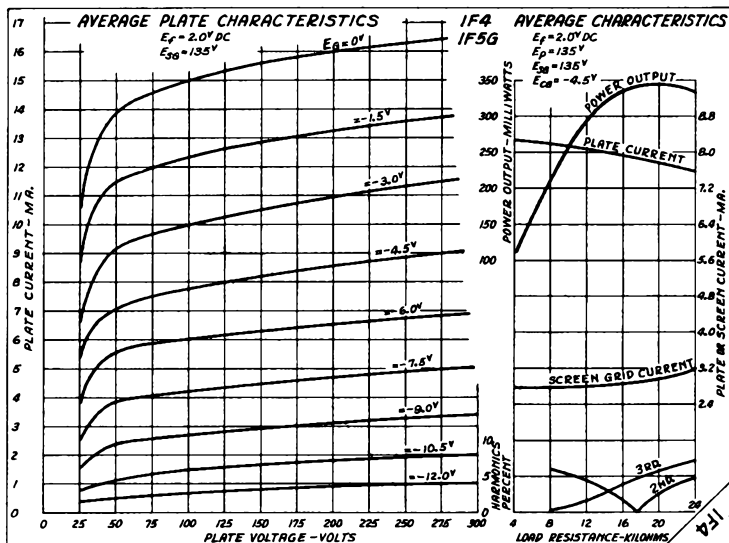

DUO-DIODE PENTODE
DETECTOR AMPLIFIER

Filament Type Glass Bulb

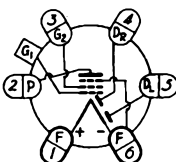
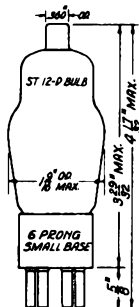

BOTTOM VIEW OF SOCKET

The 1F6 is a duo-diode pentode type amplifier tube designed for service as a combined diode detector, AVC rectifier, and high or audio frequency amplifier in battery operated receivers. The ratings and electrical characteristics are identical with those of the type 1F7G.

RATINGS

Filament Voltage	2.0 d-c volts
Filament Current	0.060 amp
Max. Plate Voltage	180 volts
Max. Screen Voltage	67.5 volts

DIRECT INTERELECTRODE CAPACITANCES - PENTODE SECTION

Grid to Plate	0.007 max.* μ mf
Input	4 μ mf
Output	9 μ mf

AMPLIFIER - CLASS A - PENTODE SECTION

Plate Voltage	180	volts
Screen Voltage	67.5	volts
Grid Bias	-1.5	volts
Amplification Factor (approximate)	650	
Plate Resistance (approximate)	1	megohm
Transconductance	650	μ mhos
Plate Current	2	ma
Screen Current	0.6	ma
Transconductance at -12 volts bias	15	μ mhos

AMPLIFIER - CLASS A (Resistance Coupled)-PENTODE SECTION

Plate Supply Voltage	135	135	135	volts			
Screen Supply Voltage	135	135	135	volts			
Grid Bias†	-1.0	-1.5	-2.0	volts			
Plate Resistor	0.25	0.25	0.25	megohm			
Screen Resistor	1	0.9	0.8	megohm			
Signal Peak Voltage	0.64	0.63	0.62	volts			
No-Signal Plate Current	0.42	0.42	0.42	ma			
Max.-Signal Plate Current	0.34	0.34	0.34	ma			
Grid Resistor‡	1	0.5	1	0.5	megohm		
Output Peak Voltage‡	30.8	28	29.4	26.6	28	25.2	volts
Total Harmonic Distortion	5	5	5	5	5	5	percent
Voltage Amplification	48	43	47	42	46	41	

DIODE SECTION

The two diodes are located at the negative end of the filament. They are independent of each other and of the pentode section except for the common filament. The diodes may be used as a half wave or as a full wave rectifier or one diode may be used as a half wave rectifier for detection, and the other diode used as a rectifier to obtain AVC voltage.

*With tube shield.

†If a grid resistor is used, its value should not exceed 1 megohm.

‡For following tube.

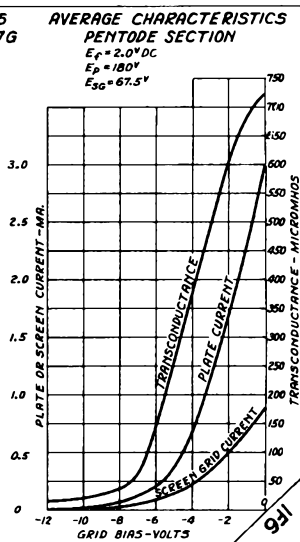
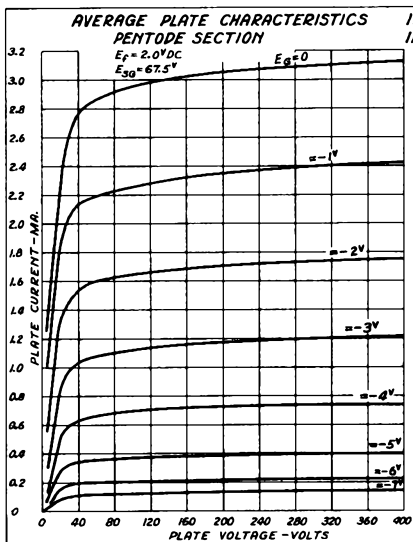

DUO-DIODE PENTODE
DETECTOR AMPLIFIER

Filament Type Glass Bulb

The 1F7G is a duo-diode pentode type amplifier tube designed for service as a combined diode detector, AVC rectifier, and high or audio frequency amplifier in battery operated receivers. The ratings and electrical characteristics are identical with those of the type 1F6.

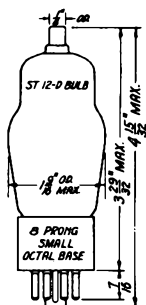
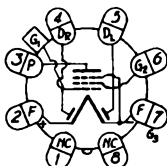

RATINGS

Filament Voltage	2.0 d-c	volts
Filament Current	0.060	amp
Maximum Plate Voltage	180	volts
Maximum Screen Voltage	67.5	volts

DIRECT INTERELECTRODE CAPACITANCES-PENTODE SECTION

Grid to Plate (with tube shield)	0.007 max.	μmf
Input	4.0	μmf
Output	9	μmf

AMPLIFIER - CLASS A - PENTODE SECTION

Plate Voltage	180	volts
Screen Voltage	67.5	volts
Grid Bias	-1.5	volts
Amplification Factor (approximate)	650	
Plate Resistance (approximate)	1	megohm
Transconductance	650	μmhos
Plate Current	2	ma
Screen Current	0.6	ma
Transconductance at -12 volts bias	15	μmhos

AMPLIFIER - CLASS A - RESISTANCE COUPLED - PENTODE SECTION

Plate Supply Voltage	135	135	135	135	volts		
Screen Supply Voltage	135	135	135	135	volts		
Grid Bias†	-1.0	-1.5	-2.0	-2.0	volts		
Plate Resistor	0.25	0.25	0.25	0.25	megohm		
Screen Resistor	1.0	0.9	0.8	0.8	megohm		
Signal Peak Voltage	0.64	0.63	0.62	0.62	volts		
No-Signal Plate Current	0.42	0.42	0.42	0.42	ma		
Max-Signal Plate Current	0.34	0.34	0.34	0.34	ma		
Grid Resistor‡	1.0	0.5	1.0	0.5	megohm		
Output Peak Voltage‡	30.8	28	29.4	26.6	28	25.2	volts
Total Harmonic Distortion	5	5	5	5	5	5	percent
Voltage Amplification	48	43	47	42	46	41	

DIODE SECTION

The two diode units are independent of each other and of the triode section except for the common filament. The diodes may be used as a half-wave or as a full wave rectifier; or one diode may be used as a half-wave rectifier for detection and the other diode used as a rectifier to obtain delayed AVC voltage.

If only one diode plate is used as an audio rectifier, D_p on pin 5 should be used because D_p is near the negative end of the filament and current will flow to this plate with zero signal when returned to the negative filament.

†If a grid resistor is used, its value should not exceed 1 megohm.

‡For following tube.

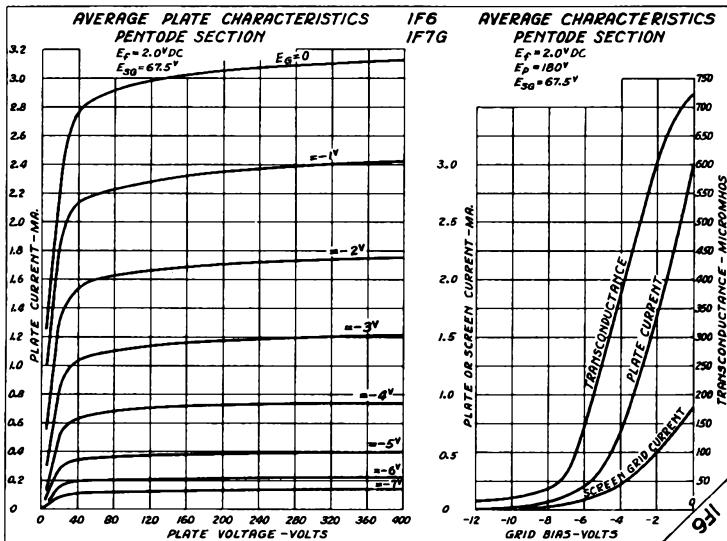

1G5G

RAYTHEON

1G5G

PENTODE
POWER AMPLIFIER
Filament Type Glass Bulb

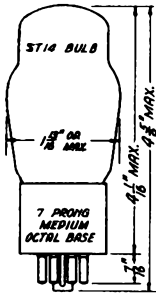

The 1G5G is a pentode type power amplifier tube designed for service in the output stage of battery operated receivers.

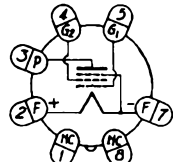

RATINGS

Filament Voltage	
Filament Current	
Maximum Plate Voltage	
Maximum Screen Voltage	

BOTTOM VIEW OF SOCKET

2.0 d-c	volts
0.12	amp
90	volts
90	volts

AMPLIFIER - CLASS A

Plate Voltage	90	volts
Screen Voltage	90	volts
Grid Bias	-6	volts
Amplification Factor	200	
Plate Resistance	0.133	megohm
Transconductance	1500	μmhos
Plate Current	8.5	ma
Screen Current	2.7	ma
Load Resistance	8000	ohms
Total Harmonics	9	percent
Power Output	0.3	watts

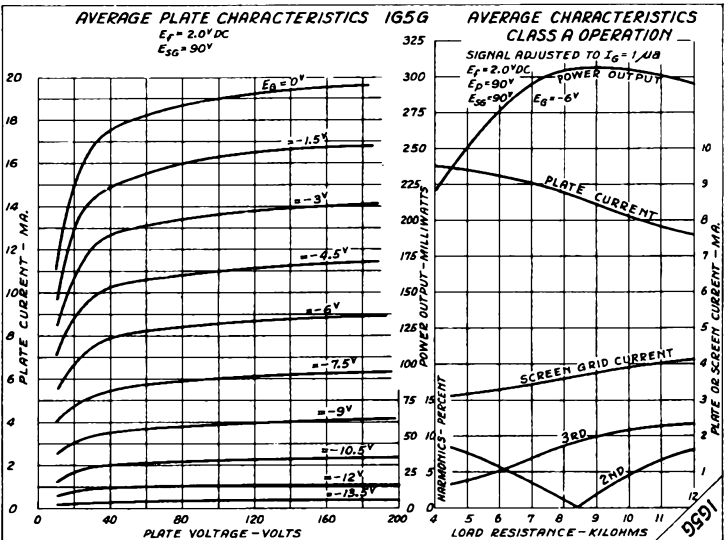

TRIODE

DETECTOR OR AMPLIFIER

Filament Type Glass Bulb

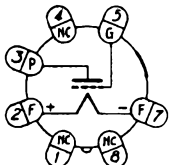
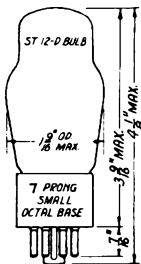

The 1H4G is a triode type amplifier tube designed for service as a detector or amplifier in battery operated receivers. The ratings and electrical characteristics are identical with those of the type 30.

RATINGS

Heater Voltage	2.0 d-c volts
Heater Current	0.060 amp
Maximum Plate Voltage	180 volts

BOTTOM VIEW OF SOCKET

DIRECT INTERELECTRODE CAPACITANCES

Grid to Plate	5	μuf
Input	3	μuf
Output	3	μuf

AMPLIFIER - CLASS A

Plate Voltage	90	135	180	volts
Grid Bias	-4.5	-9	-13.5	volts
Amplification Factor	9.3	9.3	9.3	
Plate Resistance	11000	10300	10300	ohms
Transconductance	850	900	900	μmhos
Plate Current	2.5	3.0	3.1	ma

If a grid resistor is used, its value should not exceed 2 megohms.

AMPLIFIER - CLASS B - TWO TUBES

Maximum Plate Voltage	180	volts
Maximum Peak Plate Current (per tube)	50	ma
Maximum No-Signal Plate Current (per tube)	1.5	ma
Typical Operation:		
Plate Voltage	157.5	volts
Grid Bias	-15	volts
No-Signal Plate Current (per tube)	0.5	ma
Load Resistance (plate to plate)	8000	ohms
Power Output†	2.1	watts
(With average power input = 260 mw. grid to grid)		

DETECTOR - BIASED TYPE

Plate Voltage	90	135	180	volts
Grid Bias (approximate)	-9	-13.5	-18	volts
Plate Current‡	Adjusted to 0.2 ma. with no signal			

DETECTOR - GRID LEAK TYPE

Plate Voltage	45 max.	volts
Grid	Returned to positive filament	
Grid Leak Resistance	1 to 5 megohms	
Grid Condenser	0.00025 μf	

†With one type 1H4G as driver operated at plate voltage of 157.5 volts, grid bias of -11.3 volts, plate load of approximately 18000 ohms, and input transformer ratio, primary to 1/2 secondary, of 1.165. Total distortion is 6% to 7%.

‡With normal maximum signal the average d-c plate current should not exceed 2 ma.

For additional curves refer to the type 30.

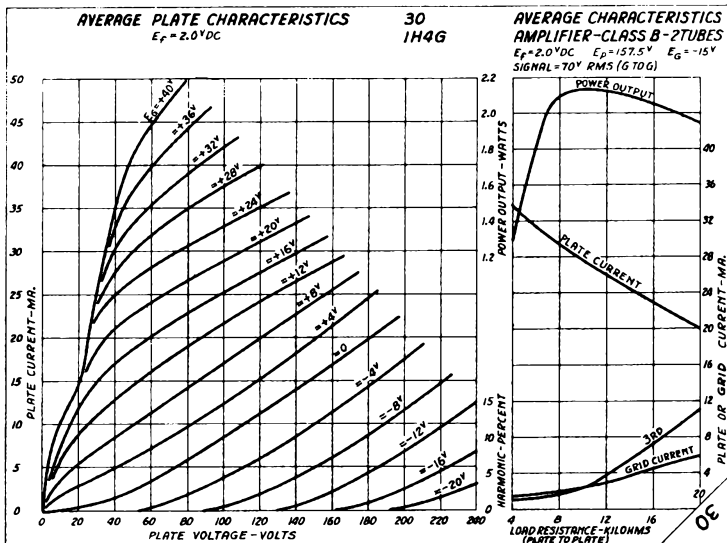

DUO-DIODE TRIODE
DETECTOR AMPLIFIER
Filament Type Glass Bulb

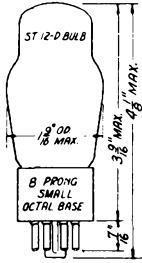

The 1H6G is a duo-diode triode type amplifier tube designed for service as a combined diode detector, AVC rectifier and audio frequency amplifier in battery operated receivers. The ratings and electrical characteristics are identical with those of the type 1B5/25S.

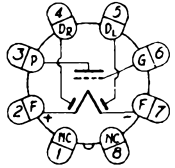

BOTTOM VIEW OF SOCKET

RATINGS

Filament Voltage	2.0 d-c	volts
Filament Current	0.060	amp
Maximum Plate Voltage	135	volts

DIRECT INTERELECTRODE CAPACITANCES - TRIODE SECTION

Grid to Plate	3.6	μ F
Input	2.0	μ F
Output	3	μ F

AMPLIFIER - CLASS A - TRIODE SECTION

Plate Voltage	135	volts
Grid Bias	-3	volts
Amplification Factor	20	
Plate Resistance	35000	ohms
Transconductance	575	μ mhos
Plate Current	0.8	ma

DIODE SECTION

The two diode units are independent of each other and of the triode section except for the common filament. The diodes may be used as a half-wave or as a full-wave rectifier; or one diode may be used as a half-wave rectifier for detection, and the other diode used as a rectifier to obtain delayed AVC voltage.

If only one diode plate is used as an audio rectifier, D_L on pin 5 should be used because D_L is near the negative end of the filament and current will flow to this plate with zero signal when returned to the negative end of the filament.

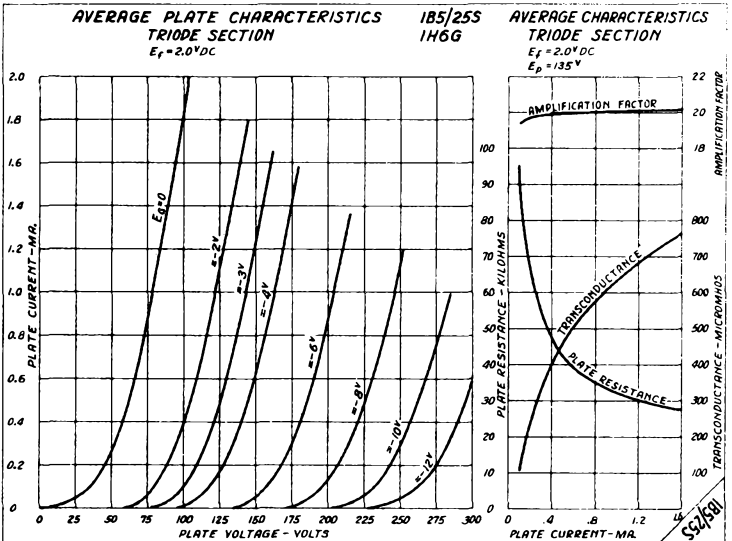

PENTODE
POWER AMPLIFIER
Filament Type Glass Bulb

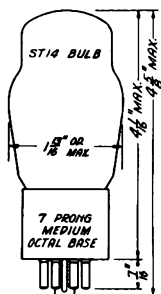

The 1J5G is a pentode type power amplifier tube designed for service in the output stage of battery operated receivers. The ratings and electrical characteristics are identical with those of the type 950.

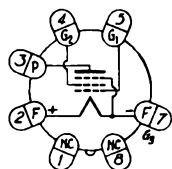

BOTTOM VIEW OF SOCKET

RATINGS

Filament Voltage	2.0 d-c	volts
Filament Current	0.12	amp
Maximum Plate Voltage	135	volts
Maximum Screen Voltage	135	volts

AMPLIFIER - CLASS A

Plate Voltage	135	volts
Screen Voltage	135	volts
Grid Bias	-16.5	volts
Amplification Factor	100	
Plate Resistance	0.1	megohm
Transconductance	1000	μmhos
Plate Current	7	ma
Screen Current	2	ma
Load Resistance	13500	ohms
Power Output	450	mW
Maximum Signal Voltage (RMS)	11.7	volts

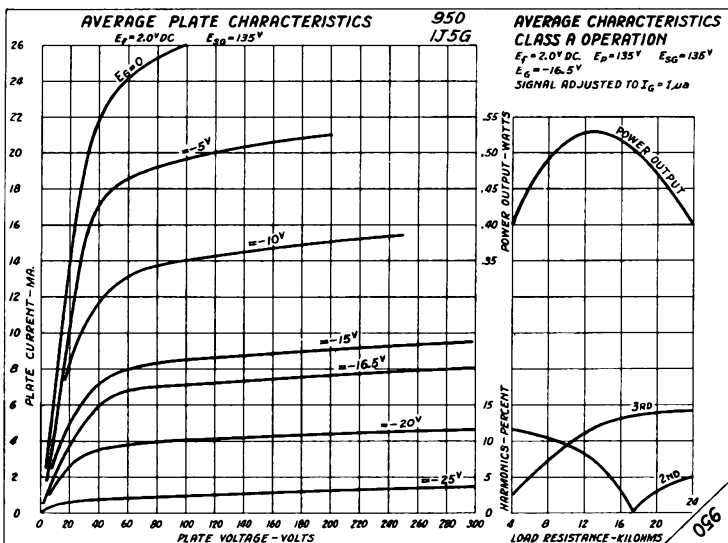

TWIN TRIODE
POWER AMPLIFIER

Filament Type Glass Bulb

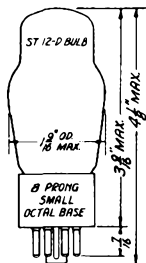

The 1J6G is a twin triode type amplifier tube designed for service as a Class B power amplifier in the output stage of battery operated receivers. The ratings and electrical characteristics, except filament current, are identical with those of the type 19.

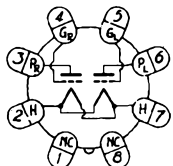

BOTTOM VIEW OF SOCKET

RATINGS

Filament Voltage	2.0 d-c	volts
Filament Current	0.24	amp
Maximum Plate Voltage	135	volts
Maximum Peak Plate Current (per plate)	50	ma

AMPLIFIER - CLASS B

Plate Voltage	135	135	135	volts
Grid Bias	-6	-3	0	volts
No-Signal Plate Current (per plate)	0.5	2	5	ma
Load Resistance (plate to plate)	10000	10000	10000	ohms
Power Output (approximate)	1.6	1.9	2.1	watts
Average Power Input (grid to grid)	0.095	0.13	0.17	watts

For additional curves refer to the type 19.

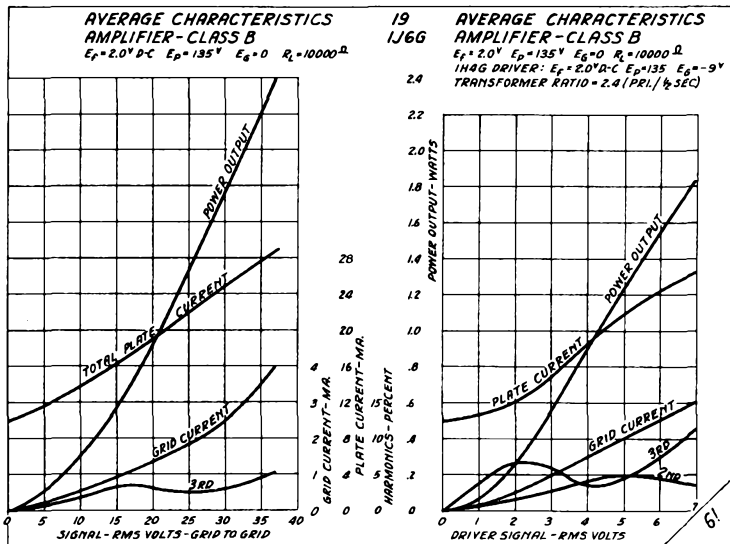

DIODE

HALF WAVE HIGH VACUUM RECTIFIER
Heater Type Glass Eulb

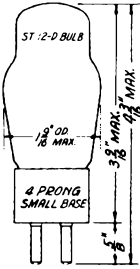

The 1-V is a half wave high vacuum type rectifier tube having a low voltage drop designed for service in power supplies for storage battery or a-c operated receivers. It is interchangeable with the mercury vapor type 1.

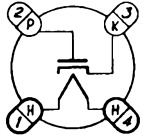

BOTTOM VIEW OF SOCKET

HALF WAVE RECTIFIER - CONDENSER OR CHOKE INPUT FILTER

Heater Voltage (a-c or d-c)	6.3	volts
Heater Current	0.3	amp
Maximum A-C Plate Voltage (RMS)	350	volts
Maximum Inverse Peak Voltage	1000	volts
Maximum D-C Output Current	50	ma
Maximum D-C Voltage between Heater and Cathode	500	volts

AVERAGE TUBE VOLTAGE DROP (At 100 ma. Output Current) 23 volts

AVERAGE OUTPUT CHARACTERISTICS

$E_f = 6.3V$

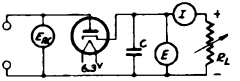

- C = 16 μ F
- - - C = 8 μ F
- C = 4 μ F

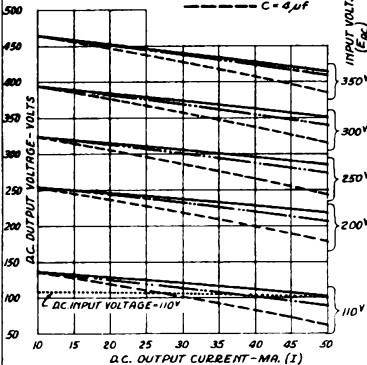

AVERAGE PLATE CHARACTERISTIC

$E_f = 6.3V$

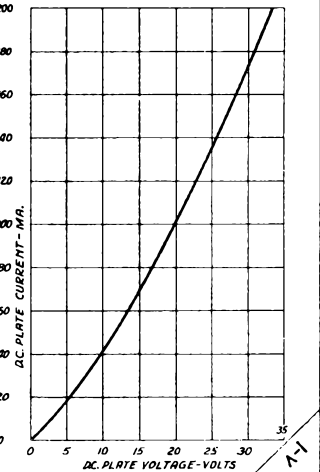

2A3 2A3H

RAYTHEON

2A3 2A3H

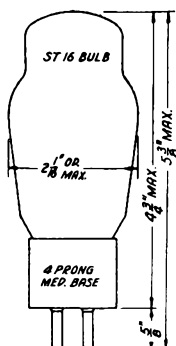

TRIODE
POWER AMPLIFIER
Glass Bulb
Filament Type-2A3 Heater Type-2A3H

The 2A3 and 2A3H are triode type power amplifier tubes designed for service in the output stage of a-c operated receivers.

RATINGS

2A3
Fil. Voltage (a-c or d-c) 2.5 volts
Fil. Current 2.5 amp

2A3H
Heater Voltage (a-c or d-c) 2.5 volts
Heater Current 2.8 amp

AMPLIFIER - CLASS A

Plate Voltage	250 max. volts
Grid Bias*	-45 volts
Amplification Factor	4.2
Plate Resistance	800 ohms
Transconductance	5250 μ hos
Plate Current	60 ma
Load Resistance	2500 ohms
Power Output (5% second harmonic)	3.5 watts

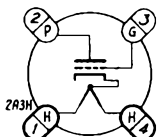
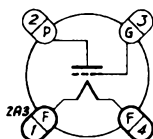

BOTTOM VIEWS OF SOCKETS
2A3H - CATHODE CONNECTED
INT. TO MID-POINT OF HEATER

AMPLIFIER - CLASS AB - PUSH-PULL - TWO TUBES

	Fixed-Bias	Self-Bias
Plate Voltage	300 max.	300 max. volts
Grid Bias*	-62	volts
Self-Bias Resistor		780 ohms
No-Signal Plate Current (per tube)	40	40 ma
Load Resistance (plate to plate)	3000	5000 ohms
Total Harmonic Distortion	2.5	5 percent
Power Output	15	10 watts

The self-bias resistor for a single tube should be approximately 750 ohms. In either single tube or push-pull operation, the self-bias resistor should be shunted by a suitable filter network to minimize grid bias changes due to current surges through the resistor.

Transformer or impedance input systems are recommended. If resistance coupling is used, the d-c resistance in the grid circuit should not exceed 0.5 megohm with self-bias or 0.05 megohm with fixed-bias.

*2A3 Grid bias measured from mid-point of a-c operated filament.

For characteristic curves refer to the types 6A3 and 6B4G. The characteristics of the 2A3 are the same as those of the 6A3 and the 6B4G except for the filament rating.

PENTODE

POWER AMPLIFIER

Heater Type Glass Bulb

The 2A5 is a pentode type power amplifier tube designed for service in the output stage of a-o. operated receivers.

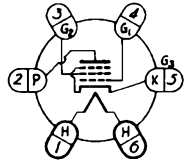

BOTTOM VIEW OF SOCKET

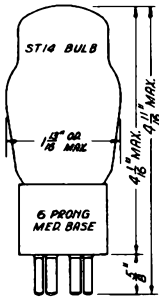

RATINGS

Heater Voltage (a-c or d-c)	2.5 volts
Heater Current	1.75 amp
Maximum Plate Voltage	315 volts
Maximum Screen Voltage	315 volts

AMPLIFIER - CLASS A

	Pentode Connection		Triode Connection†	
Plate Voltage	250	315	250 max.	volts
Screen Voltage	250	315		volts
Grid Bias	-16.5	-22	-20	volts
Amplification Factor	200‡	200‡	7	
Plate Resistance	80000‡	75000‡	2600	ohms
Transconductance	2500	2650	2700	μmhos
Plate Current	34	42	31	ma
Screen Current	6.5	8		ma
Load Resistance	7000	7000	4000	ohms
Total Harmonic Dist.	7	7	5	percent
Power Output	3	5	0.65	watts

AMPLIFIER - CLASS AB - TWO TUBES

	Pentode Connection		Triode Connection†		
	Fixed-Bias	Self-Bias	Fixed-Bias	Self-Bias	
Plate Voltage	375 max.	375 max.	350 max.	350 max.	volts
Screen Voltage	250 max.	250 max.			volts
Grid Bias	-26 min.		-38		volts
Self-Bias Resistor		340		730 min.	ohms
Signal Pk.Volt. (G to G)	32	94	123	132	volts
No-Signal Plate Current	34	54	45	50	ma
No-Signal Screen Current	5	8			ma
Load Resistance (P to P)	10000	10000	6000	10000	ohms
Total Harmonic Dist.	5	5	7	7	percent
Power Output (approx.)#	19*	19Δ	18**	14¶	watts

#With one 2A5 triode connected as driver operated at plate voltage of 250 volts, grid bias of -20 volts and plate load of approximately 10000 ohms.

*Input transformer ratio, primary to 1/2 secondary = 3.32

ΔInput transformer ratio, primary to 1/2 secondary = 2.5

**Input transformer ratio, primary to 1/2 secondary = 1.67

¶Input transformer ratio, primary to 1/2 secondary = 1.29

†Screen connected to plate

‡Approximate

For characteristic curves refer to the types 6P6G and 42. The characteristics of the 2A5 are the same as those of the 6P6G and the 42 except for the heater rating.

DUO-DIODE TRIODE
 DETECTOR AMPLIFIER
 Heater Type Glass Bulb

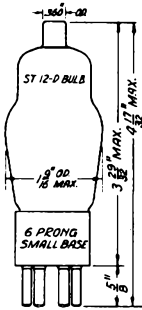

The 2A6 is a duo-diode triode type amplifier tube designed for service as a combined diode detector, AVC rectifier and resistance coupled audio frequency amplifier in a-c operated receivers.

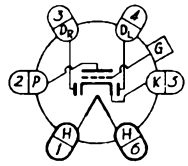

BOTTOM VIEW OF SOCKET

RATINGS

Heater Voltage (a-c or d-c)	2.5	volts
Heater Current	0.8	amp
Maximum Plate Voltage	250	volts

DIRECT INTERELECTRODE CAPACITANCES

Grid to Plate	1.7	μf
Input	2.0	μf
Output	3.5	μf

AMPLIFIER - CLASS A - TRIODE SECTION

Plate Voltage	250	volts
Grid Bias	-2	volts
Amplification Factor	100	
Plate Resistance	91000	ohms
Transconductance	1100	μmhos
Plate Current	1	ma

DIODE SECTION

The two diodes are independent of each other and of the triode section except for the common cathode. The diodes may be used as a half wave or as a full wave rectifier; or one diode may be used as a half wave rectifier for detection and the other diode used as a rectifier to obtain delayed AVC voltage.

The voltage between heater and cathode should be kept as low as possible where they are not directly connected.

For characteristic curves refer to the type 75. The characteristics of the 75 are the same as those of the 2A6 except for the heater rating.

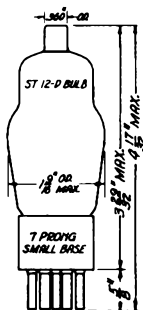

HEPTODE
PENTAGRID CONVERTER
Heater Type Glass Bulb

The 2A7 is a pentagrid type converter tube designed for service as a combined oscillator and mixer in a-c operated superheterodyne receivers.

RATINGS

Heater Voltage (a-c or d-c)	2.5	volts
Heater Current	0.8	amp
Max. Plate Voltage	250	volts
Max. Screen Voltage	100	volts
Max. Grid #2 Voltage	200	volts
Max. Grid #2 Supply	250†	volts
Min. Grid #4 Bias	-3	volts
Max. Cathode Current	14	ma

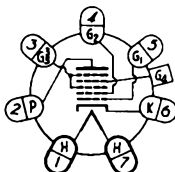

BOTTOM VIEW OF SOCKET

DIRECT INTERELECTRODE CAPACITANCES

Grid #4 to Plate	0.3 *	μf
Grid #4 to Grid #2	0.15*	μf
Grid #4 to Grid #1	0.15*	μf
Grid #1 to Grid #2	1.0	μf
Grid #4 to all other Elements (R-F Input)	8.5	μf
Grid #1 to all other Elements (Osc. Input)	7	μf
Grid #2 to all other Elements (Osc. Output)	5.5	μf
Plate to all other Elements (Mixer Output)	9	μf

FREQUENCY CONVERTER - SUPERHETERODYNE CIRCUIT

Plate Voltage	100	250	volts
Screen (Grids #3 and #5) Voltage	50	100	volts
Anode Grid (#2) Voltage	100		volts
Anode Grid Supply Voltage		250†	volts
Control Grid (#4) Bias	-1.5	-3	volts
Oscillator Grid Resistor	50000	50000	ohms
Plate Resistance	0.6	0.3	megohm
Conversion Transconductance	360	550	μmhos
Plate Current	1.1	3.5	ma
Screen Current	1.3	2.7	ma
Anode Grid Current	2.0	4.0	ma
Oscillator Grid Current	0.25	0.4	ma
Control Grid Bias (approximate)	-20	-45	volts

(For Conversion Transconductance = 2 μmhos)

The voltage between heater and cathode should be kept as low as possible where they are not directly connected.

†Applied through a 20000 ohm series resistor, by-passed by a 0.1 μf condenser.

*With tube shield.

For characteristic curves refer to the type 6A7. The characteristics of the 2A7 are the same as those of the 6A7 except for the heater rating.

DUO-DIODE PENTODE
DETECTOR AMPLIFIER
Heater Type Glass Bulb



The 2B7 is a duo-diode pentode type amplifier tube designed for service as a combined diode detector, AVC rectifier, and high or audio frequency amplifier in a-c operated receivers.

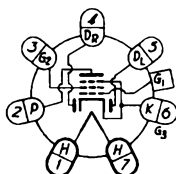

BOTTOM VIEW OF SOCKET

RATINGS

Heater Voltage (a-c or d-c)	2.5	volts
Heater Current	0.8	amp
Maximum Plate Voltage	250	volts
Maximum Screen Voltage	125	volts

DIRECT INTERELECTRODE CAPACITANCES - PENTODE SECTION

Grid to Plate	0.007 max.*	μmf
Input	3.5	μmf
Output	9.5	μmf

AMPLIFIER - CLASS A - PENTODE SECTION

Plate Voltage	100	180	250	250	volts
Screen Voltage	100	75	100	125	volts
Grid Bias	-3	-3	-3	-3	volts
Amplification Factor	285	840	800	730	
Plate Resistance	0.3	1	0.8	0.65	megohm
Transconductance	930	840	1000	1125	μmhos
Plate Current	5.8	3.4	6	9	ma
Screen Current	1.7	0.9	1.5	2.3	ma
Grid Bias	-17	-13	-17	-21	volts

(For oathode current cutoff)

AMPLIFIER - CLASS A - RESISTANCE COUPLED - PENTODE SECTION

Plate Supply Voltage	250	250	250	volts
Screen Voltage	45	50	100	volts
Grid Bias	-5	-4.5	-3	volts
Plate Resistor	0.5	0.25	0.027	megohm
Plate Current	0.25	0.65	5.4	ma

DIODE SECTION

The two diode units are independent of each other and of the pentode section except for the common cathode. The diodes may be used as a half wave or as a full wave rectifier; or one diode may be used as a half wave rectifier for detection, and the other diode used as a rectifier to obtain delayed AVC voltage.

The voltage between heater and oathode should be kept as low as possible where they are not directly connected.

*With tube shield.

For characteristic curves refer to the type 6B7. The characteristics of the 2B7 are the same as those of the 6A7 except for the heater rating.

TWIN DIODE
 FULL WAVE HIGH VACUUM RECTIFIER
 Filament Type Metal Bulb

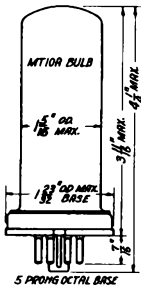

The 5T4 is a full wave high vacuum type rectifier tube designed for service in power supplies delivering high output currents.

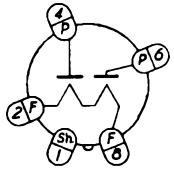

BOTTOM VIEW OF SOCKET

FULL WAVE RECTIFIER - CONDENSER INPUT FILTER

Filament Voltage	5	a-c	volts
Filament Current	2		amp
Maximum A-C Plate Voltage (RMS)	450		volts
Maximum Inverse Peak Voltage	1250		volts
Maximum D-C Output Current	250		ma

FULL WAVE RECTIFIER - CHOKE INPUT FILTER(10 henrys minimum)

Filament Voltage	5	a-c	volts
Filament Current	2		amp
Maximum A-C Plate Voltage (RMS)	550		volts
Maximum Inverse Peak Voltage	1550		volts
Maximum D-C Output Current	250		ma

AVERAGE OUTPUT CHARACTERISTICS 5T4
 $E_f = 5.0V$

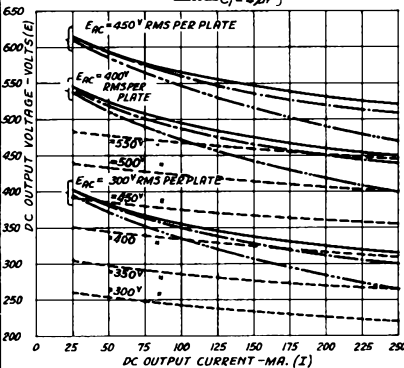
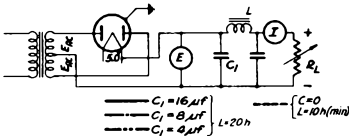

AVERAGE PLATE CHARACTERISTIC
 (EACH PLATE)
 $E_f = 5.0V$

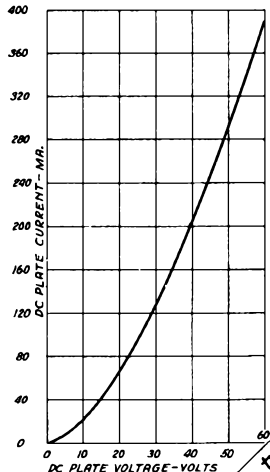

5U4G

RAYTHEON

5U4G

TWIN DIODE
 FULL WAVE HIGH VACUUM RECTIFIER
 Filament Type Glass Bulb

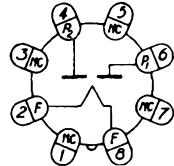

BOTTOM VIEW OF SOCKET

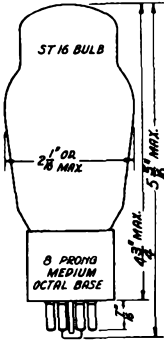

The 5U4G is a high vacuum type full wave rectifier tube designed for service in power supplies delivering high output currents. The ratings and electrical characteristics are identical with those of the types 5X4G and 5Z3.

FULL WAVE RECTIFIER
 Condenser or Choke Input Filter

Filament Voltage	5	a-c	volts
Filament Current	3	amp	
Maximum A-C Voltage per Plate (RMS)	500	volts	
Maximum Inverse Peak Voltage	1400	volts	
Maximum D-C Output Current	250	ma	

AVERAGE TUBE VOLTAGE DROP 61 volts
 (At 250 ma. output current)

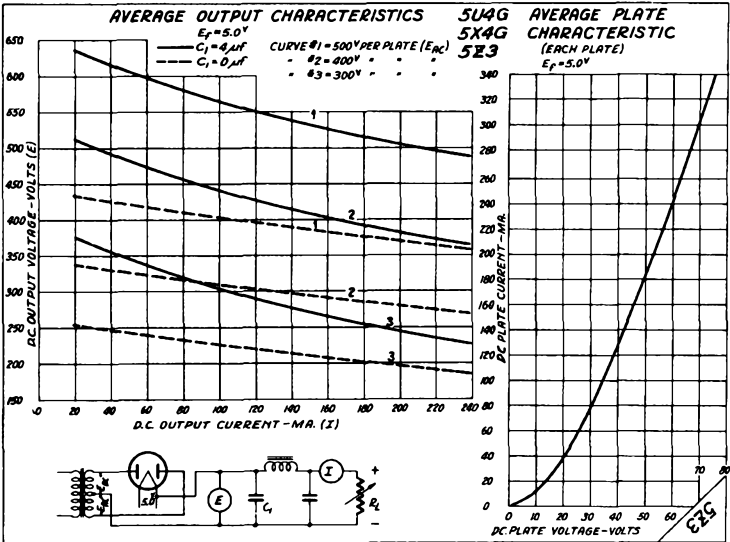

TWIN DIODE
FULL WAVE HIGH VACUUM RECTIFIER
Heater Type Glass Bulb

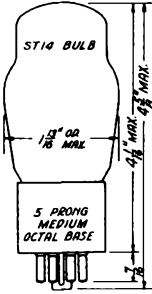

The 5V4G is a full wave high vacuum type rectifier tube having a low voltage drop designed for service in power supplies delivering high output currents. The ratings and characteristics are identical with those of type 83-V.

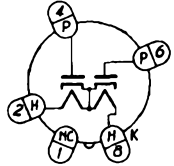

BOTTOM VIEW OF SOCKET

FULL WAVE RECTIFIER - CONDENSER OR CHOKE INPUT FILTER

Heater Voltage	5	a-c	volts
Heater Current	2		amp
Maximum A-C Voltage per Plate (RMS)	400		volts
Maximum Inverse Peak Voltage	1100		volts
Maximum Peak Plate Current	700		ma
Maximum D-C Output Current	200		ma

AVERAGE TUBE VOLTAGE DROP 25 volts
(At 200 ma. output current per plate)

The cathode is connected within the tube to the center of the heater.

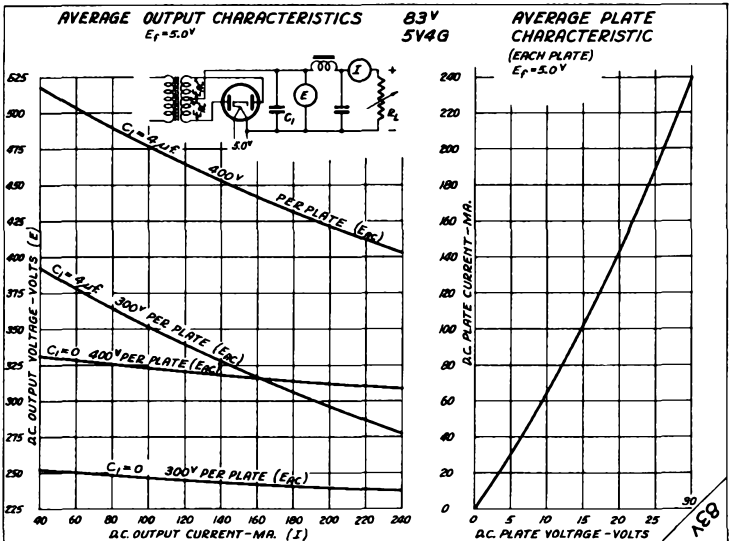

5W4 5W4G

RAYTHEON

5W4 5W4G

TWIN DIODE
 FULL WAVE HIGH VACUUM RECTIFIER
 Filament Type
 Metal Bulb-5W4 Glass Bulb-5W4G

The 5W4 is a full wave high vacuum type rectifier tube designed for service in power supplies delivering low output currents.

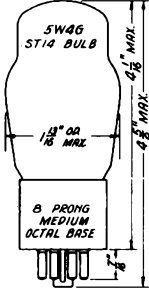
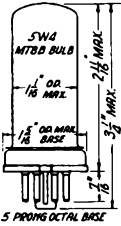

FULL WAVE RECTIFIER
 Condenser Input Filter

Filament Voltage (a-c)	5	volts
Filament Current	1.5	amp
Max. A-C Voltage (RMS)	350	volts
(per plate)		
Max. Inverse Peak Voltage	1000	volts
Max. D-C Output Current	110	ma

AVERAGE TUBE VOLTAGE DROP 50 volts
 (At 110 ma. output current per plate)

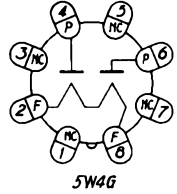
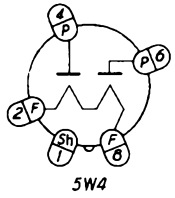

5W4G
 BOTTOM VIEW OF SOCKET

AVERAGE OUTPUT CHARACTERISTICS
 $E_f = 5.0V$ $C_1 = 4\mu F$

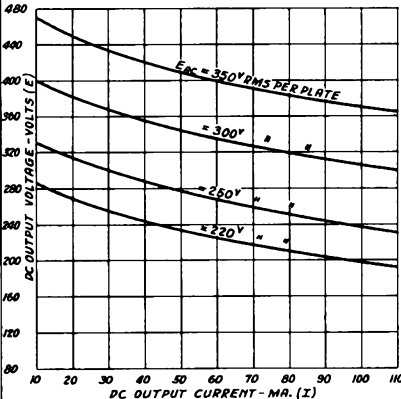
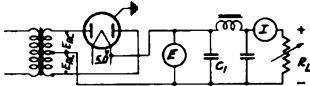

AVERAGE PLATE CHARACTERISTIC
 EACH PLATE
 $E_f = 5.0V$

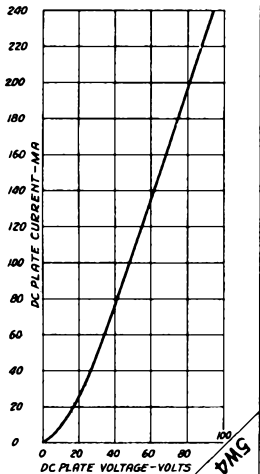

5X4G

RAYTHEON

5X4G

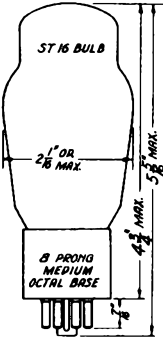

TWIN DIODE
 FULL WAVE HIGH VACUUM RECTIFIER
 Filament Type Glass Bulb

The 5X4G is a high vacuum type full wave rectifier tube designed for service in power supplies delivering high output currents. The ratings and electrical characteristics are identical with those of the types 5U4G and 5Z3.

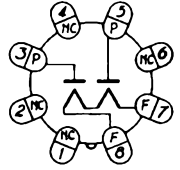

BOTTOM VIEW OF SOCKET

FULL WAVE RECTIFIER
 Condenser or Choke Input Filter

Filament Voltage	5 a-c	volts
Filament Current	3	amp
Maximum A-C Voltage per Plate (RMS)	500	volts
Maximum Inverse Peak Voltage	1400	volts
Maximum D-C Output Current	250	ma

AVERAGE TUBE VOLTAGE DROP 61 volts
 (At 250 ma. output current)

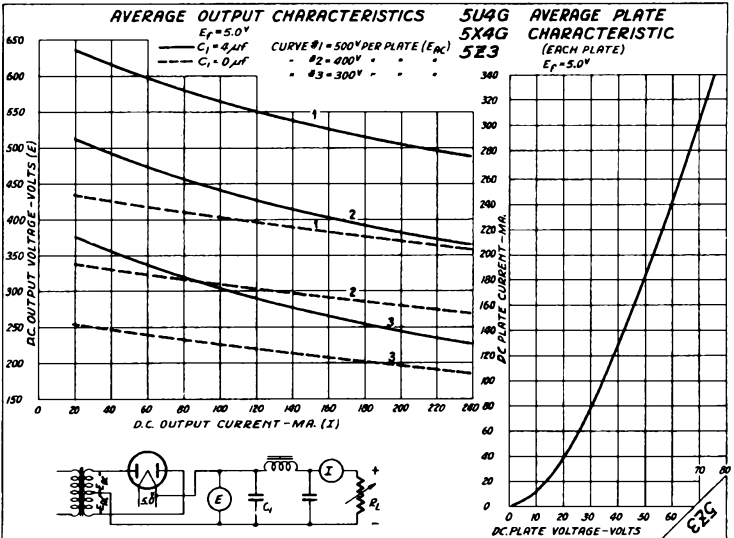

5Y3G

RAYTHEON

5Y3G

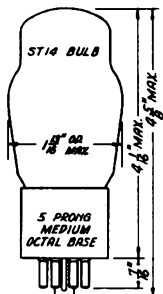

TWIN DIODE
 FULL WAVE HIGH VACUUM RECTIFIER
 Filament Type Glass Bulb

The 5Y3G is a full wave high vacuum type rectifier tube designed for service in power supplies for a-c operated receivers. The ratings and electrical characteristics are identical with those of the type 80.

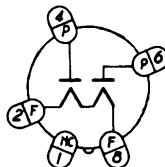

BOTTOM VIEW OF SOCKET

FULL WAVE RECTIFIER - CONDENSER INPUT FILTER

Filament Voltage	5 a-c	volts
Filament Current	2	amp
Maximum A-C Voltage per Plate (RMS)	300	400
Maximum Inverse Peak Voltage	1000	1100
Maximum Peak Plate Current	400	350
Maximum D-C Output Current	125	110

FULL WAVE RECTIFIER - CHOKE INPUT FILTER*

Filament Voltage	5 a-c	volts
Filament Current	2	amp
Maximum A-C Voltage per Plate (RMS)	550	volts
Maximum Inverse Peak Voltage	1500	volts
Maximum Peak Plate Current	300	ma
Maximum D-C Output Current	135	ma

AVERAGE TUBE VOLTAGE DROP 60 volts
 (At 135 ma. output current per plate)

*Input choke must be at least 20 henries. An input condenser of not more than 0.1 μ f. may be used.

For characteristic curves refer to the type 80.

5Y4G

RAYTHEON

5Y4G

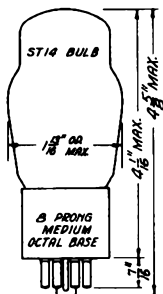

TWIN DIODE
 FULL WAVE HIGH VACUUM RECTIFIER
 Filament Type Glass Bulb

The 5Y4G is a full wave high vacuum type rectifier tube designed for service in power supplies for a-c operated receivers. The ratings and electrical characteristics are identical with those of the type 80.

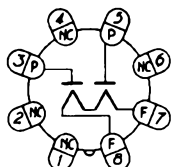

BOTTOM VIEW OF SOCKET

FULL WAVE RECTIFIER - CONDENSER INPUT FILTER

Filament Voltage	5 a-c	volts
Filament Current	2	amp
Maximum A-C Voltage per Plate (RMS)	300	400
Maximum Inverse Peak Voltage	1000	1100
Maximum Peak Plate Current	400	350
Maximum D-C Output Current	125	110

FULL WAVE RECTIFIER - CHOKE INPUT FILTER*

Filament Voltage	5 a-c	volts
Filament Current	2	amp
Maximum A-C Voltage per Plate (RMS)	550	volts
Maximum Inverse Peak Voltage	1500	volts
Maximum Peak Plate Current	300	ma
Maximum D-C Output Current	135	ma

AVERAGE TUBE VOLTAGE DROP 60 volts
 (At 135 ma. output current per plate)

*Input choke must be at least 20 henries. An input condenser of not more than 0.1 μ f. may be used.

For characteristic curves refer to the type 80.

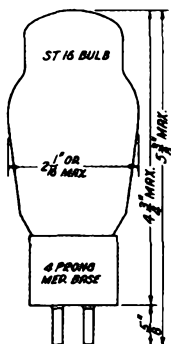

TWIN DIODE
 FULL WAVE HIGH VACUUM RECTIFIER
 Filament Type Glass Bulb

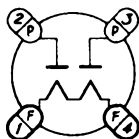

BOTTOM VIEW OF SOCKET

The 5Z3 is a high vacuum type full wave rectifier tube designed for service in power supplies delivering high output currents. The ratings and electrical characteristics are identical with those of the types 5U4G and 5X4G.

FULL WAVE RECTIFIER
 Condenser or Choke Input Filter

Filament Voltage	5 a-c	volts
Filament Current	3	amp
Maximum A-C Voltage per Plate (RMS)	500	volts
Maximum Inverse Peak Voltage	1400	volts
Maximum D-C Output Current	250	ma

AVERAGE TUBE VOLTAGE DROP 61 volts
 (At 250 ma. output current)

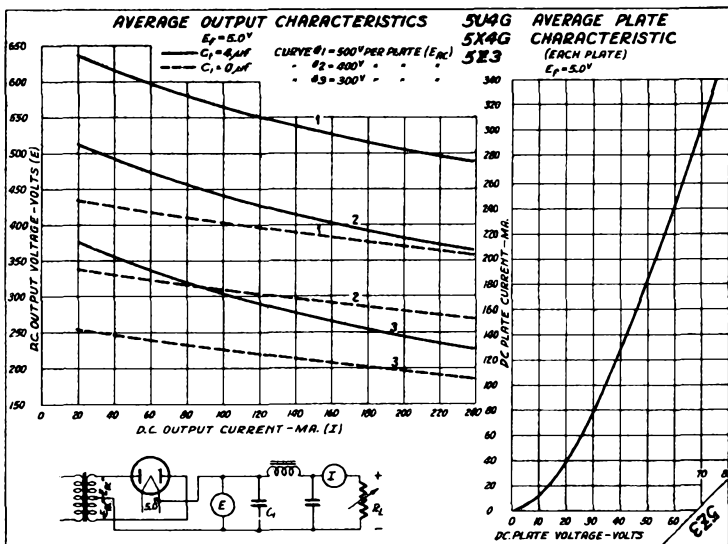

TWIN DIODE
FULL WAVE HIGH VACUUM RECTIFIER
Heater Type Metal Bulb

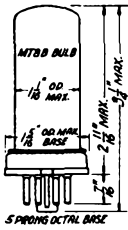

The 5Z4 is a full wave high vacuum type rectifier tube having a low voltage drop designed for service in power supplies for a-c operated receivers.

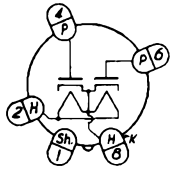

FULL WAVE RECTIFIER - CONDENSER OR CHOKE INPUT FILTER

Heater Voltage	5	a-c	volts
Heater Current	2		amp
Maximum A-C Voltage per Plate (RMS)	400		volts
Maximum Inverse Peak Voltage	1100		volts
Maximum D-C Output Current	125		ma

AVERAGE TUBE VOLTAGE DROP (At 125 ma. output current per plate) 20 volts

The cathode is connected to the heater within the tube.

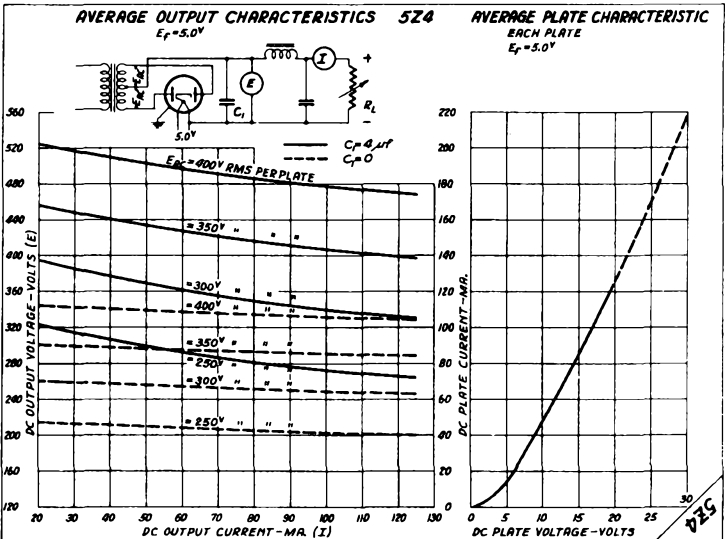

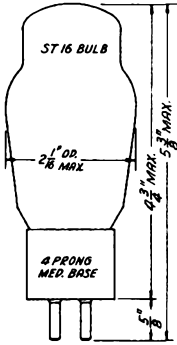

TRIODE
POWER AMPLIFIER
Filament Type Glass Bulb

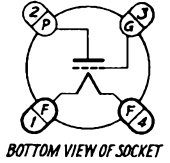

The 6A3 is a triode type power amplifier tube designed for service in the output stage of storage battery or a-c operated receivers. The ratings and electrical characteristics are identical with those of the type 6B4G.

RATINGS

Heater Voltage (a-c or d-c)	6.3	volts
Heater Current	1.0	amp
Maximum Plate Voltage	325	volts

DIRECT INTERELECTRODE CAPACITANCES

Grid to Plate	15	μmf
Input	7	μmf
Output	5	μmf

AMPLIFIER - CLASS A

Plate Voltage	250 max.	volts
Grid Bias*	-45	volts
Amplification Factor	4.2	
Plate Resistance	800	ohms
Transconductance	5250	μmhos
Plate Current	60	ma
Load Resistance	2500	ohms
Power Output (5% second harmonic)	3.2	watts

AMPLIFIER - CLASS AB - PUSH-PULL - TWO TUBES

	Fixed-Bias	Self-Bias	
Plate Voltage	325	325	volts
Grid Bias*	-68		volts
Self-Bias Resistor		750	ohms
No-Signal Plate Current (per tube)	40	40	ma
Load Resistance (plate to plate)	3000	5000	ohms
Power Output	15	10	watts
Total Harmonic Distortion	2.5	5	percent

*Grid bias measured from midpoint of a-c operated filament.

For additional curves refer to the type 6B4G.

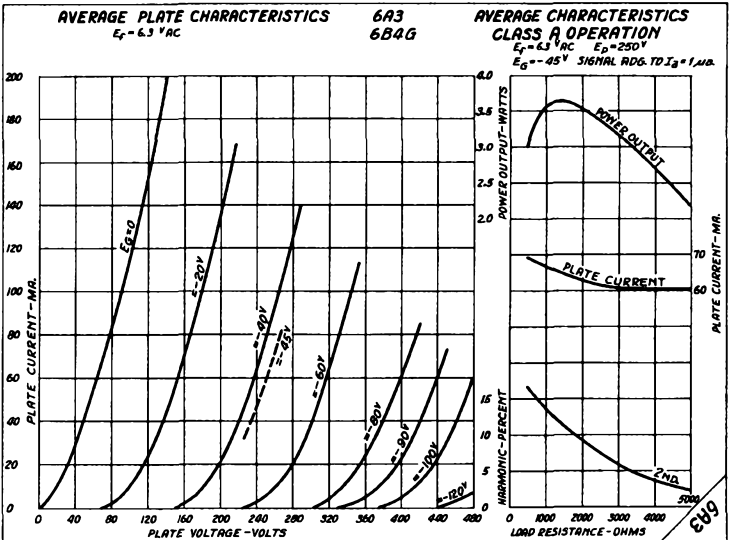

PENTOIDE
POWER AMPLIFIER
Filament Type Glass Bulb

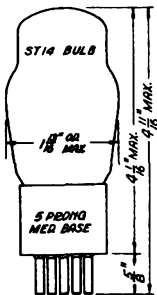

The 6A4/LA is a pentode type power amplifier tube designed for service in the output stage of storage battery operated receivers.

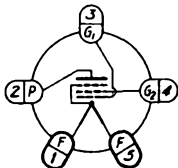

BOTTOM VIEW OF SOCKET

RATINGS

Heater Voltage (a-c or d-o)	6.3	volts
Heater Current	0.3	amp
Maximum Plate Voltage	200	volts
Maximum Screen Voltage	200	volts

AMPLIFIER - CLASS A

Plate Voltage	100	135	180	volts
Screen Voltage	100	135	180	volts
Grid Bias*	-6.5	-9	-12	volts
Amplification Factor (approximate)	100	100	100	
Plate Resistance	83250	52600	45500	ohms
Transconductance	1200	1900	2200	μmhos
Plate Current	9	14	22	ma
Screen Current	1.6	2.5	3.9	ma
Load Resistance	11000	9500	8000	ohms
Power Output	0.31	0.7	1.4	watts
Total Harmonic Distortion	9	9	9	percent

AMPLIFIER - CLASS AB - PUSH-PULL - TWO TUBES - SELF-BIAS

Plate and Screen Supply Voltage ($E_p + E_o$)	230	volts
Self-Bias Resistor	700	ohms
No-Signal Plate Current (per plate)	16	ma
Load Resistance (plate to plate)	16000	ohms
Total Harmonic Distortion	10	percent
Power Output	4.2	watts

*Grid bias measured from negative end of d-c operated filament. If the filament is a-c operated, the tabulated values of grid bias should be increased by 4 volts and be referred to the mid-point of the filament.

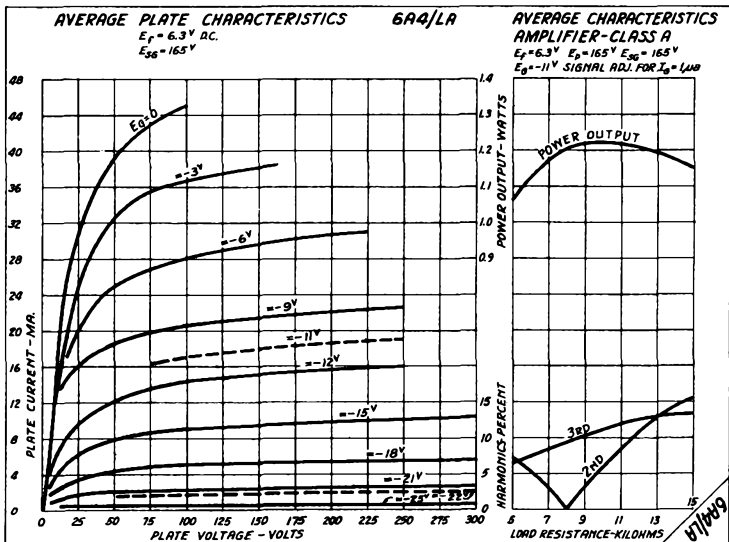

TRIODE
POWER AMPLIFIER
Heater Type Glass Bulb

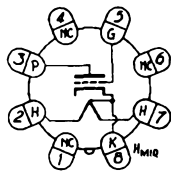
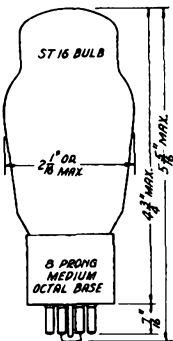

BOTTOM VIEW OF SOCKET

The 6A5G is a triode type power amplifier tube designed for service in the output stage of storage battery or a-c operated receivers.

RATINGS

Heater Voltage (a-c or d-o)	6.3	volts
Heater Current	1.25	amp
Maximum Plate Voltage	325	volts

DIRECT INTERELECTRODE CAPACITANCES

Grid to Plate	16	μ f
Input	7	μ f
Output	5	μ f

AMPLIFIER - CLASS A

Plate Voltage	250 max.	volts
Grid Bias	-45	volts
Amplification Factor	4.2	
Plate Resistance	800	ohms
Transconductance	5250	μ mhos
Plate Current	60	ma
Load Resistance	2500	ohms
Power Output (5% second harmonic)	3.75	watts

AMPLIFIER - CLASS AB - TWO TUBES

	Fixed-Bias	Self-Bias	
Plate Voltage	325	325	volts
Grid Bias	-68		volts
Self-Bias Resistor		850	ohms
No-Signal Plate Current (per tube)	40	40	ma
Load Resistance (plate to plate)	3000	5000	ohms
Total Harmonics	2.5	5	percent
Power Output	15	10	watts

The cathode is connected internally to the mid-point of the heater and to pin #8.

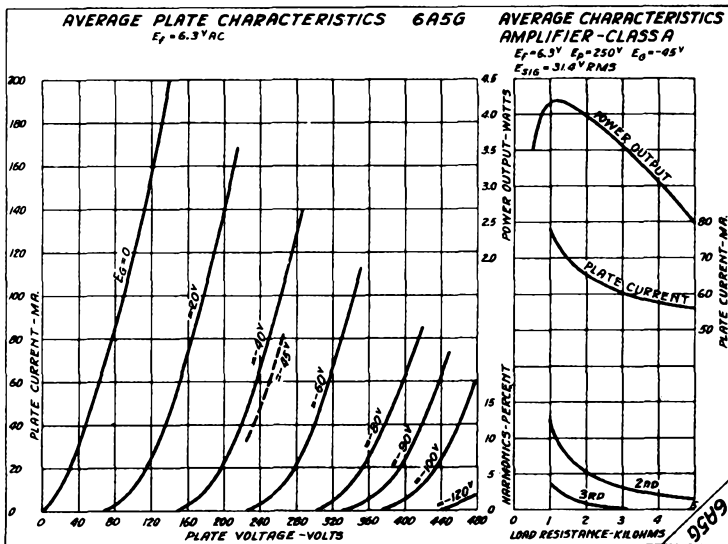

TWIN TRIODE
POWER AMPLIFIER
Heater Type Glass Bulb

The 6A6 is a twin triode type amplifier tube designed for service as a Class B power amplifier in the output stage of storage battery or a-c operated receivers. The ratings and electrical characteristics are identical with those of the types 6N7 and 6N7G.

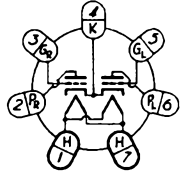

BOTTOM VIEW OF SOCKET

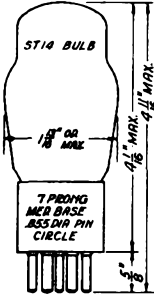

RATINGS

Heater Voltage (a-c or d-c)	6.3	volts
Heater Current	0.8	amp
Maximum Plate Voltage	300	volts
Maximum Peak Plate Current (per plate)	125	ma
Maximum Average Plate Dissipation	10	watts

AMPLIFIER - CLASS B

Plate Voltage	250	300	volts
Grid Bias	0	0	volts
No-Signal Plate Current (per plate)	14	17.5	ma
Load Resistance (plate to plate)	8000	10000	ohms
Power Output (approximate)	8	10	watts
(With average power input = 350 mw. grid to grid)			

AMPLIFIER - CLASS A - DRIVER TRIODES CONNECTED IN PARALLEL

Plate Voltage	250	294	volts
Grid Bias	-5	-6	volts
Amplification Factor	35	35	
Plate Resistance	11300	11000	ohms
Transconductance	3100	3200	μmhos
Plate Current	6	7	ma
Load Resistance - Depends on the design of the following Class B amplifier. Usually between 20000 and 40000 ohms.			
Power Output (approximate)		400	mw

†The d-c resistance in the grid circuit should not exceed 0.5 megohm with self-bias or 0.1 megohm with fixed-bias.

For additional curves refer to the type 6N7G.

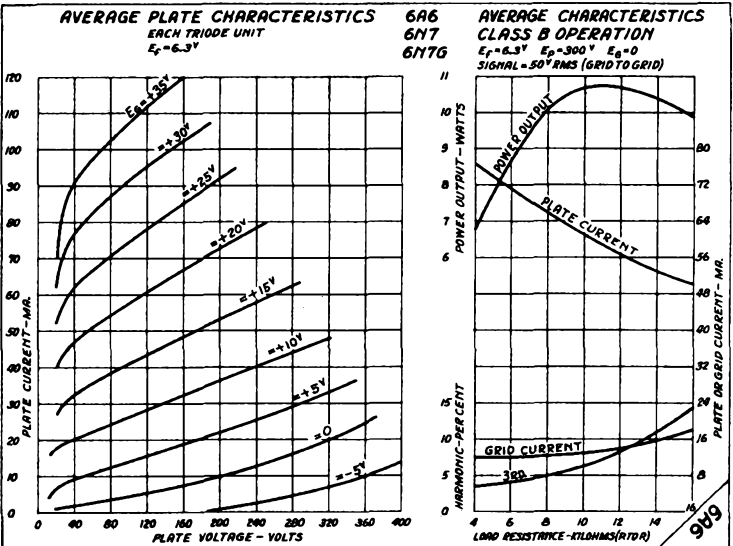

HEPTODE
PENTAGRID CONVERTER

Heater Type Glass Bulb

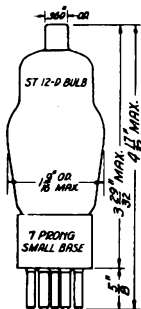

The 6A7 is a pentagrid type converter tube designed for service as a combined oscillator and mixer in storage battery or a-c operated superheterodyne receivers. The ratings and electrical characteristics are identical with those of the types 6A8 and 6A8G.

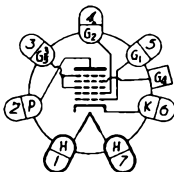

BOTTOM VIEW OF SOCKET

RATINGS

Heater Voltage (a-c or d-c)	6.3	volts
Heater Current	0.3	amp
Max. Plate Voltage	250	volts
Max. Screen Voltage	100	volts
Max. Grid #2 Voltage	200	volts
Max. Grid #2 Supply	250†	volts
Min. Grid #4 Bias	-3	volts
Max. Cathode Current	14	ma

DIRECT INTERELECTRODE CAPACITANCES.

Grid #4 to Plate	0.3*	μf
Grid #4 to Grid #2	0.15*	μf
Grid #4 to Grid #1	0.15*	μf
Grid #1 to Grid #2	1.0	μf
Grid #4 to all other Elements (R-F Input)	8.5	μf
Grid #1 to all other Elements (Osc. Input)	7	μf
Grid #2 to all other Elements (Osc. Output)	5.5	μf
Plate to all other Elements (Mixer Output)	9	μf

FREQUENCY CONVERTER - SUPERHETERODYNE CIRCUIT

Plate Voltage	100	250	volts
Screen (Grids #3 and #5) Voltage	50	100	volts
Anode Grid (#2) Voltage	100		volts
Anode Grid Supply Voltage		250†	volts
Control Grid (#4) Bias	-1.5	-3	volts
Oscillator Grid Resistor	50000	50000	ohms
Plate Resistance	0.5	0.3	megohm
Conversion Transconductance	360	550	μmhos
Plate Current	1.1	3.5	ma
Screen Current	1.3	2.7	ma
Anode Grid Current	2.0	4.0	ma
Oscillator Grid Current	0.25	0.4	ma
Control Grid Bias (approximate)	-20	-45	volts

(For Conversion Transconductance = 2 μmhos)

The voltage between heater and cathode should be kept as low as possible where they are not directly connected.

†Applied through a 20000 ohm series resistor, bypassed by a 0.1 μf condenser.

*With tube shield.

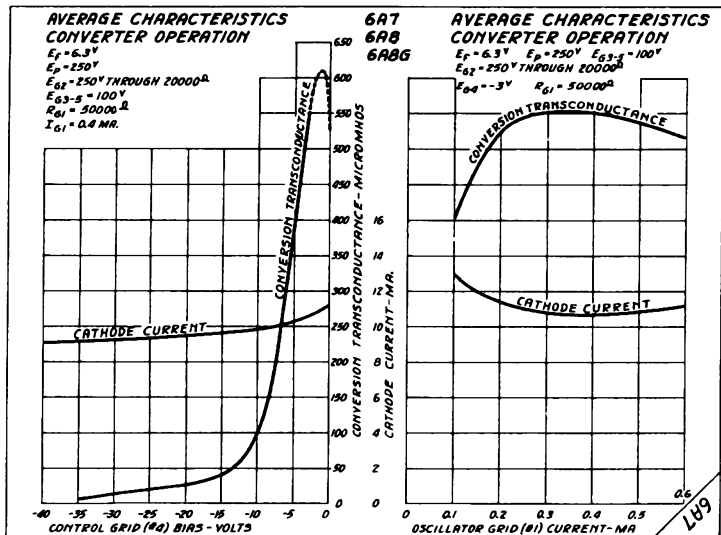

6A8 6A8G

RAYTHEON

6A8 6A8G

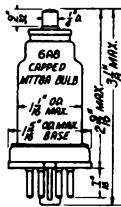

HEPTODE
PENTAGRID CONVERTER
Heater Type
Metal Bulb-6A8 Glass Bulb-6A8G

The 6A8 is a pentagrid type converter tube designed for service as a combined oscillator and mixer in storage battery or a-c operated superheterodyne receivers. The ratings and electrical characteristics are identical with those of the type 6A7.

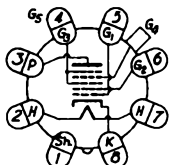

6A8G BASING SAME AS 6A8 EXCEPT NO CONN. TO PIN #1

BOTTOM VIEW OF SOCKET

RATINGS

Heater Voltage (a-c or d-c)	6.3 volts
Heater Current	0.3 amp
Max. Plate Voltage	250 volts
Max. Screen Voltage	100 volts
Max. Grid #2 Voltage	200 volts
Max. Grid #2 Supply	250† volts
Min. Grid #4 Bias	-3 volts
Max. Cathode Current	14 ma

DIRECT INTERELECTRODE CAPACITANCES

	6A8*	6A8G**	
Grid #4 to Plate	0.03	0.3	μuf
Grid #4 to Grid #2	0.1	0.2	μuf
Grid #4 to Grid #1	0.09	0.2	μuf
Grid #1 to Grid #2	0.08	1.3	μuf
Grid #4 to all other El. (r-f input)	12.5	10	μuf
Grid #1 to all other El. (osc. input)	6.5	6	μuf
Grid #2 to all other El. (osc. output)	5	5	μuf
Plate to all other El. (mix. output)	12.5	10	μuf

FREQUENCY CONVERTER - SUPERHETERODYNE CIRCUIT

Plate Voltage	100	250	volts
Screen (Grids #3 and #5) Voltage	50	100	volts
Anode Grid (#2) Voltage	100		volts
Anode Grid Supply Voltage		250†	volts
Control Grid (#4) Bias	-1.5	-3	volts
Oscillator Grid Resistor	50000	50000	ohms
Plate Resistance	0.6	0.3	megohm
Conversion Transconductance	360	550	μmhos
Plate Current	1.1	3.5	ma
Screen Current	1.3	2.7	ma
Anode Grid Current	2.0	4.0	ma
Oscillator Grid Current	0.25	0.4	ma
Control Grid Bias (approximate)	-20	-45	volts

(For Conversion Transconductance = 2 μmhos)

The voltage between heater and cathode should be kept as low as possible where they are not directly connected.

*With shell connected to cathode.

**With tube shield connected to cathode.

†Applied through a 20000 ohm series resistor, bypassed by a 0.1 μf condenser.

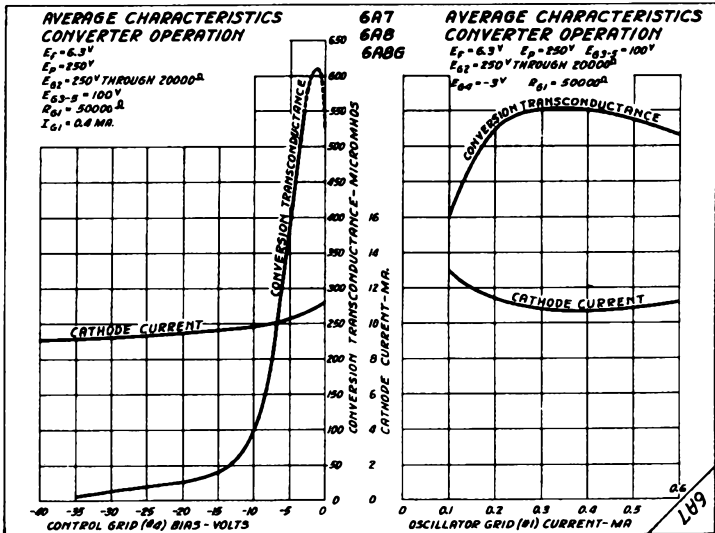

CATHODE RAY TUNING INDICATOR
Heater Type Glass Bulb

The 6AB5 is a high vacuum type indicator tube designed for service as a tuning indicator in radio receivers requiring a low heater current tube.

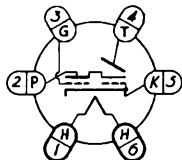

BOTTOM VIEW OF SOCKET

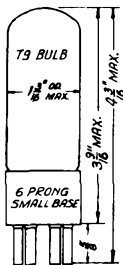

RATINGS

Heater Voltage (a-c or d-c)	6.3	volts
Heater Current	0.150	amp
Max. Plate Supply Voltage	135	volts
Max. Target Voltage	135	volts

TUNING INDICATOR

Plate Supply Voltage	135	volts
Target Voltage	135	volts
Plate Resistor	0.25	megohm
Target Current (approximate)	4.5	ma
Plate Current (zero bias)	0.5	ma
Grid Bias for Shadow Angle = 0°(approx.)	-7.5	volts
Grid Bias for Shadow Angle = 90°(approx.)	0	volts

The 6AB5 is a high-vacuum tube designed to visually indicate the effect of changing the control grid bias. The shaded pattern produced on the fluorescent target varies through an angle from 90° to approximately 0° as the control voltage is varied. The voltage on the shadow control electrode, the extension of the triode plate between the cathode and target, controls the extent of the shaded area. The voltage of the shadow control electrode is determined by the voltage of the control grid of the triode connected as a d-c amplifier. Thus the control grid voltage determines the extent of the shadow. An increase of control grid bias thus increases the shadow control voltage and decreases the shadow while a decrease of bias increases the shadow. In practical use the control grid voltage is obtained from a suitable point in the AVC network.

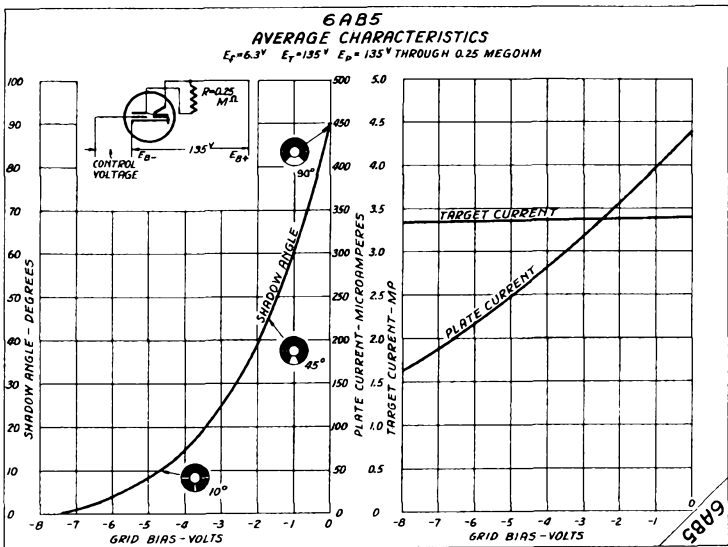

TRIODE
POWER AMPLIFIER
Heater Type Glass Bulb

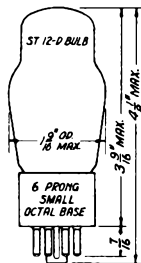

The 6AC5G is a high- μ triode power amplifier tube designed for positive bias Class A₂ operation particularly in a direct or dynamic coupled circuit using a type 76 driver tube. Two 6AC5G tubes are also adapted for use in a Class B stage.

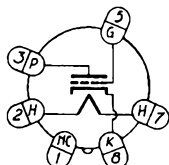

BOTTOM VIEW OF SOCKET

RATINGS

Heater Voltage (a-c or d-c)	6.3	volts
Heater Current	0.4	amp
Maximum Plate Voltage	250	volts
Maximum Peak Plate Current	110	ma
Maximum Plate Dissipation	10	watts

AMPLIFIER - CLASS A

Plate Voltage	250	volts
Grid Bias	+13	volts
Amplification Factor	125	
Plate Resistance	36700	ohms
Transconductance	3400	μmhos
Plate Current	32	ma
Grid Current	5	ma

AMPLIFIER - CLASS A - DIRECT OR DYNAMIC COUPLED

	Single Tube		Push-Pull-Two Tubes		
	1- Type 76 Driver	2- Type 76 Drivers	2- Type 6J5G Drivers	2- Type 6J5G Drivers	
Plate Supply Voltage	250	250	250	250	volts
Grid Bias	*	*	*	*	volts
No-Sig. Plate Current	32	64	48	48	ma
Max. Sig. Plate Current		76	72	72	ma
No-Sig. Driver Plate Current	5.5	10	8	8	ma
Max. Sig. Driver Plate Current		19	20	20	ma
Load Resistance	7000	10000 (P-P)	10000 (P-P)	10000 (P-P)	ohms
Max. Signal Voltage RMS (Driver)	16.5	47 (G-G)	50 (G-G)	50 (G-G)	volts
Total Harmonics	10	10	10	10	percent
Power Output	3.7 †	9.5	9.5	9.5	watts

AMPLIFIER - CLASS B - TWO TUBES

Plate Voltage	250	volts
Grid Bias	0	volts
Signal Peak Voltage (grid to grid)	70	volts
No-Signal Plate Current	5	ma
Load Resistance (plate to plate)	10000	ohms
Power Output (approximate) (With peak input of 950 mw. grid to grid)	8	watts

* No external grid bias is required as the direct or dynamic coupled circuit automatically supplies the proper bias to both tubes. The total d-c resistance in the grid circuit of the type 76 driver tube should not exceed 1.0 megohm.

† Maximum power output at start of driver grid current is 4.3 watts with total harmonic distortion of approximately 16%.

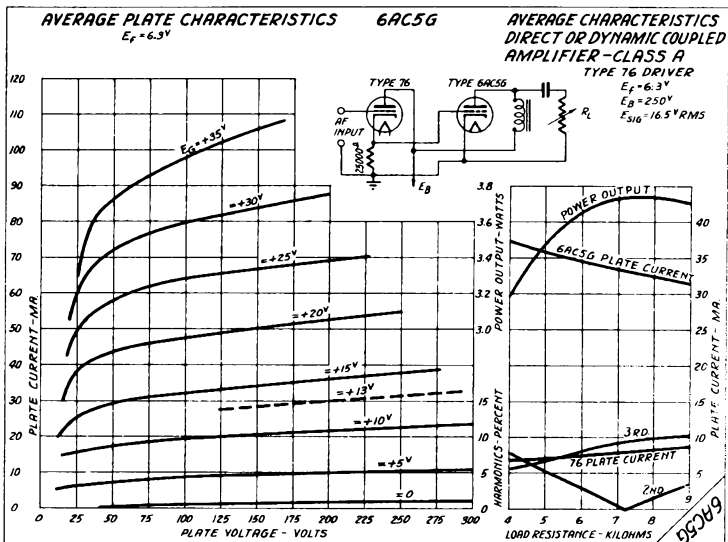

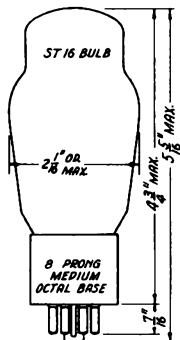

TRIODE
POWER AMPLIFIER
Filament Type Glass Bulb

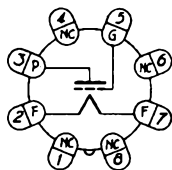

BOTTOM VIEW OF SOCKET

The 6B4G is a triode type power amplifier tube designed for service in the output stage of storage battery or a-c operated receivers. The ratings and electrical characteristics are identical with those of the type 6A3.

RATINGS

Heater Voltage (a-c or d-c)	6.3	volts
Heater Current	1.0	amp
Maximum Plate Voltage	325	volts

DIRECT INTERELECTRODE CAPACITANCES

Grid to Plate	16	μmf
Input	7	μmf
Output	5	μmf

AMPLIFIER - CLASS A

Plate Voltage	250 max.	volts
Grid Bias*	-45	volts
Amplification Factor	4.2	
Plate Resistance	800	ohms
Transconductance	5250	μmhos
Plate Current	60	ma
Load Resistance	2500	ohms
Power Output (5% second harmonic)	3.2	watts

AMPLIFIER - CLASS AB - PUSH-PULL - TWO TUBES

	Fixed-Bias	Self-Bias	
Plate Voltage	325	325	volts
Grid Bias*	-68		volts
Self-Bias Resistor		750	ohms
No-Signal Plate Current (per tube)	40	40	ma
Load Resistance (plate to plate)	3000	5000	ohms
Power Output	15	10	watts
Total Harmonic Distortion	2.5	5	percent

*Grid bias measured from midpoint of a-c operated filament.

For additional curves refer to the type 6A3.

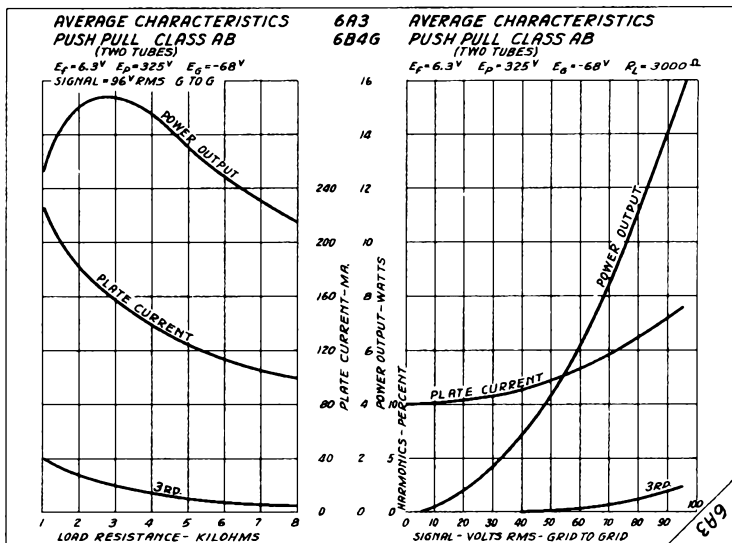

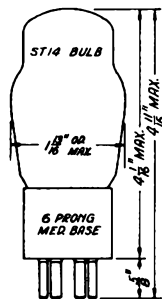

DUO-TRIODE
DIRECT COUPLED POWER AMPLIFIER
Heater Type Glass Bulb

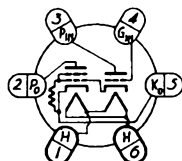

BOTTOM VIEW OF SOCKET

The 6B5 is a direct coupled power amplifier tube designed for service in the output stage of storage battery or a-c operated receivers. The ratings and electrical characteristics are identical with those of the type 6N6G.

RATINGS

Heater Voltage (a-c or d-c)	6.3	volts
Heater Current	0.8	amp
Maximum Plate Voltage	325	volts

AMPLIFIER - CLASS A

Output-Plate Voltage	250	300	325	volts
Input-Plate Voltage	250	300	325	volts
Grid Bias	0	0	0	volts
Amplification Factor		58		
Plate Resistance		24100		ohms
Transconductance		2400		μmhos
Output-Plate Current	33	45	51	ma
Input-Plate Current	6.5	8	9	ma
Load Resistance	7000	7000	7000	ohms
Total Harmonic Dist.	5	5	5	percent
Power Output	2.5	4	5.2	watts
Signal Voltage RMS	13.5	15	17	volts

AMPLIFIER - CLASS A - PUSH-PULL - TWO TUBES

Output-Plate Voltage	250	300	325	volts
Input-Plate Voltage	250	300	325	volts
Grid Bias	0	0	0	volts
Output-Plate Current (per tube)	33	45	51	ma
Input-Plate Current (per tube)	6.5	8	9	ma
Load Resistance (plate to plate)	10000	10000	10000	ohms
Total Harmonic Distortion	5	5	5	percent
Power Output	8.5	10	13.5	watts
Signal Voltage RMS (grid to grid)	38	38	42	volts

The voltage between heater and cathode should not exceed 50 volts and in no case should the heater be left floating.

If a grid resistor is used its value should not exceed 0.5 megohm.

For additional curves refer to the type 6N6G.

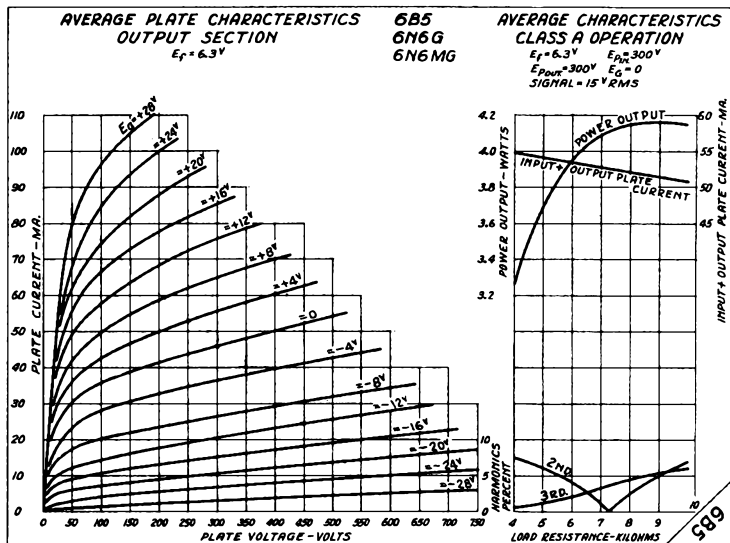

DUO-DIODE TRIODE
DETECTOR AMPLIFIER
Heater Type Glass Bulb



The 6B6G is a duo-diode triode type amplifier tube designed for service as a combined diode detector, AVC rectifier and resistance coupled audio frequency amplifier in storage battery or a-c operated receivers. The ratings and electrical characteristics are identical with those of the type 75.

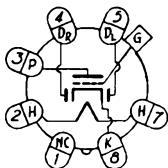

BOTTOM VIEW OF SOCKET

RATINGS

Heater Voltage (a-c or d-o)	6.3	volts
Heater Current	0.3	amp
Maximum Plate Voltage	250	volts

DIRECT INTERELECTRODE CAPACITANCES

Grid to Plate	1.3	μ if
Input	2.7	μ if
Output	4.5	μ if

AMPLIFIER - CLASS A - TRIODE SECTION

Plate Voltage	250	volts
Grid Bias	-2	volts
Amplification Factor	100	
Plate Resistance	91000	ohms
Transconductance	1100	μ mhos
Plate Current	1	ma

DIODE SECTION

The two diodes are independent of each other and of the triode section except for the common cathode. The diodes may be used as a half wave rectifier; or one diode may be used as a half wave rectifier for detection and the other diode used as a rectifier to obtain delayed AVC voltage.

The voltage between heater and cathode should be kept as low as possible where they are not directly connected.

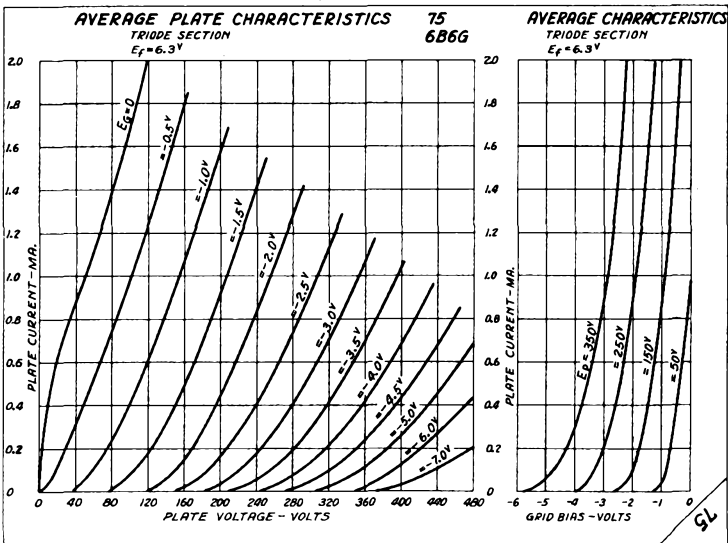

DUO-DIODE PENTODE
DETECTOR AMPLIFIER
Heater Type Glass Bulb



The 6B7 is a duo-diode pentode type amplifier tube designed for service as a combined diode detector, AVC rectifier, and high or audio frequency amplifier in storage battery or a-c operated receivers.

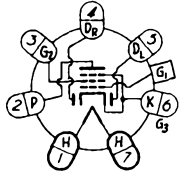

BOTTOM VIEW OF SOCKET

RATINGS

Heater Voltage (a-c or d-c)	6.3	volts
Heater Current	0.3	amp
Maximum Plate Voltage	250	volts
Maximum Screen Voltage	125	volts

DIRECT INTERELECTRODE CAPACITANCES - PENTODE SECTION

Grid to Plate	0.007 max.*	μ f
Input	3.5	μ f
Output	9.5	μ f

AMPLIFIER - CLASS A - PENTODE SECTION

Plate Voltage	100	180	250	250	volts
Screen Voltage	100	75	100	125	volts
Grid Bias	-3	-3	-3	-3	volts
Amplification Factor	285	840	800	730	
Plate Resistance	0.3	1	0.8	0.65	megohm
Transconductance	950	840	1000	1125	μ mbos
Plate Current	5.8	3.4	6	9	ma
Screen Current	1.7	0.9	1.5	2.3	ma
Grid Bias	-17	-13	-17	-21	volts

(For cathode current cutoff)
AMPLIFIER - CLASS A - RESISTANCE COUPLED - PENTODE SECTION

Plate Supply Voltage	250	250	250	volts
Screen Voltage	45	50	100	volts
Grid Bias	-5	-4.5	-3	volts
Plate Resistor	0.5	0.25	0.027	megohm
Plate Current	0.25	0.65	5.4	ma

DIODE SECTION

The two diode units are independent of each other and of the pentode section except for the common cathode. The diodes may be used as a half wave or as a full wave rectifier; or one diode may be used as a half wave rectifier for detection, and the other diode used as a rectifier to obtain delayed AVC voltage.

The voltage between heater and cathode should be kept as low as possible where they are not directly connected.

*With tube shield.

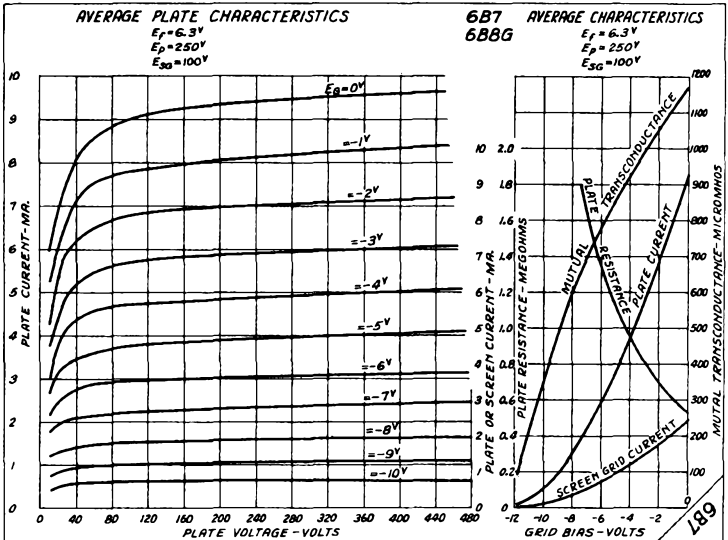

DUO-DIODE PENTODE
DETECTOR AMPLIFIER

Metal Bulb Heater Type

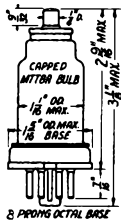

The 6B8 is a duo-diode pentode type amplifier tube designed for service as combined diode detector, AVC rectifier and r-f, i-f, or a-f amplifier.

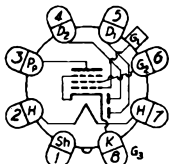

BOTTOM VIEW OF SOCKET

RATINGS

Heater Voltage	6.3 volts
Heater Current	0.3 amp
Max. Plate Voltage	250 volts
Max. Screen Voltage	125 volts

DIRECT INTERELECTRODE CAPACITANCES - PENTODE SECTION
(Shell connected to cathode)

Grid to Plate	0.005	max.	μf
Input	6		μf
Output	9		μf

AMPLIFIER - CLASS A - PENTODE SECTION

Plate Voltage	250	volts
Screen Voltage	125	volts
Grid Bias	-3	volts
Amplification Factor	800	approx.
Plate Resistance	0.6	approx. megohm
Transconductance	1325	μmhos
Plate Current	10	ma
Screen Current	2.3	ma
Grid Bias for Cathode Current Cutoff	-21	approx. volts

DIODE SECTION

The two diode units are independent of each other and of the pentode section except for the common cathode. The diode units may be used as a half wave or as a full wave rectifier; or one diode may be used as a half wave rectifier for detection, and the other diode used as a rectifier to obtain delayed AVC voltage.

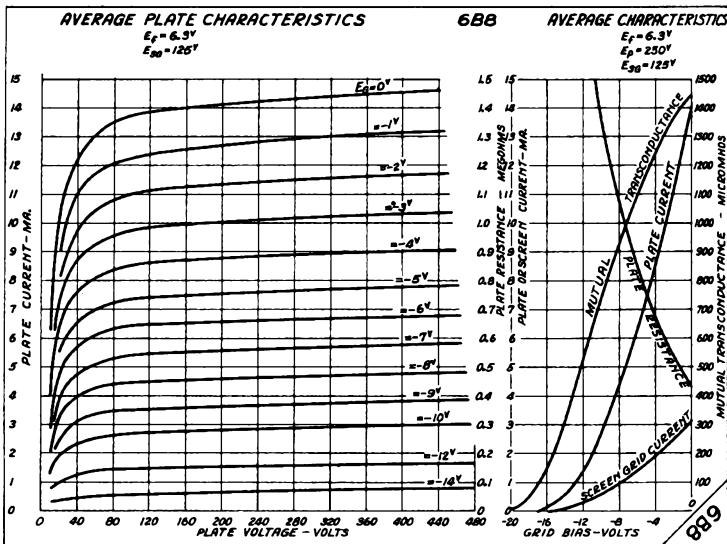

DUO-DIODE PENTODE
DETECTOR AMPLIFIER

Heater Type Glass Bulb

The 6B8G is a duo-diode pentode type amplifier tube designed for service as combined diode detector, AVC rectifier and r-f, i-f, or a-f amplifier.

RATINGS

Heater Voltage	6.3	volts
Heater Current	0.3	amp
Max. Plate Voltage	250	volts
Max. Screen Voltage	125	volts

DIRECT INTERELECTRODE CAPACITANCES - PENTODE SECTION
(With close fitting shield connected to cathode)

Grid to Plate	0.007	max. μf
Input	3.5	μf
Output	9.5	μf

AMPLIFIER - R-F or I-F - PENTODE SECTION

Plate Voltage	100	180	250	250	volts
Screen Voltage	100	75	100	125	volts
Grid Bias	-3	-3	-3	-3	volts
Amplification Factor	285	840	800	730	
Plate Resistance	0.3	1	0.8	0.65	megohm
Transconductance	950	840	1000	1125	μmhos
Plate Current	5.8	3.4	6	9	ma
Screen Current	1.7	0.9	1.5	2.3	ma
Grid Bias	-17	-13	-17	-21	volts

(For Cathode Current Cutoff)

AMPLIFIER - RESISTANCE COUPLED - PENTODE SECTION

Plate Supply Voltage	250	250	250	volts
Screen Voltage	45	50	100	volts
Grid Bias	-5	-4.5	-3	volts
Plate Resistor	0.5	0.25	0.027	megohm
Plate Current	0.25	0.65	5.4	ma

DIODE SECTION

The two diode units are independent of each other and of the pentode section except for the common cathode. The diodes may be used as a half wave or as a full wave rectifier; or one diode may be used as a half wave rectifier for detection, and the other diode used as a rectifier to obtain delayed AVC voltage.

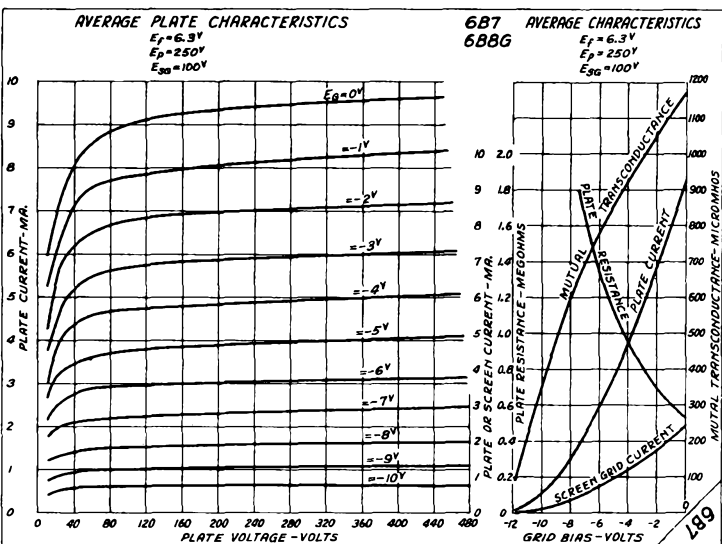

**6C5
6C5G**

RAYTHEON

**6C5
6C5G**

TRIODE
DETECTOR OR AMPLIFIER

Heater Type
Metal Bulb-6C5 Glass Bulb-6C5G

The 6C5 is a triode type amplifier tube designed for service as a detector or amplifier in storage battery or a-c operated receivers.

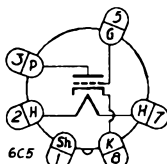

**BOTTOM VIEW OF SOCKET
6C5G - INT. SHIELD
CONNECTED TO #1 PIN**

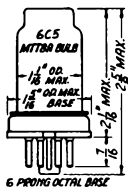

RATINGS

Heater Voltage (a-c or d-c)	6.3 volts
Heater Current	0.3 amp
Maximum Plate Voltage	250 volts

DIRECT INTERELECTRODE CAPACITANCES

	Grid to Plate	Input	Output	
6C5*	1.8	4.0	13	$\mu\mu\text{f}$
6C5G**	2.5	4.5	9.5	$\mu\mu\text{f}$

AMPLIFIER - CLASS A

Plate Voltage	250	volts
Grid Bias	-8	volts
Amplification Factor	20	
Plate Resistance	10000	ohms
Transconductance	2000	μmhos
Plate Current	8	ma

AMPLIFIER - CLASS A - RESISTANCE COUPLED

Plate Supply Voltage	250	volts
Grid Bias (approximate)	-5	volts
Plate Resistor	50000 to 10000	ohms
Plate Current	1 to 2	ma
Voltage Amplification	14	
Voltage Output (5% second harmonic) RMS	42	volts

DETECTOR - BIASED TYPE

Plate Voltage	250	volts
Grid Bias (approximate)	-17	volts
Plate Current	Adjusted to 0.2 ma. with no signal	

DETECTOR - GRID LEAK TYPE

Plate Voltage	45 to 100	volts
Grid	Return to Cathode	
Grid Leak Resistance	0.1 to 1.0	megohm
Grid Condenser	0.00005 to 0.0005	μf

The voltage between heater and cathode should be kept as low as possible where they are not directly connected.

*With shell connected to cathode.

**Internal shield connected to cathode.

**AVERAGE PLATE CHARACTERISTICS
 $E_f = 6.3V$**

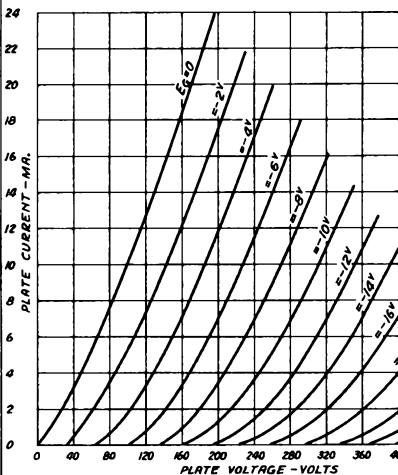

**6C5
6C5G**

**AVERAGE CHARACTERISTICS
 $E_f = 6.3V$
 $E_p = 250V$**

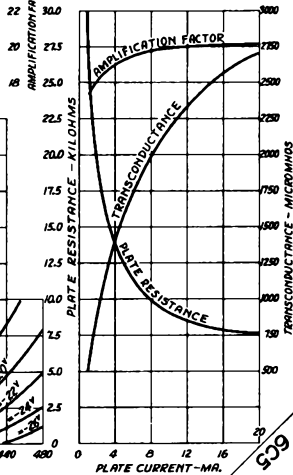

PENTODE
DETECTOR OR AMPLIFIER
Heater Type Glass Bulb

The 6C6 is a pentode type amplifier tube designed for service as a detector or high frequency amplifier in storage battery or a-c operated receivers.

RATINGS

Heater Voltage (a-c or d-c)	6.3 volts
Heater Current	0.3 amp
Maximum Plate Voltage	250 volts
Maximum Screen Voltage	100 volts

DIRECT INTERELECTRODE CAPACITANCES

	Pentode Connection	Triode Connection†
Grid to Plate	0.007 max.*	2.0 μf
Input	5.0	3.0 μf
Output	6.5	10.5 μf

AMPLIFIER - CLASS A

	Pentode Connection	Triode Connection†
Plate Voltage	100 250	250 volts
Screen Voltage	100 100	volts
Grid Bias	-3 -3	-8 volts
Suppressor	Connected to Cathode at Socket	
Amplification Factor	1185 1500 min.	20 approx.
Plate Resistance	1 1.5 min.	0.0105 megohm
Transconductance	1185 1225	1900 μmhos
Plate Current	2 2	6.5 ma
Screen Current	0.5 0.5	ma
Grid Bias (approximate)	-7 -7	volts

(For cathode current cutoff)

DETECTOR - BIASED TYPE

	100	100	250	250	volts
Plate Supply Voltage	100	100	250	250	volts
Screen Voltage	12	30	50	100	volts
Grid Bias	-1.16	-1.83	-1.95	-4.3	volts
Cathode Resistor	18000	10000	3000	10000	ohms
Suppressor	Connected to Cathode at Socket				
Cathode Current (no signal)	0.063	0.183	0.65	0.43	ma
Plate Resistor	1.0	0.25	0.25	0.5	megohm
Blocking Condenser	0.01	0.01	0.03	0.03	μf
Grid Resistor (for following tube)	1.0	0.5	0.25	0.25	megohm
R-F Signal Voltage (RMS)	1.05	1.6	1.18	1.37	volts
Output Peak Voltage	17	17	17	17	volts

(At grid of following tube with signal modulated 20%)

The shield in the dome of the tube is connected internally to the cathode. The voltage between heater and cathode should be kept as low as possible where they are not directly connected.

*With tube shield.

†Grids #2 and #3 connected to plate.

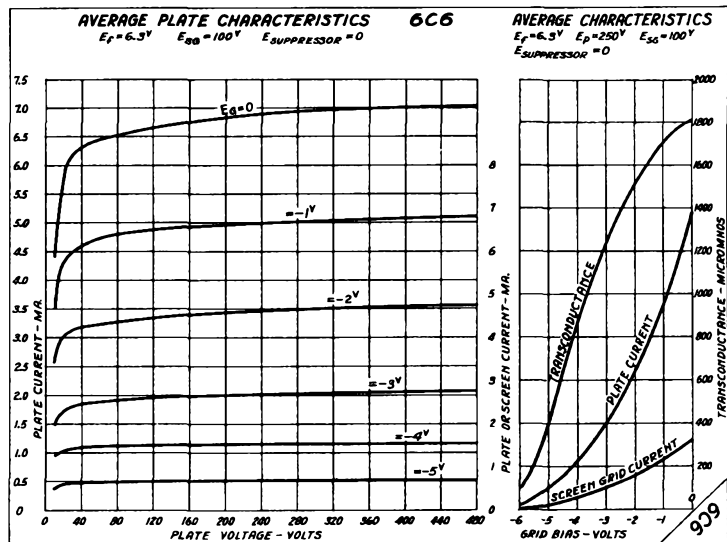

TWIN TRIODE
AMPLIFIER

Heater Type Glass Bulb

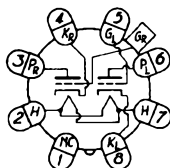
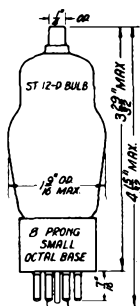

BOTTOM VIEW OF SOCKET

The 6C8G is a twin triode type amplifier tube designed for service as voltage amplifier or phase inverter. The triode units are independent of each other as the elements of each triode are brought out to separate terminals.

RATINGS

Heater Voltage (a-o or d-o)	6.3 volts
Heater Current	0.3 amp
Max. Plate Voltage	250 volts

DIRECT INTERELECTRODE CAPACITANCES

	Triode L (Triode R to Cathode)	Triode R (Triode L to Cathode)	
Grid to Plate	2.5	2.4	μ f
Input	3.4	2.5	μ f
Output	3.5	3.9	μ f
Grid to Grid		0.1	μ f
Plate to Plate		1.5	μ f

AMPLIFIER - CLASS A - EACH TRIODE

Plate Voltage	250	volts
Grid Bias	-4.5	volts
Amplification Factor	38	
Plate Resistance	26000	ohms
Transconductance	1450	umhos
Plate Current	3.1	ma

PHASE INVERTER

Plate Supply Voltage	250	250	volts
Grid Bias	-3	-3	volts
Plate Current (per plate)	1.7	1	ma
Plate Resistor (per plate)	0.05	0.1	megohm
Grid Resistor (following tubes)	0.1	0.5	megohm
Maximum Output Voltage RMS (G to G)	60	80	volts
Cathode Resistor (common to both triodes)	900	1500	ohms

The voltage between heater and cathode should be kept as low as possible where they are not directly connected.

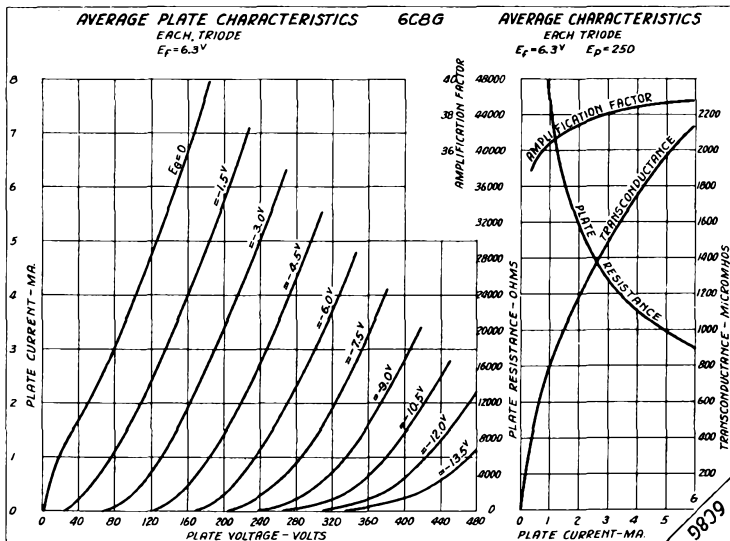

PENTODE
REMOTE CUTOFF AMPLIFIER
Heater Type Glass Bulb



The 6D6 is a pentode type amplifier tube with remote cutoff characteristics designed for service as a high frequency amplifier or mixer in storage battery or a-c operated receivers. The ratings and electrical characteristics are identical with those of the type 6U7G.

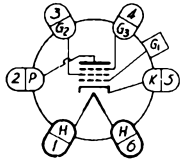

BOTTOM VIEW OF SOCKET

RATINGS

Heater Voltage (a-c or d-c)	6.3	volts
Heater Current	0.3	amp
Maximum Plate Voltage	250	volts
Maximum Screen Voltage	100	volts

DIRECT INTERELECTRODE CAPACITANCES

Grid to Plate	0.007 max. *	μmf
Input	5.0	μmf
Output	6.5	μmf

AMPLIFIER - CLASS A

Plate Voltage	100	250	volts
Screen Voltage	100	100	volts
Grid Bias	-3	-3	volts
Suppressor	Connected to Cathode at Socket		
Amplification Factor	375	1280	
Plate Resistance	0.25	0.8	megohm
Transconductance	1500	1600	μmhos
Plate Current	8	8.2	ma
Screen Current	2.2	2	ma
Grid Bias for Transconductance = 2 μmhos	-50	-50	volts

MIXER - SUPERHETERODYNE CIRCUIT

Plate Voltage	100	250	volts
Screen Voltage	100	100	volts
Grid Bias	-10	-10	volts
Suppressor	Connected to Cathode at Socket		

The grid bias is not critical with an oscillator peak swing 1 volt less than the grid bias.

The voltage between heater and cathode should be kept as low as possible where they are not directly connected.

The shield in the dome of the tube is connected internally to the cathode.

*With tube shield.

For additional curves refer to the type 6U7G.

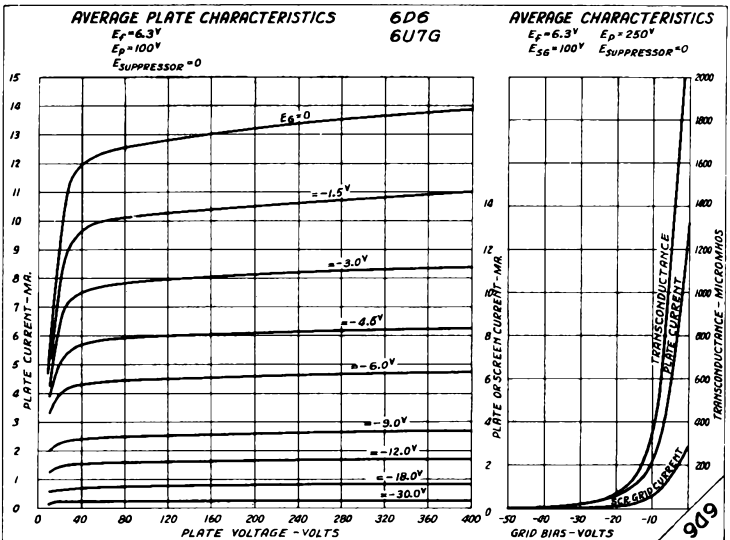

HEPTODE
PENTAGRID CONVERTER

Heater Type

Glass Bulb

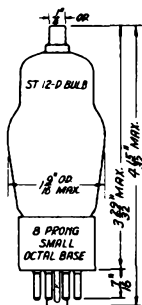

The 6D8G is a pentagrid type converter tube designed for service as a combined oscillator and mixer in storage battery or a-c operated receivers requiring a low heater current tube.

RATINGS

Heater Voltage (a-c or d-c)	6.3 volts
Heater Current	0.150 amp
Max. Plate Voltage	250 volts
Max. Screen Voltage	100 volts
Max. Grid #2 Voltage	200 volts
Max. Grid #2 Supply	250† volts
Min. Grid #4 Bias	-3 volts
Max. Cathode Current	13 ma

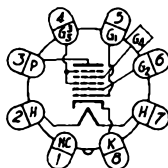

BOTTOM VIEW OF SOCKET

DIRECT INTERELECTRODE CAPACITANCES*

Grid #4 to Plate	0.3	μuf
Grid #4 to Grid #2	0.2	μuf
Grid #4 to Grid #1	0.2	μuf
Grid #1 to Grid #2	1.3	μuf
Grid #4 to all other Elements (R-F input)	8.8	μuf
Grid #1 to all other Elements (Osc. input)	6	μuf
Grid #2 to all other Elements (Osc. output)	5	μuf
Plate to all other Elements (Mixer output)	11	μuf

FREQUENCY CONVERTER - SUPERHETERODYNE CIRCUIT

Plate Voltage	135	250	volts
Screen (Grids #3 and #5) Voltage	67.5	100	volts
Anode Grid (#2) Voltage	135		volts
Anode Grid Supply Voltage		250†	volts
Control Grid (#4) Bias	-3	-3	volts
Oscillator Grid (#1) Resistor	50000	50000	ohms
Plate Resistance		0.32	megohm
Conversion Transconductance	325	500	μmhos
Plate Current	1.2	3.3	ma
Screen Current	2	3.2	ma
Anode Grid Current	3.4	4	ma
Oscillator Grid Current	0.45	0.5	ma
Control Grid Bias	-25	-38.5	volts
(For Conversion Transconductance = 10 μmhos)			
Grid #1 to Grid #2 Transconductance	1150	1000	μmhos
(At 0 volts bias on Grid #1)			

†Applied through a 20000 ohm series resistor, bypassed by a 0.1 μf. condenser.

*With tube shield connected to cathode.

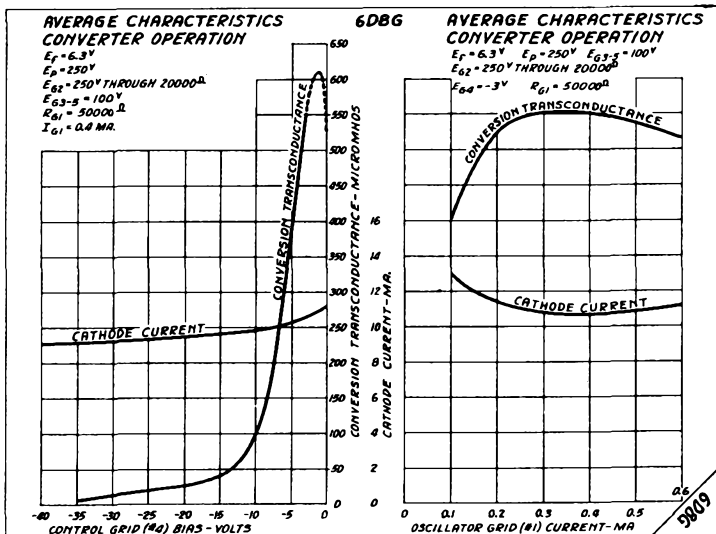

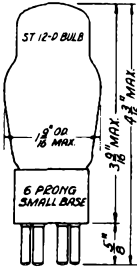

CATHODE RAY TUNING INDICATOR
Heater Type Glass Bulb

The 6E5 is a high vacuum type indicator tube designed for service as a tuning indicator in radio receivers.

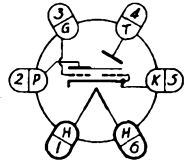

BOTTOM VIEW OF SOCKET

RATINGS

- Heater Voltage (a-c or d-c)
- Heater Current
- Maximum Plate Supply Voltage
- Maximum Target Voltage
- Minimum Target Voltage

6.3	volts
0.3	amp
250	volts
250	volts
90	volts

TUNING INDICATOR

Plate Supply Voltage	100	200	250	volts
Target Voltage	100	200	250	volts
Plate Resistor	0.5	1	1	megohm
Target Current (approx.)	4.5	4.5	4.5	ma
Plate Current (zero bias)	0.19	0.19	0.24	ma
Grid Bias (approx.) (For shadow angle = 0°)	-3.3	-6.5	-8	volts
Grid Bias (approx.) (For shadow angle = 90°)	0	0	0	volts

The 6E5 is a high vacuum tube designed to visually indicate the effect of changing the control grid bias. The shaded pattern produced on the fluorescent target varies through an angle from 90° to approximately 0° as the control voltage is varied. The voltage on the shadow control electrode, the extension of the triode plate between the cathode and target, controls the extent of the shaded area. The voltage of the shadow control electrode is determined by the voltage of the control grid of the triode connected as a d-c amplifier. Thus the control grid voltage determines the extent of the shadow. An increase of control grid bias thus increases the shadow control voltage and decreases the shadow while a decrease of bias increases the shadow. In practical use the control grid voltage is obtained from a suitable point in the AVC network.

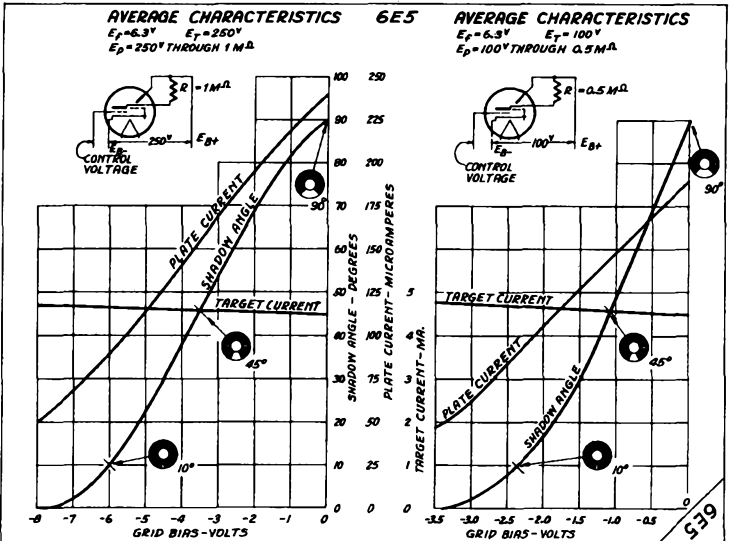

TWIN TRIODE
POWER AMPLIFIER
Heater Type Glass Bulb

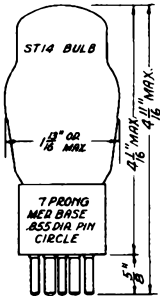

The 6E6 is a twin triode type power amplifier tube designed for service as a Class A push-pull amplifier in the output stage of storage battery or a-c operated receivers.

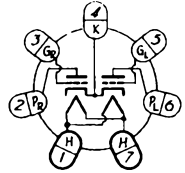

BOTTOM VIEW OF SOCKET

RATINGS

Heater Voltage (a-c or d-c)	6.3	volts
Heater Current	0.6	amp
Maximum Plate Voltage	250	volts

AMPLIFIER - CLASS A - EACH TRIODE

Plate Voltage	180	250	volts
Grid Bias	-20	-27.5	volts
Amplification Factor	6	6	
Plate Resistance	4300	3500	ohms
Transconductance	1400	1700	μmhos
Plate Current	11.5	18	ma

AMPLIFIER - CLASS A - PUSH-PULL

Plate Voltage	180	250	volts
Grid Bias	-20	-27.5	volts
Plate Current (per plate)	11.5	18	ma
Load Resistance (plate to plate)	15000	14000	ohms
Power Output	0.75	1.6	watts

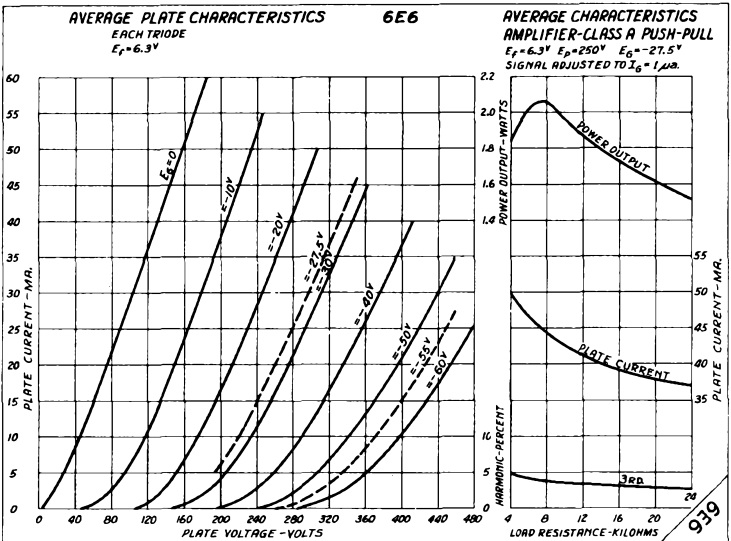

9339

**6F5
6F5G**

RAYTHEON

**6F5
6F5G**

TRIODE
AMPLIFIER
Heater Type
Metal Bulb-6F5 Glass Bulb-6F5G

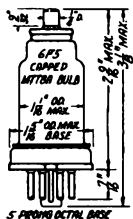

The 6F5 is a triode type amplifier tube designed for service as a resistance coupled audio frequency amplifier in storage battery or a-c operated receivers.

RATINGS

Heater Voltage (a-c or d-c)	6.3	volts
Heater Current	0.3	amp
Maximum Plate Voltage	250	volts

DIRECT INTERELECTRODE CAPACITANCES

	Grid to Plate	Input	Output	
6F5*	2.0	6	12	μ f
6F5G	2.0	2.5	3.5	μ f

AMPLIFIER - CLASS A

Plate Voltage	250	volts
Grid Bias†	-2	volts
Amplification Factor	100	
Plate Resistance	66000	ohms
Transconductance	1500	μ mhos
Plate Current	0.9	ma

AMPLIFIER - CLASS A - RESISTANCE COUPLED

Plate Supply Voltage	250	250	volts
Grid Bias	-1.3	-1.3	volts
Plate Resistor	0.25 to 1.0	0.25 to 1.0	megohm
Grid Resistor‡	0.25	0.5	megohm
Plate Current	0.2 to 0.4	0.2 to 0.4	ma
Voltage Output (RMS) †	11 to 20	14.5 to 25.5	volts
(5% second harmonic)			
Voltage Amplification	52 to 56	51 to 60	

The voltage between heater and cathode should be kept as low as possible where they are not directly connected.

*With shell connected to cathode

†The d-c resistance in the grid circuit should not exceed 1 megohm.

‡For following tube

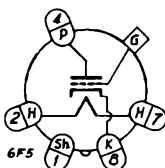

**BOTTOM VIEW OF SOCKET
6F5G - NO CONNECTION
TO #1 PIN**

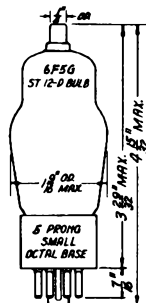

AVERAGE PLATE CHARACTERISTICS
 $E_f = 6.3V$

**6F5
6F5G**

AVERAGE CHARACTERISTICS
 $E_f = 6.3V$

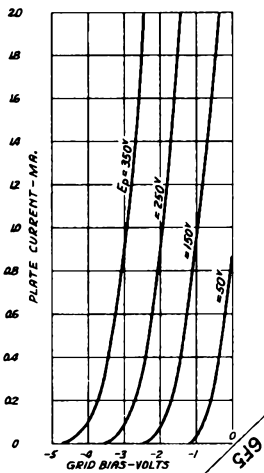
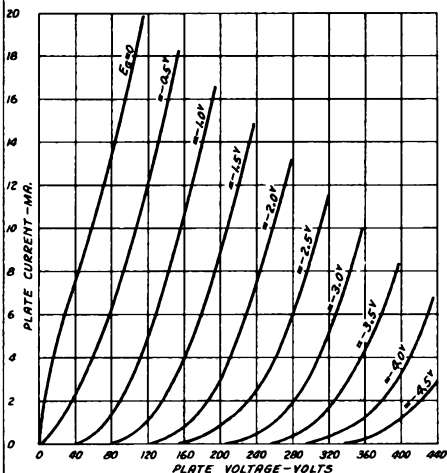

6F6 6F6G

RAYTHEON

6F6 6F6G

PENTODE
POWER AMPLIFIER
Heater Type
Metal Bulb-6F6 Glass Bulb-6F6G

The 6F6 is a pentode type power amplifier tube designed for service in the output stage of storage battery or a-c operated receivers. The ratings and electrical characteristics are identical with those of the type 42.

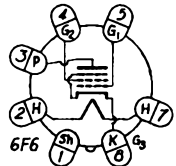

BOTTOM VIEW OF SOCKET
6F6G - NO CONNECTION TO #1 PIN

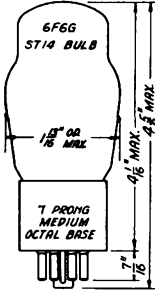
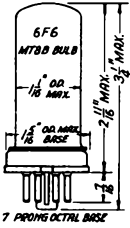

RATINGS

Heater Voltage (a-c or d-c)	6.3 volts
Heater Current	0.7 amp
Maximum Plate Voltage	315 volts
Maximum Screen Voltage	315 volts

AMPLIFIER - CLASS A

	Pentode Connection		Triode Connection†		
Plate Voltage	250	315	250 max.		volts
Screen Voltage	250	315			volts
Grid Bias	-16.5	-22	-20		volts
Amplification Factor	200‡	200‡	7		
Plate Resistance	80000‡	75000‡	2600		ohms
Transconductance	2500	2650	2700		μmhos
Plate Current	34	42	31		ma
Screen Current	6.5	8			ma
Load Resistance	7000	7000	4000		ohms
Total Harmonic Dist.	7	7	5		percent
Power Output	3	5	0.85		watts

AMPLIFIER - CLASS AB - TWO TUBES

	Pentode Connection		Triode Connection†		
	Fixed-Bias	Self-Bias	Fixed-Bias	Self-Bias	
Plate Voltage	375 max.	375 max.	350 max.	350 max.	volts
Screen Voltage	250 max.	250 max.			volts
Grid Bias	-26 min.		-38		volts
Self-Bias Resistor		340 min.		730 min.	ohms
Signal Pk. Volt. (G to G)	82	94	123	132	volts
No-Signal Plate Current	34	54	45	50	ma
No-Signal Screen Current	5	8			ma
Load Resistance (P to P)	10000	10000	6000	10000	ohms
Total Harmonic Dist.	5	5	7	7	percent
Power Output (approx.)#	19*	19A	18**	14‡	watts

#With one 6F6 or 6F6G triode connected as driver operated at plate voltage of 250 volts, grid bias of -20 volts and plate load of approximately 10000 ohms.

*Input transformer ratio, primary to 1/2 secondary = 3.32

ΔInput transformer ratio, primary to 1/2 secondary = 2.5

**Input transformer ratio, primary to 1/2 secondary = 1.67

‡Input transformer ratio, primary to 1/2 secondary = 1.29

†Screen connected to plate.

‡Approximate

For additional curves refer to the type 42.

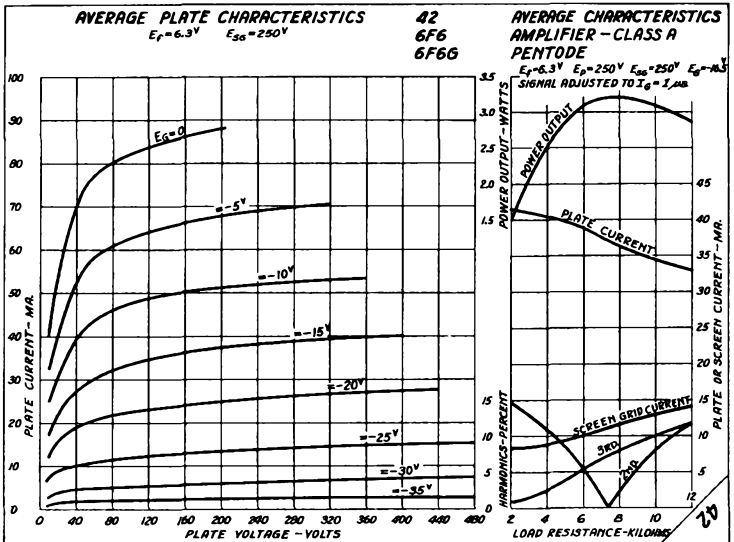

TRIODE-PENTODE
AMPLIFIER OR CONVERTER

Heater Type Glass Bulb

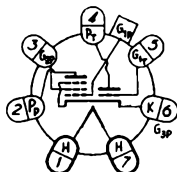
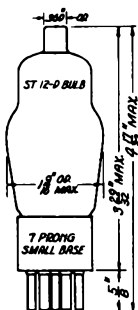

BOTTOM VIEW OF SOCKET

The 6F7 is a duplex tube, combining in one bulb a triode and a remote cutoff pentode, designed for service as an oscillator and mixer or as a high frequency amplifier and second detector, in storage battery or a-c operated receivers. The ratings and electrical characteristics are identical with those of the type 6P7G.

RATINGS

Heater Voltage (a-c or d-c)	6.3	volts
Heater Current	0.3	amp

DIRECT INTERELECTRODE CAPACITANCES

	Grid to Plate	Input	Output	
Triode Section **	2.0	2.5	3.0	μuf
Pentode Section **	0.008 max. #	3.2	12	μuf

AMPLIFIER - CLASS A

	Triode Section	Pentode Section	
Plate Voltage	100 max.	100	250 max. volts
Screen Voltage		100	100 max. volts
Grid Bias	-3	.3	-3 min. volts
Amplification Factor	8	300	900
Plate Resistance	0.016	0.29	0.85 megohm
Transconductance	500	1050	1100 μmhos
Plate Current	3.5	6.3	6.5 ma
Screen Current		1.6	1.5 ma
Transconductance (at -35 volts bias)		9	10 μmhos

FREQUENCY CONVERTER

	Triode Section	Pentode Section	
Maximum Plate Voltage	100	250	volts
Maximum Screen Voltage		100	volts
Minimum Grid Bias	†	-3 #	volts
Maximum Oscillator Plate Current (average)	4		ma

Typical Operation:

Plate Voltage	100†	250	volts
Screen Voltage		100	volts
Grid Bias	†	-10 Δ	volts
Plate Resistance		2	megohm
Conversion Transconductance		300	μmhos
Plate Current	2.4	2.8	ma
Grid Current	0.15	0	ma
Screen Current		0.6	ma
Oscillator Peak Voltage Input		7	volts

The voltage between heater and cathode should be kept as low as possible where they are not directly connected.

†With tube shield. ‡Other section connected to ground.

‡Usually obtained by means of a grid leak.

#Grid bias should be at least 3 volts greater than the peak oscillator voltage applied to the pentode grid.

ΔMay be obtained from 250 volt supply through 60000 ohm series resistor.

∇Obtained by means of 1700 ohm cathode resistor.

For additional curves refer to the type 6P7G.

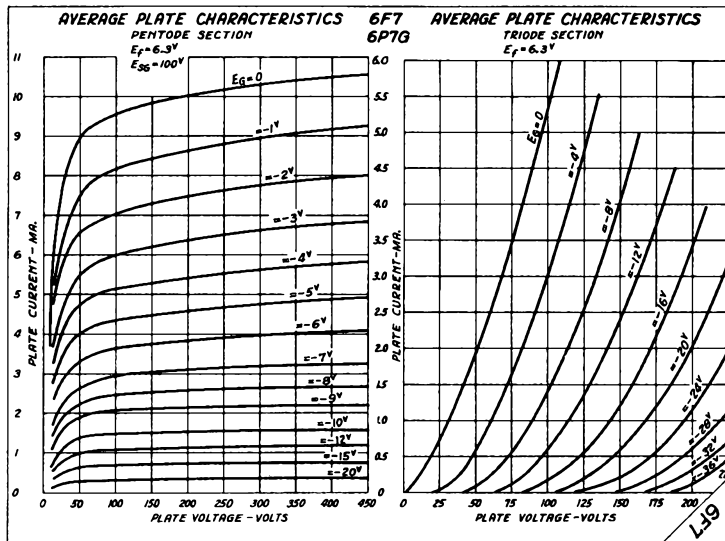

TWIN TRIODE
AMPLIFIER

Heater Type Glass Bulb

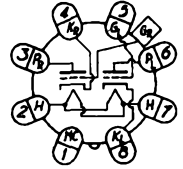

BOTTOM VIEW OF SOCKET

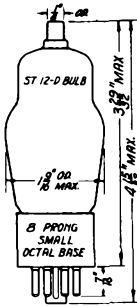

The 6F8G is a twin triode type amplifier tube designed for service as a voltage amplifier. The ratings and electrical characteristics of each triode unit are identical with those of the type 6J5G. The triode units are independent of each other as the elements of each triode are brought out to separate terminals.

RATINGS

Heater Voltage (a-c or d-c)	6.3	volts
Heater Current	0.6	amp
Maximum Plate Voltage	250	volts

DIRECT INTERELECTRODE CAPACITANCES

	TRIODE L (Triode R to Ground)	TRIODE R (Triode L to Ground)	
Grid to Plate	4.5	4.16	μ lf
Input	3.3	3.0	μ lf
Output	1.5	2.0	μ lf
Grid to Grid		0.13	μ lf
Plate to Plate		1.2	μ lf
Grid R to Plate L		0.2	μ lf

AMPLIFIER -CLASS A - EACH TRIODE

Plate Voltage	250	volts
Grid Bias	-8	volts
Amplification Factor	20	
Plate Resistance (approximate)	7700	ohms
Transconductance (approximate)	2600	μ mhos
Plate Current	9	ma

The voltage between heater and cathode should be kept as low as possible where they are not directly connected.

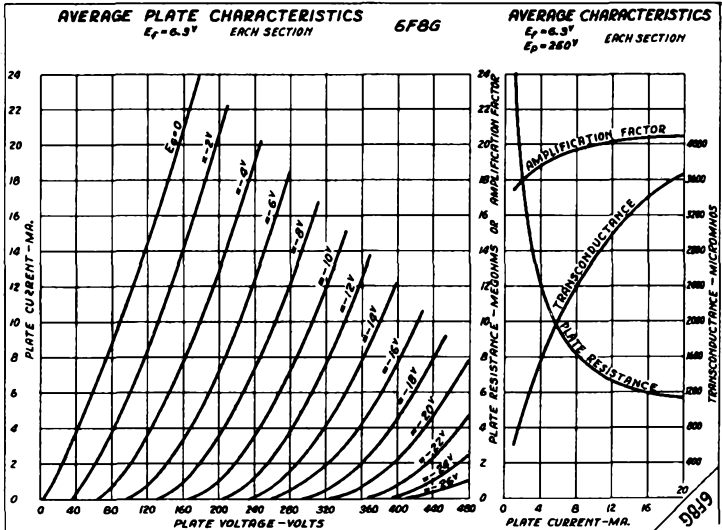

CATHODE RAY TUNING INDICATOR
Heater Type Glass Bulb

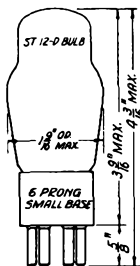

The 6G5/6H5 is a high vacuum type indicator tube with remote cutoff characteristics designed for service as a tuning indicator in radio receivers. The ratings and electrical characteristics are identical with those of the type 6U5.

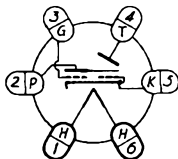

BOTTOM VIEW OF SOCKET

RATINGS

Heater Voltage (a-c or d-c)	6.3	volts
Heater Current	0.3	amp
Maximum Plate Supply Voltage	250	volts
Maximum Target Voltage	250	volts
Minimum Target Voltage	90	volts

TUNING INDICATOR

Plate Supply Voltage	100	200	250	volts
Target Voltage	100	200	250	volts
Plate Resistor	0.5	1	1	megohm
Target Current (approximate)	4.5	4.5	4.5	ma
Plate Current (zero bias)	0.19	0.19	0.24	ma
Grid Bias (approximate)	-8	-18.5	-22	volts
(For shadow angle = 0°)				
Grid Bias (approximate)	0	0	0	volts
(For shadow angle = 90°)				

The 6G5/6H5 is a high vacuum tube designed to visually indicate the effect of changing the control grid bias. The shaded pattern produced on the fluorescent target varies through an angle from 90° to approximately 0° as the control voltage is varied. The voltage on the shadow control electrode, the extension of the triode plate between the cathode and target, controls the extent of the shaded area. The voltage of the shadow control electrode is determined by the voltage of the control grid of the triode connected as a d-c amplifier. Thus the control grid voltage determines the extent of the shadow. An increase of control grid bias thus increases the shadow control voltage and decreases the shadow while a decrease of bias increases the shadow. In practical use the control grid voltage is obtained from a suitable point in the AVC network.

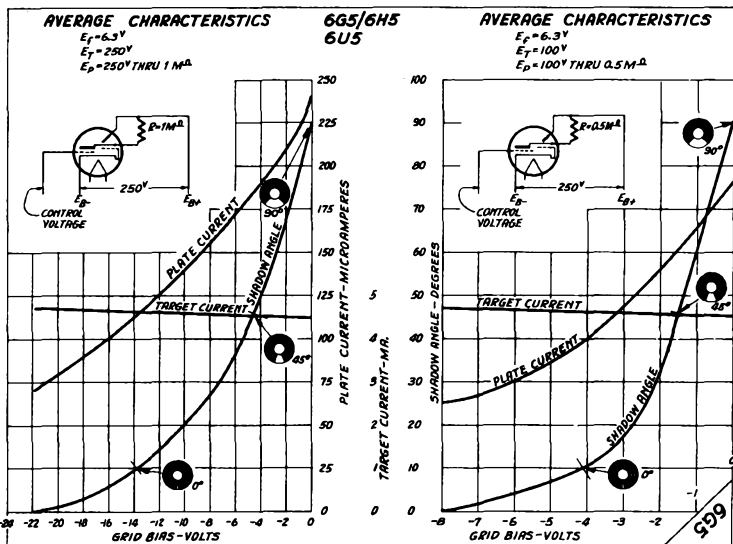

PENTODE
POWER AMPLIFIER
Heater Type Glass Bulb

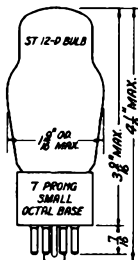

The 6G6G is a pentode type power amplifier tube designed for service in the output stage of receivers where maximum overall efficiency is required.

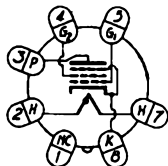

BOTTOM VIEW OF SOCKET

RATINGS

Heater Voltage (a-c or d-c)	6.3	volts
Heater Current	0.15	amp
Maximum Plate Voltage	180	volts
Maximum Screen Voltage	180	volts

AMPLIFIER - CLASS A

Plate Voltage	135	180	volts
Screen Voltage	135	180	volts
Grid Bias	-8 *	-9 *	volts
Self-Bias Resistor	440	510	ohms
Amplification Factor	360	400	
Plate Resistance	0.170	0.175	megohm
Transconductance	2100	2300	μmhos
Plate Current	11.5	15	ma
Screen Current	2	2.5	ma
Load Resistance	12000	10000	ohms
Total Harmonic Distortion	7.5	10	percent
Power Output	0.6	1.1	watts

The voltage between heater and cathode should be kept as low as possible where they are not directly connected.

* Transformer or impedance input systems are recommended. If resistance coupling is used the d-c resistance in the grid circuit should not exceed 0.5 megohm with self-bias. With fixed-bias the d-c grid circuit resistance should not exceed 0.5 megohm under the 135 volt operating conditions or 0.05 megohm under the 180 volt conditions.

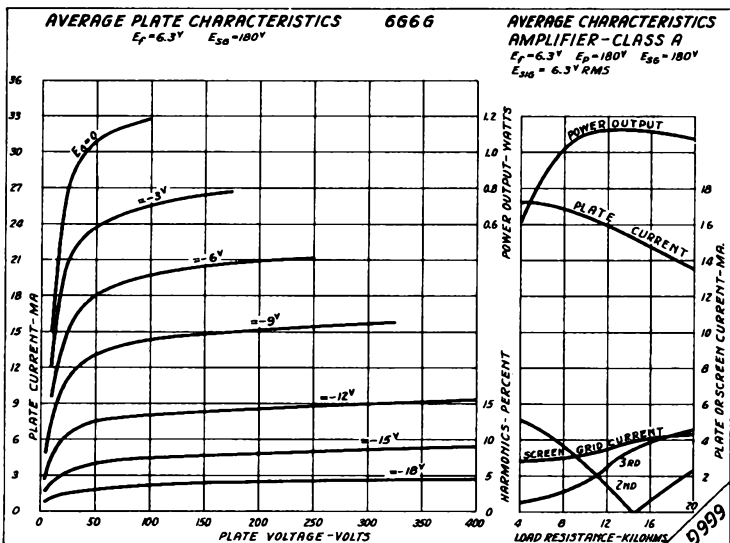

6H6 6H6G

RAYTHEON

6H6 6H6G

TWIN DIODE
DETECTOR
Heater Type

Metal Bulb-6H6 Glass Bulb-6H6G

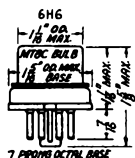

The 6H6 is a twin diode tube designed for service as a diode detector and AVC rectifier or as a low current rectifier in storage battery or a-c operated receivers.

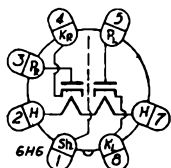

**BOTTOM VIEW OF SOCKET
6H6G-INT. SHIELD
CONNECTED TO #1 PIN**

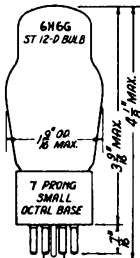

RATINGS

Heater Voltage (a-c or d-c)	6.3	volts
Heater Current	0.3	amp
Maximum A-C Voltage per Plate (RMS)	100	volts
Maximum D-C Output Current	4	ma

DIRECT INTERELECTRODE CAPACITANCES

	Plate to Plate	Plate to Cathode	
6H6*	0.02 max.	1.2	μ f
6H6G**	0.4	1.5	μ f

The voltage between heater and cathode should be kept as low as possible where they are not directly connected.

*With shell connected to cathode.
**With internal shield connected to cathode.

6J5
6J5G

RAYTHEON

6J5
6J5G

TRIODE
AMPLIFIER
Heater Type
Metal Bulb-6J5 Glass Bulb-6J5G

The 6J5 is a triode type amplifier tube designed for service in storage battery or a-c operated receivers.

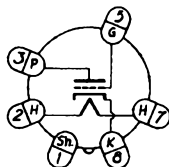

BOTTOM VIEW OF SOCKET
6J5G-NO CONNECTION
TO #1 PIN

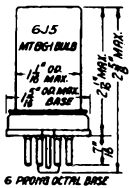

6 PRONG OCTAL BASE

RATINGS

Heater Voltage (a-c or d-c) 6.3 volts
Heater Current 0.3 amp
Maximum Plate Voltage 250 volts

DIRECT INTERELECTRODE CAPACITANCES

	Grid to Plate	Input	Output	
6J5	3.4	3.4	3.6	μf
6J5G	3.4	3.8	3.3	μf

AMPLIFIER - CLASS A

Plate Voltage 250 volts
Grid Bias -8 volts
Amplification Factor 20
Plate Resistance 7700 ohms
Transconductance 2600 μmhos
Plate Current 9 ma

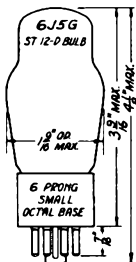

6 PRONG SMALL OCTAL BASE

The voltage between heater and cathode should be kept as low as possible where they are not directly connected.

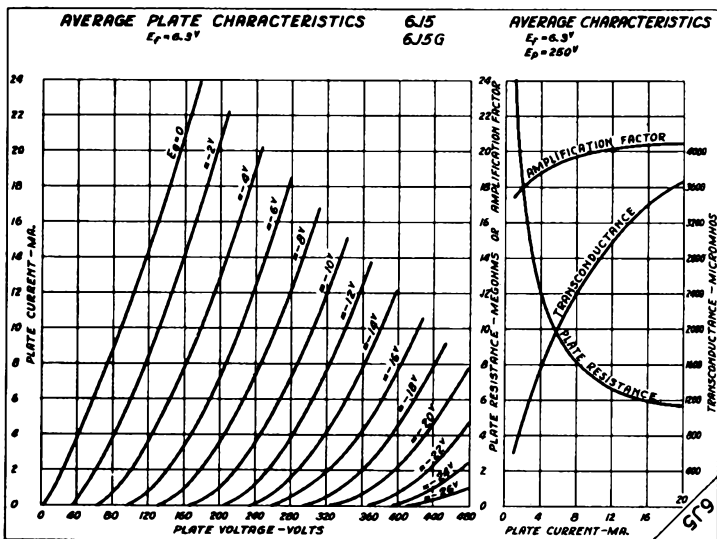

6J7
6J7G

RAYTHEON

6J7
6J7G

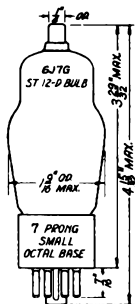
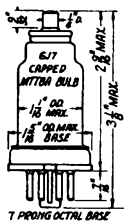

PENTODE
DETECTOR OR AMPLIFIER
Heater Type

Metal Bulb-6J7 Glass Bulb-6J7G

The 6J7 is a pentode type amplifier tube designed for service as a detector or high frequency amplifier in storage battery or a-c operated receivers.

RATINGS

Heater Voltage	6.3 volts
Heater Current	0.3 amp
Max. Plate Voltage	250 volts
Max. Screen Voltage	125 volts

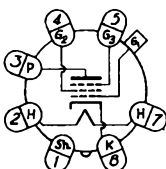

6J7G BASING SAME AS 6J7, EXCEPT SHIELD CAGE CONN. TO PIN #1
BOTTOM VIEW OF SOCKET

DIRECT INTERELECTRODE CAPACITANCES

	GRID TO PLATE	INPUT	OUTPUT	
* 6J7	0.005 max.	7	12	μmf
**6J7G	0.005 max.	4.5	12	μmf

AMPLIFIER - CLASS A

Plate Voltage	100	250	volts
Screen Voltage	100	100	volts
Grid Bias	-3	-3	volts
Suppressor	Connected to Cathode at Socket		
Amplification Factor	1185	1500 min.	
Plate Resistance	1	1.5 min.	megohms
Transconductance	1185	1225	μmhos
Plate Current	2	2	ma
Screen Current	0.5	0.5	ma
Grid Bias	-7	-7	approx. volts

(For Cathode Current Cutoff)

DETECTOR - GRID BIASED TYPE

Plate Supply Voltage	250	250	250	250	volts
Screen Voltage	50	33	100	100	volts
Grid Bias	-2	-1.7	-3.9	-4.3	volts
Cathode Resistor	3000	3000	4000	10000	ohms
Suppressor	Connected to Cathode at Socket				
Cathode Current (No Signal)	0.65	0.21	0.97	0.43	ma
Plate Resistor	0.25	0.5	0.25	0.5	megohm
Blocking Condenser	0.03	0.03	0.03	0.03	μf
Grid Resistor (For Following Tube)	0.25	0.25	0.25	0.25	megohm
R-F Signal Voltage (RMS)	1.18	1.21	1.38	1.37	volts
Output Peak Voltage	17	17	17	17	volts

(At grid of following tube with signal modulated 20%)

When a resistor is used in the grid circuit, its value should not exceed 1 megohm.

The voltage between heater and cathode should be kept as low as possible where they are not directly connected.

* With shell connected to cathode

**With tube shield and internal shield connected to cathode.

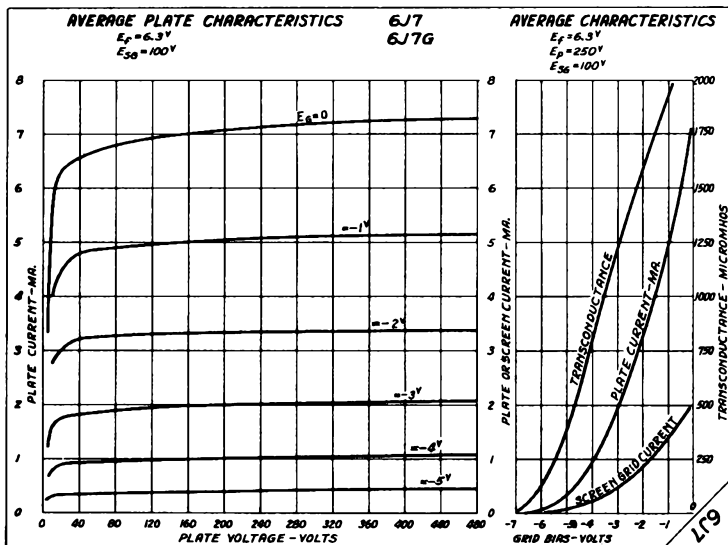

TRIODE HEPTODE
FREQUENCY CONVERTER
Heater Type Glass Bulb

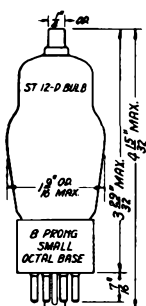

The 6J8G is a duplex tube containing a triode unit and a heptode unit, having a common cathode in the same envelope. The grid of the triode unit is connected internally to the injector grid of the heptode unit. It is designed for converter service in circuits similar to those employing a separate triode oscillator and pentagrid mixer.

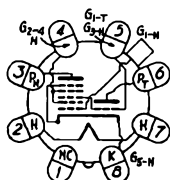

BOTTOM VIEW OF SOCKET

RATINGS

Heater Voltage (a-c or d-c)	6.3	volts
Heater Current	0.3	amp
Maximum Plate Voltage (Heptode)	250	volts
Maximum Screen Voltage (Heptode)	100	volts
Maximum Plate Supply Voltage (Triode)	250*	volts

FREQUENCY CONVERTER

Mixer Plate Voltage (Heptode)	250	volts
Mixer Screen Voltage (Heptode)	100	volts
Mixer Control Grid Bias (Heptode)	-3	volts
Oscillator Plate Voltage (Triode)	250*	volts
Oscillator Grid Resistor (Triode)	50000	ohms
Mixer Plate Current (Heptode)	1.2	ma
Mixer Screen Current (Heptode)	2.8	ma
Oscillator Plate Current (Triode)	5.0	ma
Oscillator Grid Current (Triode)	0.4	ma
Mixer Plate Resistance (Heptode) (approx.)	4	megohm
Conversion Transconductance	290	μ mhos
Conversion Transconductance	2	μ mhos

(At mixer control grid bias = -20 volts)

* Applied through a 20000 ohm series resistor by-passed by a 0.1 μ f condenser.

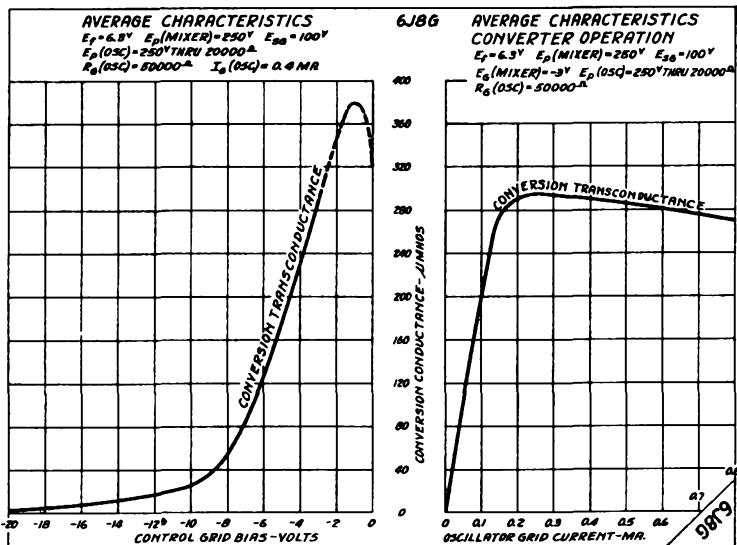

6K5G

RAYTHEON

6K5G

TRIODE
AMPLIFIER

Heater Type

Glass Bulb

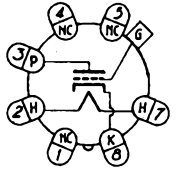

BOTTOM VIEW OF SOCKET

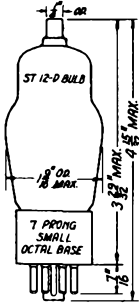

The 6K5G is a triode type amplifier tube designed for service as a resistance coupled audio frequency amplifier in storage battery or a-c operated receivers.

RATINGS

Heater Voltage (a-c or d-o)	6.3	volts
Heater Current	0.3	amp
Maximum Plate Voltage	250	volts

DIRECT INTERELECTRODE CAPACITANCES

Grid to Plate	2.0	μf
Input	2.4	μf
Output	3.6	μf

AMPLIFIER - CLASS A

Plate Voltage	100	250	volts
Grid Bias	-1.5	-3	volts
Amplification Factor (approximate)	70	70	
Plate Resistance (approximate)	78000	50000	ohms
Transconductance	900	1400	μmhos
Plate Current	0.35	1.1	ma

The voltage between heater and cathode should be kept as low as possible where they are not directly connected.

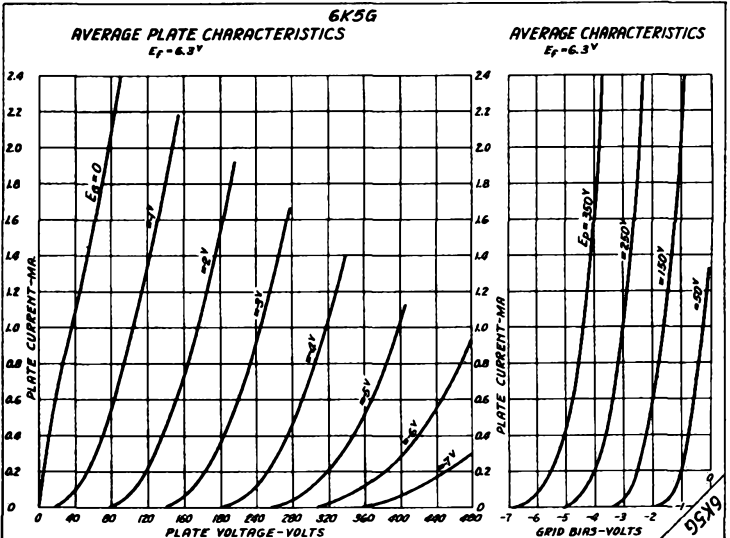

PENTODE
POWER AMPLIFIER
Heater Type Glass Bulb

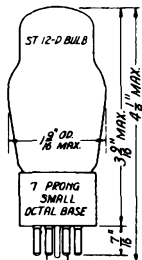

The 6K6G is a pentode type power amplifier tube designed for service in the output stage of storage battery or a-c operated receivers. The ratings and electrical characteristics are identical with those of the type 41.

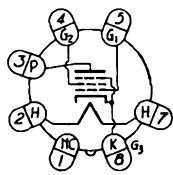

BOTTOM VIEW OF SOCKET

RATINGS

Heater Voltage (a-c or d-c)	6.3	volts
Heater Current	0.4	amp
Maximum Plate Voltage	250	volts
Maximum Screen Voltage	250	volts

AMPLIFIER - CLASS A

Plate Voltage	100	135	180	250	volts
Screen Voltage	100	135	180	250	volts
Grid Bias	-7	-10	-13.5	-18 †	volts
Amplification Factor (approx.)	150	150	150	150	
Plate Resistance (approx.)	103500	94000	81000	68000	ohms
Transconductance	1450	1600	1850	2200	μmhos
Plate Current	9	12.5	18.5	32	ma
Screen Current	1.6	2.2	3	5.5	ma
Load Resistance	12000	10400	9000	7600	ohms
Total Harmonic Distortion	10	10	10	10	percent
Power Output	0.33	0.75	1.5	3.4	watts

Transformer or impedance input coupling devices are recommended. If resistance coupling is used, the d-c resistance in the grid circuit should not exceed 1 megohm with self-bias, or 0.1 megohm with fixed-bias.

The voltage between heater and cathode should be kept as low as possible where they are not directly connected.

†A bias of -16.5 volts and a load resistance of 7000 ohms will give power output of 3.2 watts with 7% total harmonic distortion.

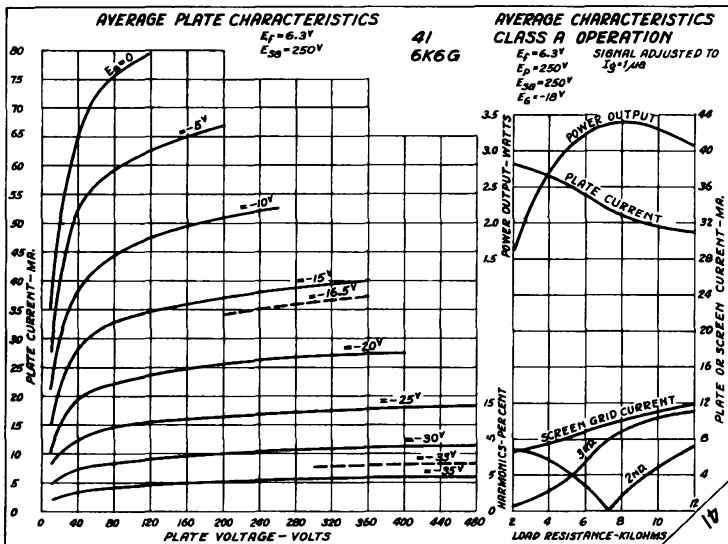

**6K7
6K7G**

RAYTHEON

**6K7
6K7G**

PENTODE
REMOTE CUTOFF AMPLIFIER

Heater Type
Metal Bulb-6K7 Glass Bulb-6K7G



The 6K7 is a pentode type amplifier tube with remote cutoff characteristics designed for service as a high frequency amplifier or mixer in storage battery or a-c operated receivers. The ratings and electrical characteristics are identical with those of the type 78.

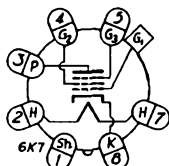

**BOTTOM VIEW OF SOCKET
6K7G - NO CONNECTION
TO #1 PIN**

RATINGS

Heater Voltage (a-c or d-c)	6.3	volts
Heater Current	0.3	amp
Maximum Plate Voltage	250	volts
Maximum Screen Voltage	125	volts

DIRECT INTERELECTRODE CAPACITANCES

	Grid to Plate	Input	Output	
6K7*	0.005 max.	7	12	μ f
6K7G**	0.005 max.	4.5	12	μ f

AMPLIFIER - CLASS A

Plate Voltage	90	180	250	250	volts
Screen Voltage	90	75	100	125	volts
Grid Bias	-3	-3	-3	-3 min.	volts
Suppressor		Connected to Cathode at Socket			
Amplification Factor	400	1100	1160	990	
Plate Resistance	0.315	1.0	0.8	0.6	megohm
Transconductance	1275	1100	1450	1650	μ mhos
Plate Current	5.4	4	7	10.5	ma
Screen Current	1.3	1	1.7	2.6	ma
Grid Bias	-3B.5	-32.5	-42.5	-52.5	volts

(For Transconductance = 2 μ mhos)

MIXER - SUPERHETERODYNE CIRCUIT

Plate Voltage	250	volts
Screen Voltage	100	volts
Grid Bias†	-10	volts
Suppressor	Connected to Cathode at Socket	

The voltage between heater and cathode should be kept as low as possible where they are not directly connected.

The internal shield in the 6K7G is connected to the cathode within the tube.

* With shell connected to cathode.
**With tube shield connected to cathode.

† The grid bias is not critical with an oscillator peak voltage 1 volt less than the grid bias.

For additional curves refer to the type 78.

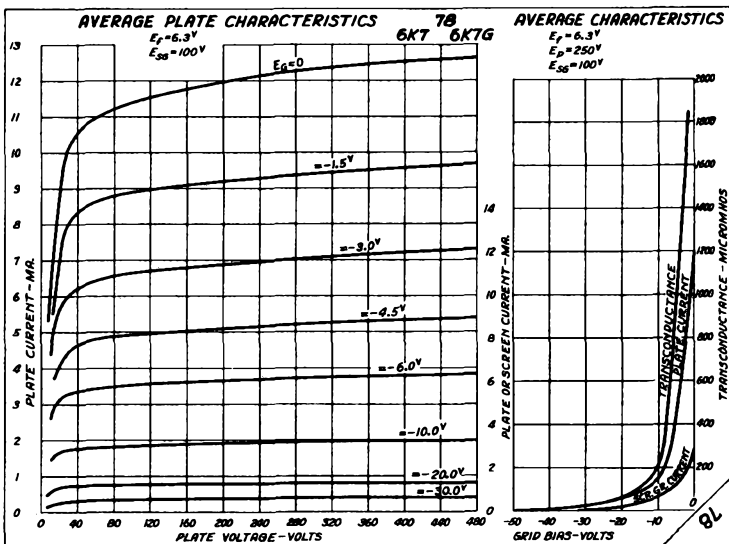

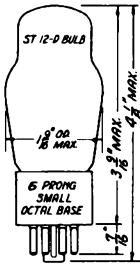

TRIODE
DETECTOR OR AMPLIFIER
Heater Type Glass Bulb

The 6L5G is a triode type amplifier tube designed for service as a detector or amplifier in storage battery or a-c operated receivers requiring a low heater current tube.

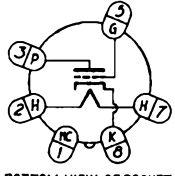

BOTTOM VIEW OF SOCKET

RATINGS

Heater Voltage (a-c or d-c)	6.3	volts
Heater Current	0.15	amp
Maximum Plate Voltage	250	volts

DIRECT INTERELECTRODE CAPACITANCES*

Grid to Plate	2.7	μ f
Input	3	μ f
Output	5	μ f

AMPLIFIER - CLASS A

Plate Voltage	135	250	volts
Grid Bias	-5	-9	volts
Amplification Factor	17	17	
Plate Resistance	11300	8900	ohms
Transconductance	1500	1900	μ mhos
Plate Current	3.5	8	ma
Grid Bias for Plate Current Cutoff	-11	-20	volts

The voltage between heater and cathode should be kept as low as possible where they are not directly connected.

*With tube shield connected to cathode.

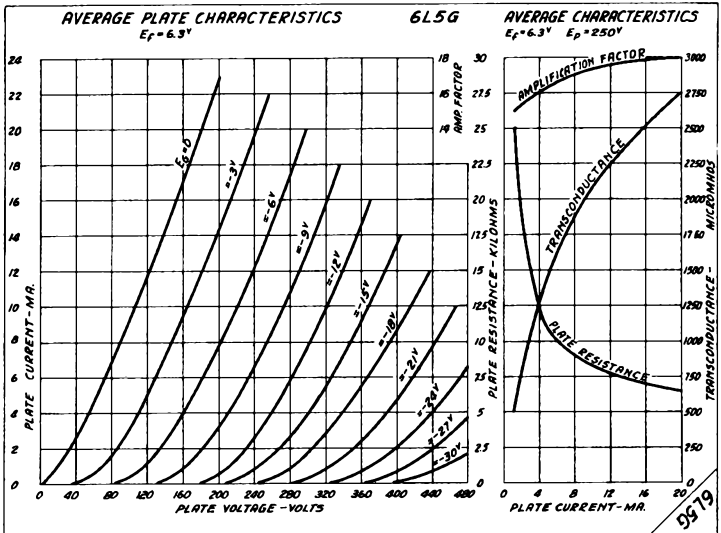

**6L6
6L6G**

RAYTHEON

**6L6
6L6G**

TETRODE
POWER AMPLIFIER
Heater Type

Metal Bulb-6L6 Glass Bulb-6L6G

The 6L6 is a tetrode type power amplifier tube designed for service in the output stage of storage battery or a-c operated receivers.

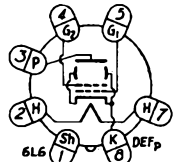

**BOTTOM VIEW OF SOCKET
6L6G - NO CONNECTION
TO #1 PIN**

RATINGS

Heater Voltage (a-c or d-c)#	6.3	volts
Heater Current	0.9	amp
Max. Plate Voltage	400	volts
Max. Screen Voltage	300	volts
Max. Plate & Screen Dissipation (total)†	24	watts
Max. Screen Dissipation	3.5	watts

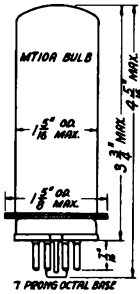

AMPLIFIER - CLASS A - FIXED BIAS

Plate Voltage	250	300	375	375 max.	volts
Screen Voltage	250	200	125	250 max.	volts
Grid Bias	-14	-12.5	0	-17.5	volts
Signal Peak Voltage	14	12.5	8	17.5	volts
Amplification Factor	135				
Plate Resistance	22500				ohms
Transconductance	6000				umhos
No-Sig. Plate Current	72	48	24	57	ma
Max. Sig. Plate Current	79	55	26	67	ma
No-Sig. Screen Current	5	2.5	0.7	2.5	ma
Max.-Sig. Screen Current	7.3	4.7	2	6	ma
Load Resistance	2500	4500	14000	4000	ohms
Total Harmonics	10	11	9	14.5	percent
Second Harmonic	9.7	10.7	8	11.5	percent
Third Harmonic	2.5	2.5	4	4.2	percent
Power Output	6.5	6.5	4.2	11.5	watts

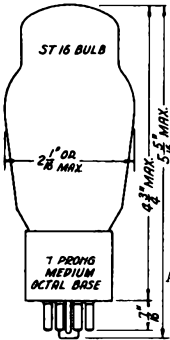

AMPLIFIER - CLASS A - SELF-BIAS

Plate Voltage	375	300	250	volts
Screen Voltage	125	200	250	volts
Self-Bias Resistor	365	220	170	ohms
Signal Peak Voltage	8.5	12.5	14	volts
No-Sig. Plate Current	24	51	75	ma
Max.-Sig. Plate Current	24.3	54.5	78	ma
No-Sig. Plate Current	0.7	3	5.4	ma
Max.-Sig. Screen Current	1.8	4.6	7.2	ma
Load Resistance	14000	4500	2500	ohms
Total Harmonics	9	11	10	percent
Second Harmonic	8	10.7	9.7	percent
Third Harmonic	4	2.5	2.5	percent
Power Output	4	6.5	6.5	watts

Continued on next page

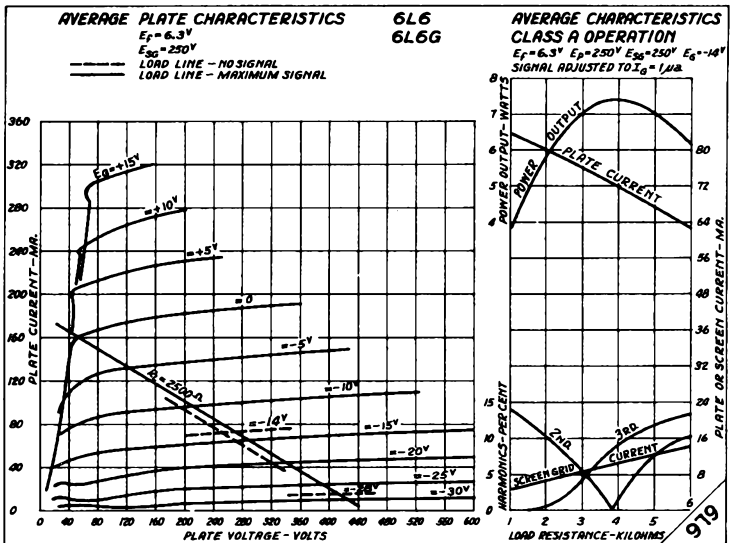

AMPLIFIER - CLASS A - PUSH-PULL - TWO TUBES

		Fixed-Bias	Self-Bias	
Plate Voltage	375 max.	250	250	volts
Screen Voltage	250 max.	250	250	volts
Grid Bias		-16		volts
Self-Bias Resistor			125	ohms
Signal Peak Voltage (grid to grid)		32	35.6	volts
No-Signal Plate Current		120	120	ma
Max.-Signal Plate Current		140	130	ma
No-Signal Screen Current		10	10	ma
Max.-Signal Screen Current		16	15	ma
Load Resistance (plate to plate)		5000	5000	ohms
Total Harmonics		2	2	percent
Third Harmonic		2	2	percent
Power Output		14.5	13.8	watts

AMPLIFIER - CLASS AB₁ - PUSH-PULL - TWO TUBES

		Fixed-Bias				Self-Bias		
Plate Voltage	400	400	400	400	400	400	volts	
Screen Voltage	250	250	300	300	250	300	volts	
Grid Bias	-20	-20	-25	-25			volts	
Self-Bias Resistor					190	200	ohms	
Signal Peak Voltage (g to g)	40	40	50	50	43.8	57	volts	
No-Signal Plate Current	88	88	102	102	96	112	ma	
Max.-Signal Plate Current	124	126	152	156	110	128	ma	
No-Signal Screen Current	4	4	6	6	4.6	7	ma	
Max.-Signal Screen Current	12	9	17	12	10.8	16	ma	
Load Resistance (p to p)	8500	6000	6600	3800	8500	6600	ohms	
Total Harmonics	2	1	2	0.6	2	2	percent	
Third Harmonic	2	1	2	0.6	2	2	percent	
Power Output	26.5	20	34	23	24	32	watts	

AMPLIFIER - CLASS AB₂ - PUSH-PULL - TWO TUBES

		Fixed-Bias		
Plate Voltage	400	400	400	volts
Screen Voltage	250	300	300	volts
Grid Bias	-20	-25	-25	volts
Signal Peak Voltage (grid to grid)	57	80	80	volts
No-Signal Plate Current	88	102	102	ma
Max.-Signal Plate Current	168	230	230	ma
No-Signal Screen Current	4	6	6	ma
Max.-Signal Screen Current	13	20	20	ma
Load Resistance (plate to plate)	6000	3800	3800	ohms
Peak Driving Power	180	350	350	mW
Total Harmonics †	2	2	2	percent
Third Harmonic ‡	2	2	2	percent
Power Output	40	60	60	watts

#Under maximum dissipation conditions the heater voltage should never fluctuate so that it exceeds 7.0 volts. The voltage between heater and cathode should be kept as low as possible.

†The rated dissipation should not be exceeded with expected line voltage fluctuations, especially in fixed-bias operation. Fixed-bias values up to 10% of each typical screen voltage can be used without increasing distortion.

‡With ideal driver and perfect power supply regulation.

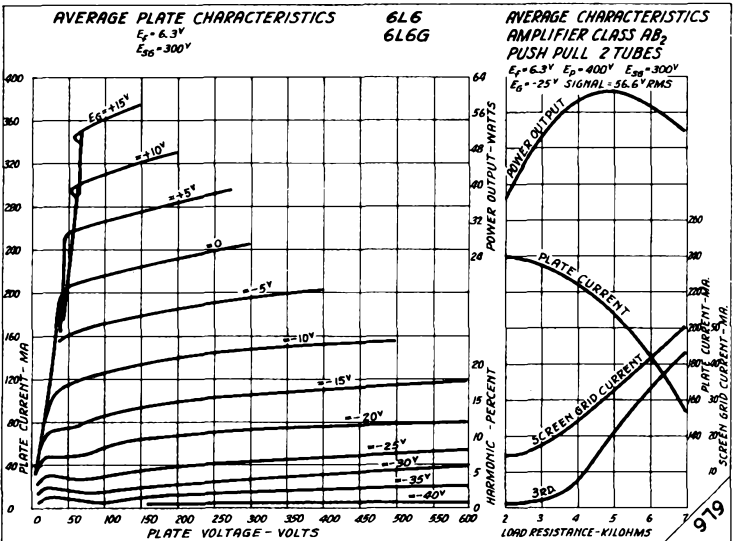

6L7 6L7G

RAYTHEON

6L7 6L7G

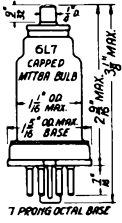

HEPTODE PENTAGRID MIXER or AMPLIFIER

Heater Type
Metal Bulb-6L7 Glass Bulb-6L7G

The 6L7 is a pentagrid type tube designed for service as a mixer in storage battery or a-c operated superheterodyne receivers using a separate oscillator.

RATINGS

Heater Voltage	6.3	volts
Heater Current	0.3	amp
Max. Plate Voltage	250	volts

DIRECT INTERELECTRODE CAPACITANCES

	6L7*	6L7G**	
Grid #1 to Plate	0.0005	0.003 max.	µuf
Grid #1 to Grid #3	0.12	0.15	µuf
Grid #3 to Plate	0.025	0.25	µuf
Grid #1 to all other Elements	8.5	5.8	µuf
Grid #3 to all other Elements	11.5	11.5	µuf
Plate to all other Elements	12.5	9	µuf

AMPLIFIER - CLASS A

Plate Voltage	250	volts
Screen (Grids #2 & #4) Voltage	100	max. volts
Control Grid (#1) Bias	-3	min. volts
Control Grid (#3) Bias	-3	volts
Amplification Factor	880	
Plate Resistance	0.8	megohm
Transconductance	1100	µmhos
Plate Current	5.3	ma
Screen Current	6.5	ma
Transconductance (Grid #1 Bias = -15 volts; Grid #3 Bias = -15 volts)	5	µmhos

MIXER - SUPERHETERODYNE CIRCUIT

Plate Voltage	250	250	volts
Screen (Grids #2 & #4) Voltage	100	150	max. volts
Signal Grid (#1) Bias	-3	-6	min. volts
Oscillator Grid (#3) Bias	-10	-15	volts
Oscillator Peak Voltage (Grid #3)	12	18	volts
Plate Resistance	Greater than 1	megohm	
Conversion Conductance	350	350	µmhos
Plate Current	2.4	3.3	ma
Screen Current	7.2	9.2	ma
Signal Grid (#1) Bias	-30	-45	volts
(Conversion Conductance = 5 µmhos)			

* With Shell connected to cathode.
** With tube shield connected to cathode

The D-C resistance in the oscillator grid (#3) circuit should not exceed 50000 ohms.
The voltage between heater and cathode should be as low as possible where they are not directly connected.

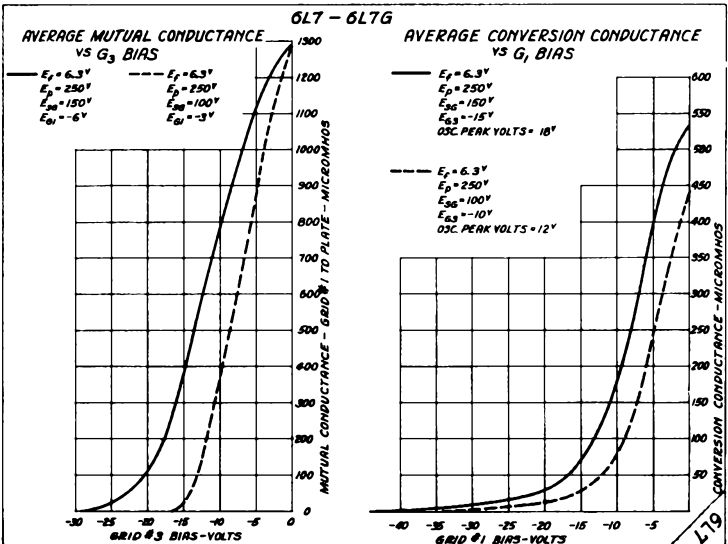

CATHODE RAY TUNING INDICATOR
Heater Type Glass Bulb

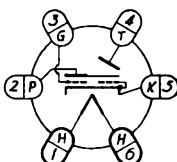
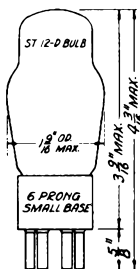

BOTTOM VIEW OF SOCKET

The 6N5 is a high vacuum type indicator tube designed for service as a tuning indicator in radio receivers requiring a low heater current tube.

RATINGS

Heater Voltage (a-c or d-c)	6.3	volts
Heater Current	0.15	amp
Maximum Plate Supply Voltage	135	volts
Maximum Target Voltage	135	volts

TUNING INDICATOR

Plate Supply Voltage	135	volts
Target Voltage	135	volts
Plate Resistor	0.25	megohm
Target Current (approximate)	4.5	ma
Plate Current (zero bias)	0.5	ma
Grid Bias for Shadow Angle=0° (approx.)	-12	volts
Grid Bias for Shadow Angle=90° (approx.)	0	volts

The 6N5 is a high-vacuum tube designed to visually indicate the effect of changing the control grid bias. The shaded pattern produced on the fluorescent target varies through an angle from 90° to approximately 0° as the control voltage is varied. The voltage on the shadow control electrode, the extension of the triode plate between the cathode and target, controls the extent of the shaded area. The voltage of the shadow control electrode is determined by the voltage of the control grid of the triode connected as a d-c amplifier. Thus the control grid voltage determines the extent of the shadow. An increase of control grid bias thus increases the shadow control voltage and decreases the shadow while a decrease of bias increases the shadow. In practical use the control grid voltage is obtained from a suitable point in the AVC network.

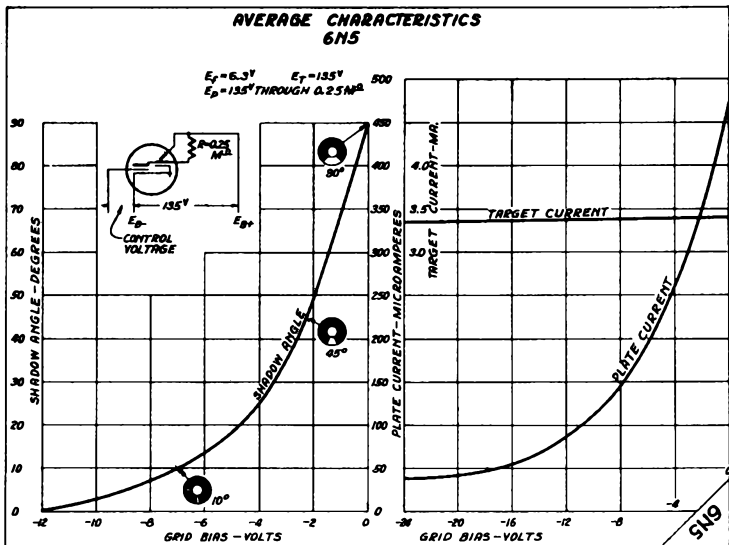

6N6G 6N6MG

RAYTHEON

6N6G 6N6MG

DUO-TRIODE
DIRECT COUPLED POWER AMPLIFIER
Heater Type
Glass Bulb-6N6G Meta-Glass-6N6MG

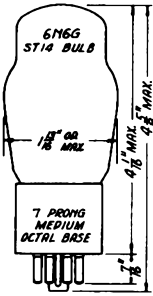

The 6N6G is a direct coupled power amplifier tube designed for service in the output stage of storage battery or a-c operated receivers. The ratings and electrical characteristics are identical with those of the type 6B5.

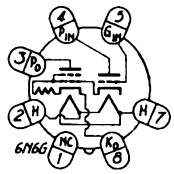

BOTTOM VIEW OF SOCKET
6N6MG - SHELL CONNECTED
TO #1 PIN

RATINGS

Heater Voltage (a-c or d-o)	6.3	volts
Heater Current	0.8	amp
Maximum Plate Voltage	325	volts

AMPLIFIER - CLASS A

Output-Plate Voltage	250	300	325	volts
Input-Plate Voltage	250	300	325	volts
Grid Bias	0	0	0	volts
Amplification Factor		58		
Plate Resistance		24100		ohms
Transconductance		2400		μmhos
Output-Plate Current	33	45	51	ma
Input-Plate Current	6.5	8	9	ma
Load Resistance	7000	7000	7000	ohms
Total Harmonic Dist.	5	5	5	percent
Power Output	2.5	4	5.2	watts
Signal Voltage RMS	13.5	15	17	volts

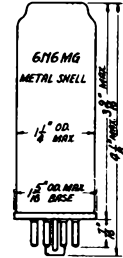

AMPLIFIER - CLASS A - PUSH-PULL - TWO TUBES

Output-Plate Voltage	250	300	325	volts
Input-Plate Voltage	250	300	325	volts
Grid Bias	0	0	0	volts
Output-Plate Current (per tube)	33	45	51	ma
Input-Plate Current (per tube)	6.5	8	9	ma
Load Resistance (plate to plate)	10000	10000	10000	ohms
Total Harmonic Distortion	5	5	5	percent
Power Output	8.5	10	13.5	watts
Signal Voltage RMS (grid to grid)	38	38	42	volts

The voltage between heater and cathode should not exceed 50 volts and in no case should the heater be left floating.

If a grid resistor is used its value should not exceed 0.5 megohm.

For additional curves refer to the type 6B5.

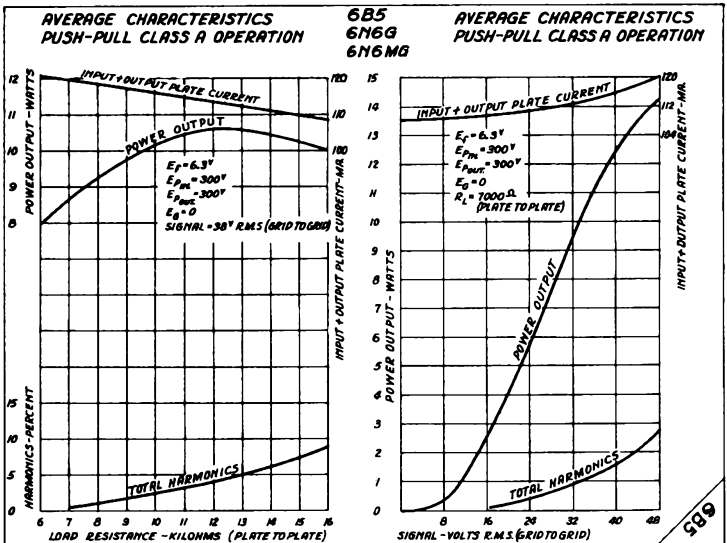

6N7 6N7G

RAYTHEON

6N7 6N7G

TWIN TRIODE
POWER AMPLIFIER
Heater Type

Metal Bulb-6N7 Glass Bulb-6N7G

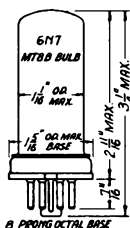

The 6N7 is a twin triode type amplifier tube designed for service as a Class B power amplifier in the output stage of storage battery or a-c operated receivers. The ratings and electrical characteristics are identical with those of the type 6A6.

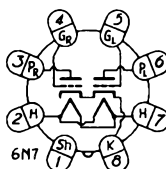

BOTTOM VIEW OF SOCKET
6N7G- NO CONNECTION
TO #1 PIN

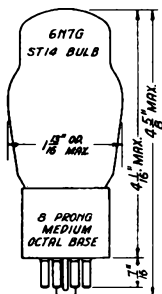

RATINGS

Heater Voltage (a-c or d-c)	6.3	volts
Heater Current	0.8	amp
Maximum Plate Voltage	300	volts
Maximum Peak Plate Current (per plate)	125	ma
Maximum Average Plate Dissipation	10	watts

AMPLIFIER - CLASS B

Plate Voltage	250	300	volts
Grid Bias	0	0	volts
No-Signal Plate Current (per plate)	14	17.5	ma
Load Resistance (plate to plate)	8000	10000	ohms
Power Output (approximate)	8	10	watts
(With average power input = 350 mw. grid to grid)			

AMPLIFIER - CLASS A-DRIVER TRIODES CONNECTED IN PARALLEL

Plate Voltage	250	294	volts
Grid Bias†	-5	-6	volts
Amplification Factor	35	35	
Plate Resistance	11300	11000	ohms
Transconductance	3100	3200	umhos
Plate Current	6	7	ma
Load Resistance - Depends on the design of the following Class B amplifier. Usually between 20000 and 40000 ohms.			
Power Output (approximate)		400	mw

†The d-c resistance in the grid circuit should not exceed 0.5 megohm with self-bias or 0.1 megohm with fixed-bias.

For additional curves refer to the type 6A6.

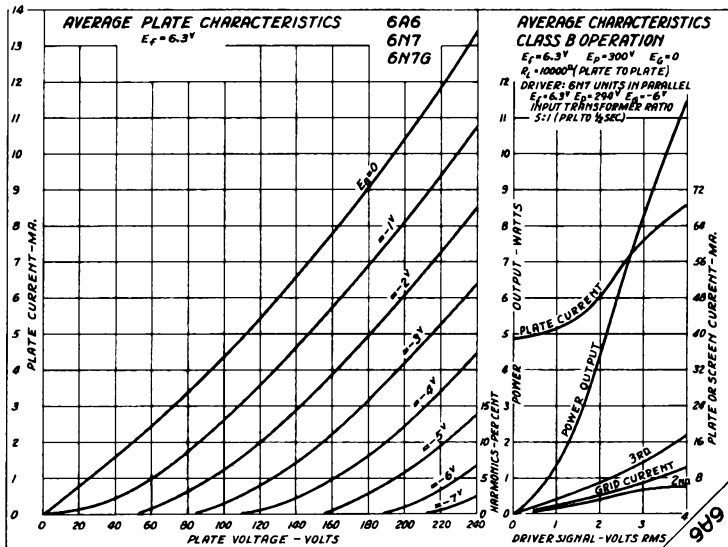

TRIODE-PENTODE
AMPLIFIER OR CONVERTER
Heater Type Glass Bulb

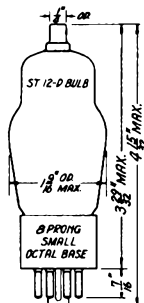

The 6P7G is a duplex tube, combining in one bulb a triode and a remote cutoff pentode, designed for service as an oscillator and mixer or as a high frequency amplifier and second detector, in storage battery or a-c operated receivers. The ratings and electrical characteristics are identical with those of the type 6F7.

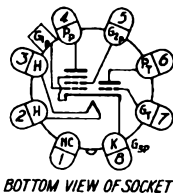

BOTTOM VIEW OF SOCKET

RATINGS			
Heater Voltage (a-c or d-c)		6.3	volts
Heater Current		0.3	amp

DIRECT INTERELECTRODE CAPACITANCES				
	Grid to Plate	Input	Output	
Triode Section *	2.0	3.5	3.0	μf
Pentode Section*	0.008 max.	3.5	12	μf

AMPLIFIER - CLASS A

	Triode Section	Pentode Section	
Plate Voltage	100 max.	100	250 max. volts
Screen Voltage		100	100 max. volts
Grid Bias	-3	-3	-3 min. volts
Amplification Factor	8	300	900
Plate Resistance	0.016	0.29	0.85 megohm
Transconductance	500	1050	1100 μmhos
Plate Current	3.5	6.3	6.5 ma
Screen Current		1.6	1.5 ma
Transconductance (at -35 volts bias)		9	10 μmhos

FREQUENCY CONVERTER

	Triode Section	Pentode Section	
Maximum Plate Voltage	100	250	volts
Maximum Screen Voltage		100	volts
Minimum Grid Bias	†	-3 #	volts
Maximum Oscillator Plate Current (average)	4		ma
Typical Operation:			
Plate Voltage	100‡	250	volts
Screen Voltage		100	volts
Grid Bias	†	-10 Δ	volts
Plate Resistance		2	megohm
Conversion Conductance		300	μmhos
Plate Current	2.4	2.8	ma
Grid Current	0.15	0	ma
Screen Current		0.6	ma
Oscillator Peak Voltage Input		7	volts

The voltage between heater and cathode should be kept as low as possible where they are not directly connected.

*With tube shield connected to cathode and other section connected to ground †Usually obtained by means of a grid leak.

#Grid bias should be at least 3 volts greater than the peak oscillator voltage applied to the pentode grid.

‡May be obtained from 250 volt supply through 60000 ohm series resistor.

ΔObtained by means of 1700 ohm cathode resistor.

For additional curves refer to the type 6F7.

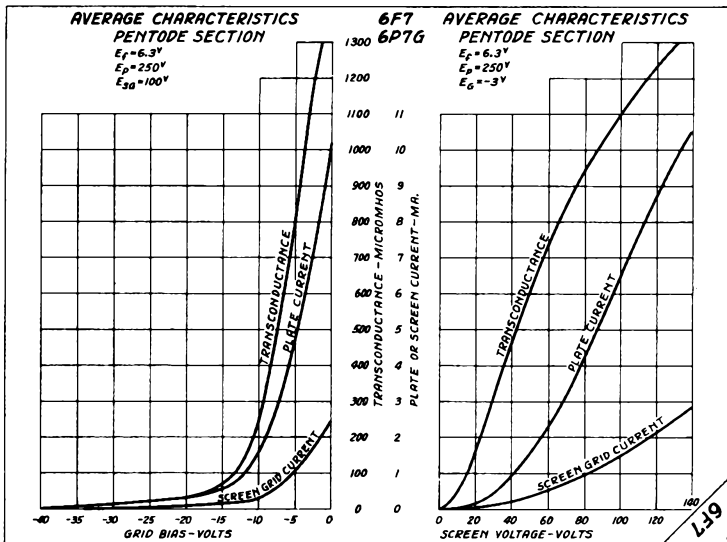

**6Q7
6Q7G**

RAYTHEON

**6Q7
6Q7G**

DUO-DIODE TRIODE
DETECTOR AMPLIFIER

Heater Type
Metal Bulb-6Q7 Glass Bulb-6Q7G

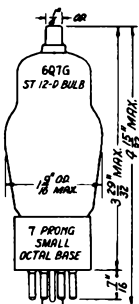
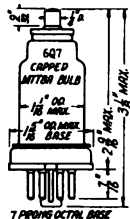

The 6Q7 is a duo-diode triode type amplifier tube designed for service as a combined diode detector, AVC rectifier and resistance coupled audio frequency amplifier in storage battery or a-o operated receivers.

RATINGS

Heater Voltage (a-c or d-c)	6.3	volts
Heater Current	0.3	amp
Maximum Plate Voltage	250	volts

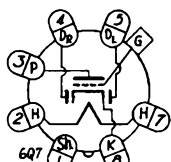

**BOTTOM VIEW OF SOCKET
6Q7G-NO CONNECTION
TO #1 PIN**

DIRECT INTERELECTRODE CAPACITANCES - TRIODE SECTION

	Grid to Plate	Input	Output	
6Q7*	1.5	5.5	5	μ f
6Q7G	1.3	2.7	4.5	μ f

AMPLIFIER - CLASS A - TRIODE SECTION

Plate Voltage	100	250	volts
Grid Bias	-1.5	-3	volts
Amplification Factor	70	70	
Plate Resistance	87500	58000	ohms
Transconductance	800	1200	μ mhos
Plate Current	0.35	1.1	ma

AMPLIFIER - CLASS A - RESISTANCE COUPLED - TRIODE SECTION

Plate Supply Voltage	100	250	volts
Grid Bias	-1.1	-2	volts
Plate Resistor	0.15	0.2	megohm
Plate Current	0.25	0.5	ma
Grid Resistor†	0.5	0.5	megohm
Voltage Amplification	35	43	

DIODE SECTION

The two diode units are independent of each other and of the triode section except for the common cathode. The diodes may be used as a half wave or as a full wave rectifier; or one diode may be used as a half wave rectifier for detection, and the other diode used as a rectifier to obtain delayed AVC voltage.

The voltage between heater and cathode should be kept as low as possible where they are not directly connected.

*With shell connected to cathode.
†For following tube.

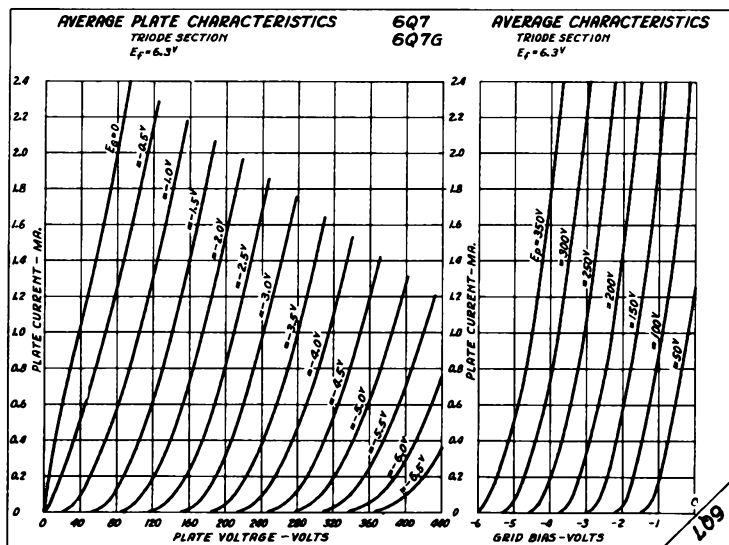

6R7 6R7G

RAYTHEON

6R7 6R7G

DUO-DIODE TRIODE
DETECTOR AMPLIFIER

Heater Type
Metal Bulb-6R7 Glass Bulb-6R7G

The 6R7 is a duo-diode triode type amplifier tube designed for service as a combined diode detector, AVC rectifier and audio frequency amplifier in storage battery or a-c operated receivers.

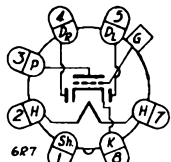

BOTTOM VIEW OF SOCKET
6R7G - NO CONNECTION
TO #1 PIN

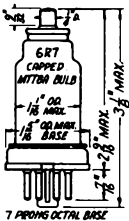

RATINGS

Heater Voltage (a-c or d-o)	6.3	volts
Heater Current	0.3	amp
Maximum Plate Voltage	250	volts

DIRECT INTERELECTRODE CAPACITANCES - TRIODE SECTION

	Grid to Plate	Input	Output	
6R7*	2.5	5.5	4.0	$\mu\mu\text{f}$
6R7G	3.5	2.5	4.5	$\mu\mu\text{f}$

AMPLIFIER - CLASS A - TRIODE SECTION

Plate Voltage	250	volts
Grid Bias	-9	volts
Amplification Factor	16	
Plate Resistance	8500	ohms
Transconductance	1900	μmhos
Plate Current	9.5	ma
Load Resistance	10000	ohms
Power Output (5% second harmonic)	280	mw

AMPLIFIER - CLASS A - RESISTANCE COUPLED - TRIODE SECTION

Plate Supply Voltage	250	volts
Grid Bias (approximate)	-6	volts
Plate Resistor	0.05 to 0.1	megohm
Plate Current	2.4 to 1.3	ma
Grid Resistor†	0.5	megohm
Voltage Amplification	12	
Voltage Output (RMS)‡	51	volts

DIODE SECTION

The two diode units are independent of each other and of the triode section except for the common cathode. The diode may be used as a half wave or as a full wave rectifier; or one diode may be used as a half wave rectifier for detection, and the other diode used as a rectifier to obtain delayed AVC voltage.

The voltage between heater and cathode should be kept as low as possible where they are not directly connected.

*With shell connected to cathode.

‡For following tube.

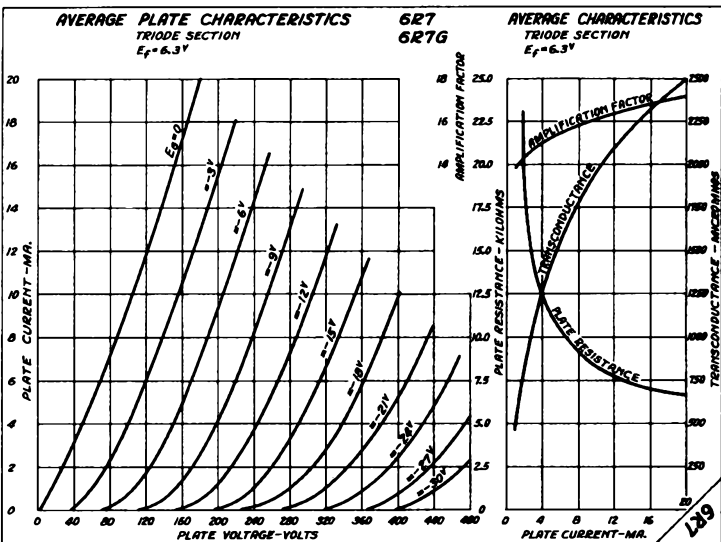

PENTODE
REMOTE CUTOFF AMPLIFIER
Heater Type Glass Bulb

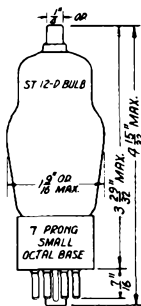

The 6S7G is a pentode type amplifier tube with remote cutoff characteristics designed for service as a high frequency amplifier in storage battery or a-c operated receivers requiring a low heater current tube.

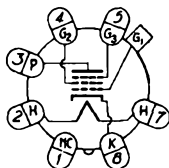

BOTTOM VIEW OF SOCKET

RATINGS

Heater Voltage (a-o or d-c)	6.3	volts
Heater Current	0.15	amp
Maximum Plate Voltage	250	volts
Maximum Screen Voltage	100	volts

DIRECT INTERELECTRODE CAPACITANCES*

Grid to Plate	0.007 max.	μf
Input	4.6	μf
Output	7.8	μf

AMPLIFIER - CLASS A

Plate Voltage	135	250	volts
Screen Voltage	67.5	100	volts
Grid Bias	-3	-3	volts
Suppressor	Connected to Cathode at Socket		
Amplification Factor	850 min.	1100 min.	
Plate Resistance	0.68 min.	0.63 min.	megohm
Transconductance	1250	1750	μmhos
Plate Current	3.7	8.5	ma
Screen Current	0.9	2	ma
Grid Bias	-25	-38.5	volts

(Transconductance = 10 μmhos)

*With tube shield.

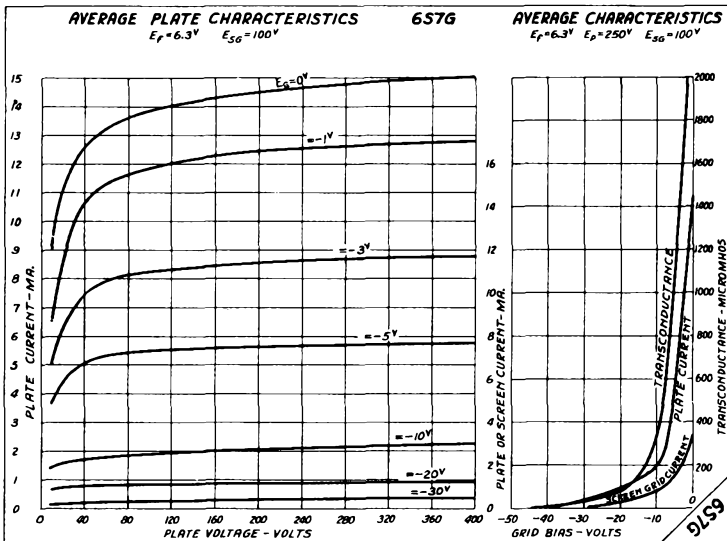

CATHODE RAY TUNING INDICATOR
Heater Type Glass Bulb

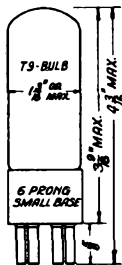

The 6T5 is a high-vacuum type indicator tube with remote cutoff characteristics designed for service as a tuning indicator in radio receivers. The shaded pattern on the fluorescent target is annular in shape.

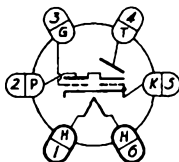

BOTTOM VIEW OF SOCKET

RATINGS

Heater Voltage (a-c or d-c)	6.3	volts
Heater Current	0.3	amp
Max. Plate Supply Voltage	250	volts
Max. Target Voltage	250	volts

TUNING INDICATOR

Plate Supply Voltage	250	volts
Target Voltage	250	volts
Plate Resistor	1	megohm
Target Current (approximate)	3	ma
Plate Current (zero bias)	0.24	ma
Grid Bias for Min. Shadow Diameter	-22	volts
Grid Bias for Max. Shadow Diameter	0	volts

The 6T5 is a high vacuum tube designed to visually indicate changes of control grid bias. With the triode section connected as a d-c amplifier, the voltage of the shadow control electrode which is connected to the triode plate increases with an increase of control grid bias and causes a reduction in shadow diameter. Similarly, a decrease of control grid bias increases the shadow diameter. In tuning indicator service the control grid bias is obtained from a suitable tap in the AVC network.

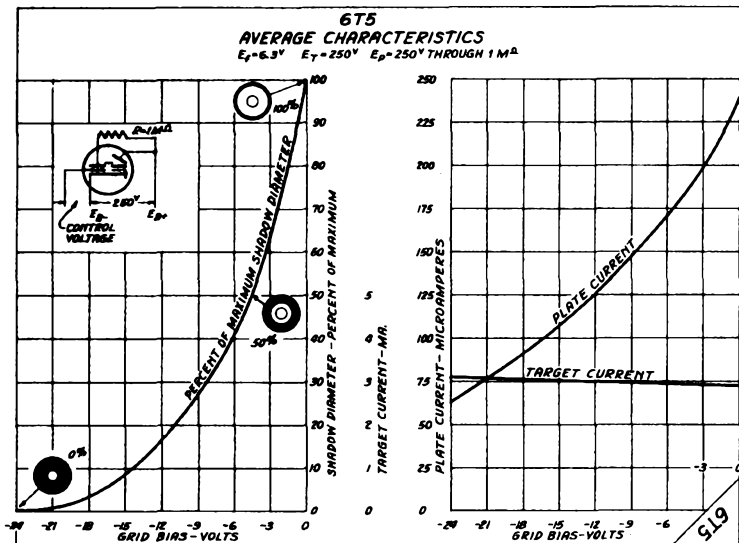

DUO-DIODE TRIODE
DETECTOR AMPLIFIER

Heater Type

Glass Bulb

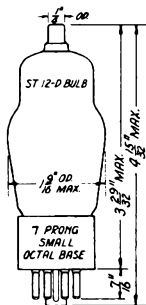

The 6T7G/6Q6G is a duo-diode triode type amplifier tube designed for service as a combined diode detector, AVC rectifier, and audio frequency amplifier in storage battery or a-c operated receivers requiring a low heater current tube. The 6T7G/6Q6G replaces the type 6Q6G, single-diode triode.

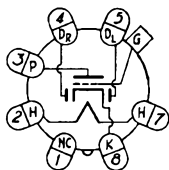

BOTTOM VIEW OF SOCKET

RATINGS

Heater Voltage (a-c or d-c)	6.3	volts
Heater Current	0.15	amp
Maximum Plate Voltage	250	volts

DIRECT INTERELECTRODE CAPACITANCES - TRIODE SECTION

Grid to Plate	1.3	μ f
Input	2.7	μ f
Output	4.5	μ f

AMPLIFIER - CLASS A - TRIODE SECTION

Plate Voltage	135	250	volts
Grid Bias	-1.5	-3	volts
Amplification Factor	65	65	
Plate Resistance	65000	62000	ohms
Transconductance	1000	1050	μ mhos
Plate Current	0.9	1.2	ma

DIODE SECTION

The two diode units are independent of each other and of the triode section except for the common cathode. The diodes may be used as a half wave or as a full wave rectifier; or one diode may be used as a half wave rectifier for detection, and the other diode used as a rectifier to obtain delayed AVC voltage.

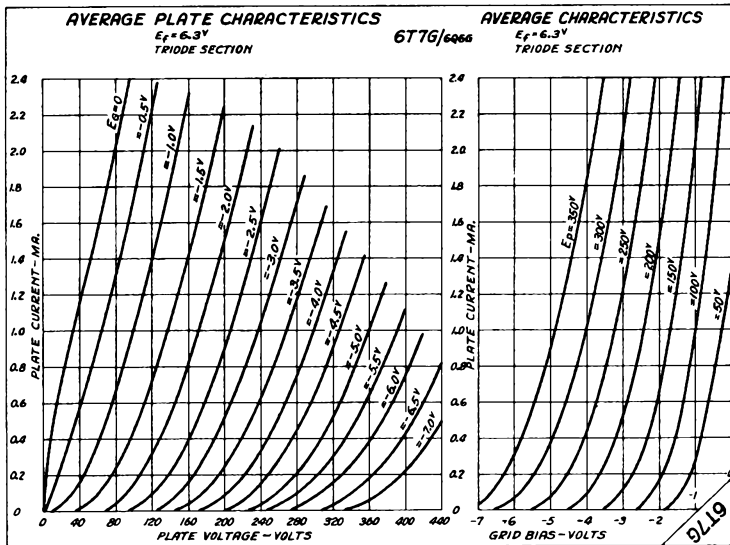

CATHODE RAY TUNING INDICATOR
Heater Type Glass Bulb

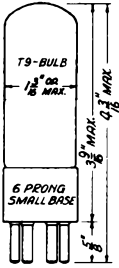

The 6U5 is a high vacuum type indicator tube with remote cutoff characteristics designed for service as a tuning indicator in radio receivers. The ratings and electrical characteristics are identical with those of the type 6G5/6H5.

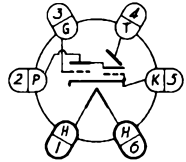

BOTTOM VIEW OF SOCKET

RATINGS

Heater Voltage (a-c or d-c)	6.3	volts
Heater Current	0.3	amp
Maximum Plate Supply Voltage	250	volts
Maximum Target Voltage	250	volts
Minimum Target Voltage	90	volts

TUNING INDICATOR

Plate Supply Voltage	100	200	250	volts
Target Voltage	100	200	250	volts
Plate Resistor	0.5	1	1	megohm
Target Current (approximate)	4.5	4.5	4.5	ma
Plate Current (zero Bias)	0.19	0.19	0.24	ma
Grid Bias (approximate) (For Shadow angle = 0°)	-8	-18.5	-22	volts
Grid Bias (approximate) (For Shadow angle = 90°)	0	0	0	volts

The 6U5 is a high vacuum tube designed to visually indicate the effect of changing the control grid bias. The shaded pattern produced on the fluorescent target varies through an angle from 90° to approximately 0° as the control voltage is varied. The voltage on the shadow control electrode, the extension of the triode plate between the cathode and target, controls the extent of the shaded area. The voltage of the shadow control electrode is determined by the voltage of the control grid of the triode connected as a d-c amplifier. Thus the control grid voltage determines the extent of the shadow. An increase of control grid bias thus increases the shadow control voltage and decreases the shadow while a decrease of bias increases the shadow. In practical use the control grid voltage is obtained from a suitable point in the AVC network.

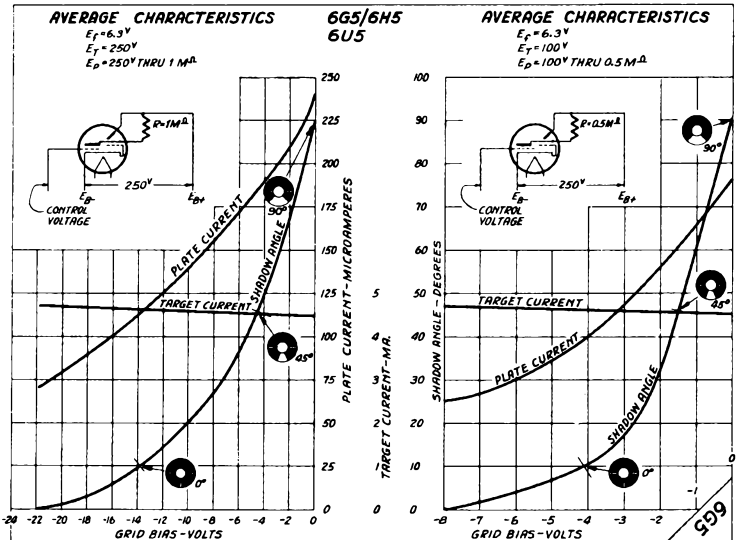

PENTODE
REMOTE CUTOFF AMPLIFIER
Heater Type Glass Bulb

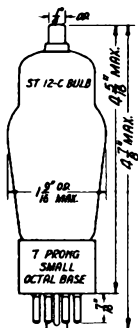

The 6U7G is a pentode type amplifier tube with remote cutoff characteristics designed for service as a high frequency amplifier or mixer in storage battery or a-c operated receivers. The ratings and electrical characteristics are identical with those of the type 6D6.

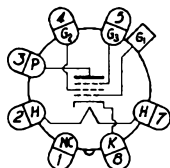

BOTTOM VIEW OF SOCKET

RATINGS

Heater Voltage (a-c or d-c)	6.3 volts
Heater Current	0.3 amp
Max. Plate Voltage	250 volts
Max. Screen Voltage	100 volts

DIRECT INTERELECTRODE CAPACITANCES

Grid to Plate	0.007 max.* μf
Input	4.5 μf
Output	9.0 μf

AMPLIFIER - CLASS A

Plate Voltage	100	250	volts
Screen Voltage	100	100	volts
Grid Bias	-3	-3	volts
Suppressor	Connected to Cathode at Socket		
Amplification Factor	375	1280	
Plate Resistance	0.25	0.8	megohm
Transconductance	1500	1600	μmhos
Plate Current	8	8.2	ma
Screen Current	2.2	2	ma
Grid Bias for Transconductance = 2 μmhos	-50	-50	volts

MIXER - SUPERHETERODYNE CIRCUIT

Plate Voltage	100	250	volts
Screen Voltage	100	100	volts
Grid Bias	-10	-10	volts
Suppressor	Connected to Cathode at Socket		

The grid bias is not critical with an oscillator peak swing 1 volt less than the grid bias.

The shield in the dome of the tube is connected internally to the cathode.

The voltage between heater and cathode should be kept as low as possible where they are not directly connected.

*With tube shield

For additional curves refer to the type 6D6.

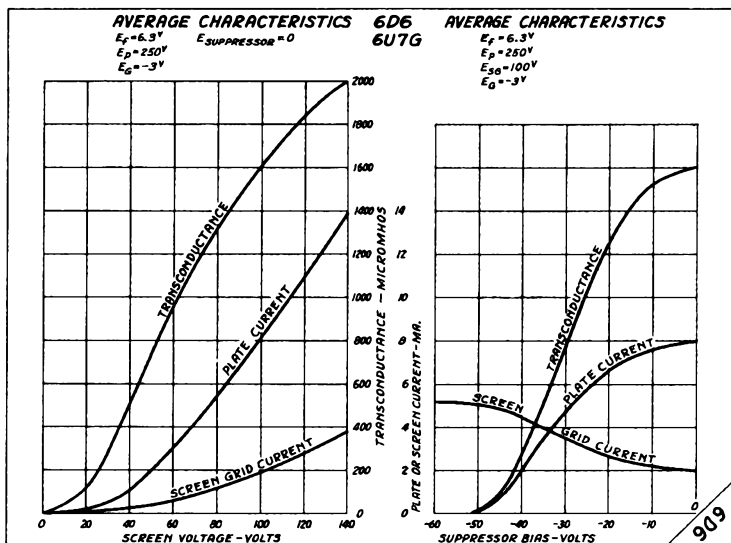

6V6 6V6G

RAYTHEON

6V6 6V6G

TETRODE
POWER AMPLIFIER
Heater Type

Metal Bulb-6V6 Glass Bulb-6V6G

The 6V6 is a tetrode type power amplifier tube designed for service in the output stage of storage battery or a-c operated receivers.

RATINGS

Heater Volt. (a-c or d-c)	6.3	volts
Heater Current	0.45	amp
Max. Plate Voltage	300	volts
Max. Screen Voltage	300	volts
Max. Plate and Screen Dissipation (total)	12.5	watts

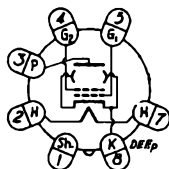

BOTTOM VIEW OF SOCKET
6V6G - NO CONNECTION
TO #1 PIN

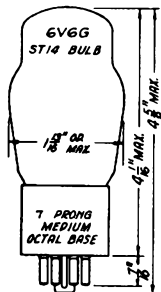
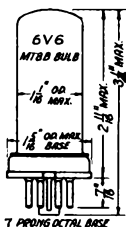

AMPLIFIER - CLASS A

Plate Voltage	180	250	max. volts
Screen Voltage	180	250	max. volts
Grid Bias*	-8.5	-12.5	volts
Signal Peak Voltage	8.5	12.5	volts
Amplification Factor		218	
Plate Resistance		52000	ohms
Transconductance		4100	umhos
No-Signal Plate Current	29	45	ma
Max.-Signal Plate Current	30	47	ma
No-Signal Screen Current	3	4.5	ma
Max.-Signal Screen Current	4	6.5	ma
Load Resistance	5500	5000	ohms
Power Output	2	4.25	watts
Second Harmonic	5.5	4.5	percent
Third Harmonic	2.5	3.5	percent

AMPLIFIER - PUSH-PULL - CLASS AB - TWO TUBES

Plate Voltage	250	300	volts
Screen Voltage	250	300	volts
Grid Bias*	-15	-20	volts
Signal Peak Voltage (grid to grid)	30	40	volts
No-Signal Plate Current	70	78	ma
Max.-Signal Plate Current	79	90	ma
No-Signal Screen Current	5	5	ma
Max.-Signal Screen Current	12	13.5	ma
Load Resistance (plate to plate)	10000	8000	ohms
Power Output	8.5	13	watts
Third Harmonic	3.5	3.5	percent
Total Harmonics	4	4	percent

*Transformer or impedance input systems are recommended. If resistance coupling is used, the d-c resistance in the grid circuit should not exceed 0.5 megohm with self-bias, or 0.05 megohm with fixed-bias.

The voltage between heater and cathode should be kept as low as possible where they are not directly connected.

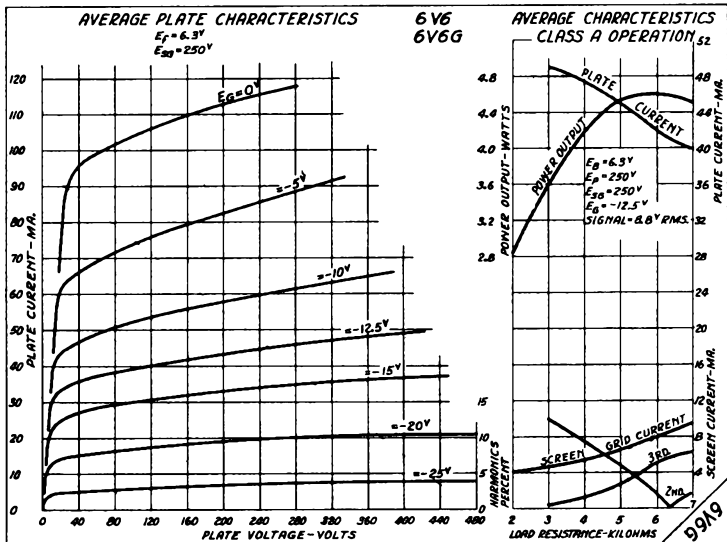

DUO-DIODE TRIODE
DETECTOR AMPLIFIER

Heater Type Glass Bulb

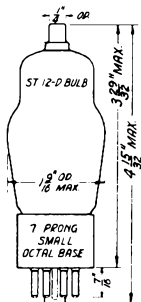

The 6V7G is a duo-diode triode type amplifier tube designed for service as combined diode detector, AVC rectifier, and a-f amplifier in storage battery or a-c operated receivers. The ratings and electrical characteristics are identical with those of type 6S.

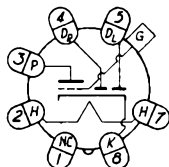

BOTTOM VIEW OF SOCKET

RATINGS

Heater Voltage (a-c or d-c)	6.3 volts
Heater Current	0.3 amp
Maximum Plate Voltage	250 volts

DIRECT INTERELECTRODE CAPACITANCES - TRIODE SECTION

Grid to Plate	1.7	μuf
Input	2.0	μuf
Output	3.5	μuf

AMPLIFIER - CLASS A - TRIODE SECTION

Plate Voltage	135	180	250	volts
Grid Bias	-10.5	-13.5	-20	volts
Amplification Factor	8.3	8.3	8.3	
Plate Resistance	11000	8500	7500	ohms
Transconductance	750	975	1100	μmhos
Plate Current	3.7	6	8	ma
Load Resistance	25000	20000	20000	ohms
Power Output	75	160	350	mW

DIODE SECTION

The two diode units are independent of each other and of the triode section except for the common cathode. The diodes may be used as a half wave or as a full wave rectifier; or one diode may be used as a half wave rectifier for detection, and the other diode used as a rectifier to obtain delayed AVC voltage.

The voltage between heater and cathode should be kept as low as possible where they are not directly connected.

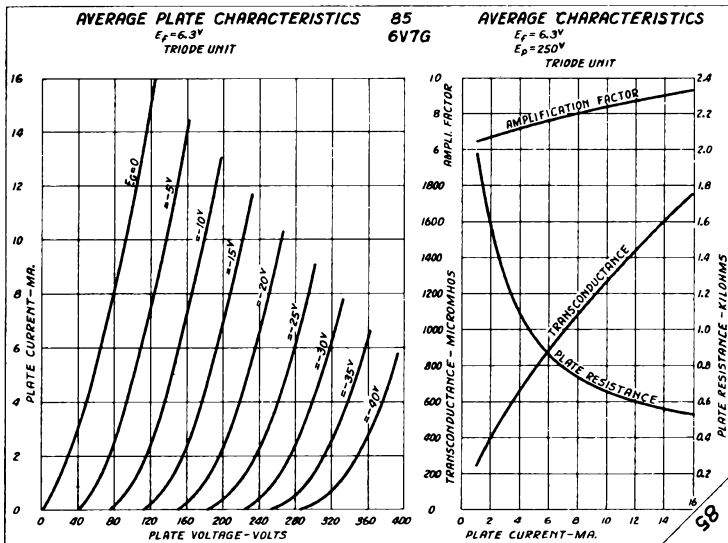

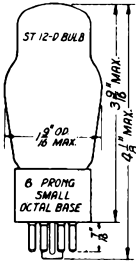

TWIN DIODE
 FULL WAVE HIGH VACUUM RECTIFIER
 Heater Type Glass Bulb

The 6W5G is a full wave high vacuum type rectifier tube designed for service in either vibrator type or a-c operated power supplies.

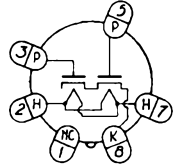

BOTTOM VIEW OF SOCKET

FULL WAVE RECTIFIER - CONDENSER OR CHOKE INPUT FILTER

Heater Voltage (a-c or d-c)	6.3	volts
Heater Current	0.9	amp
Maximum A-C Voltage per Plate (RMS)	350	volts
Maximum D-C Output Current	100	ma
Maximum D-C Voltage between Heater and Cathode	500	volts

AVERAGE OUTPUT CHARACTERISTICS
 $E_f = 6.3V$

6W5G

AVERAGE PLATE CHARACTERISTICS
 EACH PLATE
 $E_f = 6.3V$

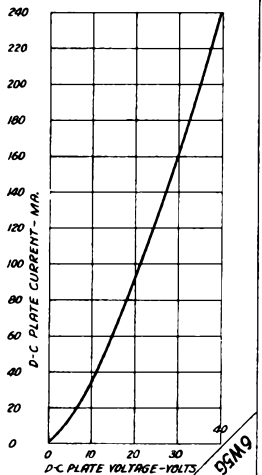
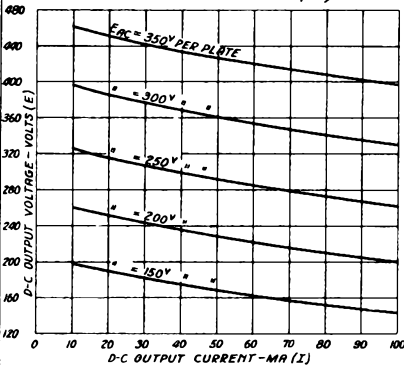
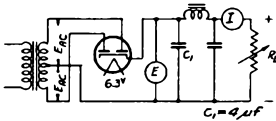

6X5 6X5G

RAYTHEON

6X5 6X5G

TWIN DIODE
FULL WAVE HIGH VACUUM RECTIFIER
Heater Type
Metal Bulb-6X5 Glass Bulb-6X5G

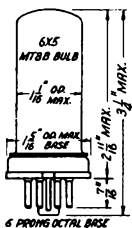

The 6X5 is a full wave high vacuum type rectifier tube designed for service in power supplies for storage battery or a-c operated receivers.

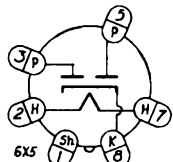

6X5
BOTTOM VIEW OF SOCKET
6X5G - NO CONNECTION TO #1 PIN.

FULL WAVE RECTIFIER
Condenser or Choke Input Filter

Heater Voltage (a-c or d-c)	6.3	volts
Heater Current	0.6	amp
Maximum A-C Voltage per Plate (RMS)	350	volts
Maximum Inverse Peak Voltage	1250	volts
Maximum D-C Output Current	75	ma
Maximum D-C Voltage between Heater and Cathode	400	volts

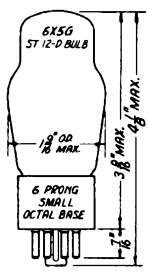

AVERAGE TUBE VOLTAGE DROP
(At 75 ma. output current per plate) 22 volts

There are certain 32 volt receivers designed with 6X5G tubes operated in series. The filament current value used in this design was 0.5 ampere. Type 6X5G tubes marked '500' under the type designation may be obtained for this service.

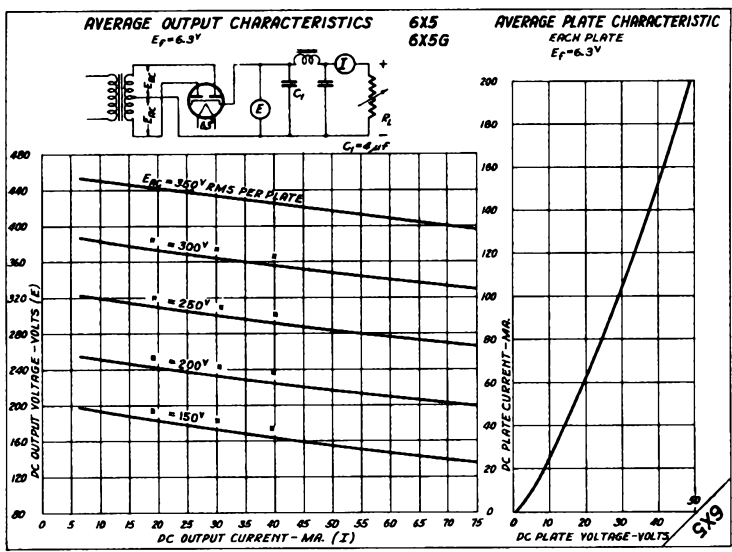

TETRODE
POWER AMPLIFIER
Heater Type Glass Bulb

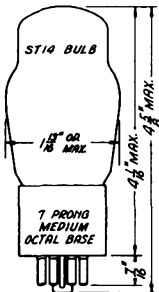

The 6Y6G is a tetrode type power amplifier tube designed for service in the output stage of a-c operated receivers having relatively low plate supply voltages.

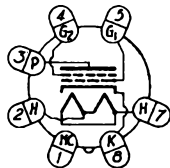

BOTTOM VIEW OF SOCKET

RATINGS

Heater Voltage (a-c or d-c)	6.3	volts
Heater Current	1.25	amp
Maximum Plate Voltage	135	volts
Maximum Screen Voltage	135	volts

AMPLIFIER - CLASS A

Plate Voltage	135	volts
Screen Voltage	135	volts
Grid Bias	-13.5	volts
Signal Peak Voltage	13.5	volts
Amplification Factor	70	
Plate Resistance (approximate)	10000	ohms
Transconductance	7000	umhos
No-Signal Plate Current	58	ma
Max.-Signal Plate Current	60	ma
No-Signal Screen Current	3	ma
Max.-Signal Screen Current	17	ma
Load Resistance	2000	ohms
Second Harmonic Distortion	2.5	percent
Third Harmonic Distortion	9	percent
Power Output	3.6	watts

The voltage between heater and cathode should be kept as low as possible where they are not directly connected.

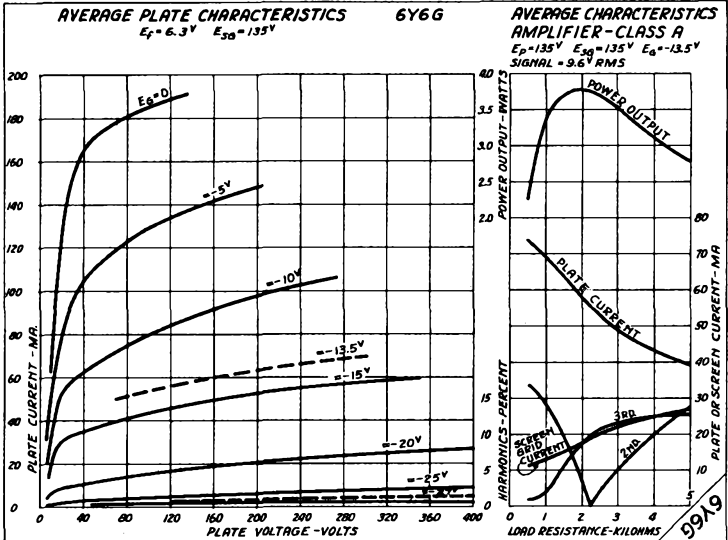

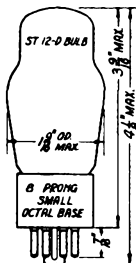

TWIN TRIODE
POWER AMPLIFIER
Heater Type Glass Bulb

The 6Y7G is a twin triode type power amplifier tube designed for service as a Class B amplifier in the output stage of storage battery or a-c operated receivers. The ratings and electrical characteristics are identical with those of the type 79.

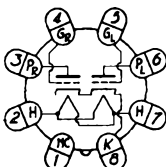

BOTTOM VIEW OF SOCKET

RATINGS

Heater Voltage (a-c or d-c)	6.3 volts
Heater Current	0.6 amp
Maximum Plate Voltage	250 volts
Max. Peak Plate Current (per plate)	90 ma
Max. Av. Plate Dissipation	11.5watts

AMPLIFIER - CLASS B

Plate Voltage	180	250	volts
Grid Bias	0	0	volts
No-Signal Plate Current (per plate)	3.8	5.3	ma
Load Resistance (plate to plate)	7000	14000	ohms
Power Output	5.5	8	watts

(With average power input = 380 mw. grid to grid)

The voltage between heater and cathode should be kept as low as possible where they are not directly connected.

For additional curves refer to the type 79.

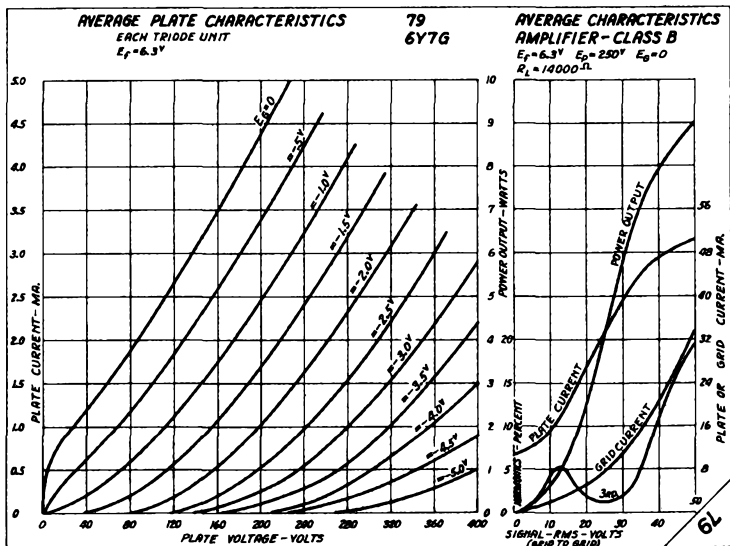

TWIN TRIODE
POWER AMPLIFIER
Heater Type

Dual Grid

Glass Bulb

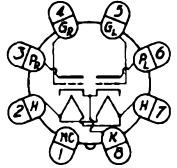
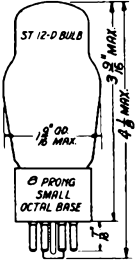

BOTTOM VIEW OF SOCKET

The 6Z7G is a twin triode type amplifier tube designed for service as a Class B power amplifier in the output stage of storage battery or a-c operated receivers requiring a low heater current tube.

RATINGS

Heater Voltage (a-c or d-c)	6.3	volts
Heater Current	0.3	amp
Maximum Plate Voltage	180	volts
Max. Peak Plate Current (per plate)	60	ma
Max. Av. Plate Dissipation	8	watts

AMPLIFIER - CLASS B

Plate Voltage	135	180	volts
Grid Bias	0	0	volts
No-Signal Plate Current (per plate)	3	4.2	ma
Load Resistance (plate to plate)	15000	20000	ohms
Power Output (With average power input = 80 mw. grid to grid)	1.5	2.2	watts
Load Resistance	9000	12000	ohms
Power Output (With average power input = 320 mw. grid to grid)	2.8	4.2	watts

The voltage between heater and cathode should be kept as low as possible where they are not directly connected.

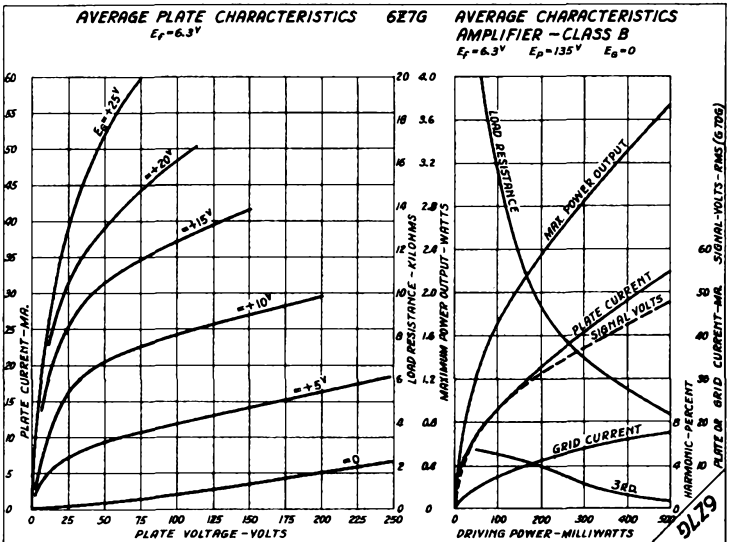

TWIN DIODE
 FULL WAVE HIGH VACUUM RECTIFIER
 Heater Type Glass Bulb

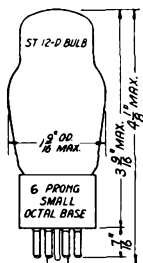

The 6ZY5G is a full wave high vacuum type rectifier tube designed for service in power supplies for storage battery or a-c operated receivers requiring a low heater current tube.

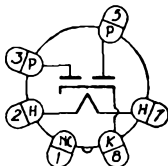

BOTTOM VIEW OF SOCKET

FULL WAVE RECTIFIER

Heater Voltage (a-c or d-c)	6.3	volts
Heater Current	0.3	amp
Maximum A-C Voltage per Plate (RMS)	350	volts
Maximum D-C Output Current	35	ma
Maximum Inverse Peak Voltage	1000	volts
Maximum Peak Plate Current per Plate	150	ma
Maximum D-C Voltage between Heater and Cathode	400	volts

AVERAGE TUBE VOLTAGE DROP (approximate) 16.5 volts
 (At 35 ma. output current per plate)

AVERAGE OUTPUT CHARACTERISTICS
 $E_f = 6.3V$

6ZY5G

AVERAGE PLATE CHARACTERISTIC
 EACH PLATE
 $E_f = 6.3V$

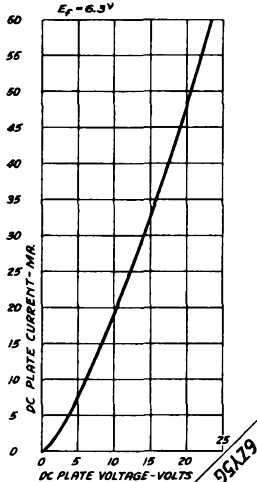
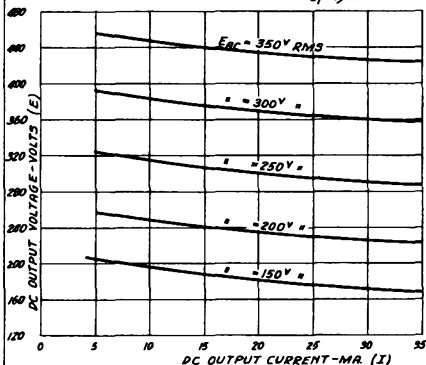
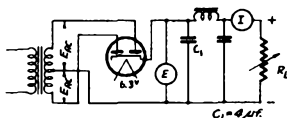

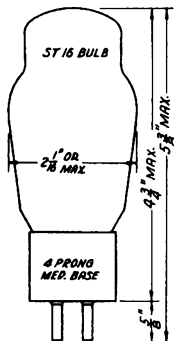

TRIODE
POWER AMPLIFIER
Filament Type Glass Bulb

The 10 is a triode type amplifier tube designed for service in the output stage of power amplifiers.

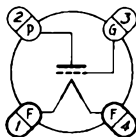

BOTTOM VIEW OF SOCKET

RATINGS

Filament Voltage (a-c or d-c)	7.5	volts
Filament Current	1.25	amp
Maximum Plate Voltage	425	volts
Maximum Plate Dissipation	12	watts

DIRECT INTERELECTRODE CAPACITANCES

Grid to Plate	7	μf
Input	4	μf
Output	3	μf

AMPLIFIER - CLASS A

Plate Voltage	250	350	425	volts
Grid Bias†	-23.5	-32	-40	volts
Signal Peak Voltage	18.5	27	35	volts
Amplification Factor	8	8	8	
Plate Resistance	6000	5150	5000	ohms
Transconductance	1330	1550	1600	μmhos
Plate Current	10	16	18	ma
Load Resistance	13000	11000	10200	ohms
Power Output	0.4	0.9	1.6	watts

AMPLIFIER - CLASS B - TWO TUBES

Maximum Plate Voltage	425	volts
Maximum Plate Current with Signal (per tube)‡	60	ma
Maximum Plate Input with Signal (per tube)‡	25	watts
Maximum Plate Dissipation (per tube)‡	12	watts

Typical Operation:

Plate Voltage	250	350	425	volts
Grid Bias† (approximate)	-28	-40	-50	volts
Signal Peak Voltage (approximate)	110	120	130	volts
No-Signal Plate Current (per tube)	4	4	4	ma
Max. -Signal Plate Current (per tube)	55	55	55	ma
Load Resistance (plate to plate)	4000	6000	8000	ohms
Power Output (approximate)	13	20	25	watts
Driving Power - grid to grid (approx.)	2.1	2.3	2.5	watts

†Grid bias values are given with respect to the mid-point of a-a-c operated filament. If d.c. is used the tabulated values of grid bias should be decreased by 5 volts and referred to the negative end of the filament.

‡Averaged over any audio frequency cycle.

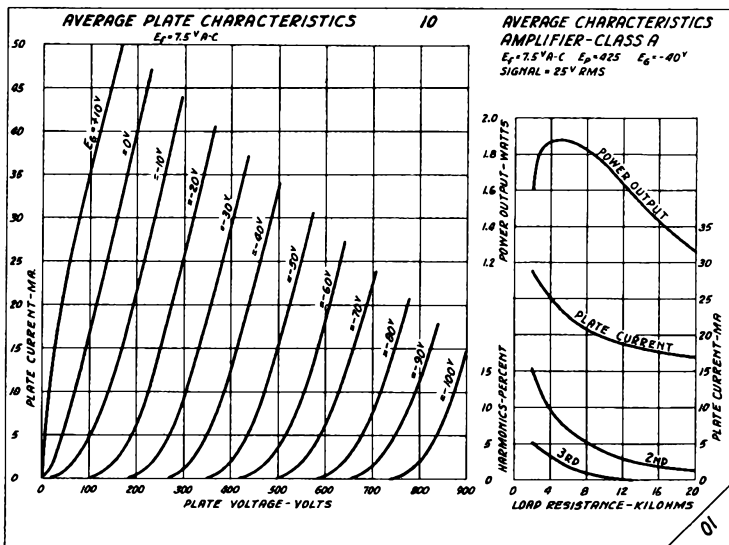

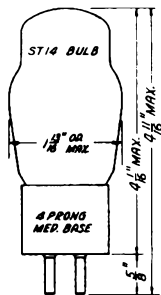

TRIODE
DETECTOR OR AMPLIFIER
Filament type Glass Bulb

The 12-A is a triode type amplifier tube designed for service as a detector or amplifier in storage battery operated receivers.

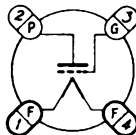

BOTTOM VIEW OF SOCKET

RATINGS

Filament Voltage	5.0 d-c volts
Filament Current	0.25 amp
Maximum Plate Voltage	180 volts

DIRECT INTERELECTRODE CAPACITANCES

Grid to Plate	7.5	μf
Input	4	μf
Output	3	μf

AMPLIFIER - CLASS A

Plate Voltage	90	135	180	volts
Grid Bias	-4.5	-9	-13.5	volts
Amplification Factor	8.5	8.5	8.5	
Plate Resistance	5400	5100	4700	ohms
Transconductance	1575	1650	1800	μmhos
Plate Current	5	6.2	7.7	ma
Load Resistance	5000	9000	10650	ohms
Power Output (5% second harmonic)	0.035	0.13	0.285	watts

If a grid resistor is used, its value should not exceed 1 megohm.

DETECTOR - BIASED TYPE

Plate Voltage	135	180	volts
Grid Bias (approximate)	-15	-21	volts
Plate Current	Adjusted to 0.2 ma. with no signal		

DETECTOR - GRID LEAK TYPE

Plate Voltage	45	volts
Grid	Return to positive filament	
Grid Leak Resistance	0.25 to 5	megohm
Grid Condenser	0.00025	μf

PENTODE
POWER AMPLIFIER
Heater Type Glass Bulb

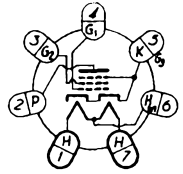
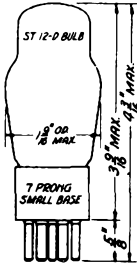

BOTTOM VIEW OF SOCKET

The 12A5 is a pentode type power amplifier tube having two heaters which may be connected in series for a heater voltage of 12.6 volts, or connected in parallel for a heater voltage of 6.3 volts.

RATINGS	Series Connection	Parallel Connection	
Heater Voltage (a-c or d-c)	12.6	6.3	volts
Heater Current	0.3	0.6	amp
Maximum Plate Voltage		180	volts
Maximum Screen Voltage		180	volts

AMPLIFIER - CLASS A

Plate Voltage	100	180	volts
Screen Voltage	100	180	volts
Grid Bias	-15	-25	volts
Amplification Factor	70	85	
Plate Resistance	41000	36000	ohms
Transconductance	1700	2400	umhos
No-Signal Plate Current	17	45	ma
No-Signal Screen Current	3	8	ma
Load Resistance	4500	3300	ohms
Second Harmonic	2.5	6.5	percent
Third Harmonic	9	8	percent
Power Output	0.7	3.4	watts

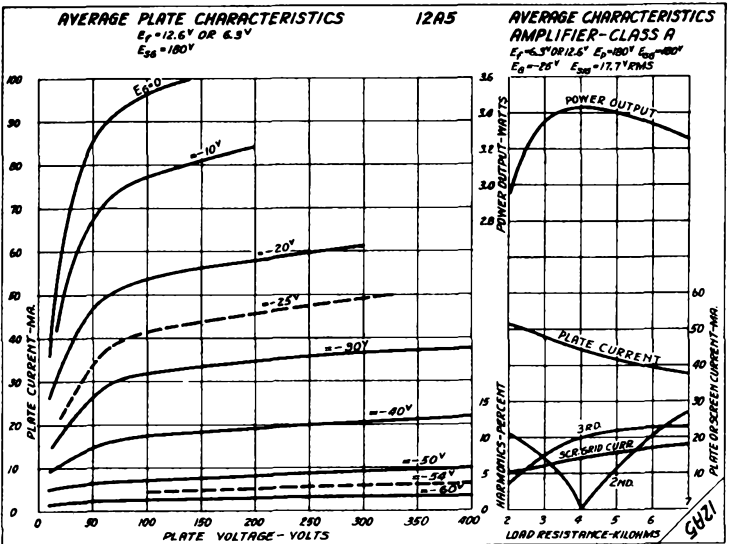

DIODE-PENTODE
RECTIFIER-POWER AMPLIFIER
Heater Type Glass Bulb

The 12A7 is a diode-pentode type tube designed for service as a half wave rectifier and power amplifier in the output stage of a-o - d-c receivers.

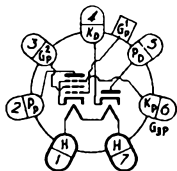

RATINGS

Heater Voltage (a-c or d-o)	12.6	volts
Heater Current	0.3	amp
Pentode Section		
Maximum Plate Voltage	135	volts
Maximum Screen Voltage	135	volts

BOTTOM VIEW OF SOCKET

AMPLIFIER - CLASS A - PENTODE SECTION

Plate Voltage	135	volts
Screen Voltage	135	volts
Grid Bias	-13.5	volts
Amplification Factor	100	
Plate Resistance	0.102	megohm
Transconductance	975	μ mhos
Plate Current	9	ma
Screen Current	2.5	ma
Load Resistance	13500	ohms
Power Output	0.55	watts

HALF WAVE RECTIFIER - RECTIFIER SECTION

Maximum A-C Plate Voltage (RMS)	125	volts
Maximum D-C Output Current	30	ma
Average Tube Voltage Drop (At 60 ma. output current)	15	volts

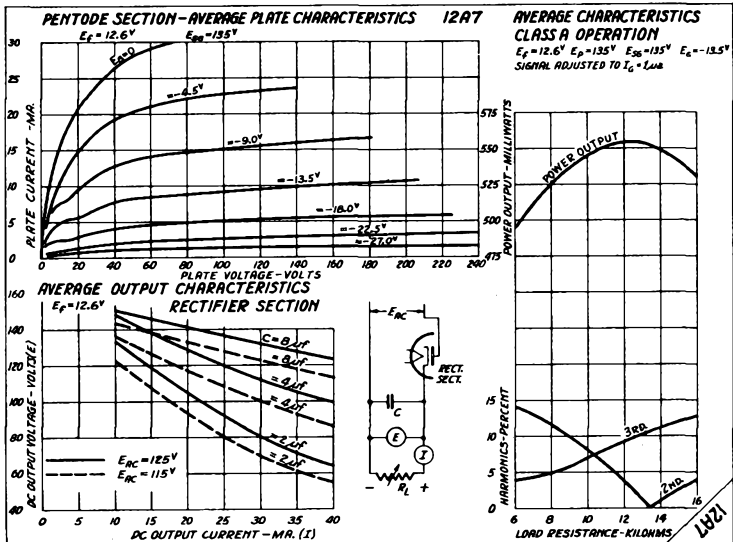

DIODE
 HALF WAVE HIGH VACUUM RECTIFIER
 Heater Type Glass Bulb

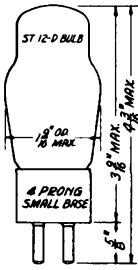

The 12Z3 is a half wave high vacuum type rectifier tube designed for service in a-c - d-c receivers.

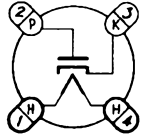

BOTTOM VIEW OF SOCKET

HALF WAVE RECTIFIER
 Condenser or Choke Input Filter

Heater Voltage (a-c or d-c)	12.6	volts
Heater Current	0.5	amp
Maximum A-C Plate Voltage (R.S)	250	volts
Maximum Inverse Peak Voltage	700	volts
Maximum D-C Output Current	60	ma
Maximum D-C Voltage between Heater and Cathode	350	volts

AVERAGE TUBE VOLTAGE DROP 18 volts
 (At 120 ma. output current)

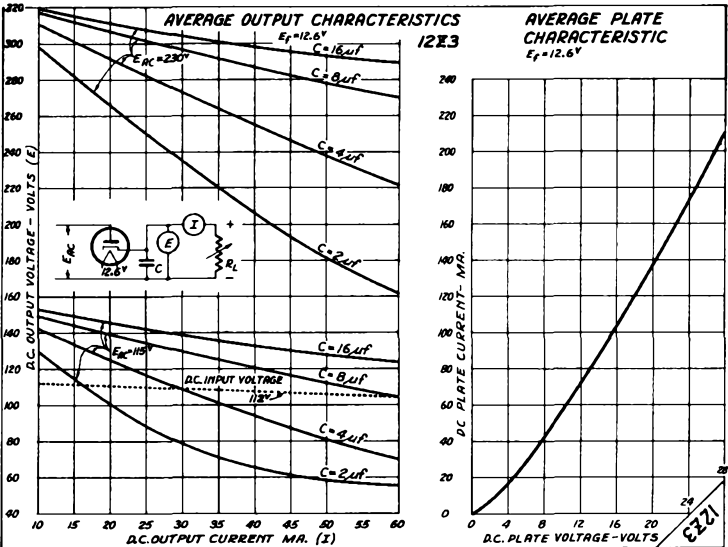

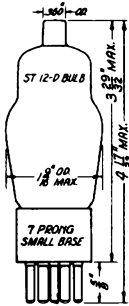

PENTODE
AMPLIFIER
Heater Type Glass Bulb

The 15 is a pentode type amplifier tube designed for service in battery operated receivers requiring a low voltage heater type tube.

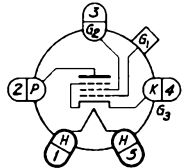

BOTTOM VIEW OF SOCKET

2.0	d-o	volts
0.22		amp
135		volts
67.5		volts

RATINGS

Heater Voltage	
Heater Current	
Max. Plate Voltage	
Max. Screen Voltage	

DIRECT INTERELECTRODE CAPACITANCES

Grid to Plate (with shield)	0.01	max.	$\mu\mu\text{f}$
Input	2.35		$\mu\mu\text{f}$
Output	7.8		$\mu\mu\text{f}$

AMPLIFIER - CLASS A

Plate Voltage	67.5	135	volts
Screen Voltage	67.5	67.5	volts
Grid Bias	-1.5	-1.5	volts
Amplification Factor	450	600	
Plate Resistance	0.63	0.8	megohm
Transconductance	710	750	μmhos
Plate Current	1.85	1.85	ma
Screen Current	0.3	0.3	ma

The voltage between heater and cathode should be as low as possible. It should never exceed 22.5 volts.

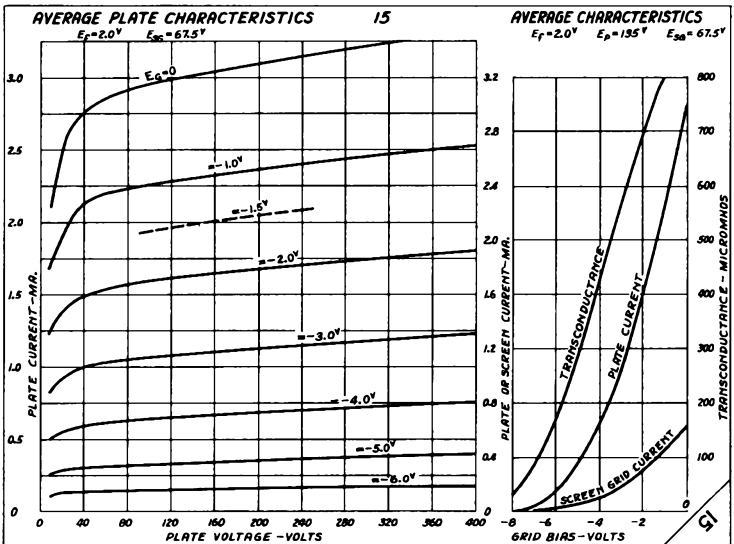

TWIN TRIODE
POWER AMPLIFIER
Filament Type Glass Bulb

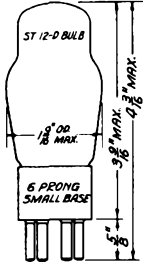

The 19 is a twin triode type power amplifier tube designed for service as a Class B amplifier in the output stage of battery operated receivers. The ratings and electrical characteristics, except filament current, are identical with those of the type 1J6G.

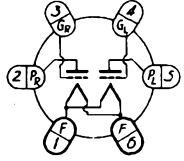

BOTTOM VIEW OF SOCKET

RATINGS

Filament Voltage	2.0 d-c	volts
Filament Current	0.26	amp
Maximum Plate Voltage	135	volts
Maximum Peak Plate Current (per plate)	50	ma

AMPLIFIER - CLASS B

Plate Voltage	135	135	135	volts
Grid Bias	-6	-3	0	volts
No-Signal Plate Current (per plate)	0.5	2	5	ma
Load Resistance (plate to plate)	10000	10000	10000	ohms
Power Output (approximate)	1.6	1.9	2.1	watts
Average Power Input (grid to grid)	0.095	0.13	0.17	watts

For additional curves refer to the type 1J6G.

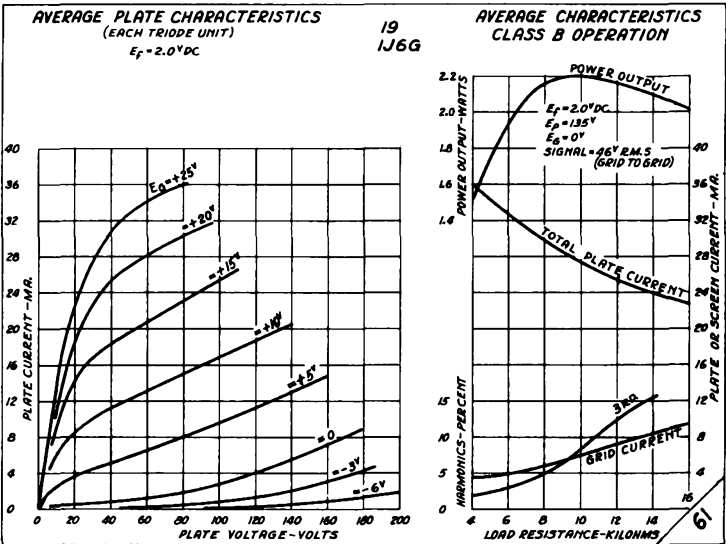

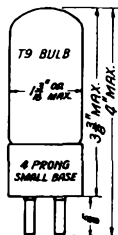

TRIODE
POWER AMPLIFIER
Filament Type Glass Bulb

The 20 is a triode type power amplifier tube designed for service in the output stage of battery operated receivers.

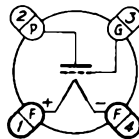

BOTTOM VIEW OF SOCKET

RATINGS

Filament Voltage	3.0	3.3 d-c	volts
Filament Current	0.125	0.132	amp
Maximum Plate Voltage		135	volts

DIRECT INTERELECTRODE CAPACITANCES

Grid to Plate	4.1	μ f
Input	2.0	μ f
Output	2.3	μ f

AMPLIFIER - CLASS A

Plate Voltage	90	135	volts
Grid Bias	-16.5	-22.5	volts
Amplification Factor	3.3	3.3	
Plate Resistance	8000	6300	ohms
Transconductance	415	525	μ mhos
Plate Current	3	6.5	ma
Load Resistance	9600	6500	ohms
Power Output (5% second harmonic)	45	110	mW

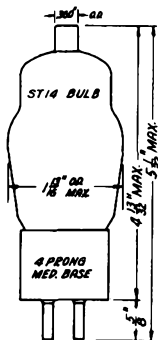

TETRODE
AMPLIFIER
Filament Type Glass Bulb

The 22 is a tetrode type amplifier tube designed for service as a highfrequency amplifier in battery operated receivers.

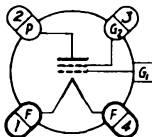

BOTTOM VIEW OF SOCKET

RATINGS

Filament Voltage	3.3 d-c	volts
Filament Current	0.132	amp
Maximum Plate Voltage	135	volts
Maximum Screen Voltage	67.5	volts

DIRECT INTERELECTRODE CAPACITANCES

Grid to Plate	0.020 max.*	μ f
Input	3.3	μ f
Output	12	μ f

AMPLIFIER - CLASS A

Plate Voltage	135	135	volts
Screen Voltage	45	67.5	volts
Grid Bias	-1.5	-1.5	volts
Amplification Factor	270	160	
Plate Resistance	0.725	0.325	megohm
Transconductance	375	500	μ mhos
Plate Current	1.7	3.7	ma
Screen Current	0.6	1.3	ma

If a grid resistor is used, its value should not exceed 5 megohms with a screen voltage of 45 volts, or 1 megohm with a screen voltage of 67.5 volts.

*With tube shield

25A6 25A6G

RAYTHEON

25A6 25A6G

PENTODE
POWER AMPLIFIER
Heater Type

Metal Bulb-25A6 Glass Bulb-25A6G

The 25A6 is a pentode type power amplifier tube designed for service in the output stage of a-o-d-c receivers. The ratings and electrical characteristics are identical with those of the type 43.

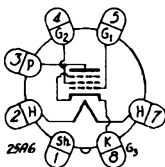

BOTTOM VIEW OF SOCKET
25A6G - NO CONNECTION
TO #1 PIN

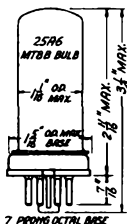

RATINGS

Heater Voltage (a-c or d-c)	25 volts
Heater Current	0.3 amp
Max. Plate Voltage	180 volts
Max. Screen Voltage	135 volts

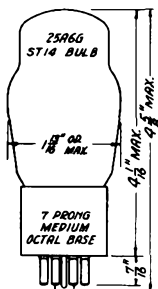

AMPLIFIER - CLASS A

Plate Voltage	95	135	180	volts
Screen Voltage	95	135	135	volts
Grid Bias	-15	-20	-20	volts
Amplification Factor (approx.)	90	85	100	
Plate Resistance (approx.)	45000	35000	40000	ohms
Transconductance	2000	2450	2500	μmhos
Plate Current	20	37	38	ma
Screen Current	4	8	7.5	ma
Load Resistance	4500	4000	5000	ohms
Total Harmonic Distortion	11	9	10	percent
Power Output	0.9	2	2.75	watts

Heater to cathode bias should not exceed 90 volts d-c, as measured between the negative heater terminal and the cathode.

For additional curves refer to the type 43.

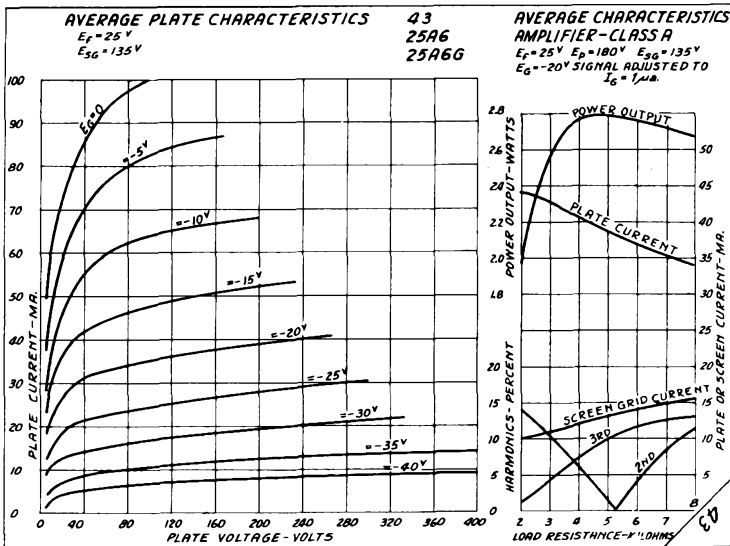

DIODE PENTODE
RECTIFIER POWER AMPLIFIER
Heater Type Glass Bulb

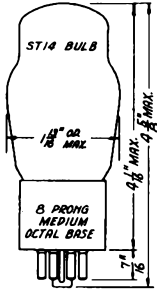

The 25A7G is a diode-pentode type tube designed for service as a half wave rectifier and power amplifier in the output stage of a-c - d-c receivers.

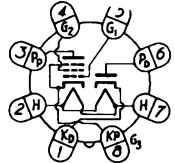

BOTTOM VIEW OF SOCKET

RATINGS

Heater Voltage (a-c or d-c)	25	volts
Heater Current	0.3	amp
Pentode Section		
Maximum Plate Voltage	100	volts
Maximum Screen Voltage	100	volts

AMPLIFIER - CLASS A - PENTODE SECTION

Plate Voltage	100	volts
Screen Voltage	100	volts
Grid Bias	-15	volts
Amplification Factor	90	
Plate Resistance	30000	ohms
Transconductance	1800	μmhos
Plate Current	20.5	ma
Screen Current	4	ma
Load Resistance	4500	ohms
Total Harmonic Distortion	9	percent
Power Output	0.77	watts

HALF WAVE RECTIFIER - RECTIFIER SECTION

Maximum A-C Plate Voltage RMS	125	volts
Maximum D-C Output Current	75	ma

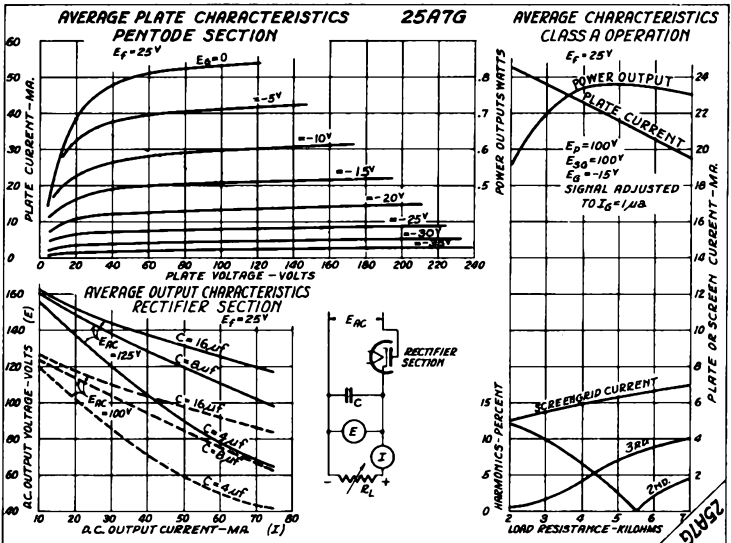

25B6G

RAYTHEON

25B6G

ALIGNED GRID PENTODE
POWER AMPLIFIER
Heater Type Glass Bulb

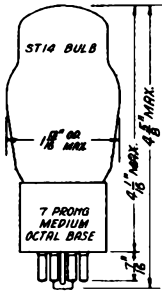

The 25B6G is an aligned grid pentode type power amplifier tube designed for service in the output stage of a-c - d-c receivers.

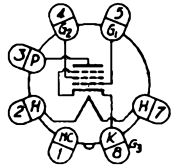

BOTTOM VIEW OF SOCKET

RATINGS

Heater Voltage (a-c or d-o)	25	volts
Heater Current	0.3	amp
Maximum Plate Voltage	95	volts
Maximum Screen Voltage	95	volts

AMPLIFIER - CLASS A

Plate Voltage	95	volts
Screen Voltage	95	volts
Grid Bias	-15	volts
Plate Resistance	Subject to considerable variation	
Transconductance	4000	μmhos
Plate Current	45	ma
Screen Current	4	ma
Load Resistance	2000	ohms
Total Harmonics	10	percent
Power Output	1.75	watts

The voltage between heater and cathode should be kept as low as possible where they are not directly connected.

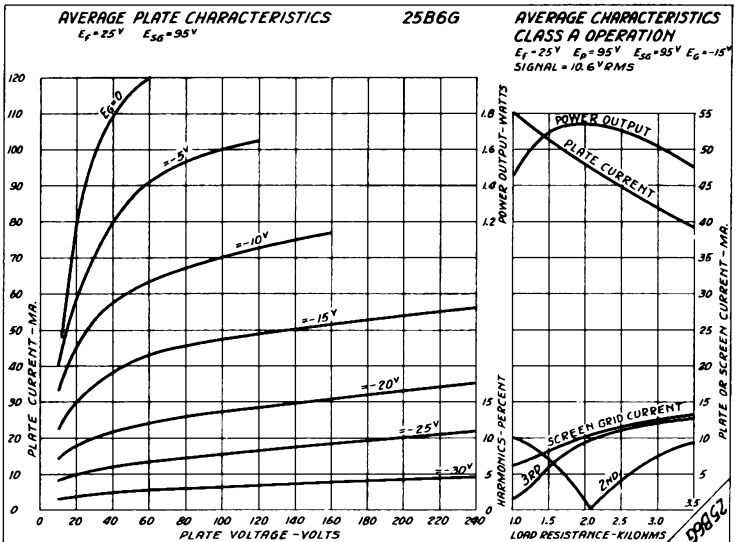

25L6 25L6G

RAYTHEON

25L6 25L6G

TETRODE
POWER AMPLIFIER
Heater Type
Metal Bulb-25L6 Glass Bulb-25L6G

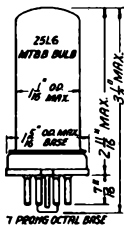

The 25L6 is a tetrode type power amplifier tube designed for service in the output stage of a-c - d-c receivers.

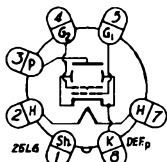

BOTTOM VIEW OF SOCKET
25L6-NO CONNECTION
TO #1 PIN

RATINGS

Heater Voltage (a-c or d-c)	25	volts
Heater Current	0.3	amp
Maximum Plate Voltage	110	volts
Maximum Screen Voltage	110	volts

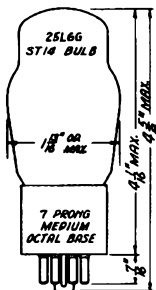

AMPLIFIER - CLASS A

Plate Voltage	110	110	volts
Screen Voltage	110	110	volts
Grid Bias*	-7.5	-7.5	volts
Signal Peak Voltage	7.5	7.5	volts
Amplification Factor	82	82	
Plate Resistance (approx.)	10000	10000	ohms
Transconductance	8200	8200	umhos
No-Signal Plate Current	49	49	ma
Max.-Signal Plate Current	54	50	ma
No-Signal Screen Current	4	4	ma
Max.-Signal Screen Current	9	11	ma
Load Resistance	1500	2000	ohms
Total Harmonic Distortion	11	10	percent
Second Harmonic Distortion	10	3.5	percent
Third Harmonic Distortion	4	8.5	percent
Power Output	2.1	2.2	watts

The voltage between heater and cathode should not exceed 90 volts, as measured between the negative end of the heater and the cathode.

*Transformer or impedance input systems are recommended. If resistance coupling is used, the d-c resistance in the grid circuit should not exceed 0.5 megohm with self-bias, or 0.1 megohm with fixed-bias.

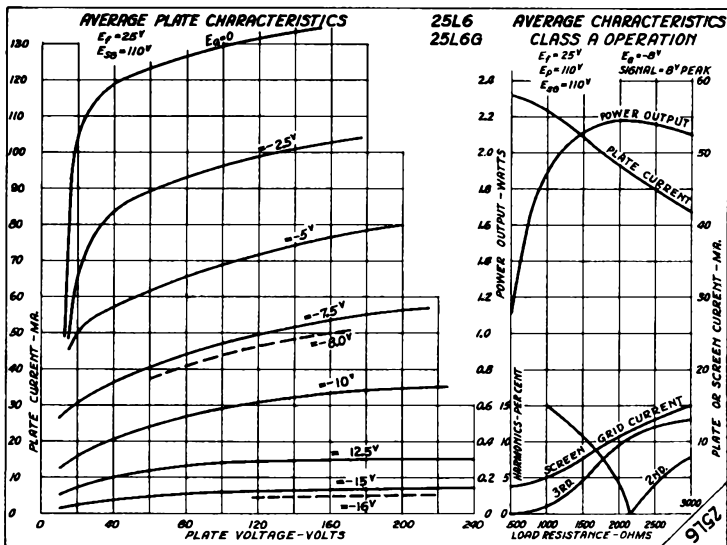

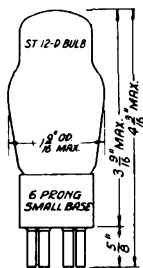

TWIN DIODE
HIGH VACUUM RECTIFIER
VOLTAGE DOUBLER
Heater Type Glass Bulb

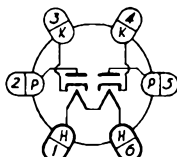

BOTTOM VIEW OF SOCKET

The 25Z5 is a high vacuum type rectifier tube designed for service as a half wave rectifier or voltage doubler in a-c - d-c receivers.

VOLTAGE DOUBLER

Heater Voltage (a-c or d-c)	25	volts
Heater Current	0.3	amp
Maximum A-C Voltage per Plate (RMS)	125	volts
Maximum Peak Plate Current	500	ma
Maximum D-C Output Current	100	ma

HALF-WAVE RECTIFIER

Heater Voltage (a-c or d-c)	25	volts
Heater Current	0.3	amp
Maximum A-C Voltage per Plate (RMS)	125	volts
Maximum Peak Current per Plate	500	ma
Maximum D-C Output Current per Plate	85	ma

	Without Series Resistor	With Series Resistor*	
Heater Voltage (a-c or d-c)	25	25	volts
Heater Current	0.3	0.3	amp
Maximum A-C Voltage per Plate (RMS)	125	250	volts
Maximum Peak Current per Plate	500	500	ma
Maximum D-C Output Current per Plate	85	85	ma

As a half-wave rectifier, the two sections may be used either separately or connected in parallel.

*A-C plate voltages greater than 125 volts require the use of a 100 ohm series resistor in each plate lead or a 100 ohm series resistor common to both plates. The latter connection gives somewhat poorer regulation.

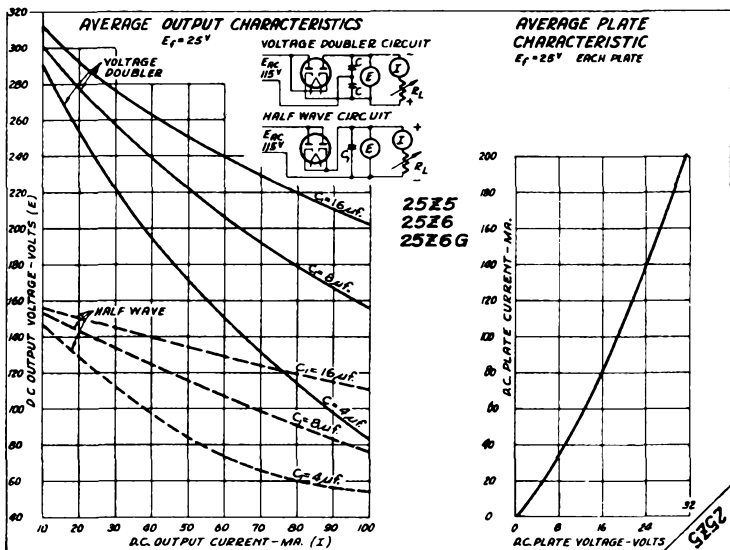

25Z6 25Z6G

RAYTHEON

25Z6 25Z6G

TWIN DIODE
HIGH VACUUM RECTIFIER
VOLTAGE DOUBLER
Heater Type

Metal Bulb-25Z6 Glass Bulb-25Z6G

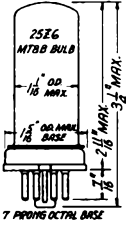

The 25Z6 is a high vacuum type rectifier tube designed for service as a half-wave rectifier or voltage doubler in a-c - d-o receivers.

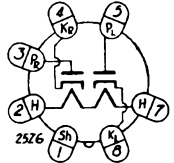

BOTTOM VIEW OF SOCKET
25Z6G-NO CONNECTION
TO #1 PIN

VOLTAGE DOUBLER

Heater Voltage (a-c or d-c)	25	volts
Heater Current	0.3	amp
Maximum A-C Voltage per Plate (RMS)	125	volts
Maximum Peak Plate Current	500	ma
Maximum D-C Output Current	85	ma

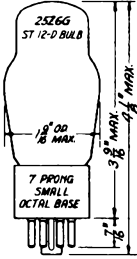

HALF WAVE RECTIFIER

	Without Series Resistor	With Series Resistor*	
Heater Voltage (a-c or d-c)	25	25	volts
Heater Current	0.3	0.3	amp
Max. A-C Voltage per Plate (RMS)	125	250	volts
Max. Peak Plate Current per Plate	500	500	ma
Max. D-C Output Current per Plate	85	85	ma

As a half-wave rectifier, the two sections may be used either separately or connected in parallel.

*A-C plate voltages greater than 125 volts require the use of a 100 ohm series resistor in each plate lead or a 100 ohm series resistor common to both plates. The latter connection gives somewhat poorer regulation.

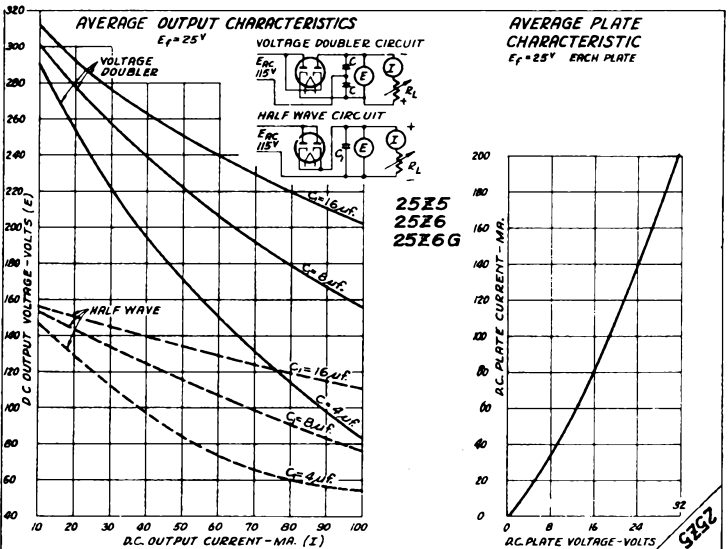

TRIODE
AMPLIFIER

Filament Type Glass Bulb

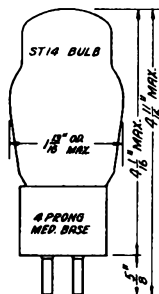

The 26 is a triode type amplifier tube designed for service in a-c operated receivers.

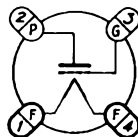

BOTTOM VIEW OF SOCKET

RATINGS

Filament Voltage (a-c or d-o)	1.5	volts
Filament Current	1.05	amp
Maximum Plate Voltage	180	volts

DIRECT INTERELECTRODE CAPACITANCES

Grid to Plate	8.1	μ f
Input	3.5	μ f
Output	2.2	μ f

AMPLIFIER - CLASS A

Plate Voltage	90	135	180	volts
Grid Bias†	-7	-10	-14.5	volts
Amplification Factor	8.3	8.3	8.3	
Plate Resistance	8900	7600	7300	ohms
Transconductance	935	1100	1150	μ mhos
Plate Current	2.9	5.5	6.2	ma

†Grid Bias measured from mid-point of a-c operated filament.

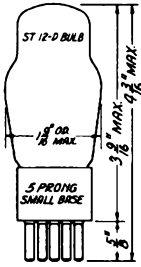

TRIODE
 DETECTOR OR AMPLIFIER
 Heater Type Glass Bulb

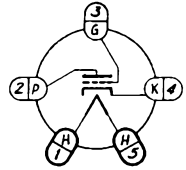

The 27 is a triode type amplifier tube designed for service as a detector or amplifier in a-c operated receivers.

RATINGS

Heater Voltage (a-c or d-c)
 Heater Current
 Maximum Plate Voltage

BOTTOM VIEW OF SOCKET
 2.5 volts
 1.75 amp
 250 volts

DIRECT INTERELECTRODE CAPACITANCES

Grid to Plate 3.3 μ f
 Input 3.5 μ f
 Output 3.0 μ f

AMPLIFIER - CLASS A

Plate Voltage	90	135	180	250	volts
Grid Bias	-6	-9	-13.5	-21	volts
Amplification Factor	9	9	9	9	
Plate Resistance	11000	9000	9000	9250	ohms
Transconductance	820	1000	1000	975	μ mhos
Plate Current	2.7	4.5	5.0	5.2	ma

If a grid resistor is used, its value should not exceed 1 megohm

DETECTOR - BIASED TYPE

Plate Voltage 250 275 max. volts
 Grid Bias (approximate) -30 -33 volts
 Plate Current \ddagger Adjusted to 0.2 ma. with no signal

DETECTOR - GRID LEAK TYPE

Plate Voltage 45 volts
 Grid Return to Cathode
 Grid Leak Resistance 1 to 5 megohms
 Grid Condenser 0.00025 μ f

The voltage between heater and cathode should be kept as low as possible where they are not directly connected.

\ddagger With normal maximum signal the average d-c plate current should not exceed 5 ma.

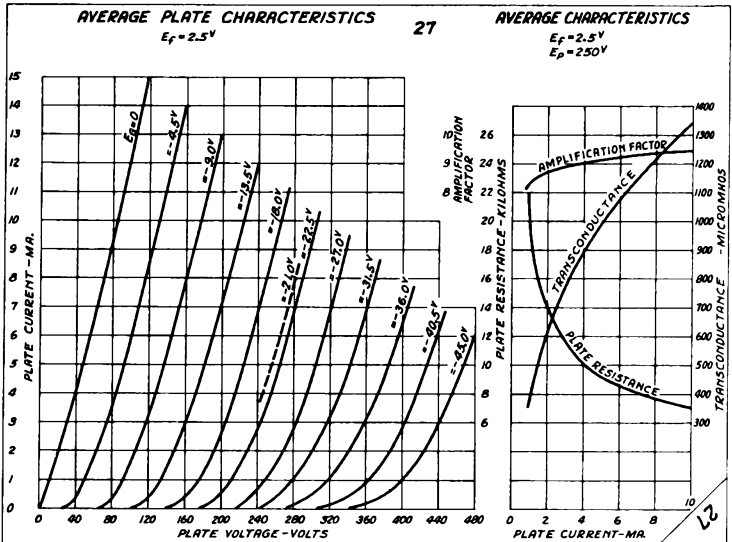

TRIODE
DETECTOR OR AMPLIFIER
Filament Type Glass Bulb

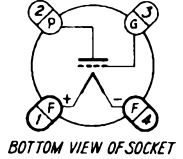
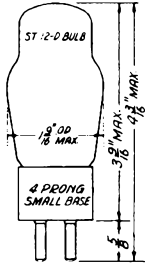

The 30 is a triode type amplifier tube designed for service as a detector or amplifier in battery operated receivers. The ratings and electrical characteristics are identical with those of the type 1H4G.

RATINGS

Heater Voltage	2.0 d-c volts
Heater Current	0.060 amp
Maximum Plate Voltage	180 volts

DIRECT INTERELECTRODE CAPACITANCES

Grid to Plate	6.0	μf
Input	3.7	μf
Output	2.1	μf

AMPLIFIER - CLASS A

Plate Voltage	90	135	180	volts
Grid Bias	-4.5	-9	-13.5	volts
Amplification Factor	9.3	9.3	9.3	
Plate Resistance	11000	10300	10300	ohms
Transconductance	850	900	900	μmhos
Plate Current	2.5	3.0	3.1	ma

If a grid resistor is used, its value should not exceed 2 megohms.

AMPLIFIER - CLASS B - TWO TUBES

Maximum Plate Voltage	130	volts
Maximum Peak Plate Current (per tube)	50	ma
Maximum No-Signal Plate Current (per tube)	1.5	ma
Typical Operation:		
Plate Voltage	157.5	volts
Grid Bias	-15	volts
No-Signal Plate Current (per tube)	0.5	ma
Load Resistance (plate to plate)	3000	ohms
Power Output†	2.1	watts
(With average power input = 260 mw. grid to grid)		

DETECTOR - BIASED TYPE

Plate Voltage	90	135	180	volts
Grid Bias (approximate)	-9	-13.5	-18	volts
Plate Current†	Adjusted to 0.2 ma. with no signal			

DETECTOR - GRID LEAK TYPE

Plate Voltage	45 max.	volts
Grid	Returned to positive filament	
Grid Leak Resistance	1 to 5 megohms	
Grid Condenser	0.00025	μf

†With one type 30 as driver operated at plate voltage of 157.5 volts, grid bias of -11.3 volts, plate load of approximately 18000 ohms, and input transformer ratio, primary to 1/2 secondary, of 1.165. Total distortion is 6% to 7%.

‡With normal maximum signal the average d-c plate current should not exceed 2 ma.

For additional curves refer to the type 1H4G.

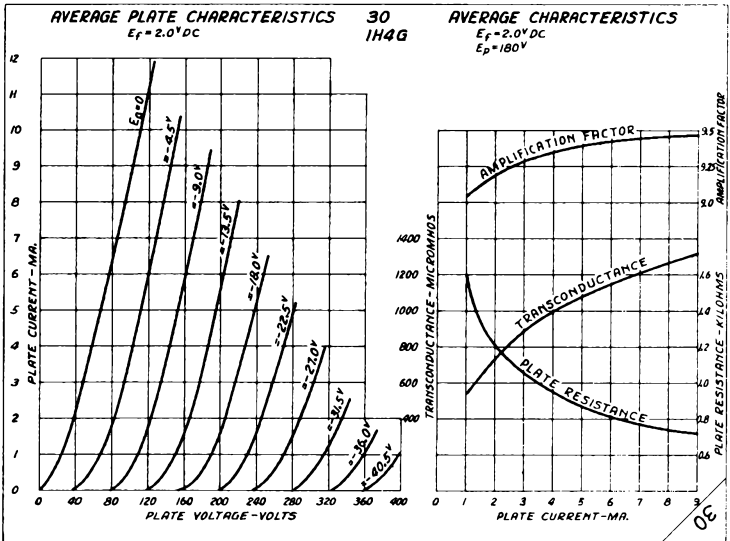

TRIODE
POWER AMPLIFIER

Filament Type Glass Bulb

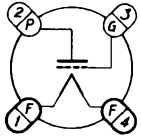

BOTTOM VIEW OF SOCKET

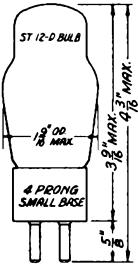

The 31 is a triode type power amplifier tube designed for service in the output stage of battery operated receivers.

RATINGS

Filament Voltage	2.0 d-c	volts
Filament Current	0.13	amp
Maximum Plate Voltage	180	volts

DIRECT INTERELECTRODE CAPACITANCES

Grid to Plate	5.7	μ lf
Input	3.5	μ lf
Output	2.7	μ lf

AMPLIFIER - CLASS A

Plate Voltage	135	180	volts
Grid Bias	-22.5	-30	volts
Amplification Factor	3.8	3.8	
Plate Resistance	4100	3600	ohms
Transconductance	925	1050	μ mhos
Plate Current	8	12.3	ma
Load Resistance	7000	5700	ohms
Power Output (5% second harmonic)	185	375	mw

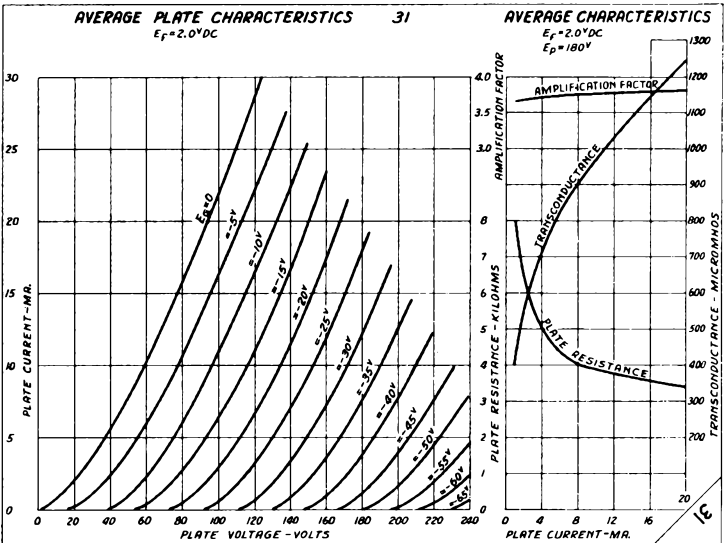

TETRODE
DETECTOR OR AMPLIFIER
Filament Type Glass Bulb

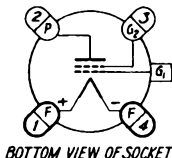
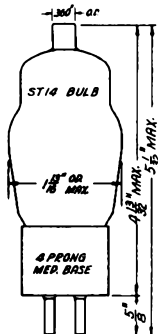

The 32 is a tetrode type amplifier tube designed for service as a detector or amplifier in battery operated receivers.

RATINGS

Filament Voltage	2.0 d-c	volts
Filament Current	0.060	amp
Maximum Plate Voltage	180	volts
Maximum Screen Voltage	67.5	volts

DIRECT INTERELECTRODE CAPACITANCES

Grid to Plate	0.015 max. *	μ f
Input	5.3	μ f
Output	10.5	μ f

AMPLIFIER - CLASS A

Plate Voltage	135	180	volts
Screen Voltage	67.5	67.5	volts
Grid Bias	-3	-3	volts
Amplification Factor	610	780	
Plate Resistance	0.95	1.2	megohm
Transconductance	640	650	μ mhos
Plate Current	1.7	1.7	ma
Screen Current	0.4	0.4 max.	ma

If a grid resistor is used, its value should not exceed 2 megohms.

DETECTOR - BIASED TYPE

Plate Supply Voltage	135	180	volts
Screen Voltage	45	67.5	volts
Grid Bias (approximate)	-4.5	-6	volts
Plate Load	0.1 megohm or equivalent impedance		
Plate Current	Adjusted to 0.2 ma. with no signal		

DETECTOR - GRID LEAK TYPE

Plate Voltage	135	volts
Screen Voltage	Up to 45	volts
Grid	Return to positive filament	
Plate Load	0.1 megohm or equivalent impedance	
Grid Leak Resistance	1 to 5	megohm
Grid Condenser	0.00025	μ f

*With tube shield.

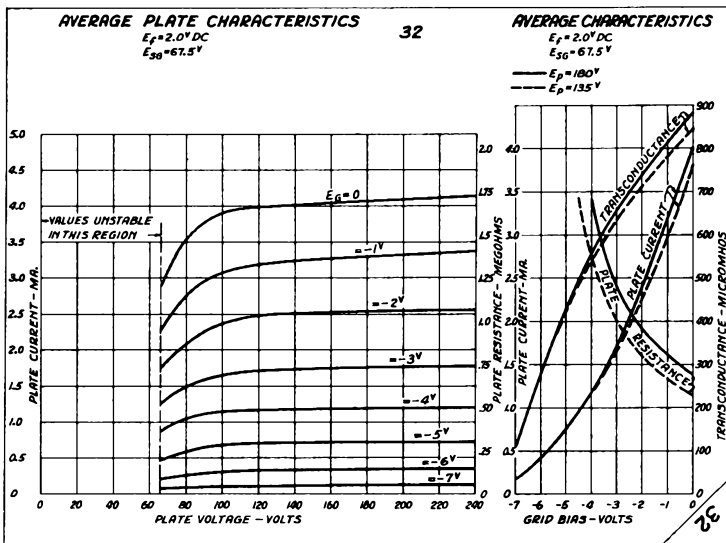

PENTODE
POWER AMPLIFIER
Filament Type Glass Bulb

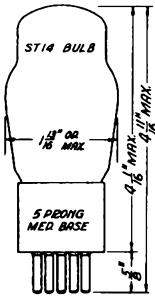

The 33 is a pentode type power amplifier tube designed for service in the output stage of battery operated receivers.

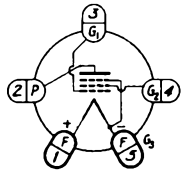

BOTTOM VIEW OF SOCKET

RATINGS

Filament Voltage	2.0 d-c	volts
Filament Current	0.26	amp
Maximum Plate Voltage	180	volts
Maximum Screen Voltage	180	volts

AMPLIFIER - CLASS A

Plate Voltage	135	180	volts
Screen Voltage	135	180	volts
Grid Bias	-13.5	-18	volts
Amplification Factor	70	90	
Plate Resistance	50000	55000	ohms
Transconductance	1450	1700	μmhos
Plate Current	14.5	22	ma
Screen Current	3	5	ma
Load Resistance	7000	6000	ohms
Power Output (7% total distortion)	0.7	1.4	watts

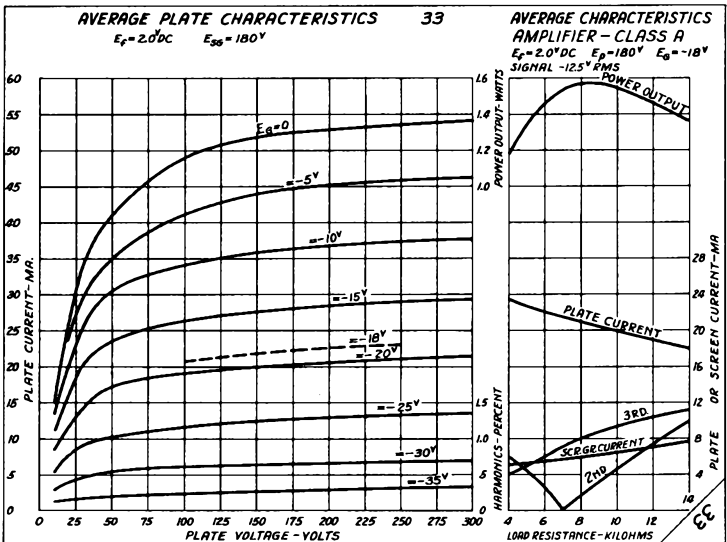

PENTODE
REMOTE CUTOFF AMPLIFIER
Filament Type Glass Bulb

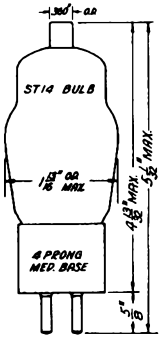
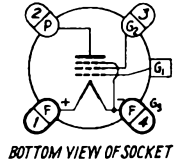

The 34 is a pentode type amplifier tube with remote cutoff characteristics designed for service as a high frequency amplifier or mixer in battery operated receivers.

RATINGS

Filament Voltage	2.0 d-c volts
Filament Current	0.060 amp
Maximum Plate Voltage	180 volts
Maximum Screen Voltage	67.5 volts

DIRECT INTERELECTRODE CAPACITANCES

Grid to Plate	0.015 max.* μ f
Input	6 μ f
Output	11.5 μ f

AMPLIFIER - CLASS A

Plate Voltage	67.5	135	180	volts
Screen Voltage	67.5	67.5	67.5	volts
Grid Bias	-3	-3	-3	volts
Amplification Factor	224	360	620	
Plate Resistance	0.4	0.6	1	megohm
Transconductance	560	600	620	μ mhos
Plate Current	2.7	2.8	2.8	ma
Screen Current	1.1	1.0	1.0	ma
Transconductance (At -22.5 volts bias)	15	15	15	μ mhos

MIXER - SUPERHETERODYNE CIRCUIT

Plate Voltage	67.5	135	180	volts
Screen Voltage	67.5	135	180	volts
Grid Bias (approximate)†	-5	-5	-5	volts

†The grid bias shown is minimum for an oscillator peak voltage of 4 volts
*With tube shield.

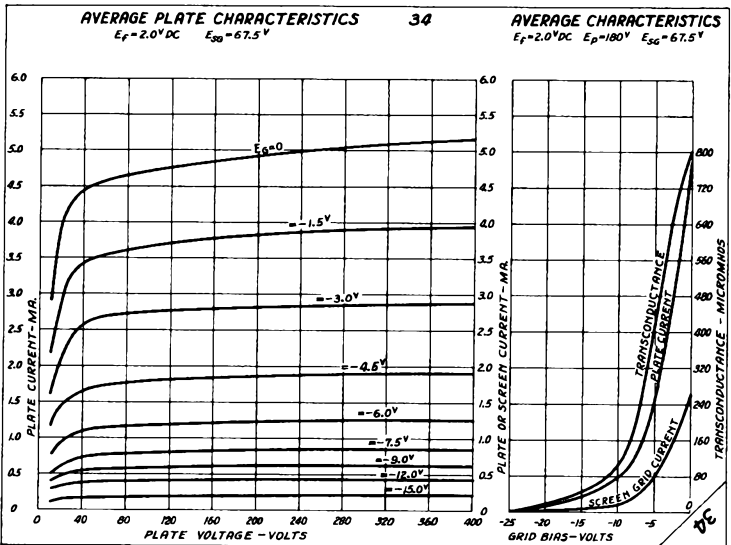

TETRODE
REMOTE CUTOFF AMPLIFIER
Heater Type Glass Bulb

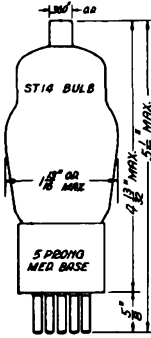

The 35/51 is a tetrode type amplifier tube with remote cutoff characteristics designed for service as a high frequency amplifier or mixer in a-c operated receivers.

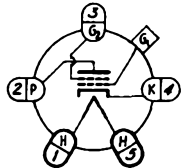

BOTTOM VIEW OF SOCKET

RATINGS

Heater Voltage (a-c or d-c)	2.5	volts
Heater Current	1.75	amp
Maximum Plate Voltage	250	volts
Maximum Screen Voltage	90	volts

DIRECT INTERELEKTRODE CAPACITANCES

Grid to Plate	0.007 max.*	μf
Input	5	μf
Output	10.5	μf

AMPLIFIER - CLASS A

Plate Voltage	180	250	volts
Screen Voltage	90	90	volts
Grid Bias	-3 min.	-3 min.	volts
Amplification Factor	305	420	
Plate Resistance	0.3	0.4	megohm
Transconductance	1020	1050	μmhos
Plate Current	6.3	6.5	ma
Screen Current	2.5	2.5	ma
Transconductance (At -42.5 volts bias)	2	2	μmhos

MIXER - SUPERHETERODYNE CIRCUIT

Plate Voltage	250	volts
Screen Voltage	90	volts
Grid Bias (approximate)	-7	volts

The grid bias is not critical with an oscillator peak voltage 1 volt less the grid bias.

The voltage between heater and cathode should be kept as low as possible where they are not directly connected.

*With tube shield.

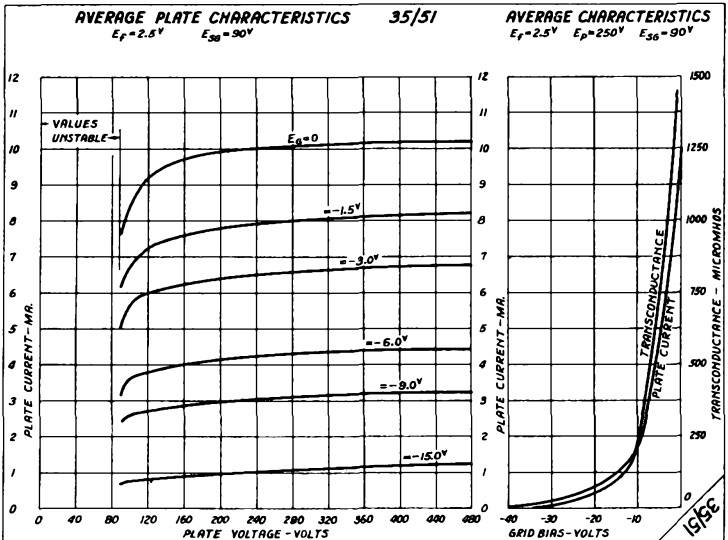

TETRODE
 DETECTOR OR AMPLIFIER
 Heater Type Glass Bulb

The 36 is a tetrode type amplifier tube designed for service as a high or audio frequency amplifier or detector in storage battery or a-c operated receivers.

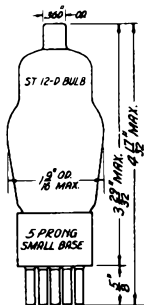
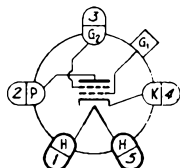

RATINGS

Heater Voltage (a-c or d-o)	6.3	volts
Heater Current	0.3	amp
Maximum Plate Voltage	250	volts
Maximum Screen Voltage	90	volts

BOTTOM VIEW OF SOCKET

6.3	volts
0.3	amp
250	volts
90	volts

DIRECT INTERELECTRODE CAPACITANCES

Grid to Plate	0.007*	μf
Input	3.7	μf
Output	9.2	μf

AMPLIFIER - CLASS A

Plate Voltage	100	135	180	250	volts
Screen Voltage	55	67.5	90	90	volts
Grid Bias	-1.5	-1.5	-3	-3	volts
Amplification Factor	470	475	525	595	
Plate Resistance	0.55	0.475	0.50	0.55	megohm
Transconductance	850	1000	1050	1000	μmhos
Plate Current	1.8	2.8	3.1	3.2	ma
Screen Current				1.7 max.	ma

DETECTOR - BIASED TYPE

Plate Supply Voltage	100	180	250	volts
Screen Voltage	55	67.5	90	volts
Grid Bias (approximate)	-5	-6	-8	volts
Plate Load	0.25	0.25	0.25	megohm
Plate Current	Adjusted to 0.1 ma. with no signal			

DETECTOR - GRID LEAK TYPE

Plate Supply Voltage	135	volts
Screen Voltage	Up to 45	volts
Grid	Return to Cathode	
Plate Load	0.25	megohm
Grid Leak Resistance	2 to 5	megohm
Grid Condenser	0.00025	μf

The voltage between heater and cathode should be kept as low as possible where they are not directly connected.

*With tube shield

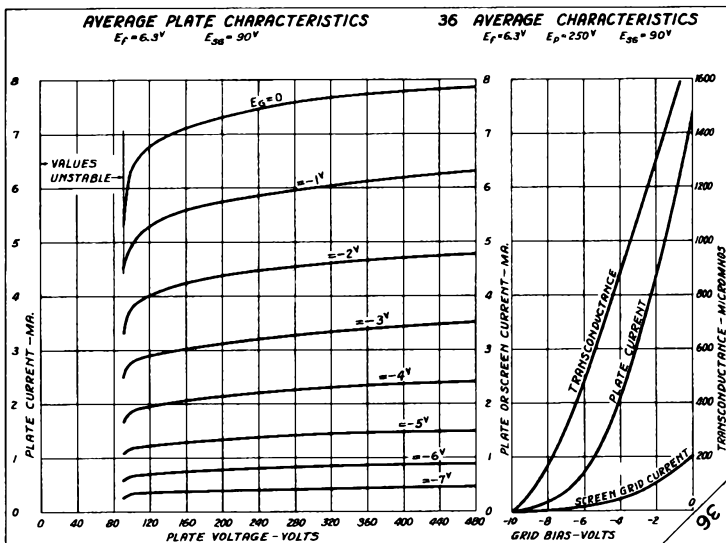

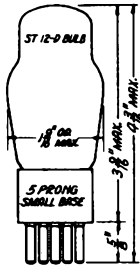

TRIODE
DETECTOR OR AMPLIFIER
Heater Type Glass Bulb

The 37 is a triode type amplifier tube designed for service as a detector or amplifier in storage battery or a-c operated receivers.

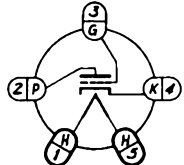

RATINGS

Heater Voltage (a-o or d-o)	6.3	volts
Heater Current	0.3	amp
Maximum Plate Voltage	250	volts

BOTTOM VIEW OF SOCKET

DIRECT INTERELECTRODE CAPACITANCES

Grid to Plate	2.0	μf
Input	3.5	μf
Output	2.2	μf

AMPLIFIER - CLASS A

Plate Voltage	90	135	180	250	volts
Grid Bias	-6	-9	-13.5	-18	volts
Amplification Factor	9.2	9.2	9.2	9.2	
Plate Resistance	11500	10000	10200	8400	ohms
Transconductance	800	925	900	1100	μmhos
Plate Current	2.5	4.1	4.3	7.5	ma

If a grid resistor is used, its value should not exceed 1 megohm.

DETECTOR - BIASED TYPE

Plate Voltage	90	125	180	250	volts
Grid Bias (approximate)	-10	-15	-20	-28	volts
Plate Current		Adjusted to 0.2 ma. with no signal			

DETECTOR - GRID LEAK TYPE

Plate Voltage	45	volts
Grid	Return to Cathode	
Grid Leak Resistance	1 to 5	megohms
Grid Condenser	0.00025	μf

The voltage between heater and cathode should be kept as low as possible where they are not directly connected.

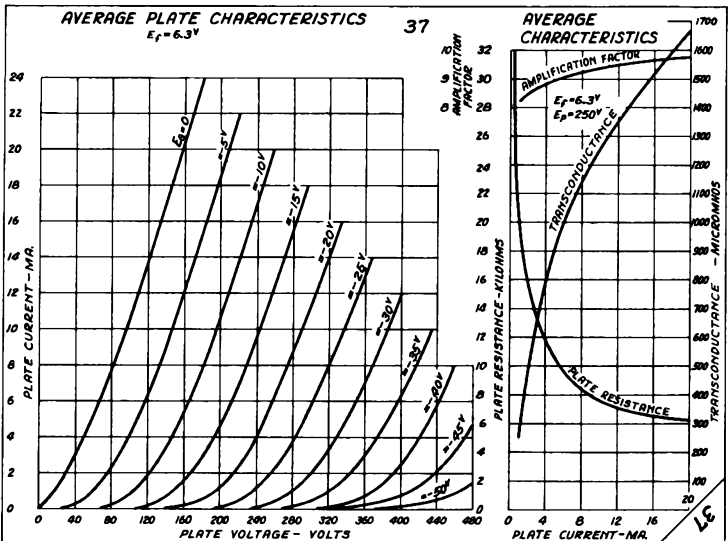

PENODE
POWER AMPLIFIER
Heater Type Glass Bulb

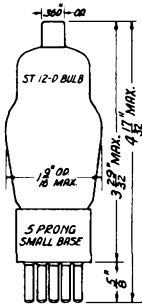

The 38 is a pentode type power amplifier tube designed for service in the output stage of storage battery or a-c operated receivers.

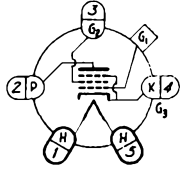

BOTTOM VIEW OF SOCKET

RATINGS

Heater Voltage (a-c or d-c)	0.3	volts
Heater Current	0.3	amp
Maximum Plate Voltage	250	volts
Maximum Screen Voltage	250	volts

DIRECT INTERELECTRODE CAPACITANCES

Grid to Plate	0.3	μf
Input	3.5	μf
Output	7.5	μf

AMPLIFIER - CLASS A

Plate Voltage	100	135	180	250	volts
Screen Voltage	100	135	180	250	volts
Grid Bias*	-9	-13.5	-18	-25	volts
Amplification Factor	120	120	120	120	
Plate Resistance	0.14	0.13	0.115	0.1	megohm
Transconductance	875	925	1050	1200	μmhos
Plate Current	7	9	14	22	ma
Screen Current	1.2	1.5	2.4	3.8	ma
Load Resistance	15000	13500	11600	10000	ohms
Total Harmonics	8	10	8	5	percent
Power Output	0.27	0.55	1	2.5	watts

The voltage between heater and cathode should be kept as low as possible where they are not directly connected.

*The d-c resistance in the grid circuit should not exceed 1 megohm.

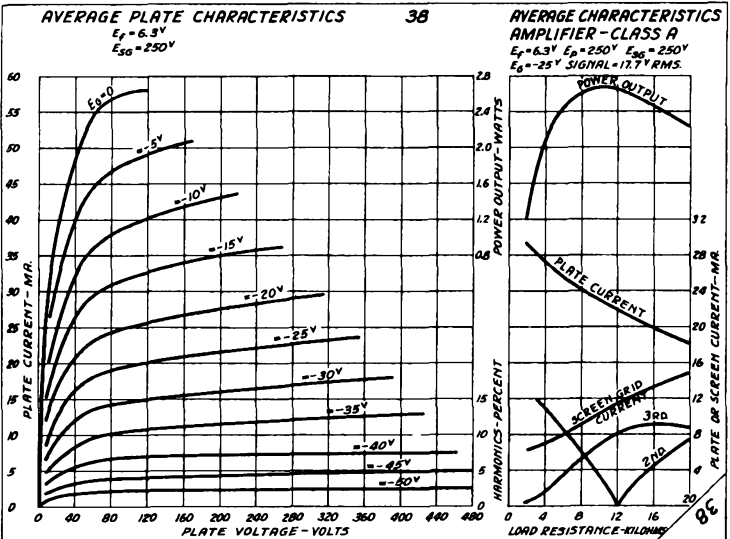

PENTODE
REMOTE CUTOFF AMPLIFIER
Heater Type Glass Bulb

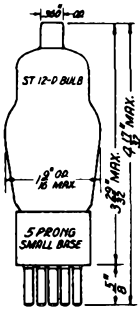

The 39/44 is a pentode type amplifier tube with remote cutoff characteristics designed for service as a high frequency amplifier or mixer in storage battery or a-c operated receivers.

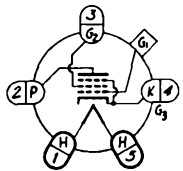

BOTTOM VIEW OF SOCKET

RATINGS

Heater Voltage (a-c or d-c)	6.3	volts
Heater Current	0.3	amp
Maximum Plate Voltage	250	volts
Maximum Screen Voltage	90	volts

DIRECT INTERELECTRODE CAPACITANCES

Grid to Plate	0.007 max*	μuf
Input	3.5	μuf
Output	10	μuf

AMPLIFIER - CLASS A

Plate Voltage	90	180	250	volts
Screen Voltage	90	90	90	volts
Grid Bias	-3	-3	-3	
Amplification Factor	360	750	1050	
Plate Resistance	0.375	0.75	1.0	megohm
Transconductance	960	1000	1050	μmhos
Plate Current	5.6	5.8	5.8	ma
Screen Current	1.6	1.4	1.4	ma
Transconductance (At -42.5 volts bias)	2	2	2	μmhos

MIXER - SUPERHETERODYNE CIRCUIT

Plate Voltage	90	180	250	volts
Screen Voltage	90	90	90	volts
Grid Bias (approximate)†	-7	-7	-7	volts

The voltage between heater and cathode should be kept as low as possible where they are not directly connected.

†The grid bias is not critical with the oscillator peak voltage 1 volt less than the grid bias.

*With tube shield.

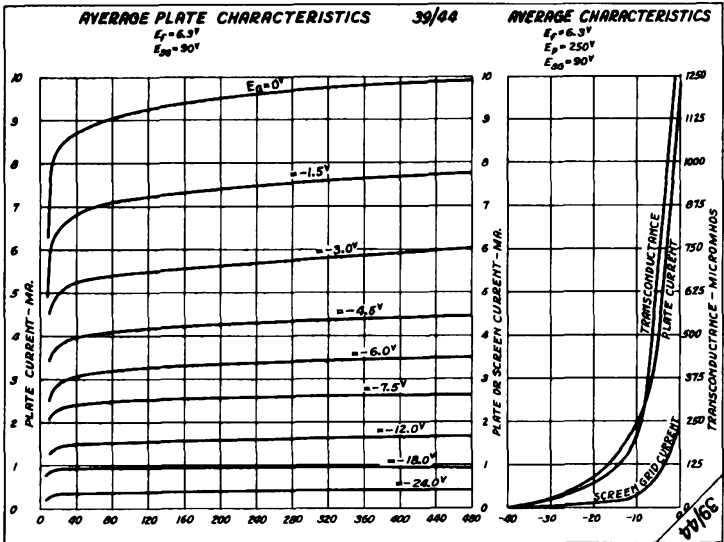

TRIODE
AMPLIFIER

Filament Type Glass Bulb

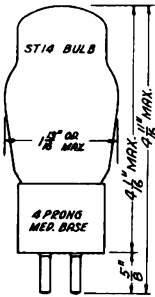

The 40 is a high mu triode type amplifier tube designed for service as a resistance coupled amplifier or detector in storage battery operated receivers.

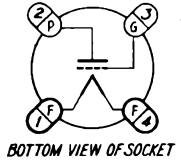

RATINGS

Filament Voltage	5.0 d-c	volts
Filament Current	0.25	amp
Maximum Plate Voltage	180	volts

DIRECT INTERELECTRODE CAPACITANCES

Grid to Plate	8.8	μ f
Input	3.4	μ f
Output	1.5	μ f

AMPLIFIER - CLASS A

Plate Supply Voltage	135	180	volts
Grid Bias	-1.5	-3	volts
Plate Resistor	0.25	0.25	megohm
Amplification Factor	30	30	
Plate Resistance	0.15	0.15	megohm
Transconductance	200	200	μ mhos
Plate Current	0.2	0.2	ma

DETECTOR - BIASED TYPE

Plate Supply Voltage	135	180	volts
Grid Bias	-3	-4.5	volts
Plate Resistor	0.25	0.25	megohm

DETECTOR - GRID LEAK TYPE

Plate Supply Voltage	135 to 180	volts
Grid	Return to Positive Filament	
Plate Resistor	0.25	megohm
Grid Leak Resistance	2 to 5	megohms
Grid Condenser	0.00025	μ f

PENTODE
POWER AMPLIFIER
Heater Type Glass Bulb

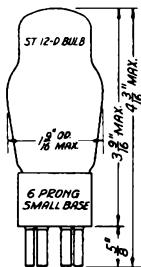

The 41 is a pentode type power amplifier tube designed for service in the output stage of storage battery or a-c operated receivers. The ratings and electrical characteristics are identical with those of the type 6K6G.

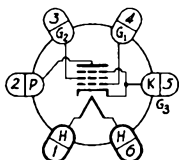

BOTTOM VIEW OF SOCKET

RATINGS

Heater Voltage (a-c or d-c)	6.3	volts
Heater Current	0.4	amp
Maximum Plate Voltage	250	volts
Maximum Screen Voltage	250	volts

AMPLIFIER - CLASS A

Plate Voltage	100	135	180	250	volts
Screen Voltage	100	135	180	250	volts
Grid Bias	-7	-10	-13.5	-18 †	volts
Amplification Factor (approx.)	150	150	150	150	
Plate Resistance (approx.)	103500	94000	81000	68000	ohms
Transconductance	1450	1600	1850	2200	μmhos
Plate Current	9	12.5	18.5	32	ma
Screen Current	1.6	2.2	3	5.5	ma
Load Resistance	12000	10400	9000	7600	ohms
Total Harmonic Distortion	10	10	10	10	percent
Power Output	0.33	0.75	1.5	3.4	watts

Transformer or impedance input coupling devices are recommended. If resistance coupling is used, the d-c resistance in the grid circuit should not exceed 1 megohm with self-bias, or 0.1 megohm with fixed-bias.

The voltage between heater and cathode should be kept as low as possible where they are not directly connected.

†A bias of -16.5 volts and a load resistance of 7000 ohms will give power output of 3.2 watts with 7% total harmonic distortion.

For additional curves refer to the type 6K6G.

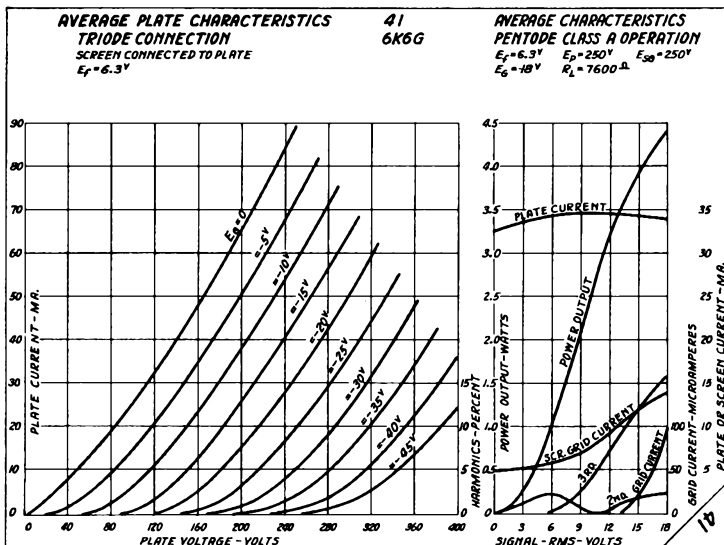

PENTODE
POWER AMPLIFIER
Heater Type Glass Bulb

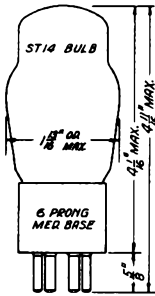

The 42 is a pentode type power amplifier tube designed for service in the output stage of storage battery or a-c operated receivers. The ratings and electrical characteristics are identical with those of the types 6F6 and 6F6G.

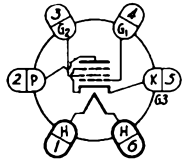

BOTTOM VIEW OF SOCKET

RATINGS

Heater Voltage (a-c or d-c)	6.3	volts
Heater Current	0.7	amp
Maximum Plate Voltage	315	volts
Maximum Screen Voltage	315	volts

AMPLIFIER - CLASS A

	Pentode Connection		Triode Connection	
Plate Voltage	250	315	250 max.	volts
Screen Voltage	250	315		volts
Grid Bias	-16.5	-22	-20	volts
Amplification Factor	200†	200†	7	
Plate Resistance	80000‡	75000‡	2600	ohms
Transconductance	2500	2650	2700	μmhos
Plate Current	34	42	31	ma
Screen Current	6.5	8		ma
Load Resistance	7000	7000	4000	ohms
Total Harmonic Dist.	7	7	5	percent
Power Output	3	5	0.85	watts

AMPLIFIER - CLASS AB - TWO TUBES

	Pentode Connection		Triode Connection†		
	Fixed-Bias	Self-Bias	Fixed-Bias	Self-Bias	
Plate Voltage	375 max.	375 max.	350 max.	350 max.	volts
Screen Voltage	250 max.	250 max.			volts
Grid Bias	-26 min.		-38		volts
Self-Bias Resistor		340 min.		730 min.	ohms
Signal Pk.Volt. (G to G)	82	94	123	132	volts
No-Signal Plate Current	34	54	45	50	ma
No-Signal Screen Current	5	8			ma
Load Resistance (P to P)	10000	10000	6000	10000	ohms
Total Harmonic Dist.	5	5	7	7	percent
Power Output (approx.)#	19*	19A	18**	14¶	watts

#With one 42 triode connected as driver operated at plate voltage of 250 volts grid bias of -20 volts and plate load of approximately 10000 ohms.

- *Input transformer ratio, primary to 1/2 secondary = 3.32
- Δ Input transformer ratio, primary to 1/2 secondary = 2.5
- **Input transformer ratio, primary to 1/2 secondary = 1.67
- ¶ Input transformer ratio, primary to 1/2 secondary = 1.29
- †Screen connected to plate.
- ‡Approximate

For additional curves refer to the type 6F6G.

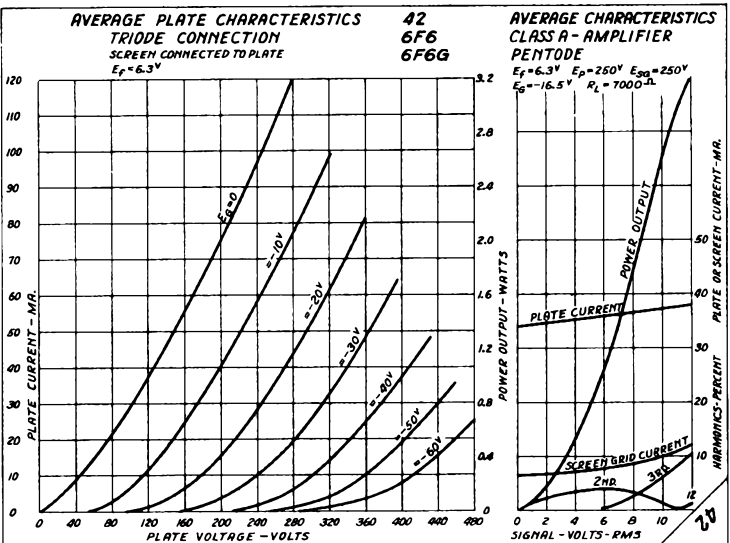

PENTODE
POWER AMPLIFIER
Heater Type Glass Bulb

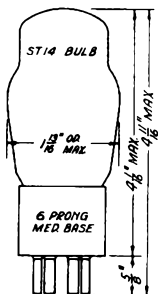

The 43 is a pentode type power amplifier tube designed for service in the output stage of a-c - d-c receivers. The ratings and electrical characteristics are identical with those of the types 25A6 and 25A6G.

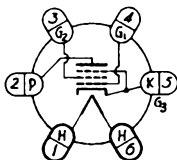

BOTTOM VIEW OF SOCKET

RATINGS

Heater Voltage (a-o or d-c)	25	volts
Heater Current	0.3	amp
Maximum Plate Voltage	180	volts
Maximum Screen Voltage	135	volts

AMPLIFIER - CLASS A

Plate Voltage	95	135	180	volts
Screen Voltage	95	135	135	volts
Grid Bias	-15	-20	-20	volts
Amplification Factor (approximate)	90	85	100	
Plate Resistance (approximate)	45000	35000	40000	ohms
Transconductance	2000	2450	2500	μmhos
Plate Current	20	37	38	ma
Screen Current	4	8	7.5	ma
Load Resistance	4500	4000	5000	ohms
Total Harmonic Distortion	11	9	10	percent
Power Output	0.9	2	2.75	watts

Heater to cathode bias should not exceed 90 volts d-c, as measured between the negative heater terminal and the cathode.

For additional curves refer to the type 25A6G.

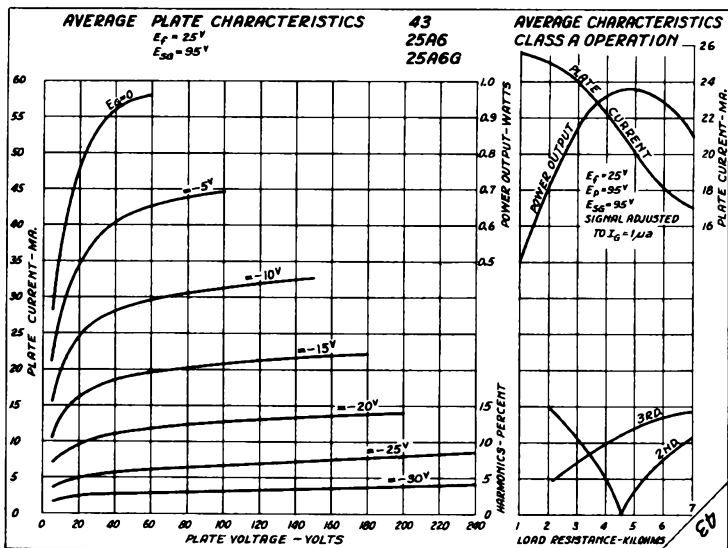

TRIODE
POWER AMPLIFIER
Filament Type Glass Bulb

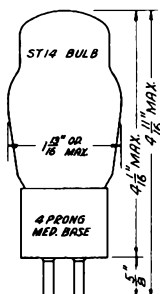

The 45 is a triode type amplifier tube designed for service in the output stage of a-c operated receivers.

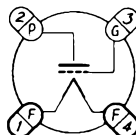

BOTTOM VIEW OF SOCKET

RATINGS

Heater Voltage (a-c or d-c)	2.5	volts
Heater Current	1.5	amp
Maximum Plate Voltage	275	volts

DIRECT INTERELECTRODE CAPACITANCES

Grid to Plate	7	μf
Input	4	μf
Output	3	μf

AMPLIFIER - CLASS A

Plate Voltage	180	250	275	volts
Grid Bias†	-31.5	-50	-56	volts
Amplification Factor	3.5	3.5	3.5	
Plate Resistance	1650	1610	1700	ohms
Transconductance	2125	2175	2050	μmhos
Plate Current	31	34	36	ma
Load Resistance	2700	3900	4600	ohms
Power Output (5% second harmonic)	0.825	1.6	2	watts

AMPLIFIER - PUSH-PULL - CLASS AB - TWO TUBES

	Fixed-Bias	Self-Bias	
Plate Voltage	275	275	volts
Grid Bias†	-68		volts
Self-Bias Resistor		775	ohms
No-Signal Plate Current (per tube)	14	36	ma
Max.-Signal Plate Current (per tube)	69	45	ma
Load Resistance (plate to plate)	3200	5060	ohms
Total Harmonic Distortion	5	5	percent
Power Output	18	12	watts
Average Power Input (grid to grid)	656	461	mW

†Grid Bias measured from mid-point of a-c operated filament.

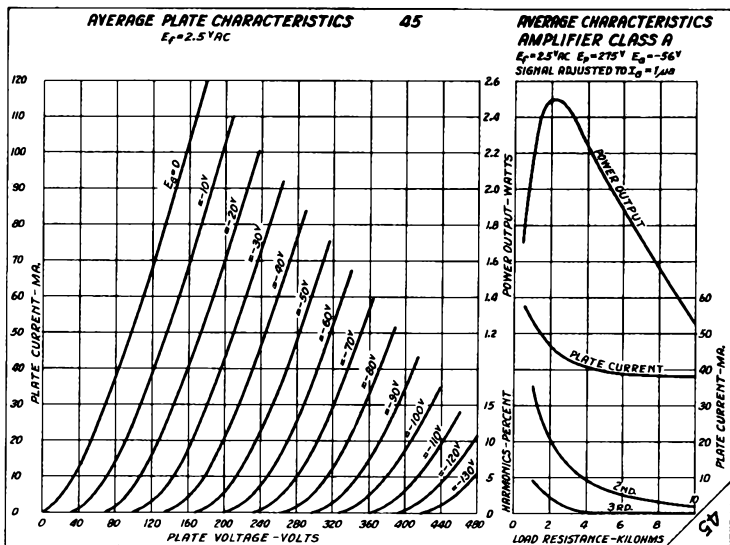

DUAL GRID TRIODE
POWER AMPLIFIER
Filament Type Glass Bulb

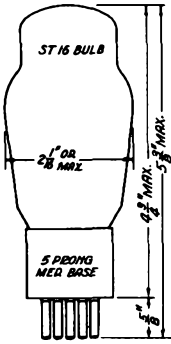

The 46 is a dual grid type power amplifier tube designed for service in the output stage of a-c operated receivers.

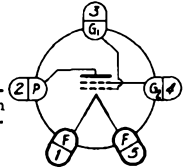

BOTTOM VIEW OF SOCKET

RATINGS

Filament Voltage (a-c or d-c)	2.5	volts
Filament Current	1.75	amp

AMPLIFIER - CLASS B - TWO TUBES
Grid #1 Connected to Grid #2

Maximum Plate Voltage	400	volts
Maximum Peak Plate Current (per tube)	200	ma
Maximum Average Plate Diss. (per tube)	10	watts

Typical Operations:

Plate Voltage	300	400	volts
Grid Bias†	0	0	volts
No-Signal Plate Current (per tube)	4	6	ma
Load Resistance (plate to plate)	5200	5800	ohms
Power Output (approximate)	16	20	watts
Average Power Input (grid to grid)	950	650	mw

AMPLIFIER - CLASS A
Grid #2 Connected to Plate

Plate Voltage	250 max.	volts
Grid Bias†	-33	volts
Amplification Factor	5.6	
Plate Resistance	2380	ohms
Transconductance	2350	μmhos
Plate Current	22	ma
Load Resistance	6400†	ohms
Power Output (5% second harmonic)	1.25	watts

†Grid bias measured from mid-point of a-c operated filament.

‡Approximately twice this value is recommended when the tube is used as a driver for a Class B stage.

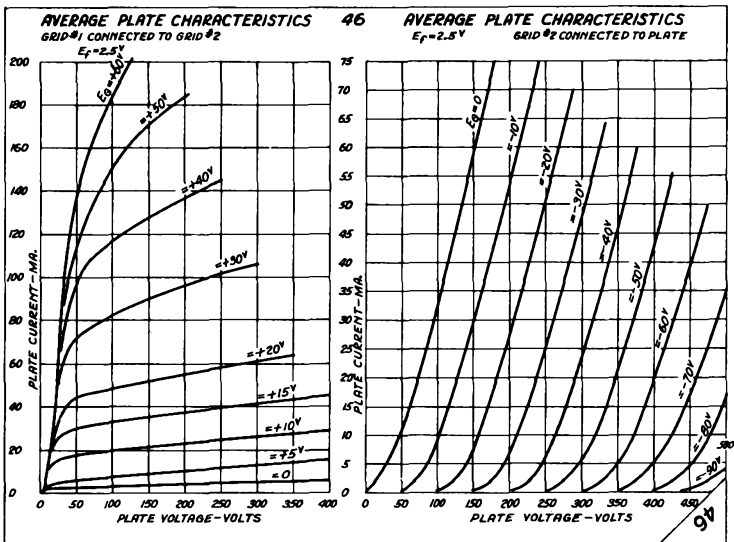

PENTODE
POWER AMPLIFIER
Filament Type Glass Bulb

The 47 is a pentode type power amplifier tube designed for service in the output stage of a-c operated receivers.

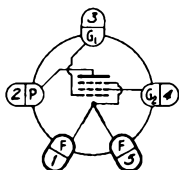

BOTTOM VIEW OF SOCKET

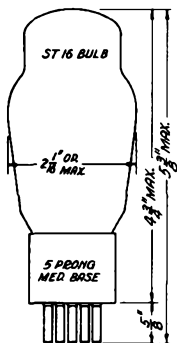

RATINGS

Filament Voltage (a-c or d-c)	2.5	volts
Filament Current	1.75	amp
Maximum Plate Voltage	250	volts
Maximum Screen Voltage	250	volts

AMPLIFIER - CLASS A

Plate Voltage	250	volts
Screen Voltage	250	volts
Grid Bias†	-16.5	volts
Amplification Factor	150	
Plate Resistance	60000	ohms
Transconductance	2500	μmhos
Plate Current	31	ma
Screen Current	6	ma
Load Resistance	7000	ohms
Total Harmonic Distortion	6	percent
Power Output	2.7	watts

*Grid bias measured from mid-point of a-c operated filament.

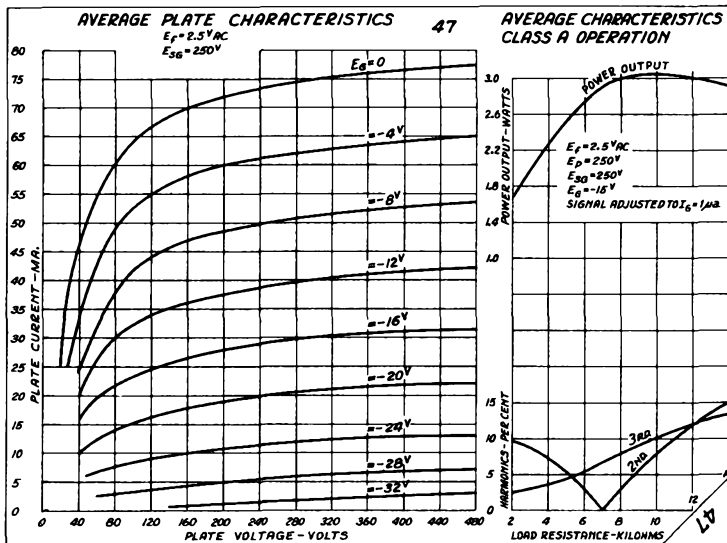

PENTODE
POWER AMPLIFIER
Heater Type Glass Bulb

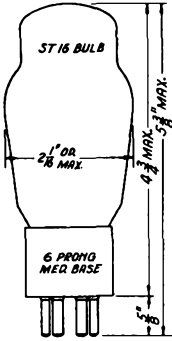

The 48 is a pentode type power amplifier tube designed for service in the output stage of d-c receivers.

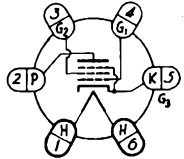

RATINGS

Heater Voltage (a-c or d-c)	30	volts
Heater Current	0.4	amp
Maximum Plate Voltage	125	volts
Maximum Screen Voltage	100	volts

BOTTOM VIEW OF SOCKET

AMPLIFIER - CLASS A

	Pentode Connection		Triode Connection†		
	96	125	80	125	
Plate Voltage	96	125	80	125	volts
Screen Voltage	96	100			volts
Grid Bias‡	-19	-20	-20	-32.5	volts
Amplification Factor	Subject to Considerable Variation		2.5	2.5	
Plate Resistance	Considerable Variation		760	675	ohms
Transconductance	3800	3900	3300	3700	μmhos
Plate Current	52	56	31	52	ma
Screen Current	9	9.5			ma
Load Resistance	1500	1500			ohms
Total Harmonic Dist.	9	9			percent
Power Output	2	2.5			watts

AMPLIFIER - CLASS A - PUSH-PULL - TWO TUBES

	Pentode Connection	Triode Connection†	
Plate Voltage	125	125	volts
Screen Voltage	100		volts
Grid Bias	-20	-32.5	volts
No-Signal Plate Current (per tube)	56	52	ma
Load Resistance (plate to plate)	3000	1250	ohms
Total Harmonic Distortion	9	2	percent
Power Output	5	2.1	watts

The voltage between heater and cathode should not exceed 90 volts where they are not directly connected.

‡The d-c resistance in the grid circuit should not exceed 10000 ohms.
†Screen Grid connected to plate

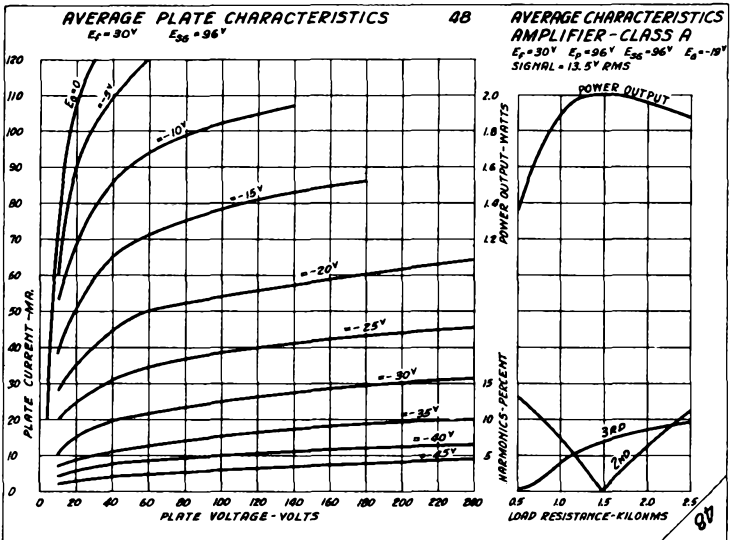

DUAL GRID TRIODE
POWER AMPLIFIER

Filament Type Glass Bulb

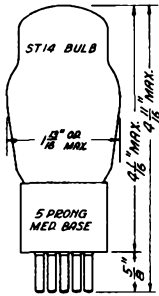

The 49 is a dual grid type power amplifier tube designed for service in the output stage of battery operated receivers.

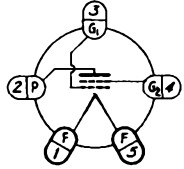

BOTTOM VIEW OF SOCKET

RATINGS

Filament Voltage
Filament Current
Maximum Plate Voltage

2.0 d-c volts
0.12 amp
180 volts

AMPLIFIER - CLASS B - TWO TUBES
Grid #1 connected to Grid #2

Maximum Plate Voltage	180	volts
Maximum Peak Plate Current (per tube)	50	ma
Typical Operation:		
Plate Voltage	135	180 volts
Grid (#1 and #2) Bias	0	0 volts
No-Signal Plate Current (per tube)	1.3	2 ma
Load Resistance (plate to plate)	8000	12000 ohms
Power Output (approximate)	2.3	3.5 watts

AMPLIFIER - CLASS A
Grid #2 connected to plate

Plate Voltage	135 max.	volts
Grid (#1) Bias	-20	volts
Amplification Factor	4.7	
Plate Resistance	4175	ohms
Transconductance	1125	ohms
Plate Current	6	ma
Load Resistance	11000*	ohms
Power Output (approximate)	0.17	watts

*Approximately twice this value is recommended when the tube is used as a driver for a Class B stage.

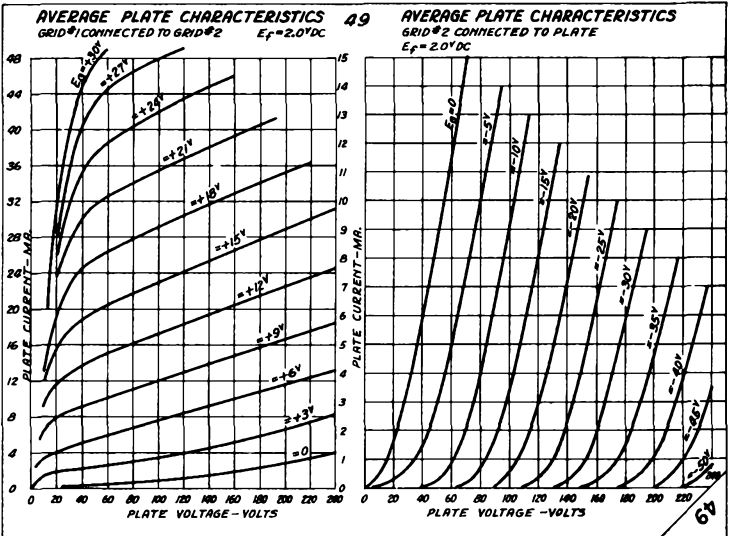

TRIODE
POWER AMPLIFIER
Filament Type Glass Bulb

The 50 is a triode type power amplifier tube designed for service in the output stage of radio receivers.

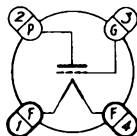

BOTTOM VIEW OF SOCKET

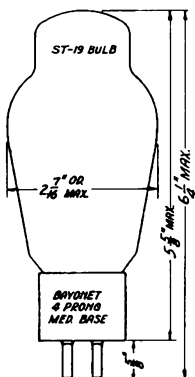

RATINGS

Filament Voltage (a-c or d-c)	7.5	volts
Filament Current	1.25	amp
Maximum Plate Voltage	450	volts

AMPLIFIER - CLASS A

Plate Voltage	300	350	400	450	volts
Grid Bias†	-54	-63	-70	-84	volts
Amp. Factor	3.8	3.8	3.8	3.8	
Plate Resistance	2000	1900	1800	1800	ohms
Transconductance	1900	2000	2100	2100	μmhos
Plate Current	35	45	55	55	mA
Load Resistance	4600	4100	3670	4350	ohms
Power Output	1.6	2.4	3.4	4.6	watts
(5% second harmonic)					

Self-Bias is recommended for all operating conditions.

The d-c resistance in the grid circuit should not exceed 10000 ohms.

†Grid Bias measured from mid-point of a-c operated filament.

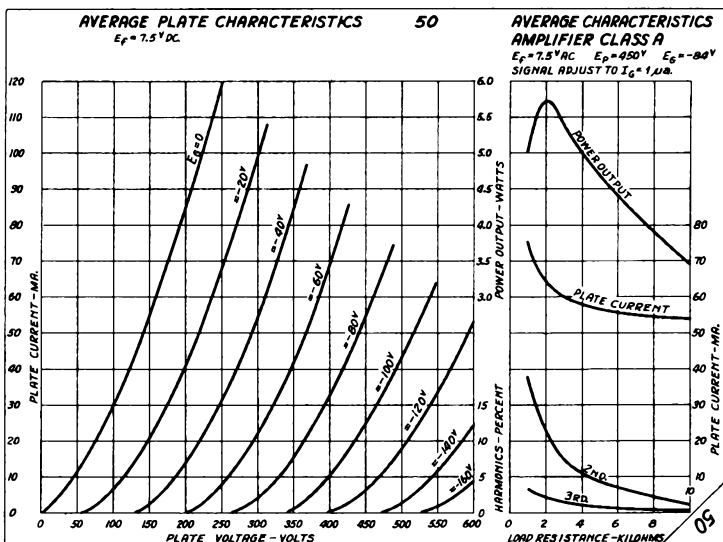

DUAL GRID TRIODE

POWER AMPLIFIER

Filament Type Glass Bulb

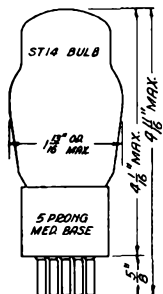

The 52 is a dual grid type power amplifier tube designed for service in the output stage of storage battery operated receivers.

RATINGS

Filament Voltage (a-c or d-c)
 Filament Current
 Maximum Plate Voltage

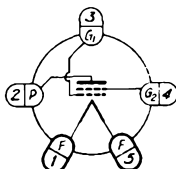

BOTTOM VIEW OF SOCKET

6.3 volts
 0.3 amp
 180 volts

AMPLIFIER - CLASS B - TWO TUBES
 Grid #1 connected to Grid #2

Maximum Plate Voltage	180	volts
Maximum Peak Plate Current (per tube)	75	ma
Typical Operation:		
Plate Voltage	180	volts
Grid (#1 and #2) Bias	0	volts
No-Signal Plate Current (per tube)	1.5	ma
Load Resistance (plate to plate)	10000	ohms
Power Output	5	watts

AMPLIFIER - CLASS A
 Grid #2 connected to plate

Plate Voltage	100	110 max.	volts
Grid (#1) Bias	0	0	volts
Amplification Factor	5.2	5.2	
Plate Resistance	1900	1750	ohms
Transconductance	2700	3000	μmhos
Plate Current	37	43	ma
Load Resistance	2000	2000	ohms
Power Output*	1.2	1.5	watts

*Driving power will be required in either single tube or push-pull operation. One type 6A4/LA is recommended as a driver tube. An input transformer ratio, primary to 1/2 secondary, of 3.0, with a 3000 ohm resistor connected across each half of the secondary is recommended.

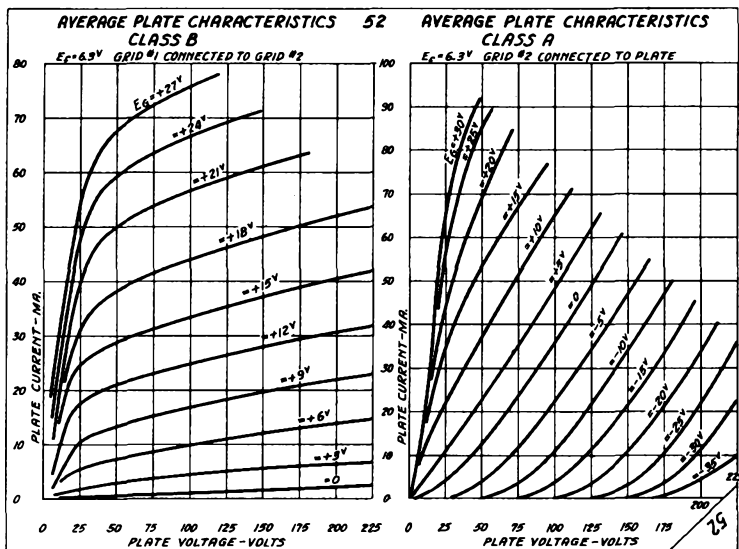

TWIN TRIODE
POWER AMPLIFIER
Heater Type Glass Bulb

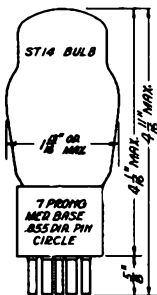

The 53 is a twin triode type amplifier tube designed for service as a Class B amplifier in the output stage of a-c operated receivers.

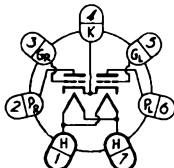

BOTTOM VIEW OF SOCKET

RATINGS

Heater Voltage (a-c or d-c)	2.5	volts
Heater Current	2.0	amp
Maximum Plate Voltage	300	volts
Maximum Peak Plate Current (per plate)	125	ma
Maximum Average Plate Dissipation	10	watts

AMPLIFIER - CLASS B

Plate Voltage	250	300	volts
Grid Bias	0	0	volts
No-Signal Plate Current (per plate)	14	17.5	ma
Load Resistance (plate to plate)	8000	10000	ohms
Power Output (approximate)	8	10	watts

(With average power input = 350 mw. grid to grid)

AMPLIFIER - CLASS A DRIVER - TRIODES CONNECTED IN PARALLEL

Plate Voltage	250	294	volts
Grid Bias†	-5	-6	volts
Amplification Factor	35	35	
Plate Resistance	11300	11000	ohms
Transconductance	3100	3200	μmhos
Plate Current	6	7	ma
Load Resistance - Depends on the design of the following Class B amplifier. Usually between 20000 and 40000 ohms.			
Power Output		400	mw

†The d-c resistance in the grid circuit should not exceed 0.5 megohm with self-bias or 0.1 megohm with fixed-bias.

For characteristic curves refer to the types 6A6 and 6N7G. The characteristics of the 53 are the same as those of the 6A6 and the 6N7G except for the heater rating.

DUO-DIODE TRIODE
DETECTOR AMPLIFIER

Heater Type Glass Bulb

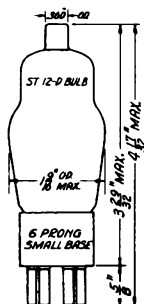

The 55 is a duo-diode triode type amplifier tube designed for service as a combined diode detector, AVC rectifier and audio frequency amplifier in a-c operated receivers.

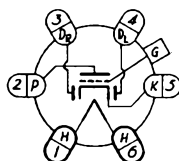

BOTTOM VIEW OF SOCKET

RATINGS

Heater Voltage (a-c or d-c)	2.5	volts
Heater Current	1.0	amp
Maximum Plate Voltage	250	volts

DIRECT INTERELECTRODE CAPACITANCES - TRIODE SECTION

Grid to Plate	1.7	μmf
Input	2.0	μmf
Output	3.5	μmf

AMPLIFIER - CLASS A - TRIODE SECTION

Plate Voltage	135	180	250	volts
Grid Bias	-10.5	-13.5	-20	volts
Amplification Factor	8.3	8.3	8.3	
Plate Resistance	11000	8500	7500	ohms
Transconductance	750	975	1100	μmhos
Plate Current	3.7	6	8	ma
Load Resistance	25000	20000	20000	ohms
Power Output	75	160	300	mw

DIODE SECTION

The two diode units are independent of each other and of the triode section except for the common cathode. The diodes may be used as a half wave or as a full wave rectifier; or one diode may be used as a half wave rectifier for detection and the other diode used as a rectifier to obtain delayed AVC voltage.

For characteristic curves refer to the type 85. The characteristics of the 55 are the same as those of the 85 except for the heater rating.

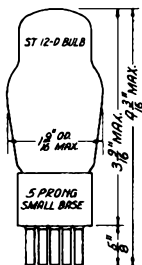

TRIODE
DETECTOR OR AMPLIFIER
Heater Type Glass Bulb

The 56 is a triode type amplifier tube designed for service as a detector or amplifier in a-c operated receivers.

RATINGS

Heater Voltage (a-c or d-c)	2.5	volts
Heater Current	1.0	amp
Maximum Plate Voltage	250	volts

DIRECT INTERELECTRODE CAPACITANCES

Grid to Plate	3.2	μf
Input	3.2	μf
Output	2.2	μf

AMPLIFIER - CLASS A

Plate Voltage	100	250	volts
Grid Bias†	-5	-13.5	volts
Amplification Factor	13.8	13.8	
Plate Resistance	12000	9500	ohms
Transconductance	1150	1450	μmhos
Plate Current	2.5	5	ma

DETECTOR - BIASED TYPE

Plate Voltage	100	250	volts
Grid Bias (approximate)	-8	-20	volts
Plate Current	Adjusted to 0.2 ma. with no signal		

DETECTOR - GRID LEAK TYPE

Plate Voltage	45	volts
Grid	Return to Cathode	
Grid Leak Resistance	1 to 5	megohms
Grid Condenser	0.00025	μf

The voltage between heater and cathode should be kept as low as possible where they are not directly connected.

†The d-c resistance in the grid circuit should not exceed 1 megohm.

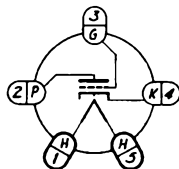

BOTTOM VIEW OF SOCKET

2.5	volts
1.0	amp
250	volts

For characteristic curves refer to the type 76. The characteristics of the 56 are the same as those of the 76 except for the heater rating.

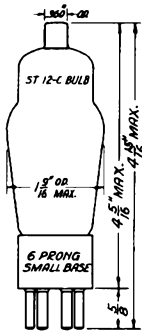

PENTODE
DETECTOR OR AMPLIFIER
Heater Type Glass Bulb

The 57 is a pentode type amplifier tube designed for service as a detector or high frequency amplifier in a-c operated receivers.

RATINGS

Heater Voltage (a-c or d-c)	2.5 volts
Heater Current	1.0 amp
Maximum Plate Voltage	250 volts
Maximum Screen Voltage	100 volts

DIRECT INTERELECTRODE CAPACITANCES

	Pentode Connection
Grid to Plate	0.007 max.*
Input	5.0
Output	6.5

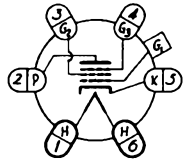

BOTTOM VIEW OF SOCKET

AMPLIFIER - CLASS A

	Pentode Connection		Triode Connection†	
Plate Voltage	100	250	250	volts
Screen Voltage	100	100		volts
Grid Bias	-3	-3	-8	volts
Suppressor	Connected to Cathode at Socket			
Amplification Factor	1185	1500 min.	20 approx.	
Plate Resistance	1	1.5 min.	0.0105	megohm
Transconductance	1185	1225	1900	µmhos
Plate Current	2	2	6.5	ma
Screen Current	0.5	0.5		ma
Grid Bias (approximate)	-7	-7		volts

(For cathode current cutoff)

DETECTOR - BIASED TYPE

Plate Supply Voltage	100	100	250	250	volts
Screen Voltage	12	30	50	100	volts
Grid Bias	-1.16	-1.83	-1.95	-4.3	volts
Cathode Resistor	18000	10000	3000	10000	volts
Suppressor	Connected to Cathode at Socket				
Cathode Current (no sig.)	0.063	0.183	0.65	0.43	ma
Plate Resistor	1.0	0.25	0.25	0.5	megohm
Blocking Condenser	0.01	0.01	0.03	0.03	µf
Grid Resistor (for following tube)	1.0	0.5	0.25	0.25	megohm
R-F Signal Voltage (RMS)	1.05	1.6	1.18	1.37	volts
Output Peak Voltage	17	17	17	17	volts

(At grid of following tube with signal modulated 20%)

The voltage between heater and cathode should be kept as low as possible where they are not directly connected.

The shield in the dome of the tube is connected internally to the cathode.

*With tube shield

†Grids #2 and #3 connected to plate

For characteristic curves refer to the type 6J7G. The characteristics of the 57 are the same as those of the 6J7G except for the heater rating.

PENTODE
REMOTE CUTOFF AMPLIFIER
Heater Type Glass Bulb

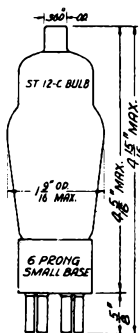

The 58 is a pentode type amplifier tube with remote cutoff characteristics designed for service as a high frequency amplifier or mixer in a-c operated receivers.

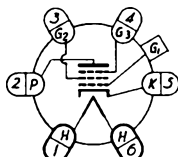

BOTTOM VIEW OF SOCKET

RATINGS

Heater Voltage (a-c or d-c)	2.5	volts
Heater Current	1.0	amp
Maximum Plate Voltage	250	volts
Maximum Screen Voltage	100	volts

DIRECT INTERELECTRODE CAPACITANCES

Grid to Plate	0.007 max*	μ f
Input	5.0	μ f
Output	6.5	μ f

AMPLIFIER - CLASS A

Plate Voltage	100	250	volts
Screen Voltage	100	100	volts
Grid Bias	-3	-3	volts
Suppressor	Connected to Cathode at Socket		
Amplification Factor	375	1280	
Plate Resistance	0.25	0.8	megohm
Transconductance	1500	1600	μ mhos
Plate Current	8	8.2	ma
Screen Current	2.2	2	ma
Grid Bias for Transconductance = 2 μ mhos	-50	-50	volts

MIXER - SUPERHETERODYNE CIRCUIT

Plate Voltage	100	250	volts
Screen Voltage	100	100	volts
Grid Bias †	-10	-10	volts
Suppressor	Connected to Cathode at Socket		

The voltage between heater and cathode should be kept as low as possible where they are not directly connected.

The shield in the dome of the tube is connected internally to the cathode.

†The grid bias is not critical with an oscillator peak voltage 1 volt less than the grid bias.

*With tube shield.

For characteristic curves refer to the types 6D6 and 6U7G. The characteristics of the 58 are the same as those of the 6D6 and the 6U7G.

PENTODE
TRIPLE GRID POWER AMPLIFIER
Heater Type Glass Bulb

The 59 is a triple grid type power amplifier tube designed for service as a Class A triode, Class A pentode or Class B triode power amplifier in the output stage of a-c operated receivers.

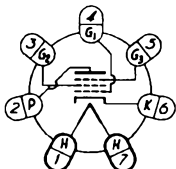

BOTTOM VIEW OF SOCKET

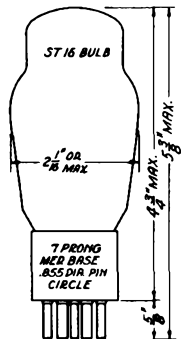

RATINGS

Heater Voltage (a-c or d-c)	2.5	volts
Heater Current	2.0	amp
Maximum Plate Voltage - Class A	250	volts
Maximum Plate Voltage - Class B	400	volts
Maximum Screen Voltage	250	volts

AMPLIFIER - CLASS A

Triode Connection† Pentode Connection‡

Plate Voltage	250	250	volts
Screen (Grid #2) Voltage		250	volts
Grid (#1) Bias	-28	-18	volts
Amplification Factor	6	100	
Plate Resistance	2300	40000	ohms
Transconductance	2600	2500	μmhos
Plate Current	26	35	ma
Screen Current		9	ma
Load Resistance	5000*	6000	ohms
Total Harmonics	5	7	percent
Power Output	1.25	3	watts

AMPLIFIER - CLASS B - TWO TUBES

Grid #1 connected to grid #2
Grid #3 connected to plate

Maximum Plate Voltage	400	volts
Maximum Peak Plate Current (per tube)	200	ma
Maximum Average Plate Dissipation (per tube)	10	watts
Maximum Average Grid (#1 and #2) Dissipation (per tube)	1.5	watts

Typical Operation:

Plate Voltage	300	400	volts
Grid (#1 and #2) Bias	0	0	volts
No-Signal Plate Current (per tube)	10	13	ma
Load Resistance (plate to plate)	4600	6000	ohms
Power Output (approximate)	15	20	watts

The voltage between heater and cathode should be kept as low as possible where they are not directly connected.

†Grids #2 and #3 connected to plate.

‡Grid #3 connected to cathode.

*Approximately twice this value is recommended when the tube is used as driver for a Class B stage.

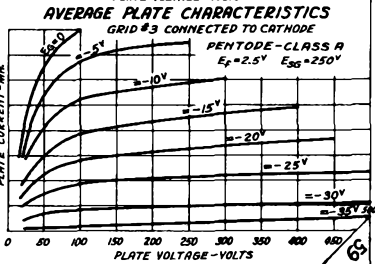
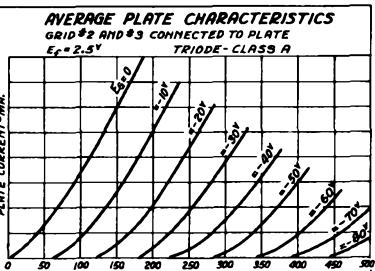
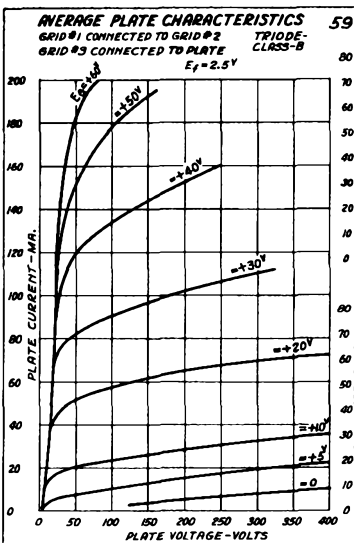

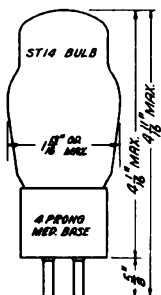

TRIODE
POWER AMPLIFIER
Filament Type Glass Bulb

The 71-A is a triode type power amplifier tube designed for service in the output stage of storage battery operated receivers.

RATINGS

Filament Voltage (a-c or d-c)	5	volts
Filament Current	0.25	amp.
Maximum Plate Voltage	180	volts

AMPLIFIER - GLASS A

Plate Voltage	90	135	180	volts
Grid Bias†	-16.5	-27	-40.5	volts
Amplification Factor	3	3	3	
Plate Resistance	2170	1820	1750	ohms
Transconductance	1400	1650	1700	μmhos
Plate Current	10	17.3	20	ma
Load Resistance	3000	3000	4800	ohms
Total Harmonic Distortion	5	5	5	percent
Power Output (5% second harmonic)	125	400	790	mw

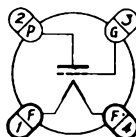

BOTTOM VIEW OF SOCKET

†Grid bias measured from negative end of d-c operated filament. If a grid resistor is used, its value should not exceed 0.5 megohm.

DUO-DIODE TRIODE
DETECTOR AMPLIFIER
Heater Type Glass Bulb

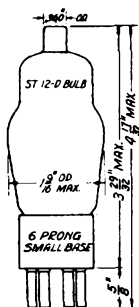

The 75 is a duo-diode triode type amplifier tube designed for service as a combined diode detector, AVC rectifier and resistance coupled audio frequency amplifier in storage battery or a-c operated receivers. The ratings and electrical characteristics are identical with those of the type 6B6G.

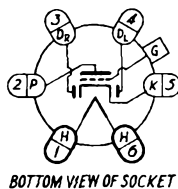

RATINGS

Heater Voltage (a-c or d-o)	6.3	volts
Heater Current	0.3	amp
Max. Plate Voltage	250	volts

DIRECT INTERELECTRODE CAPACITANCES

Grid to Plate	1.7	μf
Input	2.0	μf
Output	3.5	μf

AMPLIFIER - CLASS A - TRIODE SECTION

Plate Voltage	250	volts
Grid Bias	-2	volts
Amplification Factor	100	
Plate Resistance	91000	ohms
Transconductance	1100	μmhos
Plate Current	1	ma

DIODE SECTION

The two diodes are independent of each other and of the triode section except for the common cathode. The diodes may be used as a half wave or as a full wave rectifier; or one diode may be used as a half wave rectifier for detection and the other diode used as a rectifier to obtain delayed AVC voltage.

The voltage between heater and cathode should be kept as low as possible where they are not directly connected.

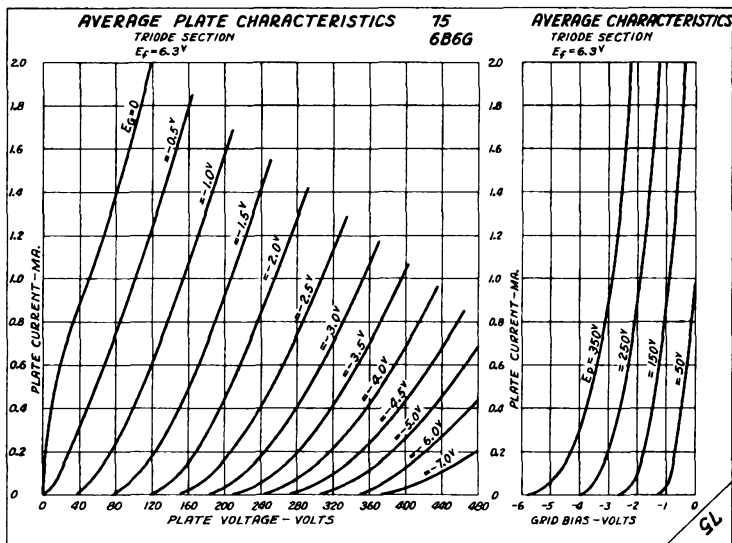

TRIODE
DETECTOR OR AMPLIFIER
Heater Type Glass Bulb

The 76 is a triode type amplifier tube designed for service as a detector or amplifier in storage battery or a-c operated receivers.

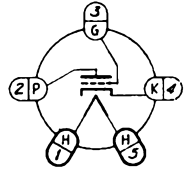

BOTTOM VIEW OF SOCKET

6.3	volts
0.3	amp
250	volts

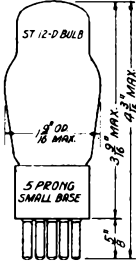

RATINGS

Heater Voltage (a-c or d-c)	6.3	volts
Heater Current	0.3	amp
Maximum Plate Voltage	250	volts

DIRECT INTERELECTRODE CAPACITANCES

Grid to Plate	2.8	μ if
Input	3.5	μ if
Output	2.5	μ if

AMPLIFIER - CLASS A

Plate Voltage	100	250	volts
Grid Bias†	-5	-13.5	volts
Amplification Factor	13.8	13.8	
Plate Resistance	12000	9500	ohms
Transconductance	1150	1450	μ mhos
Plate Current	2.5	5	ma

DETECTOR - BIASED TYPE

Plate Voltage	100	250	volts
Grid Bias (approximate)	-9	-20	volts
Plate Current	Adjusted to 0.2 ma. with no signal		

DETECTOR - GRID LEAK TYPE

Plate Voltage	45	volts
Grid	Return to Cathode	
Grid Leak Resistance	1 to 5	megohms
Grid Condenser	0.00025	μ f

The voltage between heater and cathode should be kept as low as possible where they are not directly connected.

†The d-c resistance in the grid circuit should not exceed 1 megohm.

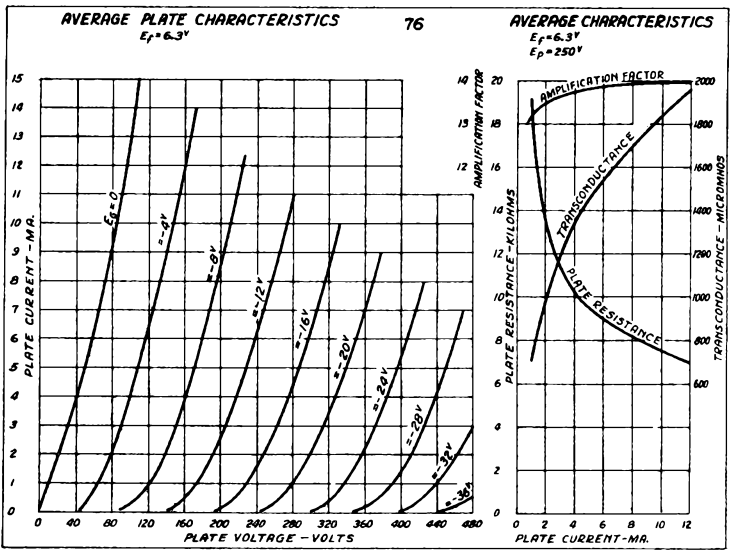

PENTODE
DETECTOR OR AMPLIFIER
Heater Type Glass Bulb

The 77 is a pentode type amplifier tube designed for service as a detector or high frequency amplifier in storage battery or a-c operated receivers.

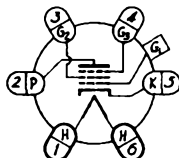

BOTTOM VIEW OF SOCKET

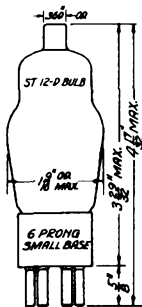

RATINGS

Heater Voltage (a-o or d-o)	6.3 volts
Heater Current	0.3 amp
Max. Plate Voltage	250 volts
Max. Screen Voltage	100 volts

DIRECT INTERELECTRODE CAPACITANCES

Grid to Plate	0.007 max.*	μf
Input	4.0	μf
Output	11	μf

AMPLIFIER - CLASS A

Plate Voltage	100	250	volts
Screen Voltage	60	100	volts
Grid Bias	-1.5	-3	volts
Suppressor	Connected to Cathode at Socket		
Amplification Factor	715	1500	
Plate Resistance (approx.)	0.65	1.5	megohms
Transconductance	1100	1250	μmhos
Plate Current	1.7	2.3	ma
Screen Current	0.4	0.6	ma
Grid Bias (approx.)	-5.5	-7.5	volts

(For cathode current cutoff)

DETECTOR - BIASED TYPE

Plate Supply Voltage	100	250	250	volts
Screen Voltage	36	50	100	volts
Grid Bias	-1.95	-1.95	-4.3	volts
Cathode Resistor	12500	3000	10000	ohms
Suppressor	Connected to Cathode at Socket			
Cathode Current (no signal)	0.155	0.65	0.43	ma
Plate Resistor	0.25	0.25	0.5	megohm
Blocking Condenser	0.01	0.03	0.03	μf
Grid Resistor (for following tube)	0.25	0.25	0.25	megohm
R-F Signal Voltage (RMS)	1.88	1.18	1.37	volts
Output Peak Voltage	14	17	17	volts

(At grid of following tube with signal modulated 20%)

When a resistor is used in the grid circuit, its value should not exceed 1 megohm. The voltage between heater and cathode should be kept as low as possible where they are not directly connected. The internal shield is connected to the screen grid within the tube.

*With tube shield

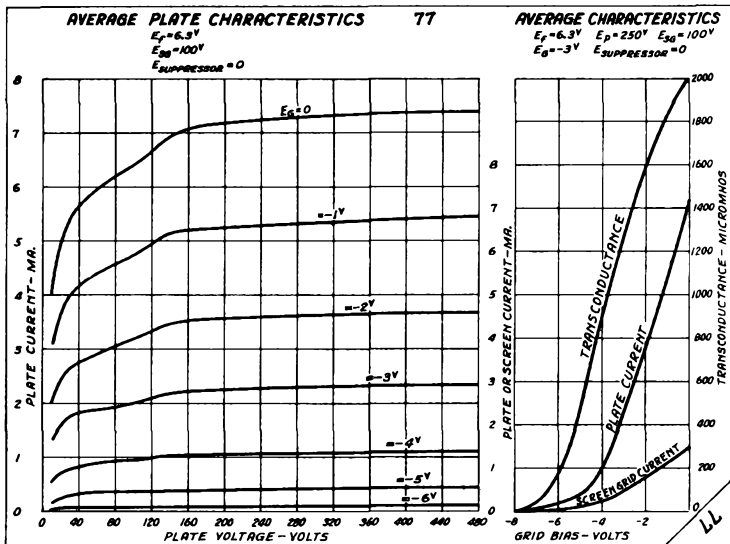

PENTODE
REMOTE CUTOFF AMPLIFIER
Heater Type Glass Bulb

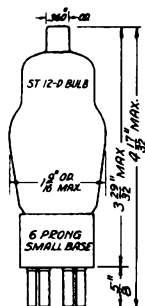

The 78 is a pentode type amplifier tube with remote cutoff characteristics designed for service as a high frequency amplifier or mixer in storage battery or a-c operated receivers. The ratings and electrical characteristics are identical with those of the types 6K7 & 6K7G.

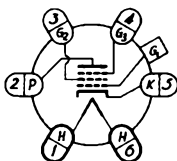

BOTTOM VIEW OF SOCKET

RATINGS

Heater Voltage (a-c or d-o)	6.3	volts
Heater Current	0.3	amp
Maximum Plate Voltage	250	volts
Maximum Screen Voltage	125	volts

DIRECT INTERELECTRODE CAPACITANCES

Grid to Plate	0.007 max.*	μf
Input	4.0	μf
Output	11	μf

AMPLIFIER - CLASS A

Plate Voltage	90	180	250	250	volts
Screen Voltage	90	75	100	125	volts
Grid Bias	-3	-3	-5	-5	min. volts
Suppressor				Connected to Cathode	at Socket
Amplification Factor	400	1100	1160	990	
Plate Resistance	0,315	1.0	0.8	0.6	megohm
Transconductance	1275	1100	1450	1650	μmhos
Plate Current	5.4	4	7	10.5	mA
Screen Current	1.3	1	1.7	2.6	mA
Grid Bias	-38.5	-32.5	-42.5	-52.5	volts

(For transconductance = 2 μmhos)

MIXER - SUPERHETERODYNE CIRCUIT

Plate Voltage	250	volts
Screen Voltage	100	volts
Grid Bias†	-10	volts
Suppressor	Connected to Cathode	at Socket

The voltage between heater and cathode should be kept as low as possible where they are not directly connected.

The internal shield is connected to the cathode within the tube.

†The grid bias is not critical with an oscillator peak voltage 1 volt less than the grid bias.

*With tube shield.

For additional curves refer to the type 6K7G.

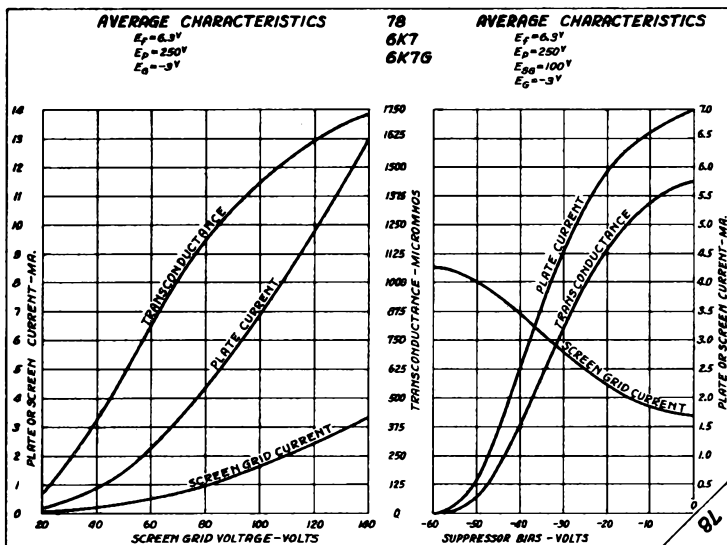

TWIN TRIODE
POWER AMPLIFIER
Heater Type Glass Bulb



The 79 is a twin triode type power amplifier tube designed for service as a Class B amplifier in the output stage of storage battery or a-c operated receivers. The ratings and electrical characteristics are identical with those of the type 6Y7G.

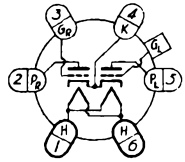

BOTTOM VIEW OF SOCKET

RATINGS

Heater Voltage (a-c or d-c)	6.3	volts
Heater Current	0.6	amp
Maximum Plate Voltage	250	volts
Maximum Peak Plate Current (per plate)	90	ma
Maximum Average Plate Dissipation	11.5	watts

AMPLIFIER - CLASS B

Plate Voltage	100	250	volts
Grid Bias	0	0	volts
No-Signal Plate Current (per plate)	3.8	5.3	ma
Load Resistance (plate to plate)	7000	14000	ohms
Power Output (approximate)	5.5	8	watts

(With average power input = 300 mw. grid to grid)

The voltage between heater and cathode should be kept as low as possible where they are not directly connected.

For additional curves refer to the type 6Y7G.

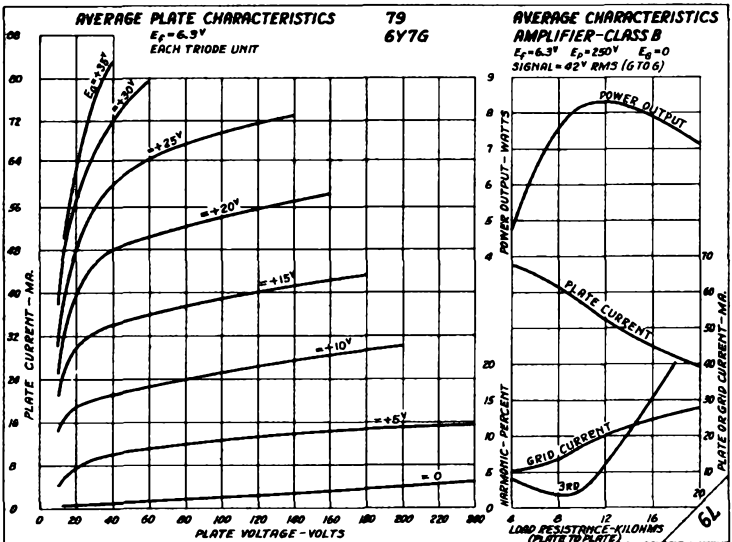

TWIN DIODE
FULL WAVE HIGH VACUUM RECTIFIER
Filament Type Glass Bulb

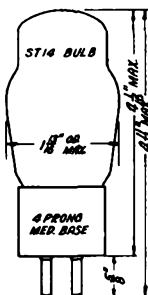

The 80 is a full wave high vacuum type rectifier tube designed for service in power supplies for a-c operated receivers. The ratings and characteristics are identical with those of types 5Y3G and 5Y4G.

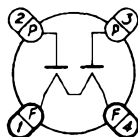

BOTTOM VIEW OF SOCKET

FULL WAVE RECTIFIER - CONDENSER INPUT FILTER

Filament Voltage	5	a-c	volts
Filament Current	2		amp
Maximum A-C Voltage per Plate (RMS)	350	400	volts
Maximum Inverse Peak Voltage	1000	1100	volts
Maximum Peak Plate Current	400	350	ma
Maximum D-C Output Current	125	110	ma

FULL WAVE RECTIFIER - CHOKE INPUT FILTER *

Filament Voltage	5	a-c	volts
Filament Current	2		amp
Maximum A-C Voltage per Plate (RMS)	550		volts
Maximum Inverse Peak Voltage	1500		volts
Maximum Peak Plate Current	300		ma
Maximum D-C Output Current	135		ma

AVERAGE TUBE VOLTAGE DROP 60 volts
(At 135 ma. output current per plate)

*Input Choke must be at least 20 henrys. An Input Condenser of not more than 0.1 μ f may be used.

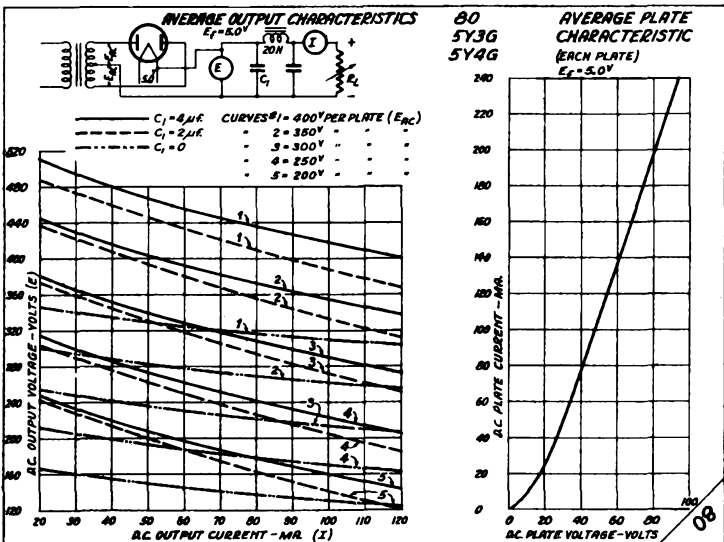

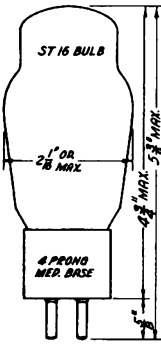

DIODE
 HALF WAVE HIGH VACUUM RECTIFIER
 Filament Type Glass Bulb

The 81 is a high vacuum type half wave rectifier tube designed for service in high voltage power supplies.

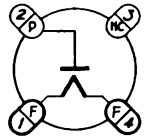

BOTTOM VIEW OF SOCKET

HALF WAVE RECTIFIER
 Condenser or Choke Input Filter

Filament Voltage	7.5	a-c	volts
Filament Current	1.25		amp
Maximum A-C Plate Voltage (RMS)	700		volts
Maximum D-C Output Current	85		ma

FULL WAVE RECTIFIER - TWO TUBES
 Condenser or Choke Input Filter

Filament Voltage	7.5	a-c	volts
Filament Current per Tube	1.25		amp
Maximum A-C Voltage per Plate (RMS)	700		volts
Maximum D-C Output Current	170		ma

AVERAGE TUBE VOLTAGE DROP 91 volts
 (At 170 ma. output current)

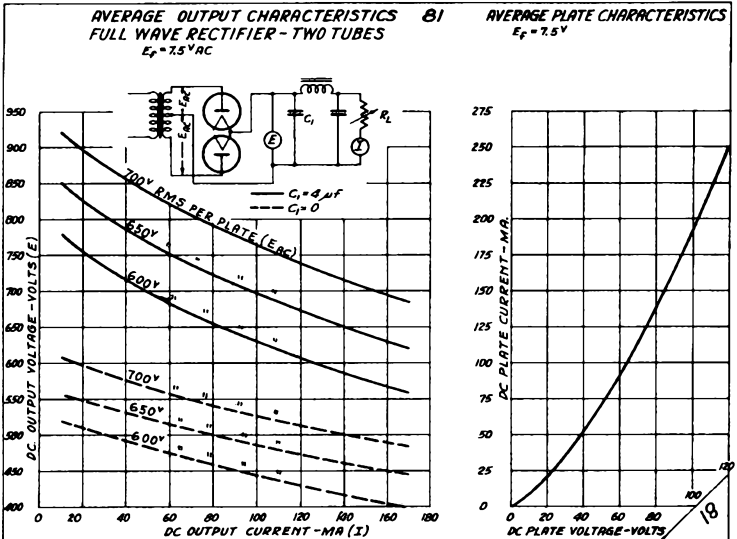

TWIN DIODE
 FULL WAVE MERCURY VAPOR RECTIFIER
 Filament Type Glass Bulb

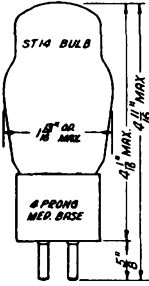

The 82 is a full wave mercury vapor rectifier tube designed for service in power supplies for a-c operated receivers.

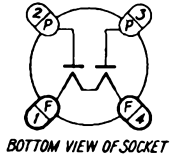

FULL WAVE RECTIFIER

Filament Voltage	2.5 a-c	volts
Filament Current	3	amp
Maximum A-C Voltage per Plate (RMS)	500	volts
Maximum Inverse Peak Voltage	1400	volts
Maximum Peak Plate Current	400	ma
Maximum D-C Output Current	125	ma
Tube Voltage Drop (approximate) (Independent of output current)	15	volts

Shielding of this tube, particularly in sensitive receivers, may be necessary to eliminate objectionable noise.

Radio frequency chokes (1 mh. or more) connected in series with each plate lead and placed within the shielding, if used, are usually necessary in receivers having high sensitivity.

Full plate load should not be applied to this tube until the filaments have reached their normal operating temperature. Under normal operating conditions the filaments heat quickly when the set is turned on and are ready to supply full load current before the tubes in the receiver require it.

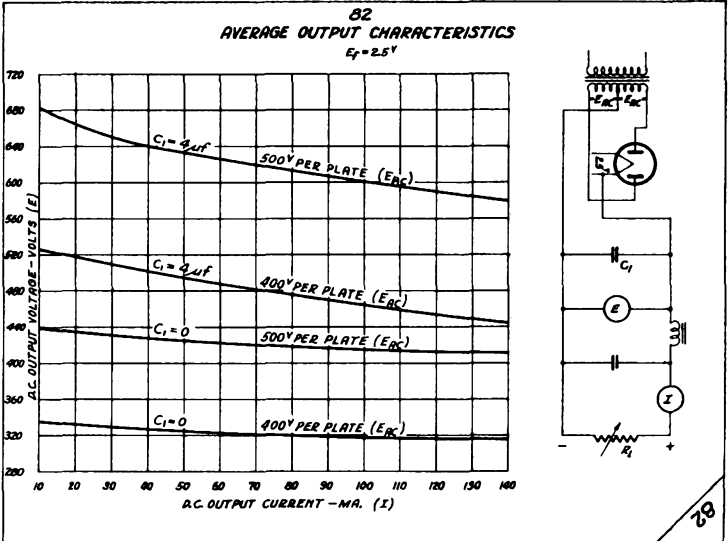

TWIN DIODE
 FULL WAVE MERCURY VAPOR RECTIFIER
 Filament Type Glass Bulb

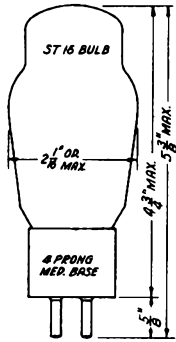

The 83 is a full wave mercury vapor rectifier tube designed for service in power supplies for a-c operated receivers.

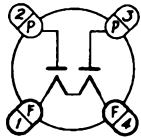

BOTTOM VIEW OF SOCKET

FULL WAVE RECTIFIER

Filament Voltage	5	a-c	volts
Filament Current	3		amp
Maximum A-C Voltage per Plate (RMS)	500		volts
Maximum Inverse Peak Voltage	1400		volts
Maximum Peak Plate Current	800		ma
Maximum D-C Output Current	250		ma
Tube Voltage Drop (approximate)	15		volts
(Independent of output current)			

Shielding of this tube, particularly in sensitive receivers, may be necessary to eliminate objectionable noise.

Radio frequency chokes (1 mh. or more) connected in series with each plate lead and placed within the shielding, if used, are usually necessary in receivers having high sensitivity.

Full plate load should not be applied to this tube until the filaments have reached their normal operating temperature. Under normal operating conditions, the filaments heat quickly when the set is turned on and are ready to supply full load current before the tubes in the receiver require it.

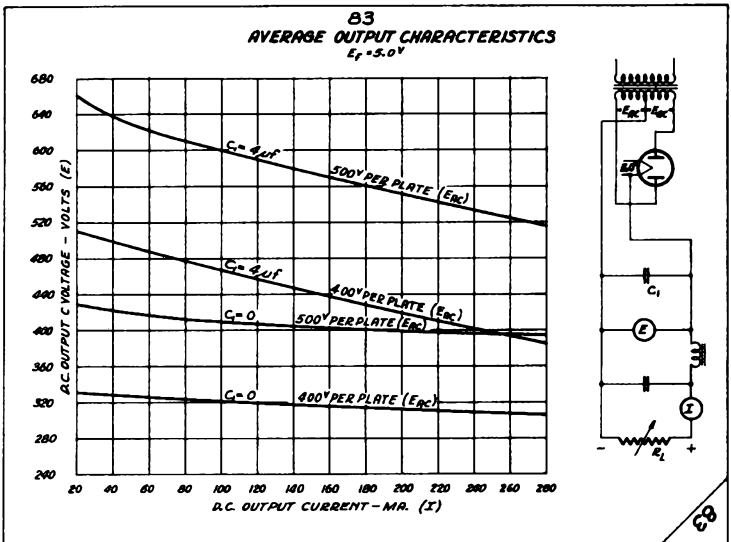

TWIN DIODE
FULL WAVE HIGH VACUUM RECTIFIER
Heater Type Glass Bulb

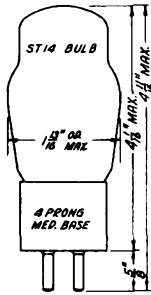

The 83-V is a full wave high vacuum type rectifier tube having a low voltage drop designed for service in power supplies delivering high output currents. The ratings and characteristics are identical with those of type 5V4G.

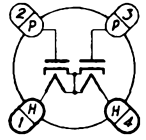

BOTTOM VIEW OF SOCKET

FULL WAVE RECTIFIER - CONDENSER OR CHOKE INPUT FILTER

Heater Voltage	5 a-c	volts
Heater Current	2	amp
Maximum A-C Voltage per Plate (RMS)	400	volts
Maximum Inverse Peak Voltage	1100	volts
Maximum Peak Plate Current	700	ma
Maximum D-C Output Current	200	ma

AVERAGE TUBE VOLTAGE DROP 25 volts
(At 200 ma. output current per plate)

The cathode is connected within the tube to the center of the heater.

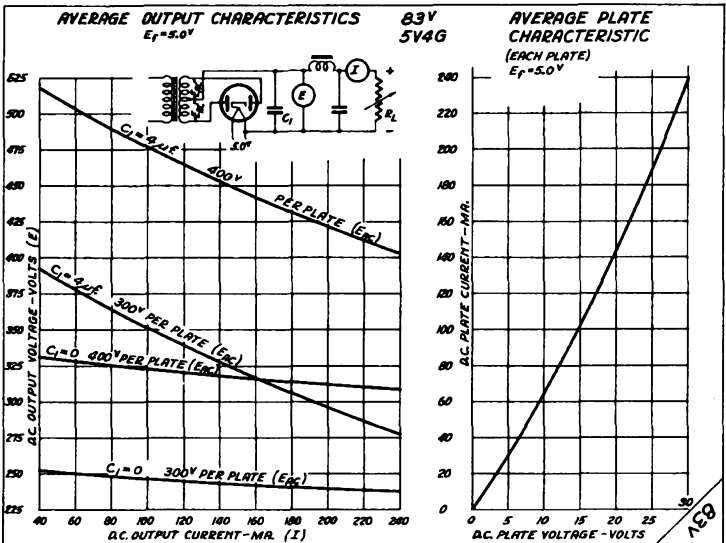

TWIN DIODE
FULL WAVE HIGH VACUUM RECTIFIER
Heater Type Glass Bulb

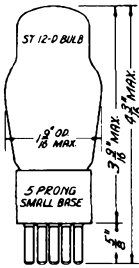

The 84/6Z4 is a full wave high vacuum type rectifier tube designed for service in power supplies for storage battery or a-c operated receivers.

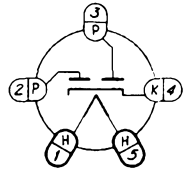

BOTTOM VIEW OF SOCKET

FULL WAVE RECTIFIER
Condenser or Choke Input Filter

Heater Voltage (a-c or d c)	6.3	volts
Heater Current	0.5	amp
Maximum A-C Voltage per Plate (R.M.S)	350	volts
Maximum Inverse Peak Voltage	1000	volts
Maximum D-C Output Current	60	ma
Maximum D-C Voltage between Heater and Cathode	500	volts

HALF WAVE RECTIFIER (Plates in Parallel)
Condenser or Choke Input Filter

Heater Voltage	6.3	volts
Heater Current	0.5	amp
Maximum A-C Plate Voltage (R.M.S)	350	volts
Maximum Inverse Peak Voltage	1000	volts
Maximum D-C Output Current	75	ma
Maximum D-C Voltage between Heater and Cathode	500	volts

AVERAGE TUBE VOLTAGE DROP 22 volts
(At 75 ma. output current per plate)

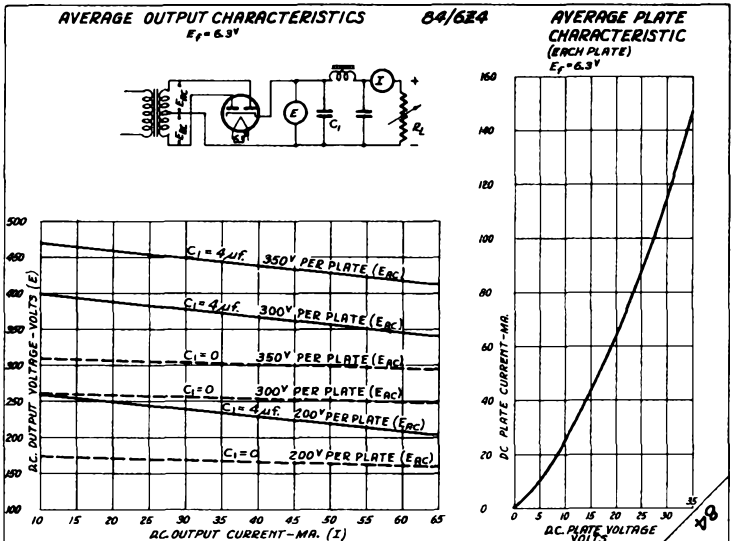

DUO-DIODE TRIODE
DETECTOR AMPLIFIER
Heater Type Glass Bulb

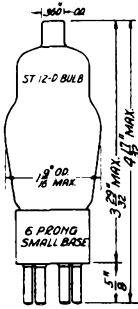

The 85 is a duo-diode triode type amplifier tube designed for service as a combined diode detector, AVC rectifier, and audio frequency amplifier in storage battery or a-c operated receivers. The ratings and electrical characteristics are identical with those of the type 6V7G.

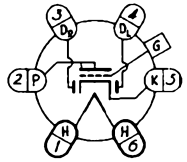

BOTTOM VIEW OF SOCKET

RATINGS

Heater Voltage (a-c or d-c)	6.3	volts
Heater Current	0.3	amp
Maximum Plate Voltage	250	volts

DIRECT INTERELECTRODE CAPACITANCES - TRIODE SECTION

Grid to Plate	1.7	μmf
Input	2.0	μmf
Output	3.5	μmf

AMPLIFIER - CLASS A - TRIODE SECTION

Plate Voltage	135	180	250	volts
Grid Bias	-10.5	-13.5	-20	volts
Amplification Factor	8.3	8.3	8.3	
Plate Resistance	11000	8500	7500	ohms
Transconductance	750	975	1100	μmhos
Plate Current	3.7	6	8	ma
Load Resistance	25000	20000	20000	ohms
Power Output	75	160	350	mw

DIODE SECTION

The two diode units are independent of each other and of the triode section except for the common cathode. The diodes may be used as a half wave or as a full wave rectifier; or one diode may be used as a half wave rectifier for detection, and the other diode used as a rectifier to obtain delayed AVC voltage.

The voltage between heater and cathode should be kept as low as possible where they are not directly connected.

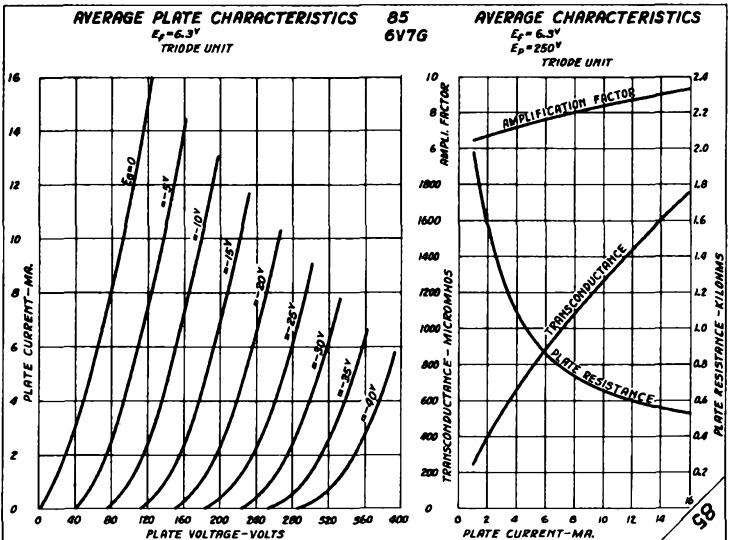

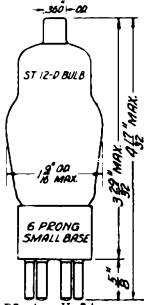

PENTODE
TRIPLE GRID POWER AMPLIFIER
Heater Type Glass Bulb

The 6X4 is a triple grid type power amplifier tube designed for service as a Class A triode, Class A pentode or Class B triode power amplifier in the output stage of storage battery or a-c operated receivers.

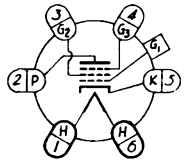

BOTTOM VIEW OF SOCKET

RATINGS

Heater Voltage (a-c or d-c)	6.3	volts
Heater Current	0.4	amp
Maximum Plate Voltage	250	volts
Maximum Screen Voltage	250	volts

AMPLIFIER - CLASS A - TRIODE CONNECTION

Grids #2 and #3 connected to plate

Plate Voltage	160	180	250	volts
Grid (#1) Bias	-20	-22.5	-31	volts
Amplification Factor	4.7	4.7	4.7	
Plate Resistance	3300	3000	2600	ohms
Transconductance	1425	1550	1800	μmhos
Plate Current	17	20	32	ma
Load Resistance*	7000	6500	5500	ohms
Power Output (5% second harmonic)	0.3	0.4	0.9	watts

AMPLIFIER - CLASS A - PENTODE CONNECTION

Grid #3 connected to cathode

Plate Voltage	100	135	180	250	volts
Screen (Grid #2) Voltage	100	135	180	250	volts
Grid (#1) Bias	-10	-13.5	-18	-25	volts
Amplification Factor	125	125	125	125	
Plate Resistance	104000	92500	80000	70000	ohms
Transconductance	1200	1350	1550	1800	μmhos
Plate Current	9.5	14	20	32	ma
Screen Current	1.6	2.2	3.0	5.5	ma
Load Resistance	10700	9200	8000	6750	ohms
Total Harmonics	9	9	9	9	percent
Power Output	0.33	0.75	1.5	3.4	watts

AMPLIFIER - CLASS B - TWO TUBES

Grid #1 connected to Grid #2
Grid #3 connected to plate

Maximum Plate Voltage	250	volts
Maximum Peak Plate Current (per tube)	90	ma
Maximum Average Grid (#1 and #2) Dissipation (per tube)	0.35	watts

Typical Operation:

Plate Voltage	180	volts	
Grid (#1 and #2) Bias	0	volts	
No-Signal Plate Current (per tube)	3	ma	
Load Resistance (plate to plate)	13600	9400	ohms
Power Output (approximate)	2.5	3.5	watts

The voltage between heater and cathode should be kept as low as possible where they are not directly connected.

*Approximately twice this value is recommended when the tube is used as a driver for a Class B stage.

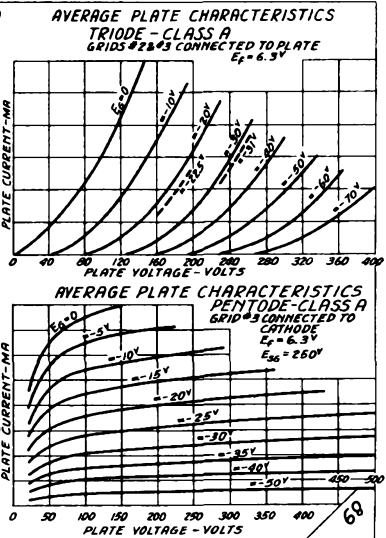
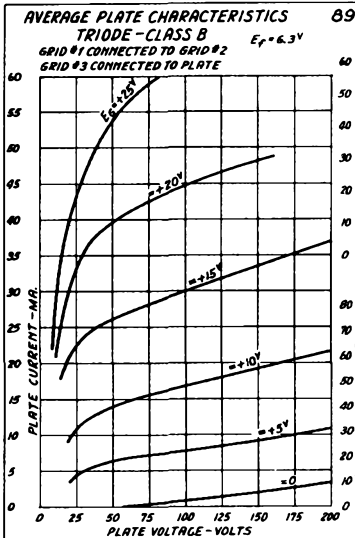

PENTODE
POWER AMPLIFIER
Filament Type Glass Bulb

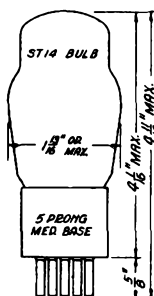

The 950 is a pentode type power amplifier tube designed for service in the output stage of battery operated receivers. The ratings and electrical characteristics are identical with those of the type 1J5G.

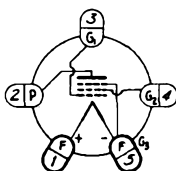

BOTTOM VIEW OF SOCKET

RATINGS

Filament Voltage	2.0 d-c	volts
Filament Current	0.12	amp
Maximum Plate Voltage	135	volts
Maximum Screen Voltage	135	volts

AMPLIFIER - CLASS A

Plate Voltage	135	volts
Screen Voltage	135	volts
Grid Bias	-16.5	volts
Amplification Factor	100	
Plate Resistance	0.1	megohm
Transconductance	1000	umhos
Plate Current	7	ma
Screen Current	2	ma
Load Resistance	13500	ohms
Power Output	450	mw
Maximum Signal Voltage (RMS)	11.7	volts

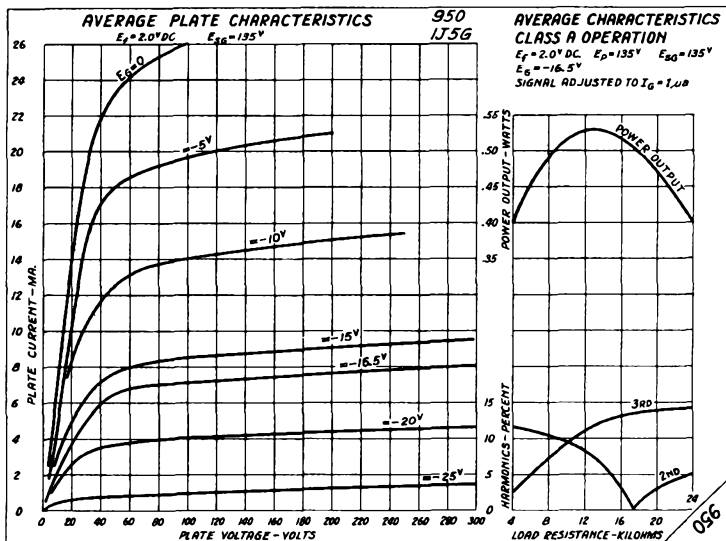

**WD-11
WX-12**

RAYTHEON

**WD-11
WX-12**

TRIODE
DETECTOR OR AMPLIFIER
Filament Type Glass Bulb

The WD-11 and WD-12 are triode type amplifier tubes designed for service in battery operated receivers. Their ratings and electrical characteristics are identical.

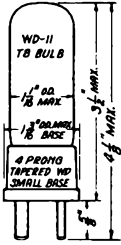
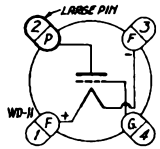

RATINGS

Filament Voltage	1.1 d-c	volts
Filament Current	0.25	amp
Maximum Plate Voltage	135	volts

DIRECT INTERELECTRODE CAPACITANCES

Grid to Plate	3.3	μf
Input	2.5	μf
Output	2.5	μf

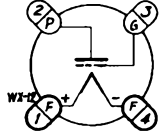

BOTTOM VIEWS OF SOCKETS

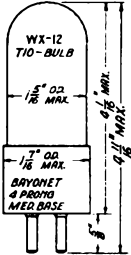

AMPLIFIER - CLASS A

Plate Voltage	90	135	volts
Grid Bias	-4.5	-10.5	volts
Amplification Factor	6.6	6.6	
Plate Resistance	15500	15000	ohms
Transconductance	425	440	μmhos
Plate Current	2.5	3	ma

DETECTOR - BIASED TYPE

Plate Voltage	90	135	volts
Grid Bias (approximate)	-10.5	-18	volts
Plate Current	Adjusted to 0.2 ma. with no signal		

DETECTOR - GRID LEAK TYPE

Plate Voltage	45	volts
Grid	Return to positive filament	
Grid Leak Resistance	0.25 to 5	megohms
Grid Condenser	0.00025	μf

**V99
X99**

RAYTHEON

**V99
X99**

TRIODE
DETECTOR OR AMPLIFIER
Filament Type Glass Bulb

The V-99 and X-99 are triode type amplifier tubes designed for service in battery operated receivers. Their ratings and electrical characteristics are identical.

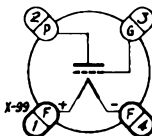
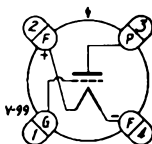

BOTTOM VIEWS OF SOCKETS

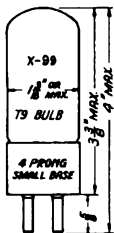
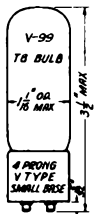

RATINGS

Fil. Voltage	3.0	3.3 d-c volts
Fil. Current	0.060	0.063 amp
Max. Plate Voltage	90	volts

DIRECT INTERELECTRODE CAPACITANCES

Grid to Plate	3.3	μf
Input	2.5	μf
Output	2.5	μf

AMPLIFIER - CLASS A

Plate Voltage	90	volts
Grid Bias	-4.5	volts
Amplification Factor	6.6	
Plate Resistance	15500	ohms
Transconductance	425	μmhos
Plate Current	2.5	ma

DETECTOR - BIASED TYPE

Plate Voltage	90	volts
Grid Bias (approximate)	-10.5	volts
Plate Current	Adjusted to 0.2 ma. with no signal	

DETECTOR - GRID LEAK TYPE

Plate Voltage	45	volts
Grid	Return to positive filament	
Grid Leak Resistance	0.25 to 5	megohms
Grid Condenser	0.00025	μf

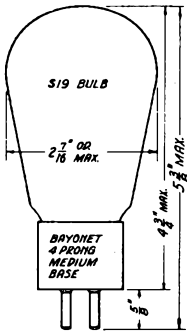
BA**RAYTHEON****BA**

TWIN DIODE
GAS FILLED FULL WAVE RECTIFIER
Cold Cathode Type Glass Bulb

The BA is a gas filled full wave rectifier tube of the cold cathode type requiring no heater supply voltage. It is designed particularly for service in B battery eliminators for radio receivers.

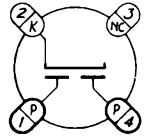

BOTTOM VIEW OF SOCKET

FULL WAVE RECTIFIER

Maximum A-C Voltage per Plate (RMS)	350	volts
Maximum D-C Output Current	350	ma
Maximum Peak Plate Current	1000	ma
Maximum Inverse Peak Voltage	1000	volts
Minimum Starting Peak Voltage	400	volts
Average Dynamic Voltage Drop	80	volts

The type BA tube was developed primarily for use in B battery eliminators for radio receivers. It has the typical characteristics of all gas filled rectifiers as regards a constant voltage drop and ability to handle high peak currents. Any tendency of the tube to generate r-f noise may be eliminated by proper shielding and filtering.

The BA is filled with a permanent gas rather than a vapor filling. The tube characteristics are independent of the surrounding temperature.

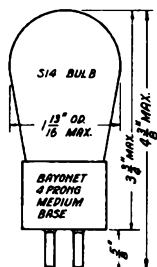
BH**RAYTHEON****BH**

TWIN DIODE
 GAS FILLED FULL WAVE RECTIFIER
 Cold Cathode Type Glass Bulb

The BH is a gas filled full wave rectifier tube of the cold cathode type requiring no heater supply voltage. It is designed particularly for service in B battery eliminators for radioreceivers.

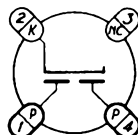

BOTTOM VIEW OF SOCKET

FULL WAVE RECTIFIER

Maximum A-C Voltage per Plate (RMS)	350	volts
Maximum D-C Output Current	125	ma
Maximum Peak Plate Current	400	ma
Maximum Inverse Peak Voltage	1000	volts
Minimum Starting Peak Voltage	350	volts
Average Dynamic Voltage Drop	90	volts

The type BH tube was developed primarily for use in B battery eliminators for radio receivers. It has the typical characteristics of all gas filled rectifiers as regards a constant voltage drop and ability to handle high peak currents. Any tendency of the tube to generate r-f noise may be eliminated by proper shielding and filtering.

The BH is filled with a permanent gas rather than a vapor filling. The tube characteristics are independent of the surrounding temperature.

BR

RAYTHEON

BR

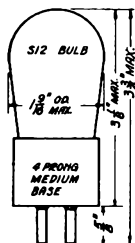

DIODE
GAS FILLED HALF WAVE RECTIFIER
Cold Cathode Type Glass Bulb

The BR is a gas filled half wave rectifier tube of the cold cathode type requiring no heater supply voltage. It is designed for service where it is desirable to use a half-wave rectifier.

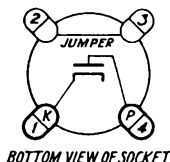

HALF WAVE RECTIFIER

Maximum A-C Plate Voltage (RMS)	300	volts
Maximum D-C Output Current	50	ma
Maximum Peak Plate Current	200	ma
Maximum Inverse Peak Voltage	850	volts
Minimum Starting Peak Voltage	300	volts
Average Dynamic Voltage Drop	60	volts

The type BR tube was developed primarily for use in vibrator type B supply units for automobile receivers. It has the typical characteristics of all gas filled rectifiers as regards a constant voltage drop and ability to handle high peak currents. Any tendency of the tube to generate r-f noise may be eliminated by proper filtering and shielding. The shielding and filtering commonly used to eliminate vibrator noise will usually be sufficient.

The BR is filled with a permanent gas rather than a vapor filling. The tube characteristics are independent of the surrounding temperature.

RESISTANCE TUBES
FOR BATTERY OPERATED
TWO VOLT TUBE RECEIVERS

Octal Base Glass Bulb

The series of resistance tubes, NB-1 to NB-8, is designed for two volt tube receivers having filament current drains of 300 to 720 milliamperes, in steps of 60 milliamperes.

RATINGS

Type	Filament Current Drain	ma
NB-1	300	ma
NB-2	360	ma
NB-3	420	ma
NB-4	480	ma
NB-5	540	ma
NB-6	600	ma
NB-7	660	ma
NB-8	720	ma

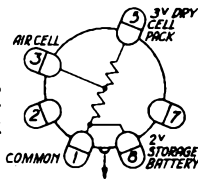
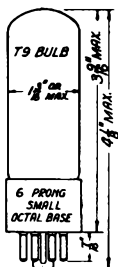

BOTTOM VIEW OF SOCKET

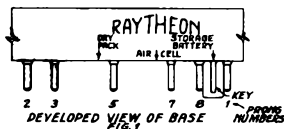

DEVELOPED VIEW OF BASE

The NB tubes have one common tap; one short circuiting tap, for use with a 2 volt storage battery; one resistor tap, for use with an air cell; and one ballast resistor tap, for use with a 3 volt dry cell pack. The curve on the accompanying sheet shows the typical relation between filament voltage and applied voltage, using the tap for dry cell pack.

The resistors in the NB tubes are operated in air, in a sealed container and the moderate ballasting action obtained when the tap for dry cell pack is used is due only to the change of resistance with temperature of the wire used. These resistors operate at a relatively low temperature and their resistance characteristics are permanent if the rated nominal current is not exceeded, so that the NB tube should not need replacement because of change in characteristics during life.

The NB tubes are stamped with locating arrows marked "Storage Battery", "Air Cell" and "Dry Pack" on the base of the tube, as shown in Fig. 1. If a reference mark is placed on the chassis mid-way between pins #1 and #8 and the socket wired, as shown in Fig. 2, a special socket with three keyways and a special socket with the keyway drilled out may be used to connect the battery to the proper tap. In either of the above cases the arrow corresponding to the type of battery used should be lined up with the reference mark. A terminal strip may also be provided for connecting the filament battery, to the proper tap of the NB tube. In the latter case, the tube is left fixed and the filament battery is wired to the proper point on the terminal strip.

TYPE OF BATTERY	PLACE LOCATING KEY IN
2 volt storage	Position A
Air Cell	Position B
3 volt Dry Cell Pack	Position C

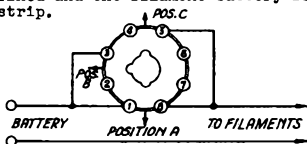
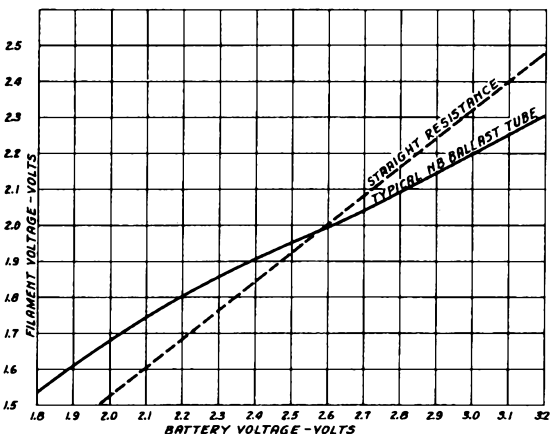

FIG. 2
BOTTOM OF SPECIAL SOCKET

TYPICAL BALLASTING CHARACTERISTIC CURVE
NB RESISTANCE TUBE
3 VOLT DRY CELL CONNECTION



K49C-B

RAYTHEON

K49C-B

RESISTANCE TUBE FOR A-C - D-C RECEIVERS

Metal Bulb Octal Base

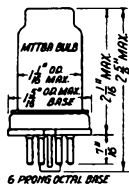

The K49C-B is a resistance tube designed for use as a voltage dropping resistor in the filament circuit of a-c-d-c receivers. A ballast resistor tap provides voltage for one or two 6.3 volt pilot lamps.

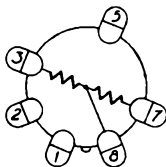

**BOTTOM VIEW OF SOCKET
CONNECT PILOT LAMPS
BETWEEN PINS #7 & #8**

RATINGS

Voltage Drop at 300 ma.	49	volts
Supplies correct filament voltage to:		
3- 6.3 volt 300 ma. tubes and		
2- 25 volt 300 ma. tubes in series		
Pilot Lamp Voltage at 300 ma:		
2- 6.3 volt 150 ma. lamps in series	10	volts
1- 6.3 volt 200 ma. lamp	6.6	volts
1- 6.3 volt 250 ma. lamp	4.8	volts

When the pilot lamp voltage in an a-c - d-c receiver is taken from a tap on the filament voltage dropping resistor, which usually has no ballasting action, the peak voltage applied to the pilot lamps at the instant the line switch is closed may be several times the rated voltage of the lamps, due to the high initial current drawn by the tubes in the set. In order to limit this peak voltage to a reasonable value, the resistance of the pilot lamp section of a straight resistance tube must be considerably lower than that required to operate the lamps at their rated voltage with the tubes hot. Thus, with a straight resistance tube, the life of the pilot lamps is shortened by the high peak voltage and the final brilliancy is reduced by the low operating voltage.

In the K49C-B the pilot lamp section is a ballast resistor which changes from a low value of resistance with the tube cold to several times its initial value as the tube heats. This limits the peak voltage applied to the pilot lamps to a value within their voltage rating, and operates the lamps at a higher voltage than with a straight resistance tube, increasing the life and final brilliancy of the lamps. The ballasting action also makes it possible to use several different types of pilot lamps with satisfactory results. The characteristic curves show the relation between pilot lamp voltage and time for a typical K49C-B tube and a typical straight resistance tube with similar ratings.

The resistors in the K49C-B are operated in air and the ballasting action obtained in the part shunted across the pilot lamps is due to the heat of the total winding. The resistors operate at relatively low temperature and their resistance characteristics are permanent if the normal rated current is not exceeded.

Resistance tubes with other ratings may also be made. There is considerable power available for ballasting action so that the total voltage drop may be changed to fit other tube combinations requiring either more or less voltage drop.

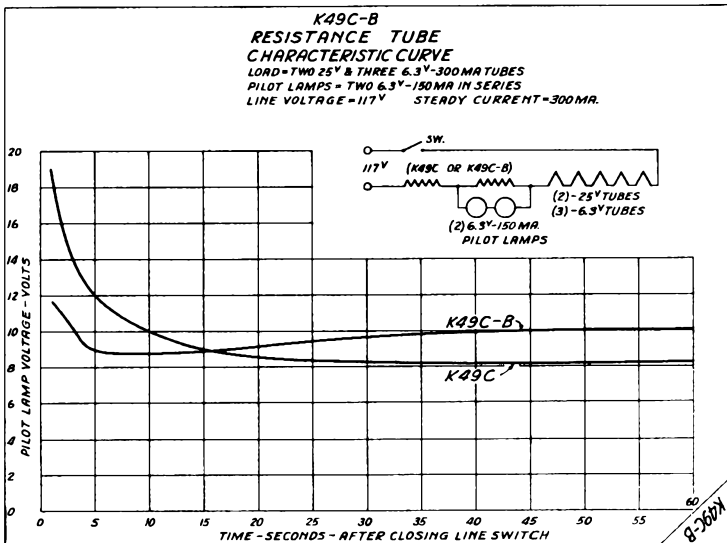

— N O T E S —

RAYTHEON