

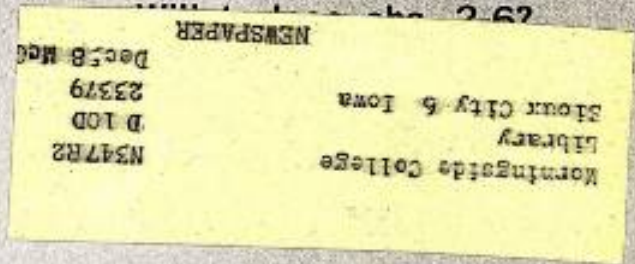

BROADCASTING TELECASTING

THE BUSINESSWEEKLY OF RADIO AND TELEVISION APRIL 1, 1957 35¢ PER COPY

IN THIS ISSUE	COMPLETE INDEX	PAGE	ID
Military zeros in on vhf channels 2-6		Page 31	
It's time to talk money with ASCAP again		Page 42	
Government sues Loew's for block booking		Page 46	
NARTB previews: What's on tap in Chicago		Page 79	



PIN POINT POWER GETS BEST RESULTS

Radio Station W-I-T-H "pin point power" is tailor-made to blanket Baltimore's 15-mile radius at low, low rates—with *no waste coverage*. W-I-T-H reaches 74%* of all Baltimore homes every week—delivers more listeners per dollar than any competitor. That's why we have twice as many advertisers as any competitor. That's why we're sure to hit the sales "bull's-eye" for you, too.

*Cumulative Pulse Audience Survey

Buy

Tom Tinsley
President
R. C. Embry
Vice Pres.

W-I-T-H

C O N F I D E N C E

National Representatives: **Select Station Representatives** in New York, Philadelphia, Baltimore, Washington.
Forjoe & Co. in Chicago, Seattle, San Francisco, Los Angeles, Dallas, Atlanta.

RELAX and PLAY on a *Bermuda Holiday!*

You fly to Bermuda in less than 4 hours!



OPERATION:

FACELIFT FOR STATION WHTN-TV

rebuilding to keep pace with the increasing importance of Central Ohio Valley . . . expanding to serve the needs of America's fastest growing industrial area better!

Draw on this Powerhouse of Facts for your Slogan:

When OPERATION *FACELIFT is completed this Spring, Station WHTN-TV's 316,000 watts will pour out of an antenna 1000 feet above the average terrain! This means . . .

- REBUILT AND IMPROVED STATION WHTN-TV will be the ONLY "FULL POWER" STATION in Ohio Valley between Cincinnati and Wheeling!
- REBUILT AND STRENGTHENED STATION WHTN-TV will be the ONLY STATION to put a Grade A signal over the four top markets of Portsmouth, Ashland-Ironton, Huntington and Charleston!
- REBUILT AND EXPANDED STATION WHTN-TV will put city grade service over the two principal major markets of Huntington and Charleston!
- REBUILT AND RE-VITALIZED STATION WHTN-TV will be THE ONLY STATION with the sustained dominance of TV-power to insure your sales messages reaching the many families earning far above the average in the fast-growing industrial centers of Central Ohio Valley, living near and in the buying centers of Central Ohio Valley.
- REBUILT, REFURBISHED, REFRESHED STATION WHTN-TV, one of the fine Cowles stations, on Channel 13 over ABC basic network will dominate Central Ohio Valley. If you want your products to sell in this important market, plan to use the station that will blanket this entire area . . . STATION WHTN-TV.

OPERATION:

PAYOFF FOR YOU—AND HER!

write a slogan to sum up the exciting WHTN-TV story and



WIN A GLORIOUS BERMUDA SUNSHINE HOLIDAY FOR TWO! OR THE CASH EQUIVALENT IF YOU PREFER!

In as few words as possible, no more than fifteen, write a slogan that dramatizes the TV-viewing appeal of Station WHTN-TV . . . that tells why Station WHTN-TV offers the TV-advertiser such dynamic dominance for his advertising money!

EASY! FUN! NOTHING TO BUY! EVERYTHING TO ENJOY! 103 PRIZES IN ALL!

- 6 happy days in Bermuda with round trip airplane transportation between New York and Bermuda • round trip transfers in Bermuda between airport and hotel • room for two with private bath at the Castle Harbor Hotel for 6 nights • use of private beach and swimming pool facilities at hotel • breakfast and dinner daily • sightseeing excursion • Not included personal items, tips and Bermuda head tax (payable in Bermuda) of \$2.85.

2nd Prize: \$150. 3rd Prize: \$75.

100 ADDITIONAL AWARDS FOR MERITORIOUS ENTRIES.

Contest open to the personnel of advertising agencies and their clients, except the Cowles Co. and their agencies.

PRIZE WINNERS WILL BE ANNOUNCED IN THE JUNE 17TH ISSUE OF THIS MAGAZINE.

WHTN-TV CONTEST

JUST FOLLOW THESE EASY RULES

Fill in and Mail Today!

1. In space provided on this entry blank, print plainly your suggested slogan for Station WHTN-TV.
2. Entries must be postmarked not later than midnight, May 15, 1957.
3. Slogans will be judged on basis of originality, uniqueness, and aptness. Contest will be judged by Mr. Norman Glenn, publisher of SPONSOR, Mr. Robert Hutton of the Edward Petry Company, Mr. S. T. Paul, publisher of BROADCASTING • TELECASTING, and Mr. Sol Tishoff, publisher of BROADCASTING • TELECASTING.
4. Contest subject to all Federal, State and local regulations. Winners will be notified by mail.

SUGGESTED SLOGAN FOR STATION WHTN-TV:

Print your name, age and address below.
Cut this coupon and mail to:

STATION WHTN-TV SLOGAN CONTEST
625 Fourth Avenue, Huntington 8, W. Va.

your name your firm your age

your position your home address zone

city state

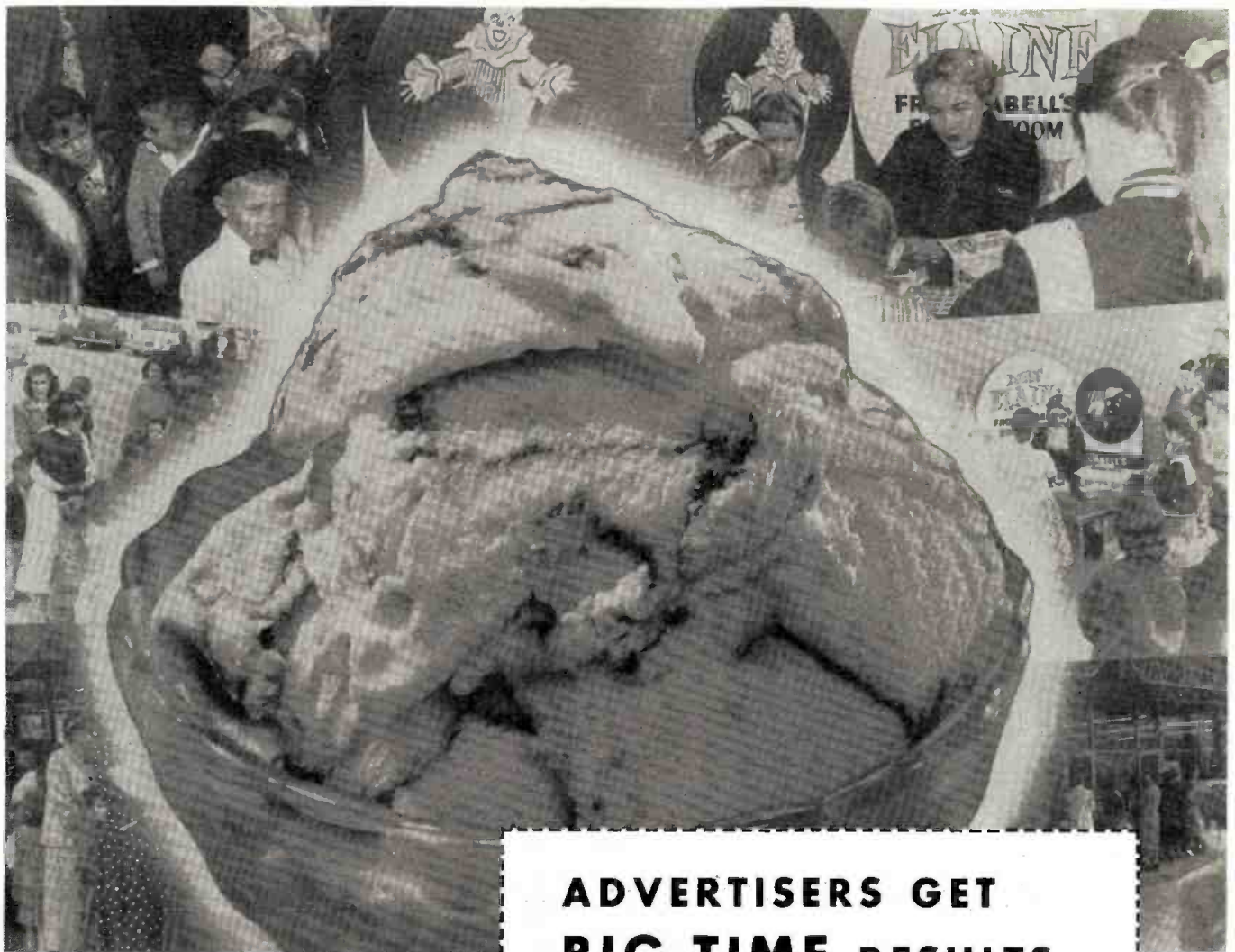

**ADVERTISERS GET
BIG-TIME RESULTS
WITH WFAA-TV!...**

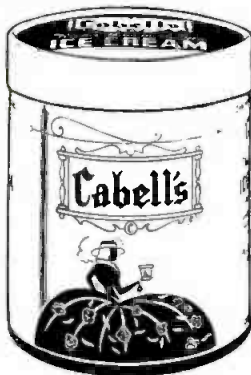

In line for free ice cream?

No. These small-fry by the hundreds are waiting patiently in line to say "Hello" to Miss Elaine, of WFAA-TV's popular "Romper Room". It's the parents who will be buying the ice cream. CABELL'S ice cream . . . "'cause Miss Elaine says to buy Cabell's." Not only ice cream, but milk and all the other fine Cabell dairy products.

How well do they heed her advice? Enough to prompt this advertiser to extend an already successful schedule to five full 30-minute segments per week! Further proof that advertisers do get "big-time" results with WFAA-TV!

WFAA-TV

CHANNEL 8 - DALLAS

Blanketing 564,080 North
Texas television homes

Call Your
PETRYMAN

for complete market data
and availabilities.

108206



starting its ninth year in a new home

WGAL-TV

LANCASTER, PENNA.

NBC and CBS

Since the date of its first telecast, March 18, 1949, WGAL-TV has had eight happy and eventful birthdays. None has been happier nor more eventful than the latest one, which was made noteworthy by the "Dedication to Public Service" of the new WGAL-TV building, with its latest modern equipment and complete color facilities. These new facilities make it possible for WGAL-TV to give a birthday gift of better service to its countless viewers and its numerous communities, which combine to form America's 10th TV Market.

STEINMAN STATION · Clair McCollough, Pres.

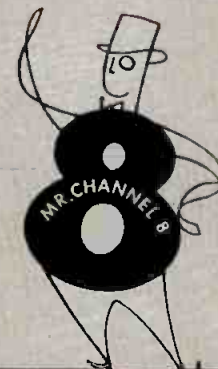

316,000 WATTS

Representative: The MEEKER Company, Inc. · New York · Chicago · Los Angeles · San Francisco

WHOSE AIR? Sen. Charles E. Potter, of Michigan, second ranking Republican on Commerce Committee and former chairman of Communications Subcommittee, is so deeply concerned about scarcity of vhf spectrum space that he plans to propose overall high-level analysis of spectrum utilization both by government (military) and private users. He's alarmed over reports current in higher circles that military already is seeking low band vhf tv channels (2-6) through direct allocation by President. He questions whether maximum utilization of spectrum now is being made and whether frequency exchanges could not be worked out to ultimate advantage of both military and non-military users and, at same time, effect spectrum conservation. (See story page 31.)

B•T

FILING of government antitrust suit against Loew's Inc. for allegedly block-booking features to tv (story page 46) doesn't mean Justice Dept.'s investigation of film dealing stops there. It's known that Justice agents are still looking into practices of other film distributors.

B•T

JAHNCKE TO FCC? Friends of Ernest Lee Jahncke Jr., former ABC vice president, are urging his appointment to FCC if Chairman McConaughy elects to leave upon expiration of his term June 30. Mr. Jahncke, 20-year veteran in broadcasting at age 44, is native of Connecticut and life-long Republican. He resigned from ABC with departure of Robert E. Kintner as president.

B•T

BROADCASTERS supporting Jahncke candidacy on "if" basis point out need for businessman-broadcaster and feel Mr. Jahncke's two decades of experience would be asset (he started with NBC in 1937; was assigned to Blue network which eventually became ABC under independent ownership). He's understood, moreover, to have support of Connecticut GOP senators. He's Naval Academy graduate and is commander in Reserve. His father was Assistant Secretary of Navy under President Hoover.

B•T

SHAKE-UP • Seemingly all inclusive coverage of San Francisco earthquake given by all news media overlooked one facet of particular interest to broadcast buyers and sellers. Number of commercials had to be made good because of interruptions caused by trembling turntables or palpitating projectors. Other weather victims last week were Clark George, general manager, and Bob Wood, commercial manager, of KNXT (TV) Los Angeles, who feared stormy skies and so entrained for New York to be sure to arrive in time for meet-

ing of executives of CBS-owned tv stations on Monday. Result of their caution was to find their train snowbound and to reach their destination, via plane from Chicago, day and half behind schedule.

B•T

ONE question considered sure to be raised by CBS-TV affiliates at their annual meeting with network officials this week is almost perennial proposal for longer station breaks. Breaks now are 40 seconds; at least some stations would like lengthening to accommodate two 20-second spots in addition to I.D. Network, however, feels this not feasible. Annual convention is Friday and Saturday in Chicago, preceding NARTB convention.

B•T

SECRET SESSIONS • FCC network study staff—now armed with hearing and subpoena powers authorized by FCC two weeks ago [B•T, March 25]—would like to conduct hearings, if any are ordered, in secret. Whether this is possible under existing rules and law is under consideration by network staff and FCC legal aides. Meanwhile FCC is pondering what will happen after June 30 when \$241,000 appropriated for network study runs out. Thinking at FCC is that some means will be found to continue staff, or at least skeleton, if study is not completed.

B•T

NBC Radio's hourly five-minute newscasts, center of hot controversy when launched early this year (Jan. 14, et seq.), have picked up first sponsorship renewal. Brown & Williamson Tobacco Co. has signed as co-sponsor for another 13 weeks, effective April 29, through Ted Bates & Co., New York. Other co-sponsor is Bristol-Myers whose renewal notification is not due till about end of month. Bristol-Myers agency is Young & Rubicam, New York.

B•T

PEOPLE'S CHOICE • Col. Edward M. Kirby, wartime Army radio chief and before that public relations director of NARTB (then NAB), has been named public relations director of People-to-People Inc., Eisenhower-inspired project to give impetus to worldwide program for amity. Project, privately undertaken, is designed to augment government (USIA) and Crusade for Freedom programs. Radio-tv committee, one of 41 different segments, is jointly chairmanned by Frank Stanton, CBS Inc. president, and Harold E. Fellows, NARTB president.

B•T

NEW unit designed to eliminate scratch impressions on film (developed by Richard Sassenberg, traffic manager at RKO Television Inc.) is expected to be revealed at NARTB convention. It can be attached to 16 mm film projector in 15 minutes, hides marks during projection (dust, for example,

causes scratches on film's surface), already has been tested on 16 mm film projected on WOR-TV New York. It's claimed device not only would assure excellent film picture on air but also could save as much as 50% of film reproduction cost, double film print's life and even permit same print to be used for its entire commercial film exposure on tv.

B•T

ASK THE BOSS • NARTB and AFM officials were trying to locate James Caesar Petrillo at weekend. AFM president was motoring somewhere in West. NARTB wanted to know if it would be all right for Great Lakes Naval Training Center Band to play "The Star Spangled Banner" as background to U. S. Marine Corps Color Guard ceremony opening formal convention proceedings Tuesday morning. Complication centered around need for music czar's permission before military band can perform. Convention, incidentally, is paying neat sum for banquet musicians.

B•T

RECURRING reports of imminent sale of WOV New York were held to be without foundation by M. S. Novik, president of WOV Broadcasting Corp. Acknowledging that offers have been made, Mr. Novik says he and his associates are "flattered" but that "we are not interested in selling."

B•T

NEW NAME IN RADIO-TV • J. H. Whitney Co. understood to be setting up "front office" for its owned stations—WISH-AM-TV Indianapolis, WANE-AM-TV Ft. Wayne, KOTV (TV) Tulsa, KGUL-TV Galveston—in form of newly-organized Corinthian Broadcasting Corp. C. Wrede Petersmeyer, president of all owned stations but KGUL-TV, is slated for Corinthian presidency. New company will be "front office" to fill need for "a common denominator—a service organization for all the stations," according to one Whitney official. It will advertise Whitney stations as unit—through newly-appointed agency, Anderson & Cairns, New York—but no change in sales representation contemplated. Edward Petry & Co. will continue to represent Ft. Wayne and Tulsa stations; Bolling Co. will stay with Indianapolis outlets, and CBS Tv Spot Sales with Galveston. Corinthian headquarters will be 630 Fifth Ave., New York 22. Tel.: Plaza 7-0500.

B•T

J. J. (JOE) BERNARD, vice president-general manager of WGR-AM-TV Buffalo, is acting as consultant for new ch. 2 KTV1 (TV) St. Louis. Station, to be ABC affiliated, has target date of April 15, having gone dark March 20 as uhf on ch. 36 to install new equipment. It's Mr. Bernard's first consultancy.

WDAY-TV DELIVERS 520% MORE FARGO-MOORHEAD HOMES THAN STATION "B"!

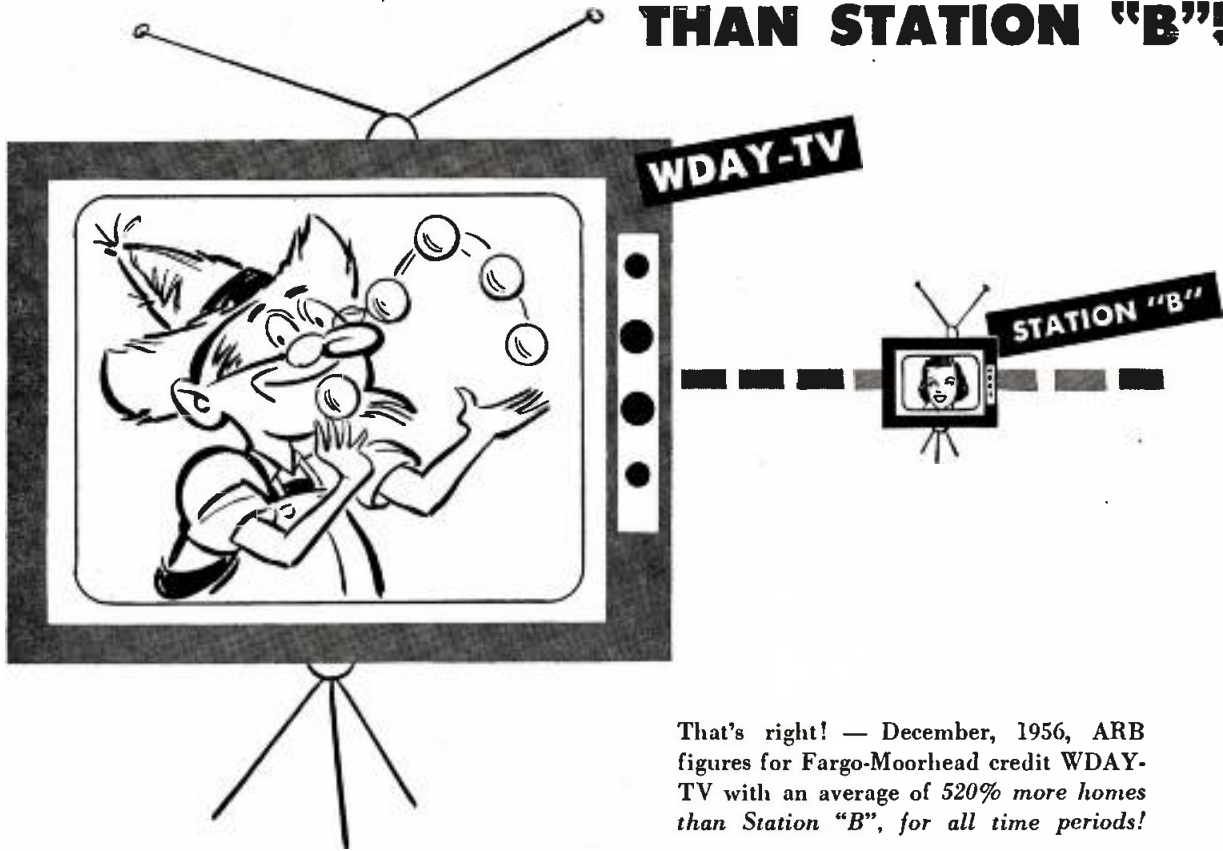

That's right! — December, 1956, ARB figures for Fargo-Moorhead credit WDAY-TV with an average of 520% more homes than Station "B", for all time periods!

WDAY-TV gets—

- 760% More—12 Noon to 5:00 P.M.!
- 872% More—5:00 P.M. to 6:00 P.M.!
- 181% More—6:00 P.M. to 10:00 P.M.!
- 270% More—10:00 P.M. to Sign-Off!

That's just the Fargo-Moorhead picture. June, 1956 ARB figures (left) prove that WDAY-TV is almost as popular in five other Red River Valley cities — each between 40 and 60 miles away!

Your Peters, Griffin, Woodward Colonel has all the facts.

P. S. Average ARB Rating, 6:00 - 10:30 P.M., WDAY-TV—43.6. Station "B"—11.9.

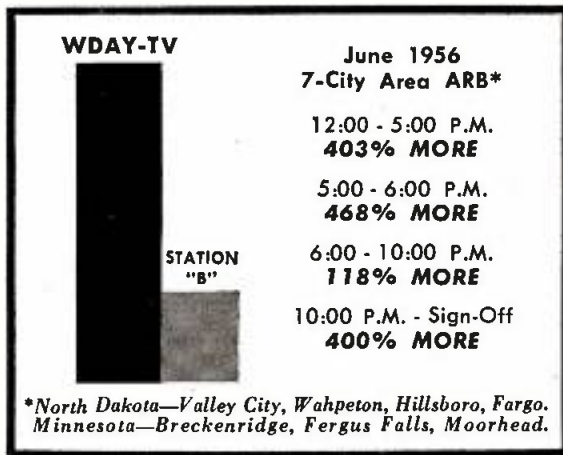

WDAY-TV

FARGO, N. D. • CHANNEL 6

Affiliated with NBC • ABC



PETERS, GRIFFIN, WOODWARD, INC.
Exclusive National Representatives

Magnuson Letter Explores Broadcast Rating Services

EXPLORATION into broadcast rating services has been started by Sen. Warren G. Magnuson (D-Wash.), chairman of Senate Commerce Committee, B•T learned Friday.

Sen. Magnuson has sent letters to leading research firms asking many questions, some pointed. Aside from queries about nature of services, methods, techniques, etc., letter asks researchers such questions as these (paraphrased):

What effect if any does type or quantity of service ordered by customer have on manner in which you conduct measurements?

Do you try to correlate your results with those of other services?

Does publication of your ratings affect success of programs or stations?

What percentage of your income comes from networks, stations, agencies, others?

Confirming report he had dispatched letters only day before, Sen. Magnuson told B•T Friday he was exploring rating field because of complaints. He did not elaborate.

Loew's Tells What It Paid For Percentage of Stations

LOEW'S Inc. paid \$1,625,000 for quarter interest in KTTV (TV) Los Angeles, Loew's President Joseph R. Vogel told meeting of board at which four-man executive committee was elected unanimously. They include Mr. Vogel, George L. Killion, Frank Pace Jr., and Ogden R. Reid (named committee chairman). Mr. Vogel said Loew's 25% interest in KMGM (TV) Minneapolis cost Loew's \$750,000 and reported option to buy quarter share of KTVR (TV) Denver for \$525,000. He also noted firm's share earnings for second quarter of this fiscal year to be 18 cents per share, bringing six-month total to 51 cents. Loew's Inc. is being sued by Justice Dept.'s Antitrust Div., which has asked for injunction to prevent "block-booking" of feature films to tv (story page 46).

Week Brings \$3.1 Million Into NBC-TV Sales Totals

NBC-TV daytime sales swelled with additional \$3.1 million in new business last week, William R. (Billy) Goodheart Jr., vice president, NBC Television Network Sales, reported Friday, bringing total sales in two week period to nearly \$10 million.

SOS Co. (scouring pads) through McCann-Erickson bought quarter-hour segments of Monday-Friday *Queen for a Day* and *Tic Tac Dough* and quarter-hour segment alternate Fridays on *Tennessee Ernie Ford Show* for 52 weeks starting July 12. Standard Brands, through Ted Bates & Co., will sponsor 26 alternate Tuesday segments of *Queen for a Day* starting April 23. This is in addition to previous order for same segment on alternate weeks starting April 16 and will give Standard Brands sponsorship of first quarter-hour segment on Tuesday for 52 consecutive weeks.

The Dixie Cup Co. (paper cups and plates) will sponsor quarter-hour segments of *Queen for a Day* and *Tennessee Ernie Ford Show* on 13 alternate Wednesdays starting April 10 through Hicks & Greist. Drackett Co. (Windex) will sponsor quarter-hour segments of both *Queen for a Day* and *Tennessee Ernie Ford*

Show on April 8 and 22 only. Young & Rubicam placed.

Fortnight ago Lever Bros. and Procter & Gamble bought total \$6.5 million in daytime programs on network, marking new daytime venture on NBC-TV for Lever [B•T, March 25]. Meanwhile, H. J. Heinz Co., through Maxon Inc., Friday renewed for third year sponsorship of *Captain Gallant of the Foreign Legion* effective March 30 in new spot, Saturday 11:30 a.m.-12 noon.

First Three Complaints Issued From FTC Monitoring Unit

FEDERAL Trade Commission today (Mon.) is issuing first three of its long-awaited series of complaints against alleged false and misleading radio-tv commercials.

FTC charges were against Mentholatum Co. for false advertising of its Mentholatum Rub on CBS-TV and NBC-TV; Whitehall Pharmaceutical Co. with similar false claims for its Infrarub and Heet on CBS-TV and MBS; and Omega Chemical Co. with falsely advertising its Omega Oil on radio stations Deceptive advertising in newspapers and on products themselves also are charged in some cases. All are given 30 days to file answers, with hearings scheduled for Whitehall June 3 and Omega June 5, both in New York, and Mentholatum June 7 in Buffalo.

Complaints were first issued as result of monitoring by FTC's Radio-Tv Unit established last October.

Mentholatum is charged with showing video representation of arthritic hands and asking viewer to notice result after Mentholatum Rub application: "Soon a pleasing glow is felt right where it hurts . . . bringing deep relief to pain-racked joints."

Whitehall is charged with claiming on tv that Infrarub "speeds up the flow of fresh, rich blood . . . drives away pain-causing congestion . . . relieves ordinary pain of arthritis, rheumatism, backache and muscle aches for hours—or money refunded."

Omega, FTC said, presented radio testimonial claim by backache sufferer that after using Omega Oil he "felt like a boy again," and claimed product would also relieve neuritis and rheumatic pains.

Oppose Pressure Groups, Bartley Tells Broadcasters

BROADCASTERS not only should maintain vigilance against any form of government censorship but also against censorship attempted by private pressure groups, FCC Comr. Robert T. Bartley told Virginia AP Broadcasters, meeting in Washington Friday. "Through devious, indefinable, and sometimes insidious means, these private groups and organizations . . . attempt to impose their own views as to the suitability and acceptability of program material upon the broadcaster or his advertiser-sponsor . . .", Mr. Bartley said.

Importance of news from "diverse" sources was emphasized by Mr. Bartley. "In a democracy, the effort is and must continue to be to provide the citizen with information, ideas and news from diverse sources—all with the purpose of permitting him to form his own opinion," Mr. Bartley said.

• BUSINESS BRIEFLY

Late-breaking items about broadcast business; for earlier news, see ADVERTISERS & AGENCIES, page 32.

WHISK AGAIN • Lever Bros. (Whisk), N. Y., planning another flight of television spots, starting May 1 in first markets. Length of contract will vary but may be as long as 20 weeks. BBDO, N. Y., is agency.

KATZ ACCOUNTS • Five new am accounts added by Joseph Katz Co., N. Y. and Baltimore: Roselux Chemical Co. (Rosex bleaches and starch); Lillian Dairy Products Corp. (Sodus and Crowley brand products), Chesterfield Music Shops, Price Premiums Co. and Dorman Co., all N. Y.

SWITCH IN WORKS • Genesse Brewing Corp., Rochester, N. Y., regional advertiser now being serviced by Rogers & Porter, Rochester, expected to name New York agency. Decision to be made early this week.

SECOND THOUGHT • Purex Corp. (bleach), which renewed as alternate week sponsor of *The Big Surprise* on NBC-TV, has reconsidered and instead will alternate with Speidel watch bands, on *The Arthur Murray Show* for next 13 weeks (NBC-TV, 8-8:30 p.m.). Both advertisers will then sponsor film show for summer. Agencies: Foote, Cone & Belding for Purex and Norman, Craig & Kummel for Speidel.

LOCAL ACCENT • N. W. Ayer & Son, N. Y., is advising stations that effective April 1, both Illinois Bell Telephone and Rubin H. Donnelley Corp. (yellow pages) will be serviced out of agency's Chicago office. Reason stated is that "we are deviating from our established policy for these clients because it is imperative that they be recognized as true local advertisers." Letter emphasizes that all other broadcast accounts will continue to be handled by New York office and that these two accounts are "the only exception."

BREEZE IN TOP 50 • Lever Bros. (Breeze), N. Y., placing radio spot campaign in top 50 markets, effective May 1 for about 20 weeks. BBDO, N. Y., is agency.

TEXACO BUYING • Texas Co. (Texaco), N. Y., starting its second flight of four-week spots in both radio and television April 15 in eastern and southern markets and on May 15 in all other areas. Cunningham & Walsh, N. Y., is agency.

WIIC-TV Pittsburgh Joins NBC-TV

AFFILIATION of WIIC (TV) Pittsburgh (ch. 11) with NBC-TV announced jointly Friday by Harry Bannister, vice president in charge of station relations for NBC, and Oscar M. (Pete) Schloss, president of WWSW Inc., operator of tv station. Agreement was concluded after Westinghouse Bcstg. Corp. notified NBC-TV it would shift its affiliation for WBC-owned KDKA-TV Pittsburgh to CBS-TV when WIIC (TV) begins operations (story page 126). Target date for WIIC (TV) is July 15.



**your advertising
becomes a family
matter... on the
Meredith Stations**

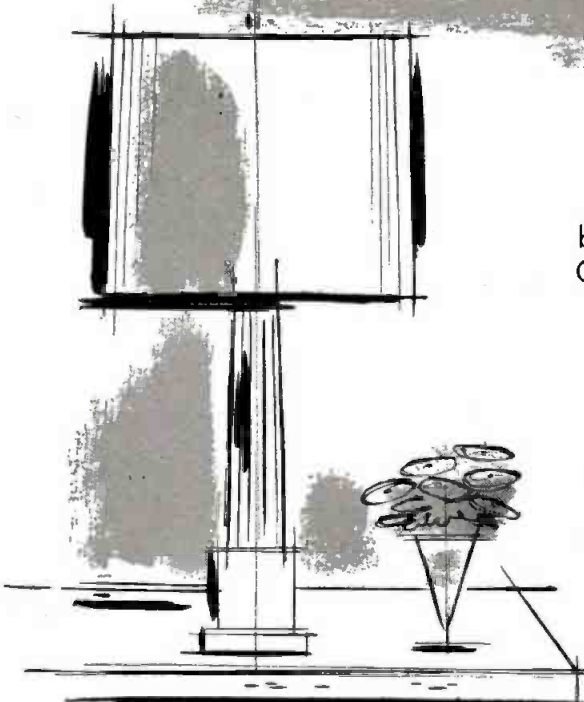

... and in the 4 key markets of Syracuse, Omaha, Kansas City and Phoenix this combination assures sales growth for advertisers. Combined dollar volume of Metropolitan County Retail Sales alone approximates \$3,000,000,000.00* The station managers will be happy to give you complete information.

DOLLAR VOLUME OF METROPOLITAN COUNTY AREAS

Estimates, 1955, for TOTAL RETAIL SALES

Area and State	Rank In Group	Total Retail Sales	Percent
Total for United States (260 Markets)		\$132,669,192,000	100.000%
Kansas City, Missouri	15	1,360,225,000	1.025
Phoenix, Arizona	51	525,567,000	.396
Omaha, Nebraska	55	502,402,000	.378
Syracuse, New York	57	475,635,000	.358
Total four cities		\$2,863,829,000*	2.158%

**KANSAS CITY
SYRACUSE
PHOENIX
OMAHA**

**KCMO
WHEN
KPHO
WOW**

**KCMO-TV
WHEN-TV
KPHO-TV
WOW-TV**

**The Katz Agency
The Katz Agency
The Katz Agency
John Blair & Co.-TV: Blair-TV**

Meredith Stations Are Affiliated With Better Homes and Gardens and Successful Farming Magazines

at deadline

FCC AWARDS ST. LOUIS CH. 11 TO CBS

FCC Friday announced award of St. Louis ch. 11 to CBS, bearing out predictions publicly known over last several months. Denied were applications by St. Louis Telecasting Inc. (60% owned by St. Louis U.), St. Louis Amusement Co., 220 Television Inc. and Broadcast House Inc., former operator of ch. 36 KSTM-TV East St. Louis, Ill. FCC Comrs. McConnaughey, Doerfer, Mack and Craven favored CBS; Comrs. Hyde and Lee dissented; Comr. Bartley favored 220 Television Inc.

CBS' "superior" performance in operating KMOX St. Louis impressed FCC. "The present proceeding," FCC said, "evidences a CBS comparative showing, taking into consideration all factors, favorable or unfavorable, superior to that of the other applicants."

Question of diversification of ownership and CBS' network operations were discussed at length and "significant" preference was awarded all other applicants in this category. However, FCC said, "In awarding the preference note was taken of the fact that CBS in its various ownerships faces a considerable competition; that its station ownerships are removed from one another, except that the tv station here applied for would serve the same community as CBS-owned KMOX. Note has also been taken of the fact that in none of the CBS

operations is monopoly discerned or coercive practice presented."

In another section of the 128-page decision, Commission stated: "To hold differently, under the circumstances developed in this proceeding, in the judgment of the Commission, would be to assign to diversification of the media of mass communications factor a quality and significance other than comparative."

Applicants for St. Louis ch. 11 were designated for hearing in December 1953. An initial decision was issued by hearing examiner in September 1955 favoring CBS. Network owns WCBS-TV New York, WBBM-TV Chicago, KNXT (TV) Los Angeles, WXIX (TV) Milwaukee, and WHCT (TV) Hartford, Conn. Latter two are uhf stations. CBS also owns WCBS-AM-FM New York, KNX-AM-FM Los Angeles, WBBM-AM-FM Chicago, KCBS-AM-FM San Francisco, KMOX St. Louis, WEEL-AM-FM Boston.

Also Friday Commission issued memorandum opinion and order denying petitions to reopen record by Broadcast House Inc., 220 Television Inc. and St. Louis Telecast Inc. At issue were deintermixture actions allocating ch. 2 to St. Louis from Springfield, Ill., and alleged changes in CBS' holdings since hearings ended. Comrs. Hyde, Bartley and Lee dissented to this action.

RCA, ABC Affiliates, BPA Add Meets to Chicago Agenda

THREE MEETINGS not on official NARTB agenda were scheduled Friday as convention planning neared final stage (see NARTB convention coverage starting page 79).

RCA scheduled two-day seminar to acquaint tv broadcasters with latest developments in color tv broadcast equipment and techniques along with demonstration of equipment. Event will be held April 12-13, following close of formal convention events April 11. Site will be Hotel Sheraton-Blackstone, across street from Conrad Hilton Hotel.

Meeting of ABC Affiliates Assn. was called Sunday, April 7, 1-1:45 p.m. by Frederick S. Houwink, WMAL-AM-TV Washington, chairman of association. New board of governors will be elected and reports will be heard from Joseph F. Hladky Jr., KCRG-AM-TV Cedar Rapids, Iowa, association secretary, and Joe Drilling, KJEO (TV) Fresno, Calif., treasurer. Meeting will be held in Sheraton Room of Sheraton-Blackstone Hotel, preceding ABC sales presentation (story page 119).

Officers and directors of Broadcasters Promotion Assn. will meet Monday noon, April 8, at Chicago Press Club.

Hatfield Bidders Go To Court In Protesting Deintermixture

FCC's deintermixture actions last February drew their second court appeal Friday when competing ch. 9 Hatfield, Ind., applicants WVJS and WOMI, both Owensboro, Ky., filed notices of appeal and review in U. S. Court of Appeals, Washington. They claimed FCC took action without proper notice of rule-making, not giving them opportunity to file comments and counter-comments.

Commission moved ch. 9 out of Hatfield to Evansville, Ind., where it reserved vhf channel for educational use. This was part of move wherein FCC took ch. 7 from Evansville and moved it to Louisville. Initial decision favoring WVJS issued Feb. 18. There was no request for a court stay. Earlier in week WIRL-TV Peoria, Ill., filed court appeal against move of ch. 8 from Peoria to Davenport-Rock Island-Moline area (story page 60).

Meanwhile, General Electric Co. filed notice with FCC Friday that it will demand "full and fair" hearing on FCC's order moving ch. 6 from Schenectady (where GE's WRGB [TV] operates) to Syracuse, N. Y. GE already had announced it would fight loss of vhf channel [AT DEADLINE, March 18].

WTVW (TV) Evansville, which lost its ch. 7, Friday filed petitions with FCC requesting (1) reconsideration of the Commission's action, (2) stay of April 15 deadline to issue show cause order as to why it should not operate on ch. 31, and (3) request for rulemaking, with two proposals offered (one of which would make Louisville all uhf).

Also Friday, Capitol Tv Corp. (Harry Pinkerson) asked Commission to reconsider its order which left ch. 3 in Hartford, Conn. (WTIC-TV), and to assign that channel to Providence, R. I. Capitol charged FCC reasoning in reaching its decision was "illogical and unsound."

UPCOMING

April

April 5-6: Oregon State Broadcasters Assn., Eugene.

April 8: Daytime Broadcasters Assn., Sheraton Hotel, Chicago.

April 7-11: NARTB annual convention, Conrad Hilton, Chicago.

For other Upcomings see page 144

PEOPLE

MYRNA McCAULEY, formerly in tv department of Needham, Louis & Brorby, Chicago, to copy staff of Foote, Cone & Belding, same city.

JOSEPH H. CARO, vice president at The Buchen Co., Chicago, elected senior vice president. Before joining agency in 1952 he was vice president and director at Earle Ludgin & Co., same city.

PHIL GOULDING, 39, staff announcer and program conductor on WMGM New York and stockholder in WCAP Lowell, Mass., died Friday morning at home in New York. He was brother of RAY GOULDING of comedy team "Bob and Ray." Funeral services to be held in Lowell today (Mon.).

WILLIAM A. CHALMERS, manager of Los Angeles office, Calkins & Holden, to vice president in charge, succeeding HARRY A. WITT, resigned to head new L. A. office of Reach, McClinton (story page 36).

RICHARD F. HESS named assistant to CBS Radio vice president in charge of station administration, JULES DUNDES. Mr. Hess joined CBS in 1939, and since 1951 has been director of research of CBS Radio Spot Sales.

BUD SHERAK, director of research, Kenyon & Eckhardt, N. Y., elected vice president. He has been with agency since 1951.

WNEW, KATZ, KMOD Sales Filed for Commission Approval

THE record-breaking \$7.5 million sale of WNEW New York [B•T, March 25] topped three station sales filed Friday for FCC approval. Others were KATZ St. Louis and KMOD Modesto, Calif. [B•T, March 4].

DuMont Broadcasting Corp. is purchasing WNEW from Richard D. Buckley, J. D. Wrathner Jr. and John L. Loeb (Mr. Buckley took DuMont stock for his 25% interest). Latest WNEW balance sheet (Jan. 31) listed an earned surplus for previous 12 months of \$352,870. DuMont Jan. 26 balance sheet showed that company has lost \$83,752 since Dec. 29, 1956, and on latter date had deficit of \$1,648,228.

Paramount Pictures Corp., largest DuMont stockholder, listed (as of Sept. 29, 1956) total income for first nine months of 1956 of \$71,580,496. Current assets were \$83,055,016, total assets \$136,462,196, current liabilities \$14,922,774 and capital surplus \$59,428,853. DuMont owns WABD (TV) New York and WTTG (TV) Washington.

Rollins Broadcasting Co. is buying KATZ from Bernice Schwartz and Coralee Garrett for \$110,000. Rollins Jan. 31 balance sheet listed net worth of \$317,118, current assets \$231,669, total assets \$492,338 and current liabilities \$66,445.

Owners of KSRO Santa Rosa, Calif. (Mrs. Ernest L. Finley, Frank McLaurin and Evert B. Person) purchased KMOD for \$170,000. Sellers include Don C. Reeves, Judd Sturtevant and John E. Griffin. KMOD listed current assets as of Dec. 31, 1956, of \$34,328, total assets \$74,986, current liabilities \$20,192 and earned surplus \$50,743.

KONG Visalia Sold for \$35,000

KONG Visalia, Calif., 250 w outlet on 1400 kc, was sold Friday to Harry C. Layman of Phoenix, Ariz., for \$35,000, subject to FCC approval. Sellers were Amelia Schuler, L. E. Chenault and Bert Williamson, d/b Radio KYNO, Voice of Fresno. Mr. Layman formerly owned WJOC Jamestown, N. Y. Broker was Hamilton, Stubblefield, Twining & Assoc.

the week in brief

THE NARTB CONVENTION

Golf Tournament prizes	70
Opens next weekend at Chicago	79
Management Conference agenda	80
Engineering Conference roundup	82
Automatic logs hold interest	88
Advance registration	93
Radio-tv network coverage	119

MILITARY SEEKS CHANNELS 2-6

President reported considering secret request for lower half of vhf band. Careful consideration given pre-empting's effects on the public 31

Y&R TO LEASE COAXIAL CABLES

Agency announces it will use closed-circuit facilities to feed material to clients in their offices 32

NIELSEN SURVEY ON THE SPOT

New York society hears four speakers criticize, suggest and ask questions about 1956 figures 34

PLAY BALL! MAJOR LEAGUE PLANS

Sponsors to spend \$65 million minimum for coverage of baseball teams on radio-tv stations, networks 40

TV FACES ASCAP BARGAINING

Entire morning of NARTB convention to be devoted to problem, with all tv stations invited. Present rates considered too high 42

JUSTICE DEPT. SUES LOEW'S INC.

Second court action taken as government charges block-booking of MGM feature film to tv stations 46

WILL FCC HOLD PAY-TV TESTS?

Commission discusses subject but thus far has reached no decision on whether to hold full and open hearing 50

FCC URGES LONGER LICENSES

Five-year terms favored in arguments submitted to Congress. Bartley wants 'indeterminate' terms 51

STORER ENTERS PHILADELPHIA

FCC approves purchase of WPFH (TV) Wilmington, Del.; proposal to buy WMUR-TV Manchester, N. H., draws fire from Westinghouse interests 54

TWO NETWORKS RAISE PAYMENTS

Over 100 CBS-TV and 75 ABC-TV stations get rate increases in new rate cards 118

VTR: OUT ON THE FIRING LINE

First shakedown tests of tv tape recording near completion. All three networks making it backbone of efforts to solve daylight time problem 120

STORZ SELLS KOWH OMAHA

\$822,500 is figure for transfer of outlet to William F. Buckley Jr., publisher of 'National Review' 128

WLW OPENS NEWS CENTER

Communications unit brings information to central point, bringing more efficiency to sports, weather and news broadcasts 132

CANADIAN CHANGES ADVOCATED

Royal Commission recommends new 15-man board to control and regulate CBC and private radio-tv stations 134

Broadcasting Publications Inc.
 Sol Taishoff President
 Maury Long Vice President
 Edwin H. James Vice President
 H. H. Tash Secretary
 B. T. Taishoff Treasurer
 Irving C. Miller Comptroller

BROADCASTING* TELECASTING

THE BUSINESSWEEKLY OF RADIO AND TELEVISION
 Published every Monday by Broadcasting Publications Inc.

Executive and Publication Headquarters
 Broadcasting • Telecasting Bldg.
 1735 DeSales St., N. W., Washington 6, D. C.
 Telephone: MEtropolitan 8-1022

EDITOR & PUBLISHER: Sol Taishoff
 MANAGING EDITOR: Edwin H. James
 SENIOR EDITORS: Rufus Crater (New York), J. Frank Beatty, Bruce Robertson (Hollywood)
 NEWS EDITOR: Fred Fitzgerald
 SPECIAL PROJECTS EDITOR: David Glickman
 ASSOCIATE EDITOR: Earl B. Abrams
 ASST. TO MANAGING EDITOR: Donald V. West
 ASSISTANT NEWS EDITOR: Munsey Slack
 ASSISTANT EDITORS: Harold Hopkins, Dawson Nail
 STAFF WRITERS: Art Brandel, Argyll Campbell, Jacqueline Eagle, Ann Tasseff
 EDITORIAL ASSISTANTS: Hilma Blair, Jere McMillin, Frances Pelzman, Rita Wade
 LIBRARIAN: Catherine Davis
 SECRETARY TO THE PUBLISHER: Gladys L. Hall

BUSINESS

VICE PRESIDENT & GENERAL MANAGER: Maury Long
 SALES MANAGER: Winfield R. Levi (New York)
 SOUTHERN SALES MANAGER: Ed Sellers
 PRODUCTION MANAGER: George L. Dant
 TRAFFIC MANAGER: Harry Stevens
 CLASSIFIED ADVERTISING: Wilson D. McCarthy
 ADVERTISING ASSISTANTS: Doris Kelly, Jessie Young
 COMPTROLLER: Irving C. Miller
 ASSISTANT AUDITOR: Eunice Weston
 SECRETARY TO GENERAL MANAGER: Eleanor Schadi

CIRCULATION & READER'S SERVICE

MANAGER: John P. Cosgrove
 SUBSCRIPTION MANAGER: Frank N. Gentile
 CIRCULATION ASSISTANTS: Gerry Cleary, Bessie Deese, Charles Harpold, Donald Rodgers, Bertha Scott, Violet Quigley

BUREAUS

NEW YORK
 444 Madison Ave., Zone 22, Plaza 5-8355
 Editorial

SENIOR EDITOR: Rufus Crater
 BUREAU NEWS MANAGER: Lawrence Christopher
 AGENCY EDITOR: Florence Small
 ASST. NEW YORK EDITOR: David W. Berlyn
 NEW YORK FEATURES EDITOR: Rocco Famighetti
 STAFF WRITERS: Frank P. Model, Beverly Berl

Business

SALES MANAGER: Winfield R. Levi
 SALES SERVICE MANAGER: Eleanor R. Manning
 EASTERN SALES MANAGER: Kenneth Cowan
 ADVERTISING ASSISTANT: Donna Trolinger

CHICAGO

360 N. Michigan Ave., Zone 1, Central 6-4115
 MIDWEST NEWS EDITOR: John Osbon
 MIDWEST SALES MANAGER: Warren W. Middleton,
 Barbara Kolar

HOLLYWOOD

6253 Hollywood Blvd., Zone 28, Hollywood 3-8181
 SENIOR EDITOR: Bruce Robertson
 WESTERN SALES MANAGER: Bill Merritt, Virginia Bilas
 Toronto, 32 Colin Ave., HUDson 9-2694
 James Montagnes

SUBSCRIPTION INFORMATION

Annual subscription for 52 weekly issues: \$7.00. Annual subscription including BROADCASTING Yearbook (53d issue): \$9.00, or TELECASTING Yearbook (54th issue): \$9.00. Annual subscription to BROADCASTING • TELECASTING, including 54 issues: \$11.00. Add \$1.00 per year for Canadian and foreign postage. Regular issues: 35¢ per copy; 53d and 54th issues: \$3.00 per copy.

ADDRESS CHANGE: Please send requests to Circulation Dept., BROADCASTING • TELECASTING, 1735 DeSales St., N.W., Washington 6, D. C. Give both old and new addresses, including postal zone numbers. Post office will not forward issues.

BROADCASTING* Magazine was founded in 1931 by Broadcasting Publications Inc., using the title: BROADCASTING*—The News Magazine of the Fifth Estate. Broadcast Advertising* was acquired in 1932, Broadcast Reporter in 1933 and Telecast* in 1953.

*Reg. U. S. Patent Office
 Copyright 1957 by Broadcasting Publications Inc.

BROADCASTING • TELECASTING

departments

Advertisers & Agencies	32	Government	46	Opinion	138
At Deadline	7	In Public Interest	22	Our Respects	26
Awards	137	In Review	15	Personnel Relations	69
Closed Circuit	5	International	136	Professional Services	118
Colorcasting	33	Lead Story	31	Program Services	42
Editorial	150	Manufacturing	134	Ratings	39
Education	136	Networks	118	Stations	128
Film	69	On All Accounts	28	Trade Assns.	70
For the Record	140	Open Mike	18	Upcoming	144



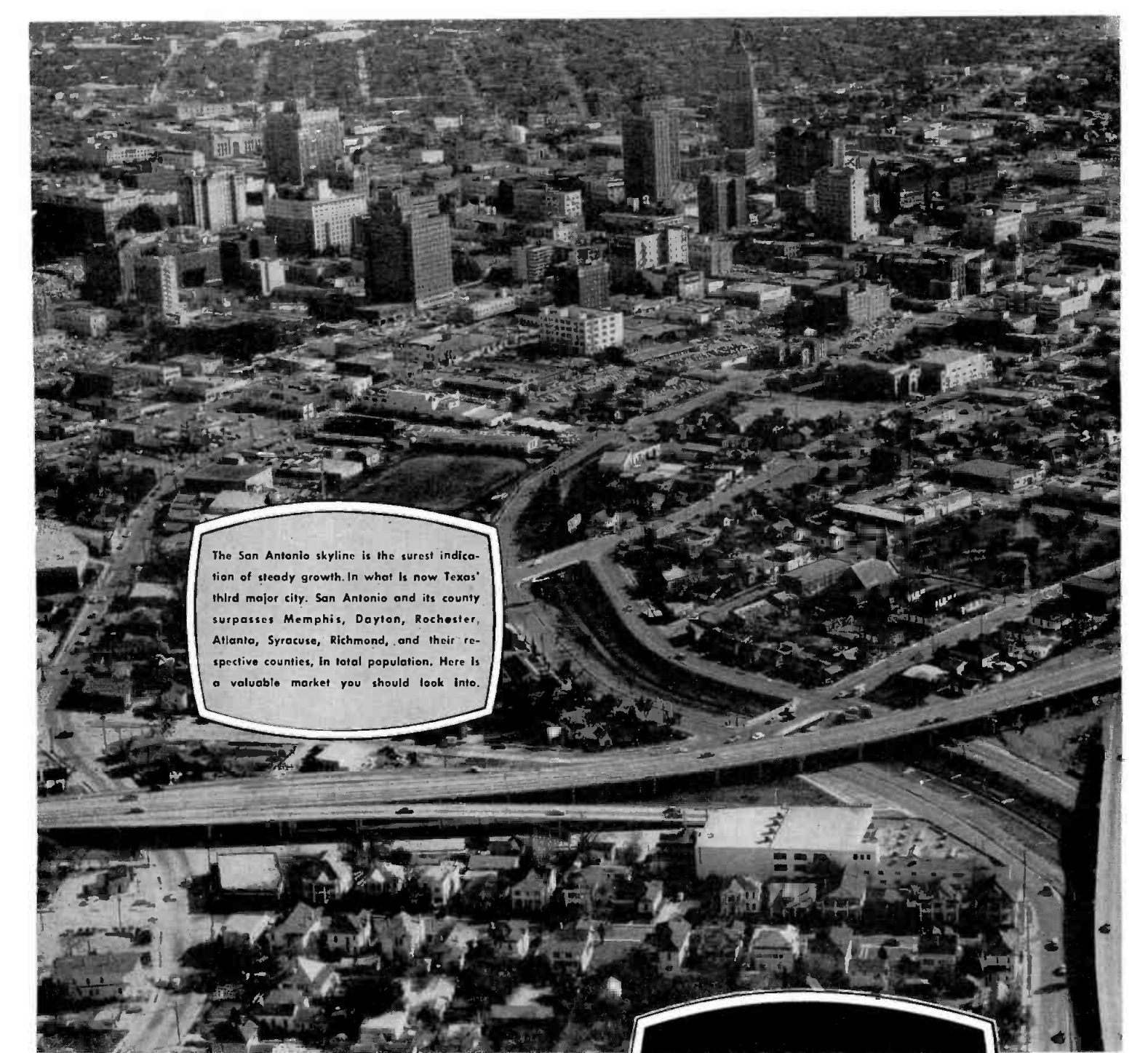

The San Antonio skyline is the surest indication of steady growth. In what is now Texas' third major city. San Antonio and its county surpasses Memphis, Dayton, Rochester, Atlanta, Syracuse, Richmond, and their respective counties, in total population. Here is a valuable market you should look into.

KENS-TV

EXPRESS-NEWS STATION

5



SAN ANTONIO, TEXAS

**IN EACH TELEVISION MARKET
THERE IS ONLY ONE LEADER.*
IN SAN ANTONIO, IT'S KENS-TV**



REPRESENTED BY PETERS, GRIFFIN, WOODWARD, INC.

* See the latest — ARB, PULSE, RORABAUGH



MAKING IDEA FOR STATIONS!

**EXCITEMENT
CONVENTION!**

W D O

SOUND EFFECTS GAME!

"SOUND-O" GIVES YOUR STATION NEW PRESTIGE, NEW IDENTIFICATION in your community . . . makes yours the EXCITING station that SELLS AND SELLS for your advertisers! Wide-awake merchants in every line will want to be in on the "talk of the town". National and regional advertisers, too, will be eager to cash in on this new merchandising and selling opportunity.

See **SOUND-O** and other sales-boosting ideas galore in ROOMS 512 and 513, N.A.R.T.B. CONVENTION April 7th thru 11th, 1957, Hotel Conrad Hilton, Chicago

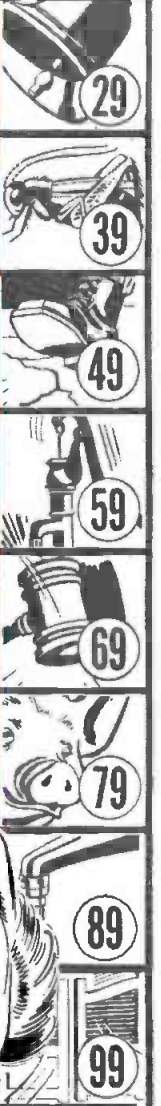

**WORLD
SALES AND
PROGRAM SERVICE**

WORLD BROADCASTING SYSTEM, INC.
488 Madison Avenue, New York 22, New York

CINCINNATI

HOLLYWOOD

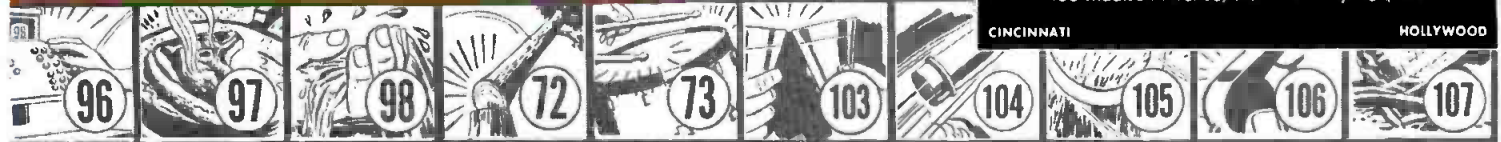

RCA will announce
a new development
in TV camera tubes
for black-and-white
and color

See it at the RCA Exhibit at the NARTB in Chicago, April 7-11



RADIO CORPORATION OF AMERICA

TUBE DIVISION

HARRISON, N. J.

THE TRIAL OF LIZZIE BORDEN

THERE's a simple ballad Down East about Lizzie Borden who "took an axe and gave her mother 40 whacks and when she saw what she had done she gave her father 41." Upon this and the 65-years-ago trial *Omnibus* based an effective drama-ballet presentation March 24.

Integrated drama and ballet is commonplace. But *Omnibus* separated the two in a dual presentation of the same theme. Rather than creating undue repetition, the preceding drama heightened interest in Agnes DeMille's "Fall River Ballet," in which dancers interpreted the tortured, unhappy life of the Fall River spinster on trial for the murders.

The drama followed the actual case history climaxing with the acquittal. However, the running critique of lawyer Joseph Welch raised question as to the propriety of the verdict. In the second portion of the 90-minute show, the ballet implied Lizzie's guilt and conviction.

Technically, the whole show was up to *Omnibus'* fine standards. Robert Preston and Richard Kiley as defense counsel and prosecutor, respectively, did particularly well. The ballet itself was absorbing and near perfect, if one is to wholly accept Freudian concepts that circumstances rather than the individual can be responsible for a crime.

Production Costs: \$80,000.

Sponsored by Aluminium Limited through J. Walter Thompson and Union Carbide & Carbon Corp., through J. M. Mathes. Producer: Robert Saudek.

Directors: Charles Dubin, dance segments; Richard Dunlap, dramatization.

Narrator: Alistair Cook; Joseph Welch narrated dramatization.

Script: Joseph Hurley.

Music for ballet segment by Morton Gould; ballet by Agnes DeMille.

ONE MINUTE TO DITCH

ROBERT MONTGOMERY took a cue from the documentary boys last week in presenting "One Minute to Ditch," and did rather well by the technique. In dramatizing the story of the trans-Pacific airliner that had to ditch in mid-Pacific last October, and her subsequent rescue by the Coast Guard cruiser *Pontchartrain*, Mr. Montgomery produced a tight, interesting show, focusing only on the event and sticking close to fact all the way. The result was an excellent "slice of life" production.

Once the plane had left the Honolulu airport, the camera stayed within a limited scene—the cockpit and passenger section of the plane, and the cruiser. Excellent camera work switched scenes neatly, and the contrast of the tensions on the ship and the plane steadily developed suspense, which was considerable by the end of the hour.

Realism was heightened with glimpses of the people involved—the sailor who thought the alarm was just another drill, the serviceman worried about being AWOL, the woman who worried only about the loss of her orchid lei. However, there was little panic, from the first shock when a propeller went bad until the safe rescue of all 31 people

aboard, and this, too, follows reports of what actually happened.

It was a well-balanced play, suspense and tension intermingled with humor, all contributing to a solid production.

Production costs: \$55,000.

Sponsored by Mennen Co. through Grey Adv. on NBC-TV Mon., March 25, 9:30-10:30 p.m. EST.

Producer: Robert Montgomery; director: Perry Laffety. Adapted for tv by James Benjamin from Cornelius Ryan's Collier's article.

Cast: Charles Cooper, Frank Maxwell, Gail Paige, Don Briggs, Reedy Talton, Paul Maxursky, Marc May, Elva Meehan, Aneta Corsaut.

THE BLACK STAR RISES

BIRTH of the nation of Ghana in Africa was portrayed with vigor in a special half-hour film documentary over CBS-TV on March 25. In a 15-minute segment, the historical background of the nation and its importance as a force in the battle between the free and the Communist world was presented skillfully in words and pictures.

Howard K. Smith, chief European correspondent for CBS, served as live narrator. The initial 15 minutes offered a recapitulation of the recent tour of Africa by Vice President Richard M. Nixon. This segment tended to be repetitious and monotonous, with film depicting Mr. Nixon's arrival in the various African countries and meeting dignitaries there. Although it undoubtedly was designed to show the interest of the United States in the attitudes of Africa, as a whole, this purpose could have been achieved by a summary of developments on the continent by Mr. Smith.

This approach would have resulted in more time for an expansion of the compelling Ghana story. The last 15 minutes caught the spirit of restlessness, burning desire for equality and the single-mindedness of purpose of the inhabitants of this new nation.

A special note of commendation is in order for the striking set designs and the original music that caught the mood of a continent in ferment.

Production costs: \$17,500

Broadcast sustaining on CBS-TV March 24 (5-5:30 p.m. EST).

Produced by CBS News; editors: Leslie Midgley, Ed Hoyt; narration; Howard K. Smith; director: Vern Diamond.

SEEN & HEARD

A striking performance by dynamic Hedda Hopper, who made tv screens fairly sizzle with her knowing portrayal of a Washington society queen bee, saved the day for "The Hostess With the Mostes" on CBS-TV's *Playhouse 90* (9:30-11 p.m. EST, March 21). Otherwise the video version of Perle Mesta's life story had little to recommend it. The production as a whole added up to glorified soap opera, with Shirley Booth, looking exactly like Shirley Booth, providing a surprisingly lifeless characterization of the woman famed for her parties, her charities, and her brief career as ambassador to Luxembourg.

Just in!
Seattle · San Diego
San Francisco
**OUTRATES ALL
COMPETITION
FIRST RATED
TELECASTS**

22.3 KING, Pulse 2/6/57
23.5 KFMB, Pulse 2/6/57
16.4 KPX, Videodex 2/5/57

HAWKEYE

AND THE

**LAST OF THE
MOHICANS**

starring

John HART
Lon CHANEY

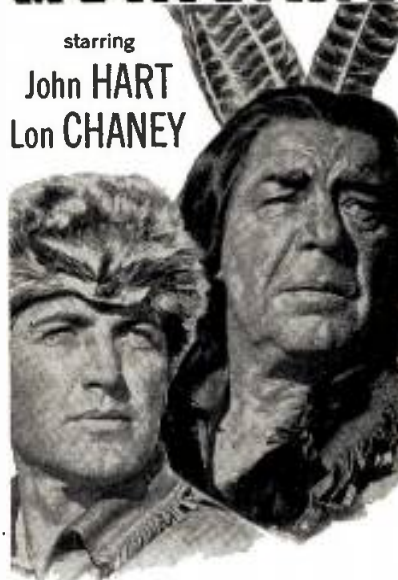

VISIT US
NARTB
CONRAD HILTON HOTEL
SUITE 532A, 533A, 534A

Television Programs of America, Inc.
488 Madison Ave., N. Y. 22 • PLaza 5-2100

THANKS

FOR MAKING THE BOSTON CONFERENCE A SUCCESSFUL, PRODUCTIVE FIRST!

To the station managers and program managers . . . educators . . . governmental leaders . . . members of the clergy . . . press representatives . . . performers . . . to all who came and listened and watched and spoke in the interests of exciting, appealing local public service programming—our humble thanks.

The original concept of the Boston Conference—started almost two years ago for the WBC stations and later expanded to cover a cross-section of all radio and TV stations—grew into a result that far exceeded our expectations. Our only regret is that physical limitations restricted invitations to 110 stations.

What happened in Boston? A lot of things.

Over 200 thoughtful men and women sat down to discuss radio and TV news, religious and children's programs, documentaries and spots and showmanship in all forms of public service programming, to name just a few subjects.

They talked. They questioned. They argued, and they dreamed. Their thoughts and ideas in this broad and too-often neglected programming area were provocative, wondering, frank, exciting, and often brilliant.

Today, the effects of the Boston Conference—as reflected in much-appreciated letters and comments—seem to be echoing in the farthest corners of the broadcasting industry. The result, we feel, has been a long-needed spotlighting of public service programming. We trust that, from the enthusiasm of those who participated, the calibre, appeal and effectiveness of public service programming on stations everywhere—for people everywhere—will soar.

And yet, our enrichment from attention to public service can be greater. There is still much to be done. These facts, coupled with overwhelming requests, bring us to the announcement that we will repeat the Conference on Local Public Service Programming in 1958. Among many new features will be participation by the sales side of our industry.

We are already excited over the prospect. For no experience at WBC has ever approached the Boston Conference in confirming our belief that *broadcasting is most effective on stations that have earned the respect and confidence of the communities they serve.*

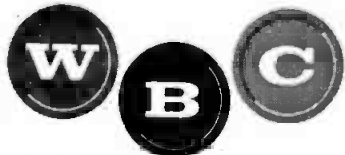

WESTINGHOUSE BROADCASTING COMPANY, INC.

RADIO

TELEVISION

BOSTON	WBZ+WBZA	BOSTON	WBZ-TV
PITTSBURGH	KDKA	PITTSBURGH	KDKA-TV
CLEVELAND	KYW	CLEVELAND	KYW-TV
FORT WAYNE	WOWO	SAN FRANCISCO	KPIX
CHICAGO	WIND		
PORTLAND	KEX		

WIND represented by AM Radio Sales • KPIX represented by The Katz Agency
All other WBC stations represented by Peters, Griffin, Woodward, Inc.

Joel F. Carlson, WTAR, Norfolk • Richard Earnstein, Voice of America, Bernard C. Barth, WNDU-TV, South Bend • Gloria Dapper, Jack Patterson, Business Week, New York • Robert E. Lee, FCC Robert H. Forward, KMPC, Los Angeles • Judith Waller, NBC, Leon Goldstein, WMCA, New York • Ralph A. Renick, WTB, Gordon Kinney, Advertising Council • J. E. Baudino, WBC, "Big Jon" Arthur, ABC, New York • Jim Frankel, Cleveland Joseph A. Short, WHCU, Ithaca • Norbert J. Hrubby, University Caleb Paine, WGY-WRGB, Schenectady • Alice Lowe, KYTV, James T. Aubrey, Jr., ABC-TV, New York • Dr. Bergen Raymond S. Green, WFLN, Philadelphia • Dr. Philip William Kaland, WBC, New York • Ed Reynolds, Ketchum, Robert Foster, San Mateo Times, California • Fran David Muggeridge, Fairchild Publications, Boston • Carl Daniel W. Kops, WAVZ, New Haven • James H. Ferguson, Barrie Thorne, BBC, New York • Michael Hayward, Samuel Barstein, WAVZ, New Haven • Perry M. Beaumont, Bill Noble, Radio-Television Daily, New York • W. C. Swartley, Mary Davidson, WBC, New York • Doug Elleson, Robert W. Breckner, KTTV, Los Angeles • Robert H. Francis E. Wylie, WMIT, Boston • Win Fanning, Pittsburgh Ed Codel, The Katz Agency, New York • Burton Paulu, M. S. Gibbons, Ketchum, MacLeod & Grove, New York Anne W. Langman, "The Nation" • Jo Ransom, WMGM, Glenn Dollberg, BMI, New York • Edward Stanley, NBC, Colby Lewis, WTTW, Chicago • Ralph Hansen, WHAS-TV, Keith Tyler, Institute for Education by Radio-Television, Arnold Wilkes, WBAL & WBAL-TV • Rear Admiral H. G. Richard M. Pack, WBC, New York • Manny Rempelikas, Thomas Y. Gorman, WEEI, Boston • Al Naroff, Trans Charles Siverson, WROC-TV, Rochester • Dr. Ralph J. Lynn Poole, Johns Hopkins University • John Lerner, Dody Sinclair, WJAR-TV, Providence • George Forsythe, Robert Hudson, Educational Television & Radio Center Rod MacLeish, WBZ + WBZA, Boston • Bruce Wallace Kenneth I. Tredwell, Jr., WBTV, Charlotte • Howard Jerome R. Reeves, KDKA-TV, Pittsburgh • Ben A. Gerrie McKenna, WBC, New York • Thomas Dukehart, Joe Levine, Boston Traveler • Roy Schwartz, WBZ, Boston Robert Holmes, WWLP, Springfield • Joseph Fogarty, Perry Bascom, WBC, New York • Albert Corey, University Philip Hopkins, United Community Services, Boston, Paul E. Mills, WBZ + WBZA, Boston • Bernard Platt, Carl Vandagriff, WOWO, Fort Wayne • John W. Tinnea, Richard Fraxier, WAVY & WAVY-TV, Portsmouth, Va. Fred Keller, WBEN & WBEN-TV, Buffalo • Sherwood J. Robert Cody, Radio Liberation, New York • Ray Trent, George Rosen, Variety, New York • Maury Shugrue, TV Arthur E. Haley, WORL, Boston • Milton Krents, Jewish Norman Reed, WWDC, Washington, D.C. • A. Donovan Faust, Peter Thornton, KDKA-TV, Pittsburgh • Jay Nelson Tuck, New Van Buren W. De Vries, WGR & WGR-TV, Buffalo • Burnell Franklin A. Tooke, WBZ-TV, Boston • Albert Warren, TV Digest, Ben Strouse, WWDC, Washington, D.C. • Arnold L. Wilkes, Howard Finch, WJIM, & WJIM-TV, Lansing • Arthur Hungerford, Philip H. Cohen, Sullivan, Stauffer, Colwell & Bayles, New York Martin Bookspan, WQXR, New York • R. J. Bowley, WBC, New John Highlander, KPIX, San Francisco • Arthur J. Bellaire, Dr. Leo Bogart, McCann-Erickson, New York • Parker Wheatley, Mel Bailey, KEX, Portland, Oregon • Sherman K. Headley, Graham B. Poyner, WPTF, Raleigh • Harold Lund, KDKA & Frank Luther, WNAC & WNAC-TV, Boston • Hal Cessna, WOWO, Paul O'Friel, KDKA & KDKA-TV, Pittsburgh • Rolland V. Tooke,

Washington, D.C. • Sam Chase, Billboard, New York • Ray Stone, Maxon Agency, New York • Carl Sandburg, Flat Rock, N.C. National Citizens Council for Better Schools, New York • Mike Wallace, WABD, New York • D. H. McGannon, WBC, New York • Jules Dundes, CBS Radio, New York • Garnet Garrison, University of Michigan • Sam Serota, WIP, Philadelphia New York • Grady Edney, WBZ, Boston • Dorothy E. Lewis, United Nations • Dr. Milton Eisenhower, Johns Hopkins University Miami • Frank Baxter, University of Southern California • Frank Beatty, Broadcasting-Telecasting, Washington, D.C. Washington, D.C. • Gloria Chandler, KING, Seattle • Richard Hull, Ohio State University • Cal Jones, KDKA-TV, Pittsburgh Press • Louis Corbin, WFBR, Baltimore • Gordon V. McLendon, KLIF & KLIF-TV • Merrill Panitt, TV Guide, Philadelphia of Chicago • Perry Harten, WBC, New York • Walter Neiman, WQXR, New York • Vice President Richard M. Nixon Springfield, Mo. • Anthony LaCamera, Boston American • Herbert B. Cahan, WBZ-TV, Boston • James H. Quello, WJR, Detroit Evans, Northwestern University • Fred A. Keller, WBEN-TV, Buffalo • Rev. Walter L. Flaherty, Catholic Archdiocese of Boston Eisenberg, Motivation Analysis, Inc. • John Comas, WSJS, Winston-Salem • George Probst, Edison Foundation, New York MacLeod & Grove, New York • Helen Parkhurst, New York • Joseph N. Welch, Esq., Boston • Fred Kugel, Television Magazine Corcoran, WBZ-TV, Boston • George McConnaughey, FCC • Louis G. Cowan, CBS, New York • Jack Miller, CBS, New York Haverlin, BMI, New York • John Steen, WBC, New York • N. W. Russo, National Telefilm, Boston • Robert L'Heureux, FCC WSAZ-TV, Huntington • Robert Saudek, Ford Foundation, New York • Charles Van Doren, Columbia University United Nations • Seymour Siegel, WNYC, New York • Mary Handy, Christian Science Monitor • J. J. Kelly, WBC, New York WMBD, Peoria • Henry Morgenthau, III, WNYC, New York • Mrs. Gertrude Broderick, Office of Education, Washington, D.C. WBZ & WBZ-TV, Boston • Armand Lopez, University of Massachusetts • John F. Kennedy, U.S. Senator, Massachusetts KRON-TV, San Francisco • Melvin C. Wissman, WWJ-TV, Detroit • Charles Lewis, WCAX & WCAX-TV, Burlington Teter, WBC, New York • Cameron De War, Billboard, Boston • Len Hornsby, WVDA, Boston • Dorothy Wilson, CARE, Boston Post-Gazette • Nicholas Zapple, Senate Interstate and Foreign Commerce Commission • James Day, KQED, San Francisco KUOM, Minneapolis • James Macandrew, Board of Education, New York • Woody Brown, University of Massachusetts Carl Fox, KYTV, Springfield, Mo. • D. E. Partridge, WBC, New York • Verne Burnett, Ketchum, MacLeod & Grove, New York New York • Bruce Wallace, WTMJ, Milwaukee • Vic Diehm, WVDA, Boston • W. H. Baldigan, TV Digest, Washington, D.C. New York • Bill Burns, KDKA-TV, Pittsburgh • John K. M. McCaffery, WRCA-TV, New York • Guy Livingston, Variety, Boston Louisville • Charles Vanda, WCAU-TV, Philadelphia • Wylie Hance, ABC, New York • Francis Murphy, Portland Oregonian Columbus • Carl Fox KYTV, Springfield • Jim Snyder, KDKA, Pittsburgh • Terrence O'Flaherty, San Francisco Chronicle Rickover, U.S. Navy • Sy Resnick, The Billboard • Robert B. Cochrane, WMAR-TV, Baltimore • Angela Rich, TV Guide, Boston TV Week, Boston • Bill Tracy, National Social Welfare Assembly, New York • Joseph Connolly, WCAU, Philadelphia Lux TV Corporation • Bob Messinger, WBZ, Boston • Fred Remington, Pittsburgh Press • James C. Hirsch, TvB, New York Bunche, United Nations • Gordon Hawkins, WBC, New York • Edward Sherburne, WGBH, Boston • Tom McDonough, TV Guide Red Cross, Boston • Mary Cremmen, Boston Globe • Dave Croninger, WIND, Chicago • Dwight Newton, San Francisco Examiner Boston Traveler • Gordon Davis, KYW, Cleveland • Robert J. Covington, WBT, Charlotte • John White, WQED, Pittsburgh Ann Arbor • J. B. Conley, WBC, New York • Sanford Markey, KYW, Cleveland • Jack Kerrigan, WHO & WHO-TV, Des Moines WTMJ, Milwaukee • John Maloy, WNAC & WNAC-TV, Boston • Lewis Freedman, WCBS-TV, New York • Mark Olds, KYW, Cleveland Mumford Jones, American Council of Learned Societies, Cambridge • Arthur Fetridge, Boston Herald-Traveler Hudelson, WBC, New York • Clarence Worden, WCBS-TV, New York WAAM-TV, Baltimore • Charles F. Dolan, Sterling Movies U.S.A., Inc. Arthur C. King, WEEL, Boston • A. W. Dannenbaum, WBC, New York WPRO-TV, Providence • Douglas Grant, WMT & WMT-TV, Cedar Rapids of State of New York • Richard O'Connor, WCRB, Waltham, Mass. Ralph Steetle, Joint Council on Educational TV, Washington, D.C. Sponsor, New York • Wilbur D. Clark, Pittsburgh Sun-Telegraph KWK & KWK-TV, St. Louis • Richard M. Mall, Ohio State University Dr. Richard V. McCann, WBZ-TV, Boston • Guy Harris, KDKA, Pittsburgh Tarlow, WHIL, Medford, Mass. • Elizabeth Sullivan, Boston Globe KDUB & KDUB-TV, Lubbock, Texas • Leonard Patricelli, WTIC, Hartford Week, Boston • John Scheuer, WFIL & WFIL-TV Philadelphia • Barbara Collins, WBC, New York Theological Seminary, New York • Richard Heffner, Metropolitan Educational Television Association, Inc., New York WJR-TV, Flint • Mel Goldberg, WBC, New York • Patrick Hazard, Scholastic, New York • Richard Carlton, Trans-Lux Films, Inc. York Post • Herbert Bachman, KEX, Portland, Ore. • Sherwood R. Gordon, WSAI, Cincinnati • James Eberle, WWJ, Detroit Poole, Jr., WCSH-TV, Portland, Maine • Albert Crews, National Council of Churches of Christ in America, New York Washington, D.C. • Ralph N. Harmon, WBC, New York • Bill Greeley, Television Age, New York • Roy V. Whisnand, WCOP, Boston Hearst Radio, Inc. • Edward J. Roth, WNDU-TV, South Bend • Ralph N. Harmon, WBC, New York • Sam Elber, WERE, Cleveland Metropolitan Educational Television Association, New York • Ray Hubbard, WBZ-TV, Boston • Jack Grogan, WNEW, New York Phillip Lasky, KPIX, San Francisco • James H. Ferguson, WSAZ, Huntington • Dr. Douglas S. Moore, Columbia University York • Seymour Horowitz, WJAR & WJAR-TV, Providence • Lev Pope, WPIX, New York • Irvine H. Millgate, Boy Scouts of America Batten, Barton, Durstine & Osborn, Inc., New York • R. Clifton Daniel, WCAE, Pittsburgh • Jack Williams, KDKA, Pittsburgh WGBH, Boston • Jack Kerrigan, WHO & WHO-TV, Des Moines • Edward F. Ryan, WTOP & WTOP-TV, Washington, D.C. WCCO & WCCO-TV, Minneapolis • Chet Collier, WBZ-TV, Boston • Gordon V. McLendon, KLIF & KLIF-TV, Dallas KDKA-TV, Pittsburgh • Andrew C. Fuller, WTAG, Worcester • Bill Dempsey, KPIX, San Francisco • Jim Allen, WBZ-TV, Boston Fort Wayne • John Gentry, WKOX, Framingham, Mass. • Cal Bollwinkel, WOWO, Fort Wayne • W. H. Hauser, WBZ-TV, Boston KYW & KYW-TV, Cleveland • Rev. Edmund Joyce, WNDU-TV, South Bend • H. W. Lundquist, WBZ + WBZA, Boston

Souvenir of
The Boston
Conference

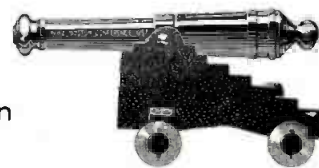

presented to all participants.

Station Sales

KIDDER,
PEABODY
& CO.—

- Has an established relationship with most of the important sources of investment capital in the country.
- Maintains close contact with all phases of the Television and Radio industry.

We invite the station owner to take advantage of this dual coverage when considering the sale of his property.

KIDDER,
PEABODY & CO.

FOUNDED 1865

NEW YORK BOSTON PHILADELPHIA
CHICAGO SAN FRANCISCO

Offices and correspondents in thirty other principal cities in the United States

Address inquiries to:

ROBERT E. GRANT
Kidder, Peabody & Co.
First National Bank Building
Chicago 3, Illinois
Telephone ANdover 3-7350

OPEN MIKE

Ratings Lament

EDITOR:

The following verse is with apologies to Joyce Kilmer:

UP A TREE

I think that I shall never see
A Nielsen, Pulse or ARB,
Whose figures sweetly coincide
When laid out neatly side-by-side.
A diary, recall, coincidental
That looks more sure than accidental,
A sets-in-use just like Trendex's
With proper breakdown of the sexes.
A cost-per-thousand base on a sample
That without question would be ample,
Ratings are used by fools like me
While I take refuge up a tree.

*Alice Ross, Timebuyer
Franklin Bruck Adv., New York*

No Sooner Asked

EDITOR:

A client of ours has developed a unique point-of-purchase display idea that we feel will prove extremely interesting to sponsors of major league baseball broadcasts and telecasts.

Could you possibly furnish us with the names of national concerns who have contracted with the major networks and ball clubs to sponsor major league baseball?

*Harvey H. Strobusch
Harvey H. Strobusch Adv.
San Francisco*

EDITOR'S NOTE: We refer Mr. Strobusch and other interested readers to B-T's baseball round-up in Advertisers & Agencies.]

Difference a Day Makes

EDITOR:

The cover ad on the March 18 B-T salutes WSB Radio [Atlanta] as "the South's oldest station."

WBT's [Charlotte, N. C.] broadcast license from the Dept. of Commerce is dated April 10, 1922. WSB's is dated April 11, 1922.

Fuel for argument is in illimitable supply but we think the date of the Dept. of Commerce license for broadcasting is a pretty good criterion.

*J. R. Covington
V.P.-Managing Director
WBT Charlotte, N. C.*

To Split or Not To

EDITOR:

Ed Kobak [OPEN MIKE, March 18] thinks radio and tv should go their own ways in trade organizations. You disagree and so do I, since we dare not weaken our position numerically or financially.

But wouldn't the problem be simplified if there were a change in NARTB by-laws disqualifying for radio office any person em-

ployed by a broadcaster also in tv? Of course, we could do that ourselves, by our nominations and elections, but I'd rather see it spelled out.

*Jerome Sill, President
WFPG Atlantic City, N. J.*

Reader Reaction

EDITOR:

The article [OUR RESPECTS, March 11] was very accurate and I appreciate your interest in my career as well as your interest in NBC.

*Thomas Sarnoff, V.P.
NBC, Burbank, Calif.*

EDITOR:

We don't deserve such wonderful treatment, but we're mighty grateful for the story on our new agency in this week's copy of B-T [March 18]. We've had lots of comment on it already.

*Edward LaGrave Jr.
Truppe, LaGrave & Reynolds
Des Moines, Iowa*

EDITOR:

We were all pleased and delighted with your story about Playhouse Pictures and our client Frank Taylor Ford in the March 11 B-T.

*Adrian D. Woolery
Playhouse Pictures
Hollywood*

EDITOR:

We of National Religious Broadcasters appreciate immensely the fine coverage you gave our recent convention in Washington, D. C., in your issues of Jan. 21 and Feb. 4.

*James DeForest Murch, Pres.
National Religious Broadcasters Inc.
Cincinnati*

Yearbook Fan

EDITOR:

Please send me a copy of the new BROADCASTING YEARBOOK-MARKETBOOK . . . [it is] the most valuable reference in our industry.

*Len Higgins
General Manager
KTNT-TV Tacoma, Wash.*

Management Mixup

EDITOR:

We were surprised to read in your March 18 issue that Ralph Davison Jr. has been named executive vice president and general manager of KTVR (TV) Denver. [The fact is that] Hugh Ben LeRue is still executive vice president and general manager. Mr. Davison joined the staff of KTVR as sales manager.

*Ray Gallagher
Program Director
KTVR (TV) Denver*

In Louisville-

the more you compare programming,
ratings, coverage, or costs per
thousand — the more you'll prefer

WAVE Radio

WAVE-TV

LOUISVILLE

NBC AFFILIATES

NBC SPOT SALES, EXCLUSIVE NATIONAL REPRESENTATIVES

108206



BEST FEATURES! One of the best features of WCBS-TV's feature film programming is that everyone—viewers, advertisers and the industry itself—*agrees* it's the best.

THE INDUSTRY: The Billboard's Fifth Annual TV Film Service Awards (a poll of hundreds of stations, sponsors, agencies and producers) voted WCBS-TV "the best station in the nation for imaginative and effective feature film programming." (Gratifying but not new: this is WCBS-TV's third win in five years.)

THE VIEWERS: WCBS-TV's feature films (from M-G-M, Warner Brothers and other major studios) are commanding the biggest audiences in their history... far bigger average audiences than feature films on any other New York station (The Early Show 81% larger, The Late Show 112% larger).

THE ADVERTISERS: Sponsors consistently invest more in WCBS-TV's features than in any other feature film programs in New York—and get far bigger returns on their investments!

But the best feature of all, from the advertisers' point of view, is that Channel 2 commands much larger average audiences than any other New York station not only during feature film periods—but throughout the entire week as well. And has done so month after month, for years!

Represented by CBS Television Spot Sales • CBS Owned • Channel 2 in New York

WCBS-TV

'Medicine Chest' Drive Boosted

NBC reports it devoted more than \$250,000 worth of radio time to its March Medicine Chest public service campaign. The campaign, in cooperation with Civil Defense and the Red Cross, was designed to persuade the public to keep protective and preventative medical supplies on hand, particularly in automobiles.

Prison Gets Record Library

MARION Correctional Institution (Div. of Ohio Bureau of Prisons) now claims possession of a music appreciation department—because of the public service efforts of WMRN Marion, Ohio. When the station heard the institution had received a record-player from private sources and had no music, it donated records from its library. To date, WMRN reports, it has contributed over 800 classical and nearly 200 popular discs to the prison.

Tv Series Impetus for Ford Grant

WXIX (TV) Milwaukee is credited with being "instrumental" in the award of a \$10,000 Ford Foundation grant to that city's Junior Bar Assn. WXIX produces *Milwaukee Reports*, a public service series, in coopera-

tion with the legal group. In a letter to Warren Bush, station public affairs director, the association lauded WXIX for helping it to obtain a grant to engage in a study involving the constitution and the bill of rights.

Radio Alerts Avert Explosion

QUICK results from alerts on WSPB and WKKY, both Sarasota, Fla., averted a possible tragedy. Four youngsters, playing near a construction project, had hidden a box of electric blasting caps, planning to keep them to play with. The warmth of a person's hand could have set off the caps, which are used to detonate dynamite. A foreman reported the loss, and both local stations broadcast news alerts. The mother of one of the children, hearing them talk about dynamite, put two and two together, and her call led to a safe removal of the caps.

Spot Campaign Aired for YMCA

WJAR-TV Providence, R. I., used a spot saturation campaign as part of its community service plan to support a fund for a new YMCA building in Cranston, R. I. Civic leaders made on-camera appeals for contributions aiming at a \$218,000 fund.



Nielsen Study # 2 Shows WPTF

A Better Buy Than Ever!



More daily listeners than any other North Carolina, South Carolina or Virginia station!

Reaches over 50% of all radio homes in 84 counties! Three more counties than 1952 study.

BIGGER MARKET!

Population	3,065,600
Households	746,740
Spendable Income	\$3,304,021,000
Retail Sales	\$2,355,862,000
Food Sales	\$530,006,000
Drug Sales	\$63,459,000
Gen. Merchandise	\$304,263,000
Apparel Sales	\$124,228,000
Home Furn. Sales	\$138,186,000
Automotive Sales	\$517,228,000
Gas Station Sales	\$206,042,000
Farm Population	1,208,500
Gross Farm Income	\$1,002,864,000

*Source: Standard Rate and Data



WPTF

50,000 WATTS 680 KC

NBC Affiliate for Raleigh-Durham and Eastern North Carolina

R. H. Mason, General Manager
Gus Youngsteadt, Sales Manager

PETERS, GRIFFIN, WOODWARD, INC.
National Representatives

IN GIVING, WDIA RECEIVES

THAT "it is in giving that we receive" is exemplified in the public service efforts and programming of WDIA Memphis, Tenn.

Through its many public service programs, the Memphis 5 kw station has improved race relations in that city and brought greater understanding between the Negroes and whites in parts of an eight-state area (the Midsouth) which it serves.

This is the gist of a *Coronet* magazine article (February issue) about the station's many activities entitled "WDIA—It Made Good Will Pay" by Henry La Cossitt.

Owned by John R. Pepper, president of the Bluff City Bcstg. Co., and Bert Ferguson, general manager, WDIA is "the principal source of information and communication for the Negro community, not only of Memphis but of the surrounding territory . . ." (the Midsouth) in which some 1,300,000 Negroes live, the *Coronet* article states. One third of the station's employees—including its entire performing personnel—are Negroes.

With its "open door" policy for "people in trouble and want," WDIA constantly helps its listeners (both Negroes and whites) to get jobs, to solve their personal and family problems. The station annually presents a "Goodwill Review" and "Starlight Review"—the proceeds of which help finance many things which WDIA does for Negroes in Memphis and the surrounding area.

Among other regular programs are WDIA's weekly show, *Brown America Speaks*, a half-hour forum, on which

current issues and Negro problems including race relations, are debated and discussed. Also there is *Teen Town Singers*, a group of high school boys and girls directed by a Negro former biology teacher, now a disc jockey. Each year the station awards a \$200 cash scholarship to the outstanding participant from each of the seven Negro schools taking part in the program.

Through the efforts of WDIA's general manager, Mr. Ferguson, the station achieved the establishment in Memphis in 1955 of a school for crippled Negro children. The city has furnished the building, a former white school, while WDIA funds bought two busses to provide transportation. Some 40 pupils—victims of polio, cerebral palsy and mishaps—regularly attend the school, which has a good teacher, a practical nurse and a physical therapist in attendance.

In addition to its daily services, which include the recovery of lost people, livestock and articles, the station has helped to place Negroes on such civic committees as Fire Prevention, the Community Chest and the March of Dimes, and has aided in reducing the city's delinquency rate through its organization and sponsorship of a junior baseball league. WDIA also has been credited with fine support of the policy traffic-safety program.

WDIA's owners don't claim to be professional "do-gooders", however.

"We're in business," the *Coronet* article quotes Mr. Ferguson, who notes that the station's annual revenue at \$600,000 is growing steadily. "I guess it pays to be nice to people," Mr. Ferguson says.



ANOTHER FABLE OF PROFITS*

(The Till Will Tell)

ONCE UPON A TIME there was a station manager who, unlike William Tell, couldn't keep his eye on the target. His aim was dangerously low*, and no matter how hard he tried he never (well, hardly ever) scored.

Then one day after stalking down the Michigan Boulevard Preserve in a vain search for a buck, he happened into the Bolling suite at the Hilton. They were very happy to see him and helpfully showed him how to restring his bow, straighten his aim, and knock down the game.

Today he is a marksman of wide renown and always bags the limit wherever he hunts.

The moral of this story is... a low blow gets no dough.

**Aim higher with us.*

THE BOLLING COMPANY INC.

STATION REPRESENTATIVES

247 PARK AVENUE, NEW YORK CITY, N. Y.

CHICAGO • BOSTON • LOS ANGELES • SAN FRANCISCO

"AND

THEY

JUST



KEEP COMING...!"

This poor fellow is suffering from a plethora of radio-tv publications. As a busy buyer of radio and television time for one of America's biggest agencies, he'll receive this year approximately 165 regular and special issues of various magazines — all claiming themselves indispensable to his welfare and knowledge of the radio-tv business.

Their bulk weight will total close to 90 pounds, and a new one will arrive on the average of every 36 hours during the working week.

This is a lot of reading. If he *did* read them all, there'd be no time to do his job. "What gets *me*," he moans, "is that I never *asked* for all this generosity. There's only *one** magazine I really need, and I pay the subscription price to get it. The others just keep coming and coming for free. All I hope is the stack doesn't fall over and smother me someday."

His plight is shared by hundreds of other important agency and advertiser people. Virtually all of them receive BROADCASTING-TELECASTING every week — not gratuitously, but because they *want* and *pay* to get this dominant business weekly of radio and television. (In fact — and unlike the others — if they don't pay, they *don't* get it.)

What does all this mean to you as a prospective advertiser in BROADCASTING-TELECASTING? Well, only B-T can present *verified* figures on *paid* circulation, accurately classified by types of readers, and backed by the solid reputation of the Audit Bureau of Circulations. For B-T alone, among the publications purporting full attention to radio and television business, has qualified for ABC membership.

An ABC statement has the genuine respect of agencies and advertisers all over America — because it is the truest measure of any publication's worth: *its PAID circulation*. No partiality, no ambiguity . . . honest weight with nothing hidden.

BROADCASTING-TELECASTING's current ABC statement shows almost 17,000 average *paid* distribution — far more than that of any other publication in the radio-tv field. When you advertise in its well-studied pages, you know your messages are going to the people who count. What's more, they'll be *seen* when they get there.

Why smother in the "might-read-sometime" stack? Go first-class in the *one* magazine that lies open on more important desks than any other!

* We've signed our name prominently to this advertisement, just in case you don't already know. Anything B-T doesn't cover in radio-tv isn't worth a busy man's time.



1735 DeSales Street, N.W., Washington 6, D.C.

a member of the Audit Bureau of Circulations

WILS

Steady radio audience growth for more than 8 years.*

5000
LIVELY WATTS

20 to 1 power in the Central Michigan area.

LANSING

Where industry pays 2nd highest wage rate in Michigan — over \$2.44 per hour. ‡

*C. E. Hooper, Inc.
‡Michigan Employment Sec. Bulletin

WILS
music news sports

1320 KC Represented Nationally by Venard, Rintoul & McConnell, Inc.

OUR RESPECTS

to Ely Abraham Landau



A FIVE-YEAR dream comes true today (Monday) for Ely A. Landau, president of National Telefilm Assoc., New York, and of the NTA Film Network, as the network launches operations on a commercial basis [see NETWORKS].

The film network, to a remarkable degree, underlines two of Mr. Landau's characteristics that colleagues regard as his strong points: a visionary zeal and dogged determination to succeed. Over the past five years he has made several attempts to establish a film network because he believes that film must assume the dominant role in the network of the future. Each attempt stalled until last October when he lined up more than 100 station affiliates and promised to provide them with 1½ hours of feature film programming a week.

The project was viewed with skepticism by many industry observers and this attitude deepened when sponsorship of the network did not develop for several months. But Mr. Landau and his associates kept up a steady barrage of presentations to advertisers and their agencies and finally signed the Warner-Lambert Pharmaceutical Co. and P. Lorillard Co. as co-sponsors [B•T, March 4].

Mr. Landau's plans for the NTA Film Network are by no means modest. A 90-minute "kiddie" show currently is being prepared for a fall debut and several of the half-hour program series currently in production for National Telefilm Assoc., the parent company, will be assigned to the network. Mr. Landau is convinced that in five years even the major networks will be programming film shows almost exclusively, with live programs carried only for special events, sports and one-time spectaculars. His thesis is that the cost of the coaxial cable will be economically indefensible.

Ely Abraham Landau was born in New York City on Jan. 20, 1920. At 17, following graduation from Manhattan's Seward Park High School, he began his business career as a salesman on the road for Alpha Aromatic Labs. He served also on the sales staff of Detecto Sales Co. before joining the U. S. Air Corps in 1942. He was released as a sergeant after service in the China-Burma-India theater.

Mr. Landau's first post-war project involved the New York distribution of a southwestern snack called Peppcorn Chips, with which he had become acquainted during Air Force service in Texas. He advertised the product by buying spot announcements on WCBS-TV New York before, during and after the Brooklyn Dodgers baseball telecasts. In six months, Peppcorn Chips was on the shelves of more than 10,000 outlets in the New York area. Despite the encouraging success, Mr. Landau was forced to give up the business because the product could not withstand the northern climate.

BUT the singular success he had achieved with television's help was not lost on Mr. Landau. He decided then to embark on a career in television. In 1948 he joined the tv program packaging company of Ray Nelson Productions, New York (Mr. Nelson currently is vice president of the NTA Film Network) and the next year became television director of Moss Assoc., New York, an advertising agency. In 1950 he was appointed television director of the Emil Mogul Co., New York, where he was credited with having expanded the agency's television department to formidable proportions and having increased the billings of Esquire Boot Polish and Ronzoni Macaroni Co. to more than \$1.5 million each yearly in tv.

In 1951 Mr. Landau formed Ely Landau Inc. as an independent tv film producer. It was this company that developed into National Telefilm Assoc. Mr. Landau's first attempt at a film network came early in 1952 when he worked to organize the First Federal Film Network. He tried to interest stations to buy shares in the network and program it with series to be produced by Ely Landau Inc. The proposition did not appeal to the stations. Then, in order to acquire nationwide distribution for his product and raise production capital, he sold franchises for distribution rights in various areas throughout the country. In May 1954, when Oliver Unger, now executive vice president, and Harold Goldman, now vice president in charge of sales for NTA, joined forces with Mr. Landau, he retired all franchises. NTA's corporate assets now are reported to be in excess of \$14 million.

In quick succession, Mr. Landau acquired the PSI-TV library of serials from Bernard Prockter in December 1953, feature films from J. Arthur Rank and David Selznick in January 1955 and finally—the grand prize—the 20th Century-Fox features. The company has 130 Fox features and the option to buy an additional 312. Fox acquired 50% of the film network, although NTA maintains operational control.

Mr. Landau realizes that the feature film bonanza can last only two to three years, and his blueprint for the future highlights half-hour film serials. To this end, he has made agreements with Desilu Productions and Fox to produce about a dozen tv series.

In 1942, Mr. Landau married the former Hannah Klein of New York. They have two children—Neil, 10, and Lester, 6. The Landaus live in Manhattan.

1st in Columbus, Ohio



1st in Ratings

Three short years ago WTVN-TV ranked as a poor third in the three-station Columbus, Ohio, market. Since that time, the great forward strides of ABC-TV combined with the aggressive local programming of WTVN-TV have resulted in a steady climb in audience acceptance. This rating trend has now progressed to the point wherein the latest Nielsen Study shows WTVN-TV *FIRST* in total audience.

1st with Vidicon

ANOTHER FIRST—Maintaining our position as Central Ohio's top station, we take great pride in announcing the installation of the RCA Vidicon film projection equipment.

WHAT DOES THIS MEAN TO ADVERTISERS AND TIME BUYERS?

The installation of this advanced RCA equipment assures WTVN-TV advertisers, using film commercials and film programs, of sharp—clear—virtually noise-free pictures of live picture quality. Channel 6's new Vidicon equipment will show every detail that is on the film. Truly, the NEW WTVN-TV film picture is —

The Picture That POPS!

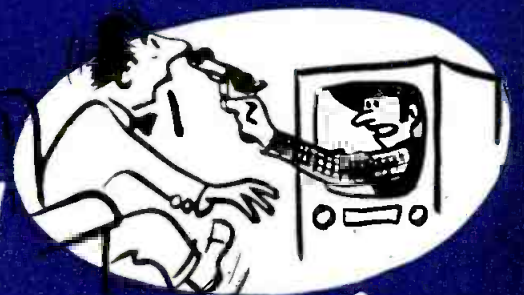

WTVN-TV

Channel 6

GRACE

Nielsen Survey shows WJDX still superior

41,520

more WEEKLY RADIO HOMES

than any other Mississippi station!

NIELSEN NCS No. 2

For coverage and audience...

WJDX Radio 620

JACKSON, MISSISSIPPI

WJDX delivers 121,840 weekly radio homes in Mississippi and Louisiana!

Mississippi's only
fulltime radio
news and farm
departments

superior
coverage
both day & night since 1929

NBC WJDX
AM • FM

For complete details NCS No. 2
George P. Hollingbery Co.
or WJDX, Jackson, Miss.

ON ALL
ACCOUNTS

Edith Krams



EDITH KRAMS, media director for Anderson-McConnell Adv. Agency, Los Angeles, is a firm believer in buying local radio and tv programming with local personalities whose connections can give the advertised product a valuable plus in merchandising.

"Local merchandising can make the difference between a good campaign and a fabulous campaign," Miss Krams declares. She learned that lesson at KDUB-TV Lubbock, Tex., she says, where as Edith Bennett she conducted a daily woman's program and a daily children's show a few years back.

At Anderson-McConnell, Miss Krams is using radio and tv for Cromwell Oil Co.'s X-3, an oil additive; Boyle Pharmaceutical Co.'s many products; Glenn Wallich, Music City, records, sheet music and musical instruments; Thriftmart food stores; Metropolitan Savings & Loan Co.; Maier Brewing Co.'s Brew 102, plus a number of purely local accounts. She also places the advertising for KXLA Pasadena and KXO El Centro, both Calif.

TALL (5 ft. 8 in.), blonde and blue-eyed, Edith Wright Krams Jr. (who insists the Jr. is on her birth certificate and therefore an integral part of her name) is one of the prettiest as well as one of the youngest of media directors (she's 26). But she's no Jennie-come-lately to the advertising business, which she entered 10 years ago, while still in college, as girl-of-all-work for Emerson Advertising Agency, Los Angeles. After graduation from the U. of California with a degree in business administration she stayed with Emerson long enough to become production manager and handle some time and space buying. Then, in rapid succession, came jobs doing public relations for Milton Weinberg Adv. Co., as advertising manager of the Millicent Deming Commercial Modeling Studio and production manager of Glasser-Gailey Inc.

After the stint in Lubbock and the on-camera job at KDUB-TV, Miss Krams returned to Los Angeles and the agency business, first in media and production work at Richard N. Meltzer Adv. and, since last Dec. 3, as media director of Anderson-McConnell.

She now lives with her parents, her son—Karl Frederick Hautz III, her brothers and an assortment of dogs, cats, rabbits and other domestic animals in Windsor Square, residential section of Los Angeles.

Miss Krams' hobbies are largely athletic to counteract her days behind a desk. She plays golf (only fair) about twice a month, rides horseback at least once a week, fences daily and flies whenever the opportunity presents itself. She's had her pilot's license for eight years.

Any Way You Look At It

WSAV reaches more people

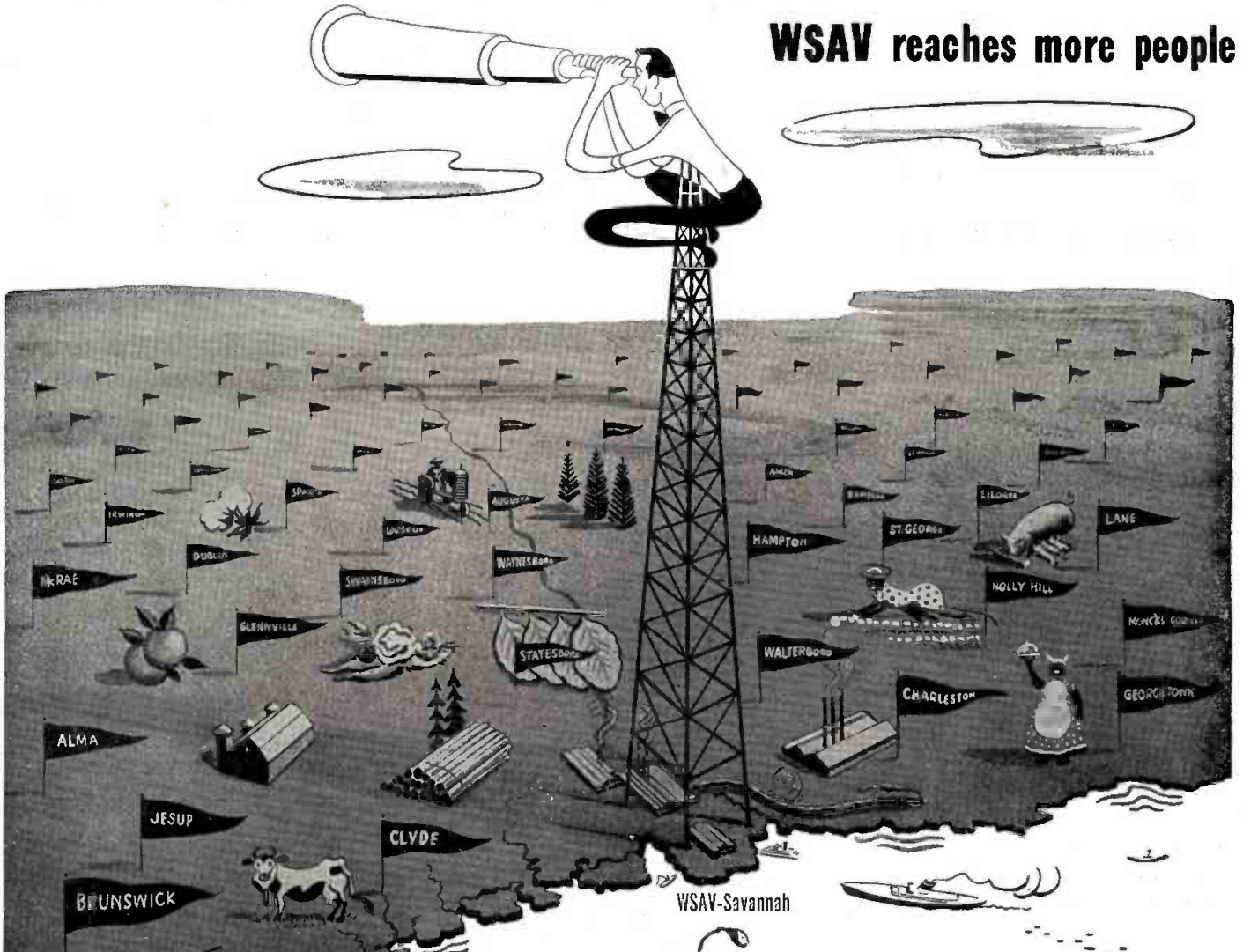

Have you seen the new Savannah Trading Area Pulse?

WSAV has complete audience domination in all of the important local program periods—6:30 to 10:00 AM, 3:30 to 7:00 PM, and from 9:15 PM to Sign-off.

For instance, here are the ratings for the breakfast hour from 7 to 8 AM:

STATION	7:00 AM	7:15 AM	7:30 AM	7:45 AM
WSAV	7.0	6.8	7.8	7.5
STATION "A"	1.4	1.6	2.2	2.2
STATION "B"	.7	1.0	.9	1.0
STATION "C"	1.4	2.1	2.3	3.1
STATION "D"	.5	.6	.6	.7
STATION "E"	5.8	6.0	6.7	7.0

... and, in the late afternoon:

STATION	5:00 PM	5:15 PM	5:30 PM	5:45 PM
WSAV	8.6	8.7	8.5	7.5
STATION "A"	.5	.6	.4	.5
STATION "B"	1.2	1.3	1.6	1.5
STATION "C"	3.3	2.8	OFF	OFF
STATION "D"	.7	1.0	1.0	.9
STATION "E"	6.7	6.8	7.0	6.9

The PULSE proves it . . . the NIELSEN proves it . . . WSAV REACHES MORE PEOPLE AT A LOWER PER-PERSON COST THAN ANY OTHER SAVANNAH MEDIUM!

It's **630**  in Savannah

WSAV

630 kc.
5,000 watts
Full Time



REPRESENTED BY

Sales
IN THE CAROLINAS
power

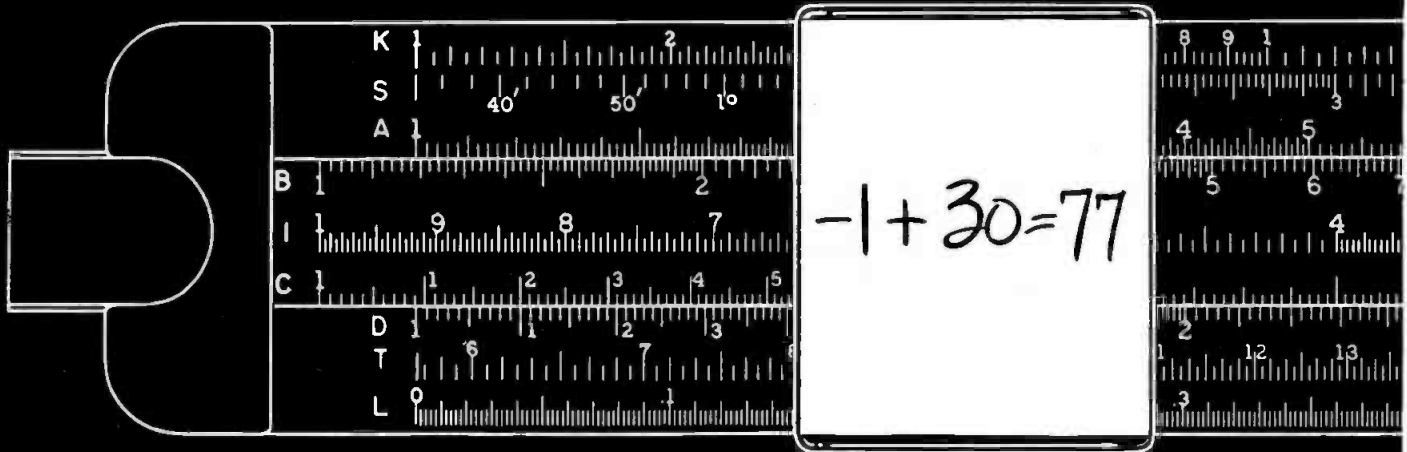

A HARBINGER OF GOOD NEWS FOR YOU!

There's good news for you in the NCS #2 report on actual viewing of Southeastern TV families.

$-1 + 30 = 77$ may even stump Univac, but for the discerning advertiser it means simply that WBTV lost one county in the NCS #2, but picked up 30 counties for a total coverage area of 77 prosperous North and South Carolina, Tennessee and Virginia counties.

Here's your good news:

- A population increase in WBTV's coverage area of 49.8% for a new total of 3,821,700 potential customers.*
- A 43.3% increase in Effective Buying Income brings the new total to \$4,258,069,000.*
- A retail sales increase of 45.2% giving a new total of \$3,028,602,000.*

WBTV's dominant position overpowers the Carolinas' second-place station by 48.5%; submerges the third-ranked station by 63.6%; and swamps the fourth-ranked station by 80%.

Forget your former formula. Translate $-1 + 30 = 77$ into potent Sales Power for you! Contact WBTV or CBS Television Spot Sales for the complete Nielsen story on the Southeast's top television station.

*1956 "Survey of Buying Power"



JEFFERSON STANDARD BROADCASTING COMPANY

to Pep-
BROADCASTING



MILITARY SEEKS VHF CHANNELS 2-6

- **Eisenhower now reportedly is considering secret request**
- **Will 200-plus vhf stations have to move to ultra highs?**

A FORMAL request has reached the White House from the military, probably through the Joint Chiefs of Staff, asking that President Eisenhower preempt low band vhf television spectrum space for military purposes.

While detailed information is not available, it was ascertained that the request has the personal attention of the President and that it has been discussed in high councils during the past fortnight. Because of the untold disruption of service it would cause to millions of viewers, as well as to stations, the request is receiving highest level consideration, it is learned.

Giving credence to the immediacy of the problem is recent testimony of FCC Chairman George C. McConaughy and other FCC members before both Senate and House committees that channels 2-6 are in jeopardy because of "demands" from the military and from other non-broadcast users, whose growth has mushroomed. This is the underlying reason for the pressure to move all tv to uhf.

Because the military operates in a vacuum of self-imposed secrecy in the communications area, no one in public office wants to be quoted. While there was no comment in response to the inquiries from B•T about the formal request for vhf spectrum space from the military, there were no flat denials. Informed sources said high level consideration was being given to the problem, and in one quarter it was said that Presidential Assistant Sherman Adams currently is in consultation with the President on it.

Under the Communications Act, there is split jurisdiction over spectrum allocations. The FCC handles allocations for non-government services. But the President has full authority to assign spectrum space to government for any service considered necessary for national security or vital public interest. There is no requirement for government services to justify their demands. The allegation repeatedly has been made

that the military dominates government allocations.

Because of the billions of dollars of public investment in television receivers, aside from the investments of broadcasters in transmitting plants and facilities, the notion that the President would yield to the military for low band channels when no emergency exists is regarded as unlikely. But the warnings sounded by members of the FCC of the imminent danger to channels 2-6, according to informed observers, cannot be taken lightly.

Efforts to solve the problem of "dual authority" over spectrum allocations have

reliable means of long-range communications, as well as the development of jet aviation are given as reasons for the government need for vhf space. Industrial users in the mobile services also have been lobbying hard; feeling they could share facilities with the military without undue interference.

For some months, important military figures have been sending up trial balloons on the need for additional spectrum space if our boundaries are to be protected. Early this year, Maj. Gen. Alvin L. Pachynski, Air Force communication chief, published a brief military "justification" for more vhf space in an aviation publication. Last month,

Signal, publication of the Armed Forces Communications & Electronics Assn., carried a lead article on forward scatter requirements by Rear Admiral H. C. Bruton, director of Naval Communication. Here's one quote on Adm. Bruton's call for more space in the 25-60 mc region: "... we feel that some provision for the use of scatter is a 'must'."

Presumably, the President and his advisors must determine whether the military demand is valid at this time, or whether it is premature. Interwoven in the military "pitch", it was obviously deduced, is the incessant campaign to have all tv move into the uhf spectrum, where, at the present state of the art, coverage areas are restricted in contrast to vhf,

with the consequence that many people in outlying or even suburban areas, would be deprived of service if vhf operations are curtailed.

Informed sources feel that the military is beginning its campaign for the low band vhf space, not with the notion that stations would move overnight, but rather that machinery would be set in motion to effect the transition perhaps in the next decade. The military—principally the Air Force—is shooting at the lower end of the band because there is a natural "split" in the allocations. For example, channels 2 to 4 run from 54 megacycles to 72 mc. There is a break of

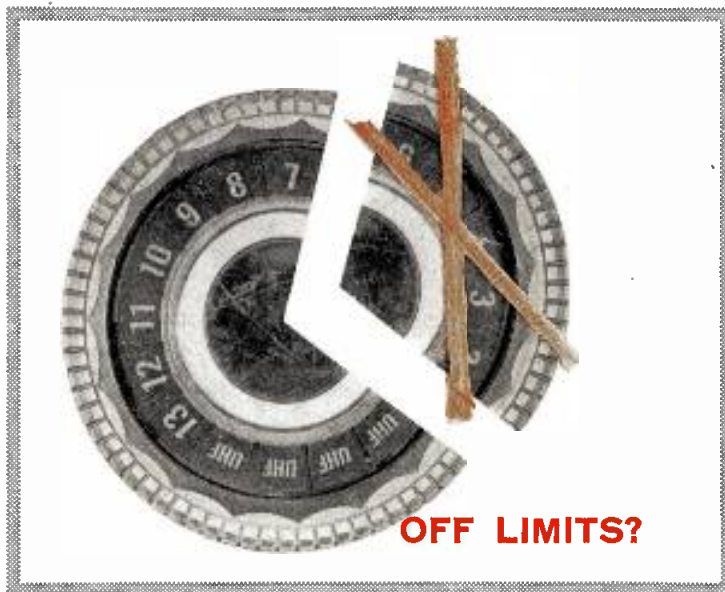

been made for the past two decades. But despite several high level studies, and an equal number of erudite reports, the system remains unchanged.

At this time, the military and the non-broadcast users are not exerting pressure beyond channels 2-6. They probably would even settle for channels 2-4 which constitute the first segment of the low band. Thus, channels 7-13 in the vhf band appear to be safe from immediate attack. The effort is to move the 200-odd stations now in channels 2-6 to uhf over a "transitional" period of years.

The evolution of forward scatter as a

four mc for government operational fixed services, and then channels 5 and 6 from 76 to 88 mc. Channel 7 does not cut in until 174 mc, running through the "high" end of the vhf band to channel 13 at 216 mc. Then uhf begins at 470 mc with channel 14 and runs through to 890 mc or channel 83.

The magnitude of the upheaval that would be wrought through displacement of stations on channels 2-6 is apparent in toting up the stations now operating in the area. As of last week, there were 203 stations—most in major markets—on those bands, with investments in the hundred millions.

An official of the Office of Defense Mobilization told B•T Friday that as far as his of-

fice knows "there is no request pending" at the White House from the JCS for additional spectrum space. He added that the whole matter was up about a year ago, at which time ODM concluded, after a thorough exploration, that no spectrum space in vhf now occupied by government could be relinquished to tv, and that if anything, government eventually would require additional vhf space.

To alleviate the tv allocations problems, efforts have been made during the past several years to induce the military and other government users to relinquish some of their spectrum space to tv—notably in vhf areas contiguous to the present vhf bands. But

these were met with the retort that the military needed more, not less, vhf space.

Charts show that the military and other government services now are using substantially half of the usable spectrum.

Recently, it was learned, Sen. Charles Potter (R-Mich.), a member of the Senate Interstate Commerce Committee, inquired of ODM how the military could "justify" so much vhf spectrum space when the requirements of the public for additional channels are evident. ODM replied, it is learned, that not only could the government (military) not relinquish space, but that the probability is that it will need additional vhf area for national defense purposes.

ADVERTISERS & AGENCIES

Y&R HINTS COAXIAL CABLES' USE TO FEED TELEVISION TO CLIENTS

ON THE HEELS of other major New York agencies which have installed closed circuit television system to simulate broadcast conditions in preparation of shows and commercials, Young & Rubicam announced last week that it would go further and be able to feed the material to clients no matter where in the U. S. they are located.

Presumably the feeds around the country would be accomplished by AT&T lines.

Y&R said it is installing tv transmission facilities at its headquarters, 285 Madison Ave., along with a film theater and audition studio.

Although other agencies recently have established closed circuit studios, such as J. Walter Thompson Co. and McCann-Erickson, Y&R said its system differs in that the agency will be able to show its creative wares to clients in their own offices. Y&R said the system should be ready in June. The studio and its facilities will allow the agency to show clients a selection of tv shows and commercials and permit auditioning of performers under broadcast conditions.

The facilities will include use of 35 mm telecast projectors and vidicon tv cameras such as employed by tv networks. The equipment will also permit screening of color film with appraisal of its black and white transmission quality.

The specially equipped film theatre and tv audition studio will be located in the agency's headquarters at 285 Madison Ave., New York.

The facilities will provide improved quality control of tv commercial production. The addition allows full time use of a film theatre and, adjoining it, in a newly designed audition studio, a standard broadcast vidicon camera will duplicate tv broadcast conditions over a closed circuit. It will also be equipped with the latest tape recording units.

The audition studio will allow the agency to check on color of packages, labels, products, art work, etc., prior to actual network studio rehearsal.

This marks the first time, according to Young & Rubicam, that an agency can make available to its clients, and personnel, use of the same type of 35 mm telecast currently

used by the tv networks, with special design modifications that permit straight projection of 35 mm tv films as well as transmission of the same material through a vidicon film chain of the latest mode. Monitoring sets will be located in strategic locations throughout the agency.

The new equipment also will let the agency and its clients view 35 mm work prints of all commercials in interlock form and then screen answer prints having optical as well as magnetic sound tracks. By re-running the film through multiplexing mirrors, which focus the image through a vidicon film camera chain, conditions of home reception can be duplicated for closed circuit viewing.

Seven-Up to Co-sponsor Disney's 'Zorro' on ABC-TV

SEVEN-UP Bottling Co. has contracted for its first national network television sponsorship on a continuing basis with its alternate weeks buy of Walt Disney's *Zorro* on ABC-TV.

The soft drink firm's sponsorship will begin with the opening of the program this fall, according to Ben Wells, vice president in charge of sales-advertising for the company. Exact time of the new show, and its co-sponsor, will be announced shortly, Mr. Wells said.

Seven-Up has used short-term buys in network tv in past years, and currently has a regular spot radio schedule. The company will continue its sponsorship of *Soldiers of Fortune*, MCA-TV film series on a "spot-booked" basis through this May.

Scott Paper Co. Buys MacKenzie Next Season on NBC-TV

SCOTT PAPER Co. (paper napkins, towels, etc.) will sponsor a new program, the *Gisele MacKenzie Show*, on NBC-TV Saturdays, 9:30-10:30 p.m., next fall. The program will be produced by J & M Productions, which is owned by Jack Benny, through the Music Corp. of America, talent agency that represents Miss MacKenzie, Mr. Benny and the comedian's company.

It is expected Miss MacKenzie's programs will be live and possibly in color.



ANN FIORILLO, "Advertising Miss 1956," presents Elon Borton (l), president of the American Federation of Advertisers, the first ticket to the seventh annual Inside Advertising Week banquet scheduled this Thursday (April 4) in the Hotel Biltmore, New York. John J. Patafio Jr., president of the Assn. of Advertising-Men & Women, sponsor of Inside Advertising Week, looks on.

Pepsodent Asks D.J.s To Push New Contest

RADIO has been selected by Pepsodent (Division of Lever Bros.) to play the major role in a contest promotion starting April 22 that ties in its "where the yellow went" theme, with prizes worth a total of \$88,025 to winning contestants.

Simultaneously, Pepsodent is running a "contest" for disc jockeys but limited to those personalities who are heard on stations slated to run Pepsodent's spots. For them Pepsodent will give away 18 prizes worth \$15,000, the "top disc jockey" to receive the grand prize: A swimming pool from International Swimming Pool Corp., White Plains, N. Y., of which Esther Williams is president.

To further the station contest, Pepsodent, via its agency, Foote, Cone & Belding, New York, has mailed letters to station managers explaining the contest, with follow-ups to station personalities (teaser letters from Miss Williams), suggested materials for both station and disc jockey and dossier

sodent sales forces.

An assertion by a broadcaster that Pepsodent was attempting to get further mileage out of its paid campaign by by-passing station management was denied by both Lever Bros. and agency spokesmen. They said "no complaints" from radio stations had been received, although requests for "additional materials" were coming in from stations. It was not the intent of Pepsodent to obtain unpaid air time to supplement the campaign, they told B•T, although the station and/or disc jockey could choose any promotional effort desired.

Rather, they explained, Pepsodent was interested in encouraging a merchandising promotion on behalf of the contest, helping both the advertiser and promoting the station. Station managers are extended an invitation, they added, to contact either Pepsodent or the agency for a personal and full explanation of the campaign's purpose and how it will be conducted.

A spokesman for the agency emphasized that only its regular schedule of stations (reportedly about 200 in 100 markets) is being invited to participate in the station part of the contest.

Defense of Advertiser Control Of Tv Programs Made by Jones

A STRONG defense of commercial control by the advertiser of television programming has been offered by Ernest A. Jones, president of MacManus, John & Adams, Bloomfield Hills, Mich., and New York.

Addressing approximately 150 New York City schoolteachers at the *New York Herald Tribune's* television and radio seminar March 10, Mr. Jones discussed the question, "Does Advertising Interfere with Television Programming?" The answer, according to the Michigan agency executive, is yes—but only to the following extent: television must necessarily be interrupted for commercials, television must be beamed to the broadest segment of the population and television programming is "inextricably" identified with the sponsor, thus the sponsor "must watch the editorial content . . . rigidly."

The seminar is a weekly affair sponsored by the *Tribune* in cooperation with the New York City High Board of Education. Future guests include NBC Continuity Acceptance Director Stockton Helffrich (April 2); CBS Director of Public Affairs Irving Gitlin (April 9), and Ed Stanley, project supervisor of the NBC educational programs now being aired by non-commercial outlets (April 16).

Dairy Assn. Seeks New Show

NETWORK tv plans of American Dairy Assn. for 1957-58 reportedly hit a snag last week, with CBS-TV's *I Love Lucy* and other properties involved in negotiations at the agency and client level.

The association had voted to sponsor *Lucy* on alternate weeks this fall on the basis that no new film production would be involved and it could select choice runs of past years [B•T, March 25]. Negotiations faltered, however, with the revelation of CBS-TV plans to slot a new show, *Big Rec-*

ord, three weeks each month and run a full-hour *Lucy* in the fourth week. It's understood proposed new films would cost over \$300,000 each, making the package prohibitive for American Dairy.

Campbell-Mithum Inc. had an option to purchase for both American Dairy and Gold Seal Co. (Glass Wax) whose accounts it handles on alternating weeks.

After the snag developed, it was learned, the agency sought to buy a third sponsorship, again on alternating weeks, of the fall *Perry Como Show*, but negotiations fell through. Client also was represented as not interested in a CBS-TV proposed 90-minute special series planned for Monday evening this fall and is reportedly shopping for other network availabilities.

Meanwhile, American Dairy is set for a staggered 52-week schedule of participations and station breaks on NBC Radio—in the hours 10 a.m.-5 p.m., starting his summer—to kick off its "June Is Dairy Month" promotion, with a maximum of 15 minutes of spot announcements per week.

Kenyon & Eckhardt Names Two

DON O'LEARY and J. Clarke Mattimore have been elected vice presidents of Kenyon & Eckhardt, New York. Mr. O'Leary has been with the agency since January 1956 as account executive and Mr. Mattimore has been account executive since May 1955.

Lowe Corp. Buys 'Popsicle'

CONFIRMATION of a purchase by Joe Lowe Corp., New York, for a nine-week series of comedy shows on ABC-TV starting May 18 was made last week by Slocum Chapin, the network's vice president in charge of sales [AT DEADLINE, Feb. 4]. Titled *Popsicle Five Star Comedy Party*, the Saturday 5:30-6 p.m. EDT strip will feature Paul Winchell and Jerry Mahoney, Senior Wences, Olson & Johnson, Ben Blue and Jerry Colonna. The sponsor will use the series to promote Popsicles, Fudgsicles, Creamsicles and Lowe Corp.'s "Popsi Doodle Contest." Contract was placed through Paris & Peart, New York, agency for Joe Lowe Corp.

Refinery to Use All Media

AMERICAN Sugar Refining Co. (Domino Sugars) has started an intensive advertising campaign using television, radio and newspapers to promote the low-calory sugar "story." At least 70 major markets will be used in tv spots plus an additional radio campaign in several major markets. The tv spots for Domino extra fine granulated sugar will be animated commercials. Ted Bates & Co., New York, is placing the campaign.

COLORCASTING

The Next 10 Days
Of Network Color Shows
(All times EST)

CBS-TV

April 2 (9:30-10 p.m.) *Red Skelton Show*, S. C. Johnson & Son through Foote, Cone & Belding and Pet Milk Co. through Gardner Adv.

April 3 (8-9 p.m.) *Arthur Godfrey Show*, participating sponsors and agencies (also April 10).

April 5 (3:30-4 p.m.) *Bob Crosby Show*, participating sponsors and agencies.

April 11 (8-9 p.m.) *Shower of Stars*, Chrysler Corp. through McCann-Erickson.

NBC-TV

April 1-5 (1:30-2:30 p.m.) *Club 60*, cooperating sponsors and agencies.

April 1-5 (3-4 p.m.) *Matinee Theatre*, participating sponsors and agencies.

April 1 (8-9:30 p.m.) *Producer's Showcase*, "The Great Sebastians," with Alfred Lunt and Lynn Fontanne. RCA-Whirlpool-Seeger through Kenyon & Eckhardt and John Hancock Mutual Life Insurance Co. through McCann-Erickson.

April 2 (10:30-11 p.m.) *Hold That Note*, Lanolin Plus through Russel M. Seeds.

April 3, 5, 10 (7:30-7:45 p.m.) *Xavier Cugat Show*, sustaining.

April 3 (8:30-9 p.m.) *Masquerade Party*, Assoc. Products, Inc. through Grey Adv.

April 3 (9-10 p.m.) *Kraft Television Theatre*, Kraft Foods Co. through J. Walter Thompson Co.

April 4 (10-11 p.m.) *Lux Video Theatre*, Lever Bros. through J. Walter Thompson Co.

April 5 (10:45-11 p.m.) *Red Barber's Corner*, State Farm Insurance Co. through Needham, Louis & Brorby.

April 6 (8-9 p.m.) *Perry Como Show*, participating sponsors and agencies.

April 7 (4-5 p.m.) *Washington Square*, with Ray Bolger, Helene Curtis through Earle Ludgin and Gordon Best agencies.

April 8 (8-8:30 p.m.) *Adventures of Sir Lancelot*, Whitehall Pharmaceutical through Ted Bates & Co. and Lever Bros. through Sullivan, Stauffer, Colwell & Bayles.

April 8 (9:30-10:30 p.m.) *Robert Montgomery Presents*, S. C. Johnson & Son through Needham, Louis & Brorby and Mennen Co. through Grey Adv.

April 10 (8:30-10 p.m.) *Hallmark Hall of Fame*, Hall Bros. Cards through Foote, Cone & Belding.

FACTIONS HAVE SAY ON NCS FOR '56

- Nielsen radio survey questioned, criticized at RTES luncheon
- Participants in talks: Kibrick, Dorrell, Denenholz, Hoffman
- Rating service's flag still aloft at conclusion of discussion

FOUR speakers stepped up to the firing line to hurl suggestions, questions and criticisms as well as laurels at A. C. Nielsen Co.'s coverage survey of 1956 (Nielsen Coverage Survey No. 2) at an unusual forum held Tuesday in New York.

After the massive and detailed display was over, Nielsen's flag still flew aloft.

Under auspices of Radio & Television Executives Society, the luncheon forum was held particularly to discuss the radio portion of the radio-tv coverage study.

It was apparent that everybody had got his lick in—the agency, the station representative, the Nielsen firm and the individual station. The Radio NCS No. 2 has caused some consternation and controversy, since seemingly marked declines in individual radio station audiences were noted in comparing NCS No. 1 1952 with No. 2 [AT DEADLINE, Dec. 17, 1956].

About a month later, Adam Young Inc., station representative firm, issued an analysis of "limitations" of the NCS radio study asserting the alleged shortcomings ought to be kept in mind by agencies and others making use of it [B•T, Jan. 21].

Capsuled highlights of the RTES session:

- Agency (Robert Kibrick, media buyer, Kenyon & Eckhardt)—Agencies have accepted and used NCS No. 2. Some buyers are confused, however, by the "many NCS measures available" and are getting help from media research staffs but should know more about how to use them. Stations should acquaint themselves with NCS data, and an industry group ought to work out standards, classify the many ways NCS measurements can be used, suggest methods for updating, and tackle the problem of how to compute the total station audience reached.

- Nielsen (Vice President John K. Churchill)—NCS is seen as "the industry's substitute for a census of station listeners." It's the raw material that comes before other types of broadcast audience research or media analysis. NCS supplies a "uniform standard way" to determine county-by-county location and overall size of audiences. Some of the by-product findings are as important as the station information sought.

- Station Representative (Daniel Denenholz, director of research-promotion, The Katz Agency, on formulas based on NCS; Ward Dorrell, vice president and director of research, John Blair & Co., on "tremendous differences" in the survey)—They argued against the use of NCS reports as the base against which ratings are projected and the

figure of homes research for cost-per-thousand calculations (Denenholz) and sharply questioned wide "discrepancies" between NCS No. 2 and the first such survey of 1952, particularly in radio coverage patterns (Dorrell).

- Individual Station (Robert M. Hoffman, director of promotion and planning, WOR New York)—WOR, while it has "no axe to grind" on the station's position in NCS for "as far as I know every coverage measurement credits WOR Radio with the largest station audience in America," feels that the current NCS study "shortchanged" its coverage and failed to measure the entire station audience.

Speaking in defense of the survey, Mr. Churchill met Mr. Kibrick's suggestion for teams to work up standards on use of NCS with the comment that A. C. Nielsen Co. would be willing to work with the industry groups designated but warned this would take money and time.

On clustering of counties—an objection voiced by Mr. Kibrick—Mr. Churchill explained NCS did this to "save money and not waste effort" on areas deemed relatively unimportant.

In commenting on Mr. Denenholz' emphasis on the method of projecting a rating survey, Mr. Churchill cautioned that in using the Station Representative's Assn., or other such formulas, "the burden of proof is on yourself."

To a charge by Mr. Dorrell that a radio station's coverage had dropped "illogically" according to the second Nielsen survey of 1956 compared to the first completed four years previously, Mr. Churchill reminded that A. C. Nielsen Co. had cautioned against making "headlong comparisons."

Mr. Churchill also traded views with Mr. Dorrell on method used by NCS, such as how out-of-home measurement was obtained, the proportion of personal interviewing to mail balloting, size of sample, questionnaires, etc.

Meeting criticism by Mr. Hoffman, Mr. Churchill took issue with the WOR new radio study (see story, page 130), noting that he would "challenge the validity of aided recall" (WOR is using Pulse for its study cited), and added that Nielsen in its coverage survey tries to provide "all the accuracy it can" but not the "type of accuracy as stated by Mr. Hoffman."

Mr. Kibrick warned that while the media buyer's mail box is full of promotion pieces, "the stations have not helped the buyers enough in their use of the NCS data" and that "in some agency quarters the material is not being used adequately because no one has told them how to use it." While he found that agencies "credit NCS with many strengths and advantages for their buyers and analysts," Mr. Kibrick pointed to "weak points," particularly "the manner in which counties are clustered and the difficulty in



PRINCIPALS in the debate on Nielsen Coverage Survey No. 2 which took place in New York last week at a luncheon forum sponsored by Radio & Television Executives Society are (l to r) Robert M. Hoffman, director of promotion and planning, WOR New York; Daniel Denenholz, research-promotion director, The Katz Agency; Ward Dorrell, vice president and director of research, John Blair & Co.; Robert Kibrick, Kenyon & Eckhardt, and John K. Churchill of A. C. Nielsen Co.

up-dating the findings—television especially.”

He pointed out also that K&E has no “rigid rules” on how to use NCS “but in planning and reviewing our media programs we have very definite principles that guide us and within which our imperfect measuring devices must serve.”

Of the SRA formula, Mr. Kibrick said “We use it, as do many agencies, simply because it is the best make-shift device developed so far. It is easy to use. Its results are not significantly different from other methods we know about,” he observed. “We feel in the absence of total station area rating reports, additional information is needed before we can erase the shadow lingering around the formula. We need to know not only how station circulation varies county by county, but how listening intensity varies by county. If we get this, and I’d like to know whether Nielsen can supply it, there might be an additional basis for using the SRA formula as it is, or perhaps some modification of it.”

General “quality and acceptability” of the NCS “appear to be established,” Mr. Kibrick reported, and there is a general feeling among agencies that despite the error in the NCS—that “must exist in this as in other sample surveys”—the degree of error “is probably not intolerable” because of the help and benchmarks furnished by the buyers.

(The SRA formula—in simplified terms—divides a station’s home-county NCS percentage into its total-area NCS, and the local rating of a program is then projected against the result to get its total-area rating.)

The only “valid” projection that can be made to arrive at a figure of homes reached, Mr. Denenholz pointed out, is to multiply the rating by the number of radio (or tv) homes in the rating area. But once the attempt is made to project the audience beyond the rating area, “you are in trouble.”

Mr. Denenholz then proceeded to outline various formulas using NCS data to define an area for a station.

In a like manner, Mr. Denenholz combed through still other projection formulas explaining where he saw weaknesses in them, concluding that the “least bad method” was the “adjusting rating” method, *i. e.*, adjust the rating that is a percent of all radio homes in the home county to a percent of the NCS circulation in the home county and then apply this adjusted percent to the total NCS circulation.

His verdict: “We deplore the practice of projecting home county ratings to a coverage area. But we must resign ourselves to the realities—that it is being done and will continue to be done, like it or not, until we have rating surveys with a big enough sample that use the station’s full coverage area as the rating area.”

Mr. Dorrell noted that while there is “mutuality” between buyer and seller of broadcast time in the expectation of ratings or coverage, or any type measurement designed to provide information, this mutuality exists only in planning stages. Once the measurement is made known many station men are not going to agree with the

SINGLE DENOMINATOR ON ALL MEDIA

BROADCAST media deliver an advertising impression at a cost far below newspapers, newspaper supplements and magazines, judging by a media efficiency study just completed by Leo Burnett Co., major advertising agency.

The study covers the calendar year 1956. According to Leonard S. Matthews, vice president in charge of the Burnett media department, the figures rule out reliance “on concepts of the past which no longer apply in today’s moving media market.”

Frankly, the figures involve “apple and orange” comparisons, Mr. Matthews explained, but they eliminate a lot of guesswork in selecting advertising media.

These criteria form the basis of comparisons:

BROADCASTING—One person viewing or listening to a one-minute commercial as measured by Nielsen average audience ratings.

PRINT—One person noting the average four-color full-page food ad in magazines; the average black-and-white food ad in daily newspapers, as measured by Daniel Starch & Assoc.

Radio cost-per-thousand-people exposures show the lowest figure, 95 cents. Tv ranges from \$1.05 to \$1.55. Magazines run all the way from \$3.67 to \$6.48. Newspaper supplements span a similar range, \$3.71 to \$6.04. Newspapers start at \$6.59 and run to \$13.10.

“These figures represent only one way to look at a comparison of major media and do not take into consideration the many intangible factors which also must be considered in selecting media to carry a specific advertising theme,” Mr. Matthews said. “This is merely one comparison based upon a specific period of Nielsen and Starch ratings. The absolute figures are not important—the general relationships are.”

Major arguments arise in the area of relative “quality” or “impact” of advertising in the media and the “equivalence of noting” of print advertising vs. tuning to a program, he said. “Despite the cost efficiency handicap under which print must operate,” he continued, “it still can do several jobs better than broadcast media.” Finally, he emphasized the Burnett study “has eliminated much of the guesswork in picking media.”

RELATIVE MEDIA COST EFFICIENCY STUDY *

Medium	Unit	Cost Per/M People Exposures 1956
TELEVISION		
Average evening ½ hour program	1-min. commercial	\$ 1.42
Average ¼ day hour program	1-min. commercial	1.05
Daytime spots (60 seconds)	1-min. commercial	1.31
Nighttime spots (20 or 60 seconds)	1 commercial (varying length)	1.55
RADIO		
Average day quarter hour program	1-min. commercial	.95
MAGAZINES		
General weeklies	Page, 4-color	3.67
	Page, black & white	4.87
Women’s service & home service	Page, 4-color	3.76
	Page, black & white	6.48
NEWSPAPER SUPPLEMENTS		
	Page, 4-color	3.71
	Page, black & white	6.04
NEWSPAPERS		
	Page, ROP black & white	10.79
	1,000-line ROP black & white	6.59
	Page, ROP 4-color	13.10

* See media criteria in text.

SOURCES:

Broadcasting—Nielsen for program audiences and costs; American Research Bureau for program audience composition; Spot-ratings based upon fall 1956 ARB reports in 50 markets; cost from Standard Rate & Data Service, 104-time rate.

Print—Audiences from a variety of sources; Individual media; Bureau of Advertising; ANPA Daniel Starch & Assoc., etc.

so-called objective worth of their product.”

While the need for a method of measurement to permit the buyer “properly” to allocate his money among “competitors for the advertising dollar” is readily recognized, it “would be wishful thinking to hope that any one measurement would be enthusiastically accepted by each of the competitors and by the buyer.”

Mr. Dorrell then drew the analogy of the totem pole—the broadcaster sitting on top thinks the method is perfect, but the low man thinks otherwise.

“Illogical” parts of the first Nielsen coverage survey of 1952-53 he said, were ignored with broadcasters soon learning to accept and live with those measurements

deemed logical, and, he said, “it was anticipated by those who were the least bit realistic that some change in the size of the audience would be shown, [in the second survey] but I don’t believe the most pessimistic radio broadcaster anticipated the tremendous differences between NCS No. 1 and No. 2.”

WOR’s Robert Hoffman attacked the questionnaire used by A. C. Nielsen in its coverage survey, noting that it “unintentionally has a psychological bias in favor of television despite efforts by the Nielsen Co. to have people report first on radio listening and then on their television watching.”

He also was critical of what he called the

"open-end" question that he described as being based solely on unaided recall, e.g., "what tv stations have you or members of your family tuned to in the past month or so?"

Faced with such a question, Mr. Hoffman asserted, people tend to think first of stations they listen to most, and often forget to list others. "This is especially significant in the case of a coverage survey, whose primary purpose is to measure the station's coverage beyond the local rating area." Summing up, Mr. Hoffman declared his "prime reservations" on the "reliability" of NCS No. 2 were on the "way the information was obtained". Major portion of the information came from a mail questionnaire; both tv and radio were measured together, and an "open-end" question was used to obtain specific audience figures. He asserted that each factor works "in the direction of underestimating the size of the radio audience."

Mr. Hoffman concluded with this charge: "If you want to add even more confusion to the audience measurement picture, I suggest that you try to explain the differences existing in many areas between a station's standing in the NCS as compared with the NSI (the Nielsen ratings) in a station's home market.

540 Take New Nielsen Study

A. C. NIELSEN CO. reported it has a total of 540 subscribers to its Nielsen Coverage Service Study No. 2, including six agency and 18 station clients added since Feb. 1. New agency clients are Applegate Adv. Agency, Calkins & Holden, Campbell-Mithun, C. J. LaRoche, Arthur Meyerhoff and Tucker Wayne & Co.

New stations subscribers are KCNO Garden City, Kans.; KNEB Scottsbluff, Neb.; KSTP St. Paul-Minneapolis; KUGN Eugene, Ore.; KVET Austin, Tex.; KWOS Jefferson City, Mo.; WCBI Columbus, Miss.; WCCO Minneapolis; WCEC Rocky Mount, N. C.; WCKB Dunn, N. C.; WMMN Fairmont, W. Va.; WNHC-TV New Haven, Conn.; WOAI San Antonio, Tex.; WTMJ Milwaukee; WTTM Trenton, N. J.; KCEN-TV Temple, Tex.; KVWO Cheyenne, Wyo., and WKIS (FM) Orlando, Fla.

Victor Ratner Joins B&B

VICTOR RATNER, vice president of McCann-Erickson, New York, for the past four years, joins Benton & Bowles, same city, effective today (Monday), as a vice president, it was announced last week by Robert E. Lusk, president of B&B. Mr. Ratner, who has worked on new business presentations at McCann-Erickson, will be doing similar work for B&B. Before joining McCann-Erickson, Mr. Ratner was director of advertising for Macy's Department Store and prior to that was vice president and head of sales promotion at CBS.



MR. RATNER

ACTIVITY

HOW PEOPLE SPEND THEIR TIME

THERE WERE 122,378,000 people in the U. S. over 12 years of age during the week, March 17-23. This is how they spent their time:*

70.7%	(86,521,000) spent	1,853.6 million hours	WATCHING TELEVISION
56.1%	(68,654,000) spent	969.8 million hours	LISTENING TO RADIO
82.1%	(100,472,000) spent	401.7 million hours	READING NEWSPAPERS
29.2%	(35,734,000) spent	164.3 million hours	READING MAGAZINES
24.1%	(29,493,000) spent	276.5 million hours	WATCHING MOVIES ON TV
26.7%	(32,639,000) spent	138.2 million hours	ATTENDING MOVIES

These totals, compiled by Sindlinger & Co., analysts, Ridley Park, Pa., and published exclusively by B•T each week, are based on a 48-state, random sample of 7,000 interviews (1,000 each day). Sindlinger's monthly "Activity" report, from which these weekly figures are drawn, furnishes comprehensive breakdowns of these and numerous other categories, and shows the duplicated and unduplicated audience between each specific medium. Copyright 1957 Sindlinger & Co.

* All figures are average daily tabulations for the week with exception of the "attending movies" category, which is a cumulative total for the week. Sindlinger tabulations are available within 2-7 days of the interviewing week.

Schwerin Gives Remedy For Some Commercials

ANOTHER researcher has joined the ranks of those who feel tv commercials may be missing the mark.

As if to amplify last month's remarks by Dr. Ernest Dichter of the Institution for Motivational Research [B•T, March 25], Horace S. Schwerin, president of Schwerin Research Corp., charges "over a quarter of a billion dollars of advertising money is being wasted annually through ineffective commercials."

His reason—as outlined to the New Orleans Advertising Club—is that "not enough research is aimed at (the goal) . . . of unfettering rather than hampering the creative man."

In testing some 6,000 tv commercials, one of the things the Schwerin organization has discovered is the need for "better identity." Effectiveness of a commercial, noted the Schwerin Research Corp., is dependent on whether "viewers feel favorably involved with the characters, settings and events . . ."

The research group goes on to give examples: While commercials featuring a boy will be more effective among boys (and one featuring girls will be more effective among girls), boys will reject the commercials that feature a "mama's boy" running home to his mother for comforting after being hurt at play. Husbands will likewise reject commercials that stress "added leisure" for their wives. Older women will reject beauty-aid commercials delivered by young models, etc.

"Identification," declares Schwerin, "is a two-edged tool. To avoid getting wounded with the wrong end of it, asking three questions about planned commercials should prove worthwhile:

"Is someone or something featured in the commercial with which the viewer you want to reach can identify?"

"Is there some dangerously negative possibility about that someone or something?"

"If the commercial's approach does not de-

pend on identification, is there some alternative clearly-thought-out approach (convincing demonstration, persuasive mood) that will motivate the viewer to choose the product?"

By asking such questions beforehand, Schwerin points out, agencies can take "identification" out of the "just-theory" state and make it "pay handsome dividends."

Harry Witt Appointed

HARRY W. WITT, vice president, Calkins & Holden's Los Angeles office, has joined Reach, McClinton & Co. as head of agency's west coast operations. H. L. (Hay) McClinton, formerly was president of Calkins & Holden from which he resigned to become president of Reach, McClinton [AT DEADLINE, March 18]. Reach, McClinton has been appointed, effective May 15, as agency for Prudential Insurance Co. of America, Newark, N. J., a \$6 million account, after the resignation of Calkins & Holden [B•T, March 25].

Owen Joins Donahue & Co.

LEWIS F. OWEN, associate creative director, McCann-Erickson, New York, will join Donahue & Coe, same city, on or about April 22 as vice president and associate creative director. With McCann-Erickson for 18 years, Mr. Owen resigned last week.



MR. OWEN

During his tenure with the agency, Mr. Owen served for three years as tv group head and later as tv advisor to M-E's international division. He has also headed M-E's sales promotion department.

Central Iowa Loves WHO-TV!

NCS No. 2 CIRCULATION

	DAYTIME HOMES		NIGHTTIME HOMES	
	WEEKLY	DAILY	WEEKLY	DAILY
WHO-TV	181,490	121,620	211,500	166,460
Station B	175,650	123,430	204,280	163,920
Station C	176,340	104,930	218,690	148,320

It gives us a lot of satisfaction that the new Nielsen N.C.S. No. 2 runs very parallel to the audience coverage shown by the 1955 Iowa Television Audience Survey.

N.C.S. No. 2 now proves *again* that, day in and night out, WHO-TV gets into more Central Iowa homes than any other television station in the region!

You who have known the WHO *Radio* operation, over the years, will understand the Central Iowa audience preference for WHO-TV. Decades of highest integrity, public service, confidence and *believability* all add up to a **QUALITY** audience and **QUALITY RESULTS**.

WHO-TV is part of
Central Broadcasting Company,
which also owns and operates
WHO Radio, Des Moines
WOC-TV, Davenport



WHO-TV

Channel 13 • Des Moines

Col. B. J. Palmer, President
P. A. Loyet, Resident Manager
Robert H. Harter, Sales Manager



Peters, Griffin, Woodward, Inc.
National Representatives





ENERGETIC • INGENIOUS

*...and twelve months
out of every year
stations under the sign of MEEKER
benefit by:*

INGENIOUS investigation into each sales problem, looking beyond the obvious facts to develop profitable answers.

ENERGETIC endorsement of all industry organizations to promote the cause of Broadcasting and Spot Sales. We are charter members of RAB, TVB, SRA and members of NARTB.

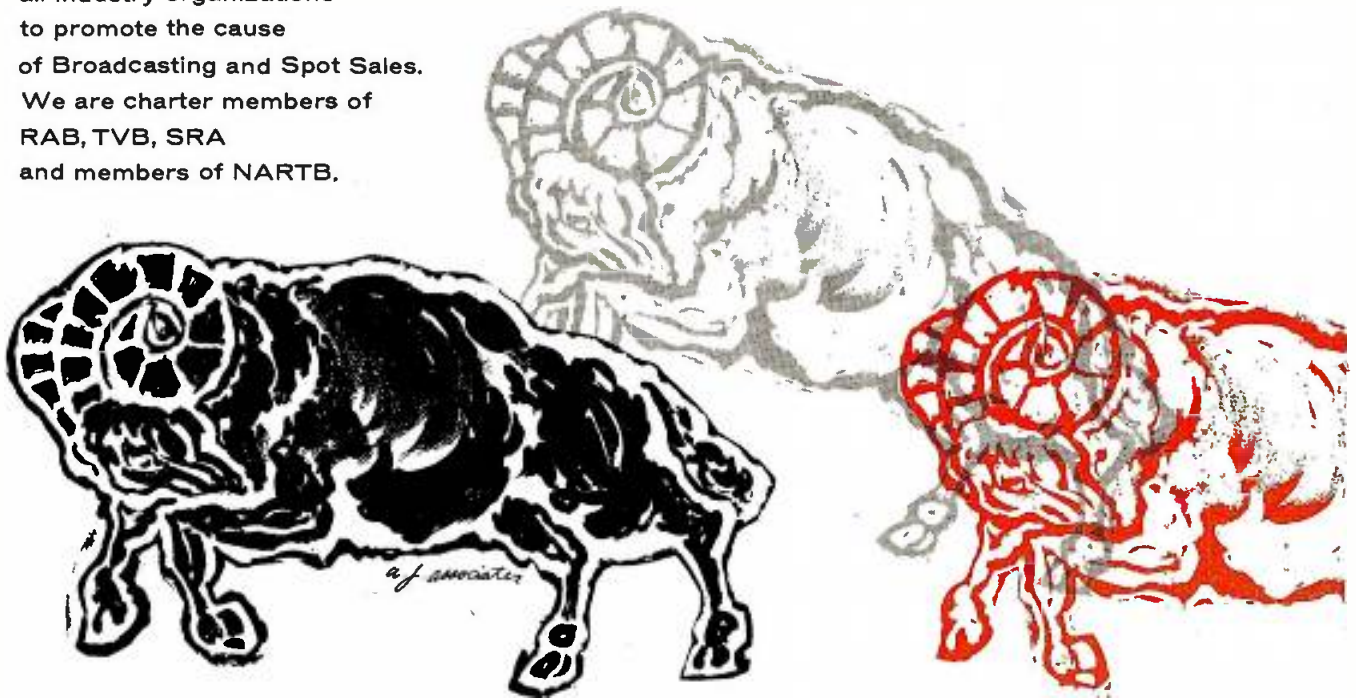

the meeker company, inc.

radio and television station representatives

new york chicago san francisco los angeles philadelphia

LATEST RATINGS

NIELSEN TV

Two Weeks Ending Feb. 23 1957

NIELSEN TOTAL AUDIENCE (†)

Rank	NUMBER OF TV HOMES REACHED (000)	Rating
1.	Ed Sullivan	17,213
2.	GE Theatre	17,017
3.	Disneyland	16,034
4.	Perry Como	15,759
5.	Alfred Hitchcock	15,445
6.	I Love Lucy	15,327
7.	Steve Allen	15,091
8.	December Bride	14,816
9.	\$64,000 Question	14,777
10.	Dragnet	14,502

NIELSEN AVERAGE AUDIENCE (‡)

Rank	Rating	
1.	GE Theatre	15,759
2.	I Love Lucy	14,738
3.	Alfred Hitchcock	14,462
4.	\$64,000 Question	13,873
5.	December Bride	13,676
6.	Dragnet	13,519
7.	Ed Sullivan	13,362
8.	Ford Show	13,166
9.	Perry Como	13,087
10.	Disneyland	12,969

PERCENT OF TV HOMES REACHED *

1.	Ed Sullivan	45.2
2.	GE Theatre	45.0
3.	Disneyland	42.0
4.	Alfred Hitchcock	42.0
5.	Perry Como	41.7
6.	I Love Lucy	40.0
7.	Steve Allen	39.7
8.	December Bride	38.8
9.	\$64,000 Question	38.5
10.	Dragnet	37.8

1.	GE Theatre	41.7
2.	Alfred Hitchcock	39.4
3.	I Love Lucy	38.4

BACKGROUND: The following programs, in alphabetical order, appear in this week's B•T tv ratings roundup. Information is in following order: program name, network, number of stations, sponsor, agency, day and time.

Alcoa Tv Playhouse (NBC-102): Alcoa (Fuller & Smith & Ross) alt. Sundays 9-10 p.m.
 Steve Allen (NBC-129): U. S. Time (Peck), Jergens (Orr), Brown & Williamson (Bates), Polaroid (Doyle Dane Bernbach), Sun. 8-9 p.m.
 Burns & Allen (CBS-145): Carnation Co. (Erwin, Wasey), B. F. Goodrich (BBDO), Mon. 8-8:30 p.m.
 Caesar's Hour (NBC-141): Knomark (Mogul), Bab-O (D-F-S), Wesson Oil (D-F-S), Carter (SSC&B) Sat., 9-10 p.m.
 Captain Kangaroo (CBS-various): Participating sponsors and agencies, Mon.-Fri. 8-9 a.m.
 CBS News (CBS-100): American Home Products (Bates), Mon.-Thurs. 7:15-7:30 p.m.
 \$64,000 Challenge (CBS-111): P. Lorillard (Y&R), Revlon (BBDO), Sun. 10-10:30 p.m.
 Climax (CBS-153): Chrysler (M-E), Thurs. 8:30-9:30 p.m.
 Perry Como (NBC-121): Gold Seal (Campbell-Mithum), Kimberly-Clark (FC&B), Noxema (SSC&B) Sunbeam (Perrin-Paus), RCA (K&E), S&H Green Stamps (SSC&B), Sat. 8-9 p.m.
 December Bride (CBS-183): General Foods (B&B), Mon. 9:30-10 p.m.
 Disneyland (ABC-178): American Motors

4.	\$64,000 Question	36.2
5.	December Bride	35.8
6.	Dragnet	35.3
7.	Ed Sullivan	35.1
8.	Perry Como	34.6
9.	Ford Show	34.3
10.	Disneyland	34.0

(†) Homes reached by all or any part of the program, except for homes viewing only 1 to 5 minutes.

(‡) Homes reached during the average minute of the program.

* Percented ratings are based on tv homes within reach of station facilities used by each program.

For a complete report to your readers, we suggest that all four NTL rankings be used.

Copyright 1957 by A. C. Nielsen Company

VIDEODEX

VIDEODEX TOP TEN NETWORK PROGRAMS

February 1-7, 1957

Name of Program	# of Cities	% Tv Homes
1.	Ed Sullivan	171 37.4
2.	Perry Como	145 33.2
3.	I Love Lucy	157 32.8
4.	Dragnet	169 32.6
5.	\$64,000 Question	175 32.2
6.	Playhouse 90	126 31.1
7.	Producer's Showcase	127 30.8
8.	Studio One	102 30.2
9.	Jackie Gleason	168 29.8
10.	Alcoa Tv Playhouse	117 29.6

Name of Program	# of Cities	# Tv Homes (000's)
1.	Ed Sullivan	171 12,381
2.	\$64,000 Question	175 10,800
3.	Dragnet	169 10,631
4.	I Love Lucy	157 10,607
5.	Perry Como	145 10,580

(Geyer-BSF&D), American Dairy (Campbell-Mitchum), Derby Foods (M-E), Wed. 7:30-8:30 p.m.
 Dragnet (NBC-168): Liggett & Myers (M-E), Schick (Warwick & Legler), Thurs. 8:30-9 p.m.
 Ford Show (NBC-172): Ford (J. Walter Thompson) Thurs. 9:30-10 p.m.
 GE Theatre (CBS-148): General Electric (BBDO), Sun. 9-9:30 p.m.
 Jackie Gleason (CBS-170): P. Lorillard (Lennen & Newell), Bulova (M-E) Sat. 8-9 p.m.
 Arthur Godfrey (CBS-99): Participating sponsors and agencies, Mon.-Thurs., 10-11:30 a.m.
 Godfrey's Scouts (CBS-163): Lipton (Y&R), Toni (North), Mon. 8:30-9 p.m.
 Alfred Hitchcock (CBS-110): Bristol-Myers (Y&R), Sun. 9:30-10 p.m.
 I Love Lucy (CBS-180): General Foods (Y&R), Procter & Gamble (Grey), Ford (J. Walter Thompson), Fri. 10-10:30 p.m.
 I've Got a Secret (CBS-189): R. J. Reynolds Tobacco Co. for Winston cigarettes (Wm. Esty Co. Inc.) Wed. 9:30-10 p.m.
 Art Linkletter (CBS-114): Participating sponsors and agencies, Mon.-Fri. 2:30-3 p.m.
 Love of Life (CBS-153): American Home Products (Bates), Mon.-Fri. 12:15-12:30 p.m.
 Matinee Theatre (NBC-56): Participating sponsors and agencies, Mon.-Fri. 3-4 p.m.
 Mickey Mouse Club (ABC-94): Participating sponsors and agencies, Mon.-Fri. 5-6 p.m.
 Modern Romances (NBC-137): Sweets (Eisen), Alberto Culver (Wade), Sterling Drug (D-F-S), Kraft (Thompson), Mon.-Fri. 4:45-5 p.m.

6.	Jackie Gleason	168	9,801
7.	Playhouse 90	126	9,707
8.	I've Got a Secret	183	9,391
9.	Producer's Showcase	127	9,360
10.	Gunsmoke	154	9,191

Copyright, Videodex Inc.

PULSE TV

TOP 20 WEEKLY SHOWS

	Feb. '57	Jan. '57
1.	Ed Sullivan	43.0 45.1
2.	I Love Lucy	34.9 37.3
3.	Playhouse 90	33.7 29.1
4.	You Bet Your Life	33.6 31.3
5.	Perry Como	32.4 33.1
6.	\$64,000 Question	32.4 32.0
7.	Climax	30.2 28.9
8.	Disneyland	29.1 30.2
9.	GE Theatre	28.9 31.8
10.	December Bride	28.3
11.	Alfred Hitchcock	28.2 31.3
12.	Jackie Gleason	28.1 27.8
13.	Godfrey's Scouts	27.7 30.1
14.	Phil Silvers	27.5 28.1
15.	Producer's Showcase	27.4
16.	Burns & Allen	27.3 28.1
17.	What's My Line	26.8 30.2
18.	\$64,000 Challenge	26.2 27.2
19.	Jane Wyman	26.0 25.8
20.	Wyatt Earp	25.3

TOP 12 MULTI-WEEKLY

1.	Mickey Mouse Club	20.1 13.6
2.	Queen For A Day	12.9 11.5
3.	NBC News	10.7 10.2
4.	Arthur Godfrey	10.2 9.8
5.	Art Linkletter	9.5 9.1
6.	Captain Kangaroo	9.4 9.1
7.	Garry Moore	9.0 8.3
8.	Love of Life	8.8 9.1
9.	CBS News	8.7 8.6
10.	Modern Romances	8.6 8.3
11.	Matinee Theatre	8.6
12.	Search For Tomorrow	8.6 9.1

Garry Moore (CBS-116) Participating sponsors and agencies, Mon.-Thurs. 10-10:30 a.m., Fri. 10-11:30 a.m.
 NBC News (NBC-116): Participating sponsors and agencies, Mon.-Fri. 7:45-8 p.m.
 Playhouse 90 (CBS-188): Philip Morris (Burnett), American Gas Assn. (Lennen & Newell), Ronson (Norman, Craig & Kummel), Bristol-Myers (BBDO), Singer Sewing (Y&R), Thurs. 9:30-11 p.m.
 Producer's Showcase (NBC-105) RCA-RCA Whirlpool (K&E), John Hancock (M-E), Monday 8-9:30 p.m.
 Queen for a Day (NBC-132): Participating sponsors and agencies, Mon.-Fri. 4:30-5 p.m.
 \$64,000 Question (CBS-148): Revlon (BBDO), Tues. 10-10:30 p.m.
 Search for Tomorrow (CBS-125): Procter & Gamble (Burnett), 4-4:15 p.m.
 Phil Silvers (CBS-165): R. J. Reynolds (Esty), Amara Refrigeration (Maury, Lee & Marshall), Tues. 8-8:30 p.m.
 Strike It Rich (CBS-130): Colgate-Palmolive (Esty), Mon.-Fri. 11:30-noon.
 Studio One (CBS-99): Westinghouse Electric Corp. (M-E), Mon. 10-11 p.m.
 Ed Sullivan (CBS-185): Lincoln-Mercury (K&E), Sun. 8-9 p.m.
 Wednesday Night Fights (ABC-176): Mennen Co. (M-E), Wed. 10-11 p.m.
 What's My Line (CBS-87): Jules Montenier (Ludgin), Remington Rand (Y&R), Sun. 10:30-11 p.m.
 Jane Wyman (NBC-132): Procter & Gamble (Compton), Tues. 9-9:30 p.m.
 You Bet Your Life (NBC-155): DeSoto (BBDO), Thurs. 8-8:30 p.m.
 Your Hit Parade (NBC-176): American Tobacco (BBDO), Warner - Lambert (K&E), Sat. 10:30-11 p.m.

HOW THEY'LL COVER THE MAJORS

MAJOR and minor league baseball coverage by radio and tv stations and networks, augmented by heavy schedules of pre-game and post-game features as well as adjacencies, will exceed \$65 million during the 1957 season, judging by a B•T roundup.

Tv coverage of games continues to increase, though the Milwaukee Braves and Kansas City Athletics still refuse to permit camera coverage.

An important trend this season appears in the increased number of games to be telecast on national and regional networks. Both CBS-TV and NBC-TV have Saturday games and Sports Programs Inc., New York, is lining up a Sunday tv schedule.

Agencies and advertisers were still negotiating for coverage rights to portions of some games, with split sponsorship increasing each year. (The major league season opens April 15.) Radio coverage of training camp activities and games is being carried on an unprecedented basis.

As usual the beer and tobacco sponsors are prominent in the list of advertisers. Oil companies again are active. Busch beer, companion beer of Budweiser (Anheuser-Busch), is a heavy buyer of baseball this year. Last year Busch was active in radio and tv sports, probably ranking next to Falstaff among brewery

time buyers. Other sponsors include food producers, soft drinks, restaurants, and auto dealers and accessories.

Mutual will continue with its *Game of the Day* broadcasts for the eighth straight year, covering day games on a seven day per week basis. In the event a major league game is not available, the program will cover an outstanding minor league game. The broadcasts will be sponsored on Saturday by Quaker State Oil Refining Corp. (Kenyon & Eckhardt) in 367 markets and on other days will be sold on a local co-op basis.

CBS-TV will begin the third year of its *Game of the Week* telecasts on Saturday afternoons, with sponsorship in 170 markets by Falstaff Brewing (Dancer-Fitzgerald-Sample), American Safety Razor Co. (McCann-Erickson) and Marlboro cigarettes (Leo Burnett). The telecasts will originate in 10 National and American League parks and will cover 26 games.

NBC-TV for the first year also will carry a 26-week schedule of American and National League games on Saturday afternoons in 130 markets, with one-quarter sponsorship by R. J. Reynolds Tobacco Co. (Wm. Esty Co.). In the event that no additional national sponsor is obtained, NBC-TV will offer the remainder of the schedule on a local co-op basis. The games will feature 13 major league clubs.

GIANTS

WMCA New York will carry a total of 170 games this season. This includes eight exhibition games between March 9 and April 7. Sponsor, Jacob Ruppert Brewery (Ruppert, Knickerbocker, Ruppiner beers), New York, through Warwick & Legler Inc., New York, also will feed audio to some eight or nine northeast stations.

WPIX (TV) New York, which will carry a total of 154 games (Giants and Yankees on alternating basis), has scheduled its season April 16 to Sept. 29, but will carry exhibition games beforehand. Of the 154, 16 will be doubleheaders and 37 night games. Ruppert will sponsor the Giants games, and will also sponsor video feed on two as-yet-undesignated stations in New England.

YANKEES

WINS New York will air all 193 games, including 35 exhibition games, March 9-April 15, and 154 regular games in the season beginning April

16. Games are sponsored by P. Ballantine & Son (beer) and R. J. Reynolds Tobacco Co., both through William Esty Co., New York. Games will be fed to 30 stations in upstate New York, New England, New Jersey and Pennsylvania.

WPIX (TV) New York, in its dual coverage of Yankee and Giants games, will air Yankee home games, also under Ballantine-Reynolds sponsorship. Its scheduling for the Yankees began March 23 when it picked up the first of two exhibition games from Miami between the Yanks and the Dodgers, and will also include a repeat exhibition game from New York April 14.

DODGERS

Radio sponsorship of the complete 152-game schedule on WMGM New York, will be by the F & M Shaefer Brewing Co., Brooklyn, N. Y., and American Tobacco Co., New York (both through BBDO, New York). All games will be fed to a 19-station hookup in upstate New York, Connecticut, Massachusetts and

Pennsylvania. The same sponsors will present 77 home and 25 road games on WOR-TV New York with 58 of the telecasts in the evening.

PIRATES

The complete schedule will be broadcast on KDKA Pittsburgh by Pittsburgh Brewing Co., through Ketchum, McLeod & Grove, Pittsburgh, and Atlantic Refining Co., Philadelphia (N. W. Ayer & Son, Philadelphia), and will be relayed to 10 stations in Pennsylvania, West Virginia and Maryland. The same advertisers will sponsor 24 games of the Pirates' schedule on weekends over KDKA-TV Pittsburgh, said to mark the first time that Pittsburgh games have been telecast on a regular basis. Feeds will go to WSTV-TV Steubenville and WJAC-TV Johnstown.

PHILLIES

WIP Philadelphia will carry the full schedule, with Atlantic Refining (Ayer), Ballantine Beer (Wm. Esty Co.) and Tasty Baking Co. (Ayer) and

AGENCY APPOINTMENTS

Procter & Gamble Co. appoints Grey Adv., N. Y., to handle Pin-It home permanent, switching account from Benton & Bowles. Grey also handles P & G's Lilt and Party Curl home permanents. B & B will continue to handle Ivory Snow, Tide, Crest and Prell among other products.

RCA Victor Distributing Corp. (Chicago branch) appoints Kenyon & Eckhardt Inc.

Best Foods Inc., N. Y., appoints Guild, Bascom & Bonfigli, same city, for its Nucoa margarine, effective in mid April, switching account from Dancer-Fitzgerald-Sample, N. Y.

Fla. Land & Homes Bureau, Daytona Beach and N. Y., seller-developer of Fla. real estate, appoints Hoffman-Manning Inc. N. Y.

Doyle Packing Co. of New Jersey (Strongheart dog food), Long Branch, N. J., appoints Geyer Adv., N. Y., to service its account along the eastern seaboard and west to Buffalo and Pittsburgh, succeeding Roy S. Durstine Inc., N. Y.

A&A SHORTS

Leo Burnett Co., Chicago, announces it will pay \$647,000 from its 1956 earnings into company's employes profit sharing trust. Payment was described as largest in 14-year history of trust, which comprises 437 of agency's 690 employes.

Hixson & Jorgensen Inc., L. A., opening new office in Grosvenor Bldg., 500 Wall St., Seattle, for purpose of serving Richfield Oil Corp.'s tv program, *Success Story*. Edward Arndt, producer of show, named

manager of new office and Bob Denby appointed to handle publicity-promotion. Elaine Younglove named office secretary.

A&A PEOPLE

William T. Miller, president-general manager of Colgate-Palmolive Co.'s Mexican subsidiary, elected vice president in charge of company's newly-created household products division.

Joseph I. George, marketing director, Wilson, Haight, Welch & Grover Inc., Hartford, Conn., elected vice president.

Joseph H. Caro, vice president of The Buchen Co., Chicago, elected senior vice president.

Jack W. Edwards, Grant Adv. Inc., S. F.,

Bayuk Cigars (Feigenbaum & Wermen, Philadelphia) sharing sponsorship. A network of 16 radio stations in Pennsylvania and Delaware will carry the games on a feed. A 75-game home-and-away schedule has been arranged for television with the same sponsors as in radio. Carrying 25 games each will be WRCV-TV and WFIL-TV Philadelphia and WPFH (TV) Wilmington-Philadelphia. Thirty-nine games of the tv schedule will be relayed to WGAL-TV Lancaster and WILK-TV Wilkes-Barre.

RED SOX Sponsorship of the Boston team's complete schedule of games will be divided by Atlantic Refining (Ayer), Narragansett beer (Cunningham & Walsh) and Liggett & Myers' Chesterfield cigarettes (McCann-Erickson). The broadcasts will be picked up by 50 stations of a New England regional network. The radio advertisers also will sponsor 51 games of the schedule over WBZ-TV Boston, which will be fed to WNBC-TV Hartford, WJAR-TV Providence, WHYN-TV Holyoke, Mass., WCHS-TV Portland, Me., and WABI-TV Bangor, Me.

SENATORS Thirteen exhibition games and all 154 regular season games will be sponsored (under a three-year contract), live on WWDC Washington, which also will feed a 50-station radio network. National Brewing Co. is sponsoring 4½ innings of each regular season game, and all nine innings of pre-season games, and the other half of regular schedule is to be sold participating. On television, National also is sponsoring 48 Senators games, 24 home and 24 away, on WTTG (TV). Agency for National is W. B. Doner Co., Baltimore.

ORIOLES Gunther Brewing Co. will sponsor 58 games of the Orioles on the three Baltimore tv stations (WMAR, WBAL-TV, WAAM) using a rotating schedule. A tv network will include Washington; Salisbury, Md.; Harrisburg and York, Pa. All 154 Orioles games will be carried by Gunther on WBAL Baltimore, which will feed a 36-station hookup. WBAL-TV will handle pickup during first half of season, WMAR during second half. WTOP Washington is carrying 119 Orioles games, half of them under Gunther sponsorship, and WTTG (TV) Washington will present 26 Oriole games at night or weekends—also sponsored by Gunther. The beer company's

agency is Sullivan, Stauffer, Colwell & Bayles.

WHITE SOX All games will be carried on WCFL Chicago with General Finance Co. buying half of every other game on a 58-station network. Gordon Best Co. is General agency. Other sponsors sharing this schedule are Oklahoma Oil Co., through Maryland Adv. Agency; General Cigar Co., through Young & Rubicam, and Anheuser-Busch (Busch beer) through Gardner Adv. Co. St. Louis. WGN-TV Chicago will carry 55 home daytime games. Sponsors are Theodore Hamm Brewing Co., through Campbell-Mithum, Minneapolis, and Oklahoma Oil Co.

CUBS Four sponsors will broadcast radio play-by-play on WIND Chicago, covering the entire schedule. Sponsors are Pabst Brewing Co., through Leo Burnett Co.; Oklahoma Oil Co. and Perfect Power (Standard Oil of N. J.); General Finance, and Sidney Smith Enterprises (restaurants), through W. B. Doner & Co. WIND will feed a 30-station hookup. Pabst is sharing some of the network schedule. WGN-TV will telecast the 77-game home schedule. Sponsors are Theodore Hamm and Oklahoma Oil.

BRAVES No telecasting is permitted. WTMJ and WEMP Milwaukee will share all home and road games under sponsorship of Miller Brewing Co. and Clark Oil & Refining Co., both placed by Mathisson & Assoc. Miller is buying a 38-station network, alternating innings with Clark.

CARDINALS Half of each game for the entire schedule will be sponsored on KMOX St. Louis, by Anheuser-Busch (Busch beer), with the other half for local sale. KMOX will feed a 90-station network in three states. KTVI (TV) will telecast 65 road games starting in late April after the station moves from ch. 36 to ch. 2. Busch agreed to sponsor all tv coverage if no co-sponsor is signed.

ATHLETICS KMBC Kansas City will feed a 47-station network. Jos. Schlitz Brewing Co. is sponsor, placing through Majestic Adv. Agency, Milwaukee. Schlitz is paying the full bill in some markets and part in others. No tv coverage is allowed.

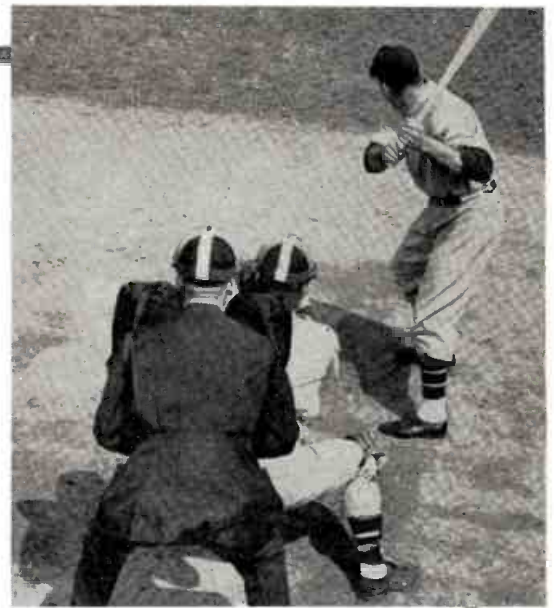

TIGERS Radio-tv simulcasting will be sponsored on WJBK-AM-TV Detroit by Goebel Brewing Co., placing through Campbell-Ewald Co., and Speedway Petroleum, placed by W. B. Doner. Radio coverage goes to 25 stations. WJBK-TV will key coverage of 45 home and road games to WJIM-TV Lansing, WKZO-TV Kalamazoo, WWTV (TV) Cadillac, WNEM-TV Bay City, all Michigan, and WSPD-TV Toledo.

INDIANS Radio coverage of all games will be sponsored on WERE Cleveland by Carling Brewing Co., through Lang, Fisher & Stashower, and Central National Bank, through Fuller & Smith & Ross. Carling will sponsor half of games on some stations in a 45-station hookup. Fifty-four home and road games will be telecast on WEWS (TV) by Standard Oil Co. of Ohio, through McCann-Erickson, and Carling.

REDLEGS Burger Brewing Co., through Midland Adv. Agency, is sponsoring the complete radio schedule on WKRC Cincinnati and feeding 45 stations. WLWT (TV) will telecast 53 games under sponsorship of Hudepohl Brewing Co., through Stockton, West & Burkhart, and local Ford dealers through J. Walter Thompson Co. WLWT will feed Crosley's WLWC (TV) Columbus, and WLWD (TV) Dayton.

named vice president-manager of Grant's Dallas office.

Philip Brooks and John Rockwell, account executives, Doherty, Clifford, Steers & Shenfield Inc., N. Y., elected vice presidents.

Shepard Spink, formerly vice president of Crowell-Collier Publishing Co., to American Airlines, N. Y., as vice president of merchandising.

Guy A. Leriche, French auto rental executive, to Hertz System Inc., Chicago, as vice president. He will direct European division of Hertz.

Jack F. Kerr, account executive, Raymond R. Morgan Co., Hollywood, to Hixson & Jorgensen Inc., L. A., as vice president-account supervisor.

Robert E. Gorman promoted from advertising director to vice president in charge of advertising for Allstate Insurance Co. (subsidiary of Sears, Roebuck & Co.), Chicago.

John P. Scholl and Van Cunningham, account executives, Doyle, Kitchen & McCormick, N. Y., named vice presidents.

Edwin W. Buckalew, director of sales, Wayne Steffner Prod. Inc., Hollywood, named vice president in charge of sales.

Paul Doniger, vice president-media director, Battistone, Bruce & Doniger Inc., N. Y., to Hoffman-Manning Inc., same city, as account executive-media consultant.

Thomas Peterson, owner of Peterson Adv. Agency, Fort Dodge, Iowa, to L. W. Ram-

sey Adv. Agency, Chicago and Davenport, Iowa, as account executive specializing in farm market.

Donald Plouff, president of Fessel & Plouff, Louisville, Ky., to Grey Adv., N. Y., as account executive. **Helen Marshall**, publicity information representative with TWA, also has joined Grey as copywriter.

Montgomery N. McKinney, account supervisor, Leo Burnett Co., to Doyle Dane Bernbach, L. A., in similar capacity.

Robert L. Edens, copy group supervisor, Warwick & Legler, N. Y., named copy chief.

Albert W. Reibling, general manager of radio-tv department, Kudner Agency, N. Y., to Ted Bates & Co., radio-tv department as assistant business manager.

TV FACES NEW BARGAINING WITH ASCAP

Last time it took 4½ years and \$100,000 expenses to reach agreement

BROADCASTERS will begin next week to grapple with one of the thorniest problems in the business—that of negotiating new ASCAP music performance licenses for television.

One entire morning during the NARTB convention will be devoted to this specific problem. Its significance is emphasized by the fact that NARTB, while not itself sponsoring the meeting, nevertheless rearranged the convention schedule to accommodate it. Moreover, the meeting will be opened to non-members (at \$5 each) as well as members of NARTB [B•T, March 11].

Out of the meeting, slated Thursday morning, is expected to come the makings of an all-industry copyright committee operating outside NARTB.

Main order of business for the session is expected to be (1) a review of the problem, with emphasis on the disproportionately high payments which broadcasters make to ASCAP as compared to those made by other ASCAP licensees, and (2) an appraisal of possible approaches which broadcasters might take to get more favorable rates in the forthcoming new tv licenses.

The current tv licenses expire Dec. 31 of this year. A clue to the magnitude of the problem ahead is that negotiating the present licenses took approximately four and a half years during which the industry-wide negotiating committee and its members spent more than \$100,000 for legal, research, travel and other expenses. ASCAP and the committee reached agreement early in 1954, and networks and stations accepted the contracts for four-year terms retroactive to Jan. 1 of that year.

The ASCAP radio licenses, which became effective Jan. 1, 1949, for a nine-year term, expire Dec. 31 of next year.

Chief complaint of telecasters is sure to be that the current ASCAP rates are far too high. ASCAP, on the other hand, is expected to hold out for more, not less.

The rate for use of ASCAP music on commercial tv programs, under the local blanket contracts now in effect with stations, is 2.05% of time sales, plus a sustaining fee of the station's highest quarter-hour card rate per month. For network business the fee is slightly higher: 2.5% of time sales, plus a sustaining fee of 110% of the highest half-hour rate per month.

The current per-program tv licenses, which a minority of broadcasters elected to sign four years ago in preference to the blanket contracts, call for a commercial rate of 9% of net revenue from the sale of time or announcements during which ASCAP music is used, except that when ASCAP music is used only as background on films not made primarily for television the rate is 4%. The per-program sustaining rate is 3.5% of the card rate applicable

to each sustaining program carrying ASCAP music, but the total annual sustaining fee may not exceed 12 times the station's highest quarter-hour rate.

The blanket rates represent a reduction of approximately 20% from those which had been in effect before—a fact which ASCAP may be expected to emphasize in the forthcoming negotiations.

But to broadcasters the rates still seem far out of line. For instance, these broadcasters point out, by all odds the greatest volume of ASCAP's revenues comes from the broadcasting industry—in 1956 probably more than 80% or close to \$20 million of ASCAP's total income, which, also unofficially, is around \$24 million.

To emphasize his point that other licensees "pay practically nothing" to ASCAP, compared to the radio-tv payments, one broadcaster noted that ASCAP cannot charge motion picture exhibitors under outstanding court rulings, and that a motion picture producer will pay only a very small fee for a film at the time he negotiates the so-called

forthcoming negotiations is the three-year-old suit, still pending, which was brought by a group of songwriters—all of them ASCAP members—seeking to dissolve NARTB, divorce Broadcast Music Inc. from its broadcasting ownership, and collect \$150 million in damages [B•T, Nov. 16, 1953, *et seq.*].

Pre-trial examinations in that suit have made it clear that the suing songwriters' major complaint is directed against broadcasters' programming practices—in short, that broadcasters discriminate against ASCAP music in favor of BMI music, with the result that ASCAP music doesn't get the proper build-up and that therefore ASCAP members aren't getting as much money from their songs as they ought to get.

Thus ASCAP, even though it disassociates itself as an organization from the songwriters' suit, presumably would find it embarrassing to enter the negotiations willing to accept lower rates. This phase of the problem is no less acute because of the fact

ASCAP Releases Names of New Board Members

ELECTION of writer members and publisher members to the board of American Society of Composers, Authors & Publishers, effective today (Monday), was confirmed last week by ASCAP President Paul Cunningham.

The writer members in the popular-production field were Stanley Adams, L. Wolfe Gilbert, Oscar Hammerstein II, Otto A. Harbach, Alex C. Kramer, George W. Meyer, Ned Washington, Jack Yellen and Mr. Cunningham. Ned Washington replaces the late Gene Buck in the popular-production field of writer members of the board. In the standard writer group, Deems Taylor,

John Tasker Howard and Dr. Douglas Moore were elected. Dr. Moore replaces incumbent A. Walter Kramer.

The publisher directors elected in the popular-production group were Louis Bernstein, Saul H. Bourne, Irving Caesar, Max Dreyfus, John D. Marks, Jack Mills, Maurice Scopp and Herman Starr. John D. Marks, president of St. Nicholas Music Inc., replaces J. J. Robbins of Words & Music Inc. The publisher directors elected in the standard group were Frank H. Connor, Gustave Schirmer and Adolph Vogel of Elkan-Vogel Co. Mr. Vogel succeeds incumbent Donald Gray of H. W. Gray Co.

sync rights with the publisher. But the same film when carried on television requires a substantial payment to ASCAP by the telecaster.

Tv authorities also stress that television's dependence on music is much less than radio's. The current ASCAP tv rates are approximately 10% below those for radio, but in dollars tv's payments are rising steadily. Unofficial estimates for last year indicate that of the approximately \$20 million paid in by radio-tv, about half came from tv and about half from radio. Accordingly, these telecasters argue, the past trend toward lower ASCAP rates for tv, vis-a-vis those for radio, should be extended in the new negotiations as they were in the last. Before that, the tv rate had run 10% higher than the rate for radio.

A major complicating factor in the

that ASCAP's own president, Paul Cunningham, is one of the 33 songwriter-plaintiffs.

And yet it is a fact that ASCAP and the industry negotiating committee agreed upon the current contracts after, rather than before, the songwriters' suit was filed. Broadcasters see in this an indication that ASCAP not only was satisfied with the new license terms but was willing to risk criticism from its litigating members, including the member who later became president, Mr. Cunningham. Indeed, some ASCAP authorities at the time were quoted as saying the rates were "advantageous."

Broadcasters point out that it also is a fact that ASCAP could accept substantially lowered rates and still, because of the sizeable increase in the number of stations and in their time rates since 1954, net substan-

in **BOSTON**

ALL* of the Top Ten
Syndicated Film Programs
are on

wnac-tv

*10 out of 10 **ARB**, January 1957
and

10 out of 10 **PULSE**, December 1956

*...If you're buying **BOSTON**
select the Leader...*

wnac-tv **7**
CHANNEL

the kids are eating their spinach again

Spinach rates high with the kids when Popeye's back in town. So does Popeye himself. In 21 cities across the country—all markets rated thus far by ARB—Popeye cartoon programs earned a resounding rating of 16.2 on a weekly average, regardless of station, time-period or competition.

Here are the actual figures: WBZ-TV, Boston, 20.7; WBEN-TV, Buffalo, 14.4; WBBM-TV, Chicago, 14.0; WBNS-TV, Columbus, 13.9; KBTU, Denver, 23.3; WDSM-TV, Duluth-Superior, 25.2; KTLA, Los Angeles, 12.0; WTVJ, Miami, 15.9; WPIX, New York, 14.9; KPHO-TV, Phoenix, 16.6; WCSH-TV, Portland, Me., 15.2; WPRO-TV, Providence, 19.5; KCRA-TV, Sacramento, 10.7; KUTV, Salt Lake City, 14.2; KFSD-TV, San Diego, 15.5; KRON-TV, San Francisco, 10.6; WSBT-TV, South Bend, 14.9; KREM-TV, Spokane, 18.7; KTVX, Tulsa, 14.9; KFDX-TV, Wichita Falls, 13.6; WFMJ-TV, Youngstown, 20.0.

So—never mind the spinach sales.
To snare audience and advertiser alike,
let Popeye make a muscle in your area.
For details, write or phone

a.c.p. Inc.

345 Madison Ave.,
New York City, MURRAY HILL 6-2323

CHICAGO: 75 E. Wacker Dr., DEARBORN 2-4040

DALLAS: 1511 Bryan St., RIVERSIDE 7-8553

LOS ANGELES: 9110 Sunset Blvd., CRESTVIEW 6-5886

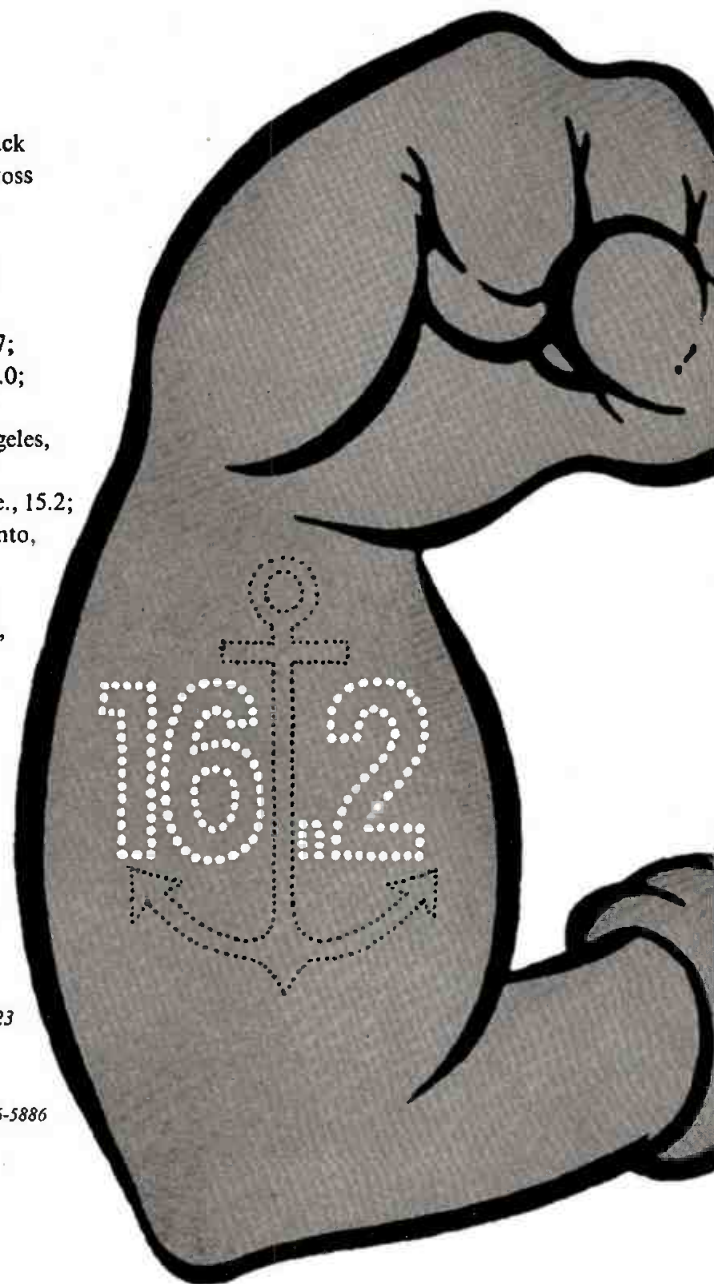



tially more money than the society was getting then.

The continued existence of the songwriters' suit also raises legal questions bearing on the negotiations. ASCAP is an unincorporated society. Broadcasters note that if ASCAP is not bound by the radio-tv contracts—which would seem to be one implication of the suit, since a stated objective of the litigation is to get more money from broadcasting—then obviously the contracts are one-sided, binding only on the broadcasters. In short, by this reasoning, the contract establishes a "floor" but imposes no "ceiling" on what members of ASCAP feel broadcasters should pay.

The negotiations must also be considered against the background of Congressional probing of the years-old ASCAP-BMI fight. ASCAP members reiterated their charges of broadcaster discrimination against ASCAP at great length in last fall's tv hearings before the House Antitrust Subcommittee. And only 10 days ago, counsel for the House Small Business Subcommittee No. 5 indicated that its proposed investigation of ASCAP royalty distribution and voting procedures would be broadened to include a probe of ASCAP complaints against BMI [B•T, March 25].

Joseph L. Nellis, special counsel for Subcommittee No. 5, which is headed by Rep. James Roosevelt (D-Calif.), said the group had about 60 complaints against ASCAP, including charges by ASCAP members that the society's royalty distribution methods and voting formula are "unfair and inequitable."

BMI Sooner or Later

Mr. Nellis said he hoped to confer with ASCAP officials and complaining members on May 11 and that sometime afterward he would talk with BMI executives, before a hearing is started. Any investigation involving ASCAP, he said, involves BMI "sooner or later."

In looking toward the forthcoming negotiations, some telecasters—especially those who feel the continued existence of the songwriters' suit implies that radio-tv contracts do not really bind ASCAP—think the best course would be to ask the courts to fix a reasonable fee. This course is open under a 1950 amendment to the consent decree which ASCAP signed in the early 1940's, when it agreed to reorganize along non-monopolistic lines. Indeed, toward the end of the last negotiations some 80 telecasters initiated action to have the court determine the rates, but dropped it when ASCAP accepted the terms offered by the all-industry negotiating committee.

The availability of this court course also offers one bright collateral assurance: Even if ASCAP and the broadcasters become hopelessly deadlocked in their own negotiations, there need be no repetition of the early months of 1941 when radio stations, rather than accept ASCAP's terms, operated without ASCAP tunes altogether.

JUSTICE DEPT. SUES LOEW'S INC. FOR BLOCK-BOOKING TV FEATURES

- It's second court action in government's tv probe
- But main investigation still aimed at tv networks

THE SECOND antitrust suit to spring from the Justice Dept.'s relentless investigation of television was filed last week in New York.

This one charged Loew's Inc. with block-booking MGM feature films to television stations.

It followed by less than four months the filing of a government suit against RCA-NBC for allegedly coercing Westinghouse into an exchange of Philadelphia and Cleveland stations [B•T, Dec. 10, 1956].

Though both suits contain implications of wide concern in the television field, neither is more than a byproduct of the main investigation which the Justice Dept. has been conducting for almost exactly a year. That investigation, B•T learned last week, is proceeding under full draft on the course chartered at its outset.

The main effort is still primarily directed at the television network business.

That the Justice Dept. had embarked on a major probe of networks was officially announced last September when Assistant Attorney General Victor R. Hansen, in charge of the Antitrust Division, testified before the House Antitrust Subcommittee.

At that time Mr. Hansen said that since the previous March, Justice Dept. attorneys—reinforced by FBI agents—had been engaged in an investigation which "now spans every relevant facet of network operations." The probe, he said, "embraces (1) the pricing of shows, both network and independent; (2) discounts; (3) rebates; (4) program rejections; (5) kinescoping; (6) production facilities, both live and film; (7) demand for and supply of network time; (8) the percentage of prime network time occupied by network-owned or controlled shows; (9) scenery and set production, and finally (10) long-term contractual arrangements by networks with talent, actors, producers and directors."

Mr. Hansen predicted last September that it would take from one to two years to complete the investigation.

The project is now one year old. It was learned on high authority last week that the Justice Dept. has not modified Mr. Hansen's timetable.

THE SUIT which the government filed last week in federal court in New York charged that since Loew's began to sell its backlog of more than 700 pre-1948 MGM feature films to tv last year, it had refused to sell less than the entire package.

The government said that Loew's had licensed its package "to many television stations in many different markets." It added that in "at least three instances" the film company had taken 25% interests in tv stations as payment for the MGM features. Although the stations were not named in the

suit, they are KTTV (TV) Los Angeles, KMGH-TV Minneapolis and KTVR (TV) Denver.

This method of selling, the complaint alleged, had four effects:

- Tv stations have been forced to buy features they didn't want.

- The playing time of stations has been "arbitrarily preempted, thus preventing them from securing film from other producers and distributors."

- Stations which couldn't afford to buy the full package have been prevented from buying the number of films they could afford.

- Stations have played "inferior" films which they would not have played if they had not been forced to buy them in the package.

The suit asked for an injunction to prevent Loew's from insisting that its customers buy the MGM films as a group. The court was also asked to direct Loew's to



HANSEN OF JUSTICE
TRUST BUSTER GOES AFTER FILM

renegotiate existing contracts with tv stations "so as to give any . . . station an opportunity to license defendant's feature films on a picture-by-picture and station-by-station basis."

Commenting on the suit, Assistant Attorney General Hansen compared the Loew's television sales practice to that outlawed in the motion picture industry.

"In the 1948 Paramount case," Mr. Hansen said, "the Supreme Court declared illegal the compulsory block-booking of copyrighted feature motion pictures. While that decision was given in the context of the theatrical motion picture industry, we be-

● ONE OF A SERIES



- American Meat Institute
- American Oil Company
- American Tobacco Co.
- Brock-Hall Dairy Co.
- Bruns, Nordeman and Co.
- Budweiser Beer
- Castro Convertibles
- Calo Dog Food
- Cerribelli Co.
- Chesebrough-Pond's, Inc.
- Chrysler Corp.—Chrysler Div
- Continental Baking Co.
- Curtis Circulation
- Diamond Crystal Salt
- Dolcin Corporation
- Drackett Company
- Dromedary Dates
- Duffy-Mott Company
- Eveready Batteries
- Ex-Lax, Inc.
- Ford Dealers Association
- General Foods Corp.
- General Motors Corp.
- Good Humor
- Grand Union Stores
- Gulf Oil Corporation
- Robert Hall Clothes
- H. B. Cough Drops
- H. P. Hood & Sons, Inc.
- Household Finance Corp.
- Jack & Jill Cat Food
- Keebler Biscuit Company
- Lever Brothers
- Time, Inc.
- Liggett & Myers
- Lincoln-Mercury Corp.
- Martinson's Coffee
- Maryland Pharmaceutical
- Miles Shoes
- Monarch Wine
- Montebello Liquors
- Narragansett Brewing Co
- National Biscuit Company
- National Cranberry Assoc
- The Nestle Company
- North American Dye Corp.
- Perkins Products Company
- Pillsbury Pie Crust
- B. Pio, Incorporated
- Plough, Incorporated
- Readers Digest
- R. J. Reynolds Company
- O. M. Scott & Sons, Inc.
- Shell Oil Company
- Sunkist Growers
- Tetley Tea Company
- Texas Company
- Welch Grape Juice
- Welch Tomato Juice
- White Rose Tea
- J. B. Williams Co.

Partial list of WAVZ advertisers.

“You’re in Good Company on WAVZ”

WAVZ's success spells success for many of its national advertisers. That's why so many use New Haven's Number One* Station.

*October 1956 pulse

WAVZ dominates every quarter hour.

Representatives: National: Hollingbery Co.
New England: Kettell-Carter



152 TEMPLE STREET, NEW HAVEN, CONN.

Daniel W. Kops, Executive Vice President and General Manager • Richard J. Monahan, Vice President and Commercial Manager

A black and white illustration depicting a scene of birds feeding. In the upper portion, a single bird is shown in flight, its wings spread wide, flying towards the right. Below it, a large, textured mound of earth or sand rises. At the base of this mound, a group of approximately seven birds is gathered on the ground, which is covered with numerous small, oval-shaped seeds. The birds are shown in various postures, some pecking at the ground, indicating they are eating. The overall style is that of a classic illustration, possibly from a children's book or a nature magazine. The text "good spot to be in!" is written in a bold, italicized font across the middle of the image, positioned over the mound of earth.

good spot to be in!



Easy pickings for some... a serious step for others. Depends who, what and where you are, and everybody's different.

Of all national sales media, spot television is most effective at catering to *local differences* and adapting to *local problems*. Consider the recent experience of the Arkansas Rice Growers Cooperative Association.

Short-grain rice was selling like hotcakes in eastern South Carolina, the nation's second-largest rice consuming area, but—because of local tastes—long-grain rice was not. Until WBTW, Florence, came up with a summer schedule tailored to build a demand for the long-grain variety. Then, according to E. G. Wells, Jr., of W. H. Sydnor & Co., food brokers: "Sales of our Riceland Long-Grain Rice for the period of June through November 1956 showed an *increase of 960%* over the same period in 1955. This gain is all the more remarkable because it was accomplished without losing ground in our strong short-grain rice business. In fact, we had an increase there too." *Good spot to be in!*

Spot television's adaptability to local tastes and customs is another reason why more and more advertisers are using the 13 stations and the regional network represented by...

CBS TELEVISION SPOT SALES Representing: WCBS-TV New York, WCAU-TV Philadelphia, WTOP-TV Washington, WBTW Charlotte, WBTW Florence, WMBR-TV Jacksonville, WXIX Milwaukee, WBBM-TV Chicago, KSL-TV Salt Lake City, KGUL-TV Galveston-Houston, KOIN-TV Portland, WHCT Hartford, KNXT Los Angeles and the CBS Television Pacific Network

lieve that the same rule applies in television.

"The present action should be especially helpful to unaffiliated stations which, not having access to network programs, must place their main reliance on films, particularly feature films."

Attorney General Herbert Brownell Jr., in a statement, said that the government's action would not prevent television stations from buying large lots of features at one time if they chose but would make it possible for the stations to select the features they wanted.

The suit charged that Loew's had violated Sec. 1 of the Sherman Antitrust Act by unlawful restraint of trade.

In New York, Joseph R. Vogel, president of Loew's, denied that the company had engaged in block-booking. "I see no dif-

ficulty in persuading the government or anyone else of that fact," he said.

"We have made our television deals 'at arm's length' and I am confident as to the satisfaction of the buyer as well as the seller. We have no hesitancy in cooperating with the government in its objective of establishing the principle of non-forcing deals since that is the only way we have conducted or will conduct ourselves."

Meanwhile, Loew's was involved in another court action. In New York a federal judge took steps to speed the divorcement of Loew's Theatres from Loew's Inc., to comply with a consent decree now more than five years old.

Obstacle to the divorcement has been the unsettled question of how to divide between the new companies a \$30 million funded debt. Judge Edmund L. Palmieri said he

wanted the advice of independent experts and appointed Weldon Powell, Haskins & Sells, an accounting firm, as advisor.

He also named two new directors to a six-man board of Loew's Theatres, replacing two men already on the board as constituted under terms of a 1954 agreement that authorized the court to appoint three members to the board until the division is made final. The judge said his action did not imply the two replaced directors were disqualified, but he said he was "dismayed" at the time that had passed without the completion of divorcement.

New directors are Allan L. Melhado and Karl D. Pettit, both financial consultants. They replace Thomas L. Norton, dean of the City College of New York business school, and George T. Baker, president of National Airlines.

FCC DILEMMA: SHOULD HEARINGS BE HELD BEFORE PAY TV TESTS?

THERE's a test in television's future—a test of subscription tv.

But, whether the test authorization is going to come before or after a full, open evidentiary hearing was the big question in Washington last week.

Pay tv was the subject of a full day's discussion by the full Commission last Tuesday. No clearcut decision was made. However, the Commission instructed the staff to draw up two documents:

(1) A board authorization to permit nationwide tests of fee tv, but limited in many respects, and (2) a request for further, detailed and definitive answers from pay tv proponents on many questions, the answers being the base on which the Commission will decide whether or not open hearings should be held prior to, or after tests have run.

Lurking in the background, still uncertain, is the biggest question of all: Should the FCC grapple with the determination of policy or should it buck that decision to Congress. The policy question is simple: Is pay tv broadcasting as defined by the Communications Act, or is it a common carrier or public utility type of operation, with its concomitant spectre of rate regulations?

And, allied with this fundamental poser was another: Should the policy determination, whether by the FCC or Congress, be made before or after tests?

Tomorrow (Tuesday), the Commission meets again to see if it can find a common meeting ground.

A test vote last week indicated that there were four commissioners who were ready to authorize tests. The tests would be limited—they would be allowed in four-station markets only, and to non-network affiliates only, for example—but they would be nationwide. And, it was also apparent, there would be careful legal language specifying in detail that the authorizations were only good for experimental operation and that they could be withdrawn instantly whenever the FCC decided to call a halt.

There was no such clear division on inter-

mediate steps. Before each commissioner was a staff document which suggested that there are a host of unknown quantities about pay tv which should be answered before another step is taken.

The questions raised by the staff ranged the area of the subscription tv controversy:

- Should pay tv be limited to large markets or small markets? Or both?
- Should pay tv be confined to vhf or uhf? Or both?
- Should pay tv be limited to four-station markets or permitted also in single station cities?
- Should network affiliates as well as independents be permitted to engage in pay-as-you-see tv or should authorizations be allowed only to independents?
- Should there be unlimited hours of fee tv operation, or should the amount of time a station may broadcast scrambled pictures be set by the Commission? What about hours per day, per week or per month?
- Should authority be given to only one system or to all systems of pay tv? Should a single system be established for each city, although different cities might have different systems?

• What role would stations play as program purveyors?

• Who would own the equipment used by stations to scramble telecasts?

• Who would own the equipment used by the public? Who would set rates for program viewing? Who would maintain equipment in the hands of the station, the public?

• Who would administer the distribution of codes to the public? How would the fees be collected and who would be responsible? Who would determine the split between the program provider, the station and any third party?

Implicit, it is understood, is the desire to array a unanimous, or substantially unanimous Commission, on two points: Permission to begin testing over the air, and a hearing to seek answers to not only details of operation but also to aid in answering the tangled policy determination.

Comrs. McConnaughey, Doerfer, Lee and Craven apparently favor some sort of test authority even before hearings. Comrs. Hyde, Bartley and Mack just as obviously favor a full-scale hearing before any tests begin.

A compromise, it appears, might be forthcoming. This could take the form that applications would be accepted for test authority. At the same time pay tv advocates would be asked to inform the FCC in detail regarding the who, what and how of on-the-air pay tv. Upon submission of these answers, by a given date not too distant, the Commission would proceed to decide whether to hold hearings before or after tests. There would also be the opportunity to decide more fully whether a Congressional mandate was required—even for test permits.

An essential element which pervades all thinking is the position of the FCC in supervising pay tv—even the experimental operation. It is this: The Commission only has jurisdiction over stations. It cannot regulate subscription tv entrepreneurs. If any experimentation is authorized—and if toll tv is ever commercially authorized—the requests for such operation must come from the licensee, the station. On this there seems to be unanimity.

BE IT RESOLVED

THE MINUTES of the FCC meeting a fortnight ago will record that Annette E. Hutterly was commended. A resolution to that effect will be incorporated in the minutes after the general counsel phrases it in the appropriate language.

For 30 years Mrs. Hutterly has been with the FCC and its predecessor, the Federal Radio Commission. She is now chief of the FCC's minutes division. She has served 37 years in government.

As she entered the meeting last Wednesday, the commissioners gave her a standing ovation. Mrs. Hutterly duly recorded the event.

FCC GIVES CASE FOR EXTENDING STATION LICENSES TO CONGRESS

THE FCC told Congress last week why it believes the license terms of broadcast stations should be extended to five years—instead of the present maximum of three years. Comr. Robert T. Bartley added a statement suggesting that broadcast station licenses be indeterminate.

Under Sec. 307(d) of the Communications Act, the maximum for non-broadcast station licenses is five years, with broadcast station licenses limited to three years. Over the years there have been suggestions that no distinction be made between broadcast and non-broadcast license terms. Last year both FCC Chairman George C. McConnaughey and Comr. John C. Doerfer publicly called for a revision of this provision. Mr. McConnaughey called for five-year terms; Comr. Doerfer for indeterminate terms. Comr. Bartley, up to now, did not publicly make his views known.

In its "justification" for the proposed revision of Sec. 307 (d) the Commission declared there are "sound" business reasons for making the license period for broadcast stations five years. "The construction and operation of a commercial radio broadcasting station are expensive and television costs are more expensive. Business can receive more favorable terms with longer licensing period in which to plan leases, contracts, financing, etc. . . ."

Not the least significant, the Commission said, is that tv and radio have "come of age" and should be able to obtain financing on a responsible business basis and not on a "speculative" basis.

The FCC has been discreet in granting license terms, the Commission pointed out. In 1927, broadcast radio licenses ran for 60 days; in 1928 this was made three months; in 1931, six months; in 1939, one year; in 1941, two years, and in 1943, three years. Tv licenses were initially issued for one year and were extended to three years in November 1953.

Comr. Bartley objected to the Commission majority's statement on the ground that it was based on the private business requirements of licensees. He claimed that the history of broadcast expansion belied the restrictive inference of three year licenses.

Rather, he declared, the Communications Act should be amended to delete any reference to fixed license terms. Instead, he said, Congress should give the FCC "additional broad authority and discretion" to deal more effectively with regulatory problems. The Commission, he added, needs flexibility.

"The Congress should be asked to amend the Communications Act," Comr. Bartley stated, "so as to provide for an indefinite license term, with expanded powers in the Commission to make necessary changes in spectrum usage, after appropriate inquiry to determine the facts and policy, and the Commission having determined it to be necessary in the public interest."

Comr. Bartley would protect licensees' property rights by tax benefits in the event

the license was modified before full amortization of equipment and plant. He also suggested that the Commission require licensees to submit periodic "accounting" of stewardship, in place of formal renewal applications every three years. He also suggested that there be retained the principle that a competing application may be filed for a facility at "appropriate" times, similar to the regulation which permits a new application to be filed for an existing facility at license renewal time.

So far, three bills have been introduced, all in the House, to amend the Communications Act to permit broadcast stations to be licensed for five years. These are HR-5935, by Rep. Oren Harris (D-Ark.), chairman of the House Commerce Committee; HR-3514 by Rep. Gardner R. Withrow (R-Wis.), and HR-6430 by Rep. Donald E. Tewes (R-Wis.).

KOB Albuquerque Gets Extension On FCC Order to Directionalize

KOB Albuquerque last week was given 30 additional days, until April 25, to comply with the FCC's order to directionalize its nighttime signal on 770 kc to protect Class I WABC New York. However, in granting the additional time the Commission said that any further extension "would not be warranted in the circumstances of this matter."

KOB, assigned 1030 kc, has been operating on 770 kc on a temporary basis since 1941. And, for just about as many years, ABC-owned WABC has been trying to get the station forced off its channel. The FCC's action in ordering KOB to directionalize came following a Court of Appeals ruling that WABC's signal must be protected [B•T, Dec. 3, 1956]. At that time, the Commission gave KOB 120 days to comply.

In extending KOB's present operation, the Commission ordered the station to complete construction of its directional array and submit proof of performance by April 23. KOB, an NBC affiliate, operates with 50 kw daytime and 25 kw night. The station estimated that the order would cause it to lose 18% (48,988 people) of its nighttime coverage. KSTP-AM-TV Minneapolis last month received FCC approval for purchase of the station from equal-owners Time Inc. and Wayne Coy, former FCC chairman [B•T, March 18].

Tewes Bill Would Extend Periods Of Broadcast Licensees Two Years

BILL to extend radio-tv broadcast license periods to five years from the present three years was introduced last week by Rep. Donald E. Tewes (R-Wis.).

Rep. Tewes submitted the measure (HR 6430) after introducing by mistake the previous week a bill (HR 6216) that would extend am-fm license periods only. The Wisconsin Republican said after HR 6216 had been introduced that he would withdraw it and offer a bill covering am-fm and tv licenses [B•T, March 25].

Reps. Gardner R. Withrow (R-Wis.) and

Oren Harris (D-Ark.) are authors of similar bills and the FCC last week formally requested such legislation (see story, this page), although the Commission majority has favored an extension of radio-tv for some time.

Senate Unit Schedules Hearings on Daytimers

HEARINGS on complaints of small daytime radio broadcasters will be held April 29-30 by the Senate Small Business Committee's Daytime Radio Broadcasting Subcommittee, Sen. Wayne Morse (D-Ore.), the unit's chairman, said last week.

The three-man subcommittee, also including Sen. Alan Bible (D-Nev.) and Sen. Andrew F. Schoepel (R-Kan.), was named the week before [B•T, March 25]. The Senate group will investigate complaints by Daytime Broadcasters Assn. that the FCC has failed to act on daytimers' requests for extended hours of operation—although various requests by daytime stations have been before the Commission more than ten years.

Daytimers seek extension of hours of operation from the present sunrise-to-sunset limitation as follows: from 5 a.m. or sunrise (whichever is earlier) to 7 p.m. or sunset (whichever is later).

The DBA complaints allege the present FCC policy denies local stations the right to operate during important hours in deference to fulltime regional stations, thus denying small businessmen the right to advertise in local markets and listeners the benefits of local news and other coverage.

Sen. Morse felt changes in radio and technology in the 30 years since the FCC rule was written on frequency allocation may "well warrant revision and modernization of those allocations." He thought it "unfortunate" that FCC has not acted on daytimers' complaints and said the daytimer petitions at least are "entitled to prompt attention."

Views from daytimer spokesmen, fulltime stations and the FCC are invited at the hearings, Sen. Morse said.

The FCC testified earlier that the daytime broadcasting issue is "tied up" with clear channel matters, but that the Commission will go into the subject soon [B•T, March 18].

FCC Grants 5 Radio Cps, Issues Two Initial Decisions

THE FCC last week announced the grant of five construction permits for new radio stations and one more appears due. Also announced were two initial decisions.

The grants were:

Carmel, Calif.—Seaside Electronic Assoc., 1410 kc, 500 w daytime. Seaside co-owners are Albert R. Pearl, retired banker, and Paul F. Hanson, freelance radio-tv producer.

Cocoa, Fla.—Irving Braun, 1480 kc, 1 kw daytime. Mr. Braun has tv and appliance interests.

Leesburg, Fla.—Clyde T. Hodgson, 1410 kc, 1 kw daytime. Mr. Hodgson prints the *Lakeland (Fla.) Ledger*.

Mount Dora, Fla.—George R. Smith, 1580 kc, 1 kw daytime. Mr. Smith has real



The "best dramatic series" of the year

(HAS ROOM FOR ONE MORE ADVERTISER)





PLAYHOUSE 90 set out to do something that had never before been tried in television :

To offer a nationwide audience the important dramatic entertainment that can be achieved only by using sufficient time to develop the full potentialities of plot and character.

To contribute a new dimension to the medium by presenting an hour and a half of this full-scale drama every week on a *regularly scheduled* basis.

The achievement proved even more exciting than the idea.

It won the sustained applause of the nation's critics, who continue to give serious attention to each production.

It captured the enthusiasm of the nation's best writers and performers, anxious to take part in an adventure that gave full scope to their talents.

Its unique accomplishments were recognized *for the 18th time* this season with the announcement of the "Emmy" awards the other day.

But the most important reward is the enthusiasm of 25 million intensely loyal viewers who return week after week for the next production.

The advertiser who sponsors the only remaining segment of *Playhouse 90* will inherit all the extra values of a program that each week generates new excitement as it continues to make history on **CBS TELEVISION**



estate and insurance interests in Arcadia, Fla.

Kellogg, Idaho—Radio Kellogg Inc., 900 kc, 1 kw daytime. Roger L. Hagadone is 99% owner of Radio Kellogg and also president and general manager of KYME Boise, Idaho.

Two initial decisions, looking toward am grants, were issued last week. Hearing Examiner H. Gifford Irion issued a decision in favor of Great South Bay Broadcasting Co. for 540 kc, 250 w daytime in Islip, N. Y. and denied competing applications of American Family Broadcasting Co. and Stern Broadcasting Co., Ridgewood, N. J.

Hearing Examiner J. D. Bond issued a decision in favor of Stephenville Broadcasting Co. for 1350 kc, 500 w daytime in Tahlequah, Okla. and denied competing application of Osage Broadcasting Co. Bartlesville, Okla.

The Commission directed preparation of a document looking toward grant of the application of Babylon-Bay Shore Broadcasting Co. for a new am on 1440 kc, 500 w daytime in Babylon, N. Y. This announcement is of proposed disposition of the case and does not constitute Commission action.

N.Y. Bills Offered To Repeal News Bans

A MOVE to repeal Section 52 of the New York state civil rights law—which prohibits radio, television and newsreel coverage of any legislative and judicial hearing in which compulsory testimony is involved—was introduced in both houses of the New York legislature last week. Sponsoring the move was the Radio-Newsreel-Television Working Press Assn. of New York, which has been conducting a "running fight" with the New York City Council to permit tv cameras and microphones in its hearings.

Two specific bills were introduced on Monday—AI-4172 in the state Assembly and SI-3666 in the Senate—both demanding repeal on grounds that Sec. 52 is "discriminatory against the radio-tv news medium and . . . a violation of freedom of the press as guaranteed by the first amendment." Sec. 52 was passed in 1952 by the administration of then Gov. Thomas E. Dewey following the close of 1951's Kefauver hearings.

Pushing through the amending bills is the New York State Assn. of Radio & Television Broadcasters. Contacted by B•T in Albany, John R. Titus, legislative counsel for the association, said there was "still a chance" both bills would be passed before the scheduled adjournment of Senate and Assembly this past Saturday. On Thursday the bills were still in committee, but Mr. Titus felt that once they reached the floor, approval would be "just a matter of a few hours."

Less optimistic was Gabe Pressman, WRCA-AM-TV New York news director, who has been spearheading the fight to allow cameras and microphones into the City Council's chambers. Mr. Pressman, chairman of the Radio-Newsreel-Television Working Press Assn.'s "Freedom of Information Committee," felt there was not sufficient time left in which to press the issue.

FCC OKAYS STORER PURCHASES IN WILMINGTON AND PHILADELPHIA

STORER Broadcasting Co. last week won FCC approval to the purchase of a tv station in Wilmington, Del., and its companion radio stations in Philadelphia—and virtually agreed to sell its Birmingham outlets to Radio Cincinnati Inc. (Hulbert Taft Jr. and family) for a price understood to be between \$6 and \$6.5 million.

At the same time its proposed purchase of WMUR-TV Manchester and its move toward Boston came under fierce attack by Westinghouse Broadcasting Co. (WBZ-TV Boston) and others.

The Commission's approval of the WPFH (TV) Wilmington, Del., and WIBG-AM-FM Philadelphia purchases by Storer was contingent on Storer disposing of one of its existing radio and tv properties.

Mr. Taft said last Thursday negotiations for the purchase of WBRC-AM-TV Birmingham were still continuing but that they were beyond the handshaking stage.

The Taft stations are WKRC-AM-FM-TV Cincinnati, WTVN-AM-TV Columbus, both Ohio, and 30% of WBIR-AM-FM-TV Knoxville, Tenn. The family also publishes *Cincinnati Times-Star*. In 1953, the Tafts bought WTVN (TV) Columbus from Edward Lamb for \$1.5 million.

Storer bought the Birmingham outlets in 1953 from Eloise Hanna and others for \$2.4 million.

Other Storer stations are WGBS-AM-FM-TV Miami, WJBK-AM-FM-TV Detroit, WSPD-AM-FM-TV Toledo, WAGA-AM-FM-TV Atlanta, WJW-AM-TV Cleveland, WWVA-AM-FM Wheeling, W. Va., and KPTV (TV) Portland, Ore.

The negotiator in the Wilmington-Philadelphia transaction was R. C. Crisler & Co., Cincinnati.

Only One Dissenter

The Commission approved Storer's \$5.6 million purchase of ch. 12 WPFH (TV) Wilmington, Del., and companion radio stations WIBG-AM-FM Philadelphia with only one dissenting vote. This was by Comr. Robert T. Bartley who called for the issuance of a McFarland letter on the question of trafficking in licenses. The approval came one month after the application was filed [B•T, March 4] and was contingent on Storer disposing of either its Birmingham or Atlanta radio-tv properties.

The purchase price also included assumption of obligations totaling more than \$1.5 million. Paul F. Harron, major stockholder of WPFH Broadcasting Co., licensee of the Wilmington-Philadelphia outlets, will also receive a \$150,000 consultant's fee over a 10-year period.

Mr. Harron bought the ch. 12 Wilmington outlet in 1955 for \$3.85 million. The station then was owned by the Steinman interests (WGAL-AM-TV Lancaster, Pa., and others) and bore the call letters WDEL-TV. The Steinmans still own WDEL-AM-FM in Wilmington. Mr. Harron and associates have

owned the WIBG stations since 1941. WIBG operates on 990 kc with 10 kw; WIBG-FM on 94.1 mc with 20 kw. Pending FCC approval is an application by WPFH to move its transmitter from downtown Wilmington to Pittman, N. J. The purchase application stated that Storer would operate WPFH as a "local" Wilmington station serving that city and Philadelphia.

Since September 1955, WPFH has lost \$425,000. The WIBG stations have been profitable, the sale application disclosed. WPFH Broadcasting Co. has 10 million \$1 par value stock authorized; 7.5 million Class A and 2.5 million Class B. Outstanding are 3,750,875 Class A and B shares, with Mr. Harron owning 1,351,109 Class B shares. Storer acquired the assets of WPFH Broadcasting Co., which also owns National Wired Music Corp., serving Philadelphia and environs.

Westinghouse slashed at Storer's response to the Commission's McFarland letter justifying the \$850,000 purchase of ch. 9 WMUR-TV Manchester, N. H., and its move to Georgetown, Mass., outside of Boston [B•T, March 25].

Charged With 'Trafficking'

In essence, WBC charged Storer with "trafficking" in licenses. Since 1940, Westinghouse alleged, Storer has bought and sold eight stations. Pending before the FCC now, WBC declared, are five other Storer transactions.

In listing Storer sales and purchases, WBC itemized this list: WHIZ Zanesville, Ohio, sold in 1947; WLOK Lima, Ohio, bought in 1940 and sold in 1951; WSAI Cincinnati, Ohio, bought in 1951, sold in 1953; WMMN Fairmont, W. Va., bought in 1937, sold in 1953; KPTV (TV) Portland, Ore., bought in 1954; WBRC-AM-TV Birmingham, Ala., bought in 1953; WJW-AM-FM-TV Cleveland, Ohio, bought in 1954; KEYL (TV) and KABC San Antonio (now KENS-AM-TV), bought in 1951 and 1953, sold in 1954.

The five transfer applications pending before the FCC, Westinghouse noted, are Storer's purchase of ch. 3 KSLM-TV Salem, Ore., and its move toward Portland, Ore.; ch. 9 WMUR-TV Manchester, N. H., and its move closer to Boston; ch. 12 WPFH (TV) Wilmington, Del., and WIBG-AM-FM Philadelphia (approved last week, see above); and Storer's agreement to sell WAGA-AM-FM-TV Atlanta, Ga., to the Washington Post Co. This latter contract is understood to have expired Feb. 15, but, WBC said, the application for the transfer has not yet been dismissed. The fifth transaction, WBC cited, was the option held by George Haggarty, Detroit lawyer and oilman, to buy KPTV.

Westinghouse estimated that Storer's "clear profit" on the Atlanta transaction will be \$3 million. This is based, it noted, on

to all our friends...

A CORDIAL
INVITATION TO

H-R

HOSPITALITY
HEADQUARTERS

THE 23RD FLOOR
MORRISON HOTEL

NARTB

CONVENTION
CHICAGO

APRIL 7-11



FRANK HEADLEY, President
DWIGHT REED, Vice President
FRANK PELLEGRIN, Vice President
PAUL WEEKS, Vice President

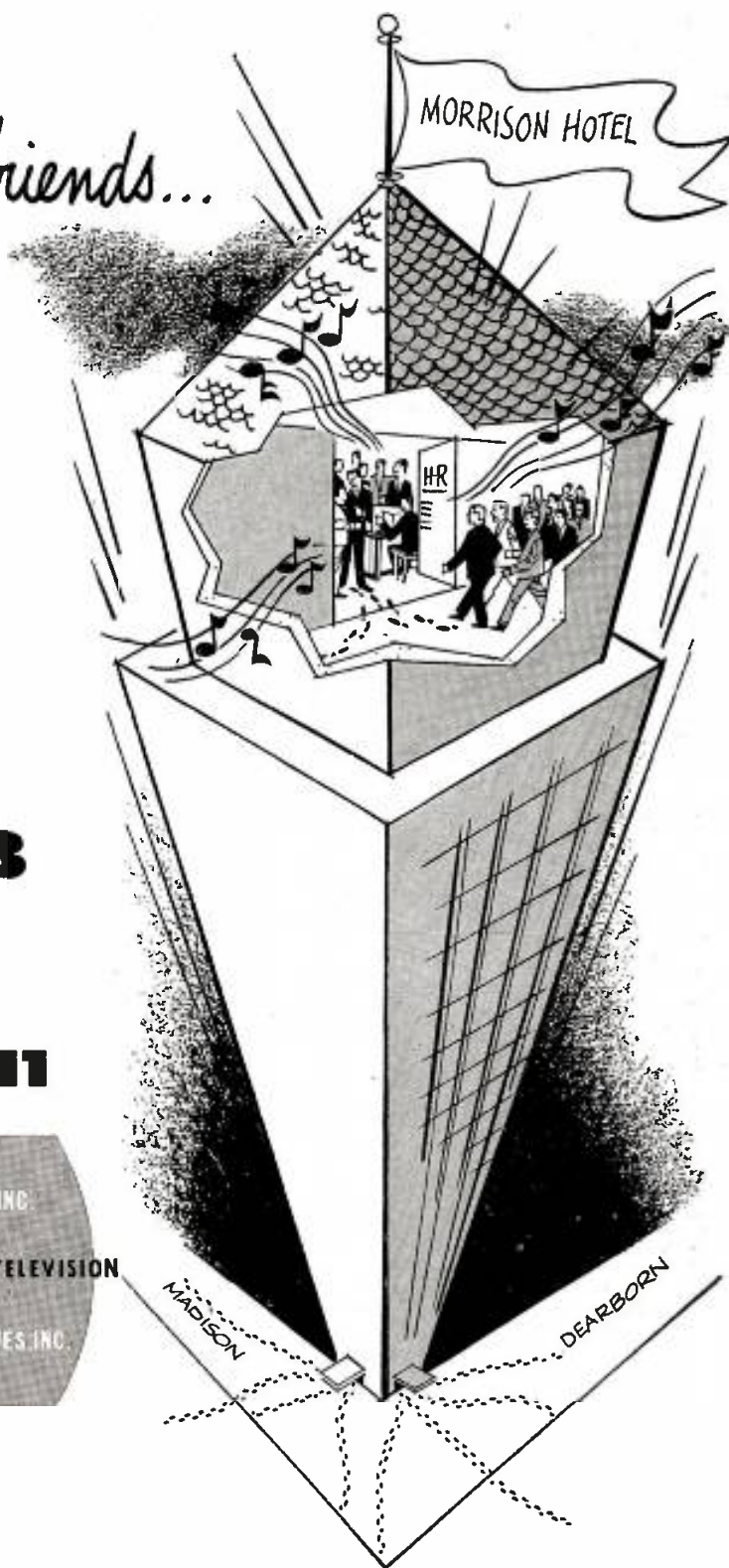

380 Madison Ave.
New York 17, N. Y.
OXford 7-3120

35 E. Wacker Drive
Chicago 1, Illinois
RAndolph 6-6431

6253 Hollywood Boulevard
Hollywood 28, Calif.
Hollywood 2-6453

155 Montgomery Street
San Francisco, Calif.
YUkon 2-5837

416 Rio Grande Bldg.
Dallas, Texas
Riverside 2-5148

101 Marietta Street
Bldg.
Atlanta, Georgia
JACKson 3-7797

520 Lovett Boulevard
Room No. 1D
Houston, Texas
JACKson 8-1601

910 Royal Street
Canal 3917
New Orleans, La.

529 Pan American Bank Bldg.
Miami, Fla.
FRanklin 3-7753



BUFFALO'S OWN AGENCIES
AND ADVERTISERS CHOOSE

WBUF, CHANNEL 17, AS THE

NEW MOVING FORCE IN BUFFALO

TO PROMOTE THE EXTENSION OF NIAGARA MOHAWK SERVICE IN AMERICA'S 14TH MARKET, BUFFALO'S BBD&O BUYS "WEATHER LOG," STARRING MAC MCGARRY, ON WBUF.

"WEATHER LOG," with its nightly forecasts (M-F, 11:10 pm), is a "natural" for this power company's public service advertising—an economical way to combine year-round continuity with the prestige of "owning" a program. "Weather Log" is the only TV advertising Niagara Mohawk uses in Buffalo.

MAC MCGARRY's selling personality has really clicked in Buffalo. Mac's suggestions to viewers ("Write today for this *Live Better Electrically* booklet"; "Phone House Power for free rewiring information") bring Niagara Mohawk a constant flow of requests.

"WBUF," in the words of BBD&O account executive Jay S. Larmon, "is now serving the Buffalo market with top-notch network and local programming. Since our weather program went on the air, our audience has increased by more than 50%. We, as well as the client, are pleased with the show's results."

Coverage up! Ratings up! Billings up! WBUF, the fastest-moving force in Buffalo, is ready to go to work for *you* today!

Exciting things are happening on



Left to right:
Frank Buxton, Pgm. Director for WBUF; John H. Fogarty, BBD&O Acct. Supervisor; Mac McGarry; Jay S. Larmon, BBD&O Acct. Executive on Niagara Mohawk.

the fact that the contract was signed Oct. 15, 1956, the deadline for the issuance of tax certificates in situations where a broadcaster must sell a property in order to remain within the FCC's rules limiting single ownership to seven stations.

Using words such as "fantastic," "distorted," "half-truths" and "glaring errors" in referring to the Storer McFarland letter response, WBC maintained that:

"Storer's only purpose in building up a property is to promptly sell it at a major capital gain and the public interest is non-existent in its operation."

A major portion of WBC's attack was on the engineering aspects of the WMUR-TV move toward Boston. WBC maintained that Manchester would receive a poor signal from its Georgetown site because of intervening hills. At its proposed site, WBC alleged, WMUR-TV will serve only 3,200 square miles with a New Hampshire population of 347,000, compared to its present service covering 5,900 square miles and 467,714 Hampshiremen. The figures were based on Grade B contours.

Move of ch. 9 to the Boston area, Westinghouse maintained, must be done through rule-making. It cannot and should not, WBC declared, be accomplished through the application process seeking a change of transmitter site.

Rate Comparison Made

Answering Storer's offer to halve the time charges for Manchester businessmen as against the rate for Boston advertisers, WBC noted that WBZ-TV and WNAC-TV in Boston charged \$2,250 and \$2,600 respectively and that would mean Manchester advertisers would have to pay about \$1,000 or more. This is much too rich for Manchester advertisers' blood, WBC declared.

Storer, WBC pointed out, identified itself as the smallest of group owners as far as coverage of people are concerned; 7,331,832. But, WBC charged, in its stock prospectus Storer took credit for covering 14,673,240 in 1955 and for 14,835,468 in 1956.

WBC said Storer has grown in gross television revenues from \$31,539 in 1948 to \$19,688,830 in 1955, and \$11,971,418 for the first six months of 1956. Storer's radio grosses approached \$5 million in 1956, WBC said. This adds up to a \$12 million earning before taxes, WBC declared. George B. Storer, principal owner of Storer Broadcasting Co., has an "indicated" fortune in excess of \$30 million, WBC said. These figures were presented as WBC's rebuttal to the alleged Storer claim it is a small entity in the broadcasting business.

WBC also said it understood WMUR-TV had made a profit of \$10,000 in the last six months of 1956. This was WBC's refutation of the WMUR-TV and Storer contention that WMUR-TV must cover the Boston market as well as Manchester in order to survive. Also, WBC said, was the fact that there was a New Hampshire group offering to buy WMUR-TV and keep it in Manchester and that there were comparable communities which are supporting, in some

cases, more than one tv outlet.

Westinghouse asked that the FCC deny the applications, or at least set them for hearing.

Also filed last week was the response of WNAC-TV Boston to the Storer McFarland answer. The RKO Teleradio Pictures Inc. station declared that the move would be in contradiction to the assignment plan in the 1952 Sixth Report and Order whereby channels were assigned to individual cities. WNAC also called attention to the purported \$10,000 profit made by WMUR-TV in the last six months of 1956. Also referred to was Storer's offer to establish a local Manchester rate card that would be 50% of its Boston rate. "It appears most unlikely that local Manchester advertisers will find it possible to pay 50% of the rate charged local Boston advertisers. To make time available to Manchester advertisers at a rate they cannot pay is a worthless gesture." WNAC-TV said.

Meanwhile, WMUR-TV and Storer filed a pleading with the FCC asking that the application filed by the Radio Voice of New Hampshire Inc. for ch. 9 be dismissed. The application was filed for consideration with WMUR-TV's license renewal application. The ch. 9 outlet's license expires today (April 1)—but stations are usually authorized to continue operation pending the outcome of controverted pleadings. Radio Voice of New Hampshire, Storer said, does not represent New Hampshire interests. The same people, Storer added, have fought its purchase of WMUR-TV and have in fact offered to buy the station themselves. Their offer is more than \$100,000 less than Storer's offer, Storer said.

Rep. Harris Buys Interest in KRBB (TV)

REP. OREN HARRIS (D-Ark.), chairman of the House Interstate & Foreign Commerce Committee and of its Transportation & Communications Subcommittee, has bought 25% interest in KRBB (TV) El Dorado, Ark., for \$5,000, the station announced last week.

Rep. Harris, who was named a KRBB vice president, said in Washington last week that he bought into the station to prevent purchase by outside, non-local interests. The station is filing for increased antenna height and increased power from its present 24 kw visual and the maximum 316 kw, at Rep. Harris' suggestion, and other area residents will be offered stock to finance the improvements, he said.

The House Commerce Committee chairman, recognized as a congressional authority on broadcast matters, said he had been promoting the ch. 10 station from the time it was first applied for, and since it went on the air in December 1955, to bring better television service to the people of southern Arkansas and northern Louisiana. The other owners, holding 25% each, are Dr. Joe F. Rushton, president; William M. Bigley, general manager, and W. C. Blewster, banker, all of Magnolia, Ark., 35 miles from El Dorado.

FCC Approves Sales Involving \$3 Million

IN ADDITION to the Storer Broadcasting Wilmington-Philadelphia station purchase (see story, page 54), the FCC last week approved five other large station sales involving \$3,125,000.

Ch. 3 KEYT (TV) Santa Barbara, Calif., was sold by Colin Selph, Charles H. Jackson Jr. and associates to a newly-formed corporation, Key Television Inc., for \$1,640,000 [B•T, March 4]. Key principals include President Richard C. D. Bell (16.66%), William F. Luton (Mr. Bell's first cousin) and wife Nancy, and Robert H. Dunlap, Pasadena, Calif., attorney. The Lutons and Mr. Dunlap own 83.33% of the stock.

Mr. Bell was assistant to the president of KPIX (TV) San Francisco prior to that station's sale to Westinghouse Broadcasting Co. in 1955. He will become manager of KEYT. Others in the selling group include actor Ronald Coleman and Harry C. Butcher, former CBS Washington vice president and present owner of KJST Santa Barbara.

KEYT is affiliated with all three networks and began operations in July 1953.

Houston Broadcasting Corp. (Milton R. Underwood and Philip R. Neuhaus) received approval of its purchase of KXYZ-AM-TV Houston from Glenn H. McCarthy. Messrs. Underwood and Neuhaus are partners in a Houston stock brokerage firm and also have minority interests in KTHT Houston and KRIS Corpus Christi, Tex. The KTHT interest will be sold.

Fred Nahas, present president-general manager of KXYZ, will continue in that capacity under the new owners. ABC-affiliated KXYZ is on 1320 kc with 5 kw; ch. 29 KXYZ-TV is not on the air.

Also in Houston, McLendon Investment Corp. (Gordon B. McLendon and his father, B. R. McLendon) was granted assignment of license of KLBS from Howard W. Davis for \$525,000. Just two weeks ago, McLendon received FCC approval for the \$750,000 sale of KELP and KILT (TV) El Paso, Tex., to the owners of KXLY-AM-TV Spokane, Wash. [B•T, March 25]. McLendon also owns KLIF Dallas, and KTSA-KOKE-FM San Antonio; Mr. Davis owns KMAC-KISS-FM San Antonio. Independent KLBS is on 610 kc with 5 kw.

WCTC-AM-FM New Brunswick, N. J., was sold for \$215,000 to a group composed of Joseph L. Rosenmiller, Peter A. Bordes and Louis J. Appell Jr. by Chanticleer Broadcasting Co. (James L. Howe, president and owner of WIRA Fort Pierce, Fla.). The buyers also recently acquired WESO Southbridge, Mass., and plan to obtain other station properties. Mr. Appell is president of WSBA-AM-TV York, Pa. WCTC is on 1450 kc with 250 w; the fm outlet operates on 89.3 mc with 1 kw.

James L. Stuart, who owns KFOR Lincoln, Neb., purchased KRGI Grand Island, Neb., from Robert L. Lester and associates for \$145,000. Independent KRGI is on 1430 kc with 1 kw.

For other sale approval, see FOR THE RECORD, page 140.

CHECK WTCN... where BIG things are happening!

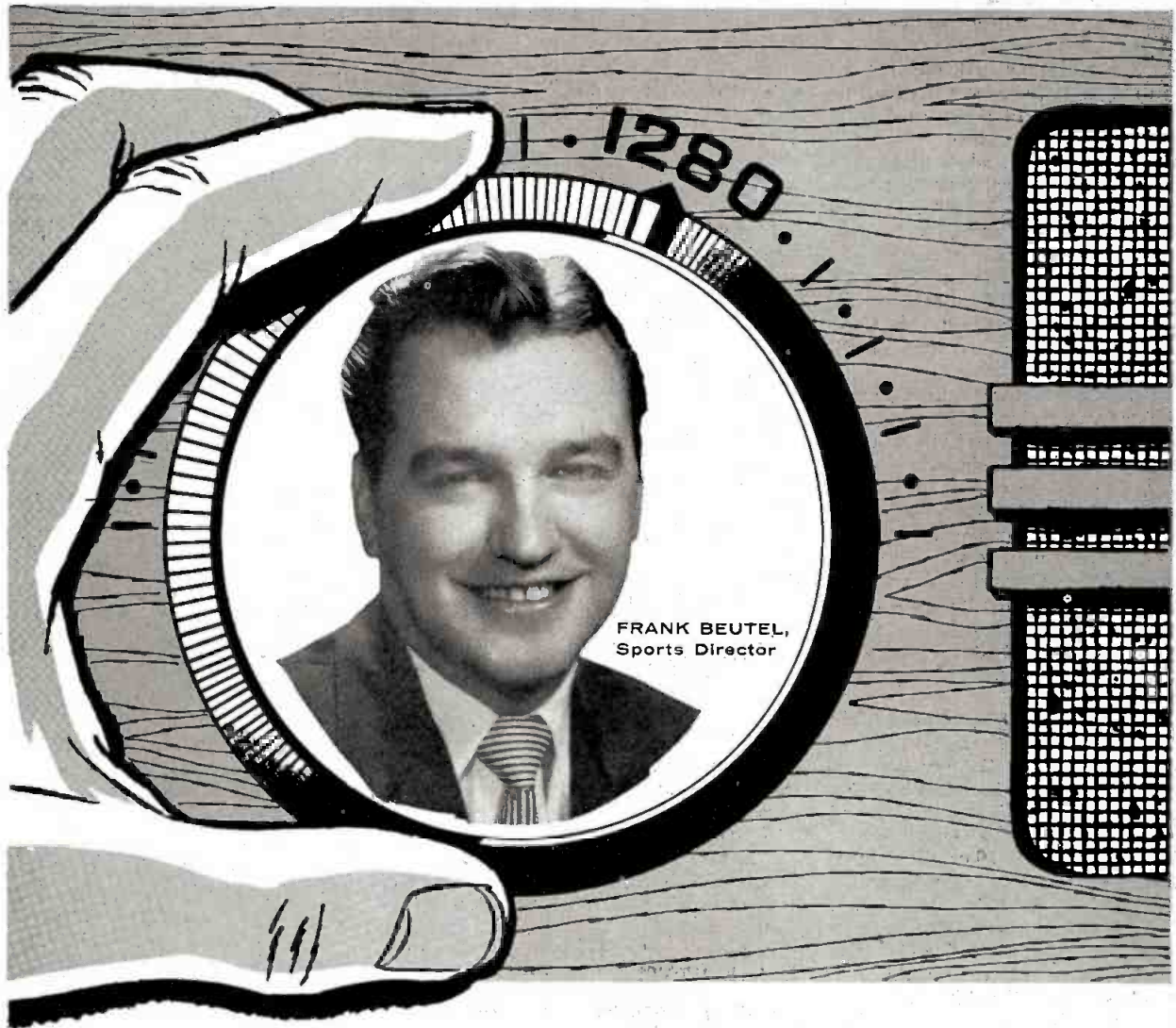

Top sports station in sports-minded market!

And in 3 out of 4 years, WTCN Sports Director Frank Beutel named top Twin Cities Sportscaster! He and his staff broadcast play-by-play reports of Minneapolis Millers Baseball, University of Minnesota football—basketball—hockey—and baseball, golf tournaments, and professional boxing . . . for year-round sports programming, *more* sports than any other Twin Cities station! Check your Katz representative today for ratings and availabilities!

WTCN MINNEAPOLIS - ST. PAUL
5000 WATTS ABC 1280 Kc.

Represented nationally by Katz Agency, Inc. Affiliated with WFDF, Flint; WOOD AM & TV, Grand Rapids; WFBM AM & TV, Indianapolis.

WIRL-TV IN COURT TO SAVE CH. 8; FCC PROPOSES STILL MORE SHIFTS

FIRST vhf permittee whose channel is subject to a move to another community went to court last week—asking not only that the FCC decision be reversed, but that the court order an immediate stay against the FCC's implementation of February deintermixture actions [B•T, March 4].

WIRL-TV Peoria, Ill., which claimed it won the ch. 8 contest after four long years and the expenditure of \$50,000, filed an appeal in the U. S. Court of Appeals, Washington, against the Commission's Feb. 28 action moving ch. 8 from Peoria to the Davenport, Iowa-Rock Island-Moline, Ill., area. It also asked the court to stay the Commission's action pending outcome of the court litigation.

In further actions last week, the Commission instituted rule-making proceedings last Wednesday, which would add vhf channels in six cities and a uhf channel to one. Standing to lose v's are at least three U. S. cities, while Reading, Pa., faces the loss of one of its two u assignments. Interested parties were given until April 30 to file comments and 10 additional days for reply comments. Involved are the following cases:

- Assignment of ch. 12 to Lamar, Colo., (proposed by KLMR that city). Lamar presently is assigned ch. 18, for which there have been no takers.

- Assignment of ch. 10 to Presque Isle, Me., which presently is assigned ch. 8 WAGM-TV and ch. 19. The proposal was made by Northeastern Broadcasting Co., applicant for a new am in Presque Isle and owned principally by stockholders of WABI-AM-TV Bangor, Me. Ch. 10 can be assigned to Presque Isle by substituting ch. 6 for 10 in Ste. Anne de la Pocatière, Que.; ch. 7 for ch. 6 at Rivière du Loup, Que., and ch. 11 for ch. 6 at Matane, Que. The Canadian Dept. of Transport has notified the FCC it has no objections to the shifts.

- Shift of ch. 8 Muskogee, Okla. (KTVX [TV]), to Tulsa (proposed by KTVX). Tulsa currently is assigned chs. 2 (KVOO-TV), 6 (KOTV [TV]), educational 11 (KOED-TV), 17 (KSPG [TV]) and 23 (KCEB [TV]). In addition to ch. 8, Muskogee is assigned unoccupied uhf chs. 45 (educational) and 66. KTVX, KVOO-TV and KOTV are on the air. KCEB has been on but now is dark.

Assignment of either ch. 10 or ch. 12 to Moscow, Idaho, by deleting 10 from Pullman, Wash., or 12 from Coeur d'Alene, Idaho (proposed by KMOS-TV Inc., Moscow). Moscow currently is assigned educational ch. 15.

Shift of ch. 13 Yuma, Ariz. (assigned to KYAT [TV]), to El Centro, Calif. Yuma currently is assigned ch. 11 (operating KYAT [TV]) in addition to ch. 13. El Centro is allocated chs. 16 and 56, both unoccupied. The channel shift was proposed by Wrather-Alvarez Broadcasting Co., permittee of KYAT.

Assignment of ch. 12 to Farmington, N. M., which now is allocated ch. 17 only. Seeking the assignment is Farmington Broadcasting Co., whose principals operate

a community antenna system there rebroadcasting the signal of ch. 4 KOB-TV Albuquerque.

To decide between conflicting proposals to shift ch. 33 from Reading to York and Harrisburg, all Pa. Ch. 33 presently is assigned to dark WEEU-TV Reading. Ch. 71 WTPA (TV) Harrisburg is seeking the channel for that city; ch. 49 WNOW-TV York for that city. WTPA also proposed changing the educational reservation in State College, Pa., from ch. 48 to 69. York also is assigned operating ch. 43 WSBA-TV; Harrisburg ch. 27 WCMB-TV and ch. 55 WHP-TV, both on the air. In addition to ch. 33, Reading is assigned ch. 61 WHUM-TV (dark).

At the request of Bi-State Co. (KHOL-TV Kearney and KHPL-TV Hayes Center, both Neb.) and following rule-making proceedings, the FCC allocated ch. 3-plus to Ainsworth, Neb. In the same action, the offset carrier requirement of KOTA-TV Rapid City, S. D., was changed from ch. 3-plus to 3-minus and in Miles City, Mont., from ch. 3-minus to 3-even.

Bi-State plans to apply for the channel as a satellite operation.

Operating ch. 67 Columbia, S. C., petitioned the FCC to set aside the Commission's instructions to its staff which would deny the assignment of ch. 5 to Columbia. WNOK-TV asked the FCC to accept and consider "supplementary comments" relating to the station's income, which has shown a "sharp and complete" reversal.

WNOK-TV said that its loss in revenue for the first six months of 1957 will amount to substantially more than the station's entire net income for 1956. The station will be forced off the air, it said, unless relief is forthcoming. Also operating in Columbia is ch. 10 WIS-TV.

FCC ACTION BRISK ON ST. LOUIS MOVE

- KTVI (TV) switch draws fire
- Two vote their approval

A HORNET'S NEST of activity continues to revolve around the FCC's decision to deintermix Springfield, Ill., by shifting ch. 2 to St. Louis and Terre Haute, and ch. 36 from St. Louis to Springfield [B•T, March 25 *et seq.*]. Most filings are protests against the temporary use of ch. 2 by ch. 36 KTVI (TV) St. Louis. Among last week's developments:

- The Commission denied a request by Louisiana Purchase Co. asking immediate stay of authorization to KTVI for temporary operation on that channel.

- Louisiana Purchase immediately appealed this Commission action to the Washington Court of Appeals.

- WMAY-TV, which held a conditional grant for ch. 2 in Springfield, asked the FCC to reconsider its action in taking away ch. 2.

- Ch. 4 KWK-TV St. Louis protested the

temporary authority to KTVI and asked for a rehearing.

- Sangamon Valley Tv Corp. protested the shift of ch. 2 from Springfield, Ill., and assignment of ch. 36 there, and asked for a rehearing.

- St. Louis Telecast Inc. agreed with assignment of ch. 2 to St. Louis but attacked KTVI's use of the channel.

- Ch. 20 WICS (TV) Springfield and ABC both filed petitions supporting the Commission's action regarding Springfield and St. Louis.

In denying Louisiana Purchase's request for an immediate stay of the KTVI authorization, the FCC said: "Our examination of the various pleadings filed by Louisiana Purchase does not reveal any facts or arguments which were not fully considered before the adoption of the orders complained of." By withholding the temporary authority for ch. 2 at St. Louis until after a comparative hearing, the Commission said, the purpose of its action would be defeated (making ch. 36 available immediately for Springfield and at the same time insuring the continuance of a third tv service in St. Louis).

FCC emphasized that no final decision has been reached on the protests of KTVI operation on ch. 2 and that all pleadings on file will be considered before a final decision is reached. Neither Louisiana Purchase nor any other applicant is being denied the right to a fair and full comparative hearing (as claimed by many protestants), the Commission stated.

The ink was hardly dry on this order before Louisiana Purchase went to the Court of Appeals seeking to have the Commission overruled on its decision and to force a stay of KTVI's operation on ch. 2.

WMAY-TV said the Commission's determination that Springfield is predominantly uhf is "wholly arbitrary and capricious." During substantial portions of the week, WMAY-TV claimed, the most-watched station in Springfield is ch. 3 WCIA (TV) Champaign, Ill. However, the protestant said, "if the Commission should adhere to the erroneous decision that ch. 2 should be deleted from Springfield, then . . . it is imperative that ch. 36 . . . be assigned to Springfield."

KWK-TV charged that FCC had "delegated to Signal Hill Telecasting Corp. (KTVI) the sole discretion to determine whether ch. 36 should be deleted from St. Louis and whether ch. 36 or ch. 39 should be assigned to Springfield, Ill." The action taken by the Commission was not a lawful basis for granting KTVI the right to telecast on ch. 2, KWK-TV stated, and scored KTVI's operation from a site that does not meet the required mileage separation from ch. 2 in Terre Haute, Ind.

Sangamon, an applicant for ch. 2 in Springfield, said the Commission action is arbitrary, capricious and unlawful and asked the FCC to stay, reconsider and vacate its action.

St. Louis Telecast Inc., one of four applicants awaiting a final decision for St. Louis ch. 11, claimed the outcome of any comparative hearing for ch. 2 has been prejudged by FCC in awarding KTVI use of

BE THE PREMIERE STATION IN YOUR CITY

WITH

39 OF COLUMBIA PICTURES GREATEST FEATURE FILM SUCCESSES

NOW
SET TO
PREMIERE IN
THESE CITIES!

WABC
NEW YORK CITY

KRON
SAN FRANCISCO

WTVN
COLUMBUS

KSL
SALT LAKE CITY

KCRA
SACRAMENTO

WSM
NASHVILLE

YOU CAN'T TAKE IT WITH YOU

YOU WERE NEVER LOVELIER

ONLY ANGELS HAVE WINGS

THE AWFUL TRUTH

DEAD RECKONING

JOHNNY O'CLOCK

GOLDEN BOY

DESTROYER

AND 31 OTHER

SMASH

HITS

For complete information on
HOLLYWOOD PREMIERE PARADE

see us at the N.A.R.T.B. Convention,
Suite 512A-513A, Conrad Hilton Hotel

SCREEN GEMS

TELEVISION SUBSIDIARY OF COLUMBIA PICTURES



SPORTA

BRAGAN — "If I had Mantle on my team with Mays, Snider or Verdon — he'd be playing left field — The Giants will finish in 8th place."



LANE — "The Cards will finish 10 games better than last year — but don't get me wrong — we can still finish 4th."



LOPEZ — "I say the Yankees can be beaten."



A new word, a new idea in radio
...with Howard Cosell

SPORTACULARS

Pick any big spectator sport — like baseball. Track down the important names in the game. Go to the field, locker room, front office. Capture the voices of the top stars of the top teams. Ask searching questions and get unvarnished answers. Weave what you get into 30 or 60 minutes of drama and excitement . . . and broadcast it on the eve of the season opener over a nationwide network. The result — SPORTACULAR.

Then preview the **Kentucky Derby** in May with a Racing SPORTACULAR. Get the champions together for a **World Series** SPORTACULAR in September. Anticipate the first big fall weekend with a **Football** SPORTACULAR. Plan for all eleven of the most engrossing

sports programs ever broadcast. Howard Cosell is doing just that. He's already lined up the best of 200 interviews for the **Baseball** SPORTACULAR on Sunday, April 14, 6:30-7:25 PM (NYT). (See the samples below).

Howard Cosell's weekend series on ABC Radio, "Speaking of Sports," has come up with exclusive, provocative, human interest material that has won acclaim from players, colleagues and listeners.

The 55-minute, April 14 **Baseball** SPORTACULAR costs \$11,235 for time and talent. And, there's a generous advertising and promotion plan.

Get the full story on SPORTACULARS now from ABC Radio.



ROBERTS — "I didn't hide my injury last year, but to tell you the truth, I think it was my pitching that ached me — not my injury."



ROBINSON — "I don't think I have a penchant for controversy, but I am a man who must say what he believes. I guess I should be sorry I said what I did about the Braves — but if it helps them, I'm glad I did it."



MOON — "A real pro can play for any manager whether he likes him or not."



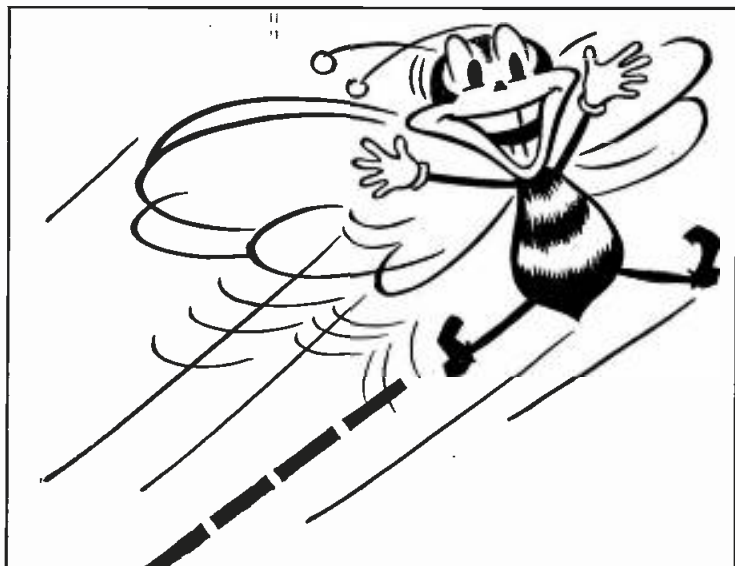

Glory be! The new Raleigh ARB (February) is out and it's a honey! Ask our H-R man. WRAL-TV, Channel 5, NBC full power. Raleigh TEMPLE 3-5553 . . . the most important television station in the risen South.

the channel. Telecast Inc. also asked for a rehearing.

Support of the Commission's action came from WICS and ABC. Both said that the public interest would be served if the changes are made effective as promptly as possible and attacked with gusto the pleadings of Louisiana Purchase Co.

KFDM-TV Faces Loss Of Ch. 6 to KRIC-AM-FM

AN initial decision favoring grant of ch. 6 in Beaumont to KRIC-AM-FM there (*Beaumont Enterprise and Journal*) was issued last week by Examiner Annie Neal Hunting, who found that the current occupant of the channel, KFDM-TV had in entering into an agreement with Houston broadcaster-publisher W. P. Hobby and KTRM Beaumont, got itself into "a dilemma of its own making."

The initial decision last week favoring KRIC was a switch from the FCC's final decision released Aug. 6, 1954, awarding ch. 6 to KFDM. The U. S. Court of Appeals for D. C. on Dec. 29, 1955, reversed the case and remanded it to the FCC, and new hearings were held last fall. KFDM-TV has been on the air since April 1955.

Examiner Hunting's position: KFDM, on Dec. 15, 1954, after the FCC had stayed the grant and scheduled oral argument before the Commission *en banc*, entered into an agreement with Mr. Hobby and KTRM which subsequently has made it impossible for KFDM to carry out the proposals on which the 1954 grant was conditioned. The alternative: a grant to KRIC.

The 1954 agreement: KFDM and KTRM, separate applicants competing with KRIC, and W. P. Hobby (president of the *Houston Post* and KPRC-AM-FM-TV Houston), a non-applicant, agreed to an arrangement in which (1) KTRM would receive \$55,000 payment for "out-of-pocket" expenses incurred in pursuing its application, to be lent by Mr. Hobby to KFDM, and passed on to KTRM, with KTRM withdrawing its application and Mr. Hobby to be refunded the \$55,000 by KFDM if the latter ultimately kept ch. 6; (2) Mr. Hobby would receive an option to buy 32½% of a new corporation to be formed by KFDM to pursue the application. KFDM was to retain 67½% of the new corporation. Mr. Hobby, who held an option to acquire 35% of KTRM agreed to, and did divest himself of KTRM holdings. At that time, Mr. Hobby held 10% of KTRM.

An FCC hearing was held Oct. 29 and Nov. 26 last year and the record closed. A petition by Mr. Hobby last Nov. 9 to intervene was denied by the Chief Hearing Examiner Nov. 20, and Mr. Hobby's appeal was denied by the FCC last Feb. 20.

Examiner Hunting found relevant two contentions advanced by KRIC for denying a grant to KFDM: (1) The character of KFDM has been so radically changed by the 1954 tri-partite agreement that it would be improper under Sec. 1.365 of Commission rules to permit amendment of the application to show the changed nature of the ap-

KQUE — 920 — KQUE — 920 — KQUE — 920 — KQUE

Albuquerque is Booming!



Yes, Albuquerque is booming . . . and KQUE audiences are zooming to new highs. In this "Atomic Energy Empire" they're tuned to 920 for music and news 24 hours daily. News on the hour, local capsules on the half-hour and the controlled-music formula always . . . makes your advertising effective.

ALBUQUERQUE'S ALL DAY, ALL NIGHT MUSIC STATION

MUSIC

5,000 WATTS

KTRI

SIoux CITY
IOWA

920 KC

KQUE

ALBUQUERQUE, NEW MEXICO

NEWS

540 KC

KEOK

FORT DODGE
SERVING ALL
OF IOWA

EVERETT - McKINNEY, Inc.

NATIONAL REPRESENTATIVES

KQUE — 920 — KQUE — 920 — KQUE — 920 — KQUE

WHIO-TV



1 FOR THE MONEY
Three States, 41 Counties, 747, 640 TV Homes!
That's what NCS Market Coverage reports for
WHIO-TV, the No. 1 station in this great mar-
ket. High tower (1104 ft.) and maximum power
give it proven superiority.

2 FOR THE SHOW
WHIO-TV programs keep dials tuned our way.
Pulse consistently rates us with 13, 14 and *even*
15 of the top 15 weekly shows.

3 TO GET READY
Stock your dealers before you sing out in this
market! Sales Management calls area retail sales
at \$3,361,973,000.

4 TO GO
How? Easy! Call our National Rep—Gamester
George P. Hollingbery!

CHANNEL **7** DAYTON, OHIO



One of America's
great area stations

The Champ Is Still Champ!



4 OF 5 TOP NIGHT-TIME SHOWS

You say that's not enough? Then how about 20 out of 35 top night-time shows? (Nov. '56, A. R. B.)



CHAMP IN THE DAY-TIME, TOO!

16 of top 25 week-day strips . . . including Buckskin Bill, whose top rating is a full 7 points above the No. 2 day-time show. If you want a breakdown. . . .



8 OF 10 TOP MORNING SHOWS

and 8 out of the top 15 afternoon shows, for a clean-sweep victory, morning and afternoon.



6 WINNERS IN 6 NATIONAL CONTESTS

WAFB-TV is tops in merchandising, too. Four firsts, one second, and one "top four" in these shows; 1956-57 "Frank Leahy Show" . . . "The Millionaire" . . . "Screen Gems Programs" . . . "Lucy Show" . . . 1956 Billboard Promotion . . . 1955-56 "Frank Leahy Show" . . . six more reasons for you to sell more in Baton Rouge on WAFB-TV.

WAFB-TV

CBS ABC

Reps: Blair Television Associates

First in TV in Baton Rouge

plicant and, conversely, it would be improper to make a grant to KFDM without such an amendment because of the change of the applicant's character; (2) the payment of \$55,000 to KTRM was based on the value of the station withdrawing from the contest rather than upon "a clear showing" of its out-of-pocket expenses.

She found that Sec. 1.365 prohibits amendment of an application after hearings and initial and final decisions issued, and that KFDM, by entering into an agreement from which it apparently cannot extricate itself, "has precluded itself from reverting to its original proposal."

FCC RENEWAL FORMS GET MODERNIZATION

- First change since WW II
- Approval only a formality

NEW forms for radio and television stations seeking license renewals may become a reality before another week is up. The new forms, simplified yet reflecting more truly the state of broadcasting under present-day conditions, are the outcome of a year-long study by the Broadcast Industry Committee of the Advisory Council on Federal Reports and an FCC staff group, working with the Bureau of the Budget.

The proposed forms—first change in program information since the end of World War II—will be laid before the FCC at its regular meeting this week. Commission approval is considered a formality, although some days may elapse before the official order is issued publicly.

The new forms for radio are based on one premise: That the program information hitherto called for by the FCC was detailed, burdensome and did not truly reflect the operation of radio stations in today's broadcast scene. Although the tv form will also be revised, no major changes were made in programming information details. This was because the committee felt that the Commission needs specific and detailed information on the newer art, television.

Changes proposed in the radio form:

- Deleting the requirement that established stations describe their staffing.
- Using FCC composite week instead of minimum weekly schedules.
- Changing program classifications were made to embrace three major categories which today largely comprise radio programming: news, community service and entertainment. Space is provided for narration to permit individual stations to indicate significant variations. The new "community service" category embraces religious, educational, agricultural, instructional and informative programs. In present forms, detailed answers are required to a host of categories.
- Eliminating time divisions since day and night differentials have disappeared. The analysis of spot announcements is based on a composite week.

In the tv renewal form, these changes have been proposed:

- Using composite week instead of minimum weekly schedule.
- Adding a new category, "Public Af-

ROCHESTER LOVES US!

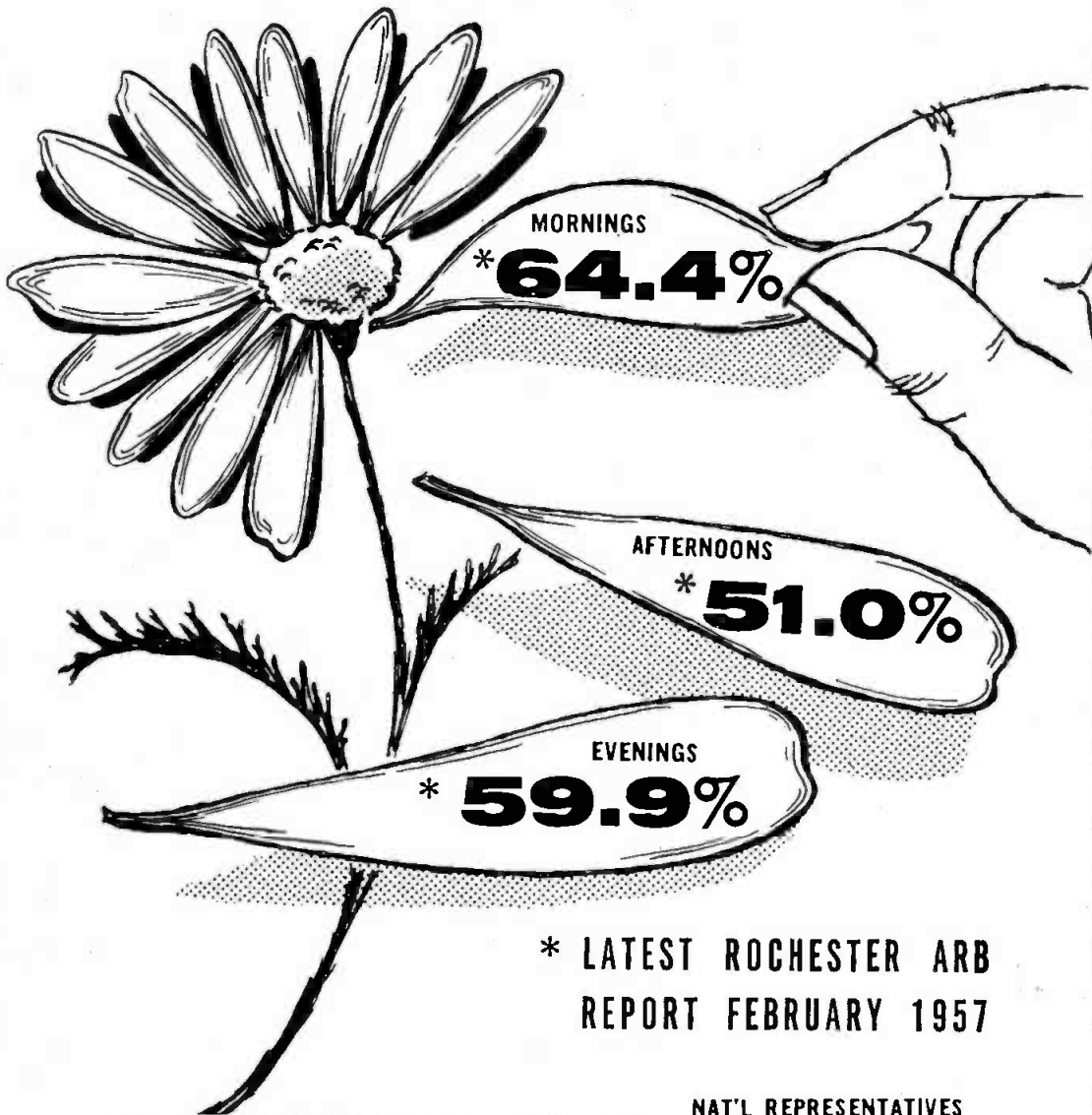

* LATEST ROCHESTER ARB
REPORT FEBRUARY 1957

ROCHESTER, N. Y.

NAT'L REPRESENTATIVES
THE BOLLING CO., INC.
EVERETT-McKINNEY

IT ALL
ADDS UP TO

10

I'M JOE FLOYD . . .



I CONSIDER MYSELF A HELLUVA SALESMAN!

Whether you want to go the
radio or tv route . . .

If you want to cover a healthy,
husky slice of America—
measured in terms of South
Dakota, Minnesota, Iowa and
Nebraska—then see me!

BUY JOE'S RADIO

KELO Now increased
from 5,000 watts to 13,600 watts.

and

BUY JOE'S TV!

You can't beat this single market
buy!

KELO-TV

SIOUX FALLS (New 1,032-ft. Tower)

SATELLITE **KDLO-TV**

ABERDEEN-HURON-WATERTOWN

and this June **KPLO-TV**

PIERRE-WINNER-CHAMBERLAIN

All inter-connected!

NBC • CBS • ABC

THAT'S RIGHT! J. F. IS A HELLUVA SALESMAN

and you can reach him quick at KELO,
Sioux Falls . . . or through

H-R REPRESENTATIVES

fairs."

- Revising definitions of agriculture, news, educational, instructive and informative have been made. All are broadened in order to give the FCC a more rounded picture of programming.

- Dividing the broadcast day into daytime (6 a.m. to 6 p.m.) and nighttime (6 p.m. to 6 a.m.) periods.

- Matching spot announcement schedule to composite week and dividing it into daytime and nighttime tables. Requirement that promotional announcements be counted in spot tabulations has been eliminated. Also deleted have been "wire commercial" and "wire sustaining" categories.

- Revising the definition of a recorded program to match present-day practices. The new definition requires a recorded announcement if more than half the program comprises mechanical reproduction. The old form required this designation whenever any mechanical reproduction was used, other than where used incidentally (e.g., newsreels used in a live newscast).

FCC Asked to Fix WHAS-TV Antenna Site

THE perennial air hazard ball was thrown to the FCC last week and the government agency was told to run with it. WHAS-TV Louisville, after five years of fruitless quests for a new antenna site on which to build a 2,000 ft. radiator, told the Commission it was up to that agency to insist that the Airspace Panel find the spot.

Otherwise, WHAS-TV warned, the Commission's priority number one, to provide at least one tv service to all the U. S., was being negated by aviation interests.

The sizzling retort, a response to the FCC's February McFarland letter indicating the necessity of a hearing on the Louisville station's application for a 2,000 ft. tower, maintained a hearing shouldn't be held, and that instead the Commission should:

- Return the application to the Washington Airspace Panel.

- Insist the Panel live up to aviation's 1952 commitment to cooperate with tv in the use of airspace.

- Reject the Panel's "grab" for exclusive use of airspace for 20 miles around Louisville.

- Insist the Panel find a site "within a reasonable and practical distance from Louisville."

In recounting the history of its 25 unsuccessful surveys to find a site for a 2,000 ft. tower, including options on five of them totaling 1,516 acres, WHAS-TV charged aviation has "blacked out" an area of 20 miles around Louisville. Only site within this range not covered by an airway or approach path is restricted, WHAS-TV pointed out. This is the Fort Knox reservation.

WHAS-TV explained it needs a 2,000 ft. tower because Kentucky is essentially rural and it is necessary for tv stations to have wide coverage. At several sites, submitted unsuccessfully by the *Louisville Courier-Journal* and *Times'* station to Airspace Panels, some 660,000 Kentuckians stood to benefit either by a first Grade B signal or a

second program choice. At one site WHAS-TV offered to accept a 1,779 ft. tower, but this, too, was turned down by the Panel.

WHAS-TV challenged the contention that there was not one site within the 20-mile radius of Louisville that could be approved. It bluntly charged that "there is cause to suspect that the real basis for aviation objections to the proposed tower relates to operating costs and not flight safety."

The Panel, WHAS-TV said, "generously" suggested the vicinity of Ramsey, Ind., in Zone I where towers are limited to 1,000 ft.

In a side issue, involving the question whether WHAS-TV's proposed move would blanket Lexington, Ky., with a vhf signal (WLEX-TV on ch. 18 operates there), WHAS-TV said Lexington is 75 miles from Louisville and if it were not for air space requirements, WHAS-TV would not begin to think of going so far outside its home city.

Supreme Court Won't Rule on McClatchy

BIGGEST winner was the FCC when the U. S. Supreme Court last week refused to rule on a protest by McClatchy Broadcasting Co. that it (McClatchy) was denied a cp for a new tv station in Sacramento, Calif., strictly because of newspaper and radio-tv interests.

McClatchy, which was favored in an initial decision, had protested the 1954 grant of ch. 10 to Sacramento Telecasters Inc. (now KBET-TV). "Never before in the entire history of federal radio regulation has the Commission held that an applicant otherwise superior to its competitor should be denied solely because of its interests in other media," McClatchy stated in its appeal.

Early last year [AT DEADLINE, Jan. 30, 1956], the Washington, D. C. Court of Appeals denied the protest on the grounds that the FCC is the final judge of which applicant should be chosen for a tv grant—provided the Commission's decision is not "arbitrary or capricious." The Supreme Court's action, in essence, upheld this decision.

The appeals court held that ". . . the Commission is entitled to consider diversification of control in connection with all other relevant facts and to attach such significance to it as its judgment dictates . . . The Commission is free to let diversification of control of communications facilities turn the balance, if it reasonably concludes that it is proper to do so."

McClatchy owns KFBK-AM-FM Sacramento, KERN-AM-FM Bakersfield, KMJ-AM-FM-TV Fresno, KBEE-AM-FM Modesto, all Calif., KOH Reno, Nev., and newspapers in Sacramento, Fresno and Modesto.

Not affected by the Supreme Court's ruling is a McClatchy protest against the modification of KBET-TV's cp. Less than 60 days after receiving the grant, KBET-TV was authorized a change in its transmitter site and decrease in antenna height by the FCC. McClatchy filed a protest to this action, which the Commission denied on the ground that McClatchy had no further standing. This was appealed to the courts, which ruled that the FCC must give the protestant a hearing [B•T, Oct. 22, 1956].

ABC-TV Film Appoints Four In Expansion of Sales Staff

REALIGNMENT and expansion of the sales staff of ABC-TV Film Syndication are being announced today (Monday) by Don L. Kearney, vice president in charge of sales for the film unit.



MR. MARCATO

Robert E. Marcato, formerly on the sales staff of NBC-TV, has been named eastern sales manager, with his area enlarged to include West Virginia, North Carolina and South Carolina as well as



MR. DALCHAU

MR. HOOPER

the 12-state New England-Middle Atlantic regions. Robert Dalchau, former Dallas manager, has been promoted to southern sales manager to supervise nine southern states. Bill Hooper recently with Ziv television programs, has been added to the eastern sales staff, and Richard Hurley, formerly with Television Programs of America in the Southwest, has been named to the midwest sales staff of ABC-TV Film Syndication.

Screen Gems Creates Division To Sell 'B' Features for Tv

ESTABLISHMENT by Screen Gems Inc., New York, of a new sales division to specialize in the distribution of so-called "B" feature films to tv, was announced last week by Jerry Hyams, director of syndication for Screen Gems.

Mr. Hyams said the initial project of this division will be to sell 52 Columbia Pictures films incorporated in a new package called "Hollywood Value Parade." The pictures, Mr. Hyams said, are first-run to tv and are the "adventure-action type." Their price to stations will be from 25 to 50% less than the so-called "A" feature film, depending on the market.

Mr. Hyams announced that George Gilbert, formerly with Allied Artists and Interstate Television Corp., has been added to the staff as the first salesman on the new venture.

Cosmetic Firms Buy Ziv Re-runs

IN a major sale of its re-run film series, Ziv Television Programs, New York, announced last week that four cosmetic advertisers have signed to sponsor jointly 128 half-hours of programming in 15 cities at a

total cost of \$765,000. The four advertisers, which are non-competing, are Helaine Seager Inc., Cosmetics Corp. of America, Tint 'n Set Inc. and Diversified Cosmetics of America, all represented by Dunnan & Jeffrey Adv. New York. Programs in the package include *Boston Blackie* and *The Unexpected* and various other re-run properties. The contract is for 52 weeks on a multiple-run basis. The programs will start on the air within 60 days.

Texanco Signs Syndication Pact With Harry Goodman Productions

TEXANCO Enterprises Inc., the newly-formed program packaging and syndication firm headed by John Reagan (Tex), McCrary Jr., New York public relations executive and NBC personality, today (Monday) will announce the signing of syndication contracts with Harry S. Goodman Productions, New York, and G. N. Mackenzie Ltd., Toronto. Product to be syndicated throughout the U. S. and the English-speaking world (save Canada) by Goodman and in Canada by Mackenzie is a series of condensed "celebrity interviews" by Mr. McCrary and his wife, Jinx Falkenburg. They are taken from the McCrarys' weeknight WRCA New York programs [CLOSED CIRCUIT, Dec. 24, 1956, *et seq.*]

Presently sponsoring the series in four major cities is Slenderella International, Stamford, Conn. The slenderizing chain is currently identified with the 10-minute *New York Close-Up* strips thrice weekly on four NBC Radio o&o stations: WRCV Philadelphia, WMAQ Chicago, KSD St. Louis and KOA Denver. Slenderella also holds an option to enlarge its purchase to 35 other markets [AT DEADLINE, Jan. 14], and is expected to reach a decision this week. In Canada, the series is now heard in 10 markets, including Montreal, Winnipeg, Vancouver, Edmonton and Calgary. According to Jerome M. Landay, Texanco vice president who negotiated the two contracts, negotiations are now under way with a number of other advertisers, including a major brewer, several auto dealers, a bakery and two banks.



TEX and JINX McCrary sign worldwide distribution contract with Harry S. Goodman Productions, program syndicators. L to r: Mr. McCrary; Everett Goodman, Texanco sales manager; Mrs. McCrary; Jerry Landay, Texanco vice president, and Mr. Goodman.

17 Los Angeles Outlets Negotiate with Unions

A committee representing 17 independent radio stations in the Los Angeles area has begun negotiations with locals of the American Federation of Television-Radio Artists and The International Brotherhood of Electrical Workers for new contracts to succeed the present pacts, both expiring April 30. Cal Smith, general manager, KFAC, is chairman of the station committee.

AFTRA is asking for an overall increase of \$35 a week for announcers from the present base wage scale, which starts at \$92.50 for announcers at 250-watt stations and runs to \$129 for the largest independents, with extra fees for newscasts and a straight eight hours out of nine hours a day in place of the present arrangement permitting an announcer to be kept at a station for ten hours to work his eight, according to Claude McCue, AFTRA's Western regional director.

Leo Phillips, business manager of IBEW Local 202, told B•T the union is asking for a five-year contract in place of the present two-year pact and previous three-year deals. The proposal includes demands for a wage increase for each year (with the heavier increases at first), leveling off at the three-year point and having only slight increases thereafter.

Tv Alliance, Guild Sign Pact Retroactive to April, 1956

CONTRACT between Writers Guild of America and Alliance of Independent Television Film Producers has been signed and becomes effective retroactive to April 21, 1956.

Terms are similar to those in the Guild's contract with major film tv subsidiaries, which was concluded last December, when the pact with the independent tv film producer hit a snag on the eve of signature. Minimum fee for the writer of both story and teleplay for a 60-minute film program, for example, would get \$1,610 if the film is a low-budget production or \$2,000 if it is a high-budget production, the dividing line for an hour show being \$52,250.

The Alliance contract also contains special provisions adopted from the network film tv contract, such as the minimum of \$350 per writer per week on a once-a-week comedy-variety series. The Guild reported it has also signed contracts with the three tv networks, the three sets of contracts: networks, major film tv subsidiaries and Alliance, concluding 18 months of negotiations. Retroactive payments are now being calculated under all three pacts.

AFTRA Chicago Nears Accord

SEVEN of Chicago's eight independent radio stations have come to terms with the local chapter of American Federation of Television & Radio Artists on two-year pacts covering staff and freelance announcers. Contracts already completed call for pay boosts in the range of 8 to 15%, varying for the stations involved. Another feature is extension of pension and welfare benefits for all announcers, including freelancers.

Indiana Broadcasters Elect Spencer President

LEGISLATIVE, judicial and internal organization problems were explored by the Indiana Broadcasters Assn. at its annual meeting in Indianapolis on March 22, with Lester G. Spencer, general manager of WKBV Richmond, elected as the new president. He succeeds Daniel C. Park, commercial manager of WIRE Indianapolis.

New officers include Joseph Higgins, WTHI Terre Haute, vice president-am; Bernard Barth, WNDU-TV South Bend, vice president-tv; Howard White, WCTW New Castle, vice president-fm; Dennis Keller, WITZ Jasper, secretary-treasurer, and Roy L. Hickox, WLRP New Albany, assistant treasurer. Elected to the board were Dee Coe, WWCA Gary; Henry Sanders, WBNL Booneville; Carl Vandagriff, WOWO Fort Wayne; Don Martin, WSLM Salem, and Mr. Park.

IBA dues structure revision also was approved, with combination am-tv station members paying dues based on their highest one-time quarter-hour tv rate instead of on am rates. American Bar Assn.'s controversial Canon 35, prohibiting courtroom broadcast pickups and the taking of pictures, also was reviewed. Increased station coverage of this year's Indiana high school basketball tournament was cited, also with a review of state legislative proposals.

Public's Right to Know Defended in Fellows Speech

THE PUBLIC'S right to know must be weighed against any proposals to censor broadcasting of public events, NARTB president Harold E. Fellows said a fortnight ago in an address to the legislative dinner of the



PLAQUE honoring service of Phil Hoffman (right), KLZ-AM-TV Denver, for service during presidency of Colorado Broadcasters & Telecasters Assn. was presented as he left for new Time Inc. assignment in Minneapolis-St. Paul (WTCN-AM-TV). Presenting award were Jerry Fitch (left), KREX-AM-TV Grand Junction, new president, and Robert Dolph, KFTM Fort Morgan, who succeeds Mr. Fitch as vice president. Harry W. Roth, KRDO-AM-TV Colorado Springs, continues as secretary-treasurer.



THE B•T TOURNEY: TO THE VICTORS . . .

MORE than a score of trophies and prizes will be awarded golfers who play in the annual B•T tournament to be held next Sunday at Chicago. Conventioneers can drive their own cars to Midwest Country Club, at nearby Hinsdale, Ill., or catch the tournament buses leaving at 9:30 a.m. from the south entrance of the Conrad Hilton Hotel.

The first instalment of prizes started arriving at B•T's Chicago office last week (see cut). Two silver trophies will be awarded low gross and low net scores.

Among donors of prizes are: WBKB (TV) Chicago, two Naxon electric Frymasters; WGN Chicago, portable tv receiver; WBBM Chicago, CBS portable

record player; WEMP Milwaukee, two clock radios; WJOL Joliet, Ill., pepper mill-salt shaker set; WFMT (FM) Chicago, am-fm receiver; WLS Chicago, transistor radio; WMAQ Chicago, am-fm receiver; WNBQ (TV) Chicago, Nadco 500 caddy cart; John Pearson Co., Waring blender; WIND Chicago, Westinghouse portable radio; WMCA New York, Westinghouse portable radio; Gill-Perna, Magnavox 17-inch portable tv; Al Levine, Sportlight, silver ash tray; Edward Petry Co., surprise gift; Playboy magazine, year's subscription; WCFL Chicago, Raytheon transistor radio; Keystone Broadcasting System, clock radio; H-R Representatives, dispatch case.

Michigan Assn. of Radio & Television Broadcasters, held at Lansing Civic Center.

Over 125 state senators and representatives were guests at the banquet. They were welcomed by J. P. Scherer, WHFB Benton Harbor, MARTB president. Mary Jane Morris, FCC Secretary, was guest at the Thursday dinner.

Mr. Fellows asked Michigan legislators to consider problems created by efforts of organized political groups "to bar from the air program content which does not please them, but may be applauded by a great many others."

William Hunt New President Of Alabama Broadcasters Assn.

WILLIAM W. HUNT, commercial manager of WCOV-AM-TV Montgomery, is new president of the Alabama Broadcasters Assn. Mr. Hunt was elected at a two-day meeting of the association March 22-23 in Birmingham.



MR. HUNT

The association's Oct. 10-11 meeting will be at U. of Alabama, Tuscaloosa.

Tom Garten Elected President Of West Virginia Bcstrs. Assn.

C. TOM GARTEN, assistant general manager of WSAZ Inc. (WSAZ-AM-TV Huntington, W. Va.), was elected president of the West Virginia Bcstrs. Assn. during the 13th



MR. GARTEN

annual meeting of the group. Mr. Garten, who had served as secretary-treasurer of the organization, succeeded A. Baren Ferrise, managing director of WMMN Fairmont, W. Va., as president.

Re-elected vice president was Robert W. Ferguson, executive vice president and general manager of WTRF-TV Wheeling. C. Leslie Golliday, general manager of WEPM Martinsburg, was chosen secretary-treasurer.

Guest speaker at the dinner meeting of the group was C. Yates McDaniel, former WW II correspondent now in the Washington bureau of the Associated Press, who said the Defense Department's size and complexity are to blame for some of the delays and omissions in release of information.

Special NARTB Convention
Section Starts on Page 79

COUNT ON
SUCCESS

1

2

3

STRIP FOR

TV'S MOST PROFITABLE HOUR STRIP!

TRY

*starring
in*

56

to adults every time!

tional spot

*ertisers like Alka Seltzer, Mont-
Ward, Arrid, National Dairies, Chef Boy-
Poll Parrot Shoes, Reddi-Wip, Prince
mi, Hostess Cup Cakes, Top Value Stamps,
Bread, Nabisco, My-T-Fine, Baker's Choc-
Bosco, Toni, Revlon, Snow-Crop, Robert
othes, Beeman's Gum*

hour-long features

*made by Republic Pictures
Corporation and available to
local advertisers and stations.*

**mca
tv**

Film Syndication

AMERICA'S NO. 1 DISTRIBUTOR OF TELEVISION FILM PROGRAMS

GENE A



★ 50%

★ No

adv

gomen

ar-dee

Macar

Wonde

olate,

Hall C



12

OF TELEVISION'S

WESTERN

the best from the West!

stripped by stations
everywhere, with huge
Monday-thru-Friday cumulative
ratings that are giving competing
shows the old "1-2-3"!

OPEN THESE DOORS



3

MOST SUCCESSFUL

FEATURES

the best from the West!

now consistently topping
direct network and local
competition (ARB—October,
1956 thru January, 1957).

TO SALES SUCCESS

FEATURES

starring
in

67

low cost per
hour and for kids and adults

KA Pittsburgh has just
multiple runs of all 123 features and
runs 5 hours a week for 2½ years to
FEATURES STARRING GENE AUTRY
STERN FEATURES STARRING ROY
Call us about sensible price patterns
for one, two or three years of pro-
gramming!

hour-long features

made by Republic Pictures
Corporation at an original
production cost of
\$250,000 each!

mca
tv

Film Syndication

AMERICA'S NO. 1 DISTRIBUTOR OF TELEVISION FILM PROGRAMS

ACTION!

CONSISTENTLY OUTRATES COMPETITION!

ROY RO



★ Low
thousa

★ KD
bought n
will devo
WESTERN
and WE.
ROGERS.
whether
grammin

COUNT ON SUCCESS...RATING SUCCESS...SALES SUCCESS
WITH THESE 123 FULL-HOUR **WESTERN FEATURES**

56

STARRING
GENE AUTRY



67

STARRING
ROY ROGERS



WITH HOLLYWOOD GREATS LIKE

Jimmy Duranté
John Carradine
Ann Miller

Dale Evans
Ann Rutherford
Sterling Holloway

Andy Devine
Paul Kelly
Buster Crabbe

Gabby Hayes
Sons of the Pioneers
Gale Storm

give a hoot and a holler to
your representative at

mca tv

598 Madison Avenue, New York 22, N.Y. (PLaza 9-7500)

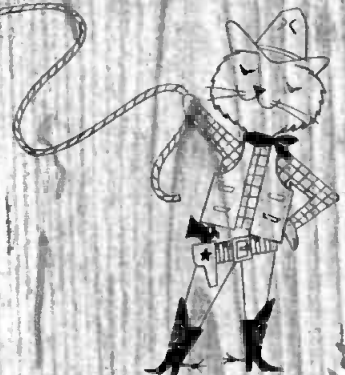

THE NARTB CONVENTION

A SKY-PIERCING city within a city will be operations headquarters for more than 3,000 broadcasters as NARTB convention delegates hold their annual series of meetings, conferences, expositions and social events.

The sprawling wings of the 26-story Conrad Hilton Hotel, Chicago, world's largest convention plant, will be packed with broadcasters starting next weekend and continuing through Thursday afternoon, April 11. Its vast corridors and jammed elevators will teem with broadcast managers, salesmen, engineers, advertisers, agency executives, government officials and newsmen.

With the largest collection of auditoriums and dining rooms, under one roof, the Conrad Hilton will also provide sleeping accommodations for over 2,000 broadcasters and industry delegates. This will force a thousand or so latecomers into other hotels, since all Conrad Hilton space had been assigned a week ago.

When delegates head toward Chicago late this week they will find hotel rooms scarce in nearby blocks. The adjoining Sheraton-Blackstone will house a hotel greeter's convention and premium buyers are meeting at the Morrison. Experienced convention-goers make their reservations in advance, so NARTB officials figure there will be facilities for everyone though perhaps not in first-choice hotels.

The movement toward Chicago starts late this week as CBS-TV affiliates meet Friday-Saturday for a network conference (see story this issue). A number of Saturday non-NARTB meetings will be held, with the

convention programming getting under way Sunday noon as the exhibits and display floors are opened.

Convention programming was complete at the weekend except for minor details such as a firm commitment from the mayor of Chicago, Richard J. Daley, to greet delegates when formal management meetings open April 9.

Registration for the two main conventions—management and engineering—totaled 1,606 last week as NARTB closed books on advance enrollment. Of the total, 1,224 registered for the management and 382 for the engineering conference. By the time the convention gets under way, total registration will likely hover near the 2,000 mark. This figure will not include wives of delegates. The advance registrations are running about 5% above last year.

"It looks awful big," NARTB President Harold E. Fellows told B•T as he scanned reports from the advance guard of staff executives who have been at the Conrad Hilton more than a week.

A new feature inserted in the program is a discussion of Television Allocations Study Organization, with George R. Town, executive director, explaining the workings of this group. It appears on the television management agenda at 2:30 p.m. Tuesday.

After weekend non-convention meetings and social events, specialized management meetings will be held Monday. The engineering program, a four-day event dovetailed into the management agenda at several points, will start Monday morning.

ABC and MBS networks will hold affiliates sessions Sunday. The annual B•T golf tournament will be held Sunday, with buses leaving the Conrad Hilton at 9:30 a.m. for Midwest Country Club, near Chicago.

Everett Revercomb, NARTB secretary-treasurer, is convention manager. William Walker, assistant treasurer, is in charge of the registration desk.

Convention programming is in charge of a committee headed by Kenneth L. Carter, WAAM (TV) Baltimore, NARTB Tv Board chairman, and Herbert L. Krueger, WTAG Worcester, Mass., Radio Board chairman. Other members are Campbell Arnoux, WTAR-TV Norfolk, Va.; E. K. Hartenbower, KCMO Kansas City; Ward Ingram, KHJ Los Angeles; Gaines Kelley, WFMY-TV Greensboro, N. C.; Merrill Lindsay, WSOY Decatur, Ill.; Ward L. Quaal, WGN-TV Chicago; W. D. Rogers Jr., KDUB-TV Lubbock, Texas; Harold P. See, KRON-TV San Francisco; F. C. Sowell, WLAC Nashville, and Edward A. Wheeler, WEAW-FM Evanston, Ill.

REGISTRATION

NARTB's registration desk in the lower lobby of the Conrad Hilton will be open

Sunday, April 7: 7 a.m. to 7 p.m.
Monday, April 8: 7 a.m. to 7 p.m.
Tuesday, April 9: 7 a.m. to 7 p.m.
Wednesday, April 10: 9 a.m. to 5 p.m.
Thursday, April 11: 8 a.m. to 5 p.m.

EXHIBITS

THE exhibition hall and individual exhibits on the fifth and sixth floors will be open

Sunday, April 7: 12 noon to 6 p.m.
Monday, April 8: 9 a.m. to 6 p.m.
Tuesday, April 9: 9 a.m. to 6 p.m.
Wednesday, April 10: 9 a.m. to 6 p.m.
Thursday, April 11: 8 a.m. to 2 p.m.



NARTB MANAGEMENT AGENDA *All meetings are in the Conrad Hilton*

MONDAY, APRIL 8

1:30 p.m.-3:30 p.m.
Williford Room

"FM'S EXPANDING FUTURE" A Panel Discussion

Presiding: Edward A. Wheeler, WEAW-FM Evanston, Ill.; chairman NARTB Fm Radio Committee.

Panelists: Ray Stone, Maxon Inc.; FCC Comr. Robert T. Bartley; Leonard Asbach, Majestic Intl., members of NARTB Fm Radio Committee.

2:00 p.m.-3:00 p.m.
Upper Tower

TELEVISION FILM PANEL

Presiding: Harold P. Sec, KRON-TV San Francisco, chairman, NARTB Television Film Committee, and Campbell Arnoux, WTAR-TV Norfolk, chairman, NARTB Television Board.

Panelists: Richard M. Pack, Westinghouse Broadcasting Co.; Ralph N. Cohn, Screen Gems; John L. Sinn, Ziv Television Programs Inc.

3:30 p.m.-5:30 p.m.
Upper Tower

LABOR CLINIC (For station management only)

Presiding: Leslie C. Johnson, WHBF-AM-TV, Rock Island, Ill., chairman, NARTB Employer - Employee Relations Committee.

"Wages: How High? Hours: How Many?" EERC slide film presentation on wage bargaining.

"Methods and Techniques in Settling Labor Disputes": Peter Seitz, noted arbitrator and authority on labor disputes, New York.

"Crises in Broadcasting Labor Relations": Case histories.

Open Discussion

TUESDAY, APRIL 9

10:30 a.m.-12:00 Noon
Grand Ballroom

JOINT SESSION: MANAGEMENT AND ENGINEERING CONFERENCES

Presiding: Kenneth L. Carter, WAAM (TV) Baltimore; co-chairman, 1957 Convention Committee.

Invocation: His Eminence Cardinal Stritch, D. D., Archbishop of Chicago.

Presentation of the Colors: United States Marine Corps Color Guard.

Music by: Great Lakes Naval Training Center Band.

12:30 p.m.-2:30 p.m.
Grand Ballroom

Address: Gen. Alfred M. Gruenther, president, American National Red Cross.

Presentation of Keynote Award by Harold E. Fellows, president and chairman of the board, NARTB, to former President Herbert Hoover.

Response in Behalf of President Hoover: C. M. Jansky Jr., chairman of board, Jansky & Bailey.

Benediction: Cardinal Stritch.

LUNCHEON

Presiding: Herbert L. Krueger, WTAG Worcester, Mass.; co-chairman, 1957 Convention Committee.

Invocation: The Very Rev. Howard S. Kennedy, dean of the Cathedral of St. James.

Special Feature: Judith Buonaccorsi, San Leandro, Calif., national co-winner, Voice of Democracy Contest.

Address: George C. McConaughy, Chairman, FCC.

2:30 p.m.-5:00 p.m.
Williford Room

RADIO MANAGEMENT CONFERENCE

Presiding: Mr. Krueger. "This Year of Grace:" John M. Outler, Jr., WSB Atlanta, chairman, NARTB Radio Board.

"This Business of Radio—Inventory 1957:" Grover C. Cobb, KVGB Great Bend, Kan.; chairman, NARTB Am Radio Committee; Lawrence Webb, managing director, Station Representatives Assn.; Arthur Hull Hayes, president, CBS Radio.

"You and The Automobile Dealer:" Adm. Frederick J. Bell, executive vice president, National Auto. Dealers Assn.

2:30 p.m.-5:00 p.m.
Upper Tower

TELEVISION MANAGEMENT CONFERENCE

Presiding: Mr. Carter.

Television Allocations Study Organization: Dr. George R. Town, executive director.

Television Code: *Introduction of the speaker* by Edward H. Bronson, director, Television Code Affairs, NARTB; *address* by G. Richard Shafto, WIS-TV Columbia, S. C.; chairman, NARTB Television Code Review Board.

6:00 p.m.-7:30 p.m.
Williford Room and
Normandy Lounge

7:30 p. m.
Grand Ballroom

WEDNESDAY, APRIL 10

9:30 a.m.-12:00 Noon
Williford Room

12:00 Noon
Williford Room

12:45 p.m.-2:30 p.m.
Grand Ballroom

2:45 p.m.-5:00 p.m.
Williford Room

Television Management Organization Planning and Direction—*Panelists*: Samuel L. H. Burk, director of industrial relations, National Assn. of Manufacturers; Donald R. Booz, staff executive, Jewel Tea Co.; John S. Hayes, The Washington Post Broadcast Division; Lawrence H. Rogers II, WSAZ-TV Huntington, W. Va.

ANNUAL CONVENTION RECEPTION

ANNUAL CONVENTION BANQUET

JOINT SESSION: Radio and Television Management Conferences.

Presiding: Mr. Krueger.

Remarks: Robert D. Swezey, WDSU-TV New Orleans, chairman, NARTB Freedom of Information Committee.

Film Presentation: "Electronic Journalism in the Court Room."

Panel Discussion featuring the FCC: George C. McConaughy, Rosel H. Hyde, Robert T. Bartley, John C. Doerfer, Robert E. Lee, Richard A. Mack and T. A. M. Craven; moderator, Mr. Fellows.

ANNUAL MEMBERSHIP MEETING

Business Session

LUNCHEON

Presiding: Mr. Carter.

Invocation: Rabbi Henry Fisher, president, Chicago Rabbinical Association.

Special Presentation to Mrs. J. Percy Priest, widow of the Tennessee Congressman.

Report to the People: Harold E. Fellows, president and chairman of the board, NARTB.

RADIO MANAGEMENT CONFERENCE

Presiding: Mr. Krueger.

"Radio Week Rally": NARDA, NARTB, RAB, RETMA.

"Everybody's Doing It," *Radio Advertising Bureau Presentation*: Kevin B. Sweeney, president; John F. Hardesty, vice president and general manager; Sherril Taylor, vice

7:30 p.m.
Grand Ballroom

THURSDAY, APRIL 11

10:00 a.m.-12:00 Noon
Boulevard Room

10:00 a.m.-12:00 Noon
Williford Room

12:30 p.m.-2:30 p.m.
Grand Ballroom

2:30 p.m.-5:00 p.m.
Grand Ballroom

4:00 p.m.
Williford Room

president and director of promotion.

"Counting the Audience": E. K. Hartenbower, KCMO, Kansas City, chairman, NARTB Radio Research Committee; Ward Dorrell, vice president and research director, John Blair and Co.

RADIO PIONEERS DINNER

RADIO MANAGEMENT CONFERENCE

Presiding: Mr. Krueger.

"Program of Engineering Progress": A. Prose Walker, manager, Engineering Department, NARTB.

"Automatic Programming": Myron Jones, WJET Erie, Pa.; L. J. Cervone, general sales manager, Gates Radio Co.

"Program Logging with Punch Cards": Presentation of the Service Bureau Corp., subsidiary of International Business Machines.

"They Got Me, Pal—or Wage-Hour Woes": Charles H. Tower, manager, Employer-Employee Relations Dept., NARTB.

TELEVISION MANAGEMENT CONFERENCE: ALL-INDUSTRY TELEVISION MUSIC LICENSE MEETING

LUNCHEON

Presiding: Mr. Krueger.

Invocation: Dr. Preston Bradley, Peoples Church of Chicago.

Address

"People, Products and Progress; 1975": Arch N. Booth, executive vice president, Chamber of Commerce of the United States.

TELEVISION MANAGEMENT CONFERENCE

"Television — 1957's Salesman",

Television Bureau of Advertising Presentation: Norman (Pete) Cash, president; George Huntington, assistant to the president and director of sales development; William Colvin, director, station relations.

TELEVISION BUSINESS SESSION
Tv Board Elections

SPOTLIGHTING THE ENGINEERING CONFERENCE

FOUR days of programming are scheduled for the 11th annual NARTB Broadcast Engineering Conference to be held April 8-11 at the Conrad Hilton Hotel, Chicago. John G. Leitch, WCAU-AM-TV Philadelphia, is chairman of the engineering program committee. A. Prose Walker, NARTB engineering manager, is conference director.

Papers covering operating problems of old and new equipment will be read, along with treatises on studio techniques, antennas and towers. Many of the papers will deal with newly-developed automation processes. Two of the six half-day sessions devoted

to technical papers will cover radio topics with the other four devoted to television. The annual FCC Roundtable Wednesday morning will cover both radio and tv.

Programs start next Monday at 9 a.m. and wind up Thursday at 5 p.m. The agenda has been criss-crossed with the management sessions for the Tuesday-Wednesday-Thursday luncheons, the Tuesday morning management program and the FCC Roundtable, at which the seven Commissioners will be questioned. Synopses of the technical papers, with Engineering Conference agenda, follow. Sessions will be held in the Waldorf Room of the Conrad-Hilton.

Monday, April 8 Morning—Radio

9:9:15 a.m.

OPENING OF ENGINEERING CONFERENCE

Raymond Guy, NBC
A. Prose Walker, NARTB



PRESIDING OFFICER:
JAMES H. GREENWOOD
WCAE PITTSBURGH

9:20-9:45

A NEW 50 KW AM TRANSMITTER DESIGNED AROUND MODERN COMPONENTS

By Neville Mapham,
Canadian Electric Co.



THE vast majority of today's broadcast transmitters are designed around well-known and time-tested circuits. These circuits and components, although acceptable, can be greatly improved upon by

the use of developments which are available to us today.

This paper deals with updating our present techniques by the use of newer tubes, devices and controls. The adoption of these newer circuits and components will provide for greater reliability, simpler operations, and improved accessibility in half the space required for previous transmitters. In this new design, expendable tube rectifiers have been replaced with Germanium Diodes which in turn eliminate the need for rectifier filament transformers and temperature control equipment.

9:50-10:05

PROGRESS REPORT ON REMOTE CONTROL PETITION AND AUTOMATIC RECORDING PROJECT

By A. Prose Walker,
manager of engineering, NARTB



ON Feb. 15, 1956, the NARTB filed with the Federal Communications Commission a petition to extend remote control authorization to stations using directional antennas and powers up to and including 50 kw. The petition was set for

rule making on April 12, 1956, (Docket 11677) and the record was officially closed in this proceeding Oct. 22, 1956.

This paper will discuss in detail the status of the remote control petition along with pertinent information which may be of general interest to those concerned.

Also to be discussed will be the next phase of NARTB's plan to modernize our radio concepts, namely current experiments in the use of automatic logging equipment in lieu of the present day written transmitter log.

10:10-10:35

AUTOMATIC RECORDING OF THE CRITICAL PARAMETERS OF A DIRECTIONAL ANTENNA SYSTEM AND A STANDARD BROADCAST TRANSMITTER

By Gustave Ehrenberg, applications engineer, Brown Instruments Div., Minneapolis-Honeywell Regulator Co.



A REMOTELY-controlled broadcast station is designed for semi-automation.

All tedious repetitious activities should be relegated to machinery when possible to allow men to

concentrate on work that requires reasoning and judgment. Manual logging of data is just such an activity and can be easily eliminated with a gain in both reliability and accuracy.

Over a single pair of telephone wires twenty-four independent variables can be telemetered and recorded remotely on a multipoint strip chart recorder with only a few seconds interval between points. The system and equipment have been in general use in process industries for many years.

10:40-11:05

THE RADIO STATION OF THE FUTURE

By John Haerle,
broadcast sales manager, Collins Radio Co.



THIS discussion will begin with a review of the technical aspects of the small station over the past decade, followed by a summary of the present state of the art. Subjects covered will include transmitters, monitors, metering, logging, directional antennae, remote control, studio control, remote pickup, automatic programming.

Secondly, the trend established by past

and present considerations will be projected into the future. Particular attention will be devoted to the trend toward automation.

Finally, because of the partially abstract nature of a look into the future, the last 10 minutes of the discussion will be thrown open for ideas, questions and suggestions.

11:10-11:45

KEEPING STANDARD BROADCAST TRANSMITTERS UP TO DATE

By Charles Hallinan, chief engineer, WKOP Binghamton, N. Y. (Part I)



THE complete reconstruction and modernization of a Western Electric Model 355E1 transmitter will be discussed. The transmitter was first converted from water-cooled to air-cooled tubes. After a year of

operation a further conversion from the old style 343AA to modern coaxial terminal 6423F tubes was successfully accomplished. A similar improvement in rectifier tubes was also made. Old style Western Electric 258B and 315A tubes were replaced by the more widely used 866A and 575A types. Further modernization through the substitution of 6894's for 575A's is also being made. A description of circuit changes, new components installed and associated directional antenna system will be given. Resulting increased safety factor and overall reliability make this transmitter more suitable for remote control.

By Henry Hulick Jr., chief engineer, WPTF Raleigh, N. C. (Part II)



STANDARD broadcast transmitters, such as the Westinghouse Type HG-1 with which this part is concerned, may be updated by keeping abreast of new developments in the art and how they may

be used in improving your own operation. Thought should be given to the initial cost and operation against money saved in the years to follow.

Newer tubes can be used in transmitters designed years ago to improve the overall operation at a lower cost. By discussing such changes with the manufacturers the modifications can be done by station engineers without the expense of outside engineering.

Old type transmitters may be cleaned up by improvements in reduction of harmonics and other spurious radiations so that they



GO "OUT OF DOORS" WITH GATES REMOTE EQUIPMENT

The Dynamote

A name in remote amplifiers almost as old as broadcasting, yet always symbolic of the very finest. Four channels, tilt up 4" V.U., printed wiring, self-contained power supply with optional automatic switch over to batteries, usually high gain and weighs only 22 pounds in its leatherette covered carrying case. Supplied with tubes and Cannon XL connectors.

Price\$326.80



The Twinsistor



Two channels with V.U. and batteries 100% transistorized, yet only 7 1/2" x 7" x 3 1/8" in size. Including batteries, weighs only 7 lbs. 78 Db. gain, 70-15,000 cycle response and guaranteed 55 Db. or better noise reduction below +14 Dbm. output. Twinsistor has sold to more major market stations than any other model. Deduct \$4.95 if carrying case not desired.

Price\$199.95

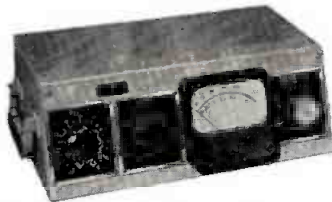

The Biamote

A terrific seller in both radio and TV. Only 5" high for easy over top vision. Two mixing channels, 4" illuminated V.U., 90 Db. gain, 30-15,000 cycle response and entirely self-contained. For 115V., 50/60 cycles. Size: 14" x 8 1/2" x 5". Weight 15 1/4 lbs. Supplied with tubes and Cannon XL connectors.

Price\$196.80

The Transmote

This single channel unit employs five transistors in four temperature stabilized stages and weighs only four pounds with case. — And don't worry about noise when it's guaranteed down 55 Db. below +14 Dbm., measured at -60 Dbm. input. Response 70-10,000 cycles at 2% distortion. Size: 9 1/2" x 3 1/2" x 2 1/2". Comes with leather carrying case and strap.

Price\$145.00

With Electro-Voice 684 microphone as illustrated\$194.00

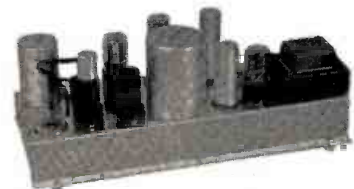

Single Channel SA-134

Visit any radio or TV station and seven chances out of ten you'll find one or more SA-134's. The most used remote and all-purpose amplifier in all of broadcasting. 82 Db. gain, 50-15,000 cycle response, 1% distortion and noise 60 Db. below +14 Dbm. output, measured at -60 V.U. input. Comes with tubes and Cannon XL connector.

Price\$82.50

AT NARTB

Make our heavy equipment booth or hotel suite at the Chicago Conrad Hilton your headquarters when at NARTB. The usual Gates "feel at home" atmosphere will prevail, we are sure!

GATES

RADIO COMPANY, Quincy, Ill., U. S. A.

MANUFACTURING ENGINEERS SINCE 1922

OFFICES — NEW YORK - WASHINGTON D. C. - LOS ANGELES - HOUSTON - ATLANTA
In Canada . . . The CANADIAN MARCONI COMPANY

become in most respects real high fidelity.

12 Noon

ENGINEERING RECEPTION

12:30 p.m.

ENGINEERING LUNCHEON

*Speaker: Alex G. Jensen,
Bell Telephone Laboratories*

AFTERNOON—TELEVISION

**PRESIDING OFFICER: BENJAMIN WOLFE,
VICE PRESIDENT FOR ENGINEERING,
WAAM (TV) BALTIMORE**

2:30-2:55

**OPERATIONAL CONSIDERATIONS OF
THE AMPEX VIDEOTAPE RECORDER**

By Charles P. Ginsburg, manager, Advanced Videotape Development, Ampex Corp.



ONE of the most timely topics to be presented at this time is videotape recording. It is a subject which is now being widely discussed throughout the television industry and has been the subject of much

debate over the past several months.

At the present time, 10 engineering prototypes of the Ampex videotape recorder have been in actual use for some months at several network centers. This paper will outline how the recording and playback operations are accomplished on these delivered units. Comments will assume a given television signal in a commercial television station and how it is recorded and played back from an operations standpoint. The maintenance requirements of the Ampex videotape recorder will also be discussed in detail.

3:3-2:5

FIVE MONTHS WITH VIDEOTAPE

By Howard A. Chinn, chief engineer, Audio-Video Div., CBS Television Engineering



THE videotape recorder was first introduced to the broadcast industry during the 1956 NARTB convention in Chicago. Since that time several prototype models have been delivered to the various network centers throughout the country.

On Nov. 30, 1956, CBS introduced the use of the videotape recorders on a regular basis for the first time in the history of television. The experience gained by daily use in the intervening five months will be reported. In addition, the present status of commercial videotape recording and potential future applications will be described.

3:30-3:55

**CONTROL OF COLOR APPEARANCE
IN TV STUDIO LIGHTING**

By R. G. Williams, manager, Color Lighting Dept., Century Lighting Inc.



THIS paper will discuss the layout and types of lighting equipment for television color studios. Dimmer control systems will also be reviewed.

The effect of controlled differences in spectral quality of light will be discussed and meth-

ods of control outlined. Specific applications of colored lighting in television studios will be detailed, including color rendition of objects, dramatic effects, delineation of form, composition of luminous color and mood effects.

A new type of high intensity luminous color background will be described.

4-4:25

COLOR TELEVISION TEST SIGNALS

By C. G. Nopper, chief engineer, WMAR-TV Baltimore, moderator, and George Nixon, NBC; Richard S. O'Brien, CBS Television; Robert S. Morris, American Broadcasting Co.; J. R. Popkin-Clurman, Telechrome; John W. Wentworth, Radio Corp. of America; John Thorpe, American Telephone & Telegraph Co. and E. W. Allen, chief engineer of the FCC.



Nopper



Nixon



O'Brien



Morris



Popkin-Clurman



Wentworth



Thorpe



Allen

WITH more and more stations being equipped to transmit color, it is becoming evident that a network color test signal is needed. Several such systems have been proposed, with each system having special merits which warrant full consideration. It is the purpose of this panel to discuss the relative advantages and disadvantages of the various color test signal with emphasis on their practicability, effects which might be introduced into the system, integration into our present operating system, and the use of such signals in receiver servicing. Many other aspects of color test signals will be thoroughly discussed.

**Tuesday, April 9
Afternoon—Radio**

**PRESIDING OFFICER: CARL J. MEYERS,
ENGINEERING MANAGER,
WGN CHICAGO**

2:30-2:55

**A COMPATIBLE SINGLE-SIDEBAND
SYSTEM DESIGNED FOR USE IN THE
BROADCAST SERVICE**

By Leonard R. Kahn, Kahn Research Laboratories



A NEW SYSTEM for allowing an increase in the number of am broadcast channels is described which is called compatible single sideband. This system would require use of a transmitter adapter but does not necessitate any change in the home

receiver. One of the advantages of this system is that the signal occupies approximately one-half the spectrum normally taken up by a conventional am double-sideband signal, thereby reducing adjacent and co-channel interference. A reduction in fading and distortion is also accomplished plus an improvement in signal-to-noise ratio. Included in the discussion will be a block diagram of an adapter suitable for use with any standard am transmitter.

3-3:25

**A NEW APPROACH TO AUDIO
CONSOLES**

By Emil P. Vincent, chief audio facilities engineer, American Broadcasting Co.



WITH ever-increasing demands on audio facilities in television studios, far more flexible audio systems are required. The situation is one whereby facilities requirements vary greatly from show to

show. It is presently quite difficult to anticipate all possible needs and as a result the normalizing concept of systems becomes questionable. Greater use of patching procedures is suggested, keeping in mind that a patch cord is nothing more than a pair of swingers on a rather complicated switch and affords maximum system flexibility from unitized system components. Employment of transistorized amplifiers becomes increasingly more desirable in the interest of minimum equipment outages and maximum use of available equipment space.

3:30-3:55

**DESIGN AND INTEGRATION OF
AUTOMATIC PROGRAM EQUIPMENT**

By John K. Birch, audio development engineer, Gates Radio Co.



SUCCESSFUL automatic or semi-automatic programming requires not only equipment with desirable capabilities, but also a careful integration of the equipment into the programming methods of

each station. This paper will discuss the various ways of achieving automatic operation, both of tape recorders and transcription turntables or record changers. The very rigid requirements imposed by the necessity of fast and simple preparation, dependable playback, auxiliary switching for expansion, and graceful integration with the existing programming system directs the ultimate design into very definite channels.

4:-4:25

BRINGING RADIO TO THE PUBLIC

By Harry Dennis, chief engineer, WERE-AM-FM Cleveland



NEW methods of programming are continually being devised to stimulate and attract the radio listener. In presenting this paper the speaker will endeavor to explain the use of portable facilities as used at his station for broadcasting remote

PUT YOUR I.O. ON THE SHELF

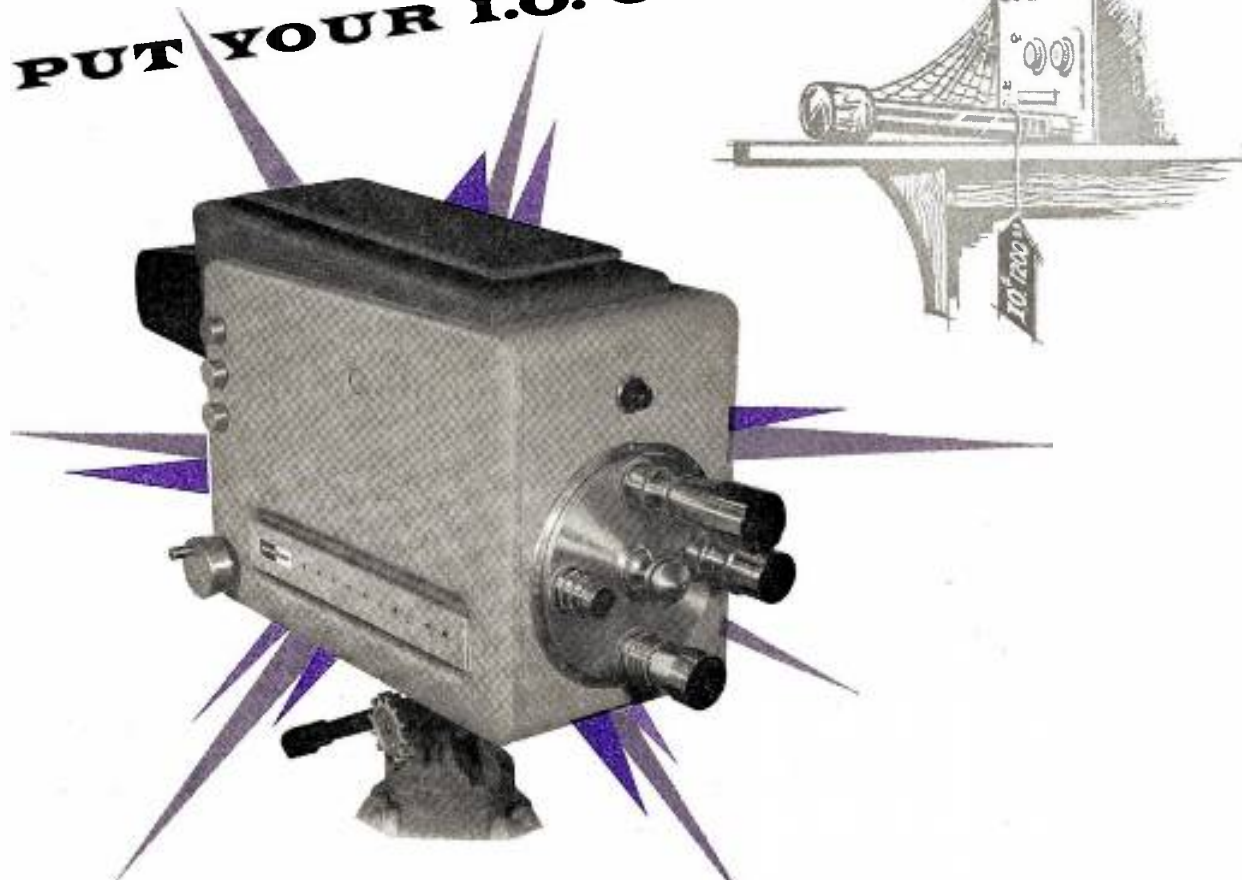

You Can Lease* KIN TEL VIDICON Broadcast Camera Chains for Less Than I.O. Operating Costs

The Vidicon Has Come of Age. Every major TV equipment manufacturer is now making vidicon cameras. But KIN TEL pioneered and perfected equipment is proven for professional broadcast applications.

Cut Live Programming Costs. KIN TEL vidicon cameras provide better performance at lower initial and operating costs . . . Eliminate burn-in problems . . . Ideal for studio or remote live programming, commercials, newscasts, opaques.

Proved by Professional Broadcasters in day-to-day use throughout the country, KIN TEL TV equipment more than meets all FCC-RETMA requirements. An exceptionally complete line — studio and field camera chains, film chains, monitors, switching, audio, and transmitting equipment — allows us to custom design complete station packages to meet your exact requirements.

** Lease payments can be applied to purchase price.*

BOOTH 3 NARTB



Field engineers in all major cities.

5725 KEARNY VILLA ROAD • SAN DIEGO 11, CALIFORNIA • BROWNING 7-6700

TRANSMITTERS CAN BE MINIATURE, TOO

THE DAY of the miniature radio receiver is here, and—if by miniature we mean smaller, more compact, with the same if not greater efficiency—the day of the “miniaturized” transmitter is around the corner.

That development is apparent to the initiated who see in GE's new 50 kw radio transmitter the beginning of a trend that will have as much impact on mighty, heat-generating transmitters as transistorized receivers have had in the radio set business.

Heart of the miniature radio is the transistor. Heart of the transistor is a semiconductor—that slice of germanium or silicon which not many years ago was considered more an insulator than a conductor. It is this semiconductor which is also the heart of the new development in radio transmitters.

It is germanium that makes GE's new BT-50A transmitter significant in the forward move of broadcast transmitter refinements. For not only has GE been able to reduce the number of expensive and fragile vacuum tubes in a 50 w transmitter—from an average 35 to 16—but it has also, it is held, increased the reliability of the instrument.

For the racks of glass tubes in radio transmitters need nursing. No one will deny that. Therefore, if a solid substance is substituted for “bottles,” there is less need for this degree of care.

The new GE transmitter will be the top feature of that company's exhibit at the NARTB convention in Chicago next week. An engineering paper on the development will be one of the highlights of the engineering conference. This paper will be read by Neville Mapham, broadcast project engineer, Canadian General Electric Co. Ltd., Toronto.

GE's goal was a transmitter with these high priority objectives: Reliability, usability with remote control gear, low tube cost, low power consumption, ease of adjustment and maintenance, small size and reasonable price.

These goals were reached, GE believes, by the use of modern components, particularly germanium (No. 32 on the atomic scale, 72.6 times heavier than hydrogen). Germanium has many advantages, not the least of which is that it is a stable element at warm temperatures. Silicon on the other hand is extremely good at very high temperatures, 185° Fahrenheit and above.

Germanium, silicon and other semiconductors until quite recently were associated more with insulators, not conductors. But, the art of solid-state physics in recent years has advanced to the point where solids have now become part of the technology of conductance.

Using germanium rectifiers in place of vacuum tube rectifiers means there is no need for filament transformers and temperature control equipment. That means there is no warmup time required. The usual mercury vapor tubes require a

controlled temperature (between 90° and 100° Fahrenheit) to operate most efficiently and prevent arc-backs. Germanium eliminates these precautions. And, also, there is no need for high voltage supplies.

Other innovations in the new GE transmitter are vacuum switches for plate contactors. These are power controls. Also used are Machlett (Type 6427) tubes for the power amplifier and modulator. Ordinarily there are four such tubes used for these functions. Each weighs a good 225 lbs., and requires hydraulic hoists to “pull” them and to replace them with new tubes. The Machlett tube weighs 28 lbs., capable of being handled by a girl. And, in place of mica capacitors, ceramic condensers are used in the radio frequency circuit. This is considered another plus for reliability and long life. Ceramic is considered more capable of taking higher voltages than comparable mica condensers.

The 50A transmitter has 16 vacuum tubes and six rectifier supplies. Naturally one rectifier does not take the place of one tube; a group of rectifiers performs the function of the displaced tube.

The size of the new GE transmitter is almost one-half that of former 50 kw power equipment. If floor space is a problem, here is one answer. Whereas the standard transmitter of years past needed 28 ft. for length, the new GE powerhouse uses only 13½ ft. In width and height it is about the same as past transmitters, 4½ ft. wide and 7 ft. high.

The price of the new GE transmitter is \$95,000—competitive with other transmitters of this size. But, says GE, it is not the saving in initial price that counts; it is the saving in reliability and operating costs that makes it significant.

This trend toward the substitution of other materials for vacuum tubes is not new. In the early 1930s, RCA marketed a transmitter using copper oxide rectifiers in the low power stages. These lasted, in the words of one broadcast engineering veteran, “a hell of a long time.” Even now, he pointed out, a 5 kw station, operating 24 hours a day, changes its rectifier tubes once every four months. That's pretty good service and the expense is not extremely high.

This same technical expert called attention to the fact that vacuum tubes have played a vital part in bringing broadcast technology to the high engineering stature it now occupies. There are tubes which have given 50,000 hours of life, he points out.

It is uncontradicted that the major advances in transmitter improvements have been in the tube category. The trend is toward lower tube costs, both initially and in operation. That also means the use of other materials performing the same functions.

The GE 50A can be considered pointing the way to the acceleration of this movement.

disc jockey programs. Slides will be shown depicting the changes of equipment from the early use of a studio-type turntable culminating with the operation of a complete studio on wheels, equipped with turntables, tape recorder and mobile transmitter.

This paper will also endeavor to show the close alliance required between the engineering department and the promotional department.

4:30-5

APPLICATION OF MODERN TECHNIQUES IN MAKING GOOD RECORDINGS

By C. J. LeBel, vice president, Audio Devices Inc.



BY UTILIZING modern techniques the broadcaster may produce recordings of greatly improved quality. In the disc field, desirable steps include adoption of hot stylus, negative feedback around the cutting head, diameter equalization, and an improved lathe. In the tape field, it is desirable to use better transport mechanism, adopt NARTB equalization, and add multi-channel facilities. Multi-channel facilities may be used for stereo or to permit remixing during re-recording or mastering. To use this equipment to full advantage it is necessary to improve studio facilities by inclusion of greater speech input system flexibility, introducing more diffusion in the acoustical treatment, using microphones of better quality and more flexible reverberation control (such as by the use of a reverberation generator).

Wednesday, April 10
Afternoon—Television

PRESIDING OFFICER:
GEORGE S. TURNER,
CHIEF, FIELD ENGINEERING &
MONITORING BUREAU, FCC



2:30-2:55

SPECIAL EFFECTS IN COLOR PROGRAMMING

By John H. Roth, engineer, Philco Corp.



A GENERAL review will be made of “special effects” presently used in monochrome systems and shortcomings which have limited use of these techniques in color programming. A description of recently developed color circuits for special effects and discussion of features and advantages will be given. Discussion of typical applications demonstrating the versatility and flexibility of the system will round out this paper.

3:3-3:25

NEW FIELD INTENSITY MEASURING TECHNIQUES

By Howard T. Head, A. D. Ring & Assocs., Washington, D. C.

THE requirements for field intensity meas-

BROADCASTING • TELECASTING



GPL 3-VIDICON
COLOR
FILM CHAIN

provides color
picture of unmatched
quality



GPL VIDICON
**MONO-
CHROME**
FILM CHAIN

outstanding picture
sharpness, contrast
and definition

GPL
35 MM
TELECAST
PROJECTOR



superior color,
monochrome film
and single frame



GPL
16 MM
TELECAST
PROJECTOR

bright, crisp
pictures, high
fidelity sound



telecine equipment

has been doing a first-class job, day in and day out for years, in many of the finest and best-equipped stations in the country. With all its high quality performance, GPL professional television equipment is reasonably priced... low in maintenance...

gives you the best for less

find
out why
today

COLOR

MONO-
CHROME

35 MM

16 MM

Broadcast Sales,
GENERAL PRECISION LABORATORY INCORPORATED
63 Bedford Road, Pleasantville, New York.

Please send me information on the telecine equipment checked.

NAME _____ STATION _____

ADDRESS _____

CITY _____ ZONE _____ STATE _____

THE ENGINEER'S LOG: NEW TARGET FOR AUTOMATION

ONCE upon a time engineers arrived at a radio station's transmitter house in the cold, early morning—when only milkmen and police prowls cars are moving—and went through the motions of turning on the transmitter.

They pushed a button here and pulled a switch there, opening up the mass of wiring and tubing to the pulsating force of electricity and water. After about four to five minutes of warm-up the transmitter was ready for on-the-air operation.

Today, if a transmitter is 10 kw or less in power, and if the station's antenna is omni-directional, the same process is repeated from the warm studio, via remote control devices.

Tomorrow, it is obvious, all radio transmitters will be turned on this way, from the studio. For since February 1956, an NARTB petition has been before the FCC to extend the privileges of remote control to all radio stations, irrespective of their power or the pattern of their antennas. From all indications this will, sooner or later, be authorized by the FCC.

The day after tomorrow, it also is obvious, will bring complete automatic operation of unattended broadcast transmitters. It's in the cards, according to those who have studied its feasibility. The equipment is ready. Transmitters have been proved stable; in fact, in many a non-broadcast operation, the automatic operation of a transmitter is standard procedure. There are methods to flash warnings when something goes out of kilter. It's just a matter of time—and the FCC changing some of its rules.

If transmitters are going to run robot-like, something will have to be done about logging. Under present conditions, an engineer must check the meters of the various components of a transmitter. The Commission requires certain readings to be made every half hour. These are phase monitor, current ratios, plate voltage and plate current and modulation and frequency deviation.

Most stations also check anywhere from six to 12 other dials. These include such readings as water pressure and temperature, grid current, grid bias, plate current, grid voltage, filament voltages, lower stages plate and current voltage, driver stage plate and current voltage, and leakage current. This is done for their own protection and because they are interested in maintaining the cleanest signal possible. The more powerful the transmitter the more such checks are made.

An engineer, walking down the aisle of steel-glass equipment racks can read and log a dozen flicking dials in about 10 minutes. This must be done every 30 minutes. That means that in an ordinary eight hour day, up to two hours and 40 minutes can be spent in this under-

taking. That's about one-third of the working day. It is a sizable amount of time, and an expensive way of doing a job that can, and should, be done by a machine.

There is a machine capable of doing this job—automatically, continuously, and accurately. It is a device put together by the Brown Instruments Div. of Minneapolis-Honeywell Regulator Co., the company best known, perhaps, for thermostats to keep householders warm in winter and cool in summer, but better known in industry circles as the maker of regulator instruments.

In fact, a discussion of an automatic logger will be one of the papers featured at the NARTB engineering conference in Chicago next week. It bears the formidable title, "Automatic Recording of the Critical Parameters of a Directional Antenna System and a Standard Broad-

Simply stated the Minneapolis-Honeywell device works this way. Measured variables are reduced to a small electrical direct current voltage. This is then fed to a telemeter transmitter, sequentially to touch various points required. This transmitter produces current proportional to the incoming small voltage and it is designed so current will flow regardless of the changes in transmission line resistance.

In more technical language, the circuit includes a transducer which changes various measurements into millivoltage direct current. This is fed to the telemeter transmitter. A selector switch at the transmitter, operated by tones over the same pair of telephone wires which are used for measuring the various circuits, sequentially transfers the various input quantities to the telemeter transmitter. This then activates a recording

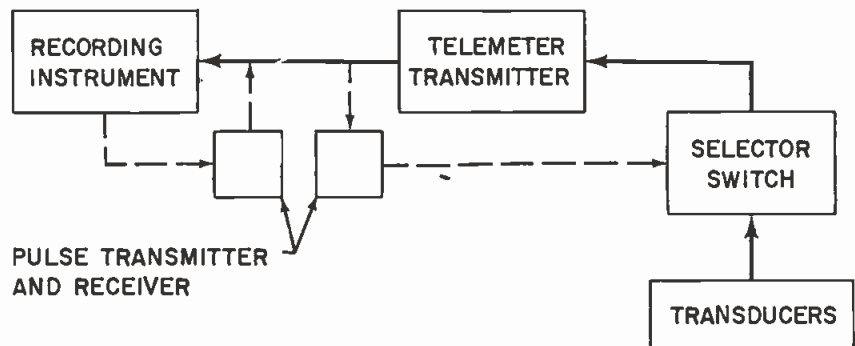

AUTOMATIC logging of transmitter functions developed by Brown Instruments Div., Minneapolis-Honeywell Regulator Co., is pictured in schematic form in this block circuit diagram. The information is fed from transducers through the selector switch to a telemeter transmitter, which in turn operates a recording instrument at the studio. A pulse transmitter and receiver operates the remote stepping switch over the measuring circuit transmission line.

cast Transmitter." This awesome mouthful will be delivered by Gustave Ehrenberg, applications engineer with Brown Instruments.

What Mr. Ehrenberg will talk about—and what Minneapolis-Honeywell has done—is the putting together of a form of potentiometer which records on paper the readings of the dials at the transmitter. It is a form of telemetering, but it goes a step further; it records the telemetered information automatically.

The gear has been tested over 5-kw WFIL Philadelphia (on 560 kc) and will be used experimentally on 50 kw WTOP Washington (on 1500 kc) in the near future. Both WFIL and WTOP have three-element arrays.

At WFIL, recordings were made of four vital statistics: (a) final plate voltage, (b) final plate current, (c) common point current, and (d) current amplitude ratios between towers. Actually, according to Mr. Ehrenberg, 24 independent variables can be noted.

instrument at the studio. The recorder uses a 12-in. wide charge. The position of the numbers on the chart indicates the values of the measured quantities. The number identifies the item being measured.

A unique feature of the circuit is the use of a second audio tone to "home" the selector switch.

Any failure in this apparatus would be obvious to the trained reader—the readings would be out of line with data before and after the erroneous recording.

The instrument is said to have an accuracy of $\pm .25$ of 1%. It is also said to have a reproducibility of 1/32d of 1%. It will cost anywhere from \$6,000 to \$8,000 depending on the number of points to be recorded.

For forward looking technical management, this operation is worthy of a second look. It is virtually certain that automatic logging is in the future for all broadcasters.



urements at the frequencies employed for television broadcasting are reviewed. Various methods which have been proposed and employed for making these measurements are discussed, as well as new methods under consideration. Data are presented showing a comparison of the various methods with particular emphasis on uhf measurements in varying types of terrain.

3:30-3:55

EMERGENCY STANDBY FACILITIES FOR THE AURAL TELEVISION TRANSMITTER

By Benjamin Wolfe, vice president for engineering, WAAM (TV); Clyde Haehnle, senior engineer, WLWT (TV) Cincinnati



THIS paper discusses a simple and economical method for using the visual carrier of a television broadcast station for the purposes of transmitting both the aural and visual signals. The method is intended for use during emergency operation when the sound portion of the television transmitter is "off the air" and the visual portion is in working order. While various methods of transmitting the sound on the picture carrier are known, a simple and economical method of multiplexing is desirable for a television broadcasting station. This multiplex signal is fed directly to the visual transmitter, without requiring transmitter modifications or adjustments.

4-4:25

APPLICATION OF VERY PRECISE FREQUENCY CONTROL TO MINIMIZE TV CO-CHANNEL INTERFERENCE

By Wendell C. Morrison, senior member, Technical Staff, RCA Laboratories



EARLY investigations into the reduction of television co-channel interference by offset carriers revealed that the improvement was obtained by interlacing. The present allocation plan utilizes this technique by relating the visual carrier offset frequency to the television horizontal line frequency. At the time the offset system was established, it was known that an additional improvement could be obtained by relating the offset frequency to the vertical field frequency but the stability requirements made any such proposal impractical.

This paper will discuss recent advances in the art of frequency control which have made practical the use of precise carrier frequency control to further reduce the visibility of co-channel interference.

4:30-5

TELEVISION ENFORCEMENT PROGRAM USING A MOBILE MONITORING UNIT

By Raymond L. Day, engineer in charge, Mobile Television Monitoring Unit, Field Engineering & Monitoring Bureau, FCC

ADEQUATE monitoring of the television broadcast service cannot be done by the



monitoring stations and field offices maintained by the Commission. The necessary instruments for observing television are installed in a panel truck. An engineer is permanently assigned to the monitoring unit, and he takes the unit to the localities served by television stations.

As many as possible of the aspects of the television signal are checked for conformity with the Rules and Regulations for the service. An inspection is also made of each station monitored.

The monitoring and inspection program is aimed at maintaining high quality of service to the public through contact with the technical personnel of the stations.

Thursday, April 11 Morning—Television

PRESIDING OFFICER:

CLYDE HUNT,
VICE PRES. FOR ENGINEERING
THE WASHINGTON POST
BROADCAST DIV.



9-9:25

ADVANCED PERFORMANCE AND STABILITY IN COLOR TV CHANNEL AMPLIFIERS

By M. H. Diehl, General Electric Co.



THE use of three-channel automatic gain control, precision gamma circuits, and high-level black clippers, yields long-time stability of the critical parameters affecting color balance. With large

amounts of negative feedback in the monitoring section, drastic reduction in the number of controls, and built-in calibration features, set-up and adjustment can be accomplished very rapidly when necessary. This paper will thoroughly discuss the subject matter in detail and will be liberally supported by appropriate slides.

9:30-9:55

VIDEO SWITCHING AT TELEVISION OPERATING CENTERS

By V. R. Hatch, service engineer, Long Lines Dept. American Telephone & Telegraph Co.



THIS paper describes a new video switching arrangement for Bell System television operating centers. The system has been designed to meet the exacting transmission requirements of color television and to incorporate operating safeguards which simplify the complicated switching job necessitated by present day network operations.

These new centers utilize remotely controlled switches, balanced input and output video amplifiers, and balanced video transmission paths. Unique equipment designs along with careful cabling and wiring to insure nearly ideal transmission characteristics are discussed in detail. These new switches are now in service at Chicago, Los Angeles, New York, and Washington and

will be placed in service at a number of other locations in the next few months.

10-10:25

EXPERIENCE WITH VIDICONS AND REMOTE CONTROL IN LOW POWER TELECASTING

By Richard T. Silberman, vice president, Kin Tel



OPERATIONAL considerations and limitations of low power television station installations are discussed. Particular emphasis is placed on the extent to which vidicon camera chains are useful for large studio pickup. Special lighting techniques which have proven most successful with live vidicon cameras are outlined. Several typical installations are reviewed and actual coverage obtained with lower power transmitter reviewed. The equipment and personnel operating costs are presented and areas of potential expansion of low power operations and economy and remote control installations projected.

10:30-10:55

THE COLOR STUDIOS OF WRAMC

By Andrew F. Inglis, manager, Systems Engineering Group; Lannes E. Anderson, supervisor, Systems Engineering, Commercial Electronics Products, Radio Corp. of America.



Anderson Inglis

THE first permanent installation of compatible color television equipment for the purpose of medical education has been

made at the Walter Reed Army Medical Center, Washington, D. C. Although this system was designed primarily for closed circuit use and is probably the largest closed circuit system in the world, it has many features in common, with television broadcast studio installation. The technical features of this installation are described with special emphasis on those which are of interest to broadcast engineers.

11-11:25

USE OF A 100 KW TRANSMITTER TO OBTAIN 316 KW ERP

By James L. Middlebrooks, director of Engineering, KING-TV Seattle



THIS paper will discuss why and how KGW-TV, Portland, Ore., pioneered with RCA with development of a new type of television transmitting antenna and the world's first 100 kw television transmitter in order to obtain 316 kw ERP. The paper will describe in detail the design, installation, and operation of this unique antenna, transmitter, and associated RF and power switching system.

The antenna can be either used as two four-bay antennas or combined into one eight-bay antenna. Antenna gains can be controlled remotely by coax switches located at top of tower. The transmitter consists of

two 50 kw units used either combined or separately depending on which antenna gain is used.

11:30-Noon

A NEW LEASE ON LIFE FOR RETIRED IMAGE ORTHICONS

By F. Cecil Grace, chief engineer, Visual Electronics Corp.



A DEVICE will be described which reduces "burn-in" on an image orthicon tube by as much as 90%. The operation of the device is relatively simple. It consists of a mechanism to slowly oscillate the lens board of a television camera, while providing electrical cancellation of the resulting horizontal and vertical motion through sine and cosine function corrections applied to the centering circuits of the camera by a small transistor amplifier. This device should allow a television station to realize much longer life from certain image orthicon tubes and, just as important, eliminate "burn-in" objectionable to the television viewer.

oscillate the lens board of a television camera, while providing electrical cancellation of the resulting horizontal and vertical motion through sine and cosine function corrections applied to the centering circuits of the camera by a small transistor amplifier. This device should allow a television station to realize much longer life from certain image orthicon tubes and, just as important, eliminate "burn-in" objectionable to the television viewer.

**Thursday, April 11
Afternoon—Television**

PRESIDING OFFICER:
LESTER H. BOWMAN,
TECHNICAL OPERATIONS DIR.,
CBS-TV (HOLLYWOOD)



2:30-3

PROGRESSIVE STEPS TOWARD AUTOMATION IN TELEVISION PROGRAMMING

By A. H. Lind, engineering manager, Audio & Mechanical Devices, Radio Corp. of America.



WITH the prospect of more and more television stations being authorized and the ever-increasing costs for operating and programming, management is now looking for ways and means to streamline their station operation.

Possibilities for automatic operation of

program signal producing equipment in tv studios are attracting the growing interest of broadcasters. Greater efficiency, increased performance and reduced operating costs are all potential products of the application of automation techniques.

This paper discusses problems of mechanization and logical, progressive steps toward the goal of a high degree of automation. System concepts and equipment requirements are presented.

3:05-3:40

TOWER DESIGN, CONSTRUCTION AND MAINTENANCE

By J. Roger Hayden, product sales manager; Orville Pelkey, chief tower design engineer, Dresser-Ideco Co.



Pelkey Hayden

REGARDLESS of the size or height of the contemplated tower there are four basic considerations involved in the design. These considerations are: the dimensions, use to which the tower will be put, equipment and other loads placed on the structure, and equipment to be installed upon the tower.

This paper will discuss tower design calculations using the above data progressing step by step from design to fabrication. Also described will be the erection plus equipment which has been developed and used for fast, safe, and efficient tower erection. Tower maintenance, including periodic re-painting and inspection will be thoroughly treated.

3:45-4:15

A HIGH GAIN LOW COST EMERGENCY OR AUXILIARY ANTENNA SYSTEM

By Peter K. Onnigian, chief engineer, KBET-TV Sacramento, Calif.



AN auxiliary antenna system is described which provides a power gain of approximately 10 with an omnidirectional pattern for channels 7 through 13. It can be made directional with a gain of 15 DB.

With a 5 kw channel 7-13 transmitter, the

system will provide approximately 150 kilowatts of effective radiated power, in a 60-degree angle, using four bays in a directional pattern. On the low channels from 2-6, gains up to 10 DB appear feasible. The antenna system is light in weight and can be side mounted on most existing towers.

Measured performance of the antenna will be given as well as construction details. A typical installation under \$2,000 including transmission lines, diplexer, antennas and mounting is discussed.

The entire system makes a high gain, low cost, standby antenna possible for most vhf television stations.

4:20-5

PREDICTING OPERATION CHARACTERISTICS OF CLOSELY SPACED ANTENNAS ON THE SAME SUPPORTING STRUCTURE

By Irl T. Newton, Jr., manager, Antennas, Towers and Transmission Line; Dr. M. S. Siukola, engineer, Commercial Electronics Products, Radio Corp. of America.



Siukola Newton

IN ADDITION to technical advantages, recent concern with the hazard to air navigation created by tall television towers has stimulated

interest in multiple antenna structures to minimize the number of hazards. The feasibility of vertical stacking has been adequately demonstrated by a large number of installations and the methods of design are discussed with examples of existing installations. The use of side-by-side placement is less common with only one installation in use. Demonstration of feasibility by model measurements in the existing installation and in the proposed Baltimore installation is discussed, together with new analytical techniques, which will permit analyzing the performance of proposed candelabra systems without the need for model tests.

Time Thursday Not Yet Designated

CHROMACHRON

By William J. Wagner, art director, KRON-TV San Francisco



CHROMACHRON is a palette design to assist scenic and graphic artists working in color television.

It reduces the number of basic colors to five. Nevertheless, this is more than adequate for producing

color art for television. The few formulas for achieving the many variations of these colors make this a practical and economical approach to painting for television.

Each color is given a number which corresponds to a gray scale value. This tells the artist how his colors will reproduce in black and white. The artist also knows whether or not he is working within the color system's twenty-to-one light ratio limitations.

Planning a Radio Station?

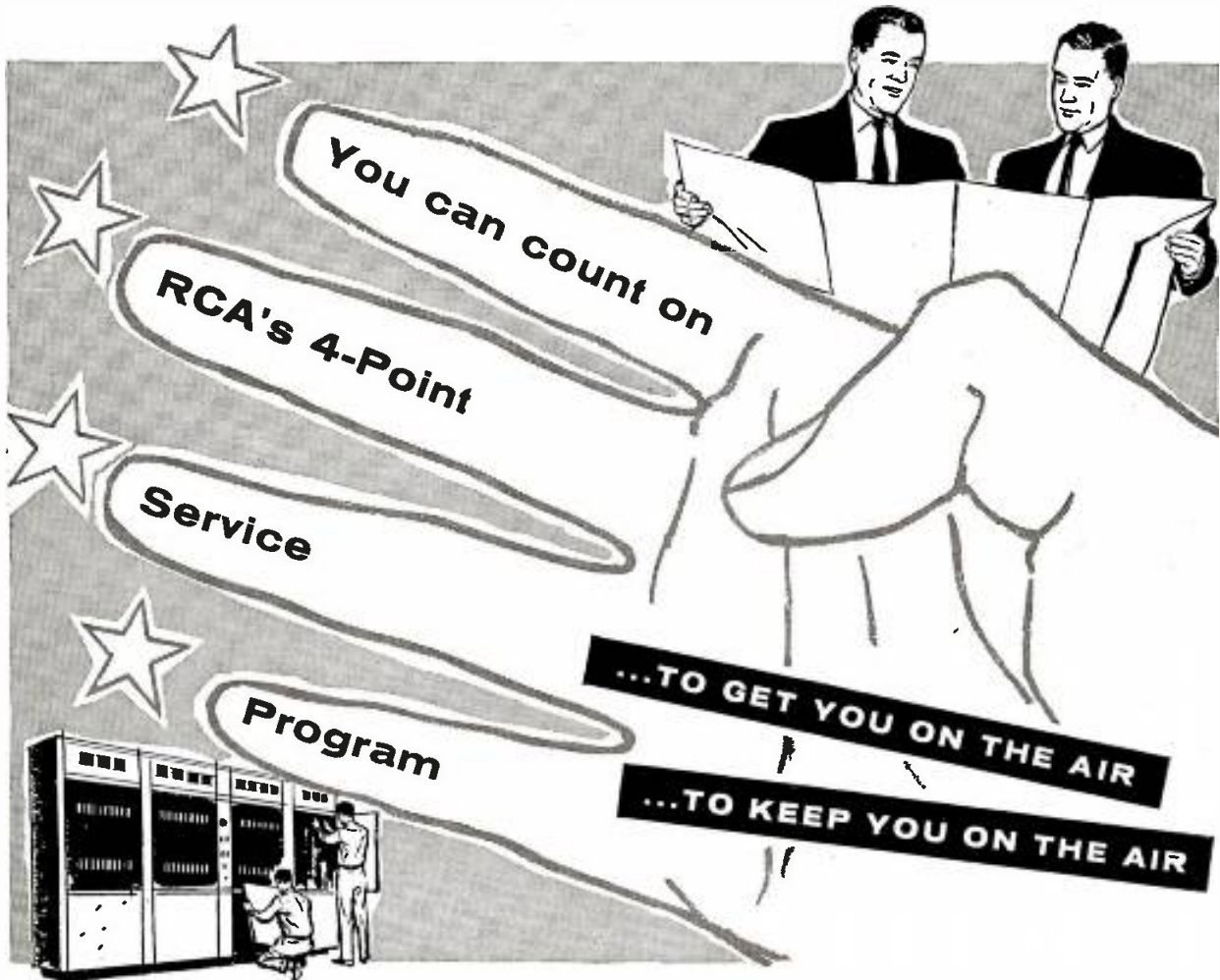

1 PLANNING ASSISTANCE

RCA is interested in helping you in your initial phases of planning, *even before you have your C.P.* 25 years of RCA station experience are at your service day or night . . . before and after you're "on-air."



2 EQUIPMENT COUNSEL

Expert product analysts, specializing in audio, transmitter, antenna and tower, who know their product lines thoroughly from first-hand station experience are here to advise you, and answer any questions.



3 FIELD SERVICE

Technical field service by broadcast specialists is available through RCA Service Company, Inc. strategically located throughout the United States . . . in Dallas, Los Angeles, Chicago, Atlanta, and Camden.



4 EMERGENCY REPAIRS

Your business is our business. When an emergency develops, you can call your RCA Field Man or EMERGENCY SERVICE in Camden. Twenty-four hour service, 7 days a week. We provide exact replacements. You get service in *hours*—not days—to keep you on the air!

RCA . . . *your first source of help in station planning*



RADIO CORPORATION of AMERICA
BROADCAST AND TELEVISION EQUIPMENT • CAMDEN, N. J.

In Canada: RCA VICTOR Company Limited, Montreal

25,000,000 WATTS...

FOR \$25,000,000

LAST CALL-L-L-L!

*plan subject to withdrawal April 15

SEE IT AT BOOTH

25

N A R T B

(hospitality rooms 601-602)

the new self-liquidating
S-E silver dollar plan
for boosting power!

**standard electronics
corporation**

A SUBSIDIARY OF DYNAMICS CORPORATION OF AMERICA, INC.
285-289 Emmett Street, Newark 5, New Jersey

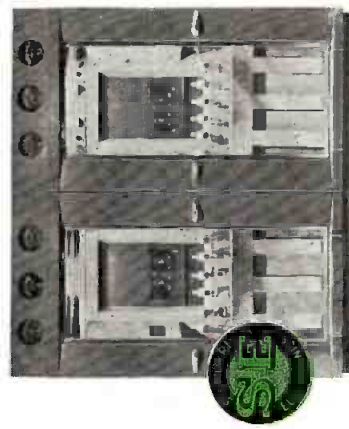

25-KW AMPLIFIER (low or high band)

ADVANCE REGISTRATION

NARTB Management Conference and Broadcast Engineering Conference

A

Abel, Charles, KFMB San Diego, Calif.; Abrams, Earl, Broadcasting • Telecasting, Washington, D. C.; Adams, Irwin S., KGO Portland, Ore.; Adanti, Paul, WHEN-TV Syracuse, N. Y.; Adler, Ben, Ader Electronics Inc., New Rochelle, N. Y.; Aley, William, WHOT Youngstown, Ohio; Agostino, James R., KXLY Spokane; Akers, C. B., KVOO-TV Tulsa; Albertson, Roy L., Jr., WBNY Buffalo; Albrecht, Harry F., Crosley Broadcasting Corp., Chicago; Alexander, Arthur, M. and A. Alexander Productions, Inc., Hollywood, Calif.; Alford, Andrew, Alford Mfg. Co., Boston; Allicote, Charles A., Radio-TV Daily, New York; Alisky, Marvin, WFUI Bloomington, Ind.; Allen, Edward M., KWNO Winona, Minn.; Allen, Hugh, S. Jr., Lang-Worth, New York; Alquist, Nelson, KBTB New York; Alspaugh, Harold P., SRDS Evanston, Ill.; Anderson, Ed M., WBOB Forest City, N. C.; Anderson, Harold E., WDEF-TV Chattanooga, Tenn.; Andres, Hoyt T., WKY Oklahoma City; Anson, Alfred E., WKWB Buffalo; Arkedis, George, CBS-TV Chicago; Armstrong, George W., WHB Kansas City, Mo.; Arnoux, Campbell, WTAR Norfolk, Va.; Arvidson, Paul, WOC Davenport, Iowa; Asher, James D., WSDA Quincy, Mass.; Atkinson, Frank, ABC Radio New York; Atkinson, John R., WHBU Anderson, Ind.; Atlas, H. Leslie, CBS-TV Chicago; Atlas, Ralph L., WIND Chicago; Atwood, Jack S., WCSH-TV Portland, Maine; Avery, Lewis H., Avery Knodel Inc., New York; Axton, Bailey, KTPO Topeka; Bain, David, RCA Camden, N. J.; Baker, Phillip M., Attorney, Washington, D. C.; Baker R. Karl, WLDS Jacksonville, Ill.; Baker, Raymond W., KSO Des Moines.

B

Baker, Ross B., KWWL-TV Waterloo, Iowa; Baker, T. B., Jr., WLAC-TV Nashville, Tenn.; Baker, William, CFRB Toronto, Ont.; Bakke, Neale, WTMJ-TV Milwaukee; Balch, Frank, WJOY, Burlington, Vt.; Baldwin, John M., Intermountain Broadcasting & TV Corp., Salt Lake City; Baldwin, Philip, WHDH Boston, Mass.; Balhorce, Charles, KITE San Antonio, Texas; Baltimore, David M., WERE-TV Wilkes-Barre, Pa.; Bandle, Homer, KSCV, Richfield, Utah; Bannister, Harry, NBC New York; Bare, John D., WTVR Hanover, Pa.; Barnes, Howard, CBS Radio New York; Barnes, Maurice R., Barnes & Neilson, Washington, D. C.; Barnes, Milan, Boston University, Boston; Barnes, Wade, Bonded TV Film Service New York; Baron, Theodore, Scharfeld & Baron, Washington, D. C.; Barr, James E., FCC Washington, D. C.; Barrett, Mike, KTFY Brownfield, Texas; Barrett, Morton A., The Bolling Company, Inc., New York; Barry, Charles C., MGM-TV New York; Barthelme, Stewart, WABC New York; Bartlett, Marcus, WSB-TV Atlanta; Barton, Jack, Hamilton, Stubblefield, Twining & Assoc., Atlanta; Barton, Morris C., KSLA-TV Shreveport, La.; Batson, Charles A., WIS-TV Columbia, S. C.; Baudino, Joseph E., Westinghouse Broadcasting Company, Inc., Washington, D. C.; Baugh, Briggs, ABC Radio New York; Baughn, Edward F., WPAG Ann Arbor, Mich.; Baylor, Ben B., Jr., WINT Ft. Wayne, Ind.; Beadell, Walter, G.P. Parma Inc., Chicago; Beaton, W. J., KWKW Pasadena, Calif.; Beatty, J. Frank, Broadcasting • Telecasting, Washington, D. C.; Beckham, Ben, Jr., KSLA-TV Shreveport, La.; Beckjorden, Elisabeth M., Station Network Rep., New York; Beckman, Alfred R., ABC-TV New York; Beeson, Sterling B., The Headley-Reed Co., New York; Bell, Edgar T., KWTB Oklahoma City; Bellwood, LeRoy A., KFSD San Diego, Calif.; Benedict, Edward H., WFIL Philadelphia; Benham, Edward E., KTTV Los Angeles; Benton, N. L., WLOL Minneapolis; Berntson, Ben, WGN New York; Berger, Lawrence S., KTWQ-TV Jasper, Wyo.; Bernard, Joe, WGR Buffalo; Berryhill, J. L., KRON-TV, San Francisco; Betts, Floyd G., KPAC Port Arthur, Texas; Betts, J. W., WFTM Maysville, Ky.; Beville, Ross, WWDC Washington, D. C.; Bice, Max H., KTNT-TV Seattle-Tacoma, Wash.; Biederman, Les, WTCM, Traverse City, Mich.; Bigley, William M., KVMA Magnolia, Ark.; Bingham, George W., WKIPoughkeepsie, N. Y.; Binns, F. D., WLAC Nashville, Tenn.; Bishop, Don, NBC New York.

Bitter, Harry M., Jr., WFBB Indianapolis; Blackburn, J. W., Blackburn & Co., Washington, D. C.; Blackburn, Richard K., WHEC Rochester, N. Y.; Blackman, E. G., WLAC Nashville Tenn.; Blair, James, TelePrompTer Corp., New York; Blair, John, John Blair & Co., New York; Bland, Thomas A., Crosley Broadcasting Corp., Cincinnati; Blechta, George E., A. C. Nielsen Co., New York; Blohm, Olga, Standard Radio Transcription Services, Inc., Chicago; Bloom, Joseph, Forjoe & Company, Inc., New York; Blume, Jack P., Fly, Shuebruk, Blume & Gaguine, Washing-

ton, D. C.; Boatright, Glenn, KPAC Port Arthur, Texas; Boerner, T. J., RCA Camden, N. J.; Boice, Hugh K., Jr., WEMP Milwaukee; Bolling, George W., The Bolling Co., Inc., New York; Bolling, George W., III, The Bolling Co., Inc., Los Angeles; Bolton, L. D., WNAK Yankton, S. D.; Bondy, Hugo A., WAGA Atlanta; Bone, John H., WBRZ, Baton Rouge, La.; Bonebrake, Matthew H., KOCY, Oklahoma City; Bookwalter, L. S., KOIN Portland, Ore.

Booth, Robert M., Jr., WSAL Logansport, Ind.; Booth, Robert W., WTAG Worcester Mass.; Bostic, Tom, KIMA Yakima, Wash.; Bourgeois, James F., WNUR-FM Evanston, Ill.; Bourgeois, James, Northwestern Univ., Evanston, Ill.; Bowden, J. L., WKBN Youngstown, Ohio; Bowley, Raymond J., Westinghouse Broadcasting Co., Inc., New York; Bowman, L. H., CBS-TV Los Angeles; Bowry, Walter A., WTVR Richmond, Va.; Boyd, Ray, KNOE-TV Monroe, La.; Brace, Clayton H., KJLZ-TV Denver; Braden, Paul F., WPFB Middletown, Ohio; Brady, Francis X., Harry B. Cohen Advertising Inc., New York; Bradshaw, J. D., WRFD Worthington, Ohio; Brakefield, Charles, WREC Memphis, Tenn.; Brandt, Otto, KING Seattle; Brazy, Robert L., KFMU-FM Los Angeles; Bremser, Lyell, KFAB Omaha; Brennan, William H., Jr., CBS Los Angeles; Bretherton, Thomas S., WTOL Toledo, Ohio; Brewer, Dudley D., Branham Co., Chicago; Bricker, G., RCA Camden, N. J.; Bridges, W. C., WEAU-TV Eau Claire, Wis.; Brines, Paul C., WSJV-TV South Bend-Elkhart, Ind.; Britt, Charles B., WLOS-TV Asheville, N. C.

Brokaw, Harold, WOWO Ft. Wayne, Ind.; Broman, Edward J., Ziv Television Programs, Cincinnati; Brown, Blake, H., WDEJ-TV Roanoke, Va.; Brown, Charles F., WCSH-TV Portland, Maine; Brown, G. H., RCA Camden, N. J.; Brown, H. S., WRRD, Ithaca, N. Y.; Brown, Kenyon, KWTF Wichita Falls, Texas; Browne, Frank, Screen Gems, Inc., New Orleans; Bryan, Robert F., J. H. Whitney & Co., New York; Buchan, Alex, WING Dayton, Ohio; Burchfield, Norman, WSEV Sevierville, Tenn.; Burgess, John Y., Jr., RCA New York; Burke, Harry, KODE Joplin, Mo.; Burkland, Carl J., WAVY-TV Norfolk, Va.; Burton, Don, WLBC-TV Muncie, Ind.; Bush, E. Ogden, WDLA Walton, N. Y.; Butts, James, KOA-TV Denver.

C

Cady, Charles A., General Radio Co., Cambridge, Mass.; Caldwell, S. W., S. W. Caldwell, Ltd., Toronto, Ont.; Caley, Charles C., WMBD Peoria, Ill.; Campbell, Dick, KNAC-TV Fort Smith, Ark.; Campbell, Mrs. Marianne, WJEH Gallipolis, Ohio; Campbell, T. E., WJAC-TV Johnstown, Pa.; Campbell, Wendell, MBS New York; Cardall, Freeman W., WBAL Baltimore; Carey, John T., WIND Chicago; Carhart, G. Warren, S. R. D. S., Evanston, Ill.; Carino, Larry, KTNT-TV Seattle-Tacoma, Wash.; Carter, Ken, WAAM Baltimore; Case, Ross E., KWAT Watertown, S. D.; Caskey, William B., WPFN, Philadelphia; Cassens, G. J., WLDS Jacksonville, Ill.; Chalk, Rodney, British Information Services, New York; Chandler, Robert M., WKXN, Saginaw-Bay City, Mich.; Chapin, Richard W., KFOR Lincoln, Neb.; Chapman, Red G., WANE Ft. Wayne, Ind.; Chase, Eugene A., WKJG Ft. Wayne, Ind.; Chauncey, Tom, KOOL Phoenix; Chernoff, Howard L., Channel Two, Inc., Oakland, Calif.; Chisman, Thomas P., WVEC Norfolk, Va.; Chismark, Albert H., WHEN-TV Syracuse, N. Y.; Christy, Orrin E., Jr., Morse International, Inc., New York; Churchill, Clinton D., WKBW Buffalo; Cislis, S. A., KDFC San Francisco; Cissna, Norman, The Meeker Co., Inc., Chicago; Clark, V. V., KOOK, Billings, Mont.; Claussen, Gene, KXIC Iowa City, Iowa.

Clay, Henry B., KWKH Shreveport, La.; Clayton, Vincent E., KSL Salt Lake City; Cline, Clay, WSEV Sevierville, Tenn.; Cline, Neil, WHAS, Louisville, Ky.; Clinton, George H., WPAR Parkersburg W. Va.; Close, Richard H., NBC Spot Sales, New York; Cobb, Grover C., KYVG Bend, Kan.; Cobb, Wilton, WMAZ Macon, Ga.; Codel, Edward, Katz Agency, Inc., New York; Coe, Dee C., WWC-A Gary, Ind.; Coe, Robert, ABC-TV New York; Cohen, John C., KSWB Salinas, Calif.; Cohen, Jules, Vandiver, Cohen & Wearm, Washington, D. C.; Cohen, Julius, George C. Davis, Washington, D. C.; Cohen, Nat L., WGR Buffalo; Cohn, Marcus, Cohn & Marks, Washington, D. C.; Cole, John J., Guild Films Co., Inc., New York.

Coley, James L., WRFPS Alexander City, Ala.; Collins, Alfred H., CKLB Oshawa, Ont.; Collins, Earl R., Hollywood Television Service Inc., North Hollywood, Calif.; Collins, J. M., ASCAP, New York; Collins, Robert, The Pulse, Inc., New York; Colman, Ben, Screen Gems, Inc., New York; Comte, George, WTMJ-TV Milwaukee; Conger, Fred L., KWVB Hutchinson, Kan.; Conner, John H., KOOK Billings, Mont.; Connolly, James H., San Francisco; Connolly, Joseph T., WCAU Philadelphia; Constant, A. H., KBAK-TV Bakers-

field, Calif.; Cook, Charles R., WJPF Herrin, Ill.; Conwell, John O., KOMU-TV Columbia, Mo.; Cook, Kenneth H., KTVH Hutchinson, Kans.; Cooke, Kenneth R., WGBI Scranton, Pa.

Cooper, Donald H., WTOP-TV Washington, D. C.; Cooper Jack D., Employers Reinsurance Corp., Kansas City, Mo.; Cooper, Jim W., WFAA Dallas; Corken, Maurice, WBBR, Rock Island, Ill.; Corwin, Serrill, KAKE-TV, Wichita; Covell, Arthur E., WKZO-TV Kalamazoo, Mich.; Covey, Dick, KRNT-TV Des Moines; Covington, J. Robert, WBT Charlotte, N. C.; Cowan, F. A., A. T. & T. Co., New York; Cowan, Ken, Broadcasting • Telecasting, New York; Cowan, Phil, Screen Gems, Inc., New York; Cowley, Charles C., Muzak Corp., New York; Craddock, Douglas L., WLOE Leaksville, N. C.; Craig, W. F., WLBC-TV Muncie, Ind.; Crater, Rufus, Broadcasting • Telecasting, New York; Crawford, Robert P., Michigan State U., East Lansing, Mich.

Crawley, Lee, CHCT-TV; Cribb, Wayne W., WTAD Quincy, Ill.; Cripe, Jesse, WTVJ Miami; Crowl, H. K., WAVI, Dayton, Ohio; Crowther, Frank, WMAZ Macon, Ga.; Crutchfield, Charles H., WBT Charlotte, N. C.; Culver, John P., WGKA Atlanta; Culver, Ronald H., Lohnes & Culver, Washington, D. C.; Cundiff, John F., KCRG-TV Cedar Rapids, Iowa; Cuneen, M. J., WDLA Walton, N. Y.; Cunningham, Marion, KCSJ Pueblo, Colo.; Curbow, William B., KWTV Oklahoma City; Curran, Robert, ABC-TV New York; Curry, William F., KITS Springfield, Mo.; Curtis, Ralph W., Sr., Walter Reed Army Medical Center, Washington, D. C.

D

Dahl, Howard, WKBH La Crosse, Wis.; Dallier, E. W., KTVH Hutchinson, Kan.; Danforth, Harold P., Sr., WDBO Orlando, Fla.; Dannenbaum, A. W., Jr., Westinghouse Ecstec. Co., Inc., New York; Danziger, Jerry, WRTV Bloomington, Ind.; Dautenmeyer, Howard, WTRF-TV, Wheeling, W. Va.; David, George C., George C. Davis Consulting Engineers Washington, D. C.; Davidson, Bryan, WFTW, Fairfield, Ill.; Davidson, William N., WRCA New York; Davis, Edward, KDFC-TV San Francisco; Davis, Walter L., George C. Davis Consulting Engineers, Washington, D. C.; Day, Carl, WOC Davenport, Iowa.

Deaderick, Joe, WMPB Memphis, Tenn.; Deason, Willard, KVET Austin, Texas; DeDominicis, Aldo, WHAY, New Britain, Conn.; DeGray, E. J., ABC-Radio, New York; DeGroot, Don, WWJ Detroit; DeLaney, C. Glover, WHEC Rochester, N. Y.; Demers, Roch, CFCL Timmins, Ont.; Denious, Jess, Jr., KGNU Dodge City, Kans.; Dennis, Harry, WERE Cleveland, Ohio; Denny, Charles E., Charles E. Denny TV Radio Broker, Erie, Pa.; DeRose, Charles N., WHYN Springfield, Mass.; DeSmit, Donald, WKZO-TV Kalamazoo, Mich.; Deters, Arthur, Vic Diehm Radio Group, Boston; Devney, E. J., J. H. McGillivra, New York; Dewing, Harold, WCVS Springfield, Ill.

DeWitt, Clyde F., Employers Reinsurance Corp., Chicago; DeWitt, John H., Jr., WSM Nashville, Tenn.; Dickoff, Charles R., WBEV Beaver Dam, Wis.; Diehl, Max E., General Electric Co., Syracuse, N. Y.; Dillaber, Maynard E., WMA Martinsville, Va.; Dillard, Everett L., Commercial Radio Equipment Co., Washington, D. C.; Dillon, Bob, KRNT-TV, Des Moines; Dinsmore, Richard, Screen Gems, Inc., Los Angeles; Dippell, Ralph E., Jr., G. C. Davis Consulting Engineers, Washington, D. C.; Dirks, Dietrich, KTVI St. Louis City, Iowa; Dix, Thomas S., Jr., Philco Corp., Philadelphia; Dixon, Donald S., U. of Alabama, Tuscaloosa, Ala.; Dobin, Paul, Cohn & Marks, Washington, D. C.; Dodson, Eugene B., WSFA-TV Montgomery, Ala.; Doebler, C. W., CBS-TV Chicago.

Doerr, William, Jr., WEBR Buffalo; Doherty, R. P., TV-Radio Mgmt. Corp., Washington, D. C.; Donegan, Louise N., KPAC Port Arthur, Texas; Donovan, Robert, KVTY Sioux City, Iowa; Dossy, Norlyn, WDAN Danville, Ill.; Doty, Dwight D., Haley, Doty & Wollenberg, Washington, D. C.; Dougherty, Frank, Harrington, Righter & Parsons, Inc., San Francisco; Douglas, Harold, KMMO Marshall, Mo.; Dreher, Robert L., WGAL Lancaster, Pa.; Drenth, William G., WCML-FM Chicago; Dressbach, C. T., WPAV Portsmouth, Ohio; Druwry, H. K., KSWO, Lawton, Okla.; Dudley, Stanley, Screen Gems, Inc., Detroit; Dugan, James, KWWL-TV, Waterloo, Iowa; Duke, Walter A., WDBL Springfield, Tenn.; Dukehart, Thomas V., WAAM Baltimore; Duncan, C. G., American Telephone & Telegraph Co., New York; Dundes, Jules, CBS-Radio, New York; Dunn, Emmett B., RCA, New York; Duszak, H., RCA, Camden, N. J.; Duvall, Charles F., Fisher, Wayland, Duvall & Southmayd, Washington, D. C.

E

Eagan, R. Russell, Kirkland, Fleming, Green, Martin & Ellis, Washington, D. C.; Eastman, Robert E., John Blair & Co., New York; Eastwood, Clive, CFRB Toronto, Ont.; Ebel, A. James, KOLN-TV Lincoln, Neb.; Eekersley, Vance L., WGBI Scranton, Pa.; Edison, Edward, Robert L. Hammett, San Francisco; Edwards, William J., WKXN Saginaw-Bay City, Mich.; Ehrenberg, Gustave, Minneapolis Honeywell Regulator Co., Philadelphia; Eicholzer, Albert J., WSYR Syracuse, N. Y.; Ekberg, William A., KFVR-TV Bismarck, N. D.; Elber, Sam, WERE Cleveland; Ellerman, Gene, WWTW Cadillac, Mich.; Elliott, K. B., Houston Fearless, Los Angeles.

Elliott, Paul, KRNT-TV Des Moines; Elliott, Wendell, KGNU Dodge City, Kan.; Ellis, Charles J., KCHA, Charles City, Iowa; Ellis, Robert D., KKTU Colorado Springs; Ellsworth, William C., Westinghouse Broadcasting Co., Inc., New York; Ely, Tom, KPIX San Francisco; Enoch, Robert D., WXLW Indianapolis; Eppel, Ray, KORN Mitchell, S. D.; Epperson, Joseph B., WEWS Cleveland;

Essex, Harold, WSJS Winston-Salem, N. C.; Evans, Ralph, WOC Davenport, Iowa; Ewing, Clayton, WFRV-TV Green Bay, Wis.

F

Faber, Marshall, KBTU Denver; Fagans, Allan J. S. R. D. S., New York; Falkenstein, Max, WREN Topeka; Farahan, Jay, WGN Chicago; Faust, A. D., WJRT Flint, Mich.; Feldman, S. E., ASCAP, New York; Felix, Ernest, WEHT Evansville, Ind.; Ferguson, Robert W., WTRF-TV Wheeling, W. Va.; Ferri, John V., WPRO Providence, R. I.; Ferrise, A. Garen, WMMN Fairmont, W. Va.; Fetzer, John E., WKZO Kalamazoo, Mich.; Flala, Albert M., Jr., WROW Albany, N. Y.; Fiedler, Leroy, WKWB Buffalo; Fielder, Ted M., CFRS Simcoe, Ont.; Fielding, James F., WCIA Champaign, Ill.; Figli, Mig, WAUX Waukesha, Wis.

Filion, Edgar B., The Meeker Co., Inc., New York; Finch, J. M., Jr., WFTM Maysville, Ky.; Fisher, Albert T., Jr., WOIC Columbia, S. C.; Fisher, Ben C., Fisher, Wayland, Duval & Southmayd, Washington, D. C.; Fisher, C. H., KUGN Eugene, Ore.; Fitch, Joseph S., S. R. D. S., New York; Fitzgerald, Edward R., J. Walter Thompson Co., Chicago; Fitzgerald, D. C., Fitzgerald, Harold, Sesac, Inc., New York; Fitzpatrick, Horace, WSLR Roanoke, Va.; Flaherty, Eugene T., KSCJ Sioux City, Iowa; Flanders, Robert W., WFRM-TV Indianapolis; Fleckenstein, William, WHOT Youngstown, Ohio; Fletcher, Frank U., Spearman & Roberson, Washington, D. C.; Fletcher, Henry H., KSEI Pocatello, Idaho; Fletcher, Ruthe A., KSEI Pocatello, Idaho; Flett, Deane R., KSLA-TV Shreveport, La.

Flood, David P., Alford Mfg. Co., Boston; Floyd, C. W., A. T. & T. Co., White Plains, N. Y.; Floyd, Joe, KELO-TV Sioux Falls, S. D.; Fones, Henry N., WDIA Memphis, Tenn.; Foster, Michael J., ABC New York; Fotdry, Tsymont, KTAG-TV Lake Charles, La.; Fox, Bill, KFMB-TV San Diego, Calif.; Fox, W. H., WLS Louisville, Ky.; Flynn, George, WOV, Omaha; Fogarty, Frank, WOV Omaha; Foreen, Hildie, W. W. W. Wausau, Wis.; Frase, E. C., Jr., WMC Memphis, Tenn.; Frechette, George T., WSAU-TV Wausau, Wis.; Freed, Don, WTRC Elkhart, Ind.; Freeman, Sid, Telemat, Los Angeles; Freiert, Willis, WBAL Baltimore; Friedheim, Robert, World Broadcasting System, Inc., New York; Friedenthal, A., WJR Detroit.

G

Gaguine, Benito, Fly, Shuebruk, Blume & Gaguine, Washington, D. C.; Gaines, James W., WQAL San Antonio, Texas; Gaither, Frank, WSB Atlanta; Gallimore, J. A., WSNW Seneca, S. C.; Gallimore, J. A., (Mrs.), WSNW Seneca, S. C.; Galuska, Edward, Adler Electronics, Inc., New Rochelle, N. Y.; Gamble, Joseph E., KWIP Merced, Calif.; Ganzenhuber, John H., Hughey & Phillips, Inc., Burbank, Calif.; Garman, William E., WKBO Harrisburg, Pa.; Garner, W. Eldon, WKMF, Flint, Mich.; Garten, C. T., WSAZ Huntington, W. Va.; Gaston, Otis, WKZO Kalamazoo, Mich.; Geiser, Reginald, Employers Reinsurance Corp., Kansas City, Mo.; Geist, Henry J., Hughey & Phillips, Inc., Stamford Conn.; George, Carl E., WGAR Cleveland; George, Delores, KSLA-TV Shreveport, La.

Giaquinto, Joseph E., ABC-TV New York; Giddens, Kenneth R., WKRG-TV Mobile, Ala.; Gill, Helen, Gill-Perna Inc., New York; Gillespie, Henry, Screen Gems, Inc., Chicago; Gilring, H. E., RCA Camden, N. J.; Gilbert, Jack, KHOL-TV Holdrege, Neb.; Gilmore, John C., Community Club Awards, Norfolk, Va.; Gilreath, Howard, WVOF Vidalia, Ga.; Ginsburg, Charles, Ampex Corp., Redwood City, Calif.; Gittleson, Norman A., WMUR-TV Manchester, N. H.; Glenn, Locke E., WGKA Atlanta; Glycagdis, Bruce, WJEF Grand Rapids, Mich.; Godt, Gene, WCCO-TV Minneapolis; Goebel, A. R., A. T. & T. Co., Chicago.

Goetz, William E., KFSD San Diego, Calif.; Goldenson, Leonard H., AB-PT, New York; Goldman, Harold, National Telefilm Assoc., New York; Goldman, Simon, WJTN Jamestown, N. Y.; Goodman, Harry S., Harry S. Goodman Productions, New York; Goodnow, Arthur C., Westinghouse Broadcasting Co., Inc., New York; Gore, Theodore, KAKE-TV Wichita; Gorman, Thomas Y., WEEI Boston; Gottlieb, Ralph, WKBR Manchester, N. H.; Grace, F. Cecil, Visual Electronics Corp., New York; Grams, Harold, KSD St. Louis; Grant, Douglas B., WMT Cedar Rapids, Iowa; Grant, William, KOA Denver; Gray, George J., WLW Cincinnati; Gray, Gordon, WOR-TV New York.

Grayson, Syd, KSYD Wichita Falls, Texas; Greeley, W. M., KHOL-TV Holdrege, Nebr.; Greenberg, Lewis S., Branham Co., Chicago; Greenmeyer P., RCA, Camden, N. J.; Greenwood, James H., WCAE Pittsburgh; Grenier, Theodore B., ABC-TV Center, Hollywood, Calif.; Gresham, Stokes, Jr., WISH Indianapolis; Griffin, John T., KTVX Tulsa; Griffin, Mike, I. N. S. Telenevs, Chicago; Griffith, E. T., RCA, Camden, N. J.; Griggs, Keith, KAKE-TV Wichita; Grimes, Walter, Allen Kander & Co., Washington, D. C.; Grimm, David, The Meeker Co., Inc., New York; Grissold, Glenn G., KFEQ St. Joseph, Mo.; Gross, Arthur, Guild Films Co., Inc., New York; Grove, William C., KFBC Cheyenne; Gulick, J. Robert, WGAL Lancaster, Pa.; Guenther, Walter W., FCC, Washington, D. C.; Gunderson, Allan, Intermountain Broadcasting & TV Corp., Salt Lake City; Gundy, Phil, Ampex Corp., Redwood City, Calif.; Gunn, Hartford, N. J., WGBB-FM Cambridge Mass.; Gureckis, Peter, V. John H. Mullaney Consulting Radio Engineers, Washington, D. C.; Guth, Raymond E., WOC Davenport, Iowa; Guy, Raymond F., NBC, New York; Guziewicz, Henry J., Stainless, Inc., North Wales, Pa.

H

Haften, C. Van, KTWO-TV Casper, Wyo.; Haeg, Larry, WCCO Minneapolis; Haerle, John M., Collins Radio Co., Cedar Rapids, Iowa; Hagen, Raymond, TelePrompTer Corp., New York; Hagerity, George E., Westinghouse Broadcasting Co., Inc., New York; Haines, Homer M., WNAE, Warren, Pa.; Hairgrove, Jim, KFSD Rosenberg, Texas; Hale, Harold H., KWBB Wichita, Kan.; Haley, Andrew G., Haley, Doty & Wollenberg, Washington, D. C.; Haley, Arthur E., WORL Boston; Hall, Edward, CBS, New York; Hall, Gladys, Broadcasting & Telecasting, Washington, D. C.; Hall, J. Milton, KWBB Wichita, Kan.; Hall, Payson, Meredith Radio & Television, Des Moines; Halle, Charles F., WMUR-TV Manchester, N. H.; Hallinan, Charles, WKOP Birmingham, N. Y.

Hamilton, Arthur, WRCA New York; Hamilton, Charles E., KFI Los Angeles; Hamilton, G. Edward, ABC, New York; Hamilton, Ray V., Hamilton, Stubbelfield, Twining & Assoc., Inc., Chicago; Hammerschmidt, A. L., NBC, New York; Hammett, Robert L., Consulting Engineer, San Francisco; Hance, Kenneth M., KSTP St. Paul-Minneapolis; Hancock, Paul, NBC, New York; Hanlon, Jim, WGN Chicago; Hanna, Michael R., WHCU Ithaca, N. Y.; Hannon, W. A., Employers Reinsurance Corp., Kansas City, Mo.; Hansen, Carroll, CBS New York; Harden, W. Frank, WIS Columbia, S. C.; Hardesty, John F., Radio Advertising Bureau, Inc., New York; Harkrader, John W., WDBJ Roanoke, Va.; Harmon, Ralph N., Westinghouse Broadcasting Co., Inc., New York; Harper, Richard A., MGM-TV New York.

Harrington, John E. Jr., Harrington, Righter & Parsons, Inc., New York; Harris, Burt, KTWO-TV Casper, Wyo.; Harris, C. L., WGRC Louisville; Harris, Jack, KPRC Houston, Texas; Harrison, Gerald, WMAS Springfield, Mass.; Hartenbower, E. K., KCMO Kansas City, Mo.; Harter, Robert H., WHO Des Moines; Hartford, George F., WTOP-TV Washington, D. C.; Hartley, J. Harrison, WEWS Cleveland; Harvey, George W., WFLA Tampa, Fla.; Harvey, Jack V., Blackburn & Co., Washington, D. C.; Harwood, Kenneth, Univ. of Southern California, Los Angeles; Hastie, Kenneth L., WMT Cedar Rapids, Iowa; Hatch, Vern R., A. T. & T. Co., New York; Hatcher, Ralph, ABC-TV New York; Hathaway, D. L., KSPR, Casper, Wyo.

Hausman, Louis, CBS New York; Havens, Wilbur M., WTVR Richmond, Va.; Hawkins, Lloyd, KRTN Raton, N. Mex.; Hayden, J. Roger, Dresser-Ideco, Columbus, Ohio; Hayes, Arthur Hull, CBS-RADIO New York; Hayes, Gordon, CBS-RADIO New York; Hayes, Howard B., WOKO Albany, N. Y.; Hayes, John S., WTOP Washington, D. C.; Hayes, Susan, WOKO Albany, N. Y.; Head, Howard T., A. D. Ring & Associates, Washington, D. C.; Head, Sydney W., APBE; Hedges, William S., NBC New York; Hedrick, Phil, WSJS Winston-Salem, N. C.; Heinecke, Alice, Sesac Inc., New York; Heller, C. B., WIMA Lima, Ohio; Hembrooke, Emil F., Muzak Corp., New York; Henderson, W. C., KSLA-TV Shreveport, La.; Hendrix, Cliff, KCSJ Pueblo, Colo.; Hennessey, Philip J., Jr., Segal, Smith & Hennessey, Washington, D. C.

Henzel, John R., WHDL Olean, N. Y.; Herbst, Edna A. (Miss), KCRG-TV Cedar Rapids, Iowa; Herbuveaux, Jules, WNBQ Chicago; Herman, A. M., WEAP Fort Worth, Texas; Hernreich, George, KNAC-TV Fort Smith, Ark.; Herold, Joseph, KBTU Denver; Hess, F. LeRoy, S. R. D. S., Evanston, Ill.; Hickox, Sheldon B., NBC Hollywood, Calif.; Hiebert, A. G., KTVA Anchorage, Alaska; Higgins, Leonard H., KNTN-TV Seattle-Tacoma; Hilberg, Henry, WEHT Evansville, Ind.; Hill, E., RCA Camden, N. J.; Hill, Harry, WFRV-TV Green Bay, Wis.; Hillebrand, W. A., WMHE Toledo, Ohio; Himmel, Martin, Dunnam & Jeffrey, New York.

Hirsch, Oscar C., KFVS Cape Girardeau, Mo.; Hirsch, Robert O., KFVS Cape Girardeau, Mo.; Hix, Robert, KOA Denver; Hixenbaugh, George, WMT Cedar Rapids, Iowa; Hobler, Herbert W., TelePrompTer Corp., New York; Hochhauser, Edward, Jr., Muzak Corp., New York; Hoffman, Karl B., WGR Buffalo; Hoffman, Phil, KLZ Denver; Hogan, Thomas P., WPFB Middletown, Ohio; Hohndorf, Paul, KPRC-TV Houston, Texas; Holben, Robert, WIVH Peoria, Ill.; Holbrook, R. A., WSB Atlanta; Holcomb, Douglas, WGBI Scranton, Pa.; Holcomb, Madge Megargee, WGBI Scranton, Pa.

Holder, James B., WINC Winchester, Va.; Holm, William, WLPO LaSalle, Ill.; Holtman, H. B., WAVE Louisville; Hoos, William, WFER Baltimore; Hopkins, A. R., RCA Camden, N. J.; Hornsby, Len, WVDA Boston; Horton, Keith W., WELM Elmira, N. Y.; Hough, Harold, WEAP Fort Worth, Texas; Hovel, Ben F., WKOW Madison, Wis.; Howard, Leo, WEAU-TV Eau Claire, Wis.; Howard, Thomas E., WBT Charlotte, N. C.; Hubbard, J. H., KTXL-TV, San Angelo, Texas; Hubbard, Stanley E., KSTP St. Paul-Minneapolis; Hucaby, Ralph L., WLAC-TV Nashville, Tenn.; Hudson, W. E., WAVE-TV Louisville; Huelster, Robert A., WCCO-TV Minneapolis; Hulick, Henry, Jr., WPTF Raleigh, N. C.; Hunt, Clyde M., WTOP Washington, D. C.; Hunter, Charles, Northwestern Univ., Evanston, Ill.; Huntress, Frank G., Jr., KBNS San Antonio, Texas; Hyams, Jerry, Screen Gems, Inc., New York; Hyland, Robert, KMOX St. Louis.

I

Iglehart, Raymond W., WPFB Middletown, Ohio; Ing, George W., KONO San Antonio, Texas; Ingram Alan, S. R. D. S., Evanston; Inman, Don E., KWWL-TV Waterloo, Iowa; Ioset, Don, WPTT Pittsburgh, Pa.

J

Jackson, Aubrey, KGNC-TV Amarillo, Texas; Jackson, Richard E., WSAJ Logansport, Ind.; Jackson, William J., KBNS San Antonio, Texas; Jacobs, Bernard, WFMT Chicago; Jacobs, George G., KOTV Tulsa; Jacobs, Harry N., KGOTV San Francisco; Jacobson, Daniel, FCC Washington, D. C.; Jaeger, C. P., MGM-TV New York; Jahncke, Ernest Lee, Jr., New York; James, Edwin H., Broadcasting & Telecasting, Washington, D. C.; Jefferay, William W., KXKL St. Louis; Jeffers, Charles, WOAI San Antonio, Texas; Jenkins, Eugene F., KLZ-TV Denver; Jenness, Ernest W., Assn. of Maximum Service Telecasters, Inc., Washington, D. C.; Jensen, J. Allen, KSL Salt Lake City; Jeit, E. K., WMAF-TV Baltimore; Jewett, Carlton, The Meeker Co., Inc., Chicago; Jobs, Ray, WVET Rochester, N. Y.; Jöhler, Ray, KSD-TV St. Louis.

Johnson, Albert D., KENS San Antonio, Texas; Johnson, E. M., WCAW Charleston, W. Va.; Johnson, Howard, WIEA Madison, Wis.; Johnson, Leslie C., WHEE Rock Island, Ill.; Johnson, Merrill C., WGL Ft. Wayne, Ind.; Johnson, Mott M., KFDM-TV Beaumont, Texas; Johnson, Wallace E., FCC Washington, D. C.; Johnson, William E., KYNT Yankton, S. Dak.; Johnson, William L., WJMS Ironwood, Mich.; Johnston, Henry P., WAPI Birmingham, Ala.; Johnstone, R. W., Nat'l Assn. of Mrs., New York; Jolley, G. A., WMRC Greenville, S. C.; Jones, J. Grayson, Conrac, Inc., Glendora, Calif.; Jones, Kathryn, WJET, WHOT Erie, Pa.-Youngstown, Ohio; Jones, Myron, WJET WHOT Erie, Pa.-Youngstown, Ohio; Jones, Robert A., W. F. Kean Consulting Engineers, Riverside, Ill.; Jones, William, Pye Canada Limited, Toronto, Ont.

K

Kahle, Douglas D., KWG Stockton, Calif.; Kahn, Irving B., TelePrompTer Corp., New York; Norman C., WAAM Baltimore; Kaland, William J., Westinghouse Broadcasting Co., Inc., New York; Karol, John, CBS-Radio New York; Kassens, Harold L., FCC Washington, D. C.; Kaye, Richard L., WCRB Waltham, Mass.; Kean, Walter F., W. F. Kean Consulting Engineers, Riverside, Ill.; Kearl, Wayne, KENS-TV San Antonio, Texas; Kearney, Don L., ABC Film Syndication, New York; Keese, Alex, WFAA Dallas; Keesee, Frederick L., WMBO Auburn, N. Y.; Keim, Edwin L., WWVA Wheeling, W. Va.; Kelley, Boyd, KTRN Wichita Falls, Texas; Kelley, Gaines, WFMY-TV Greensboro, N. C.

Kellner, Morris S., Katz Agency, Inc., New York; Kelly, Arthur W., WHAM Rochester, N. Y.; Kelly, Edward H., RCA New York; Kelly, Ewing C., KCRB-TV Sacramento, Calif.; Kelly, Robert, Harry B. Cohen Advertising Inc., New York; Kelsor, Philip L., Philip L. Kelsor & Associates, New York; Kemp, Charles, Gill-Perna, Inc., New York; Kennedy, John, NBC Los Angeles; Kennedy, Raymond L., WRVA Richmond; Kennedy, William J., Walter Thompson Co., Chicago; Kenney, T. C., KDKA Pittsburgh, Pa.; Keough, Emmett, KSWO Lawton, Okla.; Kerman, Arthur, Governor Television Attractions, Inc., New York; Kidd, N. W., WAYB Waynesboro, Va.; Kilchli, Jeff, KGHL Billings, Mont.; Kiley, William F., WFBM Indianapolis; Kilian, James J., WAAM Baltimore.

Kilpatrick, Leroy E., WSAZ-TV Huntington, W. Va.; King, Paul L., WOHO Toledo, Ohio; King, William C., Jr., WVEC Norfolk, Va.; Kirksey, T. W., KWWL-TV Waterloo, Iowa; Klatt, John F., S. R. D. S., Evanston, Ill.; Klaus, Dick, WERE Cleveland; Klink, Granville, WTOP-TV Washington, D. C.; Knight, D. T., KODE Joplin, Mo.; Knodel, J. W., Avery-Knodel, Inc., Chicago; Kobak, Edgar, WTWA Thomson, Ga.; Kocher, C. F., WXYZ Detroit; Koehler, Frank E., WDBJ Roanoke, Va.; Koelker, Tony, WMA Omaha; Koessler, Walter, WGBS-TV Miami; Kolar, Barbara, Broadcasting & Telecasting, Chicago; Kolata, Carl, WTTN Watertown, Wis.; Kops, Daniel W., WAVZ New Haven, Conn.; Korenchen, George, KNUJ New Ulm, Minn.; Koster, H. William, WEAN Providence; Kotec, Bernard, Kotec & Burt, Washington, D. C.; Kozanowski, H., RCA Camden, N. J.

Kramer, Worth, WJR Detroit; Kreider, Kenneth L., WGAL Lancaster, Pa.; Krueger, Herbert L., WTAG Worcester, Mass.; Kugel, Frederick A., Television Magazine, New York; Kusack, W. P., WBKB Chicago; Kusack, William, WBKB Chicago; Kuykendall, Abe, WREC Memphis, Tenn.

L

Lackey, F. Ernest, WHOP Hopkinsville, Ky.; Lackey, Hecht S., WSON Henderson, Ky.; Labunski, Stephen B., WDGW Minneapolis; Laeser, Philip, WTMJ-TV Milwaukee; LaForge, E. E., Employers Reinsurance Corp., New York; Lahey, James L., Dage Television Div. Thompson Products, Inc., Michigan City, Ind.; Laing, Malcolm, ABC-TV New York; Lamb, M. J., WIMA-TV Lima, Ohio; Lambe, Robert M., WTAR Norfolk, Va.; Lambert, Edward C., KOMU-TV Columbia, Mo.; Land, Thomas S., WFIW Fairfield, Ill.; Landis, Dewitt, Hamilton Stubbelfield, Twining & Assoc., Inc., Dallas; Lane, C. Howard, KOIN-TV Portland, Ore.; Lane, Frank S., KRMG Tulsa; Lanford, T. B., KRMD Shreveport, La.; Lang, Robert L., Hughey & Phillips, Inc., Chicago; Langlois, C. O., Jr., Lang-Worth, New York; Langlois, John D., Lang-Worth, New York.

Lansing, Gerry, KLTV Tyler, Texas; Lansing, Lucille, KLTV Tyler, Texas; Lapkin, Nat. WTRI Albany, N. Y.; Larsen, Dale, KTVH Hutchinson,

ALL VIDEO TRANSMISSION TEST

STANDARDS in a suitcase



The Original Full Rack and the Portable Unit Produce the same Precise Test Signals.



TELECHROME
INCORPORATED

Model 1003-B

Video Transmission Test Signal Generator

- ★ Completely self contained ★ Portable
- ★ Multi-frequency burst ★ Stairstep ★ Modulated stairstep
- ★ White window ★ Composite sync ★ Regulated power supply.

Now, Telechrome Video Transmission Test Equipment is available as a completely portable 12 1/4" standard-rack mounting unit.

Everyday these Test Signals generated by Telechrome equipment, are transmitted Coast-to-Coast by NBC, CBS, ABC, the Bell System, Canadian Bell and leading independent TV stations throughout the U.S. and Canada. Hundreds of network affiliated TV stations and telephone TV centers thus check incoming video signals.

The compact, inexpensive, portable Model 1003-B is all that is required to generate signals for local and remote performance checking of your entire video, cable, or micro-wave facilities.

DELIVERY 30 DAYS

Literature on the above and more than 100 additional instruments for monochrome and color TV by TELECHROME are available on request.

The Nation's Leading Supplier of Color TV Equipment
28 Ranick Drive Amityville, N. Y.

Lincoln 1-3600

See Our Interesting Exhibit
NARTB Show—Booth 10

TELECHROME
INCORPORATED



MULTI-FREQUENCY BURST AMPLITUDE vs FREQUENCY. Check wide band coaxial cables, microwave links, individual units and complete TV systems for frequency response characteristics without point to point checking or sweep generator.



WHITE WINDOW LOW & HIGH FREQUENCY CHARACTERISTICS. Determine ringing, smears, steps, low frequency tilt, phase shift, mismatched terminations, etc. on TV signals or systems.

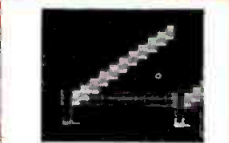

STAIRSTEP SIGNAL modulated by crystal controlled 3.579 mc for differential amplitude and differential phase measurement. Checks amplitude linearity, differential amplitude linearity and differential phase of any unit or system. Model 1003-C includes variable duty cycle stairstep (10-90% average picture level).

Model 608-A HI-LO CROSS FILTER for Signal analysis.



MODULATED STAIRSTEP signal thru high pass filter. Checks differential amplitude.

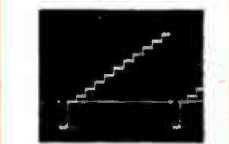

MODULATED STAIRSTEP signal thru low pass filter. Checks linearity.

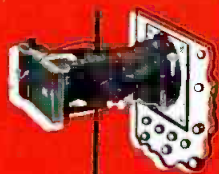

1521-A OSCILLOSCOPE CAMERA—Palaroid type for instantaneous 1 to 1 ratio photo-recording from any 3" oscilloscope.



1004-A VIDEO TRANSMISSION TEST SIGNAL RECEIVER for precise differential phase and gain measurements. Companion for use with 1003-B.

Kans.; Larson, C. A., Meredith Radio & Television, Des Moines; Larson, G. Bennett, Inter-mountain Broadcasting & TV Corp., Salt Lake City; Lasker, H. Peter, Crosley Broadcasting Corp., New York; Lasky, Philip G., KPIX San Francisco; Lasko, Edwin J., WSJV-TV South Bend-Elkhart, Ind.; Laux, John J., WPIT Pittsburgh, Pa.; Lawhon, J. D., WMAZ Macon, Ga.; Lawlor, Boyd, WWCA Gary, Ind.; Lawrence, Richard, World Broadcasting System, Inc., New York; Lawrence, Val, KROD-TV, El Paso, Texas; Layman, Carroll, Harrington, Righter & Parsons, Inc., Chicago; Layman, Mike, WSFC Somerset, Ky.; Layne, C. N., KID-TV Idaho Falls, Idaho.

Leach, Harold H., Alford Mfg. Co., Boston; Leake, James C., KTVX Tulsa; Leavitt, Mel, WDSU New Orleans, La.; LeBel, C. J., Audio De- vices, Inc., New York; Lebeck, Robert, KTW- TV Casper, Wyo.; Lee, Carl E., WKZO-TV Kalamazoo, Mich.; Lee, Terry H., KOVR-TV Stockton, Calif.; Leeman, Al, WKBH La Crosse, Wis.; Leibach, Jay, WLEC Sandusky, Ohio; Leitch, John G., WCAU Philadelphia; Lemly, F. W., Phelps Dodge Copper Products Corp., New York; Lemon, Robert, WTTV Bloomington, Ind.; LeMoyné, Joseph, WPFB Middletown-Portsmouth, Ohio;

Leonard, Joe M., Jr., KGAF Gainesville, Texas. Leslie, John, Ampex Corp., Redwood City, Calif.; Levi, Win., Broadcasting • Telecasting, New York; Lewin, Richman, KTRF Lufkin, Texas; Lewis, Robert, Television Magazine, New York; Lewis, William J., WCDA Albany, N. Y.; Linam, Henry E., KSLA Shreveport; Linam, Winston B., KSLA-TV Shreveport, La.; Lind, A. H., RCA, Camden, N. J.; Lindberg, Carl L., WPIK, WOKO Alexandria, Va./Albany, N. Y.; Lindberg, Mary V., WPIK, WOKO Alexandria, Va./Albany, N. Y.; Lindell, Richard L., WTAR Norfolk, Va.; Linder, Bill, KWLM Willmar, Minn.; Lindow, Lester W., Assn. of Maximum Service Telecasters, Inc., Washington, D. C.; Link, Louis J., WSUN St. Petersburg, Fla.; Little, Lee, KTUC Tucson; Livesay, Ray, WLBH Mattoon, Ill.; Livingston, Sam, WPSD-TV Paducah, Ky.; Lloyd, C. G., General Electric Co., Syracuse, N. Y.; Locke, C. B., KFDM Beaumont, Texas; Lockwood, Edward C., WGBS Miami. Lockwood, Howard M., KRIZ Phoenix; Loers, Lloyd D., KGLQ Mason City, Iowa; Lohnes, George M., Lohnes & Culver, Washington, D. C.; Long, Maury, Broadcasting • Telecasting, Washington, D. C.; Lorentz, Edward F., Commercial Radio

Equipment Co., Washington, D. C.; Loucks, Philip G., Loucks, Zia, Young & Jansky, Washington, D. C.; Love, Edgar J., WJF Detroit, La. Pa.; A. WHO Des Moines; Lucia, Ray, WHAM Rochester, N. Y.; Luddy, E. N., RCA, Camden, N. J.; Lund, Harold C., KDKA-TV Pittsburgh; Lyford, E. B., NBC, New York; Lyke, Ervin F., WVET Rochester, N. Y.; Lynch, Charles, WKZO-TV Kalamazoo, Mich.

M

MacFarland, F. R., A. T. & T. Co., New York; Mackey, David R., Boston University, Boston; MacMillan, Lowell H., WHEC Rochester, N. Y.; Magee, Robert G., WHUM Reading, Pa.; Malcarney, A. L., RCA, Camden, N. J.; Malone, Edward A., KIEM, Medford, Ore.; Maloney, Evan J., Collins Radio Co., Cedar Rapids, Iowa; Malter, N. J., WBen-TV Buffalo; Manning, Robert J., WHLD Niagara Falls, N. Y.; Manrow, William M., WAVY-TV Norfolk, Va.; Manship, Douglas L., WBRZ Baton Rouge, La.; Mapham, Neville W., Canadian General Electric, Toronto, Ont.; Marks, Leonard H., Cohn & Marks, Wash- ington, D. C.; Marsh, Bill, WREC Memphis, Tenn.; Marshall, Clifford B., Blackburn & Co., Atlanta; Marshall, Glenn, Jr., WMBR-TV Jack- sonville, Fla.

Martin, Jack, CBS-Radio, New York; Martin, Jerrold L., WKMH Dearborn, Mich.; Martin, Joe, WDSC Dillon, S. C.; Martin, Ray L., Collins Ra- dio Co., Cedar Rapids, Iowa; Martin, Stuart T., WCAJ Burlington, Vt.; Marts, Carroll, MBS Chi- cago; Marx, Frank, ABC New York; Mason, Robert T., WMRN Marion, Ohio; Mathiot, J. E., WGAL Lancaster, Pa.; Matthews, Joseph B., Community Club Awards, Norfolk, Va.; Matthews, Joseph R., A. C. Nielsen Co., Menlo Park, Calif.; Maudlin, Howard, KTNM Tucumcari, N. Mex.; McCabe, Aloysius B., Kirkland, Fleming, Green, Martin & Ellis, Washington, D. C.; McGannon, Donald H., Westinghouse Broadcasting Co., Inc., New York; McCausland, Pete, TelePrompTer Corp., New York; McClanathan, George, KPFO Phoenix; McClymonds, Clyde C., Storer Broad- casting Co., Miami Beach; McCollough, Clair, WGAL Lancaster, Pa.; McConnell, C. Bruce, WHBU Anderson, Ind.; McConnell, James V., Venard, Rintoul & McConnell Inc., New York; McConnell, Robert B., WISH Indianapolis.

McDermott, Gerard B., KBUR Burlington, Iowa; McDermott, John, WJBC Bloomington, Ill.; McDermott, Mrs. G. B., KBUR Burlington, Iowa; McDougald, Worth, University of Georgia, Athens, Ga.; McElroy, R. J., KWLL-TV Water- loo, Iowa; McFadden, Thomas B., NBC New York; McGrath, William B., WHDH Boston; Mc- Guineas, William, WGN Chicago; McIntosh, Robert J., WWJ Detroit; McKay, R. M., Jr., WKRM Columbia, Tenn.; McKearney, Miles C., Foster & Davies, Inc., Cleveland; McKenna, J. R., Philco Corp., Philadelphia; McKenna, James A., McKenna & Wilkinson, Washington, D. C.; Mc- Kenzie, Stan, KWED Seguin, Texas; McKinzie, Max., WVOF Vidalia, Ga.; McNaughten, N. K., RCA, Camden, N. J.; Meeker, Robert C., KCOH Houston, Texas; Meeker, Robert D. C., The Meeker Co., New York.

Megargee, Mary, WGBI Scranton, Pa.; Meier, Evans, WJAG Norfolk, Neb.; Melson, William, WBT Charlotte, N. C.; Melville, Clyde B., KTKL- TV San Angelo, Texas; Mendelsohn, Monroe, MGM-TV New York; Mendelson, Robert F., WJNC Jacksonville, N. C.; Menck, Dore, WFBM- TV Indianapolis; Mercer, Donald, NBC New York; Merkle, Joseph, ABC-TV New York; Merla, Michael L., WBNY Buffalo; Merritt, Bill, Broad- casting • Telecasting, Hollywood; Meyers, Carl J., WGN Chicago; Meyers, Howard B., Venard, Rin- toul & McConnell Inc., New York; Michael, Jack, WREC Memphis, Tenn.; Middleton, Warren, Broadcasting • Telecasting, Chicago; Midlen, John H., Attorney, Washington, D. C.; Mikita, Joseph K., WROW Albany, N. Y.; Millar, George M., WKMH Dearborn, Mich.

Miller, A., RCA, Camden, N. J.; Miller, C. E., KOMO Seattle; Miller, Clare I., WORK York, Pa.; Miller, Harold E., WGAL Lancaster, Pa.; Miller, John J., Community Club Awards, Norfolk, Va.; Miller, Kenneth W., FCC, Washington, D. C.; Miller, Neville, Miller & Schroeder, Washington, D. C.; Miller, Roy, Katz Agency, Inc., Chicago; Miller, Samuel, Attorney, Washington, D. C.; Milsten, David, Sesac Inc., New York; Miner, Bob, Ampex Corp., Redwood City, Calif.; Minton, Robert W., WIBC Indianapolis; Mitchell, Frank, KIMA, Yakima, Wash.; Moe, Anton J., WGBI Scranton, Pa.; Monahan, Richard J., WAVZ New Haven, Conn.; Moore, Dale G., KBMN Bozeman, Mont.; Moore, F. S., WJR Detroit; Moore, James H., WSLs Roanoke, Va.; Moore, Louis J. F., The Meeker Co., Inc., New York; Moore, Richard A., KTTV Los Angeles.

More, Herbert R., Kliegl Bros., New York; Moreland, Earl, WMCT Memphis, Tenn.; More- land, William J., Conrac Inc., Glendora, Calif.; Moritz, K. C., Philco Corp., Philadelphia; Mor- reney, J. M., WFAA Dallas; Morney, Jim Jr., WFAA Dallas; Morris, David H., KNUZ Houston, Tex.; Morris, George, RKO Teleradio Pictures, Chicago; Morris, R. M., ABC, New York; Morris, Truman A., WBEK Chillicothe, Ohio; Moseley, Thomas B., Continental Electronics Mfg. Co., Dallas; Motley, Lyle C., WBTM Danville, Va.; Motley, Ray, WMOH Hamilton, Ohio; Moudy, Dale, KOWH Omaha; Muehlenbeck, James B., WHLS Port Huron, Mich.; Mullaney, John H., John H. Mullaney Consulting Radio Engineers, Washington, D. C.

Mullin, Earl, ABC, New York; Munkhof, Soren H., WFRV-TV Green Bay, Wis.; Murdoch, D. Lennox, KSL-TV Salt Lake City; Murphy, Kle- ran T., Crosley Broadcasting Corp., Cincinnati;

Success Minded TV and Film Pros

... look to CECO for Top tools and techniques

As Most Pros know, CECO is headquarters for the world's finest cameras, recording and editing equipment and photographic accesso- ries. But CECO is more than that. It maintains the finest service department in the East— ALSO AN ENGINEERING AND DESIGN DE- PARTMENT. CECO is always happy to consult with film makers—either beginners or Acad- emy Award Winners—about their technical problems. May we help you?

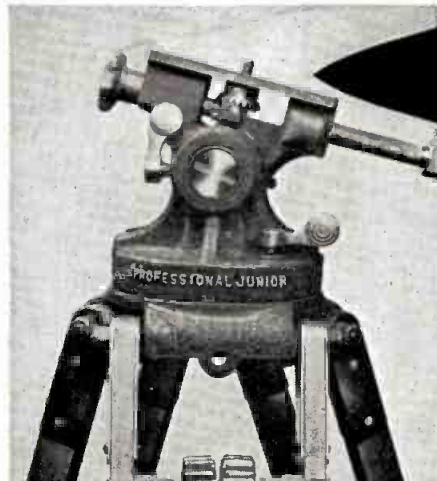

The improved PROFESSIONAL JR.* Tripod with re- movable head is the world standard of quality among tripods. Features simplified camera attach- ing method, double leg lock adjusting knobs, tele- scoping pan handle, sockets for left, right and reverse tilts. \$150.00

*Reg. U.S. Pat. Off. Pat. No. 2318910



PROFESSIONAL FILM VIEWER is portable, views film from left to right on large illuminated screen. Easy threading. \$350.00



Full Line of Studio Lighting Equipment. COLORTRAN GROVERLITE "5000" Senior Kit contains two Senior Lights, with con- verter. 2 chromed steel stands. Other kits for every purpose. \$265.00

AURICON CINE-VOICE Conversion Camera

modified to accept 1200 ft. external magazines; in- cludes torque motor for take up; also Veeder foot- age counter. \$450.00 Conversion only.



\$232.00

AKG D-25 MICROPHONE is dynamic cardoid type. Completely shock mounted, weighs only 2 ounces. AKG Models for every need.

SALES SERVICE • RENTALS

ADDITIONAL PRODUCTS: "BALANCED" TV HEAD • MICRO- WAVE RELAY BEAM REFLECTOR HEAD • ALL METAL TRIPODS • Silent & Sound Projectors • Ace Clear Vision Splitters • Electric Footage Timers • Editing Tables • Split Apart Reels Prices subject to change without notice

FRANK C. ZUCHER
AMERA EQUIPMENT Co., Inc.

Dept. B 315 West 43rd Street, New York 36, N. Y.

TARZIAN HAS DEVELOPED AND OFFERS EQUIPMENT TO MEET VARIED REQUIREMENTS OF ALL TV STATIONS

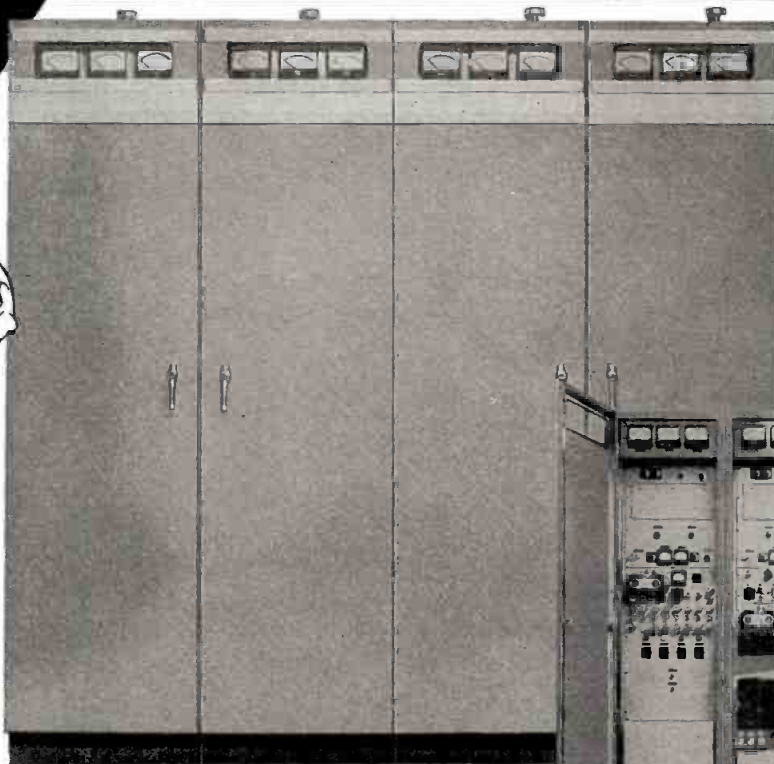

... and that goes for large and small stations—high power or low power—open circuit or closed circuit.

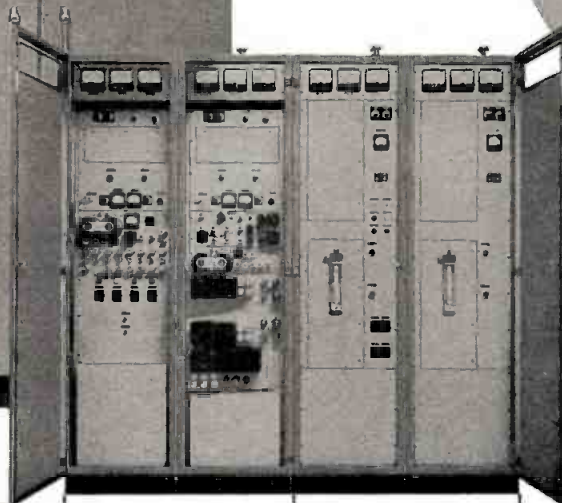

\$8,000

\$9,000

\$17,000

SPECIFICATIONS

Electrical Characteristics

	VISUAL	AURAL
Emission	A5	F3
Frequency Range	Channels 2-13	Channels 2-13
Rated Power Output	250 Watts Peak 1 KW Peak	125 Watts 600 Watts
RF Output Impedance	50/51.5 ohms	50/51.5 ohms
RF Output Connection	3/8" Flange	3/8" Flange
Carrier Frequency Stab.	±1 KC	±4 KC
Input Impedance	75 ohms	600/150 ohms
Input Level	1-2.5 volt p-p	±10 ±2dbm

POWER REQUIREMENTS: 220v AC Single Phase
3 WIRE grounded neutral

Typical of the Tarzian product line is this 250 watt transmitter. The visual portion of the transmitter is designed to deliver a standard AM signal of 250 watts peak power, when a composite video signal is fed to the visual transmitter input. With the aural portion, the equipment makes up a complete 250 watt television transmitter, the output of which—after diplexing—may be fed into a suitable television antenna. Transmitter can be used—without modification—as the driver for a 1 KW transmitter, and in addition, the 1 KW transmitter can be used as a driver to go to higher power.

Sarkes Tarzian can supply you with a complete low power Television Station for less than \$45,000. Write for our new 1957 catalogue of complete broadcast equipment. Or, better still, visit our plant; see the equipment in operation, and get complete details first-hand.

See Our Display
SPACE #12 NARTB CONVENTION
Conrad-Hilton • April 7-11

Sarkes Tarzian, Inc.
BROADCAST EQUIPMENT DIVISION
Bloomington, Indiana

Here's the only



Network



Color Studio



B/W Studio



Remote



Color Film



B/W Film



Special Effects, Montage, etc.



Applicable anywhere in TV system Meets highest performance standards

1. Crosstalk better than 55 db down.
2. Ideally suited to studio, master or transmitter control.
3. Switch action makes all contacts simultaneous within one millisecond.
4. Holds differential gain within 0.1 db.
5. Limits differential phase to below 0.1 degree.
6. Perfect input match to 75 ohm line . . . requires no high frequency compensation . . . flat to 7 mc.
7. Module design permits 10 or 15 inputs and 2, 4 or 6 outputs per switch.
8. 10 x 6 switch requires only 21" of rack space . . . Controls grouped for easy identification and operation.

proven TV switching system for all color and monochrome!

*New Philco switch provides centralized—transientless—control of
simultaneous color . . . coded-color . . . monochrome for studio control, master control or transmitter*

Before you expand station facilities or update present equipment . . . get the facts on simultaneous switching from Philco. This new switch offers significant savings over other systems in requirements for video processing equipment . . . handles TV color or monochrome—composite or non-composite—by remote control.

Only the new Philco switching system permits use of a single color or two colors alone. The scope of special program effects is greatly increased

since switching can be accomplished before the signal has been color coded.

Audio switching, sync insertion, tally-lights and change from color to monochrome may be easily interlocked with video switching. Low voltage DC Relays eliminate costly video cabling. This new switching system has been proven over thousands of hours of operation on RGB and composite switching. Life tested for more than a million switching cycles without maintenance or failure.

**SEE THIS SWITCH AND THE COMPLETE CINESCANNER SYSTEM DEMONSTRATED AT NARTB,
CONRAD HILTON HOTEL, CHICAGO, APRIL 7-11, BOOTH #11**



Studio Control



Master Control



Transmitter

PHILCO® CORPORATION

GOVERNMENT AND INDUSTRIAL DIVISION

Philadelphia 44, Pennsylvania • In Canada—Philco Corporation of Canada Limited, Don Mills, Ontario

Murphy, John T., WLW-TV Cincinnati; Murphy, Thomas S., WCDA Albany, N. Y.; Murray, Dana, All-Canada Radio Facilities Ltd., Toronto, Ont.; Murray, Paul T., The Meeker Co. Inc., New York; Murray, W. R., WKAZ Charleston, W. Va.; Muselman, B. Bryan, WSAW Allentown, Pa.; Myers, Robert L., WCIA Champaign, Ill.; Myers, W. F., Sesac Inc., New York.

N-O

Nahas, Fred, KXYZ Houston, Tex.; Nason, Richard E., WGBI Scranton, Pa.; Neal, Harold Jr., WKYZ Detroit; Neary, J. F., Lehigh Structural Steel Co., New York; Needs, William R., WGBS-TV Miami; Nelson, C. E., Utlity Tower Mfg. & Fab., Oklahoma City; Nelson, Ivar, KFYR-TV Bismarck, N. D.; Newby, Harold H., KAKE-TV Wichita; Newton, I. T., RCA, Camden, N. J.; Nichols, Dean C., KOMW Omak, Wash.; Nimmmons, Ralph, WTVJ Miami; Niven, Harold, Ohio State U., Columbus.

Nolte, Vernon A., WJBC Bloomington, Ill.; Nopper, C. G., WMAR-TV Baltimore; Norman, Hugh R., The Norman Co., Davenport, Iowa; North, John E., WDXI-TV Jackson, Tenn.; Northrop, Johnston F., J. H. Whitney & Co., New York; Nostrand, Lew Van, WMT Cedar Rapids, Iowa; Nunan, Thomas R. Jr., WGAL, Lancaster, Pa.; Nybo, Ken, KBMY Billings, Mont.

O'Connell, Raymond T., NBC, New York; O'Connor, Timothy A., Allen Kander & Co., Chicago; O'Daniel, Joseph E., WTVW Evansville, Ind.; O'Donnell, Frank J., RCA, New York; O'Donnell, William C., KXOK St. Louis; Odson, Robert L., WMOH Hamilton, Ohio; O'Hara, J. M., WMAN Mansfield, Ohio; O'Harrow, John W., WKZO Kalamazoo, Mich.; Oliphant, Paul, WLAC Nashville, Tenn.; Olson, Kenneth, WDJV Minneapolis; Onken, Carl, WTTV Bloomington, Ind.; Osbon, John, Broadcasting • Telecasting, Chicago; Outler, John M., WSB Atlanta.

P-Q

Pack, Richard M., Westinghouse Broadcasting Co. Inc., New York; Page, Allen, KGWA Enid, Okla.; Page, Kenneth J., S. W. Caldwell Ltd., Toronto, Ont.; Paltridge, J. G., KROW Oakland, Calif.; Pamphilon, L. Edward, USIA, Washington, D. C.; Pardoll, Arthur S., Foote, Cone & Belding, New York; Parham, Carter M., WDEF Chattanooga, Tenn.; Paris, Herman M., WWDC Washington, D. C.; Park, Warren S. Jr., WMUR-TV Manchester, N. H.; Parks, Sherwood R., KVOE Emporia, Kan.; Parsons, James O. Jr., Harrington, Righter & Parsons Inc., New York; Partridge, David E., Westinghouse Broadcasting Co. Inc., New York; Patt, John F., WJR Detroit; Patterson, Helen, WRCP-TV Chattanooga, Tenn.;

Patton, Billy, WJAR Providence.

Paxton, E. J. Jr., WPSD-TV Paducah, Ky.; Payne, Mather M., WRGA Rome, Ga.; Peace, B. H. Jr., WFBC-TV Greenville, S. C.; Peffer, John C., WTAR Norfolk, Va.; Pendleton, W. E., WMAZ Macon, Ga.; Perkins, George M., WROW Albany, N. Y.; Perna, John J. Jr., Gill-Perna Inc., New York; Persons, C. P. Jr., WKRG-TV Mobile, Ala.; Persons, Charles B., WELY Ely, Minn.; Persons, June A., WELY Ely, Minn.; Petersmeyer, C. Wrede, J. H. Whitney & Co., Tulsa; Peters, Francis J., WMRN Marion, Ohio; Peterson, E. Richard, Keystone Broadcasting System Inc., Chicago; Peterson, Edwin R., Keystone Broadcasting System Inc., Chicago; Peterson, Howard O., KTVH Hutchinson, Kan.; Peterson, Roger, Jansky & Bailey Inc., Washington, D. C.; Peterson, Thomas, CBS, New York; Petric, Jack, KETV Omaha.

Petry, Edward, Edward Petry & Co. Inc., New York; Phillips, Elaine (Miss), WDSU-TV New Orleans; Phillips, Hal, WTVH Peoria, Ill.; Piano, Vincent, The Meeker Co. Inc., New York; Pieper, John, WILY Pittsburgh; Pierce, Morrie, WNTV (TV) Ft. Wayne, Ind.; Pierce, Theodore, WEST Easton, Pa.; Pierce, W. F., S. R. D. S., New York; Plant, R. E., Phelps Dodge Copper Products Corp., New York; Poinard, R. L., ABC, New York; Pond, C. C., Philco Corp., Philadelphia; Pontius, Donald, The Meeker Co. Inc., San Francisco; Poor, John B., MBS, New York; Pope, L. F., WENY Elmira, N. Y.; Porsow, Wallace, WFRV-TV Green Bay, Wis.; Posner, Gene, WMLL Milwaukee; Potter, David, WNAE Warren, Pa.

Potter, Hugh O., WOMI Owensboro, Ky.; Powell, Edwin J., WOHO Toledo, Ohio; Pratt, D., RCA, Camden, N. J.; Pratt, Robert L., KGGF Coffeyville, Kan.; Pratt, Roy W., WHO Des Moines; Press, Lillian, WBKY Lexington, Ky.; Press, O. Leonard, WBKY Lexington, Ky.; Presti, Biagio, Sarkes Tarzian Inc., Bloomington, Ind.; Preston, J. G., ABC, New York; Pricer, Robert, WCLT Newark, Ohio; Prior, Thomas C. J., WJAR Providence, R. I.; Provost, D. L., WBAL-TV Baltimore; Pruden, Booker, John F. Beasley Construction Co., Muskogee, Okla.; Pryor, Emerson J., WDVA Danville, Va.; Putnam, R. E., General Electric Co., Syracuse, N. Y.; Putnam, William L., WVEC Norfolk, Va.; Pyle, George A., WMBD Peoria, Ill.

Quaal, Ward L., WGN Chicago; Quarton, William B., WMT Cedar Rapids, Iowa; Quentin, Charles, WHTN-TV Huntington, W. Va.; Quinlan, S. C., WBKB Chicago.

R

Raabe, R. W., WRVA Richmond; Rabell, Dorothy, KSON-FM, San Diego, Calif.; Rabell, Fred, KSON San Diego, Calif.; Rambeau, William G., William G. Rambeau Co., New York; Ramsey, Glenn, Sesac Inc., New York; Raney, Wilson, WREC Memphis, Tenn.; Rauer, Guy, WESL Scranton, Pa.; Rawls, Lucien, WSM-TV Nashville, Tenn.; Rawls, R. B., KPFO Phoenix; Read, A. Louis, WDSU New Orleans; Reams, Frazier, WTOL Toledo, Ohio; Redding, K. B., NEMS-Clarke Inc., Silver Spring, Md.; Redditt, William M., KSLA-TV, Shreveport, La.; Reed, Elmo W., WJPG Green Bay, Wis.; Reed, Oscar, W. B. Jr., Jansky & Bailey Inc., Washington, D. C.

Reeve, Lydia R., Foote, Cone & Belding, Los Angeles; Reeves, Jerome R., KDKA-TV Pittsburgh; Reid, Robert H., I. N. S. Teleneews, New York; Reider, Robert S., WRAW Reading, Pa.; Reilly, William F., RCA, New York; Reinsch, J. Leonard, WSB Atlanta; Reiss, Saul, I. N. S. Teleneews, New York; Renfrow, Kenneth, KCSJ Pueblo, Colo.; Reuschle, Robert M., WLAC-TV Nashville, Tenn.; Reynolds, Paul E., WDBJ Roanoke, Va.; Reynolds, Robert O., KMPC Los Angeles; Rhea, Henry E., WFIL Philadelphia; Rich, W. Robert, A. A. P. Inc., New York; Rich, William H., WMGW New York; Richardson, Laurence E., WTOP Washington, D. C.; Richardt, Roland W., WSAU-TV Wausau, Wis.; Richdale, James C. Jr., KOTV Tulsa; Richter, Edwin G. Jr., WEHT Evansville, Ind.

Riddle, Lindsey G., WDSU New Orleans; Rifkin, M. J., Ziv Television Program, New York; Righter, Volney, Harrington, Righter & Parsons Inc., New York; Riggs, John S., WELM Elmira, N. Y.; Rines, William H., WCSH Portland, Me.; Rintoul, Stephen R., Vernard Rintoul & McConnell Inc., New York; Ripley, William A., WTRI Albany, N. Y.; Risk, Ed, KSD St. Louis; Rittenhouse, Paul, NBC, New York; Rizk, Joseph, WMBR-TV Jacksonville, Fla.; Roberson, W. R. Jr., WITN Washington, D. C.; Robert, Wallace, CKSO Sudbury, Ont.; Robertson, B. G., KTHS Little Rock, Ark.; Robertson, Miller C., WTCN Minneapolis; Robinson, Stanley, WTNS Coshocton, Ohio; Robison, Charles, WOOD Grand Rapids, Mich.; Robitaille, Glen A., CFPL London, Ont.

Roe, J., RCA, Camden, N. J.; Rogers, James G., KFSD San Diego, Calif.; Rogers, Lawrence H., WSAZ-TV Huntington, W. Va.; Rogers, Thomas A., WCLT Newark, Ohio; Rogers, W. D. (Dub), KDUB-TV Lubbock, Tex.; Rohrer, Raymond E., Jansky & Bailey Inc., Washington, D. C.; Rohrs, Bob, KJAY Topeka, Kan.; Rollo, Reed T., Kirkland, Fleming, Green, Martin & Ellis, Washington, D. C.; Rosen, Leonard, Paul Venze Associates, Baltimore; Roslow, Laurence, The Pulse Inc., New York; Roslow, Sydney, The Pulse Inc., New York; Ross, Chester M., Bonded TV Film Service, New York; Roth, Bob A., KONO San Antonio, Tex.; Roth, Jack, KONO San Antonio, Tex.; Roth, John H., Philco Corp., Philadelphia.

Rothrum, William V., WSYR Syracuse, N. Y.;

AMPEX AUTOMATIC BROADCASTING AN EVOLUTION NOT A REVOLUTION

It is a building block system that

adapts automatic
broadcasting gradually
to your existing equipment,
programming and
personnel. It repays its
price in a hurry —
a buy-as-you-earn
way to evolve a
more profitable
station
operation.



*See it in action
at the NARTB Convention*

Ampex Exhibit, Room 602-A, Conrad Hilton Hotel
Or write Ampex, 934 Charter St., Redwood City, Calif.

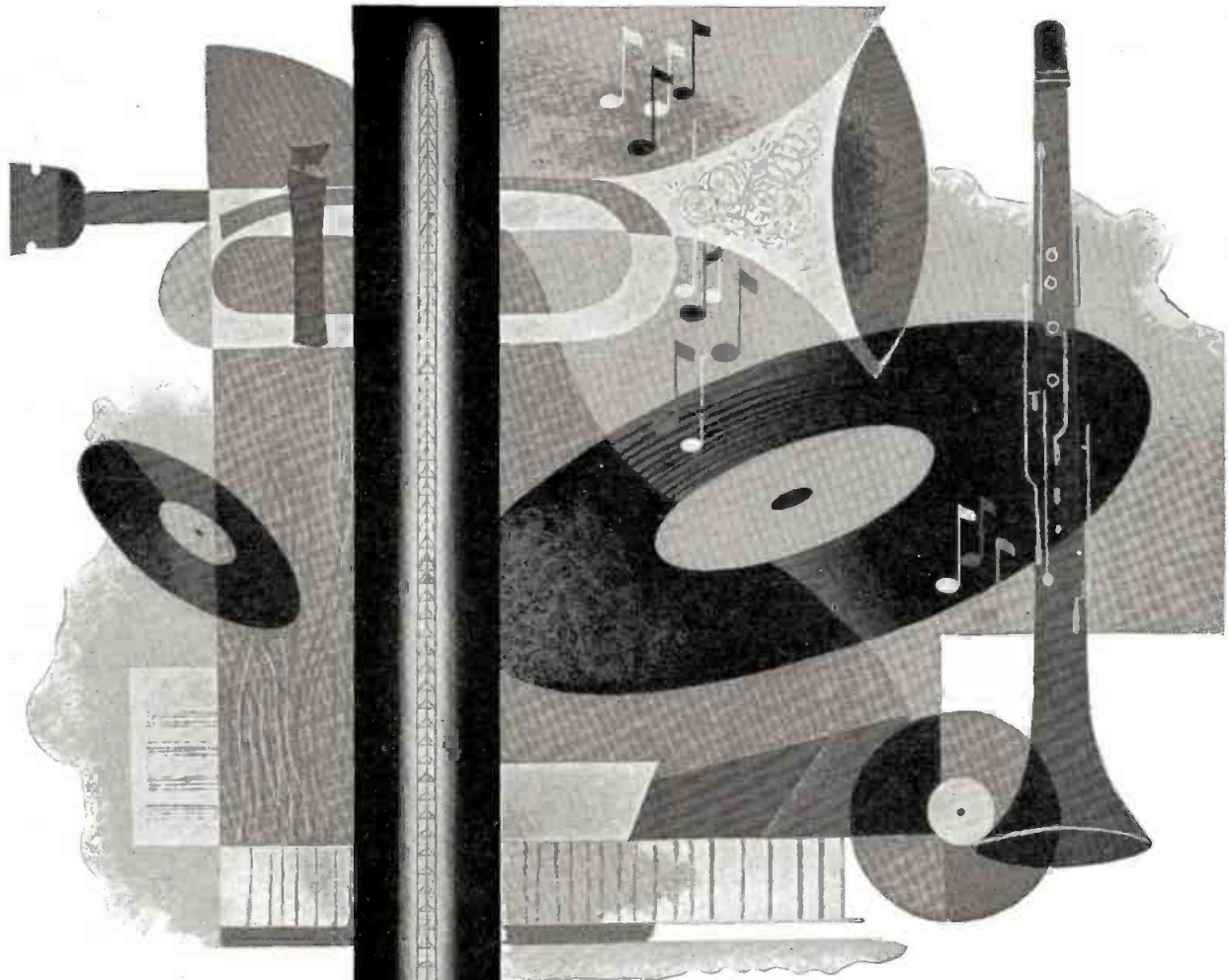

**TRUSCON
STEEL
TOWERS**

STATION WFMJ-TV
Youngstown, Ohio
1015 feet tall



help keep your DJ's on the air

When the wind starts to whistle, there's one sure way to keep the air waves humming. Own a tower that won't let you down when the weather blows its top.

Weather-tested Truscon Steel Towers provide the dependability you need for day-in-day-out programming. This was proved by actual performance during east coast hurricanes, when *not a single Truscon tower was reported damaged by the savage winds.*

Responsible for hundreds of successful installations the world over, our staff of highly skilled engineers can offer you unmatched experience in tower design and construction. They're equipped to produce exactly the tower you need—whether it be tall or small, guyed or self-supporting, tapered or uniform—for AM, FM, TV or Microwave.

For complete information on Truscon Steel Towers phone or write any Truscon district office. Or call us collect in Youngstown. Send coupon for literature.

TRUSCON®



**TRUSCON STEEL DIVISION
REPUBLIC STEEL**

YOUNGSTOWN 1, OHIO



A NAME YOU CAN BUILD ON

TRUSCON STEEL DIVISION • REPUBLIC STEEL CORPORATION
1074 Albert Street, Youngstown 1, Ohio

Please send me latest catalog showing specifications and other details of Truscon Steel Towers.

Name _____ Title _____

Company _____

Address _____

City _____ Zone _____ State _____

C-8028

Rothschild, Walter J., KHQA-TV Quincy, Ill.; Rounsaville, Robert W., WQXI Atlanta; Rowell, Russell, Spearman & Robertson, Washington, D. C.; Rudloff, Everett, WLJK Asbury Park, N. J.; Ruegg, Fred, KNX Los Angeles; Rugheimer, Gunnar, CBS-Export; Runnerstrom, Robert O., WMBD Peoria, Ill.; Rush, Herman, Official Films Inc., New York; Russell, F. M., NBC, Washington, D. C.; Russell, James D., KKTU Colorado Springs; Russell, Percy, Kirkland, Fleming, Green, Martin & Ellis, Washington, D. C.; Ruwisch, Lee, WTVJ Miami; Ryder, J. Maxim, WBRV Waterbury, Conn.

S

Saddler, Owen, KMTV Omaha; Sague, S. R., WRSR Cleveland, Ohio; Salberg, Murray, CBS Radio, New York; Salline, Eric H., CBS Radio, New York; Sambrook, A. B., RCA, New York; Sammons, Elizabeth, KSCJ Sioux City, Iowa; Sanders, Ben B., KICD Spencer, Iowa; Sanders, Ernest C., WOC Davenport, Iowa; Sanderson, J. V., WAPI Birmingham, Ala.; Sandler, Jack L., WQAM Miami; Savage, Robert R., WMAZ Macon, Ga.; Sawyer, Roger, KGLO Mason City, Iowa; Saxon, Joe H., WTKO-TV Meridian, Miss.; Schaaf, Harold, WRFD, Worthington, Ohio; Scharfeld, Arthur W., Scharfeld & Baron, Washington, D. C.

Schenkan, Robert F., U. of Tex., Austin, Tex.; Scheuer, John D. Jr., WFIL Philadelphia; Schiavone, James, WWJ-TV Detroit; Schlafly, Hubert J., TelePrompTer Corp., New York; Schmidt, Pel, WAAM Baltimore; Schmidt, Robert E., KAYS Hays, Kan.; Schmitt, Kenneth F., WIBA Madison, Wis.; Schoen, Arnold F. Jr., WPRO Providence, R. I.; Schroeder, Arthur H., Miller & Schroeder, Washington, D. C.; Schroeder, Frank C. Jr., WJZ Decatur, Ill.; Schroeder, Ray, KMTV Omaha; Schroeder, Willard, WOOD Grand Rapids, Mich.; Schrott, Alvin D., WJAC-TV Johnstown, Pa.; Schudt, William A. Jr., CBS-Radio, New York; Schultz, James, KQV Pittsburgh, Pa.

Schwieder, A. W., KID-TV Idaho Falls, Idaho; Scofield, Charles L., KEYZ Williston, N. D.; Searle, William A., KGLC Miami, Okla.; Sears, Charles, WMBR-TV Jacksonville, Fla.; Seavey, Hollis M., Clear Channel Broadcasting Service, Washington, D. C.; Sebastian, Daryl, WWTV Cadillac, Mich.; Secrist, Carroll R., KID-TV Idaho Falls, Idaho; Seebeck, Charles E., WTON Staunton, Va.; See, Harold P., KRON-TV San Francisco; Seidemann, Robert, Screen Gems Inc., New York; Sellars, Emil A., WBTW (TV) Florence, S. C.; Sellers, Ed, Broadcasting-Teletcasting, Washington, D. C.; Sepaugh, L. M., WSLI Jackson, Miss.; Severson, E. C., WKOW Madison, Wis.

Seward, James, CBS, New York; Seydel, Victor, Anderson & Cairns Adv., New York; Shaffer, Max, WDN Danville, Ill.; Shaffer, Russel, KBOL Boulder, Colo.; Shafto, G., Shafter, WIS-TV Columbia, S. C.; Shaheen, Richard A., Allen Kander & Co., Chicago; Shapiro, Mike, KTVX Tulsa; Sharpe, Virgil, KOWH Omaha; Shaw, Donald S. Jr., ABC-TV, New York; Shaw, William D., KSFO San Francisco; Shawn, Fred P., WSUN St. Petersburg, Fla.; Shay, John A., WTVJ Miami; Sheetz, Richard A., WGAL Lancaster, Pa.

Sheftall, Parry, WJZM Clarksville, Tenn.; Shelton, Aaron, WSM-TV Nashville, Tenn.; Shepherd, Charles, WPIT Pittsburgh, Pa.; Sheridan, Edward, WAVY Norfolk, Va.; Sherman, Gordon, WMAV Springfield, Ill.; Sherman, John M., WCCO-TV Minneapolis; Shipley, W. H., KDUB-TV Lubbock, Tex.; Shirk, Kenneth C., WIND Chicago; Shively, Dick, WTVW Evansville, Ind.; Sholis, Victor A., WHAS Louisville; Shomo, E. H., WBEM Chicago; Shuebruk, Peter, Fly, Shuebruk, Blume & Galigne, Washington, D. C.; Shupert, George T., ABC Film Syndication, New York.

Shurtleff, Dave, WJAR-TV Providence, R. I.; Sigmon, Loyd C., KMPC Los Angeles; Sill, Jerome, WFPG Atlantic City, N. J.; Sillerman, Michael M., TPA, New York; Silverman, Mort, WMRV New Orleans; Simon, Arthur, Radio-TV Daily, New York; Sinton, Richard C., Muzak Corp., New York; Sinclair, J. S., WJAR-TV Providence, R. I.; Sিনnett, Robert J., WHEB Rock Island, Ill.; Skinner, Paul F., WHBL Sheboygan, Wis.; Sklom, George M., W. F. Kean Consulting Engineers, Riverside, Ill.; Slane, Henry P., WTVH Peoria, Ill.; Slavick, H. W., WMC Memphis, Tenn.; Sloan, Sam W., WOHO Toledo, Ohio; Slusser, Jess, KOA Denver; Small, Franklyn H., WFEM Indianapolis; Smullin, William B., KIEM Eureka, Calif.; Smullin, William B. (Mrs.), KIEM Eureka, Calif.

Smith, Al, KTIV Sioux City, Iowa; Smith, Alois, WHLD Niagara Falls, N. Y.; Smith, Calvin J., KFAC Los Angeles; Smith, Carleton D., WRC Washington, D. C.; Smith, Charles H., J. H. Whitney & Co., New York; Smith, H. Needham, WTRF-TV Wheeling, W. Va.; Smith, Harvey C., WDEL Wilmington, Del.; Smith, Hugh M., WCOV Montgomery, Ala.; Smith, J. Porter, WGRC Louisville; Smith, Jim, WEAR-TV Pensacola, Fla.; Smith, Lydell Jon, KJIV Huron, S. D.; Smith, Roy A., WLAC-TV Nashville, Tenn.; Smith, William M., KYNT Yankton, S. D.; Smithgall, Charles, WRGA Rome, Ga.; Snelgrove, J. T. Jr., WMAZ Macon, Ga.; Snider, Robert E., KTVX Tulsa; Snyder, Reed E., WHO Des Moines; Soell, John B., WISN Milwaukee.

Sonnenfeld, Nathan J., Century Lighting Inc., New York; Southmayd, John P., Fisher, Wayland, Duvall & Southmayd, Washington, D. C.;

Sowell, F. C., WLAC Nashville, Tenn.; Sparks, Garnet G., WEXL Royal Oak, Mich.; Sparks, Gordon A., WEXL Royal Oak, Mich.; Spence, Sylvia (Mrs.), Robert E. Sherwood Awards Fund for the Republic, New York; Spencer, Lester G., WKBV Richmond, Ind.; Spheris, A. M., WEMP Milwaukee; Spokes, Alfred E., WEAV, Plattsburgh; Spring, J. L., WIMA-TV Lima, Ohio; Staley, Max F., KJTV Huron, S. D.; Stanbery, John F., Collins Radio Co., Cedar Rapids, Iowa; Standard, Charles E., The Meeker Co. Inc., New York.

Stanfield, Ray M., WIST Charlotte, N. C.; Stark, Howard E., New York; Starnes, Rudy, KDUB-TV Lubbock, Tex.; Stebbins, John D., The Bolling Co., Chicago; Stecher, Bentley A., WEBB Baltimore; Steel, David L. Sr., Page, Creutz, Steel & Waldschmitt Inc., Washington, D. C.; Steinberg, Charles, CBS, New York; Steine, David H., KBUR Burlington, Iowa; Steine, D. H. (Mrs.), KBUR Burlington, Iowa; Stephan, Milton J., Allen & Reynolds Adv., Omaha; Stern, Edgar B. Jr., WDSU New Orleans; Sternberg, George, The Pulse Inc., New York; Stevens, Elby, WFST Caribou, Me.; Stevens, George, KOTV Tulsa; Stewart, Herbert S., CHCT-TV Calgary, Alta.; Stewart, Larry, WDWWS, Champaign, Ill.; Stewart, William, KOWH Omaha.

Stoll, Jack L., Jack L. Stoll & Assoc., Los Angeles; Stone, Charles M., WMBR-TV Jacksonville, Fla.; Stone, Peggy, Harry S. Goodman Productions, New York; Stone, Robert L., WABC-TV New York; Storz, Todd, KOWH, Omaha; Stowman, Kenneth W., WFIL Philadelphia; Strack, Eugene W., WXLW Indianapolis; Straub, N. L., WJAC Johnstown, Pa.; Strouse, Ben, WWCW-TV Tusculum, D. C.; Stuart, Harold C., KVOO-TV Tulsa; Stubblefield, William T., Hamilton, Twining & Assoc. Inc., Washington, D. C.; Suerker, Kermit, WCCO Minneapolis; Sugg, P. A., WTVT Tampa, Fla.; Sullivan, Cornelius K., NBC, New York; Sullivan, Donald D., KVTU Sioux City, Iowa; Sulzer, Elmer G., WFIU Bloomington, Ind.; Swanson, Leonard, WWTW Cadillac, Mich.; Swartley, Wilmer C., Westinghouse Broadcasting Co. Inc., Boston.

Sweeney, Kevin B., Radio Advertising Bureau Inc., New York; Swezey, Robert D., WDSU New Orleans; Swift, G. Richard, The Bolling Co., New York; Swift, Pat, WGR-TV Buffalo; Swisher, Arden, KMTV, Omaha.

T

Taft, Paul E., KGUL-TV Galveston, Tex.; Talshoff, Sol, Broadcasting-Teletesting, Washington, D. C.; Tait, W. F., Philco Corp., Philadelphia; Talley, Hayward L., WSMI Litchfield, Ill.; Talley, Hayward (Mrs.), WSMI Litchfield, Ill.; Talley, Ruth C., WLAC-TV Nashville, Tenn.; Talmage, F. E., RCA, Camden, N. J.; Tannen, Ernest, WILY Pittsburgh; Tanner, Harold I., WLDM Detroit; Tansey, John B., WRVA Richmond; Tarlow, Sherwood J., WHIL Medford, Mass.; Taylor, A. Robert, Standard Electronics Corp., Newark, N. J.; Taylor, E. Crawford, KTFY Brownfield, Tex.; Taylor, F. Chase, WVEE Rochester, N. Y.; Taylor, J. Glenn, WOR New York; Taylor, J. P., RCA, Camden, N. J.; Taylor, Sherri W., Radio Advertising Bureau Inc., New York; Taylor, W. J., Southern Calif. Broadcasters Assn., Hollywood, Calif.

Telch, W. J., KOEL Oelwein, Iowa; Telford, Donald H., KIEM Eureka, Calif.; Terry, Hugh B., KLZ Denver; Teter, Robert H., Westinghouse Broadcasting Co. Inc., New York; Tharpe, James B., Visual Electronics Corp., New York; Thiriot, Richard V., KSL-TV Salt Lake City; Thomas, Eugene S., KETV Omaha; Thomas, James S., WDXI-TV Jackson, Tenn.; Thomas, Max W., WKTV Saginaw-Bay City, Mich.; Thomas, Morris W., KWTV Oklahoma City; Thomas, Robert E., WJAC Norfolk, Neb.; Thomas, Robert R. Jr., WOAY Oak Hill, W. Va.; Thompson, Doyle D., WFMV-TV Greensboro, N. C.; Thompson, Lois, The Meeker Co. Inc., Chicago; Thompson, Leo, All-Canada Radio Facilities Ltd., Toronto, Ont.; Thoms, Edward G., WKJG Ft. Wayne, Ind.

Thornburgh, Donald W., WCAU Philadelphia; Thorne, Barrie, British Broadcasting Corp., New York; Thorpe, John, AT&T Co., New York; Tierney, James, WCAK Burlington, Vt.; Tighe, James S., WPHR Wisconsin Rapids, Wis.; Timlin, J. F., WHTM-TV Huntington, W. Va.; Fincher, Robert E., WSPR Springfield, Mass.; Tipton, Jack, KLZ-TV Denver; Tisdale, James M., WVCH Chester, Pa.; Tjaden, Montez, KWTV Oklahoma City; Tobin, Joseph H., WENT Gloversville, N. Y.; Tooke, Roland V., KYW-TV Cleveland; Torgerson, Stan, WMC Memphis, Tenn.; Tornberg, Edwin, Allen Kander & Co., New York.

Torry, William H., KGNC Amarillo, Tex.; Tostlebe, Ted O., KWLL-TV Waterloo, Iowa; Town, George R., TASO Washington, D. C.; Townner, Orrin, WHAS Louisville; Townsend, George R., WVEC Norfolk, Va.; Tracy, E. C., RCA, Camden, N. J.; Trafer, M. A., RCA, Camden, N. J.; Traylor, Ferris E., WTVW Evansville, Ind.; Tredwell, Kenneth I. Jr., WBTV Charlotte, N. C.; Trevarthen, W. H., ABC, New York; Treyz, Oliver, ABC-TV, New York; Troeglen, Karl, KCMO Kansas City, Mo.; Troman, Robert A., Blaw-Knox Co., Pittsburgh, Pa.; Trouant, V. E., RCA, Camden, N. J.; Tucker, Art, KSCV Richfield, Utah; Tuhy, Stephen Jr., attorney, Washington, D. C.; Turell, Saul J., Sterling Television, New York; Turner, George S., FCC, Washington, D. C.; Twining, W. R., Hamilton, Stubblefield, Twining & Assoc. Inc., San Francisco.

U-U

Udey, Don, WRRD Ithaca, N. Y.; Umansky, Martin, KAKE-TV Wichita; Unger, Alvin E., Ziv Television Programs Inc., Chicago; Unger, Irwin, Gill-Perna Inc., Chicago; Untermyer, Henry, KCBS San Francisco.

Vance, Fred L., KWTU Oklahoma City; Vance, John W. Jr., WTOG-TV Savannah, Ga.; Vanda, Charles, WCAU-TV Philadelphia; Vandagriff, Carl W., WOWO Ft. Wayne, Ind.; Varnum, W., RCA, Camden, N. J.; Veihmeyer, Fred D., Lohnes & Culver, Washington, D. C.; Venard, Lloyd George, Venard, Rintoul & McConnell Inc., New York; Versulis, Leonard A., WLAV Grand Rapids, Mich.; Vickers, Marjorie R., KPAC Port Arthur, Tex.; Vieracker, Math, WBKE Chicago; Vincent, E. P., ABC, New York; Vondell, John H. Jr., WREB Holyoke, Mass.; Vordemark, Ernest, WMBR-TV Jacksonville, Fla.; Voss, Victor H., WWCA Gary, Ind.

W-X-Y-Z

Wade, Peter H., ABC, New York; Wagner, George, KFI Los Angeles; Wagner, Jay, WLEC Sandusky, Ohio; Wagner, William D., WOC Davenport, Iowa; Wagner, William J., KRON-TV San Francisco; Wagstaff, Walter E., KGW-TV Portland, Ore.; Walker, James P., KTUL Tulsa; Walker, Merrill H., WOAP Owosso, Mich.; Walker, Osborne, General Electric Co., Syracuse, N. Y.; Walker, William, WBEV Beaver Dam, Wis.; Walker, William L., NARTB, Washington, D. C.; Wallace, Bruce, WTNS, Coshocton, Ohio; Wallace, C. E., WINT, Ft. Wayne, Ind.; Wallace, George, KTKT Tucson; Wallace, M. G., AT&T Co., New York; Wallace, Tom Jr., KTKT Tucson; Wallace, Wesley H., U. of North Carolina, Chapel Hill, N. C.; Wallack, C., RCA, Camden, N. J.; Ward, Carl, WCBN New York; Ward G. Pearson, KTTN Springfield, Mo.

Warren, W. B., KOMO Seattle; Watkins, F. A., Jr., KWKH Shreveport, La.; Watkinson, Barry, KIMA Yakima, Wash.; Watson, Stewart, WKOW Madison, Wis.; Watson, Tee V., J. Walter Thompson Co., Chicago; Wayland, Charles V., Fisher, Wayland, Duvall & Southmayd, Washington, D. C.; Wayne, E. O., WJR Detroit; Wearn, Wilson C., WMRC Greenville, S. C.; Weathers, James, World Broadcasting System Inc., New York; Weatherby, J. Patrick, WBRZ Baton Rouge, La.; Webber, Frank M., Gill-Perna Inc., New York; Weber, L. E., ASCAP, New York; Weber, Ted, WGN Chicago; Webster, William C., WOHO Toledo, Ohio; Wehrman, Harvey E., KLZ Denver; Wehrmann, H. F., WTPS New Orleans; Weis, Pierre, Ziv Television Programs Inc., New York.

Welch, Vincent E., Welch, Mott & Morgan, Washington, D. C.; Welcome, Ed, WTVW Evansville, Ind.; Weldon, William H., Blair-TV, New York; Weller, Donald, WISN-TV Milwaukee; Wells, Ray, KYMA Magnolia, Ark.; Wentworth, J., RCA, Camden, N. J.; West, Charles A., WTVH Peoria, Ill.; Weston, Edward, WCOX Cincinnati; Whaley, James W., WRFS Alexander City, Ala.; Wheeler, Edwin K., WWJ Detroit; Wheeler, Edward A., WEAW Evanston, Ill.; Wheeler, Mel, WEAR-TV Pensacola, Fla.; Whitaker, Stanley, Blackburn & Co., Atlanta.

White, Henry S., Screen Gems Inc., New York; White, Thomas, WKZO Kalamazoo, Mich.; Whitlock, E. S., WRNL Richmond, Va.; Whitney, George, KFMB San Diego, Calif.; Wiig, Gunnar O., KQV Pittsburgh, Pa.; Wilner, John T., WBAL Baltimore; Wilkinson, Vernon L., McKenna & Wilkinson, Washington, D. C.; Williams, Charles E., WAUX Waukesha, Wis.; Williams, Gene, KWBB Wichita, Kan.; Williams, R. P., WWJ Detroit; Williams, Ray J., KESJ Pueblo, Colo.; Williams, Wayne, WL0L Minneapolis; Williamson, W. P. Jr., WKBN Youngstown, Ohio; Williamson, W. P. III, WKBN Youngstown, Ohio; Wilson, George, WWTV Cadillac, Mich.; Wilson, Hal, WITN Washington, N. C.; Wilson, Robert J., WHLD Niagara Falls, N. Y.

Windsor, Walter M., KCMC-TV Texarkana, Tex.; Wirth, Don, WFRV-TV Green Bay, Wis.; Wismer, John F., Stevens-Wisner Broadcasting Co., Port Huron, Mich.; Wittenberg, Bud, Muzak Corp., New York; Wittenberg, Lionel, WISN-TV Milwaukee; Woodell, Ken, WLBN Mattoon, Ill.; Woodill, W. J., CKSO Sudbury, Ont.; Wooten, Hollis, WREC-TV Memphis, Tenn.; Wooten, Hoyt B., WREC Memphis, Tenn.; Wodlinger, Mark, WOC Davenport, Iowa; Wolfe, Ben, WAAM Baltimore; Wolfe, Howard H., WKNX Saginaw-Bay City, Mich.; Wolfenden, Robert C., WMEV Marlon, Va.; Wolfson, Louis, WTVJ Miami; Wolfson, Mitchell, WTVJ Miami; Woodland, Cecil, WEJL Scranton, Pa.

Woods, W. W., WHO Des Moines; Woog, D. H., RCA, Camden, N. J.; Worley, David R., KTNM Tucumcari, N. M.; Wright, Jay W., KSL Salt Lake City; Wright, Robert F., WTKO-TV Meridian, Miss.; Wurz, Wally, WTVH Peoria, Ill.; Wyatt, Judd, KMMO Marshall, Mo.; Wyatt, William R., A. C. Nielsen Co., Chicago.

Yarbrough, J. E., WDBO Orlando, Fla.; Yates, Richard G., Hollywood Television Service Inc., New York; Yoder, Lloyd E., WRCV Philadelphia, Pa.; Young, J. E., RCA, Camden, N. J.; Younts, J. S., WEEB, Southern Pines, N. C.

Zellmer, Lester W., WSJV-TV South Bend-Elkhart, Ind.; Zillger, William H., Standard Electronics Corp., Newark, N. J.

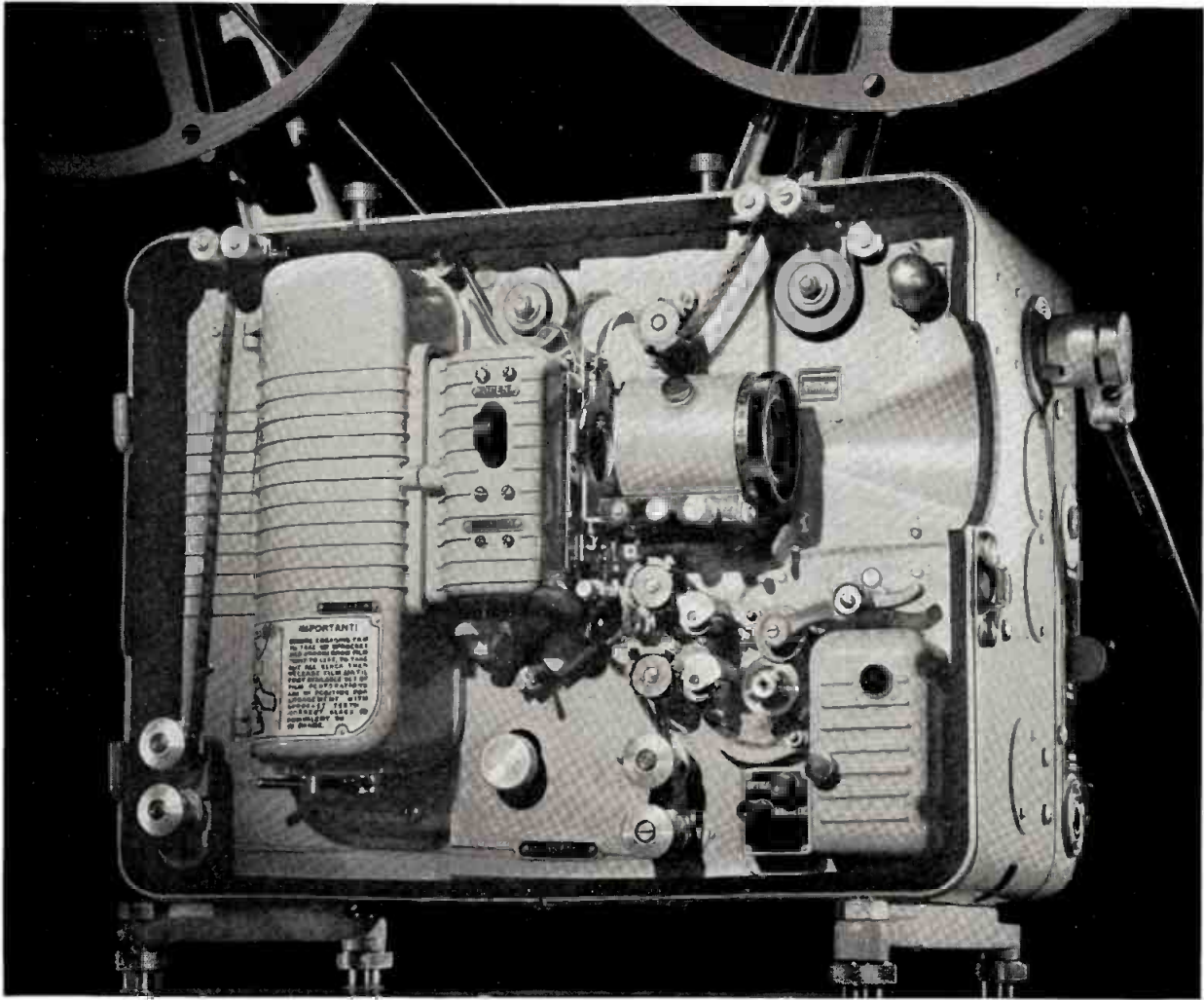

BELL & HOWELL VIDICON PROJECTORS

Versatile Programming... Low Initial Cost

Originally produced to meet rigid JAN (Joint Army-Navy) specifications, this Bell & Howell projector is noted for its ruggedness, trouble-free performance, simplicity and ease of servicing. It includes the following special features: Optical and magnetic sound reproduction • Fixed-axis framing • Easy threading Built-in loop setter • Forward and reverse • Operating hour meter • Single-phase operation • 600-ohm balanced line output.



As an integral part of Vidicon film chains, this new 16mm Bell & Howell projector provides many unique advantages. For example, you get complete manual control, plus connection for remote control. At the push of a button, you can change from picture and sound on one projector to the same set-up on the other.

This Bell & Howell projector also conforms to proposed new ASA standards for placement of magnetic sound. All in all, the full potential of versatile programming is in direct proportion to the creativeness of your production people.

Talk to your Systems Supplier soon. His quotation will be a pleasant surprise. Or write for specifications on Design 614 CVBM projector. Bell & Howell, 7139 McCormick Road, Chicago 45, Ill.



FINER PRODUCTS THROUGH **IMAGINATION**

Bell & Howell

PREVIEWING THE EXHIBITS IN CHICAGO

TWO floors and the lower lobby of the Conrad Hilton Hotel, Chicago, will house several score exhibits of heavy equipment, light gear, tv film and other industry services as the annual industry show opens at noon Sunday, April 7.

Many new types of equipment will be shown by exhibitors. The entire display is managed by George Gayou, of St. Louis, who handled the event last year.

Both radio and tv transmitters and associated devices are included in the individual exhibits, described on these pages. Among typical items of interest are new 50 kw transmitters being shown by RCA

and General Electric Co. A complete color studio will be operated by RCA.

Translators, prompters, towers, relay equipment operating at 7000 mc and recently developed models of television apparatus will be shown.

The heavy equipment will be shown in the lower lobby of the Conrad Hilton. Light equipment, program services and entertainment suites will have their exhibits of the fifth and sixth sample floors.

Following are summaries of individual exhibits:

Equipment Manufacturers

ADLER ELECTRONICS INC.

Space 19

ADLER ELECTRONICS Inc., affiliated with Adler Communications Labs., will display the Adler UST-10 tv translator-transmitter, a new type of television transmitter. UST-10 makes it possible for tv stations to fill in shadowed or fringe areas caused by terrain anomalies, or the distance between transmitter and audience areas. It has FCC type approval (TR-50). A companion piece, a four stacked unitized antenna, the Adler USTA-16, also will be on display.

Adler representatives attending will include Ben Adler, president, Adler Electronics; Edward Galuska, sales engineer; Martin Silver, representative; Wilson Leeper, representative; Robert J. Myers, representative; James P. Quinn, representative.

ALFORD MFG. CO.

Space 7

DIRECTIONAL and omni-directional tv broadcast transmitters are among the Alford apparatus to be on display for NARTB delegates. Other items include diplexing filters and bridges, and coaxial transmission line switches and components. Harold H. Leach will be the company representative.

AMERICAN ELECTRONICS INC.

Suite 551A

TAPE recorders for the trade will be on display. Attending will be Jack Amsterdam, advertising manager.

AMERICAN MICROWAVE CORP.

Space 35

AMERICAN MICROWAVE will put on display 7,000 mc and 13,000 mc microwave relay equipment, featuring three new units. American also will show a 50 watt mc superpower amplifier. The firm will be represented in Chicago by F. W. Bailey and sales and engineering personnel.

AMERICAN TELEPHONE & TELEGRAPH

Space 27

FEATURED at the American Telephone & Telegraph exhibit this year will be telephotograph and facsimile, TWX and telephone. The tv network routes, both for black and white and color, will be outlined on a single map to show strides in nationwide coverage.

New models of telephone booths and two types of Bell system answering services—Amy and Amanda—will be on exhibit. Amy is for recording only, Amanda both answers and records.

Bell representatives will be F. A. Cowan, V. R. Hatch, F. R. MacFarland, John Thorpe, M. G. Wallace, C. W. Floyd, A. R. Goebel, E. McCaffrey, F. A. Robinson Jr. and H. A. Carlson.

AMPEX CORP.

Suite 602A

A WORKING demonstration of video tape recorders in network operation will be staged at the Chicago Daily News Bldg. in conjunction with the ABC-TV network. Actual

recording and playback will be shown, along with interchangeability of tape between machines. A schedule of demonstration periods will be announced at the convention.

The Conrad Hilton demonstration by Ampex, which last year stole the convention with its dramatic unveiling of tv tape recording, will include a new simplified control system for automatic operation and a one-hour loop delay recorder for daylight time use. Professional audio recorders (Nos. 350, 601, 620) will be demonstrated. Representatives will be Phillip Gundy, vice president and manager of the audio division; Robert Miner, sales, and Charles Ginsberg, who will read a paper on video tape recording at the Engineering Conference.

HIGHSPOTS ON EXHIBITORS' ROW



Gates Radio's auto-station production unit. Page 108



Adler's television translator transmitter. Page 104



General Radio's tv transmitter monitor. Page 110



Perkin-Elmer's new Auto-Zoom lens. Page 112



Richard Leitner, Production & Dist. Mgr. of Abbott Laboratories, Oak Ridge, Tennessee, says:

"In a few brief hours — this atomic drug will be useless!"

"In a hospital 700 miles from Abbott Laboratories' Oak Ridge plant, radioisotope experts have scheduled use of a radioactive drug . . . a drug whose radioactivity lasts only a limited time. A drug prepared by electronic bombardment in the huge atomic pile at Oak Ridge near Knoxville, Tenn.

"If this radioisotope doesn't arrive *on time*, it will be useless for this patient. We've relied on Air Express for literally tens of thousands such shipments!

"Our radioisotope business exists because of Air Express. With its swift, regular flights on all scheduled airlines, its radio-controlled trucks, its national teletype network — no other service can match it.

"Yet we save money by specifying Air Express. For instance, a 23-pound shipment from Knoxville to Chicago costs \$5.36. That's \$1.39 less than any other complete air service."



Air Express



30 YEARS OF GETTING THERE FIRST via U.S. Scheduled Airlines

CALL AIR EXPRESS . . . division of RAILWAY EXPRESS AGENCY

VISIT US IN
ROOMS 542-544A
NARTB SHOW
APRIL 7-11, 1957
CONRAD-HILTON
CHICAGO

NEMS • CLARKE, INC.
 SILVER SPRING, MARYLAND

PRECISION ELECTRONICS SINCE 1909

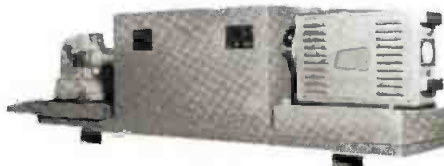

CALL
FOTO-VIDEO

for anything in studio TV telecasting or test equipment—from a test slide to a vidicon film multiplexer. You get experienced know-how and FAST SERVICE. Ask for free catalog: FOTO-VIDEO Laboratories Inc., 25 Amity St., Little Falls, N. J. LI-4-2557.

Reps in U.S.: Ack Radio Supply, Birmingham, Ala.
 Peninsula Associates, Redwood City, Calif.
 Export Agents: CBS International Div., 485 Madison Ave., New York City, N. Y.

At NARTB—Visit Foto-Video in Main Exhibit Hall

ANDREW CORP.

Space 22

ANDREW Corp. will show a new automatic and remotely controlled coaxial switch, Type 6710. It provides for fast switching of 3/8" coaxial transmission line at frequencies up to 1000 mc, and can be used in high-power communications systems, as well as vhf and uhf stations.

Use of the motor-operated switches eliminate manual changes of coaxial transmission line connections. In the event of main equipment failure, the spare equipment can be switched with little or no off-the-air time.

Andrew also will display a 3/18 coaxial line with a new type insulator support and new pressurized copper-clad steel waveguide.

BEASLEY CONSTRUCTION CO.

BOOKER V. PRUDEN, vice president of the John F. Beasley Construction Co., will represent the company at the convention.

BROWNING LABORATORIES

Suite 609

LATEST simplex and multiplex fm transmitting and receiving equipment will be demonstrated. Gardiner G. Greene, president, and Mrs. Greene will be in charge of the exhibit.

CATERPILLAR TRACTOR CO.

Space 16

CATERPILLAR Tractor Co. will exhibit standby power units and associated equipment. Two diesel electric sets (D 337 and 315) will be shown. The D 337 will be in cutaway form to give full vision of the internal workings of the engine and the new, specially designed generator. It produces 150 kw continuous power at 1800 rpm and was designed for efficient utilization of restricted space.

The 315 diesel electric unit is equipped with automatic stop-start system, assuring that the set will be brought into operation the instant outside power fails or falls below required voltage.

Representatives for the company will include R. V. Bradley, W. N. Foster, Frank Boyle, K. Grimes, J. H. Ashton and C. E. Skillman.

CENTURY LIGHTING INC.

Space 24

PROVIDING a variable luminous area of diffused color, the Color Value Wall, made by Century Lighting Inc., of New York, will highlight that firm's exhibit.

In connection with color tv studio lighting, Rollo Gillespie Williams, manager of the color lighting department, will present a paper entitled "Control of Color Appearances in Tv Studio Lighting." The paper will review the layout and types of lighting equipment for tv color studios; dimmer control systems; the effect of controlled differences in spectral quality of light; specific applications of color lighting in television studios, and a new type of high intensity luminous color background.

Many other types of theatrical and tele-

Another way SRDS helps sell time



**your Service-Ad gives you "a last chance point"
from which your prospect can get
the final briefing on your story**

**as he nears the deadline of his decision —
whether that decision is to put you on the
preliminary list or keep you on the final list. *SRDS*
With your Service-Ad
in Standard Rate & Data**

you are there

selling, by helping people buy!

SRDS Standard Rate and Data Service, Inc.
1740 Ridge Avenue, Evanston, Ill.
Sales Offices: New York • Evanston • Los Angeles



vision lighting equipment will be displayed at the convention by Century officials. Some 17 sales representatives for national and international equipment distributors will be on hand to assist in explaining and planning tv studio lighting, wiring and control systems. Distributors whose equipment will be included are DuMont, General Electric, Graybar, RCA, RCA International, Rocke International, Thompson Products (Dage), Visual Electronics, General Precision Laboratories, and certified electrical distributors.

Century Lighting representatives slated to attend the convention are Louis Erhardt, James J. Fedigan, George Gill, Earl Koehler, Edward F. Kook, Paul Kyack, Bill Merrill, Stanley McCandless, Dale Rhodes, Gordon Stofer, N. Sonny Sonnenfeld, and Fred M. Wolff.

COLLINS RADIO CO.

Space 36

COLLINS Radio Co. will display representative major units of its broadcast line. Featured will be the 212E dual-channel audio console and the 81M Phasor. Also included: the 21E/M 5/10 kw am transmitter; 20V-2 kw am transmitter; 212F single channel audio console; 212Y one-channel remote amplifier; 212U two-channel remote amplifier; Collins/Rust remote control system, and the new TV-STL microwave relay system.

Collins representatives: John Haerle, Harold Olson, Gene Randolph, Bob Hancock, Chuck Lowder, Carl Rollert, Evan Maloney, John Stanbery, Bill Valentine, Jim Young, Bob Sidwell, Forrest Wallace and George Wetmore.

CONRAC INC.

Suite 657

A NEW color tv monitor (CH21B) will be presented in the Conrac exhibit. Two new 14-inch monitors (CK14, CK15) will be on display as well as the AV-12B off-the-air tuner. Conrac executives at the exhibit will be W. J. Moreland, president; J. Grayson Jones, vice president-chief engineer; Kenneth Williams, engineer; Russell M. Alston, plant superintendent, and Parker Wickham.

DAGE TV DIV. OF THOMPSON PRODUCTS

Space 5

THE Pro (320) and Junior Pro (103) black-and-white cameras feature the live and film demonstrations in the Dage booth. Low-cost upkeep is claimed for the equipment. Personnel include James L. Lahey, manager of Dage Tv Div.; Joe W. Alinsky, chief engineer; Gene Crow, assistant chief engineer; James Campbell, industrial equipment engineer; Neff Cox Jr., director of professional equipment; Robert E. Green, director of educational tv, and John Howland, sales manager.

DRESSER-IDECO CO.

Suites 604, 605, 607

SCALE MODEL television towers of all sizes and load carrying capacities will be displayed by Dresser-Ideco. A special section of the exhibit will illustrate multi-antenna candelabra platform top towers.

Representing Dresser-Ideco at the meeting will be Joe Hogan, general sales manager; Roger Hayden, product sales manager for

towers; Dan Byrd, advertising manager; Ken Brust, Los Angeles branch manager, and George Iles, sales engineer. Caricaturist Lenn Redman, former Walt Disney animator, will be in the Dresser-Ideco suites to sketch caricatures of convention visitors.

ELGIN METALFORMERS CORP.

Space 9

NEW items for studio and equipment use, emphasizing a line of pi-section units "meeting requirements of human and environmental engineering" will be shown. The EMCOR enclosure system is described as adapted to installation of equipment in areas not normally accessible to standard equipment. Audio and video monitoring-type consoles will be demonstrated. Recording and rack style cabinets will be shown. Attending will be Jack Sullivan, salesman; H. C. Golz, chief engineer; James G. Wells, sales vice president, and S. K. Frankel, president.

FOTO-VIDEO LABORATORIES

Space 31

HIGHLIGHT of the convention display by Foto-Video Laboratories Inc., Little Falls, N. J., will be a demonstration of high quality transmission through a mile of video cable.

The exhibit will include four lines of products: picture-improving video units, minimum-maintenance sync equipment, test instruments using new measurement concepts and tv light boxes for monochrome and color.

Expected to attend the meeting are the following Foto-Video officials: Albert Barakat, president and chief engineer; A. R. Fiore, vice president; C. E. Underwood, Elmer Sperry, Bert Findlay, all in sales; Hans Nord, engineering; and southern representatives of Ack Radio Supply, far western reps of Peninsula Assoc., and export reps of CBS International division of CBS Inc.

GATES RADIO CO.

Suite 561

GATES Radio Co. will show automatic radio programming by the auto-station, which will "speak for itself." It will explain the mechanics incorporated in the unit and will show how to cope with difficult production problems. The auto-station is two separate units—one the production unit, the other the playback.

Also on display will be the BC-J kw transmitter which tunes from 540 to 1600 kc. Other exhibit features: the Gates BC-5P 5 kw am transmitter, the yard audio console for am and tv, the Dualux console, new transistorized remote amplifiers, the state-level automatic program level amplifier, and the auto-trans, which is an automatic transcription turntable equipment for 45 rpm records that needs only the push of a button to start the next record.

Gates representatives will be Nibs Jochem, Wally Kabrick, Larry Cervone, and Stan Ponte.

GENERAL ELECTRIC

Space 26

A 50 kw am transmitter designed around modern components; a wrap-around tv

One Call for all You Need in LIGHTING EQUIPMENT RENTALS

ANYTIME - ANYWHERE!

For quick service, expert advice and one low price for equipment, installation and removal, call on one of the nation's largest suppliers of temporary lighting facilities—Jack Frost. His lighting equipment inventory is unexcelled. Below are just a few of the many items available for quick delivery whenever and wherever needed.

Write or Wire for Catalog and Free Estimates

JACK A. FROST

Dept. BT

234 Piquette Ave., Detroit 2, Mich.
Canadian Office:

41 Kipling Ave., South, Toronto, Ontario

LIGHTING

Complete M. R. Incandescent Equipment, M.R. High Intensity Arc Equipment, Dimmer Equipment 250 W — 10,000 W, Diffusion, Scoops, Reflectors, Ballboards, Cable.

PORTABLE POWER EQUIPMENT

AC and DC Generators 15 Amps to 1500 Amps (Truck or Caster-mounted). Portable Transformers — Dry and Oil, Portable Substations.

DOLLIES

Fearless and Roby Panoram Dollies, Crab and Western Dollies.

GRIP EQUIPMENT

MacTan Turntable for Cams and Displays, Mole Richardson Boom and Perambulator, Parallels, Ladders and Steps, Scrim and Flaps, Dais and Stands.

This trick's on you!

A bucket of water over the door is one of the risks of April Fool's Day. But being tricked on *other* days is something else again.

Yet that's what happens as far as your taxes are concerned. Part of your taxes are used to help pay the cost of electric service for customers of federal government power systems.

First, your taxes help build the federal power plants that produce electricity for these people. Then, you have to be taxed *more* because they don't pay all the taxes in *their* electric bills that you pay in *yours*. People who get electricity from the TVA, for example, pay less than *one-fifth* of the taxes on electric service that you pay.

Next time you hear someone talk in favor of federal government electricity, ask him about the trick it plays with your taxes (and his). Chances are, he'll stop talking and start thinking. *America's Independent Electric Light and Power Companies**.

*Company names on request through this magazine





VICTOR C. DIEHM, President and Gen. Mgr.

Like Hundreds of Broadcasters...

Station Manager
VICTOR C. DIEHM of

WAZL

and Chief Engineer
ELWOOD TITO

Selected STAINLESS TOWERS



ELWOOD TITO, Chief Engineer

LEARN WHY MANY BROADCASTERS CHOOSE
STAINLESS TOWERS



Call or Write
for Informative
Literature.

Stainless, inc.

NORTH WALES • PENNSYLVANIA

antenna requiring no mast; a re-designed film scanner system, and a new automatic station programmer for scheduling all switching necessary for programming slides, films, network and audio, will be among the many exhibits to be displayed by General Electric's technical products department, Syracuse, N. Y.

The GE exhibit will feature a Western motif, with give-aways, accessories and decorations to match.

Other products to be shown at the meeting are vidicon cameras for spare-parts uses and flexible uses; audio and video units with built-in automatic gain control; tubes for 35 kw tv transmitters which have been clocked up to 10,000 hours.

Staff managers from the company's technical products department slated to attend the convention are William J. Morlock, general manager; Paul L. Chamberlain, manager of marketing for broadcasting equipment; Frank P. Barnes, marketing manager for industrial television; C. Graydon Lloyd, engineering manager; Marshall E. Minich, finance manager; John Wall, sales manager for broadcast equipment; Charles J. Simon, sales manager for industrial television; M. Alves, manager of manufacturing, and Raymond E. Baker, legal counsel.

Harold A. Strickland Jr., general manager of GE's Industrial Electronics division, who directs the technical products department and three other departments, also is scheduled to attend.

Other technical products department managers planning to attend are Wells R. Chapin, manager of product planning and market research for broadcast equipment; M. R. Duncan, manager of broadcast service engineering; S. J. Eby, manager of advertising and sales promotion for broadcast equipment; and Albert F. Wild, manager of sales, military-industrial electronics. Regional managers for broadcast equipment will be James H. Douglas, southern region, and Charles T. Haist Jr., western region. District managers from 11 broadcast sales districts also are expected to attend.

GENERAL PRECISION LABORATORY

Space 30; Suite 637

GPL will exhibit a variety of equipment, including monochrome and color film chains, 16 mm and 35 mm telecast projectors, varifocal lens, color test and accessory equipment, pulse and distribution amplifiers, a rack-mounted sync generator, and others.

Company representatives expected to attend are Dr. R. L. Garman, executive vice president and technical director; Blair Foulds, vice president; N. M. Marshall, national sales manager; J. W. Belcher, application engineering manager; Dr. F. N. Gillette, director of industrial product engineering; L. L. Pourciau, R. H. Johnson, R. K. Hunsicker, E. J. Manzo, A. F. Brundage, A. C. Balletta and W. E. Smyth.

GENERAL RADIO CO.

Space 1

GENERAL Radio Co. will show its new Type 1184-A television transmitter monitor. GR am frequency and modulation monitors, color-subcarrier (3.58) monitor, and distortion and noise measuring equip-

ment also will be on display, as well as R-F bridge and uhf admittance meter, with adapters, for impedance measurements on antennas and transmission lines from 400 kc to 1500 mc.

Representatives will include Charlie Cady, Joe Belcher, and Bill Thurston.

THE HARWALD CO.

Space 14; Suite 560A

DESIGNED to facilitate film handling in tv stations, the new Model Q Inspect-O-Film Editor machine will highlight the exhibit by Harwald, manufacturer of audio-visual equipment.

The film handling machine, to be displayed for the first time by The Harwald Co., permits film to be inspected electronically, viewed, inspected for sound, cleaned and measured in one simultaneous automatic operation.

The manufacturer also will exhibit its new Splice-O-Film automatic splicer.

Slated to represent the company are Robert Grunewald, president; Robert Menary, sales manager; Richard Wallace, technical director; and Howard Bowen, service manager.

HUGHEY & PHILLIPS INC.

Suite 660

TOWER obstruction lighting equipment by Hughey & Phillips Inc. will include a demonstration of its remote lamp failure indicator system providing a continuous means of monitoring lamps. Also demonstrated will be tower light control and alarm units for unattended microwave relay stations.

Representatives: J. H. Ganzenhuber, H. J. Geist, W. L. Hotz, R. L. Lang, T. F. Sears.

KAY LAB

Space 3

KAY LAB will show three new products: Kin Tel camera with seven-inch kinescope; broadcast field chain consisting of ASC-7 broadcast camera, Model APG-4 sync generator, Model 1985B camera control, Model AFM-1 7" field monitor and Model ASF-2F four-channel switcher-fader unit; studio monitor ARM-13B in Model ACH-4 13-inch console housing.

To be at the convention: Richard Silberman, Gary Gramman, Willard Walker, Al Braun.

KLIEGL BROS.

Suite 614-616

LIGHTING directors of the Kliegl Bros. Universal Electric Stage Lighting Co. Inc., will advise guests—especially tv station officials—on their lighting and production problems as the company's part in the coming convention.

Company representatives will schedule appointments for those who wish to discuss any lighting or production problems.

LAMBDA PACIFIC ENGINEERING

Space 37

LAMBDA PACIFIC Engineering Inc. will display a newly-tested 50 w amplifier for use in the 5.4 to 7.4 KMC band. The Model 5500 amplifier unit employs the re-

cently developed Eitel-McCullough klystron type X563 tube. Also on display will be Model 6700 microwave repeater which combines 1.0 microwave transmitter and receiver for unattended operation.

MAGNE-TRONICS

Suite 612

MAGNE-TRONICS INC. will exhibit one of its typical franchise studios for reproducing and transmitting tape-recorded background music programs (Motivation Music).

Recorded on eight-hour tapes for automatic unattended studio operation, the company's Motivation Music currently is being transmitted via fm simplex, multiplex and land line to subscribers in over 80 cities in the U. S., Hawaii, Canada and Bermuda.

Highlight of the display will be a demonstration of multiplex transmission on a closed circuit basis, in which programs originating on tape reproducing equipment are fed to a multiplex channel and picked up at the same location on multiplex receivers.

Representatives will be Vice Presidents Joseph F. Hards and Roger L. Thaxter.

MOTOROLA CO.

Space 15

COMPLETE lines of microwave and tv relay equipment top the display of Motorola in the lower lobby. Representatives will be Leonard Walker, marketing manager for microwave and industrial control products; Walter C. Byrne, microwave-industrial sales manager; Stephen Pozgay, industrial communications engineer; James Harring, sales engineering supervisor; Stanley Lapin, microwave marketing representative, and Gene Bird, convention supervisor of national sales.

MULTIPLEX SERVICES CORP.

Suite 613

OPERATION of fm services on sub-channels will provide a theme for the multiplex equipment. A transmitter and receiver will be set up to show how equipment operates. Representatives include W. S. Halstead, president, and Don Lewis, general manager.

MUZAK CORP.

Suite 704-05-06

MUZAK's exhibit will be built around its "completely automatic" tape playback unit, which starts at a pre-determined time, stops, pre-selects specialized music as desired, reverses itself and changes tracks automatically, rewinding, shutting itself off and cutting in a companion tape mechanism. A typical two unit franchiser studio requires no attendance except normal maintenance and a visit once a day to change reels. The 4,800-ft. Muzak long-playing tape is played four hours in one direction, then four hours in another direction on the other track for a total of eight hours per machine.

Representatives: Charles C. Cowley, executive vice president; Edward Hochhauser Jr., vice president and merchandising director; Emil Hembrooke, engineering vice president.

BROADCASTING • TELECASTING

a shape in your future

10,500-13,500 MCS

color microwave system

Lambda **LPE** Pacific

KU LINK

Now serving both TV Broadcast and Common Carrier KU Bands

- ULTRA-PORTABLE FOR REMOTES
- FULL TIME ALTERNATE STL CHANNEL

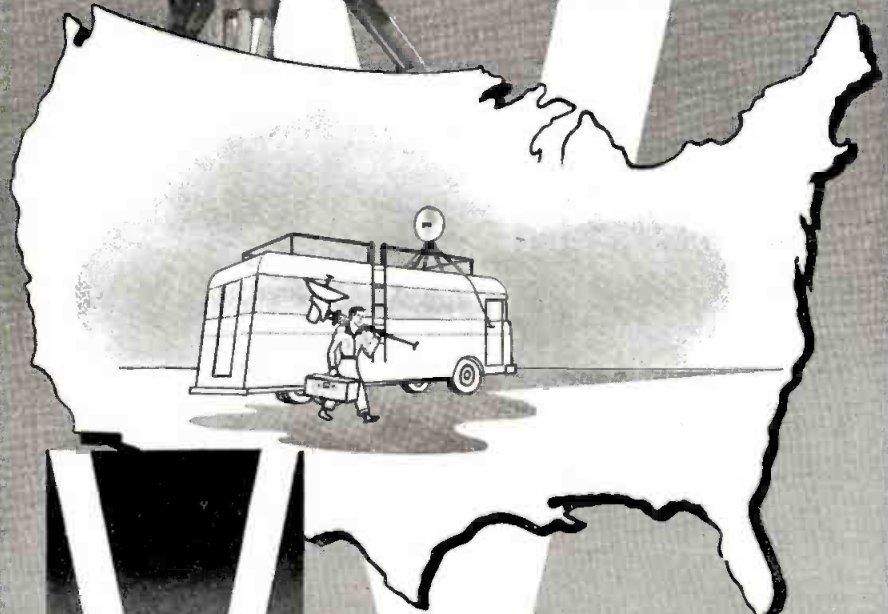

Distributed Nationally by . . .

VISUAL ELECTRONICS CORP.

342 WEST 40TH STREET, NEW YORK, N. Y. DEPT. MB

Gentlemen: Please send me complete specifications on the KU Band microwave system.

Name Title

Address

"Keeps You in View!"

STAND-BY TV TRANSMITTING ANTENNAS

for channels 7-13

No Diplexer Needed

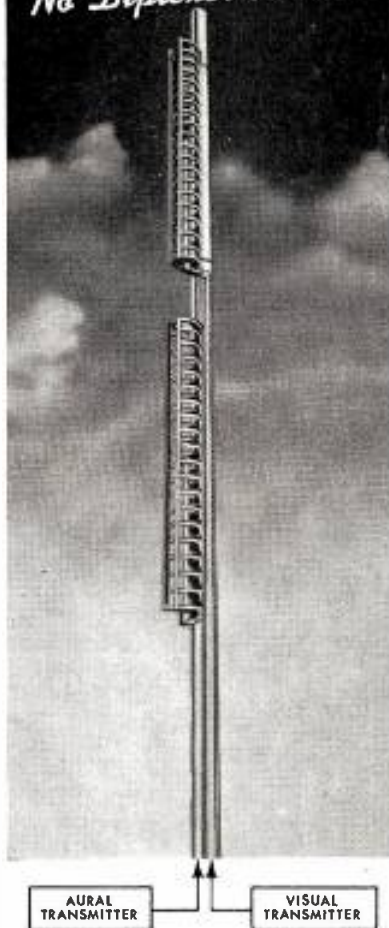

A simple, versatile and *economical* standby system consisting of two separate bays of the AMCI Type 1020 Antenna mounted on a mast or existing tower leg can be used with a 50 kw transmitter. No diplexer of any kind is needed. The aural and visual transmission lines need not be of equal lengths.

Write for Bulletin B-457.

ANTENNA SYSTEMS—COMPONENTS
AIR NAVIGATION AIDS—INSTRUMENTS



NATIONAL MUSITIME CORP.

Suite 535A

NATIONAL Musitime Corp. will show an Ampex 457 automatic station set up for automatic transmission, unattended, of background music and main channel commercials activated through silent sensing.

NEMS-CLARKE

Suites 542A-544A

A NEW color rebroadcast receiver (TRC-1) will head the list of items to be displayed. This unit is a color version of the TR-1 off-the-air receiver. Also on display will be field intensity meters (120D, 107A), phase monitor (108), and video jacks, jack strips and patchcords. Company representatives will be K. B. Redding and R. P. May, sales representatives, and Raymond Rosenberg and Edward Swanson, engineering department.

PERKIN-ELMER CORP.

Space 2

THE Perkin-Elmer Corp. exhibit will be exclusively devoted to the Auto-Zoom lens, a variable focus tv lens. Peter Moller will represent the company.

PHELPS DODGE COPPER PRODUCTS

Suite 649

STYROFLEX, Spirafil and Foamflex coaxial cables will feature the display by the Phelps Dodge Copper Products Corp.

Expected to attend are C. D. Dimity, E. J. Jean, G. A. Johnson, T. J. Kelly, F. W. Lemly, J. B. Lynch, J. F. McGuire, H. A. McCormick, S. F. Murphy, H. L. Olds, F. K. Packard, R. E. Plant, and G. A. Yates.

PHILCO CORP.

PHILCO will show newly designed tv signal processing equipment for gamma correction and electronic masking; universal switching and fading equipment capable of handling any kind of tv signal, and special effects equipment, integrated with switching and fading to explore the possibilities of special effects in color.

Also to be shown will be a completely integrated tv system in a typical layout, fully flexible and adaptable to the operational requirements of any station for either color or black-and-white.

PRODELIN INC.

Suite 550A

THEME of the Prodelin exhibit will be antennas, transmission lines and towers for radio-tv microwave relay. Prodelin President L. A. Bondon will head the firm's convention delegation, and accompanying him will be J. F. Cosgrove, sales manager; G. A. Lakin, sales engineer, and D. F. Kojjane, technical service engineer.

RAYTHEON MFG. CO.

Space 8

LATEST developments in tv microwave relay equipment by Raytheon will be displayed.

Included among the firm's exhibits will be a new version of the KTR television microwave relay series, and a prototype of an all-traveling wave tube microwave repeater

system. The company will display its KTR links in both the portable and the rack-mounted versions, and also will show several new accessory items including a wideband waveguide diplexer.

With the theme of "Let's Talk Design," the Raytheon showing will include an informal discussion session.

Raytheon officials in Chicago will be D. J. Webster, marketing manager; A. E. Keleher, manager of communication product planning; and Ed Alpert, assistant manager for communication product planning.

RCA

Space 17; Suites 604A-605A-607A

RCA will feature 15 new developments in studio and transmitting equipment. Highlighted will be a monochrome tv studio camera (TK-15) with a vidicon pickup tube. The camera has a seven-inch kinescope lens, four-lense turret, built-in video operating controls and a new non-linear optical focus.

E. C. Tracy, manager of RCA's broadcast-tv equipment department, said a complete RCA color tv studio will be in continuous operation, featuring latest equipment. Economical size and cost as well as improved performance are claimed for these new items. Exhibits are built around complete lines of equipment for vhf-uhf color and monochrome stations and for am/fm radio stations.

A traveling wave antenna for operation in the vhf high band will be shown. It is engineered with a slotted cylinder and a simple feed system, providing optimum vertical patterns and a simplified structure with less windload and no protrusions.

Slide projector for tv with a capacity of 36 2x2 transparencies will be shown. The projector is designated TP-7A.

Two vhf high-band, 500 w tv transmitters for low-power originating or satellite operation will be featured. One, TTL-500AL, is for chs. 2 through 6; the other TT500AH is for chs. 7 through 13.

RCA's 50 kw am Ampliphase transmitter (BTA-50G) will illustrate the new design approach for am transmission, including remote control operation.

Much of the color apparatus will be shown at work. A highlight in the am display will be a completely equipped radio station.

Among featured items are:

A 21-inch monitor for showing color pictures from live and film cameras—TM-21.

Universal coaxial transmission lines for simplified installation and minimized maintenance and procedure.

An RCA stabilizing amplifier, TA-9, designed to eliminate low frequency disturbances.

Transistorized portable amplifier and audio tape recorder.

New video studio, audio and am gear.

Representatives of RCA will include Arthur L. Malcarney, vice president and general manager, RCA's Commercial Electronic Products; G. H. Brown, chief engineer; A. R. Hopkins, manager, commercial electronic marketing; Mr. Tracy; M. E. Trainer, merchandising manager, and J. P. Taylor, advertising manager.

Other executives of the RCA Broadcast and Tv Equipment Dept.: E. N. Luddy, manager, transmitter and antenna equip-

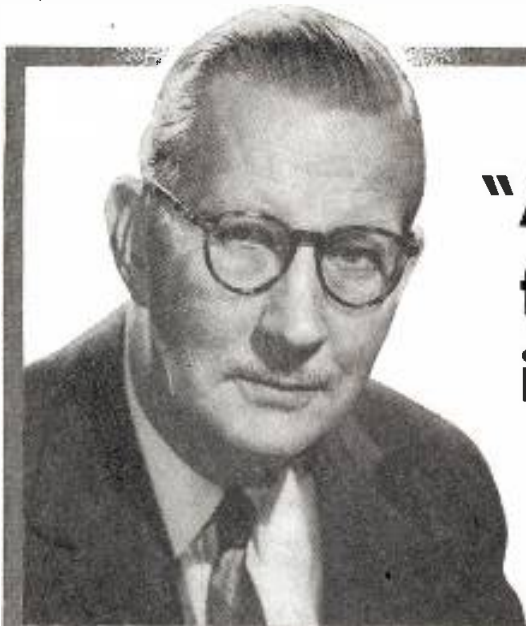

"Advertising Age fills an important spot in our business..."

says J. H. S. ELLIS
President and General Manager
Kudner Agency, Inc.

"I follow Ad Age for the news of the advertising business . . . it provides alert, accurate and interesting coverage of what's going on in the field of advertising. It is on my desk every Monday morning and always packed with timely information an agency head needs."

J. H. S. ELLIS

Mr. Ellis brought over 38 years of agency experience to Arthur Kudner, Inc. in 1944, when he joined that firm as its president. His work experience began in Indiana when he started his own outdoor advertising plant. After World War I, he became a copywriter in Columbus, Ohio. Since 1945, when he and other key members of the staff formed the Kudner Agency, annual billings have grown from \$15.0 million to \$66.2 million. Mr. Ellis maintains a keen and continuous interest in the creative side of the business, patterning many of his clients' campaigns. Engaged in many advertising activities, he is a past treasurer and director of the 4 A's, and current chairman of the N.O.A.B.

In the fast-moving field of advertising where today's important decisions are often shaped by yesterday's developments, Advertising Age fills an important spot for most of the executives who are important to you. More than a news magazine, Ad Age keeps advertising-marketing executives in touch with trends and developments—yes, and sales stories of important media—that help guide market and media selections. AA is packed with information vital not only to those who *activate*, but to those who *influence* these marketing decisions.

The Kudner Agency, for example, ranks high among important-to-broadcast agencies. In 1956, its combined radio-TV billings of \$13,000,000 placed it 24th among the top agencies handling broadcast advertising.* Among its important accounts are such firms as Goodyear Tire and Rubber Co. and General Motors Corp.—where Kudner handles advertising for nine subsidiaries including Buick Motor Division, Frigidaire Division and Fisher Body Division.

Every week, 49 *paid subscription copies* of Ad Age get intensive readership in the homes and offices of Kudner executives. Further, 74 *paid subscription copies* get similar readership each week at General Motors, its subsidiaries and Goodyear Tire and Rubber Co.

Add to this AA's 37,000 paid circulation, its tremendous penetration of advertising with a weekly paid circulation currently reaching over 10,000 agency people alone, its intense readership by top executives in national advertising companies, its unmatched total readership of over 141,000—and you'll recognize in Advertising Age a most influential medium for swinging broadcast decisions your way.

*Broadcasting-Teletesting 1956 Report.



1 Year (52 issues) \$3

important to important people

200 EAST ILLINOIS STREET • CHICAGO 11, ILLINOIS
400 LEXINGTON AVENUE • NEW YORK 17, NEW YORK

ment sales; V. E. Trouant, chief engineer; W. B. Varnum, manager, studio equipment sales, and Dana Pratt, manager broadcast field sales. RCA broadcast field sales representatives will be in attendance at the RCA exhibit.

THE RUST INDUSTRIAL CO.

Suites 658A-659A

REMOTE control systems for radio stations, including the deluxe 108-D 25-function system, the deluxe 108-C 10-function system and the economy 108-F 10-function system, will be displayed by Rust.

Also on exhibit will be the new Rust remote control units. Slated to be in Chicago are William F. Rust, president and general manager, and Donald G. Inman, broadcast sales manager.

broadcast transmitters will be demonstrated. Present will be Paul Schafer, head of the company; William Amidon, chief engineer and Jaye Smith.

STANDARD ELECTRONICS CORP.

Space 25

STANDARD's new 25-kw amplifiers (Models AL-634, chs. 2-6, and AH-634, chs. 7-13) will be featured at Space 25, Main Exhibit Hall. They have been used as drivers with RCA, GE, DuMont, Federal and Gates transmitters and feature "built-in patchovers, full-length glass doors, unlimited flexibility and economy in operation." Standard also will show one of its 500-w tv transmitters without cabinetry for an unobstructed view.

Personnel: William H. Zillger, Allen R. Taylor, William H. Rappolt, James T. Camp-

their display include vertical interval test signals, portable video transmission test equipment, a new portable sync generator and a portable video transmission test signal receiver for precise measurement of differential phase and differential gain.

In addition to the corporation's exhibit, J. R. Popkin-Clurman, Telechrome's director of engineering, will deliver a paper on "New Signals for Testing and Control During Programming of Monochrome and Color Tv."

Representing the company at the convention will be H. Charles Riker, vice president in charge of sales, and Mr. Popkin-Clurman.

TELEPROMPTER CORP.

Space 29, 18

TELEPROMPTER says it will be third

**HIGHSPTS
ALONG EXHIBITORS' ROW**

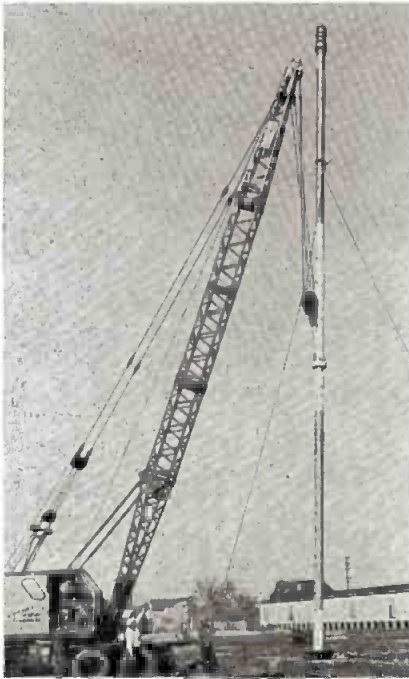

RCA's traveling wave antenna for vhf.
Page 112



Lambda-Pacific's new 50 kw amplifier.
Page 111

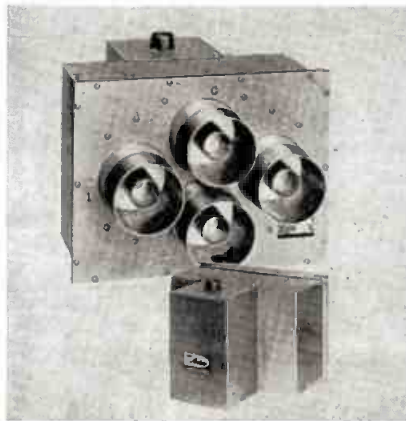

Andrew's remote control coaxial switch.
Page 106



The Kin Tel broadcast studio monitor.



American Microwave relay equipment.
Page 104

SCHAFER CUSTOM ENGINEERING

Suites 653-656

THE sixth floor display will be built around a new remote control system (400R) and accessories. A remote control unit for all bell, S. Perry Jenkins, Robert C. Hutchins, Lewis E. Pett, H. Duncan Peckham Jr.

TARC ELECTRONICS INC.

Space 20

TARC will show 11 pieces of its line of gear for the tv broadcasting industry, including its new color tv switcher, several of which now are performing satisfactorily in the field, Tarc reports. Also will be shown Tarc's new field-type sync generator, automatic gain amplifier and an expanded line of distribution amplifiers and power supplies.

Page 114 • April 1, 1957

SARKES TARZIAN INC.

Space 12

VIDICON and orthicon cameras will be shown, including newly developed features. Other equipment on display will be film equipment, transmitter microwave gear, kinescope receiving apparatus and miscellaneous video accessories. Personnel will include Biago Presti, sales manager; Dan Meadows, John Mahler, Mel Berstler and Ubar Donovan, sales engineers; Wendell Fuller, chief engineer.

TELECHROME MFG. CORP.

Space 10

PRODUCTS to be featured by Telechrome Mfg. Corp., Amityville, L. I., N. Y., in

largest exhibitor with two exhibition areas. Featured will be the new Mod V TelePrompTer and a new rear screen projector, the TelePro II, plus elements of TeleMation and TeLights. In its other exhibition area it will have a PCA exhibit with Western Union equipment, manned by TelePrompTer personnel.

Representing TelePrompTer: Irving B. Kahn, president; H. J. Schlafly, engineering vice president; Hebert W. Hobler, sales vice president; James Blair, production director; Ray Hagen, production executive; Paul McCausland, equipment service manager; Curt Howard, technician; Joe Kovalchik, head technician, Chicago; Ted Boisumbeau, manager, Chicago office.

UTILITY TOWER CO.

Space 32

UTILITY Tower Co., will exhibit a "completely new idea" in plastic tower structure (Plasteal utility tower), besides the standard tubular tower models now on the market and the new utility solid round towers.

Representatives: C. E. Nelson, Mrs. Jerry Nelson and Assistant Manager V. G. Duvall.

TELEVISION EQUIPMENT CO.

Space 33

BOTH heavy and lightweight lighting equipment, plus newsreel cameras and a new tv prompting device, will be displayed by Television Equipment Co., Chicago. Heavy duty equipment (manufactured by J. J. McAllister) consists of Kleig and flat lines, while economy will be stressed in lighter equipment of Colortran. Latter is designed to give maximum lighting with limited current and budget. Prompting device utilizes closed circuit television hookup between monitor and projector. Newsreel cameras (Auricon and Arriflex) will be shown. Television Equipment Co. also plans to exhibit editing equipment. In attendance at its booth will be Bill Behrend, president; Jack Behrend, vice president, and Fred Voss, salesman.

VISUAL ELECTRONICS CORP.

Space 23

A NEW device for extending the useful life of image orthicon tubes will be among the displays by Visual.

Many of the corporation's engineering sales representatives will be on hand to aid in demonstration of the equipment made by manufacturers whom Visual represents: Lambda-Pacific microwave equipment for remote pickup, STL intercity relay; GPL film equipment for color and black and white; Telechrome Video Transmission test equipment; Tarc Master Control and Terminal equipment; Alford antennas and diplexing equipment; Conrac color and black and white quality monitors, and others.

Scheduled to represent the company: From headquarters, James B. Tharpe, Pat Gallagher, Morris Mayers, Cecil Grace. Slated to attend from regional offices, Felix Bonvouloir, Dayton, Ohio; Lewis Radford, Atlanta, Ga.; Wayne Marcy, Houston, Texas; Hal Armant, Los Angeles; Lyle Keys, Denver, Colo., and Walt Schaefer, Chicago.

**Tv Film & Radio
Program Services**

ABC FILM SYNDICATION INC.

Room 509; Suites 2316-2319

TWO headquarters will be maintained in the Conrad Hilton by ABC Film to showcase ABC Film properties, promotions and services.

Personnel to be on hand: President George T. Shupert; Don L. Kearney, vice president in charge of sales; Robert Marcato, eastern sales manager; Lee Francis, advertising-promotion manager; Howard Anderson, midwest sales manager; Robert Miehle, midwest salesman, and Robert Fisk, film manager.

M & A ALEXANDER PRODUCTIONS

Suite 515A-517A

NEW film series will be displayed, including *Byline Steve Wilson* and feature releases just added to the line. Westerns also will be shown. Representatives will be Arthur Alexander, Larry Stern and Arnold Stern.

ASSOCIATED ARTISTS PRODUCTIONS

Suite 507-A

AAP's display will highlight Warner Bros. features and cartoons and the "Popeye" cartoons. Representatives attending: Eliot Hyman, W. Donald Rich, Donald Klauber, Jay H. Smolin, Arthur Kalman, Len Hammer, Jean Smith, Herbert Richek, Herman Katz, Robert Morin, Lester Tobias, Buck Long, Kirk Torney, Marguerite Blaise, Robert Montgomery, Ben Elrod, John McCormick, Dave Hunt, Paul Kwartin, Norman Katz and Al Sussman.

BONDED TV FILM SERVICE

Suites 1104-A, 1105-A, 1106-A

BONDED and its associate firm, TeleShippers Inc., will maintain a hospitality suite. On hand will be President Chester M. Ross, Wade Barnes, general sales manager, and Emanuel Kandel, executive vice president.

Bonded Tv distributes tv films, services advertising agencies on syndicated sales and, through its print procurement service, procures tv commercials for agencies and clients for national and international distribution. TeleShippers services the majority of tv stations in America.

CALIFORNIA NATIONAL PRODUCTIONS

Blackstone Hotel

CNP, subsidiary of NBC, will be represented: President Robert D. Levitt; H. Weller Keever, director of sales, NBC Television Films; Clifford Ogden, western sales manager, NBC Television Films, and Edward A. Montanus, central sales manager of NBC Tv Films.

CBS TELEVISION FILMS SALES INC.

Suite 1900

WHIRLYBIRDS series and CBS Newsfilm will be starred at the CBS Television Film Sales exhibit in the Conrad Hilton. Visitors may stop to be photographed with a Whirlybird model at the controls of a helicopter at the suite entrance. Inside they will find an eight-ft. map of the world with lights to mark CBS news bureaus, distribution points, location of cameramen and cities where CBS Newsfilm is shown. Other displays will be devoted to *Amos 'n' Andy*, *Range Rider*, *Gene Autry*, *Brave Eagle*, *Buffalo Bill Jr.*, *Life with Father*, *San Francisco Beat*, *Under the Sun*, *The Whistler*, *Adventures of Champion*, *Annie Oakley*, *Fabian of Scotland Yard*, *Files of Jeffrey Jones* and *Terrytoons*.

Officers at the exhibit will be Leslie Harris, vice president; Fred J. Mahlstedt, director of operations and production; Thomas W. Moore, general sales manager; Walter A. Scanlon, merchandising manager; John C. Sebastian, publicity manager, and three Chicago account executives: Donald R. Goldsmith, Lee Stone and Bernard J. Johnston.

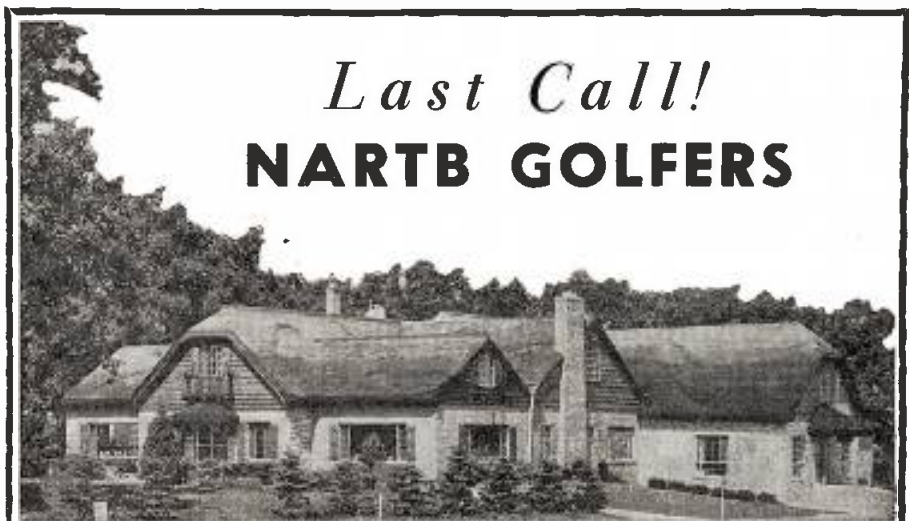

Last Call!
NARTB GOLFERS

B•T's annual Blind Bogey Golf Tournament will be held Sunday, April 7, at the 27-hole Midwest Country Club (above), Hinsdale, Ill. Over 20 prizes, including B•T's silver trophies for low gross and low net, will be awarded. Tee-off time is 9:30.

MAIL THIS RESERVATION TODAY, TO:
BROADCASTING • TELECASTING 1735 DeSales St., N.W., Wash., D. C.

Name

Address

Firm

I will want a ride to the club

Convention Headquarters: Conrad Hilton, Suite 704A

HARRY S. GOODMAN PRODUCTIONS

Suites 556A-557A

GOODMAN Productions has taken a suite at the Conrad Hilton, appropriating one room for station executives who just want to relax, and the other for "fireworks," as Harry S. and Everett Goodman describe their collection of radio program packages and services. These include Tex and Jinx McCrary's new syndicated program, *New York Closeup*, A. L. Alexander's quarter-hour *Court of Human Relations*, eight new mystery-adventure programs currently in production and the Goodman station jingle service. Station and agency executives who respond to the Goodman invitation, "Radio—we believe in it. If you do, come in and see us," will be offered unusual gifts.

GUILD FILMS CO.

Suites 528A-530A

GUILD Films' exhibit emphasis at the convention will be on two new shows, Jack London's *Capt. David Grief* and *Kingdom of the Sea*. Both were filmed in color and black-and-white. Other displays in the Guild suite will feature the *Liberace Show*, *Confidential File*, *Molly*, Raymond Massey's *I Spy* and the Lantz cartoons. Guild officers in the suite will be President R. R. Kaufman; John J. Cole, vice president for sales; Lou Shainmark, vice president for public relations; Arthur Gross, assistant to the president; Lou Dickey, regional sales supervisor; Jerry Liddiard and Irving Feld. Bob DeVinney, head of Chicago sales, will serve as host.

HOLLYWOOD TELEVISION SERVICE

Suites 2500-01-02A

CURRENT syndicated series of Hollywood Television Service, selling hundreds of features, action series, adventure subjects and other film programs, will be demonstrated in a large exhibition suite. Rex Allen, star of *Frontier Doctor*, will be present. HTS plans a surprise announcement for a new syndicated series.

Executives at the convention will be Earl Collins, president; Richard G. Yates, vice president, and Sam Seplowin, sales representative.

INTERNATIONAL NEWS SERVICE

Suite 600

INS Television Div. has taken a Hilton suite to feature *Telenews Daily Newfilm* and other services. The latter include *Telenews Weekly News Review*, *This Week in Sports*, produced, with the daily newfilm, by Hearst-Metrotone News Inc.; *Ask the Camera*, INS 35mm tv photo service, INS news wire, stock film footage and INS Special Services (fact-finding, research, photo and film assignments anywhere in the world, booklets and brochure produced to order).

Robert H. Reid, television division manager, will head the INS Chicago delegation. Accompanying him are Saul Reiss, national tv sales; Gene Roguski, INS central division manager; Michael Griffin, central division sales representative; Frank Koza, Chicago Telenews bureau manager, and Peter Harris, Chicago manager, International News Photos.

KEYSTONE BROADCASTING

Suites 804-05-06

KEYSTONE Broadcasting System will play host to representatives from its 932 affiliated stations and advertising clients. KBS executives in attendance will include Sidney J. Wolf, president; Edwin R. (Pete) Peterson, vice president; E. Richard Peterson Jr., account executive, and Blanche Stein, stations relations director.

LANG-WORTH

Suites 536A & 547A

LANG-WORTH Feature Programs Inc. will exhibit the use of jingles for the local merchant. Commercial material for the local merchant includes "Radio Hucksters" and "Airlifts." The material is recorded in cooperation with the radio broadcaster. Talent is diversified—solos, trios, quartettes, mixed groups—single instrument to full orchestra background.

In attendance will be Cy Langlois Sr., Johnny Langlois, Cy Langlois Jr., Winnie O'Keefe, Hugh Allen, Bob Hall, Charlie Hess, Ed Gardner and Bob Boehmer.

MCA-TV LTD.

MCA-TV Ltd. will be represented by David Sutton, vice president in charge; Vice Presidents Wynn Nathan, Lou Friedland, Ray Wild, Bob Greenberg, DeArv Barton, and Publicity Director Ed Aaronoff.

MGM-TV

Suites 534 (exhibit) & 2405 (hospitality)

MGM-TV will show original theatrical movie trailers from MGM films. In addition, there will be a complete display of promotional material and props, and original costumes worn by models.

Attending will be Charles C. (Bud) Barry, vice president for television; Richard A. Harper, Pete Jaeger, Maurie Gresham, Charles Alsup, Paul Mowery, Jack Tilden, Monroe Mendelsohn.

NATIONAL TELEFILM ASSOCIATES

Suites 505, 506, 507

THEME of the NTA convention exhibit will be, "NTA gives you the big show, everytime." The three rooms will include a dixie band and feature films will be shown in a little theatre. Polaroid cameras will be awarded daily plus a portable tv set as grand prize.

Heading the NTA delegation will be Ely A. Landau president, accompanied by Oliver A. Unger, executive vice president; Harold Goldman, vice president, sales; Edythe Rein, vice president; Edward Gray, vice president, West Coast sales; E. Jonny Graff, vice president, Midwest sales; Bernard Tabakin, director of national program sales; Aaron Beckwith, business development director; Martin Roberts, promotion-sales service director; Kermit Kahn, advertising director; Harry Albus, publicity director; Harvey Chertok, promotion coordinator.

Representing NTA Film Network will be Raymond Nelson, vice president-general manager; William Koblenzer, director of sales; Anthony Azzato, director of station relations, and Frank Young, director of publicity.

OFFICIAL FILMS

OFFICIAL FILMS Inc. will display in graphic form its library of products and multi-colored poster blow-ups. There will be an analysis of half-hour programming versus features, stressing package plans and new sales concepts.

Attending will be Herman Rush, vice president sales; Wells Bruen, Art Breecher, Jack Garrison, Bobby Conn, Barney Mackall, Jerry Lee and Jeff Davis.

The firm handles among others—*Adventures of Sir Lancelot*; *Colonel March of Scotland Yard*; *Rocky Jones*, *Space Ranger*.

RCA RECORDED PROGRAM SERVICES

Suite 500

RCA Recorded Program Services will give away a 1957 Dodge as one of the door prizes. The giveaway ties in with the The-saurus' half-hour musical series *The New Lawrence Welk Show*. Other prizes will be an RCA Victor Hi Fi Console and an RCA Victor personal tv set. A daily champagne hour from 4 to 5 will also be a part of the display.

STANDARD RADIO TRANSCRIPTION

Suite 539A

FEATURED by Standard Radio Transcription Services Inc. will be the "Lawrence Welk Library," a transcription package of Mr. Welk's "latest and best," with voice tracks, themes, program formats; "Shorty Tunes," a monthly service of 20 tune pops and standards by "leading bands and combos," all instrumental; sound effects library; Standard Program Library of 5,000 music selections and a collection of commercial aids and jingles. Examples may be auditioned on the spot.

Representatives: Milton M. Blink, president; Olga Blohm, general manager; Charles Michelson, eastern representative.

WALTER SCHWIMMER CO.

Suite 553

SCHWIMMER Co.'s filmed program exhibits will be *Championship Bowling*, films featuring match elimination games between bowling champions, filmed by a new five-camera continuous "live" action method; *Eddy Arnold Time*, pop and country musical series featuring Mr. Arnold singing "his all-time RCA Victor hit songs"; *All-Star Golf*, films featuring elimination matches between such champion golf pros as Sam Snead and Cary Middlecoff and other leading golf professionals.

Representatives: Walter Schwimmer, president; Bernard Crost, sales vice president; Arthur E. Pickens Jr., programming vice president.

SCREEN GEMS

Suites 512A-513A

TWELVE representatives of Screen Gems will be hosts. Among featured displays will be the *Ford Theatre* and *Father Knows Best* film series. Representatives include Ralph Cohen, John Mitchell, Henry White, Jerry Hyams, Bob Seidelman, Phil Cowan, plus area managers Ben Colman, Richard Dinsmore, Henry Gillespie, Frank Browne and Stanley Duddleson.

SIGNET TV

Suite 635A-636A

SIGNET will display 35 feature films, all Paramount. Nat Gassman, owner, describes this as the "Action Package," claiming it was sold in 20 top markets in 45 days, plus smaller markets. With Mr. Gassman will be Bill Pomeroy, regional representative.

STERLING TELEVISION CO.

Suite 509A

THEME of this year's exhibit by Sterling Television Co. Inc. centers around three new tv series properties—*Time In For Sports*, *Cartoon Classics Serials*, and *Recordtoons*. Special screenings of the three series films will be held.

Time In For Sports, a half-hour series, features spot coverage of dramatic sports events; *Cartoon Classics Serials* is a cartoon serialization of many favorite children's stories, and *Recordtoons* combines three elements of children's entertainment—television, animation and some 50 children's records.

TELEMAT

Suite 519A-520A

THE animated commercials in kit form for use by tv stations in selling local and regional accounts will provide the exhibit theme. A new color line will be introduced. Representatives will be Sid Freeman, Robert Boak and Bill Tennell.

TELEVISION PROGRAMS OF AMERICA

Suites 532A, 533A, 534A

A HOSPITALITY SUITE will be set up by officials of Television Programs of America Inc. There will be no TPA exhibit this year.

Representing TPA will be Milton A. Gordon, president; Michael M. Sillerman, executive vice president; Bruce Eells, vice president of the Western division; William H. Fineshriber Jr., vice president, New York; Kurt Blumberg, assistant vice president; Walt Plant, central division manager; Pat O'Brien, account executive; Stanley Levy, account executive, and Jerry Franken, director for press and promotion.

TRANS-LUX TELEVISION

Suite 546

TRANS-LUX will give away in folder presentations printed at a cost of \$3 each, on "101 Programs for Television," suggestions on how to use the Encyclopedia Britannica Film Library for "expensively produced yet low cost programs." Trans-Lux has exclusive tv rights to the Britannica Library. A paneled display on the walls will describe use of EB education films as commercial tv programs. The EB collection boasts 650 films and 50 more are added yearly.

Representatives: Richard Carlton, vice president in charge of sales; Leo Brary, eastern sales manager; Al Naroff, west coast manager.

SESAC INC.

Suites 524A-526A

SESAC's special attraction will be "a new concept in transcribed music libraries—the Sesac Transcribed Library," which lets the

broadcaster "choose the package that fits your programming best." Regardless of its programming format, the station now can order individual sections from the Sesac library to conform with its local musical programming format. Sesac will introduce artists Faron Young and the Anita Kerr Singers, Alfredo Antonini, Joe Venuti, Elliot Lawrence, Buddy Weed and others, plus three new script series—"Rendezvous With Maltby," "Magic Holiday" and "Tuneful Topics."

Representatives: Alice Heinecke, Evarard S. Prager, assistant to president; Robert Stone, director of program service; Jim Myers, director of station relations; Sidney Guber, station relations; and field representatives Harold FitzGerald and Glenn Ramsey, plus David R. Milsten, Sesac's western counsel.

UNITED PRESS ASSN.

Suites 546A-548A

UNITED PRESS Movietone will exhibit the UP's radio-television wire; Unifax, the UP's facsimile newscasters for tv; the press association's Movietone newsfilm and script wire; and its sports wire and business wire.

Those representing the United Press at the convention will be LeRoy Keller, vice president and general sales manager; William C. Payette, assistant general news manager; C. Edmonds Allen, director of special services; William R. Higginbotham, manager, UP Movietone; Bert Masterson, central division manager; Francis T. Leary, central division news manager; Edward L. Brant, central division business manager; Jesse Bogue, central division news editor; Richard L. Dugan, business representative, Louisville, Ky.; Rhea Eskew, Southern division business manager; James M. Flinchum, business representative, Dallas; Henry E. Minard, Pacific division business manager, and James J. Smith, business representative, Albany, N. Y.

WORLD BCSTG. SYSTEM INC.

Suite 512

SOUND-O, a dynamic radio sound effects game, will highlight the exhibits by World Bcstg. System Inc., New York. World's newest merchandising idea will be on display.

With its central theme, "W-O-R-L-D SPELLS SALES FOR RADIO STATION," the World exhibit will feature many "sales for profit" opportunities for radio stations, said Dick Lawrence, general manager of the program service company. The exhibit will include merchandising ideas, new stars, across-the-board features, special-event shows, production aids and special sales-producing campaigns for the local level, Mr. Lawrence noted.

Representing World Broadcasting at the convention will be Mr. Lawrence; Robert W. Friedheim, vice president; James Weathers national sales manager; Ken Joseph, assistant sales manager and other officials of the program service firm.

ZIV TELEVISION PROGRAMS INC.

Suites 556, 557, 560

SYNDICATED tv shows by Ziv Television Programs Inc. will be shown. Among the programs to be displayed by Ziv are *High-*

way Patrol, *The Man Called X*, *I Led Three Lives*, *Men of Annapolis*, *West Point*, *The New Adventures of Martin Kane*, *Dr. Christian*, *Mr. District Attorney*, *Boston Blackie*, *Favorite Story*, *Times Square Playhouse*, *Science Fiction Theatre*, *Cisco Kid* and others, Heading the special division will be Pierre Weiss, general manager, and Stanley Florsheim, general sales manager.

Among the series to be offered on an across-the-board basis from Ziv's "Economee Tv" division are *Mr. District Attorney*, *I Led Three Lives*, *Boston Blackie*, *Favorite Story* and *Times Square Playhouse*.

Representing Ziv at the convention will be Frederic W. Ziv, chairman of the board; John L. Sinn, president; M. J. Rifkin, vice president in charge of sales; Alvin E. Unger, vice president in charge of the Chicago office; Ed Broman, Midwest division sales manager; Jack Gregory, Eastern division sales manager; and other officials from the syndicated sales and national sales departments.

Ratings & Other Services

AMERICAN RESEARCH BUREAU

Suite 630A-631A

COVERAGE of every television station located in a market that has been surveyed will be shown on an 8x10-ft. map. Coded buttons for each station will reveal its coverage electrically through a network of lights. ARB will demonstrate survey information for its services, including tv audience measure with complete reports covering the entire United States and 130 separate metropolitan areas. Reception studies cover 341 additional markets, including uhf information. Representatives include James W. Seiler, president; Roger N. Cooper, station relations manager; Jack Gross, New York manager; Bill Shafer, Los Angeles manager.

COMMUNITY CLUB SERVICES INC.

Suite 818-820A

COMMUNITY Club Services, sales merchandising and public relations consultant service, will be on hand. Feature plan of the service is the Community Club Awards Campaign, now in use in more than 160 markets in this country and Canada. Joseph B. Matthews, William M. Carpenter, Vic Diehm and John C. Gilmore will represent CCS at the convention.

A. C. NIELSEN CO.

Suite 1000

ACCURACY of "small, well-selected samples" will be demonstrated by A. C. Nielsen Co. with continuous operation of its "sugar scoop" display at the convention.

Nielsen also plans other displays, including its audimeter and recordimeter devices for measuring radio-tv set usage, and will unveil two new broadcast media brochures—"Radio Facts 1957" and "Television Facts 1957." A new leaflet on differing aspects of "coverage" and "ratings," reflecting current industry interest, also will be made available. The "sugar scoop" display is designed to be a "seeing is believing" demonstration of sampling, with a running box score on performance promised each day.

Nielsen representatives will be George E.

Blehta, vice president-manager, eastern Nielsen station index territory; William R. Wyatt, vice president-manager, central NSI territory, and Joseph R. Matthews, vice president-manager of west coast broadcast operations.

STANDARD RATE & DATA SERVICE

Suite 1706A

ADVANCED market data from the May SRDS issues will be featured, plus survey material and copies of radio and tv publications. Attending will be John Williams, sales liaison; Warren Carhart, Roy Hess, Alan Ingram, Allen Fegans, Joseph Fitch and Bill Pierce, district managers; Leonard Schultz, marketing analysis representative, will also be on hand at SRDS Convention suite in Chicago.

PROFESSIONAL SERVICES

Whitaker Joins Blackburn & Co.; Will Be in Atlanta Office

STANLEY WHITAKER, former Southern division manager for the United Press, stationed at Atlanta, today (Monday) joins the radio-television-newspaper brokerage firm of Blackburn & Co. Mr. Whitaker, who had served with the UP in Atlanta for the past 22 years, will remain in that city and join Clifford B. Marshall in the Blackburn office there.

PROFESSIONAL SERVICE PEOPLE

Howard Berk, trade news editor, CBS Radio press information department, to Bernard Relin & Assoc., N. Y., public relations firm, radio-tv department.

PROFESSIONAL SERVICE SHORTS

Wolcott & Assoc. Inc., L. A. public relations counselors, announces establishment of S. F. office in cooperation with its national affiliate, Albert Frank-Guenther Law Inc. Address of new office: 425 Bush St. David Shawe, account executive with Wolcott, and Lucrezia Kemper, vice president and S. F. office manager for Albert Frank-Guenther Law, will be in charge, according to the firm's announcement.

NETWORKS

NETWORK RATE CARDS LIST HIKES FOR AFFILIATES OF ABC-TV, CBS-TV

MORE than 100 CBS-TV affiliates and more than 75 ABC-TV stations get network rate increases in the new rate cards currently being circulated by those networks.

In addition, officials reported last week that CBS-TV will reduce station time rates for network broadcasts between station sign-on and 9 a.m. local time in the eastern and central time zones, effective April 8. This is being achieved through the establishment of a new Class D time category, which will be 37.5% of Class A (this time segment formerly was part of Class C, which is 50% of Class A).

Another reduction also will be effected by CBS-TV on April 8 by extending Class B time on Sunday afternoon from 2 to 6 p.m., instead of the present 2 to 5 p.m. The 5-6 p.m. Sunday period up to now has been part of Class A. Class B time is 75% of Class A.

The new CBS-TV rate card, No. 13, was effective as of March 10. ABC-TV's new card, No. 7, went into effect March 1.

ABC-TV affiliates getting higher network rates in ABC's new rate card No. 7 include the following, with old and new Class A hourly rates also shown. (At least one ABC-TV affiliate, WTVR (TV) Richmond, received a cutback, from \$950 to \$875, a comparison of the cards shows.) Getting increases are:

KTEN (TV) Ada, Okla., from \$150 to \$200; KTBC-TV Austin, Tex., \$400 to \$525; KBAK-TV Bakersfield, Calif., \$150 to \$200; WBRZ-TV Baton Rouge \$375 to \$400; WNEM-TV Bay City, Mich., \$500 to \$575; KFDM-TV Beaumont, Tex., \$300 to \$400; WABT (TV) Birmingham \$800 to \$850;

WNAE-TV Boston \$2,400 to \$2,600; KXLF-TV Butte, Mont., \$100 to \$150; WWTV (TV) Cadillac, Mich., \$250 to \$300; KCRG-TV Cedar Rapids \$350 to \$450; WCSC-TV Charleston, S. C., \$300 to \$400; WBTW (TV) Charlotte \$1,000 to \$1,200; WDEF-TV Chattanooga \$475 to \$500; WBKB (TV) Chicago \$3,000 to \$3,300; WEWS (TV) Cleveland \$2,000 to \$2,300;

WRBL-TV Columbus, Ga., \$300 to \$400; WTVN-TV Columbus, Ohio, \$900 to \$1,025; WFAA-TV Dallas \$1,300 to \$1,400; WLWD (TV) Dayton \$975 to \$1,025; WTVP (TV) Decatur, Ill., \$300 to \$350; WXYZ-TV Detroit \$2,200 to \$2,300; KDAL-TV Duluth \$350 to \$450; WTVD (TV) Durham-Raleigh, N. C., \$450 to \$550; WGLV (TV) Easton, Pa., \$150 to \$200; WDAY-TV Fargo, N. D., \$300 to \$400; WFTW (TV) Florence, S. C., \$300 to \$400; WINK-TV Fort Myers, Fla., from bonus to \$50; WINT (TV) Fort Wayne, Ind., \$350 to \$500; WBAP-TV Fort Worth \$1,300 to \$1,400; KJEO-TV Fresno, Calif., \$400 to \$475; WOOD-TV Grand Rapids \$1,000 to \$1,100; WFRV (TV) Green

Bay, Wis., \$350 to \$400; WFMY-TV Greensboro, N. C., \$825 to \$900;

WNCT (TV) Greenville, N. C., \$300 to \$350; WSWA-TV Harrisonburg, Va., \$200 to \$250; KTRK-TV Houston \$800 to \$900; WJHP-TV Jacksonville, Fla., \$200 to \$325; WKBT (TV) La Crosse, Wis., \$250 to \$300; KABC-TV Los Angeles \$2,300 to \$2,600; WAVE (TV) Louisville \$1,025 to \$1,100; WTOK-TV Meridian, Miss., \$225 to \$275; WISN-TV Milwaukee \$1,050 to \$1,250;

KNOE-TV Monroe, La., \$250 to \$350; WSFA-TV Montgomery, Ala., \$350 to \$400; WMTW (TV) Mount Washington, N. H., \$300 to \$400; WNHC-TV New Haven \$1,100 to \$1,400; WJMR-TV New Orleans \$250 to \$300; WABC-TV New York \$4,700 to \$4,800; WTAR-TV Norfolk \$875 to \$925; KGEO-TV Oklahoma City-Enid \$150 to \$600; KMTV (TV) Omaha \$900 to \$950;

WDBO-TV Orlando, Fla., \$275 to \$300; WTAP-TV Parkersburg, W. Va., from bonus to \$100; WTVH (TV) Peoria, Ill., \$300 to \$450; WFLN-TV Philadelphia \$2,600 to \$3,100; KTVK (TV) Phoenix \$350 to \$400; KOAM-TV Pittsburg, Kan., \$250 to \$300; WPTZ (TV) Plattsburgh, N. Y., \$200 to \$275; WGEM-TV Quincy, Ill., \$300 to \$350; WREX-TV Rockford, Ill., \$400 to \$450; WHBF-TV Rock Island, Ill., \$700 to \$850; KSWB-TV Roswell, N. M., \$100 to \$175; KSD-TV St. Louis \$1,600 to \$1,700; KGO-TV San Francisco \$1,900 to \$2,100; WTOG-TV Savannah, Ga., \$200 to \$275; WISN-TV Milwaukee \$1,050 to \$1,250; TV Sioux Falls, S. D., \$320 to \$410; KREM-TV Spokane, Wash., \$300 to \$350;

KYTV (TV) Springfield, Mo., \$240 to \$275; WTHI-TV Terre Haute, Ind., \$400 to \$500; WCTV (TV) Thomasville, Ga., \$175 to \$200; KWTX-TV Waco, Tex., \$200 to \$250; WMAL-TV Washington \$1,100 to \$1,200; KAKE-TV Wichita \$500 to \$550; WILK-TV Wilkes-Barre, Pa., \$300 to \$350; WKBN-TV Youngstown, Ohio, \$450 to \$500;

CBS-TV affiliates getting increased network rates include the following, also showing their old and new one-hour gross rates:

In 56—basic required group: WCBS-TV New York \$6,250 to \$8,000; WAGA-TV Atlanta, \$1,050 to \$1,200; WERC-TV Birmingham \$825 to \$1,000; WNAC-TV Boston \$2,400 to \$2,800; WBEN-TV Buffalo \$1,275 to \$1,400; WCHS-TV Charleston, W. Va., \$500 to \$600; WBTW (TV) Charlotte, \$1,000 to \$1,200; WBBM-TV Chicago \$3,700 to \$4,100; WJW-TV Cleveland \$2,000 to \$2,400; WBNS-TV Columbus, Ohio, \$950 to \$1,100;

WHIO-TV Dayton \$975 to \$1,100; KLZ-TV Denver \$700 to \$800; KRNT-TV Des Moines \$550 to \$700; WBEK-TV Detroit, \$2,300 to \$2,800; WFMY-TV Greensboro-Winston-Salem \$825 to \$900; WHCT (TV) Hartford \$500 to \$650; KGUL-TV Houston-Galveston \$800 to \$1,100; WISH-TV Indianapolis \$1,200 to \$1,400; KCMO-TV Kansas City \$1,200 to \$1,400; KNXT (TV) Los Angeles \$3,200 to \$3,500; WREC-TV Memphis \$900 to \$1,000; WTVJ (TV) Miami \$850 to \$1,000; WCCO-TV Minneapolis \$1,400 to \$1,650; WLAC-TV Nashville \$650 to \$850; WTAR-TV Norfolk \$875 to \$925;

KWTV (TV) Oklahoma City \$750 to \$850; WOW-TV Omaha \$900 to \$950; WCAU-TV Philadelphia \$3,100 to \$3,500; KOIN-TV Portland, Ore., \$800 to \$950; WPRO-TV Providence \$1,100 to \$1,200; sharetimers WHEC-TV and WVET-TV Rochester \$700 to \$750; WHBF-TV Rock Island-Davenport \$700 to \$850; KBET-TV Sacramento \$550 to \$750; KWK-TV St. Louis \$1,500 to \$1,750; KTKL-TV and KENS-TV San Antonio \$800 to \$700; KPXI (TV) San Francisco \$2,000 to \$2,300; KSLA-TV Shreveport, La., \$425 to \$525; WTVT (TV) Tampa, Fla., \$500 to \$700; KOTV (TV) Tulsa \$750 to \$825; KTVH (TV) Wichita-Hutchinson, Kan., \$500 to \$650;

In the 50-station basic optional group—WFBG-TV Altoona, Pa., \$600 to \$700; WRD-W-TV Augusta, Ga., \$250 to \$350; KTBC-TV Austin \$350 to \$525; KFDM-TV Beaumont \$300 to \$400; WCAX-TV Burlington, Vt., \$300 to \$450; WMT-TV Cedar Rapids, Iowa, \$500 to \$650; WCIA (TV) Champaign, Ill., \$700 to \$850; WCSC-TV Charleston, S. C., \$300 to \$400; WRBL-TV Columbus, Ga., \$300 to \$400; KDAL-TV Duluth, Minn., \$350 to \$450; WBTW (TV) Florence, S. C., \$300 to \$400; WINT (TV) Fort Wayne \$300 to \$500; WBAW-TV Green Bay, Wis., \$500 to \$750; WNCT (TV) Greenville, N. C., \$300 to \$450; WJTV (TV) Jackson, Miss., \$300 to \$450; WJHL-TV Johnson City, Tenn., \$300 to \$350;

KTHV (TV) Little Rock \$350 to \$450; WKRG-TV Mobile \$375 to \$450; WCOV-TV Montgomery, Ala., \$200 to \$225; WDSU-TV New Orleans \$900 to \$1,000; WDBO-TV Orlando, Fla., \$275 to \$450; WGAN-TV Portland, Me., \$300 to \$450; WDBJ-TV Roanoke, Va., \$500 to \$600; WREX-TV Rockford, Ill., \$400 to \$450; WGBI-TV Scranton \$250 to \$550; KVTW (TV) Sioux City, Iowa, \$350 to \$500; WSBT-TV South Bend, Ind., \$350 to \$450; KXLY-TV Spokane \$350 to \$500; WHYN-TV Springfield-Holyoke, Mass., \$250 to \$350; KTTSTV Springfield, Mo., \$250 to \$325; WSTW-TV Steubenville-Wheeling \$400 to \$500; WTHI-TV Terre Haute \$400 to \$500; WIBW-TV Topeka \$250 to \$300; WKBN-TV Youngstown, \$450 to \$500;

In 52-station supplementary group—KFDA-TV Amarillo \$250 to \$300; WTWO (TV) Bangor, Me.,

Cincinnati's Most Powerful Independent Radio Station

50,000 watts of SALES POWER



CINCINNATI, OHIO
THE L.B. Wilson
STATION



On the Air everywhere 24 hours a day—seven days a week



MANAGERS of CBS-owned radio stations and network executives gathered for lunch on opening day of their annual meeting in New York, held March 18-21 at the Hotel Pierre. Clockwise from lower left are Gordon F. Hayes, general manager of CBS Radio Spot Sales; Richard F. Hess, research director, CBS Radio Spot Sales; Arthur Hull Hayes, president of CBS Radio Div.; Fred Ruegg, general manager of KNX Los Angeles; Thomas Gorman, general manager, WEEI Boston; Dr. Frank Stanton, president of CBS Inc.; Carl S. Ward, general manager of WCBS New York; E. H. Shomo, assistant general manager of WBBM Chicago; James M. Seward, executive vice president of CBS Radio; Edward W. Wood Jr., general manager of Housewives' Protective League; Robert Hyland, general manager, KMOX St. Louis; Jules Dundes, CBS Radio vice president in charge of station administration, and Henry Untermeyer, general manager of KCBS San Francisco.

\$250 to \$275; WWTW (TV) Cadillac, Mich., \$250 to \$300; KFVS-TV Cape Girardeau, Mo., \$250 to \$450; KKTW (TV) Colorado Springs \$150 to \$225; KRGG (TV) Jefferson City, Mo., \$200 to \$275; KODE-TV Joplin, Mo., \$200 to \$300; KHOL-TV Kearny, Neb., \$200 to \$300; WKBT (TV) La Crosse, Wis., \$180 to \$300;

WGAL-TV Lancaster, Pa., \$1,050 to \$1,200; KOLN-TV Lincoln, Neb., \$300 to \$350; KGLO-TV Mason City, Iowa, \$200 to \$400; WTOK-TV Meridian, Miss., \$200 to \$275; KNOE-TV Monroe, La., \$250 to \$350; WMTW (TV) Mount Washington, N. H., \$300 to \$400; KOSA-TV Odessa, Tex., \$150 to \$200; WTVH (TV) Peoria, Ill., \$300 to \$450; KHQA-TV Quincy-Hannibal \$250 to \$450; WKNX-TV Saginaw, Mich., \$225 to \$300;

KSBW-TV Salinas-Monterey, Calif., \$250 to \$325; WTOG-TV Savannah, Ga., \$200 to \$275; KOPO-TV Tucson \$200 to \$225; KXJB-TV Valley City, N. D., \$300 to \$400; WSAU-TV Wausau, Wis., \$150 to \$300; KSYD-TV Wichita Falls, Tex., \$250 to \$350; WCTV (TV) Tallahassee, Fla.-Thomasville, Ga., \$175 to \$200;

In 32-station extended market plan group—WFAM-TV Lafayette, Ind., \$70 to \$85; KLAS-TV Las Vegas \$85 to \$100; KTVO (TV) Olatumwa, Iowa, \$85 to \$115; WJDM-TV Panama City, Fla., \$70 to \$80; KPAR-TV Sweetwater-Abilene, Tex., \$125 to \$150; KREX-TV Grand Junction, Colo.-KFXJ-TV Montrose, Colo., \$65 to \$100 (no charge, no rebate on Montrose); KOTA-TV Rapid City, N. D., \$50 to \$100.

NETWORKS TO COVER '57 NARTB MEETING

- Greatest coverage scheduled
- Top speeches to be telecast

ALL FOUR national radio networks and two tv networks will bring highspots of the NARTB convention (Chicago, Conrad Hilton Hotel, April 7-11) to the nation. The coverage will far surpass any past broadcasting of industry proceedings (see convention roundup story and features starting page 79).

Live telecasts will include FCC Chairman George C. McConaughy's luncheon talk (Tues., 2:30-3 p.m. EST) on CBS-TV and NARTB President Harold E. Fellows' report to the people (Wed., 3-3:30 p.m. EST) on ABC-TV.

NBC and CBS radio networks will pick up

the opening address of Gen. Alfred M. Gruenther, American National Red Cross president. Gen. Gruenther is the principal speaker at the Tuesday opening of management meetings.

NBC also will broadcast a radio pickup of the presentation of the NARTB Keynote Award to former President Herbert Hoover. The award will be accepted from President Fellows by C. M. Jansky Jr., board chairman of Jansky & Bailey, who will represent Mr. Hoover. The NBC delayed coverage of the award is scheduled for 8:30-9 p.m. EST the same day. CBS will broadcast a taped version of Gen. Gruenther's speech 10:30-11 p.m. EST in the East and Midwest.

Chairman McConaughy's address will be heard at 10:05-10:30 p.m. EST on the CBS radio network. ABC and Mutual will carry live broadcasts of Mr. Fellows' Wednesday speech. CBS will carry this speech delayed at 10:05-10:30 p.m. EST.

Dozens of private meetings and social events are being scheduled starting Friday with the CBS-TV affiliates meeting (story, page 124). Added to the list [B•T, March 25] was an open house at the McCann-Erickson offices, 318 S. Michigan Ave., Monday, 5-7 p.m. The offices are close to the Conrad Hilton. Delegates and station representatives will be guests. A number of station representative firms are planning receptions.

ABC-TV Affiliates to Meet

ABC-TV affiliates will convene in Chicago next Sunday prior to the opening of the NARTB convention, it was announced last week by Alfred R. Beckman, vice president in charge of station relations for ABC-TV. The affiliates meeting will be in the Grand Ballroom, Blackstone Hotel, at 2 p.m.



STAKE YOUR CLAIM ON THE SOUTHWEST'S GIANT ECONOMY SIZE PACKAGE—DOLLAR FOR DOLLAR YOU CAN'T BEAT IT ANYWHERE!



K D U B - T V
LUBBOCK, TEXAS

K P A R - T V
ABILENE-SWEETWATER, TEXAS

K E D Y - T V
BIG SPRING, TEXAS

President and Gen. Mgr., W. D. "DUB" ROGERS
National Sales Mgr. E. A. "Bezz" HENSLER

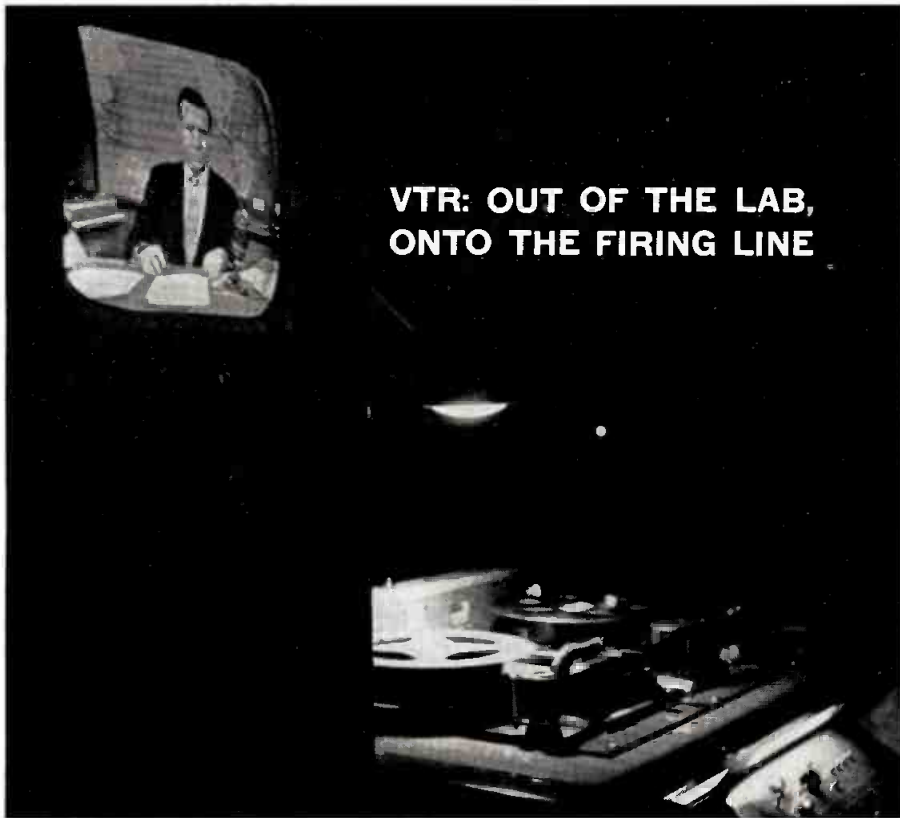

VTR: OUT OF THE LAB, ONTO THE FIRING LINE

WITHIN the next few weeks, video tape recording—the dream which Ampex Corp. showed to be marketable commodity at last year's NARTB convention—will finish its first series of shakedown runs and enter the most rigorous phase of testing it has yet faced.

All three television networks are making it the backbone of their various schemes for maintaining sensible schedules during the lunatic months of dislocation created by daylight saving time. From April 28 through Oct. 26, it'll be VTR vs. DST, with the tape recording equipment getting day-and-night workouts under actual broadcast conditions.

Two of the three networks have been working with the equipment for months, on the air as well as off. CBS-TV has been at it longer, having placed the first order with Ampex and received its first unit last Nov. 3 (CBS now has five units in operations, seven others on order). NBC got delivery of three units last December (eight others are on order) and like CBS has been putting them through their paces to see what they can do and how they may be made to do it better.

ABC-TV, currently in the process of installing its three units, has had less time for testing and its officials accordingly feel they'll need a few weeks of DST experience before they can make a proper appraisal.

From CBS and NBC engineers who have worked closely and almost continuously with the Ampex tape operation for months, however, it is possible to draw certain conclusions:

1. Although many problems remain to be cleared up before VTR can approach its full potentialities as a broadcast tool, it is clearly a workable system that now provides picture quality better than kinescope record-

ings and approaching that of film.

2. The big problem now is not in the equipment but in the tape, although both CBS and NBC are working on equipment improvements to compensate for some of the tape's shortcomings.

3. Tape will be infinitely less expensive than film, saving some of the networks close to \$10,000 a week in film stock and film processing costs during the DST months alone. The ultimate saving is incalculable at this point, being dependent on the extent to which VTR ultimately replaces film.

4. Nobody has done more than think about the range of uses to which VTR may be put. Until now, and certainly for the DST months, its principal use is for delayed broadcasts to overcome time differentials.

5. The expectation that tape "life" may eventually be raised to at least 100 plays—that's 200 times through the machine: 100 recordings and 100 playbacks—does not seem extravagant.

Networks Ironing Out Problems

CBS-TV's William B. Lodge, vice president of station relations and engineering, who has supervised CBS-TV's work with Ampex from the beginning, and his associates on the project—notably Blair Benson, senior project engineer, and Howard Chinn, chief audio-video engineer—speak with engineers' natural caution in evaluating any new gadget.

"On developments of this nature," Mr. Lodge points out, "you keep opening new horizons—and finding new problems—so that you cannot possibly expect to have complete answers at this stage."

But he has seen enough to convince him that the "promise" held out for the Ampex machines a year ago—a "promise" which,

incidentally, led broadcasters who saw the original unit in operation at the NARTB convention to plunk down close to \$4 million in orders on the spot—will be fulfilled, and that the problems foreseen then can be overcome.

The biggest immediate problem is in the tape—defects which show up on the screen as "drop-outs" or result in too high a noise level.

"Drop-outs" are those streaks that show up from time to time, similar to automobile ignition interference, which occupy a relatively minute portion of the picture but are distracting nevertheless. Generally they are caused by scratches, pinholes, or "little mountains and little valleys" on the surface of the tape.

Many tapes are not sufficiently free of these flaws to provide a usable picture. Accordingly, at least for now, the supply of usable tape is limited.

This problem is being approached from two directions. While the tape manufacturers—Minnesota Mining & Mfg., Reeves, ORRadio, and Audio Devices are the principal ones—are trying to perfect the tapes, the electronic engineers at Ampex, CBS, NBC and presumably ABC are working on the equipment itself, to make it capable of handling less than perfect tapes.

At NBC, work with the Ampex equipment is under the direction of Andrew L. Hammerschmidt, vice president and chief engineer; Charles H. Colledge, vice president for facilities operations; Anthony M. Henning, director of tv production, and George M. Nixon, director of engineering development. At ABC, the work is under supervision of Frank Marx, vice president in charge of engineering and general services.

Both NBC and CBS have minimized the drop-out problem by an electronic inversion process through which the drop-outs, which normally show up white, are made to appear on the screen as a less noticeable gray color.

Also Ampex has recently made a change in the equipment to eliminate picture "wobble" that has been apparent on certain types of tv receivers.

In the Ampex machine itself, the recording head appears to be the critical component. Rotating at exceptionally high speed—14,400 revolutions per minute—the head wears out relatively quickly, and rebuilding it is a several hundred dollar item. CBS-TV doesn't feel that it has yet had enough experience to build up an actuarial table on the life expectancy of the average recording head, but Ampex is guaranteeing 100 hours per head and recent experience indicates this is a reasonable expectation at this point.

Curiously enough, the performance of the head improves with use—right up to the breaking point.

CBS-TV's on-air use of VTR started slowly and has progressed cautiously. "We realized there would be growing pains and we didn't want to subject the public to them," Mr. Lodge explains.

Accordingly, when CBS-TV went on the air with VTR late in November, after four weeks of testing, it limited its use to west coast delayed feeds of the quarter-hour Doug

Edwards evening news show. A little later an Arthur Godfrey program was "delayed" via VTR, another one was put on the network via tape while Mr. Godfrey was in Africa, and in the future the tape will be used regularly for west coast delays on his show. The next step was to do a 45-minute and then a one-hour *See It Now* program on VTR. In addition, one Bob Crosby program has been taped and two others are slated.

The Godfrey program presented in his absence and the three taped Crosby shows represent a step forward from the earlier policy of using the Ampex equipment primarily to overcome time differentials. They point up another area of usage which undoubtedly will be exploited more fully when VTR units are generally available and begin to take their place as standard broadcast gear.

Present Problems Enough

This is the area of the specially taped show, recorded under live telecast conditions but held for broadcast weeks or even months later. This type of usage, when it comes, may open up a whole new set of union problems, but for the moment network officials are too much engrossed with the task at hand—that of learning all they can about the equipment itself, and trying to make it work better—and are too limited in the number of units available to plan ahead to extensive "new" uses.

Therefore, in those cases in which VTR has been employed to date for purposes other than overcoming time differentials, it has been used to solve specific problems.

In the case of the Bob Crosby telecasts, for instance, the three programs are being put on tape (one already has been) because all available studio space was slated to be tied up by other CBS-TV productions at the Crosby show's regular broadcast times on three dates. So in each case an audience is invited in at a time when studio space is available and the show is staged exactly as if it were being broadcast, except that it is tape-recorded rather than put directly on the air. To date, one Crosby show has been tape-cast; the others are scheduled for April 11 and May 9.

NBC-TV is using VTR to solve another type of production problem. *Truth or Consequences*, an audience participation show, originates in Hollywood and is carried on the network at 11:30 a.m. to 12 noon. Feeding it to the network live would mean that it would have to originate on the Coast at 8:30 a.m. local time—not a good hour to attract a wide-awake studio audience. So NBC-TV stages the half-hour daily program at a more convenient local time, tapes it, and then feeds it to the network from VTR the following day.

During the DST months, CBS-TV plans to tape a total of 24¼ hours of programming each week, while NBC expects to tape about 30 hours a week and ABC-TV will tape all of its live programming—an average of about 10 hours a week. CBS-TV and NBC-TV will operate all of their Ampex units from Hollywood, while ABC-TV is installing its equipment in Chicago.

Actually, the Ampex units will be in use

during DST two or three times the number of hours of programs involved. First, it is standard procedure to record on two machines, as a precautionary measure. Second, each recorded program must go through one of the two machines twice—once to record, once to play back. Finally, some programs will be played back more than once (to different legs of the network). Putting all this together, CBS-TV figures that recording 24¼ hours of its programs each week will actually mean around 125 hours of "machine use" each week, and the increment in the case of the other networks probably will be of similar order.

The figures on DST usage also serve to point up the financial savings that VTR can mean.

CBS-TV estimates that each hour of programming it "delays" via film costs around \$350 for film stock and film processing. Simple arithmetic, then, shows that by delaying 24¼ hours a week via VTR rather than film, CBS-TV will be saving itself better than \$8,400 a week in film stock and processing alone.

Add to this the fact that tape can be erased and re-used—for up to around 100 plays at the present stage of development—while film, once used, cannot be exposed again.

In terms of original cost there appears to be no great difference between film and tape equipment. A complete film system costs around \$42,000 while the cost of the Ampex units, which ranged around \$75,000 for the prototype models that CBS, NBC, and ABC now have, has been brought down to about \$45,000 for a production model. An hour's worth of 35 mm film, with development, costs about \$350, as compared to \$200 for an hour of tape, which of course is re-usable.

Stands Alone at CBS-TV

CBS-TV passed a significant milestone a few weeks ago. Until then, each program it taped for on-air use was duplicated on 35 mm film, for use in case the VTR went on the blink. NBC-TV still follows this procedure, using either 16 mm or 35 mm, and presumably ABC-TV will do the same at the outset of own VTR operation. But CBS-TV, which has been working with the Ampex units longer than the others, concluded five weeks ago that VTR could stand on its own feet. Having thus attained "confidence" in VTR, CBS-TV stopped making standby films.

If CBS-TV engineers needed any justification for this decision, they presumably found it a short time ago when they staged a dry run of their DST operation. They taped and replayed their entire DST schedule for a full week, exactly as they plan to handle it when DST goes into effect except that the VTR playbacks were not put on the network. Not a single bobble occurred in the entire test, Mr. Lodge and his associates report with considerable satisfaction.

Among other developments which CBS-TV reports after its five months of work with the machines are (1) the finding that it is possible to re-record from one tape to another with results that, while not quite up to

"ROANOKE—

Bigger than

RICHMOND?"



"YES, BIGGER...

BIGGER than

Richmond by

*12,800**

Television

Families!"



*Television Magazine,
March, 1957

Note—Use the count YOU favor, but it's generally agreed that the ROANOKE TELEVISION market is sizeably ahead of the RICHMOND TELEVISION market.

Check YOUR set count . . .
then BUY Roanoke!

Call, your nearest Peters,
Griffin, Woodward "Colonel",
— or WDBJ • Television!

WDBJ-TV

Channel 7

ROANOKE, VA.

Owned and operated by
the Times-World Corp.

KTBC-TV
is growing older...
taller... stronger

NOW!
a **TALLER tower**
(1280' above average terrain)
MORE coverage
(1137' above ground)
and right in the
HEART of TEXAS

KTBC
CHANNEL 7
CBS • NBC • ABC
316 kw

CBS

590 to RADIO
CBS
5,000 watts (15)

AUSTIN, TEXAS

Represented Nationally by
Paul H. Raymer Co., Inc.

Since 1943
(Over 14 years)

Economy Auto Stores has
sponsored

"8 O'CLOCK NEWS"

15-Minutes Daily
6 days a week!

Quite a record of continuous
sponsorship . . . but this
WLAG feature has quite a
record for results, too!

Call Indie Sales or Dora-Clayton
Agency for suggestions and avail-
abilities for your client.

WLAG
LaGrange, Georgia

NETWORKS

the quality of the first tape, are "quite usable" on the air, and (2) through various adjustments, and by the use of 14-inch reels, the amount of tape that can be recorded continuously can be increased from one hour, generally regarded as the maximum when the machines were first introduced, to an hour and a half.

It is possible to splice tape before it is recorded but not afterward. This is definitely a limiting factor, although some authorities feel it is "not an un-mixed blessing." When it becomes possible to splice tape that has already been recorded, these experts fear, producers will want to "re-shoot" any scene or line that doesn't come off perfectly and the era of the motion pictures' heyday, when hours could be spent on a single sequence, will have fallen on television with all the added expense that such painstaking perfectionism involves.

Nor can the Ampex units yet handle color, although Ampex itself is known to be working on this problem just as others in the field are doing. Aside from Ampex, two of the leaders in the race for color tape are RCA, which demonstrated tape recording of color programs in its laboratories in Princeton more than three years ago [B•T, Dec. 7,

1953], and Minnesota Mining & Mfg., which last year acquired the video tape research products developed by the electronics division of Bing Crosby Enterprises. RCA scored a color "first" last fall by putting a segment of the *Jonathan Winters Show* on NBC-TV through its experimental color tape process [B•T, Oct. 29, 1956].

It is this inability of the Ampex units to handle color, and the impossibility of editing (splicing) it, which in the opinion of NBC authorities represent VTR's major drawbacks at the present time. They are hopeful that the editing problem may be solved shortly after Ampex starts turning out production equipment—a stage Ampex hopes to reach late this year. Indeed, they feel that "from here on out, advances are going to be terrific."

NBC-TV's two Hollywood VTR units—a third, now in New York for study and tests by NBC engineers, will be shipped to Hollywood before the DST operations begins—currently are in "broadcast" use about eight hours a day. The recordings encompass an hour of *Today*, an hour of *Home*, the quarter-hour *News Caravan*, an hour of *Tonight*, and the half-hour *Truth or Consequences*.

Since *Truth or Consequences* is fed to the

NBC RADIO TACTICS ASSAILED BY SRA

A BLAST at NBS Radio's pricing and competitive tactics was unleashed last week by Station Representatives Assn.—and promptly answered by NBC officials.

In a "Memorandum to All Affiliates of the NBC Radio Network," SRA Managing Director Lawrence Webb undertook to caution the stations on "how your affiliated network is competing with you for essential business."

NBC authorities denied the SRA charges and countered that "if SRA had spent its time promoting the sale of the new availabilities delivered to the stations by the NBC no-waste policy, rather than making attacks on the network, SRA would have served the stations better."

Mr. Webb in his memorandum said that the current radio upsurge would seem "a new opportunity for stations to raise rates and bring them into line with those of other media and other businesses. But, he continued, "the NBC Radio network is making this opportunity increasingly difficult to realize by pricing their radio product so low—by the device of virtually eliminating station compensation—that the stations themselves cannot compete with their own network, even though the product the stations have to sell is today a substantially bigger, better, more effective advertising device than ever before."

He said a recent presentation by the NBC Radio network sales department, in comparing a proposed network campaign with a hypothetical spot radio campaign, contained many flaws.

The SRA memorandum acknowledged that "no one . . . can tell a network how to price the product it is selling, or how they should sell it. The stations, however, should

have the privilege of calling into question sales practices which tend unfairly, even dishonestly, to depreciate the value of one of the stations' prime sources of revenue—spot radio. . . .

"We have no quarrel with the networks themselves, and no doubt of their continued existence. We simply wish to call to your attention what you as a station operator face competitively, since your welfare and ours go hand in hand."

NBC authorities asserted that they were "selling network radio" and in no instance would make a presentation on spot radio except upon invitation by an advertiser or agency, and then only when they were led to believe that the budget was large enough to accommodate both network and spot. Such was the case in the presentation criticized by SRA, they maintained, adding that it was not "against" spot but rather designed to show what network plus spot could do for the advertiser. They were led to believe, they said, that the advertiser had a budget to include both.

NTA's Film Network Begins Commercially

NTA Film Network begins operations today (Monday) on a commercial basis, with Warner-Lambert Pharmaceutical Co. and P. Lorillard Co. (Old Gold cigarettes) sponsoring one and one-half hours of feature film programming per week in 133 markets [B•T, March 4].

Throughout this week, the "Premiere Performance" series of 20th Century-Fox feature films will be carried on the stations, with playing dates varying from market to market. The initial film presentation will be "Suez," starring Tyrone Power, Anabella and Loretta Young.

Ely A. Landau, president of the NTA

eastern network by tape in addition to the west coast repeats of this and the other taped shows, this means 3¾ hours of taping each day and 4¼ hours of playback for a total of eight hours of machine use daily, Monday through Friday.

NBC-TV "backs up" its tapes with 16 mm or 35 mm films—and in one case had to put the film into use when the tape version failed to work satisfactorily.

NBC authorities can envision many potential uses for VTR. They see it especially as an important news tool, cutting by hours the time lag that is imposed on film coverage by the need to process films after they have been shot (both NBC-TV and CBS-TV tape-recorded President Eisenhower's inaugural ceremonies in January and broadcast from the tapes within half an hour, but as yet there has been no other instance of news coverage by VTR).

Other examples:

- For recording commercials, thereby not only giving the advertiser assurance that his spot is "right" but also enabling him to "bunch" his shooting and thereby save time and money (some advertisers have already asked to use VTR on commercials, but neither NBC nor CBS has anywhere near

enough machines to accommodate such requests yet).

- For pre-recording, to solve the always tough problem of studio space (as CBS-TV is doing in the case of the three Bob Crosby programs).

- To solve awkward origination-time situations (as in the case of NBC and *Truth or Consequences*).

- For use in dramatic programs where quick costume or scene changes are needed (an actor can be shown falling into a pool of water via tape and still be seen bone-dry the next moment in a live pickup).

These, of course, are elementary examples of the possibilities. Many of the ultimate uses of VTR probably haven't even been thought of yet. As in the case of the electronic problems, networks authorities admit readily that not only do they not know all the answers, but quite conceivably they don't know all the questions yet.

But they do feel that, since Ampex first showed the machines at the 1956 NARTB convention, they and Ampex—working individually and in cooperation with Ampex—have managed to compress about three years of progress into 12 months' time.

Film Network and of National Telefilm Assoc., parent company (see OUR RESPECTS column), claims his is the first tv film network to "become a commercial reality," and that this marks the first time that a series of feature films will be promoted and advertised nationally. It is Mr. Landau's intention to expand the network programming gradually to encompass several hours weekly within a few years.

CBS-TV Cancels Play About Editorializing

CBS-TV's plans to air a teleplay about a network news commentator's right to editorialize were abruptly cancelled last week, just two weeks before the script was scheduled to be presented on Westinghouse Electric Corp's *Studio One*. The play, titled "The Commentator," was written by John Secondari, chief of ABC's news bureau in Washington.

The play was rejected by the network, not the agency (McCann-Erickson), it was learned. Hubbell Robinson Jr., CBS-TV executive vice president in charge of programs, insisted "there is nothing unusual about our action—we have rejected other plays in the past." Observers were prone to link the network's decision to its recent action concerning a "controversial" Eric Sevareid newscast [B•T, Feb. 11, *et seq.*], but Mr. Robinson denied the existence of such a link. He said that "the cancellation is for creative reasons only. . . ."

Producer Herbert Brodtkin, who brought the script over to *Studio One* after resigning from NBC-TV's *Goodyear Tv Playhouse-Alcoa Hour* series last fall, would not elaborate on anything his superiors said. "As an employe of CBS," Mr. Brodtkin said, "I can only go along with network policies."

Contacted in Washington, Mr. Secondari

said he had been given no reason why the play was cancelled. Told of Mr. Robinson's explanation, e. g., cancellation for "creative reasons," the ABC newsman replied that no one had ever intimated to him that his play was anything but good. In fact, he noted that he has letters from various CBS officials that describe his play as "terrific."

This is the second time Mr. Secondari's "Commentator" has been scratched. The first was in 1956 by NBC-TV. Mr. Brodtkin had commissioned the script but the network never scheduled it. NBC's director of continuity acceptance, Stockton Helffrich, said he did not turn it down and didn't know at what echelon of the network—or sponsor or agency—the play was rejected.

Mr. Secondari said his play deals with a situation surprisingly like his own: a newsman takes an unpopular editorial stand on the air, then faces sponsor difficulties and network pressures. The difference between the play's commentator and himself, Mr. Secondari noted, was that his fictionalized character *does* go on the air while he (Secondari) "got the pressure first."

Mr. Secondari also got his money first. For "The Commentator" he has been paid by NBC (three quarters of the agreed price) and also by CBS (the entire amount).

Asked if there were a possibility his own network, ABC-TV, might do the play, Mr. Secondari said that while ABC presently does not have a dramatic hour showcase, he felt "sure" the script would be accepted if it did. John Daly, ABC vice president in charge of news and public affairs, said that he has a copy of the script, but that any decisions regarding "The Commentator" as a vehicle for next season's ABC-TV schedule would have to be made by James T. Aubrey Jr., vice president in charge of programming and talent.



Of Florida's *nine* Metropolitan County Areas with retail sales in excess of \$150,000,000 — *four* are within the WFLA-TV 30-county Sales Area, *blanketed* by WFLA-TV's *unduplicated* NBC live programming!

Add the six additional counties within the WFLA-TV Sales Area with retail sales in excess of \$40,000,000, and you have the *greatest concentration* of principal retail sales areas available with *one Florida TV buy!*

WFLA-TV delivers Florida's **SECOND** TV-Market! For top rated availabilities on this sales powerhouse of Florida's West Coast, see your Blair-TV man — today!

(Figures from Sales Management's Survey of Buying Power)



National Representative—BLAIR-TV Inc.

INVEST

YOUR TV DOLLARS
WHERE THEY BRING
LARGER DIVIDENDS

The latest NIELSEN SURVEY proves that KTBS-TV, CHANNEL 3 gives you more . . . more TV homes . . . reaches more of these TV homes MONTHLY and WEEKLY . . . delivers more for your money.

316,400 HOMES in KTBS-TV Area give you a bonus of 31,900 homes over Station B, according to A. C. Nielsen Co., world's largest statistical and rating organization.

157,980 TELEVISION HOMES in KTBS-TV AREA, a bonus of 13,120 over Station B, is shown by the Nielsen Survey.

136,860 HOMES REACHED MONTHLY by KTBS-TV, a bonus of 6,740 over Station B, proven by Nielsen.

131,870 HOMES REACHED WEEKLY by KTBS-TV, a bonus of 5,120 over Station B is shown by Nielsen.

KTBS-TV with its maximum power is the place to be . . . there's more to see on Channel 3 . . . and more people see it!

KTBS-TV
CHANNEL
SHREVEPORT
LOUISIANA
3

E. NEWTON WRAY,
President & Gen. Mgr.

NBC and ABC

Represented by

Edward Petry & Co., Inc.

NEW YORK - CHICAGO - ST. LOUIS - BOSTON - LOS ANGELES - SAN FRANCISCO - PHOENIX

NETWORKS

AB-PT 1956 INCOME SETS NEW RECORD

- Report made to stockholders
- Gross take: \$206,916,000

A RECORD gross income of \$206,916,000 was established by American Broadcasting-Paramount Theatres Inc. in 1956, Leonard H. Goldenson, AB-PT president, announced last week in the annual report to stockholders. Gross income in 1955 was listed at \$198,350,000.

Consolidated net earnings for 1956 were placed at \$8,477,000, or \$1.96 per share, compared with \$8,373,000, or \$1.93 per share, in 1955. It was pointed out that \$742,000 of the 1956 earnings and \$155,000 from the 1955 earnings came from capital gains.

The income for the ABC division was reported at \$98,759,000, as against \$81,117,000 in 1955. Mr. Goldenson said the division has had "year-to-year improvement in income and earnings with a substantial increase in gross time billings for the television network over 1955." He noted that the 1956 fourth quarter results were below those of the same period of 1955 as sales had not come up to expectations.

ABC Radio, Mr. Goldenson said, improved "its relative competitive position among the four networks . . . and assumed audience leadership over the other networks in the important commercial morning time periods." He observed that as of April 1, ABC Radio increased its rates for morning programs, which represented the first increase in years and serves to signify "renewed recognition of the national medium's real worth."

The overall profit of the company's owned and operated stations—five tv and four radio—showed improvement in 1956 over 1955, according to Mr. Goldenson. He said their growth reflected "one of the best years in local and national spot business, as well as increased audience acceptance for the tv stations' local and national programs."

Mr. Goldenson indicated the ABC division's outlook for the future is bright, with a major factor being the accessibility of network programs in markets that up to now have had only two tv stations. He pointed out that in the last year, 12 major markets were added to the ABC-TV lineup and said there is a likelihood that the FCC, soon would grant licenses for additional stations in such cities as Boston, St. Louis, Miami and Omaha.

Along with this strengthening lineup, Mr. Goldenson mentioned that ABC-TV is in the process of bolstering its programming for next fall.

ABC Film Syndication, the subsidiary that distributes film programming, became active in the overseas market during 1956, according to Mr. Goldenson.

Last August, Mr. Goldenson reported, the company expanded its interests in the electronics and nucleonics fields with the acquisition of a 25% interest in the Wind Tunnel Instrument Co., Newton, Mass. AB-PT also has a 33 1/3% interest in Microwave Assoc., Burlington, Mass., and a 25%

THINGS TO COME

ABC's annual gross billings by 1960 are expected to reach \$250 million, mostly from tv income, predicts Leonard H. Goldenson, president of American Broadcasting-Paramount Theatres, in an article in the April issue of *Fortune* magazine.

According to the article, Mr. Goldenson also expects the AB-PT theatre operation at that time to be about \$100 million. For the first time in its history, the firm made as much from its radio-tv operations as from its theatres, with half the company's \$8 million profit coming from the former.

Under the title of "AB-Paramount Moves In," the article also pays tribute to ABC's drive to establish greater tv competition with the other networks. A discussion of ABC's plans and prospects for next season also are outlined.

interest in Technical Operations Inc.

Network Executives to Speak At CBS-TV Affiliates Meeting

CBS-TV Affiliates Assn. will hold its third general conference on Friday and Saturday of this week at the new WBBM-TV Chicago studios. Key executives of the network will present a progress report on the past season and outline plans for next fall.

The meeting will begin at 10:15 a.m. Friday with talks by C. Howard Lane, vice president-managing director of KOIN-TV Portland and chairman of the association, and Merle S. Jones, who will be addressing the group for the first time in his new capacity as president of CBS-TV. Highlight of the first day's meeting will be the luncheon address by Dr. Frank Stanton, president of CBS Inc.

Network executives who will speak during the two days are William H. Hylan, vice president of sales administration; Hubbell Robinson Jr., executive vice president in charge of network programs; Oscar Katz, vice president in charge of daytime programming; Jay Eliasberg, director of research; Thomas Dawson, vice president, network sales; Sig Mickelson, vice president in charge of news and public affairs; John P. Cowden, operations director of advertising and sales promotion; Charles J. Oppenheim, director of information services; Edward P. Shurick, vice president and director of station relations; Ralph W. Hardy, vice president, Washington, D. C.; William B. Lodge, vice president of station relations and engineering, and Robert F. Jamieson, sales service manager.

Cohan to CBS Radio Post

PHIL COHAN has been appointed trade news editor of CBS Radio Press Information effective April 1, according to Charles S. Steinberg, director of the department. Mr. Cohan has been a senior press representative with CBS Television Press Information since January 1956.

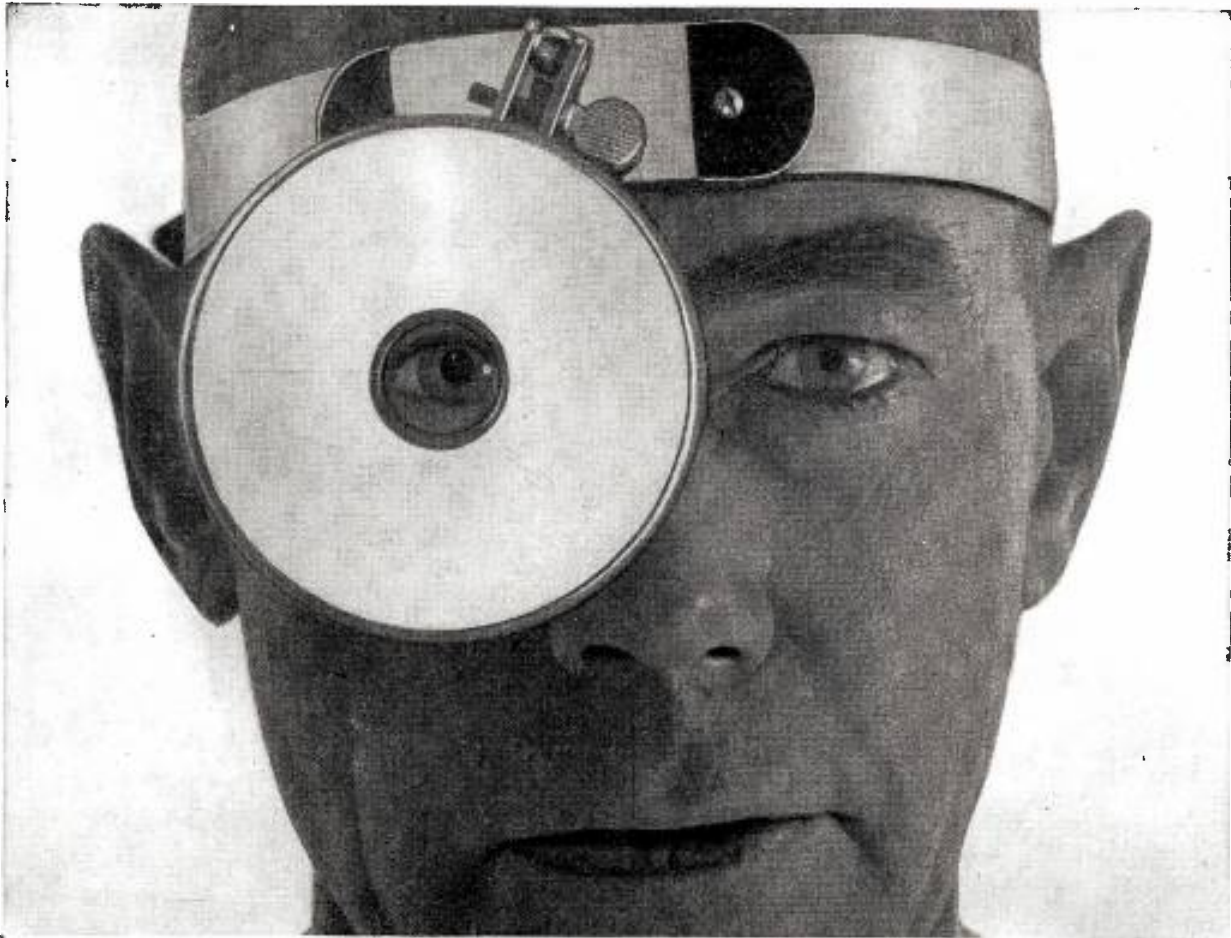

How Many? How Much?

Today 1 in 3 Americans are saved from cancer. Ten years ago only 1 in 4 were saved. Such an improvement is due to early detection and prompt treatment. But people don't know this. You of the broadcasting industry can tell them. Will you? At the same time you can help us raise \$30,000,000 needed for education, for service, and for cancer research — research that will find the final cure for cancer. Here's the way we'll help you help us!

Radio:

Transcribed Spot Announcements
Spot Announcement copy
Transcribed Quarter-Hour Shows
A one-hour Great Jazz show, starring
YOUR deejay. We provide music, includ-
ing collector's items, program notes
and scripts.

Television:

20-second and 1-minute film spots,
including George Gobel, Debra Paget,
and Martha Hyer
Flipboards, slides and telops
Copy for live announcements

For further information, consult the American Cancer Society Unit in your community or write to:

AMERICAN CANCER SOCIETY
RADIO AND TELEVISION SECTION
521 West 57th Street
New York 19, New York



THE CALIF.-ORE. TV TRIO

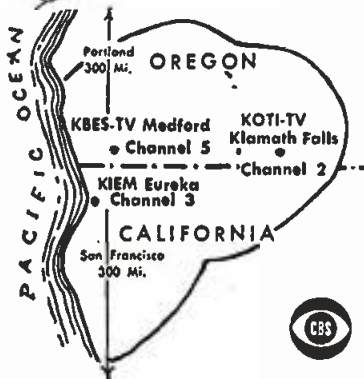

The Smullin TV Stations

KOTI	CHANNEL 2	} CBS NBC ABC
	Klamath Falls, Ore.	
KIEM	CHANNEL 3	
	Eureka, Calif.	
KBES	CHANNEL 5	
	Medford, Ore.	

Three markets — one billing

MARKET FACTS

POPULATION	338,800
FAMILIES	109,800
TV FAMILIES	81,252
RETAIL SALES	\$474,450,000
CONSUMER SPEND- ABLE INCOME.....	\$591,194,000

"The Calif.-Ore. TV TRIO bridges the gap between San Francisco & Portland with EXCLUSIVE VHF Coverage on Channels 2, 3 & 5."

for CALIF.-ORE. TV TRIO
call Don Telford, Mgr.

Phone Eureka, Hillside 3-3123 TWX EK18

or ask **BLAIR Television ASSOCIATES INC.** national representatives

New York, Chicago, San Francisco, Seattle, Los Angeles, Dallas, Detroit, Jacksonville, St. Louis, Boston.



EXECUTIVES of Crosley Broadcasting and ABC witness the signing of WLWI (TV) Indianapolis as a basic affiliate of the network. Seated (l to r): John T. Murphy, vice president in charge of television for Crosley; James D. Shouse, Crosley chairman of the board; Robert E. Dunville, Crosley president; and standing (l to r) Eric A. Jensen, general manager of Crosley's WLWD (TV) Dayton, Ohio, an ABC affiliate; Oliver Treyz, vice president in charge of the ABC Television Network; Alfred E. Beckman, vice president in charge of ABC station relations, and Harry Le Brun, general manager of WLWA (TV) Atlanta, also ABC-affiliated.

Crosley WLWI (TV) Signed As Basic ABC-TV Affiliate

WLWI (TV) Indianapolis (ch. 13) will become a primary affiliate of ABC-TV on Sept. 14, it was announced jointly last week by Robert E. Dunville, president of the Crosley Broadcasting Corp. and Alfred R. Beckman, vice president in charge of station relations for ABC-TV. WLWI is scheduled to begin operation in September, with effective radiated power of 316 kw visual.

"The affiliation of WLWI with the 'action' network is a further extension of the relationship which has long existed between the Crosley Broadcasting Corp. and ABC-TV," Mr. Dunville said. "The rapid growth and expansion of ABC-TV and its vigorous plans for the coming season make us certain that our newest television station will be launched successfully."

Other Crosley tv stations: WLWA (TV) Atlanta, ABC-TV; WLWT (TV) Cincinnati, NBC-TV; WLWC (TV) Columbus, NBC-TV; and WLWD (TV) Dayton, ABC-TV and NBC-TV.

NBC Radio Promotes Graham

PROMOTION of George A. Graham Jr. to director of sales planning for NBC Radio,



MR. GRAHAM

from the post of director of radio network sales service was announced last week by Matthew J. Culligan, vice president in charge of NBC Radio. Mr. Graham joined NBC-TV as a salesman in July 1953 and on Jan. 1, 1956, was appointed administrator of NBC-TV Sales.

CBS Signs KDKA-TV As Basic Affiliate

SIGNING of Westinghouse Broadcasting Co.'s KDKA-TV Pittsburgh as a basic required affiliate of CBS-TV was announced jointly Friday by Harold C. Lund, WBC vice president-Pittsburgh, and Edward P. Shurick, CBS-TV vice president and station relations director.

KDKA-TV currently is affiliated with all three networks and will continue to carry programs from all until Pittsburgh's second vhf station, WHC (TV), goes on the air.

KDKA-TV commenced operation Jan. 11, 1949, as WDTV (TV). It was then owned by DuMont. The change to KDKA-TV came in January 1955 when WBC bought it from DuMont. It is on ch. 2. Jerome R. Reeves is general manager.

Mr. Lund said KDKA-TV, after the shift in basic affiliation, would carry some ABC-TV shows.

The KDKA-TV change will mark the second Westinghouse tv station affiliation with CBS-TV. KPIX (TV) San Francisco, which WBC bought in July 1954, is CBS-TV-affiliated. Other two WBC tv stations—WBZ-TV Boston and KYW-TV Cleveland—are NBC-TV outlets.

Speculation centered last week on probable affiliation of WIIC with NBC-TV. Though ABC-TV reportedly has dickered with the station, it is believed that since more NBC-TV programs have been carried in the market on ch. 2 as the city's only vhf station since Jan. 11, 1949, the NBC-TV affiliation would be more logical. O. M. (Pete) Schloss, president of WIIC, was in New York last week talking to networks.

Awaiting final FCC action is a five-way contest for ch. 4 in Pittsburgh, which would give the market its third vhf outlet. ABC-TV long has sought its own outlet there.

EASTMAN MAY BE ABC RADIO HEAD

Robert E. Eastman, executive vice president of John Blair & Co., station representation firm, last week was reported to be all but in as head of the ABC Radio network.



MR. EASTMAN

Although neither he nor ABC would give confirmation, reports abounded that he was at least on the verge of signing to take over the ABC Radio top spot that has been vacant since Don Durgin moved to NBC-TV as vice president for sales planning [B•T, March 4].

There was some conflict as to just what his title would be, however. Some said Mr. Eastman was slated to become ABC vice president in charge of the radio network, the title which Mr. Durgin had held. Others speculated that ABC might be divided into separate divisions for radio and television, with Mr. Eastman becoming president of the radio division.

Mr. Eastman got his start and spent many

years in network radio. He started with NBC as a page, rising shortly to co-op programs sales and later NBC Spot Sales before moving over to the Blair Co. in 1943. John Blair & Co. represents all ABC owned radio stations except KABC Los Angeles. They are WABC New York, KGO San Francisco, WXYZ Detroit and 50% of WLS Chicago.

May 16 Dedication Ceremonies Set for ABC Chicago Studios

ABC's new Chicago headquarters [B•T, March 18, 4], built at a cost of \$1.5 million, will be dedicated on May 16, it was announced last week by Frank Marx, ABC vice president in charge of engineering and general services.

The new studios for ABC and WBKB (TV), the network's Chicago owned and operated station, are located at 190 N. State St. They occupy the top three floors in the ABC-States Lake Bldg. The new studios, Mr. Marx said, give the network and WBKB (TV) "60% greater space than previously, with the most advance telecasting facilities incorporated in the new location."

General and administrative offices will be located on the 10th floor, production and engineering rooms on the 11th and studios and technical facilities on the 12th. The new facilities are designed for conversion to color television in a minimum amount of time. Air conditioning units and lighting circuits to accommodate the needs of color television also have been installed.

Leonard H. Goldenson, president of AB-PT, will head the group of ABC executives participating in the dedication ceremonies.

ABC-TV Series to Star Brennan

NEW situation comedy series, *The Real McCoys*, starring Walter Brennan, has been acquired by ABC-TV for the 1957-58 season, it was announced last week by James T. Aubrey, ABC-TV vice president in charge of programming and talent. Created and produced by Irving Pincus, the new series deals with the problems of a family adjusting to the new surroundings of their recently inherited California ranch. Sheldon Leonard is director and Norman Pincus is associate producer. The show is produced jointly by the Brennan-Westgate Corp. and Merterto Productions and is written by Bill Manhoff.

NBC-TV Names Rittenberg

APPOINTMENT of Morris Rittenberg as manager, special program sales of NBC-TV, was announced last week by Michael H. Dann, vice president, Network program sales. Mr. Rittenberg, who has been manager of sales development for television network sales since January 1956, joined the network in 1953 as an operations analyst and later served as supervisor in program plans and policy evaluation, and as supervisor of financial evaluation.

WITHOUT A "PEER"
in the Rockford Area!

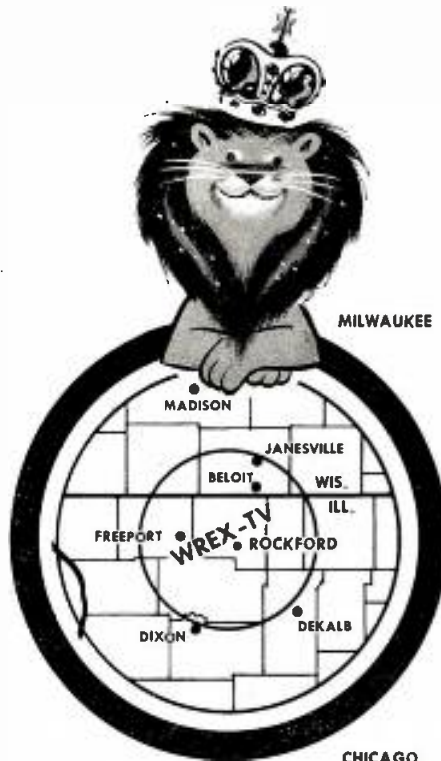

IN THIS \$ BILLION-PLUS
SALES EMPIRE WREX-TV
IS THE KING SALESMAN

The Rockford TV Area — Illinois' 1st market outside Chicago — is 400,195 families strong, with \$2,357,080,000 income. It embraces rich farm counties whose cities house industrial giants like General Motors, Fairbanks-Morse, Parker Pen, Burgess Battery, Sundstrand . . . and show sales indexes like Rockford's 158, Beloit's 151, Janesville's 153, DeKalb's 184, Freeport's 176, Dixon's 203. Sales total \$1,706,962,000, average \$4,265 per family — \$447 above average.

The most recent viewership survey again shows WREX-TV as the favorite, by better than 3 to 1. It's favored by advertisers too . . . for its consistent results, at much lower cost per thousand.

J. M. BAISCH, GENERAL MANAGER
Represented by H. R. TELEVISION, Inc.



Zugsmith, Oxarart Plan New Western Network

FORMATION of Intercontinental Broadcasting System as a network of western radio and tv stations was announced last week by Frank Oxarart, president of Continental Telecasting Corp. (KRKD-AM-FM Los Angeles, KITO San Bernardino). Outlets, in addition to the CTC stations, were announced as including KVSM San Mateo, Calif.; KMI-KSHO-TV Las Vegas, Nev.; KBYE Oklahoma City and KULA-AM-TV Honolulu, in which Mr. Oxarart, Arthur B. Hogan, John D. Feldmann and Albert Zugsmith have varying interests.

Mr. Zugsmith has been elected board chairman of IBS. Its other directors include Mr. Oxarart, president; Mr. Feldmann, executive vice president; Richard Schofield, vice president; Edward Jansen, treasurer; Ira Laufer, secretary, and Melville Tucker, executive of Universal Pictures. Mr. Laufer is newly appointed general manager of the Las Vegas stations, in which he holds a 20% interest [B•T, March 25].

Although the word "network" was used in the announcement, there are no plans for connecting the stations by telephone lines, Mr. Zugsmith said. The development is still in the formative stage, with the first meeting of affiliates still to be held, he said, but the idea is to make programs which have proved themselves successful in one market available to the rest of the group by transcriptions or tape recordings. It is possible that IBS might sell time for the full network as well as provide it with programs, Mr. Zugsmith said, stressing that it is yet too early to tell just what will eventually be worked out.



STATIONS

STORZ SELLS KOWH FOR \$822,500; SEVEN OTHER AM STATIONS SOLD

SALE of Todd Storz's KOWH Omaha, Neb., led a list of eight stations which changed hands, subject to FCC approval, last week. Involved were stations in Washington, Missouri, South Carolina, Georgia, Alabama and Florida.

KOWH was sold to National Weekly Inc., headed by William F. Buckley Jr., of New York and Stamford, Conn., for \$822,500. Seller was Todd Storz, heading the Storz Stations, who plans to transfer his operating headquarters to Miami [CLOSED CIRCUIT, March 25].

Mr. Buckley, 33, son of the operator of independent oil companies in South America and the Middle East, publishes the *National Review*, a weekly news magazine with national circulation, and was at one time associated with the *American Mercury*. He is the author of the controversial *God and Man at Yale*, published several years ago, and co-author of *McCarthy and His Enemies*, published more recently. Mrs. Buckley is a native of Omaha.

National Weekly Inc. acquires 100% of the station and is entirely owned by the Buckley family. The transaction involves a cash payment of \$650,000 with the balance to be paid following FCC approval.

Chairman of the board of National Weekly Inc. is Al Brent Bozell, son of the late Leo B. Bozell, founder of Bozell & Jacobs, national advertising agency which began business in Omaha. Mr. Bozell was the successor to Roy Cohn as counsel of the McCarthy Investigating Committee several years ago and is the co-author of the book on McCarthy.

KOWH was the first of the stations to be acquired by Mr. Storz, having been purchased in 1949 from the *Omaha World-Herald* for \$75,000. It operates on 660 kc with 500 w day. Other Storz stations are WDGY Minneapolis; WHB Kansas City; WTIK New Orleans and WQAM Miami.

Ray Hamilton of Hamilton, Stubblefield, Twining & Associates negotiated the transaction.

Acquisition of its sixth station, KTIK Seattle, Wash., was announced by Tele-Broadcasters Inc. (H. Scott Killgore) last week. The 5 kw daytime Seattle outlet (on 1590 kc) was bought for a total consideration in excess of \$320,000 from W. Gordon Allen, Mr. Killgore reported, and is subject to FCC approval.

Tele-Broadcasters already owns WPOW New York, N. Y.; KALI Pasadena, Calif.; WKXV Knoxville, Tenn.; WPOP Hartford, Conn.; KUDL Kansas City, Mo.

KTIK went on the air last year. Mr. Allen owns four other stations: KGAL Lebanon-Albany, KGAY Salem, both Ore.; KBAM Longview-Kelso, Wash., and KMAR Winnboro, La. There will be no change in the KTIK staff, Mr. Killgore announced.

Sale of KATZ St. Louis by St. Louis Broadcasting Co. to Rollins Broadcasting Co. for \$110,000 was announced last week.

The station, 1 kw on 1600 kc with a cp for 5 kw, is owned by Bernice Schwartz and Coralee Garrett. Allen Kander & Co. was broker.

Upon FCC approval Rollins will revamp KATZ format to program for Negro audience. This will make Rollins' fifth station using race programming; others are WRAP Norfolk, Va.; WNJR Newark, N. J.; WBEE Harvey, Ill. (Chicago area), and WGEE Indianapolis, Ind. Rollins also owns WJWL Georgetown and WAMS Wilmington, both Del., and WPTZ (TV) Plattsburgh, N. Y. (ch. 5). Rollins group was organized in 1950, is owned principally by O. Wayne and John W. Rollins.

Personnel of KATZ will remain unchanged, it was announced.

WJAT Swainsboro, Ga., was sold for \$125,000 by Jack A. and Nancy M. Thompson to James R. Denny and county music personality Webb Pierce. Messrs. Denny and Pierce are partners in three Nashville music publishing firms. In addition, Mr. Pierce performs on WSM-AM-TV Nashville and records for Decca records. Mr. Denny will serve as general manager of WJAT, which is on 800 kc with 1 kw daytime.

WFBF Fernandina Beach, Fla., 1 kw daytime on 1570 kc, sold by Marshall W. Rowland to Edward G. Murray, Norristown, Pa., for \$65,500. Mr. Rowland holds grant for WSIZ Douglas, Ga. Mr. Murray formerly was film director of WRCV-TV, and predecessor WPTZ [TV] Philadelphia) and vice president, WTBO Cumberland, Md. He now is program consultant for Storer Broadcasting Co.

WPFD Darlington, S. C., 500 w daytime on 1350 kc, sold by Robert R. Hilker to Ralph W. Hoffman for \$41,500. Mr. Hilker also owns WCHC Belmont, N. C. Mr. Hoff-



PAPERS are signed for the \$822,500 sale of KOWH Omaha by Todd Storz to William F. Buckley Jr. Here are seated (l to r) Mr. Buckley and Mr. Storz; standing (l to r) Peter Shuebruk, Fly, Shuebruk, Blume & Gaguine, Mr. Buckley's attorney; Ray V. Hamilton, Hamilton, Stubblefield, Twining & Assoc., broker in transaction, and Francis X. McDonough, Dow, Lohnes & Albertson, Mr. Storz' attorney.

Somewhere Every Day

Radio and Television Stations are accused of Committing

LIBEL
SLANDER
PIRACY
PLAGIARISM
INVASION OF PRIVACY
COPYRIGHT VIOLATION

based upon acts of Station, Staff, Announcers, Speakers, Performers, Commentators

You can't predict claims — BUT YOU CAN INSURE

effectively against embarrassing loss by having our unique policy at almost trifling cost.

WRITE FOR DETAILS AND RATES

EMPLOYERS REINSURANCE CORPORATION

21 WEST TENTH STREET
 KANSAS CITY, MO.



NBC President Robert Sarnoff and three other network officials inspect the suburban studios of WKY-AM-TV Oklahoma City during a visit to that community a fortnight ago. L to r: front row, David Adams and Harry Bannister, NBC vice presidents; Edward L. Gaylord, executive vice president of Oklahoma Publishing Co.; Hoyt Andres, WKY-AM-TV manager; Mr. Sarnoff; back row, Aaron Britton, WKY's production director, and Donald Mercer, NBC director of station relations.

man formerly had interest in WULA Eufala, Ala.

Blackburn & Co., station broker, handled the transactions in both the above sales.

WLAY Muscle Shoals, Ala., was sold by Michael R. Freeland to a three-party buyer comprising John M. Latham, Robert G. Watson, and Fred L. Thomas for a total sum of \$69,000. Mr. Latham is former part owner of WKTU Mayfield, Ky., and Mr. Thomas is the present owner of WKTU. WLAY operates on 1450 kc with 250 w.

WJVB Jacksonville Beach, Fla., was sold by Lyle Williams Jr. and associates to Andrew B. Letson, owner of WCNH Quincy and WMOP Ocala, both Fla., for \$60,000. WJVB is 1 kw daytime on 1010 kc, and showed a deficit of \$45,000 as of Dec. 31, 1956, according to the balance sheet submitted with the application last week.

Both above transactions were handled by Paul H. Chapman Co., Atlanta, Ga.

Hollander to WABC-TV Post

AL HOLLANDER, manager of radio and television at Edward Kletter Assoc., New York advertising agency servicing the Phar-



"I'm so glad we ran out of gas, Charles—now we can listen to something romantic on KRIZ Phoenix."

maceuticals Inc. account on NBC-TV's *Twenty-One* and CBS-TV's *To Tell The Truth*, today (Monday) assumes the position of program director of WABC-TV New York. He succeeds George Rice, transferred to a management post at KGO-TV, the ABC o&o station in San Francisco.

Ceremonies to Mark WDAU-TV Dedication

THE FLICK of a switch at noon today (Monday) will signal the change of WGBI-TV Scranton (ch. 22) to WDAU-TV, the transformation of the station's power from 178 kw to 1,000 kw, and the use of new transmitting equipment and the highest antenna tower in that part of the country.

Simultaneously with his ribbon cutting to open the northeastern extension of the Pennsylvania Turnpike linking the Scranton area with Philadelphia, Dr. Merritt Williamson, vice chairman of the state's Turnpike Commission, will throw a switch signaling the station's changeover to begin a two-day dedication ceremony for WDAU-TV.

The celebration will be climaxed tomorrow night at a dinner given by the Scranton Chamber of Commerce in that city's Mosque Temple. WDAU-TV cameramen will televise the affair.

Principal speaker at the dinner, to be attended by Scranton-Wilkes-Barre area mayors, state legislators, CBS-TV stars and officials and others, will be Charles Collingwood, host for CBS' *Odyssey* program. Other network entertainers expected to attend are Carmel Quinn, Irish singing star of the *Arthur Godfrey Show*; Warren Hull, master of ceremonies for *Strike It Rich* and Frank Fontaine, tv screen and radio comedian. Added attractions will be Jim Lewis of the "Mariners" and one of Philadelphia's Mummer (string) bands (55 pieces).

Donald W. Thornburgh, president and general manager of WCAU-AM-FM-TV (owned by the *Philadelphia Bulletin*) and

ILLINOIS' 2nd BIG MARKET

PIMITEOUI*

*Old Indian word for Peoria area meaning "land of plenty."



TOP AREA!

TOP SHOWS!

TOP POWER!

TOP TOWER!

TOP COVERAGE!

Only Chicago tops Metropolitan Peoria in population, income and retail sales.

PEORIA "Sets In Use" TOP 19 MAJOR TV MARKETS

- 28.1 Avg. (7 AM-Midnight)
- 47.6 Avg. (5 PM-Midnight)
- Higher than 19 of the top major TV markets

(compiled from ARB 11/56)

ONLY WTVH DOMINATES WITH CBS-ABC:

- 14 of the top 20 shows
- 151 of 196 evening ¼ hours
- (ARB 11/56)
- covers 18 rich counties



EDW. PETRY & CO.
NATIONAL REPS.

affiliated with
Peoria Journal Star

WTVH

Channel 19
PEORIA, ILLINOIS

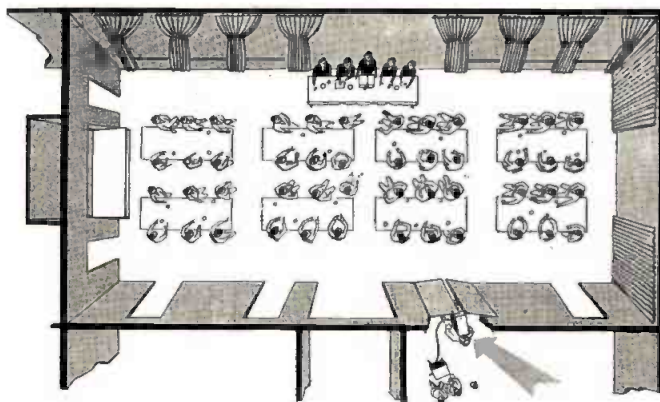

BROADCASTERS will place their case for access to courtrooms "where it belongs—at the mercy and discretion of the individual judge in the individual circumstance," W. D. (Dub) Rogers Jr., president-general manager of Texas Telecasting Inc., told the Lubbock County Bar Assn. March 23.

Arguing for broadcast coverage, Mr. Rogers revealed at the close of his address that the proceeding had been telecast on a closed-circuit system without the knowledge of many of those

present.

Mr. Rogers, who is a NARTB Tv Board member, showed how a camera and monitor had been installed in an adjoining room, with the camera shooting through a tiny aperture. A member of the association verified the coverage.

The pickup was handled by Rudy Starnes (at camera), KDUB-TV Lubbock chief engineer. Buddy Adams, a member of the bar group, sat at the adjacent monitors.

president of Scranton Broadcasters Inc., licensee of WDAU-AM-TV, will receive the keys to the twin cities of Scranton and Wilkes-Barre from their respective mayors.

Controlling interest in the station was purchased by WCAU Inc. last August and officially transferred last Dec. 3. It is affiliated with CBS.

WOR Discloses Plans For New York Survey

IN WHAT was claimed last week as "probably the most extensive coverage study ever ordered by an individual radio station," WOR New York disclosed that it has commissioned the Pulse Inc. to measure the au-

dience of major New York stations throughout an area of 153 counties in 13 states.

Plans were announced by Robert J. Leder, WOR vice president and general manager, after Robert M. Hoffman, the station's director of promotion and planning, unveiled the technique used and results obtained from a field test in Philadelphia before a forum held on Nielsen Coverage Survey No. 2 (see story page 34).

The Pulse-WOR survey plans include about 14,000 personal interviews conducted in March and through the middle of this month. All counties in which any New York radio station showed 10% or better audience penetration in the 1952 Standard Audit & Measurement (SAM) study will be checked.

Used will be a roster of stations serving each particular county surveyed, which according to WOR, "eliminates the flaws inherent in previous coverage studies and at the same time contains two safeguards designed to eliminate possible 'over reporting' by families being interviewed." Safety measures to be contained in the survey will be the inclusion of call letters of a non-existent station in the roster, and any respondent claiming to have listened to any New York station will be required to name a specific program on that station in the past week.

(Nielsen's Vice President John K. Churchill at the RTES forum asserted that with the "aided recall" technique "you get big numbers" which is all right if that's what is wanted. He also doubted effectiveness of the use of "bogus" call letters as a corrective because people usually can detect it when placed with a list of known stations).

WOR claims that its Philadelphia test via the roster methods indicated a 13% greater audience per week than with the so-called "open end" question (depends on person's memory at the particular moment a question is asked). The station asserts also that the weekly audience for the five major New York stations averages 79% greater with the roster question than with "open end."

HOW'S THIS FOR ...

WINGSPAN?

TELEPROMPTER CORPORATION'S GROWTH PATTERN

- 1953** . . . 1st DISPLAY AT NARTB
- 1954** . . . EXPAND EXHIBIT to fill TWO hotel rooms
- 1955** . . . ENLARGE OPERATION to main floor exhibit
- 1956** . . . 6th LARGEST EXHIBITOR AT NARTB

NOW 1957 THE 3rd LARGEST!
NARTB EXHIBITOR!

FEATURING
NEW AND EXCITING
DEVELOPMENTS FOR THE TV INDUSTRY!

New MOD V (all new 1957 TelePrompTer) . . . NEW TELEPRO "6000" Last word in REAR SCREEN projection . . . NEW Expansion program, TelePrompTer Corporation's NEW Group Communications Division, specializing in CLOSED-CIRCUIT television services.

TELEPROMPTER CORPORATION

311 West 43rd St., New York 36, N. Y. • JUdson 2-3800

HERBERT W. HOBLER, V. Pres. Sales JAMES BLAIR, Eqpt. Sales Mgr.

LOS ANGELES • CHICAGO • WASHINGTON, D.C. • PHILADELPHIA
DETROIT • MIAMI • TORONTO • LONDON

Westinghouse Forms News Bureau in D.C.

TO BRING national and world news stories into relative focus for the various markets served by Westinghouse Broadcasting Co. Stations, WBC today (Monday) establishes a news bureau in Washington to serve



MR. MacLEISH

its radio and tv outlets. Bureau Chief is Rod MacLeish, news director of Westinghouse-owned WBZ Boston - WBZA Springfield [CLOSED CIRCUIT, March 25].

Mr. MacLeish last week fed WBC outlets coverage of Dave Beck's testimony before a Senate committee.

The Westinghouse stations are WBZ-WBZA Boston and Springfield; WBZ-TV Boston; KDKA-AM-TV Pittsburgh; KYW-AM-TV Cleveland; WOWO Fort Wayne; WIND Chicago; KPIX (TV) San Francisco and KEX Portland, Ore.

Westinghouse has not yet chosen a successor for Mr. MacLeish at WBZ, but Leo Egan, newscaster and sports director for the station, last week was assigned to handle Mr. MacLeish's local broadcasts. Mr. MacLeish last week also was chosen an Outstanding Young Man by the Greater Boston Junior Chamber of Commerce.

Murphy Replaces Rainsberger

JOHN MURPHY has been named general manager of KFAM-AM-FM St. Cloud, Minn., replacing Dale Rainsberger.

Appointed assistant manager and program manager for the station was Jack Lund. The new appointments were announced by Fred C. Schilpin, president of the Times Publishing Co., station licensee.



FINAL details on appointment of Simmons Assoc., New York and Chicago, as national sales representative of WPET Greensboro, N. C., are set by Dave Simmons (l), president of Simmons Assoc., and Hugh Holder, president of the daytime station that broadcasts with 500 w on 950 kc. The appointment coincided with new ownership of the station.

Choose the package that fits your programming needs!

from the
Sesac Transcribed Library

- "A" Folk Music
- "B" Band Music
- "C" Popular Classics
- "G" Gospel Music
- "H" Hawaiian Music
- "N" Novelty (Dance & Jazz)
- "P" Polka Music
- "R" Religious Music
- "S" Spanish Music

SEE SESAC

AT THE
NARTB Convention, April 7-11, 1957
The Conrad Hilton Hotel, Chicago
Suite Nos. 524A—526A

Producers of the famous
SESAC
Transcribed Library

"the best music in America"

Sesac, Inc.



THE COLISEUM TOWER
10 COLUMBUS CIRCLE
NEW YORK 19, N. Y.



WHO SALUTES

If you buy radio time by the "Let's run it up a flagpole and see who salutes" method, WBNS Radio is at the top of the staff. Our salutin', listenin' friends have \$2,739,749,000 to spend. They and Pulse place us first in any Monday-through Friday quarter-hour, day or night. Ask John Blair.

WBNS RADIO
COLUMBUS, OHIO



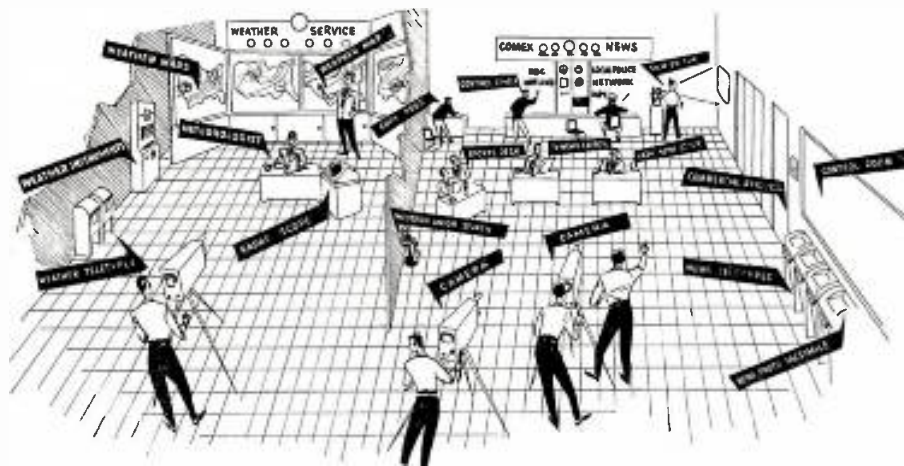

EVERYTHING going into a newscast and out to radio and tv transmitters is fitted neatly together in the new communications exchange (Comex) of WLW-WLWT (TV) Cincinnati, which will be formally unveiled Friday. The schematic layout shows how facilities and personnel are efficiently controlled. News personnel work in quick reach of camera and microphone (lower left). In action are (l to r) Paul Lunford, tv news editor; Don Grenley, news writer; Peter Grant, top newscaster; Arthur Nevins, tv news film editor, and Terry Flynn, radio news editor. A network of apparatus and communications facilities provides weather service for Jim Fidler, WLW-WLWT chief meteorologist, shown at a radar screen that visually tracks rough weather in the Ohio and Kentucky hills. Tv cameras dolly from newsroom to weather studio, separated by a partial partition.

EMPHASIS IS ON EFFICIENCY AT COMEX, NEWS PIVOT SETUP FOR WLW-WLWT (TV)

A NEW nerve-center into which all the information used by WLW-WLWT (TV) Cincinnati program operations is fed and out of which all news, service and sports broadcasts are delivered, will be formally opened Friday by Crosley Broadcasting Corp.

This communications exchange, appropriately titled Comex, combines an intricate array of equipment, personnel and functions into an operation that Robert E. Dunville, president-general manager of the stations, believes will set new industry standards for efficiency and public service.

Located in a new building across the street from Crosley Square, as the Crosley headquarters is known, Comex consists of two basic units—news-sports center and adjoining weather studio. The key units are separated by a partial partition, allowing camera crews to dolly easily from one to the other.

In substance, the news side of Comex has a collection of wire, electronic and film communications apparatus that provides all that news and sports personnel need to get their program material and put it on the air—audio, video and simulcast. The weather unit has complete meteorological facilities for radio and tv broadcasting, including a

radar weather unit that can show the tv audience actual storms and squalls as they move across that part of the country.

The entire setup is open to public gaze through reflection-free panorama windows along the sidewalk.

With radio and tv schedules that emphasize news, weather, sports and service programming, the Crosley Comex plant is operated as a remote studio—not very remote, however, since camera and technical crews merely walk across the street. An underground viaduct carries camera and aural cables to the main building.

The evolution of Comex dates back to the autumn of 1955 when the Crosley stations billed their news coverage under a *World Now* label, with more emphasis on local news and a larger staff. As the communications nerve-center idea began taking hold, Mr. Dunville, Al Bland, program vice president, and his assistant, John Babcock, came up with the Comex designation. "Now the news from Comex" became a familiar introduction around the Cincinnati stations' coverage area.

Gene Dailey, formerly at WBBM Chicago under Mr. Bland, joined the Crosley stations last May as news director. He found himself at the head of a complex program setup

scattered from basement to garret of Crosley Square. The toughest part of his job was communicating with his organization.

Now Mr. Dailey, from Crosley Square, directs the complete Comex operation. The separate radio and tv news programming personnel sit at desks equipped with microphones. Two cameras can dolly around the two Comex departments where four were needed in Crosley Square. If necessary, three cameras can operate in Comex and there is wiring for a fourth.

The Comex news-special event room includes nine news teletypes, facsimile for stills, Western Union sports ticker, two Ampex 600 rack-mounted tape recorders, police radio, two turntables, two RCA tv cameras. NBC Hot Line box, lighting for black-and-white tv with provision for color, radio control room with provision for tv control at later date, city desks, writers' desks, row of clocks, maps, newsfilm equipment, network monitors, and air switches.

Commercials can now be picked for tv programs right in Comex, whereas they formerly had to be handled in Crosley Square. This cuts down camera costs.

The Comex weather service, directed by chief meteorologist, Jim Fidler, has complete professional equipment for forecasting plus what is claimed to be the only radar equipment built into an on-the-air broadcast service. A score of weather broadcasts are scheduled every day—all of them sponsored. With three shifts of professional meteorologists, WLW and WLWT weather service utilizes humidity, wind, barometer, temperature and rainfall gear located in the studio and out on the roof of the new Comex building.

The British Decca radar pickup is located atop the tv tower on a Cincinnati hill. Its readings are fed to Comex, converted by infra-red tube into a pickup camera and then put on the air when storms are around the area. When the radar image is enlarged through a map-grid overlay, the WLWT audience can watch storms moving across the screens of tv receivers.

Mr. Fidler has a large corps of volunteer weather scouts ("Echo Detectives") around the WLW-WLWT area. Their tips supplement instrument reports, aviation weather service and other information. Sometimes one of the meteorologists will go up in the Crosley Piper Apache plane for a quick look at a trouble spot.

WBLN (TV) Nearer Reopening With \$25,000 Sale of Shares

WBLN (TV) Bloomington, Ill., which suspended operation earlier this year, has received about half of a needed \$50,000 in sale of public shares looking toward resumption of full-scale telecasting this month.

Advertisement in the local *Pantagraph* (WJBC-AM-FM) claims "we can go over the top if several hundred people will buy one or more shares at \$25 per share." The uhf (ch. 15) outlet, licensed to WBLN Television Inc., now plans to resume partial operation soon, according to Worth S. Rough, president and general manager. Station began operation in December 1953 and went off the air last February because of financial difficulties.

WFGA-TV Names Cripe, Nimmons Station Manager, Sales Manager

JESSE H. CRIFE and Ralph W. Nimmons have been announced as station manager and general sales manager, respectively, of WFGA-TV Jacksonville, Fla., now under construction.

Mr. Cripe comes to the ch. 12 facility



MR. CRIFE

MR. NIMMONS

from WTVJ-TV Miami, where he formerly was assistant operations manager. Mr. Nimmons was manager of WFAA-TV Dallas, Tex.

WFGA-TV will operate with 316 kw from a 28,000-sq. ft. plant and a 1,000-ft. tower.

Screen Named WDSU Manager

JOHN F. SCREEN has been appointed manager of WDSU-AM-FM New Orleans, it was announced last week by Robert D.



MR. SCREEN

Swezey, executive vice president and general manager of WDSU Bcstg. Corp. Since April 1951 when he joined the WDSU staff as a sales representative, Mr. Screen has served successively as assistant commercial manager for radio,

a tv sales representative (after the separation of the radio and tv sales staffs in 1954), then assistant commercial manager for WDSU-TV.

WANE, WINT(TV) Name Petry

INDIANA Broadcasting Corp., recently purchased by J. H. Whitney Co., has appointed Edward Petry & Co., New York, as its national sales representative for WANE-AM-TV Fort Wayne, Ind., effective today (Monday) [CLOSED CIRCUIT, March 18.] WANE-TV, formerly WINT (TV), is affiliated with CBS-TV and operates on ch. 15 with ERP of 470 kw visual and 254 kw aural.

THE COMMUNITY NEWS VOICE

RADIO WSRS

GREATER CLEVELAND'S
NUMBER 1 STATION
SRS "Radio-Active" MBS

BROADCASTING • TELECASTING

HIGH ON THE HILL

LIVE coverage of the Capitol Hill appearance by Teamsters Union President Dave Beck cost WTOP-TV Washington about \$15,000 in business sacrificed, but it earned the station incalculable viewer gratitude and the distinction of being the only television station in the country to carry the hearings live. Networks carried film accounts of the two days' testimony.

With dismissal of the truck drivers' leader Wednesday at 5:05 p.m., WTOP-TV wound up nearly 11 hours of continuous and exclusive live coverage. The probe had started at 10 a.m. Tuesday and Wednesday and ended around 5 each afternoon, with midday lunch breaks. WTOP-TV's decision to carry the hearings meant the station would forego daytime network programs, spot business and a local daily children's show.

Peggy Stone Named President Of Radio Tv Representatives

APPOINTMENT of Peggy Stone, vice president of Radio Tv Representatives Inc., New York, as president of the company is being announced today (Monday). Miss Stone suc-



MISS STONE

MR. GOODMAN

ceeds Harry S. Goodman, who has been named chairman of the board. Radio Tv Representatives recently completed an expansion program, adding several account executives to the staff. The company also has moved into larger quarters in New York at 7 E. 47th St.

STATION PEOPLE

G. Roger Bower, vice president, Sir Walter Tv Co. (WNAO-TV and WKIX, both Raleigh, N. C.), appointed general manager of WNAO-TV and WKIX.

Duane W. Ramsey, general manager, KMLW Marlin, Tex., to KTXL San Angelo as manager.

Malcolm A. Campbell Jr., WNAV Annapolis, Md., to WAJR-AM-FM Morgantown, W. Va., as manager, succeeding Richard E. Nason.

Richard L. Stahlberger, assistant sales promotion manager of WCBS New York, named sales promotion manager succeeding Murray Gross, to TvB as assistant to bureau's director of sales development.

Ted Eiland, general manager-sales director, WPTV (TV) West Palm Beach, Fla., to WTVJ (TV) Miami as local sales manager.

'WAY OUT IN FRONT!

ONLY
WSAZ-TV
COVERS
THE
HUNTINGTON-CHARLESTON
MARKET

NIELSEN: NCS # 2 1956			
% PENETRATION OF COUNTIES IN COVERAGE			
WSAZ-TV	STA. B	STA. C	
100% COVERAGE COUNTIES	21	1	1
MORE THAN 75% COVERAGE COUNTIES	45	21	5
MORE THAN 50% COVERAGE COUNTIES	56	30	15
TOTAL COUNTIES COVERAGE	69	50	22

ARB: 8 out of TOP 12*
*February 1957

WSAZ-TV
CHANNEL 3
1953
HUNTINGTON-CHARLESTON, W. VA.
N.B.C. NETWORK
Affiliated with Radio Stations
WSAZ, Huntington & WKAZ, Charleston
LAWRENCE H. ROGERS, PRESIDENT
Represented by The Katz Agency

Ampex Establishes Subsidiary For Hi-Fi Consumer Products

AMPEX Corp. (magnetic tape recorders), Redwood City, Calif., has created a subsidiary firm, Ampex Audio Inc., Sunnyvale, Calif., for high fidelity consumer retail products. Phillip L. Gundy, vice president and audio division manager of the parent company, is president of Ampex Audio Inc.

Herbert L. Brown, administration manager of the old audio division, will be vice president and general manager of the new corporation. Austin Ellmore has been named chief engineer, Arthur Stofen manufacturing manager and Bernard Quinn, manager of finance.

Ampex decided to form the new company because of success it has enjoyed upon entry into the consumer field. The new unit, employing 250 persons, has set July 1 to occupy quarters in Sunnyvale.

Admiral Corp.'s Net Sales Drop About \$20 Million in '56

DESPITE an increase in unit sales over 1955, Admiral Corp.'s consolidated net sales dropped from \$202,361,797 to \$182,046,168 in 1956 because of lower average selling price and consequent lower dollar volume.

In the company's annual report released Monday, Ross D. Siragusa, Admiral president, also made note of the first strike in Admiral's 23-year history and a \$9 million sales decrease of Canadian Admiral Corp.

Admiral had consolidated net income of \$1,037,274 (or 44 cents a share on 2,362,096 shares outstanding) compared with 1955 earnings of \$3,932,144 (\$1.66 per share) before special charges and \$2,282,144 (97 cents per share) after special charges.

MANUFACTURING PEOPLE

Ernest H. Ulm, product sales manager of electronics, Sylvania Electric Products, Woburn, Mass., named general sales manager of Semiconductor Div.

Bill Neumann, chief engineer, KRLC Lewiston, Idaho, to Gates Radio Co., same city, as sales engineer for Wash., Idaho and eastern Ore.



MR. NEUMANN

Edmour F. Giguere, vice president of sales, Clevite Transistor Products, Waltham, Mass., to RCA Components Div., Camden, N. J., as

manager of new market coordination.

M. Ross Yeiter, product sales specialist, Sylvania Electric Products, N. Y., named sales manager for special tube operations.

Edward W. Allen Jr., publicity-publications manager, Allen B. DuMont Labs, named public relations manager, succeeding Benjamin C. Bowker, who joins U. S. Plywood Corp.

FOWLER REPORT ADOPTION URGED; WOULD TAKE AWAY REINS FROM CBC

- Commission supports new 15-man regulatory body
- Would break CBC monopoly on tv in major markets
- Color tv by mid-1959 offered as another objective

NEARLY 21 years of regulating its competition will end for Canadian Broadcasting Corp. if recommendations of Royal Commission on Broadcasting, announced noon Thursday at Ottawa, are adopted by the government. The long-awaited commission report recommended a new 15-man broadcasting board to control and regulate both CBC and privately-owned radio and television stations in Canada.

While the report at times scolded the Canadian Assn. of Radio & Television Broadcasters, it recommended an independent regulatory body, the main goal for which private broadcasters had fought for more than a decade. The report also recommended establishment of second television stations in Canadian cities, after adequate regulations are formulated to guard program quality. At the present time, cities with CBC tv outlets are reserved against privately-owned competition.

A goal of mid-1959 for CBC color television was suggested in the report.

Report was written by Robert M. Fowler, chairman of the Canadian Pulp & Paper Assn., Montreal, with James Stewart, president, Canadian Bank of Commerce, Toronto, and Edmund Turcotte, former Canadian ambassador to Columbia. It followed almost a year of hearings across Canada, in United States and Europe. The report contained 289 pages and 229 pages of appendices.

Would Drop Dominion

The commissioners stated that CBC should drop its Dominion Radio Network, be allowed to solicit local advertising on radio and television, charge advertisers for a larger part of its television program production costs, trim its staff for greater efficiency, and be financed from general Canadian treasury. Future financing of CBC was a major reason for the commission inquiry. The commission suggested CBC financing should be equal to a yearly fractional percentage of Canadian personal expenditures on consumer goods and services as estimated by Dominion Bureau of Statistics, Ottawa. This would vary from quarter of one percent in 1959 to one-third of one percent in 1963. This would mean for 1958 about \$44 million, and \$74 million by 1963.

These sums were recommended for CBC's operating expenditures, in addition to its commercial revenue. Capital expenditures should come from the present 15% excise tax levied on the manufacturers' price for radio and television sets and tubes. The commission anticipated CBC capital expenditures for 1958 at \$10.5 million and revenue from excise taxes at \$16 million. Excise tax revenue by 1963 of \$26 million was forecast.

The proposed 15-man broadcasting board would be appointed for five year periods,

with individuals for varying length. No CBC officials would be on the board. Members would be appointed from the public, and technical knowledge would not be required. The board would meet monthly. The executive committee of four would not be permanent personnel, with chairman paid a maximum \$10,000 yearly and the vice-chairman \$5,000.

This board would have quasi-judicial licensing powers, with the Dept. of Transport overseeing technical aspects for final approval. The board would have sweeping regulatory and control powers, and be the final court of appeal. It would enforce regulations with the power to fine for breach of regulations. Fines for first offenses would range from \$500 to \$1,000.

The report recommended Canadian control over broadcasting station ownership, with a maximum 20% foreign ownership, approximately the present regulation. The commissioners saw no monopoly evil in operation of both radio and television stations, but noted that licenses granted independents were preferable. The report urged that the new board formulate regulations on programs, advertising content and Canadian productions, and insist on avoiding "stupefying mediocrity" that commissioners often found marked private station presentations.

The commissioners recommended that CBC continue operation of networks, and granting private stations temporary not permanent, network privileges. It pointed out private radio and television operators were certainly not lacking for profits, and urged them to spend more for original programming with special emphasis on Canadian live talent shows. In many instances the commissioners praised private stations for community and regional programming policies.

The commissioners thought CBC would

CBC Realigns News Executives Following Television Expansion

REALIGNMENT of Canadian Bcstg. Corp.'s top news executives was announced on March 20 by W. H. Hogg, chief news editor, Toronto headquarters. The changes were designed to strengthen the news service after four years of expansion in television news. CBC has 11 newsrooms across Canada and produces 90 radio newscasts and 12 television newscasts daily.

C. G. Gunning, 42, senior CBC news editor at Winnipeg, Man., has been appointed general news editor at Toronto, Ont. D. J. Macdonald, 36, tv news editor at Toronto since 1955, becomes general supervisor of tv news. Laurence Duffey, 36, news editor of radio and tv at Vancouver, B. C., was appointed manager of national tv news at Toronto.

not need a fulltime chairman, but rather a parttime president and fulltime general manager. CBC production facilities should be expanded in Toronto and Montreal, away from midtown areas. It warned against decentralization of production facilities to satisfy regional pride. While the report praised CBC for starting two Canadian historical adventure film series last year, it suggested this work could be better done by government's National Film Board.

It suggested color television be started by

mid-1959 and that half of CBC television be in color by 1963.

How soon the recommendations will be implemented is now the big question in Canadian broadcasting circles, since the government is expected to call a federal election in June and this leaves no time for enacting legislation. The present government is expected to be returned to power next election, and legislation may be started by next winter.

MANY TOPICS FEATURE CARTB MEET

BETTER radio programming for listener wants, more audience research, television advertising, Canadian radio week promotion, and office automation featured discussions of the three-day 32nd annual convention of the Canadian Association Radio and Television Broadcasters at Chateau Frontenac, Quebec City last week. The largest attendance in the association's history, over 500, heard Tennessee's Governor Frank G. Clement exhort Canadians to continue their role of interpreter between United States and the remainder of the world for peace at last Tuesday's formal dinner.

Contentious problems were absent as Canadian broadcasters awaited the report of the Royal Commission on Broadcasting, finally released Thursday (story, page 134) and which is expected to establish government policy on radio and television for the next few years. Constructive plans for possible pooling of program talent, establishment of regional networks, and researching of audience wants for both radio and television accounted for most discussions at both the general and closed meetings.

Vern Dallin, CFQC-AM-FM Saskatoon, Sask., was elected president of the CARTB at Tuesday's business session. He succeeds Fred Lynds, CKCW-AM-TV Moncton, N. B. D. A. Gourd, CKRN Rouyn, Que., and Geoff Stirling, CJON-TV St. John's, Newfoundland, were elected vice presidents. Jim Allard was renamed executive vice president.

Directors elected in addition to the above officers, were J. A. Manning, CKCL Truro, N. S.; F. B. Ricard, CHNO Sudbury, Ont.; Lionel Morin, CJMS Montreal; Tom Burham, CKRS-TV Jonquiere, Que.; J. M. Davidson, CJKL Kirkland, Lake Ont.; J. A. Dupont, CJAD Montreal; E. E. Fitzgibbons, CKCO-TV Kitchener, Ont.; W. H. Stoven, CJBQ Belleville, Ont.; W. M. Hawkins, CFOS Owen Sound, Ont.; R. J. Buss, CHAT Medicine Hat, Alberta; J. O. Blick, CJOB Winnipeg, Man.; N. Botterill, CJLH-TV Lethbridge, Alberta; C. J. Rudd, CHUB Nanaimo, B. C.; A. G. Seabrook, CJIB, Vernon, B. C.; and D. M. Armstrong, CKEH-TV Victoria, B. C.

Radio's future featured Monday's opening session. Barney Corson, advertising director, Tidy House Products Co., Shenandoah, Iowa, warned Canadian broadcasters not to follow the example of American broadcasters in siphoning off the best creative brains and talent from radio into television. He urged them to develop belief of the community in its station, program-

ming that is of interest to listeners, improved public relations with retail outlets, better knowledge of the market so one can talk intelligently to advertisers, sale of your medium for what it can do and what it is worth.

Knowledge of a station's market and what it can do for advertisers was stressed by Fred Gregg, account executive, Young and Rubicam, New York. He stated advertisers were looking for facilities that will sell a product, and stations have the right to charge for facilities that deliver sales.

Changing dimensions of radio were discussed by Arthur Porter, media director for J. Walter Thompson Co., New York. (See text, page 138.)

Monday afternoon's session opened with a group of unidentified sponsors telling why they don't like radio. The group was chaired by Bill Byles, H. S. Stovin & Co., Toronto station representative firm. The reasons they advanced included hodgepodge rate structure of Canadian stations, blatant promotional material, radio stations inability to react to change in programming and selling methods, the need for greater co-operation between agencies and stations, the lack of adequate information supplied by stations to representatives, and failure to announce deals on rate cards.

Editorializing for radio stations was discussed by President Danial Kops, executive vice president of WAVZ New Haven, Conn. He stated that "a radio editorial is an official expression of station management to its community, distinct from the station's news broadcasting. The prestige and stature that a station builds by editorializing is worth a great deal. A station that identifies itself with the wants of the people of a community and fights their fights will always be distinctive."

More collaboration between Canadian radio stations and universities, following a pattern established in the United States, was urged by Paul Lazarsfeld, of the Columbia U. sociology department. He reported on various studies made in mass communications, and told broadcasters how to use simple techniques to study audience reactions to programs and commercials.

At a luncheon meeting of the French-language Assn. of Radio & Television Broadcasters, D. A. Gourd, CKRN Rouyn, Que., was elected president, and Rene Lapointe, CKBL Matane, Que., vice president.

Directors elected were Tom Burham, CKRS Jonquiere, Que.; Maurice Boulianne, CJSO Sorel, Que.; Marcel Leboeuf, CKCV



WHBF

RADIO & TELEVISION

the station
of marketing success
in the Quad-Cities



Stories from the Sports Record

Spring Continuities

Music and sports team up in this series devoted to eye-witness accounts of dramatic action on the spring sports scene.

This continuity package contains 12 fifteen minute programs featuring the sports of the spring season . . . baseball, car racing, horse racing, track, along with some of the great . . . anecdotes of the world of sports.

Your Station Program Department should be receiving this script package regularly. If not, please write to BMI's Station Service Department for "Stories from the Sports Record."

BROADCAST MUSIC, INC.
589 FIFTH AVE. NEW YORK 17, N.Y.
NEW YORK • CHICAGO • HOLLYWOOD • TORONTO • MONTREAL

BROADCASTING • TELECASTING
1735 DeSole's Street, N.W., Washington 6, D. C.

Enter my subscription to include the 1957 BROADCASTING Yearbook-Marketbook—\$9.00

Adjust my subscription to include the 1957 BROADCASTING Yearbook-Marketbook—\$2.00

Please send me copies of 1957 BROADCASTING Yearbook-Marketbook @ \$3.00.

name _____ position/title _____

company _____

street _____

city _____ state _____

... JUST PUBLISHED

1957 BROADCASTING YEARBOOK MARKETBOOK

The 23rd consecutive edition of "Radio's One-Book Reference Library" is being mailed to subscribers. If you're not already a B•T subscriber, or if your subscription does not include the BROADCASTING Yearbook-Marketbook please check and mail this order form

INTERNATIONAL

Quebec; Roland Couture, CKSB St. Boniface, Man. Andre Daveluy, CKAC Montreal, was elected secretary-treasurer of the 33 French-language station association.

Retiring President Fred Lynds reported at Tuesday's closed session on plans to step up assistance to French-language stations, on the expansion of the association's sales divisions with new officers at Montreal, and on taxation and copyright problems.

Executive Vice President Jim Allard suggested various methods of pooling Canadian talent for program improvement, of utilizing co-operative methods of cost control and operating economies, of researching audience wants, of training personnel in an era of growing labor and executive shortage, and of studying office and program automation.

At a closed business session the convention decided to defer action of the proposed name change from CARTB the former Canadian Assn. of Broadcasters for further legal study, and unanimously resolved to assist students at Ryerson Institute of Technology, Toronto, with scholarships and bursaries. The convention also unanimously resolved to refuse free time for programs of any kind with a commercial origination, product, name or service. The resolution urging stations to sell banks on the value of radio and television met unanimous approval.

At a short BBM annual meeting, the group's constitution was changed to provide board of five from each of advertiser, agency and broadcaster organizations, and new fee basis were announced. Broadcasting board members elected were Horace Stovin, Toronto; Lloyd Moore, CFRB Toronto; Andre Daveluy, CKAC Montreal; Ross McCreath, All-Canada Radio Facilities, Toronto, and Cliff Wingrove, CFPL-TV London, Ont.

Wednesday's television day started off with Canadian station and agency executives being given a practical lesson on retail advertising as used by Fowler, Dick and Walker Department Store, Wilkes-Barre, Pennsylvania. John Green, store advertising manager, took Canadian advertisers through all stages of preparation of copy and programming, and showed them how to educate retailers in the use of television economically and successfully. He explained retailers have little knowledge of what television can do for them. Rodney Erickson, vice president of Young and Rubicam, New York, showed Canadians (with slides and figures) the latest data on program audience reaction from his agency's studies; he emphasized that television can sell anything with well balanced programming. He reported the growth of feature films for both daytime and night programming, and the use of magazine type daytime shows. Mr. Erickson stated that engineers would be forced to develop foolproof color receivers due to the slowdown of black-and-white set sales.

Television sales featured closing Wednesday afternoon session, with W. Dekker, media director. McCann-Erickson, New York, outlining the increasing importance of audience research to assist broadcast media buyers in purchasing time for clients.

EDUCATION

Ford Makes Grants In Communications

THE FORD Fund for Adult Education has announced names of recipients of grants for 1957-58 study, 12 of them in the field of broadcasting. At the same time the foundation said it is making about 20 grants available for mass communication study in 1958-59.

Radio-tv grantees for 1957-58: Graydon L. Ausmus, director, broadcasting services, U. of Alabama; Norman De Marco, associate professor and manager, fine arts center, U. of Kansas; Robert W. Clyde, tv news director, WREX-TV Rockford, Ill.; Milton W. Metz, announcer, WHAS-TV Louisville; Sister M. Annella, OSB, chairman, speech and drama dept., College of St. Scholastica, Duluth, Minn.; William T. Pettit, writer-director, Continental Films-WCCO-TV Minneapolis.

Clarence E. Flick, assistant professor and director of radio-tv, U. of Nebraska; Roswell C. Williams, director of communication arts, Creighton U.; Ben L. Yablonky, associate professor of journalism, New York U.; Nazaret Cherkezian, assistant to director, office of radio-television, New York U.; Shelby Gordon, writer-producer-director, CBS Television; Gerald H. Elliott, station manager-news director, WCBT Roanoke Rapids, N. C.

Applications may be obtained by writing to Leadership Training Awards (Mass Media), Fund for Adult Education, 320 Westchester Ave., White Plains, N. Y.

WQED (TV) Adds Sunday Hours To Carry NBC-TV Programming

AS AN OUTGROWTH of the educational television project of NBC-TV and the Educational & Television Radio Center, WQED (TV) Pittsburgh, educational station which now broadcasts five days a week, will go on the air Sundays also, starting this week. The station's Sunday schedule will consist of six regular NBC-TV shows.

Since NBC-TV lines were set up for the educational programs and the center provided local "loops", WQED has scheduled the following Sunday NBC-TV programs: *Zoo Parade*, *Outlook*, *Mr. Wizard*, *Meet The Press* and *Frontiers of Faith*. The programs are all unsponsored except for *Meet the Press*, and that show will be carried on WQED (TV) with the commercial portions deleted.

ETRC Establishes Program For Educational Tv Production

EDUCATIONAL Television & Radio Center, Ann Arbor, Mich., announced last week that it has established a three-year program of grants, totalling \$300,000, for educational radio production. The project will be conducted in cooperation with the National Assn. of Educational Broadcasters.

Applications for \$100,000 grants each in 1957-58-59 can be made by accredited educational institutions before June 15 to the NAEB, Gregory Hall, Urbana, Ill. Programs developed under the grants will be made available for broadcast by the 136 educational am's of the NAEB network.

HUNTLEY, STATIONS GET duPONT AWARDS

- KNXT (TV), WFMT (FM) Named
- NBC newsmen only individual

WINNERS of the Alfred I. duPont Radio & Television Awards for 1956 were announced Friday at the annual awards dinner at the Mayflower Hotel in Washington, D. C. They are KNXT (TV) Los Angeles, WFMT (FM) Chicago and NBC commentator Chet Huntley.

Awards were accepted at the dinner by Mr. Huntley, WFMT President and General Manager Bernard Jacobs and Clark George, KNXT general manager.

Winners received plaques and checks for



MR. GEORGE

MR. JACOBS

\$1,000, with the opportunity offered to use



MR. HUNTLEY

the cash to establish communications scholarships at institutions they designate. Foundation Curator O. W. Riegel, director of the Lee Memorial Journalism Foundation at W&L U., at the banquet reviewed scholarship activities being underwritten by previous award winners.

The duPont Awards were established in 1942 by Mrs. Jessie Ball duPont in memory of her late husband.

CBS-owned KNXT was cited for the "scope and generally high quality of programs serving the cultural and social interests of the Los Angeles area." Dr. Francis P. Gaines, president of Washington & Lee U., Lexington, Va., and chairman of the awards committee of the duPont Foundation, commended KNXT's "apparent willingness to devote its best production talent and resources to programs of social value," and singled out the station's *Journey* series on the arts and sciences, its independent current affairs coverage and programs on books and school activities.

WFMT was recognized as a relatively small station distinguished for "the integrity of its programming policies in giving first priority . . . to the advancement of good music, good plays and the intellectually mature spoken word in prose and poetry." Dr. Gaines also mentioned the "remarkable esteem and loyalty" of WFMT listeners.

Mr. Huntley's "consistently authoritative, intelligent and responsible reporting and

analysis of public affairs" gained him the committee citation. His service during the 1956 political conventions and campaigns demonstrated "a clearly evident seriousness of character and purpose," Dr. Gaines said. The citation further stated that the newscaster has "the ability to infuse his words with an interest arising from his lively intelligence."

Media Cameramen Win Awards In Annual Newsreel Contest

CBS-TV and NBC-TV, along with Tele-news Film Corp. and individual stations, were named winners in the 14th annual newsreel competition sponsored by the National Press Photographers Assn. and Encyclopedia Britannica, it was announced last week.

Gordon Yoder, INS-Telenews, was top individual cameraman with four honors, including distinction as "newsreel cameraman of the year." He also was cited as co-winner of first prize in the news category and for first and second prize honors in sports. Third in sports was Harry Mammias, of INS-Telenews.

Network citations went to Paul Bruck and Jerry Swartskopff, both CBS, as first and second finishers, and to Dexter Alley, NBC, third-place, all in the news category; and to Maurice Levy and Simon Avnet, NBC, second place and honorable mention, respectively, in features.

Station newsreel cameramen cited were Ken Martin, WBAP-TV Fort Worth, honorable mention in news; Dick Winer, WCKT (TV) Miami, Fla., first place, features; Lew Clark, WCAU-TV Philadelphia, honorable mention, feature; Skip Nelson, KSTP-TV St. Paul-Minneapolis, and Robert Gelberg, WTVJ (TV) Miami, first and second, sync sound category. Special award was presented to Eugene Broda, Movietone News, for "outstanding display of intelligent activity" in covering a news assignment.

Peabody Awards Set April 16

ANNUAL George Foster Peabody awards for radio and tv will be presented in New York on April 16 at a luncheon in the grand ballroom at the Hotel Roosevelt. The Radio & Television Executives Society is luncheon host at the awards which are administered by the Henry W. Grady School of Journalism of the U. of Georgia under the direction of Dean John E. Drewry. The RTES, meanwhile, announced that film syndication will be the topic of its next roundtable discussion on April 24, also slated to be held at the Roosevelt.

AWARD SHORTS

Jackie Pierce, WTVJ (TV) Miami women's show personality, presented certificate of award from Hialeah-Miami Springs Chamber of Commerce for her "spectacular contributions" to public service.

Mulford M. Brandt, RCA commercial electronic products division, cited by Drexel Institute of Technology, Philadelphia, for "professional achievement in electronics and community service." He is alumnus of Drexel.

HOWARD E. STARK
 BROKERS and FINANCIAL CONSULTANTS
 RADIO and TELEVISION STATIONS

50 EAST 58th STREET EL 5-0405
 NEW YORK 22, N. Y.

All Inquiries Confidential

THERE'S ONLY ONE LEADER...

KXLF-TV4 MONTANA

THE CONTINENTAL DIVIDE STATION, BUTTE

BUY SOUND-FACTOR PLAN

RADIO WSRS

GREATER CLEVELAND'S
 NUMBER 1 STATION
 SRS "Radio-Active" MBS

SEVEN REASONS WHY RADIO IS BACK IN AGENCY FAVOR

IF we didn't question such phrases as "television has sounded the death knell of radio" or "practically nobody ever listens to radio any more" or "radio just doesn't have the impact of television or magazines," we'd probably all get more sleep and lots less midnight oil would be burned on Madison Avenue.

Fortunately for us all, during the past few years many ingenious and inquiring advertising men have been deeply interested in studying the changing dimensions of radio. The sharpness of these changes can be seen best if we compare its present dimensions with what they were back in the late forties. Based on a major study of the changing place of radio that has recently been completed by our company, I'd like to appraise seven of the most significant developments that have taken place during this period.

1. SIZE OF AUDIENCE

Back in 1949, the average evening sponsored network program reached about 5½ million families. Today it reaches less than a million. The average daytime network program reached 3 million homes, compared with less than a million and a half today.

Does this mean that radio has lost its punch or its ability to communicate to mass audiences? Not at all.

According to Nielsen, a radio commercial every 30 minutes throughout the week will, on many stations, reach nearly half the radio homes in a station's coverage area an average of 13 times during the week. Minute participations in three network programs can deliver commercials to an audience of nearly 6 million families in four weeks, an average of nearly three times. It is estimated that 100 spots a week, strategically placed in peak listening hours, can succeed in reaching half of the radio homes in a station's area an average of 3-5 times per week.

So radio *can* reach mass audiences today—not at one time period or on one day, but on a cumulative basis—and as an advertiser accumulates audience size, he puts additional frequency of impressions against the hard core of his listening audience.

A timid, cautious use of radio won't produce this effect. One program a week or 5 to 10 spots a week won't do it. But for the advertiser who has grasped this new dimension and who goes in aggressively with adequate frequency, radio can crowd plenty of the right people into his tent.

2. THE CHANGE IN LISTENING HABITS

No longer is the family available—as a family—to evening radio. Daytime has outstripped evening, and the early morning hours. The noon period and early evening hours have emerged as the peak listening periods when the largest audiences are to be had.

These changes are related really to two factors. One certainly is the result of programming developments and the public's acceptance of radio as a leading news medium. The other is a reflection of living habits, the fact that radio has followed people into the bedroom, the kitchen, has become a part of the alarm clock and the family car. Some of these are areas where television perhaps can never succeed as well. We can't watch a tv set while we're shaving in the morning, or while we're driving to the station or while we're lying on the beach or while we're driving a tractor.

The latest figures I've seen show that of the 124 million radio sets in working order in the U. S., only 25% are in the living room, 26% are in automobiles, 21% are in bedrooms, 16% are in kitchens, 4% are in the dining room and 7% in other places throughout the house.

With an average of nearly three sets per family today, availability is one of radio's greatest strengths.

3. THE AUTOMOBILE

Back in 1946 when radio was delivering those big single broadcast audiences, only one family in five had a car radio. Even in 1951 only one family in four was equipped. But the latest figure

for 1956 is 72%, nearly three out of four families in the U. S. with car radios. This amounts to 35 million cars on the highway—an audience that at the particular moment of exposure, with the exception of outdoor advertising, is an exclusive audience for radio.

Today over 80% of all new cars sold to the public are radio-equipped, and according to the best research available, they are in perpetual use; almost 75% of all automobile radio families tune in at some time during a typical week, and the average length of time spent with the radio on is nearly seven hours a week.

If I were in the business of selling radio today, I believe I would try to approach it as an entirely different and unique sort of advertising medium. Radio performs quite differently from the others—certainly differently from television. Radio reaches the individual on a more personal basis. Radio is more of a boudoir channel of communication, while television is more of a spectator, family medium.

Radio cannot create the impact of a *Tennessee Ernie Ford* or a *Lux Video Theater* or a four-color, bleed spread in a national magazine.

But radio can talk convincingly to an awful lot of individuals in lots of different places and by continually tapping away at consumer consciousness it can fill a terribly important place in a total advertising program. Radio is a natural addition to an advertising program in other media—an addition capable of doing a perpetual, personal sort of selling job leaving the bombast and the block-busting to the others.

If I were in the radio business, it seems to me I'd want to translate what I had to sell—not on a statistical comparison with other media alone, on homes reached, and cost per thousand—but rather on the basis of the differences involved. The big network television commercial is often staged by well-known personalities to demonstrate important product benefits to millions of families in their living rooms, their eyes glued to the set—with all the impact and drama this implies. The radio commercial is more likely to be delivered to the housewife with her hair in curlers finishing the breakfast dishes, or her husband driving home from the office or the kids while they're doing their homework.

Perhaps radio could capitalize more on the intimacy and the personal aspects of the times and the manner in which it reaches its audiences than to continue to match its strength against other media just on the quantitative front of the cost per thousand.

If I were in the business of selling radio, I'd take a very realistic look at my rate structure.

I'd keep my rates as low as possible with the most generous possible discount plans as an incentive for the advertiser to make a full, adequate use of my station. Speaking for the U. S. advertiser in these days of growing competition and mounting costs, the relatively low cost of achieving good coverage and frequency of impressions against his market is one of radio's most attractive features.

CAN'T DO IT ALONE

TELEVISION in a few short years has grown to major proportions. Its dynamics are unquestioned, its force and impact and selling power are a matter of record. But, after all, there is no single advertising medium that is capable of doing the whole job by itself for a major national advertiser.

Television is the ideal medium of demonstration but as yet it can't provide color on a broad basis.

National magazines provide color and an editorial environment of authority and compatibility of a product message, but generally their circulation is thinly spread across the population.

Newspapers provide intensive coverage of the local areas they serve but used on a national basis they become very costly.

Outdoor has the advantage of large space, color and good market

The pendulum has swung for radio. It wasn't long ago that one heard only dire predictions of its fate. Today its advocates are almost standing in line to give testimonial. The one on these two pages is outstanding for its comprehensiveness. It was given by Arthur Porter, vice president and media director of J. Walter Thompson Co., before the Canadian Assn. of Radio & Tv Broadcasters last week.



coverage but it is capable of delivering only a reminder message rather than a thorough product story.

So actually, in the last analysis, it is the efficiency and the effectiveness of the total combination that helps the national advertiser accomplish his sales objective, not dependence on any single avenue of communication.

On an average, this audience amounts to about 20% of the total audience available through radio, but in peak listening hours it becomes even more important. The car radio audience amounts to 25% of the total in early morning hours and over 30% of the total in early evening hours and on weekend afternoons.

The increase in auto listening has helped to offset decreased listening at home since 1949. Although afternoon and evening have taken good sized dips, the automobile audience has actually increased the size of the morning radio audiences by 4% since 1949.

4. A STABLE YEAR-ROUND AUDIENCE

While it is true that sets-in-use and ratings for any single time period are far lower than they were in the pre-tv era, the fact that there is no longer a significant difference between summer and winter programming has brought about a stability in the audience to radio that didn't exist before.

Daytime radio audiences used to drop 25% in the summer; now they drop only about 15%. Evening audiences used to be cut in half, now they drop only about 13%.

The advertiser can use radio today on a year-round basis and maintain an even amount of advertising weight, without having to step up his expenditure during summer months to avoid a loss of audience. For products with a year-round sales pattern, this is an important consideration.

5. THE CHANGE IN PROGRAMMING

In 1949 there were 10 sponsored situation comedies on the networks; today there are two. General dramatic programs have gone from 17 to 2. Where there were 15 variety comedy shows in 1949, there is one today. Quiz shows have dropped from 12 to 5. In 1949, we had 19 sponsored mystery shows on the networks, today we have 7. There were 18 music variety programs in 1949, one today.

But compare 5-minute and 15-minute sponsored news programs. In 1949 there were 53, today there are 207.

Radio has emerged as a major source of news and information.

As we all recognize, radio still offers general entertainment features—*Amos 'n Andy*, *Gunsmoke* and others—but the major job of entertainment and drama has been taken over by television where it can be so much more dramatically and effectively handled.

6. THE RISE OF THE INDEPENDENT STATION

Another marked change in the proportions of radio has been brought about by the tremendous growth of stations and markets and the consequent split in audience that has attended this growth. Since 1949, stations in the U. S. have increased from under 800 to over 3,000, with network affiliated stations in about 600 markets.

This tremendous growth of stations—of which many obviously are independent, programming with local personalities to local interests—has had an effect on the division of the listening audience between network and independent stations. Previously, during the daytime hours, the independent stations siphoned off about a quarter of the listening audience; today they get about a third.

Shows with strong, local appeals, shows devoted to community service and local projects have popped up, many of which have demonstrated outstanding audience values—something like the values inherent in the local weekly or small daily community newspaper that serves the people not by reporting the latest on the situation in the Middle East, but rather by concentrating on the

progress of the city council's highway program or raising the money for the new high school.

The fact that the networks have been forced to share the available audience with strongly programmed independent stations, in my opinion, has added to radio's basic strength.

7. THE CHANGING SALES PATTERN

There was a time, as we all know, when there were prestige and importance connected with exclusive program sponsorship, either on the network or on the local station. But as television grew and radio audiences diminished, and as the excitement in broadcasting was transferred from radio to tv, this prestige element, by and large, was lost. Radio's job had changed. There wasn't much merchandising velocity left in *Fibber McGee* or *Amos 'n Andy*.

But weren't the audience values still there if the jig-saw could be put together differently? Couldn't you accumulate large audiences if you bought into several or maybe many programs on a participation basis?

The answer was yes, and the network and the local station and the advertiser started to work on an entirely new basis.

Back in '49, about 90% of all network daytime segments were sponsored exclusively. Today more than half are on a "participation" basis. In the evening practically all programs were exclusively sponsored; today 60% are participations. These changes had to be made because in no other way could a sponsor spend his dollars to accumulate a mass audience on an efficient basis.

Radio rates also are being brought into line, in terms of time costs as well as talent. The highest cost program in 1949 was Fred Allen at \$28,000 per. It is estimated that \$10,000 is the peak tab today. Station discount structures have been adjusted. They used to end at 260 or 312 times, today they extend to 520 or 1000.

Recently CBS Radio announced a reduction in its evening and weekend rates which forces the cost of a 5-minute segment as low as \$800 for both time and talent.

The net result of these rate adjustments is that for the sponsor who uses radio *right*, it can be as good or better a buy today—in cost efficiency—as it was before the television deluge. Some recent studies show that in terms of the audience reached per dollar, even in nighttime hours, some network programs are today delivering more homes per dollar invested than they did back in the era before tv.

During the past couple of years, by studying and digging, we've learned a good bit about Radio's New Look.

[Among other things] we've learned not to be dogmatic about these peak listening time periods because there is plenty of ore to be mined in afternoon and evening time periods as well. A recent Nielsen study showed that on a cumulative basis in terms of sheer numbers about as many people can be reached Monday through Friday during the hours of 6-9 p.m. as can be reached in the period from 6-9 a.m.

It seems to me that one of radio's major problems today is to create an adequate demand for time outside of peak listening hours—and these are generally the periods with lower price tags.

One of the interesting things about radio is that the more we know about it—the more we take it apart and look at how it performs and what it delivers and how much it costs—the more attractive and desirable it appears.

PLAYBACK

QUOTES WORTH REPEATING

TV BESTS SENATORS

Columnist John O'Donnell, writing in the New York Daily News March 27:

NOW, for the first time, it appears that three news reporters sitting on a tv panel can get more information from a reluctant witness than eight smart senators, plus a highly competent committee counsel. That happened in the questioning of Dave Beck, president of the Brotherhood of Teamsters [before the McClellan committee on labor racketeering]. He clammed up before the senators when asked the same questions he had answered so freely on a national tv show—CBS-TV's *Face the Nation* on March 17.

It was on this broadcast that Beck freely admitted that he had borrowed somewhere between \$300,000 and \$400,000 from his union's treasury without paying any interest on the loan. Today, with the transcript of the Beck tv broadcast before them, the senators were unable to get from Beck the admission that he had ever made the statement, or whether it was true or false.

TWO FACES OF TV

J. L. Van Volkenburg, immediate past president of CBS-TV, addressing the Miami (Fla.) Junior Chamber of Commerce March 3:

AS VIEWERS, we look on television as a boundless source of entertainment. As businessmen, we look on television as a remarkable sales instrument. This is the paradox of the broadcasting business, and there are still a few businessmen who find it perplexing. They are inclined to be a little wary of a business which is so closely intertwined with non-business activities. These people are still committed to the literal meaning of the phrase "business is business." It is hard for them to see what the Kentucky Derby or the World Series has to do with making razor

blades, or perhaps I should say making more razor blades.

Equally, television's dual function of providing entertainment and distributing information about the products of American industry lies at the heart of much of the criticism that is directed against it. With certain groups there is something unpalatable about having the world of art and ideas mixed up with the world of business. To such people these are separate worlds not to be confused, and are contaminated when they are brought together.

What they neglect or refuse to recognize is that many of the things they admire most in television exist only by virtue of the world of business. They forget the fundamental fact that advertising support is the lifeblood of the business of broadcasting—the precondition to providing a steadily increasing quality of entertainment and public service both to local as well as to nationwide audiences.

UNDEFINED FREEDOM

Editorial in The Commonweal, influential Catholic lay publication, commenting on the WGN-TV Chicago—"Martin Luther" incident:

THERE can be little doubt that the flood of phone calls and letters objecting to the film came from Catholics. They have damaged the fabric of our society because they have placed in jeopardy the still undefined "freedom" of the tv screen.

These Catholics have widened the breach between Catholics and Protestants which the best of recent scholarship has done so much to narrow.

There can be little doubt that the "Martin Luther" affair was deplorable. It indicates the need for extending to the tv screen the guarantees it does not yet possess. And it raises serious questions concerning the pressure which any religious group can reasonably exercise without violating the democratic charter.

FOR THE RECORD

New Tv Stations . . .

APPLICATIONS

St. Louis, Mo.—Louisiana Purchase Co., vhf ch. 2 (54-60 mc); ERP 100 kw vis., 50 kw aural; ant. height above average terrain 995 ft., above ground 831 ft. Estimated construction cost \$448,352, first year operating cost \$1,500,000, revenue \$1,500,000. P. O. address 407 N. 8th St., St. Louis. Studio location St. Louis. Trans. location Jefferson County. Geographic coordinates 38° 24' 53" N. Lat., 90° 26' 24" W. Long. Trans.-ant. RCA. Legal counsel Arthur H. Schroeder, Washington, D. C. Consulting engineer Commercial Radio Equipment Co., Washington, D. C. Lon Hocker (24.33%), insurance interests, and nine others will be owners. Announced March 25.

Youngstown, Ohio—Jet Bcastg. Co. uhf ch. 45 (656-662 mc); ERP 196.36 kw visual, 98.64 kw aural; antenna height above average terrain 565 ft., above ground 641 ft. Estimated construction cost \$235,000, first year operating cost \$388,800, revenue \$405,000. P. O. address 18th and Ash, Erie, Pa. Studio location Youngstown. Transmitter location Mahoning County. Geographic coordinates 41° 5' 26" N. Lat., 80° 38' 56" W. Long. Trans.-ant. GE. Consulting engineer John H. Mullaney, Washington, D. C. Myron Jones (63½%) majority owner WJET Erie, licensee WHOT Youngstown and 32% WTIV Titusville, Pa., and William Fleckenstein (36½%), general manager WHOT and vice president WJET, will be owners. Announced March 27. (Resubmitted.)

Nacogdoches, Tex.—East Texas Bcastg. Co., uhf ch. 19 (500-506 mc); ERP 20.1 kw vis., 10.75 kw aural; ant. height above average terrain 292 ft., above ground 300 ft. Estimated construction cost \$42,000, first year operating cost \$45,000, revenue \$60,000. P. O. address % Lee Scarborough, Box 248, Nacogdoches. Studio location Nacogdoches. Trans. location Nacogdoches County. Geographic coordinates 31° 35' 26" N. Lat., 94° 37' 28" W. Long. Trans. DuMont, ant. RCA. Legal counsel Haley, Doty & Wollenberg, Washington, D. C. Consulting engineer Guy C. Hutcherson, Arlington, Tex. Mr. Scarborough, owner KELS-FM Nacogdoches, Joe D. Prince, soft drink bottling interests, and T. Gillette Tilford, lumber and grocery interests, will be equal partners. Announced March 22.

Port Arthur, Tex.—WDSU Bcastg. Corp. vhf ch. 12 (204-210 mc); ERP 316 kw visual, 158 kw aural; antenna height above average terrain 966 ft., above ground 991 ft. Estimated construction cost \$894,000, first year operating cost \$636,000, revenue \$840,000. P. O. address 820 Royal St., New Orleans, La. Studio location Port Arthur. Transmitter location Jefferson County. Geographic coordinates 29° 42' 57" N. Lat., 93° 51' 46" W. Long. Trans.-ant. RCA. Legal counsel Pierson, Ball and Dowd, Washington, D. C. Consulting engineer Page, Creutz Steel and Waldschmitt. Principals include Edgar B. Stern Jr. (67%), 67% WDSU-AM-FM-TV New Orleans, Robert D. Swezey (20%), 20% WDSU-AM-FM-TV, A. Louis Read (10%), 10% WDSU-AM-FM-TV, and Lester E. Kabacoff (3%), 3% WDSU-AM-FM-TV. Announced March 27.

New Am Stations . . .

ACTIONS BY FCC

Carmel, Calif.—Seaside Electronic Assoc., granted 1410 kc, 500 w D. Post office address P. O. Box 1144, Seaside, Calif. Estimated construction cost \$35,118, first year operating cost \$42,000, revenue \$60,000. Principals are equal owners Albert R. Pearl, retired banker, and Paul F. Hanson, freelance radio-tv producer. Announced March 27.

Cocoa, Fla.—Irving Braun, granted 1480 kc, 1 kw D. Post office address 8027 Chesapeake Blvd., Norfolk, Va. Estimated construction cost \$19,700, first year operating cost \$36,000, revenue \$40,000. Mr. Braun holds tv appliance interests. Announced March 27.

Leesburg, Fla.—Clyde T. Hodgson granted 1410 kc, 1 kw D. P. O. address 813 Demington St., Lakeland, Fla. Estimated construction cost \$13,081, first year operating cost \$24,000, revenue \$30,000. Mr. Hodgson is printer, Lakeland Ledger. Announced March 27.

Mount Dora, Fla.—George R. Smith, granted 1580 kc, 1 kw D. P. O. address Box 267, Arcadia, Fla. Estimated construction cost \$16,180, first year operating cost \$18,000, revenue \$24,000. Mr. Smith has real estate and insurance interests in Arcadia. Announced March 27.

Kellogg, Idaho—Radio Kellogg Inc. granted 900 kc, 1 kw D. remote control trans. P. O. address No. 2 McKinley Ave., Kellogg. Estimated construction cost \$18,856, first year operating cost \$31,132, revenue \$42,400. Principals include Roger L. Hagadone, pres.-99% owner who also is pres.-gen. mgr., KYME Boise, Idaho, and Vp., applicant for new am in Mountain Home, Idaho. Announced March 27.

APPLICATIONS

Claypool, Ariz.—Willard Shoecraft, 1340 kc, 250 w unid. P. O. address % Mr. Shoecraft, 326 S. High St., Globe, Ariz. Estimated construction cost \$11,623, first year operating cost \$18,000, revenue \$24,000. Mr. Shoecraft, manager, KWJB Globe, will be sole owner. Announced March 21.

Hemet-San Jacinto, Calif.—Hemet-San Jacinto

BROADCASTING TELECASTING

THE BUSINESS WEEKLY OF RADIO AND TELEVISION

1735 De Sales Street, N. W., Washington 6, D. C.

PLEASE START MY SUBSCRIPTION WITH THE NEXT ISSUE.

- CHECK ONE
- 52 weekly issues of BROADCASTING • TELECASTING \$7.00
 - 52 weekly issues and BROADCASTING Yearbook-Marketbook 9.00
 - 52 weekly issues and TELECASTING Yearbook-Marketbook 9.00
 - 52 weekly issues and both Yearbook-Marketbooks 11.00

Enclosed Bill

name _____ title/position _____

company name _____

address _____

city _____ zone _____ state _____

Please send to home address — —

Station Authorizations, Applications (As Compiled by B • T)

March 21 through March 27

Includes data on new stations, changes in existing stations, ownership changes, hearing cases, rules & standards changes and routine roundup.

Valley Bestg. Co. 1340 kc. 250 w uni. P. O. address Fred W. Volken, Box 2304-D, Pasadena, Calif. Estimated construction cost \$11,030, first year operating cost \$23,000, revenue \$28,000. Mr. Volken (40%), radio engineer-consultant, John F. Stroud (30%), carpenter, and N. V. Parsons (30%), CBS engineer, will be owners. Announced March 26.

Hollister, Calif.—James H. Rose and Howard E. Slagle d/b as San Benito Bestg. Co., 1490 kc. 250 w uni. P. O. address 10814 Encino Ave., Granada Hills, Calif. Estimated construction cost \$14,024, first year operating cost \$28,200, revenue \$42,800. Lt. Col. Rose, Armed Forces Radio, and Mr. Slagle, Postal Transport Service, are equal partners. Announced March 25.

Sebring, Fla.—George W. Fee and Claude C. Tillman Jr. d/b as Radio Sebring. 1340 kc. 250 w uni. P. O. address % Mr. Fee, 809 W. River Dr., Tampa, Fla. Estimated construction cost \$8,200, first year operating cost \$36,000, revenue \$42,000. Mr. Tillman, 50% WARN Fort Pierce, Fla., and Mr. Fee, sales manager WALT Tampa, will be equal partners. Announced March 26.

Bainbridge, Ga.—Earl Petty 1410 kc. 1 kw D. P. O. address % Mr. Petty, 1715 N. E. Sixth Terrace, Gainesville, Fla. Estimated construction cost \$17,270, first year operating cost \$41,000, revenue \$48,000. Mr. Petty, insurance and drygoods interests, will be sole owner. Announced March 26.

Pelham, Ga.—Monroe C. Reaves, 1360 kc. 1 kw uni. P. O. address % Mr. Reaves, 712 W. Magnolia St., Fitzgerald, Ga. Estimated construction cost \$15,874, first year operating cost \$29,000, revenue \$38,500. Mr. Reaves, railroad engineer, will be sole owner. Announced March 25.

Somerset, Ky.—Pulaski Bestg. Corp. 1490 kc. 1 kw D. P. O. address % Oris Gowen, Columbia, Ky. Estimated construction cost \$19,600, first year operating cost \$30,000, revenue \$45,000. Mr. Gowen (20%), program director WAIN Columbia, Ky., Ervin T. Buis (20%), farmer and timberbuyer, Rexford C. Vaught (16%), farmer, Andrew W. Spaw (16%), farmer, Ethridge D. Elmore (16%), farmer and Warren G. Adams (12%), farmer will be owners. Announced March 27.

South St. Paul, Minn.—Florida East Coast Bestg. Co., 1590 kc. 5 kw D. P. O. address 350 N.E. 17th St., Miami, Fla. Estimated construction cost \$64,381, first year operating cost \$90,000, revenue \$100,000. Harry Trenner (60%) and Herbert Schorr (40%) will be owners. East Coast is licensee of WFEC Miami. Announced March 25.

Fayetteville, N. C.—Daniel F. Owen, 1600 kc. 1 kw D. P. O. address % Mr. Owen, 2908 Fort Bragg Rd., Fayetteville. Estimated construction cost \$9,980, first year operating cost \$36,000, revenue \$48,000. Mr. Owen, tv and appliance dealer,

DA—directional antenna. cp—construction permit. ERP—effective radiated power. vhf—very high frequency. uhf—ultra high frequency. ant.—antenna. aur.—aural. vis.—visual. kw—kilowatts. w—watt. mc—megacycles. D—day. N—

night. LS—local sunset. mod.—modification. trans.—transmitter. unl—unlimited hours. kc—kilocycles. SCA—subsidiary communications authorization. SSA—special service authorization. STA—special temporary authorization. *—educ.

Abbreviations:

Am-Fm Summary through March 27

	On Air	Licensed	Cps	Appls. Pending	In Hearing
Am	3,021	3,001	217	356	148
Fm	540	520	49	51	0

Tv Summary through March 27

Total Operating Stations in U. S.:

	Vhf	Uhf	Total
Commercial	383	91	472 ¹
Noncomm. Education	18	5	23 ²

FCC Commercial Station Authorizations As of February 28, 1957 *

	Am	Fm	Tv
Licensed (all on air)	3,000	513	290
Cps on air	31	16	225
Cps not on air	133	23	123
Total authorized	3,164	552	638
Applications in hearing	119	0	70
New stations requests	303	10	56
New stations bids in hearing	67	0	10
Facilities change requests	146	11	45
Total applications pending	900	112	353
Licenses deleted in February	0	2	0
Cps deleted in February	0	0	1

* Based on official FCC monthly reports. These are not always exactly current since the FCC must await formal notifications of stations going on the air, ceasing operations, surrendering licenses or grants, etc. These figures do not include noncommercial, educational fm and tv stations. For current status of am and fm stations see "Am and Fm Summary," above, and for tv stations see "Tv Summary," next column.

Grants since July 11, 1952:

(When FCC began processing applications after tv freeze)

	Vhf	Uhf	Total
Commercial	350	323	673 ¹
Noncomm. Educational	26	21	47 ²

Applications filed since April 14, 1952:

(When FCC began processing applications after tv freeze)

	New Amend.	Vhf	Uhf	Total
Commercial	1,077	337	838	1,411 ³
Noncomm. Educ.	65	37	27	65 ⁴
Total	1,142	337	875	600

¹ 176 cps (33 vhf, 143 uhf) have been deleted.
² One educational uhf has been deleted.
³ One applicant did not specify channel.
⁴ Includes 44 already granted.
⁵ Includes 718 already granted.

NATION-WIDE NEGOTIATIONS • FINANCING • APPRAISALS

RADIO • TELEVISION • NEWSPAPER

EASTERN

MIDDLE ATLANTIC

\$150,000

Unlimited independent doing a top job in an excellent market.

MIDWEST

FULLTIME INDEPENDENT

\$50,000

Excellent opportunity for owner-manager. Terms of \$15,000 down available.

SOUTH

INDEPENDENT WANTED

\$100,000

We need a property in the market of 20,000 to 40,000 population for a buyer who can pay up to \$30,000 down.

SOUTHWEST

WEST TEXAS INDEPENDENT

\$60,000

A good small profit-maker located in an oil-rich market. Terms available.

WEST

ROCKY MOUNTAIN INDEPENDENT

\$155,000

An excellent earning record on this daytime major market property. \$35,000 down required.

WASHINGTON, D. C.

Wm. T. Stubblefield
1737 DeSales St., N. W.
EX 3-3456

CHICAGO, ILL.

Ray V. Hamilton
Tribune Tower
DE 7-2755

ATLANTA, GA.

Jack L. Barton
1515 Healey Bldg.
JA 3-3431

DALLAS, TEX.

Dewitt (Judge) Landis
Fidelity Union Life Bldg.
RI 8-1175

SAN FRANCISCO

W. R. (Ike) Twining
111 Sutter St.
EX 2-5671

Call your nearest office of

HAMILTON, STUBBLEFIELD, TWINING & ASSOCIATES

will be sole owner. Announced March 25.
 Eugene, Ore.—W. Gordon Allen, 990 kc, 250 w D. P. O. address % Mr. Allen, 260 Hansen Ave., Salem. Estimated construction cost \$9,200, first year operating cost \$48,000, revenue \$72,000. Mr. Allen, owner KRGA Springfield, 70% KGAL Lebanon and KRGA Cottage Grove, % KGAY Salem, all Ore., 50% KBAM Longview, owner KTX Seattle, both Wash., and 48% KMAR Winsboro, La., will be sole owner. Announced March 25.

Eugene, Ore.—Community Bestg. Co. of Oregon 980 kc, 1 kw D. P. O. address % Don J. Bevilacqua, 11549 24th N. E., Seattle, Wash. Estimated construction cost \$22,183, first year operating cost \$48,000, revenue \$80,000. Mr. Bevilacqua, program director KTW Seattle, Virgil A. Parker, 50% owner KRSN Los Alamos, N. M., and Darrel K. Burns, 50% KRSN, will be equal partners. Announced March 27.

Emporium, Pa.—Emporium Bestg. Co., 1250 kc, 1 kw D. P. O. address 210 S. Broad St., Emporium. Estimated construction cost \$21,855, first year operating cost \$36,000, revenue \$42,000. Cameron Manufacturing Corp., Emporium, will be 98.8% owner. Announced March 25.

Woonsocket, R. I.—Milford Bestg. Co. 990 kc, 500 w D. P. O. address % Lorraine M. Salera, 25 Seventh St., Providence, R. I. Estimated construction cost \$12,395, first year operating cost \$22,000, revenue \$31,000. Principals include Mrs. Salera (55%), free-lance announcer, and Arthur L. Movsovitz (45%), advertising interests. Will be owners. Announced March 27.

Silsbee, Tex.—Harvard C. Bailes and Val D. Hickman d/b as The Hardin County Bestg. Co., 1300 kc, 500 w D. P. O. address % Mr. Bailes, Box 487, Cleveland, Tex. Estimated construction cost \$19,225, first year operating cost \$36,000, revenue \$50,000. Mr. Bailes, licensee-manager KVLB Cleveland, and Mr. Hickman, lumber interests, will be equal partners. Announced March 22.

Fredericksburg, Va.—Eastern Shore Bestg. Co. 1330 kc, 1 kw D. P. O. address % G. R. Chambers, 414 French St., Wilmington, Del. Estimated construction cost \$12,691, first year operating cost \$48,000, revenue \$55,000. Mr. Chambers, owner WDVW Pocomoke City, Md., will be sole owner. Announced March 27.

Existing Am Stations . . .

ACTIONS BY FCC

CALL LETTERS ASSIGNED

KRTU Tucson, Ariz.—Associated Bcstrs. of Tucson, 790 kc. Changed from KCTU.

KPIK Colorado Springs, Colo.—Western Bestg. Co., 1580 kc.

WGOR Georgetown, Ky.—Robert E. Johnson, 1580 kc.

WKYV Loyall, Ky.—Tri-State Radio Corp., 1050 kc.

KBCL Bossier City, La.—Bossier Bestg. Service, 1220 kc.

WDVL Vineland, N. J.—The Delsea Bcstrs., 690 kc.

WBUZ Fredonia, N. Y.—Louis W. Skelly, 1570 kc.

KADO Marshall, Tex.—Caddo Bestg. Co., 1410 kc.

APPLICATIONS

WIBW Topeka, Kan.—Seeks mod. of license to change studio location. Announced March 26.

WLAU Laurel, Miss.—Seeks cp to change frequency to 1600 kc, power to 5 kw, hours to D and ant.-trans. and studio location. Announced March 25.

KOFI Kallispell, Mont.—Seeks cp to change

frequency to 930 kc, power to 5 kw and type trans. Announced March 27.

KSWs Roswell, N. M.—Seeks cp to change frequency to 810 kc, power to 10 kw, ant.-trans. location and install DA-DN. Announced March 22.

KVIT (TV) Santa Fe, N. M.—Seeks mod. of cp to change ERP to 28.2 kw vis., 14.3 kw aur. Announced March 26.

KBAM Longview, Wash.—Seeks cp to change frequency to 1270 kc, power to 5 kw and type trans. Announced March 27.

KPOR Quincy, Wash.—Seeks mod. of cp to change ant.-trans. and studio location. Announced March 26.

New Fm Stations . . .

ACTIONS BY FCC

Takoma Park, Md.—Washington Missionary College Inc., granted 91.9 mc, 10 w, unl. P. O. address % Stephen S. Hiten, WMC Takoma Park, Washington 12, D. C. Estimated construction cost \$1,575, no revenue. Proposed grant is for non-commercial educational purposes. Announced March 27.

Babylon, N. Y.—WGLI Inc. granted 103.5 mc, 15 kw. P. O. address Livingston Rd. at Madison Ave., Babylon. Cost and estimated revenue incorporated in application of WGLI Inc. for new am in Babylon (B.T. Jan. 2, 1956). Announced March 27.

Troy, N. Y.—Rensselaer Polytechnic Institute granted 91.5 mc, 710 w. P. O. address % Ralph Asher, same as above. Estimated construction cost \$1,185, first year operating cost \$100. Rensselaer is owner of WHAZ Troy. Station will be non-commercial educational. Announced March 27.

Ownership Changes . . .

ACTIONS BY FCC

KCHV Coachella, Calif.—Granted assignment of license to Coachella Bestg. Co. for \$3,500. KCHV part owner Edward W. Gorges is sole owner of Coachella Bestg. Announced March 27.

KEYT (TV) Santa Barbara, Calif.—Granted assignment of license from Santa Barbara Broadcasting and Television Corp. to Key Television Inc. for \$1,400,000. Principals include William F. Lutton (41.67%) and Nancy Lutton (41.67%). Announced March 27.

KRGI Grand Island, Neb.—Granted assignment of license from Grand Island Bestg. Co. to Grand Island Bestg. Ltd. for \$145,000. James Stuart, owner KFOR Lincoln, Neb., will be sole owner. Announced March 27.

WCTC-AM-FM New Brunswick, N. J.—Granted assignment of license from Chanticleer Bestg. Co. to Raritan Valley Bestg. Co. for \$215,000. Raritan owners will be Joseph L. Rosenmiller (52%), 58% owner WESO Southbridge, Mass., Louis J. Appell Jr. (25%), pres.-director WSBA-AM-TV York, Pa., and Peter A. Bordes (23%), 17% owner WESO. Announced March 27.

WWSC Glens Falls, N. Y.—Granted transfer of control of licensee corporation from Alexander P. Robertson and Glens Falls Post Co. to Martin Karig for \$13,000. Mr. Karig, who will own 75% is minority stockholder WNDR Syracuse, treasurer WSPN Saratoga Springs, gen. mgr. WWSC and controls WIPS Ticonderoga, all N. Y. Announced March 27.

KXYZ Houston, Tex.—Granted assignment of license from Shamrock Bestg. Co. to Houston Bestg. Corp. for \$600,000. Houston principals are Milton R. Underwood (30%), banker. Catherine F. Underwood (40%), housewife, and David M. Underwood (30%). Announced March 27.

WDDY Gloucester, Va.—Granted transfer of

control of licensee corporation from S. L. Goodman to Charles E. Springer for \$4,000. Mr. Goodman, 100% owner WILA Danville and WYTI Rocky Mount and 60% WYSR Franklin all Va., will be sole owner. Announced March 27.

WLDL LaCrosse, Wis.—Granted assignment of license from Lyons Bestg. Co. to LaCrosse Radio Inc. for \$35,000. Owners will be Joseph H. Rohrer (51%), former gen. mgr. KIOA Des Moines, Iowa, Roy L. Philippe (25%), former 33 1/2% owner WLXC LaCrosse, and Jean Glitz (24%), 1 1/2% owner KRDO-AM-TV Colorado Springs, Colo. Announced March 27.

APPLICATIONS

KERO-TV Bakersfield, Calif.—Seeks assignment of license and cp from Kern County Bcstrs. Inc. to Wrather-Alvarez Bestg. Co., for \$2,150,000. Wrather-Alvarez owns KFMF-AM-TV San Diego, Calif. and cp for KYAT (TV) Yuma, Ariz. Announced March 21.

WGCS Arlington, Fla.—Seeks assignment of cp from William F. Askew to Thomas Carr for remuneration for actual expenses and time spent acquiring cp. Mr. Carr owns WDAT Daytona Beach, Fla. Announced March 25.

WSTN St. Augustine, Fla.—Seeks assignment of license from James D. Sinyard to St. Augustine, Fla. Bestg. Co. for \$44,000. Carmen Macri (90%), permittee of WQIK-TV Jacksonville, Fla. and owner WWOX Charlotte, N. C., and James B. Lumpkins (10%), banker, will be owners. Announced March 27.

WEAT-AM-TV West Palm Beach, Fla.—Seeks transfer of license corporation from RKO Teledrama Pictures Inc. to Palm Beach Television Inc. for \$600,000. plus. Bertram Lehbar Jr. (20%), manager of WEAT-AM-TV, and Rand Bestg. Co. (80%), licensee of WINZ Miami, are Palm Beach owners. Rand principals include Rex Rand and Nathaniel J. Klein. Announced March 25.

WAKE Atlanta, Ga.—Seeks assignment of license from Bartel Bestg. Inc. to WAKE Bcstrs. Inc. for \$80,000. Corporate change. No change of control. Announced March 27.

WJAT Swainsboro, Ga.—Seeks assignment of license from Jack A. and Nancy M. Thompson to James R. Denny and Webb Pierce for \$125,000. Mr. Denny and Mr. Pierce, music publishing interests, will be equal partners. Announced March 27.

WHLT Huntington, Ind.—Seeks assignment of cp from Huntington Valley Bcstrs. to Huntington Bestg. Co. for \$1 and payment of expenses incurred in procuring cp. Corporate change. No change of control. Announced March 26.

WINN Louisville, Ky.—Seeks relinquishment of positive control of licensee corporation by Emil J. Arnold, through sale of stock to Robert Wasdon (25%) and Jack Siegel (25%) for \$500 from each Mr. Wasdon and Mr. Siegel own WIOD Sanford, Fla., 50% WALT Tampa, Fla. and WHY Orlando, Fla. and both are directors of WMFJ Daytona Beach, Fla. and WINN. Announced March 26.

WORC Worcester, Mass.—Seeks negative control of licensee corporation by Robert F. Bryar through purchase of stock (25% from Shirley L. Bryar for \$10,000. Announced March 22.

WPAG-AM-TV Ann Arbor, Mich.—Seeks transfer of negative control of licensee corporation from Arthur E. Greene, deceased, to Florence G. Greene, executrix of estate of Mr. Green. Announced March 27.

WPAG-AM-TV Ann Arbor, Mich.—Seeks positive control of licensee corporation by Edward F. Baughn, through purchase of stock (1% from Florence G. Greene. (Contingent on grant of transfer negative control, see above.) Announced March 27.

WISK St. Paul, Minn.—Seeks assignment of license from Antonio, Victor and Nicholas Tedesco to Victor and Nicholas Tedesco. Victor and Nicholas will pay their father (Antonio) \$75 a week for life. Upon his death his widow will receive \$75 a week and Antonio's estate will be paid \$35,000. Announced March 13. (Corrected item.)

KLCB Libby, Mont.—Seeks assignment of license from Lincoln County Bcstrs. Inc. to Frank Reardon for \$23,000. Mr. Reardon, owner 90% KBOW Butte, Mont. and stockholder KGEZ Kallispell, Mont., will be sole owner. Announced March 27.

WHVH Henderson, N. C.—Seeks assignment of license from Lawrence Brandon to WHVH Inc. Corporate change. No change of control. Announced March 26.

WBAX Wilkes-Barre, Pa.—Seeks assignment of license from estate of John H. Stenger (deceased) to Anna Stenger. Mrs. Stenger is executrix of estate. Announced March 21.

WPAW Pawtucket, R. I.—Seeks transfer of control of licensee corporation from Dominick A. Hyszko and Neal D. Murphy to Mr. Hyszko. Sum of \$19,000 will be paid Mr. Hyszko for money advanced the company. Mr. Hyszko also owns 22 1/2% WNAF Providence. Announced March 25.

KHIT Walla Walla, Wash.—Seeks assignment of license from Dale Issenbuth, Arch LeRoux and LeSalle LeRoux to Leader Bestg. Inc. Corporate change. No change of control. Announced March 26.

WHIS-AM-TV Bluefield, W. Va.—Seeks transfer of control of licensee corporation from Jim H. Shott and Hugh I. Shott Jr., individually, and as executors of estate of Hugh I. Shott Sr. to Hugh I. Shott Jr., individually, and as executor of estate of Hugh I. Shott Sr. Hugh I. Shott Jr.

**You are cordially invited
 to visit us at the
 NARTB CONVENTION
 Conrad Hilton Hotel
 Suite 2118A-2119A-2120A**

NEGOTIATIONS • FINANCING • APPRAISALS

Blackburn & Company

WASHINGTON, D. C.
 James W. Blackburn
 Jack V. Harvey
 Washington Building
 STerling 3-4341

ATLANTA
 Clifford B. Marshall
 Stanley Whitaker
 Healey Building
 Jackson 5-1576

PROFESSIONAL CARDS

JANSKY & BAILEY INC.
Executive Offices
1735 De Sales St., N. W. ME. 8-3411
Offices and Laboratories
1339 Wisconsin Ave., N. W.
Washington, D. C. ADams 4-2414
Member AFCEC*

JAMES C. McNARY
Consulting Engineer
National Press Bldg., Wash. 4, D. C.
Telephone District 7-1205
Member AFCEC*

—Established 1926—
PAUL GODLEY CO.
Upper Montclair, N. J. Pilgrim 6-3000
Laboratories, Great Notch, N. J.
Member AFCEC*

GEORGE C. DAVIS
CONSULTING ENGINEERS
RADIO & TELEVISION
501-514 Munsey Bldg. Sterling 3-0111
Washington 4, D. C.
Member AFCEC*

Commercial Radio Equip. Co.
Everett L. Dillard, Gen. Mgr.
INTERNATIONAL BLDG. DI. 7-1319
WASHINGTON, D. C.
P. O. BOX 7037 JACKSON 5302
KANSAS CITY, MO.
Member AFCEC*

A. D. RING & ASSOCIATES
30 Years' Experience in Radio
Engineering
Pennsylvania Bldg. Republic 7-2347
WASHINGTON 4, D. C.
Member AFCEC*

GAUTNEY & JONES
CONSULTING RADIO ENGINEERS
1052 Warner Bldg. National 8-7757
Washington 4, D. C.
Member AFCEC*

Lohnes & Culver
MUNSEY BUILDING DISTRICT 7-8215
WASHINGTON 4, D. C.
Member AFCEC*

RUSSELL P. MAY
711 14th St., N. W. Sheraton Bldg.
Washington 8, D. C. REpublic 7-3984
Member AFCEC*

L. H. CARR & ASSOCIATES
Consulting
Radio & Television
Engineers
Washington 6, D. C. Fort Evans
1001 Conn. Ave. Leesburg, Va.
Member AFCEC*

**PAGE, CREUTZ,
STEEL & WALDSCHMITT, INC.**
Communications Bldg.
710 14th St., N. W. Executive 3-5670
Washington 5, D. C.
303 White Henry Stuart Bldg.
Mutual 3280 Seattle 1, Washington
Member AFCEC*

KEAR & KENNEDY
1302 18th St., N. W. Hudson 3-9000
WASHINGTON 6, D. C.
Member AFCEC*

A. EARL CULLUM, JR.
CONSULTING RADIO ENGINEERS
INWOOD POST OFFICE
DALLAS 9, TEXAS
LAKESIDE 8-6108
Member AFCEC*

GUY C. HUTCHESON
P. O. Box 32 CRestview 4-8721
1100 W. Abram
ARLINGTON, TEXAS

ROBERT M. SILLIMAN
John A. Moffer—Associate
1405 G St., N. W.
Republic 7-6646
Washington 5, D. C.
Member AFCEC*

LYNNE C. SMEBY
CONSULTING ENGINEER AM-FM-TV
4806 MONTGOMERY LANE
WASHINGTON 14, D. C.
Oliver 2-8520

GEO. P. ADAIR ENG. CO.
Consulting Engineers
Radio-Television
Communications-Electronics
1618 Eye St., N.W., Washington, D. C.
Executive 3-1290 Executive 3-5851
Member AFCEC*

WALTER F. KEAN
CONSULTING RADIO ENGINEERS
Associates
George M. Sklom, Robert A. Jones
1 Riverside Road—Riverside 7-2153
Riverside, Ill.
(A Chicago suburb)

WILLIAM E. BENNS, JR.
Consulting Radio Engineer
3802 Military Rd., N. W., Wash., D. C.
Phone EMerson 2-8071
Box 2468, Birmingham, Ala.
Phone 6-2924
Member AFCEC*

ROBERT L. HAMMETT
CONSULTING RADIO ENGINEER
821 MARKET STREET
SAN FRANCISCO 3, CALIFORNIA
SUTTER 1-7345

JOHN B. HEFFELFINGER
8401 Cherry St. Hiland 4-7010
KANSAS CITY, MISSOURI

**Vandivere,
Cohen & Wearn**
Consulting Electronic Engineers
612 Evans Bldg. NA. 8-2698
1420 New York Ave., N. W.
Washington 5, D. C.

CARL E. SMITH
CONSULTING RADIO ENGINEERS
4900 Euclid Avenue
Cleveland 3, Ohio
HEnderson 2-3177
Member AFCEC*

J. G. ROUNTREE, JR.
5622 Dyer Street
EMerson 3-3266
Dallas 6, Texas

VIR N. JAMES
SPECIALTY
Directional Antenna Proofs
Mountain and Plain Terrain
1316 S. Kearney Skyline 6-1603
Denver 22, Colorado

JOHN H. MULLANEY
Consulting Radio Engineers
2000 P St., N. W.
Washington 6, D. C.
Columbia 5-4666

A. E. TOWNE ASSOCS., INC.
TELEVISION and RADIO
ENGINEERING CONSULTANTS
420 Taylor St.
San Francisco 2, Calif.
PR. 5-3100

LOWELL R. WRIGHT
Aeronautical Consultant
serving the radio & tv industry
on aeronautical problems created
by antenna towers
Munsey Bldg., Wash. 4 D. C.
District 7-1740
(nights-holidays telephone
Herdon, Va. 114)

SERVICE DIRECTORY

**COMMERCIAL RADIO
MONITORING COMPANY**
PRECISION FREQUENCY
MEASUREMENTS
A FULL TIME SERVICE FOR AM-FM-TV
P. O. Box 7037 Kansas City, Mo.
Phone Jackson 3-5302

**CAPITOL RADIO
ENGINEERING INSTITUTE**
Accredited Technical Institute Curricula
3224 16th St., N.W., Wash. 10, D. C.
Practical Broadcast, TV Electronics engi-
neering home study and residence courses.
Write For Free Catalog, specify course.

COLLECTIONS
For the Industry
ALL OVER THE WORLD
TV—Radio—Film and Media
Accounts Receivable
No Collections—No Commissions
STANDARD ACTUARIAL WARRANTY CO.
220 West 42nd St., N. Y. 36, N. Y.
LO 5-5990



TV STATION OWNERS:

How
much
of your
market
is lost
in the
shadows?

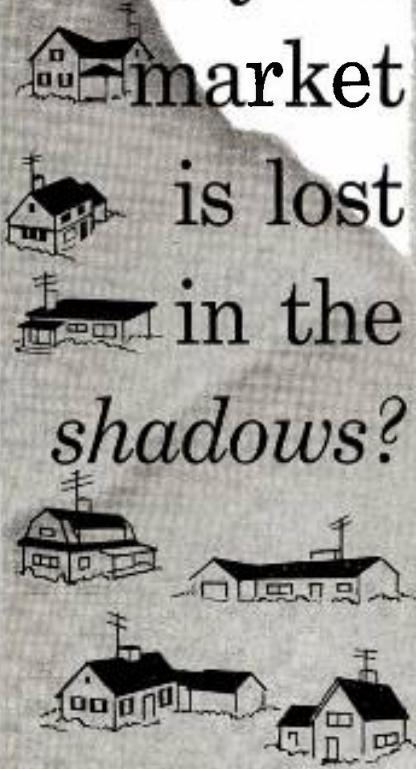

The TV broadcaster operating at less than full authorized power can fill in coverage gaps with low-cost TV Translators. "Shadow" and fringe areas get city-quality reception with Adler Translators repeating the mother station's signal on interference-free UHF channels 70 through 83. Investigate Adler's TV Translator now!

ADLER ELECTRONICS'
UST-10 TV
TRANSLATOR.
RATED OUTPUT:
TEN WATTS



WRITE FOR FULLY DESCRIPTIVE
"QUESTIONS ANSWERED" BROCHURE



ADLER ELECTRONICS, INC.
NEW ROCHELLE, N. Y.

FOR THE RECORD

will own 52.8% of corporation. Announced March 21.

NARBA Notifications . . .

List of changes, proposed changes, and corrections in assignments of Mexican Broadcast Stations modifying the appendix containing assignments of Mexican Broadcast Stations (Mimeograph 47214-6) attached to the recommendations of the North American Regional Broadcasting Agreement Engineering Meeting January 30, 1941.

- Mexican List #200 Feb. 11, 1957
- 980 kc
XEIA San Andres, Tuxtla, Veracruz—250 w. Class IV. 2-11-57. (Change in call letters from XETV.)
 - XECC Cuernavaca, Morelos—250 w. Class IV. 2-11-57. (Change in call letters from XEJC.)
1110 kc
 - XEVS Villa de Seris, Sonora—250 w. Class II. 8-11-57.
1310 kc
 - XEEX La Paz, Baja, Calif.—500 w. Class III-B. 2-11-57. (Change in call letters from XEAL.)
1320 kc
 - XENI Neuva Italia, Michoacan—1 kw D, 250 w N. Class IV. 8-11-57.
1340 kc
 - XEJC Cuernavaca, Morelos—500 w D, 250 w N. Class IV. 8-11-57.
 - XELU Ciudad Serdan, Puebla—250 w. Class IV. 8-11-57.
1450 kc
 - XEGC Sahuayo, Michoacan—1000 w D, 250 w N. Class IV. 5-11-57.
1540 kc
 - XENO Celaya, Guanajuato—250 w N, 1 kw D. Class II. 5-11-57.

CANADIAN TV ASSIGNMENTS

SUPPLEMENT NO. 2

March 1, 1957

NEW STATIONS

- CFCR-TV (ch. 4) Kamloops, B. C.—Granted Twin Cities Television, 100 kw vis., 50 kw aur., ant. height above ground 100 ft., above mean sea level 1,260 ft. Geographic coordinates 50° 40' 34" N. Lat., 120° 19' 51" W. Long.
- CKMI-TV (ch. 5) Quebec, Que.—Granted Tele- vision de Quebec (Canada) Ltd., 5.8 kw vis., 2.8 kw aur., ant. height above ground 420 ft., above mean sea level 685 ft., above average terrain 457 ft. Geographic coordinates 46° 47' 4" N. Lat., 71° 15' 54" W. Long.
- CHAT-TV (ch. 6) Medicine Hat, Alta.—Granted Monarch Bcstg. Co. Ltd., 4.78 kw vis., 2.39 kw aur., ant. height above ground 279 ft., above mean sea level 2,728 ft., above average terrain 313 ft. Geographic coordinates 50° 4' 36" N. Lat., 110° 47' 40" W. Long.

CHANGES

- CJIC-TV (ch. 2) Sault Ste. Marie, Ont.—Change ERP to 28 kw vis., 15 kw aur.
- CHEK-TV (ch. 6) Victoria, B. C.—Change ant. height to 203 ft. above ground, 423 ft. above mean sea level, 340 ft. above average terrain.
- CLJH-TV (ch. 7) Lethbridge, Alta.—Change ant. height to 693 ft. above average terrain.
- CBLT (TV) Toronto, Ont.—Delete.

Routine Roundup . . .

March 21 Applications

ACCEPTED FOR FILING

Modification of Cp

Following seek mod. of cp to extend completion dates as shown. KRBB (TV) El Dorado, Ark., to 9-57; WFLB-TV Fayetteville, N. C., to 11-21-57; WCDB (TV) Haganan, N. Y., to 7-1-57.

License to Cover Cp

- KMAU-TV Wailuku, Hawaii—Seeks license to cover cp which authorized new tv.
- WLAC-TV Old Hickory, Tenn.—Seeks license to cover cp which authorized new tv.
- WFMS (FM) Indianapolis, Ind.—Seeks license to cover cp which authorized new fm.
- KPEG Spokane, Wash.—Seeks license to cover cp which authorized new am.

March 22 Applications

ACCEPTED FOR FILING

Modification of Cp

WBZ-TV Boston, Mass.—Seeks mod. of cp to extend completion date to 7-8-57.

License to Cover Cp

- WKNX-TV Saginaw, Mich.—Seeks license to cover cp which authorized new tv.
- WFMX (FM) New York, N. Y.—Seeks license to cover cp which authorized new fm.

March 25 Applications

ACCEPTED FOR FILING

Modification of Cp

Following seek mod. of cp to extend comple-

tion dates: WKPN (FM) Philadelphia, Pa., KMOS Tyler, Tex.

License to Cover Cp

WHLM-FM Bloomsburg, Pa.—Seeks license to cover cp which authorized new fm.

WORA-FM Mayaguez, P. R.—Seeks license to cover cp which authorized new fm.

March 27 Applications

ACCEPTED FOR FILING

Modification of Cp

Following seek mod. of cp to extend completion dates as shown. KULA Honolulu, Hawaii, WXLJ Hazelhurst, Ga.; WHOL Allentown, Pa., WPAB Ponce, P. R., WRAL-TV Raleigh, N. C., to 10-23-57, WGAL-TV Lancaster, Pa., to 10-20-57, KDUB-TV Lubbock, Tex., to 6-20-57.

License to Cover Cp

WPAT-FM Paterson, N. J.—Seeks license to cover cp which authorized new fm.

WBOR (FM) Brunswick, Me.—Seeks license to cover cp which authorized new fm.

WTJU (FM) Charlottesville, Va.—Seeks license to cover cp which authorized new fm.

UPCOMING

April

- April 5-6: Oregon State Broadcasters Assn., Eugene.
- April 8: United Press Broadcasters of Michigan, Olds Hotel, Lansing.
- April 6: Daytime Broadcasters Assn., Sheraton Hotel, Chicago.
- April 7-11: NARTB annual convention, Conrad Hilton, Chicago.
- April 8-11: Premium Adv. Assn. of America annual Premium Buyers' Exposition, Navy Pier and Morrison Hotel, Chicago.
- April 9: Premium Advertising Conference, Navy Pier, Chicago.
- April 22: Connecticut Broadcasters Assn., Hartford, Conn.
- April 22-26: American Film Assembly, Statler Hotel, New York.
- April 24-26: Annual Conference, American Public Relations Assn., Warwick Hotel, Philadelphia, Pa.
- April 25: United Press Broadcasters of Illinois, Allerton Park, Ill.
- April 25-27: Annual meeting of the American Assn. of Advertising Agencies, the Greenbrier, White Sulphur Springs, W. Va.
- April 25-27: New Mexico Broadcasters Assn., Deming.
- April 25-28: Annual convention, American Women in Radio & Television, Chase Park-Plaza Hotel, St. Louis.
- April 26: United Press Broadcasters of Mississippi, Buena Vista Hotel, Biloxi.
- April 28-May 4: Brand Names Week.

May

- May 1-3: Electronic Components Symposium, Morrison Hotel, Chicago.
- May 2-3: International convention of International Advertising Assn. Inc., Hotel Roosevelt, New York City.
- May 5-11: National Radio Week
- May 6-8: Annual meeting, Assn. of Canadian Advertisers, Royal York Hotel, Toronto, Ont.
- May 13-15: Aeronautical and Navigational Electronics national conference, Dayton, Ohio.
- May 15-17: Pennsylvania Assn. of Broadcasters, Hotel Bedford Springs, Bedford Springs.
- May 15-17: Radio-Electronics-TV Mfrs. Assn. convention, Sheraton Hotel, Chicago.
- May 20-21: Wisconsin Broadcasters Assn., Hotel Plankinton, Milwaukee.
- May 22-23: Kentucky Broadcasters Assn., Hotel Sheraton-Seelbach, Louisville.

June

- June 6-7: Virginia Assn. of Broadcasters, Hotel John Marshall, Richmond.
- June 17-19: NATRFD Spring Meeting, Washington.
- June 17-19: Nat. Convention on Military Electronics, Sheraton-Park Hotel, Washington.
- June 19-21: Annual meeting, Western Assn. of Broadcasters, Jasper Lodge, Jasper, Alta.

CLASSIFIED ADVERTISEMENTS

Payable in advance. Checks and money orders only.

- DEADLINE: Undisplayed—Monday preceding publication date. Display—Tuesday preceding publication date.
- SITUATIONS WANTED 20¢ per word—\$2.00 minimum • HELP WANTED 25¢ per word—\$2.00 minimum.
- All other classifications 30¢ per word—\$4.00 minimum. • DISPLAY ads \$15.00 per inch.

No charge for blind box number.

APPLICANTS: If transcriptions or bulk packages submitted, \$1.00 charge for mailing (Forward remittance separately, please). All transcriptions, photos, etc., sent to box numbers are sent at owner's risk. BROADCASTING • TELECASTING expressly repudiates any liability or responsibility for their custody or return.

RADIO

Help Wanted

Managerial

Wanted for immediate opportunity. One hard-hitting time salesman with creative ideas who thinks he is ready to be a commercial manager in leading regional station operation in this rich quarter million market potential. Rush resume and picture to Box 751E, B.T.

Here's a chance of a lifetime for program director or chief announcer to step up to management level. Growing organization in eastern United States needs a young married man with car for assistant managers position. Job offers opportunity at managership in near future. Send tape, resume, photo to Box 861E, B.T.

Need energetic, experienced young radio man strong on sales seeking first opportunity as manager. Salary plus override on station gross. Box 138G, B.T.

Major Illinois independent needs an outstanding producer strong on sales. Excellent deal for the right man. Box 168G, B.T.

Radio station manager with successful sales background. Immediate opening. New Mexico 250 watt station. Write Box 122, Albuquerque, New Mexico.

Salesmen

Outstanding ten year old daytime in midwest city of 25,000 offers a salary-commission arrangement that pays up to 40%. \$4000 billings will pay you \$800 per month. No ceiling. We will match your new billing up to \$1,000 with established billing, and give you full commission on total. \$400 per month guarantee for three months. Protected account lists. Only experienced, proven salesman considered. Please send full details on personal and employment background. Each application will be held confidential until closing arrangements are imminent. Write Box 894E, B.T.

Opportunity for radio salesman to move up the ladder to a big station in a major market. Sales representatives wanted by 50,000 watt, clear channel station in the midwest. This major network affiliate is recognized as one of the country's top stations. Only interested in someone who believes in radio . . . and good radio. Send full details to Box 119G, B.T.

Progressive daytime station needs thoroughly competent and experienced salesman. Salary \$100 weekly plus percentage. Box 137G, B.T.

Salesman or salesman-wife team for three Texas daytime stations. To rotate between stations, two weeks at a time each place. High presuring not wanted. Want accounts, though small, to stay sold. Box 151G, B.T.

Young man with potential, or older man with established sales record needed. Medium multi-station market. Groom for sales manager. Complete background and photo. All replies confidential. Box 161G, B.T.

Single station, medium size market. Draw against commission. Excellent opportunity with attractive future. Please forward details, photo and references. Box 170G, B.T.

Salesman—midwest—over 1/2 million market—5 kw daytime—independent—offers guarantee, 15% commission, protected account list. Prefer well-rounded sales and radio experience in small market ready to move into a real big money market. Box 211G, B.T.

Sales-announcer, with know-how. Excellent opportunity for live-wire, with independent day-timer. KTAN, Sherman, Texas.

Good opportunity for proven salesman, possibility manager. Reference. KTKT, 10 kw, music and news, Tucson, Arizona.

RADIO

Help Wanted—(Cont'd)

Salesman

Need top radio salesman! Receive top pay! No gimmicks, sound solid organization operating 7 radio and 1 tv station. Write, wire George Norman, Thoms Enterprises Inc., 92 Haywood Street, Asheville, N. C.

Announcers

Want to work for a swinging outfit? We need at least three good DJ's who know the music and news operation. Top pay for those DJ's who know how not to talk. Send tape and background to Box 916E, B.T. We will return your tape.

Experienced morning man-salesman combination. 17,000 east North Carolina market. \$80.00 salary, expenses, 10 percent commission. \$5,200 easily first year. Send complete data. Box 961E, B.T.

Top midwest station needs experienced announcer immediately. Fine opportunity in corporation owning radio and tv stations. Give all information, plus photo in first letter, including credit references. Send audition, tape or record. Box 984E, B.T.

Want to move up? What can you show us? Versatile staff announcer with several years solid experience wanted by kilowatt indie in fast growing Illinois community. Liberal bonus, insurance, other benefits. Require personal interview. Include age, education in resume. Box 996E, B.T.

1000 watt, near Philadelphia, needs disc jockey. Salary, talent, profit sharing. Parttime sales available. Box 129G, B.T.

Negro DJ. Big opportunity in major market with Number 1 negro station. Must have outstanding voice and personality with radio experience, write immediately with audition tape following. Box 132G, B.T.

Good announcer with first class ticket. \$500 per month. Box 157G, B.T.

If you know the location of Jack Collette, write Box 181G, B.T.

First ticket announcer. No maintenance. \$110 for an experienced man. Ohio. Box 190G, B.T.

Immediate opening for aggressive announcer in leading independent station in large mid-south market. Experience as staff DJ and some news. Send complete information, tape of music, commercials, news. Tape returned. Box 195G, B.T.

Immediate opening for announcer in small college community in western North Carolina resort area. Box 212G, B.T.

Experienced announcer for midwest station. Must have mature personality and deliver good commercial. Right person will also be used for television work. Send resume, photo and tape. Box 217G, B.T.

One more, top, all-around staff man for independent. Must have at least 3 years experience, know pops and standards. \$400-\$450 month for 42 hour week. Send tape and all information to KOLE, Fort Arthur, Texas.

First phone man with an Arthur Godfrey voice. Also, newsman who sounds like Frank Hemingway. We're going from 250 watts to 5000, and need both within a month. Send tapes and when available. KSEM, Moses Lake, Washington.

Louisiana's largest NBC outlet needs wide awake morning DJ. Run own board. Rush tape, photo and resume to Paul Bernard, KTBS-Radio, Shreveport, Louisiana.

Immediate opening for staff announcer. Send complete information and audition tape. WASA Harve de Grace, Maryland.

RADIO

Help Wanted—(Cont'd)

Announcers

WFRL, Freeport, Illinois, has immediate opening for experienced staff announcer. 48 hour week, overtime over 40 hours, paid vacations, free insurance, daytime operation. Write or call Bud Walters.

Combo man with first phone . . . emphasis on announcing . . . \$80 for 40 hour week, addition to staff . . . phone collect, WMIC, Monroe, Michigan. Cherry 1-5554. Ask for George Stearns or Bob Norwood.

Experienced announcer wanted for Washington, D. C., area independent. Send audition or call Jack Moran, WPIK, Alexandria, Virginia.

Announcer—experienced in all phases. Soon 5000 watts. Contact General Manager, WWHG, Hornell, New York.

Immediate opening for staff announcer in north-central Pennsylvania. Prefer man with some play-by-play sports experience who desires permanency . . . WWFA, Williamsport, Pennsylvania.

Man who knows popular music . . . not rock and roll . . . news, and can deliver a good selling commercial wanted by top-flight Michigan network station. Fine working conditions, usual employe benefits. Personal interview a must for man who has commercial experience. Call Kalamazoo, Fireside 5-2101 for appointment.

Wanted: Good voice, with commercial announcing ability, able to write idea copy, build two and three voice commercials with sound effects, for Thoms Enterprises Inc. We operate 7 radio and 1 tv station. Wire or write George Norman, 92 Haywood Street, Asheville, North Carolina.

Record specialist. Are you a qualified announcer with a good voice? Can you personally conduct a well planned and smoothly executed disc show? Can you help us build a strong music schedule? Are you qualified to supervise all music programming and be contact between station and recording companies, distributors and artists? If you think you're our man, send tape of air work and letter to Forjoe, 580 5th Avenue, New York, N. Y.

Radio regional midwest CBS station has immediate opening for staff announcer. Minimum of two years experience on-camera tv experience helpful as job includes work on full wft CBS affiliate. Send audition tape, picture and full background to Merritt Milligan, Assistant Manager, Lee Broadcasting Co., Quincy, Illinois.

Pacific northwest. We're looking for several good announcers with good production sense who can be built into strong local personalities. Send tape with broad sample of commercials, record intros and news, plus full details about yourself to: Forjoe, 580 Fifth Avenue, New York 36, New York.

Technical

Expanding organization needs a chief engineer with good maintenance ability. Must have car and be able to assume responsibility for repair and purchase. Good salary. Possibility of installing new station in near future. Send photo and resume to Box 860E, B.T.

Wanted: 1st class engineer-announcer. Emphasis announcing. Midwest. Box 189G, B.T.

Need first class engineer. Car necessary. Transmitter work. 44-hour week. KGNO Dodge City, Kansas.

First-phone operator. Immediate opening. Full particulars first letter, WASA, Havre de Grace, Maryland.

Wanted immediately—combination engineer-announcer must have a first class ticket. Good salary. Send your tape and data to L. Lansing, WBRV Radio, Boonville, New York.

RADIO

Help Wanted—(Cont'd)

Technical

First class engineer-announcer. \$5000 plus. WFKY, Frankfort, Kentucky.

Chief engineer for new 5000 watt daytimer. Send complete details and salary first letter. WHYY, Fort Gatlin Hotel Building, Orlando, Florida.

1st class engineer-announcer for west central Pennsylvania daytimer. Call Bill Raihall, WNCC Radio, Barnesboro, Pa. Telephone 1010.

Chief engineer-announcer for 1000 watt am-fm operation in midwest. Light announcing, salary \$430 per month to start. Be sure you are qualified. Phone S. A. Hassan, WROY, Carmi, Illinois.

Need first phone for 5 kw regional in college town, Pittsburgh area. Good pay, excellent recreational facilities, vacation, benefits. An opportunity to join a young staff on a booming station. Call Bill Harrington, Morgantown, West Virginia, 9488.

Chief engineer for fulltime 250 watt CBS affiliate. No air work. Fine college town. Good pay—permanency. Call Joe Termin, 5-5511, Indiana, Pennsylvania.

Programming-Production, Others

Administrative opportunity in network for man experienced in program and production costs in station in medium size or larger market, willing to relocate in major market. Degree in accounting of general business preferred. Under 35. Send detailed resume to Box 823E, B·T.

5 kw Mutual station, central U.S., desires experienced, aggressive program director, who knows successful metropolitan radio. Need good idea man to build ratings. Excellent opportunity. Good salary. Send air check and full info to Box 913E, B·T.

Workhorse program director to gather, write, announce local news, handle copy, traffic, promotion. North Carolina network affiliate. You name salary. Write fully. Box 962E, B·T.

Newsman wanted for 5 kw Ohio major market. You must be seasoned reporter and newswriter as well as good rapid fire airman. Right pay to right man. No rip and run boy need apply. Box 103G, B·T.

Need experienced program director-announcer. Fulltime. ABC station. Small, friendly southeast market. Send tape, photo and telephone number. Box 191G, B·T.

Need newsman for one of Iowa's top radio news operation. Air experience desirable, but not necessary. Call or write Radio Station KROS, Clinton, Iowa.

New daytime kilowatt station. Needs news director; announcers; copywriter; other staffers. Interested in a progressive operation in the prime beef center of the world? Shoot all details first letter to Steve Bellinger, WRAM Monmouth, Illinois.

RADIO

Help Wanted—(Cont'd)

Programming-Production, Others

News-caster-legman. Well known northwest local news department needs newscaster who can gather and write local news. On-the-air delivery is important, however, it must be subordinate to actual local leg-work. Send tape, sample of your writing and letter of application to Forjoe, 580 5th Avenue, New York 36, New York.

Situations Wanted

Managerial

Radio manager. Young; college; married. Want radio managerial position, tv, or agency. Currently managing midwest 1 kw independent. Want a future with top organization. Willing to take salary cut to prove my abilities. Box 155G, B·T.

Seeking change, 12 years experience all phases of radio accent on a economical operation and sales. A-1 references. Box 179G, B·T.

Manager or technical supervisor—experienced in all phases of broadcasting; management, sales and engineering. Construction experience, both non and directional arrays. First phone, family man, age 34. Presently own station but must change climate for family health. Available in June. Preference Northwest, west coast or southwest. Box 188G, B·T.

General manager with wide experience desires managerial position in city of 50-100,000, Michigan or Wisconsin. Presently earning \$12,000.00 per year. Will be at NARTB and can arrange personal interview. Box 197G, B·T.

Present part-owner and manager of two radio stations desires to expand ownership. Will invest in property in market with base city in excess of 25,000. Will be at NARTB. Box 198G, B·T.

Available if your offer is good enough. Station manager or commercial manager with recorded and proven sales ability, including national spot radio and tv representative, experienced retail radio sales, radio sales director, station manager. Send complete details your market and station to receive resume. Box 213G, B·T.

Salesmen

Successful salesman—sports director, seeks more lucrative opportunity. College, married. Box 985E, B·T.

Mature salesman. Employed as sales manager metropolitan market. Managerial experience. Desires to locate midwest or Florida. Age 30, family man, veteran. Four years sales experience both small and large markets. Available upon notice to employer. Sports background. Box 174G, B·T.

Salesman or announcer-salesman; 6 years experience. This family man has done everything! Can sell it, service it, announce it, and collect it! Desires change, soonest. Need bucks . . . will travel! Box 203G, B·T.

Announcers

Personality-DJ—strong commercials, gimmicks, etc., run own board. Steady, eager to please. Go anywhere. Box 109E, B·T.

RADIO

Help Wanted—(Cont'd)

Announcers

Girl personality—DJ, run own board, eager to please. Free to travel. Gimmicks and sales. Box 688E, B·T.

Deep, resonant voice. 4 years staff announcing experience. Prefer midwest. \$90 minimum. Box 796E, B·T.

Baseball play-by-play announcer. Seven years experience. Finest references. Box 975E, B·T.

Experienced sportscaster—newsman desires full-time sports minded station in Pennsylvania, Ohio, Indiana, Michigan, or Illinois. Box 895E, B·T.

Experienced first class announcer with first class ticket wants first class job. Box 999E, B·T.

Sportscaster—powerful delivery, knowledge of baseball. Tape, references. All offers considered. Box 114G, B·T.

DJ-staff—presently employed top southern market seeks relocate northeast-Florida-California. Box 135G, B·T.

Disc jockey, idea gal, program director, station's best pal. Production expert guaranteed. Hire me now. I'm what you need. Box 152G, B·T.

Combo-first phone—emphasis announcing. Available immediately. References. Eastern U. S. Box 154G, B·T.

Announcer: 3 years' experience news, commercials, DJ, sports, available immediately. Box 159G, B·T.

Good samaritan needed! Not blessed with network voice. Hard worker. 10 years experience. Good references. Get along with people. Married. 32. Box 160G, B·T.

Sportscaster: Radio and television—four years experience—presently employed—desires baseball play-by-play. Box 162G, B·T.

Employed. 3½ years experience. Seeks position with progressive New England operation. Box 165G, B·T.

Two years experience, graduate from radio school in May. Prefer southwest. Available first of June. Strong on news. Married. Box 166G, B·T.

Sportscaster-DJ-MC. 8 years radio, 1 year tv. Employed in one of midwest's largest markets. Play-by-play over 200 baseball, football, basketball games since May 1956. Gimmicks approach to records. Want radio or radio-tv. Box 169G, B·T.

Announcer: Have little experience, plenty of ambition. Married, vet, 24 years old. Operate own board. Prefer East Coast, but will consider all replies. Box 171G, B·T.

Experienced announcer—1st phone—family—limited sales work, would like more—seeking permanent position, futurewise and improvementwise. Nothing sensational, just hard working. Box 172G, B·T.

Announcer, DJ, newsman. Five years experience. \$100 for 40 hours. First phone. Tape. Box 176G, B·T.

Where is opportunity's open door in profession? 3 years college, 18 months production, non-drinker. Box 184G, B·T.

Announcer: 14 years experience, 35, married. Desires northeast. Special talents. Box 192G, B·T.

Recently graduated announcer seeking first spot as newscaster-DJ, excellent voice, reliable, neat. Box 193G, B·T.

Want relocation northeast. Smiles to your community. Veteran, married, experienced. Box 194G, B·T.

Top-notch country DJ—staff announcer. Young, reliable, experienced. Wishes to locate in southern California. Now employed—tape and recommendations on request. Box 202G, B·T.

Is there a station carrying minor league baseball that will give beginner a chance doing play-by-play? Have excellent possibilities—can operate board, do other sports, news, music, commercials. Box 204G, B·T.

Announcer-salesman. Radio-tv. Experienced radio. Copywriter. Ambitious. College graduate. Box 206G, B·T.

Play-by-play, all sports, staff, currently sports director, southwest. Seek station with heavy sports schedule. Box 207G, B·T.

SEE YOU IN CHICAGO...

- To buy or sell a station.
- To discuss management problems.
- To advance your executive career.
- To find a well-qualified executive.

Howard S. Frazier will be at the Palmer House
April 7th through April 10th.

HOWARD S. FRAZIER

Tv and Radio Management
Consultants

Negotiations • Appraisals

333 Trans-Lux Bldg. • 724 Fourteenth St., N. W. • Washington 5, D. C.

**BROADCASTERS EXECUTIVE
PLACEMENT SERVICE, INC.**

Confidential Contact
Nationwide Service

RADIO

Situations Wanted—(Cont'd)

Announcers

Sports-announcer baseball's best. Versatile, sincere. Ex-pro—college. Try and you'll buy. Box 207G, B.T.

Sepla girl! Aggressive, staff, working south 6 months prefers midwest, Chicago, Indiana, etc. Box 208G, B.T.

Announcer, 5 years experience all phases. Operate board. Excellent references. Box 210G, B.T.

Personality-DJ—strong commercials, gimmicks, etc., run own board. Steady, eager to please. Go anywhere. Box 215G, B.T.

Employed, experienced. Must relocate due to change in personnel. Good references. Charlie Doll, WAFC, Staunton, Virginia.

Announcer-DJ, 4 years experience wants to relocate in New Jersey, Pennsylvania, Connecticut or surrounding area. Bob Douglas, 1883 Crotona Avenue, Bronx 57, New York. Tel. TR 8-9706.

Versatile announcer and chief engineer—twelve years experience—college graduate—know all phases of radio good references—prefer Texas—Call Jim Lynn, 8211, Baytown, Texas. Will consider all replies.

Announcer: B.A. Degree Speech, Radio and Tv Communications; B.S. Degree Agriculture, University of Illinois; experienced farm advisor. Strong on news and commercials. Age 27, single, presently employed night operations, NBC Chicago. Bob Reynek, 625 Clinton Place, River Forest, Illinois. Forest 9-8087.

Floridian desires permanent change to home state. Experienced DJ, newscaster, reliable. Box 20, LaLuz, New Mexico.

Technical

Experienced engineer, 1st phone, available. Have own car, married, no children. Contact Box 187G, B.T.

Engineer, 1st phone, 6½ years experience radio and tv. Some microwave experience. College and night school, don't drink. Only permanent jobs considered. Box 187G, B.T.

First class phone, 5 years experience in electronics, midwest or west preferred. Bill Culver, 2116 31st Street, S.E., Washington 20, D. C.

Two first phone men—one with limited technical experience and one with no experience—now available for broadcasting jobs. Contact Grantham School, 1505 N. Western Avenue, Hollywood, California.

Programming-Production, Others

News editor: Aggressive midwest radio-tv editor with loyal following tired of operating newsroom on "make-do" budget. Have reached my peak here, what can you offer? minimum \$600. Sober, young, reliable married veteran. Prefer west coast but will consider all offers. 10 years radio-tv experience. Box 153G, B.T.

Young lady . . . five years radio experience . . . air . . . copy . . . production . . . desires challenging opportunity . . . eastern metropolitan location. Box 175G, B.T.

Newsman: Built local news reputation for Wisconsin station from nothing to excellent in less than three years. Experienced in every phase of radio reporting. Marquette University Journalism graduate, member SDX, RTNDA, 30, married. Current salary \$6,500. Desire new challenge with commensurate remuneration. Box 183G, B.T.

No loud mouth claims, here! If you're looking for a sensible PD-writer team, send for our tape. All self-contained and an immediate indication of two fireballs to sparkle your station. Both employed. Box 205G, B.T.

Experienced radio news director . . . successful as time salesman for local station . . . write copy . . . university grad. with A.B. degree in radio. Presently employed . . . dependable family man . . . active in church and community civic organization . . . best of references. Wants work as program director or newsman with reputable organization which does not solicit beer advertising. Brooks Dawson, 203 Ataman Building, Auburn, Indiana.

TELEVISION

Help Wanted

Salesmen

Salesman, veteran or draft exempt, with one to three years radio—television sales experience. Good opportunity to become part of established station in expanding market. Write Personnel Department, WSBT-TV, South Bend 1, Indiana.

Announcers

Announcer for midwest vhf network tv station. Must deliver good commercial both on and off camera. Good radio personality may qualify. Send resume, photo and tape. Tape will be returned. Box 216G, B.T.

Enterprising announcer with some commercial background who wants to learn the business thoroughly in a top operation. Staff announcer-copywriter job now open. Personal interview in Michigan absolute necessity. Phone Kalamazoo, Fireside 5-2101 for appointment. Good working conditions, employee benefits. Fine, alert staff.

Technical

Assistant chief engineer: Immediate opening with southwest vhf CBS station. Should be familiar with operation and maintenance. State experience and education. Box 178G, B.T.

Wanted immediately, tv technician, FCC first class radio telephone license required. No experience necessary. Well established company offers unusual opportunities for advancement. State experience, salary desired, and enclose snapshot. Box 209G, B.T.

Wanted: Engineer-operator for vhf station in Lewiston, Idaho, Heart of America's recreation area. Must have first phone. Good pay, opportunity for advancement. Company operates three uhf tv stations, two am stations and one vhf-tv station. Phone collect Chief Engineer, KLEW-TV, Lewiston, Idaho.

First class license tv transmitter operator. Tv experience desirable but not essential. If you like sking this is an unparalleled opportunity. Transmitter at Stowe, Vermont. Station provide head skis. Liberal food allowance plus mileage. Reply Chief Engineer, WCAX-TV, Burlington, Vermont.

Programming-Production, Others

Television newsman and photographer. Require some on-camera ability, mostly aptitude with cameras and newsroom familiarity. Will train man with limited experience and good potential. Address Program Director, WOC-TV, Davenport, Iowa; include complete resume and salary requirement.

Situation Wanted

Managerial

Manager-commercial manager. 6 years tv, 10 years radio. Also network and agency. Best references previous stations. Box 200G, B.T.

Technical

Engineer—fully qualified studio/transmitter operations or supervisory. Mature. Box 657E, B.T.

Programming-Production, Others

Assistant director-cameraman, 4 years experience; presently employed. Desires permanent association established operation. Excellent references. Box 989E, B.T.

Standout newsman available for standout job in news direction, newscasting and station promotion. Ideal for big city tv-radio-newspaper combination or tv that recognizes inevitable enlargement of news programming. Qualifications unequalled. Now earning \$9,000. Box 158G, B.T.

Want to join real news organization. Need competition. 10 years radio-tv news. Top air delivery, know-how to use film, pics, develop stringer systems. Send for full resume. Box 158G, B.T.

Film director. 3 years experience. Fully qualified. Married, family. Presently employed. Box 182G, B.T.

Cinematographer, film director, cameraman . . . 4 years experience producing clips and program length films for university radio-tv department. A.B. Liberal Arts, one-year graduate work. 29 years old. Write news and feature copy. Good reporter. Bob Mauldin, 206 McCauley Street, Chapel Hill, North Carolina.

Available immediately, practically-trained, top-flight production personnel, all categories. Call Northwest First, Northwest Radio & TV School, 1221 NW 21st, Portland 6, Oregon. Also Hollywood, Chicago, Washington, D. C.

THE LATCHSTRING IS OUT AT SUITE 1018-20 IN THE CONRAD HILTON

Make a note now of our headquarters for NARTB convention, and drop in anytime.

On hand to greet you will be Ed Tornberg of our New York office; Walter Grimes of our Washington office; Dick Shaheen and Tim O'Connor of our Chicago office.

Whether your interest is swapping gossip, checking rumors or something more serious, you're as welcome as a favorable FCC decision.

We're proud to be a part of the dynamic broadcasting industry. We share your anticipation in the greatest of NARTB conventions.

We hope to see you there.

ALLEN KANDER AND COMPANY

Negotiators for the Purchase and Sale of Radio and Television Stations

WASHINGTON

1625 Eye Street, N.W. National 8-1990

NEW YORK

60 East 42nd Street Murray Hill 7-4242

CHICAGO

35 East Wacker Drive Randolph 6-3688

FOR SALE

Stations

For sale: Kilowatt am in northwest college town. Full price \$50,000.00, \$10,000.00 down, balance terms. Write Box 798E, B.T.

New England major network affiliate. \$125,000. Cash or terms. Box 173G, B.T.

Old established fulltime station in good secondary market, middle-Atlantic states. Top county Nielsen. Grossing \$135,000 which will increase. High profits with probable four-year payout. Combo operation with valuable buildings. \$50,000 down payment four-year balance. No brokers please. Only those stating financial qualifications will be answered. Sale indirectly due to force sale of another property. Box 180G, B.T.

We would welcome opportunity to talk with parties interested in buying or selling stations at NARTB meeting next week, Chicago. Our rooms will be 1735-36A, Conrad Hilton. Paul H. Chapman Company.

Florida station, growing market area, showing \$25,000 income to owners. \$135,000 price for control. This and 14 other stations currently available through Paul H. Chapman Co., 84 Peachtree, Atlanta.

The Norman Company, 510 Security Bldg., Davenport, Iowa. Sales, purchases, appraisals, handled with care and discretion, based on operating our own stations.

Write now for our free bulletin of outstanding radio and tv buys throughout the United States. Jack L. Stoll & Associates, 6381 Hollywood Blvd., Los Angeles, Calif.

250 watt, 1370 kilocycles. daytime and extra. All new equipment. \$10,000 down will handle; or will sell quarter interest with \$3,000 down and \$1,400 year. Our No. 9881. May Brothers, Binghamton, New York.

Equipment

Tapak portable recorder windup (\$439 list new, used 6 months) will trade for mikes, power tape recorders. Box 150G, B.T.

3M recording tape, type 101A, paper base, 1/4" x 4800 ft. on NAB reels in individual boxes, unused, approximately 460 available. Price below wholesale. Box 214G, B.T.

Gates RCM-12 remote control, complete, like new. Going combination studio-transmitter unit available about April 15th. KBOK, Malvern, Arkansas.

PROMOTION, MERCHANDISING, ADVERTISING PERSONNEL:

LOOKING FOR A NEW OPPORTUNITY?

BROADCASTERS:

LOOKING FOR COMPETENT
PROMOTION PERSONNEL?

Maybe the Broadcasters' Promotion Association can help you get together!

BPA is setting up a clearing house for broadcast promotion personnel looking for new opportunities—and for broadcasters seeking experienced, competent promotion help. Please note: BPA makes no recommendations, but simply tries to get the two parties together. And for both parties, the price is right, the service is free! No fees of any kind.

If you're looking for a job, send a COMPLETE resume of background and experience, plus location desired and salary requirements. If you're looking for promotion help, let us know the type of person and experience you're after.

Write:
**BROADCASTERS' PROMOTION
ASSOCIATION**
Suite 2100, 122 East 42nd Street,
N. Y. 17, N. Y.

FOR SALE

Equipment

For sale: One General Electric 10kw fm amplifier, model 4BF3A1, with four GL 5518 tubes. Price in Sacramento: \$2,800.00. Also, one Collins 37M4 side mount ring antenna. Price: \$700.00. For information contact KGMS, Hotel Sacramento, California.

1 self-supporting Lehigh tower 170' six Hazard lights in excellent condition. Dismantled \$850 takes it. WKNY, Kingston, New York. Telephone Kingston 4500.

300-foot Blaw-Knox self-supporting tower. 33 feet square at base. Will support fm antenna or light tv antenna. Available immediately. Contact WTBF, Troy, Alabama.

For sale: RCA TG-1A sync generator TK-1A monoscope camera TA-1A distribution amplifier, 480C power in two racks \$2,500. Also one TG-1A requiring slight modification \$1,000. Mautner Laboratories, 380 Oak Street, Copiague, Long Island, New York.

Am radio tower—self-supporting, 178 feet high. Now located on 3 story building. Can be easily dismantled and re-erected. Will give good service for many years. Bargain priced. Write or phone John Stauffer, Kansas City, Kansas.

WANTED TO BUY

Stations

Wanted to buy: Small market station, preferably, but not necessarily, daytimer. Single station market preferred. Can arrange meeting at NARTB Convention in Chicago. No brokers. All inquiries confidential. Write or wire Box 126G, B.T.

Network personality moving to Florida wants to buy radio station or substantial interest. Will consider any Florida station, large or small, for active or inactive participation. Box 163G, B.T.

Qualified buyer, presently owner and manager of two stations desires to purchase all or part of a Wisconsin or Michigan station. Will assume active role as manager. Box 199G, B.T.

Conservative Private Service. Texas, Louisiana, Colorado, Missouri, Kansas, Arkansas, Oklahoma. Ralph Erwin, Licensed Broker, Tulsa.

Up to \$80,000 cash down payment on immediate purchase profitable am station billing 125 to 250 thousand. Our No. 9879, May Brothers, Binghamton, New York.

Equipment

Used equipment suitable for new 250 watt station, and 100 foot tower. Box 109G, B.T.

One, three, of five kw. Fm transmitter, and monitor. Box 164G, B.T.

Have you for sale sick fulltime station in market of at least 250,000. Box 201G, B.T.

Want video low pass filter DuMont 5397A or RCA MI27132. KSPR-TV, Box 930, Casper, Wyoming.

Wanted—used console. State condition and price. Contact Chief Engineer, WSBA, York, Pennsylvania.

Wanted, good rack mounted Magnecord tape recorder with amplifier, advise condition, model, age, speed, price, etc.—Bill Tomberlin, 2917 W. Temple Street, Los Angeles 28, California.

INSTRUCTION

FCC first phone in 12 weeks. Home study or resident training. Our schools are located in Hollywood, California, and Washington, D. C. For free booklet, write Grantham School of Electronics, Desk B-A, 821 19th Street, N. W., Washington 6, D. C.

FCC first phone license. Start immediately. Guarantee coaching. Northwest Radio & Television School, Dept. B, 1627 K Street, N. W., Washington, D. C.

FCC first phone license in six weeks. Guaranteed instruction by master teacher. Phone Fleetwood 2-2733. Elkins Radio License School, 3605 Regent Drive, Dallas, Texas.

RADIO

Help Wanted

WE'VE GOT IT!!!

5000 WATTS ON 560KC

CBS NETWORK

Located in scenic Southern West Virginia.

And openings for Staff Workers.

WE NEED

Sports Announcers

Staff Announcers

News men

Disc Jockeys

Announcer-Salesmen

The salary is open if you are honest, reliable, aggressive and have unusual to offer. Rush full particulars or telephone Program Manager, WJLS, Beckley, West Virginia.

Salesmen

WANTED . . .

TWO \$25,000 A YEAR SALESMEN

FOR

WMMA, MIAMI, FLORIDA

A young aggressive organization needs two top-notch experienced salesmen for a 5,000 watt station currently under construction. Owner is 36 years old, has been a salesman all his life, has come up the hard way himself, and knows and understands what a radio salesman is, his problems, his needs, and his desires. Therefore, if you are factually a salesman whether in a small, one-radio market, or if you are employed by a large metropolitan station, your application is invited and it will be reviewed carefully and confidentially by another salesman-owner. Your record of sales performance and experience must accompany your application and all applicants who apply by mail and give complete details will be considered. Positively, no phone calls or inquiries will be received. The owner guarantees any successful applicant a big guaranteed salary, not a commission or draw, but a large salary plus 15% commission which is not chargeable against the salary. With this goes the guarantee of an unbelievable opportunity to move even higher by advancement to other big radio-tv properties owned by the organization. No wishy-washy words, intents, or purposes are expressed or implied in this ad. . . it is simply an honest, factual statement of opportunity and a statement of what this owner will do in order to secure and keep big-time sales people. Send your complete, written record immediately to:

Keith Moyer

Box 481

Taylorville, Illinois

RADIO

Help Wanted—(Cont'd)

Salesmen

SALES ENGINEERS

Broadcast equipment manufacturer has opening for sales engineers to call on radio stations in following territories.

West Coast
Upper Southern States
Middle Atlantic

Technical background essential, previous sales experience desirable. High remuneration. Please send complete resume to

Box 790E, B•T

Radio Salesman Wanted

50,000 watt Midwest radio station is looking for energetic time salesman of executive caliber. Right man can soon advance into responsible position. Give age, experience and business history.

Box 185G, B•T

Situations Wanted

Managerial

37 YEARS RACKED UP IN BROADCAST INDUSTRY

Familiar with all phases news, sales, program direction, production. Half that time with 50kw network stations. Acted as station manager; considered top commercial announcer, good executive. Steady, sober and married—not a drifter. Seeking management or other type responsible job in large or small, net or indie station within 100 miles of Chicago—prefer north—including Milwaukee, or allied industry. Available for interview any afternoon during NARTB Convention after 2 p.m. or any evening. Now employed.

Box 186G, B•T

TELEVISION

Help Wanted

Programming-Production, Others

URGENT

NEED COMPETENT NEWSMAN, PREFERABLE WITH JOURNALISM DEGREE TO JOIN TV NEWS STAFF IN STATE CAPITAL. REPORTING AND REWRITE ABILITY A MUST, BUT WOULD ALSO LIKE MAN CAPABLE OF ON-CAMERA WORK. INTEREST IN NEWS ESSENTIAL. SOME NEWSPAPER, RADIO, OR TV EXPERIENCE DESIRED. SALARY \$375 PER MONTH. SEND TAPE, PHOTO AND COMPLETE INFO FIRST LETTER. SPEED ESSENTIAL.

BOX 177G, B•T

TELEVISION

Help Wanted—(Cont'd)

Programming-Production, Others

PROMOTION-PUBLICITY DIRECTOR WANTED FOR NEW VHF IN TOP SOUTHEASTERN MARKET!

Immediate opening for creative self-starter. Must be able to write publicity, plan and produce sales aids, and aggressively accomplish all station promotion. Send photo, salary requirements in first letter to
Box 196G, B•T

FOR SALE

Stations

See HASKELL BLOOMBERG

Radio and Television

Business Broker

And Muriel Bloomberg, Ass't
NARTB CONVENTION, CHICAGO
SUITE 833-834A
CONRAD HILTON HOTEL

Equipment

TAPE RECORDERS

All Professional Makes

New—Used—Trades

Supplies—Parts—Accessories

STEFFEN ELECTRO ART CO.

4405 W. North Avenue
Milwaukee 8, Wisc.

Hilltop 4-2715

America's Tape Recorder Specialists

NEW TUBES

Excess inventory must be disposed of before end of fiscal year. Will sacrifice at 50% of cost. 891, 891R, 892R, 3K, 20,000LK, 207, 251A, 849, 889, 889A, 889RA, 5531, 5606, 6019, 6183.

Box 855E, B•T

WANTED TO BUY

Stations

STATION OWNERS

Florida, Michigan, Ohio, Indiana, Illinois and adjacent states. Am private party interested in purchasing station billing \$75 to \$150,000. All replies strict confidence. Principals only. Will identify self completely. Financially responsible.

Box 987E, B•T

EMPLOYMENT SERVICES

TOP JOBS—TOP PEOPLE

We have, or will find, just the person or job you're looking for.
Contact M. E. Stone, Manager

NATIONAL RADIO & TELEVISION
EMPLOYMENT SERVICE

5th floor, 1627 'K' St. NW.
Washington, D. C.—RE 7-0243

Planning a radio station?

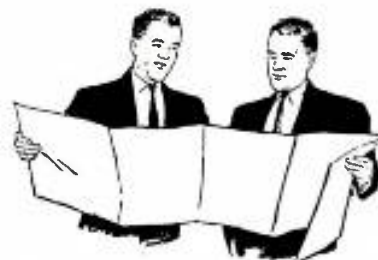

You can count
on RCA's 4-point
service program
...to get you on
the air...to keep
you on the air.

- PLANNING ASSISTANCE
- EQUIPMENT COUNSEL
- FIELD SERVICE
- EMERGENCY REPAIRS

**RADIO CORPORATION
of AMERICA**



Loew's Blow

WHATEVER its legal outcome, the suit filed last week against Loew's Inc. by the Dept. of Justice is bound to have immediate practical effects, and we predict they will be salutary.

Loew's is charged with violating the antitrust laws by selling its MGM feature films to television as a package instead of individually. The procedure, according to the government's suit, constitutes block-booking of the kind outlawed in the Paramount case of 1948. The government wants Loew's to sell picture-by-picture.

In this case the government's desires are shared, we venture to say, by most television stations. The common complaint of tv broadcasters is that to get the feature films they want they must buy feature packages containing films of little or no value.

There can be no doubt that the package deal—or block-booking as the government chooses to call it—works to the advantage of the film distributor. Indeed it is not unlikely that the enticements of the package deal were at least partly responsible for the decision of major movie makers to release their backlogs to television.

For the distributor it is manifestly easier to sell, say, 700 films in a lot than to dicker individually over each of the 700. What is more, the package sale assures the distributor that all the pictures in his kit—good or bad—will move in the market as a unit.

It is logical to expect that feature film distributors will at once change their selling practices, even though the Loew's case is still only a suit and may be years from a decision. Distributors who continue block-booking will expose themselves to serious consequences if the government is successful in its action.

In our view this is all to the good. Dealing individually with features will complicate the business of film distributing, but it will benefit the viewing public and the broadcaster. It will no longer be necessary for the broadcaster to find himself loaded with unattractive features which he plays, to the impoverishment of his program schedule and the boredom of his audience, or which he is forced to buy but refuses to play, to the detriment of his profits.

The Doerfer Doctrine

IT hasn't happened before and it may not happen again. The FCC has voluntarily stripped itself of regulatory power—a radical departure from the bureaucratic penchant for arrogating more and more authority. And in so doing the FCC opens an entirely new and wholesome era in licensing—unless it is tripped up by the courts.

By a decisive 5-2 vote, the FCC 10 days ago concluded that it does not have the legal authority to consider economic injury to existing stations in acting upon an application that otherwise meets its criteria for new stations. But it went even beyond that in respect to its authority in the broadcast field. It limited itself to the power to regulate only “with respect to electrical interference and with respect to the qualifications of the licensee or applicant”.

This may become known as the Doerfer Doctrine. Actually it is a return to the original Congressional intent, but from which predecessor commissions have gradually departed during nearly two decades.

The new 5-2 decision goes far beyond policy. It now is a matter of law, as construed by the majority.

The decision came in what appeared to be an innocuous case. It involved Cleveland, Tenn., a town of under 13,000 (1950 Census). The existing 250-watter protested an April 1955 grant of a 1 kw daytimer in the market, on the ground that the economic potential was such that two stations could not survive, or if they did, their programming would be degraded. In sustaining the examiner, the FCC majority said: “Restriction of competition is a corollary of exclusivity, and exclusivity is tolerable only by the application of public utility concepts or techniques”. That means rate regulation and control of product—in short, censorship.

Whether or not the aggrieved 250-watter in Cleveland, Tenn., goes to court to test the validity of the FCC's action, it seems certain that the issue will be litigated sooner or later. Two of the veteran Commissioners—Hyde and Bartley—disagree with the majority as to the law, but not as to policy. There is sharp disagreement on the interpretation of past court opinions.

We think the Congressional intent is clear. We like the majority opinion. The logical corollary in keeping with the reaffirmation of the “free enterprise” concept is to move out of the sphere of programming and of “counting spots”, except where specific statutes would be violated.

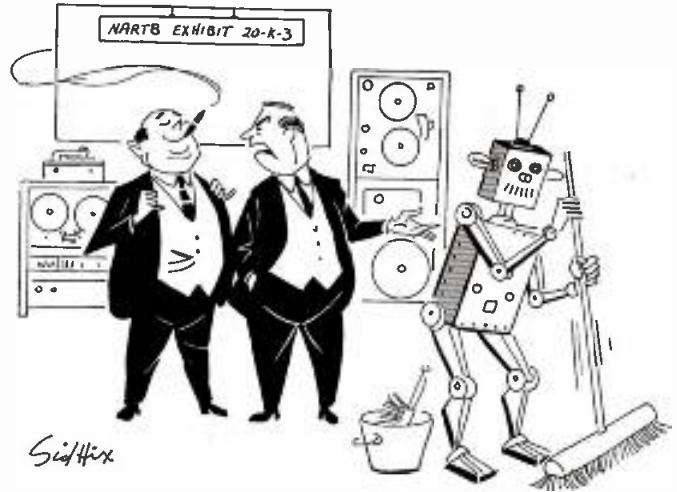

Drawn for BROADCASTING • TELECASTING by Sid Hix

“Personally, I think you're overdoing this automation thing!”

A Question For Chicago

WHAT could be the forerunner of a national, closed-circuit system of subscription tv is shaping up in several quarters.

A number of theatre chains in the Southwest have announced plans to pipe first-run movies into the television sets in subscribers' homes. International Telemeter, the Paramount subsidiary, has announced its readiness to equip such operations.

So far, these plans are confined to individual cities and to movies as exclusive program fare. It would be easy, however, to enlarge operations, especially if the relatively uncomplicated process of delivering wired motion pictures to homes in individual communities works out successfully.

The next steps obviously would be to expand and diversify the programming and to link the individual systems into one or more networks. Once these steps were taken, subscription television would have arrived.

In our view, it would have arrived by the proper evolution and in the proper form—using cables instead of scarce broadcast frequencies. Of utmost importance, it would have been established without depriving the public of any television service it now receives free.

This is not to say that wired toll tv would not be competitive with free television. It would definitely be in competition with free tv for the leisure time of the public. To the extent it was successful in attracting viewers it would dilute the audience available to free tv.

But that would be a healthy kind of competition. The public would have a wider choice of programs and hence would benefit. To put toll tv on the air would mean lessening the public's choice in programs and eventually would lead to the conversion of most if not all television to subscription service.

It is that eventuality which the government is virtually assuring if it approves the use of broadcast frequencies by toll tv.

TWICE in the past fortnight the FCC has wrestled—painfully, according to reports—with the subscription television problem.

Before it wrestles itself into a position of possible embarrassment, the FCC would do well to consider the obvious virtues of a closed-circuit system of subscription television—which, at least in its early stages of confinement to individual communities, would need no FCC approval.

Would it not be realistic for the FCC to postpone a decision on broadcast subscription television until some of the wired systems have been put to work?

Certainly that question is worth consideration. Indeed, we suggest it be considered when the FCC appears before the NARTB in a forum discussion April 10.

The FCC's appearance in Chicago will provide not only an opportunity for open discussion of subscription tv during the forum but also a chance for individual Commissioners to seek out the views of practical broadcasters.

No question before the FCC is of greater moment than that of toll tv. It can hardly escape attention at Chicago.

1956 Nielsen Market
Coverage Study shows:

KSTP RADIO DELIVERS LOWEST COST-PER-THOUSAND IN NORTHWEST MARKET!

Here's the proof that KSTP Radio—
The Northwest's *QUALITY* Station—
is your *best* buy in the vital Northwest
market.

- N. C. S. No. 2 Spring, 1956 shows
that in Ramsey County (city of St.
Paul) KSTP reaches *more homes* every
month than any other Twin City
Radio Station.
- In Hennepin County (city of Minne-
apolis) KSTP is *second* among all
stations in number of homes reached
monthly.
- In station *total* homes reached month-
ly *and* weekly, KSTP is a strong
second.

- As a result of these figures, a com-
parison of rates shows that KSTP
Radio offers *you* the **LOWEST COST-
PER-THOUSAND HOMES** in this mar-
ket of more than 900,000 radio families.

To reach and *sell* the growing, active-
buying Northwest most *effectively*, most
economically, KSTP Radio is your *first*
buy and your *best* buy!

For further information, contact your
nearest Edward Petry office or a KSTP
representative—today.

KSTP *Radio*
50,000 WATTS

MINNEAPOLIS • ST. PAUL *Basic NBC Affiliate*

"The Northwest's *QUALITY* Station"

Represented by Edward Petry & Co., Inc.



All three

agree!

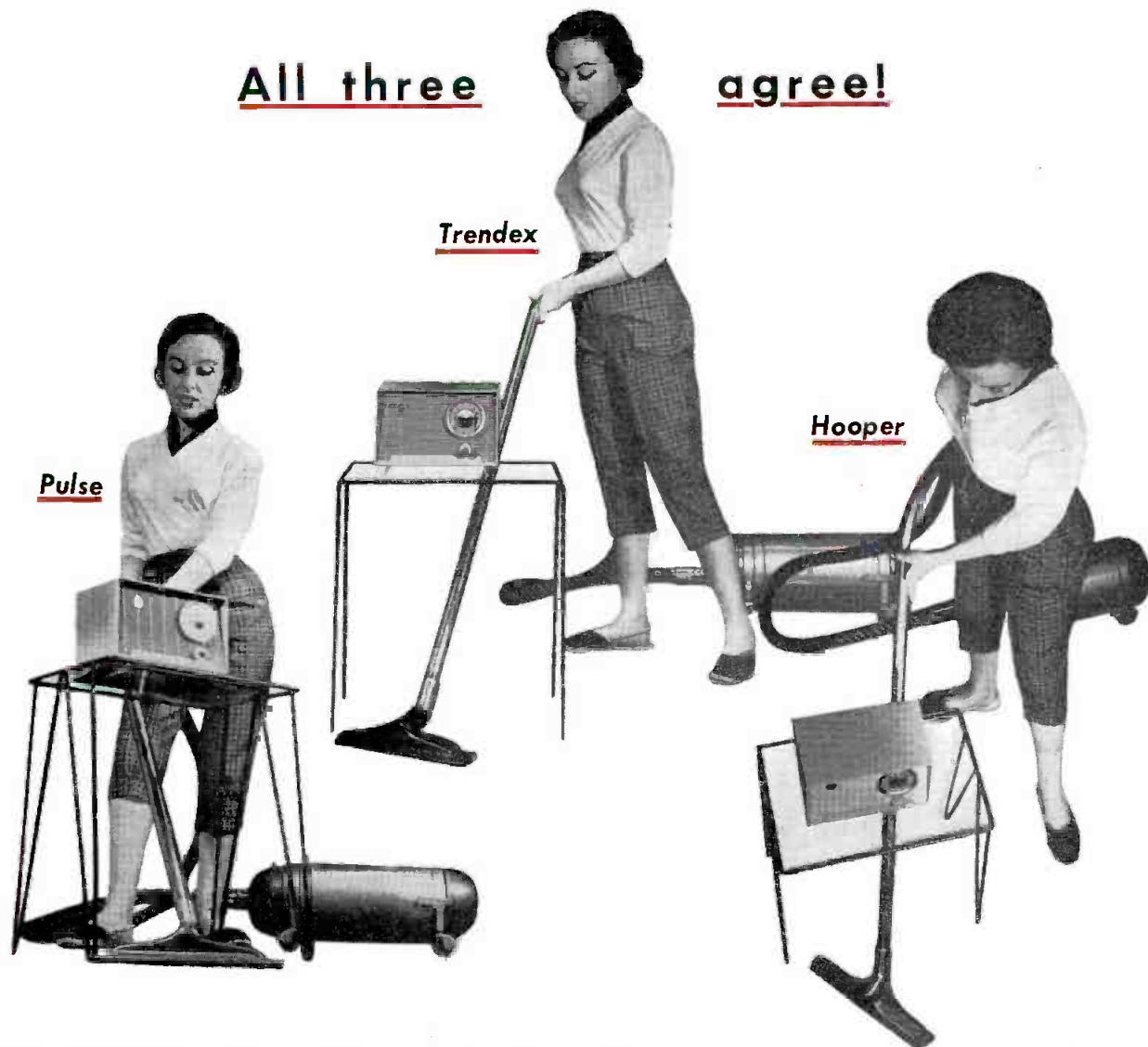

KOWH is No. 1 in Omaha audience!

Take Pulse, for example. KOWH is first in 216 out of 240 daytime quarter hours. More evidence, added to previous data, of KOWH's decisive dominance of Omaha radio. Feb.-March Hooper has KOWH out in front, too, as ever! Trendex gives KOWH top spot, too.

This is the kind of market-dominance which Storz Station ideas, programming and broad (660 kc.) coverage *continue* to make possible for national and local advertisers. Results prove it, too.

Get Adam Young's point of view . . . or talk it over with General Manager Virgil Sharpe.

LATEST PULSE SAYS:

KOWH leads next independent
by nearly

2 to 1

The Storz Stations
Today's Radio for Today's Selling

TODD STORZ,
President

WDGY
Minneapolis-St. Paul

WHB
Kansas City

WQAM
Miami

KOWH
Omaha

WTIX
New Orleans

Represented by John Blair & Co.

Represented by Adam Young Inc.