

BROADCASTING TELEVISION

COAF Air University
Library Serials Section
Acquisitions Branch
M/R AF1799 LO (DI-600) 2481
Maxwell Air Force Base Ala
MAR 54 NP
NS-51
D 100
5346

IN THIS ISSUE:

Assistance May Alter
MBS Sales Plan

Page 27

Short Term Spots
Highlight Buying

Page 28

CC Probes Lamb's
Qualifications

Page 48

List 4 Thanks Ike
for Naming Hyde

Page 34

FEATURE SECTION

Starts on Page 83

23RD year

THE NEWSWEEKLY
OF RADIO AND TV

Buy WHO

and Get Iowa's **Metropolitan** Areas..

Plus the **Remainder** of Iowa!

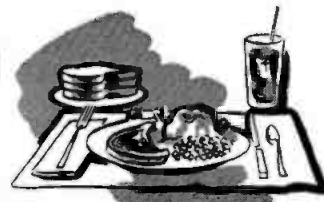

**TAKE SALES OF
EATING AND DRINKING
PLACES, FOR INSTANCE!**

Figures add to more than 100%
because Rock Island County, Illinois
is included in Tri-Cities.

THE "REMAINDER OF IOWA" ACCOUNTS FOR THESE SALES:

(Which You MISS Unless You Cover the Entire State)

- 65.4% Food Stores
- 61.6% Eating and Drinking Places
- 44.8% General Merchandise Stores
- 55.6% Apparel Stores
- 60.7% Home Furnishings Stores
- 65.1% Automotive Dealers
- 73.2% Filling Stations
- 79.6% Building Material Groups
- 60.4% Drugstores

Source: 1952-'53 Consumer Markets

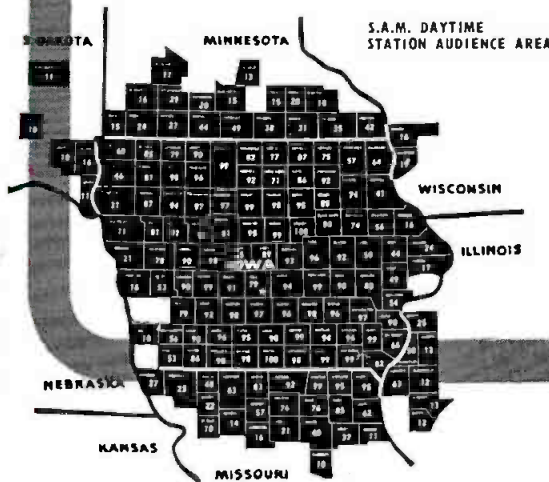

FREE & PETERS, INC.
National Representatives

**BUY ALL of IOWA—
Plus "Iowa Plus"—with**



Des Moines . . . 50,000 Watts

Col. B. J. Palmer, President

P. A. Loyet, Resident Manager



SERUTAN and GERITOL DO A COMPLETE JOB . . .

SO DO HAVENS AND MARTIN, Inc. STATIONS . . .

**WMBG
WCOD
WTVR**

Ever since it was introduced to the American people twenty years ago, Serutan has been the leader in its field. Constant, careful research and high-quality control have made Serutan a product people trust completely. And this same confidence carries over to Geritol and other products distributed by the Serutan Company.

Building listener confidence for the advertiser and his product has been the object of Havens & Martin, Inc., Stations. The result . . . large and loyal audiences in the rich areas around Richmond. The means . . . quality-controlled entertainment and public service. Build sales results on confidence in your product through WMBG, WCOD and WTVR, the First Station of Virginia.



FIRST STATIONS OF VIRGINIA

WMBG AM WCOD FM WTVR TV

Havens & Martin Inc. Stations are the *only* complete broadcasting institution in Richmond. Pioneer NBC outlets for Virginia's first market. WTVR represented nationally by Blair TV, Inc. WMBG represented nationally by The Bolling Co.

5 DAYS A WEEK NORTHERN CALIFORNIA

WONDERS—

WHAT'S in
SANDY'S
HAT?

VARIETY

SANDY SPILLMAN SHOW
With Shirley Spillman, organist
Eloise Rowan

Producer: Sam Ewing
Director: Bob Davy
30 Mins., Tues., Thurs., Fri. (15
Mins., Mon., Wed.)

Participating
KPIX, San Francisco

Music, prizes and magic salted
with quiz quickies make midday
dialing fun for this stanza aimed
at a femme audience.

Sandy Spillman pumps magical
life into what might be just another
quizzier by reading the minds
of contestants and plying sleight
of hand tricks for audience amuse-
ment. His yack is smooth flowing,
tricks are clever, and his cheerful
personality and sincerity wring in-
teresting comments from guests.

Contestants, introduced by em-
cee's petite wife Shirley, guess
tune titles played by organist Eloise
Rowan, answer true or false que-
ries, and identify film clips. If cor-
rect answers are given to three
questions, contestant wins chance
to name the article in Spillman's
magic top hat.

When time allows, emcee walks
his mike into the studio audience
and chats with visitors, teases
them with tricks and asks a "ques-
tion of the day."

Cameras are deft in keeping
pace with emcee's magic working
hands. Commercials are ear-easy
and sincere. *Tone.*

from Variety, September 2, 1953

New and refreshingly different, the
Sandy Spillman show is already tops
in Northern California TV productions.
And we'll let you in on something.
Spillman's got something in his hat
beside a happy prize; he has a selling
genie all his own who can do a
wonderful job for you. Ask your
Katz man about participations in
The Sandy Spillman Show on ...



Affiliated with CBS and DuMont Television Networks...represented by the Katz Agency

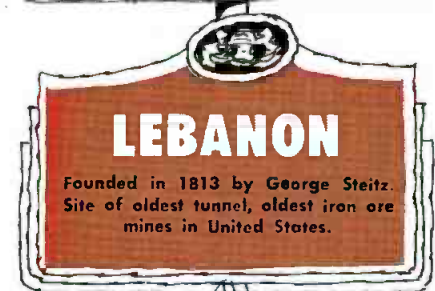
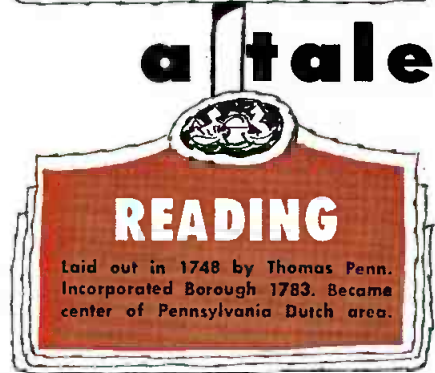
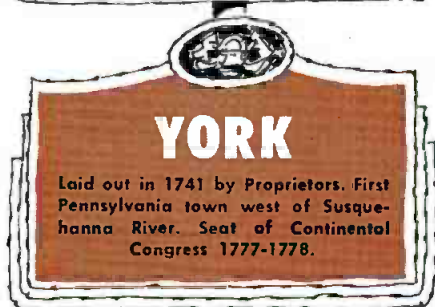
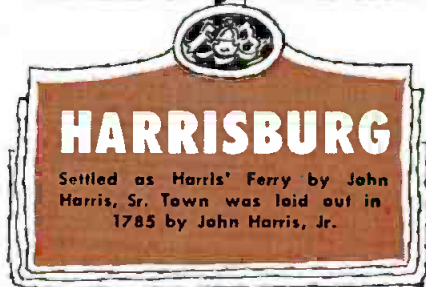

WGAL-TV

NBC · CBS · ABC · DU MONT
Lancaster, Pa.

*A great profit opportunity
for advertisers—*

the Channel 8 large, rich Pennsylvania industrial and farm area includes Harrisburg, York, Reading, Lebanon, Lancaster and hundreds of smaller cities and towns. This consistently prosperous WGAL-TV enthusiastic buying audience spends \$1,723,599,000 each year for retail merchandise.

a tale of five cities

Stimulating local interest and public service programs and top shows from four networks build viewer loyalty. In its **FIFTH YEAR** of successful selling for top local and national advertisers, WGAL-TV can increase sales—profitably, economically—for your product.

Represented by

MEEKER

New York
Chicago
Los Angeles
San Francisco



Steinman Station Clair McCollough, President

WGAL
AM TV FM

closed circuit

AGENCIES for Colgate-Palmolive-Peet Co. and General Mills quietly re-evaluating audience measurements used or proffered for their radio and tv programs, in line with similar study launched last month [CLOSED CIRCUIT, Sept. 14] by Procter & Gamble agencies. Effect of these studies, coupled with exhaustive analysis of whole broadcast rating picture now under way by special committee of Advertising Research Foundation, could be radical change in present rating service picture.

★ ★ ★

IDEA of astronomical sums involved in color tv reflected in estimate by RCA-NBC Chief David Sarnoff that \$30 million will be required to equip NBC-TV so it can originate color programs in New York, Chicago and Los Angeles. Single theatre studio, like that set up in New York's Colonial Theatre, entailed \$2 million for equipment, lighting, air-conditioning, etc. RCA-NBC during "introductory year" of color tv, when it will rotate its network advertisers in using color, gratis, will spend another estimated \$15 million.

★ ★ ★

NOVEMBER will find FCC at its busiest. All Commissioners will be on deck to cope with (1) color tv, on which record now is all but closed (approval seen); (2) daytime sky-wave interference problem (rule-making indicated); (3) what to do about specialized fm services like storecasting, functional music, transitcasting, etc. (it's anybody's guess now) and (4) number of cases already argued orally involving precedent-rulings. Also awaiting action is multiple-ownership limitation proposal, which now provides maximum of five tv stations in single hands, but suggestion has been made to lift limit and to give unit values for less than control holdings.

★ ★ ★

EFFORTS of sunrise-to-sunset stations to get NARTB district meeting endorsement of proposals to standardize hours of operation met with opposition at current meetings. NARTB officers hold issue is partisan, like clear channel case, and that district meetings are not proper forum. Likelihood is that limited-time stations will petition FCC for 6 a.m. to 6 p.m. operation as part of overall daytime station problem.

★ ★ ★

REVEALED to NARTB's 4th District meeting in Asheville last Thursday was fact that NBC, under its radio rejuvenation program, is paying its radio salesmen considerably more than its tv sales executives as incentive. Consensus of radio-television broadcasters at meeting disclosed same general pattern at station level, with radio sales men paid substantially higher commissions than in tv.

★ ★ ★

WITH APPOINTMENT of Chris Witting as president of Westinghouse Radio Stations Inc., effective Jan. 1 (see story page 70), there's possibility that name of company

will be changed to Westinghouse Broadcasting Co. as more representative of its functions in radio and television.

★ ★ ★

BEST SPOT month in history will be reported for October by WRC Washington (NBC owned). Station will show 110% increase over October last year in national spot sales; 60% more than any other October in past; both national spot and local 44% more than all-time high.

★ ★ ★

ANY NOTION that NBC is taking WBEN-AM-TV Buffalo switch to CBS lying down is dispelled by reports from hinterland. NBC station relations men reportedly are going after some "big ones" at personal command of Brig. Gen. David Sarnoff, RCA-NBC chairman, who is filling in as NBC president, and probably will continue to for some months.

★ ★ ★

DISCLOSURE of plans for Paul H. Raymer Co. acquisition of O. L. Taylor Co. [CLOSED CIRCUIT, Oct. 19] brought on "open season" for ferreting of Taylor-represented stations by other representatives. Number of stations understood to be considering proposals, but no switches made as yet. Lloyd George Venard, president of Taylor, also understood to have had several offers from other representation firms. Meanwhile, transfer of Taylor Co. ownership from Taylor to Raymer slowed down by multitude of details, but expected to be finalized this week.

★ ★ ★

WITH Administration emphasizing economy, there's little chance that FCC will fill vacant secretaryship prior to early next year. T. J. Slowie, who resigned by request following administration change, is still drawing his pay and will until January. FCC isn't disposed to pay two salaries for same job. When job is filled, however, it probably will be up-graded with pay of \$11,000-plus, as against present \$10,300 rating.

★ ★ ★

UNLESS FCC goes outside agency for its hearing division chief, it's good bet Assistant Hearing Chief Robert J. Rawson will take over. Besides losing Hearing Chief Frederick W. Ford to Dept. of Justice last month, division in last year also has lost Max D. Paglin, now legal assistant to Comr. Robert T. Bartley, and James O. Juntilla, to private practice.

★ ★ ★

FM multiplexing system introduced by Maj. Edwin H. Armstrong Oct. 13 demonstrating simultaneous transmission of programs, is being described privately by radio inventor as "only the beginning." He evidently is holding under wraps other developments for which patents have not yet finally cleared before demonstrating them. Fm enthusiasts predict these developments will nail efforts of industrial users to grab any fm bands on grounds of limited use.

LEAD STORY

It's not smooth sailing for Mutual's new affiliate compensation plan. There's a chance that resistance among MBS stations will force modification or cancellation. *Page 27.*

ADVERTISERS & AGENCIES

Trend toward short-term spot campaigns shows in week's timebuying. *Page 28.*

FILM

Motion Pictures for Television Inc. announces expansion. *Page 29.*

FACTS & FIGURES

Average commercial on tv network show is seen by 41% of program's audience, Starch study shows. *Page 30.*

PROGRAM SERVICES

All-Industry Committee promises aggressive effort to get "fair" fees for Ascap music. *Page 32.*

TRADE ASSOCIATIONS

NARTB's District 4 thanks President Eisenhower for appointing Rosel Hyde chairman of FCC. *Page 34.*

Richard P. Doherty, NARTB vice president, predicts tv revenue in 1954 will near half-billion mark but warns that not all stations will hit jackpot. *Page 38.*

Radio-Television News Directors Assn. opens annual convention in Washington today. *Page 42.*

GOVERNMENT

FCC confirms it has Edward Lamb's record under study to determine whether he is qualified to hold radio-tv licenses. *Page 48.* Meanwhile Mr. Lamb names J. Howard McGrath, attorney general under Truman administration, as executive vice president of Lamb Enterprises. *Page 50.*

FCC issues revised priority list for competitive tv hearings. *Page 54.*

STATIONS

Weekly roundup of new tv stations and those expecting to begin operation in next month. *Page 60.*

NETWORKS

Ted Bergmann is virtually set to succeed Chris Witting as managing director of DuMont Television Network. *Page 70.*

Broadcast division of American Broadcasting-Paramount Theatres lost money in third quarter but expects to make profit in fourth. *Page 71.*

NBC-TV offers special holiday inducement to advertisers. *Page 76.*

FEATURES

Why listeners listen. *Page 85.*
What high-fidelity means to broadcasters. *Page 86.*

Radio network showsheet. *Page 90.*
Is tv already in a rut? *Page 94.*

FOR THE RECORD

TELESTATUS weekly summary of tv stations on the air and their estimates of tv set distribution. *Page 137.*

New tv grantees' commencement target dates. *Page 140.*

Only the Best

In Houston, the South's FIRST market, KPRC continues conclusively FIRST. For 28 years, KPRC has shown top results because of leadership in popular live local programs...top local news coverage...audience rating...cost per thousand... coverage... network affiliation.

Behind these facts stand a sound organization of top personnel, hustling audience promotion and merchandising, plus public acceptance and prestige built up throughout the years.

FIRST by FIRST, and all combined, KPRC is the best buy in the Gulf Coast area. Call Edward Petry & Co., or write us direct for availabilities.

FIRST

FIRST in Circulation
FIRST in News
FIRST in Ratings
FIRST in Local Talent
FIRST in Live Shows
FIRST in Merchandising and Promotion
FIRST in Public Service
FIRST in Physical Equipment

STAYS *First*

FIRST

IN CIRCULATION

DAYTIME

	Weekly Circulation 50 - 100% Penetration	Weekly Circulation 10 - 100% Penetration
KPRC	371,940	410,570
Station B	314,590	372,050
Station C	249,350	270,430

NIGHT-TIME

	Weekly Circulation 50 - 100% Penetration	Weekly Circulation 10 - 100% Penetration
KPRC	339,240	364,320
Station B	269,340	331,400
Station C	225,580	242,220

Nielsen Coverage Service, 1952

While KPRC gained radio family coverage since 1949, its principal competition (Station "B") dropped 5% daytime, 6% at night.

KPRC

HOUSTON

NBC and TQN on the Gulf Coast

JACK HARRIS, Vice President and General Manager

Nationally Represented by EDWARD PETRY & CO.

NOW SMEDLY D. TRACE

was a researching "ace"
(A strong random sample exponent),



Who sought to compile where
the Omaha dial
Was tuned every listening mo-
ment.



But all of his toil proved only that oil
Was needed to break dials loose . . .



For each sample call showed simply that
all
Were **STUCK FAST ON KOWH**
THROUGH DISUSE!

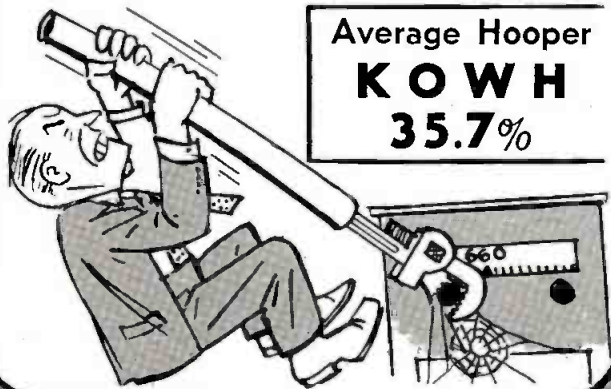

Moral

**EVERY GOOD TIME-BUYER
KNOWS KOWH HAS THE:**

- *Largest total audience of any Omaha station, 8 A.M. to 6 P.M. Monday thru Saturday! (Hooper, Oct., 1951, thru August, 1953)*
- *Largest share of audience, of any independent station in America! (August, 1953.)*

Kowh

OMAHA

"America's Most Listened-to Independent Station"



General Manager, Todd Storz; Represented Nationally By The BOLLING CO.

at deadline

RCA-NBC Set Color Tv Showing for West Coast

FIRST use of color film and first West Coast showing of color tv to be staged by RCA-NBC Nov. 3 for press and industry leaders at tv center in Burbank, Calif., network announced today (Mon.). Half-hour show will be programmed in New York and sent by closed circuit over 4,000-mile microwave link to Coast.

Brig. Gen David Sarnoff, RCA-NBC board chairman, will head New York task force at demonstration. Others making trip: Frank Folsom, RCA president; Sylvester L. (Pat) Weaver, vice chairman of the board, RCA; Robert Sarnoff, vice president in charge of Film Division; Mannie Sacks, RCA executive vice president; C. B. Jolliffe, vice president-technical director, and O. B. Hanson, vice president and chief engineer. John K. West, NBC West Coast vice president, will host the demonstration.

Press showing is scheduled for 11 a.m. PST; hour not selected for demonstration before representatives of advertisers, agencies, movie industry, stations and talent.

Philip Morris Merges With Benson & Hedges

PHILIP MORRIS & CO., fourth-ranking cigarette company, and Benson & Hedges, seventh, merged into one corporation to be known as Philip Morris & Co., subject to stockholders' approval. Philip Morris products are Philip Morris, king-size and regular; Dunhill, king-size, Marlboro, English Ovals, and Spuds. Benson & Hedges makes Parliament filtered cigarettes.

Board of new company would be composed of present directors of Philip Morris & Co., plus B & H President Joseph F. Cullman Jr. and Executive Vice President Joseph F. Cullman 3d. Alfred E. Lyon and O. Parker McComas, chairman and president, respectively, of Philip Morris, would serve new company in

RCA RECORD

RCA sales hit all-time record of \$609 million in first nine months of 1953, 29% above last year, Brig. Gen. David Sarnoff, board chairman, said Friday. Earnings before Federal income taxes were \$54 million compared to \$36 million year ago, with net profits of \$25 million compared to \$17 million in 1953, up 41%. Third quarter sales of \$199 million set new record.

similar capacities. Joseph F. Cullman Jr. would be chairman of executive committee, of which Messrs. Lyon and McComas also would be members. Joseph F. Cullman 3d would become a vice president of new company.

Benson & Hedges would operate as separate division, with present Philip Morris sales organization adding Parliament cigarettes to line of tobacco products it distributes and promotes.

NBC Sale for 'Weekend'

FIRST sale on NBC's new *Weekend* radio show (Sun. 4-6 p.m. EST) was reported Friday with announcement that B. F. Goodrich Co., Akron, will sponsor two participations on program, effective yesterday (Sun.). Show sold under plan offering eight participations on each one-hour segment [B*T, Sept. 21]. Goodrich agency is BBDO, N. Y.

Cash to ABC Radio Sales

APPOINTMENT of Norman E. Cash as an assistant sales manager of ABC radio [CLOSED CIRCUIT, Oct. 19], effective Nov. 2, was to be announced today (Monday) by Charles T. Ayres, vice president in charge of ABC radio. Mr. Cash has had extensive experience in radio and served most recently as general sales manager of WLW Cincinnati. Before joining WLW, he was with NBC for 12 years as director of radio station relations.

BUSINESS BRIEFLY

PM, PET CO-SPONSOR • Philip Morris Co. and Pet Milk to co-sponsor all-Negro soap opera, *Ruby Valentine*, quarter-hour, five days a week, on 40 radio stations to be selected. Agencies: Biow Co. for PM, Gardner Adv. for Pet Milk.

LEVER TO EXPAND • Lever Bros. planning to expand its half-hour *Lux Video Theatre* on CBS-TV to full hour, Thursdays, 9-10 p.m. Lever's *Big Town*, now in Thursday 9:30-10 p.m. period, will be moved to make room for expanded *Video Theatre*. Meanwhile, Lever currently negotiating with all four networks to clear Class A evening time for *Big Town*.

PARKER TO SPONSOR • Parker Pen Co., Janesville, Wis., has signed to sponsor two quarter-hour programs immediately following professional football games over 105 DuMont Television Network stations either on Dec. 5 and 6 or Dec. 12 and 13. Agency: J. Walter Thompson Co., Chicago.

COOKERY PARTICIPATIONS • Macmillan Co., book publishers, buys participations on NBC-TV's *Creative Cookery*, Saturdays, telecast on stations in Chicago, New York, Cleveland and Washington, D. C. Fleischmann's yeast and National Selected Products Inc. (frosting) buy two spots per week on local version of show on WNBQ (TV) Chicago.

BUY ELECTION RETURNS • Hebrew National Kosher Meat Products Co., N. Y., has purchased complete election night radio coverage of New York and surrounding area elections on WCBS, WABC and WOR in New York. Agency: Rockmore Co., N. Y.

BOWES TO NBC • Walter Bowes, chief time-buyer, Hewitt, Ogilvy, Benson & Mather, N. Y., reportedly will resign shortly to join NBC sales development staff.

NESTLE NAMES D-F-S • Nestle's Chocolate for its new product (Decaf, a coffee without caffeine) naming Dancer-Fitzgerald-Sample, N. Y., to handle advertising. Television test spot announcement schedule expected soon.

PAPER-MATE NAMES • Paper-Mate Co. and Paper-Mate Eastern Inc., which use radio and television spot announcements, name Foote, Cone & Belding, N. Y.

'King Lear' Cost \$78,000

PRODUCTION of "King Lear" on Oct. 18 program of Ford Foundation Tv-Radio Workshop *Omnibus* series on CBS-TV (Sun., 5-6:30 p.m. EST) cost approximately one-half of \$150,000 at which amusement press reported it, Workshop spokesmen said Friday. (Actual cost was understood to be about \$78,000.) Spokesman said true facts about "King Lear" cost were important since they show it within range of *Omnibus* average weekly cost of around \$60,000, which they said compares favorably with that of programs of shorter length and accordingly is within reach of regular commercial advertisers. *Omnibus* is available to four sponsors on a pro rata basis, with three advertisers currently signed: American Machine & Foundry, Scott Paper, and Greyhound.

LOCAL-SPOT RADIO TO RISE \$100 MILLION

SPOT and local radio, showing continuous 20-year upward trend, will increase another \$100 million in next few years, according to C. L. Jordan, executive vice president of N. W. Ayer & Son, Philadelphia.

Addressing NARTB District 3 dinner at Philadelphia Friday (district meeting stories pages 34-40), Mr. Jordan based prediction on 1953 BROADCASTING YEARBOOK radio advertising analysis showing that spot and local have been gaining \$30 to \$40 million yearly for last six years.

He predicted curve will continue for several years and suggested stations provide agencies with more factual information designed to help timebuyers.

Spot radio's future, he said, "is limited only by the number of spots that can be put on the air." He cited spot's flexibility and said main variables in measuring its audience are average rating and number of spots per week.

"We are all just beginning to learn how to sell spot radio most effectively," he disclosed, add-

ing that advertiser using 15 spots weekly on program with rating of 4 can reach 55% of homes within station's coverage area in four-week period.

Citing time-saving devices creating new pattern of living, he said radio fits this new pattern "like a glove" at home and outdoors. He called radio best way to get deeper appreciation for good music (see hi-fi story page 86) and said time saved by appliances and fast travel is more than time spent looking at television.

"Radio was supposed to be doomed by television, but it's about the healthiest corpse I ever saw," he said. Time sales hit \$464 million last year he declared, citing B*T YEARBOOK, \$100 million above pre-television years.

Whether area has television or not, or whether spots are aired day or night, makes little difference except in audience composition, according to Mr. Jordan. He praised adaptability of spot to almost every variety of sales problem and audience.

tops IN ATLANTA*

waga-tv

★ **11** out of the top **15** once-a-week shows

★ **30%** greater share of the audience than station "B"
146% greater share of the audience than station "C"
(Monday through Friday—7 a.m.—12 midnight)

★ More quarter hour firsts than both other stations combined
(Sunday through Saturday—9 a.m.—11 p.m.)

★ PLUS—the top LOCAL Woman's Show, Sports Show, Hillbilly Show, Panel Show, Public Service Show and Kitchen Show

FOR TOP RESULTS CHOOSE:



NOW 100,000 WATTS

waga-tv

CHANNEL 5 CBS-TV IN ATLANTA, GA.

Represented Nationally by the KATZ AGENCY, Inc.
Tom Harker, V.P. and Nat'l Sales Director, 118 E. 57th St., New York 22
Bob Wood, Midwest National Sales Manager, 230 N. Michigan Ave., Chicago



*ATLANTA TELEPULSE, AUGUST, 1953

at deadline

Initial Decision Denies Muskegon Grant Protest

PRECEDENT-SETTING economic protest by Music Broadcasting Co. against uhf ch. 35 grant at Muskegon, Mich., to Versluis Radio & Tv Inc. would be denied by FCC Hearing Examiner H. Gifford Irion in initial decision announced Friday which also would allow Versluis to use directional antenna to feed required signal to unserved public park area discovered in early case by Music.

Music operates WGRD Grand Rapids. Its Sec. 309(c) protest of alleged injury on grounds Versluis' ch. 35 WTVM (TV) was actually Grand Rapids station affected court suit in which U. S. Attorney General refused to support FCC opposition to complaint. Multiple protests of new tv grants flowed from action.

Opinion of examiner said, "It may be a windfall that the proposed operation will find a rich potential audience such as Grand Rapids within its 80 dbu contour or it may be the result of meticulous planning. But this is incidental. The test, stated broadly, is not whether the station will serve Grand Rapids more but whether it will serve Muskegon less." He concluded programs and coverage proved WTVM would be "Muskegon" station, recommended confirmation of ch. 35 grant.

Westinghouse Radio Set Sales

SALES of Westinghouse radio sets in September five times those of year ago, according to T. J. Newcomb, manager of Tv-Radio Div. Additional facilities for home radio production now available at Sunbury, Pa., plant. September tv set sales up 216%.

STERLING BLASTS MAKERS FOR BAD SETS

RADIO-TV receiver and transmitter manufacturers will be taken to task today (Monday) by FCC Comr. George E. Sterling for "disappointing" progress in overcoming serious spurious radiation conditions which are hurting adjacent aviation and other safety of life services as well as am-tv broadcast bands. He speaks at Toronto before tv interference symposium of Radio Fall Meeting sponsored by engineering department of Radio-Electronics-Television Mfrs. Assn. of U. S., Radio-Television Mfrs. Assn. of Canada and Professional Groups Committee of Institute of Radio Engineers [B•T, Oct. 19].

Citing excessive radiations of most uhf sets in Portland area measured by FCC, plus finding that color sets will be greatly more susceptible to 41.25 mc intermediate frequency than is monochrome, prepared text of speech released Friday also chides set makers for inconsistency in producing tv receivers which will ruin am reception, hence am set sales. Text states:

Most of you are manufacturing radio receivers. I wonder if it is good business to omit a few cents worth of shielding on a television receiver which by horizontal sweep radiation will limit the market for sound receivers. As manufacturers, most of you spend considerable money and effort to extoll the merits of your radio receivers to the public, including some with high-frequency bands, encouraging the public to listen in on international broadcasting, marine and other services, but on the other hand you permit horizontal sweep frequency harmonics from tv receivers to interfere with aural reception on these bands; whereas, if a little shielding and

COLOR TIME-TABLE
COLOR time-table, according to FCC Comr. John C. Doerfer, answering inquiry at National Conference of Business Paper Editors in Washington last week: Staff report first or second week in November. A week or two for Commissioners to digest the report. First vote in about four weeks. Probable final decision, before Christmas.

UHFA Urges Stricter Rules

MORE stringent fair trade rules in behalf of uhf tv were recommended Friday by Ultra High Frequency Assn. in letter to Federal Trade Commission. UHFA counsel William A. Roberts urged FTC to incorporate two provisions in pending fair trade practice rules: (1) "television receiver" must be one capable of receiving all channels allocated by FCC for tv, and (2) "adapter" or "converter" must be capable of making vhf receiver able to receive uhf signals. Earlier this week, UHFA wrote FCC explaining uhf problems and reasons for its organization (see story page 46).

DuMont Gets Trophy

DR. ALLEN B. DuMONT, president of Allen B. DuMont Labs. Inc., will be presented with an "Oscar of Industry" trophy today (Monday) by *Financial World* magazine in recognition of DuMont organization's 1952 annual report to stockholders, which has been adjudged best of 300 submitted by nation's television, radio and electronics companies.

filtering were added to the tv receivers, this interference would be eliminated. When you return to your home, take one of your own radio receivers and tune through the standard broadcast band and you will understand the magnitude of this interference of which I speak.

So, it seems apparent to me that manufacturers are following an inconsistent as well as a short-sighted policy in the design and manufacture of communication equipment. Within the same family we find one branch manufacturing receivers for military, aeronautical and other services with high sensitivity and selectivity; whereas, another branch of the same family is manufacturing receivers as home products that spew their harmonics and other spurious emissions into the bands for which the other equipment was designed; thus defeating the whole effort looking towards maximum utilization of the spectrum by the government and non-government services.

Speech notes FCC in fiscal 1953 received 22,264 interference complaints of which more than 12,600 resulted from spurious responses of broadcast receivers and over 6,100 from tv sets. Some 9,600 complaints involved transmitters.

UPCOMING
Oct. 26-28: Radio Television News Directors Assn., convention, Sheraton-Park Hotel, Washington, D. C.
Oct. 26-28: Joint meeting, U. S. & Canadian Radio - Electronics - Television Mfrs. Assns., Toronto.
Oct. 29-30: NARTB Dist. 2 meeting, Ten Eyck Hotel, Albany, N. Y.
For other Upcomings see page 153.

PEOPLE

WILLIAM B. TEMPLETON, director of radio and tv, Sherman & Marquette, N. Y., elected vice president in charge of that department. He has been with agency for past two years and prior to that was with Kudner Adv. as producer of Milton Berle show.

PATRICIA GABANY, program promotion department, NBC, to N. W. Ayer & Son, N. Y., as member of radio-tv publicity department.

TOM FLANAGAN, managing director of Station Representatives Assn., will address Chicago Television Council's first fall meeting at Sheraton Hotel Oct. 28. He will speak on "Network and Station Tv Conflicts," according to Council. Election of officers also slated.

RALPH RADETSKY, aide to Mayor Quigg Newton of Denver, named KOA-AM-TV Denver manager of news and public relations, absorbing duties of **BILL DAY**, news and special events director for 12 years. Mr. Day's future plans are not set.

Baltimore Ch. 18 Again In Conflict; Other Actions

BALTIMORE's uhf ch. 18 was put into conflict for second time Friday as United Broadcasting Co., operator of WSID there, filed bid competitive to request of WITH-TV Baltimore for change to ch. 18 from grant on uhf ch. 60 [B•T, Oct. 19].

New Radio Station at Bowling Green

NEW am station on 730 kc with 250 w daytime, directional, at Bowling Green, Ohio, authorized by FCC Friday. It made final initial decision favoring application of local lumber dealer Howard R. Ward [B•T, Sept. 21].

California Effective Date Stayed by FCC
EFFECTIVE date of mid-September initial decision proposing grant of uhf ch. 30 at San Bernardino, Calif., to Orangebelt Telecasters was stayed by FCC Friday "pending review" of decision and record. Orangebelt plans \$26,000 home-built, three man station [B•T, Sept. 21].

WSSB Durham Denied Petition

RENEWED petition by WSSB Durham, N. C., for reconsideration of its once dismissed Sec. 309 (c) protest against uhf ch. 46 grant to T. E. Allen & Sons Inc. for WCIG-TV Durham was denied by FCC Friday. WSSB has bid pending for uhf ch. 73 there.

KTVR (TV) Hitchcock, Tex., Is Deleted

KTVR (TV) Hitchcock, Tex., was deleted by FCC late last week. Permittee of the uhf ch. 41 facility was M. B. Rudman, trading as Rudman Television Co. The deletion of KTVR and WRBJ (TV) Beloit, Wis., boosts to 20 the total of post-thaw tv grantees who have surrendered their authorization (see story page 50).

Beth Black to Cohen

BETH BLACK, media director, Joseph Katz Co., N. Y., appointed head of radio-television timebuying department of Harry B. Cohen Adv. Co., N. Y., effective Nov. 16. Mary Dunlavey, radio-tv media director for Cohen for past three and one-half years, resigned effective Nov. 1 and is expected to announce new affiliation shortly. Arthur Harrison, formerly with Charles Antell, will continue as timebuyer on several specific accounts at Cohen agency.

the **WHLI** *my island story*

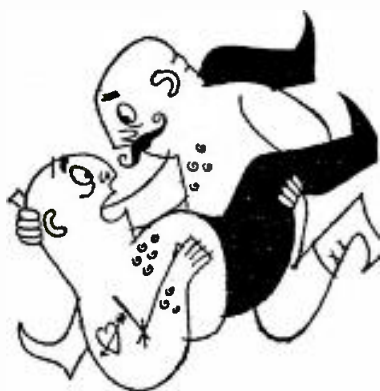

what did you say?

Long Island's
amazing
Nassau County
ranks
24th
nationally in
RETAIL SALES...
\$838,171,000
(Sales Management)



WHLI has a larger
daytime audience in the
big booming major
LONG ISLAND
MARKET
than any network or
combination of inde-
pendents... (Conlan)

WHLI AM 1100
FM 98.3

HEMPSTEAD *the voice of*
LONG ISLAND, N. Y. *long island*
PAUL GODOFKY, Pres.

index _____

BROADCASTING
TELECASTING

THE NEWSWEEKLY OF RADIO AND TELEVISION
Published Every Monday by Broadcasting
Publications, Inc.

Advertisers & Agencies	28	For the Record	137	Open Mike	16
At Deadline	9	Government	48	Our Respects	22
Awards	135	In Review	14	People	126
Closed Circuit	5	International	132	Personnel Relations	82
Editorial	154	Lead Story	27	Professional Services	134
Education	132	Manufacturing	82	Programs & Promotion	123
Facts & Figures	30	Networks	70	Program Services	32
Feature Section	83	On All Accounts	24	Stations	60
Film	29			Trade Associations	34

Executive and Publication Headquarters

870 National Press Bldg.; Washington 4, D. C. Telephone Metropolitan 8-1022

Sol Taishoff, *Editor and Publisher*

EDITORIAL

Art King, *Managing Editor*; Edwin H. James, *Senior Editor*; J. Frank Beatty, Earl B. Abrams, *Associate Editors*; Fred Fitzgerald, *Assistant Managing Editor*; David Berlyn, *Assignment Editor*; Lawrence Christopher, *Technical Editor*; Patricia Kielty, *Special Issues*; Staff: Joe Gitlitz, Harold Hopkins, Louis Rosenman, Harriet Sinrod, Don West; *Editorial Assistants*: Ruth Barker, Anna Campbell, Kathryn Ann Fisher, Joan Sheehan, Gladys L. Hall, *Secretary to the Publisher*.

BUSINESS

Maury Long, *Business Manager*; George L. Dant, *Adv. Production Manager*; Harry Stevens, *Classified Advertising Manager*; Eleanor Schadi, Fred Reidy, Shirley Harb, Mary Jeffries, Betty Bowers; B. T. Taishoff, *Treasurer*; Irving C. Miller, *Auditor and Office Manager*; Eunice Weston, *Assistant Auditor*.

Duane McKenna, *Art and Layout*.

CIRCULATION & READERS' SERVICE

John P. Cosgrove, *Manager*; Elwood M. Slee, *Subscription Manager*; Robert Deacon, Doris J. Frazier, Joel H. Johnston, Loel Millar.

BUREAUS

NEW YORK

444 Madison Ave., Zone 22, Plaza 5-8355.
EDITORIAL: Rufus Crater, *New York Editor*; Bruce Robertson, *Senior Associate Editor*; Florence Small, *Agency Editor*; Rocco Famighetti, Joyce Barker, Selma Gersten.

BUSINESS: Winfield R. Levi, *Sales Manager*; Eleanor R. Manning, *Sales Service Manager*; Kenneth Cowan, *Eastern Sales Manager*; Dorothy Munster.

CHICAGO

360 N. Michigan Ave., Zone 1, Central 6-4115.
Warren W. Middleton, *Midwest Sales Manager*.
John Osbon, *News Editor*.

HOLLYWOOD

Taft Bldg., Hollywood & Vine, Zone 28, Hollywood 3-8181.
David Glickman, *West Coast Manager*; Leo Kovner, Marjorie Ann Thomas.
Toronto: 417 Harbour Commission, Empire 4-0775. James Montagnes.

SUBSCRIPTION INFORMATION

Annual subscription for 52 weekly issues: \$7.00. Annual subscription including BROADCASTING Yearbook (53rd issue): \$9.00, or TELECASTING Yearbook (54th issue): \$9.00. Annual subscription to BROADCASTING • TELECASTING, including 54 issues: \$11.00. Add \$1.00 per year for Canadian and foreign postage. Regular issue: 35¢ per copy; 53rd and 54th issues: \$5.00 per copy. Air mail service available at postage cost payable in advance. (Postage cost to West Coast \$41.60 per year.)

ADDRESS CHANGE: Please send requests to Circulation Dept., BROADCASTING • TELECASTING, National Press Bldg., Washington 4, D. C. Give both old and new addresses, including postal zone numbers. Post Office will not forward issues.

BROADCASTING® Magazine was founded in 1931 by Broadcasting Publications Inc., using the title: BROADCASTING®—The News Magazine of the Fifth Estate.
Broadcast Advertising® was acquired in 1932 and Broadcast Reporter in 1933.

®Reg. U.S. Patent Office

Copyright 1953 by Broadcasting Publications Inc.

U.I.P.'s book passage on "Big Mo"



Yes, a host of important, forward-lookin g national and regional advertisers like those shown on the dock above are ticketed FIRM for passage aboard "Big Mo." Many other well-known merchandisers are negotiating for choice spots on KSTM-TV, St. Louis' new ABC-TV outlet. You'll be missing a choice bet for reaching a large segment of this rich, Mississippi valley market, if you don't reserve space aboard "Big Mo" . . . today. Yes, to put your product in good company . . . phone, wire or write

H-R TELEVISION INC. NEW YORK • CHICAGO • SAN FRANCISCO • LOS ANGELES

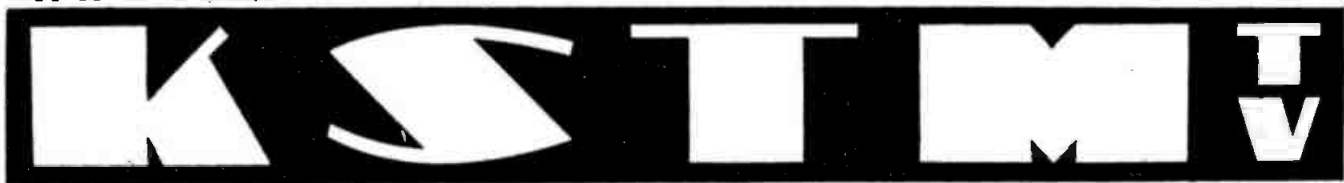

ST. LOUIS

AFFILIATED WITH AMERICAN BROADCASTING COMPANY AND RADIO STATION KSTL

RADIO STATION

WSAZ

HUNTINGTON, WEST VIRGINIA
SERVING 3 STATES

FARMERS AND CITY-FOLK

Flock
To Hear

"FARMER CLICK'S PARTY LINE"

NOW AVAILABLE

For
PARTICIPATING
or
COMPLETE
SPONSORSHIP

TUESDAY
THURSDAY
& FRIDAY
6:45-7:00 AM

5,000 WATTS DAY
1,000 WATTS NIGHT
930 KC

WSAZ



TELEVISION AFFILIATE
WSAZ-TV

Represented by THE KATZ AGENCY

IN REVIEW

PERSON TO PERSON

Network: CBS Television
Time: Friday, 10:30-11 p.m. EST
Interviewer and Co-Producer: Edward R. Murrow
Co-Producers in cooperation with Mr. Murrow: John Aaron and Jesse Zousmer
Director in Studio: Franklin Schaffner
Remote Directors: Robert Sammon and Charles N. Hill
Editorial Associates: David Moore and John Horn
Sponsors: American Oil Co. in East and Hamm Brewing Co. in Midwest
Agencies: Joseph Katz Co. and Campbell-Mithun Inc.
Guests on Oct. 16 Program: James C. Petrillo and Richard Simon

JAMES CAESAR PETRILLO, president of the American Federation of Musicians, was visited by a CBS camera crew—and several million members of the tv audience—on the Oct. 16 telecast of Edward R. Murrow's new series, *Person to Person*.

The program opened with Mr. Petrillo in the kitchen of his apartment on Chicago's "Gold Coast," pouring drinks for his eight grandchildren, who were grouped in the Petrillo living room and who behaved with exceptional decorum during their time on the air. Not so their grandfather. If Mr. Murrow had any thoughts of showing Mr. Petrillo as a home-loving family man, his guest quickly dissipated them by turning his living room into a platform for a lecture on his favorite subject.

"I love children," the musicians union head declared, going on to explain that is why he fears for the two million children in the public schools who are being taught to play musical instruments. Addressing himself to their fathers and mothers, he cried, "Don't let your children grow up to become professional musicians. It's a starvation business."

Child Labor

Of the 250,000 AFM members, some 150,000 are now unemployed, Mr. Petrillo said, charging that many of them are not working because unpaid school children, exploited by "cheap politicians," are performing in their places. "The children I want to help," he shouted, "are the kids of the professional musicians who aren't working and being paid because amateurs have taken their jobs."

Picking up a cornet, the instrument he played when he was a working musician, Mr. Petrillo declined an invitation to perform, saying "the union would fine me for playing below scale." He told Mr. Murrow, "Your program is OK. What we're opposed to is shows that substitute canned music for live musicians."

Followed by the cameras into his study, where he pointed out photographs of himself making President Truman an honorary AFM member and shaking hands with President Eisenhower, Mr. Petrillo was asked what he thought of a labor party. His vehemently expressed view: "A labor party government would not only be the finish of labor but of the country as well."

When Mr. Murrow said he'd heard Jimmy Petrillo called a dictator, his guest answered, "Anyone who fights for his people is called a dictator. I do fight for my people."

In contrast to the polemics of Mr. Petrillo, the program's second guest, Richard Simon of Simon & Schuster, discoursed quietly and without heat on the pleasures and problems of publishing.

In *Person to Person* viewers see Mr. Murrow in his studio in New York talking to

his guests in their own homes, their pictures appearing behind what seems to be the window of the room where Mr. Murrow is—a rather clumsy technique.

Mr. Murrow makes much of the fact that *Person to Person* is completely "live," with the cameras actually present in the homes of his famous interviewees at the time of the telecast and no films employed. This attitude is hard to understand from one who has used film as successfully as Mr. Murrow has done and continues to do in his weekly *See It Now* series. If Mr. Murrow, who remains in the studio, actually visited his guests "person to person" and interviewed them with the cameras present to get it all down, the program's present awkward pauses and irrelevancies could be eliminated and a more entertaining and informative program would result.

MAKE ROOM FOR DADDY

Network: ABC-TV
Time: Tues., 9-9:30 p.m. EST
Cast: Danny Thomas, Jean Hagen, Sherry Jackson, Rusty Hamer, Ben Lessy, Horace McMahon, Phil Arnold, Frank Jenks, Ann Doran
Sponsor: Alternating sponsorship by the American Tobacco Co., and the Spedel Co.
Agency: BBDO for American Tobacco; and Sullivan, Stauffer, Colwell & Bayles Inc., for Spedel
Producer: Lou Edelman
Produced by: Marterto Productions
Produced at: DPI
Director: Bill Ahsler
Music: Earl Hagen and Irv Spencer
Origination: Hollywood

THE merry-go-round existence of a successful entertainer and the problems which ensue if he also happens to be a family man provide the basis for a new weekly film series on ABC-TV called *Make Room For Daddy*. Danny Thomas in the lead role turns out a more convincing performance in a supper club than he does in his own home, a domicile occupied by a pretty wife and two ultra-modern moppets who, contrary to tradition, are heard as well as seen. The children, particularly the little boy, are the most bothersome elements in the series. They are not precocious youngsters. They are miniature adults far removed from a realistic concept of the children they are intended to portray.

For quite some time, tv writers have presumed that sentiment in large doses is almost sure to cover up a lack of quality. Tragically enough, they have often been correct in their presumption. They were correct again on the Oct. 20 telecast of *Make Room For Daddy*, when Mr. Thomas discovered that his mother-in-law was, of all things, a human being. He wasn't observant enough to draw this conclusion all by himself. It took a little coaching from his six-year-old son to make daddy see that grandma was really a pretty nice gal, capable of greater things than baby sitting. And what's more, since she used to be in show-business she might like to get to a night club now and then. Dutiful son-in-law picked up the cue and grandma wound up in his act at the club for a one-night stand.

It was a shallow, overworked yarn but one with "heartstring" value, an asset that will probably keep the series on tv and sell lots of Lucky Strike cigarettes and Spedel watch bands, alternately. This sort of programming gets by. It sometimes even lasts a long time. But once it is over it is not greatly missed or long remembered.



“Allow for windage, allow for windage! Is that all you can say?”

Fortunately for the flora and fauna of McGregor, Iowa, most of the 1502 bows and 500 dozen arrows custom-built in 1952 by archery tackle man Eddings were exported. Archers say his bows are works of art, as finely tuned as a concert-pitch piano. They're laminated, with a core of native Iowa northern maple, and capable of pulls from 23 to 115 pounds. Sold to non-belligerents in Hong Kong, Chicago, and points between and beyond, they could have made things a lot tougher for early Iowans in the Indian battles of the Nineteenth Century.

Eddings doesn't advertise on WMT, and would rather shoot arrows than listen to the radio. How he ever got in a WMT ad almost defies explanation, except one of the fellows at the station had this idea for a drawing. Eddings is a small sample of the Iowa industrial population which jumped 67% in eight years while the nationwide ind. pop. jumped 39%, and which now drags down a \$600,000,000 payroll.

Moral: *Don't lose sight of the Iowa industrial forest for the cornstalk trees.*

Hatch



CBS FOR EASTERN IOWA

Mail Address: Cedar Rapids
 Represented nationally by the Katz Agency

**ON TOP
IN IDAHO**

**...Idaho's ONLY
TV Station**

Affiliated with
NBC • CBS • DUMONT



Hearth of the 5th Market
of The Great Northwest
...Purchasing Center
for a tremendous area
400 miles from any other
metropolitan center or
TV station.

**KIDO-TV
BOISE**

CHANNEL 7

**EFFECTIVE
RADIATED POWER**

53 kw Video
26.5 kw Aural

ANTENNA HEIGHT:
850 ft.
Above Terrain

Represented by
BLAIR TV Inc.

OPEN MIKE

Agency Recognition

EDITOR:

Our sincere thanks for your article "Test for Television: Toy Sales in January," appearing in the Oct. 19 issue. We certainly appreciate your recognition of the unusual step we took for Playskool Manufacturing Co. in bringing them into tv at the post-Christmas period—a venture which, as you indicated, proved so successful that we repeated the program's format with our current Chicago series.

We are happy to report that as of our first Chicago program of *The Pioneer Playhouse*, we began to see the same excellent results—in terms of both audience response and store sales—that made our own "Philadelphia Story" so encouraging. . . .

Incidentally, we'd certainly appreciate receiving from you 100 reprints of the article at your earliest convenience. We are sure our Chicago dealers—as well as dealers in future television markets—will want to read your "review" of our show.

*Lee Friend
Friend Reiss McGlone
New York*

* * *

Hi-Fi

EDITOR:

. . . It seems to me that the average station operator, particularly those with both am and fm operations, would do well to clean up the fm transmitter and then program at least a small percentage of material which would be real hi-fi. Carry it on both transmitters but tell the listeners honestly that if they want to hear it as it really sounds they will need an fm set of reasonable fidelity, or better still, a real hi-fi installation.

After a reasonable time of duplication on both am and fm some special programs might be placed on fm only, with some high powered promotion for the shows on am; the addition to the fm audience might be rather startling. WEPM and WEPM-FM are about ready to give this sort of thing a try. . . .

*C. Leslie Golliday, Gen. Mgr.
WEPM-AM-FM Martinsburg,
W. Va.*

[EDITOR'S NOTE: For a comprehensive article on high-fidelity and its meaning to broadcasters, see page 86 of this issue.]

* * *

How-To Series

EDITOR:

We are trying to locate a syndicated series of tv films devoted to "do-it-yourself" activities around the home, dealing with construction and improvements, to be sponsored by a local building supply wholesaler.

Do you know whether or not a series of this kind has ever been made?

*Calvin G. Bersch Jr., Acct. Exec.
Bonsib Adv. Agency, Fort Wayne, Ind.*

[EDITOR'S NOTE: Princeton Film Center, Carter Road, Princeton, N. J., has such a series available.]

* * *

Off The Record

EDITOR:

Here's a matter which has been galling me for some time. The various record companies want to charge radio stations for promotional copies of the records they want "plugged." To be sure, the station receives the good music but actually insofar as almost every radio station subscribes to at least one e.t. library, the good is felt far more by the record company. . . .

I have a suggestion which might be of interest



Local Appliance Dealers
sponsor more programs
on KITE than any other
station in the market—
Radio or TV!

KITE



San Antonio's
Leading
Independent

Nat'l Rep. John E. Pearson Co.



*Check
First*

**CLEVELAND'S
CHIEF STATION**

5,000 WATTS—850 K.C.
BASIC ABC NETWORK

REPRESENTED
BY

H - R REPRESENTATIVES



CLEVELAND'S Chief STATION

BROADCASTING • TELECASTING



IT'S UNOBTRUSIVE. UMBER gray coloring blends it right into the TV picture. Minimum reflection.

**In the show . . .
without stealing the act**
RCA's new ribbon-pressure **"STARMAKER"**

SO SLIM YOU MUST LOOK sharply to see it . . . so skillfully styled its shape and coloring fade right into the scene . . . this tubular microphone has won the favor of entertainers and announcers wherever it has been shown.

Designed by RCA Laboratories after more than three years of painstaking research, the STARMAKER meets the long need of broadcasting, television, and show business for a high-fidelity microphone that—will not hide the features of performers—is easier to handle—and yet retains all the high-quality features of RCA professional microphones. Pick-up is non-directional. Frequency response is uniform, 50 to 15,000 cps.

Here is a "carry-around" microphone free from wind blast and air rumble. It contains no tubes, no condensers, no high-impedance circuits, no special amplifiers, or power supplies—is virtually impervious to mechanical shock.

The STARMAKER fits any standard microphone stand . . . and can be substituted for any professional high-quality RCA microphone. *No extra attachments needed!*

For price and delivery, call your RCA Broadcast Sales Engineer. Or write Dept. 22 VD, RCA Engineering Products, Camden, N. J.



IT'S COMFORTABLE TO HANDLE . . . weighs only 1 lb.



IT'S SMALL. Diameter of body is only 1¼ inches. Diameter of pick-up point is only ⅜ inch!



RADIO CORPORATION of AMERICA
ENGINEERING PRODUCTS DEPARTMENT, CAMDEN, N. J.

THE NEWS PERSONALITY OF SOUTHEASTERN OHIO

ALLAN LAND



Allan Land gives the tops in national, regional and local news each evening at 6:30 over WHIZ-TV, Zanesville, Ohio.

Sponsored by "The Ohio Fuel Gas Co.," Land is a self-styled popular personality seen and heard Monday thru Friday on his show, "Land Views the News."

Combining United Press stories, Associated Press news copy, special slides, local and national films pointing toward regional news programming, Land puts together the fastest moving quarter-hour show on television.

Southeastern Ohio people who want their news reported factually, without bias and in a personable manner watch "Land Views the News" on

WHIZ-TV

ZANESVILLE, OHIO

Established May 23, 1953

NBC Primary Affiliate • CBS • ABC • DU MONT

Represented Nationally by John E. Pearson TV, Inc.

OPEN MIKE

to other broadcasters who are similarly irritated by this oligarchic action.

If all radio stations would make a note of what companies require a charge for their records and prohibit the name of that company or a mention of the particular "label" on their station, it would, I'm sure, force the issue to a show-down . . .

The co-operating companies, on the other hand, would be rewarded by numerous mentions or "plugs" and would be greatly benefitted thereby.

*Truman H. Walrod, Prog. Mgr.
KRSD Rapid City, S. D.*

* * *

Happy Birthday

EDITOR:

On my behalf and as president of the Federal Communications Bar Assn., I wish to congratulate you and B•T on your 23 fine years of public service to the broadcasting and television industry. . . .

*Fred W. Albertson, President
Federal Communications Bar Assn.
Washington, D. C.*

* * *

Added Attractions

EDITOR:

Please . . . add two new subscriptions to BROADCASTING • TELECASTING to [our] present order. The additional features of the magazine will be of great value, we feel, to our sales force . . .

*Ben Holmes
Assistant Manager
KOMA Oklahoma City*

* * *

Multiplexing

EDITOR:

In spite of Commissioner Webster's Sun Valley speech, I do not feel that the Commission can seriously consider the taking of some of the broadcasters' fm frequencies for industrial purposes . . .

The answer to the shortage of industrial frequencies would be to have the Commission permit fm broadcast stations to multiplex additional services without deterioration to existing fm service.

*Edward A. Wheeler, President
WEAW-AM-FM Evanston, Ill.*

* * *

Remember When

EDITOR:

I note in your Oct. 19 issue some reference to the subject of giveaways, the FCC and the United States Supreme Court.

May I suggest that you go through back volumes of BROADCASTING • TELECASTING magazine and you will find in one of the October issues in the year 1948 a back cover advertisement signed by me as president of MBS. . . . This advertisement was written at a time when the subject of "audience buying" and "give-away" programs was receiving a great deal of attention. . . .

*Edgar Kobak, Owner
WTWA Thomson, Ga.*

[EDITOR'S NOTE: Summarized, the advertisement saw in the FCC anti-giveaway ruling "a danger to which we cannot close our eyes . . . if it is possible, today, for the FCC to say 'away with giveaways,' it will be possible, tomorrow, for the same or another body to say 'away with mysteries, or symphonies, or comics or drama or documentaries.'"]



When in R^home, do as the R^homans

Et tu, Brute . . . even Brutus would lend an ear
 (and eye) and join the legions of Rhomans who
 enjoy their favorite gladiators from the comfortable
 vantage of their living room arenas *via* WFAA-TV. Out of
 Rhome, too, they do as Rhomans — even in Eden, Styx
 Venus and Prosper (only a chariot's race from the
 Channel 8 Colosseum) — for throughout this lush
 DALLAS - Ft. Worth market you'll find them attuned to Channel 8.
Great Caesar's Ghost, ask a Petry man!

*Last count — 295,000 sets
 in the Channel 8 picture.*

Channel

8

WFAA-TV
 DALLAS
 NBC - ABC - DUMONT



Really Loaded!!!

This representative en route to an agency is loaded — in fact he's *overloaded*. He has all the material — surveys, availabilities, rate cards, coverage maps and program releases. Even his station list takes two pages.

His intentions are the best but chances are he will never have the opportunity to use most of his ammunition. Even some of the "best" stations in that bulging briefcase will only get a "once over", very lightly. Others may not even get a casual mention, for his time in the advertiser's office will run out before he gets half way down his list.

Good national sales representation requires experience and ability . . . but just as important, it requires sufficient manpower per station to analyze each advertiser's purpose and problem and then to apply every station story in all its best aspects.

A high ratio of manpower per station assures Raymer men the time necessary to give the individualized attention that assures the proper share of business to each station.

If you feel that your station is buried too deep in somebody's briefcase, let us show you what Personalized Representation has done for some of the Raymer stations — and what it can do for you.

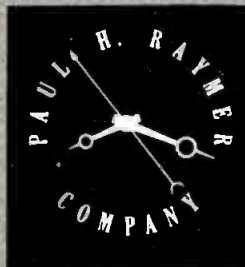

PAUL H. RAYMER COMPANY, INC.

RADIO AND TELEVISION STATION REPRESENTATIVES

NEW YORK • CHICAGO • DETROIT • ATLANTA • SAN FRANCISCO • HOLLYWOOD

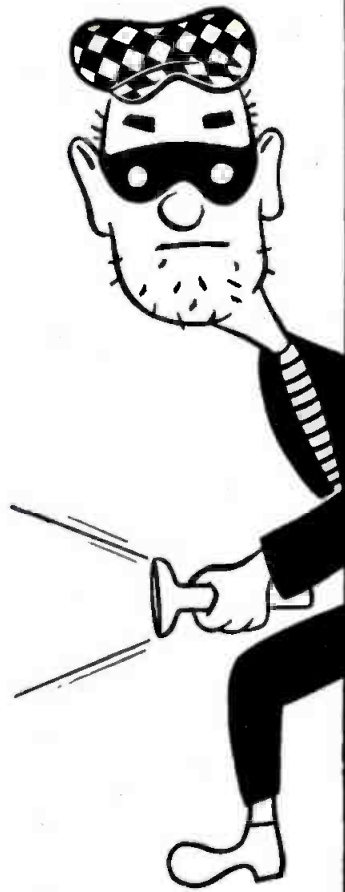

GET INTO MORE HOMES

in Youngstown

Yes, dollar for dollar, WBBW gets into more homes in busy Youngstown, Ohio. Here is the lowest cost per thousand homes in Ohio's third largest market. And, according to Hooper, *WBBW shows the share of audience increased in the morning, afternoon and evening. Compare the rate—compare the weight.

97%

of all homes in Mahoning County
tune in

WBBW

ABC in Youngstown where Eastern Ohio and Western Pennsylvania hear all the Cleveland Browns and Notre Dame Games.

*Ask Forioe about latest Hooper.

our respects

to EARLE LUDGIN



"IF you get a generation of youths who won't listen to commercials on radio and television, you're in trouble!"

The speaker was Earle Ludgin, president of Earle Ludgin & Co., Chicago advertising agency, and the words were not uttered heatedly or with a wagging finger. And yet, to this soft-spoken executive, they seem to represent the crux of the whole problem facing advertising today.

Specifically, as he sees it, advertising's biggest problem is to make commercials listened to. Mr. Ludgin notes that a whole generation of youths was brought up on radio and that most children insisted they be permitted to listen to the radio and study at the same time.

Named AAAA Board Chairman

Mr. Ludgin was named last month to fill the office of board chairman of the American Assn. of Advertising Agencies, left vacant by the recent death of Henry M. Stevens of J. Walter Thompson Co., New York. He had been vice chairman since last April and a national director of AAAA for the past four years.

A native of Chicago, born July 22, 1898, Mr. Ludgin attended Wendell Phillips High School and later the U. of Chicago.

He claims an interest in advertising and related pursuits (theatre, script-writing) at the university where he majored in English. He quit work to attend school, writing the script for the Black Friars musical play.

His first business experience came with the Albert Pick Co. (hotel outfitter) from 1917-24 as assistant advertising manager. Then he moved to the Paul Floring industrial agency, handling general accounts and becoming a partner.

In June 1927, Mr. Ludgin was persuaded by friends and associates to found his own agency. He brought the Albert Pick Co. account into the house.

The Earle Ludgin & Co. agency has enjoyed success, largely because of the guiding hand and philosophy of its founder who thinks his business is the "most wonderful and exciting" thing of its kind—and one of the toughest.

Says Mr. Ludgin:

"We're at the level where the decisions are made—where the work is done and thus you

make businesses grow. It's a hard-fisted business.

"We've got a job to do—we've got to sell. It's not a matter of buying a program or advertising. It's not a question of a 16.7 rating. We're competing against each other. You've got to fight your way on the shelves and off the shelves."

Mr. Ludgin's agency took Jules Montenier three years ago and built its Stopette into a household word. It has gained results, too, for Best Foods' All-Purpose Rit and Shinola Dress Parade polish. Montenier's *What's My Line?* is a top-rated network program on CBS-TV, though it shares the sponsorship now with Remington Rand, and Rit has Garry Moore on CBS-TV. Ludgin also represents Bendix Home Appliances, which sponsored the successful Hoagy Carmichael show on NBC-TV last summer.

Other clients are: Hartman Luggage, International Furniture, W. F. McLaughlin Co., Allen Wrisley Soap Co. and Rath Packing. It's noteworthy that in the more successful case histories, radio and tv were used heavily.

Opinion On Tv

Says Mr. Ludgin of tv:

"We have been able to make it pay for our clients. The share of the market has been very indicative of the power of television." He feels, however, that the prospect of two and three-station markets may pose some problems with respect to claims for audience shares.

Mr. Ludgin finds time for a project for training youths and educators in advertising. Another is the Advertising Research Foundation, of which Mr. Ludgin is a director.

Mr. Ludgin, a former chairman of the AAAA's Central Council, is chairman of the U. of Chicago's Alumni Foundation, a trustee of the Chicago Art Institute, trustee of the American Federation of Arts and member of the Orchestral Assn. of Chicago and Chicago Federated Advertising Club. He rides horseback and collects paintings.

Mr. Ludgin married the former Mary MacDonald and they live in Hubbard Woods. They have five children, including one married daughter and a son, Earle Jr., who is with Foote, Cone & Belding, Chicago. Two other sons, Quentin and Roger, are in school and a third, Donald, is in the Army.

in the **BIG** Oregon market
EVERYBODY
 is watching



**a new station
 with a 28-year reputation**

What a success story! On the air since October 15th and already a leader in the market. WHY? Because KOIN-TV has benefited by the loyalty and audience acceptance which radio station KOIN has built over the past 28 years. Viewers have confidence in KOIN-TV's programming—they are enthusiastic over the sharp clear picture that VHF assures. *This is the kind of impact that sells merchandise.*

A POWERFUL station reaching a BIGGER market

What a prosperous market! KOIN-TV's 56,000 watts of power (100,000 soon) is reaching out to a family of cities with per capita sales MORE THAN DOUBLE the national per capita retail sales average*. Set sales are booming—with over 150,000** in use now and the number growing every day. It's a rich, bustling ready-to-tap market.

Write, phone, or wire for complete information and availabilities.

*208%—based on 1952-53 Consumer Markets.
 **Estimated as of October 1, 1953.



EVERY KNODEL, INC. National Representatives
 New York • Chicago • Los Angeles • San Francisco • Atlanta • Dallas

it's here . . . **NOW!**

TV in CHARLESTON, W. VA.

with **WKNA-TV**

*selling
the rich
multi-million
dollar
Charleston
market!*

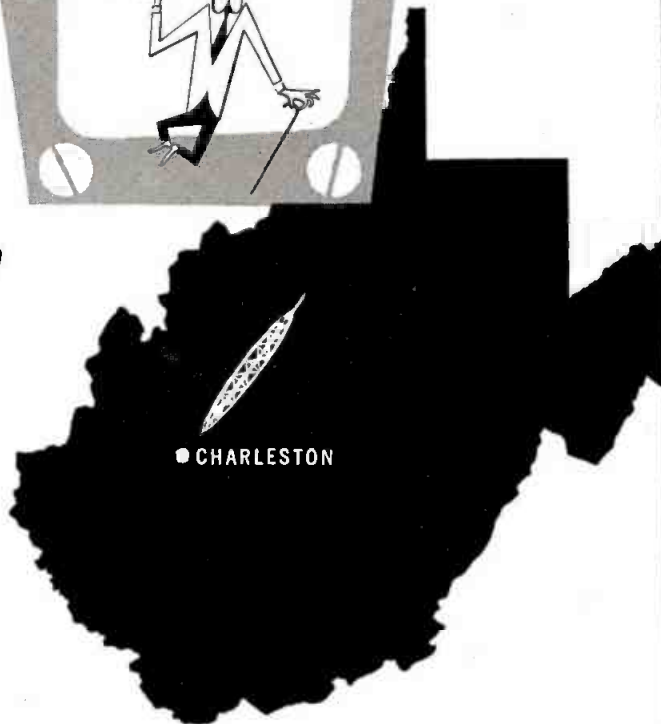

The television gateway is now open to tap this rich, well-populated industrial market that spends over \$620,000,000 annually. And your product or service gets tremendous consumer acceptance because of double network programming, and the fact that WKNA-TV is Charleston's own television station!

affiliated with ABC and DUMONT Television Networks

the personality station



Joe L. Smith, Jr., Incorporated
Represented nationally by WEED TELEVISION



Grace Porterfield

on all accounts

"IT'S 'good to the last drop' and we believe in pouring it on. Quality in quantity."

Thus did Grace Margaret Porterfield, time-buyer, Benton & Bowles, New York, characterize her attitude toward the product and the saturation campaign (as many as 200 spots per week per station) which she places for Maxwell House Instant Coffee.

Herself a dedicated coffee-lover (seven cups a day), Miss Porterfield previously had displayed the magnitude of her dedication by buying and clearing time for Maxwell House on the largest regular television hookup on record, 127 stations on CBS-TV for the *Red Buttons Show*, seen Mondays, 9-9:30 p.m.

A native New Yorker, Miss Porterfield began preparation for her present work at Hunter College where she majored in economics, then switched to the Washington Secretarial School in New York, where she qualified as a secretary. She was graduated with honors and in 1942 got her first secretarial job as assistant to Murphy & Lanier & Quinn, New York attorneys and certified public accountants.

Two years later she joined Jordanoff Aviation as an editorial assistant, helping to write manuals and instruction booklets for the Armed Forces.

First Radio Buy

In 1946 she moved to the Catherine Ogelsby Adv. Agency, which then handled the Harriet Hubbard Ayer account. Here she bought her first radio time.

In 1946 she joined Benton & Bowles, New York, as secretary to Esty Stowell, then executive on Maxwell House coffee (now account supervisor and a vice president). She worked on budgets for the account and then moved into the media department as assistant timebuyer to Mary McKenna. In February 1953 she became a full-fledged timebuyer with Maxwell House as her special account. She was one of the first persons in the agency to work on the account seven years ago and one of the few who have stayed with it since.

Besides her spot purchases and her activity on the *Red Buttons Show*, she also bought CBS Radio time for the daytime strip *The Second Mrs. Burton*. Maxwell House Instant Coffee currently is using 20 radio markets with its usual four-week nationwide saturation campaign.

Miss Porterfield, a bachelor girl, lives in a Gramercy Park apartment. She is an avid New York Yankee fan and a devotee of scrabble and canasta. She also is an active member of the Town Hall Club, a social-civic group.

JUNE 5, 1953--100,000 WATTS

MARCH 9, 1953--50,000 WATTS

JULY 15, 1949--16,300 WATTS



now operating at television's top power

... the Carolinas' first television station is also first to reach maximum power. Twenty-first station in the nation in sets served (eighth among single-station markets) WBTV reaches out to almost 4,000,000 people with effective buying income of \$3,800,000,000.

The Television Service of
JEFFERSON STANDARD LIFE INSURANCE COMPANY
Represented Nationally by CBS TV Spot Sales

According to FCC Engineer, Edward Allen, 100,000 watts on Channel 3 equals 316,000 watts on Channels 7-13, 5,000,000 watts on UHF Channels. WBTV's low channel, maximum power and mountain-top transmitter, located 1090 feet above average surrounding terrain, give the station exceptional geographical coverage.

**KWKH's cost
per-thousand-families
is 46.4% LESS
than the second
Shreveport station!**

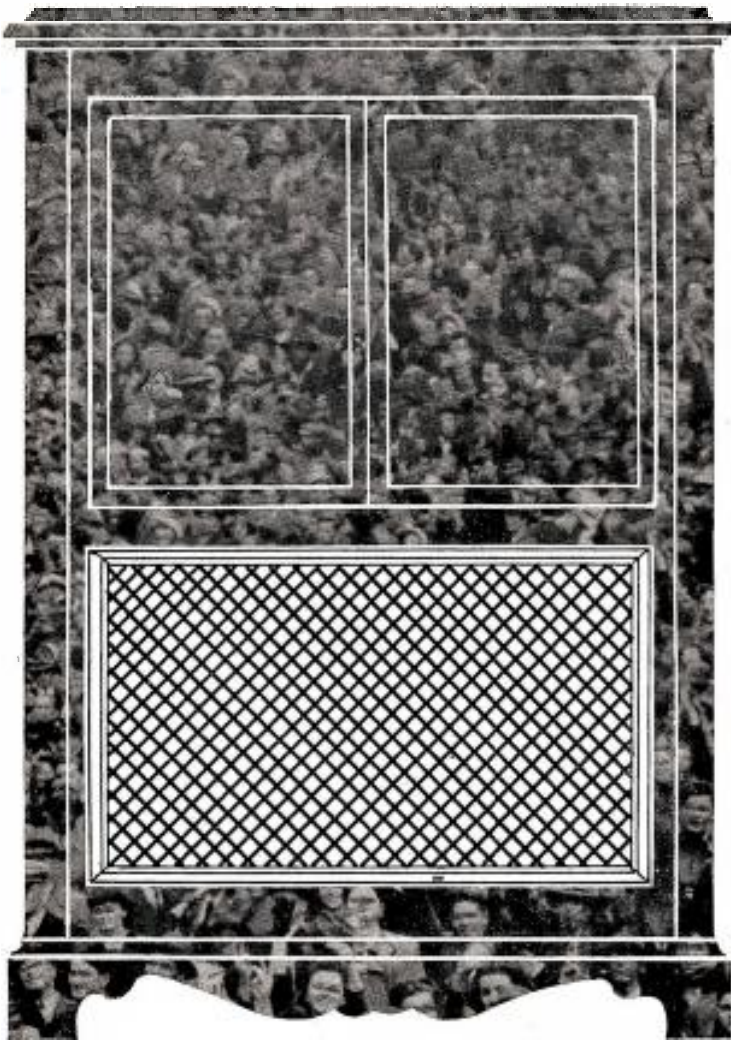

KWKH, Shreveport, not only delivers the biggest radio audience in the prosperous Arkansas-Louisiana-Texas area—it also delivers the most listeners per dollar. Its “cost-per-thousand” is 46.4% less than the second Shreveport station!

These audience figures are from the new Standard Station Audience Report—the more conservative of the two recent audience surveys made in this area. Ask your Branham representative!

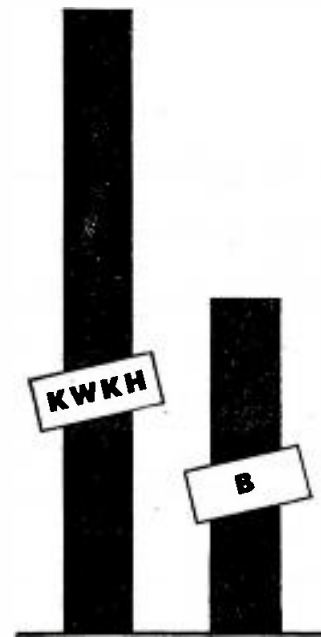

LISTENERS PER DOLLAR
(1-time, 1/4-hour daytime rates)

50,000 Watts • CBS Radio •

KWKH
A Shreveport Times Station

SHREVEPORT **LOUISIANA**
Texas
Arkansas

The Branham Co.,
Representatives

Henry Clay, General Manager
Fred Watkins, Commercial Manager

DECISION ON MBS PLAN AWAITS NOV. 4 MEETING

Unconvinced Mutual affiliates balk at 'time-payment' plan—and word from Spencer, Iowa, is that the idea 'takes the 50-cent spot to Madison Ave.' Missouri, Oklahoma, Iowa and South Carolina are the trouble spots.

MUTUAL network's affiliation formula may be overhauled, or even shelved, within a fortnight if station opposition warrants such action.

While network officials would not comment, it was obvious at the weekend that action awaits a meeting of the Mutual Affiliates Advisory Committee of 14 to be held Nov. 4 in New York. While the MAAC group helped devise the new plan and approved it unanimously, seven new members will take part in the Nov. 4 meeting.

Evidence that active resistance to the plan persists in many sections was found in reports to B•T, particularly from the Midwest and South, and from a nationwide survey [B•T, Oct. 12].

The new attitude at Mutual was in line with a report that MBS might abandon the whole scheme this week due to lack of support. This report was based on what was described as a positively "horses-mouth source."

The survey was made by Missouri Broadcasters Assn. [B•T, Oct. 12]. Results were disclosed over the weekend to a meeting of MBA at Jefferson City. The survey showed:

- 152 reporting stations have signed MBS contracts.
- 210 have not.
- 28 are not involved in survey (Don Lee or Yankee affiliation).

MBA's Research

The Missouri poll was made following an MBA protest meeting held in late September. President G. Pearson Ward KTTS Springfield, was directed to ask all state broadcaster associations for reports on their areas. The polling was conducted by Catharine Roer, KWOS Jefferson City, MBA secretary-treasurer.

These results do not distinguish between "pay" and "bonus" affiliates of the network, which comprises roughly 560 stations in all of which around 200 are on the bonus side.

Oklahoma, Iowa and South Carolina, besides Missouri, appeared to be trouble spots for the network, judging by reports from those areas.

On the other hand MBS appeared to have scored a major victory when WWDC Washington disclosed it was signing a contract. Ben Strouse, WWDC vice president-general manager, had previously told B•T the station could not see any possible way of giving up 35 hours a week from its sold-out schedule.

South Carolina made known its opposition through the South Carolina Mutual Affiliates Assn. This militant group of 15 outlets adopted a series of strongly worded conclusions:

1. That the contract offered by MBS as of Oct. 1, 1953, is not in our interest; that it pro-

hibits programming in the public interest in that its distribution of time is such that we are unable to program certain local events that the public requires.

2. That Mutual's interpretation of this contract as shown by its conference call of Sept. 25 pre-empts 83 station breaks per week that have been recognized as salable property of each radio station. The loss of this time would mean a serious loss of revenue to each station.

3. That Mutual by its arbitrary demand for option time as the alternate to signing this contract constitutes a violation of good faith and fair practice by wasting the only resource which we have—namely—time; that the proposal is so foreign to our previous relationship with the network, or to our knowledge of any other networks' affiliation agreement, that we feel bound to resist these proposals of MBS as individual stations and as a group, and that any action by the network shall be deemed as an act against all stations undersigned.

Members are: WUSN Charleston, WGTN Georgetown, WLAT Conway, WALD Walterboro, WHSC Hartsville, WFIG Sumter, WGCD Chester, WBCU Union, WKDK Newberry, WNOK Columbia, WJAN Spartanburg, WMRC Greenville, WGSW Greenwood, WRHI Rock Hill, WDIX Orangeburg.

Besides loss of program and salable time, critics of the MBS plan in other areas claim it will upset the whole network structure by forcing other networks to adopt a similar operating technique.

ABC told B•T Thursday there was no foundation to a report that the network had sent out a feeler to affiliates indicating it might adopt aspects of the Mutual formula. An ABC spokesman, after issuing a categorical denial, said that on the contrary ABC radio affiliates were told specifically the network was not going to undertake such a plan.

Iowa Resistance

One of the hot spots of affiliate resistance is Iowa, where Ben Sanders of KICD Spencer, president of Iowa Broadcasters Assn., said no station in the state had "capitulated" to Mutual. Mr. Sanders was one of those who predicted the MBS idea might create chaos.

"The MBS plan takes the 50-cent spot to Madison Ave.," Mr. Sanders told B•T. "This will sink MBS and drag representatives and networks into the same rut."

Suggesting MBS has made "a lot of verbal agreements and concessions" in lining up important stations, he said, "I'll sign for Spencer on the same basis they sign Washington, Baltimore and Cincinnati."

He proposed that an MBS affiliates committee "truly representative of affiliates" should be formed, charging that no member of the net-

work's affiliation group had talked to any Iowa station.

A point emphasized by those battling the MBS idea is the loss of control over station rates with the network described as able to sell spots at any price it wishes and far undersell a station's own national spot scale.

Among station representatives, who naturally oppose the plan violently, the charge was made that MBS "insiders" were beginning to decide the plan would not work. Here again MBS officials were noncommittal but it was evident they have been hearing so many rumors that they can't become too concerned over a few more.

T. F. Flanagan, managing director of Station Representatives Assn., told B•T that representatives have been aware of danger to stations in the MBS contract. "Spot business is the best in history," he said. "When we started our Spot Radio Crusade last spring, 1953 looked like a fair year. September, however, was a sensation. We'll run 10% or maybe even 20% above last year."

Further Misgivings

One midwestern station manager who didn't want to be quoted charged that many affiliates who didn't realize what the contract meant are "wondering if spots are being sold from under them." This source was one of several that contended liberal concessions are being made in key areas, and was concerned, too, over "take-it-or-leave-it" aspects of the problem.

All sorts of oral reservations have been made, some affiliates contend. These cover a demand that MBS honor sports and public interest features, with some signatories deciding to fight it out later if the network refuses to yield.

Demand for playback rights has arisen in a number of cases. One affiliate claimed to have been promised playback concessions but got no reply to requests made to the network.

Cy Casper, WBRZ Ponca City, Okla., president of Oklahoma Broadcasters Assn., who has signed an MBS contract for WBBZ, said there still is strong opposition to the contract within the state. He signed following similar action by KOCY Oklahoma City.

Poll of MBS affiliates in Oklahoma indicated that three are signing but 12 have refused. One affiliate said the signatory stations had signed on condition 90% of MBS affiliates sign.

Other states in which strong resistance is shown in the Missouri survey include Georgia, Illinois, Kentucky, Louisiana, Mississippi, Nebraska, Ohio and West Virginia.

In some instances the reports of state associations don't agree with those from stations.

MBS refused last week to revise its claim made a fortnight ago that the network had signed 75% of its rate card.

The 200 bonus stations do not need to sign contracts, it was pointed out. Most of the stations that have signed thus far are described as pay stations.

There was genuine concern among representatives that the whole spot industry might undergo radical changes, with networks becoming spot organizations selling announcements on programs fed over their lines.

SHORT-TERM SPOTS LEAD WEEK'S BUYS

Five major advertisers take radio and television spot business in small lots. Another buyer adds stations to its list.

SPOT BUSINESS activity last week was marked by an advancing trend toward short-term announcements, with five major advertisers enlisting for three and four-week campaigns and one enrolling for as little as three days. The "short burst" action involved both radio and television; the campaigns are scheduled for November and December.

In addition, one major advertiser added new stations to its going list.

The short-term emphasis appeared to be a spontaneous development that is being watched with interest by the industry. Significantly, few of the products being promoted in that fashion could be considered "short-run" or Christmas season items.

The six advertisers signing for the brief schedules were Cashmere Bouquet, Vitamin Corp. of America, Drug Supply Corp., Nash Cars, Sinclair Refining Co., and Northwest Airlines.

The sponsor adding new stations to its current list was Vick Chemical Co.

Cashmere Spots

Cashmere Bouquet hand lotion will launch a short-term spot announcement campaign in more than 50 radio markets on Nov. 3 for three weeks. Several tv markets also will be used. Sherman & Marquette, New York, is the agency.

Drug Supply Corp. for the second consecutive year will use a radio-tv spot announcement campaign to urge persons to buy Christmas gifts in their local drug stores. Approximately 49 radio and 21 television stations will be used, starting Dec. 2 and continuing through Dec. 23. Ruthrauff & Ryan, New York, is the agency.

Vitamin Corp. of America, for its calometric product, will start a three-to-four-week spot schedule in 25 television markets effective Nov. 1. BBDO, New York, is the agency.

Nash cars, through Geyer Inc., New York, on Nov. 19 will start a three-day campaign

using both radio and television on a national scale.

Sinclair Refining Co. has launched its fall and winter advertising campaign for Sinclair Power X, which will continue into December. The radio spot announcements will be carried on 156 radio stations in 110 cities and 24 tv stations in 20 cities. Morey, Humm & Johnstone, New York, is the agency.

Northwest Airlines, through Cunningham & Walsh, New York, is planning to use spot radio in Canada for the first time. The agency is asking for availabilities in major cities.

Vick Chemical Co., through Morse International, New York, is planning to add several markets, effective Nov. 2 for about 10 weeks, mostly in the South.

Chicago Dodge Drive Set

GRANT Advertising Inc. has wrapped up a comprehensive program for Chicagoland Dodge Dealers, utilizing radio, television and other media to introduce the new 1954 Dodge.

Grant scheduled 240 radio and 40 tv announcements on Chicago stations over a three-week period on behalf of 54 Dodge dealers. Dealer association also contracted for sponsorship of Northwestern U. football broadcasts on WIND. Other commitments include a 13-week half-hour show, *Inside Football*, each Saturday on WBBM-TV, and the *Dodge Sports Preview* on WBBM each Saturday evening.

Heet Anti-Freeze Spots Ready

HEET DIV. of Demert & Dougherty is launching an extensive radio spot announcement campaign in 39 northern markets Nov. 1, it was learned last week. Agency is Arthur Meyerhoff & Co., Chicago.

Company will use two or three stations in each market to advertise Heet Anti-Freeze, with 30-second spots and station breaks ranging from 30 to as high as 80 per week in each area over a 13-week period. Tv spot campaign will be launched early next year.

Campaign is described as the "broadest" in the history of the company with the radio budget up considerably over last year. Other media also will be used.



IN HIS initial appearance on television, William B. Lewis, president of Kenyon & Eckhardt Advertising Agency, appeared on Meg Kingbay's *Talk of the Town* over WMIN-TV St. Paul, Minn.

Bryson to General Foods

GEORGE D. BRYSON, formerly vice president of Young & Rubicam, N. Y., where he devoted himself largely to the General Foods account, has been elected General Foods vice president in charge of international operations.

NEW BUSINESS

Readers Digest is placing radio spot announcement campaign to increase circulation. This schedule will start Nov. 7 in six midwest states and run for one week only. Announcements are bids for subscriptions to *Digest*.

Dale Dance Studios, N. Y., nationwide chain of dancing schools, has launched its fall-winter radio advertising schedule on following stations: WMCA and WINS New York; WAAT and WPAT Newark; WIND Chicago; WJBK Detroit; WLOL Minneapolis; KTLN Denver; KJBS San Francisco; WITH and WWIN Baltimore; WIP Philadelphia, and WEAM Washington. Other cities are to be added. William Warren, Jackson & Delaney, N. Y., is agency.

Selective Auto & Fire Insurance Co. of America, Seattle, starts Tues. and Thurs. broadcasts of *Edward R. Murrow News* on 22 CPRN stations, 5-5:15 p.m. PST, for eight weeks from tomorrow (Tuesday). Agency: MacWilkins, Cole & Weber, that city.

Quaker Oats Co.'s Coast Fisheries Division (Puss 'n Boots cat food) is conducting television and radio participation campaign in more than 70 cities. Campaign started Monday, Oct. 19 and ends Nov. 26.

J-R Watch Bands, N. Y., to sponsor *Back That Fact* on ABC-TV, starring Joey Adams, on alternate weeks, Thursday, 9-9:30 p.m., starting Nov. 12. Lewis, Williams & Saylor, N. Y., is agency.

NETWORK RENEWALS

Pet Milk Co. and its subsidiary Sego Milk Products Co. renew sponsorship of *Truth or Consequences* and *Mary Lee Taylor Show* on NBC Radio for 52 weeks, through Gardner Adv. Co. and Gillham Adv. Agency, respectively. *Truth or Consequences* is broadcast Thurs., 9-9:30 p.m.; *Mary Lee Taylor Show*, Sat., 10:30-11 a.m.

Faultless Starch Co. renews *Faultless Starch Time*, NBC Radio, Sun., 11-11:15 a.m., for 52 weeks. Agency: Bruce B. Brewer Co.



J. CARLISLE MacDONALD, (l), assistant to the board chairman of U. S. Steel, talks about the initial tv production of *The United States Steel Hour* with (l to r) stars Richard Kiley and Gary Merrill and Alexander Stronach Jr., ABC vice president of television network. Mr. MacDonald will directly supervise the hour-long program, which begins tomorrow night on ABC-TV at 9:30 EST, on an alternate Tuesday night schedule.

MPTV NAMES THREE TO EXPAND SALES IN STEPPING-UP OF FILM SYNDICATION

Merritt, Behnke and O'Driscoll assume account executive duties. Other personnel appointments are made in moves to boost syndication activities.

APPOINTMENTS of three sales executives and additional personnel in publicity, advertising and promotion, and business administration were announced last week by Edward D. Madden, vice president of Motion Pictures for Television Inc., as part of a stepping-up of activities for the company's film syndication division.

New account executives for the syndication division are Bill Merritt, formerly with Wyatt & Schuebel, New York; Verne W. Behnke,



Mr. Behnke

Mr. Merritt

previously an account executive with CBS-TV Film Sales, and Francis A. O'Driscoll, formerly sales manager in Detroit for Procktor Productions. Messrs. Merritt and Behnke have been assigned to the eastern sales division in New York and Mr. O'Driscoll to the east-central division with headquarters in Detroit.

Handling publicity for the division will be Michael O'Shea, theatrical press agent and writer, who will operate out of the home office in New York. Guy Cunningham, formerly director of sales promotion for CBS Radio Spot Sales, has been appointed director of advertising and promotion, and Lewis P. Blumberg,

TAP Sues for \$400,000

DEMANDING \$400,000 as its net profits due on the *Crusader Rabbit* cartoon series, and asking an accounting, Television Arts Productions Inc., filed a breach of contract suit in Los Angeles Superior Court Monday against Jerry Fairbanks Inc., NBC and Consolidated Television Sales. TAP claims it produced the 195 five-minute cartoons and charges the amount of money requested represents a 50% share of net profits due from sale of the series under a contract signed Oct. 4, 1950. The defendants deny any such claim, alleging they are sole owners of the series.

'Superman' Premiere Set

NATIONAL Comics Publications Inc., New York, announced last week that the 15-minute *Superman* film it produced for the Savings Bonds Division of U. S. Treasury Dept. will have its premiere screening at the Mayflower Hotel, Washington, on Nov. 4. Secretary of the Treasury George Humphrey and all state directors of the Treasury Dept. are expected to attend the showing.

previously vice president of B & K Films, has been named administrative assistant.

"The film syndication division is now ready to launch a concentrated sales, advertising and promotion drive across the country on MPTV's film production now under way," Mr. Madden said. "MPTV productions will be sold for local television station placement. The programs will offer a variety of shows to national, regional and local advertisers and will cover all audiences, children, adults and the entire family."

Weiss Joins Guild Films; 'Palooka' Plans Outlined

IN line with its expansion program, Guild Film Co. announced last week the appointment to its sales staff of George Weiss, who recently resigned as national sales manager of United Television Programs. Mr. Weiss has been assigned to handle eastern division sales for various Guild shows.

Reub Kaufman, Guild president, said Mr. Weiss' appointment will be followed by several other additions to the staff in the near future.

Plans for national and world distribution of the Guild Film Co.'s new filmed tv series, *Joe Palooka Story*, also were announced last week by Mr. Kaufman, who said the series already has been sold in two markets, to KLAC-TV Los Angeles and KBTW (TV) Denver.

The first six episodes have been completed at Republic Studios for \$27,000 each, Mr. Kaufman revealed. He added that seven more episodes are in the cutting room and that the next series of 13 shows is scheduled for production in November. The series will consist of 78 episodes produced at a cost of about \$2 million, Mr. Kaufman said.

Film Sales

Frederic W. Ziv Co. announced last week that its hour-long *Hour of Stars*, featuring Tony Martin, Dick Powell, Ginger Rogers, and Peggy Lee, has been sold in more than 500 markets, with latest sales to WHK Cleveland, KEX Portland and WHBF Davenport, Iowa.

Sale of the *Victory at Sea* tv film series in five new markets was announced last week by John B. Cron, national sales manager for the NBC Film Division, who noted that the series is currently syndicated in 69 markets. The new markets are WPMT-TV Portland, Me.; KTVU (TV) Stockton-Sacramento; WSJV-TV Elkhart; KBES-TV Medford, Ore., and WTSK (TV) Knoxville. Recent sales on other division properties, Mr. Cron said, has raised the number of total markets carrying *Dangerous Assignment* to 136; *Hopalong Cassidy* to 130, and *Douglas Fairbanks Presents* to 106.

Screen Gems, N. Y., announced that *Professor Yes 'n' No*, quarter-hour tv quiz program on film, has been set for sponsorship by 14 local advertisers in the past few weeks. The series consists of 26 quarter-hour shows.

Production

Sovereign Productions, Hollywood, currently filming CBS-TV *General Electric Theatre* series, has signed Dennis Morgan, Peter Lawford, Virginia Bruce, Edward Arnold, Jack Carson and other Hollywood names for upcoming films in

the series. Richard Quine has been added to the firm's group of directors. Stuart Reynolds is executive producer.

Screen Gems Inc., Hollywood, is completing "The Happiest Day" for NBC-TV *Ford Theatre*, in which Larry Parks, after a two-year absence from films, makes his video debut co-starring with Teresa Wright.

Arrow Productions, Hollywood, next week starts another group of 13 half-hour films in *Ramar of the Jungle* series starring Jon Hall. Spencer Bennet has been signed to direct the new films to be distributed by Television Programs of America.

Distribution

Louis Weiss & Co., Los Angeles, has acquired distribution rights to five quarter-hour Christmas tv films produced by Lew King and directed by Adrian Weiss in Phoenix. Titled *The Little Story Shop*, the films feature the Rex Castle marionettes in seasonal stories with the All-Youth Choir of Phoenix providing the choral background.

M & A Alexander Productions, Hollywood, has acquired telecasting rights to "Guilty of Treason," feature film based on the story of Cardinal Mindzenty. Produced by Jack Wrather, the film stars are Bonita Granville and Charles Bickford.

Random Shots

Filmack Studios, Chicago, reduced prices of all tv slides 25% "because local and national advertisers, advertising agencies and an ever-increasing number of tv stations" have contributed deluge of tv slide orders in past nine months, Irving Mack, Filmack president, announced. Filmack has expanded its facilities 50% in the past few months, he added.

Gordon MacRae, star of NBC Radio *Railroad Hour*, now released from his Warner Bros. contract, has formed a partnership with dance director Al White to produce an hour-long tv film series based on university shows. Being negotiated are rights to such shows as Harvard's Hasty Pudding Club, Pennsylvania's Mask & Wig and others. Series will feature Hollywood talent with Mr. MacRae serving as packager-producer.



CONSOLIDATED Television Sales' 70th sale of its "Station Starter Plan" is made to WKAQ-TV San Juan, P. R. At signing (l to r): Ralph Barush, CTS account executive; Halsey Barrett, CTS eastern sales manager; Angel Ramos, president, WKAQ-AM-TV, and R. Delgado-Marquez, stations' general manager.

41% OF VIDEO VIEWERS NOTE COMMERCIALS—STARCH

Daniel Starch & Staff's Jack Boyle outlines to RTES workshop some fresh data on tv network commercials gathered by telephone interviews within an hour after the viewing was done.

THE average commercial on the average network tv program is seen by 41% of the people who see the program, Jack Boyle of Daniel Starch & Staff reported Thursday evening at the opening workshop session of Radio & Television Executives Society of the 1953-54 season, held in ABC's tv Studio 3 in New York.

This figure, he said, corresponds remarkably close to the 40% of readers of a magazine who see a four-color page ad. Range of commercial noting runs from 15% to 66%, so even the best commercial is missed by a third of those who watch the program, Mr. Boyle said.

Two-thirds of a program's viewers see one or more of that program's commercials, Mr. Boyle said. The range here is from 55% to 79%, with two out of 10 viewers not seeing any commercial at best. Leaving the room when the commercial comes on, talking and reading are the most common reasons given for not seeing the commercials, he said.

System Explained

Data on commercial viewing are gathered by Starch interviewers through telephone interviews made within an hour after the end of the telecast, Mr. Boyle said. If the person called says he saw the program, he is then asked to describe any of its commercials, and if he can do that he is asked what was brought out about the product. "If we get anything at all it's apt to be pretty accurate," Mr. Boyle said. Process is essentially copy research, to see what points in the tv sales message make the deepest impression on viewers. As an example, he cited the case of commercials for two electrical appliances, both middle commercials in dramatic shows. One was identified by 66% of those who saw the program, with 55% of the program's viewers able to repeat the salient points of the commercial, while only 41% saw the second product's commercial and only 28% recalled what it said. The first commercial therefore was doing twice as good a job as the second, Mr. Boyle noted. That's why the service is of value, he commented.

Dr. Morgan Neu described a second type of Starch research on the effectiveness of tv commercials, which is done on the lines of the company's magazine advertising research—interviewers visiting homes and asking about tv commercials the respondent has seen, then correlating that information with the product use of the family. If 20% of the homes where the commercial is not seen have the product and 25% of homes where the commercial is seen have it, then the spread of 5% represents the effectiveness of the commercial, assuming all

Levoy Tv Poll Begins

SIXTH annual Gordon Levoy Television Poll has started with over 1,000 questionnaires in the mail to station program directors, national and local agency tv directors, advertising managers of network and prominent regional and local advertisers and tv editors. Respondents are asked to list preferences in type and length of programs, method of dramatic programming and type of production. Additionally, they are asked this year to evaluate the best creative sources and Hollywood's role in tv and to list opinions regarding the most significant development in tv during the past year and its foremost need for the coming year. Report on the tabulation is expected late next month.

other influences are equal, Dr. Neu explained.

Different commercials for the same product are then compared and analyzed to try to find out why one may produce a spread three or four times as large as another, Dr. Neu said, stating that no commercial is ever studied for less than three months and sometimes the study lasts for a year or more. Using three sets of tv commercials as examples for Ipana, Blatz and Pabst—Dr. Neu compared them on such factors as approach, scene changes, style of announcing, personality prestige of the announcer, and display of brand name. These are only a few of the factors actually considered, he said, reporting that when Starch began this kind of research more than four years ago it included 55 factors and "many more have been added since then."

On the basis of the few examples shown Thursday evening, it appeared that the direct approach (addressing the viewer as "you" and relating the product to him) is more effective than the indirect approach; the fewer scene changes the better; the conversational style of announcing is preferable to the "standard announcer" style; an announcer who is related to the product in some way or is a program personality does better than an unrelated anonymous announcer; brand names steadily displayed so they can be read throughout the commercial are better than short flashes of the name.

Asked about the emotional effect of commercials, Mr. Boyle said there seems to be no correlation between a viewer's like or dislike of tv commercials and his use of the product. There is, however, a definite relationship between the length of a commercial and its effectiveness, with the most effective commercials consistently running about twice as long as the least effective ones.

All of these conclusions are for commercials on network programs, Mr. Boyle said, since most of the Starch tv research has been done on them and very little on tv spots. That little, he said, has been enough, however, to indicate pretty clearly that between-program spots rank far below those within the program in getting seen. "The minute the viewer is sure the program is over, you've lost him," he said.

'See It Now' Places High on Nielsen Ratings

CBS-TV's *See It Now*, commentator Edward R. Murrow's news-documentary show which was moved this fall from Sunday afternoons to the 10:30-11 p.m. EST slot Tuesdays, placed third on the A. C. Nielsen Co.'s ratings in percent of tv homes reached for the two weeks ending Sept. 26, with the network's *Racket Squad* No. 1 in this category. NBC-TV's *Dragnet* was first in number of tv homes reached.

The Nielsen listings:

NIELSEN-RATING* NUMBER OF TV HOMES REACHED		
RANK	PROGRAM	HOMES (000)
1	Dragnet (NBC)	12,966
2	Racket Squad (CBS)	12,901
3	Arthur Godfrey (Liggett & Myers Tobacco) (CBS)	11,381
4	You Bet Your Life (NBC)	10,924
5	Toast of the Town (CBS)	10,640
6	Arthur Godfrey's Scouts (CBS)	9,860
7	Arthur Godfrey (Pillsbury) (CBS)	9,833
8	Arthur Godfrey (Toni) (CBS)	9,668
9	Westinghouse Theatre (CBS)	9,257
10	Ford Theatre (NBC)	9,245

PER CENT OF TV HOMES REACHED PROGRAM STATION BASIS		
RANK	PROGRAM	HOMES %
1	Racket Squad (CBS)	55.3
2	Dragnet (NBC)	53.8
3	See It Now (CBS)	49.9
4	Arthur Godfrey (Liggett & Myers Tobacco) (CBS)	47.6
5	Toast of the Town (CBS)	46.2
6	Jackie Gleason Show (CBS)	46.1
7	You Bet Your Life (NBC)	44.1
8	Arthur Godfrey's Scouts (CBS)	44.0
9	Arthur Godfrey (Pillsbury) (CBS)	43.3
10	Red Buttons (CBS)	42.3

(* Homes reached during all or any part of the program, except for homes listening only 1 to 5 minutes. For 5-minute programs, average audience basis is used.

Copyright 1953 by A. C. NIELSEN CO.

Trendex Rates 'Lucy' Tops

TOP 10 Trendex ratings for evening sponsored network tv programs, based on the one live telecast during the week of Oct. 1-7, are:

1.	I Love Lucy (CBS)	53.0
2.	Talent Scouts (CBS)	47.8
3.	Dragnet (NBC)	45.5
4.	Godfrey's Friends (CBS)	40.6
5.	Milton Berle Show (NBC)	37.3
6.	Jackie Gleason Show (CBS)	37.0
7.	You Bet Your Life (NBC)	35.5
8.	T-Men in Action (NBC)	34.4
9.	Comedy Hour (Martin & Lewis) (NBC)	32.8
10.	Red Buttons (CBS)	32.5

Bakeries Increased Spot Tv Use 57% in Six Months

TREND among bakeries to depend more heavily upon spot television advertising was pointed up last week by the television division of Edward Petry & Co., station representatives in a presentation which showed that between the end of 1952 and mid-1953 the number of such firms using tv had grown from 116 to 182—a gain of 57%—and that the number of markets involved had gone from 51 to 70.

The study, based largely on statistics compiled by WOAI-TV San Antonio, showed that 90 bakery tv sponsors used half-hour programs, 101 used announcements and participations, and 9 used quarter-hour programs. A total of 21% of those which sponsored half-hour shows also placed schedules of spot announcements and participations to implement their program sponsorships.

Called "The Baking Industry and Television" and designed to assist bakeries in general in formulating tv plans, the presentation reported that more than nine out of ten of the half-hour programs consisted of western films (30 of the 90 firms sponsoring 30-minute shows used *Cisco Kid*, with four firms alone accounting for sponsorship of this series in 28 markets, while *Hopalong Cassidy*, *Range Rider*, and *Cowboy G-Man* were singled out as other bakery favorites). Increased baking firm sponsorship of adventure-mystery films and locally produced variety shows also was noted.

In addition to the increasing number of bakeries in tv, the study pointed out that many leading companies in this field boosted the number of markets used and also increased schedules in individual markets.

RADIO, TV NETWORKS' AUGUST SALES UP OVER 1952; YEAR'S TOTALS ALSO RISE

Publishers Information Bureau figures show that sales by radio and tv networks not only are up for August and for this year, but also that top advertisers have increased their time purchases.

BOTH radio and tv networks sold more time in August this year than the same month of last, according to figures compiled by Publishers Information Bureau, which also show

advertisers purchased more time on both types of networks in the first eight months of this year than in the like period of 1952.

The top advertisers for each type of network also have increased their individual time purchases, according to PIB, which shows nine of the top 10 radio network clients spending more this August than last, while the tv network top 10 shows eight who spent more and two who decreased their time purchases in the year.

Comparing the total time purchases of each type of network advertiser this year and last it is noteworthy that network radio seems to be improving its relative position as the year

progresses, while network tv seems to be losing ground. For August, 17 client groups spent more money for radio network time and seven groups less this year than last, while for the January-August period there were 14 which spent more and 12 which spent less in 1953 than in 1952. Conversely, the August record of the tv networks shows 11 groups spending more and 12 spending less for time this August than in August 1952. For the eight-month period, 18 tv network client groups spent more this year than last compared to 10 groups who spent less.

TOP TEN RADIO NETWORK ADVERTISERS IN AUGUST 1953

1. Procter & Gamble Co.	\$1,070,845
2. Miles Labs.	596,148
3. Lever Brothers Co.	483,727
4. Gillette Co.	456,998
5. General Foods Corp.	436,690
6. Colgate-Palmolive-Peet Co.	414,466
7. Sterling Drug	322,453
8. General Motors Corp.	305,573
9. Manhattan Soap Co.	290,845
10. Kaiser Motors Corp.	272,701

* * *

TOP TEN TV NETWORK ADVERTISERS IN AUGUST 1953

1. Procter & Gamble Co.	\$1,027,778
2. Colgate-Palmolive-Peet Co.	964,626
3. R. J. Reynolds Tobacco Co.	668,256
4. American Tobacco Co.	615,780
5. Gillette Co.	495,814
6. Liggett & Myers Tobacco Co.	492,127
7. General Foods Corp.	482,238
8. P. Lorillard Co.	462,543
9. Lever Brothers Co.	456,125
10. Philip Morris & Co.	439,113

* * *

LEADING RADIO NETWORK ADVERTISERS BY PRODUCT GROUPS DURING AUGUST 1953

Product Group	Advertiser	Gross Time Purchases
Agriculture & Farming	Allis-Chalmers Mfg. Co.	\$ 43,767
Apparel, Footwear & Acces.	Cannon Mills	17,835
Automotive, Auto. Access. & Equipment	Kaiser Motors Corp.	272,701
Beer, Wines & Liquor	Falstaff Brewing Corp.	114,853
Bldg. Materials, Equip. & Fixtures	Holland Furnace Co.	126,485
Confectionery & Soft Drinks	William Wrigley Jr. Co.	117,570
Consumer Services	American Tel. & Tel. Co.	78,746
Drugs & Remedies	Miles Labs.	596,148
Food & Food Products	General Foods Corp.	429,690
Gasoline, Lubricants & Other Fuels	Standard Oil Co. of Indiana	98,331
Household Equipment & Supplies	Philco Corp.	122,543
Household Furnishings	Owens-Corning Fiberglass Corp.	59,940
Industrial Materials	Reynolds Metals Co.	5,404
Insurance	Mutual Benefit Health & Accident Assn.	98,554
Jewelry, Optical Goods & Cameras	Jacques Kreisler Mfg. Corp.	19,500
Publishing & Media	First Church of Christ Scientist	14,508
Radios, Tv Sets, Phonographs	RCA	79,542
Musical Instruments & Acces.	Dr. Miss Shoe Stores	1,545
Retail Stores & Direct Mail	Liggett & Myers Tobacco Co.	213,332
Smoking Materials	Procter & Gamble Co.	662,223
Soaps, Cleansers & Polishes	Gillette Co.	456,998
Toiletries & Toilet Goods	Assn. of American Railroads	79,241
Transportation, Hotels & Resorts	American Federation of Labor	97,898
Miscellaneous		

* * *

LEADING TV NETWORK ADVERTISERS BY PRODUCT GROUPS DURING AUGUST 1953

Product Class	Advertiser	Gross Time Purchased
Apparel, Footwear & Acces.	Griffin Mfg. Co.	\$ 43,820
Automotive, Auto. Access. & Equipment	Ford Motor Co.	384,263
Beer, Wines & Liquor	Pabst Brewing Co.	182,384
Confectionery & Soft Drinks	Coca-Cola Co.	176,984
Consumer Services	Electric Companies' Advertising Program	25,512
Drugs and Remedies	American Home Products Corp.	229,179
Entertainment	Loew's Inc.	11,428
Foods & Food Products	General Foods Corp.	482,238
Goso'ine, Lubricants & Other Fuels	Gulf Oil Corp.	97,830
Household Equipment & Supplies	Westinghouse Electric Corp.	341,500
Household Furnishings	Admiral Corp.	145,995
Industrial Materials	Revere Copper & Brass, Inc.	70,815
Insurance	Mutual Benefit Health & Accident Assoc.	106,282
Jewelry, Optical Goods & Cameras	Spaid Corp.	62,535
Office Equipment, Writing Supplies, Stationery & Acces.	W. B. Sheaffer Pen 'Co.	74,292
Publishing & Media	Crowell-Collier Publishing Co.	15,653
Radios, Tv Sets, Phonographs, Musical Instruments & Acces.	RCA	128,178
Smoking Materials	R. J. Reynolds Tobacco Co.	668,256
Soaps, Cleansers and Polishes	Procter & Gamble Co.	1,027,778
Toiletries & Toilet Goods	Colgate-Palmolive-Peet Co.	765,429
Miscellaneous	Quaker Oats Co.	54,780

* * *

Gross Radio Network Time Sales by Product Groups for August and January-August 1953 Compared to 1952

Product Group	Aug. 1953	Jan.-Aug. 1953	Aug. 1952	Jan.-Aug. 1952
Agriculture & Farming	\$ 95,347	\$ 791,392	\$ 63,248	\$ 471,155
Apparel, Footwear & Acces.	34,765	644,437	33,716	195,279
Automotive, Auto. Access. & Equip.	678,889	4,377,526	256,381	2,496,265
Beer, Wine & Liquor	129,700	1,162,042	148,488	1,605,472
Bldg. Materials, Equip. & Fixtures	200,361	908,638	109,866	680,798
Confectionery & Soft Drinks	232,657	2,039,307	528,155	3,967,543
Consumer Services	151,524	1,617,021	129,021	1,480,489
Drugs & Remedies	1,434,597	14,302,943	1,408,665	13,833,500
Food & Food Products	2,456,575	24,080,891	2,443,058	23,948,148
Gasoline, Lubricants & Other Fuels	396,179	3,276,989	434,394	3,536,981
Horticulture	107,324	109,923
Household Equipment & Supplies	532,311	4,822,833	527,153	2,971,906
Household Furnishings	169,219	1,414,003	150,823	837,385
Industrial Materials	5,404	739,231	26,507	1,204,868
Insurance	234,159	1,395,598	310,633	2,339,216
Jewelry, Optical Goods & Cameras	19,500	565,370	527,048
Office Equip., Stationery & Writing Supplies	366,312	361,557
Political	11,634	108,969
Publishing & Media	17,854	149,948	10,632	478,930
Radios, Tv Sets, Musical Instruments & Acces.	217,745	1,545,665	183,444	1,050,018
Retail Stores & Direct Mail	1,545	10,506	3,360	18,414
Smoking Materials	875,960	10,123,313	776,349	11,027,554
Soaps, Cleansers & Polishes	1,268,219	10,176,561	1,250,418	11,943,421
Toiletries & Toilet Goods	1,964,739	17,926,953	1,597,618	14,804,751
Transportation, Hotels & Resorts	79,241	554,708	61,986	603,421
Miscellaneous	509,804	3,602,344	471,695	3,379,729
TOTAL	\$11,706,295	\$106,701,855	\$10,937,244	\$103,982,740

Gross Tv Network Time Sales by Product Groups for August and January-August, 1953, Compared to 1952

Product Group	August '53	Jan.-Aug. '53	August '52	Jan.-Aug. '52
Agriculture & Farming	4,303
Apparel, Footwear & Acces.	117,614	1,523,655	96,801	1,950,150
Automotive, Auto. Access. & Equip.	1,543,040	11,884,278	1,131,454	9,518,436
Beer, Wine & Liquor	367,757	3,163,068	384,331	3,808,149
Bldg. Materials, Equip. & Fixtures	136,655	329,014
Confectionery & Soft Drinks	231,014	3,457,310	361,362	3,284,289
Consumer Service	25,512	393,102	81,301	256,686
Drugs & Remedies	561,749	5,701,429	367,723	3,371,619
Entertainment	11,428	11,428
Food & Food Prods.	3,347,824	25,641,816	2,375,287	21,508,779
Gasoline, Lubricant & Other Fuels	121,532	1,909,784	172,620	2,335,788
Horticulture	6,113	12,370
Household Equip. & Supplies	1,319,164	11,360,479	664,143	6,471,343
Household Furnishings	24,370	1,554,885	138,806	1,461,186
Industrial Materials	150,557	2,712,676	226,725	2,581,494
Insurance	106,282	786,114	34,360	260,928
Jewelry, Optical Goods & Cameras	135,193	1,744,582	169,300	1,439,444
Office Equip., Stationery & Writing Supplies	95,652	847,316	118,350	1,042,255
Political	9,570	142,722
Publishing & Media	18,372	203,130	81,036	554,396
Radios, Tv Sets, Phonographs, Musical Instruments & Acces.	252,328	2,321,841	359,664	2,820,638
Retail Stores & Direct Mail	23,175	127,721	814,501
Smoking Materials	2,979,051	22,810,870	2,232,063	17,999,893
Soaps, Cleansers & Polishes	1,889,385	14,341,635	1,383,162	11,973,479
Sporting Goods	51,723
Toiletries & Toilet Goods	2,822,860	22,983,868	2,110,607	16,567,410
Transportation	222,774
Miscellaneous	155,277	1,484,076	110,135	1,162,733
TOTALS	\$16,275,961	\$137,282,085	\$12,736,521	\$111,667,702

August Tv Shipments Better July by 48%

TELEVISION set shipments to dealers in August rose 48% over July, according to Radio-Electronics-Tv Mfrs. Assn. August shipments were 462,570 compared to 313,012 in July and 315,332 (up 39%) in August last year.

The eight-month total of tv set shipments in 1953 reached 3,797,832 compared to 2,722,089 in the same 1952 period. Following are tv set shipments to dealers for first eight months of 1953:

State	Total	State	Total
Alabama	60,593	Nebraska	32,718
Arizona	25,260	Nevada	3,951
Arkansas	25,142	New Hamp.	12,360
California	304,354	New Jersey	102,912
Colorado	47,980	New Mexico	11,058
Connecticut	56,589	New York	357,087
Delaware	8,975	N. Carolina	72,179
D. C.	30,767	N. Dakota	9,364
Florida	68,265	Ohio	227,050
Georgia	63,596	Oklahoma	70,864
Idaho	10,987	Oregon	48,706
Illinois	225,374	Pennsylvania	325,040
Indiana	123,510	Rhode Island	16,764
Iowa	80,607	S. Carolina	35,204
Kansas	46,554	S. Dakota	10,326
Kentucky	55,037	Tennessee	55,130
Louisiana	55,310	Texas	239,498
Maine	31,239	Utah	24,979
Maryland	46,628	Vermont	6,850
Mass.	118,327	Virginia	82,176
Michigan	157,616	Washington	88,701
Minnesota	66,771	W. Virginia	50,469
Mississippi	28,817	Wisconsin	80,891
Missouri	90,577	Wyoming	1,743
Montana	3,137		
		Grand Total	3,797,832

Listening, Viewing Rises To All-Time High—Nielsen

HOURS of broadcast reception now are at an all-time high, according to A. C. Nielsen Co., which reported listening-and-viewing averages 5 hours 18 minutes per day per U. S. radio home. The figure for the first half of the year has grown steadily since 1946 (pre-tv), when it stood at 4 hours 12 minutes.

Total tv viewing is down 4% from last year—4 hours 54 minutes (first half of 1953) against 5 hours 6 minutes (first half of 1952) due in part, Nielsen said, to growing tv ownership among small families whose viewing time is less than for large ones. But, Nielsen pointed out, audience levels are at all-time high because of the addition of 6 million homes to the tv total.

Radio listening volume in the morning continues to rise, Nielsen data show, with 6.4 million homes tuned in between 7 and 10 a.m. on an average weekday, March-June 1953, to 6,334,000 the year before.

Bachelor to Direct Ad Research Program

DR. JOSEPH E. BACHELDER has been appointed to the staff of Gallup & Robinson Adv. Research, Princeton, N. J., to direct a program which will attempt to isolate and analyze advertising factors directly influencing sales.

An announcement said last week Dr. Bachelder was hired specifically to carry forward work the company has conducted the past two years on tv commercials. Preliminary studies indicate it is possible to go beyond the measurement of idea registration and attitudes to measuring the impact of television commercials on actual sales, the announcement said.

Dr. Bachelder comes to Gallup & Robinson from the U. of Illinois, where he was research professor in the Institute of Communications Research.

EFFORTS TO GAIN 'FAIR' MUSIC FEES OUTLINED BY ALL-INDUSTRY GROUP

Open letter to all tv stations reiterates intent to get a 'reasonable' scale, either by negotiation or litigation.

AGGRESSIVE prosecution of television's fight to secure fair and reasonable fees for the music it uses—either by negotiation or litigation, and both avenues will be fully explored—was promised last week by the All-Industry Local Tv Music License Committee in an open letter sent Friday to all U. S. tv stations, non-subscribers as well as those who have already authorized the committee to act on their behalf.

Stations which have not yet contributed their share of the committee's expenses incurred on behalf of all tv broadcasters are urged to join up now on the same basis as earlier subscribers—four times their highest one-hour card rate. The original group of 54 tv stations which more than two years ago pledged that amount to finance the legal action asking the Federal District Court in New York to set fair rates for the use of Ascaph music on television already have been joined by 24 others, including both pre-freeze and post-freeze stations, the committee reported. In addition, "there are a number of other stations who are taking the initial steps necessary to join the suit," the letter stated.

Present status of the litigation, the committee reported, is preparation for oral examination of Ascaph officials. This step was postponed at Ascaph request until the court had ruled on Ascaph's motion for amendments of the consent decree, which the All-Industry Committee vigorously opposed. After Simon H. Rifkind, committee special counsel, had petitioned the court to allow WATV (TV) Newark to intervene in the hearing on the Ascaph motion on behalf of all tv stations requesting the court to set fair music fees [B•T, Sept. 28], Ascaph abruptly withdrew its motion *in toto*, following which the committee also withdrew its motion to intervene.

Asks Decree Amendment

"Ascaph's motion," the committee letter explained, "asked that the decree be amended: (1) to permit Ascaph to tax spot announcements containing no music which were adjacent to programs containing Ascaph music and (2) to permit Ascaph to decline to grant per program licenses to any radio or television station which had any type of license with BMI."

Now that this motion is out of the way, examinations of Ascaph officers will "be commenced as soon as we can get Ascaph to produce their people—very likely around the end of this month," the committee said.

Not relying on the legal approach solely, the committee said that a subcommittee plans to meet with a similar Ascaph group "in the very near future" to see if an agreement cannot be reached on what constitutes a fair price for the use of Ascaph music on television under either blanket or per program licensing agreements. The original committee which attempted to negotiate with Ascaph on behalf of the tv stations was concerned solely with terms for a per program license, as those for a blanket license had already been worked out and accepted by three of the four tv networks and some individual stations. Those blanket license contracts expire the end of this year, however, and with this in mind the tv station operators, meeting during the NARTB 1953 Convention

in Los Angeles [B•T, May 4], broadened the scope of the committee's authority to include blanket as well as per program license fees.

Every attempt to secure fair fees by negotiation will be made, despite the failure of the earlier negotiations, which continued for nearly two years, to do so, and despite the lack of progress the tv network committee has achieved in recent meetings with Ascaph to discuss acceptable terms for new blanket licenses to succeed those expiring on Dec. 31, 1953, the committee said.

The committee reported the appropriation of "a very considerable sum for an expanded program of research to ascertain the use of Ascaph music in television and other facts pertaining to the program habits of the various stations."

Referring to the network negotiations, the committee expressed the understanding that "no progress has been made. The networks continue their firm position that the rates they are currently paying must be sharply reduced beginning on Jan. 1." These rates amount to 3.025% of the gross income of the tv networks, 10% more than the rate for the Ascaph radio blanket licenses and appreciably more in dollars per year.

Ascaph has offered to renew its blanket licenses at the present rate. The network representatives have counter-offered to sign new agreements at 50% of the radio rate [B•T, Sept. 28]. With neither side budging it has been speculated that unless the situation changes radically within the next few weeks the networks may well approach the problem by the legal route already taken on the stations' behalf by the All-Industry Committee asking the court to set fair fees, for networks as well as stations, as provided for in the consent decree accepted by Ascaph at the end of its break with radio in 1941.

Dwight W. Martin, vice president, General Tele-radio Inc., is chairman of the all-industry local tv music license committee. Its other members are: Paul Adanti, WHEN (TV) Syracuse; Campbell Arnoux, WTAR-TV Norfolk; Roger W. Clipp, WFIL-TV Philadelphia; Wayne Coy, KOB-TV Albuquerque; Walter J. Damm, WTMJ-TV Milwaukee; Jack Harris, KPRC-TV Houston; Gaines Kelley, WFMY-TV Greensboro; Philip G. Lasky, KPIX (TV) San Francisco; Nathan Lord, WAVE-TV Louisville; Don McGannon, DuMont network; W. D. Rogers Jr., KDUB-TV Lubbock, Tex.; Irving Rosenhaus, WATV (TV) Newark; Robert D. Swezey, WDSU-TV New Orleans; Hugh B. Terry, KLZ-TV Denver; C. Robert Thompson, WBBN-TV Buffalo. Thad H. Brown, vice president and counsel to the Tv Board, NARTB, is a non-voting observer member of the committee.

World's Weis Announces Tv Music-Sound Library

WORLD Broadcasting System announced last week it will make available to television stations what it claimed is "the first transcribed service of music and sound for the television industry."

According to Pierre Weis, World general manager, the company has prepared for tv stations a large catalogue consisting of all possible music themes, backgrounds, bridges and sound that program managers may need. The catalogue, he noted, is divided into three principal sections in which there are listed more than 5,000 different tv program applications. The three sections consist of an index to program themes and backgrounds by program type, index to selections by moods and types, and an alphabetical index.

Good pickin's for Turkey Raisers

in

Paul Bunyan Land!

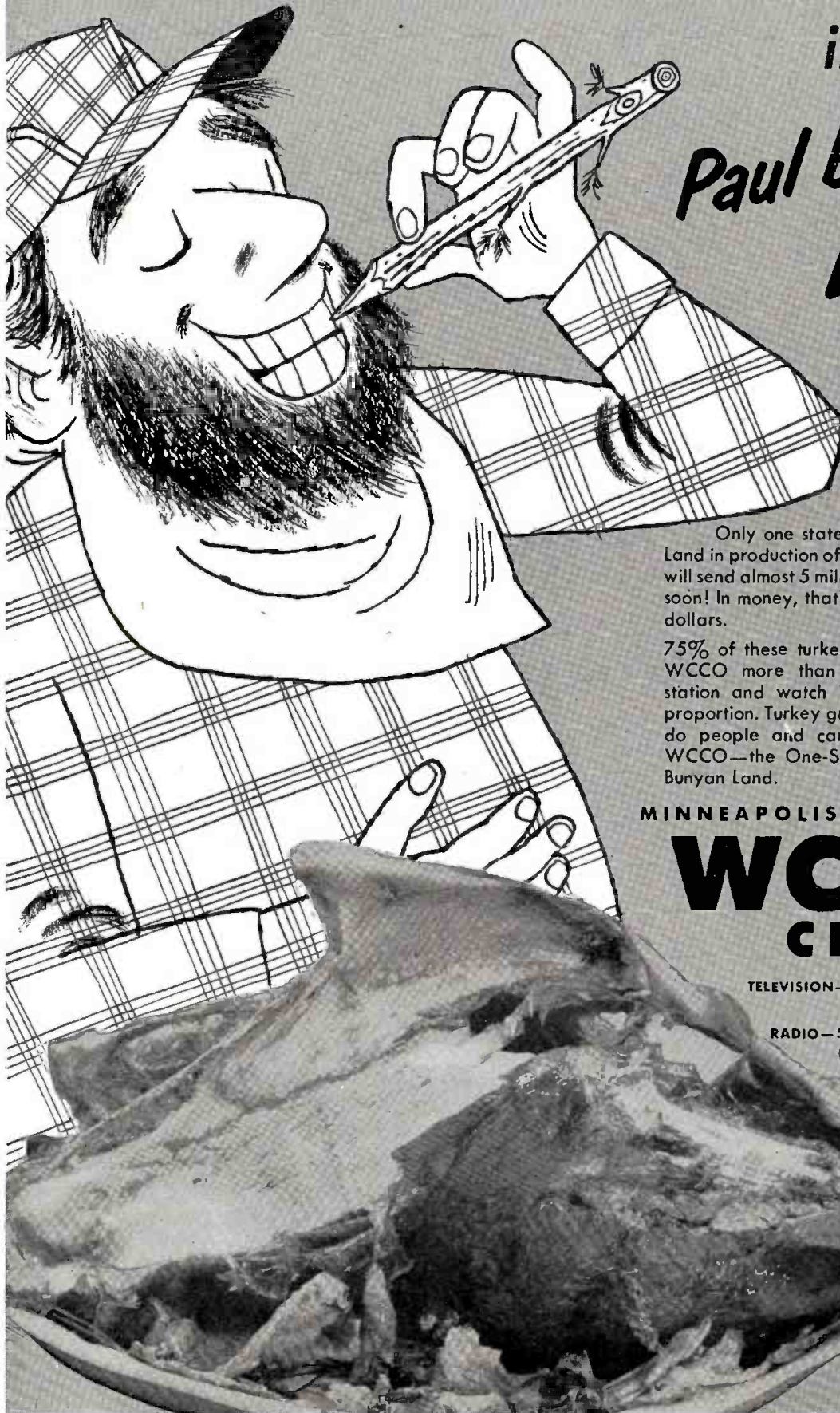

Only one state tops Paul Bunyan Land in production of turkeys. Our farms will send almost 5 million birds to market soon! In money, that's about 25 million dollars.

75% of these turkey tycoons listen to WCCO more than any other radio station and watch WCCO-TV in like proportion. Turkey growers are well-to-do people and can be reached by WCCO—the One-Station Buy in Paul Bunyan Land.

MINNEAPOLIS • ST. PAUL

WCCO

CBS

TELEVISION—100,000 Watts—Ch. 4
(Free and Peters)

RADIO—50,000 Watts—830 K.C.
(Radio Spot Sales)

clear channel

Fred Ahlert, Composer, Dies; Former President of Ascap

FRED E. AHLERT, 61, composer of popular songs and a former president of Ascap, died last Tuesday in New York. He was president of Ascap from 1948-50, during which time the first network television licensing contract was negotiated.

Some of the songs he wrote were "Walkin' My Baby Back Home," "I'll Get By," "I Don't Know Why," "Mean to Me," "Love, You Funny Thing," and "When the Blue of the Night Meets the Gold of the Day," which for many years was Bing Crosby's theme song.

Doctors See Medical News In Closed Circuit Tv Tests

USE of closed circuit or "private" television as a means of showing the latest developments in the field of medicine was highlighted in two separate telecasts originating from New York last Tuesday.

From 4 to 4:30 p.m. a demonstration was conducted on the use of atomic energy for treating such deadly diseases as leukemia and cancer and various circulatory deficiencies. The telecast originated from WOR-TV New York and was seen by physicians gathered at three locations in New York and Newark.

From 5 to 6 p.m. the American Cancer Society presented the first in a series of 30 weekly, one-hour color telecasts on the latest methods of detecting, diagnosing and treating cancer. The closed circuit program, originating from New York's Memorial Cancer Center, was viewed by physicians in New York, Boston, Philadelphia, Pittsburgh, Detroit, Toledo and Dearborn.

The telecasts employed CBS' field sequential color system.

500 Carry Ziv Show

ZIV's *Hour of Stars*, hour-long, five-times-a-week radio program, has been purchased by WCAU Philadelphia, WONS Hartford and WFOX Milwaukee, latest of the more than 500 stations now carrying the series, Alvin E. Unger, vice president in charge of radio sales for Frederic W. Ziv Co., has reported. Program has been completely sold out on WSAI Cincinnati, with nine sponsors signed after a single audition, Ziv reported.



ASHEVILLE'S NARTB District 4 meeting drew these broadcasters: Seated (l to r) Carleton Smith, WRC, WNBW (TV) Washington; Cecil Hoskins, WWNC-AM-FM Asheville; Harold Essex, WSJS-AM-TV Winston-Salem, district director; Carla B. Keys, WFLO Farmville, Va.; A. D. Willard Jr., Augusta. Standing, R. T. Eskew, United Press; Frank M. Stearns, Associated Press; Charles H. Crutchfield, WBT-AM-FM WBT (TV) Charlotte; Robert A. Jolley, WMRC-AM-FM Greenville; Mitchell Wolfson, WTVJ (TV) Miami; James H. Moore, WSLS-AM-TV Roanoke, and Kenneth H. Berkeley, WMAL-AM-FM-TV Washington.

DISTRICT 4 THANKS IKE FOR HYDE APPOINTMENT

Broadcasters at Asheville meeting depart from the run of resolutions by asking that President Eisenhower be thanked for naming Comr. Hyde to FCC chairmanship and by asking FCC to speed up the tv hearings pace. Other meetings were held at Atlanta and Philadelphia.

NARTB's 4th District meeting in Asheville, N. C., last Wednesday and Thursday maintained its "rebel" status by departing from traditional trade association activity. It adopted a resolution calling upon the NARTB national board to express thanks to President Eisenhower for naming Rosel H. Hyde chairman of the FCC.

The District 4 (N. C., S. C., Va., D. C.) meeting was one of three held last week—District 5 (Ala., Fla., Ga., P. R.) at Atlanta Monday-Tuesday and District 3 (Pa., Md., W. Va., Del.) Friday-Saturday at Philadelphia.

Only two meetings remain on the schedule—District 2 (N. Y., N. J.) Thursday-Friday at Albany and District 1 (New England) Nov. 4-5 at Boston.

Urge Speedy Hearings

In another resolution, avoiding the stereotypes of preceding district meetings, District 4 urged the FCC to speed its pace in setting hearings for contested tv channels. It praised the FCC for its expediting procedures but held this wasn't enough by imploring the Commission to put more steam behind its hearing processes.

The 4th District session drew a disappointing 88-delegate registration, smallest in years. Harold Essex, WSJS-AM-TV Winston-Salem, district director, presided. Among other NARTB directors present were Campbell Arnoux, WTAR-AM-TV Norfolk (Television Board) and A. D. (Jess) Willard Jr., WGAC Augusta (medium stations radio director).

The resolutions included the usual group praising NARTB executive organization, Director Essex for his fine stewardship and C. E. Arney Jr., NARTB secretary-treasurer, who attended his first district meeting of the 1953 series. Members of the resolutions committee were: James H. Moore, WSLS-AM-TV Roanoke, chairman; Richard H. Mason, WPTF Raleigh, Mr. Arnoux; Walter J. Brown, WORD Spartanburg, and Mel Warner, WCEC Rocky Mount, N. C.

The resolution commending the appointment of Mr. Hyde to the chairmanship cited that

the NARTB had consistently refrained from espousing the candidacy of any individual for public office but had always encouraged appointment of qualified persons to agencies responsible for the administration of the communications laws. The resolution then recommended to the board of directors that "it express appreciation to the President of the United States for his action elevating to the chairmanship of the FCC, Rosel H. Hyde, a career government officer who, for over two decades of public service, had demonstrated admirably his devotion to the welfare of the public in the administration of affairs pertaining to federal communication."

The resolution dealing with tv hearings cited that the NARTB expressed its appreciation to the FCC for its diligence in expediting tv authorizations but added that the FCC "is urged" to exert every effort to accelerate the processing of competitive applications for television facilities in all presently under-served areas to the end that equitable television service will be provided the public, this to be accomplished with the greatest possible dispatch.

Fellows Keynotes

The two-day session covered the same agenda followed at previous district meetings, with President Harold Fellows delivering the keynote address on NARTB stewardship; with Vice President Richard P. Doherty covering personnel trends as well as the television economic outlook (see story page 38); Ralph W. Hardy, vice president in charge of government relations, on principles of profitable radio station operation, and presentation of the "Small Market Television Management 'Clinic'" by James D. Russell, KKTU (TV) Colorado Springs, Mr. Doherty and John Crandall, media director, Sherman & Marquette, New York.

John Fulton, WQXI Atlanta, presided at the District 5 Atlanta meeting as district director. NARTB headquarters speakers handled the first morning followed by the closed session on station problems. Speaker at the dinner meeting was William W. Neal, partner in Liller, Neal &



CLOSE ATTENTION was paid to the speaker at NARTB's District 4 meeting by this group: (l to r) front row, Vincent T. Wasilewski, NARTB; Don Elias, WWNC Asheville; Campbell Arnoux, WTAR-AM-FM-TV Norfolk. Second row, C. E. Arney Jr., NARTB; Walter Brown, WORD WDX (FM) Spartanburg; Richard Mason, WPTF-AM-FM Raleigh.

Pictures from Districts 5, 6 & 13 on pages 38-40

THIS FALL

(AS EVERY FALL SINCE 1948)

The **BIG TV SHOWS**

ARE BEING SEEN AND HEARD IN MEMPHIS OVER

WMCT

exclusively

- 
- ★ GROUCHO MARX
 - ★ TOAST OF THE TOWN
 - ★ I LOVE LUCY
 - ★ KATE SMITH
 - ★ DRAGNET
 - ★ MILTON BERLE
 - ★ GILLETTE FIGHTS

- ★ PABST FIGHTS
- ★ KRAFT THEATRE
- ★ FIRESIDE THEATRE

- ★ PHILCO PLAYHOUSE
- ★ THE COMEDY HOUR
- ★ ROBERT MONTGOMERY

These big shows, and others which space won't permit our listing, are the shows with PROVED RATINGS. Memphis listeners and viewers are tuned to the established CHANNEL 5 STATION—WMCT.

TO SELL MEMPHIS YOU NEED

WMCT CHANNEL 5
MEMPHIS' PIONEER TV STATION

- NATIONAL REPRESENTATIVES THE BRANHAM COMPANY
- OWNED AND OPERATED BY THE COMMERCIAL APPEAL
- AFFILIATED WITH NBC
- ALSO AFFILIATED WITH CBS, ABC, AND DuMONT



ONLY TV DIE-HARDS STILL SAY:

"I do not



choose to re-run!"

When popular television film shows are repeated, they almost invariably reach a greater audience than they did the first time.

It's a fact!

Shows like "Boston Blackie" prove it. In a 6-city ARB summary reported in Billboard, "Blackie" reached a weekly average of 199,000 homes per city on its first run, and leaped to an average of 272,000 homes on its second run.

Shows like "Hollywood Half Hour" prove it. In a 5-city Pulse summary reported in Sponsor, the series reached an average of 88,000 homes per city on its first run, 143,000 homes on its second run, and 250,000 homes *the third time around!*

Shows like NBC FILM DIVISION'S own "Hopalong Cassidy" prove it. The one-hour series was run four times in New York. "Hoppy" reached a weekly average of 147,000 homes on its first run, and 297,000 homes *the fourth time around.* When you figure in the lower re-run program cost, it adds up to a truly great buy.

How come these increased audiences?

First, the television audience is growing at a fantastic rate—re-runs are first runs to these millions of new viewers . . . almost half a million new TV homes every month. *Second,* millions miss even the highest-

rated shows the first time 'round . . . 25,883,750 viewers in the TV audience missed the highest-rated episode of "Dragnet"! *Third,* successful shows have fans by the millions who watch for return engagements of favorite episodes.

Yes, when top-rated television film shows are repeated, they almost invariably reach a greater audience than they did the first time.

And among all re-runs, we believe that there is no more remarkable value than NBC FILM DIVISION'S own profit-proved successes.

Now is the time to investigate the opportunity afforded you for sponsorship of such top-rated shows as "*Badge 714*," formerly "Dragnet," which consistently rated among the top four in all television. Or "*Captured*," which as "Gangbusters" boasted an average Nielsen of 42.9 in its last season. Or "*Dangerous Assignment*," popular with audiences, critics and sponsors in 131 cities. Or "*The Visitor*," formerly "The Doctor," now compiling enviable records in over 46 markets.

These successful proven selling shows are now on their way to even greater heights. You'll find them hard to beat for drawing audiences . . . and sales results. Before your favorite series is snapped up in your particular markets, call or wire today.

NBC FILM DIVISION

SERVING ALL SPONSORS...SERVING ALL STATIONS



EIGHT-MAN group at NARTB District 6 meeting at Biloxi (l to r): Seated, Larry Baird, WWL New Orleans; Henry B. Clay, KWKH Shreveport, district director; L. M. Sepaugh, WSLI Jackson; Hugh O. Jones, WGCN Gulfport, Miss. Standing, Vic Vickery, Sesac; Hollis Wooten, WREC Memphis; Harold Wheelahan, KSYL Alexandria; Ron Heral WAFB-TV Baton Rouge.



AT BILOXI meeting (seated, l to r): William Stubblefield, Blackburn-Hamilton; F. C. Sowell, WLAC Nashville; George H. Thomas KVOL Lafayette, La.; Norman Thomas, WDOD Chattanooga. Standing, Irving Waugh, WSM Nashville; Earl Moreland, WMC Memphis; Robert McRaney, WCBI Columbus, Miss.; Cliff Marshall, UP; John Crandall, Sherman & Marquette; E. Newton Ray, KTBS Shreveport.

Battle. Mr. Neal discussed merchandising methods.

Tuesday speakers at Atlanta were Mr. Russell, who conducted last week's small-market television clinics, and NARTB staff executives. On the tv panel were Shelton Weaver, WSIX-TV Nashville; Mr. Doherty, NARTB, and Mr. Crandall. Among those taking part in the discussion were John M. Outler Jr., WSB-AM-TV Atlanta; Glenn C. Jackson, WAGA-AM-TV Atlanta; Louis A. Draughon, WSIX-TV, and Hugh M. Smith, WCOV-TV Montgomery.

Resolutions followed the pattern of other meetings in the 1953 series. Members of the Resolutions Committee were Owen Uridge, WQAM Miami; Henry P. Johnston, WAPI WABT (TV) Birmingham, and Allan M. Woodall, WRDW Augusta.

NARTB Am Unit Adds Fineshriber, Johnson

MEMBERSHIP of the NARTB Am Committee last week was increased under board directive. William H. Fineshriber Jr., NBC Radio vice president, will represent that network and Earl M. Johnson, MBS vice president in charge of engineering and station relations, is the MBS representative.

G. Richard Shafto, WIS Columbia, S. C., is committee chairman. Other members are J. J. Bernard, KOMA Oklahoma City; Grover C. Cobb, KVGB Great Bend, Kan.; William C. Grove, KFBC Cheyenne; James L. Howe, WCTC New Brunswick, N. J.; Lester W. Lindow, WFDF Flint, Mich.; Paul W. Morency, WTIC Hartford; William D. Pabst, KFRC San Francisco; and F. C. Sowell, WLAC Nashville.

NARTB President Harold E. Fellows named Hugh B. Terry, KLZ-AM-TV Denver, to represent NARTB on the Accrediting Committee of the American Council on Education for Journalism. It marks the first time NARTB has been represented on this committee, which supervises and conducts visits to colleges to examine curricula for journalism and broadcast training.

TV REVENUE WILL NEAR HALF-BILLION IN 1954, NARTB DISTRICTS ARE TOLD

NARTB Vice President Doherty and Sherman & Marquette's John Crandall outline some economic aspects of tv to broadcasters. Mr. Doherty says 30% of new tv outlets will lose during the next year, while Mr. Crandall expounds on the high costs of tv.

TOTAL television revenues in 1954 will near the half-billion-dollar mark and run at least 50% over 1952, Richard P. Doherty, NARTB labor vice president, told NARTB district meetings last week in Atlanta, Asheville, N. C., and Philadelphia (see district meeting story page 34).

Mr. Doherty joined John Crandall, media director of Sherman & Marquette, New York, in reviewing economic aspects of television. Mr. Crandall explained how former ideas of what comprises a market have been changed by television.

Any idea that 1954 will be a "jackpot" for new tv stations was dispelled by Mr. Doherty, however, when he warned that the year will be one "of over-expanded capacity during which new operations will tend to expand at a relatively faster rate than total tv revenue will rise."

30% Will Lose

At least 30% of new tv stations will lose money during the next 12 to 15 months, he said, with the red ink showing up at both vhf and uhf stations. Some of the losing operations will be affiliates of networks, he predicted.

Mr. Doherty said these losses will not be due to the "dynamic character of the industry" but rather to "the naive innocence of many persons who have rushed into the field."

"Within a few years," Mr. Doherty said, "television income will adequately support at least 500 stations but the interim growth process will be rough on the inadequately conceived, over-capitalized and inadequately-managed new stations. The impact of this new station growth will unquestionably also be felt by some of the established stations.

"Already we are seeing a few two-station markets where a 50-50 split of income provides a very slim profit margin for each station;

other markets which have a potential for two good, profitable tv stations are in the process of getting three or four stations. Near-term marginal or even over-marginal operations are bound to emerge in such markets."

Television's "gold-mine" hopes, he said, "have attracted the venture capital of many persons and groups who seem to know very little about the economics of sound broadcast station management. These persons and groups will learn the hard way and the experience will cost them plenty of money before they turn red ink into legitimate profits.

"Marginal operations are not likely to do the best programming and operating job. If such marginal operations are fairly widespread, the tv industry itself may suffer as a medium serving the public interest."

Mr. Doherty said he had talked with many tv licensees "who seem to have no idea of adequate tv station staffs, or of sound cost operating structures." He said he has been "appalled at the utter lack of basic understanding possessed by some prospective tv operators concerning proper capital investments, market potentials, film costs and other essential details."

Looking deeper into this lack of basic business knowledge, he said some persons having television grants know little about practical broadcasting, figuring that a license backed up by physical facilities and some sort of staff are the only ingredients necessary to success. He contended they will need plenty of information, guidance and experience before mastering the art of profitable tv station operations.

The next year or so will bring an increase in "management know-how," he predicted. At the end of next year the unsound and inadequate operations will be obvious to all, he said, "especially those who tossed their money into this 'sure thing' and figured that a tv tower was akin to an oil-well derrick." He said well-run tv stations, new and those already operat-



LARRY VARNELL
"Sport Shop"

SHERIFF SCOTTY
"Tales of the
Wild West"

CARL HERZMAN
"TV Farm Reporter"

CARL AKERS
"KLZ Television News"

HARRIET RIPLEY
"Through the
Kitchen Window"

GENE MCGUANE
"A Look at the
Weather"

PAUL SHANK
"Through the
Kitchen Window"

strong local programming

plus

CBS TELEVISION

ON THE AIR
NOVEMBER 1ST

are combined by KLZ-TV to bring to audiences in the Denver area the finest TV entertainment on the air-waves. Greater audience ... captured with the combination of top local productions and CBS Television Network shows across the board ... means greater market penetration, more sales, for advertised products.

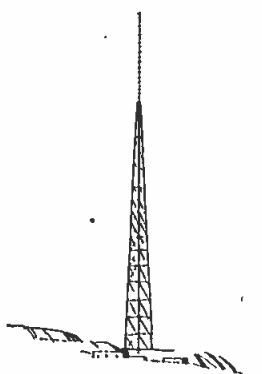

Antenna 2380 ft. above
mile-high Denver
Maximum 316,000 watts
authorized

KLZ-TV

ALADDIN
RADIO AND
TELEVISION,
INC.

CHANNEL 7 DENVER

OUT IN FRONT FOR DOMINANT COVERAGE OF THE
MULTI-BILLION DOLLAR DENVER AREA MARKET



DEEP SOUTH broadcaster group at the NARTB's Atlanta district meeting (l to r): seated, Clarence L. Menser, WJBS DeLand, Fla.; John M. Outler Jr., WSB Atlanta; NARTB President Harold E. Fellows; Owen F. Uridge, WQAM Miami; Henry Gillespie, Screen Gems. Standing, George W. Harvey, WFLA Tampa; Richard P. Doherty, NARTB; Jim Howe, WIRA Fort Pierce; John Langlois, Lang-Worth; Jerry Stone, WNDB Daytona; Hugh M. Smith, WCOV-TV Montgomery.



ATLANTA district meeting sextet (l to r): William Wyatt, BAB; Jim Hicks, WGST Atlanta; M. N. Babcock, WGBS Miami; Glenn C. Jackson, WAGA Atlanta; Henry P. Johnston, WAPI-WABT (TV) Birmingham; John Fulton, WQXI Atlanta.

ing, "will prosper even in the face of mounting competition."

Mr. Doherty predicted that television, as an industry, "has a fabulous future ahead but the process of growth and expansion will be hard and cruel upon the inadequately managed stations. Even in comparatively small tv stations relatively heavy losses can be incurred. In large stations, annual losses can run into the hundreds of thousands of dollars.

"The complexity of problems in television station operations requires a high type of competent broadcast management. Tv management 'know-how' cannot be measured by set circulation in any given market but by that kind of service to the viewing audience and to the sponsors which is reflected in a profitable station operation."

Old Concepts Disappear

Mr. Crandall said old radio-newspaper concepts of what constitutes a market have disappeared with television. It is now "market area" which can encompass more than one city or market, because of tv's normally greater coverage. Describing tv as the "most expensive medium strictly in the blue chip class," Mr. Crandall said great care is exercised in station selection to come within budgets. He pointed out that a Class A hour on 85 stations comprising a major network costs \$5.5 million for 52 weeks; a commercial minute costs \$1 million for a single announcement once a week for 52 weeks. For 125 markets the Class A

one-hour would run \$9 million and one commercial minute, \$1.5 million.

Because it is the "most expensive medium extant," Mr. Crandall said, "we can't afford to fool around with television placements. We've got to be right." While the cost is high, Mr. Crandall said, television is the most potent of all media. He said much of the money spent in tv is derived from other media, including radio and newspapers.

No Objection to Uhf

Basically, Mr. Crandall declared, there is no objection to uhf. It depends upon market and other individual factors. Normally, when uhf does a "good job of promotion," it is selected, he said. One station in a market cannot accommodate all desirable network programs, he pointed out, and the uhf outlet, if the only other available station, will get network and national business. "But where there are two good vhf's, a uhf station is in for a lot of trouble," he said. Mr. Crandall cited WSBT-TV South Bend as an example of efficient uhf operation. There is no vhf in the market but Chicago stations are picked up. WSBT-TV found the formula by putting on live basketball in the hot sports market. Within a month, he said, the conversions to uhf had increased from 20 to 50%. The practice among agencies, Mr. Crandall said, is never to cut back on radio in a market until tv gets at least 35% saturation of homes. He pointed out that even when tv saturation has

reached 60% there are still 40% of radio-only homes, plus the listening that goes on in tv homes. This, he said, represents a substantial buy for the radio advertiser.

When the broadcaster adds television, he should not forsake radio, District 4 Director Harold Essex, WSJS Winston-Salem, said on the basis of 22 days of experience with WSJS-TV. He pointed out that radio has been the breadwinner for many years and that it still must provide revenue for the joint operations. "Don't become enchanted with tv to the extent that you forget radio," he admonished.

AAAA Southeast Chapter Sets Nov. 13 Speakers

A PARTIAL list of speakers who will address the annual fall meeting of the Southeast chapter of the American Assn. of Advertising Agencies Nov. 13 at the Kinkler-Plaza Hotel in Atlanta was announced last week.

The speakers include: John Cunningham, Cunningham & Walsh, New York; Sherwood Dodge, marketing vice president, Foote, Cone & Belding, New York; Fred Gamble, AAAA president; J. P. Napier, executive vice president, A. C. Nielsen Co., Chicago; Mark Seelan, vice president and general art director, Outdoor Adv. Inc., New York; Earle Ludgin, president, Earle Ludgin & Co., Chicago; Walter Guy, president, Atlanta chapter of the American Assn. of Newspaper Representatives, and J. Leonard Reinsch, managing director, Cox radio and television properties, Atlanta.



AT TEXAS NARTB district meeting (l to r): seated, Thad Brown, NARTB; Martin Campbell, WFAA Dallas; Jack Harris, KPRC Houston; Alex Keese, WFAA. Standing, Louis Cook, KNOW Austin; Al Stein, AP; Joe Bryant, KCBD Lubbock; Ralph W. Hardy NARTB; Charles McDowell, Ascap.



MORE TEXANS (l to r): seated, George Cranston, WBAP Fort Worth; Kenyon R. Brown, KWFT Wichita Falls, district director; Frank O. Meyers, KCMC Texarkana; George B. Storer Jr., KEYL (TV) San Antonio. Standing, Lewis Siebert, KGKL San Angelo; Gordon Thompson, KFYO Lubbock; O. L. (Ted) Taylor, KRGV Weslaco; Ralph Nimmons, WFAA-TV Dallas; W. D. Rogers Jr., KDUB-TV Lubbock.



2 out of 3 DETROIT WORKERS **DRIVE** TO WORK!



Detroit is the world's Motor City in usage, as well as in production. Autos and auto radios get plenty of mileage!

Two-thirds of Detroit area workers **DRIVE** to their daily employment. 12% of them drive 30 miles or more each day. Another 13% drive from 20 to 29 miles. **Less than one-half of one percent** ride on Detroit's one commuter railroad!

What a BONUS audience that represents for Detroit's radio advertisers!

In this market of 980,000 cars, WWJ is the favorite radio station. It has been for 33 years. And, because it delivers the most listeners per dollar, it's the most economical buy.

To put your product in the driver's seat in the Detroit market, put your story on WWJ.

Associate
Television Station WWJ-TV



Basic
NBC Affiliate

AM—950 KILOCYCLES—5000 WATTS
FM—CHANNEL 246—97.1 MEGACYCLES

THE WORLD'S FIRST RADIO STATION • Owned and Operated by **THE DETROIT NEWS**

National Representatives: **THE GEO. P. HOLLINGBERY COMPANY**

RTNDA OPENS WASHINGTON MEET TODAY

Briefings with high government officials, panels on radio and tv news will occupy busy three-day schedule.

RADIO and tv news directors will combine briefing sessions with high Washington officials and workshop meetings at the annual Radio-Television News Directors Assn. convention, opening today (Monday) at the Sheraton Park Hotel, Washington. Some 250 delegates are expected.

Tom Eaton, WTIC Hartford, will open proceedings as RTNDA president. The opening day program includes a State Dept. briefing; luncheon talk by James C. Hagerty, White House news secretary; atomic energy and defense briefings; cocktail party and supper with General Motors as host, and evening forum on coverage of radio-tv news in Washington.

Taking part in the Monday evening forum will be Martin Agronsky, president of Radio Correspondents Assn., chairman; Richard Harkness, NBC; Everett Holles, MBS; Lewis Shollenberger, CBS.

Richard Oberlin, WHAS-AM-TV Louisville, will report Tuesday morning on wire services. A discussion on the future of radio and tv news will be led by Robert K. Richards, NARTB administrative vice president. The panel includes Edwin H. James, senior editor of B•T, and John S. Hayes, president of WTOP-AM-TV Washington.

NARTB President Harold E. Fellows will speak at the Tuesday luncheon, with Sears, Roebuck & Co. as host. Julian Goodman, NBC-TV, will conduct an afternoon tv news work-

shop. An evening cocktail party and buffet will be held with Ford Motor Co. as host.

Quaker Oats Co. will entertain at a Wednesday breakfast. Jim Bormann, WCCO Minneapolis, will report as chairman of the freedom of information committee with J. Russell Wiggins, *Washington Post* managing editor, speaking as chairman of a similar committee of the American Society of Newspaper Editors.

Theodore Streibert, director, U. S. Information Agency, and Leonard F. Erikson, director of the Voice of America, will describe operations of their units, with Attorney General Herbert Brownell Jr. speaking on government information. United States Steel will be host at the luncheon with Charles Campbell, Washington director of British Information Services, as speaker.

Business sessions will be held Wednesday afternoon followed by the annual banquet and presentation of RTNDA awards.

NARFD SETS CLINIC NOV. 2 IN NEW YORK

Some 300 representatives of 50 stations will hold an all-day farm radio-tv sales clinic.

IN an atmosphere of booming farm radio business, some 300 representatives of approximately 50 stations are expected to meet in an all-day farm radio-tv sales clinic conducted by the National Assn. of Radio Farm Directors at the Hotel Commodore in New York on Nov. 2, officials said last week.

Mal Hansen of WOW Omaha, president of NARFD, pointed out that the volume of farm business has gained 119% in the spot radio field and 50% at the local level within the past year. He said:

"Radio that appeals to rural listeners still reaches more people and sells more products at lower cost than any other advertising medium. The fact that national advertising expenditures for farm radio have increased in spot radio from \$2,764,000 to \$6,043,000 (up 119%) and in local radio from \$7,722,000 to \$11,599,000 (up 50%) within the last year is certainly proof that our radio farm directors and the stations they represent are doing a good job."

Phil Alampi, farm and garden director of ABC's WABC-AM-TV New York and former president of NARFD, is chairman for the Nov. 2 clinic, third in a series conducted by NARFD. Harold E. Fellows, president of NARTB, will be principal luncheon speaker. Other features of the meeting, which will open at 10 a.m. and run to 3:30 p.m., include:

Welcome by President Hansen; talk on "How Are You Going to Reach Them Down on the Farm?" by Kevin B. Sweeney, BAB; "The RFD—Your Key," by Ed Slusarczyk, chairman, NARFD Region 2; "Public Service Can Be Commercial," by R. B. Hanna Jr., WGY and WRGB (TV) Schenectady; "Nighttime Farm Radio," by Bill Givens; "Farm Tv," by Chuck Calkins, Conklin Mann & Son Adv., New York; "The Advertising Agencies' Analysis of Radio in Relation to the Farm Market," by Rodney Erickson, Young & Rubicam, New York; "Farm Radio-Tv Tips and Results," by Norman Glenn, *Sponsor* magazine; "How to Get the Most From Your Farm Radio and Tv," by Bill Brown, Gardner Adv., St. Louis; question-and-answer session, followed by a summary by Mr. Alampi.



NARTB's trophy for the winner of a softball game between FCC and Federal Communications Bar Assn. at the annual FCBA outing Oct. 17 is presented to Fred Albertson (r), FCBA president, by NARTB's Robert K. Richards (c) with sportsmanlike approval from FCC Chairman Rosel H. Hyde. FCBA beat FCC 17 to 4.

Cone Will Address AAAA Eastern Meet

FAIRFAX CONE, president of Foote, Cone & Belding, will address the AAAA's 1953 eastern annual conference in New York Nov. 24, his Chicago office reported last week.

Mr. Cone will speak on the "Ten Tv Commercials I Wish We Had Done." He made a similar talk during a session of the AAAA's central council meeting in Chicago Oct. 16.

The eastern meeting will be held at the Hotel Roosevelt Nov. 23-24, with addresses by top advertising executives [B•T, Oct. 19].

Other Chicago addresses were made by Lou Brockway, executive vice president of Young & Rubicam, and Richard de Rochemont, J. Walter Thompson Co.

Highlight of the AAAA Chicago meeting was a luncheon address by Thomas D'Arcy Brophy, president of the American Heritage Foundation. Recounting his recent trip to Europe, Mr. Brophy described the exploits of Radio Free Europe.

NTFC May Establish West Coast Chapter

POSSIBILITY of establishing a West Coast chapter of the National Television Film Council was reported by the organization last week following discussions in New York by Melvin L. Gold, chairman of the board of NTFC, and Louis D. Snader, president of the National Society of Television Producers.

An announcement from NTFC said Mr. Snader originally objected to an organization housing all tv film entities, but added that he now has agreed to NTFC "in principle." Mr. Snader has returned to the West Coast to talk over the advisability of such a move with producers, distributors, advertising agencies and television stations, and will resume his talks with Mr. Gold at a later date.

Mr. Gold stated that he had stressed in his discussions the benefits that have accrued to NTFC over the past five years, including the group's standard exhibition contract and representation of all entities before congressional committees and in union negotiations.

Tv's Service to Medicine Extolled in AMA Letter

PUBLIC service role of television in presenting medical and scientific programs "of great educational value" is praised by Dr. Edward J. McCormick, president of the American Medical Assn., in a letter released by NARTB.

The visual medium has become "a vitally important tool in the medical armamentarium," Dr. McCormick wrote NARTB. The letter was printed in one of a series of tv information bulletins titled "Facts About Tv."

AMA found in a survey last May that 77% of county medical societies and 91% of state societies use some form of radio and television. Dr. McCormick wrote:

Such shows have given the entire nation a better concept of good health and how to preserve it—and a better understanding of the newest techniques, discoveries, and devices which spell continual medical progress. Tv allows medical information to be delivered in a direct, personalized manner with dramatic appeal. It brings the family doctor into the homes of millions to talk medicine face to face, informally and in understandable terms.

NARTB cited an American Research Bureau showing over 11 million people saw March of Medicine telecasts from the AMA clinic in Denver in Dec. 1952.

Some of the programs cited by Dr. McCormick were *Health Talks*, WGN-TV Chicago; *Stories of the Human Body*, WTMJ-TV Milwaukee; *Utah Health Council* programs on Salt Lake City tv stations; *From the Cradle to Maturity*, WSYR-TV Syracuse; *What to Do Until the Doctor Arrives*, KING-TV Seattle.

Dr. McCormick said tv, especially in color, has proved "a brilliant new addition to the teaching tools of medicine."

KEY TO A LOCKED DOOR

This is the Steubenville-Wheeling metropolitan area—52nd market in the United States—and that's all you pay for! Rates are set on the basis of 155,872 television homes in the Steubenville-Wheeling area. There's no charge for that part of the 595,472 television homes in the Pittsburgh area which WSTV-TV is sure to deliver.

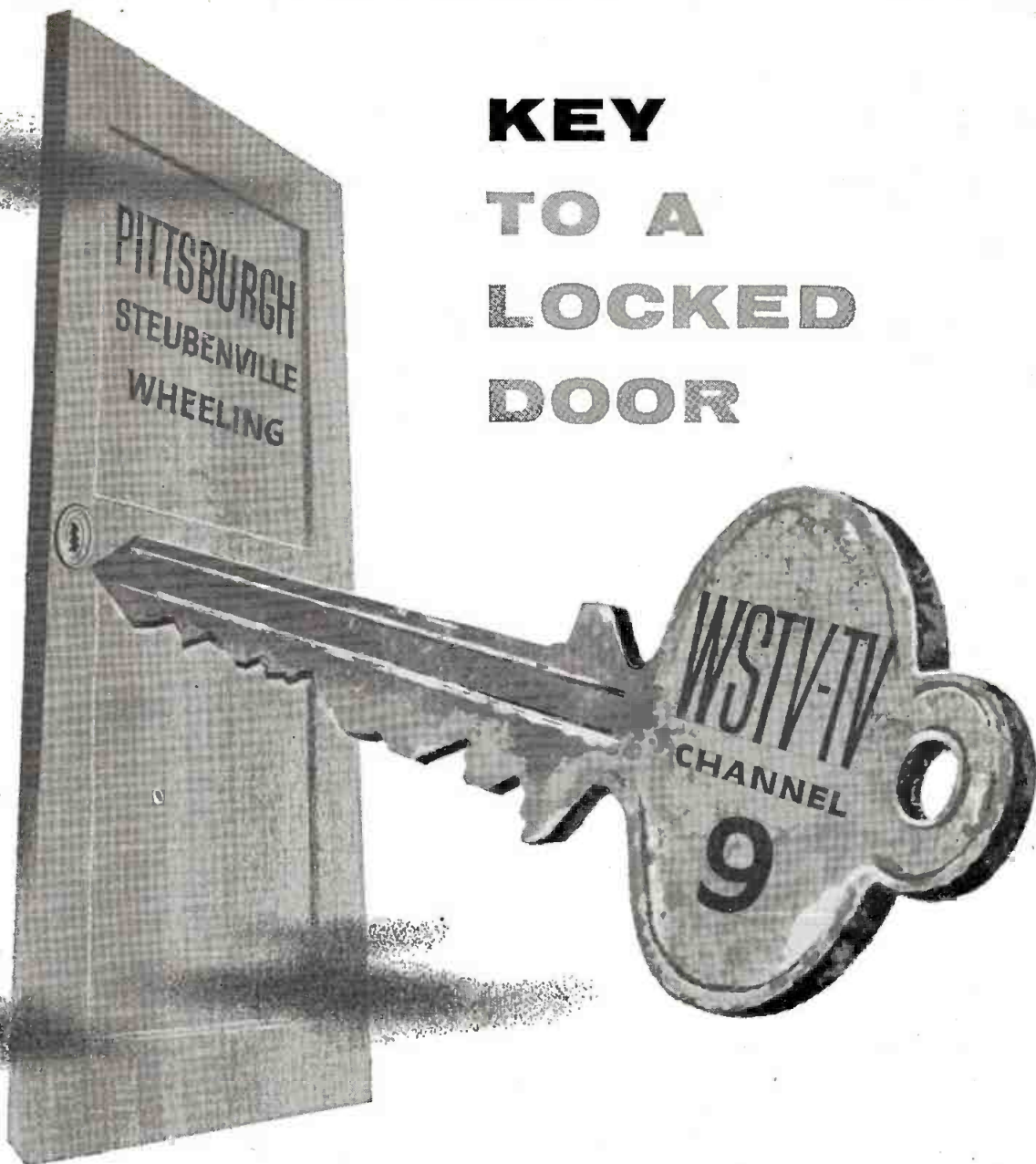

As a time buyer, how many times have you rattled the door to the Pittsburgh market, but walked away empty-handed? Here, without doubt, has been one of television's "brick wall" markets.

Not after November 30th, though!

On that date this important market, along with Steubenville, Wheeling and the tri-state area, will enjoy VHF, yes, we said *VHF* coverage.

On that date WSTV-TV will blanket the Steubenville-Wheeling metropolitan area... and Pittsburgh, to boot.

Here is a *unique opportunity* to cover not one, but *several* of America's essential markets with outstanding spot adjacencies on one of the nation's most important new TV stations.

For prime availabilities call your Avery-Knodel man *today!*

WSTV-TV

STEUBENVILLE, OHIO CHANNEL 9

CBS Network

ANOTHER **AVERY-KNODEL** REPRESENTED STATION

AMERICAN MAKES
HISTORY WITH THE

First NONSTOP



SERVICE - COAST TO COAST!

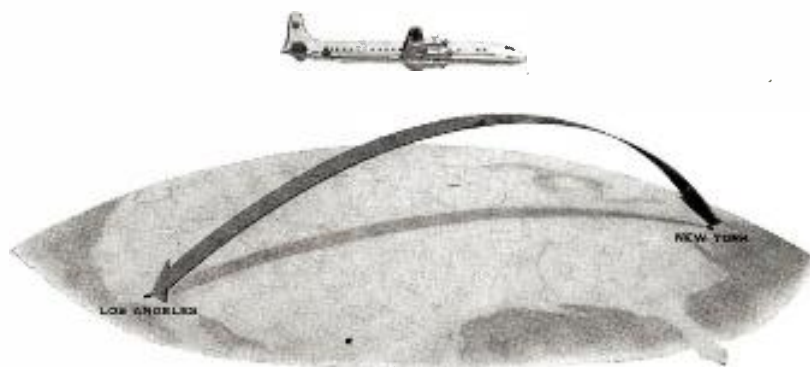

Now-Transcontinental Travel UNDER 8 HOURS on the New DC-7 Flagship

In introducing the new DC-7 Flagship, American Airlines again demonstrates its leadership in air transportation with the first *nonstop* coast-to-coast service. For the first time in history—and at no extra fare—travelers will span the nation in less than eight hours.

Highlighting the many new developments in this magnificent Flagship are the special soundproofing that makes it the quietest plane aloft, the new 3250-horsepower "Turbo Compound" engines, and an air conditioning system that operates on the ground as well as in the air.

Beginning November 29th, there will be daily DC-7 nonstop transcontinental service at regular Flagship fares. Make your reservation with American Airlines now. Be among the first travelers in history to enjoy coast-to-coast service *nonstop*.

AMERICAN AIRLINES INC.

America's Leading Airline

UHF ASSOCIATION TELLS FCC 'WHY'

Newly-banded uhf operators write Chairman Hyde to appraise the ultra high service and explain their organizing to promote it.

FRANK appraisal of the difficulties facing uhf television was made to the FCC last week when the newly-formed Ultra High Frequency Assn. [B*T, Oct. 19] submitted an official recital of the reasons for its organization to FCC Chairman Rosel H. Hyde.

A letter, written by William A. Roberts, general counsel of UHFA, listed the following as "obvious and serious disabilities":

1. Delay in procuring "moderate and high power" transmitters.
2. Lack of adequate converters and the production of moderately-priced all-channel sets.
3. "Disinclination" of national networks to affiliate with uhf stations.
4. Changes in the Commission's processing plan, resulting in "the derogation of the National Allocation Plan."
5. "Extraordinary" number of withdrawals of mutually exclusive applications "and in other legalistic devices hastening the development of vhf competition over and above that which uhf investors feel they had a right to expect at the time of the promulgation of the Sixth Report and Order."
6. Proposals to add additional vhf channels to markets now served by uhf stations "have disastrously upset the orderly program of receiver conversion to uhf channels, and have utterly confused advertisers . . ."

UHFA Purpose

In speaking of the formation of UHFA, Mr. Roberts intimated that one of its objectives may be the deletion of vhf telecasting and the sole use of uhf for television. He said:

"They [UHFA organizers] . . . are at the same time convinced of the Commission's recititude in finding that the technical superiority of the ultra high frequencies and the necessity for efficient utilization of spectrum space would ultimately dictate that all of the television broadcast service employ the so-called uhf band. . . ."

Mr. Roberts said that UHFA intended to bring to the attention of Congress, the FCC, manufacturers, advertisers and the public "any unreasonable obstacles" to the progress of uhf tv.

He also declared that none of UHFA's members intended to divorce themselves from "continued participation" in NARTB.

"The association will conduct engineering and economic surveys," Mr. Roberts' letter continued, "and will participate in legal proceedings toward promotion of uhf television in the public interest."

Elected president of the new organization at an Oct. 16 meeting in Chicago was Lou Poller, WCAN-TV Milwaukee. Other officers, chosen to serve until the annual meeting scheduled for sometime in February, were: Don Faust, WENS (TV) Pittsburgh, vice president, and Henry Tennenbaum, WTVI (TV) Belleville, Ill. (St. Louis), treasurer. Directors elected were the officers and Ben Baylor, KEDD (TV) Wichita, Kan.; Marshall H. Pengra, KSTM-TV St. Louis; Jack G. Garrison, KACY (TV) Festus, Mo. (St. Louis), and Sherwin Grossman, WBUF-TV Buffalo, N. Y.

Present at the Chicago meeting were:

Sherwin Grossman, Gary T. Cohen, WBUF-



ATTENDING the reception which concluded the fall meeting of New York's chapter of American Woman in Radio & Television, held at United Nations headquarters last Monday, were (l to r) Dorothy Kemble, chapter president; Mrs. Frances P. Bolton, U. S. delegate to the UN; Mrs. Dorothy Lewis, coordinator, U. S. Stations Relations, UN Radio, and Mrs. Doris Corwith, national president of AWRT.

TV Buffalo, N. Y.; Bill Johns, WOSH-TV Oshkosh, Wis.; Stanley H. Durwood, Ben Baylor, KEDD (TV) Wichita, Kan.; Paul E. Peltason, Henry Tennenbaum, WTVI (TV) Belleville, Ill. (St. Louis); Marshall H. Pengra, KSTM-TV St. Louis; Jack G. Garrison, Robert E. Kilker, KACY (TV) Festus, Mo. (St. Louis); Lou Poller, Berthold L. Berkwich, WCAN-TV Milwaukee; Don Faust, WENS (TV) Pittsburgh; Harold Cowgill, WTBP (TV) Decatur, Ill.; Ted Nelson, WFIE (TV) Evansville, Ind.; U. R. Norman, WTVH-TV Peoria, Ill.; Brownie Ackers, WEEK-TV Peoria, Ill.

'Brotherhood Week' To Get Tv Backing

PLANS for television support of the 1954 Brotherhood Week sponsored by the National Conference of Christians and Jews were formulated Wednesday at a meeting of the week's tv committee at the Hotel New Weston in New York.

The event—Feb. 21-28—will endeavor to expand on a nationwide scale the neighborhood parties tried out last year in Chicago and Minneapolis.

Committee members representing stations, networks, advertising agencies, station representatives, advertisers, film companies, package program producers and talent agencies divided up the tasks of preparing the material for use by the nation's tv stations and networks. Each station will receive a kit of visual material.

BAB Promotion Tour

IN a promotional effort to garner a larger share of the retailer's advertising budget for radio, four BAB executives last week embarked on a 30-day tour of 32 cities in nine states. BAB President William B. Ryan visited Detroit, Minneapolis, Kansas City and Oklahoma, working with stations on the organization of sales committees for joint solicitation of retail business. Vice President Kevin B. Sweeney conducted retailer sales clinics in Los Angeles, San Diego, Sacramento, San Francisco and other West Coast cities. Working on assignments similar to Mr. Sweeney's were John F. Hardesty, director of local promotion, and David Kimble, director of national promotion, who were in Texas and Georgia, respectively.

Individual Programming Styles For Tv Advised by Saudek

Warns against following pattern of early-day radio.

TELEVISION is acting too old for its age, Robert Saudek, director of the Ford Foundation's Radio-Tv Workshop, declared Wednesday in a talk on "Television-1963" given at the 12th annual luncheon of The Pulse, audience measurement organization. There are too many indications that tv is blindly following the pattern developed by radio a generation ago rather than striking out and building a new world of its own, he said.

"The curse of television in 1953 is that it is made up of one part show-business and nine part rate cards, contiguous rates, dollar volume discounts, annual rebates, 15% commissions, favorable adjacencies, unique opportunities and double spotting," he stated.

"And, to carry this a step farther, these nine parts are nothing but a carry-over from the days of radio. Nothing new has happened to this business under the bright sunshine of television. Too many station owners spend too much time fishing and too little time on television. Too many station managers, compensated as they are in proportion to their station's annual revenue, are offered no incentive to invent new ways of doing their jobs."

Looking ahead at what might happen in the next decade, Mr. Saudek said that instead of all networks trying to do exactly the same thing, they might specialize their programming as national magazines do, one modeling its appeal on that of the "Saturday Evening Post, others on Life, Readers' Digest or Ladies' Home Journal." Or, he said, a network might divide its program department four ways, one group handling only women's programs, another in charge of children's shows, a third for evening programming and the final group to concentrate on shows for Sunday.

"Then, at least," he noted, "we should be giving each part of the television schedule the care it deserves; we should be rearing a generation of experts and replacing a jerry-built schedule with a schedule that shows some architecture and engineering."

Under the present system, he said, the creative people of television have to do too many different kinds of things and none of them is ever permitted the opportunity to reach his potential. Liking the situation to the manager of a baseball team using his best pitcher every day, Mr. Saudek said that the management end of tv might follow baseball practice and set up a training for creative people comparable to the farm system of baseball.

Ad Council Names SSC&B

SULLIVAN, Stauffer, Colwell & Bayles, N. Y., has been appointed by the Advertising Council to serve as volunteer advertising agency for the Council's campaign in behalf of the 1954 Red Cross fund drive.

Small Agencies to Organize

A PLAN to set up an association of small advertising agencies, with up to eight employes, is being launched in Philadelphia by Louis B. Klein of Louis B. Klein Advertising and Edward I. Stonehill and William J. Barber of Advertising Assoc. The idea is to provide the smaller agencies with a medium for the exchange of ideas. The new group will be known as Advertising Agency Executive Council.



HEIGHT COUNTS MOST!

WAVE-TV Delivers:

66.7% GREATER COVERAGE AREA
than any other television station
in Kentucky and Southern Indiana!

19.8% GREATER CIRCULATION
than the area's leading
NEWSPAPER!

627.3% GREATER CIRCULATION
than the area's leading
NATIONAL MAGAZINE!

(WAVE-TV's superiority as of July 1, 1953, and still growing!)

Tower Height is by far the most important factor in a television station's coverage, particularly in "reaching out" to fringe areas. *Low Channel* is second in importance, and *Power* is third.

WAVE-TV's new tower on top the highest hill in this area gives us an over-all height of 1585 feet above sea level — 419 feet higher than Louisville's second station!

WAVE-TV's Channel is 3!

WAVE-TV's 100,000 watts of radiated power is the *maximum permitted by the FCC for Channel 3!*

100,000 watts at our new tower height and lower channel is equivalent to 600,000 watts from our old downtown tower on Channel 5!

Ask your local dealers and distributors about WAVE-TV's amazing new coverage and about the great WAVE-TV television market.

LOUISVILLE'S

WAVE-TV

Channel 3

FIRST IN KENTUCKY
Affiliated with NBC, ABC, DUMONT

Free & Peters, Inc., Exclusive National Representatives

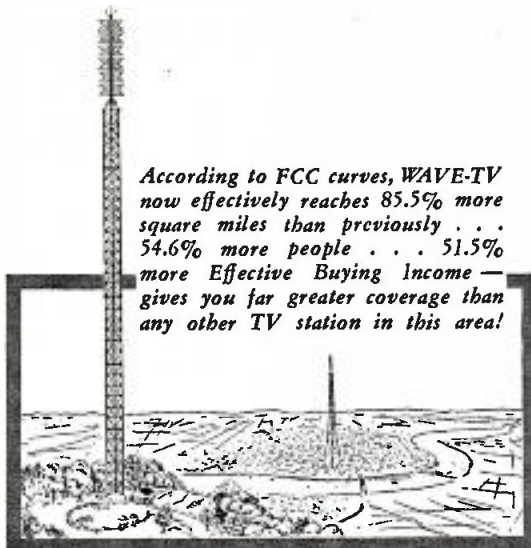

According to FCC curves, WAVE-TV now effectively reaches 85.5% more square miles than previously . . . 54.6% more people . . . 51.5% more Effective Buying Income — gives you far greater coverage than any other TV station in this area!

FCC SIFTING LAMB HISTORY; POLITICAL MOTIVES DENIED

Comr. Doerfer acknowledges inquiry is underway, says broadcaster welcomes chance to clear doubts about his qualifications as licensee once and for all.

ONCE AGAIN the much-investigated background of Edward Lamb is under investigation.

This was acknowledged last week by FCC Comr. John C. Doerfer, who affirmed earlier reports that he had urged the Commission's review of the broadcaster's qualifications to clear any doubt now and for all [CLOSED CIRCUIT, Sept. 14].

Other high Commission sources, however, disclaimed the term "investigation," pointing out FCC is only "studying the record" for the benefit of its "newcomers" and because of new information which it is believed was not before the Commission in the past. It was emphasized that no decision has been made by the Commission as to the course it will take.

Meanwhile, on Thursday Mr. Lamb announced the appointment of J. Howard McGrath, former U. S. Attorney General and onetime chairman of the Democratic National Committee, as executive vice president of Lamb Enterprises Inc. (see story page 50).

Mr. Lamb, a Toledo attorney who gained prominence in the 1930s as a civil liberties and labor counsel, is principal owner, with his wife, of WTOD Toledo; WIKK and vhf ch. 12 WICU (TV) Erie, Pa., where he also owns the *Erie Dispatch-Herald*; uhf ch. 23 WMAC-TV Massillon, Ohio, and WHOO Orlando, Fla. He has purchased the construction permit of uhf ch. 47 WTVQ (TV) Pittsburgh, subject to FCC consent, and has tv applications pending at Toledo and Orlando, both in contest with other applicants. Aside from these radio-tv and newspaper interests, Mr. Lamb and his wife, through Lamb Enterprises Inc., have extensive industrial, business and real estate holdings.

Purpose of Inquiry

Comr. Doerfer, the Wisconsin Republican who was appointed by President Eisenhower to neutralize FCC's political balance, denied any suggestion that the inquiry into Mr. Lamb's "qualifications to be a broadcast licensee" involved a Republican effort to rattle skeletons in the Democratic closet.

"I certainly don't want to attach any political significance to our study of this matter," Comr. Doerfer said. "It just wouldn't be fair to the man. Since these questions have come up, he is entitled to a hearing and a chance to settle this thing once and for all."

Referring further to rumors of political significance to the study, underway now for some weeks, Comr. Doerfer said he "didn't even know Mr. Lamb was a Democrat, until the stories came up about his possible selection as treasurer of the Democratic National Committee. I had thought he was an Independent."

Comr. Doerfer said he didn't know there was a Mr. Lamb until he joined FCC, but Mr. Lamb since has sent him data, saying he would welcome settlement of the matter.

"Investigations" of Mr. Lamb have cropped up from time to time ever since he entered the broadcasting field after World War II. The reasons were usually the same: Why had he written a book in the early 1930s titled *The Planned Economy of Soviet Russia* and why was his name "associated" with certain organi-

zations which later turned up on the Attorney General's subversive list.

Mr. Lamb consistently has denied the insinuations and welcomed a fair opportunity to defend his claim as a vigorous anti-Communist. He describes the book as an exposure rather than defense of the USSR. He contends his name was used without permission and unknowingly by the "letterhead organizations" now termed subversive.

Comr. Doerfer's comments on the Lamb inquiry arose during questioning about his action last Tuesday as Motions Commissioner upon a petition by Woodruff Inc. for dismissal of its application for uhf ch. 30 at Portsmouth, Ohio. Woodruff is a Lamb interest. Comr. Doerfer said he did not dismiss the application outright, usually a routine action, but referred the matter to the whole Commission "because I thought they would like to know about it" in view of the pending study. The Commission approved the dismissal Thursday "without prejudice" and without comment.

Proposed Grant to Woodruff

The Woodruff application had been the subject of an initial grant by a hearing examiner in June, but the effectiveness of the initial ruling was stayed by Commission order in July, presumably because of the inquiry. The initial grant had been made possible by withdrawal of a competing application by WPAY Portsmouth.

In its petition to dismiss the Portsmouth bid, Woodruff noted the "substantial period of time" which has elapsed since the application was first filed. During this time, it was noted, "the applicant's thinking on both the engineering and economic feasibility of establishing a uhf station in a market as small as Portsmouth has changed." Counting the two tv authorizations held by the Lambs, plus the proposed purchase of WTVQ and the Toledo and Orlando bids, the petition noted the FCC limit of five tv stations for a single interest and said it was decided to give up Portsmouth.

The Woodruff file includes two protests. One is from E. McFarland, Americanism chairman of James Dickey Post 23 of the American

A Fair Shake

RADIO, tv and newspaper reporters are giving President Eisenhower fair and impartial treatment, the President believes, according to James C. Hagerty, his news secretary. He made the statement over MBS Wednesday in an interview with commentator Les Higbie. As to commentators and columnists, Mr. Hagerty said, "You take those as they come. Of course, I don't agree with many of the things that are said about the administration. Some I think are unfair. Some are probably well-founded."

He said the news conferences are a 50-50 proposition giving the President a cross-section of questions on the minds of American people and permitting him to give out what he regards as important news of his Administration.

Legion, Portsmouth. The other is from Forest L. Williams of Williams Mfg. Co., Portsmouth, maker of women's shoes. Mr. Williams recited a local court hearing in a 1936 strike against his firm during which Mr. Lamb was counsel for CIO-United Shoe Workers of America. The letter related that Mr. Lamb's conduct resulted in a disbarment proceeding, but after he apologized to the court the matter was dropped.

The FCC public files show both local praise and protest when Mr. Lamb acquired WIKK Erie. The purchase was praised by Mayor Thomas W. Flatley; Rev. G. Weir Hartman, executive minister, Erie Council of Churches; John M. Hickey, superintendent of schools, and Very Rev. Msgr. W. Lawrence Franklin, editor-business manager of the *Lake Shore Visitor-Register*, official Catholic newspaper of the Diocese of Erie. All cited the public service precedent of WICU (TV).

To the protest of a local citizen, FCC in March 1952 replied in part:

When this Commission had under consideration a previous application of Mr. Lamb, it withheld action until it had contacted the Federal Bureau of Investigation and received a summary of information in the Bureau's files regarding Mr. Lamb. Upon the basis of the record and material furnished by the FBI, the Commission was unable to find that he was unqualified to be a licensee. For your further information, the material referred to was furnished the Select Committee of the House of Representatives, 80th Congress, which conducted an investigation of the activities of this Commission. A part of the file report of that Commission (H. Rep. 2479, 80th Cong., 2nd Session) was devoted to Mr. Lamb.

There also was objection to Mr. Lamb's purchase of WHOO, the Commission files show. It was filed by Donald J. McQuade, national commander, Catholic War Veterans, whose protest cited Mr. Lamb's questionable "affiliations." The protest later was withdrawn for lack of other information, an action publicized in a news release by WTOD.

Charges Mis-representation

After return from a trip abroad, Mr. McQuade offered a new protest, contending Mr. Lamb's news release misrepresented the withdrawal of the earlier protest and falsely attributed to CWV a commendation of the public service record of the Lamb stations. While the CWV official was abroad, however, FCC granted the WHOO transfer in January 1952.

FCC wrote Mr. McQuade that while it thought the press release "prepared by Mr. Lamb's staff might be less ambiguous, it does not appear to warrant the Commission's taking any further action to set aside" the WHOO transfer approval.

All of the files for the Lamb stations have been under study by the FCC staff since early August. Some of these records also were reviewed earlier in the year by investigators on the staff of the Senate subcommittee directed by Sen. Joseph R. McCarthy (R-Wis.), Commission spokesmen recall.

Sen. McCarthy brought up Mr. Lamb's name in his recent hearing on Communist infiltration of the United Nations [B•T, Sept. 14]. The Senator asked ex-Communist John Lautner, who was testifying on Reds in U.N., whether he knew Mr. Lamb, then under consideration for treasurer of the Democratic Committee. Mr. Lautner, now employed by the Justice Dept., said Mr. Lamb was "held in very high esteem" by Communist Party leaders, but he did not know whether he was a party member.

Mr. Lamb, in a statement said, "I do not recall knowing a man by the name of Lautner. Last week I announced that I would not be able to accept the responsibilities of treasurer of the Democratic Party. Finally, I am proud of my anti-Communist record over the years."

The Commission has been withholding action on all applications pending by Lamb stations for some time. WICU (TV) license renewal

KFYR of the DAKOTAS

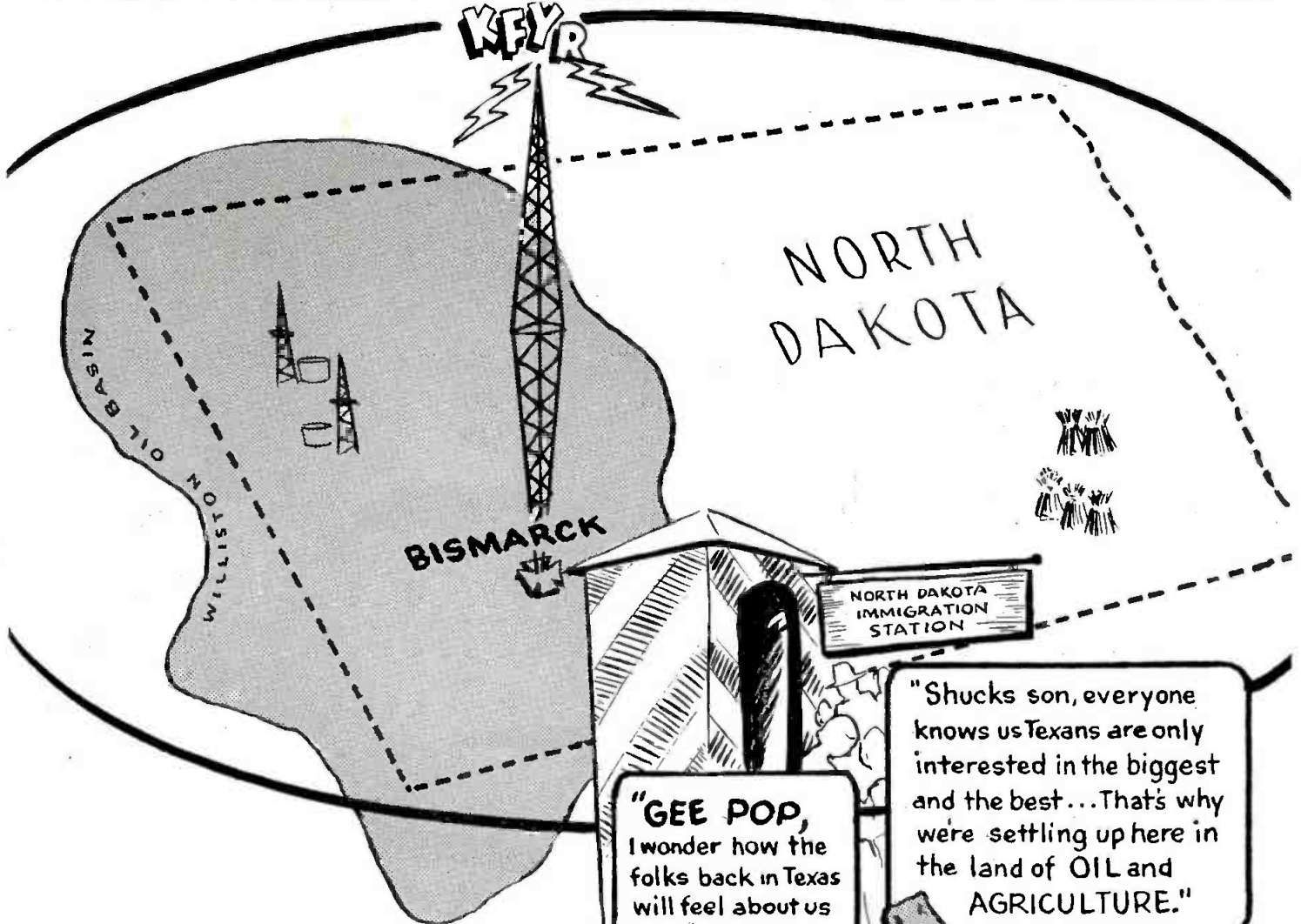

"GEE POP, I wonder how the folks back in Texas will feel about us moving up to NORTH DAKOTA?"

"Shucks son, everyone knows us Texans are only interested in the biggest and the best... That's why we're settling up here in the land of OIL and AGRICULTURE."

Yes sir-e-e, it's time to revise your figures—and thinking—when you talk about Midwest markets. Things have been happening up in North Dakota, and the Williston Basin. The discovery of rich, new oil fields, together with a steady, above-average farm income which last year topped \$582 million, pinpoints North Dakota as the promised land for wealth, expansion and a major market. KFYR offers you the nation's largest area coverage—where coverage counts!

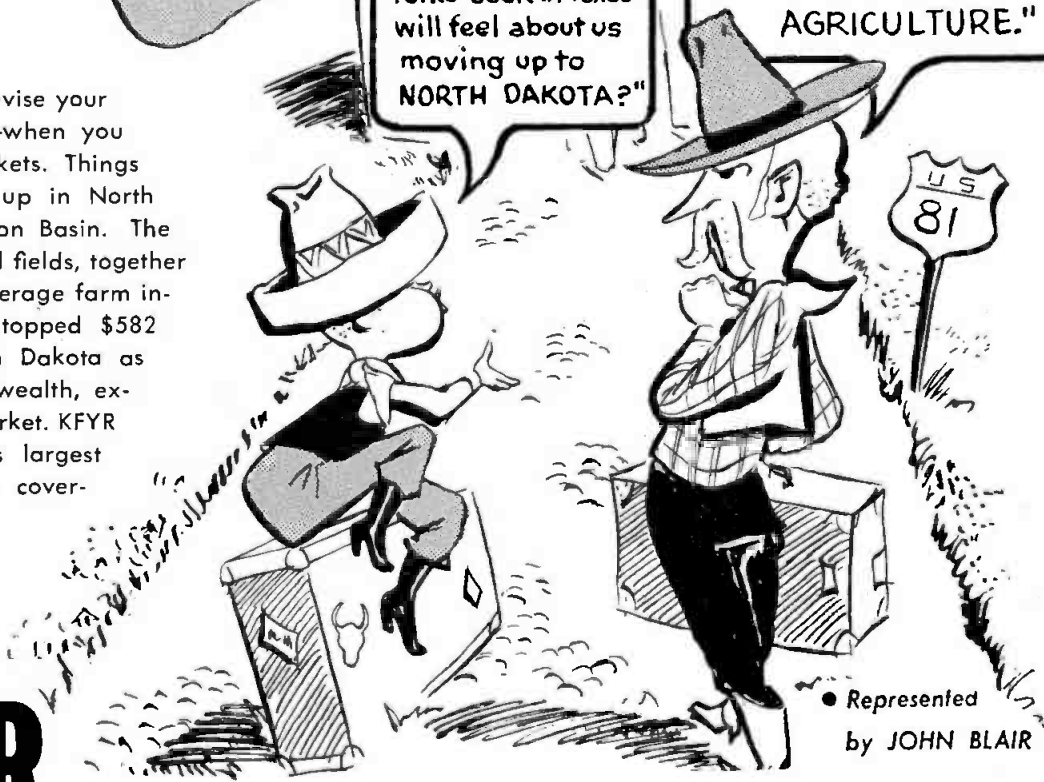

• Represented by JOHN BLAIR

KFYR BISMARCK, N. DAK. • NBC AFFILIATE • 550 KC 5000 WATTS

has been on file since April and a power boost request since May. The WTVQ (TV) transfer was filed in July. WMAC (TV) asked for change of transmitter site in May so it could commence construction.

WICU has promised its transmitter to the noncommercial educational WQED (TV) Pittsburgh, assigned vhf ch. 13, but can't make delivery until it gets its new, higher power equipment.

In the McFarland letters sent to WTOP and WHOO respecting their tv applications, FCC said it "is studying information which may possibly bear on Mr. Lamb's qualifications to own and operate a broadcast station. Should it determine that additional issues be drawn with respect to the matters under study, it will advise you accordingly by subsequent letter. . . ."

Mr. Lamb summarized his position in his "Publisher's Notebook" column in a recent issue of the *Dispatch-Herald*. Recalling his early legal experiences and other background, Mr. Lamb noted that "even now, some politician is discovering that I, with Supreme Court Justice Robert Jackson, Justice Ferdinand Pecora, and many others, organized the National Lawyers Guild. While we remained members, I am sure that all of us merely thought that we were attempting to improve economic conditions of the American lawyer. We resigned many years ago when the purposes of the organization seemed to get on international issues and many of its positions did not agree with our individual sentiments."

Mr. Lamb wrote further: "There were many other letterhead organizations to which my name was used, sometimes even without my knowledge. Much later, they popped up on Attorney General J. Howard McGrath's list, but I even now have the satisfaction that I had long previously severed my connection with them."

"At least the record is clear that I never knowingly belonged to any Communist-front organization. I, of course, never belonged to the Communist party, I never registered or voted for a Communist. If there was a Communist like Louis Budenz or Gus Hall, in any trade union which I represented, I was representing the union—and I didn't choose its members. Indeed over the years, I developed a violent hatred for Communists and their tactics."

Relating that he has donated to candidates of both Republican and Democratic Parties and supported Republicans as well as Democrats in his paper, Mr. Lamb said he wants "the records always to show that I did not contribute a penny to any Communist, or even Socialist party."

"I was blasted by the Commies for our editorial policies and my broadcast activities," Mr. Lamb said. "I hardly think that I was 'esteemed' by them, at least, I never solicited or accepted their friendship or aid."

Self-Policing by Industry Advocated by Comr. Doerfer

SELF-POLICING by the broadcast industry of its own problems was advocated by FCC Comr. John C. Doerfer Thursday in an address before the National Conference of Business Paper Editors at Washington's Hotel Statler.

Comr. Doerfer reminded the editors that the FCC has no censorship powers other than that it can suspend the license of a station which transmits obscene words, language or meanings. He stated his desire to "leave it there." Regulation of program content should be left to the industry and to public indignation, he said.

McGRATH NAMED LAMB EXEC. V.P.

APPOINTMENT of J. Howard McGrath, former U. S. Attorney General, as executive vice president of Edward Lamb Enterprises Inc. and the various broadcasting and manufacturing companies it controls was announced last Thursday by Edward Lamb.

FCC currently is reviewing Mr. Lamb's qualifications to be a broadcast licensee (see story, page 48).

Mr. Lamb's other principal interests include the *Erie Dispatch-Herald*; the C. L. Bryant Corp., Cleveland furnace manufacturer, and White Products Corp., Middleville, Mich., maker of electric water heaters. He has additional business and real estate interests, including the recent \$600,000 purchase of Toledo's Produce Exchange Bldg.

Mr. McGrath, who will continue to main-



Mr. McGrath

Mr. Lamb

tain his law offices in Washington and Providence.

In making public the appointment of Mr. McGrath, Mr. Lamb commented that "Mr. McGrath's whole history reflects excellent business and legal training, a maturity of judgment and a confidence in the American system of free enterprise which our organization seeks to perpetuate. Mr. McGrath will spend considerable time at each of our operations and I know that the people of each community will learn to look upon him with fondness and confidence."

Mr. McGrath is former governor of Rhode Island, onetime U. S. Senator and former chairman of the Democratic National Committee.

FCC Deletes WRBJ (TV); Turn-Back Total Now 19

WITH deletion by FCC last week of WRBJ (TV) Beloit, Wis., on uhf ch. 57, a total of 19 post-thaw tv grantees have surrendered their authorizations, chiefly for economic reasons.

The other permittees to give up their grants were: KGKL-TV San Angelo, Tex., vhf ch. 3; WTVS (TV) Gadsden, Ala., uhf ch. 21; KTV (TV) Austin, Tex., uhf ch. 24; KMID-TV Midland, Tex., vhf ch. 2, Permian Basin TV Co. (ch. 2 subsequently has been reauthorized to Midessa TV Co. under same call); WROV-TV Roanoke, Va., uhf ch. 27 (the only operating grantee to drop out); KRIO-TV McAllen, Tex., uhf ch. 20; KCTV (TV) Austin, Tex., uhf ch. 18; WHHH-TV Warren, Ohio, uhf ch. 67; WWOD-TV Lynchburg, Va., uhf ch. 16; KTVW (TV) Wichita Falls, Tex., uhf ch. 22; WKMI-TV Kalamazoo, Mich., uhf ch. 36; KCNA-TV Tucson, Ariz., vhf ch. 9; WLEC-TV Sandusky, Ohio, uhf ch. 42; KNDK (TV) Minot, N. D., vhf ch. 10; KBMS (TV) Bismarck, N. D., vhf ch. 12; WNOH (TV) Northampton, Mass., uhf ch. 36; WVJS-TV Owensboro, Ky., uhf ch. 14; KTVR (TV) Galveston, Tex., uhf ch. 41.

KFXD-TV Nampa, Idaho, has returned its STA but said it intends to complete the ch. 6 station.

WRBJ's deletion came after Sidney H. Bliss, trading as Beloit Broadcasting Co., petitioned FCC fortnight ago to cancel his construction permit because of his inability to get network affiliation and the present availability of vhf service in his market [B•T, Oct. 12].

Ike to Open Drive

PRESIDENT Dwight D. Eisenhower will launch the 1953 national campaign of Religion in American Life in a quarter-hour program to be broadcast on ABC radio, Friday, 11:15-11:30 p.m., and on ABC television, Sunday, 1:15-1:30 p.m. Rosalind Russell and Samuel Goldwyn also will participate.

KSTM Asks for Vhf In Lieu of Uhf Permit

KSTM-TV St. Louis, new uhf ch. 36 station now testing, filed application with FCC last week for change of frequency to vhf ch. 11, now in contest among KMOX, WEW, 220 Television Inc. and St. Louis Amusement Co. KSTM-TV asked the Commission to waive the rule which forbids a tv station from seeking another channel while holding authorization for its present assignment.

The request to be included in the ch. 11 contest is an alternate proposal to KSTM-TV's earlier petition seeking substitution of uhf chs. 64, 70, 76 and 82 for vhf chs. 4 and 11 there [B•T, Oct. 19]. KWK and KXOK St. Louis are in contest for ch. 4.

Since uhf ch. 30 is available, KSTM-TV believes it more logical to make five channels available for six contestants rather than two for six. The uhf ch. 36 station also cited economic factors, noting nearby WTVI (TV) Belleville, Ill., is operating on uhf ch. 54 while WIL-TV St. Louis is constructing on uhf ch. 42. KSD-TV St. Louis is operating on vhf ch. 5 while educational KETC (TV) is building on vhf ch. 9, a noncommercial channel.

KSTM-TV's counsel and part owner, Franklin C. Salisbury, explained the alternative ch. 11 application does not affect the station's support of the newly organized Ultra High Frequency Assn. [B•T, Oct. 19].

KSTM-TV told the Commission in the ch. 11 application that should FCC decide to continue the St. Louis vhf assignments, the station should be allowed to apply for ch. 11 "and thus improve its chance to serve St. Louis." The station contended its ability to serve "will be materially impaired if an additional vhf station is assigned to St. Louis and granted to any competing applicant."

NFL Awaits Court Ruling; Bell Says 'Tv Helps Sport'

OFFICIALS of the National Football League "are not going to lose" the government's anti-trust case against the league, Bert Bell, NFL commissioner, predicted last Monday. The case has been heard by Judge Alan Grim of U. S. District Court in Philadelphia; decision is being awaited.

Addressing the Football Writers Assn. in New York, Mr. Bell said player salaries have gone up 400% in the last decade principally due to television and radio income. If NFL loses the court case, he added, salaries would have to come down. He defended blacking out of telecasts in areas where a game is being played.

Comr. Bell said tv "has helped the sport tremendously, with attendance well above last season." Games are being telecast on over 150 stations. He added, "Because we are televising our 'away' games, interest is remarkable everywhere. New fans are being made each week."

AT YOUR SERVICE...

Meet the folks who **SELL**
for YOU in **TWO** major
markets of the great Southwest.
(one of a series)



J. Paul McCaslin

J. Paul McCaslin, manager of KFPW, Fort Smith's pioneer CBS Radio station, is a veteran of 25 years in the radio business. Versatile and genial, McCaslin's experience includes engineering, sales, service and merchandising. He is well versed in the art of keeping a "good operation" on the air—and making it produce results for its advertising clients. McCaslin recently succeeded James P. Walker as manager of KFPW, when Walker was appointed general manager of KATV, Griffin-owned VHF Television station which will serve the Pine Bluff-Little Rock market of Central Arkansas on Channel 7.

KTUL
TULSA, OKLAHOMA

KFPW
FT. SMITH, ARKANSAS

The staff members of these two stations represent an accumulative total of 524 years of radio "KNOW-HOW" at your Service!

* Reach the billion-dollar market of Tulsa and Eastern Oklahoma—PLUS the multi-million dollar trade area of Fort Smith and Western Arkansas at the lowest cost per listener. ONE OPERATION—ONE NETWORK, CBS Radio. Earn greater discounts by using BOTH STATIONS.



Avery-Knodel, Inc., National representative
Affiliated with KOMA, Oklahoma City



some spots are better

You've got to hand it to the women! They've mastered the fine art of getting money. The ladies, bless them, now own 70% of the nation's private wealth and they spend 85 cents of every American dollar.

To induce them to spend more of *their* money on *your* product, the local Radio stations we represent have created a brand-new line up of profit-making shows. They're built strictly for women, strictly for sales.

For the best spot, at the right time, at the right place



than others

These local shows are low in cost, delivering impressionable women listeners for as little as 70 cents per thousand. They feature local top-flight personalities who are real pros at entertaining and selling! In addition, their programs offer you exciting, new merchandising possibilities.

Women who pull the purse strings go all out for

Faye Emerson in New York *Mary Merryfield in Chicago*
Captain Glenn in Cleveland *Playhouse Party in St. Louis*
Marjorie King in San Francisco *Nancy Osgood in Washington*
Josephine Biehl in Honolulu, Hawaii



SPOT SALES

30 Rockefeller Plaza, New York 20, N. Y.

Chicago Detroit Cleveland Washington San Francisco
 Los Angeles Charlotte* Atlanta* *Bomar Lowrance Associates

representing
 RADIO STATIONS:

	KSD	St. Louis
	WNBC	New York
	WMAQ	Chicago
	WTAM	Cleveland
	KNBC	San Francisco
	WRC	Washington
	KGU	Honolulu, Hawaii

representing
 TELEVISION STATIONS:

	KSD-TV	St. Louis
	WNBW	Washington
	KPTV	Portland, Ore.
	WRGB	Schenectady-Albany-Troy
	WNBT	New York
	WNBQ	Chicago
	KNBH	Los Angeles
	WPTZ	Philadelphia
	WBZ-TV	Boston
	WNBK	Cleveland
	KONA	Honolulu, Hawaii

FCC REVISES TV HEARING PRIORITY; GROUP A DROPS 31, GROUP B LOSES 23

West Palm Beach takes first place in the A category, with Fort Worth ahead in the B's. Revisions came under the policy of bringing the list up to date every 60 days.

REVISED priority list for the processing of competitive television applications was issued by FCC Friday morning, reducing the former priority list by 31 cities in Group A (no local operating station) and 23 cities in Group B (one or more operating) [B•T, Aug. 31, 24]. There are 42 cities in the new Group A, 21 in Group B.

Since the Commission by last Thursday night had processed and issued McFarland letters in the old Group A lineup to and including Mansfield, Ohio, and in the Group B lineup to and including Miami, the new priority is headed by West Palm Beach, Fla., in Group A and by Fort Worth, Tex., in Group B. Fort Worth is followed in order by Richmond, Jacksonville, Tulsa, Charlotte, Phoenix, Huntington, Charleston, Raleigh and Asheville.

The revised priority was due Saturday, Oct. 24, since FCC proposed to revise the list every 60 days. It was issued Friday with all changes in markets reflected through Thursday night. All cities to which McFarland letters have been issued are removed in the new list since processing of those applications and hearings now proceed without regard to the priority.

Under the priority procedure, FCC starts processing the first Group A city applications, then the first Group B city, continuing down the list and alternating between Group A and B.

Following is the revised priority list. Population is given for each city to determine rank, and in Group B the population is followed by local commercial operating stations, which also determine rank. Pending applications and contented channels involved also are indicated.

GROUP A LIST

1. W. Palm Beach, Fla.—43,162 pop. Applics.: ch. 5—WJNO, Palm Beach Tv Inc.; ch. 12—WWPG Palm Beach, Tv Theatre of the Palm Beaches Inc.
2. Lake Charles, La.—41,272 pop. Applics.: ch. 7—KLOU, KPLC.
3. Joplin, Mo.—38,711 pop. Applics.: ch. 12—KSWM, KFSB.
4. Cumberland, Md.—37,679 pop. Applics.: ch. 17—WDYK, WTBO.
5. Biloxi, Miss.—37,425 pop. Applics.: ch. 13—WLOX, WVMI.
6. Muskogee, Okla.—37,289 pop. Applics.: ch. 8—Tulsa Bcstg Co. (KTUL Tulsa), KBIX.
7. Spartanburg, S. C.—36,795 pop. Applics.: ch. 7—WORD, WSPA.
8. Hagerstown, Md.—36,260 pop. Applics.: ch. 52—WARK, WJEJ.
9. Enid, Okla.—36,017 pop. Applics.: ch. 5—KCRC, Streets Electronics Inc.
10. Alexandria, La.—34,913 pop. Applics.: ch. 5—KSYL, KALB.
11. Fayetteville, N. C.—34,715 pop. Applics.: ch. 18—WFLB, WFNC, WFAI.
12. Ottumwa, Iowa—33,631 pop. Applics.: ch. 15—Valley Tv & Radio Inc., Ottumwa Telecasting Corp.
13. Paducah, Ky.—32,828 pop. Applics.: ch. 6—Columbia Amusement Co., WKYB, ch. 43—WPAD, Paducah Tv Co.
14. Bristol, Tenn.—32,725 pop. Applics.: ch. 5—WOPI Bristol, Tenn., WCYB Bristol, Va.
15. Reno, Nev.—32,497 pop. Applics.: ch. 4—Western Tv Co., R & L Co.
16. Clarksburg, W. Va.—32,014 pop. Applics.: ch. 12—WBLK, WPDJ; ch. 22—J. Patrick Bea-com & Assoc., Clarksburg-Fairmont Corp.
17. Albany, Ga.—31,115 pop. Applics.: ch. 10—WJAZ, WALB, WGPC.
18. Wausau, Wis.—30,414 pop. Applics.: ch. 7—Wis. Valley Tv Corp., WOSA.
19. Jackson, Tenn.—30,207 pop. Applics.: ch. 9—WTJS, Dixie Bcstg. Co.
20. Daytona Beach, Fla.—30,187 pop. Applics.: ch. 2—WNDB, WMFJ.
21. Odessa, Tex.—29,495 pop. Applics.: ch. 7—

- KECK, KOSA, Odessa Tv Co.
22. Provo, Utah—28,937 pop. Applics.: ch. 11—KOVU, KCSU.
23. Grand Forks, N. D.—26,836 pop. Applics.: ch. 10—KNOX, Grand Forks Bcstg. Co.
24. Sharon, Pa.—26,454 pop. Applics.: ch. 39—WPIC, Leonard J. Shaftz.
25. Rapid City, S. D.—25,310 pop. Applics.: ch. 7—The Hills Bcstg. Co., KOZY Tv Inc.
26. Jefferson City, Mo.—25,099 pop. Applics.: ch. 13—KWOS, Capital Tv Corp., L. H. P. Co.
27. El Dorado, Ark.—23,076 pop. Applics.: ch. 10—Southern Ark. Tv Co., Tv Enterprises Inc. (KARK Little Rock).
28. Florence, S. C.—22,513 pop. Applics.: ch. 8—Jefferson Standard Bcstg. Co. (WBT Charlotte, N. C.), Pee Dee Tv Corp.
29. Hastings, Neb.—20,211 pop. Applics.: ch. 5—KHAS, Strand Amusement Co.
- 30.—Beckley, W. Va.—19,397 pop. Applics.: ch. 6—WJLS, So. W. Va. Tv Inc., WHIS.
31. Bogalusa, La.—17,798 pop. Applics.: ch. 39—WIKC, Miss-Lou Inc.
32. Modesto, Calif.—17,389 pop. Applics.: ch. 14—Charles Thieriot, Ralph M. Brown, KTRB.
33. Big Spring, Tex.—17,286 pop. Applics.: ch. 4—Texas Telecasting Inc. (KDUB-TV Lubbock), KBST, Big State Telecasting Co.
34. Klamath Falls, Ore.—15,875 pop. Applics.: ch. 2—KFJI, Klamath Falls Tv Inc.
35. Clearwater, Fla.—15,581 pop. Applics.: ch. 32—Pioneer Gulf Tv Bcstrs., WBOY Inc. (WBOY Tarpon Springs, Fla.)
36. Sunbury, Pa.—15,570 pop. Applics.: ch. 65—WKOK, WISL Shamokin, Pa.
37. Marinette, Wis.—14,178 pop. Applics.: ch. 11—WMAM, WMAW Menominee, Mich.
38. Wenatchee, Wash.—13,072 pop. Applics.: ch. 55—Central Wash. Telecasters, Westcoast Bcstg. Co. (KVOS Bellingham).
39. El Centro, Calif.—12,590 pop. Applics.: ch. 16—Valley Empire Telecasters, Valradio Inc.
40. Irwin, Pa.—4,228 pop. Applics.: ch. 4—KQV Pittsburgh, WLOA Braddock, Irwin Community Tv Co., Wespen Tv Inc.
41. Henderson, Nev.—3,643 pop. Applics.: ch. 2—Boulder City Bcstg. Co. and Southwestern Pub. Co.
42. Hatfield, Ind.—410 pop. Applics.: ch. 9—WVJX, WOMI, both in Owensboro, Ky.

GROUP B LIST

1. Ft. Worth, Tex.—278,778 pop. WBAP-TV. Applics.: ch. 11—KFJZ, Lechner Tv Co., Fort Worth Tv Co.
2. Richmond, Va.—230,310 pop. WTVR. Applics.: ch. 12—WRNL, WRVA, Richmond Tv Corp.; ch. 29—Dixie Tv Corp., Winston-Salem Bcstg. Co.
3. Jacksonville, Fla.—204,517 pop. WMBR-TV. Applics.: ch. 12—WJAX, Fla.-Ga. Tv Co., WPDQ.
4. Tulsa, Okla.—182,740 pop. KOTV. Applics.: ch. 2—Central Plains Enterprises Inc., Oil Capital Tv Corp., TulsaVision Inc.; ch. 17—Tulsa Tv Co., Arthur R. Olson.
5. Charlotte, N. C.—134,042 pop. WBTV. Applics.: ch. 9—WIST, WSOC, Piedmont Electronics & Fixture Corp., Dan Nicholas.
6. Phoenix, Ariz.—106,818 pop. KPHO-TV. Applics.: ch. 3—Arizona Tv Co., KTAR, Desert Adv. Co.
7. Huntington, W. Va.—86,353 pop. WSAZ-TV. Applics.: ch. 13—WCMI Ashland, Ky., WHTN, WFLH.
8. Charleston, S. C.—70,174 pop. WCSC-TV. Applics.: ch. 2—WUSN, WHAN, WTMA.
9. Raleigh, N. C.—65,879 pop. WNAO-TV. Applics.: ch. 5—WRAL, WPTF.
10. Asheville, N. C.—53,000 pop. WISE-TV. Applics.: ch. 13—WLOS, Community Tv Co., WWNC, William W. Orr.
11. Green Bay, Wis.—52,735 pop. WBAY-TV. Applics.: ch. 6—WJPG, Valley Telecasting Corp.
12. Fort Smith, Ark.—47,942 pop. KFSA-TV. Applics.: ch. 5—American Tv Co., George T. Herneich.
13. Tyler, Tex.—38,968 pop. KETX. Applics.: ch. 7—KGKB, KTBB.
14. Las Vegas, Nev.—24,624 pop. KLAS-TV. Applics.: ch. 13—KRAM, Western Tv Co.
15. Boston, Mass.—801,444 pop. WBZ-TV, WNAC-TV. Applics.: ch. 5—WHDH, Greater Boston Tv Corp., WEEI, Mass. Bay Telecasters.
16. San Antonio, Tex.—408,442 pop. KEYL, WOAI-TV. Applics.: ch. 12—KONO, K TSA, Bex-ar County Tv Corp.
- 17.—Omaha, Neb.—251,117 pop. KMTV, WOW-TV. Applics.: ch. 7—KBON, Herald Corp., KFAB.
18. San Francisco-Oakland, Calif.—1,159,932 pop. KGO-TV, KPX, KRON-TV, KVEC-TV. Applics.: ch. 2—KFRC, KLX Oakland, Ch. 2 Inc. of Oakland, KROW.
19. Minneapolis-St. Paul, Minn.—833,067 pop. WCCO-TV, KSTP-TV, WTCN-TV, WMIN-TV. Applics.: ch. 9—KEYD, WLOL, Upper Midwest Tv Co., WDGY.
20. Pittsburgh, Pa.—676,806 pop. WDTV, WKJF-TV, WENS. Applics.: ch. 11—WJAS, KDKA, WCAE, WWSW. For ch. 4 see Irwin, Pa., No. 40 in Group A.
21. Buffalo-Niagara Falls, N. Y.—671,004 pop. WBEN-TV, WBUF-TV, WBES-TV. Applics.: ch. 2—WGR, Victory Tv Corp., Niagara Frontier Amusement Corp.; ch. 7—WEBC, Copper City Bcstg. Corp., WKBW.

DEMOS MAY BLAST LEE APPOINTMENT

New Commissioner's part in Tydings-Butler campaign incident may be further explored.

POSSIBILITY that the confirmation of Robert E. Lee to be an FCC Commissioner will touch off the first all-out attack by Democrats on President Eisenhower was foreseen last week as the recess appointment of the former FBI agent to the FCC came under attack in Congress.

Bears Looking Into

Sen. A. S. (Mike) Monroney (D-Okla.) said last week that he thought Mr. Lee's involvement in the 1950 Maryland Senatorial campaign, which saw the defeat of then incumbent Sen. Millard Tydings (D) by Sen. John Marshall Butler (R), would bear further looking into.

Sen. Monroney was chairman of the special subcommittee which investigated charges of irregularities in the Maryland campaign. Terming it "despicable," the subcommittee referred findings to the Dept. of Justice. Attorney General Herbert Brownell Jr. announced Oct. 16 that the Justice Dept. had found no evidence of Federal violations.

Mr. Lee, who has made no bones about his activities in that campaign, had appeared before the investigating subcommittee to report on a \$5,000 campaign contribution he received

from Alvin M. Bentley, now a Republican Congressman from Michigan, in a meeting with Mr. Bentley in the office of Sen. Joseph R. McCarthy (R-Wis.).

Mr. Lee testified that he had taken the check to the Butler headquarters and that it had been endorsed over to Mr. Lee's wife and used by Mr. and Mrs. Lee in a direct-mail campaign in behalf of Mr. Butler. The subcommittee found that the \$5,000 was not reported until after it had begun its investigation.

Referring to this, Mr. Lee last week said there was nothing irregular in his acceptance and use of the Bentley contribution. "It apparently was not reported to the proper Maryland authorities as a contribution but I don't see how I could have helped that," he said. "I had no responsibility for reporting it."

Close Split

Closeness of the GOP-Democratic division of the Senate would indicate that Mr. Lee might have difficulty being confirmed if the Democrats decided to make a party issue of his appointment. At present the Senate is divided 48 Democrats, 47 Republicans and one Independent. The Senate Commerce Committee, to which Mr. Lee's name will be sent for confirmation, is now divided with seven Republicans and seven Democrats. Among the members of the committee are Sens. Monroney and Butler, and also Sen. Lyndon Johnson (D-Tex.), Democratic leader.

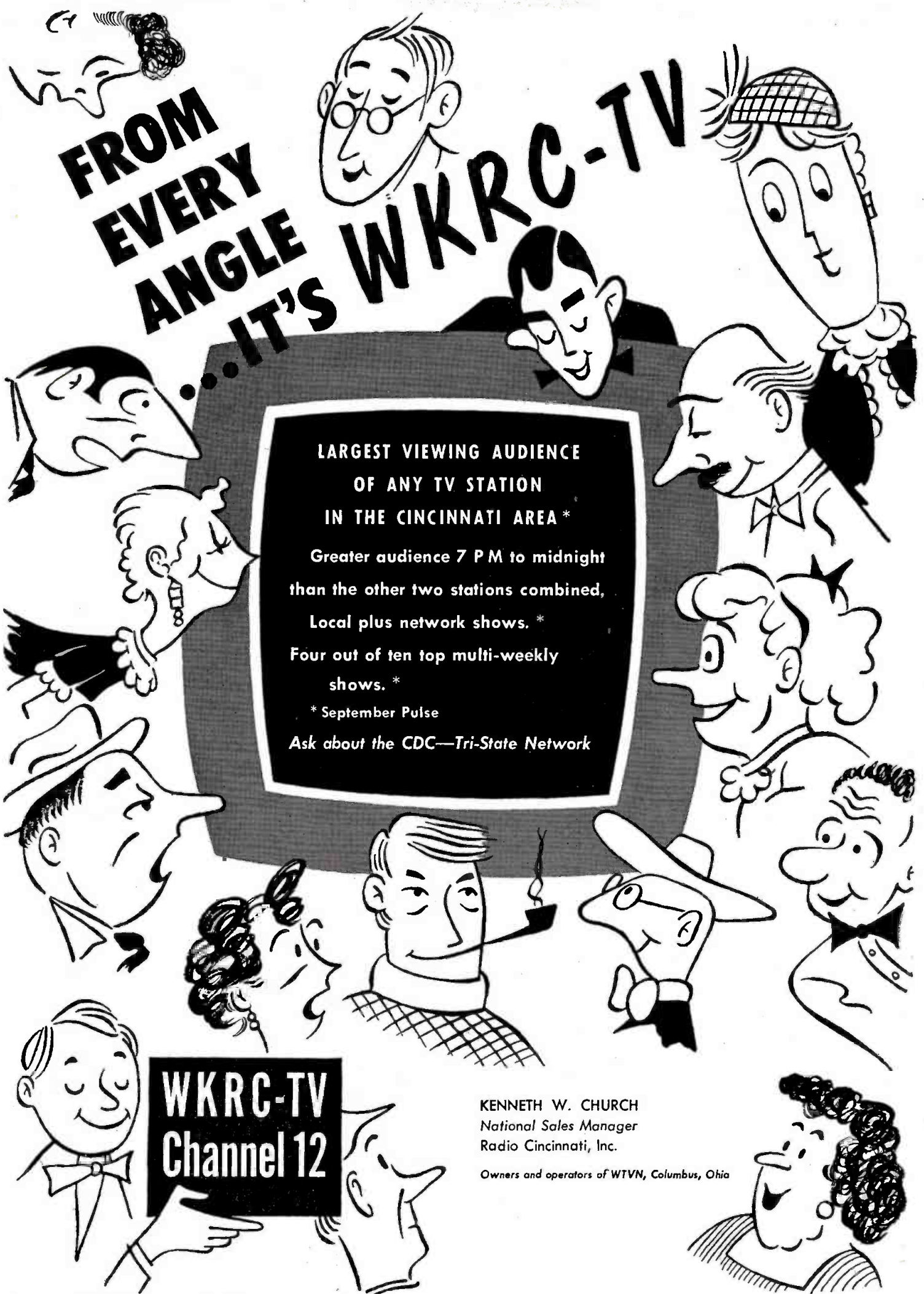

FROM EVERY ANGLE ... IT'S

WKRC-TV

**LARGEST VIEWING AUDIENCE
OF ANY TV STATION
IN THE CINCINNATI AREA ***

Greater audience 7 P M to midnight
than the other two stations combined,
Local plus network shows. *

Four out of ten top multi-weekly
shows. *

* September Pulse

Ask about the CDC—Tri-State Network

**WKRC-TV
Channel 12**

KENNETH W. CHURCH
National Sales Manager
Radio Cincinnati, Inc.

Owners and operators of WTVN, Columbus, Ohio

REPRESENTED BY THE KATZ AGENCY

CBS TELEVISION NETWORK

'APPROVE COLOR' PRESSURE PUT ON FCC

Congressional spokesmen—Colorado's Sen. Johnson and New Jersey's Rep. Wolverton—urge the Commission to waste no time in okaying the NTSC standards.

THE FCC found itself last week under mounting Congressional pressures to authorize compatible color television immediately.

At the same time, it was learned there was no possibility of formal Commission consideration before next week. This was due to the fact that two commissioners have been away from Washington and are not due back until this coming weekend. It is believed that Chairman Rosel H. Hyde does not wish to take up the subject with less than a full Commission present.

With the lack of any significant opposition to the standards proposed by the all-industry National Television System Committee—and with the general acknowledgment that the demonstrations in New York two weeks ago left few doubts regarding the effectiveness of the color signals [B•T, Oct. 19]—it is thought in some circles that the Commission might approve compatible color tv by or before Nov. 15.

Other observers of Commission activity are less sanguine. They recall that both Chairman Hyde and Comr. Edward M. Webster warned that so momentous a decision was not going to be made hastily. It was also pointed out that it was normal to expect a number of official Commission meetings before any significant matter received the approval of all seven commissioners.

'Clear Up the Confusion'

Sen. Edwin C. Johnson (D-Colo.), senior Democratic member of the Senate Commerce Committee who has taken an active interest in color tv from the beginning, wired Chairman Hyde from Denver with a plea to "clear up the confusion."

The demonstration was successful, Sen. Johnson declared he had been informed. He said he has been asked when color tv would be a reality all over the country.

Unless there are some defects known to the FCC, Sen. Johnson went on, there is no reason why the standards cannot be adopted at this time.

Rep. Charles A. Wolverton (R-N.J.), chairman of the House Commerce Committee which investigated the color tv question last spring, urged the "prompt adoption" of the NTSC color standards.

In a statement, Rep. Wolverton called the demonstration "an outstanding success." "It seems to me that unless the Commission now specifies with particularity any questions or reservations it has with regard to the proposed new standards, it should proceed immediately to adopt these standards," Mr. Wolverton said.

Senate Commerce Committee Counsel Robert D. L'Heureux also wrote the FCC last week asking for information on the status of color tv. He said that he needed the information in order to answer queries from members of the Senate committee.

Why the FCC has been put under pressure by "Hill" solons has Commission members guessing. One line of thinking leans to the theory that Congressmen fear influences are at work to hold off a final FCC decision until after the Christmas selling season is passed.

There is also the fear, it is apparent, that some FCC engineers or lawyers may be so con-

cerned with the record that they will urge an oral session to clear up questions regarding receiver and studio equipment costs and complexities raised by Paramount Television, Chromatic Television Labs., and by CBS.

Away from Washington at the present time are Comr. Webster, who has been in Chicago and will be in San Francisco this week, returning to Washington Nov. 1, and Comr. Robert T. Bartley, who has been in Texas, and who is due to return Nov. 2.

Meanwhile, RCA announced last week that first deliveries of its compatible color equipment to permit stations to transmit network color programs will be delivered beginning in December. RCA also announced that the first technical color seminars for broadcast engineers and executives would be held in Camden Oct. 28-29, for consulting engineers.

One or more stations in 57 cities have ordered RCA color broadcast equipment, T. A. Smith, RCA Victor Engineering Products vice president said. Equipment for the origination of live and filmed color shows will be ready for delivery in March 1954, Mr. Smith added. He said that stations in the following cities have ordered color equipment:

Atlanta, Austin (Texas), Baltimore, Bethlehem, Birmingham, Boston, Buffalo, Charlotte, Chicago, Cincinnati, Cleveland, Columbus, Dallas, Dayton, Denver, Detroit, Fort Lauderdale, Fort Worth, Grand Rapids, Harrisburg (Pa.), Houston, Huntington (W. Va.), Indianapolis, Jackson (Miss.), Johnstown (Pa.), Kansas City, Lancaster, Los Angeles, Louisville, Memphis, Milwaukee, Minneapolis, New Haven, New Orleans, New York City, Norfolk, Oklahoma City, Omaha, Philadelphia, Portland (Ore.), Providence, Richmond, Roanoke, Rochester (N. Y.), St. Louis, Salt Lake City, San Antonio, San Francisco, South Bend, Spokane, Syracuse, Toledo, Tulsa, Washington (D. C.), Wilkes-Barre, Wilmington (Del.), and Youngstown.

Zenith-CBS Chicago Case Gets New Legal Argument

ZENITH Radio Corp. has raised a question regarding the legality of the FCC's proposal to hold a comparative hearing on its application for Chicago's ch. 2 in consolidation with the renewal application of CBS-owned WBBM-TV Chicago. This was the subject of "McFarland letters" sent to both last month [B•T, Sept. 29].

In its answer, Zenith said that the U. S. Court of Appeals had stayed any action on Chicago's ch. 2 until it has decided the Zenith appeal against the FCC. This was the action which dismissed Zenith's application for that frequency.

Also, Zenith added, the WBBM-TV renewal application is for ch. 4, not ch. 2. WBBM-TV is operating on ch. 2 under temporary FCC authority.

CBS' reply to the FCC's McFarland letter said that it is willing to have the WBBM-TV renewal application set for comparative hearing with Zenith if the latter so desired or if it failed to answer the Commission notice. CBS, however, questioned the validity of Zenith's application, which it pointed out had been dismissed by the Commission.

Zenith, in its response to the Commission, pointed out that one of the issues in the Court of Appeals was whether, if its initial application should be heard, the hearing should be against Balaban & Katz Inc. or CBS. Balaban & Katz owned WBKB (TV) Chicago on ch. 4, and sold those facilities to CBS for \$6 million early this year when the Paramount case was decided. The Zenith application for ch. 2 was filed in 1948. In the end-of-the-freeze report the FCC deleted Chicago's ch. 4 and ordered then WBKB to move to ch. 2.

* Green Pastures surround WIBA



* with Greenbacks for your product

WIBA's rich SAM's 16-county area is one of the most agriculturally productive and progressive in the nation. Recent U.S. census of agriculture figures show that in 56 categories, counties in the WIBA area rank among the top hundred 118 times. WIBA is first in listeners in this "green pasture" area — first in value to advertisers. Write today for latest surveys and market data

FIRST IN MADISON FOR 28 YEARS!



5000 WATTS ON 1310

Established 1925

EVERY-KNODEL, INC.
REPRESENTATIVES

BADGER BROADCASTING COMPANY
MADISON, WISCONSIN

When planning an *ADVERTISING* schedule for OKLAHOMA, remember . . .

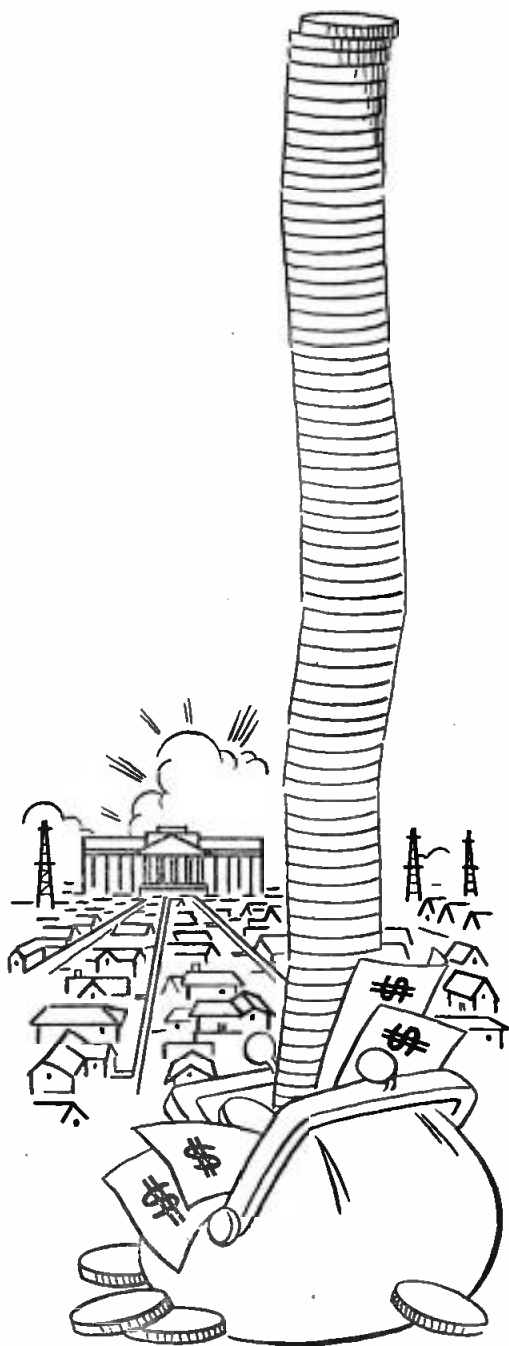

WKY

**-third oldest
radio station
in the nation
serves more
Oklahoma homes
from its state
capitol...**

**-covers more
Oklahoma buying
power from
its largest
city...**

**than any other
station!**

Sources: Nielsen and Sales Management

WKY RADIO

930 KC • NBC

Owned and operated by The Oklahoma Publishing Co.
The Daily Oklahoman • Oklahoma City Times
The Farmer-Stockman • WKY-TV
Represented by KATZ AGENCY

Sale of KGW Among Multiple Approvals

FCC authorizes a bumper crop of transfers that amount to more than a million dollars.

APPROVAL was granted by FCC last week to more than a million dollars worth of radio and tv station transfers, including sales of KGW Portland, Ore.; WNJR and WVNJ Newark; KABS (TV) Honolulu; WPNX Phenix City, Ala., and WGBA Columbus, Ga. (details of all transfers in FOR THE RECORD).

The Commission authorized sale of KGW-AM-FM by publisher Samuel I. Newhouse Jr. for \$500,000 to KING-AM-TV Seattle (40%) and principals in North Pacific Television Inc., vhf ch. 8 contestant there. KING controls North Pacific. For dropping a competitive bid for vhf ch. 6 at Portland, Mr. Newhouse acquired option for substantial minority holding in KOIN-TV, the ch. 6 grantee.

At Newark, FCC approved the Evening News Pub. Co.'s sale of WNJR for \$145,000 to Rollins Broadcasting Inc. and its purchase of WVNJ from Earle H. Rodney, Arthur Walsh and associates [B•T, Sept. 28, 7]. The News pays \$96,750 for WVNJ and assumes 4% bearer notes totaling \$300,000 plus.

Concerning a protest by an "employees group" at WNJR who said the staff would be cut and Negro programming instituted, FCC wrote:

Upon consideration of the matters raised in your petitions and the facts appearing in the application, the Commission is of the opinion that Rollins Broadcasting Co. has made a showing that it is in the public interest for the Commission to consent to the assignment of license of WNJR. The Evening News operated WNJR at a loss for many years. It is unrealistic to expect a station to operate indefinitely at a financial loss. The method of operation proposed by the new applicant is designed to put the station on a sound financial basis.

Rollins Broadcasting, whose board chairman is Delaware Lt. Gov. John W. Rollins, operates WRAD Radford, Va.; WFAI Fayetteville, N. C.; WJWL Georgetown, Del., and WRAP Norfolk. The firm holds permit for uhf ch. 40 WHRN (TV) Dover, Del., and has a tv application pending at Fayetteville. New am station bids are pending at Jacksonville, Fla.; Indianapolis; Wilmington, Del., and Houston, Tex.

Rollins concurrently announced appointment of Albert Lanphear, vice president of Richard Eaton's United Broadcasting Co., to be manager of WNJR.

The WRBL, WGBA and WPNX transfers stem from merger of the principals in WGBA and WRBL for a vhf ch. 4 grant at Columbus [B•T, Aug. 31]. The Columbus *Ledger-Enquirer* sells WGBA for \$25,000 to Community Broadcasting Co. (WPNX owner) which in turn sells WPNX for \$30,000 to L. H. Christian and C. A. McClure, owners of WRFC Athens, Ga. Community will move WGBA on 1460 kc (1 kw fulltime, directional) to Phenix City, changing call to WPNX, while Christian & McClure will switch the present WPNX on 1270 kc (1 kw day) from Phenix City to Columbus, changing call to WGBA. Changeover is to commence today (Monday), it was reported.

WRBL is assigned by J. W. Woodruff interests to Columbus Broadcasting Co., new merger firm holding the ch. 6 grant. The Woodruff group holds 49% and R. W. Page Corp., *Ledger-Enquirer* owner, 51%.

The ch. 4 permit for KABS (TV) Honolulu is assigned from American Broadcasting Stations Inc. (WMT-AM-TV Cedar Rapids) to Pacific Frontier Broadcasting Co., whose ownership is divided between the WMT group and principals in KJBS San Francisco. Pacific Frontier is operator of KULA Honolulu.

WAY PAVED FOR HARTFORD MERGER BY FCC UHF CH. 18 GRANT THERE

FCC also makes final its proposed grant to WIBG Philadelphia for ch. 23. WQXI Atlanta gets an initial decision towards authorization on ch. 54.

PREVIEWING a merger of the Hartford radio-tv interests of General Teleradio Inc. (WONS) and the *Hartford Times* (WTHT), FCC last week granted a construction permit for uhf ch. 18 there to General Times Television Corp., a new firm owned 100% by General Teleradio but in which 45% option is held by the *Times*.

The merger proposal was disclosed to FCC Tuesday when the new General Times Television Corp. bid was filed and WONS and WTHT withdrew their respective competing ch. 18 applications. After the merger is effected and approved by the Commission, it is planned to dispose of the WTHT assignment (1230 kc, 250 w fulltime) and to continue the WONS operation (1410 kc, 5 kw fulltime, directional day and night).

Aiken Ch. 54 Awarded

In other television actions, FCC (1) awarded uhf ch. 54 at Aiken, S. C., to Aiken Electronics Advertising Corp., operator of WAKN there; (2) made final an examiner's initial decision to grant uhf ch. 23 at Philadelphia to Daily News Television Co., licensee of WIBG there, and (3) announced an initial decision by Examiner Hugh B. Hutchison looking toward grant of uhf ch. 36 at Atlanta, Ga., to Robert W. Roundsville, operator of WQXI Atlanta.

The ch. 18 authorization is Hartford's first commercial tv station. Uhf ch. 24 there is under permit to the Connecticut State Board of Education for noncommercial WEDH (TV). Only other channel available is vhf ch. 3, in contest between WTIC and Hartford Telecasting Co. WTIC has a merger agreement pending with former ch. 3 contestant WDRC, should it win out [B•T, Sept. 28]. Hartford Telecasting, meanwhile, has protested the legality of the WTIC application [B•T, Oct. 19].

The WONS-WTHT merger plan was jointly announced by Thomas F. O'Neil, president of General Teleradio, the radio-tv subsidiary of General Tire & Rubber Co., and by David R. Daniel, publisher of the *Times*. General Teleradio owns the Don Lee and Yankee Networks (including WONS) and WOR-AM-TV New York, plus control of Mutual.

'Welcome Association'

Mr. O'Neil commented, "I welcome this association with the *Hartford Times* because of the increased service that General Teleradio Inc. can render greater Hartford and central Connecticut by availing itself of the knowledge of the interests and desires of the community and the ability to meet those desires which the *Hartford Times* has gained through its many years of outstanding service. We will bend every effort to serve greater Hartford and central Connecticut with television as quickly as possible."

Mr. Daniel said, "Our newspaper, with its long and widely recognized record of service to the community as well as our 17 years in broadcasting, will combine with an organization of long experience in the television field. This combination should provide greater Hartford and central Connecticut area with the type of

television service which such an important area deserves."

WONS is a Mutual affiliate. WTHT is an ABC outlet.

Details of last week's grants follows:

Hartford, Conn.—General Times Television Corp. granted uhf ch. 18; effective radiated power 209 kw visual and 112 kw aural; antenna height above average terrain 820 ft. Authorization is subject to condition that it is without prejudice to any action the Commission may take with respect to any future applications which are filed to effectuate the merger agreement between General Teleradio Inc. and Hartford Times Inc.

Philadelphia—Daily News Television Co. (WIBG). In final decision, FCC granted uhf ch. 23; ERP 1,000 kw visual and 500 kw aural; antenna height above average terrain 620 ft. Ruling was made possible by withdrawal of competing bid by Lou Poller, operator of WCAN-AM-TV Milwaukee.

Aiken, S. C.—Aiken Electronics Advertising Corp. (WAKN) granted uhf ch. 54; ERP 17.4 kw visual and 9.33 kw aural; antenna height above average terrain 350 ft.

At Atlanta, the initial ruling proposing to grant ch. 36 to WQXI was made possible by withdrawal of a competitive bid by the U. of Georgia's WGST Atlanta. WQXI reimbursed WGST for expenses in the amount of \$4,500 and promised to allow the school to train students in tv technique at its prospective tv outlet.

Premature Construction

The Commission moved to settle a question of premature construction in the Savannah, Ga., vhf ch. 3 case last week and ordered inclusion of a new issue to determine "whether construction of the station proposed by WSAV Inc. has been begun within the meaning of Sec. 319 of the Communications Act." Sec. 319 says FCC may not license a station prematurely built before it was authorized.

The order was based upon a petition by ch. 3 contestant WJIV Savannah which earlier sought disqualification of the WSAV bid, then, when unsuccessful, asked for certification of the partially completed record to the Commission for ruling on WSAV's evidence on the WJIV charge of illegal construction [B•T, Oct. 12].

In the ch. 3 contest at Madison, Wis., FCC turned down Badger Television Co.'s (WIBA) petition to return as defective and illegal an amendment filed by Radio Wisconsin Inc. (WISC) showing changes in stock ownership which have occurred since the original bid was filed. FCC also denied Badger's plea for enlargement of issues respecting Radio Wisconsin's financial qualifications.

Respecting the uhf ch. 46 contest between Notre Dame U.'s Michiana Telecasting Corp. at Notre Dame and South Bend Broadcasting Corp. (WHOT), South Bend, Ind., the Commission granted a petition by Michiana to delete hearing issues concerning its financial and technical qualifications since these have been clarified. FCC denied WHOT's plea that the issues be retained with another issue included concerning Michiana's legal qualifications.

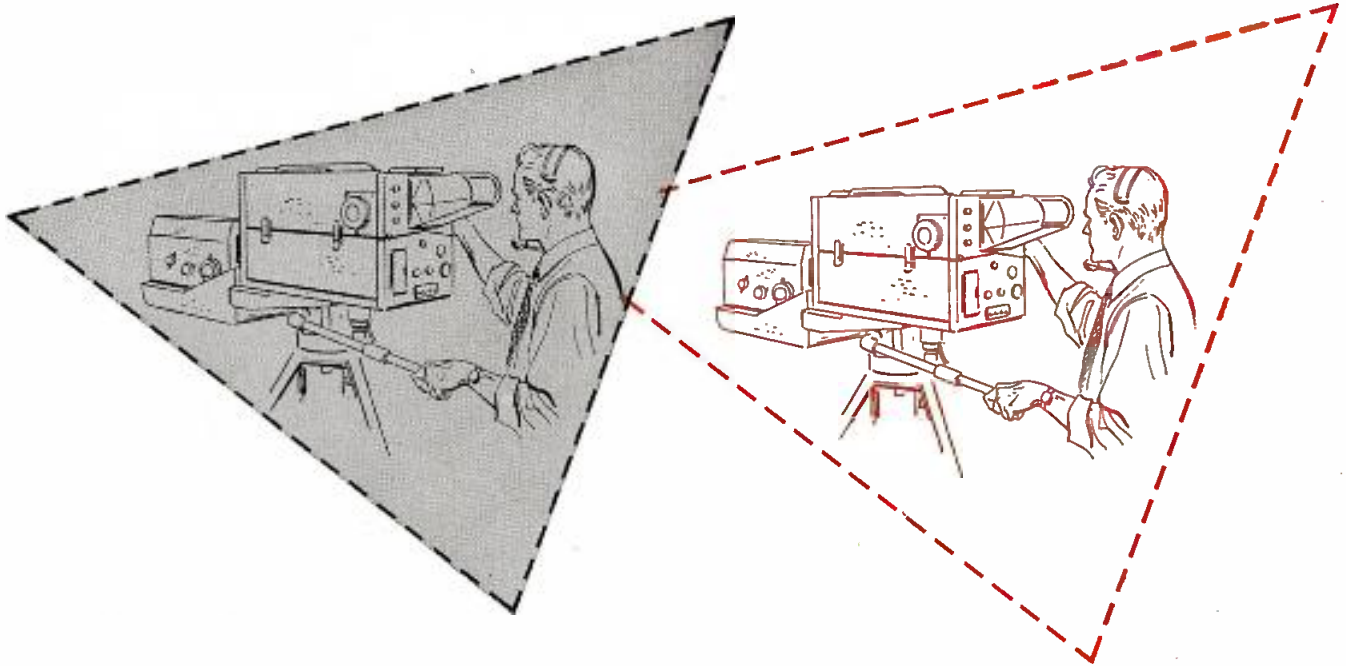

TURN YOUR CAMERA into **TWINS**...

with the **GPL** VARI-FOCAL
LENS

(3" to 15" or
6" to 30" range)

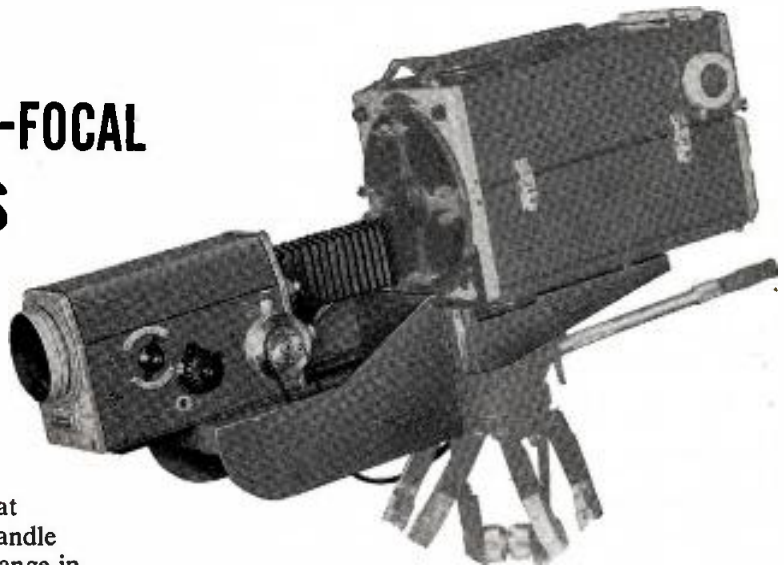

One camera and a GPL vari-focal lens equals the work of two or more chains... at only the cost of a lens. One camera can handle an entire show, for the lens has a 10:1 change in focal length in two 5:1 steps—from 3 to 15 inches and 6 to 30. One camera can be used in studio or field with either range. Interchangeable back elements provide quick shift of two ranges.

Fully color-corrected, this lens has perfect overall focus at $f/5.6$ or higher numbers, in 3-15 range. Flat field over entire range. Motor driven lens is operated from camera or control room.

The GPL Vari-Focal Lens is adaptable to image orthicon cameras of all types.

Now in network use, this lens offers station operators new scope in camera work—new economy in making twins of any camera.

Write, wire or phone for full optical and mechanical specifications.

General Precision Laboratory

INCORPORATED
PLEASANTVILLE NEW YORK



Export Department:
13 East 40th St., New York City
Cable address: Arlab

Cable address: Prelab

Camera Chains • Film Chains • Field and Studio Equipment • Theatre TV Equipment • GPL-Continental Transmitters

Tower Marking Deadline Plan Studied by FCC

A DEADLINE for marking radio and tv antenna towers—so hazards to air navigation will be known even while the tower is under construction—is under consideration at the FCC. The proposal may be forthcoming in a week or two.

Under present rules, towers must be lighted and marked, but there is no specific time limit set for such warning signs except that the provision is part of the construction permit and must be accomplished before the license is granted.

Lighting already is provided for under the rules, so that each time a radio or tv tower rises to a specified height, a light is required to serve as a warning to airplane pilots.

However, painting and additional markings—such as the word "Hazard" in 30-ft. high letters—are not required until completion of the terms of the CP. This is the provision for which a change is under study, to require action before the tower is completed.

Color Tv Threatens Radar for Armed Forces—Adm. Ruble

VEILED implication that the advent of color tv may hamper the procurement of radar equipment for the armed services was voiced last week by Rear Admiral R. W. Ruble, USN, director, Aviation Plans Division, Office of the Chief of Naval Operations, before more than 300 delegates to the fall assembly of the Radio Technical Commission for Aeronautics in Washington.

Admiral Ruble was the featured dinner speaker Thursday night. His remarks touching on color tv followed a tribute to the efficacy of radar during World War II. "We couldn't get it fast enough and we couldn't get enough of it," he said. "We still can't—and with the coming general use of color television, that problem will be intensified."

FCC Allocation Changes Made

FCC made final last week its proposal to add vhf ch. 3 minus to Wilmington, N. C., and vhf ch. 4 to Fayetteville, W. Va., with changes of the offset carrier requirements to plus for ch. 3 at Savannah, Ga., and ch. 4 at Chapel Hill, N. C.

The Commission denied the petition of High Point Enterprises Inc. to assign ch. 6 to High Point, N. C., by deleting that channel from Wilmington, N. C., and Beckley, W. Va., and substituting therefore chs. 3 and 4 respectively. The petitioner operates WHPE High Point. FCC also denied a petition by the Daily Telegraph Printing Co. to assign ch. 6 to Bluefield, W. Va., where it owns WHIS, by substituting ch. 4 for ch. 6 at Beckley.

In another allocation action, FCC noted the counterproposal of WEBC Duluth to add vhf ch. 10 to Duluth (it earlier sought allocation of ch. 12 there) and adopted further proposed rule-making to assign ch. 10 to Duluth and ch. 13 to Buhl, Minn., with uhf ch. 32 to be deleted from Superior, Wis.; vhf ch. 10 from both Hibbing, Minn., and Hancock, Mich., and uhf ch. 26 from Virginia, Minn. Buhl is between Hibbing and Virginia. FCC extended deadline for comments until Nov. 2, with replies due Nov. 12.

TOWER COLLAPSE DELAYS WJHL-TV; SEVEN MORE TV STATIONS COMMENCE

List of starters includes first outlets in five markets, a second for Knoxville, and a third for St. Louis. WJHL-TV plans to quickly erect an emergency tower.

PLANS have been drawn by WJHL-TV Johnson City, Tenn., to construct a temporary 60-ft. antenna tower so it can begin operations as soon as possible in the wake of the collapse of its 556-ft. steel tower Oct. 17, Hanes Lancaster Sr., president, said last week.

Station was scheduled to commence regular programming Oct. 24. All but 120 ft. of the steel tower crashed to the ground, injuring two men. Damage to the transmitter building was not ascertained immediately. Part of the tower steel came to rest on the beams of the unfinished studio building.

This was the second tower to be built for the station. The first was discarded because of defective steel.

First local tv stations came to five cities last week when seven new grantees began regular operation. The five cities getting their initial local outlets are: Yuma, Ariz.; Panama City, Fla.; Lebanon, Pa.; Parkersburg and Wheeling, W. Va. Second local station began airing in Knoxville, Tenn., and the third in St. Louis, Mo.

Of the seven newly operating stations, four were uhf and three vhf. They were:

KIVA (TV) Yuma, Ariz., vhf ch. 11 (DuMont), represented by W. S. Grant.

WJDM (TV) Panama City, Fla., vhf ch. 7 (CBS, ABC), represented by George P. Hollingbery Co.

KSTM-TV St. Louis, Mo., uhf ch. 36 (ABC), represented by H-R Tv Inc.

WLBR-TV Lebanon, Pa., uhf ch. 15.

WTSK (TV) Knoxville, Tenn., uhf ch. 26, represented by Pearson Tv Inc.

WTAP (TV) Parkersburg, W. Va., uhf ch. 15 (ABC, DuMont), represented by Forjoe Tv Inc.

WTRF-TV Wheeling, W. Va., vhf ch. 7 (NBC), represented by George P. Hollingbery Co.

Scheduled to begin commercial operation Dec. 10 on vhf ch. 4, KOMO-TV Seattle made its public bow early this month with a week-long closed circuit telecast, received on sets placed throughout the Bon Marche, Seattle department store, the station reported.

WITV (TV) Fort Lauderdale, Fla., bringing coverage to the Miami area, has moved operations personnel, equipment and supplies to its new studio building in Hallandale in preparation for its first telecast in November on uhf ch. 17. Adjacent to the studio are 35 acres

which WITV will use for outdoor programming, the station said.

Governor John S. Fine of Pennsylvania was to "throw the switch" when WLBR-TV Lebanon, Pa., made its first commercial telecast Sunday on uhf ch. 15, according to the station.

KATV (TV) Pine Bluff, Ark., vhf ch. 7, with target date of Dec. 1, paraded its 1,000-ft. tower on a convoy of trucks through the streets of Pine Bluff and Little Rock en route to the transmitter site.

WKNY-TV Kingston, N. Y., held ground breaking ceremonies last week. Mayor Oscar V. Newkirk was among the speakers. The station expects to be on the air in January on uhf ch. 66.

Stations due on the air in the next 30 days are:

CALIFORNIA

KQED (TV) Berkeley-San Francisco, vhf ch. *9, Nov. 1.

KTVU (TV) Stockton, uhf ch. 36, represented by George P. Hollingbery Co., Oct. 30.

KCOK-TV Tulare-Fresno, uhf ch. 27 (DuMont), represented by Forjoe Tv Inc., Nov. 9.

COLORADO

KLZ-TV Denver, vhf ch. 7 (CBS), represented by The Katz Agency, Nov. 1 (granted STA Oct. 15).

GEORGIA

WRBL-TV Columbus, vhf ch. 4, represented by George P. Hollingbery Co., Nov. 1.

ILLINOIS

WBLN (TV) Bloomington, uhf ch. 15 (ABC), represented by Joseph McGilvra Inc., Nov. 1.

WCIA (TV) Champaign, vhf ch. 3, represented by George P. Hollingbery Co., Nov. 7.

INDIANA

WFIE (TV) Evansville, uhf ch. 62, represented by O. L. Taylor Co., Nov. 1 (granted STA Aug. 6).

WKJG-TV Fort Wayne, uhf ch. 33 (NBC), represented by Paul H. Raymer Co., Nov. 15.

WRAY-TV Princeton, uhf ch. 52, represented by Walker Representation Co., Oct. 31.

IOWA

KGTU (TV) Des Moines, uhf ch. 17, represented by George P. Hollingbery Co., Nov. 11.

KANSAS

KOAM-TV Pittsburg, vhf ch. 7 (NBC, CBS, DuMont), represented by The Katz Agency, Nov. 15.

WIBW-TV Topeka, vhf ch. 13 (CBS), represented by Capper Sales, Nov. 15 (granted STA Sept. 22).

LOUISIANA

KTAG (TV) Lake Charles, uhf ch. 25 (CBS,



NEGOTIATORS of a contract whereby Avery-Knodel Inc. becomes the national representative for WSTV-TV Steubenville, Ohio, can look through this window to the site of the station's present fm and future tv tower. The pactmakers are (l to r) John J. Laux, WSTV-TV vice president-general manager; Lewis Avery of the representation firm; Carl Weinman, secretary, and Jack N. Berkman, president, of WSTV-TV.



YOU MIGHT GET A 1600-lb. BULL MOOSE

**BUT . . . YOU NEED WKZO-TV
TO BAG TV AUDIENCES
IN WESTERN MICHIGAN**

WKZO-TV gets more than twice as many viewers as the second Western Michigan station, morning, afternoon and night. Here's why:

WKZO-TV has a higher TOWER . . . lower CHANNEL . . . greater POWER . . . better RE-LAY FACILITIES . . . finer PROGRAMMING!

WKZO-TV is the Official Basic CBS Television Outlet for Kalamazoo-Grand Rapids. Its brilliant Channel 3 picture effectively serves more than 300,000 TV homes in 27 Western Michigan and Northern Indiana counties—a far larger television market than is available in and around such cities as Rochester, New Orleans or Denver!

Get all the facts and you'll choose WKZO-TV, the dominant station in Western Michigan and Northern Indiana.

WKZO-TV AREA PULSE
(27 COUNTIES)
SHARE OF AUDIENCE—MON.-FRI.—APRIL, 1953

	8 a.m.- 12 noon	12 noon- 6 p.m.	6 p.m.- 12 midnight
WKZO-TV	62% (a)	52%	52% (a)
STATION "B"	26%	25%	25% (a)
OTHERS	12%	23%	23%

(a) Does not telecast for complete period and the share of audience is unadjusted for this situation.



The Fetzer Stations

WKZO—KALAMAZOO
WKZO-TV—GRAND RAPIDS-KALAMAZOO
WJEF—GRAND RAPIDS
WJEF-FM—GRAND RAPIDS-KALAMAZOO
KOLN—LINCOLN, NEBRASKA
KOLN-TV—LINCOLN, NEBRASKA
Associated with
WMBO—PEORIA, ILLINOIS

WKZO-TV

OFFICIAL BASIC CBS FOR WESTERN MICHIGAN

Avery-Knodel, Inc., Exclusive National Representatives



OREGON Gov. Paul Patterson (2d r) officially dedicated Portland's KOIN-TV when it began operations Oct. 15. With the governor are (l to r): C. Howard Lane, managing director of the CBS-affiliated station; M. J. Frey, publisher of the *Portland Oregonian*, and Ted R. Gamble, president of KOIN-AM-FM-TV. The station is the first vhf in Portland, which has had uhf KPTV (TV) for a year.

ABC, DuMont), represented by Adam Young Tv Inc., Nov. 1.

WJMR-TV New Orleans, uhf ch. 61 (DuMont), represented by The Bolling Co., Nov. 1 (granted STA Oct. 14).

MASSACHUSETTS

WWOR-TV Worcester, uhf ch. 14, represented by Paul H. Raymer Co., Nov. 1.

MICHIGAN

WBCK-TV Battle Creek, uhf ch. 58, represented by Headley-Reed Tv Inc., Nov. 1.

MINNESOTA

WJON-TV St. Cloud, vhf ch. 7, represented by William G. Rambeau Co., November '53.

MISSOURI

KOMU-TV Columbia, vhf ch. 8 (ABC, CBS, DuMont, NBC), represented by H-R Tv Inc., Nov. 1.

MONTANA

KOOK-TV Billings, vhf ch. 2 (CBS, DuMont), represented by Weed Television, Nov. 1 (granted STA Aug. 11).

NEBRASKA

KHOL-TV Kearney, vhf ch. 13 (CBS, DuMont), represented by Meeker Tv Inc., Nov. 13.

NEW YORK

WHCU-TV Ithaca, uhf ch. 20, Nov. 15.

WHEC-TV Rochester, vhf ch. 10 (ABC, CBS), represented by Everett-McKinney Inc., Nov. 1 (share time with WVET-TV).

WVET-TV Rochester, vhf ch. 10 (ABC, CBS), represented by The Bolling Co., Nov. 1 (share time with WHEC-TV).

NORTH CAROLINA

WAYS-TV Charlotte, uhf ch. 36 (ABC), repre-

mented by The Bolling Co., Nov. 15.

WCIG-TV Durham, uhf ch. 46 (DuMont, NBC), represented by H-R Tv Inc., Nov. 1.

WCOG-TV Greensboro, uhf ch. 57 (ABC-TV), represented by The Bolling Co., Oct. 30.

WNCT (TV) Greenville, vhf ch. 9 (CBS, DuMont), represented by John E. Pearson Tv Inc., Nov. 15.

OHIO

WIFE (TV) Dayton, uhf ch. 22, represented by Headley-Reed Tv Inc., Oct. 26.

OKLAHOMA

KLPR-TV Oklahoma City, uhf ch. 19 (DuMont), represented by The Bolling Co., Nov. 1.

KCEB (TV) Tulsa, uhf ch. 23, represented by The Bolling Co., Nov. 14.

PENNSYLVANIA

WNOW-TV York, uhf ch. 49 (DuMont), represented by George P. Hollingbery Co., October '53.

SOUTH CAROLINA

WIS-TV Columbia, vhf ch. 10 (NBC), represented by Free & Peters Inc., Nov. 7.

TENNESSEE

WSIX-TV Nashville, vhf ch. 8 (CBS), represented by George P. Hollingbery Co., Nov. 15 (granted STA Sept. 9).

TEXAS

KMID-TV Midland, vhf ch. 2, Nov. 1.

KCEN-TV Temple, vhf ch. 6 (NBC), represented by George P. Hollingbery Co., Nov. 1.

VIRGINIA

WTOV-TV, Norfolk, uhf ch. 27 (ABC, DuMont), represented by Forjoe Tv Inc., Nov. 15.

ALASKA

KFIA (TV) Anchorage, vhf ch. 2 (ABC, CBS), Nov. 1.

Storer Retains Michaels As Manager of KABC

BILL MICHAELS, manager of KABC San Antonio since 1946, will continue as manager of the station under its ownership by Storer Broadcasting Co., George B. Storer Jr., vice president and general manager of San Antonio Broadcasting Co., licensee of KABC and KEYL (TV), announced last week. Storer Broadcasting acquired KABC from Gene L. Cagle, president of Texas State Network, and associates a few months ago. Mr. Michaels has been with the station since 1940, has been broadcasting Southwest Conference football since 1942.



Mr. Michaels



MISS Joan Carol Petry, daughter of Mr. and Mrs. Edward Petry of New York and Spring Lake, N. J., and LeGrand Snowden Redfield were married Oct. 17 in New York. Mrs. Redfield's father is head of the Edward Petry & Co. station representation organization. Mr. Redfield is the son of L. L. Redfield of Picard, Marvin & Redfield Advertising Agency, New York, and is a time salesman for the Petry organization. (New York Times photo).



ARCHITECT'S drawing depicts the \$250,000 building being constructed by Storer Broadcasting Co. in Miami, where Storer will consolidate its national headquarters. Executive offices in Toledo, where the Storer operation started as the Fort Industry Broadcasting Co. 26 years ago, and in Birmingham, Mich., where executive and staff officials (except finance) have been located for the past five years, will transfer to the new 14,000-square-foot building at Broad Causeway (96th St.) and West Bay Harbor Drive. The two-story building, topped by a penthouse, is expected to be completed early next year.

Baskerville Gets WNAO Post

CHARLES G. BASKERVILLE has been appointed general manager of WNAO-AM-FM-TV Raleigh, N. C., station President John W. English announced last week. Mr. Baskerville succeeds Charles W. Stone, who is returning to business interests in Erie, Pa. Mr. Baskerville had been with KRIC Beaumont, Tex., as general manager since May 1952, and earlier was manager of WFLA Tampa, Fla., during his more than 20 years in radio.



Mr. Baskerville



HATCHED!

**WHBQ-TV-MEMPHIS-
IS ON THE AIR!**

Now . . . it's 13 for 11. WHBQ-TV, Channel 13 - a CBS affiliate - now covers the 225,000 television sets (September 1st estimate) in the nation's eleventh wholesale market. Write, wire or telephone for availabilities.



WHBQ-TV

HOTEL CHISCA • MEMPHIS, TENNESSEE

• TELEPHONE 5-0825

• A CBS AFFILIATE

REPRESENTED NATIONALLY BY BLAIR-TV, INC.

BAXTER TO WSFA, MARTIN HEADS WAPI

THE resignation of Lionel F. Baxter, vice president of The Television Corp. and radio operations manager for WAPI Birmingham, to become vice president-general manager of Montgomery Broadcasting Co. Inc., operator of WSFA-AM-TV Montgomery, Ala., was announced last week by Henry P. Johnston, president of The Tv Corp., licensee of WAPI WAFM (FM) WABT (TV) Birmingham, and managing director of the Birmingham News Co.'s radio-tv properties.

Herbert M. Martin Jr., WAPI sales manager



Mr. Martin

Mr. Baxter

since July 1 and formerly sales manager of WSGN Birmingham under Birmingham News Co.'s ownership, will succeed Mr. Baxter at WAPI, Mr. Johnston said. The changes are effective Nov. 15.

Mr. Baxter, who joined WAPI in 1934 as an announcer, became program director in 1938

and in 1949 was made operations manager for WAPI and WAFM. He is president of the Birmingham Advertising Club, a board member of Alabama Broadcasters Assn. and the Birmingham Symphony Orchestra and is past president of the Catholic Men's Club there.

"It is with real regret that we are losing Mr. Baxter, but our best wishes go with him in the new opportunity which has come to him," Mr. Johnston said.

Mr. Martin joined WSGN in May 1950 as sales manager. He came to Birmingham in 1946 and was with a local advertising agency and served a year with the Birmingham Post advertising staff. A native of Auburn and a graduate of Alabama Polytechnic Institute, he was an army officer in World War II and presently is public information officer of the 87th Infantry Division of the U. S. Army Reserve Corps.

WAAM (TV) Sets New Rates

WAAM (TV) Baltimore last week announced new rates effective Nov. 1. The new rates range from \$850 for one hour of Class A time to \$250 for one hour Class E. The station time for the vhf ch. 13 outlet is broken down as follows: Class A—Sunday through Saturday 7:29 p.m.-10:30 p.m.; Class B—Sunday through Saturday 6:59 p.m.-7:29 p.m., 10:30 p.m.-10:59 p.m.; Class C—Monday through Friday 5:59 p.m.-6:59 p.m., Sunday through Saturday 10:59 p.m.-11:29 p.m., Saturday and Sunday 12:59 p.m.-6:59 p.m.; Class D—Monday through Friday 11:59 a.m.-5:59 p.m., Sunday through Saturday 11:29 p.m.-11:59 p.m., Saturday and Sunday 11:59 a.m.-12:59 p.m.; Class E—Sunday through Saturday 11:59 p.m.-11:59 a.m.

HARRE TO MANAGE WENR CHICAGO

ARTHUR F. HARRE, formerly general manager of WJJD and WCFL Chicago, was appointed manager of WENR that city last week.



Mr. Harre

He will report directly to Sterling C. (Red) Quinlan, general manager of WENR and WBKB (TV), who announced the appointment, effective last Tuesday.

Mr. Quinlan said that Mr. Harre's "impact is certain to be felt in the new programming and commercial activities now underway

at WENR" and termed his job as one of the station's "key operating positions."

WPIX (TV) Oct. Sales Up 30%

BUSINESS at WPIX (TV), New York independent, is 30% over that of October 1952, Fred M. Thrower, vice president and general manager of the station, reported last week. He pointed out that sale of spot announcements reached a record high during August and continued "at an even greater pace" during September and October. Mr. Thrower said the current total of 94 individual advertisers is the largest number of accounts for the station.

Worth waiting for!



On the air Christmas Eve...

...NBC
FULL 100kw POWER
CHOICE CHANNEL 4 ★

The Denver Picture

KOA^{TV} 4
NBC in DENVER

CALL PETRY



78 NEW

fifteen minute dramas on film

PLAYHOUSE 15

FIRST RUN in over 115 TV markets

TOP QUALITY

- Made for television by the producer of the network hit shows *BIG STORY* and *T-MEN IN ACTION*.
- Finest stories... best authors
- Leading Broadway and Hollywood actors

HIGH UNIVERSAL APPEAL

- Full variety of stories... comedy... drama... suspense... mystery... human interest
- Combines two of the highest Nielsen popularity classifications—*drama* and *mystery* (averaging 25.7 and 28.4)

LOW, LOW COST

- Costs drastically less for time and program than a half-hour show—yet gives you the same amount of commercial time

FREQUENCY AND IMPACT

- Enables you to reach your customer two, three, or five times weekly as required.

Phone, wire or write today your nearest MCA-TV office for a private screening.

another advertising
SHOWCASE ON FILM from



NEW YORK: 598 Madison Avenue — Plaza 9-7500
CHICAGO: 430 North Michigan Ave. — DEIaware 7-1100
BEVERLY HILLS: 9370 Santa Monica Blvd. — CRestview 6-2001
SAN FRANCISCO: 105 Montgomery Street — EXbrook 2-8922
CLEVELAND: Union Commerce Bldg. — CHerry 1-6010
DALLAS: 2102 North Akard Street — PROspect 7536
DETROIT: 1612 Book Tower — WOdward 2-2604
BOSTON: 45 Newbury Street — COpley 7-5830
MINNEAPOLIS: Northwestern Bank Bldg. — LINcoln 7863
ATLANTA: 611 Henry Grady Bldg. — LAMar 6750

NOW!

Exclusively
in **MEMPHIS** over
WMC 7-8:30 A.M.
STARTING
SEPT. 28

"The HOUR of STARS"

You have heard about this great new Ziv show. We are running it from 7-8:30 A.M., Monday through Friday, to make it the biggest daytime radio buy in Memphis. There will be local tie-ins — civic leaders, men on the street, housewives, all participating and assuring "THE HOUR OF STARS" Memphis' biggest radio audience.

TONY MARTIN

GINGER ROGERS

DICK POWELL

PEGGY LEE

**PARTICIPATING SPOTS NOW BEING SOLD.
CALL OR WIRE YOUR BRANHAM MAN IMMEDIATELY**

W M C

MEMPHIS

NBC AFFILIATE 5,000 WATTS — 790 K. C.

National representatives, The Branham Company

WMCF 260 KW Simultaneously Duplicating AM Schedule

WMCT First TV Station in Memphis and the Mid-South

Owned and Operated by The Commercial Appeal

SOULE, KTFI-KSEI OWNER, DIES AT 81

FUNERAL services were held Tuesday in Salt Lake City for O. P. Soule, 81, principal owner and president of radio stations KTFI Twin Falls and KSEI Pocatello, Idaho.

Mr. Soule, long a prominent attorney in Utah and southern Idaho, died Oct. 17 of a heart attack. He was the senior partner in the law firm of Soule, Day & Cayias, and was active in his work up to the time of his death.

Mr. Soule entered the broadcasting field in 1928 when he and his son, the late Stanley Soule, founded KTFI and later KSEI. Born in Farmington, Utah, Mr. Soule attended the U. of Utah and held a law degree from the U. of Michigan. He was a member of the Radio Pioneers and the Salt Lake City Advertising Club and was a deacon in the Salt Lake Congregational Church.

Mr. Soule is survived by his wife, Hanna Hansen Soule; a daughter, Florence Gardner, two brothers, and a sister. Following Stanley Soule's death in 1937, Mrs. Gardner became general manager of KTFI.

Reeder to Head WCOL Following Smith Death

CHARLES REEDER, program director of WING Dayton for 17 years, has been appointed acting manager of WCOL Columbus, Ohio, J. P. Williams, executive vice president of Air Trails Network, said last week.

Mr. Reeder replaces Neal A. Smith, WCOL station manager, who died Oct. 10 after a heart attack. Mr. Smith managed WCOL from 1937-44, then served at WLW Cincinnati, returning as WCOL manager in January 1952



Mr. Reeder

Mr. Smith

when the station was purchased by Charles Sawyer.

Mr. Williams also announced appointment of Michael Ryan as WCOL program director to replace Myles Foland, who has relinquished that position to devote full time to his radio shows on the station. Mr. Ryan had been at WMRF Lewistown, Pa., NBC New York, WIP Philadelphia and most recently at WLEA Hornell, N. Y., where he was program manager for four years.

Bob Wery, chief announcer and production director at WMNC Morgantown, N. C., has joined WCOL as an announcer and will have his own disc jockey show, Mr. Williams said.

Whitelaw to East for KCBS

SEYMOUR WHITELAW, account executive with CBS-owned KCBS San Francisco, has been named to the new post of eastern sales representative for KCBS, with headquarters in New York. He will work in cooperation with CBS Radio Spot Sales in promoting KCBS sales in the East.

Channel 5 in Kansas City . . .

NEW Low-Band TV

*with that Same
Strong SELL!*

The famous KCMO SELLING ABILITY is now available on television—low-band Channel 5 in Kansas City.

Channel 5 is the low-band hot spot—right in the middle of Kansas City's TV selling picture.

And the sales picture is great! Kansas City and Mid-America make up a rich, diversified big-city, small-town and rural market with high, stable income from agriculture and industry alike.

Fresh, bright programming . . . low-band Channel 5 position . . . strong selling ability, tested and seasoned in radio—it's the KCMO-TV combination that pays off. Ask the Katz Agency, Inc.

Radio—where the KCMO STRONG SELL was developed—is still a top buy. Ask the Katz Agency, Inc., about Kansas City . . . Mid-America . . . KCMO Radio and KCMO-TV.



This is Mr. Harry Wiseman

President, Empire Tire Company,
General Tire Distributor, Billings, Montana



This is what he says

"We have sponsored Fulton Lewis, Jr. over KBMY (Billings, Mont.) for seven consecutive years. Throughout this period our sales have consistently increased. We have been able to trace a large part of this increase directly to our sponsorship of Mr. Lewis. Through the publicity derived, the Empire Tire Co., General Tire Distributor, has become the best known in the Billings trade area."



This is Fulton Lewis, Jr.

whose 5-times-a-week program is available for sale to local advertisers at local time cost plus pro-rated talent cost. Currently sponsored on 364 Mutual stations by more than 750 advertisers, the program offers a tested means of reaching customers and prospects. Check your local Mutual outlet or the Cooperative Program Dept., **Mutual Broadcasting System**, 1440 Broadway, NYC 18 (or Tribune Tower, Chicago 11).

Omaha Stations Stage Red Feather Simulcast

ALL of Omaha's radio and television stations participated in a half-hour simulcast Oct. 11 on behalf of the Omaha Community Chest, according to Harold Soderlund, KFAB Omaha general sales manager and chairman of a simulcast committee of radio-tv executives.

The simulcast's title was "Life Begins With Forty," referring to the 40 Red Feather agencies in Omaha. Stations participating were KBON KFAB KMTV (TV) KOIL KOWH and WOW-AM-TV.

Other members of the simulcast committee were Dick Welna, KBON; Garry Schroeder, KOIL; Frank Fogarty, WOW-AM-TV; Glen Harris, KMTV; Todd Storz, KOWH, and Harry Burke, KFAB. The simulcast was sponsored by the Omaha Advertising Club, which acts as the Chest's publicity committee. Henrietta Keiser of Bozell & Jacobs, Omaha, was chairman of the radio and tv committee.

The program was written by Amos Eastridge of KMTV and Jim Harker of KBON, directed by Paul Borge of KMTV and produced by Lou Jeffrey of KMTV. Most of the radio-tv stations canceled time to clear for the public service program, according to Mr. Soderlund.

The Omaha Community Playhouse furnished actors who created tableaux depicting various problems which the Chest agencies help to solve. Newscasters who told how the agencies solved the problems were Lyell Bremser, KFAB; Ray Clark, WOW-AM-TV; Floyd Kalber, KMTV; Dick McCann, KBON; Dean Naven, KOIL and Virgil Sharpe, KOWH.

Leslie W. Joy Dies; Former KYW Manager

LESLIE W. JOY, former general manager of KYW Philadelphia, died last Wednesday at his home in Chester Springs, Pa.

He had been manager of the station 12 years before retiring in 1947. He also was manager of WDAS Philadelphia for about a year.

Mr. Joy started his radio career at NBC New York as an announcer and was in radio more than 25 years.

Surviving are his wife, the former Ann Lutz; a son; a sister, and two brothers.

T. J. Fontelieu Dies

FUNERAL services for Theodore J. (Teddy) Fontelieu, 56, sales manager of WSMB New Orleans, were held there Oct. 14. He had been sales manager of the station 25 years and conducted several of its early-day disc jockey and special events programs. Mr. Fontelieu was known in New Orleans broadcasting as "the dean of radio."

Mrs. Evans Nord Dies

MRS. NAN NORD, wife of Evans Nord, general manager of KELO-AM-TV Sioux Falls, S. D., died Oct. 17 after a lengthy illness. She is survived by her husband, three children and her parents.

WILS-TV Completes Link

WILS-TV Lansing, Mich., has completed its privately-owned microwave link to Detroit in 24 days, the station announced last week. WILS-TV will carry ABC-TV and DuMont network programs over the connection.

the OK Group



FIRST! FIRST!

FIRST!

YOUR BEST BUY . . . COVER THE GOLD COAST OF THE GULF AREA

CONTINUOUS COVERAGE FROM THE TEXAS BORDER TO PENSACOLA, FLORIDA

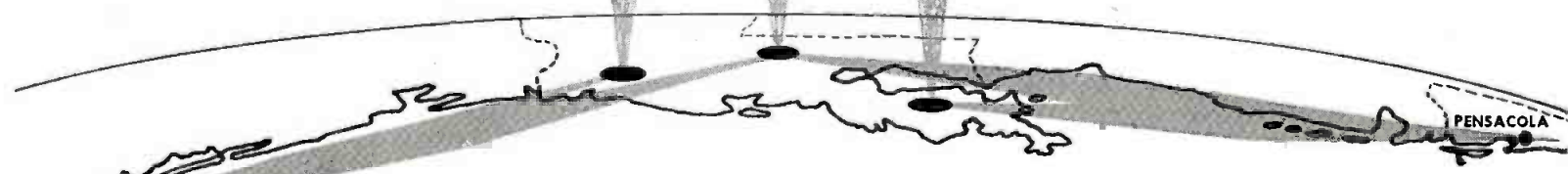

MOONSVILLE
KAOK
★ **FIRST**

WXOK
★ **FIRST**

WBOK
★ **FIRST**

IN

IN

AMONG ALL
INDEPENDENTS IN

LAKE CHARLES

According to the latest O'Connor survey for the month of August, KAOK has the largest share of audience during the entire broadcast day from 7:00 AM to 10:00 PM with 45.1% of the listeners; station "B" has 27.3% and station "C" 19.5%. This big audience with the highest purchasing power in the State of Louisiana has a real potential for national advertisers.

Proven Programming and Results

KAOK's Hillbilly and Negro programs carry a share of audience as high as 70% . . . largest of all stations in the market. Actual proven results for well known national and regional advertisers make this a must for Southwest Louisiana. At low, low rates KAOK on the OK Group package deal is economy purchase that cannot be beat.

BATON ROUGE

According to the latest Hooper survey for the months of June-July WXOK is first in total audience between the hours of 8:00 AM to 6:00 PM with 25.4% of the audience, leading three network stations by substantial amounts. WXOK captured this large share of audience with its tested block programming beamed at the Negro and Hillbilly listeners. National, regional and local advertisers such as bread . . . beer . . . drugs . . . soft drinks . . . coffee . . . department stores . . . appliances . . . have already tested WXOK and have gotten startling results.

Top Notch DJs

Diggie Doo for Blues and Jive . . . Golden Boy for spirituals are the top rated Negro shows in Baton Rouge. Cornpone Bishop and Buzzy Fuzz lead the entire market for 16 consecutive quarter hours during their hillbilly programs. You can't miss with these master pitch men.

NEW ORLEANS

According to the July Hooper report WBOK was first in the morning with a 12.8 share of audience and first in the afternoon with a 12.3 among all independent stations and third in the 11 station market both morning and afternoon. In the quarter hour breakdown WBOK is first in 23 out of 24 quarter hours programmed to reach the Negro. With its hillbilly western programs WBOK is first in reaching this type of White audience. ON WBOK you have block programming with top rated pitch men who dominate the White and Negro market at one low cost.

Major Market Dominance

You can buy New Orleans and the three station OK GROUP at one low cost. Top rated in all three markets you reach a total of over 1,500,000 people with continuous coverage stretching from Panama City, Florida to Orange, Texas.

A Low Cost Buy . . . One Contract . . . One Affidavit . . . One Billing.

Nobody . . . but nobody can reach more people or sell more goods at a lower cost per thousand on the Gold Coast of the Gulf Coast than THE OK GROUP Stations. Make the 3 station buy and save money . . . give your advertiser high power coverage at low priced cost.

WRITE . . . WIRE . . . FOR AVAILABILITIES.

Forjoe and Co.
National Reps.
New York, Chicago,
Los Angeles, San
Francisco and Atlanta



Stanley W. Ray Jr.
Vice President and
General Manager
505 Baronne Street
New Orleans, La.

BERGMANN SEEN SURE TO SUCCEED WITTING AS DTN MANAGING DIRECTOR

The network's general manager is virtually certain to fill the vacancy due Jan. 1 when Witting joins Westinghouse Radio Stations as its president. Further expansion of the WRS broadcasting ventures is indicated by the hiring of the new chief.

ELEVATION of Ted Bergmann from general manager to managing director of the DuMont Television Network was understood to be virtually assured last week in the wake of Managing Director Chris J. Witting's acceptance of the presidency of Westinghouse Radio Stations, effective Jan. 1.

The promotion of Mr. Bergmann to the top operating executive post of the 186-station net-

work has gone through FCC hearings on an application for a tv adjunct for KEX and has applied for a station in Pittsburgh.

In announcing the selection of Mr. Witting as WRS president, Mr. Huggins said it "reflects the increasing importance Westinghouse is placing on its broadcasting activities." Mr. Witting "brings with him an intimate experience with both network and station operations which should prove invaluable to us as we broaden the scope of our television and radio activities," the current WRS chief said.

With the DuMont organization since 1947, Mr. Witting has directed the network operation since 1951, having risen from the general managership. He helped to set up and later directed the organizations which operated WABD (TV) New York, WTTG (TV) Washington, and WDTV (TV) Pittsburgh, all owned by Allen B. DuMont Labs, which also operates the network.

Since his assumption of the managing directorship, the DuMont Tv Network has expanded to a present total of 186 stations, and billings this year are expected to aggregate \$186 million.

Mr. Witting also is chairman of the television committee for Brotherhood Week (see story page 46); was on the committee which super-



MR. BERGMANN

work would be in line with DuMont's policy of promoting from within and also would give recognition to the sales record he compiled during his tenure as director of sales before he was made general manager last July.

Selection of Mr. Witting as full-time president of Westinghouse's pioneering radio-tv station interests was seen as indication that the company intends to put greater emphasis not only on tv, in which it is seeking expansion, but also on the overall commercial aspects of all its broadcasting operations, both radio and television.

E. V. Huggins, who currently holds the WRS presidency, cannot devote full time to that post because of his additional responsibilities as a vice president of the parent company, Westinghouse Electric Corp. But he will continue to maintain top-level supervisory interest in WRS, with Mr. Witting reporting to him.

WRS currently operates five radio stations and two television outlets and is seeking two other tv stations. Its administrative headquarters is in Washington, but—lending credence to reports of increased concentration on commercial phases—the possibility of moving "home offices" to New York coincident with Mr. Witting's assumption of duties reportedly is being considered.

The WRS radio stations are WBZ and WBZA Boston and Springfield (am and fm); KDKA-AM-FM Pittsburgh; KYW-AM-FM Philadelphia, WOWO-AM-FM Fort Wayne, Ind., and KEX-AM-FM Portland, Ore. WRS tv stations are WBZ-TV Boston and WPTZ (TV) Philadelphia. Additionally, the company



MR. WITTING

vised the merger of the NAB and the old Television Broadcasters Assn. into the present NARTB, on whose board he continues to serve; is a member of the Advertising Council, and, last week, was named to the Broadcast Advisory Council of the U. S. Advisory Commission on Information. He was an executive advisor of USO camp shows during World War II, and currently is a member of its advisory board.

Like Mr. Witting, Mr. Bergmann joined the DuMont organization in 1947. He started in the sales department and rose to the post of sales director two years ago, continuing in that office until his promotion to general manager of the network last summer. He is credited with guiding negotiations for many national accounts, including Procter & Gamble, General Foods, and Westinghouse.

*Everybody's
Asking What's*

WVEC-TV's

Conversion Score

In The

Norfolk Area

44,000

As of Monday, October 26,
1953 and growing steadily
at a rate of 2,000 a week!

These conservative figures are based on a dealer survey made by Chilton, Sheffield & Hilton, certified public accountants of Norfolk, and accepted by the NBC Television Research Department for network use. Our sponsors are pleased that so many families converted, within five weeks, to see the great NBC Television programs only on

WVEC-TV

The "Star" Station

Represented by Rambeau

AB-PT QUARTERLY PROFITS \$1 MILLION

ABC division of AB-PT has operated at a loss since the merger, but a profit is expected for this year's last quarter, says AB-PT President Leonard Goldenson.

CONSOLIDATED earnings for the third quarter of 1953 for American Broadcasting-Paramount Theatres amounted to \$1,009,000, although the broadcast division operated at a loss for the third quarter and to date, Leonard H. Goldenson, AB-PT president, announced last week in a report to stockholders.

He pointed out that the loss sustained by the broadcasting operations had been anticipated and he attributed it to "normal seasonal slack and the initial costs involved in reorganizing and strengthening the operations of the radio and television networks and stations of ABC."

Mr. Goldenson said the earnings reflected a profit in the operations of the theatres amounting to \$946,000 and to \$63,000 in capital gains. He said theatre attendance in "certain of the major metropolitan areas which have reached tv set saturation in the past year or two has continued strong." He commented that the third quarter brought the public unveiling of Cinemascope with the movie, "The Robe," and its success "lends substance to the belief that wide-screen presentations can make an important contribution to the motion picture industry."

Despite the losses suffered by the ABC division to date, Mr. Goldenson said, the division is expected to operate at a profit in the fourth quarter. He pointed out that several of the new ABC television programs have received favorable public response and referred to the extensive advertising and promotion campaign over ABC stations as another factor that will stimulate the public interest in ABC.

"With the public looking and listening more and more to the television network and its affiliates," Mr. Goldenson said, "advertisers and advertising agencies are turning in increased numbers to ABC as an effective advertising and merchandising medium."

Mr. Goldenson noted that figures for the third quarter and for the nine months of 1953 included the ABC division as of Feb. 10, 1953, and prior to that date included WBKB (TV) Chicago, which was sold after the merger to comply with government regulations.

The third quarter figure of \$1,009,000, Mr. Goldenson said, compares with net earnings of \$1,927,000 for the same period of 1952, of which \$300,000 represented capital gains. For the first nine months of the year AB-PT consolidated earnings of \$7,559,000 were reported, of which \$4,377,000 was listed as capital gains. This compared with net earnings of \$5,435,000 for the corresponding period of 1952, of which \$1,465,000 was capital gains.

AT&T Hookups Reach 207

WROW-TV Albany, WKLO-TV Louisville and WTVH-TV Peoria have been connected with AT&T's nationwide tv network facilities, making a total of 207 interconnected stations in 131 cities, AT&T has announced. The company also reported that a new Louisville-Atlanta microwave route has been opened, immediately providing two new telephone channels in each direction and with a southbound tv channel to be made available later this year for program transmission from Louisville to Nashville.

Factory-fresh

SEALED

for your protection

Now you can be sure the RCA-5820 Image Orthicon you buy for replacement use is new, unused and untouched by human hands since it left the factory. Each RCA-5820 is sealed in its own tamper-proof, transparent container.

The unbroken seal is visible assurance that you are the first to take the factory-fresh 5820 from its container.

Customer protection like this is a typical example of RCA's never-ending effort to provide TV and broadcast stations with the most dependable tubes the industry can offer.

See your local RCA Tube Distributor for fast service on factory-fresh Image Orthicons . . . and all types of RCA Tubes.



RADIO CORPORATION of AMERICA
ELECTRON TUBES

HARRISON, N. J.

The tumult and
the shouting dies

... And WTAR-TV
Remains the only
Station that Delivers
the Norfolk Market

ARB Reports on VHF — UHF Reception
in the Norfolk Metropolitan Area: *

VHF (WTAR-TV) Saturation	79.6%
	(140,175 TV homes)
UHF (Channel 15) Saturation	10%
	(17,521 UHF homes)
Total WTAR-TV Circulation in 41 counties ... Oct. 1 ...	199,600 TV homes

*ARB Survey Sept. 15 — 21 inclusive covering the Norfolk-Portsmouth
and Hampton-Warwick-Newport News Metropolitan Areas.

WTAR-TV

All in the Family

NBC is taking pains to point out that "Dragnet," the song based on the radio and television show of the same name, reached—and has been heard on—the *Hit Parade*. With Liggett & Myers sponsoring the *Dragnet* shows for Chesterfield cigarettes and American Tobacco Co. (Lucky Strike cigarettes) underwriting the *Hit Parade* on an alternating basis, there had been speculation as to whether the *Dragnet* theme would ever be heard on the *Hit Parade's* "Lucky Seven" [B•T, Sept. 14]. NBC pointed out that it made it—and was heard Oct. 10. NBC's interest? The network carries both *Dragnet* and *Hit Parade*.

NBC Uses New Camera Tube To Transmit 2 Film Shows

WHAT NBC claims is the smallest television film camera tube ever developed for broadcast use was introduced on two NBC-TV film programs fortnight ago. It is a Vidicon tube, described by NBC as weighing only two ounces but possessing three times the sensitivity of the iconoscope tube normally used for film pickup [B•T, Oct. 5].

O. B. Hanson, NBC vice president and chief engineer, said the tube was used in the transmission of *Superman* on WNBT (TV) New York and the *RCA Victor Show* starring Dennis Day over the full NBC-TV network (Mon., 9-9:30 p.m. EST).

The tube was developed by the RCA Victor Division of RCA, and is the outgrowth of the Vidicon tube for industrial closed-circuit tv systems announced by RCA last year. It measures one inch in diameter and six and one-quarter inches in length. Among features are:

It equals or exceeds the iconoscope tube in quality of picture produced; because of its small size and simplicity, it makes possible more compact and less expensive tv film cameras and associated equipment for film pickup; it contributes no appreciable noise to the video signal; it needs only one-third the light requirements of an iconoscope tube for televising motion picture films; it is "highly suitable" for reproduction of color films on a monochrome system; it shows no grain structure and provides a precise picture reproduction unaffected by electron distribution, edging effects or flare; with a spectral response characteristic approaching that of the human eye, it produces a picture with "vastly improved" gray scale.

ABC-TV Adds 4 Outlets, Bringing Total to 163

ADDITION of four stations to ABC-TV as affiliates, raising the total to 163, was announced last week by Alfred R. Beckman, national director of the ABC radio and television station relations departments. The new affiliates are: WROL-TV Knoxville (ch. 6), owned and operated by the Mountcastle Broadcasting Co., with W. H. Linebaugh as general manager, effective Oct. 1; KCRI-TV Cedar Rapids, Iowa (ch. 9), Cedar Rapids Television Co., with Frank D. Rubel as general manager, Oct. 15; KTVQ (TV) Oklahoma City (ch. 25), Republic Television & Radio Co., with John Esau as general manager, Oct. 25, and KRBC-TV Abilene (ch. 9), Reporter Broadcasting Co., with Howard Barrett as general manager, about Nov. 1.

WINSTON-SALEM NORTH CAROLINA

HEART OF THE BILLION DOLLAR
PIEDMONT TOBACCO MARKET

WTOB-TV

FIRST with Television in
WINSTON-SALEM

NOW IN FULL OPERATION



nationally represented by

H-R

TELEVISION, INC.

NEW YORK • CHICAGO • SAN FRANCISCO • LOS ANGELES

ABC
DUMONT
INTERCONNECTED
CHANNEL 26

JAMES S. AYERS, Southeastern Representative



DuMont Adds 25 Shows, Sees 'Strongest' Schedule

INCORPORATION of 25 new shows into the DuMont Television Network's programming this fall has resulted in "the strongest and most attractive schedule" ever presented by DuMont, according to James L. Caddigan, director of programming and production.

He said the programming covers a wide range of formats and has been designed for viewers of varied tastes and interests. He listed such programs as the *Chicago Symphony Orchestra* and *Opera Cameo Shows* for the serious music lover; *Foursome*, *Mono-Drama* and a series featuring actor Joseph Schildkraut, for the drama fan; *The Roy Doty Show*, *Magic Cottage* and *Saddle Scouts*, for children, and *Love Story*, *Glamour Secrets*, *Kitchen Faire* and *The Igor Cassini Show*, for women.

Two Buy 'Today' Time

LUDEX'S Inc., Reading, Pa., will sponsor nine participations on NBC-TV's *Today* program (Mon.-Fri., 7-9 a.m. EST), starting tomorrow (Tuesday), and the National Cranberry Assn., Hanson, Mass., has ordered three participations on the same show, starting Nov. 3. Agencies are J. M. Mathes, N. Y. (Luden's) and BBDO, N. Y. (National Cranberry Assn.).

TO KTVQ TELEVISION CHANNEL 25 OKLAHOMA CITY

NOW! LIVE CLEARANCE for your programs in the Oklahoma City market, one of America's richest markets!

Watch Oklahoma City . . . Watch KTVQ Television



To Reserve Time on KTVQ, Write, Wire or Call John Esau, or —

H-R TELEVISION, INC.

NEW YORK 17, N. Y.
Chrysler Bldg.
MUrray Hill 9-2606

CHICAGO 1, ILLINOIS
35 E. Wacker Dr.
RAndolph 6-6431

SAN FRANCISCO, CAL.
110 Sutter St.
EXbrook 2-3407

HOLLYWOOD, CAL.
Equitable Bldg.
GRonite 1480



SHAKING hands on it after KHOL-TV Kearney, Neb., signs a primary affiliation agreement with CBS-TV are Herbert V. Akerberg (l), CBS-TV vice president in charge of station relations, and Duane L. Watts, KHOL-TV station manager.

WKY-TV to Drop CBS-TV As KWTV Nears Affiliation

WKY-TV Oklahoma City last week served notice on CBS-TV, which recently signed KWTV (TV) as its forthcoming basic affiliate there, that it will not carry CBS-TV programs after Nov. 14. KWTV is slated to start operations about mid-December.

WKY-TV, a basic NBC-TV affiliate, was said to have taken the position that it was not feasible to continue to carry CBS-TV programs which soon would be moving to an opposition station. The same attitude reportedly caused two other NBC-TV basic outlets, WDAF-TV Kansas City and WTMJ-TV Milwaukee, to cancel CBS-TV programs in the past few months.

WKY-TV was said to have been carrying approximately 30% of the CBS-TV commercial program schedule.



Throughout The Rochester Area



THEY'RE WATCHING



ROCHESTER BECOMES A TWO TV STATION CITY ON NOVEMBER 1st . . . and every TV viewer in the whole Rochester area is pretty excited about it.—And why shouldn't they be?—For Channel 10 will bring this third largest market in New York State the galaxy of star-studded CBS and

CHANNEL 10

ABC net work shows,—most of which have never been seen here before.

It's not too early—nor too late—to get your product on the station that all eyes are on!

CHANNEL 10 VHF

CBS BASIC • ABC AFFILIATE

OPERATED SHARE TIME BY

WHEC-TV • WVET-TV

FOR AVAILABILITIES, ADDRESS ERVIN F. LYKE
CHANNEL 10, ROCHESTER 4, NEW YORK

ROCHESTER, N.Y.

EVERETT-McKINNEY, INC. • NATIONAL REPRESENTATIVES • THE BOLLING CO., INC.

NBC-TV'S 'ROSAH' SEEKS HOLIDAY ADS

PLAN to attract to television some of the holiday advertising dollars traditionally spent in printed media, which was announced Monday by Sylvester L. (Pat) Weaver, NBC vice chairman and head of NBC-TV Network programs, met with a generally favorable reception by the network's tv affiliates, he reported later in the week.

Called "Run-of-Schedule Advertising—Holidays," the plan offers advertisers the chance to run one-minute filmed announcements in unsold portions of five NBC-TV weekday morning programs, with NBC to determine the precise location of each announcement, as magazines deter-

mine the position of the advertisements in any issue. ROSAH became effective immediately and runs through Dec. 31.

In his message announcing the ROSAH plan to all NBC-TV affiliates, Mr. Weaver said, "A purchaser will be informed, probably after the run, where and when his advertising appeared and the circulations reached where ratings are available. It is expected that Nielsen ratings can be sent advertisers for their records and, of course, all advertisers can judge from general program ratings what the average value in circulation terms will be."

Programs included in ROSAH are all broadcast Monday through Friday, between 10 a.m. and noon. They are: *Ding Dong School*, 10-10:30 a.m.; *Glamour Girl*, 10:30-11 a.m.; *Hawkins Falls*, 11-11:15 a.m.; *The Bennett*

Story, 11:15-11:30 a.m.; *Three Steps to Heaven*, 11:30-11:45 a.m., and *Follow Your Heart*, 11:45 a.m.-12 noon.

Price of each announcement is \$3,530 gross, commissionable. Two one-minute participations will be placed in 15-minute programs, three in half-hour shows, Mr. Weaver said.

"We will always place orders with you for an entire program period of either 15 or 30 minutes, specifying products to be advertised," he told the stations. "We will place such orders as far in advance as practicable and in every case you will have advance notice of at least one full working day. You will receive your full compensation for each program period on the same basis as if one sponsor had purchased an entire period."

ABC Cites Station Growth For Improved Tv Position

IN ITS STUDY of uhf and the importance of that portion of the tv band (see story page 78), ABC took occasion to point out its own improved position as a network with the growth in number of stations.

"The launching of uhf stations, together with the construction of new vhf stations, vastly improves ABC's clearance picture," the network said in its booklet, "The P's and Q's of V's and U's.". "This fall, ABC-TV can assure the network advertiser of broad coverage and excellent clearance."

Before the lifting of the licensing freeze last year, ABC asserted, ABC-TV had 63 affiliates, about two out of three of which were in single-station markets. "By Sept. 1 [1953]," the report continued, "ABC had 154 affiliates, an increase of 150%. Of these affiliates, three out of five—59%—are in multichannel markets."

Further, the report asserted, "ABC-TV has considerably better inside coverage of the top 200 retail sales markets than any other network." Of these 200 markets, the report said, ABC-TV has local stations in 127, whereas "the nearest competing network has inside coverage of only 116" (CBS-TV).

Officials said ABC-TV currently has signed 57 to 60 uhf affiliates.

LaRosa, Bleyer Dismissals Attributed to Outside Work

DISMISSAL of singer Julius La Rosa from all Arthur Godfrey CBS programs and of musical conductor Archie Bleyer from all Godfrey shows except the Monday night *Talent Scouts* was announced last week in a move attributed to the outside professional activities of Mr. La Rosa and Mr. Bleyer.

Mr. Godfrey told a news conference in New York Wednesday that Mr. La Rosa had been dismissed largely because he had signed a talent management contract the previous week with the General Artists Corp. though he knew of the Godfrey policy that prohibits outside management for his entertainers. He said Mr. Bleyer had been released largely because he had made a recording featuring Don McNeill, an ABC personality, for his record company, Cadence Records and Publications Co., New York, with which Mr. La Rosa also is associated. He said that Mr. Bleyer's contract for the *Talent Scouts* program has eight more weeks to run, and indicated that the conductor will be retained for an indefinite period beyond that date.

Mr. La Rosa's contract with CBS is still in effect. The singer would join Ed Sullivan on *Toast of the Town*, starting yesterday (Sunday).

Judge a Station By the Companies It Keeps—

As of October 1, during the prime hours of 6:00 P.M. to Midnight, sixteen different *programs* were being sponsored by national or regional spot advertisers on WGN-TV.

Twenty other *programs* were being sponsored by local retail advertisers.

WGN-TV produces results for advertisers—large or small—so why not make your next buy your best buy—WGN-TV in Chicago.



The Chicago Tribune Television Station

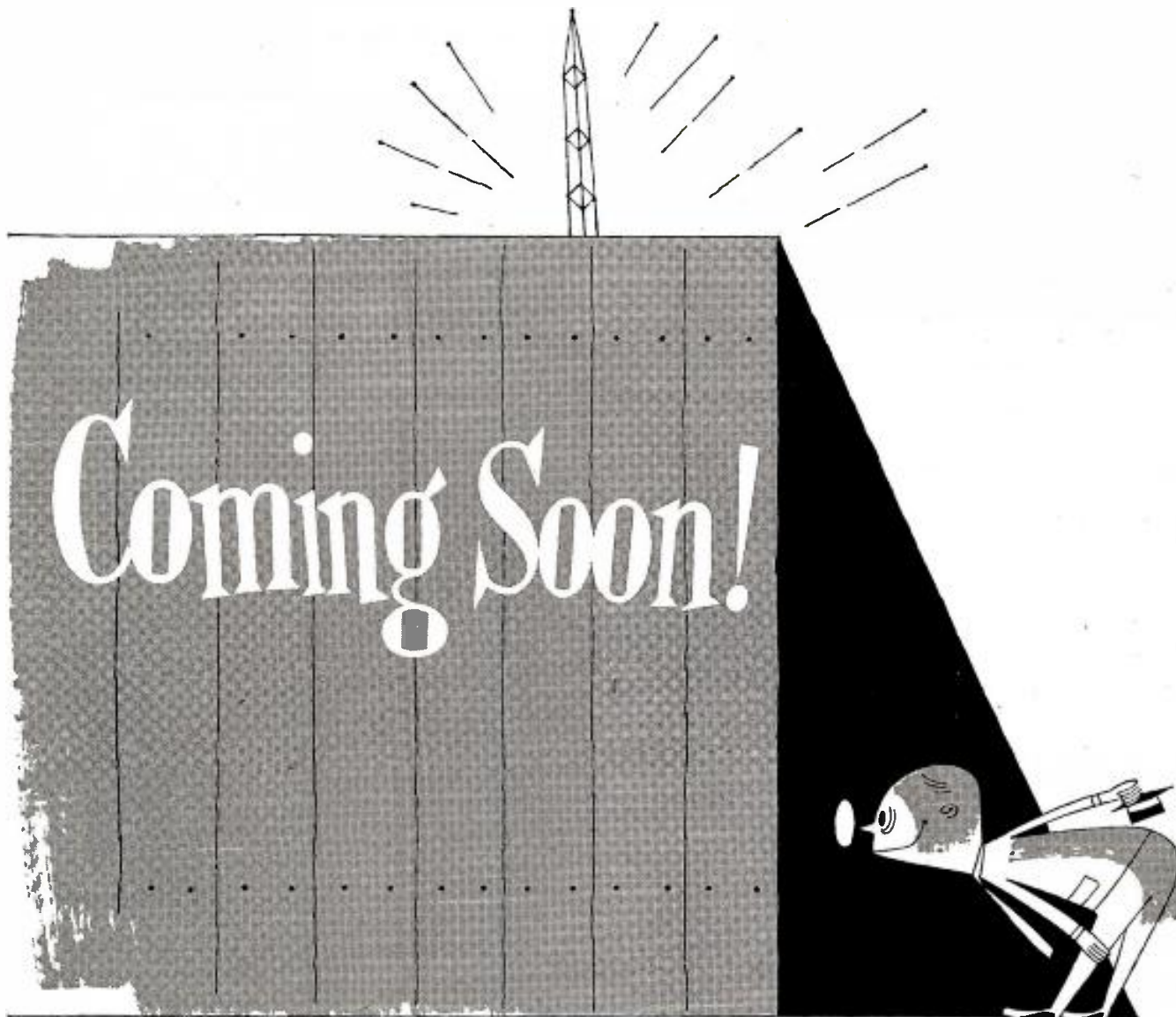

With a 5-fold increase in power

WOWO

FORT WAYNE

**will extend its signal to cover a
rich Midwestern market including**

1,700,000 additional people

Now nearing completion at a cost of more than a quarter-million dollars, the new WOWO transmitter is another example of Westinghouse's continuing faith in radio. WOWO, always outstanding for *audience-action*, will become Indiana's only full-time 50,000-watt station . . . serving 3,701,600 people and offering advertisers a greater value than ever!



WESTINGHOUSE RADIO STATIONS Inc
WBZ • WBZA • KYW • KDKA • WOWO • KEX • WBZ-TV • WPTZ
 National Representatives, Free & Peters, except for TV;
 for WBZ-TV and WPTZ, NBC Spot Sales

ABC BOOKLET COMPARES UHF AND VHF

Network releases booklet designed to set the record straight about uhf as compared with vhf in providing nationwide service. The network in mid-November also will release an ARB study on viewing habits in uhf-converted homes.

A DRIVE to set the record straight about uhf and its essential role alongside vhf in providing nationwide television service was launched last week by ABC with the release of a 59-page booklet, "The P's and Q's of V's and U's."

Unveiling the study to newsmen Thursday afternoon preliminary to distributing it among advertisers, agencies and others, ABC officials also disclosed that the network has commissioned American Research Bureau to conduct what ABC considers the first nation-wide study of viewing habits in tv homes which have converted to uhf. Results are expected to be available in mid-November and officials said that, perhaps for the first time among networks, ABC was committing itself in advance to reveal the findings "even though we do not know now what they will be."

Oliver Treyz, ABC director of research and sales development, pointed out that approximately three homes out of five now have tele-

vision and estimated that approximately 10% are uhf-equipped. He said ARB studies had shown that, as of September, there were 50 markets reached by both uhf and vhf signals and that, in these markets, the median penetration of uhf in television homes was about 50%.

To point up uhf's growth, Mr. Treyz noted that in June there were 32 such "mixed" markets and that uhf's median penetration in these was 46% of the tv homes. For these same 32 markets the median penetration of uhf had increased to 62% by September, he asserted. It also was estimated that in the "typical" market uhf reaches or passes 50% conversion in 60 to 90 days.

Referring to the forthcoming ARB viewing-habits study, Mr. Treyz said:

"It is believed that the homes which first convert to uhf are the heavy viewing homes. It is known that television, like any other medium, is somewhat selective, in that certain homes view more than others.

"It is quite likely, therefore, that the heavy viewing homes are the first to convert to uhf. The study which ABC has commissioned ARB to undertake this month will develop data on the hours of total viewing by uhf-equipped and vhf-only homes. It will develop national ratings for specific network programs in two classifications: vhf-only homes and homes equipped to receive both uhf and vhf stations."

Ernest Lee Jahncke Jr., ABC vice president and assistant to the president, said it is ABC's view that uhf's only "disadvantage" as compared to vhf is in circulation—and that this will be cleared up in time. From the standpoint of stations, it was pointed out that as of the preceding week there were 199 vhf and 93 uhf outlets on the air; counting stations authorized and under construction as well as the operating stations, uhf had almost pulled even, with 241 grants and stations compared to 281 vhf grants and stations, while in the matter of total allocations uhf is far ahead, FCC having provided for 1,281 uhf and 504 vhf stations.

Asked about sponsors' attitudes toward uhf, Mr. Treyz said he knew of no "sponsor defections" from uhf, but did know of uhf "sponsor accretions."

Engineering Vice President Frank Marx, discussing technical features, predicted that within two years at least one uhf station would be on the air with the maximum permitted power of 1,000,000 w (one megawatt).

Phillipson Quits ABC In Policy Differences

WILLIAM PHILLIPSON, general manager of ABC Western Division, last Monday in New York resigned (effective Nov. 1) over disagreements on policy with Earl Hudson, Western Division vice president. Not elaborating on the nature of the disagreements, Mr. Phillipson said he was in complete accord with other network executives.

Although offered an executive post with ABC in New York, Mr. Phillipson said he turned it down, preferring to remain on the West Coast. A practicing attorney in New Jersey before joining ABC New York four years ago, he became Western Division general manager a year ago. For a year prior to that he was Western Division director.

After Mr. Phillipson's resignation, Mr. Hudson announced that the post of Western Division general manager has been eliminated. Besides absorbing some of those responsibilities himself, others have been assigned to Fran Conrad and Donn B. Tatum, director of radio and television, respectively, for ABC Western Division, he said.



take a shot at a

HALF-BILLION DOLLAR MARKET
over Columbia, South Carolina's most powerful station—

WNOK-TV

COLUMBIA — one of America's fastest-growing cities! U. S. Census reports 39.3% increase between 1940 and 1950 — three times the national average.

COLUMBIA — center of thriving 14-county trading area. Population: 595,700. E.B.I. \$578,686,000!*

*SOURCE—Sales Management Survey of Buying Power May 10, 1953 — covering 14-county trading area credited to Columbia, S.C.

Network Affiliation:



WNOK-TV Channel 67
CBS-TV—Du Mont
WNOK 1230 kc.
MUTUAL



PALMETTO
RADIO CORPORATION

Studios: 1811 Main Street • COLUMBIA S.C.



Early 18th Century Blunderbuss

KROD-TV

The MOST POWERFUL TRANSMITTER IN THE FABULOUS SOUTHWEST!



NOW YOU'LL SELL EVEN MORE on CHANNEL 4

KROD-TV has been operating on full power — 56,300 watts, since August 1st, from the finest transmitter location in the Southwest, atop Mt. Franklin, 1585 feet above downtown El Paso.

This means **EVEN BETTER COVERAGE** of the Fabulous Southwest. This means **EVEN BETTER PICTURES** in an enlarged KROD-TV Trading Area.

This means that more of the best programs — locally and on the CBS, DuMont and ABC networks will reach an even greater audience.

Naturally you'll sell **EVEN** more on KROD-TV because you'll reach more prospects.

Planning a TEST Campaign? El Paso is the perfect test market. It's more than 400 miles away from any city of equal size or larger. It is the center of distribution for the Fabulous Southwest.

It's the Nation's largest trade territory with a total population of over half a million. Write us for complete details on our amazing, low-cost testing plan.



Affiliated with KROD — 600 Kc — CBS — 5,000 Watts
and the El Paso Times

**RODERICK
BROADCASTING CORPORATION**

Dorrance D. Roderick
Chairman of Board

Val Lawrence
Pres. & Gen. Mgr.

Dick Watts
Gen. Sales Manager

Nationally Represented by the
BRANHAM COMPANY



what a row of beans can amount to . . . with **wfmy-tv**

Rows of canned beans, to be exact . . . pinto beans. One year ago the Mountain View Canning Company took the wise step of advertising its Luck's Pinto Beans on WFMY-TV.

Well sir, a hillbilly band was featured on a weekly 15-minute show — and the fame of Luck's Pinto Beans raced across WFMY-TV's 29 counties with the speed of Jack's Beanstalk!

Last year Mountain View produced about 750 cases of Luck's Pinto Beans a week. This year it's over 5,000 cases a week! Factory space and staff have tripled, and still grocers can't keep a row of these beans on the shelf!

Sales magic like this is nothing new with WFMY-TV. When the people in 29 surrounding counties have \$1,500,000,000 to spend . . . the only TV station tapping all that buying power is bound to be popular with advertisers and viewers!

wfmy-tv

Basic CBS Affiliate — Channel 2
Greensboro, N. C.

Represented by
Harrington, Righter & Parsons, Inc.
New York—Chicago—San Francisco

RADIO IS MEDIUM OF TRUTH—SARNOFF

RCA-NBC board chairman speaks at luncheon where he received citation for contributions to religion and democracy.

ALONG with churches and synagogues, radio was described last week by Brig. Gen. David Sarnoff, chairman of the boards of RCA and NBC, as the institution that brings truths to the peoples of the world behind and outside the Iron Curtain.

Gen. Sarnoff offered this evaluation Thursday at a luncheon in New York at which he received a citation from the Jewish Theological Seminary of America for his contributions to "religion in all its manifestations, to American democracy and to civilization itself." The citation was presented in commemoration of the tenth anniversary of the *Eternal Light* radio program (Sunday, 12:30-1 p.m. EST), which is carried as a public service by NBC under the auspices of the seminary.

Gen. Sarnoff acknowledged that his characterization of radio as a carrier of truths, along with churches, was a "startling statement," and he conceded he had not thought of radio in this light until he heard a former Polish diplomat tell of his experiences behind the Iron Curtain. At an American Heritage Foundation dinner in Washington Wednesday night, Gen. Sarnoff said, this man spelled out clearly that the churches and the free radio stations were the only media that could carry the truth to freedom-starved peoples.

"The invisible waves of radio, truly a manifestation of an 'infinite reason,' recognize no national origins or territorial frontiers," Gen. Sarnoff asserted, "nor do they discriminate against race, religion or creed. And no matter how hard the forces of evil try, they cannot control the air waves. Somehow, people who want the truth badly will hear it."

The citation was presented to Gen. Sarnoff by Dr. Louis Finkelstein, chancellor of the seminary, and was read by Edgar J. Nathan Jr., member of the board of directors of the seminary and chairman of the *Eternal Light* Committee. It read in part:

David Sarnoff, Brigadier General, U. S. Army, chairman of the board, Radio Corp. of America and the National Broadcasting Co., on behalf of the faculties, board of directors and board of overseers of the Jewish Theological Seminary of America, we extend to you and your associates in NBC cordial felicitations at the opening of the tenth year of the *Eternal Light* radio program. The notable achievements of this instrument for spiritual enlightenment of the whole community are based on the remarkable teamwork developed between the officers and staff of NBC and their colleagues at the seminary. . . . Your vision has contributed mightily to Judaism as a faith, to religion in all its manifestations, to American democracy and to civilization itself.

Brief talks were made by Rev. Edwin B. Broderick, director of radio and television communications for the Archdiocese of New York; Rev. Clayton Griswold, chairman of the board, Broadcasting & Film Commission of the National Council of the Churches of Christ in U.S.A., and Rabbi Simon Kramer, past president of the Synagogue Council of America.

CBS-TV Signs Director Vail

LESTER VAIL, veteran director of stage, radio and tv, has signed a long-term contract with CBS Television, Hubbell Robinson Jr., CBS Television vice president in charge of network programs, announced Thursday. His initial assignment will be to direct *Meet Millie*, returning to CBS-TV Oct. 31, Sat., 7-7:30 p.m.

Milwaukee's New Baby is no longer an Infant

FROM TODDLER TO MILWAUKEE'S **BIG TV**
STATION IN A FEW SHORT WEEKS

Yes, **WCAN-TV** Milwaukee's million-dollar TV baby, changed from diapers to long trousers fast. On the air a week and **WCAN-TV** was walking right into tens of thousands of Milwaukee homes. NOW, only FIVE WEEKS LATER, **WCAN-TV** is running high, wide, and handsome all over town, into almost 150,000 homes.

He's really covering the rich Milwaukee market for canny local advertisers. And **WCAN-TV** is getting blanket coverage for America's largest and smartest national advertisers.

So, if you haven't seen Milwaukee's newest baby, take a peek now. For even a baby knows that in Milwaukee you're seen best on Channel 25, **WCAN-TV**.



PRIMARY AFFILIATE

CHANNEL 25, MILWAUKEE

REPRESENTED NATIONALLY BY O. L. TAYLOR & CO. ALEX ROSENMAN, NEW YORK, BUSINESS MANAGER

FCG Endorsed by NABET; Covers Production Employees

Film Craftsmen's Guild sets worker classifications. New organization hopes to avoid 'feather-bedding,' prepares invasion of AFL jurisdiction.

JURISDICTION over employes of all types in any kind of motion picture production will be held by the recently organized Film Craftsmen's Guild whose affiliation with the National Assn. of Broadcast Engineers & Technicians was endorsed at the recent NABET national convention in Buffalo. With only the affiliation terms to be worked out, FCG is preparing for an invasion of the AFL-held motion picture production field.

The constitution, as set up by the fifty-member charter group of Hollywood workers in FCG, encompasses workers in two classifications: Type A covers production of films over two minutes in length made for television release and production of films intended for theatrical release which are budgeted over \$50,000 each; Type B covers production of films primarily for training, industrial, government and education purposes, budgeted under \$50,000 each and television commercials of less than two minutes in length.

Established work classifications include director, unit manager, production manager, assistant director, first, second, third and animation cameraman, sound mixer, electrician, carpenter, prop man, art director, picture, sound and tv newsreel editor, script clerk and others.

FCG has been designed, a NABET spokesman pointed out, to eliminate "feather-bedding" by furnishing complete production units to producers, thus necessitating their dealing with only one union.

Officers of the new organization are Donald Henderson, production manager, president; Melvin R. Kells, cameraman and editor, vice-president; John E. Mattias, film editor, secretary, and Marcia Endore, film editor, treasurer. Richard Kaplan, writer-producer and film technician, is membership committee chairman.

Through FCG, NABET is expected to add more video film bargaining contracts to those already in effect in the field in addition to those held for radio-tv station publicists, engineers, transcription clerks, office workers and others.

KFRE to Vote on IBEW

ELECTION to decide if technical employes wish to be represented by IBEW has been ordered at KFRE Fresno, Calif., by National Labor Relations Board. The bargaining unit as specified by NLRB includes technicians as well as employes cutting, processing and spinning records, transcriptions and tapes, with professional and supervisory employes excluded. The station had contended that tv employes should not be included in the unit since the station is merely an applicant. NLRB reached no decision regarding employes who have been operating tv test equipment.

TWA's Writing Course

TELEVISION Writers of America offers its second weekly seminar course of eight lectures for writers hoping to enter the field, starting Oct. 28. The course, held in Hollywood, features talks by established tv writers, producers, actors and agents on the art and craft of preparing various types of tv scripts.

GE, DuMont Report Transmitter Shipments

GE shipped transmitters and amplifiers to the following tv stations and grantees last week: 5 kw transmitter to KHOL-TV Kearney, Neb. (ch. 13); 20 kw amplifier and six-bay antenna to WSIX-TV Nashville, Tenn. (ch. 8); 35 kw amplifier to WRGB (TV) Schenectady, N. Y. (ch. 6); 1 kw amplifier to KFSA-TV Fort Smith, Ark. (ch. 22); 12 kw transmitter to KTVU (TV) Stockton, Calif. (ch. 36). Also shipped were six-bay antennas to KTTV (TV) Los Angeles (ch. 11); KTVA (TV) Anchorage, Alaska (ch. 11) and WTVJ (TV) Miami (ch. 4). Five-bay antennas were shipped to KCOK-TV Tulare-Fresno, Calif. (ch. 27); WJMR-TV New Orleans (ch. 61); KLPR-TV Oklahoma City (ch. 19), KACY (TV) Festus, Mo. (ch. 14); WKAR-TV East Lansing, Mich. (ch. 60), and WLOU-TV Louisville, Ky. (ch. 41). A four-bay antenna was shipped to KING-TV Seattle.

GE also announced that new contracts signed last week were as follows: for November delivery, 5 kw transmitter to Ridson Inc., Superior, Wis. (ch. 6), and WAPA-TV San Juan, P. R. (ch. 4). Signed for delivery of a 12-kw amplifier was WCAN-TV Milwaukee (ch. 25) and for a 12 kw transmitter WTVT (TV) Chattanooga, Tenn. (ch. 43).

DuMont announced that it has sold a 25 kw transmitter to Lee Radio Inc., Mason City, Iowa (ch. 3), and that it has shipped a 25 kw transmitter to its owned WDTV (TV) Pittsburgh (ch. 2).

GE Electronics Creates Laboratories Department

CREATION of a Laboratories Department within GE's Electronics Division was announced Friday by Dr. W. R. G. Baker, GE vice president and general manager of the division.

Brig. Gen. Tom C. Rives (U.S.A.F. Ret.) has been named to direct the unit, which will comprise activities of the Electronics laboratory at Syracuse, N. Y., and the Advanced Electronics Center at Cornell U., Ithaca, N. Y. The new unit's headquarters will be at Syracuse.

Gen. Rives has been manager of technical military liaison for GE since 1950.

DuMont Sales Up 26%

NET SALES of Allen B. DuMont Labs. for the first 40 weeks of 1953 were reported last week at \$65,896,000, which was said to represent a 26.4% increase over sales of \$52,128,000 for the same period in 1952.

Profit before provision for Federal income taxes amounted to \$1,910,000 as compared with \$718,000 for the corresponding period last year. Net profit after taxes was \$935,000 as against \$359,000 for the 40-week period in 1952.

RETMA's 'Kite and Key'

DEVELOPMENT of the electronics industry from Benjamin Franklin's kite flying days to the present age is depicted in layman's language in a new booklet, *The Kite and the Key*, which Radio-Electronics-Television Mfrs. Assn. is distributing. Publication was authorized by RETMA's board of directors on recommendation of its membership promotion committee. The electronics story takes in radio, tv and then pushes forward from mass communications to modern warfare, medicine and electronic gadgets. Distribution can be handled in limited quantities by RETMA's headquarters, 777 14th St. N. W., Washington 5, D. C.

Graham Named to Duties Of Electrotechnical Unit

ELECTION of Virgil M. Graham, director of technical relations of Sylvania Electric Products Co., New York, as a vice president and member of the executive committee of the U. S. National Committee of the International Electrotechnical Commission was announced last week by the American Standards Assn., the American parent body of IEC.

IEC is the international standardizing organization in the electrical and electronics field with the objective of promoting the interchangeability of the electrical and electronic equipments of various nations in all countries.

Mr. Graham, who has been active in standardization work in the radio and electronics field for 30 years, is chairman of the communications and electronics sections of the electrical standards board of the joint electron tube engineering council of the Radio-Electronics-Television Mfrs. Assn. and the National Electrical Mfrs. Assn., and associate director of the RETMA engineering department.

Ideco Promotes Irwin

PATRICK IRWIN has been appointed erection department manager of Ideco, Columbus, Ohio,



Mr. Irwin

C. E. Ponkey, president, announced last week. Mr. Irwin will supervise the erection of Ideco radio and television towers and industrial and commercial steel buildings.

Mr. Irwin, who joined Ideco in July 1946, was an engineer in the building engineering department prior to his present promotion.

During World War II he served as commanding officer of a tanker after attending the Coast Guard Academy at New London, Conn.

Record Sales for Sylvania

RECORD net sales and earnings for Sylvania Electric Products Inc. for the first nine months of 1953 were reported Thursday. Sales, at \$224,469,087, were 38% over the \$162,222,117 for the same period last year; income, at \$7,562,941, was 50% over the \$5,031,701 of 1952. Per-share basis on stocks was \$2.73 on 2,425,506 common shares outstanding; last year's per-share was \$2.18 on 1,867,872.

RCA Gear to WATZ, WTCM

RCA Victor Division's Engineering Products Dept. has shipped new 250 w am transmitters to WATZ Alpena and WTCM Traverse City, both Michigan, and both licensed to Midwestern Broadcasting Co., the department said last week. WATZ is on 1450 kc, WTCM is on 1400 kc.

Gates Ships Three

TRANSMITTERS for one new station, one which is replacing its old unit and one which is increasing power have been shipped by Gates Radio Co., it was announced last week by L. J. Cervone, Gates' general sales manager. In order, they are: a 250 w unit to WMTS Murfreesboro, Tenn.; a 250 w unit to WJMB Brookhaven, Miss.; and a 500 w transmitter to WWPF Palatka, Fla.

BROADCASTING

TELECASTING

features

anyway you survey it . . .

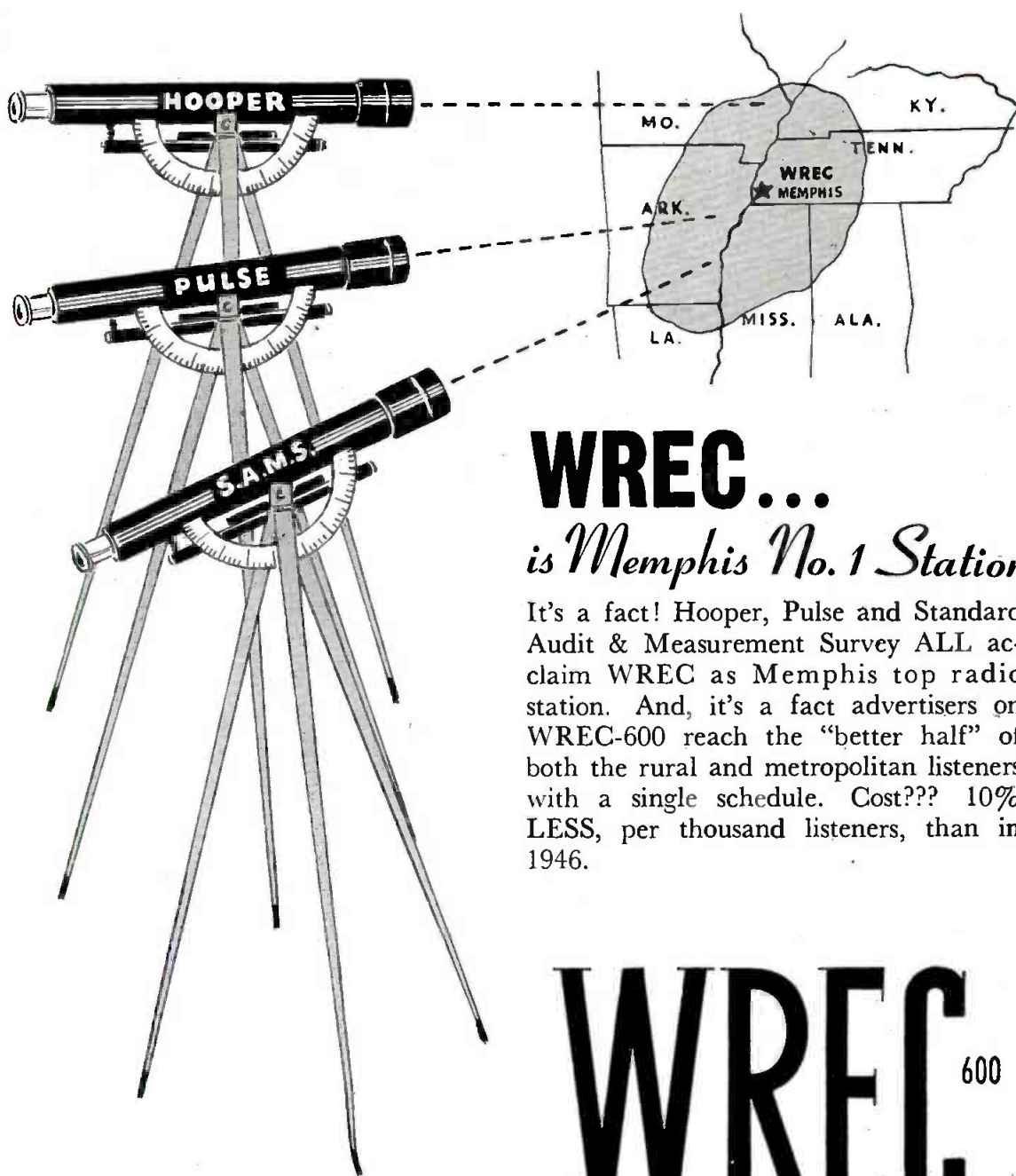

WREC...

is Memphis No. 1 Station

It's a fact! Hooper, Pulse and Standard Audit & Measurement Survey ALL acclaim WREC as Memphis top radio station. And, it's a fact advertisers on WREC-600 reach the "better half" of both the rural and metropolitan listeners with a single schedule. Cost??? 10% LESS, per thousand listeners, than in 1946.

WREC

600

MEMPHIS NO. 1 STATION

REPRESENTED BY THE KATZ AGENCY . . . Affiliated with CBS Radio—600 KC—5,000 Watts

Reprints of articles
appearing in this section
are available
at nominal cost. Write to

BROADCASTING - TELECASTING
Readers' Service, Room 870
Nat'l Press Bldg., Washington 4, D. C.

TV PREMIERE!

THE UNITED STATES STEEL HOUR

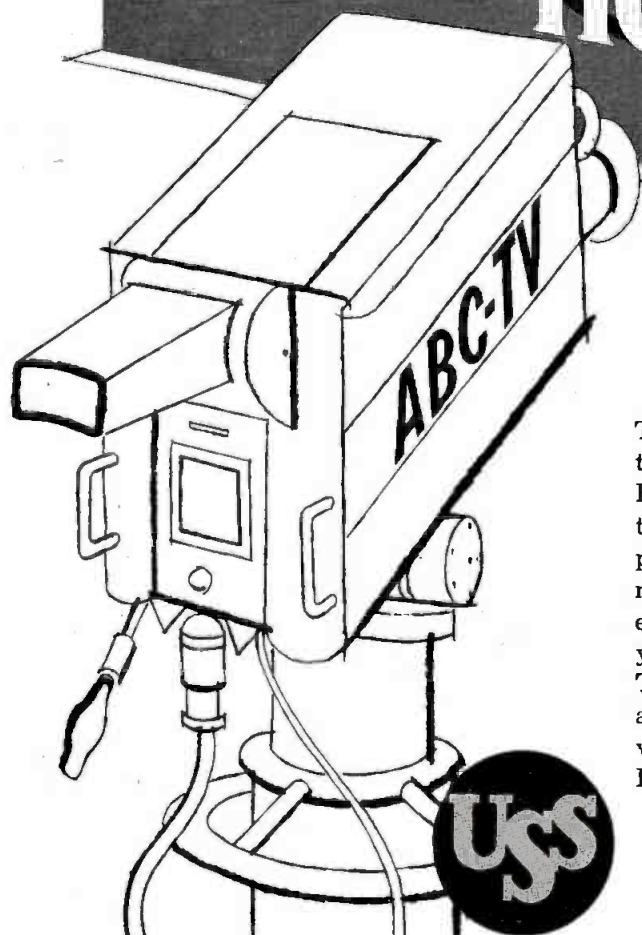

The United States Steel Corporation announces with pride the first performance of **THE UNITED STATES STEEL HOUR**—a new TV show designed to bring fine dramatic entertainment into homes across the nation. The stories: new plays written especially for TV and adaptations of famous novels, all with a broad popular appeal. The stars: both established personalities of movies and TV and promising youngsters on their way to the top. Produced by the famous Theatre Guild, **THE UNITED STATES STEEL HOUR** aims to compel the interest of America's discriminating viewers. *The first show is "P.O.W." and it stars Gary Merrill.* Don't miss it.

9:30 p.m. *Alternate Tuesdays*
WABC-TV — CHANNEL 7

In other cities, check your local newspapers for station, channel, day and time

f features

- The low-down on hi-fi: What it means to broadcasters. Page 86.
- Is tv already in a rut? Two top agency men think so. Page 94.
- How Toni Co. promoted national prom queen contest. Page 98.

Getting the word at its source

Listeners Tell Why They Are

WHY do listeners like radio?

WGAR Cleveland decided to find out by asking the listeners themselves. Accordingly, the station conducted two "I Like Radio Because . . ." contests—one on Henry Pildner's show at 5:15 p.m. and the other on Hal Morgan's classical music program at 10:30 p.m.

The result was 3,000 letters from listeners, with a total of 12,000 reasons why they preferred the aural medium. The information originally was intended to be used as a WGAR guide for future program planning, according to the station, but the tabulation of radio's appeals has evolved into an effective promotional weapon.

WGAR, which reports it already had suspected that radio's "lusty 1953 status is based on key assets never adequately documented," said nearly 48% of the survey responses indicated that people like radio because it is possible for them to do something else while listening.

The key reasons favoring radio, as disclosed by the replies to WGAR, are:

▶ Because it is a great time saver. "People can listen while doing other things.

▶ Because of its versatility and wide program selection. With several stations available in most areas, there's always something on radio to fit the mood.

▶ Because it is the most relaxing form of entertainment. It lightens the most arduous form of work.

▶ Because it is mobile, moving from room to room and outdoors, wherever people go.

▶ Because it is effortless, requiring only the twist of a dial for information and entertainment.

▶ Because it exercises the imagination, providing drama with limitless scenery.

▶ Because it is timely, presenting last-minute news in relatively unbiased fashion.

▶ Because it is available anytime, providing 'round-the-clock news and musical service in most regions.

▶ Because its freedom of choice represents and helps preserve American freedom and democratic ideals.

WGAR reports it also collected a number of "snappy advertising slogans" from the contests. Examples: "You can only stay in the know, wherever you go, with radio." "With cost so low and entertainment so high, radio must surely be today's best buy." "Radio has first word in news, last word in entertainment." "Radio enables me to see with my ears while I look at what I'm doing." "Wherever I go, I take my show, with a portable radio."

WGAR also tabulated individual preferences of listeners, with popular music first choice among 57% of respondents. Some 49.6% listed drama, comedy and variety as favorite program types. News-casts and commentary rated second behind music on 51% of returns. Other favorite program types were sports, religion, home-making, discussions, weather and time reports.

The station said it is "hammering away on the all-media promotional front" with the ideas documented through the study, and that WGAR Program Director Reg Merridew is planning drastic format changes to take better advantage of radio's exclusive qualities.

Best expressing radio's relation to television, WGAR reported, was this entry:

"I like my radio because of its single sense-appeal sound. Like a good impressionist painter, radio leaves to my own creative mind the pleasurable occupation of completing the picture. I thereby create characters physically appealing to me, settings that fit my fancy, and unite them in emotions befitting the occasion."



*A big new bet for radio
is the music-loving audience
that buys high-fidelity gear*

LOW-DOWN

HIGH-FIDELITY (Hi-Fi), a new hobby that has touched off another mass production industry, has many definitions—almost as many definitions as cycles.

They range all the way from just plain “good-listening” and “realism” to “psycho-acoustical sophistication.”

The enthusiasms of the hobby’s addicts cover just as wide a range. Most of these addicts play their avocation from the depths of living-room sofas as lovers of realistic reproduction of music. At the other extreme are the tinkerers whose torrid enthusiasm over the shriek of a clarinet is exceeded only by the searing heat of a nearby soldering iron.

At the living-room end of the hi-fi hobby rests the makings of a new market for manufacturers of electronic and audio devices.

More important to broadcasters is the audience potential—probably the most promising source of new listeners and increased listening that has developed since television started competing for public attention.

Putting it bluntly, hi-fi will greatly improve the broadcaster’s product at the point of delivery—the listener’s ears.

This relatively new burst of interest in the quality of reproduced sound means that the public wants to enjoy more fully two products of long standing—broadcast signals and phonograph records.

It promises to start, at last, a new era for ears.

It promises, also, to dispel the illusion that lovers of long-hair music are the only people who like good sound from their loudspeakers.

The facts of hi-fi life have been grossly exaggerated and dramatized in recent magazine articles, whose very appearance is a testimonial to the rapid growth of public interest in good listening. Sales of the

components that go into custom and hobbyist installations have been estimated as high as \$700 million a year at retail, and the number of homes with very good sound systems has been placed at figures soaring upwards to five million.

Wringing out the enthusiasm and sales puffery of hi-fi’s ardent protagonists, the actual retail situation looks about like this:

- Sales of component parts to public in 1953—\$70 million.
- Sales of phonograph records in 1953—\$225 million.
- Sales of all types of radio sets in 1953—\$241 million.
- Sales of all types of tv sets in 1953—\$1,377 million.

That’s the 1953 equipment situation, based on best available information from Radio-Electronics-Tv Mfrs. Assn., RCA and other sources. A rather small share of radio and tv production can be described as hi-fi.

Now, how about 1954, assuming entrance of hi-fi into the mass production phase brings the public response anticipated by major manufacturers? Here is an educated guess, based on the same sources:

- Sales of component parts and hi-fi radio-phonograph assemblies—\$200 to \$300 million, depending on how fast the mass-produced stuff catches fire.

Should that goal be attained, there will be at least five times as many homes with very good sound systems at the end of 1954 as there are today. RCA Victor, which has been working hard for some months on the hi-fi problem, hopes the total may be 10 times the 1953 figure.

That raises the question nobody can answer: How many homes are equipped with sound devices that will turn out good reproduction?

RETMA has been trying for months to set up a statistical system for hi-fi, but thus

far hasn’t been able to get its manufacturing members to agree on definitions of minimum standards.

If one out of 25 radio homes of the estimated 43 million has high-quality sound, the hi-fi audience could be estimated at 1.7 million homes. Some of hi-fi’s best friends, however, place it at around a million.

The surest sign that hi-fi has emerged from the fad phase to enter the mass market is found in the sudden activity at RCA-Victor, Philco, Admiral, General Electric and other major manufacturers.

These companies have been scanning the reports of their statisticians and engineers. They see in hi-fi a new business opportunity. That’s why their recent advertising has started to emphasize the ability of their radios, phonographs and tv sets to supply high-quality sound.

Mass production for a mass market will be reflected soon in much more intensive advertising—and intensive advertising has been responsible for nearly every industrial success story in the nation’s history.

Those who have been crystal-balling hi-fi’s future believe that one out of every four or five homes is a good prospect for good sound equipment.

The big electronic manufacturers contend that hi-fi can attain mass proportions only if it can be supplied in a ready-made package that can be fit into the living room as easily as a television set. A compromise is found in the lines of most manufacturers, mass and custom. These firms now supply speakers, amplifiers, pickups, turntables and other gear in flexible assortments that can be assembled with a screwdriver, to suit the buyer’s taste and pocketbook.

For the fussy there are combinations that cost up to \$1,000, and on up some more, if desired. Then there are modest starter outfits that can be put together for \$100.

Some of the consumer advertising for this

By J. Frank Beatty

ON HI-FI

equipment is really luscious. For instance: "silky smooth"; "hemispheric sound"; "gratify your wish for excellence"; "incomparable"; "golden matched"; "concert hall realism."

An excursion into the salubrious semantics of hi-fi promoters will leave the non-technical customer in a temporary tizzy but after a few hours of study the situation starts to clear up and he'll be tossing off such terms as "tweeter" and "woofer" with the abandon of a veteran (see glossary, page 88).

Right inside the broadcasting industry rages a hi-fi argument that's good for heated debate any time am and fm executives get together.

The fm-only operator is likely to insist that wide-range sound with a high degree of fidelity is unobtainable on am. The fm proponent will argue unto death that if it isn't flat to 15,000 cycles it isn't hi-fi. Raymond S. Green, who runs WFLN (FM) Philadelphia, contends that if it isn't fm, it isn't hi-fi broadcasting.

On the other hand, Elliott M. Sanger, operating WQXR-AM-FM New York and one of the first of the good-music broadcasters, contends his am stations audio signal is flat to 8,000 cycles, and falls off 5 db at 15,000 cycles. This, he contends, satisfies most of the music lovers, so long as harmonic distortion is avoided.

Another good-music operator who has both am and fm, Robert Rogers of WGMS-AM-FM Washington, D. C., points out that an am station can be flat to 10,000 cycles and that the transmitter can be modulated to 15,000 cycles if side-band splatter doesn't clash with stations on adjacent channels. In an area four or five miles around the transmitter, he added, am can be about as good as fm depending on static and other interference.

Frank H. McIntosh, consulting engineer

and developer of high-rated amplifier circuits, says am stations can easily adapt their equipment to compare favorably with fm both as to distortion and signal-to-noise ratio close-in to the station. He explains that am modulators are available that will effect an on-the-air distortion, both harmonic and intermodulation, of less than 1% from 20 to 20,000 cycles.

Pickups, pre-amplifiers and main amplifiers, he adds, will perform at less than 0.5% distortion "and in fact will compare as above stated with fm in all respects except from background and noise-rejection standpoints." He said all weak links such as poor microphones and poor recordings must be eliminated.

Hi-Fi Broadcasting

To obtain high-fidelity, according to Mr. McIntosh, the broadcast station (am particularly) needs a new modulator, recheck and analysis of the audio channel from microphone and pickup head out. For the fm station, there should be a re-check of noise and distortion characteristic of transmitter (which ordinarily should be well below 1%), plus a check of the audio channel right from the microphone and pickup.

He says the theory that the ear could not appreciate less than 4% to 5% distortion is no longer subscribed to by experienced engineers since tests show people can detect a change in distortion of 0.5% or less.

Mr. McIntosh stresses the importance of record pickups that will play without plowing off the high-frequency waveforms.

Any time two people try to define the term "high-fidelity" and the more popular "hi-fi" the results are likely to be diversified if not confusing. The purist thinks in terms of a perfectly true signal from 30 to 15,000 cycles whereas the more practical manufacturer, thinking in terms of volume

markets, is willing to settle for maybe 60 to 10,000 cycles and throw in a latitude of plus or minus 8 db—a tolerance whose mere mention is likely to rip asunder the sensitive ear drums of the purist.

Everett L. Dillard, operator of WASH (FM) Washington, who has helped nurse fm through what he confidently believes are its worst years, defines hi-fi this way: "low harmonic distortion in transmission and reception, wide audio frequency band width and low noise level." Getting less technical, he paraphrases it this way: "realism in reception or feeling of presence."

Harry F. Olson, of RCA Labs., offers this simple definition for the layman: "sound reproduction in which characteristics of the original are reproduced with realism and naturalness."

Manufacturers have been disagreeing for years on what constitutes high-fidelity and some of the claims actually are of no help to the buyer who knows what he wants. With the skyrocketing of hi-fi popularity in the last two years they have been trying, through RETMA, to reduce this technical jargon to some form of uniformity so people would be able to buy intelligently.

Unfortunately the joint effort by equipment makers to agree on standards and definitions as well as a hi-fi seal has run afoul of intra-industry feuding. A set of definitions was nearing the final stages a fortnight ago under a subcommittee headed by F. M. Slaymore of Stromberg-Carlson. This RETMA-sponsored movement was set back months when the small component makers staged an anti-big-fellows debate. They charged that a set of minimum standards would ruin the terms hi-fi and high-fidelity because everyone would cut down to the minimum.

The large production-line companies argue that phony advertising claims of high-fidelity for obviously inferior stuff will spoil

these terms, now backed by years of prestige and promotion. They note that the small custom firms still can make superior gear far above the minimum standards and attract the big spenders.

Last Oct. 15 Mr. Slaymore's subcommittee threw up its hands and an impasse has been reached while a new subcommittee is named to study what action should be taken towards adoption of a code of advertising practices [B•T, Oct. 19].

Had the small vs. big factories feud not developed, RETMA might have been able to insert the advertising code into the Fair Practice Code soon to be adopted for the whole set manufacturing industry under Federal Trade Commission sponsorship.

So the manufacturers find themselves unable to adopt a seal that would prevent sale of inferior goods under a hi-fi banner. With possibility that hi-fi advertising abuses continue there may be need for an entirely new set of terms. RETMA's board may solve the problem at its November meeting.

Hi-fi's peculiar value to broadcasters lies in the fact that all but the tinkering faddists are interested in music—classical, semi-serious and popular. Even the tinkerers are music lovers, spending much more time listening than gadgeteering.

Good Music Fans

Stations specializing in the more enduring forms of music have found that one out of ten radio listeners likes classical selections of the operatic, symphonic and concert type. They figure that 3½ million families are regular listeners to good musical broadcasts.

This figure is steadily increasing, sparked by the fast-expanding supply of good-music programming on fm and the astonishing improvement in the quality of phonograph records.

Good Music Broadcasters Inc., a 14-station group stretching across the nation, claims it regularly serves 1½ million homes, and its list does not include many of the major cities. Another 22 stations want to join the group, which sells time on any segment or all of the stations.

GMBI has such national sponsors as John Middleton tobacco, Omega watch, Swiss Knight cheese, Air France, French government tourist office, *Atlantic Monthly*, Scandinavian air lines and Macmillan books.

The spread of hi-fi already has doubled the audience of some music stations. This audience, contrary to popular conception, is not limited to retired professors of philosophy and dreamy students. It is quite the contrary—a cosmopolitan group of lawyers, bricklayers, mechanics, doctors, housewives, high school kids, ministers, clerks, reporters, chemists and assorted others.

At the same time it is above average in that 55% are college-educated and 50% own their homes.

Even if it were confined to lovers of long-hair music, GMBI recalls that 30 million people attend concerts in a year compared to the 45 million who see ball games.

It reminds, too, that good-music listeners listen an average of three hours a day and 20 hours a week, with a majority in the 32-50-year-old bracket.

WQXR-AM-FM New York feeds an extensive northeastern hookup with its hi-fi

HI-FI JARGON

AUDIO—Alternating current translated into sound by the ear; usually between 50 and 15,000 cycles.

AUDIOPHILE—Hi-fi fan who takes it seriously.

BAFFLE—Loudspeaker chamber partition giving additional front-to-back low-frequency radiations.

CARTRIDGE—Crystal or magnetic device converting movement of needle into electrical signals.

CROSSOVER NETWORK—Filter dividing passage of different frequencies to separate speakers.

CYCLE—Basic unit of sound frequency (cycles per second).

DECIBEL—Comparative unit of loudness.

DRIFT—Slow changes in pitch due to uneven turntable speed (not wow); shift of signal on dial.

DISTORTION—Added sound frequencies not found in original performance.

FILTER—Electrical device altering frequency response.

FLUTTER—Rapid change in pitch due to uneven turntable speed.

MAGNETIC PICKUP—Electrical coil in magnetic field changing needle motion into electrical signals.

RUMBLE—Noise caused by poorly mounted turntable motors.

TWEETER—Loudspeaker for high-frequency sounds.

WOOFER—Loudspeaker for low-frequency sounds.

WOW—Severe changes in tone pitch caused by uneven turntable speed.

musical service, most of the stations taking the fm signal out of the air and supplying fm service to their listeners. Starting out in the 30s as W2XR on 1560 kc with wide-band service, John V. L. Hogan and Elliott M. Sanger pioneered serious music programming. The *New York Times* bought WQXR in 1944.

The two WQXR signals are now broadcast on a "binaural" or two-channel basis so that persons who want all possible realism can feed an am set in one corner of a room and an fm set in the other. WQXR now claims a half-million families as regular listeners in the New York area, and estimates 40% of New York's 3½ million homes have fm receivers.

Operating in the Northeast is another regional hookup, Rural Radio Network, aiming originally at the farm populace of New York State. It grew out of a cooperative effort by 10 farm organizations, starting with six stations in 1948 and now comprising a 13-station fm network feeding specific programs to a 16-station am network.

Donald K. deNeuf, RRN general manager, said the network has an agreement with WQXR, carrying 10 hours a day of WQXR programming from New York. RRN's own audience, he said, runs around 128,000 families. Its list of advertisers has

included such national firms as Allis-Chalmers, Aluminum Corp. of America, Amana, Avco, Ball Bros., Beech-Nut, General Electric, Simon & Schuster, United Fruit and Zenith, to mention a few.

Continental hi-fi network, with WASH (FM) Washington as key, feeds a 15,000-cycle intercity high-fidelity line with musical programming. Symphonic programs, concerts and service band music are fed over the line to WFKN (FM) Philadelphia, KE2XCC Alpine, N. J. (Maj. Armstrong's fm station), WXHR (FM) Cambridge and WGBH (FM) Boston (educational). Programming averages three hours an evening. WCFM (FM) and WGMS Washington are cooperating with WASH in supplying live concert material to Continental.

WFLN (FM) Philadelphia started hi-fi music of the serious type in 1949. Growth of interest in music is shown, Mr. Green said, by audience expansion from 50,000 homes in 1950 to 125,000 in 1952 and 270,000 in 1953.

Similar stories of growth are told by WGMS; Jean Putnam of WCFM (FM) Washington; Steven A. Cisler, KEAR (FM) San Francisco; Edward A. Wheeler, WEAW (FM) Evanston, Ill., and many others.

Robert Rogers, with both am and fm at WGMS (call letters stands for "good music station"), argues that stations can't live on long-hairs alone. Programming of the stations ranges from Burl Ives and show music to the symphonies and operas. Education of young people to the charms of better music broadcast with fidelity is bringing results, he said.

Hi-Fi Advertising

He observes that retailers, distributors and manufacturers of hi-fi radio and phonograph gear are finding hi-fi stations an excellent way of reaching their best prospects.

C. Leslie Golliday, of WEPM-AM-FM Martinsburg, W. Va., says the expansion of the hi-fi hobby means "more listeners, and all radio station operators should be highly interested in anything which means more dials tuned to their frequency. Perhaps in high-fidelity we have the salvation of fm broadcasting and at the same time something which can offer television stiff competition. Above all, high-fidelity enthusiasts are concerned with 'listening'."

One way of measuring interest in good-music stations is to note the number of listeners who pay \$1 upward to buy monthly program listings. A few examples: WQXR, 60,000 subscribers; WGMS-AM-FM 7,500; WFLN 10,000 and KEAR KXKY (FM) San Francisco, 6,000. KEAR has a Friends of Good Music Club whose members pay \$5 a year dues and get the program guides free, plus other benefits. Last summer Mr. Cisler offered to sell 1,000 shares of KEAR preferred voting stock at \$50 to finance a 10 kw transmitter and supply capital for a year. The alternative was to drop good music July 1. Listeners showed their loyalty by subscribing and paying in over \$53,100.

Listener loyalty is one of the important phases of the two "goods"—good music and good sound reproduction. Music listeners spend more time listening to radio and owners of hi-fi equipment use it consistently.

At that point arises one of the special

(Continued on page 93)

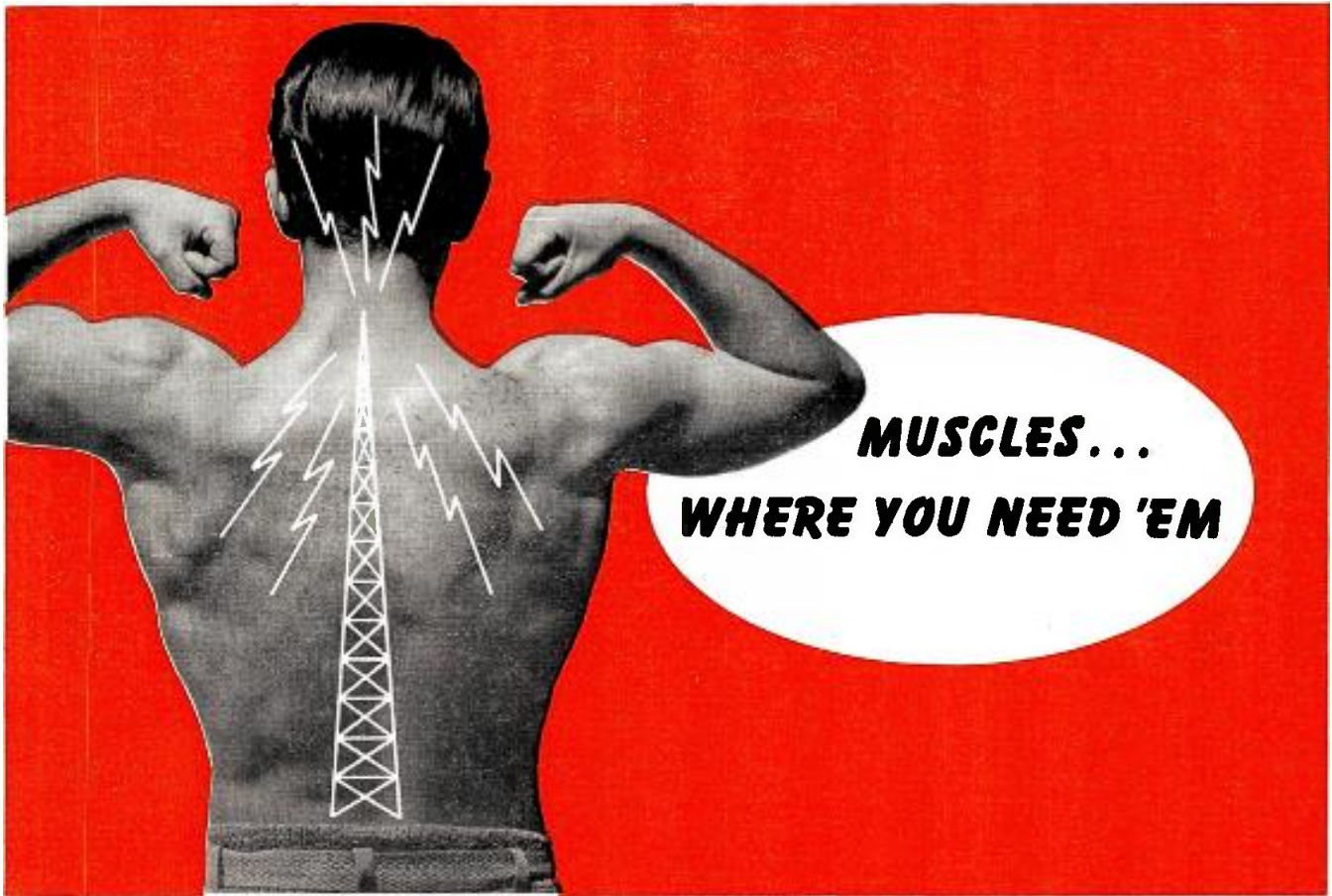

KBS Is A Market By Itself . . . 53 Million Strong!

Investigation proves that the voice of **HOMETOWN AND RURAL AMERICA** gets through to a vast multi-million market that richly rewards advertisers. And **KEYSTONE** goes a step farther . . . puts "muscles" in your merchandising with a consistent pattern of localizing your message . . . adding the warmth and sincerity of local

flavor in each and every area.

Here is an amazing but true story of merchandising "beyond the call of duty" that has paid off for others . . . can pay off handsomely for *you*. Here is a rich market that can be reached effectively and economically by **KEYSTONE**—and *only* by **KEYSTONE**.

• **WRITE, WIRE OR PHONE FOR COMPLETE MARKET INFORMATION AND RATES**

CHICAGO
111 W. Washington St.
State 2-6303

NEW YORK
580 Fifth Avenue
PLaza 7-1460

LDS ANGELES
1330 Wilshire Blvd.
DUnkirk 3-2910



✓ TAKE YOUR CHOICE

A handful of stations or the network . . . a minute or a full hour . . . it's up to you, your needs.

✓ MORE FOR YOUR DOLLAR

No premium cost for individualized programming. Network coverage for less than "spot" cost for same stations.

✓ ONE ORDER DOES THE JOB

All bookkeeping and details are done by **KEYSTONE**, yet the best time and place are chosen for you.



THE VOICE OF HOMETOWN AND RURAL AMERICA

	SUNDAY				MONDAY				TUESDAY				WEL CBS	
	ABC	CBS	MBS	NBC	ABC	CBS	MBS	NBC	ABC	CBS	MBS	NBC		ABC
6:00 PM	Lorillard Monday Morning Headlines	Wm Wrigley Gene Autry (190) R	6-6:25 Nick Carter Libby, McNeill	Mutual Benefit H&A—On the Line, J. Conside (183)	Not in Service	Metro. Life Ins. Allan Jackson (30)		Kaltenborn	Not in Service	Metro. Life Ins. Allan Jackson (30)		News	Not in Service	Metro. Life Ins. Allan Jackson (30)
6:15	Beltoné Paul Harvey	Gene Autry (190) R	6-25 State Farm Ins., C. Brown	Ask Hollywood		Dwight Cook's Guest Book	Repeat of Kid Strips	NBC Sports Review (MM)		Dwight Cook's Guest Book	Repeat of Kid Strips	NBC Sports Review (MM)		Dwight Cook's Guest Book
6:30	Co-op George Sokolsky	C-P-P Our Miss Brooks (205) R	Squad Room Carter & Camels		Budweiser Bill Stern	No Service		No Network Service		Budweiser Bill Stern	No Service	No Network Service		Budweiser Bill Stern
6:45	Vacationland U.S.A.			Socony-Vacuum NBC Symphony (178)	Co-op George Hicks	Kaiser-Frazier Lowell Thomas (155) R		Sun Oil Co. 3-Star Extra (34)	Co-op George Hicks	Kaiser-Frazier Lowell Thomas (155) R		Sun Oil Co. 3-Star Extra (34)	Co-op George Hicks	Kaiser-Frazier Lowell Thomas (155) R
7:00	This Week Around The World	Amer. Tobacco Jack Benny (212) R	Rod & Gun Club-Co-op 7:25 Titus Moody		Vandercook C10	Toni, Man. Soap Family Skeleton (174) R	Co-op Fulton Lewis, Jr. (342)	Inter. Harvester Alex Drier (53) Man on the Go	Vandercook C10	Toni, Man. Soap Family Skeleton (174) R	Fulton Lewis, Jr. (342)	Inter. Harvester Alex Drier (53) Man on the Go	Vandercook C10	Toni, Man. Soap Family Sk (174)
7:15					Co-op Elmer Davis	General Foods M. W. F. Beulah (110) R	Co-op Three Suns	No Network Service	Co-op Elmer Davis	Beulah	Co-op Three Suns	No Network Service	Co-op Elmer Davis	General Foods Beulah (110)
7:30	What's The Name of That Song	Rexall Drug Amos 'N Andy (212) R	Chamber Music	The Marriage	Gen. Mills. Lone Ranger (153) (See Footnote)	Junior Miss Am. Oil-Hamm. Ed. R. Murrow (98)	Amer. Home Prod. Gabriel Heatter	Miles Labs News of World (166)	Starr of Space (See Footnote)	Longines Wittnauer Choraliers (100) R	Credit Union Nat'l Assn. Heatter	Miles Labs. News of World (168)	Gen. Mills. Lone Ranger (153)	Murir Junior N (204)
7:45							Liggett & Myers Perry Como	Miles Labs 1 Man's Family (166) R		Am. Oil-Ed. R. Murrow (98)	7:50-8 Bonnie Blue & Her Boys	Miles Labs 1 Man's Family (166) R	Gen. Mills. Lone Ranger (153) (See Footnote)	Am. Oil-H. Ed. R. M (98)
8:00		General Electric Bing Crosby Show (203) R	Hawaii Calls	The Hollywood Story	General Motors Henry Taylor (159)	Auto-Lite Suspense (196) R	The Falcon	AA of RR's Railroad Hour (192)	3-City Byline	Mars Inc. People Are Funny (172)		Coca-Cola Coke Hour (195)	3-City Byline	Brylcreem! FBI in Pe War (19)
8:15	American Music Hall		Enchanted Hour	8:25 News	Sammy Kaye			Burlington Mills Sammy Kaye	Hollywood Starway	Halo, Palmolive Mr & Mrs North (203) R	(Co-op) High Adventure	Chevrolet Dina Shore (186)	Burlington Mills Sammy Kaye	Brylcreem! FBI in Pe War (19)
8:30		Philip Morris My Little Margie (203) R		Six Shooter *OT	Mike Malloy	Lever-Lipton Godfrey Talent Scouts (173) R	Co-op Counter Spy	Firestone Voice of Firestone (152)	Mike Malloy			Barrie Craig *OT	Hollywood Starway	Chesbrough Dr. Chris (188) R
8:45			8:55-News											
9:00	Green & Carter Walter Winchell	Hallmark Radio Hall of Fame (199)	Salute to The Nation	Stroke of Fate					Co-op Town Meeting	Wrigley Johnny Dollar (194)	(Philip Morris) Sports—"Ten"	Liggett & Myers Dragnet (197)	Philoa Radio Playhouse	Cathy & E Lewis On
9:15	Lorillard Taylor Grant			9:25 News	Celebrity Table	Lever Brothers Lux Radio Theatre (186)	Co-op News Reel	Bell Telephone Telephone Hour (185) R						
9:30	Call Me Freedom S	Cons. Cosmetics Edgar Bergen Charlie McCarthy Show (204)	London Studio Melodies	Royal Theatre			Co-op Reporters Roundup	Cities Service Band of America (113) R	Chr. S. Publ. Co. Irwin D. Canham (20)	21st Precinct	Search That Never Ends	Swayze News Stewart-Warner	Sterling Drug Mystery Theatre	Crime Cla
9:45														
10:00	Co-op Paul Harvey (118)	Man of the Week	Hardy Burt	Last Man Out	ABC Late News 10:00-10:05	R. J. Reynolds Vaughn Monroe (187)	A. F. of L. Frank Edwards (151)	Fibber McGee & Molly	ABC Late News 10:00-10:05	C-P-P, L. Creme Louella Parsons (188) R	A. F. of L. Frank Edwards (151)	Fibber McGee & Molly	ABC Late News 10:00-10:05	Broadwa Is My Be
10:15	Allstair Cooke S		Hazel Markel Co-op	10:25 News	Co-op Headline Edition Gunnar Back		Put It To Pat	Can You Top This?	Co-op Headline Edition Gunnar Back	Russ Morgan	Put It To Pat	Can You Top This?	Gunnar Back	
10:30	Songs by Fisher	10:30-10:35 p. m. Daniel Schorr 10:35-45 p. m. U. N Report	Co-op Bert Bachrach	Meet the Press	Orchestra (See Footnote)	10:30-35 Robert Toot	Dance Orchestra Washington Statler Hotel	Jason and the Golden Fleece	Orchestra (See Footnote)	10:30-35 Robert Toot	Co-op State of the Nation	G. I. Joe, L/P 11/7	Front & Center 10:35-11 (See Footnote) S	10:30-3 Robert Tr Cedric Ad Dance Orch
10:45	Outdoors with Bob Edge	John Derr Sports Reports	Co-op Rukeyser Reports											
11:00	Beyond The Stars	News	Co-op Ed Pettitt	News from NBC	Valentino	Three Suns News	Co-op Ed Pettitt News	No Network Service	Valentino S	News	Co-op Ed Pettitt-News	No Network Service	Valentino S	News
11:15 PM		Dance Orchestra	Dance Orchestra	Joseph C. Harsch Commentary	Sports Report S	Dance Orchestra	U. N. Highlights	News of the World Morgan Beatty	Sports Report S	Dance Orchestra	U. N. Highlights	News of the World Morgan Beatty	Sports Report S	Dance Orchestra

	SUNDAY				MONDAY - FRIDAY				SATURDAY				ABC	
	ABC	CBS	MBS	NBC	ABC	CBS	MBS	NBC	ABC	CBS	MBS	NBC		
9:00 AM	Milton Cross OperaAlbum S	Music Room	Dr. Wyatt Wings of Healing	Co-op World News Lockwood Doty	Quaker-Toni Breakfast Club (290)	Co-op News	Co-op Rebt. Hurleigh	No Network Service	Co-op News	Skelly Oil This Farming Business (30)			1:30 PM	National Vespers S
9:15		News S		Youth Brings You Music	Swift & Co. Breakfast Club (290) R	No Service	Co-op Cliff's Family	Home Edition of the News	Garden Gate	Howdy-Doody 8:30-9:30 a.m.*			1:45	Healing Wat Inc. Dr. Oral Rob
9:30	Prophecy, Inc. Voice of Prophecy (99)	E. Power Biggs	Christian Rel. Church Back to God	Carnival of Books	Philoa Corp Breakfast Club (289)	Knemark Kellogg Godfrey (192) R	Co-op Cliff's Family	Ev'ry Day MM	Murine's Galen Drake (187)	My Secret Story			2:00	
9:45				Faith In Action			Co-op Cliff's Family		Animal, Ft. Galen Drake 10:10-15 (75)	Woman in Love			2:15	
10:00	Message of Israel S		Radio Bible Class (311)	National Radio Pulpit S	Sterling Drug My True Story (212)	Glinion Intl. Celluc. Godfrey (199) R	Co-op Cecil Brown (92)	P&G Watcome Travelers (150)	Robt. O. Lewis Milner Products (125)	Woody Woodpecker			2:30	Dr. Wyatt Wings of He
10:15		Church of Air S				Star-Kist Frigidaire-Arthur Godfrey (198) R	10:25 Co-op Spotlight Parade Faith In Dur Time	General Foods Bob Hope (139)					2:45	
10:30	Negro College Choirs S		Voice of Prophecy (327)	Dr. Peale Art of Living S	G. Mills M-W-F Toni Tu&Th Whispering Streets (224)	Toni Lever Bros. Arthur Godfrey (203) R	10:30 S. C. Johnson News 10:35-11 Co-op Spotlight Parade	Miles Labs Break the Bank	Ralston Space Patrol (284)	Let's Pretend	10:30-10:35 Johnson News 10:35-11 Woody Woodpecker Co-op		3:00	Marines I. Review S
10:45				News Highlights S	When A Girl Marries (185)								3:15	
11:00	Fine Arts Quartet S	Salt Lake City Tabernacle	Dawn Bible Frank & Ernest	Faultless Starch Time (59) Spl.	Ex-Lax (MWF) Co-op (T & Th) Modern Romances	National Biscuit Pillsbury Godfrey (203) R	Sterling Ladies Fair 11-11:25	C-P-P Strike II Rich (179)	Platterbrains	Romance	Helen Hall		3:30	Dr. Billy Gr: Hour of Dec (229)
11:15			TBA	Viewpoint USA	Paging the Judge	Liggett & Myers WMF Pillsbury Tu-Th (206) R	Queen For a Day			No Network Service	The Big Preview		3:45	
11:30	The Christian In Action S	Invitation to Learning* S	Northwestern U. Review S	U.N. Is My Beat S	Campbell Double or Nothing 11:30-11:55	Contnl. Baking Make Up Your Mind (35)	Tues. & Thur. Quaker M W F-Sust.	C-P-P The Phrase that Pays (183)	All-League Clubhouse S	Cannon Mills Give & Take (156)	Farm Quiz		4:00	
11:45				Keesler Air Force Base Male Chorus	Toni-Tu&Th Turn to a Friend 11:55-12:25	P&G Ivory Snow Rosemary (116)	M-F 11:45-12 P. Lorillard	Second Chance					4:15	Gasped Best: Old-Fashion Revival Hr.
12:00 N	Gloria Parker S	Washington U. S. A.	College Choirs	Music by Mantovani	Jack Berch Prudential 12:25-12:30	General Foods Wendy Warren (160)	Miles Labs Curt Massey Time		101 Ranch Boys S	Cream of Wheat Theatre of Today (159)	Quaker Man on the Farm		4:30	
12:15 PM						Lover Bros. Aunt Jeany (177)	Johnson & Son News 12:15-12:20						4:45	
12:30	The World Tomorrow Radio Church of God	Foreign Affairs Report	Bill Cunningham Co-op	The Eternal Light S	General Mills The Bill Ring Show	Whitehall Helen Trent (185)	12:20-12:30 Carl Warren's Guest Time	No Network Service	American Farmer S	Carnation Stars Over Hollywood (201)	5th Army Band		5:00	Cinema Mi Hall
12:45		Bill Costello News	Mutual Music Box		Not in Service	Whitehall Our Gal Sunday (179)	12:30-1 No Service						5:15	
1:00	Churches of Christ Herald of Truth (108)	20th Century Concert Hall	Keep Healthy	For Better Living	Co-op Paul Harvey	P&G Ivory Road of Life (153)	Co-op Cedric Foster		Navy Hour S	Toni Fun For All (205)	Dance Orch		5:30	Goodyer Greatest S Ever To
1:15			Co-op Merry Mailman	Report on America	Co-op Ted Malone	P&G Oxydol Ma Perkins (165)	Music By Willard						5:45 PM	

DAY	THURSDAY				FRIDAY				SATURDAY				
	MBS	NBC	ABC	CBS	MBS	NBC	ABC	CBS	MBS	NBC	ABC	CBS	MBS
Special of Kid Strips	Kallenborn	Not in Service	Metro. Life Ins. Allan Jackson (30)	News	Not in Service	Metro. Life Ins. Allan Jackson (30)	Kallenborn	Labor	Sam Jones Politics	Dance Orchestra	George Hicks News	6:00 PM	
	NBC Sports Review (MM)	Budweiser Bill Stern	Dwight Cook's Guest Book	RBC Sports Review (MM)	Not in Service	Dwight Cook's Guest Book	NBC Sports Review (MM)	Management S	UN on the Record	H. V. Kallenborn News	6:15		
n Lewis jr. (342)	No Network Service	No Service	No Service	No Network Service	Budweiser Bill Stern	No Service	No Network Service	Co-op Bob Finnegan Sports	Saturday Sports Roundup	Dinner Date	TBA	6:30	
	Sun Oil Co. 3-Star Extra (34)	Co-op George Hicks	Kaiser-Frazier Lowell Thomas (155) R	Sun Oil Co. 3-Star Extra (34)	Co-op George Hicks	Kaiser-Frazier Lowell Thomas (155) R	Sun Oil Co. 3-Star Extra (34)	Una Mae Carlisle	Daniel Schorr News			6:45	
Co-op ree Suns	Inter. Harvester Alex Drier (53) Man on the Go	Vandercook C10	Toni. Man. Soap Family Skeleton (174) R	Fulton Lewis jr. (342)	Inter. Harvester Alex Drier (53) Man on the Go	Toni. Man. Soap Family Skeleton (174) R	Fulton Lewis jr. (342)	Inter. Harvester News Parade (33)	Disaster Strikes	Co-op Al Heller		7:00	
er. Home Prod. Heat	No Network Service	Co-op Elmer Davis	Beulah	Co-op Three Suns	No Network Service	Co-op Elmer Davis	Co-op Three Suns	No Network Service	The 3 Suns	Report From The Pentagon		7:15	
at & Myers try Como	Miles Labs News of World (158)	Starr of Space (See Footnote)	Longines Wittnauer Choraliers (107) R	Deepfreeze Appliance Gabriel Heatter	Miles Labs News of World (158)	Gen. Mills, Lone Ranger (153) (See Footnote)	Junior Miss	Union Pharma. Gabriel Heatter	Dinner At The Green Room S	7:30-7:55 Where In The World	NBC Lecture Hall	7:30	
Deadline	Miles Labs 1 Man's Family (166) Rp	3-City Byline S	Am. Oil-Ed. R. Murrow (98)	7:50-8 Bonnie Blue & Her Boys	General Foods Roy Rogers (162)	3-City Byline S	Brylcreem P & G Mr. Keen (199) R	Miles Labs 1 Man's Family (166) Rp	Coca-Cola Co. Coke Time (193)	Gen. Foods Gunsmoke (99) R	20 Questions	8:00	
	R. J. Reynolds Walk & Mile (196)	Burlington Mills Sammy Kaye	Brylcreem Meat Millie (199) R	Official Detective	News 8:25	Burlington Mills Sammy Kaye		Chevrolet Dinah Shore (198)	Amer. Dairy Bob Hope (198)	Sanka Salute (99) R	College Quiz Bowl	8:15	
Co-op Bulldog Drummond	Kraft Gildersleeve (160)	Hollywood Starway	Rogers of the Gazette	Co-op Nightmare	General Foods Father Knows Best (160)	Hollywood Starway	Mike Malloy	Co-op Starlight Theatre	Dancing Party S	Gangbusters	Co-op Virginia Barn Dance	8:30	
9:05 Philip Morris Sports-"Ten"	DeSoto Plymouth Dealers, Groucho (191)	The George Jessel Show	GE Meet Mr. McNulty (206)	9:05 Philip Morris Sports-"Ten"	Pel Milk Truth or Consequences (166)	Hotpoint & Lambert Ozzie & Harriet	Stage Struck	9:05 Philip Morris Sports-"Ten"		P. Lorillard Two For The Money (205)	(Co-op) New England Barn Dance Jamboree	8:45	
Co-op Newsreel	Amer. Dig. & Cig. Big Story (192)	Horatio Hornblower	Jergens Time for Love (130)	Philip Morris My Little Margie	Swayze News Stewart-Warner	Corliss Archer ECAD 9:30-9:35	Locke Slove Duke of Paducah (26)	Co-op Newsreel	Swayze News Stewart-Warner	Lombardoland U.S.A. S	R. J. Reynolds Grand Ole Opry (91)	9:00	
Family Theatre	Fiber McGee & Molly	ABC Late News 10:00-10:05	A. F. of L. Frank Edwards (151)	Fiber McGee & Molly	9:55-10 Sports	Capitol Cloakroom	A. F. of L. Frank Edwards (26)	Fiber McGee & Molly	Orchestra S	Saturday Night Country Style	Ralston Purina Eddie Arnold Show (115)	9:15	
	Can You Top This?	Co-op Headline Edition Gunnar Back	Amer. Tob. Horace Heidt (212)	Put It To Pat	Can You Top This?	10:30-10:35 Robert Trout	Can You Top This?	Listen to Washington	Treasury Show	Chicago Theatre of the Air S	Pee Wee King Show Co-op	10:00	
Co-op Landing Board	Report from the White House	Orchestra (See Footnote)	10:30-35 Robert Trout Cedric Adams	Melodies For Relaxation	Jane Pickens Show	Cedric Adams	Dance Orchestra	Dance Orchestra				10:15	
Co-op Ed Pettitt-News	No Network Service	Martha Lou Harp S	News	No Network Service	No Network Service	Martha Lou Harp S	News	No Network Service	News S	News	Ed Pettitt	10:30	
U.N. Highlights	News of the World Morgan Beatty	Sports Report S	Dance Orchestra	U.N. Highlights	News of the World Morgan Beatty	Frank & Jackson	Dance Orchestra	News of the World Morgan Beatty	Orchestra	Dance Orchestra	Dance Orchestra	Joseph C. Harsch Commentary	10:45
													11:00
													11:15 PM

I M E

DAY	SUNDAY			MONDAY - FRIDAY			SATURDAY		
	CBS	MBS	NBC	CBS	MBS	NBC	CBS	MBS	NBC
Syncopation Piece	Lutheran Hour	U. of Chicago Roundtable	Closed Circuit	P&G Crisco Dr. Malone (182)	Luncheon with Lopez	Pauline Frederick Reporting—Co-op	Vincent Lopez Show S	Hormel & Co. Music with Hormel Girls (125)	U. S. Army Band S
Longines Wittnauer Symphonette (121)	Bandstand USA	The Catholic Hour	Co-op M. M. McBride	P&G Duz Guiding Light (161)	Say It With Music	No Service			
Glys Motors Inc New York Philharmonic Symphony (204)	US Military Academy Band	American Forum of the Air	Jack's Place 2:35-4:00	GF Swan-Gal. Mrs. Burton (145)	2:35 Johnson & Son. News	Armour (191) Dial Dave Garway		1:30-35 Johnson News	
	Top Tunes with Treadler	Golden Voices		P&G Tide Perry Mason (169)	Wonderful City	Jane Pickens 2:55 News Banghart		1:35 Sports Parade. 1:45-50 R. J. Reynolds Camel Lineup 1:50 Co-op Football Game of the Week	
World Today	J. R. Wood Lanny Ross	The Golden Treasury	Gen Mills Joe Emerson (27 stns)	Toni. Seaman Nora Drake (195)	Co-op E. Hollis & News	P&G Life-Beautiful (170)	Co-op Football		
	Mr. District Attorney (Co-op)			Lever, Kelllogg Houseparty (191) R	John B. Gambling	P&G Road of Life (163)			
Music for You	Under Arrest	Jack Owens	Toni. Man. Soap Wizard of Odds (177)	Pillsbury House Party (191) R*	Co-op Baukhage-News	Pepper Young (166)			
	4:30-4:55 Crime Fighters	Weekend	Gen. Fds. (4-4:05) Robt. Q. Lewis (84)	Co-op B-Bar-B S	No Service	P&G Right to Happiness (163)			
News Cornedredry Digest (203)	4:55 News S		Co-op Sunshine Sue (55)	Co-op Welcome Ranch	Co-op Sunshine Sue (55)	Co-op Backstage Wife (175)			
	The Shadow Co-op		Music in the Afternoon S	Tu&Th Quaker Sgt. Preston of the Yukon M-W-F Songs of the B-BAR-B S	Whitehall Front Page Farrell (138)	Sterling Drug Young Widder Brown (151)			
Quiz Kids	True Detective Mysteries		Co-op Big Jon & Sparkie	Tu&Th Quaker Sgt. Preston of the Yukon M-W-F Songs of the B-BAR-B S	Whitehall Front Page Farrell (138)	Manh'n. Soap Woman in My House (181)	Martha Lou Harp		
			The Westernaires	No Service	Whitehall Front Page Farrell (138)	Whitehall Front Page Farrell (138)			
			Lum & Abner Co-op	5:30-5:55 M-W-F-Kelllogg Wild Bill Hickok Tu & Th Derby-Sky King	C.P.P. Lorenzo Jones (191)	Il Pays To Be Married	Paulena Carter		
			John Conte S	Miles Labs Curt Massey Time (149) R		Club Aluminium Club Time (20)		Saturday at the Chase	

Explanation: Listings in order: Sponsor, name of program, number of stations; S sustaining; R rebroadcast West Coast; TBA to be announced; RP repeat performance. Time EDT.

ABC—8:55-9 a.m., 2:30-2:35 p.m., 4:25-4:30 p.m., M.W.F., Time for Betty Crocker, Gen. Mills (319).

7:55-8 p.m., M-F, Chesterfield Cigarettes, Las Griffith & The News, (332).

10:30-10:35 p.m., M-F, Pblco Corp., Edwin C. Hill and the Human Side of the News (310)

Chevrolet now sponsors 24 5-minute newscasts each weekend.

12-12:05 p.m. Sat. Campans—Bill Shadel 188

CBS—8:30-9:15 a.m. Sun. General Woods Corp. Sunday Gatherin' 109.

11:30-11:35 a.m. Sun. Peter Hacks—News (S)

3:15-3:30 p.m. MWF Lever—Houseparty 180

3:15-3:30 p.m. Tue Kelllogg—Houseparty 191

3:15-3:30 p.m. Fri Green Giant—Houseparty 171

3:30-3:45 p.m. M-Th Pillsbury—Houseparty 191

3:30-3:45 p.m. Fri Kelllogg—Houseparty 192

4-4:05 p.m. M-F, Gen. Fds.—Robert Q. Lewis 84

Arthur Godfrey Clients 10-11:30 a.m.

10-10:15 a.m. Knownark & Kelllogg (alt. Fri.) 192.

10:15-30 a.m. Snow Crop & Kleenex (alt. days) 199.

10:30-45 a.m. Frigidare Tu. Th.; Star-Kist M. W. Alt. Fri. 198.

10:45-11 a.m. Lever M.-W., Toni Tu-Th. (alt. Fri.) 203.

11-11:15 a.m. Pillsbury M.-W., alt. Fri.; Natl. Bis., Tu-Th., alt. Fri. 203.

11:15-30 a.m. Liggett & Meyers M.-W.-F.; Pillsbury Tu-Th. 206.

11:25-30 a.m. Sat. Gen. Fds., Galen Drake—149.

MBS—M-F 8:55-9:00 a.m.—Gabriel Heatter—Block Drug & VCA Labs. alternate days

11:25-11:30 a.m., M-Sat., Johnson & Son, News 5:55-6:00 p.m., M-F, Cecil Brown-S. O. Johnson 9-9:05 p.m., M-F, Johns-Mancille Bill Henry

Saturday 8-8:30 p.m.—Twenty Questions—Credit Union National Assn. Sponsors 15 min only—alternate weeks—

Multi-Message Plan: Participating sponsors—M-F 8:00-8:30 p.m. R. J. Reynolds Tobacco Co.—Mon., Tues. & Thurs.

Emerson Drug—Mon. & Wed.

S.O.S. Co.—Mon-Fri 8-8:30 p.m.

Tues. & Thurs., 7:45-7:50 p.m.—Titus Moody-Emerson Drug.

Carter and Camels co-sponsor Squar Room. 6:30-7 p.m. Sun.

NBC—8-9:15 a.m., Shelly Oil. M-F, News (28); 8:15-8:30 a.m., M-F, Serutan Co., "Victor Lind-lah", 153 stations.

† Whitehall Pharm. "Just Plain Bill", "Front Page Farrell" alt. days.

• MM—"Minute Man" Programs.

• OT Operation Tandem

October 26, 1953



**BROADCASTING
TELECASTING**

YOU are one of...

75,956

readers of the weekly

BROADCASTING-TELECASTING*



American Research Bureau, Inc. study determined that each paid copy of **BROADCASTING-TELECASTING** is read by 4.68 persons per week. **BROADCASTING-TELECASTING**'s paid print order is 16,230.

(Continued from page 88)

broadcast problems—the competition of phonograph records.

Every person who buys a good record-player is a good prospect for an fm or fm-am tuner, if the outfit lacks this basic item. And every person who has this quality equipment, including tuner, is a good prospect for the broadcast station that has good engineering and musical programming.

It narrows down to competition between broadcasters and purveyors of phonograph records for the ears of hi-fi owners.

Milton Sleeper, publisher of *High Fidelity* magazine, reminds broadcasters that record manufacturers with their greatly improved product are stealing millions of listening hours from radio shows.

To win listeners, he continues, broadcasters should use 15,000-cycle network lines and improve the quality of their programming and engineering. Nearly all hi-fi installations include an fm tuner, according to Mr. Sleeper, and they're crying for more and better musical programming. Incidentally, he notes, not all stations programming music are turning out suitable signals.

Aiming at the much larger segment of the public that isn't long-hair but likes instrumental music of the semi-classical and standard type is WWDC-FM Washington, managed by Ben Strouse, NARTB board member and one of fm's fighting'est protagonists. WWDC-FM takes the air at 7 a.m. and shuts up shop at 2 a.m., carrying an entirely different set of programs from its standard broadcast brother, WWDC.

Audience Reaction

Mr. Strouse wondered recently what his fm audience thought of the service and put on several announcements explaining that the station was contemplating duplicating am programming part of the time. Within a week he had 3,005 letters of protest from professional men, college students, housewives, office workers and the wife of a Senator whose name figured prominently in the 1952 campaign.

That convinced him. WWDC-FM is doing better than ever, much better. It has a score of sponsors, including several hi-fi firms and eight proprietary accounts. A subsidiary, Tempo Inc., feeds WWDC-FM's music, purged of plugs, to 200 banks, stores and restaurants. In addition the station has a tieup with Peoples Drug Stores and is installing speakers in 78 of the chain's outlets. The "Drugcasting" service carries only the drug commercials.

WITH-FM Baltimore has one of good music's most spectacular contracts, an all-day Sunday program bought by May Co., one of the city's major department stores. The 52-week contracted series started in June and involves \$20,000 in time costs. Music is picked off the air from WGMS.

These are some of the stations that have been pioneering fm and/or good music. Some have had their hungry moments; some are doing nicely. All have suffered the trials of the ground-breaker but now they are getting results. As to the future, they're full of confidence—especially when they watch the public interest in hi-fi equipment.

John H. Smith Jr., NARTB fm manager,

contends the hi-fi surge "gives fm stations the best opportunity they have had in a long time." It's his view that parts and set manufacturers along with the recording industry, music stores and radio dealers, "are creating a promotional climate for the fm station."

He adds, "The tendency of the average listener is to seek through radio a form of entertainment that television does not provide in such quantity."

Tv, incidentally, has been educating the public to the lack of interference and static in its fm-delivered sound signals.

Mechanical reproduction of sound started in the late 70s when Thomas Edison first turned out a few recorded squeaks. The phonograph industry developed slowly, soon becoming a contest between the Edison cylinders and Victor discs. Eventually the disc won because of longer performance and easier handling.

Electronic recording came in the mid-20s when Brunswick put out its costly Panatropé. Quickly the industry converted to electronic techniques, a stimulus that was soon reflected in public appreciation.

Unfortunately, recording techniques just about stood still until World War II brought a shortage of the shellac coating used on records and transcriptions. Plastics were gradually adopted for transcriptions despite difficulty of processing. They gave quieter surfaces and permitted high-fidelity recording.

In 1944 the British started to feature high-fidelity records and American industry followed the pattern. With introduction of the General Electric magnetic cartridge in 1947, Columbia long-playing discs and RCA's 45 version, the phonograph industry finally was able to deliver to the public a reproduction that bore good resemblance to the original. Diamond needles, light-weight tone arms and tape-recording methods were

adopted and now the hi-fi hobbyist can obtain well-recorded music from discs and tapes, as well as from stations that feature live and recorded programming delivered with a well-engineered signal.

Interest in music, given its greatest stimulus by radio in three decades of development, is constantly increasing. Even the pop music fans are discovering that hi-fi gives them practically all the rhythms, basses and trebles supplied by the instrumentalists and vocalists. Schools are building record libraries and putting in hi-fi equipment. A Society of Music Enthusiasts has been formed with chapters in every state and many foreign countries. It has a regular program on WNBC New York.

Columbia Records has its 360, plus an XD unit for three-dimensional sound. RCA offers intermatched hi-fi units and assemblies with some 200 combinations. Philco has its Phonorama, Hoffman its trio-phonics.

Binaural, or dual-channel reproducing systems are reaching a commercial basis and double-grooved records are available for around \$5. Hi-fi expositions are taking place in major cities everywhere.

So what does hi-fi mean to the broadcaster?

Its industrial boosters, who think in terms of production and selling, dream of 9 or 10 million hi-fi homes in the next five years . . . and that's a good omen for fm, too.

Optimistic, perhaps, but they have found that people who first hear top-quality sound reproduction are highly impressed. They have found, too, that people who have good sound available simply won't condone the tinny tone of a cheap table radio—and there are millions of cheap fm sets, too. They have found that people with good equipment use it a lot.

It looks as though 1954 will be a good year for ears.

Here are the main elements of a hi-fi assembly, as produced by RCA. Suggested total retail price for these, plus variable reluctance cartridge with diamond stylus and sapphire stylus: \$600.28.



3-Speed Record Changer



Preamplifier



15-Inch Duo-Cone Speaker



Am-Fm Tuner



20 w Power Amplifier

Two important agency executives think television is failing to exploit its opportunities. In talks Oct. 16 at the annual meeting of the Central Council of the American Assn. of Advertising Agencies they identified the problems and suggested cures. Here are excerpts of their presentations.

Is Television Already in a Rut?

By Louis N. Brockway

IT SEEMS to me that television commercials show a greater range of quality—from a high degree of excellence to a low degree of inferiority—than you will find in a printed form.



Some of the better ones—and there are many of them—show great ingenuity and daring, as fine examples of imaginative advertising as can be found anywhere.

Is the reason for the wide range in television the fact that we do not yet have an array of facts and figures to guide us in the construction and execution of television commercials? As information about the subject grows and replaces intuition and hunch, will

commercials achieve an average of mediocrity?

I hope not because the excitement and newness of television has stimulated some fine creative commercial work which should not be inhibited by too much knowledge—knowledge not wisdom—about the subject.

The vehicle which carries our advertisements, the show, is far ahead of the commercials in going down the road that becomes a rut. And the reason is not hard to find. It appears weekly, bi-weekly, or monthly depending on what rating service you take.

We know, according to ratings, that a comedy show is the most popular type of show. But good comedians are hard to come by and they are susceptible to all kinds of trouble, even bishops.

We know that dramatic shows, as a class, are the safest. They are likely to get a good steady rating and be more durable than comedy shows.

So, by a not-to-difficult-to-follow process of reasoning, we develop a hybrid, the situation comedy, a comedian starring in a dramatic vehicle. And situation comedies break out like a rash all over the television screens.

Ratings indicate that mystery shows, as a group, have the lowest cost per thousand. So the advertiser with only a million or two to spend—a limited tv budget—finds himself with a mystery, perhaps in more ways than one.

Now I am not unaware of the practical problems besetting the agency and client going into tv. Moreover, I live in a glass office and have no desire to start a rock-throwing contest.

I submit, however, for prayerful consideration, the opportunity for creative effort in television and the responsibility of management to encourage it.

Mr. Brockway has been executive vice president of Young & Rubicam since 1943 and with the agency since 1930.

By Richard de Rochemont

I HAVE been in and about television long enough to realize that there is a job to be done, and to be done very quickly, if television is to become as effective a medium and as potent a force in American culture as its technological excellence, and what I can only call its miraculous quality, entitles it to be.



In my opinion, the gap between the promise and the fulfillment is not being closed up by the networks, nor by the packagers, nor by Hollywood. If television is to be all that it should be, and all that we want it to be, the job is very squarely up to the advertising agencies and the talents, services and experience which they are best able to mobilize. That, in brief, is all I am going to say, though it will take more words for me to say it.

My own background, as you may know, has been primarily in motion pictures and, at a time when much of television is being made on film and many shows are being put together by film-makers in Hollywood and elsewhere, I think the moment is propitious for some re-examination of the two media, as to the audience psychology of each, the purposes of each industry and the factors for change which exist in each of them.

In the first place, as has been repeated to us endlessly, the movies reach a crowd, a mass audience in a place of public assemblage. The average motion picture audience, in spite of popcorn and the crackling cellophane bags, has very little to distract it from the picture in front of it. It sits in a darkened room with very little possibility of wandering about, doing and thinking of other things.

The television audience, on the other hand, is, for the most part, subjected to all the distractions of home and the family. The phone can ring, the soup can boil over, the baby can get into trouble and, in general, attention is at a very low intensity compared to that of the motion picture audience.

This basic difference in the psychological attitude of the two audiences would seem to me to indicate that these are, in spite of certain superficial points of resemblance, two different audiences in the same way that a group of people who go to church is quite a different audience from the same people when they go to a ball game. This question of the television audience has to be thought through very carefully, with as much attention as the motion picture people ever gave to theirs, and, since the volume of entertainment offered and the hours of attention

(Continued on page 96)

Mr. de Rochemont, a vice president of J. Walter Thompson Co., is a former producer of March of Time.

▶ **GET COMPLETE INFORMATION ON**



- **Television Studio Equipment**
- **Television Microwave Equipment**
- **Communications Microwave Equipment**



Write Department BT for full details—Today!

PHILCO CORPORATION

GOVERNMENT & INDUSTRIAL DIVISION, PHILADELPHIA 44, PA.

The best way to sell the **KANSAS FARM MARKET**

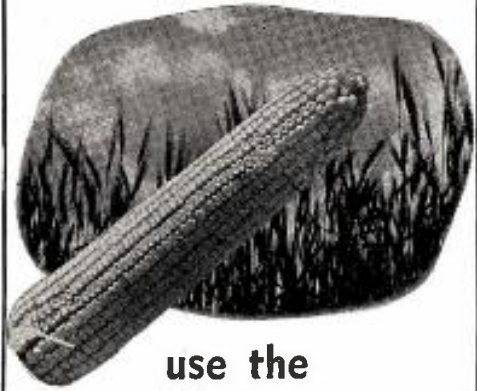

use the **KANSAS FARM STATION**

WIBW

CBS RADIO
in Topeka

Ben Ludy, Gen. Mgr., WIBW-KCKN
Rep. Capper Publications, Inc.

wan'na
buy
an -

island?



PROBABLY YOU DON'T!
and we really don't have an island for sale

But we do have the RICH, GROWING and ISOLATED

Webash Valley Market area - 70 to 175 miles from the nearest major trading center.

To be Sold - MUST BE REACHED FROM WITHIN!

WTHI your **BEST BUY** in Terre Haute
REPRESENTED BY - SOLLING CO.

De Rochemont on Tv

(Continued from page 94)

demand are much greater, with even *more* ingenuity, and primarily without prejudices of any kind.

The purposes also are different. Primarily the motion picture showman wants an audience that will pay at the box office. As in certain other entertainment establishments, people pay on the way in, not on the way out. Perhaps, if they paid on the way out, they would not pay at all.

Television, on the other hand, has what is, for practical purposes, a non-paying audience. If they pay at all, they pay on the way out, if and after they have been satisfied and when their curiosity, interest or emotional need has been reasonably rewarded.

In this connection I think we could all agree that the end to be achieved is not simply to have an audience, but to make sure that this audience, having been well pleased, pauses voluntarily at the box office, which may be the supermarket or the automobile agency, and makes its contribution gladly and without rancor. I do not mean to say that audience ratings do not have their place, as a current guide to the perpetual question "Is anybody listening?" but that we have to go beyond ratings to results, which in the case of television means sales of products and services.

The evolutionary factors are something not to be ignored either in the motion picture or in television. The motion picture has finally had its rigidity shattered, largely by the competition of television. Today the producers of motion pictures have had to revise their thinking and reach out for such devices as 3-D, wide screen, greater use of color, etc. They are doing this in a struggle for survival, but, if they show the same capacity for readjustments which they have shown in the past, I, for one, am far from predicting the end of the motion picture theatre or of the great studio.

Are Arteries Hardening?

Television, much younger, is showing some of the early symptoms of hardening of the arteries. Too many shows repeat slavishly the formulas of other shows. Programming tends to fall into rigid patterns and, although these things have not proceeded far enough to be disastrous, they do seem to indicate a trend and one which is not a very happy one.

With all due respect for the great men of the motion picture business, the great exhibitors and showmen and for television's own showmen, it is evident that the showmen's view of television is by no means a complete one. Your showman, for instance, has very little idea of the role of television as an agent in mass distribution. He has great difficulty in accepting an idea such as that of the commercial, which he is still inclined to regard with some horror, having become a real social force in our American culture. An example of this is the way children have reacted to the music and jingles of some of the more attractive commercials.

Your showman also has difficulty in

understanding what I call "the box office in escrow," that is, the idea of people who pay after thinking it over, after they have been away from the show for a week or more, instead of paying just before they see Little Egypt do her dance and having no recourse afterwards.

By and large, television has set up new ground rules and made it evident that the showman's vaunted intuition is, for the most part, bankrupt. There may be other things in television that also appear bankrupt, or close to it, but what I mean by my last remark is that no longer can a producer produce a sudden good idea for one show, as has been the case from time to time in Hollywood, and without study or examination of his market run the idea into millions of dollars. This television is evidently a business where things have to be thought out in advance and where the ingenious improvisation cannot be made to stand up for 26, 39 or 52 weeks. This is not a business for Barnums.

Perhaps I am being a little severe, or exaggerating, when I say that television is not a showman's business. What I mean is that there is more to it than selling tickets.

Mistakes Are Easy

In another sense, it is not entirely a *businessman's business*, and from time to time we are reminded how men whose judgment, in industry, seems almost infallible can make fantastic mistakes about tv.

I am not concerned with those errors due to simple ignorance or inexperience. If they had the right agency these mistakes would be corrected and avoided, we presume. What worries me, and surely some of you, is whether they have a clear concept of how television should operate, and the various roles to be played by network, producer, agency and client.

What are the limits of responsibility? Can they be defined? Is the network the custodian of all tv responsibility? Is the packager competent to assume the editorial role?

On the other hand, is the sponsor, our client, a publisher? Is he qualified, and is he willing, to take on such a grave cultural and social responsibility on his own as the production of a tv series, or a group of shows, requires him to assume? Obviously, some sponsors are. But should they, all alone? Does high competence as a business man imply this required kind of social vision? I don't mean anything obscure or double-domed when I talk about social vision. All I mean is the ability to see our country and the audience clearly, and in not one, but many of its relationships. For instance, the audience. What do we mean? We are all consumers, and to some degree we all consume the same things, and in vast quantities. This is the source of America's power, more than its power to produce, perhaps.

But as we tend to divide into separate, smaller consumer groups when we progress beyond the food and soap level of consumption, so does our audience divide, and divide almost infinitely into distinct preference groups.

Network television at its most banal seems to recognize few distinctions, beyond simple ones such as night and day, male and

CINCINNATI PAPER USES RADIO

PIONEERING in a new radio technique as one feature of its drive for newspaper leadership in the highly-competitive Ohio



Mr. Holloway

Valley, the *Cincinnati Times-Star* is relying heavily on radio in its bid for more intense readership and circulation gains. The 113-year-old newspaper owned by the Taft family reports its experiments as "highly successful."

The new technique is a five times a week, five minute, objective, common sense and humorous viewpoint on news and events titled *I See Today by Holloway*. The program is presented on WKRC, *Times-Star* affiliate, Monday through Friday at 6:40 p.m., by Hubert Holloway, former Washington correspondent and public relations consultant.

"While *I See Today by Holloway* is one of many projects of the *Times-Star* in its expanding efforts and service to readers and advertisers," said Lloyd B. Taft, executive vice president, "the program does hit home runs in our overall teamwork. We feel that it has played an important role in more intensive readership and a circulation increase of more than 10%. There is every reason to feel that the program has given Cincinnati a lift.

"In response to requests from readers and listeners, we are now considering *I See Today* for tv and as an editorial feature. Hubert Holloway has demonstrated a unique way to make friends at a time when friends are a newspapers' most valuable asset. He has also proven a new idea for greater use of radio and tv on the part of newspapers."

Mr. Taft said that there have been numerous requests that the program be given more time on the air, televised and printed as an editorial feature.

female, young and old, indoor and outdoor. But I am sure that if we could achieve the variety in television production, programming and distribution which exists among publications, we would be able to reach these many audiences which are asking for the chance to enjoy, and be satisfied by, what is definitely the technological wonder of our age, television at its best.

In too many homes, the tv tube is dark most of the time and too many members of the American community, who have been attracted by the miracle, have been driven away from it in boredom, or despair of ever finding it in what they need and can enjoy.

In my opinion, it is up to the advertising agencies to do something about this. They have the talents and the general experience in communications and they enjoy the valuable advantage of impartiality. They are not networks or stations, renters of wires and electronic impulses. They are not producers, selling primarily their particular brand of entertainment and with little interest in the other kinds.

If we could see television not as one medium, comparable to a vast picture magazine bought by everybody, where the only competition is for readership of articles and for ad position near the most-read pieces, but as a whole constellation of media, we might be nearer to the solution of television's dilemma and a fuller understanding of what the agency can do.

Remembering, as I feel sure you do, that the aim is not simply audience, but the satisfied, grateful audience, the client's own audience, you can see why the agency must be watchful, aggressive, creative and discriminating and not let the client be stampeded in his choice of programs. of time, or for that matter of the medium itself.

The agency with a reasonable cross-section of accounts is in an excellent position

to exert a powerful influence on the future of television.

Let me hark back to the history of motion pictures. At first there were silent images, lacking the dimension of sound, much as radio lacked the dimension of the image. Yet these two means of communication, silent films and radio, won themselves huge audiences, incomplete as they proved to be.

Sound came to the movies, not so long ago, only 25 years ago, and a new surge of life and profit came over the industry, reaching its peak in post-war 1947. Then something happened and it wasn't all television. The movies discovered they had lost their audience of people over 30. These older people had come, by and large, to the conclusion that the pictures had nothing more to offer them. They just stayed away.

They didn't burn down the picture houses and didn't stop the kids from attending. But there were vacant seats, as there are today many darkened tv tubes, and the results were disastrous. To avoid anything like the disaster which hit the movies, let us, who work for and with the agencies, exert our best efforts at every level to make sure that television has something for everybody, as far as is possible. Let's have great popular shows, lots of them, but let's also have programs of special interest to special groups and find a way to get them to these groups efficiently and economically.

We will need the support of all kinds of people if our industry is to prosper and we are going to have to earn that support. Of course, we will have to get behind all kinds of public service programs, real ones. But over and above that we should remember that there are whole sections of our nation asking for bread and still getting a stone.

As technicians in the molding of public opinion and public taste, we cannot afford to lose touch with those elements of the public who themselves, in their spheres, also create, shape and sanction public taste.

KDUB-TV

"Fair-est" station in the nation!

LUBBOCK, TEXAS

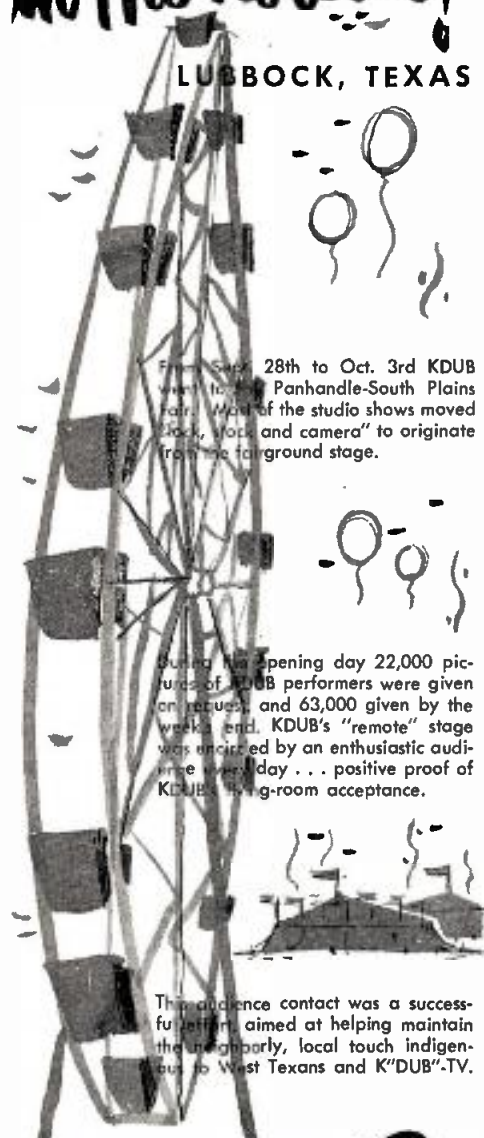

From Sept. 28th to Oct. 3rd KDUB was the Panhandle-South Plains fair. Most of the studio shows moved back, took, and camera to originate from the fairground stage.

During the opening day 22,000 pictures of KDUB performers were given on request, and 63,000 given by the week's end. KDUB's "remote" stage was encircled by an enthusiastic audience every day... positive proof of KDUB's big-room acceptance.

This audience contact was a success-fest, aimed at helping maintain the uniquely, local touch indigenous to West Texans and K"DUB"-TV.



DUMONT CBS PARAMOUNT

ASK YOUR AVERY-KNODEL MAN ABOUT

K"DUB"-TV

W. D. "Dub" Rogers, President Mike Shapiro, Asst. Mgr., Director of Sales

How radio and television gave Toni Co. a big hand in a national promotion campaign to make co-eds conscious of home permanents.

Toni Goes To College

IF YOU'RE an advertiser and want to crown your own beauty queen, your best promotion bet may be a nearby television or radio station.

In fact, the local station may step in where a broadcast critic might fear to tread, when it comes to scanning beauty.

At least, the Toni Co. is sold on the promotional value of the broadcast media, on the basis of a four-month campaign to crown a queen for its Prom Home Permanent. Radio-tv coverage was nothing short of comprehensive, according to the Prom division of the Gillette Co.

And when Marjorie Hightower, a 21-year-old, winsome lass from Dallas went out to California, the winner among eight regional finalists, Cascade Pictures tested her, not alone for the screen but television as well.

The Prom contest was a full-blown effort involving the participation of Toni's public relations office and counsel, as well as its radio-tv department. The contest was extensively promoted on its network shows and by individual stations.

College Round-Up

Last April, Toni sent letters to 1,825 U. S. and 250 Canadian colleges, announcing the contest and enclosing entry blanks. Local stations joined the effort by conducting their own contests, in some instances, and by arranging personal appearances.

Eight regional winners were chosen early in June, with more radio and tv publicity in their respective home towns. Toni phoned program directors of tv stations in areas where they lived and lined up guest appearances. Where there were no tv outlets, radio stations were called. The judging and coronation were held in Chicago June 13.

As an example of pre-regional competition, KTBC-TV Austin held its own Prom contest, selecting a U. of Texas coed to enter the national contest. But this was as nothing compared to prominence given the event by stations, once Miss Hightower was chosen. Toni successfully combined radio-

tv with a beauty contest gimmick not exactly new.

For the coronation, NBC-TV photographed her for its *Camel Caravan*. Fox Movietone tv newsreel and WGN-TV Chicago also gave it a good play.

The Prom Queen made eight radio and tv appearances while in Chicago and continued to shine along radio-tv row, back to Dallas, and out to Hollywood. The Chicago stints: Jack Eigen's *Chez Paree* show on WMAQ June 13; Danny O'Neills' program on WBKB (TV) June 15; Mr. Eigen's tv show on WBKB June 15; Mr. O'Neill's *Chicago at Night* June 15; *Hi Ladies* on WGN-TV June 16, and *Shopping with O'Reilly* on WBBM-TV June 16.

Back in Dallas, she was a guest on Julie Benell's tv show.

The Hollywood trek had all the ingredients of a high-powered campaign once the exclusive domain of the motion picture in-

dustry. The trip, as well as tv and film tests, were her prizes. She was accompanied by Walter Hiller, Toni's radio-tv director, and Eileene Oberling, the firm's beauty-fashion director.

Leo Burnett Co., which handles the Prom account, went into high gear, cooperating with Toni brass to get Miss Hightower on its sponsored West Coast radio and tv shows: *Place the Face* on NBC-TV (which shifted to CBS-TV Aug. 27), *Wizard of Odds* on CBS and *Family Skelton* on CBS.

Additionally, Miss Marjorie guested on the Al Jarvis show (ABC-TV), Ed McElroy program (NBC-TV) and *Meet the Missus* on the CBS Pacific Coast Radio Network.

Once in Hollywood (last June 28), Miss Hightower got the full treatment for Cascade Pictures of California, which makes film for all Toni products and other clients (Halmark cards, Kellogg cereals, Carnation milk, Oldsmobile).

The tv tests occupied the better part of two days at Cascade, located on the Hal Roach studio lot in Culver City. The test is being screened for all of Cascade's clients.

Miss Marjorie was on the go every minute. On July 2, she was a guest on the initial *Place the Face* tv show sponsored by Prom.

The four-month contest was handled by Robert Peck, Toni's public relations director, with assistance from Daniel J. Edelman & Assoc., public relations counsel for Toni, and Mr. Hiller.

Only college queens were eligible for the contest, with selections based on charm, poise, appearance, artistic talents, scholastic record and campus activities. Finalists came from various geographical locations of the country, each receiving an all-expense paid weekend July 13-14 at the Ambassador East Hotel in Chicago before the finalist was chosen and given a \$100 U. S. Saving Bond.

A similar contest was held in Canada, with Merne Perry winning out. She was a guest on two CFCF Montreal radio shows.

Among the judges were H. Leslie Atliss Sr., vice president of CBS Central Division, and Wendell Kling of Kling Studios Inc.



Marjorie Hightower, Toni prom queen, meets actor Richard Carlson (l), Bernard Carr, president, Cascade Pictures, and Walter Hiller (r), radio-tv manager of Toni.

BROADCASTING

TELECASTING

equipment

ON THE
FOLLOWING
PAGES:

TV and AM
equipment
items

... made by
the nation's
leading
manufacturers

and
distributed
by Graybar

Offices and
warehouses
in over 100
principal
cities

our
84th
year

Golly...
Graybar sells everything
for AM and TV!

Yes, Miss... everything needed to put your station on the air *and keep it there* — one source, one responsibility... a comprehensive service developed through more than 25 years of Graybar experience in supplying the broadcasting industry. Via Graybar you can select complete TV and AM equipment installations from among the nation's most outstanding product lines — dependable, precision-engineered items all broadcasters know and respect.

You get the planning help of capable Graybar Broadcast Equipment Representatives — expert advice on the selection, operation, and maintenance of your facilities... plus, if you desire, a complete packaged proposal covering all of the electronic equipment items you require.

For *your* TV or AM requirements, call Graybar first — it's the best way to get everything electrical for your station when and where you need it. *Graybar Electric Co., Inc. Executive Offices: Graybar Building, 420 Lexington Ave., New York 17, New York*

376-110

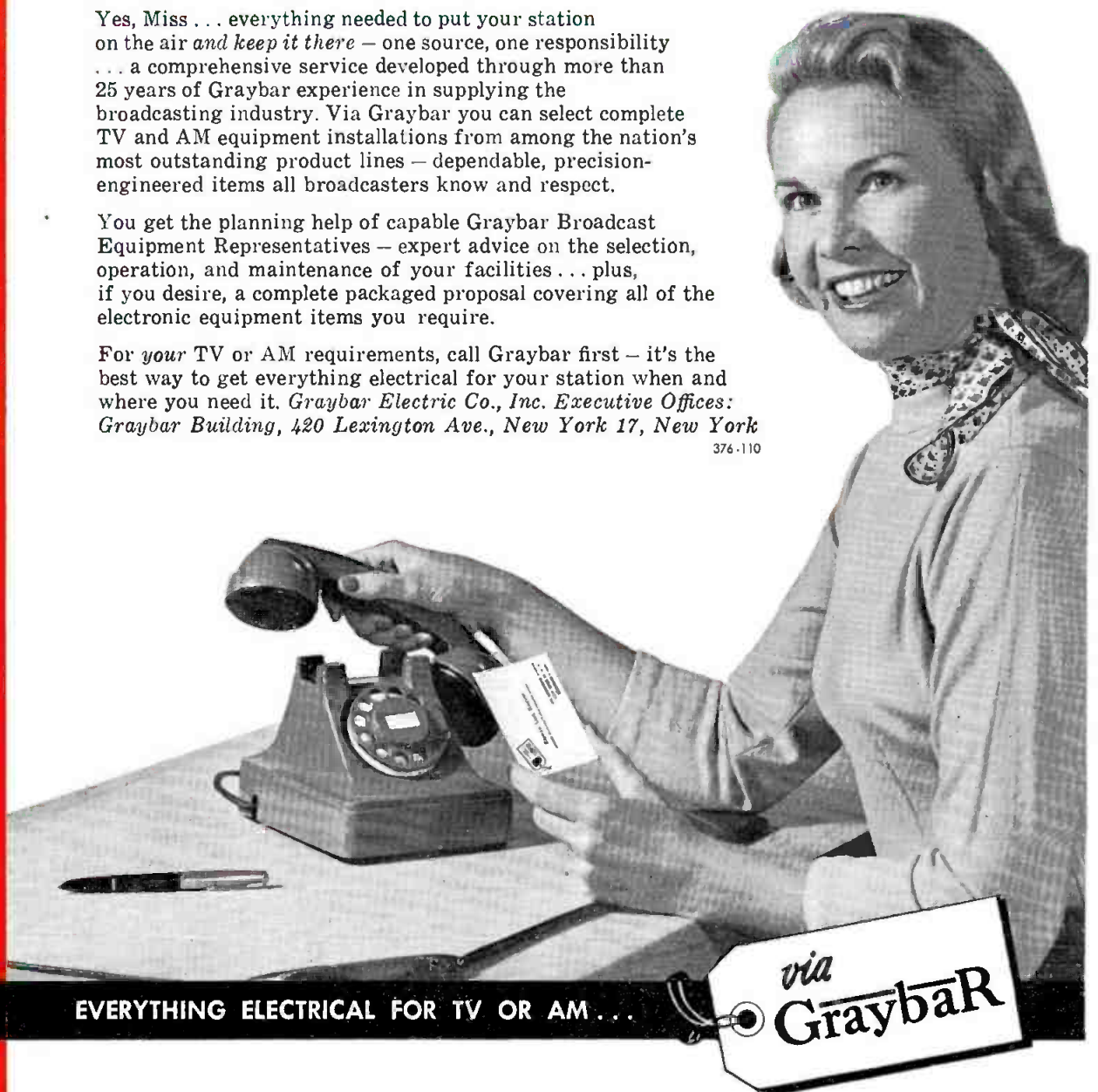

EVERYTHING ELECTRICAL FOR TV OR AM...

via
GraybaR

Another "Scotch" Brand Development!

First in the industry...

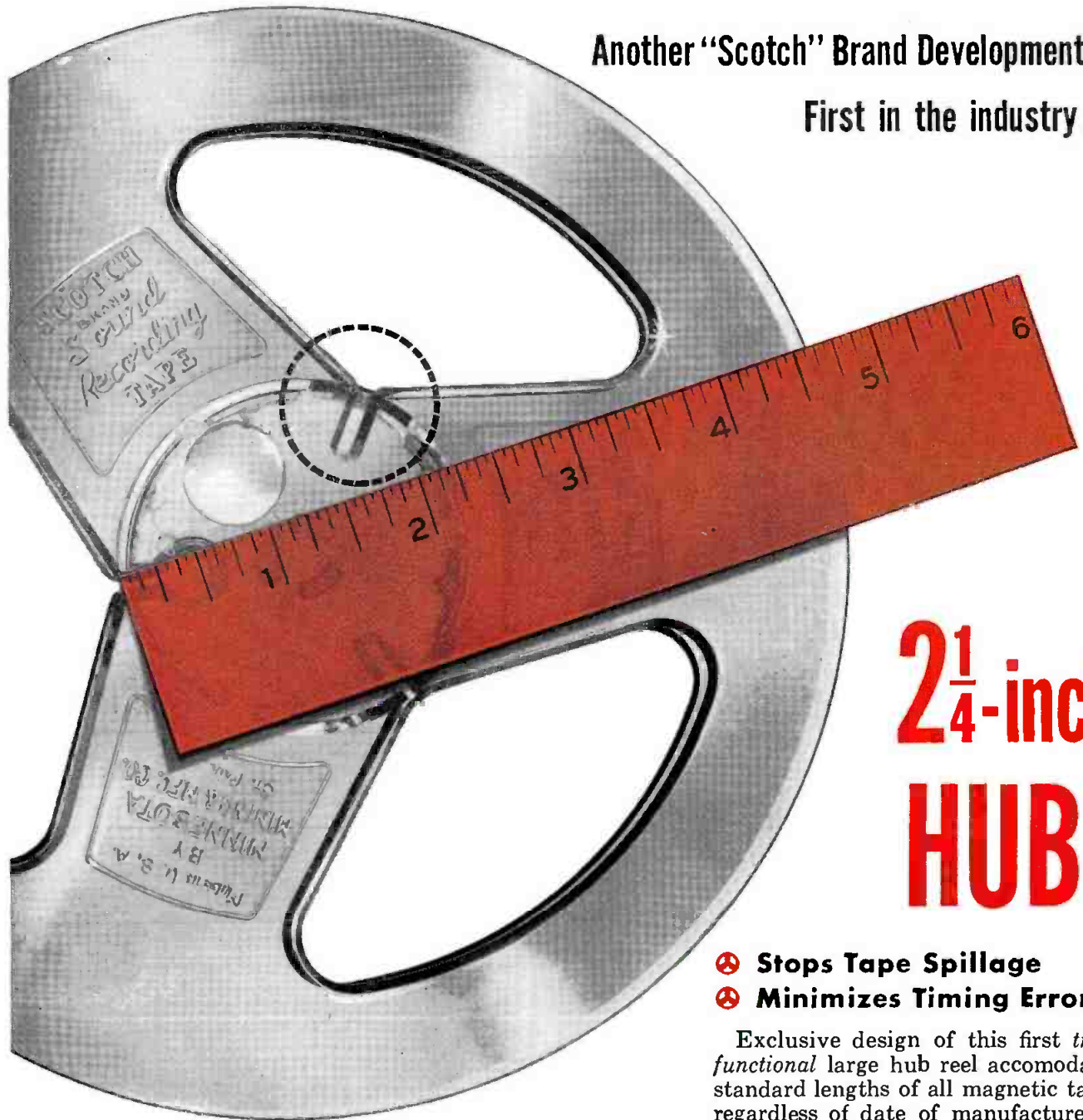

2 1/4-inch HUB!

- ⊕ Stops Tape Spillage
- ⊕ Minimizes Timing Errors

Exclusive design of this first *truly functional* large hub reel accomodates standard lengths of all magnetic tapes regardless of date of manufacture... stops tape spillage on take-up reels... minimizes timing errors. Get it today from your electronic parts distributor.



It's the "SCOTCH" Brand "V" SLOT 7" PLASTIC REEL

- ⊕ "V" SLOT offers easiest, quickest threading device available
- ⊕ WIDE SPOKES give extra rigidity, true balance
- ⊕ TAPERED FLANGES eliminate frayed tape edges
- ⊕ COSTS NO MORE than ordinary reels

REG. U.S. PAT. OFF.
SCOTCH Magnetic Tape
BRAND



The term "SCOTCH" and the plaid design are registered trademarks for Sound Recording Tape made in U.S.A. by MINNESOTA MINING & MFG. CO., St. Paul 6, Minn.—also makers of "Scotch" Brand Pressure-Sensitive Tapes, "Underseal" Rubberized Coating, "Scotchlite" Reflective Sheeting, "Safety-Walk" Non-slip Surfacing, "3M" Abrasives, "3M" Adhesives. General Export: 122 E. 42nd St., New York 17, N.Y. In Canada: London, Ont., Can.



EVERYTHING ELECTRICAL FOR TV OR AM...





the finest tape recorders for broadcast use

For uses where utmost reliability, "perfect" fidelity and accuracy of timing are of prime importance, Ampex Tape Recorders are universally preferred. America's four major broadcasting networks, the country's leading phonograph record manufacturers and various important musical organizations are among those whose usage has established Ampex as the world's standard of excellence in sound recording.



Series 300 console



Series 350 table top console on base



Series 400 single case portable

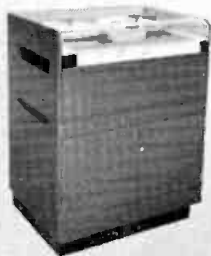

Model 450 console on base

SERIES 300

These, the finest of the Ampex line, are the machines used where speaking or musical performances justify the best recordings it is possible to make. Because of their supreme reliability, the 300 Series machines are used by major radio networks to originate, delay and rebroadcast important radio shows. Record manufacturers use the Series 300 for master recordings because of their high signal-to-noise ratio and low flutter and wow.

SERIES 350

Newest of Ampex's general purpose audio recorders, the 350 has a 30° slant on the top-plate. This puts reels, editing knobs and all controls within easier reach of the operator. Tape editing is faster and less tedious. A three motor tape transport (also used on the higher priced Model 300) provides excellent tape control and utmost reliability of operation. The Series 350 is unusually accessible for servicing.

SERIES 400

The Series 400 was the first tape recorder to bring the Ampex standard of performance within reach of smaller radio stations, schools, conservatories, high fidelity enthusiasts and semi-professional users. The 400 Series portables are the lightest of the Ampex models and consequently the best suited for professional quality recordings on location.

MODEL 450

For background music, automatic broadcasting and TV test patterns, the Model 450 Continuous Tape Reproducer provides up to 8 hours of continuous unrepeat program. The Model 450 uses 14-inch NARTB reels with double track pre-recorded tapes. Starting, stopping, reversing and program repeating are controlled automatically with no attention from a standby operator.

TAPE DUPLICATOR

Designed to make duplicate tapes at minimum labor cost, the Ampex Tape Duplicator makes from 1 to 10* duplicates simultaneously and employs a time-saving speedup. Double track tapes are made in one pass. Fidelity is high (see specifications). Duplicates of any standard tape speed can be made from masters of any standard speed.

*User has the option of buying from 1 to 10 sleeves to operate from one master unit.

SPECIFICATIONS

	Series 300	Series 350	Series 400	Model 450	Tape Duplicator
Frequency response (Tape speeds shown are not all available in all models)	15 in/sec	—30 to 15,000 cps. within ± 2 db 7½ in/sec. — 40 to 15,000 cps. within ± 4 db	40 to 10,000 cps. within ± 2 db	3¾ in/sec. — 50 to 7,500 cps. within ± 4 db	
Signal-to-noise ratio (by NARTB Standards)	Over 60 db	Over 55 db	Over 55 db	Over 50 db	Over 45 db
Flutter and wow	Well under 0.1% rms. at 15 in/sec.	Well under 0.2% rms. at 15 in/sec.	Well under 0.2% rms. at 15 in/sec.	Well under 0.4% rms. at 3¾ in/sec.	Ampex Data Bull. 3-3-1
Available mounting	Console, rack and portable				Unmounted

*Full specifications are given in bulletins on each individual series or model.

Write for further information to Dept. 1498-D



AMPEX CORPORATION

934 Charter Street • Redwood City, California
Branch offices: New York, Chicago, Atlanta, San Francisco and College Park, Maryland (Washington, D. C. area)

EVERYTHING ELECTRICAL FOR TV OR AM...



Pays for itself quickly with AM and FM operating costs saved

...the new *Continental* TRANSMITTER REMOTE CONTROL SYSTEM

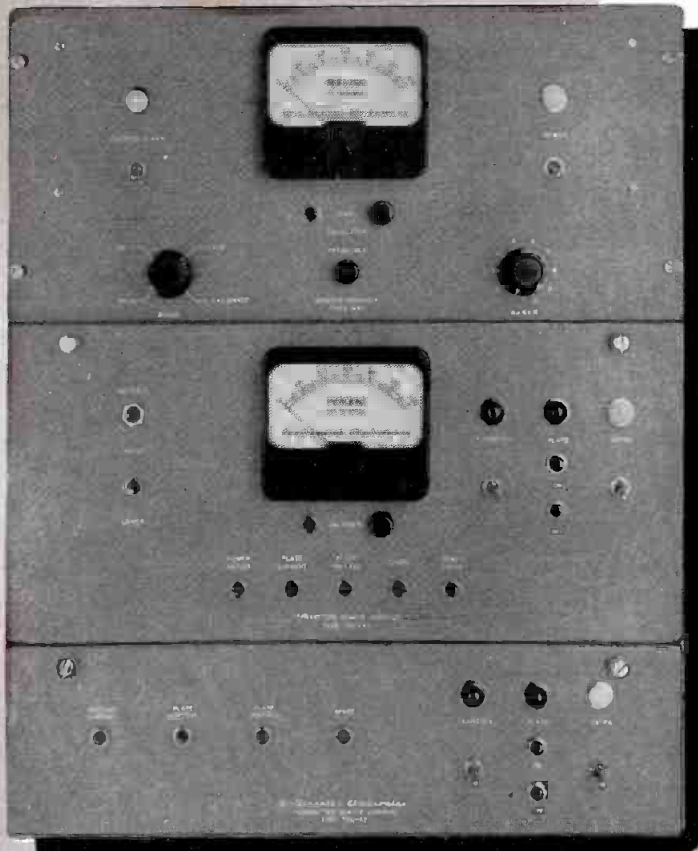

Studio Assembly

You can perform all operating, metering, and monitoring functions right at the studio with this reliable, high quality equipment. Units shown at left are for installation at studio or control point . . . units below at transmitter site.

Outstanding Features

- **SIMPLIFIED OPERATION** with no telephone dials or charts.
- **FILAMENT AND PLATE CONTROL** by a toggle switch and PLATE OFF and ON buttons. Supervisory lights show transmitter condition. Time delay protects rectifier filaments.
- **OVERLOAD INDICATION** by supervisory light operated by a return signal from the transmitter.
- **MONITOR RECEIVER** feeds modulation and frequency monitors; indicates field intensity; sounds alarm if transmitter fails.

Type MR-1
Monitor
Receiver

Type TRC-S1
Remote
Control
Unit

Type TRC-S2+
Remote
Control
Unit

Assembly at Transmitter Location

* TRC-S2 and TRC-T2 Units provide complete, independent control of a second transmitter, either AM or FM, if required. These units can be a part of the initial installation, or may be added later.

Check the money-saving features of this new Continental equipment for your new or remodeled station. Call or write your Graybar Electronic Salesman for complete details.



Type TRC-T1
Transmitter
Control
Unit

Type TRC-T2+
Transmitter
Control
Unit

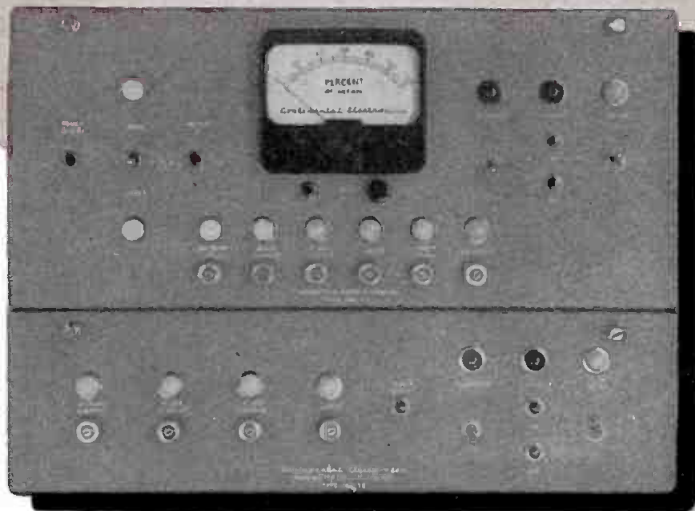

Continental Electronics

MANUFACTURING COMPANY

4212 S. Buckner Blvd.



Dallas 17, Texas

EVERYTHING ELECTRICAL FOR TV OR AM...



IDEALLY SUITED TO REMOTE CONTROL

OPERATION

...The *Continental* Type 315
5000 WATT AM TRANSMITTER

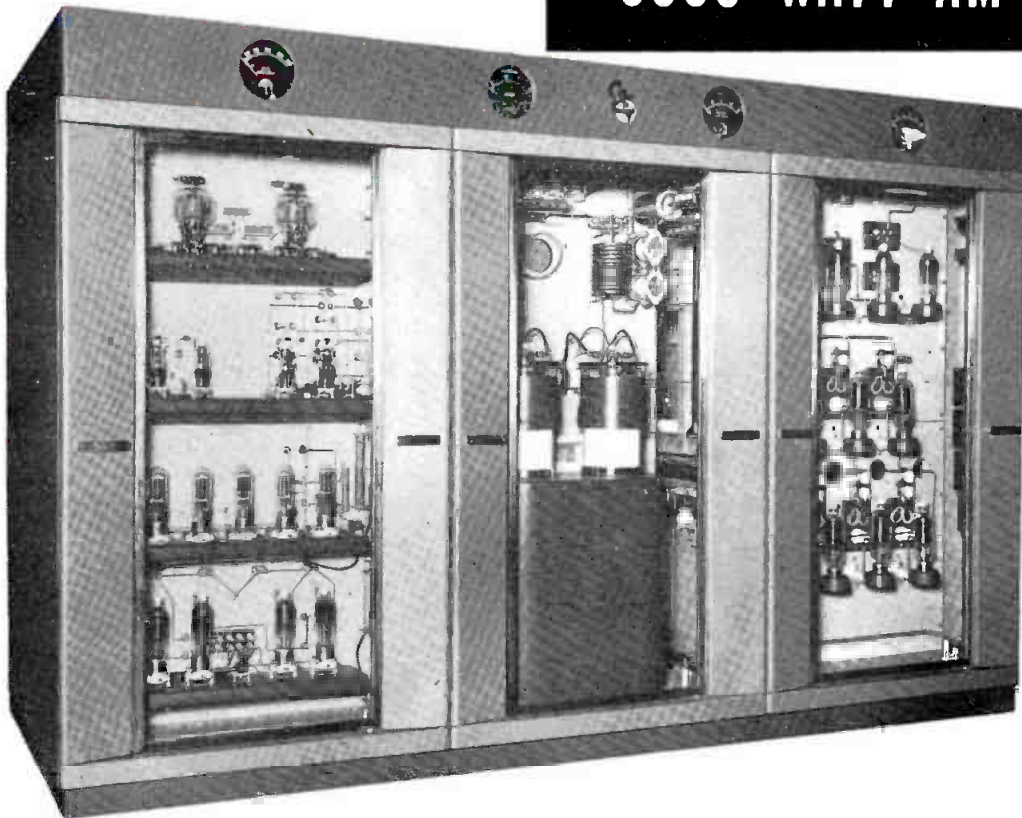

Remote Control operation emphasizes the need for utmost reliability in transmitter performance. The extra quality built into the conservative design of this sturdy, extremely stable transmitter is your assurance of trouble-free, unattended operation.

The unusual stability of operation attained in the *Continental* Type 315 Transmitter results from the use of vacuum capacitors and special ceramic coil forms in all RF circuits. All components are conservatively rated.

For 10 KW operation, *Continental* also offers Type 316 Transmitter with identical features and performance.

Your best bet for REMOTE CONTROL

When planning a new station or the modernization of your present facilities, for radio broadcasting at its best, specify a complete *Continental* installation—of both Transmitter and Transmitter Remote Control Equipment. It will bring you greater convenience . . . reliability . . . and economy.



*Continental
Electronics*

MANUFACTURING COMPANY

4212 S. Buckner Blvd.

Phone EVERgreen 1137

Dallas 1-7, Texas

EVERYTHING ELECTRICAL FOR TV OR AM...



3 ways to simplify electrical connections for TV and AM facilities...

with standard Thomas & Betts fittings

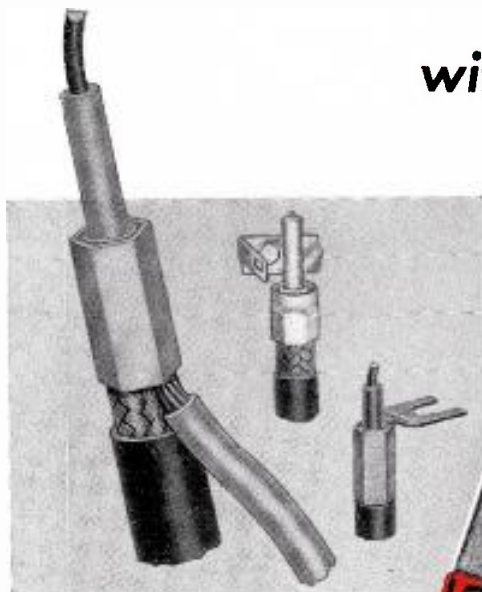

SHURE STAKE tools do the job quickly and conveniently

1. Specify T & B grounding sheath connectors for shielded conductors

Here's a neat, easy way to ground and terminate shielded or co-axial conductors. Ideal for all AF and RF applications, T & B compression-type grounding sheath connectors assure positive, uniform contact between braid strands and ground lead — without soldering . . . without damage to insulation.

Simply slip hard metal inner sleeve under conductor braid. Then, add ground lead and slip on larger soft metal sleeve. Compress with T & B SHURE STAKE hand tool and the job is done! T & B grounding sheath connectors can be supplied for conductors from .046 to .312 in diameter . . . are also available with integral terminal tongues.



Self-insulated Sta-kon

2. Specify T & B Sta-kon® pressure terminals for power circuits

Sta-kon terminals provide mechanically-strong, electrically-sound power cable connections in all current ranges as well as audio circuits.

Just slide bronze Sta-kon barrel over conductor and compress with T & B SHURE STAKE tool. Staking indenter forces conductor into copper Sta-kon tongue assuring a permanent, low-resistance joint.

Sta-kon connectors are available in a variety of tongue styles for conductors from #22 to 250 MCM. Self-insulated Sta-kons can be supplied where leads are crowded or overlapped.

3. Specify T & B construction fittings for conventional electrical systems

Lighting, power, and inter-com systems for your station can be installed faster and at less cost when you standardize on T & B products. There's a T & B engineered fitting designed for every connecting job . . . and designed to do it better.

Like all T & B products, they're sold only through leading electrical distributors in your area. The savings and convenience inherent in this method of distribution are an additional reason why it pays to standardize on T & B.



EMT fittings



floor boxes



ground fittings

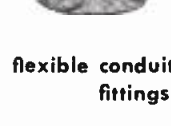

flexible conduit fittings



For free samples and engineering data, just write: Thomas & Betts Co., 21 Butler Street, Elizabeth 1, New Jersey

THE THOMAS & BETTS CO. INCORPORATE

Thomas and Betts, Ltd. Montreal, P.Q. Canada

MANUFACTURERS OF ELECTRICAL FITTINGS SINCE 189

EVERYTHING ELECTRICAL FOR TV OR AM...





Look to Graybar for the best in TV equipment

Inside and Out!

It's just good common sense to match that fine transmitter equipment in your station with the best possible tower available in both guyed and self-supporting types.

In heights to 1000 feet (or higher), you can select the Blaw-Knox tower that will insure maximum coverage. Soundly designed and sturdily constructed, with a minimum of deflection, these towers are engineered to provide the highest safety factor regardless of location. Heavy galvanizing gives longer life at lowest maintenance cost.

For over 30 years Blaw-Knox has been building towers that are considered the standard of comparison throughout the world. The result of this experience is yours for the asking . . . Graybar can furnish capable engineering assistance in selection of the right tower for your facilities.

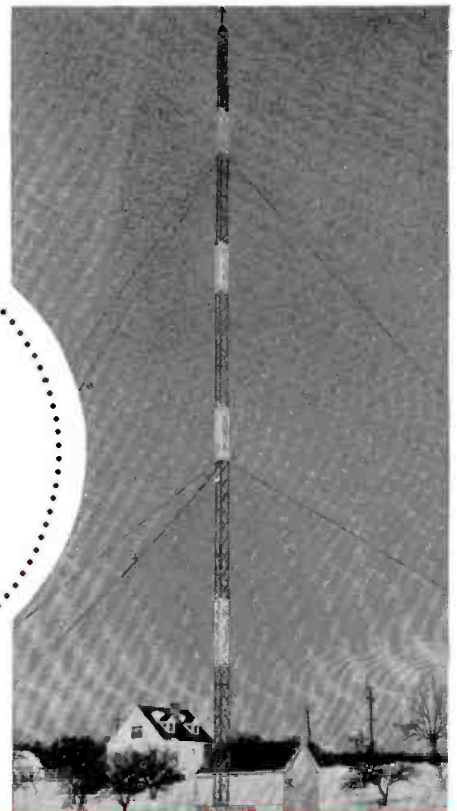

BLAW-KNOX
Antenna
TOWERS

EVERYTHING ELECTRICAL FOR TV OR AM...





Everything you need

VHF OR UHF

Your every need for complete station equipment can be supplied by Federal Telecommunication Laboratories — a single, dependable source for the finest in television station equipment. Federal's outstanding facilities for research, design, engineering, and manufacturing offer the flexibility essential to today's wide range of telecasting requirements. Federal VHF and

UHF station installations throughout the United States, Mexico, and South America are operating successfully with equipment designed to meet their specific requirements. Whether your needs are for a small "two-man" operation or an elaborate multi-studio installation, Federal has the equipment and the know-how to do the job!



Mobile TV Pick-Up Unit

A new design in Mobile Television Units. Over-all size carefully chosen for optimum maneuverability combined with spacious, efficient interior layout. Completely equipped with provisions for dual field camera chain and portable microwave link. Air-conditioned, attractive in appearance, yet moderate in cost, FTL's Mobile Unit is outstanding in every respect.

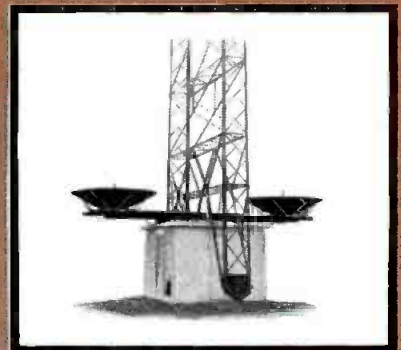

Microwave TV Links

For Studio-Transmitter Link, Inter-city Relay and Remote Pick-ups. Ground-mounted antennas, unattended automatic operation and advanced circuitry provide most widely accepted unit for this service. High-power output and crystal control provide maximum circuit dependability. Sound Channel Equipment — an exclusive FTL development — permits multiplexing audio and video.

Highest Gain Antennas for Channels 7-13. Sixteen-loop array provides maximum ERP with only 25 Kw r-f power and single transmission line. Simplified structure reduces tower and erection costs. For better over-all coverage, new phasing system eliminates minor lobe nulls... provides high field strength in primary service area. One of the greatest new advances in VHF antennas.

EVERYTHING ELECTRICAL FOR TV OR AM...



for TV... from *Federal*

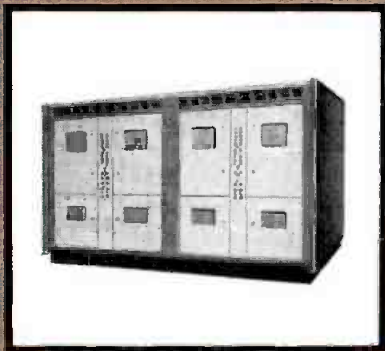

VHF and UHF Transmitters

Modern, high-efficiency VHF transmitters with outputs of 1, 5, 7.5 and 25 Kw. and UHF transmitters of 1 and 10 Kw. Proven design and performance features include: "mid-level" modulation, broad band r-f circuits, long life, and low costs. Supplied with Master Control Console. Sideband filters, dummy loads and all auxiliary monitoring equipment also available.



"Poly-Efex" Scanner

Federal's outstanding innovation for the best in television programming. Provides 4-channel video switching for its two self-contained slide sources, plus any two external signals. Permits an untold variety of special effects, montages, superpositions, wipes, 3-speed automatic or manual lap dissolves and fades—all with a single operator. Forms the operating heart of the TV station.

FEDERAL TV EQUIPMENT INCLUDES THE FOLLOWING OUTSTANDING UNITS:

- VHF and UHF Transmitters
- VHF and UHF Antennas
- Frequency and Modulation Monitors
- Transmitter Auxiliary Equipment
- Field, Studio and Film Camera Chains
- Synchronizing Generators and Auxiliary Equipment
- Flying Spot Scanners
- Master Control Equipment
- Picture Monitors
- Television Microwave Relay Links
- Mobile Pickup Units

UHF Antenna

Consisting of all-metal slotted sections... has no insulators, no de-icing problems and offers beam tilt and null fill-in for variations in vertical radiation pattern.

Custom built for each installation, this highly-rated antenna offers models with power gains of 14 and 25. Proven operating performance and dependability for every UHF channel.

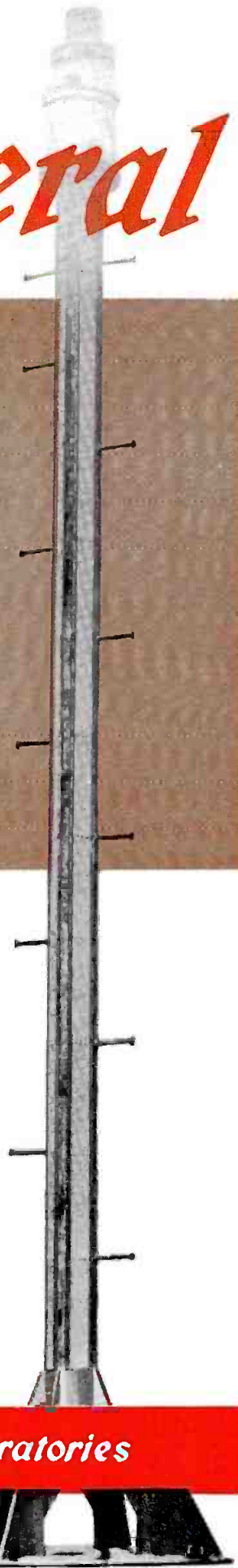

Federal Telecommunication Laboratories

TELEVISION BRANCH

ROUTE 17, LODI, N. J.

Main Office: 500 Washington Avenue, Nutley, N. J.

In Canada: Federal Electric Manufacturing Company, Ltd., Montreal, P. Q.
Export Distributors: International Standard Electric Corp., 67 Broad St., N. Y.



EVERYTHING ELECTRICAL FOR TV OR AM...

via
Graybar

Stay **ON THE AIR**

WITH THESE QUALITY PRODUCTS

TIREX MICROPHONE CORD

- A light, extremely flexible microphone cord. It has been an industry standard since the early days of radio. Widely known for its ability to withstand abuse. Smooth jacket will not catch on stages or sets.

TIREX PORTABLE CORDS

- A very tough, extremely flexible cord for a great variety of uses. Frequently used in connection with portable lights and with banks of overhead lights. Jacket is special neoprene compound that will withstand toughest service.

SIMPLEX ANHYDROPRENE

- For power distribution, panel board wiring and for signal service. Has a thin jacket of neoprene in place of fabric braids. Jacket is colored for circuit identification. A special Simplex-ANHYDROPRENE, Type WD-75, is available for use in both wet or dry locations at 167°F. (75°C.).

For these and many other Simplex wires and cables see your local Graybar branch. If they do not have them in stock they can get them for you quickly.

Simplex **WIRES & CABLES**

SIMPLEX WIRE & CABLE CO., 79 Sidney Street, Cambridge 39, Mass.

EVERYTHING ELECTRICAL FOR TV OR AM...



AURICON

16mm Sound-On-Film

for TELEVISION

Auricon 16mm Sound-On-Film Cameras provide ideal working tools for the production of Television Newsreels, film commercials, dramatic inserts and local candid-camera programming. Ask our distributor or write direct for free illustrated catalog.

CINE=VOICE

\$695.00 (and up)
With 30 day money-back
Guarantee

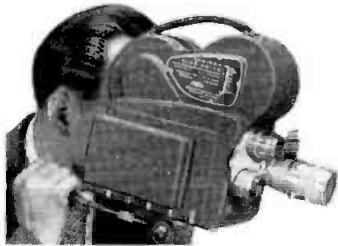

Photograph a sound track along one edge of your picture film with the Auricon "Cine-Voice" 16mm Camera. Same film cost as old-fashioned silent movies! Edit your own talking pictures on any make of 16mm sound projector.



BERNDT - BACH, INC.

7365 BEVERLY BLVD., LOS ANGELES 36, CALIF.

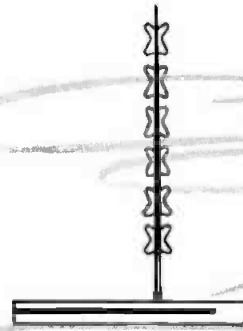

AURICON-PRO

- ★ 200 ft. film capacity for 5½ minutes of continuous sound-on-film.
- ★ Self-blipped for quiet studio operation.
- ★ Synchronous motor for "single" or "double-system" sound-recording.
- ★ Studio Finder shows large upright image.
- ★ \$1310 (and up) with 30 day money-back Guarantee.

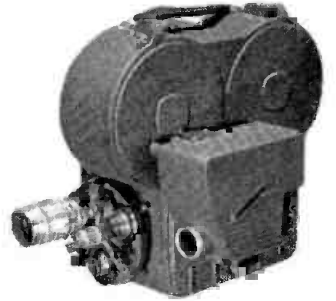

SUPER-1200

- ★ Two independent Finder Systems plus instant Ground-Glass Focusing through the Camera lens.
- ★ Self-blipped for quiet studio operation.
- ★ 1200 foot film capacity for 33 minutes of continuous recording.
- ★ Variable Shutter for fades or exposure control.
- ★ \$4652.15 complete for 16mm sound-on-film... lenses additional. Also available without sound for \$3377.90.
- ★ Sold with 30 day money-back Guarantee. RCA licensed sound.

MANUFACTURERS OF SOUND-ON-FILM RECORDING EQUIPMENT SINCE 1931

EVERYTHING ELECTRICAL FOR TV OR AM...



...TO KEEP YOU ON

with RELIABILITY

TUBES FOR AM BROADCAST SERVICE

Final Stage Amplifiers, Modulators, Drivers, and Rectifiers—Incorporating Machlett improvements in design and processing—For reliable, low-cost-per-hour operation.

FM BROADCAST TUBES

1, 3, 10 and 50 Kilowatt Amplifiers as well as Drivers and Rectifiers—Tubes for a broad range of power requirements—With Machlett advances in construction for top performance in high-frequency service.

TRANSMITTING TUBES FOR TV SERVICE

Very-High-Power Single-Tube Amplifiers for VHF Channels—Featuring: coaxial, compact, high-efficiency design; sturdy, close-tolerance construction; and Machlett-developed, special processing techniques—Providing: minimum cost, reliable performance in high-power, high-frequency service.

Graybar's selection of the Machlett line of transmitting tubes is its best assurance to you of

"keeping you on the air."

The Machlett line of broadcast tubes is designed and produced to satisfy the needs of all broadcasters

--AM, FM and TV

—and to provide reliable, low cost operation

at all power levels up to the very highest.

Manufactured by Machlett Laboratories, Incorporated,

specialists in electron tube design

and production for over 50 years,

these tubes incorporate all the techniques and skills

which have been inherently a part of

Machlett Laboratories since 1897.

This established quality,

coupled with the added advantage of immediate availa-

bility made possible by Graybar's widespread distribu-

tion system, guarantees Graybar's pledge

—"to keep you on the air."

Quality Proved by

EVERYTHING ELECTRICAL FOR TV OR AM...



THE AIR...

with ECONOMY

use MACHLETT TUBES

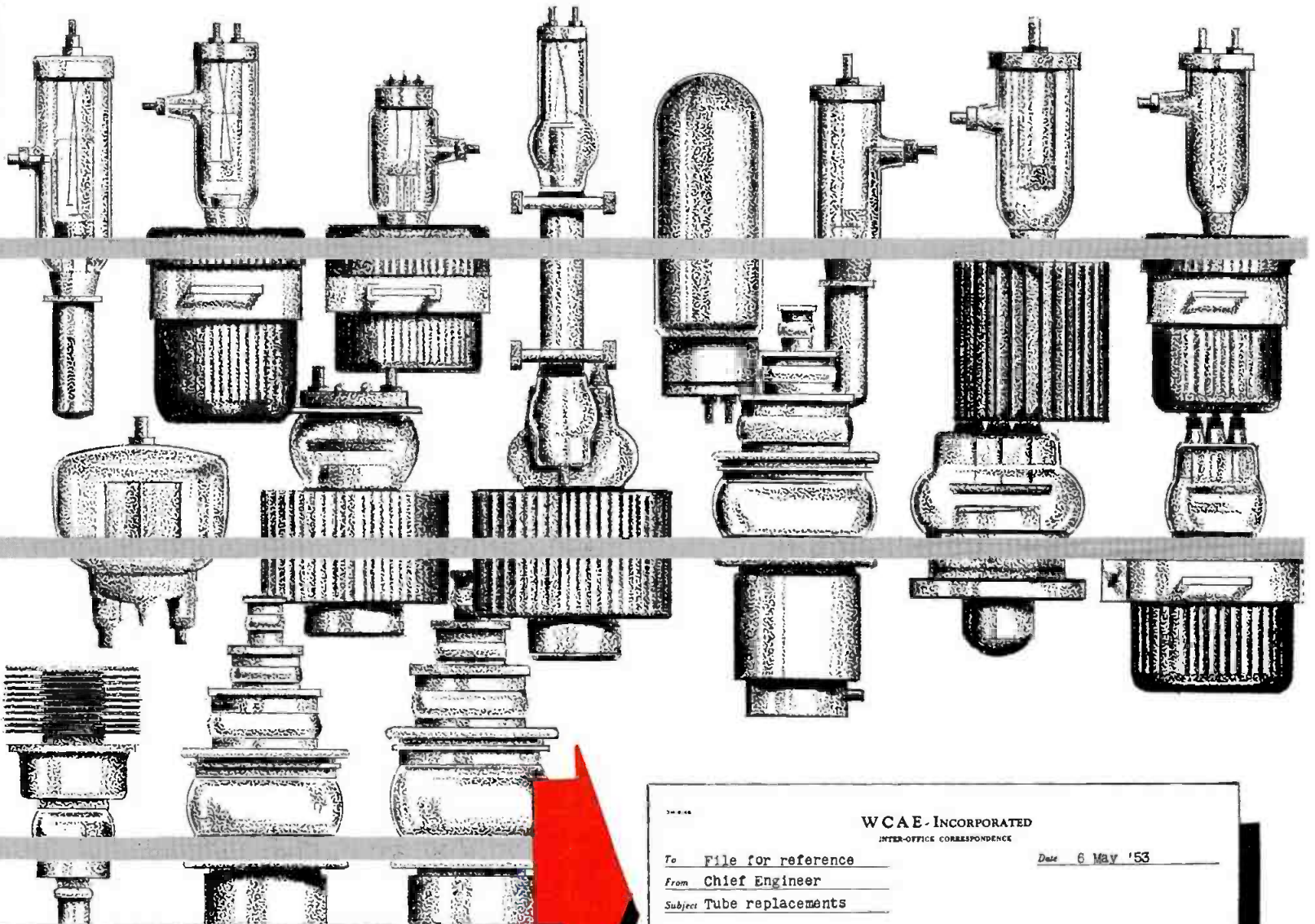

Performance

WCAE - INCORPORATED
INTER-OFFICE CORRESPONDENCE

To File for reference

Date 6 May '53

From Chief Engineer

Subject Tube replacements

When reordering 892's, specify Machlett. They are the only make 892 from which we have received more than 10,000 hours operation in this service.

James H. Beckwith

EVERYTHING ELECTRICAL FOR TV OR AM...

via
Graybar

It's EASY to plan your tower lighting

*... television, radio,
or microwave relay ...*

with **CROUSE-HINDS**

Tower Lighting Bulletin

Crouse-Hinds Technical Data Bulletin 381-F contains important information on television, radio, and microwave relay tower lighting and tells you exactly what you need to do the job. There are layout drawings with complete bills of material for lighting towers of all heights. All of the information meets the requirements of FCC and CAA specifications.

A complete line of alarm relay equipment is available for remote indication of lamp failure as required by the FCC for unattended stations.

Send for your copy of this helpful bulletin today.

CROUSE-HINDS COMPANY Syracuse 1, N. Y.

OFFICES: Birmingham — Boston — Buffalo — Chicago — Cincinnati — Cleveland — Dallas — Denver — Detroit — Houston — Indianapolis — Kansas City — Los Angeles — Milwaukee — New Orleans — New York — Philadelphia — Pittsburgh — Portland, Ore. — San Francisco — Seattle — St. Louis — St. Paul — Tulsa — Washington. RESIDENT REPRESENTATIVES: Albany — Atlanta — Baltimore — Charlotte — Corpus Christi — Reading, Pa. — Richmond, Va. — Shreveport. Crouse-Hinds Company of Canada, Ltd., Toronto, Ont.

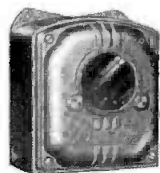

Photoelectric Control provides automatic operation of lighting circuits



Type TSS Flashing Switch

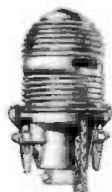

Type EOL Single Obstruction Light



Type FCB-12 Fresnel Beacon

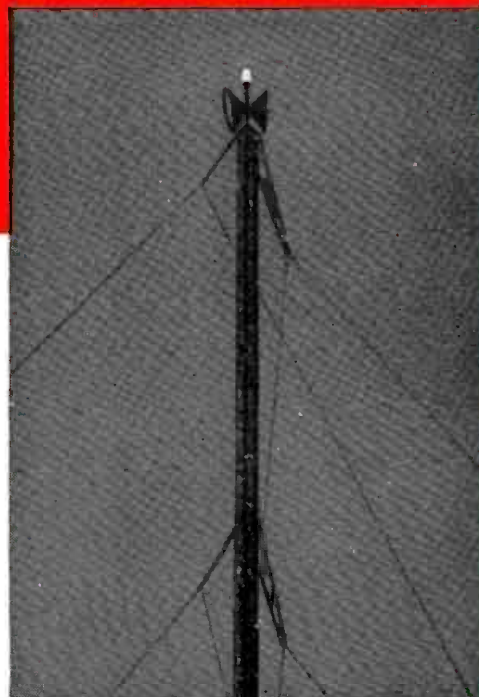

A Microwave Relay Tower with Crouse-Hinds Obstruction Lighting Equipment

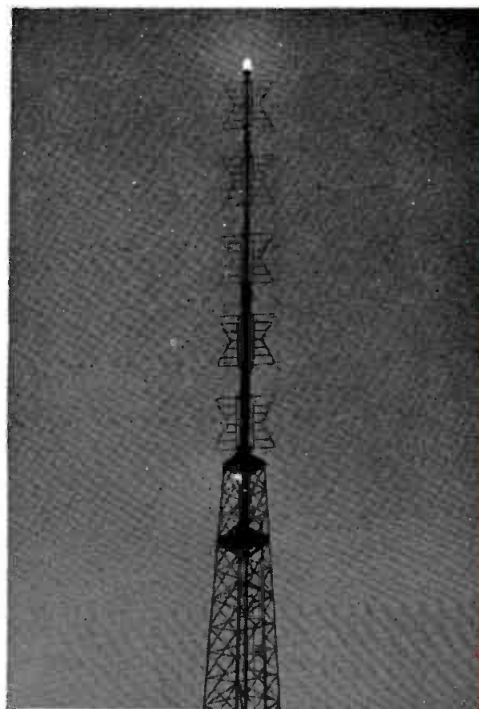

A Television Tower with Crouse-Hinds Obstruction Lighting Equipment



AIRPORT LIGHTING · FLOODLIGHTS · CONDULETS · TRAFFIC SIGNALS

EVERYTHING ELECTRICAL FOR TV OR AM...



T A P E E Q U I P M E N T

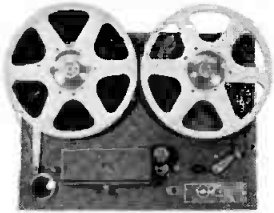

**NEWEST PRESTO TAPE
RECORDER RC-11**

Radical new "unitized" construction with self-contained capstan drive unit. Reel size up to 10½ inches; three enclosed heads; push button operation; heavy ribbed aluminum panel. PRESTO's most advanced tape recording mechanism.

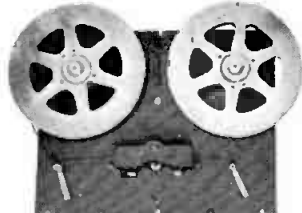

**LONG-PLAYING TAPE
REPRODUCER PB-17**

Designed especially for background music in industrial plants, entertainment locations, ships and trains. Eight hour tape cycle at 3¾"/sec.; dual track; 4800 ft. reel capacity; frequency resp. is 50 to 8,000 cps. (±2db)

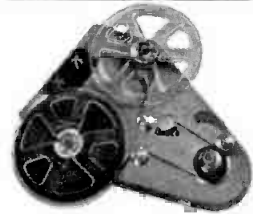

**TURNTABLE-DRIVEN TAPE
REPRODUCER TL-10**

Most amazing development to hit the recording field in years. Makes any standard 16" turntable quickly adaptable to tape. Turntable acts as motor; speeds of 7½"/sec. and 15"/sec. Plugs into standard studio speech input equipment; no preamplifier required.

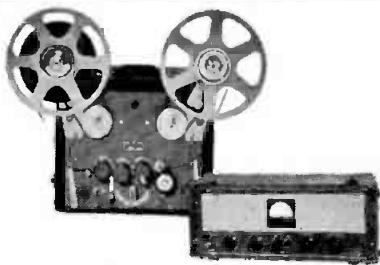

PRESTO PORTABLE PT-920

This popular portable tape machine is shown here with the new RA-1 reel adapters which increase its reel size to 10½ inches. Three motor drive without friction clutch or friction brakes, 15,000 cps. frequency response and excellent dynamic range.

R E C O R D I N G A M P L I F I E R S

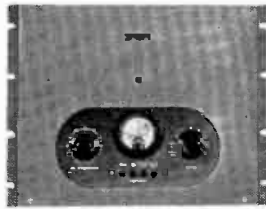

PRESTO 92-B

PRESTO's famous 60 watt recording amplifier for rack mounting. Removable front panel makes maintenance easy. Selector switch and one meter indicate output level and tube plate currents. Push-button selector for recording characteristics. Response: 20 to 17,000 cps.



PRESTO PORTABLE 90-B

Qualities of high fidelity studio console but portable, with complete facilities for remote operation. Distortion of less than 1.5% at maximum output. Equalizers for flat, NAB 33⅓ rpm, phono, NAB playback and automatic. Three-microphone input with mixer and master gain control.

D I S C E Q U I P M E N T

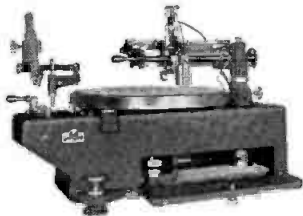

PRESTO STUDIO CONSOLE 8 D-G

Designed to cut the finest instantaneous and master recordings. Has radial cantilevered overhead requiring no turntable contact. 1-D cutting head. Direct gear drive and twin motors. Eight different feed pitches in each direction, including 250 lpi. microgroove.



**PRESTO TRANSCRIPTION TURNTABLE
10-B**

Here is an improved model of the famous PRESTO 10-A which has been the preferred turntable in hundreds of broadcast stations. The 10-B is a rim-driven table of exceptional accuracy with 3-speed mechanism. Offered as chassis only or in console cabinet.

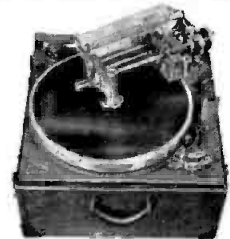

PRESTO PORTABLE RECORDER 6-N

World favorite! Unusual reliability under all recording conditions. Low mechanical noise level. Speed accuracy excellent at 78 and 33⅓ rpm. Equipped with 1-D cutting head. Microgroove attachment available at extra cost.



RECORDING CORPORATION • Paramus, New Jersey

Export Division: 25 Warren Street, New York 7, N. Y. • Canadian Division: Walter P. Downs, Ltd., Dominion Square Bldg., Montreal

WORLD'S LARGEST MANUFACTURER OF PRECISION RECORDING EQUIPMENT AND DISCS

EVERYTHING ELECTRICAL FOR TV OR AM...



FOR LONG LIFE, TROUBLE-FREE PERFORMANCE . . .

Specify the Finest*

ELECTRICAL CONNECTORS MADE



Twist-Lock*

TRADE-MARK

CONVENIENT AND EASY TO USE
A Twist of the Cap, and It's Locked.

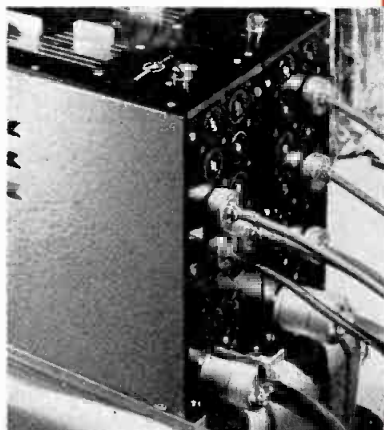
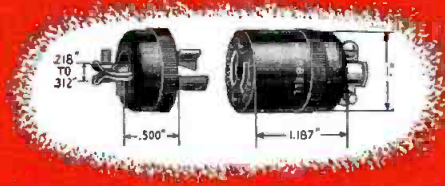

Twist-lock devices in use on a Davis portable dimmer.

Twist-lock . . . first and still the finest separable electrical connection . . . has faithfully served the Broadcasting and Stage Lighting industry for more than 23 years. It is used on permanent or portable apparatus, such as motors, power outlets, audio packs, sound equipment, loud speakers, portable lights, testing and recording equipment. The unique locking principle insures *uninterrupted electrical contact* regardless of vibration. *Twist-lock* never disconnects accidentally. *Twist-Lock* is manufactured in complete lines of two, three and four wires, grounded or not grounded. Ratings range from 10 to 50 amperes. *Twist-lock* provides a maximum of safety and a minimum of time-loss and inefficiency in operation.

Hubbellock*

TRADE-MARK

FOR HEAVY-DUTY SERVICE—
Breaks or Seals a Circuit
in a Split Second

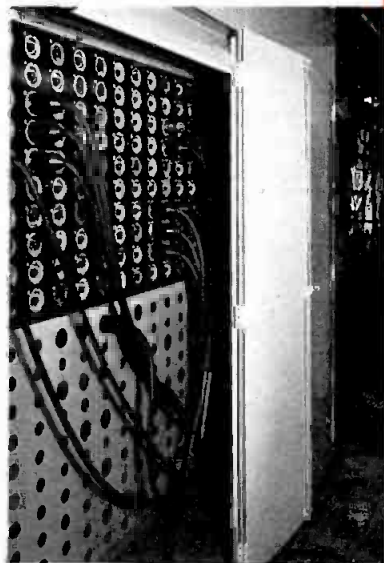

Hubbellock in use on a stage lighting panel.

Here is the ideal connector for heavy-duty use because it permits instant "make" or "break" of the circuit, yet stands up under continuous tough service. Once twisted in position, it is impossible for this device to disconnect accidentally, yet a simple turn, and presto, the spring loaded unit disconnects automatically. Vibration is no problem for *Hubbellock*. There is nothing to jam out of order. Rugged construction throughout prevents shifting out of alignment, bending or twisting. For convenience, safety and dependability, specify *Hubbellock* for heavy-duty use.

Our development laboratory will cooperate with your engineers to adapt Twist-lock or Hubbellock to your application . . . write

HARVEY HUBBELL, INC.
Bridgeport, Conn.
Dept. H

**First and still
the finest!!*



EVERYTHING ELECTRICAL FOR TV OR AM...





IT'S NEW . . . THE PERFECT SOLDERLESS WIRING CONNECTION FOR RADIO AND TELEVISION

Interlock

SINGLE WIRE CONNECTORS

For applications up to 10 amps.

Here is a revolutionary new Hubbell product that may save you endless time, effort and expense by speeding product assembly or repair. Interlock makes it possible in a matter of seconds to join the wires in a section that otherwise would take minutes or even hours. Interlock is widely used on test equipment, control panel boards, telephone equipment, sound effect equipment, patch boards, terminal strips and make-up boards.

Note these Features: Vibration-proof; Pull-proof; Automatic Locking Action; Constant Low Contact resistance.

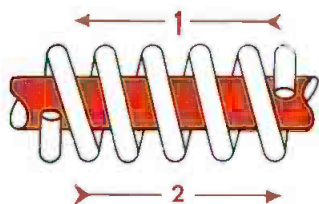

Constant coil spring pressure presses the Interlock contact head against the jack contact, thus eliminating uncertain friction and contact fatigue. Interlock controls actual contact pressure within close limits.

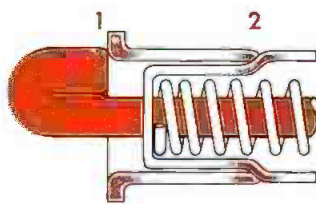

Only Interlock plugs have two separate contact surfaces in parallel. If pressure on the clamping head "1" (primary contact) decreases through vibration, impact or extreme temperature changes, pressure on the secondary sleeve contact "2" increases proportionately.



Positive locking action—vibration and impact proof. No catches or separate locking parts. The contacts themselves form the locking mechanism. The lock is as perfect as the electrical connection because they are one and the same thing.



Constant resistance is low and stays that way throughout the life of the plug due to constant spring pressure. Contact surfaces are self-wiping. Wiping action breaks through any dirt or oxide film.

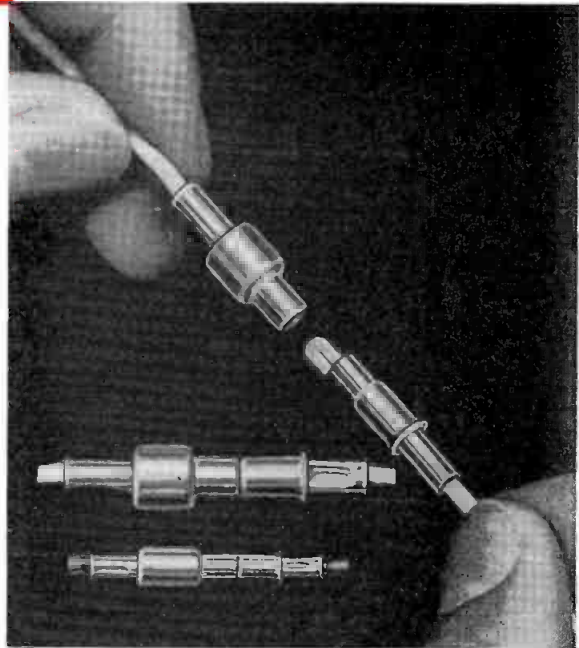

Above: Type A capacity 10 amps., and Type B capacity 5 amps. (both shown actual size)

Applications Unlimited!

How can the Hubbell Interlock help you save time, trouble and expense? Our staff of Hubbell sales engineers will gladly study your problem and recommend a solution. Write for complete information.

HARVEY HUBBELL, INC.
Bridgeport, Conn.



*FIRST . . .
and
still
the
FINEST!*

EVERYTHING ELECTRICAL FOR TV OR AM...



YOU CAN DEPEND ON US...

to supply the **finest** in **TRANSMISSION LINES & WAVEGUIDE**

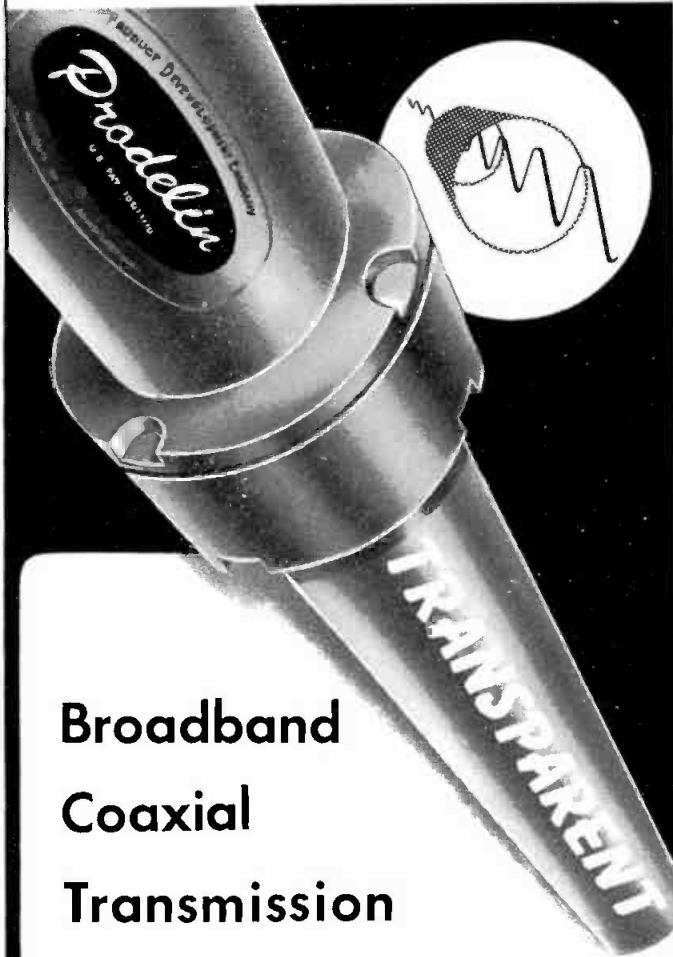

**Broadband
Coaxial
Transmission
Lines**

**Lowest Power Loss
No Electrical Discontinuity**

Designed for continuous service at any frequency to 2700 MCS, Prodelin Series 800 transmission line offers the highest microwave signal transmission efficiency with the lowest VSWR obtainable anywhere! And Prodelin Series 800 line can be cut at any point in the system, without regard for insulator spacing—it still retains its extremely high efficiency and low VSWR! Available in 7/8", 1 1/8", 3 1/8" and 6 1/8" sizes and in 50 ohm impedance.

Prodelin Air-Tite couplings are electrically smooth and completely air tight. Simple mechanical assembly cuts field installation time by 50%! (Proved in actual field installations by experienced installers.)

Prodelin

WAVEGUIDE

PROVED IN SERVICE

conserves **POWER**
in
UHF-TV!

UHF POWER LOSS WITH 3 1/8" COAXIAL TRANSMISSION LINE

Length of Transmission Line	Total Loss	ERP*	Approximate Power Loss
1000 ft.	3 db	50 kw	50 kw
500 ft.	1.5 db	70.7 kw	29.3 kw
100 ft.	0.3 db	93.5 kw	6.5 kw

*Assuming 100 kw ERP with a perfect transmission line

Small increments of attenuation in coaxial transmission lines result in excessive power losses when used in conjunction with hi-gain antennas in the UHF range. This loss of effective radiated power is often as high as 50%.

The best solution to the problem is *waveguide*. Waveguide provides lower attenuation, greater coverage for equal antenna height . . . it can be used in combination with UHF coaxial line . . . requires no dehydration or pressurization.

EVERYTHING ELECTRICAL FOR TV OR AM...

via
GraybaR

ALTEC = AUDIO

For audio equipment, smart broadcasters place their confidence in the Altec Lansing Corporation. Experience has shown that Altec equipment is always better; its quality unsurpassed; and its dependability beyond expectations. Altec equipment is designed to work together, without extra matching transformers or other expensive adaptations. Whether it is the new 601A Duplex monitor speaker or a complete speech input installation, you'll find Altec audio equipment will do the job better, longer, more economically.

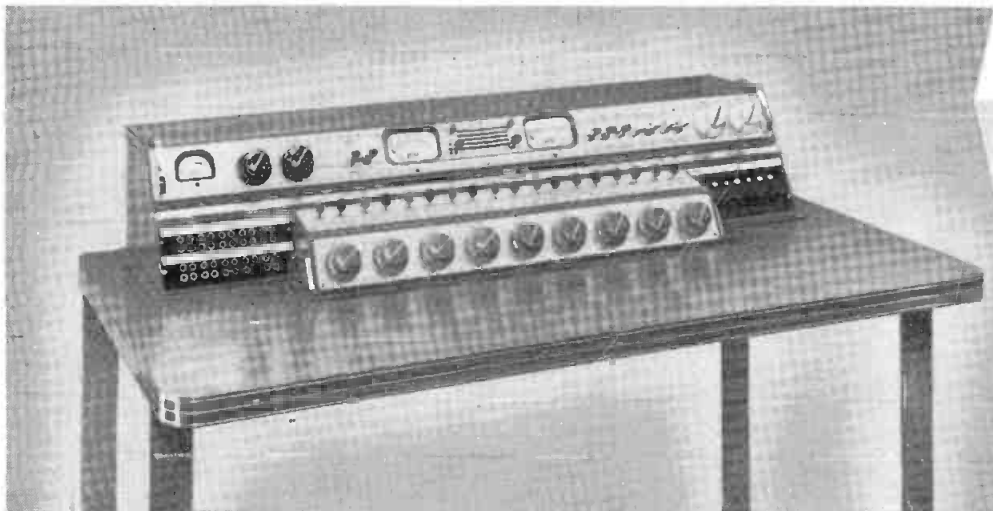

250A Console. This beautiful master console represents a new quality standard for speech input equipment. Like all Altec consoles and mixers, its frequency response, noise level and low distortion more than meet the most

stringent broadcast requirements. It is compact and completely self-contained, without external power supplies or junction boxes. All amplifiers and power supplies are precision-engineered miniature plug-in units.

Ask our distributor or write direct for complete information on any item of Altec audio equipment.

9356 Santa Monica Blvd., Beverly Hills, Calif.
161 Sixth Avenue, New York 13, New York



Plug-in Preamp. ... A-428B

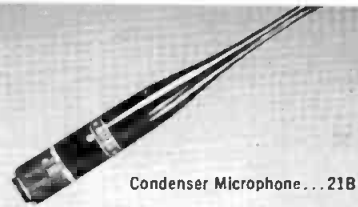
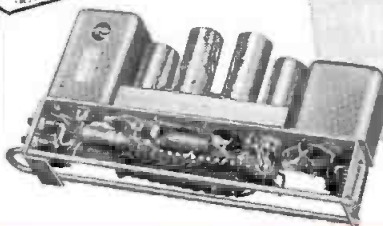

Condenser Microphone... 21B



Directional Microphone ... 639



Utility Microphone ... 633

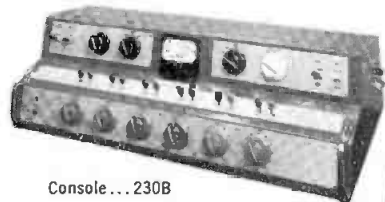

Console ... 230B

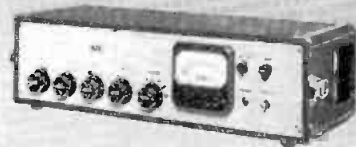

Portable Mixer ... 220A

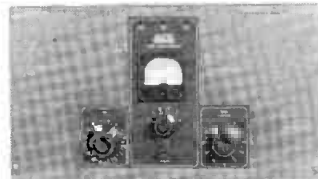

Limiter Amplifier... A-332C



30-22,000 cycle.
Monitor Speaker...
601A

EVERYTHING ELECTRICAL FOR TV OR AM...



We recommend

"PROVEN PERFORMANCE"

SEAL-O-FLANGE* UHF

**UHF HARD DRAWN SEAL-O-FLANGE*
TRANSMISSION LINE SIZE 3 1/8"***-50 OHMS**

- | | |
|--|---|
| (A) Cat. No. 200-506 Transmission Line | (F) Cat. No. 305-506 Flange, fixed type |
| (B) Cat. No. 301-506 Elbow, Mitre, 90°, flanged | (G) Cat. No. 311-506 Reducer 3 1/8" to 1 1/8", flanged |
| (C) Cat. No. 303-506 Elbow, Mitre, 45°, flanged | (H) Cat. No. 312-506 Coupling flange - Compression type |
| (D) Cat. No. 306-506 Gas Stop | (I) Cat. No. 98-506 "O" Ring gasket |
| (E) Cat. No. 310-506 Anchor insulator and inner conductor assembly | |

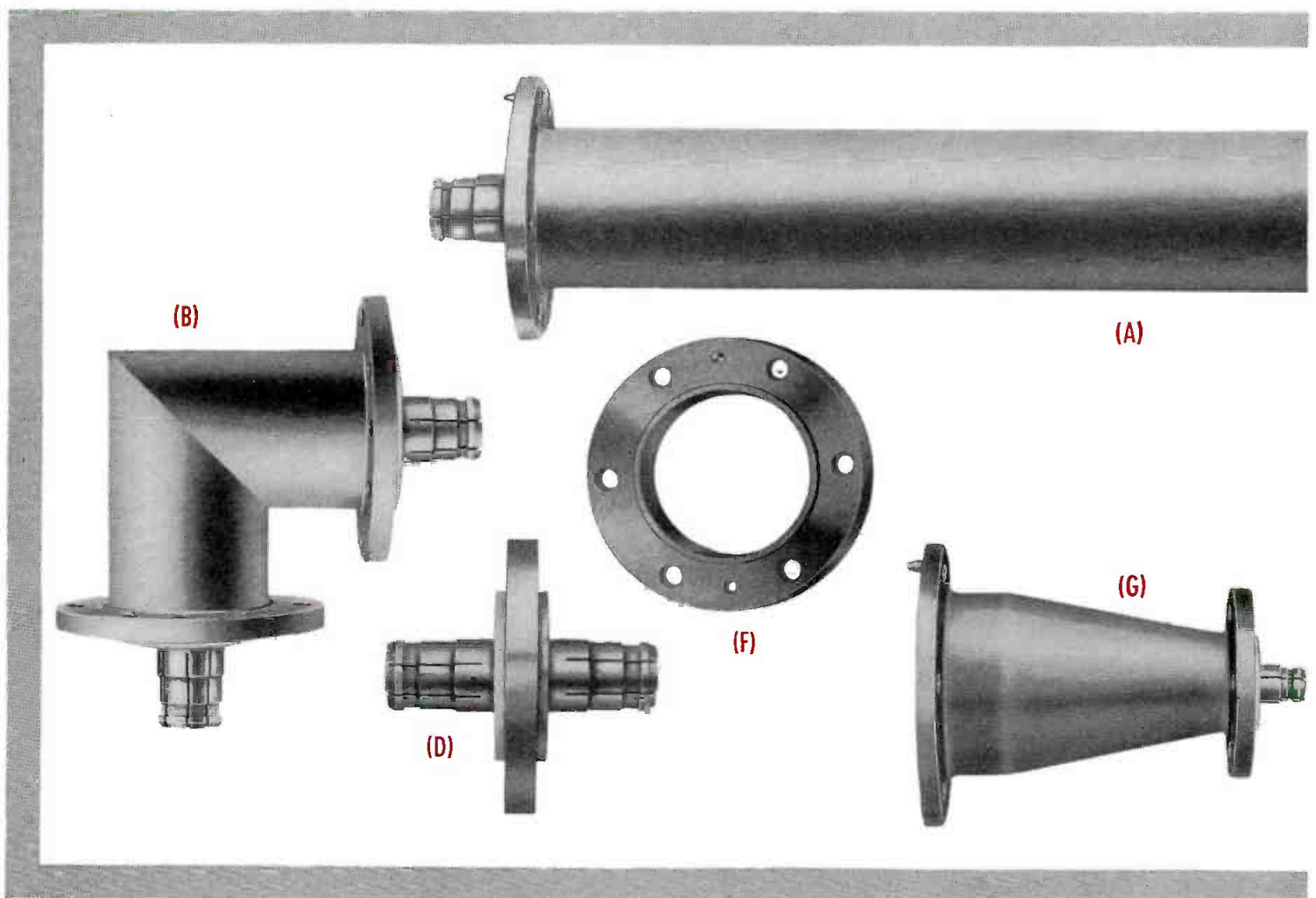

EVERYTHING ELECTRICAL FOR TV OR AM...



TRANSMISSION LINE

by

Communication Products Company, Inc.

*REGISTERED TRADE NAME

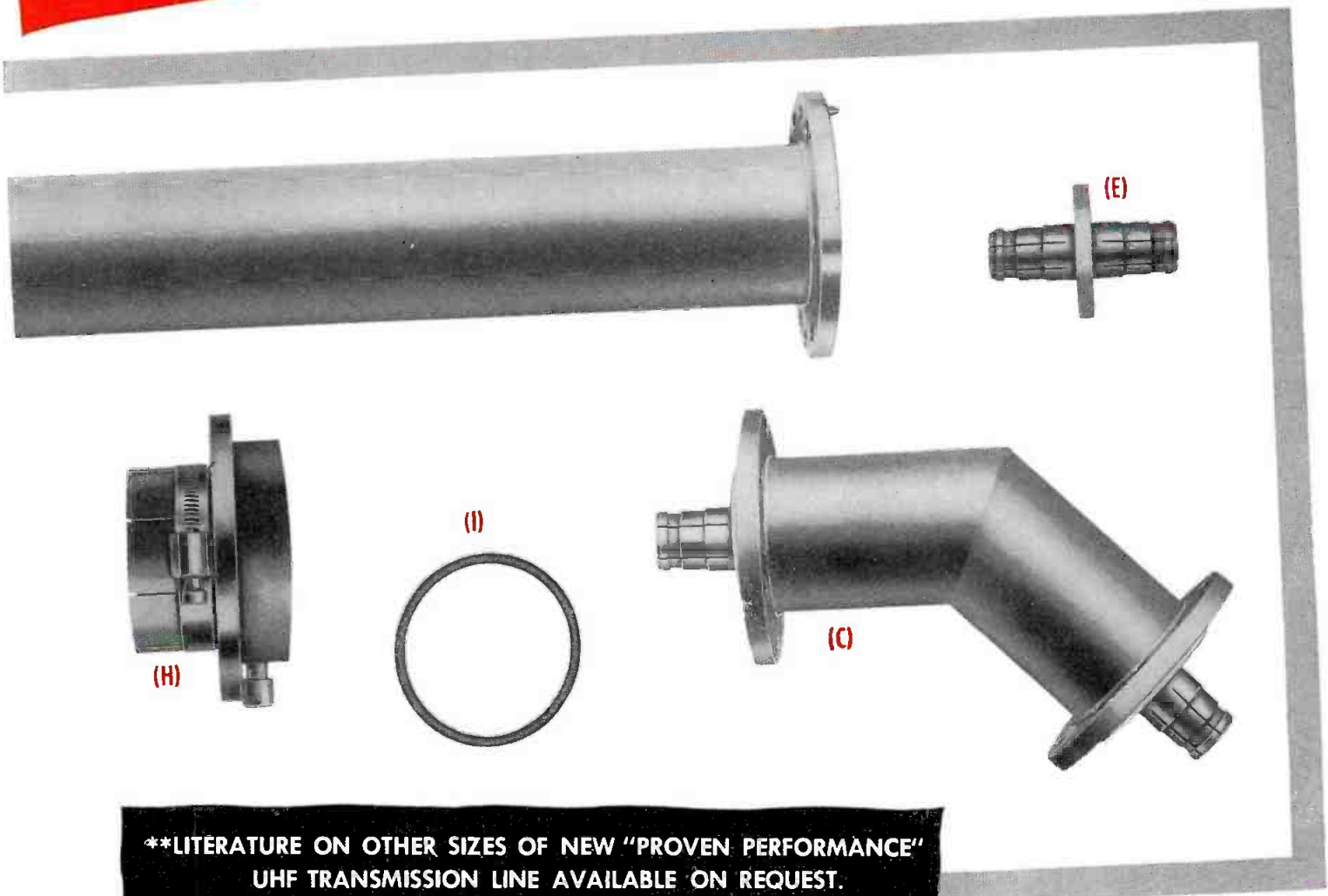

**LITERATURE ON OTHER SIZES OF NEW "PROVEN PERFORMANCE"
UHF TRANSMISSION LINE AVAILABLE ON REQUEST.

EVERYTHING ELECTRICAL FOR TV OR AM...

via
GraybaR

FOR QUICK STARTS WITHOUT

Overshoot

NEW 3-SPEED TURNTABLE PROVIDES
GUARANTEED TIMING FOR "DUBBING"
AND ON-THE-AIR BROADCASTING



Reaching *stable speed*—less than $\frac{1}{2}$ revolution at $33\frac{1}{3}$ —in minimum time, this newly designed turntable provides quick start from motor switch without overshooting. Successor to the 2-speed model 524, the Fairchild 530 is equipped with integral 3-speed drive, all three speeds synchronous. Ideal for "dubbing" operations, on-the-air broadcasting and laboratory applications, the 530 provides guaranteed accurate timing at all speeds, is virtually free of rumble and vibration. More than 300 already in use!

Accurate Equalization WITH THE FAIRCHILD 205. As demonstrated by chart at right, this unit provides matching equalization curves for various types of lateral and vertical records and transcriptions, in accordance with NAB standards.

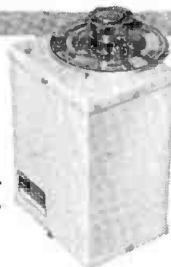
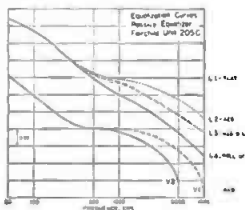

One TURRET HEAD HOLDS Three
MOVING COIL CARTRIDGES...

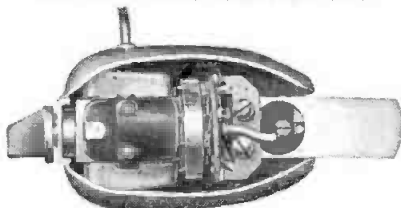

The simplicity of this 3-in-1 Turret Head obsoletes multiple arms, equalizers and throwover switch. Use only *one* Fairchild Turret Head Arm, it mounts up to three Fairchild Miniature Moving Coil Cartridges at one time—ready for instant selection at the turn of a knob, which also sets correct stylus pressure. All critical adjustments, usually inherent in viscous damped arms, have been eliminated in the current Fairchild 201-B. A completely redesigned base assembly with a new method of pivoting now incorporates automatic temperature control.

World's Finest
Tape Recording Equipment



Fairchild Tape Recorders and Accessory Equipment are built to the highest professional standards and incorporate many exclusive features, including Pic-Sync, Syncroll Drive, Automatic Framing Control and others. Fairchild Tape Recorders are also built to order for specialized applications.

FAIRCHILD RECORDING EQUIPMENT

Tenth Avenue, Whitestone, N. Y.

EVERYTHING ELECTRICAL FOR TV OR AM...



Get all your TV needs as a "Package"

from this single, convenient source—

Graybar

Graybar, today, offers you a packaged planning and supply service for new TV installations — a *complete* package that can put you on the air with efficient, well-engineered equipment in the shortest possible time.

From camera to antenna, Graybar Broadcasting Equipment Representatives will work with you or your consulting engineers to develop practical solutions to any TV problem.

Graybar also distributes a complete line of equipment and supplies for studio and tower lighting, as well as everything else you require for wiring, ventilating, and communication systems. In these fields, too, other Graybar specialists are at your service.

Whatever your telecasting (or broadcasting) requirements, call Graybar first—it's the easy way to get everything electrical *when and where* you need it. *Graybar Electric Co., Inc. Executive Offices: Graybar Building, New York 17, New York.*



346-14

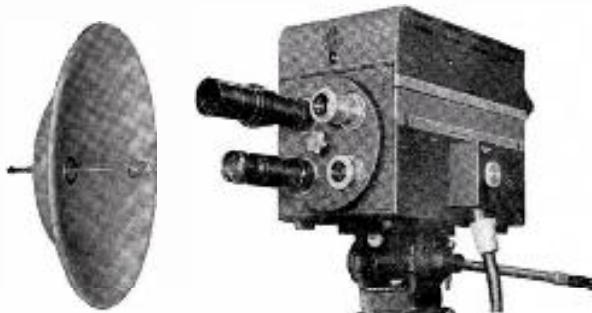
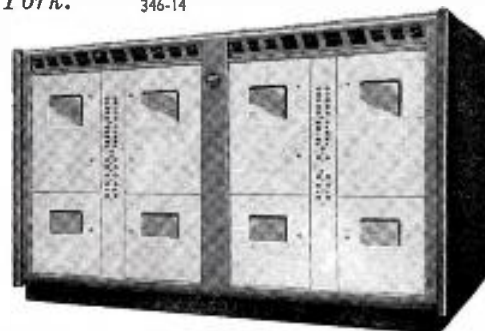

EVERYTHING ELECTRICAL TO KEEP YOU ON THE AIR ...

IN OVER
100 PRINCIPAL CITIES

Graybar's nation-wide network of more than 100 offices and warehouses assures you of convenient service wherever you are. Graybar Broadcast Equipment Representatives are located in the following 21 cities.

A Few of Our Leading Supplier-Manufacturers — Altec Lansing • Ampex • Berndt-Bach • Blaw-Knox • Cannon • Century Lighting • Communication Products • Continental Electronics • Crouse-Hinds • Daven • Fairchild • Federal Telecommunication Laboratories • General Electric • General Radio • Houston-Fearless • Karp Metal • Kliegl • James Knights • Machlett • Meletron • Minnesota Mining • Mole-Richardson • Presto • Rek-O-Kut • Sarvis • Tung-Sol • Webster • Western Electric • Zoomar

Everything Electrical For Broadcasting-Telecasting—Amplifiers • Antennas • Consoles • Frequency and Modulation Monitors, Test Equipment • Loudspeakers and Accessories • Microphones and Accessories • Recorders and Accessories • Speech Input Equipment • Towers • Tower and Studio Lighting Equipment • Transmission Line and Accessories • Transmitters, AM and TV • Tubes • Turntables, Reproducers, and Accessories • TV Cameras and Film Equipment • Video and Audio Monitors • Wiring Supplies and Devices

ATLANTA
John Klutz,
Cypress 1751

BOSTON
J. P. Lynch,
Kenmare 6-4567

CHICAGO
E. H. Taylor,
Canal 6-4100

CINCINNATI
W. H. Honsler,
Main 0600

CLEVELAND
A. C. Schwager,
Cherry 1-1360

DALLAS
C. C. Ross,
Randolph 6452

DETROIT
A. E. Byers,
Temple 1-5500

HOUSTON
R. T. Asbury,
Atwood 4571

JACKSONVILLE
W. C. Winfree,
Jacksonville 6-7611

KANSAS CITY, MO.
R. B. Uhrig,
Baltimore 1644

LITTLE ROCK
W. E. Kunkel,
Little Rock 5-1246

LOS ANGELES
R. B. Thompson,
Angelus 3-7282

MINNEAPOLIS
C. W. Greer,
Geneva 1621

NEW YORK
R. W. Griffiths,
Exeter 2-2000

OMAHA
L. J. O'Connell,
Atlantic 5740

PHILADELPHIA
J. W. Crockett,
Walnut 2-5405

PITTSBURGH
R. F. Grasselt,
Allegheny 1-4100

RICHMOND
E. C. Tams,
Richmond 7-3491

ST. LOUIS
J. P. Lenkerd,
Newstead 4700

SAN FRANCISCO
K. G. Morrison,
Market 1-5131

SEATTLE
D. I. Craig,
Mutual 0123

EVERYTHING ELECTRICAL FOR TV OR AM...



From mike to tower...everything electrical to keep you on the air



Graybar has everything you need in broadcast equipment . . . PLUS everything for wiring, ventilating, signaling and lighting your entire station and grounds.

For complete information on any of the items described on the previous pages, consult your nearest Graybar Broadcast Equipment Representative. You'll find him well qualified to assist you in every phase of station planning or expansion as well as modernization of existing transmitter and studio facilities.

The names and locations of Graybar Broadcast Equipment Representatives are listed below :

- | | |
|---|--|
| ATLANTA
John Klutz, Cypress 1751 | LITTLE ROCK
W. E. Kunkel, Little Rock 5-1246 |
| BOSTON
J. P. Lynch, Kenmore 6-4567 | LOS ANGELES
R. B. Thompson, Angelus 3-7282 |
| CHICAGO
E. H. Taylor, Canal 6-4100 | MINNEAPOLIS
L. S. Sellner, Geneva 1621 |
| CINCINNATI
W. H. Hansher, Main 0600 | NEW YORK
R. W. Griffiths, Exeter 2-2000 |
| CLEVELAND
A. C. Schwager, Cherry 1-1360 | OMAHA
L. J. O'Cannell, Atlantic 5740 |
| DALLAS
C. C. Ross, Randolph 6452 | PHILADELPHIA
J. W. Crockett, Walnut 2-5405 |
| DETROIT
A. E. Byers, Temple 1-5500 | PITTSBURGH
R. F. Grossett, Allegheny 1-4100 |
| HOUSTON
R. T. Asbury, Atwood 4571 | RICHMOND
E. C. Toms, Richmond 7-3491 |
| JACKSONVILLE
W. C. Winfree, Jacksonville 6-7611 | ST. LOUIS
J. P. Lenkerd, Newslead 4700 |
| KANSAS CITY, MO.
R. B. Uhrig, Baltimore 1644 | SAN FRANCISCO
K. G. Morrison, Market 1-5131 |
| SEATTLE
D. I. Craig, Mutual 0123 | |

A few of Our Leading Supplier-Manufacturers—Altec Lansing • Ampex • Berndt-Bach • Bishop • Blaw-Knox • Cannon • Century Lighting • Communication Products • Continental Electronics • Crouse-Hinds • Daven • Fairchild • Federal Telecommunication Laboratories • General Electric • General Radio • Houston-Fearless • Hubbell • Karp Metal • Kliegl • James Knights • Machlett • Meletron • Minnesota Mining • Mole-Richardson • Plastic Wire & Cable • Presto • Prodelin • Rek-O-Kut • Sarvis • Simplex • Thomas & Betts • Tung-Sol • Webster • Western Electric • Zoomar

Everything Electrical for Broadcasting-Telecasting—Amplifiers • Antennas • Consoles • Frequency and Modulation Monitors, Test Equipment • Loudspeakers and Accessories • Microphones and Accessories • Recorders and Accessories • Speech Input Equipment • Towers • Tower and Studio Lighting Equipment • Transmission Line and Accessories • Transmitters, AM and TV • Tubes • Turntables, Reproducers, and Accessories • TV Cameras and Film Equipment • Video and Audio Monitors • Wiring Supplies and Devices



...in over
100
principal
cities

'BALTIMORE IS DIFFERENT'

WITH Baltimore has released a colorful, multi-paged booklet entitled "Baltimore is Different" which leads up to the point that besides white marble steps and row houses, Baltimore is peculiar in regards to radio timebuying too. By means of clever illustrations, the booklet points out that the Maryland population is dominated by stations in Washington, Philadelphia and Pittsburgh and that Hagerstown and Frederick are self-contained listening areas, and network affiliates in Baltimore are duplicated in their coverage areas by affiliates in other cities. The point is that in buying time on a Baltimore station, the target is Baltimore almost exclusively, therefore it's smart economy to buy independent WITH rather than a higher-powered network affiliate. The booklet goes on to point out WITH advantages in terms of advertising results, programming, and economy.

TOUR OF UN ON CBS-TV

HOUR-LONG telecast, which took viewers on a complete "tour" of UN headquarters in New York, was scheduled to be presented over the full facilities of CBS-TV Saturday 1:30-2:30 p.m. EST. Among personalities scheduled to participate in the program were Dag Hammarskjold, UN secretary-general; Madam Vijaya Lakshmi Pandit and UN Ambassador Henry Cabot Lodge Jr. Telecast was arranged by the U. S. Committee for UN Day in cooperation with Harold Fellows, president of NARTB.

UHF BIRTHDAY BOOKLET

KPTV (TV) Portland, Ore., first commercial uhf station, has released a birthday booklet titled "The First Year of KPTV." Filled with many pictures of the station and pictures seen on KPTV, the booklet contains stories of its "firsts," a message from the station's President Herbert Mayer, excerpts from publications taking note of the uhf station's first anniversary (including B•T, Sept. 28) and pictures of the station's layout, interior photographs, letters of approbation, pictures of the staff and a summing-up by Station Manager Russell K. Olsen.

KBIG GIANT MATCH BOOK

FIFTEEN hundred advertisers and agency men have received giant match books from KBIG Avalon, Calif. On the cover is the message: "For a BIG MATCH . . . look inside. For a BIG BUY that's matchless, check KBIG, The Catalina Station, giant economy package of Southern California radio." On the 4 1/4 x 3 1/2-inch back cover is printed the station's schedule of daily, weekly and monthly special spot announcement packages, including prices for 10-second, 30-second and one-minute announcements in five different quantity orders.

WJR Airs Barn Project

WJR Detroit marked the 553d broadcast of its weekly public service presentation, *In Our Opinion*, on Oct. 18, from Almont, Mich., where moderator George Cushing interviewed a representative group from a hundred farmers who worked together to rebuild the barn of a neighbor after it was destroyed by fire. WJR described the farmers' project as a "rebirth of the American pioneer spirit."

Morning Mysteries

KSUN Bisbee, Ariz., reports it has made a radical departure in morning programming by airing adventure-mystery programs from MBS. KSUN programs *Starlite Theatre*, *Let George Do It*, *High Adventure*, *Bulldog Drummond* and *Nightmare* Mon.-Fri., 9:30-10 a.m., because a great percentage of Bisbee's population is made up of copper mining employees who work on alternate eight-hour shifts every two weeks around the clock. KSUN said it also had found "that the housewives welcome this type of program in the morning hours, because in the evening so many interruptions make it impossible to listen to these favorite adventure-mysteries unbothered."

'ONE OF TWENTY-THREE'

THE CBS network was to rebroadcast 10 minutes of the WJR Detroit documentary report, "One of Twenty-Three," revealing the turbulent home life and background of a Lincoln Park, Mich., soldier who is one of the 23 Americans renouncing their country in favor of Communism. The network broadcast was to be heard yesterday (Sunday) on *The World Today* program, 4-4:30 p.m. The original 25-minute broadcast on WJR, narrated by Joseph Hainline, included interviews with the soldier's relatives, friends, teachers, employers and former school principal in an attempt to disclose the factors that may have influenced him to reject his native land. WJR reports that the state publication of the American Legion, *The Michigan Legionnaire*, is running a front-page story about the program and reprinting the 25-minute radio script in its October issue. The publication will be mailed to all Legion state headquarters, Congressmen and Senators, as well as 75,000 Michigan Legionnaires, according to the station.

WTOV-TV MERCHANDISING PLAN

WTOV-TV Norfolk, Va., has released a brochure outlining its "Baker's Dozen" Merchandising Package which it offers to national advertisers. The sales promotion weapons listed are: (1) Out-shelf merchandising in all Colonial Stores; (2) Window displays in all Peoples Service Drug Stores; (3) Jumbo post cards mailed to all Norfolk retailers; (4) Movie trailers in six theaters; (5) Outside bus-dashes on Virginia Transit Co. busses; (6) Counter cards placed in dealer stores; (7) Window streamers in major retail stores; (8) Free courtesy announcements; (9) Promotional letters; (10) Personal calls on key jobbers and distributors; (11) News sheet mailed to retail food stores; (12) News sheet mailed to retail drug stores; (13) Monthly merchandising report.

DEPARTMENT STORE ADVERTISING

L. L. DAGGETT commercial manager of KYNO Fresno, Calif., has prepared a report entitled "Department Store Advertising" the purpose of which is to explode the myth that department stores must depend on newspapers one hundred per cent in order to have a successful advertising campaign. Using circulation figures, Mr. Daggett claims that a newspaper reaches only 30% of the population. He shows that a cessation of newspaper advertising, as was the case during the Pittsburgh printers' strike in November 1950, had no adverse effects on sales of those department stores using radio. Mr. Daggett concludes by saying that it is vir-

IN THE
Upper Midwest...

KSTP-TV
now reaches
nearly
Two Million
people
regularly
with its
100,000 watts
on
channel 5

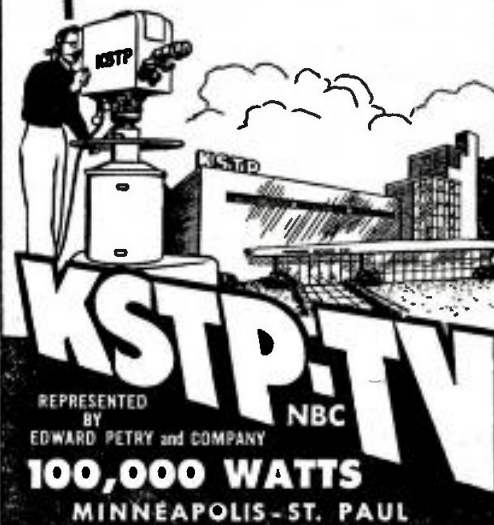



THREE WBZ Boston radio executives were guests of the New England Nash Dealers at an affair celebrating Nash sales increases during the past year: (l to r) George Rogers, Nash-Kelvinator Co.; Tom Dunn, WBZ account executive for Nash; Tom Meehan, WBZ sales manager, and Paul E. Mills, WBZ station manager.

tually economic suicide for a department store to devote all its advertising budget to either newspapers or radio, that it could save 20% of its budget and reach more people by using both.

WKRC-TV CITES MOTORISTS

MANY Cincinnati motorists have received a pleasant shock recently when stopped by traffic officers who have given them simulated gold coins instead of traffic tickets. The coins state that the motorist has been singled out for an award because of some act of courtesy as a driver. Sponsored by WKRC-TV there in cooperation with the Cincinnati police department, the Courtesy Safe-Driver awards will be handed out for the next year, averaging five a day. The "courteous" motorist is also given a card on which he writes reasons for driving courteously and mails it to the station. Each week the motorist with the best reasons is invited to the WKRC-TV studio for an interview at which time he is given a certificate proclaiming him the Courtesy Driver of the Week.

KFWB OFFERS MINK

MINK stole, valued at \$1500, will be one of 37 awards in a contest sponsored jointly by Vitamin Corp. of America (Rybutol) and Savon Drug stores (Los Angeles area chain) for finishing the statement: "I like Rybutol because . . ." in 25 words or less, on KFWB Hollywood Jerry and Beverly duo disc-m.c. program.

SHOPPING TO MUSIC

SHOPPING in downtown Compton, Calif., is done to music these days after Pan American Broadcasting Co., Beverly Hills, contracted to supply a broadcast music system along the main street of the community, with local merchants footing the bill for six weekly 11-hour programs. Broadcast schedule of KUTE (FM) Glendale is used, with commercials eliminated. Year-around contract, believed to be first of its kind in the country, was negotiated between Robert Brazy, president of Pan American, and William Jenner, secretary of Compton Chamber of Commerce.

'THE WAYS OF MANKIND'

WBBM Chicago is presenting a new program, *The Ways of Mankind*, which attempts to explore the origin and development of cultures, customs and folkways in various parts of the world. The program, which is produced by the National Assn. of Educational Broadcasters under the terms of a grant from the Fund for Adult Education, established by the Ford Foundation, has as its purpose the understanding of the ways of other peoples so that we can live with them successfully. The 13-week series premiered Oct. 16 and is heard Friday 8:30-9 p.m. CST.

CLOSED CIRCUIT CANCER DATA

THE latest techniques in cancer research and treatment will be shown to physicians and surgeons on a closed-circuit television program at the WCAU-TV Philadelphia auditorium. The program, first of a series, will originate at the Francis Delafield Hospital and Memorial Cancer Center in New York. The closed circuit will link New York, Boston, Pittsburgh, Detroit, Toledo and Philadelphia.

'THE SYMPHONY STORY' ON KPOJ

A NEW program, entitled *The Symphony Story*, has made its debut on KPOJ Portland, Ore., under the sponsorship of the Portland resident offices of J. Henry Helser & Co., West Coast investment managers. Aired Sunday, 10:30-11:30 p.m., each program in the 13-week series is devoted to the history, description and use of the instruments within a symphony orchestra. To illustrate the varying ensemble and solo uses of the instruments, the program will

Deerfield Revisited

RADIO can take credit for the re-publication of a boy's adventure book, *The Boy Captive of Old Deerfield*, which was published in 1904 and had been out of print for 17 years.

Back in 1950, WHAI Greenfield, Mass., was so dissatisfied with available children's programming that it decided to read *The Boy Captive of Old Deerfield* over the air for three weeks. Audience response was so enthusiastic, according to WHAI General Manager John Haigis Jr., that the readings were continued and expanded to include all the books of the *Old Deerfield* and *Young Puritan* series, written by Mary P. Wells Smith. Interest was so high, Mr. Haigis said, that the entire series was repeated not once, but twice with every expectation of continuing indefinitely.

Mr. Haigis added that booksellers and the Greenfield Public Library were swamped with requests for books. Starting in 1951, he worked continuously on a project to have *The Boy Captive of Old Deerfield* reissued. This entailed the acquisition of publishing rights from the author's heirs and the re-making of plates that had been destroyed.

Public response to the book reportedly is so enthusiastic that Mr. Haigis is making plans to have re-issued the seven other titles of the *Old Deerfield* and *Young Puritan* series.

For **MINUTE** spots
to **SELL**

Youngstown, Ohio

call any Headley-Reed office or . . .

WFMJ RADIO and
TELEVISION

101 W. Broadman St. Phone RI 3-4121

utilize illustrative musical passages from folk music and the classics, interwoven with explanatory material. Interviews will be scheduled with instrumentalists from the Portland Symphony Orchestra, who will perform, as well as with some of the guest conductors who will appear with the orchestra—Arthur Fiedler, Igor Stravinsky, Dimitri Mitropoulos and others. Announcements in behalf of the Portland Symphony Society will be a part of the program.

'LIFE BEGINS' ON KTBC-TV

A NEW program titled *Life Begins* adds a new educational service to the roster of KTBC-TV Austin, Tex. Designed to show the young mother or mother-to-be the do's and don't's of raising a family, the series is conducted by Eve Martin, a woman of experience who is the mother of 11 children (the 12th is on its way) whose family was featured in *American Magazine* as one of the country's most interesting families. The format allows Mrs. Martin and husband to roam through a studio home, utilizing a nursey, kitchen and living room set. Produced by Bob Hellar, the program is co-sponsored by the ABC Shop, local maternity shop owned and operated by the Martins, and Bray & Jordan Pharmacists.

NBC-TV's Quick Rio Films

NBC-TV last week claimed a possible speed record in getting on the air with films showing President Eisenhower and Mexican President Adolfo Ruiz Cortines dedicating Falcom Dam on the Rio Grande last Monday. A "hot developer" was used to process, edit, and cut the film aboard a chartered plane which flew from the dedication site to Dallas where WFAA-TV originated the coverage for the network's *Camel News Caravan* when it went on the air two hours twenty seconds after the Falcom Dam ceremony, according to Frank McCall, *Caravan* producer.

'TV COMES TO CHARLESTON'

"TV COMES to Charleston" is the headline on a recent section of the *Charleston Daily Mail*. With a cover colored in yellow, the 30-page section was devoted to news about WKNA-TV Charleston. Included were stories covering the history of tv, the various aspects of a tv station's operation, how certain effects are achieved on tv and television's relation to social living. There were a number of pictures of personnel as well as equipment.

WTOP-TV 3-D STAR

WTOP-TV Washington's morning man Roy Meachum is the first 3-D star in D. C. tv, claims the station. He is the "cover boy" in a 3-D photo featured on more than 1,000 jumbo mailing cards sent to advertising and public relations executives. The promotion, which pictures Mr. Meachum seated in his set at the studio, was made up for Colortone Press of Washington by Robert L. Green Assoc., public relations counsel. The caption reads, "Roy Meachum, Washington's only local morning television host, 7 to 9 on channel 9, WTOP-TV, and the first Washington television star to be photographed in 3-D." Copy on the card plugs: "Life-like 3-D litho by Colortone Press offers unlimited potentials for all sales literature!" Special 3-D glasses come with card.



it's New!

A low-priced professional recorder designed for the small broadcast station!



HIGH FIDELITY

portable

magne

Cordette

\$499.50 COMPLETE

The Portable Magnecordette is the first professional record-playback-P.A. system in one case, designed and priced for the small radio station! It's a standard PT6-AH recorder—first choice of broadcast stations everywhere—complete with amplifiers and speaker for high fidelity playback!

Rack-mount this Magnecordette for studio use. Carry it into the field for remotes. Use it to present recorded shows to agencies or local advertisers. Amplifier-speaker unit can be operated up to 1000 feet away from the recorder, with volume controlled by either unit. Or it can be used separately as a P.A. system, with mike, phono, radio, or other sound source.

Look in the phone book under "recorders" for your dealer.

Magnecord INC. Dept. B-10A

225 West Ohio Street, Chicago 10, Illinois

Radio is a SOUND Investment

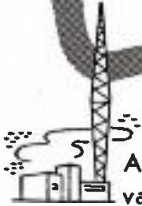

As the advertising agency for various Southern advertisers, we've found that radio pulls its weight without pulling its sales punch.

That's why we'd like to handle the trade paper advertising of one more radio station or one more television station outside the state of Tennessee.

We can point with pride to such national sales-making ideas as:



★ ★ ★ ★ ★ ★ ★ ★ ★ ★
**INDEPENDENT
BUT NOT ALOOF**

Ideas that make your station talked about—ideas and sales plans that sell your station.

Drop us a letter. We'll be glad to give full details on our setup of providing your station with full national trade paper advertising agency service.

**And have you noticed the "HATCHED" full page ad for WHBQ-TV in this issue. The series brought in the sales.*

Rosengarten & Steinke, Inc.

**A Nationally Recognized
Advertising Agency**

483 UNION AVE. • MEMPHIS, TENN.

PHONE 37-4566

If you don't want to wait to write

AFFILIATED OFFICES IN 40 CITIES
Copyright 1953 R & S, Inc.

PEOPLE

Advertisers

George W. Davidson, general sales manager, and Frederick P. Riedel, brewmaster, Piel Bros. (beer), N. Y., elected vice president in charge of personnel, traffic, sales and advertising and vice president in charge of brewing, packaging power plant and maintenance, respectively.

A. Dix Leeson appointed advertising manager of Budd Co., Phila.

Agencies

Alden H. Kenyon, formerly of Geyer Adv., N. Y., to Biow Co., N. Y., as vice president and member of key executive group.

William D. Tyler appointed to newly-created position of vice president in charge of copy department, Leo Burnett Co., Chicago.



Mr. Tyler

Geoffrey Garth named vice president, Lee Ramsdell & Co., Phila. Mr. Garth will be account executive on newly acquired account, C. R. Bard Inc., Summit, N. J.

Russ Zeininger promoted from head of media dept. to account supervisor at

McNeill & McCleary Adv., Hollywood. Media duties will be handled by John McNeill, in charge of radio and tv, and Loretta Skelton, in charge of space.

George V. Genzmer, merchandising director, Erwin, Wasey & Co., L. A., to head newly formed sales promotion department. Donald E. Gehring, formerly sales and advertising manager, Nutrena Mills Dog Food Div., named his assistant.

Anthony Joseph Walton to Lohmeyer, Adleman & Montgomery, Phila. advertising agency, as production manager.

Jay Wieder, Cecil & Presbrey, to Doyle Dane Bernbach Inc., N. Y., as production manager.

Bill Munsell to Minneapolis office of Bruce B. Brewer & Co. agency as account executive. He was formerly account executive with W. D. Lyon Co., Cedar Rapids, Iowa.

Vernon Nelson, art director at Charles Temkin Inc. advertising agency, Chicago, to Cowan & Dengler Inc., Chicago branch of N. Y. agency, in same capacity, succeeding Robert Larson who joins Klau Van Pietersom-Dunlap Agency, Milwaukee.

Elwyn R. Welshe, associate director, NBC New York, to Sherman & Marquette, N. Y., as a producer-director in radio-tv department.

Horace D. Nalle, formerly of N. W. Ayer, to Geare-Martson Inc., Phila. agency, as account supervisor and member of plans committee.

Paul H. Kerr Jr. to Geare-Marston as copy director. He was with William C. Esty Co. and BBDO. Richard Cummins, former art director of Gray & Rogers, Phila. advertising agency to Geare-Marston, in same capacity.



THREE broadcasters with an interest in plowing flew to Cobourg, Ontario, for the World Plowing Matches: (l to r) Larry Haeg, manager, WCCO Minneapolis; Jim Hill, WEAU Eau Claire, Wis., farm director, and Herb Plambeck, farm director of WHO Des Moines. All had worked with the National Plowing Contest held recently at Augusta, Wis. [B&T, Oct. 12].

Neil Leroy, account executive of Toronto office of O'Neil, Larson & McMahon, named radio-tv director, and John H. Roberts named manager of Toronto office, which has moved to new address at 67 Yonge St.

Clarence R. Palmer, media director, John Falkner Arndt & Co., Phila., has retired. Mrs. William A. Farren will succeed him. Mr. Palmer will continue with agency on consulting basis.

Edith Wright Kram, fashion coordinator, Millicent Deming Modeling Studios, Hollywood, to Glasser-Gailey Inc., L. A., as production manager.

Joseph I. George, former general merchandise manager of Patterson Bros., N. Y. hardware firm, to Wilson, Haight, Welch & Grover Inc., Hartford, Conn., and N. Y., as marketing director.

Charles H. Weissner Jr. to Roy S. Durstine Inc., N. Y., as assistant account executive. He formerly was with Morse International.

Phil Flad Jr., former program director at WAND Canton, Ohio, to radio-tv of Jack Lacey Advertising Agency, Tampa, Fla.

Fred de P. Rothermel, former director in Phila. Museum School of Art, to art department of Beaumont, Heller & Sperling, Reading, Pa., advertising agency.

Dirk Watson to service, N. W. Ayer & Son., Phila., John H. Trux Jr. to plans-merchandising; Murray E. Morse Jr., public relations, and Albert E. Stott, outdoor advertising.

Frances Lindh, Ruthrauff & Ryan and Avery-Knodel station representative, S. F., to John Cohan Adv. Inc., Salinas, Calif.

George L. Peck, former manager of promotion and publicity for WGY and WRGB (TV) Schenectady, N. Y., and associated with General Electric Co., to Robert C. Russell Adv. Agency there.

Stuart Sneed to copy staff of John Falkner

**CUT YOURSELF A SLICE
OF AMERICA'S RICHEST EMPIRE**

You Can Get A Share of East Texas
by Appointing us Your Spokesman

KFRO "Voice of Longview" - TEXAS

Arndt, Phila. He was formerly with RCA. **John Ball Jr.**, former N. Y. newspaperman, also to John Falkner Arndt.

Roy Van Hook, John Falkner Arndt, Phila., to copy department of Gray & Rogers, same city.

Maxwell Dane, Doyle Dane Bernbach Inc., N. Y., named chairman of advertising division of Federation of Jewish Philanthropies of N. Y.

John F. Devine, legal staff of J. Walter Thompson Co., N. Y., appointed chairman of Committee on Radio and Television Production of AAAA. He replaces **Walter Craig**, vice president and director of advertising for Pharmaceuticals Inc., N. Y.

Stations

W. M. Carpenter and **Joseph B. Matthews**, general manager and sales manager, respectively, of WLOW Norfolk, to WTOV-TV Norfolk where they will assume duties similar to those at WLOW. **Boh Drepperd**, program director at WLOW, also to WTOV-TV as program director. He will be succeeded at WLOW by **Art Ross**, who will be in charge of film dept. at WTOV-TV as well.

Jack Maurer, vice president of WCUE Akron, Ohio, adds duties as commercial manager of station.



Mr. Maurer

George Nickson, formerly manager of KEEP Twin Falls, Ida., to KBIF Fresno, Calif., in same capacity. In radio 20 years, he was previously manager of KXXX Colby, Kan.

Jack Powell, account executive, KVEN Ventura (Calif.), to KXOC Chico as general manager.

Fred L. Vance, formerly with O. L. Taylor Co., station representative firm, in charge of Dallas office, appointed sales manager of KWTW (TV) Oklahoma City, new vhf ch. 9 outlet which plans to start in December.

John T. (Jack) Curry Jr., CBS sales promotion departments at KMOX St. Louis and WBBM Chicago, appointed director of sales promotion at WEEI Boston.



Mr. Curry

F. A. Higgins, former general manager of WITZ Jasper, Ind., to WITY Danville, Ill., in same capacity. Other appointments are: **Ward White**, commercial manager; **Kenn Early**, program director; **Jack**

Brookbank, chief engineer; **Max Winter**, news director; **Fran Early**, traffic manager and copy chief; **Dolores Czapski**, bookkeeper; **Lynn Knox**, sales; **Jane Anne Joyce**, sales; **Charles Roeder**, engineer.

Bill Montgomery, disc jockey at WNOR Norfolk, Va., promoted to program director.

L. J. Ronder appointed program director at WCFL Chicago, succeeding **Robert Platt**.

Louis B. Ames, acting program manager of

GM DIESEL *Stand-by* GENERATOR SETS



WJR—Detroit, Michigan, uses 200 kw. GM Diesel generator set as stand-by power for 50,000-watt transmitter. Compactness of unit permitted installation in garage adjoining transmitter building—eliminating cost of a specially designed building.



WKTV—UTICA, N. Y., uses a 100 kw. General Motors Diesel generator set for stand-by power. Set can be started remotely from the control room. Low vibration characteristic of engine permitted installation in room adjacent to transmitter and within 30 feet of studio.

If you are planning stand-by power, be sure to check the advantages of General Motors Diesel generator sets, listed briefly below. GM Diesel generators are meeting the exacting requirements of military service in all parts of the world. They supply emergency power for more than 1100 telephone and telegraph exchanges—for microwave relay stations, for hospitals, government buildings, banks, airports. There is a GM Diesel distributor near you who will analyze your power requirements and make his recommendations without obligation. Look in the yellow pages of your phone book for his listing, or write direct to us.

- Wide range of models—12 1/2 to 200 kw., 220 or 440 volts, single or three-phase current.
- Excellent frequency and voltage regulation for the most exacting requirements.
- Powered by General Motors Diesel engines—dependable, smooth 2-cycle operation—low cost maintenance—easy to service.
- Built by one manufacturer—one warranty, one responsibility for both engine and power generator.
- Instant push-button power starting on safe Diesel fuel—or fully automatic starting. Immediate power, no "warm-up" period.
- Dependable starting—no spark-ignition system to fail because of dampness or corrosion—always ready to start.
- Easy to install—compact—lightweight—requires no special building, no special base. Complete instrumentation provided.
- Distributors and Dealers throughout the country.

DETROIT DIESEL ENGINE DIVISION

GENERAL MOTORS • DETROIT 28, MICHIGAN
SINGLE ENGINES . . . 16 to 275 H.P. MULTIPLE UNITS . . . Up to 840 H.P.

It pays to Standardize on

Write for Generator Set Catalog 6 SA 20.



WPIX (TV) New York promoted to program manager of station.

Donald T. Ralph, former manager of KCVR Lodi, Calif., and account executive at KSTN Stockton, Calif., appointed general manager of latter station, replacing **D. M. Greene** who has been appointed manager of operations of KTVU (TV) Stockton.

Roland (Pete) Peterson, farm news editor at WNAX Yankton, S. D., promoted to production manager.

Jack Van Nostrand, chief commercial traffic coordinator, KNXT (TV) Hollywood, promoted to sales service supervisor, replacing **Nancy Cameron**, who becomes secretary to CBS-TV producer **Bill Brennan**. **Fran Haughn**, traffic coordinator clerk, assumes Mr. Van Nostrand's duties, succeeded by **Bruce Hoffman**, CBS-TV Hollywood operations.



Mr. Peterson

Joseph McMillan, WLW Cincinnati, to WMAL-AM-TV Washington as merchandising assistant.

Paul Collin, WBEL Beloit, Wis., to WREX-TV Rockford, Ill., as traffic manager.

Richard A. Jackson, assistant editor of *Sponsor* magazine, to WOR-AM-TV New York as news editor.

Chet Randolph to WNAX Yankton, S. D., as farm service director.

Elby Stevens promoted to sports director at WTWN Johnsbury, Vt.

Kevin Drummond, commercial manager at KYOU Greeley, Colo., to KMYR Denver as account executive and disc jockey.

Robert A. Curtis to WBZ Boston sales staff.

Arnold Routson, WCOL Columbus, Ohio, to WBNS-TV there as account executive.

Henry E. Rhea, chief engineer in charge of operations for WFIL-AM-TV Philadelphia, named to newly created post of chief engineer in charge of operations and maintenance, assuming duties of **Louis E. Littlejohn** who has resigned.

Ray Brosseau, WLWD (TV) Dayton, Ohio, salesman, promoted to operations chief, his former post being filled by **George A. Jones**. **Mary Lou Myers**, formerly with Holbrook Film Library & Television Enterprises, Hollywood, to station as film director. **Bob Rhoades**, WHOO Orlando, Fla., to WLWD as announcer.

Roy Green named chief operator of CHUM Toronto.

Dominick Bruno, WPIX (TV) New York technical director and previously staff engineer at WPAT Paterson, N. J., promoted to engineering supervisor of station.

Gene Dailey promoted to assistant program director of WBBM Chicago. **Russ Mayberry**



NEW executives of WAPA-AM-TV San Juan, P. R., are signed by Jose Ramon Quinones (c), president. They are Charles E. Bell (l), former tv director for Jefferson Standard Broadcasting Co. (WBTV [TV] Charlotte, N. C.), WAPA-TV general manager, and Ary R. Moll, formerly radio-tv director for Young & Rubicam's Mexico City office, WAPA-AM general manager and assistant to the president. WAPA-TV target date has not been announced.

promoted to assistant commercial program director and **Mark Reinsberg** appointed assistant promotion director of WBBM-TV Chicago.

Herb Howard named director of *WLS National Barn Dance* at WLS Chicago. He succeeds **George Biggar**, who has resigned to head up WLBK DeKalb, Ill., as president and general manager. He is partner in purchase of station. **Betty Howard** named to succeed **John Drake**, promotion-publicity director, and **Warren Middleton**, sales promotion director, at WLS (now B•T midwest sales manager in Chicago).

Fran Walsh, WSYR-TV Syracuse, promoted to tv director. **Joe Turrisi**, cameraman and director at WTVU-TV Scranton, Pa., to WSYR-TV.

Edith M. Holland, copywriter with Allen & Reynolds Adv. Agency, to KFAB Omaha as continuity writer and promotions assistant.

Ellen Marshall to WERE Cleveland as women's director.

Jack Drees, sportscaster on CBS-TV's Wednesday evening *Pabst Blue Ribbon* fights, signed to conduct daily music-sports show on WJJD Chicago, Monday through Friday.

Maryann Meldrum appointed assistant director of women's activities at KCMO-AM-TV Kansas City.

Frank Tumpene, columnist of *Toronto Globe & Mail*, morning daily, to newcast staff of CKEY Toronto, succeeding **Lorene Greene** who has moved to legitimate theatre in N. Y.

Vince Lee has taken over as m.c. of KYW Philadelphia's *Morning Salute* program (Monday through Saturday, 5-5:30,) and has joined Farm Director **Bill Givens** on daily *KYW Farm Hour*.

Cliffie Stone, KLAC-TV Hollywood personality and m.c., signed to exclusive year \$100,000 contract by station.

Mrs. Norma J. Morse, Decca Records, to KBIG Avalon, Calif., as music librarian.

10 DAY SATURATION SCHEDULE

Sells 70 Automobiles

In August 1953, Dahl Motors, Ford agency in Davenport, received an extra shipment of new cars.

To sell these automobiles, Dahl planned ten day new car promotion sparked by 35 announcements on WOC radio. No other advertising was used except one classified ad in local paper.

Net results—41 NEW CARS SOLD . . . 29 USED CARS SOLD. This approximates \$135,000 in sales at an advertising investment of less than 1/2-of-1 per cent.

Outstanding sales successes like the above is the one big reason why BUSINESS IS BETTER THAN EVER AT WOC. Get further facts from your nearest F & P office.

BETTENDORF AND DAVENPORT IN IOWA



ROCK ISLAND MOLINE AND EAST MOLINE IN ILLINOIS



FREE & PETERS, INC.
Exclusive National Representatives

Davenport, Iowa

Basic NBC Affiliate
5008 W. — 1420 KC

Col. B. J. Palmer, President
Ernest C. Sanders, Manager

Comdr. Mortimer W. Loewi, president of WITV (TV) Miami, appointed to National Brotherhood Week Television Committee.

William H. Sylk, president of WPEN Philadelphia, named director of 32d anniversary campaign of Golden Slipper Square Club. Drive is being carried out to enable organization to continue its welfare work and provide additional help for club's camp for needy boys and girls.

Irwin D. Wolf, vice president of Kaufmann's, Pittsburgh, vice president of The May Co. and one of owners of KQV Pittsburgh, honored with citation at 21st annual Boston Conference of Distribution for significant contribution to the advancement of distribution in last 25 years.

W. C. Swartley, manager of WBZ-TV Boston, received special award from *Tv Guide* in recognition of station's film coverage of Worcester tornado disaster. Acorn Films, Boston, also received award for filming of disaster for WBZ-TV.

Donald W. Thornburgh, president and general manager of WCAU-AM-TV Philadelphia, named chairman of centennial membership enrollment of YMCA of Phila.

Nick Basso, WSAZ Huntington, W. Va., received plaque and citation in appreciation for "comprehensive news presentations" from Veterans of Foreign Wars.

Robert Mitchell, organist, KFI Los Angeles, and director, Robert Mitchell Choirboys, admitted as Fellow of Trinity College of Music, London.

Lloyd Harris, chief engineer for WMAZ Ma-

con, Ga., father of girl, Donna Elizabeth, Sept. 8.

Frank Harden, program director at WIS Columbia, S. C., has adopted daughter, Mary Dell, born Oct. 10.

Lee Millar, Hollywood radio-tv actor, father of girl, Oct. 14. Mother is Edith Simmons Millar, radio-tv actress.

NBC Globetrotters

NBC claimed last week that members of its Spot Sales staff are "the most traveled salesmen in broadcasting work." According to Hank Shepard, manager of promotion and new business for NBC Spot Sales, members of the radio and tv staff have travelled more than 200,000 miles since Jan. 1, which he estimated to be approximately eight times around the world at the equator. He added: "These modern day Marco Polos of the broadcasting industry are in constant search of more station and market information. They get a first-hand picture of what our stations have on the air, the local personalities and other important details of interest to timebuyers."

Hal Swaney, chief announcer for WIDE Biddeford, Me., father of boy, Sept. 27.

Bill Johnson, announcer at WNAX Yankton, S.D., father of boy, Oct. 1. Billy Dean, WNAX singer, father of girl, Oct. 4. Fred Burgi, instrumentalist on "One-and-Only WNAX Bohemian Band," father of girl, Oct. 4.

Al Holmes, cameraman at WAAM (TV) Baltimore, father of girl, Susan Carol, Sept. 15.

Jack Littleton, publicity director, KFI Los Angeles, and Barbara Bailey, formerly executive secretary on KLAC-TV *Hollywood on Television*, were married Oct. 16.

Networks

Henry T. Hede, administrative assistant in treasurer's office of ABC, promoted to administrative manager of television network sales for ABC-TV.

Richard Buch appointed southeastern area manager of CBS Television Sales with headquarters in Atlanta, succeeding James Orchard, who has been transferred to N. Y. office as account executive. Mr. Buch was manager of Consolidated Television Sales, Atlanta.

David Kittrell appointed manager of Atlanta office of CBS Radio Spot Sales. He replaces H. W. Maier, who was promoted to account executive of CBS Radio Spot Sales in N. Y. Mr. Kittrell served with Katz Agency in Dallas.



Mr. Kittrell

David Barnhizer returns to NBC Chicago as associate tv director after two years with U. S. Marine Corps.

Natalie Hinderas, American pianist, signed to

TWO EXCLUSIVE *Thesaurus* FEATURES

ROCKET SPONSOR SALES TO NEW HIGHS!!!

Just read these Success Stories!

- "Jingles open hundreds of sales opportunities... selling fast!" WRUF (Gainesville, Florida)
- "Jingles sensational... closing new sales daily!" KIST (Santa Barbara, California)
- "Marketing Bulletin great... big help in closing new local business!" WFMJ (Youngstown, Ohio)
- "Marketing Bulletin great sales aid... leads to many new contracts!" WFDF (Flint, Mich.)

recorded program services

RCA RADIO CORPORATION OF AMERICA RCA VICTOR DIVISION

630 Fifth Avenue, New York 20, N. Y., JUdson 2-5011 Chicago Hollywood Atlanta Dallas

talent contract by NBC. Miss Hinderas will appear on variety of programs during coming year on both network and NBC o & o stations.

Hoskins Is NCAB Head

CECIL HOSKINS of WWNC Asheville is president of the North Carolina Assn. of Broadcasters. A story in B•T's Oct. 12 issue indicating that Ward Coleman of WENC Whiteville had been named NCAB president should have read that Mr. Coleman was named president of the North Carolina Associated Press Broadcasters Assn. Other officers of NCAPBA are: first vice president, J. T. Snowden Jr., WCPS Tarboro; second vice president, Edmund H. Smith, WIRC Hickory, and secretary, Paul Hansell, North Carolina AP bureau chief.

William S. Hedges, NBC, named chairman of Radio Div. in campaign of Travelers Aid Society of N. Y. to raise \$364,000.

Hubbell Robinson Jr., CBS-TV vice president in charge of network programs, and Peter Arnell, producer of *The Wheel of Fortune* (CBS-TV, Fri., 10-11 a.m. EST), received citations from U. S. Marine Corps Friday for the "outstanding contributions" that *The Wheel of Fortune* program has made to Marine Corps.

Tom Moore, m. c. of MBS *Ladies Fair*, honored by American Red Cross for "outstanding work" in connection with "Share Your Blood for Independence Campaign."

George Gobel, NBC-TV star, named one of "Chicago's outstanding young men of the year" by Chicago Junior Assn. of Commerce & Industry.

Carroll McKenna, research director, ABC Hollywood, father of son, Michael Carroll, Oct. 14.

Gordon J. Kahn, 52, chief editor of *Information Please* television program, died of heart ailment Oct. 15.

Film

Stanley Kallis, story editor, Allied Artists, Hollywood, to William F. Brody Productions, that city, in same capacity on *Wild Bill Hickok* tv film series.

Hank McCune, star of Video Pictures' *Hank McCune Show*, tv film series, awarded a Certificate of Appreciation by Civil Defense and Disaster Corp., Los Angeles, for "The Civil Defense Story," first program in new series which "points up many problems that beset the average citizen trying to find his niche in the civil defense program."

Manufacturers

Gordon S. Humphrey, executive assistant to general manager of equipment division of Ray-

theon Mfg. Co., Waltham, Mass., appointed assistant vice president of company.

William L. Kelley, formerly vice president of Motorola Inc., Chicago, appointed to newly-created post of vice president in charge of marketing for Allen B. Dumont Labs., Nutley, N. J., with supervision of receiver sales division and receiver advertising and merchandising departments.



Mr. Kelley

John E. Martin, senior staff member, appointed director of research, Gabriel Labs., Needham Hts., Mass.

James J. Shallow, sales manager, Philco Distributors Inc. of Phila., appointed general manager of Accessory Div. of Philco Corp. He is succeeded as sales manager by David Brody.

Michael Ames, manager of public relations for Emerson Radio & Phonograph Corp., N. Y., and previously vice president of David O. Alber Assoc., N. Y., promoted to director of public relations for Emerson.

William E. Skinner, branch manager for Arvin Industries Inc., to Zenith Radio Corp.'s field sales organization as regional manager.



*what's happening to
film for television?*

Dr. O. G. Haywood Jr., formerly colonel in U. S. Air Force who headed Office of Scientific Research of Air Research and Development Command in Baltimore, to Sylvania Electric Products Inc., N. Y., as manager of engineering planning staff.



Mr. Haywood

Jack Colvin, formerly chief engineer and plant manager of Commercial Radio Co., of N. Y., appointed director of engineering of Gates Radio Co., Quincy, Ill.

James H. Sweeney, sales manager for germanium products, General Electric, Syracuse, N. Y., named manager of marketing in Germanium Products unit of newly-formed Commercial Equipment Dept. of firm's Electronics Div. Also appointed to that unit are **James E. Keister**, former manager of semiconductor engineering, as manager of engineering, and **Theodore E. Jamro**, former manager of company's germanium products plant at Clyde, N. Y., manager of manufacturing.

Marcus N. Brooks, purchasing agent for Westinghouse Standard Control Division, Beaver,

Pa., appointed purchasing agent for firm's Television-Radio Division, Metuchen, N. J. Also appointed to that division is **Henry D. Clark** who will serve as sales training manager.

Robert C. Sprague, chairman of board of Sprague Electric Co., North Adams, Mass., appointed by Senate Armed Forces Subcommittee on Preparedness to direct full-scale study of hydrogen and atomic bomb defense.

Virgil M. Graham, director of technical relations of Sylvania Electric Products Inc., N. Y. elected vice president and member of Executive Committee of U. S. National Committee of International Electrotechnical Commission.

H. Leslie Hoffman, president, Hoffman Radio Corp., L. A., elected to board of directors of Calif. Mfrs. Assn.



TWO new members of the sales department at WCCO Minneapolis confer with the bosses. The four: (l to r) **Phil Lewis**, sales manager; **Jack Lucas**, former station accountant who has been transferred to the newly-created position as sales service representative for national accounts; **Larry Haeg**, general manager, and **Richard P. McClanahan**, new account executive who formerly served KHDM Des Moines.

Youle Buys Paper

SALE of Galena, Ill., *Gazette & Advertiser*, semi-weekly, to **Clint Youle**, NBC Chicago radio-tv weather reporter and star of WNBQ-TV *The Weatherman*, was announced fortnight ago by **Peter Miller**, president of Galena Gazette Inc. and publisher of the La Salle, Ill., *News Tribune*. Mr. Miller is president of WLPO La Salle.

Services

Robert F. Fisher appointed midwestern regional manager for Cappel, MacDonald & Co., Dayton sales incentive firm.

Eugene Sayet, formerly recording engineer with WHOM New York and WIP Philadelphia, to Nola Recording Studios, N. Y., as recording engineer.

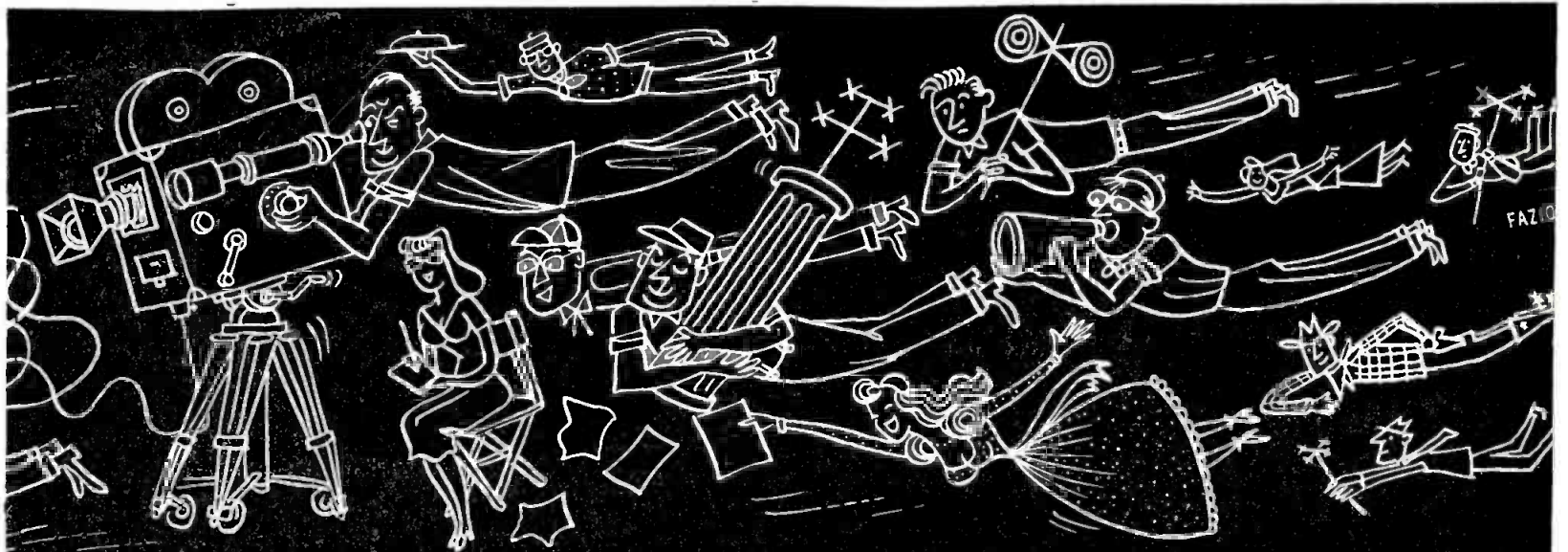

see

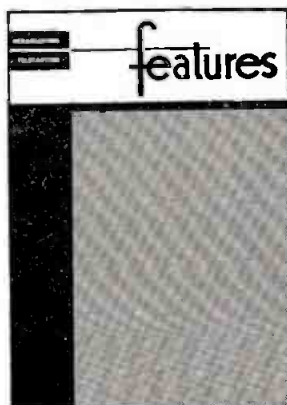

NOVEMBER 9
issue of
BROADCASTING
TELECASTING

Canada's First Tv Independent Starts

CANADA'S first independent television station was scheduled to begin operation yesterday (Oct. 25) with CKSO-TV Sudbury, Ont., commencing a regular five-hour schedule each evening. Test patterns and test films were first carried on the ch. 5 outlet last Tuesday.

According to Wilf Woodrill, manager of the CKSO-TV, the independent outlet went on the air just six months after receiving its authorization to construct.

Sudbury becomes the fourth Canadian city to have a television outlet. CKSO-TV will carry Canadian and American network shows on film.

Station is licensed to CKSO Radio Ltd., also operator of CKSO.

CBC Starts News Service For Canadian Tv Outlets

A NATIONAL television news service has been established by the Canadian Broadcasting Corp. from its Toronto program headquarters to supply CBC and independent Canadian tv stations with a Monday-Saturday 10-minute newsreel package on film. Gunnar Rugheimer has been appointed national tv news editor, under CBC news editor W. H. Hogg.

The film will be airmailed to stations from Toronto, and will be aired on the seven CBC and 14 independent tv stations which will be on the air early in 1954. In addition, the na-

tional tv news service also will prepare for stations the present weekly *CBC News Magazine* on film.

Mr. Rugheimer has been with CBC-TV at Toronto for the past year and has developed CBC's daily half-hour *Tabloid* news program and *CBC News Magazine*. He will have a staff of 12 at Toronto, and newsrooms at CBC tv centers across Canada.

CCBA Announces Agenda For Toronto Meet Nov. 2-3

SPORTS programming, news broadcasting, and service to sponsors will feature panel discussions at the annual meeting of the Central Canada Broadcasters Assn. at the Royal York Hotel, Toronto, Nov. 2-3.

A tentative agenda by CCBA President Cliff Wingrove, manager of CKTB St. Catherines, lists the opening day of the meeting for agency executives, advertisers and CCBA members. The second day's meeting is closed so CCBA members may discuss business, elect officers, and hold separate sessions for management, promotion, program and sales personnel.

The opening day will include talks and discussions on sports and community programming by Norm Marshall, CHML Hamilton; agency problems by a panel under Ev Palmer, radio-tv director of McCann-Erickson Ltd., Toronto; better handling of news by Gordon Sinclair, CFRB Toronto, and "A Better Understanding of Radio" by a panel led by Leigh Lee, CHUM Toronto.

SIEGEL DESCRIBES ROLES OF RADIO-TV

Radio and tv are the media destined to speed up education, New York City's radio director, Seymour Siegel, says at a 'New York Herald Tribune' Forum session.

RADIO and television were described last week by Seymour N. Siegel, director of radio communications for the City of New York, as the mass communication media that primarily must meet the challenge of speeding up processes of education in an era that acutely requires an informed citizenry.

Mr. Siegel advanced this view Tuesday in a talk on "New Horizons in Educational Television" before the third session of the 22d annual *New York Herald Tribune* Forum at the Waldorf-Astoria Hotel in New York. The speech and all other portions of the Forum were broadcast over the New York-owned station, WNYC, starting at 3:15 p.m. EST.

Quotes BBC Official

Mr. Siegel prefaced his remarks about the responsibility of radio and television as an educational force by referring to an observation made by Miss Barbara Ward of the British Broadcasting Co. board of governors. He quoted Miss Ward as saying the U. S. is "embarking on one of the most startling experiments mankind has ever attempted—basing government not on a single group—not on those who have the most education—but upon everybody.

"The challenge of our time," Mr. Siegel continued, "is whether education can catch up in time. Whether it can spread to enough people a sufficient sense of responsibility . . . a sufficient sense of the breadth of the problem . . . and a sufficient objectivity of mind to make them competent to carry this tremendous burden of government. This is precisely the challenge presented to the mass communication media, especially to radio and television."

In a world that is growing more complex day by day, Mr. Siegel declared, Americans have to know more now than ever before. He warned that democracy cannot endure if the majority of the people "can be taken in from one day to the next by the kind of spurious stuff that was handed out by Nazi propagandists, that is cast out to the unfortunate millions behind the Iron Curtain."

Mr. Siegel pointed out that it is unreasonable to expect commercial broadcasters, who have financial responsibilities, to "devote as much time as is necessary to develop that reasoned judgment in our citizens which can be brought about by the mass media." He declared that the broadcaster could not thus meet the mass audience he requires, but added:

"On the other hand, it surely cannot be in the best interest of our nation that such a large percentage of our listening time is devoted to soap operas, vaudeville and light music, audience participation shows . . . which are incredible even to the people who present them on the air . . . squalid crime shows, nonsensical quiz programs. This is the indictment in the broadest sense."

Mr. Siegel expressed the belief that commercial television will compel commercial radio to lift its sights. To support this contention, he mentioned that a national network has released a series of programs "presenting Shakespeare



Here's the absolute proof that WBNS is Central Ohio's most listened-to station. Five local stations broadcast Ohio State football games. All have the same game coverage . . . all are heard the same time. Yet WBNS held twice as many listeners as any other station . . . week after week!

Yes . . . WBNS is Central Ohio's most listened-to station. The 20 top-rated programs (Pulse) in this rich Central Ohio market area are heard on WBNS. CBS programming plus popular local talent gives WBNS an edge in listener appeal . . . BUT when they listen most to WBNS when *all* local stations have the same program, you *know* listening has become a habit . . . an instinctive preference sponsors can cash in on by using WBNS all the time.

CBS for CENTRAL OHIO



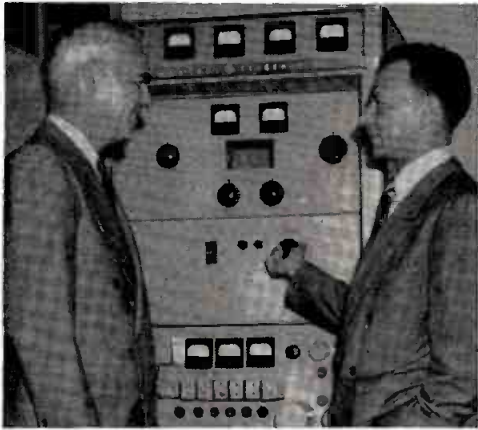

CLASS demonstrations at San Diego (Calif.) State College benefit from the use of an fm transmitter through the generosity of KFMB San Diego, which discontinued its fm broadcasting three years ago. Inspecting the transmitter are Howard L. Chernoff (r), KFMB general manager, and Dr. Malcolm Love, college president.

and straight lectures by such personalities as Toynbee and Oppenheimer."

"Hope and challenge, too, lie in the 242 television channels which have been reserved for noncommercial educational television," Mr. Siegel asserted. "The hope is that educational television will provide a mature, adult and literate program service."

In this connection, Mr. Siegel said there will be seven educational tv outlets on the air by Jan. 1 and 20 more by the next October.

Other developments in the educational broadcasting field touched upon by Mr. Siegel were the establishment of a national education and television exchange at Ann Arbor, Mich., and of an extensive culture exchange between educational radio stations of the U. S. and the broadcasting systems of Western Europe.

Buffalo Leaders Talk Educational Tv Plans

EDUCATIONAL television under community sponsorship in Buffalo, N. Y., was to have been considered last Friday in a second meeting of 20 leaders in business, labor, welfare and education. The meeting followed an Oct. 16 session at Buffalo's Hotel Statler at which George A. Newbury, executive vice president of the Manufacturers & Traders Trust Co. and acting chairman of the group, said an initial \$500,000 would be needed to make use of that city's reserved educational uhf ch. 23.

Mr. Newbury, working from information supplied by the National Citizens Committee for Educational Television, said \$350,000 would be needed to build a community educational noncommercial station and \$150,000 for the first year's operations. He said Ford Foundation's Fund for Adult Education would authorize on a matching basis grants up to \$150,000 for the station. Similar stations are underway in New York, Schenectady, Syracuse and Rochester, he added.

At the meeting U. of Buffalo Chancellor T. Raymond McConnell cited WBEN-TV's cooperation in such U.B. shows as *U. of Buffalo Roundtable*, *Modern Medicine*, *Law and You* and *Made In Buffalo*, and Buffalo State College's *Live and Learn*.

A special state commission last February ruled there was no justification for spending large amounts of public funds to carry out the State Board of Regents' proposal for a state-supported 10-station educational tv network [B•T, March 2, et seq.].

IDECO ... the one-contract tower source!

With a single contract you place all of your tower details in experienced hands. Planning and design ... fabrication ... foundation and erection ... equipment installation ... final inspection ... complete insurance coverage ... all these are in the Ideco Tower "package." Here's how you can put the entire responsibility for your tower in one set of capable hands:

PLANNED  Ideco Towers are planned from the ground up ... wind loading and sail bearing factors are computed for your individual location.

FABRICATED  Ideco Towers are shop-fabricated to close, pre-determined tolerances. All diagonal members are pre-tensioned, eliminating any possibility of inaccurate manual field adjustment.

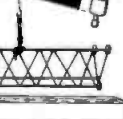
HOT-DIP  Every part of an Ideco Tower is hot-dip galvanized for complete and lasting rust protection ... maintenance costs are cut to a minimum.

TRUE  Whether your location calls for a self-supporting or guyed tower, careful Ideco design insures a "true" structure, free from indeterminate stresses ... a tower that will keep you on the air in any kind of weather.

EQUIPPED  Ideco installs the transmitting system ... also needed equipment such as lighting, call letters, microwave parabolas, de-icing circuits.

INSPECTED  Ideco engineers make a thorough final inspection ... stay with the job until you sign on the air. The complete Ideco service assures you a safe tower for the years ahead.

INSURED  Complete insurance coverage protects you throughout the entire tower erection and antenna installation.

Scientific triangular design, pioneered by Ideco, best resists distortion by wind pressure ... uses fewer members, with less dead weight. Triangular design means only three sides to paint, too.

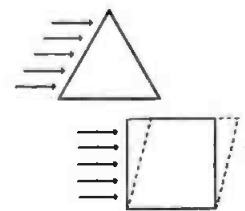

Tall or short... for TV, Microwave, AM, FM... Ideco Tower know-how keeps you on the air.

IDECO DIVISION, Dresser-Stacey Company
Department T, Columbus 8, Ohio

Branch: Dep't T, 8909 S. Vermont Ave., Los Angeles 44, Calif.



DESIGNED
FOR
YOUR
SPECIFIC
RADIO
NEEDS!

Yes, the new enlarged
SESAC Transcribed Library
is designed for all your
radio needs!—

Program wise!
Pocket wise!

The Lowest-Priced
Complete Program Service

- * Sales Aids that Sell Time for You
- * Program Notes
- * Network-Calibre Scripts
- * Bridges, Moods and Themes
- * Music for Every Type of Program and Sponsor

Keep your Sponsors
renewing—
let the

**SESAC Transcribed
Library be the backbone
of all your radio
programs!**

write for special offer

SESAC Transcribed Library

475 Fifth Ave., New York 17

WNBQ Lends a Hand

CHICAGO viewers got a chance to see educational television fare planned by an as yet non-existent educational tv outlet—thanks to the efforts of a commercial station. WNBQ (TV) Chicago Oct. 18 offered a special half-hour program, *Channel 11*, comprising three different program concepts—law, archeology and psychology. The program ended with a report by Edward L. Ryerson, chairman of the Chicago Educational Television Assn., on the progress of a fund drive for the proposed ch. 11.

Educ. Tv Prescribed As Aid to Broadcasters

A GREATER NUMBER of educational tv stations will reduce the possibility of more commercial video outlets than advertising can support and prove beneficial to commercial telecasters, Dr. John T. Rettaliata, president of the Illinois Institute of Technology, declared Oct. 15 before a luncheon session of the AAAA Central Council at Chicago's Blackstone Hotel [B•T, Oct. 19].

Dr. Rettaliata said the commercial tv industry has a "large interest" in educational television and should help promote noncommercial operations. He claimed educational channels will widen the tv audience, including that for commercial fare, and in view of high costs save commercial interests experimentation by presenting new ideas. He said there may be too many commercial outlets for the health of the industry.

The IIT president is head of a group of 17 organizations which have banded together under the Chicago Educational Television Assn. to seek vhf ch. 11 in that city.

Chicago Educ. Tv Sets Date

CHICAGO Educational Television Assn. has set Oct. 1, 1954, as target date for operation of the educational tv outlet it hopes to be granted on vhf ch. 11 in Chicago, the Illinois Institute of Technology announced Friday. More than \$774,000 of a \$1 million goal has been raised thus far.

Kirby Named to Head D. C. Promotion Unit

EDWARD M. KIRBY, former NARTB public relations director, last week was named public relations counsel for the Greater National Capital Committee, a promotional organization for Washington, D. C.



Mr. Kirby

Mr. Kirby has just completed a tour of duty as chief of the Radio-Television Branch of the Army's Public Information Division. He is a colonel in the Army Reserve; during World War II he served as radio chief for the AEF.

In addition to his public relations duties for NARTB, Mr. Kirby was secretary for the first Program Code Committee. He is the author of *Star Spangled Radio*, a story of radio's use in WW II, and won the Peabody Radio Award for his work as Army radio chief.

David Tolman Found Dead; Attorney with SS&H

FUNERAL services for David E. Tolman, 42, partner in the Washington law firm of Segal, Smith & Hennessey, who last Tuesday was found dead of a bullet wound were held there Friday. Interment was in Arlington Cemetery,

Mr. Tolman's body was found in his office. A hunting rifle was lying across his desk. He was said to have been depressed and in ill health during recent months.

Active in communications law practice, Mr. Tolman joined Paul M. Segal, senior partner, 25 years ago as a stenographer. After graduation from George Washington U. law school in 1936, he became associated with the firm as an attorney. He served in the Navy in World War II, assigned to communications work with the Joint Chiefs of Staff.

He leaves a wife and two children, Michael, 8, and Nancy, 13. They live at 4724 N. Seventh Rd., Arlington, Va.



Your One Source

For All Broadcasting Equipment



THESE OFFICES
TO SERVE YOU

- | | | |
|--------------------------------|------------------------|---------------------|
| • Quincy, Illinois | 123 Hampshire Street | Telephone 8202 |
| • New York City | 51 East 42nd Street | Murray Hill 7-7971 |
| • Washington, D. C. | 13th & E Streets, N.W. | Metropolitan 8-0522 |
| • Houston, Texas | 2700 Polk Avenue | Atwood 8536 |
| • Los Angeles, Calif. | 7501 Sunset Blvd. | Hollywood 2-6351 |
| • Atlanta, Georgia | 13th & Spring Streets | Elgin 0369 |
| • New York, International Div. | 13 East 40th Street | Murray Hill 9-0200 |
| • Montreal, Quebec, Canada | Canadian Marconi Co. | Atlantic 9441 |

DUPONT DEADLINE SET AT DEC. 31

Industry leaders are asked to nominate a commentator, a radio or tv station of less than 5 kw and a station of more than 5 kw for the 1953 duPont awards.

NOMINATIONS will be accepted through Dec. 31 for the 11th annual awards of the Alfred I. duPont Awards Foundation in the radio-tv industry for 1953, O. W. Riegel, foundation curator and director of the Lee Memorial Journalism Foundation at Washington & Lee U., said last week.

The three duPont awards—one to a radio or tv news commentator for "aggressive and consistently excellent and accurate gathering and reporting of news in the public interest," a second to a radio or tv station of more than 5 kw power and a third to a radio or tv station of less than 5 kw, both of which have performed "outstanding public service"—carry stipends of \$1,000 and embossed citations recognizing the recipient's contribution to the field.

The awards committee includes Mrs. Jessie Ball duPont, who established the awards in 1942 in honor of her husband; Dr. Francis P. Gaines, president of Washington & Lee U., which administers the awards; Ben McKelway, editor of the *Washington Star*; Dr. Hadley Cantril, director of Princeton U.'s office of public opinion research, and Mrs. Oscar A. Ahlgren, president of the General Federation of Women's Clubs.

Use of Award Money

Mr. Riegel said winners may make the cash awards the basis for scholarships and fellowships for advanced study in radio-tv in their own and the foundation's name. Nominations should be mailed to: Curator, Alfred I. duPont Awards Foundation, Washington & Lee U., Lexington, Va.

Winners in 1952 were WBNS-TV Columbus, Ohio; WMT Cedar Rapids, Iowa, and Gerald W. Johnson, commentator at WAAM Baltimore.



WPEN-AM-FM General Manager William B. Caskey (r) receives a plaque from the Philadelphia Junior Baseball League for his leadership in promoting sandlot sports. Presenting the award are Harry Hawkins (l), general business manager of the *Evening Bulletin*, and Arthur N. Hinkle, president of the Junior Baseball Federation.

MBS, WOR Honor Streibert

THEODORE C. STREIBERT, director of the U. S. Information Agency and formerly president of WOR New York and a member of the MBS board, was honored by former broadcasting colleagues last week. A committee of WOR-Mutual executives presented him a citation "in recognition of his years of leadership and services" and as "a reminder of the deep appreciation, devotion and earnest best wishes of his fellow workers." The presentation was made in Mr. Streibert's Washington offices by a committee headed by Nat Abramson, director of the WOR entertainment bureau. The committee included Jules Seebach, vice president of General Teleradio (licensee of WOR, stations) and Charles Singer, WOR chief engineer.

Praise for KEYT (TV)

KEYT (TV) Santa Barbara, Calif., has received a letter of commendation from the Santa Barbara Chamber of Commerce, citing KEYT for its "effort to bring the finest type and quality of programs to its television audiences." The Chamber indicated its appreciation for "the great promotional and publicity value of KEYT to Santa Barbara," according to Colin M. Selph, KEYT president.

When Customers Tell Dealers:



It proves your messages have the ring of authority!

WGAR commands the respect of a large listening audience because of authoritative news reporting, outstanding shows and special events, both local and CBS. This buying audience is yours—to ring up results in cash registers!

ADVERTISERS GET

RESULTS ON WGAR

Sales results obtained through use of WGAR are reflected in the number of years both local and national advertisers have been with Cleveland's Friendly Station!

- 221 advertisers 3-5 years
- 94 advertisers 6-10 years
- 17 advertisers 11-15 years
- 16 advertisers over 16 years!

WGAR'S PLEDGE

Based on 23 years' experience, "WGAR secures from its staff and its clients, careful preparation and delivery of advertising messages to maintain high standards and good taste."

Listeners quote WGAR because they've learned to respect its voice of authority. We invite you to share the impact of this voice for your sales messages.

In Northern Ohio

WGAR

THE SPOT FOR SPOT RADIO

Cleveland
50,000 watts

CBS

Eastern Office: at
665 Fifth Ave., N.Y.C.
Represented by The Henry I. Christal Co.
In Canada by Radio Time Sales, Ltd., Toronto



FIRST AGAIN!
—AND NOW BY A RECORD MARGIN!

Advertising Agency Magazine's subscribers in agencies now total:

- 20% more than Advertising Age
- 62% more than Printers' Ink
- 297% more than Tide

Never before has any advertising publication won such commanding leadership

in the agency field—center of influence for 98% of all national advertising expenditures.

The reason? *Only Advertising Agency Magazine is specifically edited for agency executives whose time-buying decisions affect you!*

Advertising Agency Magazine 48 West 38th St.
New York 18, N. Y.

IN BALTIMORE
(America's 6th City)

WMAR-TV BALTIMORE'S FIRST STATION



A SIX YEAR RECORD OF LEADERSHIP

October 27th rounds out WMAR-TV's sixth year of Television leadership in Baltimore. That date in 1947 marked the beginning of video service in Maryland, serving 1,600 receivers. Since then more than 500,000 TV receivers have been sold in Baltimore.

HERE'S THE RECORD:

RATINGS: Cumulative totals of ALL ARB ratings made in Baltimore since the beginning of 1952 show WMAR-TV leading in 50 percent of all quarter-hour segments rated while all three of the city's TV stations were on the air.

POWER: Last July 22 WMAR-TV went to the full maximum power (for Channel Two) permitted by the FCC—100,000 watts of effective radiated power. Even our "sneak previews" caused excitement in WMARland—the first one alone evoking 300 un-asked-for letters from viewers over an area that ran from north of Harrisburg, Pa., to below Richmond, Va.

REMOTES: Two mobile units, with which an outstanding record of 1,949 successful telecasts from locales remote from WMAR-TV studios has been compiled, have given our crews unusual skill and experience in this tricky phase of Television—production 'know-how' which pays off in effective programming for discerning sponsors.

PROGRAMMING: The CBS-Television network 'powerhouse' of daytime and evening programming, (which dominate the 'top ten' in any survey) plus WMAR-TV's own imaginative video shows, give CHANNEL TWO an edge in any competition for audience attention.

CLIENTS: The noteworthy selling power of WMAR-TV has attracted national attention and this station is a "must" for any campaign that includes the important Baltimore market. Cost-conscious and audience-seeking advertisers like and buy the leadership WMAR-TV offers and delivers.

In Maryland Most People Watch

WMAR-TV

CHANNEL 2 SUNPAPERS TELEVISION BALTIMORE, MARYLAND

Telephone MULberry 5-5670



TELEVISION AFFILIATE OF THE COLUMBIA BROADCASTING SYSTEM

Represented by THE KATZ AGENCY, Inc. New York, Detroit, Kansas City, San Francisco, Chicago, Atlanta, Dallas, Los Angeles

TELESTATUS

Oct. 26, 1953

TV STATIONS ON THE AIR
and Reports of Tv Sets in Their Coverage Areas—

Editor's note: Stations listed here are on the air with regular commercial programming. Each is listed in the city where it is licensed. Stations report set estimates for their coverage areas to B·T on sworn affidavits. If estimates differ among stations in same city, separate figures are shown for each. Since set estimates are from the station any question about them should be directed to that source. Total U. S. sets in use is unduplicated B·T estimate.

City	Outlets on Air and Channel	Sets in Station Area vhf	uhf	City	Outlets on Air and Channel	Sets in Station Area vhf	uhf
ALABAMA							
Birmingham	WBAT (13)			Peoria	WEEK-TV (43)	89,127	
	WBRC-TV (6)	184,300			WTVH-TV (19)	87,000	
Mabile	WALA-TV (10)	39,900		Quincy	WGEM-TV (10)	27,200	
	WKAB-TV (48)	39,900			KHQA (see Hannibal, Mo.)		
Montgomery	WCOV-TV (20)		15,200	Rockford	WREX-TV (13)	133,854	
					WTVQ (39)	49,000	
ARIZONA							
Mesa	KTYL-TV (12)	71,500		Rock Island	WHBF-TV (4)	217,000	
Phoenix	KPHO-TV (5)	71,500		Springfield	WICS (TV) (20)		
Tucson	KOPO-TV (13)			INDIANA			
	KVOA-TV (4)	16,150		Bloomington	WTTV (10)	276,000	
ARKANSAS							
Fort Smith	KFSA-TV (22)			Indianapolis	WFBM-TV (6)	394,000	
Little Rock	KRTV (17)		30,000	Lafayette	WFAM-TV (59)	30,600	
CALIFORNIA							
Bakersfield	KERO-TV (10)	51,661		Muncie	WLBC-TV (49)	37,300	
	KAFY-TV (29)		25,000	South Bend	WSBT-TV (34)	75,547	
Chico	KHSL-TV (12)	26,402		IOWA			
Eureka	KIEM-TV (3)			Ames	WOI-TV (5)	142,085	
Fresno	KJEO (47)			Cedar Rapids	KCRI-TV (8)		
	KMJ-TV (24)		49,629		WMT-TV (2)	185,000	
Los Angeles	KECA-TV (7)			Davenport	WOC-TV (5)	215,000	
	KHJ-TV (9)			Fort Dodge	KQTV (21)		
	KLAC-TV (13)			Siaux City	KVTV (9)	59,493	
	KNBH (4)			KANSAS			
	KNXT (2)			Hutchinson	KTVH (12)	45,440	
	KTIA (5)			Wichita	KEDD (16)	32,026	
	KTTV (11)	1,681,073		KENTUCKY			
	KTRE (28)			Henderson	WEHT (50)	20,240	
Monterey	KMBY-TV (8)			Louisville	WAVE-TV (3)	293,102	
Sacramento	KCCC-TV (40)				WHAS-TV (11)(b)		
Sailinas	KSBW-TV (8)	180,506			WKLO-TV (21)		
San Diego	KFMB-TV (8)			LOUISIANA			
	KFSD-TV (10)	206,382		Baton Rouge	WAFB-TV (28)	32,000	
San Francisco	KGO-TV (7)			Monroe	KNOE-TV (8)	70,000	
	KPIX (5)			New Orleans	KFAZ (43)	15,160	
San Luis Obispo	KRON-TV (4)	752,350			WDSU-TV (6)	210,076	
Santa Barbara	KVEC-TV (6)			MAINE			
	KEYT (3)	371,332		Bangor	WABI-TV (5)	39,750	
				Portland	WPMT (53)	19,000	
COLORADO							
Colorado Springs	KKTU (11)	30,253		MARYLAND			
Denver	KRDO-TV (13)	31,000		Baltimore	WAAM (13)		
	KBTV (9)				WBAL-TV (11)		
	KFEL-TV (2)	164,750			WMAR-TV (2)	502,863	
Pueblo	KCSJ-TV (5)	30,000		MASSACHUSETTS			
	KDZA-TV (3)	35,000		Boston	WBZ-TV (4)		
CONNECTICUT							
Bridgeport	WICC-TV (43)		26,664		WNAC-TV (7)	1,089,696	
New Britain	WKNB-TV (30)		90,411	Cambridge	WTAO-TV (56)	52,600	
New Haven	WNHC-TV (6)	635,190		Springfield	WHYN-TV (55)		
Waterbury	WATR-TV (53)		81,000		WWLP (61)	75,000	
DELAWARE							
Wilmington	WDEL-TV (12)	155,322		MICHIGAN			
DISTRICT OF COLUMBIA							
Washington	WMAL-TV (7)			Ann Arbor	WPAG-TV (20)	12,300	
	WNBW (4)			Battle Creek	WBKZ-TV (64)	55,924	
	WTOP-TV (9)			Detroit	WJBL-TV (2)		
	WTTG (5)	477,143			WWJ-TV (4)		
FLORIDA							
Ft. Lauderdale	WFTL-TV (23)		85,926		WXYZ-TV (7)	1,100,000	
Jacksonville	WMBR-TV (4)	175,000		Flint	WTAC-TV (16)		
Miami	WTVJ (4)	193,500		Grand Rapids	WOOD-TV (7)	259,987	
Pensacola	WPFA (15)			Kalamazoo	WKZO-TV (3)	310,900	
St. Petersburg	WSUN-TV (38)		39,000	Lansing	WJIM-TV (6)	231,000	
West Palm Beach	WIRK-TV (21)				WILS-TV (54)	17,000	
				Saginaw	WKNX-TV (57)	46,325	
GEORGIA							
Atlanta	WAGA-TV (5)			MINNESOTA			
	WLVA (8)			Austin	KMMT (6)	59,546	
	WSB-TV (2)	330,000		Duluth	WFTV (38)	32,784	
Columbus	WDAK-TV (28)		12,500	Minneapolis	WCCO-TV (4)	401,200	
Macon	WMAZ-TV (13)	50,000			WTCN-TV (11)	401,200	
Rome	WETV (47)		24,544	St. Paul	KSTP-TV (5)	395,220	
	WROM-TV (9)	75,500			WMIN-TV (11)	43,000	
IDAHO							
Boise	KIDO-TV (7)	10,900		Rochester	KROC-TV (10)		
Pocatello	KWIK-TV (10)			MISSISSIPPI			
ILLINOIS							
Bellefonte	WTVI (54)		127,000	Jackson	WJTV (25)	24,103	
Chicago	WBBM-TV (2)			Meridian	WTOK-TV (11)	11,000	
	WBKB (7)			MISSOURI			
	WGN-TV (9)			Hannibal	KHQA-TV (7)	70,000	
	WNBC (5)	1,575,000		Kansas City	KCMO-TV (5)		
Decatur	WTVF (17)		86,700		KMBC-TV (9)		
					WDAF-TV (4)		
					WHB-TV (9)	323,352	
					KCTY (25)	41,952	
				St. Joseph	KFEQ-TV (2)	75,439	
				St. Louis	KSD-TV (5)	534,500	
					WTVI (See Belleville, Ill.)		
				Springfield	KITS-TV (10)	28,817	
					KYTV (3)		
MONTANA							
Butte	KOPR-TV (4)			MONTANA			
	KXLF-TV (6)			Butte	KOPR-TV (4)		
					KXLF-TV (6)		

now
there
are
394,000
sets in
WFBM-TV's
coverage
area

... and the audience is growing every day. Put your sales message on Channel 6.

Represented nationally by The Katz Agency

WFBM-TV
INDIANAPOLIS

Affiliated with WEOA, Evansville; WFEM, Indianapolis; WFDF, Flint; WOOD AM & TV, Grand Rapids

Buy **XETV**

**CATCH THE EYES AND
EARS OF THE
SAN DIEGO MARKET**

**-for less money!*

FOR INSTANCE, IN SAN DIEGO
*20 SECOND CLASS A
ANNOUNCEMENTS COST

XETV	(ONE TIME RATE)	\$80.00
STATION B	" "	\$120.00
STATION C	" "	\$100.00

REPRESENTED BY

**WEED
TELEVISION**

NEW YORK CHICAGO DETROIT
SAN FRANCISCO HOLLYWOOD
BOSTON ATLANTA

XETV
4233 PARK BOULEVARD
SAN DIEGO 3, CALIFORNIA

BLANKETS SUNNY SAN DIEGO

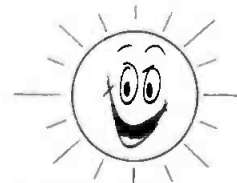

LIKE THE CALIFORNIA SUNSHINE

**-and just check our current ratings!*

New Grantees' Commencement Target Dates

This list includes all stations not yet on the air commercially. Stations on the air are listed in TELESTATUS, page 137

Information in following order: Location, call letters, channel, date granted, starting target date, network and representative.

ALABAMA

Birmingham, WJLN-TV (48), 12/10/52—Unknown.
Birmingham, WSGN-TV (42), 12/18/52—Unknown.
Decatur, WMSL-TV (23), 12/26/53-2/1/54.
Montgomery, Montgomery Bcstg. Co. (12), Initial Decision 10/7/53.

ARKANSAS

Little Rock, KARK-TV (4), 6/18/53-2/1/54, Petry.
Little Rock, KETV (TV) (23), 10/30/53—Unknown.
Pine Bluff, KATV (TV) (7), 6/18/53-11/15/53, Avery-Knadel.

CALIFORNIA

Berkeley-San Francisco, KQED (TV) (*9), 7/24/53-11/1/53.
Carona, KOWI Bcstg. Co. (52), 9/16/53—Unknown.
Fresno, KCAF (TV) (53), 8/12/53—Unknown.
Los Angeles, KPIK (TV) (22), 12/10/52-Late '53.
Merced, Merced Tv Corp. (34), 9/16/53—Unknown.
Sacramento, KBIC (TV) (46), 6/26/53-Fall '53.
Salinas, KICU (TV) (28), 1/15/53-Fall '53.
San Bernardino, KITO-TV (18), 11/6/52-Fall '53, Hollingbery.
San Bernardino, Orange Belt Telecasters (30), Initial decision 9/18/53.
San Francisco KBAY-TV (20), 3/11/53-Nov. '53 (granted STA Sept. 15).
San Francisco, KSAN-TV (32), 4/29/53-Jan. 54, McGillvra.
San Jose, KVIE (TV) (48), 6/17/53-Oct. 54.
Stockton, KTVU (TV) (36), 1/8/53-Oct. 30, Hollingbery.
Tulare-Fresno, KCOK-TV (27), 4/2/53-11/9/53—DuM, Forjoe (N. Y.), Cal-Central Network.
Yuba City, KAGR-TV (52), 3/11/53—Unknown.

Information in following order: Location, call letters, channel, date granted, starting target date, network and representative.

COLORADO

Denver, KDEN (TV) (26), 7/11/52—Unknown.
Denver, KIRV (TV) (20), 9/18/52—Unknown.
Denver, KLZ-TV (7), 6/29/53-11/1/53, CBS, Katz (granted STA Oct. 15).
Denver, KOA-TV (4), 9/9/53-12/25/53, NBC, Petry.
Denver, KRMA-TV (*6), 7/1/53—1954.
Grand Junction, KFXJ-TV (5), 3/26/53-May '54—Holman.

CONNECTICUT

Bridgeport, WCTB (TV) (*71), 1/29/53—Unknown.
Bridgeport, WSJL (TV) (49), 8/14/52—Unknown.
Hartford, General Times Tv Corp. (18), 10/21/53—Unknown.
Hartford, WEDH (TV) (*24), 1/29/53—Unknown.
New Haven, WELI-TV (59), 6/24/53—Summer '54, H.R. Television.
New London, WNLC-TV (26), 12/31/52-Dec. '53—Hegdley-Reed TV.
Norwich, WCIN (TV) (*63), 1/29/53—Unknown.
Stonford, WSTF (TV) (27), 5/27/53—Unknown.

DELAWARE

Dover, WHRN (TV) (40), 3/11/53—Unknown.
Wilmington, Delaware Bcstg. Co. (83), 10/14/53—Unknown.

FLORIDA

Fort Lauderdale, WITV (TV) (17), 7/31/52-11/30/53, DuM, Taylor.
Fort Myers, WINK (TV) (11), 3/11/53-Dec. '53—Weed TV.
Jacksonville, WJHP-TV (36), 6/3/53-Dec. '53, Perry Assoc.
Jacksonville, WOBS-TV (30), 8/12/53-Early '54.
Lakeland, WOTV (TV) (16), 12/31/52—Unknown.

Information in following order: Location, call letters, channel, date granted, starting target date, network and representative.

Orlando, Orlando Bcstg. Co. (6), 10/14/53-Apr. '54, CBS, Blair-Tv.
Pensacola, WEAR-TV (3), 6/3/53-11/2/53, CBS, Hollingbery.
Tampa, WFLA-TV (8), Initial Decision 7/13/53-Early '54, NBC, Blair Tv.

GEORGIA

Atlanta, Robert W. Rounsaville (36), Initial Decision 10/15/53.
Augusta, WJBF-TV (6), 9/16/53-11/26/53, ABC, NBC, Hollingbery (granted STA Sept. 18).
Augusta, WRDW-TV (12), 9/16/53-2/1/54, CBS, Headley-Reed.
Columbus, WRBL-TV (4), 8/27/53-11/1/53, Hollingbery.
Savannah, WTOCTV (11), 6/26/53-3/1/54, CBS, Katz.
Valdosta, WGOV-TV (37), 2/26/53—Nov. '53, Stars National.

IDAHO

Boise-Meridian, KBOI (TV) (2), 5/14/53-11/27/53 (granted STA Sept. 29).
Boise, KTVI (TV) (9), 1/15/53-October '54, ABC, Hollingbery.
Idaho Falls, KID-TV (3), 2/26/53—Unknown, CBS.
Idaho Falls, KIFT (TV) (8), 2/26/53-12/1/53, ABC Hollingbery.
Meridian-Boise, KBOI (TV) (2), 5/14/53-11/27/53 (granted STA Sept. 29).
Nampa, KFXD-TV (6), 3/11/53—Unknown, Hollingbery.
Pocatello, KISJ (TV) (6), 2/26/53—Nov. '54, CBS.
Twin Falls, KLIX-TV (11), 3/19/53-5/1/54, ABC, Hollingbery.

ILLINOIS

Bloomington, WBLN (TV) (15), 3/4/53-11/1/53, ABC, McGillvra.
Champaign, WCIA (TV) (3), 2/26/53-11/7/53, Hollingbery.
Champaign, WCUI (TV) (21), 7/22/53—Unknown.
Chicago, WHFC-TV (26), 1/8/53—Unknown.
Chicago, WIND-TV (20), 3/19/53—Unknown.
Danville, WDAN-TV (24), 12/10/52—Unknown, Everett-McKinney.
Evanston, WTLE (TV) (32), 8/12/53—Unknown.
Harrisburg, WSIL-TV (22), 3/11/53—Nov. '53.
Joliet, WJOL-TV (48), 8/21/53—Unknown.

INDIANA

Elkhart, WSJV (TV) (52), 6/3/53—Unknown.
Evansville, WFIE (TV) (62), 6/10/53-11/1/53, Taylor (granted STA Aug. 6).
Fort Wayne, WKJG-TV (33), 5/22/53-11/15/53, NBC, Raymer.
Indianapolis, WJRE (TV) (26), 3/26/53—Unknown.
Indianapolis, WNES (TV) (67), 3/26/53—Unknown.
Marion, WMRI-TV (29), 3/11/53—Unknown.
Princeton, WRAY-TV (52), 3/11/53-10/31/53, Walker.
Terre Haute, Wabash Valley Bcstg. Corp. (10), 10/7/53—Unknown.
Waterloo, WINT (TV) (15), 4/6/53-12/15/53.

IOWA

Cedar Rapids, KEYC (TV) (20), 7/30/53—Unknown.
Davenport, KDIO (TV) (36), 3/11/53—Unknown.
Des Moines, WHO-TV (13), 9/2/53—Unknown.
Des Moines, KGTV (TV) (17), 3/26/53-11/53, Hollingbery.
Mason City, Lee Radio Inc. (3), 10/14/53—Summer '54, Weed TV.
Sioux City, KCTV (TV) (36), 10/30/52—Unknown.
Waterloo, KWVL-TV (7), 9/2/53-11/26/53, Headley-Reed.

KANSAS

Manhattan, KSAC-TV (*8), 7/24/53—Unknown.
Pittsburg, KOAM-TV (7), 2/26/53-11/15/53, NBC, CBS, DuM, Katz.
Topeka, Alf M. Landon (42), Initial Decision 10/6/53.
Topeka, WIBW-TV (13), 6/3/53-11/15/53, CBS, Copper Sales (granted STA Sept. 22).

KENTUCKY

Ashland, WPTV (TV) (59), 8/14/52—Summer '53.
Louisville, WLOU-TV (41), 1/15/53—Unknown.
Paducah, Paducah Tv Corp. (43), 9/16/53—Unknown.
Richmond, WBGTV (TV) (60), 4/29/53—Unknown.

LOUISIANA

Alexandria, KSPJ (TV) (62), 4/2/53—Unknown.
Baton Rouge, KHTV (TV) (40), 12/18/52—Unknown.
Lafayette, KVOL-TV (10), 9/16/53-3/15/54 (share time with KLFY-TV).
Lafayette, KLFY-TV (10), 9/16/53—Unknown (share time with KVOL-TV).
Lake Charles, KTAG (TV) (25), 12/18/52-11/1/53, CBS, ABC, DuM, Adam Young.
New Orleans, WCKG (TV) (26), 4/2/53—Late Winter '53, Gill-Perna.
New Orleans, WCNO-TV (32), 4/2/53-1/1/54.
New Orleans, WJMR-TV (61), 2/18/53-11/1/53, DuM, Bolling (granted STA Oct. 14).
New Orleans, WTLO (TV) (20), 2/26/53—Unknown.
Shreveport, KSLA (TV) (12), 9/19/53—Unknown.

MAINE

Lewiston, WLAM-TV (17), 7/8/53-12/1/53, Everett-

BROADCASTING • TELECASTING

New
WJAS
AM & FM

MONEY
—THE SUNNY SIDE
OF THE DIAL

NOW OFFERS

THREE for the MONEY

(The biggest talent "steal" in Pittsburgh's radio history)

Put your product before *three separate audiences* every day on the ONE Pittsburgh station with personality appeal!! Saturate the fabulous Pittsburgh market across the board at tremendous savings with this "once in a lifetime" triple bonus package. Take advantage of Radio Pittsburgh's three top radio personalities—Bill Brant in the morning, Barry Kaye in the afternoon, and Hilary Bogden in the evening. As little as \$9.72 per announcement.* **THE TIME OF YOUR LIFE!!**

Serving the
GREATER PITTSBURGH
Metropolitan Area

5000 Watts 1320 KC.

Write . . . phone . . . or wire . . .
George P. Hollingbery Co.

*26 week package as published in S. R. D.S.



AFFILIATIONS for KFIA (TV) Anchorage and KFIF (TV) Fairbanks, both Alaska, with CBS-TV are reviewed by Bert Lown (l), CBS-TV station relations representative, and Dick Rollins, co-owner with Keith Kiggins of the Alaska stations. KFIA plans to start Nov. 1. KFIF is aiming for commencement next spring.

Information in following order: Location, call letters, channel, date granted, starting target date, network and representative.

McKinney (N. Y.), Kettell-Carter (Boston) (tests due Nov. 15).
 Poland, WMTW (TV) (8), 7/8/53-4/1/54.
 Portland, WCBS-TV (6), 7/30/53-12/20/53, NBC, Weed Tv.

MARYLAND

Baltimore, WITH-TV (60), 12/18/52-1/1/54-Forloe.
 Frederick, WFMD-TV (62), 10/24/52-Winter 1953.
 Salisbury, WBOC-TV (16), 3/11/53-12/25/53.

MASSACHUSETTS

Boston, WBOS-TV (50), 3/26/53-Unknown.
 Boston, WGBH-TV (*2), 7/16/53-10/1/54.
 Boston, WJDW (TV) (44), 8/12/53-Unknown.
 Braclton, WHEF-TV (62), 7/30/53-Unknown.
 Fall River, WSEE-TV (46) 9/14/52-Unknown.
 Lawrence, WGLM (TV) (72), 6/10/53-Unknown.
 New Bedford, WTEV (TV) (28), 7/11/52-Fall, Walker.
 North Adams, WMGT (TV) (74), 2/18/53-12/25/53, Walker.
 Worcester, WAA8-TV (20), 8/12/53-Spring '54, Hollingbery.
 Worcester, WWOR-TV (14) 6/18/53-11/1/53, Roymer.

MICHIGAN

Bay City, WNEM-TV (5), 9/2/53-Fall '53.
 Battle Creek, WBCK-TV (58), 11/20/52-11/1/53, Headley-Reed.
 Benton Harbor, WHFB-TV (42), 2/26/53-Unknown.
 Cadillac, WWTV (TV) (13), 4/8/53-1/1/54, CBS, ABC, DuM, Weed (granted STA Sept. 29).
 Detroit, UAW-CIO Bcstg Corp. (62), Initial Decision 10/12/53.
 East Lansing, WKAR-TV (*60), 10/16/52-1/1/54.
 Flint, WCTF (TV) (28), 7/11/52-Unknown.
 Flint, WFDF-TV (12), Initial Decision 5/11/53.
 Jackson, WIBM-TV (48), 11/20/52-12/8/53, Forloe.
 Muskegon, WTVM (TV) (35), 12/23/52-Unknown.
 Saginaw, Booth Radio & Tv Stations Inc. (51), Initial Decision 9/29/53.

MINNESOTA

St. Cloud, WJON-TV (7), 1/23/53-Nov. '53, Rambeau.
 St. Paul, WCOW-TV (17), 3/11/53-Unknown.

MISSISSIPPI

Columbus, WCBI-TV (28), 3/11/53-Unknown.
 Gulfport, WOCM-TV (56), 2/11/53-Unknown.
 Jackson, WSLI-TV (12), 7/22/53-Jan. '54-ABC, Weed Tv.
 Jackson, WJDT (TV) (3), 8/27/53-12/15/53, NBC, Hollingbery.
 Meridian, WCOC-TV (30), 12/23/53-Unknown.

Information in following order: Location, call letters, channel, date granted, starting target date, network and representative.

MISSOURI

Cape Girardeau, Hirsch Bcstg. Co. (12), 10/14/53-Unknown.
 Cape Girardeau, KGMO-TV (18), 4/16/53-Unknown.
 Clayton, KFJQ-TV (30), 2/5/53-Unknown.
 Columbia, KOMU-TV (8), 1/15/53-11/1/53, ABC, CBS, DuM, NBC, H-R Television.
 Festus, KACY (TV) (14), 12/31/52-Nov. '53.
 St. Louis, KETC (TV) (*9), 5/7/53-Unknown (granted STA Aug. 12).
 St. Louis, WIL-TV (42), 2/12/53-Late '53.
 Sedalia, KDRO-TV (6), 2/26/53-1/1/54.

MONTANA

Billings, KOOK-TV (2), 2/5/53-11/1/53, CBS, DuM, Weed (granted STA Aug. 11).
 Billings, KRHT (TV) (8), 1/15/53-Early Fall '53.
 Great Falls, KFBB-TV (5), 1/15/53-Nov. '53, CBS, Weed Tv.
 Great Falls, KMON-TV (3), 4/9/52-Unknown, Hollingbery.
 Missoula, KGVO-TV (13), 3/11/53-7/1/54, Gill-Perna.

NEBRASKA

Kearney, KHOL-TV (13), 7/22/53-11/13/53, CBS, DuM, Meeker.

NEW HAMPSHIRE

Keene, WKNE-TV (45), 4/22/53-Unknown.
 Manchester, WMUR-TV (9), 8/26/53-2/1/54.
 Mt. Washington, WMTW (TV) (8), 7/8/53-4/1/54.

NEW JERSEY

Asbury Park, WRTV (TV) (58), 10/2/52-Dec. '53.
 Atlantic City, WOCN (TV) (52), 1/8/53-Unknown.
 New Brunswick, WDHN (TV) (47), 4/2/53-Unknown.
 New Brunswick, WTLV (TV) (*19), 12/4/52-Unknown.
 Trenton, WTTM-TV (41), 7/16/53-Unknown.

NEW MEXICO

Clovis, KNEH (TV) (12), 3/4/53-Unknown.
 Sante Fe, KTVK (TV) (2), 1/23/53-Unknown.

NEW YORK

Albany, WPTR (TV) (23), 6/10/53-Unknown.
 Albany, WTUZ (TV) (*17), 7/24/52-Unknown.
 Binghamton, WQTV (TV) (*46), 8/14/52-Unknown.
 Buffalo, WTVF-TV (*23), 7/24/52-Unknown.
 Ithaca, WHCU-TV (20), 1/8/53-11/15/53.

Information in following order: Location, call letters, channel, date granted, starting target date, network and representative.

Ithaca, WIET (TV) (*14), 1/8/53-Unknown.
 Jamestown, WJTN-TV (58), 1/23/53-Unknown.
 Kingston, WKNY-TV (66), 1/23/53-Jan. '54, NBC, CBS, DuM, Meeker.
 New York, WGTV (TV) (*25), 8/14/52-Unknown.
 Poughkeepsie, WEOK-TV (21), 11/26/52-Jan. '54.
 Rochester, WHEC-TV (10), 3/11/53-11/1/53, ABC, CBS, Everett-McKinney (share time with WVET-TV).
 Rochester, WRNY-TV (27), 4/2/53-Unknown.
 Rochester, WROH (TV) (*21), 7/24/52-Unknown.
 Rochester, WVET-TV (10), 3/11/53-11/1/53, ABC, CBS, Bolling (share time with WHEC-TV).
 Rochester, WCBF-TV (15), 6/10/53-Unknown.
 Schenectady, WTRI (TV) (35), 6/11/53-1/15/54.
 Syracuse, WHTV (TV) (*43), 9/18/52-Unknown.
 Utica, WFRB (TV) (19), 7/1/53-Unknown.
 Watertown, WWNY-TV (48), 12/23/52-Unknown, Weed Tv.

NORTH CAROLINA

Chapel Hill, WUNC-TV (*4) 9/30/53-Sept. '54.
 Charlotte, WAYS-TV (36), 2/26/53-11/15/53, ABC, Bolling.
 Durham, WCIG-TV (46), 2/26/53-11/1/53-DuM, NBC, H-R Television.
 Goldsboro, Goldsboro Tv Corp. (34), 9/30/53-Unknown.
 Greensboro, WCOG-TV (57), 11/20/52-10/30/53, ABC, Bolling.
 Greenville, WNCT (TV) (9), 3/11/53-11/15/53, CBS, DuM, Pearson.
 Hendersonville, WHKP-TV (27), 3/11/53-Early '54, Headley-Reed Tv.
 Mount Airy, WPAQ-TV (55), 3/11/53-Fall '53, Clark.
 Wilmington, WMFD-TV (6), 7/30/53-Spring '54.

NORTH DAKOTA

Bismarck, KFVR-TV (5), 3/4/53-Unknown, Blair Tv.
 Valley City, KXJB-TV (4), 8/5/54-Early '54, Weed Tv.

OHIO

Cincinnati, WCIN-TV (54), 5/14/53-Unknown.
 Cleveland, WERE-TV (65), 6/18/53-Fall '53.
 Cleveland, United Bcstg. Co. (19), Initial Decision 10/15/53.
 Columbus, WOSU-TV (*34), 4/22/53-Unknown.
 Dayton, WIFE (TV) (22), 11/26/52-10/26/53, Headley-Reed (granted STA Oct. 2).
 Lima, WIMA-TV (35), 12/4/52-Late '53, Weed Tv.
 Massillon, WMAC-TV (23), 9/4/52-Unknown, Petry.

Coming to

ALBANY • TROY • SCHENECTADY

WTRI

TELEVISION

HIGHER POWER

WIDER COVERAGE

CHANNEL

35



JACKSON'S
(MISSISSIPPI)

1st VHF
TELEVISION STATION
WSLI-TV

... located in the heart of Mississippi's fastest growing market with a potential audience of 1,224,000 people who are ready, willing and able to buy.



MISSISSIPPI'S WEALTHIEST MARKET

Weed Television — National Representative

NOW!

output
uniformity
with **SOUNDCRAFT**
PROFESSIONAL RECORDING TAPE
it's **micro-polished***

Perfect reproduction — that's the reason you'll want to use Soundcraft Professional Recording Tape. Every high is crisp, clean — every low clear, full-bodied. Soundcraft Tape is Micro-Polished; polished, buffed and re-polished to a glossy smoothness, to produce greater output uniformity, lower distortion, improved high frequency response, better head contact and longer head life.

If you want quality second to none, be sure to ask for Soundcraft Professional Tape... the one and only Micro-Polished tape!



REEVES
SOUNDCRAFT
CORP.

Dept. N-105
10 East 52nd Street
New York 22, N. Y.
*PAT. APPLIED FOR

FOR THE RECORD

Information in following order: Location, call letters, channel, date granted, starting target date, network and representative.

Portsmouth, Woodruff Inc. (30), Initial Decision 6/8/53.
Stebenville, WSTV-TV (9), 8/12/53-12/1/53, CBS, Avery-Knodel (granted STA Sept. 16).
Youngstown, WUTV (TV) (21), 9/25/52—Fall '53.

OKLAHOMA

Miami, KMIV (TV) (58), 4/22/53—Unknown.
Oklahoma City, KLPR-TV (19), 2/11/53-11/1/53, DuM, Bolling.
Oklahoma City, KWTV (TV) (9), 7/22/53-12/15/53, CBS, Avery-Knodel.
Tulsa, KCEB (TV) (23), 2/26/53-11/14/53, Bolling.

OREGON

Eugene-Springfield, KTVF (TV) (20), 2/11/53—Unknown.
Eugene, Eugene Tv Inc. (13), 5/14/53—Unknown, Hollingbery.
Portland (Ore.)-Vancouver (Wash.), KVAN-TV (21), Initial Decision 6/18/53.
Salem, KPIC (TV) (24), 12/9/53-12/15/53, granted STA Aug. 4).
Salem, KSLM-TV (3), 9/30/53—Unknown.
Springfield-Eugene, KTVF (TV) (20), 2/11/53—Unknown.

PENNSYLVANIA

Allentown, WFMZ-TV (67), 7/16/53—Unknown.
Allentown, WQCY (TV) (39), 8/12/53—Unknown.
Erie, Great Lakes Tv Co. (35), 10/14/53—Unknown.
Harrisburg, WCMB-TV (27), 7/24/53-12/15/53—Cooke.
Hazleton, WAZL-TV (63), 12/18/52—Unknown, Meeker.
Lancaster, WFLA (TV) (21), 5/7/53—Late '53, Taylor.
Lewistown, WMRF-TV (38), 4/2/53—Unknown.
Philadelphia, WIBG-TV (23), Initial Decision 10/2/53.
Philadelphia, WIP-TV (29), 11/26/52—Unknown.
Pittsburgh, WQED (TV) (*13), 5/14/53-1/1/54 (granted STA Oct. 14).
Pittsburgh, WTVQ (TV) (47), 12/23/53—Fall '53, Headley-Read.
Scranton, WARM-TV (16), 2/26/53-12/1/53, Hollingbery.
Williamsport, WRAC-TV (36), 11/13/52—Unknown.
York, WNOW-TV (49), 7/11/52-Late October, DuM, Hollingbery.

RHODE ISLAND

Providence, WNET (TV) (16), 4/8/53—Unknown.
Providence, WPRO-TV (12), 9/2/53-Fall '53, Blair Tv (granted STA Sept. 23).

SOUTH CAROLINA

Aiken, Aiken Electronics Advertising Corp. (54), 10/21/53—Unknown.
Anderson, WAIM-TV (40), 9/30/53—Unknown.
Camden, WACA-TV (13), 6/3/53—Jan. '54.
Columbia, WIS-TV (10), 2/12/53-11/7/53, NBC, Free & Peters.
Greenville, WFBC-TV (4), 7/30/53-12/15/53, Weed.
Greenwood, WCRS-TV (21), 4/8/53—Unknown.
Spartanburg, WSCV (TV) (17), 7/30/53—Jan. '54.

TENNESSEE

Chattanooga, WOUC (TV) (49), 8/21/52—Unknown, Pearson.
Chattanooga, WTVT (TV) (43), 8/21/52—Unknown.
Johnson City, WJHL-TV (11), 1/29/53—Unknown, Pearson.
Nashville, WSIX-TV (8), 7/30/53-11/15/53, CBS, Hollingbery (granted STA Sept. 9).
Old Hickory, WLAC-TV [Nashville] (5), 8/5/53-1/1/54.

TEXAS

Beaumont, KBMT (TV) (31), 12/4/52—Fall '53, Taylor.
Beaumont, KTRM-TV (6), Initial Decision 7/22/53.
Dallas, KDTX (TV) (23), 1/15/53—Unknown.
Dallas, KLIF-TV (29), 2/12/53—Unknown.

Information in following order: Location, call letters, channel, date granted, starting target date, network and representative.

El Paso, KEPO-TV (13), 10/24/52—Fall '53, Avery-Knodel.
Fort Worth, KTCD (TV) (20), 3/11/53—Unknown.
Galveston, KTVR (TV) (41), 11/20/52—Early Fall '53.
Houston, KTVP (TV) (23), 1/8/53—Unknown.
Houston, KXYZ-TV (29), 6/18/53—Unknown.
Lubbock, KFYO-TV (5), 5/7/53—Late '53, Taylor.
Lufkin, KTRE-TV (9), 3/11/53—1954, Taylor.
Marshall, KMSL (TV) (16), 6/25/53—Unknown.
Midland, KMID-TV (2), 7/1/53-11/1/53.
San Antonio, KALA (TV) (35), 3/26/53—Unknown.
San Juan, WKAQ-TV (2), 7/24/52-1954, Inter-American.
Sherman, KSHM (TV) (46), 3/4/53—Late Summer '53.
Sweetwater, KPAR-TV (12), 8/26/53—Unknown, CBS, Avery-Knodel.
Temple, KCEN-TV (6), 1/29/53-11/1/53, NBC, Hollingbery.
Victoria, KNAL (TV) (19), 3/26/53—Unknown, Best.
Westaco, KRGV-TV (5), 7/16/53-11/26/53, NBC, Taylor.

UTAH

Salt Lake City, KUTV (TV) (2), 3/26/53-3/1/54, ABC, Hollingbery.

VERMONT

Montpelier, WCAX Bcstg. Corp. (3), Initial Decision 10/2/53.

VIRGINIA

Charlottesville, WCHV-TV (64), 1/29/53—Winter '53, Walker.
Danville, WBMT-TV (24), 12/18/52-1/15/54, Hollingbery.
Marion, WMEV-TV (50), 4/2/53—Unknown, Donald Cook.
Norfolk, WTOV-TV (27), 7/8/53-11/15/53, ABC, DuM, Farjoe. (Test patterns due Nov. 1).

WASHINGTON

Seattle, KOMO-TV (4), 6/10/53-12/11/53, NBC, Hollingbery.
Vancouver (Wash.)-Portland (Ore.), KVAN-TV (21), 9/25/53-1/15/54.
Yakima, KIT-TV (23), 12/4/52-Jan. '54.

WEST VIRGINIA

Bekley, WBEY (TV) (21), 6/25/53—Unknown.
Fairmont, WJPB-TV (35), 7/1/53-1/1/54—Gill-Perna.
Wheeling, WLTV (TV) (51), 2/11/53—Unknown.

WISCONSIN

Eau Claire, WEAU-TV (13), 2/26/53-12/1/53, Hollingbery.
Madison, Wisconsin State Radio Council (*21), 10/7/53—Unknown.
Milwaukee, WMIL-TV (31), 8/20/53—Unknown.
Neenah, WNAM-TV (42), 12/23/52-late Nov. '53, Clark.
Superior, Ridson Inc. (6), 10/14/53—Unknown.

WYOMING

Casper, KSPR-TV (2), 5/14/53—Unknown.
Cheyenne, KFBC-TV (5), 1/23/53-12/25/53, CBS.

ALASKA

Anchorage, KFIA (TV) (2), 7/30/53-11/1/53, ABC, CBS (granted STA Sept. 29).
Anchorage, KTVA (TV) (2), 7/30/53-12/15/53.
Fairbanks, KFFI (TV) (2), 7/1/53—Spring '54, ABC, CBS.

HAWAII

Honolulu, KULA-TV (4), 5/14/53-1/1/54.

PUERTO RICO

San Juan, WAPA-TV (4), 8/12/53—Unknown.



WCKY
50 GRAND IN WATTS
PROVIDING THE BEST
IN
PUBLIC SERVICE

The L. B. Wilson Station, Cincinnati



Station Authorizations, Applications (As Compiled By B•T)

Oct. 15 through Oct. 21

Includes data on new stations, changes in existing stations, ownership changes, hearing cases, hearing calendar, new petitions, rules & standards changes and routine roundup.

Abbreviations:

CP—construction permit. DA—directional antenna. ERP—effective radiated power. STL—studio-transmitter link, synch. amp.—synchronous amplifier. vhf—very high frequency. uhf—ultra high frequency. ant.—antenna. aur.—aural. vis.—visual. kw—kilowatts. w—watts. mc—

megacycles. D—day. N—night. LS—local sunset. mod.—modification. trans.—transmitter. unl.—unlimited hours. kc—kilocycles. SSA—special service authorization. STA—special temporary authorization. (FCC file and hearing docket numbers given in parentheses.)

FCC Commercial Station Authorizations As of Sept. 30, 1953*

	AM	FM	TV
Licensed (all on air)	2,468	540	101
CPs on air	20	31	†187
CPs not on air	113	21	246
Total on air	2,488	571	†288
Total authorized	2,601	592	534
Applications in hearing	141	2	152
New station requests	183	5	304
Facilities change requests	143	26	16
Total applications pending	898	94	415
Licenses deleted in Sept.	0	8	0
CPs deleted in Sept.	3	0	5

*Does not include noncommercial educational FM and TV stations.
†Authorized to operate commercially.

Am and Fm Summary through Oct. 21

	On Air	Licensed	CPs	Appls. Pending	In Hearing
Am	2,501	2,472	134	193	76
Fm	572	547	52	6	0

Television Station Grants and Applications Since April 14, 1952

Grants since July 11, 1952:

	vhf	uhf	Total
Commercial	172	273	445 ¹
Educational	8	14	22

Total Operating Stations in U. S.:

	vhf	uhf	Total
Commercial on air	199	93	292
Noncommercial on air	1	1	2

Applications filed since April 14, 1952:

	New	Amnd.	vhf	uhf	Total
Commercial	842	337	664	515	1,780 ²
Educational	50		24	26	50 ³

Total 892 337 688 541 1,830⁴

¹ Twenty CPs (6 vhf, 14 uhf) have been returned.
² One applicant did not specify channel.
³ Includes 22 already granted.
⁴ Includes 460 already granted.

Note: Amended processing procedures and revised city priority list (containing only those cities with contested applications) went into effect Aug. 24 [B•T, Aug. 31, 24].

ter DuMont, antenna GE. Legal counsel Arthur W. Scharfeld, Washington. Consulting engineer Kear & Kennedy, Washington. Principals include President Jacob A. Young (23.6%), president Presque Isle Bcstg. Co. (WERC); Vice President A. R. Minadeo (20%), Vice President-General Manager Charles E. Denny (10.5%), general manager WERC; Treasurer B. Walker Sennett (10.5%), Secretary James A. Quisenberry (5%). Granted Oct. 14.

Aiken, S. C.—Aiken Electronics Advertising Corp. (WAKN), granted uhf ch. 54 (710-716 mc); ERP 17.4 kw visual, 9.33 aural; antenna height above average terrain 350 ft. Estimated construction cost \$184,500, first year operating cost \$100,000, revenue \$156,000. Post office address % John Mare, Station WAKN Aiken, S. C. Studio and transmitter location on north side of old U. S. 1, east margin of village of Stiefeltown, 3.8 mi. west of business district of Aiken, at point about 250 ft. south of WAKN (AM) tower. Geographic coordinates 33° 33' 11.5" N. Lat., 81° 47' 14" W. Long. Transmitter and antenna RCA. Consulting engineer W. J. Holey, Atlanta, Ga. Principals include President B. T. Whitmire (20%), Vice President Jack Younts (10%), Vice President J. P. Williamson (10%), Secretary-Treasurer John Mare (30%), Oliver Grace (20%) and John Shealy (10%). Granted Oct. 21.

Superior, Wis.—Ridson Inc. (WDSM), granted vhf ch. 6 (82-88 mc); ERP 100 kw visual, 50 kw aural; antenna height above average terrain 791 ft., above ground 584 ft. Estimated construction cost \$406,021.75, first year operating cost \$330,000, revenue \$396,000. Post office address 921 Tower Ave., Superior, Wis. Studio location 921 Tower Ave. Transmitter location 5th Ave. W. & 10th St., Duluth, Minn. Geographic coordinates 48° 47' 20" N. Lat., 92° 06' 51" W. Long. Transmitter and antenna GE. Legal counsel Fly, Shuebruk & Blume, New York City. Consulting engineer John M. Sherman, Minneapolis. Principals include President Robert B. Ridder, officer and director of various Ridder companies; Vice President Herman H. Ridder, publisher of St. Paul Dispatch Pioneer Press; Vice President Rodney A. Quick; Vice President Joseph B. Ridder, officer and director of various Ridder companies; Vice President Daniel H. Ridder, officer and director in various Ridder companies; Vice President Walter T. Ridder, officer and director in Ridder companies; Secretary-Treasurer Bernard H. Ridder Jr., officer-director in various Ridder companies. All 800 issued and outstanding shares of the common stock of Ridson Inc. are owned by Northwest Publications Inc., which in turn is 69.4% owned by Ridder Publications Inc. Ridder Publications Inc. controls the Aberdeen News Co. Inc. (80%), licensee of KSDN Aberdeen, S. D.; Grand Forks Herald Inc. (60%), licensee of KILO Grand Forks, N. D.; Mid Con-

ACTIONS OF FCC

New Tv Stations . . .

ACTIONS BY FCC

Hartford, Conn.—General-Times Tv Corp., granted uhf ch. 18 (494-500 mc); ERP 210 kw visual, 112 kw aural; antenna height above average terrain 820 ft., above ground 401.5 ft. Estimated construction cost \$489,083, first year operating cost \$421,000, revenue \$350,000. Post office address 54 Pratt St., Hartford. Studio location 54 Pratt St. Transmitter location Montevideo Rd., Avon. Geographic coordinates 41° 48' 11.6" N. Lat., 72° 48' 07.5" W. Long. Transmitter and antenna RCA. Legal counsel Pierson & Ball, Washington. Consulting engineer I. B. Robinson, Boston. Principals include General Teleradio Inc. (100%), licensee of WNAC-AM-FM-TV Boston, WONS Hartford, WEAN Providence, WOR-AM-FM-TV New York, KHJ-AM-FM-TV Hollywood, Calif., KFRC San Francisco and KGB San Diego; President Thomas F. O'Neil; Treasurer-Secretary John B. Poor and Vice President Dwight W. Martin. The Hartford Times Inc. (WHT) has option to purchase 45% interest for the sale price of WHT. General Teleradio will pay for its 55% interest, in event option is exercised, by transferring WONS to the new corporation. WHT and General Teleradio dismissed their respective applications prior to merger agreement and filing of new application. Granted Oct. 21.

Wilmington, Del.—Delaware Bcstg. Co. (WILM), granted uhf ch. 83 (884-890 mc); ERP 13.2 kw visual, 7.1 kw aural; antenna height above average terrain 425 ft., above ground 406 ft. Estimated construction cost \$304,730, first year operating cost \$180,000, revenue \$200,000. Post office address 920 King St. Studio location 920 King St. Transmitter location adjacent to Bayard Blvd. near Rockmanor Golf Course. Geographic coordinates 39° 46' 6.5" N. Lat., 75° 32' 20.6" W. Long. Transmitter and antenna RCA. Legal counsel Bingham, Collins, Porter & Kistler, Washington. Consulting engineer Jansky & Bailey, Washington. Principals include President Ewing B. Hawkins (60%), program producer, and W. W. Hawkins Jr. (40%), drama critic of N. Y. World-Telegram. Granted Oct. 14.

Erie, Pa.—Great Lakes Television Co., granted uhf ch. 35 (596-602 mc); ERP 66 kw visual, 33 kw aural; antenna height above average terrain 415 ft., above ground 1,362 ft. Studio and transmitter location near intersection of Grandview Blvd. with Parade Blvd. Geographic coordinates 42° 05' 55.7" N. Lat., 80° 03' 14.5" W. Long. Transmitter

Bulletin To: Monochrome Television Engineers

Who Wish To Advance in the Field of

COLOR TV

In preparation for color television, RCA now has several excellent positions open in the design and development of:

COLOR CAMERA • TRICOLOR MONITORS

COLOR MULTIPLEXING EQUIPMENT

We are looking for senior engineers with design and development experience in either the monochrome or color TV field. This is an opportunity to build your future on the sound foundation of RCA's experience in television . . . advance into a stimulating field that is new and challenging.

At RCA you will enjoy unsurpassed laboratory facilities, professional recognition and pleasant suburban or country living in the greater Philadelphia area.

Interviews arranged in your city.

For additional information regarding career opportunities and benefits for you and your family . . . write today to:

MR. ROBERT E. McQUISTON, *Manager*

Specialized Employment Division, Dept. B-401, Radio Corporation of America, 30 Rockefeller Plaza, New York 20, N. Y.



RADIO CORPORATION of AMERICA

in Dayton

only

WLW-D

"plusses"

your

TV advertising

with

C. S. D.*

*Client Service Department

WSYR-TV

Syracuse, N. Y.

**Channel 3
100 kw****The Only Low-Band
V.H.F. Station in
Central New York****Headley-Reed
National Representatives**

NBC Affiliate

WSYR-TV

inent Radio-Television Inc. (50%), licensee of WTCN-AM-FM-TV Minneapolis. Former competitor Lakehead Telecasters Inc. has option to purchase 49% interest. Granted Oct. 14.

APPLICATIONS

LaGrange, Ga.—LaGrange Bcstg. Co. (WLAG-AM-FM), uhf ch. 50 (686-692 mc); ERP 21.32 kw visual, 10.66 kw aural; antenna height above average terrain 236 ft., above ground 242 ft. Estimated construction cost \$111,256, first year operating cost \$84,000, revenue \$90,000. Post office address 305-307 Broome St., LaGrange. Studio and transmitter location 305 Broome St. Geographic coordinates 33° 02' 27" N. Lat., 85° 01' 37" W. Long. Transmitter and antenna RCA. Consulting engineer W. J. Holey, Atlanta, Ga. Principals include President Roy C. Swank (33½%), owner *LaGrange Daily News*; Vice President Frederick G. Storey, as trustee of estate of Arthur Lucas (16½%), theatre owner; William K. Jenkins (16%), theatre owner and stockholder WSAV Savannah, Ga. and WHAN Charleston, S. C. and Fuller E. Callaway Foundation (33½%), charitable foundation. Filed Oct. 19.

Traverse City, Mich.—Midwestern Bcstg. Co. (WTCM Traverse City; WATT Clam Lake Twp.; WATZ Alpena Twp.; WMBN Bear Creek Twp.; WATC Gaylord, Mich.), vhf ch. 7 (174-180 mc); ERP 51.2 kw visual, 30.7 kw aural; antenna height above average terrain 761 ft., above ground 462 ft. Estimated construction cost \$188,524.70, first year operating cost \$75,000, revenue \$100,000. Post office address Paul Bunyan Bldg., Traverse City. Studio and transmitter location M-72 West, 3 miles W of center of Traverse City. Geographic coordinates 44° 46' 32" N. Lat., 85° 41' 02" W. Long. Transmitter and antenna RCA. Legal counsel Dow, Lohnes & Albertson, Washington. Consulting engineer George C. Davis, Washington. Principals include President Les Biederman (30%), Vice President William H. Kiker (16¼%), Secretary-Treasurer Drew McClay (15%), Fred G. Zierle (16¼%) and Edward G. Biederman (22½%). Filed Oct. 14.

APPLICATIONS AMENDED

St. Louis, Mo.—St. Louis Telecast Inc. amends application for vhf ch. 11 to change studio and transmitter location to 5100 Berthold Ave., St. Louis; antenna height above average terrain to 622 ft. Filed Oct. 14.

St. Louis, Mo.—Missouri Valley Tv Co. amends application for vhf ch. 4 to change studio location to 2218 Locust St., St. Louis; transmitter location to Union Rd. & Will Ave., St. Louis; antenna height above average terrain to 1,082 ft. Filed Oct. 14.

Fl. Worth, Tex.—Texas State Network Inc. (KFJZ) amends application for new tv station on vhf ch. 10 to specify vhf ch. 11 (198-204 mc); ERP 316 kw visual, 158 kw aural; antenna height above average terrain 594 ft. Filed Oct. 20.

APPLICATIONS DISMISSED

Stockton, Calif.—E. F. Peffer (KGDM) granted dismissal of bid for new tv station on vhf ch. 13 at request of attorney. Dismissed Oct. 20.

Hartford, Conn.—The Hartford Times Inc. (WHTT) granted dismissal of bid for new tv station on uhf ch. 18 at request of attorney. Dismissed Oct. 20.

Hartford, Conn.—General Teleradio Inc. (WOR New York) granted dismissal of bid for new tv station on uhf ch. 18 at request of attorney. Dismissed Oct. 20.

Cleveland, Ohio—WJW Inc. (WJW) granted dismissal of application for new tv station on uhf ch. 19. Dismissed Oct. 13.

Honolulu, T. H.—Royaltel, granted dismissal of bid for new tv station on vhf ch. 2. Dismissed Oct. 13.

Existing Tv Stations . . .

ACTIONS BY FCC

KIEM-TV Eureka, Calif.—Redwood Bcstg. Co. granted modification of CP for vhf ch. 3 to change studio location to 7th and Bay Sts. Granted Oct. 15; announced Oct. 16.

KLEM-TV Eureka, Calif.—Redwood Bcstg. Co. granted STA to operate commercially on vhf ch. 3 for the period ending March 10. Granted Oct. 9; announced Oct. 20.

KLZ-TV Denver, Colo.—Aladdin Radio & Tv Inc. granted STA to operate commercially on vhf ch. 7 for the period ending Feb. 26. Granted Oct. 15; announced Oct. 20.

WPFA-TV Pensacola, Fla.—WPFA-TV Inc. granted STA to operate commercially on uhf ch. 15 for the period ending Oct. 24. Granted Oct. 14; announced Oct. 20.

KLIX-TV Twin Falls, Idaho—Southern Idaho Bcstg. & Tv Co. granted modification of CP for vhf ch. 11 to change ERP to 26.9 kw visual and 13.5 kw aural; antenna height above average terrain 660 ft. Granted Oct. 14; announced Oct. 20.

KCRI-TV Cedar Rapids, Iowa—Cedar Rapids Tv Co. granted STA to operate commercially on vhf ch. 9 for the period ending April 4. Granted Oct. 9; announced Oct. 20.

WKLO-TV Louisville, Ky.—Mid-America Bcstg. Corp. granted STA to operate commercially on uhf ch. 21 for the period ending Oct. 24. Granted Oct. 14; announced Oct. 20.

WJMR-TV New Orleans, La.—Supreme Bcstg.

Co. granted STA to operate commercially on uhf ch. 81 for the period ending April 1. Granted Oct. 14; announced Oct. 20.

WROW-TV Albany, N. Y.—Hudson Valley Bcstg. Co. granted STA to operate commercially on uhf ch. 41 for the period ending Feb. 15. Granted Oct. 14; announced Oct. 20.

WHEN (TV) Syracuse, N. Y.—Meredith Syracuse Tv Corp. granted CP to replace expired CP which authorized new tv station on vhf ch. 8. Granted Oct. 15; announced Oct. 20.

WSTV-TV Steubenville, Ohio—WSTV Inc. granted modification of CP for vhf ch. 9 to change studio location to Altamont Hill, Steubenville Twp. Granted Oct. 15; announced Oct. 20.

KBES-TV Medford, Ore.—Southern Oregon Bcstg. Co. granted modification of CP for vhf ch. 5 to change main studio location to 2.3 miles E. of Gold Hill, Ore. Granted Oct. 15; announced Oct. 20.

WLBR-TV Lebanon, Pa.—Lebanon Tv Corp. granted STA to operate commercially on uhf ch. 15 for the period ending Feb. 26. Granted Oct. 14; announced Oct. 20.

WQED (TV) Pittsburgh, Pa.—Metropolitan Pittsburgh Educational Tv Station granted STA to operate noncommercially on vhf ch. 13 for the period ending April 13. Granted Oct. 14; announced Oct. 20.

KTVE (TV) Longview, Tex.—James Henry granted STA to operate commercially on uhf ch. 32 for the period ending Jan. 4. Granted Oct. 8; announced Oct. 20.

KANG-TV Waco, Tex.—Central Texas Tv Co. granted STA to operate commercially on uhf ch. 34 for the period ending Jan. 15. Granted Oct. 14; announced Oct. 20.

APPLICATIONS

WLTW (TV) Wheeling, W. Va.—Polan Industries seeks modification of CP for uhf ch. 51 to change ERP to 120.5 kw visual and 68.4 kw aural; antenna height above average terrain 173 ft. Filed Oct. 16.

New Am Station . . .

ACTION BY FCC

Durham, N. C.—Southern Radiocasting Co. (WKMT Kings Mountain), granted 1410 kc, 1 kw daytime. Estimated construction cost \$14,275, operating \$24,000, revenue \$35,000. Principals include general partners J. C. Greene Jr. and R. H. Whitesides. Post office address Box 641, Rock Hill, S. C. Granted Oct. 21.

APPLICATIONS

Sitka, Alaska—Voice of Sheldon Jackson Inc., 1400 kc, 250 w unlimited. First year operating cost \$22,000, revenue \$6,000. Purchased second hand station for \$7,000. Principals include Board of National Missions of the Presbyterian Church in U.S.A. (99.93%), President R. Roland Armstrong, president Sheldon Jackson Junior College, Vice President Norman C. Banfield, attorney and Treasurer R. B. Wurster, Dean of Sheldon Jackson Junior College. Post office address % R. Roland Armstrong, 206 Behrends Ave., Juneau, Alaska. Filed Oct. 12.

Marksville, La.—Avoyelles Bcstg. Corp., 1340 kc, 250 w unlimited. Estimated construction cost \$16,244, first year operating cost \$24,000, revenue \$38,000. Principals include President W. L. Billups (99.92%), oil and petroleum products, Vice President Chester J. Coco (0.04%), attorney, and Secretary-Treasurer Clarence E. Powell (0.04%), accountant. Post office address % C. J. Coco, Box 506, Marksville, La. Filed Sept. 28.

Newburyport, Mass.—Sherwood J. Tarlow, 1340 kc, 250 w unlimited. Estimated construction cost \$14,765.59, first year operating cost \$45,500, revenue \$52,300. Mr. Tarlow is owner WHIL Medford, Mass., and applicant for new am stations in Plymouth and Beverly, Mass. Post office address % WHIL, 99 Revere Beach Pkwy., Medford. Filed Oct. 15.

**HOW MUCH
For LIBEL or
SLANDER****BEST ANSWER—
OUR UNIQUE
SPECIAL INSURANCE
Covering this and related
hazards—it's surprisingly
INEXPENSIVE**WRITE FOR DETAILS AND RATES
**EMPLOYERS REINSURANCE
CORPORATION**
INSURANCE EXCHANGE
KANSAS CITY, MISSOURI

Skyharbor, Nev.—Voice of Lake Tahoe, 1490 kc 250 w unlimited. Estimated construction cost \$2,000, first year operating cost \$10,000, revenue \$36,000. Mr. Halstead, former owner-manager KZIA Auburn, Calif., is sole owner. Post office address P. O. Box 99, Auburn, Calif. Filed Oct. 12.

Muleshoe, Tex.—Theodore Rozzell tr/as Blackwater Valley Bcstrs., 1050 kc, 250 w daytime. Estimated construction cost \$8,873.06, first year operating cost \$24,000, revenue \$34,000. Mr. Rozzell is in real estate and former co-partner KBIM Roswell, N. M. Post office address Box 232, Clovis, N. M. Filed Oct. 15.

Grand Prairie, Tex.—Jessie Mae Cain, 1220 kc, 250 w daytime. Estimated construction cost \$11,231, first year operating cost \$30,000, revenue \$48,000. Miss Cain is former assistant program director-manager KTAN Sherman, Tex. Post office address P. O. Box 703, Grand Prairie. Filed Oct. 14.

Fond du Lac, Wis.—Fond du Lac Bcstg. Co., 1600 kc, 500 w daytime. Estimated construction cost \$17,330, first year operating cost \$72,000, revenue \$84,000. Principals include President William E. Walker (21 3/4%), president-50% stockholder WMAM Marinette, Wis.; president-36% stockholder WBEV Beaver Dam, Wis.; president-45.4% stockholder KXGI Madison, Iowa; president-10% stockholder Badger Tv Inc., applicant for Madison tv station on vhf ch. 3; Vice President Joseph D. Mackin (21 3/4%), secretary-treasurer and 20% stockholder WMAM; secretary-treasurer and 37.5% stockholder WBEV and secretary-treasurer and 22.8% stockholder KXGI; Vice President William E. Walker (21 3/4%), vice president and 5.7% stockholder WBEV and vice president and 10% stockholder KXGI; Executive Vice President Charles R. Dickoff (21 3/4%), vice president-5.7% stockholder WBEV. Post office address % WBEV Beaver Dam, Wis. Filed Oct. 12.

Existing Am Stations . . .

APPLICATIONS

WTAQ La Grange, Ill.—Russell G. Salter, Charles F. Sebastian and William A. Murphy d/b as LaGrange Bcstg. Co. resubmits application for CP to change from daytime to unlimited using power of 500 w with directional night and change transmitter location to 0.3 mi. SE of intersection of U. S. Hwys. 66 & 45, 2.5 mi. S of LaGrange. Filed Oct. 9.

WBEBC Duluth, Minn.—Head of the Lakes Bcstg. Co. seeks CP to change from 1320 kc directional night to 570 kc directional day and night and change transmitter location to 7.8 miles SE of Superior, Wis. Filed Oct. 9.

KDKD Warrensburg, Mo.—Clinton Bcstg. Co. seeks modification of CP to change main studio location to on Hwy. #50, 0.23 mi. E of Junction of Hwys. #50 & 13. Filed Oct. 9.

WCHL Chapel Hill, N. C.—Village Bcstg. Co. seeks CP to change hours of operation from daytime to 6 am-7:30 pm using 500 w night and 1 kw day. Filed Oct. 19.

WRIO Rio Piedras, P. R.—Master Bcstg. Corp. seeks CP to increase daytime power from 1 kw to 5 kw. Filed Oct. 19.

KERV Kerrville, Tex.—Kerrville Bcstg. Co. seeks CP to change from 1230 kc 250 w unlimited to 970 kc, 1 kw daytime. Filed Oct. 12.

KLIF Dallas, Tex.—Trinity Bcstg. Corp. seeks CP to change from 5 kw day, 1 kw night, directional to 50 kw day, 1 kw night, directional day and night. Filed Oct. 19.

APPLICATION AMENDED

WGSM Huntington, N. Y.—Huntington-Montauk Bcstg. Co. amends application for CP to increase power from 1 kw to 5 kw to specify 1 kw using non-directional antenna. Filed Oct. 15.



JOS. WEED & CO.,

350 Madison Ave., New York,

Know About the

5000 Watt Transmitter

Now in Use at

CHNS

HALIFAX NOVA SCOTIA

The Maritimes

BUSIEST

Commercial Station

New Fm Station . . .

ACTION BY FCC

Tampa, Fla.—Frank Knorr Jr., Jerome P. MacBraswell and Frieda P. MacBraswell d/b as FM Bcstrs. seek new fm station on ch. 299 (107.7 mc) with ERP of 10.44 kw. Filed Oct. 19.

Existing Fm Stations . . .

ACTIONS BY FCC

WHA-FM Madison, Wis.—State of Wisconsin State Radio Council granted CP for noncommercial educational fm station on ch. 204 to change ERP to 22 kw and antenna height above average terrain to 185 ft. Granted Oct. 14; announced Oct. 20.

APPLICATIONS

WLYC-FM Williamsport, Pa.—Lycoming Bcstg. Co. seeks CP to change ERP to 0.842 kw; antenna height above average terrain to 1,145 ft. Filed Oct. 19.

WCMF (FM) Memphis, Tenn.—Memphis Pub. Co. seeks modification of CP to change ERP to 299 kw and antenna height above average terrain to 938 ft. Filed Oct. 19.

Ownership Changes . . .

ACTIONS BY FCC

WPNX Phenix City, Ala.—Community Bcstg. Co., granted voluntary assignment of license to L. H. Christian and C. A. McClure d/b as Christian & McClure for \$30,000. Mr. Christian is vice president and 36 1/4% owner WRFC Athens, Ga., and Mr. McClure is president and 52% owner WRFC. Christian & McClure agrees to change call letters to WGBA and operate on 1270 kc in Columbus, Ga. Contingent on grant of assignment of WGBA. Granted Oct. 21.

WGBA Columbus, Ga.—Georgia-Alabama Bcstg. Co., granted voluntary assignment of license to Community Bcstg. Co. (WPNX Phenix City, Ala.) for \$25,000. Community is to change call letters to WPNX on 1460 kc in Phenix City. Georgia-Alabama conveys some assets to Christian and McClure, prospective purchaser of WPNX, for \$12,000. Sale is contingent on grant of assignment of WPNX. Granted Oct. 21.

KCLV Clovis, N. M.—New-Tex Bcstg. Inc. granted voluntary transfer of control to Odis L. Echols and Odis L. Echols Jr. through sale of 62% interest for \$10,000. Odis L. Echols handles public relations and his son is student manager of KTTCC Lubbock, Tex. Granted Oct. 21.

WBRK (AM)-WMGT (TV) Pittsfield, Mass.—Greylock Bcstg. Co. granted voluntary relinquishment of control by Leon Podolsky through issuance of new stock. Mr. Podolsky formerly owned 51% and will now own 36.06%. Granted Oct. 21.

WNJR Newark, N. J.—Evening News Pub. Co. granted voluntary assignment of license to Rollins Bcstg. Inc. (WRAD Radford, Va.; WJWL-AM-FM Georgetown, Del.; WFAI Fayetteville, N. C.; WRAP Norfolk, Va.) for \$145,000. Principals include President John R. Rollins (62.5%), Vice President-Secretary O. Wayne Rollins (33.3%) and Secretary Katherine E. Rollins (4.2%). Rollins Bcstg. is applicant for new am stations at Jacksonville, Fla., Indianapolis, Ind., and Houston, Tex., and applicant for new tv station at Fayetteville, N. C. Granted Oct. 21.

WVNJ Newark, N. J.—Newark Bcstg. Corp., granted voluntary transfer of control to Evening News Pub. Co. (WNJR) through sale of all stock for \$96,750 and assumption of 4% bearer notes totalling \$311,478.83. Principals include President Edward W. Scudder Jr. (0.7%), Vice President William E. Hocker (0.03%) and Secretary-Treasurer Edward D. Sugrue (0.03%). Sale is conditioned upon approval of sale of WNJR to Rollins Bcstg. Inc. [B•T, Sept. 7]. Granted Oct. 21.

KWCO Chickasha, Okla.—Clarence E. Wilson and Phillip D. Jackson d/b as Washita Valley Bcstg. Co. granted voluntary assignment of license to Jack L. Pink tr/as Washita Valley Bcstg. Co. for \$80,000. Mr. Pink is vice president and 2% stockholder KONO-AM-FM San Antonio, Tex. Granted Oct. 21.

KGW-AM-FM Portland, Ore.—Pioneer Bcstrs. Inc. Samuel I. Newhouse Jr. and Mitzi E. Newhouse granted voluntary transfer of control through sale of all stock for \$500,000. Principals include KING Seattle (40%); Henry A. Kuckenberg (35%), general construction and vice president and 11.16% stockholder North Pacific Tv Inc., applicant for vhf ch. 8 in Portland; Paul F. Murphy (16%), real estate and vice president and 11.17% stockholder North Pacific; Gordon D. Orput (6%), lumber manufacturer and 6% stockholder North Pacific; W. Calder McCall (2%), distributor of heating oils and vice president and 11.17% stockholder North Pacific, and Prescott W. Cookingham (1%), Portland attorney. Granted Oct. 21.

WTYC Rock Hill, S. C.—Tri-County Bcstg. Co., granted voluntary transfer of control from W. G. Reid to T. Lamar Simmons through sale of all stock for \$32,500. Simmons is 50% owner Cruise In Theatre, Lillington, N. C., and partner Erwin Supply Co., Erwin, S. C. Granted Oct. 21.

. . . Still Going



A coffee account, using KGW, increased sales in this area 42 per cent.

FOR SALES RESULTS USE KGW

Economical and efficient medium for covering the mass market.

KGW

on the efficient 620 frequency
PORTLAND, OREGON

REPRESENTED NATIONALLY BY
EDWARD PETRY, INC.
AFFILIATED WITH NBC

WHBF + CBS

Adds up to:

BETTER QUAD-CITY
COVERAGE AT NO
INCREASE IN COST!

Les Johnson, V.P. and Gen. Mgr.



Quad-Cities favorite

WHBF

TELCO BUILDING, ROCK ISLAND, ILLINOIS

Represented by Avery-Knael, Inc.

GET MORE

- POWER
- PUNCH
- PERSONALITIES

into your advertising
in
CENTRAL
PENNSYLVANIA

... and you'll get more
out of it with ...



"Altoona's only 1000 watt station"

RCA TUBES
in stock at
ALLIED!

**IMMEDIATE
DELIVERY**



RCA-892R. Forced-Air-Cooled Triode—in stock for immediate delivery. **RCA-892R, \$385**

RCA-891R. Forced-Air-Cooled Triode. **RCA-891R, \$385**

Our prices and conditions of sale are identical to those of the manufacturer. Look to ALLIED for prompt delivery of all RCA Broadcast-type tubes. Let us save you time and effort.



Refer to your ALLIED 268-page Buying Guide for station equipment and supplies. Get what you want when you want it. Ask to be put on our "Broadcast Bulletin" mailing list.

ALLIED RADIO

100 N. Western Ave., Chicago 80
Phone: HAYmarket 1-6800

KABS (TV) Honolulu, T. H.—American Bestg. Stations Inc. (WMT-AM-TV Cedar Rapids, Iowa), granted voluntary assignment of CP for new tv station on vhf ch. 4 to Pacific Frontier Bestg. Co. for \$1. Pacific assumes obligation to RCA for \$167,117. American Bestg. advances loan of \$100,000 toward construction. Principals include WMT-AM-TV (41.11%), KJBS San Francisco (33.33%), President Jack A. Burnett (10%), William B. Quarton (5%), E. P. Franklin (7½%) and Stanley G. Breyer (2½%). Granted Oct. 21.

APPLICATIONS

WHTB Talladega, Ala.—Voice of Talladega Inc. seeks voluntary transfer of control from R. A. Davidson to Talladega News Pub. Co. through sale of 80% interest for \$35,000. Principals include President-Treasurer Cecil Hornady (65%), Vice President Elizabeth N. Hornady (10%) and Alec O. Thomson (25%). Filed Oct. 12.

KFWB Los Angeles, Calif.—KFWB Bestg. Corp. seeks voluntary assignment of license to Union Bestg. Corp. of Calif. No consideration is involved as stockholders in both corporations are identical and will retain their respective shares. Upon FCC approval KFWB Bestg. will be dissolved. Filed Oct. 9.

KFSD-AM-FM-TV San Diego, Calif.—Airfan Radio Corp. Ltd. seeks transfer of control from Thomas E. Sharp to Roger Revelle, Henry Wood Shelton and Harrison G. Sloane, voting trustees for group of stockholders of T.B.C. Tv Co. The T.B.C. Tv Co. had dismissed application for vhf ch. 10 and had received an option to purchase the one-third interest (B-T, March 16). Filed Oct. 15.

WPRY Perry, Fla.—J. E. Massey and L. C. McCall d/b as Palatka Bestg. Co. seeks voluntary assignment of CP for new am station on 1220 kc, 250 w daytime to Pasco Bestg. Co. applicant for new am station in Dade City, Fla. Principals in partnership include Elmo B. Kitts (25%), general manager and ½ owner WEBK Tampa, Fla.; E. P. Martin (25%), ½ owner WEBK; Alpha Martin (25%), ½ owner WEBK; John A. Branch (12½%), Tampa attorney, and John D. Goff (12½%), Tampa attorney. Filed Oct. 12.

WLOF Orlando, Fla.—Hazlewood Inc. seeks voluntary transfer of control through sale of all stock by Joe Sears and Walter C. Shea to John W. Kluge and 5 others. Principals include President Joseph L. Brechner (26%), secretary-treasurer and stockholder WGAY Silver Spring, Md.; Secretary-Treasurer John W. Kluge (25%), president-stockholder WGAY; Mrs. John W. Kluge (10%), treasurer-stockholder WGAY; Vice President Vasil Polyzois (20%), accountant, and Horace H. Thomson (15%), vice president-stockholder WGAY. Filed Oct. 12.

WAUG-AM-FM Augusta, Ga.—Melvin H. Purvis, Chester H. Jones & George O. Nicholson d/b as Garden City Bestg. Co. seeks voluntary assignment of license to Chester H. Jones & George O. Nicholson d/b as Garden City Bestg. Co. Mr. Nicholson purchases Mr. Purvis' 50% interest for \$1,400 and 1951 Cadillac valued at \$3,600 and will now own 75%. Mr. Jones retains his 25% interest. Filed Oct. 14.

KIOA Des Moines, Iowa—Independent Bestg. Co. seeks voluntary assignment of license to Town & Farm Co. (KMMM Grand Island, Neb., KXXX Colby, Kan.) for \$150,000. Sale is necessitated by Independent Bestg. merger with WHO Des Moines in new tv venture on ch. 13 there. Principals include President Don Searle (40%), packager of radio-tv programs and executive vice president-stockholder KOA-AM-FM-TV Denver, Colo.; Vice President H. A. Searle (20%), manufacturer and marketer of petroleum products; Secretary Helen Searle Blanchard (20%), and Treasurer Herbert Hollister (20%), owner KBOL Boulder, Colo. Filed Oct. 14.

KWBW Hutchinson, Kan.—Bess Marsh Wyse tr/as Nation's Center Bestg. Co. seeks voluntary assignment of license to partnership of Bess Marsh Wyse & George H. Marsh d/b as The Nation's Center Bestg. Co. Mr. Marsh, Odessa (Tex.) accountant, purchases 5% interest for \$4,500. Filed Oct. 13.

KIYI Shelby, Mont.—Tri-County Radio Corp.

seeks voluntary transfer of control to John J. Lyon and Frank E. Krshka through sale by John J. Hurley and C. B. Aronow of 19,850 shares of stock for \$23,474.85. Mr. Lyon is in airplane crop spraying and Mr. Krshka is formerly in retail furniture business. Filed Oct. 12.

WIFM-AM-FM Elkin, N. C.—John A. Hinshaw tr/as Valley Bestg. Co. seeks voluntary assignment of license to James B. Childress for \$31,500. Mr. Childress is former manager-10% owner WHCC Waynesville, N. C. Filed Oct. 13.

WATG-AM-FM Ashland, Ohio—Mahoning Valley Bestg. Corp. seeks voluntary assignment of license to Ashland Bestg. Co. for \$65,000 cash. Principals include Robert S. Burk (50%), practicing dentist and former owner of 20% interest WONW Defiance, Ohio, and Carl N. Fox (50%), manufacturer of canning equipment and former owner of 20% interest in WONW. Filed Oct. 12.

KFYO-TV Lubbock, KGNC-TV Amarillo, Tex.—Plains Radio Bestg. Co. seeks assignment of CP to parent corporation Globe-News Pub. Co. Globe-News Pub. Co. owns 81% interest and Globe-News Employees Pool owns 19%. Filed Oct. 7.

WEMP Milwaukee, Wis.—Milwaukee Bestg. Co. seeks voluntary transfer of control to President Andrew M. Spheris and six other employees through sale and exchange of stock for \$76,500. The employe group will now own 50.5% interest. Filed Sept. 30.

Hearing Cases . . .

FINAL DECISIONS

Superior, Wis.—New Tv, vhf ch. 6. FCC announced order making effective immediately examiner's initial decision granting Ridson Inc. application for new tv station on vhf ch. 6. For details see New Tv Stations. Action Oct. 14.

Wilmington, Del.—New Tv, uhf ch. 83. FCC announced order making effective immediately examiner's initial decision granting WLM application for new tv station on uhf ch. 83. For details see New Tv Stations. Action Oct. 14.

Chester, Ill.—FCC gave notice that hearing examiner's initial decision denying for default application of Cecil W. Roberts for CP for new am station on 1450 kc, 250 w unlimited, became effective Oct. 21. Action Oct. 21.

Erie, Pa.—New Tv, uhf ch. 35. FCC announced order making effective immediately examiner's initial decision granting Great Lakes Tv Co. application for new tv station on uhf ch. 35. For details see New Tv Stations. Action Oct. 14.

INITIAL DECISIONS

Atlanta, Ga.—New Tv, uhf ch. 36. FCC Hearing Examiner Hugh B. Hutchinson issued initial decision looking toward grant of the application of WQXI for CP for new tv station on uhf ch. 36. Action Oct. 19.

Cleveland, Ohio—New Tv, uhf ch. 19. FCC Hearing Examiner Fanny N. Litvin issued initial decision looking toward grant of the application of WHK for CP for new tv station on uhf ch. 19. Action Oct. 16.

OTHER ACTIONS

Savannah, Ga.—Ch. 3 proceeding. The Commission announced its order granting petition filed by WJIV insofar as it requests enlargement of issues in proceeding involving its application and that of WSAV for new tv stations in Savannah on ch. 3, and added an issue to determine whether construction of the station proposed by WSAV has been begun within the meaning of Section 319 of the Communications Act; denied petition in all other respects. Action Oct. 16.

WHLM Bloomsburg, Pa.—FCC announced order granting petition to grant without hearing application for CP to change from 690 kc, 1 kw daytime to 550 kc, 500 w unlimited, directional. Action Oct. 14.

ALLEN KANDER

Negotiator

FOR THE PURCHASE AND SALE
OF RADIO AND TELEVISION
STATIONS

Barr Building • Washington 6, D. C., NA. 8-3233
Lincoln Building • New York 17, N. Y., MU. 7-4242

PROFESSIONAL CARDS

JANSKY & BAILEY INC.
Executive Offices
National Press Building
Offices and Laboratories
1339 Wisconsin Ave., N. W.
Washington, D. C. ADams 4-2414

JAMES C. McNARY
Consulting Engineer
National Press Bldg., Wash. 4, D. C.
Telephone District 7-1205
Member AFCCCE *

—Established 1926—
PAUL GODLEY CO.
Upper Montclair, N. J. MO- 3-3000
Laboratories Great Notch, N. J.
Member AFCCCE *

GEORGE C. DAVIS
501-514 Munsey Bldg. Sterling 3-0111
Washington 4, D. C.
Member AFCCCE *

Commercial Radio Equip. Co.
Everett L. Dillard, Gen. Mgr.
INTERNATIONAL BLDG. DL 7-1319
WASHINGTON, D. C.
P. O. BOX 7037 JACKSON 5302
KANSAS CITY, MO.
Member AFCCCE *

A. D. RING & ASSOCIATES
30 Years' Experience in Radio
Engineering
MUNSEY BLDG. REPUBLIC 7-2347
WASHINGTON 4, D. C.
Member AFCCCE *

GEORGE E. GAUTNEY
CONSULTING RADIO ENGINEERS
1052 Warner Bldg. National 8-7757
Washington 4, D. C.
Member AFCCCE *

Craven, Lohnes & Culver
MUNSEY BUILDING DISTRICT 7-8215
WASHINGTON 4, D. C.
Member AFCCCE *

FRANK H. McINTOSH
CONSULTING RADIO ENGINEER
1216 WYATT BLDG
WASHINGTON, D. C.
Metropolitan 8-4477
Member AFCCCE *

RUSSELL P. MAY
711 14th St., N. W. Sheraton Bldg.
Washington 5, D. C. REpublic 7-3984
Member AFCCCE *

WELDON & CARR
Consulting
Radio & Television
Engineers
Washington 6, D. C. Dallas, Texas
1001 Conn. Ave. 4212 S. Buckner Blvd.
Member AFCCCE *

**PAGE, CREUTZ,
GARRISON & WALDSCHMITT**
CONSULTING RADIO ENGINEERS
710 14th St., N. W. Executive 3-5670
Washington 5, D. C.
Member AFCCCE *

KEAR & KENNEDY
1302 18th St., N. W. Hudson 3-9000
WASHINGTON 6, D. C.
Member AFCCCE *

A. EARL CULLUM, JR.
CONSULTING RADIO ENGINEERS
HIGHLAND PARK VILLAGE
DALLAS 5, TEXAS
JUSTIN 6108
Member AFCCCE *

GUY C. HUTCHESON
P. O. Box 32 AR. 4-8721
1100 W. Abram
ARLINGTON, TEXAS

ROBERT M. SILLIMAN
John A. Maffei—Associate
1405 G St., N. W.
Republic 7-6646
Washington 5, D. C.
Member AFCCCE *

LYNNE C. SMEBY
"Registered Professional Engineer"
1311 G St., N. W. EX 3-8073
WASHINGTON 5, D. C.

GEORGE P. ADAIR
Consulting Radio Engineers
Quarter Century Professional Experience
Radio-Television-
Electronics-Communications
1610 Eye St., N. W., Wash. 6, D. C.
Executive 3-1230—Executive 3-5851
(Nights-holidays, Lockwood 5-1819)
Member AFCCCE *

WALTER F. KEAN
AM-TV BROADCAST ALLOCATION
FCC & FIELD ENGINEERING
1 Riverside Road—Riverside 7-2153
Riverside, Ill.
(A Chicago suburb)

WILLIAM E. BENNS, JR.
Consulting Radio Engineer
3738 Kanawha St., N. W., Wash., D. C.
Phone EMerson 2-8071
Box 2468, Birmingham, Ala.
Phone 6-2924
Member AFCCCE *

ROBERT L. HAMMETT
CONSULTING RADIO ENGINEER
230 BANKERS INVESTMENT BLDG.
SAN FRANCISCO 2, CALIFORNIA
SUTTER 1-7545

JOHN B. HEFFELFINGER
815 E. 83rd St. Hiland 7010
KANSAS CITY, MISSOURI

**Vandivere,
Cohen & Wearn**
Consulting Electronic Engineers
612 Evans Bldg. NA. 8-2698
1420 New York Ave., N. W.
Washington 5, D. C.

CARL E. SMITH
CONSULTING RADIO ENGINEERS
4900 Euclid Avenue
Cleveland 3, Ohio
HEnderson 2-3177
Member AFCCCE *

Custom-Built Equipment
U. S. RECORDING CO.
1121 Vermont Ave., Wash. 5, D. C.
Lincoln 3-2705

**COMMERCIAL RADIO
MONITORING COMPANY**
MOBILE FREQUENCY MEASUREMENT
SERVICE FOR FM & TV
Engineer on duty all night every night
JACKSON 5302
P. O. Box 7037 Kansas City, Mo.

• **TOWERS** •
AM • FM • TV
Complete Installations
TOWER SALES & ERECTING CO.
6100 N. E. Columbia Blvd.
Portland 11, Oregon

HOFFMAN RECORDS
Offering discs concerning Studebaker Cars,
punches Terrific sales for Local Dealer!
One station in Each city being approached.
Inquiries are really not necessary.
BOX 11 HOLLYWOOD

Canton, Ohio—New Tv, uhf ch. 29. The Commission announced its memorandum opinion and order which, upon consideration of a petition by WCMW for declaratory ruling or revision of hearing issues, ordered that the issues in the proceeding involving the applications of WHBC, WCMW, and Tri-Cities Telecasting, Inc., for new tv stations in Canton, Ohio, on ch. 29, may be enlarged by the hearing examiner, upon sufficient allegations of fact made in support of said enlargement, to add an issue to determine whether the funds available to WHBC, will give reasonable assurance that the proposals set forth in its application will be effectuated; further directed the examiner to go forward with the proceeding in a manner consistent with the memorandum opinion and order. Action Oct. 15.
Cleveland, Ohio—WJW Inc. (WJW). Comr. Robert T. Bartley granted petition for dismissal without prejudice of its application for new tv station on uhf ch. 19 and retained in hearing application of WHK for same channel. Action Oct. 13.

WJET Erie, Pa.—Jet Bestg. Co. FCC designated for hearing application to change from 1570 kc 250 w daytime to 1400 kc 250 w unlimited and made WBNY Buffalo, N. Y., party to proceeding. Action Oct. 21.

San Juan, Mayaguez, P. R.—By memorandum opinion and order, FCC denied joint petition of Dept. of Education of Puerto Rico and Radio Americas Corp. for waiver of Rule 3.810 (b) with regard to the mileage separation requirements applicable to transmitter sites proposed by petitioners for operation on adjacent channels 5 and 6 in San Juan and Mayaguez respectively. Action Oct. 21.

Providence, R. I.—Ch. 12 grant postponed. On protest filed by Channel 16 of Rhode Island, Inc., permittee of tv station in Providence on ch. 16, directed against the Commission's grants of construction permit and special temporary authority to Cherry and Webb Broadcasting Co. (WPRO) for a new tv station in Providence on ch. 12, the



Member AFCCCE *

CLASSIFIED ADVERTISEMENTS

Payable in advance. Checks and money orders only.

Deadline: Undisplayed—Monday preceding publication date. Display—Tuesday preceding publication date.

Situations Wanted 20¢ per word—\$2.00 minimum • Help Wanted 25¢ per word—\$2.00 minimum

All other classifications 30¢ per word—\$4.00 minimum • Display ads. \$15.00 per inch

No charge for blind box number. Send box replies to

BROADCASTING • TELECASTING, 870 National Press Bldg., Washington 4, D. C.

APPLICANTS: If transcriptions or bulk packages submitted, \$1.00 charge for mailing (Forward remittance separately, please). All transcriptions, photos, etc. sent to box numbers are sent at owner's risk. BROADCASTING • TELECASTING expressly repudiates any liability or responsibility for their custody or return.

Help Wanted

Opportunity to advance with reorganized staff, announcers, copywriter, salesmen. Contact WPDR, Portage, Wisconsin.

Salesmen

Western NBC regional, excellent market, offers radio-minded local salesman opportunity to earn \$10,000 plus. Weekly base, \$100, against 15 percent. Substantial tax-free car allowance. Pleasant middle-sized community, good schools, good weather (no snow). Box 964X, B.T.

Experienced salesman wanted. Wonderful opportunity for a young man who fully knows radio time sales and has a proven record. Rich market in Nebraska. Car necessary. Write, wire Box 165A, B.T.

Experienced, aggressive sales-manager for mid-west daytime independence. Must know radio. Generous draw against commissions totaling \$7,000-\$12,000 yearly. Sales aids and topnotch programming. Forward complete information. Box 189A, B.T.

Salesman to handle agency and local accounts in southern New England metropolitan market. Salary and excellent incentive plan. Immediate opening. All replies confidential. Box 233A, B.T.

Northwestern Ohio radio and TV station needs experienced salesman. Substantial guarantee and commission in 91st market, Stockton, California, B.T.

Permanent position with substantial guarantee and commission in 91st market, Stockton, California. Network, 1000 watt fulltime. Sizeable account list to begin with, prospects unlimited. Write Box 259A, B.T.

Immediate opening radio time salesman. \$100. guarantee against commission. Contact Manager, KCHJ, P. O. Box 262, Delano, California.

250 watt, fulltime independent wishes to add salesman to present staff. Can be short on experience but not on ambition. Straight salary, minimum \$70. Contact KNCM, Moberly, Missouri.

Commercial sales position in thriving county seat independent. Excellent market assures better than average income. \$300. monthly draw against 15% commission. Send full details and references first letter. Contact Lynn Thomas, KWRO, Coquille, Oregon.

Sales crew manager. We have an opening for an experienced phone crew manager in a very successful radio-TV promotion. Only highly capable men with a background of dependability and honesty and a record of clean selling will be considered. 40% commission, plus bonus, to an acceptable man. American Radio Publications, Inc., 119-A North Washington St., Peoria 2, Illinois.

Announcers

Immediate opening for better than average announcer. Good working conditions and excellent pay. Give salary requirements, past experience first letter, WMJM, Cordele, Georgia.

Ad-libber, madcap wit. "happy" voice, DJ. Funny ad-lib quips about records. Do "bopster" voice, Stan Freberg, Bob and Ray character voices, stage-screen impersonations. Midwest. Single. Box 131A, B.T.

Help Wanted—(Cont'd)

At once, announcer—first phone, or announcer, some experience. WVOS, Liberty, New York.

Combo man with first class ticket for central Pennsylvania AM-FM. Announcing should be diversified in abilities. Post is permanent. 40 hour, 5 day week. Paid vacation. Car necessary. Send resume. Salary \$76.00. Box 135A, B.T.

Experienced announcer wanted by a western Penna. independent station. Send tapes or discs to Box 181A, B.T.

Announcer—immediate opening. Must have at least five years experience and good references. Offer good pay for hard work. Over 40 hours weekly. Want good ad-libber able to handle board, do good newscast and adapt self to community of thirty thousand in south. Send tape, photo, background and references. Box 232A, B.T.

Experienced announcer for North Dakota 5 kw network station. Send tape, full details Box 241A, B.T.

First phone, fluent Spanish, little "Combo" work. Send photo, tape or disc, experience; all returned. Daytime operation. KEVT, Tucson, Arizona.

Experienced announcer. Position permanent to right person. Contact Dr. F. P. Cerniglia, KLIC, Monroe, Louisiana.

First class announcer with program and production experience; must have lots ad-lib ability, lots of ideas. Excellent opportunity, good pay, 5000 watt CBS affiliate. Write air mail Station Manager, KOOL, Phoenix, full details with audition.

Experienced newscaster. Send tape and details. KTBS, Shreveport, La.

Staff announcer AM and TV. Good voice, news, commercials, experience. Send audition, experience, references to KVOS, Bellingham, Washington.

Announcer, WKLO AM and TV, Louisville. Send tape with news, ad-lib commercials and record show. list experience, salary expectancy. Contact Everbach.

Experienced announcer. Fulltime MBS affiliate wants good voice and good knowledge records, start \$60.00 week. Contact WMGR, Bainbridge, Ga.

Immediate opening for announcer in Central Michigan. Experienced man who can handle console preferred. WOAP, Owosso, Michigan.

Combination man with emphasis on good announcing, 1st class license desirable but not necessary. Metropolitan Washington, D. C. WPIK, Alexandria, Virginia.

Experienced announcer with first class license for fulltime 250 watt NBC affiliate. Starting salary \$75.00 week. WPNF, Brevard, N. C.

Help Wanted—(Cont'd)

Experienced announcer for morning shift. \$70.00. for 44 hours. WVOP, Vidalia, Georgia. Telephone 3029.

Technical

Men with at least 10 years of electronic experience, preferably audio, with good mechanical knowhow to install and maintain specialized audio devices. Will be traveling continually. Must have driver's license. Transportation supplied. Good salary plus expenses. Send complete list of experiences, references and enclose a personal snapshot. Photo will not be returned. Box 645W, B.T.

Combination man. Prefer actual radio engineering experience with voice for news. Night shift till midnight. Beautiful resort country in northern Minnesota. Write Box 204A, B.T.

Wanted by established network station in heart of the hunting and fishing area. Chief engineer with some ability as announcer or traffic clerk. Better than average earnings. Permanent position with expanding organization. Box 192A, B.T.

East coast major market independent wants first class combination man. Excellent salary and working arrangement. Personal interview and audition required. Write in detail giving references which will be checked. Box 271A, B.T.

Immediately, first class transmitter engineer for 5 kw AM station. CBS affiliate. Opportunity to work into TV. Write Lloyd R. Amoo, Director of Engineering, KCJB, Minot, North Dakota.

Combination engineer-announcer. Must be experienced. Position will be permanent to right person. Contact Dr. F. P. Cerniglia, KLIC, Monroe, Louisiana.

Chief engineer, to take complete charge of 250 watt station. Write A. G. Meyer, Station Manager, KMYR, Denver, Colorado, giving complete experience, qualifications, salary desired.

Engineers with good electronic background, wanted immediately for AM-FM and TV operations. John Willis, Chief Engineer, WAIM, Anderson, South Carolina.

Immediate opening first or second class engineer. WOBT, Rhinelander, Wisconsin.

WSAZ Inc. has openings in microwave radio and TV. Write, wire or call John Clay, Chief Engineer, WSAZ Inc., Huntington, West Virginia.

Chief engineer wanted. \$82.25. for fifty hour week. WSON, Henderson, Kentucky.

Experienced, First class transmitter engineers, for 5 kw AM, FM and television, CBS affiliate. TV expansion creates opportunities to join WTOG, Savannah's pioneer station. Write to Kyle E. Goodman, Chief Engineer, WTOG, Savannah, Georgia.

Engineers, some with first phone, needed immediately in AM-TV operation. Union scale to \$88.00. per week. WTVH-TV, Peoria, Illinois. Phone Wallace Wurz, 6-5561 for interview.

Production-Programming. Others

Fulltime copywriter needed for twin network station in Maryland. Woman preferred. Box 180A, B.T.

Experienced male continuity writer for midwest radio-TV station. AFRA minimum \$4,030. first year; \$4,680. second year; three weeks vacation. Send copy samples, photo first letter. Box 225A, B.T.

Radio director for business organization in Washington, D. C. High degree of writing skill in complex economic subjects essential plus experience with radio-television media. State salary requirements. Box 235A, B.T.

Woman for continuity writing and to be generally useful in continuity department of progressive 50,000 watt radio station, CBS affiliate, southwest Texas. Good climate winter and summer and good working conditions. Write Continuity Chief. Radio Station KGBS, Harlingen, Texas.

Immediate opening commercial copywriter at friendly local station. Good pay, paid vacation, permanent position. Send full particulars, WVSC, Somerset, Pa.

Television

Salesmen

We seek the services of a top flight, experienced sales administrator for our television operations shortly to be opened in the Portland-Vancouver area. Apply in writing, giving all details you would seek were you in our position. Box 92A, B.T.

SALES ENGINEERS RADIO AND TV BROADCASTING EQUIPMENT

Prominent national manufacturer of TV, radio broadcasting and communications equipment is expanding its sales force and has openings for Sales Engineers in the Midwest, Northcentral, and West Coast territories.

These are permanent positions involving travel for qualified men who are anxious to advance with progressive midwest company. Desire to sell and knowledge of broadcasting equipment essential. These are salaried positions with increased remuneration for more sales. Send full details first letter with photo, if possible, and territory preference. Write Box 240A, B.T.

Help Wanted—(Cont'd)

TV Salesman with multi-market experience now active wanted for major market western station. Send all details, photo, references, money required, first letter. Box 260A, B.T.

WEHT-TV CBS Evansville-Henderson needs a salesman with TV or radio experience or both. Write Bill Vogel, Sales Manager, 12½ S. E. Second St., Evansville, Indiana. Phone 5-3406.

Production-Programming, Others

TV writers (2)—Chicago office national agency will supplement TV staff with two experienced TV writers for diversified accounts; \$6,000. start. Box 239A, B.T., for appointment.

Situations Wanted

Managerial

Young radio commercial manager, 29, journalism graduate. Would like to re-locate into larger market. Steady, increased sales record. Details by return mail. Write Box 171A, B.T.

Owners—your eastern station in the black on your terms. Two man, multiple purpose, management-operations team. Full data to Box 215A, B.T.

Profits? I'll make them. Low overhead specialist. 16 broadcast years. 7 years management. Box 250A, B.T.

Excellent at organization. Experienced 16 years sales, production, technical. College. Will speculate. Box 251A, B.T.

Past controlling interest owner of successful station available as station manager. Run stations to make money, do large portion of selling. I sell for renewals, I cultivate close relations with clients. (31) years, married (4) children, college, first ticket, member of Lions, Chamber of Commerce, Junior Chamber of Commerce, American Legion, native of south, desire station in south. Not afraid of competition. Available for personal interview. Box 262A, B.T.

Salesmen

Radio-minded salesman seeking employment in Rocky Mountain area or Pacific Coast. Proven sales record. Years of experience in radio—all phases. Box 228A, B.T.

Announcers

Negro announcer-disc jockey. Beginner, friendly, easy approach, reliable, will do good job. Married. Photo, disc available on request. Available two weeks. Box 226A, B.T.

Announcer. Smooth air style. Interested in permanent radio or TV position in large market. College graduate; three years experience. Box 230A, B.T.

News, music, special events . . . family man, six years experience, one as program director. Co-operative. References. Box 231A, B.T.

Looking? So am I! Presently employed announcer-producer-director. Network experience. Also write copy. Best references, tape and details upon request. Box 234A, B.T.

News-sports man; versatile for staff work; 2½ years experience; also have newspaper background; want permanent spot; aggressive, sober, reliable. Box 236A, B.T.

Recent radio school graduate. Good voice. All phases of announcing. Can handle control board. Box 237A, B.T.

Staff announcer, versatile, sports specialty. Can handle board. Data available. Box 238A, B.T.

Announcer, strong on DJ. Single, draft exempt. Limited experience. Tape on request. Box 245A, B.T.

Negro announcer, DJ, experienced. Korean veteran. Disc available. Age 24. Box 257A, B.T.

Recent MBS graduate wants to begin radio career. Good newsman, versatile. DJ. All offers considered. Disc, photo on request. Box 258A, B.T.

Six months experience, all phases, good news, commercial delivery. Reliable, veteran, good potential, Free to travel. Box 266A, B.T.

Conscientious negro DJ, announcer, board. Light experience, thoroughly trained, third ticket. Tape, resume on request. Box 272A, B.T.

Announcer. Recent broadcasting school graduate. No experience. Third class ticket. Box 183A, B.T.

Situations Wanted—(Cont'd)

Excellent staff announcer, good voice, worker, veteran, married, commercials personality. Box 274A, B.T.

Single veteran, young, versatile, news, commercial DJ. Control board. Third class ticket. Resume, tape. Free to travel. Tony Cosmo, 105 Sea View Ave., Staten Island 4, N. Y.

Young, ambitious, dependable. Heavy commercials. Board, news, DJ. Move promptly. Limited experience. Carl Dino, 781 47th St., Brooklyn, N. Y.

Announcer. 25. Experienced news, music, board. Ford, 719 S. W. 5th Avenue, Miami, Florida.

Midwestern graduate seeking employment as staff announcer. Heavy on music, rural or popular. Available immediately. Emil Ginther, 1400 N. Damen, Chicago, Illinois.

Versatile announcer, board operator. Small station experience. Brad Harris, 331 Alabama Avenue, Brooklyn 7, New York. Hyacinth 8-5479.

Announcer, mature, reliable, draft exempt, light experience, high potential, news, commercials, platters. Permanent connection, 3rd class license. Resume, references, tape. Mel Marvin, New Alpine Apts., 113 East 14th St., New York 3, New York.

Desire permanent staff announcing position, mid-west. Approximately year experience, including network outlet. University background, single, 31. Good commercial voice, news, record shows. Charles May, 4001 Bell, Kansas City, Missouri. Phone Valentine 6755.

Announcer, negro, DJ, news, personality. Control board. Married, veteran. Some experience, well trained. Tape available on request. Free to travel. Carl Motley, 244 Amherst St., East Orange, N. J. OR 3-7442.

Negro, DJ. News, personality, control board. Married, some experience. Tape available upon request. Free to travel. George Truhart, 2406 8th Ave., New York, N. Y., Apt. 12 G.

Staff announcers. Board trained, capable and sober. Write copy. Smooth DJ show. Tom Bowers and Ed Dugan. Southeast preferred. Pathfinder School of Radio, 737 11th Street N. W., Washington, D. C. ME 8-5255.

Announcer-engineer. First license, good voice, good commercial delivery. Experienced. Minimum \$75.00. Box 215, Rushville, Nebraska, or phone 286-J.

Technical

Inexperienced first class radio operator. Desires position as broadcast engineer anywhere in U. S. Box 248A, B.T.

Engineer first phone, two years technical school, seven months AM-FM experience, 18 months electronic experience. Box 219A, B.T.

First phone, TV Workshop graduate, good electronics background desires job with TV or broadcasting station. Box 229A, B.T.

Engineer operator. Experienced construction, maintenance, remotes, recording, etc. Eastern states. Box 242A, B.T.

Situations Wanted—(Cont'd)

Woman with first class license, experienced, remotes and transmitter work. Box 247A, B.T.

Chief engineer available immediately. Long and varied experience in all phases and departments. Excellent references. Will consider first class engineers assignment at a class outlet if future prospects for promotion good. Box 253A, B.T.

Chief engineer, 5 years AM-FM to 5 kw, including construction. Year as chief; operation, maintenance entire station. Interested television. Can announce. New England. Box 277A, B.T.

First phone, married, 2 years radio and engineering schooling, 3 years experience radio station AM and FM. Jack Herring, Cullman, Alabama, Route 2, phone 1028-W.

Production-Programming, Others

News director, radio-TV, 10 years experience, now midwest, wishes to relocate east. Box 210A, B.T.

Writer-producer for national consumption now sales in a 1,500,000 metro. Will sell, write and produce morning show for right salary plus usual 15 percent. Desire midwest—Michigan preferred. Married. Box 244A, B.T.

Program production executive, capably creating successful commercial cooperative presentations inexpensively. Exceptional references, experience, background, scrapbook. Box 246A, B.T.

Available now. Radio gal with experience and ability to handle programming, production, sales promotion, publicity, public relations, women's commentary, disc jockey, interviews and writing. Will locate anywhere. Box 264A, B.T.

Copywriter, experienced. A. B. Degree in writing, programming, and directing. Prefer Virginia or Carolinas. Box 278A, B.T.

Television

Managerial

General or commercial manager experienced all phases TV operation. Small-large markets. Presently employed. Will accept position on percentage basis. Box 2A, B.T.

Manager or sales manager, VHF TV station. 4 years TV sales experience, top billings on staff. Experienced in all phases, learned TV from ground up. 32, family, degree business administration. Box 268A, B.T.

Salesmen

Have car, initiative. New York television film commercial sales, "live" production background. Seek station opportunity. Box 267A, B.T.

Announcers

Weathercaster in 7th year broadcasting for weather bureau, considering TV "weatherman" propositions. Have fresh ideas for a "natural" in TV. Pilot with B. S. Degree. Box 273A, B.T.

(Continued on next page)

Radio Broadcast Equipment for sale. Complete, used (former KGVO) Western Electric, 5,000 Watt Transmitter for sale at \$10,000.00. Get into this lucrative business with a powerful station very cheaply.

MOSBY'S, Incorporated

127 E. Main St.

Missoula, Mont.

Situations Wanted—(Cont'd)

Technical

Engineer with approximately 20 years experience including three years TV desires position as a technical director or TV supervisor especially in warm climate. Box 205A, B.T.

TV-AM engineer, prefer work in home state California, experienced, presently employed, Married. Box 254A, B.T.

Production-Programming, Others

Film editor, college graduate, Korean veteran. Box 170A, B.T.

Publicity-merchandising—solid radio, television, movie background. 29. College grad. Want responsibility. Box 227A, B.T.

TV director-supervisor, 33, with 3 years TV and 4 years radio, desires change to more progressive station. Box 256A, B.T.

Program director. A veteran, seasoned TV pioneer, happily employed but looking for a challenge in newer TV station. New York, Hollywood and other references. Reasonable in every sense of the word. Box 265A, B.T.

Newsman with 14 years experience wants news job with TV station in small city. Recent European experience and 7 years in Washington. Best references. Call Logan 7-2585, Washington, D. C., or write Box 279A, B.T.

For Sale

Stations

Midwest, 5,000 watt, fulltime; good money maker, sound investment. Excellent assets, well equipped. Priced less than you could replace physical plant for. Large amount of unfulfilled advertising contracts. Station definitely in the black, but priced for immediate sale. If you're ready to make a deal in a hurry, contact Box 199A, B.T. Terms available.

Third of new 1000 watter. Reasonable. East coast. Ideal for work-ownership. Doing well. Owner, Box 275A, B.T.

1 kw daylight, best section Georgia, now off air, reorganization, bargain \$25,000, half cash. WMOC, Covington, Georgia.

Equipment, etc.

New TV towers ready for shipment October 15th. Sold only delivered and erected with all equipment. One tower 340 ft. One tower 360 ft. One tower 400 ft. Guyed type. Box 169A, B.T.

Recording equipment: Four RCA 73B recording lathes with complete auxiliary equipment consisting of four Presto 92A recording amplifiers, two RCA BA4C monitor amplifiers, two Weston UU meters, attenuators, jacks, coils, pads, etc., plus spare replacement parts. Write Box 201A, B.T.

Presto 6N in 1B case—\$350.00. Microphones 44BX—\$79.00. WE-369—\$65.00. Box 255A, B.T.

One Collins 20-T transmitter cabinet, and necessary components for three-tower directional operation less remote meters. Also, 400 feet amphenol 21-135, 72 ohm co-ax. Write, wire or call Dexter Ferry, Chief Engineer, KNED, McAlester, Okla.

10 kw AM transmitter, RCA type BTA-10F, with control console complete set tubes and some spares \$17,500.00. FOB Duluth. Also approved AM freq. and mod. monitors, ant. terminating and phasing components available. Inquire John M. Sherman, WCCO-TV, Minneapolis, Minn.

Crouse-Hinds F.C.B.-12 500W beacon with flasher. Austin lighting transformer. 60A 12V charging system for auto. Best offer, as is. Engineering Department, WDGY, Minneapolis 1, Minnesota.

210 ft. guyed tower, galvanized, mfd. by Tower Construction Co., A-3 lighting. Contact WRAY-TV, Princeton, Ind.

Truscon tower four foot triangular uniform cross-section 193 feet high with available engineering for conversion to guyed base insulated tower. Contact Carl Smith, 4900 Euclid Avenue, Cleveland 3, Ohio.

Concertone network tape recorder, faders, cases; new; unopened carton, \$940; Model 1501. \$295; FOB Long Beach; Robert Nicholas, 1012 45th Way, Long Beach, Calif.

For Sale—(Cont'd)

Bell Howell 70 D. L. camera with turret, 1" lens, 400 ft. magazine, synchronous motor. Brand new, never been used. Bargain. Central Telefilms, 810 North Sheridan, Peoria, Illinois.

Wanted to Buy

Stations

Buyer for middlewest 250 to 5,000 watt independent or affiliate station. Full details kept confidential: Box 83A, B.T.

Want small local radio station with good potential. Will buy outright or controlling interest. Will bring to operation sound big-time agency and station experience. Box 263A, B.T.

Equipment, etc.

Would like to locate good used 10 kw transmitter. Box 13A, B.T.

1 used RCA 70-C1 or D with BA2C preamplifier or equivalent. Box 19A, B.T.

Used 500 watt or 2 kw channel 2 transmitter and other studio and transmitter gear. Box 453X, B.T.

Any good used equipment for erection of 1 kw station. RCA, Collins, Gates. State complete particulars in first letter. Box 252A, B.T.

1 kw or less FM transmitter. KTKT, Tucson, Arizona.

Good used AM transmitter, 1000 watts complete: FCC approved. Please send complete information first letter and picture if available to Jay Lamb, WPNX, Phenix City, Alabama.

Used, factory built 10 kilowatt transmitter. Send price and complete information to Grant Wrathall, Aptos, California.

Miscellaneous

An American corporation operating in the Far East with principal offices in Manila has facilities and contacts to represent U. S. firms wishing to do business in publishing, radio or television, such as supplies, film libraries, equipment, features, etc. Box 194A, B.T.

FCC licenses quickly by correspondence. Also new 8-weeks resident class begins November 9. Grantham School of Electronics, 6064 Hollywood Blvd., Hollywood, California.

Help Wanted

There's always an opening for qualified radio personnel in one of Oklahoma's 46 Radio Stations. One contact covers the state. Apply to—Guy Farnsworth, KCRC, Enid, Okla., Secretary, Oklahoma Broadcasters Association.

Production-Programming, Others

CONTINUITY WRITER

A seasoned, all-round writer for radio and television by major mid-west network affiliate. Send complete details to Box 218A, B.T.

Radio-TV program manager regional network radio station about to begin TV operations wants a top-grade manager for combined radio and television program department. Creative and executive abilities are musts for this job. Send full particulars at once to Box 280A, B.T.

Help Wanted—(Cont'd)

Television

TV JOBS IN FLORIDA

If you are interested in positions as directors, cameramen, announcers, writers, studio and transmitter technicians, film editor, news writers and photographers, set designers, artists and traffic managers; send complete background, salary and photograph in first letter to Box 819X, B.T.

Announcers

Unusual announcing position immediately available on University of Missouri commercial VHF operation. Right man with experience and imagination can qualify for chief announcer-producer position. Rush complete detailed application to Program Director, KOMU-TV, Columbia, Missouri.

Production-Programming, Others

we need a PROMOTION MANAGER..

a man with practical knowledge of TV station selling, presentation writing, and general advertising principles. He'll work in the New York headquarters of a well-known station representative, backing up sales activities with sound promotion aids.

If you're qualified for the job, write us and say why. Also state what you think your experience is worth. If you want your application confidential, we'll keep it that way. Box 269A, B.T.

Situations Wanted

Announcers

HIGHLY COMMERCIAL!!!

MR. & MRS. DJ-PERSONALITY TEAM with national award winning show. You've read about them in syndicated columns, trade papers, and national publications such as, RADIO-TV MIRROR and NEWSWEEK. A PROVEN, power-packed SALES package for station and sponsors. For information, write to box 270A, B.T.

Television

Managerial

Top network producer-director anxious to relocate outside of New York City with family so that his network and advertising agency experience will be more fully utilized as program director of television station in a progressive and alert community. Excellent references. Box 249A, B.T.

For Sale

Equipment, etc.

RCA TT2AH TRANSMITTER

used as an interim less than 1,250 hours. Immediate delivery.

BOX 282A, B.T

for sale
RCA FIELD SYNC GENERATOR
G.E. FILM CAMERA
 both nearly new
KGUL-TV, Galveston, Texas

FOR SALE
 at substantial reduction all new
 and original packing cases:
1 PE-5-A GE film camera
chain
1 PF-3-C GE slide projec-
tor and accessories
1 Zoomar Lens
1 FD-2-B Mike boom and
perambulator
 These and several smaller items also
 for sale are excess equipment acquired
 when we took over equipment contract
 of another TV station. WENS, Oliver
 Building, Pittsburgh 22, Pennsylvania.

SCOTCHLITE CALL LETTER SIGNS \$2.95

Beautiful, wide angle, red, all weather call
 letters for rear bumper or back window com-
 plete with dial setting or network plus radio
 symbols—die cut @ \$2.95 per set or 10 sets
 for \$25.00.
 Staff cars—buses—taxis

SCOTCHLITE ROAD SIGNS \$19.95

Large red 10 inch Scotchlite calls on gold
 baked lacquer background—5 feet high and
 2 feet wide. America's best stations are
 using these signs. Order yours now. Radio
 Productions, Box 1207, Madison, Wis.

Wanted to Buy

Stations

Experienced Broadcaster
 interested in purchasing 250 to
 1,000 watt station in Eastern or
 Central time zone. All corre-
 spondence will be kept confiden-
 tial. Box 216A, B*T.

Experienced operators, interested in
 buying AM station up to 5000 watts.
 Busy market preferred. Send details
 in confidence. Box 281A, B*T.

Equipment, etc.

Used image orthicon chain.
 Any make. DuMont pre-
 ferred. Call 7735 or wire
 Glen Winter, WNOW-TV,
 York, Pa.

TOWER WANTED
 150 feet Self standing
KGUL-TV
 Galveston, Texas

Commission granted the protest, ordered hearing
 in this matter, and postponed the effective date
 of grants pending a final determination in the
 hearing. The order setting forth the hearing
 issues, procedure and date of hearing will be
 released in the near future. Commissioner Doer-
 fer dissented. Action Oct. 16.

Madison, Wis.—Ch. 3 hearing. The Commission
 announced its orders (1), denying petition filed
 by Badger Television Co. to return as defective
 and illegal an amendment filed by WISC which
 included certain changes of stock ownership
 which had taken place since filing its original
 application for new tv station; (2), denying peti-
 tion filed by Badger Television Co. to enlarge
 the hearing issues in the above-mentioned pro-
 ceeding to include an issue to determine whether
 WISC is financially qualified to construct, own
 and operate a television station. Action Oct. 16.

Superior, Wis., Duluth, Minn.—Tv Allocation.
 The FCC announced its memorandum opinion
 and order denying petition filed Aug. 21, 1953,
 by the Head of the Lakes Broadcasting Co.
 (WEBC) for reconsideration of Commission ac-
 tion of Aug. 13 in the Superior, Wis.-Duluth,
 Minn., ch. 3 tv proceeding which, among other
 things, denied petitioner's request for leave to
 amend its application to specify ch. 6 in lieu
 of ch. 3 and to designate its amended applica-
 tion for hearing in consolidation with pending ap-
 plications for ch. 6 in Duluth-Superior, or, in the
 alternative, to designate all pending Duluth-
 Superior applications for both ch. 3 and ch. 6
 for hearing in a single consolidated proceeding;
 on Commission's own motion, amended hearing
 issue No. 5 in the ch. 3 proceeding to determine
 whether a choice can be made between the ap-
 plications on the basis of Section 307 (b) of the Com-
 munications Act and if so, whether a grant to
 one or the other of the applicants will provide
 the more fair, efficient, and equitable distribution
 of service. Action Oct. 15.

Routine Roundup . . .

October 13 Applications

ACCEPTED FOR FILING
Modification of CP

WATV (TV) Newark, N. J., Bremer Bestg. Corp.
 —Mod. CP (BPCT-57) as mod., which authorized
 new station, to change type ant. (BMPCT-1459).
 WLTV (TV) Wheeling, W. Va., Polan Industries
 —Mod. CP (BPCT-1048) which authorized new
 station, for extension of completion date to
 5/11/54. (BMPCT-1462).

License to Cover CP

WLWT (TV) Cincinnati, Crosley Bestg. Corp.—
 License to cover CP (BPCT-914) as mod., which
 authorized changes in existing station. (BLCT-
 155).

October 13 Decisions

Actions of October 6
Modification of CP

The following were granted Mod. CP's for ex-
 tension of completion dates shown:
 KTRE-TV Lufkin, Tex., to 2-1-54; WVEC-TV
 Hampton, Va., to 1-4-54; WNAM-TV Neenah, Wis.,
 to 11-30-53; KTBC-TV Austin, Tex., to 4-1-54;
 WTAP Parkersburg, W. Va., to 4-1-54.

Actions of October 5

Remote Control

The following stations were granted authority

Employment Services

BROADCASTERS
EXECUTIVE PLACEMENT SERVICE
 Executive Personnel for Television and Radio
 Effective service to Employer and Employee
HOWARD S. FRAZIER
 TV & Radio Management Consultants
 708 Bond Bldg., Washington 5, D. C.

Miscellaneous

OPPORTUNITY FOR RADIO-TV
REP SALESMAN TO
START NEW BUSINESS

Individual, with large station on
 long term contract, desires to start
 new rep firm in New York. If you
 represent two or three good radio-
 TV stations or have strong contacts
 to get them and want management
 and partnership arrangement with
 real future write Box 261A, B*T.

to operate transmitters by remote control:

WEKY Richmond, Ky.; KEYD Minneapolis,
 Minn.; WEOK Poughkeepsie, N. Y.; WJMB Brook-
 haven, Miss.; WPTS Pittston, Pa.; KTBB Tyler,
 Tex.; KLPM Minot, N. D.

Granted License

WSTR-FM Sturgis, Mich., WSTR Inc.—Granted
 license for fm station; 103.1 mc (Ch. 276), \$285
 kw, unl. (BLH-922).

Modification of CP

KOA-TV Denver, Colo., Metropolitan Television
 Co.—Granted Mod. CP for slight change in trans.
 location (coordinates only), type of ant. and other
 changes; vis. 100 kw, aur. 50.1 kw; ant. 1030 ft.
 (BMPCT-1420) (Completion date 5-9-54).

The following were granted Mod. CP's for ex-
 tension of completion dates as shown: WABD-TV
 New York, N. Y., to 4-6-54; WDIA Memphis,
 Tenn., to 1-16-54; conditions.

October 14 Decisions

By the Commission En Banc
Denied Request

KTBS Shreveport, La., KTBS Inc.—Denied re-
 quest that KDBS Alexandria, La., be required to
 change its call letters. Commission does not
 think confusion is likely.

Renewal of License

The following stations were granted renewal
 of licenses for the regular period:

KMBL Junction, Tex.; KCLF Tempe, (Clifton)
 Ariz.; KIFI Idaho Falls, Idaho; KSIL Silver City,
 N. M.; WCOH Newman, Ga.; KASL Newcastle,
 Wyo.; KBOR Brownsville, Tex.; KCBQ Lubbock,
 Tex.; KCLO Leavenworth, Kan.; KCRG Cedar
 Rapids, Iowa; KCRV Caruthersville, Mo.; KFYN
 Bonham, Tex.; KJAY Topeka, Kan.; WLNA Peeks-
 kill, N. Y.; WRGA Rome, Ga.; WPTH Port Huron,
 Mich.; WTTB Bloomington, Ind.; KCRG Enid,
 Okla.; KLO Ogden, Utah; KSUM Fairmont, Minn.;
 KTJS Hobart, Okla.; WDEM Quincy, Ill.; WSDC
 Marine City, Mich.; KSLM Salem, Ore.

October 15 Decisions

ACTIONS ON MOTIONS

By Hearing Examiner Herbert Sharfman

WKNK Muskegon, Mich., N-K Bestg. Co.—To
 accommodate examiner's hearing schedule, con-
 tinued to date to be set by later order hearing
 now scheduled for Oct. 26 (Docket 10648).

By Hearing Examiner Annie Neal Hunting

Gordon Bestg. Co., Cincinnati, Ohio—Granted
 petition to accept its late appearance in pro-
 ceeding re its tv application and that of Tri-City
 Bestg. Co., Newport, Ky. (Docket 10674, BPCT-
 1722) (Docket 10675; BPCT-1737) (Action 10/8).
 Elyria-Lorain Bestg. Co., Elyria, Ohio—Granted
 motion for change in dates for filing of briefs
 referred to in statement and order after first
 hearing conference, dated Sept. 24, 1953, and dates
 are changed from Oct. 15 and Nov. 2 to Oct. 22
 and Nov. 9, 1953, respectively (Action 10/13).

By Hearing Examiner James D. Cunningham

Radio Wisconsin Inc., Madison, Wis.—Granted
 petition for leave to amend its tv application in
 certain minor details, viz., to specify street ad-
 dress for its proposed main studio location and
 by adding two employees to its proposed staff
 (Docket 8959; BPCT-410).

Southern Tier Radio Service Inc., Binghamton,
 N. Y.—Granted petition for leave to amend its
 tv application to set forth stockholders and own-
 ership of present stock in applicant corporation
 and to list 61 new subscriptions to capital stock
 (Docket 10681; BPCT-892).

By Hearing Examiner J. D. Bond

Times World Corp., Roanoke, Va.—By memo-
 randum opinion and order denied petition for
 leave to amend its tv application (Docket 10655,
 BPCT-1056) to show increased hours of opera-
 tion, operating costs and revenues, increases in
 staff personnel and program changes.

By Hearing Examiner Basil P. Cooper

South Bend Bestg. Corp., South Bend, Ind.—
 Granted motion for leave to amend its tv applica-
 tion to substitute different type trans. (Docket
 10534, BPCT-1012) (Action 10/9).

California Inland Bestg. Co., KARM, The George
 Harm Station, Fresno, Calif.—In first order con-
 trolling conduct of hearing for ch. 12 at Fresno,
 recited action and rulings taken at Sept. 28
 hearing (Action 10/9).

Perkins Brothers Co., Sioux City, Iowa — By
 memorandum opinion and order granted petition
 of Sept. 16 to show revised cost estimates of cer-
 tain equipment, including ant. and associated
 equipment; studio technical equipment; construc-
 tion of studio building; increased hearing costs;
 revised estimates of cost of operation and rev-
 enues; current financial condition; change in
 program proposal; and change in minimum daily
 hours of operation (Docket 10672; BPCT-688)
 (Action 10/13).

By Hearing Examiner Robert T. Bartley

Meredith WOW Inc., Omaha, Neb.—Granted
 petition for leave to amend application of Radio
 Station WOW Inc. (WOW), Omaha, Neb., to sub-
 stitute Meredith WOW Inc. as party to proceed-
 ing in Dockets 9785, 9786, in lieu of Radio Station
 WOW Inc.; and to bring up to date pertinent
 information relating to operation of Station WOW.

light the way...

... to extraordinary lighting effects
... at extraordinary savings! Rent
whatever you need in specialized display,
theatrical, studio and motion picture
equipment from Jack Frost! For finer
lighting ... at fewer dollars ...
for complete lighting service that
includes installation and removal
wherever you are ...
you're headed the right way ...

the **frost** way!

For Full Information On Rental Equipment Write:

JACK A. FROST, DEPT. B, 234 PIQUETTE AVE.
Detroit 2, Michigan • TRinity 3-8030

BMI
"Pin Up" Hit
EH CUMPARI
published by
ROSARCH PUBLISHING
CORP.
RECORDED BY
JULIUS LaROSA . . . Cadence

BROADCAST MUSIC, INC.
580 FIFTH AVE., NEW YORK 36
NEW YORK • CHICAGO • HOLLYWOOD • TORONTO • MONTREAL

FOR THE RECORD

October 16 Applications

ACCEPTED FOR FILING Modification of CP

WINK Fort Myers, Fla., Fort Myers Bcstg. Co.—Mod. CP (BP-8773) which authorized erecting new ant. and mounting tv ant. on top (increase height), change trans. location (coordinates only), for extension of completion date (BMP-6337).

KLIK Jefferson City, Mo., Empire Bcstg. Co.—Mod. CP (BP-8151) which authorized new station, for approval of ant., trans. and studio location as on North Tenth Dr., 1.75 miles west of Jefferson City (BMP-6334).

WLIB New York, New Bcstg. Co.—Mod. CP (BP-8543) as mod., which authorized change in trans. location and make changes in ant. and ground system, for extension of completion date (BMP-6336).

WABT (TV) Birmingham, Ala., The Television Corp.—Mod. CP (BPCT-847) as mod., which authorized changes in existing station, for extension of completion date to 11/15/53 (BMPCT-1472).

WMSL-TV Decatur, Ala., The Tenn. Valley Bcstg. Co.—Mod. CP (BPCT-1488) which authorized new station, for extension of completion date to 4/25/54 (BMPCT-1466).

KHSL-TV Chico, Calif., Golden Empire Bcstg. Co.—Mod. CP (BPCT-1310) which authorized new station, for extension of completion date to 12/15/53 (BMPCT-1461).

KAGR-TV Yuba City, Calif., John Steventon—Mod. CP (BPCT-1336) which authorized new station, for extension of completion date to 5/11/54 (BMPCT-1467).

KIFT (TV) Nr. Idaho Falls, Idaho, Idaho Falls Tv Inc.—Mod. CP (BPCT-1278) which authorized new station, for extension of completion date to 4/25/54 (BMPCT-1470).

WPTV (TV) Ashland, Ky., Polan Industries—Mod. CP (BPCT-1009) as mod., which authorized new station, for extension of completion date to 4/13/54 (BMPCT-1464).

WJMR-TV New Orleans, La., Supreme Bcstg. Co.—Mod. CP (BPCT-1447) which authorized new station, for extension of completion date to 4/1/54 (BMPCT-1452).

WJIM-TV Lansing, Mich., WJIM Inc.—Mod. CP (BPCT-883) as mod., which authorized changes in existing station, for extension of completion date to 1/18/54 (BMPCT-1475).

WTVE (TV) Elmira, N. Y., Elmira Tv—Mod. CP (BPCT-1161) as mod., which authorized new station, for extension of completion date from 11/19/53 (BMPCT-1468).

Extension of Authority

The Hampden-Hampshire Corp., Springfield, Mass.—Authority to transmit programs to CHRC Quebec, Canada, from 1300 Liberty St., Springfield (BFP-241).

Burns Ave. Baptist Church, Detroit—Extension of authority to transmit programs from Burns Ave. Baptist Church at Detroit to CKLW Windsor, Ont., for period beginning 8/2/53 (BFP-240).

Remote Control

Following stations request to operate transmitters by remote control:

WROX Clarksdale, Miss., Birney Imes Jr. (BRC-201); **KGFV** Kearney, Neb., Central Neb. Bcstg. Corp. (BRC-200); **WJLK** Asbury Park, N. J. (BRC-199).

Renewal of License

Following stations request to renew license: **KWTC** Barstow, Calif., Mojave Valley Bcstg. Inc. (BR-1775); **KICO** Calexico, Calif., Charles R. Love (BR-1552); **KRDU** Dinuba, Calif., Radio Dinuba Co. (BR-1434); **KBOP** Pleasanton, Tex., Atascosa Bcstg. Co. (BR-2609); **KCSB** San Bernardino, Calif., F. P. D'Angelo (BR-1606); **KFMB** San Diego, Wrather-Alvarez Bcstg. Co. (BR-1133); **KSRO** Santa Rosa, Calif., Finley Bcstg. Co. (BR-939); **KTUR** Turlock, Calif. (BR-2362); **WBCU** Union, S. C., Bcstg. Co. of Union Inc. (BR-2345).

APPLICATION RETURNED

Renewal of License

KDAC Fort Bragg, Calif., Edward Mertle—Renewal of license (BR-2649).

October 19 Applications

ACCEPTED FOR FILING

License to Cover CP

WBAR Bartow, Fla., Wm. Avera Wynne—License to cover CP (BPCT-8724) as reinstated and mod., which authorized new station (BL-5121).

WLON Lincolnton, N. C., Lincoln County Bcstg. Co.—License to cover CP (BP-8693) as reinstated and mod., which authorized new station (BL-5122).

WISO Ponce, P. R., South Puerto Rico Bcstg. Corp.—License to cover CP (BP-8074) as mod., which authorized new station (BL-5120).

WJOT Lake City, S. C., Lake Bcstg. Corp.—License to cover CP (BP-8674) which authorized new station (BL-5124).

WBTN Bennington, Vt., Catamount Bcstrs. Inc.—License to cover CP (BP-8168) as mod., which authorized new station (BL-5109).

WJGN-FM Birmingham, Ala., The Jemison Bcstg. Co.—License to cover CP (BPH-1874) which authorized changes in licensed station (BLH-926).

WKPT-FM Kingsport, Tenn., Kingsport Bcstg. Co.—License to cover CP (BPH-1852) which authorized changes in licensed station (BLH-927).

Modification of CP

KUGN-FM Eugene, Ore., KUGN Inc.—Mod. CP (BPH-1642) as mod. and reinstated which authorized new station, for extension of completion date (BMPH-4857).

WHP-FM Harrisburg, Pa., WHP Inc.—Mod. CP (BPH-410) as mod., which authorized new station, for extension of completion date (BMPH-4859).

WEEK-TV Nr. Peoria, Ill., West Central Bcstg. Co.—Mod. CP (BPCT-701) as mod. which authorized new station, for extension of completion date to 12/27/53 (BMPCT-1477).

CP to Replace Expired CP

WKVM San Juan, P. R., American Colonial Bcstg. Corp.—CP for replacement of expired CP (BP-5031) as mod., which authorized changes in existing station.

Renewal of License

Following stations request renewal of license: **KIBS** Bishop, Calif., Inyo Bcstg. Co. (BR-2828); **KMAK** Fresno, Calif., The McMahan Co. (BR-2826); **KMJ** Fresno, Calif., McClatchy Bcstg. (BR-7); **KFWB** Hollywood, KFWB Bcstg. Corp. (BR-8); **KFAC** Los Angeles, Los Angeles Bcstg. Corp. (BR-14); **KECA** Los Angeles, American Bcstg.-Paramount Theatres Inc. (BR-50); **KBLF** Red Bluff, Calif., Hal K. Shade (BR-1348); **KGMS** Sacramento, Capital Radio Enterprises (BR-2719); **KDON** Salinas, Calif., Charles Blackwood Grant (BR-2208); **KJBS** San Francisco, KJBS Bcstrs. (BR-40); **WPWA** Chester, Pa., Lou Poiler (BR-1810).

October 20 Decisions

BY THE BROADCAST BUREAU

Actions of October 16

Modification of CP

WJIM-TV Lansing, Mich., WJIM Inc.—Granted mod. CP for extension of completion date to 1-18-54 (BMPCT-1475).

Actions of October 14

Renewal of License

KA-9440, area Boise, Idaho, **KIDO** Inc.—Granted renewal of license on regular basis (BRRE-1097).

Remote Control

The following stations were granted authority to operate transmitters by remote control:

WJLK Asbury Park, N. J., **KGFV** Kearney, Neb., **WROX** Columbus, Miss.

Granted License

WAFM (FM) Birmingham, Ala., The Television

Radio Station and Newspaper Appraisals

Tax, estate and many other personal problems create the need for an independent appraisal. Extensive experience and a national organization enable Blackburn-Hamilton Company to make accurate, authoritative appraisals in minimum time.

Appraisals • Negotiations • Financing

BLACKBURN • HAMILTON COMPANY

RADIO-TV-NEWSPAPER BROKERS

WASHINGTON, D. C.
James W. Blackburn
William T. Stubblefield
Washington Bldg.
Sterling 3-4341-2

CHICAGO
Ray V. Hamilton
Tribune Tower
Delaware 7-2755-6

SAN FRANCISCO
Lester M. Smith
235 Montgomery St.
Exbrook 2-5672

Corp.—Granted license for changes in fm station; 99.5 mc (ch. 258), 72 kw, unil. (BLH-924).
 WMMW-FM Meriden, Conn., Silver City Crystal Co.—Granted license for changes in fm station; 95.7 mc (ch. 239), 7 kw, unil. (BLH-923).
 WAGA-FM Atlanta, Ga., Storer Bestg. Co.—Granted license for changes in fm station; 103.3 mc (ch. 277), 43 kw, unil. (BLH-925).

Granted CP

WDAN Danville, Ill., Northwestern Publishing Co.—Granted CP to install new trans. (BP-9026).
 KWTO Springfield, Mo., Ozarks Bestg. Co.—Granted CP to install new trans. at present location of main trans., to be operated on 560 kc, 500 w (BP-8997).

Modification of CP

KTIB Thibodaux, La., Delta Bcstrs. Inc. — Granted mod. CP for approval of ant., trans. location, specify studio location and change type trans.; condition (BMP-6319).
 Saint Augustine Bestg. Co., St. Augustine, Fla. — Granted mod. CP for approval of ant., trans. location; condition (BMP-6321).

The following were granted mod. of CP's for extension of completion dates as shown:

WBRV Waterbury Conn., to 1-1-54; conditions; WVAM-FM Altoona, Pa., to 1-31-54; WLTV Wheeling, W. Va., to 4-11-54; KICU Salinas-Monterey, Calif., to 1-14-54; WJLD Homewood, Ala., to 2-10-54; WBAM Montgomery, Ala., to 12-20-53; WKBV Richmond, Ind., to 2-12-54; condition; WITY Danville, Ill., to 2-4-54; WNEW New York, N. Y., to 5-6-54; conditions; WIEK Scranton, Pa., to 12-15-53; KGAL Lebanon, Ore., to 12-2-53.

Remote Control

The following stations were granted authority to operate transmitters by remote control:
 WBRM Marion, N. C., WFRL Freeport, Ill.
 WAML Laurel, Miss.

Actions of October 15

Granted License

WAYZ Waynesboro, Pa., Richard Field Lewis Jr.—Granted license for am station; 1380 kc, 1 kw, D (BL-5114).

KRSD Rapid City, S. D., Heart of the Black Hills Station—Granted license for am station; 1340 kc, 250 w, unil. (BL-5119).

WESK Escanaba, Mich., M & M Bestg. Co. Inc. —Granted license for am station; 1490 kc, 250 w, unil. (BL-5115).

Granted CP

WLCK Campbellsville, Ky., Taylor County Bestg. Co.—Granted CP to replace expired CP (BP-8215) which authorized changes in ant. system (BP-9025).

KFIF Fairbanks, Alaska, Kiggins & Rollins—Granted mod. CP to change description of trans. and studio location; correct coordinates (not move) and make changes in ant.; ant. minus 70 ft. (BMPCT-1418).

Modification of CP

The following were granted mod. CP's for extension of completion dates as shown:
 WABT Birmingham, Ala., to 11-15-53, WPTV Ashland, Ky., to 4-13-54, KHSL-TV Chico, Calif., to 12-15-53, KIFT Idaho Falls, Idaho, to 4-25-54.

Actions of October 12

Remote Control

The following stations were authorized to operate transmitters by remote control:
 WGNF-FM Gastonia, N. C., WJLK-FM Asbury Park, N. J.

Modification of CP

WJMR-TV New Orleans, La., Supreme Bestg. Co.—Granted mod. CP for extension of completion date to 4-1-54 (BMPCT-1452).

October 20 Applications

ACCEPTED FOR FILING

Renewal of License

Following stations request renewal of license:
 KRE Berkeley, Calif., Central Calif. Bcstrs. Inc. (BR-3); KPRL Paso Robles, Calif., Radio Station KPRL (BR-1538); KAFP Petaluma, Calif., Warner Bros. (BR-2453); KDB Santa Barbara, Calif., F. Robert Bauer (BR-48); KGO San Francisco, American Bestg.-Paramount Theatres (BR-28); KARM Fresno, Calif., KARM, The George Harm Station (BR-954); KSIJ Gladewater, Tex., Gladewater Bestg. Co. (BR-2254).

Modification of CP

KEYT (TV) Santa Barbara, Calif., Santa Barbara Bestg. & Television Corp.—Mod. CP (BPCT-1122) as mod. which authorized new station, for extension of completion date (BMPCT-1476).

KFKJ-TV Grand Junction, Colo., Western Slope Bestg. Co.—Mod. CP (BPCT-1305) for extension of completion date (BMPCT-1479).

WPAQ-TV Mt. Airy, N. C., Ralph D. Epperson—Mod. CP (BPCT-1329) which authorized new station, for extension of completion date (BMPCT-1480).

KCSJ-TV Pueblo, Colo., The Star Bestg. Co.—Mod. CP (BPCT-1103) as mod. which authorized new station, for extension of completion date to 12/20/53 (BMPCT-1481).

KFDX-TV Wichita Falls, Tex., Wichtex Radio & Tv—Mod. CP (BPCT-722) as mod. which authorized new station, for extension of completion date to 11/17/53 (BMPCT-1483).

CP to Replace Expired CP

WHEN (TV) Syracuse, N. Y., Meredith Syracuse Tv Corp.—CP to replace expired CP (BPCT-434) which authorized new station (BPCT-1782).

APPLICATION RETURNED

CP to Install Antenna

WNBK (TV) Cleveland, NBC—CP to install auxiliary ant. to be located 92.5 feet from main tower. Letter 10/15/53 returned for applicant's signature and notarial seal.

October 21 Decisions

ACTIONS ON MOTIONS

By Hearing Examiner H. Gifford Irion

Gulf Coast Bestg. Co., Baptist General Convention of Texas, Corpus Christi, Tex.—Upon agreement of parties, ordered that further hearing in proceeding for ch. 8 in Corpus Christi, be continued to Oct. 30, 1953.

Darrell E. Yates, Jacksonville, Tex.—Granted petition for continuance of hearing from Nov. 23, 1953, to Jan. 11, 1954, proceeding re its application (Docket 10429; BP-8285).

By Hearing Examiner Fanney N. Litvin

The Brush-Moore Newspapers Inc., Canton, Ohio—By memorandum opinion and order denied petition for leave to amend its tv application for ch. 29 regarding proposed studio facilities (Docket 10272; BPCT-264).

By Hearing Examiner Thomas H. Donahue

South Jersey Bestg. Co., Camden, N. J.; Patrick Joseph Stanton, Philadelphia, Pa.—Upon agreement of parties, hearing in this proceeding was continued from Oct. 13, 1953, to Nov. 9, 1953 (Docket 10657; BPCT-1522) (Docket 10658; BPCT-1674) (For ch. 17).

By Hearing Examiner John B. Poindexter

Ordered pre-hearing conference in proceeding re applications of KWTX Bestg. Co. (Docket 10694; BPCT-814) and WACO Television Corp. (Docket 10695; BPCT-873) for CPs for new tv broadcast stations on ch. 10 on Oct. 20, 1953, at Washington, D. C.

UPCOMING

Oct. 26-28: Radio Television News Directors Assn., convention, Sheraton-Park Hotel, Washington, D. C.

Oct. 26-28: Joint meeting, U. S. & Canadian Radio-Television-Electronics Mfrs. Assns., Toronto.

Oct. 28: Export Advertising Assn., Presidents' Luncheon, Hotel Roosevelt, New York.

Nov. 1-7: National Radio & Television Week.

Nov. 2: North Carolina Broadcasters Assn., meeting, Asheville.

Nov. 2-3: Central Canada Broadcasters Assn., annual meeting, Royal York Hotel, Toronto.

Nov. 2-6: Amer. Institute of Electrical Engineers, fall meeting, Hotel Muehlebach, Kansas City, Mo.

Nov. 5: Upper Midwest Sales Conference, Hotel Radisson, Minneapolis.

Nov. 5-6: Ohio Assn. of Radio-TV Broadcasters, meeting, Neil House, Columbus.

Nov. 9-10: New Jersey Broadcasters Assn., fall meeting, Hildebrecht Hotel, Trenton.

Nov. 12-13: Professional Group on Vehicular Communications of the Institute of Radio Engineers, annual meeting, Somerset Hotel, Boston.

Nov. 13: AAAA's Southeast Chapter, annual meeting, Kinkler-Plaza Hotel, Atlanta, Ga.

Nov. 19-20: Louisiana Assn. of Broadcasters, election of officers, Captain Shreve Hotel, Shreveport.

Nov. 23-24: AAAA's annual Eastern Conference, Hotel Roosevelt, New York.

Dec. 7: FTC hearing on proposed trade practice rules for radio-tv industry, 10 a.m., FTC Bldg., Washington.

Dec. 10: Supreme Court to hear Oral Argument on FCC's "giveaway" regulations, Washington.

Jan. 6: Second session of 83d Congress begins.

Jan. 19-23: NARTB Combined Boards, Camelback Inn, Phoenix.

Feb. 14-20: Advertising Recognition Week.

SPECIAL LISTING

(NARTB District Meetings)

Oct. 29-30: Dist. 2, Ten Eyck Hotel, Albany, N. Y.

Nov. 4-5: Dist. 1, Somerset Hotel, Boston.

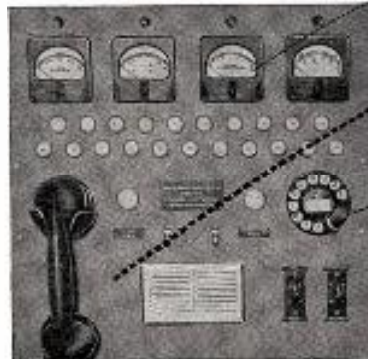

LINE UP THESE FEATURES — COMPARE THE COST

- the finest
- remote control
- system available . . .
- positive control
- 20 metering circuits
- 40 control circuits

SCHAFFER REMOTE CONTROL SYSTEM

satisfied customers coast to coast
 one year guarantee
 two weeks delivery
 complete — ready to install \$1645

HOWARD E. STARK
 Brokers and Financial Consultants
 TELEVISION STATIONS • RADIO STATIONS
 50 E. 58th St.
 New York 22, N. Y. ELdorado 5-0465

paul schaffer custom engineering
 2779 ALLESANDRO STREET
 LOS ANGELES 39, CALIFORNIA
 NO. 2-2161

Yesterday's Vision . . .

THE MOST astonishing aspect of electronics is that its scientists seem always to seek the impossible—and achieve it.

Today in government and private laboratories are projects that were regarded as wishful thinking only months ago. Before the very eyes of broadcasters a compatible color television system has been delivered during the last three years, *a la carte*.

The feature story writers are having a field day with such stories as Project Tinker-toy of the Bureau of Standards, and the printed-circuit receivers developed by the Signal Corps—that “Dick Tracy” wrist watch radio.

Not so fantastic at all. More than two decades ago, Gen. David Sarnoff predicted the “personal” radio which now is in general vogue. He also predicted the wrist watch radio innovation which now seems quite possible.

The miniaturization program in electronics is moving inexorably toward smaller, more effective units, in both transmitting and receiving apparatus. Transistors gradually will take over some of the work of the vacuum tubes. Radio transmitters of 1 kw that used to occupy a large-sized room now can be housed in a broom closet.

We have no doubt that Gen. Sarnoff's wrist watch radio, used in fantasy so successfully by Dick Tracy, is on its way. There's economic justification for it. And in electronics economic support is the mother of invention.

Let's imagine what a wrist watch radio might achieve. First, it actually could become a watch, give you the precise time by a push of the little knob, tuned to the “radio clock” station. In Havana, they have a station called “Radio Clock,” which provides a few seconds of news, a quick commercial, and the correct time.

You could get the news by “dialing” a selected station. Or, through a “hearing aid” attachment, you might listen to your favorite programs, or to a football game, without disturbing the person sitting next to you.

When the day of the wrist watch radio arrives, Webster will have to contrive a new definition for “saturation.” Today radio is the saturation medium, with more sets in use than there are homes, because there's more than one set in most homes, aside from those out of home sets, totaling a mere 35 or 40 million.

With the wrist watch receiver, one's radio will become as “personal” and as essential as his handkerchief, or, if you please, his watch. It would revolutionize the watch-making industry.

There are those who foresee the two-way wrist watch radio, with each person having his individual frequency. We're not disposed to wait around for that one—but there we go, talking the “impossible” which those geniuses in the laboratory will toss at us (and the FCC as the licensing authority) one of these days.

. . . Today's Fact

MINIATURIZATION is only one technological advance of significance to the future of broadcasting. In the welter of other developments that have occurred in recent years, at least two hold great commercial promise for radio.

In this issue of B•T is a report on the emergence of high-fidelity receiving equipment from the hobbyist's play-thing to the mass-marketed instrument. There is every prospect that the spread of hi-fi will present radio broadcasters with new opportunities.

Two weeks ago B•T reported a demonstration of fm multiplexing by Maj. Edwin H. Armstrong. Multiplexing will permit the simultaneous broadcast of two different programs within a standard fm band. The commercial potentialities of adding secondary services are obvious.

As this week's article points out, the high-fidelity audience is a devoted audience. As it grows, it will provide a bigger and more receptive advertising target, assuming, of course, that broadcasters give that audience what it seeks—good music delivered with good quality transmission. By good music we do not mean classical music alone. We mean music of all kinds but, having the common characteristic of being well played.

The technological developments of the past few years that have received the most attention have been mainly in the television field. Because tv is still a relatively novel system, it naturally holds



Drawn for BROADCASTING • TELECASTING by Sid Hix

“You advertised for an aggressive tv salesman?”

the center of the stage. But it is important to notice that the scientists have been far from idle in the field of aural communication.

Radio technology is by no means frozen. It is steadily advancing. The commercial capitalization on the technological discoveries is inevitable.

Getting Out of a Rut

TWO disquieting criticisms of television programming have been made by two very important customers of television, as explained in the article, “Is Tv Already in a Rut?,” on page 94.

Richard de Rochemont, vice president of J. Walter Thompson Co., and Louis N. Brockway, executive vice president of Young & Rubicam, are publicly worried over mediocrity and slavish imitation in tv shows.

To some extent we join Messrs. de Rochemont and Brockway in their concern. There is no doubt that the present climate of television is unhealthy for the adventurous. We cannot, however, agree that the blame for conservatism can be placed wholly on the networks and the packagers.

The unhappy fact is that a network or a packager has a very trying time indeed finding any agency that will ask a client to buy a show that strays from established formats. The principal resistance to the new or unusual comes from the agencies, not from the creators of programs. However unfortunate it may be for the good of the viewing public, this resistance is quite explainable in practical terms.

Because television costs a lot, an account can be quickly won or lost on the success or failure of a single television investment. The extreme risk that an agency runs in presenting a tv show to a client does not encourage gambles with unknown odds.

It seems to us that the responsibilities for opening the vistas of television cannot be handed over to the agencies, as Mr. de Rochemont suggests, without assuring an even more rigid adherence to tradition and tenses fear of exploration than now exist. What is needed is a clearer understanding by the agencies that freshness and imaginativeness in programming are quickly subdued if commercial support is not available.

Networks must continue to create and retain property rights to programs, else the networks deteriorate into mere conduits carrying information and amusement devised by somebody else and outside their practical control. They cannot turn over these functions to advertising agencies without abdicating their basic obligations to serve the public.

It is to the mutual advantage of telecasters, agencies and advertisers that the networks remain as the program source, that the agencies be more receptive to creative proposals and that the advertisers wait until more evidence than the first rating is available before deciding to sack a show and the agency that recommended it.



Alaska



Vancouver



Boise



Saskatoon

KFI . . .

The Pacific Coast's Only

Clear Channel

Station —

SACRAMENTO

SAN FRANCISCO

50,000 Watts - 640 Kilocycles

Serving 285 Counties

in

Western America

With **KFI** LOS ANGELES

the Best in Radio

31 Years of Uninterrupted Service

Completing 11,505 Days on the Air



Honolulu

2558 Mi.

7000 Mi.

7700 Mi.

5400 Mi.



New Zealand



Australia



Tahiti

Carle C. Anthony, Inc.



Mexico City

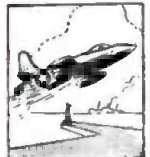

Corpus Christi



Miami



Detroit



New York



Quebec

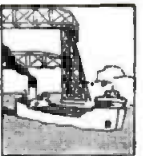

Duluth



Salt Lake City

591 Mi.



Milwaukee

1761 Mi.

2470 Mi.

2469 Mi.

1969 Mi.

1751 Mi.

2375 Mi.



Chicago

1400 Mi.

1640 Mi.

1400 Mi.

1400 Mi.

1086 Mi.

2414 Mi.

NBC for Los Angeles
Represented by
HENRY I. CHRISTAL COMPANY

ABOVE COVERAGE IS FROM LETTERS RECEIVED REGULARLY

No doubt



---that YOUR product has met every test . . . and
no doubt that you know that it is the best . . . if on
TV you'll show it, of its true merits tell . . . there are
thousands who'll want it . . .

THEN YOU WATCH IT SELL!

KOTV Channel 6 • TULSA, OKLAHOMA
WRATHER-ALVAREZ, INC.

KFMB-TV Channel 8 • SAN DIEGO, CALIF.
WRATHER-ALVAREZ BROADCASTING, INC.

NETWORK AFFILIATIONS: CBS • NBC • ABC

Exclusive National Representatives: DWARD BETRY & CO.