

BROADCASTING

The Weekly Newsmagazine of Radio

TELECASTING

MABEL BROWN
TIME INC
ROCKEFELLER CENTER
NEW YORK 20 N Y

as if you didn't know this all the time!

OR: BICYCLING GOES TO ONE'S HEAD EVENTUALLY



what makes wrinkles?

The general impression about wrinkles is that they are caused by worry, but the truth is that most of them come from laughing. Generally it has been found that the jovial, happy type forms wrinkles that enhance his facial expression.

One of WOR's more studious researchers — Parks by name — recently observed: That of the approximately 350 advertisers who used WOR during the year 1945, more than 99/100% have wrinkles that *enhance* their facial expressions.

greeting customs in other climes



It is common in Arabia to put cheek to cheek. The Hindu falls in the dust before his superior. The Australian natives practice the singular custom when meeting of sticking out their tongues at each other.

Since WOR was founded in 1922, it has become an increasingly popular custom among America's leading advertisers and their agencies to greet the majority of more than 18,000,000 people in one of the greatest listening territories on the Eastern Seaboard by using this power-full station.



LORD BYRON.

famous writers

Byron wrote "Childe Harold" when he was 20.

Dante was 50 when he completed his "Commedia".

Goethe wrote his "Sorrows of Werther" at 23.

Milton wrote "Paradise Lost" at 57.

Dickens wrote "Oliver Twist" at 26.

WOR was 23 when we wrote the 96th in a library of 102 great radio success stories. Most recent, is the story of "Press-On", a war product. WOR jumped this product's sales 100% throughout the WOR area in a few months; placed it in 43 department stores.



weather told by animals

If a cat sneezes it is a sign of rain.

When the fox barks at night it will storm.

The sandmole makes a mournful noise just before frost.

If the deer's coat is gray in October, a severe winter will follow.

If a sponsor uses WOR, it's a sign that his program will be heard in 16 of America's greatest cities of more than 100,000 people each. They include: New York City, Wilmington, Philadelphia, Trenton, Hartford, and 11 others.

WOR — that power-full station at 1440 Broadway, in New York

Mutual

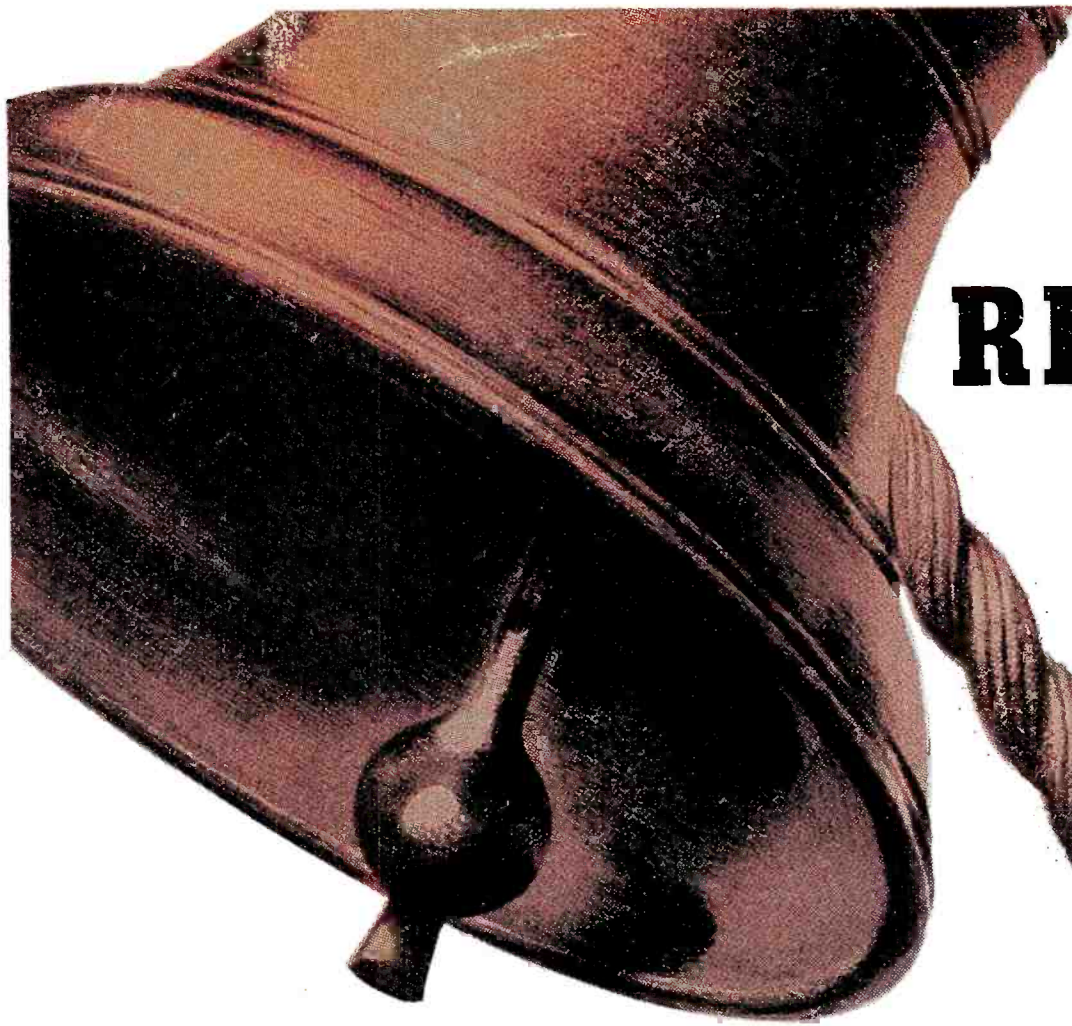

RINGING THE BELL with PUBLIC SERVICE

**Here's WLS at work for the
people — our 1945 service report**

SUBJECT	TIME	PROGRAMS	SPEAKERS
<i>Agriculture</i>	672:00	2,336	564
<i>Religion</i>	162:45	503	10
<i>Women's Interest</i>	251:55	584	245
<i>Education</i>	42:15	156	73
<i>News and Commentary</i>	779:18	3,526	83
<i>Government Aid (War and Peace)</i>	466:26	1,332	822
<i>Miscellaneous Service</i>	60:02	176	73

Service Announcements—total, 3,101

On a half-time station, doing a full-time job!

WLS SERVES THE PEOPLE OF MIDWEST AMERICA

A Clear Channel Station



CHICAGO 7

The
PRAIRIE
FARMER
STATION
BURRIDGE D. BUTLER
President
GLENN SNYDER
Manager

50,000 watts, 890 KC, American Affiliate. Represented by JOHN BLAIR & COMPANY. Affiliated in Management with KOY Phoenix, and the ARIZONA NETWORK — KOY Phoenix ★ KTUC, Tucson ★ KSUN, Bisbee-Lowell-Douglas

SCOOP!

258

WPEN-FM GETS EXCLUSIVE ROOF RIGHTS TO PHILADELPHIA'S HIGHEST BUILDING!

Philadelphians expect a lot of *The Evening Bulletin*, America's largest evening newspaper, and its up-to-the-minute stations WPEN and WPEN-FM.

Now these stations take another big step forward with the purchase of exclusive roof rights to Philadelphia's highest building—The Philadelphia Saving Fund Society. This is right in line with the WPEN—WPEN-FM policy to give Philadelphians the finest possible service. It is what they expect of *The Evening Bulletin* stations.

Every day, more and more listeners in the Philadelphia area turn to WPEN for *The Evening Bulletin* news. They know that only WPEN brings them complete local and national news every hour on the hour.

Listening to WPEN—in the middle of the dial—is as much a Philadelphia custom as scrapple for breakfast!

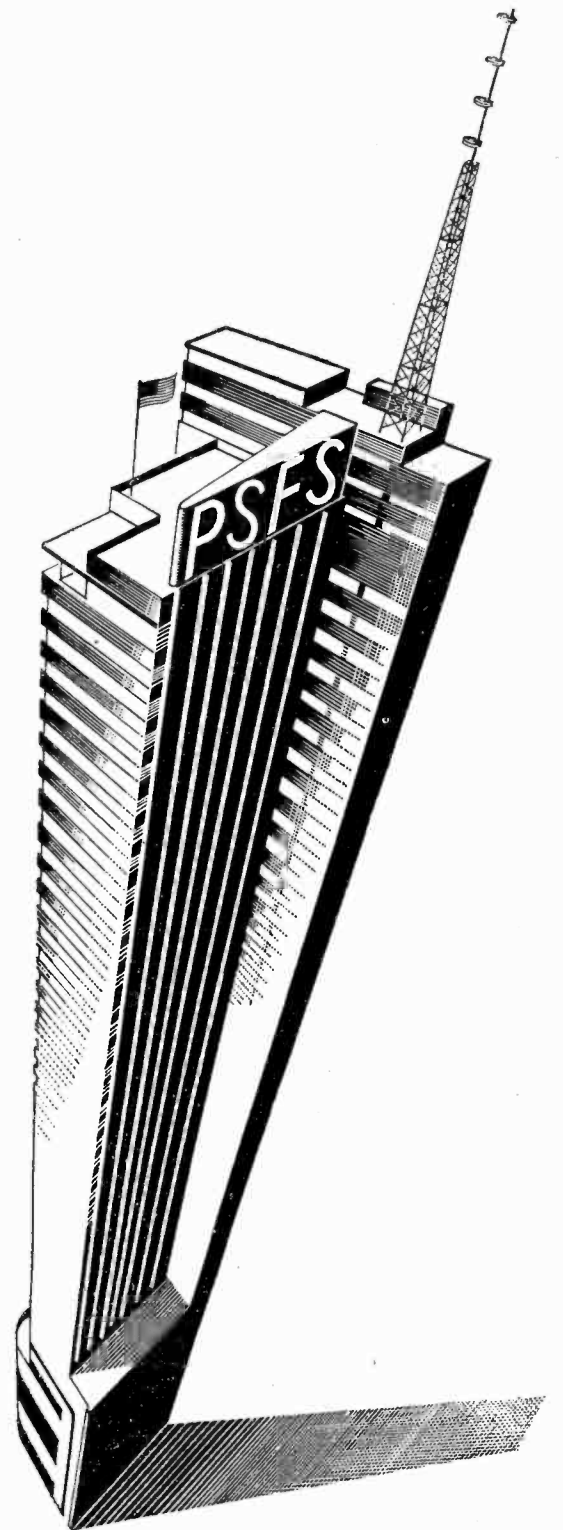

950

WPEN

258

WPEN-FM

The EVENING BULLETIN STATIONS

NATIONAL REPRESENTATIVES
HEADLEY-REED COMPANY

New York • Chicago • Detroit • Atlanta
San Francisco • Los Angeles

BROADCASTING... at deadline

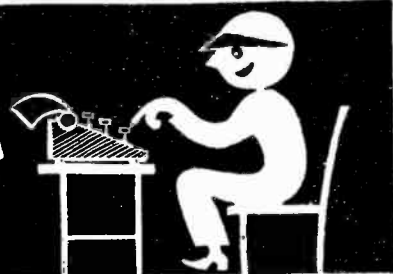

Closed Circuit

ROBERT H. HINCKLEY, who resigned as U. S. Director of Contract Settlement to become ABC vice president and director, actually will become Washington vice president of network. After breaking in for few weeks at New York headquarters, he will be permanently stationed in Capital. Kenneth H. Berkeley, WMAL general manager and Washington manager for ABC as sideline, will continue in that capacity.

STEPHEN R. RINTOUL, radio specialist of the Katz Agency Inc., station representatives, is leaving about mid-February to enter business for himself. He will remain in radio but has not divulged plans. He recently sold WSRR Stamford to the city's only newspaper after 4½ years' operation. He has been with Katz more than eight years.

THERE'LL be another sheaf of consolidated hearings unloaded forthwith by FCC to supplement list of nearly 300 separate proceedings two months ago. With some 700 standard broadcast applications for new stations or modifications on file, FCC will designate substantial number for hearing in view of Supreme Court-Ashbacker decision requiring hearings on mutually exclusive applications.

CERTAIN FCC legal masterminds are clutching at straws again. They have plucked one isolated passage from U. S. Court of Appeals decision socking FCC on proposed deletion of WOKO Albany [BROADCASTING, Jan. 28] as giving FCC control over programs. Court majority had said in passing that in handling renewal of license, "the quality of the applicant's programs * * *" along with technical adequacy are principal elements to be considered. Actually, FCC had argued in WOKO case that quality of service was in no way involved and that revocation was premised on hidden ownership.

THOSE "I told you so" boys are gloating over their Petrillo-Miller prediction. After hearts and flowers meeting of AFM and NAB presidents fortnight ago, Petrillo promised promptly to name radio negotiating committee. It hasn't happened yet, which was exactly what old-timers forecast.

ABC reported about to enter publishing business as angel for a fan magazine to be called *The Listener* which network's affiliates would distribute locally.

ENACTMENT of labor legislation stands better chance in Congress than it has for 13 years, say those in the know. Senate Education & Labor Committee may come up with stiff bill in the next fortnight. Many House members who voted for Case bill consideration last week reported wavering under flood of protesting telegrams from CIO and kindred sources, but dope is both Houses are "fed up" and will pass legislation to unyoke production. That goes double for Mister Petrillo.

WASHINGTON originated video series being planned by Red Cross under Publicity Direc-

(Continued on page 86)

Upcoming

Feb. 4: North American Regional Broadcasting Engineering Conference opens 11 a.m. Dept. of Commerce auditorium, Washington.

Feb. 11-12: NAB Joske Radio Advisory Committee, NAB hdqrs., Washington.

March 11: Hearings on FM applications before FCC Com. Durr, Boston.

(NAB District Meetings, page 83)

Bulletins

WILLIAM N. DAVIDSON and STANLEY SCHLOEDER, return from service to J. Walter Thompson Co., New York, as associate timebuyer and head of radio estimating contract division, respectively.

WILLIAM S. PALEY, chairman of board of CBS, named chairman for radio of American Brotherhood Week, Feb. 17-24, with network Presidents Niles Trammell of NBC, Mark Woods of ABC and Edgar Kobak of MBS assisting him on radio committee.

GLEN McDANIEL, New York and Washington attorney who resigned Jan. 15 as head chairman of Navy Board of Contract Appeals, appointed general counsel of RCA Communications, succeeding the late Frank B. Warren.

CAB DOUBLES BUDGET FOR 1946 OPERATION

FIRST-QUARTER budget said to be nearly 50% greater than similar period of 1945 approved last week by Board of Governors of Cooperative Analysis of Broadcasting. CAB released no report of budget figure. Increased appropriation understood to be in line with CAB's announced policy of expanded services for 1946.

Board authorized Chairman Bernard C. Duffy to appoint committee to study and report on future objectives, technical and administrative policies. Committee is in addition to another committee appointed some time ago to make detailed study of expansion of CAB's surveys.

PLUGS FOR PLUGS

CLIENTS of NBC Central Division are receiving receipted invoices for time costs amounting to \$628,538. The sum represents the amount of free advertising given to the sponsors' programs by WMAQ Chicago during 1945. Emmons Carlson, sales promotion manager of WMAQ, said invoices showed in dollars and cents what these "courtesy" announcements on behalf of sponsors' programs would have cost at card rates. In all, 20,593 live station breaks were aired over WMAQ in 1945.

Business Briefly

GARIS SPORTS ● Garis Sales Co., New York (hair tonic), effective March 4 starts sponsorship of Bill Stern sportscast 5-weekly 6:40-6:45 p.m. on NBC. Contract for 52 weeks. Agency, Wesley Assoc., New York.

STALEY REGIONAL ● Staley Mfg. Co., Decatur, Ill., Feb. 4 starts on *Town & Country Hour*, North Central Broadcasting System, and fed to Mississippi Valley Network, 75 stations in all, for Sweetose corn syrup. Contract for 52 weeks. Agency, Hill Blackett, Chicago.

CORONET COMMENTATOR ● *Coronet Magazine*, Chicago, replaces five-minute *Coronet Front Page*, on ABC with *Coronet Presents Chester Morris*, Mon.-Fri., 9:55-10 p.m. Agency, Schwimmer & Scott, Chicago.

STANDARD OIL ON 91 ● Standard Oil Co., San Francisco, starts thrice-daily spot announcement schedule on 91 Pacific Coast stations for 52 weeks. Agency, BBDO, San Francisco.

KATZ NAMED ● Oxford-Pyke Inc., New York, has named the New York office of Joseph Katz Co. as agency for Lord Oxford cigarette lighter. Radio will be used.

WELLES IS SPONSORED ● Former Assistant Secretary of State Sumner Welles has started Sunday evening series of commentaries on WOL Washington under sponsorship of Frank R. Jelleff Co., local department store.

LA ROCHE DENIES ABS INTEREST

CHESTER J. LaROCHE, former vice chairman of ABC, recently returned to agency field as president of LaRoche & Ellis, New York, last week denied reports he has been negotiating for control of Associated Broadcasting System, fifth nationwide network. Stating he had been involved in negotiations only as an "adviser to a friend," Mr. LaRoche asserted, "I don't propose to put any money into the network and I'm not getting any money out of it." He added, "I've been with a network and I am now back in the agency business."

MBS STAFF AWARDS

EMPLOYEES suggestion plan under which Mutual will offer rewards from \$10 to \$100 for accepted ideas to improve operations inaugurated last week. Sliding scale based on value of accepted suggestion.

ABC N. Y. THEATRE

ABC leases old John Golden Theatre on 58th St., New York, for three years. Theatre will be renamed ABC 58th Street Theatre and be completely re-equipped and air conditioned by April.

BROADCASTING • Telecasting

WTAG

THE latest Hooper Station Listening Index for October and November, 1945, shows WTAG with the largest share of audience in the morning, afternoon and evening, and a larger all-day average than all other stations heard in the area combined.

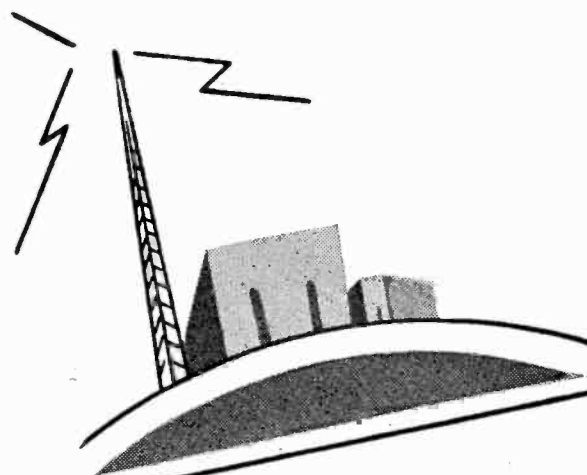

PAUL H. RAYMER CO. National Sales Representatives

WTAG



WORCESTER

OWNED AND OPERATED BY THE WORCESTER TELEGRAM-GAZETTE

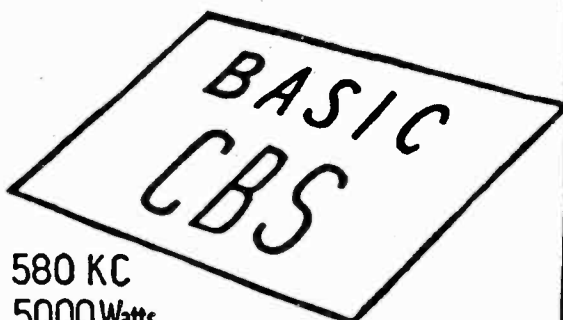

580 KC
5000 Watts

Published Weekly by Broadcasting Publications, Inc.

Executive, Editorial, Advertising and
Circulation Offices: 870 National Press Bldg.
Washington 4, D. C. Telephone: ME 1022

IN THIS ISSUE . . .

General Mills Air Budget Near 5 Million	15
KOMO Granted 50 kw	16
House May Act on Lea Bill	17
Knight Buys 42% WIND Stock	17
Eight Nations Attend NARBA Meeting	18
Conley Is Westinghouse Stations Manager	18
CBS Says Color Video Feasible in Year	20
Gibson Meets Harmco's Bid for KROY	22
Porter Says Low Frequency Video Ready	30
Public 'Disservice' Program Attacked	32
Text of Report on Lea Bill	34
WIBW Files for 540 kc, 500 kw	38
AM Decisions in Two Weeks Expected	52
Jett To Ask NARBA Expansion	60
Local News Rates in Cleveland	72
Ashbacker-Fetzer Case Still Pending	74
Ceilings Blamed for Lag on Sets	75
NAB District Meetings	83

DEPARTMENTS

Agencies	64	News	63
Allied Arts	66	Our Respects To	46
Commercial	51	Production	54
Editorial	46	Programs	68
FCC Actions	78	Promotion	62
Feature of Week	10	Sellers of Sales	10
In Public Service	57	Sponsors	58
Management	50	Sid Hix	16
Net Accounts	59	Technical	61

At Washington Headquarters

SOL TAISHOFF
Editor and Publisher

EDITORIAL

ROBERT K. RICHARDS, *Editorial Director*

Art King, *Managing Editor*; J. Frank Beatty, Bill Bailey, *Associate Editors*; Fred Fitzgerald, *Asst. to the Managing Editor*. STAFF: Jack Levy, Lawrence Christopher, Mary Zurhorst, Rufus Crater, Frank Bannister, Norma Pugliese, Adele Porter, Molly Jackson.

BUSINESS

MAURY LONG, *Business Manager*

Bob Breslau, *Adv. Production Manager*; Harry Stevens, Eleanor Carpenter, Cleo Kathas. AUDITING: B. T. Taishoff, Catherine Steele, Mildred Racoosin.

CIRCULATION

BERNARD PLATT, *Circulation Manager*

David L. Ackerman, Dorothy Young, Herbert Hadley, Leslie Helm.

NEW YORK BUREAU

250 Park Ave. PLaza 5-8355

EDITORIAL: Bruce Robertson, *New York Editor*; Edwin H. James, Florence Small, Dorothy Macarow.

ADVERTISING: S. J. Paul, *New York Advertising Manager*; Patricia Foley.

CHICAGO BUREAU

360 N. Michigan Ave. CENTral 4115
Fred W. Sample, *Manager*; Jean Eldridge.

HOLLYWOOD BUREAU

1509 North Vine St., Room 217. GLadstone 7353.
David Glickman, *Manager*; Marjorie Barmettler.

TORONTO BUREAU

417 Harbour Commission Bldg. ELgin 0775
James Montagnes, *Manager*.

BROADCASTING Magazine was founded in 1931 by Broadcasting Publications Inc., using title: BROADCASTING—The News Magazine of the Fifth Estate. Broadcast Advertising * was acquired in 1932 and Broadcast Reporter in 1933.

* Reg. U. S. Pat. Office

Copyright 1946 by Broadcasting Publications, Inc.

SUBSCRIPTION PRICE: \$5.00 PER YEAR, 15¢ PER COPY

BROADCASTING • Telecasting

WHERE?

is the
population
HERE?

OR
HERE
?

WHEN time buyers think of Nebraska markets, they think first of Omaha-Council Bluffs. It's by far the biggest, richest market in Nebraska. In fact, there are more persons (and more radio families) in the four counties comprising the immediate Omaha-Council Bluffs trade area than in three times as many counties in any other section of Nebraska or western Iowa.

KOIL delivers this rich market most effectively because it is the only station with ABC programs and news and local shows slanted specifically for this big metropolitan market. KOIL is not half farm, half city. And, it's economical, because cost per listener stays low—doesn't rise where population thins out in rural areas.

Represented by
Edward Petry Co., Inc.

GORDON GRAY
General
Manager

5000
WATTS

KOIL

1290
K.C.

Basic ABC IN Omaha

20,000
WATTS
OF
SELLING
POWER



A MARSHALL FIELD STATION REPRESENTED NATIONALLY BY LEWIS H. AVERY

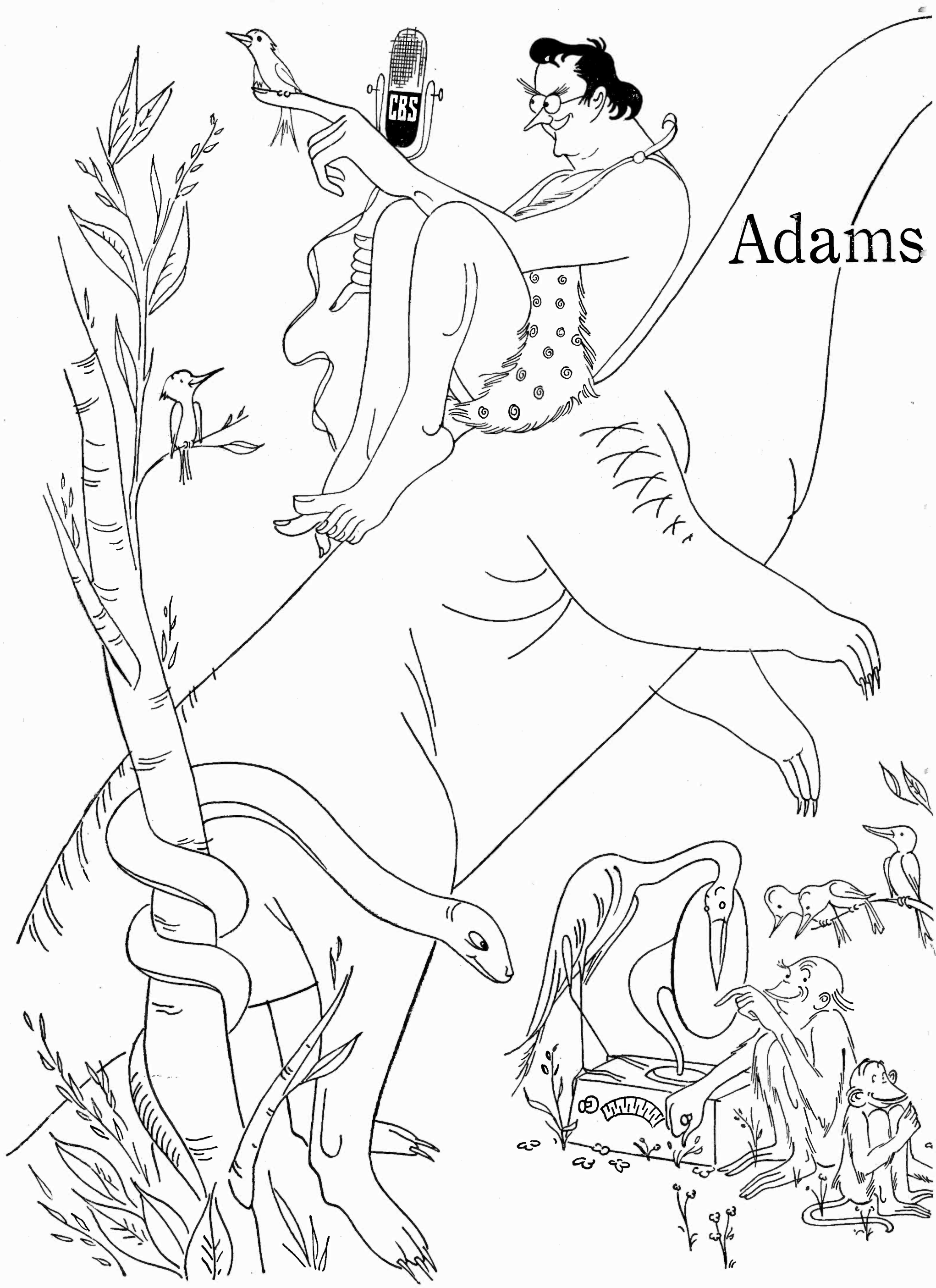

Adams

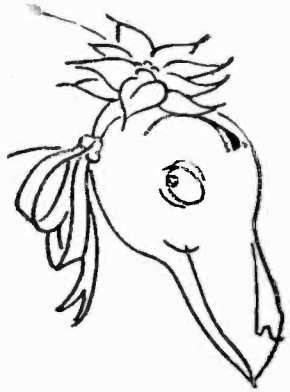

was the *first* man

... when Minnesotans voted for their radio favorites

Adam may have been the head man back in Eden...but Adams—WCCO's own Cedric Adams—is certainly head man in Northwest radio. His upward-spiralling popularity stands out every time you ask people in these parts, "What's your favorite radio program?"

The Minneapolis Star-Journal and Tribune reaffirmed that fact in its recent "Minnesota Poll"—a periodic survey covering diverse subjects of interest to Minnesota. The answers re-elected WCCO's Cedric Adams to his popularity pedestal as the leading newscaster and most outstanding radio personality in the big and prosperous Northwest.

Minnesota people voted Cedric the *highest ranking individual radio star* on the Northwest

air. He outstripped nationally-known network celebrities and programs to land No. 2 on the list—second only to *Lux Radio Theatre*, a CBS feature broadcast by WCCO. (This gave WCCO the two top places in the poll.)

With justifiable immodesty, we point out that Cedric Adams was the *only* non-network star on the whole list of eleven top favorites.† And, to make the story more complete, *five of the first eight programs* listed in the poll are heard over WCCO, indicative of the high brand of popularity we enjoy up here among the Northwest's 785,660* radio homes.

You can write your own profitable P.S. if you'll call us or the nearest Radio Sales office about the latest WCCO availabilities.

†He is also the only Northwest radio personality who is heard at least once a week by *three out of every four of the radio families* throughout...

*WCCO's Day and Night primary coverage area of 123 counties. (CBS Seventh Series Listening Areas survey, 1944, and CBS Listener Diary study, Spring, 1945)

*"Good Neighbor
to the Northwest"*

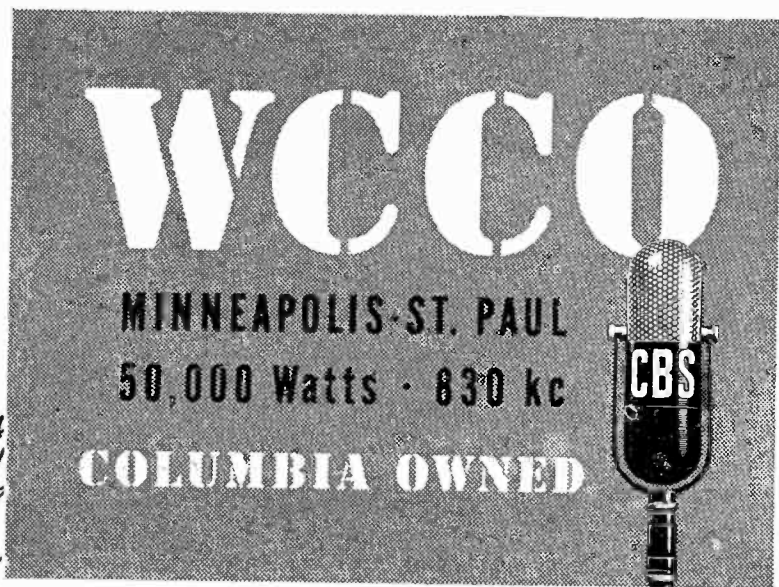

REPRESENTED BY RADIO SALES THE SPOT BROADCASTING DIVISION OF CBS
WITH OFFICES AT: NEW YORK, CHICAGO, LOS ANGELES, ST. LOUIS, SAN FRANCISCO, ATLANTA.



Puts on amazing show



Esther Van Wagoner Tufty, prominent newspaper columnist whose articles appear in 135 papers, conducts a tri-weekly forum on WVDC and the entire Associated Network. It's the only all-female forum on the air. Subjects range from atoms to zinnias.

Tufty picks the topic and invites two guests to battle it out. Recent guests have included Helen Gahagan Douglas, Mrs. Harold E. Stassen, Mrs. Clifford Durr, and other outstanding women on the American scene.

The British Broadcasting Corporation recorded several discussions and re-broadcast them in England.

The CIO asked for fifty transcriptions of one discussion to be used throughout the country. George Dixon devoted an entire syndicated column to one of Mrs. Tufty's programs. Both locally and nationally there is an ever-increasing interest in this program.

Available to a national advertiser on the entire broadcasting network, or locally on WVDC. Write Ben Strouse at WVDC for rates.

WVDC

the big sales result
station in Washington, D. C.

Represented nationally by
WEED & COMPANY

Feature of the Week

CHICAGO EDUCATORS, WLS and the *Chicago Daily Times* think they have found the solution to the old problem of making homework popular with "average" grade school students.

Since October 13, 1945, WLS and the *Daily Times* have been presenting a novel quiz program, *Radio Quiz-Down* from the Stevens Hotel and the results have been, even the joint publicity staffs admit, "sensational."

Unusual feature of *Quiz-Down* is that it is the finished product of children of grade school age. All questions are submitted by Chicago public and parochial school students in the fourth, fifth and sixth grades. Quiz-master is the famous member of ABC's *Quiz Kids*, Harve Fischman.

Instead of attempting to discover teen-age mental giants, the program restricts itself to subjects currently being studied in the three grades of school.

To be eligible for the Saturday,

10-10:30 a.m. CTS program, students must write a 100-word theme on "What I Like Best in School."

Each contestant, and there are six from each school, receive pen and pencil sets and the winners receive gold medals. The winning contestants' school receives a set of encyclopedia and an American flag.

Although the contest is open only to Chicago schools, WLS' farm audience lists it as a favorite program. It was a down-state farm boy who corrected his city-cousins about the proper place to store corn before shipping it to market. Young Fischman, who does calculus in his head, said it was a silo, but the farmer lad wrote in the correct answer, "crib." "A silo," he explained, "is for silage."

Success of the program has elicited inquiries from other newspapers, including the *Des Moines Register*, as to how they could duplicate such a program in their own communities.

Sellers of Sales

WITH EVERYONE talking about reconversion the experience of James F. (Jim) Brown, newly appointed salesman and promotion manager for John E. Pearson Co. station representative, in Chicago, should be of interest to a lot of GIs thinking about radio as a career.

Jim was a captain in the Signal Corps, attached to the 29th TAC, 9th Air Force, in Brunswick, Germany when V-E day ended the war. With six combat ribbons and 133 points he was one of the first officers to be eligible for shipment back to the states.

"After five years in the Army, two as an enlisted man," Jim says, "I was darned glad to get home. I hadn't seen my wife and two kids since going overseas in 1943 but I was also pretty confused."

Like millions of other discharged veterans, Jim wanted a job. Not a job paying \$10,000 a year, not even a job paying the same amount he was making as an officer. Just a decent living with a fair chance to prove himself. Before going into the service in 1940 as a member of the Blackhorse Troop, 106th Cavalry, Illinois National Guard, Jim had done "a little" announcing but hadn't had much of a chance to get started in business.

All he had to get him started in radio was a letter of introduction to Merritt Schoenfeld, then

assistant to Ed Borroff, of ABC in Chicago, given to him by his good friends, Ben Lyon and Bebe Daniels. He met the famous couple while in England with the 8th Air Force where he served as PRO.

The letter eventually led him to John Pearson who was looking for someone to assist him in the Chicago office. John had a lot of applicants, most of whom wanted to

make a lot of money without much qualification. Jim Brown got the job because (1) he talked about the job and not just about money, and (2) he applied for it on the basis of a civilian looking for a chance to make good.

"I was interested in the reaction of civilians to a newcomer to the representative field. I'd heard a lot of talk overseas, some of it which wasn't very good," Jim says.

"But of the scores of people I've met, I've yet to meet anyone who wasn't friendly and sincerely anxious to see me get off on the right foot."

As a discharged veteran and officer, Jim feels qualified to give his fellow officers a word of advice on their own reconversion problems. The first is to "forget your rank."

"Job hunting is just about like it was before the war. An employer wants to get the best man for the job. He either has to have experience, or he has to be willing to

(Continued on page 76)

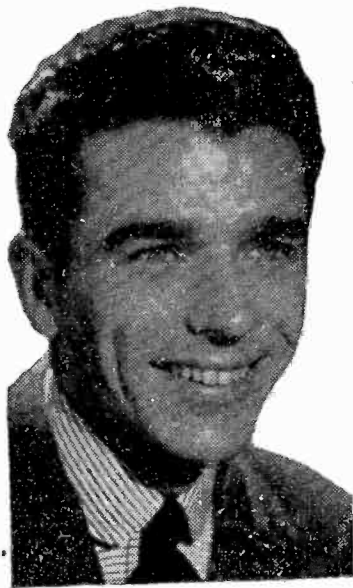

JIM

Sell WITH

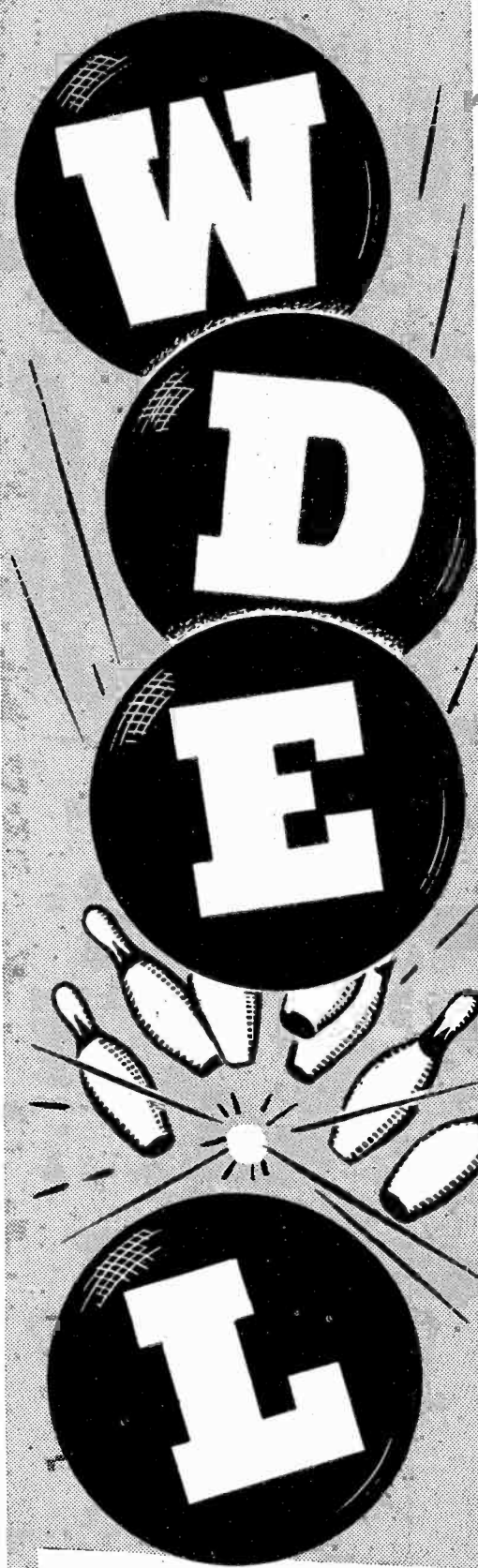

WILMINGTON DELAWARE

NBC Basic Station

5000 WATTS day and night

Represented by

RAYMER

What is a Radio FARM DEPARTMENT?



Sam Schneider, Farm Service Director of KVOO, interviews a homemaker regarding her home canning, which she has exhibited at one of the many Fairs covered by KVOO.



Back of the steer, he has just selected as the Grand Champion, stands Dean W. L. Blizzard, nationally-recognized judge of cattle. On his left is Schneider, Farm Service Director of KVOO with his microphone to broadcast the results to the southwest.

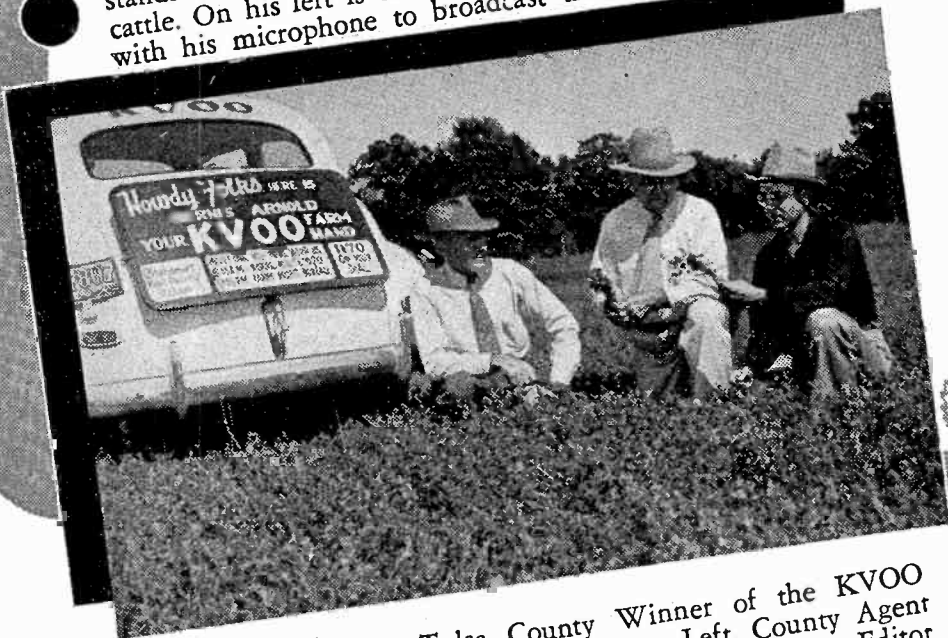

Center, Ernest Ownby, Tulsa County Winner of the KVOO Annual State Pasture Improvement Contest. Left, County Agent O. J. Moyer and right, Burnis Arnold, Associate Farm Editor of KVOO.

That's a fair question! What *is* a radio farm department? Is it made up of ballyhoo and claims for the consumption of the general public, or is it an *Honest Farm Service* department whose trained personnel consults with farmers and farm families about their daily problems . . . that broadcasts to farmers correct, dependable information about crop, weather, stock and other vital problems whose proper understanding and interpretation means money in the bank?

Is it the day by day *personal* cooperation in the field that helps a farmer transform tired, worn-out land into rich, fertile soil . . . that stops erosion . . . sets new standards of life on the farm and keeps the farmer happy and proud of his important place in the American way of life?

The KVOO FARM DEPARTMENT, Oklahoma's *first* in age, and *first* in choice of listening farmers, is dedicated to the firm belief that service is the keynote. We've operated on that plan since inception of the department nearly five years ago . . . long before any other Oklahoma station recognized or considered the need for a farm department. That's why farmers in Oklahoma, Southern Kansas, Southwest Missouri and Western Arkansas *depend* on KVOO Farm Department programs for *complete* farm and weather information.

At KVOO, it's SERVICE—not ballyhoo—in our Farm Department because it is Dedicated to a More Permanent and Prosperous Southwestern Agriculture!

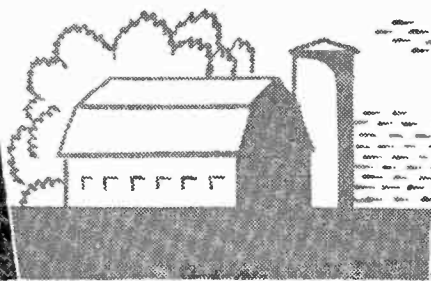

Beginning February first, KVOO's twice weekly remote broadcasts from the A. & M. College at Stillwater, Oklahoma, will be expanded to 6 programs per week from KVOO's new College studios. This is in response to many requests from farmers throughout the State.



You Can't Fool The Neighbors And KFNF

"The Friendly Farmer Station"

During November 1945

Carried

391 Spot Announcements

411 Participating Announcements

558 Commercial Quarter Hours

FOR LOCAL and REGIONAL SPONSORS

1360 INDIVIDUAL BROADCASTS, SPONSORED BY BUSINESS MEN WHO KNOW KFNF INTIMATELY—WHO APPRECIATE, AND VALUE, THE SIZE AND LOYALTY OF THE KFNF AUDIENCE, FROM PERSONAL KNOWLEDGE.

**Before Buying any Station—To Reach the Farm Market Around Shenandoah, Iowa
Be Sure—Find Out For Yourself Why So Many Home Folks Say—**

INFORMED SPONSORS BUY

KFNF

920 Kc

Shenandoah, Iowa

1000 WATTS

FOR AVAILABILITIES—WRITE OR WIRE—FRANK STUBBS, SHENANDOAH, IOWA



LT. COL. JOHN H. DeWITT

Congratulations, Jack!

Your successful transmission of a signal to the moon has fired the imagination of the world. As for us, we were not greatly surprised—for we rather felt that one day we'd be acknowledging your fine ability just as we're doing now . . .

Working with you these many years has always been a privilege . . . Now it's something to boast about . . .

Good luck . . .

Your friends at





Two years, Temple University
 Three years, Dickinson School of Law
 Seven years, Law Practice
 Two years, Partner, Lawrence & Mitchell, Public Relations
 Free & Peters (New York Office) since May, 1944

Look who's
 here —

FRED W. MITCHELL!

The day we first met Fred W. Mitchell, we knew we had discovered a *good man*, with a highly promising potential as an F&P Colonel. Fred had had years of successful experience as a lawyer, plus considerable background in public-relations work, which included a good deal of creative selling. So we quickly lured him into our shop, to work with you and us!

Yes, we're pretty proud of our ability to pluck *good men* from other industries and businesses. Among our Colonels we number successful men from manufacturing

organizations, the petroleum industry, mail-order houses, newspapers, advertising agencies, financial institutions, publishing companies and many others. The result is more than an organization of individual winners—it's a great *team* whose combined experience goes right across the board of American enterprise.

Possibly that's why we've made such strides during these years since first we hung out our shingle in 1932. Certainly it's the way we *like* to progress, here in this group of pioneer radio-station representatives.

EXCLUSIVE REPRESENTATIVES:

WGR-WKBW BUFFALO
 WCKY CINCINNATI
 KDAL DULUTH
 WDAY FARGO
 WISH INDIANAPOLIS
 KMBC KANSAS CITY
 WAVE LOUISVILLE
 WTCN MINNEAPOLIS-ST. PAUL
 WMBD PEORIA
 KSD ST. LOUIS
 WFBL SYRACUSE

... IOWA ...

WHO DES MOINES
 WOC DAVENPORT
 KMA SHENANDOAH

... SOUTHEAST ...

WCBM BALTIMORE
 WCSC CHARLESTON
 WIS COLUMBIA
 WPTF RALEIGH
 WDBJ ROANOKE

... SOUTHWEST ...

KOB ALBUQUERQUE
 KVAL BROWNSVILLE
 KRIS CORPUS CHRISTI
 KXYZ HOUSTON
 KOMA OKLAHOMA CITY
 KTUL TULSA

... PACIFIC COAST ...

KOIN PORTLAND
 KIRO SEATTLE
 and WRIGHT-SONOVOX, Inc.



FREE & PETERS, INC.

Pioneer Radio Station Representatives
 Since May, 1932

CHICAGO: 180 N. Michigan NEW YORK: 444 Madison Ave. DETROIT: 645 Griswold St. SAN FRANCISCO: 58 Sutter HOLLYWOOD: 6331 Hollywood ATLANTA: 322 Palmer Bldg.
 Franklin 6373 Plaza 5-4130 Cadillac 1880 Sutter 4353 Hollywood 2151 Main 5667

BROADCASTING

VOL. 30, NO. 5

WASHINGTON, D. C., FEBRUARY 4, 1946

\$5.00 A YEAR—15c A COPY

General Mills Air Budget Near \$5,000,000

Half Advertising Fund To Go For Radio Time

By FRED SAMPLE

GENERAL MILLS will spend upwards of \$5,000,000 in radio in 1946—making it one of the top broadcasting time buyers in the nation.

Approximately one half of its budget will be diverted to broadcasting, with the remaining half spread over the various visual media.

And something else will happen this year that is equally significant to the geniuses who have guided the General Mills advertising program. In 1946, a "career woman" who never comes out of the kitchen will observe her "Silver Anniversary."

McMein Conception

She is Betty Crocker of General Mills and she has spent 25 years serving the homemakers of America. While she, herself, is a composite, intangible figure, the evidence of her popularity is highly tangible. Today Betty Crocker is ranked as the No. 1 home service personality by all groups of housewives. Next to Mrs. Roosevelt, she is probably the best known woman in the United States.

Radio has loomed large in building her success. Last year she helped her sponsor roll up a whopping sales volume of \$281 million.

Betty's corporate being belongs to Sam Gale, vice president and ad-

vertising director of the great milling company in Minneapolis. Her face is the conception of Neysa McMein, artist who painted the familiar portrait that adorns General Mills' advertisements and packages. "The woman behind Betty Crocker" is Mrs. Marjorie Childs Husted, director of General Mills' Home Service Department since 1926. She is Betty the career

THEY will spend nearly \$5,000,000 in radio during 1946; they are pioneers in broadcasting, and their name is synonymous with their most famous radio character—Betty Crocker; they stand first among advertisers of cereal grain products, second among all food advertisers. This is the radio story of General Mills.

woman, expert cook, and housewife. Other portions of Betty's composite personality belong to Dr. Lela E. Booher, General Mills' head nutritionist, who is Betty the scientist, and to Mrs. Betty Lutz Bucholz, who is Betty the radio star, heard daily from Chicago over the networks of NBC and ABC.

Betty got into radio on the ground floor, with a local program over WCCO Minneapolis (the creation of a former company president, Donald D. Davis), back in 1924 for Washburn Crosby, General Mills' predecessor, giving cooking recipes and good housekeeping advice. Her first broadcast drew a score of letters. Today she keeps a staff of girls busy opening the 1000 or more letters she receives daily

and answering the multitude of requests ranging from how to bake a lemon chiffon pie to what to do about a philandering husband. The latter question she tactfully avoids.

A year after she made her debut on WCCO, which was then a Washburn Crosby owned station, Betty had become so popular with Northwest ladies that the company bought her a program on WGR Buffalo and a little later on 12 other stations, including WEA, KSD, WTAM, WWJ, WDAF, and KFI. With the advent of Betty on a nationwide basis, the sponsor began to experience difficulty with her changing voice, as each station aired its own Betty Crocker radio personality. Listeners served by two or more stations carrying Betty complained of imposters and the stations themselves frequently failed to guarantee time. The problem was solved by securing one Betty, Mrs. Bucholz (then Betty Lutz), and signing a contract with NBC for a 16 station network, at a total cost of \$21,000. Betty became NBC's third client on a continuous basis. Today hers is the oldest continuous daytime program on the air.

Other shows followed rapidly. Today, with respect to radio, General Mills ranks fifth among all advertisers, second among all food advertisers (General Foods is first), and first among all advertisers of cereal grain products.

With advertising, as well as with all company functions, it has always been the policy of General Mills' management (Chairman



Betty Crocker

As visualized by Artist Neysa McMein

James F. Bell, President Harry A. Bullis) to pick well-qualified people, delegating them plenty of responsibility together with the authority necessary to do the job.

Three agencies, for example, are directly responsible for the advertising of the company's well known products: Dancer-Fitzgerald-Sample, Chicago (Gold Medal Flour, Cheerios, Kix, and Softasilk Cake Flour); Knox Reeves, Minneapolis (Wheaties, Bisquick, Betty Crocker Soups, and baker promotions); and Batten, Barton, Durstine & Osborn, New York and Minneapolis (institutional advertising and home appliances).

The "Kitchen-tested" Gold Medal Flour slogan, which was substituted (Continued on page 70)

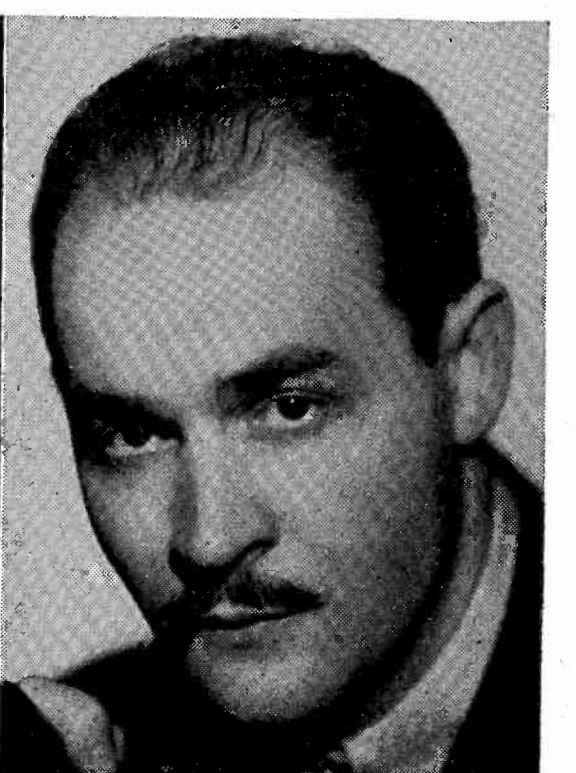
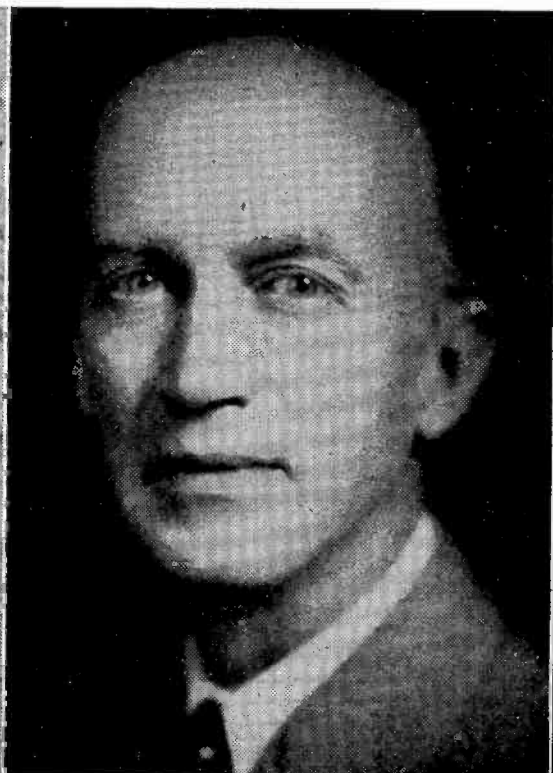

"GENERALS" of General Mills include the four shown above (l to r): Mrs. Marjorie Childs Husted, director of the Home Service Department;

Samuel C. Gale, vice president and advertising director; Dr. Lela E. Booher, head nutritionist; Edward G. Smith, radio program supervisor.

Music Negotiations Await Committees

Miller to Name Group After Action by Petrillo

APPOINTMENT of the AFM negotiating committee to meet with a similar group from the broadcasting industry was expected momentarily Friday as activity in the music situation centered on the Lea bill to curb the AFM (see story page 17).

James C. Petrillo, AFM president, was understood to have named his committee and to have prepared a letter of transmittal to Justin Miller, NAB president, in line with the agreement reached by the two at their Jan. 18 meeting in Chicago. Actual appointment of the AFM group was held up, it was believed, by the AFM head's desire to submit the matter to Joseph A. Padway, AFM and AFL counsel. Mr. Padway has been attending the AFL international executive board meeting in Miami.

The Industry Music Committee and President Miller have not yet named the broadcast negotiating committee to meet with the AFM group in an effort to reach an agreement on policies governing negotiation of local music contracts. The broadcast group will probably consist of nine or ten broadcasters representing all segments of the industry and familiar with music problems. Naming of the group has been held up pending action by Mr. Petrillo, who had indicated at the Jan. 18 meeting that he would make his appointments at once.

NAB headquarters in Washington is digesting replies from a questionnaire survey of stations on their music employment. Figures heretofore available are believed to be hopelessly antiquated and not indicative of the actual number of musicians employed as well as the amount spent for music. Better than a fourth of stations in the country have not sent in their questionnaires.

Wilder Office

NEW YORK offices of Col. Harry C. Wilder's four-station chain were opened last week to divert a greater stream from New York's advertising toward his stations. The new office, situated in Suite 901 of the Chrysler Bldg., will be under the direction of B. M. Middleton, administrative assistant to Col. Wilder. Mr. Middleton, who served in the Army, was sales manager of WABC New York before the war.

Lady Esther Renews

LADY ESTHER Ltd., New York (Lady Esther face cream), for 13th consecutive year renews its contract with CBS, continuing sponsorship of *Screen Guild Players* on Feb. 11 for 52 weeks, Mon. 10-10:30 p.m. Agency is Biow Co., New York.

KOMO Granted 50 kw; First U. S. Use of 1550 kc Approved

GRANT of 50 kw power on the Class I-B clear channel 1,000 kc, assigned to XEOY Mexico City, Mexico, was made by the FCC last Wednesday to KOMO Seattle, which now operates with 5 kw on the same frequency. The grant requires installation of a directional antenna for night use and provides that there shall be no interference with the Mexican station, which is stepping up its power from 10 kw to 50 kw. WCFL Chicago also operates as a Class I-B station, with 10 kw power, on the frequency.

The KOMO authorization was among 20 actions taken by the Commission, which included a grant for a new daytime local station on a hitherto unused frequency and designation for hearing of 17 applications for new standard stations or changes in facilities.

The one grant for a new station was made to Associated Broadcasters Inc., Indianapolis, for use of 1550 kc, also a Class I-B clear channel, which is used by CKTB St. Catherines, Ont. It was the first authorization for 1550 kc in the U. S. There are still six applications pending for the channel.

Associated Broadcasters operates the FM station WABW Indianapolis. Principals are M. J. McKee (34%), R. M. Crandall (27%), M. R. Williams (11½%), Thos. Kurrie (13½%) and B. L. Tamney (13½%). Mr. McKee is a director of Automobile Underwriters Inc., Union Trust Co., and Radell Corp. (radio equipment) and is president of the Medical Arts Bldg. Mr. Kurrie is a member of the law firm of Taylor, Kurrie & Quinn and has interests in Tripp Warehouse Co. and Andrews Oil Co. Mr. Tamney, prior to joining the Air Corps, was sales supervisor of Rodefeld & Co., radio distributors.

Among cases designated for hearing was an application for a new station by Van Curler Broad-

casting Co., Albany, N. Y. Along with four other applicants with which the case will be heard, Van Curler seeks the use of 1460 kc, the frequency now occupied by WOKO Albany. WOKO was denied renewal of its license by the FCC but the U. S. Court of Appeals reversed the Commission's action [BROADCASTING, Jan. 28]. Final action on the five applications must therefore await the outcome of the case in the Supreme Court.

Other applications designated for hearing were: Bay Broadcasting Co., Sandusky, Ohio, to be consolidated with other Sandusky applications for use of 1450 kc; KTSA San Antonio for increase in nighttime power, to be consolidated with interrelated cases scheduled for hearings Feb. 25 to March 8; Liberty Broadcasting Co., Pittsburgh, Pa., for new daytime station on 730 kc, 1 kw; KROY Sacramento, Cal., for change in frequency and more power, to be consolidated with other applications.

Also designated for hearing were Four Lakes Broadcasters, Madison, Wis., for new station on 1600 kc, 1 kw, unlimited, DA, to be consolidated with other applications; Orlando Daily Newspapers Inc. and Fred W. Mizer, both applying for new stations on 990 kc in Orlando, Fla.; Midstate Broadcasting Co., Peoria, Ill., and Lake Broadcasting Co., Gary, Ind., both applying for new stations on 1560 kc; Chester E. Daly, Cleveland, Ohio, and Samuel R. Sague, Cleveland Heights, Ohio, both applying for new local stations on 1490 kc; Tuscaloosa Broadcasting Co. and West Alabama Broadcasting Co., both seeking new local stations on 1450 kc in Tuscaloosa, Ala.; Easton Publishing Co., Easton, Pa., Louis Windmuller, Allentown, Pa., and Steel City Broadcasting Co., Beth-

(Continued on page 69)



Drawn for BROADCASTING by Sid Hix

"I sure wish the Navy'd get off that 540 channel."

Porter on Truman Top Strategy Board

One of Seven New Dealers Appointed by Hannegan

FCC CHAIRMAN Paul A. Porter is one of the group of seven "bright young men" of the New Deal who will sit on the top strategy board for the Truman administration, establishment of which was attributed last week to Robert E. Hannegan, Democratic National Committee Chairman and Postmaster General.

Mr. Porter declined to comment but it was felt that pressure of business at the FCC would leave him little or no time for extracurricular activities.

A sequel to reports current the past few weeks [BROADCASTING, Dec. 10, 1945] speculating upon appointment of Chairman Porter as top administrative assistant to the President with headquarters at the White House, the new "kitchen cabinet" will consult unofficially with Mr. Hannegan in devising legislative and party strategy. Mr. Porter persuaded the President he could serve the country and the administration more effectively by continuing his chairmanship at the FCC when proffered the White House post. He served as publicity director of the Democratic National Committee during the fourth term Roosevelt campaign.

Other members of the unofficial Hannegan committee are:

Edward F. Prichard Jr., former assistant to Secretary of the Treasury Vinson, who was named general counsel of the Democratic National Committee last week.

Leon Henderson, former Price Administrator, who will serve in an advisory capacity. He tried out on MBS as a news commentator a couple of years ago.

Robert R. Nathan, who recently resigned as deputy to John W. Snyder, Reconversion chief, and who entered an economic practice.

Other members of the "team" probably soon will be designated. Already sitting on the Hannegan "kitchen cabinet" are Sam A. O'Neal, Democratic Committee publicity director, who succeeded Mr. Porter in that capacity; Gael Sullivan, of Chicago, recently named Second Assistant Postmaster General, and Josiah E. DuBois, Treasury Department official.

Auto Wreckers Test

NATIONAL AUTO WRECKERS Assn., Washington, will place a dealer co-op test program in 20 markets for 13 weeks beginning in mid March. Titled *Pappy Howard's Good Morning Show*, series is transcribed, with open ends for local commercials. Deal was set by Al Llewelyn, radio consulting and publicity service, Cleveland, and produced by L. A. Gifford. Agency is Ohio Adv., Cleveland.

House May Act on Lea Bill This Week

Report Makes Scathing Attack on AFM And Petrillo

(Text of Lea Report, page 34)

CONGRESSIONAL impatience with the aggravated labor situation was reflected last week when the House fired a double blast in an effort to straighten out the labor-management tangle.

On Thursday morning the Rules Committee voted overwhelmingly to report out the Lea bill to prevent coercive practices against radio, clearing the way for immediate floor consideration this week.

On Thursday afternoon the House, by a 258-114 vote, adopted a rule to bring out more sweeping legislation on a wide scale, proposed by Rep. Francis Case (R-S.D.) in HR-5262, a substitute for HR-4908, the Fact-Findings bill.

Overall Labor Aspects

While the Lea bill was aimed primarily at James Caesar Petrillo and his American Federation of Musicians, the Case bill would cover overall labor aspects. It would afford protection both to broadcasters and unions in event of breached contracts or threatened strikes. It would affect negotiations between stations and AFRA, NABET, IBEW and other unions dealing with radio, whereas the Lea bill, designed as an amendment to the Communications Act, would affect primarily the AFM.

The Case bill would set up a mediation board which would attempt to bring disputants together. It would require a five-day strike notice. The board could assume jurisdiction, however, and order the status quo for 30 days. Civil damage suits for violation of labor contracts are provided. Supervisory employes would be excluded from protection under the Wagner Act.

Under the House program the Case bill was to be debated Friday. It was to be read today for amendments, with a vote to follow.

The Lea bill is expected to be brought out Tuesday. In view of the sentiment expressed in the House on the Case bill, proponents of the Lea measure were confident Friday that the House would pass the Lea bill in short order, although attempts to amend it by taking out the sting of its penal provisions are expected from the floor [BROADCASTING, Jan. 28]. The Rules Committee adopted a rule to limit general debate to two hours and debate on the rule to one hour, which means the bill could be passed the day it comes up.

In a scathing denunciation of Mr. Petrillo and his AFM, the House Interstate & Foreign Commerce Committee filed its report last Tuesday on HR-5117, urging immediate passage. The Committee earlier had voted 14-5 to report the bill favorably.

Charging that the "makeup and

operation" of the AFM "scarcely justifies its classification as a labor union," the House Committee cited incident after incident in which networks and broadcasters were literally brow-beaten into paying an annual tribute estimated at \$20,000,000 to the Petrillo union.

By-laws of the AFM "empower its president to promulgate and issue executive orders 'which shall be conclusive and binding upon all members and/or locals'", the report said, quoting from the union's by-laws. "The Federation thus composed is so organized that its membership has little control over its management or policy," the Committee asserted.

Applicants for membership in the AFM are received "without conforming to any qualification of a musician," the Committee charged. "Only about one-third of them make their living primarily by musical service."

"Broadcasting has become one of the great industries of our time," the report continued. "It is now one of the chief means of communication of our nation. It is one of our greatest implements for free speech. . . . In recent years the broadcasting industry has been subjected to extortionate demands by coercive methods which increasingly threaten to restrict and han-

dicap it in performing its rightful functions to the nation."

The Committee laid the blame for the majority of demands on broadcasters squarely on Mr. Petrillo's shoulders, and pointed out that the "voting privileges of members are so allocated as to permit a minority domination through grossly unequal allotment of voting power."

Through "coercive efforts including boycotts and strikes and threats of boycotts and strikes against broadcasters," networks and others who furnish materials for broadcast, radio has been "forced to comply rather than suffer the penalization that would follow a refusal to submit to these extortionate demands" of the AFM, the report said. It set forth many of the demands made upon broadcasting by the Petrillo union.

Demands More Frequent

"Some of these demands began several years ago but in recent years they have become more frequent and for enlarged purposes and amounts," the Lea Committee reported. "The amount of money extorted from the broadcasting industry by these methods, without moral right, has reached millions of dollars in amount and if demands now pending were granted it would, by these racketeering and extortion

Knight Buys 42% WIND Stock From R. L. Atlass for \$800,000

PURCHASE by John S. Knight, publisher of the *Chicago Daily News* and other metropolitan dailies, of a 42% interest in WIND Chicago at a reported price of \$800,000, was tentatively completed Jan. 30 subject to a condition entailing FCC action.

Stock owned by Ralph L. Atlass, president and general manager of the station and a pioneer broadcaster, as well as that held by members of his family and certain associates, would be acquired if the FCC acts by March 1. The controlling interest would continue to be held by Phil K. Wrigley, Chicago chewing gum manufacturer, who owns 38%, and H. Leslie Atlass, brother of Ralph and vice president and general manager of WBBM Chicago, who owns the remaining 20%.

Notice is being given the FCC on the transaction in a pleading in which it will be contended that consent is not required under Section 310 of the Communications Act, because sale of control actually is not involved. The Commission will be asked to confirm that view by March 1. If the FCC does not confirm or fails to act by that date, either party will have the option to cancel.

There are 1197 WIND shares outstanding, of which Ralph Atlass would deliver to Mr. Knight the 357 he holds, as well as 55 shares

held by his son, Ralph Lewis; 32 by his daughter, Pauline Marie; 33 by John T. Carey, WIND sales manager; 20 by Mrs. Mabel Walker Willebrandt, Washington attorney and former Assistant Attorney General; and one each by Miss Lou Wittal, Mr. Atlass' secretary, and Milton Dreyfus. These shares aggregate 499, or approximately 42%.

Mr. Wrigley holds 465 shares and Leslie Atlass 233 shares.

Purchase of the stock is being made in the name of *The Chicago Daily News*, with Blake McDowell, attorney representing the newspaper, Mr. Atlass, and his attorney, William Friedman signing as private individuals.

Atlass To Continue as Manager

Mr. Atlass, who also owns a controlling interest in WLOL Minneapolis, said he would continue as manager of WIND, despite sale of his minority interest.

Purchase of WIND by *The Chicago Daily News* thus gives Mr. Knight a second radio interest. Publisher also owns a half-interest in WQAM in Miami, Fla., which he purchased in October 1945.

Mr. Knight is publisher of the *Miami Herald*, which is operated in conjunction with WQAM. He also is publisher of the *Akron Beacon-Journal* and the *Detroit News*, but neither has a station affiliate al-

(Continued on page 74)

IN RAPID order last week the Lea bill (HR-5117) to protect radio from James C. Petrillo's demands was made ready for House consideration this week—possibly Tuesday. The House Interstate & Foreign Commerce Committee, reporting the bill Tuesday, denounced Petrillo's AFM; on Thursday the Rules Committee voted overwhelmingly to report the bill out.

methods, require the broadcasting industry to pay tribute probably much in excess of \$20,000,000 a year for peace against these boycotts, strikes and threats."

"The perpetuation of the offenses penalized by this bill involve moral turpitude akin to that of larceny, embezzlement, the acquisition of another's property by false pretenses, racketeering and extortion," the report stated. "They are not within the legitimate activities of any organized association of individuals for the cooperative purpose of their accomplishment. The right to strike for a lawful purpose cannot be twisted into a right to combine together to commit crimes. . . ."

Calling on all branches of organized labor to "give their condemnation to such outrageous practices committed in the name of labor," the report said, "The offenses committed in the name of the AFM are a great disservice to legitimate labor organizations as well as to the public."

Wire Reproduced

Mr. Petrillo's wire to the networks in October, ordering them to employ double musical staffs if programs are duplicated on FM [BROADCASTING, Oct. 29] was reproduced in the Committee report with this comment: "The absurdity of such a demand is apparent. Two orchestras required for simultaneous broadcast would be an anomaly."

Prompt enactment of the Lea bill was urged as the "responsibility of the Congress to take effective action to stem the rising tide of unconscionable demands upon the broadcasting industry, against which, in the present state of the law, that industry is powerless to defend itself."

It was necessary to use "broad language" to make the legislation effective, the committee explanation accompanying the report pointed out. The language covers actual and threatened boycotts and actual or threatened strikes, "because these, as well as action or threatened action of like character, could well be among the means by which the coercion, compulsion, or constraint prohibited by the bill may be accomplished or attempted to be accomplished."

The Lea bill would make unlawful any acts to "coerce, compel or constrain or attempt to coerce, compel or constrain" a licensee to do the following:

- (1) Employ persons in excess of
- (Continued on page 76)

Eight Nations Attend NARBA Meeting

deWolf Will Deliver Welcome to 50 Delegates

SOME 50 delegates from eight countries were to meet in Washington this morning to begin conversations looking toward extension of the North American Regional Broadcasting Agreement (NARBA), which expires on March 29.



Mr. deWolf

Formally designated as the North American Regional Broadcasting Engineering Conference, the session was called primarily to consider demands of Cuba for use of some 20 channels in addition to those allocated under NARBA [BROADCASTING, Oct. 8].

deWolf Greets Guests

Francis Colt deWolf, chief, Telecommunications Division, State Dept., was scheduled to deliver the address of welcome. Sr. Carlos Maristany, Undersecretary of Communications for Cuba and chairman of the Cuban delegation, was to respond on behalf of the visiting nations.

FCC Commissioner E. K. Jett, chairman of the U. S. delegation, was to preside at the opening plenary session, beginning at 11 a.m. in the Commerce Department Auditorium, 14th St. between E St. and Constitution Ave. N.W. Following the two principal addresses, a permanent chairman and vice chairman for the Conference were to be elected.

It appeared likely that Commissioner Jett, because of his wide knowledge of international broadcast and telecommunications matters, would be elected permanent chairman, with Harvey B. Otterman, assistant chief, Telecommunications Division, State Dept., as permanent vice chairman. Mr. Otterman is vice chairman of the American delegation.

To Circulate Proposals

Just before noon recess proposals of the various signatory nations to NARBA were to be circulated so that delegates might have time to study them. Committees were scheduled for appointment in the afternoon plenary session. Discussions of general problems also were in order. Once the various committees were named, they will meet in closed session at FCC headquarters, 12th St. at Pennsylvania Ave. N.W., although all decisions must be made in plenary sessions.

In addition to the delegates, the British Empire designated two official observers to sit on behalf of British possessions not parties to NARBA.

Delegates were to attend from

Canada, Cuba, Mexico, Dominican Republic, Haiti and the U. S., as original signers of NARBA on Dec. 13, 1937, in Havana. Newfoundland and the Bahamas subsequently accepted the treaty and those two countries were represented.

FCC Chairman Paul A. Porter is tentatively scheduled to address the closing session, provided the Con-

ference does not last too long. It is hoped to conclude the sessions by Feb. 15.

As chairman of the U. S. delegation, Commissioner Jett will be host to chairmen of other delegations at a luncheon Tuesday at the Blair House, official Government home for visiting dignitaries.

No agenda was to be announced until the opening plenary session,

Conley Becomes Westinghouse Stations Manager, Succeeding Wailes, Resigned

JOHN B. (Steve) CONLEY, manager of KEX Portland, Ore., for the past 13 months, has been appointed manager of Westinghouse Radio Stations Inc. Mr. Conley, a Westinghouse veteran of 20 years service, succeeds Lee B. Wailes, who has resigned to accept a new assignment soon to be announced.

The reassignments, involving personnel at three stations and at broadcast headquarters in Philadelphia were announced today by Walter Evans, vice president and executive head of the company, and vice president of the Westinghouse Electric Corp. All of the shifts are intra-company and become effective Feb. 15.

Mr. Conley, a station manager for the past five years, headed WOWO and WGI Fort Wayne, from 1940 to 1945, then taking charge of KEX. He joined Westinghouse in 1925 at East Pittsburgh, where he spent 11 years in the accounting department. From 1936 to 1940 he was auditor and assistant treasurer of WRS Inc. at Fort Wayne.

A native of Irwin, Pa., Mr. Conley was educated at the U. of Pittsburgh. While in the Northwest he was American Legion radio chairman for Oregon and a member of the Chamber of Commerce, Multnomah Athletic and University

clubs in Portland. He is married and has one daughter.

Mr. Wailes had headed the WRS organization since June 1940.

F. M. (Todd) Sloan's appointment as assistant manager of WRS Inc. was announced last month. Other recent reassignments within the Westinghouse stations group was the shift of Charles S. Young to Portland, where he succeeded Mr. Conley as manager of KEX, and the reinstatement of Wilmer C. Swartley, upon his release from the army, as manager of WBZ Boston and WBZA Springfield, Mass. Mr. Young was wartime manager of the New England stations. Both he and Mr. Swartley are employees of long standing in the company.

Gwilym A. Price, executive vice president for seven months and a vice president since 1943, was elected president of the parent company. He succeeds George H. Bucher, as president, and A. W. Robertson, chairman of the board, and becomes chief executive officer, Mr. Robertson having reached the retirement age. Mr. Bucher was elected vice chairman of the board and continues as chairman of Westinghouse Electric International Co., export subsidiary. Mr. Price is expected to be elected president of Westinghouse Radio Stations Inc. at the next board meeting.



Mr. Conley



Mr. Wailes

TWO MAJOR issues face 50 delegates from 8 nations who today were to begin the North American Regional Broadcast Engineering Conference in Washington. The issues: Whether to extend the Havana Treaty (NARBA) two years when it expires March 29; how to resolve Cuba's demands for some 20 standard broadcast channels in addition to those allotted.

although it is expected that several items will be discussed. The Conference was called after Cuba submitted demands at the Rio de Janeiro Third Inter-American Radio Conference in September for use of certain clear and regional channels, particularly below 1000 kc.

Two Formal Proposals

Only Cuba and the Bahamas have submitted formal proposals, although it is expected that several other signatory nations, including the U. S., will offer certain suggestions. Both Canada and the U. S. have proposed that NARBA be continued for two years at its expiration, but Cuba has asked for a new treaty.

Cuba specifically has made these requests:

Use of 690 kc (now assigned to Canada as a I-A channel) as a I-A clear channel on the grounds that Canada did not develop the channel to its full extent within a year after NARBA became effective on March 29, 1941.

Use of 580 kc with from 5-10 kw power; 600 kc with 50 kw; 620 kc with 20 kw maximum; 640, 730, 740 and 800 kc with 50 kw (Class II stations); 860, 910 and 920 kc for Class II outlets, 20 kw maximum power; 950, 960, 1030 and 1060 kc, with power up to 10 kw.

Use of up to four of the following channels with power from 500 w to 5 kw: 660, 670, 720, 760, 770, 880 and 890 kc.

The Bahamas requests protection on 640 kc, assigned as a Class II channel to Newfoundland and the U. S.

Delegations

Delegations registered with the State Dept. as BROADCASTING went to press follow:

UNITED STATES—Commissioner E. K. Jett, FCC, chairman; Harvey B. Otterman, assistant chief, Telecommunications Division, State Dept., vice chairman; K. Neal McNaughten, engineer, Treaty Section, International Division, FCC, secretary; Miss Frances W. Simpson, Telecommunications Division, State Dept., assistant secretary; George P. Adair, chief engineer, FCC; Rosel H. Hyde, general counsel, FCC; Donald R. MacQuivey, Telecommunications Division, State Dept.

CANADA—F. H. Soward, External Affairs Dept., chairman; G. C. W. Browne, Assistant Controller of Radio; Wilbur Smith, assistant radio engineer, Dept. of Transport; Dr. Augustine Frigon, general

(Continued on page 72)

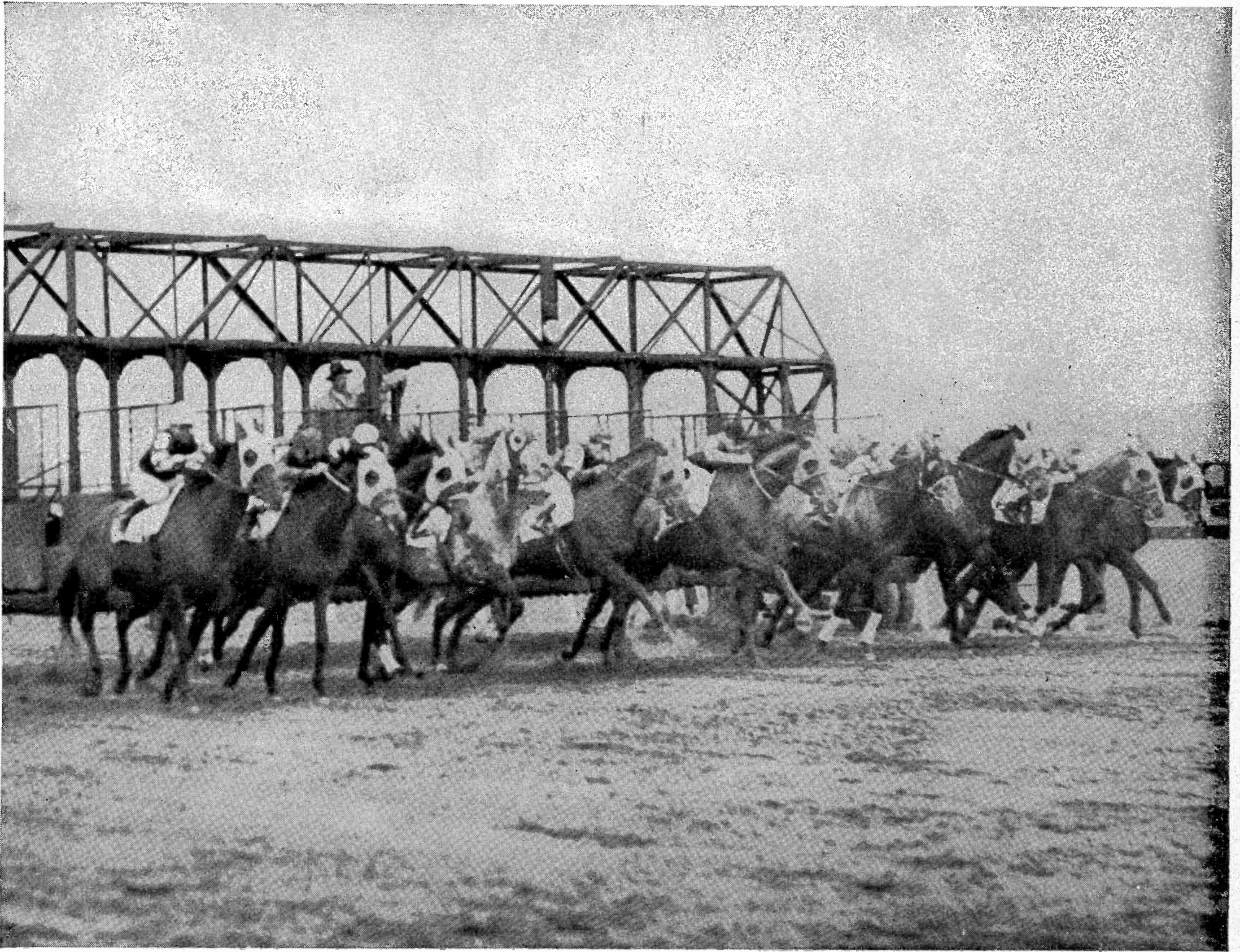

Even Start

Those ponies usually get out of the stall . . . even up.

It's the challenge . . . in the back stretch . . . then the turn for home . . . but it's the stretch run that pays off at the windows.

Amazingly enough that picture up there was shot at Pimlico. (For you fellows who don't know—that's in Baltimore, the home of W-I-T-H, the sixth largest city in the U.S.A., and where W-I-T-H delivers the largest number of listeners-per-dollar-spent.)

We hope you read the brackets, because we only started five years ago. Not quite even with the rest.

BROADCASTING • Telecasting

We did pretty well when challenged . . . and in the stretch.

Facts prove that W-I-T-H is your big buy in this big and prosperous town.



W-I-T-H

and the FM Station W3XMB

BALTIMORE, MD.

Tom Tinsley, *President* • *Represented Nationally by Headley-Reed*

February 4, 1946 • Page 19

CBS Says Color Video Feasible in Year

By BRUCE ROBERTSON

IF THE industry cooperates, full-color television broadcast on ultra-high frequencies, can be available to the public early next year, CBS executives stated last week at a press demonstration of colored images broadcast from the new CBS video transmitter in the Chrysler Bldg. and received at the network's headquarters about a half-mile away.

Demonstration subject was 16 mm film, including pictures of models displaying clothes, fabrics, chemicals, flowers, birds, children, sporting events and a portion of a Disney cartoon, with a few of the scenes shown both in black-and-white and in full color. Color quality was generally satisfactory and it was explained that any defects were due to the film and not to the broadcast transmission. How the colors are added was shown by 35 mm slide transmission.

Antenna Gain of 20

Program was broadcast by a 1 kw transmitter built and installed by Federal Telephone & Radio Corp., with an antenna designed and erected by CBS that gives a gain of 20, producing the equivalent of 20 kw output, according to Peter

New Ultra-High Showings Started; Equipment Made Since V-J Day

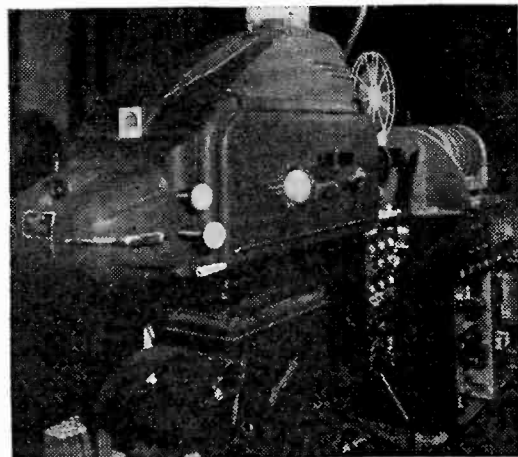

CBS FULL-COLOR ultra-high television originates with this new film pickup equipment. Arc lamp and control mechanism are in foreground. Center section contains scanning mechanism. Behind film reel is electronic dissector tube.

C. Goldmark, CBS director of engineering research and development, and inventor of the CBS method of color television.

Pictures and sound are both broadcast by a single transmitter on a single 16-mc carrier band, 480-496 mc. Colors—red, green and blue—are transmitted and received

by filter discs at the camera and receiver with each color transmitted with 525-line definition. Image is scanned by each color in rotation in 1/120th of a second, double scanning producing a full-color frame in 1/20th of a second, or 20 complete pictures a second. Sound is broadcast on the video signal in the intervals during blanking on the retrace.

Pictures were received by a movable directional antenna on the 9th floor of the CBS Bldg., well below the roofs of neighboring structures, and fed by a cable to the receiver on the 6th floor, approximating normal New York apartment conditions. Receivers, like the antenna designed and built by CBS engineers, was a direct-viewing set with a 10-inch reception tube and a thick outer glass that magnified the picture to about 12 inches. A projection receiver, with an image 16 by 22 inches, was used for the slide demonstration.

Demonstrations, heralded as the first time color pictures have actually been broadcast, rather than beamed from transmitter to re-

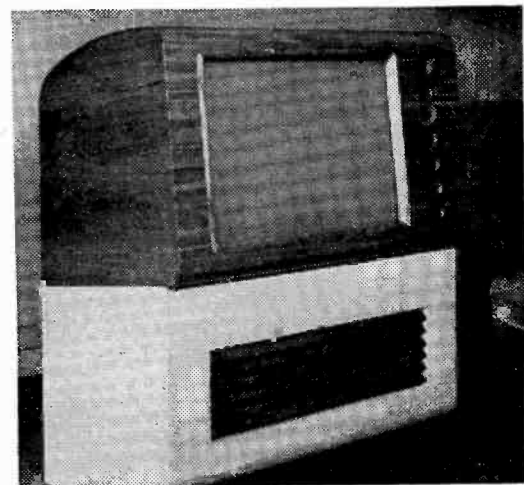

LARGE full-color television picture (22 inches wide) is projected on this CBS receiver screen. Otherwise operation is same as for smaller direct-view model.

ceiver point-to-point, will be continued on a three-a-day basis five days a week during most of February. This will afford advertisers, advertising agencies, broadcasters, transmitter and receiver manufacturers and others interested in television, as well as the press, an opportunity to see progress made since the war.

Answering claims that color television cannot be made practical in less than five years, Worthington
(Continued on page 84)

Only 2% Loss

WHAT will be the effect of AP and UP cancellation of service to the State Dept.-operated international broadcasting stations, and of INS, too, if it decides to cancel?

A survey shows that about 40% of all international programming consists of news or commentaries on the news.

Of this amount, only about one half—or 20% of the whole—is straight news.

Nearly 90% of the 20% broadcast from the East Coast is processed in the international divisions of CBS and NBC in New York—and no move has been made to deny either of these, both important clients, of the news associations.

In other words, on the East Coast—by far the most important originating point of State Dept. broadcasts because it offers service to Europe and Africa—the Government's informational service will lose, through cancellation, only 2% of its entire news schedule.

On the West Coast, in San Francisco, news services would be unavailable, however. There private operators do not lease the services for Government broadcasts.

What's Propaganda, War Censor Asks

U.S. Played News Stories Straight, Little Declares

By ROBERT K. RICHARDS

WHETHER you call the dispatches which were broadcast over international facilities under control of the Government "propaganda" or something more savory—they were taken verbatim from the news wires of United Press, Associated Press and International News Service.

That's the observation of the man who read those dispatches more critically than any other individual who scanned them—the United States wartime censor.

James S. Little, wartime Lieutenant Commander in the United States Naval Reserve, and censor in charge of all shortwave broadcasting facilities during most of the war, was asked by BROADCASTING what he thought of the altercation between the State Dept. and the AP and UP over distribution of American news service copy over shortwave stations by the Government.

"I see nothing wrong with it," he said. "The Government, during the war, took extraordinary precautions to use American news service copy verbatim. And in the vast majority of cases, the Government designated the source—

whether AP, UP or INS."

Mr. Little, now assistant to Charles Dallas Reach, who operates an advertising agency under that name in Newark and New York, pointed out that he was charged with reviewing copy for military security purposes only during the war, but naturally observed the general content of copy. He is a former AP reporter. In the latter months of the war, he saw battle service in the Pacific theatre.

Opinion Not Shared

Mr. Little's opinion obviously is not shared by Hugh Baillie, president, United Press, or Robert McLean, president, Associated Press. Both have announced their continued determination to cancel their respective gratis contracts with the State Dept.

But Wilbur Forrest, assistant editor of the *New York Herald Tribune*, agrees with Mr. Little. A member of the "news freedom" committee of the American Society of News Editors who made a world tour in 1945, he outlined his views to the New York State Publishers Assn. Jan. 31. He said he believed the Government should give the widest dissemination to news—with the proviso that each item be carefully labelled as to source.

Joseph Barnes, Director of Overseas Operations for the OWI during the war and in charge of in-

ternational broadcasting, is now foreign news editor of the *Herald Tribune*, a post he held before the conflict. During the war, it was he who wrote a memorandum to all OWI personnel insisting that all newscasts be labelled as to source.

During these developments, an ominous silence engulfed the State Dept. and the major news services in the battle of the shortwaves. After conferences with Mr. McLean and Mr. Baillie, William Benton, Assistant Secretary of State, was noncommittal—which is not at all like him.

His conversations, held Jan. 23 and 24, were followed by announcements from the news association executives, but no comment from Mr. Benton. Mr. McLean and Mr. Baillie said the services no longer would be available to the State Dept.'s shortwave informational enterprises, indicating no departure from their previously avowed policy [BROADCASTING, Jan. 21-28]. UP cancels Feb. 16. AP cancelled Jan. 16.

Benton Silent

Mr. Benton said nothing, except to confirm the AP announcement that he would address the AP board of directors April 17 on the subject of international news broadcasting.

International News Service mean-
(Continued on page 85)

CBS

STARS ARE ALWAYS SHINING OVER

Eastern Iowa VIA

WMT



“**COMING
MOTHER!**”

EZRA STONE as:
HENRY ALDRICH

*“The Aldrich Family” is a CBS-reason-why
Eastern Iowa Families keep tuned to WMT*

Come 7:00 p. m. Friday, and Eastern Iowa ears are tuned to WMT . . . for WMT means "Henry Aldrich" . . . the Andrews Sisters, Joan Davis, Phil Baker and all the other famous CBS programs brought to Eastern Iowa exclusively by WMT. Iowa's best frequency (600 KC on 5,000 watts) combined with America's best listening is the reason why WMT leads every other Eastern Iowa station in popularity—day and night. There's no better reason why WMT is your No. 1 station in Eastern Iowa . . . covering the largest population (1,200,000) of any station within its 2.5 MV line.

WMT's story is a big one to tell—and important one to hear.
Contact Your KATZ AGENCY Man at Once!

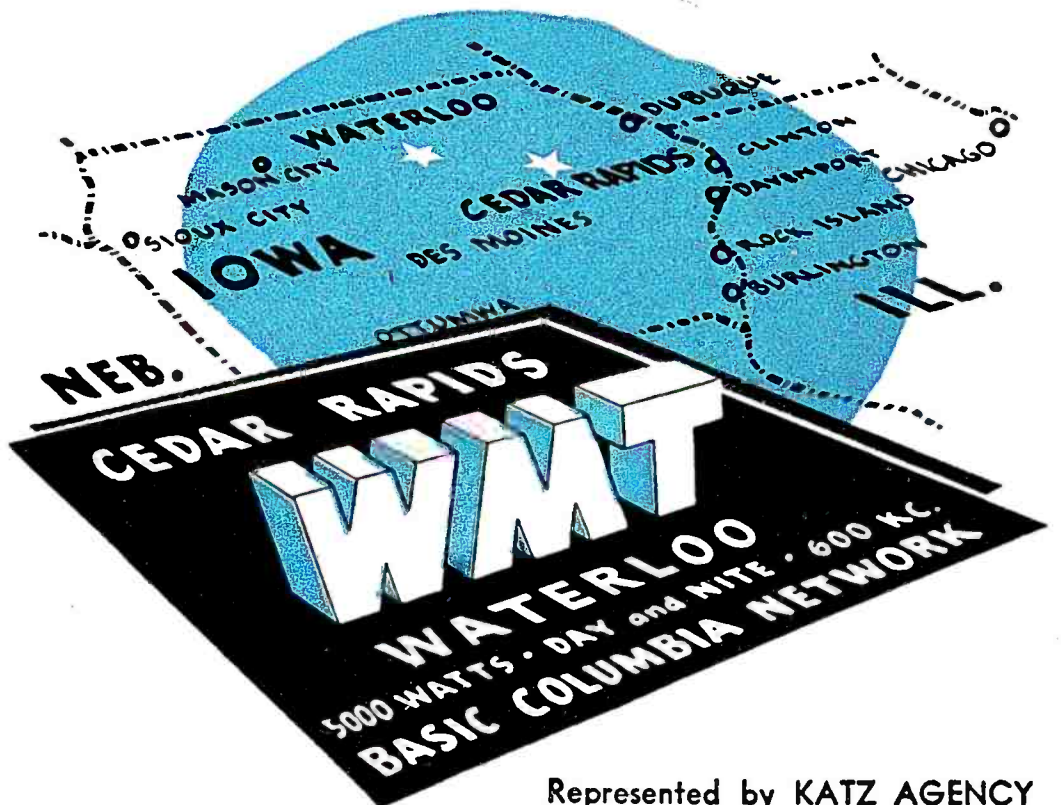

Represented by KATZ AGENCY

Rival Bid for KROY Filed by Gibson

First Competitive Offer Under 'Auction' Plan Arrives Late

FIRST COMPETITIVE bid for a station being advertised under the FCC's proposed "auction" plan was filed with the Commission last week when Luther E. Gibson, owner of KHUB Watsonville, Cal., matched Harmco Inc.'s \$150,000 offer for KROY Sacramento.

But the competitive application may have come too late. It was received by FCC on Jan. 28—two weeks after the Jan. 14 deadline set when the Commission advertised the proposed sale to Harmco last December [BROADCASTING, Dec. 3]. Whether it will be considered, FCC officials said, is a question which will be referred directly to the

Commission for an answer.

FCC authorities pointed out that the open-bid procedure, outlined first in the Crosley-Avco decision last September and put into the form of a proposed rule in December [BROADCASTING, Dec. 24], is "not as well defined as it could be" in reference to the starting time of the 60-day waiting period for competitive applications. This phase, they said, would need to be cleared up when and if the rule is formally adopted.

The proposed rule asserts that applicants in a proposed transfer or assignment must publicly advertise the terms and state that competitive bids will be accepted for 60 days from the date of the first advertisement. The rule also asserts that competitive bids will be received for 60 days from date of

filing the original application.

It was pointed out last week that, although the rule requires publication of the first advertisement "immediately following" the filing of the application, there still may be some difference between date of advertisement and date of filing—and that therefore the starting time of the 60-day period may be uncertain.

Because of this ambiguity, officials said, the Commission will be asked to decide whether Mr. Gibson's application will be considered late. The FCC's public notice on the proposed KROY-Harmco transaction stipulated 60 days from Nov. 14 as the time within which competitive applications would be accepted.

Royal Miller, Marion Miller, L. H. Penney and Gladys W. Penney,

Sun to WIND

DALE HARRISON, columnist of Marshall Field's *Chicago Sun*, Jan. 27 started program on WIND, competing station to Field's WJJD Chicago. Program is titled *Dale Harrison's Scrapbook*, 12:15-12:25 p.m. (CST). Sponsor is Gibby's Restaurant, placing for 52 weeks through United Broadcasting Co., Chicago.

a partnership doing business as Royal Miller Radio, are the present owners of KROY.

Gibson Application

In his application, Mr. Gibson, trading as Gibson Broadcasting Co., Vallejo, said that Wilton L. Gunzendorfer, now manager of KROW Oakland, and John A. Bohn, attorney, proposed to buy 24% interests in KROY with him and ultimately would be given a chance to increase their holdings to 33 1/3%. Mr. Gibson said he would then apply for transfer of license to a co-partnership composed of the three. For their 24% interests, Messrs. Gunzendorfer and Bohn would pay Mr. Gibson \$36,000 each. They also would aid in the management and operation of the station.

Mr. Gibson said he had placed in escrow \$10,000 of the proposed purchase price—the same amount set aside by Harmco pending decision on its application.

He outlined a proposed program schedule of 55% commercial and 45% sustaining operations, with 58% of broadcast time devoted to entertainment, 10.5% to news, and the rest to special events and sports, and educational, religious, agricultural and fraternal programs. He proposed no changes in construction, location, facilities, or operations "at this time."

If the Commission decides to consider the Gibson application, both it and the Harmco offer will be considered on their merits or at a hearing if necessary. Under the proposed rule, if the Commission rules in favor of the competitive application, final approval of the transfer will depend upon the competitive bidder signing an agreement with the present owners within 30 days. This agreement must be on the same terms and conditions specified in the original application "or upon such other terms and conditions as the parties may agree upon and which new terms and conditions the Commission shall find to be in the public interest."

Hearings on the proposed rule are not expected to be held before March. Briefs in opposition to its adoption are being received until Feb. 16, following which the hearing date will be set.

KOMO Moves

BUSINESS offices of KOMO Seattle, Wash., have been moved to larger quarters at 1331 Third Avenue Bldg. Studios and transmitter facilities remain at Skinner Bldg.



RAYON

by the mile is made in NASHVILLE

Rayon—such as that in this gown—is produced in great Nashville mills—employing hundreds, who help make the miles and miles of rayon needed in many post-war products. . . . Rayon workers are among the more than one million prosperous people living in the Nashville area. . . . And WSIX attracts this large audience of potential purchasers with the highest-rated programs of two networks . . . American and Mutual; gives excellent results at rates to fit your advertising budget.

**AMERICAN
MUTUAL**

**5,000 Watts
980 K. C.**



**WSIX gives you all three:
Market, Coverage, Economy**

**Represented
Nationally by
THE KATZ AGENCY, INC.**

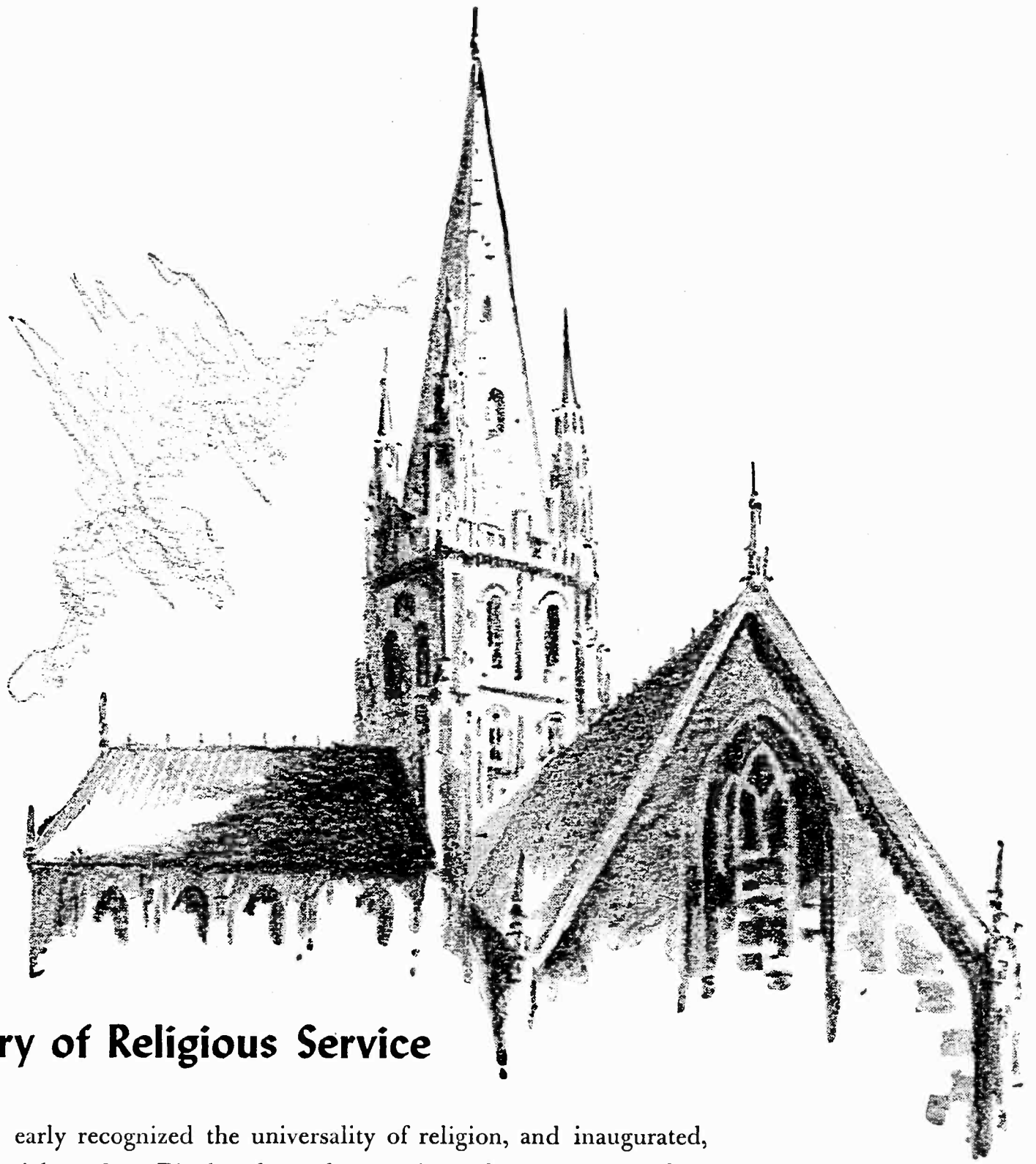

Quarter-Century of Religious Service

KDKA early recognized the universality of religion, and inaugurated, by remote pick-up from Pittsburgh's Calvary Episcopal Church, a regular church-service, on January 2, 1921. A bronze memorial in the church attests the importance of **KDKA's** contribution to religion in radio. Later in the same year, **KDKA** presented the first Catholic radio service.

TODAY, a quarter-century after its first church-broadcast, **KDKA** continues to bring the inspiration and consolation of religious services to the multitudes who worship in their homes, and hundreds of other stations do likewise . . . to serve the owners of 60,000,000 American radio sets.

RADIO knows no creed. From the beginning, the stations of Westinghouse have deemed it a high privilege to give generously of their time and facilities in broadcasting the services of all denominations.

WESTINGHOUSE RADIO STATIONS Inc

WOWO • KEX • KYW • WBZ • WBZA • KDKA

Represented Nationally By NBC Spot Sales—Except KEX • KEX Represented Nationally by Paul H. Raymer Co.



TOLEDO

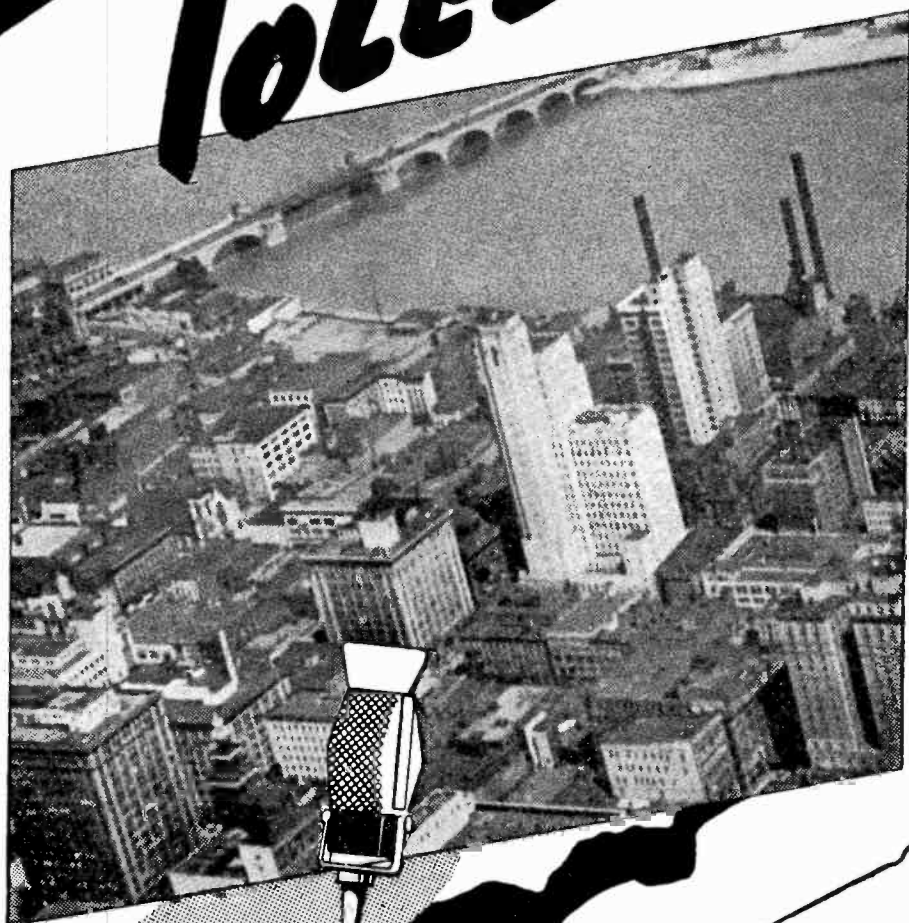

Retail sales in WSPD's Primary Coverage Area are greater than the retail sales of any of the following States:

- | | |
|-------------|-----------|
| Connecticut | Virginia |
| Kentucky | Tennessee |
| Washington | Colorado |

1370 K.C.

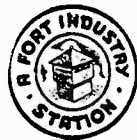

5000 WATTS

WSPD

TOLEDO, OHIO

JUST ASK KATZ



HOW THEY "shot the moon" with radar was told at the IRE convention in New York [BROADCASTING, Jan. 28] by (l to r) Herbert Kauffman, Jacob Mofsenon, radio engineers; Lt. Col. John H. DeWitt, chief engineer of WSM Nashville on leave and head of the radar "Project Diana"; Dr. Harold D. Webb; Dr. E. K. Stodola.

WILL MOON CONTACT HELP RADIO?

Little Change Expected in Immediate Future;
Long Range Effects May Be Greater

REACHING for the moon by radar has captured the public imagination, judging from the play in broadcasting and in published reports. The attention given the Army Signal Corps' accomplishment has caused some wisecracks to remark that whoever decided on contacting the moon must have had the foresight of a press agent. Would the story have been as good, they ask, if it had been the sun?

Now that the first romantic flush of the experiment has died and it is possible to clear away the avalanche of assorted labyrinthian speculations as to its significance, one question finally boils down to: What does it really mean as far as broadcasters are concerned?

The answer seems to be: Very little, as far as the immediate future is concerned. From the long range standpoint, the radar echo opens wide fields of investigation but how these would be translated only time will tell.

As a prominent radio broadcast engineer remarked: "All it proves is that you can send a signal through the ionosphere and have it come back again." There was no desire to deprecate such an achievement; the point he wanted to make was that the experiment proved radio signals are not absorbed in the vast spaces between earth and moon, which is of great scientific importance and that's all—at least for some time.

FCC Commissioner E. K. Jett regards the penetration of the ionosphere as a noteworthy achievement which should contribute to greater understanding of wave propagation. It could conceivably lead to developments making possible long-distance transmission, he feels, but is not apt to affect present-day broadcasting.

News of the moon signal furnished good program material for stations and networks, with the usual vying for beats on interviews and novel presentations. NBC car-

ried an exclusive interview with Lt. Col. John H. DeWitt, who supervised the experiment, on Jan. 25, the night after the Army announcement.

On the following Sunday, Mutual listeners heard how a radar echo from the moon sounds. The network broadcast a wire recording of the audio reception of the reflected signal received at the Army's radar laboratories at Belmar, N. J., where the experiments were conducted.

WMAQ Chicago broadcast an interview with Capt. William C. Eddy, former chief of the Navy radar training school in Chicago and now director of the Balaban & Katz television station WBKB, who saw great possibilities in the experiment in expanding the range of video broadcasting. Capt. Eddy described the radar contact as "strictly an Army show."

Here are the highlights of the week's developments following the Army announcement:

Maj. Edwin H. Armstrong, FM inventor, was revealed to have been the designer of the receiver and Dr. Frederick B. Llewellyn of Bell Telephone Labs. of the pre-amplifier unit used for the radar contact.

W. E. Osborne, a former Australian army major now conducting electronic experiments in Los Angeles, said that he and Dr. J. H. Piddington of the U. of Sydney had contacted the moon several times in Australia in October and November 1941.

G. C. Southworth, electrical engineer of the Bell Telephone Labs., reported that radio signals are being received from the sun. An unidentified Australian government scientist also reported that radar equipment had recorded "noise waves" from the sun.

Maj. Gen. George L. Van Deusen, chief of the Signal Corps' Engineering and Technical Service, announced a long range research program for radar study of the moon and the ionosphere.

MARKETS ARE PEOPLE...

and last year 285,792 people attended WGN's studio audience shows.

We are happy, naturally, to have been able to entertain over a quarter of a million studio guests in 1945. Add to that number the listening audience of these top radio productions and you'll have the receptive ear of the 2nd largest market in America.

And WGN, using Chicago talent, will continue to offer Chicago and the middle west its share of studio audience shows in 1946.

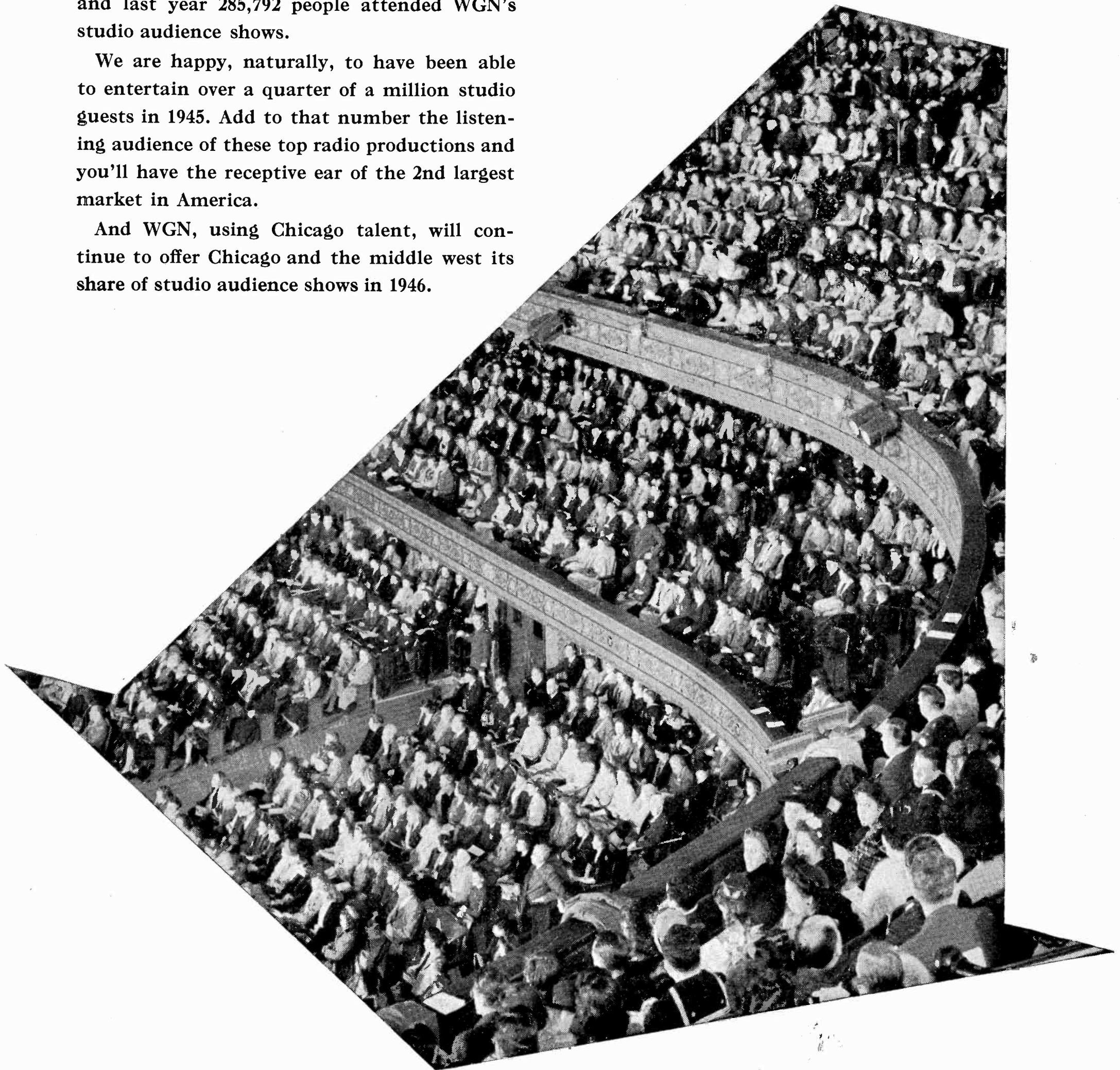

A Clear Channel Station

WGN

CHICAGO 11
ILLINOIS
50,000 Watts
72
On Your Dial



Serving the Middle West

MUTUAL BROADCASTING SYSTEM

Eastern Sales Office: 220 East 42nd Street, New York 17, N. Y.

West Coast: Edward S. Townsend Co., Russ Building, San Francisco, Cal.

WELL

this team could do

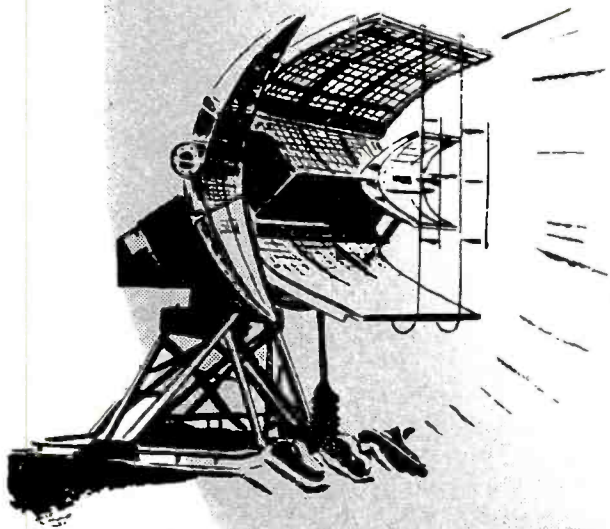

Bell Laboratories and Western Electric teamed up to supply more than 56,000 radars of 64 types—approximately 50% of the nation's radar production on a dollar volume basis.

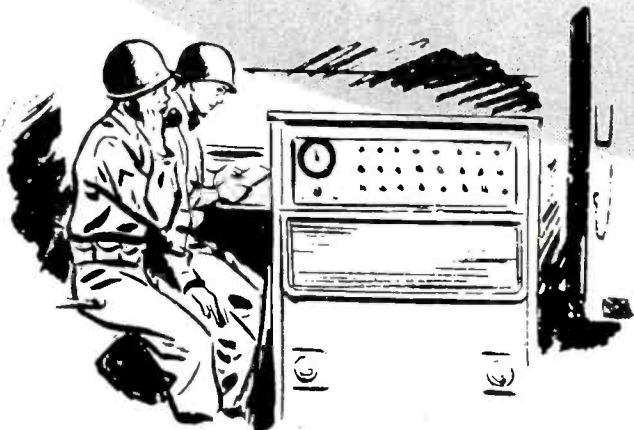

Bell Laboratories designed and Western Electric produced more than 1600 electronic gun directors and gun data computers which greatly increased the accuracy of anti-aircraft and coast defense guns.

There are three reasons why the team of Bell Telephone Laboratories and Western Electric was able to handle big war jobs fast and well.

(1) It had the men—an integrated organization of scientists, engineers and shop workers, long trained to work together in designing and producing complex electronic equipment.

(2) It had unequalled physical facilities.

(3) Perhaps most important of all, it had a long-established and thoroughly tested method of attack on new problems.

What is this method of attack?

In simple terms, it is this. Observe some phenomenon for which no explanation is known—wonder about its relationship to known phenomena—measure everything you can—fit the data together—and find in the answer how to make new and better equipment.

In the realm of *pure research*, Bell Laboratories have carried on continuing studies in all branches of science, with particular emphasis on physics, chemistry and mathematics. Often they have set out to gain new knowledge



More than 1,000,000 airborne radio receivers and transmitters were furnished by Western Electric to help coordinate attack and defense in the air.



Bell Laboratories designed and Western Electric furnished more than 139,000 multi-channel FM receivers and 74,000 multi-channel FM transmitters for use by the Armored Forces and Artillery.



Bell Laboratories and Western Electric furnished revolutionary carrier telephone terminal equipment in great quantities—all "packaged" for quick installation in the field.

war jobs like these

with no immediate prospect of an application in the communications field. Time after time, their discoveries have eventually brought about fundamental scientific advances.

Applying new discoveries

As new discoveries have reached the stage of application, Western Electric manufacturing engineers have always worked closely with Bell Laboratories men to assure a final design suited to quantity production of highest quality equipment.

During the war, the capabilities of this unique research-production team expanded rapidly. New techniques were explored—new methods were developed—new ideas were born, rich with possibilities for the future.

What this means to YOU

Today Bell Laboratories and Western Electric are once more applying their facilities and their philosophy to the development and production of electronic and communications equipment for a world at peace. Depend on this team for continued leadership in AM, FM and Television broadcasting equipment.

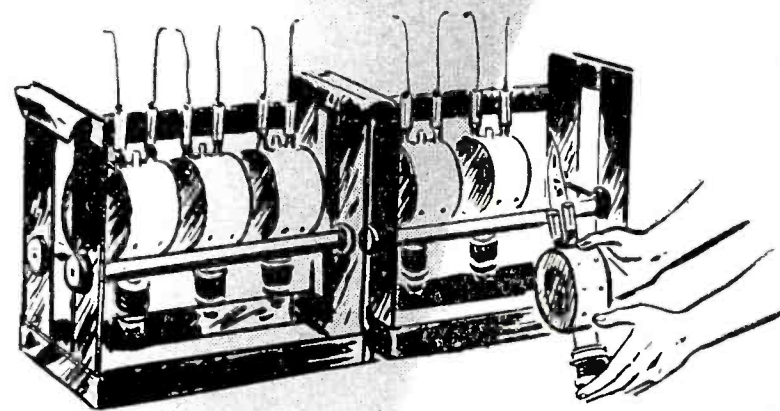

Bell Laboratories and Western Electric played outstanding roles in the design and production of magnetrons and other essential vacuum tubes for use in radar and communications.



BELL TELEPHONE LABORATORIES

World's largest organization devoted exclusively to research and development in all phases of electrical communication.

Western Electric

Manufacturing unit of the Bell System and nation's largest producer of communications and electronic equipment.

Anderson Lauds Radio Efforts To Aid Farmers

SECRETARY OF AGRICULTURE Clinton P. Anderson, in a speech over WJZ New York, last week called on U. S. farmers to exert themselves in 1946 not only to feed America, but also to "provide our share" of the food needed by our allies and liberated nations.

Mr. Anderson spoke last Monday on the broadcast initiating a new WJZ daily *Farm News* program conducted by Phil Alampi. The program is heard Mondays through Saturdays 5:45-6 a.m.

"I welcome the earnest and thoughtful endeavor of radio stations such as WJZ in their efforts to serve the best interests of the American farmer," Mr. Anderson said.

C. E. HOOPER and his coincidental telephone interview method of measuring radio audiences are described in an article "Yardstick for Radio" in February issue of *Coronet* magazine.

Latin Americans 'Exploding' Because Of Petrillo Anti-Foreign Music Edict

LATIN TEMPERS, traditionally trigger-quick, last week were reported to be exploding from Tierra Del Fuego to Ciudad Juarez. What set them popping was the recent anti-foreign music manifesto of James Caesar Petrillo, who has stirred up many a tantrum in milder lands.

To New York representatives of many a Latin radio station came word that Mr. Petrillo's edict prohibiting U. S. stations from broadcasting musical programs originating abroad had provoked at least one station to revolt.

The Havana correspondent for G. M. Basford Co., New York advertising and marketing agency, reported that RHC-Cadena Azul, Havana, had announced it would not rebroadcast any program originating in the U. S. or use any

transcription made outside Cuba.

A. M. Martinez, manager of Melchor Guzman Co., New York representatives of stations in Cuba, Mexico, Central and South America, said that although the protest had not reached such positive proportions at other Latin stations, "there is a definite feeling against Mr. Petrillo's action, particularly in Chile, Colombia and Brazil."

Latin stations, which import more broadcasts than they export, might be cutting off their noses to spite their own perspiring faces, but the fit of temper that possessed them, U. S. broadcasters agreed, was understandable.

BORDEN Co. Saturday afternoon CBS "County Fair" show is to broadcast Feb. 9 and 16 from Florida State Fair at Tampa.

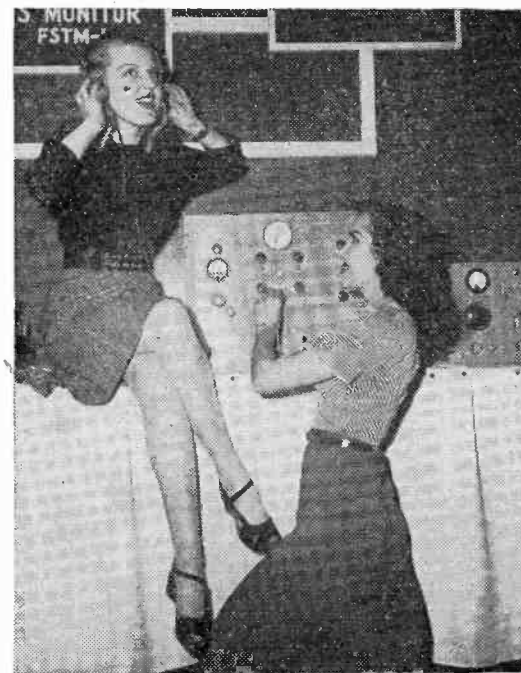

Broadcasting Inter-Office Memo

From: Ed James, N. Y.

To: Art King, Washington.

Attached art proves that even radio engineers have hearts that beat on a normal pulse rate. I can't think of a better use to put complicated radio gear to than as a backdrop for a leggy female model.

Breathlessly,

E. J.

P. S. Pix shows models with Frequency Shift Keyer, heart of transmitting system of Press-Wireless, demonstrated at N. Y. IRE meeting.

Agency Officials Blamed In Chicago Show Exodus

BLAME for the dearth of "big-time" radio shows in Chicago was placed upon agency executives last week by Irna Phillips, Chicago writer of daytime serials.

Speaking Wednesday to the Chicago Radio Management Club, she said "inter-office jealousies and dissension" frequently result in the transfer of show to New York or the West Coast without the sponsor's full approval. Many executives in both agencies and networks, she added, are reactionary regarding new ideas and new talent.

Welcome Consequences

ENDING the contest to end all contests, Ensign Richard Bartholomew on Jan. 26 correctly identified the voice of "Mr. Hush" as Jack Dempsey's, a feat which had stumped contestants on Procter & Gamble Co.'s *Truth or Consequences* for weeks, while prizes mounted higher and higher. The 22-year-old winner walked off with some \$10,000 worth of gifts, including: A \$1,000 diamond ring, \$1,000 silver fox coat, \$1,000 diamond and ruby wrist watch, 1946-model Mercury automobile, RCA Victor radio-phonograph with 100 records, washer, two-year supply of nylon hose, piano, gas range, refrigerator, round trip to New York by plane with a weekend at the Waldorf-Astoria, two-week vacation for two at Banff Springs Hotel in the Canadian Rockies, year's maid service, and two complete men's wardrobes. Program, advertising Duz, is placed by Compton Adv., New York.

everybody knows

W B I G

means good broadcasting

columbia affiliate

greensboro, n. c.

represented by hollingbery

EDMUND C. BUNKER

Joins Avery New York Office

A southern gentleman, educated in South Carolina, Ed Bunker forsook a legal career to enter radio in 1934.

His experience covers every phase of the radio field. He has been in turn control operator, announcer, writer, program director, salesman and regional sales representative for a leading southern station. After four years of regional selling experience, he went to work for Uncle Sam in 1942 as a Naval Aviator.

Now, back in civilian life, Ed automatically returned to radio advertising. Since he believes in the policy of aggressive activity in radio representation, he naturally joined Lewis H. Avery, Inc. He brings well-rounded experience to a fast-growing organization of seasoned station representatives.

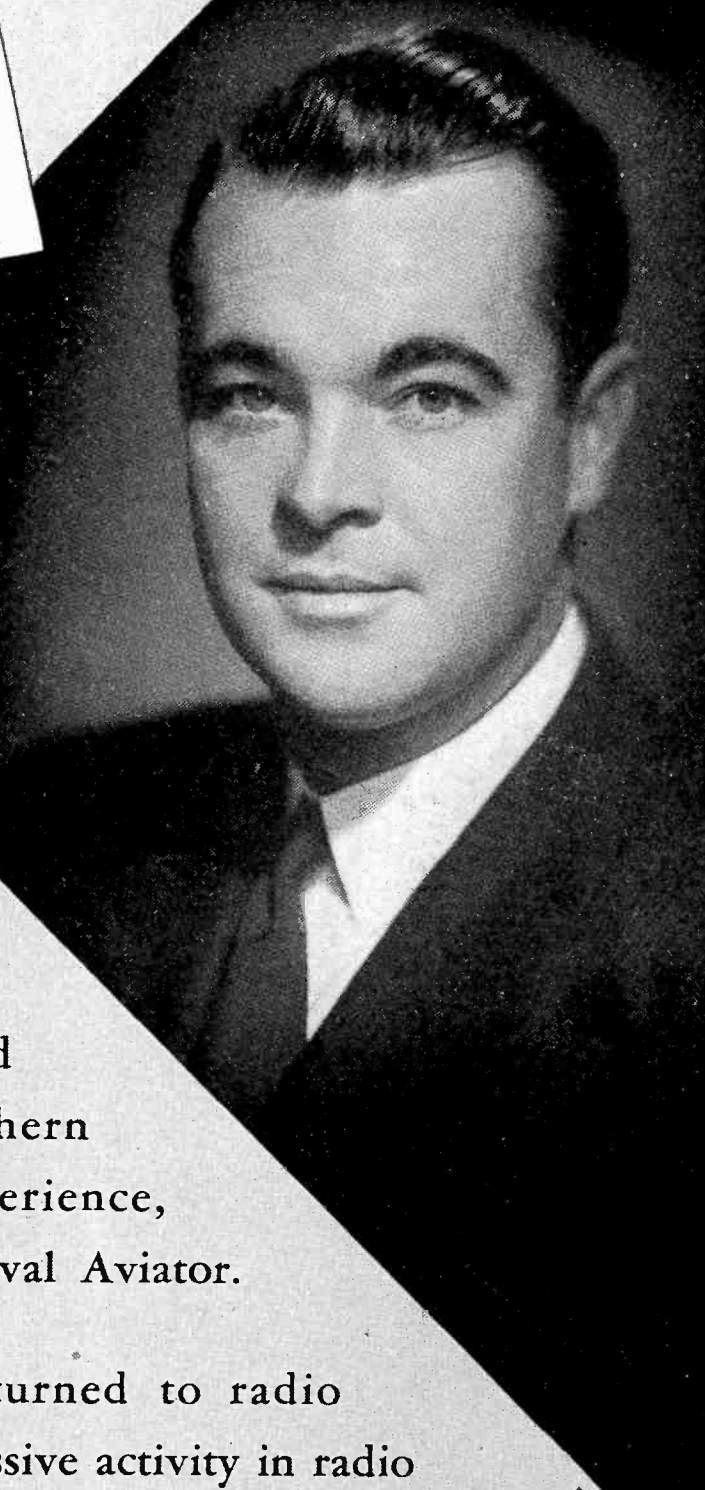

Photo by BACHRACH

LEWIS H. *Avery* INC.

Radio Station Representatives

565 Fifth Ave.
New York 17, N. Y.
PLaza 3-2622

544 Market Street
San Francisco, Calif.
DOuglas 5873

315 W. Ninth Street
Los Angeles, Calif.
TUcker 2095

333 No. Michigan Ave.
Chicago 1, Ill.
ANDover 4710

Porter Tells Video Institute Low Band Television Is Ready

FCC Chairman Adds Opinion That Competition Will Develop in Higher Frequencies

TELEVISION in the lower frequencies can perform an acceptable public service and is ready to go, FCC Chairman Paul Porter told the Television Institute conducted Jan. 29 by the Advertising Club of Washington. However, a national system of competitive television will develop in the higher frequencies, he predicted.

Recalling the early history of AM broadcasting, with its "fresh, vigorous, daring pioneer spirit," he said the cost of video progress must be shared by public and pioneers alike.

'Bowl of Peanuts'

"Those who carry television forward," he said, "will be those in whose immediate economic interest it is to advance. They will find a substantial investment necessary to keep up with the parade. Somehow, someday television will become a complete established American service."

Chairman Porter said television reminded him of the comment by a friend that it's like a bowl of peanuts on a bar—"you can't keep your fingers out." Television will progress rapidly, he said, "but we don't want it to progress over the bleached bones of our existing enterprise. We have been told the

Commission has a duty to inform the public that the land is about to be infested with a group of lightning rod salesmen. And fears have been expressed for the little fellow in this new industry.

"Pioneering costs will be very great," he cautioned. As to the Commission's duty, he said the best job it can do to stimulate television "is to act promptly on matters pending before us. The Broadcasting Division in December had 3,086 matters pending. We worked day and night and at the end of December had 3,840 matters pending. We are still losing ground but hope to reach the break-even point this month."

The institute covered much the same ground as a previous session held Oct. 15-16 in New York, with the program again in charge of the bi-monthly *Televiser* magazine. Some 250 persons attended the three sessions held during the day.

Richard Hubbell, television supervisor, Crosley Corp., Cincinnati, conducted the morning panel on television advertising and merchandising. He set the pace by referring to the visual medium as the "most efficient form of advertising."

Paul Raiburn, president of Television Productions, New York, and

economist of Paramount Pictures, cited figures he had given at the New York meeting on cost of reaching the public through various media.

Herbert E. Taylor Jr., of the Allen B. Du Mont Labs. transmitter division, said department stores stand to get the most benefit out of television. He outlined advantages of an intrastore system designed purely to sell goods as against the televised programs for public consumption, designed to entertain as well as sell.

Combination of Media

Paul Mowrey, ABC television supervisor, New York, said video will not be an expensive medium in view of results but warned that it is not a medium for the confirmed bargain hunter. "Television advertising must not be regarded as a single new medium, but rather as the combination of at least two media now in operation," he said, "making available to the advertiser the advantages both of radio and display advertising." He described the impact of a visual broadcast in which a box of Chef Boy-Ar-Dee spaghetti was prepared before the camera in 12 minutes, with a hungry soldier dipping into the finished product.

Charles J. Durban, assistant advertising manager, U. S. Rubber Co., told how the company conducted television programming. Among lessons learned were that the picture must be excellent in the studio to be good at home; that it is easy to forget the commercial

No Welles Hoax

AN OLD HAND at inter-space visitations graciously admitted competition after the Signal Corps announced it had reached the moon by radar. To an ABC microphone lumbered beefy, bumptious Orson Welles, whose celebrated 1938 broadcast of an "invasion from Mars" sent citizens fleeing to the hinterlands to escape the dread of other-worldly shock troops. As a guest on ABC's *News of Tomorrow*, Mr. Welles thought he ought to stamp the Army's announcement with the ponderous Welles seal of authority. He said: "Radar contact has been established with the moon. Since this is . . . Orson Welles speaking, I'd better repeat that . . . This time, believe me, I'm not hoaxing you."

aspects in the excitement of the studio; that those who want to learn about television should get a set at home; that the product story can be interesting and exciting.

Jack R. Poppele, chief engineer of Bamberger Broadcasting Service and president of Television Broadcasters Assn., presided at the luncheon session. Speakers besides Mr. Porter were Col. William

(Continued on page 59)



KSOO

SIoux FALLS, SO. DAKOTA

1140 K C - 5000 WATTS

National Representatives

HOWARD H. WILSON CO.



Not jet propelled...

but just as **NEW!**

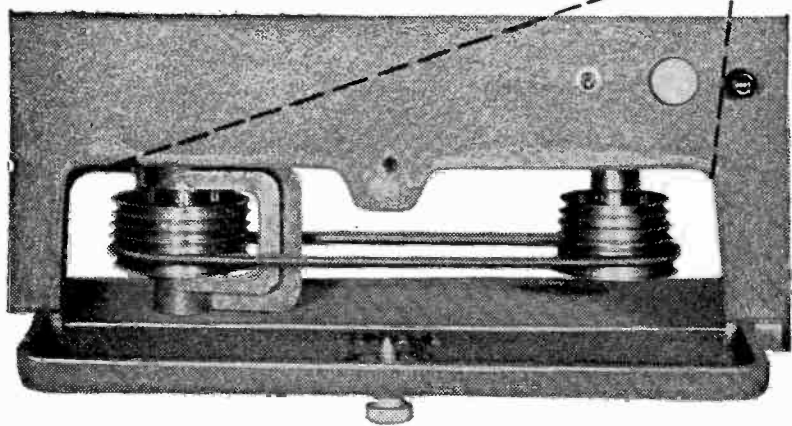

The belt on step pulleys slips instantly to any position to set cutting pitch at 96-104-112-120-128 or 136 lines per inch. Other pitches available on special order.

PRESTO'S newest *turntable*... for highest quality master or instantaneous recordings. The 8-D features instantaneous change of cutting pitch. An improved cutting head provides higher modulation level, more uniform frequency response and retains its calibration under all normal temperature conditions.

The heavy cast-iron turntable and mounting base insure exceptionally low background noise. Adjustable feet permit accurate leveling on bench or stand at a height to suit the operator.

PRESTO



RECORDING CORPORATION
242 West 55th Street, New York 19, N. Y.
Walter P. Downs, Ltd., in Canada

WORLD'S LARGEST MANUFACTURER OF INSTANTANEOUS SOUND RECORDING EQUIPMENT AND DISCS

'Public Disservice' Programs Attacked

By VERL BRATTON
General Manager, Station WREN
Lawrence, Kan.

I HAVE just finished listening to two very special "public service" broadcasts. One was presented by the National Assn. of Mfrs. and the other by the CIO. Both were made possible by donation of time "in the public interest" by the American Broadcasting Company, WREN Lawrence, and similar ABC stations throughout the country.



Mr. Bratton

It's a wonderful accomplishment when we all join hands thus and serve the public! Let me rephrase that: "It

CIO, NAM 'Name-Calling' Promotes Distrust, Says WREN Manager

would be a wonderful thing if, when we all joined hands thus, we served the public."

In the broadcasts I have just heard I can plainly see four definite services rendered. But as far as the public was concerned I feel the overall result was a disservice! The NAM has undoubtedly chalked up their broadcast as a service to associated members. The CIO broadcast was undoubtedly chalked up by the CIO leaders as a service to CIO workers. ABC undoubtedly chalked up both broadcasts against radio's obligation to devote "time" to public service. And as manager of WREN I chalked up both as

serving the public by devoting time to both sides of a controversial issue.

But did any of this effort serve the public? I think not!

If there is one need in these United States and throughout the world today it is the need for some iota of faith and trust between people. Anything which builds distrust and suspicion is certainly a disservice to all mankind.

The two broadcasts which prompted this expression of opinion did just that! The NAM ridicules in as derisive a manner as possible, and with a myriad of subtle inferences, any claims made

by organized labor. In its turn the CIO also uses every emotional trick it can devise to try to convince the poor misguided human sheep that management's only objective is to keep labor in mental darkness so it can't see the trucks back up to haul to some secret cache the day's golden profits!

How respectable organizations can have the gall to call themselves serving the public by resorting to such childish name-calling must be

SO-CALLED public service broadcasts, says Verl Bratton in the accompanying article, are really public disservice programs if they stir up suspicion and distrust. Mr. Bratton has a first-hand view of both management and labor, having served simultaneously as president of his AFM local union and as general manager of WREN Lawrence, Kan.

no less than amazing to "the public". Such "public service" efforts can only add fuel to the class-against-class fire that already burns much too hotly.

Similar tactics are often resorted to during heated political campaigns, but, thanks to their traditional pomposity, the public has learned to take them with a grain of salt and they are not long remembered after the campaign is over. But to resort to such tactics in a discussion of a national emergency that may hold more future danger than any of us realize is plain stupidity.

Presentation Condemned

I am not criticizing the "facts" brought forth by either of these organizations. I condemn them for their obviously premeditated manner of presentation. Wise decisions result from mental processes—not emotional processes.

If the propaganda practices of management representatives and labor representatives are to continue in this trend, a suggestion that they have their discussions in the back room might be a greater public service than to help them both spread further class hatred.

Ah, yes, but who would do the suggesting now that they are already "on the air." The networks? And have labor, "big business," the FCC, and a few spotlight-seeking Congressmen accuse them of "censorship?" The stations? And face the same jury?

If we'll be honest with ourselves we must admit that the only answer is a little common sense on the part of the labor and management propaganda experts. Programs of this type can be very sane and sensible at the outset, only to develop into something vicious which becomes too hot to handle on the air and too hot to take off. Broadcasters then find what started out to be a public service has turned into some-

(Continued on page 36)

How to lower your sales costs—

Let WTAR-Norfolk, top testing team give you a quick sales sample of what your product, package and plans will do

Top Test Spot - Because:

The Norfolk Metropolitan Market gives you 650,000 customers in 3 adjoining cities—Norfolk, Portsmouth, Newport News, Va.; one compact buying unit; cash-heavy and busy . . . all 3 cities rated Sales Management's High Spot star every month of 1945. Key-center for mid-seaboard distribution, easy to supply by rail or water, easy to check. Ample for profitable volume, economical to cover thoroughly with the one . . .

Top Test Medium - Because:

WTAR gives you complete, one-station, one-cost control of the Norfolk Metropolitan Market . . . more listening customers here than all other stations combined—listening to outside stations practically nil. (Hooper CM Reports, Oct.-Nov., 1945.)

Let us tell you more about it—



Pushes Your Product Promptly, Profitably

WTAR

NBC NETWORK
5000 Watts Day and Night

Edward Petry & Co.
National Representatives:

NORFOLK VIRGINIA

THE NEW RCA

SINGLE-RIBBON

MICROPHONE



... quickly adjustable to any pickup pattern you want

This multi-purpose, polydirectional microphone (Type 77-D) will help you add even greater balance, clarity, naturalness, and selectivity to your studio pickups.

By means of a continuously variable screw adjustment, located at the back of the microphone, an infinite number of pickup response patterns can be obtained—unidirectional, all variations of bidirectional, and nondirectional. Undesired sound reflections can be quickly eliminated merely by switching to a more suitable pattern.

A three-position VOICE-MUSIC switch on the bottom of the microphone is available for changing the low-frequency response, thus

permitting the selection of the best operating characteristic.

A unique single-ribbon unit combines the performance of the velocity-operated and the pressure-operated units used in previous designs.

Other outstanding features include: excellent frequency response, uniform directivity at all frequencies, shielded output transformer, shock mounting, spring-type cord guard, lightweight, small size, and an attractively styled umber-gray and chrome housing.

A bulletin completely describing this outstanding microphone is yours for the asking. Write: RCA, Dept. 17-B, Camden, New Jersey.

UNIDIRECTIONAL

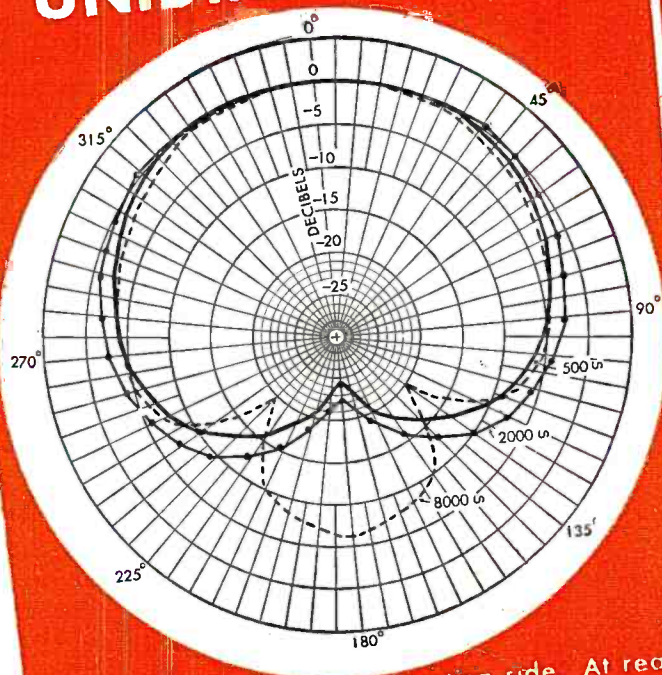

Uniform response from operating side. At rear, sounds are attenuated 14 to 20 db for an approximate 10:1 ratio of desired-to-undesired pickup.

BIDIRECTIONAL

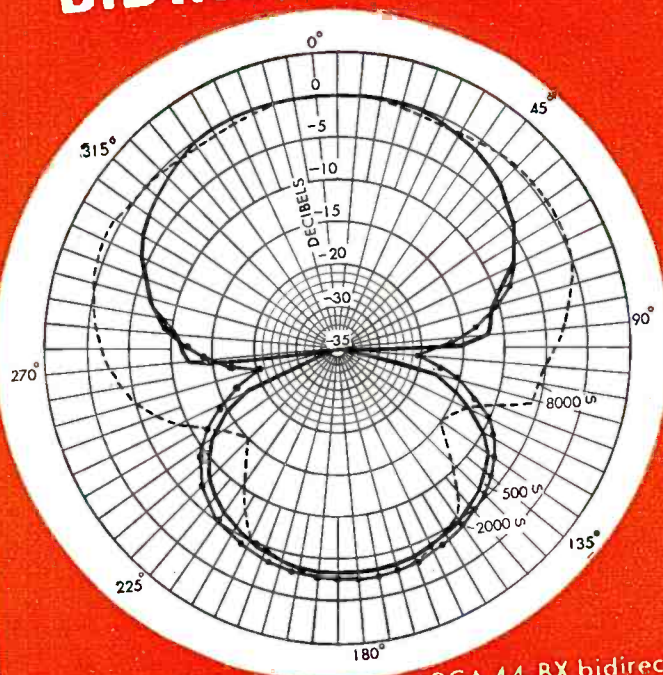

Pattern similar to conventional RCA 44-BX bidirectional microphone, except rear response is three db down compared with the response from the front.

NONDIRECTIONAL

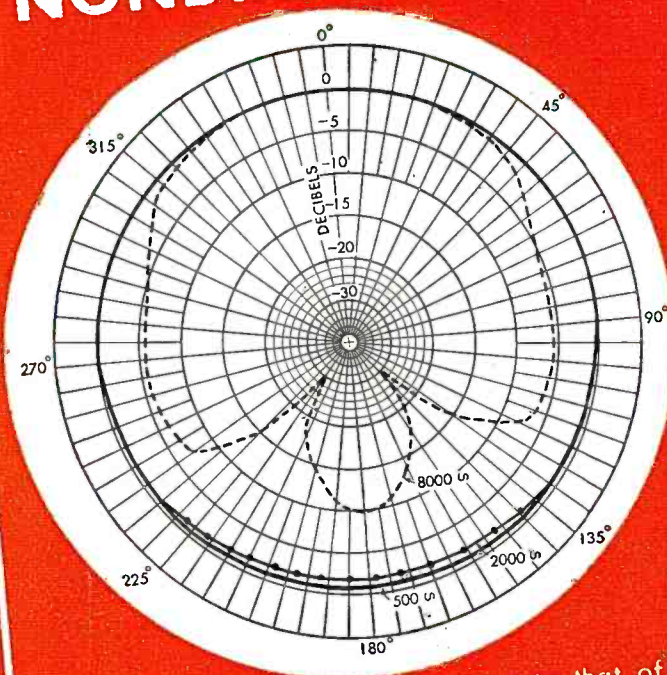

The nondirectional pattern is similar to that of other pressure microphones. Many other patterns possible by varying screw adjustment.



BROADCAST EQUIPMENT

RADIO CORPORATION of AMERICA

ENGINEERING PRODUCTS DIVISION, CAMDEN, N. J.

TEXT OF REPORT ON LEA ANTI-PETRILLO MEASURE

TEXT of the House Interstate & Foreign Commerce Committee report (No. 1508) on the Lea bill (HR-5117) to prohibit certain coercive practices affecting broadcasting, follows:

The Committee on Interstate and Foreign Commerce, to whom was referred the bill (H. R. 5117) to amend title V of the Communications Act of 1934 so as to prohibit certain coercive practices affecting radio broadcasting, having considered the same, report favorably thereon with an amendment and recommend that the bill as amended do pass.

General Statement

For some years the radio broadcasters of the Nation have been harassed by ever-increasing extortionate and rack-teering demands to which they have been forced to yield by coercive methods. The tributes thus exacted are now measured by millions of dollars.

These exactions have not been in compensation for services performed for the

broadcasters or in settlement of any obligations due from them. They have not been made for the enforcement of any rights due those who demanded them.

The object of this proposed legislation is to put an end to these exactions for the protection of the broadcasting industry and for the integrity of the Nation.

Evils at Which Directed

Broadcasting has become one of the great industries of our time. It is now one of the chief means of communication of our Nation. It is one of our greatest implements for free speech. It promptly carries news to the remotest sections of the country. It is a forum for the discussion of our political, economic, and social problems. It is a source of information, education, entertainment, music, culture, and a vehicle for the messages of all religions, utilized by practically every home in the Nation.

In recent years the broadcasting industry has been subjected to extortionate demands enforced by coercive methods which increasingly threaten to re-

strict and handicap it in performing its rightful functions to the Nation.

Those making these demands, empowered by organized groups, not only have exacted tributes from the broadcasters but have assumed and exerted the power to say what shall and shall not be communicated over the radio. True, they have limited their dominations and demands to purposes which serve their particular groups, but nevertheless they have set a pattern for a like power of private control exerted for mercenary purposes over other phases of the broadcasting industry of the Nation. The same power exercised for other purposes, if permitted, might make the right of free speech only a name and establish censorship of broadcasting for private gain.

Those who make these demands subordinate the rights of the people of the Nation to an untrammelled broadcasting service to their own mercenary purposes. They in effect say to the broadcasters, and say to the makers of recordings, "You must pay this tribute or we will not permit you to give this service to the Nation." An effective power behind the threat is the boycott and strike.

American Federation of Musicians

The make-up and operation of the American Federation of Musicians scarcely justifies its classification as a labor union. Applicants for membership are received without conforming to any qualification of a musician. Only about one-third of them make their living primarily by musical service. The voting privileges of members are so allocated as to permit a minority domination through grossly unequal allotment of voting power.

In most cases demands of the character dealt with by this proposed legislation have been made on behalf of the American Federation of Musicians by James C. Petrillo, its president.

The bylaws of the American Federation of Musicians empower its president to promulgate and issue executive orders—

"Which shall be conclusive and binding upon all members and/or locals; any such order may by its terms (a) enforce the constitution, bylaws, standing resolutions or other laws, resolutions or rules of the federation; or (b) may annul and set aside same or any portion thereof, except such which treat with the finances of the organization, and substitute therefor other and different provisions of his own making."

The federation thus composed is so organized that its membership has little control over its management or policy.

Coercive Practices

The local broadcasters of the Nation are greatly dependent on the networks for rounding out their programs. This situation has augmented the coercive power of the Federation of Musicians in forcing compliance with its demands. Through coercive efforts, including boycotts and strikes and threats of boycotts and strikes against broadcasters, the networks and those who furnish materials for broadcasters, the industry has been forced to comply rather than suffer the penalizations that would follow a refusal to submit to these extortionate demands.

Among other things, the following demands upon the broadcasting industry have thus been made in recent years: That broadcasters employ persons in excess of the number wanted; that in lieu of failure to employ such persons the broadcaster should pay to the federation sums of money equivalent to or greater than funds required for the employment of members of the federation; that payments for services already performed and fully paid for should be repeated; that payments should be made for services not performed; that broadcasters should refrain from broadcasting noncompensated, noncommercial educational or cultural programs; that broadcasters should refrain from broadcasting musical programs of foreign origin; that tributes should be paid for using recordings, transcriptions, and other materials used for broadcasting; that restrictions should be placed on the manufacture and use of recordings or transcriptions for the purpose of restricting or preventing the use of such materials for broadcasting; that tributes should be paid for recordings previously paid for; that dual orchestras should be employed for a single broadcast over two or more outlets; that over 400 small broadcast stations in the country having no live orchestras would be compelled to employ such orchestras; that the use of voluntary noncompensated orchestras be barred from broadcasts unless an orchestra of the Federation of Musicians were also employed or that the union was paid an equivalent or greater amount than the regular charge for a federation orchestra.

Some of these demands began several years ago but in recent years they have become more frequent and for enlarged purposes and amounts. These boycotts and strikes and threats have coerced compliance with a number of these demands, with pending demands now being greater than ever before. The amount of money extorted from the broadcasting industry by these methods, without moral right, has reached millions of dollars in amount and if demands now pending were granted it would, by these racketeering and extortion methods, require the broadcasting industry to pay tribute probably much in excess of \$20,000,000 a year for peace against these boycotts, strikes, and threats.

The broadcasting industry has been surrendering to these demands for

(Continued on page 65)

THE BRANHAM COMPANY

Chicago

New York

Detroit

Atlanta

Dallas

Charlotte

St. Louis

Memphis

Kansas City

San Francisco

Los Angeles

representing



WMOB Mobile, Ala.
 KTHS Hot Springs, Ark.
 KFMB San Diego, Calif.
 KWKH Shreveport, La.
 WCPO Cincinnati, Ohio
 WTJS Jackson, Tenn.
 WNOX Knoxville, Tenn.
 WMC Memphis, Tenn.
 KRIC Beaumont, Texas
 KWBU Corpus Christi, Texas
 KRLD Dallas, Texas
 WCHS Charleston, W. Va.
 WBLK Clarksburg, W. Va.
 WSAZ Huntington, W. Va.
 WPAR Parkersburg, W. Va.

**WE DON'T NEED
A COPYWRITER
TO SELL**

K * N * O * W
Frontier Broadcasting Company, Inc.
AUSTIN
P. O. BOX 842
TEXAS

January 2, 1946

Adv. Agency
Street
Texas

Dear Dave:

I am enclosing herewith a couple of copies of the Hooper report we have just received and which I thought would be of interest to you.

I believe it will make good material for an ad and I think you'll agree that it won't take much selling copy to put across the idea to those interested in selling the Austin market.

Best regards.

Sincerely yours,

Hardy C. Harvey
Manager

HCH/ab

**THESE FIGURES SPEAK
FOR THEMSELVES**



Hourly
HOOPER STATION LISTENING INDEX

CITY ZONE: AUSTIN, TEXAS

PERIOD: FALL, 1945

Total Coincidental Calls - This Period 13,164

TIME	Sets-in Use †	SHARE OF AUDIENCE							Others	HOMES CALLED
		KNOW	A	B	C	D				
MORNING 8:00-9:00 AM	19.7	68.1	0.6	9.6	1.8	18.7			1.2	977
9:00-10:00 AM	17.2	58.3	0.7	10.5	0.7	28.4			1.4	956
10:00-11:00 AM	16.4	62.6	0.8	12.9	⊕	22.1			1.6	955
11:00-12:00 AM	12.8	57.4	1.0	12.9	1.0	24.7			2.0	960
AFTERNOON 12:00-1:00 PM	18.4	50.0	1.3	19.3	0.7	27.3			1.4	964
1:00-2:00 PM	16.7	44.0	0.8	8.2	3.0	42.5			1.5	959
2:00-3:00 PM	14.6	27.7	⊕	9.2	0.9	62.5			1.7	956
3:00-4:00 PM	12.6	26.2	1.0	21.3	2.0	48.5			1.0	962
4:00-5:00 PM	14.2	22.8	1.8	7.5	0.7	54.3			2.7	947
5:00-6:00 PM	14.5	42.6	2.0	7.7	⊕	27.7			2.0	947
EVENING 6:00-7:00 PM	22.6	44.7			1.7	29.4			3.6	894
7:00-8:00 PM	28.6	30.7		28.8	1.0	37.1			2.4	890
8:00-9:00 PM	32.2	34.3		23.1	0.4	39.7			2.5	896
9:00-10:00 PM	26.0	40.9		13.8	⊕	43.8			1.5	901

Check

THESE FIGURES
They explain why
KNOW
is indispensable to any
sales promotion in the
AUSTIN MARKET

RADIO STATION
KNOW

AMERICAN, MUTUAL AND TEXAS
STATE NETWORKS STATION
WEED & CO. Representatives

NEW YORK BOSTON CHICAGO DETROIT HOLLYWOOD SAN FRANCISCO

KANSAS CITY

IS A

K

O

Z

Y

MARKET

PORTER BLDG., KANSAS CITY, MO.

EVERETT L. DILLARD
General Manager

ELIZABETH WHITEHEAD
Station Director



Pioneer FM Station in the Kansas City Area

Ask for Rate Card

Set Price Rules Revised by OPA

PRICE REGULATION changes designed to bring radio sets retailing at the familiar prewar \$60 level back on the market have been announced by the Office of Price Administration.

By adding \$1 to the upper limit of the manufacturers' medium price range, OPA explained, the amendment permits the use of lower markup factors in determining retail ceilings on certain sets which heretofore have come within the high-price range. No significant change in the consumer price level will result from the changes, the announcement asserted.

Because the markup on sets in the high-price range is substantially higher than on medium-price sets, OPA asserted, consumer ceilings in the past "broke off at about \$58, with the next highest price about \$65."

"The familiar price of \$59.95, frequently used before the war for sets in one popular quality class, was therefore eliminated, and it has seemed desirable to restore the \$60 radio to the retail market," the OPA announcement stated. "In order to do so, OPA has raised the upper limit of the medium price range by \$1, so that manufacturers are now free to apply the lower markup to slightly more expensive sets and obtain a retail price in the neighborhood of \$60."

Medium Range to \$31

The medium range now extends from \$11 to \$31, rather than \$11 to \$30.

OPA stated specifically that manufacturers of sets for export or for sale by a mail order house need not pre-ticket such sets with the retail price. It also set specific markups over manufacturer prices for sales by mail-order houses distributing under their own brand names. These markups are slightly lower than those applicable to sales by other types of retail outlets, OPA said, to reflect prewar differentials between mail order house and other retail prices for special brand radios.

Public Service

(Continued from page 32)

thing which could have far different results.

Surely the CIO and the NAM are equal to the task of putting their problems before the public in a far more adult manner.

If ever radio had a public service job to do it has one now. It's one thing to sell war bonds successfully, but it's a far greater task to try to eliminate the jealousy and distrust that Americans have for Americans today. It's a job that calls for more common sense than a great many Americans have demonstrated in the past few months. If radio is to live up to its reputation as the greatest power for molding public opinion it will need the help, not the hindrance, of all management and labor groups.



REMEMBER WHEN, says Atwater Kent (left), pioneer radio manufacturer and sponsor, to Sidney N. Strotz, veteran NBC Western Division vice president, at Hollywood Brown Derby.

Communications Panel Appointed by State Dept.

WILLIAM BENTON, Assistant Secretary of State, has appointed five special consultants to formulate advice for the State Dept. in developing U. S. proposals in the mass communications field for consideration by the United Nations Educational, Scientific and Cultural Organization.

Edward W. Barrett, editorial director of *Newsweek* and former director of OWI Overseas Branch, is chairman. Others: Thurman L. Barnard, vice president and director of Compton Adv., New York, and former executive director of OWI Overseas Branch; Don Francisco, vice president and director of J. Walter Thompson Co., New York, and former assistant coordinator, Office of Inter-American Affairs; Ferdinand Kuhn Jr., former *New York Times* London bureau chief and later deputy director of OWI and director of Interim International Information Service; John Hay Whitney, former motion picture chief of the Office of Inter-American Affairs.

Allen Miller To Direct Rocky Mountain Council

ALLEN MILLER, program manager of KOAC Corvallis, Ore., has been appointed director of the Rocky Mountain Radio Council, effective Feb. 1. He succeeds Robert B. Hudson, who resigned to become assistant director of educational programs at CBS in New York. Jack W. Lewis, former production director of the Council, becomes its associate director.

Mr. Miller was graduated from the U. of Chicago in 1926 and was radio director there until 1935. As head of the University Broadcasting Council from 1935-1940, he worked with educational groups in the Chicago area and started broadcasts supported by several foundations and the radio networks. He served as production director of KWSC Pullman, Wash. for two years before joining KOAC, which is operated by the Oregon State System of Higher Education.

Rocky Mountain Radio Council is composed of educational and civic organizations in Colorado and Wyoming, and broadcasts over 19 stations in the two states.

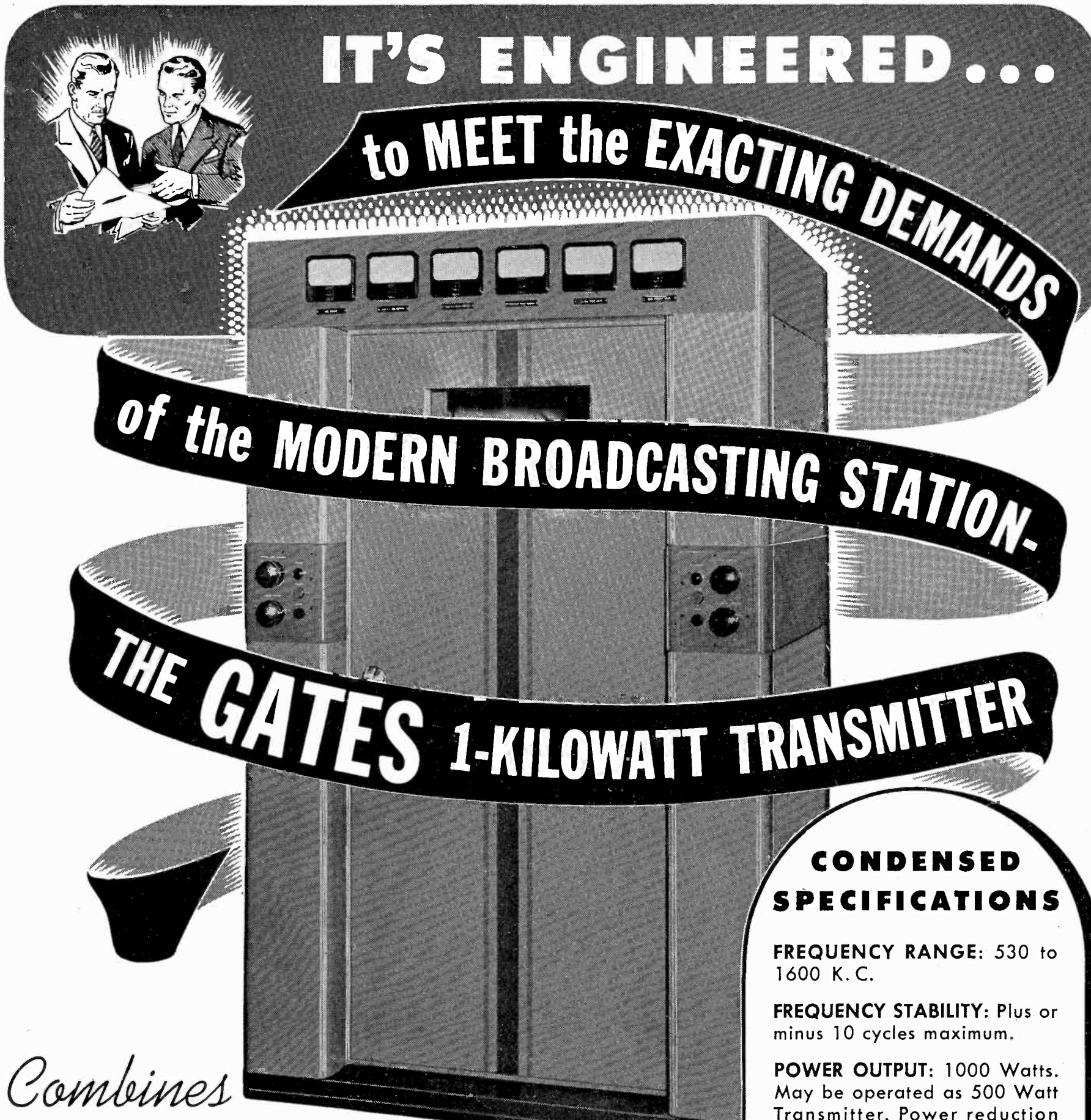

Combines

EFFICIENCY • VERSATILITY • DEPENDABILITY

The GATES Model 1-E Transmitter is the most modern installation for the 1-Kilowatt broadcasting station. It combines modern circuit developments, which are the results of strict laboratory tests, with other mechanical improvements that will make your Station outstanding in operating efficiency and showmanship. All parts are accessibly located for simple operation. The streamlined pressure-type cabinet assures dustless, cool performance. Investigate the 1-E Transmitter before considering any other.

NEW YORK
OFFICE:
9th Floor • 40 Exchange Place



SOLD IN CANADA BY:
Canadian Marconi Co.,
Ltd., Montreal

CONDENSED SPECIFICATIONS

FREQUENCY RANGE: 530 to 1600 K. C.

FREQUENCY STABILITY: Plus or minus 10 cycles maximum.

POWER OUTPUT: 1000 Watts. May be operated as 500 Watt Transmitter. Power reduction for night operation may be incorporated to suit requirements.

POWER SUPPLY: 230 Volts, 60 cycles, single phase. Regulation not to exceed plus or minus 5%.

FREQUENCY RESPONSE: Within 1½ Db. from 30 to 10,000 cycles.

DISTORTION: Less than 3% from 50 to 7500 cycles. 0-95% modulation.

NOISE LEVEL: 60 Db. below 100% modulation.

WRITE FOR COMPLETE SPECIFICATIONS

EXCLUSIVE MANUFACTURERS OF TRANSMITTING EQUIPMENT... SINCE 1922

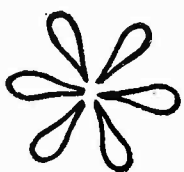

*The sure way
to More Sales!*

... THE RIGHT PROGRAM

... THE RIGHT PLACE

... THE RIGHT TIME

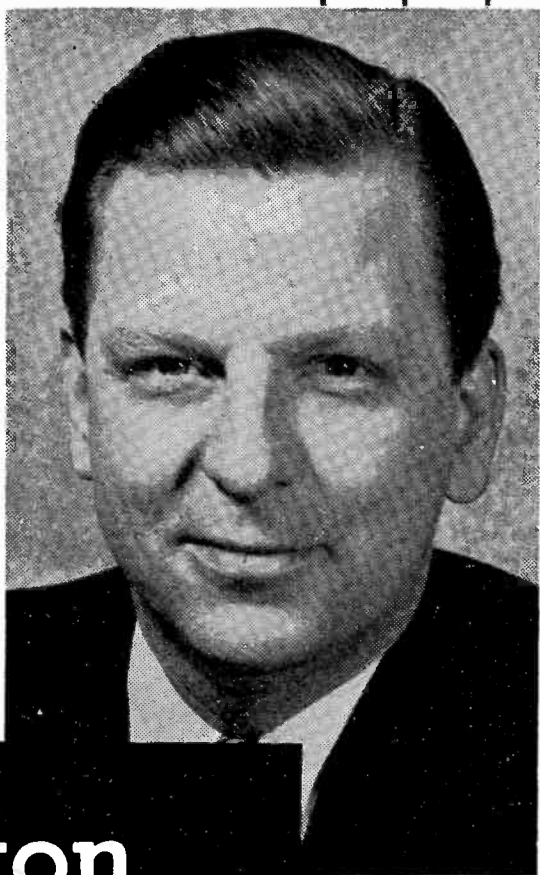

**Fulton
Lewis, jr.**

America's No. 1 Cooperative Program

Here's the perfect formula for radio sales success. Let Fulton Lewis, Jr., sell your product at lower cost to one of America's largest and most enthusiastic audiences. A few choice availabilities in important markets are now open. Wire, phone or write at once.



COOPERATIVE PROGRAM DEPARTMENT
MUTUAL BROADCASTING SYSTEM

1440 BROADWAY, NEW YORK 18, N.Y.



**WIBW Files for 540 kc; Seeks
500,000 Watt Clear Station**

AN APPLICATION for the still unavailable 540 kc frequency—with 500 kw power—has been filed with the FCC by WIBW Topeka, the Commission announced last Wednesday.

Two other stations are seeking 540 kc, now used by the Navy—KMBC Kansas City, which filed its application May 31, 1944, and WTOL Toledo, which applied Oct. 22, 1945. WIBW is the first to seek to operate the frequency with "superpower." KMBC, now on 980 kc with 5 kw, proposed to operate it with 50 kw, while WTOL, now on 1230 kc with 250 w, asked for the frequency with 5 kw.

WIBW estimated that with 500 kw power on 540 kc it could provide primary service to 6,458,016 persons daytime and 11,190,787 persons at night, with secondary service at night to approximately 90,000,000. Service area would approximate 2,964,841 square miles. Currently, on 580 kc with 5 kw, WIBW reaches approximately 1,238,890 persons within an area of 121,860 square miles.

Manufacturers Could Supply

Installation costs were estimated at \$491,000. Most of this would go for the transmitter—\$350,000. Although there are not now any FCC-approved 500-kw transmitters, the application said "several reputable manufacturers have completed basic designs and would be able to supply satisfactory equipment meeting all FCC requirements and standards." Other estimated costs include \$55,000 for antenna and ground system, \$35,000 for land and \$25,000 for buildings, \$25,000 for "other items," and \$1,000 for frequency and modulation monitors.

Capper Publications Inc., owner of WIBW and of KCKN Kansas City, would provide up to half a million dollars for the installation.

Possible future amendments in the application may be made, it was pointed out, after the FCC has decided upon its clear-channel policy.

The application noted "certain shortcomings" in the requested assignment: "In the first place, while the Commission has made the preliminary finding that 540 kc should be made available for use in the broadcast band, no final decision has been reached as to whether or not the frequency shall be used for clear, regional or local channel purposes. Secondly, the use of 540 kc in this area presents certain side-channel interference problems which in turn require suppression of the signal of the station to such a degree that the optimum desired by the applicant and needed by the listeners in the area can not be fully accomplished."

The 540-kc channel, currently used by the Navy, is not expected

to become available to U. S. broadcasters for at least a year [BROADCASTING, Jan. 7]. CBK Watrous, Sask., Canada, uses the frequency with 50 kw power, but under a 1938 U. S.-Canada arrangement CBK is to switch to a substitute channel when one becomes available, the application asserts.

Little Interference

Directional antenna would be used by WIBW day and night. The application anticipates no objectionable interference to any existing U. S. station except for "slight interference" to KWTO Springfield, Mo. (560 kc) and "very slight interference" to WNAX Yankton, S. D. (570 kc). "These 'interferences' are estimated on existing 'Standards' . . . and would be eliminated if proposed revisions were adopted," it is maintained. Actually, the application continues, there would be "no objectionable interference" to the normally protected service of any station.

The application emphasizes WIBW's program service, particularly to rural listeners, and contends the station is located to render "best possible extended coverage rural service to the most underserved section of the U. S." No basic change of program structure is anticipated.

Hogan & Hartson, Washington law firm, and Chambers & Garrison, consulting radio engineers, also of Washington, aided in preparing the application.

**L. A. Grand Jury Urges
Action on Crime Shows**

KEEPING the kettle boiling in public criticism of juvenile radio programs, retiring Los Angeles County Grand Jury has recommended that first act of 1946 jury be to "eliminate or minimize broadcasting of radio crime programs which tend to encourage juvenile delinquency." Recommendation embodied in resolution brought forth flood of opposition from local broadcasting representatives. Point was reiterated that theme back of all such series was "crime doesn't pay."

Los Angeles District Attorney Fred N. Howser and Police Chief C. B. Horrall said recently, however, that this type of program did more harm than good. On the other side of the ledger, juvenile division of Police Department survey showed that majority of arrested delinquents listened to Bob Hope and jive music type shows. Kettle was set simmering with an open letter of criticism by Los Angeles 10th District California Congress of Parents & Teachers. Protest was signed by executives of P.T.A. as well as civic, health and education leaders.



He's a Big Man With the Kids in Peoria

Peoria youngsters all know big, jovial, 325 pound Wayne West, the impresario of WMBD's famed Juvenile Theatre. This exceedingly popular public service feature is now entering its 15th consecutive year.

Thousands of letters and weekly full-house studio audiences attest to the popularity of the Juvenile Theatre. The first open-air "Park-Show" since the war brought out a crowd estimated at 20,000.

Performing before hospitals and other community institutions, these future builders of Peoria receive early training in public service . . . help make Peoria a better place to live.

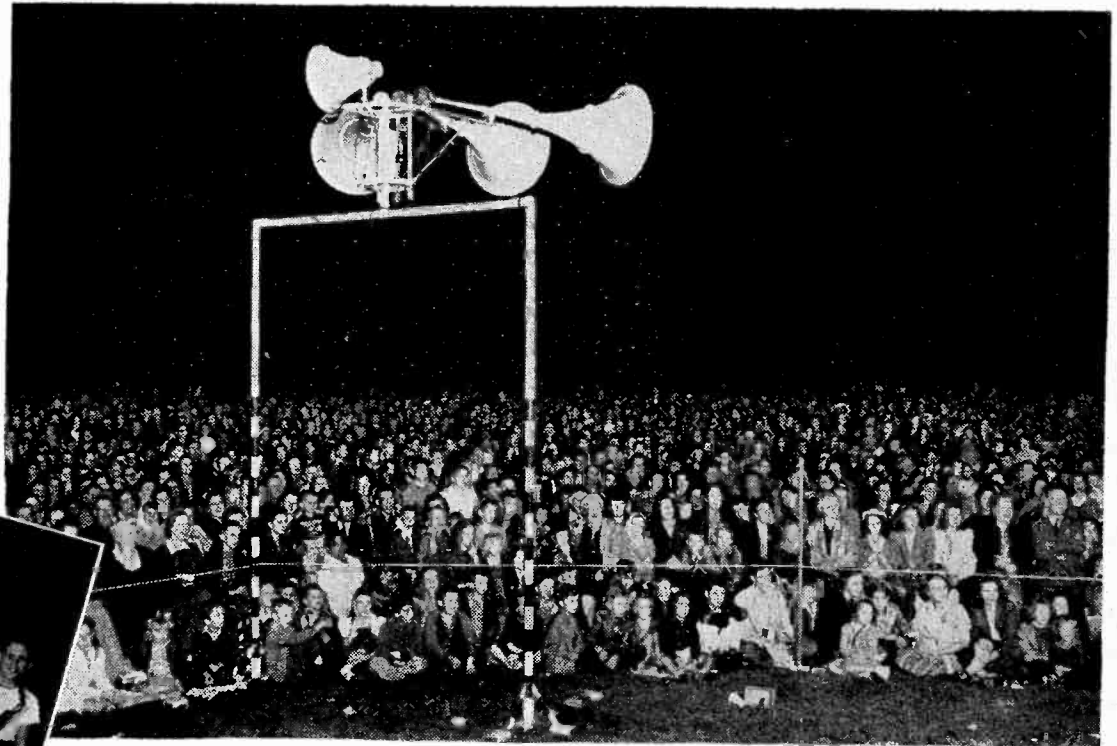

● (Upper left) Wayne West with three young singers at the Rotary Club Crippled Children Christmas party. The Juvenile Theatre renders year-round community service.

(Left) This year's complete cast. Some professional careers have had their beginning in the WMBD Juvenile Theatre.

(Above) Peoria really turned out for the "Park Show" . . . 20,000 people had a fine time.



FREE & PETERS, INC.
National Representatives



C O V E R I N G

MET. PEORIA
Pop. 200,000

PEORIA AREA
Pop. 614,200

WMBD

5000 Watts ★ CBS Affiliate



DISTORTION CAN HAPPEN ANYWHERE .



THE COLLINS 6P PREAMPLIFIER

The 6P bridges the gap between the output of a low level microphone and the input of a line, program, or limiting amplifier. Its frequency response is constant within ± 0.5 db from 30-15,000 cps. Its careful shielding allows several 6P's to be placed side by side without interaction.

**THE COLLINS
26W LIMITING AMPLIFIER**

The 26W has unequalled value in limiting loud passages, thus preventing overmodulation and the accompanying distortion and adjacent channel interference. It also effects a higher average audio level, which increases the signal to noise ratio. It may be set to catch the first cycle of a 10 kc note.



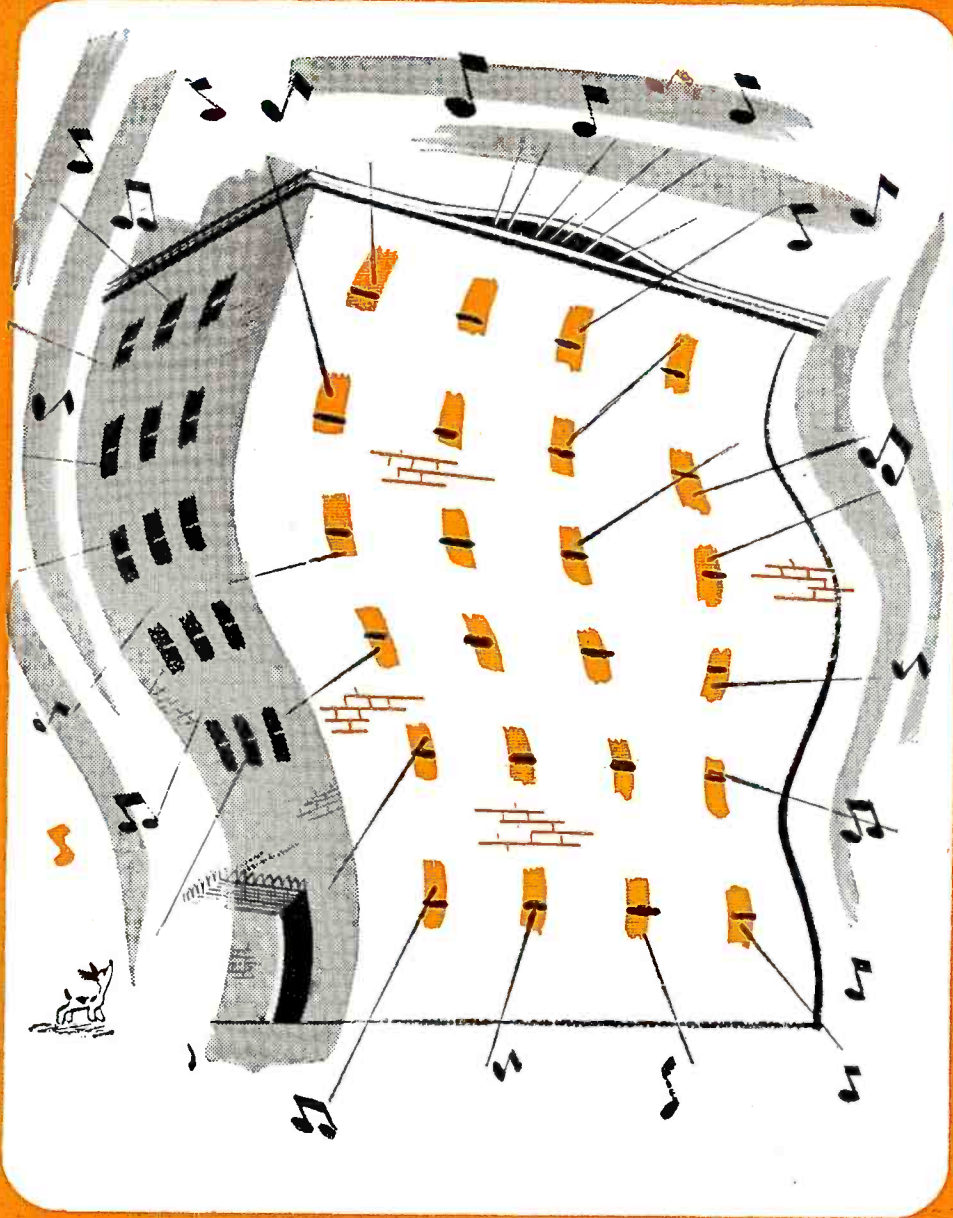

BETWEEN THE MIKE AND ANTENNA!

BUT NOT WITH COLLINS EQUIPMENT

THE KEEN EDGE of a fine performance can be dulled by distortion, noise, or lack of high fidelity in any stage of amplification. Alert broadcast management insists that the integrity of the program be maintained in minute detail through every step from the studio to the antenna. The high fidelity of Collins speech equipment safeguards the quality of sounds going into the microphone, and promotes a clear, brilliant broadcast.

Here are two new Collins products—the 6P Preamplifier and the 26W Limiting Amplifier. They are engineered to the traditional Collins high standards of performance and reliability. Only highest quality components are used, and these are operated conservatively, assuring long life with continuous, trouble-free service. Write us about your station requirements.

THE COLLINS RADIO COMPANY
Cedar Rapids, Iowa; 11 West 42nd Street, New York 18, N. Y.

FOR BROADCAST QUALITY, IT'S



BMI Pin Up SHEET

Hit Tunes for February

ARE THESE REALLY MINE? (Campbell-Porgie)

Vaughn Monroe—Vic. 20-1736 • Gene Krupa—Col. 36890

ATLANTA, G. A. (Stevens)

Sammy Kaye—Vic. 20-1795
Woody Herman—Col. • Shep Fields—Vogue (soon to be released)

BUZZ ME (Preview)

Louis Jordan—Dec. 18734 • Ella Mae Morse—Cap. 226
Sippie Wallace—Mercury 2018

COME CLOSER TO ME (ACERCATE MAS) (Melody Lane)

Larry Stevens—Vic. 20-1776
Jimmy Dorsey—Dec. • Xavier Cugat—Col. (soon to be released)

IT'S DAWN AGAIN (Goode)

The Three Suns—Maj. 1027 • Shep Fields—Vic. 20-1751

MY SHAWL (Marks)

Frank Sinatra—Xavier Cugat—Col. 36842

SLOWLY (Rudy Vallee Music)

Kay Kyser—Col. 36900 • Dick Haymes—Dec. 18746
Gordon MacRae—Music. 15052

TAKE CARE WHEN YOU SAY "TE QUIERO" (London)

Guy Lombardo—Dec. 18730 • Tommy Tucker—Col. 36916

TELL IT TO A STAR (Indigo)

Charlie Barnet—Dec. 18736 • Tony Pastor—Bl. B-11533

THE MOMENT I MET YOU (Embassy)

Tommy Dorsey—Vic. 20-1761

WAITIN' FOR THE TRAIN TO COME IN (Block)

Peggy Lee—Cap. 218 • Harry James—Col. 36887 • Louis Prima—Maj. 7156
Johnny Long—Dec. 18718 • Monica Lewis—Sig. 15010

WALKIN' WITH MY HONEY (Republic)

Sammy Kaye—Vic. 20-1713 • Ray Noble—Col. 36883
Connee Boswell—Dec. 18741

WE'LL BE TOGETHER AGAIN

Les Brown—Col. 36896 • Pied Pipers—Cap. 207 (Loft-Marmor)

THERE'S A BMI HIT
FOR EVERY TYPE OF SHOW



BROADCAST MUSIC, INC.
580 FIFTH AVENUE, NEW YORK 19, N. Y.
New York • Chicago • Hollywood

7,020 Registered For Meeting of IRE

Unprecedented Collection of Papers Arouses Interest

MEMBERS of the Institute of Radio Engineers agreed last week that their winter technical meeting, Jan. 23-26 inclusive, had been the biggest ever.

Final count of registration was 7,020, and actual attendance was even greater, since many a visitor had failed to register.



Mr. Content

Members speculated that the record crowd had been attracted to the Hotel Astor, New York, meeting by the unprecedented collection of technical papers covering subjects which had been until now forbidden to discussion by secrecy of war and by exhibits of much equipment which heretofore had been similarly obscured.

Well-deserved pats on the back were given to men responsible for arranging the meeting during the "President's Luncheon" on Jan. 25. Chief praise was given to Edward J. Content, member of the engineering department of WOR New York, who was chairman of the General Committee for the winter meeting. Dr. Frederick B. Llewellyn, incoming IRE president, although commending all committeemen for unusually efficient work, described Mr. Content's contribution as "outstanding."

The winter meeting closed Jan. 26 after a day-long presentation of technical papers on the general subjects of industrial electronics, communications systems and relay links, radio propagation, broadcast receivers and quartz crystals.

Television Programmers Address Meeting of ATS

EXPERTS in television programming addressed a luncheon meeting of the American Television Society Program Panel last Monday at Hotel Sheraton, New York.

Hoyland Bettinger, former program manager of WRGB Schenectady and author of a forthcoming book, *Fundamentals of Television Programming*, described television as a "continuous motion picture flow" which requires precise production.

Theodore Huston, radio and television director of Ruthrauff & Ryan and director of WABD's television show *Wednesdays at Nine Is Lever Brothers Time*, gave ATS members hints on the technique of television direction. Richard Manville, general chairman of ATS panels, presided.

BROCHURE of photos taken by WMBG Richmond, Va., staff photographer of inauguration of Gov. William M. Tuck, has been presented to the Governor by the station.



GREATER CHARITY hath no man than to give the shirt—and overcoat—off his back as the manager of KDB Santa Barbara, Fin Hollinger (center) is doing for the Victory Clothing Collection. Helping conduct the station's daily sidewalk interviews for the clothing drive are (l to r) KDB Chief Engineer Bill Buckley, Mr. Hollinger, and Don Roberts, sidewalk reporter for KDB.

ABC ON AIR 6,026 HOURS DURING 1946

ABC last week went to its counting board to figure how broadcast time was used in 1945. The network added, subtracted and evolved percentages as follows:

A total of 6,026 hours (excluding repeat broadcasts) was programmed by ABC in 1945. Biggest percentage of that time was music of all types: 1,698 hours or 28.2 percent of all programs.

News programs were in second place, with 1,142 hours, or 19 percent of total broadcast time. In third place were variety programs with 933 hours or 15.5 percent of the year's total time.

Dramatic programs occupied 818 hours or 13.6 percent of the time.

Of all broadcast time 3,753 hours or 62.3 percent were devoted to sustaining programs. Sponsored shows accounted for 2,273 hours or 37.7 percent.

Taking a different approach, ABC arithmeticians figured that 3,869 hours or 64.2 percent of total network time was devoted to entertainment programs and 2,157 hours or 35.8 percent to public service.

Wire Photos

SPECIAL radiophoto service for members of the armed forces was proposed last week by Press Wireless Inc. in an application for tariffs filed with FCC. Press Wireless plans to transmit photos from Frankfurt, Berne and Manila to the U. S. at first and later to inaugurate two-way service between the U. S. and those points plus other foreign capitals. Service personnel will be charged \$2 for the first five square inches of photo material, 40 cents for each additional inch.



Connecticut has a great inheritance: the first democratic constitution, adopted in 1636. Above: Seat of government in Hartford.

EVERYTHING HERE IS CAPITAL . . .

- 1. THE CAPITAL CITY** of Connecticut, Hartford is the center of the busy political, financial and industrial life of the state.
- 2. THE CAPITAL MARKET** of the country, the Hartford Trading Area is the Major Market in a state which leads all others in Effective Buying Income per family.
- 3. THE CAPITAL STATION** in this market, WDRG is a capital buy, with one low uniform rate for all advertisers, national, regional and local.

WDRG
HARTFORD 4 CONNECTICUT
WDRG - FM

BASIC CBS HARTFORD REPRESENTED BY PAUL H. RAYMER

BALTIMORE FOOD SALES



A good salesman has "sell" in his voice. In Baltimore WBAL's voice has that "sell" as proven by impressive direct sales in the food field. And at WBAL, selling thru the air is backed up by an aggressive "behind the scenes" sales promotion and merchandising department that synchronizes program advertising with effective point of sale merchandising.

Food advertisers with schedules on Baltimore's powerful 50,000 watt

HE SELLS THROUGH THE AIR

YES GREAT SALES MAN

NBC network station register sales where they count . . . at the cash register.

Normal healthy growth creates ever increasing appetites . . . and Baltimore has both. Yes sir! food sales are UP and Baltimore's Great Food Salesman is UP TO THE JOB AHEAD.

BASIC N B C NETWORK
Nationally Represented by
EDWARD PETRY & CO.

WBAL
50,000 WATTS
BALTIMORE

WITH THE GREATEST OF EASE

The Mills Grind Fine

IN THIS ISSUE we present the saga of General Mills—an advertiser who had the courage to employ radio as a medium when others viewed with alarm.

There is no scientific calibration by which General Mills can determine how much of its growth through the years is attributable to broadcasting as against other media. But none is needed. That General Mills has stayed with the medium, annually increasing its appropriation for broadcast advertising, is sufficient evidence of radio's effectiveness.

General Mills, when it decided to try broadcasting, imported talented men and women experienced in the medium. They provided the formula, and General Mills backed them to the hilt.

That, then, is the moral of the story: you cannot shoot a gun, granted you own one, unless you know how to load it.

Facts or Friction

THIS WEEK the "Little Havana Conference" gets under way in Washington to consider extension of the North American Regional Broadcasting Agreement which became effective in 1941 and expires March 29.

Commissioner E. K. Jett of the FCC, chairman of the U. S. delegation, is prepared to propose a two-year extension of the present treaty. He points out logically that during the last five years of war the NARBA provisions have not been fully tested. Scarcity of materials, manpower and technical know-how frustrated plans to meet the rigid engineering requirements.

We think the two-year extension, originally proposed by Canada and advocated by Mr. Jett, should prevail. In the interim, preparatory conferences could be held for a 1948 NARBA on a full-dress basis.

Thus far, Cuba is the only nation to project definite demands. It wants assignment rights with substantial power on some 20 additional of the 106 standard broadcast channels.

According to available current data, Cuba has a total of only 226,000 radio receivers, presumably the bulk of them in Havana. It has about 100 stations, of which some 31 are in Havana. Thus, as we compute it, Cuba has one station for each 2,600 of its population. In the United States, there are 1,000 standard stations operating or authorized. They serve 140,000,000 people, or one station for each 140,000 of population.

We know of no other yardstick that can be applied equitably in station distribution. Cuba has not made the most of its existing assignments. The same, in a lesser degree, goes for the other signatories. In the United States, stations are packed and jammed on regional and local frequencies.

We trust the delegations of our neighboring North American nations will not lose sight of these fundamental factors.

Lea-Ward or Scuttled

PITY the lowly musician for whom AFM President James C. Petrillo's heart bleeds. He asks succor, relief and alms for his charges—evidently all of it from radio.

In the last few days several events focus attention on the plight of the radio-employed AFM member. An FCC employment analysis [BROADCASTING, Jan. 28] shows the average wage of full-time employes for a typical broadcast week in 1945. In the programming end, the average production man draws \$62.49 per week; the writer, \$47.93; the announcer, \$57.79 and the staff musician a mere \$81.20. The network and network-owned station musician draws a paltry \$137.58—substantially ahead of any other program employe class.

That "staff musician" on the average station toils 10 to 18 hours per week (including rehearsals) for his radio stipend. He may perform only an hour or so a week. He usually has another job (night clubs, theatres, dance bands) if he's any good at all.

Don't take our word for it. Let's look at the report of the House Interstate and Foreign Commerce Committee on the Lea bill (HR-5117) which would outlaw the "extortionate and racketeering demands" of Petrillo and his union estimated to be in excess of \$20,000,000 a year. Here are a few excerpts:

The makeup and operation of the AFM scarcely justifies its classification as a labor union. Applicants . . . are received without conforming to any qualification of a musician. Only about one-third . . . make their living primarily by musical service. . . . The Federation thus composed is so organized that its membership has little control over its management or policy.

. . . if demands now pending were granted it would, by these racketeering and extortion methods, require . . . the broadcasting industry to pay tribute probably much in excess of \$20,000,000 a year.

The perpetration of the offenses . . . involve moral turpitude akin to that of larceny, embezzlement, the acquisition of another's property by false pretenses, racketeering and extortion. . . . The right to strike for a lawful purpose cannot be twisted into a right to combine together to commit crimes.

The offenses committed in the name of the AFM are a great disservice to legitimate labor organizations as well as to the public.

These tributes and other exactions were not payments for services. . . . They were the price paid for the peace of being relieved from the penalties of refusal. As a reward the broadcasting industry has been confronted with more and greater demands of equal viciousness. It is the responsibility of the Congress . . . to stem the rising tide of unconscionable demands upon the broadcasting industry, against which, in the present state of the law, that industry is powerless to defend itself".

The text of the Lea report appears in this issue. If, after reading it, any broadcaster, radio advertiser or agency executive can restrain himself from wiring or calling his Congressman in lusty support of the Lea bill, he should consider retiring from the field. For he lacks the vigor, vitality and interest in his nation's and his own welfare that have made America what it is.

Petrillo's soft-shoe artists and other lobbyists of organized labor are wending in and out of cloakrooms and offices on Capitol Hill. Radio's voice hasn't been raised.

This week, anyway, the telephone and telegraph are not strikebound. Radio, of all pursuits, shouldn't be tongue-tied when its own salvation is at stake.

Our Respects To -



WILLIAM CRAWFORD EDDY

TRYING to write a story about William Crawford Eddy, director of Balaban and Katz television station WBKB, in Chicago, is like explaining the principle of the atom bomb in 10 minutes.

In fact, Eddy's personality is about as complicated as the atom since it ranges from A (for author) to Z (for Zoo, which he maintains on his Michigan City, Ind., farm).

Captain Eddy, now retired for the second time from the U. S. Navy, has been called everything from "genius" to "gadget-man," and since he is both, television has welcomed his undisciplined and unorthodox mind with open arms. The long (6'6") lanky (172 lbs) television pioneer got into radio from the ground up, a truism, since he dug ditches for underground cable for Phil Farnsworth, in 1934 until the latter realized his brain was mightier than his brawn.

Despite the 100 odd inventions Mr. Eddy holds for television and the electronics sciences, his first love is the Navy and particularly submarines. A graduate of Annapolis in 1926, where he acquired 148 points—two short of expulsion—Mr. Eddy lost his hearing as a result of experimental tests in depth diving sometime in 1932. As a result he was placed on the retired list when he went before a naval board for promotion to full lieutenant. Undaunted, he turned his inventive mind to the problem and came up with a new gadget—a "hearing pipe". Instead of tobacco, Mr. Eddy built a tiny amplifier in the bowl of an ordinary pipe, connected it to a wire running up his sleeve and listened through the vibrations against his teeth!

In 1937, the National Broadcasting Company heard of the brilliant work Mr. Eddy was doing for Farnsworth and prevailed upon him to become chief of video sound effects. He likes to recall the time he was televising a miniature port scene, with modern battleships preening before the television camera. Eddy felt the water was too calm to pass the critical eye of the most confirmed land-lubber and into it he deposited two tiny turtles. As they swished about the bottom the waves churned against the sides of the ships to create a perfect Nor'easter. Unfortunately, a few seconds after the cameras began to turn, one of the turtles poked a horny beak out of the water, creating the effect of a sorrowful Loch Ness monster, fully capable of scuttling the pride of Uncle Sam's fleet.

Of the hundreds of gadgets Mr. Eddy has

(Continued on page 48)



Focused on Two New York Markets

AS a result of giving listeners the programs they want to hear, WOV has developed and holds two distinct and important audience groups in the metropolitan New York area. Two great markets listen to WOV. Two great markets that, in their respective listening hours, combine to give this station a constant, controlled, around-the-clock selling power. In the daytime, WOV overwhelmingly dominates New York's Italian speaking audience of 520,000 radio homes. And in the evening, between the Hooper Hours of 7:30 and 10:00 p.m., WOV delivers one of the largest metropolitan audiences of any New York independent station . . . *at less than half the cost of the next ranking station.*

RALPH N. WEIL, General Manager
JOHN E. PEARSON CO., Nat'l Rep.



Respects

(continued from page 46)

devised, his *L'il Joe* was the most ubiquitous. A cowboy puppet 18 inches tall and operated by springs and gears, *L'il Joe* could perform 15 feats, including smoking a cigarette and leading a horse.

Mr. Eddy left NBC in 1941 to come to Chicago, where for Balaban and Katz, he put together a television station from miscellaneous and secondhand police transmitters, piano-wire and rubber cement.

By March, station W9XBK was on the air. By June it was acknowledged No. 3 in the country, topped only by NBC and CBS. The day after Pearl Harbor Mr. Eddy was on a train bound for Washington, with a determination to get back into uniform. The U. S. Navy felt differently. Yes, the board recognized former Lt. Eddy as one of the nation's outstanding electronics experts. Yes, the Navy badly needed a radar school such as Lt. Eddy suggested.

Unfortunately, the board also recognized the fact that former Lt. Eddy had no less than 11 physical defects, including deafness and too much space between his head and his toes. Sorry, old man. Why not try the Army?

In desperation, Eddy played his trump-card. How would the Navy like a complete television outfit as a radar training center? Oh, yes indeed! Wonderful. The next day, Balaban & Katz learned they had been taken over by the Navy. But the Navy insisted Eddy would have to be retained as a "civilian director."

Finally, after repeated rejections, the then Secretary of the Navy Frank Knox ordered Eddy back into uniform, and without a physical! Overage, oversize and almost stone deaf, the Navy needed "Bill" Eddy.

As senior officer in charge of Radio Chicago, Lt. (jg) William C. Eddy began the task of training three-quarters of a million American boys, most of whom thought radar was something out of Buck Rogers. He devised the Eddy test, two hours long, for prospective students. With Elmer Upton he wrote a mathematics text in three weeks and 350,000 copies were sold. It's designed to cram two years of algebra into 24 hours and it was written while he commuted daily on the train from Michigan City to Chicago. He still commutes and he still uses his time to write, or make cartoons, at which he also excels.

A few weeks ago, Captain William C. Eddy put away his blues for the second time and returned to the task he began in 1941: to make Chicago a great center of television.

The biggest problem facing television is whether or not the FCC

Gillin Again Named Director At NAB 10th District Session

JOHN J. GILLIN Jr., general manager of WOW Omaha, was re-elected director of the NAB 10th District (Iowa, Mo., Neb.) Jan. 25-26 meeting in Omaha [BROADCASTING, Jan. 28], marking the 14th consecutive year he has represented the district in the NAB.

Resolutions were passed seeking adoption by Congress of uniform time legislation applicable to all states and territories; establishment of a program department within the NAB; pledging support to NAB Standards of Practice.

Stations were asked by President Justin Miller and Secretary-Treasurer C. E. Arney Jr. to send in all facts pertinent to labor relations for analysis by the association's Employee-Employer Relations Dept.

Speakers on the music problem, besides NAB officials, were Frank Chizzini, NBC Radio-Recording, Chicago; George Johnston, SESAC, New York; Al Marlin, BMI, New York, and Gus Hagenah, Standard Radio Chicago. The Lea Bill was informally approved as "a step in the right direction."

Crites Supports BMB

Lowry Crites, advertising controller and director of media for General Mills, Minneapolis, recommended support for Broadcast Measurement Bureau, explaining that the data will eliminate coverage confusion and "enable the advertiser, agency and station to sell more intelligently, economically and with better results."

Melvin Brorby, vice president of Needham, Louis & Brorby, Chicago, also supported BMB "because management of agencies spends more time on radio programs than any other form of advertising and needs more data about radio reduced to its simplest forms. BMB

is to move television into the higher frequencies or to leave it where it is.

Whichever they decide, Mr. Eddy wishes they'd hurry up, because the industry is at a standstill until it knows just where it's going.

Mr. Eddy is 43 now, married, (he met his wife in Hawaii and married her in China, where she was a nurse) and the proud father of three children, named Nancy, Corky and Tinky. All the children fly, and Nancy and Corky have their own planes. When Tinky becomes 16, she'll have one too.

Since a man is only as good as his boss thinks he is, listen to John Balaban's opinion of Eddy: "The guy is a showman. Why, everything he does is a production!"

Quite different from the sour report he once received from a naval laboratory which termed one of his inventions, "the product of an unbalanced mind."

will measure radio more accurately against the clients' sales problems."

Work of the Broadcast Advertising Dept. was described by Frank Pellegrin, its director. John Alexander, KODY North Platte, presided at a Small Market Stations meeting. Wendell Campbell, KMOX St. Louis, was chairman of the Sales Managers Clinic, with Eugene Flaherty, KSCJ Sioux City, Ia., handling the Program Managers report. Discussion of uniform time included views of Mr. Gillin; Gordon Gray, KOIL Omaha; Buryl Lottridge, WOC Davenport; Joe DuMond, KXEL Waterloo; James Connolly, ABC station relations, Chicago. Agency recognition project was discussed, with Harold Soderlund, KFAB, presiding.

Cocktail party at the Omaha Athletic Club, with Omaha stations as host, closed the two-day meeting. List of those registered follows:

H. G. Alexander, Gates Radio; John Alexander, KODY; M. R. Aldridge, KFBU; C. E. Arney, Jr., NAB; Lewis H. Avery, Lewis H. Avery Inc.

David Bain, RCA Victor; Eugene A. Barcott, Graybar Elec.; Frosty Blair, KOIL; E. Hale Bondurant, WHO; L. J. Bormann, Assoc. Press; Edward Breen, KVFD; Lyle Bremser, KFAB; Melvin Brorby, Needham Louis & Brorby; Harry Burke, KFAB.

Craig Campbell, INS; Wendell Campbell, KMOX; Jim Carpenter, WKBB; Frank E. Chizzini, NBC Radio Recording; Arthur B. Church, KMBC; P. H. Clark, KCA; James H. Connolly, ABC; B. C. Corrigan, KOWH; Wayne W. Crites, KHAMO; M. Crozhan, KOIL; Lowry Crites, General Mills.

Lyle De Moss, WOW; W. P. Dietz, KFAB; Robert Dillon, KRNT; Betty Dixon, KFOR; Dietrich Dirks, KFAB; Bob Dooley, KFAB; Melvin Drake, KFOR; Jack Dumond, KXEL; Joe Dumond, KXEL.

Fred E. Doener, WOW; Wm. Edholm, KOIL; F. C. Eighmey, KGLQ; Ralph Evans, WHO.

Harold Fair, WHO; Hugh Feltis, BMB; L. O. Fitzgibbons, WOC; Gene Flaherty, KSCJ; Paul Fry, KBON.

Jerry Gill, Assoc. Press; John J. Gillin, Jr., WOW; Ken Gordon, KJTH; Doug. Grant, WMT; Gordon Gray, KOIL; G. G. Griswold, KREQ.

Gus Hagenah, Standard Radio; Edward W. Hamlin, KSD; John Harrison, KFOR; E. K. Hartenpower, KCMO; Ralph S. Hatcher, CBS; Carl Haverlin, MBS; Wick Heath, KMMJ; George J. Higgins, KSO; L. L. Hilliard, KDKY; Phil Hoffman, KRNT; Harold Hugnes, KOIL; Dick Hull, WOI.

J. J. Isaacson, WOW. George W. Johnston, SESAC; Bill Johnson, KOIL.

A. W. Kanev, NBC; Don E. Kassner, KXEL; Scotty Keck, NBC; Les Kennon, KWTO; Karl Koerber, KMBC.

Al Larson, WOW; Rex Latham, KMMJ; Edmund J. Linehan, KSO; Maury Long, BROADCASTING Magazine; Buryl Lottridge, WOC.

G. B. McDermott, KBUR; Mrs. G. B. McDermott, KBUR.

Bert Masterson, United Press; A. L. Marlin, BMI; James A. Mahoney, Mutual; Bill Martin, KMMJ; Earl E. May, KMA; Edward W. May, KMA; M. M. Meyers, WOW; Charles Miller, KRNT; Justin Miller, NAB; L. A. "Jiggs" Miller, KFAB; Soren Munkhof, WOW.

A. M. Nicoll, KOIL. Ray Olson, WOW; Em Owen, KXEL. Kenneth M. Parke, WIL; Harry Peck, KOIL; Frank E. Pellegrin, NAB; Howard O. Peterson, KMA; Ernest S. Priesman, KBON.

Wm. Quarton, WMT. J. D. Rankin, Jr., KMA; Carter Ringler, KMOX; Glenn G. Rippon, KMMJ; Harold E. Roll, KFAB; Russ Rullman, Caples Co.

Owen Saddler, KMA; Robert P. Samardick, WOW; Ben B. Sanders, KICD; John T. Schilling, WHB; Morgan Sexton, KROS; John S. Shafer, KVFD; Frank Shopen, KBON; Harold Soderlund, KFAB; Elizabeth Sammons, KSCJ; Ken Stewart, KFOR; Harold Storm, WOW; Charles T. Stuart, KOIL; Frank Stubbs, KFNF; Donald D. Sullivan, WMT; David



NEW DOINGS AT NIGHT



Jovial ex-serviceman, Al Poska, is back among the air voices on KFI with the latest program addition. His new hour-long show is known as the "MIDNIGHT FLYER," and it does just that every night except Sunday at the stroke of twelve. Between a limitless variety of popular platters, Al gives out with that same brand of humor which put over "The Musical Clock," "Poor Poska's Almanac" and "The Unclassic Hour" prior to the war. Because the show is just one week old at this writing, we don't have a mail count to report. However, give Al and his "MIDNIGHT FLYER" a couple of months and the results will probably stagger you. When that happy incident comes about (and it's more than a probability), you will be doing yourself a favor to call KFI Sales Department or Edward Petry for the costs and such connected with the program.

THE UNSUNG HEROES



Occupying the end office in the KFI building are two little ladies who deserve a big hand for their services. The office we're talking about is the Mail Room, and the little ladies are Dorothy Narwick and Joyce Rainwater. Not only do these two receive and deliver the heavy volume of mail that comes to KFI, but they have the thankless side job of forwarding, each day, around 500 mis-addressed letters to persons who have either left KFI or have connections with other stations.

CLEAR CHANNEL
640 KILOCYCLES **KFI** 50,000 WATTS
Barb C. Anthony, Inc.
NBC for LOS ANGELES
Represented Nationally by Edward Petry and Company, Inc.

At 10th District NAB Meet



V. Sutton, KMOX; Lawrence Swars, Noble & Swars.

Art Thomas, WJAG; Chet Thomas, KXOK; Anson E. Thomas, KGFW; John A. Toothill, Burn Smith Co.

R. B. Uhrig, Graybar Elec. Co.; Lumir Urban, KORN.

Duane L. Watts, KHAS; Pearson G. Ward, KTTS; George W. Webber, KDTH; Dick Welna, KBON; Elizabeth Whitehead, KOZY; Earl C. Williams, KFAB; Bill Wiseman, WOW; Woody Woods, WHO.

Guy E. Yeldell, KSD.

More Chicago Net Shows Being Planned by Mutual

MUTUAL'S plans to make Chicago a key originating point neared completion last week following a visit by Phil Carlin, MBS vice president in charge of programming.

Mr. Carlin went to Chicago to investigate the quality of night club and theatre talent available for several proposed shows which would be aired over Mutual's Chicago outlet, WGN.

"We have already cleared Wednesdays, 9:30-10 p.m. CST, for a variety show which would develop the wealth of talent available in the city," he declared, adding that "we feel it is possible to make Chicago the stepping-stone it was in former days." Principal reason for originating more shows from Chicago, Mr. Carlin said, is that it makes it more helpful in servicing midwest clients.

KVOO Tulsa has started erection of three 450 foot towers to replace present twin 225 foot towers at the transmitter ten miles east of Tulsa. Plans were started before the war, but construction was delayed because of steel restrictions. The special electronic switch which floods the transmitter building with lights as cars pass, has been turned on again, KVOO engineers also announced.

TENTH DISTRICTERS turned out—130 of them—for NAB meeting at Omaha. Representing local stations (top photo l to r) were: Front row, Lyle DeMoss, WOW; President Justin Miller of NAB headquarters, who presided; Harry Burke, KFAB; back row, Bernard Corrigan, KOWH; Paul Fry, KBON; Gordon Gray, KOIL-KFOR. From other cities (second photo) came: Front row, Frank Stubbs, KFNF Shenandoah; James Carpenter WKBB Dubuque; Mahlon Aldridge, KFRU Columbia, Mo.; Frank Chizzini, NBC Radio Recording, Chicago; back row, Glen Rippon, KMMJ Grand Island, Neb.; C. L. Thomas, KXOK St. Louis; Lewis Avery, Lewis Avery Co., Chicago; E. Anson Thomas, KGFW Kearney. Trio of shop talkers (bottom), John J. Gillin Jr., WOW Omaha, re-elected district director; Lowry Crites, advertising comptroller and director of media, General Mills; Melvin Brorby, vice president, Needham, Louis & Brorby, Chicago.

Publisher Does Not See Great Hope of Facsimile

"IT HAS become obvious that radio and newspaper are destined to supplement each other," John H. Hoagland, manager of Christian Science Publishing Society, publisher of the *Christian Science Monitor*, declared in addressing members of the Los Angeles Advertising Club at luncheon meeting in the Biltmore Hotel.

Revealing increased figures on newspaper circulation, he stated that "accepting the best promise I have yet heard we must foresee a facsimile half the size of one page of your present full size daily newspaper. This sheet will be printed on one side. But what will be their visual quality? I have not seen a sample where even the largest type could be described as a good clear reproduction."

BRITISH MAY WIDEN USE OF RADIO ADS

BELIEF that English advertisers will make much more extensive use of radio in the coming years than they did before the war was advanced by Peter Taylor of the London agency of Colman Prentis & Varley Ltd., now on his way back to England after a month's visit to the U. S. But, he hastened to add, there is no indication that BBC will let down its bars against program sponsorship, and the English advertisers will again be forced to turn to stations outside of the United Kingdom.

Before the war, he told BROADCASTING, English-language advertising accepted by Radio Luxembourg and other continental stations, aimed at British listeners, was used chiefly for the cheaper drug products, with programming on about that level too. Now, he said, the continued shortage of newsprint is encouraging other advertisers to consider the use of radio on a basis more nearly parallel with U. S. commercial radio.

Mr. Taylor said his agency handles British advertising for Elizabeth Arden, Hudson cars and Sanforizing and has recently been given a new American account of "a very large company with many advertised products and one of the major users of radio in the U. S." Colman Prentis & Varley is planning to build studios for the production of transcribed programs, he reported.

S. African Radio Plans

INTENTION of the South African Broadcasting Corp. to sell time to advertisers was reported last week. Like BBC, SABC has obtained its revenue from licensing radio sets. The South African Government Information Bureau said the SABC contemplated the addition of a commercial broadcasting system to the two it now operates. The present "A" system is medium-wave, the "B" short-wave. The Information Bureau said the new system, to be known as "C," would probably be another medium-wave one, but carrying commercial programs.

Radio Excise Rises

INTERNAL Revenue Bureau collections for radio sets, components, phonographs etc. in December 1945 totaled \$970,212 compared to \$361,127 in December 1944.

TRANSMITTER Division of General Electric Co., Electronics Dept., is issuing eight-page booklet "Electronics for Education," describing ways in which electronics are employed in education. Illustrations of technique and equipment are included.

FOUR million words of radio talk are monitored weekly by Radio Reports Inc., New York, radio research organization, according to an article by A. D. Rathbone IV, in recent issue of Liberty Magazine. Firm listens, records, transcribes, and furnishes verbatim manuscripts, daily and weekly digests of radio opinion, and various special analyses and evaluations of news and comment and other material on radio.



Sell The

#1 MARKET

WINSTON-SALEM
GREENSBORO
HIGH POINT



In the South's

#1 STATE

NORTH CAROLINA



With

WSJS



For the Tri-Cities

Representatives

HEADLEY-REED COMPANY

PAUL W. MORENCY, general manager of WTIC Hartford, last week was named a vice president of Travelers Broadcasting Service Corp., Travelers Insurance Co. radio subsidiary, it was announced by J. W. Randall, president of Travelers companies. He has headed WTIC since 1929 and previously had served as assistant secretary and more recently as secretary of the broadcasting corporation. He has served several terms as an NAB board and executive committee member.

LES RYDER, manager of WCED DuBois, Pa., has been elected treasurer of newly formed DuBois Radio-Press Club, composed of members of the staff of WCED and DuBois Courier-Express.

GRANT F. ASHBACKER, president of Ashbacker Radio Corp., licensee of WKBZ Muskegon, Mich., appointed publicity director of the Greater Muskegon Chamber of Commerce, has prepared a promotion booklet for the Chamber in which radio is listed under "Civic Facilities." Mr. and Mrs. Ashbacker are now in Florida for two months' stay.

DON C. WIRTH, vice president and managing director of Wisconsin Network, has returned from the West Coast where on Dec. 28 he married Mary E. Voge. Mrs. Wirth had been with

MANAGEMENT

Standard Oil Co. of California at Los Angeles.

G. S. (Pete) WASSER, vice president and general manager of KQV Pittsburgh, again has been appointed chairman of the radio committee for Pittsburgh District American Red Cross fund drive.

J. HAROLD RYAN, past president of NAB, now back at his post as vice president of Fort Industry Co., has been honored by the National War Fund for his services as chairman of the Fund's radio committee. More than a billion listener impressions are accounted in four weeks campaign. Radio's contribution is estimated to have commercial value in excess of \$2,000,000.

LEWIS C. RYAN, secretary and director of WSYR Syracuse, N. Y., and director of WELI New Haven, Conn., last

week was reelected president of the New York State Bar Assn.

A. D. (Jess) WILLARD, NAB executive vice president, and **GLADYS HALL**, his secretary, were honor guests at a staff luncheon Jan. 29 in Washington tendered by **EARL H. GAMMONS**, Washington director of CBS. Mr. Willard, former WTOP (nee WJSV) general manager, and Miss Hall, former top CBS secretary, were presented with gifts. Guests included **HARRY C. BUTCHER**, former CBS Washington vice president; **STEPHEN T. EARLY**, Pullman Co. vice president and former secretary to President Roosevelt; **GEORGE ALLEN**, RFC nominee and presidential adviser, and **DOROTHY PAGE**, secretary to **PAUL A. PORTER**, FCC chairman.

RICHARD F. CONNOR, vice president in charge of operations of ABS, has resigned effective Jan. 26 to devote time to his newly acquired interest in an unnamed station in the West. In radio since 1929, he left Mutual in 1944 to help organize Associated. He had been MBS director of station relations in New York. Mr. Connor is onetime manager of KMPC Hollywood.

A. DAVIDSON DUNTON, chairman of the CBC board of governors, accompanied by **GEORGE R. YOUNG**, CBC supervisor of station relations, is making a tour of western Canadian privately-owned stations Feb. 6-20 with calls at Vancouver, Victoria, Edmonton, Calgary, Regina, Saskatoon and Winnipeg. It is his first visit to private broadcasting stations since his appointment Nov. 15.

JOHN F. ROYAL, NBC vice president in charge of television, is in Hollywood for three or four weeks, reportedly in connection with NBC's proposed activities in the production of motion picture films for television use.

JOHN W. ELWOOD, general manager of KPO San Francisco, has been elected executive vice president and director of San Francisco Down Town Assn.

EDGAR KOBAK, Mutual president, is planning to spend most of February on the road. Following meeting of Marketing Executives Society Feb. 1-2 in Atlantic City which he conducted as MES president, Mr. Kobak leaves New York Feb. 5 for Chicago, Los Angeles and San Francisco. Schedule calls for his return to New York Feb. 22 and on 26th he leaves for Akron where following day he will be chief speaker at ceremonies in connection with first anniversary of WHKK. March 2 he is to be in St. Louis conferring with KWK executives.

WENDELL B. CAMPBELL II, general manager of KMOX St. Louis, Jan. 29 was host to U. of Missouri student winners of St. Louis Advertising Club College Awards. Winning students received two-week visit to St. Louis to observe all phases of advertising. Tour of KMOX was included.

TED R. MORROW has been appointed manager of CKPR Fort William, Ont. He was formerly manager of CKGB Timmins, Ont., and on commercial department staffs of CKEY Toronto and CHML Hamilton, Ont.

LEE SAUNDERS has taken over his duties as assistant manager and program director of KGVO Missoula, Mont.

LEONARD A. VERSLUIS, president of ABS, is to attend dinner given Feb. 9 by Women's National Press Club in Washington as guest of **ESTHER VAN WAGONER TUFTY**, conductor of ABS "Tufty Topics" program. President Truman is to be guest of honor at dinner.

Hinckley's Successor

H. CHAPMAN ROSE, deputy director of the Office of Contract Settlement, has been appointed by President Truman to succeed Robert H. Hinckley as director of OCS. Mr. Hinckley resigned effective Jan. 31 and will become vice president and member of the board of ABC [BROADCASTING, Jan. 28].

H. C. HURD Jan. 24 assumed duties as general manager of KFJB Marshalltown, Ia. He recently was released from Navy as lieutenant (jg) after three and a half years' service, two of which were spent in South Pacific. He formerly had been with KABR Aberdeen, S. D.

BRUCE WALLACE, program manager of the Milwaukee Journal stations WTMJ and WTMJ-FM, has been promoted to assistant manager. His successor in program post is **JIM ROBERTSON**, announcer. Both have been with stations for two years.

E. A. ALBURY, general manager of WHBQ Memphis, Tenn., is on business trip to Chicago, New York and Washington.

DON IOSET, executive director of WMOH Hamilton, O., has received a silver U. S. Treasury award mounted in plexiglas for his individual interest in activities of Treasury Dept., State and local War Finance Committees.

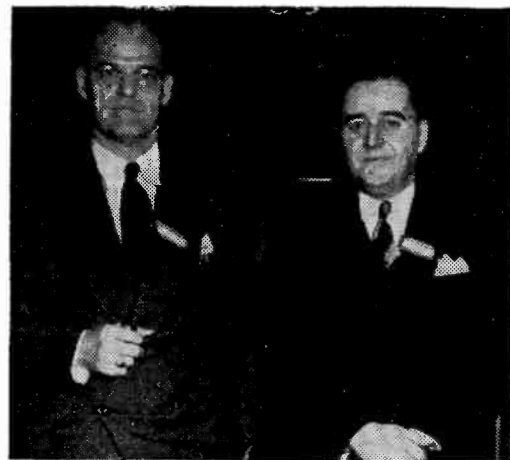

NEW VICE PRESIDENTS of KFOR Lincoln and KOIL Omaha were announced at Omaha NAB 10th District meeting by KFOR-KOIL owner, Charles T. Stuart. They are Melvin Drake (left), KFOR, and Gordon Gray, KOIL. Mr. Stuart has bought WDGY Minneapolis, subject to FCC approval.

RICHARD H. GRAHAM, released from Navy with rank of lieutenant, has resumed as RCA and NBC Western Division attorney and is headquartered in Hollywood. **DONN B. TATUM**, who has been representing RCA and NBC during Mr. Graham's absence, returns to his former practice.

IRVING B. ROSENHAUS, president and general manager of WAAT Newark, N. J., participated Jan. 28 in round-table discussion at Conference on Postwar Problems of Education held at Stacey-Trent Hotel, Trenton, N. J.

ARTHUR B. CHURCH, president of KMBC Kansas City and owner of syndicated "Texas Rangers," left for Mexico City Jan. 29 to contact Mexican stations on transcribed series, plus other Church production features. He was accompanied by Mrs. Church and C. W. (Chuck) MYERS, president of KOIN Portland, and Mrs. Myers, who are long-time friends.

Wireless Anniversary

VETERAN Wireless Operators Assn. will celebrate its 21st anniversary at a "Radio Victory Dinner" Feb. 16 at the Hotel Astor in New York. Annual Marconi Memorial Service plaques will be awarded to the Institute of Radio Engineers and the American Radio Relay League. Marconi Memorial medals will also be awarded to Gen. Harry C. Ingles, Chief Signal Officer of the U. S. Army; Adm. Joseph R. Redman, retired director of Naval Communications; Gen. H. M. McClelland, Air Command Officer of Army Air Forces; Comm. E. M. Webster, director of Coast Guard Communications.

Vet Show Offered

LT. COMDR. TY KRUM's "Veterans Advisor," broadcast over NBC for nine months as a public service, has been offered by the network as a cooperative program for local sponsorship. Program will keep present time, Sat. 1:30-1:45 p.m.

WDBJ for Roanoke and Southwest Virginia

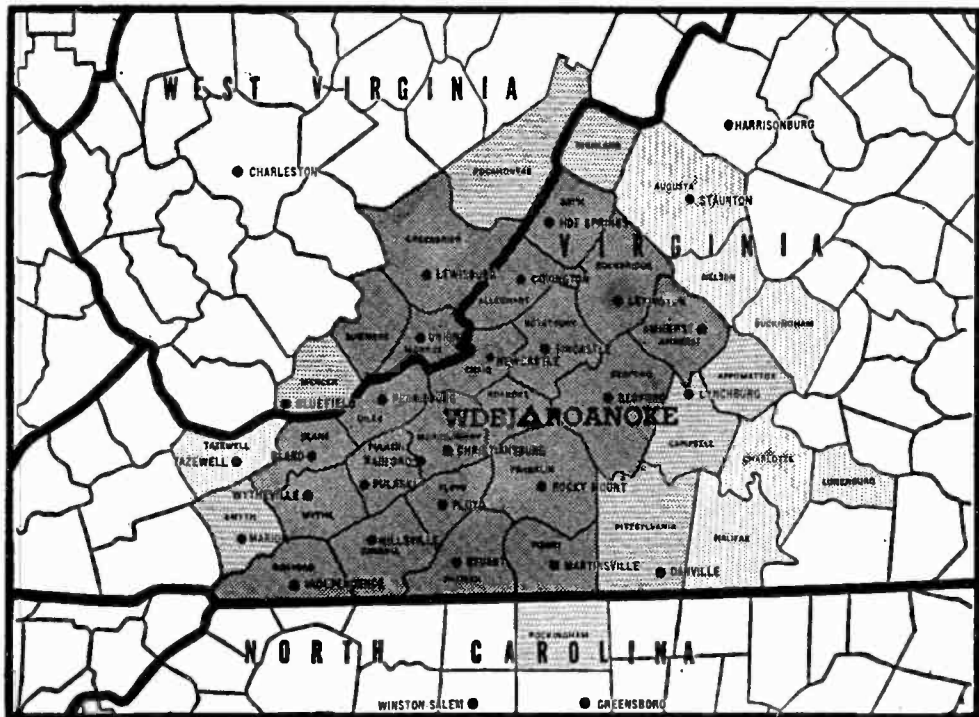

There's only one station that covers the prosperous Roanoke and Southwest Virginia market. That station is WDBJ. Its daytime primary and secondary coverage areas have a total population of 841,700 (148,000 radio homes), with retail sales of more than \$297,000,000. Ask Free & Peters!

CBS • 5000 Watts • 960 KC
Owned and Operated by the
TIMES-WORLD CORPORATION



FREE & PETERS, Inc., National Representatives



COMMERCIAL

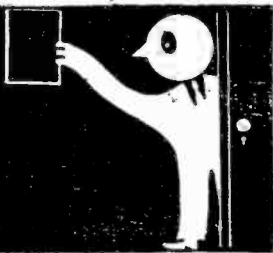

DAN STARR and **BILL HUBBACH**, both account executives of KOMO Seattle, Wash., have returned to station following release from Navy as air corps lieutenants.

IRVING F. TEETSELL has been appointed sales manager of WFPG Atlantic City. He formerly was district manager of Norwich Pharmaceutical Co., Norwich, N. Y., and was associated with WJTN Jamestown, N. Y. He will handle local, national and network sales.



GEORGE ROSS has been promoted to commercial manager of KDON Monterey, Cal.

ROGER KELLY, released from the Navy and formerly with KDKA Pittsburgh, has been appointed sales manager of KFXJ Grand Junction, Col. Homer Griffith Co. is now exclusive national representative.

PEGGY BREESE, secretary to the advertising and program departments of WTAR Norfolk, Va., has become commercial traffic director. **MAUDE BUTT** succeeds **HELEN DORE**, who resigned as traffic clerk.

WALTER S. HOLDEN, discharged from the Navy, has joined the MBS Midwest sales department, Chicago. Prior to military service he was radio director of Hayes-MacFarland (now MacFarland-Aveyard) and with George P. Hollingbery Co., Chicago, stations representative.

BUELL E. HERRICK, former production manager of WGRC Louisville, Ky., is now member of the sales staff of WINN Louisville.

BILL BIXBY, out of Navy, has joined sales staff of KLX Oakland, Cal. Previously in sales work, he was lieutenant commander on Carrier San Jacinto during Naval duty.

TOM PRICE, sales manager of WWSW Pittsburgh, is father of a girl.

STEPHEN A. MACHCINSKI Jr., formerly with the Katz Co., New York, has joined Adam J. Young Jr., New York, station representative, as an account executive.

GEORGE JEFFERY, salesman of CJOR Vancouver, B. C., has been appointed sales manager of CKPR Fort William, Ont.

ELDON CAMPBELL, program manager of KEX Portland, Ore., assumed new duties Feb. 1 as sales manager of station. **MEL BAILEY**, production head, succeeds him in program post. Mr. Campbell has been with Westinghouse Radio Stations Inc. for seven years.

WESTFORD F. SHANNON, account executive of WSPD Toledo, O., has been appointed local sales manager for the station. He has been with WSPD sales staff for 13 years.



THE ANSWER to the smiles on these faces is the signing of Todd Russell (right) for long term run as m.c. of Mutual's *Double or Nothing*, Sunday, 9:30-10 p.m. Gifford R. Hart (center) is advertising manager of Pharmaco Inc., sponsor, and Walter M. Cramp is account executive of Ruthrauff & Ryan, agency.

LOUIS G. FROELICH rejoins the sales staff of WING Dayton, O., after two and a half years' service in AFRS.

JACK K. TAYLOR, head of the accounting department of KABC San Antonio, Tex., is father of a boy.

CARLETON COVENY, head of Carleton Coveny & Co., Hollywood, is in New York conferring with Mutual executives about Erskine Johnson series of Hollywood commentaries currently broadcast as an MBS co-op program.

POPPELE, ENGINEER OF WOR, NAMED VP

J. R. POPPELE, chief engineer of WOR New York since 1922, was elected a vice president of the station at a meeting of the board of directors last Monday. He retains the titles and duties of secretary and director of the corporation.



Mr. Poppele

Originally sole engineer of the station, Mr. Poppele now heads a staff of more than 80 technical experts. He instituted and has maintained a research laboratory at WOR in which many devices now in common use were developed. Much of the equipment of the station's 50 kw transmitter, including the directional antenna, was designed under his supervision.

A pioneer in FM and television, Mr. Poppele is now president of Television Broadcasters Assn., senior member of the Institute of Radio Engineers, board member of the Veteran Wireless Operators Assn., a fellow of the Radio Club of America, and a member of the Acoustical Society of America, the Society of Motion Picture Engineers and the Twenty Year Club.

Valentine Granted Leave

LEWIS J. VALENTINE, former New York police commissioner, now commentator on ABC's *Gang Busters* has been granted leave to help reorganize Japan's civilian police. Gen. Douglas MacArthur requested his services in Tokyo and his sponsor, L. E. Waterman Fountain Pen Co., New York, has agreed to give him leave. Whether or not he will go will be decided by the War Dept.

AMERICAN SCHOOLS AND COLLEGES ASSN. has awarded a plaque to Mutual "You Make the News" (Thurs. 10-10:30 p.m.) for "impartial, analytical and entertaining presentation."

ON-THE-SPOT reporting has been started on KGO San Francisco. Coverage is being made on all local and regional news fronts by station's news staff members with an additional corps of reporters. Newsroom now claims largest news staff west of Chicago.

DRIVE on behalf of UNRRA clothing collection has been assisted by ABS and its affiliates with spot announcements on news and music programs at regular intervals.

Three Return

THREE MUTUAL overseas correspondents arrived in New York last week. Arthur Mann, head of Mutual's London bureau, came home for a rest after seven years in Europe. Robert Stewart, Manila correspondent who scored an exclusive broadcast of the Yamashita death sentence, and Dorothy Williams, returning from Madrid, were the others.

Comic Strip Character

ARCHIE ANDREWS, featured on "Adventures of Archie Andrews," Sat. 10:30 a.m. on NBC, will be created in a new medium when he appears as hero of a comic strip drawn by Bob Montana to be released through McClure Newspaper Syndicate.

Feud for Thought

ABC's ABLE Chicago press chief, El Henry, would have you believe that Don McNeill and Tom Breneman are feud-in'. Recent releases promise "plenty of fireworks" when Mr. Breneman visits Mr. McNeill's *Breakfast Club* during his seven day stay in Chicago, Feb. 7. It's all good, clean fun, and incidentally the Hollywood version of *Breakfast in Hollywood* makes its debut in Chicago at the same time. Catch?



WHAT'S THE PRICE-TAG ON CHEAP (Ky.)?

Cheap (Ky.) is a jenny-wine town, alright, alright—but regardless of Cheap's name, we know that the radio power necessary to reach very many such thinly-populated places in this big State, costs money! That's why WAVE makes no attempt to do so—and concentrates on the Louisville Trading Area. Here our crystal-clear signal is heard by crowds of people, with more money than is to be found in the rest of Kentucky combined. Cheap's no bargain—but the L. T. A. truly IS!

LOUISVILLE'S WAVE

N. B. C.
FREE & PETERS, INC.,



5000 WATTS . 970 KC
NATIONAL REPRESENTATIVES

AM Decisions Expected in Two Weeks

20 Days Are Allowed For Filing Any Exceptions

FIRST proposed decisions on standard broadcast hearing cases are expected to be handed down within the next two weeks by the FCC.

With the issuance of the findings, all applicants involved will be granted 20 days to file exceptions and request oral arguments. Final action, it was learned, will probably be taken about a month later.

Heard 100 Applications

Having completed about a third of the record schedule of 268 broadcast cases projected for the first quarter of 1946, in addition to 12 cases in December, the Commission has now heard approximately 100 applications since the resumption of normal licensing last October. With the exception of six applications for television stations in Washington, all have been for standard facilities.

On the basis of its experience in January, the Commission feels confident the remainder of the schedule will be carried out successfully. "We've been very pleasantly surprised," a Commission official said, "the way radio lawyers have been able to cooperate. There have been fewer postponements than we expected. With a few exceptions, the hearings have been held on schedule."

Space for New Hearings

The official added that despite the crowded docket the Commission will make space for several additional sets of hearings. Three applications designated but not previously scheduled for hearing will be heard in February and a few more cases will be squeezed into the March calendar.

The Commission plans to keep open the first two weeks in April to complete engineering testimony on applications heard in the field. Although it was contemplated that evidence on substantial engineering questions would be taken in Washington on all field cases, it was found possible to complete testimony in the field on many applications.

The experience thus far also demonstrated the value of pre-hearing conferences in eliminating nonessential testimony and reducing time of proceedings. With the cooperation of counsel for the various applicants, standard hearings have been held at the rate of one case per day, the rate called for in the Commission schedule, or in less than that time. A consolidated proceeding involving nine cases was completed in six days.

As a result of the effectiveness of the streamlined procedure employed by Chairman Porter in hearing the Washington television ap-

THE FCC will begin handing down proposed decisions on AM hearing cases within two weeks. The Commission has already heard about 100 applications since lifting of the wartime freeze and has completed a third of the heavy schedule of hearings projected for the first quarter of 1946.

plications [BROADCASTING, Jan. 28], the Commission expects that considerable time will be saved on future video proceedings. The Washington cases, first to be heard on television, served as the "guinea pig" for about a dozen consolidated hearings to be designated on video applications from large cities. It is planned to begin hearings on these applications in May. Most of the proceedings will be held in the field, with a member of the Commission presiding.

To speed up proceedings on FM cases, Commissioner Durr plans to hold a pre-hearing conference on Boston cases, to be heard March 11 providing the number of applications still exceeds the available frequencies by Feb. 9, the deadline for entering the hearings. The Boston applications are the only FM cases scheduled for hearing and are intended to set the pattern for other consolidated proceedings, several of which have been designated. On the basis of the screening procedure used on the first television hearings, it is expected that FM cases will be heard at the rate of better than one a day. Following the Boston proceedings, the Commission plans to hear other FM cases beginning about May 1. Most of these will also be in the field.

As with the schedule for the first three months of the year, the Commission will attempt to have not more than two members away at one time for future field hearings, keeping five commissioners in Washington to conduct regular business. With the exception of two days in the beginning of January, such an arrangement has

been followed thus far. However, a change in Commissioner Walker's schedule, postponing the Dallas, Tex., hearings from Jan. 21 to Jan. 30 will mean that there will be three commissioners away during part of February.

The Dallas proceedings were postponed because of a large number of withdrawals. There were originally 19 applications from the area consolidated for the hearings but with dismissals, and new applications added, the number of cases now stands at 12. Except for the Dallas hearings, all field proceedings in January were heard on schedule.

All But One on Schedule

Of a total of approximately 30 applications scheduled for hearing in Washington during January, all but one were heard on schedule.

Commission records showed that there was a sizable number of withdrawals from hearings but these were about offset by new cases consolidated with the proceedings. In several proceedings the number of applicants was reduced, in others the number was expanded.

Because of withdrawals from proceedings and requests to switch frequencies, the Commission was able to grant six of the applications without hearings. Two of these were in Florida, two in Idaho, one in Louisiana, and one in West Virginia. Several other applicants have been permitted to withdraw from consolidated proceedings to apply for different frequencies.

100,000 Sets in Dec.

SHIPMENTS of domestic radio sets in December were about 100,000 sets, or 8% of prewar average, according to incomplete reports to the Civilian Production Administration. Shipments of small non-reporting manufacturers may have increased this total. Military orders still account for major portion of industry shipments, it is stated.

★
REMEMBER

ROCKFORD

W

R

O

K

AN ABC STATION

METROPOLITAN POP.

111,000

A GREAT INDUSTRIAL AND
FARM MARKET IN NORTH-
ERN ILLINOIS AND SOUTH-
ERN WISCONSIN

WROK's Natl. Rep.:

HEADLEY-REED

Worthy of an Engineer's Careful Consideration

TYPE 111-A AMPLIFIER

The 111-A Amplifier consists of two individual pre-amplifiers on a single chassis for use in high quality speech input equipment. Its compact unitized construction saves rack space. Input impedances of 30, 250 and 600 ohms; output impedance 600 ohms. It is quiet and has excellent frequency characteristics and ample power output with low distortion products.

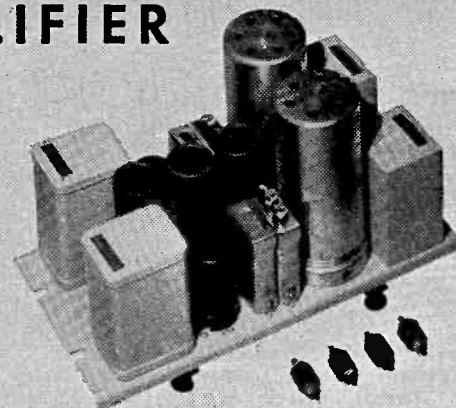

The Langevin Company

INCORPORATED

SOUND REINFORCEMENT AND REPRODUCTION ENGINEERING

NEW YORK

SAN FRANCISCO

LOS ANGELES

37 W. 65 St., 23

1050 Howard St., 3

1000 N. Seward St., 38



BOARD OF GOVERNORS of the Canadian Broadcasting Corp. is pictured in its first photo since A. D. Dunton became fulltime chairman: (l to r) Dr. A. W. Trueman, B. K. Sandwell, F. J. Crawford, Vice Chair-

man Rene Morin, General Manager Dr. Augustin Frigon, Chairman Dunton, Assistant General Manager Donald Manson, Howard B. Chase, Dean Adrien Pouliot, Mrs. T. W. Sutherland, W. J. Parker.

FEE INVESTIGATION ASKED FOR CAPAC

ROYAL COMMISSION to investigate payment of fees under copyright laws to Composers, Authors & Publishers Assn. of Canada (CAPAC) and BMI (Canada), is being recommended by the Canadian Copyright Appeal Board, Ottawa, following hearings on Jan. 24. Canadian Assn. of Broadcasters and Canadian Broadcasting Corp. were represented at the hearings to determine fees to be paid for 1946.

The Copyright Appeal Board stated at the outset of the hearings that since the problem of fees had come up annually for the past 10 years, it would recommend to the Secretary of State the formation of a Royal Commission to investigate the entire problem. Meanwhile, fees will be paid for 1946 by broadcasting stations on the wartime basis of eight cents for each licensed receiver to CAPAC and one cent for each licensed receiver to BMI (Canada).

CAPAC had filed a tariff requesting fees at the eight cents rate amounting to \$140,728 plus 2% on total commercial broadcasting revenue, and BMI (Canada) had filed for a quarter of these fees or for the wartime rates if accorded to both organizations [BROADCASTING, Nov. 19, 1945]. Official report of the Copyright Appeal Board has not yet been issued.

Big Jump

BRIARHOPPERS have hopped right onto the concert stage. The WBT Charlotte hillbilly group were featured with the Charlotte Symphony Orchestra Jan. 31. Briarhoppers have been broadcasting a half-hour show on WBT six days weekly for 11 years. Their diary rating is 70% of available audience, the highest rating of any program on the station, sustaining or commercial.

Clarostat Changes

CLAROSTAT Mfg. Co., Brooklyn, has filed application with the Securities & Exchange Commission for issuance of stock to the general public in order to refinance itself "on a scale commensurate with the expansion required to meet postwar electronic demands." The company manufactures resistors, controls and resistance devices. New officers are General Manager Victor Mucher, now president; Chief Engineer George Mucher is, in addition, vice president; William Mucher is treasurer; Charles Burnell, who has handled the legal, patent and labor relations of the firm, is now secretary.

AUDIO-VISUAL AID EXPANSION AT RCA

EXPANSION of RCA Victor's education and training division to cope with expected increased use of audio-visual aids in education and personnel training has been announced by Frank M. Folsom, executive vice president.

U. S. interest in audio-visual techniques was stimulated by their widespread use by armed forces and war industries, said RCA, and the heightened interest demands attention.

Director of the expanded RCA Victor division will be Walter M. Norton, formerly with Montgomery Ward & Co. in Chicago and New York. Dr. Forrest H. Kirkpatrick, dean of Bethany College, will act in a consulting capacity as director of school and college relations.

Educational field directors have been appointed in each RCA Victor regional sales office to serve schools, Mr. Folsom said.

Among items of equipment which RCA will make available for educational and industrial fields are sound systems, broadcast equipment including FM and AM transmitters and receivers, television transmitters and receivers, recording equipment and the RCA electron microscope.

Weather by Radio

NEW radar and automatic sending and recording equipment perfected during the war will be used by the Weather Bureau in an expansion program drawn up by B. C. Haynes, Chief, Observation Section. "Rason" is the term used to describe the method of recording weather information at high altitudes. Installation is planned at 43 weather stations in 1946.

WHYN Radio Course

SIXTEEN-WEEK course on radio techniques and dramatics is being offered by WHYN Holyoke, Mass., at its South Hadley Falls studios under auspices of Massachusetts Department of Education, University Extension. Staff members of station conduct classes.

Adds 11 Stations

MISSISSIPPI Valley Network full-hour "Town and Country Time," daily 6-7 a.m. (CST), is now aired over 75 stations with addition of Texas stations: KBST KFRO KPLT KRRV KCMC KNOW KBWD KTHT WACO WRR.

BIRMINGHAM

ALABAMA'S RICHEST MARKET



RETAIL SALES

Annual retail sales in the WBRC primary area amount to \$215,188,000. Of this, \$44,423,000 are food sales, \$7,297,000 are drug sales. Total population of this area is 1,243,268, of which 575,000 is metropolitan. This is the market you can dominate when you use WBRC.

WBRC

NBC
5000
WATTS
DAY and
NIGHT

BIRMINGHAM'S
BEST RADIO BUY

5000 WATTS

WORLD'SMEMORABLEBATTLEGROUNDS

IDERMARKETBETTERGUARANTEE

NBC IN RICHMOND, VA.

BALTIMORE'S
Listening Habit

**W
C
B
M**

MUTUAL BROADCASTING SYSTEM

JOHN ELMER President
GEORGE H. ROEDER General Manager

FREE & PETERS, Inc.
Exclusive National Representatives

JOHN W. HAIGIS Jr., for three and a half years weather observer with AAF, has been named program director at WHAI Greenfield, Mass., succeeding **FREDERICK H. GREBE** who now devotes fulltime to duties as chief announcer.

ROBERT STANLEY, WOR New York assistant musical director, has resigned effective March 2.

JAMES SCHULLINGER has been appointed associate editor in the western division editing department of CBS. He transfers from duties with CBS-KNX Los Angeles as contact producer.

EDGAR KOBAK Jr., recently discharged from the Army, has resigned from the traffic division of NBC international department and has started as disc jockey on WBYN Brooklyn.

WILLIS M. GREEN, released from the AAF as major, has returned to announcing and special events staff of KPQ Wenatchee, Wash. He was an electronics officer with the AAF in Africa, Italy and Europe.

TOM HILL, 20, announcer of CKRM Regina, and RCAF veteran, is in Toronto taking six months production course at recently formed Academy of Radio Arts.

LLOYD KNIGHT, WGN Chicago sound effects man recently discharged from the Army, has returned to the station.

REED BROWNING, released from Merchant Marine, has rejoined ABC Hollywood as announcer.

CLIFF THORSNESS, **CLARK CASEY**, **GENE BALLANTYNE** and **GENE TWOMBLY**, released from the armed forces, have returned to CBS Hollywood sound effects department.

BILL DEMLING has been added to CBS "Jack Kirkwood Show" as comic and writer.

STEPHEN DaCOSTA Jr., released from the Coast Guard, has joined the music department of KMPC Hollywood.

HENRY SULLIVAN has rejoined the announcing staff of WGTM Wilson, N. C., after three years in the Navy. Before the war he was on the production staff of WGTM and WBIG Greensboro.

MAURICE BRASWELL, WGTM Wilson, N. C., announcer, has entered the U. of North Carolina.

PRODUCTION



GARNET WEST has joined the announcing staff of WPEN Philadelphia. Real name is Jack Davis, formerly of comedy air team known as the Two Jays—Jack Davies and Joe Carney.

HARRY KING, continuity writer of WPEN Philadelphia, is father of a boy.

WILLARD W. WARREN, with KOMO Seattle, Wash., for nine years before call to military duty, has returned to the station as program director.



Mr. Warren

Entering Navy in 1942, he was returned to inactive duty as lieutenant commander. **BILL WARD**, KOMO writer, has returned to station after two years in Alaska as Army Signal Corps technical sergeant. **WARREN McCLOY**, continuity director, returns to station following three and a half years' service as Navy lieutenant in South Pacific. **CLIFF HANSON**, announcer, resumes duties upon release from Army Signal Corps. He also was sergeant in Alaska. **JOHN MURPHY**, AAF lieutenant, rejoins staff as does **PARKER COLLINS**, writer of "Housekeeper's Calendar," following two years' duty in India as AAF corporal.

VIRGINIA WADE, program manager of WCED DuBois, Pa., has been elected president of new Business and Professional Women's Club and of the Women of the Round Table, oldest DuBois club for women.

DICK GARTON, released from Army, has returned to KFVB Hollywood as announcer.

JACK EIGEN, Broadway and Hollywood reporter for WMCA New York, is doing a column for monthly Mayfair magazine.

WILLIAM SPIER, producer of CBS "Suspense" series, has completed negotiations with Simon & Schuster for publication of his book, "Omnibus of Suspense."

COMDR. A. W. SCOTT'S "Romance of the Highways," based on his weekly Don Lee Broadcasting System radio program, is now in book stores.

BILL LAWRENCE, producer of CBS "Screen Guild Players," in addition to directing radio and film stars, also is building swimming pools for them. He is with an established company as a sideline.

GERTRUDE HOFFMAN, ABC continuity acceptance director, New York, is in Hollywood for conferences on network policy with **DOROTHY BROWN**, head of Western Division continuity acceptance.

FRANK ECKERSLEY has joined the announcing staff of CKWX Vancouver, B. C.

DR. W. J. GALLAGHER, commentator of CBC on church news, is in Switzerland attending meeting of World Council of Churches as Canadian representative.

JOE KELLY, quizmaster of ABC "Quiz Kids," will be absent from the Chicago-originated program for one month for rest on advice of his physician. He is to return to show March 3.

ALICE HOLLIDAY, continuity writer, is new addition to staff of WPTF Raleigh, N. C.

GUY A. AYLWARD, Jr., graduate of WEEI Boston first Announcers School for Veterans, has been added to staff of WSAR Fall River, Mass.

GEORGE T. CASE, program director of KABC San Antonio, Tex., is father of a boy.

HUGH BADER, released from AAF, has returned to program production department of KBON Omaha, Neb. **ANNETTE CRAWFORD** has been promoted to KBON continuity editor, replacing **LOIS JOHNSON**.

STAN LOCKE, chief announcer of KWSC Pullman, Wash., Feb. 1 was to transfer to KXRO Aberdeen, Wash., as announcer.

WILLIAM RODDY, discharged from Army, has rejoined KPO San Francisco as announcer. **LON KING**, also released from service, has returned to station traffic department.

WARD QUaal, WGN Chicago announcer who entered the Navy in 1942 as an apprentice seaman and later rose to rank of lieutenant (sg), has returned to the station. In the Navy he served with Amphibious Forces Atlantic Fleet.

JIM DOYLE, WCBS Springfield, Ill., announcer, has rejoined the staff following his discharge from AAF.

WALT NEWTON, WGN Chicago announcer who entered the Marine Corps May 1944, has returned to the station. A second lieutenant, he served overseas at Pelelu and Guam.

DOROTHY REYNOLDS, with Mutual's Chicago office since Dec. 1939, has been appointed office manager.

WILL DOUGLAS, announcer at WKBN Youngstown, O., has returned to station following release from Army as captain. First assignment upon return was interview with Maj. Gen. R. L. Beightler, only commanding general to retain his National Guard Division throughout the war.

RICHARD COVEY has returned to the announcing staff of KkNT Des Moines following release from AAF. He was returning from B-29 raid on Tokyo when V-J Day was officially announced. **BILL CHANDLER**, out of the Army, has been appointed musical director. He formerly was with WHO Des Moines.

EDDIE ALBRIGHT, former production manager of KJJ Hollywood, has been placed in charge of production department KGrJ Los Angeles. **DOUGLAS FLEDGER**, formerly with ABC Hollywood, is new KGrJ announcer.

TOMMY SNOWDEN, announcer at WEED Rocky Mount, N. C., and **BILL HOLM**, program department member, have rejoined station after three years' AAF duty.

DAVE CRANDALL, former television producer for Paramount Pictures, Hollywood, has joined television station WBkB Chicago.

DR. R. VINCENT BYBEE, Richmond, Va., chiropractor, has entered his 17th year on WMBG Richmond as conductor of weekly health talk program.

PAUL KEEFE, Navy lieutenant and Pacific veteran, and **ELLIS DIERDOFF**, Army ETO veteran, return to the announcing staff of WCOP Boston following release from service.

BILL RUTHLEDGE, announcer at KARK Little Rock, Ark., is father of a boy.

JIM TODD rejoins announcing staff of KVOO Tulsa, Okla., following two years in the Navy on Atlantic fleet duty.

DICK BRILL, former writer of ABC Hollywood, has joined the production staff of KQW San Jose.

FOUR TOP MARKETS!

Central Kentucky
WLAP Lexington, Ky.

Amarillo
KFDA Amarillo, Tex.

The Tri-State
WCMI Ashland, Ky.
Huntington, W. Va.

Knoxville
WBIR Knoxville, Tenn.

All four stations owned and operated by Gilmore N. Nunn and J. Lindsay Nunn. Represented by The John E. Pearson Co.

Serving

The Third Largest Market

in the

Fourth Richest State

•

W C O L

COLUMBUS

The Listening Habit of Central Ohio

•

Represented by

THE HEADLEY-REED CO.

Backward Script Saves Broadcast

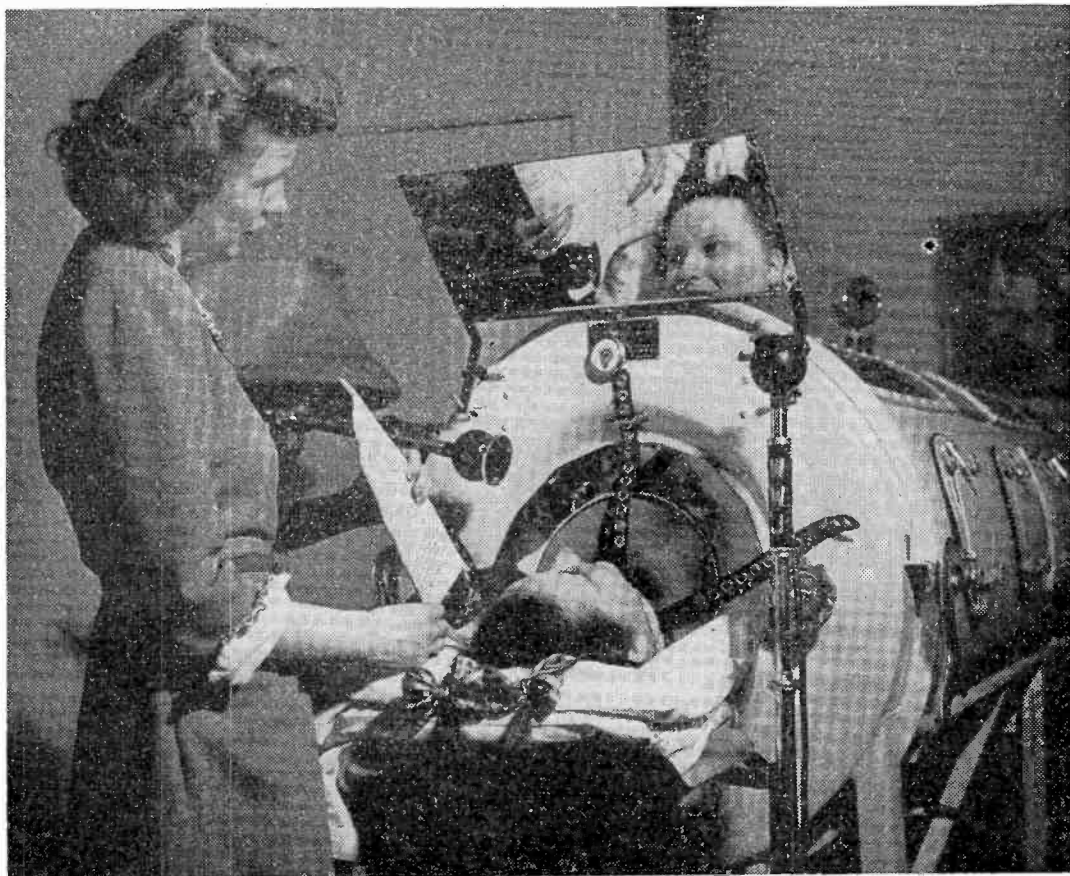

DOUBLE-FACE carbon paper solved a problem which threatened the effectiveness of WWJ Detroit's broadcast of a March of Dimes appeal by 25-year-old Mrs. Karen Oaks, Detroit polio victim, from her iron lung. WWJ's special events announcer, Anne Collins (shown above with Mrs. Oaks), discovered in a pre-broadcast interview that Mrs. Oaks' script could not be used on the reading rack because page-turning would break the continuity and create unnecessary sounds. Using the lung's mirror wouldn't work because the mirror reverses the type. Lanny Pittman, WWJ publicity manager, came up with the solution: Double-face carbon was used in typing the script so that Mrs. Oaks' pages, held backwards facing the mirror, reversed to normal.

HUGH BRUNDAGE, released from armed forces, has joined KFAC Los Angeles as announcer.

VINCE WILLIAMS, former ABC Hollywood announcer and prior to that with KOA Denver, has joined KMPC Hollywood.

DOROTHY BROWN, head of ABC Western Division continuity acceptance, is recovering from injuries received in an auto collision in Hollywood on Jan. 17.

STANLEY MAXTED, formerly BBC war correspondent with British paratroops in Holland, Germany and with American forces in first landings at Tokyo, has returned to Canada to rejoin CBC as producer after five war years with BBC. First Canadian production since his return was "Salute to Australia" Jan. 25 in honor of 158th anniversary of Australia's founding.

BERNE ENTERLINE, former WMBD Peoria, Ill., announcer, has returned to station as assistant program director after service in the armed forces. **MILTON BUDD** was to return to announcing staff Feb. 1 and **BOB CARLTON**, announcer, is expected back shortly.

KEN GFELLER has returned to his post

as continuity director of WHO Des Moines upon discharge from the Navy. **QUINN KRAMER**, acting continuity director, has transferred to production department as writer.

SHIRLEY WILSON has been named research assistant to **FOSTER MAY**, ABC Hollywood commentator.

BOB SCOTT, Army veteran, is new announcer at KFXJ Grand Junction, Col. **ROBERT MOORE**, ex-Army captain, joins music staff as organist.

WILLIAM ROBERTS, first violinist of the Salon Orchestra of WTAR Norfolk, has returned to station after three years in Navy.

KENNETH YEEND, program director of KIRO Seattle, Wash., has been elected to the board of directors of Seattle downtown Kiwanis Club.

AL GRAY, one of the original members of the announcing staff of WSTV Steubenville, O., has returned to the station following three and a half years Army service.

LIONEL J. POULTON, former freelance producer and actor, has joined production staff of KDKA Pittsburgh.

EDWARD KOOPS, recently discharged from the Army, has joined the KDKA Pittsburgh production staff. He was formerly with WSJS Winston Salem, N. C., and WOWO Fort Wayne, Ind.

JAMES BEGLEY, program director of KYW Philadelphia, is back at his desk after an absence of several months during which he recuperated from an operation.

GUY and **CARMEN LOMBARDO** have completed judging more than 250,000 entries in their song title contest. Winners of the \$10,000 will be announced on the Feb. 5 broadcast of "Guy Lombardo and His Royal Canadians," sponsored by Lewis & Brothers Co., Richmond, for Chelsea cigarettes, Tues. 9 p.m. on ABC.

WILLIAM HARVEY, former announcer of KYW Philadelphia, joins staff of WHAT Philadelphia.

GUS OHLSON, released from the Army, has joined KQW San Jose, Cal., as announcer.

BOB GOERNER, announcer of KQW San Jose, Cal., has taken a three months leave of absence because of illness.

JACK DOUGLAS has been signed as

writer on CBS "Durante-Moore Show". Staff also includes **HENRY TAYLOR**, **LEO SOLOMON** and **ALAN WOODS**.

JAN SAVITT has been assigned musical director on weekly ABC Louella Parsons program.

LEE LAWLEY, KPRO Riverside, Cal., program director, has been made director of news bureau and chief announcer. **CHARLIE GIBSON**, recently released from Army, joins KPRO as script and continuity writer.

JOHN FENTON MURRAY, writer on NBC "People Are Funny", has resigned to devote time to similar duties on NBC "Red Skelton Show". **ROBERT DWAN**, **BERNIE SMITH** and **BILL SHAY** have been added to writing staff of former series.

BILL STULLA, released from AFRS, has returned to KFI Los Angeles as announcer. During service he was for two years station manager of AFRS headquarters station VU2ZY New Delhi, India.

BOB MITCHELL, released from AFRS, Los Angeles, has joined KFI Los Angeles as staff organist.

BILL CLOSE, formerly at WWVA Wheeling, has joined WSSV Petersburg, Va., as program director. **HENRY ADDISON**, announcer, has been advanced to WSSV musical director.

MARY ANNE RHAME has joined the program department of WIS Columbia, S. C., replacing **JOE MCGINLEY**.

JUNE HORACEK, formerly of WMRO Aurora, Ill., has joined the program department of WIND Chicago.

WILLIAM J. REDDICK, Jr., son of the managing director of ABC "Ford Sunday Evening Hour," has been appointed music director of KPHO Phoenix, Ariz.

CHARLES WOODS, recently discharged from Army service, has rejoined WOR New York as announcer. Before entering Army he was heard on WOR news programs.

GORDON GRAY, freelance writer in Chicago for 14 years, has joined the announcing staff of WNEW New York.

Record Preview

AUDIENCES at Borden Co.'s "County Fair" (CBS Sat. 1:30-2 p.m.) are admitted early to CBS playhouse and treated to 30-minute pre-broadcast playing of new record releases. Idea is to get audience into mood for carnival atmosphere of variety-quiz show. Kenyon & Eckhardt, New York, is agency.

KFMB

Sells

SAN DIEGO

In California's 3rd city, KFMB reaches 90% of the San Diego County population. 373,000 persons within 15 miles of our antenna . . . listening to KFMB only for the primary ABC (American) network shows.

KFMB

BASIC AMERICAN NETWORK
(Pacific Coast)

SAN DIEGO, CALIF.

Owned and Managed by JACK GROSS
Represented by the BRANHAM CO.

WDOD

SINCE 1925*

*THE BEGINNING OF
RADIO IN CHATTANOOGA

CBS

doing the

5,000 WATTS
DAY AND NIGHT

best job
in
Chattanooga

PAUL H. RAYMER CO.
NATIONAL REPRESENTATIVE

First in Chattanooga

10,000 WATTS DAY & NIGHT

We're Selling
POWER
That's Got
SELLING POWER

**NEWS
SPORTS
MUSIC**

PHILADELPHIA'S
MOST POWERFUL
INDEPENDENT

WIRG

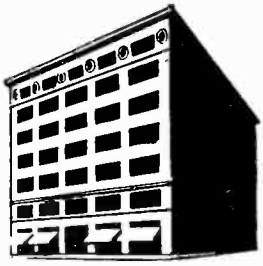

M. L. Parker Co.
DAVENPORT DEPARTMENT STORE

buys WOC for the

QUAD Cities

(DAVENPORT, ROCK ISLAND
MOLINE, E. MOLINE)

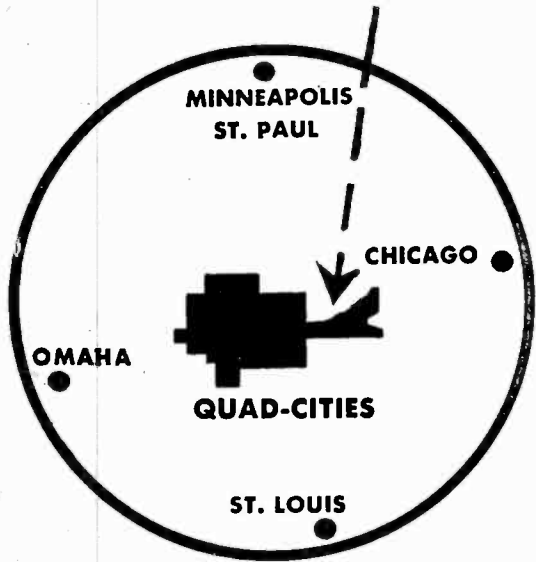

Since 1943, Hooper and Conlan surveys have shown that only WOC delivers the Quad-Cities — the largest metropolitan area between Chicago and Omaha; and between Minneapolis and St. Louis. It's the 40th retail market in the nation, with approximately 218,000 population.

ACCORDING TO HOOPER THE
40TH MARKET
IS DELIVERED ONLY BY
WOC

DAVENPORT, IOWA

B. J. PALMER, President
BURLY LOTTRIDGE, Manager

BASIC AMERICAN NETWORK
5000 WATTS—1420 Kc.
FREE & PETERS, INC., National Representatives

RIBBONS PRESENTED TO CORRESPONDENTS

"FOR OUTSTANDING and conspicuous service with the armed forces under difficult and hazardous combat conditions," 314 civilian war correspondents have been awarded the European-African-Middle Eastern Campaign Ribbon.

Of eight awards, given posthumously, one went to Thomas Treanor, who covered ETO for NBC and the *Los Angeles Times*. He was killed in France in August 1944.

Among radio correspondents awarded the ribbon were:

W. Wright Bryan (NBC), John Bryson (ABC), Winston Burdett (CBS), Edgar M. Calmer (CBS), James F. Cassidy (WLW-NBC), W. W. Chaplin (NBC), Herbert Clark (ABC), Rene A. Despouey (NBC), William R. Downs (CBS), J. Gordon Fraser (ABC), Gordon Gammack (CBS), Thomas B. Grandin (CBS), George F. Hicks (ABC), Ann Hunter (WAIT), Seymour Korman (MBS), John F. MacVane (NBC), Ted Malone (ABC), Robert Massell (ABC), Foster May (WOW), George Meier (MBS), R. E. L. Moore (Transradio), Jack D. Parker (ABC), H. A. Peters (ABC), Herbert Plambeck (WHO), Eric Seavreid (CBS), Willard F. Shadel (CBS), John D. Shelley (WHO), William Slocum (CBS), Howard K. Smith (CBS), George Wheeler (NBC), Bjorn Bjornson (NBC), Donald G. Coe (ABC), C. C. Collingwood (CBS), Janet Flanner (ABC), E. L. Haaker (NBC), Richard C. Hottelet (CBS), Arthur E. Mann (MBS), Max A. Jordan (NBC), Edward R. Murrow (CBS), Roy Porter (NBC), Sigrid L. Schultz (MBS), Charles C. Shaw (CBS).

NBC-UCLA Institute

FOURTH annual NBC-UCLA Radio Institute will open six weeks session in Hollywood June 24. Courses will include radio news and special events preparation, announcing, time sales, control operation, radio in education, production-direction, radio writing, history and survey of broadcasting. Held at network's Hollywood studios, tuition fee is \$75 with registration opening at UCLA campus June 22. Institute is supervised by Sidney N. Strotz, NBC Western Division vice president; Jennings Pierce, manager of public service and stations relations and Dr. J. Harold Williams, director of UCLA summer session. Similar sessions will also be held this year at Stanford and Northwestern.

Awarded Scroll

SCROLL in observance of WGY Schenectady, N. Y., "Farm Forum" program has been awarded by New York Power & Light Corp., Albany, to G. Emerson Markham, agricultural supervisor of station. Power firm has sponsored show for 20 years. Mr. Markham, who is in charge of all WGY science broadcasting as well as manager of FM station WGFM, started farm services in 1925.



INSPECTORS OF GAMS surrounding Johnny are Arthur Goldman (l), Biow Co. account executive on Philip Morris, and Ray Jones (r), Philip Morris vice president. Johnny's girls, who made debut at new *Follines of '46* (NBC, Tues., 8-8:30 p.m.), are Mike Travers (on Johnny's right) and Isobel Gibbs.

Essex Elected

HAROLD ESSEX, managing director of WSJS Winston-Salem, N. C., has been named vice president in charge of radio of Piedmont Publishing Co., owner of WSJS and publisher of *Winston-Salem Journal* and *Twin City Sentinel*. President Gordon Gray announced the election following the annual meeting of stockholders and directors. Mr. Essex joined WSJS in September 1939 as sales manager. He became managing director in May 1942, being succeeded by Harry B. Shaw in the sales post. Mr. Essex formerly was promotion manager of *Chicago Daily Times*, and before going to Chicago in 1930 was general manager of the Greensboro, N. C., *Record*.



Mr. Essex

WU TO CONSTRUCT RADIO RELAY NET

WESTERN UNION will replace its leased lines with a radio relay system, according to S. E. Hastings, superintendent. Towers will be 50 miles apart. Antennas in the center of reflectors will catch incoming beams and relay them automatically. Work will start late this year on a network of connecting transmitters in Chicago, Columbus, Cincinnati, Toledo and Cleveland. Program will cover 11 years and eventually operate coast-to-coast. Building cost is expected to be less than maintenance of pole lines.

Civic Service

CIVIC SERVICE is WIS Columbia, S. C., theme for staff members. Station Manager G. Richard Shafto has been appointed to Industrial Committee of Columbia Chamber of Commerce. Sales Manager J. Dudley Saumenig is publicity staff member for organization. Ray A. Furr, program director of WIS, has been appointed member of the Safety Council.

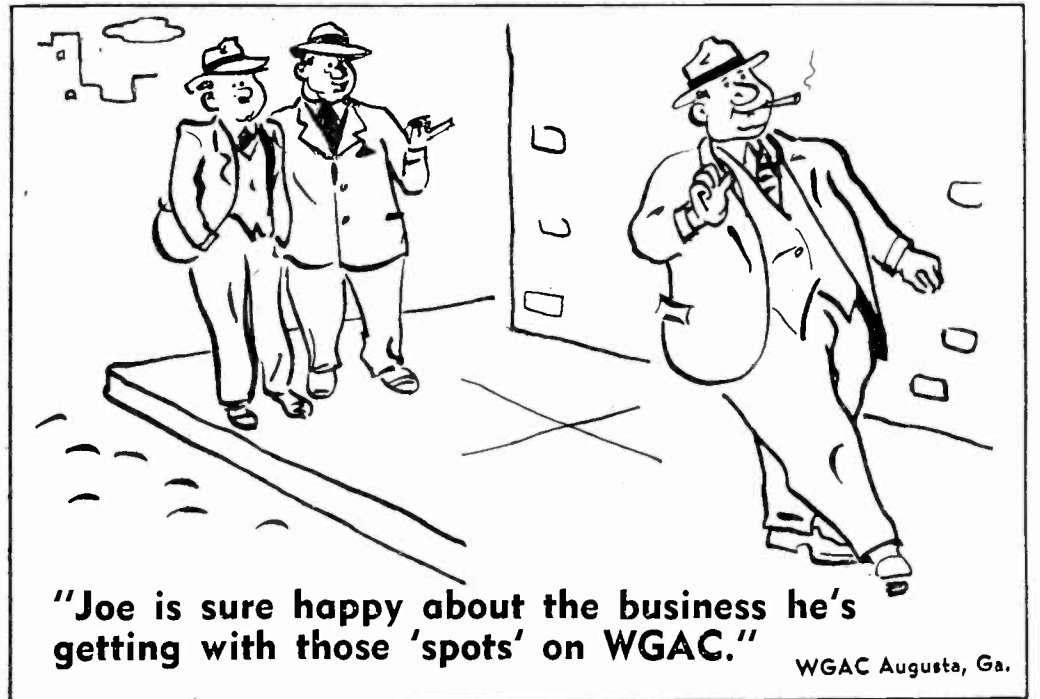

"Joe is sure happy about the business he's getting with those 'spots' on WGAC."

WGAC Augusta, Ga.

MORE DEMANDING ERA FOR NEWS

White Stresses The Alert Role Assigned Radio

As Television, FM Develop

IN THE FEW months since war's end, U. S. radio newsmen have learned that peacetime reporting is much more complex than covering a war. Speaking before the Institute for Education by Radio at Ohio State U., Paul W. White, news director of CBS, told why:

"The inherent drama of battle, plus an insatiable demand for news because of the public stake in the victory gave war reporters every advantage."

This advantage has been lost, however, in a post-war world of imponderables like atomic fission or the bewildering statesmanship of nations jockeying for favored positions. Specifically, reporters will find news gathering more difficult now, said Mr. White, because today's news gathering requires "a lot more of just plain fact-finding."

But can an accurate U. S. radio, bolstered by good writing and good reporting, contribute to the peace of the world, enable mankind to avoid a third and catastrophic world war? Mr. White thinks "maybe."

"We were the best informed public in the world in 1933," said he, "but that didn't prevent a mad man from taking over the reins of government in Germany. We were even better informed in 1941, but that didn't prevent Pearl Harbor."

"All that can be said is this: It certainly is worthwhile to be ever on the alert—to try to bring to every listener every conceivable fact that will help him to understand what is going on around him."

No discussion of the future of radio news can profitably ignore the technical developments "that seem almost certain to come," said Mr. White, "particularly in the fields of FM, television and facsimile."

FM, he predicted, would bring a few fundamental changes in the news profession, but the increase of

FM stations will increase the number of news jobs.

"Television," he said, "has tremendous possibilities," especially "if and when it becomes available on a nationwide scale." Television will give news a new dimension.

The place of facsimile in the future news world "is more doubtful," he said.

IN THE PUBLIC SERVICE

Bedside Recital

THE CHESTER VALLEY BOYS, harmonica quartet featured on WFIL Philadelphia *Hayloft Hoe-down*, travelled to Parkertown, N. J. to give a bedside recital for 8-year old Leonard Roose who is doomed to die of cancer within the next few weeks. Leonard is a cowboy fan and expressed liking for hillbilly music. The *Sleepy Hollow Gang*, heard daily over WFIL, play his requests on their programs.

Anti-Swindler Drive

FIVE-DAY CAMPAIGN against swindlers and "con" men fleeing war veterans in the Boston area was conducted on WCOP Boston's 12:45 p.m. *Boston Air Journal*. Explaining how the confidence game is operated—and how it may be detected—the scripts were prepared in cooperation with the veterans division of the Attorney General's office. Ron Cochran interviewed Attorney General Clarence Barnes on the problem in a broadcast Jan. 19.

WKY Farm Project

A FARM project of WKY Oklahoma City has been given credit for boosting pork production a minimum of 252,000 lbs. in one Oklahoma county. Through the WKY-Caddo County Pork Improvement Contest, financed and supervised by

WKY, the 504 sows entered had an average litter of 8.2 pigs, or 2.2 more pigs per litter than the state average. Four-H and F.F.A. officials in Caddo County who assisted in the contest, asked that it be made a permanent annual feature, and suggested WKY establish a similar statewide project. Principal director was Otis Parker, WKY associate farm reporter, and Edd Lemons, WKY farm reporter. Contest opened and closed with a broadcast.

* * *

Iron Lung Given

AN IRON LUNG of the twin type has been presented by KTUC Tucson, Ariz., to the Pima County Hospital, Tucson, for the use of patients "regardless of race, creed, color or ability to pay." Lee Little, manager of KTUC, made the presentation to R. H. Martin, chairman of the Pima County Supervisors, in ceremonies Jan. 22. State, county and city officials praised KTUC for its gift, which was said to be the first iron lung donated by a station to a community or a hospital.

* * *

Quick Sale

WFNC Fayetteville, N. C. quickly solved the problem of an Army lieutenant who was ordered overseas on short notice and needed help in disposing of his household furnishings, automobile and other personal belongings. When the lieutenant, stationed at nearby Ft. Bragg, called WFNC for aid, the station arranged a spot announcement telling of his plight. The announcement was used only once, but before it was off the air the lieutenant's telephone started ringing—and the calls kept coming until after he had sold the last item on his list.

* * *

Child Welfare Series

A 10-WEEK SERIES of *Children's Welfare Forum* program starts this week under sponsorship of WPEN Philadelphia and the Philadelphia Board of Education. Lectures and question-and-answer sessions will be conducted Monday evenings at the auditorium of Mastbaum Adult Evening School by parents and teachers of school children and by child welfare experts, psychologists and physicians. WPEN will transcribe each session for rebroadcast later in the evening.

* * *

Fireworks Banned

SERVICEMEN convalescing in San Antonio will no longer be bothered by the popping of firecrackers, thanks to Ken McClure, news chief of WOAI San Antonio. During a fireworks flurry in San Antonio, Mr. McClure broadcast a complaint calling attention to instances of recuperating servicemen who suffered setbacks as a result of the noise. Shortly afterward, Police Commissioner P. L. Anderson and Judge C. K. Quin rescinded a restraining order which had been placed against the city's anti-noise ordinance.

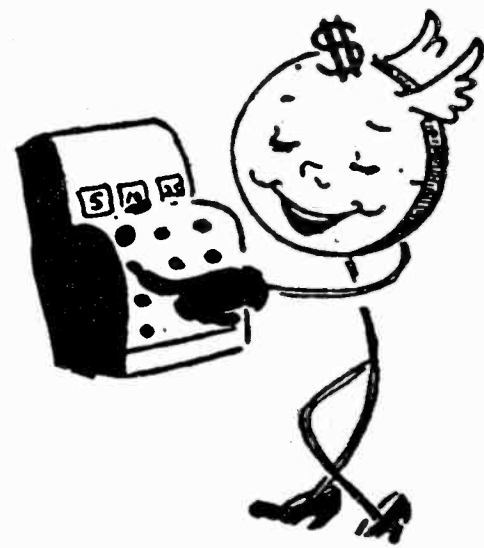

TIME IS MONEY!

And The Coins Will Come Rolling Into Your Cash Register If You Advertise On The Friendliest Spot On Your Dial!

WJHP

WJHP Offers a New Year Full of Fine Ideas For Shows ... Promotions, Plans For Selling Your Products. Off To a Good Start With The Mutual Combine, WJHP Has Been Giving Jaxons What They Wanted For a Long Time, And 1946 Will Be No Exception! Try The Music, Drama, Comedy, Quiz or News That WJHP Offers For You!

A JOHN H. PERRY STATION, AFFILIATED WITH THE MUTUAL BROADCASTING SYSTEM...IN JACKSONVILLE, FLORIDA

H O L L I S T E R

CRYSTALS

QUARTZ OSCILLATORS SINCE 1927

HOLLISTER CRYSTAL CO.

Boulder, Colorado

Hon. Curt Peterson
Marschalk & Pratt, Inc.
New York City

Dear Curt:

Just a note to tell you how we're takin' care of the ESSO REPORTER down in these parts.

You probably remember about the terrible mine disaster that happened about 150 miles from here in the little mining town of Havaco, W. Va. Well Sir, as soon as the report came over the wires about the accident, with the news that 200 men were trapped in the mine, our program director Berton Sonis really started hoppin'... in just a couple of hours, Bert and three other members of WCHS travelled the 150 miles to Havaco and put the first eyewitness report of the disaster on our 6 o'clock ESSO REPORTER. Just like the Boss was tellin' me... whenever any important news story "breaks" down here in West Virginia, you can count on your ESSO REPORTER at WCHS to take care of everything.

Yrs.
Algy

WCHS
Charleston, W. Va.

GULF OIL CORP., New York, is to start a quarter hour recorded musical show featuring George Byron, vocalist, about mid May on 300 stations throughout the country for its Gulf spray product. Agency is Young & Rubicam, New York. Through agency Gulf Feb. 3 made an audition record of a half hour show featuring Cpl. Harvey Stone with Oscar Bradley and orchestra, which may be used as a summer replacement for "We the People", Sun. 10:30-11 p.m. on CBS, or which may be used as a new fall show.

BENRUS WATCH Co., New York, returns its account to Tarcher Adv., New York, effective March 16. Young & Rubicam is currently handling account. Company is expected to continue to use station breaks.

EMANUEL CHARY, released from the Army, has joined Rogers Imports, New York, as advertising manager.

NATIONAL ASSOCIATION OF MANUFACTURERS has appointed Benton & Bowles, New York, as advertising counsel. 1946 campaign is in tentative stage at present.

P. LORILLARD Co., New York (Old Gold Cigarettes and Briggs Tobacco), has renewed its current spot campaign for 52 weeks as well as sponsorship of baseball broadcasts for summer season on WIND WJJD WHN WWDC WISH, "Racing Resume" on WHN, and "Newsreel Theatre of the Air" also on WHN. Company also has renewed for 52 weeks Fulton Lewis Jr. on KQV and CKLW for Briggs Tobacco, plus a news program (Old Golds) on Yankee Network. Agency is Lennen & Mitchell, New York.

SUNSET GAS & OIL Co., Los Angeles, marketing division of Sunset Oil Co., has begun sponsorship of Raymond Swing, ABC cooperative, Mon. through Fri. on KEX Portland, Ore. Company also sponsors commentator Mon.-Fri. on KECA Los Angeles and KFMB San Diego. Hillman-Shane-Breyer, Los Angeles, is agency.

McGOWEN EDUCATOR FOOD Co., New York (Crax breakfast food), started 8-8:15 a.m. participation on "Musical Clock" over KYW Philadelphia Monday, Wednesday and Saturday. Contract for 52 weeks was placed by Duane Jones Co., New York.

SPONSORS

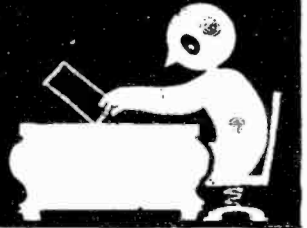

E. I. duPONT de NEMOURS & Co. and NBC last week cooperated to present new twist in advertising and broadcasting—a video preview of a network broadcast. Program was "Children of Ol' Man River" to be broadcast Feb. 4 on NBC 8-8:30 p.m. as one of weekly "Cavalcade of America" series sponsored by duPont. Three telecasts were broadcast Jan. 30 (4 and 8 p.m.) and Feb. 3, 8 p.m. on WNBT New York. BBDO New York, is agency handling duPont advertising.

JOSEPH TETLEY & Co., New York (tea), started 7:45-8 a.m. participation on "Musical Clock" over KYW Philadelphia, Tuesday, Thursday and Saturday. Contract for 13 weeks placed by Duane Jones Co., New York.

SMITHFIELD HAM & PRODUCTS Co., Smithfield, Va., has appointed Lamb, Smith & Keen, Philadelphia, as advertising agency. **DAN WETTLIN Jr.**, who serviced account through his own agency before the war, will act as account executive.

VIC MUCHER, president of Clarostat Mfg. Co., Brooklyn, is father of a girl.

R. J. REYNOLDS Co., Winston-Salem, N. C., (Camel cigarettes) has extended contract with Bud Abbott and Lou Costello (NBC Thurs. 10-10:30 p.m.) through September 1949. Agency is William Esty Co., New York.

G. WASHINGTON COFFEE REFINING Co., Morris Plains, N. J., started a spot campaign on Jan. 28 for eight weeks in 20 markets. Agency is Ruthrauff & Ryan, New York.

EMERSON DRUG Co., Baltimore (Bromo Seltzer), has started four weekly participations in "Showtime" on KFI Los Angeles. Contract is for 52 weeks. Account is said to be increasing its current spot campaign. Agency is McCann-Erickson, New York.

TEXAS Co., New York has signed Ed Wynn to continue his appearances on the CBS "Texaco Star Theatre" for an additional eight weeks following original four week engagement. Program is placed by Buchanan & Co., New York.

FLAMINGO SALES Co., Hollywood (nail polish), has appointed Allied Advertising Agencies, Los Angeles, to service account and under 52 week contract firm now is using a schedule of chain break announcements on KFI Los Angeles.

CUNNINGHAM SCHOOLS OF DRIVING. Los Angeles, has started a schedule of daily spot announcements on KFAC KFVD and will add other local area stations to list. Contracts are for 13 weeks. Allied Advertising Agencies, Los Angeles, has account.

KLUGE ELECTRONICS Inc., Los Angeles (California Kilowatt equipment), has appointed Howard Wookey Inc., Hollywood agency formerly known as Wookey & Roman, to handle advertising.

LONGINES-WITTNAUER WATCH Co., Montreal, has started weekly program "The World's Most Honored Flights" on CKAC Montreal. Agency is Russel T. Kelley Ltd., Hamilton, Ont.

QUAKER OATS of Canada, Peterborough, Ont. (cereals), Feb. 11 starts "Le Vieux Loup de Mer" on CKAC Montreal three times weekly. Agency is Spitzer & Mills, Toronto.

LT. COMDR. NORMAN R. PROUTY, USNR, formerly with Edward Petry & Co., has been elected a director and vice president in charge of sales of E. Pritchard Inc., Bridgeton, N. J. Company produces tomato juice, catsup and worcestershire sauce.

HARMON WATCH Co., New York, has bought five time signals a week on WJZ New York, effective Feb. 24 for 52 weeks. Agency is Moss Assoc., New York.

TOPPS CHEWING GUM, Brooklyn, has bought participation on "Here's Morgan", three times weekly on WJZ New York effective Jan. 30 for 13 weeks. Company also is currently running spot campaign which started Jan. 1 on New York stations WJZ WOR WNEW WHN for 52 weeks. Agency is Cecil & Presby, New York.

SOCONY VACUUM OIL CO., New York, has renewed "Information Please" featuring Clifton Fadiman as m.c., Franklin P. Adams and John Kieran as regular experts and with two guest experts, over NBC Mon. 9:30-10 p.m. for 52 weeks effective Feb. 11. Compton Adv., New York, is agency.

J. W. (Josh) HOGUE, former account executive of Ruthrauff & Ryan, Hollywood, has been appointed merchandising director of Soil-Off Mfg. Co., Glendale, Cal., (liquid paint cleaner). As adjunct to sales department, new division will coordinate national merchandising of product. Mr. Hogue was at one time sales promotion manager for Owl Drug Co and prior to that branch manager of Belknap & Thompson, Chicago sales promotion agency.



Mr. Hogue

Soil-Off is heavy user of western radio and currently is setting up plans to enter eastern markets. Frank Oxarart Co., Los Angeles, services account.

CANADA PACKERS Ltd., Toronto, (Shur Gain feed), has started twice weekly quarter-hour French-language program on CKAC Montreal and CHRC Quebec. Agency is Cockfield Brown & Co., Montreal.

BOVRIL (Canada) Ltd., Toronto (food concentrates), has started transcribed spot announcements on a number of Canadian stations. Agency is Cockfield Brown & Co., Toronto.

PEPSI-COLA Co. of Canada, Montreal (Evervess table water), has started test live announcement campaign thrice daily five days weekly on CKRC CKCO CKAC CFCF. Agency is J. Walter Thompson Co., Montreal.

PREMIER SHIRT Co., Toronto (sports-wear), has started newscasts, sport and spot announcements on a number of stations in eastern Canada. Agency is Ellis Adv., Toronto.

BISSELL-WEISERT Piano Co., Chicago, Feb. 1 began sponsorship of "The Listeners Quiz" over WGNB Chicago, WGN FM station. Contract is for 52 weeks, with 13 week option.

McKEON CANNING Co., Burbank, Cal., (sauzette seasoning), placing direct, on Jan. 30 started sponsoring daily participation in combined "Sunrise Salute" and "Housewives Protective League" programs on KNX Hollywood. Contract is for 52 weeks.

McCOY HEALTH SYSTEM, Los Angeles, to promote lecture series, is testing with spot announcement schedule on KFOX Long Beach, Cal., and will expand to other areas. General Adv. Agency, Hollywood, has account.

HOUSE OF TOMORROW, Los Angeles, (furniture), new to radio, Jan. 28 started sponsoring six-weekly quarter-hour recorded musical series "Bing Sings" on

SHREVEPORT, LOUISIANA STACKS UP!

among the 12 cities of
115,000 to 125,000 population

12TH IN POPULATION...

- 4th in Buying Income (thousands of dollars)
- 1st in Drug Sales
- 4th in Lumber, Building, Hardware Sales
- 9th in General Merchandise Sales
- 4th in Per Capita Income

THE SELLING POWER IN THE BUYING MARKET

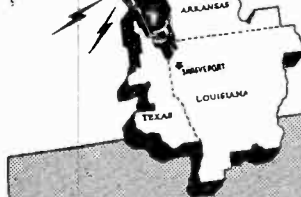

Represented by The Branham Co.

KWKH
CBS ★ 50,000 WATTS
The Shreveport Times Station
SHREVEPORT, LOUISIANA

GOING PLACES FAST
IN IDAHO

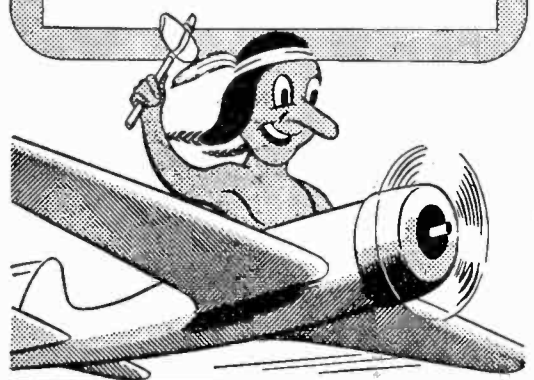

KSEI
POCATELLO · IDAHO

Steel Expands

TANGIBLE proof that the steel industry doesn't expect strike conditions to continue indefinitely is advanced by KQV Pittsburgh, whose directing head, G. S. Wasser, reported last week that Jones & Laughlin, steel corporation, had not only renewed its six-day-per-week program but had extended it from three-quarters of an hour to a full hour. Started six months ago as a half-hour musical clock feature (7-7:30 a.m.), emceed by Jimmy Thompson, it was extended another 15 minutes after having run 30 days. Then, in the thick of the strike, the program renewed on a one-year basis from 6:45 to 7:45 a.m. six days per week, with a house organ format to reach the approximately 25,000 employes in the area. Originally it was conceived as an employment builder. New agency is Bond & Starr, Pittsburgh.

KRKD Los Angeles. Contract is for 52 weeks. Agency is The Tullis Co., Los Angeles.

LEON A. MILLER, personnel director since 1942, has been named plant manager of Post Products Division of General Foods Corp., Battle Creek, Mich., succeeding the late STANLEY H. ZIMMERMAN.

R. WALLACE & SONS MFG. Co., Wallingford, Conn. (silversmiths), plans 1946 institutional advertising campaign to include radio.

JEWEL A. BOSTICK, Los Angeles (used car dealer), on Jan. 21 added to heavy local schedule a five-weekly 25-minute program of recorded music, "Bolero Time," on KMPC Hollywood. Contract is for 26 weeks. Smith, Bull & McCreery, Hollywood, has account.

GILLETTE SAFETY RAZOR Co., Boston, has received award honors from Helms Athletic Foundation of Southern California for its "noteworthy contributions to sports through the sponsorship of the 'Gillette Cavalcade of Sports'."

CLYDE BALDWIN, for three years executive assistant to CHARLES LUCKMAN, president of the Pepsodent Division of Lever Bros. Co., has been named manager of the wholesale drug department.

SUTLIFF TOBACCO Co., San Francisco, has placed account with John H. Hoefler & Co., San Francisco.

RKO PICTURES, New York, is using spot campaign Feb. 1-8 for newest picture, "Spiral Staircase," on seven New York stations. Agency is Foote, Cone & Belding, New York.

DONALD GELB has resigned from Foote, Cone & Belding to become manager of advertising and sales promotion for Goodman & Theise, New York, manufacturer of Stafford Fabrics.

DAVID TRAUM & CO., New York (Iron-tex and Heirloom needlework), has purchased participation on "Nancy Craig" show over WJZ New York, Mon.-Fri. 8:30-8:55 a.m. Contract for 14 weeks placed through Wesley Assoc., N. Y.

Network Accounts

New Business

GERMAINE PLANT & SEED Co., Los Angeles (seeds, plants), on Feb. 24 starts for 13 weeks "Gillespie's Garden Guide" on 11 ABC western stations Sun. 9:45-10 a.m. (PST). Agency: Dudley L. Logan Adv., Los Angeles.

WHITEHALL PHARMACAL (Canada) Ltd., Windsor, Ont. (Kolynos toothpaste and Anacin), Feb. 5 starts "Stars-To-Be" on 23 CBC Trans-Canada network stations Tues.-Thurs. 1:45-2 p.m. Agency: Young & Rubicam, Toronto.

PEPSI COLA Co., New York, Feb. 24 starts Quentin Reynolds on more than 280 MBS stations Sun. 6:45-7 p.m. Agency: Newell-Emmett Co., New York.

COLGATE-PALMOLIVE-PEET Co., Toronto (Colgate toothpowder, Hale shampoo), Feb. 5 starts "Theatre of Romance" on 30 CBS Dominion network stations, for 35 weeks (Feb. 5-June 25, Oct. 1-Dec. 31) Tues. 8:30-8:55 p.m., with repeat 11:30-11:55 p.m. for Pacific coast. Agency: Spitzer & Mills, Toronto.

Net Renewals

LADY ESTHER Ltd., New York (Lady Esther face cream), Feb. 11 renews "Screen Guild Players" for 52 weeks on 141 CBS stations, Mon. 10-10:30 p.m. Agency: Blow Co., N. Y.

Net Changes

UNITED REXALL DRUG Co., Los Angeles (Rexall drug products), March 8 shifts "Durante-Moore Show" on CBS stations from Fri. 10-10:30 p.m. to Fri. 9:30-10 p.m. Agency: N. W. Ayer & Son, N. Y.

Television

(Continued from page 30)

Roberts, DuMont counsel, and David Arons, publicity director of Gimbel's (Philadelphia). Mr. Arons described experiments in television conducted by the store in cooperation with RCA. Goods must be shown in actual use, he found, and suggested that larger screens and color will add to the medium's attraction.

Col. Roberts described operations of the DuMont experimental station in Washington.

At the afternoon session Mr. Hubbell spoke on radio vs. television production. E. W. Engstrom, research director of RCA Labs., described technical equipment used in television camera and receiver. William F. Valentin, advertising manager of American Central Mfg. Co., Connersville, Ind., told of a television broadcast by that company at DuMont studios at which its line of kitchen equipment was exploited.

Bob Emery, Bamberger television director, described production techniques developed during the company's experience. Ralph Austrian, executive vice president of RKO-Television Corp., suggested that much television programming should be handled by the movies.

Free Puzzle

ON THE THEORY that even in the atomic age there's still a youthful interest in cowboys and Indians, Ward Baking Co., participating sponsor in ABC co-op "Tennessee Jed," is offering free "lariat puzzles" to listeners. Program is heard Mon.-Fri. 5:45-6 p.m.

CALIFORNIA FRUIT GROWERS Exchange, Los Angeles (Sunkist oranges), has drastically cut its spot campaign commitment in major eastern markets because of reported 20% damage to orange crop on trees during recent southern California windstorm. Agency is Foote, Cone & Belding, Los Angeles.

KELLEY KAR Co., Los Angeles (used car dealer), adding to heavy local schedule, on Jan. 30 started sponsoring half-hour transcribed mystery series "The Weird Circle" on KECA Los Angeles. Contract is for 26 weeks. The Tullis Co., Los Angeles, has account.

STANDARD BRANDS Ltd., Montreal (Fleishmann's yeast), has started 15 announcements weekly on a number of Canadian stations. Agency is J. Walter Thompson Co., Montreal.

SALADA TEA Co. of Canada, Toronto, has started transcribed program "What Would You Do?" thrice weekly on nine Maritime provinces stations. Show was obtained from All Canada Radio Facilities, Toronto, account placed by Thornton Purkis Adv., Toronto.

DUSTBANE PRODUCTS Ltd., Montreal (cleanser), has started six announcements weekly on a number of Canadian stations. Agency is McKim Adv., Montreal.

MENNEN Co., Newark, N. J. (shave cream), has started early morning program "Fun at Breakfast" five days weekly on CKWX Vancouver. Account was placed by A. J. Denne & Co., Toronto.

SANDY STRONACHS, head of talent department of Young & Rubicam, New York, is father of a girl.

ELIZABETH GAWNE, formerly with the world trade division of International Business Machines, has joined foreign department of McCann-Erickson, New York.

WFIL Philadelphia has instituted a monthly award of merit to designated employes of station. Award, which comprises a scroll and \$25 Victory Bond, is presented for "outstanding service", loyalty, integrity, ingenuity and foresight in performing his or her duties. All members of staff are eligible to receive award except executives and department heads. Recommendations are made by department heads and weighed at general meeting.

W W S W

PITTSBURGH'S FIRST station in public service features.

★ PITTSBURGH'S FIRST station in complete sports coverage.

★ PITTSBURGH'S FIRST station in total sponsored time.

★ PITTSBURGH'S ONLY station offering 24-hour service.

WWSW, INC.
PITTSBURGH, PA.

Represented by
Forjoe and Company

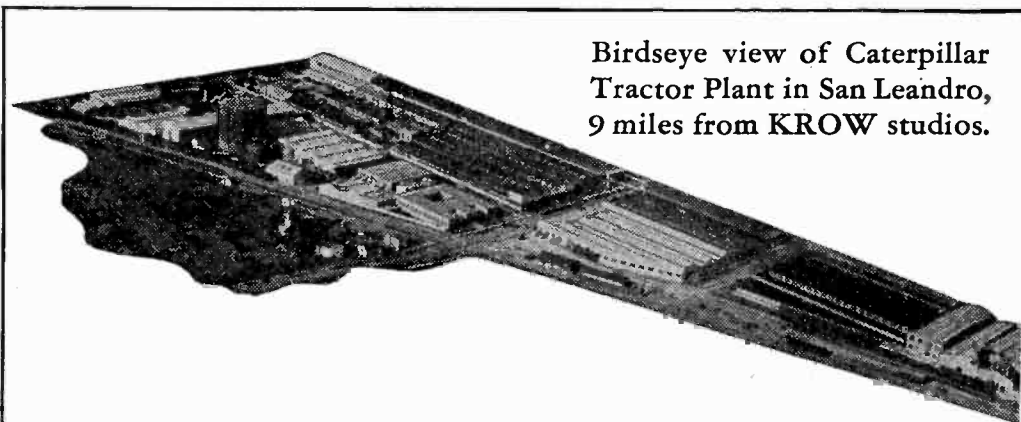

Birdseye view of Caterpillar Tractor Plant in San Leandro, 9 miles from KROW studios.

When You Think of
CATERPILLAR Tractors

—you think of their gigantic west coast plant in the heart of

The Metropolitan

OAKLAND

Area

And when you think of Oakland, you think of the thousands of prosperous peace-time workers who listen faithfully to the Home Interest Station—

K R O W

19th Street at Broadway
Oakland 12, California



Radio Advertising Co.
National Sales Representatives

Better Use

WINN
in LOUISVILLE
BASIC STATION
AMERICAN
WINN
BROADCASTING COMPANY
HARRY McTIGUE General Manager

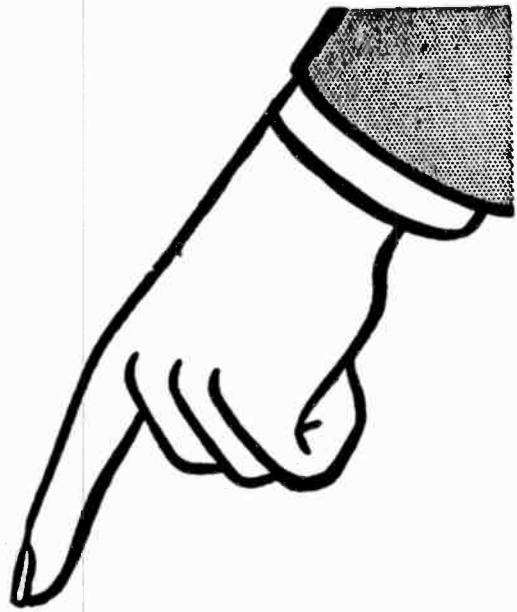

NOTICE

You cannot cover the tremendous New York market without using WBNX, because . . . WBNX reaches

- 2,450,000 Jewish speaking persons
- 1,523,000 Italian speaking persons
- 1,235,000 German speaking persons
- 660,000 Polish speaking persons

STRENGTHEN your present New York schedules with WBNX. Our program department will assist you in the translation of your copy.

WBNX
5000 WATTS DIRECTIONAL OVER NEW YORK
America's Leading Foreign Language Station

Novik Service Consultant For H. C. Wilder Station



Mr. Novik

MORRIS S. NOVIK, former manager of WNYC New York and radio consultant to former Mayor Fiorello LaGuardia, ABC commentator, last week was retained as public service consultant for the Harry C. Wilder stations—WSYR Syracuse, WTRY Troy, and WELI New Haven.

Mr. Novik, who resigned as WNYC head coincident with the change in New York City's administration Jan. 1, announced at the time that he would enter consulting field with particular reference to public interest programming. He was asked by Mayor-elect William O'Dwyer to remain as head of the station, but he declined. He had handled Mayor LaGuardia's radio assignments for the past six years, during his incumbency as station manager.

Harold E. Hendrick

HAROLD E. HENDRICK, 41, head of media for McCann-Erickson, New York, died Jan. 26 at his home in Somers, New York, of a cerebral hemorrhage. He has been with the firm since 1944. He leaves a widow, a daughter Gale and a son Harold E. Jr.

Board Chooses

BOARD OF DIRECTORS of Philharmonic-Symphony Society has reengaged Artur Rodzinski as musical director and conductor of New York Philharmonic Symphony, Sun. 3-4:30 p.m. on CBS for 1946-7 season starting Oct. 3 and running through April 13, 1947. Board also authorized following guest conductors for coming season: Charles Munch, Societe des Concerts du Conservatoire, Paris; Bruno Walter, Leopold Stokowski and George Szell.

AFRA-KFXM Pact

WITH new provision guaranteeing minimum 48-hour week, AFRA and KFXM San Bernardino, Cal., have renewed their union contract for six months. Agreement was renewed for brief period pending FCC approval of station's application for increased power and wave length change.

KOY Honored

SPECIAL COMMENDATION was awarded KOY Phoenix, Ariz., in a letter written by Brig. Gen. Robert C. Oliver of AAF for its "Pearl Harbor Day" program presented on Dec. 7, 1945. Broadcast in part paid tribute to Flying Training Command stations in Arizona for role they played in hastening end of World War

Commissioner Jett Will Ask Two-Year NARBA Extension

EXTENSION of the North American Regional Broadcasting Agreement (NARBA) for two more years to give the signatory countries an opportunity to function properly under its terms will be proposed this week by FCC Commissioner E. K. Jett, chairman of the U. S. delegation to the North American Regional Engineering Conference, which opens today.

As chairman of the U. S. delegation, Mr. Jett will serve as chairman pro tem of the Conference until a permanent chairman is elected. It was believed that Commissioner Jett, because of his broad knowledge of international broadcast matters, will be elected permanent chairman.

It was in December 1937 that six countries signed the treaty in Havana to regulate and establish principles covering use of the standard broadcast band in North America so that each country might make the most effective use of the treaty with the minimum technical interference between stations. Canada, Cuba, the Dominican Republic, Haiti, Mexico and the U. S. signed.

Subsequently the Bahamas and Newfoundland indicated they would abide by the treaty's terms. NARBA became effective on March 29, 1941, and by its terms expires March 29 this year.

Canada was at war when the treaty went into effect. Later the other signatory nations entered the war. Consequently there has been little occasion, due to scarcity of materials and manpower, for any of the nations to take full advantage of the opportunities afforded under the treaty, said Mr. Jett.

"Just now we are entering the period when equipment can be procured," Commissioner Jett said. "Therefore it seems desirable that the technical standards be maintained for at least two years after March 29, 1946, in order that the various nations may dispose of the problems confronting them during the reconversion period."

That extension would permit each of the signatory countries to study the existing standards with the view of submitting proposals looking toward revision of the treaty sometime in 1947, Commissioner Jett pointed out. He feels that continuation of NARBA under peacetime conditions is necessary if standards for the best interests of all signatory nations are to be adopted.

Canada first proposed a two-year extension of NARBA. The U. S. recommended one year. Since that time, however, the U. S. has altered its original recommendation in favor of the two-year extension.

Cuba, at the Third Inter-American Radio Conference at Rio de Janeiro last September, submitted

a proposal to draft a new treaty immediately. Cuba also wants some 20 additional channels in the standard band [BROADCASTING, Oct. 8, Dec. 24]. Commissioner Jett, Harvey B. Otterman, assistant chief, Telecommunications Division, State Dept., and K. Neal McNaughten, FCC International Division engineer, held an informal conference with Cuban officials in Havana last month [BROADCASTING, Jan. 21].

Mr. Jett said that although no formal agenda had been adopted, he hoped the final plenary session would be on or about Feb. 15, when FCC Chairman Paul A. Porter will be available to make the closing address. Mr. Porter delivered the closing address at the British-U. S. telecommunications conference in Bermuda in November [BROADCASTING, Nov. 26].

Book of Radio Plays

TWENTY-FIVE radio plays of the public service category, written by as many leading radio dramatists, have been assembled by Erik Barnouw, instructor in radio writing at Columbia U. and former assistant manager of NBC script division, and published by Farrar & Rinehart, New York, under title *Radio Drama in Action* (\$3). Volume includes Arch Oboler's "The House I Live In"; Stephen Vincent Benet's "A Child Is Born"; Millard Lampell's "The Lonesome Train"; Norman Corwin's "London by Clipper"; Pearl Buck's "Will This Earth Hold?"; Norman Rosten's "Concerning the Red Army" and Orson Welles' "Columbus Day."

Radio Novel

A FICTIONAL account of a young man's career in radio provides the peg on which Henry B. Lent hangs a great deal of factual information about the broadcasting business in "This Is Your Announcer"—*Ted Lane Breaks Into Radio* (MacMillan Co., N. Y., \$2.). Following Ted Lane's progress from a 250-w station to a network job, the reader progresses, too, in his acquaintance with the many sides of radio and its problems. While written primarily for young people of high school age, the book is suitable for older readers who want to learn about the business as it is seen through the eyes of an announcer. Mr. Lent, a writer with a New York advertising agency and the author of several books, worked with personnel of three stations in preparing this volume.

KGFJ Moves Studios

WITH remodeling and redecoration of former residence type dwelling, KGFJ has moved from downtown Los Angeles to 6314 Sunset Blvd., in Hollywood "radio row." New headquarters are known as "Hollywood House" and contain executive offices as well as studios.

TECHNICAL

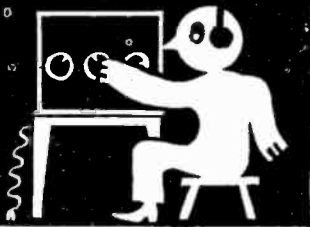

HARLAN GREGG has returned to the WBBM Chicago engineering department after 38 months in the Marine Corps. He was with WBBM ten years before entering service.

ALLEN L. GUNDERSON, since his return from Navy to KDYL Salt Lake City as engineer, has been cited by Fifth Fleet Adm. R. A. Spruance for his service as warrant officer and radio electrician aboard the USS Indianapolis until a few weeks before it was sunk. Award read in part: "As a radio technician and radio electrician, he installed and maintained in condition of highest operating efficiency the



Mr. Gunderson

flagship's radio communications equipment, under difficult conditions requiring engineering skill of a high order, sound judgment and wise leadership."

BOB NICHOLAS, engineer of KXOK St. Louis, has returned to station following release from Signal Corps as major. He entered service in July 1942.

ROBERT WOOD, released from Army, has rejoined KPO San Francisco as engineer.

EDWARD McBRIDE, engineer at WMBG Richmond, Va., has returned to station following release from Navy radar service. **ALBERT TILLERY** also rejoins staff after three years' duty in Navy.

JUDSON EDWARDS, veteran from ETO, has rejoined engineering staff of KRNT Des Moines. **ARTHUR PEAVY** returns to station in February.

ERNEST GRAHAM, ex-Marine sergeant, is new transmitter engineer at WIS Columbia, S. C.

WILLIAM E. BRADLEY, who played leading part in development of advanced FM system of Philco Corp., Philadelphia, has been appointed firm's director of research to succeed **DAVID B. SMITH**, named vice president in charge of engineering. With Philco since 1936, as research engineer in television engineering dept. and later in charge of advance research section of the research division, he was named assistant director of research in 1945.

ANDREW KASMARK, electronic technician in Navy, has returned to the engineering staff of WWSW Pittsburgh. **GORDON MILES** and **ROBERT STONE**, former AAF members, are new additions to the engineering staff of WOWO Fort Wayne, Ind.

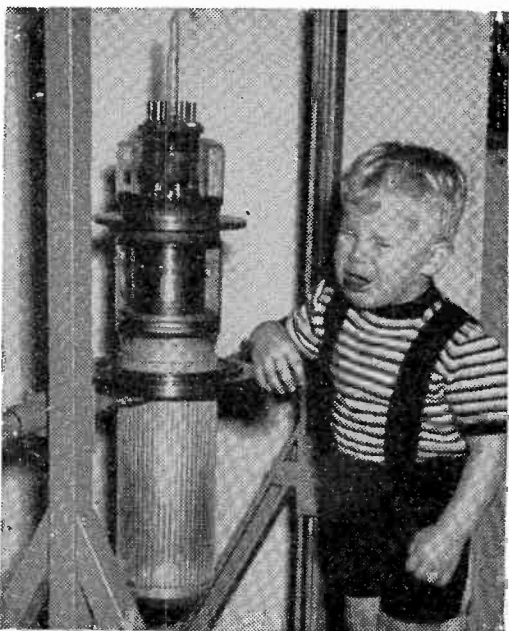

THIS GIANT 200 kw tube, most powerful in world, is used for U. S. overseas broadcasts. Scared of it is three-year-old Barry Greenwood, whose daddy is shop steward at Federal Telephone & Radio Corp., Clifton, N. J.

PAUL FOODY has returned to the transmitter staff of KYW Philadelphia following release from the Navy.

PHILIPS LABORATORIES Inc., newly organized research center for all Philips interests in the U. S., has added following members to its staff: **DR. JAMES G. BLACK**, recently working on secret project for National Defense Research Committee, named chief of division of miscellaneous projects and analytical laboratories; **CAROL M. VERONDA**, previously engaged in radar work at Naval Research Lab. and one-time with General Electric Co., named assistant engineer in microwave section; **FRANK GRACE**, from Reeves Sound Labs., also appointed assistant engineer in microwave section; **GEORGE A. ESPERSEN**, transferred from Dobbs Ferry, N. Y., plant where he was tube division engineer, to microwave section as associate physicist. **DR. VICTOR WOUK** joins the engineering laboratories staff of North American Philips Co. at Dobbs Ferry to investigate circuit theory. He formerly was with Westinghouse Electric Corp. engaged in research on mercury arc rectifiers and gaseous condition.

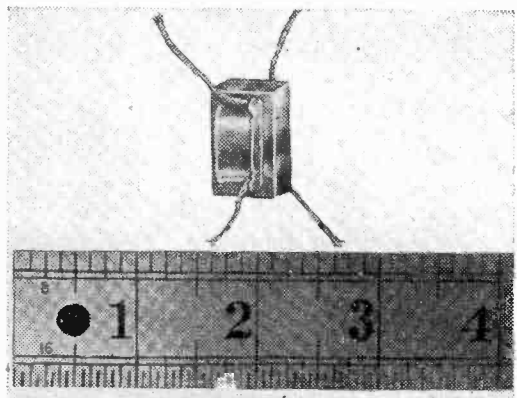

SMALL WONDER this transformer is popular for hearing aids, vest pocket radios, and other electronic uses. It weighs but one-third ounce. Called the Sub-Ouncer, it is manufactured by United Transformer Corp., New York, and was used in military equipment during the war.

O. R. SMITH, former operator of CBR Vancouver, B. C., has been appointed to the engineering staff of CBC International Shortwave Service at Montreal, following his discharge as captain from Royal Canadian Corps of Signals after four years' service overseas.

HARRY BERG, in Army Signal Corps for four years and released as captain, has rejoined the engineering staff of WJJD Chicago.

FRANK HIGGINS, transmitter engineer at WPTF Raleigh, N. C., has returned to the station following four years' Navy duty, part of which was spent in Pacific.

RALPH COWIE, transmitter supervisor of WEEL Boston, has celebrated his twentieth anniversary with station.

STROMBERG-CARLSON Co., Rochester, N. Y., has realigned certain positions in its engineering and research division because of rapid rate of company's overall expansion. **ROGER T. FURR** is named chief technical service engineer in charge of drafting and blueprint sections, physical testing labs, model shop and engineering procurement section. Instrument lab becomes part of research department under the direction of **BENJAMIN OLNEY**, director of research, while **HOWARD H. BRAUER**, formerly in charge of instrument lab, joins engineering staff organization assuming charge of business phases of the division. **OLIVER L. ANGEVINE JR.** is appointed chief sound equipment engineer in charge of engineering sound equipment division.

HERMAN KUCH has returned to WQXR New York, rejoining engineering staff after nearly four years military service.

ENGINEERING personnel of Press Wireless Manufacturing Corp. last week began moving from company's plant at Hicksville, N. Y., into company's new quarters in Long Island City.

ARCHIE SICHEL returns to WIBG Philadelphia engineering staff after two and a half years in the Navy, most of which were spent in Pacific combat zones.

DON V. R. DRENNER, during war with RAF and OWI, and **WAYNE GILLETTE**, Navy radar instructor, have returned to engineering staff of KGGF Coffeyville, Kan.

LOU FREDERICK, research and control room engineer of WHO Des Moines, is father of a boy.

GEORGE PYLE, released from military service, has returned to WMBD Peoria, Ill., as engineer.

GUY C. GLENN, formerly of NBC Hollywood and prior to that KFSD San Diego, has joined ABC Hollywood as engineer.

JACK GORDON has been appointed chief engineer of CKWX Vancouver. In radio since 1933 he joined RCAF in 1942. was discharged last Autumn and returned to CFAC.

FRANK H. POUNSETT has been appointed chief engineer of Stromberg-Carlson Co., Toronto, transferring from the government's wartime Research Enterprises Ltd., Toronto, where he was chief engineer of the radio division, manufacturing radar equipment for United Nations. Before the war he was chief engineer of the radio division of Stewart-Warner-Alemite Corp., Belleville, Ont., and engineer with DeForrest-Crosley Corp., Toronto. He is chairman of Toronto chapter of IRE.

GEORGE PEARCE, engineer of WPEN Philadelphia, is father of a girl.

PAUL FOODY returns to the transmitter staff of KYW Philadelphia as operator following release from the Navy.

CHARLES ROTHERS, **ERNEST SINDELAR**, **EARL HUGHES**, **ROBERT KALM** and **EUGENE MAJOT**, all Navy radar veterans, have been added to the engineering staff of television station WBKB Chicago.

IKE MURPHERY, out of Navy, rejoins engineering staff of WEED Rocky Mount, N. C. He served four years.

DAN WINN, chief engineer of KARK Little Rock, Ark., is father of a girl.

PHIL GOETZ has returned to his regular position as supervisor of technical operations at WCBW, CBS video station in New York, after two months temporary assignment in CBS television laboratories. **DENNIS McBRIDE**, just released from the service, has joined the station as technician. **ROBERT LIVING-GOOD**, formerly in WCBW control room, has been promoted to assistant supervisor of television remote equipment.

BRUCE VAUGHAN, formerly with WTOP Washington, has joined the engineering staff of WPIK Alexandria, Va.

LEWIS M. CLEMENT, vice president of Crosley Corp. in charge of research and engineering for manufacturing division, has returned to the U. S. following a two week trip to England to survey the British radio manufacturing industry.

FREDERICK LEWIS Jr. after serving overseas with OWI has returned to WTAR Norfolk, Va., as control operator.

KERMIT F. TRACY, chief engineer of KLRA Little Rock, Ark., has been appointed assistant manager of the station in addition to his present post.

CLYDE WHITE, supervisor of WGN Chicago engineers, is father of a boy, Richard Allen, born Jan. 16.

Federal Equipment

ANNOUNCEMENT that Federal Telephone & Radio Corp., domestic affiliate of IT&T, was building FM broadcasting equipment and had already contracted to supply several stations was made in New York last week. E. N. Wendell, Federal's vice president in charge of radio engineering and sales, said deliveries would begin at the end of March.

Federal's FM system, Mr. Wendell said, is featured by a new type of modulator-oscillator unit which only recently was brought out of the laboratory and into production. The unit makes possible a "very low" noise reception level, he said.

Federal has organized a nationwide sales organization in the FM field, the vice president reported.

GATEWAY
TO THE
RICH
TENNESSEE
VALLEY

CBS
AFFILIATE

PAUL H.
RAYMER CO.

National
Representative

WLAC
50,000 WATTS
NASHVILLE



WCKY

the 50,000

watt voice

of Cincinnati

630
ON THE DIAL

• MORE PEOPLE

LISTEN

• MORE PEOPLE

BUY

CKRC

WINNIPEG - CANADA
"THE DOMINION NETWORK"

5000 WATTS 1330 KC.

WEVD

ENGLISH • JEWISH • ITALIAN

National Advertisers consider WEVD
a "must" to cover the great Metropolitan New York Market.

Send for WHO'S WHO on WEVD
WEVD - 117 West 46th Street, New York, N. Y.

CURRENT distribution of Newsweek magazine in Memphis, Tenn., area contains insertion of promotion slip by WHBQ Memphis announcing Mutual "You Make the News" program, prepared by the magazine and broadcast by station.

RCA Booklet

STATEMENTS made Dec. 13 at a press television demonstration at the RCA laboratories by Brig. Gen. David Sarnoff, RCA president; Niles Trammell, NBC president; Frank M. Folsom, executive vice president in charge of RCA Victor Division, and Dr. C. B. Jolliffe, executive vice president in charge of RCA laboratories, have been published as a 24-page booklet titled "RCA Television Policies and Plans."

Add Vocabulary

NEWEST addition to radio's promotion vocabulary is "laffternoon," used by ABC in promoting "the new laffternoon hit, 'Bride and Groom.'" Listeners to this program, plus the "Al Pearce Show," "Ladies Be Seated" and to "Jack Berch Show" will "enjoy an ABC afternooon" according to ads now appearing on newspaper radio pages.

Movie Preview

INVITATION to members of New York radio press to attend a special preview of "Breakfast in Hollywood" starring Tom Breneman, the picture based on ABC radio show, was accompanied by a trick puzzle with explanation "It's no trick to produce a great motion picture from a great radio show." Publicists handling special preview were Earl Mullin, ABC; Hal Davis, Kenyon & Eckhardt; Virginia Travers, Compton Adv.; Richard E. Forrest, Victor M. Ratner Co.

Silver Set Prize

MISSISSIPPI Valley Network "Town and Country Time" (6-7 a.m., CST) is offering a 50-piece King George silver service for eight, made by National Silver Co., New York, for best recipe submitted each week. Offer is made to check culinary tastes of areas served by 72 stations carrying program.

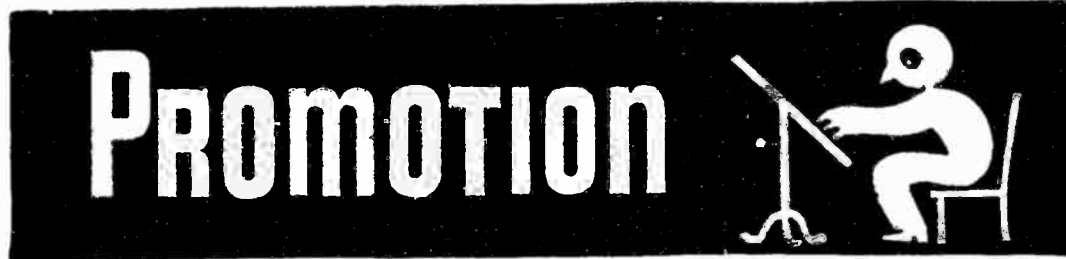

Livestock Contest

HERD IMPROVEMENT contest is being conducted by WWL New Orleans farm service director, Gordon Loudon, with prizes of a pure-bred beef bull, a dairy bull and a boar. Louisiana 4-H Club members are qualified to enter the three separate competitions. Competitors are chosen by county agents. To be an annual affair, first awards will be made at Louisiana State Junior Livestock Show April 2-7 at Baton Rouge.

WNAC Mailing Pieces

YANKEE Network has issued promotion pieces on return of Jim Britt from service in Navy Intelligence and on new program, "Six Bells" mystery series. The Britt tri-color mailing card features picture of sportscaster with information on his sports program sponsored by Narragansett Brewing Co., Cranston, R. I. "Six Bells" piece pictures a pirate chest, tells of adventure presented in programs sponsored by H. P. Hood & Sons.

Store Studio

HALF-HOUR morning "Bay Shopping Hostess" program sponsored for three years on CFAC Calgary, Alta, by Hudson Bay Co., Calgary department store, now originates from its own studio located in the store for observance by shoppers. On display around studio are merchandise items to be mentioned that day by program conductor.

Agency Folder

PROMOTION folder announcing separation of Bayard & Eccleston, Los Angeles agency, and formation of a new agency by J. W. Eccleston Jr. (BROADCASTING, Oct. 15, 1945), has been distributed by J. W. Eccleston Jr. Adv. Associates in new firm also are introduced.

CKAC Brochure

CKAC Montreal has issued a brochure "Hitch Your Wagon to a CKAC Star" featuring station's French-language performers in word and picture. Brochure tells about a dozen of the leading French-language Canadian radio artists and their programs.

CHML Bookmarks

CHML Hamilton, Ont., has distributed bookmarks to Hamilton and district schools and libraries to emphasize weekly local history program "This is where I live."

House Organ

NEW NBC Central Division house organ has been named "The Orthicon"—after RCA Image Orthicon tube, a super-sensitive television camera eye, it has been announced by Robert Guilbert, editor of the new publication (BROADCASTING Jan. 7). Winning suggestion, submitted by Ruth Buttron, sales department secretary, was selected from over 100 names submitted by employees. Miss Buttron won \$25 victory bond prize. First issue is scheduled for late February.

Luncheon News

DIRECT wire news briefs are "broadcast" now by WIBW Topeka, Kan., to 11 local luncheon clubs as a special service.

Mayor's Letter

LETTER from the Mayor of Tulsa, congratulating station on its twenty-first birthday, is reproduced on cover of current program schedule.

Personnel

JOHN H. MILLS, on military leave from NBC for three and a half years, has rejoined the network as executive assistant manager of guest relations department, with which he worked from 1935 until leaving for the Army in May 1942. After 30 months' service as a radio operator attached to 5th Air Force, he was assigned to WRTC, Army radio station in New Guinea.

RAY SCHULTZ, after three and a half years in Navy medical corps, has returned to NBC Hollywood publicity staff.

LORRAINE SUTTERS, formerly in the radio department of Lennen & Mitchell, New York, has joined the press department of WNEW New York succeeding MARILYN MARCUS who has resigned from the station to be married to Capt. Harold Mindell of AAF.

NED HULLINGER, released from Navy with rank of lieutenant-commander and prior to that on staff of Chicago Daily News, has joined ABC Hollywood publicity department. SHIRLEY AMBLER also joins department.

LEONARD FINCH, released from the Navy, has returned to CBS Hollywood publicity staff.

ARTHUR C. SHOFIELD has assumed duties as promotion director of WFIL Philadelphia. He has been assistant advertising manager of RCA Home Instrument Division.

RICHARD KROLIK, recently discharged as captain from the Army and onetime member of Mutual's publicity staff, has joined New York headquarters of the American Veterans Committee as public relations director.

BARBARA KRAFT of ABC Hollywood publicity department is convalescing from an emergency appendectomy.

GERRY SWINEHART, executive vice president of Carl Byoir & Assoc., New York, has been elected president succeeding CARL BYOIR who becomes chairman of the board of the public relations office. GEORGE HAMMOND, vice president, succeeds Mr. Swinehart as executive vice president.

MILDRED THOMPSON, Dean of Vassar College, has started a commentary series over MBS called "The World Tomorrow and What We Can Do About It." Series heard Sun. 2:45-3 p.m.

WILLIAM GARTLAND and JACK TREACY have returned to their posts as salesmen in NBC Radio-Recording Division after discharge from the Army. Both served in ETO.

WAR EFFORT AIDED BY DATA FROM HAMS

RADIO amateurs aided the war effort and added to knowledge of wave propagation and communication by cooperating in projects sponsored by the National Bureau of Standards, according to the Commerce Dept. Hams took part in three observation projects conducted by the Bureau, helping radio propagation predictions for use by Allied forces.

Two projects were conducted jointly by the Bureau and the American Radio Relay League. First project ran from July 1, 1941 to June 30, 1943 and the second to June 30, 1944. Regional coordinators named by ARRL formed observation groups to monitor the spectrum between 1500 and 30,000 kc for two-hour periods each week—noon and after dark. They reported intensity, readability and background noise intensity along with distance and direction of each observed station. The data were analyzed and results used in checking propagation predictions.

Third project, called the WWV Observing Project, ran from December 1943 to June 30, 1945. Objective was to obtain data on reception of the bureau's standard frequency station, WWV, at various distances and in different directions. Observers were recruited from hams and professional radio-men. They tuned WWV at frequent intervals, recording intensity, readability, fading and background noise intensity. This information also was used in checking propagation predictions.

RUTH ARELL, former feature editor of public relations department of National War Fund, has joined Austin Wilder, New York artist management promotion office, as feature editor and assistant to the publicity director.

TO ASSIST Paul Whiteman in his special orchestral effects for ABC "Philco Radio Hall of Fame", network engineering department set up novel "echo chamber pipe line" for initial Hollywood broadcast. Picking up violins at actual broadcast, they piped it across the street into an 8 by 14 foot echo chamber containing only speaker and mike. Strings' reverberations were then piped back with the echo and actual sounds mixed together. Effect gives illusion of greater number of violins.

WHBC gets to Canton people . . . over the ground and through the air . . . holds popular attention with local features and local services. CONLAN Telephone Survey of October-November '45 proves WHBC's local listenership claims. Put your story across in the 59th metropolitan area. Write us for details.



1000 WATTS FULL TIME

CANTON • OHIO

whbc

THE LARGEST SINGLE STATION MARKET IN THE 48 STATES!

BASIC STATION MUTUAL NETWORK

Represented by BURN-SMITH Co.



D'Lo, Mississippi?

This is a fine little community in Simpson County, but to hit "D' high" in advertising results—concentrate on JACKSON, where the value of 250 products manufactured in 1944 amounted to over 49 million dollars.

WSLI—the "Double-Return" station, offers you maximum coverage of this market—at less cost!

American Broadcasting Co.

WEED & COMPANY NATIONAL REPRESENTATIVES

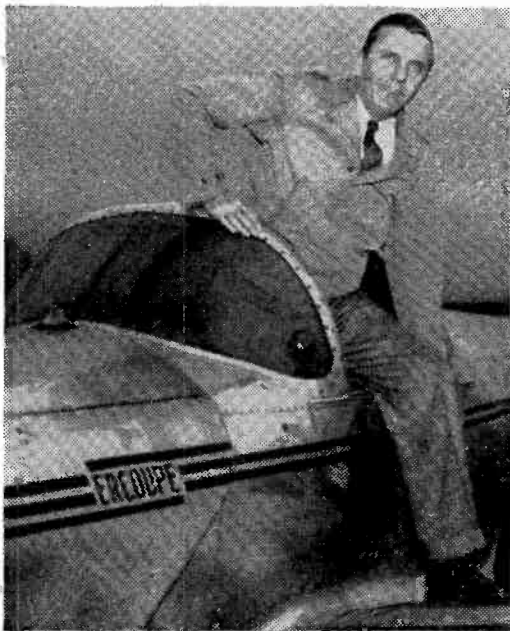

IN THE AIR as well as on the air is Charley Stookey, farm editor of KXOK St. Louis, who has 15½ hours flying time. He expects to have his private license by mid-April, when he can fly to farm events.

WCHS COVERS FIRE

Station Starts Broadcasting Day at 6:19 a.m.

IT WAS 4 a.m., when David Fulton, announcer of WCHS Charleston, W. Va., first spotted the Jan. 27 fire that destroyed 10 buildings and injured four people. He called Berton Sonis, program director, and he, in turn, called other members of the staff. By 6:19 WCHS was on the air giving a report of the worst fire to hit Charleston.

Less than 15 minutes later, Harold Miller, WCHS news editor, who had just returned from the scene of the fire, broadcast the first detailed account. Ernie Saunders and Melva Graham, "Miss 580," went on the air at 6:40, using a portable microphone located at less than a block from the fire. Firemen, telephone men, power men and eyewitnesses told their stories to WCHS listeners. The broadcast lasted one hour and twenty minutes and, by request, was rebroadcast by recording twice during the later part of the day. Howard Chernoff, managing director of WCHS, prepared the station's auditorium for possible housing of the Ruffner Hotel's guests, but the hotel was saved by firemen.

WHO

is "Listened-to-Most" in 74 of Iowa's 99 Counties

(No. 2 Station is "Listened-to-Most" in 11 Counties!)

Write for complete facts!

50,000 Watts • Des Moines
Free & Peters, Representatives

News

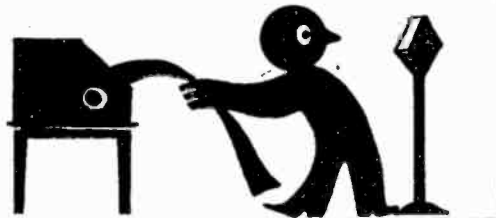

BILL WELSH, office manager of Allied Advertising Agencies, Los Angeles, has been added to sportscasters staff of Associated Oil Co., San Francisco, and is handling Friday night broadcasts of Pacific Coast Conference basketball games in southern California area.

FRANK BULL, partner of Smith, Bull & McCreery, Hollywood agency, and also a sportscaster, continues to handle Saturday home games of USC and UCLA. Mr. Welsh, in addition to his new assignment, continues twice weekly night broadcasts of Pacific Coast Hockey League games from Pan-Pacific Auditorium on KMTR Hollywood.

CARVETH WELLS, NBC Hollywood commentator who spent six years in the Far East, is putting finishing touches on his book "Introducing India," to be published in April.

FRANK McCALL, operations manager of NBC news and special events department, and **SAM KAUFMAN**, feature editor of NBC press department, will address a session of the House Magazine Institute, an organization of house organ editors, Feb. 7 at Fontainebleau Restaurant, New York. Editors are to make a tour of Radio City and will be addressed by **BURKE CROTTY** and **PAUL ALLEY** of NBC television department, on "Televising the News."

FRANK J. GILLESPIE has been appointed news editor of KSJB Jamestown, N. D. While assigned to OWI Manila he witnessed surrender of Gen. Yamashita's forces at Baguio.

RED THORNBURGH, back on staff of WSAI Cincinnati after 44 months in Navy, has been named director of sports and special events. He was with WCPO Cincinnati several years before joining WSAI in 1940.



Mr. Thornburgh

AUSTIN FENGER, director of news and special events for KSFO San Francisco, Jan. 26 discussed "This Business of News casting" as guest speaker at annual dinner of Ukiah (Cal.) Chamber of Commerce.

LEONARD O'CONNOR, former member of the news staff of NBC Central Division, Chicago, has returned to net as editor following release from Army. He served two years. **MYRTLE ROBISON KNIGHT** has resigned from staff to join her husband in the East.

LEN HOWE, discharged from Army after service in Italy, has returned to WHO Des Moines newsroom as rewrite man and newscaster.

LARRY HAEG, farm director of WCCO Minneapolis, and **SIG MICKELSON**, news editor, are to cover annual Red River Valley Midwestern Agricultural Show at Crookston, Minn., Feb. 6-7. Mr. Haeg will originate his early morning "Farm Service Report" at show and will transcribe interviews with farm leaders.

RUTH BURTON, newscaster and member of rewrite staff of WHO Des Moines, is to be married Feb. 16 to Charles Laird.

JIM ZABEL, newscaster at WHO Des Moines, Feb. 17 is to marry Mary Janice Boehm.

BILL DIAMOND, farm markets editor of WHO Des Moines, is father of a girl.

CLETE ROBERTS, ABC war correspondent, has started weekly five-minute aviation commentary "The Flying Public" on network Pacific stations.

LISA SERGIO, editor, archaeologist and WQXR New York news-commentator, becomes a lecturer effective Feb. 8 when she begins a series of lectures and discussions at John L. Elliott Institute. Subject is "United States Foreign Policy in the Atomic Age."

JOHN FACENDA, newscaster of WIP Philadelphia, broke two bones in his hands stopping his car from crashing into a group of children when it began rolling down an incline after it had been parked.

JOHN K. CHAPEL, news chief of KROW Oakland, Cal., has been elected to membership in International Footprinters Assn., world organization of police and peace officers.

BILL WHITE, chief announcer for KFJB Marshalltown, Ia., from 1938 to 1942, has returned to the station as sports editor and special events director following Army service. He also will handle station promotion.

EDGAR KIRK has been appointed news editor of newly organized WPTF Raleigh, N. C., news bureau. New to radio, he was recently discharged from the Army after five years' service in public relations and combat intelligence. He saw Pacific duty. **TED ELLIS LEEPER**, farm services announcer of WPTF, has returned to the station after two and a half years in armed service.



Mr. Kirk

CEDRIC FOSTER, Yankee Network and Mutual commentator, has returned from a week's lecture tour in the South. He addressed the Georgia House of Representatives and Senate at separate meetings as well as Baylor School for Boys, Chattanooga, Tenn., and southern group of AHEPA, fraternal Greek organization.

PAUL KILLIAM Jr., member of the news and special features division of WOR New York, and Joan Patricia Richards, New York, are engaged.

TOM SMITH, former copy writer and announcer at KXRO Aberdeen, Wash., has been assigned head of the agricultural radio department of KWSC Pullman, Wash.

ROY L. MOSHOP, former captain in

KRLD 'Serves' Pacific

KRLD—those call letters spelled HOME to a pair of Dallas Navy men somewhere out in the Central Pacific. S1/C Joe B. Dodson wrote KRLD Dallas that he and Lt. (jg) W. C. Odeneal, his ship's communications officer, also of Dallas, were listening to a California station and thinking how good it would be to hear KRLD. Then, as they jiggled the dial, "an unknown station came in so strong it almost blew the cone from the speaker" and the announcer said "KRLD, serving Dallas, Fort Worth and the great Southwest." Seaman Dodson noted that he was 5,000 miles from Dallas "as the crow flies," and suggested that the 50 kw station's identification be changed to "serving Dallas, Fort Worth and the great Pacific Ocean area." He added: "It still sounds good to me, no matter how it's said. I know it's home."

91st Division Artillery, has been added to the news staff of KMOX St. Louis as special writer.

JOHN BLAKE, formerly with WSAU Wasau, Wis., and now special events and public service director of KWSC Pullman, Wash., is father of a boy.

JOHN M. BOYLAN, recently discharged after service as captain in Army Signal Corps, has rejoined NBC as commercial traffic supervisor. He was with NBC purchasing department before Army service. **STEERE MATHEW**, NBC assistant traffic manager who during the war was commercial traffic supervisor in addition, will confine his attentions to general supervisory duties as assistant traffic manager.

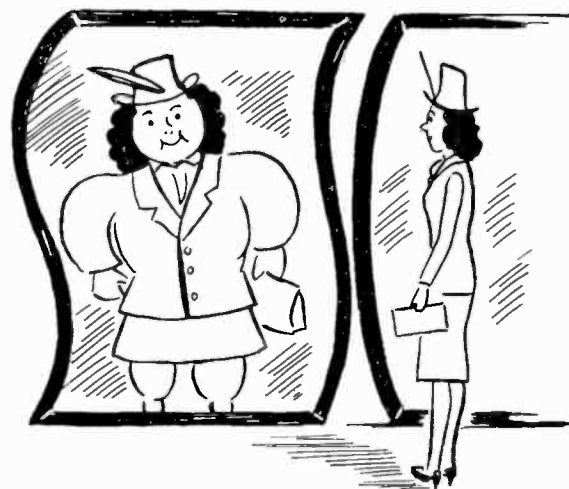

DOUBLING THE RESULTS

The Sectional Hooperatings for May-September 1945 revealed that WSGN doubled, in many cases tripled, the National and Sectional ratings awarded all American Broadcasting Company daytime programs.

Representing Greater Birmingham

WSGN

AMERICAN BROADCASTING CO.

THE NEWS-AGE-HERALD STATION
Represented by Headly-Reed



HAROLD STONE, during the war with OWI and in latter 1945 consultant to U. S. Treasury War Finance Division, has been appointed to an executive post with Pedlar & Ryan, New York. He has been in agency and distribution field for more than 20 years.

IRVING BENNETT, released from the Army as major after two years in Southwest Pacific and formerly with Pittsburgh Sun-Telegraph, has been named director of the publicity and public relations department of W. Earl Bothwell Adv., Pittsburgh. **FRED E. BAXTER** has been appointed agency controller. **JOSEPH P. O'DONNELL** returns to space department and **GORGE C. PLATACZ** to art staff following military service.

ANDY SMITH has been appointed by the Shaw Co., Los Angeles, as art director in charge of production department.

LOUIS H. FROHMAN, formerly head of his own New York agency and with H. B. LeQuatte Inc., is now managing director of Justin Funkhouser & Assoc., Baltimore. He served in AAF five years as colonel in Alaska and Washington.

WILLIAM A. LOTZ, released from armed forces, has returned to former post as copy writer at Burton Browne Adv., Chicago.

TOM LOEB, released from the Army, has rejoined Foote, Cone & Belding, New York, as assistant to **HUBBELL ROBINSON Jr.**, vice president in charge of radio.

MILTON HOFFMAN, discharged from Marine Corps after three years, has been appointed producer of Allied Advertising Agencies, Los Angeles, and is handling daily "Western Stars" program on KFVB Hollywood. **JACK GREGORY**, with release from AAF, has been added to agency as copy writer. **BILL HUNTER**, with Coast Guard discharge, is now an account executive of Allied Adv.

ROBERT L. REDD, Hollywood producer of Foote, Cone & Belding on CBS "Hollywood Star Time", is writing about his 15 years' experience as a radio producer in book "Take the Cue From Me."

FRED YOSCA has joined McCann-Erickson's foreign department after three years with the combat M.P.'s in Africa, Sicily and Italy.

AGENCIES



E. SCOTT PATTISON, with G. M. Basford Co., New York, for 10 years, has been elected a vice president.

EDMUND F. JOHNSTONE, released from the Army as lieutenant colonel, has resumed his former post as president of Redfield-Johnstone, New York.

COURTLANDT P. DIXON, released from the Navy after four years' service, has rejoined Buchanan & Co., New York, as assistant account executive on Welch Grape Juice Co. account.

ARTHUR HURD, director of media research, J. Walter Thompson Co., was to leave Feb. 2 for agency's Mexico City office to conduct continuing study of readership there for Readers' Digest.

THOMAS L. L. RYAN, president, Pedlar & Ryan, New York, is chairman of the New York publishers, broadcasters, agencies and graphic arts firms for the American Red Cross 1946 fund campaign. Division chairmen assisting Mr. Ryan include: **BEN DUFFY**, BBDO, for advertising, advertising agencies and radio; **HARRY L. MARKS**, Printers Ink, for trade papers. **JAMES M. CECIL**, president of Cecil & Presbrey, New York, has been appointed chairman of the Committee on Public Information for the drive.

ROGERS & BROWN Adv., a new agency, has been established at 200 W. 20th St., New York, by **JERRY ROGERS** and **STANLEY BROWN**, previously production head and art director respectively of William H. Weintraub & Co., New York. Accounts handled by the new agency include Robien Ltd. (Decision perfume), Franshaw Handkerchief Co. and Brovman Publishers.

BURT COCHRAN, manager of McCann-Erickson Los Angeles office, has been elected a vice president. He has been with agency since 1926.

ROBERT W. GRAHAM, partner in the firm of Gray & Rogers, Philadelphia, has been named copy director.

JOHN O'HARA HARTE is new director of public relations of the McLain Organization, Philadelphia agency.

ALFRED R. SMITH joins Shaw Adv., Philadelphia. He served as lieutenant in the Tank Corps in Europe.

W. H. SANDIFORD has resumed his duties as account executive in the



Mr. Sandiford

Seattle office of Mac Wilkins, Cole & Weber, Portland, Ore., agency. He joined firm in 1937 as radio director following 12 years in radio and show business. He entered Army in 1943 and upon release from service had been assistant advertising manager of Boeing Aircraft Co. handling employee recruitment, a national agency supervision and sales promotion campaigns before returning to agency field.

HELEN MULVANERTON, formerly with the Red Cross in Italy and Germany and prior to that with American Airlines, has joined McCann-Erickson foreign department.

MILTON V. CARLSON, former account executive of Don Lee-Mutual, has been appointed vice president of Western Adv., Los Angeles, in charge of agency's campaigns for motion picture industry. **KENNETH J. SLEE**, released from Naval Air Corps as lieutenant (jg), has joined agency's production department. **KEITH H. EVANS**, account executive in charge of foreign radio advertising and religious publicity campaigns, addressed group of religious leaders from India, Africa, China and South America who plan extensive use of radio as an aid to church activities in foreign lands.

GEORGE L. PRATER, former vice president of Anfenger Adv., St. Louis, has established Prater Adv. with offices at 705 Chestnut St., St. Louis. Directors are Mr. Prater, president; **HAROLD R. BUSCHHORN**, vice president; **VION SMIRNOFF**, secretary. Accounts include Falls City Brewing Co., Louisville, Ky.; Merit Clothing Co., Mayfield, Ky.; Monteaun Woolen Mills of California, Missouri, and New York City; Whitmire Research Labs., St. Louis.

GEORGE DIPPY, member of Young & Rubicam merchandising department for two years, has been named department manager. **CARL SCHUSTER**, with Y&R for past year and formerly partner in Facts Inc., has been named manager of Y&R new products division.

MITCHELL LINDEMAN has been appointed Hollywood producer of Roche, Williams & Cleary on NBC "Date with Judy", replacing **HELEN MACK**.

HAROLD J. CARMICHAEL has returned to Ferry-Hanley Co., New York, as assistant to H. E. LEHMAN, media director. **WARREN LEE** returns to art staff. Both were in service. **DOUGLAS PALMER**, Marine veteran, has been added to copy department and **KENNETH CARSON**, released from AAF, joins promotion department. **LT. COL. HARRY M. MONTGOMERY**, Ferry-Hanley vice president, currently with Allied Military Government, is expected to return soon to the U. S. He has been on leave of absence for two years.

ROBERT A. KLINE, recently discharged from the Navy, has joined the copy writing staff of Heller & Sperling Adv., Reading, Pa.

HARRIET STARKMAN has joined the copy staff of Packard Adv., Philadelphia.

THOMAS La BRUM, head of La Brum Adv., Philadelphia, is recuperating from an emergency appendectomy.

T. HARRY THOMPSON has been appointed vice president and director of copy at Lamb, Smith & Keen Adv., Philadelphia. He was with N. W. Ayer & Son, New York, for 18 years and more recently was copy director of Gray & Rogers, Philadelphia.

VIRGINIA FRAZIER WHITE has been shifted from the New York to the Hollywood office of Smith, Bull & McCreery.

LARRY HOSKIN has joined George C. Hoskin Assoc., Chicago agency, as radio director and western division manager and is headquartered in Glendale, Cal. His father, **GEORGE C. HOSKIN**, heads firm.

BERNARD WEINBERG, president of Milton Weinberg Adv. Co., after two weeks in St. Louis and New York on agency business, is to return to his Los Angeles headquarters Feb. 4.

HOWARD WOOKEY having acquired interests of his partner, **J. DAYNER ROMAN**, in Wookey & Roman, Hollywood agency, name has been changed to Howard Wookey Inc. Headquarters continue at 6636 Hollywood Blvd.

HAROLD M. NEWMAN, released from the Army as lieutenant, has rejoined Grey Adv., New York, as assistant account executive. **LESTER C. LEBER**, out of Navy, returns to agency for assignment as account executive. **HERBERT HOLZER** has resigned from Grey to enter new field. **RICHARD SCOTT** assumes Mr. Holzer's duties as production manager.

AL MARTHENS, before Navy service in radio and appliance fields, has joined Turner Adv., Chicago, as account executive. Formerly district sales manager of Easy Washing Machine Corp. and sales promotion and advertising manager of Philco Radio Corp. Chicago branch, he onetime was manager of former WMBF Miami, Fla.

FIL MANDL, formerly with Pontiac Engraving, Chicago, has joined Ivan Hill Adv., same city, as account executive.

MALCOLM MacDONALD, former account executive with Paris & Peart, has been added to the account executive staff of Theodore A. Newhoff Adv., Baltimore. **JOHN K. HEALY**, released from the Navy as lieutenant, is appointed Myerhoff business representative, a new post.

LEO BURNETT CO., Chicago, has made four additions to its copy department. **JOHN W. CRAWFORD** resumes as copy writer after three years Navy air service. He was attached to Adm. McCall's Pacific staff. **JOHN E. WILSON**, 8th Air Force public relations officer, also is assigned to copy. **VIOLET N. BROOKS** advances to copy staff from research department. Newcomer is **BERNARD J. GROSS**, released from AAF after three years service as air gunnery instruction supervisor. He formerly had been with Meyer Both Co., Chicago newspaper service. **PAULINE WATROS**, former Burnett timebuyer reported earlier to be moving to Hollywood [BROADCASTING, Dec. 10, 1945], remains in Chicago to head all media for Shaw-Levally Inc., agency formed last November.

RANDOLPH A. SANDBERG, former head of the accounting department of Grant Adv., Chicago, has been appointed office manager of Burton Browne Adv., Chicago.

DAVID S. HOGMER, former industrial media buyer for BBDO New York, has joined the media department of Duane Jones Co., New York, specializing in package products advertising.

AVERY McBEE, for six years director of public relations and advertising of The Glenn L. Martin Co., Baltimore, has been appointed Hawaiian manager of N. W. Ayer & Son, Philadelphia. He succeeds **JOHN S. COONLEY**, who has joined American Factors Ltd.

Vancouver's
CKWX
First
IN CANADA'S
THIRD MARKET
1000 WATTS
GOING TO 5000
Mutual Network
REPRESENTED BY
WEED and Co.

The STRANGEST STREET in America!

IT'S "MAIN STREET" IN Texas' RIO GRANDE VALLEY

"Main Street" in Valley City is 65 miles long, connects 42 homogenous communities of 185,400 population into a major Texas market larger than New Haven, Grand Rapids or Salt Lake City, with over 62 millions in retail sales. 8 out of every 10 buyers are 20 minutes, or less, away from the principal shopping centers on "Main Street", a profitable street for an advertiser to cultivate.

HARLINGEN LEADS VALLEY IN 1945 BANK DEPOSITS	
Harlingen	\$14,785,612.83
McAllen	14,212,931.26
Brownsville	13,971,244.22
Mission	12,080,151.24
Mercedes	8,854,260.85
Edinburg	6,722,700.15
Pharr	6,190,200.57
Raymondville	6,147,892.99
Weslaco	5,734,893.50

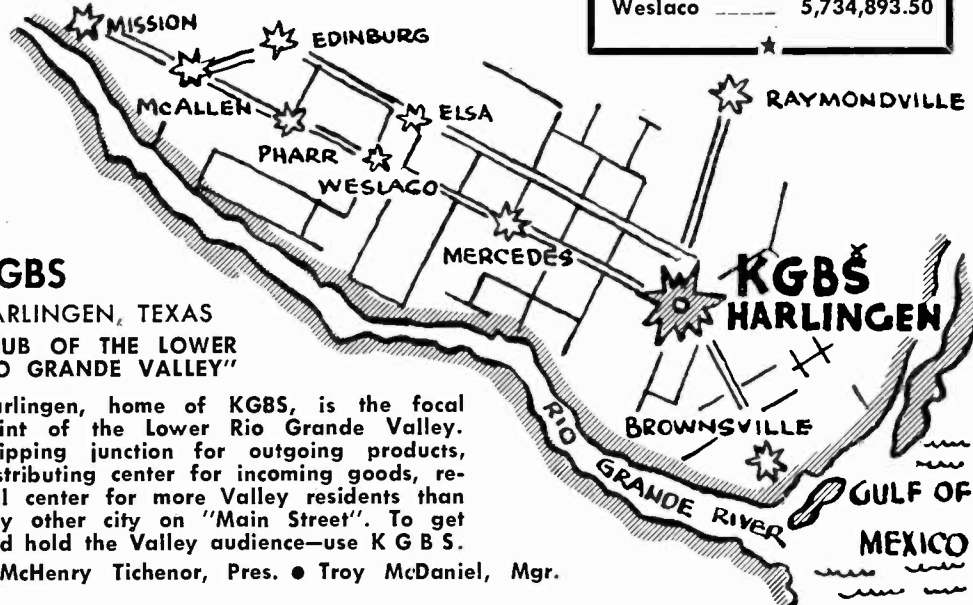

KGBS

HARLINGEN, TEXAS
"HUB OF THE LOWER RIO GRANDE VALLEY"

Harlingen, home of KGBS, is the focal point of the Lower Rio Grande Valley. Shipping junction for outgoing products, distributing center for incoming goods, retail center for more Valley residents than any other city on "Main Street". To get and hold the Valley audience—use KGBS.

• McHenry Tichenor, Pres. • Troy McDaniel, Mgr.

KGBS THE ONE AND ONLY
CBS Affiliate
WITHIN LISTENING RANGE OF THE LOWER RIO GRANDE VALLEY

Nationally Represented by THE WALKER COMPANY

KEN HANSEN, former producer of Young & Rubicam, has been released from the Navy after 45 months' service.

FRANCES WALKER, formerly with San Francisco office of Botsford, Constantine & Gardner, has joined Buchanan & Co. to serve as home economist and special food writer on Welch Grape Juice Co. account.

D. PORTER BIBB Jr., released from the Army and previously account executive for Kudner Agency, has been appointed to the executive staff of Lennen & Mitchell, New York.

ERNEST ALVIN DREHER 3d, released by the Navy, has joined the research department of Monroe F. Dreher Inc., New York.

ROBERT S. BEATTY, released from the Navy, has resumed his former post as an account executive with Rickard & Co., New York.

ROBERT M. HODGES, formerly with Young & Rubicam and J. M. Mathes Inc., both of New York, joins the copy staff of Wendell P. Colton Co., New York.

RENE PEPIN, for two years associate director of research at McCann-Erickson, New York, has joined Stockton-West-Burkhart, Cincinnati, as vice president and director of research. **JULES C. GERDING**, formerly with Jones & Bradley, joins Cincinnati agency as account executive.

WILLIAM S. KELLY Jr., formerly with Compton Adv., has been appointed in charge of media of J. M. Hickerson Inc., New York.

JOHN SIMONDS has joined G. M. Basford Co., New York, as account executive. He formerly was with Interchemical Corp. and General Electric Co.

HARRY ACKERMAN, vice president in charge of program operations of Young & Rubicam, New York, is in Hollywood for conference with **GLENHALL TAYLOR**, Hollywood manager and associate director of radio.

ALFRED DUCATO, former Navy reserve lieutenant, has joined Carl C. Wakefield Agency, San Francisco.

ROBERT L. NOURSE Jr., former vice president of Essig Co., New York, has joined Dorland International Pettingell & Fenton, New York, as account executive and member of the plans board.

JAMES V. SPADEA, head of Spadea Adv., New York, has announced incorporation of the agency effective Feb. 1. Firm now is known as Spadea Inc.

EUGENE JENNINGS has joined the sales staff of United Adv., Newark. He formerly was lieutenant with Marines.

CATHERINE NAYLOR, formerly with Monroe F. Dreher, as advertising director, has joined Doherty, Clifford & Shenfield, New York, as fashion and beauty stylist.

THOMAS D. LUCKENBILL, vice president and radio director of William Esty & Co., New York, because of strike conditions has postponed indefinitely his contemplated trip to Hollywood.

WILLIAM B. STILLWELL has joined Spadea Adv., New York.

NORTON J. WOOLF, released from the Navy, has been added to copy staff of Donahue & Coe, New York.

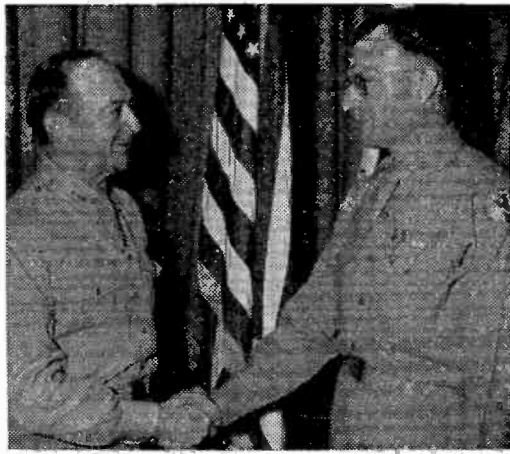

BRONZE STAR MEDAL was awarded Maj. Henry C. Putnam (r), Executive PRO MIDPAC, by Lt. Gen. Robert C. Richardson Jr., Commanding General Army Forces MIDPAC. In charge of radio division, he directed Army's broadcast activities from Pacific, trained news teams in use of wire recorder and coordinated Okinawa radio coverage. Before entering the Army in 1942 he was at KGMB Honolulu. Maj. Putnam is partner with Lt. Col. J. Elroy McCaw, half-owner of KELA Centralia, Wash., and John D. Keating in a proposed 5,000 w station in Honolulu on 630 kc, for which an application is pending at FCC.

Lea Bill

(Continued from page 34)

tribute to avoid the greater losses that would result from failure to comply.

Moral Quality of Practices Justifies Penalization

Under the terms of this bill certain specified types of coercive practices and demands are made unlawful. These prohibited practices are made misdemeanors and punishable as such.

The practices thus made unlawful are those directly affecting the broadcasting industry. By specific provisions of the bill it is not to be held to make unlawful the enforcement or attempted enforcement, by means lawfully employed, of any contract right or legal obligation.

The perpetration of the offenses penalized by this bill involve moral turpitude akin to that of larceny, embezzlement, the acquisition of another's property by false pretenses, racketeering, and extortion. They are not within the legitimate activities of any organized association of individuals for the cooperative purpose of their accomplishment.

The right to strike for a lawful purpose cannot be twisted into a right to combine together to commit crimes.

The moral quality of the offenses defined in the bill fully justifies their penalization.

These extortionate exactions from the broadcasting industry have been and are being accomplished by means of threats, intimidation, and coercive power of boycotts and strikes and threats of boycotts and strikes.

The practices proposed to be prohibited by this legislation are to prevent only the unlawful acts as defined in this bill. A strike is a privilege or right exercised for lawful purposes. The law does not contemplate that strikes shall be used as a cloak for the commission of crimes. The provisions of this bill define these unlawful practices and penalize their perpetration.

The restrictions imposed are not a limitation upon the legitimate activities of any association or combination of individuals. There is no more sanctity in crime committed by a combination of individuals than by an individual perpetrator.

Power and Duty of Congress

Congress clearly has the power and the duty of protecting the public against such exactions.

The greatest exponent of Anglo-Saxon law declared that a law is a rule of conduct prescribed by the supreme power in the state commanding what is right and prohibiting what is wrong. The first fundamental under this approach is as to whether or not the act to be prohibited is wrong. In view of the record that has been made the answer to that question cannot be one of doubt. Conceding these practices are

of such moral quality as to deserve condemnation as unlawful, the right and duty of Congress to suppress them are equally clear.

This bill provides no unjust limitation on the right to strike. The law recognizes the right to strike for lawful purposes and in a lawful manner. The right to strike should be exercised as other rights of the citizen. We have the right of free speech but that is not a justification for slander. We have the right to bear arms but that is not a justification of murder. Any persons may properly organize for lawful purposes but criminal purposes as beyond their legitimate function.

A Disservice to Labor

The offenses committed in the name of the American Federation of Musicians are a great disservice to legitimate labor organizations as well as to the public.

The situation presented by this legislation should call for the support of all branches of organized labor to give their condemnation to such outrageous practices committed in the name of labor. Legitimate labor organizations cannot afford to give their condonation to such practices or approve of them by assuming their defense.

It is incredible to believe that in the long run such practices as those here-by inhibited can redound to the credit or advantage of any organization which yields itself to these sordid methods.

A Typical Approach

A characteristic assumption of those who make these demands is carried in a wire from Mr. Petrillo to the networks in October 1945, as follows:

"This is to advise you that after the meeting between your company and the American Federation of Musicians held in my office the matter was further discussed and we came to the final conclusion that beginning Monday, October 29, 1945, wherever musicians play for FM broadcasting and AM broadcasting simultaneously the same number of men must be employed for FM broadcasting as are employed for AM

broadcasting, which means a double crew must be employed. Kindly govern yourself accordingly."

The absurdity of such a demand is apparent. Two orchestras required for simultaneous broadcast would be an anomaly. It is reported that 1 of the networks has a staff orchestra of 95 pieces and compliance with this order would require the employment of 190 musicians to needlessly duplicate and embarrass the work of one orchestra.

A circumstance that gave impetus to this legislation was an edict directed at a music school in Michigan, which prohibited a broadcast by a school orchestra unless a tribute of three times the usual price of an orchestra of the federation was paid for that privilege. The Vandenberg bill which passed the Senate and the Dondero bill introduced in the House were outgrowths of that circumstance.

Conclusion

The coercive character of the methods followed in the name of the American Federation of Musicians is attested by the indisputable fact of the millions of dollars mulcted from the broadcasting industry in recent years. Time after time broadcasters have paid tribute, and otherwise acceded, to these extortionate demands rather than suffer the greater hardships and losses that refusal to comply would involve. These tributes and other exactions were not payments for services or to satisfy an obligation owed to those who demanded them. They were the price paid for the peace of being relieved from the penalties of refusal. As a reward the broadcasting industry has been confronted with more and greater demands of equal viciousness.

It is the responsibility of the Congress to take effective action to stem the rising tide of unconscionable demands upon the broadcasting industry, against which, in the present state of the law, that industry is powerless to defend itself. To the end of meeting that responsibility, prompt enactment into law of the bill here reported is strongly recommended.

the Little station with a big Wallop

THE ONLY STATION WITH A CLEAR SIGNAL IN THOUSANDS OF IMPORTANT HOMES

WMAM

Marinette • Wisconsin

Geographic ground conditions make WMAM the BEST LISTENED TO station in a great market. Achievement results from a combination that "clicks." Here's ours—WMAM—570 ON THE DIAL—NBC! That middle link is important, for 570 on the dial is a time buyer's dream. It means virtual 5000 watt coverage at 250 watt rates. You can't cover Upper Michigan or Northeastern Wisconsin with any other one station. Get a whale of a lot for your money and buy the "little station with the big wallop." Write for details and Hooper survey.

WMAM blankets Northeastern Wisconsin and Upper Michigan. Secondary coverage includes Western Lower Michigan directly across the Lake.

570

BRANCH STUDIOS IN STURGEON BAY, WIS. • IRON MT., MICH. JOSEPH MACKIN, MANAGER

In the UTAH Market



The POPULAR Station



National Representative JOHN BLAIR & CO.



\$4,523
per Family Income

This sizable sum, estimated by Sales Management, reveals the ready buying power within WLAW's intensive coverage area. Meet this spending market of three New England states by selling thru WLAW.

WLAW

LAWRENCE, MASS.
5000 WATTS 680 Kc.
Basic Station
American Broadcasting Co.

NATIONAL REPRESENTATIVES:
WEED & CO.

J. CALVIN AFFLECK, recently released from active duty with the Navy, last week was appointed advertising and publicity manager of Radiomarine Corp. of America. Mr. Affleck was executive officer and public information officer at Atlantic Fleet's anti-aircraft training and test center, Dam Neck, Va. He had 17 months of sea duty. Before the war he was advertising manager and assistant to the general sales manager of Eisemann Magneto Corp., New York.

LAWRENCE E. WITTE, formerly with N. W. Ayer & Son, New York, has joined the radio staff of the national public relations division of the American Legion.

JERRY FRANKEN, former radio editor of the New York newspaper, PM, and of Billboard, and assistant field director for the American Red Cross in the South Pacific during the war, has been appointed advertising and promotion manager of Byron Productions, New York, producer of "Mr. District Attorney" on NBC for Bristol-Myers.

SONG LYRICS Inc., publisher of several song hit magazines, last week announced it was starting to service record jockeys, school papers and weekly newspapers with a popular music news column. Aim is to stimulate youth's interest in popular music.

MICHAEL ENZER has been appointed auditor of Radio Directors Guild succeeding the late **HARRY FUTTERMAN**.

COMPOSERS recently elected to membership in ASCAP are **AARON COPLAND**, **LUCIEN CAILLIET**, **DON GILLIS**, **ARTHUR KREUTZ**, **WILLIAM KROLL**, **CHARLES H. MARSH**, and **JOSEPH WAGNER** in standard field; **EMERY HEIM**, **JOSEPH M. DAVIS**, **PAUL NERO**, **MILTON ORENT**, **BILLY STRAYHORN**, **F. DUDLEIGH VERNOR** and **GEORGE DAVID WEISS** in popular field.

ANSON BOND, former partner in Bond-Charteris Enterprises, Hollywood program package firm, retains all television contracts that he held under partnership. Included is Gruen Watch television advertising campaign.

BERNIE MILLIGAN, Marine Corps combat correspondent for 22 months, has received honorable discharge and returned to Earle Ferris Assoc., Hollywood radio publicity service, where he heads office with **COY WILLIAMS**.

ALLIED ARTS



KSCJ Sioux City, Ia., has subscribed to BMB, bringing total to 616 stations. **RICHARD WYCKOFF**, BMB statistician, is to be in Chicago this week to check preparations for March mailing of a half million ballots to radio homes. **PHILIP FRANK**, public relations director of BMB, Jan. 30 addressed Pittsburgh Chapter of American Marketing Assn. on uses of BMB's forthcoming standardized measurement of radio stations' audiences. Following morning he spoke on "BMB, A Retailer's Guide to Radio" before a clinic for advertising directors of Frederick Atkins Department Stores. Clinic was held under auspices of U. of Pittsburgh Research Bureau for Retail Training.

WARD DORRELL, manager of the station relations department of C. E. Hooper Inc., is presenting a slide film on the telephone coincidental survey method to broadcasters in conjunction with NAB district meetings. Starting Jan. 25 in Omaha Mr. Dorrell also gave presentation Jan. 27 in Denver and Jan. 30 in Dallas and was scheduled Feb. 3 in Tulsa and Feb. 6 in Memphis.

W. BIGGIE LEVIN, head of his own Chicago radio production agency, has been appointed radio representative for All American Football Conference.

SHEP CHARTOC, on Music Corp. of America radio staff for past year, resigns effective Feb. 9 to open his own transcription business. First undertaking will be production and sales for "This Fabulous World" (quarter hour, three times weekly), owned and narrated by Commentator Alex Dreier. Office space is not yet set. Before joining MCA Mr. Chartoc was publicity and special events director for CBS Chicago.

THE CROSLLEY Corp., Cincinnati, export division, has completed arrangements for distribution in Venezuela with Riquezes y Vis, Caracas, and MacGregor y Cia., Maracaibo, Martinez y Martinez Inc., San Juan, has been appointed Puerto Rican distributor.

NEWCOMB-SWITAL Assoc., public relations firm, has been established at 4123 San Fernando Rd., Glendale, Cal., by **CHET L. SWITAL** and **CARMEN A. NEWCOMB Jr.**, both before the war in Chicago public relations work. Telephone is Citrus 1-9571.

VIVIAN ACORD, formerly with KHJ Hollywood and for 32 months overseas in Mediterranean and European theatres for American Red Cross, has been appointed chief of the radio section of the public information staff, ARC Eastern Area.

UNITED PRESS is now offering five-minute feature "America Converts to Peace", including scripts on affairs of veterans.

MORGEN-WAXMAN Assoc., New York, has been formed as a publicity service and public relations council by **JOE MORGEN**, former freelance public relations man, and **DAN WAXMAN**, released from the Army. Firm is located at 55 W. 42d St.

RAY M. REILLY has been appointed general manager in charge of sales and production of Kluge Electronics Inc. He formerly had been sales representative in music, radio and appliance fields.

FREDERIC W. ZIV Co., Hollywood, producing transcribed quarter-hour musical "Sincerely Kenny Baker" series, has announced following new placements: **WMBD** WMT WKRC WWJ WAVE WBNS WHK KWFT.

HECTOR PERRIER, formerly with the national waste paper salvage and wood pulp campaigns, has joined the Advertising Council as staff manager of U. S. Treasury campaigns succeeding **GUY LEMMON**. In his new post Mr. Perrier will work with the Treasury Dept. and the following volunteer agencies serving on the program to sell peacetime bonds: Young & Rubicam, J. Walter Thompson Co., Joseph Katz Co., G. M. Basford Co. **HERMAN HETTINGER**, director of editorial extension, Crowell-Collier Publishing Co., has been appointed coordinator for the economic stabilization campaign of Council. BBDO continues as volunteer agency on campaign.

MARION WATSON, formerly production assistant of C. C. McDONALD, Los Angeles, radio engineer, has joined Richard A. Nelson Producer, Los An-

geles record firm (Four Star, Gilt Edge records), as publicity director.

H. W. DEUKER, director of quality of Crosley Corp., has been promoted to works manager of the Cincinnati plants. For 20 years employed in executive engineering and production positions with Frigidaire Division of General Motors, Norge Division of Borg-Warner Corp., Brunswick-Balke-Collender Corp., Seeger Sunbeam Co. and Chicago Vitreous Enamel Products Co., he joined the Crosley organization in Aug. 1941 as chief inspector.

CHARLES R. BOWEN, associated with radio retailing since 1923 and former buyer of equipment department, Bullock's, Los Angeles distributor for Packard Bell Co., Los Angeles (radio set maker). He assumes former duties of **FRANK E. WARE**, now firm's sales manager.

LES HOPPER, formerly copy chief of Buchanan & Co., Chicago and more recently with Raymond R. Morgan Co., Hollywood, has formed his own organization to write radio package shows. Offices are located at 6518 Selma Ave., Hollywood.

CHARLES MICHELSON Inc., New York, radio transcription firm, has opened offices in Penfield Bldg., 1328 Chestnut St., Philadelphia 7. Branch will handle Mid-Atlantic Seaboard territory and is under supervision of **R. TRAVIS DE GROUCHY**.

NEW EDITION of Broadcast Music Inc. general index listing more than 60,000 titles of material published by BMI and affiliates and public domain compositions was mailed to stations last week. Index is more than 1,100 pages with titles arranged alphabetically, cross-indexed and classified.

RADIO WRITERS GUILD has appointed a committee to negotiate with television studios for permission to allow writers to learn the medium by conducted tours to watch television shows from the studio and the control room. Guild committee is headed by **NORMAN ROSEN**, writer-producer with television department of J. Walter Thompson Co.

FRANK BLAKE has been appointed sales executive by Electronic Corporation of America in charge of New York metropolitan area. **MORTYN K. ZEITZ**, who is owner of Radio Appliance Sales Co., Providence, R. I., has been appointed to post of New England area sales executive.

SETH N. BAKER, on terminal leave after five years' service in the Army engaged in public relations work at Thomas M. England General Hospital, Atlantic City, N. J., has been appointed by Philco Corp., Philadelphia, to firm's public relations department.

JOHN ANDREW, former service manager of Associated Program Service Inc., New York, has been appointed supervisor of service's new sales department.

FIRST television rights to the film "Pursued", has been given to Television Associates Inc., New York, by Niven Busch, Hollywood independent producer.

★ HEART OF EASTERN NORTH CAROLINA
BRIGHT LEAF TOBACCO BELT

this
WASHINGTON
IS IN
NORTH CAROLINA

In Case you didn't know!

This Washington, in the heart of Eastern North Carolina, is the home town of WRRF! Also perhaps you didn't know that Eastern North Carolina Bright Leaf Tobacco farmers sold their 1945 crop for over \$175,000,000.00.

We want you to know... that WRRF serves this market completely... a market of over 600,000 population... with 6,188 retail stores that do over \$100,000,000.00 annual sales volume.

You should know... that 67,144 radio homes depend primarily on WRRF for their favorite national and local programs.

Then you will know that WRRF is the only "buy" to cover Eastern North Carolina... WRRF will sell your product in one of America's richest agricultural belts... So remember WRRF... This Washington in North Carolina—and this "as good as gold"... market.

WRRF
930 Kc. 1000 WATTS

TAR HEEL BROADCASTING SYSTEM, INC.
"WE RADIATE REAL FRIENDSHIP"
AFFILIATED WITH THE AMERICAN BROADCASTING COMPANY
FOR JOE & COMPANY • National Representative
NEW YORK CHICAGO PHILADELPHIA

WASHINGTON
NORTH CAROLINA
"HOME OF WRRF"



UNITED PRESS



ENEMY PROPAGANDA—20,000,000 words of it picked up by CBS in six years of shortwave listening—is microfilmed by Dr. Luther H. Evans (r), Librarian of Congress, as Earl H. Gammons, director of CBS Washington office, watches. CBS donated complete file, some 96,000 pages.

Radio Auditorium Plans For White House Stay

AUDITORIUM equipped for broadcast and television pickups in the enlarged West Wing to be built at the White House is not affected by change in plans announced last week by President Truman at recommendation of the Commission of Fine Arts. Main change is elimination of a cafeteria, added to blueprints after the Commission originally approved the project.

Work has started on the addition despite moves in Congress to recall the \$1,650,000 appropriated for White House in a deficiency bill. Lorenzo S. Winslow, White House architect, said he will not issue a "stop-work" order unless requested by the President. The Fine Arts Commission noted opposition by several groups to the addition but said the entire project was of a temporary nature until more suitable quarters can be provided elsewhere.

CAL TINNEY, star of "Relax With Cal Tinney," ABC cooperative program, five weekly 6:45 p.m., has written a booklet, "Don't Quarrel—Dunk!", which the Doughnut Corp. of America will distribute nationally in connection with its annual observance of National Doughnut Week, March 24-30.

HARDWARE DEPT



"Any limit on those wolf traps you advertised over WFDF Flint?"

Pepsi-Cola Signs Reynolds For MBS Service Series

PEPSI-COLA Co., whose "Hit the Spot" jingles unloosed upon the radio public a flood of singing commercials which in turn evoked a shower of criticism upon radio's broadcasters and advertisers, is about to start another new type of national radio program, which the company's president, Walter S. Mack Jr., last week announced as

"a public service to the American people."

Starting Feb. 24 on Mutual, the soft-drink company will sponsor Quentin Reynolds in a Sunday evening series of dramatic presentations of important issues.

"In the final analysis," Mr. Mack declared, "the critical problems which must be resolved in 1946 must be decided by the people, and if Pepsi-Cola can be of service in providing the means to clear up some of the confusion that befores the issues, the company will make a real contribution, through this program, to the people."

Asserting that as people "now get the news from day to day it is difficult for them to piece it all together at one time on any one issue," Mr. Mack expressed the hope that "by the method of presentation Quentin Reynolds will employ and by covering only one issue each Sunday, the American people will fully understand that issue and its ramifications as it affects their lives." He added that the opinions expressed by Mr. Reynolds will be entirely his own and uncensored by the company.

Series, placed through Newell-Emmett Co., New York, replaces the Fulton Lewis jr. series for Caughlan's Chimneysweep Soot Remover, which has its final broadcast Sunday Feb. 17, 6:45-7 p.m.

Pulse Reports Jan. N. Y. Listening Up 'Charlie McCarthy' Rates 27 To Head Top Ten Shows

NEW YORK radio listening in January continued a seasonal increase, Pulse Inc., New York survey firm, reported last week. A 1.3% rise in average quarter hour sets-in-use over December was noted.

Figure for January was 26.1, a noticeable gain over the figure for January 1945, which was 24.3. Pulse thought this increase might be due to colds and flu which kept large numbers of persons at home.

Truman Rates 56%

An audience of 56% was reported for Jan. 3, night of President Truman's broadcast. Only larger percentage was recorded at 9 p.m. Sunday of the same week when sets-in-use reached 58.

In the same survey, Pulse reported the top ten evening programs as follows: *Charlie McCarthy* 27; *Bob Hope* 26.3; *Jack Benny* 26; *Walter Winchell* 25.7; *Lux Radio Theatre* 25.3; *Fred Allen* 24.7; *Fibber McGee & Molly* 24.3; *Mr. District Attorney* 24; *Aldrich Family* 22.3; *Red Skelton* 20.

Top ten weekday daytime shows were: *Kate Smith Speaks* 7.9; *Big Sister* 7.7; *Helen Trent* 7.4; *Life Can Be Beautiful* 7.1; *Our Gal Sunday* 7.1; *When a Girl Marries* 7.1; *Stella Dallas* 7.1; *Portia Faces Life* 6.9; *Young Widder Brown* 6.9; *Lorenzo Jones* 6.9.

Top weekend daytime shows were: *The Shadow* 9.7; *Family Hour* 9; *Nick Carter* 8.3; *The Electric Hour* 8.3; *Children's Hour* 7.7; *McCarthy-News, Sunday* 6.7; *F. H. LaGuardia* 6.7; *Westinghouse Program* 6.7; *One Man's Family* 6.7; *New York Philharmonic* 6.7; *William L. Shirer* 6.7; *Gene Autry Show* 6.7.

KXLR to MBS

KXLR Little Rock, Ark., 250 w on 1450 kc, now under construction and scheduled to open sometime in March, is new affiliate of Mutual, bringing network total to 288 stations.

PENDLETON DUDLEY of Pendleton Dudley & Assoc., New York public relations firm, succeeds SAMUEL D. FUSON of Kudner Agency, New York, as president of National Assn. of Public Relations Council.

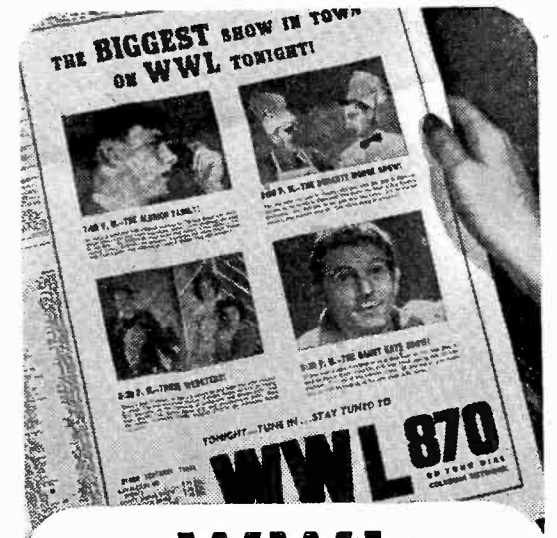

WWL

New Orleans

Shouts Its Shows in Newspaper Advertisements throughout the year

Folks turn first to—



THE GREATEST SELLING POWER IN THE SOUTH'S GREATEST CITY

50,000 Watts—Clear Channel—CBS Affiliate

Represented Nationally by The Katz Agency, Inc.

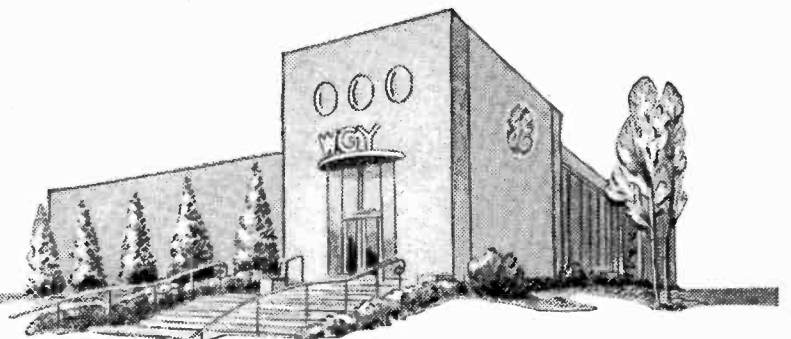

24 YEARS OF BROADCASTING IN THE PUBLIC INTEREST, CONVENIENCE AND NECESSITY

ON February 20, 1922, the first WGY signal spread through the ether to listeners in the Great Northeast. Today, no other station in central and eastern New York and western New England offers you locally originated programs for so large a listening audience—an audience built by 24 years of fine programming designed for a vast market created by WGY.

And WGY is the ONLY station which can combine all this into ONE coverage area.

WGY

50,000 watts — NBC — 24 years of service
Represented Nationally by NBC Spot Sales

GENERAL ELECTRIC
WGY-276
Schenectady, New York

PROGRAMS

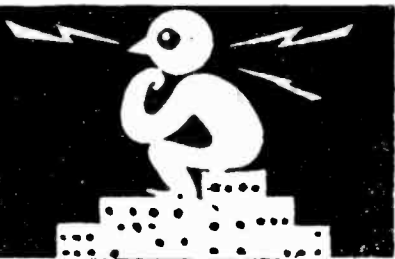

AIR SEMINAR featuring panel of four distinguished intellectuals starts on ABS Feb. 4 in Mon. 11:30-12 p.m. period. Titled "That's a Great Idea", program will examine the great ideas significant to the modern world and which have been shaping human destiny since beginning of civilization. Latter half of program will include studio audience forum discussion. Series originates in Hollywood.

University News

COOPERATIVE, non-commercial network of Nebraska stations is now carrying public service series of programs by U. of Nebraska in Sun. 12:30-12:45 p.m. (CST) period. Program highlights news of various university departments and progress being made in such fields as agricultural research, housing and veterans program. Co-op net, formed during the war to promote bond and salvage drives, includes KFOR KFAB KOIL WOW KBON KOWH WJAG KORN KHAS KMMJ KODY KDFW KGKY.

Newspaper Series

SATURDAY evening half-hour program, "This Is My Story," is being presented by "Minneapolis Sunday Tribune" on KSTP Minneapolis and a network of area stations. Originating at KSTP, program dramatizes best news stories of previous 10 days as selected by a panel of four newspapermen from the Star-Journal and Tribune and a guest editor from the Northwest. Each program features top world story, national story, northwest story, sports story and best story of week from community of guest editor. Portion also is devoted to radio version of letters to the editor. George Grim, Sunday Tribune columnist, is writer-producer. Stations also carrying series for 13 weeks are: WEBC WMFG WHLB WEAU WJMC.

Highway Interviews

IN COOPERATION with Pittsburgh Better Traffic Committee, KDKA Pittsburgh is now presenting "Hey, Mr. Motorist," Sat. 2-2:15 p.m. Motorists are flagged down and interviewed on questions of safe driving, road conditions and other safety matters.

Radio Clinic

WHAI Greenfield, Mass., is now presenting weekly quarter-hour "The Happiness Clinic", featuring Dr. Paul T. McClurkin, psychologist and lecturer, who discusses personal problems and their solutions. Private consultation is offered free of charge.

Salute to Citizens

SERIES of weekly salutes to "big, little Americans" will be started as special feature on the "Songs by Morton Downey" program, Mon.-Fri. 12:15-12:30 p.m. on Mutual. Reporters, radio newsmen and employes of the Coca Cola Co., sponsor, will act as scouts seeking everyday citizens to receive weekly salute. Agency is Darcy Adv., New York.

WMCA "Women's World"

SERIES of women's programs titled "This Woman's World" starts Feb. 4, 11:45 a.m.-12 noon on Monday through Friday on WMCA New York. Informal commentary on world affairs as they affect American women, personalized reports on concerts and organization activities, first hand news on lightening housekeeping as well as summary of important legislation and speeches of special interest to women are presented.

Treasure Hunt

CARRY ICE CREAM Co., Washington, D. C., distributor for "smooth-freeze" Meadow Gold ice cream, product of Beatrice Creamery Co., Chicago, is starting new Mon.-Wed.-Fri. program on

WOL Washington titled "Finder's Keepers." Quarter-hour program is wire-recorded previous day from some neighborhood store handling Meadow Gold ice cream and features interviews with customers and treasure hunt. Persons interviewed are given clues to prizes hidden about store—anything from alarm clocks to roasts of beef, and are given 30 seconds to recognize clue. Agency handling account, Henry J. Kaufman Adv., Washington, plans extensive poster and store display support for series. Store dealers were interested in program through audition recording.

Maritime Data

SEVEN days weekly noontime report of weather, tides, winds, water temperatures and like information is being broadcast by WPIK Alexandria, Va., as service to fishermen, boat clubs and other water sport enthusiasts in Potomac River Chesapeake Bay area. Titled "Maritime News", program is presented by Coast & Geodetic Survey Service of U. S. Dept. of Commerce and U. S. Weather Bureau.



THEY'LL DO ANYTHING for a special event in St. Augustine, judging by Red Brown's latest. WFOY announcer is astride an alligator that's headed for the breeding pen at world's largest alligator farm.

Boy Scout Salute

NBC on Feb. 9 will broadcast a half hour "Salute to Scouting" in honor of National Boy Scout Week. Radio and movie stars will participate in 6-6:30 p.m. broadcast originating in Los Angeles Shrine Auditorium with 6,700 Boy Scouts as guests.

Birthday Present

A SURPRISE broadcast on WMAL Washington honored Theodore W. Noyes, editor of "The Evening Star" (owner of WMAL), Jan. 26 on his 88th birthday. His brother, "Star" President Frank B. Noyes, and other community leaders participated in the tribute. Program included congratulatory letter from President Truman.

Student Series

WEEKLY 30-minute variety show, "Scolebrities," has been started on WING Dayton, O., by the Junior Achievement Co. of WING, composed of high school students who sold stock, wrote and produced the show. WING staff members act in advisory capacity. Program, heard Saturdays, is sponsored by a Dayton shoe store.

'Know Your Schools'

ACTIVITIES of Worcester, Mass., schools will be discussed in a series of "Know Your Schools" broadcasts by school officials on WAAB Worcester beginning Feb. 7. To be heard Thurs. 6:30 p.m., series will continue through early June. Public relations committee of Worcester School Dept. is to be in charge.

On Army Chaplains

DRAMATIC series based on experiences and activities of Army chaplains, "Chaplain Jim", returned Feb. 3 to Mutual in Sun. 10:30-11 a.m. period. Program currently heard at that time, "Snow Village Sketches," moved to Sun. 11-11:30 a. m.

KGW Public Service

PUBLIC SERVICE program heard weekly on KGW Portland, Ore., "Now Take My Case," presents public forum discussion of problems of the housewife, the returned veteran, the corner merchant, the college student, the potential businessman. Professional actors present questions, authorities offer solutions.

School Sports Revue

QUARTER-HOUR program "High School and Prep School Sports" has been started on WBYN Brooklyn as a Monday through Saturday early evening series.

State Assembly News

PUBLIC SERVICE program of WMBG Richmond, Va., is weekly resume of events in state legislature, conducted by a former member of the House of Delegates.

Challenge

KVOA Tucson, Ariz., has challenged any station in the U. S. to beat its short-short commercial for "The Desert Philosopher", heard weekdays 11:30-11:45 a.m. and featuring "homey spice and common sense ramblings." The three-second commercial, used only twice per program, contains five words—"For good bread . . . buy RAIN-BO!" No other mention is made of product or sponsor and KVOA states that sales show people are buying Rainbo Bread.

Parlor Game Quiz

QUIZ show based on parlor game "Twenty Questions" started Feb. 2, Sat. 8-8:30 p.m., on Mutual. Objects and persons suggested by listeners are identified through limited number of questions by panel of experts. A "mystery voice" gives listening audience the answers to the puzzlers—while unheard by panel.

KSFO Participation Show

PODESTA & BALDOCCHI, San Francisco (florists) and Blum's (retail candy) are participating sponsors in five-weekly half-half "Breakfast on Nob Hill" on program starting on KSFO San Francisco Feb. 4. Originating from Birch Room of Fairmont Hotel, series is preceded by breakfast. Bill Baldwin is m.c. Candy packing and flower arrangement contests will be featured. Weekly prize of weekend at Sonoma Mission Inn will be awarded with daily winners to be guests of Fairmont Hotel on 65th broadcast. These contestants will submit essay, "Why I Want to Go to the Paradise of the Pacific", with winner receiving trip for two to Honolulu and week's stay at Royal Hawaiian Hotel.

Ready for Tele

KAY KYSER'S NBC "College of Musical Knowledge" is all ready for television. Kyser has dressed every member of show in proper collegiate garb and even had scenic back-drops made up for program.

Capital Commentaries

SUNDAY early afternoon half-hour commentary "Capital Report" has started on CBC Trans-Canada network with commentaries each week from Ottawa, Washington and overseas capitals. Program replaces one Saturday evening and two Sunday commentaries, presents CBC correspondents as well as well-known radio and newspaper reporters.

WEBR Originates

NEW MUSICAL SHOW, "Tic Toc Time", has started on Mutual, Tuesday through Friday 10:30-10:45 a.m. Originating from WEBR Buffalo, program swings to the beat of a metronome.

'Date for Daddy'

HOUSEWIVES who correctly answer questions on revised WGN Chicago "The Tommy Bartlett Show," now "Date for Daddy," will make the rounds of local shows and night clubs with their husbands as escorts. Program, heard Mon. 3:15 p.m. (CST) also offers six months' free diaper service if winning couple has child under two.

WGR Sports Review

IN ADDITION to usual forecasts and resumes of sports events, "Roving Reporter" program started by WGR Buffalo, N. Y., in Mon.-Fri. 7:30 a.m. spot, will also feature discussion of sports personalities and human interest stories from every phase of field. Sig Smith, recently returned from Army, conducts.

Question Box

WTIC Hartford, Conn., in cooperation with Connecticut Veterans' Reemployment and Advisory Commission, has started Wednesday evening series of "The Veterans' Question Box" programs.

WCKY Give-Away Show

WEEK-DAY afternoon participation-give-away audience program has been started by WCKY Cincinnati under sponsorship of Lowenthal's, local furrier, and Pepsi-Cola Co. of Cincinnati. Program originates from downtown cafeteria, is titled "The Birthday Club."

Question Contest

CASH AWARDS for most intelligent and pertinent questions from listeners regarding controversial issues presented on program each week are being offered by "America's Town Meeting of the Air," Thurs. 8:30 p.m. on ABC. Questions are limited to 25 words and are judged on neatness, clarity and effective phrasing. Five dollars is given for each question used on the air and all questions are eligible for \$25 Victory Bond award.

According to **HOYLE**
and **HOOPER** too!

The "Cleveland Clambake" gets the biggest hand . . . More listeners than any other local musical in Cleveland!

WJW's "Cleveland Clambake," on the air 1:30 p.m. to 2:00 p.m., Monday thru Friday, is credited with 18,644 sets tuned in for the first quarter-hour, and 26,228 sets tuned in for the second quarter-hour—an average of 22,436 sets tuned in for each quarter-hour. This is a greater average tune-in per quarter-hour than that of any other local musical show in Cleveland.

The Clambake 2nd quarter-hour, open for sponsorship, delivers 30% to 360% greater audience in Cleveland than any other show heard in the same time period. (Competition in this period includes two popular network serials, a network musical, a network commentator, and a network human relations program.)

BASIC
ABC Network **WJW** 850 KC
CLEVELAND, O. **5000 Watts**
DAY AND NIGHT
REPRESENTED NATIONALLY BY HEADLEY-REED COMPANY

VIDEO LOSES FAMILY RESEMBLANCE

**Poppele Sees New Personality in Lusty Infant,
Denies It Will Obscure Brothers**

WILL TELEVISION, a noisy baby now ready to crawl from its crib, grow up to look like either of its older brothers, radio and films? Last week J. R. Poppele, president of Television Broadcasters Assn., looked the infant in its eager face, found that traces of resemblance to both brothers were submerged in a new personality.

His prediction: The infant will develop as an individual to make its own mark on the entertainment world.

Mr. Poppele, who is also vice president of WOR New York, spoke before a meeting of the New York chapter, American Marketing Assn., on "How Will Television Compete With Other Media?"

"Television," he said, "will operate in a realm of its own, providing a unique form of entertainment to millions of people and will help create new wealth for the nation."

But no matter how lusty television may become, it will not obscure the other members of its family. Mr. Poppele thinks it will grow to be "a lively, commercially profitable enterprise—but without replacing existing media." The impact of its personality, he said, will probably urge upon other media a keener sense of competition which should result in improvement of all.

Points to Past

He pointed to the past as an example of the future. Radio, Mr. Poppele reminded the marketers, now 25 years old, was featured originally as a new type of information agency whose new brilliance might well obliterate that of the older press.

Yet newspapers and magazines have continued to increase their circulation even as radio grew to tremendous size. The advent of the talking picture was regarded as a weapon of sure death to the stage. Yet recent Broadway seasons have been more successful than those before movies began raising their voices.

Mr. Poppele said that increased leisure in America had created a proportionately increased demand

for entertainment. A shorter work week, he said, gives Americans more time to see television, read newspapers and magazines, hear radio and see movies.

Although it promises to grow man-size in a form of its own, television will likely have to take advice from the brothers it most closely resembles: From radio, which, having the "know-how" to sell products over the air, ought to be able to enlarge this knowledge to include a new dimension; and from films, which may adapt television for showing in theatres and will probably want to use television to advertise its own form of entertainment.

Television has a characteristic in common with others in its family, he said. "Like radio and movies (it) is showbusiness," he said.

Seek N. H. Station

CHARLES S. HOLBROOK, former account executive of American Broadcasting Co., New York, has formed a partnership with Gerald Stetson and Richard Washington to build a station in Berlin, N. H. Firm name is White Mountains Broadcasting. Proposed call letters are WBNH. Mr. Washington has just been released from the Navy.

KOMO

(Continued from page 16)

lehem, Pa., all for new local stations on 1230 kc.

A petition by the Skagit Valley Broadcasting Co. Inc., Mt. Vernon, Wash., that its application for a new station on 1600 kc be severed from consolidated hearings scheduled to begin Feb. 4 to consider applicants for the same frequency and that it be granted without hearing was denied. Applicant then filed for dismissal which was granted without prejudice.

Previously, the Commission had granted construction permits for two new stations in Trinidad, Col., one a regional and the other a local. Trinidad Broadcasting Corp. was given the regional on 1280 kc with 1 kw day, 500 w night, fulltime. H. L. Corley, trading as Corley Radio & Sound Service, was awarded the local CP on 1240 kc, 250 w, unlimited time.

Officers of Trinidad Broadcasting Corp. are A. G. Mason, president (3.33%), 25% owner of Mason Candy Co., Trinidad; T. P. Mikelson, vice president (1.66%), president, Trinidad Junior College; B. H. Shattuck, secretary-treasurer (1.66%), attorney. Stanley Schultz, Akron, O., owns 50% and the remainder is held by a group of Colorado businessmen.

Mr. Corley is radio engineer for the Trinidad police and county sheriff's office, and has been in business for himself for several years.

BARBEAU TO DIRECT UNITY FM STATIONS

ERNEST A. BARBEAU, of the radio broadcast department of General Electric Co.'s Electronics Division, Schenectady, has been appointed managing director of proposed FM and television operations of Unity Corp., Toledo, in Ohio and Pennsylvania.



Mr. Barbeau is now planning

equipment installation, and recruiting of operating personnel for the corporation's FM station in Toledo, for which a construction permit has been granted. Unity also has applied for FM stations at Columbus, Springfield, Mansfield, and Lima, O., and for FM and television stations at Erie, Pa.

Mr. Barbeau studied electrical engineering at the U. of Toronto, Union College, and Columbia U. In 1922 he became assistant sales manager of Robbins & Myers Co., Springfield, O. Closely identified with the broadcasting industry for a number of years, he has been active in the field of broadcast equipment sales. His offices are at 1014 Edison Building, Toledo.

All Clear Now

FOR better understanding of what should be carried as news, and what in the rate card category, Wilton E. Cobb, general manager of WMAZ Macon has coined this phrase: "If the public wants to hear it . . . it's news. If someone wants the public to hear it . . . it's advertising."

Christian Award

FIFTH ANNUAL "Dr. Christian Award" contest designed to give new as well as established radio writers an opportunity to submit scripts for the "Dr. Christian" program starring Jean Hersholt, 8:30-8:55 p.m. Wednesday, on CBS, will run through the months of Feb. and March. Grand prize of \$2,000 will be awarded for the best scripts with lesser amounts given for others. Contest rules and instructions may be obtained by writing to the Dr. Christian Award, Chesebrough Mfg. Co., 17 State St. New York. Program is sponsored by Chesebrough Mfg. Co. through McCann-Erickson, New York.

Joins Brown & Weir

RALPH NEAVE Jr., former research director of Sherman K. Ellis & Co., New York, and more recently with Lambert Co., New York, has joined Brown & Weir, that city, as director of research department.

Radio's Most Delightful Romance

DICK & JEANIE

(Transcribed Radio Show)

A 5 minute recorded musical romance. 260 episodes available now at unbelievably low cost. 75 opening and 100 word closing commercials embracing this show will reach the greatest women audience of all ages. The Retail Stores Service Syndicate and the Quality Bakers of America endorsed this show. They know that this charming love story with its immortal music, plus all the promotional material furnished free is the road to the heart of all American women.

SALES MANAGERS! Look for the big surprise package the postman will bring you any day now!

Harry Jacobs Productions

8820 Sunset Blvd.

Hollywood 46, California

Skelton in Closet

THE SHADOW of doubt that hangs over broadcasters as to what comes out of the radio despite what goes into it was justified last week. Announcer John Rose of WROL Knoxville answered the phone one night at the station and was confronted with a juvenile voice asking, "Is red skeleton a murder mystery?" Mmmmm, the Shadow knows. . . .

KOIN

It takes an informed
community to do
a community job.

PORTLAND, OREGON

CBS Affiliate

FREE & PETERS, Inc., Nat'l Rep.

WLW

700 ON YOUR DIAL

THE NATION'S
MOST
MERCHANDISE-ABLE
STATION

The

PACIFIC
NORTHWEST

means

KIRO

The Friendly Station

50,000 Watts

710 KC

CBS

SEATTLE, WASHINGTON

Represented by FREE & PETERS, Inc

IT'S A HABIT!

FOR 20 YEARS, FARMERS IN
KANSAS AND NEARBY STATES
HAVE TURNED TO WIBW FOR
DEPENDABLE SERVICE AND
PREFERRED ENTERTAINMENT.

WIBW The Voice of Kansas
in TOPEKA

General Mills

(Continued from page 15)

for "Eventually—Why Not Now?" in 1925, was the creation of the Blackett-Sample-McFarland agency. The world famous Wheaties slogan—"Breakfast of Champions"—was an idea of the late Knox Reeves.

General Mills was one of the first national advertisers to hire a radio man to run its radio programs. In 1938 Sam Gale brought an expert radio production man, Edward G. Smith, to Minneapolis from Chicago, where he had been director of daytime programs for WGN. Today Ed Smith supervises all of General Mills' radio program activities, working with George Stellman of Dancer - Fitzgerald - Sample and King Painter and Russ Neff of Knox Reeves.

Another example of well delegated responsibility is the case of Fred Jacky, of Chicago, who for 11 years has ably directed the *Hymns of All Churches* program.

To Irna Phillips, Carl Wester and associates, Chicago, has gone the task of handling the *General Mills' Hour*, heard each afternoon over NBC.

Rule of Thumb Has No Place

Rule of thumb has had no place in General Mills' advertising scheme under Sam Gale. A new program is treated like a newly discovered germ. It must be minutely examined through the microscope of public reaction until its mathematical possibilities for success are beyond question. Nothing is left to chance, and no amount of influence by high ranking officials with pet ideas can alter the coldly-calculated gauntlet through which each new program must run.

The procedure is simple: First test the program on a small number of stations. Second, call in market research analysts, psychologists, sales experts, program and idea men.

Does the program entertain? Does it educate? Does it offend? Can the program sustain interest? These and hundreds of other questions are investigated thoroughly before a program can go network for General Mills.

"The most important function of advertising," says Gale, "is to help reduce the cost of distribution." Under this policy, radio advertising has helped expand General Mills' markets until the company has become the world's largest processor of cereal grains and the nation's leading cereal food advertiser.

This scientific elimination of guesswork from advertising has paid off phenomenally. A recent survey revealed that 9 out of 10 women in the United States know Betty Crocker, and over 5 out of 10 identify her with General Mills.

Mr. Gale's enthusiasm for gimmicks and love of family life are partly responsible for the multitude of premium offers ranging from toy airplanes to Lincoln automobiles (pre-war offer) that have

Handy to Handel

WOV New York has started a new programming theme—six hours of music, little talk, 6 p.m. to midnight, Monday-Saturday. Programs include every conceivable type of music from old New Orleans jazz through to symphonies and even liturgical music. Audience response has been heavy.

been part of all General Mills' radio advertising.

The father of two children himself, Mr. Gale takes a paternal interest in General Mills' children's programs, currently *The Lone Ranger* and *Jack Armstrong, the All-American Boy!*

When Jack Armstrong calls on his juvenile listeners to send in a Wheaties boxtop for a free "Magic Whistling Ring", response runs into the hundreds of thousands. A recent offer of a Tru-Flight model airplane (offered intermittently over a six-month period) drew 6,000,000 boxtops. Boyishly, Mr. Gale tries out the new gadgets in his office, and takes them home for pre-testing by his two sons, Jeremy, 12, and Samuel, 9.

Care is taken that General Mills' children programs are free of blood lust. Jack is a model American boy, polite, possessed of quiet, manly virtue, an example for every other American boy. As a result, thousands of youthful listeners brush their hair, clean their teeth, and practice good deeds every day without complaint or pressure because these things come natural to Jack himself.

General Mills' radio shows are beamed at all class levels and all age groups. But each character, from Valiant Lady to the Lone Ranger, has a common denominator: financially they are neither poor nor rich, but just right. They also belong to no one church and to no one segment of society. They are, in essence, the radio counterpart of "Everyman", with heavy accent on virtues that inspire listeners to become better mentally, morally and physically. And Wheaties, with milk or cream and some kind of fruit, of course, assures the latter.

Some of Best-Known Programs

On the air for General Mills are some of radio's best known and most widely heard programs. They include *Valiant Lady*, CBS, 10:00-10:15 a.m. EST, repeat 11:15-11:30 a.m.; *Light of the World*, CBS, 10:15-10:30 a.m., EST, repeat 11:30-11:45 a.m., EST; *Betty Crocker*, ABC, 10:25-10:30 a.m., EST; *Hymns of All Churches*, ABC, 10:30-10:45 a.m.; *Guiding Light*, NBC, 2:00-2:15 p.m., EST; *Today's Children*, NBC, 2:15-2:27 p.m., EST; *Betty Crocker Home Service Talks*, NBC, 2:27-2:32 p.m., EST; *Woman in White*, NBC, 2:32-2:45 p.m., EST; *Masquerade*, NBC,

2:45-3:00 p.m., EST; *Jack Armstrong*, ABC, 5:30-5:45 p.m., EST; *The Lone Ranger*, ABC, 7:30-8:00 p.m., EST, Monday, Wednesday, Friday; *Sam Hayes Breakfast News*, NBC (West Coast only), 7:45-8:00 a.m. PST; and *This Woman's Secret*, NBC (West Coast only), 4:00-4:15 p.m. PST.

The above schedule of network shows is supplemented by numerous individual "spot" programs. One of the earliest and most extensive sponsors of baseball broadcasts (discontinued during the war period), General Mills will return to baseball sponsorship next season, but not on so broad a scale as in the past. According to present plans, the broadcasts will include games at Philadelphia and Pittsburgh, co-sponsored with the Atlantic Refining Company. Wheaties, of course, will be the product discussed.

The company policy behind all radio programs is best explained in the outline drawn up by the advertising and legal departments, for Betty Crocker herself:

"Betty must be dignified; though her style may be altered according to the audience, it must always be that of a gentle woman. Betty should be friendly but not intimate. She must stick to home economics and never discuss her private life. Whenever possible Betty should say 'we' and not 'I' for it would be unsound and probably illegal to represent her as a superwoman who thinks up all her own recipes and answers her own mail. Anything said by Betty or credited to Betty must be literally true with respect to some current member of the company's home economics staff." To Mrs. Husted falls the chief responsibility for interpreting this policy.

Three Advertising Principles

For the promotion of General Mills' products, the board of directors has officially adopted three principles of constructive advertising. These principles were formulated by Sam Gale and are adhered to by all the agencies:

1. Our advertising shall be factual, informative, and educational.
2. It shall render the maximum of helpful service.
3. It shall attempt to expand markets rather than merely take business from competitors.

Just about everything ever attempted in radio has been grist for General Mills. Recipe contests, word contests, name-a-cake contests, give-aways and gimmicks—all these and many others have brought an unending flood of responses, with boxtops attached.

Perhaps the first singing commercial—"Have You Tried Wheaties?" was introduced by General Mills' famous "Wheaties Quartet", which with Betty Crocker, started General Mills into show business in a big way.

Since the days of the first Wheaties Quartet program, featur-

MBS TO TRY SCRIPTS BY UNKNOWNNS

New Dramatic 'Playhouse' Will Be Produced

By Soap Serial Writer, Mrs. Carrington

TO A FORTUNATE few of the many "undiscovered" writers who have knocked unsuccessfully on radio's doors, a passkey was promised last week.

MBS announced that gray-haired, motherly Elaine Carrington, famed author whose soap serials earn more than \$200,000 a year, would begin production of a new dramatic show built from scripts by "unknown" radio writers.

Said Phillips Carlin, MBS vice president in charge of programs: "Mrs. Carrington and I believe that the future for radio as a dramatic medium must depend, in the final analysis, upon new talent."

Sources from which Mrs. Carrington thinks many new and competent writers may come are colleges. Mutual will undertake a campaign to promote collegiate interest in the program. But MBS and Mrs. Carrington made it plain that competition is by no means limited to campuses.

The talent search, Mrs. Carrington explained, "is not confined to young writers. Writers of any age but not yet established in radio may submit scripts."

MBS will pay \$200 for each script used, and Mrs. Carrington herself is offering a \$500 prize for the best script used during the first 13 broadcasts.

The show, to be called the *Carrington Playhouse*, will be broadcast Thursdays from 8 to 8:30 p.m., beginning Feb. 21. Mrs. Carrington will select the scripts and produce the shows. Perry Lafferty will be director.

Although Mrs. Carrington's primary purpose is to discover new writers, she hopes to give "unknown" actors and announcers a break as well. Each winning writer will be given credit on the show.

Mrs. Carrington said the format of the program would be flexible and that few limitations would be imposed on the type of scripts desired. She hopes to receive comedy, romance, mystery, melodrama and all other kinds of writing.

Although MBS announced that the *Carrington Playhouse* would not be sponsored initially, Mutual executives admitted they would be pleased if it became commercial eventually. The production will probably cost Mutual about \$1500 a week.

Sponsors which currently contribute heavily to Mrs. Carrington's enviable income are General Foods and Procter & Gamble. She writes *When A Girl Marries* (Mon.-Fri., NBC 5-5:15 p.m.) for General Foods and *Pepper Young's Family* (NBC Mon.-Fri., 3:30-3:45 p.m.) and *Rosemary* (CBS Mon.-Fri., 1:30-1:45 p.m.) for P. & G.

ing a Minneapolis bailiff, undertaker, granary worker and printer, with an unknown organist named Eddie Dunstedter, General Mills has presented a steady stream of programs, some good and some bad, including the famous *Gold Medal Fast Freight* and the *Gold Medal Express*, *Skippy* (the Mills' first juvenile show, later abandoned in favor of Jack Armstrong), *Betty and Bob*, *Hymns of All Churches*, *Modern Cinderella*, *The Latest Thing*, *Hollywood In Person*, *Arnold Grimm's Daughter*, *The Gilmans*, *Curtain Time*, *The Grouch Club*, *Beat The Band*, *By Kathleen Norris*, *Rundia the Magician*, *Billy and Betty*, and many others.

Influence Tremendous

General Mills' influence over the public and the radio industry itself has been tremendous. The trials of Betty and Bob (first inspired by Frank Hummert) through marriage, parenthood, divorce and remarriage held the nation's women spellbound for eight years until the writers had wrung the last drop of emotion possible and abandoned the couple in sheer exhaustion. Jack Armstrong has been responsible for untold aches and pains of weary mailmen carrying overloaded mailbags of boxtops to Minneapolis, as well as for a definite improvement in the physical well-being of American children.

The latter program, incidentally,

as early as 1940, had the All American boy searching for a secret cache of Uranium 235, with a pack of evil foreign agents on his heels, long before the adult world learned in 1945 of the atomic bomb!

General Mills sponsorship of the daytime serial is in no way due to its proportionate low cost.

"Serials have proved to be the favorite type of program of the largest number of women listeners. When the American housewives tire of them, we will replace them with whatever the American housewife thinks she wants," Mr. Gale candidly declares.

Among the milestones passed in its long radio trail by General Mills are:

First five a week one-hour program in daytime radio, *The Gold Medal Hour*, with *Betty and Bob*, *Modern Cinderella*, *The Latest Thing* (news), *Betty Crocker*, and *Hymns of All Churches*, 60 minutes of all known, successful components of radio, music, drama, news, homey sayings, household hints, cooking recipes, on a coast-to-coast CBS network later switched to NBC.

First advertiser to broadcast the same program over two stations in one city.

First advertiser to broadcast sports nationally.

In the exploitation of daytime

Farran Is FCC Assistant Director of Information

TO ASSIST in handling increased demands of press and radio for news on communication developments, the FCC has appointed as



Mr. Farran

assistant director of information Lee Farran, recently discharged from the Army after more than four years service, mostly in the South Pacific. Mr. Farran assumed office last Monday.

A former Ohio newspaper and radio writer, Mr. Farran wrote program scripts and did publicity for Cleveland, Akron and Youngstown stations for four years prior to the war. Previously, he worked on the *Columbus Citizen* and was publisher of the *Lancaster News*. He is a graduate of Ohio State U.

Entering the Army in February 1941, Mr. Farran served in the Public Relations Office of the 37th Infantry Division, the Third Army Headquarters and the South Pacific Base Command, specializing in radio. After returning from the South Pacific, he was attached to the public relations section of Selective Service headquarters in Mississippi.

Lt. Col. George C. Gillingham, public relations officer, Chemical Warfare Service, is expected to return soon to become FCC director of information, the post he held before the war.

Saunders Heads AFN

LT. COL. ERNEST C. SAUNDERS has been appointed chief of American Forces Network succeeding Lt. Col. John S. Hayes, recently discharged from the armed forces and now general manager of WQXR New York. Col. Saunders was associated with WHO Des Moines prior to his army career.

radio, General Mills has been both a pioneer and a leader. From *Skippy* which first went on the air over NBC in 1932, to the present full hour of *Guiding Light*, *Today's Children*, *Women in White*, and *Masquerade* (a unique hour of package shows produced by one writer, Irna Phillips), General Mills has certainly been one of the dominant companies in American radio. It has done it not with high priced "names" but through wise exploitation of proven advertising devices, from contests to heart-throbs. *Betty Crocker*, *the Lone Ranger*, *Jack Armstrong*, and a host of fictitious characters, have kept General Mills' products moving off the shelves of the nation's food stores through the lean years of the depression to the present. Radio has proved the company's most successful single medium. To this one medium alone is appropriated annually approximately one-half of the advertising budget.



In the old days they fired a gun from The Citadel in Halifax, Nova Scotia, to tell the time.

Today the population listens to CHNS for the time.

NOTE: They Still Fire the Gun Keeping Up the Old Traditions!

Traditions, However, Don't Get Much Business.

CHNS DOES—Try It.

EXCLUSIVE
COVERAGE OF
THE CHAMPLAIN
VALLEY AREA

WVCAX
BURLINGTON

VERMONT'S
ONLY CBS
STATION

1000 WATTS • FULL TIME

We have the AUDIENCE

but

Do they know about
YOUR product?

KSFO 560 kc

Universal Network's
key station for
Northern California

Mark Hopkins Hotel

San Francisco

ONE OF THE GREAT STATIONS
OF THE NATION

KGW
PORTLAND OREGON



REPRESENTED NATIONALLY
BY EDWARD PRICE & CO. INC.

GROWING! GROWING!

LOS ANGELES LONG BEACH Market

Keeping pace are KGER'S alert programming and public service

★
5000 WATTS—Full Time

KGER

Represented Nationally by
JOSEPH HERSHEY McGILLVRA Inc.
New York Chicago San Francisco

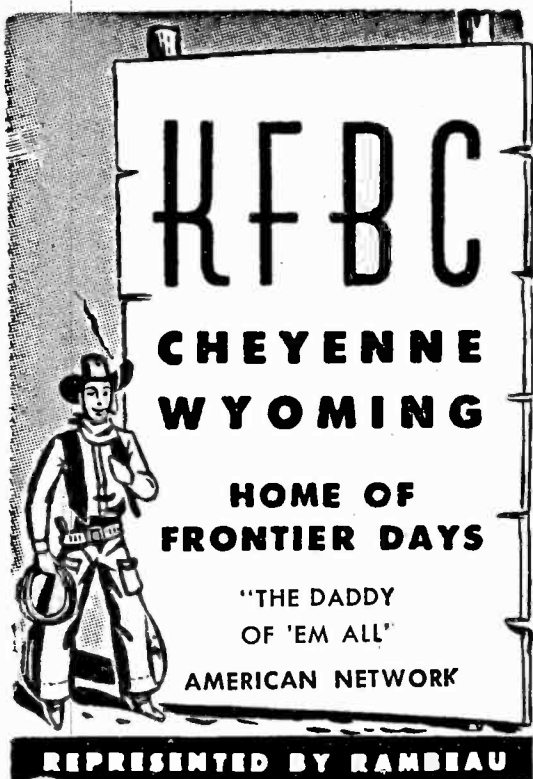

KFBC
**CHEYENNE
WYOMING**
**HOME OF
FRONTIER DAYS**
"THE DADDY
OF 'EM ALL"
AMERICAN NETWORK
REPRESENTED BY RAMBEAU



THERE'S ONLY
1
TIMES SQUARE
but
WHA REACHES 2 NEW YORKS!
(The population of WHA's primary coverage area is 15,398,401, more than TWICE the number of people in New York City proper.)
WHA
Dial 1050 50,000 watts
Metro-Goldwyn-Mayer—
Loew's Affiliate



Meet Mr. Reddy Cash!
FROM EAST TEXAS
"Black Gold" tell and sell, 500,000 people living in the heart of world's largest oil field VIA KPRO (1000 watts day & night)
• American
• Mutual
KPRO
LONGVIEW, TEX.
Texas Richest Market

Local News Rates High in Cleveland

City Events Compete With World Affairs In Popularity

MORE and more local news is being supplied Cleveland listeners as the city's newspaper pressmen's strike approaches its fifth week, portending increased attention to this phase of newscasting when newspapers once again are in the hands of the public.

Public officials and civic leaders are high in their praise of the public service given by the city's stations as they devote their facilities to the city's needs. Besides the newscasts, stations have added loudspeakers, bulletin and mimeographed sheets to their normal news activities.

Enlarged newsroom staffs are carrying the extra load. A number of reporters have been added to make extensive police, hospital and other checks as news of a purely routine nature is added to the normal local coverage.

Learned from the month-long strike is the lesson that even a city as large as Cleveland is so locally conscious that the reciting of long lists of names, such as death notices, marriage licenses and property sales will command a large and attentive audience. It is felt that some of this interest will subside when newspapers again appear on the streets, but newsmen have been impressed with the fact that the ordinary run of local news has a far stronger appeal than much of the national and international news.

Cleveland stations are supplying their special news budgets without trying to wring money out of eager sponsors. They are endeavoring to satisfy the public appetite for information by filling the special service role opened by the strike.

Two Cleveland events—National Aircraft Show and Ice Follies—were staged successfully during the strike. The aircraft show drew well over 200,000, a record attendance, without advance newspaper publicity. Attendance at sports events has been normal or better.

Here are the methods used by Cleveland stations to handle the strike situation:

WGAR

At the outset of the strike the regular newscasts—nine local and five network—were found adequate. One daily and one Sunday news program were added and two others were lengthened. The newsroom had expanded local coverage after the close of the war. Local contacts had been added and police, fire and suburban checkups had been increased in frequency, with an extra man put on the hotel and downtown beat. A wire recorder had been added for spot coverage of city council meetings, civic gatherings, name interviews and other events. Full and balanced coverage of local

and national-international news had been adopted as a policy.

During the strike the station has not used blurbs promising extra news, merely expanding service without capitalizing on the lack of newspapers. Radio bulletin board thrice-weekly lists lectures, meetings and other civic attractions. Movie and play reviews replaced man-about-town series. WGAR's Washington bureau is giving increased coverage of Ohio legislators and more specialized stories.

The station has been printing a daily mimeographed news summary, distributing 5,000 daily in restaurants, hotels, luncheon clubs and other places. Evening schedule and newscast lineup appear on back of the sheet. The strike itself has been covered factually, with statements of both sides.

WTAM

Nineteen news programs are being broadcast daily, including four extra shows—three of three minutes and one of five minutes. A Saturday afternoon quarter-hour is devoted exclusively to Ohio news. Two extra Sunday newscasts are heard at 1 a.m. and 1 p.m., plus a quarter-hour night newscast.

Bulletin board is maintained in Terminal Tower, with three complete changes daily. Practically all extra newscasts are sustaining.

WTAM feels radio news does not compete with daily papers, since stations lack manpower to cover local beats completely and do not have the flexibility to add "pages" to fixed schedules of network commitments. Local news-

casts, it is believed, must cater to the local area blanketed by the station in preference to mediocre international and national news, amply covered by network newscasts.

Many civic and governmental agencies have recognized the speed and effectiveness of local news, the station has found, especially county and local administrative and police agencies, civic drives and nonprofit cultural bodies. The station has not taken sides in the strike and has refused to sell news shows to advertisers seeking to capitalize on the strike.

WHK

Emphasis was turned to local news at WHK when the strike started, with local flashes cut into regular broadcasts. Facilities were made available for emergency announcements and local radio editors were offered air time to keep listeners abreast of news about radio.

The station pipes all news broadcasts to speakers in the Public Service Center Bldg. and Terminal Tower Bldg. Listeners have been found much more interested in local news since end of the war and good response has come from presentation of news during the strike.

Radio Council of Greater Cleveland, with 110,000 woman members, commended the station for its added service.

WHK believes the strike has shown that it is good public service to give as much news about local events and organizations as possible even though it may involve a commercial tinge because of the intense

NARBA

(Continued from page 18)

manager, Canadian Broadcasting Corp.; Donald Manson, assistant general manager, CBC; W. G. Richardson, transmission engineer, CBC; Henry S. Dawson, Canadian Assn. of Broadcasters; K. A. MacKinnon, All Canada Radio Facilities Ltd.

MEXICO—Col. Rafael Avila Camacho, president; Licenciado Carlos Duran Salazar, secretary; Manuel Espejel Rodriguez, engineer; Lazaro Barajas Gutierrez, engineer; Dr. Jose E. Larumbo, Amilio Azcarraga, Dr. Luis de la Rosa Martinez, Licenciado Jose Luis Fernandez, Juan C. Buchanan, engineer; Clemente Serna Martinez, Ignacio Dias Raygosa, Simeon Hernandez Calderon, Bernardo San Cristobal, Fidel Hernandez Calderon.

CUBA—Sr. Carlos Maristany, Undersecretary of Communications, chairman; Dr. Miguel Amezaga, secretary, Ministry of Communications, secretary; Dr. Nicholas G. Mendoza, Director of Radio, Dept. of Communications; Dr. Luis Machado, international lawyer, State Dept.; Sr. Guillerma Morales, chief, Bureau of Radio Licenses, Min-

istry of Communications; Dr. Jose Ramon Gutierrez, general counsel, Ministry of Communications; Technical advisers: Sr. Alfonso Hernandez-Cata, assistant chief, Monitoring Bureau; Sr. Mariano Durland, chief, Monitoring Station & Radio Lab., Dept. of Communications; Sr. Raoul Karman; Sr. Ventura Montez.

THE BAHAMAS—Alan D. Hodgson, director, Bahaman Telecommunications Dept.

U. S. observers registered were: NAB—T. A. M. Craven, vice president, Cowles Broadcasting Co., NAB director-at-large and former FCC commissioner.

CBS—William B. Lodge, director of general engineering; Joseph H. Ream, vice president.

RCA-NBC—Frank M. Russell, NBC Washington vice president; James P. Veach, Washington manager, RCA Frequency Bureau; Raymond F. Guy, radio facilities engineer, NBC; G. B. Margraf, Washington attorney, NBC.

WESTINGHOUSE Radio Stations—Walter Evans, vice president; John W. Steen, counsel.

McKEY & SHAW—D. B. McKey, R. C. Shaw, consulting radio engineers.

GENERAL ELECTRIC Co.—P. D. Andrews; Mrs. M. L. Busch.

desire of listeners to know what is going on in the community.

WJW

A special reporting bureau manned by experienced newsmen was set up when first news about an imminent strike was heard. The staff has become more skilled with experience and claims it has regularly outdistanced newspaper-controlled wire service by as much as a full day on local coverage. WJW is so sold on its local news staff that it may be retained as a permanent department.

Total time devoted to newscasts has about doubled. Local news must comprise at least half of each program. Emergency public service programs are not sold, nor is the nightly *Newspaper of the Air*, entirely a local program. News bulletins are maintained in entrances to the WJW Bldg. and the largest theatre. They are serviced hourly.

Early hesitancy about carrying death notices was dispelled when it was found that they increased the station's audience. Reading of local market returns is well received. During the meat strike the station was asked by the stockyards to urge farmers to ship animals, since local packers were not on strike. The station was lauded for its role in helping avert a local meat famine.

Coverage of the strike itself was made the primary responsibility of one reporter and all parties were treated fairly, according to station executives.

KECA, WING FIRST, SECOND IN CONTEST

KECA Los Angeles and WING Dayton won first (\$1,000 bond) and second (\$500 bond) prizes respectively, in the publicity and promotion managers contest sponsored by Larus & Bro. Co., Richmond, Va. (Chelsea Cigarettes and Edgeworth Tobacco) for ABC affiliates carrying Guy Lombardo's *Musical Autographs* program, Tuesday nights, 9 p.m. Station promotion was based on Chelsea's song title contest, with \$10,000 awarded for the best song titles. Winners will be announced by the judges, Guy and Carmen Lombardo, Feb. 5.

Five additional prizes of \$100 bonds each were awarded in the station promotion contest (which ran from Nov. 16 to Dec. 19) to the following stations: WROK Rockford, Ill.; WGAC Augusta, Ga.; KGFF Shawnee, Okla.; KXEL Waterloo, Ia.; KFMB San Diego.

The judges of the contest were Frank Burke, *Radio Daily*; Elbridge Peterson, *Printers Ink*; George Rosen, *Variety*; Lou Frankel, *Billboard*; Doris Lawton, *Advertising Age*; Florence Small, BROADCASTING.

Huber Resigns

E. J. (Mike) HUBER, ABC sales promotion manager, resigned last week. He will take an extended vacation.

NO MORE XMAS CARDS, PLEASE!

Mountainous Returns from Broadcast Campaign

Convince Federation of Radio's Power



(1) Katherine Fox, director of special service, and Robert E. Dunville, general manager, among 43,890 cards received at WLW Cincinnati; (2) Priscilla Fortescue and WEEI Boston's deluge; (3) Gene P. Loffler, program director, and Ursula Smith, secretary, in WNAX Yankton's 400,000; (4) Mae Hughes, secretary, in snowfall of "half a million to a million" at WITH Baltimore.

Opens Detroit Office

TRADE Development Corp., Chicago agency handling Kaiser-Frazer and Graham-Paige Motors accounts, will open a Detroit office in the Dime Bank Bldg. within a week. Although no manager has been appointed, Austin Bement, who joined firm Jan. 1 as vice president, is mentioned as likely head of Detroit office. Mr. Bement, before Army Air Forces service, headed his own Detroit agency.

OFFICIALS of the Save the Children Federation, New York, are burrowing out from under a mountain of Christmas cards that descended upon them when they asked, via radio stations, for old cards to be distributed to rural and under-privileged schools that couldn't afford expensive art supplies.

The idea was to give children in these schools a look at quality printing and pictures. The campaign incidentally satisfied the Federation that radio's pulling power is strong. Last week Federation employes had counted more than seven million cards, and they believe the number will reach ten million by the time they've finished counting. They don't want any more.

The original request for support of the Christmas card collection was sent out to all U. S. radio stations by Ralph Wallenhorst, director of information at the Federation's New York headquarters. The request was timed to reach stations about Dec. 28. On Jan. 18 another request went out—a please-cease-fire order. As of that date, six million cards had arrived and more bags of them were still coming in.

Mr. Wallenhorst says he has evidence that at least 150 stations used the announcements; he thinks more than 300 did. He hasn't been able to keep track of network support except that Fred Waring, Kate Smith, Don McNeill, the *Fitzgeralds* and John Gambling used it. Since newspaper coverage of the campaign was spotty, he credits radio with nine-tenths of the response. He added:

"For heaven's sake, don't suggest to anyone that he send us any more cards. My boss said originally I would be lucky if we got 500,000 cards. As I was a new man with his organization, I wasn't able to convince him what a tremendous response we would get from radio stations. But he knows now."

British Plan To Double License Fees Protested

BRITISH GOVT.'S plan to raise the radio receiver license fee from \$2 a year to \$4 "in the very near future" has evoked protests from a dozen members of Parliament, who demanded detailed reasons for the increase. Also planned is an increase to \$8 a year on aural-video receivers.

Meanwhile, Government officials have declined to estimate when the big television station at Alexandra Palace would resume operations, indicating that it will be "still a few months yet." Nor has it been decided whether increased revenue from set licenses will be allocated entirely to BBC. It was estimated that 10,000,000 receiver licenses already have been issued.

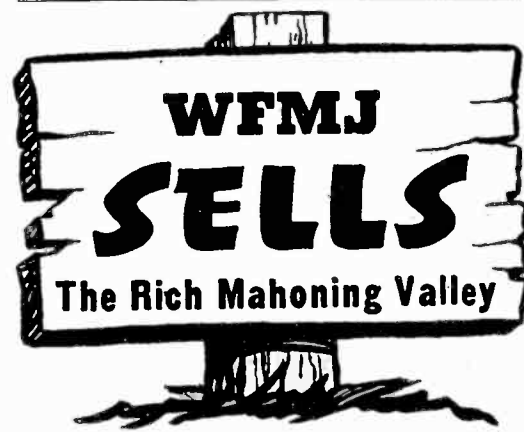

Ohio's Third Market at less cost—affiliate of the American Network.

Ask HEADLEY-REED

WFMJ
YOUNGSTOWN, OHIO

The Largest
TRANSCRIPTION
LIBRARY
OF
AMERICAN FOLK
MUSIC

M. M. COLE CO.
823 S. WABASH AVE.
CHICAGO 5, ILL.

ONLY
KROD

Covers ALL the
EL PASO MARKET

1000 WATTS CBS 600 KC

DORRANCE RODRICK Owner
VAL LAWRENCE Manager

Represented
NATIONALLY by
HOWARD H. WILSON COMPANY

M.D.
"THE DOCTOR
ON
THE AIR"

- ★ Program spots, interviews
- ★ 5 and 15 minute features
- ★ Live or transcribed

FREDERIC DAMRAU, M.D.
247 Park Ave., New York, N. Y.
Wickersham 2-3638

WIND

(Continued from page 17)

though it is believed he is interested in establishing such ownership interests, having application for FM stations in both cities.

In 1933 Ralph Atlass took over the operation of WJJD Chicago as manager and stockholder.

In 1943 he bought WLOL Minneapolis. In 1944 he disposed of WJJD due to the FCC's monopoly ownership ruling. Marshall Field was the purchaser.

Buys 24 News Broadcasts

Coincidental with the sale of his stock, Mr. Atlass announced the contracting for 24 five minute news periods on the station by *The Chicago Daily News*. The *News* recently leased two floors in its building, formerly occupied by WMAQ and the World Broadcasting System to WGN to be used as temporary studios during construction of an annex to WGN's studios in *The Chicago Tribune* building.

Mr. Atlass is one of the nation's pioneers in AM radio, having operated a 1 kw wireless station in his home in Lincoln, Ill., in 1914 as a "ham."

In 1923 the Lincoln transmitter was moved to Chicago and a year later, with his brother, H. Leslie, he began commercial broadcasts from the Broadmoor Hotel as WBBM.

Ashbacker-Fetzer Case Still In Air 30 Days After Mandate

WHAT HAPPENS when the Supreme Court reverses an appellate court which had sustained an FCC action involving two applications for the same facilities?

Normally—and under the Constitution—the word of the Supreme Court is law, at least until Congress enacts new legislation covering a particular subject. In this story the law is unchanged.

In the case of Ashbacker vs. the FCC the Supreme Court held in December that the Commission could not legally grant one application and designate another for hearing when both applications were mutually exclusive [BROADCASTING, Dec. 10]. On Jan. 4 the high court issued its mandate to the U. S. Court of Appeals for the District of Columbia.

Now, a month later, the case still is in the air. Here's the story as it unfolded:

In the spring of 1944 John E. and Rhea Y. Fetzer, licensees of WKZO Kalamazoo, filed application for a new station at Grand Rapids (WJEF) to operate on 1230 kc with 250 w power. A short time later, Ashbacker Radio Corp., licensee of WKBZ Muskegon, Mich., filed application to change frequency from

1490 to 1230 kc. That made the applications mutually exclusive.

In June 1944 the FCC granted the Fetzer application (without hearing) and at the same time designated the Ashbacker application for hearing. Ashbacker petitioned the FCC to reconsider and to deny the Fetzer application. FCC rejected the petition. Ashbacker appealed to the U. S. Court of Appeals for the District of Columbia.

FCC contended the appellate court had no jurisdiction, inasmuch as the Commission had not yet acted on the Ashbacker application, therefore Ashbacker had no cause of action. The appellate court upheld the Commission, granted its motion to dismiss. Ashbacker's attorneys, Segal, Smith & Hennessey, took it to the Supreme Court on writ of certiorari.

Meantime, WJEF went on the air in January 1945. Soon after the Supreme Court decision was handed down, it was learned that the FCC probably would issue a special temporary authorization (with conditions) to WJEF pending final outcome after hearing both the Fetzer and Ashbacker applications.

About the same time, Segal, Smith & Hennessey filed, on behalf of Ashbacker, an application for special temporary authorization to operate WKBZ on 1230 kc. Legal minds generally were agreed that under the Supreme Court decision the FCC would be bound to hear applications of both Fetzer and Ashbacker for STA's before granting either.

The Commission has taken no action, awaiting a mandate from the appellate court. (The Supreme Court doesn't deal directly with litigants, but with the court below.) Ashbacker has taken no further action, awaiting the appellate court's order. Fetzer likewise has done nothing.

Neither has the U. S. Court of Appeals for the District of Columbia. Court attaches said the next move is up to the FCC. Commission counsel said FCC couldn't move until the court interprets the Supreme Court decision and hands down its own mandate.

But last week the court of appeals took action. On Thursday the court informed the FCC that no order would be issued until the Commission files the record of the case. A court attache explained that the Ashbacker case went to the Supreme Court on a point of jurisdiction, that the court below hadn't heard the case on its merits and that in all likelihood the appellate court might well decide, after receiving the Commission's record, to hear the case on its merits.

Meanwhile WJEF continues to serve its audience on 1230 kc and WKBZ still operates on 1490 kc.

Greig, Fry Named To New ABC Posts Business Development Head Becomes Aide to Thrower



Mr. Greig



Mr. Fry

HUMBOLDT GREIG, former director of business development for ABC, has been promoted to the post of assistant to Fred Thrower, vice president in charge of sales for the network. G. T. C. (Tom) Fry, recently returned to ABC after three years with the Marines, succeeds Mr. Greig.

In his new post, Mr. Greig is being freed from office responsibilities to devote his entire time to the development of new business on the outside. He will work closely with network account executives in all special situations arising with present and prospective clients. He has been with ABC since January 1943, joining as an account executive after seven years as national sales manager of McClatchy Broadcasting Corp., California network. In 1932 he was a co-founder of Greig, Blair & Spright, station representative firm, now John Blair & Co.

Mr. Fry, who served in the ABC business development department for about a year before entering service in November 1942, had previously been sales promotion manager of the CBS Detroit office for three years. His new duties as director of business development cover the creation and supervision of sales presentations.

U. S. Advertising Co. Is Now Ewell & Thurber

U. S. ADVERTISING Co., Chicago and Toledo, henceforth will be known as Ewell & Thurber Assoc., according to an announcement last Thursday by Ward M. Canaday, who founded the agency in Toledo 25 years ago.

Mr. Canaday withdrew from active participation in the advertising business five years ago. James C. Ewell, who joined the organization in 1934, then became president. Mr. Ewell will head the Chicago office, 612 North Michigan Avenue, while Hal H. Thurber, former vice president of D'Arcy Adv., St. Louis, who joined U. S. Adv. last July, will head the Toledo office, 520 Madison Avenue. Financial backing for the renamed firm will be provided by Canaday, Ewell & Thurber Inc., a financial corporation which will not be active in the advertising business.

Unfailing Dependability



211



Han-D



99 - 999



U9S

Fill **FOUR** Impedance Requirements
with **ONE**
TURNER
U9S
DYNAMIC

Whatever impedance you need—50 ohms, 200 ohms, 500 ohms, or high impedance you can get it quickly and easily with the turn of the switch on TURNER U9S. ONE microphone does the job of four units. Ruggedly built to handle toughest jobs. Adjustable saddle permits semi- or non-directional operation. Professional gun-metal type finish. Range 40-9000 cycles free from peaks or holes. Level -52DB at high impedance. Complete with 20 ft. removable cable set.

Ask Your Distributor or Write

THE TURNER COMPANY
914 17th Street, N. E. - Cedar Rapids, Iowa
Licensed Under U. S. Patents of the American Telephone and Telegraph Co., and Western Electric Co., Incorporated.





TURNER

Pioneers in the communications field

Microphones

Free Microphone Catalog
Write for Your Copy

Ceilings Blamed For Radio Set Lag

RMA Midwinter Meeting Names Wells To Get Data

RADIO SET production will continue to lag 75% behind its post-war goal unless OPA price ceilings are lifted, manufacturing leaders warned at the Jan. 28-30 Midwinter Conference of the Radio Manufacturers' Assn.

Present production is only 10% of original Government estimates, largely due to complexities of the OPA, according to Bond Geddes, RMA executive vice president.

The RMA board of directors decided, after full discussion of the problem, that relief could be obtained only by further conferences with OPA officials in an effort to obtain revised price ceilings that would permit component parts manufacturers to return to full production.

A. S. Wells, Wells-Gardner & Co., was named chairman of a large committee to obtain extensive data on production costs for presentation to OPA.

Cabinet Shortages

Among the industry problems cited by Mr. Geddes were radio cabinet shortages resulting from higher margins of profit cabinet makers are able to obtain from furniture. The radio set industry is depressed and thousands of workers have been laid off, Mr. Geddes said. Radio manufacturers admit they do not seek complete exemption from price controls, he added, but at least want to recover costs.

Anticipated release of surplus parts by the War Assets Corp. (new war surplus sales agency) may bring some relief for makers of component parts, he suggested.

The board voted to make another effort to obtain reduction of the 10% excise tax on radios. A. H. Gardner, president of Colonial Radio Corp., Buffalo, was named chairman of a committee to press the matter. Manufacturers claim the tax represents an added cost to consumers that is unnecessary.

Frank A. Hiter, senior vice president of Stewart-Warner Corp., Chicago, in discussing OPA price ceilings, said his company is at 25% of projected levels because of parts shortages and difficulty in obtaining women workers. Parts makers have told RMA officials that removal of OPA ceilings and substitution of law of supply and demand is the surest way to peak production, he said.

A spokesman for Radio-Radar Industries Inc., a trade organization, contended that though prices may rise temporarily they will soon fall and the market will be flooded with all the parts needed. He pointed out that before the war the industry was one of the most cut-throat in the country and because of war expansion will be even more so under normal conditions. This, he went on, will act to

Gen. Colton Opening Consulting Company

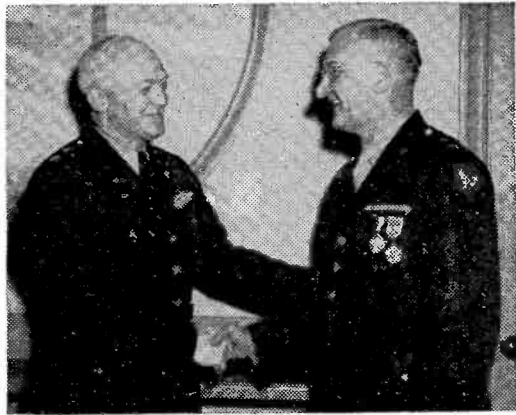

Gen. Arnold congratulates Maj. Gen. Colton

MAJ. GEN. ROGER B. COLTON, USA retired, after 35 years service, is now associated with the firm of Colton & Foss, electronic consultants specializing in broadcasting, public service communications, and radio and radar development consulting services. Firm is located at 927 15th St., N. W., Washington, D. C.

On Jan. 8, Gen. Colton was awarded both the Distinguished Service Medal and the Legion of Merit by the War Dept. He was given the DSM for his distinguished contributions to electronics as air communications officer of Air Technical Service Command and as electronics advisor to assistant chief of Air Staff-4, Sept. '44-Sept. '45. The Legion of Merit was for his "outstanding services" as chief of the Materiel Branch and later director of Supply Service, Office of Chief Signal Officer, Aug. '41-June '43.

WTON to ABC

WTON Staunton, Va., now under construction, becomes affiliated with ABC March 1 as a bonus station available at no cost to advertisers which purchase WCHV Charlottesville, Va. WTON will operate on 1400 kc with 250 w. Charles P. Blackley is owner and manager of station.

the advantage of the consumer.

The RMA board voted to appoint a new Amateur Section Committee headed by William J. Halligan, Hallicrafters Co., as chairman. Other committees and their chairmen, meeting in conjunction with the board sessions, included Radio Parts Coordinating Committee, J. J. Kahn, Standard Transformer Corp., chairman, and Radio Parts Division, R. C. Sprague, Sprague Electric Co., chairman.

Thirty-five applications for RMA membership were approved, bringing the total to 307.

Entry of RMA into the industrial relations field was approved by the RMA Employment Committee, which will conduct spot surveys of industry wage rates to secure overall normal plant averages for all types of workers. Chairman of the committee is G. W. Thompson, Noblitt-Sparks Industries.

Many Ice Inquiries

BROADCAST stations and agencies are showing intense interest in the dealer cooperative advertising drive planned by the ice industry during the coming summer [BROADCASTING, Jan. 28]. NAB Department of Broadcast Advertising, of which J. Allen Brown is assistant director, has received a large number of requests for the transcribed series *This Is the Ice Age*, which will serve as kickoff to the drive. National advertising campaign by the National Assn. of Ice Industries will be placed in magazines, with radio promotion up to local dealers.

Silent Tribute

ENGINEERS of WCSC Charleston, S. C., who are more or less accustomed to mice, lizards and frogs getting into the vital innards of the transmitter, were confronted with a new species of intruder a few nights ago. A spider made the fatal mistake of stepping onto the high voltage rectifier and his forelegs remained hooked over the wire, knocking WCSC off the air and providing a silence which officials considered "a fitting tribute" to the interloper.

Radio's Most Important Broadcast Series . . .

A Cowles Station
WOL
1527 K STREET, N.W.
WASHINGTON 6, D. C.

ARTHUR J. CASEY
ASSISTANT TO THE GENERAL MANAGER

January 14, 1946

Mr. Brad Simpson
WJW Enterprises, Inc.
WJW Building
Playhouse Square
Cleveland 15, Ohio

Dear Brad:

Mr. Welles' broadcast of Sunday, January 13 was excellent.

The Washington office of Associated Press phoned for a printed transcript which we didn't have. Is it possible to provide us with a printed continuity of Mr. Welles' commentaries, which we will make available to the District papers and press associations?

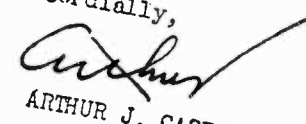
Cordially,

ARTHUR J. CASEY

AJC:mbr

SUMNER WELLES

One quarter hour weekly, still available for sponsorship by transcription in some markets

WJW ENTERPRISES, INC.

WJW BUILDING • CLEVELAND, OHIO



4,955,144
spindles
spinning
VICTORY

...daily producing cotton cloth to wrap around the world. Produced from "picker to bolt" in the 16-county WSPA Primary Area.



WSPA

SPARTANBURG,
SOUTH CAROLINA

Home of Camp Croft

5000 watts Day, 1000 watts Night
950 kilocycles, Rep. by Hollingbery

The SCHOOL of RADIO TECHNIQUE

NEW YORK • CHICAGO

America's Oldest School Devoted
Exclusively to Radio Broadcasting

Comprehensive Day and Evening
Courses in all phases of Radio
Broadcasting taught by Network
Professionals. Moderate rates.

For Full Details, Request Booklet B.

NEW YORK 20, N.Y.: RADIO CITY, R.K.O. Bldg.
CHICAGO 4, ILL.: 228 S. Wabash Avenue



Fine transcriptions
are recorded on Audi discs
AUDIO DEVICES, INC., N. Y. C.

KXOK 630 Kc.

ST. LOUIS

AMERICAN
BROADCASTING
COMPANY

5000 Watts Full Time
Represented by John BLAIR & CO.

Longines Salesmen Hear Rickenbacker

Star of New Flight Series
Is Guest at Luncheon

FORTY SALES representatives of the Longines-Wittnauer Watch Co., in New York for their annual sales convention, heard an episode of the company's new radio series, *World's Most Honored Flights*, Jan. 30 at a luncheon at which Capt. Eddie Rickenbacker, star of the series, was guest of honor. Program, depicting the progress of aviation in 13 half-hour dramas, started last week by transcription on some 150 stations, placed by Arthur Rosenberg Co., New York, advertising agency for the sponsor.

Describing the series as "an opportunity to bring a true and graphic word picture of American aviation to the American public," Capt. Rickenbacker stated that one of the programs, dealing with the Antarctic explorations of Admiral Byrd, Lincoln Ellsworth and others, will report on a proposal of Capt. Rickenbacker's to military officials that aerial surveys of the vast South Polar regions be made, following which atomic bombs be dropped to release the mineral and coal deposits known to exist there.

Fred Cartoun, executive vice president of Longines, introduced Capt. Rickenbacker and J. P. V. Heinmuller, president of the company, presented him with a set of timing watches. Programs, whose title ties up with the company's slogan, "World's Most Honored Watches," are being written by Col. H. C. Adamson, writer and historian who accompanied Capt. Rickenbacker on the Pacific flight and spent 24 days aboard the life raft with him.

Capt. Rickenbacker told the group that his fees are being paid by his sponsor to the Army Air Forces Aid Society, to help needy Air Force widows and orphans as well as disabled aviation veterans.

Congress

(Continued from page 17)

the number wanted by licensee; (2) pay any persons in excess of the number of employes wanted by the licensee; (3) pay or agree to pay more than once for services performed; (4) pay or agree to pay for services not performed; (5) refrain or agree to refrain from broadcasting noncommercial educational or cultural programs; (6) refrain or agree to refrain from broadcasting any programs originating outside the U. S.

Prohibited also under the bill are: (1) Payment of tribute for broadcasting recordings or transcriptions; (2) restrictions on use of recordings or transcriptions for broadcast; (3) tribute on recorded or transcribed broadcasts for which services previously have been paid.

Rep. Lea's bill is designed as an amendment to Title V of the Communications Act of 1934, as amended.

Hardy Honored

RALPH W. HARDY, public service director of KSL Salt Lake City, has been chosen by the Salt Lake Junior Chamber of Commerce as the city's outstanding young man of 1945. Activities which won the citation were his work in Community Chest, war bond and Utah Safety Council affairs; service as voluntary guide on the city's Temple



Mr. Hardy

Square; work as bishop of the LDS East Ensign Ward; activity in the Executives Assn. He joined KSL in 1937, later became program manager, and last summer was appointed to his present position. He is a member of the NAB Program Managers Executive Committee.

SEEK 50 KW STATION FOR SAN FRANCISCO

APPLICATION for a new 50,000 watt independent station in the San Francisco area to operate on the 1030 kc channel (WBZ-Boston dominant station) was filed with the FCC Friday by Al Nelson, president of Alvin E. Nelson, Inc., former NBC San Francisco manager.

Principals, in addition to Mr. Nelson, as president, include Calvin Kunz, Denver produce broker and Elmer Hartner, Denver real estate man and industrialist. Capitalization of firm is \$300,000.

The application sets forth that the station would devote no more than 50% of its time to commercially sponsored programs, and that it would "eliminate use of so-called 'spot announcements' between programs."

Mr. Nelson was the founder and operator of WIBO Chicago, which lost its facilities in the now famous "Davis Equalization Amendment" case in 1931, when the Radio Commission held that Illinois was overquota and Indiana underquota in facilities and that the latter state therefore was entitled to the facility. That facility now is used by WIND Chicago. He later was general manager of KOA Denver for NBC and subsequently went to San Francisco for NBC, resigning in 1942 to open his own public relations firm in San Francisco.

Counsel for the Nelson company is Miller, Sher & Oppenheimer, of Washington, with Frank H. McIntosh as consulting engineer.

RCA Victor Names Three

JOHN C. MARDEN, former procurement official in Washington for RCA, has been named assistant advertising manager and sales promotion manager of the RCA Victor home radio department. William H. Tindall, formerly with Paul Block, and Frank Schmitt, formerly with RCA as assistant advertising manager of the tube division, have been appointed staff assistants.

WOR REPORTS 1945 'MOST SUCCESSFUL'

WITH its most successful year completed, WOR New York was to mark the beginning of fiscal year 1946 with a sales and luncheon meeting today.

In a report covering the fiscal year, Feb. 1, 1945, to Jan. 31, 1946, WOR reported a 5% increase in sales over the preceding fiscal year. New business in the last year increased 9% over that of the previous year.

In 1945 Ruthrauff & Ryan led all advertising agencies in WOR billing. Other leading agencies, in order of billing, were: Donahue & Coe, BBDO, Arthur Rosenberg Co., Federal Advertising Co., Erwin Wasey, Chicago and New York, Scheck Advertising Agency, J. M. Mathes, Platt Forbes and Young & Rubicam.

Top advertisers were Longines-Wittnauer Watch Co., *New York Herald-Tribune*, Peter Paul, Lever Bros., Plough Inc., Colgate-Palmolive-Peet, Kirkman & Sons, J. F. Trommer, National Biscuit Co., Consolidated Cigar Co. and Jacob Ruppert. For the calendar year 1945, 364 advertisers used WOR, of which 25% were new accounts.

Plans for a 1946 quota of 15% increase over 1945 were to be discussed at the sales meeting. Future looks bright, R. C. Maddux, vice president, asserted. Eugene S. Thomas, WOR sales manager, was to outline the sales campaign.

Sports Interviews

SPORTS television show titled "I Saw It Happen," featuring great sports personalities in interview with Tom Dunphy, will be presented by ABC on WRGB Schenectady, N. Y., starting Feb. 6, for four successive Wednesdays.

Bruen Teaching

WELLS BRUEN, of WCKY Cincinnati sales staff, is instructing classes in radio programming and selling at the Schuster-Martin School of Drama.

Sellers

(Continued from page 10)

learn from the ground up."

His second bit of advice is, still, "forget your rank."

"Don't waste people's time telling how important you were in the war. A lot of so-called 'unimportant infantrymen' helped win the war the hard way and aren't here to get in on the glory."

Jim feels a lot of veterans, like himself, are going to get into the selling side of business. What they've learned in the service through military discipline, strange places and people, will prove an invaluable asset.

He's married to the former Dorothy Eagan and lives with his family in Chatham Park, Chicago. The children are James Russell, 3, and Marcella Cathleen, 2.

He hasn't a hobby now, except his family, but before the war his favorite sport was horses, racing and riding. In fact, when he was in high school and considerably lighter, he wanted to be a jockey.

Wharfield Is Succeeded By Lindow at War Dept.

LT. COL. LESTER W. LINDOW, former manager of WFBM Indianapolis, has succeeded Maj. Albert M. Wharfield as head of the Radio Branch, War Dept. Bureau of Public Relations. Maj. Wharfield, separated from the Army last Tuesday, is expected to return to C. E. Hooper Inc., where he was manager of national ratings before Army service.



Col. Lindow

Maj. Charles Batson, former program manager of WFBC Greenville, S. C., executive officer of Radio Branch has also been released. He is now on terminal leave. Capt. Ted Bergmann, recently returned from Public Relations Division, U. S. Forces, European Theatre, is due to report to Radio Branch this week. He was formerly with NBC New York.

Start FM Construction

SCHEDULED to begin operations on May 1, Metro-Goldwyn-Mayer Studios, Culver City, Cal., has started construction of its FM station KMGM. Equipped with 262-foot antenna on a 1,500-foot elevation at crest of Mulholland Drive in foothills behind Hollywood, FM station is to service a radius of 75 miles. Herbert L. Petzey, director of WHN New York, station owned and operated by Marcus Loew Booking Agency has been in Hollywood to complete plans for proposed FM station.

Eight Additional FM Grants Bring Total Since Lifting of Wartime Freeze to 298

TOTAL conditional grants issued for FM stations since lifting of the wartime freeze reached 298 last week with authorization by the FCC of eight additional outlets.

The Commission also designated for consolidated hearing two applications for FM stations in Buffalo, both from the Buffalo Broadcasting Corp., owners of WGR and WKBW. One of the applicant's standard stations will be disposed of under duopoly rules following separation from an agreement with Churchill Tabernacle for lease of Sunday time on WKBW, as required by the Commission [BROADCASTING, Dec. 24].

Following is a list of the grants:

City	Grantee	Type of FM Station
MARYLAND		
Hagerstown	Hagerstown Broadcasting Co. (WJEJ)	Metropolitan
MISSOURI		
St. Louis	St. Louis University (WEW)	Metropolitan
NEW YORK		
Syracuse	Radio Projects, Inc.	Metropolitan
NORTH CAROLINA		
Charlotte	Southeastern Broadcasting Co. (WBT)	Metropolitan
Gastonia	F. C. Todd (WGNC)	Metropolitan, possibly rural
OHIO		
Columbus	Lloyd A. Pixley, et al, d/b as The Pixleys (WCOL)	Metropolitan
OREGON		
Medford	Medford Printing Co. (KRNR)	Community
PENNSYLVANIA		
Clearfield	Airplane & Marine Instruments, Inc.	Metropolitan

Winchell Nominated by N. Y. Peabody Award Committee for Top Commentator

WALTER WINCHELL has been recommended for the George Foster Peabody Radio Award to news commentators by the New York Peabody awards committee.

Announcement of the committee's recommendations to the National Board of Peabody Awards at the U. of Georgia marked a precedent. Recommendations of individual committees have in the past remained secret until the final selections were announced.

Mr. Winchell was suggested as winner "for his continuous fight against tyranny, treachery, appeasement and Fascism."

Special Award to Murrow

Special award "for his outstanding service to public understanding in the field of foreign news reporting" was suggested for Edward R. Murrow, CBS vice president and former European broadcaster. Cecil Brown, Mutual newscaster, was recommended for honorable mention.

Other recommendations by the New York committee were:

For public service: Assignment Home (CBS), Wings for Tomorrow (MBS), Opinion Requested (MBS), When He Comes Home (WMCA New York).

For "outstanding entertainment in radio drama": Norman Corwin, with special mention for his On a Note of Triumph, V-E Day script.

For "outstanding dramatic presentation for an individual radio station in 1945": WMCA New York for New World A'Comin.

For music: NBC Symphony Orchestra.

Getting Your Music's Worth over WQXR New York.

For education: NBC's Our Foreign Policy, WABC New York's Transatlantic Call.

For children's program: Youth Forum, over WQXR New York, It's Up to Youth, over WOR New York.

Honorable mention for improvement of race relations: Wings for Tomorrow (MBS), Opinion Requested (MBS), New World A'Comin (WMCA New York).

New York Peabody committee, headed by Mrs. Luella S. Laudin, co-chairman, radio committee, General Federation of Women's Clubs, is composed of Jane Cowl, actress; Mrs. Merrill Denison, author; Dr. Paul Dawson Eddy, president, Adelphi College; Mrs. Catherine Edwards, associate editor, Parents magazine; Mrs. George Fielding Eliot, radio chairman, Women's Action Com-

mittee for Victory and Lasting Peace; James Lawrence Fly, former FCC Chairman; George Freedley, curator of theatre collection, New York Public Library; Henriette K. Harrison, national radio director, National Council of YMCA's; George P. Ludlam, radio director, Advertising Council; Otto Luening, chairman Barnard College music dept.; Frances McFarland, director of music, Civilian Defense Volunteer Office, New York; James F. MacAndrew, New York Board of Education Station WNYE. Adele Gutman Nathan, author; Roberta Newell, librarian, Women's Action Committee for Victory and Lasting Peace; Ruth Ottaway Sokoloff, past president of National Federation of Music Clubs; Albert R. Perkins, film and radio director, Look magazine; Dr. Randolph B. Smith, president, The Little Red School House; Olga Samaroff Stokowski, member of faculty, Juilliard Graduate School of Music, and Rex Stout, author.

RICHARD BLOW, after serving as a Navy pilot for three years, has joined the WNEW New York continuity staff.

Question:
How many farms are there in WHAM's primary area?

Answer:
140,518 prosperous farms help make up the 43 county primary area of WHAM... farms producing diversified crops for year in and year out prosperity.

WHAM

ROCHESTER, N. Y.

Your Western New York Salesman

50,000 Watts • Clear Channel • 1180 on the dial • Affiliated with NBC
National Representative: GEORGE P. HOLLINGBERRY CO.

"The Stromberg-Carlson Station"

1450 kc
NEW-AM The Bay Broadcasting Co., Sandusky, O.—CP new station 250 w unl.

1480 kc
WHBC The Ohio Broadcasting Co., Canton, O.—CP install new trans.

1490 kc
KVAL Radio Station KEEW Ltd., Brownsville, Tex.—Mod. license increase 100 w N 250 w D to 250 w DN.
NEW-AM Elmer R. Noll and Frank A. Dieringer d/b Chillicothe Broadcasting Co., Chillicothe, O.—CP new station 100 w unl.

NEW-AM Samuel R. Sague, Cleveland Heights, O.—CP new station 250 w unl. Call WSBK reserved.

1520 kc
KOMA KOMA Inc., Oklahoma City—Mod. CP increase power, install new trans. and DA-N and change trans. site, for change in trans. site.

1560 kc
WAML New Laurel Radio Station Inc., Laurel, Miss.—CP change 1340 kc to 1560 kc, increase 250 w to 1 kw, install new trans., new vertical ant. and ground system and change trans. site.
NEW-AM Washita Valley Broadcasting Corp., Chickasha, Okla.—CP new station 250 w unl.

92.1 mc
NEW-FM Puerto Rico Communications Authority, Rio Piedras, P. R.—CP new rural FM station, channel 221, 3,423 sq. mi.

105.9 mc
NEW-FM Puerto Rico Communications Authority, Rio Piedras, P. R.—CP new community FM station, channel 290.

Amendment
Orlando Daily Newspapers Inc., Orlando, Fla.—CP new station 1060 kc 1 kw N 5 kw D DA-N unl., amended to change frequency to 990 kc, increase power to 5 kw N 10 kw D, change type trans. DA-DN.

JANUARY 22

550 kc
KTSA Sunshine Broadcasting Co., San Antonio, Tex.—CP increase 1 kw N 5 kw D to 5 kw DN, install DA-N.

910 kc
KPOF Pillar of Fire, Near Denver, Col.—CP increase 1 kw DN to 1 kw N 5 kw D and install new trans.

1230 kc
NEW-AM Lewis Windmuller, Allentown, Pa.—CP new station 250 w unl.
NEW-AM Dickinson Publishing Co. Inc., Dickinson, N. D.—CP new station 250 w unl.

1240 kc
KGBS Harbenito Broadcasting Co., Harlingen, Tex.—CP install new vertical ant. (with FM ant. mounted on top).
KWLC Luther College, Decorah, Ia.—Mod. license change hours operation from D to specified hours (contingent on grant of application for new station at Decorah, filed by Telegraph-Herald).

1270 kc
KTFI Radio Broadcasting Corp., Twin Falls, Ida.—CP increase 1 kw DN to 5 kw D 1 kw N, install new trans. and change studio site (resubmitted).

1340 kc
NEW-AM Abilene Broadcasting Co., Abilene, Tex.—CP new station 250 w unl.
WFHR William F. Huffman, Wisconsin Rapids, Wis.—CP install new vertical ant.

1400 kc
NEW-AM Beverly B. Ballard, Dewey Allread Jr. and Clyde L. Goodnight d/b Peach Bowl Broadcasters, Yuba City, Cal.—CP new station 250 w unl.

1450 kc
NEW-AM Charles W. Balthrope, San Antonio, Tex.—CP new station 250 w unl. (facilities to be relinquished by KABC).
NEW-AM Henry F. Fett, Dearborn, Mich.—CP new station 1 kw D.
KONP Evening News Press Inc., Port Angeles, Wash.—Mod. license change corporate name to Radio Pacific Inc.

1470 kc
WSAR The Fall River Broadcasting Co. Inc., Fall River, Mass.—CP change 1480 kc to 1470 kc, increase 1 kw to 5 kw, install new trans. and DA-DN, change trans. site from South Somerset, Mass., to Portsmouth, R. I.

1490 kc
WMRF Lewistown Broadcasting Co., Lewistown, Pa.—CP change trans. site, install new vertical ant. and ground system (contingent on grant of application for new FM station).

Amendments
Atlantic Radio Corp., Boston—CP new station 1200 kc 5 kw unl., amended to request 550 kc, change type ant.
Caprock Broadcasting Co., Lubbock, Tex.—CP new station 550 kc 500 w unl. DA, amended to request 1590 kc 1 kw, change trans. site. make changes DA.

Applications Dismissed
Evangelical Lutheran Synod of Missouri, Ohio and other States, Clayton, Mo.—CP new noncommercial educational FM station, 42.9 mc, 250 w (request of applicant).
WHLS Port Huron Broadcasting Co., Port Huron, Mich.—CP change 1450 kc to 560 kc, increase 250 w to 1 kw, make changes in trans. equip. and install DA-N (request of attorney).

JANUARY 23

KLIZ Brainerd Broadcasting Co., Brainerd, Minn.—Mod. CP new station for approval trans. site at SE corner Oak St. and Beach St., and approval ant.

550 kc
NEW-AM Capital City Broadcasting Corp., Baton Rouge, La.—CP new station 1 kw DA-N unl.

970 kc
NEW-AM Sun River Broadcasters Inc., Great Falls, Mont.—CP new station 5 kw unl.

1240 kc
NEW-AM Union City Broadcasting Co. Inc., Union City, Tenn.—CP new station 250 w unl.

1340 kc
KMYR KMYR Broadcasting Co., Denver, Col.—Authority to determine operating power by direct measurement of ant. power (resubmitted).
KSIL Dorrance D. Roderick, Silver City, N. M.—Mod. CP new station for approval trans. and studio sites Cactus Ave. and 17th St., and approval ant.

1400 kc
KTMC McAlester Broadcasting Co., McAlester, Okla.—Mod. CP new station for change type trans., ant. and studio site.

1450 kc
KSMA Hugh G. Shurtliff, Charles A. Shurtliff, Mareby Cardella (Della) Shurtliff and Cleo Agnes Center, Santa Maria, Cal.—Mod. CP new station for change studio site.

1460 kc
WKBO Keystone Broadcasting Corp., Harrisburg, Pa.—CP change 1230 kc to 1460 kc, increase 250 w to 1 kw N 5 kw D, install new trans. and DA-N, change trans. site (facilities WHP contingent on WHP move from 1460 kc).

1490 kc
NEW-AM Harold T. Gray, Gerald L. Wise, Vernon L. Wise, Roy E. Morgan, Thomas P. Shelbourne, Leon Schwartz, Dr. Isiah C. Morgan and Mitchell Jenkins d/b Wyoming Valley Broadcasting Co., Wilkes-Barre, Pa.—CP new station 250 w unl.
NEW-AM James J. Murray, Lewisburg, Tenn.—Same.

1530 kc
NEW-AM Patrick Joseph Stanton, Philadelphia—CP new station 10 kw D.

1540 kc
NEW-AM W. J. Marshall, Cleveland—CP new station 1 kw D.

Amendments
Jim Golding and Ben H. Guill d/b Voice Berger, Borger, Tex.—CP new station 1450 kc 250 w unl., amended to request 1230 kc, request facilities from KFPA and change type trans.
Radio Springfield Inc., Springfield, Ill.—CP new station 1550 kc 250 w unl., amended to increase power from 250 w DN to 1 kw DN, change type trans., install DA-DN, specify trans. site.
H. I. Corley tr/as Corley Radio & Sound Service, Trinidad, Col.—CP new station 1240 kc 250 w unl., amended to change trans. site.

JANUARY 24

APPLICATIONS for license renewal of following AM stations: KCMC WERC WDLF WLCF KVNU KPOW WMRO KWAL KBTM WLOG WISE KWNO KHBC KMLB WHBY KGEK KAST KSUN.

550 kc
WMOB S. B. Quigley, Mobile, Ala.—CP change 1230 kc to 550 kc, increase 250 w to 1 kw, install new trans. and DA-DN, change trans. site.

710 kc
WGBS The Fort Industry Co., Miami, Fla.—CP increase 10 kw to 50 kw, install new trans. and DA-DN, change trans. site.

790 kc
KFYO Plains Radio Broadcasting Co., Lubbock, Tex.—CP change 1340 kc to 790 kc, increase 250 w to 5 kw, install new trans. and DA-N, change trans. site.
WMC Memphis Publishing Co., Memphis, Tenn.—License to cover CP install new trans.

900 kc
KLCN Harold L. Sudbury, Blytheville, Ark.—CP install new trans.

910 kc
NEW-AM The Central Connecticut Broadcasting Co., New Britain, Conn.—CP new station 5 kw DA-N unl.

1230 kc
WFAS Westchester Broadcasting Corp., White Plains, N. Y.—CP install new trans. and vertical ant., change trans. site.
NEW-AM Penn Lincoln Broadcasting Co. Inc., Williamsport, Pa.—CP new station 250 w unl.
KMLB Liner's Broadcasting Station Inc., Monroe, La.—Mod. CP change assignment for increase in power from 1 kw DN DA-N to 5 kw D 1 kw N DA-N; install new trans.

1240 kc
WGBB Harry H. Carman, Freeport, N. Y.—CP install new vertical ant. (with FM antenna mounted on top) and ground system.

1450 kc
NEW-AM Old Colony Broadcasting Co. Inc., Brockton, Mass.—CP new station 250 w unl.

1540 kc
NEW-AM N. Joe Rahall, Sam G. Rahall, Farris E. Rahall and Deem F. Rahall d/b Allentown Broadcasting Co., Allentown, Pa.—CP new station 1 kw D.

Amendments
KNOW Frontier Broadcasting Co. Inc., Austin, Tex.—CP change 1490 kc to 860 kc, increase 250 w DN to 5 kw D 1 kw N, install new trans. and DA, change trans. site, amended to request 1420 kc, make changes in DA-N and change trans. site.
S. H. Patterson, Topeka, Kan.—CP new station 1440 kc 500 w D 1 kw N unl., amended to request 1 kw N 5 kw D, install new trans. and DA-N and change trans. site.

JANUARY 28

600 kc
NEW-AM Central Broadcasting Corp., Flint, Mich.—CP new AM station 1 kw DA unl.

940 kc
NEW-AM Puerto Rico Communications Authority, Municipality of Rio Piedras, P. R.—CP new AM station 10 kw DA unl.

960 kc
NEW-AM Worth Broadcasting Co., Fort Worth—CP new AM station 5 kw D.

1060 kc
NEW-AM Stark Broadcasting Corp., Canton, O.—CP new AM station 1 kw D.

1070 kc
NEW-AM Monona Broadcasting Co., Madison, Wis.—CP new AM station 10 kw DA-N unl.

1340 kc
NEW-AM Audrain Broadcasting Corp., Mexico, Mo.—CP new AM station 250 w unl. (facilities relinquished by KHMO).

1450 kc
NEW-AM Rahall Broadcasting Co., Beckley, W. Va.—CP new AM station 250 w unl.

1490 kc
NEW-AM Douglas L. Craddock, Leaksville, N. C.—CP new AM station 100 w unl.

Amendments
Glens Falls Publicity Corp., Glens Falls, N. Y.—CP new AM station 1450 kc 250 w unl., amended to request 1230 kc 100 w.
Methodist Radio Parish, Flint, Mich.—CP new AM station 1500 kc 250 w D, amended to request 1510 kc.
Amphlett Printing Co., San Mateo, Cal.—CP new AM station 1490 kc 250 w unl., amended to request 1550 kc, ant. changes.
P. C. Wilson, Canton, O.—CP new AM station 1300 kc 1 kw D, amended to request 1540 kc.

JANUARY 30

600 kc
TRANSFER KROD Dorrance D. Roderick, El Paso, Tex.—Vol. assgn. license to Roderick Broadcasting Corp.

680 kc
NEW-AM The Tower Realty Co., Baltimore, Md.—CP new AM station 5 kw DA-N unl.

730 kc
NEW-AM Regional Broadcasting Co., (Continued on page 80)

SERVICE DIRECTORY

FREQUENCY MEASURING SERVICE

Exact Measurements - at any time

RCA COMMUNICATIONS, INC.
64 Broad Street New York 4, N. Y.

Custom-Built

Speech Input Equipment

U. S. RECORDING CO.

1121 Vermont Ave., Wash. 5, D. C.
District 1640

"GEARED TO AM-FM EXPANSION"

Radio Engineering Consultants

Commercial Radio Equip. Co.

Kansas City, Mo.
Washington, D. C. Hollywood, Cal.

MORE RF KILOWATT HOURS

PER DOLLAR WITH
F & O TRANSMITTING TUBES
Freeland & Olschner Products, Inc.
611 Baronne St., New Orleans 13, La.
Raymond 4756
High Power Tube Specialists Exclusively

FREQUENCY MEASUREMENTS

One of the best equipped monitoring stations in the nation

STANDARD

Measuring & Equipment Co.
Phones 877-2652 Enid, Okla.
Since 1939

TOWER SALES & ERECTING CO.

Radio Towers
Erection, lighting, painting &
Ground Systems
6100 N. E. Columbia Blvd.
Portland 11, Oregon
C. H. Fisher, Agent Phone TR 7303

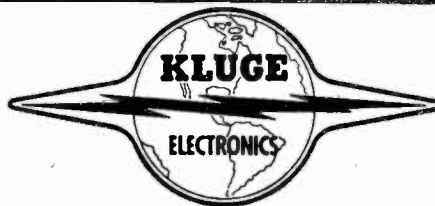

1031 N. ALVARADO • LOS ANGELES 26, CALIF

AVAILABLE NOW

PRECISION TURNTABLES—and/or ASSEMBLIES • MODULATION MONITORS • REMOTE-POWER AMPLIFIERS

SONIC ENGINEERING CO.

592 Columbus Ave., New York City, N. Y.

Transmitter Installation

Field & Antenna Measurements
BRADEN ENGINEERING CO.

3317 Kenmore Ave., Dayton 10, Ohio
Phone—Kenmore 6233

FCC Actions

(Continued from page 79)

Chicopee, Mass.—CP new AM station 1 kw D (Call "WACE" reserved).

820 kc
NEW-AM WLBG Inc., Laurens, S. C.—CP new AM station 250 w D.

1150 kc
KSAL KSAL Inc., Salina, Kan.—Authority to determine operating power by direct measurement of ant. power.

TRANSFER WAPO Joda Patterson, Ramon G. Patterson & Louise Patterson Pursley d/b WAPO Broadcasting Service, Chattanooga, Tenn.—Assn. license to Ramon G. Patterson, Louise Patterson Pursley, Ramon G. Patterson, executor, and Louise Patterson Pursley, executrix of estate of Joda Patterson, deceased, d/b WAPO Broadcasting Service.

1230 kc
TRANSFER WMOB S. B. Quigley, Mobile, Ala.—Vol. assn. license to Nunn Broadcasting Corp.

1240 kc
Luther E. Gibson, d/b as Gibson Broadcasting Co., Sacramento, Cal.—Authority to purchase KROY Sacramento.

1320 kc
NEW-AM H. M. Suthard & P. M. Mullins d/b Mayfield Broadcasting Co., Mayfield, Ky.—CP new AM station 1 kw D.

1360 kc
NEW-AM Dr. Leslie Haltom Luck and Myron Birdsel ("Patt") McDonald d/b Luck-McDonald Co., Fort Worth, Tex.—CP new AM station 1 kw DA unli.

1440 kc
KFMB Jack Gross Broadcasting Co., San Diego, Cal.—CP change 1450 kc to 1440 kc, increase 250 w to 1 kw, changes in trans. equip. (facilities to be relinquished by KPRO).

1480 kc
WRDW Augusta Broadcasting Co., Augusta, Ga.—Authority to determine operating power by direct measurement of ant. power.

Amendments

Booth Radio Stations Inc., Saginaw, Mich.—CP new AM station 550 kc 1 kw DA unli., amended to change type number of trans.

Crescent Broadcast Corp., Shenandoah, Pa.—CP new AM station 580 kc 1 kw D, amended to request 5 kw unli., change type trans. and trans. site and DA-DN. Amended to specify trans. site in Roaring Creek Township, Pa.

Booth Radio Stations Inc., Lansing, Mich.—CP new AM station 1360 kc 1 kw DA unli., amended to request changes DA system.

Mon-Yough Broadcasting Co., McKeesport, Pa.—CP new AM station 1360 kc 1 kw DA-N unli., amended to request changes in ant. system for N.

KEYS Earl C. Dunn, Charles W. Rossi, H. B. Lockhart and E. C. Hughes d/b Nueces Broadcasting Co., Corpus Christi, Tex.—CP change 1490 kc to 1440 kc, increase 250 w DN to 1 kw N 5 kw D, install new trans. and DA-N and change trans. site, amended to make changes in ant. system.

Walter A. Graham, Tifton, Ga.—CP new AM station 1300 kc 250 w unli., amended to request 1340 kc.

Greater Peoria Radiobroadcasters Inc., Peoria, Ill.—CP new AM station 1290 kc 1 kw DA-DN unli., amended to install approved trans.

JANUARY 31

550 kc
WGR Buffalo Broadcasting Corp., Buffalo, N. Y.—CP increase power from 5 kw D 1 kw DA-N to 5 kw DN and make changes in DA-N.

610 kc
KDAL Red River Broadcasting Co. Inc., Duluth, Minn.—CP increase 1 kw to 5 kw, install new trans. and make changes in DA-N.

630 kc
NEW-AM Henry C. Putnam, John D. Keating and J. Elroy McCaw d/b The Island Broadcasting Co., Honolulu, T. H.—CP new AM station 5 kw unli.

870 kc
NEW-AM Donnell C. Reeves, Hanford, Cal.—CP new AM station 250 w D.

980 kc
KMBC Midland Broadcasting Co., Kansas City—CP decrease power aux. trans. from 2½ kw to 1 kw, inst. new aux. trans.

1010 kc
NEW-AM WHOW Inc., Baltimore—CP new AM station 250 w D.

1030 kc
NEW-AM Marion Radio Corp., Marion, Ind.—CP new AM station 1 kw D.

1150 kc
NEW-AM Laurence W. Harry tr/as

Van Doren Urges Listeners To Protest Radio Censorship by Writing Sponsors

APPROXIMATELY 1,500 members attended a meeting of the Workers Fellowship of the Society for Ethical Culture last Monday in New York at which "Freedom of Speech on the Air" was discussed.

Carl Van Doren, author and critic, urged listeners to prevent censorship on the air by writing to their congressman protesting the House Committee of Un-American Activities. He also suggested that they write to the radio stations about anything that they disapproved of on the air. Taking advertisers to task, he admonished that "Nothing is so quivery as a sponsor, and a few letters make a great rumbling."

'No Objective News'

Radio news editors giving news that they claim is objective and impartial were decried by Mr. Van Doren, who said, "there is no such thing as objective news—to be objective is simply to be ineffective."

Rep. Hugh De Lacy (D-Wash) told the group that the Rankin Committee (Committee on Un-American Activities) is operating in a Fascist manner. "If the Ran-

Fostoria Broadcasting Co., Fostoria, O.—CP new AM station 1 kw D.

1160 kc
WJJD WJJD Inc., Chicago, Ill.—CP increase 20 kw limited to 50 kw limited, install new trans. and DA-DN.

1210 kc
NEW-AM Abraham Kofman and Sara F. Kofman d/b Times-Star Publishing Co., Alameda, Cal.—CP new AM station 1 kw D.

1230 kc
NEW-AM Mosby's Inc., Anaconda, Mont.—CP new AM station 250 w unli.

NEW-AM Missouri Valley Broadcasting Corp., St. Joseph, Mo.—CP new AM station 250 w unli. Call KRES reserved.

NEW-AM Steel City Broadcasting Co. of Bethlehem, Pa. Inc., Allentown, Pa.—CP new AM station 250 w unli.

1240 kc
NEW-AM Harrison Broadcasting Corp., Harrison, Ark.—CP new AM station 250 w unli.

NEW-AM Walter W. Bankhead, Jasper, Ala.—CP new AM station 250 w unli.

1340 kc
WCMI The Ashland Broadcasting Co., Ashland, Ky.—CP install syn. amp. at 625 Huntington St., Huntington, Va., 250 w unli., syn. with WCMI Ashland.

NEW-AM Andalusia Broadcasting Co. Inc., Andalusia, Ala.—CP new AM station 250 w unli.

1430 kc
NEW-AM Leo H. Beckley and Louise L. Beckley d/b Beckley Radio Co., Mt. Vernon, Wash.—CP new AM station 500 w D. Call KBRC reserved.

1450 kc
Ronald B. Woodyard, Utica, N. Y.—CP syn. amp. to be operated with new AM at Utica 50 w unli.

1490 kc
NEW-AM Crawford County Broadcasting Corp., Meadville, Pa.—CP new AM station 250 w unli.

NEW-AM Mitchell C. Tackley tr/as North County Broadcasting Co., Malone, N. Y.—CP new AM station 250 w unli.

NEW-AM C. R. Bellatti, Stillwater, Okla.—CP new AM station 250 w unli.

1560 kc
NEW-AM Unity Corp. Inc., Toledo, O.—CP new AM station 1 kw D.

Amendment

J. A. Clements, T. C. Dodd & John George Long d/b Bay City Broadcasting Co., Bay City, Tex.—CP new AM station 1110 kc 1 kw unli., amended to request operation as D.

Application Dismissed
Stephen R. Rintoul—CP new community FM station on frequency to be assigned by FCC, 1,065 sq. mi. (request of attorney).

kin Committee were really interested in freedom of the air they would not go after commentators like Steel and Gailmor but they would look into the National Assn. of Manufacturers.

"The NAM," he asserted, "actually controls 44 stations." He went on to say that the airwaves are controlled by the sponsors which are a part of the NAM and these that are not NAM members are intimidated by the NAM.

The last speaker was Johannes Steel, WHN commentator, who that same evening had been nominated for Congressman from the 19th electoral District on the American Labor Party ticket.

He discussed the networks who he stated do not have a "free press. They use Associated Press, a struggling monopoly, UP . . . and INS, the last dreams of a very old man."

STATE DEPT. DENIES WINCHELL'S CHARGE

STATE DEPT. last week denied charges broadcast Jan. 20 by Walter Winchell that two "big American ships" had just docked at Barcelona, Spain, with American arms allegedly sold to the Franco Government of Spain. Mr. Winchell, attributing his source to the "foreign underground," made the assertion during his *Jergen's Journal* broadcast, 9-9:15 p.m., on ABC.

"The Department has carefully investigated the charge and has received from Barcelona, Rome and Caserta categorical denials," said a State Dept. news release Tuesday. "A search of the records at Caserta indicates: 1, that no sale of arms to Spain has been authorized; 2, that no transportation of arms to Spain has been authorized; 3, that during hostilities no visits were made from Italy to Spain by War Shipping Administration merchant vessels, and 4, a search of the records since V-E Day shows that no U. S. vessel carried shipments of arms to Spain from Italy or elsewhere."

Mr. Winchell said the American ships were believed to have sailed from Italy to Barcelona. State Dept. said reports from Rome state that the Foreign Liquidation Commission representative has "sold no such material to the Spanish Government and knows nothing about any alleged shipment. The Embassy at Rome checked other sources and found no information on this matter which would substantiate Mr. Winchell's charge."

WQXR Asks 50 kw

WQXR New York last week applied to the FCC for a power increase from 10 kw to 50 kw on 1560 kc. Interstate Broadcasting Co., operator of WQXR, is wholly owned by *The New York Times*.

McGee and Molly Lead Nighttimers

FIBBER MCGEE & MOLLY, with a rating of 30.8, is America's favorite nighttime network program, according to the Jan. 30 report of C. E. Hooper Inc., which shows Bob Hope second, with 29.8, and *Radio Theatre* third, with 27.0. *Radio Theatre* also had the highest sponsor identification index, 88.9.

Average evening audience rating of the week of Jan. 15-21 was 10.5, up 0.2 from the week of Jan. 2-8 and up 0.1 from a year ago. Average evening sets-in-use was 33.1, up 0.3 from the last report, 0.5 from a year ago. Average available audience was 81.3, same as the last report and up 1.0 from a year ago.

Frank Sinatra had the most women listeners per receiving set, 1.67; the boxing bout had the most men per set, 1.29; *Lone Ranger* the most children per set, 1.24. *The Shadow* had the largest number of listeners per set, 3.48.

Following the first three, the rest of the top 15 programs were: *Charlie McCarthy*, 26.9; Jack Benny, 26.8; Red Skelton, 25.7; *Screen Guild Players*, 23.4; Fred Allen, 22.7; *Mr. District Attorney*, 21.2; *Walter Winchell*, 21.0; *Great Gildersleeve*, 19.7; Eddie Cantor, 19.5; Abbott & Costello, 19.4; *Jack Haley Show*, 19.3; *Take It Or Leave It*, 18.8.

Of these, Jack Benny, Fred Allen, Walter Winchell and *Radio Theatre* were also among the top rated programs 10 years ago, which also included Phil Baker, then star of the Gulf gasoline program, now m.c. on *Take It Or Leave It*.

First 15 for Jan. 15-21, 1936 were: Major Bowes, 45.2; Rudy Vallee, 28.2; Jack Benny 26.8; *March of Time*, 23.5; Burns and Allen, 23.0; *Amos and Andy*, 22.6; Fred Allen, 22.2; *First Nighter*, 22.2; *Show Boat*, 21.1; *Shell Chateau*, 20.9; Phil Baker, 20.4; *Believe It Or Not*, 19.6; Walter Winchell, 19.2; Boake Carter, 17.5; *Radio Theatre*, 16.3.

Two of the current first 15 who were on the air but not among the top 15 ten years ago are Eddie Cantor, who then rated 16.1, and Fibber McGee, 6.6.

Joske Group To Meet

JOSKE Radio Advisory Committee of the NAB will meet Feb. 11-12 in Washington to discuss the pattern to be followed in drawing up a report on the 12-month radio test conducted by Joskes of Texas, San Antonio department store. Preparation of the report has been started in a preliminary way by Lee Hart, NAB assistant director of broadcast advertising, who was radio director of the store before joining NAB. Chairman of the committee is Cecil Beaver, WOAI San Antonio. Other members are Walter Johnson, WTIC Hartford; Arthur Hull Hayes, WABC New York; Lewis H. Avery, of Lewis H. Avery Inc.

PROFESSIONAL DIRECTORY

JANSKY & BAILEY
An Organization of
Qualified Radio Engineers
 DEDICATED TO THE
SERVICE OF BROADCASTING
 National Press Bldg., Wash., D. C.

McNARY & WRATHALL
 CONSULTING RADIO ENGINEERS
 National Press Bldg. DI. 1205
 Washington, D. C.

PAUL GODLEY CO.
Consulting Radio Engineers
 LABS: GREAT NOTCH, N.J.
 OFFS: UPPER MONTCLAIR, N.J.
 Phone: MONTCLAIR 2-7859

GEORGE C. DAVIS
 Consulting Radio Engineer
 Munsey Bldg. District 8456
 Washington, D. C.

 Radio Engineering Consultants
 Frequency Monitoring
Commercial Radio Equip. Co.
 • International Building, Washington, D. C.
 • 321 E. Gregory Boulevard, Kansas City, Mo.
 • Cross Roads of the World, Hollywood, Calif.

RING & CLARK
 Consulting Radio Engineers
 WASHINGTON, D. C.
 Munsey Bldg. • Republic 2347

There is no substitute for experience
GLENN D. GILLET
 Consulting Radio Engineer
 982 National Press Bldg.
 Washington, D. C.

JOHN BARRON
 Consulting Radio Engineers
 Specializing in Broadcast and
 Allocation Engineering
 Earle Building, Washington 4, D. C.
 Telephone NATIONAL 7757

RAYMOND M. WILMOTTE
 CONSULTING RADIO ENGINEER
PAUL A. deMARS
 ASSOCIATE
 1469 Church St., N.W., Washington 5, D. C.
 Decatur 1234

 **JOHN J. CONSULTING**
RADIO
ENGINEER
 EARLE BLDG., WASHINGTON, D. C.
 NATIONAL 6513

LOHNES & CULVER
 CONSULTING RADIO ENGINEERS
 Munsey Bldg. • District 8215
 Washington 4, D. C.

Frank H. McIntosh
 Consulting Radio Engineers
 710 14th St. N.W. ME. 4477
 Washington, D. C.

MAY and BOND
 CONSULTING RADIO ENGINEERS
 ★ ★ ★
 1422 F St., N.W., Wash. 4, D. C.
 Kellogg Bldg. • Republic 3984

HAROLD B. ROTHROCK
 Consulting Radio Engineer
 •
 301 N. Greenbrier St.
 Arlington, Va.
 Chestnut 2267

Garo W. Ray
 Consulting Radio Engineers
 991 Broad St., Suite 9-11
 Bridgeport 3, Conn.
 Telephone 5-2055 Lab. Phone 7-2465

LENT and POAST
 CONSULTING ENGINEERS
 WASHINGTON, D. C.
 1319 F ST., N. W. DISTRICT 4127

HERBERT L. WILSON
 AND ASSOCIATES
 CONSULTING RADIO ENGINEERS
 AM FM TELEVISION FACSIMILE
 1018 VERMONT AVE., N.W., WASHINGTON 5, D.C.
 NATIONAL 7161

HOLEY & HILLEGAS
 CONSULTING RADIO ENGINEERS
 1146 Briarcliff Pl., N.E.
 Atlanta, Ga. ATwood 3328

ANDREW CO.
 Consulting Radio Engineers
 363 E. 75th St. CHICAGO 19
 Triangle 4400

GOMER L. DAVIES
 Consulting Radio Engineer
 P. O. Box 71 Warfield 9089
 College Park, Md.

DIXIE B. McKEY
 ROBERT C. SHAW
 CONSULTING
 RADIO ENGINEERS
 1108 16th Street N. W. Suite 405
 Washington, D. C. NAational 6982

WELDON & CARR
 CONSULTING RADIO ENGINEERS
 WASHINGTON, D. C.
 1605 CONNECTICUT AVENUE
 PHONE-MICHIGAN 4151

CHAMBERS & GARRISON
 Consulting Radio Engineers
 1519 Connecticut Avenue
 WASHINGTON 6, D. C.
 Columbia 8544

CONSULTING RADIO ENGINEERS
EQUIPMENT ENGINEERING CO.
 RADIO BROADCAST CONSULTANTS SINCE 1939
 COLORADO BUILDING • WASHINGTON, 5, D.C.
 600 PICKENS ST. • COLUMBIA, 19, S.C.

KEAR & KENNEDY
 Consulting Radio Engineers
 1703 K St. N.W. REpublic 1951
 Washington, D. C.

Universal Research Laboratories
 ROYAL V. HOWARD, Director
 1 NOB HILL CIRCLE
 Pine & Mason Streets
 SAN FRANCISCO
 DOUGLAS 5380
 A Division of Universal Broadcasting Company
 Radio Engineering Consultants

A. EARL CULLUM, JR.
 CONSULTING RADIO ENGINEERS
 HIGHLAND PARK VILLAGE
 DALLAS, TEXAS

ROBERT L. WEEKS
 CONSULTING ELECTRICAL ENGINEER
 429 Russ Bldg.
 San Francisco, California

Colton & Foss, Inc.
 Electronic Consultants
 • WASHINGTON, D. C. •
 927 15th Street NW, REpublic 3883

John Creutz
 Consulting Radio Engineer
 328 Bond Bldg. REpublic 2151
 Washington, D. C.

Broadcast - Allocation & Field Service
GILLE BROS.
 CONSULTING RADIO ENGINEERS
 1108 Lillian Way Phone: GLadstone 6178
 HOLLYWOOD 38, CALIF.

WILLIAM E. BENNS
 Consulting
 Radio Engineer
COLUMBIA, SOUTH CAROLINA
 830 Gregg St. Phone 7342

H. V. Anderson
 AND ASSOCIATES
 • Consulting Radio Engineers
 715 American Bank Bldg. Tel. RAYmond 0111
 New Orleans 12, Louisiana

RITCH & GWALTNEY
 CONSULTING RADIO ENGINEERS
 Box 5222
 State College Station
 Raleigh, N. C.

GUY C. HUTCHESON
 CONSULTING RADIO ENGINEER
 811 N. SYCAMORE ST.
 PALESTINE, TEXAS
 PHONE-739

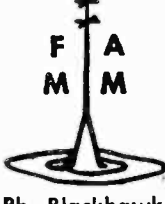
 **NATHAN WILLIAMS**
 Allocation & Field
 Engineering
 20 Algoma Blvd.
 Oshkosh, Wis.
 Ph: Blackhawk 22

Classified Advertisements

PAYABLE IN ADVANCE—Checks and money orders only—Minimum \$1.00.
Situation Wanted 10c per word. All others, 15c per word. Count 3 words for blind box number. Deadline two weeks preceding issue date. Send box replies to Broadcasting Magazine, 870 National Press Bldg., Washington 4, D. C.

Help Wanted

Combination announcer-control operator at Rocky Mountain NBC affiliate. Send references, experience record, photo, transcription. Box 792, BROADCASTING.

Wanted—Chief engineer, 250 watt CBS station. Prefer man who is good announcer. Start fifty five dollars for forty four hours. Box 796, BROADCASTING.

Manager, chief engineer and station personnel for proposed station in deep south. Box 797, BROADCASTING.

Sales manager—for fastest growing independent radio station in an eastern metropolitan market. Unusual opportunity paying the right salary to the right man. Give experience, background and references in first letter including photo. Box 802, BROADCASTING.

Announcer—Experienced on control board; remotes; interviews; dependable; licensed men paid higher rate Great Lakes Area. Box 805, BROADCASTING.

Salesman—Middlewest station. Send full history, description, photograph. Experienced men only. Box 806, BROADCASTING.

Technician—Local station in middle-west. Non-union, but pay union scale or better. Box 807, BROADCASTING.

Program director for Mutual station who can build programs directed toward local community interest in southern locality. Man with announcing experience and first class ticket preferred as this is combination work. Salary \$45 per week. Box 816, BROADCASTING.

Wanted—Combination operator-announcer experience not necessary. State salary expected. Voice transcription will be requested. Box 817, BROADCASTING.

Announcer-operators. New ABC station in Twin Falls, Idaho wants quality announcers with first class tickets. Send audition disc and your complete story, including starting salary to Frank C. Carman, KUTA, Salt Lake City, Utah.

Wanted—Radio time salesman. Salary basis. Permanent. Also, A-1 announcer. Address Box 824, BROADCASTING.

Situations Wanted

Chief engineer seeks position with progressive station. Experienced in all phases of radio station operation, maintenance and installation. Past employers and associates testify to ability as the working kind of executive who gets a job done well. Box 544, BROADCASTING.

Station manager—Fully qualified in sales, programming and management. Successful background as ass't manager, program director, director of public relations, sales promotion. University graduate. Married, family. Best references. Box 675, BROADCASTING.

Lieutenant Colonel, 39, recently released after 4½ years desires connection with some progressive broadcast organization. Married, two children, college trained. Last 15 years in radio, administrative and technical including construction, installation and maintenance. First class broadcast license. Good references. Write for details. Box 767, BROADCASTING.

Program director. More than ten years experience network and local station production and as announcer, newscaster, actor. Plenty of "know-how" on programming. Good personnel man. Tops in public relations. Best recommendations. Family man. Veteran. Available for interview with station that believes in efficiency and good programming. Box 770, BROADCASTING.

If your station needs promotion and sales service on the west coast a young sales promotion representative is now ready to handle two stations only. Will specialize on accounts and agencies. Write Box 781, BROADCASTING.

Announcer—3 years experience. News, commercial, special events. Married, age 27, veteran. Now in Chicago. Box 783, BROADCASTING.

Situations Wanted (Cont'd)

Veteran. First class radio telephone license. Three years Army radio and Radar; fifteen years active licensed radio amateur. 36 years of age. Want work as a radio operator. Box 788, BROADCASTING.

Announcer-salesman. Ex-naval lieutenant; B.S. Bus. Admin.; sales experience; passed N. B. C. (N. Y.) announcers audition (Service). Desire to work into sales, business, promotion mgrship. Personnel profile and transcription on request. Box 789, BROADCASTING.

NBC newsman past 2¼ years. 50 kw and 250 w and net. experience totaling six years. Giving up job to returning vet. Announce-write news for sales-ability and showmanship. Box 794, BROADCASTING.

Veteran—First class engineer—announcer wants announcer-operator or transmitter engineer position. Experience in maintenance. Available March 1st. Box 798, BROADCASTING.

Former sports announcer who has just completed three years as a Marine Corps Officer is seeking a baseball contract. Complete details of past experience, audition transcription available upon request. Write Box 799, BROADCASTING.

Former program director recently released from the armed forces is seeking employment. College education, experience with large and small stations, excellent references. Complete details upon request. Write Box 800, BROADCASTING.

First class license—10 years experience, broadcast to 50 kw, laboratory design development audio, FM installations development. References available. Willing travel. Box 801, BROADCASTING.

Experienced station manager, formerly in charge of national representative major office, available. Background includes all phases of local and national selling. Contacts excellent. References. Box 803, BROADCASTING.

Attorney—Exceptional record in law and as general sales and sales promotion manager of large national business organization. Desires to enter radio field in any phase where my background, experience and personal qualifications can be best utilized. Am young, personable, free to travel. Open to any interesting offers. Box 804, BROADCASTING.

Ex-Red Cross girl desires permanent position with small, progressive station east coast, educational and children's programs; writing; production; public relations. 3 years small station experience. Box 812, BROADCASTING.

Radio writer, producer, editor. Single. Knowledge German, French and English. Civilian and Army, educational and commercial experience. Seeks employment anywhere in or outside the United States. Box 813, BROADCASTING.

WANTED TO BUY

Transmitter (advise power, make, price, etc.).
Also, turntables, tower lighting equipment, monitors, etc.

Address

BOX 823, BROADCASTING

Situations Wanted (Cont'd)

Veteran desires break in announcing. Announced radio shows for Army. Amateur dramatic and writing experience. Box 814, BROADCASTING.

Commentator, producer, writer with CBS network experience in special features, talks and educational programs. Syndicate newspaper background, wrote front-page science news run in 200 papers. Non-fiction articles now appearing in two mass media magazines. Breezy style, fresh approach. Knows 4A agency problems from inside. Hard working, single, sober. Has contacts coast to coast among big names in politics, science and entertainment. Available March first. Will travel. Box 815, BROADCASTING.

Ex-prisoner of war desires sales position. Prior to the war was commercial manager of WLOF, Orlando, Florida. Thoroughly experienced in producing good solid business, in handling sales department, write good copy, handle remote programs and some engineering. Primarily interested in selling radio advertising. Ambitious, enthusiastic, hard working, executive ability. Thirty two years of age, married, have car. Box 818, BROADCASTING.

Announcer-producer. Experienced—have done news—special events. Excellent rating NBC (NY) announcers audition. Desire spot with future. Vet, young, family man. David Wolper, 42 Oakland Ave., Mt. Vernon, New York.

First class technicians available, some experienced in broadcasting. This is the former Midland Radio School with same management. Jerry Taylor president. Training period is one year and improved through our experience training 23,000 enlisted personnel. Our graduates can prove their value. Contact C. L. Foster, Central Radio School, 1644 Wyandotte, Kansas City, Mo.

Announcer. Veteran. Master's degree. Taught dramatics, English before war. Experience in well-operated radio station. Desire announcing and/or writing position southern station. Superior to average announcer. Transcription available. John Timmerman, 306 Bluff Ave., N. Augusta, S. C. Telephone 2-6922, Augusta, Ga.

Program director-announcer. Veteran. College grad, six years network and experience desires position network, agency or independent. Thorough training in radio production and publicity. NBC training in television production. Hal Lawrence, 500 Riverside Drive, New York 27, N. Y.

Veteran, with some acting, announcing experience, good voice, personality and appearance wants small station—will travel. Definitely not a floater! Ambitious, salary secondary importance. Audition disc available. John Ferriss, Hartsdale Gardens, Hartsdale, New York.

Play by play—Experienced news and special events. Program director. Veteran—married. Desire opportunity to assist station manager. Excellent references. Eight years civilian experience—2½ years overseas experience. Jack Martin, 187 Pulaski St., Brooklyn 6, N. Y.

Time salesman—Veteran, advertising degree. Four years experience in selling. Three years experience Army announcing. Desire connection with radio station or radio representative. Ambitious. Energetic, New York City or Conn. Adolph M. DiGloia, 3004 Cruger Ave., Bronx 67, New York.

WANTED! PROMOTION- PUBLICITY MANAGER

A 50,000-watt network-affiliated station in a major Southern market will enjoy hearing from an experienced sales promotion-publicity man who appreciates full rein, opportunity for advancement, alert management, and a generous budget to invest. Write fully in strictest confidence.

BOX 808, BROADCASTING

Situations Wanted (Cont'd)

Radio engineer—27, first class phone and telegraph licenses; CREI graduate. 8 years experience Marine telegraph operator and maintenance. Desire station in west or south. Edward Soltexz, 681 S. Burlington Ave., Los Angeles 5.

News-publicity-news writer, editor, announcer, licensed operator, New York experience, journalism degree, Army public relations, AFN duty. Will travel anywhere. Raymond Adams, 50 Washington Ave., North Plainfield, N. J.

Radio sales—Marine captain; journalism graduate; can sell anywhere in United States. Ambitious, future of position important, salary unimportant; advertising agency background. Best references. Available immediately. 26, married. Robert P. Schroeder, 5858 Delor St., St. Louis, Mo.

Vet—Announcing, publicity and selling background. Pre-war and Army experience. Willing to travel anywhere. College graduate. Edward L. Levenson, 734 Montgomery St., Brooklyn 13, New York.

Radio Technical USNR graduate radio materiel school, 18 months maintaining communications and radar equipment. Radio Pkane first class license. Desire connection with broadcasting station. Raymond Benton Harrell, 605 Clark Blvd., Murfreesboro, Tenn.

Engineer—1st phone, second telegraph, 16 months network station. Good references, can go anywhere. Available Feb. 15th, all offers considered. Walden P. McKim, 1616 6th Ave., Bessemer, Ala.

Engineer, 24, veteran, 3 years broadcast experience, holder of 1st phone. Maintenance and operating experience of studio, control room and transmitters up to 100 kw. Prefer midwest. Box 820, BROADCASTING.

Continuity writer desires to make change. Can also do women's show and announcing. Box 821, BROADCASTING.

Progressive young man (28), veteran, of exceptional ability and experience can help your station grow as announcer, salesman, musical director. Formerly NBC, N. Y. Box 822, BROADCASTING.

**RUSS
HODGES
IS
MOVING
UPSTAIRS**



Can YOU fill his shoes?

The New York Yankees have signed our Russ Hodges, ace WOL-Mutual sportscaster, to broadcast all their baseball AND football games this year, with Mel Allen. The kind of an offer Russ would have been crazy to refuse, so regretfully we urged him to accept it. We'll miss him.

That leaves us without a sports director at WOL, here in the nation's capital. If you're an up-and-coming sports announcer with a top-flight reputation and the stuff to fill those nationally-known Hodges shoes, send complete information—including transcription, photo and full history—to general manager Merle S. Jones, WOL, Washington, D. C.

Walker Asks Aid In FCC Problems

Addresses Dallas NAB Meet; Denver Group Names Terry

WITH new technological levels reached the big job now is to see that communications devices contribute to the greater security and comfort of all and bring higher levels of culture and civilization, FCC Commissioner Paul Walker told the NAB 13th District meeting Jan. 31 at the Baker Hotel, Dallas.

"No agency in the Government is faced with more crucial regulatory problems, with greater challenge than the FCC," Mr. Walker said. "We earnestly solicit the interest and cooperation of the broadcasters to the end that communications may become increasingly useful to all."

Hugh Terry, manager of KLZ Denver, was re-elected director of the NAB 14th District at the meeting of association members in that area held Jan. 28-29 at the Brown Palace Hotel, Denver. Members from Colorado, Wyoming, Utah, Montana and Idaho attended.

Elimination of cow-catcher and hitch-hike announcements was proposed in a resolution passed by the district. Other resolutions favored creation of periodic news clinics such as those started in December

Situations Wanted (Cont'd)

Continuity writer, 1½ years with CBS doing every type of script; specializing in dramatic, comedy, musical. Previously newspaper reporter and professional magazine writer for ten years. Navy combat veteran. Prefer spot on west coast. Harold Zimmer, 6843 Scanlan Ave., (9), St. Louis, Mo.

For Sale

Majority interest in Florida station. Will deal only with principals. Give financial references. Box 765, BROADCASTING.

For sale—Highest offer takes a 250 watt RCA type 250-E transmitter with tubes and crystal unit and a 250 foot Blaw-Knox vertical radiator complete with lighting equipment. Ready to ship immediately. Box 772, BROADCASTING.

For Sale—A large interest in midwest 250 watt network affiliate, large metropolitan market. Excellent gross figures and audience ratings make this an exceptional investment. Cash buyers only. Box 809, BROADCASTING.

Armour 50 wire recorder playback; four spools wire; microphone; used, good condition; \$400.00 Two Amertype Recordgraph embossed film recorder playbacks; new, \$500.00 each with microphone, accessories, 50 rolls film. RCA MI-4875 vertical lateral pickup, arm, filter, switch, new, \$110.00. Western Electric 9A vertical lateral pickup, filter, switch; used one hour, \$100.00. Box 810, BROADCASTING.

Brand new Federal Communications Commission approved Temco 250 watt broadcasting transmitter ready for immediate delivery. Excellent opportunity to save money on your new transmitter equipment. Box 811, BROADCASTING.

For Sale—Two used Western Electric turntables complete with lateral and vertical pickups. KRLC, Lewiston, Idaho.

Immediate delivery. New Presto #6-N Recorder complete in portable carrying case. Also, new Gates transcription turntable in cabinet. Also, slightly used RCA OP-5. Write Box 819, BROADCASTING.

Wanted to Buy

Veterans desire 250 or 1000 watt broadcast transmitter and studio equipment. Box 795, BROADCASTING.

Miscellaneous

Gags! Comedy! Free catalog. Box 616, BROADCASTING.



MOUNTAIN members of NAB gathered at 14th District meeting in Denver. Left to right: Rex Howell, KFHH; Robert Dean, KOTA; Lloyd Yoder, KOA (in shadow); Gov. John C. Vivian of Colorado, speaker at meeting; Ed Yocum, KGH; Gene O'Fallon, KFEL; Hugh Terry, KLZ (re-elected district director).

by the NAB News Committee; passage of Federal legislation for uniform time, and a permanent Broadcast Measurement Bureau.

Gov. John C. Vivian, of Colorado, told delegates that radio will be the most important factor in the postwar economic and social development of the Intra-Mountain States.

President Justin Miller and Secretary-Treasurer C. E. Arney Jr. discussed current industry problems, ranging from music to employee relations. Frank E. Pellegrin, director of broadcast advertising, discussed advertising and promotion work of the NAB. Hugh Feltis, BMB president, reviewed progress of the measurement project. Burt Squires, SESAC, Los Angeles; Ralph Wentworth, BMI, New York; Gus Hagenah, Standard Radio, Chicago, and Frank Chizzini, NBC Radio Recording, Chicago, spoke on the music question.

Walter Wagstaff, KIDO Boise, presided over the public relations discussion. Robert Owen, KOA Denver, was chairman of the engineering meeting. Ralph Hardy, KSL Salt Lake City, took charge of programming reports, and William Grove, KFBC Cheyenne, directed the sales managers clinic. R. L. Rickenbaugh, Cadillac auto advertising and merchandising executive from Detroit and Denver, discussed selling and reconversion. Denver station executives were hosts at a dinner party at Broadmoor Country Club.

Registered at the Denver meeting were:

Gene Ackerley, KID; C. E. Arney, NAB; Tom Atherstone, KFEL; Lewis H. Avery, Lewis Avery & Co.; David Bain, RCA; Frank K. Baker, KDYL; John Baldwin, KDYL; Maxson I. Bevans, KGHF; Ben Bezoff, KMYR; Frank Bishop, KFEL; Del Brandt, KPOW; Melvin Brorby, Needham, Louis & Brorby; Joe B. Carrigan, KWFT; Jim Carroll, KWYO; Frank E. Chizzini, NBC Radio Recording; Frank Conrad, ABC; V. W. Corbett, KVOD; H. L. Corley, H. L. Corley Jr.; Charles Crabtree, Radio Sales Co.; Mark C. Crandall, KFEL; Lowry Crites, General Mills.

Robert J. Dean, KOTA; Glenn Dolberg, BMI; Ward Dorrell, C. E. Hooper; T. C. Ekrem, KVOD; Hugh Feltis, BMB; Earle C. Ferguson, KOA; Henry H. Fletcher, KSEI; W. F. Flinn, KRJF; Frank Flynn, KFBC; E. S. Foster, AP; Mrs. Mildred Fuller, KFXJ; Florence M. Gardner, KTFI; A. L. Glasman, KLO; Paul O. Godt, KFEL; Wm. C. Grove, KFBC; W. Clark Grove, KFBC; Roscoe A. Grover, KSUB.

Gus Hagenah, Standard Radio; Donald Hathaway, KDFN; E. M. Halliday, KID; Mel Hallock, KWYO; Ralph W. Hardy, KSL; Ralph Hatcher, CBS; Carl Haverlin, MBS; Con Hecker, KVOD; Chas. Howell, KFXJ; Rex Howell, KFXJ; Frank E. Hurt, KFXD; George

A. Kercher, Edward Petry & Co.; Jack Weir Lewis, Rocky Mtn. Radio Council; Maury Long, BROADCASTING Magazine.

James R. MacPherson, KOA; Don McCaig, KFEL; Duncan A. McColl, KOA; H. L. McCracken, KQRS; Lynn A. McKinlay, KSL; Frank McLatchy, KSL; Arch L. Madsen, KSL; James A. Mahoney, Mutual; Don F. Martin, AP; Justin Miller, NAB; A. J. Meyer, KPOW; A. G. Meyer, KMYR; A. J. Meyer Jr., KPOW; Elwood Meyer, KMYR; Clarence C. Moore, KOA; A. J. Mosby, KGVO; Joe Myers, KFEL; Gene O'Fallon, KFEL; R. H. Owen, KOA.

Dolores Pleased, KMYR; Frank E. Pellegrin, NAB; Jennings Pierce, NBC; William D. Pyle, KVOD; O. P. Soule, KTFI; Everett Shupe, KVOR; Burt Squires, SESAC; Ben H. Stanton, KVOD; Lawrence Swars, Noble & Swars; Don Tannehill, KRJF; Hugh Terry, KLZ; Clifton A. Tolboe, KOVO; Walter Wagstaff, KIDO; Ralph C. Wentworth, BMI; Arthur K. White, KPOF; J. P. Wilkins, KFBB; Ed Yocum, KGH; Lloyd Yoder, KOA.

Broadcasting Leaders Attend Truman Lunch

DELEGATION of leading broadcasters attended a luncheon at the White House last Wednesday as guests of President Truman in connection with broadcasting's part in the March of Dimes project. Attending were A. D. Willard Jr., NAB executive vice president; Davidson Taylor, CBS vice president; Clarence Menser, NBC vice president; James D. Shouse, WLW Cincinnati; John Elmer, WCBM Baltimore; Clair R. McCollough, WGAL Lancaster; T. A. M. Craven, Cowles Broadcasting Co. Howard J. London, radio director of the drive, escorted the broadcast delegation. Unable to be present were Edgar Kobak, MBS president; Joseph O. Maland, WHO Des Moines, and Campbell Arnoux, WTAR Norfolk.

NAB District Meetings

- 12th District (Okla., Kan.), Tulsa Hotel, Tulsa, Feb. 4-5.
- 6th District (Ark., La., Miss., Tenn.), Peabody Hotel, Memphis, Feb. 7-8.
- 11th District (Minn., N. D., S. D., Wis., Mich., in part), Hotel Radisson, Minneapolis, March 18-19.
- 8th District (Mich. exc. 2 cos., Ind.), Pantlind Hotel, Grand Rapids, March 21-22.
- 9th District (Ill., Wis. in part) March 25-26, Palmer House, Chicago.
- 7th District (Ky., O.), Hotel Gibson, Cincinnati, March 28-29.
- 4th District (D. C., N. C., S. C., Va., W. Va.), Cavalier Hotel, Virginia Beach, Va., April 11-12.
- 2d District (N. Y., N. J.), Roosevelt Hotel, New York, April 25-26.
- 5th District (Ala., Fla., Ga., Puerto Rico), San Carlos Hotel, Pensacola, Fla., April 29-30.
- 1st District (Conn., Me., Mass., N. H., R. I., Vt.), Hotel Statler, Boston, May 13-14.
- 3d District (Del., Pa., Md.), Bellevue-Stratford Hotel, Philadelphia, May 17-18.

NAB Third Section Meetings Planned Last To Be Held May 16-17 In Philadelphia

THIRD section of the series of NAB district meetings has been scheduled by C. E. Arney Jr., secretary-treasurer, completing the lineup for the sessions that got under way Jan. 7 in Los Angeles.

Last meeting will be that of the 3d District, to be held May 16-17 in Philadelphia. Already held have been meetings in Districts 16 (So. Cal., Ariz., N. M.) at Los Angeles; 15 (No. Cal., Nev., Hawaii) at San Francisco; 17 (Wash., Ore., Alaska) at Seattle; 10 (Ia., Mo., Neb.) at Omaha; 14 (Col., Ida., Utah, Wyo., Mont., S. D. in part); 13 (Texas). Meetings of the 12th District (Kan., Okla.) at Tulsa Feb. 4-5 and the 6th District (Ark., La., Miss., Tenn.) at Memphis Feb. 7-8 will wind up the second leg.

Third leg will begin March 18 with the 11th District (Minn., N. D., S. D. in part, Wis. in part, Mich. in part), meeting in Minneapolis and continue with several breaks until all 17 districts have been covered.

Meetings just announced (see complete schedule below) follow:

4th District (D. C., N. C., S. C., Va., W. Va.), April 11-12, Cavalier Hotel, Virginia Beach, Va. (had been tentatively scheduled previously).

2d District (N. Y., N. J.) April 25-26, Roosevelt Hotel, New York.

5th District (Ala., Fla., Ga., Puerto Rico), April 29-30, San Carlos Hotel, Pensacola, Fla.

1st District (Conn., Me., Mass., N. H., R. I., Vt.), May 13-14, Hotel Statler, Boston.

3d District (Del., Pa., Md.), May 16-17, Bellevue-Stratford Hotel, Philadelphia.

Fishing Dramas

LEO J. PAULIN & Assoc., Washington, D. C., announced last week they had completed a series of 13 open-end transcribed programs for the National Fisheries Institute. Titled "From the Waters," the programs feature Dennis Connell, Washington actor, and Joan Winters Paulin in dramatizations of various phases of the fishing industry. Sea songs also are included. Programs are for local sponsorship by members of the Institute and others.

Color Video

(Continued from page 20)

C. Miner, manager of CBS television department, who conducted the demonstration, stressed that "virtually every element of the complete system used for this demonstration—the film scanner, the cable between here and the Chrysler tower, the Federal transmitter, the receiving antenna and the receiver itself—all were developed, built and installed in the five-month period since V-J Day."

Mr. Miner said the Federal transmitter, of commercial design, at 490 mc "gives a signal four times as strong as any television transmitter operating in the New York area today, and with one-fifth the power because the ultra-high frequencies are inherently more efficient than the lower frequencies." This transmitter, he said, "shows the present reasonability of wide-band television transmission on the ultra-high frequencies with equipment and power suitable for commercial operation."

As proof of the freedom of the ultra-high frequency signals from the interference of multi-path reflections, commonly called "ghosts," Dr. Goldmark had the receiving antenna rotated around the full 360-degree circle, sometimes losing the image on the receiver screen but getting ghost images only when the antenna was directed at points away from the transmitter. Even when the signals were received by reflection from other buildings they were clear and free from any distortion, a result he said would be impossible at the lower frequencies without using a receiving antenna 60 feet long.

Questioned about reception at points more distant from the transmitter, Dr. Goldmark said he could not answer definitely as tests are just getting under way. He said signals of a transmitter operating continuously on 700 mc are being recorded at a number of automatic receiving points between New York and New Orleans to provide a record of the long distant effect of UHF signals, but that no data are yet available.

Cost to Come Down

Reminding the group that CBS had demonstrated live pickups in color on the low video frequencies before the war, Mr. Miner said the present demonstration did not include them because equipment to operate in the higher frequencies has not been completed. He said it should be ready by May, adding that it will not be a laboratory apparatus but commercial equipment.

Questioned about the cost of the Federal transmitter, Dr. Goldmark said this first one cost CBS \$130,000. He pointed out, however, that this was less than the network paid to RCA for its first black-and-white video transmitter, predicting that the cost would fall rapidly when the UHF transmitters are put into regular production and ex-

New York Video Stations Will Be Off Air for Reconversion

WHEN VIDEO Stations WCBW (CBS) and WNBT (NBC) sign off March 1 to convert their transmitters and antennas for operation at the new frequencies assigned them by the FCC, New York teletest owners may find themselves without television program service. The hiatus will not be for long, however, as WABD (Du Mont) which began its conversion in the fall, hopes to return to the air with programs from its new studios in the Wanamaker store early in March.

CBS engineers estimate that it will take them from three weeks to a month to change the radio frequency stages from the old frequency, 60-66 mc, to the new one, 54-60 mc, and to make the alterations required in the transmitter's inductances and capacitors. The transmitting antenna will also have to be lengthened somewhat for the new frequency, they said.

NBC reported that to change WNBT from its present frequency of 50-56 mc to the newly assigned one of 66-72 mc requires scrapping

the old transmitter and replacing it with a new one. NBC engineers hope to get back on the air the first week in April, probably with temporary equipment as they do not expect the permanent video transmitter to be finished by then.

Changing the transmitter frequencies necessitates changes at the receiving end also, so that the 4,000 video receivers in the New York area can receive the programs on the new frequencies. For DuMont, whose station shifted only slightly, from 78-84 mc to 76-82 mc, the adjustment can be made with a screwdriver, it was said, but it will be a major repair job, involving the replacement of coils, to retune the receivers for NBC and CBS television programs.

Adding to the difficulties of the changeover is the fact that the receivers cannot be finally tuned until the new transmitters are on the air with test patterns, so the receiver conversion cannot be completed during the programless period.

pressing the belief that color transmitters will be less expensive than black-and-white ones. The UHF transmitter weighs only a third as much as that of WCBW, CBS video station on the lower frequencies, he said, adding that weight is a fair yardstick of the relative cost in large-scale production.

On color receiver costs, Adrian Murphy, CBS vice president, reported that estimates made by many receiver manufacturers average about 10 to 15% more than black-and-white sets. General Electric Co. is making some color receivers now, he said, but at custom-made prices as they are not on a production basis. Mr. Murphy said many manufacturers have been holding back, waiting for the CBS demonstration and that when they have seen it they will make equipment for broadcasting and receiving color pictures on UHF.

Emphasizing this point, Dr. Goldmark said most of the industry criticism of UHF and color was based on disbelief that CBS could make good on its promises. Now that CBS has shown what it can do, the industry may change, he said. Prospective video broadcasters have shown special interest in UHF, Dr. Goldmark stated, pointing out that the 13 channels available in the lower frequencies will not take care of all the applications for video stations, while there is much more room available in the 20 UHF channels.

Advertisers Interested

Mr. Miner pointed out that not only broadcasters but advertisers were greatly interested in what CBS has to show, stating that a number of advertisers had told him they would not be interested in

using television until it will show their products in full color.

Mr. Miner declared color would make television easier to sell to the public and that color and UHF in combination would remove the "constant, haunting fear of obsolescence." By obsolescence, he said, "we don't mean the normal year by year diminishing usefulness, such as you get in an automobile or a refrigerator. We mean the complete destruction of the usefulness of a television receiver, virtually overnight, as a result of a basic change of standard."

Citing again the progress made since V-J Day "by a fraction of the industry" and predicting that the picture demonstrated now is "something less than half as good as it will be in six months," Mr. Miner declared: "We believe that with the entire industry putting its shoulder to the wheel, ultra-high frequency black-and-white and color can be made available to the public by early next year." He added: "That is a brief six months behind the promises now made for delivery of low-frequency black-and-white equipment by even the most optimistic manufacturers."

Opens Own Agency

ROBERT F. BRANCH, supervisor of Coca-Cola account with D'Arcy Adv., New York, until his recent resignation, has opened his own agency, Robert F. Branch Inc., at 1246 Madison Ave., New York. Present location is temporary. For two years colonel in Office of Commanding General, Army Service Forces, Washington, Mr. Branch has been in New York and Chicago advertising and business management fields for 20 years.

LENT & POAST FORM ENGINEERING FIRM



Mr. Lent



Mr. Poast

FORMATION of the new engineering consulting firm, Lent & Poast, with headquarters in Washington, was announced last week by Washington C. Lent, for two years a consulting engineer.

LaVerne M. Poast, associated with Mr. Lent for past year and a half except for an interim period when he was a member of the wave propagation group of the Division of War Research, Columbia U., and on loan to the Communications Liaison Branch, Office of the Chief Signal Officer, U. S. Army, will be Mr. Lent's partner.

Mr. Poast was graduated from the U. of Wisconsin with a degree in electrical engineering in 1935. For the next four years he was associated with Jansky & Bailey, Washington engineering firm. In 1939-40 he did graduate study in communications engineering at Ohio State U., returning to Jansky & Bailey. At the outbreak of war he joined the Radio Section, Bureau of Standards and headed a group in direction finding research and correlation of high frequency ionospheric wave propagation.

Mr. Lent, before entering private practice two years ago, was engineer in charge of the Washington Division, RCA Frequency Bureau, and NBC director of Facilities Development and Research. Lent & Poast will expand their offices in the International Bldg., 1319 F St. N.W.

Service Challenge

QUESTION of whether radio will continue to be principally a medium of entertainment and advertising or will add more vitally needed public services was posed in a challenge Jan. 30 by FCC Chairman Paul A. Porter to graduating class of Southeastern U. School of Radio Technique, Washington. As guest speaker at exercises Mr. Porter briefly outlined purposes and objectives of the FCC stating that he believed no agency should exercise program control. Saying that many broadcasters still believe the Commission should function merely as a "traffic cop" over physical facilities, Mr. Porter, however, did point to a responsibility of seeing that the contents of broadcast traffic reflect a standard in measure with the type of service the art can bring to listeners. Southeastern radio school is headed by Al Porter, account executive with Lewis Adv., Washington.

Propaganda

(Continued from page 20)

while continued to furnish news, while its executives studied the problem.

An attempt by BROADCASTING to elicit from the combatants an indication of future battle-lines produced dismal results. The one press association in a talkative mood was Transradio Press, which stated its policy cogently: "Transradio service is available to any bonafide publication or radio broadcasting service anywhere in the world."

That was signed by Dixon Stewart, president. It was in response to the following questions, which were sent also to Mr. Baillie, Mr. McLean and Seymour Berkson, general manager, INS:

1. Do you believe that there should be shortwave broadcasts based upon news such as is developed by United States news services?

2. Would you sell your service to the State Dept. for use at its discretion in shortwave broadcasts?

3. Would you sell your service to shortwave stations under private operation for use at their discretion in shortwave broadcasts?

4. Would you sell your service to shortwave stations for use at their discretion in shortwave broadcasts if the outlets were owned by private operators but leased and staffed by the Government?

5. Would you care to offer a suggestion for the solving of Government's problem—how to procure and broadcast news?

Mr. McLean had left Philadelphia for an extended trip before the questions reached him, his secretary reported. Kent Cooper, AP executive director, was on vacation. Mr. Baillie did not respond.

Berkson "Couldn't" Answer

Mr. Berkson said that he could not answer the questions because INS still was weighing the problem. He said a proposal was under study, upon which action would be taken this week, that would erase the pertinency of the questions.

Mr. Stewart answered yes to the first question. To the second, third and fourth, he replied that the service was available to any bonafide publication or radio broadcasting service. To the fifth—did Transradio have a plan for the Government and would Transradio disclose it—he replied: "Yes—if the Government requested."

The AP's current attitude probably is summed up in a statement made by Mr. McLean before the North Carolina Press Association Jan. 25: "It is not surprising . . . that our press associations and news agencies look with alarm on any association or connection with such a program (the State Dept.'s) no matter how many assurances are given to the contrary."

Mr. Baillie said for UP on Jan. 28: "We have seen it demonstrated that no government, no matter how scrupulously careful it may be, can distribute news and not be suspected of spreading propaganda."

On Jan. 31, John S. Knight—publisher of four newspapers, part owner of two radio stations and president of the American Society of Newspaper Editors—informed Mr. Benton that the ASNE stand-

HAL BOCK DIRECTS NBC COAST VIDEO

HAL BOCK, NBC Western Division publicity manager, has been named to the new post of NBC Hollywood television department manager [CLOSED CIRCUIT, Jan. 14]. Appointment was announced jointly by John F. Royal, New York television vice president, and Sidney N. Strotz, Western Division vice president.



Mr. Bock

Mr. Bock will act as liaison between NBC and motion picture producers in video programming. For the time being he will continue as director of Western Division public relations and act in a supervisory capacity in the press department. Leslie Raddatz, his assistant, is acting press manager. Richard Eisiminger, news editor, becomes assistant manager of that department.

Public relations director since last October, Mr. Bock rose from a newscasting role with NBC in San Francisco in 1933. In 1934 he was publicity director of KFRC San Francisco, resigning shortly to rejoin NBC as Hollywood publicity representative. In 1938 he was made Western Division press department manager. Before joining NBC he had been a reporter on the *Long Beach Sun* and BROADCASTING representative in San Francisco. Mr. Bock has just completed his first book, *It's a Living*, based on his radio experiences.

Petty Takes NAB Post

DON PETTY, recently retired by the Navy as a lieutenant commander, last Friday assumed his new post at the NAB as general counsel. He succeeds John Morgan Davis, who resigned Dec. 20 to devote his full time to law practice. Mr. Davis will spend part of his time at the NAB until the new general counsel becomes familiar with the office and he will represent NAB at Albuquerque Feb. 18 when the U. S. District Court, District of New Mexico, hears protest of broadcasters against imposition of the State's 1934 gross sales tax.

ing committee on world freedom of information would be glad to undertake a study of State Dept. informational activities abroad in view of the current controversy.

When Mr. Forrest, a member of this 11-man committee, made a "freedom of news" world tour in 1945, he traveled with Dean Carl Ackerman of the Columbia U. School of Journalism and Ralph McGill, publisher of the *Atlanta Journal*.

Dean Ackerman, not unexpectedly, is sympathetic with the AP-UP stand. Mr. McGill is not.

Room on Board

DEVIATING from average path of the Washington, D. C., mass of harassed house hunters, Natalie Towle, new music librarian of WWDC Washington, as last resort answered an unusual classified ad and now is "glad to be aboard" the *Tech*, a 150-ft yacht permanently anchored in the Potomac. Just 15 minutes from work, her quarters in a "palatial little 6x8 cabin" offer not only hot and cold running water and maid service but also a port hole view of the Jefferson Memorial. She has 10 neighbors on board and numerous others just a swim away.

Westinghouse Executive Denies Charges of CIO

CHARGES of Albert J. Fitzgerald, president of the United Electrical, Radio & Machine Workers of America (CIO), before the Senate Committee on Education & Labor that Westinghouse Electric Corp. paid low wages, refused to bargain with the union and withheld merchandise from the market were denied Friday by A. W. Robertson, chairman of the Westinghouse board, who appeared before the same committee.

He declared that Westinghouse wages compare favorably with those in its own industry, that it offered to bargain with the CIO, that it provides many employe benefits and that the company made an operating profit of \$464,925 in November 1945—the first since V-J Day, while union demands for a \$2 per day wage increase would cost the company \$3,750,000 monthly. Answering charges of the CIO that Westinghouse withheld appliances in 1945 to take advantage of the excess profits tax repeal, Mr. Robertson said Westinghouse moved most of its merchandise as rapidly as possible and that the union, "by the repetition of these false and misleading charges," places "in jeopardy the jobs of the very workers for whom the union has been designated as collective bargaining representative."

Mr. Robertson offered suggestions for labor legislation.

Forms New Agency

ADVERTISING Inc. of Washington, a new agency, has been started in the Capital by Henry Liebschutz, former owner of Creative Art Service and general manager of Home and Office Beautiful. Agency executive of enterprise will be Martin J. Baker, formerly account executive, Henry J. Kaufman and Assoc. Washington. Formal opening of new agency at its headquarters, 735 11th St., will be Feb. 18. Agency will buy radio and other media.

REQUESTS FOR TWO ASSIGNMENTS FILED

APPLICATIONS for two license assignments—one in the settlement of an estate and the other to a corporation with no change in ownership—were reported last Thursday by the FCC.

Dorrance D. Roderick, owner of KROD El Paso, applied for voluntary assignment of license to Roderick Broadcasting Corp., a new \$150,000 corporation in which he holds 99 13/15% interest, with Val Lawrence, majority stockholder of KAVE Carsbad, N. M., and Kelton B. Clark each holding 1/15 of 1% to comply with Texas law that a corporation be composed of at least three persons. Mr. Roderick has been granted a construction permit for KSIL Silver City, N. M., a standard station which is due for completion by May 30. He also has applied for a CP for a standard station at Pueblo, Col., and owns 64% of Southwestern Broadcasting Corp. which has an AM application for Odessa, Tex.

Ramon G. Patterson and Louise Patterson Pursley, partners with the late Joda Patterson in WAPO Broadcasting Service, Chattanooga, applied for assignment of the WAPO license to themselves as individuals and as executor and executrix of Mr. Patterson's estate.

UE Wage Agreement

WAGE INCREASE of 17½ cents an hour retroactive to Oct. 7 is provided in an agreement reached last week by RCA and United Electrical, Radio and Machine Workers (CIO). Affected are 8,000 employes at RCA's Camden plant. Union had asked for 25 cents an hour. The agreement, announced Jan. 27 by RCA President David Sarnoff and UE Organization Director James J. Matles subject to ratification by the local union, carries a no-strike clause and calls for six paid holidays. Labor authorities thought the agreement, reached without a strike although the union had filed a strike notice with the Labor Dept., might foreshadow early settlement of strikes of some 200,000 UE workers in plants of General Electric, Westinghouse and General Motors [BROADCASTING, Jan. 21]. On Friday, however, union and company authorities indicated settlement was not yet in sight.

Miss Cuthbert Honored

MARGARET CUTHBERT, director of programs for women and children in NBC public service department, has been cited by the Women's National Press Club as the outstanding woman in the radio field for the past year. Miss Cuthbert and nine other women cited in their respective fields will be honored at an Achievement Dinner Feb. 9 at the Hotel Mayflower in Washington. She was chosen especially for her program *Story to Order* on NBC and for her book *Adventures in Radio*, published this year.

At Deadline...

People

WASHINGTON VIDEO PICKUPS TO DEDICATE COAXIAL CABLE

FIRST Washington-New York Video transmission, inaugurating new AT&T coaxial cable link between cities, will occur Feb. 12, it was learned following conference held in Washington Friday. Telecast will be joint venture of AT&T, CBS, DuMont and NBC, all of whom will broadcast pooled program.

Plans call for opening pickup from Capitol with panoramic shots of that and neighboring buildings, switching then to Lincoln Memorial for ceremonies in which Gen. Eisenhower may participate.

It was definitely stated President Truman will not take part in program. President's "State of the Union" speech to Congress Jan. 14 was to have opened coaxial video transmission between Washington and New York but that was cancelled by his decision not to deliver message in person. The President is understood to be planning to leave for Florida Feb. 11.

At deadline it was not known whether DuMont's New York video station, WABD, which has been off the air while converting its transmitter for operation in newly-assigned frequency, will be able to broadcast Washington pickup in New York. However, it was understood program will be carried by DuMont's experimental television station in Washington.

OKLAHOMA U. INSTITUTE

ANNUAL Conference on Radio Station Problems will be held March 7-10 by U. of Oklahoma, at Norman, with Sherman P. Lawton, university radio coordinator, in charge. A. D. Willard Jr., NAB executive vice president, will speak at opening dinner March 7 on "Radio in Transition."

Closed Circuit

(Continued from page 4)

tor Bourne Ruthrauff (ex-Ruthrauff & Ryan) to get underway in late February. DuMont is handling shows. Starting date probably will be late February, two weeks after DuMont Washington video debut scheduled Feb. 12.

NAVY public relations officers staying up nights trying to plan press and radio coverage of impending atom bomb tests against fleet. Problem is where to place correspondents for eyewitness views of experiment without blowing them up. In view of current state of indecision, announcement of assignments of correspondents to cover event are premature.

NAB may have three-man Employee-Employer Relations Dept. minus big-name labor expert. Original plan conceived three-division unit, topped by prominent figure but latest thought is to have three working specialists. Milton J. Kibler, formerly NAB legalite, is now rounding up technician data. Ivar H. Peterson, from NLRB, joins any day now and will handle talent. Third member will likely handle music.

"COMMUNITY" stations is designation for small market outlets that is drawing favor around NAB district meeting circuit. "Small market" appellation is deemed bad from sales standpoint for stations under 5 kw in cities of less than 50,000.

DAYLIGHT TIME MOVEMENT DISCUSSED AT DALLAS

MOVEMENT to urge passage of legislation bringing about standardized time throughout country gained momentum as NAB 13th District meeting at Dallas passed a resolution seeking action by Congress. Meeting was held Thursday and Friday at Baker Hotel.

District urged NAB Research Committee to continue development of standards and technique of audience research, and advocated permanency for BMB.

Meeting was biggest yet, with 146 present from stations in Texas, which District 13 encompasses. Martin Campbell, WFAA, presided as district director. His term expires next year. Appointment of Justin Miller as NAB president was commended. Frank E. Pellegrin Jr., NAB director of broadcast advertising, reviewed developments in that field, including standard contracts, agency recognition and program checking system.

WOMEN'S NAB MEET

ASSOCIATION of Women Directors of NAB will hold third annual campaign conference March 15-17 at Roosevelt Hotel, New York. Alma Kitchell, WJZ commentator and association president, will preside. Theme will be "Women in Communicative Arts" and their part in developing an inforal public opinion. Saturday panel (March 17) will have Lisa Sergio, Mary Margaret McBride, Elsa Maxwell and Gertrude Berg discussing "How Does Radio Sell Ideas." Over 150 members of organization expected to attend.

ARMY TECHNICIAN DRIVE

ARMY Signal Corps recruiting civilians to take place of enlisted technicians stationed in Philippines, Japan and Korea. Appointments are for one year, with transportation both ways, and salaries from \$1.50 to \$1.70 per hour for 40-hour week, plus overtime and night work differential. Quarters and subsistence provided by Army at \$40 a month or less. Jobs cover radio, radar, telephone and other lines. Facts available at any U. S. Employment Service office or Signal Corps depot.

CBS Newsreel cameramen photographed funeral procession of Harry Hopkins in New York Friday afternoon, telecasting film during WCBW news program, 8-8:15 that evening.

ELMO ROPER, market consultant and public opinion analyst, speaks Feb. 5 on part played by research in selling before Sales Executives Club, of New York.

VIDEO SYMPTOM

VIDEO controversy over black-and-white versus color "is an unhealthy sign both for television and the public," *Fortune* magazine for February declares in an article "Television—A Case of War Neurosis." If basic problems go unsolved much longer, article states, "television could conceivably turn into the biggest and costliest flop in U. S. industrial history."

MAJ. ARNOLD F. SHOEN Jr., completing terminal leave from Army Air Forces Feb. 9, appointed local sales manager of WPRO Providence. He was service director of WSYR Syracuse before entering Army in 1941.

RUSS HODGES, WOL Washington sportscaster, goes to New York March 1 on long-term contract to air Yankee baseball on WINS (White Owl and Pabst beer) and Yankee professional football. He continues college football play-by-play for Mutual.

THOMAS VELOTTA, ABC director of special events, named director of news and special events, taking over duties of Richard L. Tobin, former ABC director of news, who returns to *New York Herald Tribune* in executive capacity. John Madigan continues as national news editor of ABC under Mr. Velotta.

RICHARD H. MOULTON, former staff assistant in personnel department, promoted to staff division manager, General Foods Sales Co. Gordon Van Ark, staff assistant in personnel administration department, succeeds Mr. Moulton.

PAUL MOWREY, manager of television division of ABC's Program Dept., last week began four-week tour to confer with agency executives in Detroit, Chicago, Los Angeles and San Francisco.

GARRY CARTER, managing director of Frontenac Broadcasting Agency, Toronto, forms package transcription company, Garry J. Carter & Assoc., in New York. Offices located with Charles Michelson Inc., at 67 W. 44th St.

PAUL BROWN, former head of Brown-Alexander Agency, joins new Gould & Kuff Agency, Baltimore.

SID SIDLEY resigns as commercial manager of KSFO San Francisco to open Radio Productions in Fairmont Hotel, San Francisco.

CAPT. FRANK DANZIG, chief of operations for American Forces Network in Europe, last week reported en route to U. S. due to death of his father. Capt. Danzig formerly was with CBS and New York stations WNEW, WHN and WMCA.

ED FITZGERALD, half of the team Ed & Pegeen Fitzgerald heard over WJZ New York, has compiled book of short stories called *Tales for Males* (Cadillac Publishing Co., New York, \$2).

LYLE VANN, former NBC newscaster, replaces William Lang as commentator on Kremlin news program on MBS five-weekly, 12 noon-12:15. Agency, Erwin, Wasey & Co., New York.

RALPH B. AUSTRIAN, executive vice president of RKO Television Corp., elected president, succeeding Fred Ullmann, who remains a director, but devotes full time to RKO Pathe.

RAYMOND KATZ, released from Navy after three years' service and prior to that daytime program supervisor of WHN New York, has been named program director of station.

LT. HENRY C. L. JOHNSON has returned to his post of advertising manager of radio division, Sylvania Electric Products, after three years' with Third and Fifth fleets in Pacific. He also will direct advertising and sales promotion of Sylvania's industrial electronics and international divisions.

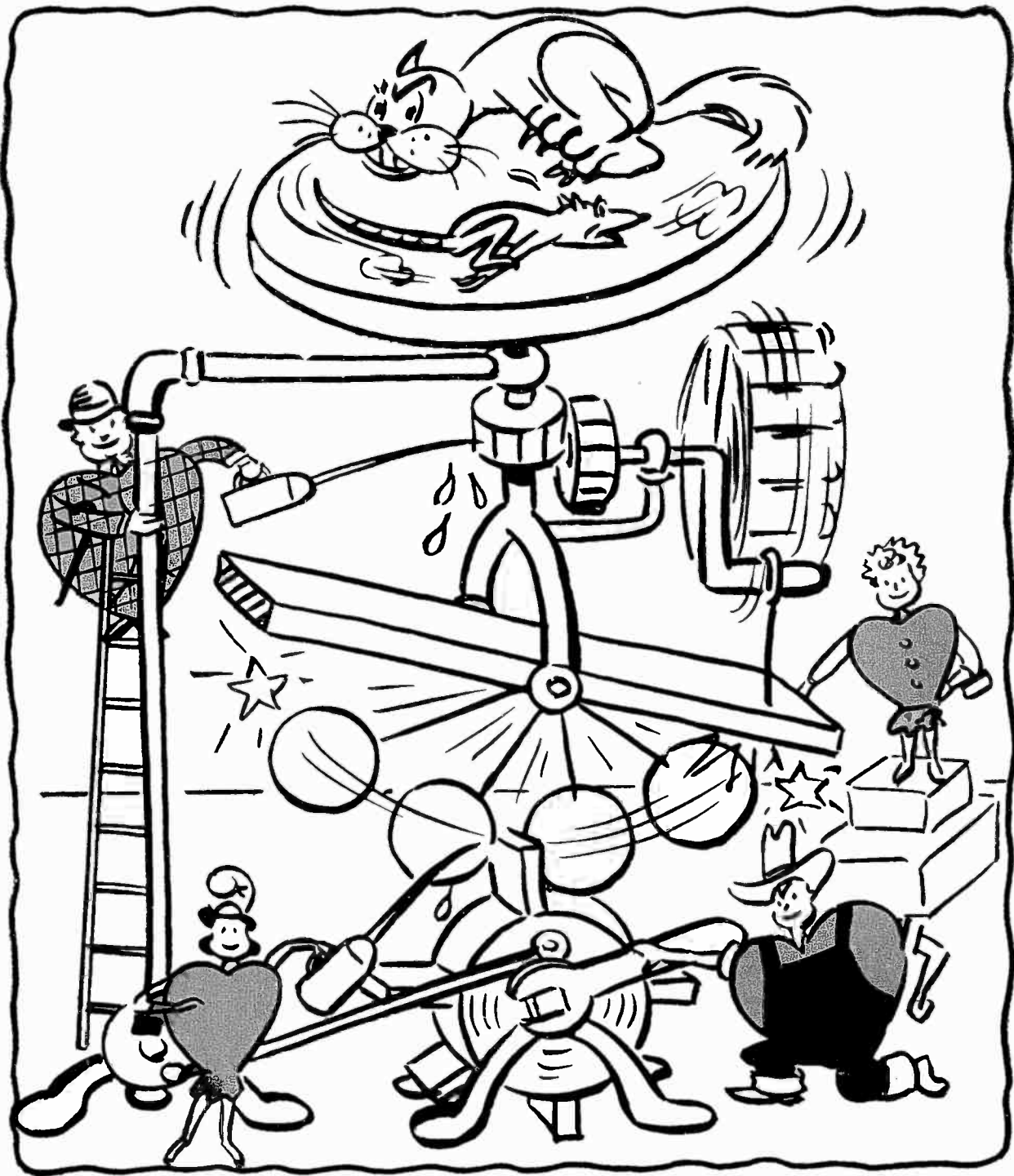

Eureka! It works!

There is such a thing as PERPETUAL proMOTION. At KMBC the wheels, without friction or wear, keep turning in the advertiser's behalf the year around. While the ink is still wet on the contract, PERPETUAL proMOTION takes over—utilizing time tested methods to win new friends and influence



listeners in the advertiser's behalf. Chances are —if you subscribe to KMBC's facilities, some evidence of PERPETUAL proMOTION is right now in the mails on the way to you.

KMBC

OF KANSAS CITY

FREE & PETERS, INC.

SINCE 1928—BASIC CBS STATION FOR MISSOURI AND KANSAS

KLZ

Denver

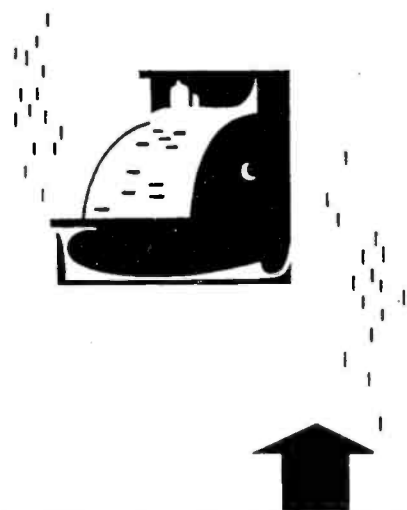

POWER YOU CAN FEEL... HERE

●
Affiliated in Management with the Oklahoma
Publishing Company and WKY, Oklahoma City
CBS—560 Kc.
REPRESENTED BY THE KATZ AGENCY

MORE ADVERTISERS—LOCAL AND NATIONAL—BUY MORE TIME ON KLZ THAN ON ANY OTHER DENVER STATION

PRINTED
IN
U.S.A.