

**PROGRAMMING KAWAI'S  
NEW K4**

# MUSIC

# TECHNOLOGY

FEBRUARY 1990 USA \$2.95 CANADA \$3.95

## **BACKSTAGE WITH THE ROLLING STONES**

### **ADVANCED SAMPLING**

*The Ultimate Loops*

### **STARR PARODI**

*Jamming with Arsenio Hall*

### **JEAN-LUC PONTY**

*New Stories from The Zeta Master*

### **REVIEWS**

*Roland Rhodes MK-80*



*Kawai K4  
Korg M3R  
Ensoniq VFXSD  
Steinberg Cubase*

# SIMPLE MIDI SOLUTIONS

## APPLICATIONS...

**MERGE** two MIDI cables into one. **FILTER** out unwanted MIDI information. Add real-time **PEDAL** control over any MIDI signal. Convert one MIDI OUT to three MIDI **IN**s. **RECORD** and play back any MIDI information including System Exclusive. **TRANPOSE** your entire MIDI system in real time. **SPLIT** any keyboard to transmit on eight separate channels. Remap any receive and transmit **CHANNEL**. Send and filter all notes off with a **PANIC**. **SYNC** and chase-lock to tape. Interface 2 merging inputs to an Apple Macintosh® with **PLUS**. Create and edit MIDI tracks with **SEQUENCER**.



## Pocket Products™

Bridge the gap between technology and creativity! These performance MIDI accessories are powerful, simple and affordable tools for today's musician. If you own any MIDI equipment, a Pocket Product™ will enhance your creative potential. Ask your Anatek dealer for a demonstration!

SEE US AT  
WINTER NAMM  
BOOTH #2631

© 1990 Anatek Microelectronics, Inc.

Anatek and Anatek logo are registered trademarks of Anatek Microelectronics, Inc.

**ANATEK**®

Music Products Division  
401 Robsonbank Avenue  
North Vancouver, B.C. Canada V7J 1G9  
Tel: (604) 980-6859 Fax: (604) 980-2722

# KeyLighting™



KEYBOARDS



CONSOLES

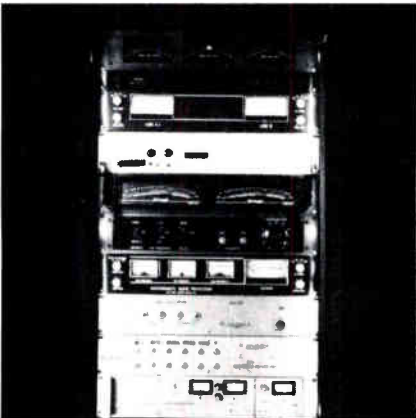

RACKS (large and small)



SEQUENCERS

Equipment shown lit by KEYLIGHTING™ ONLY



**KeyLighting** is the complete performance light system designed to light any piece of musical equipment so you can see to make program or control changes while playing or working on your equipment when insufficient light or shadows exists.

### KeyLighting:

- ◇ Lights your entire keyboard(s). Fits all single and multi-tiered stands.
- ◇ Lights up your entire equipment rack, top to bottom, front and back. Fits any size rack.
- ◇ Fits all drum machines, computers, sound and light consoles.
- ◇ Eliminates the need for flash lights, matches, cigarette lighters.
- ◇ Eliminates dark spots, shadows and glare.
- ◇ Dual light mode provides for a performance and work mode.
- ◇ Installs in seconds. No tools required.
- ◇ Low voltage operation.
- ◇ 75,000-hour lamp life replaceable.
- ◇ Will adapt to fit any configuration.
- ◇ 2-year warranty on all components.

## YOU OWE IT TO YOURSELF TO INVESTIGATE KEYLIGHTING NOW!

Ask your dealer or call us. We'll be glad to help you discover why **KeyLighting** is going to be your complete equipment lighting system for the '90s.

Distributed exclusively by:  
**KEYLIGHTING, LTD.**  
 P.O. Box 7451, Mission Hills, CA 91346.  
 Telephone: (818) 886-5558





## WHAT?!

"WHAT DID YOU SAY?!! I CAN'T HEAR YOU! THE MUSIC'S TOO LOUD!! CAN YOU READ MY LIPS?!!! WHAT?!!!!"

I *hate* when that happens! As the editor of a national music magazine, I get invited to a lot of concerts, which is great. What's not so great is the fact that, all too often, the volume level of the performance is painfully loud. I mean pushing the 120dB threshold of pain. Why does it have to be so #@?! *loud*?

Now, don't get me wrong. I've played in plenty of loud rock bands in my time (which has probably resulted in some permanent hearing loss), and I like to listen to my car stereo cranked up (perhaps *because* of the hearing loss!). Also, recording engineers usually listen to their monitors at high volume levels in order to enhance the definition and detail of the sound. However, the volume levels at several concerts I've attended recently have reached a truly painful level and been sustained beyond bearing.

For example, elsewhere in this issue, you'll read interviews with three members of the Rolling Stones conducted backstage at their L.A. concert appearance. Again, don't get me wrong. I *wanted* to see that concert. It was a *great* concert! And, I knew that it would be extremely *loud* as well – so I brought ear plugs specifically designed to reduce the sound pressure level by 26db.

I decided to see how long it would take before I had to put the plugs in. It was after the third song – and they played for over two hours after that! The plugs worked adequately to abate the volume, but they distorted the frequency spectrum unevenly. I suppose that there are higher tech ear plugs with a flatter frequency response, but why should that even be necessary at a concert (if you're concerned about protecting your hearing)?

I suppose one explanation could be that high volume forces the audience to pay attention. On the other hand, I remember going to a concert in my college days

that opened with Link Wray (remember him?), who was *excruciatingly* loud. And yet, a girl behind me was dead asleep (or dead – I wasn't quite sure).

This brings up another consideration – the psychoacoustical and physioacoustical effects. These effects are evident in our perception and response to sound. For example, it's known that the brain begins to perceive frequencies that aren't present in a sound as it grows beyond a certain volume level. The sound becomes "brighter" and "harsher" according to experimental subjects. There's also the almost physical effect of very loud low frequencies – they seem to vibrate within your entire body as if you were resonating with them. Are these effects being used to enhance the intensity of the concert experience? Does high volume heighten the emotional impact of music?

Or is it the sense of rebellion so endemic to rock 'n' roll? Who among us have never heard our parents say, "Turn that music down!" And who among us didn't want to turn it up even louder? Are the groups who play at these extreme volume levels doing so as a form of rebellion, flipping off society? Perhaps part of the purpose might also be to satiate the senses, to saturate the soul.

Some of these may be compelling reasons to play and listen to music that loudly, but none of them justify the permanent damage done to the auditory system as a result. Of course, we all make our own choices. We can choose not to attend loud concerts, or bring ear plugs, or embrace the experience fully (and suffer the consequences – the longer the exposure, the greater the damage). Personally, I would love to see performing groups take this into consideration during the sound check. I think that their music will be just as effective, even if the volume knob is eased back a bit from 11. This will also protect their fans from eventually turning a deaf ear. ♦

Scott Wilkinson

### EDITORIAL

Editor: Scott Wilkinson

Assistant Editor: Dan Rue

Technical Editor: Lawrence Ullman

Associate Editor (UK): Tim Goodyer

Editorial Assistant: Debbie Greenberg

Photographer: Melodie Gimple

Editorial Consultants:

John Schroeder (Recording)

Michael McFall (Percussion)

Specialist Correspondents:

The Cyberpunk, Yung Dragen, Gene Ferriter,

Paul Freudenberg, Aaron Hallas, Nigel Lord,

Chris Meyer, Deborah Parisi, Simon Trask,

Lorenz Rychner

### ART STUDIO

Director: Stuart Catterson

Deputy: Sam Masters

Art Assistants: Sam Gilbert, Darryl Tooth,

Hilary Reed, Chris Brennand

Photography: Michelle Clement, Melodie

Gimple, Paul Natkin, Kevin Mazur

Illustrations: Sally Cochrane, Clive Goodyer

### PRODUCTION

Production Managers:

Editorial: Trish Meyer

Advertising: Patty Clausen

Production Coordinator: Chris Williams

Production Manager (UK): Mike Stapleton

Typesetting: *CyberTYPE*

### ADVERTISING

Advertising Director: Brent Heintz

Classifieds: Patty Clausen

### ADMINISTRATION

Accounts Supervisor: Stefanie Mann

Accounts Receivable: Dave Ward

Circulation/Marketing Mgr: Debbie Miller

Subscriptions: Jim Ludeman

### MUSIC MAKER PUBLICATIONS, INC.

Executive Officers

President: Terry Day

Publishing Director: Dennis Hill

General Manager: Alan Gooles

Cover photography: Paul Natkin

MUSIC TECHNOLOGY (ISSN 0896-2480) is published monthly, 12 times per year, for \$25.00 per year, at: Music Maker Publications, Inc., 22024 Lassen Street, Suite 118, Chatsworth, CA 91311. Tel: (818) 407-0744. FAX: (818) 407-0882. GENIE: Musicmkr.LA

Second-Class Postage Paid at Chatsworth, CA and at additional mailing offices. Postmaster: Send address changes to: Music Technology, 22024 Lassen Street, Suite 118, Chatsworth, CA 91311.

EUROPEAN OFFICE: Music Maker Publications (Holdings) plc, Alexander House, Forehill, Ely, Cambs, CB7 4AF, England. Tel: 011 (44) 353-665577. FAX: 011 (44) 353-662489. (Ad Manager: Colin McKee)

All material is subject to worldwide copyright protection, and reproduction or imitation in whole or in part is expressly forbidden without written consent from the publishers. All reasonable care is taken to ensure accuracy in the preparation of the magazine, but Music Maker Publications, Inc. cannot be held legally responsible for its contents. The publishers cannot assume responsibility for the return of unsolicited manuscripts, photographs or materials. All trademarked names, whether indicated as such or not, are owned by their respective companies.

© Copyright 1990 Music Maker Publications, Inc.



# There's a fine line that separates us from other keyboard controllers.

Somebody once said that a picture is worth a thousand words. Unfortunately, most of the companies that make mother keyboards didn't seem to be listening at the time. Otherwise Roland wouldn't be the only company making MIDI controllers that actually give you a picture of your performance parameters.

Our A-80 and A-50 have a menu-driven liquid crystal display that lets you access 25 different status screens. And while the best of our competitors limit you to seven

pre-set velocity and aftertouch ranges, our curves give you literally millions of combinations to work with.

You can even reconfigure your entire system with the push of a single button.

There's so much ingenuity in our mother keyboards that we could go on for another thousand words, easy. And in fact we will. Just call (213) 685-5141 ext. 331 and we'll send you a brochure.

Complete with pictures.

## Roland®

Roland Corp US, 7200 Dominion Circle,  
Los Angeles, CA 90040-3647 213 685-5141



*A master of the Zeta MIDI violin, Jean-Luc Ponty has new tales to tell with his latest album.*



**PEOPLE**

**14 Jean-Luc Ponty**  
 The MIDI violin virtuoso is back with a new album, and a tour to kick it off. Deborah Parisi talks with Ponty and keyboardist Wally Minko about the trials and tribulations of using mega-MIDI on stage, and why the Synclavier isn't along for the ride.

**38 Backstage with The Rolling Stones**  
 Scott Wilkinson catches up with Mick Jagger and keyboardists Matt Clifford and Chuck Leavell to rap about the Rolling Stones' nationwide Steel Wheels tour, the impact of technology on the band's songwriting, and how technology has made it possible to play some of the old tunes live for the first time.

**64 Starr Parodi**  
 Arsenio Hall is one of the hottest acts on the tube these days. His musical guests are always a highlight of the show, supported by his self-declared "posse." Gene Ferriter talks with keyboardist Starr Parodi about a dream career that's snared her a gig to die for.



*Starr Parodi peeks out from behind the keyboards on the Arsenio Hall Show to let us in on the party.*

**FEATURES**

**20 Understanding Microphones, Part 3**  
 This month, Paul Freudenberg gives us some hot tips on how to choose the right mic for the job, how to place mics for drums and other tricky targets, and how to get the most out of the mics you've got.

**28 On The Road with Atlantic Starr**  
 Head tech Marc Mann and cohorts take R&B supergroup Atlantic Starr on the road. His job - to recreate the rich production and orchestration of the studio recording...live. Using a massive MIDI system, centered around two Macintoshes running in parallel, Mann has taken Atlantic Starr on the road in full style. Lawrence Ullman reports.



*Atlantic Starr has commissioned the ultimate live MIDI setup to recreate on stage what they've done in the studio.*

**STANDARDS**

**Readers' Letters..... 6**  
**Newsdesk ..... 8**  
**Listening Lab..... 26**  
 Our tasty montage this month includes Kate Bush, Camouflage, Laurie Anderson, and The Art of Noise.  
**Readers' Tapes..... 54**  
**Square One ..... 68**  
 We continue our introduction to the mixer, focusing now on auxiliary sends and returns, and channel inserts.  
**More From ..... 71**

# C O N T E N T S

## TOOLS

**32 Kawai K4**  
The newest synth from Kawai is under review by Lorenz Rychner. This multitimbral synth features high-resolution 16-bit samples, programmable filters with resonance, and a low list price. Is it a sure-fire smash hit?

**34 Roland Rhodes MK-80**  
The Rhodes piano is back, only this time the tines are digitally reproduced using Roland's S/A technology. Aaron Hallas gives us the low-down on the newest generation in a classic lineage.

**44 Steinberg Cubase**  
Steinberg's long-awaited successor to their enormously popular Pro24 sequencing software for the Atari ST has arrived, well-prepared to face the masses as King Sequencer. After a lengthy trial, Nigel Lord delivers the verdict.

**50 Korg M3R**  
Simon Trask reviews Korg's latest offspring from their AI family of synthesizers, made famous by the flagship M1. And, you won't have to lose an arm and a leg to get that coveted AI sound.

**56 Ensoniq VFX SD**  
Ensoniq has slapped a sequencer, disk drive and drums into the VFX to create this new sibling. Dan Rue checks out the added features and functions to see if it's up to snuff.



have you roarin' on it in no time

A sequencer and on-board disk drive are just two new features on Ensoniq's latest keyboard creation, the VFX SD.

## TECHNIQUES

**58 Advanced Sampling Course, Part 3**  
After months of preparation and head-spinning mathematics, we bring you to the Art of Looping – the whys and hows, the do's and don'ts, and of course, a heavy dose of heady math to remind you that this is an *advanced* course. But hey, you'll have the *best* samples on the block.



The quest for the perfect loop has come to fruition in Part 3 of our Advanced Sampling Course.

**72 K4 Contortions**  
You get it here first. Synth-maestro Lorenz Rychner takes us on a hot-off-the-assembly-line tour of Kawai's newest synth. So if you got the new K4 for Xmas (or Hannukah, or Winter Solstice), we'll

# READERS LETTERS

**While the cold winds of February blow, it's a good time to stay inside and write a letter. And while you're at it, why not drop a line to: *Music Technology*, 22024 Lassen St., Suite 118, Chatsworth, CA 91311.**

## KORG QUEST

Like thousands of other Korg M1 buyers, I am a would-be composer who bought the instrument because it would bypass much of the technological complexity of going from musical concept to demo. Within a day of receiving it, I realized that although this was definitely the right direction, I had fallen short of the mark.

The two main frustrations were the paltry lack of sequence memory and no way to save song files. Frontal Lobe seems to be the answer, but the price tag is ridiculous, considering that for less money I could buy a computer and the necessary software. Consequently, I bought an Atari 1040 ST and the Hybrid Arts EditTrack sequencer. This increased the sequencing and filing power at my disposal, and positioned me for future software developments.

However, I seem to be sinking into the realm of technological complexity again, and am presently shopping around for that miracle piece of software that will allow me to load the disk and be right back where I was within minutes when the muses beckon with a new twist on an old sequence. What is probably required is an all-in-one package designed specifically for the M1 that will, in addition to sequencing, store all M1 parameters, including effects, song names, etc. with the push of a button. It would also be desirable if the same software would store and allow easy access to all future PCM samples and related programs.

Most new software emphasizes more power, more tracks, more universality,

etc., but I don't plan to go beyond the M1 for my home demo use. I am more interested in getting the most out of it in as effortless a manner as possible.

Can you help me in my quest? Perhaps you might review some appropriate software packages or do an article on using the M1 with external sequencing software.

**Bob Morgan**  
Fairvale, N.B. Canada

**It sounds like a sequencer with SysEx (System Exclusive) capabilities might be the answer to your problems. With such a sequencer, you should be able to record your music *and* all of the sound data from the M1. Here's the basic procedure:**

- 1. Initiate a bulk dump from the M1 and record it on one track of the sequencer.**
- 2. Record your music on the other tracks of the sequencer *after* the bulk dump.**
- 3. Every time you play back the sequence, the sound data will be sent to the M1 before the music begins to play.**

Unfortunately, many sequencer programs limit the amount of SysEx data that can be recorded into them. Determine the size of the SysEx bulk dump from the M1 (it might be in the manual, or call Korg for technical support). If your sequencer can handle a SysEx bulk dump of that size, you're home free. If not, you might try to find a sequencer that does, or use an editor/librarian program for the M1 to store your sounds. In this case,

you would boot the ed/lib, send the sounds you want to the M1, then boot the sequencer and go to the town. I know that this sounds like more technological complexity, but MIDI is still evolving and we all experience growing pains once in a while.

For more information about using SysEx, please refer to the two-part article appearing in the July and August '89 issues of *MT*. — SW

## FIRST IMPRESSIONS

Several months ago, while on a guitar-string foray to my local music store, I happened across your magazine in the rack of offerings and, seeing Pat Metheny on the cover, decided to pick up a copy. I was quite impressed with the overall tone of the interviews that were presented, as they contained a mature blend of artistic insights, discussions of various equipment and the strengths and weaknesses they displayed, as well as musical and stylistic observations. I personally found this approach much more informative and educational than the usual fawning indulgence that interviewers in other contemporary music periodicals seem to engage in. As we are presently installing a MIDI recording studio here at the Music Dept. of the Community College of Philadelphia where I am a faculty member, I have ordered a subscription of *Music Technology* for the department's faculty, and am encouraging our students to do likewise!

**Anthony Ferrara**  
Philadelphia, PA



## VIDEO AGE PRAISE

Your article on 'Musicians In The Video Age' in *MT*, November '89 was excellent. How about follow-up articles on some of the techniques mentioned in the article? How about a source list for further reading on the subject? Thanks for your help.

**Bob Stenger  
Fabius, NY**

I agree that this is a subject worthy of further study, and I'm sure that we will be publishing additional articles. While I know of few if any books on precisely the material covered in the article, here are some references to related resources:

Anderson, Gary. *Electronic Post Production: The Film-To-Video Guide*, published by Knowledge Industry Publishing.

Rona, Jeff. *Synchronization: From Reel To Reel*, published by Hal Leonard Books.

Hagen, Earle. *Scoring for Film*, published by Criterion Music Corp.

Maestas, Bobby. *Recording Sessions: From Basics To Stripping the Tape With SMPTE*, published by Alexander Publishing.

Skiles, Martin. *Music Scoring For TV and Motion Pictures*, published by Tab Books.

Weis, Elizabeth, Belton, John, ed. *Film Sound: Theory and Practice*, published by Columbia University Press.

Happy hunting! — SW

## BAGGING ON FOLKS

I am happy that there is a new "folk music" and, fortunately, Travis Charbeneau's essay (*MT*, November '89) ends on an upbeat note that music "will become more and more accessible to anyone who has the vision." Unfortunately, the overall tenor of the piece seems to be "Oh my, those semi-talented people with the computers and synths are going to take music away from all us sophisticated, pure, traditional artists." Come on. I've been waiting for my computer, synths, and eight-track to get together and write me a song, but they haven't. I guess I bought the wrong stuff.

I doubt the notion that "if any rube has got the ear, he or she can now master thousands of instruments with-

out a single hour of 'practice' as has been traditionally known" will vanish any time soon. This is unfortunate because at best this is a gross overstatement, and at worst, complete nonsense. While we may be able to sequence parts with a computer and play them through machines which successfully mimic the sounds of many different instruments, this is hardly mastery of any of these instruments and certainly not done without "practice" as suggested. Go hear a master of any instrument perform live and come back to your best samples if you can't remember the difference.

The current technology is fantastic and has given many of us the opportunity to do things we previously could only dream about.

**Thad E. Eaton  
Pleasant Hill, CA**

You seem to have taken offense where none was intended. I believe, in fact, that Mr. Charbeneau would consider himself one of the "rubes," to use his word, since he considers the computer his primary instrument in his own musical endeavors (check out the 'Humanize Your Sequences' series in *MT*, January '89-June '89).

As for "...'practice' as has been traditionally known," the key word, of course, is 'traditionally.' Synths, samplers and the whole gambit of software and hardware peripherals must be regarded as instruments in and of themselves. While they require their own forms of 'practice' in order to achieve virtuosity, electronic instruments require a much shorter learning curve for the novice to create music, unlike their traditional counterparts. Ok, maybe "master" was a bit strong, but the point was certainly clear.

Finally, if you detect an elitist attitude in the article, bear in mind that the essay was written for you and the rest of the *MT* readers. You are the people already using the technologies, you are the pioneers. That is truly significant, and that is what Mr. Charbeneau was encouraging us to reflect upon. — DR

## SHORT AND SWEET

I really enjoyed your article about Russ Freeman (*MT*, Nov. '89). I would like to see more articles of this kind in *MT*.

**David A. Roth  
Westerville, OH**

CodeHead's

# MIDIMAX

*For the Atari ST -- A Powerful tool for performing MIDI musicians!*

- Create **MIDI macros** -- strings of MIDI commands that can be triggered by any **MIDI event!** Set up an entire bank of synthesizers, samplers, and drum machines with a single keypress or mouse click!
- Real-time multi-voice, multi-channel harmonization...**chords of up to 18 notes** can be generated from any single note! (Not just parallel voicings either...chord maps are fully and easily programmable, from the keyboard or from any MIDI controller!)
- Switch **instantly** to any one of 8 MIDI chord maps, and 8 sets of MIDI macros, with a single keypress or mouse click! Load and save chord maps and macros, as "bulk files" or individually!
- Turn your ST computer into an **intelligent THRU box**, with unlimited keyboard splitting, filtering, and remapping!
- MIDIMAX runs as either a GEM desk accessory or a program...use it along with your favorite GEM-based sequencer!

**Only  
\$49.95!**

CodeHead Software

P.O. Box 74090

Los Angeles, CA 90004

Phone: (213) 386-5735



Visa, Mastercard, and AmEx accepted.  
Shipping cost: US \$2, Canada \$3, Europe \$5.  
CA residents please add 6.5% sales tax.

## POETRY CONTEST

*Enter Free  
And Win \$1,000!*

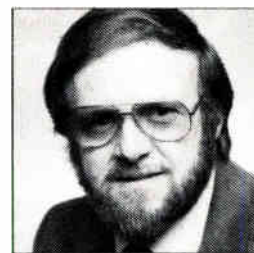

**John Campbell**  
Editor & Publisher

A \$1,000 grand prize is being offered in World of Poetry's 14th Annual Great Poetry Contest, open to everyone. **There are 200 prizes in all, totaling \$15,000!**

The deadline for entering is March 10, 1990. Winners will be notified by April 2.

Says Editor and Publisher John Campbell: "Even if you have written only one poem, or have never entered a poetry contest before, this is your big chance. I want this contest to help me discover new poets!"

To enter, send one poem 21 lines or less:  
**WORLD OF POETRY • 2431 Stockton Blvd.  
Dept. Music • Sacramento CA 95817**

*Keep copies as no poems can be returned.*

# NEWS DESK

## MIRAGE SAMPLES

Syntaur Productions' Mirage Disk 1 is a set of samples for the Ensoniq Mirage sampler that includes sounds from the classic Minimoog, the Yamaha DX7, and the Ensoniq VFX. Samples on the disk include Minimoog Bass, Minimoog+ Slap Bass, DX7 Slam Bass, VFX Breathy Flute, VFX Breathy Voices, and VFX Funk Guitar, each with four different program variations. All sampling for the Mirage Disk 1 (\$7.95) was done with the external Input Sampling Filter, for maximum rejection of aliasing noise.

**MORE FROM:** Syntaur Productions, 11116 Aqua Vista #2, North Hollywood, CA 91602. Tel: (818) 769-4395.

## PLETHORA OF POCKET PRODUCTS

One of Anatek's many new Pocket Products is the Pocket Channel, which features an in-line MIDI channel mapper, 16 channel assignments per MIDI channel, and a channel input filter. The Pocket Channel remaps channel assignments without changing sequencer data and frees-up unused MIDI channels from modules that assign them consecutively. In addition to channelizing older synths and those that only transmit on channel 1, the Pocket Channel can also be used to velocity-switch between two different samplers, synths, or drum machines.

The Pocket Panic (which can be used in live MIDI applications whenever a

## VOCALIZER SYNTHESIZER

The Vocalizer 1000 is a voice-controlled synthesizer from Breakaway Music Systems that transforms the human voice into one of 28 different MIDI-based musical instrument sounds. Among its features are a pitch-to-MIDI device, a sequencer for five-track digital recording and editing, and pre-recorded rhythm tracks. The Vocalizer (\$350) also includes a multi-timbral synthesizer with



Breakaway Vocalizer 1000

stereo-sampled waveforms, 10-note polyphonic and polytimbral sound tracks over a seven-octave range, and 12 built-in background tunes called SmartSongs. The Vocalizer 1000 weighs less than three pounds, is powered by six "C" batteries, and can be joined together with other Vocalizers with an optional Jam Link unit.

**MORE FROM:** Breakaway Technologies, Inc., 1900 Norfolk St., Suite 340, San Mateo, CA 94403. Tel: (415) 341-8300.

## B3 MIDI MOD

Keyboard Specialties has developed a MIDI retrofit for the vintage Hammond B3, C3, and A100 series organs. The MIDI Mod adds touch-sensitive MIDI output to either or both manuals of a B3 or C3, and sends on two selectable MIDI channels simultaneously. Each channel provides independently

programmable range and transpose functions. Other features include five selectable velocity curve settings, A and B MIDI channel defeat floor switches, and a floor sustain switch. The Hammond B3 MIDI Mod can be installed and regulated for \$2000 per keyboard manual.

**MORE FROM:** Keyboard Specialties, 775 50th Ave. North, St. Petersburg, FL 33703. Tel: (813) 521-1118.

## MIDI MISCELLANY

Four Designs Company has introduced Rackdrawer, a two-space rack-mountable drawer that will fit into any 19" equipment rack. Rackdrawer (\$44.95), which features special construction

for on-the-road durability, provides a convenient storage space for cables, adapters, tuners, effects pedals, tapes, and other accessories.

**MORE FROM:** Four Designs Co., 6531 Gross Ave., Canoga Park, CA 91307. Tel: (818) 716-8540.

## A WIRELESS LINK

Lync Systems has announced The Datalync, a fully digital wireless MIDI system. By adding The Datalync to any MIDI instrument, musicians are free of the MIDI cord restriction. The Datalync transmitter plugs into the MIDI Out of the controlling instrument, while the rack-mountable Datalync receiver plugs into the MIDI In of the receiving instrument. Priced at under \$1000, The Datalync System includes everything needed to digitally transmit MIDI data.

**MORE FROM:** Lync Systems, Inc., 14 Walker Way, Albany, NY 12205. Tel: (518) 452-0891.

stuck note occurs) sends an All Notes Off command on all channels, resets controllers to their default settings, and filters out All Notes Off commands that are sent too often. In addition to featuring an in-line MIDI panic button and transparent operation, the Pocket Panic also sends an OMNI Off command and enters an initialization sequence into a MIDI sequencer.

The Pocket Transpose, which features a 16-channel MIDI transposer, separate transpose intervals for each MIDI channel, and "on-the-fly" switching, can be used on keyboards that lack a transpose function or include one that is too awkward for live setups. The Pocket Transpose can expand or shift the octave range on master

keyboards, transpose each string from a guitar synth, and play two-voice harmonies from a single key by combining transposed and original data.

The Pocket Record is a 15,000 event, single-track recorder that records all 16 MIDI channels at the same time, simultaneously records Note & System Exclusive data, and retains data for four hours without power or batteries. It can be used as a single-track MIDI "notepad," as a portable demonstration tool, or on the road. Other features include a hands-free footswitch, an audible fast-forward, and automatic Internal/External Sync switching.

The Pocket Thru, which can be used with Pocket Merge to create a 2-In, 3-Out MIDI Merger, reduces In-to-Thru daisy-chains to avoid MIDI

delays. The Pocket Thru, which handles all MIDI data and allows parallel routing of MIDI data to multiple devices, features a 1-Input, 3-Output Active Thru box and buffered outputs that clean up MIDI data.

Lastly, the Power Pack powers Pocket Products when they are used with devices that do not conform to the MIDI specification or that derive power from MIDI, and when no MIDI Out or MIDI Thru jacks are available. It also boosts power when using more than four Pocket Products in a row, and allows Pocket Pedal or Pocket Filter to retain their settings when the master keyboard is off.

**MORE FROM:** Anatek Microcircuits, Inc., 400 Brooksbank Ave., North Vancouver, B.C. Canada V7J 1C9. Tel: (604) 980-6850.



PearlSound Studios, Canton Michigan

Photo by Jeff Pearl

## FOR YOUR HARD DRIVIN' MUSIC!

### LET ELTEKON'S "OVERDRIVE EX" HARD DRIVE STORAGE SYSTEMS PAVE THE WAY TO SUCCESS!

When performing or laying down tracks, the last thing you want is to fumble around for that one special floppy and then take 45 seconds to load it into your sampler! Eltekon "Hard Drives" deliver your sounds in one hot hurry; with access times as fast as 16.5 ms. You may choose from capacities of 20 megabytes to 600 meg in fixed drives or select our 44 meg removable hard drive. We have the storage system to save your entire library and retrieve it flawlessly on command. Because when every second seems like an eternity, it pays not to keep'em waiting.

The First in Rack Mounted Hard Drive storage with a unique patented shock mounting for the following systems:

- AKAI S1000
- ATARI ST
- CASIO FZ-20M
- DYNACORD ADS/K
- EMULATOR
- SOUND TOOLS
- ENSONIQ EPS/EPSM
- KURZWEIL 250
- KORG Q1
- MACINTOSH SE/HICX
- ROLAND W-30,S-550,S-770
- SUNN SPARC station 1

**SEE YOUR LOCAL DEALER  
FOR THE BEST DRIVE IN TOWN!**



**313-462-3155**

37491 SCHOOLCRAFT RD.  
LIVONIA, MICHIGAN. 48150

ALL PRODUCTS MENTIONED ARE TRADEMARKS OR REGISTERED TRADEMARKS OF THEIR RESPECTIVE HOLDERS. ELTEKON IS A TRADEMARK OF ELTEKON TECHNOLOGIES, INC.

## MX-12 MIXER

Sansui Musical Electronics has introduced the MX-12, a 12-channel recording mixer with 12 direct and 6 program outputs. The MX-12 (\$1199)

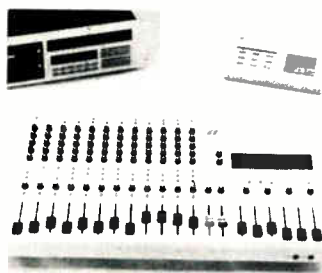

Sansui MX-12

features 12 mic/line inputs, 12 tape inputs, 12 direct outputs, balanced and unbalanced

stereo outputs, two sets of 6 program outputs, and two Auxiliary send/return loops. Each channel includes mic/line and tape input selectors, input trim with overload indicator, high and low EQ, two auxiliary send level controls, pan control, and solo and buss assignment switches. The MX-12, designed for use with multi-tape decks, is compatible with two Sansui MR-6 six-track tape decks, and becomes a 10-track cassette studio when connected with the Sansui SY-1 Sync Control Unit.

**MORE FROM:** KDS Technologies, 1399 Blue Hills Ave., Bloomfield, CT 06002. Tel: (203) 286-0498.

## JUICY TWELVE PAQ

The Twelve PAQ is the latest power source from Juice Goose. This single space rack-mountable unit features six small power outputs on the back panel, providing 9 volts AC, 18 volts AC, 9 volts DC, and 18 volts DC, with a selector switch for each output allowing the user to choose the voltage type. A Juice Goose Micropower output

cable (with a 3.5mm mini-plug on one end) connects each piece of low voltage effects equipment to the Twelve PAQ. The other end of the cable is engineered to each manufacturer's specifications. Finally, the Twelve PAQ has six more outputs for 120 volt use (twelve outputs in all, get it?).

**MORE FROM:** Juice Goose, 7320 Ashcroft, Suite 302, Houston, TX 77081. Tel: (713) 772-1404.

## ELECTRONIC EXTENSION

One of several UCLA Extension Courses in the new Certificate Program is "Connecting with Careers in Electronic Music," which meets from February 22 to March 29, 1990. Instructor Ronny Schiff (a publishing and licensing consultant with an extensive background in high technology), along with several guest speakers from the industry (including our own editor, Scott Wilkinson), will address each career area, from its creative and developmental aspects to the marketing and promotion of a product or service. The enrollment fee is \$175.

"Electronic Music II: Introduction to MIDI," which is being taught by Lachlan Westfall, president of the International MIDI Association, runs from February 21 to

March 28. ("Electronic Music I: Introduction to Synthesis," is currently being taught by our own Chris Meyer.) The course (\$175) offers demonstrations of all MIDI commands and data structure, the art of managing MIDI information, the use of special effects, and the applications of MIDI-to-record production.

Other courses currently in session this winter include "From Reel to Reel: Synchronization of Audio and/or Video Technology for Musicians," with instructor Jeff Rona and "Synthesis and Sound Design," with instructor Eric Persing. For more information regarding these classes or the Certificate Program, contact UCLA Extension at (213) 825-9064.

**MORE FROM:** UCLA Extension, P.O. Box 24901, Los Angeles, CA 90024-0901. Tel: (213) 825-1901.

## OPCODE & LONE WOLF

Just as we were finishing this edition of *Newsdesk*, it came to our attention that Opcode Systems has teamed up with Lone Wolf, developers of the MediaLink LAN (local area network) protocol and the MidiTap (see the August '89 issue of *MT* for more info on this important new technology). This collaboration will result in enhanced versions of Vision, Galaxy (Opcode's new generic ed/lib program), and other Opcode products with

special features designed to work with MediaLink, the MidiTap, and other Lone Wolf products. This is the first step towards a complete virtual studio. Engineers from both companies are currently working on these projects, with availability scheduled for early Spring 1990.

**MORE FROM:** Lone Wolf, 1509 Aviation Blvd., Redondo Beach, CA 90278. Tel: (213) 379-2036. Opcode Systems, 3641 Haven, Suite A, Menlo Park, CA 94025. Tel: (415) 321-8977.

## MICROWAVE RADIATION

Steinberg/Jones has introduced the MicroWave from Waldorf Electronics, which offers the sound capabilities of the PPG Wave 2.2 and 2.3 synthesizers in a compact two-space rack-mount unit. Two internal banks hold up to 64 Single sounds plus 64 Multi-programs, and an additional 64 Sounds and Multis can be accessed via

and an additional 12 Wave-tables that can be stored to RAM card.

Features include Quick Edit, which allows global edits to be performed, and Modulation Macros, which can instantly call up parameter settings for typical and unique modulations. The MicroWave (\$1995), which is fully MIDI compatible, also includes the ability to send and receive SysEx infor-



Steinberg/Jones MicroWave

RAM card. Wavescan technology allows sound changes to be controlled by using a Wavetable. There are 32 preconfigured Wavetables, 12 user definable Wavetables,

mation for interaction with editor/librarian software.

**MORE FROM:** Steinberg/Jones, 17700 Raymer St., Suite 1002, Northridge, CA 91325. Tel: (818) 993-4091.

## ERRATA

In 'Musicians in the Video Age' (*MT*, November '89) we claimed that the Mitsubishi U80 has direct PCM recording capabilities, when in fact it does not. Also, Digidesign's Q-Sheet does not calculate tempo maps or timings for film scoring as stated in the article.

In our interview with Russ Freeman (November '89), we said that Freeman co-wrote 'Every Step of the Way' with David Naranjo. In fact, the artist was David Benoit.

Finally, in *MicroReviews*

(December '89), Lawrence Ullman reviewed Alexander Publishing's *Electronic Arranging and Orchestration*, in which he stated, "Despite the poor production values and typos, *Electronic Arranging and Orchestration* would be a valuable addition to any composer's bookshelf." We have since discovered that the copy we reviewed was from an early test printing, and is not representative of the production values of the actual book, which are excellent as it turns out. We can now recommend the book without reservation.

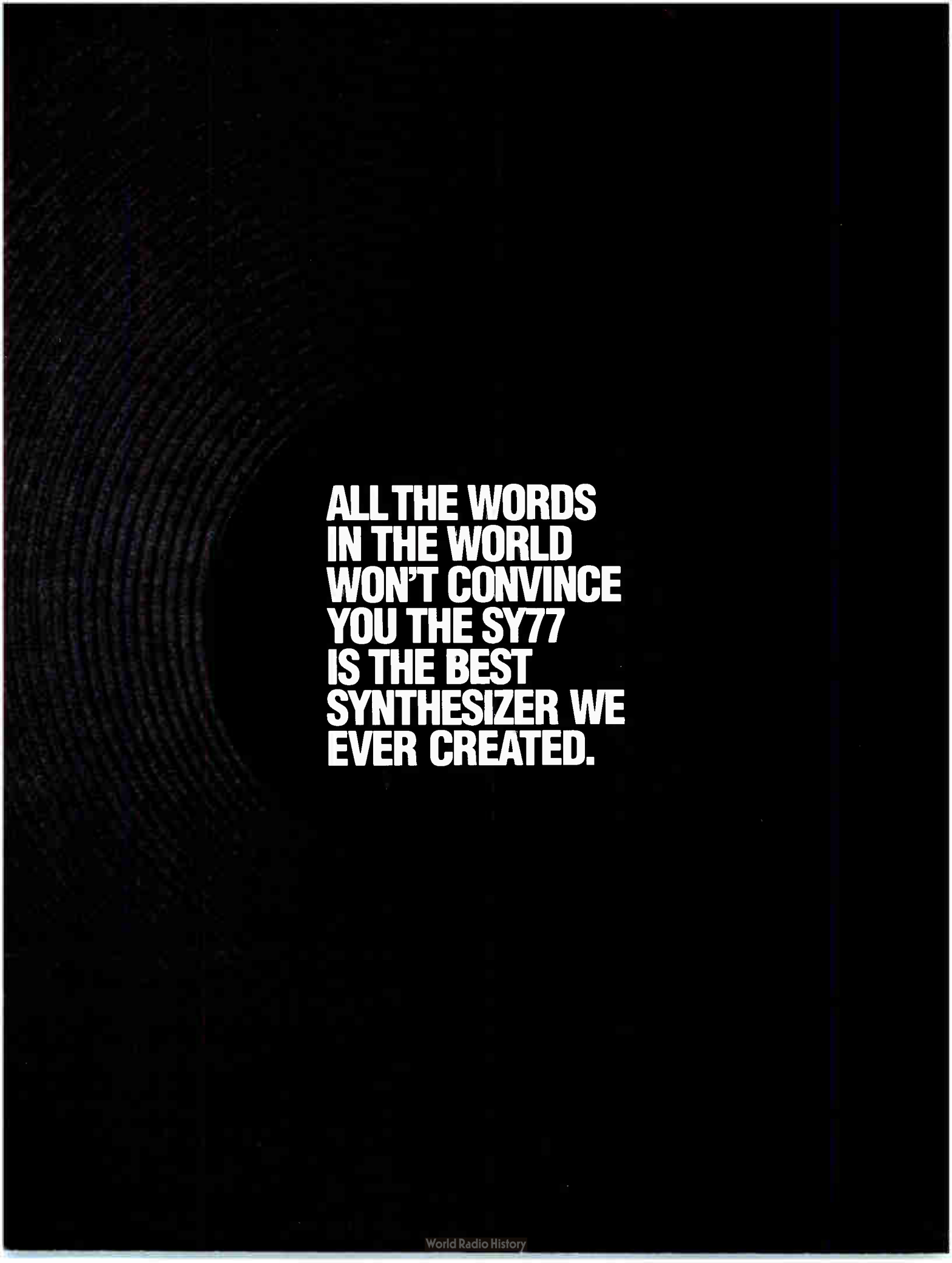

**ALL THE WORDS  
IN THE WORLD  
WON'T CONVINC  
YOU THE SY77  
IS THE BEST  
SYNTHESIZER WE  
EVER CREATED.**

A FEW NOTES WILL.



BREATH FOOT PEDAL FIBER OPTIC OPTIC EDIT PHONES L R L R POWER  
VOLUME CONTROL MUTE MATCH SPLIT OUTPUT 1/2 OUTPUT 2 ON OFF

FAHES  
AMP MUSE  
DATA ENTRY

7 8 9  
4 5 6  
1 2 3  
0

DEF  
ABC

VOLUME  
HYPER  
LAMP  
PRESET 1  
PRESET 2  
BANK

0 1 2 3 4 5 6 7 8 9  
10 11 12 13 14 15

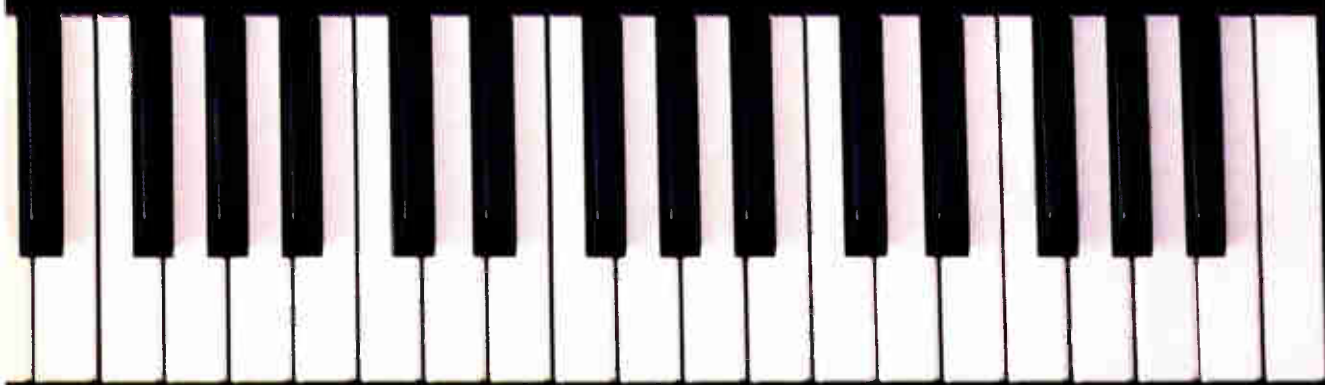

Playing mid-February at an authorized Yamaha dealer. **YAMAHA**

# A Music For All Seasons



PHOTOGRAPHY BY MICHELE CLEMENT

**The master of the electronic violin controller is back with a new album and a fresh approach. But for Jean-Luc Ponty, the synthesizer could never be left out of the story.**

*Interview by Deborah Parisi.*

**T**HE PARAMOUNT THEATRE, situated amidst high-class hotels and heavy construction in uptown Seattle, is one of those places you can never be quite sure about. One night they'll have Pat Metheny and Lyle Mays, next night

might be Mr. Big, then Oprah Winfrey, and on to Bad English or maybe somebody's version of *The King and I*.

The corresponding audiences are always, but *always*, decked out in the appropriate attire and sporting the correct attitude: casual sophisticate at

the jazz fêtes, leather and denim manic for metal, a polyester pantsuit personality for talk-show yammering, cutesy hats and oversized trousers and laughter for the terminally hip, or thoroughly tailored crepes Suzette for the theatre spectaculars. Although the scene changes dramatically from night to night, you'll always know who the audience is if you know who the act is.

As a result of this yawnable predictability, the audience that congregated during Jean-Luc Ponty's recent performance came as a delightful



# Does your ear need a tune-up?

If you're like most musicians, your ear is running a little rough. It needs a precision tuning—*fast!*

## Take this test: Do any of these apply to you?

- I get nervous when I play in front of people.
- People say I sing and/or play out of tune.
- I try to steal "licks" from records, but the tones flash by too quickly.
- I can't figure out chord progressions without having my instrument with me.
- I have all these incredible musical ideas "in my head," but I can't seem to play them without a lot of bad notes.
- It's embarrassing when I get "lost" and can't find my place.
- It takes me longer than I like to learn and memorize a new tune.
- I have difficulty singing harmony.
- It's hard for me to transpose songs to new keys.
- I improvise poorly because I can't envision what I'm about to play.
- My friends seem to enjoy music more than me because they have a better ear.
- My playing is caught in a rut that I can't seem to climb out of.

You *know* the problems. But do you know how easily they can disappear with just a *simple ear tune-up?*

Relative Pitch is essential to tune up your ear, and is a completely separate ability from Perfect Pitch. Learn more about both on your FREE Introductory Tape—available through this offer. © 1989 American Educational Music, Inc.

You've got a lot of talent hidden inside you. But you'll never fully tap into it until you *tune up your ear!*

Why? Because music is a HEARING art. Even with the best high-tech equipment, the bottom line in music is this: *how well you play depends on how well you hear.*

A tuned ear is a sleek performer. It gives you skill and control—the kind you need to handle the curves and rough spots with confidence.

An untuned ear is a hassle. It's like driving in a fog. It cramps your creativity and drags down your natural talent.

Most musicians already know the value of a great ear, but don't do anything about it. Their loss is your gain.

You can join the smart players who have discovered David L. Burge's new hearing system. They've found that the difference between being tuned or untuned is *only a matter of listening!*

### How to own a laser-sharp ear:

According to David L. Burge, you can tune your ear with *Relative Pitch*, your ability to judge relationships between tones and chords.

How important is Relative Pitch?

It's absolutely essential! Relative Pitch is what organizes the tones you hear into your own personal experience of music. Relative Pitch tells you if a chord is major, or minor, or "dominant seventh sharp five." Relative Pitch tells you if you're playing sharper or flatter than the others in your band. Relative Pitch gives you the skill to envision what you want to play. The simple truth is: Relative Pitch allows you to understand and appreciate all music.

You already have some degree of Relative Pitch. Otherwise, your ear would have stalled out long ago.

But a complete Relative Pitch tune-up is another story. How do you get it?

Just get the **Relative Pitch Ear-Training Course™** by David L. Burge. It's loaded with precise ear-opening drills, with the answers right there on tape for you. *It's easy!* All you do is put on a cassette—and listen!

You'll learn to hear and recognize a complete "catalog" of chords and countless other musical sounds. David will show you the *easy way*—and the *only way* to really do it right. The more you hear, the more your abilities will multiply. Finally, you'll have the ear you've always needed to unlock your full creative potential!

Whether you are already a good listener, or the newest beginner, the **Relative Pitch Ear-Training Course™** has all the drills you need to perfectly tune your ear from ground zero. *No music reading necessary!*

### Test-drive a tape—FREE!

Want a sample tape? If you'll cover shipping, we'll send your first tape *absolutely FREE* (a \$14.95 value)!

Or save extra shipping charges and start with more lessons—all covered by our **90-Day Money Back Guarantee**: Enjoy each tape at your own relaxed pace, one at a time. You'll gain a lightening fast ear with each lesson or simply return all unopened tapes within 90 days for a FULL REFUND! There's no risk—you keep only the tapes you actually use!

Remember: *A great ear is worth more to your music than the most expensive equipment you could ever buy!*

Don't waste your ear! Order your **Relative Pitch Ear-Training Course™**—and tune up for life! *Do it NOW!*

(See review of this Course in *Guitar Player Magazine*, March '88, p. 149. For all musicians/instruments.)

Tuning your ear is fun! Just put on a cassette and listen! No music reading required.

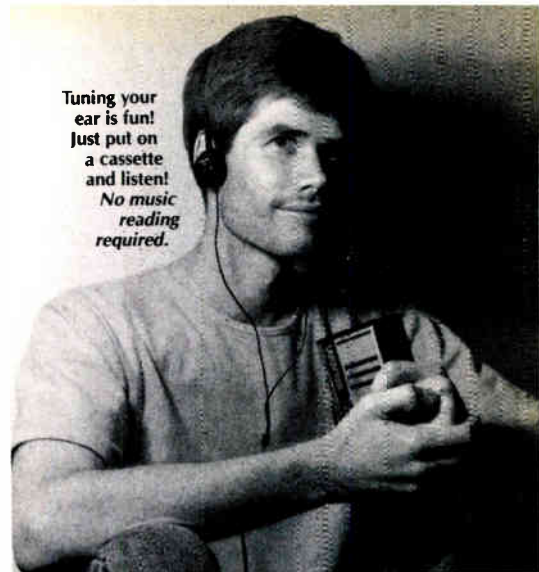

## THE RELATIVE PITCH EAR-TRAINING COURSE™ by David L. Burge.

Complete course is composed of twenty 90-minute cassettes plus FREE Introductory tape. Guaranteed to repair all major and minor ear problems.

Tune your ear for life!

Order your tapes NOW!

Call 24 hours and charge your Visa/MasterCard:

**(515) 472-3100**

### FREE TAPE

90-Minute Introductory Tape with Lesson 1 (FREE; include \$4 for shipping if ordered alone) A \$14.95 value!

Yes, I want a total ear tune-up! Send me the following **Relative Pitch Ear-Training Course™** tapes with the full **90-Day Money Back Guarantee** described in this ad:

**IMPORTANT:** You will be tuning your ear with special Relative Pitch listening techniques. So whether you are beginning or advanced, you must start with *Level 1* and hear each Lesson in its proper sequence to gain the laser-sharp listening skills we've promised you.

**8 Lessons/Four 90-minute audio cassettes per Level**

- Level 1 Tapes \$45
- Level 2 Tapes \$45
- Level 3 Tapes \$45
- Level 4 Tapes \$45
- Level 5 Tapes \$45

### COMPLETE COURSE

All 5 tape Levels only \$198\*

\* That's less than \$5/lesson for personal ear-training instruction from David L. Burge!

**FREE BONUS** (for a limited time)!

I'm ordering two or more tape levels. Please send me David's **Relative Pitch "Help Me" Tape™** at no extra charge!

Add \$4 shipping Total Enclosed: \$ \_\_\_\_\_  
Make check or money order payable to: American Educational Music.

NAME \_\_\_\_\_

ADDRESS \_\_\_\_\_

CITY \_\_\_\_\_ STATE \_\_\_\_\_ ZIP \_\_\_\_\_

Please allow 3-5 weeks for delivery. For 1 week delivery from our studio, add \$2 and write "RUSH!" on your envelope. Canadians may remit bank or postal money order in U.S. dollars. Shipping for foreign orders except Canada: \$10/Level or \$35 for Complete Course. Iowa residents add 4% tax.

I'd prefer to charge my Visa/MasterCard:

CARD # \_\_\_\_\_

EXP. DATE \_\_\_\_\_ SIGNATURE \_\_\_\_\_

Send to:  **American Educational Music**  
Music Resources Building, Dept. B-24  
1106 E. Burlington, Fairfield, IA 52556

► surprise. In a nutshell, take one of each from columns a, b, c, d, e, f and g, and you'll have a pretty good indication of the group's character. Everything from leather minis to three-piece suits, from Mom & Pop with their 10-year old in tow to sheer chic. The deduction? Ponty's music beguiles an audience that denies classification, inviting individuality and personality to rear their heads in an enthusiastic grin.

Another remarkable quality of the evening's performance came in the enthusiasm of the crowd over Ponty's new album, *Storytelling* (his second on Columbia Records). So often on promotional tours, audiences howl for the old standards (which Ponty provided as well), but the response to entirely new tunes – most notably 'In the Fast Lane' and 'After the Storm' – belied their relatively recent introduction to listeners' hearts and ears.

No doubt this enthusiastic reception comes in large part from the sheer accessibility of the new music. Several years back (in the December '87 issue of *MT*), Ponty described his then new album, *The Gift of Time*, as an indication that his music was becoming "less physical and more cerebral and spiritual." But *Storytelling* indeed spins a new yarn, one of much less lofty aspirations – and much more enjoyable results.

**"I** DID NOT WANT to prove anything with *Storytelling*," Ponty says in a still-thick French accent, "which means I didn't want to try to prove how good a composer I could be or how well I could play violin. I just wanted to have fun and stay as simple and direct as I could.

"People told me that *The Gift of Time* was difficult to understand," he continues, "because they had to listen to it at least a few times before they discovered it. But really, I just didn't feel like writing intricate music, and it just didn't come. It is a different mood. *The Gift of Time* was a darker mood. I had lost my father and my mother a few years before, and I was still in grief, and that's reflected in the music that I was putting out. But then touring extensively for a year revitalized my energy somehow and let me see things a bit differently.

"With *The Gift of Time*, we toured for about a year, and by the end of that year the band was unbelievable. It was so tight; it was so much fun!

I had to go into the studio following the tour to come up with a new album, and I decided to get back to the basics. It was a bit like the '70s – we went into the studio and performed live like we would on stage. So it's a much more

***"When I came to the States in '73, I immediately purchased an Echoplex. And now, with almost every album, I have to find a spot for it."***

basic album, much more straight-ahead playing."

*Storytelling* isn't exactly a musical stroll through the park, however. Keyboardist Wally Minko, who's been with Ponty for three years now, laughs at the thought. "The challenging thing about Jean-Luc's music is the fact that he composes on the Synclavier," he says, "and he sequences everything, does his composition and orchestration there. Eventually he gives us printouts that we can start working from, and some of these things that he sequences can be really, really challenging to play. Usually they're the kind of things that, once you figure out how to play them, they're pretty easy. But trying to figure out how to get your fingers to play them can be real challenging."

"Ever since I began using the Synclavier – since *Fables* – I've been coming up with all the sounds and the music from improvisations, and layers of improvisations," Ponty explains. "One day, I would come in, improvise something, and store it in the digital memory. Another day, I would improvise on top of that on another track with another sound. I build up layers and layers of tracks this way with different sounds.

"But how would I do that live?" he asks. "You have to distribute each part to someone, and they are all synthesizer sounds. That's why we have everybody in the band playing synthesizers at times – the guitar player as well as myself as well as the keyboardist. There is one piece where even the bass player has to go to a keyboard," he laughs.

Not all of the synth parts are being played by synthesizer keyboards, however. Ponty's technique with the Zeta violin controller now approaches mastery. Drummer Rayford Griffin's setup includes pads, samplers and a drum machine, and the guitarist uses the Photon controller (occasionally

sounding like he's playing samples of Ponty's violin!).

While Wally Minko does use a keyboard controller, even that leans towards the unusual. His mother keyboard rests inside an acoustic piano. "The grand piano is a Baldwin, which I endorse, and the MIDI system that we had installed is called the Crystal KS2, I believe, by Gulbransen," Wally says. "It's really new – I think it's only been out three or four months. And it's wonderful. I have nothing but great things to say about it.

"I don't have any experience with the Forte system, but the technician who installed my system told me that this one has much greater capabilities and that installation is a lot easier. With the new Gulbransen system, there's an initialize function where you push the button, and then just push each key once, and it reads the key travel and the pedal travel. The computer initializes it and sets everything to that. So if the piano takes abuse out on the road and the key dips start to change, you just re-initialize it. That's a great feature, I think."

Not unexpectedly, the variety of sounds coming from the grand is terrific. "I've got a DX7, an Akai S900, a D-50 and an Ensoniq sampled piano module," Minko says. "I keep the DX on top of the grand because I make my patch changes from its front panel."

The piano module might seem an odd ingredient in the setup, since he's got one of the best-sounding grands right beneath his fingertips, but it's there for practical, sound-reinforcement purposes. "The piano is miked, and in order to hear it well in the monitors you have to crank it up really, really loud," Minko explains. "Then, of course, you can have problems with distortion, feedback and piano mics picking up the drums and the bass from onstage. With the piano module, I can just trigger that and send it to the monitors so that the level doesn't have to be boosted so high."

"Wally loves piano more than synthesizers," Ponty comments, "not sound-wise so much as for the action. He's a pianist before anything. When I look at his setup, I'm amazed to see how clean and empty it looks. I remember the '70s when we had at least ten or twelve keyboards to do just ten or twelve sounds. It's a drastic change." And, at least aesthetically, a wonderful one.

Even though Jean-Luc's compositions begin at the Synclavier, often

3RD ANNUAL

# Music TECH '90!

LARGEST EVER!!!

A NEW WORLD MUSIC & SOUND PRODUCTION

Friday, February 16, 1990 ▲ Saturday, February 17, 1990

San Diego, California  
at the Holiday Inn Montgomery Field

Music Tech '90 is your chance to see the newest developments in pro audio, keyboards, guitars, basses, drums, MIDI components and instruments, software, amps, effects and more! Meet directly with manufacturer's representatives from all brands of equipment and discover the latest technological advances!

Also at Music Tech '90 . . .

- ▶ A large panel of top A & R reps from major and independent labels will be on hand to answer your questions and receive taped submissions! Please, no mail-ins accepted.

- ▶ Scott Wilkinson, editor of *Music Technology* magazine, and Alan Howarth, sound designer for the *Star Trek* films, *Poltergeist* & *Raiders of the Lost Ark*, are just two of Music Tech '90's featured guest speakers!

## MANUFACTURERS

Akai ▲ Alesis ▲ E-Mu Systems ▲ Ensoniq

Eventide ▲ E/V

Hafler ▲ JBL/Guild

JL Cooper ▲ Kawai ▲ Korg ▲ Kurzweil

KAT ▲ Lexicon ▲ Neumann ▲ Paiste

Premier ▲ Rickenbacker ▲ Tama

Tascam and Many More!

The panel of labels will be comprised of representatives from Atlantic, Columbia, EMI, Geffen, IRS, Sire, Warner Bros. and more!

To register, call us or use the form below! Tickets are \$5.00 for both days in advance (\$7.50 at the show). Call today for reservations, information, or to charge your tickets!

**(619) 569-1944** or

**(800) 854-2005**

OUTSIDE CA

SPONSORED BY

**NEW WORLD MUSIC & SOUND**  
YOUR HIGH TECHNOLOGY MUSIC STORE

**91X RHYTHM**  
TOTAL PERCUSSION MAGAZINE

HOME & STUDIO  
**Recording**  
THE MAGAZINE FOR THE RECORDING MUSICIAN

**MUSIC TECHNOLOGY**

World Radio History

REGISTRATION

Name \_\_\_\_\_

Street \_\_\_\_\_

City \_\_\_\_\_ State \_\_\_\_\_ Zip \_\_\_\_\_

Phone \_\_\_\_\_

No. of Tickets \_\_\_\_\_ X \$5.00 = \$ \_\_\_\_\_ Enclosed

Please enclose check or money order made payable to New World Music & Sound.  
Mail to: 4792 Clairemont Mesa Blvd.,  
San Diego, California 92117.

with heavily quantized sequencing, he doesn't use any type of sequencer for performances. "It's difficult to use sequencers live on a practical level," he says. "Only the drummer can really use it safely because he's the one who keeps the time together, so he can follow his own sequencer. But when it's something else that's sequenced – say the keyboard part – the musicians can get off easily if the sound is not clear in the monitors on stage.

"I have managed to do it before. I had some pieces where I used a bass sequencer, and Baron Brown had to play with it. And he had to look around for the engineer, who would give him the cues, and he'd move around to get closer to the monitors. When you play live, you just don't want to think about those things.

"And I've had bad experiences," Ponty laughs quietly. "I've announced a piece, pressed the button and it wouldn't start. Eventually I got smarter and changed my tactic. First I would play the piece, if it worked, then I would announce what the song was. If it didn't work, the band was ready to move to the next piece." That's the safe way, for sure.

***"It's difficult to use sequencers live on a practical level. Only the drummer can really use it safely because he's the one who keeps the time together."***

PONTY'S ANTICS with electronics began over twenty years ago, before his association with the Mahavishnu Orchestra (1973), before collaborating with Elton John (1972), and even before his name became known through the innovative recordings of Frank Zappa (1969). His early exploratory work with echoes and delays began while he still lived in France.

"The first band I formed that included a guitar player was before I moved to America," he says, "and the guitar player was from Belgium. He had this tape recorder that had the possibility of sound-on-sound – which was what it used to be called – that gave the echo delay. And he suggested that I use it. Strangely enough, he had the system and didn't really use it that much, and for some reason he thought I should experiment with it.

Obviously, I liked the effect.

"We were on tour in Italy when the tape recorder was stolen in the club we were playing, so then I bought a German box that did echo delay. I've forgotten the name of it, but it sounded pretty horrible. When I came to the States in '73, I immediately purchased an Echoplex – that was the big thing – and I used it a lot with Mahavishnu. And now, with almost every album, I have to find a spot for it because I like it so much.

"It's really fun to use the digital delays today – the quality of the settings and the programming you can do is a dream come true for someone who was interested in what echoes could do so long ago." Ponty's "duets" with himself using delays remain a highlight of his performances even today.

In the middle of all this electronic wonderment comes the distinct sound of acoustic instruments – beasts that haven't appeared in Ponty's music for several years. One of *Storytelling's* standout moments is his daughter's rendering of a Chopin prelude with Ponty improvising over the top. These moments on the album stem from Ponty's ever-evolving relationship with technology.

"As always, there is the positive and the negative," he says. "On the one hand, I love the results of the electronics. Once the show gets going and I don't have to think about what switch to press with my foot or my hand, then it becomes fun. But the whole process of learning kind of bugs me... it's boring. Sometimes I feel like throwing the whole thing through the window and playing the blues. It would be more fun. But I'd probably get tired of it really quick."

Dismissing the fantasy because of the boredom factor, Ponty expresses the majority opinion. "If electronics are used too much, and if you hear only that type of sound, it gets sterile and you get tired of it. We all need variety and change, and that's why some acoustic instruments will stay with us forever. All instruments should be chosen carefully for each individual piece."

Missing from this tour's equipment arsenal is Ponty's beloved Synclavier, which seemed strange. He had been so enthusiastic a few years back. "I took it on the whole American tour in '87 and throughout the South American tour, and it survived the Brazilian and Chilean highways,"

he smiles. "But it started to get a bit beaten up. Things started to break down mechanically in the keyboard. Nothing really bad – I must say it performed everywhere without any electronic problems. But I decided it was too expensive for me to risk it. Also, for me the real beauty of the system is to be able to record with it, and that part wasn't used at all on the road.

"So we sampled the sounds from the keyboard, with an Akai sampler, because there was no way that we could take all of our equipment for the European tours," he says. "It's so much easier to carry around. I might look for other samplers than the Akai now, but it's done the job so far. When I was in Brazil, I had both the Synclavier and the Akai, and we compared them. And sometimes it was very close. In a recording studio, there is no comparison. But in a live situation, in theatres where the acoustics are usually a little weird anyway, it's amazing how close it was."



L-R: Baron Browne, Wally Minko, Rayford Griffin, Jamie Glaser, Jean-Luc Ponty (center).

AFTER TOURING FOR a year in 1987–88, producing a new album in five months, and hitting the road again, you'd think this guy would be exhausted. But Ponty doesn't seem ready to quit.

"I'm going to keep doing it as long as I can," he says. "Physically, it's draining. I sure look older when I come back home, and I sure look tired. Mentally, however, it's the opposite. It keeps me young, it rejuvenates me. Playing music is very stimulating," he smiles.

His attitude towards the music shows. It's evident in his words, in his performances, and on the new album. If you liked the high-energy, mixed-meter, almost danceable qualities of his early stuff, you should probably come back for another look. Jean-Luc Ponty is alive and well and touring nearly everywhere. ♦

# THIS WILL CHANGE THE TUNE OF THE MUSIC INDUSTRY.

They're already singing the praises.

"The cleanest, clearest, quietest electronic instrument I've ever heard," reports *Electronic Musician*. A top contender for "Technological Innovation of the Year," says *Keyboard*.

What's elicited this chorus of raves is Proteus™—

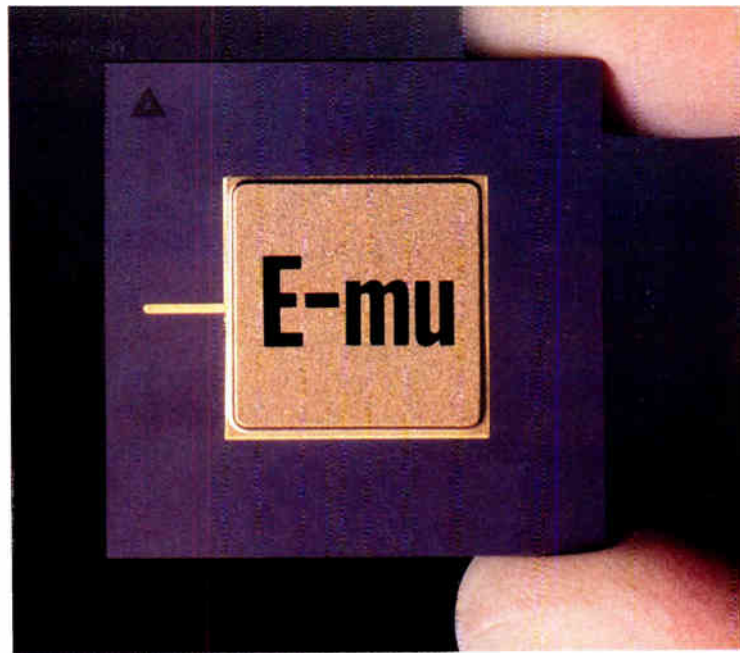

provides real-time access to over 40 performance parameters. So you'll never have trouble expressing yourself again.

To handle your most complex compositions,

Proteus' 32-voice polyphony responds multi-timbrally to all 16 MIDI

channels simultaneously. There are also six programmable stereo polyphonic outputs with integral effect send/returns for on-board mix-down.

Designed and supported in the U.S. by the people who pioneered sampling, Proteus is incredibly easy to use. Yet will satisfy even the most power-hungry programmer.

To hear the new sound of music, simply visit your local E-mu dealer.

Where Proteus is available for a song.

E-mu Systems, Inc.  
applied magic for the arts



How can we deliver the uncompromised sound quality of the EIII for under \$1000? That's the \$10,000 question.

E-mu's new 16-bit digital multi-timbral sound module.

And what makes Proteus such a noteworthy achievement is our G chip. A sliver of silicon that combines the legendary sound quality of the Emulator™ III with total, unfettered creative freedom.

For under \$1000.

An undeniably modest price to pay for 4



With 192 different presets, you can toot your own horn and then some. Our Proteus XR version has an additional 192 user presets.

Megabytes (internally expandable to 8 MB) of multi-sampled acoustic

and electronic instruments selected from the EIII library. Plus a rich palette of digital waveforms. All stored in ROM and available simply at the touch of a button.

With Proteus' extensive programmability, you can reshape and reassemble sound endlessly. Our unique MidiPatch™ modulation system

Proteus is your library card to the world's most revered sound library: the Emulator III.

© 1989 E-mu Systems, Inc. 1600 Green Hills Road, Scotts Valley, CA 95066  
All trademarks are property of their respective companies.

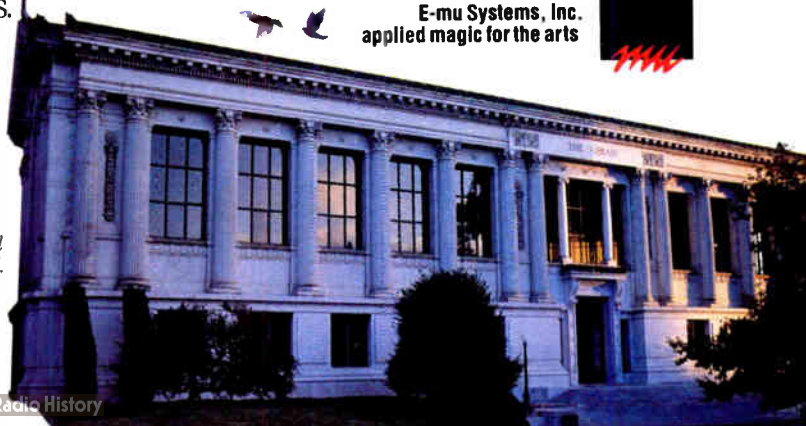

# UNDERSTANDING MICROPHONES

## *Part 3: Applications & Tips*

**In the final part of this series, the focus is on microphone selection and placement as well as helpful hints on getting the most out of the mics you might already have.**

*Text by Paul Freudenberg.*

**N**OW THAT THE basics of microphone design and performance qualities have been covered, it's time to focus on the hands-on use of these mics – what they were designed for, how they are being used, and how to get more out of what is available.

It's important to remember that there are few hard and fast rules in miking. As soon as someone says, "You can't do that!" someone else goes and does it. Some of the old microphone designers like those from Neumann, Telefunken or AKG would have a fit if they saw how close we put their respective mics to record the voice or, even worse, really loud instruments. Back in the "good



old days," it just wasn't done. Mixing consoles only had four or so inputs, and multiple miking was unheard of. And tracks? Many said that four was too many!

Enter the '90s. Microphones inches

away from drum heads, guitar amps smoldering at high levels with our trusty transducer faithfully trying to change air pressure into ear pleasure, and vocalists more intimate with steel and mesh than the lover they sing about. How did these things come to be? Did technology shape us or did our naïve experience with an infant art form mold the tools we have today?

### **Do The Right Thing**

Although the list of rules is short when it comes to using microphones, there are a couple of good ones just to keep us honest. Never use a mic on a source that will exceed the dynamic range of the element. This may sound obvious and it is harder to do nowadays given the current crop of microphones designed specifically to handle higher sound pressure levels. But as soon as I say that, I'll see someone unwittingly putting a fragile vintage ribbon mic in front of a bass drum just long enough to hear that first (and sometimes final) thump.

As a general rule of thumb, condenser mics sacrifice very high level ►

The MIDI LAN\*  
has Arrived...

MidiTap...  
Create the  
Virtual  
Studio...



**LONE WOLF**



1505 Aviation Boulevard Redondo Beach CA 90278 (213) 379-2036 Fax: (213) 374-2496

\* MIDI LAN - MIDI Local Area Network

World Radio History

► handling in favor of a flat, uncolored sound. Also, condensers are extremely sensitive to high frequency overload. For example, rattling some keys in front of an AKG 414 will cause the preamp to overload due to the transient nature of the high frequencies even though the average level barely moves the meter. When recording cymbals, wind chimes or other high, percussive instruments, take extra care in checking that the mic isn't distorting. When in doubt, use the pad to protect the preamp from sudden, high levels. Better safe than sorry. Sometimes in recording, one take is all we get. If you need to record something really loud, use a dynamic. You may find that the coloration is more appropriate anyway due to the way we hear loud sounds.

### Beware the Phantom

Try to avoid using outboard phantom power supplies at home. Many home recording units (small consoles or portable, multitrack cassettes) have unbalanced mic inputs (usually 1/4" jacks) and will not block the 48 or so volts if the line is not properly unbalanced. This requires a special unbalancing transformer (XLR female to 1/4" male). A simple adaptor will not do! When in doubt, check again. The damage phantom power can do in an instant to an unsuspecting mic input is worth another glance. And remember, always bring the fader volume down before switching on the phan-



AKG 414



tom power. The thump that is sure to result can damage speakers, not to mention your state of mind.

When using a large diaphragm condenser in a cardioid configuration, make sure the correct side is toward the source. Again, this may sound obvious, but most of these mics look the same in front as they do in back. In most sessions, the complaint report reads something like, "The mic sounded thin and low in level." Hey, I've done it myself! And I've seen it done by some bright engineers who were just careless or in a hurry. It might be wise to get familiar with how it sounds backwards just so you'll recognize it. A quick hint here, usually the manufacturers logo or nameplate faces forward.

### Mind Those Ps and Ss

Let's say that we're recording a lead vocal using a large diaphragm condenser such as an AKG 414 or Neumann U-87. The mic sounds good, but there's a little too much sizzle on the "Ss" or maybe the "Ps" are popping too much. Sure, a wind screen could help, but this is a situation where placement makes all the difference. For popping problems, moving the artist slightly off axis (away from directly in front) causes less build up right at the front of the mic. Also, moving the mic slightly higher than the performer's mouth will allow the "Ps" and "Ss" to float underneath the direct pickup range. Since this is a special case, make a note of what you did so you'll have

less trouble matching the vocal later.

And while we're on the subject of wind screens, should we or shouldn't we? The answer is a definite maybe. The foam wind screens included with most condensers do provide for excellent pop protection and furnish defense against moisture and airborne particles - you know, the stuff that flies from the singer's mouth! In defense of the purists, however, these bulky foam wind screens do color the sound a bit. Many engineers prefer a third party, "stocking" type mesh. These still allow



Sennheiser 421

for moisture and particle protection but don't do much for the dreaded "Ps." Placement is still the answer.

By the way, if moisture is allowed to collect and attract dust, these little nasties can form a bridge between the diaphragm and backplate, causing the mic to perform poorly or to short out all together. Mic cleaning should be part of routine maintenance, but it seems to be something that always gets postponed until it's too late. Cleaning the fragile diaphragm should only be done by the manufacturer or an authorized repair person.

If you are still having the "S" and "P" problem, consider changing to a high quality, large diaphragm dynamic if one is available, such as a Sennheiser 421 or Electro-Voice RE-20. These mics are much more tolerant of the little speech problems some singers tend to exhibit.

### Miking Guitars

Acoustic guitar is frequently a frustrating instrument to record. Because of all the resonating surfaces and the fact



that no two guitars record the same, mic placement becomes as important as selection. In this application, a condenser is usually preferred over a dynamic by most engineers for the uncolored response and flat, smooth high frequencies. I would tend to go for a small diaphragm condenser like the AKG 460, Sennheiser MKH-20, or the Neumann KM-100 because a small diaphragm is less sensitive to the boomy or bassy sound in front of the sound hole.

Placement over the neck gives the sound a fuller tone, richer in fundamentals; placement towards the bridge gives a tighter and brighter sound. Multiple miking can work to combine the sounds from two different surfaces, the front and side, for example, but be careful. Any multi mic configuration increases the occurrence of phase cancellation problems. The distances

***"I would recommend a good, small-diaphragm condenser to those wishing to do high quality sampling."***

between the mics is important to avoid the difficulties that are examined later. Lastly, for an acoustic guitar, I might try a PZM mic for its ability to capture a composite sound a couple of feet back rather than the focused sound of conventional close miking.

Electric guitar, on the other hand, presents a whole other set of problems. A clean, sparkling sound may require a completely different miking approach than a loud overdrive rock sound. To understand guitar amp miking, we must look at the ultimate sound source: a speaker. Similar in design to a dynamic mic, but functioning in reverse, the speaker generally consists of a thick paper cone with a cylinder of wire attached to its base (called a voice coil) supported by a heavy metal frame which also houses a magnet surrounding the coil. Get the picture? Mass. Big and heavy, the cone has to overcome a lot of resistance to get going. And just like its dynamic counterpart, the speaker cone can't get going quite fast enough to produce all of those high harmonics.

Fortunately for guitarists, our ears have become accustomed to the tailored roll off of guitar amps and in most situations, a dynamic mic works just fine. Keep in mind that the sound out of a speaker needs to develop

While others CLAIM to.....

# MUSICPRINTER® PLUS 3.0

simply  
**DOES IT!**



MusicPrinter Plus is the acclaimed musical notation and MIDI performance program that gives you the flexibility and power you need. With real time MIDI input as one of your options, MusicPrinter Plus 3.0 is even quicker and easier to use. It has a full range of musical characters, fast response, and automatic routines, including score rejustification. MusicPrinter Plus 3.0 gives you total control over the musical performance and printed score.

In addition to the elegant copy from standard and wide carriage dot matrix printers, MusicPrinter Plus 3.0 now supports HP and Canon Lasers and high resolution ink jet printers, such as the 360 dpi wide carriage BJ-130.

for  
**IBM and  
Yamaha C1  
Computers**

**tar** Temporal Acuity Products, Inc. (206) 462-1007 or  
300 - 120th N.E., Blag 1 - Bellevue, WA 98005 **1-800-426-2673** (except WA)

## FOR VALUE, SELECTION & CUSTOMER SATISFACTION DISCOVER THE PLUS!



**312 756-7625**

ALL MAJOR BRANDS OF COMPUTERS, KEYBOARDS & SOFTWARE  
IN STOCK & READY TO SHIP • YOUR MIDI / SMPTE SPECIALISTS!  
ALL MAJOR CREDIT CARDS ACCEPTED • EASY CREDIT TERMS AVAILABLE

NORTH	DOWNTOWN	SOUTH	HOURS
31 East Goll Road Arlington Hs, IL 60005 (312) 439-7625	3154 N. Clark Street Chicago, IL 60657 (312) 327-5565	3416 Chicago Road Steger, IL 60475 (312) 756-7625	Mon-Fri 12-9 Saturday 10-6 Sunday Closed



► before being picked up by the mic. A microphone shoved right up a speaker's throat is going to give a small "picture" of what's actually happening once the cabinet, room and surrounding air all have their say in coloring the sound. This is especially true when miking multi-speaker enclosures like the monster stacks from Marshall or Randall, which are designed to project sound quite far.

Trying to get that silky smooth clean sound? Start with a really clean amp, then choose a condenser for its crystal clear highs. No need to have the amp up too loud for this, just enough for the speaker to develop good bass. Also, miking an amp that's sitting on the floor of a studio (usually oak parquet, right?) presents the problem of picking up out-of-phase reflections (called "boundary interference") from the floor.

Boundary interference occurs when the path traveled by reflected sound is longer than the direct signal path (almost *always* the case to some degree). Our clean guitar example above (with the amp on the floor and the mic at the same height) creates a situation where the direct path (speaker to mic) is shorter than the reflected path (speaker to floor to mic). What you will hear is a hollow, nasal sound, sort of like bad equalization. Before you kick in the dependable console EQ, raise the amp off the floor three to four feet and place the mic very close to the floor. A PZM mic (also known as a "boundary microphone") on the floor might also work well here.

## Of Mics and Skins

By using just one mic, we stand a reasonable chance of recording something that sounds similar to the source. But what happens when we complicate the issue and try to get that close-in sound with a large, multi-voice instrument like a drum set? Today's commercial drum sound is almost a result of close miking, and much of what we hear is due to our old friend the proximity effect.

A drum is really nothing more than another form of a diaphragm; traditionally two pieces of thick skin or plastic stretched over a cylinder or shell and tuned to a desired pitch. As our microphone comes within the proximity range, the build up emphasizes the pronounced fundamental of that drum. Sometimes, the diaphragmatic action can be so pronounced (as with low

drums) that the sound lacks a sense of attack and can be quite boomy. Here again, placement is the key to achieving the desired sound without EQ.

A drum head, like a vibrating string, develops a fundamental tone and a series of (non-harmonic) partials. The fundamental is usually the loudest tone and is most pronounced in the center of the head, where the greatest displacement of air occurs. Some might conclude that since this is where the musician is striking the drum, the greatest amount of stick sound or attack comes from here. However, the center is so rich in fundamental that it's hard to focus in on the stick sound.

Fortunately for us, putting a mic so close to the center of the drum head would force a performance compromise on the part of the drummer. And besides, drummers have lousy aim (and mics are expensive!). It's much more advantageous for the engineer to move the mic towards the rim where a

pop music puts the snare even farther out in front, tuned higher and recorded brighter, requiring a different mic and technique. In this case, a small diaphragm condenser works well. Try different positions slightly farther away from the drum and towards the outside edge of the shell to get more resonance. Remember to use at least a 10dB pad if not more. Room ambience is a big part of this sound, so try abandoning the close miking technique and see what you get.

## Sampling

One of the electronic musician's greatest applications for a good mic these days is sampling. Here, too, we typically deal with close miking and fight the proximity, frequency response game. Overall, I would recommend a good, small-diaphragm condenser to those wishing to do high quality sampling. Be sure to keep the earlier cautions

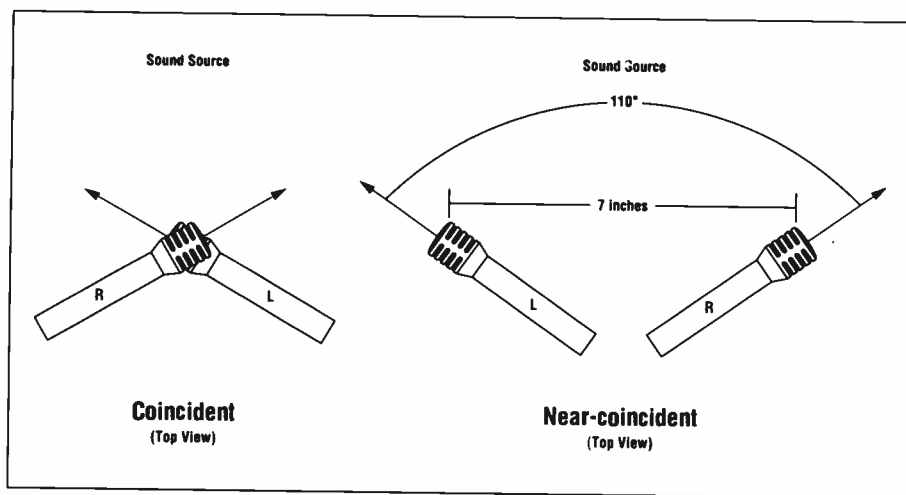

Figure 1. Coincident and near-coincident stereo miking configurations.

good balance of attack plus fundamental enhanced by the proximity effect can be achieved. You might find by experimentation that you don't even point the mic at the sticks, just down toward the head and rim.

So much for theory, how about mics? Dynamics are the usual choice, not only for their ability to handle the high SPL (sound pressure level) so close to the drum, but for their frequency response and lower cost, as well. Seven or more mics may be used on just a medium-sized drum kit.

Shure SM-57s have a small profile and good proximity effect as well as being reasonable in price. Almost a standard choice for the snare drum, the '57 hangs in as one of the workhorses of the mic closet, although recent

about phantom power in mind, though, as most sampler inputs are unbalanced.

One thing to consider when sampling is that the "pinpoint view" of close miking sometimes sounds unnatural when combined with other focused samples, as with a multiple sample of a piano for instance. Use one common miking spot farther back so the sound can develop and take all of your samples from that point.

## The XYZs of Stereo Positioning

Many technical publications for the recording engineer refer to some common stereo miking practices by name. These usually refer to the configuration of the mics or sometimes to the name of the engineer who developed them.

The most familiar of these are probably the "XY" and "MS" methods of stereo miking. The XY procedure refers to the position on an axis that the microphones represent, and can be achieved in one of two ways: "coincident" or "near-coincident" (see Figure 1).

The coincident technique uses two directional mics with the diaphragms placed close together (like a 'V' with the business end of the mics coming together at the point). This placement allows sound to arrive at both capsules of the stereo pair at nearly the same time. The near-coincident technique also uses two mics arrayed in a 'V' configuration, but this time the business ends of the mics face outward. The actual angle and distance between the mics can vary, but a common setup uses a 110° angle with 7" between diaphragms.

For the purist engineer, coincident recording provides a less dramatic stereo image, but it does allow for excellent mono compatibility and stable imaging without holes. Try coincident recording the next time you record acoustic piano. Put the stereo pair about two feet above the hammers and about a foot to the right (higher) than middle C. Near-coincident recording is often used when recording small ensembles and provides excellent stereo imaging.

Another form of coincident miking

***"On the subject of wind screens, should we or shouldn't we? The answer is a definite maybe."***

is called "MS." This stands for middle/side and requires a bit of magic to work. MS miking uses two microphones (or one mic with two separate elements) as in XY, but here, one mic, the "middle," faces directly forward with a typically cardioid pattern. The "sides" mic is always bi-directional, with elements oriented to pick up sound on either side of the middle cardioid. The signals from the two mics are then fed into a matrix network, which splits the sides mic into two signals by flipping the phase of one of the signals.

This may sound like an exercise in futility, but by using this technique, we can vary the spread of the stereo image just by increasing or decreasing the amount of sides microphone that's mixed in with the middle. In addition, because of the phasing trick, collapsing to mono causes the sides mic to "disappear," leaving the direct, mono

cardioid mic in the mix. We can also record the separate mics on two different tracks, without the matrix, and the use the matrix in the mix to restore the stereo image that we desire.

Other stereo miking techniques utilize omnidirectional mics spaced a certain distance apart and various permutations on these methods exist. When doing any stereo miking, keep in mind that phase cancellations will occur as you move the mics apart. The critical area of trouble is when the spacing is greater than 18 inches and less than six feet or so. When in doubt, listen in mono to see if any part of the sound disappears.

## Wrapping it Up

Now that this series has taken us on a whirlwind tour of microphones from design to technique, try coming up with some techniques of your own. Tape a couple of PZMs to the singer's chest for room mics or something. A good, high quality mic almost ensures a good sound; don't cheapen it by saying, "I only record vocals with it." Just keep listening. ♦

*Paul Freudenberg is a freelance writer located in Los Angeles. In addition to writing, Paul is a recording musician and sales consultant for a pro-audio sales company.*

## Masters of



Dr. T's  
MUSIC SOFTWARE

ON SALE

# MIDI

Helping You Be The BEST!

<b>Ars Nova</b>		<b>Intelligent Music</b>		<b>Note Writer 2.0</b>	MAC
Practica Musica	MAC	"M"	MAC, ST, AM	Score	IBM
<b>Blank Software</b>		RealTime	MAC	<b>Resonate</b>	
Alchemy Pro	MAC	Up Beat	MAC	Listen	MAC
Alchemy App	MAC	<b>Drumware</b>		<b>Roland Corp.</b>	
Sound File ESQ-1	MAC	Kawai Ed/Lib	ST	MPU-IPC Interface	IBM
<b>Computer Music Supply</b>		Genwave 12/16	ST	MT32/Sound Module	IBM
CMS 401	IBM	Sound Filer 5900,		<b>Sound Quest</b>	
CMS 401/Cakewalk	IBM	X7000, S612	ST	Texture	Amiga
<b>CODA</b>		<b>Jim Miller</b>		All Ed/Lib	ALL
Perceive	MAC	Personal Composer	IBM	<b>Take Note</b>	
MAC Drums	MAC	<b>L.T.A. Productions</b>		Take Note	Amiga, ST
<b>Digital Music Services</b>		Forte	IBM	<b>Temporal Acquity</b>	
Yamaha DX 711, TX802		Fwapp	IBM	Music Printer Plus	IBM
TX812, FB01 DMPZ	MAC	<b>Magnetic Music</b>		<b>Turtle Beach Software</b>	
<b>Dr. T's</b>		Prism	IBM	SampleVision	IBM
KCS	ALL	Texture Classic	IBM	<b>Twelve Tone Systems</b>	
KCSII	ALL	Texture Windows	SOON	Cakewalk	IBM
Copyist App.	ALL	<b>MicroIllusions</b>		Cakewalk Live	IBM
Copyist Pro	ALL	Music X	AM	Cakewalk Pro	IBM
X-OR	ST	<b>Music Quest</b>		Sound Globbs	IBM
All Editors	ALL	MQX16s (Smpte)	IBM		
<b>Golden Hawk</b>		PC MIDI Card	IBM		
MIDI Gold 500	AM	<b>Passport</b>			
MIDI Gold Insider	AM	MasterTracks Pro	ALL		
<b>Graphic Notes</b>		MIDI Transport	MAC		
Music Publisher	MAC	MIDI Interface	MAC		
		ClickTracks	MAC		

**EMS**

ON SALE

**WE WILL NOT BE UNDERSOLD**

**Computer  
Mart**

105 Lynn St.  
Nacogdoches, TX 75961



ORDER TOLL FREE

**800-443-8236**

Info and Pricing: 409-560-2826

# LISTENING LAB

## KATE BUSH

### *The Sensual World*

Columbia



### Pick of the Month

After four long years since the release of *Hounds Of Love*, die-hard Kate Bush fans can rejoice in yet another startling display of exceptional creative talent. In many ways, this new album is a refinement of the style that she has been cultivating for years. Her particular brand of theatrics blended with mutant Irish folk rhythms blended with far-out spacey arrangements permeates every nook and cranny of *The Sensual World* to produce a fantastically affecting brew.

As with her past recordings, she once again breaks new ground in soundscapes. The beetle's wing of the brew this time around is the inclusion of the Trio Bulgarka on four of the tracks, most notably on the tragic 'Rocket's Tail.' The bizarre vocal timbre and

nuance of these Bulgarian folk singers lend an unearthly quality to the mood of the album (as if Kate ever needed help in *that* department!).

In many ways, *The Sensual World* is more akin to her first two albums, *The Kick Inside* and *Lionheart*. Whereas *Hounds Of Love* placed major emphasis on atmosphere (and she certainly doesn't abandon this altogether - 'The Fog' is perhaps her most richly crafted tone poem to date), this album focuses on *songs*. And like her first two albums, *The Sensual World* is remarkably listenable. An excellent example can be found in 'Love and Anger,' with its infectious rhythm, propelled by a titillating inaction between the drums and wildly arpeggiating synths (*warning: the video does not do the song justice!*).

I could go on raving about this album for pages, but instead I'll simply insist that you listen for yourself. ♦ Dan Rue

## ART OF NOISE

### *Below the Waste*

China/Polydor

Several years ago, when we were all trying to figure out what our samplers were good for, Art of Noise emerged from Trevor Horn's ZTT Productions thumbing their noses and making rabbit ears with their fingers behind anyone who got bogged down in seriousness. Exploit the weakness, go for the belly laugh, any sound can serve any musical purpose - and they did it

with skill.

Well, everybody grows up - Art of Noise included. A good deal of the irreverence is gone, but the skill remains. *Below the Waste* sounds like a collection of ideas and skeletons that didn't make it onto previous AON albums which have been fleshed out with Anne Dudley's considerable powers of orchestral arrangement. This album features more of her huge, romantic, *perfect* brush strokes than any before, while the strong dance beat stays around. But instead of disco at its worst, this all manages to sound fresh and interesting.

Texture-wise, mutant voices are still the strongest trademark (weirdly intoned in some places), along with some actual (non-English) singing. Real guitarists and bass players are used, although sampled power chords and Minimoog bass are just as prevalent as the real thing (unfortunately, the album notes don't say who did what where). The mixture of a forceful string section and sampled fuzz guitar in 'Back to Back' is particularly grand. Dudley takes more piano solos, along with a few swipes at her marimba. There are also more winds involved (brass and wood) than before. Noise objects still occasionally co-opt the work of the drums ('Dilemma,' 'Flashback,' and the scrap metal intro to 'Chain Gang'), and JJ can still program a mean-ass beat, such as the Frankie Goes to Hollywood-ish rhythm section in 'Yebo!'

And yet, there are still some subtle touches. My favorite uses a conga in

place of a hi-hat in 'Yebo!' – complete with some pitch motion to the conga, which a hi-hat rarely matches. A really dirty synth sound cuts wonderfully on the second verse 'Catwalk.' Slapback echo to dirty up sounds along with timed repeats on snares also add to the seduction. Slightly disappointing is the CD bonus track 'Bond' – the big band sample bites, huge drums, and twang guitar sounds promise more than gets delivered (it sounds unfinished).

For those who found Art of Noise too weird for them (or their friends), this is a good way to ease in. But for true sampling lessons, go back to their earlier releases *Who's Afraid?*, *In Visible Silence*, and *In No Sense? Nonsense!* (and for rock 'n' roll bombast, Frankie's *Welcome to the Pleasuredome*). ♦ *Chris Meyer*

## THOMPSON TWINS

### *Big Trash*

Warner Brothers

When I think back to the surge of bands that made music so exciting in the early '80s, several stand out in my mind. I remember one particular trio who attacked the dance club scene with hits like 'Lies,' 'In the Name Of Love' and 'Love on Your Side.' I'm talking about the Thompson Twins.

After following these successes with several others over the next few years, including 'Doctor, Doctor' and 'Into the Gap,' the trio became a duo (no, they still aren't twins), the duo became parents, and now the parents have produced some new hits, namely the adolescent-sounding dance track 'Sugar Daddy' and the eye-opening 'Bombers in the Sky.'

Tom Bailey and Alannah Currie are producing more than babies these days. Besides writing and producing tracks for Deborah Harry, Jerry Harrison (of the Talking Heads), and the Tom Tom Club, the Twins have been busy songwriting and producing their new album, *Big Trash*, on their new label, Warner Bros. *Big Trash* is like nothing they've done before. Whether it's a phone call from 'The Queen of the USA' (a.k.a. Debbie Harry), the roar of fighter planes on 'Bombers in the Sky,' or the blaring sirens on 'Dirty Summer's Day,' the sounds are enticing and the songs are humorously serious.

As Bailey weaves his dark funhouse melodies with odd samples, cool synths and brilliant guitar work around Currie's boldly bizarre lyrics, we are

exposed to the danger of a world threatened by our own vandalism. Still, we groove trashily to peculiar songs like 'Wild,' 'TV On,' and the title track. All of this makes *Big Trash* an outlandish, yet well-rooted mental party.

♦ *Debbie Greenberg*

## Laurie Anderson

### *Strange Angels*

Warner Brothers

At first listen, I didn't like this album. Laurie Anderson is supposed to make challenging music – weird concepts with significant pauses in the narratives, pitch shifted and looped voices, odd samples, Adrian Belew on something that once vaguely resembled an electric guitar, Peter Gabriel on backing vocals, atmospheres (and Prophet 5 patches) that are so heavy, they make your exoskeleton implode. This is *not* 'Difficult Listening Hour' – sitting bolt upright in that straight-back chair will only make you something between uncomfortable and annoyed.

No, this one is polished. Her voice sounds like a diva's, with many layers and smooth harmonies. Bobby McFerrin is on backing vocals, and a cast of thousands add innocuous keyboards (okay – the phased pseudo-clavinet on 'The Day the Devil' is outside) and safe-sex guitars. Jimmy Bralower and Steve Gadd (along with Anton Fier, David Van Tieghem, and a cast of millions) add percussion. Two words: *sell out*.

So I pop a few alpha-enhancers, sink deep into a deceptively heavy overstuffed leather chair ripped off from E-mu, and try enjoying *Strange Angels* instead of looking for a fight. And I find that it's a damn good, soothing, subtle, professional album. The gentle rhythms hint at traces of funk and Latin. Closer study also uncovers some particularly good understated synth sounds, such as the modulated dirty analog melody on 'Red Dress' (her portrayal of female sexuality in the '90s, including the alarming fact that a woman's pay compared to a man's has only gone up one cent in the past 50 years, with parity projected for the year 3888). Many listenings later, and I still haven't bitmapped all of this album's intricacies.

If anyone other than Laurie Anderson had made this album, I would consider it brilliant. So I guess I might as well get off her case and say "Good job." ♦ *The Cyberpunk*

## CAMOUFLAGE

### *Methods of Silence*

Atlantic

Decade milestones have a way of making people sentimental. My turn: When 1980 came into being, I was enraptured with the intelligent energy, imagination, and minimalism of New Wave – especially Techno Pop (which allowed me to make a smooth transition from synthesizer lust in Progressive Rock to something trendier and more socially acceptable). Unfortunately (for me), the fad didn't last long.

Camouflage has retained many of the sounds of Techno Pop and updated them while taking a low-key (instead of "glam") approach. The songs are all minimal, with the leads being slow monophonic synth tones. Most notable among these are the bouncy resonant bass line on 'Feeling Down,' the Japan-like heavily modulated tone on 'A Picture of Life,' a cross between a synth and an obviously transposed sampled violin in 'On Islands,' and the woodwind-like lead on 'One Fine Day.' As a matter of fact, a real bassoon appears on 'Love is a Shield.'

Guitars are often acoustic or cleanly chorused (with some reverse guitar on 'One Fine Day'). The fuzz tone on 'Feeling Down' has been equalized to exhibit vocal-like formants. An analog two-note sequence takes the roll of rhythm guitar on many tunes, and the bass tends to be Minimoog-like. Processed noise augments the drums on a couple of tracks, with 'Sooner Than We Think' (which includes more analog drum sounds à la TR808) being especially notable. Samples (mainly choir) are also used in a tasteful, reserved fashion. In general, the synthesizer sounds remind me of Baumann-era Tangerine Dream (*Ricochet*, *Stratosfear*, *Encore*, etc.). The overall feel is not unlike early Depeche Mode, right down to the thin, detached-yet-mournful vocals.

Just when you think you have an (albeit pleasant) formula spotted, they throw you a curve in 'Les Rues' – a string quartet trades off with samples of breaking glass in an industrial update of Edgar Allan Poe. The Middle Eastern flair to the string charts in 'Feeling Down' also provide a different twist. And this album isn't an isolated miracle – last year's *Voices and Images* presages the path down which *Methods of Silence* wanders. If you've missed good old-fashioned monophonic synths (and can do without the faux passion), stop here. ♦ *Yung Dragen*

# You Can Take It With You!

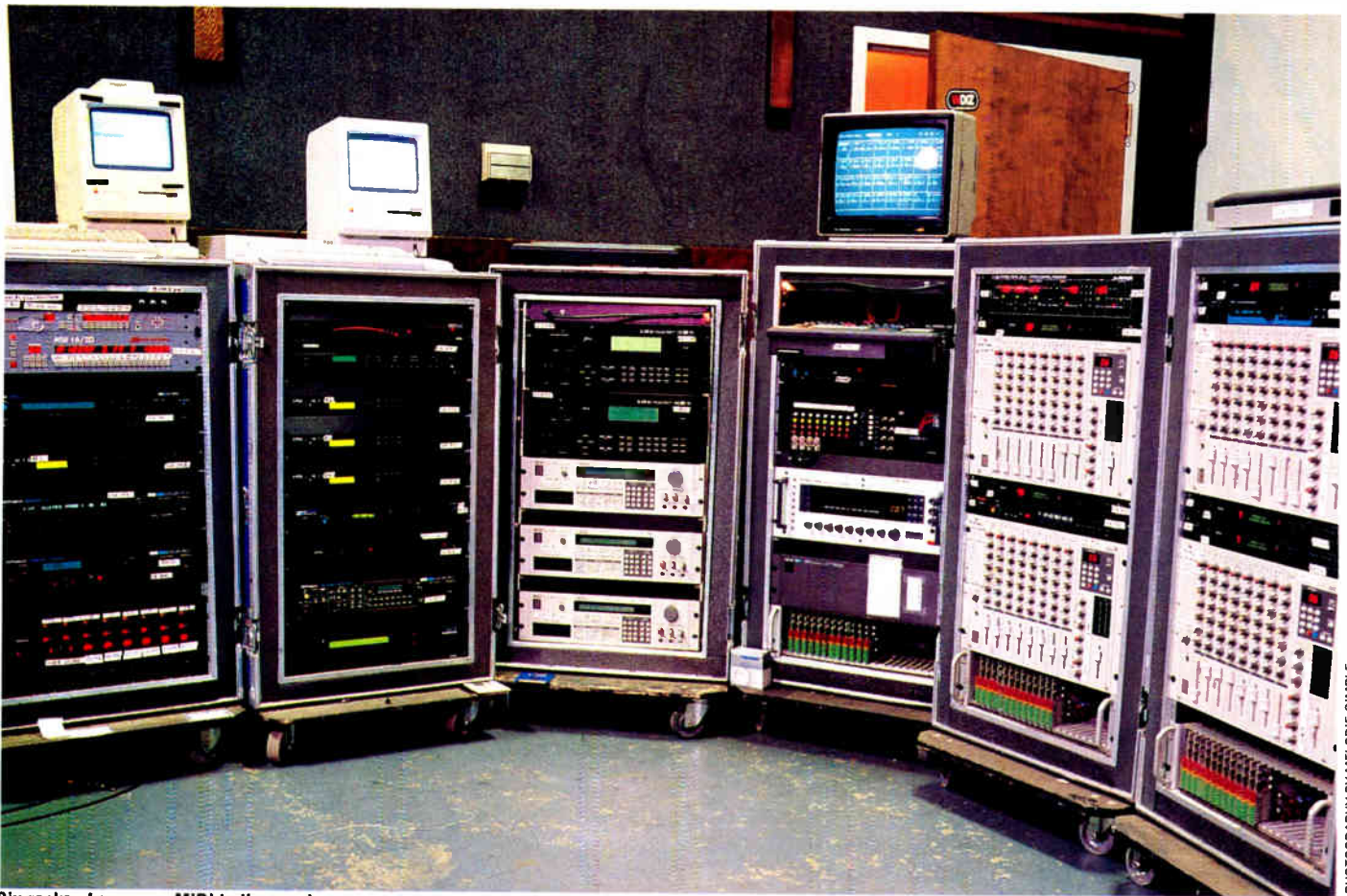

PHOTOGRAPHY BY MELODIE SIMPLE

Six racks of gear use MIDI to the max!

**R&B artists Atlantic Starr wanted to sound as good live as they do in the studio. The magic of MIDI and audio automation made it possible. Feature by Lawrence Ullman.**

**Y**OUR MISSION, SHOULD YOU choose to accept it, is to create an entirely automated "backup orchestra" that will allow Warner Bros. recording artists Atlantic Starr to recreate the big-bucks studio sound of their new CD while touring throughout the US. Some of the system requirements include: transparent automation (allowing the three keyboard players to simply play without worrying about patches, MIDI channels, etc.), duplication of the "orchestral sweetening" and backup vocals on the original recording, easy set-up and tear-down, and totally reliable operation on stage.

This was precisely the challenge presented to LA-based music technology maven Marc Mann. A keyboardist,

composer, Macintosh and MIDI expert, Mann has been working with Atlantic Starr for about three years. Following the success of their latest album, *We're Moving Up* (which includes the smash hits 'My First Love' and 'My Sugar'), the group wanted their 1989 tour to be spectacular, with none of the musical compromises that are usually tolerated when performing live. So Mann, along with Atlantic Starr keyboardist Rich Aronson and hardware wizards Chris Holbrook and Robin Taylor of IntelTronix, undertook the design and creation of a live performance system that pushes MIDI to its limits.

## MIDI with a Capital M

The system consists of six 20-space rack

cases connected by a custom wiring harness and multi-pin connectors. The brain of the system is a Macintosh Plus running Mark of the Unicorn's Performer sequencing software. An Opcode MIDI interface using both of the Mac's serial ports allows Performer to address 32 MIDI channels. Backup is critical in live performance, so a second Mac Plus is always running in parallel with the first (more on this later). MIDI controllers on stage included three Kawai M8000 keyboard controllers and a KAT DrumKat which is used as an acoustic drum trigger-to-MIDI converter.

All MIDI routing is done using a JL Cooper MSB Plus MIDI patchbay, which is in turn connected to a JL Cooper MSB 16/20 MIDI patchbay (the

16/20 has 16 MIDI Ins and 20 MIDI Outs – and all are used!). The MIDI Out ports from both Macintoshes are connected to the MSB Plus, which has a switch that allows the backup computer to be selected instantly if something goes down on the primary Mac. The “Panic Button” feature of the MSB Plus (which sends an All Notes Off command on all sixteen channels to all MIDI Outs) also came in very handy during the initial testing phase.

As you’ll soon see, the *audio* side of things had to be automated as well, which is where this system really gets unique. A central component is the Akai PG1000 MIDI controlled audio patchbay, which routes the audio from the various sound modules into one of four Akai MPX820 MIDI controlled mixers. And to put the icing on the cake, each of the four MPX820s has its own complement of MIDI controlled signal processing gear. Amazingly, only sixteen channels of pre-mixed and balanced audio are fed to the house PA system, greatly simplifying set-up and sound check.

## Supermarket of Sounds

One of Mann’s main goals was to enable each of the three keyboard players to use any combination of sound modules required to produce the best possible sound – no matter in which of the six racks they happened to be located. As he explains, “Usually, when you do a tour system, you’ve got three keyboard players, so you say ‘Okay, these are your modules. This is all you ever get to play.’ And so their colors end up being pretty much fixed.” But by automating the MIDI and audio routing, Mann was able to get around the usual limitations.

“What we did was work on one guy at a time and build up his sound. We asked ourselves, ‘What is his part [bass, strings, brass, etc.] going to be for this song?’ And we chose the modules we thought would do that sound best. So, if we wanted to have him play a marimba for a certain section, we didn’t have to compromise and accept any old marimba that happened to be coming out of whatever module he was using at the beginning of the song. We could use the best marimba that we had in the entire rig. And we’re not just dealing with patch changes – they’re complete synthesizer changes. We had a lot of flexibility, because we had a lot of sound modules that really complemented each other well.”

That they had “a lot of sound modules” is an understatement – the list reads like the inventory of a 48th Street music store. Atlantic Starr is a Kawai endorsee, so it’s no surprise that there are four K1r’s and two K5m’s in addition to the M8000 controllers. From Roland: an MKS-80 Super Jupiter, MKS-70 Super JX, MKS-50, MKS-20 Digital Piano, and D-550 Digital Synth. Yamaha is represented by a TX816 and a TX81Z. A Korg M1R and Kurzweil 1000PX round out the synthesizers. Samplers include three Akai S900s and a MPC-60 Drum Machine, a Forat F16, and a Dynacord ADD-one.

With so many sonic resources available, it became possible to create some gigantic sounds. For example, the sequenced bass sounds consisted of no less than five modules: two (out of eight) TXs, the TX81Z, the MKS-50, and the MKS-80. “With those modules, we had a lot of analog-type bass sounds to choose from. On their older records, Atlantic Starr used Moogs and Minimoogs and things like that. So, we added some digital stuff with the FM synths, and the analog synths allowed us to do what sounded like their original bass sounds. After all, when you’re live, you want a bass sound that cuts.”

The system’s MIDI routing is impressive enough, but according to Mann, “the real novelty of the system is its audio routing. I mean, MIDI you can route anywhere, but if you want to have this guy play these three modules, and you have a mixer that’s dedicated to him, how do you route the audio to that mixer?”

***“The real novelty of the system is its audio routing. If you want to play these three modules, and you have a dedicated mixer, how do you route the audio to that mixer?”***

Enter the Akai PG1000 audio patchbay and MPX820 mixers. After deciding on the combination of modules to be used by each keyboardist on a given tune, Mann programmed a patch on the PG1000 that routed the audio outputs of the modules to the appropriate MPX820 mixer. Each of the three keyboardists has his own mixer, and a fourth mixer is dedicated to sequenced parts played by Performer on the Macintosh.

The automation makes the house

sound person’s life much simpler – they only deal with the stereo outputs from each player’s mixer. This lets them turn up the bass or bring out the strings without having to guess where all the components of a sound are coming from. Net result: fast sound checks and a consistent sound venue after venue.

## Backing Vocals to the Fore

One of the major functions of the system, and one of Mann’s greatest challenges, is to reproduce the background vocals from the original albums (often sung by the lead singers themselves). At first this sounds easy – just load up a sampler with the vocal sounds and go. Unfortunately, backing vocals tend to be long samples and may take up the entire memory of a sampler. In a live performance, you have about 10 seconds between each song. So how do you load several floppy disks of data into the sampler in that amount of time? The answer: you don’t. You use a hard disk that can load an entire volume in less than six seconds in response to MIDI program change commands. Once this option became available for the S900, Mann was in business.

Through trial and error, it was discovered that a relatively low sample rate of 12kHz to 15kHz provided sufficient fidelity for the vocals without using up too much memory. As Mann explains, “It turned out that the highest vocal note is about a D4. So you’re talking about fundamental frequencies under 1kHz. So even with a sample rate of 12kHz, you have a usable bandwidth of up to 5 or 6kHz, so you’re fine. Plus, we also had to remember that this was going to be played live. If we were doing this for an album situation, we would do things a lot differently, but this is live. Over a concert hall PA system, the background vocals sound fine.

“Most of the phrases are about four to six beats long. For example, at 120 beats per minute, we’re talking maybe two or three seconds each. That lets us get an average of six to eight phrases into the memory. And, because of the musical phrasing of the background vocals, often times we’ll have the first part of a phrase, and then another part, and then the first part repeated again. So, we didn’t have to sample that part twice. Also, in the time that it takes to go to a different section, like between a bridge and a chorus, there’s enough time to send a patch change to load an entire set of new phrases. There is one



L-R: Rich Aronson, David Lewis, Marc Mann.

► song in which there are so many back-to-back phrases that we actually have to piggyback using two S900s, where one is loading while the other one is playing.

Working with sampled vocal phrases can set a song's pitch and tempo in concrete. As anyone who has used a sampler knows, you can't normally raise the pitch of a sample without speeding it up. In the case of a sampled phrase, changes in pitch will also affect the tempo of the rhythm pattern being sung, and it will no longer match the tempo of the tune. Mann found the *Alchemy* sample editing package to be an indispensable (if time consuming) tool to fix these problems.

"Alchemy allows you to change the pitch of a phrase without affecting its tempo and vice versa. You can have as many as twenty or thirty phrases in a song. That means each individual phrase has to be 'Alchemized,' as we started to call it, so that they can be at the right pitch or tempo for whatever changes were made in the overall song. And then they have to be reloaded back onto the S900 hard drive over MIDI. And that takes a little while, to

say the least. But of course they didn't realize that. They would say, 'Uh, we need to change the tempo on this because the choreography on stage isn't working right.' And we'd answer, 'Okay, give us eight hours!'"

### The Automatic Concert

The three keyboard players wanted a fantastic hi-tech sound, but they didn't want to deal with technology – all they wanted to worry about was their musical performance. To meet this requirement, the entire concert was automated by creating a huge sequence in *Performer*. Four different sequence files were created to provide sets lasting from 35 minutes to an hour and twenty minutes.

Some musical lines, such as fast moving bass and continuous percussion parts, were performed by the Macintosh in concert. Some of these lines already existed – the group had to rent a Roland MSQ-700 to transfer a few sequenced bass lines from their last tour. But in order to create a completely automated mix, "scratch parts"

had to be sequenced for all of the other lines that would eventually be played live. By using the scratch parts (which sound pretty amazing in and of themselves), Mann had a complete performance on tap (except for the lead vocals) that could be used to overdub program change and MIDI volume commands, which were recorded onto a separate track.

For example, to automate the stacked bass sound described earlier, Mann first determined the best patches to use on each synth. Then, while the scratch part played the bass line, he sub-mixed the modules using MIDI volume commands, and then recorded that data along with the appropriate program changes into *Performer*. Once all the program changes, MIDI volumes, and even Tune Request commands (for the MKS-80) were sequenced, the scratch parts could be selectively muted for use in setting up the system or deleted to create a compact file for use in the actual performance.

### One, Two... Test, Test

Making sure that all systems are go for



lift off with a network of this size and complexity is not unlike the process NASA goes through before a shuttle launch. "With a system of this size, we're still dealing with three main items just as they are found in the studio. We've got audio, MIDI, and AC power. If there is a problem, we have tests to isolate where it's coming from.

"Since the entire system is automated, the testing can be as well. We have a TX816 in the rack, which, for those who know how, can be put into a test mode and made to produce a 440Hz tone. Then, you make a patch on the audio patchbay to feed all inputs of all four mixers. You calibrate the mixers, you test the audio runs, and so on. That's an audio test. Then you do a MIDI test - we made a file in Performer that does nothing but send a Note On command and a MIDI patch change in sequence on every downbeat of a bar successively through each of the MIDI channels."

Unfortunately, not every manufacturer makes it easy to tell if data is being received. "If only everyone would put a 'MIDI indicator' on all their products! The Roland modules are great in that you can see if they're receiving [*they have an indicator light on the front panel*]. But on other instruments like the Kurzweil PX1000, you actually have to send it a patch change and then look real close to see it flip its patch. So essentially, you hit play on this test file. You have the audio up already so you can hear something play and you watch for its MIDI light or patch change. If anything was not getting MIDI or didn't sound a note, you'd

***"The automation makes the house sound person's life much simpler. Net result: fast sound checks and a consistent sound venue after venue."***

say, 'Okay, there's something going on here.' These are the kinds of things that you must do to use a system like this. You must make a habit of running through the tests."

Another key element in keeping the system operating night after night is the "Godlist." This 11"x17" printout lists every aspect of the system configuration on each song including MIDI and audio routing as well as who's playing what. "If something doesn't sound

right, you can say, 'What's Rodney supposed to be playing?' You check the list and can see that he should be play-

***"We have two Macs running in parallel for backup. And, contrary to what most people might think, they're not sync'd together."***

ing the M1, MKS-20, and TX modules 5 and 6. You can then quickly track down where the problem lies. Documenting stuff is absolutely critical."

### **Backup To The Future**

If disaster should strike during a show, this group is ready. "We have two Macs running in parallel for backup. And, contrary to what most people think, they're not sync'd together because if one goes down and it's providing the master clock, the other computer's gonna stop, too. They are started together with a macro, and even without being synchronized, they are still within one beat of each other at the end of a four-minute song." To date, they have never had to use the backup computer in performance, but it's been thoroughly tested in rehearsal.

No matter how much technology might be involved, it's still the music that matters, and this is always kept in mind. "What we're doing is equivalent to taking a forty-piece orchestra on the road. We're recreating a full orchestra, you know - strings, oboe, bassoon, clarinet, flutes, and brass. But also the R&B stuff - saxophones, spit brass, all that stuff. To get that kind of sound, you'd be traveling with forty extra players if it weren't for MIDI and for the fact that you can automate it like this. And can you imagine trying to do this without an automated audio patchbay or automated mixers? You'd need a 600-input console or some ridiculous thing. And it would take you a full day to set it up every time. Even with all the problems that we've had to overcome, it's very magical to have that kind of sound coming out of all this stuff. And, when all is said and done, that makes it all worthwhile." ♦

***For more information about this system, please contact Music Production Services at (818) 247-3322.***

**MIDI-16**

An intelligent drum pad to MIDI processor card for the IBM PC & AT. Incredibly powerful, flexible and easy to use. Loaded with features.

- 8 or 16 pad inputs.
- 1 to 4 note changes per pad.
- 1 or 2 foot switches.
- MIDI OUT Port.
- Instant patch change.
- Live setup...and more.
- \$350 for an 8 input kit.
- \$395 for a 16 input kit.

**PIKA TECHNOLOGIES INC.**  
**155 TERENCE MATTHEWS**  
**KANATA, ONTARIO**  
**CANADA K2M-1W8**  
**TEL: 613-591-1555**  
**FAX: 613-591-1488**

**PIKA**  
 PIKA TECHNOLOGIES INC.  
 A DIVISION OF SOFRAK®

# Kawai K4

## Digital Synthesizer



**Kawai's newest multitimbral synthesizer features high-resolution 16-bit on-board samples at a low-budget price. Review by Lorenz Rychner.**

**W**HERE DOES THE K4 fit in to the scheme of things? It's a multitimbral and multi-waveform instrument, in the same family as the K1 and K1II from Kawai. The addition of digital effects processing makes it comparable to Korg's M1 (except for the sequencer) and its successors (M1R, M3R, T-series), as well as Roland's D-50 (which is not multitimbral) and its offspring, the D-550, D-10, D-110, D-20, MT-32 (most of which are multitimbral).

But the K4 is different in several major respects. For one thing, it has a programmable digital filter with resonance among its synthesizer parameters, so it can make some of the fat, gritty, and sweeping sounds that analog instruments are famous

for. It can also transmit and receive a separate data-dump of its drum setup over MIDI. Take into account the modest list price of \$1445 and you know why there is quite a K4 buzz out there. Let's take a closer look.

The K4 is a sleek and surprisingly light keyboard with attack *and* release velocity, aftertouch sensitivity, and two controller wheels (one center-sprung, the other not). The 61 keys have good touch definition for a synthesizer, although I disagree with the manual's statement that "the K4 has the feeling of an acoustic piano keyboard." The rear panel has the requisite three MIDI ports, two audio outputs, a headphone output (why not in front?), a pedal connector, and a socket for the ubiquitous AC/DC adaptor.

Have you noticed the game that the factory programmers play with the first sound that comes up when the unit is turned on? Remember 'Fantasia' from the D-50 and 'Universe' on the M1? On the K4, it's 'OceanWatch,' a wonderfully California New Age experience. It demonstrates the crisp and clean sound quality of the K4 to good advantage, and it also shows off the

fact that each Single can be a layer of up to four sounds. Play it in different ways to hear the various layers, and use the modulation wheel and aftertouch. There's a lot going on within this Single program. The other factory Singles and the first 32 Multi programs are equally enjoyable, all being very musical, with the exception of a few purposely dramatic sound effects. The second set of 32 Multis (Banks C and D) are left open for the user to program and name. So what are Singles and Multis? Read on.

The memory of 64 Single sound programs is organized into four groups of 16 called A, B, C, and D. Up to eight Singles can be grouped into a Multi setup to form all kinds of layers, splits, overlaps, or other multitimbral setups. Sixty-four Multis can be stored, subdivided into 8 Sections, each playing a Single sound with some added parameters adjusted on the Multi Edit screens.

On the K4 keyboard, each Single and Multi program can have its own effects setting memorized for reverb, delay and other signal processing. On the K4r (the rack-mount module), the effects section is omitted in favor of the

memory required to route the sounds to the separate outputs (left, right, plus six assignable mono outputs). A total of 43 drum and percussion samples are available from a separate section, reprogrammable with Decay and Detune parameters. Two sounds can be layered on one key.

Singles combine two or four oscillators called Sources, each playing one of 256 waveforms. Some of these waveforms are digitally synthesized, while others are prepared samples. The synthesizer programming parameters follow the traditional oscillator/filter/amplifier architecture, with LFO and envelope generator modulation, just like in the good old analog days (although there's no portamento). The filter resonance parameter helps to recreate those analog sounds, as illustrated very well by a number of factory Singles (A4, B5, C5, D13). The sensitive response of this parameter to keyboard scaling also helps in subtle or drastic ways.

Programming is slow due to the rich variety of possible permutations with two or four Sources per Single. The individual parameter values for each Source are displayed one at a time in the restricted LCD. I'm looking forward to an editor/librarian program to help with programming. Also, I wish it had a few quick-fix tweaking options, like those on the M1, for instant reprogramming of the most important sound aspects, such as reverb.

The MIDI implementation could be more versatile. MIDI Volume (continuous controller #7) is not transmitted, while Breath Controller (#2) and Foot Controller (#4) aren't recognized. This could hang you up when sequencing. The keyboard transmits All Notes Off automatically, so watch out when you're overdubbing two sequencer parts on the same MIDI channel! On the plus side, data dumps are possible in flexible configurations.

The few problems notwithstanding, I like this keyboard a lot. It looks and feels right, it sounds great, programming is no mystery, it'll play a lot of music at once from a sequencer, and the price is certainly right. Bravo! ♦

**PRICES:** K4, \$1445; K4r, \$995

**MORE FROM:** Kawai America Corp., 2055 E. University Dr., Compton, CA 90224. Tel: (213) 631-1771.

*See Programming Compleat this month for tips on programming the K4!*

**BBE™**



# How The Best Get Better!

Ask Brett Tuggle -  
David Lee Roth Band.

*"A must for stage and studio - until BBE appeared, I didn't know how much harder my bottom end could kick and how much sharper my high end could cut."*

*Brett Tuggle*



*"You may never perform without it again."*  
- Music Paper Magazine.

Ask your local dealer for a BBE demonstration.

BBE Sound, Inc., 550...sa Ave. #245, Huntington Beach, CA 92649. Tel: 714-897-6766

## KEYBOARD SPECIALISTS

FOR MUSICIANS/BANDS/STUDIOS  
CHURCH/HOME/SCHOOLS

**ALL MAJOR BRANDS**

- SYNTHESIZERS
  - DIGITAL PIANOS
  - SAMPLERS
  - DRUM MACHINES
  - SOFTWARE
  - MIXERS/AMPLIFIERS
  - RECORDING EQUIPMENT
- VOLUME DEALER**  
**NEW & USED**  
**ALL BRANDS**  
**ALL MAJOR CREDIT CARDS**  
**PROFESSIONAL ADVICE**

Call for a catalog and pricing information

## RHYTHM CITY

287 East Paces Ferry Road N.E., Atlanta, Georgia 30305

**1 (404) 237-9552 • 1 (404) 433-2777**

# Roland Rhodes MK-80

## *Digital Piano*

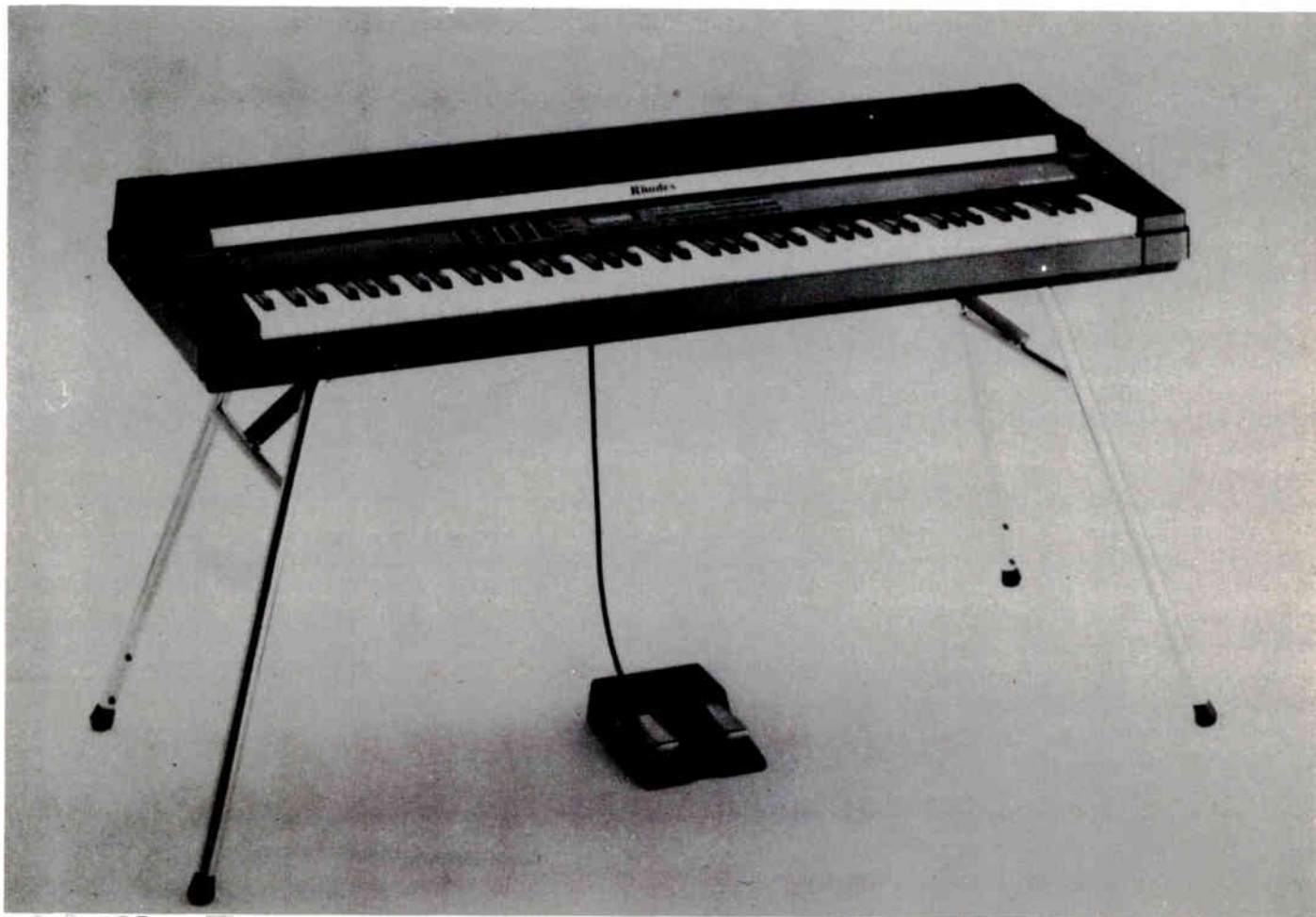

**Roland's much talked about reincarnation of the classic Rhodes piano has finally appeared. All things considered, the Rhodes appears to have a long life ahead.**

*Review by Aaron Hallas.*

**A** FEW DAYS BEFORE picking up the Roland MK-80, I decided to look through some of my old Fender catalogs, price lists, and collection of "Fender Facts" that date back to 1967. Like most people, I enjoy taking a trip down memory lane now and then. Anyway, I also wanted to get a little history on the Rhodes piano and this seemed like the logical place to start. The list price

of the Fender/Rhodes Suitcase 73 piano that I have in my studio, and have used for years, was \$940 new back in 1970.

While browsing through the catalog, it occurred to me that the Rhodes piano has been used in just about every style of music for over twenty years! When you think about all of the "signature sounds" that have come and gone over the past two decades, it becomes apparent just how significant a contribution

Harold Rhodes made to the music industry. Could he have known the impact he'd have when he first started making pianos out of scrap airplane parts for convalescing GIs during World War II? Well, enough rambling – I'm sure you're anxious to hear about the MK-80.

The MK-80 is more than just a digital Rhodes. It's a natural evolution of Roland's RD-series of instruments. The

flagship RD-1000 is a digital piano that uses Roland's proprietary S/A synthesis to recreate the sound of acoustic and electric pianos, harpsichord, clavinet, and vibraphone. It has an 88-note wooden weighted keyboard, 16 voices and ten programmable parameters.

Like all Roland digital pianos, the MK-80 uses S/A (Structured Adaptive) synthesis to recreate the sound of the renowned Rhodes piano as well as acoustic and electric pianos, clavinet, and vibraphone. It has an 88-note weighted keyboard, 16 voices, and several programmable parameters. Sharing as it does so many features with the RD-1000, a question comes to mind: is this old technology that has been repackaged? The answer is yes – and no. "Yes" because the MK-80 does feature the same clavinet and vibraphone sounds as the RD series (although Roland claims that they are further refined); and "no" because, well, read on and you will see that the MK-80 is in fact a different animal.

## The Look & Feel

This is a modern-day Rhodes piano if I've ever seen one. Its sleek black casing sports a silver faceplate adorned with the Rhodes logo. Just below the logo is an easy-to-read 32 character backlit display flanked by buttons and sliders. Sixteen of these buttons select patches and MIDI channels. The four buttons directly below the LCD select various parameters and adjust their values. Eight others are used for mode selection and determining the function of the four sliders. These sliders allow you to adjust any four parameters in real time and can also be used to adjust the chorus, phaser, tremolo, and EQ as well as sending any MIDI controller messages. To the left of the keyboard is something the RD-series doesn't have: a pitch-bend/modulation lever.

The top of the casing is flat and measures nearly ten inches deep and fifty-four inches wide. I was able to put my Atari ST computer, a monitor, and the mouse pad on top of the MK-80 with room to spare. Given a secure keyboard stand, I wouldn't hesitate to put another keyboard directly on top of the MK-80 for live performance work. Due to its size and weight (76 lbs.), the MK-80 is probably more at home in the studio. The MK-60, a sixty-four key version that weighs in at 59 lbs., might be a better choice for a portable keyboard.

The rear panel features a headphone

jack and left and right audio output jacks. Two other jacks labeled Damper and Control are for the supplied dual-pedal. The Control pedal input is user-programmable and can accommodate the supplied pedal or an expression pedal such as the Roland EV-5. MIDI In, Out and Thru ports are also present and an adjustment control is provided for the LCD contrast.

Piano players, this is a keyboard to die for. The action is tight with a very solid feel that's not too bouncy. I've played a lot of grand pianos that didn't feel this good. But don't take my word for it. Everyone who has played this keyboard that I talked to was impressed. It is probably going to feel a bit heavy to those who are used to an organ or synthesizer keyboard, but those of you who play an acoustic piano or a Rhodes regularly will feel right at home.

## The Sounds

The MK-80 offers eight preset sounds. You can program up to seven variations of each preset, so you have sixty-four patches to choose from. The preset sounds are: 'Classic,' 'Special,' 'Blend,' 'Contemporary,' 'Acoustic Piano 1 & 2,'

'Clavinet,' and 'Vibraphone.' I've been doing a lot of comparative listening to the MK-80 against my unmodified Suitcase 73, and I have to say that the MK-80 sounds more like a Classic Rhodes than my Rhodes 73. Okay, so

***"The action is tight with a very solid feel that's not too bouncy. I've played a lot of grand pianos that didn't feel this good."***

I'm exaggerating a little, but after listening for yourself, I think you'll agree that it comes awfully close.

The sound is very responsive to one's playing style. Playing softly produces a smooth round tone, but if you really stand on it Jerry Lee Lewis-style, you can get it to growl just like the original Rhodes. 'Special' is more like a modified Rhodes, still full and round but with more top-end bite. 'Blend' is just that – a blend of 'Classic' and 'Special.' 'Contemporary' is a bright FM-type sound like the one we've all heard on a million recordings since the introduction of the DX7.

Anyone who has heard the RD-series instruments will be familiar with

**MUSIC CITY**

**WE'RE THE ONE!  
WE HAVE IT ALL!**

SERVING YOU WITH OVER 50 YEARS EXPERIENCE!

**CALL NOW!**  
**800/673-0565**

4416 Johnston St., Lafayette, LA 70503

VISA MasterCard

► the acoustic and electric grand piano sounds as well as the clavinet and vibraphone. 'Acoustic Piano 1' is very rich sounding, and while it's not likely to be mistaken for a real Steinway, it does have a darker tone than 'Acoustic Piano 2,' which sounds more like a Yamaha electric grand. The piano presets are all very good and work amazingly well in a number of recording situations. Although it doesn't sound as "realistic" as some of my sampled pianos, it is more consistent over the full range of the keyboard and blends equally well with acoustic and synthesized sounds. The electric grand piano, being much brighter, really stands out in a mix – definitely well-suited for rock and fusion styles.

### Taking Control

Unlike the RD-250/300 (which gives you control over brilliance alone), or even the RD-1000 (which has only ten programmable parameters), the MK-80 allows you to modify the sounds extensively. At the tone level, you can modify the following parameters: Punch, Body, Tightness, and Brightness. "Punch" is equivalent to key knock, a very subtle nuance that's felt more than heard but adds to the percussive quality of the sound. "Body" determines the amount of fundamental and mid-range frequency content in the sound, while "Tightness" controls the release time of the sound after the key is lifted. Finally, "Brightness" determines the strength of the upper harmonics. With these four parameters, you can make subtle or dramatic changes to the presets, allowing you to shape the sound to your liking.

Several other tone modifying parameters relate to pitch modulation. These are: Bender Depth, Modulation Rate and Depth as well as four other parameters for controlling the Auto Bend feature. The built-in effects can also be modified. The Stereo Chorus is my favorite. It can use a sine wave, triangle wave or a combination of both for some very nice chorusing effects. Tremolo works on the same principle as the vibrato on the Rhodes suitcase, which is more of a panning effect. Subtle use of chorus and tremolo can bring an uncanny realism to the Rhodes and vibes presets. The Phaser effect is nice but sounds a little dated to my ears.

The built-in three-band EQ virtually eliminates the need for an outboard equalizer. The treble and bass frequencies offer boost and cut only, but the

mid-range band is parametric with a range of 200Hz to 4kHz and has Level and Bandwidth (Q) controls as well. To add even more realism to the sound, Roland has included three stretch tunings to choose from. These stretch tunings cause the octaves to be tuned

***"Playing softly produces a smooth round tone, but if you really stand on it Jerry Lee Lewis-style you can get it to growl just like the original Rhodes."***

slightly wider than pure, which is more consistent with the natural harmonic series of vibrating strings and tines. Using a combination of the tone modifying parameters, effects and EQ, I was able to modify some of the presets beyond recognition. Used in moderation, however, these parameters can make the MK-80 sound stunning.

### Yes, Master...

Although the MK-80 wasn't designed specifically as a master controller, it does have some pretty hip features. First, though, let me mention one feature that is sadly missing from the MK-80 – aftertouch. Many of my synth patches are programmed to respond to aftertouch in order to modify the timbre or volume of the sound. If you are an aftertouch kinda player like myself, you will probably want another keyboard with this feature, or purchase one of the MIDI wonderboxes that magically changes any MIDI message into any other MIDI message. Since the MK-80 does have four programmable sliders and a programmable pedal, any one of these could be made to send aftertouch information. Fortunately, my sequencer program allows me to do this in real time and I found that the footpedal was the most convenient controller to use for this purpose.

Now that you know what the MK-80 can't do, let's take a look at what it *can* do. Several MIDI parameters can be stored with each of the 56 user edited sounds. These are: MIDI channel, program change, velocity curve, and two keyboard zones. You can specify different keyboard zones for the internal sounds and incoming MIDI notes. This allows for some fairly flexible splits, and since the zones can overlap, you can do layering as well. Each zone can have its own velocity curve with eight

different curves to choose from. Two of these are inversions so you can assign opposite velocity curves to the MIDI output and the internal sounds for smooth crossfading between sounds.

These capabilities illustrate an exceptionally cool aspect of the MK-80. Its responses to the keyboard and MIDI messages are entirely separate. For example, if you send MIDI data to the instrument from a sequencer and play on the keyboard while operating the pitch-bend wheel, only the pitch of the notes you play on the keyboard will bend. Notes from the sequencer will remain unaffected.

From a performance standpoint, the MK-80 offers several nice features. The Voice Preserve function is particularly interesting. If you change patches or a parameter such as the MIDI channel while holding a note (on the keyboard or with the hold pedal), the change isn't implemented until all keys and pedals have been released. If you are using a patch that has split or layered key zones, the "ALL" button gives you temporary access to all 88 keys and the "MIDI OUT" button will temporarily turn off all MIDI transmissions. Local control of the keyboard can be disabled and the "Program Change" button allows you to send patch changes over MIDI without changing the internal sound. These are all big time savers and greatly appreciated.

There is one more thing that I would like to mention: Roland's method of dynamically allocating voices. Although the MK-80 can produce a maximum of sixteen notes (ten notes for "Contemporary" and "Clavi" sounds), I didn't notice any lost notes due to "voice stealing." All of the important notes just seemed to hang-on even with the sustain pedal depressed.

I am pleased to see that Roland is committed to refining their current technology rather than continuing the deluge of new products with new breakthroughs and new operating systems to learn and... Well, I'm just glad that the MK-80 is here. It's a great sounding instrument with a great feeling keyboard and a reasonably extensive MIDI implementation, and it's fully programmable to boot! Rhodes – the legend continues... ♦

**PRICES:** MK-80, \$2795; MK-60, \$1895; EV-5, \$75; a demo tape is available as well for a small handling charge.

**MORE FROM:** RolandCorp US, 7200 Dominion Circle, Los Angeles, CA 90040. Tel: (213) 685-5141.

# Confused About "Exciters"?

## Read the Facts.

Seems like a good thing always leads to imitators. Which is why there seems to be a rash of so-called "brightness enhancers," "phase correctors" and "exciters."

The Aphex Aural Exciter® is a *patented* audio process that will recreate and restore missing harmonics. When added, they restore *natural* brightness, clarity and presence, and actually extend audio bandwidth. All without adding any appreciable power to the signal.

As a result, the Aural Exciter has become a standard tool in the recording, film, broadcast and sound reinforcement industries around the world. It has been licensed for use in prod-

ucts sold by Yamaha, Numark, AKG, Proton, Gentner Engineering, MacKenzie Labs, and Vestax.

Other "brightness enhancers" only boost existing high frequencies, pumping as much as an additional 12dB, which can distort the amp or even blow your speakers... in addition to sounding unnatural. In fact, you could probably achieve the same effect more flexibly and economically by using any equalizer.

Don't be confused by hype. Listen to any device claiming to do what only an Aphex Aural Exciter does, then listen to the real thing. Your ears will hear the difference.



**APHEX**  
SYSTEMS

All Aphex products are designed and manufactured in the U.S.A.  
© 1989 Aphex Systems Ltd.  
Aphex and Aural Exciter are registered trademarks of Aphex Systems Ltd.

11068 Randall Street  
Sun Valley, CA 91352  
(818) 767-2929

# Steel Wheels Gather No Moss

Backstage With The Rolling Stones



PHOTOGRAPH BY PAUL NATKIN

L-R: Keith Richards, Matt Clifford, Mick Jagger.

**After 25 years of rockin' the world, the Rolling Stones have started to use musical technology in the studio and on the road. Join Mick Jagger and keyboardists Matt Clifford and Chuck Leavell backstage as they discuss life, the Steel Wheels tour, and everything electronic.**

*Interviews by Scott Wilkinson.*

**T**HIS IS CAPTAIN Crunch in JetCopter99 with a special traffic report on this rainy Sunday afternoon. The westbound Harbor Freeway is a solid sea of brake lights all the way from the four-level interchange to Exposition Boulevard due to a special event at the Coliseum, not to mention the rain. You'd better allow plenty of

extra time if you're headin' down this way, and believe me, I don't envy you if you are. JetCopter99 - out."

Great, just great! I'll slip *Steel Wheels* into the stereo to cut the radio's dismal news. I *knew* I'd hit some traffic on my way to meet Matt Clifford, Chuck Leavell and Mick Jagger backstage at the Stones concert tonight. But now it's raining - the first day of real rain

that L.A. has seen in *months*. I know we need it desperately, but why *today* of all days?

Ah, that's better - at least I've got some cool tunes while I'm sitting here in this freeway parking lot. 'Sad Sad Sad' is a real rocker! How do they do it? These guys are pushing *fifty*, for God's sake! They should be getting arthritis or something, but instead they still crank out rock 'n' roll as if they were twenty-five. Maybe it's all that aerobic activity on stage.

Then again, maybe not. Maybe it's in their blood, their genes (or is it jeans?). Mick Jagger, Keith Richards, Charlie Watts, and Bill Wyman have been playing together since... I think it was 1962 or '63, somewhere around there. I remember when Ron Wood left Rod



Stewart and Faces to join the Stones in '75. *That* was quite a coup, as I recall. (God, I wish this traffic would get moving!)

Is that some synth I hear in 'Terrifying'? It is! And some organ, too. It must be Matt and Chuck. I've always liked how the Stones used keyboards on their albums, but I don't recall ever hearing much in the way of *synthetic* sounds before. Most people think of the Stones as a guitar band (none of the core members play keyboards on stage, after all). And yet, there it is – some hi-tech licks going on. Not too old to learn some new tricks, eh boys? Maybe rock 'n' roll is the fountain of youth. Maybe it keeps your mind and body flexible enough to change with the times (if you don't burn out first).

Finally – the off ramp! What!? They want 25 bucks for parking!? Forget it, man. I'm early – I'll cruise the streets for awhile. Hey, there's a spot. Free parking on the street, and only four blocks from the Coliseum! And, it's stopped raining. This is a good sign...

Through Gate 28, backstage pass pasted on my jacket (and checked by security people every few feet), it's 5pm and Living Colour just started their set. Walking behind the stage area, the speakers are pointing the other way and it's *still* incredibly loud! The crowd seems to be into it, if their response is any indication.

The backstage area is a village of tents and trailers with lots of people milling about (not to mention more security people at every turn). No sign of any Stones yet, but plenty of hangers-on.

Ah yes, this must be Matt Clifford, the man who brought high technology to the Rolling Stones. He seems quite young, particularly considering the other members of the band – I'll have to ask him about that. Taking a seat in one of the tents, the interview begins...

**"M**Y BACKGROUND IS mainly classical, which is odd, perhaps, seeing as how I'm playing with *this* band. I started off as a choir boy in a cathedral in England. I was actually head chorister. My father is a musician and music educator. So, he always encouraged me in that direction. The instrument I learned first was the French Horn, which I'm

playing on 'You Can't Always Get What You Want' during the tour, as a matter of fact.

"After that, I went on to piano lessons. When I was around fourteen, I started getting into Yes – Rick Wakeman is a big hero of mine. He sort of provided the link into rock, if you like. I could have gone on to someplace like the World College of Music in London or the Royal Academy. But I didn't want to do that, because I didn't want to study music to the extent that I lost the joy of performing.

"Three years ago, I toured the States with Steve Howe in a group called GTR. In fact, I did a little spot in your magazine when I was with them. You did a diagram and description of the band's gear, and I was quoted in that article." I remember that, too – it's the 'On Stage' column in the September '86 issue of *MT*. "So I was there at the beginning of your magazine!

"Through that connection with GTR, I was asked to work with Jon Anderson on the new Anderson, Wakeman, Bruford, Howe album, which has just recently been released. We recorded some of that in Paris, and then we were at Air Studios in Montserrat at the beginning of the year. The producer of that project was a certain Chris Kimsey, who was also the producer

**Jagger: "When I compose on keyboards, I can get a much wider range of sounds to write with immediately, rather than having to think, 'Well, that would sound good if this was only like that.'"**

of the new Rolling Stones album. Mick and Keith were working down in Barbados while I was there. Chris suggested that I meet up with them, and it all fell into place, as it were. We got along very well."

That sounds just ducky, alright. But a young, classically trained progressive rocker with the Rolling Stones? I would think that the generation gap alone would present some interesting challenges. "I was never a great Stones fan, oddly enough. I never really knew a lot of their music – I've just turned 27, after all. I was born at about the same time that they played their first gig, which I often point out to them! Bill is twice my age, exactly.

"I think they were looking for

somebody who could play as well as program – I grew up with the piano, and it's still my main instrument. But they also wanted somebody who could introduce them, *gently* perhaps, to the new technology. Especially Mick, who's very aware of new developments and very keen to work with new things. Keith is a little more traditional, but he doesn't close his mind. Bill has a Fairlight and has used computers, sequencers, and samplers for a long time. He's just finished a new album, which isn't released yet, and he didn't play bass on it. He used a sample of his own bass in the Fairlight."

So technology isn't entirely foreign to them, eh? And yet, this is the first Stones album on which hi-tech toys are used to any great extent. How did that affect the project? "We did three weeks of preproduction in Barbados, which they'd never done before. In the past, they would walk into the studio with no songs, and write the whole album in the studio. That's why the albums all through the '70s and '80s took maybe a year or two to complete.

"This time, they had a deadline – for the first time ever. During preproduction, we had songs and arrangements, bridges, middle eights, everything. Then we did the rhythm tracks in five weeks. Everyone just came together and the moment was right. We had the overdubs finished in five weeks, and it was mixed in another couple of weeks. At one point in London, we had three studios going. I think the results speak for themselves."

I can't argue with that – the album smokes! "Of course, I played keyboards on the album, and did all of the programming. I was working with Mick and Keith together, helping them to take some shortcuts, slimming down the structures, chopping out verses, trying other ways to go into a bridge or something like that. Then the others arrived, one by one. That was a really great time, doing the rhythm tracks with just them and me. It was a tiny little room, with just the five Stones and me and a little keyboard setup I'd taken down there. It went extremely well."

Just you and the Stones in a room, jammin'. Sounds like a dream come true. But what about the technology? How was it used? "Everything is played live on the album except for one track, 'Continental Drift,' which I programmed using C-Lab's Notator on an Atari. That's quite an interesting ►



Chuck Leavell

PHOTOGRAPHY BY KEVIN MAZUR

► story, actually. It's a vaguely Moroccan or Arabian sounding riff that Mick came up with. He and I arranged the track and I programmed the basic parts with percussion. Then we went to Tangiers and recorded a Moroccan tribe in a courtyard in the Casbah using an AMS Audio File hard disk recorder. After that, we came back to London and overdubbed another African tribe onto it.

"The Audio File was configured as an 8-track system linked to SMPTE and triggered by Notator. We had six tracks with bass, drums, etc. That left us a stereo pair for the musicians, and we did many different passes. I spent a few days editing all of that, finding the best bits, putting them all together into one master file, and mixing down. We still needed a bit more percussion, so we got a group from Upper Volta, who happened to be playing at a world music festival going on in London at the time."

And once the album was finished, it was time to start thinking about this tour, I'll bet. "People are saying that this is the biggest tour ever, and the statistics are pretty mind-boggling. It takes nine thousand man-hours to put up the three stages. We have seventy-seven articulated trucks. There are about five hundred people in the crew, with more being hired in each city to help build the stages.

"The first couple of weeks in Connecticut were spent in rehearsals. We went through maybe seventy or seventy-five Stones songs. It was like, 'Name a Stones song - okay, we'll have a go at it.' And then we whittled it down. Mick didn't want to do too many of the songs that were featured on the last tour. Obviously, we're always going to play 'Satisfaction' and 'Jumpin' Jack Flash' and a few others."

Obviously - the crowd would turn ugly if you didn't. And I know that a lot of the people in that crowd are

hoping to hear those tunes sound as close as possible to the recorded versions. "Chuck is working mainly as part of the rhythm section, and I supply the melodic lines and the orchestration, if you like. He's using more traditional sounds. We've got some really good Wurlitzer patches that I tweaked around a bit.

"I spend a large part of my time being a horn section as well. Here in L.A. and in New York and some of the other dates, we're playing with the Uptown Horns, a four-piece horn section. We also have Bobby Keys, who has played for the Stones since 1970 - he played the solo on 'Brown Sugar.' So, he's very much a part of the Stones sound. When we don't have the horns, Bobby and I are the horn section.

"In terms of synthesis, what I'm doing is largely imitative. As far as sampling is concerned, I do a few acoustic guitar parts. For example, I play a 12-string guitar sound on 'One Hit to the Body,' strumming the part. I also supply the cello for 'Ruby Tuesday', and things like recorders and strings. One interesting thing I'm doing is recreating the sound of a Mellotron for '2000 Light Years from Home,' which they've never done live on stage before. I got a string patch from the S1000 and shortened the release so it sounded very unnatural. I put the Mod Wheel full up, and it sounded very much like a Mellotron. You just have to remember to play notes for a maximum of eight seconds."

So, technology allows the group to perform songs that were previously impossible to play live. "You must

**Clifford: "Although the amount of leading edge stuff will dwindle, I think it will always be there, because only through that technology can the mass market stuff be created."**

bear in mind that the last time they toured was something like seven years ago. Think about the technological advances since then. I think that the Fairlight had probably just come out, and it certainly wasn't an affordable sampling system that you could take on the road. It's never really been available to them before.

"Also, I'm putting what was there on the recordings into the live performance, rather than adding outlandish

electronic noises. People tend to forget the lovely arrangements, which are very much a part of the Stones sound, especially in the early days. If you listen to the tracks, there's some very innovative and interesting stuff going on, and that's the sort of sound that I can put back in.

"I got into it [music technology] in a way that isn't available nowadays. I learned the analog system at a time when there were no programmable synthesizers. There were no memories, so it was all playing with one hand and programming with your other. Today, people will buy a synth with a hundred sounds in it and probably never use anything else. Or they'll buy software cards, which is great, but they're still not involved in the creative process of programming, which I think is a shame. That's the way the electronic musician can be more than simply a performer. A violinist can never invent the sound of his instrument, whereas the electronic musician can invent a sound and then invent music for that sound."

Yeah, but the availability of so many sounds and instruments can actually *inhibit* people from programming,

**Leavell: "When I got involved with Korg, I said to myself, 'I'm not going to let this technology pass me by.'"**

right? "Well, the thing is, we've seen such a rush of technology. New, revolutionary products are coming out every few months. It's bewildering, and you lose the period of familiarization that you need with a new instrument. There's a great pressure to keep up, buy the new gizmo that comes out, and that's a shame.

"I remember owning a Korg Polysix for a couple of years during a period when I was doing a lot of work, recording sessions and so on. I'd spend a lot of time programming all of my own sounds into it. I would start playing and they would say, 'Oh, that sounds rather nice after all. We had one of these in last week, and it sounded horrible.' It sounded good simply because I'd taken the time to get to know the instrument and to get something of my own personality and character into it."

Now that's what I like to hear! The better you get to know your instruments, the better you'll sound on

them. Even so, technology isn't perfect. What will the future bring? "I think that the advances in memory storage are going to make an awful lot of difference. I think we're going to see the end of the floppy disk quite soon. Also, I think we're going to see a lot more instruments like the Proteus, which have the sounds that everybody is looking for, and in a very easily retrievable format."

But doesn't that lead away from the programmability you feel is so important? "Yes, but I think it's an inevitable trend, because technology is developed in response to a demand.

The percentage of people who are actually interested in creating their own sounds is very, very small. Most people are using this technology as an extension of the home organ. They want to press a brightly colored tab and get something that sounds like a string orchestra. And who can blame them? You should always cater to those people. I just hope that we can continue to develop the instruments that will allow creative programming as well. And although the amount of hi-tech leading edge stuff will dwindle, I think it will always be there, because only through that technology can the

## BUYING A KEYBOARD?

Then we've got the perfect companion. **KEYFAX 3**. Julian Colbeck's definitive guide to buying electronic keyboards.

**KEYFAX 3** is the latest edition of "the electronic musicians' bible," and it's the best ever! Hundreds of electronic pianos, synthesizers, samplers, home keyboards and sequencers are listed. For each model there's a spec sheet, an overall rating, and an in-depth analysis of its capabilities. The reviews are straightforward, detailed, and accurate, and instruments are grouped together by category to make comparisons between models easy.

It's a formula that's proved successful for literally thousands of musicians, so order your copy of **KEYFAX 3** today. Just mail the coupon, or call **(818) 407-0744**. Don't go shopping without it!



Check enclosed for \$ \_\_\_\_\_  
(Payable to Music Maker Publications)

Charge this order to my:  MasterCard  
 VISA

Name \_\_\_\_\_

Address \_\_\_\_\_

Account # \_\_\_\_\_

City \_\_\_\_\_ State \_\_\_\_\_ Zip \_\_\_\_\_

Cardholder's Signature \_\_\_\_\_ Exp. Date \_\_\_\_\_

Please send me \_\_\_\_\_ **KEYFAX 3**  
book(s) at \$19.95 each: SubTotal \_\_\_\_\_  
California residents add 6% sales tax. Tax \_\_\_\_\_  
Los Angeles residents add 6.5% sales tax. Tax \_\_\_\_\_  
Add \$2.50 for postage & handling. Shipping \_\_\_\_\_  
(Foreign orders, add \$6.00) TOTAL \_\_\_\_\_

Mail this coupon to:  
**Music Maker Publications, Inc.**  
22024 Lassen Street, Suite 118,  
Chatsworth, CA 91311

PLEASE ALLOW 6-8 WEEKS FOR DELIVERY. 192pp B&W

PRE-PAID ORDERS ONLY. SORRY, NO C.O.D.  
PLEASE DON'T SEND CASH.

► mass market stuff be created.

"I very much like the idea of things like the MIDI Grand or Chuck's B3 with MIDI – a traditional instrument being used to control electronics. I think we'll probably see a lot more of that. We'll also see more live performances integrating traditional and electronic music."

So, where do you go from here? How do you top recording and touring with the Rolling Stones at the tender age of 27? What's next? "Well, there are rumors of more touring next year in Europe and Japan, but they're not confirmed yet. That wouldn't be until the summer, anyway. I also have my own projects, which I'm always trying to do, but I never seem to have time to finish up songs because I'm always touring. Mick and I have started to do a little bit of writing together. So, that's certainly a thing that should be happening next year as well."

I see great things in this man's future. But for the moment, playing with the World's Greatest Rock Band (as they've been touted on MTV) must be plenty of excitement for one year. "The Stones aren't just recycling past glories. They're alive and writing, creating now. I think that's made a great difference. A good feeling within the band is radiating out, and I have no complaints at all. I'm having a great time." I don't doubt it one bit.

**N**OW THAT MATT has gone off to find Mick Jagger, I have a chance to chat with Chuck Leavell, the second keyboard player on the tour. We begin at the beginning as he fills me in on his background. "Basically, I'm self-educated in music. I learned from listening to my mother play at a young age. I did have some basic musical training playing tuba in the high school band." Ah ha, another fellow brass player. "My main background is listening to soul music, rhythm and blues, Ray Charles, Wilson Pickett, Aretha Franklin, and also deep delta blues..."

Would it be too far-fetched to assume that this man's from the deep South? "I was born and raised in Alabama. I eventually moved to Macon, Georgia, and hooked up with The Allman Brothers Band. I was with them from '72 to '76. After that, I was in a band called Sea Level that had four records on Capricorn and one on Arista. I've



Matt Clifford

PHOTOGRAPHY BY PAUL NATKIN

also played on a lot of sessions with different people like Tim Weisberg, Don MacLean, Kitty Wills, and Hank Williams Jr.

"Eventually, I wound up working with the Stones on the European tour in '82, and everything since then. Bill Graham suggested me to them. They wanted to try some new blood at the time, and he was a fan of mine from the Allman Brothers era. So we hooked up through him."

Impressive credentials, for sure, but those acts were not known for their use of technology. "I got involved with the Korg company in '82, and they sort of took me by the hand. You have to understand, I'm coming from the old school, so to speak. The most modern things I'd played up 'til then were Farfisa organs. A Hammond B3 was

pretty exotic. When I got involved with Korg, I said to myself, 'I'm not going to let this pass me by.' So I spent a lot of time with them and they led me through the technology – analog technology at the time. And, as things have progressed, they've kept me updated. So, I've done a lot of clinics for them around the country. I've also learned how to read manuals real well!"

His experiences with the new technology must have inspired Chuck to hold some opinions on the future of it all. "Samplers seem to be getting more sophisticated. You know the problems with looping, where you can hear the loop points, especially in pianos. I think it's not too far around the corner that most of those problems will be solved. But, you can still hear them nowadays, and it would be nice to clean up those

loose ends that still exist. As I say, I don't think it will be long."

I'll bet he has something to say about keyboard action, as well. "That's always left something to be desired. And I honestly don't think they're ever going to overcome that because of the mechanics involved in striking a note on an acoustic piano. You can use weighted action or springs or whatever you want to try compensating for it, but you're never really going to duplicate it unless you come up with some type of mechanical action. I think the action on the Korg SG-1D is as good as I've played.

"Of course, the ultimate solution is a MIDI-modified acoustic grand – that's fantastic. But when you get into situations of moving equipment around, it becomes less attractive. With the Allmans, I had a nine-foot Steinway D that I took with me everywhere, and it made a lot of roadies very unhappy. But then you have the problems of staying in tune and pickup feedback."

And after the tour? "Well, it's still up in the air whether this will carry on next year through the rest of the world. I'd certainly like to see that happen. Otherwise, I'm leaning towards production a good bit these days. I've been producing several acts lately, and also my own projects, whenever that can be arranged. My concept there is to call in people that I've worked with throughout the years. You know, just reach back and call up some people I think would be pertinent to certain songs and get on with it. I think it would be a lot of fun."

**P**EERING OUT OF the tent, I see Matt heading our way. It's time to meet the man himself. One of the original bad boys of rock. A face known to millions, perhaps billions all over the world. A body that can't stand still on stage, much to my mother's consternation when she first saw him on television twenty years ago. Mick Jagger.

Matt said that Mick was especially open to new ideas, so I ask him how musical technology has affected his songwriting. "Well, quite a lot really. I can write songs quite differently now. Not that I always do, but I have the capacity. I used to always just write them with an acoustic guitar – until they invented the electric guitar [laughs]. I do still do that. But I've

got a much larger range of choices in the way I write."

I've always thought that technology can provide its own inspiration. Apparently, Mick agrees. "It gives you different songs and rhythmic feels, much more varied moods. When I compose on keyboards, I can get a much wider range of sounds to write with immediately. I can actually do it straight away, rather than having to think, 'Well, that would sound good if this was only like that.'"

So naturally, he has an incredible setup at home, right? "It's pretty simple, really. I just bring things in as I need. I keep it very simple. I mean, I use quite a few machines, but I keep the recording end of it simple. I just record to cassette. Or I record straight onto 24-track. I just like to be on my own and record to cassette without trying to play engineer, or have an engineer and go straight to 24-track, so if I get something, I can use it if I want."

How does he remember his first meeting with Matt? "It was through Chris Kimsey. Matt was working with the Yes group, and Chris introduced him, and then I played with him. He seemed easy to get on with. I'd been working with Phil Ashley before that, who's very similar to Matt in a lot of ways – keyboard playing and programming. I was used to working with someone like Matt, so it wasn't a new thing for me."

And I'll bet that Matt has been a big help during the whole process. "He helped a lot with arranging, made it go a lot quicker. Also just playing, being there, being a keyboard player. And we worked very hard on that 'Continental Drift' track together.

Matt got very very involved with it and did a lot of work. I think it came off very good. And, you know, he worked on the whole album. He was very helpful, I thought."

As I wish for all musicians before a performance, I hope he has fun out there tonight. "Yeah – in the rain!" [laughs glumly] There is a light drizzle outside the trailer, and it had been raining off and on for the last three hours. It must be a bummer to go on in this kind of weather, especially since the stage isn't covered. But they can't very well postpone the concert – they're flying to New York tomorrow. And how do you issue refunds to 90,000 people who would sit (or dance) in the rain rather than miss the Rolling Stones? I know I would – and will.

**A**FTER RAINING THROUGH the Living Colour and Guns 'N' Roses sets, the sky is finally dry. I wish the seats were – not that I've been sitting in mine much since the Stones came on. The sight of 90,000 people dancing is pretty awesome, as if they've all been seized by a transport of religious rapture. I must admit that I can't seem to resist dancing myself, even within the confines of Row 31. After all, that's what the Stones' music is all about – I know it's only rock 'n' roll, but I like it! ♦

## THE ROADIE'S HERNIA

All of the gear being used on the tour is kept in tip-top shape by Andy Topeka, the "world's greatest keyboard technician" according to Matt and Chuck, both of whom remark that equipment failures are quite rare. The power for each system is protected by a Showpower/Toshiba UPS (uninterruptable power supply) and Juice Goose power line conditioners. The primary equipment of which Topeka takes such good care is listed below.

### Matt Clifford's System

- Roland A-50 (2)
- Yamaha KX88
- Roland MC-500 (2)
- Akai S1000 (3)
- PLI Turbo Hard Disks (2)
- Casio FZ-20 (2)
- Korg M1R (2)
- Oberheim Matrix 1000 (2)
- Roland D-550
- Roland MKS-20
- Roland MKS-70
- Roland MKS-80
- Roland P-330
- Yamaha TX7
- Yamaha TX802
- Sycologic M-16 (2)
- Korg A3 (2)
- Yamaha DMP7 (3)

### Chuck Leavell's System

- Hammond B3 (with MIDI mod by Paul Homb of Keyboard Specialties)
- Korg SG-1D
- Korg M1R
- Yamaha TX802 (2)
- Korg A3 (2)
- Conneaut Maxcon II mixer

# Steinberg Cubase

## Atari ST Sequencing Software

**Snapping mice, scissors and glue, kickers, paint brushes and magnifying glasses...welcome to the wacky world of music technology 1990 – and to an exploration of Steinberg's latest sequencer. Review by Nigel Lord.**

**T**RANSPARENCY" is a quality that we increasingly demand in the machines with which we surround ourselves. More and more, the onus is on the machine to adapt to the often capricious temperament of its human operator rather than vice versa. And, as each successive generation of equipment reaches the marketplace, its ultimate acceptance by the public seems more and more dependent on its "user-friendliness." Hence the snapping mice, scissors and glue and so on – all real-world, non-technical expressions and (not entirely coincidentally) all operating tools for Cubase, Steinberg's new music software program.

The most significant aspect of Cubase lies not in what it is, or even what it is capable of doing. Where Cubase cuts a swathe is in its ability to see things – quite literally – your way. It can lay before you reams of fiendishly complex data in an astonishingly accessible, and above all, "human" form.

Users of Steinberg's Pro24 should find many cross-over points and a definite feeling of oneness with Cubase. However, it doesn't take long before you begin to realize that, conceptually, this is a very different animal indeed. The differences can be ascribed primarily to the extensive multitasking functions of which Cubase is capable – a product of Steinberg's proprietary M•ROS (MIDI Realtime Operating System) software foundation upon which it is based.

In its simplest form, multitasking means not having to switch off playback or record in order to institute other commands (which may include

procedures as potentially "distracting" as saving and loading to and from disk). Providing you have sufficient RAM onboard the host computer (we're talking multi-megabytes here), the M•ROS Switcher utility supplied on the main disk allows you to run up to ten programs simultaneously – synth editors, mixer automation programs *et al.* Serious multitasking potential.

Of course, owners of the 1040ST aren't exactly left out in the cold by memory limitations. Even on its own, Cubase is immense in scope and could never be accused of short-changing anyone. However, as an owner of an ST with a medium resolution color monitor, I cannot help feeling disappointed that Cubase doesn't support it. Of course, the sheer quantity of screen information has necessitated some finely-detailed graphics, and these simply wouldn't be legible in medium-res (a problem that many Atari developers have confronted on previous software).

### The Architecture

Cubase places great emphasis on the arrangement and manipulation of the individual sections that make up a song or piece of music. If you can click and drag the mouse, you can arrange a song. The individually recorded sections (known as Parts) can be picked up and moved anywhere within an arrangement. They can be duplicated, deleted, overlapped, merged, pasted in or cut out, split, joined, extended, attenuated, delayed or muted. You can move them freely from Track to Track, select them singly or in combination and group them together to form indi-

vidual passages (for choruses, verses and so on) or instrument sections (for brass or percussion, perhaps).

Like most music software programs these days, Cubase is structured around a series of pages or windows, accessed from the Edit menu. Unlike most other programs, however, Cubase can support up to seven windows at a time and permit work on several different sections of a song – or even several different songs – simultaneously.

The main work environment is the Arrange window, which contains the Part display and the Track list (up to 64 tracks can be accommodated). Within the Track listing can be found mute buttons for each Track, an instrument title column, the MIDI send channel selector and a MIDI output port selector.

Immediately below this window is the Transport Bar. It's common to all of the main editing windows. In addition to the Play, Record, Fast Forward, Fast Rewind and Stop controls, this window features the Left/Right Locators used for determining Part lengths when recording (amongst other things), the Cycle (loop) on/off button, the Solo buttons, the Record Mode buttons (replace/overdub), the Song position and SMPTE position counters, the Tempo and Time Signature indicators, MIDI In/Out data indicators and the

***"Cubase cuts a swathe in its ability to see things – quite literally – your way."***

selector buttons for the Metronome, Internal/External Sync and Master Track.

Combined with the Fast Forward control is a cueing facility, which allows you to hear the music while in fast forward mode. Curiously, the system requires that you first stop playback and then select Fast Forward. However, there is a rather neat feature that allows you to increase or decrease the cueing speed by moving the mouse to the left or right of the Fast Forward icon.

Recording makes extensive use of the Left and Right Locators which determine the start and end points of a recorded section. Convenient Locator pairs (such as bars 1–4, 4–8, 8–16) can be memorized and stored under the Atari's Function keys (F1–F10). A further aid to recording is the Preroll facility, which allows you to roll through a number of bars of an existing Track before recording starts. Like most things on Cubase, there is an

interesting feature lurking behind this seemingly conventional function. In this case, it's the ability to record notes during the Precount, making it much easier to catch those which occur on the upbeat of a bar.

### Quantize Fits All

Cubase goes to town in the quantize department. In addition to Automatic Quantize, which allows you to quantize notes as they are recorded, there are no less than five different manual quantization algorithms available on Cubase, each with its own characteristics. Note On Quantize provides the sort of auto correct function with which most people are familiar - it moves notes to the nearest designated beat while preserving their original length. Over Quantize is perhaps the most useful musically: although it moves notes to the nearest quantized position, it has the ability to detect notes being played consistently ahead of or behind the beat and takes this into consideration in deference to your playing style.

Iterative Quantize allows you to move notes towards the quantize position, by a defined amount, until you achieve the kind of feel you require. And it has the option of excluding certain notes, so you have precise control over the whole process. Match Quantize enables you to match the feel of one part with that of another. So you can take a specific drum groove, for instance, and match a bass line to it in order to tighten up a rhythm section.

Groove Quantize takes us even further down this road. In simple terms, it allows you to take a Part and impose a feel upon it. This feel is selected from a menu or a Groove Map created by you. It's a complex arrangement to describe, and clearly rather subjective in nature, but it's certainly the type of feature that extends Cubase's role from a straightforward MIDI tape recorder to a creative instrument in its own right.

### MIDI, Sync & Processing

The MIDI Definition command is used to access the main MIDI data control functions, and these appear in the form of a menu with Record, Thru, Control and Channel filter boxes, a Controller number remapping area, MIDI Thru and Running Status selection boxes (the latter being a special function for compression of MIDI data), and a Thru Off Channel box which I'm quite happy to let the instruction manual

# What a difference a year makes.

If a working knowledge of Electronic Music is important to you, one of the most in-depth



The Grove School has one constant mission: preparing you to meet the real demands

**Electronic Composing and Arranging** programs is waiting for you at the acclaimed Grove School of Music in Los Angeles. This program offers the precision education you'll need to cut through the competition as a more versatile composer, arranger, songwriter, instrumentalist, producer, singer or recording engineer.

Dramatically expand your knowledge of computers, synthesizers, SMPTE, MIDI, sequencing, drum machines and sampling in performing and recording situations. You'll have the opportunity to compose, arrange and conduct your original projects with a combination of electronic and acoustic instruments in our state-of-the-art recording facilities.

The Grove Electronic Composing and Arranging Program starts in the Fall, Winter, Spring and Summer.

of today's music industry. That's why all Grove instructors are working professionals with proven ability to make a living in music.

If you want to make a living doing what you love, find out what a difference a year can make. Join the thousands of Grove graduates who are actively pursuing their music careers.

Send us the coupon below, and we'll send you more information. Or call us toll-free at 800-234-7683 (818-904-9400 within California).

**Grove**  
SCHOOL OF MUSIC

**Building Careers in Music**

**Grove** SCHOOL OF MUSIC

MAIL COUPON TO: Grove School of Music, 14539 Sylvan Street, Van Nuys, California 91411  
800-23-GROVE (818-904-9400 within California)

PLEASE PRINT

NAME: \_\_\_\_\_

STREET: \_\_\_\_\_

CITY: \_\_\_\_\_

STATE: \_\_\_\_\_ ZIP \_\_\_\_\_

PHONE: ( ) \_\_\_\_\_

I'd like to know more about the Programs checked below:  
(Please allow 3-6 weeks for delivery within the U.S.)

General Musicianship       Songwriting       Guitar

Composing and Arranging       Advanced Songwriting       Keyboard

Percussion       Film/Video Composing       Music Synthesis

Professional Instrumental       Bass       Vocal

Recording Engineering

MT 2/90

► explain to you.

Synchronization facilities are comprehensive to say the least. The Sync dialog box includes all of the options, and these fall into two main categories: SMPTE-based and Tempo-based. SMPTE sync includes the internal M•ROS timecode, SMP24 timecode, Steinberg TimeLock timecode, MIDI Time Code and Tape Controller timecode. Tempo sync, on the other hand, includes the internal tempo (as determined by the value set on the Transport Bar or on the Master Track), MIDI clock tempo (with Start/Stop, Continue and Song Pointer messages) and "Human Sync."

Readers of *MT* are likely to be familiar with the concept of human synchronization. Units such as the Kahler Human Clock and the Apex Studio Clock have been around for some time now. If the list price of Cubase seems high, it's probably worth check-

ing up on the prices of such units. Then consider this is but one feature in Cubase's arsenal.

Finally we come to the MIDI Processor, further proof that Cubase is no simple MIDI recording system. It takes the concept of MIDI echo into the realms of full signal processing, giving you the ability to produce echo, chorus and pitch-shifting effects – all from the manipulation of MIDI data.

## The Edit Windows

With the exception of Key Edit, the Edit windows were originally conceived as part of Pro24's architecture. Common to all of the Edit windows is a Function bar and Info line (above the main display area) which contain all of the track-specific data such as length, quantize and MIDI channel information.

Key Edit represents a computer simulation of a piano roll – except that the holes in the paper are represented by boxes of varying length. A graphic display of a standard keyboard on its side is aligned with a grid on which appear the boxes, moving across the screen from left to right in real time. Beneath the grid lies the Controller display in which you will find a graphic representation of velocity, controllers, pitch-bend information and so on.

The boxes (representing notes) can be dragged or "kicked" to a new position, extended, shortened, duplicated, created or deleted. Individual notes can be monitored by selecting the "ear" icon in the Functions bar and clicking on the relevant box on the grid, or by holding the magnifying glass icon over it.

The Controller display, as its name suggests, can be called upon to graphically present non-note events (in addition to note velocity) and thus reveal those Jan Hammer pitch-bend excesses in all their visual glory. Editing the controller information is also possible here, although much more comprehensive facilities for this are included in the Grid Edit window.

Unlike its counterpart in Pro24, the Grid Edit window in Cubase may contain other forms of information in addition to note data. In fact, no less than six different types of information can be listed – Note, Polyphonic Key Pressure, Control Change, Program Change, Aftertouch and Pitch bend. Depending on which type is selected, three "Value" columns display the relevant information.

## Score Writing

Somehow, I never get tired of seeing my inconsequential doodlings at the keyboard transcribed into full musical notation. Cubase is by no means a full-blown music notation package, but the Score Edit window does offer some pretty comprehensive facilities nonetheless.

Recorded Tracks are presented in conventional notation on staves that appear beneath one another in the main display area. As every literate musician knows, the same piece of music can often be written in different ways, and in this respect Cubase offers you a number of options. Parts can be transcribed on a single staff or split into treble and bass clefs (the split point being set by the user).

Notes held long enough to appear as ties in the score can be cut off in order ►

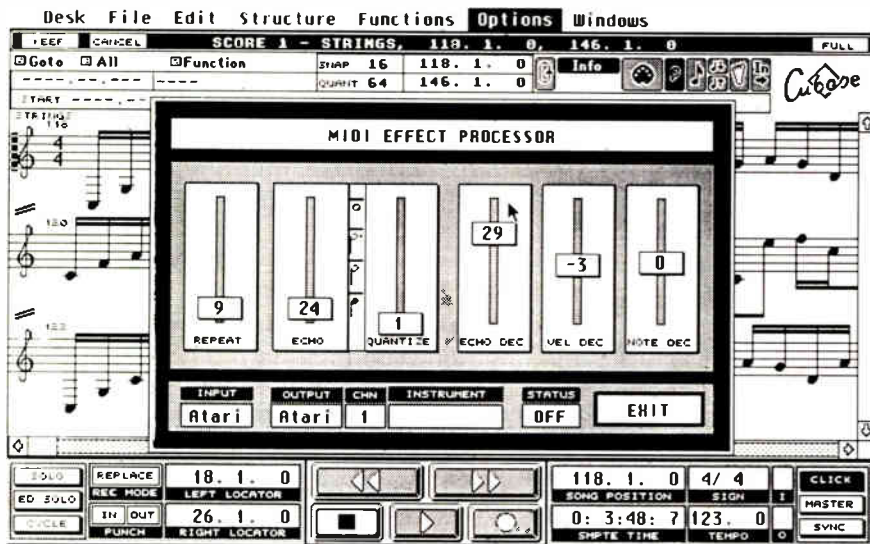

MIDI Effect Processor

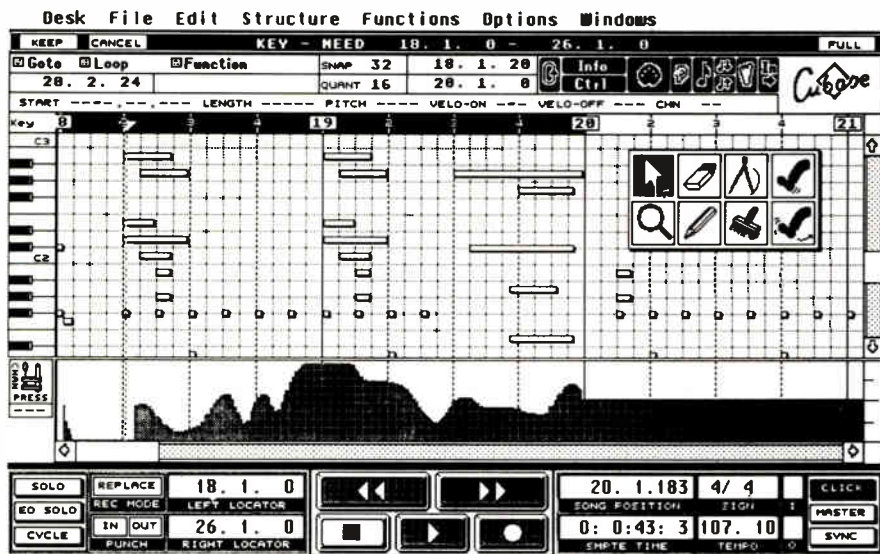

Key Edit Window



A collage of Yamaha mixers. In the top left is a Yamaha AM602 console mixer. In the top right is a rack-mounted Yamaha MV802 mixer. In the bottom right is a Yamaha MV1602 console mixer. The background is a dark, textured surface.

# If you're looking for the perfect synth mixer, we've narrowed it down to four.

Maybe you've been thinking about getting a mixer for home, or for the band. But since your expenditures for gear now rival the national debt, you've got to be smart.

It's got to be versatile. It's got to grow with you. It's got to be hot. And it wouldn't hurt if it was inexpensive, either.

At Yamaha, we don't think that's too much to ask. Because we've got not one but four synth mixers that'll fill the bill quite nicely.

The AM602 and AM802 are console mixers. The AM602 is a six input stereo mixer. All input channels accept line-level signals, while two channels can also be used with mics. The AM802 has eight inputs, six mono mic/line inputs and two stereo inputs. Plenty to keep you busy.

And not only do the Yamaha AM602 and AM802 mixers have one of the best names, they also have some of the best prices. So if you can't bring yourself to

splurge on a mixer, you won't have to.

We've got rack mounted mixers, too. Our MV802 has eight inputs and includes a VCA so you can control the mix by remote with a single foot pedal.

The MV1602 has 16 inputs—eight mic, six mono and two stereo. It also has VU meters to help you monitor the output just how you want it.

And if you outgrow one Yamaha mixer, just add on another. Stack up a couple of MV802s. Or sub-in an AM802 with an MV1602. Use any mix you like.

The Yamaha synth mixers. If you're looking for perfection, you've found it.

Yamaha Corporation of America, Professional Audio Division, P.O. Box 6600, Buena Park, CA 90622-6600. In Canada, Yamaha Canada Music Ltd., 135 Milner Avenue, Scarborough, Ontario M1S3R1.

**YAMAHA**  
Professional Audio Division

► to "clean up" the bar and make it easier to follow. Similarly, selecting the Syncopé function rewrites syncopated notes so that they are easier to interpret. For example, a pair of tied eighth notes will appear as a quarter note.

Notes and rests can be input directly onto a staff using the relevant icons in the tool box. Step-time entry is also possible. On-screen editing facilities are pretty comprehensive, but of course you must be mindful of the laws of music notation when attempting certain operations.

## Drum Editing

Drum Edit is the last of the four main Edit windows. Here we find a display optimized for the creation and editing of drum and percussion parts.

Like the Key and Grid Edit windows, a grid is used for displaying notes (or beats in this case) and anyone familiar with conventional drum machine programming should find themselves

for if you want to dump a pattern from a drum machine into Cubase and then play it back using a different sound source.

## Satellite

There's one final carrot I'll dangle in front of you – just in case there's anyone out there who might still be unconvinced that Cubase is a hot program. The carrot in question is Satellite, a utility program included on the main Cubase disk. In Steinberg's words, it "provides the missing link between sequencing software and synth editors in as much as it allows you to transfer (in either direction) banks of sounds and MIDI dumps for 50 of the most popular instruments." In conjunction with Cubase, however, it does a whole lot more...

For example, most conventional software sequencers allow you to store Program Change information in a track. Cubase, in conjunction with Satellite,

ably useful utility to have around, and like so many things on Cubase itself, it's great fun just to doodle with.

Additionally, you can store drum maps for the Korg M1 or Roland D10/D20/D110/MT32, and there's a MIDI Controller facility for generating MIDI Control Change data of any type. Oh, and I mustn't forget the option of three different kinds of files which may be saved – Standard MIDI Files, SysEx files and Pro24 format files...

## The Envelope Please

Simply put, this is the most impressive piece of music software I have yet encountered for the ST. As with most genuinely worthwhile designs, the transition from well-crafted tool to creative instrument is quite seamless. The features that give it a claim to both of these titles are universally well thought-out and meticulously presented. Not only that, it's a delight to use and one of that increasingly rare breed of technologically advanced designs that positively encourage the user to experiment.

I must mention that the manual isn't really exceptional in any way, but it *does* do the job. That said, I do like the way Steinberg has repeated parts of the text as they apply to each window. There's no need to refer back to previous chapters to find an explanation of a particular function just because it has already been described in another context.

The multitasking capabilities of Cubase really do make working with any other sequencer seem like dreadfully hard work. Not having to interrupt the music to select any other command or function doesn't sound like a big deal – until you return to a sequencer on which this would be impossible. Similarly, looking at a piece of music in two or three editing windows at the same time might sound rather over-the-top, but it has the effect of making any other sequencer seem as if it's hiding something from you. I suppose we're back to the concept of "transparency" that I mentioned at the beginning. Once loaded, it's incredibly easy to forget Cubase exists, and anyone who has spent time working with computer-based sequencing systems will know just how high a recommendation that is. ♦

PRICE: \$495

MORE FROM: Steinberg/Jones, 17700 Raymer St., Suite 1001, Northridge, CA 91325. Tel: (818) 993-4091.

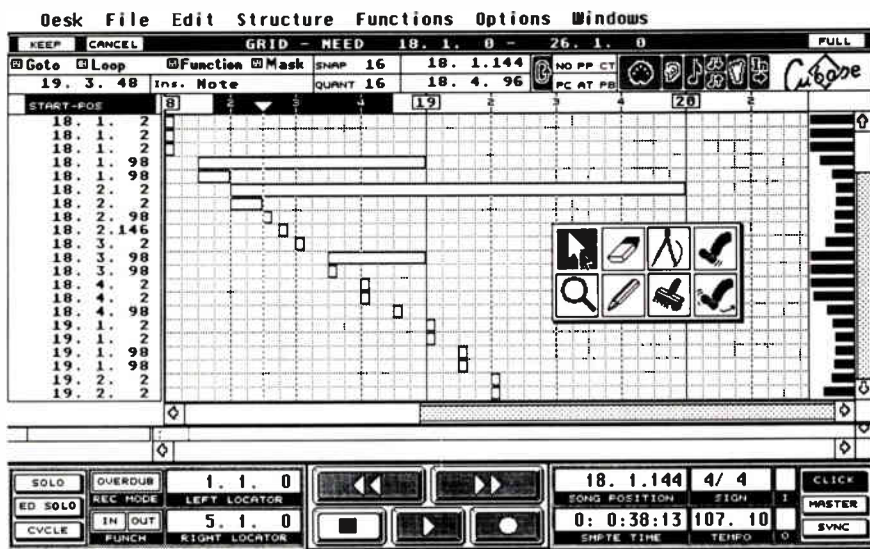

Grid Edit Window

right at home here. Drum beats appear on the grid as diamonds (the manual calls them "rhombs" after the mathematical designation of their shape, the rhombus), and take on a different pattern shading according to their velocity. As in other Edit windows, editing the beats is accomplished using any of the methods described above.

A Drum Map can be set up and displayed on the left side of the screen. It allows you to assign names and a multitude of other parameters to various keys. Once defined, the map is used to specify relevant sound and MIDI parameters when entering beats in step time, and also comes in handy

will record the SysEx data for a particular voice and send it to the synth along with the note and other data on playback. So, if a track uses a slightly modified synth voice, you don't need to use up synth memory saving it.

And speaking of editing voices, one of the things that I've often needed is a quick way of tweaking the more common parameters (like attack, brightness, release level and so on) on synths like the DX7II. With Satellite's Macro Editor at hand, it's possible to alter attack and release levels, the degree of brightness and "fatness," and the velocity sensitivity and vibrato levels for the whole sound – instantly. It's an incred-

# ***MORE ENTERTAINERS INSIST ON THE SM58 THAN ANY OTHER MIC IN THE WORLD.***

**A** recent independent survey of music dealers showed the Shure SM58 was the best selling microphone last month. The survey has shown the same result each month since it began. **M**ore rock, pop, gospel, country, and jazz vocalists and soundmen insist on the SM58 than

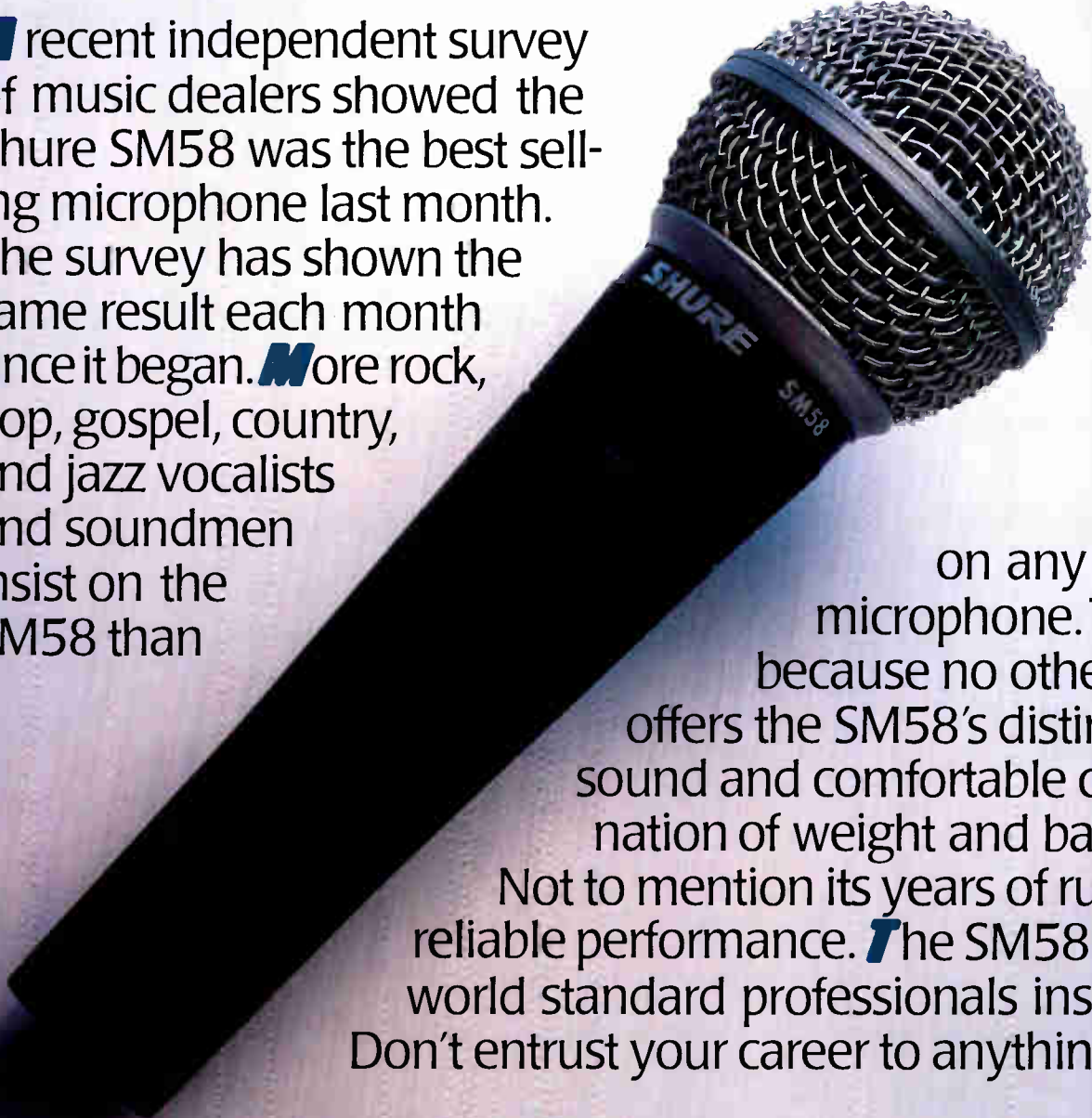

on any other microphone. That's because no other mic offers the SM58's distinctive sound and comfortable combination of weight and balance. Not to mention its years of rugged, reliable performance. **T**he SM58 is the world standard professionals insist on. Don't entrust your career to anything less.

## **SHURE®**

THE SOUND OF THE PROFESSIONALS... WORLDWIDE®

Shure Brothers Incorporated, 222 Hartrey Avenue, Evanston, IL 60202-3696. (312) 866-2553.

# Korg M3R & RE1

AI Synthesis Module & Remote Editor



Since it first appeared, Korg's M1 has set the standard against which other workstations have been judged. Now the company's M3R makes AI sounds available in a single rack space module. *Review by Simon Trask.*

PHOTOGRAPHY BY JAMES CUMPFSTY

**E**VER SINCE THEY brought out the M1, Korg has seemed in no hurry to move into lower price brackets. While other companies concentrate on repackaging their innovations in ever-cheaper versions for the masses, Korg has moved upmarket with their new T1, T2 and T3 synths. Until now, the M1R (a rack-mount version of the M1) has been the least expensive option for anyone wanting the M1's particular brand of synthesis.

With the M3R, Korg has come up with a unit that appears ready to please all of those musicians who've been longing for a budget expander version of the M1. While foregoing the

M1/M1R's onboard sequencer, the M3R retains most of its more expensive relatives' features.

However, it has only one oscillator (and therefore one sound) per Program, compared to the M1/M1R's two, and 75% of the latter's onboard ROM sample memory. Furthermore, its sample memory can't be upgraded like that of the M1 and M1R. But the polyphony remains the same (16 voices), as does the number of parts (eight), and the M3R has the same digital effects capabilities as the M1/M1R (and consequently the same audio output arrangement). It's also compatible with the M1's PCM ROM sample cards, so you're not

confined to its onboard samples.

Packaged in a 1U rack-mount casing, the M3R is operated from a set of eight buttons on the front panel, with a modest 2x16-character backlit LCD window. Realizing that this might not be to everyone's liking, Korg has also come up with a more user-friendly alternative in the form of the optional RE1 Remote Editor. This dedicated M3R hardware editor connects to the M3R by means of a special ten-foot cable.

In addition to the aforementioned LCD window and editing buttons, the front panel includes a volume knob, headphone output jack, power on/off switch, and two card slots for PCM

ROM data cards and Program/Combination data cards respectively. It's worth noting that the M3R cannot load M1 Program/Combination data cards, so Korg has been busy reprogramming their existing library specifically for the M3R.

Each of the eight edit buttons also has a red pinpoint LED which lights whenever a note is received on the corresponding Timbre's MIDI channel, resulting in quite a light show when you're running the M3R multitimbrally from a sequencer. On the rear panel are MIDI In, Out and Thru jacks, a Remote socket for connecting the RE1, and four audio output jacks (a stereo pair and two mono outs).

## Sounds

The M3R's internal sample ROM contains 89 Multisounds and 45 Drum sounds, all sampled with 16-bit resolution. The Multisounds are a mixture of multisampled instruments, attack transients and DWGS-synthesized waveforms. Korg has included a healthy variety of familiar instrumental sounds such as electric pianos, clavinet, harpsichord, acoustic and electric guitars, a variety of basses (acoustic, fretless, picked and synth), flute, clarinet, vibes, choir, ensemble and solo strings, tenor sax and trombone, as well as marimba, kalimba, koto and gamelan. Personally, I'd like to see Korg provide a much more comprehensive selection of African and Asian instruments on future plug-in PCM ROM sample cards – there are a wealth of such instruments just waiting to be sampled. For instance, how about a complete gamelan orchestra on a card?

Accompanying the instrumental sounds onboard are a range of more unusual metallic, percussive sounds and noises, many of them digitally synthesized, with names like 'Lore,' 'Pole,' 'Metal Hit,' 'Pop,' 'Spectrum,' 'Wire' and 'Digital.' These play an important part in defining the distinctive character of the M3R's sounds. Korg has also included DWGS-synthesized sine, square, pulse (10% and 20%) and sawtooth waves for more traditional synthesis.

For the most part, the Drum sounds are familiar, including bass and snare drums, open and closed hi-hats, congas, timbales and cowbell. But also included are a number of sounds that appear to have been taken from the metallic, noisy end of the Multisounds spectrum. Perhaps this is because the M3R's Drumkits can't incorporate sounds

from outside the Drum list. In that case, the inclusion of these off-the-wall percussive sounds in the Drumkits can greatly enhance the sonic vocabulary of your M3R rhythm parts.

## Architecture

Multisounds that are routed through the M3R's synth section are known as Programs. There are 100 of these onboard, and 100 more can be stored on RAM card. Multitimbral combinations of Programs are known as Combinations, and again there are 100 onboard and 100 on RAM card. A Drumkit can be selected for a Program in place of a Multisound. You can program four Drumkits into the M3R's onboard memory, each kit consisting of up to 30 drum samples assigned across the keyboard, each with its own tuning, volume level, decay time and effect/output routing.

Whereas oscillators have traditionally presented a limited number of harmonically rich waveforms, you can use *any* of the samples in the M3R (including ones from a Drumkit) as the starting point for synthesis. The Program structure follows the familiar pattern of oscillator-filter-amplifier (all digital, of course), with separate five-stage pitch, filter and amplifier envelopes (which can be modified by keyboard tracking and velocity). Also included are pitch and filter Modulation Generators (LFOs by any other name, with a choice of triangle, saw up, saw down and square waves, and frequency, delay, intensity and key sync on/off parameters).

In addition to attack velocity, the M3R will respond to channel aftertouch, which can be routed to pitch, pitch modulation, VDF (Variable Digital Filter) cutoff, VDF modulation and

***“The RE1 offers essentially the same panel editing facilities as are found on the M1, but with the significant addition of the eight data sliders.”***

VDA amplitude. Additionally, you can determine how MIDI pitch-bend will affect pitch (logically enough) and VDF cutoff, how MIDI controller 1 (Mod Wheel) will affect pitch modulation, and how MIDI controller 2 (Breath Controller) will affect filter cutoff modulation. All in all, a flexible but not overly-complicated set of synthesis parameters.

For the most part, the M3R's factory Programs don't change the Multi-

sounds all that much, even adopting many of the Multisound names as Program names. Remember, as I said earlier, unlike the M1/M1R, the M3R's Programs only have one oscillator, so you need to use the Combination memories to pair up samples.

Tuning enthusiasts will be pleased to know that the M3R allows you to select alternate scales. 'Equal Temperament 2' is equal temperament with a randomized fine-tuning for each note, while

***“Unlike the M1/M1R, the M3R's Programs only have one oscillator, so you need to use the Combination memories to pair up samples.”***

Pure Major and Pure Minor provide just intonation (complete with programmable tonic, or root, note), and a user-definable scale that allows you to specify pitch deviations ( $\pm 50$  cents in one cent increments) for each semitone in the octave.

You can select and play Programs in Program Edit mode, but digital effect settings can't be stored as part of a Program. At most, if you select Effect Interlock in Global mode, the Programs will be routed through the effect parameters of the last-selected Combination. It's preferable to play individual Programs as part of a Combination, with Single texture selected. In this way, you'll also be able to set a playback level and effect/output routing.

Combination mode allows you to select one of five textures, which govern the number of Timbres used: Single (1), Layer (2), Split (2), Velocity-switched (2) and Multi (8). For all five textures, you can define Program, volume level, pan position and sustain-pedal on/off per Timbre. Additionally, you can define the interval ( $\pm 24$  in semitone steps) and detune ( $\pm 50$  in cent steps) values for Layer. The Split texture allows you to set the split point (C#1-G9), and the Velocity-switched texture lets you set the switch point (velocity value 2-127).

The Multi texture allows you to use from one to eight Timbres at once. You define a MIDI channel for each Timbre, and you can also set a note window and a velocity window (as low/high values in each case, with each Timbre independent of the others). In this way, you can create a wide variety of textures, with combinations of layered, split and velocity-switched Timbres, or up to eight independent Timbres. You ▶

► can define semitone and cent transpositions as well as set MIDI patch change, sustain pedal, aftertouch and control change on/off selectively for each Timbre. Patch changes received on the Global channel select new Combinations.

The M3R's voices are assigned dynamically to the active Timbres, but there are no voice-reserve or Timbre-priority facilities. Remember that you've got a relatively modest 16 voices to play with, as opposed to some competing products that offer as many as 32 voices. The M3R does implement an Overflow facility which allows the polyphony to be effectively doubled if you connect another M3R to its MIDI Out, in which case it passes on incoming MIDI notes whenever its onboard 16-voice capacity is reached. Still, it's an expensive way of getting 32-note polyphony.

## Effects

The M3R scores high with its sophisticated onboard digital effects. Like the M1/M1R, the M3R offers you a choice of 33 programmable effects, eight of which are paired. You'll find six reverbs in addition to early reflections, stereo and cross delays, stereo chorus, stereo and cross flanging, phasing, tremolo, EQ, overdrive, distortion, exciter, rotary speaker, and pairings of delay with most of the above. These are all perfectly usable effects, on a par with much that is available today in the way of inexpensive multi-effects units.

Each Timbre can be routed to the A, B, C and D inputs to the digital effects. The M3R has two effects generators that can be organized in one of two configurations: serial or parallel. Inputs A and B are "hardwired" to effect one, and C and D to effect two. Similarly, effect one goes to outputs 1 and 2 (the stereo pair) and effect two to outputs 3 and 4. However, inputs C and D can alternatively be routed to outputs 1 and 2 – to A, B, or a stereo placement if you only want to use the stereo outs.

In this way, you can route each of your Timbres through one of two independent effects (serial configuration), or through both effects or effect two only (parallel configuration). What's more, by using two of the eight combination effects Korg has provided, you can route your Timbres through a possible total of four effects. Additionally, you can program a wet/dry balance for each of the two effects within a Combination, or switch out one or both

of the effects altogether.

The Drumkits are a special case, since each of the 30 drum sounds per Drumkit can be given its own effect routing. Thus, you can not only spread your drum sounds across the stereo image, but selectively route a couple of sounds via outputs C and D for separate (even external) processing.

In addition to saving the M3R's entire memory to RAM card, you can transfer it via SysEx as a single bulk memory dump or by category – Programs, Combinations, Drumkits or Global. Incidentally, the factory Programs and Combinations are stored permanently in onboard ROM and can be recalled at any time – always a handy facility, especially when the factory sounds are worth keeping, as these are.

## RE1 Remote Editor

The RE1 is a compact, fairly lightweight optional stand-alone unit, which provides an alternative front panel for the M3R. It has no power socket of its own, deriving its power from the M3R via the remote cable that connects the two units. The RE1 "takes over" the M3R as soon as you plug it in – the message "Remote Control" appears in the expander's LED window and the edit buttons are locked out (except for indicating active notes).

The RE1's purpose in life is to make operation of the M3R a great deal easier, a task at which it succeeds admirably. For starters, it provides a 2x40-character LCD window with soft blue backlighting that is much easier on the eye than the M3R's garish yellow. Underneath the LCD are eight buttons, labeled A–H, which select various parameters depending on which screen you're on. The RE1 uses the same type of buttons and sliders as the M1, but goes one better with eight data sliders for editing the parameters. You can use the data sliders without first having to select the relevant parameter – pressing the A–H buttons allows you to use the "±" edit buttons to the right of the LCD window, tells you what each parameter is, or, in some cases, instigates actions (for example, "Program Write yes/no").

The operating principles of the RE1 mirror those of the M3R, with function buttons to the left of the sliders selecting operating modes, and a pair of buttons to the right of the display stepping in either direction through the pages of the currently-selected mode. Below these are numeric buttons for directly moving to pages within the

current mode, and a pair of buttons for selecting Internal and Card memories.

Thus the RE1 offers essentially the same panel editing facilities as are found on the M1, but with the significant addition of the eight data sliders. These are particularly useful when you're editing parameters (e.g. volume) for the eight Timbres of a Multi Combination.

## Verdict

It's tempting to say that the M3R is what the M1R should have been all along – a sequencer-less version of the M1 with a few compromises which

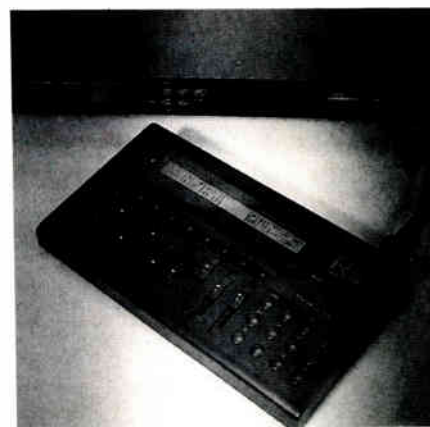

are adequately justified by the budget price. The lack of onboard sequencing isn't any great loss on an expander, and I for one can live with the reduced sample memory and the single oscillator per Program. The M3R's 1U rack-mount casing does mean that editing from the front panel is a drag, and although you can get by without the RE1 Remote Editor, it soon becomes a very tempting proposition. Full marks to Korg for providing the option, but I can't help feeling that, at over \$400, the RE1 is overpriced. Just think, that amount could go towards another piece of sound-generating gear.

But what really matters is that unique vibrant sound quality of Korg's AI synthesis, and the fact that the M3R retains the most significant features of the M1/M1R, such as sixteen-voice polyphony, eight-part multitimbrality, sophisticated onboard digital effects processing (a gift at this price), four audio outputs, and the ability to access Korg's growing library of PCM ROM sample cards and Program/Combination data cards. How can you resist? ♦

**PRICES:** M3R, \$1275; RE1, \$417.

**MORE FROM:** Korg USA, Inc., 89 Frost Street, Westbury, NY 11590. Tel: (516) 333-9100.

# Great New Books from Alexander Publishing!

## Alesis HR-16 Drum Machine

OPERATIONS & PATTERNS  
By Dan Walker with Jack Verga  
Illustrated, 166 pp., \$19.95

**S**ection One covers basic operations and recording: pattern record preparations, selecting sounds, step-time pattern record/step time, pattern record/real time, pattern edit, song record, data management. Section Two covers MIDI: HR-16 as a sound module, as a controller and MIDI sync. Section Three includes recording with the HR-16: learn about setting up your studio, sync, recording sync, four sync tutorials, the advanced MIDI studio. Section Four details hot patterns notated by Jack Verga for: Pop/Rock, Jazz/ R&B/Funk, Jazz Fusion, Country, Heavy Metal/Punk/Rap, Latin including the hottest Brazilian patterns.

## Alesis MMT-8 Sequencer

By Dan Walker  
Illustrated, 176 pp., \$24.95

**W**ritten simply and with lots of tutorials. Covers MIDI, basics of sequencing and recording. You learn, with three tutorials, MIDI hook-ups, data management, hands-on recording, recording preparations, basic editing, non-note data, event editing, creating and arrangement, advanced techniques, syncing up and more.

## The EPS Sampling Book

RECORDING AND EDITING THE SAMPLE  
By Bobby Maestas  
Illustrated, 152 pages, \$21.95

**T**his book takes you from sampling to editing the sample all the way to a finished instrument. Four sections. Section I gives you an operations overview including direct dialing individual parameters, disk drive operations and data management, articulation issues and more. Section II is about recording the sample. Includes mic techniques, recording from tape and CDs, 4-track basics applied to sampling, and a list of household sounds you can sample yourself that make for real usable gig-quality sounds. Section

III is about editing the sample step-by-step. Includes looping techniques, practical advice on finishing the raw recording into a usable finished sound and more. Section IV shows how to combine the wave samples to create sophisticated sounds that the EPS defines as an *Instrument*. Many of the things that Bobby's covered are just *not* in the manual.

## Korg M1

SEQUENCING &  
RECORDING HANDBOOK  
By Dan Walker  
Illustrated, \$24.95

**T**he artists using this book read like a Who's Who of Rock. Artists like Al Kooper, Trevor Rabin and Alan White of Yes, Steve Farris of Mr. Mister and Peter Frampton, to name just a few. This book assumes no prior experience with MIDI and synthesizers. Simply yet completely covers hook-up, the M-1 sequencer overview, data management, playback, basic song editing, advanced editing, step-time recording, non-note data and event editing, pattern recording, panning and effects, drum programming and much more. Join the other stars and order yours now.

## The M1 Effects Workbook

By Dan Walker  
Illustrated, 200 pages, \$24.95

**Y**ou get 165 effects set-ups that you can input into your M1 right away! You apply the effects to either the M1 or any effects processor. Four main sections. Section I covers all the effects that provide space or environment like reverb, delays, and early reflection. Section II covers electronic enhancement including chorus and flange as well as overdrive and distortion. Section III covers equalization and combination effects. Section IV shows you how to use both effects processors together in serial or parallel arrangement. Panning parameters are discussed in detail so you can arrange your patches in combination mode or tracks in sequencer mode. Plus, by the end of this book you'll understand how to operate and use all 33 built-in effects.

## Roland D20 Sequencing & Recording Handbook

By Dan Walker  
Illustrated, 161 pp., \$19.95

**R**ight up front Dan gives you a glossary of MIDI terms in simple English that relate to the D20. Then you learn: how the D-20 works; recording basics; more recording; erasing and quantizing; punch recording and overdub; panning, mixing and effects; reverb and delay effects; multitrack recording tutorial; disk management; manual mode; pattern record; recording patterns from scratch; track record; running outside pieces of equipment with the D-20; MIDI sync, MIDI Clock, MIDI Song Position Pointer; tape sync and SMPTE; add another sequencer; Appendix A: Rhythm Track Pattern Map; Appendix B: Group i Tones.

## Roland D110

OPERATIONS & PROGRAMMING BOOK  
By Dan Walker  
Illustrated, 250 pp., \$24.95

**C**overs multitimbral set-ups, MIDI, tweaking sounds and programming. Divided into two sections: Section One covers basic operations and multi-timbral combinations. You learn hook-up and play, architecture, setting up the internal system, MIDI implementation, timbre edit/performance controls, setting up rhythm sounds, patch edit/custom multi-timbral combinations, multi-timbral recording scenario, tweaking sounds, data management. Section Two includes tone programming and basics of sound. Editing procedures are outlined as well as tone structure, waveforms selection, pitch modulation, timbre parameters/synth waves, amplitude, putting it all together.

---

### How to Order

---

Many other new Alexander Publishing titles available. For fastest service call 1-818-407-0744. MC/VISA ok. Or Write Music Maker Publications, Dept. AP-1, 22024 Lassen St. Suite 118, Chatsworth, CA 91311. Orders shipped UPS. Sorry, no CODs. Please include \$2.50 shipping/handling (\$6.00 for orders outside U.S.) CA residence add 6.5% sales tax.

# READERS

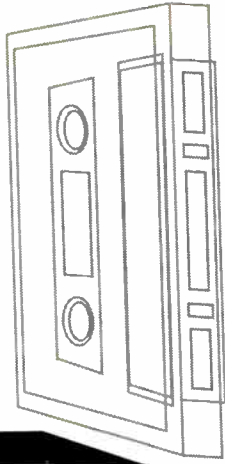

# TAPES

## It's a new decade – time to see which way the musical winds might blow.

Reviews by Yung Dragen.

ASIDE FROM SUCH forward-looking goals as the "sell line" above promises, it is also a time for a personal balancing of yin and yang, a time for breaking new personal ground. This first "submission" (I think I've been watching too much professional wrestling) is the first piece of vinyl ever reviewed in this column – the title is, after all,



*Readers' Tapes*, and it's not like I (or The Cyberpunk) have been scrounging for material. And as for balancing yin and yang (and getting my personal karma together), last month I quoted a young musician's grievances about a backwards-looking music program at a big school. This month, I'd like to lead off with a positive music program at a little school.

EMC 5 is a compilation album from the 80-strong membership that makes up the "Electronic Music Club" at Edmonds Community College (with a student body of just under 3000, it's the smallest community college in

Washington state according to 12-year director Jim Guard). Along with 8-, 4-, and 2-track reel-to-reels and the expected "academic" modular analog synth and pre-MIDI computer-based equipment (a Soundchaser system, in this case), they have a rather healthy smattering of typical MIDI equipment (a pair of Atari STs, Mirage, Juno 106, DX7IIFD, K5, DSS1, HR16, Kurzweil K1000, etc.). And unlike the stereotypical stuffy academic electronic music you would expect from some programs, most of the material on this album is an upbeat mix of rock, pop, jazz, and some classical idioms. And it's fun. Long live community colleges.

Now, on with the cassettes and early tea-leaf readings on Music in the '90s:

– **Bryan Hardie**/*Portrait*: A funny, self-effacing guitarist (now *there's* a Taoist contradiction for you) who really wanted to become a lumberjack kicks out I-play-everything synthesized rock jams with soaring guitar solos. The drumming is a bit mechanical, and I can't make up my mind if the voice sounds like an early Simple Minds garage demo or just weak. But the Yamaha DX100 work is well above average, and the guitar is okay too.

– **Jon Peterson**/*Know*: Bluesey, country/home-townish, predominantly acoustic vocal relaxation. Reminds me of some '60s-ish rock. "I do have a MIDI studio...however, this equipment is used primarily for composition. What I wanted to get on the tape was personality."

– **Omar A. Serang**/*Omar 1*: This is what "New Age" meant somewhere between its healing and metaphysical roots and the Nutrasweet jazz that radio programmers have turned it into today. Long half-flowing/half-pointilistic FM-heavy electronic pieces (with

piano, courtesy of a Yamaha TX1P) that are a bit syrupy but nice. Note: Tape oversaturates at points.

– **Monopoley**/*Earth Dance*: This is what "New Age" means to many today – somewhere between Muzak and light jazz. There's a difference here, though – it's inoffensive (in a good way) and tasty. Linn 9000 drums get overdubbed live with a DX1, GS1, PPG, Kurzweil, OB8, and DW8000.

– **Sean Kane**/*Rio Giants*: Axes: Akai S612 sampler triggered by a Roland GR700 MIDI guitar. "These pieces represent a series of exercises involving taking segments of music from the radio and tapes in a somewhat random fashion and attempting to create a whole from them." Snippets are grabbed and looped while others are juxtaposed on top in a hypnotic manner – an excellent cross between Stockhausen at his recombinant best and a modern guerilla-warfare sampling fiend. The most original tape I've heard in ages.

– **Djam Karet**/*Reflections from the Firepool*: You know you've arrived when your band's promotional sticker appears on a street sign where Topanga Canyon Blvd. meets PCH (the Pacific Coast Highway) just between Malibu and Santa Monica. These independent music favorites and earlier advocates of live, instrumental, free-form space rock have gone into the studio and kicked out a high-energy progressive rock album that brings to mind the earliest incarnations of King Crimson and Yes. There are also some unique sounds. I would have personally preferred more experimentation, but the Shocking Pink Dinosaur would stone me as a heretic if I dared say anything negative about this sharp album.

– **Adversary Bubba**/*six-song EP*: At last! New Wave! This most angular set by Susan Estes (on spaced vocals), Jonathan Tessler (on almost everything else), and a cast of thousands brings to mind Urban Verbs and Gang of Four, without being as weird or as harsh (with a dash of Syd Barret-era Pink Floyd or acid-period Beatles thrown in for good measure). Very well produced, to boot.

– **Mindspace**/*Moons of Jupiter*: The "serious New Age" aspect of Kellan Fluckiger (who's wife makes cracked wheat mush for breakfast, in reply to an earlier open question of mine). A very spacey, droney, analogy, jazzish instrumental about the title topic. Since I'm suffering from extreme future-angst these days (decade boundaries



have a way of doing that), this is a bit overly dramatic for my tastes, but it

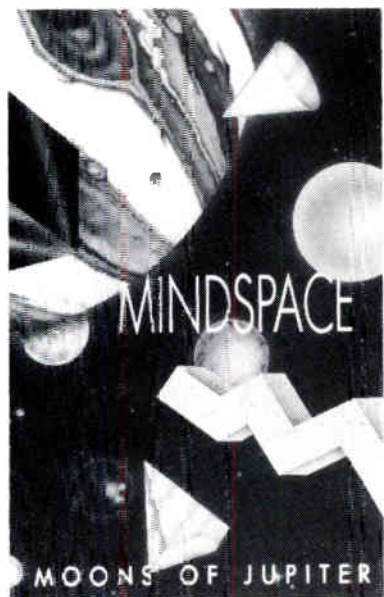

will appeal to those who like something between Isao Tomita and Patrick Gleeson.

– **Michael Mildrum and Focal Point/** *Observations*: The “adult contemporary” aspect of Kellan Fluckiger, in collabo-



**MICHAEL MILDNUM  
AND FOCAL POINT**

Reflections of life  
of love  
and of memories . . .

ration with Jim Kinch. Predominantly synthesized VH1-temperament vocal rock.

– **Quark Pair /** *Observatory*: A tape of oversequenced neo-classical electronic instrumentals with (yet another) space-oriented theme. This actually wins some points on its willingness to be richly synthetic (instead of wishy-washy imitative) and its tight execution, but I’m overdosing on all of this lack of depth (Omar, Monopoley, Mindspace, and now this). I think I’m getting too serious in my old age...

## quark pair

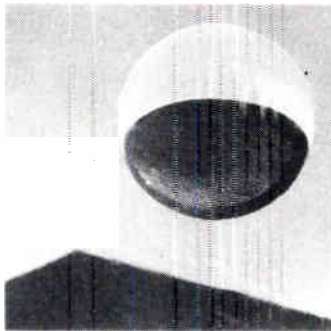

## observatory

– **Youth DK/** *The Fountain of...*: A man (or is it a “Youth?”) who has pushed a Sequential Six-Trak so hard up against its limits that the rest of the music has warped around it. Result? Bouncy, extraordinarily nervous pop derived



from but different than early Technopop. His voice fits – it should be up further in the mix, however. Side two features another extended ambient neighborhood recording (birds, distant radio, etc. on a Midwestern summer day), like those that made me dig his first tape.

– **Brian Coburn/** *seven-song demo*: Match a big rubber-spatula idea of a mechanical beat with carefully pieced-together found-tape dialogs over the top (including an amazingly balanced presentation of the flag-burning issue), and you put a glint back in my eye that there may be hope for new pop forms in the ‘90s. The lighthearted approach makes the politics palatable, and the Mirage sound quality gives it an underground sound.

– **Jim Garrison/** *seven-song demo*: Fair-quality medium-energy rock like you might get from a nondescript local band at a nondescript local club. The synth tones are a little thin, while the straight electric guitar is rather full-bodied.

– **T. Michael Colley/** *four-song demo*: A nicely swinging effort that moves from modern rock with a slight ‘60s progressive feel (‘Plastic Man’) to almost cabaret rock (‘Everybody’s Got a Secret’) to synth-funk with chic rhythm guitar, big, trashy drums, and white Prince-like no-particular-key vocals (‘Half the Truth’) to a mixture of all the above (‘It Is Not Me’). The drumming and synth bass are particularly solid.

– **John MacDonald and the Daily Planet/** *Greater Than or Equal To*: Last month was a ‘60s reconstruction from John – this month’s offering is a more modern, industrial, progressive alternative rock effort. Predominant sounds are clean, with occasional effects lunacy, and a balance of styles (would you like a difficult time signature, a ballad, weirdness, or more ‘60s reconstructions?). All without pretence. I didn’t think of him this way originally, but I’m beginning to think he’s brilliant.

This month’s score on the tea leaf readings: four retro-New Age electronic efforts, four normalish poppers, five good alternative rock directions, and a pair of forward-looking geniuses. Stay tuned as we audit the ‘90s... ♦

### Contact addresses:

**Bryan Hardie**, 3642 Hereford Road, Erie, PA 16150. Tape costs \$5 including S&H.

**Jon Peterson**, 28 Grove Street, Auburn, NY 13201. Tape costs \$8.

**Omar A. Serang**, 10484 Byrne Avenue, Cupertino, CA 95014. Tape costs \$9 plus \$1 S&H.

**Monopoley** c/o Jack Poley, 10720, Sand Key Circle, Indianapolis, IN 46256.

**Sean Kane**, 4113 W Street NW, #102, Washington, DC 20007. Tel: (202) 337-3490.

**Djam Karet** c/o Gayle Elliot, POB 883, Claremont, CA 91711. Tape costs \$7; CD costs \$12; stickers cost 50¢ (S&H included).

**Adversary Bubba** c/o B.C. Records, 10 West 65th St., #1i, New York, NY 10023. Tel: (212) 787-0062. Tape costs \$6.

**Kellan L. Fluckiger** c/o N-Space Records, POB 3183, Glendale, AZ 85311. Both tapes (MindSpace and Michael Mildrum) costs \$10 including S&H.

**Quark Pair** c/o Mark Rhodes, 330 West 72nd Street, #2C, New York, NY 10023. Tel: (212) 799-8839.

**Youth DK** c/o waRped RecoRds, 3212 Skycroft Drive, Minneapolis, MN 55418.

**Brian Coburn**, POB 460412, San Francisco, CA 94146. Tape costs \$5.

**Jim Garrison**, 3901 Ridge Road, #58, Cheyenne, WY 82001.

**T. Michael Coley**, 1423 Foxbrook Lane, Charlottesville, VA 22901. Tel: (804) 293-4320.

**John MacDonald**, POB 4635, Newark, DE 19715-4653. Tel: (302) 368-5847.

The purpose of Readers’ Tapes is to expose the *MT* readership to the work and thoughts of their peers, so that they can compare notes and maybe further their own art. Send your tape, price, equipment list, comments, and a photo to: *Readers’ Tapes*, Music Technology, 22024 Lassen St., Suite 118, Chatsworth, CA 91311.

# Ensoniq VFX<sup>SD</sup>

## Music Production Synthesizer



PHOTOGRAPHY BY MELODIE GIMPLE

**Ensoniq has introduced a sibling to the VFX, sporting more waveforms, a disk drive and a very intuitive sequencer.**

*Review by Dan Rue.*

**W**HEN I FIRST saw the original VFX, I recall thinking that a disk drive would fit *very* nicely in that so-called "cartridge holder" slot above the pitch-bend and mod wheels. It also occurred to me that with the addition of a sequencer, Ensoniq would have themselves an all-out workstation. So needless to say, I wasn't really too surprised when the VFX<sup>SD</sup> was released. Ensoniq has taken the VFX and slapped in a disk drive and a versatile 24-track sequencer, without sending the cost of the instrument through the roof. Just like Burger King, now you can have it your way.

Since the synthesizer functions are identical to the VFX, I'll waive a description of them here. You can get a

detailed description of the VFX from our review in the October '89 issue of *MT*. In a nutshell, the VFX<sup>SD</sup> is a 21-voice, 12-part multitimbral wavetable-based digital synthesizer, with a well-implemented 61-key velocity- and (channel and polyphonic!) aftertouch-sensitive keyboard.

The VFX<sup>SD</sup> does feature a couple of additions, designed to enhance the viability of the sequencer. First off, the instrument includes a pair of Auxiliary stereo/mono outputs that bypass the effects buss altogether. This allows you to buss sounds to outboard effects processors without having to fool with the sounds that are utilizing the onboard effects (they should be sent to the Main stereo/mono outputs).

Several new effects algorithms have

been developed, including a "Warm Chamber," "Gated+Room Verbs" and one I personally love, "Dirty-Roto+Delay." These new algorithms are included in the original VFX's new OS (operating system) version 2.0 – talk to your Ensoniq dealer to update.

While the original VFX included 109 waveforms in ROM, the VFX<sup>SD</sup> includes extra ROM chips containing an additional 32 waves grouped into two classes, Drum-Sound and Multi-Drum. Neither the VFX nor the VFX<sup>SD</sup> are able to change their ROM waveforms, so owners of the original VFX miss the boat on these drum sounds.

The Drum-Sound group consists of 17 individual drum and percussion sounds, including two kicks, snare and rim shot, hi-hat, ride cymbal, several toms, timbale, congas and tambourine. The samples are cleanly recorded, some dry and some with a tasteful dash of gate. With the onboard effects, the drums really come alive. The 'Gate-Snare' has a great hollow punch to it, and the 'Ride-Cymb' is convincingly



responsive to keyboard velocity.

The Multi-Drum group consists of 15 multisample waves, each with various combinations of individual drum sounds spread out across the keyboard, including an 'All-Drums' wave for your basic rock kit with a few congas and woodblocks, etc., thrown in for good measure, and an 'All-Perc' wave that assembles the full gambit of Latin and otherwise auxiliary percussion sounds.

In addition to the internal, cartridge and MIDI SysEx storage capabilities available on the VFX, the VFX<sup>SD</sup> also has a built-in 3.5" disk drive. In conjunction with the disk drive, the instrument also includes a MIDI System Exclusive Recorder. With it, SysEx messages of up to 96K bytes can be stored to disk, so you could theoretically store patches from your other MIDI instruments on your VFX<sup>SD</sup> disks. Interestingly, SysEx data dumps are stored in the Sequencer memory until you save them to disk, so it may become necessary to clear out some Sequencer banks (save to disk or cartridge) to perform more elaborate three-ring SysEx tricks.

And finally – you guessed it – the Sequencer. As I said before, the VFX<sup>SD</sup> features a 24-track sequencer, with the potential to use up to 24 different Programs at a time in a single Song (but of course you wouldn't do that without using an external sound module – the internal polyphony max's out at 21 notes, dynamically allocated). Each track of each Song or Sequence uses one Program, accessed and stored in the Multi-Program buttons (as featured on the original VFX).

With the standard memory config-

uration, the Sequencer has a capacity of over 25,000 notes (Note On/Note Off pairs). You can also expand the memory to a capacity of over 75,000 notes with the optional SQX-70. This also expands the SysEx buffer to 292K.

Essentially, you build Sequences comprised of 12 tracks, and assemble them as Steps into Songs (much like most drum machines, actually). Each Song can have up to 99 Steps with up to 99 repetitions per Step. Once you've put together a Song, you have an additional 12 tracks that run the length of the Song on which to record. This is really a brilliant setup – transition riffs between the Sequences can be created without having to break your creative inertia.

Sequences and Songs are stored in 60 memory slots, with the Songs being designated by a "\$" to keep things from getting confused. The size of Sequences is hampered only by the size of the Sequencer memory – no set note limit is imposed. This is especially advantageous because you have the option to store all of your Sequences and Songs on disk, leaving the entire memory open for the Song and accompanying Sequences on which you are currently working.

The Sequencer is *very* intuitive – I literally figured out and used every aspect of it before opening the manual. Reading through the manual felt more like checking for things that I might have missed. And there weren't many, actually – this is a basic sequencer, without some of the sophisticated operations its software counterparts are doing these days. However, in view of most of the other workstation sequencers, the VFX<sup>SD</sup>'s scores high marks – primarily due to the aforemen-

tioned intelligent and intuitive design.

As far as editing goes, we're given the basics (with a couple of goodies thrown in). For each Track in a Sequence, we are allowed to Erase a designated portion or all of the Track, Copy some or all of the Track, Quantize (1/4 to 1/64 triplet) some or all of the Track, Shift the Track in time by up to 96 clocks (quarter note) in either direction, Merge the Track into any other Track of any Sequence currently in memory, and Transpose some or all of the Track by up to 12 octaves and/or semitones in either direction.

Now for the sophisticated editing options. You can Scale the level of any one of 16 different MIDI controllers by a specified amount for some or all of the Track as well as Filter some or all of the Track. This allows you to erase or copy note data or any one of 16 types of controller data to another Track. The Sequencer also includes a full Event List of all data or a specified data type, displaying the starting time of the event, event type, key number or value, and velocity/value. Once you've selected an event or event time to edit, you can insert or delete events, alter the duration of Key Note events, alter the start time of the event, and alter the originally displayed values.

Once you've finished tweaking your Tracks, you have some basic Sequencer editing options. You can Erase the entire Sequence, Copy the Sequence to a new location, change the Tempo, Append the Sequence onto its own end (doubling its length) or onto the end of another Sequence, and change the Length of the Sequence by adding or deleting a specified number of bars.

As I said, this scheme doesn't really compete with computer sequencing programs, what with graphic editing and step-time note entry (not supported on the VFX<sup>SD</sup>), complex quantization algorithms and such. But in the workstation market, this is quite competitive – you *can* write songs, *complete* songs, and with a very friendly interface.

So the bottom line – Ensoniq has once again displayed intelligent R&D, successfully integrating more user-friendly functions into their already well-conceived and implemented synthesizer. What can I say...if you're in the market for a workstation, you must at least check this one out. ♦

**PRICES:** VFX<sup>SD</sup>, \$2595; SQX-70, \$449 (available through authorized Ensoniq repair stations)

**MORE FROM:** Ensoniq Corp., 155 Great Valley Parkway, Malvern, PA 19355. Tel: (215) 647-3930.

# Advanced Sampling Course

## Lesson 3: Crossfading Reality

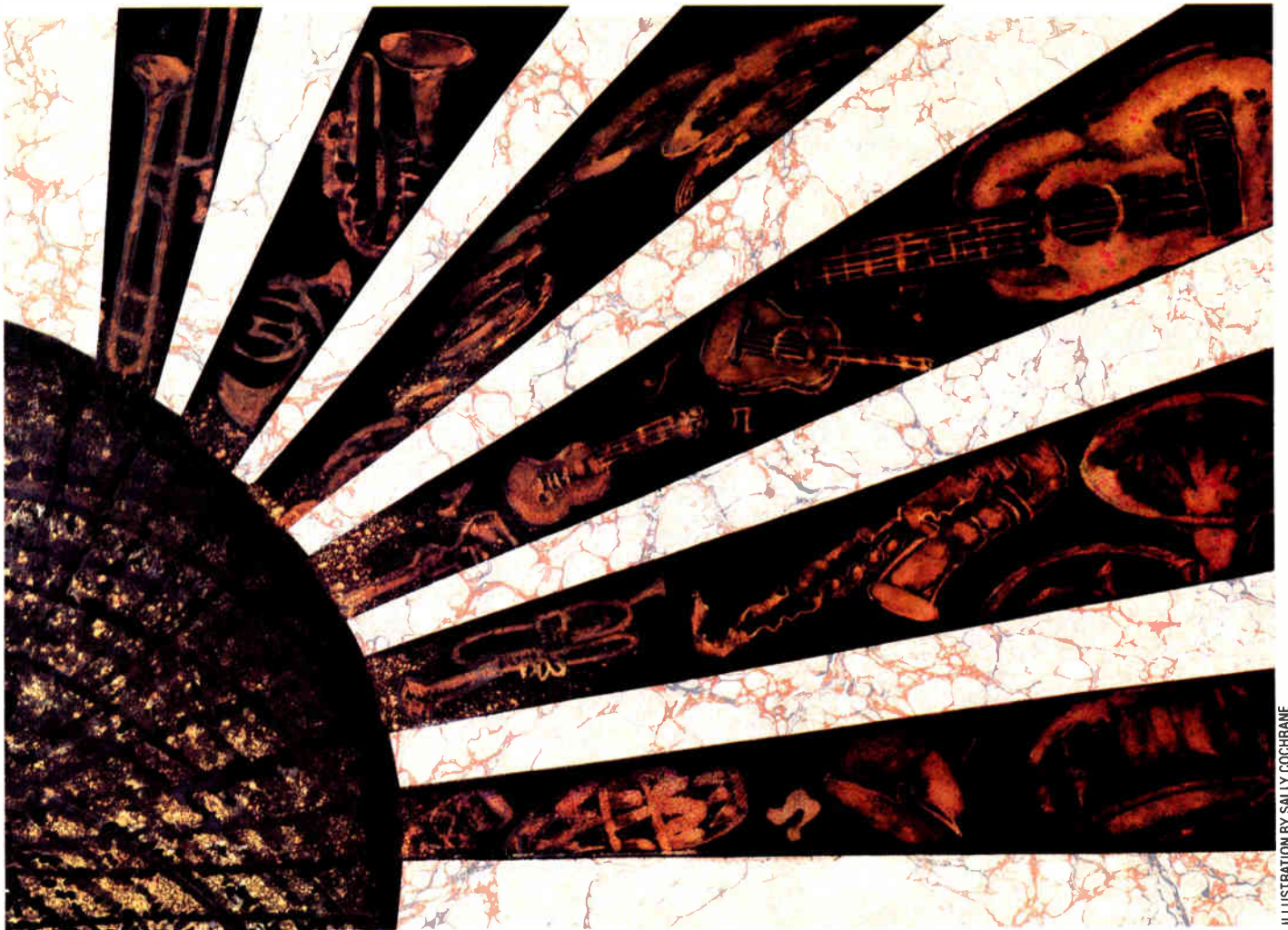

ILLUSTRATION BY SALLY COCHRANE

**Nothing too mystical this month – just lots of advice on *what* type of crossfade to use *when*.**

*Loop-the-Loop* by Chris Meyer.

**H**AVE YOU EVER been in that situation where, as soon as you fixed one problem, another one suddenly appeared? And maybe the solution for the first problem *caused* some problems of its own?

Crossfade looping is like that. In the early days of sampling, all we worried about was getting rid of the cursed “click” that occurred at the loop splice point. Crossfading plowed that click right under – only to reveal other qualities necessary to get a good loop

point, such as matching the ebbs and tides of the sound so that the loop sounded natural. And sometimes, the crossfade caused other sonic weirdnesses to appear right around the loop point itself.

This month, we’re going to plow some of those other problems right under too – or at least get a better idea of how, where, and when to apply the miracle drug known as “crossfade looping.”

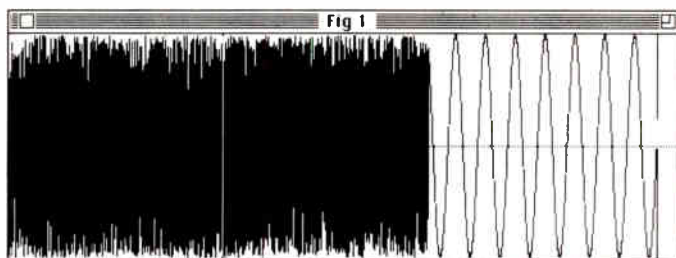

Figure 1. Before Forwards 1 crossfade.

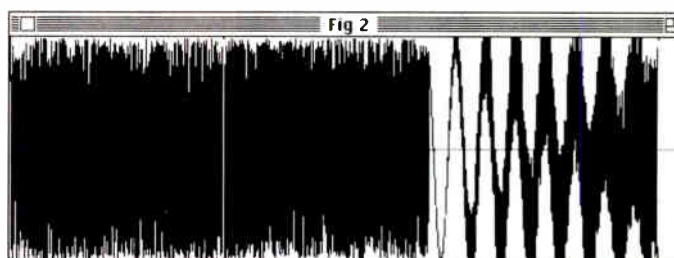

Figure 2. After Forwards 1 crossfade.

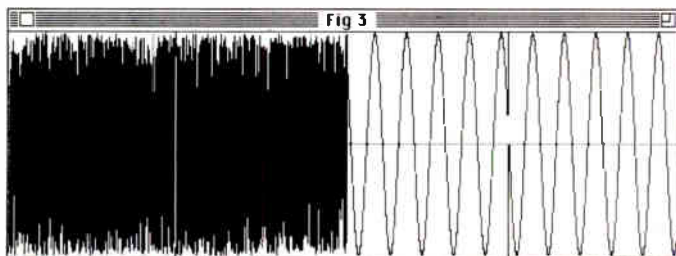

Figure 3. Before Forwards 2 crossfade.

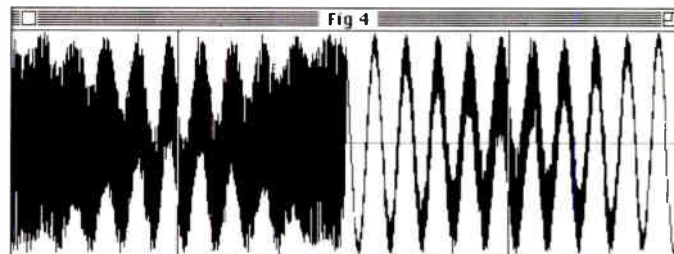

Figure 4. After Forwards 2 crossfade.

## Basic Theory

The premise of this series is that you already understand quite a bit about sampling and looping, but since crossfading is still a mystery to many, it's worth going over from scratch.

In the case of a unidirectional (forwards only) loop, clicks are evident because the waveform just before the loop end point is different than the waveform just after the loop start point. In the case of a bidirectional (backwards/forwards) loop, clicks are evident because a different waveform is created by suddenly reversing the sound just inside the loop points rather than playing the sound back straight through the loop point. In both cases, the transition at the loop point is not as smooth or natural as just playing the sound normally.

The point of crossfade looping is to make the transition at the loop point as seamless and natural as possible. In a unidirectional crossfade loop, the goal is to make the waveform near the loop start point identical to the waveform around the loop end point, so that the transition is smooth. In a bidirectional loop, the goal is to make the waveform just before the loop point a mirror image of the waveform just after the loop point. Both situations require altering the sound itself, and as you can imagine, there are different ways to alter the sound in order to get the desired results.

## Methods of Madness

There are two different ideas about the correct way to perform a unidirectional crossfade. The method we'll call

Forwards 1 is saddled with the Akai S900's looping restrictions – namely, that the loop end point is also the end of the sample. This means that there's no material just after the loop end point to mix with the sound right after the loop start point (since you want to make the two seem the same). Therefore, you can only change material before the loop start and end points.

This procedure forces the loop end point to be exactly like the loop start point. It does so by gradually replacing the material before the loop end with an equal amount of material from before the loop start point. As we get closer to the loop end, the loop start material gets mixed in more and more, until right at the loop end point, where the exact same sample is used as at the loop start. The sound before the loop start is left untouched. The maximum length of the crossfade is restricted to the distance between the loop points, or the distance between the beginning of the sound and the loop start, whichever is shorter.

Figures 1 and 2 illustrate a Forwards 1-style crossfade. **Figure 1** is a very special sound in which there is white noise between the sound start and a point between the two loop points. The rest of the sound is filled out with a sine wave (very hard to loop seamlessly without major surgery). **Figure 2** shows the result – observe the transition between the loop points from a sine wave to noise.

The method I'm calling Forwards 2 uses an algorithm that first appeared in Digidesign's Sound Designer software. It assumes that there is material to use after the loop end. It also strives for each loop point to contain a 50/50

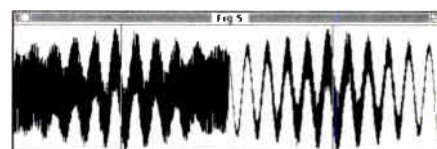

Figure 5. After an Equal Power Forwards 1

mixture of sound taken from the loop start and end points (as opposed to the 100/0 mixture at the loop end as in Forwards 1).

At a given distance before the loop start, this algorithm starts to fade out the original material and fade in the material from the same distance before the loop end. This continues until the actual loop point is reached, where a 50/50 (or in the case of an "equal power" crossfade, which we'll talk about later, a 71/71 – 71% coming from  $[\sqrt{2}/2]$  for you math lovers, out there) mix between the two sets of material is achieved. After the loop start point, the mix starts to fade back to normal, using less and less material taken from the same distance after the loop end. The same thing happens around the loop end.

The maximum allowed crossfade time is the smallest of the following three numbers: The distance between the sound start and the loop start; the distance between the loop end and the sound end; or half the distance between the two loop points. This is to make sure that the crossfades don't overlap.

Figures 3 and 4 illustrate a Forwards 2 crossfade. The sound in **Figure 3** is the same as **Figure 1**, except for some sound left between the loop end and the sound's end. **Figure 4** shows the result after the crossfade – you can see how the 50/50 mix is approached and then moved away from. **Figure 5** ▶

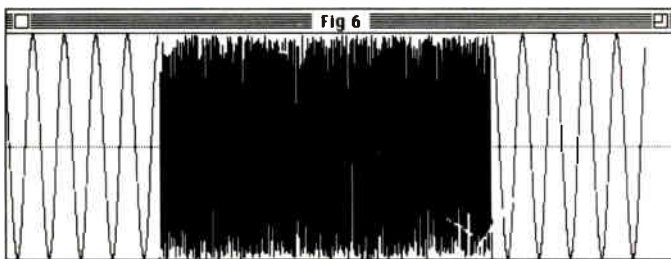

Figure 6. Before a Bidirectional crossfade.

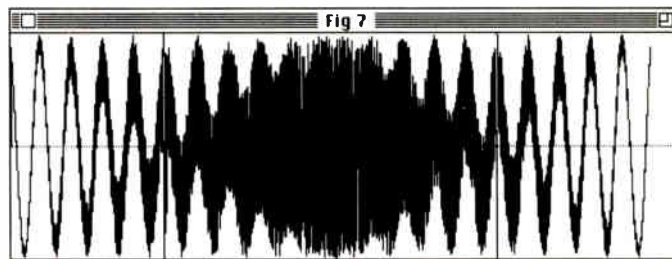

Figure 7. After a Bidirectional crossfade.

► shows the same sample, with an “equal power” Forwards 2 crossfade.

As far as I know, there is only one bidirectional crossfade method floating around. It is very similar to Forwards 2, so I’ll call it Bidirectional 2 (I’m basing these names on those used in Interval Music System’s GenWave sample editor software for the Atari ST, which is the only one I know of that implements them all). At each loop point in a bidirectional loop, playback turns around and starts to play the sound in the opposite direction. This turnaround is very sudden, and clicks a lot more often than an ordinary unidirectional loop. The idea behind a bidirectional crossfade is to make the sound at each loop point a 50/50 (or in the case of the equal power variety, 71/71) mix of

***“There are two different ideas about the correct way to perform a unidirectional crossfade.”***

the sound going forwards with the sound going backwards.

This mix is faded into gradually. At the full crossfade length before a loop point, sound from the same distance after the loop point starts to get mixed in. As you get closer to the loop point, the mix of the sound changes to use more of the sound taken from the same distance after the loop point, until the mix is 50/50 (or 71/71) at the loop point itself. Afterwards, things fade back to normal. The same thing happens around the other loop point. The maximum loop length is calculated the same way as for the Forwards 2 method.

Figures 6 and 7 illustrate a Bidirectional 2 crossfade. The weirdo sound in **Figure 6** has white noise before and after the loop points, with a sine wave in-between. **Figure 7** shows the result.

## Forward Gears

Congratulations – for the third month in a row, you’ve managed to stay awake through the theory and get to the useful

stuff. It’s time to start discussing what type of loop to use when, including how long a loop should be.

With any type of looping, it pays to pick loop points that work overall before you worry about fixing problems at the loop transitions themselves. Ignoring the click for now, place the loop start and end at points that are similar in timbre. Many sounds have a natural ebb and flow – placing the loop points to capture a full cycle (or cycles) of this movement will help your crossfading later. Try to listen through the loop click, and imagine what the sound would be like if the transition was smooth.

In times of frustration, I used to purposely pick two very dissimilar points in the sounds, thinking the crossfade would average them out – it didn’t. Therefore, if a natural ebb and flow doesn’t present itself, listen for a faked one that might just work. A visual sample editor really helps in finding matching points. Look for recurring themes in the overall amplitude profile or the actual waveform’s spikes and dips.

Beware of a sound that actually warbles in pitch – if the pitches are different at the loop points, you’ll hear two different pitches during the crossfade (a disconcerting problem I had with a certain shakuhachi flute sample – yes, that same EII sample used to death by Peter Gabriel and Tangerine Dream). Don’t worry so much about amplitude differences; the crossfade will help even those out. And try to find a good un-crossfaded loop splice before bringing out the big guns (use the techniques described in last month’s class).

If you have found a long loop that almost works “as is” (a common occurrence with wind and brass instruments), you’ll want to make a minimum amount of change in the sound to make sure that you don’t muck up the rest of it. Use a very short (1000–6000 sample) Forwards 2 crossfade. This results in a more gentle transition around the loop points. If you have a very short loop (such as looping the tail of percussive-enveloped sounds, such

as piano, bass, or vibes), use a short Forwards 1 crossfade – try to keep it to one or two cycles in length (which may be 100% of the length of a short loop). This style of crossfade is also good for keeping the amplitude even over the length of a loop in an otherwise percussive-enveloped sound.

Long loops are trickier, and this is where personal preference comes in. I personally prefer the linear “50/50” variation of the Forwards 2 style of crossfade, since it changes the sound less around the loop points than Forwards 1. I also think that it works better in cases where the sound at the loop points is dissimilar. However, the

***“The biggest mistake many people make with crossfade looping is allowing some of the attack of the sound to sneak into the crossfade.”***

maximum length of Forwards 2 crossfades tends to be shorter than for those of the Forwards 1 variety (the big limitation comes in the distance between the loop end and the sound end). So, when a long loop will work better, I’ll use Forwards 1. On the downside, Forwards 1 assumes that the sound right after the loop start is very similar to the sound right before it – if not, using a Forwards 1 crossfade will not smooth this out, whereas Forwards 2 will.

The biggest mistake many people make with crossfade looping is allowing some of the attack of the sound to sneak into the crossfade. Remember that material right after the sound’s start tends to be a lot different (brighter, etc.) than the rest of the sound, and the material between the sound start and the loop start is going to get mixed in right before the loop end point. Often, I’ll set a temporary sound start at a point where most of the attack’s strangeness has died away, just to make sure I don’t crossfade it into

# MUSIC MAKER PUBLICATIONS...



## ▲ MUSIC TECHNOLOGY

The music source for the '90s. The key to MIDI, synthesis, sampling and much more!

**\$20.00** 12 issues / 1 full year

## ▲ HOME & STUDIO RECORDING

If you've got music to play, you've got music to record!

**\$20.00** 12 issues / 1 full year

## ▲ RHYTHM

The only drum/percussion magazine that bridges the gap between acoustics and electronics.

**\$17.75** 12 issues / 1 full year

**SUBSCRIBE NOW and save up to 50% off the newsstand price on a one-year subscription. Save even more on 2- and 3-year subscriptions.**

### TO ORDER

Simply fill out and mail coupon to:

Music Maker Publications, Inc.  
22024 Lassen Street, Suite 118  
Chatsworth, CA 91311

OR

for quicker service call

**(818) 407-0744**

■ Try your first issue with *no obligation or commitment.* Just check "bill me," and if you're not completely satisfied, your introductory issue was free. Simply write "cancel" on your bill and return it to us in the postage paid envelope supplied.

#### MUSIC TECHNOLOGY:

- YES! Please send me 1 year / 12 issues at \$20.00
- Even better! 2 years / 24 issues for only \$37.00
- Better yet! 3 years / 36 issues for only \$55.00

#### HOME & STUDIO RECORDING:

- YES! Please send me 1 year / 12 issues at \$20.00
- Even better! 2 years / 24 issues for only \$37.00
- Better yet! 3 years / 36 issues for only \$55.00

#### RHYTHM:

- YES! Please send me 1 year / 12 issues at \$17.95
- Even better! 2 years / 24 issues for only \$32.95
- Better yet! 3 years / 36 issues for only \$48.95

Name \_\_\_\_\_

Address \_\_\_\_\_

City \_\_\_\_\_ State \_\_\_\_\_ Zip \_\_\_\_\_

Payment enclosed\* (Amount: \$ \_\_\_\_\_)     Bill Me, or charge my

VISA     MASTERCARD    Card # \_\_\_\_\_

Expiration Date \_\_\_\_\_ Phone (    ) \_\_\_\_\_

Cardholder's Name \_\_\_\_\_ Signature \_\_\_\_\_

\* Checks payable to: Music Maker Publications. Non-US subscriptions must add an additional \$12.00 for each year's subscription to cover postage and must be paid in U.S. Dollars via International Money Order. Please allow 6-8 weeks for your first issue.

C K Z A A

# Starr Quality



PHOTOGRAPHY BY MELODIE GIMPLE, MAKEUP BY SUE FORREST-CHAMBERS, HAIR BY JUDITH TIEDEMANN

**A fresh young talent from TV Land, Starr Parodi is currently most visible as the keyboardist in Arsenio Hall's musical Posse, which just goes to prove that talent still lives in the luster of Hollywood. *Interview by Gene Ferriter.***



**P**ERFORMING IN A band five nights a week is an enviable gig, and when the band happens to be the *Posse* on the Arsenio Hall Show, the term "dream gig" would not be an over-exaggeration. Michael Wolf leads the quintet of increasingly recognizable characters, not the least of which is his ebullient keyboard compatriot, Starr Parodi.

Parodi is highly appreciative of her current working arrangement, with nothing but accolades for her employers and bandmates. Concurrently with Arsenio's show, she works for composer Mike Post, scoring intermittent TV episodes for *Booker*, *Hunter*, *Wise Guy*, *Magnum P.I.*, *Nashville Beat* and *Thunderboat Row*. And, as if that wasn't enough, she also leads her own band, with a debut album currently in development. Approaching the age of 28, she is a consummate model of the contemporary working musician.

Remarkably, Parodi didn't begin playing piano until the age of 15, but quickly became immersed in study at the Interlochen Arts Academy in Michigan, the Ecole Normale de Musique in Paris, and with Dick Grove in Los Angeles. She landed her first prominent gig as the on-screen keyboardist in the television series *Fame* during its final three years. "I was sitting in my room one day, wondering where I was going to work next and I got a call from someone on *Fame*. I still don't know who recommended me for the show. They hadn't used women musicians before and were sort of uneasy about it at first. They were very open-minded, though, and I ended up playing in their live band for about three years."

*Fame* was only the first in a succession of film and television projects for Parodi. She has appeared on-screen in the film *Iron Eagle II* and on the TV shows *Fritz*, *Bonkers* and *American Bandstand*. In addition, she has appeared in music videos by George Howard and Bryan Duncan and commercials for Shasta Spree. Parodi wrote and arranged the music for *Fritz* and *Bonkers* as well as *Hot Team Disney*, Hanna Barbera's *Foofar* and commercials for MGM, Arco Oil, Charter Hospital and Adolph Coors Corp., among others.

It was her work on *Fritz* that led directly to the bandstand on Arsenio's show. Hall was very impressed by her one-woman band capabilities, as Parodi single-handedly created the

music for *Fritz*, with a little help from her wall of synths and sequencers. The result landed her the audition with Arsenio's band.

"The audition was different than any that I had been to before, because instead of going in and just playing for a few minutes, we really played almost all day. Michael Wolf just had a few people per day come in. Peter Maunu [guitar], John B. Williams [bass], Michael and I all got along well. We tried to do a lot of different styles, because we were anticipating having to play with a lot of different artists. He just wanted to make sure everybody could do that. Michael was also looking to find a keyboard player that was compatible with him, where we wouldn't step on each other's toes."

The *Posse* usually accompanies each show's musical guest for one or two tunes, opens and closes the show with Arsenio's theme (which he wrote), plays relevant walk-on music (the *Cheers* theme for a cast member, for example) and "get busy" for commercial lead-ins and tags. Depending upon the guests, the preparation is occasionally hectic.

"We get there about 2:15 every day and spend about an hour rehearsing. We are really trying to do a lot of new songs and keep everything really current. Michael has a great attitude towards arranging the songs. He'll bring the new material in and we'll just experiment. We'll see what works for us and know that the parts aren't written in stone. When we play for a singer, they usually want it just like the record, so we do it that way. For our bumpers, though, which we play before commercials and stuff, we really take liberties."

**A**RSENIIO FEATURES A WIDE spectrum of musical guests – the *Posse* has accompanied Whitney Houston, Quincy Jones, Rickie Lee Jones, Freddie Jackson, Jermaine Jackson, Sheila E., Andy Summers, Branford Marsalis, Nancy Wilson and many others. Among the memorable experiences, Al Green and Miles Davis seem to stand out as high points for Parodi.

"Miles was so great. When he came here, our band changed. It was just his *presence* here. We started messing around with different sounds and chords and doing all kinds of different

## PRIVATE LESSONS

The SKE Course is a unique, 36 hour, self study program packed with techniques, tips and recording skills.

You learn virtually everything needed to handle sessions with confidence, from set up to polished mix, in the privacy of your own home or studio. This course is based on a leading college textbook,



"Practical Techniques for the Recording Engineer," by Keene.

Include, one time-only (#1–28.95) for the text, and (#2–\$16.50) for the series workbook.

Cassette Albums (\$99.99) each.

- #101 Basic Study Album
- #102 Intermediate Study Album
- #103 Advanced Study Album

Add \$3. shipping per box/album. California residents add sales tax. Order by phone using Visa or Mastercard by calling:

**(818) 407-0744**

Order Yours Now From

**HOME & STUDIO RECORDING**

Music Maker Publications  
22024 Lassen St. Suite 118  
Chatsworth, CA 91311



► things. We changed. We continued to change from that point on. It was a real landmark point for the Posse. I've always loved Miles' playing and his whole concept of music. I'm trying to think of how to put it, because he's aggressive, but the melodies are really memorable and sort of street. I love that. His music feels so good to solo over or put certain chords to. It's simple and it flows. If you can write a piece of music or have a concept of the kind of music that does that, when every-

***"I love purely acoustic music and I really do appreciate it after hearing so much sequenced pop, but one really does not diminish the other."***

thing you play over it seems to flow, then I think that's a very special gift."

At the show, Parodi manipulates a healthy arsenal of equipment, including a Korg M1, Yamaha DX7IIFD, Kurzweil 1000PXA sound module, Roland Super Jupiter, and Roland D-550. At home, she uses an Akai S1000, Prophet 2000, Prophet VS, Prophet 5, Roland D-50, Korg M1 and newly acquired T3, Minimoog,

Kurzweil 1000PXA, and the Yamaha DX7, DX7IID and TX316. Her out-board effects include a Lexicon PCM70 and LXP1, a couple of SRV2000s, a DigiTech DSP128, and a Yamaha SPX90. Sequencing and sample editing are done on Atari 1040 and Mega 4 computers running Hybrid Arts' SMPTETrack II and Interval Music Systems' GenWave and GenEdit.

**P**ARODI'S COURTSHIP WITH musical high technology was not a very smooth, natural process initially. "I don't think that it was very organic. I think I fought them for a long time. Then I got a computer and when MIDI came out, that was the big turning point. I would do sessions with people and we would have *seven* DX7s – not modules – seven keyboards lined up on the floor all MIDI'd together. We were so excited, but it was defeating the purpose at some point, because often times we wouldn't even detune them. The whole purpose of using the same sound and layering it is to try to get, say, a chorusing effect or some kind of contrasting sounds. Sounds really make you play a certain way. If you have a little, dry, ticky-type sound, you might not take the soaring solo that

you would with a different sound," she says, laughing at the example. "I really think that sounds inspire you.

"I used to MIDI as many things together as I could, just to see what it would sound like. Since I was always excited by textures, I got more into it when MIDI came out. Then with the computer, I really loved programming drums and percussion. It was very intense when I first got a computer and all of the synthesizers. I was in a room with them one day, all by myself, and it was either them or me, you know," Parodi recalls, breaking up at the humor of the scenario. "So, we became friends."

Although advances in music technology have been an incredible boon to the composer and have expanded the sound options for players exponentially, there are still limitations. "Sometimes I wish that what I'm hearing could go straight from my head without having to go through synthesizers and pitch wheels and signal processors. Maybe with some new kind of breath controller or something. There are little tiny bends and other alterations in the sound that I can hear, but that I can't always create by tweaking the pitch wheel or synthesizers or effects. I might hear how a sax player can play the same note and play it differently every time – play it with tiny pitch or tone variations, going from a smooth sound to a growl or something. There is so much instrumental music focused around sax, because it's so close to voice. It's very challenging to try to create that feeling on keyboards."

Parodi's own style has a rhythmic vitality as well as a lyrical flair, sounding like a seamless hybrid of her many influences: Joe Zawinul, Herbie Hancock and Lyle Mays, to name a few. At one point in her life, she had more classical inclinations, but ultimately realized that her heart was in other areas. "I loved the idea of studying classical music in Paris, but I realized that I didn't necessarily want to become a classical pianist. I would always start improvising or just doing something else.

"I took this organ class one time and we would go to these churches to practice. At the time, we were supposed to be practicing these Bach fugues and stuff. But I would get in there and start playing Emerson, Lake & Palmer and crank up the volume pedals," she remembers. "I was never really one for having to play exactly

what was on the page all the time. I just found that my strengths lie in other areas."

Parodi's obvious strengths are her playing and composing abilities. The range of her working experience would certainly make her a good teaching candidate as well. Although she doesn't have the time to teach at this point, she has instructed privately in the past as well as giving an occasional seminar on composition.

"It's important not to expect someone to teach you everything. Listen to as many musicians as you can who play the type of music that you want to play. Play with as many different musicians as possible. I think of music in two separate ways: playing and writing. A very good way to practice playing is with a computer and a drum machine. The great thing about practicing with a computer is that you can record everything that you play. Loop some drums, lay down a bass line, and play. You can see if you're in or out of the pocket, what your solos sound like. It doesn't lie. It really tells you what you did. I think that's a great way to practice.

"As far as writing goes, I would say that it's important to study the scores of people who you really like in all different styles of music. If you're trying to write for TV, look at the images without the sound and imagine what they tell you and then listen to what the composer did and see if you agree with it. Videotape stuff and write your own music and get opinions from people you respect."

***"Sounds really make you play a certain way. If you have a little, dry, ticky-type sound, you might not take the soaring solo that you would with a different sound."***

**P**ARODI'S ABILITIES AS A composer have become quite sophisticated, yet remain very intuitive. She owes a lot of her accelerated progress in this area to her mentor, Mike Post. "Mike always says that the picture will tell you what to do. I look at the picture and try to empty my mind of all the things that I would normally think about and allow the picture to guide me. I let it tell me the tempo while I try to feel the motion of what's going on, keeping in mind what kind of show it is and what its concept is. Some shows

are more pop-rock oriented and others are a bit more orchestral. I have to watch it a few times to get a real feeling for it, and then I just try different things. I suppose that when you've been doing it for as long as Mike has, then the picture just immediately tells you what to do. I'm really learning more about that - if a scene's inside, outside, day or night, there are so many variables that help determine what sounds you'll use."

Mike Post regularly recruits Parodi and her writing partner Greg Edmonson to compose scores for his variety of shows. The process varies from project to project. "Sometimes he'll give us a thematic idea. He'll say, 'this is the bad guy lick' or 'the heavy lick' or 'this is the love interest or girl lick,'" says Parodi, laughing at the phraseology. "So sometimes he'll give us ideas as to the direction. Other times, especially recently, he just lets us do our own thing. A lot of times we just sequence things ourselves and do the whole show as a synth score and have another instrument like a guitar or flute play on top of it."

Parodi composes on her Atari Mega 4 computer and uses Hybrid Arts' SMPTETrack to sync it to video.

"It's a great writing tool. I can transfer what I'm hearing very easily because I can inventory so many ideas. So many people are afraid to have something sequenced, but if the purpose is to create a new effect or concept that you couldn't do live, then it's like a whole new instrument. I love purely acoustic music and I really do appreciate it after hearing so much sequenced pop, but one really does not diminish the other. They are just two distinctly separate and valid forms of music."

Although there is no formula for success, attitude development has been an integral part of Parodi's evolution as a musician. "When I went to Interlochen, I really changed. I realized how important finishing something was. It seems that so many people will pursue something for their whole life and never really become good at it or develop confidence at it. While I was there, I realized what I wanted to do and became more focused. Right now, I feel that I'm always going to be striving to do better and to learn more. I think that music is so exciting and so encompassing that I can't really imagine an end to what you can learn - not necessarily technically, but learning to hear." ♦

# Sam Ash<sup>®</sup>

## "Music Dealer Of The Year"

### Voted by Members Of The Music Industry In The "Third Annual Music & Sound Awards"

Respected by musicians, studios and industry professionals alike,

Sam Ash is the kind of store you like to deal with:

- Helpful, knowledgeable musician sales people.
- Tremendous selection of instruments, sound & recording equipment, computers and software, MIDI & home keyboards ... 16 million dollar inventory.
- Consistently Low Prices!

## Sam Ash<sup>®</sup> MUSIC STORES

### MUSIC • SOUND • COMPUTERS

10 Branches in and around New York City

# 1-800-4-SAM ASH

New York State

# 1-718-347-7757

©1989 Sam Ash Music Corp.

# FAÇON

This month, we finish the topic of mixers by examining auxiliary sends and returns as well as channel inserts. Instruction by Scott Wilkinson.

**MIXER:** A device that accepts a number of audio inputs, combines them in various ways, and sends them to one or more audio outputs.

AS YOU MAY recall, last month we learned about the basic inputs and outputs found on all mixers. These audio signal paths let you combine the sounds from a wide variety of sources, including synthesizers, samplers, tape decks, and microphones. Ultimately, these combined signals are usually mixed down to two channels, sent to the stereo outputs of the mixer, and recorded onto a stereo tape deck and/or projected through a PA (public address) system.

Last month's installment included an illustration of a hypothetical mixer with a typical array of controls. This illustration is reproduced here for convenience (see Figure 1), since some of these controls are examined this month.

## Auxiliary Sends

The subgroups and stereo busses aren't the only outputs on most mixers. There are additional outputs called *auxiliary* or *effects sends*. These outputs form a

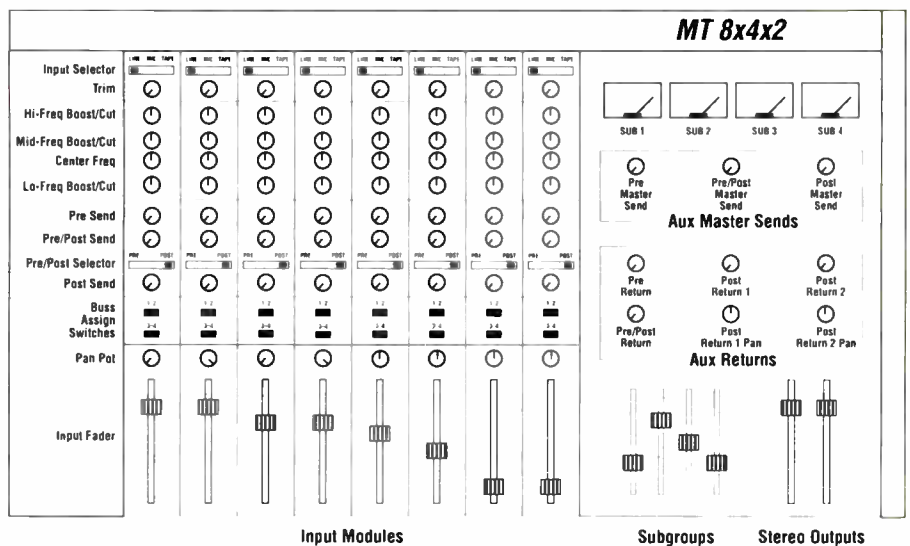

Figure 1. A hypothetical 8x4x2 mixer.

detour for the input signals. At various points within each input module, the signal is split, or tapped. One copy of the signal continues on directly to the assigned subgroups. The other copies of the signal can be sent to external devices, typically signal processors of one sort or another.

The external devices (such as reverbs, delays, choruses, etc.) do their thing and return the signals back to several extra mixer inputs called, oddly enough, *returns* (which we'll get to in a moment). The returned, processed signals are mixed with the master outputs (usually *not* the subgroups) and sent to the mixdown tape deck and/or stereo amp and speakers. Figure 2 illustrates

the basic signal path for one input module of the mixer in Figure 1.

It's important to understand that all input modules have access to the same set of external devices, usually two or three and rarely more than six (the mixer in Figure 1 provides access to three external devices). This means that all input modules share a common output to each external device. The *send* controls in each input module let you set the level of the signal from each module that is sent to each external device. The mixer in Figure 1 also includes *master send* controls that determine the overall level of the combined signal from all input modules going to each signal processor.

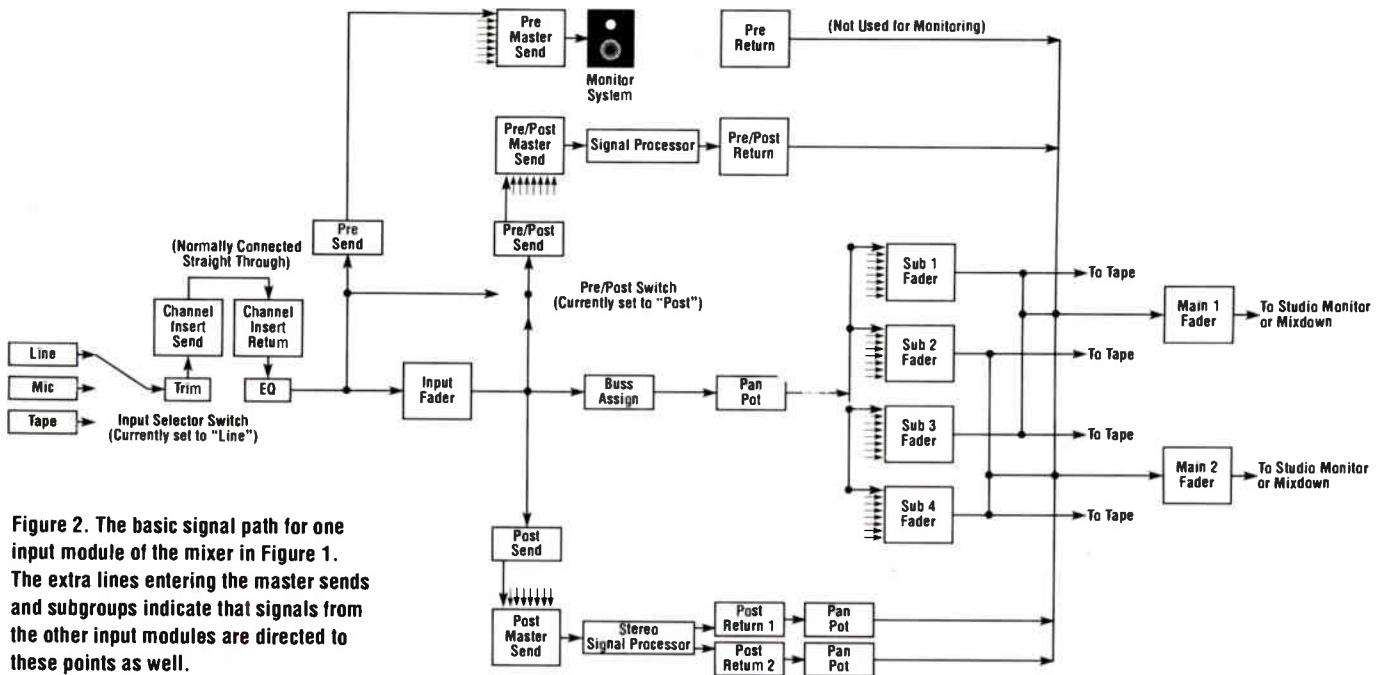

**Figure 2.** The basic signal path for one input module of the mixer in Figure 1. The extra lines entering the master sends and subgroups indicate that signals from the other input modules are directed to these points as well.

You may have noticed that the sends in Figure 1 are labeled "Pre," "Pre/Post," and "Post." These labels refer to the point at which the input signal is split and directed to each send – before (Pre) or after (Post) the input fader. In the mixer depicted in Figure 1, one send is Pre, one is Post and one can be Pre or Post, depending on the setting of the Pre/Post switch. These signal paths and splits are illustrated in Figure 2.

Pre sends are typically used for stage or headphone monitoring. These sends actually allow you to establish a mix that is completely separate from the main mix going to the tape deck in a studio or PA system in a live concert situation. The pre sends are unaffected by all input controls (except the trim, EQ, and send level itself). This is very helpful when you want to monitor the

***"There are additional outputs called auxiliary or effects sends. These outputs form a detour for the input signals."***

sound without hearing the effect of the input controls. For example, the musicians on stage generally need to hear a different mix from that of the main PA in order to hear themselves more clearly.

Post sends normally direct the signal to external signal processors such as reverbs, delays, and so on (these are also called "outboard effects" because they are located outside the mixer

itself). By sending the signal after the input fader, the processed signal is affected along with the direct signal. For example, as you lower the input fader, the direct and processed signals drop in volume.

It's possible to create some interest-

ing effects by using a Pre send to direct a signal to an effects device such as a reverb unit. In this case, you can simulate the effect of a sound source moving away from you by lowering the input fader (reducing the volume of the direct signal) while maintaining

# WISE MUSIC

"VISIT THE MIDWESTS"  
LARGEST MULTI-KEYBOARD SPECIALIST"

**KURZWEIL**  
€-mu Systems, Inc.  
**SEQUENTIAL**  
**AKAI**  
KAWAI  
**Oberlin**  
**KORG**  
CASIO  
TOA  
Lexicon  
AUDIO-TECHNICA  
ART  
FOSTEX  
dbx  
Studio Master  
**BOSE**

**RANE**  
**DAVID**  
**SIMMONS**

SOUTHWORTH  
digidesign  
**PASSPORT**  
Hybrid Arts, Inc.  
**JESPER ELECTRONICS**  
Performer

**Dr. T's**  
Opcode

**KEYBOARDS**  
**DRUM COMPUTERS**  
**SEQUENCERS**  
**PA**  
**RECORDING**  
**SOFTWARE**  
**COMPUTERS**  
**SERVICES**  
**SUPPORT**



**ST-1040-520**  
Sold and Serviced

**MIDI**  
**SMPTE**  
**SYSTEMS**  
**FOR**  
**THE**  
**PROFESSIONAL**



**800-635-WISE**  
**314-837-3030**

11740 WEST FLORISSANT AVE., ST. LOUIS, MO 63033

- ▶ the volume of the reverb sound. You can then reduce the volume of the reverb sound independently by lowering the send level at a later time.

## Auxiliary Returns

As I pointed out earlier, the returns accept the processed signal from the outboard effects and mix them with the master or stereo outputs as shown in Figure 2. This lets you hear what the effects sound like without recording them onto the multitrack tape (assuming that you're using the stereo outputs to feed your studio monitor system). Of course, if you're using a Pre send to feed a stage or headphone monitor system, there is no need to use the corresponding return.

Many mixers include at least one send/return loop in which there are actually two returns, often called a *stereo return*. These returns are used to accommodate the many signal processors on the market that produce a stereo signal (such as "ping-ponging" a delayed signal between the right and left sides of the stereo field). In fact, most mixers today have twice as many returns as sends to accommodate stereo signal processors.

***"Pre' and 'Post' refer to the point at which the input signal is split and directed to each send – before (Pre) or after (Post) the input fader."***

At this point, you may be wondering why the processed signal isn't mixed with the subgroup outputs so that it can be recorded onto multitrack tape. The reason is that effects are typically recorded onto the master tape when the multitrack is mixed down to stereo. During this process, which occurs after all of the parts have been recorded onto multitrack tape, the input selectors on the mixer are set to "tape." The signals from the multitrack (which were recorded "dry" without processing) are sent into the mixer, processed by external effects, mixed down to two tracks, and recorded onto the stereo master tape from the stereo outputs of the mixer.

When a band plays in an acoustical environment, the reverb characteristics of that environment are applied equally to the sounds produced by all of the

instruments and vocals (after all, everyone is in the same room). To simulate this effect, signal processing such as reverb is often applied to all of the signals from the multitrack as it's mixed down to the stereo master. Another reason to record the processed signal only onto the master tape is to give yourself a second chance if something goes

group outputs to be recorded onto the multitrack tape. If you have only one or two unused channel inputs and three or more returning processed signals, you can use a small external mixer, called a *submixer*, to mix the processed signals in order to accommodate the available channel inputs. Figure 3 illustrates this type of return system.

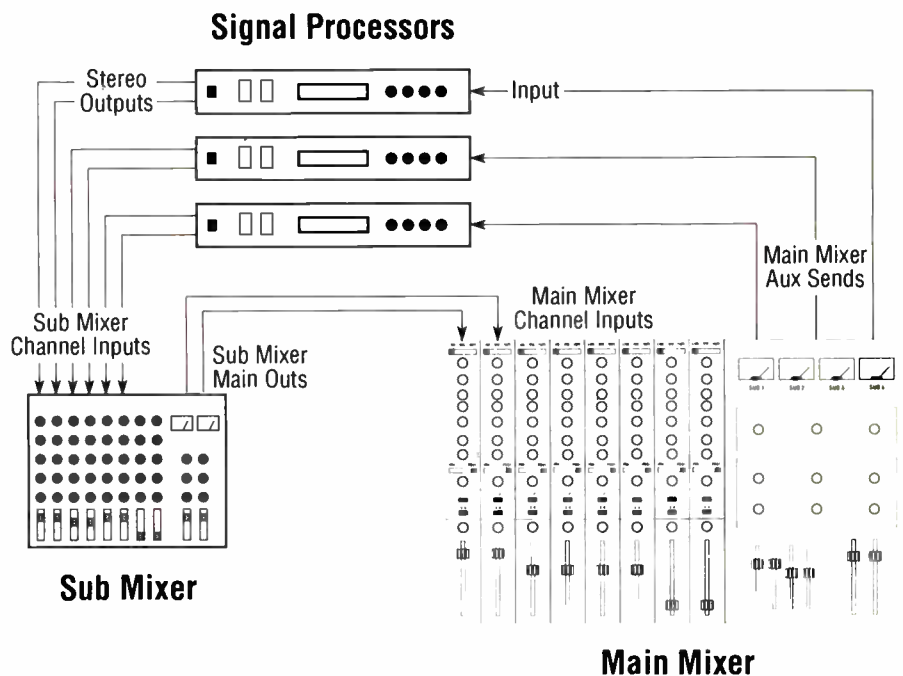

Figure 3. The outputs from several signal processors can be passed through a "submixer" and returned to two-channel inputs in the main mixer.

wrong. If you don't like the processing on the stereo master, you can always do it again. But, if you don't like the processed signal recorded on the multitrack, you're stuck with it unless you record that track again (and chances are that it's a great performance that couldn't possibly be repeated).

There are some cases in which it is desirable to record a processed signal onto the multitrack. For example, the various parts of the drum track are processed differently in much of today's popular recorded music. The snare is often heavily processed with gated or reverse reverb while the bass drum is not processed at all. In order to avoid using all of your tape tracks just for the drums, they must usually be recorded premixed onto one or two tracks. This means that they must be processed as they are recorded onto the multitrack.

There are a couple of ways to achieve this. For example, you can return the signals from the external effects to unused channel inputs. This lets you send the processed signal to the sub-

Some mixers also include a send/return loop for each channel input in addition to the normal auxiliary sends and returns. These loops are often called *inserts* or *patch points*. The inserts let you send the signal from a particular input to a particular effects device without involving any other input signal. The insert send is Pre EQ and fader, but so is the insert return. The returning signal is fed through the EQ and fader and sent on to the assigned subgroup(s). This allows you to record the processed signal onto the multitrack. The mixer in Figure 1 includes channel inserts, which are illustrated in Figure 2.

## Until Next Month...

Once again, we're out of studio time. Next month, we'll put it all together by designing the entire audio system for a small recording studio. We'll also discuss some basic techniques for using such a system to its fullest advantage. Until then, keep on making music... ♦

If there was some product mentioned somewhere in this magazine that you'd never heard of, check out the list below to get the gory details.

**414, 460:** AKG Acoustics, Inc., 77 Selleck St., Stamford, CT 06902. Tel: (203) 348-2121.

**421, 441:** Sennheiser Electronic Corp., P.O. Box 987, 6 Vista Drive, Old Lyme, CT 06371. Tel: (203) 434-9190.

**1000 HX/PX/PXA/SX Expander:** Kurzweil Music Systems, Inc., 411 Waverley Oaks Rd., Waltham, MA 02154. Tel: (617) 893-5900.

**A3:** Korg USA, Inc., 89 Frost Street, Westbury, NY 11590. Tel: (516) 333-9100.

**A50:** Roland Corp., 7200 Dominion Circle, Los Angeles, CA 90040. Tel: (213) 685-5141.

**A-100 series:** Hammond Organ Company, 1060 Thorndale Ave., Bensenville, IL 60106. Tel: (312) 595-6900.

**ADD Dne:** Dynacord Electronics, 2697 Lavery Court #16, Newbury Park, CA 91320. Tel: (805) 499-6863.

**Alchemy:** Blank Software, 1477 Folsom St., San Francisco, CA 94103. Tel: (415) 863-9224.

**Atari ST 520, 1040, MEGA 4:** Atari Corporation, 1196 Borregas Ave., Sunnyvale, CA 94086. Tel: (408) 745-2000.

**Baldwin grand piano:** Baldwin Piano & Organ Co., 422 Wards Corner Rd., Loveland, OH 45140. Tel: (513) 576-4500.

**B3, C3:** Hammond. see A-100.

**Commodore 64/128, Amiga:** Commodore Business Machines, Inc., 1200 Wilson Dr., West Chester, PA 19380. Tel: (215) 431-9100.

**Crystal KS2:** Gulbrandsen, Inc., 1004 Olive St., St. Louis, MO 63101. Tel: (314) 241-3000.

**D10, D110, D20, D50, D550:** Roland, see A50.

**DMP7/D:** Yamaha Music Corp. USA, 6600 Orangethorpe Ave., Buena Park, CA 90620. Tel: (714) 522-9011.

**DrumKAT:** KAT, 43 Meadow Rd., Longmeadow, MA 01106. Tel: (413) 567-1395.

**DSP128 Plus:** DigiTech (DOD Electronics), 5639 South Riley Lane, Salt Lake City, UT 84107. Tel: (801) 268-8400.

**DSS1:** Korg, see A3.

**DW8000:** Korg, see A3.

**DX1, DX5, DX7, DX7IID, DX9, DX11, DX21, DX27, DX100:** Yamaha, see DMP7/D.

**Editrack:** Hybrid Arts, Inc., 11920 West Olympic Blvd., Los Angeles, CA 90064. Tel: (213) 826-3777.

**EPS:** Ensoniq Corp., 155 Great Valley Parkway, Malvern, PA 19355. Tel: (215) 647-3930.

**EV5:** Roland, see A50.

**F16:** Forat, 11514 Ventura Blvd., Studio City, CA 91604. Tel: (818) 763-3007.

**FZ1, FZ10M, FZ20:** Casio, Inc., 570 Mt. Pleasant Ave., Dover, NJ 07801. Tel: (201) 361-5400.

**GenEdit, GenWave:** Interval Music Systems, Inc., 12077 Wilshire Blvd. #515, Los Angeles, CA 90025. Tel: (213) 478-3956.

**GR50, GR300, GR700:** Roland, see A50.

**HR16:** Alesis Corporation, 3630 Holdrege Avenue, Los Angeles, CA 90016. Tel: (213) 467-8000.

**Human Clock:** formerly made by Kahler.

**Juno 1, Juno 2, Juno 60, Juno 106:** Roland, see A50.

**K1/m/r, K1II, K3, K4, K4r, K5, K5M:** Kawai America Corp., 2055 E. University Dr., Compton, CA 90224. Tel: (213) 631-1771.

**K1000:** Kurzweil, see 1000HX.

**KM-100, KM 140:** Neumann, distributed by Gotham Audio Corp., 741 Washington St., New York, NY 10014. Tel: (212) 741-7411.

**Kurzweil 150FS, 250:** Kurzweil, see 1000HX.

**KX8, KX76, KX88:** Yamaha, see DMP7/D.

**Linnrum, Linn 9000:** formerly made by Linn Electronics.

**LXP1:** Lexicon Inc., 100 Beaver St., Waltham, MA 02154. Tel: (617) 891-6790.

**M1, M1/R, M3R:** Korg, see A3.

**M16 Matrix Sycologic Ltd.,** 20 Conduit Place, London, UK, W2 1HS. Tel: (UK) 01-724 2451.

**M8000:** Kawai, see K1.

**Macintosh Plus/SE/II:** Apple Computer, Inc., 20525 Mariani Ave., Cupertino, CA 95014. Tel: (408) 996-1010.

**Matrix 1000:** Oberheim-E.C.C., 2015 Davie Avenue, Commerce, CA 90040. Tel: (213) 725-7870.

**Maxcon II:** Conneaut Audio Devices, PO Box 120, Conneaut, OH 44030. Tel: (216) 593-1111.

**MC500, MC300:** Roland, see A50.

**MIDIverb/II:** Alesis, see HR16.

**Minimoog, Moog:** formerly made by Moog Instruments.

**Mirage:** Ensoniq, see EPS.

**MKH 20, MKH 70:** Sennheiser, see 421.

**MKS20, MKS50, MK60, MKS70, MKS80, MKS100:** Roland, see A50.

**MPC60:** Akai Professional, 1316 E. Lancaster, Fort Worth, TX 76113. Tel: (817) 336-5114.

**MPU401:** Roland, see A50.

**MPX820:** Akai, see MPC60.

**MSB 16/20, MSB PLUS:** JL Cooper Electronics, 13478 Beach Ave., Marina del Rey, CA 90292. Tel: (213) 306-4131

**MSQ-700:** Roland, see A50.

**MT-32:** Roland, see A50.

**Notator:** Digidesign, Inc., 1360 Willow Rd. #101, Menlo Park, CA 94025. Tel: (415) 327-8811.

**P330:** Roland, see A50.

**PCM70:** Lexicon, see LXP;

**Performer 2.41:** Mark of the Unicorn, Inc., 222 Third Street, Cambridge, MA 02142. Tel: (617) 576-2760.

**PG1000:** Akai, see MPC60.

**Photon Guitar MIDI Converter:** Phi Technologies, 4605 N. Stiles, Oklahoma City, OK 73105. Tel: (800) 346-3744.

**Polysix:** Korg, see A3

**PPG Wave 2.3:** formerly made by PPG GmbH.

**Pro 24:** Steinberg/Jones, 17700 Raymer St., Suite 1001, Northridge, CA 91325. Tel: (818) 993-4091.

**Prophet 5, Prophet 2000, 2002, Prophet VS:** formerly made by Sequential Circuits Inc.

**Proteus, Proteus XR:** E-mu Systems, 1600 Green Hills Rd., Scotts Valley, CA 95066. Tel: (408) 438-1921.

**PX1000:** Kurzweil, see 1000HX.

**RD-250/300, RD1000:** Roland, see A50.

**RE-20:** Electro-Voice, 600 Cecil St., Buchanan, MI 49107. Tel: (616) 695-6831.

**S612, S700, S900, S950, S1000:** Akai, see MPC60.

**SG1D:** Korg, see A3.

**SM-57, SM-58:** Shure, 222 Hartrey Ave., Evanston, IL 60202. Tel: (800) 257-4873.

**SMPTETrack ST:** Hybrid Arts, see Editrack.

**Sound Designer:** Digidesign, see Notator.

**SPX90/II:** Yamaha, see DMP7/D.

**SRV2000:** Roland, see A50.

**Studio Clock:** Aphex, 1316 E. Lancaster, Fort Worth, TX 76113. Tel: (817) 336-5114.

**Super Jupiter:** Roland, see A50.

**SY-1:** Sansui, 1330 Blue Hills Ave., Bloomfield, CT 06002. Tel: (203) 286-0498.

**Synclavier 3200, 9600:** New England Digital, 49 North Main St., White River Junction, VT 05001. Tel: (802) 295-5800.

**T1, T2, T3:** Korg, see A3.

**TR505, TR707, TR727, TR808, TR909:** Roland, see A50.

**TX7, TX216, TX316, TX802, TX816, TX1P, TX81Z, TX16W:** Yamaha, see DMP7/D.

**U-87:** Neumann, see KM-100.

**VFX:** Ensoniq, see EPS.

**Zeta Violin Controller:** Zeta Music Systems, Inc., 2230 Livingston St., Oakland, CA 94606. Tel: (415) 261-1702.

# THE MUSICIAN'S LOOP

Here's your chance to beat the high cost of high-tech by becoming a charter member of a unique cooperative. Put together by musicians, for musicians, and pooling our buying power, we can pass on prices from the quantity discount columns on the price sheets. And we're authorized to sell all the big names in MIDI keyboards, drum machines, software and recording equipment. We're set up for immediate delivery, quality service and plenty of helpful advice.

Members receive regular newsletters with the latest product info, tech tips and "members only" specials.

Call today for membership details and best prices.

**919-968-1616**

©1987, The Music Loft

# K4 Contortions

## Part 1: Drums and Multis

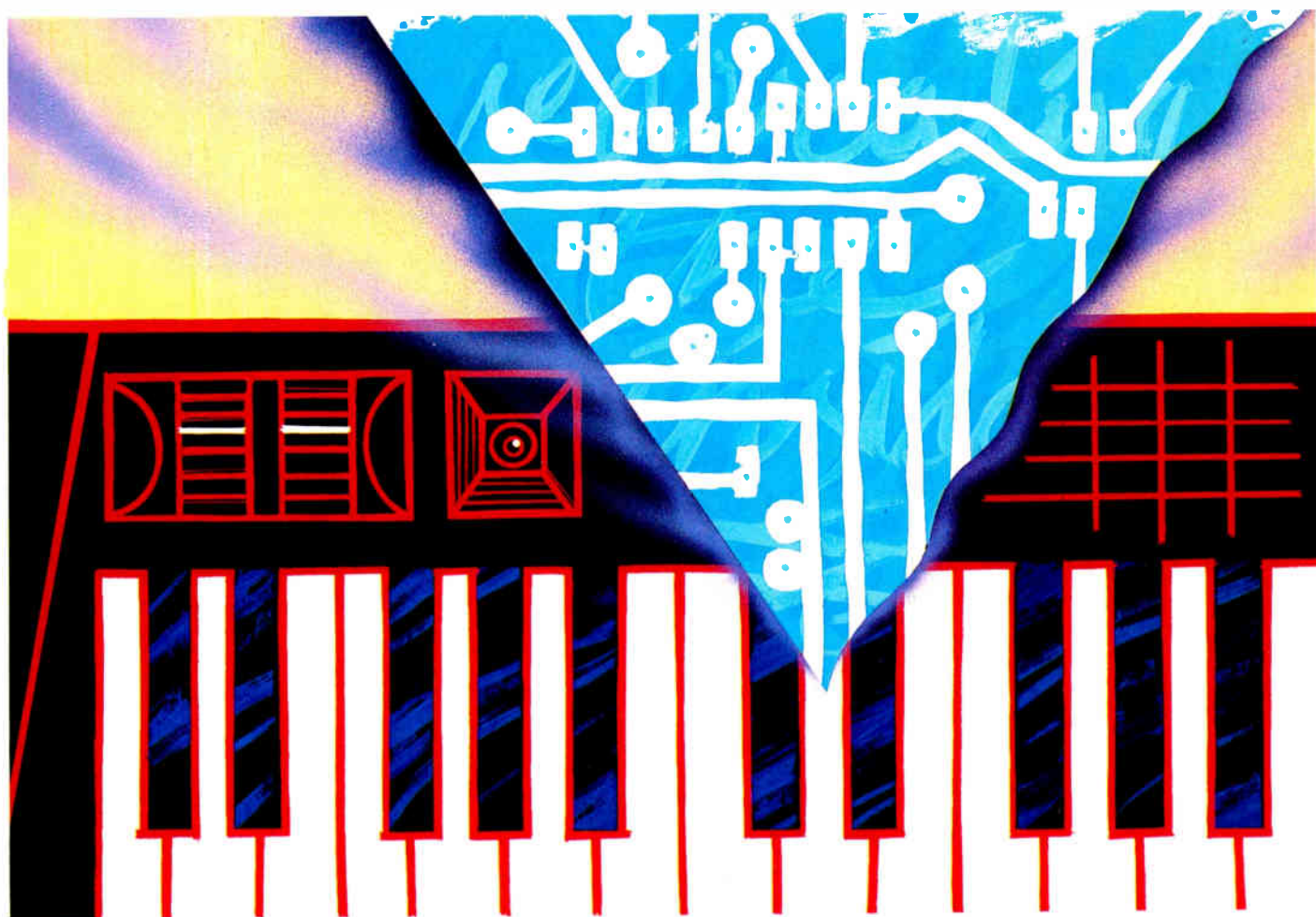

**Lorenz draws our attention to the latest synthesizer from Kawai, the K4 multitimbral 16-bit digital keyboard.**

**This month, the drum section and multitimbral operation are introduced.**

*Text by Lorenz Rychner.*

**B**Y THE TIME you read this, Christmas will have come and gone. Did you find a K4 under the tree? I know some folks who did, and they're pleased as punch. Whether you own one or not, even if you're just curious, you've come to the right place for information. A review elsewhere in this issue describes the K4, its memory structure, and its place in the latest wave of synthesizers. And in this first of two hands-on

articles, we'll look at the drum section and at the Multi programming in detail. You'll also get a clear idea about integrating the K4 into a MIDI setup as a partner to a sequencer. Next month we'll get serious about the synthesizer programming aspects.

### **Let There Be Drums**

All references to effects (reverb, delay, etc.) are only valid for the keyboard



version of the K4, not for the K4r module. Owners of the latter – please bear with me. Your instrument has extra memory regarding the output routing where the K4 has effects memory.

Select the Single program A1 'Ocean-Watch,' then press the button labeled Drums and play some keys. You hear the drum sounds, with the effect setting that is part of the currently active program (the one you had up at the time you pressed the Drum button), in this case, A1 'OceanWatch.' Press Single and A2 'Clas Grand,' then press Drums, and the reverb/delay settings change to that of the new Single. Press Multi, select A3 'Weightless,' then press Drums and you hear the Multi's effects when you play the keyboard. If you're tempted to change that effect setting by pressing Effect while playing the drums, you find that you lose the drums and you're back at the Multi or Single program.

Let me show you how you can hear the drum setup without any interference from another program, and free from any effects. For now, select the Single program A4 'OhhBe Ex-A.' Its only effect is a light chorus. To cancel it, press Effect twice and use the value slider to reduce the value for Width from 30 to 00. Now press Drums. *Caution:* Move the canary and goldfish to the living room and give your neighbors fair warning, there are some killer sounds waiting to be played. Now bang away.

## Inside The Drums

Okay, it's now an hour later, and you've just come up for air from playing the groove to end all grooves. Grab your owner's manual and unfold the double spread on page 92. That's the chart of the factory drum assignments, arranged by keys from the lowest (C1) to the highest (C6). Sooner or later, you'll want to change the current drum setup in some way, so plan ahead – take the owner's manual to a copy shop and make dupes of the blank template on page 93. There can only be one drum setup in memory at one time, so it's a good idea to write down your settings.

The drum assignment chart reveals some things that you don't see on the K4 screens. Check it yourself: Press the Drums button enough times to cycle through all of the screens. You don't see an instrument name as shown in the left-most column on page 92. You don't see a note number, either. The instrument names are strictly for your own reference on paper, so you can

invent any name you want. The note numbers don't matter until you interface this drum setup with some other MIDI device.

Each key can have two sounds assigned to it, so each drum sound can be a layer or blend of two sounds. That's a pretty hip feature – there aren't too many drum machines on which a single pad can trigger two instruments simultaneously. As you press the Drums button repeatedly, you get the two sounds listed as S1 and S2. How do you know what these wave

***“Each drum sound can be a layer or blend of two sounds. That's a pretty hip feature.”***

numbers are? Look them up on the separate K4 Wave List that came with your owner's manual.

For example, the lowest key C1 triggers Waveform 97, both as S1 and S2, which turns out to be the kick drum sample. The next two screens tell you that the decay is set to 31 for both sounds, and the next four screens tell you that both sounds are detuned by -3, and that their levels are both 95.

If you want to beef this up, try detuning one or the other sound (it doesn't matter which, here they're both identical). If one of them is at -50 or thereabouts, the sound gets deeper. Make sure to use the button labeled 'PREV' (for "previous") to step through the screens backwards. Increase the decay of either sound to 100 and you find that this is an entirely different kick drum, with a gated burst of white noise after the attack portion. Leave it at 100 and select Waveform 98 as Sound 2. Detune it to -50, then reduce the decay to 31 for sound 1 and 37 for sound 2. This gives the kick drum a whole new attitude. Use the level values to try different balances between the two. Anything goes.

There are a lot of factory drum assignments in which two different sounds are blended together. For example, E1 (low E) plays Wave 101 'Snare Hi' and Wave 102 'Rim Snare.' The adjacent key (F1) plays two kinds of tom sounds, Waves 105 and 106. G1 plays mostly the tom sound from Wave 104, with just a little of the deep snare sound from Wave 100 mixed in.

You're not restricted in your choice of Waves to the drum and percussion sounds (97-139). Any Waveform is fair game. Check out the assignment for the E4 key. To get a brush sound, a tiny

amount (level = 37) of the noise from Wave 192 is mixed in with a modest amount (level = 57) of the reversed noise from Wave 237. Neither Wave is listed under the Drum & Percussion Group heading.

Once you start to experiment, you'll find lots of combinations that work just fine. See if you like this one: S1 Wave 191 'Voice,' S2 Wave 177 'Flute 1 Shot'; Decay S1=45, S2=38; Tune S1=-50, S2=0; Level S1=60, S2=100. I made two more variations, at different tunings, and used them for fills instead of toms. Or how about this one: S1 Wave 207 'Slap Bass 1 Shot,' S2 Wave 192 'Noise'; Decay S1=40, S2=40; Tune S1=-50, S2=0; Level S1=100, S2=65. It reminds me of the analog drum sounds from semi-pro keyboards of the late '70s and early '80s, the famous boom-chi-chi-boom generation of drum sounds. If you can't afford a TR808 for your dance mixes, try making the sounds on the K4, just like I did with this last one. Nobody will know the difference except your bank manager.

## The Multi Programs

When Single programs are assigned to a Multi program, they give up certain characteristics and assume others. Most noticeably, a Single program loses its own effects settings when playing as part of a Multi. Play Single A1 'Ocean-Watch' by hitting hard and short notes around middle C. Take note of the echo bouncing from side to side in the stereo image (over a dozen times if you hit it hard). Then select Multi A2 'COSMIC' and play the same notes. There is only one echo, and it doesn't switch sides. But how do you know, other than by ear, that you're still listening to 'Ocean-Watch' as part of 'COSMIC'?

Select Multi A2, then press Edit and button A (INST). The top line of the screen says SINGLE, and to the right you see '11-----.' This tells you that only two of the eight Sections are busy playing a Single program each, and the other six Sections are inactive. The bottom of the screen displays a Single name and memory number. While editing Multi programs, use buttons 1-8 to select one of the eight Sections to which Single programs are assigned. Press button 1 and the cursor moves under the first of the two '1's, and the name 'New Galaxy' with the corresponding memory number C-11 appears at the bottom. Press button 2 to get the second Section, and there it is: A1 'OceanWatch.' Press buttons 3 through

# ADVERTISERS'

## INDEX

Alexander Publishing .....	53
Anatek .....	IFC
ApheX.....	37
BBE Sound .....	33
Codehead.....	7
Computer Mart .....	25
Creative Recording .....	63
E-mu.....	19
Eltekon.....	9
Grove School of Music.....	45
Guitar Plus.....	23
Keyfax 3 .....	41
Keylighting.....	1
Lone Wolf.....	21
Music Loft.....	71
MusiCity .....	35
New World - Music Tech.....	17
Peavey.....	OBC
Perfect Pitch .....	15
Pika Technologies.....	31
Rhythm City .....	33
Roland.....	3
Rolls Music Center.....	IBC
Sam Ash Music.....	67
Shure .....	49
SKE Publishing.....	65
Temporal Acuity Products....	23
Wise Music .....	69
World of Poetry .....	7
Yamaha .....	11, 12/13, 47

►8 to see that Sections 3 through 8 are inactive. To activate them, press buttons 11 through 16, which turns their hyphens into '1's.

### Multi Edit Parameters

The first screen that appears when you press Multi followed by Edit is always the Volume screen, with a programmed value between 0 and 100. This is the overall volume for the entire Multi. If you press Edit again, you see the Effects Patch number that is currently active for this Multi program. This can be any one of the 32 programmable Effects Patches, and each Effects Patch can use one of the 16 types of effects available from the K4's operating system. More about those in next month's installment.

Press button A (INST) to access and re-assign the Single programs to the Sections of this Multi. Button B (ZONE) brings up three screens with repeated pressings: ZONE LO, where you define the lowest key playable by the Single in the current Section, ZONE HI, where you define the highest key playable by the Single in the current Section, and VEL SW. The latter has three possible settings: ALL, LOUD, SOFT. ALL means that the Single in the current Section responds to all keystrokes in its key range, no matter how hard they are struck. SOFT means that the Single in the current Section will play only those notes that are played softer than a given velocity value, and LOUD means that the Single in the current Section will play only those notes that are struck harder than a given velocity value.

The deciding velocity value is programmed under System mode: Press System. If you see the letters SYS on the lower line, press System again until you see VELSW POINT with a value between 1 and 128. If you don't see the letters SYS, press the -No button once or twice to change TRS or RCV into SYS, then press System four times. The higher the value for VELSW POINT, the harder you have to play to trigger the Sections that are set to LOUD. Whatever value you choose applies to all Multis, since the System parameters are global.

Back in Multi Edit, press button C (SEC ch). On the first of two screens, you assign each Section to a MIDI channel on which it will respond to incoming MIDI messages. Press button C again to get to the trigger response screen. Set a Section to KYBD if it is to respond only to the K4 keys, to MIDI if

it is to respond only to incoming MIDI messages, and to MIX if it is to respond to both. Sound confusing? Maybe a quick example is in order. Let's say you have your sequencer playing the K4 drums and a K4 bass part while you want to play the keys for a chordal or lead part. You would set the Section that plays the bass Single to respond to MIDI, so that your actions on the keys only trigger the sound from the chord or lead Single in the other Section that you set to KYBD.

The last button in Multi Edit is button D (LEVEL). In this screen, you assign a maximum level to each of the Sections. Press button D again and you can transpose each Section by semitones, with a maximum of 24 semitones (two octaves) up or down. This affects the Single programs only while they are part of a Section in a Multi. Example: You sometimes play bass parts with your right hand, in the upper octaves of the keyboard, but you don't want the bass to sound in the high range. Transpose it down by -24, and the upper octaves on the keys will produce low notes.

The only exception: If the Section plays a Single that is programmed to produce a fixed pitch, which means that the sound of the Single doesn't follow the keyboard up and down, then you can't transpose it here in Multi Edit. It will only produce the specified fixed pitch. The parameter used for the fixed tuning, in Single Edit mode, is DCO KEY TRACK=OFF. If in doubt, go looking under Single Edit, press button 14 twice, and select each Source with buttons 1-4 while watching the screen.

Back to Multi Edit button D. After the Transpose screen, you see the Tune screen where each Section can be thrown slightly out of tune, from -50 to +50, roughly a half step each way. When you use this in moderation, you can fatten up many sounds by assigning the same or similar Singles into Sections that are slightly out of tune with each other. The next (and last) screen from button D deals with the Submix for each Section. This ties in with the Effects that I'll deal with next month.

For now, be curious and change things around a lot to find new sounds and combinations. Write down what you like, and remember that you can't accidentally erase any Singles or Multis while the fifth screen of the 'WRITE/DUMP' button reads PROTECT=ON. Leave it ON while you experiment. Have fun. See you next month. ♦



## CUSTOM SOUNDS FOR THE CLASSIC DX-7

Order 32 patches that you choose for only \$30.00. Send a wish list and your RAM or write for details:

Triple Gem Music, P.O. Box 838,  
Trumansburg, NY 14886.  
(607) 387-9270.

## PHOTON MIDI CONVERTOR SYSTEMS

Guitar, bass, nylon string applications; infra-red optical pick-up; fast, accurate tracking; open architecture; unparalleled MIDI implementation; sequencer; arpeggiator; foot controller; used by top artists.  
Call 1 (800) 346-3744

217 Sequences for the Contemporary Musician, written in all the keys. A helpful tool for anyone who views music as being a living, creative, and experimental art form (\$20.00 plus \$2.00 postage). A Performer/Mac disk also available (\$5.00).  
Richard Corpolongo, 3135 N. 76th Ct.  
Elmwood Park, IL 60635. (312) 456-1382.

## MUSICIANS INTERNATIONAL Network Exchange

Best advice and best referrals on equipment, hardware, and software. Large database available for referrals, gigs, everything musical. Not a store or club. No high fees! Listings free.  
(804) 467-8806.

**BE A RECORDING ENGINEER**  
Train at home for High Paying - Exciting Careers. FREE Information.  
**AUDIO INSTITUTE OF AMERICA**  
2174 Union St., Suite 22X,  
San Francisco, CA 94123.

**SONGWRITERS! MUSICIANS!**  
Do you need  
**SHORT BLANK TAPES?**



C-10, C-20,  
etc. Perfect  
for Demos.  
Top Quality,  
Clear Shells

**CLASSIC CASSETTES**  
of California  
231 W OLIVE AVENUE • BURBANK, CA 91502  
1-800-777-8939

**DISCOUNT PRICES!!!**  
Microphone, Guitar, Keyboard & Studio Cables. Complete line of cords and parts for your studio or stage rig. Write for free catalog:  
The Connection, S104 Audrey Dr.,  
N. Syr., NY 13212.  
315-699-3841

**MIDI CABLES**  
FACTORY DIRECT  
Finest Quality - Best Prices  
Full five-point wiring,  
double shielded cable  
(800) 446-3146 ■ T.L. Industries, Inc.

**HOME-STUDY SERIES**  
3 Levels of study, based on 2 College texts, back up 36 hours of cassettes, providing all the procedures you need to handle sessions with confidence.  
Call or Write: **SKE Audio Pub.**  
(800) 284-1258  
P.O. Box 2519 • Sedona, AZ 86338

**KAWAI K5 EDITOR/LIBRARIAN for IBM/PC**  
OVERTONE is the software for the K5 and PC. Mouse-driven graphic interface. Draw the spectrum you want, use standard spectra or extract spectra from sample files. Multi patches automatically adjusted when rearranging card layouts. Complete Kawai patch library (over 750 patches) included. \$99.95 from:  
**SYNTONYX**  
7 Loudoun St., SE, Leesburg, VA 22075.  
© (703) 777-1933.

**MIDI SEQUENCES**  
Hundreds of top quality Top 40 songs that sound just like the records. Ideal for duos & trios. Most popular formats.  
**TRAN TRACKS**  
133 W 72 St #601  
NY NY 10023 (212) 595-5956

**MUSICIANS NATIONAL REFERRAL**  
P.O. Box 11 Sky Forest, CA 92385-0011  
Musicians National Referral. Professional musicians seeking bands. Bands seeking professional musicians. Bands register free.  
Call now for information (800) 366-4447.

**L.A. RECORDING WORKSHOP**  
Recording Engineering Program.  
Send for Brochure & Sound Sheet:  
12268-MT Ventura Blvd.,  
Studio City, CA 91604  
(818) 763-7400

**Roland MT32/D5/D10/D110/D20 and Kawai K1 Software**  
Librarians for IBM with 256 sounds, \$25.  
256 Sounds on Autoload Disk for C64, \$25.  
Amiga Generic Dump Utility with 256 Sounds, \$25.  
Editor/Librarians for C64/128 with 256 Sounds, \$79.  
**MT-32 Mods: 128 New Sounds in EPROM** & 30 Reverb Modes, \$60.  
Battery Backup Kit, \$79. Both EPROMs and Battery Kit for \$99. Add \$3 p/h.  
**Blue Ridge Music, 3571 Sandstone Road, #MT, Charlottesville, VA 22901.**  
(804) 978-7415

The Pedal Organizer  
Only \$19.95 (4" x 15")



LOW PROFILE  
1/8" BLACK ANODIZED BASE  
VELCRO FASTENING SYSTEM  
RUBBER FEET  
— 22" MODEL \$29.95 —  
SOUND LOGIC  
1125 Eleventh St.  
Ramona, CA 92065  
619-789-6558 / 800-753-6558

**Rogue**  
The World's Largest Dealer of Used Musical Equipment  
251 West 30th St., Suite 10 fe,  
NYC, NY 10001-2801  
(212) 629-3708  
Fax (212) 947-0027

**SERIOUS ABOUT MUSIC? CHECK US OUT.**  
THE RECORDING INDUSTRY SOURCE BOOK  
IS  
■ 7,000 contacts in 60 categories both southern California and National listings  
■ Timely, Accurate  
■ Full-Color, Spiral-Bound, Over 400 pages  
■ Available on floppy disk for IBM and Macintosh, includes complete operating software  
■ Priced for the working musician  
**BOOK \$34.95 ■ DISC SET \$295.00**  
For more info. call 1-800-969-RISB or send check or money order to:  
**THE SOURCEBOOK**  
953 N. Highland Ave.  
Los Angeles, CA 90038  
(make checks payable to RISB)

**MORRISON BROTHERS MUSIC**  
EST. 1917 & PIANOS 1972  
SOUND SYSTEM INSTALLATION & SERVICE  
LOOK NO FURTHER! NEW & USED GUITARS, KEYBOARDS, MIDI, PA, RECORDING.  
Hard to find items - incredible selection - best service  
**MORRISON BROTHERS MUSIC**  
Call George or Delia (601) 352-0135

FREE sounds or sequences when you join M.U.G. (International MIDI Users Group). KORG M1, MIRAGE, Yamaha DX7, Roland MC500 and much, much more. Over 1000 current members. \$20 (1 year membership) or \$65 (lifetime membership). Send to: M.U.G., P.O. Box 615 MT, Yonkers, N.Y. 10703. Specify instrument(s).  
For more info, call (212) 465-3430.

**Le Covers™**  
CUSTOM COVERS...  
CALL NOW!  
1-800-228-DUST



**SOUND ENGINEER**  
Responsible for developing exciting quality sound effects and music synthesis for the entertainment industry. Experience should include strong analog design background, familiarity with DSP techniques and "C" language skills. Contact Charles Grempler at (301) 771-6700 or send resume to:  
MicroProse Games  
180 Lakefront Drive  
Hunt Valley, MD 21030  
Attn: C. Grempler

**The East Coast MIDI Bulletin Board System**  
You never get a second chance to make a first impression. At ECM we realize that's true. That's why we've assembled a huge assortment of MIDI applications for all computer types. From Sequencers to Librarians, it's all here. Our Synth Patch and Sample Libraries are stocked with over 5,000 killer sounds with more being added regularly. Give us a call, at speeds up to 38,400 baud (HST), 24 hours a day. We think you'll agree...a second chance won't be necessary.  
East Coast MIDI 516-928-4986 (data)  
516-928-8986 (24-hour voice info)

**ROCK STREET MUSIC**  
Music & Pro Sound  
Drums, Guitars, Amps,  
Sound & Recording Gear  
Call or write for more information:  
148 South Main St., Dept H,  
Pittston, PA 18640. (717) 655-6076

**MUSICITY**  
DO YOURSELF A FAVOR  
CALL NOW!  
800/673-0565  
4416 Johnson St.,  
Lafayette, LA 70503

Custom Cases Acoustic Foam Custom Stands Studio Furniture  
Request catalogue 800-343-1433, 516-563-0633  
Island Cases 1121-20 Lincoln Ave, Holbrook NY 11741



**OUR SERVICE, SALES, & SELECTION ARE**

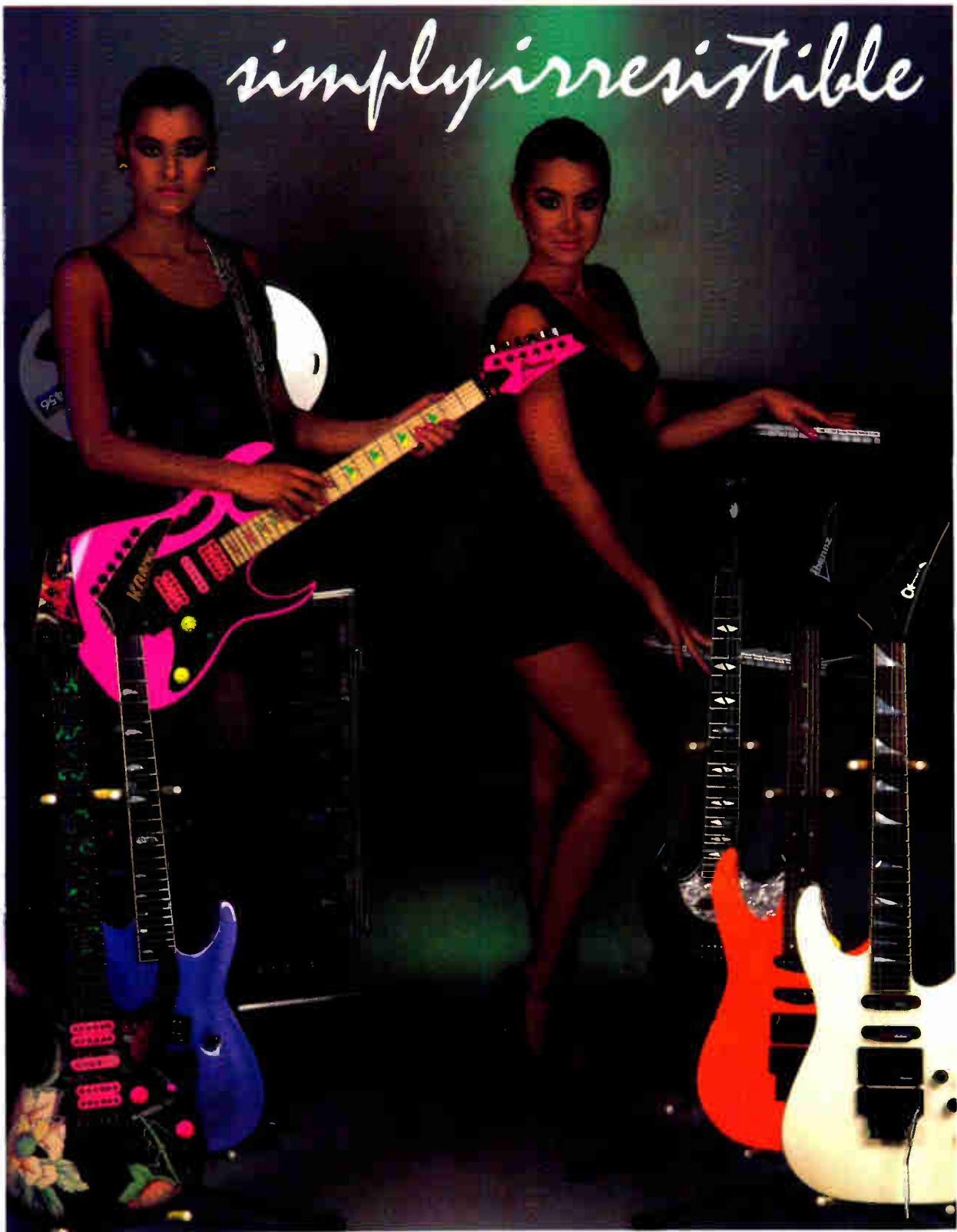

**rolls**  
**music**  
**center** inc.

**1-800-336-0199**

1065 West Broad Street Falls Church VA 22046 In VA 703-533-9500

**GUITARS AMPLIFIERS KEYBOARDS DRUMS PERCUSSION**  
**SOUND SYSTEMS DJ SYSTEMS SIGNAL PROCESSORS**  
**MULTITRACK RECORDING LIGHTING SYSTEMS**

This Irresistible Poster (20x30") can be Yours for \$9.95 plus \$1.50 shipping, VISA or MC. 1-800-836-0199

World Radio History

# Let's Come To Play



...With soul, imagination, and a power that makes other keyboards back down. The new Peavey DPM™ 3 has a sound that's gutsy and pure, and a responsiveness that puts the music back in *your* hands. And it's totally software based, making obsolescence obsolete. But best of all, it's American made—by Peavey. Need we say more? See your Peavey dealer for an amazing demonstration.

**If You're Serious About Playing...  
You're Ready For The DPM™ 3.**

