

ABC Buys Consolidated Distributors ••• A Team
Thru '75: MGM, Kama Sutra, Spoonful & Koppleman-

Rubin ••• UA
To Handle Im-
mediate In U.S.,

Canada ••• CBS & A&M Expand Int'l Publish-
ing ••• Tony Hall Forms Indie Music Set-Up.
Complete Details On Czech Music Festival

Part 1 of 2 Parts

July 8, 1967

Cash Box

WINNING TEAM SIGNS LONG-TERM DEAL

Int'l Section Begins Pg. 47

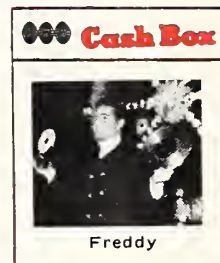

SMASH!

NEW T...

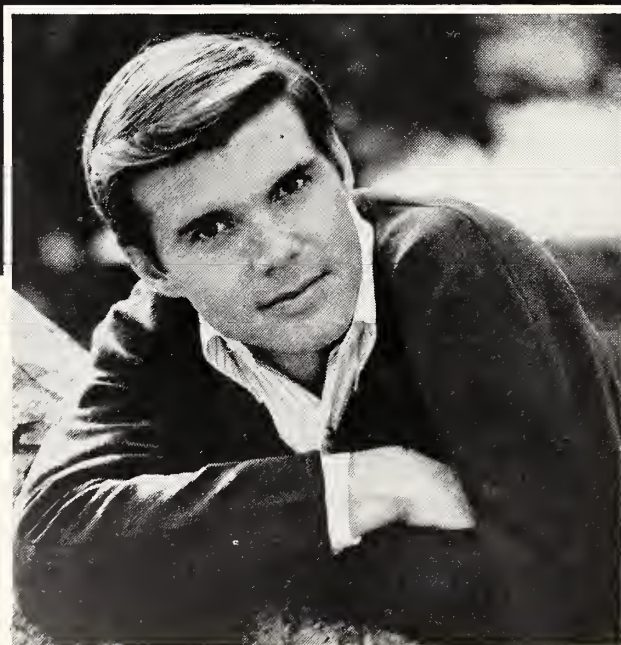

John Davidson
"If You Can Put That in a Bottle"

c/w "In the Sunshine Days" 4-44210

Where a startling Davidson departure produces a hit in the breaking.
On COLUMBIA RECORDS 



Cash Box

Vol. XXVIII—Number 50 Part 1 of 2 Parts July 8, 1967

(Publication Office)

**1780 Broadway
New York, N. Y. 10019**

(Phone: JUdson 6-2640)
CABLE ADDRESS: CASHBOX, N. Y.

GEORGE ALBERT
President and Publisher
MARTY OSTROW
Vice President
LEON SCHUSTER
Treasurer

IRV LIGHTMAN
Editor in Chief

EDITORIAL

TOM McENTEE *Associate Editor*
ALLAN DALE
DANIEL BOTTSTEIN
JOHN KLEIN

EDITORIAL ASSISTANTS

MIKE MARTUCCI
ANTHONY LANZETTA
HEDDY ALBERT

BERNIE BLAKE
Director of Advertising

ACCOUNT EXECUTIVES

STAN SOIFER
BILL STUPER
HARVEY GELLER, *Hollywood*

ART DIRECTOR—WOODY HARDING

ED ADLUM

General Manager
COIN MACHINES & VENDING
BEN JONES *Assistant*

LEE BROOKS, *Chicago, Ill.*
LISSA MORROW, *Hollywood*
CIRCULATION—**THERESA TORTOSA**, *Manager*

CHICAGO

LEE BROOKS
29 E. Madison St.
Chicago 2, Ill.
(Phone: (312) FI 6-7272)

HOLLYWOOD

HARVEY GELLER
6290 Sunset Blvd.
Hollywood, Cal. 90028
(Phone: (213) 465-2129)

EUROPEAN DIRECTOR NEVILLE MARTEN

ENGLAND
NEVILLE MARTEN
Dorris Land
9a New Bond St.,
London, W1, England
Tel: 01-493-2868

ITALY

MARIO PANVINI ROSATI
Galleria Passarella 2
Milan (Italy)
Tel: 790990

GERMANY

MAL SONDOCK
Josef Raps Strasse 1
Munich, Germany
Tel: 326410

HOLLAND

PAUL ACKET
Thereslastraat 59-63
The Hague
Tel: 837703

FRANCE

CHRISTOPHE IZARD
24, Rue Octave Feuillet,
Paris XVI Tel: 870-9358

BELGIUM

MIMI SMITH
894, Chausse Romaine
Wemmel (Brabant)
Tel: 02-78.96.63

SCANDINAVIA

SVEN G. WINQUIST
Kaggeholmavagen 48,
Stockholm-Enskede,
Sweden, Tel: 59-46 85

SPAIN

FEDERICO HALPERN
Sagasta 23,
Apartado 4025,
Madrid
Tel: 257 0907—224 8600

AUSTRALIA

RON TUDOR
8 Francis St.,
Heathmont, Victoria
Tel: 870-5677

ARGENTINA

MIGUEL SMIRNOFF
Rafaela 3978,
Buenos Aires,
Tel: 69-1538

BRAZIL

LUIS DE C. GUEDES
Rua Rego Freitas,
289—3º, andar
Sao Paulo, SP

MEXICO

ENRIQUE ORTIZ
Insurgentes Sur 1870
Mexico 20, D. F.,
Tel: 24-65-57

CANADA

JOHN MURPHY
87 North Hill St.,
Port Arthur, Ontario
Tel: (807) 344 3526

JAPAN

Adv. Mgr.:
SHOICHI KUSANO
Editorial Mgr.:
MORIHIRO NAGATA
466 Higashi-Oizumi
Neirimaku,
Tokyo

The Second Front

English acts have opened up a second front in America. A whole new crop of favorites are now riding the charts in the company of their compatriots who erupted with sufficient force about three years ago to practically overhaul the concept of pop music and its performers. Some as colorful in their sounds and mode of dress as their predecessors, they have hit our market following a long breather in which a number of American acts emerged to do a little revolutionary work of their own.

The interesting aspect of this new invasion from England is that the wave of widely-accepted acts are not filling a vacuum, as did the older British names. The first front of British stars came, it should be recalled, when the American pop sound was somewhat stale and lacking in the kind of freshness and excitement that top spots on the Top 100 thrive on. At the moment, America can hold its own in the area of inventive and colorful disk attractions. There is today a healthier balance between hits from England and those coming from abroad, with, admittedly, the edge going to stateside successes.

There is a balance, too, in the type of material turning up from both factions. Both groups are seemingly out to outdo the other in the complexity of between-the-lines meaning of what

they are trying to bring across to their listeners (e.g. Procul Harum's "A Whiter Shade Of Pale," Jefferson Airplane's "White Rabbit"). This commonground also features a softer, more melodic approach, one that has also given rise to a general Top 100 acceptance of more ballad-type material from both stateside and English acts that may not be part of the "message song" generation.

Thus, the Top 100 is, in our view, a healthier reflection of musical tastes than the time the English onslaught first made its appearance. Taking what was basically American in origin, the acts from England, nevertheless, added a touch of originality that created a new excitement in the world of pop records. There is presently an inventive interplay between the English and American pop markets that has contributed to even more refreshing ideas, leading to even more new sounds of success. It has reached the point where one does not know what act from what country will emerge to offer a new precedent in hit-making ingenuity.

In any event, the new English stars are most welcome on our best-selling lists. They have a lot to live up to, and in recent months they have given their earlier counterparts every reason to be proud of them.

SUBSCRIPTION RATES \$20 per year anywhere in the U.S.A. Published weekly. Second class postage paid at Bristol, Conn. 06012 U.S.A.
Copyright © 1967 by The Cash Box Publishing Co., Inc. All rights reserved. Copyright under Universal Copyright Convention.



Cash Box TOP 100

JULY 8, 1967

	7/1	6/24		7/1	6/24		7/1	6/24
1 WINDY			35 YOU MUST HAVE BEEN A BEAUTIFUL BABY			68 THE HAPPENING		
2 A LITTLE BIT OF SOUL	1	3	36 STEP OUT OF YOUR MIND	37	44	69 LONELY DRIFTER		
3 CAN'T TAKE MY EYES OFF YOU	4	5	37 MORE LOVE	44	53	70 I'LL ALWAYS HAVE FAITH IN YOU	73	83
4 SAN FRANCISCO—FLOWERS IN YOUR HAIR	6	8	38 SOMEBODY TO LOVE	40	49	71 GRADUATION DAY	72	80
5 LET'S LIVE FOR TODAY	7	11	39 MARY IN THE MORNING	18	6	72 GIVE ME TIME (L'AMORE SE NE LA)	75	81
6 SHE'D RATHER BE HERE WITH ME	8	13	40 NEW YORK MINING DISASTER—1941	27	33	73 SUMMER AND SANDY	83	
7 DON'T SLEEP IN THE SUBWAY	2	2	41 SILENCE IS GOLDEN			74 BLACK SHEEP	54	61
8 GROOVIN'	10	18	42 SOUND OF LOVE	17	19	75 MR. PLEASANT	78	82
9 COME ON DOWN TO MY BOAT	3	1	43 RELEASE ME	61	79	76 BLUE'S THEME	82	
10 UP-UP AND AWAY	13	16	44 FOR YOUR LOVE	31	32	77 AIRPLANE SONG	88	90
11 TRACKS OF MY TEARS	19	23	45 I GOT RHYTHM	23	7	78 LET THE GOOD TIMES ROLL & FEEL SO GOOD	81	86
12 C'MON MARIANNE	14	17	46 ALL I NEED	53	73	79 DON'T BLAME THE CHILDREN	84	
13 DING DONG THE WITCH IS DEAD	16	21	47 SHAKE RATTLE & ROLL	33	14	80 WASHED ASHORE (ON A LONELY ISLAND IN THE SEA)	80	84
14 LIGHT MY FIRE	12	12	48 THERE GOES MY EVERYTHING	49	50	81 NOW I KNOW	86	
15 ALFIE	20	30	49 TRAMP	58		82 PICTURES OF LILY	74	77
16 RESPECT	15	15	50 BABY PLEASE COME BACK HOME	36	29	83 YOU WERE ON MY MIND	96	
17 I WAS MADE TO LOVE HER	5	4	51 CHAPEL IN THE MOONLIGHT	52	63	84 TO LOVE SOMEBODY	93	96
18 7 ROOMS OF GLOOM	24	37	52 YOU WANTED SOMEONE TO PLAY WITH	63		85 THE RIVER IS WIDE		
19 MERCY, MERCY, MERCY	9	10	53 LOVE ME TENDER	56	69	86 TAKE ME (JUST AS I AM)	87	
20 HERE WE GO AGAIN	25	46	54 SOMEBODY HELP ME	59	70	87 CITY OF WINDOWS	97	
21 SOCIETY'S CHILD	26	40	55 IT'S COLD OUTSIDE	60	71	88 TESTIFY		
22 SUNDAY WILL NEVER BE THE SAME	28	31	56 HYPNOTIZED	60	71	89 MAMMY	79	85
23 WHITE RABBIT	11	9	57 THE OOGUM BOOGUM	55	56	90 MY WORLD FELL DOWN		
24 DO IT AGAIN A LITTLE BIT SLOWER	45	59	58 JOY	66	78	91 OUT & ABOUT	95	100
25 DON'T GO OUT INTO THE RAIN	21	22	59 SOOTHE ME	47	43	92 I'LL DO IT FOR YOU	100	
26 A WHITER SHADE OF PALE	35	58	60 BOWLING GREEN	71		93 COME BACK WHEN YOU'RE GROWNUP		
27 JACKSON	42	60	61 WOMAN LIKE THAT, YEAH	65	76	94 BLUEBIRD		
28 FOR YOUR PRECIOUS LOVE	39	51	62 WITH A GIRL LIKE YOU	64	72	95 FOUR WALLS		
29 PAY YOU BACK WITH INTEREST	30	39	63 SHOW BUSINESS	51	57	96 DEEP IN THE HEART OF HARLEM	98	
30 I TAKE IT BACK	29	34	64 WHO'S LOVING YOU	77		97 HEY GRANDMA	99	
31 CARRIE ANNE	41	54	65 YOUR UNCHANGING LOVE	67	74	98 GOOD FEELIN' TIME		
32 AIN'T NO MOUNTAIN HIGH ENOUGH	43	55	66 I LIKE THE WAY	76		99 DON'T LET THE RAIN FALL DOWN ON ME		
33 MAKE ME YOURS	22	25	67 YOU GAVE ME SOMETHING			100 GROOVY SUMMERTIME		
34 SOUL FINGER	33	47				100 THERE MUST BE A WAY		

ALPHABETIZED TOP 100 (INCLUDING PUBLISHERS AND LICENSEES)

A Little Bit O' Soul (Southern, ASCAP)	2	Don't Sleep In The Subway (Duchess, BMI)	7	Love Me Tender (Elvis Presley, BMI)	53	Saul Finger (East, BMI)	34
A Whiter Shade Of Pale (Essex, ASCAP)	26	Da It Again A Little Bit Slower (Earl Barton, BMI)	24	Make Me Yours (Cash Songs, BMI)	33	Sound Of Love (Jef Star, BMI)	42
Alfie (Famous, ASCAP)	15	For Your Love (Beechwood, BMI)	44	Mammy (Bourne, Donaldson, Warnock, BMI)	89	Step Out Of Your Mind (Blackwood, BMI)	36
Ain't No Mountain High Enough (Jobete, BMI)	32	For Your Precious Love (Sunflower, ASCAP)	28	Mary In The Morning (Pamca, BMI)	39	Summer & Sandy (Saturday, BMI)	73
Airplane Song (Hastings, BMI)	77	Four Walls (Megger, BMI)	95	Mercy, Mercy, Mercy (Zawinal, BMI)	19	Sunday Will Never Be The Same (Pamco, BMI)	22
All I Need (Jobete, BMI)	46	Give Me Time (Ponderosa, BMI)	72	More Love (Jobete, BMI)	37	Take Me (Just As I Am) (Fame, BMI)	86
Baby Please Come Back Home (Groovesville, BMI)	50	Goad Feelin' Time (Tennie Popper, BMI)	98	Mr. Pleasant (Noma, BMI)	75	Testify (Groovesville, BMI)	88
Black Sheep (Il Gratto, BMI)	74	Graduation Day (Travis, BMI)	71	My World Fell Down (Southern, ASCAP)	90	There Goes My Everything (Blue Crest, BMI)	48
Bluebird (Ten-East, Springala, BMI)	94	Groovin' (Slascar, BMI)	B	New York Mining Disaster 1941 (Abigail, BMI)	40	There Must Be A Way (Laurel, ASCAP)	100
Blue's Theme (Dijon, BMI)	76	Groovy Summertime (4 Star, BMI)	100	Now I Know (Helios, BMI)	81	Tracks Of My Tears (Jobete, BMI)	11
Bowling Green (Rae, BMI)	60	Happening (Jobete, BMI)	68	Oogum Boogum (Big Shot, ASCAP)	57	Tramp (Modern, BMI)	49
C'mon Marianne (Saturday & Seasons Four, BMI)	12	Here We Go Again (Dirk, BMI)	20	Out & About (Screen Gems, Columbia, BMI)	91	Up, Up And Away (Johnny Rivers, BMI)	10
Can't Take My Eyes Off You (Saturday & Seasons Four, BMI)	3	Hey Grandma (After You, BMI)	97	Pay You Back With Interest (Maribus, BMI)	29	Washed Ashore (Catalogue, BMI)	80
Carrie Anne (Maribus, BMI)	31	Hypnotized (Zira, BMI)	56	Pictures Of Lily (Essex, ASCAP)	82	White Rabbit (Copper Penny, BMI)	23
Chapel In The Moonlight (Shapiro, Bernstein, ASCAP)	51	I Can't See Nobody (Nemperor, BMI)	84	Release Me (4 Star, BMI)	43	Who's Loving You (Jobete, BMI)	64
City Of Windows (Ten-East, BMI)	87	I Like The Way (Patricia, BMI)	66	Respect (East Time, Walco, BMI)	16	Windy (Irving, BMI)	1
Come Back When You're Grownup (Painted Desert, BMI)	93	I'll Do It For You (Su-Ma, BMI)	92	River Is Wide (Saturday, BMI)	85	With A Girl Like You (Slascar, BMI)	62
Come On Down To My Boat (Picturetone & Goldstein, BMI)	9	I Take It Back (Law-Sal, BMI)	30	San Francisco—Flower In Your Hair (Trausdale, BMI)	4	Woman Like That, Yeah (The, BMI)	61
Deep In The Heart Of Harlem (January, BMI)	96	I Was Made To Love Her (Jobete, BMI)	17	Shake, Rattle & Roll (Progressive, BMI)	47	You Gave Me Something (Myto, BMI)	67
Ding Dong The Witch Is Dead (Lea Feist, ASCAP)	13	I'll Always Have Faith In You (Falart, BMI)	70	She'd Rather Be With Me (Chardon, BMI)	6	You Must Have Been A Beautiful Baby (Remick, ASCAP)	35
Don't Blame The Children (Salaon Songs, BMI)	79	It's Cold Outside (W.G.D., BMI)	55	7 Rooms Of Gloom (Jobete, BMI)	18	Your Unchanging Love (Jobete, BMI)	65
Don't Go Out Into The Rain (Unart, BMI)	25	Jackson (Bexhill, ASCAP)	27	Show Business (Raw-Lou, BMI)	63	You Wanted Someone To Play With (Edwin H. Morris, ASCAP)	52
Don't Let The Rain Fall Down On Me (Uganda, BMI)	99	Jay (Saturday, BMI)	58	Silence Is Golden (Saturday, BMI)	41		
		Let The Good Times Roll (Travis, BMI)	78	Society's Child (Dialogue, BMI)	21		
		Let's Live For Today (Dick James, BMI)	5	Somebody Help Me (Essex, ASCAP)	54		
		Light My Fire	14	Somebody To Love (Copper Penny, BMI)	38		
		Lanely Drifter (Hiale, BMI)	69	Soothe Me (Kags, BMI)	59		

How's it feel, fellas?...



to know that your fans cared enough to buy a million dollars' worth of
THE BEST OF THE LOVIN' SPOONFUL

KLP/KLPS-8056*

An R.I.A.A. Certified
GOLDEN ALBUM!



Other best-selling albums... from the 24-karat Spoonful catalog on* MGM Records a division of Metro-Goldwyn-Mayer, Inc.



KLP/KLPS-8050



KLP/KLPS-8051



KLP/KLPS-8054



KLP/KLPS-8058 ST*

Produced by Erik Jacobsen • A Product of Koppelman-Rubin Associates, Inc. for Kama Sutra Records, Inc. • * Also Available On Ampex Tape

Good timing.

ED AMES follows up his current charter
"Time, Time" with a beautiful new ballad.

"Timeless Love"

c/w "Two for the Road" #9255

If it's happening... it's here!

RCA VICTOR 

(RCA) The most trusted name in sound



Hit Team Continues Thru '75: MGM, Kama-Sutra, Spoonful, Koppelman-Rubin

NEW YORK—A long-term deal, through 1975, will maintain the winning combination of MGM Records, the Kama-Sutra label, its leading attraction, the Lovin' Spoonful, and Koppelman-Rubin Associates, the group's producers.

The deal, said to involve seven figures, will continue MGM's distribution agreement with Kama-Sutra's



FRONT COVER: (Standing, left to right): Eric Jacobsen, Charles Koppelman, Don Rubin, Mort Nasatir, Hy Mizrahi, Artie Ripp, Art Kass; (sitting on table, left to right): Bob Cavallo and Phil Steinberg.

singles and album output. Mort Nasatir, president of MGM, said that the extension of the original agreement marked the "faith MGM, Kama-Sutra and Koppelman-Rubin Associates have in one another's ability to keep pace with the Lovin' Spoonful as the group grows into the most creative musical force in American popular music." Nasatir also pointed to a "wealth of fine young talent" flowing through MGM distribution channels via Kama Sutra, including groups like Sopwith Camel, the Innocence and the Tradewinds.

On hand at the signing (see cut) were Kama Sutra toppers, Artie Ripp, Phil Steinberg, Hi Mizrahi and Art Kass, K-S comptroller; Charles Koppelman and Don Rubin, executive producer Eric Jacobsen and Spoonful manager Bob Cavallo.

The Spoonful were brought to the attention of Kama Sutra two years ago by Koppelman & Rubin. Since their first hit, "Do You Believe in Magic," their sales have reached 4½ million singles and more than 2 million albums. A single, "Summer in the City," is an RIAA-certified million-selling single.

John Sebastian is a member of the group who has emerged as a top writer, having penned the group's hit material and a soundtrack score, "You're a Big Boy Now."

ABC's Vertical Expansion Continues As Label Buys Consolidated Distributors

NEW YORK—ABC Records has continued its growth on a vertical level with the purchase of Consolidated Distributors, a large Seattle-based wholesale and retail operation.

Regarding it as the biggest record industry deal in 10 years, Larry Newton, president of the label, said that the acquisition, involving a multi-million dollar outlay, would add \$20 million in gross income to the company. Consolidated expects this billing for 1967, up from \$15 million for last year.

Effective July 6, the deal involves the acquisition of a distributorship, Stanley Distributing, C&C Distributing and Music Distributors; a rack operation, Gordon Sales, a retail disk outlet and a separate drive-in tape cartridge dealership, a distrib of toy, luggage and leather goods; and Admiral and Hamilton appliance distributorships. These companies cover the markets of Washington, Oregon, Alaska, Montana and Idaho.

Newton said that 10-leased disk departments in the area's Val-U-Mart discount chain would be spun-off back to Val-U-Mart.

Newton also said that the five principals of CD would remain in the organization. They are Lou Levinthal, vp and general manager, who will report to Newtown; Herb Rosen,

of Al Levine and Lou Klayman's New Deal wholesale operation. Newton indicated that further deals on this level, based on a company's profit picture and access to talented manpower, would continue to be considered by the label. It was pointed out that ABC Records had put up the money for these acquisitions, not its parent company, the American Broad-

ABC's 1/2 Year Income Up

NEW YORK—ABC Records' earnings for the first 24 weeks of 1967 increased to \$1,768,000 over the same period last year, reports Larry Newton, president. Income for the company for Jan.-June, 1966 was \$1,042,000. Gross sales of ABC Records and its affiliated companies during 1966 reached \$20 million. Newton said gross sales would double in 1967 to about \$43 million. This figure takes into account the acquisition of Consolidated Distributors (see separate story).

casting Co., and that the firms operate as subsidiaries of the label.

Previous Expansion Moves

Besides the acquisition of New Deal and now Consolidated, ABC has expanded its base with the acquisition of Dunhill Records, starring the Mamas & Papas, and a distribution deal with 20th Century Fox Records, which will realize such major soundtracks as "Dr. Doolittle," coming this fall, and in the future, "Hello, Dolly!," starring Barbra Streisand, and the pic bio of Gertrude Lawrence, "The Star," starring Julie Andrews, ABC's publishing unit Ampco is also publishing the Bob Merrill score for "Henry Sweet Henry," the musical version of the "World Of Henry Orient." The show, due on Broadway in Oct., will also be an ABC cast album.

Consolidated History

Stan Sulman and Lou Levinthal formed C & C Distributing in May, (Continued on page 32)

CBS Deals On Int'l Publishing Front

NEW YORK—CBS International has just completed negotiating deals with a number of major publishers, it was announced last week by Sol Rabinowitz, director of records acquisition and publishing operations for CBS Int'l. These deals will further expand the sub-publishing operations of CBS International's overseas publishing companies and will offer new exposure in many corners of the world to the various United States and foreign catalogs involved.

Heading the list is the deal Rabinowitz negotiated with Jay Morgenstern of Valando Music. Valando is one of the leading publishers of Broadway musical comedies, and as a result, CBS International gains sub-publishing rights to the scores of such box-office winners as "Fiddler on the Roof," "Cabaret," "The Apple Tree" and "Mr. Wonderful," plus the soon-to-open "Hellzapoppin' '68."

CBS International has also worked out an informal arrangement with Shapiro Bernstein for future exploitation of that company's extensive catalog throughout Latin America.

Yet another deal will give CBS International sub-publishing rights for the catalogs of three British publishing companies: Filmusic, Medallion Music and Pall Mall Music.

Other United States publishers whose entire catalogs will now be sub-published by CBS International

in various overseas countries include Dleif, Wartrain, Jowat, Nelchell, Bildo and Publin, and three folk music publishers, Cherry Lane, Cherry River and Deep Fork.

Rabinowitz has also negotiated for the sub-publishing of a number of songs from the catalogs of MacFay, Ananga-Ranga and Kangaroo Music.

In new deals for individual songs, CBS International has acquired overseas rights to sub-publish Mitch Leigh's "The Disadvantages of You," published here by Andrew Scott Music. Also, "Time, Time," a hit in the United States by Ed Ames and originally published by Editions Musicales Caravelle in France, will be sub-published by CBS International in all other English-speaking countries.

Rabinowitz also reports strong gains in strength by CBS International's overseas publishers. As an example, he cites Mexico's Mondo Musical, which has dominated the Mexican charts over the past few months with four to six songs in the Top 10 each week.

WB's Fiscal '67 Profits Nearing \$4.3 Mil Mark

NEW YORK—Warner Bros./Reprise Records' annual profit for fiscal 1967 is approaching a figure of \$4.3 million. In fiscal 1966 the firm showed a profit of \$3,309,000, which was over 33 times the net of two years before. If the \$4.3 million figure is reached, it will mean a gain of over 30% from last year and set another record for the firm.

Frank Sinatra owns one-third interest in WB/Reprise, and his share of the profits for the first half of the current fiscal year, which ended Feb. 25, came to \$704,000. His share for the first six months of fiscal '66 came to \$540,000 and his total share for '66 was \$1,103,000. This year, Sinatra's total share may come to almost \$1,435,000.

Jet Becomes ABS Sales

NEW YORK—ABC Records' wholly-owned distrib outlet in New York, Jet, is getting a change of name later this month. It will be called ABC Sales Corp. At the same time, the outlet will move into new quarters in Long Island City.

vp and head of the appliance section; Stan Jaffe, vp and head of sales & record dept.; Stan Sulman, vp of records; and Al Feurberg, vp and head of the toy dept.

ABC began a drive for vertical growth last year with the acquisition

UA Obtains Immediate For U.S., Canada

NEW YORK—Immediate Records, currently making an impact on the British best-seller lists, is being exclusively distributed in the United States and Canada by United Artists Records, according to Mike Stewart, president of UA.

Scheduled for immediate release nationally and in Canada are two Im-

mediate hits which are currently gracing the top of the British best-seller lists. These are "The First Cut Is The Deepest" by P. P. Arnold, and "Here Come The Nice" by Small Faces. Immediate product is being issued under its own banner and handled through United Artists' network of distributors and through the organization's sales, promotion, advertising and publicity staffs.

United Artists Records is anticipating a steady stream of recordings from Immediate in the weeks to come, encompassing both albums and singles. The UA label is enjoying success in recent months with artists from Great Britain, launching The Spencer Davis Group and The Easybeats as established stateside chart performers.

Stu Phillips Exits Epic

HOLLYWOOD—Stu Phillips has resigned after a year and a half as executive director on the west coast for Epic Records. He cited increasing motion picture, television and music publishing activities as the reasons. He reported to Screen Gems last week to begin his second year of composing and conducting background music for "The Monkees" TV series.

Phillips also is developing a soundtrack album based on his score for Fanfare Films' "Hells Angels On Wheels," and last month formed Irod Music Company.

Phillips, whose "Monkees Songbook" album presently is among Epic best-sellers, produced artists such as The Doodletown Pipers, Nancy Ames, Bobby Sherman and Bob Crane. His replacement was not named.

'La Mancha' A Gold LP

NEW YORK—Kapp Records has received a gold LP award for its original cast LP of the Off-Broadway smash, "Man Of La Mancha." The Record Industry Association of America (RIAA) made the certification, based on sales of \$1 million.

Biggest Directory Yet

NEW YORK—Cash Box is publishing this week the largest annual directory in its history. For the first time in the 25 year history of the publication, the directory is being published separately from the regular weekly issue. This was largely in response to many trade requests that two separate sections would make the Directory easier to handle in or out of the office.

**A&M Expands Int'l Publishing
Tony Hall Forms Indie Company
Czech Int'l Pop Festival
See Int'l News Report
Page 49**

INDEX	
Album Plans	38
Album Reviews	28, 30
Basic Album Inventory	40
Bios for D. J.'s	26
Coin Machine Section	58-64
Country Music Section	41-46
International Cover	47
International Section	47-57
Looking Ahead (Singles)	14
Mono LP Price List	24
New Chart Additions	36
Platter Spinner Patter	26
R&B Top 50	32
Radio Active Chart	10
Record Ramblings	22
Singles Reviews	16, 18, 20
Sure Shots	37
Talent On Stage	37
Top 100 Labels	57
Top 100 Albums	39
Up Coming Events	34
Vital Statistics	12

Epic Regional Meets Bow Summer Sales LP's

NEW YORK — Epic Records last week concluded a 10-day (June 19-29) series of city-by-city sales meetings. Two teams of Epic executives (Len Levy and Fred Frank comprising one team, Mort Hoffman and Nick Albarno the other) covered twenty-five major markets throughout the U.S. At the meetings, which carried the slogan, "Summer Is Where The Sales Are," 16 new albums were unveiled and Epic announced its entry into the 4 and 8 track stereo tape cartridge fields.

Summer A Big Season

Speaking at the official opening of the series, June 19, at the Waldorf Astoria, Levy, Epic's VP of sales and distribution, pointed to the label's departure from its usual mid-summer sales convention: "Although our conventions in the past have been successful, the set-up as such allowed for distributor owners solely to witness our product presentation. By going directly into individual markets, the entire distributorship sales force, as well as key buyers on the retail level rack operators, will be able to see first hand the line of product Epic is introducing for what we now know to be a big selling season, the summer months.

"Forms of entertainment have always changed to fit the mood of the times. This has been particularly noticeable during the summer months. People today are on the move. The traditional concert-in-the park has given way to transistorized portable phonographs and automobile cartridge units. More leisure time has created an increased need for entertainment and recorded music, whether at home, at the pool, at the beach or on the highway, in the most desirable and most available form of entertainment. And this means more business for you. No longer can July and August be considered slump periods. Today summertime means sales. If customers aren't waiting until fall to buy records, we see no reason to wait till then to announce new product. To

keep pace with the changing tempo of the times, we're breaking old habits and releasing a line of releases conceived and designed specifically for hot summer sales."

New Albums

Highlighting Epic's new album release are 7 pop LP's: "Those Wonderful Guys Of Stage, Screen And Radio," a 2-disk set featuring original recordings from the 1930's by Bing Crosby, Al Jolson, Frank Parker, Fred Astaire, Louis Armstrong, Rudy Vallee, Hoagy Carmichael and others; "You Got What It Takes," by the Dave Clark Five; "Little Games," by the Yardbirds; "Evolution," by the Hollies; "So Good," by Don and Goodtimes; "For The First Time," by Robert Cameron; and "Sing-Along '67," by the Doodletown Pipers.

Two classical packages are also included in Epic's new release. They are: "Granados: Goyescas/El Pelele/Escenas Romanticas," a 2-disk set by pianist Alicia De Larrocha; and "German Music For Harpsichord And Clavichord," by Igor Kipnis.

On Epic's Okeh label are 2 new LP's: "Little Richard's Greatest Hits," and "Two For The Price Of One," by Larry Williams and Johnny Watson.

Epic's Crossroads label is offering 5 new packages. 3 of these are 2-record sets: "Mahler: Symphony No. 9 In D Major," by the Czech Philharmonic Orchestra, Karel Ancerl, conductor; "Bach: The Art Of The Fugue" (transcribed for orchestra), by the Ars Rediviva, Milan Munclinger, conductor, and featuring Victoria Svihlikova on the harpsichord; and "Brahms: The Complete Quartets," by the Janacek Quartet. The two new single-disk LP's on Crossroads are "Mozart: Symphony No. 39 In E Flat/Symphony No. 41 In C Major, 'Jupiter'," by the Japan Philharmonic, Peter Maag, conductor; and "Frank: Symphony In D Minor," by the Czech Philharmonic Orchestra,

(Continued on page 36)

NARA Finalizes Convention Dates

NEW YORK — Final preparations have been made for the annual convention of the National Association of Radio Announcers (NARA), Aug. 9-13. The event will be held at the Regency Hyatt Hotel in Atlanta, Georgia.

Highlight of the convention is the 12th annual NARA awards dinner, Aug. 12. Celebrities scheduled to attend the dinner include Harry Belafonte, Sidney Poitier, Bill Cosby and Jim Brown.

Senator Leroy R. Johnson of Georgia will deliver the welcoming address to the convention on Thursday, Aug. 10. Dr. Martin Luther King will speak on Friday evening, Aug. 11.

The theme of this year's NARA convention is "Responsibility Brings A

New Profile." "NARA is making every effort to bring the outstanding persons to help develop the seriousness of the theme," Del Shields, executive VP of NARA stated. Vice President Hubert H. Humphrey has been invited, and NARA has received word that "should no conflicting business keep the Vice President in Washington, he will appear." Vice President Humphrey is sending to the New York office of NARA a greeting that will appear in the program journal of the convention.

Senator Robert F. Kennedy of New York has also been invited, along with FCC chairman, Kenneth Cox, and Dr. Benjamin E. Mays, retired president of Morehouse College in Atlanta.

Kapp Confab Outlines July-Aug Product

NEW YORK — A full-program for upcoming July-Aug. LP product was outlined at a one-day exec sales meet conducted by Kapp Records at the Friar's Club, this city. Chaired by Sid Schaffer, vp in charge of sales, future product was sampled and the communications channels between home office and the field were discussed and suggestions for improvements were implemented, with label president Dave Kapp and national sales director Joe Berger actively participating.

Schaffer noted that the Kapp district sales managers now spend a full week in each town they hit, instead of one day, since this policy inaugurated last year proved so successful.

Country & Western was discussed extensively before the lunch break and Dave Kapp stressed that the company had never left off working in that field, with his own personal experience as a record man so heavily C&W-oriented. Paul Cohen, C&W director for Kapp, showed the new

Country Music Association film and outlined a general sales program highlighting the new country releases.

After luncheon at the Friars, there was a discussion of the expansion and contraction of the play lists of some top 40 stations, and a good deal of consideration given to the ultimate fate of the mono LP with much pro and con on the eventual elimination of the mono LP altogether. Schaffer stated his belief that the average record buyer will continue to buy mono out of years of habit. The question was posed of an eventual stereo hike creating two prices again, and generally discounted as improbable.

The Kapp men spent time in discussing at length the current market and formulated plans to continue singles and LP's for the ever-growing youth movement.

Before adjournment, plans for the forthcoming Kapp sales tour by top execs were outlined.

If This Is Not Your Copy Of CASH BOX

Then You Do Not Have Our

Information-Packed Annual Directory

Get One FREE

By Starting A Year's Subscription Now!



BEING RAIDED—Jim Valley, former member of Paul Revere & the Raiders, has been signed to an exclusive pact with Dunhill Records, both as a recording artist with the label itself, and as a composer-lyricist with the firm's affiliated pubbery, Trousdale Music. Shown in the photo above, (left to right) Dunhill's Marve Helfer, manager Billy James, Valley and label general manager Jay Lasker discuss future plans, which include an all-out promo campaign to build Valley into a major recording act.

According to Lasker, Dunhill is planning to place "an unlimited amount of money and promotional effort behind the new artist, not only because of the Company's belief in the hit potential of Valley's initial record, and the built-in acceptance from his previous fans, but also because of his great star-level personality and his outstanding capabilities as a writer and as a single artist."

The first release for Valley will be "Try, Try, Try," an original composition by the artist. The introductory single will be merchandised with a special color sleeve with biographical material and photos of the artist, Lasker said.

Valley and Dunhill's Marve Helfer start a nation-wide tour early in July, coinciding with the record release date, to meet with newspaper and magazine editors, deejays and distributors in such major markets as Philadelphia, Boston, New York, Baltimore, Washington, Cleveland, Detroit, Chicago and Pittsburgh.

He didn't write the song.
But he might well have
invented the phrase...

"SHOW BUSINESS"

LOU RAWLS

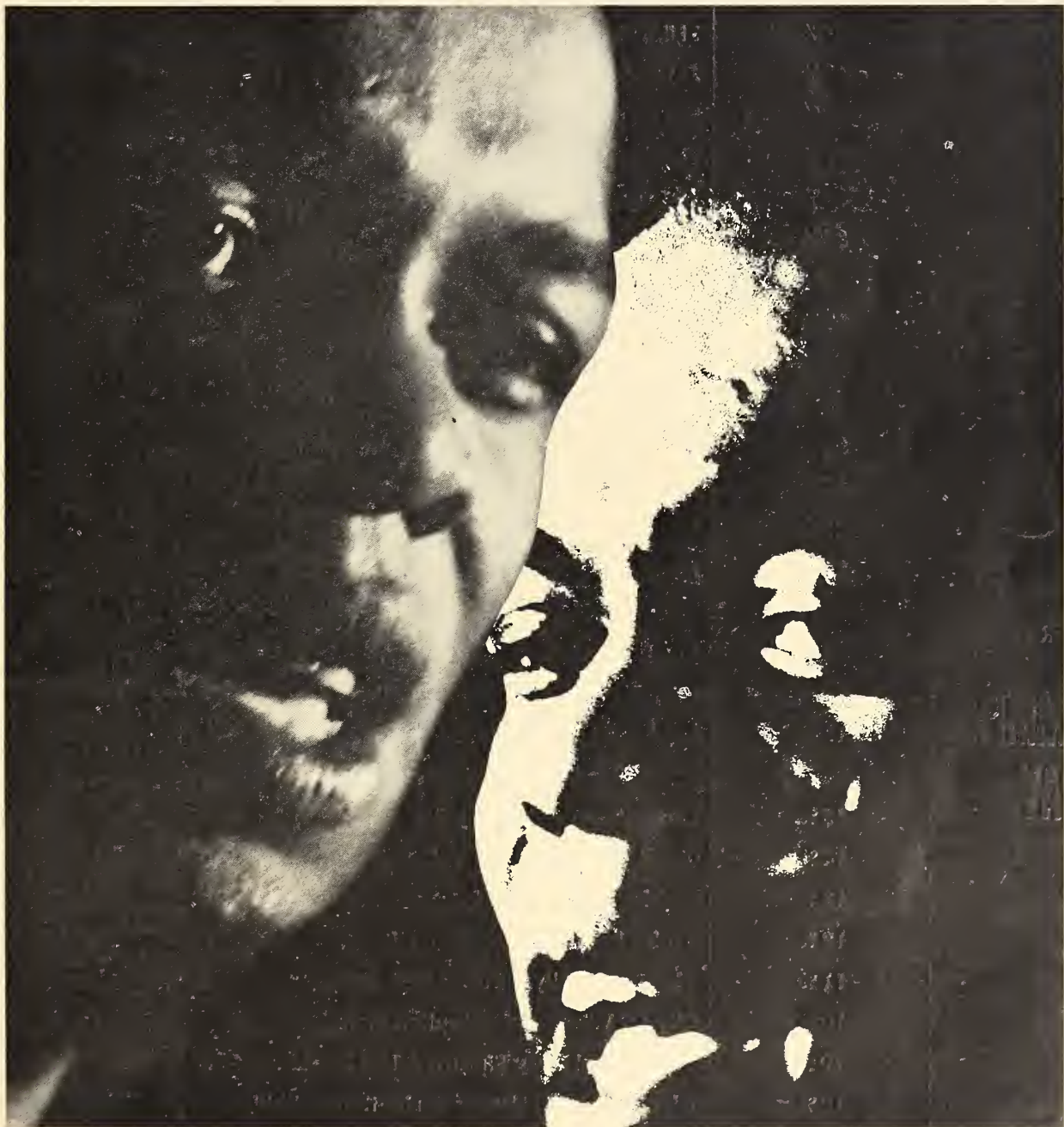

5491



IRMA THOMAS

CHEATER MAN

CHESS 2010

MAURICE & MAC

SO MUCH LOVE

CHECKER 1179

BOBBY MOORE

CHAINED TO YOUR HEART

CHECKER 1180

THE BYSTANDERS

ROYAL BLUE SUMMER SUNSHINE DAY

CHESS 2007

TOMMY TUCKER

I'M SHORTY

CHECKER 1178

CHESS

RECORDS



RADIO ACTIVE CHARTS

A survey of key radio stations in all important markets throughout the country to determine by percentage of those reporting which releases are being added to station play lists this week for the first time and also the degree of concentration combining previous reports. Percentage figures on left indicate how many of the stations reporting this week have added the following titles to their play list for the first time. Percentage figures on right include total from left plus the percentage title received in prior week or weeks. (SURVEY COMPLETED TO JUNE 28, 1967)

% OF STATIONS ADDING TITLES TO PROG. SCHED. THIS WEEK	TITLE	ARTIST	LABEL	TOTAL % OF STATIONS TO HAVE ADDED TITLES TO PROG. SCHED. TO DATE
48%	With A Girl Like You	Young Rascals	Atlantic	48%
47%	I Like The Way	Tommy James & Shondells	Roulette	91%
42%	Joy	Mitch Ryder & Detroit Wheels	New Voice	77%
40%	The Happening	Herb Alpert & Tijuana Brass	A&M	40%
39%	There Goes My Everything	Engelbert Humperdinck	Parrot	96%
37%	To Love Somebody	Bee Gees	Atco	37%
35%	Your Unchanging Love	Marvin Gaye	Tamla	70%
34%	Mammy	Happenings	B. T. Puppy	34%
31%	Somebody Help Me	Spencer Davis Group	United Artists	79%
30%	Chapel In The Moonlight	Dean Martin	Reprise	67%
28%	Show Business	Lou Rawls	Capitol	75%
26%	Let The Good Times Roll	Bunny Sigler	Cameo	60%
25%	Mr. Pleasant	Kinks	Reprise	47%
23%	Love Me Tender	Percy Sledge	Atlantic	91%
22%	Soothe Me	Sam & Dave	Stax	58%
21%	Take Me (Just As I Am)	Solomon Burke	Atlantic	21%
20%	Silence Is Golden	Tremeloes	Epic	99%
19%	Come Back	Bobby Vee	Liberty	27%
17%	For Your Love	Peaches & Herb	Date	97%
16%	Hypnotized	Linda Jones	Loma	35%
15%	Out & About	Tommy Boyce & Bobby Hart	A&M	49%
14%	Good Time Feeling	Yellow Balloon	Canterbury	23%
13%	Washed Ashore	Platters	Musicor	33%
12%	White Rabbit	Jefferson Airplane	RCA	99%
11%	Pictures Of Lily	The Who	Decca	31%
10%	City Of Windows	Stephen Monahan	Kapp	10%
10%	Jackson	Nancy Sinatra & Lee Hazelwood	Reprise	98%
10%	Give Me Time	Dusty Springfield	Philips	63%

LESS THAN 10% BUT MORE THAN 5%

Total % To Date

Don't Let The Rain Fall Down On Me Crittters (Kapp)	9%	Groovy Summertime Love Generation (Imperial)	25%	Hey Grandma Moby Grape (Columbia)	8%
You Were On My Mind Crispian St. Peters (Jamie)	35%	Morning Glory Days Pleasure Fair (UNI)	17%	Society's Child Janis Ian (Verve/Folkway)	67%
I'll Do It For You Toussaint McCall (Ronn)	8%	My World Fell Down Sagittaris (Columbia)	21%	Bluebird Buffalo Springfield (Stax)	7%

About The Will-O-Bees...

From the Bill Gavin report:

"...watch for Date to re-release their original."

From Date Records:

"...re-release immediately the ORIGINAL version of the Screen Gems Music Publishing Co. HIT..."

"Shades of Gray"²⁻¹⁵⁴³

by

The Will-O-Bees

Lyrics vital for today's market.
A powerful reading of an important song.

 date

A Dunwich Production for Screen Gems—
Columbia Supervision—Bill Traut

© "DATE", MARCA REG. MADE IN U.S.A.

More Atlantic Gold

NEW YORK—Atlantic-Atco has continued its gold record streak with Arthur Conley's "Sweet Soul Music" on Atco. The disk has been certified by the RIAA as a million seller.

This marks the eighth gold record earned during June 1967 by Atlantic-Atco. The other million sellers were: Aretha Franklin's "Respect" and "I Never Loved A Man (The Way I Love You)"; the Young Rascals' "Groovin'"; Booker T. & the MG's "Green Onions"; Mr. Acker Bilk's "Stranger On The Shore"; and two LP's with one million dollars in sales: Aretha Franklin's "I Never Loved A Man The Way I Love You" and Mr. Acker Bilk's "Stranger On The Shore."

From the Paramount Picture

BAREFOOT IN THE PARK

NEAL HEFTI (Dot)

From the Paramount Picture

ALFIE

DIONNE WARWICK (Scepter)

From the Paramount Picture

"OH DAD, POOR DAD"

ONE LITTLE GIRL AT A TIME

ED AMES (RCA Victor)

(One Afternoon On)

CARNABY STREET

THE TAPESTRY (Compass)

OUT OF NOWHERE

FRANK IFIELD (Hickory)

HOLLYWOOD WHEELS

KEN ROGERS (National)

FAMOUS MUSIC CORPORATION

1619 BROADWAY, N.Y.C.

From the Paramount Picture

EL DORADO

NELSON RIDDLE (Epic)

JACK BARLOW (Epic)

KEN ROGERS (National)

I'M INDESTRUCTIBLE

JACK JONES (Kapp)

LITTLE BY LITTLE AND BIT BY BIT

RAY CHARLES SINGERS (Com'd)

ENSIGN MUSIC CORPORATION

1619 BROADWAY, N.Y.C.

VITAL STATISTICS

DETAILED INFORMATION ABOUT NEW TITLES WHICH BROKE ONTO THE CASH BOX TOP 100 THIS WEEK

#62 WITH A GIRL LIKE YOU (2:46)

Young Rascals
Atlantic Records #2424
1841 Broadway, N.Y., N.Y.
PUBLISHER: Slacsar (BMI)
c/o Steingarten, Wedeen &
Weiss, 444 Madison Ave., N.Y.
WRITERS: Brigati & Cavaliere
ARRANGERS: Reif Mardin &
Felix Cavaliere
FLIP: "It's Love"

#66 I LIKE THE WAY (2:42)

Tommy James & The Shondells
Roulette Records #4756
1631 Broadway, N.Y., N.Y.
PRODUCER: R. Cordell B. Gentry
1631 Broadway, N.Y., N.Y.
PUBLISHER: Patricia Music (BMI)
1631 Broadway, N.Y., N.Y.
WRITER: Cordell
ARRANGER: Jimmy Wisner
FLIP: ("Baby) Baby I Can't
Take It No More"

#68 THE HAPPENING (2:25)

Herb Alpert & Tijuana Brass
A&M Records #860
1416 N. La Brea, Hollywood, Calif.
PRODUCER: Herb Alpert (A&M)
PUBLISHER: Jobete Music (BMI)
2648 W. Grand Blvd., Detroit, Mich.
WRITERS: Holland—Dozier—
Holland—DeVol
ARRANGER: Herb Alpert
FLIP: "Town Without Pity"

#84 I CAN'T SEE NOBODY (2:55)

Bee Gees
Atco Records #6503
1841 Broadway, N.Y., N.Y.
PRODUCER: Robert Stigwood—
Ossie Byrne
PUBLISHER: Nempor (BMI)
221 West 57th St., N.Y., N.Y.
WRITERS: R. Gibb—B. Gibb
FLIP: "Close Another Door"

#87 CITY OF WINDOWS (2:25)

Stephen Monahan
Kapp Records #835
136 E. 57th St., N.Y., N.Y.
PRODUCER: Charles Green—Brian
Stone—York Pala Prod.
7715 Sunset Blvd.
Hollywood, Calif.

PUBLISHER: Ten-East Music (BMI)
7715 Sunset Blvd.
Hollywood, Calif.
WRITERS: Monahan—Lazaros
ARRANGER: Don Peake
FLIP: "Lost People"

#89 MAMMY (2:45)

The Happenings
B. T. Puppy Records #530
c/o Jubilee
1790 Broadway, N.Y., N.Y.
PRODUCER: Bright Tunes Prod.
1697 Broadway, N.Y., N.Y.
PUBLISHER: Bourne
136 W. 52nd St., N.Y., N.Y.
Donaldson, 132 S. Rodeo Drive,
Beverly Hills, Calif.
Warock, 39 W. 54th St., N.Y., N.Y.
(ASCAP)
WRITERS: Donaldson—Lewis—Young
ARRANGER: Herb Bernstein
FLIP: "I Believe In Nothing"

#92 I'LL DO IT FOR YOU (2:43)

Toussaint McCall
Ronn Records #9
728 Texas, Shreveport, La.
PRODUCER: Scotty Moore
Music City Records
821 19th Ave., Nashville, Tenn.
PUBLISHER: Su-Ma (BMI)
728 Texas, Shreveport, La.
WRITER: McCall
ARRANGERS: Moore-McCall
FLIP: "The Toussaint Shuffle"

#93 COME BACK WHEN YOUR GROWNUP
(2:16)

Bobby Vee
Liberty Records #55964
6920 Sunset Blvd., Hollywood, Calif.
PRODUCER: Dallas Smith (Liberty)
PUBLISHER: Painted Desert Music
(BMI)
c/o Shapiro-Bernstein
1777 N. Vine St., Hollywood, Calif.
WRITER: Martha Sharp
ARRANGER: William Hood
FLIP: "Swahili Serenade"

#94 BLUEBIRD (1:59)

Buffalo Springfield
Atco Records #6499
1841 Broadway, N.Y., N.Y.
PRODUCER: York-Pala Prod.
7715 Sunset Blvd., Hollywood, Calif.

PUBLISHER: Ten East Springalo (BMI)
7715 Sunset Blvd., Hollywood, Calif.
Cotillion (BMI)
1841 Broadway, N.Y., N.Y.
WRITER: Stephen Stills
FLIP: "Mr. Soul"

#97 HEY GRANDMA (2:37)

Moby Grape
Columbia Records #44174
51 West 52nd St., N.Y., N.Y.
PRODUCER: David Rubinson
PUBLISHER: After You Pub. Co.
(BMI)
1725 Washington St.,
San Francisco, Calif.
WRITERS: J. Miller & D. Stevenson
FLIP: "Come In The Morning"

#98 GOOD FEELIN' TIME (2:19)

Yellow Balloon
Canterbury Records #C-513
9000 Sunset Blvd.,
Los Angeles, Calif.
PRODUCER: Yodar Critch
118 S. Weatherly,
Los Angeles, Calif.
PUBLISHER: Teenie Bopper Music
(BMI)
c/o James H. Ford
9076 St. Ives, Beverly Hills, Calif.
WRITERS: Don Grady—Gary Zekley
ARRANGER: Don Grady
FLIP: "I've Got A Feeling For Love"

#99 DON'T LET THE RAIN FALL DOWN
ON ME (2:43)

Critters
Kapp Records #838
136 East 57th St., N.Y., N.Y.
PRODUCER: Anders—Poncia (Kama
Sutra Prod.)
1650 Broadway, N.Y., N.Y.
PUBLISHER: Uganda Music (BMI)
WRITER: James Ryan
ARRANGER: Artie Butler
FLIP: "Walk Like A Man Again"

#100 GROOVY SUMMERTIME (2:22)

Love Generation
Imperial Records #66243
1556 N La Brea, Hollywood, Calif.
PRODUCER: Tommy Oliver (Imperial)
PUBLISHER: 4 Star Music (BMI)
9220 Sunset Blvd.,
Los Angeles, Calif.
WRITERS: Keith Colley—Tom Bahler
& Dick Ross
FLIP: "Playin' On The Strings On
The Wind"

Atlantic Sales Convention Set For July 6 In Miami

NEW YORK—The Atlantic-Atco sales convention kicks off at the Diplomat Hotel in Miami on Wednesday night, July 6. Convention will run through Saturday, July 8th with new LP product previewed for distributors on Friday, July 7th. The firm will introduce thirty-two (32) new albums at the convention including seven new jazz LPs on Atlantic, eight Atlantic pop releases, a new spiritual LP on Atlantic, and five Stax LPs. On the Atco label there will be nine new pop releases and two new releases on Volt. Several key new singles will also be previewed at the meeting.

Attending the convention will be Atlantic executives Ahmet Ertegun, Jerry Wexler, Nesuhi Ertegun, Bob Kornheiser, Len Sachs, Henry Allen, Juggy Gayles, Tom Dowd and Atlantic's field staffers Doug Cox, Ralph Cox, Joe Galkin, Gunter Hauer, Herb Kole, Dick Kline, Leroy Little and Arnold Theis. Frank Fenter, Atlantic label manager at Polydor Records in London is flying in for the convention.

Jim Stewart, head of Stax-Volt will be there as well as Stax-Volt promotion head, Al Bell. Producers of many of the labels associated with Atlantic will also be there including Rick Hall (Fame Records), Quin Ivy (South Camp and producer of Percy Sledge), Shadow Morton (producer of the Va-

ATCA Holds Seminar On Tape Cartridge

NEW YORK—At a dinner-seminar at the Waldorf-Astoria Hotel sponsored by the American Tape Cartridge Association on Tuesday, June 27, the leaders of the tape cartridge industry congregated to discuss the problems involved in spreading their product's message to the consumer.

George Esch, who was instrumental in the development of the tape cartridge, gave a brief rundown of the history of the product. He noted that Ray Rand, executive director of ATCA, aided in the production of the tape cartridge, and contributed constructive criticism at the time. RCA entered the field, citing its need for 1200 feet of tape on a continuous loop that would play for an hour. Later tape was used for background music and in the broadcasting industry. In 1960 or '61, Esch recalled, Earl Muntz got the tape cartridge started in the auto industry. It

nilla Fudge), Dick Simpson (producer of Atlantic's spiritual albums), and Ollie McLaughlin (Karen and Carla Records).

All Atlantic-Atco distributors from coast to coast will be present. Executives from Atlantic-Atco's Canadian distributor, Quality Records, will also attend the sales meeting. The Bee Gees are flying in to meet the Atco distributors at the convention.

Phil Ochs To Make Only One Summer PA In NY

NEW YORK—Topical song writer/singer Phil Ochs, who is currently in L.A. working on his first LP for A&M Records, will appear at the Rheingold Festival in Central Park on June 7. This will be his only concert in New York this summer. Ochs will return Oct. 1 for his third one-man concert at Carnegie Hall.

was Bill Lear, Esch stated, who sold Ford and RCA on the new product.

Ray Rand subsequently defined the nature of ATCA. ATCA, he said, cuts across all branches of the tape cartridge and associated industries. ATCA is "a need mechanism."

Jim Russell, director of marketing for Craig Panorama, emphasized the "cohesive element" necessary for the success of the tape cartridge. He focused on the importance of sales. "We are sound packagers," he said. "We're in the pleasure business." Russell also remarked on the educational responsibility inherent in the fledgling tape industry.

Jack Cummings, president of Universal Tape Decks, stated that "it is time to educate the consumer." He pointed out that the tape cartridge business was in direct competition with the record industry, and he stressed the need for a cooperative venture free of internecine squabbling.

Chris Montez has never failed *

CHRIS MONTEZ · FOOLIN' AROUND

B/W DINDI (JIN-JEE) A&M 855



***In your charts you know he's right**



LOOKING AHEAD

A compilation, in order of strength, of up and coming records showing signs of breaking into The Cash Box Top 100. List is compiled from retail outlets.

- | | | | |
|---|--|---|--|
| <p>1 MARTA
(EB Marks—BMI)
Bachelors (London 20027)</p> <p>2 YOU KEEP ME HANGING ON
(Jobete—BMI)
Vanilla Fudge (Atco 6495)</p> <p>3 OMAHA
(After You—BMI)
Moby Grapes (Columbia 44173)</p> <p>4 BROWN EYED GIRL
(Web IV—BMI)
Van Morrison (Bang 545)</p> <p>5 OUT OF NOWHERE
(Famous—ASCAP)
Frank Ifield (Hickory 1454)</p> <p>6 FINCHLEY CENTRAL
(Southern—ASCAP)
New Vaudeville Band (Fontana 1589)</p> <p>7 I'M ALL EARS
(Gallico—BMI)
Los Bravos (Press 60004)</p> <p>8 MORE MORE OF YOUR LOVE
(Jobete—BMI)
Bob Brady & Concords (Chariot 101)</p> <p>9 SLIPPIN' & SLIDIN'
(Venus—BMI)
Willie Mitchell (Hi 2125)</p> <p>10 HAPPY
(Unart—BMI)
Sunshine Company (Liberty 66247)</p> <p>11 UP, UP & AWAY
(Johnny Rivers—BMI)
Johnny Mann (Liberty 55972)</p> <p>12 HAPPY
(Unart—BMI)
Blades Of Grass (Jubilee 5582)</p> | <p>13 APPLES, PEACHES & PUMPKIN PIE
(Phil Stcox, Act III—BMI)
Jay & Techniques (Smash 2086)</p> <p>14 A THOUSAND SHADOWS
(Neil Purple—BMI)
Seeds (GNP Crescendo 394)</p> <p>15 ALL'S QUIET ON WEST 23RD
(T.M.—BMI)
Jet Stream (Smash 2095)</p> <p>16 DR. DO-GOOD
(Pomona—BMI)
Electric Prunes (Reprise 594)</p> <p>17 CREATORS OF RAIN
(Forgiveness—BMI)
Smoke & His Sister (Columbia 43995)</p> <p>18 THE JOKERS
(Shamley—ASCAP)
Peter & Gordon (Capitol 5919)</p> <p>19 SO SWEET MARTHA LORRAINE
(Joyful, Wisdom—BMI)
Country Joe & The Fish (Vanguard 35052)</p> <p>20 KATHERINE
(Pronto, Milky Way—BMI)
Ben E. King (Atco 6493)</p> <p>21 ONLY LOVE CAN BREAK A HEART
(Arch—ASCAP)
Margaret Whiting (London 108)</p> <p>22 HEAVEN AND HELL
(Miller—ASCAP)
Easy Beats (United Artists 50187)</p> <p>23 MORNING GLORY DAYS
(Artemis—ASCAP)
Pleasure Fair (Uni 55016)</p> <p>24 IT AIN'T HAPPENED
(Burdette—BMI)
Springfield Rifle (Jerden 815)</p> | <p>25 SHE MAY CALL YOU UP TONIGHT
(World United—BMI)
Left Banke (Smash 2097)</p> <p>26 39-21-46 SHOPE
(Mimit—BMI)
Showmen (Momit 32007)</p> <p>27 DEVIL'S ANGELS
(Dijon—BMI)
Arrows (Tower 341)</p> <p>28 BRAMBLE BUSH
(Leo Feist—ASCAP)
Trini Lopez (Reprise 0596)</p> <p>29 THE GREATEST LOVE
(Lowery—BMI)
Billy Joe Royal (Columbia 44103)</p> <p>30 IT'S THE LITTLE THINGS
(Chris Marc, Cotillion—BMI)
Sonny & Cher (Atco 6486)</p> <p>31 KEEP ON RUNNING
(Essex—ASCAP)
Telstars (Columbia 44141)</p> <p>32 SELF EXPRESSION
(Rambled—BMI)
Lou Christie (Columbia 44177)</p> <p>33 AGENES ENGLISH
(Su-Mo—BMI)
John Fred (Paula 273)</p> <p>34 I STAND ACCUSED (OF LOVING YOU)
(Bob Yarcy Piote—BMI)
Glores (Date 1553)</p> <p>35 TRY IT
(Blackwood—BMI)
Standells (Tower 310)</p> <p>36 BABY I LOVE YOU
(Ragmar—BMI)
Howard Tate (Verve 10525)</p> <p>37 LOVE IS
(Unart—BMI)
Bobby Goldsboro (United Artists 50138)</p> | <p>38 PEARL TIME
(Polaris John L.—BMI)
Andre Williams (Sport 4105)</p> <p>39 LIZBETH PEACH
(Dandelion—BMI)
Terry Knight (Cameo 62467)</p> <p>40 I'D RATHER GO TO JAIL
(Saturday—BMI)
Mitch Ryder (New Voice 824)</p> <p>41 YOU MAKE ME FEEL LIKE SOMEONE
(Sea Lark—BMI)
Babies (Dunhill 4085)</p> <p>42 MORE AND MORE
(Sunbeam—BMI)
Andy Williams (Columbia 44202)</p> <p>43 I COULD BE SO HAPPY
(Sid-Lee—BMI)
Magnificent Men (Capitol 5905)</p> <p>44 SO SHARP
(Routeen—BMI)
Dyke & Blazers (Original Sound 69)</p> <p>45 NIGHT OWL
(Blackwood—BMI)
Flying Machine (Rainy Day 8001)</p> <p>46 LOVIN' SOUND
(M. Witmark & Son—ASCAP)
Ian & Sylvia (MGM 13686)</p> <p>47 IT COULD BE WE'RE IN LOVE
(Destination—BMI)
Cryin' Shames (Columbia 44191)</p> <p>48 AND I DON'T WANT YOUR LOVE
(Hill Range—BMI)
Keepers of the Light (Steed 701)</p> <p>49 FOR ALL WE KNOW
(Cromwell—ASCAP)
Spinners (Motown 1109)</p> <p>50 YOU AIN'T READY
(Emalou—BMI)
Lou Courtney (Riverside 4591)</p> |
|---|--|---|--|

"ANGEL of the MORNING"

evie sands

CAMEO 475



CAMEO PARKWAY RECORDS
250 WEST 57th STREET, NEW YORK, N.Y. 10019

A TAYLOR-GORGONI
PRODUCTION



TRULY
RIGHT
AS RAIN
TRULY RIGHT
THE TEDDY
BEAR'S PICNIC
DIRTY BAND

TRULY RIGHT b/w
THE TEDDY BEAR'S PICNIC

55982 "Come on over to the Liberty Side"





RECORD REVIEWS

only those records best suited for commercial use are reviewed by Cash Box

Pick of the Week

THANK THE LORD FOR THE NIGHT-TIME (2:55) [Tallyrand, BMI]
NEIL DIAMOND (Bang 547)

Neil Diamond should have another winning deck on his hands with this driving, thumping, rhythmic, pounding venture entitled, "Thank The Lord For The Night-Time." The side is a strong contender for spins and sales aplenty and is likely to get a lot of exposure. No information available on the flip side at this time.

DARLING BE HOME SOON (3:08) [Faithful Virtue, BMI—Sebastian]
HELLO SUNSHINE (2:20) [Argent, BMI—Darin]
BOBBY DARIN (Atlantic 2420)

Here's another winning stand from Bobby Darin, this one the John Sebastian-penned "Darling Be Home Soon." Another fine vocal effort from the songster on this chartbound side. On the flip, Darin comes up with a happy-go-lucky, old-timey self-penned called "Hello Sunshine."

MY MAMMY (2:45)
[Bourne, Donaldson, Warock, ASCAP—Donaldson, Lewis, Young]

I BELIEVE IN NOTHING (2:30)
[Bright Tunes, BMI—Margo, Margo, Medress, Siegel]

HAPPENINGS (B. T. Puppy 530)

Just coming off their "I Got Rhythm" smash, the Happenings should have no trouble conquering the charts again with "My Mammy." Side is a highly infectious, full-harmonied finger-snapper with unlimited potential. "I Believe In Nothing" is a blues-oriented toe-tapper.

IT'S A HAPPENING WORLD (2:34)
[Screen Gems, Columbia, BMI—Mann, Weil]

HOW NICE? (2:55)
[Bright Tunes, BMI—Margo, Margo, Medress, Siegel]

TOKENS (Warner Bros. 7056)

"It's A Happening World" could easily put the tokens into the slot at the top of the charts. The side is a melodic, bouncy, summertime effort that should see plenty of spins and sales. On the other side, "How Nice?" offers syncopated, light-hearted sounds.

TIMELESS LOVE (2:18) [Gypsy Boy BMI—Sainte-Marie]

TWO FOR THE ROAD (2:00) [Northridge, 20th Century
ASCAP—Mancini, Bricusse]

ED AMES (RCA VICTOR 9255)

Buffy Sainte-Marie's "Timeless Love" might easily prove a chart topper for Ed Ames. The side is a rich, gentle ode to Love that should generate plenty of consumer reaction. On the other side, "Two For The Road" offers soft, lush, romantic sounds.

HAPPY AND ME (2:30) [Burdette, Shingle, BMI—Overman]

IF YOU LOVE HER, CHERISH HER AND SUCH (2:15)
[Sea Lark, BMI—Haber]

DON & GOODTIMES (Epic 10199)

"Happy And Me" might easily prove a chart-bound rocket for Don and the Goodtimes. The lid is a pulsing, pounding, dancable, good-time romp that is bound to find favor with the teens. The undercut holds a soft, bouncy, gentle romancer entitled, "If You Love Her, Cherish Her And Such."

I TAKE WHAT I WANT (2:12)

[East Cotillion, BMI—Porter, Hodges, Hayes]

SIXTEEN TONS (2:27) [American, BMI—Travis]

JAMES & BOBBY PURIFY (Bell 680)

This driving, wailing, thumping, up-beat, pulsing R&B workout entitled "I Take What I Want" offers all kinds of spins and sales potential and may well result in an upper chart berth for James and Bobby Purify. On the flip is a groovy reworking of Merle Travis' "Sixteen Tons."

Pick of the Week

LONESOME ROAD (2:27)
[Nathaniel Shilkret, Paramount, ASCAP—Shilkret, Austin]

WONDER WHO? (Philips 40471)

The Wonder Who? is back with another bouncy, light-hearted, falsetto treatment of a folksy ditty, this time it's entitled "Lonesome Road." The side should generate plenty of excitement and decorate many a turntable. No information on the flip side at this time.

CALIFORNIA UP TIGHT BAND (2:22) [Newkeys BMI—Hall]

LAST TRAIN TO CLARKSVILLE (2:28)
[Screen Gems-Columbia BMI—Boyce, Hart]

LESTER FLATT & EARL SCRUGGS (Columbia 44194)

There's a heap of good music in this latest effort from the incomparable Lester Flatt & Earl Scruggs. Titling the ditty "California Up Tight Band," the boys let loose with an infectious, loping effort that works a reversal on the while-back "Nashville Cats" romp. The flip is an excellent treatment of the Monkees' "Last Train To Clarksville."

I'LL SEE YOU IN THE SUMMERTIME (2:42)
[Beechwood BMI—D'Amato]

AND NOW YOU WANT MY SYMPATHY (2:48)
[Beechwood BMI—King, Geraci]

OUTSIDERS (Capitol 5955)

Looks like another Top 100 position is in store for the Outsiders via "I'll See You In The Summertime." Side here is a groovy, easy-swinging summer sound that should soon have the crew on the inside. "And Now You Want My Sympathy" is a thumpin' rocker.

COME BACK WHEN YOU GROW UP (2:16)
[Painted Desert, BMI—Sharp]

SWAHILI SERENADE (2:08)
[Ivan Tors, ASCAP—David, Arnold]

BOBBY VEE & STRANGERS (Liberty 55964)

Bobby Vee and the Strangers should be in for a long chart ride with this outing. Tabbed "Come Back When You Grow Up," the side is a touching, teen-slanted ballad that's sure to pile up heaps of spins and sales. On the back, Vee, minus the Strangers, offers a dreamy, mid-tempo effort called "Swahili Serenade," from the Paramount flick, "Africa-Texas Style."

MAKE ME BELONG TO YOU (2:32) [Blackwood BMI—Vera, Taylor]

THE WAY OF THE WORLD (2:16) [Paragon BMI—Shapiro]

HELEN SHAPIRO (Tower 346)

Helen Shapiro has been away from the scene for a long spell, but could get right back into the swing of things with "Make Me Belong To You." Lark does a nice job on this throbbing, rhythmic pulser. Give it a listen. "The Way Of The World" is a swinging blues stanza.

Newcomer Picks

WE'LL SING IN THE SUNSHINE (2:17)
[Lutercalia ASCAP—Garnett]

MAN SHE'S MINE (2:46) [Beechwood BMI—McNeil]

AARON McNEIL (Tower 344)

Aaron McNeil could easily win an upper chart-berth with this pulsing, rhythmic, melodic treatment of the couple-years-back Gale Garnett effort. The side should see plenty of spins and sales. On the flip, "Man She's Mine" offers steady, thumping, driving, R&B sounds.

SUMMERTIME BLUES (2:21) [Metric BMI—Cochran]

(SUCH A) BAD BOY (3:12) [Destination BMI—Butler]

YOUNG CHICAGOANS (Destination 636)

"Summertime Blues" should prove a fast moving vehicle for the Young Chicagoans. The lid is a driving, frantic, thumping, wailing, frenetic re-working of the oldie, and is likely to get plenty of spins and sales. On the flip, "(Such A) Bad Boy" offers strong, thumping, bouncy, rhythmic sounds.

Telefax

WESTERN UNION

Telefax



CALL LETTERS

WDW

GM

GH

CHARGE TO

WUBRAD

6/26/67

DENNIS GANIM
LIBERTY RECORDS
6920 SUNSET BL., LOSA

BOBBY VEE'S "COME BACK WHEN YOU GROW UP" IS DEFINITELY THE SUMMER RECORD OF 1967, THE HOTTEST PHONE ITEM AT THIS STATION. A LISTENER STRENGTH POLL SHOWED AN 8 TO 1 MAJORITY DUG THE RECORD. ANY STATION NOT ON THIS ONE IS MISSING THE GROOVE STONE SMASH. ALL THE WAY TO #1.

BWANA JOHNNY
MUSIC DIRECTOR WUBE RADIO, CINCINNATI

San Francisco

BILL GAVIN'S RECORD REPORT # 653
WEEKLY SUMMARY

June 23, 1967

Sleeper of the week: COME BACK WHEN YOU GROW UP-Bobby Vee (Liberty)
#1 sales in Spartanburg & Charlotte, now breaking in Pittsburgh and Cincinnati.



COME ON OVER TO THE LIBERTY SIDE

"COME BACK WHEN YOU GROW UP" # 55964



RECORD REVIEWS

only those records best suited for commercial use are reviewed by Cash Box

Newcomer Picks

CHEROKEE STRIP (2:44) [American BMI—G.&T. Spencer]

YOU REALLY KNOW HOW TO HURT A GUY (2:12)
[Combine BMI—Owens, Parton]

BOB BECKHAM (Monument 1018)

This wild, gentle, light-hearted, sprightly, C&W-flavored, lilting, humorous novelty ditty called, "Cherokee Strip" offers plenty of spins and sales potential that might easily result in an upper chart berth for Bob Beckham. The flip holds a bluesy effort entitled, "You Really Know How To Hurt A Guy."

THE SWEETEST THING THIS SIDE OF HEAVEN (2:55)
[Blackwood BMI—McCoy]

LOVE ME BABY (2:28) [Blackwood BMI—McCoy]

CHRIS BARTLEY (Vando 101)

Chris Bartley should have little trouble landing himself a berth on the charts with this smooth, melodic, summertimey R&B romancer entitled, "The Sweetest Thing This Side Of Heaven." The flip holds a slow, shuffling, pulser by the name of "Love Me Baby."

COMIC STRIP (2:35) [Beechwood, BMI—Conly, Emlin, Flye, Ford, King]

EVERY SINGLE WORD (2:05)
[Beechwood, BMI—Conly, Emlin, Weissman]

LOTHAR & HAND PEOPLE (Capitol 5945)

"Comic Strip" might very well prove a fun-filled trip to the upper reaches of the charts for Lothar & the Hand People. The lid is a pleasant, bouncy, fantasy romp into the world of the printed picture. "Every Single Word" offers more from the same bag on the flip.

NICE GIRL (2:27) [MRC, BMI—Hodgkins]

DROP DOWN SOMETIME (2:07) [MRC, BMI—Hodgkins]

GRAINS OF SAND (Philips 40469)

The Grains Of Sand should have no trouble scoring with "Nice Girl." The side is a light-hearted, bouncy, up-beat, pulsing, melodic, summertime romp that is likely to stir up plenty of consumer reaction. On the flip, "Drop Down Sometime" offers driving, wailing sounds.

SUMMER IN NEW YORK (2:36) [Trousdale BMI—Sloan, Barri]

I LOVE YOU WHEN YOU'RE MAD (2:10)
[Trousdale BMI—Sloan, Barri]

IMAGINATIONS (Dunhill 4092)

"Summer In New York" could easily prove a powerhouse deck for the Imaginations, especially in this current season. The side is a light, bouncy melodic venture for the romance-minded. On the flip side, "I Love You When You're Mad" offers more light-hearted, bouncy, romantic stuff.

Best Bets

BLADES OF GRASS (Jubilee 5582)

● HAPPY (2:20) [Unart, BMI—Michaels, Gormann] Could be a lofty chart berth awaiting the Blades of Grass as a result of this pleasant summer sound. Deck gets a nice treatment and deserves a listen.

(B+) THAT'S WHAT A BOY LIKES (2:20) [Pimpernel, Jerome, BMI—B./S. Jerome] Another soft, appealing sound on the flip.

ORLONS (ABC 10948)

● KISSIN' TIME (2:35) [Reliance, ASCAP—Mann, Lowe] Keep close tabs on this buoyant, lively knee-slapper. It could be a chart-destined item for the Orlons.

(B+) ONCE UPON A TIME (2:23) [Jay-Wis, KMK, BMI—Jackson, Wisner, Renzetti] Dynamic thumper on this side.

FENWYCK (Challenge 59369)

● I'M SPINNING (2:01) [4-Star, BMI—Robinson] Here's a groovy, full-harmonied rock session that could chalk up a sky-high sales figure for Fenwyck. Don't let this one out of your sight.

(B+) MINDROCKER (2:57) [4-Star, BMI—L. & K. Colley] Solid, discotheque-styled rocker on the back.

MOUSE & TRAPS (Fraternity 989)

● YA YA (1:54) [Frost, BMI—Dorsey, Lewis, Robinson] A contagious, medium-paced finger-snapper, this one could stir up a considerable amount of consumer interest. Should be especially popular with the teen set.

(B+) CRYIN' INSIDE (2:32) [Sunnybrook, BMI—Stanley, Weiss] Fast-paced wooser over here.

Best Bets

ROSCOE ROBINSON (Wand 1161)

● I GOTTA KEEP TRYING (2:36) [Scoe, Flomar, BMI—Robinson] Here's a plaintive, hope-filled love ode that might well develop into a fast-selling item for Roscoe Robinson. Stay with it.

(B+) JUST A LITTLE BIT (2:52) [Scoe, Flomar, BMI—Womack] Energetic toe-tapper for the romantically inclined.

KELLY BROS. (Excello 2286)

● YOU PUT YOUR TOUCH ON ME (2:40) [English, BMI—Emerson] Look out for this feelingful, love-oriented R&B ballad. It could make it.

(B+) HANGING IN HERE (2:09) [Red Seal, BMI—Kelly, Crume] Powerhouse rock stand on this side.

MAURICE & MAC (Checker 1179)

● SO MUCH LOVE (2:59) [Screen Gems-Columbia, BMI—King, Goffin] A potent, emotion-filled romance item, this one could send Maurice & Mac high on the charts. Winning performance by the duo.

(B+) TRY ME (2:15) [Chevis, BMI—Mc Allister, Vaill, Simmons] Contagious shouter over here.

GLORIA LYNNE (Fontana 1594)

● I CAN'T STAND IT (2:28) [Saturn, Staccato, BMI—McAllister] Gloria Lynne could make an enviable amount of coin with this stirring blueser. Don't take your eye off it.

(B+) FOOLISH DREAMER (2:45) [Staccato, Maureen, BMI—Redd] Undercut is a sincere, rhythmic love effort.

JOHN DAVIDSON (Columbia 44210)

● IF YOU CAN PUT THAT IN A BOTTLE (2:31) [Meager, BMI—Meshel] Might be a chart spot on tap for this outing. Side is a catchy bouncer with an imaginative lyric. Ought to be watched.

(B+) IN THE SUNSHINE DAYS (2:09) [Miller, ASCAP—Kusik, Snyder, Pekenikes] Tuneful, nostalgic-filled rocker.

TEE C. BEE (Lodestone 1850)

● BY THE RIVER (Part I) (2:06) [Fordell, BMI—Elliott, Ford] This one is a down-to-earth blues session that could pile up a sizeable number of spins and sales for Tee C. Bee. Listen closely.

(B+) BY THE RIVER (Part II) (1:53) [Fordell, BMI—Elliott, Ford] Harmonica and organ treatment of the flip.

ORIGINAL HAUNTED (Jet 4002)

● MONA (2:26) [Diddley] This one could turn out to be a big noisemaker for the group. Side is a funky, low-down pulser with a highly contagious beat. Keep tabs.

(B+) I'M GONNA BLOW MY LITTLE MIND TO BITS (3:38) [Burgess] Slow-paced number for the romance-minded.

NERVOUS BREAKDOWN (Take 6 1001)

● I DIG YOUR MIND (1:50) [Adam Sean, BMI—Evans] The Nervous Breakdown could beat a path to the charts with this wild rock romancer. Deserves attention. No flip info available at this time.

FLOCK (Destination 635)

● TAKE ME BACK (2:35) [Go-Mo, ASCAP—Stanley] Could be a nice amount of chart action in the cards for the Flock via this session. Side is an insistent, hard-driving foot-stomper with a real groovy sound.

(B+) EACH DAY IS A LONELY NIGHT (2:15) [Destination, BMI—Glickstein, Canoff] Flip is a thumping blueser.

HUGH MASEKELA (UNI 55024)

● BABY, BABY, BABY (2:58) [Fourteenth Hour, Pronto, BMI—White, Franklin] Slow-moving, blues-toned love-ode could make national noise for Hugh Masekela. The chanter really puts a lot of feeling into this one. Watch it.

(B+) LILY THE FOX (2:33) [Cherio, BMI—Masekela] Strong, rhythmic instrumental on the back.

O. V. WRIGHT (Back Beat 583)

● HEARTACHES-HEARTACHES (2:52) [JEC, BMI—Bryant] O. V. Wright could grab a solid foothold on the charts with this emotion-packed sobber. Give it a spin.

(B+) TREASURED MOMENTS (1:58) [Don, BMI—Jamison] Soulful, medium-paced R&Ber with a steady beat.

SCAM CITY WATER-BOYS (ABC 10950)

● DEDICATED TO THE ONE I LOVE (3:00) [Trousdale, BMI—Pauling, Bass] Groovy instrumental version of the Mama's & Papa's recent hit. Could be a big one for the Scam City Water-Boys.

(B+) SCAM CITY TEENY BOPPER (2:44) [Parkland, ASCAP—McFarland] Another nice instrumental back here.

SOUL, INC. (Boss 9920)

● STRONGER THAN DIRT (1:58) [Rayco, BMI—Williams, Busha] Could be a considerable number of spins on tap for this pounding, driving foot-stomper. Amusing lyric spoofs a well-known TV commercial.

(B+) 60 MILES HIGH (2:43) [Brownsboro, SESAC—Young, Settles] Flip is a pulsating rock effort.

SPARKY & FRIENDS (Jubilee 5581)

● TOY BALLOONS (Part I) (2:07) [Heatherfield, BMI—Mure] Happy-go-lucky bouncer here. Should sell well for child artist Sparky and his Friends. Circus-type music in background adds to disk's appeal.

(B+) TOY BALLOONS (2:07) [Heatherfield, BMI—Mure] Same tune done Chipmunks-style.



along
comes
mary
and she
never
sounded
so good

**BAJA
MARIMBA
BAND**



862

B/W WALL ST. RAG



RECORD REVIEWS

only those records best suited for commercial use are reviewed by Cash Box

Best Bets

PERCY MAYFIELD (Tangerine 9977)

● **LONG AS YOU'RE MINE** (2:52) [Tangerine, BMI—Mayfield] Here's a brisk-moving toe-tapper that could earn spins aplenty for this deck. Groovy vocal by Mayfield.

(B+) **HA HA IN THE DAYTIME, BOO HOO ALL NIGHT LONG** (3:00) [Tangerine, BMI—Mayfield] Persuasive blues item on the back.

ADAM'S APPLES (Brunswick 55330)

● **DON'T TAKE IT OUT ON THIS WORLD** (2:03) [Wanessa, BMI—Allen, Merrell] Brisk-moving, energetic advice-ode here. Could make it for Adam's Apples.

(B+) **DON'T YOU WANT ME HOME** (2:50) [Wanessa, BMI—Allen, Merrell] Feelingful love effort on the back.

MARCIA STRASSMAN (UNI 55023)

● **THE GROOVY WORLD OF JACK AND JILL** (2:18) [Duchess, BMI—Goldstein, Regan] Marcia Strassman might well have a winning item on her hands with this touching, poetic ballad. Moving effort by the lark. No information on the flip side available at this time.

AMBASSADORS (Sound Stage 2588)

● **THERE'S SOMETHING ON MY BABY'S MIND** (2:25) [Cape Ann, BMI—Orange, McDaniels] The Ambassadors could see plenty of action with this outing. Side is a slow, soul-filled R&B love-ode, loaded with chart and sales potential.

(B+) **IF YOU DON'T KNOW** (2:31) [Cape Ann, BMI—Orange, McDaniels] Rhythmic finger-snapper.

MIKE JONES GROUP (Jet 4001)

● **EACH AND EVERY DAY** (2:21) [Hugg] Might be a chart spot waiting for this groovy, danceable rock item. Watch it closely.

(B+) **FUNNY FEELING** (1:58) [Campelone] Flip is an another strong rocker.

JAMES ROYAL (Columbia 44127)

● **CALL MY NAME** (2:38) [Mills, ASCAP—Murphy, Klaeyen] This one is a stirring, feelingful romancer that could send James Royal high on the charts. Striking date.

(B+) **WHEN IT COMES TO MY BABY** (2:49) [Flomar, BMI—Simpson, Ashford] More in a similar vein over here

MARSHMELLOWS (Columbia 44159)

● **KNOT TIER** (1:58) [Spectorious, Marshmellows, BMI—Mocko] Don't take your eyes off this imaginative, mid-tempo love ballad. It could be a winner.

(B+) **JUST YOU AND I** (2:47) [Spectorious, Marshmellows, BMI—Anander] Strange-harmonized, tempo-changing item on this side.

SMOKEY AND HIS SISTER (Columbia 44207)

● **A LOT OF LOVIN'** (2:25) [Forgiveness, BMI—Smokey] Could be a lot of sales attention in store for Smokey and His Sister via this outing. Side is highly infectious melody rocker that might well find favor with the teen set.

(B+) **WOULD YOU COME HOME** (2:26) [Forgiveness, BMI—Smokey] Tender love ode back here.

ANGIE HESTER (ABC 10943)

● **THE BUMP STEP** (2:40) [Pamco, Rayven, BMI—Chase] Freaky but groovy item about a dance step. Angie Hester whispers the lyrics, while repeated rhythms in the background mesmerize the listener. Could happen.

(B+) **A KISS WILL HAVE TO DO FOR NOW** (2:37) [Cycles, Pamco, BMI—Chase] Ghostly love ode on this side.

PEARLS BEFORE SWINE (ESP—Disk 4554)

● **DROP OUT!** (2:40) [United International, ASCAP—Rapp] A groovy, highly inventive rock ballad, this one could do good things for the Pearls Before Swine. Watch it go.

● **MORNING SONG** (2:33) [United International, ASCAP—Rapp] On this side, the group offers a slow haunting item that might be destined for a place on the charts. Give it a spin.

BOBBY SCOTT (Columbia 44198)

● **WE'RE DOING FINE** (2:39) [Leatherneck, Wellmade, BMI—Ott] Bobby Scott could grab a sizeable chunk of airplay with this cheerful R&B bouncer. Chart material.

(B+) **ANOTHER STRANGE TOWN** (2:50) [TM, BMI—Young] Blues-toned rock effort on the back.

CLIMAX (Patti Platters 1025)

● **LOVE WILL FIND A WAY** (2:10) [Kama Sutra, BMI—Troy] Hope-filled, romance-oriented could excite the enthusiasm of a large teen audience. Deserves attention.

(B+) **TOGETHER BY MYSELF** (3:10) [Kama Sutra, BMI—Troy] This one is a forceful, tempo-changing love rocker.

JERRY LEE LEWIS (Smash 2103)

● **IT'S A HANG-UP BABY** (2:16) [Unart, BMI—Reeves] Jerry Lee Lewis could make a trip to the charts with this powerful, mid-tempo woe session. Watch it move.

(B+) **HOLDIN' ON** (2:59) [Screen Gems-Columbia, BMI—Barton, Dyson] Slower item in a similar vein.

EMPERORS (Brunswick 78019)

● **KARATE BOOGALOO** [Anteresgeo, BMI—Moss, Brown] Thumping, infectious rock effort with a steady beat. Might be a noisemaker for the Emperors. No information available on the flip side at this time.

Best Bets

CARL DOUGLAS & BIG STAMP- EDE (Okeh 7287)

● **SOMETHING FOR NOTHING** (2:33) [Millwick, BMI—Tubbs] Watch out for Carl Douglas & the Big Stampede to pull in a sizeable pile of coin with this funky, blues-toned finger-snapper. Rousing performance by the group.

(B+) **LET THE BIRDS SING** (2:53) [Millwick, BMI—Douglas] Undercut is an inventive, hand-clapping swinger.

VIC MIZZY & ORCH. (Tower 350)

● **THE CAPER OF THE GOLDEN BULLS** (2:57) [Jos. E. Levine, ASCAP—Mizzy] Vic Mizzy and His Orchestra could realize a lot of spins and sales with this tuneful, bouncy instrumental. Side is from the original motion picture soundtrack album of the same name.

(B+) **SAD SAM SAMBA** (1:41) [Jos. E. Levine, ASCAP—Mizzy] Contagious Latin-flavored instrumental on this side.

GROWING SOCIETY (Dunhill 4093)

● **JUST FOR FUN** (2:30) [Mr. Bones, Trousdale, BMI—Howe] Keep a close watch on this stirring, building instrumental. It could develop into a moneymaker for the Growing Society.

(B+) **THE RED FUZZ** (2:29) [Mr. Bones, Trousdale, BMI—Howe] Undercut is a strong, thumping rock instrumental.

TOMMY AMBROSE (Fontana 1592)

● **THEY DON'T GIVE MEDALS** (2:45) [Blue Seas, Jac, ASCAP—Bacharach, David] This moving, emotion-charged ballad might well prove to be a fast-moving item saleswise. Striking performance by Ambrose.

(B+) **CASINO ROYALE** (2:35) [Colgems, ASCAP—Bacharach, David] Catchy treatment of the title tune from the Columbia flick.

OSCAR HAMOD & MAJESTICS (U.S.A. 878)

● **SOULFINGER** (2:30) [East, BMI—King, Jones, Cunningham, Cauley, Caldwell & Alexander] Here's a groovy, powerhouse rock stand that could earn an enviable number of spins for Oscar Hamod & the Majestics. Bears watching.

(B+) **GOT TO HAVE YOUR LOVIN'** (2:35) [Destination, BMI—Hamod] Driving, danceable foot-stomper over here.

SIMON DUPREE (Tower 347)

● **RESERVATIONS** (2:32) [E. H. Morris, ASCAP—Albert, Hammond] This one is a fast-moving, free-wheeling finger-snapper that could stir up considerable consumer interest. Teen-age listeners especially should find this session to their liking.

(B+) **YOU NEED A MAN** (2:28) [Robbins, ASCAP—Smith, King] Potent, rhythmic romancer on the back.

JAMES DARREN (Warner Bros. 7053)

● **DIDN'T WE** (2:27) [Madelon, BMI—Webb] Look out for James Darren to make some sales noise with this melodious, romantic, blues-filled ballad. Side is a potential charter and should get a healthy amount of airplay.

(B+) **COUNTING THE CRACKS** (2:18) [Richbare, Ercolani, BMI—Glasser, Darren] Similar doings on the back.

TRUE BLUES TRAVELING DANCE BAND (Project 31315)

● **SING FOR YOUR SUPPER** (2:10) [Chappell, ASCAP—Rodgers & Hart] Steady good-times treatment of this tune from the Rodgers & Hart musical, "The Boys From Syracuse." Should sell well.

(B+) **THE WORLD IS WAITING FOR THE SUNRISE** (2:07) [Chappell, ASCAP—Seitz, Lockhart] Lively version of this years-back Les Paul and Mary Ford smash.

WAYNE NEWTON (Capitol 5954)

● **SUMMER COLORS** (2:38) [April, ASCAP—Meyer, Mann] Here's a cheerful, sunny bouncer that should please Wayne Newton's numerous devotees. A highly enjoyable performance.

(B+) **DREAM STREET ROSE** (2:11) [Mills, ASCAP—Stewart, Langley] Sentiment-filled toe-tapper on this side.

STILLROVEN (Roulette 4748)

● **SUNNY DAY** (2:20) [Bertram, BMI—Dean, Howarth] Could be big things in store for the Stillroven as a result of this session. Side is a spirited, full-bodied rock venture that deserves a careful listen.

(B+) **HEY JOE** (2:32) [Third Story, BMI—Roberts] On the back, the group lets loose with a wild, shouting foot-stomper.

MAC TRUQUE (Capitol 5951)

● **ALONG CAME LOVE** (2:08) [Four Star Television, BMI—Gordon] This one is a thumping, wailing love effort that might well pull in a nice slice of the pop sales action for the Mac Truque. Powerpacked outing from start to finish.

(B+) **MICKEY'S MONKEY** (2:50) [Jobete, BMI—Holland, Dozier, Holland] Rousing version of this frequently heard rock number.

BOBBY MOORE (Checker 1180)

● **CHAINED TO YOUR HEART** (2:20) [Kama-Sutra, BMI—Kaye, Schwartz, Donald] Bobby Moore could have a chart entry in his possession with this solid, thumping R&B. Watch it move.

(B+) **REACHING OUT** (2:45) [Fame, BMI—Penn, Oldham] This one is a pounding soul item about a guy who wants to get married and settle down.

**A Message of Gratitude
to All
Radio and TV Personalities
THANKS AGAIN, AGAIN & AGAIN
To All of You
From
All of US**



The Five Americans

We Appreciate So Much What
You Are Doing for Our

"SOUND OF LOVE"

Thanks for Making It Our
4th Big Chart Buster
and
Please Accept Our Appreciation
for What YOU Are Doing for Our
New Album Entitled

"WESTERN UNION"

Sales on It Are Out of Site—
Thanks to YOU!

"SOUND OF LOVE"
Record No. AB-120,
Album **"WESTERN UNION"**
ABLP 1967 & ABST 2067



Jon & Robin

Please Accept Our Heartfelt
Gratitude for Helping Us With
Our First Major Release

**"Do It Again—
A Little Bit Slower"**

YOU Made IT a Big One for Us,
and We Will Never Forget
YOU for It.

**"DO IT AGAIN—
A LITTLE BIT SLOWER"**
Record No. AB-119



The "In" Crowd

"BIG CITIES"

Was Our First Cut on Our Own.
Thanks to YOU,
Sales Are Booming.

Please Believe Us We Are
Truthfully Grateful to
YOU, for What YOU Are
Doing for Us.

"BIG CITIES"
Record No. AB-121

FOR BOOKINGS CONTACT:
BANKERS MANAGEMENT
AND SERVICES, INC.
825 OLIVE / RI 2-6111
DALLAS, TEXAS 75201
— CALL COLLECT —

A PRODUCT OF ABNAK MUSIC ENTERPRISES, INC.



MUSIC ENTERPRISES, INC.

DALLAS, TEXAS

FAN CLUBS
c/o ABNAK MUSIC ENTERPRISES
INC.
825 OLIVE / RI 2-6111
DALLAS, TEXAS 75201

PRODUCED BY DALE HAWKINS

"Foreign licensees contact: Publishers' Licensing Corporation, 40 West 55th Street, New York 10019, (212) 581-7970."



RECORD RAMBLINGS

NEW YORK:

Jazz guitarist, Larry Coryell is the subject of a cover story by Philip Elwood in the current issue of Jazz Magazine. That publication lists him as being among "the first wave of the love generation's contributions to jazz." The same feature also notes that the jazzmen of the '70's will probably have gotten their early experience in rock groups, as opposed to the current stand of Jazz musicians, who frequently paid their first dues with a down home R&B unit or blandly blowing around the country-club-band circuit.



MONIQUE VAN VOOREN



LOVIN' SPOONFUL



FRAN JEFFRIES



BEATLES



MARILYN MATTSON



BOBBY VINTON

Elektra's Steve Harris has just returned, with his wife Nicole and son Guy, from a 3-week sojourn to France. Having spent most of his time in and around the City of Light, Steve was greeted here by "Light My Fire" by the Doors.

The Doors have just completed a record shattering gig at Steve Paul's the Scene. . . . Liberty's Nitty Gritty Dirt Band is set for Fred Weintraub's Bitter End. . . . Every Mother's Son will play a concert with Dionne Warwick at Iona College and then splits for the coast. . . . Raun MacKinnon is set for a weekend gig at Patches' 20-Below in Timonium, Md. . . . Judy Collins and the Lovin' Spoonful just played a powerhouse night at the Forest Hills Tennis Stadium.

FLASH!!! Cash Box's own Marvin Goodman has returned from a 2-year gig with the U.S. Army.

Our East Coast Girl of the Week is Monique Van Vooren, who opened last week (26) with the St. Louis Municipal Opera Company's presentation of "Do I Hear A Waltz." Following that her summer will be taken up with summer stock and one nighters.

"Pray For Peace" is the title of the Rev. Charles K. Davis' current Sunset LP. Tom Rogan and Davis stopped up to the Cash Box offices for a visit last week.

Michael Goldstein has just returned from the coast where he attended the Monterey Pop Festival, as did Dominic Sicilia. . . . Rick Bolsom, of the Michael Goldstein office, was in Chicago last week for the NAMM convention. . . . During Dominic's absence, the Sicilia office was admirably handled by Eleanor Zadik.

There's a lot of activity at ESP-Disk. Chester Fox reports that the label has recently signed: Ivor Jerry Moore; Bruce Mackay & the Syrian Beehive; Sean Gagnier; Thelma Carpenter; Steve Miller's Blues Band; the Quicksilver Messengers; and the Holy Modal Rounders.

Off-quoted Nashville publicist Tandy Rice finally decided to visit Fun City and dropped up to the Cash Box offices while here.

Chad Mitchell is holding forth nightly at the Village Gate. . . . The Paul Butterfield Blues Band filled the Rheingold Festival July 30th on a double concert bill with the Charles Lloyd Quartet. . . . The Young Rascals/Len Chandler are set for two Rheingold concerts in Central Park on July 5th as are Phil Ochs/Spanky & Our Gang on July 7th. . . . The Vagrants played Newport this weekend.

Yes, that is an electronic organ on "A Whiter Shade Of Pale." The deck's producer, Denny Cordell, got that tone from careful experimenting with echo, Leslie speakers, baffles, and the like. Organist Matthew Charles Fisher of Procol Harum has most usually played under different conditions. . . . He's a student of classical organ at London's Royal Guildhall School of Music.

Pete Seeger played (along with many other folk musicians) at an open field folk fest in Garrison, N.Y. held by those residents (and interested parties) of the Hudson River Valley who want to promote the use of their river as something more pleasant than

a sewer. This includes the now almost forgotten pastime of sailing on the Hudson.

Fran Jeffries is shown relaxing in Monte Carlo after the first leg of an extensive European tour.

Phil Ochs sang his "I Ain't Marching Anymore" on the recent ABC-TV'er "Dissent Or Treason?"

Lester Flatt and Earl Scruggs, well known exponents of Bluegrass Music, have cut what looks like it may be a big pop/country/folk single for Columbia, it's called "The West Coast Up Tight Band." The ditty is a light-hearted examination of the influence C&W music has had on the current pop scene. The side is decorated by extremely good guitar and banjo work and sports a keen brand of humor throughout. The side is a reversal on the Lovin' Spoonful's "Nashville Cats" while-backer. The flip is a Bluegrass treatment of "Last Train To Clarksville."

Epic's Tremeloes have arrived in the United States. First on their agenda was a series of interviews in New York and then a trip to Ohio.

TRO's Al Brackman is planning to sail his Trident sloop up Long Island Sound to Newport for the Folk Festival.

MGM's Sol Handwerker reports sizable reaction to a new deck by Marvin's Circus entitled, "Come To Me." The deck is reportedly getting a lot of play.

Lark Valeri Jay was Miss Metropolitan in the Miss New York World Beauty Pageant held June 30th over WPIX-TV-New York. She is pacted to MGM.

Davie Allan & the Arrows' "Blues Theme" is, according to Hugh Dallas and Sal Licata, "number-one for the second week in Detroit and is breaking fast in Chicago, Baltimore, Washington, and Cleveland."

The Department of the Army recently presented silver trays to both Ray Charles and James Brown for their "voluntary contribution to the morale" of overseas-bound troops stationed at Ft. Eustis, Va. A horde of artists have donated their time for the troops at Ft. Eustis thus far, and all are being sent similar tokens of appreciation. Charles and Brown, whose acts have proven to cause the most excitement at the base, were the only ones to be presented the awards in person. As an interesting sidelight to the voluntary appearances at the base, the Army has been picking up the tab only for meals and transportation, but, in the case of Cadet's Ramsey Lewis, the popular

jazzman wouldn't even accept transportation costs from the Army. He footed the whole bill for he and his band by himself.

HOLLYWOOD:

Now that we've established an irrefutable fact that not one of the Beatles was anywhere near the Monterey fair grounds during that three day cycle of variegated vibratos and musical merriment (not even Keith Allison was there!) we can once again return to untangling the marvelous mystery of exactly how many cavities it takes to fill Albert Hall.

Liberty's Dick Peirce and Ed Barsky are both displaying new plaques in their respective offices, mementoes of the Charlie Barnet golf tournament in Palm Springs last week. . . . Bobby Vinton, following his successful engagement at the Copa in N.Y., is currently starring (along with Cathy King and Martha Val) at the Coconut Grove—booked for three weeks. . . . Lou Rawls is set for Fairmont in San Francisco for a similar stint beginning July 20. . . . Michael Rye tapped by "producer" Jack Levy of Liberty to narrate the special convention film for the label.

We've just been assigned the task of "judging" the I. Magnin-20th Century Fox contest on the music biz. Open to gals (15-18) in four states, they'll be offering, in 250 words or less, "What Music Means To Me." Winners get a date with the David, 20th's new hopes (current single "People Seeing, People Saying"). A&R director Jackie Mills will chaperone.

"West Coast Girl of the Week" is 18 year old, blonde haired, blue eyed Marilyn Mattson whose first single on Allied is "You Cheated" b/w "He Means So Much To Me." Marilyn has recently been cast for the lead in two forthcoming films—"Man Of The Mountain" starring Fabian and "Fear Town," both Allied Studio productions.

Incidentally, John Wegner, v.p. of Allied Records Company on East 57th in L.A., notes that his firm and affiliates do not have any association with the Allied Record label which released the Mattson and the Flower Children disks a few weeks ago. That firm is located at 4376 Sunset Drive.

July 6 is the booking date for the Animals at the Whiskey-A Go-Go (new spelling for the nitery) with Johnny Rivers and the 5th Dimension set for July 20. . . . H. B. Barnum's new Capitol single ("Searchin' for My Soul") was composed by producer Dave Axelrod with lyrics by Ben Raleigh. . . . Greene-Stone's newest uncovers are The Cake, a trio of teenage dolls. None has ever performed professionally before.

Norm Geller will be John Gary's pianist-conductor during his engagement at the Grove beginning July 8—Geller also backed Ed Ames at the Westside Room recently. . . . Takeo Hori, manager of the Spiders (Japan's top group), in L.A. this week to promote "Sad Sunset," their million seller in Japan.

Marty Paich in London this week to arrange and conduct Sammy Davis' "Dolittle" LP for Reprise. . . . A note

from Bob Leonard at Leonard Artists which reads, "It is most unusual to me that a group, Moby Grape, is being promoted to such a great extent by Columbia Records without any mention of the fact that Peter Lewis is Loretta Young's son. Is there any reason to keep this a secret?" Our reply—"please check with Columbia, Peter and Loretta and then let us know."

Currently Popping along the Pacific: "Happy" by the Sunshine Co. (Imperial) in San Francisco, "Hey Grandma" by the Moby Grape (Columbia) in San Diego, "The Happening" by Herb Alpert and the TJB (A&M) in

L.A. and "For Your Love" by Peaches and Herb (Date) in Seattle.

Beatles next single titled "Love Is All You Need." . . . Possible single (based on early reports from jocks), from the new Yellow Balloon LP on Canterbury, is "Can't Get Enough Of Your Love."

CHICAGO:

Just Rita's "Lullaby" single on Barrington label is garnering heavy airplay and sales along the eastern seaboard, according to Bill Simonini and Eva Dolin. . . . THE WILD SOUND: Roy Bourke, of Smash Records, revealed last week that Barney Pipp, the rapid-fire deejay at WCFL, just waxed a trumpet solo deck (wild!!) titled "You Can't Sit Down" with the Roving Kind (Smash). . . . Friend Sig Sakowicz (WGN, WGN-TV and WTAQ Radio & TV, will again emcee the Fourth of July Extravaganza in Soldier Field. His son Gregory will recite the Pledge of Allegiance. . . . RCA's Leslie Miller makes the deejay circuit in Windy City, July 6&7 to promote her latest, "Teach Me To Love." . . . Happy folks George Leaner and Annie du Conge, at One-Derful Records, are flippin' over the hefty action on Otis Clay's newie, "That's How It Is (When You're In Love)" One-Derful (!). . . . Mister Kelly swings into summer with the spirited song stylings of Chad Mitchell, July 16, according to our favorite host George Marienthal. Supplying the backup music are the Larry Novak Trio and the Dick Reynolds Trio. . . . Comin' up at the Regal Theater, July 7, will be Duke Records star Bobby Bland, Junior Walker and the All Stars, Freddie Scott, The Elgins, The Malabus, Vi Campbell and Brenda and the Tabulations, according to Hank Schwab. . . . Columbia Records' Rhetta Hughes and Tenison Stephens skedded a series of concerts in the Meadows Club, commencing July 6 (thru 9), also featuring the Abstractions (Barbra and Ben Farnandis), with Arlington Davis on drums, Dave Van Arsdale, bass; and the inimitable Tenison Stephens at the piano. . . . Genial Lenny Garmisa, of Garmisa Records Distribs, boasts the kind of golf scores we all wish we could attain. Lenny has been one of the better golfers in these parts for all these many years. . . . Lovely flack Audri Adams infos that Blackie Nelson and the Personalities open the Cantina of the posh Continental Plaza Hotel, July 10, for four weeks. Also, Bob Carroll returns to the Consort for a four weeker.



RAVI SHANKAR



theme from

PATHER PANCHALI

b/w GAT KIRWANI #77871



RAVI SHANKAR



MONO LP PRICE INCREASE

In answer to retailer and one-stop requests, Cash Box is providing data on those labels which have announced price increases of their mono LP's to the level of stereo. This section should be detached and placed where it can inform consumers of the price rise. Additions will be made when they arise. Cash Box urges labels not represented, but which have made similar moves to bring their moves to our attention.

ABC (BluesWays, Dunhill, Jerden & Tangerine):

Effective Date: June 19; Comments: Elimination of Command mono line.

A&M:

Effective Date: June 5

ATLANTIC:

Effective Date: June 9

AUDIO FIDELITY:

Effective Date: July 1; Comments: All \$3.79 LP's are now \$4.79; "Best Of" series, formerly \$2.98, is now \$4.79.

CBS (Columbia, Epic, Date):

Effective Date: June 5

CAPITOL (Angel):

Effective Date: July 1; Comments: Rise applies to pop & classics, "W" series.

CHESS-CHECKER-CADET:

Effective Date: June 12; Comments: Chess Sermon and Checker Spiritual LP's not included.

DECCA (Coral, Brunswick, LHI):

Effective Date: July 7

DISNEYLAND:

Effective Date: June 12; Comments: DQ series retail at \$1.89 for mono or stereo; Storytellers, formerly \$4.79 stereo, now \$3.79 stereo; Vista Fantasound \$4.79 mono or stereo; soundtracks on Vista \$5.79 for mono or stereo.

ELEKTRA:

Effective Date: June 9; Comments: Except 300 series at this time.

KAPP:

Effective Date: July 1

LAURIE:

Effective Date: June 26

LIBERTY (World Pacific, Pacific Jazz, Minit, Dolton, Blue Note, Soul City, & Robert Rheims):

Effective Date: June 12

LONDON:

Effective Date: July 3

MGM:

Effective Date: June 9

MTA:

Effective Date: July 15

MUSICOR (Dynamo):

Effective Date: Immediately

ORIGINAL SOUND:

Effective Date: July 1

RCA (Colgems):

Effective Date: June 1

ROULETTE:

Effective Date: June 25

SCEPTER-WAND:

Effective Date: June 12; Comments: Hob gospel series not included.

TOWER:

Effective: July 1; Comments: Albums by Justin Wilson are recorded in mono only and have carried a list price of \$4.79.

WARNER BROS. (Reprise, Loma):

Effective: June 19; Comments: All albums designated "R," "W," as well as those designated "RS," "WS," and "LS," indicating single albums on WB, Reprise and Loma, will bear a suggested list of \$4.79; All albums designated as "F," "B," "FS," and "BS," will carry a suggested list of \$5.79.

Warners Acquires Three Major Soundtracks

BURBANK, CALIF.—J. K. Maitland, president of Warner Bros. Records, has disclosed the acquisition of sound track album rights to three major motion pictures, "The Bobo," "Camelot," and "Finian's Rainbow."

"The Bobo," starring Peter Sellers, Britt Ekland and Rossano Brazzi, with music composed by Francis Lai, is expected to be released early this fall in conjunction with the release of the film.

"Both 'Camelot' and 'Finian's Rainbow' will represent major promotional and exploitation efforts for the company," Maitland declared, "with 'Camelot' to be released by the record company in the fall of 1967, while 'Finian's Rainbow' is scheduled for early next year."

The company has organized an extensive sales promotion campaign in conjunction with its studio counterpart, with Warners geared to exploit

the music from "Camelot" starting October 1st

"Virtually every area of the broadcast media will be blanketed," said Maitland, "with copies of the sound track album scheduled for airing on AM, FM and college radio stations."

In addition, Warners will wage an intensive in-store display and merchandising program, backed up by advertising in trade and consumer media. An elaborate "Camelot" press kit is being designed, containing story synopsis, copies of the album, and stills from the film, for music business press as well as entertainment editors throughout the country.

"Warner Bros. expects to pre-sell the album well in advance of the release of the film," said Maitland, "with elaborate plans presently being made for saturation in each city in which the film plays."

Jubilee Announces Net Sales Figures

NEW YORK—Jerry Blaine, president and chairman, has announced that in the first six months (October, 1966 thru March, 1967) of its current fiscal year, ending September 30, 1967, Jubilee Industries attained net sales of \$3,035,508 and net income of \$181,283, equivalent to 31¢ per share based on 585,462 shares currently outstanding. No comparison with the previous similar period is available.

Here are the figures for the six months ended March 31, 1967: net sales—\$3,035,508; net income—\$181,283; earnings per share—31¢; shares outstanding—585,462. No provision for federal income tax is required on net income. The figure is subject to year-end audit.

During the year ended September 30, 1966, Jubilee Industries reversed three years of losses to show net income of \$41,231 on net sales of \$4,959,684



JUST A MINIT—Pictured here (from the left) are: Minit Records' topper Ed Wright and artist-producer Jimmy Holiday, in a confab relative to the "I Wanna Help Hurry My Brothers Home" single. According to Wright, the R&B deck is busting wide open in most major markets. Holiday cocleffed the tune and is the featured artist on the disk, which is "dedicated to our armed forces serving in Vietnam."

If This Is Not Your Copy Of

THE CASH BOX

Information-Packed Annual Directory II

Get One FREE

By Starting A Year's Subscription Now!



Five Plus One—

The Fifth Dimension, in town to tape a Johnny Carson TV'er and play the Action House, holds Cash Box in its lap in this pic Standing (l. to r.) are: Ron Townson; Tom Rogan, Liberty promo man; Lamont McLemore; and Billy Davis. Seated (from left) are: Florence LaRue and Marilyn McCoo.



LOVE YEARS COMING



#758



Slay To Produce Freddy Cannon Disks

BURBANK, CALIF.—Joe Smith, vice president and general manager of Warner Bros. Records has announced that all future Freddy Cannon recordings, a long-time recording artist for Warner Bros. Records, will be produced by Frank Slay.

The Freddy Cannon/Frank Slay combine is responsible for such singles as "Abigail Beecher," "Tallahassee Lassie," "Palisades Park," and "Way Down Yonder In New Orleans."

Smith said, "These two artists obviously have a comfortable working relationship and we are extremely anxious to put them back in the studio together."



PLATTER SPINNER PATTER

Sounds Of New Orleans notes with amusement and alarm the FCC's June 2 "fairness doctrine" letter to WCBS-TV-New York. The letter indicates that radio and TV outlets carrying cigarette commercials must also devote time to warning their listeners of the hazards of smoking. SONO views this as a dangerous precedent, and runs down some of the possible results of this interpretation of the "fairness doctrine." Manufacturers of hard liquor could demand free time on stations carrying beer and wine advertising. Since they, too, sell alcoholic beverages they are being discriminated against by not being able to buy time. On outlets running spots for Preparation H a situation could arise where masochistic sufferers who enjoy the pain and discomfort could demand equal time to extoll the joys of suffering from hemorrhoids. Atheists could demand equal time to answer to many religious broadcasts on the air. A bright morning man could say "It's a beautiful day today," and the station could be deluged with hung-over listeners wanting to declare it's a lousy day. Or there's the chance of an hour a week documentary from San Quentin extolling the virtues of crime. As one can see, the possibilities are endless.

WMCA-New York pedaled into summer on June 21 by launching its newest on-the-air promotion, the "Good Guy Bike Race." At least two listeners a day win English racing bicycles. Throughout each broadcast day, the Good Guys are requesting listeners to send postcards to WMCA, listing their names, addresses, preference for a girl's or boy's bike, and desired bike size. The actual "races" began June 25. Five postcards are drawn for each race. The listeners' names and assigned post positions are announced. Then the race is run on the air with each winner receiving the bike of his or her choice. Losers receive a Good Guy Sweatshirt.

Help, help! Robert P. Sutton, general manager of KNX-Hollywood, plans to have the outlet do just that for motorists in distress. Presently KNX is arranging for jet-powered helicopters, called "KNX Help O'Copeters," to provide up-to-the-minute traffic alerts and to act as spotters for cars in trouble. KNX and Gulf Oil Stations will distribute huge signs with the word "HELP" lettered on them, which drivers may easily attach to the roof of their cars when they need assistance. In this way the "Help O'Copeter" pilots can locate cars in trouble and radio the necessary information to one of several "KNX Helpmobiles." These completely equipped service trucks will then speed to the location and help the troubled driver free of charge.

Is the garden you cultivate cursed with weeds? Do mushrooms flower where roses should bloom? Take heart, for KSFO-San Francisco has taken steps to make your weed garden the envy of the neighborhood. You're too late, as this issue goes to press, to qualify for this year's grand sweepstakes award, but hang on till next year. For KSFO, as part of its Second Annual Weed Contest on July 1, awarded prizes to lucky weed breeders for the biggest, ugliest, most artistic weeds. Garden expert Carter B. Smith offered the prizes in his Second Annual Coincidental Horticultural Competition at the 22nd Annual Marin Art and Garden Fair in Ross. The grand sweepstakes award was a KSFO Instant Garden: 600 square feet of Instant Sod, six months' supply Ortho Fertilizer and Insecticide, Wiss grass shears; 33 growing rose bushes, 57 varieties selected flower and vegetable seeds, Ortho Rose and Flower Care Systematic Pellets, and four hours of garden work when the first grass is up, courtesy of KSFO's Carter B.

WSL-Chicago has kicked off its giant "Super Summer" promotional campaign by selecting Connie Mack, 17, of Park Ridge, Ill., as "WLS Personality Page Girl." Chosen from over 2,000 entries, Miss Mack will become the outlet's official hostess; greeting visitors, conducting tours, and assisting the deejay staff. She will receive a complete wardrobe as a prize and will be paid a weekly salary. Miss Mack will be at the station on North Michigan Avenue in Chicago, every weekday afternoon when WLS is open to visitors. According to WLS program director Clark Weber, Miss Mack was selected from 15 finalists that appeared personally at the outlet on the basis of poise, personality, and neatness of appearance. A junior at Maine South High School, Miss Mack is active in the class council, Pep Club, the Girl's Club, and is a member of the Student Council.



BARRY GRAY AIRS FOUR ACES ON WMCA: Barry Gray (l.) is shown with four bright lights of the music industry after a discussion of pop music on the Barry Gray Show on WMCA-New York. They are (l. to r.): Sammy Cahn, James Van Heusen (seated with a copy of Cash Box), Charles Koppelman and Don Rubin. Oscar-winning song team Cahn and Van Heusen are currently represented with "Thoroughly Modern Millie." Red-hot producers Koppelman and Rubin are number 2 on the charts with "She'd Rather Be With Me," by the Turtles.

SPUTTERS — Klavan and Finch, WNEW-New York's morning team were honored for the fifth consecutive year at Monmouth Park Race Track on June 22. In their honor, the seventh race that day was named the Klavan and Finch Handicap. WMCA-New York Good Guy "Dandy Dan" Daniel served as master of ceremonies at the first concert of the 1967 Forest Hills Music Festival, featuring the Lovin' Spoonful and Judy Collins, at the Forest Hill Tennis Stadium on June 24.

VITAL STATISTICS—Frank Maruca, program director of WKNR and WKNR-FM-Dearborn, Detroit, has been promoted to the position of operations manager of the outlets. In the move, Paul Cannon was named program director for the stations. . . . Erwin Frankel, formerly "international" deejay for WABC-FM-New York, moves to WRFM-New York. . . . WBEE-Harvey, Ill. has added the Marty Faye Show for jazz followers, 7 to 9 A.M. Mondays through Saturdays. . . . Don Thomas, previously morning man at KFMB-San Diego has joined the staff of KDEO-San Diego in the same capacity. . . . Terrell L. Metheny, Jr., has been named a vice-president (programming) of Mid-America Broadcasting Corp., licensee of WKLO-Louisville. . . . Mike Shaw, former music man at WTOD-Toledo, now with brand new WVMO-Monroe, Mich., needs record service—rock or good music. Mailing address is: Mike Shaw, c/o WVMO Radio, P.O. Box 701, Monroe, Michigan 48161. . . . Tony Taylor, veteran air personality at WQXI-Atlanta, has been appointed operations manager of the outlet.

BIOS FOR DEEJAYS

American Breed



The American Breed, who made lots of noise with their debut single, "I Don't Think You Know Me," are currently represented on the charts with "Step Out Of Your Mind," which is number 36 this week. The group consists of Gary Liuzzo, Chuck Colbert, Alan Ciner, and Lee Anthony Graziano. Prior to their signing and recording for Acta Records, the boys had been spreading their message in the Chicago area—especially at dance dates. Since the demand for the American Breed grew rapidly it became necessary for the quartet to buy a bus to fulfill their many engagements. In 1967, after indie producer Bill Traut signed the group for a recording session, Kenny Myers, general manager for Acta was stuck in Chicago during a blizzard. Traut heard about this and cornered the captured Myers and played "I Don't Think You Know Me" for him. The American Breed was signed immediately and their first release kicked off the new label, which is a division of Dot Records. It looks like The American Breed is set to breed many a future hit.

Arrows



The Arrows, Tower Records recording artists, are comprised of Davie Allan, fuzz tone guitar; Drew, bass; Don Manning, drums, and Tony Allwine, rhythm guitar. The Arrows first gained public recognition via their popular recording of "Apache '65" a few years ago. The quartet is currently riding the charts with "Blue's Theme," which is number 76 this week. The Arrows performed most of the music in the American International Picture "The Wild Angels," which was scored by their producer Mike Curb. They also played on the sound track of Roger Corman's "Devil's Angels." That original soundtrack was recently released. The Arrows, who have been performing numerous concert dates throughout the country, performed on the sound track of American International Pictures' "Thunder Alley." They will be seen in the Omega production of Albert Peckinpaw's "Revenge," which may be released on Tower Records. The Arrows would seem to have been struck by movie magic.

2 NEW LP RELEASES

RECORDS GALORE

HE RADIANTS • DAVE 'BUBBY' CORTEZ • GUITAR GABLE • KELLY BROTHERS • TONY CLARK • WALLACE BROTHERS • THE CARTER BROTHERS • KNIGHT BROTHERS • LOWELL FULSON • ER KING • ROBBY POWELL • SEEN QUEENS • SLIM HARPO • BO DIDDLEY • THE GLADIATORS



A-BET 401



EXCELLO 8006

3 GREAT SINGLES

YOU PUT YOUR TOUCH ON ME

THE KELLY BROTHERS

EXCELLO 2286

THE PARTY

b/w

TURN ON YOUR LOVE LIGHT

BUTCH DAVIS &
THE CAPRIS

A-BET 9422

TIP ON IN

(PARTS 1 & 2)

SLIM HARPO

EXCELLO 2285

NASHBORO RECORDS 1011 WOODLAND ST.

Nashville, Tenn. 615-227-5081

The Hit Track

The Third Rail

'Run, Run, Run'

5-10191



© "EPIC", Marca Reg. T.M. PRINTED IN U.S.A.

POP PICKS



FLOWERS—Rolling Stones—London LL 3509/PS 509

Here come the Rolling Stones, riding the crest of the flower craze with an album titled, simply, "Flowers," which represents the flower of the Stones' hits. These smashes include "Ruby Tuesday," "Have You Seen Your Mother, Baby, Standing In The Shadow?" "Mother's Little Helper," and nine others. The set is certain to zoom up the charts posthaste.



INSIGHT OUT—Association—Warner Bros. W/WS 1696

The Association follows up its number 1 chart single, "Windy," with an album which includes, besides that tune, "Wasn't It A Bit Like Now (Parallel '23)," "When Love Comes To Me," "Never My Love," and "Requiem For The Masses." The group's hit sound is evident throughout the LP, and the set should soon begin climbing the charts.

The Hollyridge Strings Play The Beach Boys Song Book—Vol. 2

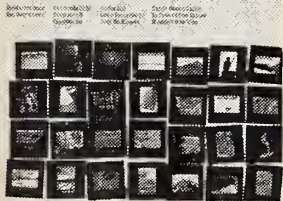

THE BEACH BOYS SONG BOOK—VOL. 2—Hollyridge Strings—Capitol T/ST 2749

The Hollyridge Strings play eleven songs which comprise the second volume of "The Beach Boys Song Book." The selections include "Good Vibrations," "California Girls," "Help Me, Rhonda," and "Wouldn't It Be Nice," chart-surfers all. The Hollyridge Strings interpret these tunes in a beguilingly lush way, and the LP figures to rack up impressive sales figures.



RHAPSODIES FOR YOUNG LOVERS/VOL. 2—Midnight String Quartet—Viva V 6008/V 36008

The Midnight String Quartet renders an album of pop songs. Included on the disk are "Born Free," "I Hear A Symphony," "Portrait Of My Love," and "My Cup Runneth Over." The Midnight String Quartet interprets the songs with classical instrumentation. The set should find fast favor with the good music, middle-of-the-road trade.



WE CAN FLY! UP-UP AND AWAY—Johnny Mann Singers—Liberty LRP 3523/LST 7523

The Johnny Mann Singers sing a tasty package of tunes which further complement the refreshing mood of their current noisemaker, "Up-Up And Away." Other ditties featured on the LP are "Portrait Of My Love," "Yellow Balloon," and "This Is My Song." The arrangements and the balance of the voices are superb. This one should be a chart contender in short order.



LIVE—Magnificent Men—Capitol T/ST 2775

The Magnificent Men are recorded in a live performance of a set of R&B-slanted ditties. Among the offerings are "I'm Gonna Miss You," "Doin' The Philly Dog," "You Don't Know Like I Know," and "Function At The Junction." The group socks out its material in energetic style, and the album should send many listeners to their record shops.



THE MUGWUMPS—Warner Bros. W/WS 1697

In 1964 the Mugwumps cut this album of nine songs. Today its members are integral parts of other acts. Cass Elliot and Denny Doherty are with the Mamas & the Papas; Zal Yanovsky was, until recently, with the Lovin' Spoonful; and Jim Hendricks is involved with the Lamp of Childhood. The songs, among them "Searchin'," "Here It Is Another Day," and "So Fine," should push the LP up the sales ladder.



TEST PATTERNS—Tommy Boyce & Bobby Hart—A&M SP 4126

Tommy Boyce and Bobby Hart perform a package of pop outings. Among the numbers are "I Should Be Going Home," "My Little Chickadee," "Sometimes She's A Little Girl," and "Girl, I'm Out To Get You." The duo rocks brightly along throughout the album, and the disk should stir plenty of consumer reaction.



ON THE SOUTH SIDE OF CHICAGO—Vic Damone—RCA Victor LPM/LSP 3765

Vic Damone chants a collection of pop tunes, including music from the Broadway stage. Among the melodies are the title track, "On The South Side Of Chicago," "I'll Sleep Tonight," "It Makes No Difference," and "Stay." The artist's clarity and precision of phrasing are always present, along with a rich, versatile baritone. The LP should be a big hit with the chanter's fans.



LONELY HARPSICORD ON A RAINY NIGHT—Jonathan Knight—Viva V 6006/V 36006

Jonathan Knight plays the harpsichord in a group of songs chosen for a mood of romance and subtle excitement. The sounds of a storm woven into the music further enhance this mood. Included on the disk are "Misty," "Dreams Of Yesterday," "What Now My Love," and "I Left My Heart In San Francisco." The LP should move well in good music circles, and should catch the fancy of mood music devotees.

POP BEST BETS



ONE NATION UNDERGROUND—Pearls Before Swine—ESP ESP 1054

Pearls Before Swine, an underground rock group, perform a package of poetic pop songs. The outings include "Another Time," "Ballad To An Amber Lady," "Morning Song," and "The Surrealist Waltz." The poetry of the soft, listenable tunes is a put-down of present day mores and anxiety-ridden living conditions. The disk should carry the group's message to a wide audience.

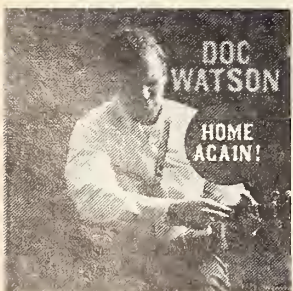

HOME AGAIN!—Doc Watson—Vanguard—VRS 9239/VSD 79239

Folk music fans will want to save a special spot on their shelves for this powerhouse LP by the great singer-guitarist, Doc Watson. Assisted by Merle Watson (2nd guitar) and Russ Savakus (string bass), Doc offers "Down In The Valley To Pray," "The Old Man Below," "Froggie Went A-Courtin'," "Rain Crow Bill," and ten others. Should sell well.

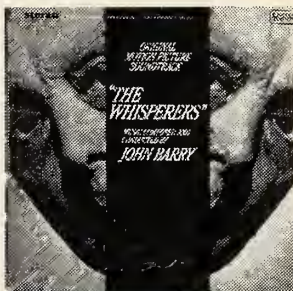

THE WHISPERERS—Original Soundtrack—United Artists UAL 4161/UAS 5161

An album which is the original soundtrack of the motion picture, "The Whisperers," starring Dame Edith Evans and Eric Portman. The disk includes the main title, "Nobody And Nothing Jazz," "We Danced Home Again," and "You're On Your Own Again." The music is evocative and mysterious and should be a hit with movie music buffs.

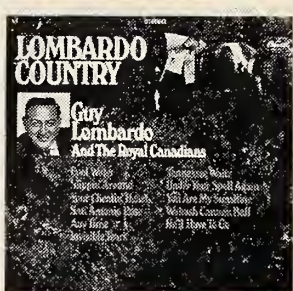

LOMBARDO COUNTRY—Guy Lombardo & Royal Canadians—Capitol T/ST 2777

Guy Lombardo and the Royal Canadians turn their mellow musical musings toward the country; Country & Western, to be exact. "The sweetest music this side of heaven" includes, on this LP, "Any Time," "Your Cheatin' Heart," "You Are My Sunshine," and "San Antonio Rose." Sure to be a favorite with Lombardo's followers, the set should also satisfy good music tastes in general.

The Excitement
of **Love** is on Tamla

MARVIN
GAYE

YOUR UNCHANGING LOVE

TAMLA 54153

SMOKEY ROBINSON
& THE MIRACLES

MORE LOVE

TAMLA 54142

POP BEST BETS

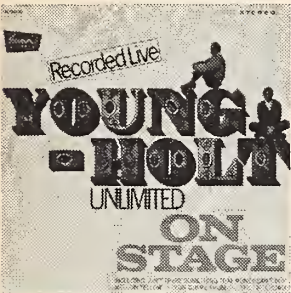

ON STAGE—Young-Holt Unlimited—Brunswick BL 54125/BL 754125

Young-Holt Unlimited is recorded live on stage at the Bohemian Cavern in Washington, D.C. Included on the set are "Mellow Yellow," the group's recent chart single, "Wack Wack," "Ain't There Something That Money Can't Buy," and "Lady Godiva." Young-Holt Unlimited's infectious, swinging music should insure the success of the album.



ENCORE—Jamie & J. Silvia Singers—ABC ABC/ABCS 592

Here's a album for people who like words with their music. Jamie and the J. Silvia Singers render a passel of pop tunes with flair and zest. The tunes include "Hold On Tight," "I've Grown Accustomed To Her Face," "You've Got Your Troubles," and "What Now My Love." The set should create lots of excitement in the marketplace.



RECORDS GALORE—Various Artists—A-Bet LP 401

An album of all time great sellers from Ernie's Record Mart in Nashville, Tennessee. The R&B tunes on this soul-packed set include "You Can't Judge A Book (By Looking At The Cover)," by Bo Diddley; "Little Darlin'," by the Gladiolas; "Baby, Scratch My Back," by Slim Harpo; and "Sweet Sixteen," by B. B. King. The package should prove a fast-moving sales item



SOMETHING BLUE — Lightnin' Hopkins — Verve/Forecast FT/FTS 3013

Lightnin' Hopkins sings nine blues tunes. The songs include "Shaggy Dad," "Shake It Baby," "Goin' Back Home," and "Talk Of The Town." Hopkins displays a resonance in his tones, a flashing, urgent phrasing in his speech, and a brilliance in his guitar. The artist's great talents represent the best of the blues. The LP should be a strong seller.



SUBURBAN ATTITUDES IN COUNTRY VERSE—John D. Loudermilk—RCA Victor LPM/LSP 3807

John D. Loudermilk sings a selection of folksy tunes concerning life in the country that the singer-composer knows so well. Included on the set are "Then You Can Tell Me Goodbye," "The Wind Knows The Truth," "You're Taking My Bag," and "Do You." The album should sell well with the artist's followers.



THE JAMES COTTON BLUES BAND—Verve/Forecast FT/FTS 3023

The James Cotton Blues Band performs a set of blues ditties. Among the tunes are "Good Time Charlie," "Don't Start Me Talkin'," "Knock On Wood," and "Blues In My Sleep." James Cotton plays the harp and sings with swinging vitality. The album should rivet the attention of blues fanciers everywhere.



HAWAIIAN MAGIC—Ken Griffin—Columbia CL 1062/CS 9444

Organist Ken Griffin plays the easy, dreamy ballads most often associated with Hawaii. The melodies include "Song Of The Islands," "A Song Of Old Hawaii," "Golden Sands And Silvery Sea," and "Red Sails In The Sunset." Griffin performs these lovely, charming tunes in expressive fashion, and the album should please listeners who enjoy atmospheric music.

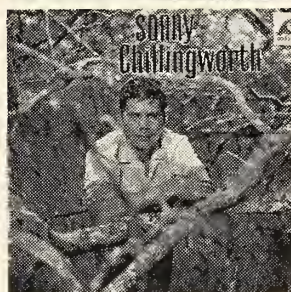

SONNY CHILLINGWORTH—Makaha M 2014

Sonny Chillingworth sings a selection of Hawaiian ditties. Included on the set are "Portuguese Washer Woman," "Aloha Ia O Wai 'Ana'e," "Nanakuli Blues," and "Planting Rice Song." The artist displays a warm, winning tone as he performs these summertime sounds, and the disk should go over big with those who dig Hawaiian music.

JAZZ PICKS



GREEK COOKING—Phil Woods—Impulse A/AS 9143

Saxist Phil Woods lays down a set of groovy jazz sessions, with Iordanis Tsomidis featured on buzukie. The numbers include the title tune, "Greek Cooking," "Zorba The Greek," "A Taste Of Honey," and "Theme From Samson & Delilah." Woods, Tsomidis and the other Greek musicians on the date all indeed cook. The LP should be a mover in jazz circles.

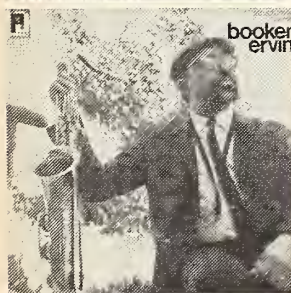

STRUCTURALLY SOUND — Booker Ervin — Pacific Jazz PJ 10119/ST 20119

Tenor saxist Booker Ervin plays eight exciting jazz sessions. He is supported by Charles Tolliver, trumpet; John Hicks, piano; Lenny McBrownie, drums; and "Red" Mitchell, bass. The warm, beautiful tracks include "Berkshire Blues," "Stolen Moments," "Boo's Blues," and "Take The 'A' Train." The set should get lots of spins from jazz enthusiasts.



PENNY LANE & TIME—Kai Winding—Verve V/V 6-8691

Trombonist Kai Winding is featured on an album of eleven jazz sessions. The instrumentation on the disk consists of four bass flutes, guitar, bass, and trombones. The set includes the two title tracks, "Penny Lane" and "Time," as well as "Eleanor Rigby" and "A Time For Love." The "new" music offered here should score successful sales with both jazz and pop aficionados.



I'LL REMEMBER APRIL—Roger Ram Trio—RCA Victor LPM/LSP 3740

The Roger Ram Trio, comprised of Roger Ram, piano, George Duvivier, bass, and Ed Shaughnessy, drums, cook up a feast of jazz dishes, calculated to please the most discriminating taste. The offerings include the title track, "I'll Remember April," "Tender Frame," "Any Wednesday," and "A Smooth One." Should be sales aplenty for this package.

CLASSICAL PICKS



VIVALDI: 'LA CETRA': TWELVE CONCERTI OPUS 9—I Musici—Philips PHM 3-595/PHS 3-993

A three-record set which features I Musici, a twelve-member chamber orchestra, performing Antonio Vivaldi's "La Cetra Opus 9," a group of concertos for violin, strings, and continuo (organ). I Musici, playing without a conductor, exhibits brilliant style, musicianship, and technique. This package should be a delight for classical music lovers.

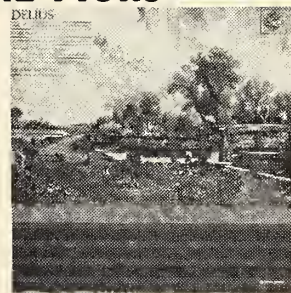

MUSIC OF DELIUS—Sir John Barbirolli/Halle Orchestra—Vanguard SRV 240 (SD)

A recording which contains music drawn from four of the six operas written by Delius. They are "Idyll: 'I Once Passed Through A Populous City,'" "Prelude To 'Irmelin,'" "Intermezzo" from "Fennimore And Gerda"; and "The Walk To Paradise Garden" from "A Village Romeo And Juliet." Sir John Barbirolli conducts the Halle Orchestra in a magnificent performance of the pieces. The LP should be popular with classical music fans.

**THE
LONELY
DRIFTER**

STORMED OUT OF THE SOUTH AND IS TAKING THE NATION

**PIECES
OF
EIGHT
854**



Crystal Appointed To UA Promo, Sales Post

NEW YORK—The appointment of Danny Crystal to the position of national coordinator of promotion and sales for United Artists Records has been announced by Mike Lipton, vice president in charge of marketing for the label.

In his new post, Crystal will be working closely with both the sales and promotion staffs of United Artists in the exploitation of specific album and single product and artists.



Danny Crystal is a youthful veteran of two decades in the entertainment industry. He began as a performer, but in recent years has been associated with such acts as Liberace, Le Poupee de Paris, Pat Boone, and Jackie Vernon. For Boone and Vernon, he served as road manager and musical coordinator.

Crystal begins work at UA at once and will headquarter at the organization's New York offices. He will report directly to Mike Lipton.

Koufax Hurls For Stereo 8

NEW YORK—The RCA Victor Record Division has announced that RCA Stereo 8 will co-sponsor the "Sandy Koufax Show" on "Monitor" for thirty-nine weeks beginning July 1, on the NBC Radio network. There are three five-minute shows per week, airing Saturday and Sunday, on which Koufax editorializes and interviews personalities on major sporting events of the period.

In announcing RCA Stereo 8 co-sponsorship of the show, a spokesman noted: "This is the first time we have employed network radio to advertise RCA Stereo 8 to the consumer, and we anticipate excellent results due both to the medium and the popularity of Sandy Koufax. Aimed at a prime audience of male prospects during the peak radio-listening season, this show will reach a total of over 8 million listeners per week."

Sandy Koufax, one of the most illustrious pitchers of all time, retired from baseball at the age of 31. In 1966, his last season, he pitched the Dodgers to their third National League pennant in four years. Now Koufax will be doing his pitching for RCA Stereo 8 cartridge tapes.

Kobrin Named Partner In Mike Merrick Co.

NEW YORK—Barry Kobrin, a vice president of the Mike Merrick Company, Inc., a public relations firm with offices in New York and Los Angeles, has been named a partner in the company, it has been announced by Mike Merrick, president.

Kobrin has been with the Merrick Company for three years and was named a vice president of the company in February of 1966. Prior to joining the firm he was on the staff of the late World Telegram and Sun and a senior executive for the public relation firms of Don Simmons and Associates and the John Roney Company.

The Mike Merrick Company was established in 1958 and some of its clients include Armstrong Circle Theater, Harry Belafonte, Robert Goulet, Alan King, Alan Jay Lerner, Steve Lawrence and Eydie Gorme, and several TV weekly series including "Dundee and The Culhane," "CBS Golf Classic" and "Dark Shadows."

ABC Buys Consolidated

(Continued from page 7)

1946. Initial lines were Mercury, Pan American, Exclusive and Excelsior. There was a total of four employees, including themselves, and a volume of approximately \$4,000 per month.

In 1950, Stan Jaffe joined the company as a full partner. In 1959, they formed Stanley Distributors to handle the numerous labels that were coming into existence and, for the same reason, formed Music Distributors a year later.

In 1961, Lavinthal, Sulman and Jaffe, in conjunction with Herb Rosen and Al Feuerberg of Allenherb Company, bought Gordon Sales Co., one of the most active record rack jobbers in the Northwest. At that time, Allenherb Company was a wholesaler of toys and luggage and had retail concessions in three large discount houses. Because of their allied interest in Gordon Sales Company, the principals decided to merge the various operations of Allenherb, Gordon Sales Company and the wholesale record companies, into one company called Consolidated Distributors, Inc. in February of 1964.

In 1966, they took on the Admiral line of radio, TV and appliance for the States of Washington and Alaska.

The company now employs approximately 250 people. It is completely computerized, both for sales analysis and all accounting procedures. It has its own complete print shop, plus a cabinet shop that builds all its fixture needs in addition to making record and tape fixtures for other accounts.

Among the 250 employees, 28 are salesmen and the record division has four full-time promotion men.

Stan Jaffe, at present, is the president of NARM and has been active in this organization for the past seven years.



TOP 50 IN R&B LOCATIONS

1	FOR YOUR PRECIOUS LOVE Oscar Toney, Jr. (Bell 672)	2	26	LET YOURSELF GO James Brown (King 6100)	25
2	RESPECT Aretha Franklin (Atlantic 2403)	1	27	YOUR UNCHANGING LOVE Marvin Gaye (Tamla 54153)	30
3	I WAS MADE TO LOVE YOU Stevie Wonder (Tamla 54151)	6	28	FOUR WALLS J. J. Jackson (Calla 133)	31
4	MAKE ME YOURS Betty Swann (Money 126)	5	29	SOUL DANCE NO. 3 Wilson Pickett (Atlantic 2412)	34
5	SOUL FINGER Bar-Kays (Volt 148)	7	30	HEY LITTLE GIRL Norm West (MOC 664)	32
6	ALFIE Dionne Warwick (Scepter 12187)	4	31	SHOW BUSINESS Lou Rawls (Capitol 5941)	38
7	AIN'T NO MOUNTAIN HIGH ENOUGH Marvin Gaye & Tammi Terrell (Tamla 54149)	9	32	NEARER TO YOU Betty Harris (Sansu 466)	42
8	HERE WE GO AGAIN Ray Charles (ABC Paramount 10938)	10	33	FUNKY BROADWAY Dyke & Blazers (Original Sound 64)	35
9	ALL I NEED Temptations (Gordy 7061)	3	34	LOSIN' BOY Eddie Giles (Murco 1031)	39
10	HYPNOTIZE Linda Jones (Loma 2070)	11	35	I LOVE YOU PORGY James Brown (Bethlehem 3089)	33
11	7 ROOMS OF GLOOM Four Tops (Motown 1110)	8	36	PEARL TIME Andre Williams (Sport 4105)	43
12	THE TRAMP Otis Redding & Carla Thomas (Stax 216)	14	37	DEEP IN THE HEART OF HARLEM Walter Jackson (Okeh 7285)	40
13	TESTIFY Parliaments (Revilot 207)	15	38	I'LL DO IT FOR YOU Toussaint McCall (Ronn 9)	45
14	MORE LOVE Miracles (Tamla 54152)	16	39	SWEETEST THING THIS SIDE OF HEAVEN Chris Bartley (Vando 101)	47
15	EIGHT MEN & FOUR WOMEN O. V. Wright (Back Beat 580)	13	40	THREAD THE NEEDLE Clarence Carter (Fame 1013)	—
16	FOR YOUR LOVE Peaches & Herb (Date 1563)	18	41	UNTIL YOU WERE GONE Aretha Franklin (Columbia 44181)	—
17	GROOVIN' Young Rascals (Atlantic 2401)	12	42	TAKE ME (JUST AS I AM) Solomon Burke (Atlantic 2416)	44
18	SHAKE, RATTLE & ROLL Arthur Conley (Atco 6494)	19	43	WHITER SHADE OF PALE Procol Harum (Deram 7507)	—
19	TOGETHER Intruders (Gamble 205)	17	44	THE TRAIN Big John Hamilton (Minaret 124)	48
20	YOU GAVE ME SOMETHIN' Fantastic 4 (Ric Tic 128)	20	45	FOR SENTIMENTAL REASONS Willie Hightower (Capitol 5916)	—
21	I STAND ACCUSED Inez & Charlie Foxx (Dynamo 104)	22	46	TIP ON IN Slim Harpo (Excella 2285)	46
22	WHO'S LOVING YOU Brenda & Tabulations (Dionn 501)	23	47	SOOTHE ME Sam & Dave (Stax 218)	49
23	COME ON SOCK IT TO ME Syl Johnson (Twilight 100)	26	48	HIP-HUG-HER Booker T & The MG's (Stax 411)	21
24	I'LL ALWAYS HAVE FAITH IN YOU Carla Thomas (Stax 222)	28	49	TO BE A LOVER Gene Chandler (Checker 1165)	24
25	BABY PLEASE COME BACK HOME J. J. Barnes (Groovesville 1006)	27	50	OOH BABY BABY 5 Steps (Windy C 609)	29

IF YOU DON'T CARE
WHAT YOUR RECORDS
LOOK LIKE OR SOUND LIKE
THEN DON'T PRESS AT
BESTWAY PRODUCTS

... BECAUSE WE BELIEVE IN QUALITY.
HOWEVER IF YOU DO CARE ... CONTACT:

JERRY MASSLER

BESTWAY PRODUCTS, GLOBE AVE., MOUNTAINSIDE, N.J.
N.Y. Phone: 212 DI-9-3668 N.J. Phone: 201 AD-2-8383

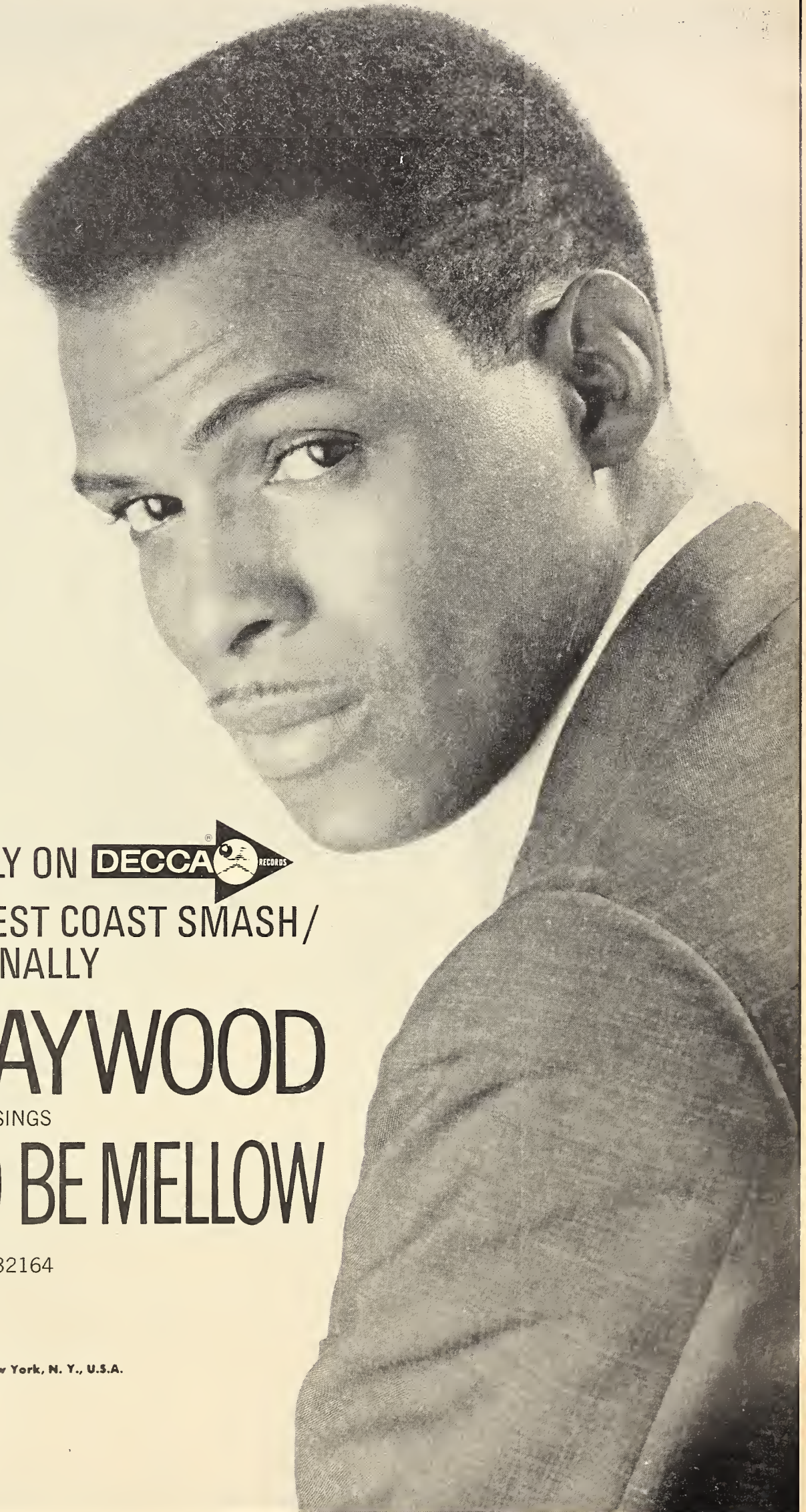

NOW EXCLUSIVELY ON **DECCA** 
THE ORIGINAL WEST COAST SMASH/
BREAKING NATIONALLY

LEON HAYWOOD

SINGS

IT'S GOT TO BE MELLOW

32164

DECCA RECORDS, A Division of MCA Inc., New York, N. Y., U.S.A.

Father O'Conner Elected President Of NY NARAS

NEW YORK—The New York Chapter of The National Academy of Recording Arts and Sciences (NARAS) last week announced the election of a new president, Father Norman J. O'Conner. Priest, author, musicologist, jazz expert, liner note writer, and master of ceremonies of the WCBS-TV "Dial 'M' for Music" show and his own radio program on WRVR, O'Conner was unanimously elected to the top spot by the new board of the New York governors at its first meeting on June 27th.

Selected to serve as officers with O'Conner were David Hall, 1st vice-president; Milt Okun, 2nd vice-president; Brad McCuen, secretary, and Billy Taylor, who was re-elected treasurer.

Indicating that he, like so many others in the field, "looked upon the recording industry with both pride and respect," O'Conner emphasized that he hopes to help the New York chapter in particular, and the Academy in general, in their continuous aim to bring greater recognition to the industry's artistic achievements. "We are still growing," he noted in his acceptance speech, "and that means we may still expect to experience growing pains as well as numerous ups and downs. But I feel that with the cooperation of our new board here—and I happen to think it's a great one that covers the entire field of recording—we should have some truly exciting activity."

Stressing the need for greater awareness of what the Academy can offer prospective members, O'Conner immediately appointed a new membership committee with Phil Ramone and John Simon as co-chairmen, and Marian McPartland and Joe Newman as members. Reflecting the feelings of the majority members of the board, O'Conner suggested to the new committee that it make a special effort to enroll "those who are making today's sounds. Up until now we have reached too few of these very productive people; they represent a vital part of our industry and as such they should have a vital voice in our affairs."

The initial meeting of the new NY board also saw the formation of a new activities committee, headed by

ASCAP Fetes Rodgers On 65th Birthday

NEW YORK — Thirty-nine stage scores, 1 play, 9 film scores, 3 TV scores and one ballet score later, Richard Rodgers was given a Happy 65th Birthday party on the stage of the Alvin Theatre in New York last week (28).

Since ASCAP was the host of the affair, time can also be measured in Rodgers' creative output, nearing the 50 year mark on a professional basis. More than 90 people attend the private box luncheon, including many stars of Rodgers' shows and New York Mayor John Lindsay. In his tribute to Rodgers, Stanley Adams, president of ASCAP, said that "in ASCAP, the 3 R's are not reading, 'riting and 'rithmetic—but Rodgers! Rodgers! Rodgers!"

Adams presented to Rodgers a piece of Steuben glass in the shape of a star, symbolic of the star stolen by Billy Bigelow in Rodgers & Hammerstein's "Carousel." The inscription read: "We stole a star, June 28, 1902, ASCAP."

Ever active, Rodgers is currently writing a new Broadway musical and a musical adaptation of "Androcles & the Lion" for television.

veteran record man Milt Gabler, with Ernie Altschuler, Will Holt and Norman Luboff selected to serve. In addition, Brad McCuen was selected to form and head a new publicity and publications committee, and David Hall was encouraged to proceed full-steam-ahead with his categories committee, which has been studying possible revisions of the new Grammy Awards set-up, and which, later during the summer, will make its final recommendation to the full board.

Why the sudden surge of committees? "I believe that by assigning specific tasks to specific committees, which can meet at their own convenience, we will be able to cover a great deal more ground and, I hope, to contribute more effectively to the Academy," opined the newly-elected chapter president.

David-Eden Moves To Larger Headquarters

NEW YORK—Ronnie Eden and Jon David, who recently formed a music business complex under the banner of David-Eden Associates, have announced the shifting of their offices to larger quarters. The new headquarters will be located in a five-story town house at 46 W. 94 St. in New York.

The two will concentrate their efforts on building a new talent roster for their indie production firm, Boutique Records, and have thus far signed the Boy Watchers, Pat Casino, Lee Darnell, the Moving Violations, who have just completed a stint at Harlow's, and the Ground Floor People, whose "Treat Me Better" is reportedly set for release on Mercury.

The firm has also expanded its staff with the addition of Glenn Elfman, who joined the operation to head the promotion-public relations segment for the firm's new artists.

In addition to the music operations, David-Eden Associates has its own modeling agency, Covermate, which has thus far been responsible for over 20 record album covers.

Luttman Success In First Six Months

NEW YORK—Ken Luttman sports the promo representation of 16 Top 100 sides over his first six months in business as Ken Luttman Enterprises. He represents such acts as the Turtles, Easybeats, Freddy Scott, the Doors, Jeff Beck, Dee Warwick and the Vanilla Fudge. He covers radio stations, one-stops in the Philly, New York, Hartford and Boston areas.

UA In Promo Campaign For 'King Of Hearts'

NEW YORK—Hard on the heels of the rave reviews garnered by Philippe De Broca's film production of "King Of Hearts," United Artists Records has opened a national promotional campaign on the original soundtrack album which the label has recently released. The promo push centers on the enthusiastic reception to the movie in New York and the fact that key national playdates will soon follow the Gotham premiere.

"King Of Hearts" was directed by Philippe De Broca and distributed by Lopert Pictures Corporation. Music was composed and conducted by Georges Delerue who composed the score the "Viva Maria," the Brigitte Bardot-Jeanne Moreau starrer of about a year ago. The international cast is headed by Alan Bates who appeared in "Zorba The Greek."



AT THE SIGNING—Vicentico Valdez (center) is flanked by Mike Lip-ton (left,) UA's vice president in charge of marketing, and Lloyd Leipzig, the label's director of creative services. Widely known as a Latin-American vocalist, Valdez has been signed to an exclusive, long-term contract by United Artists.

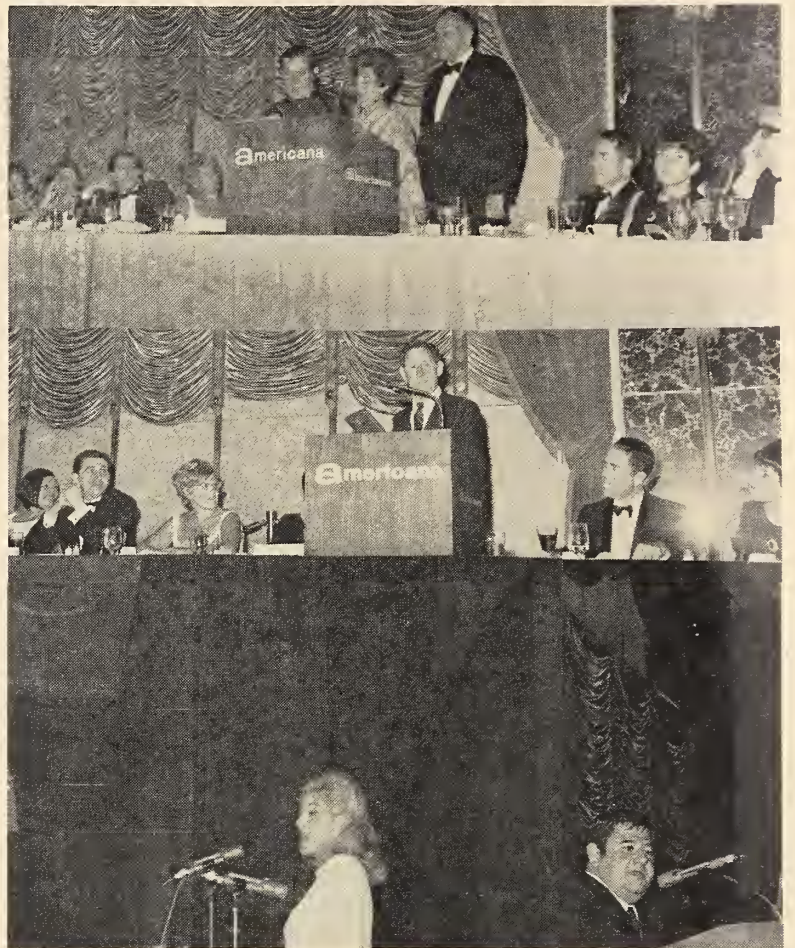

B'NAI B'RITH BLOWOUT—The Music and Performing Arts Lodge of B'nai B'rith held its third annual dinner dance June 11th, at the Americana Hotel in New York. In the top photo, Al Berman and Cy Leslie are shown receiving the Israel Bond award from Rita Chipkin on behalf of the Metropolitan Council of B'nai B'rith. In the center view, we see Jack Gilford, co-star of the "Cabaret" mainstemmer, accepting the 1967 Creative Achievement Award on behalf of Fred Ebb and John Kander, writers of the show (from the left, they are: Mrs. Ted Shapiro; Ted Shapiro, vice president of the lodge; Mrs. Al Berman; Gilford; Floyd Glinert, vice president/dinner chairman; and Mrs. Glinert. The bottom photo shows both Margaret Whiting and Buddy Hackett as they entertain the guests.

UPCOMING EVENTS

A Schedule of Major Industry Events in the Coming Months

EVENT	DATE	PLACE
NARA (DEEJAY) CONVENTION	AUG. 9-13	REGENCY HYATT HOTEL, ATLANTA, GA.
NARM MID-YEAR MEET	SEPT. 5-8	HOST FARM, LANCASTER, PA.
COUNTRY MUSIC WEEK	OCT. 19-21	NASHVILLE, TENN.
MIDEM	JAN. 29-FEB. 3, 1968	CANNES, FRANCE
NARM CONVENTION	MAR. 17-22, 1968	DIPLOMAT HOTEL, HOLLYWOOD, FLA.

LONG LEGGED GIRL ELVIS PRESLEY	RCA VICTOR Elvis Presley Music, Inc.
THAT'S SOMEONE YOU NEVER FORGET ELVIS PRESLEY	RCA VICTOR Elvis Presley Music, Inc.
WHEN I WAS YOUNG ERIC BURDON & ANIMALS	MGM Stamina Music, Inc.
A GIRL NAMED SANDOZ ERIC BURDON & ANIMALS	MGM Stamina Music, Inc.
THREE LITTLE FISHES MITCH RYDER & DETROIT WHEELS	NEW VOICE Anne-Rachel Music, Inc.
DAYLIGHT SAVIN' TIME KEITH	MERCURY Rumbalero Music, Inc. Act Three Music, Inc.
SHAKE, RATTLE AND ROLL ARTHUR CONLEY	ATCO Progressive Music, Inc.
HARRY RAG THE KINKS	REPRISE Noma Music Inc. Mondvies Music, Inc.
MR. PLEASANT THE KINKS	REPRISE Noma Music Inc. Mondvies Music, Inc.
SHE BELIEVES IN ME SAMMY DAVIS, JR.	REPRISE Noma Music Inc. Smooth Music, Inc.
LOVE ME TENDER PERCY SLEDGE	ATLANTIC Elvis Presley Music, Inc.
WHAT AM I LIVING FOR PERCY SLEDGE	ATLANTIC Progressive Music Pub. Co., Inc. Tideland Music Pub. Co.
UNTIL YOU WERE GONE ARETHA FRANKLIN	COLUMBIA Hit & Range Songs, Inc.
LEE CROSS ARETHA FRANKLIN	COLUMBIA Noma Music, Inc.
BABY IT'S YOU GARY AND THE HORNETS	SMASH Dofit Music, Inc. Mary Jane Pub. Co., Inc.
SEARCHIN' THE MUG WUMPS	W.B. TigerMusic, Inc.

THE ABERBACH GROUP
1619 Broadway, New York, N. Y.

Great Music.

The Greeks have a word for it:

LYRA

Lyra Records. An Olympic catalog of the best composers, musicians and singers recorded in Greece. On the record label most respected by Greeks throughout the world.



LYRA

Now exclusively distributed
in the United States
by MGM Records.



MGM Records is a division of Metro-Goldwyn-Mayer Inc.

**SOULA BIRBILI SINGS
THE GREAT HITS OF
MIKIS THEODORAKIS**



LYRA



LY/LYS-1001

**VIVA
ZAMBETAS**
The Bouzouki Hits
of Zambetas



LYRA

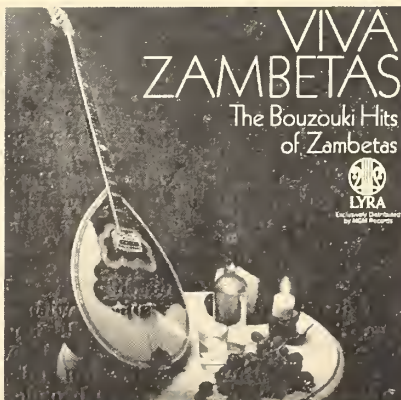

LY/LYS-1002

**Bouzouki
Instrumental
Hits**



LYRA



LY/LYS-1003

**Traditional
& Folk songs
& Dances
of Greece**



LYRA



LY/LYS-1004

Blue Note; A Sound 1st Yr. Under Liberty

NEW YORK—The Blue Note label's first year of operation as an acquisition of Liberty Records has been marked by an expansion in the promotion and distribution of product.

Bernie Block was brought in as sales manager, leaving Alfred Lion and Frank Wolf to concentrate on the A&R phase of the diskery, a function they have directed for the past 25 years.

The initial moves were in the distributor changes in markets which have Liberty branch distributors. During the label's July 1966 convention, an outline of a concentrated method for the distribution of Blue Note product in these markets was made. Part of this outline was preparing a background of data on the product that would best suit Blue Note distributors designed to give all involved a better working knowledge of the Blue Note catalog.

Product Successes

"Reaction to the product released in the past 12 month period was of a very positive nature, and this was very evident in sales and promotion of albums such as 'Search For A New Land' by Lee Morgan, 'Got A Good Thing Goin'' by John Patton, 'Bucket' by the Incredible Jimmy Smith, and 'Indestructible' by Art Blakey and the Jazz Messengers," says Block. The release of "Rough 'N Tumble" by Stanley Turrentine indicated to the label that some of its product falls into the R&B category. Sales at the R&B level have increased to a degree which Blue Note had not experienced with Turrentine in the past. Blue Note's initial

year under the Liberty management team has also seen the re-unification of The Three Sounds with the Blue Note label. In their first offering back at the label, "Vibrations," a new sound was born for this group. The combination of organ and piano proved successful.

Pearson To A&R

Block says that Blue Note's direction this year is to become "more expansive in our sound." In this regard, artist-writer Duke Pearson has just been hired on a full time A&R basis. "I feel certain that his ideas and compositions will be another great tool in the continued success of Blue Note."

Two innovations at the label in the past year, Block feels, also contributed to the company's growing sales pattern. These included the release of the label's first Little LP product, filling, Block explains, "a pipeline sorely needed, to the juke box operator," the creation of Blue Note Jazz Classics, and a compilation of the best-selling 45's. Last April saw the release of a "Gems of Jazz" Limited Edition album, which exposed such talents as Horace Silver, Miles Davis, Art Blakey, Clifford Brown, Tadd Dameron, Milt Jackson, Jay Jay Johnson, James Moody, Fats Navarro, Thelonious Monk and Bud Powell. Also, Horace Silver's "The Jody Grind," introduced the Blue Note line to the double-fold package concept.

Other strong artists at the label are Lee Morgan, Ornette Coleman and Duke Pearson.

Bell Adopts Hot Line Concept Between Distributors

NEW YORK—Now there's a Hot Line phone twist in the disk business. Bell Records has installed direct phone service between its office in New York and its distributor outlets around the country.

According to sales manager Irv

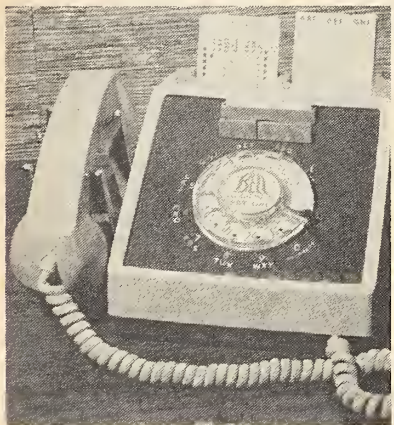

BELL'S TELEPHONE

Biegel, the installation of these phones has eliminated the lengthy wait for operators and gives Bell an instant pulse of today's market.

Installed in the Bell offices are two card dialer telephones, one on President Larry Uttal's desk and the other on Biegel's. The phones are the same shade of blue as the Bell label and the corresponding phones at the distributors are also blue. Each is equipped with a Bell logo—"Bell Records Hot Line."

To place a call from Bell's offices, all that has to be done is to insert special cards supplied by the phone company. The phones are placed strategically in each distributor's office and only pre-designated personnel can answer these calls. Biegel says "these phones give us immediate access to key personnel at the distributorship such as the sales manager and promotion man. So far we've only tried this in 12 markets but the results have been so favorable that we are now in the process of having them installed in every market in the country."

First releases, available in both 4 and 8 track cartridges, include: "The Dave Clark Five's Greatest Hits; 'Mellow Yellow.' 'Sunshine Superman', both by Donovan; 'The Monkees Songbook,' by the Golden Gate Strings; 'Glenn Miller Time—1965,' by the Glenn Miller Orchestra, directed by Ray McKinley and starring Bobby Hackett; 'A Taste Of Honey,' by the Village Stompers; and 'Bobby Vinton's Greatest Hits'.

New Ad Program

A new advertising program was also unveiled by Hoffman at the sales meets. In addition to ads in the trade press and major national consumer publications, a coordinated newspaper and radio spot campaign has been planned which is specifically geared to the teen-age market. Epic has also designed a variety of ad mats for local use, as well as a variety of in-store displays.

Cook To Scout For Epic

NEW YORK—Epic Records last week announced that Dick Cook will act as talent scout for the label's West Coast A&R division. Based in San Francisco, Cook will be responsible to David Kapralik, Epic's VP of A&R, for bringing fresh talent to the label.



NEW CHART ADDITIONS

NEW TOP 100 ALBUMS

- | | |
|--|---|
| 91—LISTEN
Ray Charles (ABC—ABC/ABC 595) | 122—DRY YOUR EYES
Brenda & Tabulations (Dionn LPM 2000) |
| 93—BELAFONTE ON CAMPUS
(RCA Victor—LPM/LPS 3779) | 125—A SPECIAL SOMETHING
Roy Charles Singers
(Command RS 914 SD) |
| 98—THE BEST OF JOHN GARY
(RCA Victor—LPM/LPS 3730) | 129—EMANCIPATION OF HUGH
MASEKELA
Chisa M 101/S-4-101) |
| 99—THE HAPPIEST MILLIONAIRE
Original Soundtrack (Vista BV 5001) | 131—FABULOUS IMPRESSIONS
(ABC—ABC/ABC-606) |
| 111—JEFFERSON AIRPLANE TAKES
OFF
(RCA Victor LPM/LPS 3584) | 134—FREAKOUT
Mothers of Invention (Verve V/VG-5005) |

NEW TO TOP 50 IN R&B

- | | |
|--|---|
| 40—THREAD THE NEEDLE
Clarence Carter (Fame 1013) | 43—WHITER SHADE OF PALE
Procol Harum (Deram 7507) |
| 41—UNTIL YOU WERE GONE
Aretha Franklin (Columbia 44181) | 45—FOR SENTIMENTAL REASONS
Willie Hightower (Capitol 5916) |

Jerry Ross Celebrates Successful Year at Merc.

NEW YORK—This week marks the first anniversary of Jerry Ross' association with Mercury Records. An association that has produced a more than substantial track record for the

In addition to compiling this enviable track record, Ross has established three new acts during the year: Keith, with "Ain't Gonna Lie," "98.6," "Tell Me To My Face," and "Daylight Saving Time"; Bobby Hebb, with "Sunny"; and Spanky & Our Gang, with "Sunday Will Never Be The Same." He also found success with "When Love Slips Away" and "I'm Gonna Make You Love Me" by Dee Dee Warwick as well as Jerry Butler's "I Dig You Baby."

Ross has three new albums in the offing, to come from Spanky & Our Gang, the Raves, and Keith. His current single efforts include: "Apples, Peaches, and Pumpkin Pie" by Jay and the Techniques; "Nobody Ever Loved Anybody The Way I Love You" by Jerry Butler; and "Theme From Caper Of The Golden Bulls" by Les McCann.

"When We Get Married" by the Dreamlovers established Ross as an indie producer. Prior to that he was a deejay at WFIL-Philadelphia and a promo man with the Cosnat distrib.



JERRY ROSS (left) & KEITH

producer, who has been frequently represented on the Top 100 for the past 52-weeks. This record includes a total of 12 charted decks, three of which were top 10 and one of which was number 1.



THIS IS THE FACTORY?—Johnny Tillotson (left) is shown with Tom Wilson, foreman of the "The Music Factory," just debuted June 24 over WABC-FM-New York. The show features MGM A & R exec Tom Wilson, who acts as a deejay and programs material highlighting today's popular sounds. The move represents the first Pop/Rock radio package ever produced by a record company in a major city. Hip and witty, Wilson is the producer of decks for such recording names as the Animals, the Mothers of Invention, the Velvet Underground & Nico, Simon & Garfunkel and Bob Dylan.

The behind-the-scenes, rock oriented deejay show spotlights MGM's own product, but 10-20% of the material will come from outside labels. The tight record format will be spiced with occasional, brief interviews, remotes from record studios around the world for between-the-take conversations with producers and artists and other such events. While recently out on the coast recording Eric Burdon & the Animals, Tom covered the Monterey Pop Festival taping interviews for future broadcast. The object of the show is to create a public airing in the most exciting manner possible of MGM, Verve, Verve/Forecast discs. DGG, Heliodor and the rest of the company's label's are also being used on the show.

Epic Sales Meets

(Continued from page 8)

Sir John Barbirolli, conductor.

First Cartridge

Epic's entry into the 4 and 8 track stereo tape cartridge fields was announced at the sales meets by Mort Hoffmann, the label's director of sales and promotion. The 4 track cartridges will carry a suggested retail price of \$5.95. The 8 track cartridges will sell for \$6.95.

PAUL RUBIO AUTHOR OF THE SMASHING SPANISH LYRICS OF THE SONG ENAMORADO FIRST RECORDED BY KEITH COLEY, NOW BY THE SANDPIPERS ON A AND M, ANDY RUSSELL ON CAPITOL (USA), LOS YORCEYS (MEXICO) SARITA MONTIEL (EUROPE), WILL WRITE LYRICS IN ENGLISH FROM SPANISH, OR IN SPANISH FROM ENGLISH, OR WILL CO-WRITE. PAUL RUBIO, PRESIDENT OF PLAYBOY RECORDS IS LOOKING FOR MATERIAL, R AND ROLL BANDS ENGLISH OR SPANISH TO RELEASE. ALSO HAS MASTERS TO LEASE TO LABELS. FOR INFORMATION WRITE TO: PAUL RUBIO PLAYBOY RECORDS. 935 1/2 N. SYCAMORE. HOLLYWOOD 36, CALIF. PH. 213-939-5429.

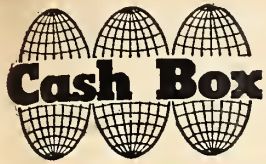

SURE SHOTS

The Cash Box "Sure Shots" highlight records which reports from retail dealers throughout the nation indicate are already beginning to sell quantity or else give every indication of doing so

- WITH A GIRL LIKE YOU**
YOUNG RASCALS Atlantic 2424
- I LIKE THE WAY**
TOMMY JAMES & SHONDELLS Roulette 4756
- THE HAPPENING**
HERB ALPERT & TB A&M 860
- PICTURES OF LILY**
THE WHO Decca 34770
- YOU WERE ON MY MIND**
CRISPIAN ST. PETERS Jamie 1310
- I CAN'T SEE NOBODY**
BEE GEE Atco 6487
- TAKE ME (JUST AS I AM)**
SOLOMON BURKE Atlantic 2416
- CITY OF WINDOWS**
STEPHEN MONAHAN Kapp 835
- MAMMY**
HAPPENING B.T. Puppy 530

Tremeloes Visit NY

NEW YORK—The Tremeloes, hot British group currently occupying the #41 spot on the Top 100 with their "Silence Is Golden" single, on the Epic label, flew to New York from London last week with their manager Peter Walsh for a short promotional visit prior to going on a 23-day performance tour of the U.S. and Canada. Cash Box interviewed the boys, who told us about their background, their current work and their plans for the future.

Three of the Tremeloes, Rick West (lead guitarist), Alan Blakely (rhythm guitarist) and Dave Munden (drummer) have been together for six years. Originally known as the Tremeloes, the group became Brian Poole and the Tremeloes for a while, and then the Tremeloes again when Poole left the group. Chip Hawkes (bass guitarist) is the newest member.

The Tremeloes do not want to limit themselves to performing any one type of music. They're after variety and like to do "a bit of everything." They admire Buddy Holly, and in their earliest days, they performed a lot of Everly Brothers numbers.

They enjoy doing live dates, feeling that their work has more immediacy on stage, but they also like recording and they usually record very quickly. Their first hit, "Here Comes My Baby," was cut in twenty minutes "as a joke." The boys never dreamed that it would become a world-wide smash.

The Tremeloes have a new disk, "Even The Bad Times Are Good," coming out in England in about three weeks. The song appears on their first LP, but they have re-recorded it for release as a single.

The Tremeloes' tour of the U.S. and Canada will take them to Ohio, Pennsylvania, Massachusetts, Ontario, Michigan and Indiana. On Sept. 16 they begin a 21-date, packaged tour of the British Isles with the Hollies.

Fearing Upped At RCA

NEW YORK—John Fearing has just been appointed administrator of field promotion at RCA Victor Records. Fearing formerly worked in RCA's reel tape planning and merchandising dept. In his new position, he will report to Vito Blando, newly appointed manager of single sales and promotion for RCA's record division.

Fearing joined RCA in 1956 as a public relations representative at RCA Exhibition Hall in New York. In 1961 he was made international marketing

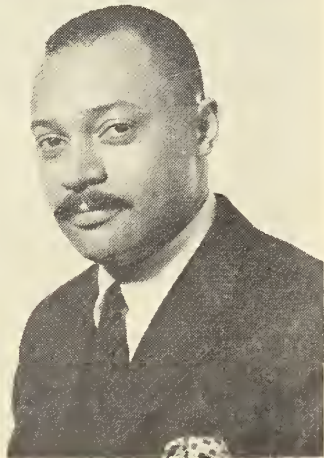

JOHN FEARING

analyst for the RCA international division. He joined the RCA Victor record division as a sales trainee in 1963, later moving into the prerecorded tape merchandising department and then the reel tape planning and merchandising department.

In his new position, Fearing will be responsible for the administration of the single record sales and promotion department, contacting the field force of radio and TV relations representatives and field sales representatives on radio play, record action and market information. He will also coordinate artists' promotion tours.

TALENT ON STAGE

NICK PALMER

NEW YORK—Nick Palmer is a former bassist-singer who decided to just sing for his supper not long before he signed a disk pact with RCA Victor Records last Jan. The rest is not history, at least until he opened at the (his first New York appearance) Copacabana last Thursday (29). Two singles have failed to spread the Palmer gospel to a wide record audience, and it was such success that the Copa booking had relied very heavily on. Anyone in the opening night audience who had seen Palmer perform during his RCA promo junket to key markets had to be impressed by his development over the past 180 days. The new Palmer method is totally committed to today's vocal demands, which can stretch from Schubert Row to Top 40. Now he can

swing for his supper in freer fashion, and his handling of the big ballad has a new intimacy, the difference between typing out a love letter and using one's own script. Darkly handsome, Palmer has a touch of the fog in his voice that brings to mind Tony Bennett, but the young performer's voice is not as brittle as the veteran singer's. The Palmer of six months ago is immediately cast aside with his opening guns, an exciting version of "It's Not Unusual." Other numbers include "This Is The Life," "Goin' Out Of My Head," "Fly Me To The Moon," "Call Me," "More," "I Will Wait For You" and other more or less recently established goodies. Nick Palmer is a 180 day wonder, during which time he has evidently found himself. And that could add up to quite a find for RCA.

DOORS

NEW YORK—Elektra's crack rock act the Doors has been filling Steve Paul's west side nitery, the Scene. Their act is every bit as strong as it sounds on the first LP, "Break On Through." Jim Morrison's strong, powerful vocals working in front of a guitar, drum, organ background, set the pace and drive each point home. The Doors have a funky, wailing, west coast type of sound not often heard live in these parts and it seems to be

just what the kids want.

The Doors' material hits high spots with "Break On Through" and "Light My Fire," their two singles to date. They occasionally slide into a Blues bag as well as doing things like Kurt Weill's "Alabama Song" from "Mahagonny."

The Doors are a particularly good live act and should be seen to be fully believed.

CHAD MITCHELL

NEW YORK—For the first five or six numbers of his performance Tuesday night, June 20, at the Village Gate, Chad Mitchell was, to this reviewer, too self-satisfied to be convincing. He did not really put anything of himself into his singing. He looked slightly bored, and that, added to his smugness, made his style seem bland. Indeed, we would be forced to say that his style is bland, were it not that as we were about to go to sleep Tuesday night, he suddenly came alive.

"Marieka," a powerful love ballad penned in French by Belgian singer/songwriter Jacques Brel, was the number that did the trick. With arms outstretched as though to embrace the girl for whom the song is named, Mitchell built to a peak of believable, if planned emotion. By the time he reached the climax of "Marieka," our opinion of his talent had altered considerably.

Following "Marieka," Mitchell per-

formed a medley from "Roar Of The Greasepaint, Smell Of The Crowd" in which he assumed first the character of an upper class Englishman and then the character of not-so-upper class Englishman. He was highly entertaining in both roles and showed himself to be an effective actor as well as a good singer.

Later on in the evening he lost us again, this time, surprise of surprises, by being gushy. He sang a syrupy, slowed-up version of Merle Travis' "Dark As A Dungeon" that would have irritated Travis no end if he had heard it.

Mitchell unquestionably has talent—polished, professional talent in fact. He has a strong voice, a facility for acting out a song, and he can convey emotion when he wants to. What he needs is sincerity, or, if he does not wish to be sincere, the illusion of sincerity. Maybe we saw him at a bad time. If so, we're sorry.

WB Hires New Umpire

NEW YORK—Augie Donatelli, National League umpire for seventeen years, has been contracted by Warner Bros./Reprise Records to perform radio promotion duties.

Donatelli, a Pennsylvanian who resides in St. Petersburg, Fla., will work with the Warner Bros./Reprise field promotion men as he visits various cities while traveling with the National League.

In announcing Donatelli's acquisition Marvin Deane, national promo mgr. for WB/Reprise, said, "Two years ago we signed Ed Runge, an American League umpire, in a similar capacity. We found him to be so effective we decided to be covered in both major leagues."

Liberty Signs Good Feeling

LOS ANGELES—The Good Feeling, a San Bernadino-based vocal-instrumental group, has been signed to a recording contract by Liberty Records' general manager, Bud Dain.

The group's first Liberty single, "I'm Captured," was produced by Bill Bellman and has just been released nationally.

Members of the Good Feeling include Paul Ballett, who plays organ, piano and tambourine; Gary Dalpiaz, lead vocal and bass; rhythm guitarist Ray Iodice; drummer Mike Kravitz; and lead guitarist Ken Myers, who wrote and arranged "I'm Captured."

Columbia Readies '67 Sales Confab

NEW YORK—The Diplomat Hotel in Hollywood, Florida will be the site of Columbia Records' 1967 sales convention, July 26-30. Over 500 persons are expected to attend this, one of the largest sales meetings in Columbia's history.

Among the convention highlights will be product presentations in all categories and the introduction of new equipment in the masterwork audio products line. In addition, the winners of the "sale aces" incentive contest will be announced during the convention. Prizes to be awarded in this contest include all-expense-paid trips to the Caribbean and prize points which winners may use in selecting a wide variety of merchandise.

Among those who will participate in the convention are Goddard Lieber-son, president of the CBS/Columbia Group; Clive Davis, vice president and general manager of CBS Records; Walter Dean, administrative vice president of CBS Records; Dick

Ascher, vice-president of business affairs; Bill Gallagher, vice president of Columbia Records A & R and special products; Albert Earl, vice president of operations for CBS Records; and Bill Farr, vice president of marketing for CBS Records, who will act as convention chairman.

Others active in the convention will be Jack Loetz, vice president of CBS Records marketing administration; Stan Kavan, vice president of planning and diversification for CBS Records; Don England director of Columbia label sales; J. J. Harris, director of audio products and accessories; Bruce Lundvall, director of merchandising; Dom Cerulli director of advertising; and Bob Cato, director of creative services.

The CBS international division will be represented at the convention by Harvey Schein, vice president and general manager, and by delegates from CBS International's numerous overseas subsidiaries.

London Releases 'Family Way' LP

NEW YORK — London Records has launched a solid drive in the field of motion picture music with two special releases. Major element of the new first quarter close-out LP merchandise is the original soundtrack from the new film "The Family Way," which stars John Mills and daughter Hayley.

Scored by Beatle Paul McCartney, the soundtrack album marks London's first property of major proportions in this area. At the same time, the "Family Way" score signals McCartney's debut as a movie score composer, aside from the music for the Beatles' own films.

On the movie side again, London has released the third volume of its highly successful series of lush instrumentals of James Bond motion picture themes, featuring the Roland Shaw Orchestra of England. Sporting a color cover festooned with Bond's favorite feminine friends the newest Bond edition contains themes from "Dr. No," "Goldfinger," "Thunderball," "From Russia With Love," and "You Only Live Twice," all of which featured Sean Connery in the role of James Bond. Also included are themes from the latest in the series, "Casino Royale," which stars a bevy of filmdom's brightest stars.

With regard to "The Family Way" track set, London has blue-printed a powerful merchandising drive in asso-

Angel Issues July LP's

HOLLYWOOD — Angel Records' July album release consists of 4 packages, all of them by the Roger Wagner Chorale. The 4 LP's are: "The Magnificats," containing works so titled by composers Vivaldi, Morales and Monteverdi; "Echoes From A 16th Century Cathedral," an album of sacred music featuring works composed by Palestrina, Victoria and Des Pres; "Belshazzar's Feast," composed by William Walton; and a set including composer Ralph Vaughn Williams' "Mass In G Minor" and Bach's "Cantata No. 4" ("Christ Lay In The Bonds Of Death").

ciation with Warner Brothers Pictures. The picture, which opened to rave reviews in England earlier this year, opened on June 27 in the United States, at which time London and Warners kicked off a promotion drive encompassing all levels of exploitation.

A host of dealer windows have already been set in the New York area, making use of a vast assortment of posters, streamers, and display album jackets provided by London. Theater lobby tie-ins are also included in the campaign, in addition to a heavy distribution of album samples to AM and FM good music stations and Top 40 outlets. The same promo formula will be followed as the picture opens in other cities.

ALBUM PLANS

Deals, discounts and programs being offered to dealers and distributors by record manufacturers.

AUDIO FIDELITY

2 free with every 10 purchased on entire catalog with the exception of the First Component Series. No expiration date announced.

DUKE-PEACOCK

Buy-7-get-one-free. No expiration date has been set.

FORTUNE

1 free album when 6 are purchased in any combination. No time limit.

GATEWAY

Two free for every 10 albums purchased on entire catalog. Expiration date indefinite.

GNP CRESCENDO

15 albums free with purchase of 100 LP's \$3.79 and \$4.79 retail. Indefinitely.

JEWEL-PAULA

One free for every five purchased on entire catalog. No expiration date.

LITTLE DARLIN'

Special 2 on 10 deal on all product. No expiration date has been set.

MONMOUTH-EVERGREEN

1 free album with every 10 purchased on entire catalog. No expiration date announced.

NASHBORO

Buy-7-get-one-free on entire catalog including new LP's. 100% exchangeable. No expiration date has been set.

ORIGINAL SOUND

15% discount on all LP's—until further notice.

PHILIPS

Discounts on new releases as well as entire catalog. SPM/SPS series are discounted 10%, all other classical albums discounted 20%. No expiration date announced.

PRESTIGE

15% discount on all LP product until further notice.

ROULETTE

15% discount in free merchandise. Expiration date indefinite.

SCEPTER-WAND

2 Albums free with every ten purchased. No termination date announced.

SIMS

3 free with every 10 purchased on entire catalog. No expiration date.

SMASH-FONTANA

Special discounts available through distribs. Expiration date not announced.

TAMLA-MOTOWN-GORDY

Buy-7-get-one-free. No expiration date has been set.

TOWER

10% discount on all albums. No expiration date announced.



TO HONOR AND BENEFIT ISRAEL—All proceeds from the just-released Columbia LP, "Israel's Finest Hour," will go to the Emergency Fund for the State Of Israel. The set contains the address to the United Nations by Abba Eban, Israel's Foreign Minister, given on June 6th (the LP was released on June 12th). Shown here standing with the album are: (from the left) Lou Weinstein, sales manager of Columbia Records sales; Tony Martell, regional sales manager of Columbia Records sales; Michael Arnon, Consul General of the State of Israel; and Frank Campana, Columbia's promotion manager.



Inking A Phenomenon

Stan Catron, general manager of Bornwin Enterprises, is shown seated with Charlie Fach (left), Mercury's director of recorded product, at the signing of the Northern Lights (rear). Bornwin will record the group for Smash.



TOP 100 Albums

JULY 8, 1967

Pos.	Last Week	Album	Label	Pos.	Last Week	Album	Label	Pos.	Last Week	Album	Label	Pos.	Last Week	Album	Label
1		SGT. PEPPER'S LONELY HEARTS CLUB BAND	Beatles (Capitol T/TS 2653)	26		S.R.O.	Herb Alpert & The Tijuana Brass (A&M LP 119/SP 4119)	51		DOUBLE TROUBLE	Elvis Presley (RCA Victor LPM/LSP 3787)	76		THE SANDPIPERS	A&M (LP 125/SP 4125)
2		MONKEES HEADQUARTERS	(Colgems COM/COS 103)	27		COLLECTIONS	Young Rascals (Atlantic M/S 8134)	52		GREATEST HITS FROM ENGLAND	Various Artists (Parrot PA 61010/PAS 71010)	77		DYNAMIC DUO	Jimmy Smith & Wes Montgomery (Verve V/VS 8678)
3		SOUNDS LIKE	Herb Alpert & Tijuana Brass (A&M LP 124/SP 4124)	28		TEMPTATIONS GREATEST HITS	(Gordy GM/GS 919)	53		GOING PLACES	Herb Alpert & Tijuana Brass (A & M LP 112/SP 4112)	78		THAT'S LIFE	Frank Sinatra (Reprise F/FS 1020)
4		SURREALISTIC PILLOW	Jefferson Airplane (RCA LPM/LSP 3766)	29		HAPPY TOGETHER	Turtles (White Whale WW 114/7114)	54		BEST OF ERIC BURDON & THE ANIMALS—VOL. II	(MGM E 4454/SE 4454)	79		THE SUPREMES SING HOLLAND DOZIER HOLLAND	(Motown M/MS 650)
5		REVENGE	Bill Cosby (Warner Bros. W/WS 1691)	30		THIS IS MY SONG	Ray Conniff (Columbia CL 2676/CS 9476)	55		ROGER!	Roger Williams (Kapp KL 1512/KS 3512)	80		CALIFORNIA DREAMING	Wes Montgomery (Verve V/V6 8672)
6		BORN FREE	Amy Williams (Columbia CL 2680/CS 9480)	31		I'LL TAKE CARE OF YOUR CARES	Frankie Laine (ABC ABC/ABCS 604)	56		KING AND QUEEN	Otis Redding & Carla Thomas (Stax (S) 716)	81		YOUNGER THAN YESTERDAY	Byrds (Columbia CI 2642/CS 9442)
7		PAUL REVERE & THE RAIDERS GREATEST HITS	(Columbia KCL 2662/KCS 9462)	32		THOROUGHLY MODERN MILLIE	Original Soundtrack (Decca DL 1500/71500)	57		HIP-HUG-HER	Booker T & MG's (Stax S-717)	82		MOBY GRAPE	(Columbia CL2698/CS 9498)
8		DR. ZHIVAGO	Soundtrack (MGM E/SE 6 ST)	33		EQUINOX	Sergio Mendes and Brasil 66 (A&M LP 122/SP 4122)	58		MAN OF LA MANCHA	Original Cast (Kapp KRL 4505/KRS 5505)	83		GOOD TIMES	Original Soundtrack (Atco M/S 214)
9		I NEVER LOVED A MAN	Aretha Franklin (Atlantic 8139/SD 8139)	34		THE MONKEES	(Colgems COM/COS 101)	59		EVERY MOTHER'S SON	(MGM E/SE 4471)	84		BORN FREE	Matt Monro (Capitol T/ST 2730)
10		A MAN AND A WOMAN	Soundtrack (United Artists UAL 4147/UAS 5147)	35		TEMPTATIONS LIVE	(Gordy 921)	60		HOW GREAT THOU ART	Elvis Presley (RCA Victor LPM/LSP 3758)	85		WILD ANGELS Volume II	Original Soundtrack (Tower T/TS 5056)
11		MORE OF THE MONKEES	(Colgems COM/COS 102)	36		WHIPPED CREAM	Herb Alpert & Tijuana Brass (A&M LP 110/SP 4110)	61		SUPER PSYCHEDELICS	Ventures (Liberty LRP 2052/LST 8052)	86		WESTERN UNION	Five Americans (Abnak ABLP 1967/ABST 2067)
12		THE MAMAS & THE PAPAS DELIVER	(Dunhill D/S 50014)	37		NEW GOLD HITS	4 Seasons (Philips PHM 200-243/PNS 600-234)	62		DADDY'S LITTLE GIRL	Al Martino (Capitol T/ST 2733)	87		ELECTRIC MUSIC FOR THE MIND & BODY	Country Joe & Fish (Vanguard VRS/VSD 9244)
13		BOB DYLAN'S GREATEST HITS	(Columbia KCL 2663/KCS 9463)	38		BEST OF EDDY ARNOLD	(RCA Victor LPM/LSP 3565)	63		CABARET	Original Cast (Columbia KOS 3040/KOL 6640)	88		FOR EMILY, WHENEVER I MAY FIND HER	Glenn Yarbrough (RCA Victor LPM/LSP 3801)
14		SOUND OF MUSIC	Soundtrack (RCA Victor LOCD/LSOD 2005)	39		THE SUPREMES SING RODGERS & HART	(Motown 659)	64		WHAT NOW MY LOVE	Herb Alpert & Tijuana Brass (A & M LP 114/SP 4114)	89		THE MOVIE ALBUM	Ramsey Lewis (Cadet LP/LPS 782)
15		CLAUDINE	Claudine Longet (A&M LP 121/LPS 4121)	40		HERE WHERE THERE IS LOVE	Dionne Warwick (Scepter M/S 555)	65		I THINK WE'RE ALONE NOW	Tommy James & The Shondells (Roulette R/SR 25353)	90		WALKIN' IN THE SUNSHINE	Roger Miller (Smash MGS 27092/SRS 67092)
16		THE DOORS	The Doors (Elektra EKS 4007/EKS 74007)	41		HEADS UP	Baja Marimba Band (A&M LP 123/SP 4123)	66		JAMES BROWN AT THE GARDEN	(King 1018)	91		LISTEN	Ray Charles (ABC ABC/ABCS 595)
17		CASINO ROYALE	Original Soundtrack (Colgems COMO/COSO 5005)	42		LET'S FALL IN LOVE	Peaches & Herb (Date TEM 3004/TEB 4004)	67		GEORGY GIRL	Seekers (Capitol T/ST 2431)	92		NEW DIRECTIONS	Gary Lewis & Playboys (Liberty LRP 3519/LST 7519)
18		THE BEST OF THE LOVIN' SPOONFUL	(Kama Sutra KLP/KLPS 8056)	43		FRANCIS ALBERT SINATRA & ANTONIO CARLOS JOBIM	Reprise (R/RS 1021)	68		BETWEEN THE BUTTONS	Rolling Stones (London LL 3499/PS 499)	93		BELAFONTE ON CAMPUS	(RCA Victor LPM/LPS 3779)
19		TOO MUCH	Lou Rawls (Capitol T/ST 2713)	44		HAPPY JACK	Who (Decca DR 74892/4892)	69		BORN FREE	Roger Williams (Kapp KL 1501/KS 3501)	94		TIME, TIME	Ed Ames (RCA Victor LPM/LSP 3834)
20		THE HOLLIES' GREATEST HITS	(Imperial LP 9350/12350)	45		JANIS IAN	(Verve Folkways FT/FTS 3017)	70		HERE COMES MY BABY	Tremeloes (Epic LN 24310/BN 26310)	95		GRATEFUL DEAD	Warner Brothers (W/WS 1689)
21		UP, UP AND AWAY	5th Dimension (Soul City SCM-91000/SCS-92000)	46		MY CUP RUNNETH OVER	Ed Ames (RCA LPM/LPS 3774)	71		TIME & CHANGES	Buckingham (Columbia CL 2669/CS 9469)	96		FIDDLER ON THE ROOF	Original Cast (RCA Victor LOC/LSO 1093)
22		RELEASE ME	Engelbert Humperdinck (Parrot PA 61012/PAS 71012)	47		WONDERFULNESS	Bill Cosby (Warner Bros. W/WS 1634)	72		ABSOLUTELY FREE	Mothers of Invention (Verve V 5013/V 6-5013)	97		ARETHA FRANKLIN'S GREATEST HITS	(Columbia CL 2673/CS 9473)
23		REWIND	Johnny Rivers (Imperial LP 9341/LSP 12341)	48		JUST FOR NOW	Nancy Wilson (Capitol T/TS 2712)	73		SPRING!	Letterman (Capitol T/ST 2711)	98		THE BEST OF JOHN GARY	(RCA Victor LPM/LPS 3730)
24		THE YARDBIRDS' GREATEST HITS	(Epic LN 24246/BN 26246)	49		THERE'S A KIND OF HUSH ALL OVER THE WORLD	Herman's Hermits (MGM E/SE 4438)	74		YOU ONLY LIVE TWICE	Original Soundtrack (United Artists UAL 4155/UAS 5155)	99		THE HAPPIEST MILLIONAIRE	Original Soundtrack (Vista BV 5001)
25		HAPPINESS IS	Dean Martin (Reprise R/RS 6242)	50		JIM NABORS BY REQUEST	(Columbia CL 2665/CS 9465)	75		A MAN AND HIS SOUL	Ray Charles (ABC 590-X/S)	100		ILLYA DARLING	Original Cast (United Artists UAL 9101/UAS 9901)
101		FRESH CREAM	Cream (ATCO 33-206 SD)	111		JEFFERSON AIRPLANE TAKES OFF	(RCA Victor LPM/LPS 3584)	121		THE DIS-ADVANTAGES OF YOU	Brass Ring (Dunhill D/DS 50017)	131		FABULOUS IMPRESSIONS	(ABC ABC/ABCS 606)
102		MR. SPOCK'S MUSIC FROM OUTER SPACE	Leonard Nimoy (Dot DLP 3794/25794)	112		PROJECTIONS	Blues Project (Verve Folkways FT/FTS 3008)	122		DRY YOUR EYES	Brenda & Tabulations (Dionn LPM 2000)	132		FOUR TOPS LIVE!	(Motown MM/MS 634)
103		FRIDAY ON MY MIND	Easybeats (United Artists UAL 3588/UAS 6588)	113		EAST COAST/WEST COAST	Don Ho (Reprise R/RS 6244)	123		SPANISH RHAPSODIES FOR YOUNG LOVERS	Midnight String Quartet (Viva V 6004/VS 36004)	133		IN CASE YOU'RE IN LOVE	Sonny & Cher (Atco 33-203/SD 33-203)
104		HOLD ME	Bert Kaempfert (Decca DL 4860/74860)	114		SPANISH MOONLIGHT	John Gary (RCA Victor LPM/LSP 3785)	124		LADY	Jack Jones (Kapp KL 1511/KS 3511)	134		FREAKOUT	Mothers of Invention (Verve V/V6-5005)
105		TOGETHER ON BROADWAY	Steve Lawrence & Eydie Gorme (Columbia CL 2636/CS 9436)	115		ZODIAC COSMIC SOUNDS	Electra (EK 4009/EKS 74009)	125		A SPECIAL SOMETHING	Ray Charles Singers (Command RS 914 SD)	135		SERGIO MENDES & BRASIL '66	(A&M LP 116/SP 4116)
106		SOMETHIN' STUPID	Lennon Sisters (Dot DLP 3797/25797)	116		HITS OF OUR TIME	Lawrence Welk (Dot DLP 3790/25790)	126		SWEET SOUL MUSIC	Arthur Conley (Atco 33-215/SD-215)	136		BUFFALO SPRINGFIELD	(Atco M/S 33-200)
107		DANNY BOY	Ray Price (Columbia CL 2677/CS 9477)	117		BILL COSBY IS A VERY FUNNY FELLOW, RIGHT!	(Warner Bros. W 1518)	127		THE SEA	San Sebastian Strings (Warner Brothers W/WS 1670)	137		GRAND PRIX	Soundtrack (MGM IE-837/IE-837)
108		SOMEWHERE MY LOVE	Ray Conniff Singers (Columbia CL 2519/CS 9319)	118		THE MAMAS & THE PAPAS	(Dunhill D/DS50010)	128		THAT'S LIFE	Billy Vaughn (Dot DLP 3788)	138		SOCK IT TO ME	Mitch Ryder & Detroit Wheels (New Voice NV/NVS 2003)
109		FIRE & FLEET & CANDLELIGHT	Buffy Sainte-Marie (Vanguard VRS 9250/VSO 79250)	119		HALLELUJAH BABY	Original Cast (Columbia KOL 6690/KOS 3090)	129		EMANICIPATION OF HUGH MASEKELA	(Chisa M 101/S 4-101)	139		MAME	Original Cast (Columbia KOL 6600/KOS 3000)
110		DIONNE WARWICK ON STAGE	(Scepter SRM 559)	120		GIMME SOME LOVIN'	Spencer Davis Group (United Artists UAL 3578/UAS 6578)	130		THE WILD ANGELS	(Soundtrack Tower T/ST 5043)	140		THE WICKED PICKETT	Wilson Pickett (Atlantic M/S 8138)

BASIC ALBUM INVENTORY

A check list of best selling pop albums other than those appearing on the CASH BOX Top 100 Album chart. Feature is designed to call wholesalers' & retailers' attention to key catalog, top steady selling LP's, as well as recent chart hits still going strong in sales. Information is supplied by manufacturers. This is a weekly, revolving list presented in alphabetical order. It is advised that this card be kept until the list returns to this alphabetical section.

MERCURY

The Platters	Encore of Golden Hits	MG20472/SR60243
Patti Page	Golden Hits	MG20495/SR60495
Eddy Howard	Golden Hits	MG20562/SR60562
Frankie Laine	Frankie Laine's Golden Hits	MG20587/SR60587
The Platters	More Encores of Golden Hits	MG20591/SR60252
Eddy Howard	More Golden Hits	MG20593/SR60593
Brook Benton	Golden Hits	MG20607/SR60607
George Jones	George Jones' Greatest Hits	MG20621/SR60621
Tiny Hill & Orch.	Golden Hits	MG20631/SR60631
Tony Martin	Golden Hits by Tony Martin	MG20644/SR60644
Sarah Vaughan	Sarah Vaughan's Golden Hits	MG20645/SR60645
Sil Austin	Sil Austin Golden Saxophone Hits	MG20663/SR60663
Royal Hawaiian	Hawaiian Golden Hits	MG20693/SR60693
Guitars		
Ted Weems	Ted Weems' Golden Hits	MG20708/SR60708
Brook Benton	Golden Hits Vol. II	MG20774/SR60774
Clyde McPhatter	Clyde McPhatter's Greatest Hits	MG20783/SR60783
Smothers Brothers	The Smothers Brothers At The Purple Onion	MG20611/SR60611
Johnny Mathis	Sweetheart Tree	MG21041/SR61041
Smothers Brothers	Tour De Farce	MG20948/SR60948
Johnny Mathis	Tender Is The Night	MG20890/SR60890
Horst Jankowski	The Genius of Jankowski	MG20993/SR60993
Dinah Washington	What A Difference A Day Makes	MG20479/SR60158
Smothers Brothers	Aesop's Fables The Smothers Bros. Way	MG20989/SR60989
Johnny Mathis	Love Is Everything	MG20991/SR60991
Horst Jankowski	More Genius of Horst Jankowski	MG21054/SR61054
Sil Austin	Sil Austin Plays Pretty For The People	MG20424/SR60096
Lesley Gore	My Town, My Guy And Me	MG21042/SR61042
Moms Mabley	Now Hear This	MG21012/SR61012
The Mitchell Trio	Typical American Boys	MG20992/SR60992
Original Soundtrack	The Sandpiper	MG21031/SR61031
Sarah Vaughan	The New Scene	MG21079/SR61079
Miriam Makeba	The Magnificent Miriam Makeba	MG21082/SR61082
Louis Armstrong	Louis	MG21081/SR61081
Dinah Washington	This Is My Story—Vol. I	MG21078/SR60788
Dinah Washington	This Is My Story—Vol. II	MG20789/SR60789
Billy Eckstine	Golden Hits of Billy Eckstine	MG20796/SR60796
Xavier Cugat	Cugat's Golden Goodies	MG20798/SR60798
Leroy Van Dyke	Greatest Hits of Leroy Van Dyke	MG20802/SR60802
Mike Nichols & Elaine May	The Best of Nichols & May	MG20997/SR60997
Lesley Gore	Golden Hits	MG21024/SR61024
Various Artists	Country & Western Golden Hits—Vol. II	MG21034/SR61034
Dave Dudley	Dave Dudley's Greatest Hits	MG21046/SR61046
Faron Young	Faron Young's Greatest Hits	MG21047/SR61047
George Jones	George Jones' Greatest Hits—Vol. II	MG21048/SR61048
Roy Drusky	Roy Drusky's Greatest Hits	MG21052/SR61052
Patti Page	Patti Page Sings Country & Western Golden Hits	MG20615/SR60615
Smothers Brothers	Think Ethnic	MG20777/SR60777
Smothers Brothers	It Must Have Been Something I Said	MG20904/SR60904
Smothers Brothers	Two Sides Of The Smothers Brothers	MG20675/SR60675
Smothers Brothers	Curb Your Tongue Knave	MG20862/SR60862
Dave Dudley	Lonelyville	MG21074/SR61074
Roy Drusky & Priscilla Mitchell	Together Again	MG21078/SR61078
Johnny Mathis	The Shadow Of Your Smile	MG21073/SR61073
Horst Jankowski	Still More Genius of Jankowski	MG21076/SR61076
Smothers Brothers	Mom Always Liked You Best	MG21051/SR61051
Smothers Brothers	Golden Hits Of The Smothers Brothers	MG21089/SR61089
Miriam Makeba	All About Miriam	MG21095/SR61095
Blues Magoos	Psychedelic Lollipop	MG21096/SR61096
Roy Drusky	If The Whole World Stopped Lovin'	MG21097/SR61097
Dave Dudley	Free and Easy	MG21098/SR621098
Johnny Mathis	So Nice	MG21091/SR61091
Faron Young	Unmitigated Gall	MG21110/SR61110
Hugh Masekela	GRR	MG21109/SR61109
Tony Randall	Vo-Vo-De-Oh-Doe	MG21109/SR61108
Johnny Mathis	Johnny Mathis Sings	MG21107/SR61107
Jerry Butler	Soul Artistry	MG21105/SR61105
Keith	98.6/Ain't Gonna Lie	MG21102/SR61102
	Chuck Berry's Golden Hits	MG21103/SR61103

MERCURY (Cont'd.)

Dee Dee Warwick	I Wanna Be With You/	MG21100/SR61100
Shangri-La's Golden Hits	I'm Gonna Make You Love Me	MG21099/SR61099
Friar Tuck	Friar Tuck And His Psychedelic Guitar	MG 21111/SR 61111
Mort Sahl	Anyway . . . Onward	MG 21112/SR 61112
Dave Dudley	My Kind Of Love	MG 21113/SR 61113
Motion Picture Track	Eric Soya's "17"	MG 21115/SR 61115
Sarah Vaughn	Sassy Swings Again	MG 21116/SR 61116
Dinah Washington	Dinah Discovered	MG 21119/SR 61119
Lesley Gore	California Nights	MG 21120/SR 61120
	MGM	
Original Sound Track	Doctor Zhivago	1E/S1E6ST
The Animals	The Best Of The Animals	E/SE-4324
Herman's Hermits	The Best Of Herman's Hermits	E/SE-4315
The Animals	Animalization	E/SE-4384
Hank Williams	The Very Best of Hank Williams	E/SE-4168
Connie Francis	The Very Best Of Connie Francis	E/SE-4167
Herman's Hermits	Both Sides Of Herman's Hermits	E/SE-4386
The Animals	Animal Tracks	E/SE-4305
Herman's Hermits	Herman's Hermits On Tour	E/SE-4295
Herman's Hermits	Introducing Herman's Hermits	E/SE-4282
Hank Williams, Jr.	Hank Williams' Life Story	E/SE-4260
Hank Williams	Hank Williams' Greatest Hits	E/SE-3918
Hank Williams	14 More Of Hank Williams' Greatest Hits, Vol. 2	E/SE-4040
Judy Garland & Orig. Cast.	The Wizard Of Oz	E/SE-3996 ST
Original Cast Album	The Fantasticks	E/SE-3872 OC
MGM Sound Track	Gigi	E/SE-3641 ST
The N.Y. Production	Kurt Weill's The Threepenny Opera	E/SE-3121 OC
With Lotte Lenya (In English)		
Connie Francis	More Greatest Hits	E/SE-3942
Hank Williams	14 More of Hank Williams' Greatest Hits, Vol. 3	E/SE-4140
Johnny Tillotson	Talk Back Trembling Lips	E/SE-4188
Hank Williams	The Very Best Of Hank Williams, Vol. 2	E/SE-4227
The Animals	The Animals	E/SE-4264
Hank Williams, Sr. & Hank Williams, Jr.	Hank Williams, Sr. & Hank Williams, Jr.	E/SE-4276
The Animals	The Animals On Tour	E/SE-4281
Hank Williams	Hank Williams Sings Kaw-Liga And Other Humorous Songs	E/SE-4300
	Born Free—Music From The Sound Track	E/SE-4368
Music Composed & Conducted By John Barry		
Hank Williams	The Legend Lives Anew	E/SE-4377
With Strings		
Hank Williams	Movin' On—Luke The Drifter	E/SE-4380
Hank Williams	The Hank Williams Story	E-4267-4
Sam (The Man) Taylor	Blue Mist	E-3973
Hank Williams	Hank Williams On Stage	E-3999
Hank Williams	On Stage—Vol. 2	E/SE-4109
Hank Williams	The Spirit Of Hank Williams	E-3955
Tommy Edwards	Tommy Edwards' Greatest Hits	E/SE-3884
Hank Williams	I Saw The Light	E-3331
Lainie Kazan	Right Now	E/SE-4340
Lainie Kazan		E/SE-4385
Connie Francis	Live At The Sahara	E/SE-4411
The Animals	Animalism	E/SE-4414
Herman's Hermits	Best Of Herman's Hermits, Vol. 2	E/SE-4416
Sam The Sham And Pharaohs	Best Of Sam The Sham And Pharaohs	E/SE-4422
Eric Burdon And Animals	Eric Is Here	E/SE-4433
Herman's Hermits	There's A Kind Of Hush All Over The World	E/SE-4438
	"You're A Good Man, Charlie Brown"	IE/S1E90c
Original Cast	Lovin' Sound	E/SE4388
Ian & Sylvia	On Broadway Today	E/SE4472
Connie Francis	Burdon & Animals—Vol II	E/SE4454
Best of Eric	Those Singin', Swingin', Stompin', Sensational Stonemans	E/SE4363
Stoneman Family	Stoneman's Country	E/Se4363



TOTAL LOCATION INVENTORY

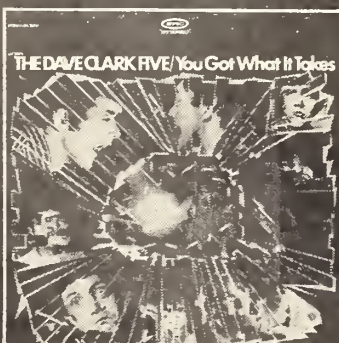

The Dave Clark Five—
You Got What It Takes
LN 24312/BN 26312*

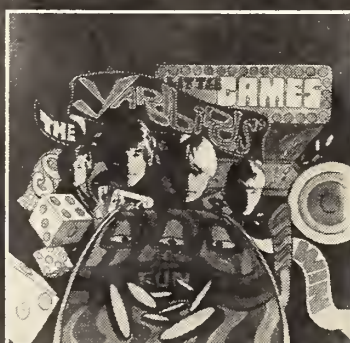

The Yardbirds—
Little Games
LN 24313/BN 26313*



Don And The Goodtimes—
So Good
LN 24311/BN 26311*



The Hollies—
Evolution
LN 24315/BN 26315*

*Stereo



COUNTRY ROUND UP

Every year about this time, Cash Box conducts a deejay poll to determine, as best we can, which artists are the most programmed in various categories. A quick glance at the list of poll winners (see accompanying Directory Issue) shows such names as Buck Owens, Loretta Lynn, Jack Greene, Lynn Anderson, the Browns, Chet Atkins, the Buckeroos, and Lloyd Green topping their respective classifications, while honorary mentions are in order for David Houston, Eddy Arnold, Nat Stuckey, Waylon Jennings, Tammy Wynette, Jeannie Seely, the Wilburn Bros., the Hardin Trio, Floyd Cramer, Roy Clark, the Brazos Valley Boys, the Texas Troubadors, Jimmie Bryant and Jerry Reed. Our congratulations to all who received their votes from deejays throughout the country.

The Stonemans blasted into Chattanooga's Lake Winnepesaukee amusement area and set an all-time attendance mark, according to park talent agent Gene Goforth, who also produces the group's popular TV series. Crowds of about 8,000 people shoe-horned their way into the park for the three performances, while TV crews shot the action in color. Tapes will be used late this summer on the Stonemans video show.

In last week's column we went on at length regarding the newly-written tune, "Elusive Dream," but we were somewhat lax in our duties when we neglected to mention that the co-writer of the song was Billy Sherrill. Sherrill, who is no slouch when it comes to writing hit material, also shares half the responsibility for one of the other numbers we mentioned in the same article, "Almost Persuaded" (and before we get in trouble again, we'd better mention that his partner in that one was none other than the Wild One, Glenn Sutton. The same two have also been responsible, in the last few months, for David Houston's "Loser's Cathedral" and "With One Exception," not to mention Tammy Wynette's "Your Good Girl's Gonna Go Bad,").

An interesting sidelight to the whole "Elusive Dreams" episode is in the fact that, while one of the writers (Curly Putman) recorded one version, a competitive David Houston-Tammy Wynette version was produced by the other writer (Billy Sherrill).

At any rate, we ask Mr. Sherrill's indulgence for our oversight.

After a month of personal appearance dates, booking and publishing operations, Dick Flood has just released his second single on his Totem label. Side contains "Sure Gets Dark When The Sun Goes Down" b/w "I Didn't See You Standing There." Flood has just taken off on another tour, this one taking him through Georgia, the Carolinas, Florida, Delaware, N.J., Alabama and Tennessee.

The Newkeys Music and Key Talent staff has been expanded with the recent addition of John Tally, well-known to Nashville folk through his WENO airwaves role. John tells us that his new position will be that of promotion and general sales manager for the firm's label, Rice Records. The first new artist to be signed to the label is Billy Grammer, who joins Linda Manning and Al Terry on the roster.

WJRZ's Bob Lockwood has begun packaging a "Summer Festival Of Stars," to be staged at Wiseglass Stadium in Staten Island, N.Y. The lineup thus far includes Dave Dudley, Johnny Dollar, Van Trevor, Elton Britt, Rose Lee Allen, Smokey Warren, Dottie Mae and Tex Barton, as well as 14 other acts, including 3 bands. The festival is set to go off on Jul. 23.

Hank Snow has recently completed Phase I of the "Hank Snow Centennial Show, a special three-part, 60-day tour of Canada, which Hank designed himself to pay tribute to his native land. Highlighted by Snow and the Rainbow Ranch Boys, Waylon Jennings & the Waylors and Dottie West & the Heartaches, the first segment was completed on Jan. 18, and, according to the Moeller Talent stable, which handled the bookings for the entourage, it represented one of the most successful turns in the agency's history. The second and third phase of the tour are set for the Fall, with concentration aimed at Maritime and West Coast concert.

Marvin Hoerner has been signed on a management pact with the Midwest TV package "The Possum Holler Opry," according to the show's producer Toby Dick Ellis. Hoerner will also take over management of Ellis, Al Harvey, Lenora Ellyn and others associated with the show. In addition, he will assist in the booking of guest artists for the program, and will be active in the filming and distribution of the show, slated for this fall. The video segment, which has received a number of awards, recently was given a citation from President Johnson for its work with youth.

Johnny and Jonie Mosby have just signed a recording pact with Capitol, with their first session due out about mid-July. The pair will be appearing at the big Navy Fourth of July picnic along with Billy Mize, then they're off for a week tour at Vandenberg A.F. Base. . . . Roy Clark knocked off two weeks at the Top Hat in Windsor, Ontario and Angelo's Supper Club in Omaha, and zipped down to L.A. on June 30 to headline the Disneyland Show with Jerry Naylor. Into Safford, Ariz. until Jul. 4, Roy then heads for Mr. Lucky's in Phoenix (5-7) and the Albuquerque Civic Center (8). . . . Smiley Wilson tells us that he recently signed Bobby "Down Came The World" Barnett to a pact with the Wil-Helm agency. . . .

Buck Owens and crew have just finished their annual swing thru Texas, with packed houses all along the route. . . . Jack Reno has just cut his first formal session, under the direction of Buddy Killen. A deejay with WXCL—Peoria, Reno was also recently signed as an exclusive writer with Tree Music. . . . Dave Dudley and the Roadrunners have been added to the list of names for the world-renowned Newport Folk Festival, set to kick off on July 15. . . . Claude Gray and the Graymen have just left Music City for a tour which will run through Aug. 7. During the junket, the boys will do a week-long gig at

(Continued on page 42)

An Epic Meet

The recent Epic sales meeting in New York was highlighted by the appearance of David Houston and manager Tillman Franks, who were in town with their respective wives for a business-vacation combination. Shown in the photo right, taken during the meeting, Houston and wife make with the smiles with Cash Box president George Albert (center), Epic sales and distribution vp Len Levy (second from right) and Tillman Franks.



Tex Ritter Named Chairman Of NCRA

NASHVILLE—One of the well-known names in the field of entertainment, Tex Ritter has been appointed Nashville chairman of the National Committee for the Recording Arts. The recently-formed assemblage of recording artists and producers is supporting a proposed copyright law amendment that would provide performance fees for recording artists, arrangers, musicians and record producers.

Handling the national chairman role in NCRA is Stan Kenton, while Nashville names such as Chet Atkins, Boots Randolph, Floyd Cramer, Red Foley and Brenda Lee are also backing the bill.

In a statement made concerning the amendment, Ritter was quoted as saying, "Commercial users of recorded music can well afford, and should, as a matter of right, pay the performers for the use of their talents. The copyright law has not been revised since 1909 and probably will not see another wholesale revision for the coming fifty years. The reason that performers on sound recordings were not included in the present law is obvious. The phonograph was in its infant stages and there were no vast radio and juke box industries that exist today. There was no protection in 1909 because it was not needed. But this is 1967 and now the correction is urgently needed to correct this injustice."



COMMENDABLE PERFORMANCE—The Southern Gentleman, Sonny James, who has been known to recruit some country fans is seen above accepting a certificate of commendation from Air Force Sgt. Crosson as a result of the songster's help in making programs for recruiting Air Force personnel.

Peer-Southern Label Bows

NEW YORK—Peer-Southern, one of the most well-known publishers on the current scene, has recently formed its own record label, also known as Peer-Southern, with the first deck, "Big Wheel Cannonball" by Dick Todd, already released.

Todd, whose past hits include "Daddy's Little Girl," "Bumming Around" and "Penny Serenade," is backed on the record by the Appalachian Wildcats. The tune was written by Vaughn Horton, whose track record includes such giants as "Mockin' Bird Hill," "Sugar Foot Rag," "Choo Choo Ch' Boogie" and "Teardrops In My Heart," among others.

Capitol's Top C&W Names Sked For Hollywood Bowl

LOS ANGELES — The Hollywood Bowl has been slated for a giant country extravaganza as a power-packed of Capitol Records artists has been set to appear on July 7 for the first Family Special of the Bowl's 46th season.

The lineup for the show includes Buck Owens & the Buckaroos, Glen Campbell, Merle Haggard & the Strangers, Bonnie Owens, Ferlin Husky, Wynn Stewart & the Tourists, Tex Ritter and the Geeszinlaw Bros., all of whom record for Capitol Records.

Houston-Wynette 'Dreams' Nears 100,000 Sales Mark

NEW YORK—The David Houston-Tammy Wynette recording of "My Elusive Dreams" is not so elusive in disk form, having come close to the 100,000 sales mark after only ten days on the market. In a recent announcement by Epic Records vp in charge of sales and distribution Len Levy, it was stated that heavy reorders have already started coming in, with strong action pop and good music areas, as well as the expected country outlets.

Produced by the tune's co-writer Billy Sherrill, the deck marks the first time that the two artists have recorded together, although both have been scoring extremely well of late as solo acts. Reaction to the single has been such that the label has cut a duet LP with the two, featuring "Elusive Dreams," and is preparing the album for a rush-release.

His New Album "COUNTRY... THE WRIGHT WAY"



DL 4846

DL 74846

GOLD STAR HITS! Two Winners From THE FIVE WILLIAMSON BROS. "WHY UNCLE SAM CALLED FOR ME"

GS 202 "I'VE GOT A BEAD ON YOU BABY"

GS 200 Bookings: ACUFF-ROSE ARTIST CORP. 2510 Franklin Rd. Nashville, Tenn.

FRANKLIN IVEY "DROWNING MY SORROWS IN WINE"

GS 203

GOLD STAR RECORDS Rt 1, Evergreen, N.C. 28438



NAGASAKI CATS—It ain't Flatt & Scruggs, and it ain't Homer & Jethro. It's a young Japanese team called the Osaki Okies, who were discovered by Buck Owens during his tour of the Far East and were taken along on the Tiger's recent shot at the Santa Clara County Fair. Word has it that they really wowed American audiences with their Yokahama yodel.



COUNTRY TOP 50



TOP COUNTRY ALBUMS

	Pos.	Last Week		Pos.	Last Week
1			26		
MISTY BLUE (Talmont—BMI) Eddy Arnold (RCA Victor 9182)	1		SNEAKIN' ACROSS THE BORDER (Hardin—BMI) Hardin Trio (Columbia 44069)	21	
2			27		
WITH ONE EXCEPTION (Gallico—BMI) David Houston (Epic 101054)	3		YOUR FOREVERS (Central Songs—BMI) Jean Shepard (Capitol 8899)	31	
3			28		
ALL THE TIME (Cedarwood—BMI) Jack Greene (Decca 32123)	5		IN THE JAILHOUSE NOW (Peer Int'l—BMI) Ernest Tubb (Decca 32123)	28	
4			29		
IT'S SUCH A PRETTY WORLD TODAY (Freeway—BMI) Wynn Stewart (Capitol S81)	2		DON'T SQUEEZE MY SHARMON (Four Star—BMI) Charlie Walker (Epic 10174)	38	
5			30		
YOUR GOOD GIRL'S GONNA GO BAD (Al Gallico—BMI) Tammy Wynette (Epic 10134)	4		THE PRIVATE (Tree—BMI) Del Reeves (United Artists S0157)	35	
6			31		
MAMA SPANK (4 Star Sales—BMI) Liz Anderson (RCA Victor 9163)	6		CINCINNATI, OHIO (Moss-Rose Publications—BMI) Connie Smith (RCA Victor 9214)	43	
7			32		
RUTHLESS (Tree—BMI) Staitler Bros. (Columbia 44070)	8		LOUISIANA SATURDAY NIGHT (New Keys—BMI) Jimmy Newman (Decca 32130)	41	
8			33		
IF YOU'RE NOT GONE TOO LONG (Sure-Fire—BMI) Loretta Lynn (Decca 32127)	9		YOU CAN STEAL ME (Jack—BMI) Bonnie Guitar (Dot 17007)	33	
9			34		
TONIGHT CARMEN (Mojave, Noma—BMI) Marty Robbins (Columbia 44128)	15		PRETTY GIRL, PRETTY CLOTHES PRETTY SAD (Wilderness—BMI) Kenny Price (Boone 1056)	36	
10			35		
WALKIN' IN THE SUNSHINE (Tree—BMI) Roger Miller (Smash 2081)	7		COME KISS ME, LOVE (Melody Trails—BMI) Bobby Bare (RCA Victor 9191)	44	
11			36		
ROARING AGAIN (Sure-Fire—BMI) Wilburn Bros. (Decca 32117)	13		37		
12			38		
I CAN'T GET THERE FROM HERE (Glad, Blue Crest—BMI) George Jones (Musicor 1243)	17		HOW LONG WILL IT TAKE (Page Boy—SESAC) Warner Mack (Decca 32142)	47	
13			39		
I'LL NEVER FIND ANOTHER YOU (Chappel—ASCAP) Sonny James (Capitol S914)	25		VIN ROSE (Acuff-Rose—BMI) Stu Phillips (RCA Victor 9219)	48	
14			40		
DIESEL ON MY TAIL (Francis Marvin, Silver Star—BMI) Jim & Jesse (Epic 10138)	14		MENTAL REVENGE (Cedarwood—BMI) Waylon Jennings (RCA Victor 9146)	39	
15			41		
LITTLE OLD WINE DRINKER ME (Moss-Rose—BMI) Robert Mitchum (Monument 1006)	18		SOMETHING FISHY (Combine—BMI) Dolly Parton (Monument 1007)	51	
16			42		
IF I KISS YOU (Greenback-Yonah—BMI) Lynn Anderson (Chart 1430)	10		DANNY BOY (Boosey & Hawkes—ASCAP) Ray Price (Columbia 44042)	9	
17			43		
POP A TOP (Nelson, Port—ASCAP) Jim Edward Brown (RCA Victor 9191)	23		BECAUSE OF HIM (Forest Hills—BMI) Claude Gray (Decca 32122)	52	
18			44		
I KNOW ONE (Jack—BMI) Charley Pride (RCA Victor 9162)	20		DOWN CAME THE WORLD (Freeway—BMI) Bobby Barnett (K-Ark 741)	49	
19			45		
JUKEBOX CHARLIE (Mayhew—BMI) Johnny Paycheck (Little Darlin' 0020)	11		ALL MY TOMORROWS (Su-Mo—BMI) Nat Stuckey (Paula 267)	26	
20			46		
PROMISES & HEARTS (Barmour—BMI) Stonewall Jackson (Columbia 44121)	24		CHET'S TUNE (Delmore—ASCAP) Some Of Chet's Friends (RCA Victor 9229)	55	
21			47		
DOWN AT THE PAWN SHOP (4-Star—BMI) Hank Snow (RCA Victor 9188)	27		HE'S LOSING HIS MIND (Sybilla, Summerhouse—ASCAP) Van Trevor (Band Box 374)	56	
22			48		
SAM'S PLACE (Blue Book—BMI) Buck Owens (Capitol S865)	12		LONG-LEGGED GUITAR-PICKIN' MAN (Perkins—SESAC) Johnny Cash & June Carter (Columbia 44158)	46	
23			49		
JUST BEYOND THE MOON (Central Songs—BMI) Tex Ritter (Capitol S839)	19		HE THOUGHT HE'D DIE LAUGHING (Mayhew—BMI) Bobby Helms (Little Darlin' 0030)	53	
24			50		
LOVE ME AND MAKE IT ALL BETTER (Barmour—BMI) Bobby Lewis (United Artists S0161)	29		THE STORM (Tuckahoe—BMI) Jim Reeves (RCA Victor 9238)	—	
25					
BLACK JACK COUNTY CHAIN (Tree—BMI) Willie Nelson (RCA Victor 9202)	34				
51			56		
MY ELUSIVE DREAMS Curly Putman (ABC Paramount 10934)			KANGAROO OF LOVE Margaret Lewis (SSS Int'l 704)		
52			57		
YOU'RE SO COLD Hugh Lewis (Kapp 830)			HE'S NOT FOR REAL Priscilla Mitchell (Mercury 72681)		
53			58		
NO ONE'S GONNA HURT YOU ANYMORE Bill Anderson (Decca 32146)			I'M IN NO CONDITION Hank Williams Jr. (MGM 13730)		
54			59		
MY ELUSIVE DREAMS David Houston & Tammy Wynette (Epic 10194)			I'M THE MAIL SHE'S WAITING FOR Chuck Wood (SSS Int'l 703)		
55			60		
TRUCKER'S PRAYER Dave Dudley (Mercury 72697)			I'LL HOLD YOU IN MY HEART Freddie Hart (Kapp 820)		

1	BEST OF EDDY ARNOLD (RCA Victor LPM/LSP)	2	16	SINGING AGAIN Ernest Tubb & Loretta Lynn (Decca DL 4872/DL 74872)	26
2	NEED YOU Sonny James (Capitol 2703)	3	17	PATSY CLINE'S GREATEST HITS (Decca DL 4854/74854)	13
3	WALK THROUGH THIS WORLD George Jones (Musicor MM 2119/MS 3119)	1	18	YOUR GOOD GIRL'S GONNA GO BAD Tammy Wynette (Epic LN 24305/BN 26305)	15
4	BUCK OWENS AND HIS BUCKAROOS IN JAPAN (Capitol T/ST 2715)	6	19	TOUCH MY HEART Ray Price (Columbia CL 2 6066/CS 9 4066)	20
5	DON'T COME HOME A-DRINKIN' Loretta Lynn (Decca DL 4842/7 4842)	4	20	DRIFTING APART Warner Mack (Decca DL 4883/74883)	19
6	LONELY AGAIN Eddy Arnold (RCA Victor LPM/LSP 3753)	5	21	IT'S SUCH A PRETTY WORLD TODAY Wynn Stewart (Capitol T/ST 2737)	21
7	I'M A LONESOME FUGITIVE Merle Haggard (Capitol T/ST 2702)	7	22	AMERICA'S MOST WANTED BAND Buckaroos (Capitol T/ST 2722)	14
8	ALL THE TIME Jack Greene (Decca DL 4904/DL 4904)	18	23	EVEN WHEN IT'S BAD IT'S GOOD Ray Pillow (Capitol T/ST 2738)	24
9	GEORGE JONES GREATEST HITS (Musicor MM 2116/MS 3116)	8	24	HEART WE DID ALL WE COULD Jean Shepard (Capitol T/ST 2690)	22
10	MY KIND OF COUNTRY Marty Robbins (Columbia CL 2645/CS 9445)	10	25	RIDE, RIDE, RIDE Lynn Anderson (Chart LP/LPS 1000)	25
11	DANNY BOY Ray Price (Columbia CL 2677/CS 9477)	9	26	15TH ANNIVERSARY ALBUM Slim Whitman (Imperial LP 9342/LSP 12342)	27
12	LOSER'S CATHEDRAL David Houston (Epic LN 24303/BN 36303)	11	27	IT'S A GUITAR WORLD (Chet Atkins (RCA Victor LPM/LSP 3728)	—
13	COLD HARD FACTS OF LIFE Porter Wagoner (RCA Victor LPM/LSP)	17	28	LOVE MAKES THE WORLD GO AROUND Kitty Wells (Decca DL 4857/74857)	30
14	THERE GOES MY EVERYTHING Jack Greene (Decca DL 4845/7 4845)	12	29	WALKIN' IN THE SUNSHINE Roger Miller (Smash MGS 27092/SRS 67092)	—
15	ANOTHER STORY Ernest Tubb (Decca DL 4867/74867)	16	30	DIESEL ON MY TAIL Jim & Jesse (Epic LM 24314/BN 26314)	—

COUNTRY ROUNDUP

(Continued from page 41)
the Golden Nugget in Las Vegas. . . . Chet Atkins goes high-tone once again this week (7 & 8) when he teams up as a guest performing artist with the New Orleans Symphony Orchestra in New Orleans. . . . Vern Stovall and Janet McBride recently headed up the bill at Tommy Trent's Fun Barn in Little Rock, Ark., then continued on to the Flame Club in Minneapolis for a week and on to Nashville where they spent two days recording. . . . Tex Clark has added 16 newspapers for his columns, "13 Top Songs" and "From Hollywood To Hicksville," bringing the total of papers carrying the items to 34. The columns hit on country, pop and folk-rock acts. . . . Red Steed and Earl Rothgeb have spent the beginning of the month promoting Red's new Major Records disk, "If The Tables Of The World (Were Turned Around)" b/w "The Hurt," throughout the middle Eastern states. Deejays needing copies may obtain them by writing to P.O. Box 208, Luray, Va. 22835. . . . The Liberty International musical, "What Am I Bid?" with LeRoy Van Dyke, Kristin Nelson, Stephanie Hill, Bill Craig, and special guest stars, Al Hirt, Tex Ritter, Johnny Sea and Faron Young, will have its world premiere at the Capri Cinerama in Dallas on Aug. 27 and at the Paramount Theatre in Nashville, Tenn. on Aug. 28. Emerson Film Enterprises, which is handling the release of the film, has sold the color movie to General Cinema Circuit for simultaneous release in four Houston first-run houses on Sept. 10.

A new label, Tawes Records, has opened its doors at 526 W. Russell Ave., in Flint, Mich., and will have an open door policy for the next few weeks. Label prexy Harry Chester announced that all radio stations are asked to write for placement on

the company's mailing list for all present and future releases.

Earl Hart at WFOR cables that the station has just gone C&W and is in desperate need of records. Disks should be sent to him at 2414 W. 7th St., Hattiesburg, Miss. . . . WWVA—Wheeling proclaimed the month of June as "Jimmy Newman Month," highlighted by the songster's appearance on the WWVA Jamboree on June 24. . . . KCIN—Victorville, Calif. recently held its second annual western Fun-A-Rama for Victor Valley Chrysler-Plymouth, with 1300 fans turning out to see Jeannie Gayland, Wild Bill Langley, the Shy Ones, Them There Kids and George Stoner. The festivities also included prizes, such as vacation trips to Las Vegas and a color TV set. . . . Anchorage, Alaska will have its first C&W station when 5,000-watt KYAK kicks off the new sound on July 8, according to co-owner and general manager Bob Fleming. Bobby Wooten, program director at KAYO—Seattle has been engaged as programming consultant and will take complete charge of programming. Records, I.D.'s, station breaks, etc. can be sent to the station at P.O. Box 1808, Anchorage. . . . KTUF—Tempe, Ariz., formerly KYND, has gone country with a bang and announces an exclusive "Buck Owens Show," Monday thru Friday, with the Tiger hosting his own record and conversation segment. Station manager under the new setup is Joe Thompson, formerly of KRDS—Phoenix, and national sales manager will be Jerry Sawyer, formerly with KHAT—Phoenix. . . . KRAK—Sacramento has added Bruce R. Wilson to its staff, where he will be working in research and development with the outlet's national and local sales dept. Wilson is currently attending Sacramento State College as a business administration major.

BILL ANDERSON

has a brand new Decca double play

**“NO ONE’S
GONNA
HURT YOU
ANymore”**

C/W

“PAPA”

32146



DECCA RECORDS
A Division of MCA INC.



Management
& Booking



HUBERT LONG
TALENT AGENCY

806 15th Ave. South
Nashville, Tenn. 37203
615/244/2424



COUNTRY REVIEWS

● Best Bet
B+ very good B good

THE CASH BOX BULLSEYE



AMERICAN POWER [Kitty Wells BMI—Anglin]

JOHNNY WRIGHT (Decca 34477)

Although Johnny Wright is just beginning to stir up some action with his recently-released deck of "Why" and "Ole Honky Tonk," Decca has released a brand new, but powerful piece of material by the songster, tabbed "American Power." This message about racial unrest has the earmarks of a giant. Watch it.

I JUST WANT TO BE ALONE (2:20) [Jack BMI—Irwin]

I LIKE A WHOLE LOT (2:19) [Novachaminjo BMI—Mann]

RAY PILLOW (Capitol 5953)

Ray Pillow's latest bid for chart honors is another ballad session, and should stand him in good stead with his many followers. Top side, "I Just Want To Be Alone," is a blues-filled effort that gets a nice treatment by the songster. "I Like A Whole Lot" is a breezy bouncer.

TOO MUCH OF YOU (2:20) [Peach, SESAC—Hood]

IF THIS IS LOVE (2:14) [Yonah BMI—Anderson]

LYNN ANDERSON (Chart 1475)

Lynn Anderson slows down the pace after riding up the charts with two gallopers in a row, and comes across with a lovely ballad titled "Too Much Of You Still On My Mind." The fine performance on this side makes it a good bet to skyrocket. "If This Is Love" is a twangy tale of a battling couple.

I FORGOT TO CRY (2:30) [Hill and Range BMI—Owens]

DRIVE ME OUT OF MY MIND (2:25) [Five L's BMI—Thompson]

CHARLIE LOUVIN (Capitol 5948)

Following right behind "On The Other Hand," Charlie Louvin serves up "I Forgot To Cry," a sentimental, feelingful ballad that's bound to see Top 50 action. Lots of spins in store for this one. "Drive Me Out Of My Mind" is a swaying, waltz-tempo stanza.

SOMEBODY KNOWS MY DOG (2:19) [Southtown BMI—Crysler]

THE END OF THE ROAD (2:08) [Starday BMI—King, Dean]

WILLIS BROS. (Starday 812)

A winning followup to their recent chart stand of "Bob," this latest effort by the Willis Brothers should be an equally hot sales piece. Side to watch, "Somebody Knows My Dog," is a light, tongue-in-cheek ode about a cheatin' wife. Looks good. "The End Of The Road" is a thunkin' ditty with a cute sound.

THROUGH THE EYES OF LOVE (2:28)

[Jack, BMI—Clement, Addington]

SHE LOVED THE WRONG MAN (2:57) [Glaser, BMI—Glaser]

TOMPALL & GLASER BROS. (MGM 13754)

Tompall and the Glaser Brothers have a real sweet sound in "Through The Eyes Of Love." A pretty, warmhearted side, this one shouldn't be overlooked by programmers. "She Loved The Wrong Man" is a funky, low-key ode also with a nice sound.

WEST CANTERBURY SUBDIVISION BLUES (2:32)

[Jack, BMI—Clement]

THE THREE CENT OPERA (2:34) [Jando, ASCAP—Malloy]

STONEMANS (MGM 13755)

Those Swingin' Stonemans made a good bit of noise with "Back To Nashville, Tennessee," and should do even better with "West Canterbury Subdivision Blues." Bound to be a lot of pop action in store for this loping ditty. "The Three Cent Opera" is a cute stanza also worth an extra listen.

I WASHED MY FACE IN THE MORNING DEW (2:40)

[Newkeys, BMI—Hall]

A PICTURE OF YOUR MOTHER (2:43) [Newkeys, BMI—Hall]

TOM T. HALL (Mercury 72700)

There's a strong message in this self-penned offering from Tom T. Hall. Tabbed "I Washed My Face In The Morning Dew," the song decries man's injustice to his fellow man. Bears watching. "A Picture Of Your Mother" is a sentimental, emotion-filled ballad.

(Continued on page 46)



COUNTRY LP REVIEWS



RUBY, DON'T TAKE YOUR LOVE TO TOWN—Johnny Darrell—United Artists UAL 3594/UAL 6594

Johnny Darrell hit big with his "Ruby, Don't Take Your Love To Town" single, and this album of the same name stands a good chance of becoming an equally fast-moving item. Leading off the package with the title track, Darrell goes on to sing eleven other selections including "Mental Revenge," "Heaven Help Your Soul," and his while-back smash, "Green Green Grass Of Home." Striking set.

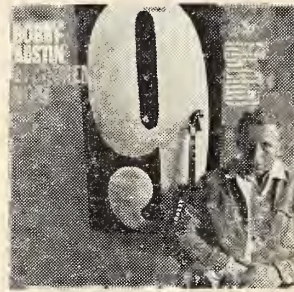

APARTMENT NO. 9—Bobby Austin—Capitol T/ST 2773

Titled after his hit single, "Apartment No. 9" (on the Tally label), Bobby Austin's first Capitol album might well be a big winner for him. In addition to the title tune, the set includes such selections as "One More Time Around," "I Don't Want To Love Again," and "I'm Not Looking For An Angel." Give this one a careful listen.



MY DIRTY, LOWDOWN, ROTTEN, COTTON-PICKIN' LITTLE DARLIN'—Geezinslaw Bros.—Capitol T/ST 2771

Here's a zany, fun-filled package of comedy ditties that's bound to go over big with the Geezinslaw Brothers' many fans. Among the numbers on the set are "S.W.A.K.," "Don't Blow Your Horn," "Someone To Love," and of course "My Dirty, Lowdown, Rotten, Cotton-Pickin' Little Darlin'." Could be a considerable number of sales on tap for this one. Watch it.



THE PO' BOYS PICK AGAIN—Po' Boys—Decca DL 4884/74884

For this, their second album, the Po' Boys have cooked up a tempting batch of country ballads and toe-tappers that could earn them loads of sales attention. Among the numbers on the set are "Sunny-Gem," "The Gods Were Angry With Me," "Before I Met You," and "Nickels, Quarters And Dimes." Should do nicely.



MARGIE BOWES SINGS—Margie Bowes—Decca DL 4816/74816

Margie Bowes could garner heaps of spins and sales with this spirited album. The lark lends her considerable talents to a dozen country tunes, notably "Big City," "Get Your Lie The Way You Want It," "It's Enough To Make A Woman Lose Her Mind," and "That Completely Destroys My Plans." Keep tabs on this one. It could go far.



COUNTRY MUSIC NORTH OF NASHVILLE—Various Artists—Wedge SR 1023

A highly interesting collection of performances by country artists from such states as Delaware, Maryland, Pennsylvania, Virginia and West Virginia, this set could prove to be popular with a wide variety of listeners. Top tracks include "When You Came In My Life," by Ralph Johnson; "Anything," by Joan Smallwood; and "You Tore My World Apart," by Kenneth Cross & the Carroll County Four. Excellent production.

Kapp Sees Booming Country Business

NEY YORK—Paul Cohen, director of Kapp Records country A&R department stated recently in New York that "country and western music has mushroomed sky-high in recent months and is continuing to boom." Accompanied by the label's C&W promotion director Chuck Chellman, Cohen was in N.Y. for Kapp's national sales meeting, at which time it was announced that the label was planning to release four new country LPs for its July-August release, including those by Bob Wills, Hugh X. Lewis,

Mel Tillis and Cal Smith. Nine more (including 3 or 4 religious country albums) are planned for the following months, bringing to 15 the total of country sets to be released by the label before the end of the year.

It was also announced that the label is contemplating signing 2 or 3 additional "name" artists to supplement the firm's roster. Represented on the Cash Box country charts with two singles, Hugh X. Lewis' "You're So Cold" (52) and Freddie Hart's "I'll Hold You In My Heart" (60), Kapp will soon be releasing a new single by Becki Bluefield, as well as a duet deck with Bob Wills and Mel Tillis.

*"American Power needs all its citizens help
We only please our enemies when we fight among ourselves
Let old hates of yesterday be gone with the wind
We must stick together or be destroyed from within."*

© Copyright 1967 by KITTY WELLS PUBLICATIONS

DECCA RECORDS

*proudly announces the release
of a moving and meaningful record*

by

JOHNNY WRIGHT

"AMERICAN POWER"

32162

*Never before has a recording captured in music and lyric a
performance with so timely a message.*

*Listen to it! We sincerely believe it is one of the most
important records of our time!*



COUNTRY REVIEWS

● BEST Bet
B+ very good

B good
C+ fair

only those records best suited for commercial use are reviewed by Cash Box

(Continued from page 44)

Newcomer Picks

- BIG BROTHER (2:61) [Jack, BMI—Clement, Lee, Reynolds]
- BIG SHOT, THE POOL SHARK (2:35) [Jack, BMI—Matthews]
- MURV SHINER (MGM 13704)

Could be lots of action in store for Murv Shiner as a result of "Big Brother." This one is a warm, plaintive stanza that has lots of twin-market appeal. "Big Shot, The Pool Shark" is a ramblin' ditty with a pleasant flavor.

- DIAMONDS FOR PEARL [Peach, SESAC—Hood]
- THE WORST IS YET TO COME [Yonah, SESAC—L./C. Anderson]
- BOB JENNINGS (Chart 1470)

Bob Jennings has come close in the past and could break out with "Diamonds For Pearl." Lid is a pleasant, waltz-time effort which may catch on with spinners and buyers. Flip is a melancholy woeer tabbed "The Worst Is Yet To Come."

- LAURA (What's He Got That I Ain't Got) (2:32) [Al Gallico, BMI—Ashley, Singleton]
- WITH THE HELP OF THE WINE (2:25) [Ashmar, BMI—Ashley, Singleton]
- LEON ASHLEY (Ashley 2003)

Leon Ashley delivers a story filled with bitterness in "Laura (What's He Got That I Ain't Got)." Bad news awaits the heroine in this one, but it could well be good news for Ashley. "With The Help Of The Wine" is a mid-tempo, traditionally-oriented blueser.

Newcomer Picks

- KATY (2:15) [Mayhew BMI—Buzzeo]
- OR IS IT LOVE (2:00) [Mayhew BMI—Buzzeo]
- LINWOOD PRYCE (Little Cowboy 3002)

Could be a good spot in the limelight for Linwood Pryce via this wallop dubbed "Katy." An infectious sound with a highly danceable rhythm, the lid may spring Pryce into the big time. "Or Is It Love" is a feelingful romancer.

- BOBBY FISCHER (Jab 9006)
 - THE GIRL I LEFT BEHIND (3:18) [Tree, BMI—Fischer] Bobby Fischer puts a lot of feeling into this poignant, shuffling ballad. Could go far.
 - (B+) SOME KIND OF LOVE (2:05) [Ally, BMI—Fischer] Romance-oriented swinger on this side.
- JIMMY PAYNE (Epic 10173)
 - WOMAN, WOMAN (3:12) [Glaser, BMI—Glaser, Payne] Watch out for this plaintive, heart-rending sobber. It could catch on.
 - (B+) MONEY CANNOT MAKE THE MAN (2:51) [Glaser, BMI—Glaser] More in a similar vein over here.

- JAMEY RYAN (Columbia 44169)
 - YOU'RE LOOKIN' FOR A PLAYTHING (2:19) [Glehi, BMI—Crockett] This one is a fast-moving, woes-slanted toe-tapper that could attract a king-sized crowd of country buyers. Eye it.
 - (B+) GROWIN' PAINS (2:13) [Window, BMI—Johnson] Flip is a plaintive sobber.

- CATHY CASS (Wayside 1003)
 - WANTED, A MAN WITH A PLAN (2:29) [Backbay, BMI—Casella] Could be loads of attention in store for Cathy Cass via this outing. Side is a tuneful toe-tapper about a gal who longs for adventure.
 - (B+) CARELESSLY I CRY (2:30) [Backbay, BMI—Casella] Flip is a sincere, slow-paced weeper.

- EARL AND AUDIE (K-Ark 753)
 - BLUE, BLUE'S IN GREEN (2:15) [Cedarwood, BMI—Westberry] Earl and Audie could make a name for themselves with this tear-stained item about a soldier who wonders whether his girl back home is still waiting for him. Keep tabs.
 - (B+) SLIGHTLY USED ENGAGEMENT RING (1:55) [Stringtown, BMI—Rae] Medium-paced heart-tugger over here.

- DICK TODD & APPALACHIAN WILDCATS (Peer-Southern 125303)
 - BIG WHEEL CANNONBALL (2:59) [Southern, ASCAP—Horton] Don't take your eye off this powerful, contagious finger-snapper. It could go far.
 - (B+) RETURN OF THE DOUBLE EAGLE (2:30) [Southern, ASCAP—Roland] Dick Todd sits out on this side as the Appalachian Wildcats perform an energetic, brisk-paced instrumental.

- "LITTLE" JIMMY DEMPSEY (ABC 10955)
 - RHODE ISLAND RED (2:23) [Mose Rose, BMI—Calvard] Lively, infectious instrumental could earn spins aplenty for guitarist "Little" Jimmy Dempsey. Groovy sound.
 - (B+) BUT FIRST A WORD FROM OUR SPONSOR (2:10) [Dempsey, BMI—Dempsey] Another catchy instrumental on the back.

- SMILEY MONROE (Toppa 1115)
 - TEMPTATION'S GOT A HOLD ON ME (2:08) [Mixer, BMI—J. & J. Mosby] This one is a stirring, remorse-filled blueser that could make this deck a sought-after item in the country marketplace. Memorable session.
 - (B+) DON'T LET IT HAPPEN TO ME (2:55) [Mixer, BMI—J. & J. Mosby] Poignant, shuffling ballad on this side.

- WADE JACKSON (Starday 809)
 - (B+) I'LL TAKE YOU BACK (2:45) [Starday, BMI—Jackson] Emotion-packed romance effort.
 - (B) A BIG WING DING (1:53) [Starday, BMI—Jackson] Buoyant, happy-go-lucky swinger.

- MARTY SMITH (Amigo 6769)
 - (B+) THE OLD SOLDIER (2:11) [Amigo, ASCAP—Smith] Touching item about an old soldier who wants to join his son in Vietnam.
 - (B) COLD COLD RIVER (2:35) [Rex Zario, BMI—Smith, Vernik] Regret-filled bouncer.

- BILL BLOUGH (Destination 634)
 - (B+) NASHVILLE SOUNDS COME TO TOWN (1:52) [Destination, BMI—Fisher] Groovy finger-snapper in praise of the "Nashville Sound."
 - (B) ON THE CRYIN' LINE (2:20) [Fab, BMI—Fisher, Willis] Woes-laden outing with an infectious beat.

- HAL WAYNE (Nugget 260)
 - (B+) HURTING ME IS ONLY HURTING YOU (2:20) [Lonzo & Oscar, BMI—Wilson, Wayne] Pain-wracked love ballad.
 - (B) LOOKING FOR SOMEONE (1:52) [Lonzo & Oscar, BMI—Wilson, Wayne] Blues-oriented outing for the romantically inclined.

If you are reading someone else's copy of **Cash Box** why not mail this coupon today!

CASH BOX
1780 BROADWAY
NEW YORK, N. Y. 10019

Enclosed find my check.

- \$20 for a full year (52 weeks) subscription (United States, Canada, Mexico)
- \$40 for a full year (Airmail United States, Canada, Mexico)
- \$30 for a full year (other countries)
- \$45 for a full year (Airmail other countries)

(Check One)

- I AM A DEALER
- ONE STOP
- DISTRIB
- RACK JOBBER
- PUBLISHER
- RECORD CO.
- DISK JOCKEY
- COIN FIRM
- OTHER

NAME
FIRM
ADDRESS
CITY STATE ZIP #

Be Sure To Check Business Classification Above!

Cash Box



July 8, 1967



Polydor's legendary star Freddy Quinn is seen here with his 10th Gold Disk for his million selling single "Freddy Auf Hoher See." Earlier this year he was awarded the MIDEM trophy as the best selling artist in Germany. Freddy is currently appearing in the smash musical "Heimweh Nach St. Pauli" (Homesick For St. Pauls) which has broken box office records in Hamburg, Vienna and Berlin. Hit song from the show "Junge Komm Bald Wieder" (Son, Come Home Soon) was also a million seller. His current charter is the Bert Kaempfert composition "Morgan Beginnt Die Welt" (The World Begins Tomorrow).



GREAT BRITAIN

Since Pye Records started their system of direct distribution way back in 1959, depots have been set up in Mitcham, Birmingham, Manchester, Leeds and Glasgow. The sixth and final depot, servicing Bristol, South Wales and the West Country, was opened at Bristol last week thus giving the company blanket distribution throughout the United Kingdom, excluding Northern Ireland. A 24-hour, nationwide service is provided by a fleet of 49 sales vans. To mark the opening of the Bristol depot parties were held in Bristol and Plymouth attended by Managing Director Louis Benjamin, General Manager Les Cocks and Sales Controller Tom Grantham.

Louis Benjamin, Managing Director of Pye Records, recently back from Japan—a market he considers to be potentially, if not already, one of the greatest record markets in the world. He met representatives of all Japanese record companies with regard to the future of Pye Records in that territory. However, he told Cash Box that it was not a record company but an artist, Don Ho, who made the biggest impression on him. He saw Don Ho (who records for Reprise) in Honolulu, and after watching his 1½ hour performance, Benjamin considered him to be one of the world's great entertainers—on a par with Sinatra, Sammy Davis, Jr., etc.—and is convinced that he will become an international star.

CBS report that Mahler's Symphony No. 8 (The Symphony Of A Thousand) recorded by the London Symphony Orchestra conducted by Leonard Bernstein and released in December, 1966, has been one of their best-ever classical sellers. Bernstein, who has already recorded Mahler's 2nd, 3rd, 5th, 7th and 8th Symphonies, recently completed the cycle by recording the 1st, 6th and 9th. The first of the three new recordings to be issued will be the 6th early in 1968. During a recent visit to Vienna to conduct a series of three concerts to commemorate Bruno Walter's 90th birthday, Bernstein was awarded the Gold Medal of the International Gustav Mahler Society. He returns to Vienna in April, 1968, to conduct the new production of Strauss' "Der Rosenkavalier" at the Staatsoper and give further concerts with the Vienna Philharmonic.

Mrs. Monique Peer-Morris, President of the Peer-Southern Organization, and David Morris in England on a business-cum-pleasure trip had meetings with Tom Ward and Bob Kingston and heads of departments at the London office. The London company is riding high in Britain with "Finchley Central" by the New Vaudeville Band and in the American Top 100 with "Little Bit Of Soul" by Music Explosion. The number was penned by Carter-Lewis, the team responsible for "My World Fell Down" by the Sagittarius which looks like being a big hit.

Walt Disney Productions, Ltd., presented the European preview of "The Happiest Millionaire" starring Tommy Steele. The film, which had its world premiere in Hollywood on June 23rd attended by Steele (who is now filming in California), will not be seen in London until October and on the continent early 1968. The British preview was attended by many top European record executives including Gramitto Ricci and David Matalon of Editions Curci (Italy); W. Jung from Electrola (Germany); Lucien Ades of Disques Ades (France); Gerry Oord of Bovema (Holland); Vidal Sapater of Hispavox (Spain), Anders Holmstedt of EMI (Sweden) and Stephen Gottlieb of EMI (Denmark). From Walt Disney Productions U.S.A. came Roy Disney and Jimmy Johnson. A strong delegation from EMI London attended the preview headed by Chairman Sir Joseph Lockwood. Following the preview, all delegates attended meetings held by Frank Weintrop, of Walt Disney's London office, to discuss plans for the British and continental release of the picture.

Immediate Records are planning an international expansion program for their artists. The first of a series of continental personal tours is already underway featuring the Small Faces, P. P. Arnold, Chris Farlowe and Twice As Much. Receptions to meet the local press, radio & TV personnel have been lined up in all countries to be visited—these include Germany, Luxembourg, Holland, Belgium, France and Switzerland. Immediate TV spectaculars will also be planned for later screening. A second tour in July will cover Scandinavia and a third package taking in Italy and Spain is now being lined up. Immediate have a current chart entry with the Small Faces "Here Come The Nice" published by Avakak/Immediate as well as P. P. Arnold's "The First Cut Is The Deepest" published by Cat.

Track Records' Jimi Hendrix starred with Ferre Grignard (Belgium) and German group the Original Exrays in "Hamburg Swings," the latest in a series of Nord Ring concerts and networked throughout Norway, Sweden, Denmark, Holland, Germany, Belgium and Great Britain.

British Group the Troggs have announced a split with Larry Page and Page One Records for another, as yet unnamed, label. A spokesman for Page One stated that the matter is in the hands of solicitors. The Troggs' first hit for Page One "Wild Thing" was issued on Fontana and consequent charts for Page One have included "I Can't Control Myself," "Anyway You Want Me" and currently "Night Of The Long Grass."

Top British folk singer Bert Jansch has renewed his contract with Nathan Joseph's Transatlantic label, the company who set him on the road to success. Jansch's first single "Life Depends On Love" was issued on Transatlantic's Big series last week. The new contract runs until 1970. Jansch recently formed a new electric group the Pentangle which also features another British folk artist John Renbourn. The group will also record for Transatlantic, and a single and album are planned for September. The Jansch-Renbourn-Pentangle disk sales were boosted following their Festival Hall concert in May, and they will appear at the Windsor Jazz & Blues Festival in August to be followed by a six-day tour of Denmark including concerts, radio and TV.

Another newly formed band the Fleetwood Mac headed by Peter Gunn (former guitarist for the Bluesbreakers Band) will make their debut at the Windsor Jazz & Blues Festival. They are contracted to and record for Blue Horizon Records who are setting up their R & B releases for English blues bands. Blue Horizon disks are distributed by Keith Prowse.

Matt Monro back in London from the U.S.A. promoting his latest Parlophone single "What To Do." Radio and TV dates include a 45 minute TV Spectacular "Matt Monro Meets Nelson Riddle" for which the American bandleader is flying in specially to accompany Matt.

Jimmy Miller, producer of the Traffic's "Paper Sun" smash planes to America in August where he will record for United Artists rhythm tracks featuring American R & B musicians for use on forthcoming Jimmy Cliff and Wynder K. Frogg recordings.

Quickies: Pye hosted reception to launch new singer Tony Crane "Anonymous Mr. Brown" . . . The Beatles appeared on BBC TV's "Our World" June 24th viewed by world wide audience of over 600,000,000 . . . Polydor rush-releasing Atlantic L.P. by Arthur Conley tagged after his "Sweet Soul Music" single smash . . . Brian Hutch of the Noel Gay Organization in New York for three weeks while Jean Powell of the Richard Armitage Agency accompanies Janis Ian on a West Coast Tour . . . Shirley Bassey starts another season at Talk of the Town July 3rd . . . John Barry plays his score from the James Bond film "You Only Live Twice" issued on CBS . . . Promoter Don Arden makes own record debut on Decca with "Sunrise, Sunset" . . .



FRANCE

AZ artist "Les Troubadours" are the winners of the "Rose De France De La Chanson" which took place in Antibes-Juan Les Pins. Their song "Le Vent Et La Jeunesse" is published by La Compagnie. Unfortunately the Festival was not as great a success as hoped, as no really "top" artists were among the participants.

Since her return from Las Vegas, Line Renaud was not in too great a hurry to record in a French studio again. But she decided to do so and her record company, Line Records, Inc., just released four new titles, 3 of which already seem to be well on the way to success. Said record has been recorded in the new Louis Gasté studio in Paris, the same studio used by the American vocal group, the What's New, discovered in the States by Line Renaud and Loulou Gasté.

Concerning the What's New, their second record will be released in the States and Great Britain and will be controlled by Bunny Lewis. One of the titles composed by one of the four What's New (Colin Scot) has just been acquired by Dick James for one of his groups.

Famous French soprano sax player Claude Luter has been awarded "Grand Prix Du Disque 1967 Du Jazz Club De France" for his Vogue EP with four tunes written by Claude and Sidney Bechet a few years ago. Titles are: "Le Vieux Bateau," "Cabalistique," "Je Suis Né En 1897," "Alpes Suisse." A few days after this record's release, Claude Luter presented a new EP with his own versions of Dutronc's "J'aime Les Filles" and of Sandie Shaw's "Puppet On A String."

Through the Ducretet Thompson label, Pathé Marconi presents this week four album of French folk music. The series is titled "En Passant Par." It concerns four great French provinces: Bearn, Aveyron, Bresse, Franche Comté.

Philips Records, will produce an important promotion broadcast on Radio Luxembourg every day from 3 p.m. to 4:30 p.m. from July 24th until August 19th. This live broadcast will be presented from a yacht in the port of Cannes. At this occasion, André Asséo, who manages the Philips public relations department and who will direct the broadcast, tells us Philips will soon launch a new LP series of mood music: "Super Stereo Sound." Original soundtrack from the Jacques Demy musical, "Les Demoiselles De Rochefort," is now on release in England in the French and the English versions.

Mr. Itoh, Victor Company of Japan manager, visited Leon Meyerstein (who manages Philips that Victor distributes in Japan). Itoh announced that French young artist Dainele Denin already sold 30,000 singles in Japan with her song "Poupées, Ballons, Chocolats." Michel Legrand is also a great success in that country with his LP album, "Michel Legrand chante Michel Legrand."

Vogue is doing a hard promotion job to win the annual battle of the "Song Of The Summer." This firm is the first to promote the new dance called the "Skate." First "Skate" record is the Nancy Sinatra new hit "Jackson." Jean Georgieff, of Vogue, tells us he will also strongly promote "Come Back Girl" by J. Edwards, "Alfie" by Dionne Warwick, "Lady" by Jack Jones, "He Said She Said" by Don Randi Trio, "Daddy's Home" and "Don't Go" by C. Jackson and M. Brown.

French EP TOP TEN

- 1 A Whiter Shade Of Pale (Procul Harum) Essex-Deram
- 2 Notre Roman (Adamo) EMI; Pathé-Marconi
- 3 C'est Ma Chanson (Petula Clark) Vogue; SEMI
- 4 Un Tout Petit Pantin (Sandie Shaw) Vogue-Pye; Tutti
- 5 Ballade En Novembre (Anne Vanderlove) Pathé-Marconi
- 6 J'aime Les Filles (Jacques Dutronc) Vogue; Alfa
- 7 Le Roi Des Fourmis (Michel Polnareff) AZ; SEMI
- 8 Adieu A La Nuit (Mireille Mathieu) Barclay
- 9 Le Téléphone (Nino Ferrer) Riviera; Beuscher
- 10 Adios Amor (Sheila) Philips-Carrère

Great Britain's Best Sellers

This Week	Last Week	Weeks On Chart	Title	Artist
1	1	6	*A Whiter Shade Of Pale	Procul Harum (Deram) Essex
2	2	4	There Goes My Everything	Engelbert Humperdinck (Decca) Burlington
3	4	3	Carrie Anne	The Hollies (Parlophone) Galto
4	3	7	*Waterloo Sunset	The Kinks (Pye) Davray
5	5	9	Silence Is Golden	The Tremeloes (CBS) Ardmore and Beechwood
6	10	3	*Okay	Dave Dee, Dozy, Beaky, Mick & Tich (Fontana) Lynn
7	6	7	The Happening	The Supremes (Tamla-Motown) Carlin
8	9	3	Groovin'	Young Rascals (Atlantic) Sparta
9	8	5	*Finchley Central	New Vaudeville Band (Fontana) Meteor
10	14	3	*Don't Sleep In The Subway	Petula Clark (Pye) Welbeck
11	16	2	She'd Rather Be With Me	The Turtles (London) Robbins
12	13	6	Sweet Soul Music	Arthur Conley (Atlantic) Cop Con
13	12	7	Then I Kissed Her	Beach Boys (Capitol) Carlin
14	—	1	*Here Come The Nice	The Small Faces (Immediate) Avakak
15	7	11	Dedicated To The One I Love	Mamas & Papas (RCA) Peter Maurice
16	19	2	If I Were A Rich Man	Topol (CBS) Valando
17	20	2	*What Good Am I?	Cilla Black (Parlophone) Carlin
18	—	1	Take Me In Your Arms	Gladys Knight (Tamla-Motown) Carlin
19	—	1	It Must Be Him	Vikki Carr (Liberty) Metric
20	—	1	Alternative Title	The Monkees (RCA) Screen Gems

*British Copyright.

Top Ten LP's

- | | |
|--|---|
| 1 Sgt. Pepper's Lonely Hearts Club Band—The Beatles (Parlophone) | 6 Release Me—Engelbert Humperdinck (Decca) |
| 2 Are You Experienced? — Jimi Hendrix (Track) | 7 Best Of The Beach Boys—Beach Boys (Capitol) |
| 3 The Sound Of Music—Soundtrack (RCA) | 8 Green Grass Of Home—Tom Jones (Decca) |
| 4 More Of The Monkees — The Monkees (RCA) | 9 Evolution—The Hollies (Parlophone) |
| 5 Fiddler On The Roof — London Cast (CBS) | 10 Monkees—The Monkees (RCA) |

Tony Hall Exits Decca To Form Indie Disk-Promo Firm

LONDON—Tony Hall has left Decca Records as head of exploitation to set-up his own organization, Tony Hall Enterprises, which will create and record new talent and establish an indie disk promotion unit for disks from other sources. Hall, with Decca for the past 13 years, is credited with being largely responsible for the success of Decca's Deram label, which

includes the world-wide hitmakers, Procum Harum.

Hall plans an "open house" policy for singers, groups, arrangers, composers and producers and especially the British counterpart of America's "underground movement." Staff appointments will be announced shortly. Meanwhile, Hall is on a short holiday.

RCA Italiana Opens Color TV Co.

ROME—The color TV era in Italy has been opened by RCA Italiana with the announcement of the formation of a new company, associated with RCA Italiana Records, called RCA Color. Announcement of the new company was announced by Robert Sarnoff, president of the Radio Corporation of America, parent company. Giuseppe Ornato, managing director of RCA Italiana, will have the same title at RCA Color.

The new company will immediately start construction of a new factory near Rome. The estimated production of color sets for the end of 1968 has been fixed at about 300,000 units. By

1970, this quantity will be increased to 2 million, with a total of 3.5 million by 1975. Units will be exported to all member countries of the European Common Market.

As the main center of RCA's European color TV operations, Italy is expected to benefit through a retention of a favorable balance of foreign trade, which took the country out of an economical crisis earlier this year.

While Italy's state-owned radio-TV company is prepared to start immediate color transmissions, the Government has decided to postpone the start of color programs until 1970.

Sir Edward Lewis Earns Albert Medal

LONDON—The gold Albert Medal of the Royal Society of Arts for 1967 has been awarded to Sir Edward Lewis, Chairman of Decca Ltd., for his contribution to the electronics industry.

Sir Edward Lewis, who is 67, has been a member of the London Stock Exchange since 1925.

The society noted: "It may fairly be claimed that the Decca Group of Companies owes its survival and growth into a national asset to his vision, tenacity and enthusiasm. He was closely concerned in the formation of the nucleus of the group, then operating solely within the gramophone industry, in 1929, and guided it through the acute financial difficulties of the years which followed. In the 1930's he promoted the firm's establishment in the United States. It was Sir Edward, again, who encouraged the initial scientific research which eventually produced the revolutionary Decca navigating equipment, first employed in the closing stages of the Second World War, and now, in its perfected form, used by ships and aircraft all over the world. Decca Marine Radar has also followed a pattern of continuous development since its introduction in 1949. More than 90% of the output of this equipment is exported from the U.K., and the Decca Radar Com-

pany has twice received The Queen's Award for export achievement."

Sir Edward's Comment

Following the award, Sir Edward said that he felt "greatly honored to join the distinguished company of men who have received the Albert Medal over the past 103 years. Decca's achievement is thanks to the loyalty, ability and hard work of all those whom I have been privileged to lead."

The Albert Medal was instituted by the Society in 1864 to commemorate the Presidency of the Prince Consort, and is awarded annually for distinguished merit in promoting arts, manufactures or commerce. It is interesting to recall that in 1867 the Medal was awarded to Sir W. Fothergill Cooke and Sir Charles Wheatstone for their joint efforts in establishing the first electric telegraph.

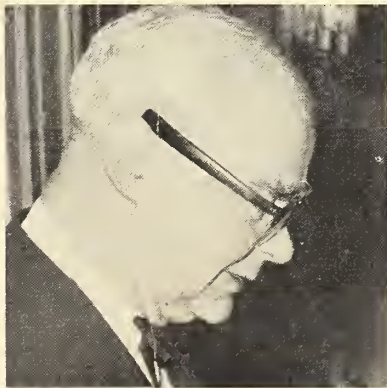

Maxin To London

NEW YORK—Arnold Maxin, vice-president and general manager of The Big 3 (Robbins-Feist-Miller) arrives in London this week to discuss music in the upcoming MGM film production "Far From The Madding

Crowd." Maxin will meet with producer Joseph Janni, director John Schlesinger and Richard Rodney Bennett who scored the picture. He will also confer with Big 3 publishing affiliates in London to set exploitation patterns for future global music drives.

Wide Interest Shown In This Year's Czech Int'l Festival Of Pop Songs

CZECHOSLOVAKIA—The presence of Sandie Shaw at the International Festival of Pop Songs of Bratislava secured world wide interest to the Slovak contest. In fact, as winner of the Eurovision Song Contest, her participation evidenced the importance that the Western world places upon this Festival.

The second Bratislava Festival took place from June 14 to 17, the first two days being devoted to the selection of five songs, each out of ten, to compete in the finals. The evening of June 17th was then devoted to the Intervention Contest. According to the foundations of the Festival, its aim is to choose the three best songs from twenty previously selected new songs, awarding them in order a Gold, Silver and Bronze Lyre. On June 17 in the wide theatre hall, overlooking the Danube, the first prize went to Czechoslovakia for "Requiem" performed by Eva Pilarova and written by B. Ondracek and J. Schneider. Second prize went to Yugoslavia with "Bokel Night" sung by Vice Vukov and written by H. Hegedusic and M. Perfileva and third prize to Finland for "I Cannot Forget You" sung by Laila Kikkunen and written by V. Laitinen and T. Valkama.

TV Audience: 350 Million

After each evening's contest a gala took place featuring international artists which widened the main feature of the Bratislava Festival with a cosmopolitan sparkling outlook. Peter and Gordon, Inge Bruck, Bill

Ramsey, Nancy Holloway, Guy Mardel and Gigliola Cinquetti stole the scene on the first two nights but the peak was really reached on June 16th when, after the Choir Horst Jankowski, Sandie Shaw electrified the Slovak audience. A line-up of top pop artists from Yugoslavia, USSR, Hungary, Poland, Finland, East Germany, Bulgaria, Romania and Czechoslovakia took place on June 17th. Through the Intervention and partly via Eurovision the Bratislava Festival had a TV audience of some 350 million people.

See Photos p. 55

It can truly be said of the Bratislava Festival that West met East commercially. For Western representatives it was a proper chance to assess the still little known Eastern markets.

Czech Disk Expansion

Dr. Pavel Smola, Director of Artia—the Czech state owned body dealing with all foreign cultural affairs—told Cash Box that the Czechoslovakian record industry is undergoing major expansion. Its Supraphon label is represented in Great Britain by Paul Hamlyn; Western Germany, Austria and Switzerland by Deutsche Grammophon Gesellschaft; Scandinavia by the Sonet Group; Benelux by Supra-

(Continued on page 57)

A&M Sets Up Foreign Publishing Deals

HOLLYWOOD—A&M Records has moved quickly to establish the international operation of its music publishing companies, reports Chuck Kaye, head of the label's publishing operation.

Almo and Irving, now have their own publishing organizations in England, Rondor Music Ltd.—Carlin Music Corporation; in Australia, Rondor Music Australia, Pty. Ltd.—Belinda Music Australia; in Mexico, Rondor Music S.A.—Grever International S.A.

Publishing affiliations for A&M companies have been set up during the past six months under Kaye's direction with companies in Germany, Sweden, France, Spain and Italy.

Kaye also revealed completion of arrangements with Charles Hanson, head of Hanson Publications, for production and distribution of A&M's

sheet music and folios. Herb Alpert's Tijuana Brass folios are currently being distributed in Britain, Sweden, France and Spain.

Within the A&M complex, under the overall direction of Kaye, assisted by Dave Hubert and Joel Sill, are the following companies: Irving Music (BMI), Almo Music (ASCAP), owned by A&M; Good Sam (BMI) and La Brea (ASCAP), administered by A&M; Rondor, Inc., which handles international arrangements for the other four.

Kaye stated: "We set out to build a strong international publishing operation knowing in front that the publishing field was an exciting area, ripe for development. We now feel we have diversified with strength in standards, chart hits, country and folk, plus jazz."



ARIOLA-LIBERTY DEAL—The new German organization of Liberty Records has signed a long term contract for pressing and distribution with Ariola-Eurodisc for this market. The contract goes into effect on July 1. This will mean that top artists such as Johnny Rivers, Gary Lewis & The Playboys, etc. will now be handled for promotion and production independently by Liberty, with Ariola taking over distribution chores. Liberty will also handle wholesaler and juke box sales alone. Seen at the signing are Standing (L-R) Ron S. Kass, director of overseas operations—Liberty, Ariola export manager Hans-Georg Ehmke, business manager of Liberty Germany, Jerg Bronner and Heinz Kirchsberg of the Sonopress pressing plant for Ariola. Seated: Dr. Werner Vogel-sang, managing director of Ariola-Eurodisc and Siegfried Loch, managing director of German Liberty Records.



ITALY

Three top events of Italian musical life are scheduled here the first fifteen days of July. First is the final night of the International Light Music Show of Venice which will be televised via Eurovision throughout Europe with many top Italian and International talents taking part. Caterina Caselli (CGD) will be awarded this year the "Golden Gondola" for her top selling disc of "Perdono."

Second event is the final night of the top contest "Cantagiuro" which will take place on July 8th in Fiuggi (resort near Rome). The contest is of particular interest this year thanks to the participation of top Italian stars such as Adriano Celentano (Clan), Rita Pavone (RCA) and Little Tony (Durium).

Last but not least is the "Festival of Naples" on July 13th, 14th and 15th, all three nights to be televised.

Curci has already confirmed their participation in the Neapolitan contest with 6 songs. First in the list is the tune "O Vesuvio" which will be sung by Domenico Modugno (Cemed Carosello) and Sergio Bruni (EMI Italiana). Sergio is the winner of last year's contest with another Curci song: "Bella."

Second song of the group is "A Canzone" sung by Robertino (Cemed Carosello) and Bruno Venturini (Italdisc). The other tunes are "Angelica" interpreted by Memo Remigi (Cemed Carosello) and Nunzio Gallo (Vis Radio), "L'Arca 'E Noe" performed by Gianni Meccia (Cemed Carosello) and Paolo Gualdi (Italdisc), "Ma Comme Va" sung by Lalla Leone (Italdisc) and Luisa Casali (Italdisc) and "Te Faje Desidera" performed by Ann German and Lara Saint Paul (both under agreement with CDI).

Phonogram has announced the arrival in Italy of the New Vaudeville Band for a concert tour throughout Italy from July 7th until July 19th. The New Vaudeville Band is currently very popular here thanks to their hit "Winchester Cathedral."

Carisch SpA. is introducing in Italy the new French talent of Philippe Olivier. The young singer, originally grooving under the Odeon label, has just recorded his first Italian single: "Il Solo Amore" and "Tu Ridevi Di Me." The promotional schedule of this new talent includes several personal appearances on our TV screens, the first scheduled for the end of July.

Ricordi has informed that the song "E' Dall'Amore Che Nasce L'Uomo," interpreted by the top group Equipe 84, will serve as leit-motiv of the Italian motion picture "La Ragazza Tutta D'Oro" (The Complete Golden Girl).

Don Backy, one of the leading artists of Clan Celentano, has just made his debut as a film actor, taking part in the film "L'Immensita'," derived, of course, from the San Remo hit.

CGD, Compagnia Generale Del Disco, has confirmed their participation in the International Light Music Show of Venice. The artists and songs they will present on the San Marco scene on the final night are: Lola Falana who will perform "Scrivimi Il Tuo Nome;" Gene Pitney will sing "Amico Ascoltami;" Caterina Caselli will present her hit "Sono Bugiarda" (I'm A Believer); Gigliola Cinquetti will introduce two songs, her "Summer" hit "La Rosa Nera" and "Una Storia D'Amore;" the young Brazilian artist Roberto Carlos will introduce to the European public the song penned by him "La Donna Di Un Amico Mio," Italian translation of "Namoradinha De Un Amigo Meu."

A big promotion now being conducted by Ariston on the name of Ornella Vanoni. The Italian star will take part in a series of TV shows. Also confirmed is her participation in the International Light Music Show of Venice where she will introduce another Brazilian song entitled "Tristeza." Also confirmed is her participation in the next "Festival Of Roses" in Rome, scheduled for next October.

Dischi Parade has just pacted the top talent of Fausto Cigliano. The well known artist, presently the star of the TV weekly series "Chitarra Club," will record a first LP entitled "Chitarra Club" (Guitar Club) including all the songs presented by him on this TV transmission.

Award 'Edisons' For Classical Music

AMSTERDAM—A week after the announcement of this year's popular Edison-Awards winners (see International News Report in last week's Cash Box), the C.C.G.C. announced the Edison-Awards winners in the classical and "serious" categories.

In the category "Concert And Instrumental Solomusic With Orchestra," winners are August Wenzinger for his conducting of Händel's complete organconcertos (Archiv) and Vladimir Ashkenazy for his Mozart piano concertos nr. 8 and 9 and Rondo K.V. 386 (Decca). Ashkenazy also got special credit for the sonatas and waltzes by Schubert.

In the second category, "Symphonic Music," an Award will be given to Otto Klemperer for his conducting of Mahler's "Das Lied Von Der Erde" (His Master's Voice); Klemperer got special credit for the "Missa Solemnis" by Beethoven (H.M.V.).

Third category, "Music For Chamber Orchestra" has conductor Jean François Paillard as prize winner. Under his direction "Symfonietta Of Roussel" by Honegger and a piece by Schmitt were recorded (Erato). Paillard also got a special credit for the "Concerti Grossi" by Händel (Erato).

Kees Otten gets the Award in the category "Chambermusic" for the performance of the "Anthology Of Early Music" (1350-1475) (Columbia). Second Edison in this category goes to I Musici for their perform-

ance of the "Brandenburg Concertos" by Bach (Philips).

"Solo-Recitals Instrumental" winners are Wilhelm Kempff for the complete Piano Sonatas by Beethoven (D.G.G.) and Dutch organist Willem Talsma for his Organrecital recorded in the Bonifatius church in Medemblik (Disco-Nederland).

"Opera"-Edisons were given to Leonard Bernstein for Verdi's "Falstaff" (CBS), Karl Boehm for Wagner's "Tristan Und Isolde" (D.G.G.) and Georg Solti for Wagner's "Die Walküre" (Decca).

In the "Choirmusic"-category Edisons are to be presented to Hendrik Czyz for his performance of Penderecki's "Lukas Passion" (Harmonia Mundi) and to Colin Davis for Händel's "Messiah" (Philips).

The "Contemporary Music" was awarded by granting an Edison to producer Dr. Werner Goldschmidt for the series "Studio-Reihe Neuer Musik" (Wergo). Henk Van Ulsem gets an Edison in the category "Drama" for the Philips-production of "Diary Of A Madman" by Gogolj. Without category-mention, producer Garcin gets an Edison Award for the Erato series "Collection Châteaux Et Cathedrales."

The jury was formed by L. Hanekroot, Ralph N. Degens, D. S. van der Meer, Joop Schrier and W. F. Strietman.



SCANDINAVIA

DENMARK

Skandinavisk Grammophon A/S, the EMI distributor here, changes the company after July 1, and for the future it will be Electric & Musical Industries (Dansk-Engelsk) A/S, with same address and phone number. Since this announcement reached this office too late to be included in the Directory Issue, Cash Box readers are kindly requested to make a note in their copies.

Just released here at the Sonet label is the Dubliners with "Seven Drunken Nights." In addition, Sonet also introduces a new local talent, Flemming Arleth, just out with first recording, a Danish version of "Release Me." Other Sonet releases include Clidows, Maia & Per Dich and the American group Seeds. Dansk Grammofonpladeforlag is also out with Stevie Winwood's Traffic on Island with "Paper Sun" and a number of LP albums on Island, Sue, Saga, Pan, Eros, Epic, Hilltop and Pickwick labels.

NORWAY

"Somethin' Stupid" with Nancy & Frank Sinatra, this week at second spot at the charts here, is published in Norway by Arne Bendiksen A/S.

Recent releases from Norsk Phonogram A/S includes the New Formula on Pye with "Do It Again A Little Bit Slower," Dusty Springfield on Phillips with "Give Me Time," and Ray Conniff on CBS with "The World Will Smile Again."

Gjermund Eggen, wellknown ski-runner in this country of famous ski-runners, recently made his debut as record artist with two songs written for him by Vidar Sandbeck. His debut record appears at the Troll label.

Cool Cats have a single at Triola just released: "Machines" and "I Love You." Arne Bendiksen A/S, who handles Triola, is also distributing the label Galaxy Blink, where Arnie & Silver Strings have done "In The Forests Of Alaska" b.w. "Gone Is My Valley." Normally, there is a very strong market in Norway for country-and-western tunes.

Norway's Best Sellers

This Week	Last Week	Weeks On Chart	Title
1	4	5	Jag Ringer På Fredag (Sven Ingvars/Svensk-American) Seven Brothers Music Inc./Edition Odeon, Sweden
2	2	10	Somethin' Stupid (Nancy & Frank Sinatra/Reprise) Arne Bendiksen A/S, Norway
3	2	11	Puppet On A String (Sandie Shaw/Pye) Musikk-Huset A/S, Norway
4	7	4	Silence Is Golden (Tremeloes/CBS) Edition Odeon, Sweden
5	5	7	Ha! Ha! Said The Clown (Manfred Mann/Fontana) Sonora Musikförlags AB, Sweden
6	—	1	Livet Er Herlig (Kirsti Sparboe/Triola)
7	6	3	Waterloo Sunset (Kinks/Pye)
8	8	3	Jag Tror På Sommaren (Mats Olin/Polar) Polar Music AB, Sweden
9	—	1	Then I Kissed Her (Beach Boys/Capitol) Belinda (Scandinavia) AB, Sweden
10	—	1	Love A Go Go (Wenche Myhre/Triola)

Sweden's Best Sellers

1	Malaika (Hep Stars/Olga) Hep House AB, Sweden
2	*Jag Tror På Sommaren (Mats Olin/Polar) Polar Music AB, Sweden
3	*Jag Ringer På Fredag (Sven Ingvars/Svensk-American) Seven Brothers Music Inc./Edition Odeon, Sweden
4	Theme from 'The Monkees' (Monkees/RCA Victor) Screen Gems Musikförlag AB, Sweden
5	Baby Talk (Dee Jays/Hep House) No publisher
6	Ha! Ha! Said The Clown (Manfred Mann/Fontana) Sonora Musikförlags AB, Sweden
7	Then I Kissed Her (Beach Boys/Capitol) Belinda (Scandinavia) AB, Sweden
8	Sprattelgumma (Puppet On A String) (Siw Malmkvist/Metronome) Thore Ehrling Musik AB, Sweden
9	En Sång, En Gång För Längesen (Green, Green Grass Of Home) (Jan Malmsjö/CBS) Palace Music (Sweden) AB, Sweden
10	The Lion Sleeps Tonight (Hounds/Gazell) Reuter & Reuter AB, Sweden

*Local copyright.

Italy's Best Sellers

This Week	Last Week	Week On Chart	Title
1	2	10	A Chi Fausto —Leali/R.I.F.I. Published by Curci
2	1	8	*Stasera Mi Butto—Rocky Roberts/Durium Published by Curci
3	3	10	*29 Settembre—Equipo 84/Ricordi Published by Ricordi L & Chris
4	9	2	*La Coppia Piu' Bella Del Mondo—Adriano Celentano/Clan Published by Clan
5	4	7	Sono Bugiarda (I'm A Believer)—Caterina Caselli/CGD, The Monkees/RCA Published by Sugarmusic
6	5	17	*Un Mondo D'Amore—Gianni Morandi/RCA Published by Mimo
7	12	2	*La Mia Serenata—Jimmy Fontana/RCA Published by RCA Italiana
8	—	1	*Se Stasera Sono Qui—Wilma Goich/Ricordi Published by Ricordi
9	6	18	Winchester Cathedral—The New Vaudeville Band/Phonogram Published by Southern
10	—	1	*La Rosa Nera—Gigliola Cinquetti/CGD Published by Sugarmusic
11	—	19	*L'Immensita'—Johnny Dorelli/CGD Published by Sugarmusic
12	7	2	Inch'Allah—Adamo/EMI Italiana Published by EMI Italiana
13	—	1	*Nel Sole—Al Bano/EMI Italiana Published by Sidet
14	13	3	La Danza Delle Note—Sandie Shaw/RCA Published by Sugarmusic
15	—	1	*Corriamo—Isabella Iannetti/Durium Published by Durium/Leonardi

*Denotes Original Italian Tunes



JIMMY FONTANA

winner
of the Italian
national radio-television
contest

"A DISK FOR THE SUMMER 1967,"

with

LA MIA SERENATA

(published by Edizioni Musicali RCA ITALIANA)

a follow-up of
the international smash
hit

IL MONDO





AUSTRALIA

A rather unusual situation has arisen in relation to the new single by Australia's hot international group the Easybeats. The record is called "Heaven And Hell" (at least that is so in Australia) and it has now become available for air play. However, when United Artists issue the deck in the United States, it will be known simply as "Heaven" and the line in the introduction reading "Finding someone else in your bed" has been changed to "Discovering that her love has gone dead" for American consumption. Apparently U/A insisted on the change to conform with the anticipated requirements of the American broadcasting authorities. The original line remains in the version being released in both England and Australia. Cash Box is aware of a couple of stations who have introduced their own self-imposed ban on playing the record. The song was written by members of the Easybeats, George Young and Harry Vanda. It is published by J. Albert & Son Pty. Ltd., and is issued in this territory by EMI on their Parlophone label. The disc was produced by Glynn Johns in England on behalf of Albert Productions who have the Easybeats on contract.

Southern Music have issued the following sheet copies recently: "Arnold Layne" (as recorded by Pink Floyd), "Finchley Central" (New Vaudeville Band), "We Must Be Doing Something Right" (Grantley Dee), "No, No, No, No, No" (Marty Rhone) and the local composition "Strange Things" as recorded by the Composers on Festival.

Radio Station WERE in Cleveland, Ohio, are showing a keen interest in Australian-produced records, and Cash Box has started the ball rolling by arranging for some samples to be sent. It is a great opportunity for Australian diskeries to get some American action which could in turn lead to a release Stateside. Record companies interested in servicing WERE should send samples (three of each if possible) care of Miss Marilyn Mervar.

George Cooper, managing director of Boosey & Hawkes (Australia) Pty. Ltd., will be back in New York on a business trip from July 5 to July 14. He can be contacted at the B & H office in New York City.

Abigail Music (Australia) Pty. Ltd., have (through APRA) placed a broadcast restriction on all titles on the first English-produced album by the Bee Gees, another Australian group who have won international stardom. The album, called "The Bee Gees First" (which isn't quite accurate when applied to this country), contains both sides of the group's new single, "To Love Somebody" c/w "Close Another Door", both of which fall under the restriction also. Abigail Music is headed up by Norman Whiteley who was formerly associated with the Belinda Music office here.

New locally produced product from the Festival group brings Bill and Boyd with "If I Were A Rich Man" from "Fiddler On The Roof" c/w "Little Miss Sorrow, Child Of Tomorrow" on the Sunshine label. Robby Snowden is on the Clarion banner with "Shiela" and "What Do You Want To Make Those Eyes At Me For," and the Lourie Allen Revue (Festival) have "Beautiful Brown Eyes" and "Saved."

Hottest new entry into our national best-seller list this issue is "Pictures Of Lily" by the Who on the Polydor label through the Phonogram organization in this country; publishing rights are held by Essex Music. Still at the top of the heap is Petula Clark with "This Is My Song." "The Happening" re-appears this week in equal ten spot for the Supremes. Joining it at ten at its first appearance is "Creque Alley" for the Mamas and Papas . . . publishing is held by Associated Music, the subsid of RCA of Australia.

The Procol Harum is well on its way to having a giant smash in this part of the world with "A Whiter Shade Of Pale." It's receiving big, big action on air and sales are about to explode. Publishing is in the hands of Essex Music who already have the sheet copy out . . . it makes Barry Kimberley a very happy man.

There is an interesting local album on Festival. It is entitled "Nature Walk-about" and it carries the original soundtrack music from the national television show of the same title. The score was written and conducted by Sven Libaek.

From RCA comes the original soundtrack album from the highly-touted movie "Casino Royale." With the inclusion of the title track by Herb Alpert & the Tijuana Brass, and the Dusty Springfield version of "The Look Of Love," the package should be a blockbuster in sales. Also from RCA comes local television identity John Mellion with "Hot Pie And Tomato Sauce" c/w "We're A Weird Mob."

Jack Argent, boss of the Leeds Music group of publishing companies, has now returned from his latest tour of the pop music centers of the world. First thing Jack did when he got back was to call Cash Box to report on the growing world interest in Australian records and talent. Through this column, Jack Argent says thanks to all those friends and associates who helped make his trip such a pleasant event.

Saw one of our favorite people and one of the most versatile talents in the country on television recently . . . we refer to Frankie Davidson. For some reason or other Frankie just hasn't made the grade on discs, but we hear tell that a major company could be interested in signing him. Frankie is very popular in the trade, and most people are keen to see him break-out with a hit.

Newies from EMI include "You Must Have Been A Beautiful Baby" by the Dave Clark Five, "More Love" from Smokey Robinson, "Windy" by the Association, and "Here Come The Nice" by the Small Faces. An interesting album from EMI comes in the form of the new set by the Shadows called "Jigsaw." It carries a fine instrumental version of the Easybeats' while back click "Friday On My Mind." The Shadows recently completed a successful club stint in Sydney.

Australia's Best Sellers

- 1 This Is My Song (Petula Clark—Astor) Leeds Music
 - 2 The Girls In Paris (Lee Hazlewood—MGM) Boosey & Hawkes
 - 3 When I Was Young (Eric Burdon & Animals—MGM) A.J.S. (Schroeder Pty.)
 - 4 Pictures Of Lily (The Who—Polydor) Essex Music
 - 5 Puppets On A String (Sandie Shaw—Astor) J. Albert & Son
 - 6 Groovin' (The Young Rascals—Festival) J. Albert & Son
 - 7 New York Mining Disaster 1941 (Bee Gees—Spin) Abigail Music
 - 8 *Minnie The Moocher (The Cherokees—Go!) J. Albert & Son
 - 9 Don't Blame The Children (Sammy Davis, Jr.—Reprise) M.C.P.S.
 - 10 The Happening (The Supremes—Tamla/Motown) Belinda Music
 - 10 Creeque Alley (Mamas & Papas—RCA) Associated Music
- *Indicates locally produced record.

5KA Awards Aussy's Talent Awards

AUSTRALIA—At a special ceremony in the Star Room of the Hotel Australia last week (26), the general manager of 5KA, K. R. Parham, presented the third series of awards for outstanding talent in the Australian record industry in the 5KA Top Talent Awards.

The awards were chosen by a select panel comprising 5KA management, executives and disc jockeys, from all Australian record releases up to and including May 31, 1967, and covered the following categories: 1—best male vocal: Johnny Young, for his recording of "Kiss Me Now" (Clarion); 2—best female vocal: Bev Harrell, for her recording of "What Am I Doing Here With You?" (H.M.V.); 3—best Australian composition: George Young and Harry Vanda of the Easybeats, for their composition "Friday On My Mind" (Parlophone); 4—best vocal group: The Twilights, for their recording of "Needle in a Haystack" (Columbia); 5—best instrumental: The Aulton Mob, for their recording of "March of the Mods" (Kommotion); 6—The Listeners' Award: The Masters Apprentices, for their record-

ing of "Undecided" (Astor); 7—the most promising artist: Cheryl Gray, for her recording of "You Made Me What I Am" (H.M.V.); 8—The Gold Award: Johnny Young, for his recording of "Stepback" (Clarion).

Paddy McCartney of the Twilights accepted the award on behalf of the Group; Bev Harrell, Cheryl Gray, Pat Aulton on behalf of the Aulton Mob; Johnny Young and Tony Geary on behalf of The Easybeats; and Mick Bower on behalf of the Masters Apprentices received their awards from K. R. Parham.

Johnny Young and the Easybeats were unable to be present to receive their awards personally due to overseas engagements.

The General Manager of 5KA, K. R. Parham, addressed the gathering of record industry executives, record retailers, advertising executives and press and TV representatives about the significance of the 5KA top talent awards.

C. Barlow, manager of EMI Records (Australia) replied on behalf of the record industry.

Japan's Best Sellers

ALBUMS

This Week	Last Week	ALBUMS
1	2	Adamo Delux—Adamo (Odeon)
2	4	Kimikoso Waga Inochi—Sam Taylor (Polydor)
3	3	Claude Chiali Delux—Claude Chiari (Odeon)
4	1	Andy Williams Delux—Andy Williams (CBS)
5	5	The Sun Ain't Gonna Shine Anymore—The Walker Brothers (Philips)

LOCAL

This Week	Last Week	LOCAL
1	1	Koyubi No Omoide—Yukari Itoh (King)
2	2	Negai-Boshi, Kanai-Boshi—Teruhiko Saigo (Crown)
3	6	Kimino Tameni—Yuzo Kayama (Toshiba)
4	4	Yogiriyo Konyamo Arigato—Yujiro Ishihara (Teichiku)
5	3	Shinjuku Blues—Hiroko Ohgi (Columbia)
6	5	Tsuretette—Mari Sono (Polydor)
7	—	Makka-Na Taiyo—Hibari Misora (Columbia)
8	10	Taiyo-No Aitsu—The Johnnys (Victor)
9	9	Koi—Akira Fuse (King)
10	—	Itoshi-No Max—Ichiro Araki (Victor)

INTERNATIONAL

This Week	Last Week	INTERNATIONAL
1	1	Let's Go Shake—The Bunnys (Seven Seas) Publisher/Seven Seas
2	2	Noi No Hallelujah—Jun Mayuzumi (Capitol) Publisher/Ishihara
3	10	Seaside Bound—The Tigers (Polydor) Publisher/Watanabe
4	3	Blue Chateau—The Blue Comets (CBS) Publisher/Watanabe
5	6	Music To Watch Girls By—Andy Williams (CBS) Sub-Publisher/Pacific
6	5	Yuhi To Tomoni—The Wild Ones (Capitol) Publisher/Watanabe
7	4	Boku No Mary—The Tigers (Polydor) Publisher/Watanabe
8	8	I Really Don't Want To Know—Andy Williams (CBS) Sub-Publisher/Aberback Tokyo
9	7	Taiyo No Tsubasa—The Spiders (Philips) Sub-Publisher/Shinko
10	13	It Must Be Love—The Rainbows (CBS) Publisher/Shinko
11	15	Everything Under The Sun—The Walker Brothers (Philips) Sub-Publisher/Toshiba
12	11	Land Of 1000 Dances—The Walker Brothers (Philips) Sub-Publisher/Shinko
13	9	Somethin' Stupid—Frank Sinatra & Nancy Sinatra (Reprise) Sub-Publisher/—
14	14	Balla Balla—The Rainbows (CBS) Publisher/Shinko
15	12	Nobara Saku Michi (The Wild Roses)—Somegoro Ichikawa (Capitol) Publisher/Shinko



MEXICO

Jimmie Nicol, "the 5th Beatle," leaves for Los Angeles at the end of the month to promote his latest RCA Victor (México) release "Estoy En La Onda" (I Got The Feeling). The drum, star singer and arranger, plans to get international "break out" for México in the pop record market. With him will go Eddy Quinn, partner in Nicolquinn which has come up with "Baroc Pop." RCA Victor (México) plans to release a single and LP of Nicolquinn Baroc Pop. Nicolquinn have also composed and arranged the music for a new Mexican experimental movie, "The Cruellest Month," and have agreed to write the music for another.

RCA is already pressing the new Monkees' album, "The Monkees Headquarters," which includes songs like "For Pete's Sake," "I Can't Get Her Off My Mind," "You Told Me," etc.

Carlos Lico, a singer that started his career as soloist at the age of 34, is becoming the most popular singer of popular music. Carlos began to sing first with trios; later with the vocal groups Los Pao and Las Vegas. With this last group, he performed in famous American TV shows as Ed Sullivan, Andy Williams, Danny Kaye, Bob Hope and many others.

(Continued on 2nd Column)

Mexico's Best Sellers

- 1 Yo Soy Aquel—Raphael (Gamma)—Carlos Lico (Capitol)—Martin Roca (Philips)
- 2 Celoso—Los Panchos (CBS)—Marco Antonio Muñoz (RCA)—Johnny Albino (Peerless)—Hnos. Ferrandiz (Musart)—Hnos. Carrión (Orfeon)—Lorenza Lori (Cisne)—Jose Feliciano (RCA)—Olga Guillot (Musart)—Rubén Zepeda Novelo (Musart)
- 3 Perdamos—Chucho del Muro (Philips)—Chelo Silva (CBS)
- 4 No—Carlos Lico (Capitol)—Antonio Prieto (RCA)—Gloria Lasso (Musart)—Angélica María (Musart)—Trio Romántico (Cisne)—Magda Franco (CBS)—Carmita Jimenez (CBS)—Olga Guillot (Musart)—Hnos. Castro (RCA) (Emmi)
- 5 Un Hombre Y Una Mujer (A Man And A Woman)—Original Sound Track (Gamma)—Hnos. Castro (RCA)—Los Dominic (Polydor)—Sonia Furió (CBS)—Ferrante & Teicher (Gamma)—David McCallum (Capitol) Bob Crewe (Capitol)—Walter Wanderlay (Verve)—Lorenza Lori (Cisne)—Frank Hunter (CBS)—Andy Williams (CBS)—Gloria Lasso (Musart)—Los Aragón (Musart) (Campei)
- 6 Adoro—Carlos Lico (Capitol)—Armando Manzanero (RCA)—Manny Bolaños (Musart)—Enrique Guzmán (Acuario)—Sonia (RCA)—Los Kuarto (Tizc)—Carmita Jiménez (CBS)
- 7 Creo Que Estamos Solos (I Think We're Alone)—Tommy James (Roulette)—Los Hitters (Orfeon)—Enrique Guzmán (Acuario)
- 8 Algo Tonto (Something Stupid)—Frank and Nancy Sinatra (Reprise)—Silvia Pinal & Enrique Guzmán (Acuario)—Johnny & Francis Laboriel (Musart)—Hnos. Carrión (Orfeon)
- 9 Tema De Los Monkees (Monkees Theme)—The Monkees (RCA)—Los Monkey's (Orfeon)—Los Shippys (Capitol) (Mumusa)
- 10 Aunque Te Olvides De Mi—Sonora Santanera (CBS)

Argentina's Best Sellers

This Week	Last Week	
1	1	Quando Tu No Estas (Fermata) Raphael (Music Hall)
2	3	*Tendras Un Altar (Popular) Herman Figueroa Reyes, Cuatro Hermanos Salteños (CBS); Los Cruceños (RCA); Julia Elena Davalos (Philips); Los Arrieros (Quinto); Ramona Galarza (Odeon); Los Ariscos (London)
3	2	*Que Sera (Relay) Palito Ortega (RCA); Los Tahures (Odeon)
4	6	Puppet On A String (Fermata) Caravelli (CBS); Sandie Shaw (Music Hall) Susanita Ramos (Odeon)
5	5	Hablemos Del Amor (Fermata) Raphael (Music Hall); Siro San Roman (Microfon)
6	4	Namoradilha De Un Amigo Meu (Fermata) Roberto Carlos (CBS); Freddy Tadeo (RCA); Ely Arcoverde (Fermata); Los Veneto's (Disc Jockey)
7	7	Propiedad Privada (Not Published) Rosamel Araya (Disc Jockey)
8	8	Amor De Pobre Miltoninho (Odeon Pops); Pepito Perez (Disc Jockey)
9	9	Cuore Matto (Fermata) Juan Ramon (RCA); Little Tony, Mario Zelinotti (Music Hall); Archibald & Tim, Franco Tozzi (Fermata); Gino, Las Cuatro Voces (CBS); Morita Sabahat (CBS); Los Tios Queridos (Odeon); Los Veneto's (Disc Jockey); Pedrito Rico (Music Hall)
10	—	Estoy Enamorado De Ti Roberto Carlos (CBS)
11	15	There Is A Kind Of Hush Herman's Hermits (Odeon); Popsingers (CBS); Claude Francois (Philips)
12	12	A Little Bit You, A Little Bit Me (Melograf) The Monkees, Palito Ortega (RCA)
13	13	Amo (J'Aime) Raphael (Music Hall); Adamo (Odeon)
14	11	Un Meche De Cheveux Adamo (Odeon); Frank Pourcel (Odeon)
15	10	Paris Brule-T-11? (Neumann); Paul Mauriat (Philips); Frank Pourcel (Odeon); Cyril Stapleton (Music Hall); Maurice Jarre (CBS); Mireille Mathieu, Christian Gaubert (Disc Jockey)
16	16	Batijugando (Melograf) Los Wawanco (Odeon); Charanga del Caribe (CBS);
17	17	I'm A Believer (Melograf) The Monkees (RCA)
18	14	The End Of A Love Blue Comets (CBS)
19	—	*Por Un Caminito Leo Dan (CBS)
20	20	*Se Quema El Rancho Coco Diaz (Odeon)
20	—	Y La Lluvia Caera Los Iracundos (RCA)

*Local

MEXICO (Continued)

In January of this year, he released his first single as a soloist on Capitol, and since then has succeeded with such songs as "No," "Adoro," "Con Estas Manos." Now Capitol has just released Lico's first album including the songs aforementioned and others as "Yo Sin Ti," "Yo Soy Aquel."

Gamma records cut the new Nancy Sinatra extended play which contains the songs "Jackson," "Summer Wind," "You Only Live Twice" and "It Ain't Me Babe," accompanied by her composer Hazlewood. Another EP is done by the McCoys with "Beat The Clock," "Stagger Lee," "Everyday I Have To Cry" and "Like You Do To Me." On the Warner Bros. line, Gamma released "Bossa Nova 67" with recordings made by Jobim, Marcos Valle, Dorival Caymmi and Quartet Em Cy.

next time you are in Spain....

.... you can check on EMI's claims about global ramifications—about recording and manufacturing facilities in every part of the world—about sales organisations which get into every conceivable outlet—about unique connections with the most active retail establishments everywhere—and about the way EMI artists are promoted here, there and everywhere to give them a truly international stature.

The EMI representation in Spain is:—

Compañia Del Gramófono-Odeon S.A.E. Urgel 234, Barcelona II, Spain: Tel: Barcelona 230.22.05

Bruno Lomas is one of the many EMI artists who enjoy good sales in Spain.

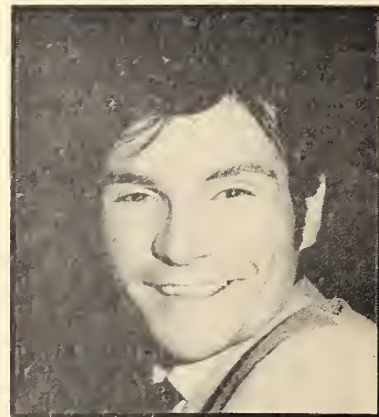

THE GREATEST RECORDING ORGANISATION IN THE WORLD

It was announced that the Grand Gala du Disque Populaire now definitely will be postponed until February or March 1968. Mr. Piet Beishuizen, director of the C.C.G.C., has already entered in negotiations with various artists. Furthermore, he is looking for a big star who is able to be the "vedette" of the programme.

Unfortunately, our list of Edison award winners '67, published in last week's Cash Box, was incomplete due to an incomplete official report to the press. In addition to the already mentioned winners Beach Boys, Beatles, John Coltrane, Donovan, Frank Sinatra, Boudewijn de Groot, Ramses Shaffy, Cuby & The Blizzards and Boy's Big Band the following artists will get an Edison '67 award: Jean Ferrat (for his LP "Jean Ferrat"), the Four Tops (for their LP "The Four Tops-Live!") and the artists performing in "Zo Zingt De Jordaan" (Willy Alberti and Ensemble), "Bah . . . September" and "Op Schoolreis."

DURECO, Amsterdam reports that Gerard de Vries, Veronica's well known C & W Deejay produced the first Dutch C & W LP "Nashville In Holland" for their Omega label. In Germany, Metronome will release three brand new Omega LP's viz. "14 Marches by the Johan Willem Friso Kapel," "Songs From Israel" by Tova Ben Zvi and "Ukrainian Folksongs" by the Utrecht Byzantine Choir. About a year ago Johnny Hoes recorded a Dutch vocal group De Heikrekels. "Waarom, Waarom" (Why, Why) is today a very hot single in the Dutch charts. Within a very short time De Heikrekels can expect their gold record for this single. A very strong seller is Luis Bordon's super stereo LP "Tropical" on the Metronome Label. Dureco is expecting high sales from the latest Bordon single: "Upa Upa." This month Dutch most popular female Telstar artist is 10 years in show business, more than 1,000,000 records found their way and the "Zangares Zonder Naam" ("Songstress Without Name") is still going strong.

John Mayall came to Holland on June 29th to congratulate his Dutch friends Cuby & the Blizzards upon the occasion of their winning an Edison Award. On this date, the new C & B LP will be released: "Praise The Blues" (Philips). This LP features American blues-singer and boogie woogie pianist Eddy Boyd. Boyd was so impressed last year by the "Desolation" LP that he decided to travel to Holland and have himself accompanied by these young Dutch blues musicians (18 to 21 years of age!) for recordings in Holland.

Herb Alpert recordings (the Tijuana Brass) keep up a steady turnover in Holland with high single peaks like "Wade In The Water," "Mame," "Flamingo," "What Now My Love" and "Tijuana Taxi." Of the albums, "S.R.O." and "Whipped Cream" are the most popular. Fans here keep complaining about Alpert not coming to Holland for a live show which might lead to a decline in sales this winter. Phonogram insists upon strong dealer-promotion and is releasing sales potential singles at regular intervals. A personal appearance by Alpert's band in combination with a direct publicity campaign might easily produce Golden Record sales figures.

Charles Chaplin's new movie "The Countess Of Hong Kong," featuring Sophia Loren, has its Amsterdam premiere the first week of July. Phonogram has released the soundtrack on Decca LP in stereo. The title song is also very popular here in Harry Secombe's version. The recent personal appearance in Holland of Dave Dee, Dozy, Beaky, Mick & Tich on TV has caused their "Okay!" recording (Fontana) to jump up the Dutch hit parade. Jumping up too is "Night Of The Long Grass" on Fontana by the Troggs, as popular a group here as Dave Dee's.

When "She'd Rather Be With Me" by the Turtles (London) was released here, a tin of turtle soup and a letter explaining why was sent to the leading deejays. The effect was instantaneous and far from watery.

Among rush releases in single hits by Phonogram we noticed "I Feel Like Crying" on Brunswick, a sweet souler by Sam and Bill. From Philips "Holiday For Clowns" by Brian Hyland and from Philips France: "Toute La Vie" by Claude François.

Two new local productions in the single field are De Zingende Zeeman (The Singing Sailor) with "Jij Hebt Mij Verleid" and Tante Bep: "Lieve Moeder." CBS has high hopes for the first CBS barrel organ album entitled "International Melodies" with greetings from Holland. With the second single by the Tremeloes "Silence Is Golden," CBS just released their sensational first album entitled "Here Come The Tremeloes" which no doubt will make quite an impact on the local market. CBS rush-released the British version of "Do It Again A Little Bit Slower" by Val & the V's, coupled with "For A Rainy Day." Already high on the U.S. charts, this single will most likely hit our market as well. New CBS additions to the classical LP field are following albums: Mahler's "Das Lied Von Der Erde" with Lili Chookasian (Mezzo) and Richard Lewis (Tenor) and the Philadelphia Orchestra conducted by Eugene Ormandy; a record by the famous French singer Andre Pernet containing arias of Rossini, Wagner, Gounod, Delibes, Moussorgski, Massenet and Offenbach.

Bospel Music's Managing Director Joop Gerrits reported to Cash Box that his publishing company got the Dutch rights of "Seven Drunken Nights"; a Dutch version by Joop Van De Marel was made for the Dureco Label. Bospel Music also got the rights for the Netherlands of "Yes, We Have No Bananas" and the Fats Waller classic "La-De-De La-De-Da."

Dominating the Dutch charts today are two Essex-Basart copyrights: the amazing newcomers Procol Harum reached the first position in one run and reportedly sold 35,000 records in ten days after release! High position is firmly held by the Who with "Pictures Of Lily." New entries in the charts of Basart controlled copyrights include "Groovin'" by the Young Rascals, "Okay!" by Dave Dee c.s., "The Wind Cries Mary" by Jimi Hendrix and the newly discovered local songstress Bojoura with "Everybody's Day." Basart's v.p. Ferry Wienneke recently visited London where mutual business matters were discussed with top execs of the various publishing firms Basart represents in Holland and the Benelux territories. Furthermore, interesting new contracts were established in the publishing as well as in the record field and various important deals are presently being negotiated. Benelux rights were acquired from Mark Pasquin to current chartrider David Garrick's "A Certain Misunderstanding."

Negram-Delta released three brand new Eurodisc LP's last week. The first is featuring world famous tenor Rudolf Schock, accompanied by Die Berliner Symphoniker directed by Robert Stolz. This LP is called "Dein Ist Mein Ganzes Herz." "Ein Leben Für Die Musik" is featuring fourteen of the most famous songs written by Robert Stolz, sung and played by Rudolf Schock, Melitta Muszely, Margit Schramm, Renate Holm, Die Berliner Symphoniker directed by the composer, a.o. The third new Eurodisc release is a record with four Concerts for horn and orchestra by Mozart.

New Reprise singles released this week include "What Now My Love" by Frank Sinatra and "You Only Live Twice" by Nancy Sinatra. "You Only Live Twice" will be backed by a special promotion campaign in cooperation with Tuschinski and publishing company Altona. Newly released LP's on the same label are "Serenade To Sweden" by Alice Babs & Duke Ellington, "Happiness

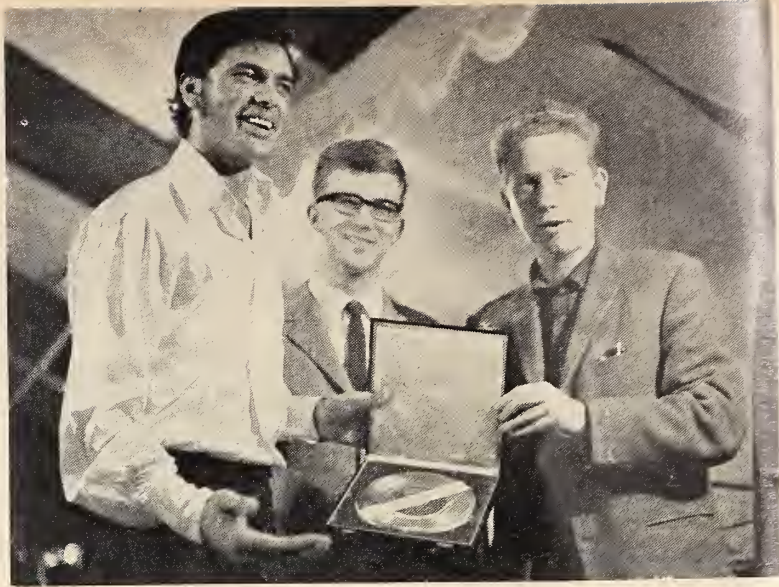

RELEASING THE GOLD— Engelbert Humperdinck received a Gold deck for the turnover of more than 100,000 copies of "Release Me" in the Benelux. The lid was number one in Belgium for 14-weeks. The gold record was a joint presentation of Fonior Belgium and Phonogram Holland. In this view (reading from the left) are: Engelbert Humperdinck; M. Hoiting, promotion manager for Decca Holland; and Jacques Verdonck, promotion manager of Decca Belgium.



SUMMIT MEETING IN FRANKFURT—The top-guns of CBS/Columbia recently met in Frankfurt to discuss plans. Shown in this view are (from the left): Peter De Rougemont, vice president of international operations; CBS/Columbia president Goddard Lieberson; Bernhard Mikulski, director of CBS-Germany; and Harvey Schein, vice president in charge of international operations.

Is" by Dean Martin and a marvelous rousing R&B album by the sensational Electric Prunes. On Warner Bros., Negram-Delta released this week a very good song by the Harpers Bizarre, written by Van Dyke Parks and called "Come To The Sunshine." The tune is given a lot of airplay on Radio Veronica, on Radio 227 and Hilversum III. Released on the same label is the LP "The Best Of Peter, Paul and Mary" including world famous songs, such as "Blowin' In The Wind," "Don't Think Twice," "Puff, The Magic Dragon" and "500 Miles."

The new single by Dutch singer Bob Smit and his Duke City Sextet is expected to become the summer hit of the year. The song, "De Laatste Keer," has already been given a lot of air play and is rush-released on the Delta Label. Negram-Delta introduced this week a very useful three record set with 133 Authentic Sound Effects to the Dutch market. This important Elektra release will supply a want. A progressive new Elektra LP, very well received by the local press, is "What's Shaking." The record features the Paul Butterfield Blues Band with five previous unreleased tracks, four tracks by the Loving Spoonful, two songs by Al Kooper and Tom Rush and three tracks by Stevie Winwood, Eric Clapton and the Powerhouse. One week after the release of the record, sales were already beyond expectation. On the very successful Hispavox Label, Negram-Delta released two more EP's by Los Hermanos Reyes: "Sevillanas De La Feria," Volume 2 & 3. The budget line of French Vogue, Mode, was extended this week with three great operas by George Bizet: "Mireille," "Carmen" and "The Pearl Divers," enormous sales are expected.

"Sweet Pea" already in the Dutch charts by Manfred Mann, is done in a very original version by Roger Williams on Kapp. The song is released this week together with "Love Me Forever." Another new Kapp release is "I'm Indestructible" by the one and only Jack Jones. New records in the soul field this week include "No Good To Cry" by Jimmy James and the Vagabonds on Pye, "Bright Shiny Colors" by the Shirelles on Scepter and "Daddy's Home" by the famous couple Chuck Jackson and Maxine Brown, also on Scepter.

Holland's Best Sellers

This Week	Last Week	
1	1	A Whiter Shade Of Pale (Procol Harum/Deram) (Essex Holland-Basart/Amsterdam)
2	4	The Wind Cries Mary (Jimi Hendrix/Polydor) (Schroeder-Basart/Amsterdam)
3	2	Waterloo Sunset (Kinks/Pye) (Belinda/Amsterdam)
4	3	Then I Kissed Her (Beach Boys/Capitol) (Belinda/Amsterdam)
5	6	New York Mining Disaster 1941 (Beegees/Polydor)
6	5	Ha Ha Said The Clown (Manfred Mann/Fontana) (Altona/Amsterdam)
7	8	Sweet Soul Music (Arthur Conley/Polydor) (Basart/Amsterdam)
8	7	Pictures Of Lily (Who/Polydor) (Essex-Basart/Amsterdam)
9	10	Mr. Pleasant (Kinks/Pye) (Belinda/Amsterdam)
10	—	Okay (Dave Dee, Dozy, Beaky, Mick & Tich/Fontana) (Impala-Basart/Amsterdam)



GERMANY

The German record stars went all out for the Israel Red Cross and did two benefit concerts in Hamburg and Munich. The stars who gave their talents included Philips toppers Esther & Abi Ofarim, Polydor's Belina, Ariola's Udo Jurgens, the popular cabaret stars the Lach & Schiessgesellschaft, Helmut Lohner, Sammy Molcho, Maria Wimmer and Ernst Stankowski. Over 19,000 dollars were raised through the two concerts.

Liberty Records have signed the pact for distribution with Ariola and pressing for their product by the Ariola press "Sono-Press." Siegfried Loch, German director of Liberty, has offices in Munich 33, Faerbergraben 1, telephone number 265093.

Sigert Publishing who put out the trade paper "Automaten-Markt" and "Musik-Informationen" are putting out the first weekly trade paper for the music industry. Called "Promo" the paper will give a weekly report on new releases, picks on LP's and singles and reports on the industry from reporters in the 5 major music capitals of Germany. Cost for the paper is 52 German marks for 52 weeks (about a quarter a week).

Journalist Hansi Hoffmann had a huge reception for his wedding held in Frankfurt last week. Representatives of all major record firms were on hand as were D.J.'s and stars to see the press reporter tie the knot. A real switch for a promotion journalist!

Electrola reports that over 100,000 copies of the "Sgt. Pepper's Lonely Hearts Club Band" LP by the Beatles have been sold in Germany. A new sales record for a group that's used to breaking sales records. The 100,000 LP's were sold in 7 days!

Speaking of sales records, "Dr. Schivago" is also setting records of another sort with the MGM single of the title song already over the 300,000 mark and the LP also over 100,000 in sales here.

Peer Music and Theo Seeger have a couple of hot goodies on their hands with "Little Bit O' Soul" from the Music Explosion, "Arnold Layne" with the Pink Floyd and "I Want You" in German from the McKinlay Sisters.

The German record industry in their annual meeting decided against publishing an official LP sales "Hit-Parade." The reason given is that singles are dependent on chart positions to make sales, but LP's have a different buyer circle who do not check out popularity of a record before buying.

The summer season came in with a bang with sales soaring for a couple of top hits including "Puppet On A String" by Sandie Shaw and "Meine Liebe Zu Dir" from Roy Black, both of which have passed the 1/4 million sales mark and sales souring for the rest of the market. Things look pretty dim for this summer with no pop music festival to rack up attractive leaders and a new tax which will probably increase the price or deminish the profits of records in the near future. Singles sales are slumping and LP sales continue to boom but the low price field is also taking the cake right now so that dollar volume is also not increasing. German language records are selling for a couple of artists, but sales of over 20,000 are the exception in this market today.

Rolf Budde reports that his publishing house has a stack of hits on the "push" list including "The Magic Book" from the Gibsons, "Night Of The Long Grass" by the Troggs, "Pineapple Market" an original German number played by Billy Vaughn, "Carrie Anne" from the Hollies, "I Got Rhythm" from the Happenings, "Kaiser Bill's Batman" and, of course, the entire LP of "Sgt. Pepper's Lonely Hearts Club Band" from the Beatles.

Ralph Maria Siegel is swinging publishing wise with an handful of top hits including "Funny Familiar, Forgotten Feeling" from Tom Jones, "It's All Over" from Cliff Richard, the German version of "Communication Breakdown" from Helmut Schmidt, his son Ralph Siegel, Jr.'s, first German waxing (self-composed) for Electrola and some German goodies as well.

Philips has teamed up Greek star Nana Mouskouri with German Gerhard Wendland for a new duo and their first LP is being released in the next few days.

Ariola star Udo Jurgens had a big time in Budapest as 7,000 fans turned out to see the German artist. It was the most exciting concert ever held in the city according to authorities who had already presented such world favorites as Gilbert Beaud, Louis Armstrong and Juliette Greco.

Horst Jankowski left his Stuttgart home to hit the trail for a 36 concert tour of South and Southwest Africa. Sammy Davis, Jr., picked up a 50,000 buck fee for a 60 minute TV special made by German TV of Sammy's European tour. Karl Heinz Muenchow has signed his Mondial label to Metronome for distribution. The start program is 3 LP's and 4 singles. Rudolf Petry who left the Polydor production department last August to work with Tutti-Lorna Music has taken over the EMI house publishing firm Edition Accord. Rudy follows Otto Demler who is now with the Polydor house publishing outfit Abarbach Music.

That's it for this week in Germany.

GERMANY—JUKE BOX-RADIO-SALES FAVORITES

(Courtesy "Automaten-Markt")

This Week	Last Week	Weeks On Chart	Title
1	1	5	Puppet On A String—Sandie Shaw—Deutsche Vogue—Hans Gerig Music
2	2	5	*Morgen Beginnt Die Welt (The World Begins Tomorrow) Freddy—Polydor—Edition Doma/Kaempfert
3	3	5	Somethin' Stupid—Nancy & Frank Sinatra—Reprise—Chappel Music/A. Seith
4	4	3	I Was Kaiser Bill's Batman—Whistling Jack Smith—Deram Mills Music
5	5	2	Ha! Ha! Said The Clown—Manfred Mann—Fontana—Edition Fanfare/P. Kirsten
6	6	5	Das Schönste Mädchen Der Welt (The Most Beautiful Girl In The World) Peter Orloff—Coronet—Hans Gerig Music
7	7	8	*Lord Leicester Aus Manchester—Manuela—Telefunken—Edition Intro/Meisel
8	8	2	Denk' Ich Immer Nur Daran (I Always Thing About It) Ivo Robic—Polydor—Edition Doma/Kaempfert
9	9	2	*S.O.S.—Herz In Not (S.O.S.—Heart In Danger) Michael Holm—Hansa—Edition Intro/Meisel
10	10	5	Please Mr. Moving Man—David Garrick—Deutsche Vogue—Melodie Der Welt/Michel



CZECHS HOLD POP FEST AT BRATISLAVA—These views of the recently-held Bratislava Song Festival show Britain's Sandie Shaw (at the top) singing her "Puppet On A String" Eurovision winner, in her usual barefoot manner. The lark was backed by an 80-piece orchestra. The winners (Eva Pilarova of Czechoslovakia, Vice Vukov of Yugoslavia, and Laila Kikkunen of Finland) are shown from the left in the center photo. The bottom view is of a party given by Supraphon at the conclusion of the Bratislava Festival. Pictured (from left to right standing) are: Dr. L. Doruzka, a Czech journalist; Paul Gyongy, Hungary; Hans R. Beierlein, Germany; Claude Pascal, France; Stewart Reid, Great Britain; Jan Hanus, Czechoslovakia; Oskar Drechsler and Prof. Vlad Seljan (seated) Karel Vlacj, Norrie Paramour, and Dr. Jaraslov Seda. (Continued on page 57)

GERMANY—RECORD MANUFACTURERS SALES

(Courtesy "Schallplatte")

This Week	Last Week	Weeks On Chart	Title
1	1	8	Puppet On A String—Sandie Shaw—Deutsche Vogue—Hans Gerig Music
2	3	3	*Meine Liebe Zu Dir (My Love For You)—Roy Black—Polydor Riva Music
3	5	3	Ha! Ha! Said The Clown—Manfred Mann—Fontana—Edition Fanfare/P. Kirsten
4	7	4	I Was Kaiser Bill's Batman—Whistling Jack Smith—Deram—Mills Music
5	—	1	Okay—Dave Dee, Dozy, Beaky, Mick & Tich—Star Club—Minerva Music/R. Von Der Dovenmühle
6	6	10	Schivago—Melodie—Maurice Jarre—MGM—Hans Gerig Music
7	10	3	*Dein Herz Das MuB Aus Gold Sein (Your Heart Must Be Made Of Gold) Anna—Lena—Metronome—Edition Intro/Meisel
8	—	1	Pictures Of Lily—The Who—Polydor—Hans Gerig Music
9	8	9	*LaB Die Sonne Wieder Scheinen (Let The Sun Shine Again) Ronny—Telefunken—Edition Maxim
10	4	6	My Friend Jack—The Smoke—Metronome—Metorion Music/A. Schacht

*Original German Copyright



CANADA

Canus Records, fledgling firm headed up by Tony Roman, appears all set for a large size hit. "The Look Of Love" has been waxed by Nanette, and, if she sings as good as she looks, the song'll be top ten in no time at all. American distribution is by Bell. The song has been making chart noise for Dusty Springfield on Philips, although that company is plugging hard for the flip by Dusty. Song is featured in "Casino Royale," and that won't hurt its chances one bit.

Best commercial waxing in a long time is out now on Yorkville. "Canada" by the Sugar Shoppe is going to take the Bobby Gimby song right back to the top of the charts. Arc's man in Winnipeg, Ron Legge, claims a #30 listing on CHUM-Toronto for the Sugar Shoppe outing, and reports that the Winnipeg pop outlet, CKRC, is also on the song in a big way. It's "Canada" alright, but this time it's extremely commercial and won't need any advanced degree of patriotism to put it over.

Peter Slywka reports that the new record by the Fifth on London is selling very well in the group's hometown, Winnipeg. A #30 listing on the CKRC has resulted from the disc's good showing on the station's voice your choice segment. Already Winnipeg sales on the release have passed to 1,000 mark.

Daniel Lazare of Gamma Records in Montreal tells C.B. that a recently released LP, "The Singer-Composers Of Quebec," has begun to show up nicely on the best seller lists throughout French-Canada. The set contains, among other selections, "La Manic" by Georges Dor, the most popular song in French-Canada in 1967. Also included in the strong selling LP are several selections by Claude Gauthier, Pauline Julien and others. Canada-wide and American distribution is now in the formative stage.

Paul Clark has the Yellow Balloon all over Toronto airwaves with their newest Canterbury outing, "Good Feelin' Time." An import from Barbados, a new album by the Merry Men, is expected to do well in Canada following P.A.'s by the group in Toronto (6/28) and at Expo's Garden Of Stars, July 2-15.

Gaston Careau, RCA Victor promo man in Montreal, tells C.B. of a recent accolade for Jen Roger. The great French-Canadian vocalist has just been named "Mister Radio-TV" for French-Canada, 1967. The vet chanter has been with the RCA Victor organization for sixteen years, and his total sales of LP's and singles now rapidly approach the magical million mark.

Quality Records have one of their biggest ever record promotions under way. A new LP series, the Quality International Series—a line of outstanding LP releases from foreign companies, will shortly debut with Quality distribribs across Canada. To highlight the new LP series, the firm is releasing, with considerable fanfare and heavy concentrated plug efforts at the broadcast level, a single by Tommy Brennan and the Monarchs. "The Dying Rebel" is expected to take the country by storm in much the same fashion as Andy Stewart's "Scottish Soldier" did several years ago. The first six LP's in the new Quality International Series originate in The Netherlands and Ireland. Harold Winslow tells C.B. that the firm is most interested in adding titles to the new series. Any interested firms, world-wide, should get in touch with Quality's Toronto H. Q. as soon as possible.

Al Mair's compo branches are up to their ears in orders for the red hot American, R&B single, "Make Me Yours" by Bettye Swann from Money Records in the U.S. Chartbuster in the States should do likewise in short order in Canada. "I'll Forget Her Tomorrow" by Witness Inc., is a strong regional seller in Canada's west. Ditto, "Walking Mary Home" by the Nomads on Damon. Both could develop national breakouts.

Adrian Bilodeau at London reports terrific sales action on two singles by artists with weird names. The Procol Harum world-wide smash on Deram, "A Whiter Shade Of Pale," practically owns all the Canadian charts from coast to coast, while "There Goes My Everything" by Englebert Humperdinck on Parrot is heard at every turning of the dial on just about every type of broadcast format in the Country. The LP by Humperdinck is being played, and sold, only in very slightly less quantities than the aforementioned single, also included in the new Parrot album.

London-distributed artists are very much on the Canadian P.A. trail this summer. Buddy Rich and his big band made the Palais Royale scene in Toronto (7/3). The Rich LP on Liberty, "Big Swing Face" enjoyed considerable exposure and promotion as a result of the band's P.A. Canada's biggest outdoor attractions this summer, The Calgary Stampede and Expo '67, have both booked artists that do very well on London-distributed lines. The T-Bones head for Calgary, while the Four Seasons do July 12th and 13th dates at Expo. The Mariachi Brass also are set for Expo '67 come July 10th through 15th. The Blues Magoos begin a string of one niters in Vancouver early in August and the Fifth Dimension appears in the west coast city later in that month.

Adrian reports that London will distribute Jet Records, latest project of Montreal musi-biz vet, Don Wayne. The fast approaching London Convention, (7/17-22) at The Mont Gabriel Lodge in The Laurentians near Montreal, will play host to all branch managers and salesmen and their wives from across Canada. In addition, numerous big names from the London family around the world will be present for the important gathering. From London in New York will come Herb Goldfarb, D.H. Toller-Bond, Terry McEwen and Walt McGuire. Expected from Decca-England: Marcel Stellman. From France, the convention will play host to Jacques Caillart from Philips. Other Philips men from the world wide organization to attend the London convention will be: Jack Boverstock, Tony Van de Haar and John Sippel of Mercury in Chicago. One-time Canadian record exec, Lee Mendell, will represent Liberty records. All of the above gentlemen are scheduled to address the gathering on their respective lines and new product.

Blocker's Tapp Acquires Bailey International

HOLLYWOOD—Don Blocker's Tapp firm, which performs administrative and national sales and promotion functions for independent labels and producers throughout the United States, has acquired Jim Bailey International. The latter is a one year old firm founded by Jim Bailey, who recently left to join the international department of RCA-Victor.

A new firm, Tapp International, will be established by Blocker which will now operate the foreign services

formerly handled by Bailey. These include the representation of several foreign labels for the placement of their catalogs, masters and copyrights with companies in the United States. In addition Tapp International will place domestic catalogs, masters and copyrights with the foreign licensees it represents.

Present clients include Hispavox, Spain; Gamma, Mexico; Astor, Australia; Quality, Canada and Gallo (Continued on page 57)



ARGENTINA

TV producer Ricardo Kleinman, is no longer allowing dubbing in his "Modart No. 1" program on Channel 7, a move they, if followed, may help to solve the problem created by the bad dubbing of several chanters and groups which causes discomfort in the audience and has been widely criticized through the press and reviews. Kleinman is also negotiating an arrangement between Channels 7 and 2 to simultaneously air his program which would allow better producing facilities for his show.

RCA's Palito Ortega will be back in Buenos Aires at the end of July or the first week of August, it was reported. After the successful run of "Que Sera," the label is releasing a second single culled from the chanter's latest album, "Magnetism," recorded in Nashville. Palito is currently in Spain shooting a film with cinema star Rocio Durcal and will jet afterwards to Rome for recording sessions at the RCA studios in that city.

Music Hall reports the release of the new album cut by Frank Sinatra with Antonio Carlos Jobim. The diskery is also preparing the first records by French lark and artist Marie Laforet who records for Festival, represented here by the Selasco-Calvo diskery. MH is also constantly increasing its Difusion Musical budget series, both with classical and pop releases. This time there are folk albums by Arsenio Aguirre, Los Hermanos Simon and Los Hermanos Aramayo, and a tango LP by Los Modernos.

Odeon has released the much discussed "Let's Spend The Night Together," by the Rolling Stones coupled with "Ruby Tuesday," as well as a single by newcomer (for this market) Rolf Harris singing "Fijian Girl" and "You Got What It Takes," and a Brazilian single by Sergio Reis, "Paper Heart," considered a potential hit. The diskery has launched a campaign under the logo "Odeon Promotes Argentine Music Through the World" with a press conference to explain the idea and the steps to be taken.

Fermata reports that Billy Bond has recorded a cover version of "Ruby Tuesday," sung in Spanish for Music Hall coupled with "Sunny." The Breachers, for the same diskery, cut "Magdalena Fue Al Mar" and "Mi Refran" (both penned by visiting star Chico Buarque), and Violeta Rivas (for RCA) has also waxed "Meu Refran." The Record Division reports the marketing of an album by French chanter Christophe and the second volume by the Troggs: "Troglodynamite."

CBS reports top promotion for the Tremeloes whose new single, "Silence Is Golden" is being put on air this week. Also coming on strongly is "Casno Royale," cut by local instrumentalist Mr. Trombone. Incidentally, the film's premiere in Buenos Aires is due soon which will mean strong promotion for all the versions of the Niven-Sellers-Bond flick. The label is also pushing strongly the Andy Williams version of "Music To Watch Girls By" which may turn into another smash.

Phonogram's Hugo Persichini feels happy with the "Martin Fierro" award received by the "Argentina Canta Asi" TV program in 1966 from the Association of TV and Radio Journalists, an equivalent of the U.S. "Emmy." The company is planning to give strong impulse to the local recordings handled under the Polydor Label which are distributed in the rest of the world by DGG. Philip's current top LP seller is "Modart En La Noche," named after Kleinman's successful radio program.

Surco has released an interesting album by U. S. duet Sonny & Cher under the Atlantic logo, "The World Of Sonny And Cher" which under proper circumstances could open a wide market for these artists. There are also an album by the Shodows of Knight ("Back Door Men"), also under the Atlantic trade mark, and a single by French lark Francoise Hardy who will reportedly visit soon, "Rendezvous d'Automne."

Disc Jockey expects a lot from the new Rosamel Araya album which presents a selection of the artist's greatest hits during his 9-year career. The record was presented at a widely attended party and is already selling strongly. Another good bet is the first record by French chanter Monty in Spanish ("Mais la-Bas") which is selling strongly in the provinces of Cordona and Mendoza.

Julio Korn Publishers report the control over seven of the "Un Disco Per L'Estate" contest including "La Rosa Nera," "Tanto Tanto Caro," "Tu Che Sei L'Amore" and others. The pubbery has also the rights to the winning song of the recent Odol Song Festival, "Pastor de Nubes," penned by Fernando Portal and Castilla.

Microfon expects good sales from its top melodic artist, Vicentico Valdes, whose version of "Strangers In The Night" is in the market along with his first album. The diskery has also released a Compact 33 by teen chanter Johnny Allon and LP's by the Vienna Symphonic Orchestra (recorded by Audio Fidelity) and jazz musician Art Tatum.

BGM's news include this week a single by Tonia under the Magenta label: "Tu te Souviendras de Moi" coupled with "Je T'Adore" and recorded with the Benny Couroyer group; a Sonet single by Ola & the Janglers ("Land Of A Thousand Dances"); and another one by Claude Lombard: "Avant-Ampres" flipped by "Tout Fou Tout Doux."



RACKING UP PLENTY OF SALES—Ernst Mosch and his Egerlander Orchestra have sold more than 6-million records for Teldec in Germany since joining the firm. At the special presentation shown here, Teldec production chief Kurt Richter (seated right) awarded Ernst Mosch (seated left) and his musicians the Diamond-Disk award for sales totaling 6-million.

Cash Box TOP 100 LABELS

A.B.C.	20, 52
Abnak	24, 42
ACTA	36
A&M	68, 69, 91
Atco	40, 47, 84
Atlantic	8, 16, 53, 62, 86
Bell	28
B. T. Puppy	45, 89
Calla	95
Canterbury	98
Capitol	39, 63
Columbia	19, 90, 97
Date	44, 71
Decca	82
Deram	26
Diann	64
Dial	61
Double Shot	57
Dunhill	5
Elektra	14
Epic	31, 35, 41
Gordy	46
Groovesville	50
Imperial	11, 29, 93, 100
Jamie	83
Jubilee	13
Kapp	81, 87, 99
Laurie	2, 77
Loma	56
Mercury	22, 73
MGM	9, 25, 30, 74
Mira	85
Money	33
Motown	18
Muscor	80
New Voice	58
Ode	4
Okeh	96
Parkway	78
Parrot	43, 48
Philips	3, 12, 72
RCA Victor	23, 38
Reprise	27, 51, 75, 79
Revilot	88
Ric Tic	67
Ronn	92
Roulette	55, 66
Scepter	15
Soul City	10
Stax	49, 59, 70, 94
Tamla	17, 32, 37, 65
Tower	76
United Artists	54, 100
Verve Folkways	21
Volt	34
Warner Bros.	1, 7, 60
White Whale	6

Czech Pop Fest

(Continued from page 49)
phon-Holland and Italy by Master Records. Supraphon itself represents for Czechoslovakia and all countries of the Eastern bloc the labels of Deutsche Grammophon Gesellschaft; Columbia U.S.A. (and CBS for Europe), Barclay, France and a deal has just been signed with Palette Records of Belgium. Negotiations are also under way with Atlantic Records. Last year's Bratislava Festival originated interest in Western countries for two Czech artists—Karel Gott and Hanna Hegerova—who are today contracted to Polydor and Philips Ton. The second edition of the Festival has started similar negotiations for five more Czechoslovakian artists—Waldemar Mutuska, Vaclav Neckar, Marta Kubisova, Helena Vondrackova and Eva Pilarova.



BRAZIL

Preparations for the "Second International Festival of Popular Song of Rio de Janeiro" are being publicized lately in the local press. We had the first contact with the organizer and Director of the Fest, Augusto Marzagão, who announced that Nelson Riddle will take part as Member of the Jury, while Quincy Jones will be the composer from the United States who will represent the country. Among others, Duke Ellington and Henry Mancini will be guests of honor. Marzagão will soon go to the United States where he will confirm several invitations to top personalities. Much talked about it the possibility that Frank Sinatra will be invited as President of the international jury.

Enrique Lebediger, Prexy of the Fermata Organization will soon return from one of his successful Latin American and U.S. tours on which he has been doing special promotion for the Brazilian music of his pubbery and diskeries (Fermata, RGE and Som/Maior). He will probably await in Argentina a star composer Chico Buarque De Hollanda whose numbers "A Banda" and "Funeral Do Lavrador" were in top positions on the charts.

It seems that something has gone wrong between the partners of the newly founded label AU (Artistas Unidos)—several changes are to be expected in the near future.

New chattrress of "a different teen-music," De Kalafe, celebrated her birthday in a cocktail party/show attended by many of her followers. The AU artist is being requested by other countries, and it is possible that several of her numbers will be included in an album made by a U.S. disk man who wants to show the world the type of music being done here by local artists and composers who are not imitating the Liverpool or U.S. sounds.

We have been receiving lately a growing number of letters from all over the world asking info about Brazilian music, a sound proof that it is becoming more and more well known, as we predicted after release of the album by Sinatra/Jobim, Sergio Mendes, Walter Wanderley and Astrud Gilberto. And more are still to come...

Brazil's Best Sellers

This Week	Last Week	Title	Artist
1	1	*O Bom Rapaz (Embi)	Wanderley Cardoso/Copacabana
2	3	*Coração De Papel (Fermata)	Sérgio Reis/Odeon
3	2	*A Praça (Edclave)	Ronnie Von/Polydor; Francisco Petronio/Continental; Wilson Simonal/Odeon
4	4	Sunny (Fermata)	Chris Montez/Fermata; Bobby Hebb/Philips; The Mustangs/RCA; Bobby Vee/RCA
5	5	*So Vou Gostar De Quem Gosta De Mim (Ed. RCA)	Roberto Carlos/CBS
6	6	Ciao Amore Ciao (Ed. RCA)	Luigi Tenco/RCA
7	8	*Faça Alguma Coisa Pelo Nosso Amor (Ed. Genial)	Os Vips/Continental
8	7	Penny Lane (Fermata)	The Beatles/Odeon
9	13	Somethin' Stupid/Coisinha Estupida (Ed. RCA)	Nancy & Frank Sinatra/Reprise; George Freedman/RCA
10	10	*Coisa Linda (Ed. Samba)	Eduardo Araujo/Odeon
11	14	*Arueira (Ed. Disparada)	Geraldo Vandré/Odeon
12	19	I'm A Believer (Mundo Musical)	The Monkees/RCA
13	9	Never Never (Fermata)	The Shakers/Fermata
14	—	Quando Dico Che Ti Amo (Ed. RCA)	Tony Renis/RCA
15	11	Piange Con Me (Ed. RCA)	The Rokes/RCA
16	20	Eu Sou O Alguem (Fermata)	Luiz Aguiar/AU
17	—	*Não Quero Voltar Atraz (Ed. RCA)	Roberto Barreiros/Chantecler
18	—	*O Charreteiro (n.p.)	Jacinto Figueira Jr./Continental
19	—	Quem Te Viu, Quem Te Ve (Fermata)	Chico Buarque de Hollanda/RGE; Nera Leão/Philips
20	15	Last Train To Clarksville (Mundo Musical)	The Monkees/RCA

Brazil's Top Ten LP's

1	1	Ronnie Von—Ronnie Von/Polydor
2	2	As 14 Mais, Vol.19—Several Brazilian Artists/CBS
3	4	Francis Albert Sinatra & Antonio Carlos Jobim—/Reprise
4	3	The Monkees—The Monkees/RCA Victor
5	5	Roberto Carlos, Vol.6—Roberto Carlos/CBS
6	6	Obrigado Querida—Agnaldo Timóteo/Odeon
7	8	Fortissimo—Several Italian Artists/RCA
8	9	O Bom—Eduardo Araujo/Odeon
9	7	Edição Extra—The Jordans/Copacabana
10	10	Um Embalo—Renato & Seus Blue Caps/CBS

Top Five Double Compacts

1	1	Coração De Papel—Sérgio Reis/Odeon
2	3	Tributo A Martin Luther King—Wilson Simonal/Odeon
3	2	Noir C' Est Noir—Johnny Halliday/Philips
4	4	Roberto Carlos, Vol.2—Roberto Carlos/CBS
5	—	Poor Side Of Town—Johnny Rivers/RCA

Blocker's Tapp Acquires Bailey International

(Continued from page 56)

(Africa) Ltd. in South Africa. Negotiations are now under way with Cosdel, Japan, Hong Kong, Singapore and the Philippines and labels and licensees in various other foreign countries.

Tapp, USA has been in business for the past year.

Once the independent label or producer who is a client of Tapp has

finished his product it is turned over to Blocker who then assumes complete control of sales, promotions, merchandising and distribution. This leaves the producer free to concentrate on the production of new product without concerning himself with business details. Currently Blocker is performing these services for Billy Vaughn's new Zar label and Milton Berle's Embassy Records among others.

THE MOST FAMOUS BRAZILIAN ARTISTS!

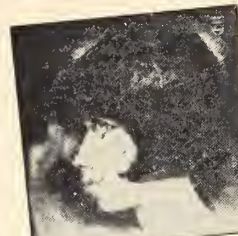

R 765.006 L (PHILIPS DE LUXE)
NARA LEÃO
Quem te viu, quem te vê
O circo and others...



P 765.001 P (PHILIPS DE LUXE)
ELIS REGINA
Roda Lunik 9 and others...



P 765.004 P (PHILIPS DE LUXE)
JAIR RODRIGUES
Disparada A Rita and others...



R 765.005 L (PHILIPS DE LUXE)
GILBERTO GIL
Louvação Proissão and others...



P 765.010 P (PHILIPS DE LUXE)
CLAUDETTE SOARES
E agora Ciúmes and others...

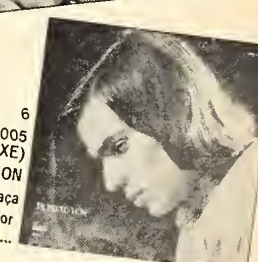

LPNG 44.005 (POLYDOR DE LUXE)
RONNIE VON
A Praça Menina-flor and others...

NARA LEÃO
ELIS REGINA
JAIR RODRIGUES
GILBERTO GIL
CLAUDETTE SOARES
RONNIE VON
ARE EXCLUSIVE ARTISTS OF



COMPANHIA BRASILEIRA DE DISCOS
AVENIDA RIO BRANCO, 311 - 4 - ANDAR
RIO DE JANEIRO BRASIL



Editorial

Cooperation — Formula For Success

The Florida Amusement and Music Associations' successful solution regarding the recent controversy between the operators and the State Beverage Department, is an impressive one, indeed. The entire dispute emerged when parents began to object to children playing on coin-operated pool tables in locations where alcoholic beverages were being consumed.

Under the very capable leadership of executive director Julius Sturm, the FAMA met in Tampa to discuss the controversy. After a reasonable and earnest discussion by members of both sides, an applicable solution was arrived at.

The first step in "nipping the bud" came from the State Beverage Director, Don Meiklejohn, when he issued directives to his enforcement agents in the field as to the legalities of free-play and pool table activity.

The free-play directive read as follows: "In the opinion of the Director, no pin ball machine is illegal or prohibited, merely because it allows or awards additional chances or uses, or 'free-play', provided it meets the following criteria: If it is not designed nor used for gambling; if there is sufficient skill required by the player so that the machine qualifies as an amusement device under the (Florida) Supreme Court holding in **Deeb V. Stoutmire**, 1951, 53 So.2d 873; if there is no arrangement whereby 'free plays' can be removed from the indicator on the machine or device, other than by bona fide play and if it is not used in such a manner as to constitute a nuisance."

The pool table directive read as follows: "A coin-operated pool table can be located on a licensed premises, but it is the opinion of the Director and the policy of this Department that Florida Statutes 849.06 permits a person under 21 to play pool or billiards on a pool table (minature, coin-operated, etc.) in a licensed establishment if, and only if, said minor is: accompanied by a parent, guardian, or; currently on active duty with the armed services of the United States, or married."

The association, in a letter to Meiklejohn from the president of FAMA, James Mullins and Leonard Pepper, FAMA Counsel, met the directives in a most intelligent manner. It was stated in the letter that, "we appreciate your problems in getting your field men 'educated' to the proper control of the legal operations of these machines, as distinguished from those which might not be legal. In any event in which there is a problem in the field which is brought to our attention, we will (as we have been advised) bring the matter to your attention for a final determination of the matter. We will cooperate in any way with your field men to see that the law is maintained."

The impressive thing in this Florida situation is the reasonable way members from both sides met it before it had a chance of getting out of hand and, very possibly, creating another "Illinois" crisis.

Trade Events

N.Y. Servicemen

Runyon Sales Company, Springfield, New Jersey, will host a vendor to 100 mm brands, Thursday, July 6, 1967 at 7 P.M. Lou Di Palma will instruct. Be sure to advise your servicemen to attend.

N.Y. State Operators

The regular meeting and dinner of the New York State operators Guild will be held at the Nelson House, Poughkeepsie, N.Y. on July 19, 1967 at 7:30 P.M.

Illinois Operators

The Illinois Coin Machine Association will hold their summer meeting at the Holiday Inn East in Springfield, July 15-16.

Montana Operators

Montana Music Operators Association members will meet at an undetermined place, to be announced at a later date, on July 22, 1967, at West Yellowstone, Montana.

South Carolina Operators

Members of the South Carolina Operators are reminded that the new date for their meeting at the Ocean Forest Hotel at Myrtle Beach is July 29-30th. Reservation confirmations are in the mail.



Visiting Cash Box last week was Marcel Grosch, prominent Belgian importer of U.S. music and amusement equipment, during his wide tour of key cities in the American market. (Left to right, Ed Adlum, Marcel and Ben Jones.)

July 14 Deadline For MOA Exhibit Space

CHICAGO—Fred Granger, executive vice president and managing director of Music Operators of America (MOA), recently sent out via mail options to exhibitors who wish to select the same space they had during last year's convention and trade show, October 28-30, in the Pick-Congress Hotel. The deadline, Granger explained, is July 14. Upon immediate notification MOA's headquarters in this city will then send formal contracts out to the exhibitors for the

forthcoming MOA Convention and Trade Show, October 27-29, in the Pick-Congress. In the event that exhibitors fail to notify MOA by July 14 the space being considered will then be made available to other exhibitors. "We cannot stress too strongly," Granger asserted, "the need for haste in making these decisions, especially if the same space is desirable. It will certainly simplify matters if the same choice is made, and tend to keep us on a healthy time schedule."

THE HOT BOX

this week's big stories

Deadline for MOA exhibit space 58
 Wurl. Dirs. name new V-P 59
 Lee Corp. Named Dist. for Fischer 59
 Profile on Norm Goldstein 59
 Bilotta hosts ser. class 63

Thirty-Two Technicians Attend New Orleans Service School



The selector system is explained by Karel Johnson (center, rear) while the students consider the selector panels which create the musical program.

NEW ORLEANS—C. B. Ross, Harry Gregg and Karel Johnson once again were "the professors" at a service school held at the Jung Hotel in New Orleans, Louisiana from June 12th thru the 16th. Robert G. DuPuy, Manager of the Wurlitzer Factory Branch in New Orleans was host to the thirty-two operator service technicians.

Due to the large number attending, several classrooms were utilized, with time devoted to the electrical/electronic components, mechanical tear down and build up, and general trouble shooting on the new Wurlitzer Americana Phonograph and other coin-operated equipment. A complete course covering correct schematic interpretation, so necessary for technicians servicing games and vending equipment as well as phonographs, was also given.

To explain the National Dollar Bill Acceptor available as optional equipment on the Americana, E. Carl Williams, National Rejectors Representative, was in attendance. Carl went over the mechanism of the Bill Acceptor, in detail, for the assembled service technicians, and also covered the slug rejector. "His attendance was appreciated by all, and added greatly to the meeting," said Ross.

An interesting point was that this was one of the very few times a woman attended the full classes. "E. S. Varcaris of Louis Amusement, Jackson, Mississippi was a very attentive student and an excellent service technician," stated Ross.

Spindel Urges Ops To Get Location Insurance

CHICAGO—Manfred (Spin) Spindel, president of Spindel Insurance Agency, Inc., a longtime insurance advisor to the coin machine distributors and operators, last week injected a timely bit of advice to the smaller operating companies throughout this country that as a result of the recent unfortunate wave of tornadoes and racial disturbances they would have been considerably more secure with their losses in damaged equipment if they had been fully covered on risk insurance for vending, games and music equipment on location.

"The big national operating companies," he continued, "naturally avoid these frightening losses by always maintaining full coverage. The smaller, independent distributor is not using good business sense in passing up this opportunity for proper insurance coverage."

Spindel Insurance Agency, Inc. has paid death claims to distributors on the lives of operators who died during 1966 in excess of \$400,000 on Credit Life Insurance, according to Spindel.

The firm, which is licensed nationwide, covers Casualty, Bonds, Fire, Group Life, Pension Trust, Profit Sharing and Automobile Insurance.

Operator principals and service personnel came from five states to attend this seminar. In attendance were: Anthony V. Rinaldo of Bruno Novelty Company, Canastota, New York; Clifford K. Krull of Great Lakes Distributors, Inc., Buffalo, New York; George D. Ferrell of Brady Distributing Company, Charlotte, North Carolina; Al Boozer of Fort Worth Vending Company, Fort Worth, Texas; Lloyd E. Felder of Gulf Coast Distributing Company, Houston, Texas; Amos G. Flores of United Vending Machine Company, Port Lavaca, Texas; Don R. Starns of Texas Amusement Inc., Houston, Texas; Benny G. Thompson of Port Lavaca, Texas; Gary L. Fremin of

(Continued on page 63)

Wurlitzer Directors Elect Herleman Company President

CHICAGO—W. N. Herleman was recently elected president of the Chicago based musical instruments division of the Wurlitzer Company, by the company's board of directors. Herleman is the former vice president and succeeds R. C. Roling, who will continue as chairman and chief operating officer.

C. M. Ingold was elected vice president and treasurer. His former position was secretary and treasurer. A Donald Arsem of engineering and research, was advanced from vice president to senior vice president.

Other new positions filled were: R. G. Myrland, vice president and will continue as manager of the Elkhart, Indiana division; Ago Koerv, secretary and designated assistant controller; and C. H. Banks, assistant secretary and controller for the Dekalb, Illinois, division of the company.

Morris Bayer, Coin Pioneer, Passes Away

PHILADELPHIA—Morris Bayer, a pioneer in the coin machine business, passed away on June 16th, at the age of 56 after a prolonged illness. Bayer is survived by his wife and a daughter.

For the past seven years, he was a sales executive at David Rosen, Inc. in Philadelphia. During the thirty years he has been active in the coin machine industry, he has been identified with distributing firms. Before joining the Rosen firm, where he was assistant to Joseph Wasserman, vice president in charge of sales, he was associated with Joe Ash's Active Amusement Co. and Banner Specialty.

Lee Corp. Named Houston Distrib. For Fischer

TIPTON, MO.—Frank Schroeder, director of sales for Fischer Manufacturing Company, announced the appointment last week of the Lee Corporation in Houston, Texas to handle distribution of Fischer's line of coin-operated pocket pool tables and accessories in the wide Houston area.

Lee Corp., headed by Lee Siegel, a longtime veteran in the billiard business, is located at 2438 Rice Boulevard, in Houston, and can be reached by telephone at (area code 713) 524-9253.

Izzie Getlan Passes Away At 56

WHITE PLAINS, N.Y.—Isadore Getlan, an amusement machine operator for over thirty years, died June 25th in White Plains Hospital of cancer. He was 56.

Getlan, a true pioneer in the coin machine industry, was described last week by his close friend Johnny Bilotta, as: "the man who brought the coin chute into locations where they'd never been before". Among those spots in which Getlan pioneered amusement operation were the Adventurers Inn chain and Nathan's Famous Restaurants.

Iz Getlan's operation is now being run by his sons Melvin and Ronald. He is also survived by his wife, Beatrice, a daughter and six grandchildren. He was interred at Mt. Zion Cemetery in Masbeth, L.I.



PROFILE ON:

NORM GOLDSTEIN — THE OHIO BUCKEYE

The Cash Box Profile Series aimed its pencil at one of the most self-educated businessmen in the coin machine industry this week and obtained an insight into the business life of articulate and soft spoken, Norman Goldstein, president of the Monroe Coin Machine Exchange in Cleveland, Ohio. Norman is also the president of the National Coin Machine Distributors Association. Durnig his preside late George George, Goldstein has been steadily expanding the firm's sales activity and in 1965 opened a branch office in Dayton to offer greater flexibility and convenience to Ohio operators.

How long have you been in the coin machine business?

I started in this business twenty-one years ago, in 1946.

How did you get started in the business?

I began as a service man covering a route of coin-operated equipment.

Did you choose the profession by choice or did it choose you?

It was a fifty-fifty proposition. I was young and the economy wasn't in complete balance, there was World War II and other contributing factors. The business was good to me so I stuck with it. I wasn't college trained, therefore it would have been difficult to obtain a better opportunity in another field.

Do you think the coin machine industry could use young blood with new ideas?

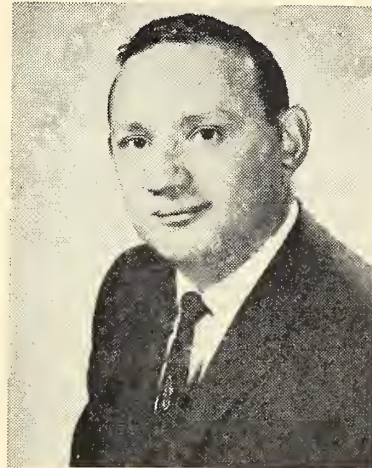

NORM GOLDSTEIN

Absolutely, there is a definite need for young men with ideas that correspond to present methods of business. Those companies not having young minds within their organization are virtually at a standstill. When the old timers brought their sons into the business, the majority of them failed to orientate their offspring in the values of following modern business methods. Dad's traditional methods of operating a business were carried on by the son for posterity's sake and the new methods were ignored. I can see tremendous growth in all directions if only the people in the business will open up their eyes to the common denominator called "progress."

What line of equipment seems to have the greatest growth in Ohio?

There is no great quantity of sales in any of the equipment lines. Although, there has been a definite growth in the vending industry.

To what extent has the old line business and games operator gotten into the vending trade?

The old line hasn't. The vending growth has been a result of the new faces entering the vending segment of our industry. There have been a few of the older music and games operators who have moved over to the cigarette vending business. That's the extent of it.

Where do you place the emphasis on your sales technique, would it be in the field, over the phone, thru the mail or in the display room?

You touched on all of them. Sales within the state of Ohio are handled primarily by calling on customers personally. Naturally, the out of state sales are made by phone and thru the mail.

What is the long range outlook for the Ohio coin machine industry, has it shown any definite advances over the years?



The outlook in Ohio is very promising. As you know, Ohio is a progressive, industrial orientated, state and has shown tremendous growth over the years. There have been advances noted in our industry and there will be more rapid advances as the prospects of better businessmen coming into the trade are evident. Naturally, there is more competition in the trade now than twenty years ago, and, while competition is the motivating force that compels us to push forward, we welcome it.

C LLECTOR'S

STANDARD SELECTIONS 1 PLAY DIME OR 2 NICKELS 3 PLAYS QUARTER

SPECIAL SELECTIONS 1 PLAY QUARTER

Rowe AMI

  	SO	RHYTHM & BLUES	LA	LET'S HANG ON	VE
	MI	KEEP ON DANCING	6	FOUR SEASONS	
	MI	THE GENTRYS	7	ON BROADWAY NIGHT	VE
	MI	MAKE UP YOUR MIND	MB	SOME ENCHANTED EVENING	
	MI	I HEAR A SYMPHONY	NC	JAY & THE AMERICANS	
	MI	THE SUPREMES	6	GIRL	VE
	MI	WHO COULD EVER DOUBT MY LOVE	7	1-2-3	
	MI	TREAT HER RIGHT	Q	LEN BARRY	
	MI	ROY HEAD	6	BULLSEYE	DVE
	MI	SO LONG, MY LOVE	R	TREAT HER RIGHT	
MI	HANG ON SLOOPY	S	ROY HEAD		
MI	RAMSEY LEWIS	6	SO LONG, MY LOVE		
MI	MOVIN' EASY	7	A LOVER'S CONCERTO		
MI	RESCUE ME	T	THE TOYS		
MI	FONTELLA BASS	U	THIS NIGHT	VE	
MI	SOUL OF THE MAN	6			
MI		7			
MI		J			
MI		K			

THE WALL-ETTE

HIGH
MED
LOW
service

A	B	C	D	E	F	G	H	J	K
L	M	N	P	Q	R	S	T	U	V
1	2	3	4	5	6	7	8	9	0

ITEM

Easier installation and faster service make the new Rowe AMI Wall-Ette a collector's dream. Its high-speed service-on-the-spot means greater profits for you. Saves a minimum of five minutes service time per box. On a 12-box location you'll save an hour's labor.

On the other side of the coin... the new Wall-Ette's sleek, compact design, "soft-touch" selector buttons and personalized stereo sound will captivate your customers. Results: more play, bigger collections!

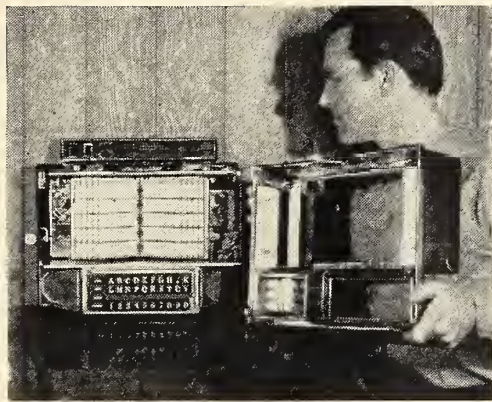

Many exclusive features make service a breeze. When used on counter, the Wall-Ette can be serviced from back without disturbing customers.



Winking waitress call-to-service light she can't ignore.

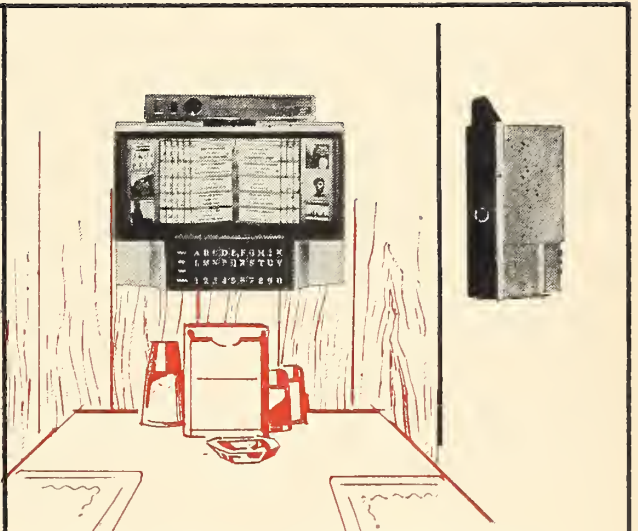
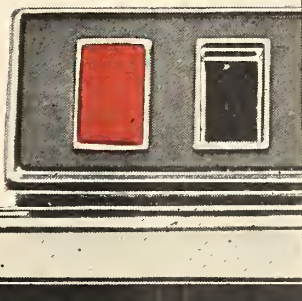

Most compact of all wallboxes. Smallest in depth and height. With handy above-counter mounting, salt, pepper, sugar can be stored underneath.

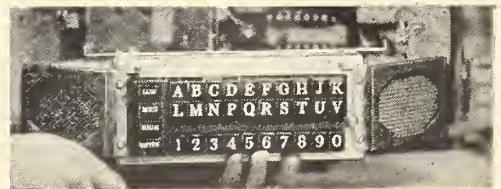

30° Stereo Round* Sound offers the finest play-promoting remote stereo reproduction available.

Rowe[®]

MANUFACTURING

Troy Hills Road, Whippany, New Jersey

*U. S. Patent No. 3,153,120





THANKS FROM U.J.A.—The generous contributions of equipment and gifts, which were raffled off at Teddy Blatt's recent UJA testimonial, were formally acknowledged by Sam Hausman, honorary chairman of the board of UJA of Greater New York in a letter of thanks to those generous members of our trade who responded. In addition to the phonograph manufacturers, who donated jukeboxes, letters were received by Irv Kaye of the Irving Kaye Co. and Art Daddis of United Billiards, Inc. The latter two were among those who answered the emergency call and doubled their pledge—in this case, two tables from each. The equipment was sold to operators and the proceeds given over to UJA. May we add our sincere thanks to all those who answered the call.

THE REALLY BIG MOVE—United Billiards prexy Art Daddis will be presiding over the move of his company's production material from the three Newark plants to a brand new complex on Prospect St. in Union, N.J. during the next few weeks. Although the move presents a monumental task for the pool table firm, Art has been planning many weeks in advance to insure that there be no slowup in table production during the hiatus to Union.

GO, GO, GO—AMI's marketing exec Fred Pollak and his promotion consultant Chuck Harrington had the pleasant task of shooting location posters from the PhonoVue spots around the country. We say pleasant 'cause the subject of these posters was a score of New York's prettiest Go-Go girls secured by Chuck from some of big town's finest clubs. Nice work if you can get it. Meanwhile, production on PhonoVue product con-

tinues unabated with several film companies solidly in the program.

THE INDUSTRY ADJUSTS—As the 100mm cigarette captures the fancy of more and more Americans, more and more of the vending manufacturers are converting to larger sized columns. Rowe's Riviera machine is now available with the longer column. Likewise, Johnny Bilotta is offering his upstate customers converted Smokeshops. Vendo's 100mm has been cooking for well over four weeks now, being one of the first available. Many distributors have capitalized on the overnight demand by converting much of their used cig machine inventory into 100mm capacity units. The ingenuity of coinbiz.

PUT ANOTHER QUARTER IN—The slow, sure and relatively unpublicized move to two-for-a-quarter jukebox play on the part of many operators is a welcome sign of the times. The changeover is long past due and we hear from more than a few ops these days that no problems in any respect have been encountered wherever they made the transition. Bill Rosebloom, Davis Distributing's promotion exec out of the Syracuse office, has been quietly pushing for the increase with marked results. Bernie Inge down at Southeastern is another distrib on the "two tunes for two bits" bandwagon. But more on this when the air over D.C. clears a bit more.

NEW DIGS FOR C-S—We dropped in on Color-Sonics chief Hank Schwartz over at the new C-S headquarters at 724 Fifth Ave. and got a sneak preview of things to come. In a word, Wow! Meanwhile, film product is being steadily minted by C-S sister firm Official Films. The 2600 model, we understand, continues to reap fine coins at tavern and lounge locations

around town.

SHUFFLIN' OFF TO LAURELS—George Holtzman, NYSCMA veep and chairman of this year's combined associations convention due to unfold Sept. 22-24 at Laurels Country Club in Monticello, N.Y., would like all operators interested in making the big weekend to return the reservation blanks they received last week as quickly as possible. "We expect a capacity turnout so don't delay," advises George. Meanwhile, MONY exec Ben Chicofsky is hard at work preparing the convention journal and info's he's getting excellent response from the record companies. Speaking of journals, the Cash Box crew put out their 25th annual coin directory this week (if you subscribe to the book, you have your copy). If you don't . . . shame!

THE JERSEY SIDE—"They're terrific, they're moving big," boasts Oscar Parkoff of the dual release by Williams of the 'Apollo' 1 pl. pin and 'Coronado' big ball bowler. . . . Meanwhile, Bert Betti over at Betson Enterprises in North Bergen, is eyeing up prospects for new ChiCoin ski ball soon to be released. "We're already doing a fine job with the Riviera shuffle alley," says Bert. . . . Nick Melone at American still grumbling a bit over loss of softball game at recent outing. "He shouldn't have taken Lipkin out in the 5th inning," advises Mike Bozza, with a smile and a wink at Sol.

HERE AND THERE—Two Floridians making the New York scene recently were Jupiter's Sam Taran and Mar-Tab's Sol Tabb. . . . Musical Distributors' Harold Kaufman delighted with movement on new amusement piece Helicopter Trainer, invites games ops to take a trial spin on the unit. . . . Dave Koenigsberg of State Sales & Service in Baltimore is back on the job after mild heart attack. "Looks and feels great," says partner Sam Weisman of his good friend and colleague.

UPPER MID-WEST MUSINGS

Art Berg, Fairmont, in town for the day buying records and parts. . . . Joe Totzke formerly in the operating business in Fairmont for many years is seriously ill. . . . Roy Foster, Sioux Falls, in the cities over the week end visiting his children. . . . Gordon Wornson and Clayt. Norberg, Manakato, in the cities for the day on a buying trip and buying records and parts. . . . The Jim Stears from Minot, returned last week from Houston, Texas where they vacationed for a few weeks. . . . Mr. & Mrs. Richard Hames on a vacation up North last week. Dick heads the credit dept. at Lieberman's. . . . Mr. & Mrs. Ike Sundem in town for a few days on a little vacation. . . . Our deepest sympathy to Mrs. Julius Koers and family. Julius passed away Monday June 12th death caused from cancer. Julius was a partner in the Rushmore Vending Company, Rapid City, So. Dakota. . . . Vern, Billy, and Terry Boerger in town for the day making the rounds. . . . Earl Ackley, Trego, spent the past week in Milwaukee at the postmasters convention. . . . Jim Donatell opens his Supper Club on the 29th one month behind schedule. . . . I. Alpert and a group of men have bought the Lake-Aire motel and are re-furbishing it from top to bottom. . . . Mr. & Mrs. Earl Berkovich, Superior, are spending the week-end in Minneapolis visiting their children. . . . Hank Kreuger in town for the day buying records and parts. . . . Shelley Berman at the Manor.

HAPPY ANNIVERSARY TO US . . . Since we don't get a chance to celebrate our 25th anniversary more than once in 25 years (that does make sense doesn't it?) we figure that there's no better time than the present to congratulate ourselves. For those on phonorow this not only marks our birthday but also the halfway point in the 67 year. For some it has been a time of prosperity for others things have been rather slow, but we are all looking forward to the summer season as one in the sales department.

WELCOME HOME CHARLIE ROBINSON . . . Home after his seven week cruise around the world, and so it's back to work with some mighty pleasant memories of a most enjoyable trip. Getting back to reality, Charlie is huddling with Al Bettelman and Hank Tronick, analyzing business for the first half of the year, and planning to keep the second half as good, if not better! Hank tells us that based on preliminary inquiries, and orders on hand, they are doubling their initial order of the new 8 ft Valley magnetic pool table, which are scheduled for delivery in the very near future. Hank also reports that Midway's "Space Gun" continues to amaze operators with some of the best collections ever on any gun game in many a year. Hear that Al B. took off for a day of relaxation and fishing in the "beautiful blue?" Public (which happens to be closer to a mossy shade of green). Al came back with sackful of fish, a terrific suntan (we're green with envy), and on top of all that, he won the jackpot for catching the biggest fish.

SECOND SHIPMENT OF MAGIC BASEBALL ARRIVES AT SIMON DISTRIBUTING . . . George reports that he is very pleased with the response that this game has been getting from operators and looks forward to doing as well with his second shipment as he did with the first. He tells us that the game is even better due to the fact that the bat has been made bigger and better. We can hardly wait to get over there and try it out for ourselves. We're told that a shipment of phonographs just departed for the Far East. While at the same time Isao Kodai of Japan, was shopping and visiting with George.

FROM THE RECORD RACKS . . . Spoke with "bubbling" Buddy Robinson who informed us of the fact that "no news is good." We don't quite go along with that line of reasoning but Buddy did manage to tell us that Herb Alpert and the Tijuana Brass are "Happening" with a disk of the same name. Don and the Goodtimes follow-up to "I Could Be So Good To You," is a deck called "Happy and Me," looks like a real winner. The Tremeloes tell us that "Silence is Golden" Peaches and Herb's newest single for Columbia "For Your Love" is getting some heavy action. Top L.P.'s are as usual, "Sgt. Peppers Lonelyhearts Club Band" by the Beatles, and the "Doors" album.

HERE AND THERE . . . Hopefully Gary Sinclair of Wurlitzer, is back in town for the 4th of July, after finishing up his tour of Japan. Clayton Ballard informs us that over seventy-five thousand seniors took part in the Disneyland Gradnite parties that took place during the last couple of weeks in June. Speaking of gradnite, we hear that Clayton's daughter, Peggy, graduated from Hoover High School in Glendale. For Peggy's work with the choral groups at Hoover, she received a cash scholarship which will help her to continue her education at Glandale City College. We're told that Kip Marin and her husband have left for Costa Rica and in her place they have hired Cecilia Marks.

If you are reading
someone else's copy of
Cash Box
why not mail this coupon
today!

CASH BOX
1780 BROADWAY
NEW YORK, N. Y. 10019

Enclosed find my check.

- \$20 for a full year (52 weeks) subscription (United States, Canada, Mexico)
- \$40 for a full year (Airmail United States, Canada Mexico)
- \$30 for a full year (other countries)
- \$45 for a full year (Airmail other countries)

Please Check Proper

Classification Below

MY FIRM OPERATES THE
FOLLOWING EQUIPMENT:

- JUKE BOXES
- AMUSEMENT GAMES
- CIGARETTES
- VENDING MACHINES
- OTHER

NAME
FIRM
ADDRESS
CITY STATE ZIP #

Be Sure To Check Business Classification Above!

Chicago Chatter

July 15 is the day the Illinois Coin Machine Operators Association and his multitude of friends in all walks of life bid farewell here to a staunch supporter of coinbiz in these environs — Lou Casola. Scene of the gala testimonial dinner honoring Lou will be the Holiday Inn East in Springfield, commencing at 7:30 p.m. CHICAGO CHATTER reminds you of this now so that you can get your checks for \$10.00 per plate in to Francis Roper, of Mid-West Distributing Co., 212 North Madison Street, in Rockford. NOTE: Anyone desiring to pay at the door is welcome to do so. Roper is chairman of the committee, which consists of Orma Johnson, of Rock Island; Chick Henske, Jacksonville; and vice prexy Harry Shaffner, of Alton Working very diligently on the committee is Lou's old buddy Charlie Marik, of Star Music in Rockford; as well as Reno Sandona, Bill Morris, and our favorite State Legislator, Zeke Giorgi, who has represented coinbiz so ably in the General Assembly. Jim Winning, ICMOA's legal counsel, will also be seated on the dais with his lovely wife, Fred Granger, executive vice pres. of MOA, will handle the emcee chores. Happily we report that Clint and Marie Pierce, of Pierce Music in Brodhead, Wisconsin, will have honor status at the Lou Casola Testimonial Dinner.

We were tickled recently to read in Cash Box that old buddy Bob Portale purchased the Los Angeles Advance Automatic Distrib from Lou Wolcher. We join all his friends throughout this country in wishing Bob the very best in his new status as prexy at Advance. . . . Art Weinand and his lovely Kay are bubbling over these days with all the happy tidings in the Weinand household. Sister Denis, whom we still fondly refer to as "Ginger," receives her R.N. on July 8 at Little Company of Mary Hospital. Alice Weinand receives her B.A. at Northeastern Illinois State College, August 16, and will be a full fledged teacher. Incidentally, she was on the dean's list throughout her college career. Son George, who works on the line at Williams Electronics during the summer hiatus, is a speech major at DePaul University. A proud family, indeed. . . . Chet Gore, of Exhibit Supply, had stars in his eyes when he told us about his 1½ year old granddaughter, Noel (she was born at Christmas Eve). Proud parents, Carol and Ronald, and Bob Gore, helped Chet and his wife, Lucille, celebrate 31 years of wedded bliss on June 20.

As we close the book on a fiscal year and plunge right into the new period we look forward to many strides in Coinbiz International. This, it appears, is the area where the greatest growth potential is. As the burgeoning of advances in communications continues to shrink the world at break neck pace business on the international level increases by leaps and bounds. Another consideration worth noting is the ever continuing mushrooming of vending and coinbiz state and regional associations. Cash Box salutes all trade associations no matter the size, scope or locale. . . . Each year at anniversary (fiscal) time our great, countless host of friends extend that much desired, lusty handshake of greetings. May we, at this time, turn the table and express our fervent wish that this fine mutual association (with all our friends in manufacturing, distribution and in operating) continues unabated for many productive, happy years.

AROUND THE HORN IN COIN-ROW: Heaviest concentration now is on the scheduling of vacation periods in the factories and distrib. Most factories will, of course, shutdown for vacation, rather than go into a complicated, costly staggering program. . . . Ross Scheer is already a "human buzzsaw" in his office at Midway Mfg. Co., in suburban Schiller Park. The firm boasts quite a capable line-

WOULD YOU BELIEVE..

It takes only \$20 a week for 25 weeks, films included, to lease the only 2-in-1 combination movies & jukebox machine. You can believe it — write, wire, phone.



TRY IT before you buy it!

Exclusive Rowe AML Distributor
Ea. Pa. - S. Jersey - Del. - Md. - D.C.

DAVID ROSEN inc

855 N. BROAD ST., PHILA., PA. 19123
Phcne: (215) CEnter 2-2900

CLOSEOUT, SEEBURG 1000' BACKGROUND MUSIC UNITS

—100 Available—

ready for locations:

BMC's — \$125. each

BMU's — \$150. each

BMS' — \$175. each

Trimount Automatic Sales Co.

40 Waltham St., Boston, Mass. 02118
Telephone—542-9480.

up of execs in Marc Wolverton, Hank Ross, Art Rapacz and Bob Jonesi, as well as Ross. And, while you're there don't forget Louis "Cyclone" Imre (the human tornado!)

Best wishes to the new slate of officers of the Florida Amusement & Music Assn., which was elected at the recent Tampa convention. The slate includes: James Mullins (pres.), Miami; Fred Deeb (v.p.), Tallahassee; Sol (the inimitable Tabb (v.p.), Miami; Frank Pell (v.p.), Orlando; Gleason Stambaugh, Jr. (v.p.), West Palm Beach; Simon Wolfe (v.p.), Jacksonville; Harvey Duckett (v.p.), Tampa; Buster Fallin (sec.), Layton; and James F. Tolisano (treas.), and prexy of Music Operators of America (MOA), of Clearwater. Julius Sturm is the executive director of FAMA.

All that excitement in Tipton is centered around the recent groundbreaking at the edge of town of another huge Fischer Mfg. plant building. We look forward to watching the rapid development of this newest Fischer building. And, of course, extend our sincerest best wishes to Ewald and Margaret Fischer, Mr. & Mrs. Marve Mertes, Frank and Maryann Schroeder, the Lou Wermers and Charles Baileys. The thing that surprises us most is that golf, which has hogged the limelight in Tipton, is now playing second fiddle to a vastly burgeoning production and shipping schedule of Fischer pool tables. . . . Another reminder: Illinois operators, don't forget to rush your checks in to Francis Roper's office in Rockford for the gala Lou Casola Testimonial Dinner. Also, the big general ICMOA meeting will be held on Sunday afternoon, July 16, in the Holiday Inn East.



JUKE BOX OPS' RECORD GUIDE

PICKS for PROGRAMMING

The following records, selected from the CASH BOX Top 100, represent tunes and performances which appear to be especially suitable to the juke box on location. Ops should check with their one-stops for availability.

*THE HAPPENING

Herb Alpert & TB (A&M 860)

THERE GOES MY EVERYTHING

Engelbert Humperdinck (Parrot 40015)

CAN'T TAKE MY EYES OFF YOU

Frankie Valli (Philips 40449)

*GIVE ME TIME

Dusty Springfield (Philips 40465)

CHAPEL IN THE MOONLIGHT

Dean Martin (Reprise 0601)

MARY IN THE MORNING

Al Martina (Capitol 5904)

TRACKS OF MY TEARS

Jahny Rivers (Imperial 66244)

DON'T SLEEP IN THE SUBWAY

Petula Clark (Warner Brothers 7049)

WINDY

The Association (Warner Bros. 7041)

WASHED ASHORE

Platters (Musical 1251)

C'MON MARIANNE

Four Seasons (Philips 40460)

THERE MUST BE A WAY

Jimmy Roselli (United Artists 50179)

I WAS MADE TO LOVE HER

Stevie Wonder (Tamla 54151)

*I LIKE THE WAY

Tammy James & Shandells (Roulette 4756)

SAN FRANCISCO FLOWERS IN YOUR HAIR

Scott McKenzie (Ode 103)

YOU WANTED SOMEONE TO PLAY WITH

Frankie Laine (ABC 10946)

(* indicates first week on chart)

Bilotta Hosts Service Class



Johnny Bilotta, (far left) is shown here with operator service personnel from the mid-state area.

NEWARK, N.Y. — Thirty-two operators and servicemen were in attendance at a service school refresher course conducted by Hank Peteet, Wurlitzer Field Service Engineer, at Bilotta Enterprises, Newark, New York on Wednesday, May 31st. Seven mid-state cities were represented by the group who listened intently as Peteet brought them up-to-date on the engineering innovations which

have been incorporated into the Wurlitzer Americana.

John Bilotta acted as host at a luncheon during the break in the training session.

Said Hank Peteet, "These fellows put in more time learning than they do in a regular working day. Seldom have I seen a group more dedicated in applying the knowledge of their equipment to actual route operation."

New Orleans Service School

(Continued)

Delta Music Company, Thibodaux, Louisiana; Stewart P. Martinez of Delta Music Company, Thibodaux, Louisiana; Tommy Kister Jr. of John Haley Music Company, Canton, Mississippi; Kermit L. Applewhite of New Orleans, Louisiana; Richard L. Williams of B. A. R. Amusement Inc., Metairie, Louisiana; Ronnie Lapeyrouse of Delta Music Company, Thibodaux, Louisiana; and Tommy N. Cuevas of Alston Amusement Company, Gulfport, Mississippi.

Also attending were: Glenn E. Pittman of Lake Charles, Louisiana; Jack Singleton of Kenner, Louisiana; Raymond D. Shive of Yazoo Novelty

Company, Yazoo City, Mississippi; Gus E. Ruschewski of Yazoo Novelty Company, Yazoo City, Mississippi; Woodrow T. Simmons of Bogalusa, Louisiana; John R. Bolling of Gulf Amusement Company, Gulfport, Mississippi; Wayne B. Neyland II of State Novelty Company, Inc., Baton Rouge, Louisiana; Merlin P. Guidry of Kenner, Louisiana; Leon J. Keating of Twin City Music Company, Morgan City, Louisiana; L. J. Peshier of Melody Music Company, Lake Charles, Louisiana; Mrs. E. S. Varvaris of Louis Amusement, Jackson, Mississippi; Herman Bustamante of Herman Enterprises, New Orleans.

CLASSIFIED ADVERTISING SECTION

CLASSIFIED AD RATE 20 CENTS PER WORD

Count every word including all words in firm name. Numbers in address count as one word. Minimum ad accepted \$5.00. CASH OR CHECK MUST ACCOMPANY ALL ORDERS FOR CLASSIFIED ADVERTISING. If cash or check is not enclosed with order your classified ad will be held for following issue pending receipt of your check or cash.

NOTICE—\$72 Classified Advertisers. (Outside USA add \$52 to your present subscription price). You are entitled to a classified ad of 40 words in each week's issue for a period of One Full Year, 52 consecutive weeks. You are allowed to change your Classified Ad each week if you so desire. All words over 40 will be billed at the rate of 20c per word. Please count words carefully. Be sure your Classified Ad is sent to each New York publication office by Wednesday, 12 Noon, of preceding week to appear in the following week's issue.

Classified Ads Close WEDNESDAY

Send all copy to: CASH BOX, 1780 Broadway, New York 19, N.Y.

WANT

WANTED TO BUY—HOCKEYS, ALL STARS, Circus Rifles, also Playland and other rifles. Must be in good condition. RELIABLE COIN MACHINE CO., 1433 W. Sherwin Ave., Chicago, Ill.

EXPERIENCED MECHANIC WANTED: PIN, bowlers, rifles, baseball. Good pay, truck, hospitalization, relocate in Los Angeles area. Send complete resume with picture. GENERAL GOLF, P. O. Box 6444, Glendale, Calif. 91204.

WANTED: WILD ARROWS. Write or phone HONESI JOHN'S, 2456 LAS VEGAS BLVD., SOUTH LAS VEGAS, NEVADA, 382-3633.

RECORDS, 45's AND LP's SURPLUS RETURNS, overstock cut-outs, etc. HARRY WARRINER KNICKERBOCKER MUSIC CO. —453 McLEAN AVE., YONKERS, N.Y. (Tel. Greenleaf. 6-7778).

USED 45 RPM RECORDS. WE PAY freight & top prices. KING SALES—1415 WASHINGTON STREET—BOSTON, MASS.

45 RPM RECORDS, NEW. NO QUANTITY TOO large or small. Highest prices paid. Write stating quantity on hand. TONY GALGANO DIST. CO., 4135 W. ARMITAGE, CHICAGO 39, ILL. (Tel. Dickens 2-7060).

WANT: RECORDS, 45's, USED OR NEW. ALSO LP stocks, any quantity. Will buy on steady basis. BEACON RECORD DISTRIBUTORS, 725 BRANCH AVENUE, PROVIDENCE, R.I. 02904 PHONE: UN-1-7500 or JA-1-5121.

WANTED—4 BAGGERS, 57 BASEBALLS, SEEBURG KD-200—Rock-Ola Princess 1493, 425, 426, Add-A-Balls of all types. CLEVELAND MACHINE EXCHANGE, Inc., 2029 Prospect, Cleveland, Ohio, To. 1-6715.

USED 45 RPM RECORDS, ALL TYPES AS they run, right off the route. No sorting or picking. We pay freight from anywhere in U.S.A. Standing order available for regular shippers. JALEN AMUSEMENT CO., 1215 S. HOWARD STREET—BALTIMORE, MD 21230.

WANT TO BUY USED AND NEW PINBALL JAMES ADDABAL one & two players every kind of models MFD 1964, 1965, 1966 and also guns, bowlers, arcade, make offer to Robert Mauro, ELECTROPHON, VIA MELCHIORRE 6101A 4to, MILANO (ITALY).

WANTED—YOUR USED 45 RPM RECORDS. We pay freight and up to 13¢. REC-O-RAC 942 DEODAR, ESCONDIDO, CALIFORNIA. (TEL. 714-745-5942).

WANT—BASEBALLS, POOL TABLES, Shuffleboard Scoring Units, Shuffleboards with anti-cheats, Guns, Bear Guns, Coon Hunts, Arcade Equipment, Personal Music. Write stating make, model, condition and best cash price. ST. THOMAS COIN SALES, 669 TALBOT ST., ST. THOMAS, ONTARIO, CANADA. Area 519-631-9550.

SELL YOUR SURPLUS 45'S TO THE NATION'S largest user. We are the nation's foremost packager of promotionally priced record packs. We purchase unlimited quantities on a steady basis. Wire or phone for quick deal. NATIONAL BAG-O-TUNES, 725 SHORE ROAD, SOMERS POINT, NEW JERSEY 08244, A.C. 609-927-5512.

WANT: NEW OR USED 45 RPM SINGLE NOT over 6 months old. We pay 11¢ each and the freight and we can use 200 of one number. Phone: 312-344-3300. CHAS. ALZNER, 2000 So. 3rd Ave., Maywood Illinois.

WE ARE ALWAYS INTERESTED IN USED AND brand new phonographs, pinballs, bingos, guns, arcade, kiddie rides, slot machines, etc., all makes, all models. QUOTE FOB SEA VESSEL TO HOLLAND BELGIE EUROPE, SPRL., 276 AVENUE LOUISE, BRUSSELS 5, BELGIUM. CABLE: HOBELEUROP/BRUSSELS.

HELP WANTED—EXPERIENCED MECHANIC for Jukeboxes, THE WURLITZER COMPANY, 154 S. Van Ness Ave., San Francisco, Calif. 94103.

WANTED TO BUY USED AND NEW PINBALL games two or four players, Wurlitzer juke boxes, Jennings slot machines every kind of models 1965, 1966, 1967 and spare parts, make an offer to AUTOMAT-TJANST N STORGATAN 19 BJUV SWEDEN

BALLY SHOOT-A-LINES, LOTTA FUNS, BARREL-O-FUNS, any other six card machines, Venus, el Ranchos, Old Plantations, Uprights, any kind. Write or call, Monroe-Brandt, rear 829 E. Market St., York, Pa. A.C. 717-848-1386.

JUKE BOX OPERATORS—DON'T THROW away those picture jackets. We need them, will pay up to 2¢ each on a steady basis. R.O.C. RECORD CORP., 1309 Edward L. Grant H.W., Bronx, N.Y. A.C. 212-537-8954.

WANT TO BUY 10 PENNY GAMES CALLED Race To The Moon. This game vends a ball of gum. Can also use other penny games. RELIABLE COIN MACHINE CO., 1433 W. SHERWIN, CHICAGO, ILL.

FOR SALE

ARCADES, OPERATORS — WE HAVE JUST what you are looking for. All new soccer game with glass enclosed playfield. Only \$295.00. Write for details. Mike Murves Corp., 577 10 Avenue, N.Y. 10036.

IF WE DON'T HAVE IT—WE'LL GET IT! YOU name it. Jennings and Mills fruit machines. Complete line of parts. Bally and Keeney Consoles, pinballs and bingos. Exporters. ATOMIC COIN, BOX 4321, N. LAS VEGAS, NEVADA. PHONE: 642-3847.

UPRIGHTS, BINGOS, ONE-BALLS: TWIN WILD CAT, TWIN RED ARROW, TWIN TIM BUC TOO. All Bingos—ALL BINGOS—TURF KINGS, ONE BALLS AND CLAW MACHINES. NEW ALL ELECTRIC HOPPER PAYOUT FRUIT (SLOT) MACHINES. Write: CROSS-DUNHAM & CO., 255 Wright Ave. "F", Greatna, La. Tel 367-4365.

FOR SALE—SLICK CHICK-MID. 2 PL RACEWAY-Will. Beat The Clock-Bally—Beauty Contest, Beach Beauty, Ice Frolics, Varieties, Bright Lights—6 card Frolics, 6 card Showboats-UN. Starlets—Bally Surf Clubs & Atlantics. NOBRO NOVELTY CO., 142 Dare St., San Francisco, Calif.

HI-SPEED, SUPER FAST SHUFFLEBOARD WAX. 24 one-pound cans per case, \$8.50 f.a.b. Dallas, Texas. Sold on money-back guarantee. Dist. for D. Gottlieb, Rock-Ola, American Shuffleboard, Irving Kaye & Midway Mfg. Co. STATE MUSIC DISTRIBUTORS INC., 3100 MAIN ST., DALLAS, TEXAS.

ATTENTION OPS! GET LOWDOWN PRICES on all billiard supplies coin machine parts, accessories, etc. DIAMOND COIN MACHINE EXCHANGE, 609 WOODS AVE., NORFOLK, VIRGINIA. (Tel. 625-1716).

WE HAVE A CHOICE SELECTION OF LATE Williams Two Players. Write for prices MIDWEST DIST., 709 LINWOOD BLVD.—KANSAS CITY, MO.

RECORD RIOT, 45S, BRAND NEW RECORDS. Some late hits, \$6.50 per 100, \$65.00 per 1000. All orders shipped immediately. Send check with order for prepaid postage. Only in United States. RELIABLE RECORD CO., BOX 136, GLEN OAKS POST OFFICE, GLEN OAKS, N.Y. 11004 PHONE: (212) 343-5881.

OPERATION HEAD START: FOR SPRING—off our own routes, clean, mechanically reconditioned. Shipmates \$275.00, Stop N Go \$225.00, Swing Along, Gaucho \$175.00. El Taro, Flying Chariots, Gi Gi \$150.00, Jumpin Jacks \$135.00, Sunset, Cover Girl, Fashion Show \$125.00, Corral, Foto Finish, Valiant \$100.00. STAN HARRIS & CO., 508 W. VENANGO ST., PHILA., PA. PHONE BA 3-5362.

IF IT'S PANORAM PARTS YOU WANT PHIL GOULD HAS 'EM. ALL TYPES OF FILMS FOR Panoram Peeks. PHIL GOULD —224 MARKET ST.—NEWARK, N.J. (Tel. 201-MARket 4-3297.)

GLASCO AUTOMATIC PRE-MIX VENDOR, 2 selection \$125.00, Seeb. KD 200's \$195.00, Gott. Liberty Belle \$200.00, Chico Champion rifle \$275.00, Wm. Hercules \$125.00, Rock-Ola 120 sel. wallboxes \$12.00 ea. More, write, JULES OLSHEIN at Greco Bros. 1288 Br'dy Albany N.Y.

NOAH'S ARK WILL SAVE THE WORLD AND you can help! Please program "I GET ALL THE LUCK" by NOAH'S ARK. Write for free bumper stickers. J.B. RECORD PRODUCTIONS, Box 14422, Tampa, Florida 33609.

FOR SALE: 2 DITCHBURN MINI-COLD \$600.00 ea., 1 Mini-Spa \$500.00; (Like new) Gott: World Fair \$150.; Slick Chick \$100.; Williams Soccer \$150., Skill Pool \$100., United Avalon S/A \$225; Crystal \$225, Bank Pool \$175; Chi Coin Citation \$250; Seeburg 3" w 1" Wall-Boxes \$8.00 ea. D-AND-L COIN MACHINE CO., 414 Kelker St., Harrisburg, Pa. Phone: 234-2235.

WE HAVE A LARGE SELECTION OF USED pingames, bowlers, arcade equipment, vending and phonographs. Direct overseas shipment from Port of Detroit. MARTIN AND SNYDER COMPANY, 13200 W. WARREN DEARBORN., MICHIGAN 48126 PHONE LU 2-2300.

SOUTHLAND ENGINEERING'S NEW IMPROVED model "Time Trials" in original cartons \$495. IMPERIAL COIN MACHINE EXCHANGE INC.—498 ANDERSON AVENUE, CLIFFSIDE PARK, N.J.

CHANGERS—NEW HAMILTON CHANGERS—25¢ and 50¢ Below wholesale cost. Original Microscope Punching Bag A-1 \$250.00; Dawney Johnson Coin Counter—Complete \$150.00. Complete stack new & used Guns —Phonos—Pool Tables—Cigarette Machines. PAUL A. LAYMON, INC., 1429 W. PICO, LOS ANGELES, CALIF., PHONE: 749-7351.

FIVE EXHIBITS: BIG BRONCO HORSE \$150.00 each, 1 Six-Shooter Gin, \$75.00 and 1 Gun Patrol Exhibits \$75.00. CENTRAL MUSIC CO., 407 EAST AVENUE, D.P.O. BOX 284, KILEEN, TEXAS.

NEW OLIVETTI UNDERWOOD ELECTRIC Typewriters. Reg. \$460—our price \$260. SEACOAST DISTRIBUTORS, 1200 NORTH AVE., ELIZABETH, N.J. (Tel: BI 8-3524).

ACE LOCKS KEYS ALIKE. SEND LOCKS AND the key you want them mastered to. \$1.00 each less 10% lots of 50 or more. RANDEL LOCK SERVICE, 61 ROCKAWAY AVENUE, VALLEY STREAM, N.Y. 11580. TEL: 516-VA 5-6216. Our 35th year in vending.

POOL TABLES, NEW COIN-OP 7 FT., \$500.00. Also home tables \$500-up. Antique jukebox 1930s. Also all kinds of vending equipment for sale at lowest prices. WEST PENN VENDING SALES, 1313 BABCOCK BLVD., PITTSBURGH, PA., 15237 (412) 931-2961.

PINGAMES: 1 GOTTLIEB EGG-HEAD, \$95.00 1 Gottlieb Corral, \$110.00; 1 Gottlieb Lancer \$135.00—1 Williams Valiant, \$125.00. TRI-STATE DISTRIBUTING CO., BOX 615, ROME, GA. 30161.

BALLY, MILLS, JENNINGS FRUIT SLOT machines. New and used. For export. We will be in Scandinavia and Europe after June 30th for two months. Call, write, wire NEVADA FRUIT (Slot) MACHINE, BOX 5734 RENO, NEVADA. (702) 329-3932.

FOR SALE: 25 ASSORTED NEW ALBUMS: \$15.00. Our Choice Guaranteed New 33 1/3 RPM LP Albums—Mailed Insured—Postpaid—Limited Sale Offer Good Only in USA. Send Check or Money Order—No COD'S. UNCLE JIM O'NEAL—BOX A—ARCADIA, CALIF. 91006.

"FOR SALE": LPC1-R Consoles \$750.00, 222DHR \$350.00, 100J \$225.00, HF100R restyled \$200.00. Shopped for location. Williams Pitch & Bat Baseball \$400.00, C. C. Super Score Rifle Gun \$495.00. Call or Write—OPERATORS SALES, INC., 4122 WASHINGTON AVENUE, NEW ORLEANS, LOUISIANA. 822-2370 (504).

FOR SALE: 10 ALL TECH AND 10 IRVIN Kaye 4 1/2 x 9 Pool Tables. Excellent condition—Like new. GLOBE VENDING, 378 GRANITE ST., QUINCY, MASS. 617-479-0010.

UNITED SHUFFLES: Pacer, \$425; Mambo, \$495; Crest \$295; Williams Tenth Inning, \$275. WANT—Seeburg LPC-1B (Blond). MOHAWK SKILL GAMES, 67 Swaggertown Road, Scotia, N.Y. 12302.

RECONDITIONED BARGAINS: BALLY GOLD Rush (1 pl) 10/3/25-\$245.00; Wurlitzer 2710-\$395.00, 2410-\$195.00, 2150-\$145.00; United Shuffles 8 1/2" Avalon-\$245.00, Stardust-\$245.00, 5-Way-\$145.00. Line-Up-\$95.00, Big Bonus-\$95.00, 3-Way-\$75.00. MICKEY ANDERSON AMUSEMENT COMPANY, 314 East 11th St., Erie, Pa. Phone 452-3207.

RECORD SALE, 45'S, NEW, NICE ASSORTMENT. Recent, oldies, D.J.'s, audition copies, \$5.65 per 100, \$50.00 per 1,000 postpaid in U.S.A. Remittance with orders. EMPIRE DISTRIBUTING CO., 4610 Liberty Ave., Pittsburgh, Pa. 15224. Tel. (412) 682-8437.

BUYERS OF USED PHONOGRAPHS—WHOLESALE or exporters. We guarantee our equipment. Write for prices. UNITED DISTRIBUTORS, INC. 902 W. Second St., Wichita, Kansas 67201. Phone: 316-AM4-6111

FOR SALE: WURLITZER—MODELS 2710, 2610, 2410, 2304, 1800 Seeburg—AY-160, M-100-C, A.M.I.—L-200, Cont'l-200, J.120, H-200, G-200. C.C. Variety Roll-down—C.C. Tournament Bowler—17 ft.—Majestic 16 ft.—Grand Prize 16 ft.—Gold Crown 16 ft.—Continental 16 ft.—Duchess 16 ft.—C.C. Texas Rangers—Mondial Football—U.S. Bill. Electro Pool—Irving Kaye Ringo—Rowe 1010-A Cold Drink w/ice—Iceberg 7 drink w/ice, Glasco Milk & Milk Shake, Keeney Pop Gun, Redwood Ball Point. MILLER—NEWMARK DIST. CO., 3767 EAST 28TH ST., GRAND RAPIDS, MICHIGAN 49503. Phone: 949-2030.

FOR SALE . . . MIDWAY GUNS . . . CAPTAIN Kid \$450.00, Monster Guns \$315.00, Rifle Champ \$245.00. Write, REDD DISTRIBUTING, 672 MAIN ST., HYANNIS, MASS. Tel: 617-775-6411.

30 BINGOS, 20 TURF KINGS (TO BE SOLD in Virginia only), 25 Novelties, 4 Guns, 4 Shuffles, 3 Baseballs, Lords Prayer. Call or write E. L. SIMMONS, DANVILLE AMUSEMENT CO., 620 WESTOVER DR., DANVILLE, VA. Phone: 792-5044.

SLOT/FRUIT MACHINES FROM £40 (\$112). All makes, models. Manual, Electric. Available English 6d only. Secondhand pintables, juke boxes, amusement machines, cheap, suitable for developing countries. HEAL ENTERPRISES LTD., 182A, NEW NORTH ROAD, LONDON, N. 1, ENGLAND.

5 PAN-O-RAMS, FILM, PARTS, 2 RIFLES, Ace Bomber, punching bag, card vendors, 2 Keeney Air-raider, Exhibit plastic vendor \$2,000.00. POLASHEK, 5971 E. 26 ST., TUCSON, ARIZONA 85711.

FOR SALE—MIDWAYS RIFLE RANGE \$250.00, Chicago Coins Texas Ranger Gun \$300.00, Midways Little League \$300.00. Bingos for export only. D. & P. MUSIC, 27 E. Philadelphia Street, York, Pa. 17401. Phones 848-1846.

FOR SALE—WMS. HERCULES, VANGUARD, Crusader & Titan Guns—Make offer. AMI HA-600 Background Units, Seeburg K-200 Hdwy. BIRD MUSIC DIST., INC. Ph. Area Code 913, Pr 8-5229, 124-126 Poyntz Ave., Manhattan, Kansas.

FOR SALE—SLOT MACHINES, BRAND NEW, original packed, double-Jackpot, illuminated, for any coinage, US—\$350 each. Contact: ALOIS DANIEK, BESSEMERSTRASSE 3, HANNOVER, GERMANY.

1 ITALIAN FOOTBALL (LIKE NEW) \$175, 1 Socko (like new) \$345. BUDGE WRIGHT'S WESTERN DISTRIBUTORS, 1226 SW 16th Avenue, Portland, Oregon.

FOR SALE — MAYFAIRS \$345., DANCING Ladys \$450., A Go Gos \$440., Casanova \$385., Hot Lines \$325., Champion Horse \$295., Deluxe Fun Cruise \$400., Kicker \$275., Beatniks \$390., Super Scope Guns \$460., C. C. Cadillac Bowler \$340., Captain Kid Guns \$375., Rifle Champ Gun \$225., Fun Ball (floor sample) \$390., also Bahama Beaches, Folies Bergeres, Laguna Beaches, Sea Islands, Bountys, etc. NEW ORLEANS NOVELTY COMPANY, 1055 Dryades Street, New Orleans, Louisiana, 70113. Tel: 529-7321. Cable: Nonovco.

MISC.

DEEJAYS . . . HUNDREDS OF JOCKS USE OUR jocks. Written BY DeeJays FOR DeeJays. Free info. and lists. MORRIS, P.O. Box 1234, Eureka, Calif. 95501.

NEW FOR DEEJAYS! SIX VOLUME LIBRARY of 6,000 riotous classified one-liners, \$5.00. Copy of comedy monthly free with order! "Comedy Spectacular", giant laugh sampler of one-liners, breaks, etc., \$2.00. Catalog free. EDWARD ORRIN, Boyer Road, Mariposa, Calif. 95338.

30,000 PROFESSIONAL COMEDY LINES! Largest laugh library in show business. Farty books of classified material, plus Orben's Current Comedy the newsmaking topical gag service featuring hip deejay lines in each issue. Great sample selection, \$5.00. Catalog free. ORBEN DEEJAY LAUGHS, 3536 Daniel Crescent, Baldwin Harbor, N.Y. 11510

LARGEST CATALOG OF "OLDIES BUT Goodies" ever compiled complete from 1950-1966, thousands of titles, with dates. \$1. P.P. J.M.B. RECORDS, BOX 2902, PHILADELPHIA, PA. 19126.

The 25th Annual Edition of the
WORLD WIDE CASH BOX DIRECTORY

... is fresh
off the press and out to the
international entertainment industry
with all the "who", the "how to" and
the "where to go" information it requires.

If you're a regular
subscriber, you've received your Directory
along with this very issue. If you
don't subscribe ... if you're sneaking a look at
someone else's copy ... then do yourself and your
business a favor and **check into this offer**:

While your friend isn't
looking, clip the subscription blank from
his copy of Cash Box and send your check
today to receive 52 weekly issues — **PLUS** — a
personal complimentary copy of the 1967-68 Directory.

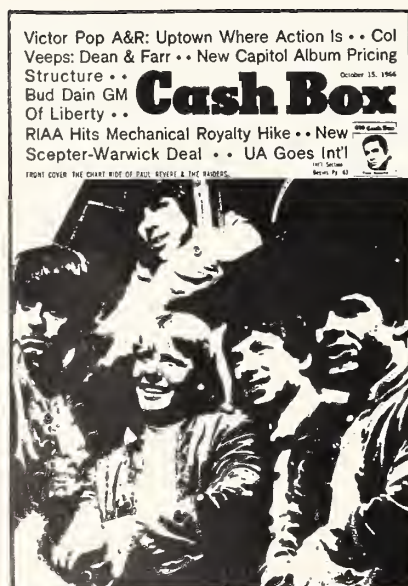

52
REGULAR
WEEKLY
ISSUES
FEATURING
CURRENT
NEWS AND
TOPICAL
CHART
INFORMATION

25th
ANNUAL
DIRECTORY
FROM COVER
TO COVER
THE BEST
TRADE
REFERENCE
AVAILABLE

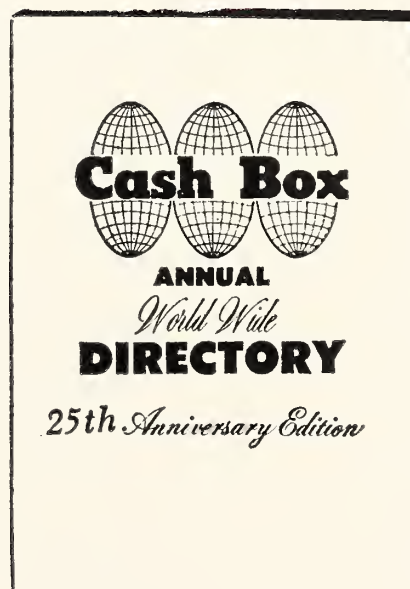

P.S. Your subscription will extend long enough into
1968 to entitle you to receive the
26th Anniversary Edition when it's published.



Cash Box

ANNUAL

World Wide

DIRECTORY

1967-1968

25th Anniversary Edition

JULY 8, 1967
Part 2 of 2 parts

Annual Cash Box Disc Jockey Poll

The Award-Winning Artists are on RCA VICTOR.
Our thanks, D.J.'s, for having programmed these
award-winning performances.

**MOST PROGRAMMED
SINGLE OF PAST 12
MONTHS**

- #1—I'm a Believer—
The Monkees
- #4—My Cup Runneth Over—
Ed Ames

**MOST PROGRAMMED
INSTRUMENTALIST**

- #2—Al Hirt
- #4—Floyd Cramer

**MOST PROGRAMMED
ORCHESTRA**

- #2—Henry Mancini

**MOST PROMISING UP &
COMING FEMALE VOCALIST**

- #4—Marilyn Maye

**MOST PROMISING UP &
COMING MALE VOCALIST**

- #2—Ed Ames
- #4—Frankie Randall

**MOST PROGRAMMED
ALBUM**

- #1—MORE OF THE MONKEES
The Monkees
- #2—THE MONKEES
The Monkees

**MOST PROGRAMMED
VOCAL GROUP**

- #1—The Monkees

COUNTRY & WESTERN

**MOST PROGRAMMED
VOCAL GROUP**

- #1—The Browns

**MOST PROMISING
VOCAL GROUP**

- #1—The Lonesome Rhodes
- #3—The Blue Boys

**MOST PROGRAMMED
MALE VOCALIST**

- #3—Eddy Arnold

**MOST PROGRAMMED
FEMALE VOCALIST**

- #2—Connie Smith
- #3—Dottie West
- #4—Norma Jean

**MOST PROMISING
MALE VOCALIST**

- #3—Waylon Jennings

**MOST PROGRAMMED
INSTRUMENTALIST**

- #1—Chet Atkins
- #2—Floyd Cramer

**MOST PROGRAMMED
ALBUM**

- #4—My World—Eddy Arnold



On the following pages you'll find the
winners together with their recent recordings.

The Monkees

Most Programmed Vocal Group
Most Programmed Single
Most Programmed Album

Hottest group in years! The single: "I'm a Believer"
#1002, the album: "More of The Monkees"
COM/COS-102. Available on Stereo 8 Cartridge Tape.

MORE OF THE

COLGEMS



COLGEMS Manufactured and Distributed by RCA



THE Lonesome Rhodes

Most Promising Vocal Group (C & W)

All roads lead to the top for these two talented young singers. Hitch onto their latest single, "The Least You Could Have Done" c/w "Nothin' But Heartaches Here" #9134 and their latest album "The Lonesome Rhodes" LPM/LSP-3759

RCA VICTOR
The most trusted name in sound

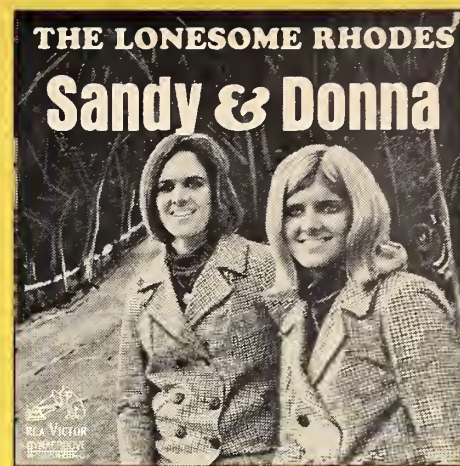



Cash Box

Vol. XXVIII—Number 50 (Part 2 of 2 Parts) July 8, 1967

(Publication Office)
1780 Broadway
New York, N. Y. 10019
(Phone: JUdson 6-2640)
CABLE ADDRESS: CASHBOX, N. Y.

GEORGE ALBERT
President and Publisher
MARTY OSTROW
Vice President
LEON SCHUSTER
Treasurer

IRV LIGHTMAN
Editor in Chief

EDITORIAL
TOM McENTEE, *Associate Editor*
ALLAN DALE
DANIEL BOTTSTEIN
JOHN KLEIN

EDITORIAL ASSISTANTS
MIKE MARTUCCI
ANTHONY LANZETTA
HEDDY ALBERT

BERNIE BLAKE
Director of Advertising

ACCOUNT EXECUTIVES
STAN SOIFER
BILL STUPER
HARVEY GELLER, *Hollywood*
ART DIRECTOR—**WOODY HARDING**

ED ADLUM
General Manager
COIN MACHINES & VENDING

LEE BROOKS, *Chicago, Ill.*
LISSA MORROW, *Hollywood*
CIRCULATION—**THERESA TORTOSA**, *Manager*

CHICAGO LEE BROOKS 29 E. Madison St., Chicago 2, Ill. Phone: (312) FI 6-7272	HOLLYWOOD HARVEY GELLER 6290 Sunset Blvd., Hollywood, Cal. 90028 (Phone: (213) 465-2129)
--	--

EUROPEAN DIRECTOR
NEVILLE MARTEN

ENGLAND
NEVILLE MARTEN
Dorris Land
9a New Bond St.,
London, W1, England
Tel: 01-493-2868

ITALY
MARIO PANVINI ROSATI
Galleria Passarella 2
Milan (Italy)
Tel: 790990

GERMANY
MAL SONDOCK
Josef Raps Strasse 1
Munich, Germany
Tel: 326410

HOLLAND
PAUL ACKET
Thereslastraat 59-63
The Hague
Tel: 837703

FRANCE
CHRISTOPHE IZARD
24, Rue Octave Feuillet,
Paris XVI Tel: 870-9358

BELGIUM
MIMI SMITH
894, Chausse Romaine
Wemmel (Brabant)
Tel: 02-78.96.63

SCANDINAVIA
SVEN G. WINQUIST
Kaggeholmsvagen 48,
Stockholm-Enskede,
Sweden, Tel: 59-46 85

SPAIN
FEDERICO HALPERN
Sagasta 23,
Apartado 4025,
Madrid
Tel: 257 0907—224 8600

AUSTRALIA
RON TUDOR
8 Francis St.,
Heathmont, Victoria
Tel: 870-5677

ARGENTINA
MIGUEL SMIRNOFF
Rafaela 3978,
Buenos Aires
Tel: 69-1538

BRAZIL
LUIS DE M. GUEDES
Rua Rego Freitas,
289—3°, andar
Sao Paulo, SP

MEXICO
ENRIQUE ORTIZ
Insurgentes Sur 1870
Mexico 20, D. F.,
Tel: 24-65-57

CANADA
JOHN MURPHY
87 North Hill St.,
Port Arthur, Ontario
Tel: (807) 344 3526

JAPAN
Adv. Mgr.:
SHOICHI KUSANO
Editorial Mgr.:
MORIHIRO NAGATA
466 Higashi-Olzumi
Neirimaku
Tokyo

from the desk of . . .

GEORGE ALBERT
OF



July, 1967

Dear Friends:

This is a particularly notable year for many music firms. A number of companies are celebrating in 1967 anniversaries that span 25, or 20 or 10 years in business. We, too, are in this worthy company, for this year marks our Silver Anniversary as a publication dedicated to serving the music industry in its many shapes and forms. All of you, especially those who have reached the aforementioned milestones, are well aware of the profound changes over the past 25 years that have realized tremendous growth (and new challenges) within the world of records. Yet, the very foundations of success in this business remain essentially the same as ever: an assessment of public taste so as to create, in responsible terms, a product that can be marketed with skill.

CASH BOX, we proudly feel, has always attempted to measure the needs of the music business and translate them into a publication designed to inform the trade, also in responsible terms, of important trade developments and to comment, when necessary, on their impact. This credo has done us in good stead for 25 years, and shall continue to guide us in the exciting years ahead. The entire staff of CASH BOX and I thank you for the support that has enabled us to serve and grow within the great world of music.

President and Publisher

SUBSCRIPTION RATES \$20 per year anywhere in the U. S. A. Published weekly. Second class postage paid at Bristol, Conn. 06012 U.S.A.
Copyright © 1967 by The Cash Box Publishing Co., Inc. All Rights reserved. Copyright under Universal Copyright Convention.

DIRECTORY INDEX

<p>Album Jacket Manufacturers 144</p> <p>ASCAP Publishers 154-160, 174-184</p> <p>BMI Publishers 162-168, 186-188, 198-204</p> <p>DJ Poll Results (Big 3 Pop Winners) 30</p> <p>DJ Poll Results (Big 3 Country Winners) 196</p> <p>DP Poll Results (Country Music) 198</p> <p>DJ Poll Results (Past Winners) 38, 40</p> <p>DJ Poll Results (Pop) 32</p> <p>Golden Albums 102, 104</p> <p>Machine Shops 120</p> <p>Million Sellers 104-110</p> <p>NARAS Awards 172</p> <p>One-Stops 96, 101</p> <p>Phono Needle Manufacturers 144</p>	<p>Printers & Lithographers 120</p> <p>Polyethylene Bag Manufacturers 120</p> <p>Rack Jobbers 128</p> <p>Record Distributors 66-94</p> <p>Record Exporters 122</p> <p>Record Manufacturers 42-64</p> <p>Record Platers 150, 162</p> <p>Record Producers 146, 148</p> <p>Record Pressers & Tape Duplicators 112</p> <p>Record Promotion & Publicity Offices 138, 140, 142, 144, 162</p> <p>Record Sleeve Manufacturers 122</p> <p>Record Sleeve Mailers 122</p> <p>Recording Studios 124</p> <p>SESAC Publishers 170</p> <p>Top Hits Of '67 163</p> <p>Trade Associations 118</p>
--	--

INTERNATIONAL INDEX

Argentina 50	Denmark 96	Holland 106	Norway 100
Australia 54	Finland 99	Italy 114	South Africa 72, 146
Belgium 102	France 88	Japan 72	Spain 57
Brazil 140	Germany 36	Mexico 132	Sweden 96
Canada 64	Great Britain 2		Switzerland 82
	Greece 62		

THANKS TO EVERYONE IT WAS A VERY GOOD YEAR

JUBILEE RECORDS

B.T. PUPPY RECORDS

MONARCH MANUFACTURING CO.

JOSIE RECORDS

R RECORDS

ETAN PRODUCTS

PORT RECORDS

FESTIVAL RECORDS

A.F.M. ENGINEERING

DANA RECORDS

TOOT RECORDS

RECORD LABELS

RAINY DAY RECORDS

G.M.C. RECORDS

ALL ONE-STOP DISTRIBUTING (N.Y.)

SELECT SOUND RECORDING STUDIO, INC.

JUBILEE INDUSTRIES

1790 Broadway

New York, New York 10019

(212) PL-8570



THE BAROQUES • FONTELLA BASS • RAY BRYANT • JAN BRADLEY • ODELL BROWN • KENNY BURRELL
MITTY COLLIER • SONNY COX • THE DELLS • SUGAR PIE DE SANTO • BO DIDDLEY • WILLIE DIXON • LOU
DONALDSON • FRANK D'RONE • KING FLEMING • REV. C. L. FRANKLIN • BUNKY GREEN • STEVIE HAWKINS
MONK HIGGINS • ILLINOIS JACQUET • AHMAD JAMAL • ETTA JAMES • JOHN KLEMMER • KNIGHT BROS.
RAMSEY LEWIS • LITTLE MILTON • MICKI LYNN • MOMS MABLEY • PIGMEAT MARKHAM • MAURICE & MAC
BOBBY MC CLURE • MEDITATION SINGERS • JAMES MOODY • BOBBY MOORE • THE RADIANTS • CLIFFORD
SCOTT • THE SHAPRELS • MARLENA SHAW • SHELL SILVERSTEIN • BILLY STEWART • SOUL STIRRERS
KOKO TAYLOR • IRMA THOMAS • TOMMY & CLEVE • MILT TRENIER • TOMMY TUCKER • VIOLINAIRES
SONNY WARNER • MUDDY WATERS • THE WILDWEEDS • SONNY BOY WILLIAMSON • HOWLIN' WOLF
THE BAROQUES • FONTELLA BASS • RAY BRYANT • JAN BRADLEY • ODELL BROWN • KENNY BURRELL
MITTY COLLIER • SONNY COX • THE DELLS • SUGAR PIE DE SANTO • BO DIDDLEY • WILLIE DIXON • LOU
DONALDSON • FRANK D'RONE • KING FLEMING • REV. C. L. FRANKLIN • BUNKY GREEN • STEVIE HAWKINS
MONK HIGGINS • ILLINOIS JACQUET • AHMAD JAMAL • ETTA JAMES • JOHN KLEMMER • KNIGHT BROS.
RAMSEY LEWIS • LITTLE MILTON • MICKI LYNN • MOMS MABLEY • PIGMEAT MARKHAM • MAURICE & MAC
BOBBY MC CLURE • MEDITATION SINGERS • JAMES MOODY • BOBBY MOORE • THE RADIANTS • CLIFFORD
SCOTT • THE SHAPRELS • MARLENA SHAW • SHELL SILVERSTEIN • BILLY STEWART • SOUL STIRRERS
KOKO TAYLOR • IRMA THOMAS • TOMMY & CLEVE • MILT TRENIER • TOMMY TUCKER • VIOLINAIRES
SONNY WARNER • MUDDY WATERS • THE WILDWEEDS • SONNY BOY WILLIAMSON • HOWLIN' WOLF
THE BAROQUES • FONTELLA BASS • RAY BRYANT • JAN BRADLEY • ODELL BROWN • KENNY BURRELL
MITTY COLLIER • SONNY COX • THE DELLS • SUGAR PIE DE SANTO • BO DIDDLEY • WILLIE DIXON • LOU
DONALDSON • FRANK D'RONE • KING FLEMING • REV. C. L. FRANKLIN • BUNKY GREEN • STEVIE HAWKINS
MONK HIGGINS • ILLINOIS JACQUET • AHMAD JAMAL • ETTA JAMES • JOHN KLEMMER • KNIGHT BROS.
RAMSEY LEWIS • LITTLE MILTON • MICKI LYNN • MOMS MABLEY • PIGMEAT MARKHAM • MAURICE & MAC
BOBBY MC CLURE • MEDITATION SINGERS • JAMES MOODY • BOBBY MOORE • THE RADIANTS • CLIFFORD
SCOTT • THE SHAPRELS • MARLENA SHAW • SHELL SILVERSTEIN • BILLY STEWART • SOUL STIRRERS
KOKO TAYLOR • IRMA THOMAS • TOMMY & CLEVE • MILT TRENIER • TOMMY TUCKER • VIOLINAIRES
SONNY WARNER • MUDDY WATERS • THE WILDWEEDS • SONNY BOY WILLIAMSON • HOWLIN' WOLF
THE BAROQUES • FONTELLA BASS • RAY BRYANT • JAN BRADLEY • ODELL BROWN • KENNY BURRELL
MITTY COLLIER • SONNY COX • THE DELLS • SUGAR PIE DE SANTO • BO DIDDLEY • WILLIE DIXON • LOU
DONALDSON • FRANK D'RONE • KING FLEMING • REV. C. L. FRANKLIN • BUNKY GREEN • STEVIE HAWKINS
MONK HIGGINS • ILLINOIS JACQUET • AHMAD JAMAL • ETTA JAMES • JOHN KLEMMER • KNIGHT BROS.
RAMSEY LEWIS • LITTLE MILTON • MICKI LYNN • MOMS MABLEY • PIGMEAT MARKHAM • MAURICE & MAC
BOBBY MC CLURE • MEDITATION SINGERS • JAMES MOODY • BOBBY MOORE • THE RADIANTS • CLIFFORD
SCOTT • THE SHAPRELS • MARLENA SHAW • SHELL SILVERSTEIN • BILLY STEWART • SOUL STIRRERS

CHESS - CADET - CHECKER

INDEX OF DIRECTORY ADVERTISERS

Cash Box is proud to announce that the 1966-1967 Annual World-Wide Directory, is the largest issue ever published in our industry. It is our pleasure to enumerate in alphabetical order the advertisers who participated in this year's Industry Directory.

MUSIC (DOMESTIC) — Part 1

A

A-I One Stop	101
A&I Dist.	72
A&L	92
A&M Records	28, 29
Abc Records	41
Abnak Records	47
Acuff-Rose Publications	206
Alco Research & Eng.	120
Allied Pressing	114
All South Dist.	66
All-State Dist. (Chi)	86
All State Dist. (N.J.)	80
Alpert, Herb & Tijuana Brass	29
Alpha Dist.	67
Am-Bat One-Stop	96
American Record Pressing	119
American Record Sales	92
Ames, Ed.	173
Amy Records	91
Anderson, Lynn	200
Apex-Martin Dist.	72
April Blackwood	166
Arnold, Eddy	167
ASCAP	155
Associated Recording Studio	124
Association	95
Atkins, Chet	Gate Fold
Atlantic Records	
(Atco, Dial)	127, 129, 131, 133, 135, 137, 139

B

Bacharach, Burt	40
Barrington Records	60
H. R. Basford Co.	82
Bay State Dist.	84
Beck, Jeff	14
Bee Gees	133
Belafonte, Harry	143
Bell Records	91
Bendig (Fermata)	64
Bennett, Tony	83
Best & Gold Dist. Co.	76
Bestway Products	116
Bibo Music	164
Bourne, Inc.	158
Brandy Co.	142
Brown Bros. One-Stop	96
Brown, James	105
Browns	Gate Fold
Buckingham	153
Burdette Music	85
Byrds	58

C

Campus Dist.	70
Capital Records	61
Cardinal Export	122
Carnival Records	62
Chod & Jeremy	152
Chadwick Records	62
Chapman Dist.	88
Chess Records	7
Chips Dist.	84
Clark, Petula	189
Columbia Pictures Music	163
Commander Music	154
Como, Perry	37
Conley, Arthur	137
Consolidated One-Stop	96
Contemporary Public Relations	140
Costo, Don	146
Cromer, Floyd	205
Criterion Music	106
Crown Albums	144

D

Dorin, Bobby	33
Dave Clark Five	15
David, Hal	40
Dean, Jimmy	193
Delta (N.O.) Dist.	90
Diamond, Neil	75
Diamond Records	185
Donovan	16
Dootie	44
Dot Records	191
Double "8" One-Stop	94

E

Eastern Record Mfg.	119
Eltron Export	122
Empire Dist.	80

Epic Records	48, 49
Eskin, David, Export	122
Essex Dist.	82
Every Mother's Son	31

F

Faithfull, Marianne	17
Fermata	64
Fiesta Records	62
Flatt & Scruggs	204
Francis, Connie	79
Franklin, Aretha	129
Freeman, Ernie	148

G

Galgano Dist.	118
Gallico, Al, Music	169
Garmisa Dist.	82
Gate City One-Stop	101
Gateway Recordings	126
Gayle, Tim	142
General Dist.	84
Globe One-Stop	100
Godwin Dist.	76
Goldsboro, Bobby	34
Goulet, Robert	145

H

Hamilton Mfg.	150
Herman's Hermits	18
Hermitage One-Stop	98
Homer & Jethro	195
Huffine Dist.	92

I

ITCC	113
Ivor Assoc.	140

J

Jackson, Mahalia	184
Jamie/Guyden	60
Jefferson Airplane	183
Jobete Music	165

K

Kaempfert, Bert	187
Kama Sutra	35
Kapp Records	45
Kay Pressing	116
Kent Modern	42
Kinks	19
Koppleman & Rubin	43

L

Laredy Dist.	80
Letterman	89
Lewis, Gary	36
Liberty Records	9
Liberty Tape Dupl.	112
Library Editions	72
Little Al's	97
Litrov-Levinson	138
London Records	175
Lonesome Rhodes	Gatefold
Longhorn Records	52
Long Mark Pressing	112
Long Wear Stamper Corp.	117
Lopez, Trini	109
Lorimar One-Stop	101
Lovin' Spoonful	151
Lowery, Talent, Bill	168
Lulu	20
Lynn, Loretta	203

M

Mala Records	91
Malverne Dist.	90
Mancini, Henry	177
Marnel of Maryland Dist.	88
Martin, Dean	149
Martin, James H. Dist.	70
Martin & Snyder One-Stop	99
Martino, Al	87
Martoni Rest.	106
Mass. Record Dist.	78
Mathis, Johnny	55
McHugh, Jimmy	156
Melody Sales	70
Memphis-Delta Dist.	90
Mercury Records	107
Merit (Det.) Dist.	74
Met-Richmond Dist.	88
Midwest Record Pressing	114
Miller, Roger	147
Mitchell, Rubin	38
Monarch Pressing	114
Monkees, The	Gatefold
Most, Mickie	21
Muntz Stereo	115
Music Merchants Dist.	68
Muscor Records	121

N

Nashboro Records	50
New Deal Sales Corp.	97
New Jersey One-Stop	101

O

O'Brien, John, Dist.	92
Oldham, Andrew Loog	22
One-Der-Ful Records	172
One Stop Service	122
Original One-Stop	100
Orpheum	62
Owens, Buck	197

P

P.M. Record Dist.	70
Peer Music	160
Pep Dist.	68
Phono Record Pressing	58
Pic-A-Tune	134
Pickett, Wilson	131
Pickwick Int'l.	71
Plastic Products	119
Premier Talent Associates	51
Privilege Dist.	86

Q

Queen City Albums	144
-------------------	-----

R

Rainbo Pressing	62
Rand, Harold Assoc.	136
Rawls, Lou	32
RCA Victor Records	Gatefold and 167, 173, 177, 181, 183, 193, 195, 199, 201
Record Merch. Dist.	74
Reeves, Jim	199
Reprise Records	59
Request Records	65
Revere, Paul & Raiders	125
Richmond Organization (TRO)	157
Richland, Tony	138
Rivers, Johnny	11
Robbins, Felst & Miller	69
Roberts Dist.	66
Rolling Stones	24, 25

Roosevelt Music	187
Rosen, David, Dist.	88
Rosen, Herb	138
Roulette Records	103
Royal Dist. Dist.	78
Ruby Sales	78

S

Saran Music	52
Saturday Music	179
Scepter-Wand Records	53
Schony's One-Stop	98
Schwartz Bros. Dist.	68
Screen Gems Music	163
Seaboard Dist.	84
SESAC	171
Seven Arts Press	174
Silver Plastics	114
Sledge, Percy	135
Smith, Connie	201
Solid Hitbound Prod.	178
Sonny & Cher	127
Southern Music	160
Southern Plastics	150
Southland Dist.	76
Specialty Pressing	118
Stan's Dist.	78
Stan's One-Stop	98
Star Title Strip	98, 132
Stax Records	39
Stereo Sonic Studio	124
Sterling Title Strip	99
Stuart, Fred	138
Stuckey, Nat	202
Summit Dist.	184
Supremes	77

T

Tanridge Productions	63
TAPP	142
Tex, Joe	139
Tone Dist.	74
Town Hall One-Stop	99
Tree Music	161
Trident	111
Trinity Dist.	94
Trousdale Music	159

U

United Artists	57
United (Chi.) Dist.	88
Universal Dist.	92

V

Vaughn, Billy	46
Vault Records	56
Vinton, Bobby	23
Volt Records	39

W

Wakefield Mfg.	114
Warner Bros. Records	59
Warwick, Dionne	73
Wax, Morty	142
Wendy Dist.	84
White, Edward R.	122
White Whale Records	123
Whiting, Margaret	54
Williams, Andy	81
Williams, Roger	93
Wilson, Murray	141

Y

Yardbirds	26
Youngbloods	181
YRS Dist.	78

Z

Zucker, Irwin	140
---------------	-----



FROM OUR GROUP



LIBERTY RECORDS, INC.

57
88
38
03
76
78

52
79
53
98
68
63
84
71
74
14
35
01
78
27
60
50
76
18
78
98
32
39
24
99
38
02
84
77

63
42
39
74
99
61
11
94
59

57
88
92

46
56
23
39

114
59
73
142
84
122
123
54
81
93
141

26
181
78

140



JOHNNY RIVERS

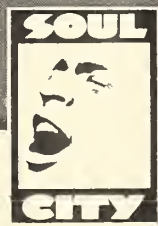
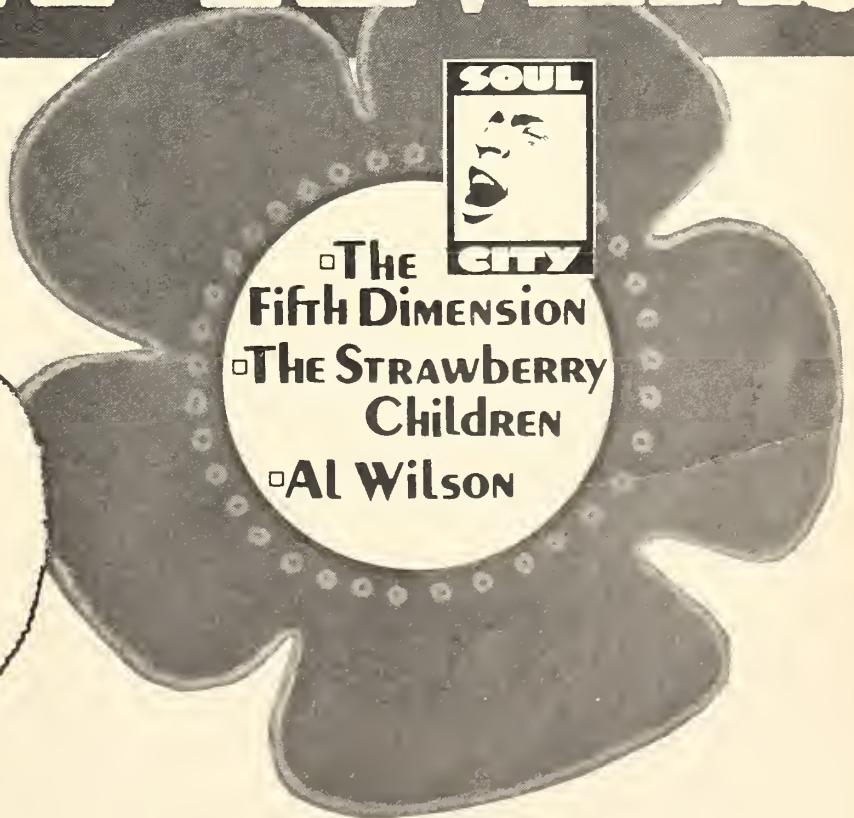

- ▣ THE FIFTH DIMENSION
- ▣ THE STRAWBERRY CHILDREN
- ▣ AL WILSON

69
19
69
36
69

66
63
64
29

967

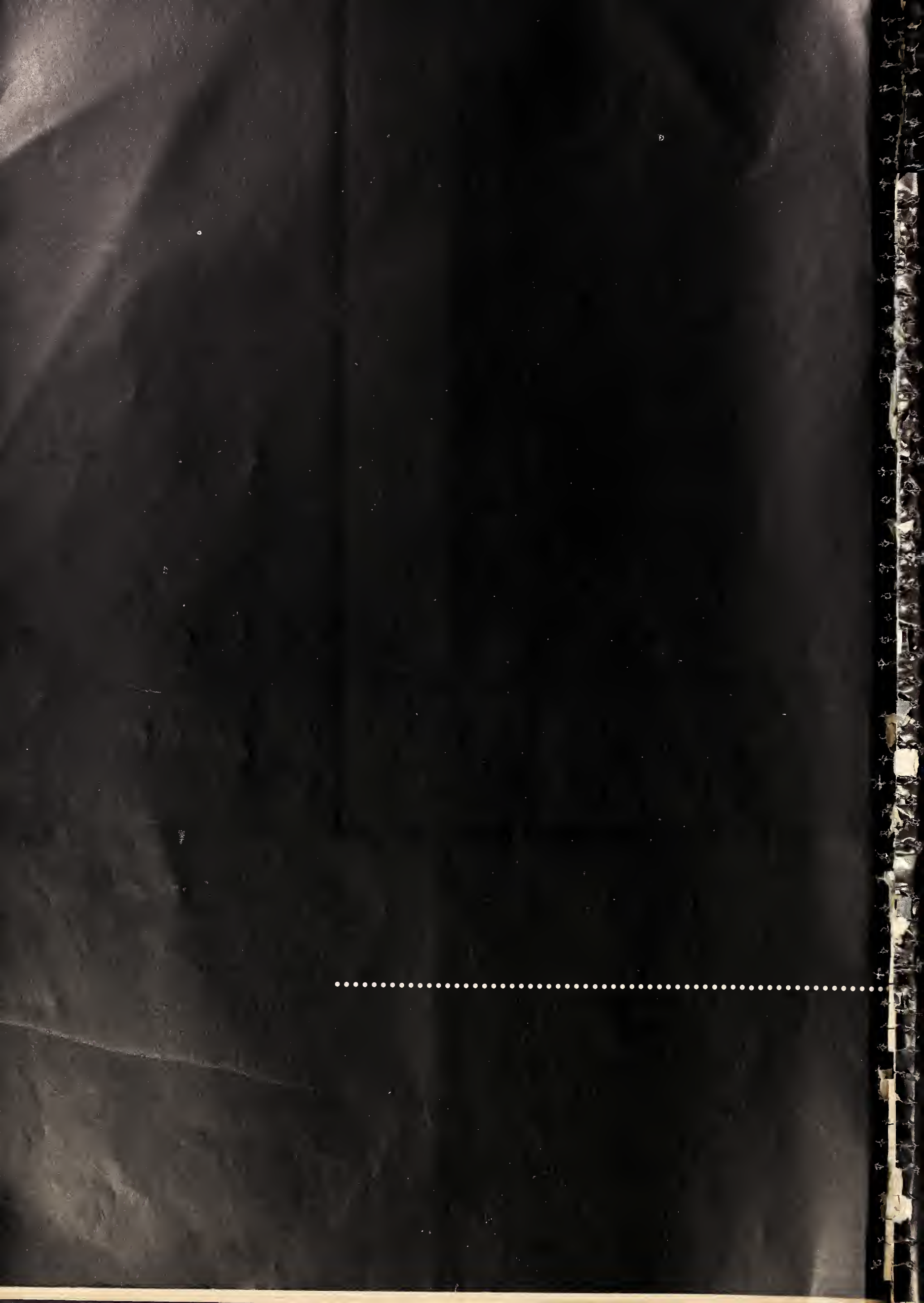



e

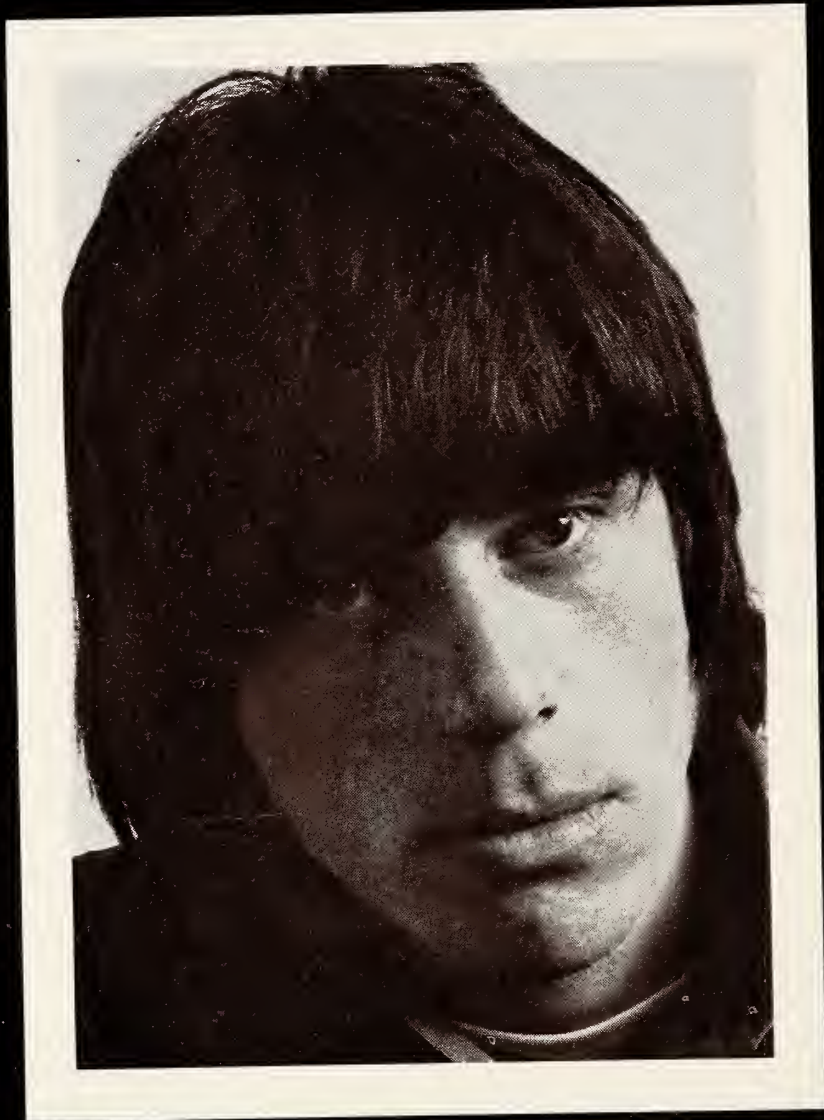



le

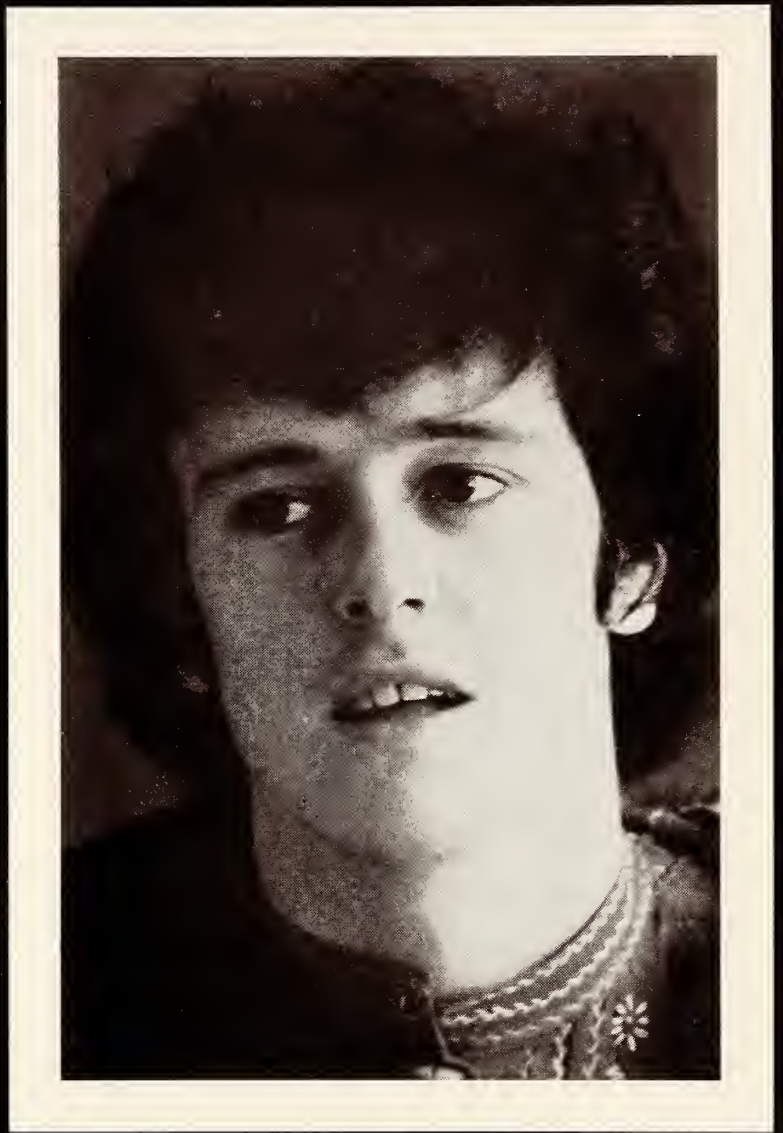



le





le





le





le

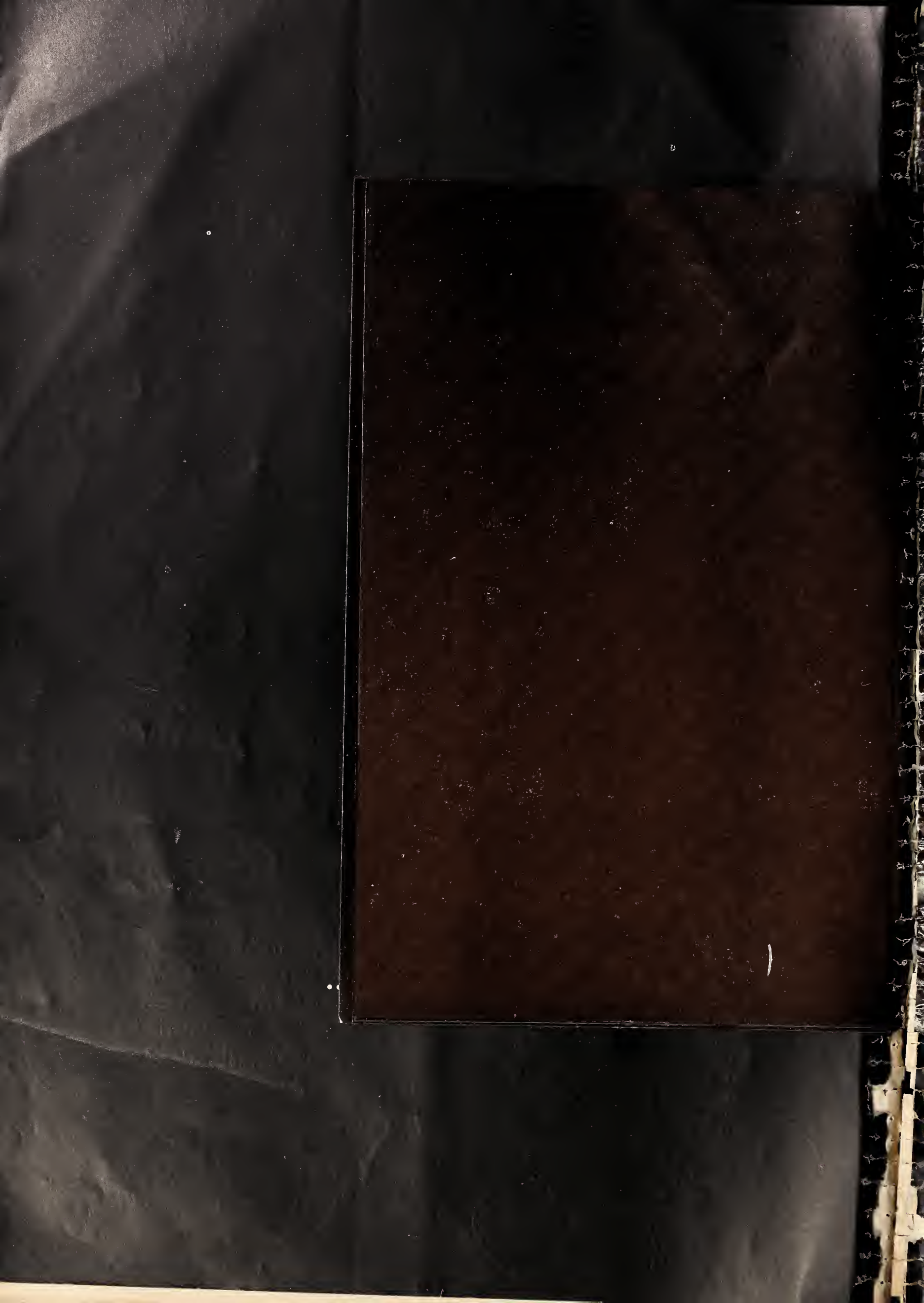



le



.....*gifted people*



SERGIO MENDES & BRASIL '66

NO. 10 most programmed vocal group

NO. 4 most promising up & coming vocal group

NO. 6 most promising up & coming instrumentalist



BAJA MARIMBA BAND

NO. 12 most programmed orchestra

NO. 2 most promising up & coming orchestra



THE SANDPIPERS

NO. 22 most programmed vocal group

NO. 7 most promising up & coming vocal group



CLAUDINE LONGET

NO. 3 most promising up & coming female vocal



WES MONTGOMERY

NO. 12 most promising up & coming instrumentalist





HERB ALPERT & The TIJUANA BRASS



NO. 1 MOST PROGRAMMED ORCHESTRA
four out of the top eight albums for 1966



THE BIG THREE

WINNERS IN EACH CATEGORY OF CASH BOX' DISK JOCKEY POLL

MOST PROGRAMMED RECORD

- Tie {
1. I'm A Believer—Monkees—Colgems—Screen Gems—Columbia (BMI)
 1. Strangers In The Night—Frank Sinatra—Reprise—Champion—Roosevelt (BMI)
 2. Winchester Cathedral—New Vaudeville Band—Fontana—Southern (ASCAP)
 3. Born Free—Roger Williams—Kapp—Screen Gems—Columbia (BMI)

MOST PROGRAMMED ALBUM

1. More Of The Monkees—Colgems
2. The Monkees—Colgems
3. SRO—Herb Alpert & Tijuana Brass A&M

MOST PROGRAMMED MALE VOCALIST

1. Frank Sinatra-Reprise
2. Andy Williams-Columbia
3. Neil Diamond-Bang

MOST PROMISING MALE VOCALIST

1. Neil Diamond-Bang
2. Ed Ames-RCA Victor
3. John Davidson—Columbia

MOST PROGRAMMED VOCAL GROUPS

- Tie {
1. Supremes-Motown
 1. Monkees-Colgems
 2. Mamas & Papas-Dunhill
 3. Ray Conniff Singers-Columbia

MOST PROGRAMMED INSTRUMENTALISTS

1. Roger Williams-Kapp
2. Al Hirt-RCA Victor
3. Ramsey Lewis Trio-Cadet

MOST PROGRAMMED ORCHESTRA

1. Herb Alpert-A&M
2. Henry Mancini-RCA Victor
3. Bert Kaempfert-Decca

MOST PROGRAMMED FEMALE VOCALIST

- Tie {
1. Petula Clark-Warner Bros.
 1. Nancy Sinatra-Reprise
 2. Nancy Wilson-Capitol
 3. Eydie Gorme-Columbia

MOST PROMISING UP & COMING FEMALE VOCALIST

1. Sandy Posey-MGM
2. Aretha Franklin-Atlantic
3. Claudine Longet-A&M

MOST PROMISING UP & COMING VOCAL GROUP

1. Buckingham-Columbia
2. Sadler & Young—Capitol
3. Happenings-B. T. Puppy

MOST PROMISING UP & COMING INSTRUMENTALISTS

1. Walter Wanderly-Verve
2. Rubin Mitchell-Capitol
3. Whistling Jack Smith-Deram

MOST PROMISING UP & COMING ORCHESTRA

1. Bob Crewe Generation-Dyno-Voice
2. Baja Marimba Band-A&M
3. Brass Ring-Dunhill

LOOK

EVERY
MOTHER'S
SON

AMERICA'S
MOST EXCITING
NEW GROUP — 1967



Direction



Management:
PETER LEEDS
39 West 55th Street
New York, N. Y. 10019

Produced by:
WES FARREL

Publicity:
DOMINIC SICILIA



MOST PROGRAMMED RECORDS

MOST PROGRAMMED ALBUMS

- TIE: I'M A BELIEVER
STRANGERS IN THE NIGHT
2. WINCHESTER CATHEDRAL
3. BORN FREE
- 4 My Cup Runneth Over
- 5 Cherish
- 6 Last Train To Clarksville
- 7 That's Life
- 8 These Boots Are Made for Walking
- 9 Happy Together
- 10 Sugar Town
- 11 Good Vibrations
- 12 Georgy Girl
- 13 Something Stupid
- 14 Poor Side Of Town
- 15 I Think We're Alone Now
- 16 Snoopy VS The Red Baron
- 17 Penny Lane
- 18 Love Is Here & Now You're Gone
- 19 Reach Out And I'll Be There
- 20 Kind Of A Drag
- 21 Eleanor Rigby
- 22 Yellow Submarine
- 23 You Can't Hurry Love
- 24 What Now My Love
- 25 California Dreamin'

- THE MONKEES
- FRANK SINATRA
- NEW VAUDEVILLE BAND
- ROGER WILLIAMS
- Ed Ames
- The Association
- The Monkees
- Frank Sinatra
- Nancy Sinatra
- The Turtles
- Nancy Sinatra
- The Beach Boys
- The Seekers
- Nancy & Frank Sinatra
- Johnny Rivers
- Tommy James & The Shondells
- The Royal Guardsmen
- The Beatles
- The Supremes
- The 4 Tops
- The Buckinghams
- The Beatles
- The Beatles
- The Supremes
- Herb Alpert & The TJB
- Mamas & Papas

- 1 MORE OF THE MONKEES
- 2 THE MONKEES
- 3 SRO
- 4 Strangers In The Night
- 5 What Now My Love
- 6 Whipped Cream
- 7 Revolver
- 8 Going Places
- 9 That's Life
- 10 Born Free
- 11 Sugar
- 12 Mamas & Papas Deliver
- 13 Mamas & Papas
- 14 Sinatra At the Sands
- 15 Georgy Girl
- 16 Brazil '66
- 17 Guantanamo
- 18 Don't Go To Strangers
- 19 In The Arms Of Love
- 20 Rubber Soul
- 21 Spanish Eyes
- 22 Somewhere My Love
- 23 Boots
- 24 Rhapsodies For Young Lovers

- THE MONKEES
- THE MONKEES
- HERB ALPERT & THE TJB
- Frank Sinatra
- Herb Alpert & The TJB
- Herb Alpert & The TJB
- The Beatles
- Herb Alpert & The TJB
- Frank Sinatra
- Roger Williams
- Nancy Sinatra
- Mamas & Papas
- Mamas & Papas
- Frank Sinatra
- The Seekers
- Sergio Mendes & The Brazil '66
- The Sandpipers
- Eydie Gorme
- Andy Williams
- The Beatles
- Al Martino
- Ray Conniff
- Nancy Sinatra
- The Midnight Strings

MOST PROGRAMMED MALE VOCALIST

1. FRANK SINATRA
2. ANDY WILLIAMS
3. NEIL DIAMOND
4. Dean Martin
5. Johnny Rivers
6. Ed Ames
7. Jack Jones
8. Ronnie Dove
9. Percy Sledge
10. Al Martino
11. Tony Bennett
12. Tom Jones
13. Elvis Presley
14. Tommy Roe
15. Mitch Ryder

16. Matt Monro
17. Wilson Pickett
18. Eddy Arnold
19. Bobby Darin
20. Steve Lawrence
21. Jerry Vale
22. Bobby Vinton
23. Robert Goulet
24. Sammy Davis, Jr.
25. Brian Hyland
26. Otis Redding
27. Nat Cole
28. James Brown
29. Donovan
30. John Gary
31. Johnny Mathis

FOR THOSE WHO "DIG" SEASONING IN THEIR SOUL FOOD

LOU RAWLS

CONTINUES TO BE

THE GREATEST
THING SINCE
BLACK PEPPER!



Exclusive Booking

Associated Booking Corp.

Joe Glaser



Personal Management

J.W. Alexander

Continued . . .

Bobby Darin

 **MUSIC INC.**
1619 BROADWAY
NEW YORK, N.Y.



BOBBY DARIN
9229 SUNSET BLVD.
LOS ANGELES, CALIF.

GOLDSBORO MEANS HITS



Bobby's Latest Single

"TRUSTY LITTLE HERBERT"

Featured In His New Exciting Album:

**"The Romantic, Wacky, Soulful
Rockin', Country Bobby Goldsboro"**

BOOKINGS

ESTABLISHED 1956

Management
LENNY DITSON
850 Seventh Ave.
New York, N.Y.

**UNITED
ARTISTS**
RECORDS

MOST PROMISING UP & COMING VOCAL GROUPS

1. BUCKINGHAMS
2. SADLER & YOUNG
3. HAPPENINGS
4. Sergio Mendes & Brasil '66
5. Tommy James & Shondells
6. Gunther Kallman
7. Sandpipers
8. Jefferson Airplane
9. Arbors
10. Spencer-Davis Group
11. Fifth Dimension
12. Pozo-Seco Singers
13. Seekers
14. Buffalo Springfield
15. Cyrkle
16. Kissing Cousins
17. Casinos
18. Blues Magoos
19. Easybeats
20. Five Americans
21. James & Bobby Purify
22. Left Banke
23. The Who

MOST PROGRAMMED INSTRUMENTALISTS

1. ROGER WILLIAMS
2. AL HIRT
3. RAMSEY LEWIS
4. Floyd Cramer
5. Chet Atkins
6. Boots Randolph
7. Walter Wanderly
8. Peter Nero
9. George Shearing
10. Ventures
11. Booker T & MG's
12. Pete Fountain
13. Horst Jankowski
14. Charlie Byrd
15. Richard "Groove" Holmes

MOST PROMISING UP & COMING INSTRUMENTALIST

1. WALTER WANDERLY
2. RUBIN MITCHELL
3. WHISTLING JACK SMITH
4. Mike Sharp
5. Cannonball Adderly
6. Sergio Mendez
7. Burt Bacharach
8. Boots Randolph
9. Pee Wee Spitalera
10. Booker T & MG's
11. Howard Roberts
12. Wes Montgomery
13. George Benson Trio
14. Arrows
15. Jimmy Bryant

MOST PROGRAMMED ORCHESTRA

1. HERB ALPERT
2. HENRY MANCINI
3. BERT KAEMPFFERT
4. Billy Vaughn
5. Ray Conniff
6. Si Zentner
7. Count Basie
8. Lawrence Welk
9. Bob Crewe Generation
10. Les & Larry Elgart
11. Percy Faith
12. Baja Marimba Band
13. Jackie Gleason
14. Mantovani
15. Enoch Light
16. Hollyridge Strings
17. Glenn Miller
18. Johnny Keating

THE WORLDS OF

Kama Sutra



KAMA SUTRA

BY MIZRAHI—ARTIE RIPP—PHIL STEINBERG



KAMA SUTRA RECORDS, INC.



KAMA SUTRA MUSIC, INC.

BUDDAH RECORDS



TENDER TUNES MUSIC CO., INC.



KAMA SUTRA PRODUCTIONS, INC.

WISH CASH BOX A HAPPY
25th ANNIVERSARY

Kama Sutra

1650 Broadway, New York, N.Y. 10019 (212) 756-3320
West Coast: 7122 Sunset Boulevard, Los Angeles, Calif. (213) 469-1101

thanks
to all my friends
it's
been another
great year
Gary Lewis



ALBUM JUST RELEASED

**GARY LEWIS
& THE PLAYBOYS
NEW DIRECTIONS**

Representation
Ashley-Farnus Agency

Recording
Liberty Records

Public Relations
Braverman Mirisch, Inc.

MOST PROGRAMMED FEMALE SINGER

1. TIE: PETULA CLARK
NANCY SINATRA
2. NANCY WILSON
3. EYDIE GORME
4. Dusty Springfield
5. Barbra Streisand
6. Brenda Lee
7. Sandy Posey
8. Peggy Lee
9. Dionne Warwick
10. Lesley Gore
11. Connie Francis
12. Jane Morgan
13. Ella Fitzgerald
14. Marilyn Maye
15. Cher
16. Aretha Franklin
17. Carla Thomas
18. Jackie DeShannon
19. Margaret Whiting
20. Barbara Lewis
21. Lainie Kazan
22. Connie Smith

MOST PROMISING UP & COMING FEMALE VOCALIST

1. SANDY POSEY
2. ARETHA FRANKLIN
3. CLAUDINE LONGET
4. Marolyn Maye
5. Grace Markey
6. Lainie Kazan
7. Carla Thomas
8. Susan Barrett
9. Jackie DeShannon
10. Nancy Ames
11. Laura Nyro
12. Lana Cantrell
13. Janis Ian
14. Bobbe Norris
15. Michelle Lee
16. Brenda Holloway

MOST PROGRAMMED VOCAL GROUPS

1. TIE: SUPREMES
MONKEES
2. MAMAS & PAPAS
3. RAY CONNIFF SINGERS
4. Beatles
5. Johnny Mann Singers
6. Lettermen
7. Ray Charles Singers
8. Seekers
9. Four Tops
10. Sergio Mendes & Brasil '66
11. Rolling Stones
12. Lovin' Spoonful
13. Anita Kerr Singers
14. Four Seasons
15. Four Freshmen
16. Mitch Ryder & Detroit Wheels
17. Beach Boys
18. Herman's Hermits
19. Temptations
20. New Christy Minstrels
21. Norman Luboff Choir
22. Sandpipers
23. Association
24. Peter, Paul & Mary

MOST PROMISING UP & COMING ORCHESTRA

1. BOB CREWE GENERATION
2. BAJA MARIMBA BAND
3. BRASS RING
4. Buddy Rich New Band
5. Sergio Mendes & Brasil '66
6. Raymond LeFevre
7. David McCallum
8. Mariachi Brass
9. Milton DeLugg
10. King Richard's Flugel Knights
11. New Vaudeville Band
12. Burt Bacharach
13. George Wilson
14. Paul Mauriat
15. Midnight Strings
16. Ralph Carmichael
17. Mystic Moods

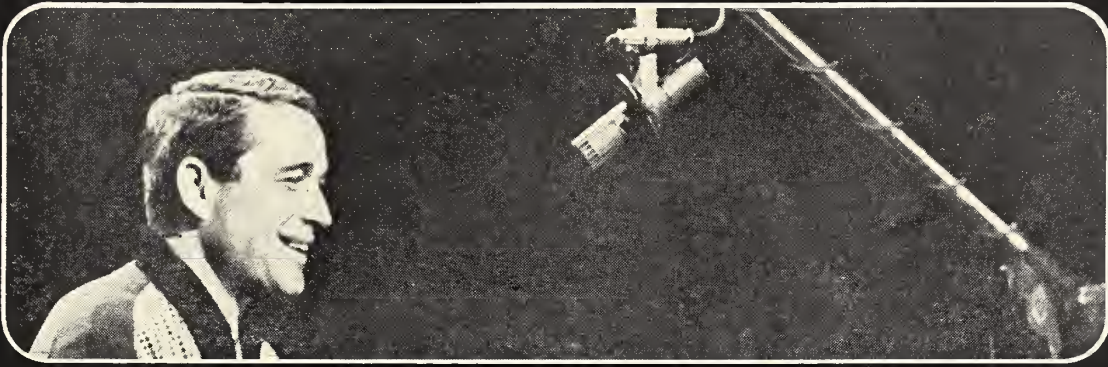

**Best Wishes
Perry Como**

PAST WINNERS: CASH BOX DJ POLL

MOST PROGRAMMED RECORD

1953—Till I Waltz Again With You—Teresa Brewer—Coral
 1954—Secret Love—Doris Day—Columbia
 1955—Melody Of Love—Billy Vaughn—Dot
 1956—Sixteen Tons—Tennessee Ernie Ford—Capitol
 1957—Don't Be Cruel—Elvis Presley—RCA Victor
 1958—All The Way—Frank Sinatra—Capitol
 1959—Tom Dooley—Kingston Trio—Capitol
 1960—Mack The Knife—Bobby Darin—Atco
 1961—Exodus—Ferrante & Teicher—United Artists
 1962—Moon River—Henry Mancini—RCA Victor
 1963—I Left My Heart In San Francisco—Tony Bennett—Columbia
 1964—I Want To Hold Your Hand—Beatles—Capitol
 1965—Downtown—Petula Clark—Warner Bros.
 1966—Satisfaction—Rolling Stones—London/Ballad Of The Green Berets—Barry Sadler—RCA Victor (Tie)
 1967—I'm A Believer—Monkees—Colgems/Strangers In The Night—Frank Sinatra (Tie)

MOST PROGRAMMED ALBUM

1956—Wee Small Hours—Frank Sinatra—Capitol
 1957—Songs For Swinging Lovers—Frank Sinatra—Capitol
 1958—Come Fly With Me—Frank Sinatra—Capitol
 1959—Come Dance With Me—Frank Sinatra—Capitol
 1960—Come Dance With Me—Frank Sinatra—Capitol
 1961—G. I. Blues—Elvis Presley—RCA Victor
 1962—Modern Sounds In Country & Western Music—Ray Charles—ABC Paramount
 1963—First Family—Cadence
 1964—Meet The Beatles—Capitol
 1965—Beatles '65—The Beatles—Capitol
 1966—Whipped Cream & Other Delights—Herb Alpert & The Tijuana Brass—A & M/Rubber Soul—Beatles—Capitol (Tie)
 1967—More of the Monkees—Colgems

MOST PROGRAMMED MALE VOCALIST

1953—Eddie Fisher—RCA Victor
 1954—Eddie Fisher—RCA Victor/Perry Como—RCA Victor (Tie)
 1955—Perry Como—RCA Victor
 1956—Perry Como—RCA Victor

1957—Frank Sinatra—Capitol
 1958—Frank Sinatra—Capitol
 1959—Frank Sinatra—Capitol
 1960—Frank Sinatra—Capitol
 1961—Frank Sinatra—Capitol/Reprise
 1962—Frank Sinatra—Reprise/Elvis Presley—RCA Victor (Tie)
 1963—Frank Sinatra—Reprise
 1964—Frank Sinatra—Reprise
 1965—Elvis Presley—RCA Victor
 1966—Frank Sinatra—Reprise
 1967—Frank Sinatra—Reprise

MOST PROGRAMMED FEMALE VOCALIST

1953—Patti Page—Mercury	1961—Connie Francis—MGM
1954—Patti Page—Mercury	1962—Connie Francis—MGM
1955—Rosemary Clooney—Columbia	1963—Connie Francis—MGM
1956—Jaye P. Morgan—RCA Victor	1964—Connie Francis—MGM
1957—Doris Day—Columbia	1965—Barbra Streisand—Columbia
1958—Patti Page—Mercury	1966—Petula Clark—Warner Bros.
1959—Connie Francis—MGM	1967—Petula Clark—Warner Bros.
1960—Connie Francis—MGM	Nancy Wilson—Capitol

MOST PROGRAMMED VOCAL GROUP

1953—Four Aces—Decca
 1954—Four Aces—Decca/Hilltoppers—Dot (Tie)
 1955—Four Aces—Decca/McGuire Sisters—Coral (Tie)
 1956—Four Lads—Columbia
 1957—Four Lads—Columbia
 1958—Four Lads—Columbia
 1959—Four Lads—Columbia/Four Freshmen—Capitol (Tie)
 1960—Kingston Trio—Capitol
 1961—Kingston Trio—Capitol/Everyly Bros.—Cadence (Tie)
 1962—Kingston Trio—Capitol
 1963—Four Seasons—Vee Jay/Kingston Trio—Capitol (Tie)
 1964—Beatles—Capitol
 1965—Beatles—Capitol
 1966—Beatles—Capitol
 1967—Supremes—Motown/Monkees—Colgems (Tie)

#2 Most Promising Instrumentalist

CASH BOX D.J. POLL — 1967

...—◆—...
THANKS
EVERYONE

...—◆—...
RUBIN
MITCHELL
 ...—◆—...



EXCLUSIVE BOOKINGS:
ASSOCIATED BOOKING CORP.
 JOE GLASER, PRES.
 445 PARK AVE., NEW YORK, N.Y.



Personal Management
QUADE & QUADE
 (518) ST-5-5222

MEMPHIS SOUND

STAX



VOLT

WORLD WIDE ARTISTS

SAM & DAVE Stax	CARLA THOMAS Stax	OTIS REDDING Volt
BOOKER T. & THE M.G.'s Stax	EDDIE FLOYD Stax	THE BAR-KAYS Volt
RUFUS THOMAS Stax	JOHNNIE TAYLOR Stax	THE MAD LADS Volt
ALBERT KING Stax	WILLIAM BELL Stax	JUDY CLAY Volt
THE ASTORS Stax	MABLE JOHN Stax	JEAN & The DARLINGS Volt
SIR MACK RICE Stax	THE MAR-KEYS Stax	THE CHARMELS Volt

Congratulations
Cash Box on your 25th YEAR



and a special thanks to
ATLANTIC RECORDS



926 East McLemore Street
Memphis, Tennessee
(901) 946-2535



MOST PROGRAMMED ORCHESTRA

1953—Ralph Flanagan—RCA Victor
1954—Ray Anthony—Capitol
1955—Ralph Marterie—RCA Victor
1956—Benny Goodman—Various Labels
1957—Les Brown—Columbia
1958—Ray Anthony—Capitol
1959—Ray Anthony—Capitol
1960—Les Elgart—Columbia
1961—Lawrence Welk—Dot
1962—Henry Mancini—RCA Victor/
Billy Vaughn—Dot/
Lawrence Welk—Dot/
Si Zentner—Liberty (Tie)
1963—Lawrence Welk—Dot
1964—Henry Mancini—RCA Victor
1965—Henry Mancini—RCA Victor
1966—Herb Alpert & The Tijuana Brass—A&M
1967—Herb Alpert & Tijuana Brass—A&M

MOST PROGRAMMED STUDIO ORCHESTRA INSTRUMENTALIST

1956—Les Baxter—Capitol
1957—Hugo Winterhalter—RCA Victor
1958—Billy Vaughn—Dot
1959—Ray Conniff—Columbia
1960—Percy Faith—Columbia
1961—Billy Vaughn—Dot
1962—Billy Vaughn—Dot
1964—Billy Vaughn—Dot
1958—Roger Williams—Kapp
1959—Duane Eddy—Jamie/Guyden
1960—Duane Eddy—Jamie/Guyden
1961—Duane Eddy—Jamie/Guyden
1962—Floyd Cramer—RCA Victor/
Ferrante & Teicher—United Artists (Tie)
1963—Duane Eddy—RCA Victor
1964—Al Hirt—RCA Victor
1965—Al Hirt—RCA Victor
1966—Herb Alpert & The Tijuana Brass—A&M
1967—Roger Williams—Kapp

MOST PROMISING MALE VOCALIST

1953—Bob Manning—Capitol
1954—Lou Monte—RCA Victor
1955—Sammy Davis, Jr.—Decca
1956—Pat Boone—Dot
1957—Johnny Mathis—Columbia/Tommy Sands—Capitol (tie)
1958—Jimmie Rodgers—Roulette
1959—Bobby Darin—Atco/Brook Benton—Mercury (tie)
1960—Jimmy Jones—Cub/Adam Wade—Coed (tie)
1961—Adam Wade—Coed
1962—Jack Jones—Kapp/George Maharis—Epic (tie)
1963—Jack Jones—Kapp/Bobby Vinton—Epic (tie)
1964—Jack Jones—Kapp
1965—Tom Jones—Parrot
1966—Bob Lind—World Pacific/Frankie Randall—RCA Victor (tie)
1967—Weil Diamond—Bang

MOST PROMISING FEMALE VOCALIST

1954—Kitty Kallen—Decca
1955—Jaye P. Morgan—RCA Victor
1956—Gogi Grant—Era
1957—Betty Johnson—Bally
1958—Connie Francis—MGM
1959—Dodie Stevens—Crystalette
1960—Connie Stevens—Warner Bros.
1961—Linda Scott—Canadian American
1962—Joanie Sommers—Warner Bros.
1963—Little Peggy March—RCA Victor
1964—Barbra Streisand—Columbia
1965—Petula Clark—Warner Brothers
1966—Nancy Sinatra—Reprise
1967—Sandy Posey—MGM

MOST PROMISING VOCAL GROUP

1954—Four Knights—Capitol
1955—Hi-Lo's—Trend/DeCastro Sisters—Abbott (tie)
1956—Platters—Mercury
1957—Hi-Lo's—Trend/Columbia
1958—Four Preps—Capitol
1959—Kingston Trio—Capitol
1960—Brothers Four—Columbia
1961—Limelites—RCA Victor
1962—Lettermen—Capitol
1963—J's & Jamie—Columbia
1964—Serendipity Singers—Philips
1965—Seekers—Capitol
1966—Mammas & the Pappas—Dunhill/Lovin' Spoonful—Kama Sutra (tie)
1967—Buckinghams—Columbia

MOST PROMISING ORCHESTRA

1954—Les Elgart—Columbia
1955—Richard Maltby—VIK
1956—Dick Jacobs—Coral
1957—Ray Conniff—Columbia
1958—Ray Conniff—Columbia
1959—Henry Mancini—RCA Victor
1960—Si Zentner—Liberty
1961—Bert Kaempfert—Decca
1962—Si Zentner—Liberty
1963—Joe Harnell—Kapp
1965—Sounds Orchestral—Parkway
1966—Herb Alpert & the Tijuana Brass—
1967—Bob Crewe Generation—Dyna Voice

MOST PROMISING INSTRUMENTALIST

1958—Champs—Challenge
1959—Dave "Baby" Cortez—Clock
1960—Bill Black's Combo—Hi
1961—Jorgen Ingmann—Atco
1962—Mr. Acker Bilk—Atco
1963—Chantays—Dot/Bill Pursell—Columbia (tie)
1964—Pete Drake—Mercury
1965—Horst Jankowski—Mercury
1966—Herb Alpert & The Tijuana Brass—A&M
1967—Walter Wanderly—Verve

Thank you
Burt Bacharach and Hal David

The World Spins On ABC



ABC RECORDS, INC., A SUBSIDIARY OF AMERICAN BROADCASTING COMPANIES, INC., NEW YORK/BEVERLY HILLS

Thanks D.J.'s

For your usual
Fine Cooperation
also

OUR CONGRATULATIONS

to

Cash Box

on your

25th ANNIVERSARY

from the group

B. B. King • Lowell Fulson • Mary Love

Clay Hammond • Jackie Day • Z. Z. Hill

Arthur K. Adams • Vernon Garrett

Johnny Adams

KENT MODERN

5810 S. NORMANDIE AVE., LOS ANGELES, CALIF.

RECORD MANUFACTURERS

A.A.
250 W. 51 St., N.Y.C.

AAA
2290 Sunset Blvd.
Hollywood, Calif.

A&M
1416 N. LaBrea
Hollywood, Calif.

ABC
1330 6th Ave., N.Y.C.

AARDVARK
609 5th Ave.
Suite 300, N.Y.C.

A-BET
1011 Woodland St.
Nashville, Tenn. 37206

ABNAK
825 Olive
Dallas, Tex. 75201

ACADEMY
157 W. 57th N.Y.C.

ACCENT
6533 Hollywood Blvd.
Los Angeles 28, Calif.

ACCLAIM
8715 W. 3rd St.
Los Angeles 48, Calif.

ACE
804 Vincent Bldg.
Jackson, Miss.

AD
843—7th Ave.
Oelwein, Iowa

AD LIB
157 W. 57th St., N.Y.C.

ADAIRE
1036 Red Bird Rd.
Augusta, Ga.

ADAM
700 S. Dearborn St.
Chicago 5, Ill.

ADAMS-ETHRIDGE
P.O. Box 434
Galveston, Tex.

ADAMS-ZETSCH
P.O. Box 3303
New Orleans, La. 70117

ADLER
683 Washington St.
Bost., Mass.

ADMIRAL
c/o AMY

ADVANCE
545 Arlington Place
Chicago, Ill.

ADVANCE
6376 Yucca St.
Hollywood, Calif. 90028

AELICA
331 Newbury St.
Boston, Mass. 02115

AETNA
See Mureo

AGE
See USA

AIRTOWN
P.O. Box 973
Richmond, Ind.

AJAX
1566 Stillwell Ave.
Bronx, N.Y.

AL-BRITE
2314—86th St.
Bklyn, N.Y.

ALAMO
16508 S. Main St.
Gardena, Calif.

ALCO
3029 Springboro
Dayton, Ohio

ALCOR
See Everest

ALDEE
1101 H St., NE
Washington, D.C.

ALDEN
See CIRCA

ALEGRE
1045 Southern Boulevard
Bronx, N.Y.

ALL
14188 E. Close St.
Whittier, Calif.

ALEAR
2433 Valley Ave.
Winchester, Va.

ALLAN
P.O. Box 940
Indianapolis, Ind. 46206

ALLEY
213 E. Monroe St.
Jonesboro, Ark.

ALLSTAR
1110 Washington St.
S. Houston, Texas

ALMO INT'L
See A & M

ALON
See Instant

ALPHA
See Don-El

ALPINE
P.O. Box 9253
Akron, Ohio

AMAZON
760½ W. Florence
Los Angeles, Calif.

AMBASSADOR
See Abnak

AMBER
2856 Kennedy Blvd.
Jersey City, N.J.

AMCO
See CIRCA

AMERICAN DISK
See Adams-Zetsch

AMERICAN-
INTERNATIONAL
Hollywood, Calif.

AMERICAN
MUSIC MAKERS
Suite 310, Carlton House
Hotel
Pittsburgh, Pa.

AMIGO
1851 Brunner St.
Phila., Pa.

AMY
1776 Broadway, N.Y.C.

ANCATH
P.O. Box 1036
Alameda, Calif.

ANCHOR
268 15th Ave.
Newark, N.J.

ANGEL
Capitol Tower
Hollywood, Calif.

ANGELTONE
See Atlas

A.P.I.
2991 Ingledeale Terrace
Los Angeles, Cal.

APACHE
3320 Barham Blvd.
Hollywood, Calif.

APEX
951 E. 47th St.
Chicago, Ill.

APEX
1023 N. LaBrea Ave.
Los Angeles, Calif.

APOGEE
9050 Santa Monica
Los Angeles, Calif.

APT
See ABC-Paramount

ARAVEL
4326 Crane St.
L.I.C., N.Y.

ARC
9155 Sunset Blvd.
Los Angeles, Calif.

ARCADE
2733 Kensington Ave.
Philadelphia, Pa.

ARDENT
1457 National
Memphis, Tenn.

ARDMORE
4438 N. Greenview Ave.
Chicago, Ill.

ARHOOLLE
Box 5073
Berkeley, Calif.

ARK
12418 Claudia Dr.
Houston, Texas

ARKAY
1851 Brunner St.
Philadelphia, Pa.

ARLEE
419 20th Ave. N.E.
Hickory, N.C. 28601

AROVOX
243 W. 18 St.
N.Y.C.

ARISTOPHONE
1564 Broadway, N.Y.C.

ARLEN
12837 Washington Blvd.
Los Angeles, Calif.

ARLEN
707 Huntington Pike
Rockledge, Pa.

ARRAWAK
761 Elton Ave.
Bronx, N.Y.

ART
P.O. Box 50-66
Miami, Fla.

ARTEMIS
9151 Sunset Blvd.
Los Angeles 69, Cal.

ARTIA
160 Passaic Ave.
Kearny, N.J.

ARTIC
See Jamie Guyden

ARTISTE
1619 Broadway
New York 19, N.Y.

ARVEE
7039 Sunset Blvd.
Hollywood, Calif.

ARWIN
250 N. Canon Dr.
Beverly Hills, Calif.

ARZEE
1739 N. 3rd St.
Phila., Pa. 19122

ASCOT
See United Artists

ASSOCIATED ARTISTS
6367 Selma Ave.
Hollywood, Calif.

ASTOR
See Abnak

ASTOR
CCM Bldg.
1232 Cambridge St.
Cambridge, Mass. 02139

ASTRO
205 St. Louis St.
Mobile, Ala.

AT LAST
See AFO

ATCO
1841 Broadway, N.Y.C.

ATILA
P.O. Box 1522
Toledo, Ohio

ATLANTIC
1841 Broadway, N.Y.C.

ATLAS-ANGLETONE
1697 Broadway, N.Y.C.

ATHENS OF THE
SOUTH
815 16th Ave. South
Nashville, Tenn.

AUDIO
4 New Hyde Park Rd.
Franklin Sq. L.I. N.Y.
11010

AUDIO FIDELITY
221 W. 57th St., N.Y.C.

AUDIO SPECTRUM
c/o Miller Int'l

AUDITION
See CIRCA

AURORA
See Amy-Mala

AURORA
25 W. 56 St.
N.Y.C.

AVANT GARDE
250 W. 57th St., N.Y.C.

AWLER
165 W. 46 St.
N.Y., N.Y.

AVENUE
570 5th Ave., N.Y.C.

AVON
15 W. 72nd St.
Suite V-5
New York 23, N.Y.

B. ATLAS
2226 McDonald Ave.
Brooklyn, N.Y.

B & B
8618 Anacortes St.
Houston, Texas

BBC
P.O. Box 9747
Atlanta, Ga.

B-W
P.O. Box 337
Wooster, Ohio

(Continued on page 46)

6%

INDUSTRY AVERAGE

(RECORDS RELEASED THAT MAKE THE TOP 100 CHARTS)

50%

OF THESE RECORDS HIT THE TOP 100

(RELEASED JULY, 1966—JUNE, 1967)

- | | |
|--|--|
| All In The Mind Of A Young Girl—Changin' Times | Is It On Is It Off—Bit A Sweet |
| And I'll Tell The World About You—Magicians | It'll Never Happen—Connie Stevens |
| Angel On The Corner—Magicians | ★ Lady From Baltimore—Bobby Darin |
| Animal Crackers—Gene Pitney | Lady Fingers—Magicians |
| ★ Another Page—Connie Francis | ★ Lovin' You—Bobby Darin |
| Black Sheep Boy—Tim Hardin | ★ Melancholy Music Man— |
| ★ Darling, Be Home Soon—Lovin' Spoonful | Righteous Brothers |
| ★★ Did You Ever Have To Make Up Your Mind | ★ Nashville Cats—Lovin' Spoonful |
| Lovin' Spoonful | Opportunity—Mandala |
| Don't Make Promises—Tim Hardin | ★★ Rain On The Roof—Lovin' Spoonful |
| ★ Full Measure—Lovin' Spoonful | ★ Six O'Clock—Lovin' Spoonful |
| ★ Girl Who Stood Beside Me—Bobby Darin | ★★ She'd Rather Be With Me—Turtles |
| ★ Girls In Love—Gary Lewis/Playboys | Soulful Sound Of Music—Bobby Freeman |
| Give And Take—Mandala | ★★ Summer In The City—Lovin' Spoonful |
| ★★ Happy Together—Turtles | Sweet And Heavenly Melody—Broadways |
| He's Good For Me—Tiffanies | They All Got Carried Away—Parrots |
| House Of Kicks—Cat's Meow | ★ Two In The Afternoon—Dino Desi & Billy |
| I Should Have Brought Her Home—Changin' Times | ★ When The Good Sun Shines— |
| If I Only Had A Song To Sing—Wayne Newton | Elmo and Almo |
| ★★ If I Were A Carpenter—Bobby Darin | I Want To Be Free—Jean Paul Vignon |

★ TOP 100

★★ TOP 10

THESE ARE A PRODUCT OF

KOPPELMAN—RUBIN ASSOCIATES

ORDER THE FUNNIEST!!!

Dooto's Best-Selling Comedy Records

AMERICA'S
MADDEST
ALBUM YET..

"SEX
CRACKS"

DTL 839

Rozelle Gayle

Super Sidesplitting Sex-Humor Galore!
A Red-Hot Package of Surefire Salespower!
Another Natural for Dooto Comedy Fans!
Stock this Sexational Sexplosive Album for
Frantic Action at the Cash Register!!!



Hail
Dooto's New
Champion
of Fun!



Stock these best-selling
albums in your inventory!



DTL 838



DTL 219



Dooto's Famous
"LAFF OF THE PARTY"
SERIES

DTL 214, DTL 220,
DTL 227, DTL 236
& DTL 265



DTL 809



DTL 275



DTL 295



DTL 828



DTL 804



DTL 815



DTL 274



DTL 833



DTL 801

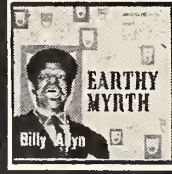

DTL 826



DTL 836



DTL 234



DTL 808



DTL 279



DTL 249



DTL 830



DTL 825



DTL 837

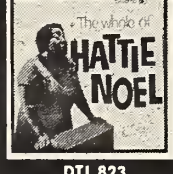

DTL 823



DTL 01



DTL 834



DTL 253



DTL 238



DTL 824



DTL 294



DTL 820



DTL 294



DTL 266

DOOTO RECORDS

13440 South Central Avenue
Los Angeles, California 90059

RECORD MANUFACTURERS

(Continued from page 42)

BABY LUV
156 W. Chanslor Ave.
Richmond, Calif.

BACK BEAT
See Duke

BAHAMA
324 N. E. 35th St.
Miami, Fla.

BAHAMAS
Box 174, Nassau,
Bahamas

BAJA
4 Broad St.
Atlanta, Ga.

BAKERSFIELD
725 34th St.
Bakersfield, Calif.

BANDBOX
5136 W. 41 St.
Denver, Colo.

BANDERA
3035 W. 38th St.
Chi., Ill.

BANDSTAND
157-36 90th St.
Howard Beach, N.Y.

BANDSTAND U.S.A.
2445 Chelsea Ave.
Memphis, Tenn. 38108

BANG
1650 B'way, N.Y.C.

BANGAR
c/o Kay Bank
2541 Nicollet Ave.
Minneapolis, Minn.

BANNER
2010 52nd St.,
Lubbock, Tex.

BARBARY COAST
4430 Santa Monica Blvd.
Los Angeles 29, Calif.

BARONET
See CIRCA

BARRE
160 Wood St.
Wilkes-Barre, Pa.

BARRINGTON
304 S. Hager St.
Barrington, Ill.

BARRY
See Old Town

BART
500 N.E. 79th St.
Miami Beach, Fla.

BAT
Box 522
Salisbury, Md. 21801

BAY-TONE
1509 Fillmore St.
San Francisco, Calif.

BEACH
Belmont Plaza Hotel
49th St. & Lexington
Ave., N.Y.C.

BEACON
518 W. 50 St.

BEL CANTO
1977 McAllister Ave.
Columbus, Ohio

BELINDA
See Jay-Gee

BELL
1776 Broadway, N.Y.C.

BELLAIRE
P.O. Box 125
Bellaire, Tex.

BELLWOOD
3012 Botohe Ave.
Richmond, Va.

BELMONT
P.O. Box 1763
Hollywood, Calif.

BELTONE
1650 Broadway, N.Y.C.

BERMA
c/o Bernice Mason
6223 Selma Ave.
Hollywood, Calif.

BEST
P.O. Box 33
Mesilla Park, N.M.

BETHLEHEM
1540 Brewster Ave.
Cincinnati, Ohio

BETTY
2009 W. 69th St.
Chicago, Ill.

BEULAH
See McKinnon

BIG D
6511 England Rd.
Houston, Texas

BIG J
13938 Vanowen
Van Nuys, Calif.

BIG R
See Era

BIG BEN
6515 Sunset Blvd.
Hollywood, Calif.

BIG COUNTRY
Box 701
Nashville, Tenn.

BIG JOHN
See Adler

BIG STYLE
P.O. Box 322
W. Memphis, Ark.

BIG TOP
See Amy
BIG WHEEL
545 5th Ave., N.Y.C.

BINGO
355 Madison Ave.
New Milford, N.J.

BIRD
122 E. Taussig Blvd.
Norfolk, Va.

BISCAYNE
642 E. 64th St.
Chi., Ill.

BLACK GOLD
P.O. Box 8033
Hollywood Station
Memphis, Tenn.

BLACK PEARL
1650 B'way, N.Y.C.

BLUE BIRD (OF ARK-
ANSAS)
3901 E. Broadway
N. Little Rock, Ark.
72114

BLUE CAT
See Red Bird

BLUE GIANT
3354 Hilton, N.E.
Massillon, Ohio

BLUE HILL
P.O. Box 394
Middletown, N.Y.

BLUE JAY
1821 Orleans Ave.
New Orleans, La.

BLUE NOTE
43 W. 61st St., N.Y.C.

BLUE ONION
P.O. BBox 4273
Cleveland, O. 44132

BLUE ROCK
See Mercury

BLUE STAR
6363 Sunset Blvd.
Hollywood, Calif.

BLUESTOWN
1820 Washington St.
Boston, Mass.

BLUESVILLE
See Prestige

BOARDWALK
114 S. Ocean Ave.
Atlantic City, N.J.

BOBBIE
17th & Sanson
Philadelphia, Pa.

BOCART
25 W. 65th, N.Y.C.

BOLO
c/o Ala Enterprises
663 5th Ave., N.Y.C.

BO-MAR
Carlton House
550 Grant St.
Pittsburgh, Pa.

BOMARC
2721 Snyder Ave.
Philadelphia, Pa.

BOMBAY
7905 Cottage Grove
Chicago, Ill.

BOOM
See ABC

BOOTLEG
2012 Noble St.
Pitts., Pa.

BORDERLINE
350 W. 40th St., N.Y.C.

BOSS
P.O. Box 14422
Tampa, Fla.

BOUNTY
See Elektra

BOURBON STREET
2939 Seratine St.
New Orleans 19, La.

BOYD
2609 N. W. 36th St.
Oklahoma City, Okla.

BRAGG
c/o John Capps
728 16th Ave. S
Nashville, Tenn.

BRAND
9109 Sunset Blvd.
Hollywood, Calif.

BRASS
7807 Truman
Kansas City, Mo.

BRAVE
1404 Arlington Blvd.
Falls Church, Va.

BREAK OUT
828 E. Meta St.,
Ventura, Calif.

BRITANIA
See Abnak

BRITE-STAR
P.O. Box 56
Newbury, Ohio

BROADWAY
See Sue 245 5th, N.Y.C.

BROKEN
200 W 57 St.
N.Y.C.

BROOKE
Radio Bldg.
Asheboro, N.C.

BRUNSWICK
445 Park Ave., N.Y.C.

BUFF
Delevan, N.Y.

BUCCANEER
328 O'Ferrell St.
Jackson, Miss.

BUCK
14610 Nimitz St.
Houston, Texas

BUCKLEY
1707 Church St.
Nashville, Tenn.

BUDDY
500 Locust St.
Marshall, Texas

BUDDY DAVIS
Rt. 1, Box 100
Blackshear, Ga.

BUDGET
See Request

BUDGET SOUND
222 W. Orange Grove
Ave.
Burbank, Calif.

BUENA VISTA
500 S. Buena Vista St.
Burbank, Calif.

BULLS EYE
See CIRCA

BUNNY
151 W. 125th St., N.Y.C.

BUZZ
52-87 79 St.
Elmhurst, N. J.

CBG
1616 Argyle Ave.
Hollywood, Calif.

CVM
1017 1/2 So. Main St.
Rockford, Ill. 61102

CADET
See Chess

CAEDMON
461 8th Ave., N.Y.C.

CAL-GOLD
See CIRCA

CALLA
1650 B'way, N.Y.C.

CARMAY
13117 Lackwood Blvd.
Downey, Calif.

CAMDEN
See RCA Victor

CAMELOT
937 South St.
Philadelphia, Pa.

CAMEO
1405 S. Locust St.
Philadelphia, Pa.
250 W. 67 St., N.Y.C.

CANADIAN AMERICAN
150 W. 55th St., N.Y.C.

CANARY
439 Brewer Dr.
Nashville 11, Tenn.

CANARY
1108 Davis
Redwood, Calif.

CANDLELIGHT
410 Main St.,
W. Orange, N.J.

(Continued on page 46)

We make good records.

ORIGINAL CAST

Man of la Mancha

"BEST MUSICAL 1966"
N.Y. DRAMA CRITICS
CIRCLE AWARD



ALBERT W. SELDEN and HAL JAMES

present

RICHARD KILEY

Irving
JACOBSON

Ray
MIDDLETON

Robert
ROUNSEVILLE

JOAN DIENER



Man of la Mancha

A NEW MUSICAL PLAY

By DALE WASSERMAN

Music by MITCH LEIGH Lyrics by JOE DARION

Choreography by
JACK COLE

Settings and Lighting by HOWARD BAY Costumes by HOWARD BAY and PATTON CAMPBELL
Musical Direction by NEIL WARNER Musical Arrangements by MUSIC MAKERS, INC.

Book and
Musical Staging by ALBERT MARRE

KRL-4505 KRS-5505

Kapp Records.



RECORD MANUFACTURERS

(Continued from page 44)

CANTERBURY
9000 Sunset Blvd.
Los Angeles, Calif. 90069

CANUSA
See Amy

CAPE
509 N. Kenwood
Glendale, Calif.

CAPITOL
Capitol Tower
Hollywood, Calif.
1290 Avenue of
Americas

CAPRI
See Jay-Gee

CARIB
4239 W. Flagler St.
Miami, Fla.

CARIB
Box 174
Nassau, Bahamas

CARICATURE
218 W. 47th St., N.Y.C.

CARLSON INT'L.
509 5th Ave., N.Y.C.

CARLTON
345 W. 58th St., N.Y.C.

CARMAY
13117 Lackwood Blvd.
Downey, Calif.

CARMEN
54 W. Randolph St.
Chicago, Ill.

CARNEY
See Jamie

CARNIVAL
24 Branford Pl., Ste. 414
Newark, N.J.

CARRIE
Box 7763
Detroit, Mich.

CATCH
See Era

CATHAY
5 Mary St.
Rittman, O. 44270

CATHAY
5637 Monte Verde Dr.
Santa Rosa, Cal.

CATHY
2547-20th Ave.
San Francisco, Cal.

CAVALCADE
23 Broad St.
Bloomfield, N.J.

CAVALIER
387 6th St.
S.F., Calif.

CELEBRITY
c/o N.Y. Record Distrib.
15 N. 20th St., N.Y.C.

CELESTE
2845 W. Pico
Los Angeles, Calif.

CELESTIAL
See DeVille

CELTIC
2403 Stewart Ave.
Westbury, N.Y.

CENTAUR
82 Aldine St.
Rochester, N.Y.

CENTER
See McKinnon

CENTURA
1219 N. Beachwood Dr.
Hollywood, Calif.

CENTURY
1429 Hawthorne St.
Pittsburgh, Pa.

CEVETONE
130 Newark Ave.
Jersey City, N.J.

CFP
See Fuller

CHA CHA
54 W. Randolph St.
Chicago, Ill.

CHADWICK
See Carnival

CHALLENGE
9220 Sunset Blvd.
Los Angeles 69, Calif.

CHANCELLOR
1320 Vine St.
Philadelphia 7, Pa.

CHANNEL
P.O. Box 173
Chicago, Ill.

CHANTE
624 S. Michigan Ave.
Chicago, Ill.

CHARGER
See Crusader

CHART
P.O. Box 73,
Nashville, Tenn.

CHASE
c/o Chips
808 N. Broad St.
Philadelphia, Pa.

CHATAHOOCHEE
710 N. Maple Dr.
Beverly Hills, Calif.

CHEATHAM
2016 N. Prairie
Dallas, Texas

CHECKER
320 E. 21st St.
Chicago, Ill.

CHENE
8831 Sunset Blvd.
Los Angeles, Calif.

CHEROKEE
915 Green Brier
Sparks, Nev.

CHESS
320 E. 21 St.
Chicago, Ill.

CHEVELL
P.O. Box 2081
Ft. Worth, Texas

CHOICE
Box 5021
Newark, N.J.

CHORDS
1697 B'way, N.Y.C.

CHRIS
209 E. 27th St.
Odessa, Tex.

CINEMA
4770 N.W. 7th Ave.
Miami, Tex.

CIRCA
1619 N. Cherokee Ave.
Hollywood 28, Calif.

CIRCUS
See Belle Meade

CITE
6108 W. Stevenson St.
Milwaukee, Wis.

CLARIDGE
250 W. 57th St., N.Y.C.

CLARION
See Adams-Zetsch

CLARK
1554 Crossroads of World
Hollywood, Calif.

CLARK
Box 400, Rt. 1
Goodlettsville, Tenn.

CLASSIC EDITIONS
See Music Minus One

CLEOPATRA
4 Mason Dr.
Hazlet, N.J. 07730

CLINTON
109 Clinton St.
New Bedford, Mass.

CLOUD
200 W. 57 St.
N.Y.C.

CQ & CE
1601 Fifth Ave.
Pittsburg, Pa.

COED
1619 Broadway, N.Y.C.

COLISEUM
See London

COLONIAL
710 W. Girard Ave.
Phila, Pa.

COLONIAL
503 W. Franklin St.
Chapel Hill, N.C.

COLUMBIA
51 W. 52nd St., N.Y.C.

COMBO
6201 Santa Monica Blvd.
Hollywood, Calif.

COMMAND
See ABC

CONCEPT
1041 N. Formosa
Hollywood, Calif.

CONCERT CLASSICS
111 W. 57th, N.Y.C.

CONCERTONE
1407 "U" St., N.W.
Washington, D.C.

CONNOISSEUR
See Artia

CONSTELLATION
1421 S. Michigan
Chicago, Ill.

CONTEMPO
See UA

CONTEMPORARY
8481 Melrose Place
Los Angeles 36, Calif.

CONTINENTAL
8730 Sunset Blvd.
Los Angeles 69, Calif.

CONTINENTAL
500 5th Ave. N.Y.C.

CONTINENTAL ARTS
1650 B'way, N.Y.C.

CONVERSAPHONE
132 W. 32nd St, N.Y.C.

COOKIN'
1136 Columbus Ave.
Boston 20, Mass.

COOL
617 Exchange Bldg.
Nashville, Tenn.

CORAL
445 Park Ave., N.Y.C.

CORECO
209 Washington St.
Huntsville, Ala. 35801

CORONA
9341½ Olympic Blvd.
Beverly Hills, Calif.

CORONET
See Premier

CORRECT-TONE
9031 12th St.
Detroit 6, Mich.

CORSICAN
273 Prospect Ave.
Buffalo, N.Y.

CORTLAND
1501 W. Cortland St.
Chicago, Ill.

COSMO
See Simon Says

COTTON
P.O. Box 128
Tucker, Ga.

COUN-TREE
4200 Missouri
E. St. Louis, Mo.

COUNTERPOINT
1674 B'way
N.Y.C.

COUNTRY JUBILEE
Demorest, Ga.

COVER
577 Sharon Dr.
Memphis, Tenn.

COWTOWN
P.O. Box 192
Avery, Texas

COX
2510 Rountree
Abilene, Texas

CRACKERJACK
See Sue

CRESCENDO
3725 Crescent St.
Long Island City, N.Y.

CRESCENT
See A-bet

CREST
See CIRCA

CRESTMORE
See Globe

CRESTVIEW
See Elektra

CRICKET
See Pickwick

CRITERIA
31 W. Market St.
Akron, O. 44308

CRITERION
6124 Selma Ave.
Hollywood 28, Calif.

CROSBY
1990 Fremont St.
Las Vegas, Nev.

CROSSFIRE
P.O. Box 206
Lake Elsinore, Calif.
92330

CROWN
1435 So. La Crensga
Los Angeles, Calif.

CRUSADER
6411 Hollywood Blvd.
Hollywood, Calif.

CRYSTAL
340 Wauhegan Rd.
Glenview, Ill.

CUB
See MGM

CUCA
123 Water St.
Sauk City, Wis.

CURRENT
313 N. Virginia St.
Ontario, Calif.

"D"
P.O. Box 115
Madison, Tenn.

DC
930 F. Street, N.W.
Suite 1615
Washington, D.C.

DCP
729 Seventh Ave., N.Y.C.

D.P.G.
c/o East Coast Dist.
612 E. Liberty
Norfolk, Va.

DA VINCI
264 5th Ave., N.Y.C.

DANA
818 W. 48th St., N.Y.C.

DANCE ALONG
111 W. 57th St., N.Y.C.

DANCELAND
18956 Wyoming
Detroit, Mich.

DANCO
1650 Broadway, N.Y.C.

D'ARCY
5600 Curlew
Norfolk, Va.

DARAN
4148 S. Parkway
Chicago, Ill. 60653

DARCY
6515 Sunset Blvd.
Hollywood, Calif.

DARE
P.O. Box 2055
Bell Gardens, Calif.
90201

DAREM
49 St. Mark Ave.
Brooklyn, N.Y.

DATE
51 W. 52nd St., N.Y.C.

DAVID
1650 Broadway, N.Y.C.

DAVIS
3301 W. Flourney
Chicago, Ill.

DAVON
See Horizon

DAWILLA
12457 Ventura Blvd.
N. Hollywood, Calif.

DAWN
40 Congress Int'l.
550 10th Ave., N.Y.C.

DAY DELL
c/o Jamie/Guyden
919 N. Broad St.
Philadelphia, Pa.

DE VILLE
1607 El Centro
Hollywood, Calif.

DE VOICE
c/o Penthouse
6119 Pofrero
El Cervito, Calif.

DEARBORN
13200 W. Warren
Dearborn, Mich.

DEAUVILLE
1138 N.E. 2nd Ave.
Miami, Fla.

DEB
P.O. Box 3185
Lubbock, Texas

DECANTER
See Fargo

DECCA
445 Park Ave., N.Y.C.

DEE GEE
1953 Pontious Ave.
L.A., Calif.

DEESU
1211 St. Philip St.
New Orleans, La. 70116

DEL-FI
6277 Selma Ave.
Hollywood 28, Calif.

DEL-MAR
186 Rogers St.
Atlanta, Ga.

DEL-MAR
1602 Ave. S
Nashville, Tenn.

DEL NORTE
711 Woodland N.W.
Albuquerque, N.M.

DEL-RAY
5168 Franklin Ave.
Hollywood, Calif.

DEL-RIO
9076 St. Ives Dr.
Los Angeles, Calif.

DEL-TONE
6363 Sunset Blvd.
Hollywood, Calif.

DELAWARE
116 Gentry Court
Roselle, Ill.

DELL
8490 Wade St.
Los Angeles, Calif.

(Continued on page 50)

**Thank you
DEEJAYS!**

And thanks to
Randy Wood

**BILLY
VAUGHN**



THE NATION'S BEST SELLING RECORDS

Hottest Brands Going!

*Thanks for Making it
a Very Good Year!*

ABNAK RECORDS

JET STAR RECORDS

STAR TIME RECORDS



BRITANIA RECORDS



The Five Americans



Jon & Robin



Jon & Robin and The In Crowd



Bobby Patterson and The Mustangs

FOR BOOKINGS CONTACT:
BANKERS MANAGEMENT
AND SERVICES, INC.
825 OLIVE / RI 2-6111
DALLAS, TEXAS 75201
— CALL COLLECT —



MUSIC ENTERPRISES, INC.

DALLAS, TEXAS

THE IN CROWD
FAN CLUB
c/o ABNAK MUSIC ENTERPRISES
INC.
825 OLIVE / RI 2-6111
DALLAS, TEXAS 75201

PRODUCED BY DALE HAWKINS

A PRODUCT OF ABNAK MUSIC ENTERPRISES, INC.

"Foreign licensees contact: Publishers' Licensing Corporation, 40 West 55th Street, New York 10019, (212) 581-7970."

A world of thanks to who lend an



The Hollies

Jeff Beck



The Yardbirds



The Dave Clark Five



Lulu



©"EPIC", Marcas Reg. T.M. PRINTED IN U.S.A.

these recording artists international flavor to the Epic label.

Donovan



The Tremeloes

Cliff Richard



Andy Stewart



The Shadows

Rolf Harris



THE BEST
IN RHYTHM & BLUES
FROM
EXCELLO
AND
A-BET RECORDS

THE BEST
IN SPIRITUALS
FROM
NASHBORO
AND
CRESCENT RECORDS

SEE YOUR NEAREST DISTRIBUTOR
FOR A COMPLETE CATALOG.

ATLANTA, GEORGIA
—Southland

BALTIMORE, MD.
—General

BOSTON, MASS.
—Mass Records

BUFFALO, NEW YORK
—Best

CHARLOTTE, N. C.
—Bertos Sales

CHICAGO, ILL.
—United

CINCINNATI, OHIO
—A & I

CLEVELAND, OHIO
—Mainline

DALLAS, TEXAS
—Big State

DETROIT, MICH.
—Record Dists.

EAST HARTFORD, CONN.
—Trinity

EL PASO, TEXAS
—M. B. Krupp

HIALEAH (MIAMI), FLA.
—Tone

HOUSTON, TEXAS
—H. W. Daily, Co.

LOS ANGELES, CALIF.
—California, Dists.

MEMPHIS, TENNESSEE
—Record Sales

MINNEAPOLIS, MINN.
—Heilicher Bros.

NASHVILLE, TENNESSEE
—Music City

NEWARK, NEW JERSEY
—Essex

NEW ORLEANS, LA.
—All South

NEW YORK, N. Y.
—Malverne

OAKLAND, CALIF.
—Chatton

PHILADELPHIA, PENN.
—A & L

PHOENIX, ARIZONA
—M. B. Krupp

PITTSBURGH, PENN.
—Klein Logan Variety

ST. LOUIS, MO.
—Westcot

SHREVEPORT, LA.
—Stans Record Service

NASHBORO RECORDS 1011 WOODLAND ST.
Nashville, Tenn. 615-227-5081

RECORD MANUFACTURERS

(Continued from page 46)

DELSEY
See Impala

DELTA
286 W. 55th St., N.Y.C.

DELTA
90 Sandy Record Sales
Albuquerque, N.M.

DELTA INT'L
1584 E. 31 St.
Cleveland, O.

DETAR
6376 Yucca St.
Hollywood, Calif.

DELUXE
1540 Brewster Ave.
Cincinnati, Ohio

DERAM
See London

DERBY TOWN
154 Spring St.
Charlestown, Ind.

DERRY
13380 Capitol Ave.
Detroit, Mich

DEVILLE
1607 El Centro
Hollywood, Calif.

DEUTSCHE-GRAMMOPHON
See MGM

DIABLO
3518 Champlain Ave.
Youngstown, Ohio 44502

DIADON
5607 Melrose Ave.
Hollywood, Calif.

DIAL
See Atlantic

DIAMOND
1650 Broadway, N.Y.C.

DIONN
See Jamie

DIRECTIONAL SOUND
See Premier

DISCOSCENE
4030 Chestnut St.
Phila., Pa. 19104

DISNEYLAND
500 S. Buena Vista St.
Burbank, Calif.

DISSO
See Adams-Zetsch

DISTINCT
c/o Kay-May Prod.
231 Myrtle Ave.
Irvington, N.J.

DISTINGUISHED
See Scepter

DITTO
See Bluestown
1820 Washington St.
Boston, Mass.

DI VENUS
1122 Rhinelander Ave.
Bronx, N.Y. 10461

DIXIELAND JUBILEE
8566 Sunset Blvd.
Los Angeles 46, Calif.

DOCK-MACK
2537 Adams Ave.
San Diego, Calif.

DOCUMENTARIES, UNLIMITED
1201 34th Ave., L.I.C.,
N.Y.

DOLPHIN
575 Madison Ave., N.Y.C.

DOLTON
See Liberty

DOMAIN
1313 North Ave.
Hollywood 28, Calif.

DOMAIN
1489 Vine St.
Hollywood, Calif.

DOMAIN
c/o London
539 W. 25 St.
N.Y.C.

DOMAR
449 W. Lewis
Scottsdale, Ariz.

DON-EL
2020 Ridge Ave.
Philadelphia, Pa.

DONNA
6277 Selma Ave.
Hollywood, Calif.

DOOTO
9512 S. Central Ave.
Los Angeles, Calif.

DORE
1481 No. Vine St.
Hollywood, Calif.

DORIAN
1815 N. Kenmore Ave.
Hollywood 27, Calif.

DOT
1507 No. Vine St.
Los Angeles, Calif.

DOTTIE
2534 W. Pico Blvd.
Los Angeles 6, Calif.

DOUBLE L
See Liberty

DOUBLE CHECK
2104 Lake Ave.
Baltimore, Maryland

DOUBLE SHOT
6515 Sunset Blvd.
Hollywood, Calif.

DOUBLET
111 W. Washington St.
Chicago, Ill.

DOVER
748 Camp St.
New Orleans, La. 70130

DOWNBEAT
See Golden Artists

DOWNNEY
13117 Lakewood Blvd.
Downey, Calif.

DRANDELL
2106-5th Ave.
Los Angeles, Calif.

DREW
18292 Wyoming
Detroit, Mich. 48221

DRUM BOY
2452 S. Kedzie Ave.
Chicago 23, Ill.

DRUMMOND
13380 Capitol Ave.
Oak Park, Mich.

DUB
P.O. Box 275
Nashville, Tenn.

DUBAYEWE-EFF
See Ancath

DUEL-TONE
1840 South Elena
Redondo Beach, Calif.

DUKE
2809 Erastus St.
Houston 26, Tex.

DUNHILL
See ABC

DUO
See Stereoddities

DUO-DISC
8831 Sunset Blvd.
Los Angeles, Calif.

DYER-BENNETT
P.O. Box 235
Woodside 77, N.Y.

DYMO
577 14 St.
Oakland, Calif.

DYNOVOICE
See Amy

EL DORADO
755 S. Grand
Mesq. Ariz.

EM
2863 N. 16th St.
Phoenix, Ariz.

EMBER
161 West 54th St., N.Y.C.

EPI
1477 Main St.
Bridgeport, Conn.

EARTH
2829 Rosedale
Dallas, Tex.

EASTERN
See Sue

EBB TIDE
See CELTIC

EBONY
920 So. Laurel
Mishawaka, Ind.

EBONY
1417 S. 13th St.
Abilene, Texas

ECO
See Acclaim

EDEN
See Era

EDGEWOOD
150 W. 55th St., N.Y.C.

EKCO
832 Leona Ave.
Columbus, Ohio

EDIT
See London

EKO
c/o TRUE-EKO
6004 7th Ave.,
Brooklyn, N.Y.

ELECT
6223 Selma Ave.
Hollywood 28, Calif.

ELEKTRA
1855 B'way, N.Y.C.

ELF
See Bell

ELVITRUE
306 S. 16th St.
Wilmington, N.C.

EMBER INT'L.
Ste. 1203
161 W. 54th St., N.Y.C.

EMERSON
See Musicnote

EMIT
See Diamond

EMKAY
1650 Broadway, N.Y.C.

EMMY
See Original Sound

EMPALA
See DeVille

EMPEROR
310 Wilbert St.
Wheeling, W. Va.

EMPIRE
20014 James Couzens
Detroit, Mich.

EMPIRE
323 Cedar St., S.W.
Washington, D.C.

EMPIRE
90 World-Wide
1650 Broadway, N.Y.C.

EMPIRE
477 Park Ave.
E. Hartford, Conn.

EMPIRE STATE
1502 Central Ave.
Cincinnati, O. 45214

EMPRESS
See Valmor

END
See Roulette

ENJOY
271 W. 125th St., N.Y.C.

ENTERPRISE
c/o Arc Dist.
13415 Lyndon
Detroit, Mich.

ENTREE
3155 Industrial Road
Las Vegas, Nevada

EPIC
51 W. 52 St., N.Y.C.

ERA
6515 Sunset Blvd.
Hollywood, Calif.

ERMINE
See CORTLAND

ESP-DISK
180 Riverside
New York, N. Y.

ESQUIR
11410½ Hempstead Hwy.
Houston, Texas

ETC.
1697 Broadway, N.Y.C.

ETIQUETTE
P. O. Box 582
Tacoma 1, Wash.

EUROTONE
47 E. 44th St.
N.Y.C.

EVA
Box 2921
Hollywood 28, Calif.

EVENT
10 Hardy Rd.
Westbrooke, Me.

EVENT
See Adams-Zetsch

EVEREST
1313 N. Vine
Hollywood

EVERLAST
See Enjoy

EXCELLO
See A-Bet

EXCLUSIVE
617 Exchange Bldg.
Nashville, Tenn.

EXECUTIVE
19 S. LaSalle St.
Chicago, Ill.

EXODUS
See CIRCA

E-X-P-A-N-D-E-D
13117 Lakewood Blvd.
Downey, Calif.

EXPO
See Palette

EXPRESS
711 Crescent
Memphis, Tenn.

FGF
9416 Highland Pl.
Arvada, Colo.

FABBRI
6533 Hollywood Blvd.
Hollywood, Calif.

FABOR
2609 W. Olive
Burbank, Calif.

FAGYEES
See Ancath

FAIRLANE
See King

FAIRMOUNT
See Cameo Paveway

FAIRWAY INT'L
2221 W. Olive
Burbank, Calif.

FALCON
21129 S. Michigan Ave.
Chicago 16, Ill.

FALEN
1270 6th Ave., N.Y.C.

FALEW
1270 Sixth Ave.
N.Y.C.

FAMILY
See Request

FANNIN
P.O. Box 38
Blue Ridge, Ga.

FANTASY
855 Treat Ave.
San Francisco 3, Calif.

FARGO
P.O. Box 656
Lynbrook, L.I., N.Y.

FARO
5004 Melrose Ave.
Hollywood, Calif.

FEDERAL
1540 Brewster Ave.
Cincinnati, Ohio

FELSTED
See London

FERNWOOD
297 N. Main St.
Memphis, Tenn.

FESTIVAL
See King

FIDELITY
8508 Sunset Blvd.
Hollywood 46, Calif.

FIASCO
See Audio Engineering

FIESTA
1819 Broadway, N.Y.C.

FILMWAYS
See Valiant

FINER ARTS
60 So. Glencoe St.
Denver 22, Colorado

FLAG
P.O. Box 827
Lucedale, Miss.

FLAME
1325 Franklin Ave.
New Orleans, La.

FLAMINGO
105-21 66th Ave.
Forest Hills, N.Y.

FLAT-GIT-IT
11703 E. Everest St.
Norfolk, Calif.

FLICK
18424 Gallagher
Detroit 34, Mich.

FLIP
618 S. Ridgeley Dr.
Los Angeles, Calif.

FLORIDA
458 W. 27th
Hialeah, Fla.

FOCUS
See Atlantic

FOLKWAYS
165 W. 46th St., N.Y.C.

FONTANA
See Mercury

FORD
125 E. 50 St.
N.Y.C.

FORD
322 Main St.
Stamford, Conn.

FOREST GREEN
1225 6th Ave.
N.Y.C.

FORTE
756 Burton S.E.
Gr. Rapids, Mich. 49507

FORTUNE
3942 Third Ave.
Detroit 6, Mich.

FORUM
See Roulette

FOUNTAIN
1540 Brewster Ave.
Cincinnati 7, Ohio

FOUR J
3507 S. Bronson Ave.
Los Angeles Calif.

4 CORNERS
See Kapp

FOURMOST
7118 Coldwater Canyon
N. Hollywood, Calif.

FOUR BROTHERS
3234 W. Roosevelt Rd.
Chi., Ill.

FOUR STAR
305 S. Fair Oaks Ave.
Pasadena, Calif.

49th STATE HAWAII
1023 N. La Brea Ave.

FRAN
711 Crown St.
Brooklyn, N.Y.

FRAN-TEL
P.O. Box 3023
New York, N.Y.

FRANC
5433 North 22nd Rd.
Arlington 5, Va.

FRANK BUCK
Cooperstone, N.Y.

FRATERNITY
Rm. 105
Sheraton Gibson Hotel
Cincinnati, Ohio

FREEDOM
6920 Sunset Blvd.
Hollywood, Calif.

FRIENDLY
Cornelia, Ga.

FRIENDLY FIVE
1250 S. Albany
Chicago, Ill.

FRISCO
1140 N. Claiborne Ave.
New Orleans 18, La.

(Continued on page 52)



**SOME ACTS
WILL NEVER
MAKE IT**

This is a great example of booking wrong act at the wrong time.

It would never have happened if PTA had been around.

Our acts are hotter than Nero—and leaves your place in much better condition.

Animals • Herman's Hermits •
Spencer Davis Group • Yardbirds •
Freddie and the Dreamers • Peter
and Gordon • Chris and Peter Allen
• Mitch Ryder Show • The Blues
Magoos • The Casinos • The Fifth
Estate • Harpers Bizarre • The Left
Banke • Music Explosion • ? & The
Mysterians • Magnificent Men •

The Who • Syndicate of Sound • The
Terry Knight Show • Mojo Men •
Mandala • The Staple Singers •
The Vagrants • Fortunes • Wayne
Fontana • Mindbenders • Liverpool
Five • Crystals • Shirelles • Ruby
and the Romantics • Exciters • John,
Jeffrey & Brother Tom • The Critters
• Brian Hyland and the Jokers •

Dovells • The Rich Kids • Rainy Daze
• Richard and the Young Lions • The
Sidekicks • The Beau Brummels •
Goldie and the Gingerbreads • Gary
U.S. Bonds • Freddy Cannon • Jimmy
Clanton • Lenny Welch • Bobby Free-
man • Tommy Roe • Sammy Turner
• Lotti Golden • Denny Belline •



PREMIER TALENT ASSOCIATES, INC.

200 WEST 57th STREET, NEW YORK, NEW YORK 10019 (212) 757-4300

FRANK BARSALONA, PRESIDENT

RECORD MANUFACTURERS

(Continued from page 50)

- FRISKY**
See Artia
- FROLIC**
4965 Bruce Dr.
Beaumont, Texas
- FUSIMO**
347 W. Lusher Ave.
Elkhart, Ind.
- FULLER**
P.O. Box 10513
Tampa, Fla.
- FULTON**
723 E. 81 St.
Brooklyn, N. Y.
- FUTURE**
1086 East College Ave.
Batesville, Ark.
- G-CLEF**
19 Arlington St.
Boston, Mass.
- GJM**
875 Main St.
Buffalo, N.Y. 14203
- GNP**
9165 Sunset Blvd.
Hollywood 28, Calif.
- G. S. P.**
1635 N. Hudson
Hollywood 28, Calif.
- GABLE**
P.O. Box 10163
Knoxville, Tenn.
- GALAHAD**
11703 E. Everest St.
Norwalk, Calif.
- GALAXY**
See Fantasy
- GALENA**
11922 E. 7th St.
Tulsa, Okla.
- GALLIO**
P.O. Box 535
Santa Paula, Calif.
- GALLANTRY**
1676 W. Swan
Tucson, Arizona
- GALLERY**
609 Fifth Ave., N.Y.C.
- GAMA**
See DC
- GAMBLE**
1650 B'way, N.Y.C.
- GAME TIME**
1650 B'way, N.Y.C.
- GAMBIT**
See CIRCA
- GARDENA**
145 W. 154th St.
Gardena, Calif.
- GARLIN**
11034 Blix St.
N. Hollywood, Calif.
- GARPAX**
Box 669
Hollywood, Calif.
- GASS**
6201 Santa Monica Blvd.
Hollywood, Calif.
- GATEWAY**
234 Forbes Ave.
Pittsburgh, Pa.
- GAYE**
P.O. Box 13612, Station
K
Atlanta, Georgia 30324
- GAYNOTE**
See Coast
- GEE-BEE**
Box 174, Albany, Ga.
- GEE**
See Roulette
- GENERAL AMERICAN**
See World Artists
- GENERAL AMERICAN**
See Lantam
- GENEVA**
65 E. 55th St.
N.Y.C.
- GETIT**
114-17 145th St.
Jamaica, N.Y.
- GIBRALTAR**
60 Main St.
E. Orange, N.J.
- GLAD**
560 5th Ave., N.Y.C.
- GLAD-HAMP**
165 W. 46th St., N.Y.C.
- GLENN**
Box 82
Palmdale, Calif.
- GLENN**
P.O. Box 841
Hammond, Ind.
- GLodus**
1650 Broadway, N.Y.C.
- GLOVER**
1697 Broadway, N.Y.C.
- GO GO**
19 Southland Dr.
Glen Cove, N.Y.
- GOLD**
See Amy
- GOLD ARROW**
See CIRCA
- GOLDBAND**
P.O. Box 254
Lake Charles, La.
- GOLD STANDARD**
Box 35
Nashville, Tenn.
- GOLD WAX**
2445 Chelsea Ave.
Memphis, Tenn.
- GOLDEN**
See A.A.
- GOLDEN CREST**
220 Broadway
Huntington Station, N.Y.
- GOLDEN EAGLE**
See Jamie/Guyden
- GOLDEN GROOVE**
300 Mt. Lebanon Blvd.,
Suite 228
Pittsburgh, Pa. 15234
- GOLDEN LEAF**
1663 Eddington Rd.
Cleveland Heights, Ohio
- GOLDEN STATE**
665 Harrison
San Francisco, Calif.
- GOLDEN WORLD**
4039 Buena Vista
Detroit, Mich.
- GONE**
See Roulette
- GOOD TIME JAZZ**
8481 Melrose Place
Los Angeles 46, Calif.
- GOOFUS**
402 Wooster Rd.
Mt. Vernon, Ohio
- GORDON**
See McKinnon
- GORDY**
See Tamla
- GOSPEL**
See Savoy
- GOTHAM**
1401 S. 10th St.
Philadelphia 46, Pa.
- GRAHAM**
See Circa
- GRAND AWARD**
1330 6th Ave., N.Y.C.
- GREEN-SEA**
28 Pemhroke Rd.
Hamden, Conn. 06514
- GREGG**
101 N. 8th St.
Ft. Smith, Ark. 72901
- GREGMARK**
1610 N. Argyle
Hollywood, Calif.
- GREGORY**
See Airtown
- GROOVE**
See RCA Victor
- GROOVESVILLE**
517 Pavilion
1 Lafayette Plaisance
Detroit, Mich. 48207
- GUITARSVILLE**
222 E. Garvey
Monterey Pk., Calif.
- GULF**
157 W. 57th St., N.Y.C.
- GUY**
310 W. 73rd St., N.Y.C.
- GUYDEN**
See Jamie
- H.I.T.**
See DeVille
- HALIFAX**
4135 Armitage
Chicago 39, Ill.
- HALL**
Box 849, Beaumont, Tex
- HALL-WAY**
P.O. Box 849
Beaumont, Texas
- HAMMOND**
P.O. Box 2063
Baton Rouge, La.
- HARMON**
345 W. 58th St., N.Y.C.
- HANNA BARBERA**
3400 W. Kahvenga
Hollywood, Calif.
- HARMONY**
799 7th Ave., N.Y.C.
- HARVEST TIME**
See Bolo
- HEART**
1618 1/2 3rd Ave., No.
Birmingham, Ala.
- HEARTBEAT**
410 S. Michigan Blvd.
Chicago 3, Ill.
- HEIDI**
27 W. 125th St., N.Y.C.
- HEIGH-HO**
1674 Broadway, N.Y.C.
- HENDON**
See Mira
- HEP**
2551 Aldine N.
St. Paul, Minn. 55113
- HERALD**
150 W. 55th St., N.Y.C.
- HERCULES**
See Jamie
- HERMITAGE**
1719 W. End Bldg.
Nashville, Tenn.
- HI**
See London
- HIBACK**
6311 Yucca St.
Hollywood, Calif. 90028
- HICKORY**
2510 Franklin Rd.
Nashville, Tenn.
- HIFI-RECORD**
7039 Sunset Blvd.
Hollywood, Calif.
- HILLCREST**
Box 6278
Bakersfield, Calif.
- HILLTOP**
See Amy
- HI-MAR**
R. D. 1
Muncy, Pa. 17756
- HIT**
See DeVille
- HIT KINGDOM**
See McKinnon
- HIT PARADER**
Capitol Dist., Co.
Derby, Conn.
- HITSVILLE**
c/o Jersey Disc. Prod.
1650 Broadway, N.Y.C.
- HOB**
111 Mack Ave.
Detroit 1, Mich.
- HOLIDAY**
Santa Monica, Calif.
- HOLIDAY INN**
P.O. Box 7129
Memphis 18, Tenn.
- HOLLYWOOD**
P.O. Box 115
Madison, Tenn.
- HOLTON**
850 7th Ave., N.Y.C.
- HOLY CROSS**
See McKinnon
- HOME OF THE BLUES**
107 Beale St.
Memphis, Tenn.
- HONEY**
Box 22
Tolleson, Ariz.
- HONOR**
7322 19th St.
Brooklyn, N.Y.
- HOOKS**
254 E. 29 St.
Los Angeles, Calif.
- HOPE**
See Image
- HORIZON**
6290 Sunset Blvd.
Hollywood, Calif.
- HOWARD**
550 5th Ave., N.Y.C.
- HUE**
1705 W. 7th St.
Ft. Worth, Texas 76102
- HULL**
1595 Broadway, N.Y.C.
- HUMCO**
313 El Tejon Ave.
Oildale, Calif.
- HUMMINGBIRD**
135 S. 3rd St.
Salt Lake City, Utah
- HURD**
101 First St.
Utica, N.Y.
- HURON**
See King
- HUSH**
382 Clarence Ave.
Sunnyvale, Calif.
- IBC**
147 Mulberry St.,
N.Y.C.
- I.R.P.**
19802 N. E. 12th Pl.
N. Miami Beach, Fla.
- IDEAL**
119 S. Sam Houston
Blvd.
San Benito, Texas
- IMPACT**
17111 3rd Ave.
Detroit, Mich.
- IMPALA**
250 S. Broad St.
Philadelphia, Pa.
- IMPALA**
P. O. Box
Crenshaw Station
Los Angeles, Calif.
- IMPALLA**
501 W. Shahonee Trail
Mt. Prospect, Ill.
- IMPERIAL**
1556 N. LaBrea
N. Hollywood, Calif.
- IMPEX**
See Top Pop
- IMPULSE**
See ABC
- IN**
See Horizon
- INDEPENDENCE**
8560 Sunset Blvd., Ste.
702 Hollywood, Calif.
90069
- INDIGO**
3330 Barham Blvd.
Hollywood, Calif.
- INDUSTRY**
Box 38631
Hollywood, Calif.
- INFINITY**
9808 Wilshire Blvd.
Beverly Hills, Calif.
- INSIGNIA**
530 W. Main
Hendersonville, Tenn.
- INSTANT**
2401 Orleans Ave.
New Orleans, La.
- INTEGRITY**
3663 Daleford Rd.
Cleveland, Ohio
- INTRASTATE**
P.O. Box 554
Los Gatos, Calif.
- INVADER**
10 Claude Lane
San Francisco, Calif.
- IT**
8745 Sunset Blvd.
Los Angeles, Calif. 90069
- JIB**
P.O. Box 14422
Tampa, Fla. 33609
- JJC**
33 E. 48th St.
N.Y.C.
- JAB**
5019 S. Normandie
Los Angeles, Calif.
- JALYNNE**
1920 Chestnut St.
Philadelphia, Pa.
- JAMA**
1617 N. El Centro
Hollywood, Calif.
- JAMECO**
91-02 Sutphin Blvd.
Jamaica, N.Y.
- JAME**
919 N. Broad St.
Philadelphia, Pa.
- JAY**
415 S. Walnut Ave.
Sidney, Ohio
- JAY-DEE**
Hallock, Minn.
- JAY-EM**
8588 W. Pico Blvd.
Hollywood, Calif.
- JAY-GEE**
318 W. 48th St., N.Y.C.
- JAY-GEE INT'L**
See Jay-Gee
- JAY-JAY**
See Premier
- JAYTONE**
1920 Chestnut St.
Los Angeles, Calif.
- JEFF**
P. O. Box 1522
Toledo, Ohio

THANKS A MILLION EVERYBODY FROM



JANET McBRIDE



VERN STOVALL

Bookings:
Bob Neal Agency
Nashville

and all of us at
**Longhorn Records and
Saran Music Co.**
P. O. Box 17014
Dallas, Texas 75227

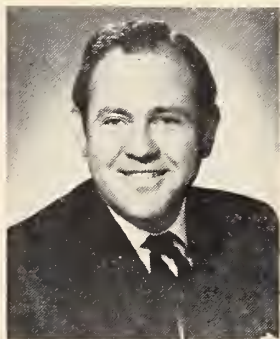

LEON RAUSCH

Bookings
Leon Gibbs
2525 Squire
Irving, Texas 75060

Watch for
LH#580 I'm So Glad Mom Can't See Me Now
b/w Painted Ang

**THE
SWEET
SOUND
OF
SUCCESS
IS ON
SCEPTER
WAND**

*Featuring
America's
Most Talented
Recording
Artists*



DIONNE WARWICK

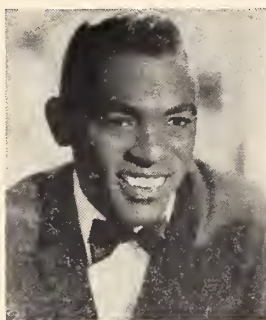

CHUCK JACKSON



MAXINE BROWN

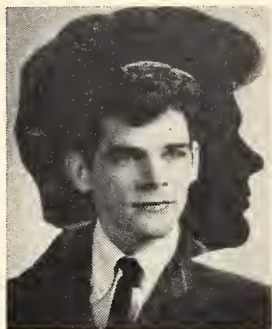

B. J. THOMAS



THE SHIRELLES



THE KINGMEN

PLUS / ROSCOE ROBINSON — MOVING SIDEWALKS — RONNIE MILSAP

... AND HOB "The First In Soul"

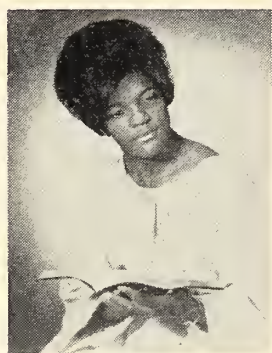

EVANGELIST
SHIRLEY CAESAR



SWAN SILVERTONES



BLIND BOYS OF
ALABAMA

PLUS / JESSE DICKSON
JAMES CLEVELAND

... AND MACE RECORDS CLASSICS

Extravagant Music For The Parsimonious



BELA BARTOK/
MIKROKOSMOS



VISKT ENIGMA/LISZT



J. S. BACH/SIX
ENGLISH SUITES

... AND THESE PEOPLE

Florence Greenberg, President Marvin Schlacter, Executive V.P.
Sam Goff, V.P. Pete Garris, National Promotion Mgr.
Joe Zerga, International Div. Stanley Greenberg, Dir. A & R
Flomar Music Publishing

... AND PERSONAL MANAGEMENT

PAUL CANTOR

SCEPTER-WAND 254 West 54th St., New York, N. Y. 10019 (212) CI 5-2170

RECORD MANUFACTURERS

(Continued from page 52)

JERDEN
971 Thomas St.
Seattle, Wash. 98109

JERDEN
See ABC

JERICO
See Bandera

JET SET
519 Davis Building
Washington, D.C.

JETSTAR
See Abnak

JEWEL
P.O. Box 1832
Shreveport, La.

JODY
See B-Atlas

JOEY
727 Penn Ave.
Pittsburgh, Pa.

JOHNSON
1619 Broadway, N.Y.C.

JOLAR
132 Boylston St.
Boston, Mass.

JOR-DAN
See Lantam

JORDAN RECORDS
2227 Fifth Ave.
Seattle, Wash.

JOSIE
318 W. 48th St., N.Y.C.

JOX
Box 28123, San Antonio,
Tex.

JOY
1790 Broadway, N.Y.C.

JUBILEE
1790 B'way, N.Y.C.

JULIE
1312 N. Garray Ave.
Monterey Park, Calif.

JUNIOR
See Jamie

KC
250 W. 57th St., N.Y.C.

KR
See Chess

KAMA SUTRA
1650 B'way N.Y.C.

KANDY
203 N. Wabash
Chicago, Ill.

KANGAROO
7902 Dewey Ave.
San Gabriel, Calif.

KANWIC
445 N. Oliver
Wichita, Kansas

KAPP
136 E. 57th St., N.Y.C.

KARATE
See Audio Fidelity

KAREN
See Atlantic

KARIE
See Shepherd

KATHY
1500 Oredmoro Ave.
Pittsburgh, Pa.

KAYDEN
37 Saddle Lane
Cherry Hill, N.Y. 08034

KEEN
8715 W. 3rd St.
Los Angeles, Calif.

KELIT-AURORA
239 W. 18 St.
N.Y.C.

KELTONE INT'L
14213 Oxnard St.
Van Nuys, Calif.

KENOVA
801-17th Ave., So.
Nashville 4, Tenn.

KENT
5810 So. Normandie
Los Angeles, Calif. 90019

KHOURY'S
Railroad & Bilbao Sts.
Lake Charles, La.

KIMBERLY
5810 S. Normandie
Los Angeles, Calif.

KIMLEY
See Circa

KING
1540 Brewster Ave.
Cincinnati 7, Ohio

KISKI
Box 116
North Apolla, Pa.

KISMET
Penn-Sheraton Hotel
Pittsburgh, Pa.

KISS-KISS
261 Cumberland St.
Brooklyn, N.Y.

KITE
2520 Amarillo St.
Baton Rouge, La.

KLIME
See KM

KLUB
4 Column St.
Greenville, S.C.

KNIGHT
6425 Hollywood Blvd.
Hollywood, Calif.

KNOCKOUT
Sunset-Vine Tower
Hollywood, Calif.

KO
See Scepter

L-G
4200 Missouri Ave.
E. St. Louis, Ill.

L.I.M.S.
1005 Walton Ave.
N.Y.C. 10452

LLP
345 W. 58th N. Y. C.

LMI
408 W. 57th St., N.Y.C.

LTD
See Monument

LA BELLE
1617 El Centro
Hollywood, Calif.

LA LOUISIANNE
2823 Johnston St.
Lafayette, La.

LA SALLE
22821 Hayden Rd.
Farmington, Mich. 48024

LAGUNA
2400 S. Western
Los Angeles, Calif.

LANCE
P.O. Box 8207
Albuquerque, N.M. 87108

LANDA
See Jamie

LANOR
P.O. Box 233
Church Pt., La., 70525

LANTAM
821 N. Broad St.
Phila., Pa.

LANROD
Box 935
Irving, Texas

LAREDO
See Bandera

LARGO
See CIRCA

LARK
122 E. Alexandra Blvd.
Gardena, Calif.

LASH
1326 Kerper St.
Philadelphia 11, Pa.

LAUREN
See Michele

LAUREN
5920 Smiley Dr.
Culver City, Calif.

Laurie
35 W. 45 St., N.Y.C.

LAVENDER
32nd & Jasper Rd.
Springfield, Ore.

LAVETTE
1650 Broadway, N.Y.C.

LAWN
See Swan

LE MONDE
See Le Grand

LEADER
136 E. 57th St., N.Y.C.

LEE
P.O. Box 14422
Tampa, Fla. 33609

LEE
P.O. Box 434
Galveston, Texas

LEE
2038 Vardon Lane
Flossmoor, Ill. 60422

LEFEVRE
See Bat

LEGEND
153 W. 51st St., N.Y.C.

L'ELGANT
113 W. 47th St., N.Y.C.

LEO
See Gateway

LESSIE
P. O. Box 207
San Antonio, Texas

LEWCO
881 10th Ave.
New York, N.Y.

LIBAN
5606 Greer Ave.
Los Angeles, Calif.

LIBERTY
6920 Sunset Blvd.
Hollywood, Calif.

LIBRARY EDITIONS
See Request

LIMELIGHT
See Mercury

LINDA
See Faro

LINDA
P.O. Box 423
Jacksonville, N.C.

LINK
See GNP

LION
See MGM

LITTLE DARLIN'
101 W. 55th St.
N.Y.C. 10019

LITTLE NASHVILLE
45 Allen Dr.
Charleston Heights, S.C.

LITTLE SHIRLEY
See Mayhams

LITTLE STAR
1600 N. La Brea
Hollywood 28, Calif.

LITTLE TOWN
Box 851
Fall River, Mass.

LITTLE WALT
85 Billings Ave.
Medford, Mass. 02155

LIVING LEGEND
6000 Sunset Blvd.
Hollywood 28, Calif.

LIVING LIBRARY
See Fuller

LIZA
1700 Broadway, N.Y.C.

LODE
9109 Sunset Blvd.
Los Angeles, Calif.

LODESTAR
11225 Ewing Circle
Minneapolis, Minn.

LOMA
4000 Olive Ave.
Burbank, Calif.

LONDON
539 W. 25th St., N.Y.C.

LONGHORN
2631 Fonville Dr.
Dallas, Tex.

LOOP
See D.C.

LORRAINE
411 Gordon St.
Reading, Pa.

LOUD
See Horizon

LOUIS
See London

LUCKY
P.O. Box 631
Cincinnati, Ohio

LUCKY ELEVEN
1318 W. Court
Flint, Mich.

LUCKY FOUR
5304 W. 25th St.
Chicago, Ill.

LUCKY SOUNDS
See Ron

LUCKY TOKEN
Box 38053
Hollywood, Calif.

LUTE
7250 Beverly Blvd.
Hollywood, Calif.

LUXOR
38 Marlene Dr.
Syosett, N.Y.

LYNNE
549 N. Vine
Hollywood, Calif.

LYRIC
1747 N. 33rd St.
Philadelphia, Pa.

M-PAC
See One-der-ful

MCR
10637 S. Vermont
Los Angeles, Calif.

MGM
1350 Av. of Americas,
N.Y.C.

MMC
P.O. Box 111
Ralston, Nebraska

MOC
See London

MTA
26 W. 58th St., N.Y.C.

MVR
21 New Hyde Park Rd.
Franklin Sq., N.Y.

MAGNA
337 1/2 Valley Dr. N.
Beckley, W. Va.

MAGNET
1616 N. Argyle
Los Angeles, Calif.

MAHALO
McCully Square
1888-H Kalakaua Ave.
Honolulu, Hawaii

MAINLINE
1260 E. 38 St.
Cleveland, Ohio

MAINSTREAM
1290 6th Ave., N.Y.C.
See Amy

MAHAKA
1006 Waimanu St.
Honolulu, Hawaii 96814

MALA
See Amy

MALTESE
P.O. Box 12281
Norfolk, Va. 23502

MAMA
3814 E. 147th St.
Cleveland, Ohio

MANCO
P.O. Box 10188
Ft. Worth, Tex.

MARGIE
See McKinnon

MARION
See McKinnon

MARK II
5371 W. Pico Blvd.
Los Angeles, Calif.
90019

MAR-VEL
See Glenn

MAR-V-LUS
c/o One-Der-Ful
1829 S. Michigan Ave.
Chicago, Ill.

MAR-TONE
Box 247
Harrodsburg, Ky.

MASON
2716 Decatur
Bronx, N.Y.

MAST
See CIRCA

MASTERS, INC.
6290 Sunset Blvd.
Hollywood, Calif.

MAVERICK
12065 Beacon
Seattle, Wash.

MAXX
See Amy

MAYHAMS
12 West 117 St.
N.Y.C.

McKINNON
411 Gordon St.
Reading, Pa. 19601

MECCA
970 3rd Ave.
Seattle, Wash.

MEDALLION
See Kapp

MEDLEY
See Moonglow

MEGA SOUND
25 Heid Ave.
Dayton, Ohio

MEL-O-DY
See Tamla

MELLO
See Little Walt

MENORAH
257 E. Broadway, N.Y.

MER-BRI
1616 Walnut St.
Phila., Pa.

MERCURY
35 E. Wacker Dr.
Chicago, Ill.

MERRY-GO-ROUND
1650 Broadway, N.Y.C.

MESA
7101 University Ave.
La Mesa, Calif.

MET RICHMOND
LATIN
RECORDS
2155 Utica Ave.
Brooklyn, N.Y.

(Continued on page 56)

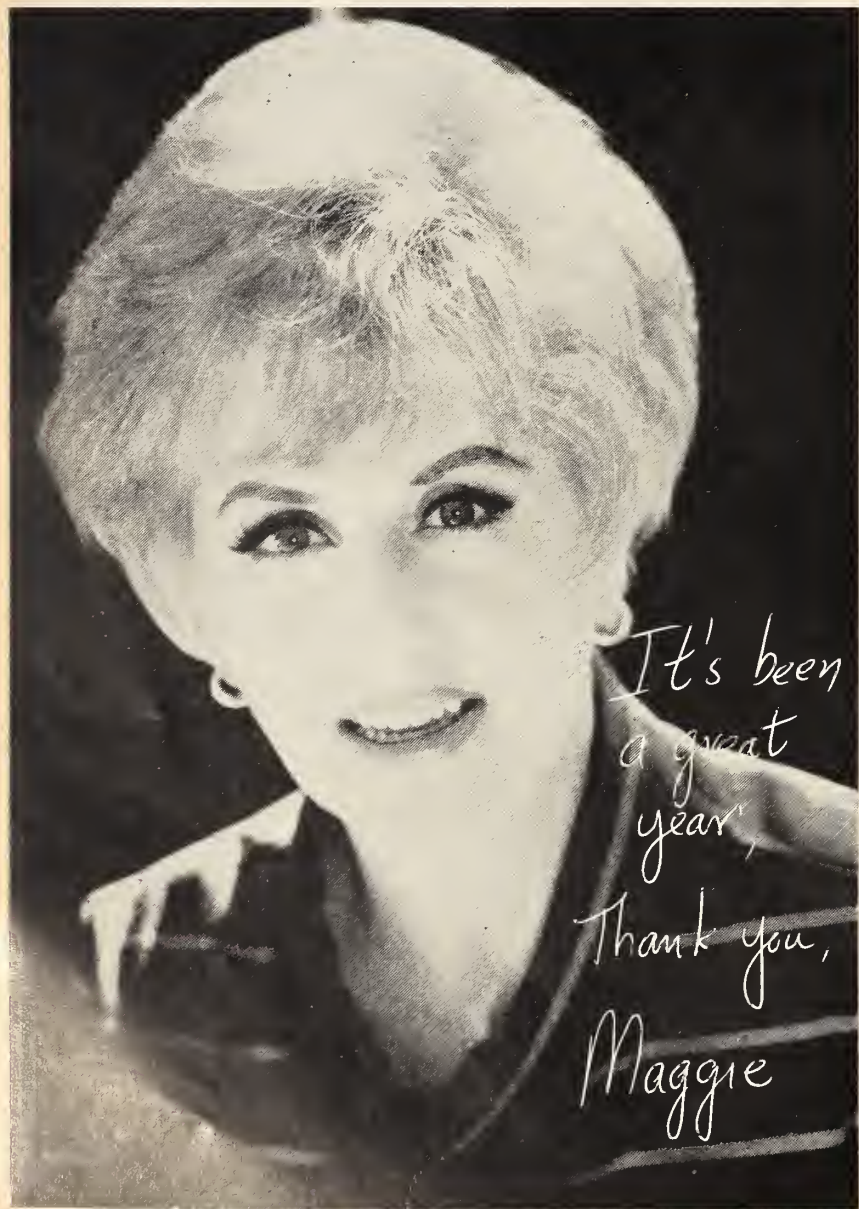

*It's been
a great
year,
Thank you,
Maggie*

THANK YOU!



JOHNNY MATHIS

WOW!!

LATEST RELEASES



The Best of the Beau Brummels
LP No. 114

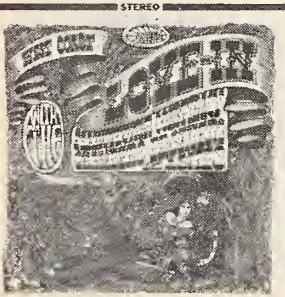

West Coast Love In
• Peanut Butter Conspiracy
• Chambers Bros.
• The Ashes
LP No. 113

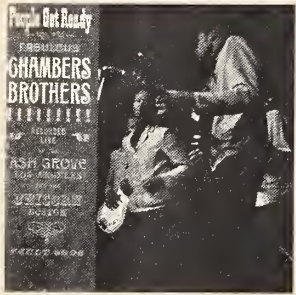

People Get Ready
The Chambers Bros. LP No. 9003

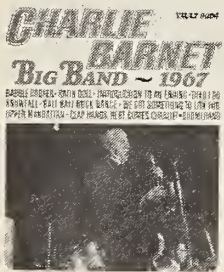

Big Band—1967
Charlie Barnet LP No. 9004

COMING SOON
115—Now The Chambers Bros.
116—The Look Of Love
Sam Fletcher

Recording Studio Available
Rates On Request

VAULT RECORDS

2525 W. 9TH ST.
LOS ANGELES, CALIF. 90006

RECORD MANUFACTURERS

(Continued from page 54)

- METEOR**
1794 Chelsea Ave.
Memphis, Tenn.
- METRO**
See MGM
- METROBEAT**
P.O. Box 775
Minneapolis, Minn. 5540
- MICHELLE**
220 E. 26th St.
N.Y.C.
- MID-SOUTH**
See Fernwood
- MIDNIGHT**
See Aravel
- MIKE**
1650 B'way, N.Y.C.
- MILESTONE**
See CIRCA
- MINARET**
1808 West End Bldg.
Nashville, Tenn.
- MINIT**
P.O. Box 650
New Orleans, La.
- MINOTAUR**
3520 Burgundy St.
New Orleans, La. 70117
- MINUTEMAN**
1040 Tremont St.
Boston, Mass.
- MIRA**
9145 Sunset Blvd.
Los Angeles, Calif.
- MISTER MAESTRO**
7 Central Park West
N.Y.C.
- MIZON**
See Dock-Mack
- MOBILE FIDELITY**
Box 336
Burbank, Calif.
- MODE**
8295 Sunset
Culver City, Calif.
- MODERN**
9317 W. Wash. Blvd.
Culver City, Calif.
- MOHAWK**
145 W. 47th, N.Y.C.
- MONARCH**
4852 W. Jefferson
Los Angeles, Calif.
- MONEY**
1065 E. Vernon Ave.
Los Angeles, Calif.
- MONITOR**
413 W. 60th St., N.Y.C.
- MONITOR**
1916 Fairbanks Rd.,
Balto, Md.
- MONMOUTH-
EVERGREEN**
157 W. 57th St., N.Y.C.
- MONUMENT**
530 W. Main St.
Hendersonville, Tenn.
- MONUMENTAL**
See Bat
- MOMENTUM**
1680 N. Vine St.
Hollywood, Calif.
- MOODSVILLE**
See Prestige
- MOONGLOW**
6539 Selma
Hollywood, Calif.
- MOSAIC**
See Era
- MOTHER LODE**
550 Fifth Ave., N.Y.C.
- MOTOWN**
2648 W. Grand Blvd.
Detroit 8, Mich.
- MURBRO**
136 W. 52 St., N.Y.C.
- MUSART**
16508 S. Main St.
Gardena, Calif.
- MUSIC CITY**
1815 Alcatraz
Berkeley, Calif.
- MUSIC GUILD**
See ABC
- MUSIC MAKERS**
6 W. 57th St., N.Y.C.
- MUSIC MINUS 1**
43 W. 61st St., N.Y.C.
- MUSIC NOTE**
250 W. 57th, N.Y.C.
- MUSIC PIT**
4 Broad St. S.W.
Atlanta, Ga.
- MUSICTONE**
445 W. 50th St.
New York, N. Y.
- MUSIC VOICE**
826 7th Ave, N.Y.C.
- MUSIC WORLD**
1650 B'way
N.Y.C.
- MUSICOR**
826 7th Ave, N.Y.C.
- MUSTANG**
6277 Selma Ave.
Hollywood, Calif.
- NALASTA**
See Anceath
- NASHBORO**
See A-Bet
- NASHVILLE**
P.O. Box 115
Madison, Tenn.
- NATIONAL**
209 Stahlman Bldg.
Nashville, Tenn. 37201
- NERO**
50 E. Oak St.
Chicago, Ill.
- NEW STAR**
Goodlettsville, Tenn.
- NEW VOICE**
See Amy
- NEW YORK SKYLINE**
81 Spring Valley Rd.
Paramus, N.J. 07652
- NEWAY**
75 Front St., Bklyn, N.Y.
- NEWPORT**
See King
- NEWTONE**
1650 B'way N.Y.C. 10019
- NIKE**
7601 "S" St.
Chicago, Ill.
- NILE**
7120 O Street
Sacramento, Calif.
- NINA**
614 8th Ave., N.Y.C.
- NOB**
6727 1st Ave.
St. Petersburg, Fla.
- NOCTURNE**
International City
Miami Springs, Fla.
- NOLA**
2117 Orleans Ave.
New Orleans, La. 70117
- NONSUCH**
See Electra
- NORMAN**
1914 Washington
St. Louis, Mo.
- NOSLEN**
4200 Mission Ave.
E. St. Louis, Ill.
- NUCLEAR**
1248 Broadway
Columbus, Ga.
- NUGGETT**
Route 1, Box 400
Goodlettsville, Tenn.
- NU-SOUND**
P.O. Box 9429
Rochester, N.Y. 14604
- OASIS**
See Request
- O'DELL**
See Herald
- OCAMPO**
735 Gen. McMullen
San Antonio, Tex.
- OCTAVE**
See ABC-Paramount
- ODE**
See Columbia
- OHIO**
P.O. Box 655
Hudson, Ohio 44236
- OKEH**
See Epic
- OLD GOLD**
See Adler
- OLD TIMER**
2675 Morris Ave.
Bronx, N.Y.
- OLD TOWN**
1697 Broadway, N.Y.C.
- OLIVER**
See ABC
- OLYMPIA**
See Jamie-Guyden
- OMEGA**
P.O. Box 558
N. Hollywood, Calif.
- OMEN**
See A & M
- OMNIBUS**
See Circa
- ONE-DERFUL**
1829 S. Michigan Ave.
Chicago, Ill.
- OPEN**
See Loadstone
- OPERATORS**
770 Lexington Ave.,
N.Y.C.
- OPOSSUM**
1111 S. Pine St.
Grand Island, Neb. 68801
- OP'S**
355 Madison Ave.
New Milford, N.J.
- ORCHID**
4139 Bronxwood Ave.
Bronx, N.Y.
- ORDELL**
See Jay-Gee
- ORIGINAL SOUND**
7120 Sunset Blvd.
Hollywood, Calif.
- ORPHEUM**
235 W. 46 St.
N.Y.C.
- OTOAO INT'L**
204 W. 96th St., N.Y.C.
- PJ**
See Rhythm Int'l
- P-K-M**
See London
- P.R.O.**
See Maltese
- PACIFIC COAST**
1774 N. La Brea
Hollywood 46, Calif.
- PACIFIC JAZZ**
8715 W. 3rd
Hollywood, Calif.
- PALA**
See Amy
- PALETTE**
1733 Broadway, N.Y.C.
- PALISADES**
Englewood Cliffs, N.J.
- PALMER**
13401 Lyndon Ave.
Detroit, Mich.
- PALOMAR**
See London
- PAM**
852 E. 63rd St.
Chicago, Ill.
- PAMELA**
2058 Monterey Rd.
South Pasadena, Cal.
- PAN**
959 Main
Buffalo, N.Y.
- PANART**
276 Park Av. So., N.Y.C.
- PANDA**
See Artia
- PANETTE**
320 W. 55th St., N.Y.C.
- PANTOMINE**
P.O. Box 2902
Phila, Pa.
- PARK AVE.**
6201 Santa Monica Blvd.
Hollywood, Calif.
- PARKER**
See MGM
- PARKWAY**
See Cameo
- PARLIAMENT**
See Artia
- PARLO**
See Dover
- PARROT**
See London
- PARNASO**
275 South 2nd St.
Brooklyn, N.Y.
- PART**
See Jay/Gee
- PARTHENON**
See Athens of the South
- PAT**
1650 Broadway, N.Y.C.
- PAT MAK**
320 W. 55 St.
N.Y.C.
- PATTY**
See Holton
- PATHE**
1721 Broadway
- PAULA**
728 Texas St.
Shreveport, La.
- PEACH**
P.O. Box 147
Louisville, Ga.
- PEACOCK**
2309 Erastus St.
Houston, Texas
- PELHAM**
See MVM
- PEN**
13 N. Manassas St.
Memphis, Tenn.
- PENNANT**
1207 Horn Ave.
Hollywood, Calif.
- PENTHOUSE**
720 Baker St.
San Francisco, Calif.
- PEORIA**
6355 Yucca
Hollywood, Calif.
- PEPPER TREE**
6376 Yucca St.
Hollywood, Calif.
- PERFECT**
See Epic
- PERISCOPE**
89 Hollingsworth St.
Boston, Mass.
- PERRI**
See Bolo
- PETAL**
Drawer 90
Southern Pines, N.C.
- PETER PAN**
See Ambassador
- PHAROS**
6290 Sunset Blvd.
Hollywood, Calif.
- PHI-DAN**
See Philles
- PHIL SPECTOR**
See Philles
- PHILIPS**
35 E. Wacker Drive
Chicago, Ill.
- PHILLES**
9130 Sunset Blvd.
Los Angeles, Calif.
- PHILLIPS INT.**
639 Madison Ave.
Memphis, Tenn.
- PAN**
959 Main
Buffalo, N.Y.
- PICKWICK**
8-16 43rd Av., L.I.C., N.Y.
- PIECES OF EIGHT**
3263 Oakdell Rd.
North Hollywood, Calif.
- PILOT**
See Maltese
- PINK**
See Ace
- PIONEER**
See Empire
- PIONEER**
2050 Ludlow St.
Phila., Pa.
- PIROUETTE**
See Ambassador
- PIT**
5652 Daniels Ave.
Dallas, Texas
- PLA-ME**
903 Louisiana
Muskogee, Okla.
- PLATEAU**
See Cameo
- PLATINUM**
1688 Meridian Ave.
Miami Beach, Fla.
33139
- PLAZA**
8333 Sunset Blvd.
Hollywood, Calif.
- POLLY**
4542 Live Oak
Mesquite, Tex.
- POLLYVOX**
369 15th St.
Norwood, N.J.
- PORT**
See Jubilee
- POSH**
1255 Post St.
San Francisco, Calif.
- POW**
200 W. 57th St., N.Y.C.
- POWERTREE**
144 W. 57th, N.Y.C.
- PRAISE**
See Prism
- PRAISE**
Dept. C
Stoneboro, Pa. 16153
- PREMIER**
356 W. 40th St., N.Y.C.
- PRESIDENT**
See London
- PRESS**
See London
- PRESTA**
79 E. Monterey
Phoenix, Ariz.
- PRESTIGE**
203 S. Washington Ave.
Bergenfield, N.J.
- PRINCE**
See Criterion
- PRISM**
49 Heid Ave.
Dayton, O.
- PROGRESS**
c/o Celeste
- PROGRESSIVE SOUND**
6034 Atlantic Blvd.
Maywood, Calif.
- PROMENADE**
See Ambassador
- PROSCENIUM**
See Music Minus One
- PROTONE**
2847 Effie St.
Los Angeles, Calif.
- PURE GOLD**
c/o Fernwood
297 N. Main St., Memphis
- PUSSY CAT**
See Maltese
- PYRAMID**
6417 W. 84th St.
Los Angeles, Calif.
- QQ**
526 Mesilla St. N.E.
Albuquerque, N.M.
- QUALITY**
380 Birchmont Rd.
Toronto 13, Ont., Can.
- QUEEN**
See King
- QUICK**
364 N. Madison
Pasadena, Calif.
- RCA VICTOR**
155 E. 24th St., N.Y.C.
- R & L**
General Delivery
Big Sur, Calif.
- RMT**
See Reach
- RODG**
c/o A & L
1819 Fairmount
Philadelphia, Pa.

(Continued on page 55)

Cash Box—July 8, 1967





PRESSING COMPANY

COMPLETE

**CUSTOM RECORD
PRESSING SERVICE**

ALL SPEEDS

**LABELS
PLATING**

Fastest Service

CONTACT: CHARLIE ROMAGOS

**NEW ORLEANS (509) 367-8822
91 1ST STREET, GRETNA, LA.**

RECORD MANUFACTURERS

(Continued from page 56)

- RPM**
9317 W. Wash. Blvd.
Culver City, Calif.
- R.R.C.**
See Recordland
- RSVP**
1619 Broadway, N.Y.C.
- RADIANT**
61 S. Orange
South Orange, N.J.
- RAGE**
1149 N. Las Palmas
Hollywood, Calif.
- RAINBOW**
c/o Chips Dist.
808 N. Broad St.
Philadelphia, Pa.
- RAINBOW**
285 Huntington Ave.
Boston, Mass.
- RAINES**
See Amaker
- RAINY DAY**
See Jay-Gee
- RAMCO**
3830 N. 7th St.
Phoenix, Ariz.
- RAMPART**
5004 Melrose Ave.
Hollywood, Calif.
- RAVEN**
801 17th Ave. S.
Nashville, Tenn.
- RAYCO**
1549 N. Vine St.
Hollywood, Calif.
- RAYDIN**
79-16 256 St.
Glen Oaks, N.Y. 11004
- RAYNOTE**
6331 Hollywood Blvd.
Hollywood, Calif.
- REACH**
1528-30 Overington St.
Philadelphia, Pa.
- READING**
See McKinnon
- RE-CAR**
2948 1st Ave., S.
Minneapolis 8, Minn.
- REBEL**
P.O. Box 246
Mount Ranier, Md.
- REBEL**
297 N. Main St.
Memphis, Tenn.
- RECORD DISTRIBUTORS OF AMERICA**
780 W. 27th St.
Hialeah, Fla.
- RECORD LAND**
13673 Wales
Oak Park, Mich.
- RECORDO**
6359 Selma Ave.
Hollywood, Calif.
- RED-BIRD**
1619 Broadway, N.Y.C.
- RED CAP**
19808 Woodingham Dr.
Detroit, Mich.
- RED FOX**
Box 3183
Hollywood, Calif.
- REDCOAT**
1600 N. LaBrea
Hollywood, Calif.
- RED FEATHER**
Box 3, Belen, N.H.
- REEF**
6227 Delmar
St. Louis, Mo.
- REFLECTION**
182-41 89th Ave.
Hollis, L.I., N.Y.
- REGENCY**
6000 Sunset Blvd.
Hollywood, Calif.
- REGENT**
See Savoy
- REL**
9116 Cimmaron
Los Angeles, Calif.
- RENDEZVOUS**
6367 Selma Ave.
Hollywood, Calif.
- REPEAT**
5782 E. 2nd St.
Long Beach, Calif.
- REPRISE**
See Warner Bros.
- REPUBLIC**
3830 N. 7th St.
Phoenix, Arizona
- REQUEST**
66 Mechanic St.
New Rochelle, N.Y.
- RESCUE**
1916 Fairbanks Road
Baltimore 9, Md.
- REV**
3703 N. 7th Ave.
Phoenix, Ariz.
- REVEILLE**
P.O. Box 669
Hollywood, Calif.
- REVILOT**
See Groovesville
- REVOLVO**
1432 N. Wilcox
Hollywood, Calif.
- REX**
729 Park Ave.
Covina, Calif.
- REXFORD**
6223 Selma Ave.
Hollywood 28, Calif.
- RIC**
801 16 Ave. So.
Nashville, Tenn.
- RIC TIC**
2307 Edison
Detroit, Mich.
- RICE**
812 16th Ave.
S. Nashville, Tenn.
- RICH**
P.O. Box 868
Nashville, Tenn.
- RICHIE**
P.O. Box 961
Wilmington, Dela.
- RICHMOND**
See Acclaim
- RIDDLE**
Huntington Bldg.
Miami, Fla.
- RIDGEWAY**
6087 Sunset Blvd.
Hollywood, Calif.
- RIDON**
5124 N.E. 34th Ave.
Portland, Ore. 97211
- RING-A-DING**
8425 Melrose
Hollywood, Calif.
- RISING SONS**
See Monument
- RIVERSIDE**
235 W. 46th St., N.Y.C.
- RIVIERA**
See U.S.A.
- RIVIERA**
1609 Hawkins St.
Nashville, Tenn. 37203
- RIVOLI**
See Legend
- RMT**
1528-30 Overington St.
Philadelphia, Pa.
- ROBBEE**
Carlton House
Pittsburgh, Pa.
- ROBIN**
1016 Baltimore Ave.
Kansas City, Mo.
- ROCK-IT**
598 W. Edgemont Dr.
San Bernardino, Cal.
92405
- ROMUR**
431 S. 62nd St.
Phila., Pa. 19143
- RON**
P.O. Box 14602
Baton Rouge, La.
- ROOMATE**
113-14 72 Rd.
Forest Hills, N.Y.
- ROOST**
See Roulette
- ROULETTE**
1631 Broadway, N.Y.C.
- ROWE**
1614 E. State St.
Trenton, N.J.
- ROYAL**
2871 E. Ponce DeLeon
Atlanta, Ga.
- RUBYSTONE**
10910 S.E. Foster Rd.
Portland, Ore.
- RUMAC**
P.O. Box 2087-D
Pasadena, Calif.
- RUST**
See Laurie
- RUVAL**
1535 Shore Pkwy.
Brooklyn, N. Y.
- S&R**
16508 So. Main St.
Gardena, Calif.
- SPQR**
See London
- SSS INT'L**
1650 B'way, N.Y.C.
- SAGE AND SAND**
5653 1/2 Hollywood Blvd.
Hollywood 28, Calif.
- SAHARA**
959 Main St.
Buffalo, N.Y.
- SALEM**
111 Main St.
Salem, Va.
- SAMTER**
522 Lafayette St.
Gretna, La.
- SAN-DEE**
212 N. 12th St.
Philadelphia, Pa.
- SANDY**
P.O. Box 248
Mobile, Ala.
- SANSU**
See Deesu
- SANWAYNE**
Box 433
Forrest Park, Ga.
- SAPIAN**
See Acclaim
- SASHAY**
318 Summit St.
Toledo, Ohio
- SAR**
6425 Hollywood Blvd.
Los Angeles, Calif.
- SARA**
See Cuca
- SATURN**
See Bomare
- SAVANNAH**
Vaughn Bldg.
Dallas, Texas
- SAXONY**
P.O. Box 177
Cincinnati, Ohio
- SCEPTER**
254 W. 54th St., N.Y.C.
- SCOPE**
2635 W. Grand Blvd.
Detroit, Mich. 48208
- SEA ELL**
P.O. Box 362
Pasadena, Texas 77502
- SEA-HORN**
See Arnold
- SEAFAIR**
See CIRCA
- SECURITY**
See Holton
- SEDCO**
P.O. Box 148
Elsinore, Calif.
- SEECO**
39 W. 60th St., N.Y.C.
- SELECT**
See Joy
- SENTAR**
See Cameo
- SEVILLE**
See London
- SHALIMAR**
1314-24 S. Howard
Philadelphia, Pa.
- SHAMROCK**
1310 S. New Hampshire
Los Angeles, Calif.
- SHAR**
6128 W. Belmont Ave.
Chicago, Ill.
- SHAR-DEE**
c/o Hansen
1842 West Ave.
Miami Beach, Fla.
- SHARON**
Box 2343
Hollywood, Calif.
- SHASTA**
4720 Forman Ave.
Hollywood 8, Calif.
- SHERATON**
355 Madison Ave.
New Milford, N.J.
- SHIRLEY**
43465 Sweetwood St.
Fremont, Calif.
- SHOMAR**
2306 Louisiana
Houston, Texas
- SHOUT**
See Bang
- SHOWBOAT**
P.O. Box 955
Nashville, Tenn.
- SHREVE**
P.O. Box 1068
Shreveport, La.
- SIDRA**
See Drew
- SIGNET**
See CIRCA
- SILVER CROSS**
See Bluestown
- SILVER SEAL**
654 1/2 N. Sweetzer Ave.
Los Angeles, Cal. 90048
- SIMON SAYS**
See ABC
- SIMS**
801 17th Ave., S.
Nashville, Tenn.
- SKY**
P.O. Box 9162
Jackson, Miss.
- SKYLAR**
See Era
- SKYLARK**
5109 1/2 Hollywood Blvd.
Los Angeles, Calif.
- SKYLITE**
133 S. Atlantic Blvd.
Compton, Calif.
- SKYROCKET**
1739 N. 3rd St
Philadelphia, Pa.
- SKYSCRAPER**
See Holton
- SKYWAY**
Box 133
Hollywood, Cal.
- SLEEPER**
Box 662
Meridian, Miss.
- SLIDE**
See McKinnon
- SMASH**
35 E. Wacker Dr.
Chicago, Ill.
- SMOKE**
310 Chadwick Ave.
Newark, N.J. 07112
- SMOKEY**
P.O. Box T-5087
Mobile, Ala.
- SODESKA**
177 Beach 141st St.
Belle Harbor, L. I. N.Y.
- SOLAR**
818 6th St.
Union Beach, N.J. 07786
- SOLID GOLD**
713 18th Ave. S.
Nashville, Tenn.

(Continued on page 60)

THE **Byrds**



The first name in sound!

To play and play again!

WARNER BROS. RECORDS INC. BURBANK, CALIF.



JAMIE / GUYDEN

**THE SMALLEST RECORD MANUFACTURER
HAS 4083 SALESMEN, TOO!**

THANK YOU RADIO AMERICA!

brenda & the tabulations

the kit kats

crispian st. peter

barbara mason

the showstoppers

helene smith

dionn
RECORDS

RADIO
RECORDS

Phil L.A.
RECORDS OF SOUL

R & B DIVISIONS
OF

Jamie / Guyden RECORDS



TRADITION IN SOUND

WE AT BARRINGTON RECORDINGS WOULD LIKE
TO THANK THE ENTIRE RECORDING INDUSTRY
FOR THE COOPERATION THEY HAVE EXTENDED
TO OUR COMPANY AND ITS REPRESENTATIVES.

WILLIAM J. SIMONINI, JR.
PRESIDENT

RECORD MANUFACTURERS

(Continued from page 58)

SOLID HIT
See Groovesville

SOMA
119 N. 9th Ave.
Minneapolis, Minn.

SOMERSET
See Miller Int'l

SOUL
See Tamla

SOUL CITY
1560 N. LaBrea
Hollywood, Calif.

SOUL POWER
P.O. Box 14422
Tampa, Fla. 33609

SOUL SALAD
See Ancath

SOUL SOUND
1812 Constantinople St.
New Orleans, La. 20115

SOULIN'
See Soul Sound

SOULVILLE
234 Auburn Ave.
Atlanta, Ga.

SOUND-O-RAMA
7056 Lanewood Ave.
Hollywood, Calif.

SOUND OF SOD
1823 Hill St.
Richmond, Va.

SOUND STAGE-7
See Monument

SOUNDEX
See Ron

SOUTHLAND
520 St. Louis St.
New Orleans, La.

SPAR
P.O. Box 7663
Nashville, Tenn.

SPARTAN
111 Mack Ave.
Detroit, Mich.

SPECIALTY
8300 Santa Monica Blvd.
Hollywood, Calif.

SPINNING
510 N. Dearborn St.
Chicago, Ill.

SPIRAL
875 5th Ave., N.Y.C.

SPORT
9120 Livernois
Detroit, Mich. 48204

SPOT
1053 Lynn Garden Dr.
Kingsport, Tenn.

SPOTLITE
2 Geary St.
S.F., Calif.

SPRINGBOARD
2318 Coles Blvd.
Norristown, Pa.

STADIUM
Box 38631
Hollywood, Calif.

**STAGE ENTERTAIN-
MENT**
4010 Concord Ave.
Wilmington, Del.

STAGEDOOR
58 Dayton Ave.
Passaic, N.J.

STAGG
#10 Marlo Dr.
Belleville, Ill.

STAR DISCOS
100-102 Texas Ave.
El Paso, Tex.

STAR-A-FIRE
151 W. 154th St.
Gardena, Calif.

STAR PRODUCTIONS
398 Main St.
Orange, N.J.

STARDAY
P.O. Box 115
Madison, Tenn.

STARDUST
107 E. Third St.
Mount Vernon, N.Y.

STARDUST
881 7th Ave., N.Y.C.

STARKE
16 Union St.
Memphis, Tenn.

START

See Checker

STARTIME

See Aknak

STAX

See Atlantic

STELLAR

550 5th Ave., N.Y.C.

STEPHENY

510 N. Dearborn St.
Chicago, Ill.

STEREODDITIES

259 S.W. Terrace
Ft. Lauderdale, Fla.

STOP

See Bluestown

STUDIO

See 20th Fox

STYLE

c/o World-Wide
1674 Broadway, N.Y.C.

STYLETONE

1732 E. 4th St.
Bklyn., N.Y.

SUCCESS

165 W. 46 St.
N.Y.C.

SUE

265 W. 54th St.
New York, N.Y.

SUERTE

1733 Broadway
New York, N.Y. 10019

SUMMIT

1158 Skipper Dr.
Mobile, Ala.

SUN

639 Madison Ave.
Memphis, Tenn.

SUPREME

See Detroit

SURE

Box 94
Broom Hall, Pa.

SURE-FIRE

319 Seventh Ave., N.
Nashville, Tenn.

SURE-SHOT

See Duke

SURFSIDE

2805 Biscayne Blvd.
Miami 37, Fla.

SUTTON

1023 N. La Brea
Hollywood, Calif.

SWAN

N.W. Corner 8th &
Fitzwater St.
Philadelphia, Pa.

SWINGIN'

See CIRCA

SWINGLINE

P.O. Box 3164
Shreveport, La.

SYMBOL

See Sue

T-NECK

See Atlantic

TCF

See 20th-Fox

TNT

1422 W. Poplar
San Antonio, Tex.

TAB

1121 Market
Galveston, Tex.

TAD

8 E. 48th St., N.Y.C.

TAHITI

See Criterion

TAKE 6

6565 Sunset Blvd., Suite
210 Hollywood, Cal. 90028

TALLEY-HO

Commercial Trust Bldg.
Philadelphia, Pa.

TALLY

Box 842
Bakersfield, Calif.

TAMLA

2648 W. Grand Blvd.
Detroit 8, Mich.

TAMMY

708 Fifth St.
Struthers, O.

TANGERINE

See ABC

TAPE

See CIRCA

TARGET

2847 1/2 W. Pico Blvd.
Los Angeles, Cal.

TAURUS

6510 St. Clair
Cleveland, Ohio

TEARDROP

See Jamie

TEEN

See CIRCA

TEENA

See Circa

TELEFUNKEN

See London

TEMPE

6365 Selma Ave
Hollywood 28, Cal.

TEMPLE

2080 Delaware
Detroit, Mich.

TEMPUS

423 First Nat'l Bank
Bldg.
Peoria, Ill.

TEMPWOOD V

See Jay-Gee

TENA

205 E. 42nd St.
N.Y.C.

TENOR

205 E. 42 St.
N.Y.C.

TERI DE

2106 5th Ave.
Los Angeles, Calif. 90016

TERON

1158 N. Highland
Hollywood, Calif.

TERRACE

See London

TERRY

See Airtown

TEXAN

Box 935
Irving, Texas

THELAMA

1457 National Ave.
Memphis, Tenn. 38122

THOR

399 Fullerton Pkwy.
Chi., Ill.

THUNDER

5825 So. Morris Blvd.
Tucson, Ariz.

TIARA

835 Hamilton Ave.
Fort Wayne, Ind.

TICO

See Roulette

TIDAL

2513 Colby Ave.
Los Angeles, Calif.

TIDE

2146 W. View St.
Los Angeles 16, Calif.

TIFTON

c/o Ambassador

TIGER

See Red-Bird

TIGERTOWN

See Fuller

TIGRE

2907 W. Hollywood
Chicago, Ill.

TIKVAH

1650 Broadway, N.Y.C.

TILT

See London

TILTON

See Continental

TIMBRE

1407 N.E. 47th St.
Seattle, Wash.

TIME

1290 6 Ave.
N.Y.C.

TIMES SQUARE

1104-6th Ave.
New York, N.Y.

TIP

792 E. 48th St. N.
Tulsa, Okla.

TIP TOP

See U.S.A.

(Continued on page 62)



Here's a sentimental token
from another member
of the Class of '42.
Happy Birthday, Cash Box!

RECORD MANUFACTURERS

(Continued from page 60)

TITAN
5334 Concord
Detroit 11, Mich.

TITANIC
1310 So. New Hampshire
Ave.
Los Angeles, Calif.

TODD
1719 West End Ave.
Nashville, Tenn.

TOKEN
3303 W. Ohio St.
Midland, Texas

TOLLIE
See VeeJay

TOP POP
6620 Kindred St.
Phila., Pa.

TOPIC
See B. Atlas

TOPIX
See London

TOPPA
729 Park Ave.
Covina, Calif.

TOPPER
1010 Cadillac Tower
Detroit, Mich.

TOPS
5810 S. Normandie
Los Angeles, Calif.

TOU-SEA
See Deesu

TOWER
151 W. 46
N.Y.C.

TOWN
1916 Fairbanks Rd.
Baltimore, Md.

TRADITION
80 E. 11th St., N.Y.C.

TRAIN
1201 Plymouth Ave.
Nashville, Tenn.

TRANS-WORLD
7250 Beverly Rd.
Los Angeles, Calif.

TRAYDEL
3511 DuPont Ave.
Kensington, Md.

TREND
P.O. Box 201
Smyrna, Ga. 30080

TREND/SIDE
See Trend

TRI
See London

TRI-ODE
1639 Broadway, N.Y.C.

TRI-PHI
592 Farnworth Ave.
Detroit, Mich.

TRIBE
See London

TRIBUTE
250 E. 51 St., N.Y.C.

TRILL
9341 1/2 Olympic Blvd.
Beverly Hills, Calif.

TROY
6201 Santa Monica Blvd.
Hollywood, Calif.

TRU-SOUND
See Prestige

TRUMP
1320 Armand Circle
Decatur, Ga.

TRUMPET
Box 62
Atlanta, Ga.

TURBAN
4811 Laurel Canyon Blvd.
N. Hollywood, Calif.

TURNABLE
235 W. 49th St.
New York 19, N.Y.

TUXEDO
132 Nassau St., N.Y.C.

TWENTIETH CENTURY-FOX
See ABC

TWENTIETH FOX
444 W. 56th St., N.Y.C.

TWIN
90-06 215th St.
Queens Village, N.Y.

TWIN HITS
See Operators

TWIN SPIN
320 Washington Ave.
Owensboro, N. Y.

TWIRL
20 W. Alexandrine
Detroit, Mich.

TYMENA
430 Pearce Rd.
Pittsburgh, Pa.

U.P.G.
1650 Broadway, N.Y.C.

U.S.
355 Madison Ave.
Milford, N.J.

U.S.A.
1448 S. Michigan Ave.
Chicago, Ill.

UTC
See Music Minus One

ULSYRA
35 W. 53 St.
N.Y.C.

UNI
8255 Sunset Blvd.
Los Angeles, Calif.

UNIQUE
See Globe

UNIQUE
1640 S. Ridgeway
Chicago, Ill.

UNITED ARTISTS
729 7th Ave., N.Y.C.

UNITED SOUTHERN
125 Albert Pike
Hot Springs Nat'l Park,
Ark.

UNITED WORLD
6004 7th Ave.
Brooklyn, N.Y.

UNITY
1560 N. La Brea
Hollywood, Calif.

UNIVERSAL ARTISTS
232 W. 48 St.
N.Y.C.

UNIVERSITY
480 Ridgeway
Little Rock, Ark.

UPTOWN
See Tower

URANIA
See Artia

URANIA
233 Main St.
Belleville, N.J.

UTOPIA
1617 No. Broad St.
Philadelphia, Pa.

V.I.P.
See Tamla

VALIANT
6290 Sunset Blvd.
Hollywood, Calif.

VALLI
1813 S. William St.
South Bend, Ind.

VALMOR
225 W. 57
N.Y.C.

VANDA
See Adams-Zetsch

VANDAN
8435 Maddox Ave.
Dallas, Texas

VANGUARD
154 W. 14th St., N.Y.C.

VANITY
253 21st St.
Paterson, N.J.

VARIETY
54 W. Randolph St.
Chicago, Ill.

VAULT
2525 W. Ninth
Los Angeles, Cal. 90006

VAULT OF OLDIES
See Little Walt

VENTURE
See Adams-Zetsch

VENUS
901-02 E. 108th St.
Los Angeles, Calif.

VERSAILLES
1650 Broadway, N.Y.C.

VERSATILE
See Wink

VERVE
See MGM

VERVE/FORECAST
See MGM

VESUVIUS
See MGM

VI-WAY
See CIRCA

VIBRO
612 15th Ave.
Belmar, N.J.

VIKING
P.O. Box 281
Crowley, La.

VILLA
445 Webster St.
San Francisco, Calif.

VILLAGE
P.O. Box 104
Long Beach, Miss.

VILLAGE GATE
See Amy

VIM
See Clock

VIRTUE
8500 Fayette St.
Philadelphia, Pa.

VISCOUNT
Carlton House, Pittsburgh

VISION
1000 Burwell Bldg.
Knoxville, Tenn.

VISTA
477 Madison Ave., N.Y.C.

VITA
1486 N. Fair Oaks
Pasadena, Calif.

VITALENT
See Jay-Gee

VIVA
1800 Argyle Ave.
Hollywood, Calif.

VOKES
P.O. Box 1203
New Kensington, Pa.

VOLCANO
c/o The Allen Ent.
P.O. Box 830
Hollywood, Cal. 90028

VOLT
See Atlantic

(Continued on page 64)



ESTABLISHED 1939

1041 N. LAS PALMAS H0. 6-7516
HOLLYWOOD 38, CALIF.

The largest independent pressing
plant in Hollywood. Matrix—
Labels—Albums—D.J. Mailings
—Drop Shipments—Warehousing—
Immediate Service—Competitive
Prices.

HAPPY ANNIVERSARY

From

CARNIVAL

&

CHADWICK RECORDS

And

ITS FAMILY OF HIT ARTISTS

★★

THE MANHATTANS
NORMA JENKINS
THE LOVETTES
THE TOPICS

LEE WILLIAMS
&
THE CYMBALS
PHIL TERRELL
HARRY CALDWELL

CARNIVAL RECORD CORPORATION
CHADWICK RECORD CORPORATION

24 Branford Place; Newark, New Jersey
(201) 623-3328

Fiesta

The leaders **GRECOPHON**



in the
international field, featuring
music from around the world

Many thanks to our foreign affiliates

FIESTA RECORD CO., INC.
1619 BROADWAY, N.Y. N.Y. 10019
212 PL 7-7760-1

.....**These Great Labels**.....
Now Available!
...from
ORPHEUM PRODUCTIONS
RIVERSIDE, JAZZLAND (Jazz)
WONDERLAND (Childrens)
WASHINGTON (Classical)
BATTLE (Gospel)

Write for catalogs and information:
ORPHEUM PRODUCTIONS, INC.

235 W. 46th Street, New York, N. Y. 10036

Hey, Paul!

**HERE WE ARE,
JUST MOLLY & ME**

Johnny Tillotson



FEATURING
Latest Single:

"Don't Tell Me It's Raining"

B/W

"Takin' It Easy"

RECORD #K13738

Molly Bee



FEATURING
Latest Single:

"You Win Again"

B/W

"I Hate To See Me Go"

RECORD #K13770

TANRIDGE PRODUCTIONS, INC.

161 W. 54th St., New York City, N.Y. 10019

Executive Producer:
PAUL TANNEN

RECORD MANUFACTURERS

(Continued from page 62)

VOX
236 W. 55th St., N.Y.C.

VULCAN
817 Bradford,
Sherwood Terrace
Nashville, Tennessee

W-E-D
P.O. Box 25187
Los Angeles, Calif.

WG
66 Elmwood Ave.
Holyoke, Mass. 01040

WGW
21 Franklin St.
Somerville, N. J.

WAND
See Scepter

WARE
217 W. 53 St.
N.Y.C.

WARNER BROS.
4000 Warner Blvd.
Burbank, Calif.

WASHINGTON
1340 Connecticut Ave.
Washington, D.C.

WAYSIDE
49 Concord St.
Maynard, Mass.

WEBER
9015 Wilshire Blvd.
Beverly Hills, Calif.

WEDGE
3101 Fleet St.
Baltimore, Md.

WES MAR
31 W. Market St.
Akron, Ohio 44308

WESTERN AMERICAN
Box 38306
Hollywood, Cal. 90038

WESTEX
Box 6406
Odessa, Tex.

WESTMINSTER
See ABC

WHALE
1721 Broadway, N.Y.C.

WHEEL CITY
See Music Merchants
WHEELING
Box 902, Wheeling,
Va.

WHEELSVILLE, U.S.A.
See D-Town

WHIP
510 Anderson Ave.
Cliffside Park, N.J.

WHIPPETT
8566 Sunset Blvd.
Los Angeles, Calif.

WHIRLYBIRD
c/o Audio Arts
5607-11 Melrose Ave.
Hollywood, Calif.

WHIT
See Paula

WHITE CLIFFS
748 Camp St.
New Orleans, La.

WHITEHALL
See ABC

WHITE ROCK
401 Wintermantle Ave.
Scranton, Pa. 18505

WHITE WHALE
8961 Sunset Blvd.
L.A., Calif.

WILBEE RECORDS
160 Wood Street,
Wilkes-Barre, Pa.

WILD DEUCE
1619 B'way
N.Y.C.

WILDCAT
1611 Broadway
San Antonio, Tex.

WIN
27 Stegman Pl.
Jersey City, N.J.

WIN GATE
See Golden World

WINDY C
See Cameo

WING
See Mercury

WINDSOR
See CIRCA

WINSTON
P.O. Box 1982
Abilene, Tex.

WORD
P.O. Box 1780
Waco, Texas

WORLD
See Robbee

WORLD PACIFIC
See Liberty

WORLD WIDE
524 Plasters Ave.
Atlanta, Ga. 30324

WORLD WIDE
56 Ferry St.
Newark, N.J.

WYE
625 Warwick Ave.
Warwick, R.I.

WYNCOTE
c/o Cameo Parkway

YALE
9 Jefferson Ave.
Elizabeth, N.J.

YORK
See Amy

YORKTOWN
347 Litchfield Ave.
Babylon, N. Y.

YOUMER
c/o Gaye Talent Pro-
duction P.O. Box 13612
Station K Atlanta, Ga.
30324

YOUNG PEOPLE'S
100 Sixth Ave., N.Y.C.

YUCCA
P.O. Box 641
1507 10th St.
Alamogordo, N.M.

ZEBRA
31 Brompton Rd.
Garden City, N.Y.

ZIP
818 64th St.
Union Beach, N.J.

ZONE
P.O. Box 4692
Memphis, Tenn.

FERMATA LEADS AGAIN

-1967-

34 AWARDS 34

More than in any previous first-half year!

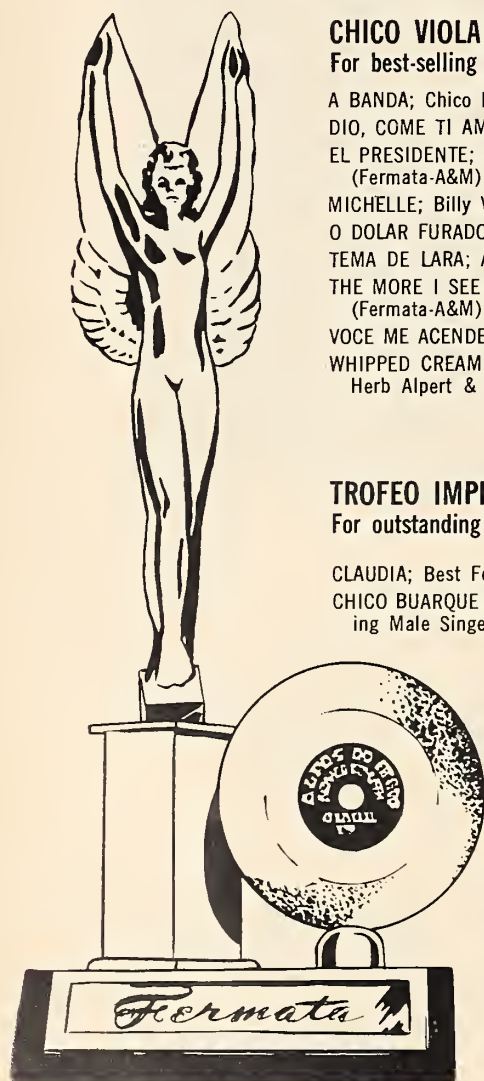

CHICO VIOLA AWARD:

For best-selling record of the year.

A BANDA; Chico Buarque de Hollanda (RGE)
DIO, COME TI AMO; Gigliola Cinquetti (RGE)
EL PRESIDENTE; Herb Alpert & TJB
(Fermata-A&M)
MICHELLE; Billy Vaughn (RGE-DOT)
O DOLAR FURADO; Sound Track (Fermata)
TEMA DE LARA; Al Korvin (Fermata)
THE MORE I SEE YOU; Chris Montez
(Fermata-A&M)
VOCE ME ACENDE; Erasmo Carlos (RGE)
WHIPPED CREAM & OTHER DELIGHTS;
Herb Alpert & TJB (Fermata-A&M)

TROFEO IMPRENSA AWARD:

For outstanding TV performance.

CLAUDIA; Best Female Singer (Discos RGE)
CHICO BUARQUE DE HOLLANDA; Most promis-
ing Male Singer (Discos RGE)

PREMIO GUARANI AWARD:

For exceptional performance on record.

HERB ALPERT & TJB; Best Orchestra
(Fermata-A&M)
CHICO BUARQUE DE HOLLANDA;
Best Composer (RGE)
SERGIO MENDEZ & BRASIL '66; Best Brazilian
Music recorded abroad (Fermata-A&M)
CHRIS MONTEZ; Most Promising Young Singer
(Fermata-A&M)
SOM TRÉS; Best Instrumental Group
(Som/Maior)
TOQUINHO; Most Promising Young Musician
(Fermata)

INT'L. RECORD FESTIVAL AWARDS:

For world-wide record competition.

BEN MOLAR; Best Producer of Popular Music—
"14 Con El Tango"
HERB ALPERT & TJB; Int'l. Dance Music Award
SACHA DISTEL; Best Performance by a
Foreign Artist
THE TROGGS; Best New Interpreters of
Teen-Age Music
ENRIQUE DUMAS; Special Mention—Vocalist—
"14 Con El Tango"

OUTSTANDING COPYRIGHTS AWARDS:

A BANDA (original copyright) Double Award	MEU BEM
A TUA VOZ	MICHELLE — Double Award
A VOLTA (original copyright)	STRANGERS IN THE NIGHT
CORUJA (original copyright)	TRISTEZA (original copyright)
HELP	YESTERDAY

WON BY:

Discos RGE Ltda.; Produções Fermata; Discos Som/Maior;
Producciones Fermata; Fermata do Brasil

You are offered unusual opportunities for recording and/or publishing in the U.S. and Canada.
Choose from world-acclaimed catalogue of current Latin-American favorites.

For information regarding recording or publishing, contact:

FERMATA INT'L. MELODIES, Inc. (A.S.C.A.P.)
BENDIG MUSIC CORP. (B.M.I.)

D. FRENKIEL, Mgr. 6290 Sunset Boulevard
Hollywood, Calif. 90028 • Phone: (213) 462-7473

REQUEST RECORDS

LEADS THE **INTERNATIONAL FIELD**

with **MUSIC OF MANY LANDS,**

beautifully packaged,

featuring the finest,

AFRICAN, AMERICAN, ARABIC, ARMENIAN, AUSTRIAN, BALINESE, CAUCASIAN, CUBAN, CZECHOSLOVAKIAN, FRENCH, GERMAN, GREEK,

GUIANIAN, GYPSY, HAITIAN, HUNGARIAN, INDIAN, IRISH, ISRAELI, ITALIAN, JAPANESE, JEWISH, KOREAN, LATIN, LITHUANIAN, MEXICAN, POL-

ISH, PORTUGUESE, ROUMANIAN, RUSSIAN, SCOTTISH, SPANISH, TURKISH, UKRANIAN, WEST INDIAN, YIDDISH, YUGOSLAVIAN

artists.

and many more to come.

Distribution for some countries still available.

REQUEST RECORDS, 66 Mechanic Street, New Rochelle, N. Y. 10801—Telephone 914 633-6055, 914 633-6059

In Canada, we know a good thing when we sell it. We've got a meltingpotful of people from many different countries, but since we're a young nation they haven't all melted yet. They go in a big way for listening to the music of their native lands and cultures. That's why REQUEST RECORDS are selling tremendously well here, and we know they're a good thing!

EXCLUSIVELY
RCA VICTOR
The most trusted name in sound

RCA VICTOR (Canada) Ltd.
Distributors of REQUEST RECORDS
in Canada

WE ARE PROUD TO BE ASSOCIATED WITH
THE EXCELLENT REQUEST RECORDS
INTERNATIONAL CATALOG.

NOW AVAILABLE FROM YOUR
RCA VICTOR/RCA CAMDEN
DISTRIBUTORS.

For free catalog, write
Foreign Records, RCA Victor Records,
155 E. 24th St., N.Y. 10010.

RCA VICTOR
The most trusted name in sound

RECORD DISTRIBUTORS

AND THE LINES THEY HANDLE •NARM MEMBERS

ARIZONA

TUCSON—16021

Action Record Distributors
815 East Broadway
Frank Davis—623-0318
(Santa Cruz, Thunder, Copper State, Ole)

CALIFORNIA

LOS ANGELES—(213)

Advance Distributors
6376 Yucca Street
(Hollywood)
Tim Gayle—463-2151
(Advance, Chroma, Pepper Tree, Yvette, Capa, Buff, Round-Up, Sommers, Drink Small, Pony, Blue Bird, Thompson)

California Record Distributors
2525 West 9th Street
Ralph Kaffel—386-1821
(Amy, Alegre, Archives Of Folk Music, Archives Of Piano Music, Arvee, Audio Arts, Audicon, Aurora, Baroque, Bell, Big Top, Cadet, Chess, Checker, Choral, Carnival, Cetra, Concertdisc, Chisa, Debut, Diamond, Dynovoice, Dollie, Elf, E.S.P. Disk, Everest, Esoteric, Fantasy, Fairmount, Fiesta, Fat Fish, Flashback, Grecophon, Kalaxy, Goldwax, Gamble, Groovy, Groovesville, Hifi, Janus, Kent, K.R., Kenwood, Laurie, Legend, Lucky 11, Mala, Musicland, USA, Modern, Monitor, Magnum, Mardigras, Newvoice, Prestige, Revitol, Ric Tic, Round, Rust, Renaissance, Squier, St. Lawrence, Sansu, Sphere Sound, Solid Hit, Scorpio, Scala, Showtime, Showplace, Tomorrow, Thomas, Tradition, Taurus, Tuba, Tico, United, Virgo, Windy C, Winchester, Wilson, York)

Capitol Records Dist.
3117 San Fernando Rd.
Charlie Bratnaber—CL 7-8224
(Angel, Capitol)

Chapman Dist. Co.
2645 W. Pico Blvd.
Al Chapman—385-3636
(Accent, Alwin, Air Town, Band Box, Cabot Lang., Cambridge, Canaan, Chattahoochie, Conversaphone, Continental, Connoisseur Soc., Children Rec. Guild, CMS, Cricket, Haydn-Soc., International Artist, Kalamo, Living Lang., Milestone, Motivation, Music Minus One, Peter Pan, Pickwick, Sacred, Serenus, Simon Says, Spoken Arts, Sword, Tikva, Titan, Whittier, Whirlybird, Word, Yardbird, Young Peoples Rec.)

Creative Sound Productions
9000 Sunset Blvd.
Bob Cotterell—CR 1-4843
(Creative Sound, Surfari, Sunset, Pickwick/33, 101 Strings (Alshire Presents), Design, Liberty (Premium), Somerset, Happy Time, Audie Bible Studies, Grand Prix)

Creast Sales, Inc.
2542 W. Pico Blvd.
386-8720
(Discos Columbia, Fuentes, Miami, Regina, Ideal)

Columbia Records
6922 Hollywood Blvd.
Robert E. Murphy—466-2481
(Columbia, Date, Ode, Masterwork Phonographs)

Decca Distributing Corporation
4750 Santa Monica Blvd.
Louis Verzola—463-7126
(Decca, Coral, Brunswick, LHI, Berlitz, Vocalion)

Diamond Distributing Company
2990 West Pico Boulevard
Abe Diamond—731-6311
(ABC, Command, Dunhill, Fraternity, Grand Award, Impulse, Mahalo, Music Guild, Nippon, Time, 20th Century Fox, Waikiki, Westminster)

Festival Record Dist.
2769 West Pico
John Filchich—734-6220
(Ace of Clubs, Alector, Apon, Avoca, Artia, B&F, Balkan, Barenreiter, Bruno, Canary & Parakeet, Colonial, Colosseum, Continental, Dana, Dover, Eurotone, Gateway, Gregorian Institute, Helios, I.M.F. Kismet, Nina, Rainbow, Standard, Ultraphone)

Hart Dist., Inc.
1845 Orchard Avenue
Ross Burdick—748-2281
(Warner Bros., Reprise, Loma, Disneyland, Buena Vista, Veep)

Hitsville, Inc.
2525 W. 9th St.
Ralph Kaffel, Gil Bogas—386-1821
(Gordy, Melody, Motown, Soul, Tamla, VIP, Workshop)

Liberty Records Dist.
3018 W. Pico Blvd.
David Hunter—733-1134
(Dalton, Imperial, Liberty, World Pacific, Sunset, Blue Note, Stereo Tape)

Merit Distributing Corp.
2525 West 9th Street
Jack Lewerke, Wm. Pieper—386-1821
(Atlantic, Atco, Ace of Hearts, Ace of Clubs, Back Beat, Battle, Brooklyn, Carlo, Challenge, Choir, Clarion, Contact, Contemporary, Dakar, Dial, Duke, Dunwich, Fame, Flashback, Focus, Good Time Jazz, Jazzland, Karen, Lost Nite, Mainstream, Moonglow, Peacock, Phyllis, Riverside, Milestone, Jazzman/Riverside, Specialty, Stax, Tomorrow, Triumph, Vault, Venus, Volt, Won-Der-Ful, Washington)

Merrec Distributors
2617 South Broadway
George A. Steiner—748-9821
(Mercury, Philips, Smash, Fontana, Limelight, Wing, 4 Track Tape, B Track Tape, Cassette Tapes, Mercury Home Entertainment Products)

Metro Record Distributors
2053 Venice Blvd.
Mel Price—733-2112
(MGM, Verve, Metro, VSP, D.G.G., Verve/Folkways, Heliodor, Leo the Lion, Original Sound, Golden, Canterbury)

PEP Record Sales
2958 W. Pico Blvd.
Ron Ricklin—RE 5-1297
(Alon, Arco, Audio Fidelity, Boone, Coedmon, Chart, Colonial, Delmark, Double Shot, Dyer-Bennett, El Dorado, Epic, Eterna, Experiences Anco, Federal, Folk Legacy, Folkways, 49th State, Go Go, Hollywood, Hilltop, King, Longhorn, Lyrichord, Mosrite, Motivation, MTA, Okeh, Pow, Project 3, Ramco, Starday, SunGlow, Testament, Tiara-Tahiti, Uni, Vanguard, Vox)

Privilege Distributors
2818 W. Pico Blvd.
Norm Goodwin—731-3148
(United Artists, Monument, Tower, GNP Crescendo, Hickory, Alshire 101 Strings, Somerset Stereo Fidelity, Fink, Rampart, Peerless, ECO, Sonart, CISNE, Mobile Fidelity, Mustang, Bronco)

RCA Victor Dist. Corp.
6051 Telegraph Road
David G. Pearce—723-6661
(RCA Victor)

Record Distributors
2980 W. Pico Blvd.
Raymond Shevin—731-4133
(Orfeon, Musart, Bego, Primovox, Colonial, Sunghow, Teardrop, Demarco, Gema, Discuba)

Record Merchandising
2580 W. Pico Blvd.
Sid Talmadge—DU 5-9161
(A&M, Artic, Calla, Cameo, CO & CE, Dooto, Dore, Elektra, Era, Flip, Four Corners, Highland, Jamie, Josie, Joda, Jubilee, Kapp, Money, Mira, Mirwood, Parkway, Musicart, Parrot, Pure Soul, Savoy, Scepter, Sue, Sun, Swan, Ten Star, Wand, White Whale)

Record Sales Company
222 W. Orange Grove Avenue
(Burbank)
Al Sherman—849-4671
(Somerset-Stereo Fidelity, Audio Spectrum, Alshire 101 Strings, Paloma, Azteca)

Record Sales Inc.
2958 West Pico Blvd.
Ron Ricklin—RE 5-1297
(Alon, Arco, Arhoolie, Boone, Coedmon, Chart, Colonial Delmark, Double Shot, Dyer-Bennett, El Dorado, Epic Eterna, Experiences Anco, Federal, Folk Legacy, Folkways, 49th State, Go Go, Hollywood, Hilltop, King Longhorn, Lyrichord, Mosrite, Motivation, MTA, Okeh, Pow, Project 3, Ramco, Starday, SunGlow, Tesetment, Tiara-Tahiti, Uni, Vanguard, Vox, Audio Fidelity)

United Tape Corporation
2525 W. 9th Street
Ralph Kaffel—386-1821
(ABC-Paramount, A&M, Amy, Atco, Atlantic, Audio Fidelity, Bang, Bell, Borderline, Brunswick, Cadet, Cameo, Capitol, Charter, Checker, Chess, Col-Pix, Command, Coral, Crescendo, Decca, Del-Tone, Dot, Dunhill, Dunwich, Dynovoice, Elektra, Everest, Fantasy, Fat Fish, Focus, Fontana, 49th State, Good Time Jazz, Gordy, Grand Award, Hamilton, Hi, Hi-Fi, Impulse, Kama Sutra, Kapp, King, Laurie, Liberty, Life, Limelight, London, Mainstream, Mercury, MGM, Monitor, Monument, Moonglow, Motown, Musicor, New Voice, Original Sound, Parkway, Philips, Phyllis, Pickwick, Press, Reprise, Roulette, Scepter, Smash, Soul, Starday, Stax, Tamla, Tico, 20th Century Fox, Valiant, Vanguard, Vault, Vee-Jay, Verve, Viva, Volt, Waikiki, Wand, Warner Bros., White Whale)

World-Wide Record Dist.
2596 W. Pico Blvd.
Ted Pansetti—387-8127
(Dot, Viva, Acta)

OAKLAND—(415)

Chatton Distributing Co.
2517 San Pablo Avenue
Bob Chatton, Vince Cosgrave—444-5677
(Accent Atlantic Cadet, Checker, Chess, Dial, Dore, Era, Excelllo, Focus, Four Corners, Fraternity, Jewel, Kapp, LeGrand, Living Language, Nashboro, Paula, Specialty, Stax Tahiti)

SAN FRANCISCO—(415)

Acme Sales Company
P.O. Box 5603
Olen Harrison—UN 3-6674
(Proverb, Gospel Corner, Carnival, Glad Hamp, Ideal, Audio-Gospel, Rae Cox, Lyrichord, Experience, Eterna, Smogville, Mosley)

Callectron
460 Talbert Avenue.
Merritt B. Kirk, Ted Fullmer—586-7000
(RCA Victor, RCA Camden, Vanguard, All Lines—4-Track, All Lines—8-Track, All Lines—Reel-to-reel, Cassette)

H. R. Basford Co. (I.M.S.)
800 Mariposa St.
Jack Selinger—626-5494
(Abnak, Amy, Archive of Folk Music, Arctic, Attack, Audicon, Audio Arts, Avant Garde, Backbeat, Bang, Barry, Belfast, Bell, Bethlehem, Blue Note, Brent, Bronco, Calla, Cameo, Captain, Challenge, Charay, Charger, Chart, Chisa, Co&Ce, Coed, Constellation, Cotique, Crusader, Dance Along, Dearborn, Diann, Dollie, Duke, Dynovoice, Elf, Emerald, Everest, Federal, First Amendment, Flashback, Flip, Freedom, Gamble, Golden State, Goldwax, Gordy, Groovy, Guyden, Halo, Hi-Fi, Hob, I.A., In, Instant Learning, Jaguar, Jamie, Jerhart, Jetstream, Keane, Kellmac, Kent, King, Laurie, Lucky 11, Mala, Mar-V-Lus, Milestone, Mira, Mirwood, Modern, Monitor, Monte, MoSoul, Motown, M-Pac, MTA, Mustang, NewVoice, One/der/ful, Original Sound, Parkway, Peacock, Phyllis, Pickwick, Rajac, Scepter, Sentar, Shout, Songbird, Soul, Sphere Sound, Tamla, Taurus, Teardrop, Uni, United, UTC, Villa, VIP, Wand, White Whale, Windy C, World United, York)
(Archive, Archive of Piano Music, Artia, Baroque, Cetra, Classic Editions, Concert Disc, Counterpoint, Composers Recordings, Deutsche Grammophon, Everest, Mace, Monitor, Music Minus One, Parliament, Period, Pickwick, Piroquette, Renaissance, Rutgers, Scala, Stradivari, Summit, Turnabout, Vox)
(Azteca, Bega, Bronco, Cisne, Colonial, Discmoda, Discos Columbia, Disco Grande, DLV, Eco, Falcon, Fuentes, Gema, Miami, Musart, Orfeon, Paloma, Pan-Am, Peerless, Primovox, Sonart, Secca, Tropical)
(Tapes—Gordy, Motown, Pickwick, Soul, Tamla)

Capitol Record Dist. Co.
475 Barneveld St.
Bob Setzer—VA 6-5454
(Capitol, Angel)

Columbia Record Sales
Fox Plaza Suite 810
Ed Hall—431-6996
(Columbia, ODE, Date)

C & C Stone Distributing Co.
233 Utah Avenue, So.
Ralph Parsons, Bob Ellis—871-8677
(ABC, Command, Dunhill, Impulse, 20th Fox, A&M, Liberty, Imperial, Dalton, Monument, London, Disneyland, Buddha, United Artists)

Decca Distributing Corp.
66 Dorman Ave.
Bob Eggers—824-0161
(Decca, Coral, Brunswick, LHI, Word, Berlitz Language)

Eric-Mainland Dist.
645 Bryant St.
William Wieland—989-6286
(MGM, Verve, Metro, Leo, VSP, Heliodor, Kama Sutra, Verve Folkways, ATCO, Audio Fidelity, Volt, Moonglow, Dunwich, Folkways, Fiesta, Golden, Hanna Barbera, Mainstream, Time, Musicor, Prestige, Dynamo, Project 3, Riverside, Wanderland, Jazzland, Roulette, Tico, Allegre, Mardi Gras, Savoy, Starday, Sun, 101 Strings, Roost, Makaha, Little Darlin, MGM, Playtape, Rhapsodia, Compass, Alvorado)

Festival Record Dist.
161 Turk St.
Ed Kremers—775-3434
(Ace of Clubs, Alector, Amadeo, Angelicum, Apon, Arab Tunes, Avoca, B&F, Balkan, Barenreiter, Bruno, Cambridge, Canary, Children's Record Guild, Colonial, Colosseum, Conversaphone, Dana, Dover, Dyer-Bennett, Eterna, Eurotone, Folkkraft, Gregorian Institute, Harmonia Mundi, Haydn Society, Helios, I.M.F., Kismet, Lyrichord, Music Library, Nina, Russell, Spoken Arts, Standard, Steno Speed, Stinson, Tikva, Ultraphone, Young People's Records)

Melody Sales Co.
444 Sixth Street
Al Brame, Tony Valerio—621-8740
(Coedmon, Contemporary, Crescendo, Crossroads, Elektra, Epic, Fantasy, Hickory, Nonesuch, Okeh, Pacific Jazz, Reprise, Warner Bros., World Pacific)

Privilege Dist.
82 Dorman Ave.
Jack Nelson—648-6870
(Aertoun, B.T. Puppy, Chex, Gross, Josie, Jubilee, K.R. Media, Mobile-Fidelity, Morocco, Port, (R), Rampart, Riot, Sidewalk, Take 6, Todd, Tower, Uptown)

World Wide Record Dist.
70 Dorman Ave.
Bob Davenport—648-5061
(Dot, Viva, Acta, Fiesta, Hamilton)

COLORADO

DENVER—(303)

Action Record Dist. Co.
1622 Federal Blvd.
Earl Woolf—222-1681
(ABC Paramount, Award Artists, Audio Fidelity, Audio Rarities, Blue Verve, Challenge, Colpix, Command, Crossroads, Dunhill, DGG, Double Shot, Electro, Epic, Fiesta, Fox, Grand Award, Gordy, Heliodor, Impulse, Impact, Jorden, Karate, Kama Sutra, Little Darling, Leo, MGM, Mainstream, M.T.A., Motown, Mira, Mirwood, Metro, Movietone, Music Guild, Mustang, Nonesuch, Original Sound, Okeh, Red Bird, Soul, Simon Says, Surrey, Tamla, Tangerine, Truth, Tuba, Universal City, V.I.P., Verve Folkways, Verve Trend, Verve, Veep, VSP, Westminster)

Boyd Distributing Co., Inc.
1661 West Third Ave.
Joe Caravana—222-7701
(Capitol, Angel, Melodiya, Angel, Seraphim)

Craig Corporation
4959 Colorado Blvd.
Bob Stevens—399-0434
(Columbia, Epic, Okeh, ODE)

(Continued on page 68)

WE'RE PROUD
OF MAKING HITS
FOR QUALITY DISTRIBUTION

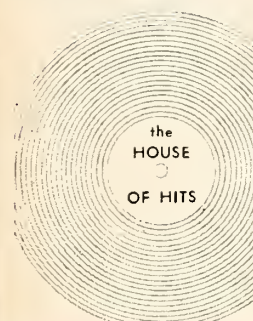

ROBERTS
RECORD
DISTRIBUTING
COMPANY
1900 WASHINGTON AVE., ST. LOUIS, MISSOURI 63103

IN THE SOUTH
IT'S
ALL SOUTH

ALL SOUTH DISTRIBUTING CO.

1924 Lafayette St., New Orleans, La.

Henry Hildebrand, Jr.

504-522-1157

TRI-STATE DISTRIBUTION

New Jersey

New York

Connecticut

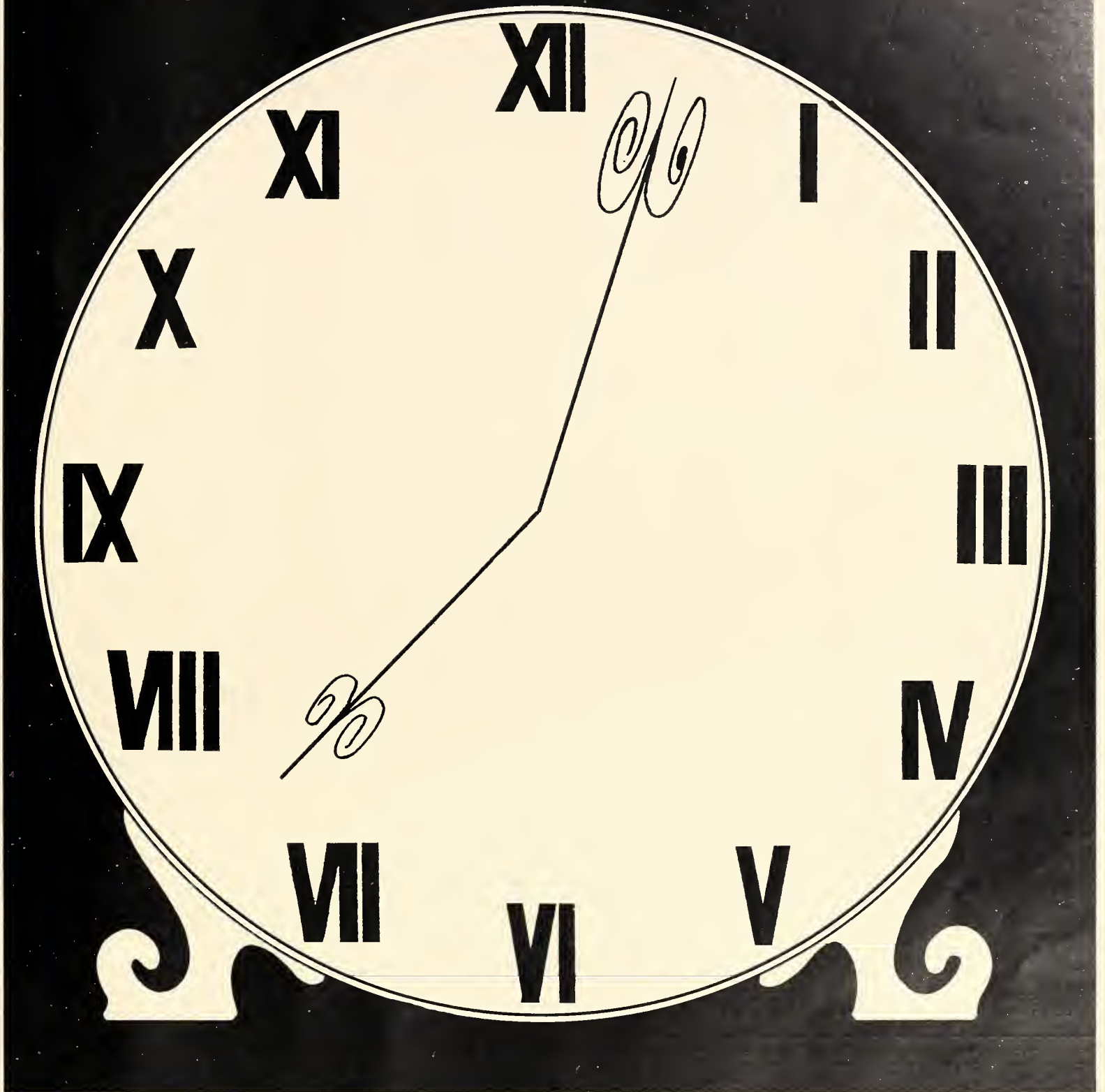

MOST DEPENDABLE INDEPENDENT DISTRIBUTOR.

ALPHA DISTRIBUTING CORP.

20 West End Ave. New York, N.Y. 10023 A/C (212) CI-5-7933

RECORD DISTRIBUTORS

and the lines they handle •NARM members

DISTRICT OF COLUMBIA

WASHINGTON D.C.—(202)

•Columbia Records Sales
Suite 1113 Universal Building North
1875 Connecticut Avenue, N.W.
George Deacon—332-2300
(Columbia, Date)

General Dist. Co., Inc.
2329 Pennsylvania Avenue
(Baltimore, Maryland)
Henry Nathanson—669-6411
(See Baltimore for Lines Handled)

•Schwartz Brothers, Inc.
2146 24th Place N.E.
James Schwartz—529-5700

(A&M, Atco, Volt, Carla, Fame, Dunwich, Atlantic, Stax, Karen, Dial, Bang, Shout, Blue Note, Humorsonic, Cadet, Chess, Checker, Challenge, Deutsche Grammophon, Esp-Disk, Electra, Nonesuch, GNP, Crescendo, Good Time Jazz, Hickory, Jewel, Paula, Ronn, Kapp, Four Corners, King, Federal, Liberty, Imperial, Dalton, Minit, Sunset, World Pacific, Pacific Jazz, Soul City, Main Line, Manument, Sound Stage 7, Matown, Gordy, Soul, Tamla, V.I.P., Compass, Musicor, Original Sound, Polmer, Project 3, Somerset, Stereo Fidelity, Alshire, Reprise, Riverside, Wonderland, Roulette, End, Kenwood, Raast, Tico, Gone, Sama, Stereo-Odities, Starday, Hollywood, Nashville, U.S.A., Destination, Universal City, Vanguard, Verve, Verve Folkways, Heliodor, VSP, Warner Bros., Valiant, White Whale, Loma, Abnak, Chariot, Legrand)

FLORIDA

HIALEAH—(305)

Capitol Records Dist. Corp.
80 East 10th Ave.
Paul Butler—887-4319
(Angel, Capitol)

Tone Distributors
495 S.E. 10th Ct.
Henry Stone, Milt Oshins—888-1685
(ABC, Amy, Mala, Atlantic, Atco, Bang, Shout, Chess, Checker, Cadet, Cameo, Parkway, Duke, Dade, Dial, Dunhill, Diamond, Impulse, Manument, Soundstage, London Group, Ron, Stax, Matown, Tamla, Gordy, Soul, V.I.P., Jubilee, Jasie, Kent, Modern, Roulette, Fame, 20th Century, Original Sound, Laurie, Rust, Dover, Parlo, Jewel, Paia, United Artists, Warner Bros., Reprise, Universal, Wand, Scepter, Destination, USA, Revilott, Ric-Tic, Command, Westminster, Fraternity, Tangerine, Vogue)

MIAMI—(305)

Campus Record Distributing Corp.
6751 N.W. 37th Court
Joseph Stanzone—691-3140
(Epic, Okeh, Crossroads, A&M, Jamie/Guyden, Starday, Peacock, Back Beat, Canadian American, Double Shot, White Whale, Tower, Music Minus One, Challenge, Abnak, International Artists, Peacock, Ra-Joc, Arctic, Diann, Phil-La of Saul, Crash, Hollywood, Impact, Mustang, Nashville, Songs of Faith, Alshire, Independence, Mo Jo, Sidewalk, Minaret, Money, Deep City, Sure-Shot, Charoy, Dynamo, Halo, Hi-Way, Songbird, Onerful/Marvlus, Vault, Fat Fish)

•Columbia Records Dist.
3641 N.W. 67th St.
Bob Beasley—OX 6-0033
(Columbia, Date, ODE)

•Decca Dist. Corp.
2452 N.W. 77th Terrace
Bert Jones—691-4816
(Decca, Coral, Brunswick, LHI, Berlitz Language Records and Tapes)

•Liberty Records Dist. Co. of Flo.
2453 N.W. 77th Terrace
Dominic Alvino—696-2010
(Liberty, Dalton, Imperial, World Pacific, Minit, Pacific Jazz, & Sunset, Cartridge Tapes)

•Main Line Record Service
54 N.E. 181st Street
Sherman Lieberman—621-3694
(MGM, Verve, Prestige, Crescendo, Deutsche Grammophon, Valiant, Musicor)

•Merrec Distributors
Biscayne Shopping Plaza—Suite 227
561 N.E. 79th Street
Ronald M. Kultau—758-4797
(Mercury, Philips, Smash, Fontana, Limelight)

Music Sales of Florida, Inc.
2450 N.W. 77th Terrace
Don Smith—691-0340
(Allegro, After Hours, Audio Book, Audio Fidelity, Bottle, Bethlehem, Boone, Canaan, Coedman, Carib, Chort, Contemporary, Crestview, Dooto, Elektro, E.S.P., Fantasy, Fax, Federal, Galaxy, Golden, Good Time Jazz, Happy Time, Hickory, K-Ark, Living Language, London, Mainstream, MTA, Nonesuch, Richmond, Riverside, Sacred, Sims, Sama, Stereodities, Wonderland, Word, Pre-Recorded Tapes, Ampex, G.R.T., London, Mercury, Muntz, Philips, Richmond, Smash)

Sea Coast Appliance Dist., Inc.
3575 N.W. 60th Street
J. W. Shockey—635-0951
(RCA Victor, RCA Camden, RCA Victor, Colgems, Request, RCA Stereo 8, RCA Mexican)

•World Wide Record Dists.
2335 N.W. 8th Ave.
Polly Reese—633-0643
(Dot, Vivo, Acta, Fiesta, Hamilton)

(Continued on page 70)

•Davis Sales Co.
3825 Newport

S. William Davis—355-1638
(Atco, Atlantic, A&M, Everest, Kent, Dot, Imperial, Laurie, Liberty, London, Monument, Tower, Scepter-Wand, Somo, Time, World Pacific, Duke, Bang, Dover, Co & Co.)

•Denver Record Dist.
3825 Newport

S. William Davis—355-1638
(Amy, Bell, Mala, New Voice, Dynavoice, Reprise, Warner Bras., Vanguard, Happytime, Twinkle)

One Stop Record Dist.
725 So. Broadway

Robert M. Baker—777-4431
(United Artists, Kopp, Project 3, Fraternity, Little Golden, Ascot, Music Minus One, Tale Spinners, Solid State, Pondo, Vox, Stereo Fidelity)

Pan American Record Supply Co. Inc.
77 Kalamath St.

Louis Oxman—255-2021
(Zithlooid, Blue Note, B/T Puppy, Cadet, Chess, Checker, Cameo, Conversaphone, GNP, Crescendo, Diamond, Distation Disc, Dooto, Fantasy, Finer Arts, Hickory, Jubilee, King, Living Language, Parkway, Prestige, Riverside, Roulette, Jamie Guyden, Vanguard, White Whale, Starday, Jewel, Paula, Whit, Nashville Sound)

Ward Terry & Co.
70 Ria Grande Blvd.

Robert K. Davis—266-3181
(RCA Victor, RCA Camden)

CONNECTICUT

EAST HARTFORD—(203)

•Allied Record Distributors
360 Tolland Street

Frank Butler—289-7431
(ABC, Blue Note, Bluesway, Command, Dunhill, Fleetwood, Hickory, Hob, Impulse, Mace, Monument, Music Guild, Philes, Prestige, Scepter, Sun Tangerine, Tower, 20th Century Fax, Verve, Verve Folkways, VSP, Wand, Westminster)

•Associated Record Distributors
360 Tolland Street

Frank P. Kelley—289-7431
(Alshire, Archive, Audio Fidelity, B. T. Puppy, Bert & I, Cabot, Caedman, Challenge, Dauntless, DGG, Dictation Disc, Dover, Fiesta, Golden, Gramophone, Hanno-Barbera, Hoydn Society, Heliodor, Hilltop, Jasie, Jubilee, Life, Little Darlin', Mainstream, Manitar, Music Minus One, Pickwick, Reprise, Riverside, Somerset, Stereodities, Sterea Fidelity, Warner Bros., Wonderland)

•Columbia Record Sales
100 Constitution Plaza

Stephen J. Capone—522-7151
(Columbia, Date, ODE, Odyssey)

•Eastern Record Distributors, Inc.
360 Tolland Street

Dick Godlewski—289-7431
(Bach Guild, Bang, Children's Record Guild, CO & CE, Crossroads, Dyno, Epic, Four Corners, Jay Jay, Koma Sutra, Kapp, Lea the Lion, Living Language, Laren, Lyra, Metra, MGM, Motivation, MTA, Okeh, Project 3, Shout, Starday, Tom Lehrer, Valiant, Vanguard, Young People)

Globe Record Distributing Corp.
308 Tolland St.

Carl Padula—289-6424
(Abnak, Airtown, Alector, Ambassador, Asch, Avante Garde, Bandabax, Banshee, Big Wheel, Braadside, Calla, Cameo, Canaan, Capa, Chort, Current, Davy Jones, Destination, Dover Classics, Downbeat, Evergreen, Fairmount, Fat Fish, Fortune, Fury, Gamble, Glasco, Groovesville, Groovy, Goodtime, Halo, Hep, International Artist, Johnson, K-Ark, Kayden, Listen and Learn, Longhorn, Lucky Eleven, Mar V Lus, Magic City, Nina, One Der Ful, Pacific Challenger, Pathway of Sound, Parkway, Peter Pan, Pow, RBF, Rebel, Revilott, Sacred, Sahara, Sentor, Showplace, Sims, Solid Hit, Sound On Sound, Stop, Terry-Gregory, Tomorrow, Thunderbird, Tubo, Turnabout, USA, Vault, Vox, Washington, Windy C, Winchester, Ward)

Radio & Appliance Dist., Inc.
95 Leggett Street

Alan Sack—528-6581
(RCA Victor)

•Seaboard Dist., Inc.
275 Park Ave.

Marv Ginsburg—289-9361
(Amy, Atco, Atlantic, Bell, Codet, Checker, Chess, Diamond, Disneyland, Dial, Dalton, Dynavoice, Elektro, Imperial, Liberty, Limelight, Mercury, New Voice, Pacific Jazz, Philips, Roulette, Stax, Sunset, Crescendo, Original Sound, Tico, UNI, Visto, Valt, White Whale, World Pacific, Nonesuch)

Trinity Record Dist.
477 Park Ave.

Big Ed DiNallo—289-4349
(A&M, Asch, Archive of Folk Music, Ascot, Athlooid, Beacon, Bonif, Baroque, Bethlehem, Conversaphone, Concert Disc, Counterpoint, Cetra Opera Series, Dance Along, Duke, Dynamo, Dionne, Everest, Excello, Fantasy, Folkways, Fontana, Federal, Fraternity, Galaxy, Gordy, Gospel, Hi Fi, Jamie, Jewel, King, Laurie, Life, Matown, Musicor, Mark Two, Noshboro, Peacock, Paula, Pelnor, Period, Regent, Savoy, Smash, Soul, Specialty, Spoken Arts, Shorp, Solid State, Songbird, Tomolo, Tikva, United Artists, VIP, Veep)



SCHWARTZ BROTHERS, INC.

AREA'S LARGEST DISTRIBUTOR

2146 24th Place, N.E.
Washington, D.C. 20018
(202) 529-5700

SERVING: MARYLAND—VIRGINIA—
W. VIRGINIA, DELAWARE &
DISTRICT OF COLUMBIA

DISTRICT RECORDS, INC.

AREA'S MOST MODERN RECORD MERCHANDISER USING AUTOMATED SYSTEMS

2146 24th Place, N.E.
Washington, D.C. 20018
(202) 832-3600

For "Instants" in the West

PROMOTION EXPLOITATION PROFIT

RON RICKLIN



RECORD SALES, INC.
3009 WEST PICO BLVD.
LOS ANGELES, CALIFORNIA 90006

LOS ANGELES
LOS ANGELES
LOS ANGELES

In Detroit

The Fanfare is for . . . OUR 7th ANNIVERSARY

music merchants, inc.

3731 Woodward Ave., Detroit 1, Mich. TE 2-0870

WE BREAK RECORDS

(sometimes just for fun)

WE MOVE PRODUCT

(the way it should be done)

Marvin M. Jacobs Pres. and Gen. Mgr.	Joe Goleski Sales Mgr.	Ed Berson Asst. Mgr.	Jack Millman Promo Mgr.
---	---------------------------	-------------------------	----------------------------

HOW WOULD YOU FEEL IF YOU PROMOTED A WORLD-WIDE HIT AND IT WASN'T YOUR COPYRIGHT?

We Feel Just Fine

Because our huge publishing network is a wide open shop equipped to hit-promote *all current copyrights* in today's international market. Pick the overseas territory you want and leave the actual music exploitation to us. Wherever it is we're already there and set to go with publishing affiliates, associates, agents and branch offices in LONDON - PARIS - MILAN - VIENNA - AMSTERDAM - BRUSSELS - COLOGNE - FRANKFURT - STOCKHOLM - MADRID - GENEVA - TORONTO - TOKYO - SYDNEY - MEXICO CITY - RIO DE JANEIRO - BUENOS AIRES - HOLLYWOOD and NEW YORK.



in New York at 1350 Avenue Of The Americas

WE'RE STILL ACTING LIKE
IT'S OUR FIRST YEAR AND
WE'RE RUNNING LIKE HELL!

MIAMI'S
HOTTEST DISTRIBUTORSHIP

**PROMOTION — SALES
MERCHANDISING**

CAMPUS
RECORD DISTRIBUTING, INC.

6751 N.W. 37th Court

Miami, Fla. 33147 (305) 691-3140

Joe Stanzione, Mgr.

RECORD DISTRIBUTORS

and the lines they handle •NARM members

TALLAHASSEE—(305)

MMM Distributors, Inc.
222 North Duval St.
Mary M. Martin—224-4015
(Abnok, Ambassador, Astor, BBC, B-C, Chont, Conservative, GNP Crescendo, Jawor, Judge's Chambers, Honor, Mork II, Mojo, Polaris, Rebel, Reb Time, Sims)

GEORGIA

ATLANTA—(404)

Capitol Records Dist. Corp.
1670 N.E. Freeway
Tom Beckwith—634-5191
(Capitol, Angel, Melody, Serophim)

Comstock Distributing Co.
1323 Spring Street
Don Comstock—876-0321
(Columbia, Epic)

Criteria Record Distributors
Box 13612, Station K
Johnny Brooks—874-2781
(World-Wide, S.O.A., Goye, Spoce, Rose, Youmer)

Decca Distributing Corp.
156 Alexander Street, N.W.
Kent Ortman—JA 4-8428
(Decca, Coral, Brunswick, London, Coedman, Berlitz Language Series, Vocalion, LHI, Richmond, Derom)

Godwin Distributing Co.
1227 Spring Street, N.W.
Arthur D. Godwin—876-5719
(A&M, Amy, Aurora, Bell, Bethlehem, Big Top, Cannon, Challenge, CO&CE, Comand, Crestview, Doot, Dynovoice, Elektro, Elf, Federal, Galoxy, Golden, Goldwox, Gordy, Gospel, Hickory, Hob, King, Laurie, Lomo, Mace, Molo, Motown, Musicland, New Voice, Nonesuch, Regent, Reprise, Rust, Sacred, Savoy, Scepter, Sharp, Sphere Sound, Tomla, Tower, Valiant, Village Gate, VIP, Wond, W. Bros., Word, Audio-Fidelity)

Liberty Record Dist. Co.
P.O. Box 20175, Station N
Gerry LaCoursiere—355-9350
(Liberty, Dolton, Sunset, Imperial, World Pacific, Blue Note, Liberty Stereo Tape)

Merrec Distributors
1231 Collier Rd., N.W.
Romeo Davis—351-2044
(Mercury, Limelight, Philips, World Series, Smosh, Fontano, Cumberland, Wine, Storyteller, 8 Track Cartridge Tapes, 4 Track Cartridge Tapes, 4 Track Cassettes (The Mercury Family plus Roulette, Audio-Fidelity, Crescendo, Codet, Hi Fi Tapes), Mercury Phonographs and Mercury Cassette Tape Recorders, Lear Jet Stereo 8)

RCA Victor Distributing Corp.
1500 Marietta Blvd., N.W.
Sam Wallace—355-2960
(RCA Victor, Camden, Colgem, Prestige—Stereo 8 Tape Cartridges—RCA Victor, RCA Camden, Bueno Visto, Kopp, Diamond, Prestige, Scepter, Wond)

Southland Records Distributing Company
1235 Techwood Drive, N.W.
Gerald Friedman—873-2081
(ABC, Atco, Atlantic, Bong, Codet, Comeo, Chort, Checker, Chess, Crescendo, Deutsche Grammophon, Dial, Diamond, Disneyland, Duke, Dunhill, Excello, Impulse, Jamie, Jubilee, Komo Sutra, Kopp, Kent, Living Language, London Group, MGM, Mainstream, Monument, Musicor, Mustang, Noshboro, Old Town, Original Sound, Parkway, Parrot, Peacock, Philles, Prestige, Riverside, Roulette, Skylite, Somo, Songs of Faith, Starday, Stox, Sun, United Artists, Vanguard, Verve, Visto, Volt)

HAWAII

HONOLULU—(808)

Craig Corp.
345 Canajee Street
Masao Tanaka—586-771
(Columbia, Epic, OKEH, ODE)

Decca Dist. Corp.
1217 Hapaka Street
L. C. Gilman—504-211
(Decca, Coral, Brunswick)

Eric of Hawaii
607 Coral Street
Irv Pineski—511-657
(ABC, Impulse, Warner Bros., Reprise, MGM, Verve, United Artists)

Microphone Music Co.

605 Coral St.
Ken Kaizawa—502188
(Atco, Atlantic, Codet, Comeo, Checker, Chess, Compress, Challenge, Dot, Disneyland, Duke, Four Corners, Golden, Jamie, Jubilee, Kopp, Living Language, Monument, Music Tapes, Moonglow, Parkway, Red Bird, Roulette, Riverside, Scepter, Sue, Swan, Stox, Tower, Valiant, Volt, Voul, Wond)

Music Craft Dist. of Hawaii, Ltd.
636 So. Queen Street
Walter Y. Kurakawa—501-223
(Amy, Bell, Blue Note, Co & Ce, Comand, Grand Award, Hickory, King, Laurie, Monitor, Original Sound, Philips, Prestige, Project 3, Starday, Vanguard)

Nylen Bros. & Co., Ltd.
P.O. Box 2958
Ed Nielsen—581-171
(A&M, Audio Fidelity, Coedman, Contemporary, Dolton, Ero, Fontosy, Good Time Jazz, Gordy, Imperial, Loni, Liberty, Mokoko, Minit, Motown, MMO, Pace, Pacific Jazz, Sunset, Soul, Soul City, Tomla, UNI, White Whale, World Pacific)

Radio Television Corporation Ltd.
432 Keawe Street
Hector H. Venegas—502-901
(RCA Victor, RCA Camden, Colgem, Mercury, Smosh, Fontano, Limelight, Wing, London, Parrot, Phase 4, Richmond, Hi, Coliseum, Derom, Press, Morlin, RCA Stereo 8 Tapes, Mele-O-Hoinoi)

ILLINOIS

CHICAGO—(312)

Allstate Record Distributing Company, Inc.
1450 S. Michigan Avenue
Paul J. Glass—939-3675
(Abnok, Alegre, Atlantic, Archive, Accent, Borry, Bethlehem, Baroque, Boone, Bright Star, Codet, Corlo, Cetra, Checker, Chess, Cine-Voice, Co & Ce, Colique, Crescendo, Destination, Dial, Diamond, Diann, Doot, Esp-Disk, Everest, Fat Fish, Federal, Focus, Gordy, GNP-Crescendo, Groovy, Guyden, Honno/Borbero, Hi-Fi, Hollywood, Impact, Jamie, Jewel, Koren, King, Kenwood, Maurci, Motown, Musicor, Paulo, Philles, Life, Quill, Riviera, Ronn, Roase, Roulette, Seeco, Senator, Sims, Soft, Soul Baby, Specialty, Squire, Starday, Stox, Tico, Tradition, Tuff, U.S.A., Vault, V.I.P., Workshop-Jazz)

K. O. Asher Inc.
7818 S. Stony Island Avenue
K. O. Asher—REgent 1-1741
(Alector, Apon, Argo, Arhoolie, Asch, Audio-Precision, B&F, Bortok, Berlitz, Blues Classic, Bormand, Broodside, CMS, Coedman, Combridge, Contate, Cavalier, Classic Edition, Colonial, Composers, Connoisseur, Contact, Contemporary, Continental, Conversophone, Danish Odeon, Desto, Dover, Dyer-Bennet, EMS, Elektro, Enrichment, Euphonic, Evergreen, Eureka, Experience Anonyme, Eterno, Festival, Folk-Legacy, Folk-Lyric, Folkways, GHB, GMS, Golden Crest, Good Old Jazz, Gregorian Inst., Happy Jazz Band, Harmony, Haydn Society, Helios, Historical Jazz, Icon, Jazz Crusade, Jazzologie, Lexington, London International, Lyricord, MMO, Mace, Melodeon, Mirro, Monitor, Monmouth, Motivation, Music Guild, Music Library, Music Minus One, Nino, Nobility, Norsemen, Odeon, Oiseau-Lyre, Olympic, Original Jazz, Over-tone, Parker, Pothe, Pathway, Pinnacle, Playhouse, Portent, Prosecrenium, Quallion, RBF, River Boot, Rutgers University, Sogo, Scandinavian, Society f. forg. Music, Societe Francaise du Son, Southland, Spo, Spire, Spivey, Spoken Arts, Spoken Word, Standard, Takomo, Telefunken, Testament, Theatre Master Works, Tradition, Turnabout, UTC, Ultraphone, Vocob, Vox, Voix de L'Auteur, Vulvon, Westminster, Windin' Ball, World Library of Sacred Music, Old Timey)

Columbia Record Sales
5404 West Touhy
Mert Paul
(Columbia, Masterwork Phonographs, Dote, Harmony, Ode)

Decca Dist. Corp.
425 N. Michigan Avenue
A. Weiner—DE 7-1100
(Decca, Coral, Brunswick, LHI, Phonographs, Guitars and Accessories, Drums, Tambourines, Berlitz Language Courses, 4x8 Track Cartridges)

Garmisa Dist. Co.
1700 S. Michigan Avenue
Leonard Garmisa, Robert Garmisa—922-7455
(ABC, UA, Dunhill, Comand, Prestige, Impulse, Jerden, Senote, 20th Century, Ascot, Solid State, Tongerine, Bluesway, UA International)

(Continued on page 72)



P. M. Records, Inc.
and
Record Promotion Service

Brand new, young and energetic record distributing and independent record promotion in Pittsburgh and the tri-state area.

1901 Fifth Avenue Pittsburgh, Pa. 15219

Telephone: Area Code 412 471-2376

Paul McGrath, President

We Are Proud of Our Association
... with Great Record Labels
and with the Men Who Make Them Great!



444 6th Street
San Francisco, Calif.
415-621-8740

Record Distributors Since 1946
Power Packed Promotion—Product—Personnel

Al Bramy—Tony Valerio
(Management)

Walt Calloway—Pete Marino
(Promotion)

Best Wishes
TO CASH BOX ON YOUR
25th ANNIVERSARY

from

JAMES H. MARTIN, INC.

DISTRIBUTORS OF

LONDON—LONDON GROUP—SOMERSET—STEREO FIDELITY—
MONUMENT—HILLTOP—VANGUARD—PICKWICK 33

BORG WARNER STEREO CAR & HOME UNITS, AND ALL BRANDS 8-TRACK TAPE CARTRIDGES

2419 So. MICHIGAN AVE., CHICAGO, ILL.

Phone: Victory 2-4440

Pickwick... The Globe Trotter



pickwick/33
RECORDS

HILLTOP
The Authentic Sounds Of
Country & Western Music

pickwick/4
Continuous Play
4 Track Cartridge

pickwick/33
BY ARRANGEMENT WITH
CAPITOL
RECORDS



pickwick/8
Continuous Play
8 Track Tape Cartridge

BRAVO!
RECORDS

allegro
RECORDS
Available through
Pickwick International Inc.
(Great Britain) Ltd.

FINLAND
SWITZERLAND
GREECE
HONG KONG
THAILAND
KENYA
DENMARK
ITALY
SINGAPORE
NETHERLANDS
AUSTRALIA
BERMUDA
GREAT BRITAIN
PHILIPPINES
AUSTRIA
AND FIFTY OTHER COUNTRIES
SWEDEN

PICKWICK INTERNATIONAL, INC. 8-16 43RD AVENUE, LONG ISLAND CITY, NEW YORK 11101 / LOS ANGELES/ATLANTA/LONDON, ENGLAND/TORONTO, CANADA



A GREAT NEW LINE OF DRAMATIC PLAYS List Price \$3.98

FEATURING THE STAR OF STAGE AND T.V. ("I SPY" ETC.)

ROBERT CULP

- LADY WINDERMERE'S FAN by Oscar Wilde LLP 4001
- GHOSTS by Henrik Ibsen LLP 4002
- UNCLE VANYA by Anton Chekhov LLP 4003
- THE RIVALS by Richard Sheridan LLP 4004
- DR. FAUSTUS by Christopher Marlowe LLP 4005
- THE WAY OF THE WORLD by William Congreve LLP 4006
- ALL FOR LOVE or THE WORLD WELL LOST by John Dryden LLP 4007
- THE MASTERBUILDER by Henrik Ibsen LLP 4008
- THE DOCTOR IN SPIKE OF HIMSELF by Moliere LLP 4009
- SHE STOOPS TO CONQUER by Oliver Goldsmith LLP 4010

ALEXANDER KIRKLAND ACTING GROUP

- SALOME by Oscar Wilde LLP 4011
- THE SEA GULL by Anton Chekhov LLP 4012
- A DOLL'S HOUSE by Henrik Ibsen LLP 4013
- THE SCHOOL FOR SCANDAL by Richard Sheridan LLP 4014

LIBRARY EDITIONS

66 Mechanic St. New Rochelle, N.Y. Tel. 914-NE 3-6055

FAST DISTRIBUTION

FOR AMERICA'S *FASTEST* SELLING RECORDS!

A & I

RECORD DISTRIBUTORS

1000 BROADWAY, CINCINNATI 2, OHIO

(513) 241-7644

AGGRESSIVE SALES AND PROMOTION . . .

JOE NATHAN, GENERAL MANAGER

RECORD DISTRIBUTORS

and the lines they handle •NARM members

•Liberty Records Distributing Co. of Illinois
5251 W. North Avenue
Russell Bach—237-7762
(Liberty, Imperial, World Pacific, Pacific Jazz, Blue Note, Minit, Aura, Dalton, Sunset, Liberty Stereo-Tape)

•James H. Martin, Inc.
2419 South Michigan Avenue
James H. Martin—VI 2-4440
(London Records, Inc., Vanguard Records, Inc., Manument Records, Stereo Fidelity, Pickwick International, and all B Track Stereo Tapes)

•Merrec Dist. Co.
1402 So. Michigan Avenue
Frank Peters—939-1425
(Mercury, Phillips, Smash, Fontana, Limelight)

•Metro Record Dist.
1112 So. Michigan Avenue
Morris S. Price—341-0660
(MGM, Verve, Metro, Helidar, Verve Folkways, V.S.P., Leo, Elektra, Nonesuch, D.G.G., Golden, Koma Sutra, 4 Track and 8 Track Cartridge Tape)

M.S. Distributing Co.
1550 S. State Street
Vic Faraci—225-2929
(Academy, Admiral, Amy, Audio Arts, Aurora, Bell, Betty, Big D, Big Top, Cameo, Challenge, Compass, Dollie, Dore, Dynavoice, Era, Eskee, FLB, Fling, Four Corners, Fraternity, Gen'l Int'l, Goldwax, Highland, Ivnohoe, Independence, Jet Set, Kapp, Kenwood, KJB, Laurie, Living Language, Lama, Lucky Eleven, Mainline, Mala, Mox, Money MTA, Musicland, New Voice, New World, Nite Life, Nabman, Pace, Parkway, Pure Soul, Redd Faxx, Reprise, Round, Rust, Sidewalk, S.P.A.R., Sphere Sound, S.P.Q.R., Sunburst, Ten Star, Tower, Uptown, Valiant, Warner Bros., Young People's Records, Yark, Warner Bros./ Reprise 4-Track Stereo Tape Cartridges, Warner Bros./ Reprise 8-Track Stereo Tape Cartridges)

Ron-Jac Records, Inc.
2828 N. Pine Grove Ave.
Jack Barthel—281-1700
(JB, Cherry Lane, Cliff, Deer, Little Fort, Moestra)

•Royal Disc Distributing, Inc.
1400 S. Michigan
Edward Yalowitz, Kent Beauchamp—939-2661
(Atco, Volt, Jubilee, Project 3, Maonglow, BT Puppy, Palmer, Riverside, Original Sound, Fame, Ole', Dunwich, Wonderland, Contemporary, Gaadtime Jazz, Jazzland, Josie, Toot, Festival, Veep, LeGrand, HIP, Seascope)

Seebra Distributing Co.
2019 S. Michigan Avenue
R. Siegal—842-8221
(Seebra Record Rocks, Seebra Record Cases, Seebra Record Pales and Tables, Fidelitone Needles, Peter Pan, Golden, Design, Happy Time, Diplomat, Rocking Horse, Tiffan, Twinkle, Caranet, Panda, Spino-rama, Scotch Tape, Pegboard Wire Display Baskets)

•Summit Distributors, Inc.
7447 No. Linder Avenue
Jack White, Seymour Greenspan—463-1833
(A&M, Audio Fidelity, Big A, Brancha, Capa, Chart, Crossroads, Disneyland, Double Shot, Early Bird, Epic, Exodus, Fantasy, Fidelity Sound Recordings, Galaxy, General Recorded Tapes, 60-60, Groovesville, Hickory, Karate, K-Ark, Lil' Darlin, Longhorn, Main Stream, Mobile Fidelity, Mosrite, Mustang, Okeh, Romco, Rebel, Ric-Tic, R.S.V.P., Solid Hitbound, Samo, Time, Tuba, UNI, Vista, White Whale)

•United Record Distributors, Inc.
1827 South Michigan Ave.
Ernest Leaner—225-6605
(Abet, Backbeat, Ballad, Bigwheel, Calla, Carnival, Crescent, Duke, Dynamo, Enjoy, Excella, Fairmount, Gamble, Glad-Hamp, Gospel, Hala, Hab, M Pac, Mork II, Mayfield, Marvius, Modern, Nashboro, Nala, Oonderful, Parlo, Regent, Revilat, St. Lawrence, Sovoy, Scepter, Saul, Tamlo, Wand, Windy C, Sound Stage Seven, Tip Top, Mellow)

•World Wide Record Dist.
1140 West Washington
Morry Goldman—TA 9-3553
(Dat, Vivo, Acta, Fiesta, Hamilton)

DES PLAINES—(312)

RCA Victor Distributing Corp.
424 E. Howard Street
Irwin J. Brusso—827-0033
(RCA Camden, RCA Victorla, Calgems, RCA Victor International, RCA Stereo B Cartridge Tapes, RCA Victor 7 1/2 and 3 1/4 4-track Reel Tapes)

NILES—(312)

Capitol Records Distributing Corporation
6401 Gross Point Road
George H. Gerken—647-8338
(Capitol, Angel)

INDIANA

FORT WAYNE—(219)

Tri-State Distributors
3434 Broadway
Cliff Ayers Ostermeyer—744-5607
(Capo, Black Gold, Raindrops, Ballad, Colony Park, Mosrite, Geep, Celestial, Crest, Scaldran, Leo, Ray-nord, DiVenus, Clarity, Canary, Enterprise Thirteen, General American, Crossfire, Dominion, Lifetime, Pioneer, Royal Crest, Blue River, Rayce, Delta International, ABS, All Star, Alto, Angletane, Arrowak, Art, Arvee, Atlas, Avenue, Bandbox, Bartell, Baton, Boy Uke, Bee, Beltane, Buddy, Bullseye, C&M, Campus, Cardinal, Chattahoochee, Chroma, Cimar-ron, Clare, Cammerce, Cantaur, Crescenda, Crown, Delden, Desert, Dome, Ebb, Emerald, Empire, Era, Excella, Fox, Flick, Fla-Ja, Ford, Golden World, Horvard, HiFi, Hit, Hudson, Hugo, Injun, Jamie, Kean, Kenco, Lincoln, Longhorn, Lucky Four, Mar-vello, Moymhos, Mecca, Miracle, Maan, Motif, Mat-tawn, Nashboro, Neptune, Orbit, Peacock, Petal, Prima, RSVP, Rae-Cox, Ram, Rebel, Rena-Smiley, Robbins, Randalett, Sobre, Sage, Sand, Shee Sims, Spirit, Storday, Tamlo, Tampa, Taylor, Vanity, Variety, Vita, Wagner, Wedge, Westport)

INDIANAPOLIS—(317)

Associated Dist., Inc.
210 S. Meridian
Lynne Jenks—ME-4-2591
(RCA Victor-Camden, Vox, Audio Fidelity, Living Language, Starday, Disneyland, 4 & 8 Track Car-ridge Tapes)

John Robert Co.
1327 N. Capitol Avenue
Mrs. Pattie Johnson—637-4312
(ABC, United Artist, Dunhill, Impulse, Prestige, Bluesway, Cammand, Solid State, Warner Bros., Re-prise, Kapp, Living Language, Tower, Amy-Mala, Bell, Dynavoice, New Voice, Challenge, Frat, Cameo, Parkway, Four Corners, Laurie, Valiant)

IOWA

DES MOINES—(515)

Mid-America Dist. Corp.
1630 Locust Street
Jack Mishler—AT 8-0182
(Mercury, Phillips, Smash, Warner Bros., Reprise, Starday, Monument, Prestige, Blue Note, Jubilee, Josie, Joy Gee, Ward, Little Golden)

KANSAS

KANSAS CITY—(913)

•RCA Victor Dist. Corp.
Old Santa Fe Trail at 102nd St.
(Shawnee Mission)
Gil Karwoski—TU 8-1440
(RCA Victor, RCA Camden, RCA Victorla, Request, RCA Mexicana, RCA International, Stereo B Tape, RCA Victor, RCA Camden, Kapp, Calgem, Ward, Scepter, Buena Vista, Diamond, Prestige)

KENTUCKY

LOUISVILLE—(502)

Foster Distributing Company
722 W. Main St.
R. M. Foster—584-6207
(Capitol, Ambassador, Lyric Cases and Racks)

LOUISIANA

NEW ORLEANS—(504)

•All South Distributing Corporation
1924 Lafayette Street
Henry J. Hildebrand, Jr.—522-1157
(A&M, After Hours, Artic, Ascat, Backbeat, Caedman, Canadian American, Challenge, Congress, Diamond, Dalton, Daato, Doubleshot, Duke, Ero, ESP, Excella, Four Corners, Gateway, Golden, Ha-Ha, Half & Half, Heliadar, Hi, Hilltop, Hab, Impact, Index, Instant Learning, Jamie, Jerden, Jin, Kama Sutra, Kapp, King, La Louisiane, Lea, Liberty, Lama, London American, Moce, MGM, Metro, Monument, Motown, Musicor, Nashboro, Original Sound, Parrot, Peacock, Phillies, Press, Project 3, Reprise, Riot, Scepter, Sing, Skylight, Solid State, Songs of Faith, Sound Stage, Sunset, Swallow, Tamlo, Teardrop, Tribe, United Artists, Valiant, Vanguard, Veep, Verve, Verve-Falk-ways, Vip, Wand, Warner Bros., White Whale)

•Columbia Record Sales
(John Hancock Building)
1055 St. Charles Avenue
William H. Shaler—524-4546
(Columbia, Odyssey, Date, Epic, Okeh, Crossroads, Ge-Ga)

(Continued on page 74)



APEX MARTIN

175 CLINTON PLACE, NEWARK, N. J. (201) 923-7474 • JERRY COHEN, Gen. Mgr. • JOE MARTIN, Pres.

The Brilliant Artistry of Dionne is on **SCEPTER**

Dionne Warwick

From the recording studio . . . to the concert hall . . . from television to Las Vegas . . . the brilliant sound of the talent that is Dionne can be heard all over the world. In a little more than four years, she has developed a loyal following that each year buys millions of her singles and over a million of her albums. And their number is increasing every day. Dionne's extraordinary talent has found a #1 spot in both worlds: R & B and Pop. She has brought a new dimension to contemporary music. The result has been an enrichment of the beautiful creativity of Burt Bacharach and Hal David . . . her discoverers . . . her writers . . . her arrangers . . . her conductors and her producers.

Current Hit Single:
ALFIE (Scepter 12187-B)

Current Chart LP's:
Here Where There Is Love (Scepter 555)
On Stage and In the Movies (Scepter 559)

APPEARING

June, 1967 — TV
Joey Bishop and Steve Allen Shows
San Francisco — Venetian Room,
Fairmount Hotel (June)
Los Angeles — West Side Room,
Century Plaza Hotel (July)
Atlantic City — Club Harlem (August)
New York — Rheingold Festival,
Central Park (August 14, 1967)
European Tour — Italy, France, Spain
(August/September, 1967)

COMING UP

Hollywood, Fla. — Diplomat Hotel
Chicago — Mr. Kelly's
Las Vegas — Flamingo
Washington, D.C. — Shoreham Hotel
New York — Copacabana (Return engagement)
Boston — Blinstrubs (Return engagement)



Personal Management:

PAUL CANTOR,
WAND, 254 WEST 54TH STREET
NEW YORK, N. Y. 10019
(212) Circle 5-2170
CABLE: SCEPTERMUS





**SALES SOAR
IN THE
SUNSHINE
STATE**

WITH

TONE

DISTRIBUTORS INC.

495 South East 10th Ct., Hialeah, Fla.

(305) 888-1685

HENRY STONE

MILT OSHINS — DAVE BENJAMIN

CONGRATULATIONS ON YOUR 25th

We're now into our 21st—the west coast's

oldest young distributorship

**RECORD MERCHANDISING
COMPANY, INC.**

2580 West Pico Blvd.
Los Angeles, California 90006

213-385-9161

**RECORD
DISTRIBUTORS**

and the lines they handle •NARM members

•Decca Distributing Corporation
517 Canal Street
Robert N. McCormick—522-1786
(Decca, Coral, Brunswick, Vocalion, London, Elektra,
Richmond, None-Such, Word, Berlitz Language Sets,
Guitars, Ukeleles, Drums, and Musical Accessories,
Needles)

•Delta Record Distributing Co., Inc.
1023 Baronne Street
Ed. Walker—525-7104
(ABC, Abnak, Academy, Accent, Amy, Archive, Atco,
Atlantic, Audio Arts, Audio Fidelity, Aurora, Bang,
Barry, Bell, Big Top, Boone, Bluesville, Bluenote,
Bluesway, Brahma, Brent, Bright Star, Bronco, Brook-
lyn, B. T. Puppy, Buena Vista, Cadet, Canterbury,
Carla, Centra, Charger, Checker, Chess, Chisa, Class,
Co & Ce, Clarion, Command, Contemporary, Con-
trast, Crash, Dade, Destination, DGG, Dial, Dicta-
tion Disc, Disneyland, Dixie Land Jubilee, Dollie,
Dunhill, Dunwich, Dynamo, Dyno-Voice, Elf, Ember,
Everest, Fame, Fat Fish, Fax, Fraternity, GNP, Good
Time Jazz, Gold Wax, Gordy, Gospel, Grand Award,
Gross, Halo, Happy Jazz, Hib, Hi Back, Hickory,
Hi-Fi, Hip, Hot Shot, Imperial, Impulse, Interna-
tional Folklore, Jerden, Jerhart, Jetset, Jet Star,
Jewel, Josie, Jubilee, Karen, Kel-Mac, Kent, Ken-
wood, KR, Laurie, Legrand, Life, Like, Living Language,
Mainstream, Mala, Maxx, Minit, Modern, Money,
Montel-Michelle, Moonglow, Movietone, M-Pac, MTA,
Musicland, Mustang, New Voice, One-Der-Ful, Pacific
Jazz, Paula, Port, Pow, Prestige, Pure Soul, Regent,
Riot, Rojac, Ronn, Roulette, Rust, St. Lawrence,
Sansu, Savoy, Shout, Sidewalk, Simon Says, Sims,
Soma, Soul, Soul City, Spade, Speciality, Sphere
Sound, Stax, Stereodiddies, Sue, Sun, Surefine, Sym-
bol, Tangerine, TCF, Thomas, Tico, Time, Toot,
Tower, Tuba, Tuff, Uni, Uptown, USA, Vault, Volt,
Westminster, World Pacific)

New Orleans Distributing Co., Inc.
748 Camp Street
Leonard Samuels—523-7474
(Ace, Atlas, Audio-Fidelity, Battle, Big Wheel, Calla,
Capa, Cameo Parkway and Subsidiary Labels, Carni-
val, Chart, Ciro, Dore, Dover (All Products), Faro,
Gamble, Glasco, Last-Nite, M.A.P., Marvelous, May-
field, Mira, Mirwood, Palmer, Rampart, Revilot, Ric-
tic, Riverside, Rajac, Score, Sidra, Solid Hitbound,
Sound of Nashville, Tag, Ltd., Tru-Glo-Town, Uptite,
Whit)

McDonald Sales Corp.
5500 Jefferson Highway
Milton H. Munch—733-6653
(RCA Victor, RCA Camden)

World-Wide Record Dist.
605 Baronne St.
Jim Flattmann—522-3661
(Dot, Hamilton, Viva, Starday, Hollywood, Nash-
ville, Fiesta)

SHREVEPORT—(318)

Stan's Record Service
728 Texas
Stanley J. Lewis—422-7182
(ABC, Atlantic, Amy, Atco, A&M, B. T. Puppy, Back-
beat, Bang, Bell, Canaan, Cameo, Chess, Checker,
Cadet, Dunhill, Diamond, Dooto, Disneyland, Duke,
Doubleshot, Dunwich, Dynavoic, Dollie, Excello,
End, 20th Century Fox, Gordy, HBR, Hickory, Im-
pulse, Jubilee, Jamie, Jorden, Josie, Kama Sutra,
King, Kent, Musicor, MGM, Motown, Mala, Mirwood,
Moonglow, Montel-Michelle, Modern, Monument,
Murco, New Voice, Original Sound, Roulette, Stax,
Scepter, Sims, Sun, Starday, Speciality, Soul, Sound
Stage 7, St. Lawrence, Tangerine, Tamla, Thomas,
United Artist, Volt, Verve, Wand, White Whale,
Sharp, Songbird, Revelation, Gotham, Federal,
Acquarium, Savoy, Peacock, Nashboro, Halo, Gospel,
Jewel, Proverbs, Hob, D Town, Staff, Exodus, Hy-
Tone, Highway)

MAINE

PORTLAND—(207)

Commercial Dist.
50 Diamond St.
V. Harry Mooradian—775-5644
(RCA Victor, RCA Camden)

MARYLAND

BALTIMORE—(301)

Bonnie Brae Distributors
4724 Bonnie Brae Road
Samuel Anoff—655-4031
(Ace, Advance, Ambassador, Banner, Baronet, Bingo,
Crown, Delta, Diplomat, Impalla, Jewel, Peter Pan,
Radiant, Rich, Spar, Twirl, Wyncote)

•Capitol Records Dist. Corp.
6910 Harford Road
Bill Dawson—444-6030
(Angel, Capitol)

D&H Distributing Company, Inc.
2921 Worcester Street
Lester B. Pyle—727-5100
(RCA Victor, RCA Camden)

•Decca Dist. Corp.
2921 Alexander Avenue
Ed Keefan—367-0710
(Decca, Coral, Brunswick, Vocalion, Berlitz, Phono's,
Accessories, Musical Instruments (Guitar-Drums)

General Distributing Company, Inc.
2329 Pennsylvania Avenue
Henry Nathanson—669-6411
(Acta, Arctic, Barry, Boone, Canaan, Carnival, Dia-
mond, Dot, Excello, Fiesta, Fraternity, Gateway,
Gospel, Grecophon, Groovesville, Hamilton, Hob,
Impact, Jamie, Kent, Keymen, King, Mace, Mark II,
Mobile Fidelity, Mo Soul, Modern, Nashboro, Nola,
One/Der/Ful, Parlo, Phil L.A. of Soul, Prestige,
Revilot, Ric Tic, Savoy, Scepter, Solid Hit Bound,
Sun, Viva, Wand)

Marnel of Maryland
3000 Ridgewood Avenue
Stan Hoffman, Marv Slaveter—664-8500
(Dollie, Drew, Epic, Double Shot, Duke, Mustang,
Okeh, Golden, Living Language, Gamble, Back Beat,
Jubilee, Josie, Mayfield, Tower, BT Puppy, Laurie,
Pickwick, Peacock, Calla, Uptight, Groovy, Garrison,
Mainstream, Rojac, Valiant, Marlus, Chisa, Caedmon)

•Marshall-Mangold Dist. Co.
4805 Nelson Avenue
Manny Goldberg—542-7214
(Amy, Mala, Disneyland, Everest, Heartwarming, Sing,
Skylite, Concert, Disc, Vista, Goldwax)

•Schwartz Bros.
2146 24th Place, N.E.
(Washington, D.C.)
(See District of Columbia for Lines Handled)

Southern Wholesalers Inc.
2500 Schuster Drive
(Cheverly)
George Nesline—322-3500
(RCA Victor)

Y-R-S Distributors, Inc.
3123 W. North Avenue
Earnest L. Burston—566-5400-01
(Dynamo, Tangerine, St. Lawrence, Thomas, Gospel,
Pearl, Loop, Valise, Allchurch, Alto, Achillean, Cel-
tex, Bee Cee, Goodtime, Ready, Nation, Score.)

Jos. M. Zamaiski Co.
1101 DeSoto Road
Jerry Friedman, Maury Bass—644-2900
(ABC, Acta, Buddah, Bluesway, Cameo-Parkway, Can-
terbury, Deram, Command, Audio-Fidelity, Dunhill,
Fairmont, Hi, Impulse, Jerden, Kama Sutra, Good-
time, Korate, London, Little Darlin', Lucky Eleven,
MGM, Marlin, MTA, Parrot, Press, Solid State, Se-
ville, Senate, Sentar, Tribe, 20th Century, Veep,
Windy "C", Villa, United Artists)

MASSACHUSETTS

BOSTON—(617)

Columbia Record Sales
75 Third Avenue
George Ryan—899-3814
(Columbia, Date, Ode)

Capital Records Dist. Corp.
71 Fourth Avenue
Frank McGrath—HI-9-0770
(Capitol, Angel)

(Continued on next page)



**We Are From Detroit
We Are Now 5 Years Old
We Are Now Representing:**

**A&M · AMY-MALA-BELL · BRENT ·
COLONIAL · DANCE ALONG ·
DEARBORN · DISNEYLAND · DYNOVOICE · EXODUS · GORDY ·
HICKORY · LISTEN & LEARN · MIRA · MONUMENT · MTA · MUSIC
MINUS ONE · NEW VOICE · PACIFIC JAZZ · SOUL CITY · SOUND
STAGE · TAMLA · VIP · WHITE WHALE · WORLD PACIFIC**

WON'T YOU JOIN US!

NEXT YEAR WE WILL BE 6 YEARS OLD

MERIT MUSIC DISTRIBUTORS, INC.

15761 Wyoming Avenue Detroit 38, Michigan (313) UN 3-9119

MY SINCEREST THANKS, DEEJAYS, For Voting Me...

#1 MOST PROMISING
UP AND COMING
MALE VOCALIST!

AND

#3 MOST PROGRAMMED
MALE VOCALIST!

NEIL DIAMOND

Exclusively on **BANG RECORDS**

CURRENT ALBUM: "THE FEEL OF NEIL DIAMOND"

FREDANA MANAGEMENT

FRED WEINTRAUB — BILLY FIELDS

180 THOMPSON ST. • NEW YORK, N. Y.

(212) GR 5-7754

SPECIAL THANKS TO
MY PRODUCERS

**JEFF BARRY &
ELLIE GREENWICH**

PUBLICITY

JOE CAL CAGNO

BOX 96

ROCKVILLE CENTRE, N. Y.

(516) 536-7186





**WE
DELIVER
FIRST**
in the
southern
market
**BIGGER SALES
BETTER PROMOTION**

**GODWIN
Record Distributors**

Atlanta, Georgia
1227 Spring St., N.W. (404) 876-5719

RECORD DISTRIBUTORS

and the lines they handle •NARM members

MICHIGAN

DETROIT—1313

Arc Dist. Co.
13415 Lyndon Ave.
Henry Draz—BR 2-4872
(United Artists, Veep, Solid State, ABC, Dunhill, Impulse, 20th Century, Comand, Bluesway, Tangorine, Comeo, Parkway, Collo, GNP, Crescendo, Diamond, London Group, Jomie, Hideout, Imperial, Minit, Joy Joy, Audio Fidelity, Kepp, 4 Corners, King, Lourie, Legend, Rust, Motown, Soul, Musicor, Stordoy, Original Sound, Philles, Warner Bros., Reprise, Lomo, Roulette, Swon, Compass, Independence, West Minister, Living Language, Project 3)

Cadet Dist. Co., Inc.
13380 Capital Ave.
Harry Levin—548-3171
(Auro, Avant Gorde, Budapest, Challenge, Chottahoochee, Contemporary, Dee Gee, Derry, Disneyland, Dalton, Dooto, Drummond, Freeport, Good Time Jazz, Honno Barbero, Liberty, Monitor, Pacific Jazz, SVR, Specialty, Stor, Sun, Sunset, Universe, Visto, World Pacific)

Capitol Records Dist. Corp.
18921 Wyoming Avenue
Arnold Orleans, Jim Blackwood—UN 4-5001
(Capitol, Angel)

Columbia Record Sales
16141 W. Eight Mile
John Kotecki—273-8616
(Columbia, Dote, Ode, Masterwork Phonographs)

Decca Dist. Corp.
12730 Puritan Avenue
Mario Defilippo—DI 1-6040
(Decca, Coral, Brunswick, Vocalion, Berlitz, Longuoe)

Jay Kay Distributing Company
13401 Lyndon
John S. Kaplan—BR 3-7000
(Atlantic, Bong, Canterbury, Dial, Dot, Everymon, Focus, Fontano, Hamilton, Heliodor, Komo Suro, Kent, MGM, Mercury, Metro, Polmer, Phillips, Smosh, Somo, Somerset, Stereo Fidelity, Stereodivities, Sue, Tower, VSP, Vanguard, Verve, Verve Folkways, Vivo, Wing)

Merit Music Distributors, Inc.
15761-65 Wyoming Ave.
John H. Schlee—863-9119

(A&M, Ace, Amy, Audio Gospel, Avant Gorde, Bell, Big D, Big Too, Breat, Bueno Visto, Chiso, Colonial, Constellation, Contrast, Donce Along, Dearborn, Diamond Jim, Disneyland, Dynovoice, Elf, Ero (Oldies), Exodus, Flosback (Oldies), Fraternity, Goldwox, Gordy, Harvey, Hideout, Hickory, K-Ark, Listen & Learn, Magic City, Molo, Moxx, Miro, Miracle, Mirwood, Money, Monument, M.T.A., Music Minus One, New Voice, Pacific Jazz, Ponik, Profidence, Riley, Riot, Soul City, Sound Stage, Stordord, Steno Disc, Tomlo, Tenstor, Vee Joy (Oldies), U.T.C., V.I.P., Visto, White Whole, World Pacific, York, Cortridge Topes: A&M, Gordy, Monument, Motown, Tomlo, Soul, Reel to Reel Topes: Ampex)

Music Merchants, Inc.
3731 Woodward Ave.
Marvin Jacobs—832-0870
(Atco, Carlo, Fome, Stox, Volt, Karen, Dunwich, Closs, Barry, Brent, Mainstream, Time, Coedmon, B.T. Puppy, Jubilee, Josie, Grass, Token, Chess, Checker, Codet, St. Lawrence, Thomas, K-R, Cornivol, Dono, Double Shot, Epic, Okeh, Crossroads, Go Go, Everest, Concert Disc, Esoteric, Cetra, Emorcy, Limelight, Folkways, Fontosy, Arhaalie, Goloxy, FSR, Gospel Corner, Proverb, Hi-Fi, Life, Impact, Jewel, Poulo, Ronn, Ko Ko, Mustang, Bronco, Moyfield, Moonshot, One-Der-Ful, Jerhot, Parliment, Prestige, Rainbow, Semor, Sims, Surfine, Tubo, USA, Uptown, Sidewalk, Vault, Fat Fish, Woyout, Blade, Mosoul, Keyman, Solid Hit, Ero, Dore, Rojoc, Picwick, R.S.V.P.)

Radio Distributing Company
15470 Schaefer Hwy.
George MacDuff—273-6740
(London)

RCA Victor Dist. Corp.
7400 Intervale
Dan MacDonald—834-3500
(RCA Victor, RCA Comden)

MINNESOTA

MINNEAPOLIS—1612

Columbia Record Sales
88 So. 6th Street
Ron Piccolo—338-7001
(Columbia, Ode, Dote)

Decca Dist. Corp.
6150 Wayzata Blvd.
Ozzie Lowe—544-7707
(Decca, Coral, Brunswick)

F. C. Hayer Co.
701 Washington Ave., North
Arthur R. Patch—339-0201
(RCA Victor, RCA Comden, RCA Victor Stereo B Cortridge Tape, Request, Colgems)

Heilicher Bros. Inc.
7600 Wayzata Blvd.
Amos Heilicher—544-4201
(ABC, Abnak, Accent, Amy, Atco, Atlantic, Audio Fidelity, Audiophile, Auro, Bell, Big Hill, Boom, B.T. Puppy, Codet, Coedmon, Carlo, Challenge, Checker, Chess, Childcroft, Co & Ce, Colonial, Comand, Crescendo, Cumberland, Cross Roads, Dial, Diamond, Disneyland, Dalton, Dollie, Dore, Dunhill, Dunwitch, Dynovoice, Destination, Double Shot, Elektro, Emorcy, Epic, Ero, Exello, ESP Disk, Fome, Fiesta, Focus, Folkways, Fontano, GNP, Golden, Golden Crest, Golden Ring, Gordy, Gregmork, Gross, Honno Barbero, Imperial, Impulse, Joy Joy, Jerden, Josie, Jubilee, Korote, Koren, Laurie, Liberty, Limelight, Lomo, Lil Dorlin, Mainstream, Molo, Mercury, Minit, Mobile Fidelity, Money, Monogram, Moonglow, Matown, MTA, Musicland USA, Music Minus One, Mustang, New Voice, Nonesuch, Okeh, Original Sound, Poulo, Pacific Jazz, Phillips, Pow, Pure Soul, Romco, Reprise, Scepter, Sermon, Sims, Smosh, Somo, Soul, Soul City, Stordord, Stox, Stereodivities, Story Teller, Sunglow, St. Lawrence, Tomlo, Thomas, 20th Century Fox, Uni, USA, VIP, Visto, Volt, Wand, Warner Bros., Westminster, White Whole, Wing, World Pacific)

(Continued on next page)

HAPPY 25th ANNIVERSARY
BEST
 &
GOLD
RECORD DISTRIBUTORS
 959 Main Street, Buffalo, New York
 (716) TT 2-0427
Leonard Silver **Steve Brodie**

Decca Distributing Corp.
138 Ipswich St.
Allan M. Ross—266-5110
(Decca, Coral, Brunswick, Vocalion, Berlitz, LHI Labels, Decca Phonos, Guitors, Drums, Tombourines, and Music Instrument Accessories)

Disc Distributors, Inc.
1136 Columbus Avenue
Jack Sager—445-3550
(Tomlo, Motown, Gordy, Soul, VIP, Melody, Sue, Gumble, Ric Tic, Revilot, Solid Hit, One-Der-Ful, Mor-V-Lus, M-Pac, Miro, Mirwood, Cookin', Swon, Boone, Keymen, Mo-Soul, Atlas, Dynomo, Groovy, Glod-Homp, Getaway, Groovesville, Kellmac, Michigan Avenue, Tru-Glo-Town, Mork II, Tog)

Mass. Record Dist. Co.
1820 Washington St.
Fred LeBlanc, Skippy White—442-3830
(Airo-American, Big Jim, Bluestown, Coso Grande, Cotamount, Cot-Time, Cornivol, Constellation, Dilto, Exello, Exodus, Fortune, Hi-Way, Hob, Jewel, Kent, Lost Nite, Modern, Murco, Noshboro, Oldies 45, Old Gold, Poulo, Pow, Relic, Ronn, Romur, Sohoro, Scone, Silver Cross, Sims, Surfine, Stop, Times Square, United, Wee, Wheelsville, Woyout, Whit, Wild)

Music Suppliers Inc.
78 No. Beacon Street
Harry Carter—254-1780
(ABC, Deutsche Grammophon, Dunhill, Impulse, Komo-Suro, Kopp, Laurie, M.G.M., Reprise, 20th-Century Fox, Vanguard, Verve, Warner Bros., Westminster, Vox)

CAMBRIDGE

The Eastern Co.
620 Memorial Drive
A. J. Shuffer—TR 6-4720
(RCA Victor, RCA Comden, RCA Victrola, RCA Stereo B Topes)

DORCHESTER

Mutual Distributors, Inc.
157 Washington St.
Frank Holland—288-5700
(A&M, Abnak, Ampex, Bell, Disneyland, Dolton, Double Shot, GNP, Honno Barbero, Hickory, Independence, Imperial, Liberty, London, London Group, Monument, MTA, Musicor, Poca, Project 3, Top Productions, Tower, United Artists, Voliant, White Whole, Visto, Buddoh)

WOBURN

Bay State Record Dist. Corp.
30 Nashua Street
Bob Levinson, Bill Walsh—935-4700
(Atlantic, Bong, Coedmon, Comeo, Chess, Clover, Colonial, Diol, Duke, Distinguished, Elektro, Ero, Emerald, Fontosy, Flip, Focus, Goloxy, Gospel, Hob, Mace, Nashville, Nonesuch, Philles, Porkway, Pothways of Sound, Regent, Sovoy, Scepter, Stordord, Specialty, Stordoy, Sixx, Sounds of Nashville, Voult)

Dumont Record Dist. Corp.
30 Nashua Street
Donald E. Dumont—935-4700
(Atco, Avaco, Bert & I, BT Puppy, Blue Note, Codet, Cambridge, Challenge, Checker, CO & CE, Comand, Copley, Crossroads, Diamond, Dunwich, Epic, ESP, Fiesta, Fraternity, Golden, Gold Star, Grand Award, Grecophone, Jomies, Josie, Jubilee, King, Living Language, Mainstream, Minute Mon, Okeh, Original Sound, Pickwick 33, P Jazz, Prestige, Roost, Roulette, Soma, Squire, Time, U.S.A., Virgo, UNI, Volt, Young People's, W. Poc.)

**TOPS IN SALES
TOPS IN PROMOTION**

SOUTHLAND

RECORD DISTRIBUTING COMPANY

Gerald Friedman, President
1235 Techwood Dr., N.W., Atlanta, Ga.
(404)TR-3-2081

Number One

The Supremes

Exclusively on

**MOTOWN
RECORD CORP.**

The Sound of Young America[®]



**PROMOTION
SALES & SERVICE
DISTRIBUTING
THE HITS**

**STAN
THE RECORD MAN**

(HITMAKER OF THE SOUTH)

STAN'S/728 Texas Street/Shreveport, Louisiana,/(318) 422-7182

RECORD DISTRIBUTORS

and the lines they handle •NARM members

•Jayther Distributing Corporation

730 North Lyndale Avenue
Jack A. Taylor—374-3420
(A&M, Artie, Ascol, Band Box, Bethelhem, Boone, Chart, Contempo, Conversophone, Dearborn, Delta International, Dynamo, F. S. R., Hep, Hickory, International Artists, Jamie, King, Living Language, Longhorn, Musicor, Scotty, Solid State, Specialty, Starday, Summit, Sun, Tom Lehrer, United Artists, Project Three (3), Children's Record Guild, Young People's Records, Veep, Diann, Nola, Parlo, K-Ark, S. R. C., Pickwick International)

•Harold N. Lieberman Co.

9549 Penn Ave., So.
Al Abrams—888-5521
(Bach Guild, Bong, Bear, Best, Callo, Cameo, Chairman Coliseum, Dol, Felsted, Folk Sing, Four Corners, Garpox, Group, Hamilton, Heliodor, Hi, Impact, Jay Jay, Kapp, Koma Sutra, Leo the Lion, London, Louis, Lucky Eleven, Medway, Metro, Moc, Monument, Parkway, Parrot, Phillis, Press, Prestige, Richmond, Roulette, Seville, Sidewalk, Sound Stage 7, SPQR, Swan, Tico, Tower, Tribe, VSP, Vanguard, Verve, Verve Folkways, Viva, Windy C, MGM, 49th State)

MISSOURI

KANSAS CITY—(816)

Capitol Records Dist. Corp.
701 Linwood Blvd.
John Swenson—JE 1-0435
(Capitol, Angel)

Choice Records Dist.
321 1/2 South West Blvd.
Harold Hassler—421-2540

(Abnok, Boone, Chart, Dover Group, Hickory, Starday, Jewel, Paulo, Ronn, Sound of Nashville, Original Sound, Wand, Scepter, Hob, Hep, Ric Tic, Groovesville, Little Darling, Jack "O" Diamonds, Cars, Felitstone Needles)

•Decca Dist. Corp.

2729 Gillham Road
Tom Kelley—471-4030
(Decca, Coral, Brunswick, Vocalion, Word, Canaan, Sacred, Caedmon, LHI, Berlitz Language Courses)

ST. LOUIS—(314)

•Columbia Records Sales

2151-59th Street
Robert Van Metre—MI 7-5101
(Columbia, Harmony, Masterworks, Odyssey, Dote, Ode, Columbia Masterwork Radios and Phonographs)

•Commercial Music Co.

2721 Pine
Bud Lampe—JE 5-1515
(Epic, Mercury, Roulette, United Artists, Living Language, WB, Reprise, Lomo, Play Tapes, Diamond, Sun, Project 3, Conversaphone)

•Decca Dist. Corp.

1923 Delmar
Max Melton—231-6600
(Decca, Coral, Brunswick, L.H.I., Berlitz Records, Word Records, Decca Phonos, Guitars, Drums, and Accessories)

Interstate Supply Co.

2218 S. Jefferson Avenue
R. N. Decker—PR 6-1020
(RCA Victor, RCA Camden, Caedmon, Tape Cartridges—RCA Victor, RCA Camden, Coedmon, Decca, ITCC, ABC Command, Mercury, Pickwick)

•Liberty Records Dist. Co. of Mo.

1905 Washington Ave.
Jim Saltzman—GA 1-3326
(Liberty, Dolton, Imperial, Minit, World, Pacific Jazz, Blue Note)

•Record Merchandisers, Inc.

1919 Delmar Blvd.
Al Chotin—MA 1-0966
(A&M, Audio Fidelity, Bang, Choice, Cumberland, Current, Delmark, Emarcy, Fantasy, Fiesta, Fontana, Galaxy, Gordy, Gospel, Grecophone, Hickory, Hilltop, Hob, Korale, Lighthouse, Little Darlin', MTA, Mace, Modern, Money, Motown, One-Der-Ful, Phillips, Pickwick 33, Savoy, Scepter, Sharp, Shout, Simco, Simpson, Smash, Soul, Tamla, Valiant, V.I.P., Wand)

•Roberts Record Dist. Co.

1902 Washington Ave.
Robert L. Hausfater—Ma 1-0470
(Abnak, Amy, Ara, Argo, Arlen, Arctic, Arwin, Alco, Atlantic, Audio Arts, Aurora, Avant Garde, B.T. Puppy, Back Beat, Bell, Berlitz, Bethlehem, Big Top, Blue Cat, Boone, Brent, Bright Star, Cadet, Calla, Cameo, Con-Am, Carnival, Dearborn, Deesu, Deram, Co & Ce, Congress, Dade, Dearborn, Duesu, Deram, Dial, Disneyland, Dooto, D.G.G., Diann, Double L, Double Shot, Duke, Dunwich, Dyno-Voice, E.S.P., Eastern, Era, Excella, Fame, Federal, Four Corners, Fraternity, GNP Crescendo, Gamble, Golden, Golden World, Goldwax, Groovy, Gross, Guyden, Hanno Barbera, Hi, Hi Fi, Hiback, International Artists, Jamie, Jetstar, Jewel, Josie, Jubilee, Koma Sutra, Kapp, Karen, King, Laurie, Legrand, Life, London, Lucky 11, M-Pac, M.S.L., MGM, Mainstream, Mala, Marlin, Maxx, Metro, Mira, Mirwood, Montel, Moonglow, Mossoul, Mutual, Monument, Musicland, Noshboro, Norman, Nola, Parkway, Parlo, Parrot, Pavla, Peacock, Port, Prestige, Press, Rainbow, Red Bird, Revitol, Ric Tic, Riverside, Ronn, Rosemar, Round, Rust, Sofice, Sahara, Senlar, Sidewalk, Solid Hit, Sound Stage, Sphere Sound, St. Lawrence, Starday, Stox, Surrey, Time, Toot, Tower, Tribe, Turntable, Uptown, Uni, Vault, Verve, Verve/Folkways, Visto, Volt, Whit, Windy-C, Wyncote)

MONTANA

GREAT FALLS—(406)

Interstate Distributing Co.
457 Daniels Street
James A. Whitson—245-5141
(RCA Victor Records, RCA Victor Stereo B Tapes, Mercury Stereo B Tapes)

Music Service Co., Inc.

316 6th St. South
R. E. Holm—761-2420
(A&M, Dolton, Epic, Fontana, Hi, Hill Top, Imperial, Instant Language, Jubilee, Laurie, Liberty, London, M.G.M., Mercury, Monument, Okeh, Parrot, Phyllis, Phillips, Pickwick, Reprise, Smash, Starday, Vanguard, Verve, Warner Bros.)

NEBRASKA

OMAHA—(402)

•Jayther Dist. Corp.
2500 Horney St.
Darwin—342-1545
(Bigtop, Borderline, Bull, Cameo, Conversophone, Del Fi, Dooto, Ember, End, Goldisc, Guyden, Herald, Hickory, Jomie, Kem, Tom Lehrer, Living Language, Musicor, Omega, Parkway, Rainbow, Specialty, Starday, Summit, Sun, United Artists, Westminster)

Sidles Co.

7302 Pacific Street
Ralph Woodward—393-2233
(RCA Victor, RCA Camden)

NEW JERSEY

CAMDEN—(603)

•Decca Dist. Corp.
1722 Federal St.
Sam Passamano—966-7111
(Decca, Coral, Brunswick, Voc., Berlitz Language)

(Continued on next page)

CELEBRATING 2nd ANNIVERSARY

DISTRIBUTING IN THE
MARYLAND, WASHINGTON, D. C., VIRGINIA &
W. VIRGINIA AREAS

Y-R-S DISTRIBUTORS, INC.

3123 W. North Avenue
Baltimore, Md. 21216

Ernie Burston—Pres.
Jimmy Buston—Sales

Dennie Picasso—Promotion
(301) LO-6-5400/01

Best Wishes to Cash Box from
Reuben W. Lawrence

SPECIALTY SERVICE is our Business — Packaging — Creative Merchandising — Allied Specialty Items for the Record Trade

We Buy — Sell — and Exchange Goods

RUBY SALES CO.

4038 W. Armitage Ave., Chicago, Ill. 60639 Phone: 276-5484

WE HUSTLE*

*That's because we're New England's newest and most aggressive record distributor. (Celebrating Our 1st Anniversary)

WANT MORE HUSTLE ON YOUR LINE?

Contact

MASS. RECORD DISTRIBUTORS

"The distributor with soul"

1820 Washington Street, Boston, Mass. 02118
Call Skippy White at (617) 442-3830

Promotion: Bob McAlpine
Sales: Arthur Hartling

ROYAL DISC DIST. CO.

Kent Beauchamp

Edward Yalowitz

FEATURING TOP Sales & Promotional Coverage with:

ATCO — VOLT — VEEP — JUBILEE — BANG — RIVERSIDE — MOONGLOW
ORIGINAL SOUND—BT PUPPY — DUNIWICH — FAME — DELMAK — GROSS
PROJECT III — SHOUT.

ALL TAPES DIST. CO.

SUPER SERVICE with the FIRST & MOST EXPERIENCED
Jobber & One-Stop in Reel-to-Reel and Cartridge Tapes in
the MIDWEST HANDLING ALL LINES.

AMPEX — RCA VICTOR — CAPITOL — COLUMBIA — DECCA — MERCURY
STEREO TAPES — MUSIC TAPES — ORISONIC — ITCC — CRT
UNITED ARTISTS — TAMLA — MOTOWN

RAPID ONE-STOP

HANDLING ALL TOP Selling 45's & LP's
POP and RHYTHM & BLUES

ROYAL DISC DIST. CO. — ALL TAPES DIST. CO. — RAPID ONE-STOP
1400 S. Michigan Ave. — Chicago, Ill. — Phone: (312) 222-2222

land,
lana,
llap,
lace,
Pick-
imp-

Alca,
B.T.
Top,
alla,
hess,
rom,
e L,
Cast-
Fra-
lden
Bar-
mie,
app,
11,
rlin,
Ma-
Nor-
ack,
Ric
ice,
ge,
ey,
ini,
hit,

er-

ol,
n,
s,
d,

el,
d,
y,
.



Thank you....
Connie

EXCLUSIVELY ON:



PERSONAL MANAGEMENT:

GEORGE SCHECK
161 WEST 54TH ST.
NEW YORK, N.Y.
(212) JU 6-6767

RECORD DISTRIBUTORS

AND THE LINES THEY HANDLE • NARM MEMBERS

Liberty Record Dist. Co.
7025 Colonial Highway
(Pennsauken)
Sterling Devers—WA 3-3196
(Liberty, Dolton, Sunset, Imperial, World Pacific, Blue Note, Liberty Stereo Tape)

NEWARK—(201)

• All-State New Jersey, Inc.
321 Sherman Avenue
Irwin R. Fink—242-6500
(Ascol, Alco, Audio Fidelity, Brook-Lyn, Carlo, Class, Coliseum, Compass, Congress, Deram, Dunwich, Fame, Felsted, Four Corners, Garpax, Hi, Heidi, H.I.P., Jab, Kapp, Karen, London, Little Darlin', Main Line, Monument, Moonglow, Musicor, Palmer, Palomar, Parrot, Phase 4, Press, Richmond, Seville, Solid State, Sound Stage 7, Soma, Tomorrow, Tribe, United Artists, Volt, Ampex Tape, United Artists Tape)

Apex-Martin Record Soles, Inc.
175 Clinton Place
Jerry Cohen, Joe Martin—923-7474
(A&M, Epic, Okeh, Tamla, Motown, Gordy, Soul, VIP, Tower, Uptown, UNI, White Whale, Canterbury, Chisa, Amy, Malo, New Voice, Dynavoice, Goldwax, York, Palo, Elf, SSS, Black Pearl, Bang, Shout, Dionn, Jamie, Guyden, Windy C, Tomorrow, Showplace, Goodtime, Cotique, Carnival, Alshire, Kent, Modern,

Go Go, Starday, Nashville, Galaxy, Deesu, Nola, Parlo, Double Shot, Arctic, Like Chart, Phillies, Calla, M.M.O., Walco, Lost Nite, Relic, Catamount, Snowflake, Amber, Taurus, Galaxy)

Essex Record Dist., Inc.
10 Fenwick Street
Joe Cohen, Irv Cohen—243-7700
(ABC, Abet, Allegre, Atlantic, Back Beat, Blue Note, Bluesway, Boom, Bright Star, B.T. Puppy, Cadet, Checker, Chess, Co & Ce, Colonial, Constellation, Copley, Crescent, Dana, Dial, Diamond, Diplomat, Dooto, Dunhill, Duke, End, Excello, Exodus, Fleetwood, Gee, Golden, Gone, Gospel, Halo, Hob, Impulse, Jerden, Jewel, Josie, Jubilee, Kellmac, Laurie, LeGrand, Lupine, Mace, Money, Nashboro, Oldies, Old Town, Original Sound, One-Der-Ful, Paula, Peacock, Pel-Nor, Peter Pan, Pure Soul, Ric Tic, Ronh, Roulette, Savoy, Scepter, Sharp, Simpson, Song Bird, Specialty, Standard, Stax, Stella, Sun, Sure Shot, Swan, Tangerine, Tico, Wand, Whit, Tape Cartridge—ABC, ITCC, GRT, Original Sound)

Ideal Record Products
357 Lyons Ave.
Jock Kosloff—923-6333
(Brent, Gold Star, Headline, Helios, Time)

Krich New Jersey, Inc.
428 Elizabeth Ave.
N. I. Sourmon—248-7400
(RCA Victor, RCA Camden, Request)

Loredy Record Dist. Corp.
46 Green Street
Joseph Fechner—623-5984
(Betty White Dance Records, Challenge, Command, Contact, Conversaphone, Disneyland, Grand Award, Living Language, Loma, Project 3, Reprise, Space, Sure, Veep, Vista, Warner Bros., Command Reel and Cartridge Tapes, Project 3 Cartridge Tapes, Reprise Cartridge Tapes, Warner Bros. Cartridge Tapes)

Wendy Distributors, Inc.
37 William St.
Jerry Winston—623-5845
(Cameo Parkway, Dolton, Elektra, Liberty, Imperial, World Pacific, Sunset Era, Crescendo, Hanna Barbera, Hickory, King, Mainstream, Nonesuch, Prestige, Vanguard, Abnak, Tru G'o, Soul City, Big Wheel, Minit, Sentor, Independence, Lucky 11)

NEW YORK

ALBANY—(518)

Dello Record Distributors, Inc.
1260 Broadway
Robert E. Devere—462-6653
(ABC-Paramount, Artists, Arwin, Boom, Cadet, Checker, Chess, Command, Dunhill, Four Corners, Grand Award, Impulse, Kapp, Monument, Musicor, Reprise, Veep, Warner Bros., Airtown, Arbet, Audio Fidelity, Band Box, Barry, Bell, Bethlehem, Cameo, Challenge, Co & Ce, Crown, Deesu, Dynavoice, Fleetwood, Garrison, Gateway, Glasco, Goldwax, Gospel, Hanna-Barbera, Jetstar, Jewel, Kent, King, Laurie, Lucky 11, Mala, Mosoul, New Voice, Nola, Old Town, One-Der-Ful, Parkway, Parlo, Paula, Peacock, Phillies, Prestige, Pure Soul, Rajac, Rust, Savoy, Scepter, Sentor, Sidra, Soma, Sue, Swan, Terry, Toot, Tradition, Valiant, Wand, Whit, Wayout, York)

J-S Record Dist., Inc.
98 Everett Road
Joseph Spence—489-5446
(Abnak, Arc, B. T. Puppy, Bang, Barrington, Brent, Bronco, Carnival, Chart, Dearborn, Destination, Dore, Dooto, Faber, Fairmont, Fatfish, Fraternal, Gamble, Good Time, Groovy, Hollywood, Impact, Inferno, Jerhart, Josie, Jubilee, Kayden, Kell-Mac, Keyman, Krishna, Look, Mainstream, Mellic, Merben, Minute-man, Mosoul, Mustang, Palmer, Penny, Pow, Rainbow, Ric Tic, S S International, Sahara, Scarlet, Shout, Showplace, Shur-Fine, Sims, Sounds of Nashville, Starday, Stereo-Fi, Thunderbird, Time, Tomorrow, Toot, Tubo, Twirl, Todlin' Town)

Mohawk Records, Inc.
12 Commercial Road
Pete Vosgerichion—489-8371
(ABC, Ambassador, Ascol, Boom, Cadet, Calla, Checker, Chess, Children's Record Guild, Command, Conversaphone, GNP Crescendo, Crestview, Dunhill, Elektra, Everyman's Classics, Fiesta, Folkways, Golden Records, Gordy, Grand Award, Hanna Barbera, Happy Time, Heartwarming, Hickory, Hob, Impulse, Jay Jay, J.E. BO Products, Bluesway, Living Language, Mace, Mira, Mirwood, Monument, Motown, Musicor, Nonesuch, Original Sound, Project 3, Roulette, St. Lawrence, Scepter, Sidewalk, Somerset & Stereo Fidelity, Soul, Sound Stage 7, Starday, Tamla, Tangerine, Tico, Tower, 20th Fox, United Artists, Uptown, Vanguard, Veep, V.I.P., Wand, Young Peoples)

RTA Distributors, Inc.
991 Broadway
Joe Paone—HO 5-7346
(RCA Victor, RCA Camden)

Leonard Smith, Inc.
Shaker Park (Lotham)
L. Smith—758-1350
(Camden, Fiesta, Starday, Vanguard, Disneyland, International Tape Cartridges, Request, Play Tapes)

Trinity Record Dist.
477 Park Avenue
Tony Geno—289-4349
(Ascol, Beacon, Bethlehem, Dance A Long, Dynamo, Dionne, Excello, Fantasy, Fontana, Federal, Galaxy, Gordy, Jamie, Motown, Musicor, Mark Two, Nashboro, Smash, Soul, Solid State, Tamla, United Artists, V.I.P., Veep)

BUFFALO—(716)

Action One Stop, Inc.
875 Main Street
Jerry Meyers—883-2555
(Barrington, Black Pearl, Drew, GJM, Ivanhoe, Jowar, Krishna, LaSalle, SSS International, Stop, Sound)

Bert Record Distributors, Inc.
959 Main St.
Leonard Silver—882-0427
(Alco, Bang, Cameo Parkway, Crescendo, Crusader, Challenge, Diamond, Disneyland, Dunhill, Epic, Golden World, Jamie, Jubilee, King, Kapp, Nashboro, Phillies, Red Bird, Roulette, Scepter Wand, Sarcay, Pure Soul, White Whale and others)

NEW YORK CITY—(212)

AJC Record Soles Corp.
45-50 54th Ave. (Maspeth)
Walter Lom
(ABC, Award Artists, Command, Dunhill, Equinox, Grand Award, Impulse, Jerden, Senate, Simon Says, Tangerine, Accappella, Contact, Menotti, Pantomime, Relic, Snowflake, Times Square)

• Alpha Dist. Corp.
20 West End Ave.
Harry Apostoleris, Murray Viscoso—CI 5-7933
(A&M, Alecor, Ansonia, Ascol, Avoca, Bell Records, Adventure, Amy, Bell, Flashback, Goldwax, Mala, Musicland, Rolate, San Su, Sphere Sound, Colonial, Challenge, Chess, Checker, Cadet (Argo), St. Lawrence, Disneyland, Buena Vista, Dynavoice, Euratec, Everest, Concert Disc, Baroque, Counterpoint, Esoteric, Period, Pirouette, Archive of Folk, Archive of Piano, Cetra, GUP Crescendo, Accent, Gordy, Hickory, Hi Fi, Humor in'l, International Artists, Italdisc, Jewel, JJC, Life, Loma, Monument, Motown, NARM, New Voice, Paula, Ronn, Reprise, Red Fox, Soma, Stereodaddies, Soul, Starday, Nashville, Stella, Sun, Standard, Tamla, United Artists, Ascol, Veep, Sound Stage, Valiant, Vanguard—Upstate Only, V.I.P., Warner Brothers, Whit—Tape Cartridges 4 & B Track—A&M, Chess, Checker, Cadet, Motown, Tamla, Saul, Gordy, United Artists, Warner Brothers Reprise)

Argus Record Dist., Inc.
160 W. 46th St.
Rose Soggio—765-2585
(Aries, Book, Buff, Continental, Cottillion, Criterion, Dapt, Gospel Recording, Johnson, Monmouth, Evergreen, Pa-Dik, Prince, Riccio, Tapes, Cartridges)

• Beto Record Dist., Inc.
599 Tenth Ave.
John Holonko, Ed Kleinbaum—CH 4-3744
(Abnak, Barry, Brent, Alegre, Calla, Cesto, Co & Ce, Cotique, Diamond, Dooto, Duke, Fanra, Fleetwood, Fantasy, Fonseca, Fairmont, Fraternity, Golden Crest, Hob, Golden Records, Impact, Jamie, Kent, Laurie, Nola, Marvelous, Jazzland, Peacock, Parlo, Riverside, Tico, Roulet'e, Rust, Roost, Scepter, Wand, Windy C, Wanderland, Villa, U.S.A., Wheelsville)

Bruno-New York, Inc.
460 West 34th St.
Phil Silverman—564-3062
(RCA Victor Records & Tapes, RCA Camden Records & Tapes, Buena Vista Stereo-8 Cartridge Tapes, Kopp Stereo-B Cartridge Tapes, Diamond Stereo-B Cartridge Tapes, Scepter Stereo-B Cartridge Tapes, Prestige Stereo-B Cartridge Tapes, Wand Stereo-B Cartridge Tapes)

Conol Record Distributors, Inc.
50 Conol St.
Saul Korp—925-9010
(Famous, Gale, Rotona, Vision and Sound)

• Capitol Records Dist. Corp.
1290 Avenue of the Americas
Charles Nuccio—765-0890
(Capitol, Angel, Seraphim, Phonographs and Accessories, B Track Tape Decks and B Track Cartridges)

• Columbia Record Soles
545 Madison Avenue
Tony Martell—HA-1-4700
(Columbia, Harmony, Date, Ode)

Domino Distributors
1122 Rhineland Ave.
Al Vee—892-8092
(DiVenus, Domino, Famm, Baby)

• Decco Dist. Corp.
34-24 56th Street
(Woodside)
James McDonald
(Decca, Coral, Brunswick, Vocalion, LHI)

Hager Distributors
711 Crown Street
(Brooklyn)
Isaac Hoger—HY 3-8131
(Fran, Neginah, Rone, Famous, Greer Recording)

(Continued on next page)

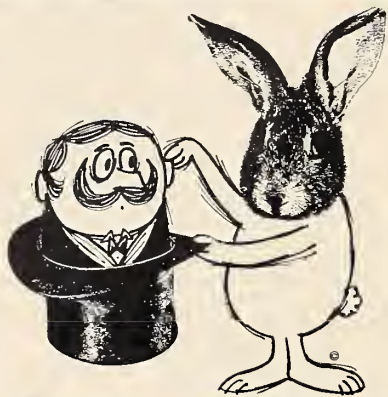

WE DON'T USE MAGIC

... But we must be doing something right!
12 YEARS OF SERVICE, SALES AND PROMOTION

LAREDY

RECORD DISTRIBUTING CORP.

46 GREEN ST. P.O. BOX 783
NEWARK, N. J. (201) MA 3-5984
Joe Fechner (Pres.)

EMPIRE DISTRIBUTING COMPANY

CASH BUYERS OF MAJOR LABEL ALBUMS
FOR PREMIUMS AND PROMOTIONS

4610 LIBERTY AVENUE PITTSBURGH, PA. 15224
Telephone (412) 682-8437

IN NEW JERSEY

You will get the strong sales coverage and merchandising know-how of our professional staff

ALL-STATE

MEL KOENIG Pres. • SHERMAN KOENIG Treas. • IRWIN FINK Vice Pres.

Promotion: Milt Eidelman
HARD-HITTING HUNGRY SALESMEN

ALL-STATE, N.J., INC., 321 SHERMAN AVE., NEWARK, N.J. (201) 242-6500

ANDY! ANDY! ANDY!
ANDY! ANDY! ANDY!



RECORD DISTRIBUTORS

AND THE LINES THEY HANDLE •NARM MEMBERS

Hector Dist. Co.
48 W. 22nd St.
Frank Warren—242-1989
(Acousto-Graphic, Arhoolie, Art, Blues Classics, County, Delmark, Educo, FSR, Heirloom, Historical Jazz, Louisville Music Library, Major, Melodeom, Mobile Fidelity, Opus, Origin Jazz Library, Old Timey, Owl, Revelation, Rococo, Stanyon, Spivey, Takoma, Venus, Vocab, Waikiki)

Ideal Record Products, Inc.
170-21 Jamaica Avenue
Sam Keenhardt—AX 1-8700
(Tom Lehrer, Distinguished, Gold Star)

● **Liberty Records Dist. Co., Inc.**
8-15-37 Avenue
(Long Island City)
Len Chapman, Tom Ragan—937-1100
(Liberty, Imperial, Dolton, World Pacific, Pacific Jazz, Blue Note, Soul City, Minit, Sunset)

● **London Record Dist. Co.**
521 W. 25th Street
Phil Wesen—AL 5-8350
(London, Deram, Hi, Press, Tribe, Deaux, Palomar, Coliseum, Parrot, Seville, Marlin, Circle, Moc, Watch)

Malverne Distributors, Inc.
601 W. 50th St.
Al Hirsch-Joe Grippo—PL 7-0070
(A-Bet, Atco, Atlantic, Bright Star, Cameo, Carla, Carnival, Class, Cook, Dial, Double Shot, Dunwich, Epic, Era, Excello, Fame, Focus, Go Go, HBR, Karen, Lucky Eleven, MTA, Mayfield, Nashboro, Okeh, Moon-glow, Mustang, Parkway, Prestige, Rojac, Savoy, Sen-tar, Stax, UNI, Vault, Volt, White Whale)

● **Merrec Dist. Corp.**
32-02 Queens Blvd.
(Long Island City)
Frank A. Cama—729-6660
(Mercury, Philips, Smash, Fontana, Wing, Emarcy, World Series, Limelight, Childcraft, Playcraft, Story-teller)

Met Richmond Latin Record Sales, Inc.
1637 Utica Ave.
(Brooklyn)
David Last—253-4600
(Alma, Norca, BBM, MR, Eddissa, Seeco, Tropical, Rhumba, Riney, Colonial, BMC, Pergasus, Metropolitan, Carvier, Baroneza, Bocar, BRC, ASA, Encanto, Amex, Jardin, Reli, Samar, Skipper, Filtra, Economy, Kasin, Quica, Prominent, Progresso, Columbia, Tres Banderas, Revancha, Antilano, Ponce, Serenata, Iberia, Mona, Sunset, Key Rio)

● **Metro Record Distributors**
547 W. 52nd St.
Stan Drayson—CO 5-1871
(MGM, Verve, Metro VSP, Heliodor, Elektra, Nonesuch, Contemporary, Mira, Original Sound, Living Language, Audio Fidelity, Mardi Gras, Verve Fore-cast, Project 3, Windy C, Lost Nite)

Olympia Distributing Corp.
239 West 18th Street
Ervin Litki—989-7200
(Kelit, Aurora, Galiko, Golden, Ambassador, Pick-wick, Design, Diplomat, Grand Prix, Hilltop, Instant Language, Somerset, Stadium, Tifton, Parliament, Artia, Panda, Hamilton, Wyncote)

Polka Towne Music
23 Marian Lane
(Jerichol)
T. Kalinowski—OV-1-7356
(Ampol, Bel-Aire, Cardinal, Chicago, Delta Interna-tional, Dyno, Continental, Eurotone, Family, Gateway, Glo, Dearborne, Jay-Jay, JB, Jody, International Ar-tists, Lush, Major, Monitor, P.A.S.A., Pan, Rave, Re-quest, Polka, Surprise, Rex, Ridgemoor, Silverbell, Steljo, Sunglow, U.S.A.)

Stanley-Lewis Record Dist. Co.
534 West 58th St.
Harry Lew—CO 5-7955
(Archive, Avakian (John Cage Set), Bach Guild, Baeren-reiter, Barclay, Bartok, Boite A Musique, Broadside (Folkways), Caedmon, Cambridge, Classic Editions, CMS (Children's Spoken Records), Composer's Record-ings (CRI), Conversaphone, Credo, Cricket, Connois-seur Society, Desto, Deutsche Grammophon, Dover, Richard Dyer-Bennet, EMS, Enrichment, Eterna, Experi-ence Anonyme, E.S.P., Ficker, Folkways, Gregorian Institute, Haydn Society, Lexington, Lyricbird, Mile-stone, Monitor, Motivation, Musica Sacra, Music Guild, Music Minus One (MMO), Oak Publications, Pathways of Sound, Proscenium, Quote, Rutgers Music Dictation, SPA, Spoken Word, Spoken Arts, Tradition, Turnabout, Vanguard, Voix de la'Auteur, Vox, West-minster, Wonderland, Word)

● **States Record Distributing Corp.**
56-40 54th Ave.
(Maspeth)
Al Levine-Lou Klavman—786-6255
(Alshire, Tifton, Take 6, Stereo Fidelity, 20th Century Fox, Time, Shout, Current, Tower, Phyllis, Mace, Ambassador, Shad, ESP, Dictation Disc, Somerset, Audio Spectrum, Mainstream, Bang, Chisa, Pickwick (3000 & 4000 series), Movietone, Emerald, Golden, Twirl)

Trinity Record Dist.
524 W. 43rd Street
Mort Waters—247-4970
(Audio Lab, Beacon, Bethlehem, Dynamo, Faith, Fed-eral, Humoresque, King, Mark Two, Musicor)

World Wide Dist.
101 West 55th St.
Mickey J. Addy—581-2995
(Dot, Viva, Acta, Hamilton)

SYRACUSE—(315)
Columbia Records Sales
218 Harrison Street
Irwin Medway
(Columbia, Date, Harmony, Ode)

Morris Distributing Co., Inc.
1153 W. Fayette St.
Oscar Dachs—475-6531
(RCA Victor, Decca Stereo-8 Cartridges)

NORTH CAROLINA

CHARLOTTE—(704)
Arnold Distributing Co.
2704 Freedom Drive
Bert Fleishman—399-9741
(ABC, Atco, Bang, Boom, Cameo, Carla, Challenge, Class, Custom, Dooto, Dunhill, Dunwich, Dynamic, Elektra, Fame, Four Brothers, Impulse, Jerden, Karen, Loma, Lucky Eleven, Moonglow, Musicor, Mustang, Nonesuch, Parkway, Reprise, Shout, Sue, Symbol, Tan-gerine, Three Rivers, 20th Century Fox, Vault, Volt, Warner Bros., Windy C, Wyncote, Command, Valiant, HIP, Bluesway)

Bertos Sales Corp.
2214 W. Morehead St.
Phil Goldberg—375-2517
(Boone, B. T. Puppy, Cadet, Chess, Checker, Epic, Excello, Fraternity, Gross, Gordy, Josie, Jubilee, Mira, Motown, Nashville, Nashboro, Okeh, One-Der-Ful, Soul, Starday, Soma, Sims, Tamla, Verve, V.I.P., Valiant, Verve, United Artists, Nola, Dee-Ju, Black Pearl)

Carol Dist. Co.
124 W. Morehead St.
Joe Vaynow—333-9457
(Decca, Coral, Brunswick, LHI, Vocalion)

F & F Enterprises, Inc.
2704 Freedom Drive
Bert Fleishman—399-9741
(A&M, Abnak, Arctic, Atlantic, Backbeat, Band Box, Bright Star, Canaan, Clarion, Diamond, Dial, Dolly, Duke, End, Faber, Focus, Golden, Guyden, Hanna, Barbera, International Artist, Jamie, Kenwood, Laurie, LeGrand, Like, Little Darlin', Mayfield, Montel, MSL, Peacock, Phyllis, Roulette, Roast, Rust, Soft, Song-bird, Sound of Soul, Stax, Sure-Shot, Tico, Vanguard, Westminster, Project 3, Dade, Mayfield)

Mangold Dist., Inc.
2212 W. Morehead
Herb Weisman—334-0866
(MGM, London, Kapp, Monument, Disneyland, Sun, Bell, White Whale, Savoy, Specialty)

Southern Radio Corporation
P.O. Box 8309
H. F. Fesperman—376-4461
(RCA Victor, RCA Camden)

GREENSBORO—(919)
Southland Musical Merchandise Corp.
826 Winston St.
Lee Ingber—272-5123
(Living Language, Music Minus One, Conversaphone, CRG-TPP)

OHIO

AKRON—(2161)
Twelgrem Enterprises, Inc.
2775 Yellow Creek Rd.
J. Hugh Macey—836-5591
(ABC (school), ASP, Aqua, Artists Life, Balance, Bal-kan, Belco, Black Mountain, Blue Star, Bogan, Bowery, CEM, Country Dance Society, Dance Along, Danro, Family Squares, Fiesta, Flip, Folk Dancer, Folk Arts Bazaar, Folkcraft, Go, Glenn, HiHat, Hactor, Honor Your Partner, Israeli, J Bar L, Jewel, Kalox, Keeno, Longhon, Lore, MacGregor, Magic, Mayflower, Mibs, Mustang, Old Timer, Panpiper, Prairie, Rainbow, Rockin-A, Roper, Russell, SMC, SNR, Sets In Order, Lloyd Shaw, Square L, Square Tunes, Scope, Sunny Hills, Swinging Square, TNT, Top, Wagon Wheel, Western Jubilee, Windsor, World Of Fun)

(Continued on next page)



We
are where it's at!

San Fran Cis Co. It's a big-ger-than-a-city-place. The world capi-tal of good taste and new tastes; 4.5 million pace-setting, fad-mad, music-conscious, record-happy, radio-bred buyers. Add the whole top half of this No. 1 State for 6 million total plus the contiguous Northwest's 4 or 5 million and you have 11 million tuned-in, buy-minded souls at the reach of Northern California's old-est, biggest, most promotionally-orientated, independent Independent distributor: H. R. Basford Co.

If you want to start breaking big in this market, ask Jack Solinger or Denny Zeitler what Basford can do for you, like starting tomorrow. They're at 800 Mariposa St., San Francisco, 94107, 621-8545 (Area Code 415).

Where are you?
H.R. BASFORD CO.

OUR HEARTIEST CONGRATULATIONS

LENNY and BOB GARMISA

Representing

ABC	DUNHILL	SOLID STATE
COMMAND	UNITED ARTISTS	BLUESWAY
GRAND AWARD	ASCOT	JERDEN
IMPULSE	PRESTIGE	20TH CENTURY
TANGERINE	SENATE	

GARMISA DISTRIBUTING CO., INC.

1700 So. MICHIGAN AVE., CHICAGO, ILL. 60616
ALL PHONES: 922-7455

**NEW JERSEY'S LEADING
INDEPENDENT DISTRIBUTORS**

**ESSEX
RECORD DISTRIBUTORS INC.**

**10 FENWICK ST.
NEWARK 12, NEW JERSEY**

201-BI 3-7700



CONGRATULATIONS CASH BOX
ON YOUR

25th ANNIVERSARY

AND MANY HAPPY RETURNS—



TONY

HARTFORD'S OLDEST INDEPENDENT RECORD DISTRIBUTOR
SERVING

Conn.—Western Mass.—Upstate N.Y.—Vermont

TRY US and SEE
WHY WE ARE NO. 1

PROMOTION • SALES • SERVICE

SEABOARD DISTRIBUTORS, INC.

AN AFFILIATE OF ROSKIN DISTRIBUTORS INC.

275 PARK AVE. Phone 203-289-9361 East Hartford, Conn.

Marv Ginsburg—Sales Manager / Jerry Greenberg—Promotion

WE'RE NOT THE BIGGEST
BUT WE WORK HARDEST!

MOST AGGRESSIVE
NEW ENGLAND DISTRIBUTOR

BAY STATE

RECORD DISTRIBUTOR
30 NASHUA STREET; WOBURN, MASS.
(617) 935-4700
BOB LEVINSON—Pres.

Mr. Manufacturer
When it Comes to your Records

O-O-O-O-O-O-O-O-O-O

Do We Worry

**WENDY
DISTRIBUTORS**

37 WILLIAM ST., NEWARK, N. J. 07102
Jerry Winston, Pres. (201) 623-5845

FOR DISTRIBUTION IN
PHILADELPHIA

You Can't Match

Chips

CHIPS DISTRIBUTING CORP.

2750 N. BROAD ST., PHILADELPHIA, PA. 19132 (215) BA 6-4600

Ernie Santone



RECORD DISTRIBUTORS

and the lines they handle • NARM members

CINCINNATI—(513)

A & I Record Dist. Co., Inc.
1000 Broadway
Joe Nathan—241-7644

(Abnak, Atco, Alshire, B. T. Puppy, Bang, Bluesville, Calla, Carlo, Co & Ce, Conversa-Phone, Diamond, Double-Shot, Duke, Dunwich, Era, Gross, Hob, Jewel, Josie, Jubilee, Karen, Kent, Lama, Mace, Mira, Mirwood, Modern, Maadsville, Moonglow, Nashboro, Ohia State Band, New Jazz, Paula, Peacock, Philips, Prestige, Red Foxx, Reprise, Roulette, Roost, Savoy, Scepter, Shout, Soma, Somerset, Sterea Fidelity, Surrey, Sterea Oddities, Swingsville, Tower, U.N.I., U.S.A., Volt, Wand, Warner Bros.)

Capitol Records Dist. Corp.
Executive Bldg., Suite 612
35 E. 7th St.
John Leffler—721-5616
(Capitol, Angel)

Columbia Records Sales
Suites 444-447, Carew Tower
Bill Kelly—241-4088
(Columbia, Harmony, Date, Ode, Masterwork Phonographs)

Decca Dist. Corp.
Daylight Bldg., 6th & Court Sts.
Jack D. Brown—721-4210
(Decca, Coral, Brunswick, Vocalion, London, Ward, Tribe, Press, Hi, Parrot, Deram, LHI, Berlitz, Guitars, Drums, Tambourines, Phonographs)

Ohio Appliances, Inc.
7624 Reinhold Drive
Jerry Weiner—821-6414
(RCA Victor, Disneyland, Golden, Living Language, Fraternity, Sun)

Summit Distributing, Inc.
617 Central Trust Tower
Jack White—241-6361
(Airtown, Attack, Audio Fidelity, Big A, Brent, Brancho, Crossroads, Epic, ESP, Exodus, Go-Go, Hala, Karate, Kellmac, Little Darlin', M-Pac, Mainstream, Mar-V-Lus, Mayfield, Moonshot, Mustang, Okeh, One-Der-Ful, Ric-Tic, R.S.V.P., Time)

Supreme Distributing Company
1000 Broadway at Court
Al Klayman—421-0747
(ABC, Amy, Atlantic, Bluesway, Boone, Caedmon, Chart, Command, Contemporary, Dial, Emarcy, Fantasy, Fiesta, Fantana, Galaxy, Goodtime Jazz, Heartwarming, Hickory, Impulse, K-Ark, Limelight, Mala, Mercury, Monument, Musicor, Musictapes, Nashville, Original Sound, Phillies, Sims, Sing, Skylight, Smash, Songs Of Faith, Sound Stage Seven, Star Day, Stax, 20th Century Fax, & Wing Childcraft)

CLEVELAND—(216)

Capitol Records Dist. Corp.
2800 Euclid
Jim Johnson—861-9187
(Capitol, Angel, Capitol Phonographs and Cartridge Tape Equipment)

Cleve-Disc Distributing Company
1550 East 33rd Street
Jim Toppe—391-1320
(ABC Paramount, Apt, Baam, Impulse, Dunhill, Jorden, Music Guild, Tangerine, Westminster, Atco, Alert, Brooklyn, Carla, Class, Fame, Heidi, Jaker, Jatis, Moonglow, Vault, Volt, Way Out, York, Sunburst, Delta International, Dynavoice, New Voice, Esp, Epic, Okeh, Living Language, London Group, Press, Hi, Manument, Reprise, 20th Century Fax, Warner Bros., Lama, Vax, Simon Says, Crossroads, B & F Badapest, Bear, Capco, Dee Jee, Ga-Go, Parrot, Tribe, Marlin, Sound-Stage, Soma, 4 Sisters, Stereaddities, Co & Ce.)

Columbia Record Sales
3510 Chester Avenue
Gene Setfeler—431-6300
(Columbia, Date, Ode)

Decca Dist. Corp.
745 W. Superior Ave.
Bill Green—621-9770
(Decca, Coral, Brunswick, Word, London, Deram, Berlitz)

Grossman Music Corp.
1278 West 9th St.
Al Diamond—861-3900
(Music Minus One, Golden Crest, Grand Award Artist)

Liberty Record Dist. Co.
7002 Euclid Avenue
Robert Galinski—881-5050
(Liberty, Dolton, Sunset, Imperial, World Pacific, Blue Note, Liberty Stereo Tape)

Main Line Records
1260 E. 38th St.
Gene Shipley—391-1800
(A&M, Abnak, Accent, Amy, Back Beat, Bang, Bell, Bethlehem, Buddah, Cadet, Canterbury, Challenge, Checker, Chess, Chisa, Compass, Deutsche, Gramophon, Dollie, Double Shot, Duke, Elektra, Era, ESP, Disc, Excella, Four Corners, Fraternity, GNP Crescenda, Gordy, Gospel, Heliador, Hi Fi, Jamie, Jewel, Kama Sutra, Kapp, King, Laurie, LeGrand, Life, MGM, Main Line, Mala, Matawn, Musicor, Nashboro, Nonesuch, Paula, Peacock, Phillies, Project 3, R.S.V.P., Ronn, St. Lawrence, Savoy, Shout, Solid State, Saul, Tamla, Thomas, UNI, United Artists, V.I.P., Vanguard, Veep, Verve, White Whale, York, RCA Victor, RCA Camden, Colgems, Request, Star-day)

(Continued on next page)

ASK ANYONE WHO KNOWS!
THEY WILL TELL YOU WE'RE THE
#1 DISTRIBUTOR IN PROMOTION AND SALES
IN MARYLAND, WASHINGTON, D.C., VIRGINIA AND WEST VIRGINIA

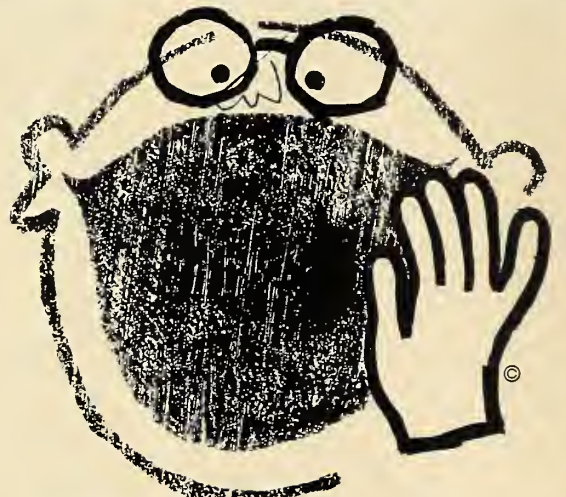

(IF THEY SAY OTHERWISE . . .
TELL THEM TO KEEP THEIR BIG MOUTH SHUT!)

General

HENRY NATHANSON, PRES.

2329 PENNSYLVANIA AVE. BALTIMORE 17, MD. (301) NO. 9-6411

DISTRIBUTING
CO., INC.

Burdette

MUSIC COMPANY

SONGS OF TODAY BY TODAY AND TOMORROW'S STARS

Exclusively published by Burdette:



- 1 **JIM VALLEY***
Columbia Records
- 2 **THE KINGSMEN*****
Wand Records
Producer: Jerden Music Inc.
Management: Scandore & Shayne
- 3 **DON & THE GOODTIMES****
Epic Records
Management: Bob Levinson
- 4 **THE NEW YORKERS**
Scepter Records
Producer: Jim Bailey
Management: R.A.M., Inc.
- 5 **MAGIC FERN**
Jerden Records
Producer: Jerden Music Inc.
- 6 **THE SONICS**
Jerden Records
Producer: Jerry Dennon,
Management: R.A.M., Inc.
- 7 **DANNY O'KEEFE**
Jerden Records
Producer: Jerden Music Inc.
- 8 **IAN WHITCOMB**
Tower Records
Producer: Jerden Music Inc.
Management: Jerry Dennon
- 9 **THE SPRINGFIELD RIFLE**
Jerden Records
Producer: Jerden Music Inc.
Management: R.A.M., Inc.
- 10 **THE BARDS**
Jerden Records
Producer: Jerden Music Inc.
Management: R.A.M. Inc.
- 11 **BRAVE NEW WORLD**
Epic Records
Producer: Bill Fredericks for
Jerden Music Inc.
Management: Bob Fletcher

Burdette

MUSIC COMPANY
971 Thomas Street
Seattle, Washington 98109
(206) MAin 2-0470

*co-published by Gentle Mind Publishing Co.
**co-published by Shingle Music Co.
***co-published by Sharow Music/Flomar Music
Proprietor: Jerry Dennon

PRIVILEGE
DISTRIBUTORS
INC.

"It is our privilege to serve you"

2818 W. PICO BLVD.
LOS ANGELES, CALIF. 90006
(213) 731-3148

Happy 25th Anniversary!

Speaking of anniversaries, we have just celebrated our first!!
Thanks to our sources we have had an outstandingly successful year—even to the point of opening a spanking new branch in San Francisco

We still hold title as the youngest, most progressive distributor on the coast

Jack Nelson
General Manager
San Francisco Branch
82 Dorman Avenue
415-648-6870

Norman Goodwin
President

RECORD DISTRIBUTORS

and the lines they handle • NARM members

Sound Sales Company, Inc.
7706 Carnegie
Milton Weiss—432-0080
(Airtown, Combo, Dooto, Faro, Flip, Highland, Luau, Mira, Mirwood, Money, Nansibor, Scamm, Solid Hit, Ten Star)

Seaway Distributors, Inc.
3142 Prospect Avenue
David R. Glew—EX 1-7300
(Alon, Atlantic, Stax, Focus, Dial, Like, Bright Star, Clairon, Sims, Audio Fidelity, Command, Grand Award, Diamond, Disneyland, Vista, Dot, Hamilton, Viva, Everest, Fiesta, Garrison, Golden, Hickory, Impact, Instant, Jay Jay, Jubilee, Gross, B. T. Puppy, Josie, Port, Van Dam, Dano, Dictorian Disc, Keymen, MaSoul, Mainstream, Brent, Time, Monitor, Mustang, Bronco, Old Town, Original Sound, Pickwick, Hill-top, Scepter, Wand, Hob, Simca, Jet Stream, Mace, Seven B, Swan, Tower, U.S.A., Cameo, Parkway)

OKLAHOMA

OKLAHOMA CITY—(405)

B & K Dist. Co.
129 N. W. 23rd St.
Bill Burton—JA 5-7509
(Liberty, ABC Paramount, Parkway, Cameo, Reprise, Roulette, Chancellor, Swan, Duke, Delfi, Dolton, Blast, Jamie, Diamond, Command, Grand Award, Kapp, Living Language, Philles, Sue, Peacock, Old Town, Atco, Volt, Impulse, Disneyland, Vista, Gaden, Choro, Dunes, Big Top, Malo, Amy, Dimension, Monogram, Guyden, Back Beat)

Dulaney's
100 N.W. 44th Street
Clyde C. Ball—JA-8-0511
(RCA Victor, RCA Camden, Fraternity, Cartridge Tapes, RCA Victor, RCA Camden, Auro Sonic, Capital, Columbia, Pickwick, Mercury, Smash, Philips, Fontana, ITCC, Ampex Group)

OREGON

PORTLAND—(503)

North Pacific Supply Co., Inc.
2950 N.W. 29th Avenue
Harry Salvus—228-9576
(RCA Victor, RCA Camden, Request)

PENNSYLVANIA

BETHLEHEM—(215)

Capitol Records Dist. Corp.
2980 Avenue B
Tom Takayoshi—868-1401
(Capitol, Angel)

HARRISBURG—(717)

D&H Distributing Company, Inc.
2525 North Seventh Street
David Press-Endo Corsetti—761-2805
(RCA Victor, Stella, Word, Heartwarming, Jay-Jay, Tapes: RCA Victor, Decca, ITCC, Muntz, Ampex, United Artists, Mercury, Philips, Smash, Fontana)

PHILADELPHIA—(215)

A & L Distributors, Inc.
1811 Fairmount Ave.
Albert Melnick—PO 5-4300
(Academy, Adventure, Afro, Alector, Amy, Audio Fidelity, Audio Rarities, Aurora, Avoca, Backbeat, Bell, Big Hill, Big Top, Brent, Calla, Conversophone, Betty White Dance Series, Language Courses, Steno-Speed Courses, Colonial, Crescent, Dearborn, D-Town, Duke, Dynovoice, Elektra, E.S.P., Exodus, Excello, Fantasy, Flashback, Folkways, Galaxy, Glad Hamp, Golden Crest, Goldwax, Happy Time, Headline, Impact, Jet Set, Karate, Little Darlin, Mala, Mayfield, Milestone, Mobile Fidelity, Monitor, Murnil, Musicland, Music Minus One, Classic Editions, Procinum, Nashboro, New Voice, Nina, Nonesuch, Peacock, Pickwick 33, Richard Dyer Bennett, Riot, Song Bird, Sphere Sound, Spoken Arts, Standard, Sure Shot, Turnabout, Vox. Accessories—Peerless, Claricon, Honey Tone Tapes & Radios, Narske Organs & Books, Magnus Organs & Books, Organaire & Books, RCA Batteries, Standard Radios, Ampex Tapes, Music Tapes, Webcor Players, D.J. Players)

Capitol Records Dist. Corp.
7708 City Line Ave.
Howard Aranson—877-4167
(Capitol, Angel)

Chips Dist. Corp.
2750 N. Broad St.
Ernie Santone—BA 6-4600
(Artia, Avant Garde, Boone, Cameo, Canaan, Carnival, Diamond, Dyno, Disneyland, Dare, Dover, Eurotone, Fleetwood, Fraternity, GNP, Gamble, Gateway, Gordy, Lucky Eleven, Mira, Mirwood, MTA, Motown, Nola, Parkway, Parliament, Parlo, Soul, Stella, Tamla, VIP, Vista, Wayout, Windy C, Word, Wyncote. Tape Cartridges—Gordy, Moton, Soul, Tamla, Word, Fidelitone Needles)

Columbia Records Sales
4 Penn Center Plaza—Suite 224
E. Masterson—LO 8-4445
(Columbia, Columbia-Masterwork Phonographs, Date, Ode, Harmony, Odyssey)

J. M. B. Records
P.O. Box 2902
WA 7-0253
(Amber, B.J., Candelite, Cool Sound, Ditto, Dawn, Bobby's, Fellatio, J.D.F., Kape, Nason, Pantomime, Power, Old Timer, Shield, Siamese, Snowflake, Speedy, Rendezvous, Red Fox, & Oldies But Goodies)

Marnel Dist. Co., Inc.
2512 N. Broad St.
Marshall Verbit—226-1222
(Atlantic, Alegre, Bang, B. T. Puppy, Chetra, CO & CE, Caedmon, Dial, Dooto, E.S.P., Everest, Fiesta, Gross, HBR, Hi Fi, Jay Jay, Jubilee, Laurie, Living Language, Last Nite, Mainstream, Prestige, Rojac, Riverside, Roulette, Savoy, Specialty, Starday, Stax, Shout, Sun, Time, Tico, Tower, United Artists, Valiant, Vanguard, Riot)

David Rosen Incorporated
851-53-55 N. Broad Street
Harry Rosen—CE 2-2900
(ABC, Award Artists, Bethlehem, Bluesway, Cadet, Checker, Chess, Chisa, Command, Compass, Congress, Deluxe, Dunhill, Four Corners, Golden, Grand Award, Hickory, Impulse, Independence, Jerden, Kapp, Kent, King, Loma, Modern, Monument, Movietone, Music Guild, Musicor, Palmer, Post, Reprise, Somo, Sound Stage 7, Sure, Tangerine, Twentieth Century Fox, Warner, Westminster. Accessories: Recoton, Astatic, Pickering, Le Bo, Gavin)

(Continued on next Page)

ALL STATE



DISTRIBUTING CO

1507 SOUTH MICHIGAN AVE. • CHICAGO, ILL. 60605
PHONE (312) 939-3675

SERVING THE INDEPENDENT MANUFACTURER WITH AGGRESSIVE PROMOTION • SALES • MERCHANDISING ON POP — R&B — C&W — SINGLES & LP'S

LEE HOWARD • PAUL GLASS • HOWARD BEDNO & CY GOLD
Sales Manager President Promotion

ALL STATE RECORD DISTRIBUTING CO.



**Many
Thanks
For A
Wonderful
Year**

Al Martino



MET RICHMOND LATIN RECORD SALES INC.

"The largest selection of Spanish Budgets in U.S.A."

1637 Utica Avenue, Brooklyn, New York
Tel: 212 253-4600 DAVID LAST, Pres.

If you have Spanish speaking trade in your area we are your answer.

Our vast library of Spanish tapes for LP's is available for lease.

Special attention to Cartridge Manufacturers.

EXCLUSIVE DISTRIBUTORS OF M ñ R RECORDS

HAPPY ANNIVERSARY CASH BOX

NATIONAL HIT BUILDERS

- ☆ TOP SALES
- ☆ TOP PROMOTION
- ☆ TOP SERVICE

ERNE LEANER — BILL LEANER

Promo Men: LEROY PHILLIPS—CORY WADE—MIKE ALLEN

UNITED RECORD DISTRIBUTORS, INC.

1827 South Michigan Ave., Chicago 16, Ill.
(All Phones: CALumet 5-6605)

CHAPMAN DISTRIBUTING CO. LA's Finest Distributor

Manufacturers' Inquiries Most Welcome.
Your Product Deserves Personal Attention.

Contact:

CHAPMAN DISTRIBUTING CO.

2645 W. Pico Blvd. Los Angeles, Calif. 90006
Phone (213) 385-3636

YES

There IS Another Distributor
Covering

WASHINGTON, WEST VIRGINIA
MARYLAND AND VIRGINIA

MARNEL OF MARYLAND

(The Other Distributor)

3000 Ridgewood Ave. (301) 664-8500
Baltimore, Md. 21215

Stan Hoffman

Marv Slaveter

RECORD DISTRIBUTORS

and the lines they handle •NARM members

Raymond Rosen & Co., Inc.
51st & Parkside Ave.

Paul Knowles—TR-8-2200

(RCA Victor, RCA Camden, RCA Victrola, London, London Phase 4, London International, Richmond, MGM, Verve, Metro, Kama Sutra, Coliseum, Heliador, VSP, Leo the Lion, Verve, Folkways, RCA Stereo B Tape Cartridges, MGM & Verve Stereo B Tape, RCA Victor & Camden Reel-to-Reel)

Universal Record Dist. Corp.
919 N. Broad St.

Leonard Radcliff—CE 2-3333

(A&M, Atco, Epic, London Group, Jamie, Original Sound, Contemporary, Mustang, White Whale, Canterbury, Volt, Project 3, Scepter, Wand, Challenge, Jewel, Paula, Double Shot)

PITTSBURGH—(412)

Capital Record Dist. Corp.
110 St. Joseph St.

Dennis Letzler—431-5803

(Capitol, Angel, Seraphim, Duotone Needles & Accessories)

Columbia Records Sales
220 Porter Bldg.

Ran Ehrle—261-2844

(Columbia, Epic, Date, Okeh, Ode)

Fenway Record Corp.

1601 Fifth Ave.

Herbert S. Cohen—391-3973

(Amy, Artie, Ascot, Atlantic, Atteru, Autumn, Bang, Banner, Blue Cat, Blue Note, Boom, Canadian-Amer., Centaur, Charger, Chattahoochee, Checker, Chess, Claridge, Co & Ce, Colpex, Congress, Constellation, Dial, Diamond, Dimension, Donna, Dore, Dyno, Dyno-Voice, End, Everest, Fenway, Fiesta, Four Corners, Fraternity, Gee, Glover, Golden-Crest, Golden-World, Gone, Gordy, Hi, Hickory, Hob, Hull, Jacida, Jay Jay, Joda, Kellmac, Laugh-Time, Lesage, London Groups, Moce, Mar-V-Lus, Maxx, Minuteman, Motown, Musicland, Mustang, New Time, New-Voice, NPC, Old Time, One-Derful, Parrot, Paule, Press, Pure-Soul, Red Bird, Ricky, Roost, Roulette, Sahara, Scepter, Sims, Somo, Soul, Stax, St. Lawrence, SunGlow, Tamlo, Thomas, Tico, Tribe, 20th Century Fox, United Artists, USA, Wand, Whit)

Hamburg Bros., Inc.

24th St. & A.V.R.R.

Marton Lacker—471-0808

(RCA Victor, Camden Victrola, ABC Paramount, Bach Guild, B. T. Puppy, Colgems, Dana, Dalton, Dunhill, E.S.P., Fraternity, Golden, Gross, Hanna Barbero, Hilltop, Impulse, Jerden, Josie, Jubilee, King, K-Ark, Liberty, Living Language, Mira, Mirwood, Monument, Music Guild, Nashville, Original Sound, Pacific Jazz, Pickwick 33, Port, Sound Stage 7, Starday, Sunset, Tangerine, Tower, 20th Century Fox, Uptown, Vanguard, Westminster, White Whale, World Pacific)

Standard Dist.

1601 Fifth Ave.

Herbert S. Cohen—391-3973

(Atco, Blue Rock, Cameo, Carla, Challenge, Class, Colonial, Command, DCP, Era, Fame, Flip, Gateway, Grand Award, Horizon, Impact, Imperial, Interphone, Kent, Laurie, LeGrand, Modern, Moonglow, Original Sound, Palmer, Parkway, Phillies, Reprise, Rice, Rust, Simpson, Smash, Sun, Sunburst, Swan, Tallie, Valiant, Vee Jay, Volt, Warner Brothers, Wayout)

TENNESSEE

KNOXVILLE—(615)

McClung Appliances

310 Georgia St.

Albert W. Smith—524-1811

(RCA Victor, RCA Camden, Pickwick Intl, Heartwarming, RCA Stereo B Tape, Heartwarming Stereo B, Pickwick Intl. Stereo B, ITCC Stereo 8)

MEMPHIS—(901)

Decca Dist. Corp.

741 Galloway Ave.

Graham Hediker—527-4539

(Decca, Brunswick, Vocalion, Coral)

McDonald Brothers Co.

994 South Bellevue

Charles F. Smith—948-2771

(RCA Victor, Atlantic, Mercury, Atco, Smash)

Memphis-Delta Record Dist. Co., Inc.

596 Lane Ave.

Ewell Rausseil—525-0756

(Stax, Volt, Shout, Motown, Tamla, Gordy, VIP, Soul, King, Parlo, Chess, Checker, Bar, Rojac, Barry, Mosoul, Jerhart, Instant, Fraternity, Mayfield, Cameo, Parkway, Mar-V-Lus, Sue, Jewel, Paula, Murco, Nola, Calla, Windy C, Ronn, Deesu, Mirwood, Sims, One-Der-Ful, Speciality, Whit, GNP Crescendo, Moon Shot, Seven B's, Atlas, Raines, Thomas, Phillies, M-Pac, Kellmac, Mustang, Riverside, Goodtime, Julmar, Ric Tic, Sun, Jet Star, Hollywood, Impact, Bang, Chess, Checker, Diamond, U.S.A., Parlo, Jewel, Paula, Cameo, Parkway, Tower, Mira, CO & CE, B. T. Puppy, Musicor, Phillies, GNP Crescendo, Nola, Arbut, Calla, Mayfield, Lucky 11, Hip, I-A, Fraternity, Ronn, Windy C, Roulette, Bar, Centaur, Destination, Moon Shot, Seven B's, Atlas, Raines, Thomas, Mustang, Riverside, Ric Tic, Impact, Murco, Sun, Abnak, Hollywood, Cadet, Everest, Contemporary, Good Time Jazz, Riverside, Chess, Checker, Dooto, Tower, La Louisianne, Jubilee, Chess, Fax, Humorsonic, Riot, M.F. (Redd Fox), Starday, Sims, Sun, Boone, Hot, Gold Standard, Hilltop, Paula, Savoy, Gospel, Halo, Chalice, Chess, Checker, Hilltop, Pickwick, Surrey, Mainstream, Living Language, Dictation Disc, Audio Fidelity, Cartridge (B & 4 Track) Tapes—GRT, ITCC, Ampex, Mercury, Muntz, Motown, Tamla, Gordy, Soul, Pickwick)

Record Sales Corporation

311 Exchange Avenue

Bill Biggs—526-7361

(ABC, A-Bet, Airtown, Amy, Backbeat, Bell, Best, Big Wheel, Bishop, Black Pearl, Blue Note, Boom, Bullet, Command, Crash, Crown, Dollie, Dalton, Double Shot, D-Town, Duke, Dunhill, Dynovoice, Excelsior, Garrison, Goldwax, Group, Heartwarming, Hi, Hickory, Hob, Impulse, Imperial, Jet Stream, Jet Set, Kent, Labet, Laurie, Liberty, Loma, Mellow, Minit, Modern, Mojo, Money, Monument, Movin, M-Pac, Musicland, Musette, Nashboro, New Voice, N-Joy, Pacific Jazz, Parrot, Peacock, Press, Reprise, Scepter, Songbird, Sound Stage, Spheresound, Sunset, Sureshot, Statue, St. Lawrence, Tag LTG, Tangerine, Tarpon, 20th Century Fox, Tribe, Tru-Glow, United Artists, United Modern, Valiant, Veep, Wand, Warner Bros., Wheelsville, Word, World Pacific, York)

(Continued on next page)

★ AGGRESSIVE PROMOTION

★ DYNAMIC SALES STAFF

★ TOP-RATE DIRECTION

★ FINEST FACILITIES



DAVID ROSEN inc.

855 N. BROAD ST. • PHILADELPHIA, PA. 19123

* HARRY ROSEN
Vice-President

(215) CE 2-2900

TO ALL OUR FRIENDS AT CASH BOX

Congratulations on your first 25 years

May the next 75 be as wonderful



THE LETTERMEN

(Jim, Tony and Bob)

Exclusive
Booking
XXX
WILLIAM MORRIS

Personal Management:
JESS RAND ASSOC.
Beverly Hills
Calif.



FOR MANUFACTURERS WHO WANT

THE BEST IN MERCHANDISING

THE BEST IN PROMOTION

THE BEST IN SERVICE

IN NEW YORK IT'S

MALVERNE

DISTRIBUTORS INC.

601 West 50th St.
New York, N.Y. 10019
(212) PL 7-0070

AL HIRSCH, Pres.

RECORD DISTRIBUTORS

and the lines they handle •NARM members

NASHVILLE—(615)

Music City Record Dist., Inc.
127 Lafayette Street
Hutch Carlock—255-7315

(ABC, Ambassador, Ara, Atca, Atlantic, Audio Back, Bang, Bethany, Bethlehem, Big Wheel, Boom, Calla, Camea, Carla, Carnival, Celeste, Chart, Clarion, Courier, Charger, Co & Ce, Dial, D-Tawn, Dunhill, Dunwich, Enjoy, Ero, Esp-Disk, Excella, Fabar, Fan-

tasy, Federal, Fontana, Four Brothers, Fraternity, Fury, Galaxy, Gamble, Gorpax, Graovy, Grass, Hanna-Barbera, Hi, Hi Fi, Hab, Impact, Instant, Jerdan, Jet Stream, Jubilee, Kopp, Karen, Kent, King, La Louisiana, Laurie, Limelight, Longhorn, Lupine, Mar-V-Lus, M-Pac, Mercury, Mercury-Wing, Mercury-Childcraft, Mercury-Playcraft, Mercury-Storytellers, Mirwood, Mira, Moanglaw, Mac, Money, Monument, Nashboro, Nashville, One-Der-Ful, Our Bag, Parkway, Parrot, Phillies, Press, Price-Wise, B. T. Puppy, Pure Soul, Rampart, Rem, Saffice, Scepter, Serack, Seven-B, Simca, Smash, Sims, Sound of Nashville, Sound Stage 7, Spokane, Speciality, SPQR, Starday, Stax, Sun, Swan, Swingin', Tangerine, Thelma, 20th Century Fax, Tribe, Tubo, Vanguard, Vault, Wand, Watch, Fidelitone Needles & Accessories, Freedman Artcraft Racks)

COVER THE SOUTH



ED WALKER, Gen. Mgr.

1023 BARONNE ST., NEW ORLEANS, LA. 70130. TELEPHONE (504) 525-7104.

Southern Record Distributor Co., Inc.

467 Chestnut Street

Howard Allison—254-1991

(A&M, Cadet, Backbeat, Bell, Challenge, Checker, Chess, Crescendo, Diamond, Duke, Dyna Voice, Gardy, Hickory, Jamie, Kama Sutra, USA, Jewel, MGM, Mala, Michelle, Motown, Musicar, Parla, Nala, Paula, Peacock, Philips, Prestige, Raulette, Savoy, Sama, Saul, Sure Shot, St. Lawrence, Thomas, Tamala, Tower, United Artist, Verve, White Whale, Wayout)

World Wide Dist.

535 Fourth Ave. So.

Jim Wardlaw—AL 5-5451

(Dot, Viva, Acto, Hamilton)

TEXAS

DALLAS—(214)

Adleta Co.

1914 Cedar Springs

David Eisenlohr—741-3152

(RCA Victor, RCA Camden, RCA Stereo B Cartridge)

The B & K Record Dist. Co.

1411 Round Table Drive

Bill Burton—ME 7-1920

(Alshire, Archive, Audio Fidelity, Buena Visto, Ca-Ce, Disneyland, DGG, ESP, Heliador, Hickory, Lamo, Kama Sutra, MGM, Melra, Mira, Nala, Parla, Prestige, Project 3, Reprise, Riverside, Savoy, Solid State, Stereo Fidelity, United Artist, VSP, Veep, Verve, Warner Brothers, Tape Cartridges—General Record Tape, Kama Sutra, MGM, Muntz, Playtape, Reprise, United Artist, Verve, Warner Brothers)

Big State Record Dist. Corp.

1337 Chemical Street

Bill Emerson—ME 1-1100

(A&M, Atca, Atlantic, Amy, Bell, Bang, Back Beat, Blue Note, Cadet, Chess, Checker, Camea, Challenge, Diamond, Dolan, Duke, Dynavoice, Excella, Fantasy, Fraternity, Gordy, Hi, Hanna Barbera, Imperial, Jewel, Jamie, Josie, Jubilee, Kent, Laurie, Liberty, Landon, Living Language, Mala, Mainstream, Minni, Motown, Monument, Moanglaw, Musicar, Nashboro, New Voice, Paula, Phillies, Parrot, Parkway, Peacock, Press, Pacific Jazz, Raulette, Sun, Starday, Stax, Swan, Scepter, Soul, Tamla, Teardrop, U.S.A., Vanguard, Vault, Volt, Wand, World Pacific)

Capitol Record Dist. Corp.

5105 Lakawana St.

John Griffith—ME 7-1890

(Capitol, Angel)

Columbia Record Sales

8808 Empress Row

Tom Cade—ME 1-5680

(Columbia, Epic, Okeh, Date, Ode)

Decca Distributing Corporation

139 Cole Street

C. W. Doherty—742-3739

(Decca, Coral, Brunswick, L.H.I., Elektro, Caedman, Nonesuch, Berlitz Language)

Dot Records World-Wide Dist.

1347 Chemical

David Gibson—ME 1-0630

(Dot, Hamilton, Viva, Acto, Parade, Original Sound, Little Dorlin)

Merrec Distributors

814 Stemmons Tower South

Tom Colley—ME-1-3531

(Mercury, Philips, Smash, Fontana, Limelight, Wing Childcraft, Playcraft, Storyteller, World Series 4 & B Track Tape, Cassette Tapes, Mercury Phonographs & Tape Recorders)

EL PASO—(915)

M. B. Krupp Distributors Inc.

P. O. Box 222, 311 So. Sante Fe Street

M. B. Krupp, Ruben Irizarry—532-4961

(A&M, Abcamy, Argo, Atca, Atlantic, Back Beat, B. T. Puppy, Bego, Branco, Camea, Challenge, Chart, Checker, Chess, Colonial, Columbia (Mexican), Cameta, Carona, DLV, Dektr, Delo, Del Valle, Del West, Disco Grande, Dimension, Daatone, Dore, Duke, Duncan, El Zarape, Ero, Falcan, Fome, Fraternity, Fragdeath, Fuentes, Galaxy, Hurricane, Hickory, Ideal, Infol, Jamie, Josie, Jubilee, Kent, Key Lac, Laurie, Le Grand, Mala, Managram, Musart, Parkway, Philips, Nashville, Original Sound, Orfeon, Parkway, Phillies, Pon American, Peerless, Raulette, Ranchera, Relompaga, Rasina, Rust, Scepter, Sun, Sunlaw, Swan, Sombrero, Talent Scout, Tear Drop, Wand, Valmon, Yucca)



**MEMPHIS
-DELTA
DISTRIBUTING CO.**

596 Lane Avenue
Memphis, Tennessee
(504) 525-0756

Ewell Roussell, Mgr.
Representing the Independent
Manufacturer with effective
sales promotion, merchandising
know-how and fast service.



(Continued on next page)

Allen Toussaint • Marshall E. Sehorn • Don Schroeder • Bob Crewe • Herb Bernstein • Charles Stewart
Garrie Thompson • Steve & Bill Jerome • Shelby Singleton • Budd Granoff • Madelon Baker • Jim Riley
Buzz Cason • Bobby Russell • Quinton Claunch • Rudolph Russell • Charles Greene • Brian Stone
Charles Koppelman • Don Rubin • Kama-Sutra • Tony Roman • Bob Crewe • Marshall E. Sehorn •

Lee Dorsey • Mighty Sam • Clyde McPhatter • Chris Cerf • Mitch Ryder • The Van Dykes • Paul Vance
James & Bobby Purify • Syndicate of Sound • The Attractions • The Doughboys • Tennessee Guitars •
Mr. Bo & His Blues Boys • Lou Johnson • Tony Roman • The Bob Crewe Generation • The Emperors
James Carr • The Ovations • Spencer Wiggins • Percy Milem • Joey Powers • Betty Harris •
United Fruit Co. • The Poor • Priscilla Paris • The Changing Times • Diamond Joe • Eldridge Holmes
Oscar Toney Jr. • Kitty Kallen • The Incredibles • Al Kooper • Eddie Hodges • Clifford Curry • Fantasia

Allen Toussaint • Marshall E. Sehorn • Don Schroeder • Bob Crewe • Herb Bernstein • Charles Stewart
Garrie Thompson • Steve & Bill Jerome • Shelby Singleton • Budd Granoff • Madelon Baker • Jim Riley
Buzz Cason • Bobby Russell • Quinton Claunch • Rudolph Russell • Charles Greene • Brian Stone
Charles Koppelman • Don Rubin • Kama-Sutra • Tony Roman • Bob Crewe • Marshall E. Sehorn •

Lee Dorsey • Mighty Sam • Clyde McPhatter • Chris Cerf • Mitch Ryder • The Van Dykes • Paul Vance
James & Bobby Purify • Syndicate of Sound • The Attractions • The Doughboys • Tennessee Guitars •
Mr. Bo & His Blues Boys • Lou Johnson • Tony Roman • The Bob Crewe Generation • The Emperors
James Carr • The Ovations • Spencer Wiggins • Percy Milem • Joey Powers • Betty Harris •
United Fruit Co. • The Poor • Priscilla Paris • The Changing Times • Diamond Joe • Eldridge Holmes
Oscar Toney Jr. • Kitty Kallen • The Incredibles • Al Kooper • Eddie Hodges • Clifford Curry • Fantasia

Allen Toussaint • Marshall E. Sehorn • Don Schroeder • Bob Crewe • Herb Bernstein • Charles Stewart
Garrie Thompson • Steve & Bill Jerome • Shelby Singleton • Budd Granoff • Madelon Baker • Jim Riley
Buzz Cason • Bobby Russell • Quinton Claunch • Rudolph Russell • Charles Greene • Brian Stone
Charles Koppelman • Don Rubin • Kama-Sutra • Tony Roman • Bob Crewe • Marshall E. Sehorn •



Lee Dorsey • Mighty Sam • Clyde McPhatter • Chris Cerf • Mitch Ryder • The Van Dykes • Paul Vance
James & Bobby Purify • Syndicate of Sound • The Attractions • The Doughboys • Tennessee Guitars •
Mr. Bo & His Blues Boys • Lou Johnson • Tony Roman • The Bob Crewe Generation • The Emperors
James Carr • The Ovations • Spencer Wiggins • Percy Milem • Joey Powers • Betty Harris •
United Fruit Co. • The Poor • Priscilla Paris • The Changing Times • Diamond Joe • Eldridge Holmes
Oscar Toney Jr. • Kitty Kallen • The Incredibles • Al Kooper • Eddie Hodges • Clifford Curry • Fantasia

Allen Toussaint • Marshall E. Sehorn • Don Schroeder • Bob Crewe • Herb Bernstein • Charles Stewart
Garrie Thompson • Steve & Bill Jerome • Shelby Singleton • Budd Granoff • Madelon Baker • Jim Riley
Buzz Cason • Bobby Russell • Quinton Claunch • Rudolph Russell • Charles Greene • Brian Stone
Charles Koppelman • Don Rubin • Kama-Sutra • Tony Roman • Bob Crewe • Marshall E. Sehorn •

Lee Dorsey • Mighty Sam • Clyde McPhatter • Chris Cerf • Mitch Ryder • The Van Dykes • Paul Vance
James & Bobby Purify • Syndicate of Sound • The Attractions • The Doughboys • Tennessee Guitars •
Mr. Bo & His Blues Boys • Lou Johnson • Tony Roman • The Bob Crewe Generation • The Emperors
James Carr • The Ovations • Spencer Wiggins • Percy Milem • Joey Powers • Betty Harris •
United Fruit Co. • The Poor • Priscilla Paris • The Changing Times • Diamond Joe • Eldridge Holmes
Oscar Toney Jr. • Kitty Kallen • The Incredibles • Al Kooper • Eddie Hodges • Clifford Curry • Fantasia

Allen Toussaint • Marshall E. Sehorn • Don Schroeder • Bob Crewe • Herb Bernstein • Charles Stewart
Garrie Thompson • Steve & Bill Jerome • Shelby Singleton • Budd Granoff • Madelon Baker • Jim Riley
Buzz Cason • Bobby Russell • Quinton Claunch • Rudolph Russell • Charles Greene • Brian Stone
Charles Koppelman • Don Rubin • Kama-Sutra • Tony Roman • Bob Crewe • Marshall E. Sehorn •

Lee Dorsey • Mighty Sam • Clyde McPhatter • Chris Cerf • Mitch Ryder • The Van Dykes • Paul Vance
James & Bobby Purify • Syndicate of Sound • The Attractions • The Doughboys • Tennessee Guitars •
Mr. Bo & His Blues Boys • Lou Johnson • Tony Roman • The Bob Crewe Generation • The Emperors
James Carr • The Ovations • Spencer Wiggins • Percy Milem • Joey Powers • Betty Harris •
United Fruit Co. • The Poor • Priscilla Paris • The Changing Times • Diamond Joe • Eldridge Holmes
Oscar Toney Jr. • Kitty Kallen • The Incredibles • Al Kooper • Eddie Hodges • Clifford Curry • Fantasia

Allen Toussaint • Marshall E. Sehorn • Don Schroeder • Bob Crewe • Herb Bernstein • Charles Stewart
Garrie Thompson • Steve & Bill Jerome • Shelby Singleton • Budd Granoff • Madelon Baker • Jim Riley
Buzz Cason • Bobby Russell • Quinton Claunch • Rudolph Russell • Charles Greene • Brian Stone
Charles Koppelman • Don Rubin • Kama-Sutra • Tony Roman • Paul Vance • Marshall E. Sehorn •

Bell Records 1776 Broadway, New York, N.Y. 10019



The WINNER

The Most Aggressive
Independent
Distribution in
Pennsylvania,
New Jersey
and Delaware.

BEST IN SERVICE
BEST IN SALES
BEST IN PROMOTION

OUR BEST ENDORSEMENT
IS OUR SATISFIED
MANUFACTURERS

You're a Winner when you
call:

AL MELNICK

A&L

DISTRIBUTORS, INC.

1811 Fairmount Ave.
Philadelphia, Pa.
(215) POplar 5-4300

RECORD DISTRIBUTORS

AND THE LINES THEY HANDLE •NARM MEMBER

Sunland Supply Company, Inc.
2227 Texas Avenue
William M. Shapiro—533-5901
(Artio, Audibook, Bronca, Bruno, Caedmon, Design,
Discos, Columbia, Deutsche Grammophon, Children's
Record Guild, Cricket, Cumberland, Crown, Falcon,
Fiesta, Folkways, King Group, Living Language,
London Group, Monitor, Montillo, Monument, Musort,
Original Sound, Parliament, Peter Pan, Pickwick,
Richmond Specialty, Turnabout, Vanguard, Vox, Young
People's Records)

HOUSTON—(713)
Allied Recorded Sound, Inc.
2704 Polk Avenue
Ben Baker—CA 7-2316
(All major and independent 4 & 8 track cartridge
tape labels, reel to reel tape, auto and home stereo
cartridge units)

**OUR
BUSINESS
IS
RECORD
DISTRIBUTION**

**OREGON
WASHINGTON
NORTHERN IDAHO
ALASKA**

**TOP SALES
COVERAGE**

**HUFFINE
DISTRIBUTING
COMPANY**

3131 Western Avenue
Seattle 1, Washington
206 ATwater 48633

Art Jones & Co., Inc.
4301 Gulf Freeway
W. L. Whitehead—CA 3-4281
(RCA Victor, RCA Camden, RCA Victrola, Colgems)

•H. W. Daily, Inc.
314 E. 11th
Bud & Don Daily—UN 1-6868
(Abnok, Amy, Arhollie, Aurora, Boch Guild, Bong,
Borry, Bell, Big Top, Block Hawk, Blues Classics,
Boone, Brent, B. T. Puppy, Comeo, Conadion Ameri-
con, Carnival, Challenge, Chotto Hoochee, Coliseum,
Converso-Phone, Constellation, D, Diamond, Dictation-
Disc, Dollie, Double Shot, Dynamic, Dyno Voice, El
Zarape, Ember, Ero, Excello, Fantasy, Fleetwood,
Fraternity, Golox, Goldwox, Gross, Group, Homo,
Hoppy Jazz, Hi, Hollywood, Hot Shot, Imperial, Joy
Jay, Josie, Jox, Jubilee, Keylock, Lourie, Legronde,
London, Lucky Eleven, Moinstream, Malo, Morlin,
Mor-V-Lus, Minit, Musicland, Musicor, Nashboro,
Nashville, New Voice, Oldies, Old Timer, Old Town,
Orfeon, Original Sound, Palomar, Parkway, Porro,
Philles, Press, Romco, Richmond, Shout, Somo, Star-
doy, Stereoditties, Tomi, Tribe, Tru Gla Town, Voli-
ant, Vanguard, Wheelsville, White Whale, Windy C,
Wyncote)

United Record Dist. Co.
1613 St. Emmonuel
Steve Pancia—CA 8-8151
(Argo, Ascot, Artic, Ark, Aro, Auro, Astro, Atco,
Arbee, Atlantic, Atlantic Jazz, Autumn, Berlitz,
Brooklyn, Bock Beat, Bethlehem, Boone, Belloire, Blue
Note, Big Thunder, Blue Cot, 4-Bros., Clorion, Compus
Song, Corney, Comp Clombaker, Corson, Conjo, Coms,
Checker, Cyclone, Coun-tree, Cee-Jom, Copa, Copri,
Codd, Collo, Climox, Celeste, Codette, Capitol,
Chalice, Colpix, Corlo, Chess, Codet, Crozy Cojun,
D.C.P., Delca, Dooto, Diol, Dolton, Dode, Destina-
tion, Donte, Duke, Dimension, EP, Enjoy, Eldo, Em-
ber, Eric, Foirlond, Focus, Fury, Federal, Fobor,
Fome, Frolic, Frisco, Groovy, Gospel, Guyden, Gen,
Gadget, Golden World, Gold Bond, Golden Eagle,
Hob, Hub-City, Herald, Hermitage, Heidi, Interlude,
Lost-Nite, Levee, Lew, Liberty, Lupine, Lyric, Lomo,
L & K, Lo Louisiana, Lori, Jin, Jamie, Jay, Jewel,
Joed, Junior, Jotis, Jet-Stream, Jomol, Jodo, Jomodo,
Jocido, Jell, Joker, J-Beck, King, Kirk, Kontic, Kent,
Mantel, Michell, Monument, Moonglow, Moe, Morvel,

Modern, Midtown, Music-City, Musicode, Matrix, Neal,
Nola, Omen, Prestige, Peacock, Price Wise, Pam,
Pocific Jazz, Pic 1, Princess, Project, Proise, Paradise,
Poulo, Ploboy, Pocemoker, Rompart, Red Bird, Regent,
Roscoe, Reprise, Rheims, Riviero, Rhythmaires, Renner,
Rosemort, Renfro, Ric Tic, Roulette, Select, Sovoy,
Scepter, Sonoro, Spode, Sims, Simco, Sing Song,
Sound Stage 7, Specialty, Stax, Sun, Swallow, Swan,
Serman, Songbird, Sure Shot, Sharp, Saface, Sunburst,
Seofair Belo, Sincere, Spokane, Sonsu, Satellite, Sully,
Sobro, Sorg, Sor, Sunshine, Soul Sound, Show, Shone,
Stone Way, Shozam, Suove, Spinner, Symbol TNT,
TCF-Hall, Teardrop, Tico, Tower, Trey, Texan, Turn-
table, Triumph, Tuff, Typhoon, Twirl, Tamm, Tomorrow,
U.S.A., United Artists, U.T. Talent, Uptown, Volt,
Vault, Ventural, Von, Verna, Warner Bros., Wand,
World Pacific, Word, Woy Out, Wingote)

SAN ANTONIO—(512)
Perry Shankle (Co.)
1801 S. Flores
J. J. Schneider—CA 3-1801
(RCA Victor, RCA Camden, RCA Mexicana, Liberty,
Dolton, Ideal, Bego, Volmon, El Zorope, Folcon, Jester,
Musort, Orfeon, Peerless, Pon Am, RCA, Rosino, Co-
lumbio Sunslow, Keyloc, Tomi, Valman)

Tanner 'N' Texas Soles Corp.
1414 West Poplar
Charles Cole—PE 28072
(Bego, Bronco, Cometo, Delo, Del West, Disco
Grande, DLV, El Toro, El Zarope, Folcon, Jester,
Musort, Orfeon, Peerless, Pon Am, RCA, Rosino, Co-
lumbio Sunslow, Keyloc, Tomi, Valman)

SAN BENITO—(512)
Rio Grande Music Company
P.O. Box 861
Paco Befancourt—EX-9-1471
(Ideal, Alfa, Norco, Chico, Bego, Bronco, Columbio,
Cometo, Cobre, Corono, Colonial, Coast, Cima, Del
Volle, Del West, D.L.V., Dela, Folcon, Fome, Fuentes,
Capoca, Gobe, Gaviota, Grnde, Impala, Jilguero,
Key Lac, Liro, Lygo, Miomi, Musort, Mex Melody,
Napol, Norteno, Oro, Orfeon, Peerless, Popular, Rio,
Rivol, Relompogo, Rosino, Sombrero, Sunslow, Tear-
drop, Tomi, Torerfo, Volmon, Victor, Zarape)

(Continued on next page)

OLDIES are happening!

WITH EVERY IMPORTANT STATION IN THE
COUNTRY PLAYING OLDIES, HOW MANY
TIMES CAN YOU AFFORD TO SAY "NO" TO
YOUR CUSTOMERS REQUESTS FOR THEM?
why not STOCK OLDIES?

Watch your mark-up and sales go OUT OF SIGHT!
Best selection (all labels)! Lowest prices! at
America's only OLDIES ONE-STOP.
"We have what the others don't."

WRITE FOR LATEST CATALOGS

**american
record**

215-769-3900

sales inc.

1242 west girard avenue,
philadelphia, pa. 19123

IN PHILADELPHIA
Promotion In Motion Merchandising
Volume Sales

Universal

LEN RADCLIFF, Gen. Mgr.
record distributing corporation
919 N. Broad St. Philadelphia 23, Pa.
Enter 2-3333

JOHN

'BRIEN

DISTRIBUTING, INC.

SALES
PROMOTION
SERVICE

5829 NORTH 96TH STREET • MILWAUKEE, WISCONSIN 53225
(414) 462-5590

WHO SAID 13 IS UNLUCKY!

*#1 Again—Roger Williams—For 13 Years a top recording artist—has been named
“MOST PROGRAMMED INSTRUMENTALIST”*

*1967-1968
Cash Box D-J Poll*



*Thanks to everybody who made it happen for
ROGER!*

AGENTS:
AGENCY FOR THE
PERFORMING ARTS

PRODUCTION:
R-J PRODUCTIONS, INC.

EXCLUSIVE:
KAPP RECORDS



RECORD DISTRIBUTORS

AND THE LINES THEY HANDLE • NARM MEMBER

UTAH

SALT LAKE CITY—(801)

●Billinis Dist. Co.
3575 So. 700 West
John Billinis—266-3548

(A&M, MGM, U.A., Musicor, Motown, Tamla, Gordy, Disneyland, Buena Vista, Chess, Checker, Cadet, King, Phyllis, Kapp, Starday, B. T. Puppy, Laurie, Hickory)

Cordova's Importers & Distributors
543 West 3rd North P.O. Box 16065
Carl C. Cordova—355-0642

(Bego, Bravo, Columbia Mexican, Cometa, Colonial Latin, Bronca, Dekta, D.L.V., Del Norte, Del Valle, Eco, Falcon, Fuentes, Hurricane, Ideal, Infal, Liro, Nopal, Norfeno, Musart, Peerless, Orfeon, Rival, Sombrero, Son-Art, Teardrop)

Huish Dist. Co.
2525 South 8th St. West
Ross J. Davis—486-7611

(RCA Victor, RCA Camden, Vanguard, Cameo, Parkway, ITCC Tapes, Muntz Tapes)

WASHINGTON

SEATTLE—(206)

●Capitol Records Dist. Corp.
1907 15th Ave. W.
Charles A. Dolok—AT 3-3550

(Capitol, Angel, Phonographs, Accessories)

●C & C Dist., Inc.
1000—1st Ave. So
Stan Sulman—MU 2-7188

(Chess, Checker, Argo, Atlantic, Liberty, Dalton, Jubilee, MGM, Verve)

●Consolidated Distributors
1000 First Avenue South
Seattle, Washington

(Lines unavailable at press time)

●Craig Corporation
540 S. Front St.
Jim Fuscaldo—RO 3-2450

(Columbia, Date, Ode)

●Decca D'st. Corp.
3131 Western
Mel Nimon—AT 4-8060

(Decca, Coral, Brunswick, Word, Berlitz Language, Decca Phonograph and Musical Instruments)

●D. J. Distributing
1000 First Avenue South
Jerry Dennon—MU 2-7188

(A&M, Scepter/Wand, Tower, Pacific Jazz, World Pacific, Dunhill, Jerden, Uni, Era)

●Fidelity Electric Co.
5301 Shilshole, N.W.
W. J. Toiles—SU 4-9100

(RCA Victor, Kapp, Philips, King, Cameo, Parkway, White Whale, Valiant, Phyllis, Fraternity, Mira, Mirwood, Maryland, Rojac, Bethlehem, Request, Co & Ce, Emerald, Chisa)

Huffine Distributing Co.
3131 Western Ave.
Andy Huffine—AT 4-8633

(Accent, Amy, Audio Fidelity, Aurora, Bell, Big Hill, Crescendo (GNP), Cricket, Dynavoice, Fiesta, GNP (Crescendo), Gold Wax, Golden Crest, Gordy, Hickory, Karate, Motown, Music Minus One (MMO) Maxx, Monitor, Music Guild, New Voice, Soul, Tamla, V.I.P., Westminster, Motown B & 4 Track, Lear Tape Cart.)

●Music Distributors, Inc.
1000—1st Ave. S.
Stan Sulman—MU 2-7188

(Epic, Crossroads, Command, Elektra, Folkway, Imperial, Mercury, Starday, United Artist, Vanguard)

WISCONSIN

MILWAUKEE—(414)

●Morley Murphy Co.
5151 W. State St.
Henry Aubuchon—453-7200
(Columbia, Date, Ode)

●John O'Brien Distributing, Inc.
5825 North 96th Street
John F. O'Brien—462-5590

(Cadet, Atco, Volt, Vault, Moonglow, Brooklyn, Atlantic, Stax, Focus, Chess, Checker, Destination, B. T. Puppy, King, Clorion, Diamond Dunwich, Gee, Gordy, Gross, Hi-Fi, Jamie, Guyden, Arctic, Jasie, Jubilee, Montel, Motown, Musicor, Phyllis, Riviera, Roulette, Roost, Specialty, Tear Drop, Tico, USA, Co & Ce, Soul Everest)

●Taylor Electric
4080 No. Port Washington Road
J. A. Taylor, P. D. Stocke—964-4321

(Allegro, Cricket, Cuca, Happy Time, Hickory, Hilltop, Pickwick 33, RCA Camden, RCA Victor, Sterea 8 Tape, ITCC, Motown)

PUERTO RICO

BAYAMON

●Fortoleza Record Dist., Inc.
P.O. Box 612
Tony Rivera—785-99666
(Most U.S. Labels Are Available)



DOUBLE "B"
gives
TRIPLE "A" SERVICE
The One-Stop
where Everything Goes!

Complete Selection

4 & 8 Track STEREO TAPE CARTRIDGES

LP's — ALL LABELS — SINGLES

DOUBLE "B" RECORDS & TAPE CORP.

240 East Merrick Road, Freeport, Long Island FR 8-2222
Bernard Boorstein/Donato Liberatore/Zeke Lengua

NEW YORK CITY — CONNECTICUT — WESTERN MASS. — ALBANY, N. Y. — VERMONT — NEW YORK CITY

VERMONT — CONNECTICUT — NEW YORK CITY — VERMONT

NEW YORK CITY — CONNECTICUT — WESTERN MASS. — ALBANY

NOW IN THREE MARKETS
WHY NOT JOIN US AND GET
COMPLETE COVERAGE ON YOUR LINE

IN

NEW YORK CITY

PROMOTION—OTIS POLLARD

PROMOTION—FRANK BERMAN

CONNECTICUT

AND

WESTERN MASS.

10 SALESMEN TO SELL YOUR CATALOGUE
2 PROMOTION MEN TO GET EXPOSURE

ALBANY, N.Y. AND VERMONT

CONN. & ALBANY, N.Y.—477 PARK AVE.—EAST HARTFORD, CONN. (203) 289-4349/289-4624—BIG ED DINALLO • JACK MANUS
NEW YORK CITY—524 WEST 43 STREET—(212) 565-0861—MORT WATERS

N.Y. — VERMONT — NEW YORK CITY — CONNECTICUT — WESTERN MASS. — ALBANY, N.Y.

TRINITY
RECORD DISTRIBUTORS
(RACKING—ONE STOP—LEASING—RETAIL STORES)





Management—Patrick Colechio, 9000 Sunset Blvd., L. A., Calif. 90069
Booking—Associated Booking Corp., New York, Beverly Hills, Chicago, London
Recording—Warner Brothers Records, 4000 Warner Ave., Burbank, Calif.

ONE STOPS

ALABAMA

M&F
1607 5th Ave., N.
Birmingham, Ala. 35203—
Flip Flippone

Music Center
416 N. 19th St.
Birmingham, Ala. 35203—
Virgil Lugar

IN THE UPPER MIDWEST

WHY
DO MORE ROUTE OPERATORS
BUY
ALL OF THEIR 45'S
FROM
THE TWIN CITIES'
NO. 1 ONE-STOP
BBI?

SERVICE-SELECTION-RELIABILITY

BROWN BROS., INC.
2321 WASHINGTON AVE. NORTH
MINNEAPOLIS, MINN. 55411
JA 2-6648—AREA CODE 612

Victory Record Service
1028 N. First Ave.
Birmingham, Ala. 35203

The Record Shop Annex
11A Parkway City
Huntsville, Ala.

Franco Dist.
3728 Princeton Blvd.
Montgomery, Ala.

Prichard Music & Appl.
112 Main St.
Prichard, Ala. 36601

ARIZONA

Arizona One Stop
2029 N. Black Canyon
H'way
Phoenix, Ariz. 85009

Arizona Rec. Dist.
4971 N. Central Ave.
Phoenix, Ariz. 85012—
Tony Evans

Flash Dist.
3907 East Yale
Phoenix, Ariz. 85008

ARKANSAS

Moses Melody
505 Main St.
Little Rock, Ark. 72201—
Jim Moses

CALIFORNIA

Western
1461 Park Avenue
Emeryville, Calif. 94608—
David Watson

California Music
2933 W. Pico Blvd.
Los Angeles, Calif. 90052
—Jerry Barish

Dale Record Service
5873 Rodeo Rd.
Los Angeles, Calif. 90016
—Martin Shaw

Disc Mobile
2567 W. Pico Blvd.
Los Angeles, Calif. 90052

New Deal Record Service
Corp.
3660 West Pico Blvd.
Los Angeles, Calif. 90019
—Alan Atkins

Norty's
436 N. Fairfax Ave.
Los Angeles, Calif. 90052—
Norton Beckman

Sun State Dist.
2669 W. Pico Blvd.
Los Angeles, Calif. 90052

Luenhagen
2277 W. Pico Blvd.
Los Angeles, Calif. 90052
—Mary Salle

Op's One Stop
2647 W. Pico Blvd.
Los Angeles, Calif.

Sunstate Music
2669 W. Pico Blvd.
Los Angeles, Calif.

Westad
131 Phoenix Ave.
Modesto, Calif. 95351—
Jim Petros, Jr.

West Coast Music Sales
3160 West Pico Blvd.
Los Angeles, Calif. 90019—
Richard Susser

M. T. S., Inc.
1518 Broadway
Sacramento, Calif.

Braviroff Piano & Music
1170 East Street
San Bernardino, Calif. 92402

Dial Sales
1835 Fifth St.
San Diego, Calif. 92101

Ratner Elec.
745 Broadway
San Diego, Calif. 92101

Nor Cal One Stop
233 Utah Ave.
San Francisco, Calif.—
Godfrey Dickey

R. F. Jones
240 Shotwell St.
San Francisco, Calif.

Western
645 Bryant St.
San Francisco, Calif. 94107—Leon Bohn

Hit Line Record Sales
P.O. Box 15293
San Diego, Calif. 92115—Frank Mitzker

Discorama
235 South First St.
San Jose, Calif. 95113—Art Walker

COLORADO

Mile Hi
77 Kalamath St.
Denver, Colo.—Joe Oxman

Mountain Distributors
3630 Downing St.
Denver, Colo. 80202—Peter Geritz

A&N
P.O. Box 2671
Denver, Colo. 80201—James Scott, Sr.

Morton Record Co.
945 East Evans Ave.
Pueblo, Colo. 81001

CONNECTICUT

Central
477 Park Ave.
E Hartford, Conn. 06180—
John Roccanella

Globe One Stop
308 Tolland St.
E. Hartford, Conn.—Gene Gotthelf

Record & Rack Sales
76½ Tolland St.
E. Hartford, Conn.

Dave's One Stop
171 Park Ave.
E. Hartford, Conn. 06180—Dave Bratter

Park Dist.
275 Park Ave.
E. Hartford, Conn.

Leslie Dist. N.E.
275 Park Ave.
E. Hartford, Conn. 06108—Ed Stein

Cutler's
33 Broadway
New Haven, Conn. 06510

New Deal Record Service Corp.
215 Lambertson St.
New Haven, Conn. 06519—Sid Dicker

DISTRICT OF COLUMBIA

Supermusic
1245 9th St., N.W.
Washington, D.C.—Phil Levine

Quality Music
1836 7th St., N.W.
Washington, D.C. 20013—
Max Silverman

FLORIDA

Southern Record Service
1020 E. 14th St.
Hialeah, Fla. 33010—Dave Shedd

Budisco Record Sales
236 N.W. 29th St.
Miami, Fla. 33101—Raoul Shapiro

Budisco Inc.
60 Riverside Ave.
Jacksonville, Fla. 32201

Southland Appliance
9500 S.W. 69th Court
Miami, Fla. 33156

Sunshine State Record Dist.
8170 N.W. 36th Ave.
Miami, Fla.

Ernie Reyer
2815 S.W. 63rd Ave.
Miami, Fla. 33101

H & L Record Mart
66 W. Church St.
Orlando, Fla.

Record Supply Co.
2634 Taft Ave.
Orlando, Fla. 32802

Southern Music
503 W. Central
Orlando, Fla. 32802

Budisco Record Service
1723 Cypress
Tampa, Fla.

Florida Electronics
2106 Main St.
Tampa, Fla. 33607—Linda Santos

D&M Postcard & Record Co.
P.O. Box 6433
5011 Georgia Ave.
West Palm Beach, Fla. 33405

GEORGIA

All Purpose Service
1456 Northside Dr. N.W.
Atlanta, Ga. 39304

DEALERS and OPERATORS

For PROMPT, EFFICIENT Service
Try Our COMPLETE ONE-STOP Facilities
2 Locations to Serve You

AM BAT RECORDS, INC.

1667 Central Parkway, Cincinnati, Ohio 45214
Phone 621-3252
Vern Hawk

and
1336 Xenia Ave., Dayton, Ohio 45410
Phone 256-4212

ONE STOP MEANS SERVICE

That's how we made our reputation

- Most Complete and only one stop in Detroit handling all LP labels
- Complete stock of singles for dealers and operators
- We carry the standards in our inventory

Having the most complete inventory enables you to get immediate service, one shipping charge, filling of special orders that means time saved by you. Contact:

CONSOLIDATED ONE STOP, INC.

13254 Linwood Avenue, Detroit, Michigan 48238 (313) TO 5-8665

ONE STOPS

L & F
720 14 St. N.W.
Atlanta, Ga.—Jack Gelbart

The Music Pit
4 Broad St., S.W.
Atlanta, Ga.

Gate City Record Serv
1231 D. Collier Rd., N.W.
Atlanta, Ga. 30318

Hit Records
1209 Techwood Dr.
Atlanta, Ga. 30318

Record Center
2581 Piedmont Rd., N.E.
Atlanta, Ga. 30304

Clarksville Record Sales
P.O. Box 190
Clarksville, Ga. 30523

Ralph's One Stop
Hwy. 441—Box 117
Demorest, Ga. 30535

Southeast Record Sales
138 East 5th St.
Tifton, Ga. 31794

ILLINOIS

ABCO
3313 N. Springfield Ave.
Chicago, Ill. 60607—T. H. Gorman

All Records
3006 N. Elston Ave.
Chicago, Ill. 60607

Barney's
3234 Roosevelt
Chicago, Ill. 60624

Galgano Distributing
4135 W. Armitage Ave.
Chicago, Ill. 60639—
Anthony & John Galgano

Joe's Record Shop
550 E. 43rd St.
Chicago, Ill.

Little Al's
3216 W. Lawrence Ave.
Chicago, Ill. 60625—Al Temaner

Lormar Record Dist.
2311 N. Western Ave.
Chicago, Ill. 60647

Marquette Records
3215 W. 63rd
Chicago, Ill.—James O'Dwyer

Mid American Specialty
752 N. Milwaukee
Chicago, Ill. 60607

Minetts Record Dist.
2029 S. Michigan Ave.
Chicago, Ill. 60607

Music Box
1410 S. Michigan Ave.
Chicago, Ill.—Harry Losk

New Deal Record Service of
Illinois, Inc.
1414 S. Michigan Ave.
Chicago, Ill. 60605—Irv Rothblatt

Pan American One Stop
1344 S. Halsted St.
Chicago, Ill. 60607—M. S. Frankel

Profit Venders
3216 W. Lawrence
Chicago, Ill. 60607

Singer
1812 W. Chicago
Chicago, Ill. 60607—Fred Sipiora

World Dist.
2021 S. Michigan
Chicago, Ill. 60616

Decatur Rak Sales
1130 E. Eldorado—312 N. Water
Decatur, Ill. 62523

Original One Stop
312 N. Water
Decatur, Ill. 62523

World Dist.
5531 Main
Morton Grove, Ill.

S & G Music Store
403 So. Adams
Peoria, Ill. 61602—
Ruby A. Duncan

Hi Fi One Stop
804 N. Main St.
Peoria, Ill. 61601

Van Goor
1715 2nd Ave.
Rock Island, Ill.
Platter Record Shop
208 S. 4th St.
Springfield, Ill. 62601

INDIANA

Associated Dist.
210 S. Meridan
Indianapolis, Ind. 46206—
L. E. Randle, Jr.

C C Record Co. of Indiana
1312 Capitol Ave.
Indianapolis, Ind.—Chas. Collier

Caleron Dist. Co.
423 N. Alabama St.
Indianapolis, Ind. 46206—
Al Caleron

Ed Whitehead Enterprises
817 North Fares Ave.
Evansville, Ind.

Klahen's Record Shop
1230 South Anthony
Ft. Wayne, Ind.

J & J Dist. Co.
1661 W. 16 St.
Indianapolis, Ind.

IOWA

Dart Records
515 E. Locust
Des Moines, Iowa 50309—
John Pittman

Mars Sales
1630 Locust
Des Moines, Iowa 50318—
Eddie Dunker, Chuck Taylor

Lieberman Record One Stop
1406 E. Grand
Des Moines, Iowa

Records, Inc.
315 12th St.
Des Moines, Iowa 50318

Major Records
1212 Grand Ave.
Des Moines, Iowa 50309—
Bob Pockrandt

KANSAS

Giant
221 E. Williams
Wichita, Kans. 67202—I. Albert

LITTLE AL'S

Records & Accessories

Tapes & Accessories
3216 W. Lawrence Ave.
Chicago 25, Illinois 60625
(Phone: IR 8-1441)

Presently Supplying...

Record Shops
Department Stores
Variety Shops
Appliance Stores
Furniture Stores
Drug Stores
Discount Centers
Advertising Agencies
Schools & Studios
All Little Al Record Shops

One Delivery, One Invoice,
Guaranteed Sale—
Guarantees Profit



**ON-THE-GO
COAST TO COAST**

NEW DEAL RECORD SERVICE CORP.

Al Levine, Lou Klayman



**MOBILE
ONE STOP
ALL LABEL RECORD
SERVICE**

The Most Complete, Versatile Distribution Network.
Rack Jobbing • Servicing
Promotion Planning • One-Stop Service
Prompt-As-Promised Delivery—Check the New Deal Office nearest you

NEW DEAL RECORD
SERVICE CORP.
46-50 54th AVE.
MASPETH, N.Y.
212-786-6255
Morris Weissman
Peter Hyman

NEW DEAL RECORD
SERVICE CORP.
c/o DON FAERBER
4918 PLUM TREE LANE
HAZELWOOD, MO.
314-865-0482
Don Faerber

NEW DEAL RECORD
SERVICE CORP.
1414 SOUTH MICHIGAN
CHICAGO, ILLINOIS
312-922-6245
Irv Rothblatt
Chuck Myers

NEW DEAL RECORD
SERVICE CORP.
3660 W. PICO BLVD.
LOS ANGELES, CALIFORNIA
213-731-9313
Alan Atkins

NEW DEAL RECORD
SERVICE CORP.
2503 NORTH BROAD ST.
PHILADELPHIA, PA.
215-229-4555
Pete Voss

NEW DEAL RECORD
SERVICE CORP.
c/o DONALD BRIDGES
1124 EL CAMINO REAL
BURLINGAME, CALIF.
415-347-2473

NEW DEAL RECORD
SERVICE CORP.
1601 GUILFORD AVENUE
BALTIMORE, MARYLAND
301-837-2773
Ronny Bollon

NEW DEAL RECORD
SERVICE CORP.
215 LAMBERTON ST.
NEW HAVEN, CONN.
203-777-5793
Sid Dicker
Lou Celone

NEW DEAL RECORD
SERVICE CORP.
15329 LIVERNOIS AVENUE
DETROIT, MICHIGAN
313-863-2226
Dave Lasher

STATE RECORD DIST. CORP.
46-50 54th AVE.
MASPETH, N.Y.
212-786-6255
Morris Weissman
Peter Hyman
COMPLETE DISTRIBUTION
FACILITIES

NINETEEN YEARS

of Satisfying Service to thousands of customers thru the 50 States with our FAST one-day mail-order service via our nightly shows on:

KWKH, Shreveport
(50,000 watts)

KEEL, Shreveport
(50,000 watts)

KAAY, Little Rock
(50,000 watts)

YOU GET THE ACTION YOU WANT FROM:

• • • STAN THE RECORD MAN • • •
(HITMAKER OF THE SOUTH)

ONE-STOP SERVICE TO STORES AND OPERATORS

★ Best Prices ★

• Export Service & Advice • Complete Stack of Singles • LP's—Little LP's • Gold Standard Catalogue • Oldies But Goodies • Spirituals • R&B—Pop—C&W • Juke Box Standards • Free Title Strips

So—No matter what your need may be—STAN THE RECORD MAN has it in stock and can give you ONE DAY SERVICE (Orders Shipped Same Day Received).

Phone (318) 422-7182

STAN'S RECORD SERVICE

728 TEXAS STREET

SHREVEPORT, LOUISIANA

The Most EXPERIENCED...AGGRESSIVE

ONE-STOP

furnish STAR PRINTED TITLE STRIPS

☆☆☆

MR. OPERATOR—Check with your local One-Stop today or write to us for the name and address of a "STAR SUPPLIED" One-Stop near you.

★

STAR TITLE STRIP COMPANY, INC.

842 Western Avenue Area Code 412 231-4314 Pittsburgh, Pa. 15233

HERMITAGE MUSIC CO.

ONE OF THE SOUTH'S

LARGEST

ONE STOP RECORD SUPPLIERS

469 Chestnut St. Nashville, Tenn.

(615) 244 1790

L. SCHONBERGER

"SCHONY'S" ONE-STOP

(Established 1943)

2602 TILDEN AVENUE

BROOKLYN 26, NEW YORK

(PHONES: BUCKMINSTER 7-3576 AND 7-4581)

WE STOCK ALL LABELS. SPECIALIZING IN OLD RECORDS. ALL ORDERS SHIPPED SAME DAY.

ONE STOPS

The Record Shop
221 E. Williams St.
Wichita, Kans. 67202

Pioneer Dist. Co.
2059 S. Kansas Ave.
Wichita, Kans.

Davidson One Stop
1719 S. Hillside
Wichita, Kansas

KENTUCKY

Central Electronics
217 E. First St.
Campbellsville, Ky. 42718

Kentuckiana Record Sales
P.O. Box 261
Louisville, Ky. 40201

Shivley One Stop
4464 Dixie Hwy.
Louisville, Ky. 40261

Variety
645 S. 4th St.
Louisville, Ky. 40201

Vine
400 E. Broadway
Louisville, Ky.

Wax Works
320 Washington Ave.
Owensboro, Ky. 42301

LOUISIANA

Fifth Ave. Shoppe
319 3rd St.
Baton Rouge, La. 70801

Territo's
522 Lafayette St.
Gretna, La.

Staggs Music Shops
1006 Cameron
Lafayette, La. 70501

One Stop Record
330 S. Rampart St.
New Orleans, La. 70112

Operators One Stop
4006 Eden St.
New Orleans, La. 70125—
Jack Bernard

Stan's Record Shop
728 Texas St.
Shreveport, La. 71101—Stan Lewis

Floyds Record Shop
Box 506, East Main St.
Ville Platte, La. 70586

MAINE

Viners
20-24 Broad St.
Bangor, Maine

New England Record
212 Anderson St.
Portland, Maine 04101

Boyd Corp.
84 W. Cove St.
Portland, Maine 04101

Portland Record
84 West Cove
Portland, Maine 04101

MARYLAND

Ellis Dist. Corp.
5216 Fairlawn Ave.
Baltimore, Maryland 21215

Musical Sales
140 W. Mt. Royal Ave.
Baltimore, Md. 21233—Joe Sadler

New Deal Record Service of
Maryland
1601 Guilford Ave.
Baltimore, Md. 21233—
Ronald Bollon

One Stop Record Service
2566 Madison Ave.
Baltimore, Md. 21233

Redisco
1815 Guilford Ave.
Baltimore, Md. 21233—
Oscar Buchman

Super Music
570 N. Gay St.
Baltimore, Md. 21233

Wollman Music Store
233 S. Broadway
Baltimore, Md. 21233

Stacey Record Dist.
P.O. Box 2668
Baltimore, Md. 21215

Coronet Music
4724 Bonnie Brae Rd.
Pikesville, Md. 21208—Sam Anoff

MASSACHUSETTS

Boston Record Dist.
150 Vernon St.
Boston, Mass. 02109—Gerry Flatto

Circle Dist. Corp.
75 N. Beacon St.
Boston, Mass.—
Vaughn Aghajanian

Dick's Records
1335A Washington St.
Boston, Mass. 02109—
Dick Mitchell

New England OS
354 Mass. Ave.
Boston, Mass. 02115

Oldies But Goodies
683 Washington St.
Boston, Mass. 02111—
Big John & Little Walt

Rec. Wholesalers Of N.E.
157 Washington St.
Dorchester, Mass. 02716

W.S. Music Dist.
126 Lincoln St.
Brighton, Mass. 02109—
Elliot Stone

E-Z One Stop Record Service
893 Dorchester Ave.
Dorchester, Mass. 02125—
Michael Sciarappa, Robert Levin

Whitmarsh Music Co.
41 Bedford St.
East Bridgewater, Mass. 02333

Somerset Corp.
203 Plymouth Ave.
Fall River, Mass. 02720

Leslie Sales
590 Deadham St.
Newton Center, Mass.

Disco
37 Fremont St.
Somerville, Mass. 02109

One Stop
30 Nashua St.
Woburn, Mass. 01801

MICHIGAN

Lucky's
713 E. Midland St.
Bay City, Michigan 48706

Martens Mobile
2256 W. Lawrence
Charlotte, Mich. 48813

Martin & Snyder
13200 W. Warren
Dearborn, Mich. 48120

Angott Dist. Co.
2616 Puritan Ave.
Detroit, Mich. 48233

New Deal Record Service of
Michigan, Inc.
15329 Livernois Ave.
Detroit, Mich.—Dave Lasher

Cadet Dist.
13380 Capitol Ave.
Detroit, Mich.

Consolidated
13254 Linwood Ave.
Detroit, Mich. 48233

State Song Shop
3419 Hastings
Detroit, Mich.

Lake Shore Dist.
2605 Lake Shore Dr.
Escanba, Mich. 49829—
Larry Demins

Record City
41 S. Division St.
Grand Rapids, Mich. 49501

Record World
14044 Woodward
Highland Park, Mich. 48203—
Mr. Wilkins

Jackson Automatic
643 E. Michigan Ave.
Jackson, Mich. 49201

(Continued on next page)

ONE STOPS

MINNESOTA

Automatic Games & Supply
Box 305
Fairbault, Minn. 55021

Brown Bros.
2321 Washington Ave. N.
Minneapolis, Minn. 55411

All Records
7600 Wayzata Blvd.
Minneapolis, Minn. 55426—
Tom Prenovost

Dart Records, Inc.
730 N. Lyndale Ave.
Minneapolis, Minn. 55401—
Irv Gorson & Dick Daly

Rapid Merchandising
8175 Lewis Rd.
Minneapolis, Minn. 55427—
Bill Taylor & Noel Korngold

Record Service
1913 Plymouth Ave.
Minneapolis, Minn.

Sam Sales
321 Plymouth Ave. N.
Minneapolis, Minn. 55401—
Sam Sales

Jim's Records
1724 University Ave.
St. Paul, Minn. 55101—
Jim Christianson

LeBeau Novelty Sales
1902 University Ave.
St. Paul, Minn. 55101

Star Novelty
182 N. Dale
St. Paul, Minn. 55102

MISSOURI

New Deal Record Service Corp.
4918 Plum Tree Lane
Hazelwood, Mo.—Don Faerber

Davidson's
321 Southwest Blvd.
Kansas City, Mo. 64108

Original One Stop Record Service
3230 Roanoke Rd.
Kansas City, Mo. 64108

L & R One Stop
1901-05 Delmar
St. Louis, Mo. 63103

Laclede Music Co.
4060 Laclede Ave.
St. Louis, Mo.

Original One Stop Record Serv
2721 Pine St.
St. Louis, Mo. 63155

Pat's One Stop
1911 Washington Ave.
St. Louis, Mo. 63155—Pat Blunda

Uptown
617 N. Kings Hwy.
St. Louis, Mo. 63155—
Harry Brockman

Record Van
11154 Ebert
St. Louis, Mo.

MISSISSIPPI

Modern Appl. & Music
Box 516
McComb, Miss. 39648

NEBRASKA

Al Dahle
Box 7—Sta. "A"
Omaha, Nebr. 68102

Davidson One Stop
1214 Farnam
Omaha, Nebr. 68102

Records
2500 Harney
Omaha, Nebr.

Dart Records
2500 Harney Ave.
Omaha, Nebr. 68102—
George Sheamer

Lieberman's
809 25 Street
Omaha, Nebr.—Evelyn Dalrymple

NEW HAMPSHIRE

Manchester Music
89 Manchester St.
Manchester, N.H. 03105

NEW JERSEY

Record Rendezvous
1004 Pacific Ave.
Atlantic City, N.J.—
Edward Richard Marcus

Fairbanks & Co.
818 S. High St.
Burlington, N. J.

Able Record Sales
730 Division St.
Elizabeth, N.J. 07208—
Tony Villanova

Melody Record Shop
1172 Elizabeth Ave.
Elizabeth, N. J.

Regent Music
14-16 Plaza Rd.
Fairlawn, N. J.

Relic Rack
136 Main St.
Hackensack, N. J.

Belmont
268 15th Ave.
Newark, N.J.—Frank Gottlieb

A. Giacobbe Records
261 So. Orange Ave.
Newark, N. J.

Service One Stop
16 Fenwick St.
Newark, N.J.—Ralph Schectman

Branford Music
14 Branford Place
Newark, N. J.

Ideal Records
357 Lyons Ave.
Newark, N.J.—Jack Kaslof

New Jersey OS
175 Clinton Place
Newark, N.J. 07112—Ed Gries

Raymar Sales
357 Lyons Avenue
Newark, N.J. 07102—
Sam Keenholtz

Red Top
261 S. Orange Ave.
Newark, N.J.—Ralph Giacobbe

Service One Stop
Route 22 & Fadem Rd.
Springfield, N.J. 07081

Garden State Dist.
68 W. Passaic St.
Rochelle Park, N.J. 07662

NEW MEXICO

Gulf Mart
5000 San Mateo N.E.
Albuquerque, N. M.

Melo-D-Lane
2421 Aztec N.E.
Albuquerque, N. M.

Western Wholesale
1701 Williams, S.E.
Albuquerque, N. M.

NEW YORK STATE

Bee Gee Dist.
26 Rear No. 3rd St.
Albany, N. Y.

Delta
1260 Broadway
Albany, New York 12201
Bob Devere, Dick Sukel

Harper's
97 N. Pearl St.
Albany, N.Y. 12201

J-S Record Dist.
98 Everett Rd.
Albany, N.Y.

Almor & Co.
10 Leonard St.
Amsterdam, N.Y. 12010

All Records
35-05 Broadway
Astoria, N. Y.

National Record Service
496 Chenango
Binghamton, N. Y.

Action One Stop
875 Main St.
Buffalo, N.Y.—Jerry Meyers

(Continued on next page)



! RIGHT HERE!

FOR THE BEST IN

ONE-STOP RECORD SERVICE

NOW CELEBRATING OUR 21st & GREATEST YEAR
SERVICING DEALERS IN ALL OF THE 50 UNITED STATES

THE WISE DEALER IS THE ONE WHO REALIZES THAT HE CANNOT AFFORD TO DEAL WITH ANYTHING LESS THAN THE BEST RECORD SUPPLY SERVICE AVAILABLE—THAT HE DOES HIMSELF AND HIS BUSINESS AN IRREPARABLE DISSERVICE IN SETTLING FOR A MEDIOCRE SUPPLY SERVICE, WHEN A SUPERIOR SERVICE IS AVAILABLE.

LET US HELP YOU MAKE EXTRA SALES, MORE CUSTOMERS & GREATER PROFITS WITH OUR RELIABLE, EFFICIENT, SERVICE AND OUR UNBEATABLE FILL OF YOUR ORDERS.

—TRY US AND CONVINCE YOURSELF—

WE GUARANTEE:

- MOST COMPLETE FILL OF YOUR ORDERS (WE INVITE YOU TO TRY US ON THE ITEMS THAT YOUR PRESENT SUPPLIERS HAVE BEEN UNABLE TO FILL.)
- RELIABLE, EFFICIENT, SAME DAY SERVICE
- COMPETITIVE PRICES

WE CARRY THE MOST COMPLETE STOCK OF "OLDIE" 45's IN THE COUNTRY. WRITE FOR OUR NEW GIANT "OLDIES" CATALOG LISTING 3000 BEST SELLING "GOLDEN OLDIES."

NOW IN STOCK

- COMPLETE INVENTORY OF STEREO-8 TAPE CARTRIDGES
- GET YOUR SHARE OF THIS FAST GROWING, "EXTRA", BUSINESS

WRITE! WIRE! PHONE! FOR DETAILS—NOW!

MAKE A MOST IMPORTANT MOVE TO IMPROVE YOUR BUSINESS

TOWN HALL

RECORD ONE-STOP

9131 BEDELL LANE BROOKLYN 36, N.Y.

212-BR2-9702

STERLING SUPER SERVICE

FOR ALL RECORD LABELS

STRIP SOURCE FOR ONE-STOPS



WORLD'S LARGEST STOCK OF STANDARDS



HIT PROGRAM SERVICE AUTOMATIC WEEKLY MAILINGS

STERLING TITLE STRIP COMPANY, INC.
1175 BROAD ST. 201-243-0222 NEWARK, N.J. 07114

MARTIN & SNYDER

ONE-STOP

THE MOST COMPLETE ONE-STOP IN THE MIDWEST
Complete Line of Standards and Foreign Records

IF IT'S A RECORD... WE HAVE IT

13200 W. Warren
(313) LU 2-5850

Dearborn, Michigan
Chet Kajeski, President

ONE STOPS

Buffalo One Stop
959 Main St.
Buffalo, N. Y.

Florence One Stop
875 Main St.
Buffalo, N. Y.

Merit Vending
1503 Broadway
Buffalo, New York

Transcontinental
959 Main St.
Buffalo, N. Y.

Double B
Albany Ave.
Freeport, L.I., N.Y. 11520—
Bernie Boorstein

Wilmi Sales
3 W. Moreland
Hicksville, L.I., N.Y. 11802—
Ed Smith

Variety Record Dist.
93 Arleigh Rd.
Kensington, N. Y.

Bee Gee Record Merch.
10 Northway Lane, N.
Latham, N.Y. 12110—Lenny Smith

L&L Dist.
Shaker Park
Latham, N.Y. 12110

Steadman's One Stop
200 So. 14th Ave.
Mount Vernon, N.Y. 10550—
Lenny Book, Sam Weiss

Superior
3236 Lawson Blvd.
Oceanside, N.Y.—11572
Stanley Stone, Sam Weiss

Bandstand Record
15½ N. Main St.
Pt. Chester, N.Y. 10573

Toy House Of Hudson Valley
Manchester Rd.
Poughkeepsie, N.Y. 12601

Rochester One Stop
215 Monroe Ave.
Rochester, N.Y.—Phillip Martin

Star One Stop
17 Clinton Ave. N.
Rochester, N.Y.—John Schreiber

One Stop Record Sales
517 Erie Blvd. E.
Syracuse, N. Y.

Syracuse One Stop
233 N. Lafayette St.
Syracuse, N. Y.

Tarantelli Ent., Inc.
475 Oswego Blvd.
Syracuse, N.Y. 13202—
Tom Tarantelli

Mal Hurwitz
6 Dellwood Rd.
White Plains, N.Y. 10602

All Records
67 Hillside Ave.
Williston Park, N.Y. 11596

NEW YORK CITY

Schony's One Stop
2602 Tilden Ave.
Brooklyn, N.Y. 11226—
L. Schoenberger

Town Hall
9131 Bedell Lane
Brooklyn, N.Y. 11236—
Ben Reminick

Fulton Radio Service
490 Clarmont Parkway
Bronx, N.Y. 10457

Stratford Dist.
178-22 Jamaica Ave.
Jamaica, N.Y. 11431

Raymar
170-21 Jamaica Ave.
Jamaica, N.Y. 11431

New Deal
45-18 Court Sq.
Long Island City, N.Y. 11101—
Morris Weissman, GM; Peter
Hyman, Sales Manager

A-1 Record Sales
659 10th Ave.
New York, N.Y. 10036

All One Stop Dist.
315 West 47th St.
New York, N.Y. 10036

Coulas
324 W. 49th St.
New York, N. Y.

Consolidated One Stop
315 West 47th St.
New York, N.Y. 10036—
Elliot Blaine

Eastern Record
666 10th Ave.
New York, N.Y. 10036

Gen-Mar Dist.
Box L—Chelsea Station
New York, New York 10011—
L. Guttenplan

Independent Record Promo
259 W. 18th St.
New York, N.Y. 10011

King Karol
444 W. 42nd St.
New York, N.Y. 10036

New York Record Dist.
15 W. 20th St.
New York, N. Y.

Otao
204 W. 96th St.
New York, N. Y.

Record Shack
2132 2nd Ave.
New York, N.Y. 10029

Win Records
858 9th Ave.
New York, N.Y. 10019—
George & Sam Weiss

NEVADA

Ranchito Dist.
5680 West Virginia
Rena, Nevada 89501

NORTH CAROLINA

Bid Dist.
124 W. Morehead St.
Charlotte, N.C. 28202—
Joe Voynow, Bill Norman

Southeastern
P.O. Box 1697, 2706 Freedom Dr.
Charlotte, N.C. 28202—
A. Burt Fleishman

OHIO

M&G Record Serv.
47 E. Mill St.
Akron, Ohio 44309

Ambat
1667 Central Parkway
Cincinnati, Ohio 45214—Vern Hawk

Duchess One Stop
1036-38 Gilbert Ave.
Cincinnati, Ohio

Royal Dist. Inc.
1210 Glendale-Milford Rd.
Cincinnati, Ohio 45202—Jack Pierce

Whirling Disc
1036 Gilbert Ave.
Cincinnati, Ohio

Northern Record Sales
2006 Prospect
Cleveland, Ohio 44101—
J. G. Freeman

Century Record Sales
849 N. High St.
Columbus, Ohio—Dave Harman

Ambat
1336 Xenia Ave.
Dayton, Ohio 45401—Matha Baker

Stark Record Service
1226 Duncan Ave., S.W.
Massillon, Ohio 44646

Keller's Melody Sales
904 Delaware
Toledo, Ohio 43601

Plaza
309 Boardman Plaza
Youngstown, Ohio 44501—
F. Valicenti, J. Smith

Record Rendezvous
301 W. Federal St.
Youngstown, Ohio

OKLAHOMA

Advance One Stop
129 N.W. 23rd St.
Oklahoma City, Okla. 73102

All Records
520 Classen Blvd.
Oklahoma City, Okla. 73106

Phil's One Stop
705 N.W. 4th St.
Oklahoma City, Okla.—Wayne Dunbar

Record World
1516 N. Fordson Drive
Oklahoma City, Okla.

Tops
213 East 6th St.
Tulsa, Okla.

OREGON

Thompson
62 Broadway
Eugene, Ore. 97401

Portland One Stop
511 S.W. 6th Ave.
Portland, Ore.—M. C. McMahon

Seaport Records
21 N.W. 7th Ave.
Portland, Ore. 97232—Dave Smith

Sixth Ave. Records
511 S.W. Sixth
Portland, Ore.

PENNSYLVANIA

Roper Records
8123 Hawthorne Lane
Elkins Park, Pa. 19117—Irv Perlman

D&H Dist.
2525 N. 7th St.
Harrisburg, Pa. 17105—David Press

Wambachs
67 Colonial Park Plaza
Harrisburg, Pa.

Green Records
127 South First St.
Lenigton, Pa. 18235—Ken Betchel

Bandstand
2522 N. Broad St.
Philadelphia, Pa. 19132—
Mary Picano & Jerry Rappoport

American Record Sales
1242 W. Girard Ave.
Philadelphia, Pa.

OLDEST & BIGGEST ONE STOP IN THE MIDWEST

"The Original" ONE STOP RECORD SERVICE

- Complete Single and L.P. Inventory
- Regular Wholesale Prices
- Orders Shipped Same Day Received
- Any Mode of Shipping You Name
- Free Title Strips

"The Original" ONE STOP RECORD SERVICE

2721 Pine Street St. Louis 3, Mo. Jefferson 5-4172
3230 Roanoke Rd. Kansas City 11, Mo. Logan 1-8076
312 N. Water St. Decatur, Ill. 428-6653

Write or Call for Details



308 TOLLAND STREET

P.O. BOX 372
EAST HARTFORD, CONN.

ONE DAY SERVICE OVERNIGHT DELIVERY

100% FILL

GENE GOTTHELF—Pres.

(203) 289-6424

WAYNE MARSHALL—Mgr.

ONE STOPS

Ham-Cil
855 N. Broad St.
Philadelphia, Pa. 19104

I. J. Morgan
511 N. Broad
Philadelphia, Pa. 19104

J.M.B. Records
P.O. Box 2902
Philadelphia, Pa. 19126—James Alfe

Eastern
334 N. Broad
Philadelphia, Pa. 19104—Ray Petrolli

New Deal Record Service of
Pennsylvania, Inc.
2503 N. Broad St.
Philadelphia, Pa.—Ed McKeown

Oldies But Goodies Land
P.O. Box 2902
Philadelphia, Pa. 19126

Slotkin's
4095 Lancaster
Philadelphia, Pa.

Williams
817 N. Broad
Philadelphia, Pa. 19123—Sid Williams

All Brands
1903 Fifth Ave.
Pittsburgh, Pa. 15219—Barney Stein

Continental Racks
1901 Fifth Ave.
Pittsburgh, Pa. 15219

East Coast
633 Liberty Ave.
Pittsburgh, Pa. 15219

Empire Distributing
4610 Liberty Ave.
Pittsburgh, Pa. 15224—S. R. Canterman

Klein's Logan Variety
2111 Center Ave.
Pittsburgh, Pa.—Travis Klein

Lomakin
633 Liberty Ave.
Pittsburgh 22, Pa.—Nick Lomakin

B. Klein Mobile Record Service
Box 2879
Pittsburgh, Pa. 15230

One Stop
1704-1708 Fifth Ave.
Pittsburgh, Pa. 15219

Regal Records
1623 Blvd. of the Allies
Pittsburgh, Pa. 15219—Donny Gray

Stor Title Co.
842 Western Ave.
Pittsburgh, Pa. 15233

United
Dept. 1-A
411 Gordon St.
Reading, Pa. 19603—Leonard McKinnon

Bellmash Dist.
Elmhurst Blvd. & Watres Dr.
Scranton, Pa. 18505—Richard Platkin

Dee Jay
528 Main St.
Stroudsburg, Pa. 18360

Bornes Record Dist.
13 W. White St.
Summit Hills, Pa. 18250—Wm. Barnes

RHODE ISLAND

Beacon Shops
821 N. Main St.
Providence, R.I. 02904—Rube Zeidman

SOUTH CAROLINA

Savitz
115 Public Sq.
Abbeville, S.C.—Al Savitz

South Carolina OS
107 E. Washington St.
Abbeville, S.C.

Fox
537 King St.
Charleston, S.C.

South Carolina One Stop
107 E. Washington St.
Abbeville, S.C.

TENNESSEE

Jack's
906 Market St.
Chattanooga, Tenn. 37401

Knox Record Rack
2000 Western Ave.
Knoxville, Tenn. 37901—Sam Morrison

Bluff City Records
3442 Jackson
Memphis, Tenn.

Tucker's Record Shop
22½ Market St. & Mall
Knoxville, Tenn. 37901—Dale Clark

Home of the Blues
107 Beale St.
Memphis, Tenn. 38101—Ruben Cherry

Poplar Tunes
308 Poplar
Memphis, Tenn. 38101—Joe Cuoghi

Buckley's
1707 Church St.
Nashville, Tenn. 37202

D&G Record Mart
542 Fatherland St.
Nashville, Tenn. 37202—Dudley Bonds

Hermitage Music
469 Chestnut St.
Nashville, Tenn.

Sanders Dist.
612 8th Ave.
Nashville, Tenn.

Volunteer
435-37 Ave. N.
Nashville, Tenn.

TEXAS

Western Merchandise
1601 West 3rd Ave.
Amarillo, Texas 79100—Ed Perry

D.J.
2315 Briarwood Lane
Carrollton, Texas 75006—Don Bresler

South Texas One Stop
470 Palerma
Corpus Christi, Texas

Big State Dist.
1337 Chemical Row
Dallas, Texas 75201

L & F One Stop Record
1327 Chemical Row
Dallas, Texas

Mershaw of America
1327 Chemical Row
Dallas, Texas

B & C Record Sales
5821 Normont Way
El Paso, Texas 79912—Lindy Cash

Julius Berg
412 San Francisco
El Paso, Texas

Conwell Dist. Co.
1830 Mills St.
El Paso, Texas

M. B. Krupp Dist.
311 S. Santa Fe
El Paso, Texas

Star Discos
100 Texas Ave.
El Paso, Tex. 79946—Joe Gillman

Sunland
2227 Texas Ave.
El Paso, Texas

Central Sales
2104 Leeland St.
Houston, Texas 77002

H. W. Daily, Inc.
314 E. 11th St.
Houston, Texas 77002

Record Service
610 Dennis St.
Houston, Texas 77002

Recordland U.S.A.
3819 Avenue A
Lubbock, Texas 79408—Bob Israel

Rosen Wholesale
621 Broadway
Lubbock, Texas

E & R Record Shop
911 E. Houston
San Antonio, Texas 78205—Russ Schran

J. J. Schneider
1801 S. Flores
San Antonio, Texas—Perry Shankle

Santone Sales
121 Navarro
San Antonio, Texas

Tanner 'N' Texas
1414 W. Poplar
San Antonio, Texas 78207—Charles Cole

Rio Grande Music
P.O. Box 861
San Benito, Texas 78586—
Paco Betancourt

THE MOST COMPLETE ONE STOP & RACK SERVICE!

GATE CITY RECORD SERVICE COMPANY

1231D COLLIER RD., N.W., ATLANTA, GEORGIA—(404) 351-4821
Ted Pausman—Mgr.

NEW JERSEY ONE STOP CORP.

175 Clinton Place

(Tel. 201-923-6472)

Newark, N. J.

JOE MARTIN, Pres.

EDDIE GREIS, Mgr.

A-1 RECORD SALES

659 Tenth Ave., (212) Circle 6-1234, New York City 36

EXCLUSIVE SPECIALISTS FOR THE JUKE BOX OPERATORS

The One-Stop with a complete selection of Singles, LP's, Standards and Background Music.

FREE TITLE STRIPS

Immediate Delivery
Mail Orders Our Specialty

WE CARRY THE COMPLETE LINES OF SINGLES AND LP'S

To Offer Greater Service and Selection
to our Music Operator Friends

LORMAR SHIPS RECORDS ANYWHERE IN THE USA

Our New Location is at

LORMAR Record Dist. Co.

2311 N. Western Ave., Chicago 47, Ill.

Phones: BR. 8-8300

GOLDEN ALBUMS

THE LIST OF ALBUMS BELOW REPRESENTS THOSE RELEASES THAT THE RECORD INDUSTRY ASSOCIATION OF AMERICA (RIAA) HAS CERTIFIED AND AUDITED AS HAVING EACH SOLD AN AMOUNT WORTH AT LEAST \$1 MILLION AT FACTORY PRICES. THEY CONSTITUTE, NEEDLESS TO SAY, THE EVERGREEN CATALOG OF LP MERCHANDISE—IN ALL PHASES OF MUSIC—CURRENTLY AVAILABLE. THERE IS ALWAYS CONSUMER INTEREST IN THEM, AND WISE IS THE DEALER WHO CAN IMMEDIATELY FULFILL THE REQUEST FOR MOST, IF NOT ALL OF THE GOLD-DISK ALBUMS. DISPLAY OF THIS SHEET ALONG SIDE A BROWSER CALLED "GOLDEN ALBUMS" COULD INCREASE SALES.

1967

I NEVER LOVED A MAN—Aretha Franklin (Atlantic 8139/SD 8139)
 SGT. PEPPER'S LONELY HEARTS CLUB BAND—Beatles (Capitol T/ST 2653)
 JUST LIKE US—Paul Revere & The Raiders—Columbia CL 2451/CS 9251
 MORE OF THE MONKEES—Colgems—COM/COS 102
 S.R.O.—Herb Alpert & The Tijuana Brass—A&M LP 119/SP 4119
 GOT LIVE IF YOU WANT IT—Rolling Stones—London LL 3493/PS 493
 TILL—Roger Williams—Kapp KL/KS 1081
 SONGS OF THE FABULOUS FIFTIES, PART 1—Kapp KL 1209/KS 3209
 SONGS OF THE FABULOUS FIFTIES, PART 2—Kapp KL 1210/KS 3210
 ROGER WILLIAMS GREATEST HITS—Kapp KL 1260/3260
 YAKETY SAX—Boots Randolph—Monument
 THAT'S LIFE—Frank Sinatra—Reprise F/FS 1020
 LOU RAWLS LIVE—Capitol T/ST 2459
 THE TWO SIDES OF THE SMOTHERS BROS.—Mercury MG 20675/SR 60675
 BETWEEN THE BUTTONS—Rolling Stones—London LL 3499/PS 499
 MIDNIGHT RIDE—Paul Revere & The Raiders—Columbia CL 2508/CS 9308
 THOROUGHLY MODERN MILLIE—Original Soundtrack—Decca DL 1500/71500
 THE BEST OF MANCINI—Henry Mancini—RCA Victor LPM/LSP 2693
 AN EVENING WITH BELAFONTE—Harry Belafonte—RCA Victor LPM/LSP 3415
 BEST OF THE BEACH BOYS—Capitol T/DT 2545
 WINCHESTER CATHEDRAL—Lawrence Welk—Dot DLP 3774/DLP 25774
 SPIRIT OF '67—Paul Revere & The Raiders—Columbia CL 2595/CS 9395
 MAMAS & PAPAS DELIVER—Dunhill D/S 50014
 BORN FREE—Roger Williams—Kapp KL 1501/KS 3501
 MAME—Original Cast—Columbia KOL 6600/KOS 3000
 HEADQUARTERS—Monkees—Colgems COM/COS 103
 MY CUP RUNNETH OVER—Ed Ames—RCA Victor LPM/LPS 3774
 STRANGERS ON THE SHORE—Mr. Acker Bilk—Atco

1966

DEAN MARTIN HITS AGAIN—Reprise R 6146/RS 6146
 BOOTS—Nancy Sinatra—Reprise R/RS 6202
 BOBBY VINTON'S GREATEST—Epic LN 24098/BN 26098
 LITTLE DEUCE COUPE—Beach Boys—Capitol T/ST 1998
 SHUT DOWN, VOL. 2—Beach Boys—Capitol T/ST 2027
 WINCHESTER CATHEDRAL—New Vaudeville Band—Fontana SRE 67560/MGF 27560
 SPANISH EYES—Al Martino—Capitol T/ST 2435
 SUMMER DAYS—Beach Boys—Capitol T/ST-2354
 GOLDEN HITS—Roger Miller—Smash 27073/67073
 BALLADS OF THE GREEN BERETS—S/Sgt Barry Sadler—RCA Victor LPM-3547/LSP-3547
 ROY ORBISON'S GREATEST HITS—Monument—8000/18000
 LIVING LANGUAGE SPANISH—Young People's—
 LIVING LANGUAGE FRENCH—Young People's—
 COLOR ME BARBRA—Barbra Streisand—Columbia CL-2478/CS-9278
 I'M THE ONE WHO LOVES YOU—Dean Martin—Reprise—6170/S-6170
 BIG HITS (HIGH TIDE & GREEN GRASS)—The Rolling Stones—London LP-1
 OLIVER—Original Cast—RCA Victor LOCD/LSOD-2004
 SOUTH OF THE BORDER—Herb Alpert's Tijuana Brass—A&M LP/SP-108
 THE LONELY BULL—Herb Alpert's Tijuana Brass—A&M LP/SP-101
 WHAT NOW MY LOVE—Herb Alpert's Tijuana Brass—A&M LP-114/SP-4114
 HERB ALPERT'S TIJUANA BRASS, VOL. 2—A&M LP/SP-103
 MY WORLD—Eddy Arnold—RCA Victor LPM/LSP-3466
 SOUTH PACIFIC—Original Cast—Columbia OL-4180/OS-2040
 IF YOU CAN BELIEVE YOUR EYES AND EARS—Mamas & Papas—Dunhill D/DS 50006
 YESTERDAY & TODAY—Beatles—Capitol T/ST 2553
 THE BEST OF JIM REEVES—RCA Victor LPM/LSP 2890
 THE BEST OF THE ANIMALS—MGM E/SE 4324
 DANG ME—Roger Miller—Smash MFS 27049/FRS 67049
 GOLD VAULT OF HITS—Four Seasons—Philips PHM 200-196/PHS 600-196
 AFTERMATH—Rolling Stones—London LL 3476/PS 4776
 DR. ZHIVAGO—Soundtrack—MGM E/SE 6 ST
 THINK ETHNIC—Smothers Bros.—Mercury MG 20777/SR 60777
 STRANGERS IN THE NIGHT—Frank Sinatra—Reprise F/FS 1017
 REVOLVER—Beatles—Capitol T/ST 2576
 THE DAVE CLARK FIVE'S GREATEST HITS—Epic LN 24185/BN 26185
 SOMEWHERE MY LOVE—Roy Conniff Singers—Columbia CL 2519/CS 9319
 THE SHADOW OF YOUR SMILE—Andy Williams—Columbia CL 2499/CS 9299
 THE BEST OF AL HIRT—RCA Victor LPM/LSP 3309
 I STARTED OUT AS A CHILD—Bill Cosby—Warner Bros. W/WS 1567
 WONDERFULNESS—Bill Cosby—Warner Bros. W/WS 1634
 WHY IS THERE AIR—Bill Cosby—Warner Bros. W/WS 1606
 BILL COSBY IS A VERY FUNNY FELLOW, RIGHT!—Warners Bros. W/WS 1518
 JEANNETTE MAC DONALD & NELSON EDDY FAVORITES—RCA Victor LPM/LSP 1738
 PERRY COMO SINGS MERRY CHRISTMAS MUSIC—Camden CAL/CAS 660
 THE MONKEES—Colgems COM/COS 101
 ELVIS PRESLEY—RCA Victor LPM/LSP 1254
 ELVIS' GOLD RECORDS, VOL. 2—RCA Victor—LPM/LSP 2075
 ELVIS' GOLD RECORDS, VOL. 3—RCA Victor—LPM/LSP 2765
 JOAN BAEZ, VOL. 2—Vanguard—VRS 9094/VSD 2097
 JOAN BAEZ—Vanguard—VRS 9078/VSD 2077
 JOAN BAEZ IN CONCERT—Vanguard—VRS 9112/VSD 2122
 SOUL AND INSPIRATION—Righteous Brothers—Verve V/V-6 5001
 MAMAS AND PAPAS—Dunhill D/S 50010
 THE MONKEES—Colgems—Com/Cos 101
 MY NAME IS BARBRA, TWO—Barbra Streisand—Columbia CL-2409/CS-9209
 THE BEST OF HERMAN'S HERMITS—MGM 4315/S-4315
 DECEMBER'S CHILDREN—The Rolling Stones—London 3451/451
 SEPTEMBER OF MY YEARS—Frank Sinatra—Reprise 1014/S-1016
 A MAN & HIS MUSIC—Frank Sinatra—Reprise 1016/S-1016

1965

GLAD ALL OVER—Dove Clark Five—Epic LN-24093/BN-26093
 PETER, PAUL & MARY IN CONCERT—Warner Bros. 1555/S-1555
 EVERYBODY LOVES SOMEBODY—Dean Martin—Reprise R-6130/RS-6130
 WONDERLAND OF GOLDEN HITS—Andre Kostelanetz—Columbia CL-2039/CS-8839
 BARBRA STREISAND/THE THIRD ALBUM—Columbia CL-2154/CS-8954
 RING OF FIRE—Johnny Cash—Columbia CL-2053/CS-8853
 BEACH BOYS IN CONCERT—Capitol TAO-2198/STAO-2198
 ALL SUMMER LONG—Beach Boys—Capitol T-2110/ST-2110
 SUGAR LIPS—Al Hirt—RCA Victor LPM-2965/LSP-2965
 PEOPLE—Barbra Streisand—Columbia CL-2215/CS-9015
 THE SOUND OF MUSIC—Soundtrack—RCA Victor LOCD-2005/LSOD-2005
 TRINI LOPEZ AT P.J.'S—Reprise R-6093/RS-6093
 GETZ/GILBERTO—Stan Getz—MGM/Verve 8545/68545
 BEATLES VI—Capitol T-2358/ST-2358
 DEAR HEART—Andy Williams—Columbia CL 2338/CS 9138
 HELPI—The Beatles—Capitol MAS-2386/SMHS-2386
 INTRODUCING HERMAN'S HERMITS—MGM 4282/S-4282
 HERMAN'S HERMITS ON TOUR—MGM 4295/S-4295
 MORE ENCORE OF GOLDEN HITS—The Platters—Mercury 20591/60252
 RETURN OF ROGER MILLER—Smash 27061/67061
 GREAT SONGS FROM MY FAIR LADY—Andy Williams—Columbia CL-2205/CS-9005
 GUNFIRE BALLADS & TRAIL SONGS—Marty Robbins—Columbia CL-1349/CS-8158
 LOOK AT US—Sonny & Cher—Atco 177
 THE BEACH BOYS TODAY—Capitol T-2269/ST-2269
 THE PINK PANTHER—Henry Mancini—RCA Victor LPM-2795/LSP-2795
 OUT OF OUR HEADS—The Rolling Stones—London 3429/429
 FIDDLER ON THE ROOF—Original Cast—RCA Victor LOC-1093/LSO-1093
 SURFER GIRL—The Beach Boys—Capitol 1981/ST-1981
 SURFIN' USA—The Beach Boys—Capitol T-1890/ST-1890
 SINATRA'S SINATRA—Frank Sinatra—Reprise 1010/9-1010
 WELCOME TO THE LBJ RANCH—Capitol W-2423/WS-2423
 MY NAME IS BARBRA—Barbra Streisand—Columbia CL-2336/CS-9136
 THE DOOR IS STILL OPEN TO MY HEART—Dean Martin—Reprise 6140/S-6140
 GOING PLACES—Herb Alpert's Tijuana Brass—A&M LP-112/SP-4112
 WHIPPED CREAM & OTHER DELIGHTS—Herb Alpert's Tijuana Brass—A&M LP/SP-110
 RUBBER SOUL—The Beatles—Capitol T-2442/ST-2442

1964

MY FAIR LADY—Original Cast—Columbia OL 5090/OS 2015
 JOHN FITZGERALD KENNEDY—A MEMORIAL ALBUM—Premier CXF 402099
 CAROUSEL—Film Soundtrack—Capitol W 694/SW 694
 THE KING AND I—Film Soundtrack—Capitol—W 74/SW 740
 RAMBLIN' ROSE—Nat "King" Cole—Capitol T 1793/ST 1793
 MEET THE BEATLES—The Beatles—Capitol T 2047/ST 2047
 HONEY IN THE HORN—Al Hirt—RCA Victor LPM 2733/LS 2733
 THE BEATLES' SECOND ALBUM—The Beatles—Capitol T 2080/ST 2080
 THE SECOND BARBRA STREISAND ALBUM—Barbra Streisand—Columbia CL 2045/CS 8854
 HELLO, DOLLY!—Original Cast—RCA Victor LCO 1087/LSO 1087
 HELLO, DOLLY!—Louis Armstrong—Kapp 1364/3364
 THE WONDERFUL WORLD OF ANDY WILLIAMS—Columbia CL-2137/CS-8937
 CHRISTMAS HYMNS & CAROLS—Robert Shaw—RCA Victor LM-2139/LSC-2139
 VICTORY AT SEA, Vol. 1—Robert Russell Bennett—RCA Victor LM-2335/LSC-2335
 SOMETHING NEW—The Beatles—Capitol T-2108/ST-2108
 THE BEST OF THE KINGSTON TRIO—Capitol T-1705, 2280/ST-1705, 2280
 UNFORGETTABLE—Nat King Cole—Capitol T-357/DT-357
 RAMBLIN'—New Christy Minstrels—Columbia CL-1596/CS-8855
 THE BARBRA STREISAND ALBUM—Columbia CL-2007/CS-8807
 FUNNY GIRL—Original Cast—Capitol VAS-2059/SVAS-2059
 JOHNNY HORTON'S GREATEST HITS—Columbia CL-1596/CS-8396
 COTTON CANDY—Al Hirt—RCA Victor LPM-2917/LSP-2917
 THE ANDY WILLIAMS CHRISTMAS ALBUM—Columbia CL-2087/CS-8887
 CALL ME IRRESPONSIBLE—Andy Williams—Columbia CL-2171/CS-8971
 MY FAIR LADY—Soundtrack—Columbia KOL-8000/KOS-2600
 BEATLES '65—Capitol T-2228/ST-2228
 THE BEATLES STORY—Capitol TBO-2222/STBO-2222
 MARY POPPINS—Soundtrack—Vista 4026/S-4026

1963

WEST SIDE STORY—Original Soundtrack—Columbia OL-5670/OS-2070
 GLORIOUS SOUND OF CHRISTMAS—Eugene Ormandy—Philadelphia Orchestra—Columbia ML-5769/MS-6369
 1812 OVERTURE-TSCHAIKOVSKY—Antal Dorati and The Minneapolis Symphony—Mercury MG-50054/SR-90054
 EXODUS—Original Soundtrack—RCA Victor LOL-1058/LSO-1058
 CALYPSO—Harry Belafonte—RCA Victor LPM-1248/LSP-1248
 G. I. BLUES—Elvis Presley—RCA Victor LPM-2256/LSP-2256
 SEASON'S GREETINGS FROM PERRY COMO—Perry Como—RCA Victor LPM-2066/LSP-2066
 VIVA—Percy Faith—Columbia CL-1075/CS-8038
 THE MUSIC MAN—Soundtrack—Warner Bros. B-1459/BS-1459
 TIME OUT—Dave Brubeck Quartet—Columbia CL-1397/CS-8192
 I LEFT MY HEART IN SAN FRANCISCO—Tony Bennett—Columbia CL-1869/CS-8669
 ELVIS' CHRISTMAS ALBUM—Elvis Presley—RCA Victor LOC-1035/LPH-1951
 GIRLS, GIRLS, GIRLS—Elvis Presley—RCA Victor LPM-2621/LSP-2621
 BELAFONTE RETURNS TO CARNEGIE HALL—Harry Belafonte—RCA Victor LOC-6007/LSO-6007
 BELAFONTE—Harry Belafonte—RCA Victor LPM-1150
 JUMP-UP-CALYPSO—Harry Belafonte—RCA Victor LPM-2388/LSP-2388
 MOVIN'—Peter, Paul & Mary—Warner W/WS 1473
 EXODUS—Mantovani—London LL-3231/PS-224

(Continued on page 104)

ROULETTE AROUND THE WORLD

FALL 1967
SUPPLEMENTARY CATALOG AND NEW RELEASES

INVENTORY		CATALOG NUMBER	TITLE & ARTIST	ORDER	
MONO	STEREO			MONO	STEREO
ROULETTE					
		(S)R-25351	Spanish Spoken Here — Johnny Richards Orchestra		
		(S)R-25352	Songs Of My People (Yiddish and Hebrew Folk Songs) — Tova Ronni		
		(S)R-25353	I Think We're Alone Now — Tommy James And The Shondells		
		(S)R-25354	Parallel-A-Stitt — Sonny Stitt		
		(S)R-25355	Somethin' Special! — The Best of Tommy James And The Shondells		
ROULETTE COMEDY SERIES					
			Dedicated To Our Armed Forces — Marty Allen And Steve Rossi		
TICO					
		(S)LP-1152	Joe Cuba Presents The Velvet Voice of Jimmy Sabater — Joe Cuba Sextet		
		(S)LP-1153	Mi Mundo (My World) — Hugo Leonel Vaccaro		
		(S)LP-1154	El Rey Y Yo (The King And I) — Tito Puente and La Lupe		
		(S)LP-1156	What Now My Love — Shawn Elliott / Tito Puente		
		(S)LP-1157	Bravo Celia Cruz Recorded in Mexico) — Celia Cruz		
		(S)LP-1158	Con Todos Los Hierros! (Everything But The Kitchen Sink!) — Rafael Cortijo & Ismael Rivera		
ALEGRE					
		LPA-855 SLPA-8550	I Like It Like That / A Mi Me Gusta Asi — Pete Rodriguez		
		LPA-856 SLPA-8560	El Celio De Siempre — Celio Gonzalez		
		LPA-857 SLPA-8570	Jala Jala & Boogaloo — Ricardo Ray		
		LPA-858 SLPA-8580	Either You Have It Or You Don't (Hay Que Estar En Algo) — Charlie Palmieri		
		LPA-859 SLPA-8590	Concierto De Amor / Concert of Love — Gilberto Monroig		

DEALER _____

DATE _____

ADDRESS _____

SALESMAN _____

CITY _____ STATE _____

DIST. _____

*To my closest friends
the DJs, Distributors,
Rack Dealers and all
who helped make
this...*

A WONDERFUL YEAR
James Brown

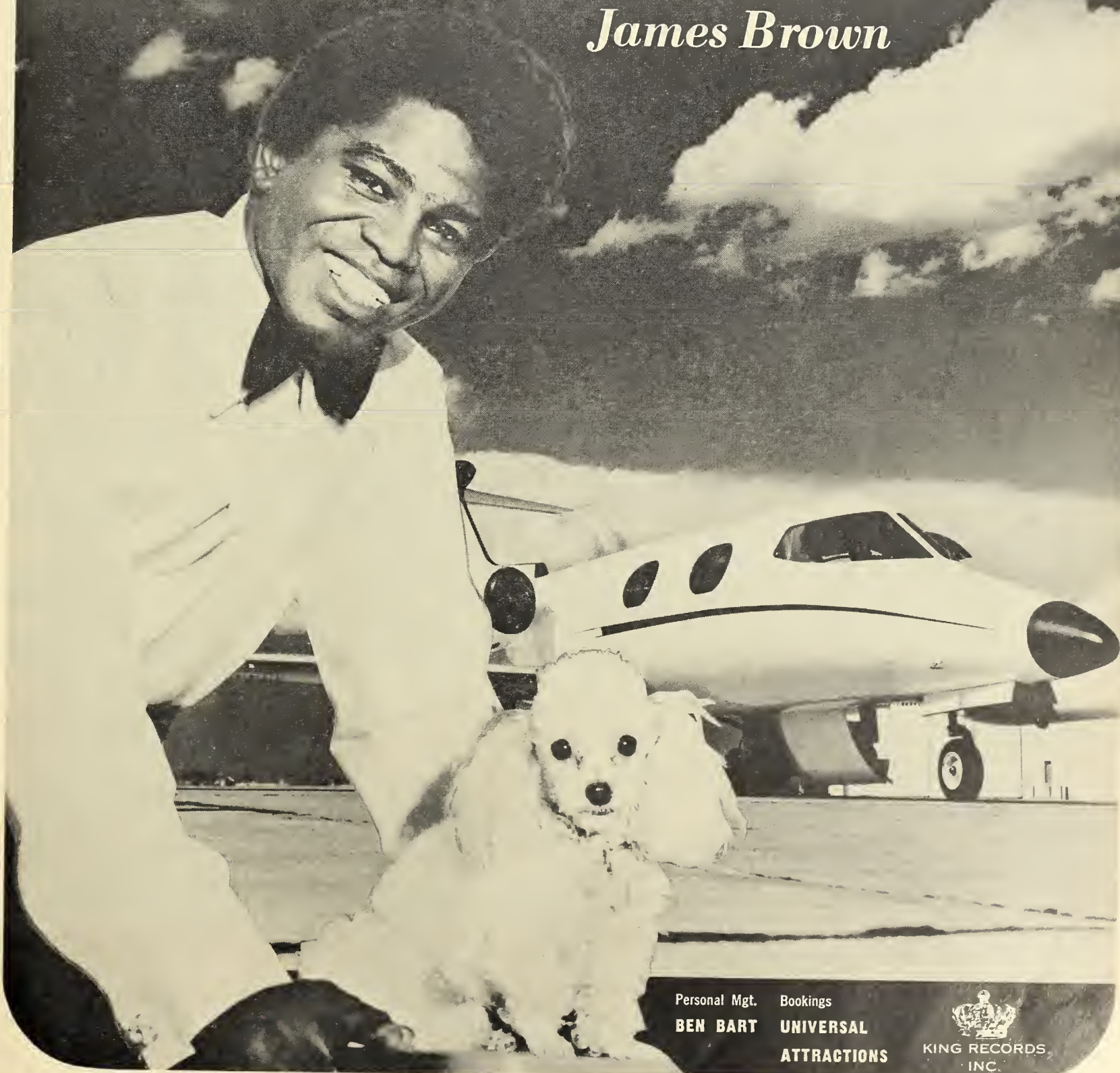

Personal Mgt. Bookings
**BEN BART UNIVERSAL
ATTRactions**

**KING RECORDS
INC.**

MILLION-SELLERS

• RIAA-Certified Million-Seller

Como, Perry	Temptation	Victor 1945	Dalhart, Vernon	Prisoner's Song	Victor 1924
	Hubba Hubba	Victor 1945	Damone, Vic	You're Breaking My Heart	Mercury 1949
	Till The End Of Time	Victor 1945	Danny & Juniors	At The Hop	ABC-Par 1958
	Prisoner Of Love	Victor 1946	Darin, Bobby	Splash Splash	Atco 1958
	When You Were Sweet Sixteen	Victor 1947		Dream Lover	Atco 1959
	Because	Victor 1948		Queen Of The Hop	Atco 1959
	Don't Let The Stars Get In			Mack The Knife	Atco 1960
	Your Eyes	Victor 1952	Day, Bobby	Rockin' Robin	Class 1958
	Wanted	Victor 1954	Day, Doris	Secret Love	Columbia 1954
	Hot Diggity	Victor 1956		Whatever Will Be, Will Be	Columbia 1956
	Papa Loves Mambo	Victor 1956	Dean, Jimmy	*Big Bad John	Columbia 1961
	Round And Round	Victor 1957	Dee, Joey & Starlites	The Peppermint Twist	Roulette 1961
	*Catch A Falling Star	Victor 1958	Del-Vikings	Come Go With Me	Dot 1957
	Do You Love Me	Gordy 1962	Denny, Martin	Quiet Village	Liberty 1959
	You Send Me	Keen 1958	Diamonds	Little Darlin'	Mercury 1957
	*Sweet Soul Music	Atco 1967		The Stroll	Mercury 1958
	Tea For Two Cha Cha	Decca 1958	Dinning, Mark	Teen Angel	MGM 1960
	Last Date	1961	Dion	Runaround Sue	Laurie 1961
	Sh-Boom	Mercury 1954	Doggett, Bill	Honky Tonk	King 1956
	That'll Be The Day	Brunswick 1957	Domino, Fats	The Fat Man	Imperial 1948
	Silent Night	Decca 1942		Goin' Home	Imperial 1952
	Sunday, Monday, Or Always	Decca 1943		You Said You Loved Me	Imperial 1953
	I'll Be Home For Christmas	Decca 1943		Please Don't Leave Me	Imperial 1953
	Swinging On A Star	Decca 1944		Going To The River	Imperial 1953
	Too-Ra-Loo-Ra-Loo-Ral	Decca 1944		Love Me	Imperial 1954
	I Can't Begin To Tell You	Decca 1945		All By Myself	Imperial 1955
	Dear Hearts And Gentle People	Decca 1946		I Can't Go On	Imperial 1955
	New San Antonio Rose	Decca 1946		Ain't That A Shame	Imperial 1955
	MacNamara's Band	Decca 1946		I'm In Love Again	Imperial 1956
	Sweet Leilani	Decca 1946		Bo Weevil	Imperial 1956
	White Christmas	Decca 1946		Blue Monday	Imperial 1956
	Now Is The Hour	Decca 1948		Blueberry Hill	Imperial 1956
	Galway Bay	Decca 1948		It's You I Love	Imperial 1957
with Andrews Sisters	Pistol Packin' Mama	Decca 1943			
	Jingle Bells	Decca 1943			
	Don't Fence Me In	Decca 1944			
	South America, Take It Away	Decca 1946			
with Gary Crosby	Play A Simple Melody	Decca 1950			
with Grace Kelly	True Love	Decca 1950			
with Fred Waring	Whiffenpoof Song	Capitol 1957			

(Continued on page 108)

ADVERTISEMENT

Criterion Music Continues Hit Pace In 1967

Criterion Music has had four songs in the Top 100 this year, continuing more than 20 years of keeping pace with the trends and tastes of the popular music scene under the guidance of prexy, Michael H. Goldsen, Lee Hazelwood, contract writer, scored with three in the Top 20 with SUGAR TOWN, SUMMER WINE & LOVE EYES, all disked by Nancy Sinatra for Reprise Records. Leon Prober clefted TINY BUBBLES, the "new wave" Hawaiian hit for Don Ho, also of Reprise, which is the all-time best selling record for island artists. Currently "LET THE GOOD TIMES ROLL" is breaking with the Bunny Sigler disk on Cameo.

Since the firm opened its doors in 1943, Criterion has turned out hits consistently, meeting the challenge of every trend and style. Johnny Mercer, one of Goldsen's former partners, was responsible for the all-time standard, DREAM. The '40's also saw these other famous titles reach top popularity: ACROSS THE ALLEY FROM THE ALAMO; DREAMS ARE A DIME A DOZEN; INVITATION TO THE BLUES; IT'S A GOOD DAY; MANANA; TAMPICO; LAZY MOOD; MOONLIGHT IN VERMONT; MOUNTAIN HIGH, VALLEY LOW; MY SUGAR IS SO REFINED; PRETENDING; SAVE THE BONES FOR HENRY JONES; SHOO FLY PIE AND APPLE PAN DOWDY; STUFF LIKE THAT THERE; WHAT MORE CAN A WOMAN DO?; etc.

During the '50's, the catalogue kept building in the pop field with such great tunes as: OFF SHORE; THE END; M.T.A. (The Boston Subway Song); QUIET VILLAGE; WHEN THE WORLD WAS YOUNG; (Have I Stayed) TOO LONG AT THE FAIR; IT HAPPENED ONCE BEFORE; NOW YOU KNOW; SONG OF INDIA; (Johnny Mercer lyric); LA LA COLLETTE; EVENING RAIN; THE HOUSE OF BAMBOO; etc.

The 1960's have been most productive with the signing of such successful writers as Lee Hazelwood, Joey Cooper, Red West, and Leon Prober. The resulting chart hits included: THESE BOOTS ARE MADE FOR WALKIN'; HOW DOES THAT GRAB YOU, DARLIN'?; HOUSTON; FRIDAY'S CHILD; SO LONG, BABE; NOT

THE LOVIN' KIND; REBEL KIND; BAJA; MOVIN'; SUGAR TOWN; SUMMER WINE; IN OUR TIME; LOVE EYES and other great ones by Hazelwood. Others were: I'M A FOOL; SO MANY WAYS; LOOK IN MY EYES; WHO DO YOU THINK YOU ARE?; THE POWER OF LOVE; PEARLY SHELLS; & the Elvis Presley Christmas hit, IF EVERY DAY WAS LIKE CHRISTMAS; etc.

A well-rounded catalogue, Criterion has some of the biggest island hits of all times in its hundreds of titles. Besides TINY BUBBLES, Prober's PEARLY SHELLS is now firmly entrenched as a world-wide hit. Others in the select circle of standards are WAIKIKI; MAPUANA; SEA BREEZE; NO HUH; VINI VINI (from Tahiti); SINGING BAMBOO; KAINOA; (There Goes) KEALOHA; BEYOND THE RAINBOW; FAREWELL; LOVELY HULA GIRL; TIARE; SILHOUETTE HULA; THAT'S THE HAWAIIAN IN ME; THERE'S NO PLACE LIKE HAWAII; E MALIU MAI (Hawaiian Love Call); & many more which are island favorites.

Among the Latin hits were MANANA; TAMPICO; MARINA; HIS FEET TOO BIG FOR DE BED; MOONSTRUCK IN MADRID; QUANDA LA LUNA; WALK TO THE BULL RING; and Laurindo Almeida tunes like THE NAKED SEA, a picture title song.

The exotic field is led by Les Baxter's QUIET VILLAGE & BANGKOK COCKFIGHT, plus dozens of exciting tunes in his best selling L.P.'s.

Jazz, blues and dixieland included such great ones as: HE'S A REAL GONE GUY; GEE, BABY AIN'T I GOOD TO YOU; HURRY ON DOWN; LET THE GOOD TIMES ROLL; etc. Instrumental favorites are ROBBIN'S NEST; THE CHAMP; Charlie Parker's CONFIRMATION, MOOSE THE MOOCHE & 28 other Parker tunes; BERNIE'S TUNE; JUMPIN' WITH SYMPHONY SID; INTERMISSION RIFF; Gerry Mulligan's WALKIN' SHOES & dozens more of his tunes; and such dixie favorites as TAILGATE RAMBLE; THE BIG PARADE (In New Orleans); etc.

The country and folk field are well represented with Woody Guthrie's PHILADELPHIA LAWYER & OKLAHOMA HILLS. Many of the

other oatuens are such hits as COW TOWN; DEAR JOHN (I Sent Your Saddle Home); I LEARNED TO LOVE YOU TOO LATE (My Darling); I'M A-BRANDIN' MY DARLIN' WITH MY HEART; I'M GONNA LEAVE YOU LIKE I FOUND YOU; A LITTLE TOO FER; LONG TIME GONE; LOVE ME NOW; THAT'S WHAT I LIKE ABOUT THE WEST; THE TOUCH OF THE MASTER'S HAND; WHEN YOU LEAVE, DON'T SLAM THE DOOR; etc.

The organization is world-wide with California as the headquarters at 6124 Selma Avenue, Hollywood; the New York office at 150 West 55th Street is under the helm of Joe Goldfeder. Internationally, the hub is in Paris where Jack Robinson heads the European scene at 27 Boulevard des Italiens, c/o Enoch & Cie. Representatives handle the British Isles, Japan, Australia & New Zealand, & Central & South America. THESE BOOTS ARE MADE FOR WALKIN' was number one in 14 countries throughout the world.

The activities include supplying recorded tapes for background music, television shows, songs for feature films, and national commercial product tie-ups. In addition, Criterion has published more than 75 books and folios in its extensive publication department. Its sales, production, and promotion in this field have attracted other publishers who use these facilities. Some of the latest are Antonio Carlos Jobim's firm, IPANEMA MUSIC, which publish many of his current hits with lyrics by Ray Gilbert, his business partner; also, Barney Kessel's fabulous book, THE GUITAR, printed under his Windsor Music. As a selling agent for songs, it handles MUSIC TO WATCH GIRLS BY, MY KIND OF TOWN, NO MATTER WHAT SHAPE (Your Stomach's In), & many more.

The various companies that comprise the Criterion Music organization are Michael H. Goldsen, Inc.; Granite Music Corp.; Atlantic Music Corp.; Tex Ritter Music; and Tyler Music. Affiliated with Criterion are four record labels which help launch tunes and artists. In the pop field there are PRINCE and CRITERION. For Hawaiian, the Banner is PALM; while for Tahitian albums, it is REO TAHITI.

ADVERTISEMENT

TO CASH BOX
AND ALL OUR
FRIENDS IN
The INDUSTRY
RING DING DING
MARIO & TONY
FROM
MARTONI
RESTAURANT
1523 N. CAHUENGA
HOLLYWOOD, 90028
466-3441

Mercury Record Corporation Salutes Cash Box For Its Consistent Exciting Coverage • Philips, Smash, Fontana, Limelight And Mercury Congratulate Albert, Ostrow, Lichtman, Blake, Et Al for Continuing The Great Cash Box Tradition • • • Mercury Record Corp. Looks Forward To Celebrating Again With Cash Box In 1992.

Cash Box



MILLION - SELLERS

• RIAA-Certified Million-Seller

Donovan	I'm Walkin'	Imperial 1957	Impalas	Sorry (I Ran All The Way Home)	Cub 1959
Dorsey, Jimmy	I Still Love You	Imperial 1957	Ink Spots	To Each His Own	Decca 1946
	Whole Lotta Lovin'	Imperial 1960		The Gypsy	Decca 1946
	*Mellow Yellow	Epic 1967	James, Harry	Ciribiribin	Columbia 1939
	Maria Elena	Decca 1946		One O'Clock Jump	Columbia 1941
	Green Eyes	Decca 1946		You Made Me Love You	Columbia 1946
Dorsey, Tommy	So Rare	Fraternity 1957	James, Joni	Why Don't You Believe Me	MGM 1953
	Marie	Victor 1937		Your Cheating Heart	MGM 1953
	Boogie Woogie	Victor 1938		Have You Heard	MGM 1954
	There Are Such Things	Victor 1942	James, Sonny	Young Love	Capitol 1957
Draper, Rusty	Gambler's Guitar	Mercury 1953			
Drifters	There Goes My Baby	Atlantic 1960	James, Tommy & the Shondells	*Hanky Panky	Roulette 1966
	True Love, True Love/Dance With Me	Atlantic 1960	Jenkins, Gordon with The Weavers	Maybe You'll Be There	Decca 1947
Duke Of Earl	Save The Last Dance For Me	Atlantic 1961	Jolson, Al	Goodnight, Irene	Decca 1950
	Duke Of Earl	Vee Jay 1962		April Showers b/w Swanee	Decca 1945
Eckstine, Billy	I Apologize	MGM 1951		California Here I Come b/w	
Edwards, Tommy	It's All In The Game	MGM 1958		Rockabye Your Baby	Decca 1946
Elegants	Little Star	APT 1958		You Made Me Love You b/w	
Eva, Little	The Loco-Motion	Dimension 1962		Ma Blushin' Rosie	Decca 1946
Everly Bros.	Bye Bye Love	Cadence 1957	Jones, Jimmy	Sonny Boy b/w My Mammy	Decca 1946
	Wake Up Little Susie	Cadence 1957		Anniversary Song	Decca 1946
	All I Have To Do Is Dream	Cadence 1958		Handy Man	Cub 1960
	Bird Dog/Devoted To You	Cadence 1958	Jones, Spike	Good Timin'	Cub 1960
	Cathy's Clown	Warner Bros. 1960		Cocktails For Two	Victor 1944
				All I Want For Christmas	Victor 1948
Fabric, Bent	Alley Cat	Atco 1962	Jordan, Louis	Choo Cho Ch'Boogie	Decca 1946
Faith, Percy	The Song From Moulin Rouge	Columbia 1953	Justis, Bill	Raunchy	Phillips Int 1958
	*Theme From A Summer Place	Columbia 1960			
Ferrante & Teicher	Exodus	Un. Artists 1961	Kaempfert, Bert	Wonderland By Night	Decca 1961
Fiedler, Arthur	Jalousie	Victor 1938	Kalin Twins	When	Decca 1958
Fisher, Eddie	Anytime	Victor 1951	Kallen, Kitty	Little Things Mean A Lot	Decca 1954
	I'm Walking Behind You	Victor 1953	King, Claude	Wolverton Mountain	Columbia 1962
	Oh My Pappa	Victor 1953	King, Pee Wee	Slow Poke	Victor 1951
	I Need You Now	Victor 1954	Kingston Trio	*Tom Dooley	Capitol 1958
Fitzgerald, Ella	Into Each Life Some Rain Must Fall	Decca 1944	Knight, Evelyn	A Little Bird Told Me	Decca 1948
& Ink Spots		Dolton 1959	Kyser, Kay	Three Little Fishes	Columbia 1941
Fleetwoods	Come Softly To Me	Dolton 1959		Jingle Jangle Jingle	Columbia 1942
	Mr. Blue	Dot		Praise The Lord	Columbia 1942
Fontane Sisters	Hearts of Stone	Capitol 1955		Strip Polka	Columbia 1942
Ford, Tennessee Ernie	Sixteen Tons	Decca 1951		Who Wouldn't Love You	Columbia 1942
Four Aces	Tell Me Why	Decca 1955		Woody Woodpecker	Columbia 1948
	Love Is A Many-Splendored Thing		Laine, Frankie	That's My Desire	Mercury 1947
				Shine	Mercury 1948
Four Lads	Moments To Remember	Columbia 1955		Mule Train	Mercury 1949
	No Not Much	Columbia 1956		Lucky Ol' Sun	Mercury 1949
Four Seasons	Sherry	VeeJay 1962		Jezebel	Columbia 1951
	Big Girls Don't Cry	VeeJay 1962		I Believe	Columbia 1953
	*Rag Doll	Philips 1964	La Rosa, Julius	Moonlight Gambler	Columbia 1957
			Lanza, Mario	Eh Cumpari	Cadence 1953
Francis, Connie	Who's Sorry Now	MGM 1958		Be My Love	Victor 1950
	My Happiness	MGM 1959	Lawrence, Steve	Loveliest Night of the Year	Victor 1951
	Among My Souvenirs	MGM 1959	Lee, Brenda	Go Away Little Girl	Columbia 1963
	Mama/Teddy	MGM 1960	Lee, Peggy	I'm Sorry/That's All You Gotta Do	Decca 1960
	Everybody's Somebody's Fool/ Jealous Of You	MGM 1960	Lewis, Jerry	Manana	Capitol 1948
	Together	MGM 1961		Rock-A-Bye Your Baby With A Dixie Melody	Decca 1956
	Many Tears Ago	MGM 1961	Lewis, Gary	*This Diamond Ring	Liberty 1967
	Where The Boys Are	MGM 1961	Lewis, Jerry Lee	Great Balls Of Fire	Sun 1957
Franklin, Aretha	*Respect	Atlantic 1967		Whole Lot of Shakin' Going On	Sun 1958
	*I Never Loved A Man	Atlantic 1967	Lombardo, Guy	Third Man Theme	Decca 1944
Freberg, Stan	St. George And The Dragonet	Capitol 1953		Humoresque	Decca 1946
				Easter Parade	Decca 1947
Gibbs, Georgia	Kiss Of Fire	Mercury 1952	with Andrews Sisters	Christmas Island	Decca 1946
	Tweedle Dee	Mercury 1955	London, Julie	Cry Me A River	Liberty 1955
	Dance With Me Henry	Mercury 1955	London, Laurie	*He's Got The Whole World	Capitol 1958
	*Sugar Shack	Dot 1963	Long, Johnny	Shanty Town	Decca 1940
Gilmer, Jimmy & Fireballs	Beer Barrel Polka	Victor 1938	Lovin' Spoonful	*Summer In The City	Kama Sutra 1966
Glahe, Will	Melancholy Serenade	Capitol 1953	Lowe, Jim	Green Door	Dot 1957
Gleason, Jackie	Too Fat Polka	Columbia 1947	Luke, Robin	Susie Darlin'	Dot 1958
Godfrey, Arthur	Suddenly There's A Valley	Era 1955	Lund, Art	Mam'selle	MGM 1947
Grant, Gogi	Wayward Wind	Era 1956	Lynn, Vera	Auf Weidersehn	London 1955
			Maddox, Johnny	Crazy Otto	Dot
Haley, Bill	Shake, Rattle And Roll	Decca 1955	Mamas & Papas	*California Dream	Dunhill 1966
	Rock Around The Clock	Decca 1955		*Monday, Monday	Dunhill 1966
Hamilton IV, George	A Rose And A Baby Ruth	ABC-Par 1958	Mangano, Sylvana	Anna	MGM 1953
Harris, Phil	The Thing	Victor 1950	Marterie, Ralph	Caravan	Mercury 1952
Harrison, Wilbert	Kansas City	Fury 1959		Pretext	Mercury 1953
Hayes, Bill	Davy Crockett	Cadence 1955	Martin, Dean	That's Amore	Capitol 1953
Haymes, Dick	You'll Never Know	Decca 1943		Memories Are Made Of This	Capitol 1955
	Little White Lies	Decca 1948	Martin, Freddy	*Everybody Loves Somebody	Capitol 1964
	*Sunny	Phillips 1966		Piano Concerto in B Flat	Victor 1941
Hebb, Bobby	Deep In The Heart Of Texas	Columbia 1941		White Christmas	Victor 1942
Heidt, Horace	My Special Angel	Decca 1957	Martindale, Wink	Deck Of Cards	Dot 1960
Helms, Bobby	Laura	Columbia 1945		Please Mr. Postman	Tamla 1960
Herman, Woody	Woodchopper's Ball	Decca 1947	Marvelettes		
Herman's Hermits	Mrs. Brown You've Got A Lovely Daughter	MGM 1965	Mathis, Johnny	Chances Are	Columbia 1957
	*I'm Henry VIII, I am	MGM 1965		It's Not For Me To Say	Columbia 1957
	*There's Kind Of Hush	MGM 1967	McGuire, Sisters	Sincerely	Coral 1955
	Michael	United Artists 1961		Sugartime	Coral 1958
Highwaymen	P.S. I Love You	Dot	McPhatter, Clyde	A Lover's Question	Atlantic 1958
Hilltoppers	Paggy Sue	Coral 1958		American Patrol	Victor 1939
Holly, Buddy	Alley-Oop	Lute 1960	Miller, Glenn	In The Mood	Victor 1939
Hollywood Argyles	*Battle Of New Orleans	Columbia 1959		Little Brown Jug	Victor 1939
Horton, Johnny	To Each His Own	Mercury 1946		Sunrise Serenade	Victor 1939
Howard, Eddy	12th Street Rag	Capitol 1951		Pennsylvania 6-5000	Victor 1940
Hunt, Pee Wee	Oh	Capitol 1953		Tuxedo Junction	Victor 1940
	Young Love	Dot 1957			
Hunter, Tab	Itsy Bitsy Teenie Bikini	Kapp 1960			
Hyland, Brian					

(Continued on page 110)



TO

CASH BOX

Congratulations On Your 25th Anniversary

Your Singing Amigo

TRINI LOPEZ

LATEST REPRISE SINGLE

Produced by DON COSTA

"The Bramble Bush"

b/w

"The Ballad of the Dirty Dozen"

Reprise #0596

ASHLEY FAMOUS AGENCY
GEORGE BULLETS DURGOM
Los Angeles / New York
London / Rome

LATEST REPRISE ALBUM

Produced by DON COSTA

"Trini Lopez in London"

Reprise #6238

MSEI PUBLIC RELATIONS
Los Angeles / New York



MILLION - SELLERS

• RIAA-Certified Million-Seller

Miller, Mitch	Chattanooga Choo Choo Kalamazoo Yellow Rose Of Texas	Victor 1941 Victor 1942 Columbia 1955	Rolling Stones	Kisses Sweeter Than Wine Secretly Oh-Oh I'm Falling In Love Again *Satisfaction *Ruby Tuesday Walk Right In The Stripper Snoopy Vs The Red Baron Wild One/Little Bitty Girl	Roulette 1958 Roulette 1958 Roulette 1958 London 1965 London 1967 Vanguard 1963 MGM 1962 Laurie 1967 Cameo 1959
Miller, Roger	*King Of The Road	Smash 1965	Rooftop Singers	*Ballad Of The Green Berets Sukiyaki	RCA Victor 1966 Capitol 1963
Mills Brothers	You Always Hurt The One You Love Paper Doll The Glow-Worm	Decca 1944 Decca 1948 Decca 1952	Rose, David	*Woolly Bully *Lil' Red Riding Hood Teen Age Crush Sleepwalk My True Love/Leroy What In The World's Come Over You Witch Doctor Chipmunk Song Alvin's Harmonica Runaway Mashed Potato Time Begin The Beguine Star Dust Summit Ridge Drive Soldier Boy Buttons And Bows Get A Job *Sounds Of Silence Young At Heart *These Boots Are Made For Walking	MGM 1965 MGM 1966 Capitol 1957 Can-Am 1959 Carlton 1958 Top Rank 1960 Liberty 1958 Liberty 1958 Liberty 1959 Bigtop 1961 Cameo 1962 Victor 1938 Victor 1940 Victor 1940 Scepter 1962 Columbia 1948 Ember 1958 Columbia 1966 Capitol 1954 Reprise 1966
Mitchell, Guy	My Heart Cries For You Singing The Blues	Columbia 1950 Columbia 1957	Royal Guardsmen	*Sugartown *Something Stupid *When A Man Loves A Woman I Got You Babe Rose O'Day Temptation Make Love To Me It's In The Book Wheel Of Fortune Rock And Roll Waltz Pink Shoelaces Moonglow & Picnic Theme I Hear You Knockin' To Know Him Is To Love Him	Reprise 1967 Reprise 1967 Atlantic 1966 Atco 1965 Columbia 1941 Capitol 1948 Columbia 1954 Capitol Capitol 1952 RCA Victor 1955 Crystalette 1958 Decca 1956 Dot Dore 1958
Modugno, Domenico	Nel Blu Dipinto Di Blu (Volare)	Decca 1958	Rydell, Bobby	Chanson D'Amour *The Lion Sleeps Tonight *A Lover's Concerto Oh, Johnny *Happy Together It's Only Make Believe Lonely Blue Boy	Era 1957 Victor 1961 Dynavoice 1965 Columbia 1939 White Whale 1967 MGM 1958 MGM 1960
Monkees	*Last Train To Clarksville *I'm A Believer A Little Bit Me, A Little Bit You Racing With the Moon There I've Said It Again Ballerina Riders In The Sky Pepino Four Leaf Clover Cruising Down The River Blacksmith Blues Sugar Blues	Colgems 1966 Colgems 1966 Colgems 1967 Victor 1941 Victor 1945 Victor 1947 Victor 1949 Reprise 1963 MGM 1948 Decca 1949 Capitol 1952 Decca 1946	S Sgt. Barry Saddler Sakamoto, Kyu Sam The Sham & The Pharoahs	Donna Melody Of Love Sail Along Silv'ry Moon Broken Hearted Melody Take Good Care Of My Baby *Roses Are Red	Del-Fi 1958 Dot 1956 Dot 1957 Mercury 1959 Liberty 1961 Epic 1962
Monroe, Vaughn	Teenager's Romance Stood Up Be Bop Baby Poor Little Fool/Lonesome Town Believe What I Say It's Late/Never Be Anyone Else But You Travelin' Man/Hello Mary Lou	Verve 1957 Imperial 1957 Imperial 1958 Imperial 1958 Imperial 1958	Seville, David	Primrose Lane Stardust 'Twas The Night Before Christmas Baby (You Got What It Takes)	Challenge 1960 Liberty 1957 Decca 1942 Mercury 1960
Monte, Lou	Travelin' Man/Hello Mary Lou	Imperial 1959 Imperial 1961	Shannon, Del	On Top Of Old Smoky Let Me Go Lover Heartaches *Calcutta Whispering Three O'Clock In The Morning Cara Mia The Tree In The Meadow Slipping Around Indian Love Call Secret Love Rose Marie I'm Gonna Sit Right Down Autumn Leaves Smoke, Smoke, Smoke What Am I Living For Night/Doggin' Around Canadian Sunset Purple People Eater	Decca 1951 Columbia 1954 Decca 1950 Dot 1961 Victor 1920 Victor 1922 London 1956 Capitol 1948 Capitol 1949 Imperial 1951 Imperial 1953 Imperial 1954 Coral 1957 Kapp 1955 Capitol Atlantic 1958 Brunswick 1960 Victor 1956 MGM 1958
Mooney, Art	Winchester Cathedral	Fontana 1966	Sharp, Dee Dee	*Groovin	Atlantic 1967
Morgan, Russ	Only The Lonely *Oh, Pretty Woman Tennessee Waltz Mockingbird Hill I Went To Your Wedding Doggie in the Window Changing Partners Cross Over the Bridge Allegheny Moon Tonight You Belong To Me *Hey Paula How High The Moon Mockin' Bird Hill The World Is Waiting For the Sunrise Vaya Con Dios Earth Angel Sea Of Love Monster Mash Only You The Great Pretender My Prayer Twilight Time Smoke Gets In Your Eyes Beep Beep Cherry Pink And Apple Blossom White *Patricia Heartbreak Hotel I Want You, I Need You, I Love You Love Me Tender All Shook Up Don't Be Cruel/Hound Dog Too Much Teddy Bear/Loving You Jailhouse Rock Wear My Ring Around Your Neck Don't I Got Stung *Hard Headed Woman A Fool Such As I Stuck On You It's Now Or Never Are You Lonesome Tonight Surrender *Can't Help Falling In Love Good Luck Charm Return To Sender Running Bear Stagger Lee Personality	Monument 1960 Monument 1964 Mercury 1950 Mercury 1950 Mercury 1952 Mercury 1952 Mercury 1953 Mercury 1954 Mercury 1956 Liberty 1956 Philips 1960 Capitol 1947 Capitol 1949	Shaw, Artie	Valens, Ritchie Vaughn, Billy	Decca 1951 Columbia 1954 Decca 1950 Dot 1961 Victor 1920 Victor 1922 London 1956 Capitol 1948 Capitol 1949 Imperial 1951 Imperial 1953 Imperial 1954 Coral 1957 Kapp 1955 Capitol Atlantic 1958 Brunswick 1960 Victor 1956 MGM 1958
Morse, Ella Mae	Monument 1960 Monument 1964 Mercury 1950 Mercury 1950 Mercury 1952 Mercury 1952 Mercury 1953 Mercury 1954 Mercury 1956 Liberty 1956 Philips 1960 Capitol 1947 Capitol 1949	Monument 1960 Monument 1964 Mercury 1950 Mercury 1950 Mercury 1952 Mercury 1952 Mercury 1953 Mercury 1954 Mercury 1956 Liberty 1956 Philips 1960 Capitol 1947 Capitol 1949	Sinatra, Frank	Vaughan, Sarah Vee, Bobby Vinton, Bobby	Decca 1951 Columbia 1954 Decca 1950 Dot 1961 Victor 1920 Victor 1922 London 1956 Capitol 1948 Capitol 1949 Imperial 1951 Imperial 1953 Imperial 1954 Coral 1957 Kapp 1955 Capitol Atlantic 1958 Brunswick 1960 Victor 1956 MGM 1958
McCoy, Clyde	Capitol 1949 Capitol 1953 Dooto 1957 Mercury 1959 Garpax 1962 Mercury 1955 Mercury 1955 Mercury 1956 Mercury 1958 Mercury 1959 Roulette 1958	Capitol 1949 Capitol 1953 Dooto 1957 Mercury 1959 Garpax 1962 Mercury 1955 Mercury 1955 Mercury 1956 Mercury 1958 Mercury 1959 Roulette 1958	Sinatra, Nancy	Wallace, Jerry Ward, Billy Waring, Fred Washington, Dinah & Benton, Brook	Decca 1951 Columbia 1954 Decca 1950 Dot 1961 Victor 1920 Victor 1922 London 1956 Capitol 1948 Capitol 1949 Imperial 1951 Imperial 1953 Imperial 1954 Coral 1957 Kapp 1955 Capitol Atlantic 1958 Brunswick 1960 Victor 1956 MGM 1958
Nelson, Ricky	Capitol 1949 Capitol 1953 Dooto 1957 Mercury 1959 Garpax 1962 Mercury 1955 Mercury 1955 Mercury 1956 Mercury 1958 Mercury 1959 Roulette 1958	Capitol 1949 Capitol 1953 Dooto 1957 Mercury 1959 Garpax 1962 Mercury 1955 Mercury 1955 Mercury 1956 Mercury 1958 Mercury 1959 Roulette 1958	Standley, Johnny	Weavers, The Weber, Joan Weems, Ted Welk, Lawrence Whiteman, Paul	Decca 1951 Columbia 1954 Decca 1950 Dot 1961 Victor 1920 Victor 1922 London 1956 Capitol 1948 Capitol 1949 Imperial 1951 Imperial 1953 Imperial 1954 Coral 1957 Kapp 1955 Capitol Atlantic 1958 Brunswick 1960 Victor 1956 MGM 1958
New Vaudeville Band	Capitol 1949 Capitol 1953 Dooto 1957 Mercury 1959 Garpax 1962 Mercury 1955 Mercury 1955 Mercury 1956 Mercury 1958 Mercury 1959 Roulette 1958	Capitol 1949 Capitol 1953 Dooto 1957 Mercury 1959 Garpax 1962 Mercury 1955 Mercury 1955 Mercury 1956 Mercury 1958 Mercury 1959 Roulette 1958	Starr, Kay	Whitfield, David Whiting, Maggie with Jimmy Wakely Whitman, Slim	Decca 1951 Columbia 1954 Decca 1950 Dot 1961 Victor 1920 Victor 1922 London 1956 Capitol 1948 Capitol 1949 Imperial 1951 Imperial 1953 Imperial 1954 Coral 1957 Kapp 1955 Capitol Atlantic 1958 Brunswick 1960 Victor 1956 MGM 1958
Orbison, Roy	Capitol 1949 Capitol 1953 Dooto 1957 Mercury 1959 Garpax 1962 Mercury 1955 Mercury 1955 Mercury 1956 Mercury 1958 Mercury 1959 Roulette 1958	Capitol 1949 Capitol 1953 Dooto 1957 Mercury 1959 Garpax 1962 Mercury 1955 Mercury 1955 Mercury 1956 Mercury 1958 Mercury 1959 Roulette 1958	Stevens, Dodie	Williams, Billy Williams, Roger Williams, Tex Willis, Chuck Wilson, Jackie Winterhalter, Hugo Wooley, Sheb	Decca 1951 Columbia 1954 Decca 1950 Dot 1961 Victor 1920 Victor 1922 London 1956 Capitol 1948 Capitol 1949 Imperial 1951 Imperial 1953 Imperial 1954 Coral 1957 Kapp 1955 Capitol Atlantic 1958 Brunswick 1960 Victor 1956 MGM 1958
Page, Patti	Capitol 1949 Capitol 1953 Dooto 1957 Mercury 1959 Garpax 1962 Mercury 1955 Mercury 1955 Mercury 1956 Mercury 1958 Mercury 1959 Roulette 1958	Capitol 1949 Capitol 1953 Dooto 1957 Mercury 1959 Garpax 1962 Mercury 1955 Mercury 1955 Mercury 1956 Mercury 1958 Mercury 1959 Roulette 1958	Stoloff, Morris	Young Rascals	Decca 1951 Columbia 1954 Decca 1950 Dot 1961 Victor 1920 Victor 1922 London 1956 Capitol 1948 Capitol 1949 Imperial 1951 Imperial 1953 Imperial 1954 Coral 1957 Kapp 1955 Capitol Atlantic 1958 Brunswick 1960 Victor 1956 MGM 1958
Patience & Prudence	Capitol 1949 Capitol 1953 Dooto 1957 Mercury 1959 Garpax 1962 Mercury 1955 Mercury 1955 Mercury 1956 Mercury 1958 Mercury 1959 Roulette 1958	Capitol 1949 Capitol 1953 Dooto 1957 Mercury 1959 Garpax 1962 Mercury 1955 Mercury 1955 Mercury 1956 Mercury 1958 Mercury 1959 Roulette 1958	Storm, Gale		Decca 1951 Columbia 1954 Decca 1950 Dot 1961 Victor 1920 Victor 1922 London 1956 Capitol 1948 Capitol 1949 Imperial 1951 Imperial 1953 Imperial 1954 Coral 1957 Kapp 1955 Capitol Atlantic 1958 Brunswick 1960 Victor 1956 MGM 1958
Paul & Paula	Capitol 1949 Capitol 1953 Dooto 1957 Mercury 1959 Garpax 1962 Mercury 1955 Mercury 1955 Mercury 1956 Mercury 1958 Mercury 1959 Roulette 1958	Capitol 1949 Capitol 1953 Dooto 1957 Mercury 1959 Garpax 1962 Mercury 1955 Mercury 1955 Mercury 1956 Mercury 1958 Mercury 1959 Roulette 1958	Todd, Art & Dotty		Decca 1951 Columbia 1954 Decca 1950 Dot 1961 Victor 1920 Victor 1922 London 1956 Capitol 1948 Capitol 1949 Imperial 1951 Imperial 1953 Imperial 1954 Coral 1957 Kapp 1955 Capitol Atlantic 1958 Brunswick 1960 Victor 1956 MGM 1958
Paul, Les & Mary Ford	Capitol 1949 Capitol 1953 Dooto 1957 Mercury 1959 Garpax 1962 Mercury 1955 Mercury 1955 Mercury 1956 Mercury 1958 Mercury 1959 Roulette 1958	Capitol 1949 Capitol 1953 Dooto 1957 Mercury 1959 Garpax 1962 Mercury 1955 Mercury 1955 Mercury 1956 Mercury 1958 Mercury 1959 Roulette 1958	Tokens		Decca 1951 Columbia 1954 Decca 1950 Dot 1961 Victor 1920 Victor 1922 London 1956 Capitol 1948 Capitol 1949 Imperial 1951 Imperial 1953 Imperial 1954 Coral 1957 Kapp 1955 Capitol Atlantic 1958 Brunswick 1960 Victor 1956 MGM 1958
Penguins	Capitol 1949 Capitol 1953 Dooto 1957 Mercury 1959 Garpax 1962 Mercury 1955 Mercury 1955 Mercury 1956 Mercury 1958 Mercury 1959 Roulette 1958	Capitol 1949 Capitol 1953 Dooto 1957 Mercury 1959 Garpax 1962 Mercury 1955 Mercury 1955 Mercury 1956 Mercury 1958 Mercury 1959 Roulette 1958	Toys		Decca 1951 Columbia 1954 Decca 1950 Dot 1961 Victor 1920 Victor 1922 London 1956 Capitol 1948 Capitol 1949 Imperial 1951 Imperial 1953 Imperial 1954 Coral 1957 Kapp 1955 Capitol Atlantic 1958 Brunswick 1960 Victor 1956 MGM 1958
Phillips, Phil	Capitol 1949 Capitol 1953 Dooto 1957 Mercury 1959 Garpax 1962 Mercury 1955 Mercury 1955 Mercury 1956 Mercury 1958 Mercury 1959 Roulette 1958	Capitol 1949 Capitol 1953 Dooto 1957 Mercury 1959 Garpax 1962 Mercury 1955 Mercury 1955 Mercury 1956 Mercury 1958 Mercury 1959 Roulette 1958	Tucker, Orrin		Decca 1951 Columbia 1954 Decca 1950 Dot 1961 Victor 1920 Victor 1922 London 1956 Capitol 1948 Capitol 1949 Imperial 1951 Imperial 1953 Imperial 1954 Coral 1957 Kapp 1955 Capitol Atlantic 1958 Brunswick 1960 Victor 1956 MGM 1958
Pickett, Bobby	Capitol 1949 Capitol 1953 Dooto 1957 Mercury 1959 Garpax 1962 Mercury 1955 Mercury 1955 Mercury 1956 Mercury 1958 Mercury 1959 Roulette 1958	Capitol 1949 Capitol 1953 Dooto 1957 Mercury 1959 Garpax 1962 Mercury 1955 Mercury 1955 Mercury 1956 Mercury 1958 Mercury 1959 Roulette 1958	Turtlse		Decca 1951 Columbia 1954 Decca 1950 Dot 1961 Victor 1920 Victor 1922 London 1956 Capitol 1948 Capitol 1949 Imperial 1951 Imperial 1953 Imperial 1954 Coral 1957 Kapp 1955 Capitol Atlantic 1958 Brunswick 1960 Victor 1956 MGM 1958
Platters	Capitol 1949 Capitol 1953 Dooto 1957 Mercury 1959 Garpax 1962 Mercury 1955 Mercury 1955 Mercury 1956 Mercury 1958 Mercury 1959 Roulette 1958	Capitol 1949 Capitol 1953 Dooto 1957 Mercury 1959 Garpax 1962 Mercury 1955 Mercury 1955 Mercury 1956 Mercury 1958 Mercury 1959 Roulette 1958	Twitty, Conway		Decca 1951 Columbia 1954 Decca 1950 Dot 1961 Victor 1920 Victor 1922 London 1956 Capitol 1948 Capitol 1949 Imperial 1951 Imperial 1953 Imperial 1954 Coral 1957 Kapp 1955 Capitol Atlantic 1958 Brunswick 1960 Victor 1956 MGM 1958
Playmates	Capitol 1949 Capitol 1953 Dooto 1957 Mercury 1959 Garpax 1962 Mercury 1955 Mercury 1955 Mercury 1956 Mercury 1958 Mercury 1959 Roulette 1958	Capitol 1949 Capitol 1953 Dooto 1957 Mercury 1959 Garpax 1962 Mercury 1955 Mercury 1955 Mercury 1956 Mercury 1958 Mercury 1959 Roulette 1958	Valens, Ritchie		Decca 1951 Columbia 1954 Decca 1950 Dot 1961 Victor 1920 Victor 1922 London 1956 Capitol 1948 Capitol 1949 Imperial 1951 Imperial 1953 Imperial 1954 Coral 1957 Kapp 1955 Capitol Atlantic 1958 Brunswick 1960 Victor 1956 MGM 1958
Prado, Perez	Capitol 1949 Capitol 1953 Dooto 1957 Mercury 1959 Garpax 1962 Mercury 1955 Mercury 1955 Mercury 1956 Mercury 1958 Mercury 1959 Roulette 1958	Capitol 1949 Capitol 1953 Dooto 1957 Mercury 1959 Garpax 1962 Mercury 1955 Mercury 1955 Mercury 1956 Mercury 1958 Mercury 1959 Roulette 1958	Vaughn, Billy		Decca 1951 Columbia 1954 Decca 1950 Dot 1961 Victor 1920 Victor 1922 London 1956 Capitol 1948 Capitol 1949 Imperial 1951 Imperial 1953 Imperial 1954 Coral 1957 Kapp 1955 Capitol Atlantic 1958 Brunswick 1960 Victor 1956 MGM 1958
Presley, Elvis	Capitol 1949 Capitol 1953 Dooto 1957 Mercury 1959 Garpax 1962 Mercury 1955 Mercury 1955 Mercury 1956 Mercury 1958 Mercury 1959 Roulette 1958	Capitol 1949 Capitol 1953 Dooto 1957 Mercury 1959 Garpax 1962 Mercury 1955 Mercury 1955 Mercury 1956 Mercury 1958 Mercury 1959 Roulette 1958	Valens, Ritchie		Decca 1951 Columbia 1954 Decca 1950 Dot 1961 Victor 1920 Victor 1922 London 1956 Capitol 1948 Capitol 1949 Imperial 1951 Imperial 1953 Imperial 1954 Coral 1957 Kapp 1955 Capitol Atlantic 1958 Brunswick 1960 Victor 1956 MGM 1958
? Question Mark & the Mysterians	Capitol 1949 Capitol 1953 Dooto 1957 Mercury 1959 Garpax 1962 Mercury 1955 Mercury 1955 Mercury 1956 Mercury 1958 Mercury 1959 Roulette 1958	Capitol 1949 Capitol 1953 Dooto 1957 Mercury 1959 Garpax 1962 Mercury 1955 Mercury 1955 Mercury 1956 Mercury 1958 Mercury 1959 Roulette 1958	Vaughn, Sarah		Decca 1951 Columbia 1954 Decca 1950 Dot 1961 Victor 1920 Victor 1922 London 1956 Capitol 1948 Capitol 1949 Imperial 1951 Imperial 1953 Imperial 1954 Coral 1957 Kapp 1955 Capitol Atlantic 1958 Brunswick 1960 Victor 1956 MGM 1958
Ray, Johnnie	Capitol 1949 Capitol 1953 Dooto 1957 Mercury 1959 Garpax 1962 Mercury 1955 Mercury 1955 Mercury 1956 Mercury 1958 Mercury 1959 Roulette 1958	Capitol 1949 Capitol 1953 Dooto 1957 Mercury 1959 Garpax 1962 Mercury 1955 Mercury 1955 Mercury 1956 Mercury 1958 Mercury 1959 Roulette 1958	Vee, Bobby		Decca 1951 Columbia 1954 Decca 1950 Dot 1961 Victor 1920 Victor 1922 London 1956 Capitol 1948 Capitol 1949 Imperial 1951 Imperial 1953 Imperial 1954 Coral 1957 Kapp 1955 Capitol Atlantic 1958 Brunswick 1960 Victor 1956 MGM 1958
Rays	Capitol 1949 Capitol 1953 Dooto 1957 Mercury 1959 Garpax 1962 Mercury 1955 Mercury 1955 Mercury 1956 Mercury 1958 Mercury 1959 Roulette 1958	Capitol 1949 Capitol 1953 Dooto 1957 Mercury 1959 Garpax 1962 Mercury 1955 Mercury 1955 Mercury 1956 Mercury 1958 Mercury 1959 Roulette 1958	Vinton, Bobby		Decca 1951 Columbia 1954 Decca 1950 Dot 1961 Victor 1920 Victor 1922 London 1956 Capitol 1948 Capitol 1949 Imperial 1951 Imperial 1953 Imperial 1954 Coral 1957 Kapp 1955 Capitol Atlantic 1958 Brunswick 1960 Victor 1956 MGM 1958
Reeves, Jim	Capitol 1949 Capitol 1953 Dooto 1957 Mercury 1959 Garpax 1962 Mercury 1955 Mercury 1955 Mercury 1956 Mercury 1958 Mercury 1959 Roulette 1958	Capitol 1949 Capitol 1953 Dooto 1957 Mercury 1959 Garpax 1962 Mercury 1955 Mercury 1955 Mercury 1956 Mercury 1958 Mercury 1959 Roulette 1958	Wallace, Jerry		Decca 1951 Columbia 1954 Decca 1950 Dot 1961 Victor 1920 Victor 1922 London 1956 Capitol 1948 Capitol 1949 Imperial 1951 Imperial 1953 Imperial 1954 Coral 1957 Kapp 1955 Capitol Atlantic 1958 Brunswick 1960 Victor 1956 MGM 1958
Reynolds, Debbie	Capitol 1949 Capitol 1953 Dooto 1957 Mercury 1959 Garpax 1962 Mercury 1955 Mercury 1955 Mercury 1956 Mercury 1958 Mercury 1959 Roulette 1958	Capitol 1949 Capitol 1953 Dooto 1957 Mercury 1959 Garpax 1962 Mercury 1955 Mercury 1955 Mercury 1956 Mercury 1958 Mercury 1959 Roulette 1958	Ward, Billy		Decca 1951 Columbia 1954 Decca 1950 Dot 1961 Victor 1920 Victor 1922 London 1956 Capitol 1948 Capitol 1949 Imperial 1951 Imperial 1953 Imperial 1954 Coral 1957 Kapp 1955 Capitol Atlantic 1958 Brunswick 1960 Victor 1956 MGM 1958
Riddle, Nelson	Capitol 1949 Capitol 1953 Dooto 1957 Mercury 1959 Garpax 1962 Mercury 1955 Mercury 1955 Mercury 1956 Mercury 1958 Mercury 1959 Roulette 1958	Capitol 1949 Capitol 1953 Dooto 1957 Mercury 1959 Garpax 1962 Mercury 1955 Mercury 1955 Mercury 1956 Mercury 1958 Mercury 1959 Roulette 1958	Waring, Fred		Decca 1951 Columbia 1954 Decca 1950 Dot 1961 Victor 1920 Victor 1922 London 1956 Capitol 1948 Capitol 1949 Imperial 1951 Imperial 1953 Imperial 1954 Coral 1957 Kapp 1955 Capitol Atlantic 1958 Brunswick 1960 Victor 1956 MGM 1958
Righteous Bros.	Capitol 1949 Capitol 1953 Dooto 1957 Mercury 1959 Garpax 1962 Mercury 1955 Mercury 1955 Mercury 1956 Mercury 1958 Mercury 1959 Roulette 1958	Capitol 1949 Capitol 1953 Dooto 1957 Mercury 1959 Garpax 1962 Mercury 1955 Mercury 1955 Mercury 1956 Mercury 1958 Mercury 1959 Roulette 1958	Washington, Dinah & Benton, Brook		



TRIDENT PRODUCTIONS

TRIDENT PRODUCTIONS IS SAN FRANCISCO for: MGM/VERVE, DECCA and A&M ■ **RECORDING:** Columbus Recording Studio ■ **PUBLISHING:** Neenah-Menasha Music; SFO Music ■ **MANAGEMENT:** Talent Development Corp. ■ **SHOWCASING:** Little Fox Theatre ■ **COMMUNICATIONS:** SFO Views ■ All the facilities for the **HEAR** and **NOW** ■ **TRIDENT PRODUCTIONS** ■ a division of Werber Productions, Incorporated **Columbus Tower** ■ **SAN FRANCISCO**

Design: The Dirigiblewerks / San Francisco

RECORD PRESSERS & TAPE DUPLICATORS

• Tape Duplicators

Abbey
160 Passaic Ave.
Kearny, N.J.

AFM Engineering
6201 Santa Monica Blvd.
Los Angeles, Calif.

A. A. Allen Revivals, Inc.
P. O. Box 8595
Dallas, Texas

Alberti Record Mfg. Co.
1300 West Garvey Blvd.
Monterey Park, California

Alco Research & Engineering
6201 Santa Monica Blvd.
Los Angeles 38, Calif.

All Disc Records, Inc.
625 W. First Ave.
Roselle, N. J.

Allentown Record Co., Inc.
10th & Walnut Sts.
Allentown, Pa.

Allied Record Mfg. Co.
2437 E. 57th St.
Hollywood, Calif. 90058

Amer. Record Pressing
1810 W. King St., Owosso, Mich.

A-N-L Recording Corp.
4465 North Lincoln Ave.
Chicago 25, Illinois

Archer Record Pressing
6552 E. Davison
Detroit, Mich. 48212

Arrow Record Mfg. Co.
5212 East 14th St.
Oakland, California

Artrec Productions Ltd.
1688 Meridian Ave.
Miami Beach, Fla. 33139

Audiofax
821 19th Ave. S.
Nashville, Tenn.

Banaba Music Co.
2452-6 South Kedzie
Chicago 23, Ill.

Bard Record Co.
66 Mechanic St.
New Rochelle, N. Y.

Betancourt Ent.
119 S. Sam Houston Blvd.
San Benito, Texas 78586

Bestway
Globe Ave., Mountainside, N.J.

John Brumage
P.O. Box 14422
Tampa, Fla. 33609

Cadet Record Pressing Co.
146 W. 37th Pl.
Los Angeles, Calif.

Capitol Custom
151 West 46th St.
New York, N. Y.

Capitol Custom
3061 Fletcher Dr.
Hollywood, Calif.

Capitol Custom
300 Brook St.
Scranton, Pa.

Capitol Custom
1 Capitol Way or Box 385
Jacksonville, Ill.

Carter Wright Ent.
6533 Hollywood Blvd.
Hollywood, Calif. 90028

Cavendish Record Mfg. Co.
5810 South Normandie
Los Angeles, Calif.

Century Record Mfg. Co.
Poly Laboratories, P.O. Box 30
Saugus, California

Clarion Record Mfg. Co. Inc.
1021 Ridge Ave.
Philadelphia 23, Pa.

Clark Phonograph Record
718 Wilhelm
Harrison, N. J.

Coast Record Mfg. Co., Inc.
2846 W. Pico Blvd.
Los Angeles, Calif.

• Columbia Record Prod. (Tape
Duplicator)
51 W 52 St.
New York, N.Y. 10022

• Columbia Record Prod. & Tape
Duplicator
630 N. McClurg St.
Chicago, Ill. 60611

• Columbia Custom & Tape
Duplicator
2990 West Grand Blvd.
Detroit, Mich. 48202

• Columbia Prod. & Tape
Duplicator
804 16th Ave.
Nashville, Tenn. 37203

Columbia Record Prod. & Tape
Duplicator
6121 Sunset Blvd.
Hollywood, Calif. 90028

Compo Records (Ontario) (Ltd.)
Lachine, Quebec, Canada

Cook & Associates
5905 W. Slauson Ave.
Los Angeles, Calif.

Creative Sound Productions
9000 Sunset Blvd.
Los Angeles, Calif. 90069

Crown Records
9317 W. Washington Blvd.
Culver City, Calif.

RECORD PRESSING SPECIAL

Finest Quality

Fast Service

Quantity	45 rpm Mono.	12" 33 1/3 Mono.
100	58.00	110.00
300	78.00	180.00
500	90.00	225.00
1000	130.00	360.00

This price includes mastering, processing, any color label, and plain sleeve.

Inquire about our demo work, national promotion and distribution.

Records shipped in 5 days after order is received. Reorders shipped same day we receive them.

Longmark Productions Incorporated

P.O. Box 116, New York Mills, New York

Phone 315-737-7341 or 315-732-9488

(Continued on page 114)



The country's newest and most modern plant.

The first plant built

with cartridge duplicating in mind.

MANUFACTURING:

reel to reel

4 and 8 stereo cartridges

cassettes

LIBERTY TAPE DUPLICATING, INC. ■ 1201 PACIFIC STREET ■ OMAHA, NEBRASKA 68108

(402) 348-1770

The tape cartridge revolution. We're leading it!



Today, ITCC is the world's largest maker of 4 and 8 Track Stereo Cartridges.

ITCC has the names! ITCC has the labels! ITCC has the artists—including MGM, Verve, Verve Forecast and Kama Sutra artists exclusively on 4 track stereo.

ITCC Cartridges feature such names as—Herb Alpert and the Tijuana Brass, Jack Jones, Lawrence Welk, Dionne Warwick,

Baja Marimba Band, Enoch Light, Aretha Franklin, Mitch Ryder, Dion, George Jones, Count Basie—and hundreds of others including original motion picture sound tracks.

Sold to distributors only—write for name of your nearest distributor.

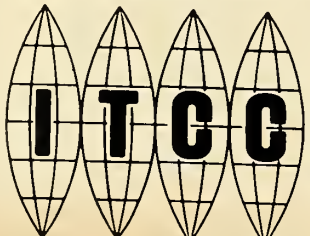

International Tape Cartridge Corp.

663 Fifth Avenue, New York, N.Y. 10022 • 212/421-8080



SILVER PLASTICS INCORPORATED

SPECIALIZING IN SERVICE & DEPENDABILITY
FOR LEADING INDIE RECORD COMPANIES

SILVER PLASTICS INC.

SOUTHAMPTON INDUSTRIAL HIGHWAY

SOUTHAMPTON, PA.

(215) ELMWOOD 7-1175

(215) HOBART 4-3270

Joe Stewart—Plant Manager

Congratulations

CASH BOX

*Where Independents
Meet Independents*

For Continuing Success, Press
With Your Independent Pressing Plant

MONARCH

RECORD MFG. CO.

A Division of THE COSNAT CORPORATION
4852 W. Jefferson Blvd., Los Angeles 16, Calif.
213-Re-2-6185

WAKEFIELD MANUFACTURING, INC.

1836 WEST MORELAND PHOENIX, ARIZONA 85005
CUSTOM RECORD PRESSING TELEPHONE (602) 252-5644 MAILING ADDRESS PO BOX 6037

★
PRECISION PRODUCT

★
RAPID SERVICE

★
COMPETITIVE PRICES

7"-10"-12"

TRY US and join our Family of Satisfied Customers



ALLIED RECORD COMPANY

Custom Pressing—Plating—Mastering

Label Printing—Shipping—Warehousing

Art and Album Services—All Sizes—All Speeds

OVER THIRTY YEARS OF SERVICE TO THE RECORD INDUSTRY

Call Daken Broadhead and/or Jack Wegner

Cable: All record
Phone: 213-582-0841

2437 E. 57th St.,
Los Angeles, Calif. 90058

RECORD PRESSERS & TAPE DUPLICATORS

• Tape Duplicators

Customatrix (Columbia)
Lambs Rd. & Woodbury Rd.
Pitman, N.J. 08071

Customatrix (Columbia)
1400 N. Fruitridge Ave.
Terre Haute 14, Ind.

Customatrix (Columbia)
900 E. Stowell Rd.
Santa Maria, Calif. 93454

Decca Manufacturing
Div. of Decca Distributing
Gloversville, New York

Decca Manufacturing
Div. of Decca Distributing
Pickneyville, Ill.

Diskmakers, Inc.
925 N. Third St.
Philadelphia, Pa. 19125

Dunn Record Pressing Co.
4756 S. Cottage Grove Ave.
Chicago, Illinois

Dynamic LP Stereo
900 Passaic Ave.
East Newark, N. J.

Empire Record Co.
800 E. 141 St.
Bronx 54, N. Y.

Falcon Records
2616 Crooks Rd.
Royal Oak, Mich.

Flama Record Co.
35-47 31st St.
Long Island City, N. Y.

Four Star Record Co.
305 Fair Oaks
Pasadena, Calif.

•Gauss Electrophysics
1850 Westwood Blvd.
West Los Angeles, Calif.

Gem Custom
(Formerly Royal Plastics)
1540 Brewster Ave.
Cincinnati, Ohio

Gospel Recordings, Inc.
146 Glendale
Los Angeles, Calif.

•GRT (General Recorded Tape)
1262 Lawrence Station
Sunnyvale, Calif.

Hodge Record Mfg. Co.
3208-16 So. 84th St.
Philadelphia, Pa.

Houston Record Company
3318 Jensen Drive
Houston, Texas

Ideal Recording Co.
P. O. Box 861
San Benito, Texas

•International Tape Cartridge
663 Fifth Ave.
New York, N.Y.

Jay Jay Record Company
2456 South Kedzie
Chicago, Illinois

J. B. Research & Development
1117 East Redondo Blvd.
Inglewood, Calif.

Kay Records, Inc.
110 Bergen Pike, Little Ferry, N.J.

Kay Bank Recording
2541 Nicollet Ave., Minn., Minn.

King Records
1540 Brewster Ave.
Cincinnati, Ohio

Kiski Recording Co.
Box 116
North Apollo, Pa.

Korelich Engineering Mfg. Co.
1141 N. Highland
Los Angeles, Calif.

James J. Lee Record Processing
9040 Culver Blvd.
Culver City, Calif.

Lewis Record Mfg. Co.
307 East Beach Ave.
Inglewood 3, Calif.

Liberty Tape Duplicating
1201 Pacific St.
Omaha, Neb.

Longmark
P.O. Box 116
N.Y. Mills, N.Y.

MGM Records
120 Arlington Ave.
Bloomfield, N. J.

C. P. MacGregor
729 S. Western
Los Angeles, Calif.

•Magnetic Stereo Cartridge
1604 W. 139th St.
Gardena, Calif.

•Magnetic Tape Duplicators
7925 Santa Monica
Hollywood, Calif. 90046

Mecca Records
920 3rd Ave., Seattle 4, Wash.

Mercury Records
35 E. Wacker Drive
Chicago, Ill.

Miami Pressers
2819 N. W. 7th Ave.
Miami 37, Fla.

(Continued on page 116)

Complete, Quick Service

**PROCESSING • LABELS
PRESSINGS • DROP SHIPMENTS**

CENTRALLY LOCATED

for Custom Work at Economy Prices

JAMES GANN

RUSS FRATTO

MIDWEST RECORD PRESSING, INC.

320 E. 21st St.

Chicago, Illinois 60616

PHONE: 225-4150

MEET THE MUNTZ CAR STEREO GENERATION!

You Really Ought To Get To Know Them Because They...

are the most music-oriented age bracket . . .
have the most money to spend on entertainment . . . demand the best value for their dollar . . . are the most affluent age group in history . . . understand the quality and economics of car stereo.

By 1970, 117 million of this country's predicted population of 214 million persons will probably be less than 30 years old - and, in the car stereo generation.

THAT'S A LOT OF CUSTOMERS AND THEY'RE ALL YOURS

If you give them what they want. You get what they want from Muntz Stereo-Pak, Inc., first and foremost name in car stereo - offering a world of brilliant stereophonic entertainment for cars, homes and boats.



The world's most complete lineup of stereo products - a wide selection of models for every taste at revolutionary mass-market prices - a broad inventory of speakers and stereo accessories - and the world's largest library of cartridge entertainment, a fantastic selection of 100,000 titles. All the great musical stars and the major labels from the cartridge-stereo giant! Muntz Stereo-Pak - the world's only single-source for all cartridge products.



NOT AFFILIATED WITH MUNTZ TV

7715 DENSMORE AVENUE / VAN NUYS, CALIFORNIA

RECORD PRESSERS & TAPE DUPLICATORS

• Tape Duplicator

Midwest Record Pressing
320 E. 21st St.
Chicago, Ill.

Miller International Co.
P. O. Box 45
Swarthmore, Pa.

Minato Record Pressing Co.
2667 Long Beach Ave.
Los Angeles 58, Calif.

Mission Aids, Inc.
100 East Montecito
Sierra Madra, Calif.

Monarch
4852 W. Jefferson Blvd.
Los Angeles, Calif.

• Muntz Stereo Pak
7715 Densmore
Van Nuys, Calif.

Musical Products Company
561 West 16th St.
Chicago 16, Illinois

National Recording
2871 E. Ponce De Leon
De Catur, Ga.

Norman Record Pressing
1486 N. Fair Oaks
Pasadena, Calif.

Oasis Record Pressing Co.
275 South 2nd St.
Brooklyn, N. Y. 11211

Parliment Records
Box 341-A, RD2
Parkesburg, Pa.

Paramount Record Mfg. Co.
1314 S. Howard St.
Philadelphia, Pa.

Peacock Records
2809 Erastus St.
Houston, Texas

Peerless Record Corp.
2820 W. Pico
Los Angeles, Calif.

Phono Record
91 1st St.
Gretna, La.

Plastic Products
1746 Chelsea Ave.
Memphis, Tenn.

Plastylite Corp.
333 North Drive
North Plainfield, N. J.

Praise
Dept. C
Stonebore, Pa. 16153

Premier Albums of N. J.
140 Delawanna Ave.
Clifton, N. J.

Presswell Records, Inc.
White Horse Pike & Bates Mill Road
Anchorage, N. J.

Purdy Records
1721 Broadway
New York 19, N. Y.

Rainbow Record Mfg. Corp.
1041 N. Las Palmas
Hollywood, Calif.

Raleigh Records, Inc.
881-7th Ave.
New York, N. Y.

• RCA Custom Record Sales
445 North Lake Shore Drive
Chicago, Illinois 60611
(312) 944-3215

• RCA Custom Record Sales
155 E. 24th St.
New York, 10, N.Y. 10010
(212) MU 9-7200

• RCA Victor
6363 Sunset Blvd.
Hollywood 28, Calif. 90028
(213) 461-9171

• RCA Custom Record Soles
800-17th Ave. South
Nashville 3, Tenn. 37203
(615) 255-5781

Record Broadcast
237 S. Bent Ave.
San Marcos, Calif.

Record Pressing
145 West 154th St.
Gardena, Calif.

Recordings, Inc.
1130 E. Cold Spring La.
Baltimore, Md.

Research Craft Company
1011 North Fuller Ave.
Los Angeles 46, Calif.

Rite Records
3930 Spring Grove Ave.
Cincinnati 23, Ohio

Romaba Records Co.
33 Thirty Fourth St.
Brooklyn, N. Y.

R.P.I.
151 W. 154th St.
Gardena, Calif.

S. F. Record Mfg. & Matrix Co.
1038 Taraval St.
San Francisco 16, Calif.

S & R Record Mfg. Co.
16508 So. Main St.
Gardena, Calif.

San Marcos Record Company
1149 J Bent Ave.
P. O. Box 278
San Marcos, Calif.

Shelley Products
220 Broadway
Huntington Station, L. I., N. Y.

Silver Park Records
286 Kinderkermack Road
Riveredge, N. J.

Silver Plastics
Southampton Industrial Highway
Southampton, Pa.

Sonic Recording
27 Ludy St.
Hicksville, L. I., N. Y.

Sound of Nashville
160 2nd Ave., So.
Nashville, Tenn.

Southern Plastics
453 Chestnut St., Nashville, Tenn.

Sparton of Canada, Ltd.
London, Ontario, Canada

Specialty Records
210 North Valley Ave.
Olyphant, Pa. 18447

Standard
415 Fourth Ave. S.
Nashville, Tenn.

Starday Records
1248 S. Berendo St.
Los Angeles, Calif.

Sun Plastics
900 Passaic Ave.
East Newark, N. J.

Superior Plastics
748 Comp St.
New Orleans, La. 70130

Superior Recordings Co., Inc.
1023 North LaBrea
Hollywood, Calif.

Tanner "N" Texas, Inc.
1422 W. Popular St.
San Antonio, Texas

(Continued on page 118)

DON'T CALL US

For Record Pressing

UNLESS

You Want Quality
and Service
That's Unbeatable
Anywhere!

ALL SPEEDS

KAY RECORDS, INC.

110 Bergen Pike, Little Ferry, N. J.
Diamond 3-5721-2

NOBODY CAN MATCH BESTWAY'S SERVICE

BESTWAY feels that a promise is something special and has to be kept. Maybe that's what accounts for our reputation.

BESTWAY DELIVERS WHAT YOU WANT . . . WHEN YOU WANT IT (if not sooner)

Specializing in: **CUSTOM PRESSING . . .
FROM PLATE TO COMPLETED PRODUCT . . .
LABELS . . . WAREHOUSING . . .
DROP SHIPPING . . .**



BESTWAY PRODUCTS

MOUNTAINSIDE, NEW JERSEY (201) ADAMS 2-8383

**FACE
THE
FACTS !!!**

**LONG WEAR STAMPER
DOES
A
BETTER JOB
FOR
YOU**

We specialize in record plating !

Our Technicians devote full effort
to give you the best product !

Plating is our only endeavor !

We give you expert service !

Personal attention !

Ultimate in quality through the
latest equipment and methods
available !

SEE FOR YOURSELF

Call: **JACK BERMAN**
(212)EX2-4718

LONG WEAR STAMPER CORP.

36-41 36th St. Long Island City 6, N.Y.

RECORD PRESSERS & TAPE DUPLICATORS

• Tape Duplicators

(Continued)

• Todd-Ao
1021 No. Seward
Hollywood, Calif.

Taps Records
5810 S. Normandie
Los Angeles, Calif.

Union City Plastics
716-22nd St.
Union City, N. J.

United Recorders
535 No. Fairfax
Los Angeles, Calif.

H. V. Waddell
231 W. Olive
Burbank, Calif.

Wakefield
1836 West Moreland
P.O. Box 6037
Phoenix, Ariz.

Western Custom
16909 So. Broadway
Gardena, Calif.

Wildcat Records, Inc.
P. O. Box 207
San Antonio, Texas

Windsor Records
830 River Drive, Garfield, N.J.

XERB Radio & XEG Radio
737 3rd Ave. Keystone Bldg.
Chula Vista, Calif. 92010

SPECIALTY

FOR
**PERSONALIZED
SERVICE**
PLUS
QUALITY

COMPRESSION MOLDERS OF
45, 7" LP, 10" LP, 12" LP, ALL SPEEDS
TAPE TO RECORD

Phone: (717) 489-4717 TWX: (510) 656-3649

SPECIALTY RECORDS CORPORATION



FABRICATORS OF

Phonograph Records

210 NORTH VALLEY AVENUE
OLYPHANT, PENNA. 18447

BELOW WHOLESALE
PRICES



**ONE STOP
SERVICE**

WRITE OR PHONE FOR THE
GALGANO PRICE!!!

- RACK JOBBING and PROMOTIONAL RECORDS
- ALL TYPES OF RECORDS FOR PREMIUMS and GIV-A-WAYS
- COMPLETE SELECTIONS OF L.P.s, 45s and ACCESSORIES

OUR
39th
YEAR

GALGANO DISTRIBUTING CO.
4135 W. ARMITAGE AVE. CHICAGO, ILL. 60639
ALL PHONES: A.C. 312/342-7060

TRADE ASSOCIATIONS

American Guild of Authors & Composers (AGAC)
158 W. 55 St.
New York, N. Y. PL 7-8833

American Guild of Variety Artists (AGVA)
551 Fifth Ave.
New York, N. Y. TN 7-5600

American Tape Cartridge Assoc.
527 Madison Ave.
New York, New York 10022
Tel. 212-753-3305

Country Music Assoc. (CMA)
801-16th Ave. South
Nashville, Tenn. 615-244-2840

Electronic Industries Assoc.
1721 De Sales St., N.W.
Washington 36, D.C.

Int'l Record & Music Mens Club (IRMMCI)
c/o Walter Hofer
221 West 57th St.
New York, N. Y. JU 2-5030

International Rhythm & Blues Assoc.
711 West 60th St.
Chicago, Ill. 60621
Tel. 312-874-6808

Magnetic Recording Industry Assoc. (MRIA)
See Electronic Industries Assoc.

Music Operators of America (MOA)
228 N. La Salle St.
Chicago 1, Ill. 726-2810-1

National Music Publishers' Association
460 Park Ave.
New York, N. Y. PL 1-1930

National Assoc. of Music Merchants (NAMM)
222 W. Adams
Chicago 6, Ill. AN 3-0679

Nat'l Academy of Recording Arts & Sciences (NARAS)
New York: 21 W. 58 St., PL 5-1535
Hollywood: 1741 Ivar Ave., HO 5-2124
Chicago: 46 E. Walton, MI 2-6465
Nashville: Box 6155, Acklen Station
255-6535

Nat'l Assoc. of Retail Record Dealers
150 W. 34th St.
New York, N.Y. 10001
212-244-1884

Nat'l Assoc. of Radio Announcers (NARA)
850 7th Ave.
New York, N.Y. 10019
Tel. 212 582-5814

Nat'l Assoc. of Record Merchandisers (NARM)
Suite 703 Trianon Building
20 Conshohocken State Rd.
Bala Cynwyd, Pa. 19004

Professional Music Men, Inc.
1270 Sixth Ave.
New York 20, N. Y. CO 5-7362

Record Industry Assoc. of America (RIAA)
1 E. 57 St.
New York 22, N. Y. MU 8-3778

ONE STOPS (Cont.)

UTAH

Record Express
209 E. 9th St.
Salt Lake City, Utah 84111—
Dick La Duke

Utah Sundries
1550 S. Redwood Rd.
Salt Lake City, Utah—John Billinis

VIRGINIA

Giant Music
110 W. Broad St.
Falls Church, Va.

Pat's
1st & Canal St.
Richmond, Va. 23219—Pat Cohen

Ponderosa
216 E. Main St.
Richmond, Va. 23219

WASHINGTON

Disc City
410 Elliot W.
Seattle, Wash. 98101

Seattle Record One Stop
125 1st Ave., N.
Seattle, Wash. 98101

Music Box
417 W. Riverside Ave.
Spokane, Wash. 99210

WEST VIRGINIA

Elkins Music
160 Court St.
Charleston, W. Va. 25510—Red Elkins

Courts
Box 9
Culloden, W. Va. 25510—Luke Smith

Music Man
803 8th Ave.
Huntington, W. Va. 25701

WISCONSIN

Music Mart
164 E. Washington St.
Burlington, Wisc.

Hoffman's
5707 Sixth Ave.
Kenosha, Wisc. 53140—Joseph Hoffman

Midwest Radio
3414 W. North Ave.
Milwaukee, Wisc. 53202

Modern Rec. Dist.
2715 W. Lisbon St.
Milwaukee, Wisc.

Radio Doctors
213 W. Wells St.
Milwaukee, Wisc. 53202—Stu Glassman

Record City
5600 W. North Ave.
Milwaukee, Wisc. 53202

Soulville
507 Main St.
Racine, Wisc. 53401—J. Huennekens

ONE STOP CUSTOM PRESSING COMPLETELY INTEGRATED

(Matrix, Labels & Jacket Fabrication)

Serving The East With Over-Night Delivery

TOP QUALITY

EASTERN RECORD MANUFACTURING COMPANY

901 East Clements Bridge Road

Runnemede, New Jersey 08078

(201) 931-0558

NORM DUFOUR JOHN DUNN R. E. (BUSTER) WILLIAMS



**OUR SERVICE IS
THE FINEST
AND INCLUDES...**

- PRESSING
- LABELS
- MASTERING
- WAREHOUSING
- DROP SHIPPING

Ideally located to serve the Midwest, South and Southwest



Manufacturers of Plastic Products

1746 Chelsea Ave., Memphis 7, Tennessee

Plant and Sales Office—Area (601)-622-4341

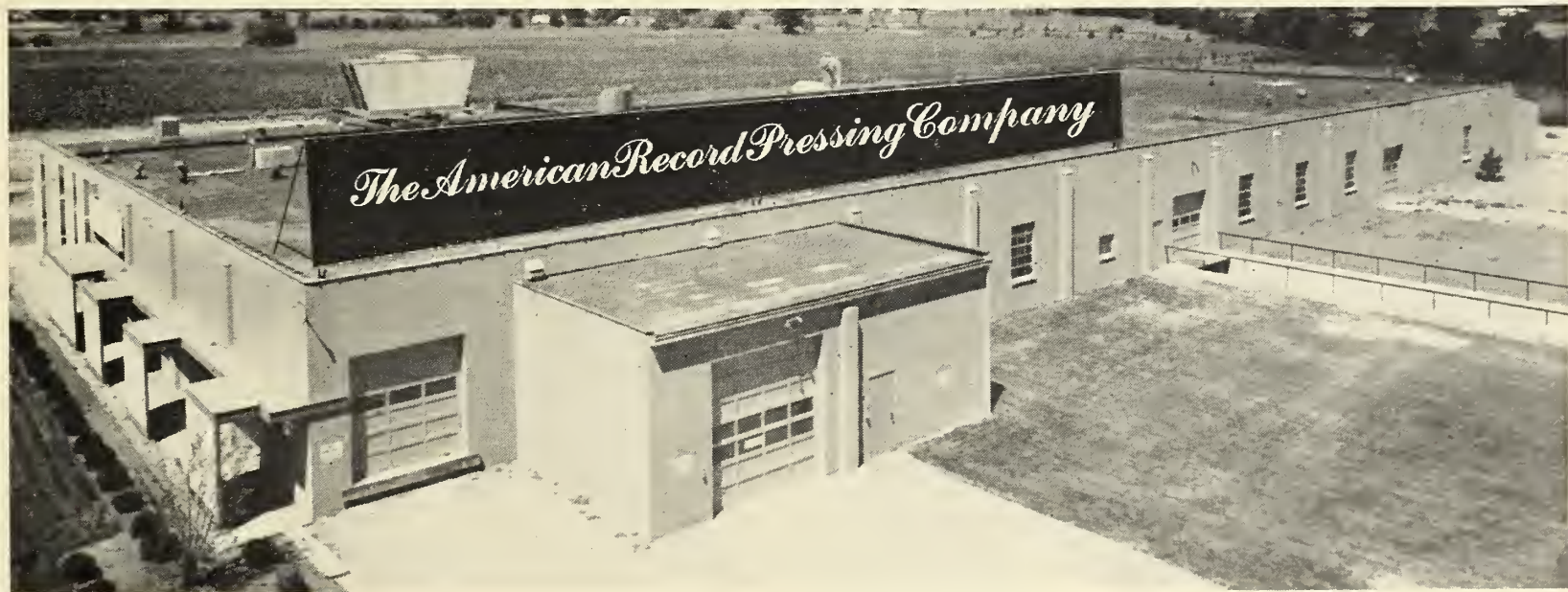

For Quality and Service

*The
American
Record Pressing
Company*

1810 W. King Street

Owosso, Michigan

Tel. (517) 725-8176

POLY BAG MANUFACTURERS

Allied Record Dist. Co.
1041 N. Las Palmas
Hollywood, Calif.

Celanese Plastic Co.
744 Broad St.
Newark 2, N. J.

Chicago Trans. Bag Co.
4806 W. Chicago Ave.
Chicago, Ill.

Clear Print Co.
3639 Dyre Ave.
New York, N. Y.

Carl Cordover & Co.
104 Liberty Ave.
Mineola, N. Y.

D. & A. Transparent Bag Co.
550 Fifth Ave.
New York, N. Y.

Diamond Cellophane
2724 S. Michigan
Chicago, Ill.

Mehl Mfg. Co.
2057 Reading Rd.
Cincinnati 2, Ohio

Research Craft Corp.
1011 N. Fuller Ave.
Los Angeles 46, Calif.

Whitaker Paper Co.
Eggleston Ave., 6th & Lock
Cincinnati, Ohio

Aragon Products, Inc.
639 Island View Dr.
Santa Barbara, Calif.

Beckstrand Hoffman Machine & Tool
4126 E. Anaheim
Long Beach, Calif.

Coast Export Co.
2846 W. Pico Blvd.
Los Angeles, Calif.

Eckstein Recording Products Co.
8637 W. Washington Blvd.
Culver City, Calif.

Finebilt Mfg. Co.
2846 W. Pico
Los Angeles, Calif.

Garden City Mfg.
Garden City, L. I.

Garden States Hydraulics Corp.
189 Mall Dr.
North Plainfield, N. J.

Holland Electroplating Equipment
475 Keap St.
Brooklyn, N. Y.

Indus Manufacturing Co.
Indianapolis, Ind.

Johnson Machine & Tool
1702 W. 134th St.
Gardena, Calif.

King Records and Royal Plastics
1540 Brewster Ave.
Cincinnati, Ohio

M G M Records
Bloomfield, N. J.

RCA Victor
Hollywood, Calif.

RCA Victor
501 N. LaSalle St.
Indianapolis, Ind.

RCA Victor
Route 46, Franklin Ave.
Rockaway, N. Y.

RCA Victor
155 E. 24th St.
New York 10, N. Y.

Standard Paper Box Machine
476 Broome St.
New York 13, N. Y.

Standard Tool & Die
Kearny, N. J.

Alan Insulated Mfg.
1107 McCarter Highway
Newark 4, N. J.

Amberg File & Index
1637 Duane Blvd.
Kankakee, Ill.

Astatic
252 Harbor St.
Conneaut, Ohio

Beard Mfg. Co., Inc.
4553 W. Harrison
Chicago, Ill.

Capitol Records
(see local distributors)

Samuel Caplan
Philadelphia, Pa.

Carol Industries
335 Carroll St.
Brooklyn 31, N. Y.

Casecraft (Div. of Red Rope Stationery)
70 Washington Ave., Brooklyn, N. Y.

Cole Publishing Co.
823 So. Wabash Ave.
Chicago, Ill.

Columbia Records
(see local distributor)

Columbus Plastic Prod. Inc.
1625 W. Mound St.
Columbus, Ohio

Deccafile
Decca Records, Inc.
445 Park Ave.
New York, N. Y.

Disc Mate Cases
Red Rope Industries
70 Washington St.
Brooklyn 1, N. Y.

Embro Mfg. Co.
P.O. Box 407
908 Lawrence Rd., N.E.
Canton, Ohio

Enterprise
Toronto, Ont., Canada

Fine-Tone
7111 20th Ave.
Brooklyn 4, N. Y.

Freeman Artcraft Record
Display Fixtures
Charlevoix, Mich.

PRINTERS AND LITHOGRAPHERS

Alemo Ltd.
737 Drake St.
New York, N.Y.

Audio Paks
Swarthmore Industrial Center
Box 486
Swarthmore, Pa.

Bertco Press
4862 Santa Monica Blvd.
Los Angeles, Calif.

Colorcraft
200 Henry St.
Stamford, Conn.

Community Press
6047 Woodland Ave.
Phila., Pa.

Container Kraft
Carton & Paper Supp. Co.
801 E. 61st St.
Los Angeles, Calif.

Crown Album Co.
2925 N. Broad St.
Phila., Pa.

Design and Printing
207 W. 25th St.
New York, N.Y.

Folkraft Press
1159 Broad St.
Newark, N.J. 07114

Globe Productions
1255 Oak Pt. Ave.
New York, N.Y.

Gopher Litho of Calif.
Box 812
Berkeley, Calif.

Gregg Moore Lithographing
111 N. Whacker Dr.
Chicago 6, Ill.

Gugler Lithographic Co.
1339 N. Milwaukee St.
Milwaukee, Wisc. 53202

Harrison Art Advg.
2032 W. 16th St.
Philadelphia, Pa.

Ivy Hill
Community Drive
Great Neck, N.Y.
1919 E. 51st St.
L.A. 58, Calif.

Kaumagraph
1214 Walnut St.
Philadelphia, Pa.

King Records
1540 Brewster Ave.
Cincinnati, Ohio

Lee-Myles Assoc.
40 W. 57th St.
New York, N.Y.

Lithographer Corp. of America
1501 State St.
Bridgeport, Conn.

Mac Murray Press, Inc.
22 Jones St.
New York, N.Y.

Mehl Manufacturing Co.
2057 Reading Rd.
Cincinnati, Ohio

Micitone Printing Corp.
11 Ave. D
New York, N.Y.

J. Monheimer & Co., Inc.
108 Fulton St.
New York 38, N.Y.

(Continued on page 121)

MACHINE SHOPS

Adams & Associates
1062 N. Orange Grove
Hollywood, Calif.

Alco Research & Engineering
6201 Santa Monica Blvd.
Hollywood, Calif. 90038

American Packaging Co.
P. O. Box 71743
Florence Branch
Los Angeles 1, Calif.

Aragon Products, Inc.
72 Concord St.
Newark 12, N. Y.

Beckstrand Hoffman Machine
& Tool
4126 E. Anaheim
Long Beach, Calif.

Coast Export Co.
2846 W. Pico
Los Angeles, Calif.

Eckstein Recording Products Co.
8637 W. Washington Blvd.
Culver City, Calif.

Finebilt Mfg. Co.
2846 W. Pico
Los Angeles, Calif.

Garden City Mfg.
Garden City, L. I.

Garden States Hydraulics Corp.
189 Mall Dr.
North Plainfield, N. J.

Holland Electroplating Equipment
475 Keap St.
Brooklyn, N. Y.

Indus Manufacturing Co.
Indianapolis, Ind.

Johnson Machine & Tool
1702 W. 134th St.
Gardena, Calif.

King Records and Royal Plastics
1540 Brewster Ave.
Cincinnati, Ohio

M G M Records
Bloomfield, N. J.

Palmer M. May
3117 Cambridge Road
Charlotte, N. C.

RCA Victor
1016 N. Sycamore St.
Hollywood, Calif.

RCA Victor
501 N. LaSalle St.
Indianapolis, Ind.

RCA Victor
Route 46, Franklin Ave.
Rockaway, N. Y.

RCA Victor
155 E. 24th St.
New York 10, N. Y.

Standard Paper Box
Machine
476 Broome St.
New York, 13 N. Y.

Standard Tool & Die
Kearny, N. J.

Tools Manufacturing
701 Spring St. (U.S. Rte. 1)
Elizabeth, New Jersey

Complete Facilities for:
LABELS — PRESSING — MATRIX
• since 1943 •

ALCO RESEARCH & ENGINEERING, INC.

6201 Santa Monica Blvd.
Hollywood, Calif. 90038

for prompt service phone General Manager
Jim Stevenson at 213-466-1101

GREAT STARS

Carry the **SOUND** of



Around the World!

IN JUST TWO SHORT YEARS, MUSICOR HAS GATHERED TOGETHER THIS OUTSTANDING ARRAY OF GREAT RECORDING STARS...A ROSTER THAT INCLUDES THE TOP NAMES IN POP, COUNTRY, RHYTHM AND BLUES, LATIN AMERICAN AND CHILDREN'S RECORDS ...TOP NAMES THAT ARE PROVEN SELLERS AND CHART MAKERS TIME AND TIME AGAIN.

Every year we grow a little taller



MUSICOR'S STAR-STUDED LATIN LINE-UP IS WITHOUT PEER ANYWHERE IN THE WORLD. BRILLIANT SOLO VOCALISTS, OUTSTANDING GROUPS AND MAGNIFICENT ORCHESTRAS COMPRISE THIS BEST-SELLING, FASTEST-GROWING LATIN LINE IN THE BUSINESS. AND THERE ARE MORE TO COME... SOON!

*On Dynamo Records — Distributed by Musicor



TATO DIAZ



INEZ & CHARLIE FOXX*



TOMMY HUNT*



BARBARA & BRENDA*



THE DAYDREAMS*



THE JIVE FIVE



MELBA MONTGOMERY



PAUL TRIPP



GENE PITNEY
THE MOST POPULAR INTERNATIONAL ARTIST IN THE WORLD!



THE PLATTERS
NOW GREATER THAN EVER, ALWAYS THE FAVORITE!



GEORGE JONES
AMERICA'S GREAT C & W ARTIST, AND IN ALL ENGLISH SPEAKING COUNTRIES ALL OVER THE WORLD!



LOS HISPANOS



TITO RODRIGUEZ



LA PLAYA SEXTET

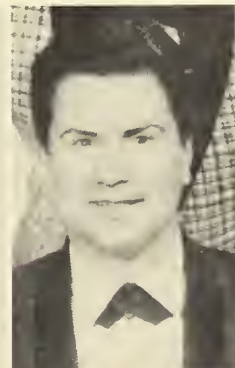

CHANO SCOTTY



ORQUESTA BROADWAY



BOBBY CAPO

MUSICOR RECORDS A DIVISION OF TALMADGE PRODUCTIONS INC., 240 W. 55th ST., NEW YORK, N.Y. 10019

RECORDING STUDIOS

A-1 Sound Studios
234 W. 56th St.
New York, N. Y.

A.E.A. Sound Studios
477 Alexander Blvd.
Elmhurst, Ill.

A & R Recording, Inc.
112 West 48th St
New York, N. Y.

Academy Record Co.
3035 W. Fullerton
Chicago, Ill.

Agency Recording
20 N. Wacker
Chicago, Ill.

Air Check Servlces
1743 W. Nelson
Chicago, Ill.

Akron Recording
790 Moin St.
Akron, Ohio

Allegro Sound Studios, Inc.
1650 Broadway
New York, N. Y.

Allstar Recording Studios
1110 Washington St.
South Houston, Texas 77587

Tommy Allsup Rec. Studios
5600 E. Country Rd.
Odessa, Texas 79762

American Music
Bennie Dillon Building
Nashville, Tenn.

American Recording Co
11386 Ventura
N. Hollywood, Calif.

Ardent Recordings
1457 Notional
Memphis, Tenn. 38122

Arthur Smith
5457 Old Monroe Rd.
Charlotte, N.C. 28211

Ardent Recordings
1457 National Ave.
Memphis, Tenn. 38122

Arlee Recording Studio
419—20th Ave. N.E.
Hickory, N.C. 28601

Associated Recording Studios
723 Seventh Ave.
New York, N.Y. 10019

Astor Recording Co.
CCM Building
1232 Cambridge St.
Cambridge, Mass. 02139

Austin Drew Inc.
P.O. Box 131
White Plains, N. Y.

Apex
1023 N. La Brea Ave.
Hollywood, Calif.

Artists Recording Co.
2931 W. Touhy
Chicago, Ill.

Ashna Music
115 3rd Ave. N.
Nashville, Tenn.

Assoc. Rec. Studios
723 7 Ave.
New York, N. Y.

Atlanta Sound
524 Plasters Ave. N.E.
Atlanta, Ga.

Atlantic Recording Studio
11 W. 60th St.
New York, N. Y.

Audio Arts
5607 Melrose Ave.
Hollywood 38, Calif.

Audio Craft
11359 S. Lothar
Chicago, Ill.

Audio Engineering Assoc.
477 Alexander Rd.
Elmhurst, Ill.

Audio Recording
Four New Hyde Park Rd.
Franklin Square
Long Island, N. Y. 11010

Audio Recording
2227 Fifth Ave.
Seattle, Washington

Audio Recorders of Ariz.
3830 N. 7th St.
Phoenix, Ariz.

Audio Techniques
247 W. 46th St.
New York, N. Y.

Austin McCoy's Studio
13221 S. Avalon
Los Angeles, Calif.

Authentic Recordings
110 S. Dearborn
Chicago, Ill.

Balkan Music Co.
6917 Cermak
Berwyn, Ill.

Barney Kugel Sound
161 E. Grand
Chicago, Ill.

Bell Sound Studios
237 West 54th St.
New York, N. Y.

Belle Records

Beltone Recording Corp.
4 West 31st St.
New York, N. Y.

Belvedere Recording Studio
319 W. 48th St.
New York, N. Y.

Boulevard Recording Studios
632 N. Dearborn
Chicago, Ill.

Bradley's Recording Co.
531 N. Howard St.
Baltimore, Md. 21201

Bradley's Studios
804 16 Ave., S.
Nashville, Tenn.

Bradley's Barn
1609 Hawkins St.
Nashville, Tenn. 37203—Jerry O. Brad

Broadway Recording Studios
1697 Broadway
New York, N. Y.

Capitol Records
Capitol Tower
Hollywood, Calif.

Capitol Records
806-16th Avenue S.
Nashville, Tenn.

Capitol Records, Inc.
151 West 46th St.
New York, N. Y.

Charles Fuller
Studio A—3013 Granada
Studio B—2722 So. Macdill Ave.
Tampa, Fla.

Chess Record Corp.
2120 S. Michigan
Chicago, Ill.

Cinematlon
Paul-Helen Building
Iowa City, Iowa

Coast Recording
960 Bush St.
San Francisco, Calif.

Coast Recording
2534 W. Pico
Los Angeles, Calif.

Columbia Records
630 No. McClure Court
Chicago, Ill.

Columbia Records
6121 Sunset Blvd.
Hollywood, Calif.

Columbia Records
804 16th Ave. So.
Nashville, Tenn.

Columbus Recording
916 Kearny St.
San Francisco, Calif.

Concert Classics
111 W. 57th St.
New York, N. Y.

Conway Recorders
1441 No. McCadden Pl.
Hollywood, Calif.

Cook & Associates Recorders
3905 W. Slauson Ave.
Los Angeles 43, Calif.

Coreco Recording Studios
209 Washington St.
Huntsville, Ala. 35801

Cosimo Recording Studio
748 Camp St.
New Orleans, La. 70130

Criteria Recording Studios
1755 N.E. 149th St.
Miami 61, Fla.

Crooked Fox Productions
4280 Government St.
Baton Rouge, La. 70802

Crystal Studios
36 W. Randolph
Chicago, Ill.

Custom
4 Column St.
Greenville, S. C.

Custom Recorders
5151 Strohm
Los Angeles, Calif.

Decca Records
50 West 57th St.
New York, N. Y.

Delsey Sound Studios
2509 N. Front St.
Philadelphia, Pa.

Delta Recording Corp.
236 W. 55 St.
New York, N. Y.

Delta Records
4304 W. Fullerton
Chicago, Ill.

Delta Recording Center
3225 West Fourth St.
Fort Worth, Texas

Deryck Warling Recordings
37 E. 49 St.
New York, N. Y.

Dial Records
905-16th Avenue S.
Nashville, Tenn.

Dick Charles Recording Studios
729 7th Ave.
New York 19, N. Y.

Dulcet
4334 Stern Shoks
Los Angeles, Calif.

Dynamic Sound
249 Broadway
Hicksville, N. Y. 11801

Edgewood Recording
1627 K Street N.W.
Washington, D.C. 2006

Electrovox Recording Studios
5546 Melrose Ave.
Hollywood, Calif.

Empire Broadcasting
480 Lexington Ave.
New York, N. Y.

Fidelity Recording Studios
1354 Vine
Los Angeles, Calif.

Film City
1485 Vine St.
Los Angeles, Calif.

Filmtown
1354 Vine St.
Los Angeles

Fine Recording Co., Inc.
118 West 57th St.
New York, N. Y.

Fink Recording
2732 Beachmont
Norfolk, Va.

Fortune Recordings
3942 3rd Ave.
Detroit, Mich.

Fred Foster Recording Studios
Nashville, Tenn.

Gaity Record Studio
1501 Newton Ave
Minn. 11, Minn.

Galewood Records
333 N. Michigan
Chicago, Ill.

Garrison Recording Studios
6252 Santa Monica Blvd.
Hollywood, Calif.

Globe Recording
230 N. Michigan
Chicago, Ill.

Globe Recording Studio
420 A Broadway
Nashville, Tenn.

Golden State Recorders
665 Harrison St.
San Francisco, Calif.

Gold Star Recording Studios
6252 Santa Monica Blvd.
Hollywood, Calif.

Gold Wax Recording Studios
1260 N. Hollywood
Memphis, Tenn. 38108

Gotham Rec. Corp.
2 West 46th St.
New York, N. Y. 10036

Hall Recording
307 S. Wabash
Chicago, Ill.

Harmony Recorders
1479 N. Vine St.
Hollywood, Calif.

Harnett National Music Studios
210 West 42nd St.
New York, N. Y.

Hickory Records
25-10 Franklin Rd.
Nashville, Tenn.

High Fidelity Recording
445 N. Oliver
Wichita, Kansas 67208

Hollywood Control Studios, Inc.
1538 Cahuenga Blvd.
Hollywood, Calif.

Hollywood Recording Guild
166 No. La Brea
Los Angeles, Calif.

(Continued on page 124)

SOUND? SERVICE?

For Best Sound
and Service
Leading Independents
use

**associated
recording
studios**

723 Seventh Ave. N. Y. C. 19
Circle 5-7640



RECORDING STUDIO

Serving the Record Industry

- MASTERING
- DEMO SESSIONS
- MONAURAL OR STEREOPHONIC
- 4 TRACK RECORDING
- ON LOCATION RECORDING

Stereo-Sonic

RECORDING CORPORATION
226 S. Wobosh, Chicago, Ill.
Phone: 922-0132

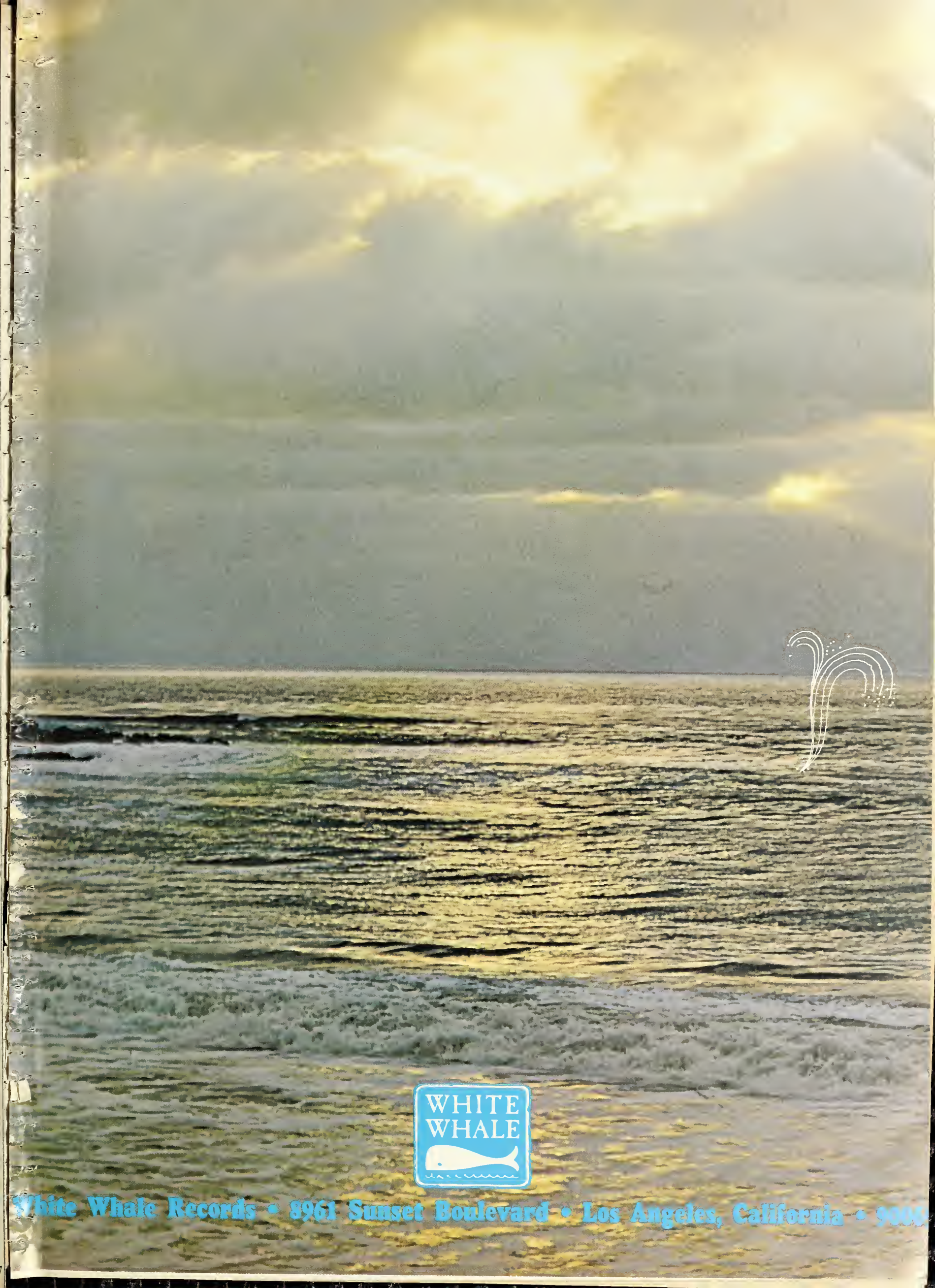

White Whale Records • 8961 Sunset Boulevard • Los Angeles, California • 90069

U.S. RECORD IMPORTERS & EXPORTERS

Airdisc USA
949 Broadway
New York, New York 10010

American Record Sales
1242 West Girard Ave.
Philadelphia, Pa. 19123

Amesay Trading Co., Inc.
55 Broadway, N.Y.

Airdisc U.S.A.
Box 545—Radio City Stn.
New York, N.Y. 10019

Bruno-New York, Inc.
460 W. 34th St.,
N.Y., N.Y.

Calif. Music Export Co.
2933 West Pico Blvd.
Los Angeles, Calif.

Cardinal Export Corp.,
135 W. 29th St.,
N.Y., N.Y. 10001

Daro Exports, Ltd.,
424 Madison Ave., N.Y.C.

Darris Ent.
5825 So. Morris Blvd.
Tucson, Arizona

Dixie Record Service
700 N. Conception
Mobile, Ala.

Eltron Export Co.,
122 Broad St., N.Y.C.

Empire Distributing
4610 Liberty Ave.
Pittsburgh, Pa. 15224

David Eskin-Int. Sales
400 Riverside Dr.,
N.Y., N.Y. 10025

Gemini Record Corp.
2364 Legion St.
Bellmore, N.Y. 11104

Gateway Mercantile Co.
408 S. Alvarada St.
Los Angeles 57, Calif.

Harbor Record Export
8701 Shore Rd.,
B'klyn 9, N.Y.

Horizon Int'l.
6290 Sunset Blvd.
Hollywood, Calif. 90028

Kaco Ent.
2444 Throop Ave.
Bronx, New York

Musical Export Supply, Inc.
4500 N.W. 36 Ave.
Miami, Florida 33142

Otao Record Co. Int'l.
204 W. 96th St.
New York, New York 10025

Pan World Import Export Co. Inc.
2020 W. Washington Blvd.
Los Angeles 18, Calif.

Paradiso
71 East Ave.
Norwalk, Conn.

Record & Tape Sales Corp.,
821 Broadway
655 Lexington Ave.
New York, New York

Reliable Buyers
147 W. 35th St.
New York, N.Y.

Alex S. Roberts Associates, Inc.
99 Beekman St.,
New York 38, N.Y.

Albert Schultz, Inc.
116 W. 14th St.,
N.Y. 11, N.Y.

M. Sluis Co.
44 Whitehall St.
New York, N.Y. 10004

RECORD SLEEVES MANUFACTURERS

P. L. Andrews
Andrews Rd.
Hicksville, L. I., N. Y.

Alemo Ltd.
737 Drake St.
New York 59, N.Y.

Arlington Sales
1334 Webster Ave.
Bronx, N. Y.

Berto Press
4862 Santa Monica Blvd.
Los Angeles, Calif.

Chuiterman Paper Co.
517 W. 21st St.
Chicago 8, Ill.

Cohoes Envelope Co.
Cohoes, N. Y.

Cole Corp.
823 S. Wabash Ave.
Chicago, Ill.

Container-Kraft
Carton & Paper Supp. Co.
801 E. 61st St.
Los Angeles, Calif.

Creative Sound Prod.
9000 Sunset Blvd.
Los Angeles, Calif. 90069

Crown Album Corp.
1217 Carpenter St.
Philadelphia, Pa.

D & G Transparent Bag Co.
550 Fifth Ave.
New York, N. Y.

Diamond Cellophane
2724 S. Michigan
Chicago, Ill.

Dual Phono Record Env. Co.
148 Broadway
Melrose Park, Ill.

Equitable Paper Bag Co.
45-50 Van Dam
Long Island City, N. Y.

Fine-Tone
7111 20th Ave.
Brooklyn, N. Y.

•Globe Albums
1255 Oak Point Ave.
New York 59, N. Y.

RECORD SLEEVES & MAILERS

CALIFORNIA

Bert-Co Ents.
1855 Glendale Blvd.
Los Angeles, California

Container-Kraft
721 East 61 Street
Los Angeles, California

Golden State Graphics
615 South Flower
Los Angeles, California

Szarko Organization
10680 West Pico
Los Angeles, California

DISTRICT OF COLUMBIA

Record Safe Mailers
4915 Earlston Drive
Washington, D.C.

MASSACHUSETTS

U.S. Envelope
21 Cypress Street
Springfield, Mass.

NEW YORK

Andrews-Nunnery
205 Park Avenue
Hicksville, Long Island, New York

One Stop Serv.
133 East 84 Street
New York City, New York 10028

Queens Envelope
52-35 Barnett Avenue
Long Island City, New York

Edward R. White
342 Madison Avenue
New York City, New York

TENNESSEE

Atlantic Envelope
P.O. Box 888
Nashville, Tennessee

PRINTERS & LITHOGRAPHERS

(Continued)

Motivestor
P.O. Box 1036
Alameda, Calif.

One Stop Service, Inc.
100 W. 42 St.
New York, N.Y.

Photo Press
Congress Expressway
Gardner Rd.
Broadview, Ill.

Queen City Album Co.
2774 Blue Rock Rd.
Cincinnati, Ohio

Queens Litho
Kaltman Press
52-25 Barnett Ave.
Long Island, N.Y.

Records Labels
6201 Santa Monica Blvd.
Hollywood, Calif.

Rite Records Products
3930 Spring Grove Ave.
Cincinnati, Ohio

Shorewood Press
305 E. 45th St.
New York, N.Y.

Sterling Title Strip
1175 Broad St.
Newark, N.J.
Supreme Printing Service
130 W. W. 46th St.
New York, N.Y.

RECORDS • EXPORT
All Speeds • Low Prices
All American brands
combined into
ONE SHIPMENT!
ELTRON
Export Company
122 Broad Street New York 4, N. Y.
Cable: ELTRONCOMP

ALL American Records
ALL Imported Records
ALL Prerecorded Tapes
ALL Car Tapes
ALL Your Needs In One Shipment
AT LOW, LOW Prices

FREE CATALOGUES ON REQUEST

DAVID ESKIN
International Sales
400 Riverside Drive
New York 10025 U.S.A.

RECORDS
For Export
All American Labels,
Extremely Attractive Prices
and
Speedy Service
CARDINAL
EXPORT CORP.
135 West 29th St.
New York, N.Y. 10001

- RECORD ENVELOPES, all sizes
- CORRUGATED BOARDS AND RECORD MAILERS
- STOCK LEGAL CONTRACTS for Music Publishers and Record Companies
- PRESSURE-SENSITIVE LABELS (for Recording Studios)
- FAN CLUB PHOTO CARDS

Sleeves—Stationery—Album Jackets
Invoices—Business Cards
Offset and Letterpress Printing
Custom Designed for the Music Industry
Price Lists Available Upon Request
ONE STOP SERVICE, INC.
133 E. 84th St. New York, N.Y. 10028
BU 8-4338 — Adam Gary

PROMOTIONAL 45 R.P.M. RECORD MAILING ENVELOPES

12" LP RECORD MAILING SYSTEM

Unique Record Mailers—For 1 to 2 LP's
Variable Record Folders—For 3 to 15 LP's
7"—10"—12" ENVELOPES & BOARDS



Edward R. White INC.
342 MADISON AVE., NEW YORK 17, N. Y.
MUrray Hill 7-2167

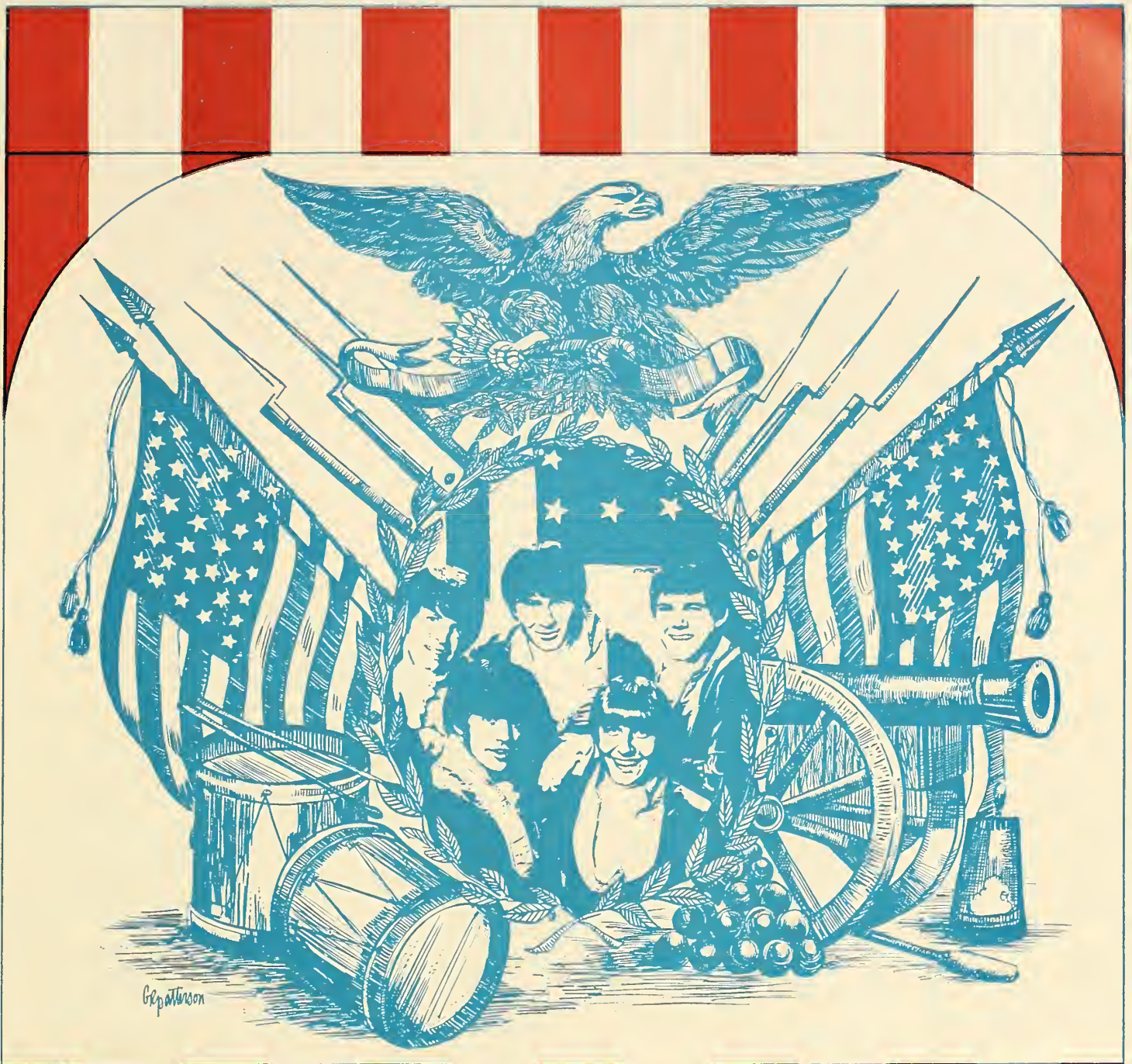

PAUL REVERE AND THE
RAIDERS

HERE THEY ARE:

Five groovy guys who make up America's most famous fivesome. What can be said except, thank you, D.J.'s! And thanks to Dick Clark and "Where the Action Is," the Hollywood Palace, Milton Berle, the Smothers Brothers, the Tonight Show, Batman, the Mike Douglas Show, Coliseum, and Ed Sullivan. The Raider story has a long way to go and much to be written and many more hits to be made. Wait, watch and listen to what another year will add to Paul Revere and the Raiders.

Management:
 Roger Hart
 9126 Sunset Blvd.
 Hollywood, Calif.



Public Relations:
 Contemporary Public Relations
 Beverly Noga—Bobbie Cowan
 9100 Sunset Blvd., Suite 250, Hollywood, Calif.

RECORDING STUDIOS

(Continued from page 122)

Horizon Studios
Sunset & Vine Tower
Hollywood, Calif. 90028

Ideal Recording
119 S. Sam Houston Blvd.
P.O. Box 861
San Benito, Texas 78586

Impact
7102 1/2 Castor Ave.
Philadelphia, Pa. 19149

Ind-O-Pro Recording Assocs.
1733 B'way
New York, N. Y.

International Recording
5619 W. Division St.
Chicago, Ill.

International Sound, Inc.
5539 Sunset Blvd.
Hollywood 28, Calif.

Iowa Great Lakes Recording Studios
906 9th St.
Milford, Iowa 51351

J.A.C. Recording Service
152 West 58th St.
New York, N. Y.

Jay Jay Recording
2452 So. Kedzie
Chicago, Ill.

Jaysna Ent.
143 W. 51 St.
New York, N. Y. 10019

Jimmy Jones
148 No. Pasadena
Pasadena, Calif.

Joy Recording Studios
111 E. Ontario
Chicago, Ill.

Kasko
P.O. Box 45
Santa Claus, Ind. 47579

KM Studios
Palmer Hill Road
Port Crane, New York

Knickerbocker Studios
146 W. 47th St.
New York, N. Y.

King Records
1540 Brewster Ave.
Cincinnati, Ohio

Kiskl Recording Co.
Box 116
North Apollo, Pa.

LaVette Records
1205 Madeira S.E. Suite 124
Albuquerque, New Mexico 87108

Little Nashville Record Corp.
45 Allen Drive
Charleston Hgts., South Carolina

Location Recording Service
2201 W. Burbank
Burbank, Calif.

Lyn-Lou Music Inc.
1518 Chelsea
Memphis, Tenn. 38108

Lynn Ollver Studios
250 W. 89th St.
N.Y.C.

MacQuarrie Ent.
2696 Santa Rosa
Altadena, Calif. 91001

C. P. MacGregor
729 So. Western
Los Angeles, Calif.

Manhattan Sound Corp.
New York, New York

Sam Phillips Studios
319 7th Ave. No.
Nashville, Tenn.

Phonotone Recording Service
176-11 Jamaica Avenue
Jamaica, N. Y.

Master Records Research
770 West 27th St.
Hialeah, Miami, Florida 33011

Master Sound Studios Inc.
1224 Fernwood Circle, N.E.
Atlanta, Georgia 30319

Masterstone Recording Studios
130 West 42nd St.
New York 36, N. Y.
M.B.S. Recording Studios
228 S. Wabash
Chicago, Ill.

Mega-Sound
49 Heid Ave.
Dayton, Ohio 45404

Metcalfes (Thesaurus)
116 West Franklin St.
Dayton, Ohio

Mills Recording Co.
161 N. Michigan
Chicago, Ill.

Mirasound Studio
145 W. 47th St.
New York, N. Y.

Monument Records
530 W. Main St.
Hendersonville, Tenn.

Moss Recording Studios
1908-1910 California St.
Omaha 2, Nebr.

Music City Recorders
821 19th Ave. S.
Nashville, Tenn.

N. H. Supreme Recording Studio
1502 Central Ave.
Cincinnati, Ohio 45214

Nashville, Tenn.
505 Melrose
Hollywood, Calif.

Natural Sound Studios
102 Hudson Rd.
Sudbury, Mass.

National Recording Corp.
2871 E. Ponce De Leon Ave.
Decatur, Ga

Nola Studios
111 West 57th St.
New York, N. Y.

Nugget Studios
Finnen Rd.
Nashville, Tenn.

O-D-O Recording
254 West 54th St.
New York 19, N. Y.

Olmsted Sound Studios, Inc.
1 East 54th St.
New York, N. Y.

Orbison Associates
530 W. Main St.
Nashville, Tenn.

Orbit Radio
P.O. Box 1644
Louisville, Ky.

Original Sound Studios
7120 Sunset Blvd.
Hollywood, Calif.

Pac 3 Recording Co.
7106 Greenfield
Dearborn, Mich. 48126

Pantomime Recordings
P.O. Box 2902
Philadelphia, Pa. 19126

Park Recording
200 East 66th St.
New York, N. Y.

Parliament Records
Box 341-A R.D.2
Parkersburg, Pa.

Pepper Sound Studio
62 South Diana
Memphis 4, Tenn.

Petrucci & Atwell
331 Newburg St.
Newton, Mass.—02115

Norman Petty Studios
Clovis, N. Mexico

Pharaoh Records
P.O. Box 969
McAllen, Texas

Sam Phillips Studios
639 Madison Ave.
Memphis, Tenn.

Sam Phillips Studios
319 7th Ave. No.
Nashville, Tenn.

Phonotone Recording Service
176-11 Jamaica Avenue
Jamaica, N.Y.

Pioneer Recording
20014 James Couzens
Detroit, Mich. 48235

Michael Piorek
625 Burnside Ave.
Bridgeport, Conn.

Plastic Products
1746 Chelsea Ave.
Memphis 7, Tenn.

Plaza Sound Studios
55 W. 50th St.
New York, N. Y.

Praise Recordings
Dept. C
Stoneboro, Mass. 16153

Progressive Sounds of America
2704 East Florence
Huntington Park, Calif.

Radio Recorders
7000 Santa Monica Blvd.
Hollywood, Calif.

R.J. Recorders
6359 Selma Ave.
Hollywood, Calif.

RCA Custom Record Sales
155 East 24th Street
New York, New York 10010
(212) MU 9-7200

RCA Custom Record Sales
800 17th Avenue South
Nashville, Tennessee 37203
(615) 255-5781

RCA Custom Record Sales
445 North Lake Shore Drive
Chicago, Illinois 60611
(312) 944-3215

RCA Custom Record Sales
6363 Sunset Blvd.
Hollywood, California 90028
(213) 461-9171

Reco-Art Sound Recording
212 N. 12th St.
Philadelphia 7, Pa.

Record Broadcast
237 S. Bent. Ave.
San Marcos, Calif.

Recordings, Inc.
1130 E. Cold Spring Lane
Baltimore 12, Md.

Recording of Nashville
115 1/2-3rd Avenue N.
Nashville, Tenn.

Recording Studios, Inc.
Capitol Theatre Bldg.
1639 Broadway
New York, N. Y.

Reeves Sound Studios, Inc.
304 East 44th St.
New York, N. Y.

Regent Sound Studios
25 West 56th St.
New York, N. Y.

Replica Transcriptions
37 West 57th St.
New York, N. Y.

Rex Recording Co.
931 S. W. King
Portland, Ore. 97205

Ridon Productions
5124 N.E. 34th Ave.
Portland, Ore. 97211

Richcraft Recording
2314—63rd St.
Brooklyn, N. Y.

Rite Records Productions, Inc.
3930 Spring Grove Ave.
Cincinnati 23, Ohio

Rockhill Recording
18 East 50th St.
New York, N. Y.

(Continued on page 128)

**SO WHAT'S
SO GREAT
ABOUT
GATEWAY?**

A spacious recording studio equipped with a four track Scully and a master control board that handles up to sixteen inputs in the hands of skilled engineers; a mastering department with Scully lathes, Pultec equalizers and Grampian amplifiers to transfer from tape to master disc; a modern pressing plant equipped with precision Finebilt presses that turns out the best pure vinyl pressing; an art department and a far reaching distribution system; a Gateway label which has recorded Harold Betters; and the Dyno label, the largest polka label in the nation.

**WHICH ADD UP TO
TOTAL RECORDING
SERVICE IN PITTSBURGH**

OH!



Gateway Recordings, Inc.
234 Forbes Avenue
Pittsburgh, Pa. 15222
(412) 471-5875
(412) 471-5877 (NITE LINE)

Write for free plant or studio rate card.

Sonny & Chér



Management: DeCarlo-Kresky Enterprises

Booking
XXX
WILLIAM MORRIS

RACK JOBBERS

•NARM Member

ALABAMA

Music Center
416 N. 19th St.
Birmingham, Ala.

Victory Record Service
1028 N. 1st. Ave.
Birmingham, Ala.—Joe Vetrano

Dixie Record Service
700 North Conception St.
P.O. Box 1192
Mobile, Ala.
Floyd E. Hall—Ed Farver

Reliable Records
1018 Christopher Ave.
Gadsden, Ala.—C. R. O'Neal

M&F Record Suppliers
4008 Dophin Island Parkway
Birmingham, Ala.—Fred Filippone

Music City
567 Houston St.
Mobile, Ala.—Albert Pardo

ARIZONA

•Arizona Sundries Co.
2949 N. 30th Ave.
Phoenix, Ariz. 85017—
George Souvall

•Associated Distributors
2350 W. Comelbock Rd.
Phoenix, Ariz. 85015—
Leonard Singer

•Record Service, Inc.
3036 N. 30th
Phoenix, Ariz.—Jack Sharpe

ARKANSAS

•Siebert's News Agency
6301 Forbing Road
Box 4375 Asher Station
Little Rock, Ark.—Sieg Siebert

CALIFORNIA

•Rapid Merchandising Co.
1802 American St.
Anaheim, Calif.—Herbert Sondel

Pic-A-Tune
P.O. Box 8004
Emeryville, Calif. 94608—
John Edgerton

•Western One Stop
1461 Pork Ave.
Emeryville, Calif.

•Record Service Co.
116 Goodman St.
Bakersfield, Calif.—Sam Castro-Vinci

•M&M Records
295 N. Hartz Ave.
Danville, Calif.—Gordon C. George

Western News Supply
461 North Weber
Fresno, Calif.—Bob Tenscher

Mel-Q-Disc Record Co.
16228 South Boll St.
Gardena, Calif.—Charles Burk

•Bertel Distributing Co.
5414 West Washington Blvd.
Los Angeles, Calif. 90016—
Herb Siegel

Julian Brown Enterprise
9106 S. Western Ave.
Los Angeles, Calif.
Lorin Wilson—Lloyd Thompson

•Cal Raks, Inc.
1499 West Washington Blvd.
Los Angeles, Calif. 9007—
George Hortstone—Ben Bortel

•California Record Rack
2933 W. Pico Blvd.
Los Angeles, Calif.—Sam Ricklin

•Laurel Record Sales
1845 South Orchard
Los Angeles, Calif.—Morty Gobler

•Leader Sales
3416 West Pico Blvd.
Los Angeles, Calif. 90019—
Len Silver

M&M Record Distributors
7070 Waring Ave.
Hollywood, Calif.
Donville, Calif.—Milt Levine

•Merchandise Promotions of America
1348 Venice Boulevard
Los Angeles, Calif.—Mildred Miller

•Music City Records Racks Inc.
10711 Venice Blvd.
Culver City, Calif.
Los Angeles 27, Calif.
Glen C. Becker—Stuart Burnat

•New Deal Record Rock Service
3660 W. Pico Blvd.
Los Angeles, Calif.—Richard Susser

•Record Rack Service, Inc.
5873 Rodeo Road
Los Angeles 29, Calif.—Ed Mason

•Record Service
911 East 59th St.
Los Angeles, Calif.—Larry Nunes

Canterbury Records
805 East Colorado
Pasadena, Calif.

Central Valley Record Stocks
Alhambra Jay Bldg. Suite #70
Sacramento, Calif. 95816—
Russell Solomon

•Pic-A-Tune
2147 Borstow St. Bldg. B
Sacramento, Calif. 95815—
John LeCompte

•Tip Top Music Co.
1224 North "B" St.
Sacramento, Calif.—Bob Ferrero

•Record Rack Service
1340 E. St.
San Diego, Calif.

•Record Service Co.
3736 University
San Diego, Calif.—Bob Jones

•Colectron, Inc.
33 Cough St.
San Francisco, Calif.—Merritt B. Kirk

•Nor Cal
233 Utah Ave.
So. San Francisco, Calif. 94080—
Lee Hortstone, Don Ayers

Rapid Merch. Co.
640 Army St.
San Francisco, Calif.

Record Supply Dist.
154 S. Van Ness Ave.
San Francisco, Calif.

•Tip Top Music Co. Inc.
900 Minnesota St.
San Francisco, Calif.—Monroe Goodma
(Continued on page 130)

RECORDING STUDIOS

(Continued)
Roi Recording
821-19th Avenues
Nashville, Tenn.

Ronson Recording
1521 Texas Ave.
Lubbock, Texas

Rossi Ent.
2005 W. 8th St.
Brooklyn 23, N.Y.

Sombo Sound Studio
9912 Taylorsville Road
Louisville, Kentucky 40299

Sanders Rec. Studios, Inc.
167 West 48th St.
New York, N. Y.

Sara Sound Studios
123 Water St.
Sauk City, Wisc.

Seely John Associates
1717 N. Highland
Los Angeles, Calif.

Sheldon Recording Studios
1725 N. Wells
Chicago, Ill.

Shelley Products
220 Broadway
Huntington Station, L. I., N. Y.

Fletcher Smith Studios
259 S.W. 21st Terrace
Ft. Lauderdale, Fla.

Sonic Arts
333 N. Michigan
Chicago, Ill.

Sonico Recording Studios
319 7th Ave.
Nashville, Tenn.

Sound City
1705 West Seventh St.
Ft. Worth, Texas 76102

Sound Makers
6 W. 57th St.
New York, N. Y.

Sound Studios
230 N. Michigan
Chicago, Ill.

Sound Unlimited
906 Lynn Drive
Valley Stream, New York

Soundings Recording Service
215 East 12th St.
New York, N. Y.

Spectra-Sound, Inc.
6110 Santa Monica Blvd.
Hollywood, California 90038

Star Production
398 Main St.
Orange, N. J.

Stark Records
628 South St.
Mount Airy, N. C.

Starday Sound Studios
Dickerson Rd.
Madison, Tenn.

Stea-Phillips
781 7th Ave.
New York, N. Y.

Stereo Masters
5538 Melrose
Los Angeles, Calif.

Stereo-Sonic
226 S. Wabash
Chicago, Ill.

Stereo Sound Studios
238 East 26th St.
New York, N. Y.

Studio & Artists
6087 Sunset Blvd.
Hollywood, Calif.

Studio Center
1721 B'way
N.Y.C.

Studio F
6021 W. Sunset
Los Angeles, Calif.

Studio 3 Inc.
146 East 57th St.
New York 22, N. Y.

Sumet Sound Studios
5652 Daniels Ave.
Dallas, Texas

Sunset Sound Recorders
6650 Sunset Blvd.
Los Angeles, Calif.

Swallow Studios
434 E. Main, Box 506
Ville Platte, La.

Talentmasters
126 West 42nd St.
New York, N. Y.—Erni Adono
Ter-Mar Recording Studios
2120 S. Michigan
Chicago 16, Ill.

Texas Sound Studios
506 W. Hildebrand Ave.
San Antonio 12, Texas

Titra Sound Corp.
1600 Broadway
New York, N. Y.

Todd Recording
1719 Westend Ave.
Nashville, Tenn.

Tommy Allsup
Box 6406, 5600 E. Country Rd.
Odessa, Texas

Topper Music
1587 Highland
Detroit, Mich.

Tower Sound Studios
1697 Broadway
New York, N. Y.

David Trimble
205 West 57th St
New York, N. Y.

True Tone Rec. Co.
160 West 73rd St.
Studio 4-F
New York, N. Y.

Ultimate Sound Recorders
7619 W. Sunset Blvd.
Hollywood, Calif.

United Recording Co. of Nevada
3143 Industrial Rd.
Los Vegas, Nev.

United Recording Corp.
6052 Sunset Blvd.
Hollywood, Calif.

United Rec. Labs, Inc.
681 Fifth Ave.
New York, N. Y.

Universal Recorders
6757 Hollywood Blvd.
Hollywood, Calif.

Universal Recording
46 E. Walton
Chicago, Ill.

Variety Sound Corporation
225 West 46th St.
New York 36, N.Y.

Vault Recording Studio
2525 West Ninth
Los Angeles, Calif. 9606

Virtue Recording Studio
1618 N. Broad St.
Phila., Pa.

Wally Heider Recording
6373 Selma Ave.
Hollywood, Calif.

WG Records
66 Elmwood Ave.
Holyoke, Mass. 01040

WTTW Recording Services
5400 North Saint Louis
Chicago, Ill.

Webb Recording
812 N. Dearborn
Chicago, Ill.

Wedge Recording
3308 Eastern Ave.
Baltimore, Md. 21224

West Coast Sound
1721 N. Vermont
Los Angeles, Calif.

Western Recorders
6000 Sunset Blvd.
Hollywood, Calif.

Woodlond Sound Studio
1001 Woodland St.
Nashville, Tenn.

World Artists United
1595 Broadway
New York, N. Y.

World Pacific Studio
8175 W. 3rd
Los Angeles, Calif.

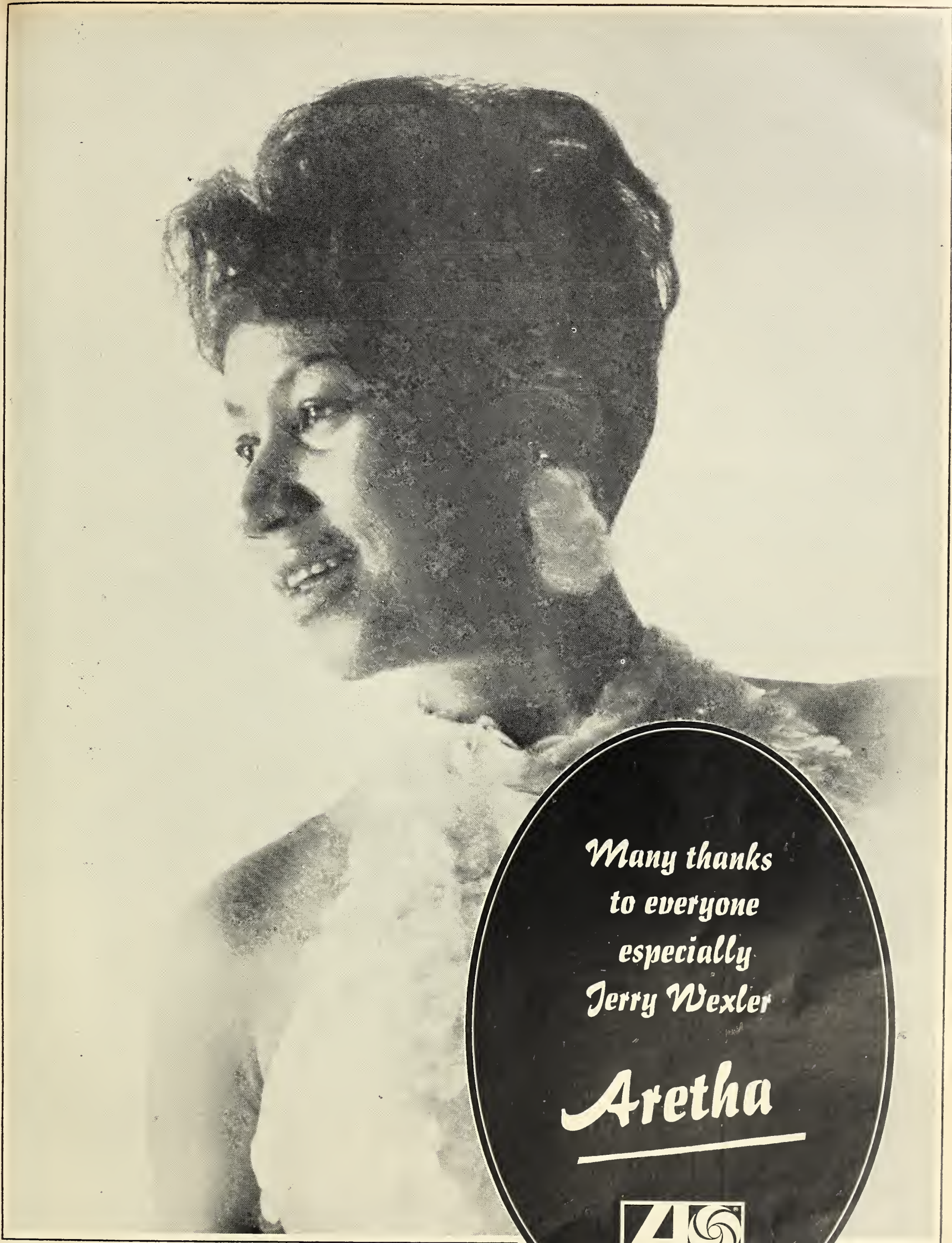

*Many thanks
to everyone
especially
Jerry Wexler*

Aretha



Personal Management:
TED WHITE
1721 Field Street
Detroit, Michigan 48214

RACK JOBBERS

• NARM Member

Western Tape Dist.
2160 Palou
San Francisco, Calif. 94124—
Mike Daniels

•Tip Top Music Co.
2855 Florence Ave.
San Jose, Calif.—Ed Hartman

•Barbary Coast
612 South Railroad Ave.
San Maeo, Calif.

COLORADO

Gorman Dist. Co.
1303 Harlan St.
Denver (Lakewood), Colo.
Jim Gorman

Le Mac Distribution Corp.
451 East 58th Ave.
Denver, Colo.—Lee Cantrell

•Mershaw Midwest
3990 Grape St.
Denver, Colo. 80207—Paul Marcus

J. L. Racks
77 Kalamath St.
Denver, Colo. 80223

Jay Record Co.
945 East Evans
Pueblo, Colo.—Herb & Max Martin

•Music Merchandisers Of
Denver
3825 Newport
Denver, Colo. 80207—
Bill Turner

Pan American Record Supply
77 Kalamath St.
Denver, Colo.

Tip Top Music Co.
817 Broadway
Denver, Colo.—Dale Williams

Western Merchants Wholesale
6265 E. Evans St.
Denver, Colo.—Robert Baker

CONNECTICUT

Music City Co.
959 State St.
Bridgeport, Conn.—Bill Bileca

Beacon Records
76½ Tolland St.
East Hartford, Conn.

•Park Record Dist.
275 Park Ave.
East Hartford, Conn. 06108—
Ed Stein

Trinity Records
477 Park Ave.
East Hartford, Conn.—Ed Di Nallo

Thompson Records, Inc.
Box 101
Quinebaug, Conn.

DELAWARE

Delaware News Agency
9th & Locust St.
Wilmington, Delaware—Stanley Borne

DISTRICT OF COLUMBIA

•District Records, Inc.
2146 24th Place NE
Washington, D.C.—Jay Jacobs-
James Schwartz

Richray Dists., Inc.
2400 17th St., N.W.
Washington 9, D.C.
D. Custer

Stacey Distributing Co.
1100 "F" Street N.W.
Washington, D.C.—Ed Fitch

FLORIDA

Rack Merchandising
413 Coral Drive
Cape Coral, Fla. 33904—
Frederick Benton

•Recordwagon
684 North Edgewood Ave.
Jacksonville, Fla. 32205—
Louis Rice

Budisco One Stop
280 N.W. 29th St.
Miami, Fla.

•Mershaw Dist.
8160 N.W. 36th Ave.
Miami, Fla.—Ed Chapman

•Gold State Record Dist.
4500 N.W. 36th Ave.
Miami, Fla.—Marvin Lieber, Allan Wol

Hicks News Agency
1316 N. Palm Ave.
Ocala, Fla.—Clarence Hicks

•Record Supply Co.
2634 Taft St.
Orlando, Fla.—R. Stultz

Orange News Co.
122 Canal St.
Tallahassee, Fla.

Tampa Records
P. O. Box 5524
Tampa, Fla. 33605—S. Delgado

D & M Post Cards & Records
5011 Georgia Ave.
West Palm Beach, Fla.—Don Ebbert

GEORGIA

All Purpose Service Co.
1456 Northside Drive N.W.
Atlanta 18, Ga.—Peter Paris

•Gate City Record Service
1231-D Collier Road N.W.
Atlanta, Ga. 30318—
Gerald Friedman & Ted Pousman

Sound Marketing, Inc.
1319 Spring St. NW
Atlanta, Ga.—Don Comstock

Budget Merchandising
207 Walker St. SW
Atlanta, Ga.

•L & F Record Service
720 14th St. N.W.
Atlanta, Ga. 30318—Jack Geldbart

Clarksville Record Sales
P.O. Box 198, Washington St.
Clarksville, Ga.—Peter Roseffy

Joe Head Prod.
P.O. Box 291
Mableton, Ga.—Joe Head

•Carmichael Enterprises
P.O. Box 388
Norcross, Ga. 30071

Southeast Record Sales
138 East 5th St.
Tifton, Ga.—Gus Statras

HAWAII

Music-Hawaii, Inc.
474 Ena Road
Honolulu 15, Hawaii

Rack Service Hawaii
1354-A Kapiolano Blvd.
Honolulu, Hawaii—Bill Shipman

ILLINOIS

•Ali Tapes Distributing
1400 S. Michigan Ave.
Chicago, Ill. 60605—
Kent Beauchamp, Ed Yalowitz

Brason Associates
512 S. Peoria
Chicago, Ill.—Dave Lande

•Car Tapes, Inc.
2017 S. Michigan Ave.
Chicago, Ill.—Harry Beckerman

Chicago Drug Co.
1335 W. Altgeld
Chicago 14, Ill.—Moe Handleman

Consolidated Record Sales
101 S. Cicero Ave.
Chicago 44, Ill.

•Hit Records
10614 S. MacKinaw
Chicago, Ill. 60617—Charles Stevens

•James H. Martin Co.
2419 S. Michigan Ave.
Chicago, Ill.—James H. Martin

•Mid-America Specialty Dist.
752 N. Milwaukee Ave.
Chicago, Ill.—Howard Rosen

•Musical Isle Record Corp.
1550 S. State St.
Chicago, Ill.—Victor Faraci

•New Deal Record Service
1414 S. Michigan Ave.
Chicago, Ill.—Irv Rothblatt

Randolph Enterprises
1130 E. Eldorado
Decatur, Ill.—Harvey Randolph

•Rak Sales
312 N. Water St.
Decatur, Ill.

•R & R Record Dist.
7059 W. Addison St.
Chicago, Ill.—Richard Sundling

•Tape Distributors of America, Inc.
1450 S. Michigan Ave.
Chicago, Ill.—Paul Glass, Lee Howard

Illinois News Service
507 N. Franklin
Peoria, Ill.

Paul Allen Rack Sales
111 Sun Valley Ct.
Peoria, Ill. 61614

•R&R Record Distributors
313 Franklin St.
Peoria, Ill.—Ronald Salpietro

The Record Bar
109 N. Glendale Ave.
Peoria, Ill.

INDIANA

Midwest Dist.
123 McKinnie
Fort Wayne, Indiana 46806

Associated Distributors, Inc.
210 South Meridian St.
Indianapolis, Ind.—L. E. Randle, Jr.

•Rak Sales, Inc.
2027 East Minnesota
Indianapolis, Ind.

Tri-State Dist.
933 Nuttman Ave.
Fort Wayne, Ind.
Indiana Merchandise Co.

IOWA

Iowa News
115 7th St. S.E.
Cedar Rapids, Iowa—Stanley Seidler

Mid-State Dist.
1501 First Ave. S.E.
Cedar Rapids, Iowa—Bob Pockrandt

•Major Record Corp.
1212 Grand Ave.
Des Moines, Iowa 50309—
Jack Silverman

Mars Sales Corp.
1630 Locust St.
Des Moines, Iowa—Jack Mishler

•Quality Record Service Co.
1234 Harding Road
Des Moines 14, Iowa
Ralph Anderson

KANSAS

•Rak Sales
609 Quincy St.
Topeka, Kansas

•Pioneer Dist. Co.
2955 S. Kansas
P.O. Box 517
Wichita, Kansas 66106—
Alvin M. Driscoll

KENTUCKY

A. J. Eyi Co.
Industry Road
Lexington, Ky.

Handleman Co.
1023 S. 21st St.
Louisville, Ky.

Joy Record Co.
P.O. Box 126
Midway, Ky. 40347—Bill Buster

Peyton's Inc.
716 W. Main St.
Louisville 2, Ky.

LOUISIANA

Top Rak Record Service
524 Lafayette St.
Gretna, La.

Record Rack Sales
P.O. Box 10386
Jefferson Parrish, La.

•Modern Record Service
P.O. Box 3727
Lafayette, La. 70501—George Berry

Hel-lo Record Co., Inc.
710 Aris Ave.
Metairie, La.—Vincent Lafoso

Record Rack Service
108 Frisco Ave.
Metairie, La.

•Modern Record Service
755 Central Ave.
New Orleans, La. 70121—Geo. Berry

MAINE

•The Boyd Corp.
84 W. Cove St.
Portland, Maine 04101—C. Roy Rice

Caron Co.
73 India St.
Portland, Maine—Jules Abramsor

Diamond Corp.
212 Anderson St.
Portland, Maine

•Portland Records
84 West Cove St.
Portland, Me. 04101—C. Roy Rice

MARYLAND

B & D Music
2342 E. Monument St.
Baltimore, Md.—Bill Gerhardt

•D&H Dist. Co. Inc.
2025 Worchester St.
Baltimore, Md.—
Julius Rainess, Lester Pyle

Jalen Amusement Co., Inc.
1215 South Howard St.
Baltimore, Md. 21230—J. Jones

Ellis Distributing Co.
5216 Fairlawn Ave.
Baltimore, Md.—Edgar Ellis

•New Deal Record Service
1601 Guilford Ave.
Baltimore, Md.—Ronnie Ballon

Stacey Distributing Co.
2275 Reiserstown Road
Baltimore, Md.—Ed Fitch

Interstate Record Distributors
116 North Potomac St.
Hagerstown, Md.—
Melvin & Richard Greenwald

Coronet Music
4724 Bonnie Brae Rd.
Pikesville, Md. 21208—Sam Anoff

MASSACHUSETTS

Boston Record Dist.
450 Harrison Ave.
Boston 18, Mass.

•Disco Inc.
141 Milk St.
Boston, Mass. 02109—Fred Traub

Boyd Corp.
33 Moulton St.
Cambridge 38, Mass.—James Boyd II

•Record Wholesalers of New Eng.
157 Washington St.
Dorchester, Mass. 02121—Fred Furfey
(Continued on page 132)

- 
- A black and white photograph of Wilson Pickett performing on stage. He is wearing a light-colored shirt and a dark vest, with his right arm raised and his left hand holding a microphone. He has a joyful expression with his eyes closed and a wide smile.
- *Land Of 1000 Dances*
 - *Mustang Sally*
 - *Everybody Needs Somebody To Love*
 - *I Found A Love*
 - *Soul Dance Number Three*

Thanks for a great year...

Wilson Pickett



Personal Management:
JAMES EVANS
200 West 57th Street
New York, N.Y. (CO. 5-3553)

RACK JOBBERS

•NARM MEMBER

Temple Sales
4 Gordon St.
Jamaica Plain, Mass.—Myer Tannenba

•Somerset Corp.
203 Plymouth Ave.
Fall River, Mass. 02722—
Louis Freedman

U. S. Records
185 Riverside Ave.
Somerset, Mass.—Dan Gittleman

•Recordwagon Inc.
30 Nashua St.
Woburn, Mass. 01801—Cecil H. Steen

Alan Sales Co.
45 Stoughton Ave.
Webster, Mass. 01570—John Stularczy

Thompson Record Dist. Co.
Perryville Road
Webster, Mass.—H. Hammond

MICHIGAN

Cornell Records
13380 Capital Ave.
Oak Park, (Detroit), Mich.

•Consolidated One Stop, Inc.
13254 Linwood
Detroit, Mich. 48238—
Charles Gray, Thomas Mutter

Handleman Co.
670 E. Woodbridge
Detroit 26, Mich.
David Handleman—David Strome

Ludington News
1600 E. Grand Boulevard
Detroit, Mich.—Joe Sandifer

•New Deal Record Service
15329 Livernois Ave.
Detroit, Mich.—Dave Lasher

•Monroe Dist. Co.
2431 Clyde Park S.W.
Grand Rapids, Mich. 49509—
Herman Rubin

Keego Dist.
12866 Woodward Ave.
Highland Park, Mich.

•Canfield Supply
210 Mill St.
Lansing, Mich.—Robert R. Canfield

Handleman Co.
1307 Turner St.
Lansing, Mich.

McGregor News
212 W. Michigan
Mount Pleasant, Mich.

Publisher News
U. S. at Grand Beach
New Buffalo, Mich.

Cornell Records
13380 Capital Ave.
Oak Park (Detroit), Mich.—Harry Levin

MINNESOTA

Dasco, Inc.
410 12th Ave. N.
Minneapolis, Minn.—Ken McGowan

•Dart Records
730 Lyndale Ave. N.
Minneapolis, Minn.—Jack Taylor

•J. L. Marsh Co.
7600 Wayzata Blvd.
Minneapolis, Minn. 55426—
Dan & Amos Heilicher

•Rapid Merchandising Co.
8175 Lewis Road
Minneapolis, Minn. 55427—
Noel Korengold

•Sam Sales, Inc.
321 Plymouth Ave. North
Minneapolis, Minn. 55411—
David Lieberman—Richard Moerbitz

MISSISSIPPI

Record Rak, Inc.
110 Rear Cedars of Lebanon Road
Jackson, Miss.—John Reeves

MISSOURI

Top Notch Record
1415 Bobolink Place
Brentwood 17, Mo.

•K. C. Rak Sales, Inc.
3230 Roanoke Road
Kansas City, Mo.

Kansas City News Dist.
4231 E. 75th Terrace
Kansas City, Mo. 64132

Reco Dist. Co.
4931 S. Benton
Kansas City, Mo.

Bootheel Music
203 S. Main St.
Kennett, Mo.—
Dick Hillburs, John McMullan

•Decatur Rak Sales
2721 Pine St.
St. Louis, Mo.
John Pohl

•Missouri Discs
1906 Washington Ave.
St. Louis, Mo.—
Robert & Norman Hausfater

•Rak Sales Inc.
2549 Sullivan Ave.
St. Louis, Mo. 63107—Ed Ockel

MONTANA

Playhouse Inc.
1015 Poplar
Helena, Montana—Ben Hopkins

NEVADA

Music City Racks Of Nevada
5409 Gypsy Ave.
Las Vegas, Nevada—Alex Fox

•Record Service Co.
3127 Industrial Rd.
Las Vegas, Nev.—Gene Hotchkins

Pic-A-Tune (Ranchito)
1524 Matley Lane
Reno, Nevada—D. Jones

NEW HAMPSHIRE

Sullivan News
9 Odd Fellows Ave.
Concord, N. H.

Verham News
75 Main St.
W. Lebanon, N. H.

NEW JERSEY

A. L. Fairbanks Co.
818 High St.
Burlington, N. J.
A. L. Fairbanks

Record Distributors
1050 Sherman Ave.
Elizabeth, N. J.—Frank Arace

Cleopatra Records Inc.
4 Mason Dr.
Hazlet, N.J. 07730

Metropolitan Supermarket Services
1601 W. Edgar Rd.
Linden, N.J.—Charlie McAllister

•National Merchandising Services
Stokes Road
Medford, New Jersey 08055—
Larry Coughan, Bill Brown

Market Merchandisers Inc.
14-20 Wharton St.
Newark, N.J.

Garden State Record Dist.
68 West Passaic St.
Rochelle Park, N.J. 07662—
Stanley M. Sterling

NEW MEXICO

•Mershaw
4115 Silver S.E.
Albuquerque, N.M. 87108—
Sandy Kahn

•Record Service Co.
828 San Mateo Blvd.
Albuquerque, New Mexico—
E. D. Shaffer

NEW YORK

•Mershaw Of America
100 Watervliet St.
Albany, N.Y.—12206—
Charles Schlang

•Almor Playtime Co. Inc.
P.O. Box 111
Amsterdam, N.Y.—Albert Hyman

All Record Dist.
35-05 Broadway
Astoria, L.I.C., N.Y.—Michael Lajacoma

Gemini
2364 Legion St.
Bellmore, N.Y. 11104—Norm Seeman

G&G Record Dist.
3 Bellevue Heights
Binghamton, New York 13905—
Ken Glassman

R.O.C. Record Co.
1309 E. L. Grant H'way
Bronx, N.Y. 10452—S. Sahler

B&R Record Dist.
1029 East 163rd St.
Bronx, N.Y.—Jack Baum

Kaco Ent.
2444 Throop Ave.
Bronx, N. Y.

Tiechner & Co.
70 Strong St.
Bronx 68, N. Y.

Akorn Housewares Corp.
502 Flushing Ave.
Brooklyn 5, N. Y.

Candy Stripe Records
674 Midwood St.
Brooklyn, N. Y. 11203—Bernard Kell

Fine Tone Audio Prod.
7111 20th Ave.
Brooklyn, New York—Stuart Mont

Met Richmond Record Sales
723 E. 81st St.
Brooklyn 36, N.Y.—David Last

Rack Profits
24 E. 52nd St.
Brooklyn, N. Y.—Sy Friedman

•Discerles Inc.
861 Washington St.
Buffalo, N.Y. 14203—Carl Glazer

Transcontinent Record Sales
961 Main St.
Buffalo, N. Y.—
Leonard Silver, Steve Brodle

National Bag-O-Tunes, Inc.
224-09 Linden Blvd.
Cambria Heights 11, N. Y.

Tak-A-Toy Inc.
102-05 Northern Blvd.
Corona, N. Y.—Jack Israel

Bocar Sales
124 W. 10th St.
Deer Park, L. I., N. Y.
William Bernstein

Guy Barry Ent.
13 Wesley Drive
East Rockaway, N.Y.

Service Housewares
102 4th Ave.
Garden City Park, L. I., N. Y.

American Album & Tape
850 7th Ave.
New York, New York 10019—
David King

•Steadman
200 So. 14th Ave.
Mt. Vernon, New York 10550—
Lenny Book, Sam Weiss

Arovox Record Corp.
620 West 51st St.
New York City, New York—
Marty Schesinger

Arrow Record Services
P.O. Box 316 Times Sq. Sta.
New York, N. Y. 10036—George Kurtz

Eastern Record Sales & Dist. Inc.
751 Tenth Ave.
New York 19, N. Y.

Independent Record Promotions
259 W. 18th St.
New York, N. Y. 10011—Larry Guttentag

•Interstate Record Dist.
1290 Ave. of Americas
New York, N.Y. 10019—Manny Wells

National Record Dist.
111 8th Ave.
New York, N. Y.—Ed Stein

Rack Profits
191 7th Ave.
New York, N.Y.—Sy Friedman

•Win Records
858 Ninth Ave.
New York, New York 10019—
George & Sam Weiss

Superior
3236 Lawson Blvd.
Oceanside, Long Island 11572—
Stanley Weiss & Sam Weiss

•Toy House Of Hudson Valley
Manchester Rd.
Poughkeepsie, N.Y. 12603—
Lou Kustas

Finger Lake Home Mdse. Co.
240 Hemingway Dr.
Rochester, N. Y.

Rochester Record Service
196 Ward St.
Rochester, N. Y.—Bill Cyrkin

Statewide Record Sales
119 Roswood Terrace
Rochester, N. Y.—Len Friedman

Universal Record Sales
1326 Clinton Ave. N.
Rochester, N. Y.

Superior Mdse. Co.
350 Nassau
Roosevelt, L. I., N. Y.

•Almor Co.
207 Irving Ave.
Syracuse, N. Y.

•Mershaw Of N. Y. Inc.
468 S. Sallina St.
Syracuse 3, N. Y.

•Platters, Inc.
1411-A W. Genesee St.
Syracuse, N. Y.

Toyman
70 Fallsade Ave.
Yonkers, N. Y.

(Continued on page 134)

A SERVICE FOR THE RACK JOBBERS

☆☆☆

All Types of INDEX STRIPS and PRICE LABELS

"TAILOR MADE" for your needs.

SEND FOR A COMPLETE BROCHURE TODAY.

★

STAR TITLE STRIP COMPANY, INC.

842 Western Avenue Area Code 412 231-4314 Pittsburgh, Pa. 15233

The most significant new
musical talent of 1967

The Bee Gees

Exclusive U.S. Representation:
NEMPEROR ARTISTS LTD.
New York



Sole Direction:
ROBERT STIGWOOD
NEMS ENTERPRISES
London



PAT/WOS

Covering all phases of distribution

PIC-A-TUNE, INC.

1461 Park Ave.
Emeryville, Calif. 94608

One of the nation's oldest
San Francisco &
Northern Calif.
Finest rack jobbers
Not a rack
but a customized
record dept.
with complete service.

WESTERN ONE STOPS

1461 Park Ave., Emeryville
645 Bryant, San Francisco

Two locations
Serving the west.
Ask to be on our
Mailing list.

ERIC-MAINLAND

645 Bryant, San Francisco

Where the hits
come to happen!

San Francisco's leading
independent distributor
with the hardest running
promo people in town.

Pic-A-Tune Western Tape Division

645 Bryant — San Francisco

RACK JOBBERS

•NARM MEMBER

NORTH CAROLINA

Alexander News Co.
25 Carolina Lane
Asheville, N. C.
Clarence Shuttle—William Alexander

C & M Distributing Co.
100 Southside Drive
Charlotte, N. C.—Ted Conder

Southeastern Record Merchandisers
P.O. Box 1697, 2706 Freedom Dr.
Charlotte, N. C.

•Dixie News Co.
2100 Freedom Dr.
Charlotte, N.C. 28208—
Tim Braswell—DeWitt Brown

Handleman Co.
320 Isley St.
Greensboro, N. C.—Charles Justice

Rocky Mount News
2900 S. Church Ave.
Rocky Mount, N. C.

J. B. Armstrong News
601 South Broad St.
Winston Salem, N. C.

OHIO

Associated Records
101 S. Union
Bedford, Ohio

Valley Enterprises
868 E. Washington
Chagrin Falls, Ohio

Album Record Sales of America
6566 Montgomery
Cincinnati, Ohio—LeRoy Goodlander

•Canfield Supply Service
8100 Reading Road
Cincinnati, Ohio 45215—
Robert Canfield

Joyce Dist.
1111 Paxton
Cincinnati, Ohio

K. C. Dist.
4508 Homer St.
Cincinnati 27, Ohio

•All Label Record Service
7777 Exchange St.
Cleveland, Ohio 44125—Hess Budin

Handleman Co.
6116 Broadway
Cleveland 27, Ohio—Carl Lombardo

•Mainline Record Service
1260 E. 38th St.
Cleveland, Ohio 44114—
Ross Halamay

Mid West Music
2112 Payne Ave.
Cleveland, Ohio

Modern Record Rack Service
1958 E. 101 St.
Cleveland 8, Ohio
J. W. Burke

•Stark Record Service
2797 Hamilton
Cleveland, Ohio 44114—
Charles Murray

Universal Music
5270 Euclid Ave.
Cleveland, Ohio

Handleman & Co.
550 E. Mound
Columbus, Ohio—Joe Glaser

John J. Getrau & Son Inc.
212 N. 4th St.
Columbus 15, Ohio

Dayton Record Service
2223 Springboro Pike
Dayton 39, Ohio

M. P. Record Co.
5934 Beechwood Dr.
Poland, Ohio

Service Dist.
24 Union St.
Portsmouth, Ohio—Wilburn Carrington

•Stark Record Service
1226 Duncan Ave. SW
Massillon, Ohio 44646—Paul David

Hoffman News Agency
25 W. Washington Ave.
Springfield, Ohio

Bartley Co.
921 Brown Ave.
Toledo, Ohio—Richard Bernard

Buckeye Spectacles
1102 Summit St.
Toledo, Ohio—Ruth Redfox

Northwest Dist.
1020 Sylvania Ave.
Toledo, Ohio—George LaCorse

Wells Market Service
5053 Stickney Ave.
Toledo 12, Ohio

National Records
Cedar Center Rd.
University Heights, Ohio

Handleman Co.
4018 Simon Rd.
Youngstown 12, Ohio

Samco Co.
1483 S. Ave.
Youngstown, Ohio—Sam Couch

OKLAHOMA

•Mid Continent News Co.
Box 985
324 N.W. 11th St.
Oklahoma City 3, Okla.
Don Byers—C. Albro
Southwest Dist. Co.
1159 Madison Ave.
Oklahoma City 3, Okla.
Ken Hensley—M. Woodruff

•Oklahoma News Co.
909 W. 23rd St.
Tulsa 7, Okla.
Glenn White 74107—Stan White

OREGON

McDonald Candy Co.
2250 W. B'way
Eugene, Ore.

•Tip Top Music Co.
825 Beekman St.
Medford, Oregon—Dave Urban

Patty Day Inc.
326 N. River Rd.
Milwaukee, Ore.
Jullan Brown Enterprise
3560 N.E. Kinningsworth
Portland 11, Ore.—Wm. G. Blackburn

Record Mdse. Service
105 N.E. 62nd Ave.
Portland 13, Ore.

•Souval Bros. of Portland
9300 N.E. Multnomah
Portland, Ore.

•Tip Top Music Co.
4616 North Albina St.
Portland, Ore. 97217—Al Zangrillo

Paul Jackson Co.
1308 N.W. Park St.
Roseburg, Ore.

Hick Sundries Co.
3060 N. River Rd.
Salem, Ore.

PENNSYLVANIA

Rec O Rac
1011 Baltimore Ave.
East Lansdowne, Pa.—Harry Blaufield

E. P. Records Of Erie
3103 Garland St.
Erie, Pa.

•D&H Dist. Co.
500 Terminal Rd.
Hampden Industrial Center
Camp Hill, Pa. 17011—
David Press, Endo Corsetti

Record Bar Rock
1127 State St.
Erie, Penna.

Shulman Distributors
912 Henrietta Ave.
Huntington Valley, Pa.

•Richmark Sales Co.
1072 Lincoln Highway West
Irwin, Pa. 15642—James Walker

Lebanon News Agency
33 N. 8th St.
Lebanon, Pa.

Triangle News Co.
301 Muson Ave.
McKees Rocks, Pa.—George Fine

Bandstand Record Service
2522 N. Broad St.
Phila., Pa.—Jerry Rappaport

D&H Dist. Co. Inc.
P.O. Box 1967
Harrisburg, Pa. 17105

Michael Adler Ent.
P.O. Box 2902
Philadelphia, Pa. 19126—
Michael Adler, George Peterson

I. J. Morgan Co.
511 North Broad St.
Phila., Pa.

•New Deal Record Service
2502 North Broad St.
Philadelphia, Pa.—Ed McKeown

Slotkin's
4095 Lancaster Ave.
Philadelphia, Pa.—Herb Slotkin

Brux Co.
351 Freeport Road
Pittsburgh, Pa.—Charles Wright

•Continental Rack Service
1704 Fifth Ave.
Pittsburgh, Pa. 15219—
Dick Zimmer, Bill Lawrence

Handleman Co.
129-30 First Ave.
Pittsburgh, Pa.

Mid-Penn News Agency
100 Eck Circle
Williamsport, Pa.—C. Mayer

RHODE ISLAND

H. V. Papazian & Co.
803 Broadway
East Providence, R. I.
Harold V. Papazian

•Beacon Record Dist.
725 Branch St.
Providence, R.I. 02904—
Milton Israeloff

SOUTH CAROLINA

•Brown Sales Co.
1423 Ellerbe St.
Columbia, S. C.—Grady Brown

TENNESSEE

•Knox Record Rack Co.
2000 Western Ave.
Knoxville 21, Tenn. 37921—
Sam Morrison
Volunteer Dist. Co.
1108 17th Ave.
Nashville, Tenn.—Weber Parrish

Bill's Music Co.
Union City, Tenn.

TEXAS

•Western Merchandisers
1601 W. Third
P.O. Box 1969
Amarillo, Texas
Dick Williamson—Ed Perry

Nueces News
414 S. Port
Corpus Christi, Texas

•Mershaw of America
1327 Chemical St.
Dallas, Texas 75207—Kerry Charlton

•Pioneer Dist. Co. of Texas
2406 Irving Boulevard
Dallas 7, Texas
Guy E. Willard

•Record Service Co.
3815 Pictureline Drive
Dallas, Texas

•Recordwagon
2531 Farrington
Dallas, Texas—Glenn Mosley

(Continued on page 136)



**Thank
you
PERCY SLEDGE**



**Quin Ivy &
Marlin Greene**
(Producers)

South Camp

Distributed by ATCO Records

**Don Varner
Al Johnson
June Edwards
Mickey Buckins**

QUINVY MUSIC CORPORATION Sheffield, Alabama

RACK JOBBERS

●Records Of Dallas Inc.
1345 Chemical St.
Dallas, Texas 75207—Bill Emerson

B & C Record Sales
427 W. San Antonio St.
El Paso, Texas—Herbert Berg

Trinity News
1320 W. B'way
P.O. Box 1806
Ft. Worth 4, Texas—Louis Page

Record Dist. Co. Inc.
901 Commerce
Houston 2, Texas 77002—
Larry Rosmorin

●Records of Houston, Inc.
314 East 11th St.
Houston, Texas—Bud Doily

Rec Rac
3438 Leeland
Houston, Texas

Lubbock News
1001 Ave. B
Lubbock, Texas

Meio-D-Lane
3422 Ave. H
Lubbock, Texas—Paul Brink

●Recordland U.S.A.
3819 Avenue A
Lubbock, Texas 79404—
Allan Rosen—Bob Israel

J's Music Land
1209 W. Washington
Midland, Texas

Johnson News Agency Inc.
300 E. Indiana
Midland, Texas

●Western Merchandisers
3316 Delano
Midland, Texas—Ron Lewis

Panhandle Dist. Co.
206 S. Main St.
Perrytown, Texas

Rack Suppliers
519 Gibson St.
Seogoville, Texas—Gene Ackerman

Weiner News Co.
101 Menchaca
P.O. Box 12093
San Antonio, Texas—Stan Weiner

UTAH

●Billinis Distributing Co.
3575 South 700 West
South Salt Lake, Utah—John Billinis

Mountain West Dist.
2195 SW Temple
Salt Lake City, Utah

VERMONT

St. Johnsbury Record Dist.
Railroad St.
St. Johnsbury, Vermont—Loren Phelps

●Almor Co.
Dorset St.
South Burlington, Vermont—Ray Baron

VIRGINIA

Turner Candy Co.
516 Rorer Ave. S.W.
Roanoke, Va.—Andy Turner

Valley Food Co.
Paper Mill Rd.
Box 564
Winchester, Va.

WASHINGTON

●Consolidated Dist.
1000 First Ave. So.
Seattle, Washington 98134—
Stanley Jaffe, Stanley Sulman

●General Record Service
408 S. River St.
Seattle, Washington 98108—
Poul Portteus

●Major Record Service
902 N.W. 49th St.
Seattle, Washington—
Wolly Toiles

Pacific Records
1541 Thorndyke St.
Seattle, Wash.

●Souvall Dist. Co.
804 6th Ave. S.
Seattle, Wash.—Harry Bradley

●Tip Top Music
2213 15th St. West
Seattle, Wash.

United Record Supply
Box 7459, Bitter Lake Station
Seattle 3, Wash.

Austin Brothers Inc.
N 2925 Martin St.
Spokane, Wash.
Bill Austin—Bob Clark

●Tip Top Music Co.
431 East Sprague
Spokane, Wash.—Fred Stewart

Randle-Brewer Co.
108 W. Mead
Yakima, Wash.

Yakima News Agency
1011 Pitcher St.
Yakima, Wash.—Bill Ring

WEST VIRGINIA

Handleman Co.
5606 McCorkie S.E.
Charleston 4, W. Va.—Bill Hanson

F. P. Kirby
M. B. Dist. Co.
822 6th Ave.
Huntington, W. Va.

H. B. Dist.
4541 Piedmont Rd.
Huntington, W. Va.

WISCONSIN

Arrow Racks
417 S. Barstow St.
Eau Claire, Wisc.
Rapid Sales Co.
2702 Monroe
Madison, Wisc.—Rolf Voeglin

●Record City Record Racks
5600 West North Ave.
Milwaukee, Wisc.—Harold Rietz

●Midwest Tape Distributors
5401 West State St.
Milwaukee, Wisc. 53208—
James Tiedjens

CANADA

Continental Rec. Co., Ltd.
1244 Caledonia Rd.
Toronto 19, Ont.

Fireco Sales, Ltd.
33 Racine Road
Rexdale, Ont., Canada
Barney G. Ryan

●EMI Ltd.
446 Birchmount Rd.
Scarboro, Ontario, Canada—
John Douglas Macmillan

●Western Rack Services Ltd.
120 W. Hastings
Vancouver 3, British Columbia
John MacMillan

RECORD PROMO & PUBLICITY OFFICES

ALAMEDA, CALIFORNIA

Motivestor
P.O. Box 1036

ALBUQUERQUE, N.M.

Dick Stewart & Assoc.
P.O. Box 8207
87108
(505) 268-7919
(505) 268-7741

ATLANTA

BBC Publicity Unlimited
P.O. Box 9747
30319
(404) 261-8889

Burkap Assoc.
Morley Siskin
330 Peachtree Bldg. N.E.
522-3153/524-2189

Music Pit
Jack Lynn
4 Broad St. S.W.
70 Pryor St. S.W.
523-2678

Notional Artist Talent
Johnny "Bee"
3379 Peachtree Rd. N.E.
(404) 261-8359

BATH, MAINE

Critique Record
Carl Strube
20 Spring St.
207-443-3751

BATON ROUGE, LA.

E. Overton Perkins Entertainment
3101 East Lakeshore Dr.
70808
(504) 344-9597

BEAUFORT, S.C.

Phonosonic Entertainment
Bobby Lee
1602 Greenlawn Pk.
524-5177

BELEN, N.M.

Little Richie Johnson
Box 3
87002
(505) 864-7185

BLOOMFIELD, CONN.

Mock Clark Promotions
860 Park Ave.
06002
242-0315

BOSTON

Ed Hurvitz
Music Promotions
89 Hollingsworth St., Mattapon
298-0574

Ed Penny
St. George Hotel
Kenmore Sq.
CO-6-0060

Motuda Enterprises
P.O. Box 509
Astor Station
02123

New England Record Promo
Ed Dwellingham
106 Northampton St.
HI-2-3830

New England Record Promo
Steve Sandler
495 Huntington Ave.
Hyde Park
361-2567

BUFFALO

Carl Cisco
1106 Elmwood Ave.
Cherry, N.J.
Gardner Co.
116 E. Cherry Hill Apts.



Is your publicity making the charts?

HAROLD RAND & COMPANY
Publicity·Public Relations

310 Madison Avenue, New York, N. Y. 10017
Tel: (212) 986-9095 Cable: HARANDPUB

COMPANY PROFILE AVAILABLE ON REQUEST.



ARTHUR CONLEY

Sweet Soul Music

Shake, Rattle & Roll



Produced by **OTIS REDDING**



Exclusive Direction
PHIL WALDEN
Artists & Promotions
Macon, Ga.

RECORD PROMOTION & PUBLICITY OFFICES

CHICAGO

Erwin Barg
5335 N. California Ave.
UP 8-9164

Newsmakers From Eva Dolin
952 N. Michigan Ave.
Chicago, Ill.—60613
944-5545

Irving W. Garmisa
110 So. Dearborn St.
DE 2-5262

Earl Glicker
1770 Winthrop Rd.
Highland Park
ID-3-1771

Cooper C. Golin
360 N. Michigan
ST 2-4372

Paul Gallis
161 E. Erie
MO 4-6670

Kiderian Productions
Ray Peck
4926 W. Gunnison St.
312-545-0861

Bonnie Kroll
10 W. Elm
SU 7-1549

Peter H. Wright Associates
185 N. Wabash
236-6185

Record Promo
Waco Austin
2443 W. 34th Pl.
847-6779

Recordland Record Corp.
Ed Kaplan
13673 Wales-Oak Park
LI 2-2338

H. R. Schwab Assoc.
1525 E. 53
324-7300

Tri-State Productions
Paul Wilczynski
3645 N. Pueblo Ave.
625-6848
Chula Vista, Cal.
XERB Radio & XEG Radio
737 3rd Ave.

CINCINNATI

Mainline Cleveland, Inc.
Julie Godsey
265 Jupiter Dr. 45238
921-8722

CLEVELAND

Betty K. Gardner
2329 Lyndway Rd
Beechwood Village
Howard Riemer, Inc.
3529 Silsby Rd.
Cleveland, Ohio 44118

Perry Stevens
2208 Edgerton Rd.
University Hts.
321-0641

Marv Helfer
2130 Marshfield Rd.
449-5635

COLUMBUS, OHIO

Dave Segel
1049 Oakwood Ave.
252-5839

COLUMBIA, S.C.

Charlie Huckabee Music
2708 Ansel St.
(803) 252-5836

CORNING, CALIF.

Ivan Evans' Curious Co.
324 West St.
96021
(916) 824-5895

DALLAS

Artist & Record Promo Enterprises
3747 McMillan
TA 7-4623

DETROIT

Al Abrams
2648 W. Grand Blvd.
TR 1-3340

Sheldon Brown
3942 3rd Ave.
TE 3-5383

IBA Enterprises
Ian Gaum
19961 Prest
831-7326/342-8022

Pioneer
19496 Tracey
342-2594

El Paso
Star Discos
100-102 Texas Ave.

Al Valente
13400 Fenkell Ave.
313-835-4831

ELIZABETH, N.J.

Al Fleckenstein Assoc.
585 Newark St.
07208
(201) MA-4-5575
(201) EL-4-5683

FAIR LAWN, N. J.

Mike Siegel
796-4192

FARMINGTON, CONN.

Dave Fox
22127 Malden

FT. SMITH, ARK.

Gregg Records
101 North 8th St.
72901
(501) 783-8969
(501) 783-1916

FRESNO, CAL.

R. W. Tyrcha Ent.
4879 San Gabriel
93726
(209) 291-2317

HUDSON, OHIO

EPD Enterprises
P.O. Box 655
44236
(216) 653-8295

HASBROUCK HEIGHTS, N.J.

R. J. Promotions
Ron Luciano
37 Woodside Ave.
(201) 288-8948

JACKSONVILLE, FLA.

Jet Set Enterprises
2506 Hirsch Ave.
(904) 721-0099

JERSEY CITY

James Buckowski
158 Woodlawn Ave.
HE 3-7693

KEY WEST

Steve Keegan
P. O. Box 810

LAKE ELSINORE, CALIF.

Crossfire Recording
P.O. Box 206
Lake Elsinore, Calif. 92330
(714) 674-2412

LAS VEGAS

Mary DuBose Reetig
5035 S. Tamarus
RE 3-1570

LINCOLN PARK, MICH

Kit Wright Enterprises
2093 Malvina
928-3262

LOS ANGELES

Barbara Best
6223 Selma
HO 6-4246
Jay Berstein
435 N. Bedford
Beverly Hills
Chuck Blore
10439 Valley Spring Lane
N. Hollywood
761-9844

Brandy & Pam
226 So. Beverly Dr.
CR 4-6928

Braverman-Mirisch
9255 Sunset Blvd.
CR 5-5169/BR 2-8608

Carr/Horowitz
9155 Sunset Blvd.
CR 3-8500

Colbert & Edwards
6257 Leland Way

Contemporary Public Relations
9100 Sunset Blvd.
(213) 273-8430
90069

Corcoran-Tanner & Co.
161 W. 54 St.
765-0528

Enyart & Rose
5735 Melrose Ave.
HO 6-1176

Ernie Farrell
999 N. Doheny Dr.
CR-1-7858

Fields Unlimited
Barney Fields
5750 Melrose Ave.
HO 7-0450

Maury Foladare Assoc.
1717 No. Highland

Freeman-Sutton Assoc.
6606 Sunset Blvd.
HO 2-2395

Tim Gayle
6376 Yucca St.
465-6258

Dave Gershenson
Capitol Tower
Great Western Assoc.
Pat Shields
1737 Northwestern Ave.
HO 6-0874

Hanson & Schwam
6705 Sunset Blvd.
HO 6-9222

Lou Herscher
9926 1/2 Robbins Dr.
Beverly Hills

Hit Promotions
P.O. Box 1563
Hollywood 28, Cal.

Hoenig-Edwards
7185 W. Sunset

Hollywood Promotions
8406 W. 4 St.
653-7526

Honeycomb Productions
6606 Selma Ave.

Jerry Hoffman & Paladino
9165 Sunset Blvd.

Arthur Jacobs
9229 Sunset Blvd.

George Jay
6290 Sunset Blvd.
HO 9-5838

Jerry Johnson
5645 Radford Ave.
PO 2-6951

N. Hollywood
Bob Jones
Box 38530

Bernard F. Kamins
190 N. Canon Dr.
CR 1-8141

Kragen-Carroll
451 N. Canon Dr.
Beverly Hills
273-5011

Sam Laine
9012 Sunset Blvd.

Ray Lawrence, Ltd.
1511 Laurel Canyon Blvd.
Hollywood
654-4410

Frank Liberman
8733 Sunset Blvd.

Litrov/Levinson
9171 Wilshire Blvd.
Suite 540
90210
(213) 274-0873

Jim Mahoney & Assoc.
120 El Camino
Beverly Hills
CR 4-8867

Mann Scharf & Co.
9056 Santa Monica Blvd.
CR 4-6222

Bernice Mason
6223 Selma Ave.
HO 7-3084

(Continued on page 140)

litrov / levinson
creative communications

(area code 213) crestview 4-0873

9171 wilshire boulevard / suite 540

beverly hills, california 90210

BOB LEVINSON
ALEX LITROV

**FOR TOTAL PROMOTION COVERAGE
In The East Coast**

CONTACT

HERB ROSEN PROMOTIONS

888 8th Avenue New York, N.Y. 10019
(212) 765-1380

FRED STUART ASSOCIATES

9126 SUNSET BOULEVARD

LOS ANGELES, CALIFORNIA, 90069

(213) 274-0674

On The West Coast . . .

TONY RICHLAND

. . . Record Promotion
Artist-Publisher Representation

Ho-7-2151
6363 Sunset Blvd.
Hollywood, Calif., 90028

THANKS JOE TEX



Dial

DIAL RECORDS
Distributed by Atlantic Records

Exclusive Writer
TREE PUBLISHING CO., INC.
Nashville, Tennessee

Management:
DICK ALEN
200 West 57th Street
New York, New York 10019

RECORD PROMOTION & PUBLICITY OFFICES

McFadden, Strauss, Eddy,
Irwin & Goodman
1017 N. La Cienega Blvd.
OL 7-4330

Jerry Pam & Assoc.
9255 Sunset Blvd.
Suite 713
CR 1-5633

Stan Pat Promo
6269 Selma Ave.
HO 6-4439

Portman Agency
6269 Selma Ave.
HO 3-8080

Prestige Promotions
Derek Taylor
6290 Sunset Blvd.
NO. 9-3641

Progressive Sounds of America
6034 Atlantic Blvd.
Maywood
583-5921

Promotions, Ltd.
6119 Potrero Ave.
El Cerrito, 94530
235-6037

G. W. Purcell Assoc., Ltd.
6269 Selma Ave.
Hollywood 28, Calif.
HO-6-4439

Tony Richland
Suite 705
6363 Sunset Blvd.
(213) HO 7-2151

Charlotte Rogers
7000 Hollywood Blvd.

Rogers & Cowan
250 No. Canon Dr.

Glenn Rose
8440 Sunset Blvd.
654-3800

George Russell
1308 N. Martel
PO 6-7161

Lenny Salamone Promo
24320 Calvert St.
TR 7-5441

Robert Sande
7141 No. Ivar Ave.

Ray Sanders Productions
Box 38631
763-4374

Shaw & Roberts
420 No. Camden Dr.
Beverly Hills, Cal.
274-8307

Gene Shefrin Assoc.
141 El Camino
CR 3-6226

Sloan Co.
8979 Sunset Blvd.

Fred Stuart Associates
9126 Sunset Blvd.
90069
274-0674

(213) 274-0674

Studio City Advertising
Sandy Beck

2559 W. Pico Blvd.
388-3251

Talco Ent.
6201 Santa Monica Blvd.

Tres Promotions
6223 Selma Ave.

View Music Co.
Marvin Liblick

965 So. Magnolia Ave.
383-0226

Winter & Kafafian
1551 N. La Brea

John Young
5436 Hollywood Blvd.
464-0718

Irwin Zucker
6515 Sunset Blvd.
466-9594

LOUISVILLE, KY.
Orbit Radio
P.O. Box 1644

LURAY, VA.
Earl Rothgeb Promo
P.O. Box 208
RI 3-5394

MACON, GA.
Phil Walden
535 Cotton Ave.

MIAMI
National Entertainment
2805 Biscayne Blvd.
374-1231

Professional Programming
Robert R. Harris
9701 Southwest 77th Terrace
271-0839

Yvonne Williams Artist &
Management
8730 N.W. 16th Ave. 33147
(305) 696-1481

MONTREAL, QUEBEC
Superior Sound Service
6550 Westbury Ave.
(514) 737-7871

Vic O'Brien's Disc Spinners
2575 De La Salle
(514) 256-5608

NASH, TEX.
Doug Davis Promotions
Box 86
75569
838-8657

NASHVILLE
Noble-Dury Public Relations
110 21st Ave. So.
Baker Building
(615) 244-4361

Tandy Rice Public Relations
Suite 307-RCA Bldg.
806 17th Ave., South
255-2159

NEWBURY, OHIO
Bright Star Promotions
P.O. Box 56, Downtown
44065
(216) JO-4-2211

NEW KINGSTON, PA.
Vokes Music, Record & Promo.
P.O. Box 1203
828-6864

NEW ORLEANS, LA.
Dover Records Promo
748 Camp St.
70130

NEW YORK
Floyd F. Ackerman Assoc.
145 West 55th St.
CO 5-4122

Adrian Associates
130 West 42nd St.
OX 5-7965

Advance Public Relations, Inc.
234 West 44th St.
LO 3-4370

ALA Enterprises
663 Fifth Ave.
10022
(212) EL-5-5633

Allstan Enterprises, Inc.
255 W. 55 St.
JU 6-2948

Sidney Ascher Assoc.
1545 Broadway
LT 1-2287

David O. Alber
44 East 53rd St.

N. W. Ayer & Son
Florence McDermott
1271 Ave. of The Americas
PL 7-5700

Austin-Drew Assoc.
520 5th Ave.
10036
(212) MU-2-5844

Buddy Basch
17 East 45th St.
MU 7-8351

Joyce Becker
c/o Pioneer
1650 Broadway
LT 1-0030

Doc Berger
931 E. 28th St.
DE 8-5965

Ivan Black
400 Madison Ave.
PL 5-4760

Raysa Bonow
523 E. 78th St.
TN-7-2260

Tim Boxer
1650 Broadway
CI 7-6646

Mal Braveman
15 East 48th St.
EL 5-7752

Breakout Promotions
Bob Yorey
1650 Broadway
CI 5-2772

Chuck Brown
400 Madison Ave.
HA 1-4580

Paul Brown
507 5th Ave.
MU 7-3071

Budd Prod.
Budd Mellowell
157 W. 57th St.
CI 7-4896

Ron Delsener
35 East 35 St.

Connie DeNave
200 West 57th St.
JU 6-1330

Discotheque-A-Roaming
250 Beach 137 St.
634-2242

Bill Doll
1700 Broadway
JU 6-8894

Domino Record Service
1122 Rhinelander Ave.
Bronx—892-8290

Henry O. Dormann
988 Fifth Ave.

Marvin Drager
424 Madison Ave.
MU 8-1078

Hermie Dressel
850 7th. Ave.
CO 5-5587

Austin Drew, Inc.
Phillip Austin
P.O. Box 131—White Plains

WH. 9-5263
Charlie Earle
1776 Broadway
JU 6-6994

Jack Egan
45 Wendover Rd.
Yonkers

YO 8-7969

Ehrlich & Gluck
200 W. 57th St.
LT 1-6342

Alan Eichler Assoc.
864 Broadway
AL 4-7604

Harold Ettus
Hotel Empire
Broadway & 63rd St.
CO 5-7400

Alan Fashko
350 W. 52nd St.
JU 2-2417

The Lynn Farnol Group
50 Rockefeller Plaza
JU 6-5777

Mildred Fields
67-11 Parsons Blvd.
Fourbees Enterprises, Inc.

Buddy Friedlander
850 7th Ave.
JU 6-8790

Chester Fox
18 W. 70th St.
SU 7-1597

Kim Garfield Assoc.
527 Madison Ave.
HA 1-0225

Garnett Advertising
210 Fifth Ave. 10010
Suite #1102
(212) MU 3-9221

Richard Gersh Assoc.
Dick Gersh
200 W. 57th St.
CI 7-4161

Michael F. Goldstein
1681 Broadway
LT-1-7600

Glenn Productions
Ben Arrigo
157 W. 57th St.
CO 5-6585

Gordon-Mansfield Ent.
250 West 57th St.

Ren Grevatt
200 W. 57th St.
247-4163

(Continued on page 142)

ia

IVOR ASSOCIATES, PRESS AND PUBLIC RELATIONS

NEW YORK
(212) 586-7898

LOS ANGELES
(213) 278-3313

TO CASH BOX, DISK JOCKS AND EVERYONE—

THANKS!

CPR

Contemporary/Public Relations/Record Promotion

9100 Sunset Blvd. Suite 250
Los Angeles, Calif., 90069
Area Code 213-273-8430

BOBBI COWAN

BEVERLY NOGA

Representing: Paul Revere and the Raiders, The Seeds,
The Mandala, The Robbs, Robie Porter,
The Teddy Neely Five and Elmo and Almo.

PROMOTION IN MOTION

IRWIN ZUCKER

(Steve Adler—Ina Someroff
Linda Mack—Rona Elliot)

6515 Sunset Blvd.
Hollywood, Calif. 90028
(213) HO 6-9594



CAPITOL SALUTES BRIAN WILSON!

STEREO

The Hollyridge Strings Play The Beach Boys Song Book-Vol. 2



Good Vibrations
God Only Knows

California Girls
Sloop John B
Caroline, No

Surfer Girl
Little Deuce Coupe
Help Me, Rhonda

Dance, Dance, Dance
Be True To Your School
Wouldn't It Be Nice



(S) T 2749

PRODUCED BY AL DELORY



RECORD PROMOTION & PUBLICITY OFFICES

Gurman-Brown Assoc.
850 Seventh Ave.
Suite 1209
10019
CI 5-4771

Gurman-Vandervort & Bob Cochran
161 W. 54th
CI 5-4771

Jim Harrison
110 W. 47th St.
JU 6-6300

Dave Hepburn Ent.
1697 Broadway
CI 6-2398

Heroic Age Publicity, Inc.
888 Eighth Ave.
Suite 4-C

Eli Lloyd Hoffman
16 Court St.
875-6825

Constance Hope Assoc.
225 W. 57th, N.Y.C.

Horizon Talent Promotions
225 W. 57th St.
10039
(212) LT-1-4471-(2)

Bernie Ilson
400 Madison Ave.
HA 1-4580

Ivor Associates
150 W. 55th St.
(212) 278-3313

Arthur P. Jacobs Co.
17 East 54th St.
TE 8-0730

Eddie Jaffe
156 W. 48 St.

J. B. Promotion
37 Lawrence St.
Yonkers, N.Y. 10705
(914) GR 6-2636

JLJ Enterprises
40 Central Pk. So.

Milton Karle
440 East 56th St.
MU 8-8788

The Kalmus Corp.
445 Park Ave.

Monte Kay
200 W. 57th St.

Kragen-Carroll
39 W. 55th St.
CO 5-5938

Ken Kendall
50 W. 57th St.

Michael Laurence
30 W. 86th St.
595-2632

Philip Leshin Assoc.
18 E. 41 St.
889-4840

John Levy Ent.
119 West 57th St.
CI 5-2488

Jim Mahoney
510 Madison Ave.
PL 1-2060

Whit Marshall
Hotel Somerset
150 W. 47th St.
PL 7-2780

The Merrick Co.
18 E. 48th St.
PL 2-4111

Jim McCarthy
1619 Broadway

McFadden, Strauss, Eddy & Irwin
509 Madison Ave.
421-7610

Dick Miller
1545 Broadway
LT 1-9161

Joe Morgan
50 Central Park W.

Walter J. Murphy
336 E. 86th St.
TR 9-6148

Music Makers
Shelton Towers
49 St. & Lexington Ave.
PI 3-4951

Bert Nevins, Inc.
527 Madison Ave.

New Action, Ltd.
888 Eighth Ave. 10019
(212) 581-3257

Non-Stop Music Pub'g.
30-75 34 St.
Long Island City, N.Y.
11103
(212) 721-1659

Richard H. Roffman Assoc.
675 West End Ave.
RI 9-3647

Rogers & Cowan
598 Madison
PL 9-6272

Herb Rosen
888 Eighth Ave.
765-1380

Dorothy Ross
300 W. 55 St.
247-5560

Sanfris
1674 Broadway
Suite 703
New York City
10019
JU-2-5799

Henry Okun
157 W. 47th St.

Larry Penzell
501 Madison Ave.
PL 9-3890-1-2

Bob Perilla
745 5th Ave.

Fred Perri
1472 Broadway
BR-99642

Joe Petralia
Park Sheraton Hotel
JU-66935

Arthur Pine Assoc.
1780 Broadway
CO 5-7330

Gerald Purcell
210 E. 53rd St.
PL 3-7602

Queen Artist Corp.
1697 Broadway
CI 6-2398

Public Relations Corp. of America
Saul Richmond
151 E. 50th St.
PL 2-0040

Reggie Riccardi
135 W. 55th St.
CI 7-1233

Saul Richfield
1697 Broadway
CI 7-5907-8

Seven Investors Co.
Tom Della Corte
P.O. Box 348—Yonkers
BE 7-0381

Eve Siegel Assoc.
35 West 53rd St.
MU 8-4598

Don Simmens & Assoc.
1841 Broadway
JU 2-6311

Jerry Simon
RSVP
1650 Broadway
JU 6-6707

Solters, O'Rourke & Sablison
62 W. 45th St.
TN 7-8500

Bill Spitalsky
40 West 57th St.
246-4280

John Springer Assoc.
667 Madison Ave.
421-6720

SRO Artists
240 Central Park South

Gary Stevens
Al Thal
42 E. 52nd St.
PL 3-1755

Phil Strassberg Assoc.
1841 Broadway
265-5760

Irving L. Straus Associates
375 Park Ave.
10022
421-5656

Mario Trombone
40 E. 49th St.
PL 2-8660

William F. Treadwell, Inc.
Time & Life Bldg.
PL 7-7656

Triple "A"
1619 B'way.

Universal Public Relations
342 Madison Ave.

Uptight Productions
121-08 235 St.
Laurelton, N.Y. 11422
(212) 525-3720

Harriet Wasser
2850 Claflin Ave.
Bronx, N.Y.

Morty Wax
1650 Broadway
CI 7-2159

Gene Weber Assoc.
730 5 Ave.
JU 2-3925-6

Jay Weston
50 Central Park West
TR 4-2060

W. H. Schneider
15 W. 44th St.
10036

Al Wilde
240 Central Park So.
CI-5-7450

Yvonne Music Enterprises
210 Fifth Ave.
Suite 1102
10010
(212) MU-3-9222

Irving Zussman
400 Madison Ave.
EL 5-5773

NORFOLK, VIRGINIA

Carolina Charlie
P.O. Box 12281
23502

OAK PARK, MICH.

Recordland
13673 Wales Ave.
LI 2-2338

OKLAHOMA CITY, OKLA.

Bobby Boyd Record Promotion
2609 N.W. 36th St. 73112

National Record Promotion
2609 N.W. 36 St.

OAKLAND, CAL.

Ocampo Records
1741 Market St.

Sol Abrams
Palisades Amusement Park
WH 5-1000

PALATINE, ILL.

M Productions
206 N. Brockway, #15

PHILADELPHIA

Michael Adler Enterprises
P.O. Box 2902
19126
WA-7-0253

George E. Costello
232 Jamestown St.

Ed Cotlar
723 Spruce St.
MA 7-7826

Buzz Curtis
2201 Bryn Mawr Ave.
19131
GR 3-4030

Philip Gaber
7141 Rutland St.
19149
(215) RA-8-1699

Jecoa Productions
5744 Pearl St.
19139
GR-2-7561

Ross Associates
250 So. Broad St.
PE 5-1050

(Continued on page 144)

RECORD PROMOTION & PUBLICITY

Complete disc jockey coverage . . . Trade paper publicity.

CONSULTATION

All questions answered . . . Distribution, Pricing, Recording, Union Rules, Music Publishing.

PRESSING

No job too small.

DISTRIBUTION ARRANGED



**MORTY WAX
PROMOTIONS**

1650 B'WAY • N.Y. 19, N.Y. • CI 7-2159

TAPP USA

COMPLETE
ADMINISTRATIVE
SALES AND
PROMOTIONAL
SERVICES FOR
INDEPENDENT LABELS
AND PRODUCERS

TAPP INTERNATIONAL

COMPLETE
REPRESENTATION
FOR FOREIGN LABELS
AND LICENSEES IN
THE UNITED STATES

DON BLOCKER TAPP

1347 Cahuenga Blvd.
Hollywood 90028, Calif.
Phone: (213) 462-6613
Cable: TAPPREC

TRUST YOUR
WEST COAST AND
NATIONAL PROMOTION
TO AN EXPERT:

TIM GAYLE

28 YEARS SOLID EXPERIENCE
6376 YUCCA STREET
HOLLYWOOD, CALIF. 91028
TEL. (213) 463-2151

BEST IN THE BUSINESS

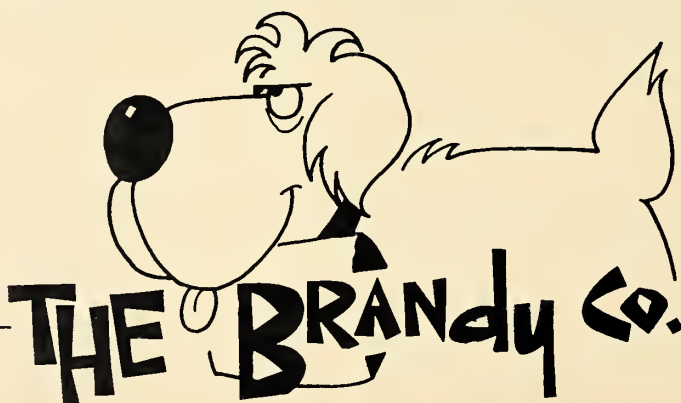

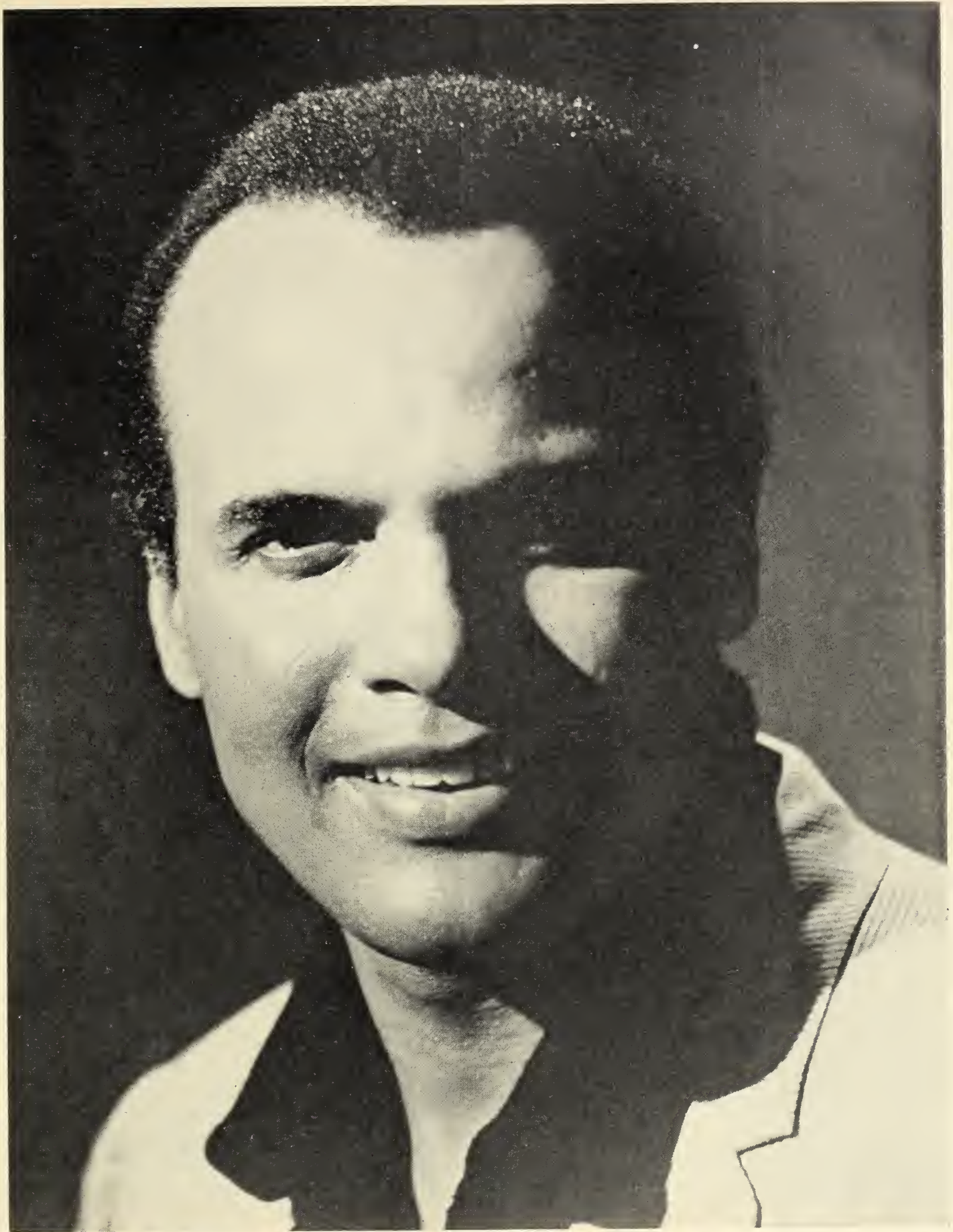

BELAFONTE

EXCLUSIVELY
RCA VICTOR
The most trusted name in sound

apa
AGENCY FOR THE PERFORMING ARTS, INC.
New York Chicago Beverly Hills Miami San Juan

M
THE MIKE MERRICK COMPANY, INC.
M
public relations

QUEEN CITY
has the
Right Combination

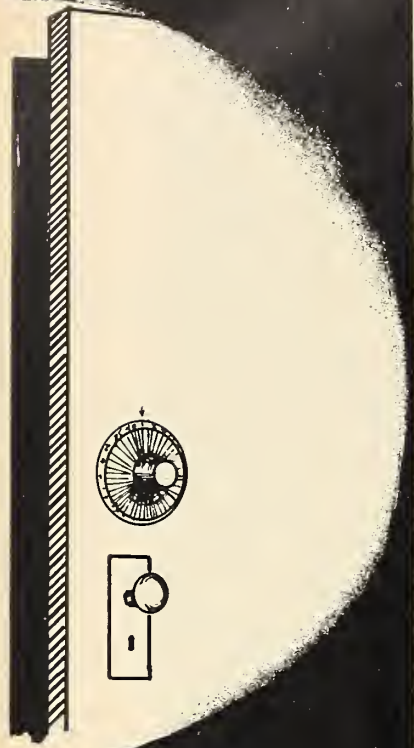

**TO OPEN YOUR
RECORD SALES
DOOR!**

A Complete Package

- ° Custom Pressing
- ° Custom and Stock Jackets

Write for our illustrated catalog,
containing package prices.

QUEEN CITY ALBUM, INC.
2832 SPRING GROVE AVE.
CINCINNATI, OHIO 45225
PHONE 513-681-8400

MFRS ALBUM JACKET

AA-1 Products
245 7 Ave.
New York, N. Y.

Artrec Productions Ltd.
1688 Meridian Ave.
Miami Beach, Fla. 33139

Bert Co. Press
9862 Santa Monica Blvd.
Los Angeles 29, Calif.

Calcraft Album Co. Inc.
1211 N. Western
Los Angeles 29, Calif.

Chicago Album Specialty Co.
426 S. Clinton
Chicago, Ill.

The Chromart Co.
711 Spring Garden St.
Philadelphia, Pa.

Coburn & Co.
732 South Federal St.
Chicago 5, Illinois

Cole Corp.
823 S. Wabash Ave.
Chicago, Ill.

Community Press
6047 Woodland Ave.
Philadelphia, Pa.

Container Kraft
801 E. 61 St.
Los Angeles, Calif.

County Box & Albums
201 S. 2nd Ave.
Mt. Vernon, N. Y.

Crown Album Co.
2925 N. Broad St.
Philadelphia, Pa. 19132

Fi-Hi Rec. Saver
P. O. Box 6417
Cleveland, Ohio

Folkraft Press
1159 Broad St.
Newark, N.J. 07114

Gailyn Packaging
1475 Southern Blvd.
New York, N. Y.

Gem Album Co.
1119 Worthen St.
New York 59, N. Y.

Globe Albums
1255 Oak Point Ave.
New York 59, N. Y.

Imperial Paper Box Corp.
252 Newport St.
Brooklyn 12, N. Y.

Imperial Paper Box Corp.
733 W. Heary
Indianapolis, Ind.

King Records
1540 Brewster
Cincinnati, Ohio

Modern Album & Finish. Co.
119-01 22 Ave.
College Point, N. Y.

Modern Album & Finish. Co.
2011 S. Third St.
Terre Haute, Ind.

Modern Album & Finish. Co.
3116 Van Owen St.
Burbank, Calif.

One Stop Service
133 E. 84th St.
New York City

Praise Recordings
Dept. C
Stoneboro, Mass. 16153

Queen City Album Co.
2832 Spring Grove Ave.
Cincinnati, Ohio 45225

J. Radley Metzger Co.
119 E. 38th St.
New York, N. Y.

Record Packaging Corp.
1 Ivy Hill Rd.
Bklyn, 11, N. Y.

Record Printing Co.
1418 W. Florence Ave.
Los Angeles, Calif.

Southern Envelope Mfrs.
794 Berry Rd.
Nashville, Tenn.

Strathmore Sales
56 S. 11th St.
Brooklyn, New York

T. Packaging
214 Sullivan St.
New York, N. Y.

U.S. Envelope Co.
3 Ann St.
Hartford 1, Conn.

Wakefield Industries
Lowell,
Mass.

PHONOGRAPH NEEDLE MFRS.

Admiral
3800 W. Cortland
Chicago, Ill.

American Laubscher
250 West Fifty-Seventh St.
New York, N. Y.

American Phono-ton
Kiamesha Lake, N. Y. 12751

American Stylus
Pageant Needles
436 Wyoming Ave.
Scranton, Pa.

Astatic
Harbor & Jackson Sts.
Conneaut, Ohio

Capps
20 Addison Place
Valley Stream, N. Y.

Clearstone Reproductions Corp.
18-06 127 St.
College Pt., N. Y.

Duotone
Locust St.
Keypport, New Jersey

Electro-Voice
Buchanan, Michigan

Fidelltone
6415 Ravenswood Ave.
Chicago, Illinois

Fine-Tone
7111 20th Ave.
Brooklyn, N. Y.

Heart Products
Box 6267
Philadelphia, Penn.

Jensen Industries
7333 W. Harrison St.
Forest Park, Ill.

Olympia Mfg.
614 51st St.
New York, N. Y.

Pfanstiehl
104 Lake View Ave.
Waukegan, Illinois

Philco Accessory Div.
Tloga & "C" Sts.
Philadelphia, Pa.

Qualltone Industries, Inc.
102 Columbus Ave.
Tuckahoe, N. Y.

Recoton
46-23 Crane St.
Long Island City, N. Y.

Televox
46 Lakeview Ave.
Yonkers, N. Y.

Transcriber Co., Inc.
Dept. C-Box 478
Attleboro, Mass.

Tetrad Co.
62 St. Mary St.
Yonkers, N. Y.

Walco
60 Franklin St.
East Orange, N. J.

RECORD PROMO & PUBLICITY

(Continued from page 142)

R/P Radio Promotions
2200 Pine St.
HO 2-7993

PITTSBURGH
Jane Oliver
9 Club Drive, East
884-4172

"Rock" Productions
Robert L. Weils
444 Hoodridge Dr.
412-341-3963

ROCHESTER, N. Y.
Jet Sound Enterprises
9 Lawrence St.
14604
325-3061

Torch Records
201 Edgebrook Lane—14617
(716) 342-7220

SAN ANTONIO, TEXAS
Ocampo Records
735 McMullen
GE 3-1461

(Continued on page 162)

RECORD JACKETS

Guaranteed 72 hour delivery Capacity 200 M per day
Offset Printing of Liners Competitive Prices

CROWN ALBUM COMPANY

Division of

CROWN ASSOCIATED PRODUCTS

2925 N. Broad Street, Phila., Pa. (215) BA 9-8986



ROBERT GOULET

COLUMBIA 

Personal Management:
NORMAN ROSEMONT
THE PLAZA



ENTERPRISES INC.
NEW YORK

Direction: -
CMA

THE MIKE MERRICK COMPANY, INC.
public relations

PRODUCERS OF TOP 100 HITS

APRIL THRU JUNE 1967

Action Productions
401 Main
Greenwood, S.C.

Adler, Lou
800 Stone Canyon
Bel Air, Calif.

Alpert, Herb
c/o A&M Records
1416 No. La Brea
Hollywood, Calif.

Atkins, Chet
c/o RCA Victor Records
800 17th Ave. So.
Nashville, Tenn.

Axelrod, David
c/o Capitol Records
1750 N. Vine St.
Hollywood, Calif.

Bahari, Joe
c/o Kent Records
5810 So. Normandie
Los Angeles, Calif.

Barnes, J. J.
c/o Groovesville Records
517 Pavilion, 1 Lafayette Pl.
Detroit, Mich.

Barrett, Art
c/o Original Sound Records
7120 Sunset Blvd.
Los Angeles, Calif.

Barry, Jeff
c/o Tallyrand Music
200 West 57th St.
New York, N.Y.

Barry, Steve
c/o Dunhill Records
449 So. Beverly Dr.
Beverly Hills, Calif.

Bateman, Robert
515 E. 85th St.
New York, N.Y.

Berniker, Mike
c/o Columbia Records
51 West 52nd St.
New York, N.Y.

Berns, Bert
c/o Shout Records
1650 Broadway
New York, N.Y.

Blackwell, Chris
c/o Island Records
155 Oxford St.
London, W1, England

Bogart, Neil
c/o Cameo/Parkway
250 West 57th St.
New York, N.Y.

Bono, Sonny
7715 Sunset Blvd.
Los Angeles, Calif.

Bowen, Jimmy
c/o Warner Bros. Records
4000 Warner Blvd.
Burbank, Calif.

Boyce, Tommy
c/o A&M Records
1416 La Brea
Hollywood, Calif.

Bradley, Owen
c/o Decca Records
803 16th Ave. South
Nashville, Tenn.

Bright Tunes Productions
c/o Seymour Barash
Williamsburg Savings Bank
Hanson Pl.
Bklyn, N.Y.

Bristol, J.
c/o Tamla Motown Records
2648 W. Grand Blvd.
Detroit, Mich.

Brown, Doug
c/o Bill Sharpley
Detroit Sound Music Co.
2120 Ewald Circle, Suite 23
Detroit, Mich.

Brown, James
200 West 57th St.
New York, N.Y.

Byrne, Ossie
c/o N.E.M.S. Enterprises
Sutherland House
Argyle St.
London W2, England

Carney, Richard E.
Box 834, Greenwood Lake
New York, N.Y.

Carson, Buzz
812 17th Ave. S.
Nashville, Tenn.

Cates, George
c/o Dot Records
1507 No. Vine
Hollywood, Calif.

Charles, Ray
c/o ABC Records
1330 Ave. of Americas
New York, N.Y.

Chiprut, E.
1674 Broadway
New York, N.Y.

Clark, Dave
c/o Epic Records
51 West 52nd St.
New York, N.Y.

Clark, Sam
1330 Ave. Of The Americas
New York, N.Y.

Clinton, George
c/o Revilot Records
8832 Puritan Ave.
Detroit, Mich.

Coleman, Austin
c/o Original Sound Records
7120 Sunset Blvd.
Los Angeles, Calif.

Concert House Productions
315 W. 57th St.
New York, N.Y.

Cooper, Ted
c/o Epic Records
51 West 52nd St.
New York, N.Y.

Corday, Mitch
c/o Chartbuster Productions
1203 28th St. N.W.
Washington, D.C.

Cordell, Ritchie
c/o Roulette Records
1631 Broadway
New York, N.Y.

Cordell, Denny
c/o Decca Records
Decca House
London, England

Cosby, H.
c/o Tamla Motown Records
2648 W. Grand Blvd.
Detroit, Mich.

Crew, Bob
1841 Broadway
New York, N.Y.

Critch, Yoder
c/o Canterbury Records
9000 Sunset Blvd.
Hollywood, Calif.

Curb, Mike
1750 No. Vine
Los Angeles, Calif.

Davis, Carl
58 E. Roosevelt Rd.
Chicago, Ill.

Davis, Don
c/o Groovesville Records
517 Pavilion, 2 Lafayette Pl.
Detroit, Mich.

Dean, J.
c/o Tamla Motown Records
2648 W. Grand Blvd.
Detroit, Mich.

Diamond, Neil
c/o Tallyrand Music
200 W. 57th St.
New York, N.Y.

Dozier, Lamont
c/o Tamla Motown Records
2648 W. Grand Blvd.
Detroit, Mich.

Dunwich Productions
25 W. Chestnut
Chicago, Ill.

Farrell, Wes
c/o Coral Rock Productions
39 W. 55th St.
New York, N.Y.

F.G.G. Productions
1619 Broadway
New York, N.Y.

Finiz, Bob
919 N. Broad
Philadelphia, Pa.

Fogelsong, Jim
c/o RCA Victor Records
155 E. 24th St.
New York, N.Y.

Franz, Johnny
c/o Philips Records
London, England

Fugua, H.
c/o Tamla Motown Records
2648 W. Grand Blvd.
Detroit, Mich.

Galligan, Neil
c/o Scepter/Wand Records
254 West 54th St.
New York, N.Y.

Gamble, Kenny
c/o Gamble Records
1650 Broadway
New York, N.Y.

Garrett, Snuff
c/o Viva Productions
1800 No. Argyle
Hollywood, Calif.

Gentry, Bob
c/o Roulette Records
1631 Broadway
New York, N.Y.

Gernhard Enterprises
6747 First Ave. S.
St. Petersburg, Fla.

Glasser, Dick
c/o Warner Bros. Records
4000 Warner Blvd.
Burbank, Calif.

Gold, Jack
c/o Columbia Records
6121 Sunset Blvd.
Hollywood, Calif.

Goldstein, Jerry
c/o U.N.I. Records
8255 Sunset Blvd.
Hollywood, Calif.

Gordon, Marc
Soul City, 1560 No. La Brea
Hollywood, Calif.

Green, Stan
c/o Scepter/Wand Records
254 West 54th St.
New York, N.Y.

Greenberg, Jerry
28 Pembroke Rd.
Hamden, Conn.

Greene, Marlin
Norala Recording Corp.
101 East 2nd St.
Sheffield, Alabama

Greenwich, Ellie
c/o Tallyrand Music
200 West 57th Street
New York, N.Y.

Grill, Hy
c/o Kapp Records
136 East 57th Street
New York, N.Y.

Guercio, James, W.
151 El Camino Dr.
Beverly Hills, Calif.

Handler, Ken
c/o Canterbury Records
9000 Sunset Blvd.
Hollywood, Calif.

Hart, Bobby
c/o A&M Records
1416 La Brea
Hollywood, Calif.

Hatch, Tony
c/o Pye Records
A.T.U. House
G. T. Cumberland Pl.
London W2, England

Hawkins, Dale
c/o Abnack Records
825 Olive St.
Dallas, Texas

Hayes, Isaac
c/o Stax Records
1841 Broadway
New York, N.Y.

Hazlewood, Lee
4635 Ledge Ave.
No. Hollywood, Calif.

Hedafy, Najeeb
c/o Roulette Records
1631 Broadway
New York, N.Y.

Holland, Brian
c/o Tamla Motown Records
2648 W. Grand Blvd.
Detroit, Mich.

Holland, Eddy
c/o Tamla Motown Records
2648 W. Grand Blvd.
Detroit, Mich.

Holtzman, Marvin
c/o Capitol Records
1750 No. Vine
Hollywood, Calif.

Howe, Bones
447 Cromwell Ave.
Los Angeles, Calif.

Huff, Leon
c/o Madara White Productions
250 S. Broad St.
Philadelphia, Pa.

Hughes, Gene
c/o Fraternity Records
Rm. 105, Sheraton Gibson Hotel
Cincinnati, Ohio

Hunter, Ivy
c/o Tamla Motown Records
2648 W. Grand Blvd.
Detroit, Mich.

Ivy, Quin
Norala Recording Corp.
102 E. 2nd Street
Sheffield, Alabama

Jacobsen, Erik
c/o Koppelman & Rubin
1650 Broadway
New York, N.Y.

Jarrard, Rick
c/o RCA Victor Records
155 East 24th Street
New York, N.Y.

Jaye, Jerry
c/o London Records
539 West 25th Street
New York, N.Y.

Jerome, Bill
Real Good Productions
1697 Broadway
New York, N.Y.

Jerome, Henry
c/o United Artists Records
729 7th Ave.
New York, N.Y.

Jerome, Steve
Real Good Productions
1697 Broadway
New York, N.Y.

Johnston, Bob
c/o Columbia Records
51 West 52nd Street
New York, N.Y.

(Continued on page 148)

CONGRATULATIONS

from

DON COSTA

EDDIE LAMBERT

and

PATTI



DON COSTA PRODUCTIONS, INC.

8961 Sunset Blvd.

Los Angeles, Calif. 90069



ROGER MILLER

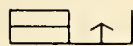

BERNARD/WILLIAMS
Artists Personal Representatives



PRODUCERS OF TOP 100 HITS

APRIL THROUGH JUNE 1967

Kapp, Dave
c/o Date Records
136 East 57th Street
New York, N.Y.

Kapralik, Dave
c/o Date Records
51 W. 52nd St.
New York, N.Y.

Kasnetz, J.
1674 Broadway
New York, N.Y.

Katz, J.
1674 Broadway
New York, N.Y.

Kent, Al
c/o Ric-Tic Records
2307 Edison
Detroit, Michigan

Kerr, George
Tra-San Productions
66 Teford St.
E. Orange, N.J.

Killen, Buddy
c/o Tree Music
905 16th Ave. So.
Nashville, Tenn.

Klein, Gary
c/o Koppelman & Rubin
7033 Sunset Blvd.
Hollywood, Calif.

Koppelman, Charles
1650 Broadway
New York, N.Y.

Lambert, Kit
6 Chesterfield Gardens
London W1, England

Madara, John
c/o Madara White
Productions
250 S. Broad St.
Philadelphia, Pa.

Mayfield, Curtis
c/o Queens Booking
1650 Broadway
New York, N.Y.

Meaux, Huey
c/o Music Enterprises, Inc.
3111 Leeland Ave.
Houston, Texas

Melcher, Terry
c/o Columbia Records
51 West 52nd Street
New York, N.Y.

Mersey, Robert
c/o Columbia Records
51 West 52nd Street
New York, N.Y.

Miller, Jimmy
c/o Island Records
155 Oxford St.
London, W1, England

Milo, Ron
c/o Centar Records
3339 N. Orlando St.
Chicago, Ill.

Mitchell, Willie
4968 William Arnold Rd.
Memphis, Tenn.

Moman, Chips
827 Thomas St.
Memphis, Tenn.

Montague
c/o Mark II
5371 West Pico Blvd.
Los Angeles, Calif.

Morgan, Tom
c/o Capitol Records
1750 N. Vine
Hollywood, Calif.

Morton, Shadow
1650 Broadway
New York, N.Y.

Moss, Jerry
c/o A&M Records
1416 No. La Brea
Hollywood, Calif.

Most, Mickie
c/o RAK Music Mgt. Ltd.
The Penthouse
155 Oxford St.
London W1, England

Nelson, Ken
c/o Capitol Records
1750 No. Vine
Hollywood, Calif.

Nitzsche, Jack
c/o Epic Records
51 West 52nd Street
New York, N.Y.

Nossel, Trod
10 George Street
Wallingford, Conn.

Papa Don Productions, Inc.
Mobil Op. JS-4-3538
Pensacola, Fla.

Par-Lo Productions
728 Camp Street
New Orleans, La.

Paul, Clarence
c/o Tamla Motown Records
2648 W. Grand Blvd.
Detroit, Mich.

Penn, Dan
c/o American Sound Studio
827 Thomas St.
Memphis, Tenn.

Philips, John
499 So. Beverly Dr.
Beverly Hills, Calif.

Poe, Bobby
c/o Chartbuster Productions
1203 28th St. N.W.
Washington, D.C.

Polhemus, Art
c/o Longhair Productions
200 West 57th Street
New York, N.Y.

Porter, David
c/o Stax Records
1841 Broadway
New York, N.Y.

Rascals, Young
c/o Atlantic Records
1841 Broadway
New York, N.Y.

Ratner, Norm
c/o Dunhill Records
449 So. Beverly Dr.
Beverly Hills, Calif.

Redding, Otis
c/o Phil Walden
Artists & Promotion
Macon, Ga.

Reno, Bob
c/o Cameo/Parkway
250 West 57th Street
New York, N.Y.

Richards, Ron
c/o A.I.R. London Ltd.
101 Baker Street
London W2, England

Rinehart, Bill
c/o Atco Records
1841 Broadway
New York, N.Y.

Riopell, Jerry
1416 La Brea
Hollywood, Calif.

Rivers, Johnny
Soul City
1560 N. La Brea
Hollywood, Calif.

Robinson, Smokey
c/o Tamla Motown Records
2648 W. Grand Blvd.
Detroit, Mich.

Ross, Brian
2991 Ingledeale Terr.
Los Angeles, Calif.

Ross, Jerry
c/o Mercury Records
745 5th Ave.
New York, N.Y.

Rothchild, Paul A.
c/o Elektra Records
1855 Broadway
New York, N.Y.

Rowe, Dick
c/o Decca Ltd.
9 Albert Embankment
London S.E.11, England

Rubin, D.
1650 Broadway
New York, N.Y.

Sandusky, Vernon
c/o Chartbuster Productions
1203 28th St. N.W.
Washington, D.C.

Sehorn, M. E.
1211 St. Philip
New Orleans, La.

Simon, John
c/o Columbia Records
51 West 52nd Street
New York, N.Y.

Slone, P. F.
c/o Dunhill Records
449 So. Beverly Dr.
Beverly Hills, Calif.

Smith, Mike
c/o Peter Walsh
6 South Hampton Pl.
London WC 2, England

Stevenson, Mickey
c/o Mikim Music
37 West 57th Street
New York, N.Y.

Stewart, Jim
c/o Stax/Volt Records
926 E. McLemore
Memphis, Tenn.

Stigwood, Robert
c/o N.E.M.S. Enterprises
Sutherland House
Argyle Street
London W1, England

Sullivan, Peter
A.I.R. London Ltd.
101 Baker Street
London W1, England

Tangerine Records
1330 Ave. of Americas
New York, N.Y.

Thiele, Bob
c/o ABC Records
1330 Ave. of Americas
New York, N.Y.

Tokens, The
1697 Broadway
New York, N.Y.

Toussaint, A.
1211 St. Philip
New Orleans, La.

Tybalt, Marcus
c/o Brompton Productions
8255 Sunset Blvd.
Los Angeles, Calif.

Usher, Gary
c/o Columbia Records
51 West 52nd Street
New York, N.Y.

Waronker, Lenny
c/o Warner Bros. Records
4000 Warner Blvd.
Burbank, Calif.

Weatherspoon, William
c/o Tamla Motown Records
2648 W. Grand Blvd.
Detroit, Mich.

Weems, Herman
c/o Ric-Tic Records
2307 Edison
Detroit, Mich.

Welk, Lawrence
c/o Dot Records
1507 No. Vine
Hollywood, Calif.

Wexler, Jerry
c/o Atlantic Records
1841 Broadway
New York, N.Y.

White, Dave
c/o Madara White Productions
250 S. Broad St.
Philadelphia, Pa.

Whitley, Ray
c/o Bill Lowery
P.O. Box 9687
Atlanta, Ga.

Williams, Ken
c/o Date Records
51 West 52nd St.
New York, N.Y.

Wilson, Frank
c/o Tamla Motown Records
2648 W. Grand Blvd.
Detroit, Mich.

Wilson, Tom
c/o MGM Records
1350 Ave. of Americas
New York, N.Y.

Wingate, Ed
c/o Ric-Tic Records
2307 Edison
Detroit, Mich.

Winn, Hooven
8255 Sunset Blvd.
Hollywood, Calif.

Wissert, Joe
c/o Koppelman & Rubin
1650 Broadway
New York, N.Y.

Wood, Randy
c/o Dot Records
1507 No. Vine
Hollywood, Calif.

Woods, Pearl
100 West 85th Street
New York, N.Y.

Wylie, Richard "Popcorn"
3044 Taylor Ave.
Detroit, Mich.

Wyld, Bob
c/o Longhair Productions
200 West 57th Street
New York, N.Y.



May you continue to prosper . . .

ERNIE FREEMAN

Dean Martin

In Release

Rough Night at Jericho—Universal

Soon to be Released

Band of Gold—Columbia

Just Completed

The Ambushers—Columbia

Band of Gold—Columbia

Latest for



Chapel in the Moonlight

(#0601)

Current Chart Albums

Happiness Is

(R/RS 6242)

Dean Martin TV Show

(R/RS 6233)



OUR SPECIALTY: **CUSTOM PRESSING**
FROM TAPE TO COMPLETED PRODUCT
LABELS . . . DROP SHIPPING . . . WAREHOUSING!

NO ONE CAN EQUAL OUR SERVICE FOR THE SOUTH

SOUTHERN PLASTICS, INC.

453 CHESTNUT STREET, NASHVILLE, TENNESSEE (615) 244-1293

RECORD PLATING PLANTS

AFM Engineering Company
 6201 Santa Monica Blvd.
 Hollywood, Calif.

Alco Research & Eng. Inc.
 6201 Santa Monica Blvd.
 Hollywood 38, Calif.

Allentown Record Co. Inc.
 10th & Walnut Sts.
 Allentown, Pa.

Allied Record Mfg. Co.
 1041 N. Las Palmas
 Hollywood 38, Calif.

Audio Matrix
 915 Westchester Ave.
 New York, N. Y.

Audio Plating
 1037 North Sycamore
 Hollywood, Calif.

Cadet Record Pressings Co.
 146 W. 37th Pl.
 Los Angeles, Calif.

Century Record Mfg.
 Sangus, Calif.

Chicago Matrix, Inc.
 4750 S. Cottage Grove Ave.
 Chicago, Ill.

Coldwater Industries Inc.
 Coldwater, Miss.

Cook & Associates Recorders
 3905 W. Slauon Ave.
 Los Angeles 43, Calif.

Duicet Tone Corp.
 12-14 B'way
 Long Island City, N. Y.

(Continued on page 162)

HAMILTON

SERVING THE RECORD INDUSTRY SINCE 1946

EQUIPMENT FOR THE RECORD MANUFACTURING INDUSTRY

- RECORD MOULDS
- RECORD FLASH TRIMMERS OF ALL KINDS
- COINING DIES
- CRIMPING & PUNCHING DIES
- HYDRAULIC PRESSES FOR CRIMPING & COINING
- STAMPER SHEARS
- RECORD LABEL PUNCHES (MATERIAL SALVAGE)
- OPTICAL STAMPER CENTERING & PUNCHING MACHINES

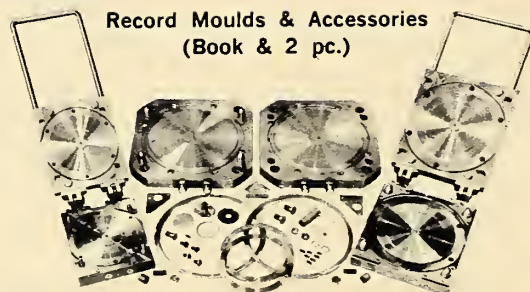

Record Moulds & Accessories
 (Book & 2 pc.)

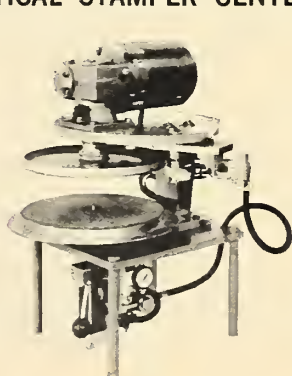

M-202B 10-12
 RECORD FLASH TRIMMER



M-214B 7" 45
 RECORD FLASH TRIMMER

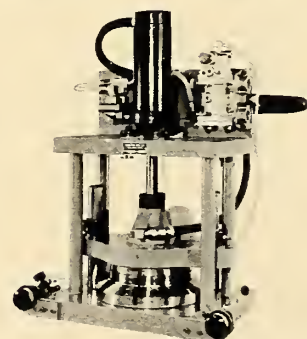

M-212 7" 45
 RECORD PUNCH



HAMILTON MANUFACTURING CORP., Dept. C

510 FIRST AVE., WEST HAVEN, CONN. 06516 • Area Code (203) 933-1625

THE LOWMAN SHOWS

Personal Management:
Bob Cavallo
1414 Avenue of the Americas
New York, N.Y. 10019
(212) 421-9365

General Artists Corporation
600 Madison Avenue
New York, N.Y. 10022
(212) 935-4000

Publicity:
Daniel J. Moriarty
Bob Cavallo Management
(212) 421-9365

Chad Stuart & Jeremy Clyde

YESTERDAYS GONE
SUMMERS SONG
WILLOW WEEP FOR ME
IF I LOVED YOU
WHAT DO YOU WANT
WITH ME?
BEFORE AND AFTER
I DON'T WANT TO LOSE
YOU BABY
TEENAGE FAILURE
DISTANT SHORES

CHAD & JEREMY'S ALBUMS
YESTERDAYS GONE
CHAD & JEREMY SING
FOR YOU
CHAD & JEREMY'S
GREATEST HITS
MORE CHAD & JEREMY HITS
BEFORE AND AFTER
I DON'T WANT TO LOSE
YOU BABY
DISTANT SHORES
CABBAGES AND KINGS



Kittyhawk Graphics

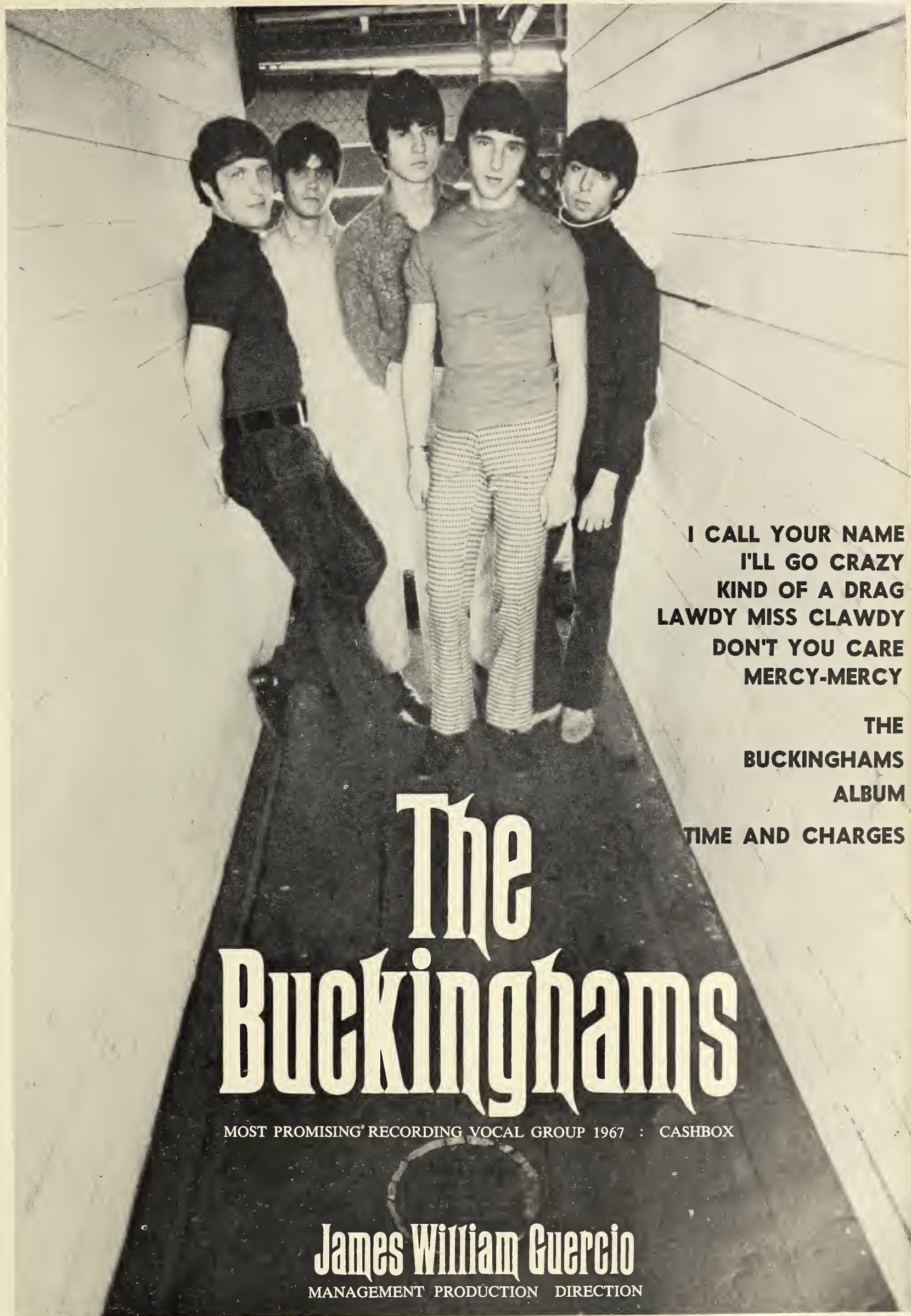

**I CALL YOUR NAME
I'LL GO CRAZY
KIND OF A DRAG
LAWDY MISS CLAWDY
DON'T YOU CARE
MERCY-MERCY**

**THE
BUCKINGHAMS
ALBUM
TIME AND CHARGES**

The Buckinghams

MOST PROMISING⁹ RECORDING VOCAL GROUP 1967 : CASHBOX

James William Guercio

MANAGEMENT PRODUCTION DIRECTION

ASCAP PUBLISHERS

A

A Bar S 360 N. Camden, Beverly Hills, Calif.
 A-H c/o Louis P. Randell, Esq. 1501 Broadway N.Y.C.
 A-M 609 Fifth Ave., N.Y.C.
 A.M.C. 1264 W. 1st Los Angeles, Cal. 90026
 A-1 3144 S. 33rd St., Milwaukee 15, Wisc.
 Aalbor 10 E. 49th St., 3rd Floor, N.Y.C. 10017
 Aardvark 609 Fifth Ave., Ste 300, N.Y.C. 10017
 Abcoa c/o Stark 1163 President St., Brooklyn, N.Y. 11225
 Abilene c/o Orland, Chase & Mucci 6 E. 45th St., N.Y.C. 10017
 Acacia c/o Alan Klein 1271 Sixth Ave., N.Y.C. 10029
 Academy (Ethnoc) 9165 Sunset Blvd., Los Angeles, Calif. 90069
 Acamor 233 East 32nd St., N.Y.C. 10016
 Accadia 9926 1/2 Robbins Dr., Beverly Hills, Cal. 90024
 Accolade 351 Veteran Ave., Los Angeles, Calif. 90024
 Ackerman Harding Pl 508, Nashville, Tenn. 37211
 Active 3170 S.W. 8th St., C 315, Miami 35, Fla.
 Addax 780 N. Gower St., Hollywood, Cal. 90038
 Ad-Lib 4548 Irvine Ave., N. Hollywood, Calif.
 Ad-Singers (Singers Inc.) 1549 N. Vine St., Suite 8 Hollywood, Calif.
 Ad-Staff 1680 N. Vine St., Suite 712, H'wood, Calif. 90028
 Adams, Geo, 681 Fifth Ave., 3rd Floor, N.Y.C. 10022
 Adams, Stanley 3 Woodland Pl., Great Neck, L.I., N.Y.
 Adamson c/o Forest W. Monroe 420 S. Beverly Dr., Beverly Hills, Calif.
 Adaros 170 S. Elm St., Denver, Colo.
 Adcon 3116 McFarlane Ave., Burbank, Calif.
 Adrawn c/o George Howe 8365 Cantaloupe Ave., Panorama City, Calif. 91402
 Admont 1290 Ave. of the Americas, N.Y.C. 10019
 Adoration 1320 Vine St., Phila. 19107
 Adrienne c/o Bert Maun 222 W. 83rd St., N.Y.C. 10024
 Advanced, Attn. Victor Blau 488 Madison Ave., N.Y.C. 10022
 Advertisers 54 W. Randolph St., Chicago, Ill.
 Aetna 306 16th Ave., S. Suite 212 Nashville, Tenn. 37203
 Agenda 1944 Michigan Ave., Miami Beach, Fla.
 Agrun, c/o Julian J. Aberbach 1619 Broadway N.Y.C. 10019
 Ahlert-Burke 15 E. 48th St., N.Y.C. 10017
 Ahlert, Fred 15 E. 48th St., N.Y.C. 10017
 Airwaves, c/o Richard Wolfe 150 W. 55th St., N.Y.C. 10019
 Alamo 1619 Broadway, 11th Floor N.Y.C. 10010
 Alanbee, c/o Betty Hutton 9653 High Ridge Dr., Beverly Hills, Calif. 90210
 Alben 325 W. 86th St., N.Y.C. 10024
 Alber, c/o Bregman 1428 N. Havenhurst, Hollywood, Calif.
 Albert 13724 Valley Vista Blvd., Sherman Oaks, Calif.
 Albino, c/o Rudolph Polizzi 272 Sixth Ave., Brooklyn, N.Y. 11215
 Album, c/o Morton Goode 123 W. 57th St., N.Y.C. 10019
 Albums 1111 N. Evergreen St., Burbank, Calif. 91505
 Alessandro 300 W. 55th St., #96, N.Y.C. 10019
 Alexandra, c/o Glenn Paxton 1160 5th Ave., N.Y.C. 10029
 Alexis c/o Lee Magid 408 W. 57th St., N.Y.C. 10019
 Alfred 75 Channel Dr., Port Washington, N.Y. 11059
 Algine 4520 Clinton St., Los Angeles, Calif. 90004
 Algrove 644 Schuykill Ave., Reading, Pa.
 Algren c/o Alfred Cini 250 Suburban Station Bldg., Philadelphia, Pa. 19103
 Alinot (Alton) 76-363 Fairway Dr., Palm Desert, Calif. 92260
 Alison 15 Raymond Circle, Ormond Beach, Fla.
 Allegro P.O. Box 11371, L.A., Calif. 90011
 Allen 1410 Republic Bank Bldg., Dallas, Tex. 75201
 Allison's c/o Allie Wrubel 535 So. Curson Ave., Los Angeles, Calif. 90056
 All-Points c/o Perry Stevens 2208 Edgerton Rd., University Hts. 18, Ohio
 Allstar, 1110 Washington St., S. Houston, Tex.
 All-World c/o Aki Aleong 1329 S. Redondo Blvd., Los Angeles, Calif. 90019
 Almanac 10 Columbus Circle, Suite 1406 N.Y.C. 10019
 Alma's P.O. Box 217, Hollywood, Ala. 35752

Apollo 301 W. 41st St., N.Y.C. 10036
 App 28 Knollwood Dr., Cherry Hill, N.J. 08034
 Apple 3489 Wonderview Dr., H'wood, Calif.
 Applesed 200 W. 57th St., Suite 1304, N.Y.C. 10019
 April, Attn: Gerald Teifer, 1650 B'way Rm. 201, N.Y.C. 10019
 Apt 1330 Ave. of the Americas, N.Y.C. 10036
 Aqua 2505 Highland Ave., Broomall, Pa.
 Aquarius c/o Lennie Lacour, 2201 W. North Ave., Milwaukee, Wisc. 53205
 Aragain 6290 Sunset Blvd., H'wood, Calif. 90028
 Arbee c/o Arthur Pine 515 Madison Ave., N.Y.C. 10022
 Arcade 2733 Kensington Ave., Phila., Pa.
 Arce c/o David Rivera, 153 Manhattan Ave., N.Y.C. 10025
 Arch 25 W. 56th St., N.Y.C. 10019
 Archer 80 Van Cortlandt Park So., Bronx, N.Y. 10063
 Arcot 250 W. 57th St., Suite 700, N.Y.C. 10019
 Argon 3113 Brookview Blvd., Parma, Ohio 44134
 Argoy c/o Hy Zaret, 631 Orienta Ave., Mamaroneck, N.Y.
 Aria 2345 Linwood Ave., No. 1E, Fort Lee, N.J.
 Arista c/o Louis Scheff, Esq., 64 Wall St., N.Y.C. 10005
 Arjay Box 48638 Briggs Station, L.A., Calif. 90048
 Arkayem c/o Rose Mozian, 7 Winthrop Ave., Yonkers, N.Y.
 Arko c/o Edwin H. Morris & Co., Inc., 31 West 54th St., N.Y.C. 10019
 Arloun 609 Fifth Ave., N.Y.C. 10017
 Arnot 151 W. 51st St., N.Y.C. 10019
 Arnel c/o John S. Kelley, Jr., 1540 Brewster Ave., Cincinnati, Ohio
 Arovox (Leona Music) 239 W. 18th St., N.Y.C. 10011
 Arpege c/o Gold, Mason, & Co., 515 City National Bank Bldg., Beverly Hills, Calif.
 Arrow 2570 Superior Ave., Cleveland, O. 44115
 Arto 145 No. Maple, Burbank, Calif. 91505
 Artemis c/o A. Mills, 8721 Sunset Blvd., Los Angeles, Calif. 90060
 Arthur, Irving, c/o Eleanor Squires, 125 Ocean Parkway, Brooklyn, N.Y. 11218
 Arthur 1614 Argyle Ave., H'wood, Calif. 90028
 Artist 1049 E. Parkway So., Memphis, Tenn. 38104
 Artixo 575 Lexington Ave., N.Y.C. 10022
 Artists 250 N. Canon Dr., Beverly Hills, Calif.
 Art 2741 Pleasant So. (P.O. Box 5523), Minneapolis, Minn. 55408
 Artsongs 1063 No. W. 119th St., Miami, Fla. 33168
 Asa 1556 No. La Brea Ave., H'wood, Calif. 90028
 Ascher 745 Fifth Ave., N.Y.C. 10022
 Ascot 780 N. Gower, Los Angeles, Calif. 90038
 Ascot c/o Frank Thomas 33 W. 42nd St., No. 1031, N.Y.C. 10036
 Ascot-Jolon c/o Kip Records Corp., 45 W. 39th St., N.Y.C. 10018
 Ashton, A Colorado Corp., 3045 So. Monroe, Denver, Colo. 80210
 Ashwyn c/o Edna Lewis, 430 E. 63rd St., N.Y.C. 10021
 Asquith 608 Fifth Ave., N.Y.C. 10020
 Asset Att: Clyde Otis, 1650 B'way, Suite 502, N.Y.C. 10019
 Associated Students of Stanford University Old Union Bldg., Stanford, Calif.
 Astor 103 Union St., Lodi, N.J. 07644
 Astron 1595 B'way, Rm. 308, N.Y.C. 10019
 Astronaut 2550 Briggs Ave., Bronx N.Y. 10058
 Athwarn c/o Victor Blau, 488 Madison Ave., N.Y.C. 10022
 Atlas Attn: Victor Blau, 488 Madison Ave., N.Y.C. 10022
 Atrium 1619 B'way, Suite 511, N.Y.C. 10019
 Attarack, Forsythe Div., 3220 Sunset Blvd., Suite 330, Los Angeles, Calif. 90069
 Atterbury 7520 N. Gravenstein, Portland 17, Ore.
 Auburndale c/o Mack H. Kay, 194-06 A 39th Ave., Flushing, N.Y. 10058
 Audio Music c/o Accadia, 9926 1/2 Robbins Dr., Beverly Hills, Calif. 90210
 Audio Unlimited 1418 No. Stevens St., Rhineland, Wisc. 54501
 Audophone 157 John Sims Parkway, Valparaiso, Fla. 32580
 Audubon 119 W. 57th St., N.Y.C. 10019, Aut 6830 Pacific View Dr., Los Angeles, Calif. 90028
 Avalona 264 W. 73rd St., N.Y.C. 10023
 Avant Garde (Avant Garde Music Div.) 37 W. 57th St., Suite 503, N.Y.C. 10019
 Avant Garde 37 W. 57th St., Suite 503, N.Y.C. 10019
 Avas 250 W. 57th St., N.Y.C. 10019
 Avatar 121 Clinton Ave., Newark, N.J. 09114
 Avenue 551 Dutch Valley Rd., N.E., Atlanta 9, Ga.
 Ayuga c/o Sheldon B. Keller, 258 So. Bedford Dr., Beverly Hills, Calif.
 Azar 232 W. 48th St., N.Y.C. 10036
 Azbill 1704 Kenyon Pl., Las Vegas, Nev. 89106
 Aztec c/o Bregman 1428 No. Havenhurst, H'wood, Calif.

Bal & Bal 4612 Lasheart Dr., La Canada, Calif. 91011
 Bal Masque 30 Cabot Rd. W., Masapequa, N.Y.
 Bal c/o Charles Bernard, 333 W. 56th St., N.Y.C. 10019
 Balladier c/o Stanley Davis, 151 E. 49th St., N.Y.C. 10017
 Baller, J. T., 226 Blake Av., Somerset, N.J. 08873
 Ballet 36 W. 44th St., Rm. 1313, N.Y.C. 10036
 Baltimore 35 Euclid Ave., Worcester, Mass. 01610
 Balto 1650 B'way, Suite 1119, N.Y.C. 10019
 Baltor 745 S. Spaulding Ave., Los Angeles, Calif. 90036
 Banjoe c/o Bob Banner Associates, 545 Madison Ave., N.Y.C. 10022
 Bantam 15639 Woodfield Pl., Sherman Oaks, Calif. 91403
 Barbil 6290 Sunset Blvd., Los Angeles, Calif. 90028
 Barber-Picone c/o Copyright Service Bureau 221 W. 57th St., N.Y.C. 10019
 Barbro 8008 Rodgers Rd., Elkins Park, Pa.
 Barclay c/o Shapiro, Bernstein & Co., 666 Fifth Ave., N.Y.C. 10019
 Barcel c/o Barbara Carroll, 450 E. 63rd St., N.Y.C. 10021
 Barcu-Berry (Taepier Music Div.) 5782 E. Second St., Long Beach, Calif. 90803
 Bark Attn: Jack Smolen, 163-07 Depot Rd., Flushing, N.Y. 11358
 Barnaby c/o Rosenfeld Meyer & Susman, 9601 Wilshire Blvd., Suite 444, Beverly Hills, Calif. 90212
 Baron P.O. Box 149, Oyster Bay, N.Y.
 Barr 135-41 78th Rd., Kew Gardens Hills, Flushing, N.Y. 11367
 Barricade 850 Seventh Ave., N.Y.C. 10019
 Barrington 1650 Broadway, Rm. 610, N.Y.C. 10019
 Barrister c/o Richard M. Shelton, Esq., 79 W. Monroe St., Chicago 3, Ill.
 Barry, 8 B'way, Lynbrook, L.I., N.Y.
 Barthel & Assoc. 2149 Lincoln Ave., Chicago, Ill. 60614
 Barton 116 Central Park So., N.Y.C. 10019
 Basie 1631 B'way, N.Y.C. 10019
 Bassman P.O. Box 5336, Sherman Oaks, Calif. 91403
 Bauer 121 Greenway, Albertson, N.Y.
 Bax 9220 Sunset Blvd., Los Angeles, Calif. 90069
 Baysons 2158 Westview St., Los Angeles, Calif. 90016
 Bayshore 645 Larkin St., San Francisco 9, Calif.
 Beachside c/o Ben Sabia 127 Princeton Ave., Vallejo, Calif. 94590
 Beacon 518 W. 50th St., N.Y.C. 10019
 Beacon Sales (Pratt Div.) 208 Melwood St., Winters, Tex.
 Beatrice 1500 N. Dayton St., Chicago, Ill. 60622
 Beaujolais c/o Copyright Service Bureau Ltd., 212 W. 57th St., N.Y.C. 10019
 Beaver 1650 B'way, N.Y.C. 10019
 Bed c/o Jerome Bl Lurie, Esq., 717 Fifth Ave., N.Y.C. 10022
 Bedack c/o Valando Corp., Attn: Arthur Valando, 22 W. 48th St., N.Y.C. 10036
 Bedford c/o John W. Green, 903 N. Bedford Dr., Beverly Hills, Calif.
 Bee Cee P.O. Box 870, H'wood, Calif. 90028
 Beejaye P.O. Box 2707, St. Petersburg, Fla. 33731
 Bee-Jay-Kay 1578 No. Gower St., H'wood, Calif. 90028
 Beekman 17 W. 60th St., Rm. 503, N.Y.C. 10023
 Behning 5844 Irvine Ave., No. H'wood, Calif. 91601
 Bel-Air c/o Basil G. Adlam, 608 Walden Dr., Beverly Hills, Calif.
 Belan 4418 Spellman, Houston 35, Tex.
 Bellino 3529 Big Dalton, Baldwin Park, Calif. 91706
 Bellmore c/o Herald Records, Inc., 150 W. 55th St., N.Y.C. 10019
 Belmont P.O. Box 49961, Los Angeles, Calif. 90049
 Belwin, 250 Maple Ave., Rockville Center, N.Y. 11571
 Ben Gen c/o Mike Gendel, 1595 B'way, N.Y.C. 10019
 Benco c/o Arch Music Col, Inc., 25 W. 56th St., N.Y.C. 10019
 Bendoli c/o Dotty Wayne, 1153 1/2 No. Edgemont Dr., Los Angeles, Calif.
 Benliss 1639 B'way, Rm. 310, N.Y.C. 10019
 Benner 135 So. 52nd St., Phila., Pa. 19139
 Benjamin 1619 B'way, N.Y.C. 10019
 Benross 1549 N. Vine St., Suite 6, H'wood, Calif. 90028
 Benson 136 Fourth Ave., No., Nashville, Tenn.
 Benton 896 Oneonta Dr., Los Angeles 65, Calif.
 Benziger 7 E. 51st St., N.Y.C. 10022
 Ben Mar 4801 Railroad Ave., E. Chicago, Ind.
 Berdoc c/o Doc Berger 931 E. 28th St., Bklyn, N.Y. 11210
 Bergmann 33 E. 48th St., N.Y.C. 10017
 Berklee 284 Newbury St., Boston, Mass. 02115
 Berlin, Irving 1290 Ave. of the Americas, N.Y.C. 10019
 Bernal 12127 Iredell St., Studio City, Calif.
 Bernie, Dave 1423 No. Fuller, H'wood 46, Calif.
 Bernstein, M., c/o Morey Bernstein 60 So. Glencoe St., Denver 22, Colo.
 Bersand c/o Epstein & Schewter, 516 5th Ave., N.Y.C. 10036
 Bertha c/o Guy Wood, 445 Closter Dock Rd., Closter, N.Y.
 Bet c/o Nick Bolin, 1950 Tamarind, H'wood 28, Calif.
 Beta c/o Arthur Talmadge, 240 W. 55th St., N.Y.C. 10019
 Beth-Ann 615 Baldwin Lane Carrcroft Crest, Wilmington 3, Del.
 Bethany c/o Roy O. Ward, 3788 Paradise Rd., Las Vegas, Nev.
 Beverly c/o Famous, 1619 B'way N.Y.C. 10019
 Bexhill c/o Norman Gimbel 15 W. 81st St., Apt. 13A, N.Y.C. 10024
 Bibo 2444 Wilshire Blvd., Santa Monica, Calif. 90403

B

B & R 164 W. 79th St., Apt. 140, N.Y.C. 10024
 B.F.T.R. 45 W. 56th St., N.Y.C. 10019
 B-H-V 119 W. 57th St., Room 1106, N.Y.C. 10019
 B.K. 6078 Dovetail Dr., Lake Lindero Agoura, Calif. 91301
 B. J. & H. c/o Larry Speer, Inc. 1650 B'way, N.Y.C. 10019
 B. R. B. 425 E. 63rd St., N.Y.C. 10021
 B-Sharp 1890 Seventh Ave., #5C, N.Y.C. 10026
 Bab c/o Joe Breeze, 71 Grohman Lane, Bethpage, L.I., N.Y.
 Babell 8433 Melvin Ave., No. Ridge, Calif. 91325
 Bae N.W. Cor. 8th & Fitzwater Sts., Phila., Pa.
 Baer, Abel, c/o Robbins-Feist-Miller, 1350 Ave. of the Americas, N.Y.C. 10019
 Baker 1270 Ave. of the Americas, Suite 3016, N.Y.C. 10020

Best Wishes

Johnny Mercer Marshall Robbins

COMMANDER PUBLICATIONS

1610 N. Argyle Ave.

Hollywood 28, Calif.

469-0878

(Continued on page 156)

Cash Box—July 8, 1967

THE NEW ASCAP BIOGRAPHICAL DICTIONARY.

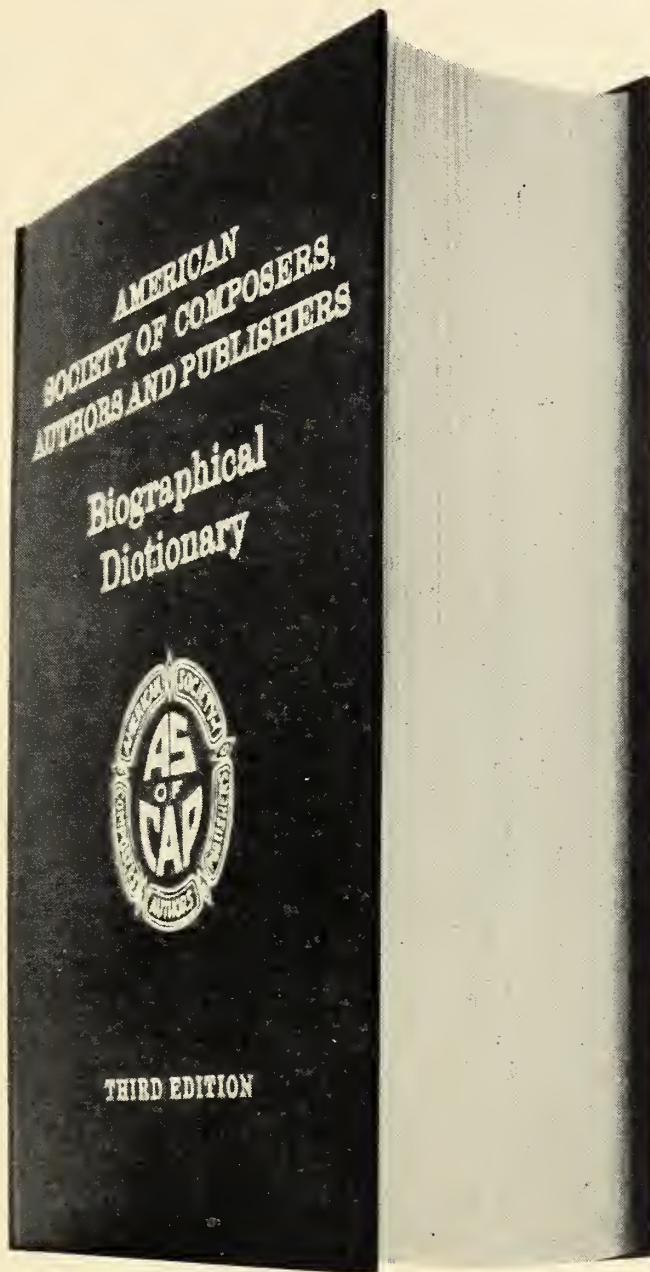

The American Society of Composers, Authors and Publishers presents a newly revised Third Edition of the ASCAP BIOGRAPHICAL DICTIONARY.

This unique, fact-packed book highlights the careers and achievements of some 5,238 writer-members of the world's largest association of music creators. In addition, there is a complete listing of all publisher-members.

This handsomely bound reference book of the outstanding music men and women of our nation is of invaluable help to all those interested in the development of musical programs for any medium of entertainment.

The book may be purchased for \$5.25 including mailing costs.



American Society of Composers, Authors and Publishers
575 Madison Avenue, New York, New York 10022

ASCAP, 575 Madison Avenue, New York, New York 10022

Please send me () copy(ies) of the ASCAP BIOGRAPHICAL DICTIONARY.

Enclosed is my check (or money order) in the amount of \$ _____.

NAME: _____

ADDRESS: _____

CITY: _____ STATE: _____ ZIP: _____

Some of the 5,000 Writers You Will Find in This Book:

Harold Adamson	Hoagy Carmichael	Sammy Fain	Edward Heyman	Dr. Douglas Moore	Harry Warren
Steve Allen	Betty Comden	Dorothy Fields	Tom Jones	Mitchell Parish	Ned Washington
Leroy Anderson	Adolph Green	Lukas Foss	Harvey Schmidt	Vincent Persichetti	Franz Waxman
Harold Arlen	J. Fred Coots	Arthur Freed	Gus Kahn	Cole Porter	Paul Francis Webster
Louis Armstrong	Aaron Copland	Rudolf Friml	Jerome Kern	Andy Razaf	Kurt Weill
Burt Bacharach	Mack David	George Gershwin	Burton Lane	Leo Robin	Meredith Willson
Hal David	B. G. DeSylva	L. Wolfe Gilbert	Carolyn Leigh	Richard Rodgers	Harry Woods
Samuel Barber	Lew Brown	Mack Gordon	Alan Jay Lerner	Sigmund Romberg	Jack Yellen
Irving Berlin	Roy Henderson	Morton Gould	Frederick Loewe	David Rose	Vincent Youmans
Elmer Bernstein	Howard Dietz	Oscar Hammerstein II	Henry Mancini	John Philip Sousa	Victor Young
Leonard Bernstein	Arthur Schwartz	W. C. Handy	Ernest Maresca	Dr. Wm. Grant Still	
Nacio Herb Brown	Walter Donaldson	E. Y. Harburg	Jimmy McHugh	Igor Stravinsky	
Irving Caesar	Vernon Duke	Lorenz Hart	Gian Carlo Menotti	Jule Styne	
Sammy Cahn	Bob Dylan	Victor Herbert	Johnny Mercer	Charles Tobias	
James Van Heusen	Duke Ellington	Jerry Herman	Bob Merrill	Albert Von Tilzer	

ASCAP PUBLISHERS

(Continued from page 154)

Big-B 9511 Shore Rd., Bklyn, N.Y. 11209
 Big Beat 22 Nelson Rd., Valley Stream, N.Y.
 Big Boot 214 Tower Life Bldg., San Antonio, Tex.
 Big Four (4) 17040 Rancho St., Encino, Calif. 91316
 Big Island c/o Stanley Zabka 500 East 77th St., Apt. 2521, N.Y.C. 10021
 Big League 3580 Washington Blvd., Cleveland, O. 44118
 Big M R.R. #2, Box 224, Spirit Lake, Iowa 51360
 Big Shot 8255 Sunset Blvd., Los Angeles, Calif. 90046
 Bikini 1631 B'way, N.Y.C. 10019
 Biljaci 2704 Westbrook Dr., Cincinnati, Ohio 45211
 Billboard c/o Jerry S. Levy, 243 South Lasky Dr., Beverly Hills, Calif. 90212
 Billet 6290 Sunset Blvd., Suite 703, H'wood, Calif. 90028
 Billeve 5 Melville Lane, Willingboro, N.J.
 Biltmore c/o Dave Dreyer 345 West 58th St., Suite 8A, N.Y.C. 10019
 Bing c/o Joseph Piccola 35 West 53rd St., Suite 34, N.Y.C. 10019
 Birdees Attn: Sidney Herman 1501 B'way, N.Y.C. 10036
 Bishop 5101 Matilija, Sherman Oaks, Calif.
 Bismark 297 Seventh Ave., N.Y.C. 10001
 Blackstone 17 26th St., 8th Floor, N.Y.C. 10023
 Blairwood 13027 Blairwood Dr., Studio City, Calif. 91604
 Blane, Ralph 1115 Kenwood Ave., Broken Arrow, Okla. 74012
 Blasco 11240 No. Oak Trfwy., Kansas City, Mo. 64155
 BLB c/o Robert S. Taran 7920 East Drive, Miami Beach 41, Fla.
 Blen 11670 Sunset Blvd., Apt. 302, Los Angeles 49, Calif.
 Bleu Disque 146 West 54th St., N.Y.C. 10019
 Blithe c/o Kenneth H. Wilhoit 6948 Woodman Avenue, Van Nuys, Calif.
 Bloch 31 West 31st St., N.Y.C. 10001
 Bloom, Ben 1619 B'way, Rm. 503A, N.Y.C. 10019
 Bloom, Edward Leon 940 Oneida St., Denver, Colo.
 Blueboy 1111 South Pine, Grand Island, Neb. 68801
 Blue Dot 1324 1/2 Canton Rd., Akron, O. 44312
 Blue Star 766 East 61st St., N.Y.C. 10022
 Blue Seas 1507 Sunset Blvd., Suite #1, H'wood, Calif. 90046
 Blue Sun c/o Pail Perry, 1092 Joselson Ave., Bay Shore, L.I., N.Y.
 Bluebell Attn: Phil Terry, 5659 Heiskell St., Phila. 44, Pa.
 BNP Attn: Alfred Perry, 4030 Radford Ave., No. H'wood, Calif. 91604
 Bobby K 206 So. Vermont Avenue, Glendora, Calif. 91740
 Bobby Tunes 6277 Selma Ave., H'wood 28, Calif.
 Bobcat PPX Enterprises, 1650 B'way, N.Y.C. 10019
 Boda 1650 B'way, N.Y.C. 10019
 Boelke-Bomart, Hillsdale, N.Y.
 Bogard 321 West Chester St., Long Beach, N.Y.
 Boland 320 Central Park West, Suite 9N, N.Y.C. 10025
 Bond, Carrie Jacobs, & Son 116 Boyston St., Boston 16, Mass.
 Bond Street c/o Ralph P. Ritchey, 43 Bond St., Brooklyn N.Y. 11201
 Bonfen c/o Howard Fenton, 399 East 72nd St., N.Y.C. 10021
 Bonjour c/o Alouette 1619 B'way, Suite 914, N.Y.C. 10019
 Bonnie Attn: George Goldner, 1631 Broadway, N.Y.C. 10019
 Bonny c/o Bendes, Stork & Amron, 733 Third Ave., N.Y.C. 10017
 Bonnyview 7120 Sunset Blvd., H'wood, 46, Calif.
 Bonwit 1549 N. Vine St., Suite #10, H'wood, Calif. 90028

Boosey & Hawkes, 30 West 57th St., N.Y.C. 10019
 Borge c/o J. H. Cohna Co., 510 Broad St., Newark, N.J.
 Boss 18634 Kipton Pl., Tarzana, Calif. 91356
 Boston 116 Boylston St., Boston 15, Mass.
 Boulder 9 Rockefeller Plaza, N.Y.C. 10020
 Bourne 136 West 52nd St., N.Y.C. 10019
 Bourne-Filmusic, Inc. 136 West 52nd St., N.Y.C. 10019
 Bowdoin College, Brunswick, Me. 04011
 Bowles, Paul, c/o Audrey Wood, 1301 6th Ave., N.Y.C. 10019
 Boyle ABC Paramount Records, 1330 Avenue of the Americas, N.Y.C. 10019
 Box & Cox 305 West 52nd St., Apt. 5G, N.Y.C. 10019
 Bradbury 425 1/2 Normal Ave., H'wood, Calif. 90029
 Bradford 205 Bwllbur Rd., Thousand Oaks, Calif. 91358
 Brams 81-11 Pettit Ave., #6F, Elmhurst, N.Y. 11373
 Brandom 1323 South Michigan Ave., Chicago 5, Ill.
 Bravo 17115 Nanette St., Granada Hills, Calif. 91342
 Brazilliance P.O. Box 5265, Sherman Oaks, Calif.
 Breen & De Rose 606 Eighth Ave., N. Asbury Park, N.J.
 Breezy Willow 6411 H'wood Blvd., H'wood, Calif. 90028
 Bregman, Vocco & Conn. Inc., 1619 Broadway, N.Y.C. 10019
 Breland 40 West 55th St., N.Y.C. 10019
 Bridgton 200 West 57th St., Suite 1304, N.Y.C. 10019
 Briegel, George F. 17 West 60th St., N.Y.C. 10023
 Brigh 9547 Prospect Ave., Chicago, Ill. 60643
 Bright, Sol K. P.O. Box #8380, Honolulu, Hawaii 96815
 Brighton 1780 Broadway, Suite 804, N.Y.C. 10019
 Brightwater c/o Fong & Tong Public Accounts 916 Kearney St., San Francisco, Calif.
 Brill 830 Lakeshore Dr., Delray Beach, Fla. 33444
 Brisk 1651 Cosmo St., Hollywood, Calif. 90028
 Brismat 65-12 Yellowstone Blvd. Apt. 2Y, Forest Hills, N.Y. 11375
 Bristol 345 W. 58th St., Suite 8, N.Y.C. 10019
 Broadway 135 W. 50th St., Suite 1920, N.Y.C. 10019
 Brockwin 200 W. 57th St., Suite 607, N.Y.C. 10019
 Brodt 1409 N. Independence Blvd., Charlotte, N.C.
 Bromaur c/o Maurice Shapiro 6817 Tulip Hill Ter., Washington 16, D.C.
 Bronston, Samuel 10 Columbus Cir., N.Y.C. 10019
 Brookhouse c/o Mrs. L. Lenya Weill-Detwiler 116 S. Mt. Rd., N.Y.C. 10956
 Brooks c/o Orland, Chase & Mucci 6 E. 45th St., N.Y.C.
 Brooks, Joey 109 E. 73rd St., N.Y.C. 10021
 Bro-Sil 959 Main, Buffalo, N.Y. 14203
 Broude Brothers 56 W. 45th St., N.Y.C. 10019
 Brown, Marshall c/o Charles Colin 315 W. 53rd St., N.Y.C. 10019
 Brown, Robert B. 1815 N. Kenmore Ave., Hollywood 27, Calif.
 Buckeye Sheraton Gibson Hotel, Rm. 105, Cincinnati, O. 45202
 Buckingham 1674 Broadway, N.Y.C. 10019
 Budd 1619 Broadway, Rm. 501, N.Y.C. 10019
 Bullet 1007 17th Ave. S., Nashville, Tenn. 37212
 Bulls-Eye 6526 Selma Ave., Hollywood 28, Calif.
 Burbank 400 Warner Blvd., Burbank, Calif. 91505
 Burdett 1911 S. Cheyenne, Tulsa, Okla. 74119
 Burdge & Company, 6311 Yucca St., Hollywood, Calif. 90028
 Burke & van Heusen 250 W. 57th St., Suite 901, N.Y.C. 10019
 Burke, Joe 15 E. 48th St., N.Y.C. 10017
 Burke, Johnny 250 W. 57th St., N.Y.C. 10019
 Burlington 539 W. 25th St., N.Y.C. 10010
 Burmark 20510 Michale St., Canoga Park, Calif. 91303
 Burnett, 49 Franklin Ave., Saranac Lake, N.Y.
 Burning Bush c/o Louis F. Bush 1344 N. Beverly Dr., Beverly Hills, Calif. 90210
 Burthen 609 5th Ave., N.Y.C. 10017
 Bushkin, Hoe c/o Wilzin & Halperin 1740 Broadway, N.Y.C. 10019
 Busillo, N. A. 1023 N. 67th St., Philadelphia, Pa. 19151
 Butterfly c/o Criterion 6124 Selma Ave., Hollywood, Calif. 90028
 Buxton Hill 609 5th Ave., N.Y.C. 10017
 Byron c/o Arthur Talmadge 240 W. 55th St., N.Y.C. 10019
 Byron-Douglas P.O. Box 565, Phoenix, Ariz. 85001

C.C. Attn.: Ernest Evans Swedesford Rd., Paoli, 19301
 CCRI 778 S. Pearl St., Denver, Colo. 80209
 C.M.A. Attn: Miss Pearl Aimes 1619 Broadway N.Y.C. 10019
 C.R. 17 W. 60th St., 18th Pl., N.Y.C. 10023
 Caaron 15 W. 70th St., N.Y.C. 10023
 Cab 200 W 57th St., Suite 507, N.Y.C. 10019
 Caber 8150 Beverly Blvd. #302, Los Angeles, Calif. 90048
 Cabot, Tony 90 Riverside Dr., N.Y.C. 10024
 Cadence 119 W. 57th St., Rm. 301, N.Y.C. 10019
 Cadenza 6263 Leland Way, Hollywood 28, Calif.
 Caesar, Irving 1619 Broadway, N.Y.C. 10019
 Cafazzo, Wakefield, Va.
 Cahn c/o Edward Traubner 132 S. Rodeo Dr., Beverly Hills, Calif. 23888
 Caj 240 W. 55th St., N.Y.C. 10019
 Cailliet, Lucien P.O. Box 155, Medford, N.J. 08055
 Cal c/o Joseph Meyer 174 E. 74th St., Apt. 9A, N.Y.C. 10024

Callee 15 E. 48th St., N.Y.C. 10017
 Callender, Red 6016 Sunset Blvd., Hollywood 28, Calif.
 Calvert c/o William S. Goldstein 723 Foster Rd., Cheltenham, Pa.
 Camelback Mountain 666 5th Ave., N.Y.C. 10019
 Camelot 53 E. 54th St., N.Y.C. 10022
 Campbell-Connelly 565 5th Ave., N.Y.C. 10019
 Campbell, Lloyd 1800 Broadway, San Francisco 9, Calif.
 Candell 84-20 51st Ave., Elmhurst, N.Y. 11373
 Candy c/o Thomas P. Cain 2062 N. McVay Dr., Mobile, Ala.
 Cannon 202 N. Canon Dr., Beverly Hills, Calif. 90210
 Canterbury c/o Sid Cooper 556 Mohawk Rd., W. Hempstead, N.Y. 11552
 Canyon Press 17 Kearney St., E. Orange, N.J.
 Capa c/o Alvin K. Schiller 7600 S. Marquette Ave., Chicago, Ill. 60649
 Capano 237 Chestnut St., Westville, N.J.
 Capital Press c/o Ralph Hermann 1 W. 66th St., N.Y.C. 10023
 Captivation c/o Garpax Box 669, Hollywood, Calif. 90028
 Captured c/o Kathleen M.L.M. Quinn 18 Hill St., Elmont, N.Y.
 Car-Mar 15417 Sutton St., Sherman Oaks, Calif.
 Caravelle 10513 Santa Monica Blvd., Los Angeles, Calif. 90025
 Carbaugh 332 S. Mich. Ave., Suite 1040, Chicago 4, Ill.
 Carew, Roy J. 818 Quintana Pl., N.W., Washington, D.C.
 Carlfred c/o Carl Stutz Radio Sta. WRVA, Richmond, Va.
 Carli 511 S. Mariposa Ave., Apt. 403, Los Angeles, Calif. 90005
 Carlyle c/o Larry Spier, 1650 Broadway, N.Y.C. 10019
 Carmel c/o Pat Vegas 5957 Carlton Way, Los Angeles, Calif. 90028
 Carmen 50 Broadway Rm. 2701, N.Y.C. 10004
 Carmichael 119 W. 57th St., N.Y.C. 10019
 Carnes, Josef R., Hillsboro, Ind.
 Carrie 17 W. 60th St., 8th fl., N.Y.C. 10023
 Carroll c/o Pauline Baker Carroll 1340 Sierra Dr., Arroyo Grande, Calif. 93420
 Carroll, David 79 W. Monroe, Chicago, Ill.
 Carsan P.O. Box 19024, Houston, Tex. 7724
 Carwin c/o Edwin H. Morris, 31 W. 54th St., N.Y.C. 10019
 Case c/o Paul J. Case 240 Central Pk. S., N.Y.C. 10019
 Catawba 1619 Broadway, No. 404, N.Y.C. 10019
 Cathryl 608 5th Ave., N.Y.C. 10019
 Catullus 211 E. 51st St., N.Y.C. 10022
 Cavalcade 136 E. 57th St., N.Y.C. 10022
 Cecilia Mary Lou Williams, Pres. 63 Hamilton Ter., Apt. 21, N.Y.C. 10021
 Cee Bee 11333 Blythe Ave., Sun Valley, Calif. 91352
 Cello 6650 Sunset Blvd., Hollywood 28, Calif.
 Cenci 411 Gordon St., Reading, Pa. 19601
 Center 808 N. Broad St., Phila., Pa. 19130
 Central Park c/o Louis Alter or Paul Taubman 57 E. 55th St., N.Y.C. 10022
 Central Park South 1650 Broadway, Suite 304A N.Y.C. 10019
 Cessna 5966 Lakeview, Detroit 13, Mich.
 Chadbourne c/o Franklin Fried 156 E. Superior St., Chicago, Ill.
 Chadick 6087 Sunset Blvd., Hollywood 28, Calif.
 Chalet 1631 Broadway N.Y.C. 10019
 Chamber 168 W. 48th St., N.Y.C. 10036
 Champagne 2444 Wilshire Blvd., Santa Monica, Calif.
 Chandler 17 W. 60th St., 8th fl., N.Y.C. 10023
 Chandler 1048 N. Carol Dr., Los Angeles 69, Calif.
 Channel Attn: Doug Cooper 12227 Addison St., Hollywood, Calif. 91607
 Chanson 4522 Louise Ave., Encino, Calif. 91316
 Chappell 609 5th Ave., N.Y.C. 10017
 Chappell-Styne 609 5th Ave., N.Y.C. 10017
 Char-Mar Hickory Kingdom Farms, Bedford Village, N.Y.
 Charjane Box 295, Miami Shores, Fla.
 Charlin 1607 El Centro St., Hollywood, Calif. 90028
 Charling 31 W. 54th St., N.Y.C. 10019
 Charter House c/o Lyle Ritz 1971 N. Curson Ave., Los Angeles Calif. 90046
 Chasbro 2905 Fantasy La., Decatur, Ga. 30033
 Chatham 1609 Broadway N.Y.C. 10019
 Chatsworth c/o George Paxton 1619 Broadway N.Y.C. 10019
 Ched c/o Charles Tobias 1650 Broadway, N.Y.C. 10019
 Cherokee 18964 Pacific Coast Hwy., Malibu, Cal.
 Cherry Hill 116 E. Cherry Hill Apts., Cherry Hill, N. J. 08034
 Cherry Lane 15 E. 48th St., (202) N.Y.C. 10017
 Cherybell 10513 Santa Monica Blvd., W. Los Angeles, Calif. 90025
 Cherylynn 805 E. 3rd., Trinidad, Col. 81082
 Chesnick c/o Norman Rosemont Plaza Hotel, N.Y.C. 10019
 Chester 401 Broadway, N.Y.C. 10013
 Chestnut 706 Chestnut St., St. Louis, Mo.
 Childhood 165 W. 46th St., N.Y.C. 10017
 Chilton 2233 Bellefontaine Blvd., Houston, Tex.
 Chiplin 645 Beacon St., Boston, Mass. 02215
 Chippendale 6087 Sunset Blvd., Hollywood, Cal.
 Chiquita 1619 Broadway, Rm. 503, N.Y.C. 10019
 Choice 9109 Sunset Blvd., Hollywood 46, Calif.
 Choral 1976 Corbin Dr., Chatsworth, Cal. 91311
 Chord 7239 Glenthorne Rd., Upper Darby, Pa.
 Chordinators 850 7th Ave., Suite 8C, N.Y.C. 10019
 Chriskil 49 Croydon Rd., Framingham, Mass. 01701
 Christopher 336 W. Spazier Ave., Burbank, Calif. 91506
 Chucklin 101 W. 55th St., N.Y.C. 10019
 Church, John, Bryn Mawr, Pa.
 Cimino 479 Maple Ave., Westbury, L.I., N.Y. 11590
 Cina-Star 2341 S. 16th St., Philadelphia 45, Pa.
 Cindy 157 W. 57th St., N.Y.C. 10019
 Cinema Songs c/o A. J. Silvermand 12412 Ventura Blvd., Studio City, Cal. 91604
 Cinton c/o Perry & Neidorf 315 S. Beverly Dr., 211, Beverly Hills, Calif. 90212

Circus c/o Charles O'Flynn 200 Hillside Ave., Allendale, N.J.
 Citation 485 5th Ave., Suite 1042, N.Y.C. 10017
 Claire 75 Chanel Dr., Port Washington, N.Y. 11050
 Clara 120 W. 57th St., N.Y.C. 10019
 Clarick c/o Fred H. Rheinheimer 21 Blind Brook La., Greenwich, Conn.
 Claridge 6362 Hollywood Blvd., Hollywood, Calif. 90028
 Clarion c/o Harry Kogen 421 Melrose St., Chicago 13, Ill.
 Claro 145-55 180th St., Springfield Gdns., 13 N.Y.
 Clay-Miller P.O. Box 336, Burbank, Cal. 91503
 Clearview c/o Nicholas A. Busillo 1023 N. 67th St., Philadelphia, Pa. 19151
 Clinton, D. W. c/o Stern & Wineor 745 5th Ave., N.Y.C. 07102
 Clover c/o Herb Reis 1619 Broadway N.Y.C. 10019
 CLW P.O. Box 1463, Edgewater, Colo. 80214
 Coca c/o N. L. Zuckerbrot 19 W. 44th St., N.Y.C. 10019
 Codell c/o Nick Acquaviva 136 E. 55th St., N.Y.C. 10022
 Chohan, George M. 1776 Broadway, N.Y.C. 10019
 Colby c/o Mr. Samuel Jesse Buzzell 460 Park Ave., N.Y.C.
 Coleman-Ross 550 5th Ave., N.Y.C. 10036
 Colgens 711 5th Ave., N.Y.C. 10022
 Collegiate 111 S. 3rd St., Delavan, Wis. 53115
 Collie c/o Miss Virginia Richmond 2054 Kenilworth Ave., Los Angeles 39, Calif.
 Colombo, Franco, 16 W. 61st St., N.Y.C. 10023
 Colonesi c/o Mr. James Robert Halpharo 599 Walton Ave., N.Y.C. 10051
 Colony c/o Mr. Elliot Wexler 419 S. 48th St., Philadelphia 43, Pa.
 Columbia 666 5th Ave., N.Y.C. 10019
 Columbia 1816 M St., N.W., Washington, D.C. 20036
 Comac 670 N. Mich. Ave., Rm. 502, Chicago 11, Ill.
 Comet 1780 Broadway, N.Y.C. 10019
 Commander 1610 N. Argyle, Hollywood, Calif.
 Commercial 1619 Broadway, N.Y.C. 10019
 Commonwealth 69-01 175th St., Flushing, N.Y.
 Comparsa c/o Lou Perez 255 W. 75th St., N.Y.C. 10023
 Composers 8481 Melrose Pl., Los Angeles, Cal.
 Composers 4941 Ambrose Ave., Los Angeles 27, Calif.
 Compton 250 W. 57th St., N.Y.C. 10019
 Comsat 521 W. 26th St., N.Y.C. 10001
 Comstock 711 5th Ave., N.Y.C. 10022
 Comstock 8321 Beverly Blvd., Hollywood, Calif. 90043
 Concentric 148 E. 53rd St., N.Y.C. 10022
 Concerto c/o Mr. Jack Fina 3686 Valley Meadow Rd., Sherman Oaks, Calif.
 Concertone Songs 1780 Broadway, Suite 1200, N.Y.C. 10019
 Congress 401 N.E. 17th St., Miami, Fla. 33132
 Congressional 3 1st St., Cowell, Calif. 94520
 Conifer 8500 N. 6th Ave., Birmingham, Ala. 35206
 Conley 6367 Hollywood Blvd., Suite 306, Hollywood Calif. 90028
 Connelley, Reg 1619 Broadway, 11th Fl. N.Y.C. 10019
 Conquest 133 W. 50th St., Suite 1920, N.Y.C. 10019
 Consolidated 33 W. 60th St., N.Y.C. 10023
 Consonant 224 W. 49th St., N.Y.C. 10036
 Consul c/o Larry Shayne 6290 Sunset Blvd., Suite 1003, Hollywood, Calif. 90028
 Contemporary c/o David Stafford Gollinson 488 Shurs La., Philadelphia 28, Pa.
 Contree 1619 Broadway, Suite 405, N.Y.C. 10019
 Cooper c/o Ben Barton 309 W. 57th St., N.Y.C. 10019
 Copa 1650 Broadway, Suite 1405, N.Y.C. 10019
 Corda Box 5126, Las Vegas, Nev. 89111
 Cornucopia 1270 6th Ave., Rm. 2724, N.Y.C. 10020
 Coronet 1650 Broadway, N.Y.C. 10019
 Corsair 9025 Wilshire Blvd., Beverly Hills, Cal.
 Cosmic c/o Perry & Neidorf 315 S. Beverly Dr. Beverly Hills, Suite 311, Calif. 90212
 Cosmopolitan 545 5th Ave., Rm. 812, N.Y.C. 10022
 Counselor c/o Peter J. Peluso 250 E. 116th St., N.Y.C.
 Country Star 439 Wiley Ave., Franklin, Pa. 16323
 Court c/o Fong & Tong Public Accounts 916 Kearney St., San Francisco, Calif.
 Cove P.O. Box 227, Long Island City 1, N.Y.
 Cover 1865 Galloway, Memphis, Tenn. 38112
 Crafo 7323 Jordan Ave., Canoga Park, Calif. 91303
 Crane P.O. Box 1271, Springfield 1, Mass.
 Crazy c/o Bogart 1270 6th Ave., N.Y.C. 10020
 Creative 1431 Hollywood Ave., Glenview, Ill.
 Credo 5504 Van Noord Ave., Van Nuys, Calif.
 Crescendo 1619 Broadway N.Y.C. 10019
 Crescent 1650 Broadway, N.Y.C. 10019
 Cressada c/o Allen Miller 565 5th Ave., N.Y.C. 10017
 Crest c/o Irving Fields 116 Central Pk. S., N.Y.C. 10019
 Crestview Attn: Ivan Mogull 33 W. 60th St., N.Y.C. 10023
 Crick & Ecton 6660 W. 87th Pl., Los Angeles, Calif. 90045
 Crisscott 10807 Wellworth Ave., Los Angeles 24, Calif.
 Criterion 6124 Selma Ave., Hollywood 28, Calif.
 Cromo 37 W. 57th St., N.Y.C. 10019
 Cromwell 10 Columbus Cir., Suite 2160, N.Y.C. 10019
 Cross Keys 319 7th Ave. N., Nashville, Tenn.
 Cross-Tie 6622 Andasol Ave., Van Nuys, Calif.
 Crudwell c/o Geist 335 E. 10th St., N.Y.C. 10019
 Cruise 32 Hillcrest La., Levittown, N.J. 08046
 Crum Lynne 322-D S. Morris Ave., Crum-Lynne, Pa.
 Crystal 6380 Wilshire Blvd., Suite 1007, Beverly Hills, Calif. 90048
 Cubo 144 W. 57th St., N.Y.C. 10019
 Culver 1432 N. Wilcox Ave., Hollywood 28, Cal.
 Cumulus 12 E. 213th St., Bronx, N.Y. 10467

(Continued on page 158)

5
 in the
TOP 100
JIMMY McHUGH
 ASCAP
TONY BENNETT-Col.
 "ON THE SUNNY SIDE
 OF THE STREET"
 "CAN'T GET OUT OF THIS MOOD"
ED AMES-RCA
 "DON'T BLAME ME"
 "CAN'T GET OUT OF THIS MOOD"
PEACHES & HERB
 "I'M IN THE MOOD FOR LOVE"
 PLAY A **JIMMY McHUGH**
JULY BIRTHDAY TRIBUTE

TRO

Throughout the world...
the symbol of creative music
publishing and exploitation for
composers, authors and publishers

TRO

The RICHMOND ORGANIZATION

10 Columbus Circle, New York, New York 10019

AL BRACKMAN, General Manager · MARVIN CANE, Director, Talent Development
LARRY COLEMAN, Editorial Director · ALAN L. SHULMAN, Director of Business Affairs

Canada: ESSEX MUSIC OF CANADA LTD.

TRO

The ESSEX MUSIC GROUP

Dumbarton House, 68 Oxford St., London W. 1, England

DAVID PLATZ, Managing Director

TRO | ESSEX MUSIC OF AUSTRALIA PTY. LTD. King York House, 32 York St., Sydney, Australia. Barry Kimberley, General Manager

TRO | EDITIONS ESSEX S.A.R.L. 28 Boulevard Poissonniere, Paris 9e, France. Ellen Nathan, Gerant · Jean Bertola, Professional Manager

TRO | ESSEX MUSIKVERTRIEB G.M.B.H. Drususgasse 7-11, Cologne 1, Germany.

TRO | EDIZIONI AROMANDO Galleria Del Corso 4, Milan, Italy. Sandro Pieralli, Professional Manager

TRO | LES EDITIONS ESSEX-HOLLAND Leidsegracht 11, Amsterdam-C, Holland.

TRO | MUSIKFORLAGET ESSEX A/B Regeringsgatan 45, Stockholm, Sweden.

TRO | EDICIONES ESSEX ESPANOLA Diputacion, 337-1, 2, Barcelona 9, Spain.

TRO | The RICHMOND ORGANIZATION 14 Ryogoku-Nihonbashi, Chuo-ku, Tokyo, Japan.

TRO | The RICHMOND ORGANIZATION 1 Any Ma'amin St., Ramat-Hasharon, Israel.

BOURNE CO.

Music Publishers

136 West 52nd Street
New York, New York 10019

Affiliated Companies

ABC MUSIC CO.

BACH MUSIC

BOURNE - FILMUSIC INC.

BOGAT MUSIC

HARBORN MUSIC, INC.

LADY MAC MUSIC

MURBO MUSIC

PUBLISHING, INC.

OAKLAND MUSIC INC.

SCHUMANN MUSIC CO.

Hollywood Office

6381 Hollywood Blvd.
Hollywood, California 90028

ENGLAND

Bourne Music Limited
34/36 Maddox Street
London W.1, England

FRANCE

Bourne-France
67 Rue de Provence
Paris, 9e, France

"MUSIC BORN TO LIVE"

ASCAP PUBLISHERS

(Continued from page 156)

Cunningham, Paul 60 Sutton Pl. S., Apt. 3E S. N.Y.C. 10022
Curtain Call c/o Becker & London, Esqs. 518 5th Ave., N.Y.C. 10036
Curtis c/o Al Wilde 25 Central Pk. W., N.Y.C. 10023
Cusenza, Frank J. 80 Rhode Island, Detroit, HP, Mich. 48203
Cybello 6807 40th Ave., University Pk., Mo. 20782
Cy c/o Hubert Cyril Cain P.O. Box 955 Mobile, Ala.

D

D & L 99-31 64th Ave., Forest Hills, N.Y. 11374
D & L 28 E. 1st St., Mt. Vernon, N.Y.
D & M 6134 S. Kolmar, Chicago, Ill.
Da Fran 75-63 195th St., Flushing, N.Y.
Daco 1607 El Centro, H'wood, Calif. 90028
Daino 2934 New Hope St., Philadelphia, Pa.
Danamos c/o Richard M. Shelton, Esq. 79 W. Danamon, Tadd 235 W. 46th St., N.Y.C. 10036
Damian Box 592, Blacehorse Pyke, Williams-town, N.J.
Damus c/o Richard M. Shelton, Esq. 79 W. Monroe St., Chicago 3, Ill.
Dana, Bill c/o David C. Light 9171 Wilshire Blvd., Suite 408, Beverly Hills, Calif.
Dana-Don, 780 N. Gower St., Hollywood, Calif.
Danamos c/o Richard M. Shelton, Esq. 79 W. Monroe St., Chicago 3, Ill.
Danar c/o Sam Alabaster 186 Monroe, Memphis, Tenn.
Dance King 613 N.W. Elkcam Blvd., Port Charlotte, Fla.
Danielle 5417 Fleet Ave., Cleveland, O. 44105
Daniels, Charles N. 1619 Broadway, 11th fl., N.Y.C. 10019
Darcy 429 Hill Ave., Whittier, Calif. 9060
Darlan 136 W. 46th St., N.Y.C. 10036
Dartmouth 10 Columbus Cir., Suite 2160, N.Y.C. 10019
Darwood 10 W. 74th St., No. 8D, N.Y.C. 10023
Dash, Connelly c/o Mr. Erwin Dash Essex House, 160 Central Pk. S., N.Y.C. 10019
Daval 20 Tanner St. Haddonfield, N.J. 08033
Davandon c/o Mr. Don Reid 730 5th Ave., N.Y.C. 10019
David 220 Pascack Rd., Park Ridge, N.J. 07656
Davis, Benny 240 Central Pk. S., N.Y.C. 10019
Davis, Joe 518 W. 50th St., N.Y.C. 10019
Dawn c/o Billy Hayes 1416 Brooklyn Ave., Apt. 6C, Brooklyn, N.Y. 11203
Dawnlught 608 5th Ave., N.Y.C. 10020
Dawson 132 Broadway, Hillsdale, N.J.
Dayben c/o Halperin, Morris, Granett & Cowan 1740 Broadway, N.Y.C. 10019
Daymer 729 7th Ave., N.Y.C. 10019
Dayton 1800 N. Argyle Ave., Suite 407, Hollywood 28, Calif.
De Franco, Joseph 10834 Haskill Ave., Granada Hills, Calif.
De Genova 8627 W. 44th St., Lyons, Ill. 60534
De Lange 418 S. Roxbury Dr., Beverly Hills, Calif.
De Masi 16 Northfield Ave., W. Orange, N. J. 07059
De Sylva, Brown & Henderson, 609 5th Ave., N.Y.C. 10017
Dean 4532 Ben Ave., N. Hollywood, Calif.
Dean 14 Yale St., Nutley, N.J.
Deane & Dod 555 Kappock St., Riverdale, N.Y. 10471
Deane, E. V. 555 Kappock St., Riverdale, N.Y. 10571
Debbie Anne 4847 Pulaski Ave., Philadelphia, Pa. 19144
Debbie-Jo c/o Lester Sill 1608 N. Argyle Ave., Hollywood, Calif. 90028
Deblyn 276 Myrtle Ave., Irvington, N.J. 07111
Debmar c/o Copyright Service Bureau, Ltd. 221 W. 57th St., N.Y.C. 10019
Deb-Mi c/o Jimmie Crane 15 Hillview Ave., Providence, R.I.
Debutone 19027 Wells Dr., Tarzana, Cal. 91356
December c/o Ross Jungnickel 1619 Broadway, N.Y.C. 10019
Deeds P.O. Box 72, Brooklyn, N.Y. 11224
Deekay c/o Raymond Datz 40 W. 55th St., N.Y.C. 10019
Deem 12345 Ventura Blvd., Suite W, Studio City, Calif.
Deep Fork 15 E. 48th St., 202, N.Y.C. 1000
Deep River c/o Mr. Frank J. Sampson 155 E. 24th St., N.Y.C. 10010
Dee-Pam 4155 Mary Ellen St., N. Hollywood, Calif. 91604
Deerhaven 300 Madison Ave., N.Y.C. 10019
Del-Pat 1039-1000 Oaks Blvd., Thousand Oaks, Calif. 91360
Delancy 3830 Buena Pk. Dr., Studio City, Cal. 91604
Delaware 1674 Broadway, N.Y.C. 10019
Delkas c/o Leeds Attn: Hal Haas, Music Corp. of America Universal Studios, Universal City, Calif. 91601
Dellwood 160 S. Keswing Ave., Saddle Brook, N.J. 07662
Delmore P.O. Box 2324, Menlo Pk., Cal. 94025
Delroy 5524 Ruthwood Dr., Calabasas, Calif. 91302
Delphine Box 97, Rt. 5, Saugerties, N.Y. 12477
Del-Scerbo 1211 Wharton St., Phila. 47, Pa.
Delta 855 Treat Ave., San Francisco 10, Calif.
Demarest 369 15th St., Norwood, N.J. 07648
Demartino 145-7 Mulberry St., N.Y.C. 10013
Demco 3303 Wilson Ave., Ashtabula, Ohio
De Milo 15533 La Brador St., Sepulveda, Calif.
Dena 6758 Colgate Ave., Los Angeles 48, Calif.
Dene 1808 Shady Ave., Pittsburgh, Pa. 15217
Denjan 444 N. Larchmont, Los Angeles, Calif.
Den-Lan 1414 Side Ave., Port Washington, N.Y.
Denny 815 16th Ave., S. Nashville, Tenn. 37203
Denper c/o Maurice M. Kahn 6381 Hollywood Blvd., Hollywood, Calif. 90028
Denric c/o Samuel Berke 9350 Wilshire Blvd., Beverly Hills, Calif. 90210
Denslow c/o Peggy Lee 1195 Tower Grove Dr., Beverly Hills, Calif. 90210
Denton & Haskins c/o Barney Young Box 340, Radio City P.O., N.Y.C. 10019
Desilu 119 W. 57th St., N.Y.C. 10019
Desmo c/o Orland, Chase & Mucci 6 E. 45th St., N.Y.C. 10017
Deutsch, M. G. 393 W. End Ave., N.Y.C. 10024
Devere 6357 Selma Ave., Hollywood, Cal. 90024

Dexter 387 6th St., San Francisco, Cal. 94103
Dey-Way 8029 Limerick Ave., Canoga Pk., Cal. Dez 48 Market St., Newark, N.J.
Diana c/o Sidney Mills 210 W. 89th St., N.Y.C. 10023
Diane Lisa 1800 N. Argyle, Suite #303, Hollywood, Calif. 90028
Dickson c/o Dick Manning 140 E. 56th St., N.Y.C. 10022
Diena 4 W. 58th St., N.Y.C. 10019
Dino P.O. Box 296, Bloomfield, N. J. 07003
Diogenes 1140 N. Cahuenga, Hollywood, Calif. 90038
Disemaker's c/o Random 825 Madison Ave., (3R) N.Y.C. 10021
Disney, Walt 800 Sonora Ave., Glendale, Calif. 91201
Distinguished 4622 N. Warnock St., Phila., Pa. 19140
Ditson, Oliver, Bryn Mawr, Pa.
Do-Ra-Me 5610 Bella Dr., Rubidoux City, Calif.
Dolan, John 563 E. Capitol Dr., Hartland, Wis. 53209
Dolcedo 6124 Selma Ave., Hollywood 28, Calif.
Dolfi c/o Ross Jungnickel 1619 Broadway, 11th fl., N.Y.C. 10019
Dolores Attn: Dolores Fuller 8115 Mulholland Ter., Los Angeles, Calif. 90046
Domco 6 Ware St., Dorchester, Mass. 02125
Dominant c/o Mr. Bernard Green 271 Central Pk. W., Apt. 9W, N.Y.C. 10024
Dominion 1680 Mass. Ave., Cambridge, Mass. 02138
Donald 200 W. 57th St., Rm. 710, N.Y.C. 10019
Don-De c/o Donald D. Delucia 54 W. Randolph St., #700, Chicago, Ill.
Don-Dor c/o John F. Nagy 785 W. End Ave., N.Y.C. 10025
Donaldson c/o Edward Traubner 132 S. Rodeo Dr., Beverly Hills, Calif.
Dondoe c/o Mr. Sam Riina 22880 Hayes Ave., E. Detroit, Mich. 48021
Dongan Attn: Bob Gans 400 Ocean Ter., Staten Island, N.Y. 10301
Dontone 117-23 134th St., S. Ozone Pk. N.Y. 11420
Dorabel c/o Barry Lee Cohen, Esq. 40 E. 49th St., N.Y.C. 10017
Dorabet 9250 Wilshire Blvd., No. 204, Beverly Hills, Calif.
Dorchester 6058 Goodland Ave., N. Hollywood, Calif.
Dore c/o Charles Paul Wolver Hollow Rd., Oyster Bay, N.Y.
Dorella 609 5th Ave., N.Y.C. 10017
Dorian 501 Madison Ave., Suite 1802, N.Y.C. 10022
Dor's Gee c/o Jack Pearl & Martin G. Pearl 515 Madison Ave., N.Y.C. 10022
Doris 5516 Danbury Pl., Woodland Hills, Calif. 91364
Dornelle, P.O. Box 6B, Hollywood 28, Calif.
Dorothy 21843 Salmon Ave., Long Beach 10, Cal.
Dorsey Bros. 33 W. 60th St., N.Y.C. 10023
Dorton c/o Arthur Skimkin 15 Central Pk. W., N.Y.C. 10028
Dorvi 655 Coolidge Ave., Woodbridge, N.J. 07095
Dottie 1225 5th Ave., Suite 303, N.Y.C. 10019
Double-A c/o Billy Rose Ziegfeld Theater, 1347 6th Ave., N.Y.C. 10020
Double M 9823 Stonehurst Ave., Sun Valley, Calif.
Douglas-Davilio 1619 Broadway, N.Y.C. 10019
Douglas 609 5th Ave., N.Y.C. 10017
Dov c/o MCA University Studios, University City, Calif. 91608
Dove c/o Marcia Hintz 1674 Broadway, N.Y.C. 10019
Dovine 1240 Northridge Rd., Columbus 24, O.
Dragon 22328 W. Pacific Coast Hwy., Malibu, Calif.
Drake 2601 Henry Hudson Pkwy., N.Y.C. 10063
Dralo 51 5th Ave., N.Y.C.
Drexel 9300 Wilshire Blvd., 6th fl., Beverly Hills, Calif. 90212
Drysen c/o Mr. Harry Bell 75 E. 55th St., N.Y.C. 10022
Duane c/o Mr. Allen Miller 565 5th Ave., N.Y.C. 10017
Dublin 166 E. 96th St., Suite 1A, N.Y.C. 10028
Dubonnet 485 5th Ave., Suite 104A, N.Y.C. 10017
Duet c/o Joan Edwards 350 W. 57th St., N.Y.C. 10019
Dufferin 1650 Broadway, N.Y.C. 10019
Duke Vernon 567 Almoloya Dr., Pacific Palisades, Calif.
Dulcet 1650 Broadway, Rm. 516, N.Y.C. 10019
Duluth 509 5th Ave., N.Y.C. 10017
Duncan, Jimmy 2009 Ebony La., Houston, Tex. 77018
Duncan, Vivian 14412 Greenleaf, Sherman Oaks, Calif. 91403
Dunhill c/o Ben P. Baumer 60 E. 42nd St., N.Y.C. 10017
Dunwich 25 E. Chestnut St., Chicago, Ill. 60611
Durante, Jimmy 8710 Wilshire Blvd., Beverly Hills, Calif. 90211
Dawrf c/o Pryor, Braun & Cashman 640 5th Ave., N.Y.C. 10019
Dwigar 119 W. 57th St., N.Y.C. 10019
Dymor c/o Jerome E. Lurie, Esq. 717 5th Ave., 19th fl., N.Y.C.

E

E.D.M. c/o Mr. Ed Marmor 4644 Arriba Dr., Tarzana, Calif.
E.P.I. 1604 N. Vista Del Mar Ave., Los Angeles, Calif. 90028
E.Z.M. 5823 Kings Hwy., Brooklyn, N.Y. 11203
Earl c/o Mr. Earl S. Shuman 111 E. 88th St., Suite 3B, N.Y.C. 10028
Easide 25 W. 81st St., N.Y.C. 10024
East Hill 6290 Sunset Blvd., Hollywood, Calif. 90028
East-West 1619 Broadway, N.Y.C. 10019
Eastlake P.O. Box 509, Montclair, N. J. 07042
Easy Listening 101 W. 55th St., N.Y.C. 10019
Ecaroh 400 Central Pk. W., Suite 14L, N.Y.C. 10025
Ecco Box 1465, Beverly Hills, Calif.
ECF c/o Eddie Fritz 2308 S. Highland Ave., Berwyn, Ill. 60402
Edbert c/o Edward Barbato 29 Woodvalley La., Port Washington, N.Y.
Eddie-O 8071 Selma Ave., Los Angeles 46, Cal.

Edfor 3511 Givernaud Ter., N. Bergen, N.J. 07047
Edition Musicus-New York 333 W. 52nd St., N.Y.C.
Edition Omicron 475 5th Ave., No. 1012 N.Y.C.
Editone c/o George H. Greeley 12316 Landale St., Studio City, Calif.
Edmonds, Shepard N. 169 Hamilton Ave., Columbus 3, Ohio
Ednan c/o Barovick & Konecky 555 Madison Ave., N.Y.C. 10022
Educational 905 Gaffield Pl., Evanston, Ill.
Edwards, H. & S. 15 E. 48th St., Suite 801, N.Y.C. 17
Edwards 135 W. 50th St., Rm. 1920, N.Y.C. 10019
Ego 46 Martin Dr., New Orleans 26, La.
Eisenstadt 3636 16th St., N.W., Washington, D.C. 20010
El Dorado 2990 W. Peco Blvd., Los Angeles 6, Calif.
El Tee 5904 Sunset Blvd., Hollywood, Calif. 90028
El-Tone, Damascus, Md.
Elar c/o Chappell 609 5th Ave., N.Y.C. 10017
Electra c/o Milton Somerfield 511 5th Ave., N.Y.C.
Electro Sew Vac 2308-B W. 8th St., Cincinnati, Ohio
Elephant c/o La Porte & Meyers 74 Trinity Pl., N.Y.C. 10006
Eleventh Avenue Theatricals 770 11th Ave., N.Y.C. 10019
Elgin Box 92, Newberry, Ohio 44065
Eliana c/o Reni Schulman 155 W. 68th St., N.Y.C. 10023
El Jay 310 S. Sherbourne Dr., Apt. 102, Los Angeles, Calif. 90048
Elkan, Henri 1316 Walnut St., Phila., Pa.
Elkan-Vogel Col, Attn: Mr. Adolph Vogel 1716 Sansom St., Philadelphia 3, Pa.
Ellabar 1697 Broadway, N.Y.C. 10019
Elliot 144 Jolind Rd., Paoli, Pa.
Ellipsis c/o Harold Libsius 919 N. Broad St., Philadelphia, Pa. 19123
Elm Drive c/o Frank R. Cohen 608 5th Ave., N.Y.C. 10020
Elmway 101 W. 57th St., Rm. 612A, N.Y.C. 10019
El-Ray c/o Elsa Lanchester 1825 N. Curson Ave., Hollywood, Calif.
Elsa-Childs 10 E. 40th St., #2910, N.Y.C. 10016
Elsmo Bros. 1800 N. Main, Racine, Wis.
Em Ru 64 E. Van Buren St., Chicago 5, Ill.
Emanuel 641 Lexington Ave., N.Y.C. 10022
Emar 8530 Wilshire Blvd., Beverly Hills, Calif. 90211
Emarcy 35 E. Wacker Dr., Chicago, Ill. 60601
Emery 230 W. 41st St., N.Y.C. 10018
Emes 621 N. Alta Dr., Beverly Hills, Calif.
Emily Attn: Mr. Lee J. Pockriss 160 W. 73rd St., N.Y.C. 10023
Emjay 887 N. 66th St., Philadelphia 51, Pa.
Empire 1901 Peyton Ave., "R," Burbank, Cal. 91504
Empress 119 W. 57th St., N.Y.C. 10019
Encino 15917 Valley Vista, Encino, Cal. 91316
Encore 22296 Cass Ave., Woodland Hills, Calif. 91364
Engine 9000 Sunset Blvd., Suite 702, Los Angeles, Calif. 90069
Enlight 451 N. Canon Dr., Beverly Hills, Calif. 90210
Ensemble Box 35, Summit, N.J.
Enterprise 11360 Dona Dorotea Dr., Studio City, Calif.
Entre 792 W. Lake Ave., Rahway, N.J.
Envoy c/o Milton Somerfield 511 5th Ave., N.Y.C. 10017
Epstein 37 Chatham Rd., New Rochelle, N.Y. 10804
Erasmus c/o Asher, Beldock & Kushnick 720 5th Ave., N.Y.C. 10019
Erica 35 W. 53rd St., N.Y.C. 10019
Erosa 333 S. Windsor Blvd., Los Angeles 5, Calif.
Erwin-Howard c/o David Pollowitz Esq. 272 Main St., New Britain, Conn.
Esca Paul 2515 Wilmette Ave., Wilmette, Ill.
Esquire 1245 Vine St., Hollywood, Calif. 90038
Essenjay 8036 Loma Verde, Canoga Pk., Calif. 91304
Essex 10 Columbus Cir., Suite 2160, N.Y.C. 10019
Ecstasy 1697 Broadway, Rm. 906, N.Y.C. 10019
Eta 1614 E. State St., Trenton, N.J. 08609
Etcetera c/o Danny Gould 12315 Rye St., N. Hollywood, Calif.
Ethelbert 818 Kendall Dr., Nashville, Tenn.
Eurasia 816 Hyppander Ave., Los Angeles 29, Calif.
Eureka 1619 Broadway, N.Y.C. 10019
Evans, Redd 1619 Broadway, N.Y.C. 10019
Exeter 10 Columbus Cir., Suite 2160, N.Y.C. 10019
Exotica 8721 Sunset Blvd., Suite 201, Los Angeles, Calif. 90069

F

F & W 6114 Santa Monica Blvd., Hollywood, Calif. 90038
Fabulous c/o John Colonna 1417 N. Bronson, Hollywood 28, Calif.
Fabyan 175 Mirmar Ave., Santa Barbara, Cal. 93103
Fain c/o Sammy Fain 1640 San Ysidro Dr., Beverly Hills, Calif.
Fairbanks 250 W. 57th St., N.Y.C. 10019
Fairlane 8625 Santa Monica Blvd., Los Angeles 69, Calif.
Fairway Attn: Mr. Goldberg 609 5th Ave., N.Y.C. 10017
Faith & Freedom c/o Hazel Davis 5901 Rose Ave., Long Beach 5, Calif.
Faith-Song c/o S. Samuel Venchans 53 W. Skyline Lake Dr., Wanaque, N.J.
Fajob c/o Allan E. Rudney 1500 Chestnut St., Philadelphia, Pa. 19102
Famous c/o Sidney Herman 1501 Broadway, N.Y.C. 10036
Fanfare 1337 N. Orange Dr., Hollywood 28, Calif.
Fantasy c/o Silverstone & Rosenthal 250 W. 57th St., N.Y.C. 10019
Far West 2859 Holt Ave., Los Angeles, Calif. 90034

(Continued on page 160)

TROUSDALE MUSIC HAS FLOWER POWVER

NINE SONGS IN THE TOP 10 IN 17 MONTHS:

CALIFORNIA DREAMIN'
MONDAY MONDAY
A MUST TO AVOID
SECRET AGENT MAN
I SAW HER AGAIN
SAN FRANCISCO
DEDICATED TO THE ONE I LOVE
CREEQUE ALLEY
WORDS OF LOVE

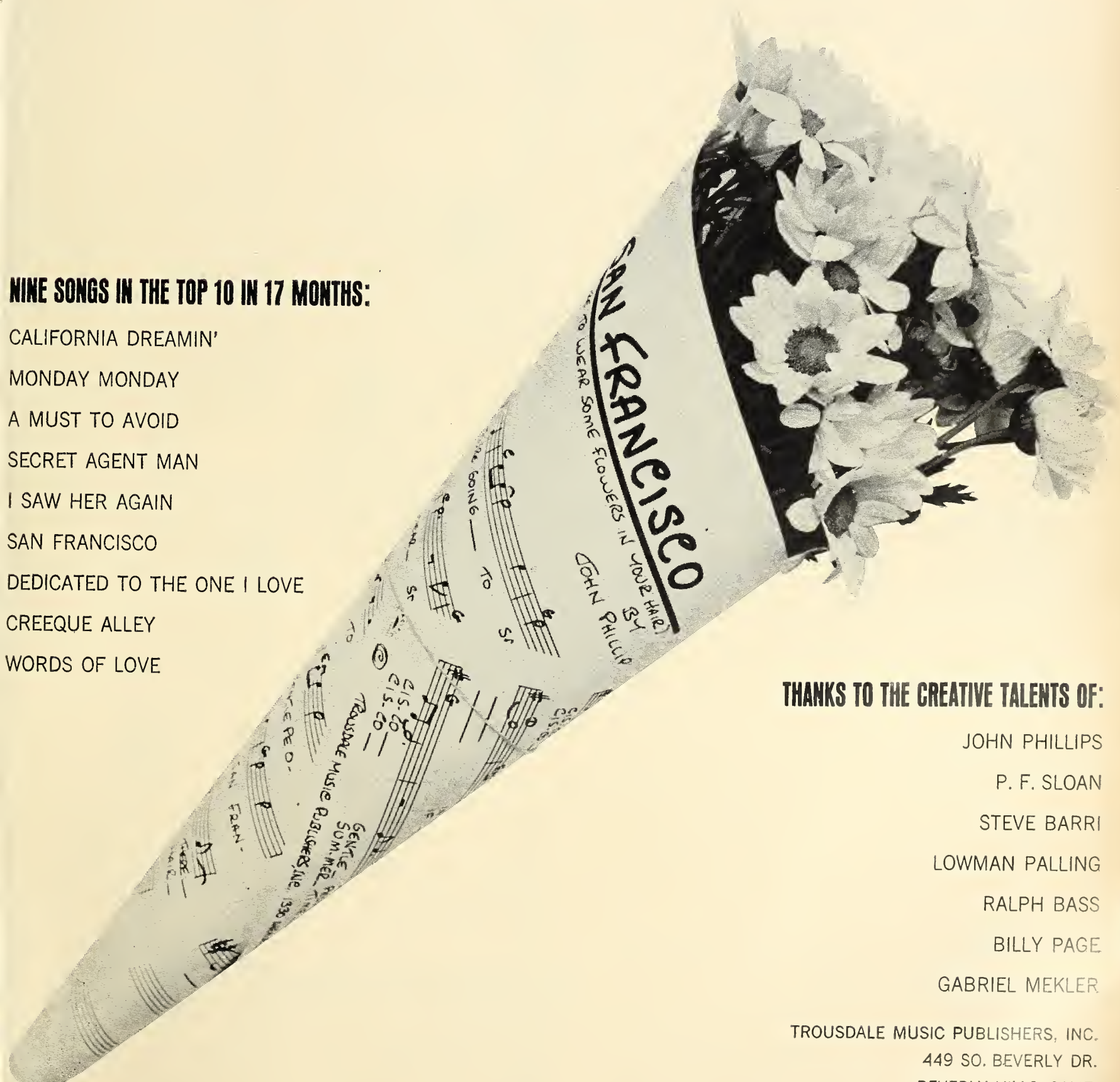

THANKS TO THE CREATIVE TALENTS OF:

JOHN PHILLIPS
P. F. SLOAN
STEVE BARRI
LOWMAN PALLING
RALPH BASS
BILLY PAGE
GABRIEL MEKLER

TROUSDALE MUSIC PUBLISHERS, INC.
449 SO. BEVERLY DR.
BEVERLY HILLS, CALIF.

ASCAP PUBLISHERS

(Continued from page 158)

G

Farber 56-28 230th St., Bayside, N.Y. 11364
 Farel 1247 N. Flores, Los Angeles 46, Calif.
 Farmer c/o Mr. C. L. Greenberg 12178 Ventura Blvd., Studio City, Calif.
 Farrell, Ern'e 999 N. Doheny Dr., Los Angeles, Calif. 90069
 Farrell, Wes 1650 Broadway, N.Y.C. 10019
 Farrow 340 E. 5nd St., N.Y.C. 10022
 Favorite 1619 Broadway, N.Y.C. 10019
 Fay-Ro c/o Joe Rosenfield Jr. 118 E. 31st St., N.Y.C. 10016
 Features 235 E. 45th St., N.Y.C. 10017
 Febro 10335 S. Bensley Ave., Chicago, Ill. 60617
 Fest, Leo 1350 Avenue of the Americas, N.Y.C. 10019
 Felisa 119 W. 57th St., Suite 1106, N.Y.C. 10019
 Fennario 154 W. 14th St., N.Y.C. 10011
 Fenner 1429 W. 110 Pl., Los Angeles, Calif. 90047
 Fermata International Melodies Suite 514, 6290 Sunset Blvd., Hollywood, Calif. 90028
 Festival Attractions c/o Arnold Moss 30 Beekman Pl., N.Y.C. 10022
 Festival Music 1570 53rd St., Brooklyn, N.Y.
 FIA 812 17th Ave., So., Nashville, Tenn. 37203
 Fidelio c/o Zissu, Marcus, Edenstein & Stein, 292 Madison Ave., N.Y.C. 10017
 Fideree 119 West 57th St., Rm. 701, N.Y.C. 10019
 Fiedel (FMI) Sam Fiedel 664 Hemlock St., Brooklyn, N.Y. 11208
 Fielding 408 N. Rodeo Dr., Beverly Hills, Calif. 90210
 Fifth Avenue 7715 Sunset Blvd., H'wood, Calif. 90046
 Fillmore c/o Carl Fischer 56 Cooper Sq., N.Y.C. 10003
 Fine Arts 1200 Linwood, Oklahoma City, Okla. 73106
 First Division 250 Maple Ave., Rockville Centre, N.Y.
 Fischer, Carl, c/o Frank H. Connor, President 62 Cooper Sq., N.Y.C. 10003
 Fischer J. & Bro., Harristown Rd., Glen Rock, N.J.
 Fisher, Fred, 1619 Broadway, N.Y.C. 10019
 Fitzpatrick 9000 Sunset Blvd., Los Angeles, Calif. 90069
 Fitzsimons 6290 Sunset Blvd. Suite 1003, Hollywood, Calif. 90028
 Five Jays c/o Copyright Service Bureau Ltd., 221 West 57th St., N.Y.C. 10019
 Flagstaff c/o Shapiro, Bernstein & Co. 666 Fifth Ave., N.Y.C. 10019
 Flagstone 9148 12th St., Sacramento, Calif. 95814
 Flamingo 1619 B'way, 11th Floor, N.Y.C. 10019
 Flammer, Harold 251 W. 19th St., N.Y.C. 10011
 Flanka 200 W. 57th St., Suite 1510, N.Y.C. 10019
 Fleischman, David 2710 Morris Ave., Bronx, N.Y. 10468
 Fletcher, Tex, 57 Third Ave., N.Y.C., 10003
 Flight 11346 Dona Dorotea Dr., Studio City, Calif. 91604
 Flo 59 East 54th St., N.Y.C. 10022
 Flojan 42 Lafayette Pl., Woodmere, N.Y. 11598
 Flonan 105 Regency Park Apt. Ramsey, N.J. 07446
 Florence c/o F. D. Huddleston 60 Fifth Ave., N.Y.C. 10017
 Flower 2241 New Haven Ave., Far Rockway, N.Y. 11691
 Flywheel c/o Fong & Tong 916 Kearny St., San Francisco 11, Calif.
 Foley, Charles 156 West 44th St., N.Y.C. 10036
 Folklore 176 Federal St., Boston, Mass. 02110
 Fontaine c/o MCA Universal Studios, Universal City, Calif. 91608
 Ford c/o Sherman Ford, Jr., 1757 Ponus Ridge Rd., New Canaan, Conn. 06840
 Foreign and Domestic, c/o Samuel Commins, Gen. Mgr., 153 Neptune Ave., New Rochelle, N.Y.
 Mgr., 153 Neptune Ave., New Rochelle, N.Y.
 Foremost 8983 Sunset Blvd., H'wood 69, Cal.
 Forster 216 South Wabash Ave., Chicago, Ill.
 Forte 157 West 57th St., N.Y.C. 10019
 Fortuna c/o Ken Greengrass 729 Seventh Ave., N.Y.C. 10019
 Fortune 11346 Dona Dorotea Dr., Studio City, Calif. 91604
 42 18 East 48th St., Rm 1401, N.Y.C. 10017
 Forward 82-46 62nd Ave., Forest Hills, N.Y. 11375
 Fosteo P.O. Box 783, Marquette, Michigan 49855
 Foster 200 West 57th St., Rm 1505, N.Y.C. 10019
 Foundation 1631 Broadway, N.Y.C. 10019
 44 221 East 50th St., N.Y.C. 10022
 Four Jays 9425 Sunset Blvd., Beverly Hills, Calif.
 Fox, Fred, 1841 Broadway, N.Y.C. 10023
 Fox, Sam 1841 Broadway, N.Y.C. 10023
 Frama 833 E. 14th Ave., Denver, Colo.
 Franca P.O. Box 3062 42 East First St., Reno, Nev. 89501
 Frances c/o Fay Tishman, Gooseneck Pt., Oceanport, N.J. 07757
 Franks 17 S. Maryland Ave., Atlantic City, N.J.
 Frank 119 West 57th St., N.Y.C. 10019
 Franklin St., 15 East 48th St., N.Y.C. 10017
 Franklin, Jimmie c/o Lewis J. Franklin 149 Jean Terrace, Union, N.J. 07083
 Franzed Chews & Williamtown Rd., Erial, N.J.
 Freberg 8720 Sunset Blvd. Los Angeles, Calif. 90069
 Fred 414 East 52nd St., N.Y.C. 10022
 Fredericks, Marc 46 Marlene Dr., Syosset, N.Y.
 Freestone 1680 Vine St., H'wood, Cal. 90028
 French 35 Wacher Dr., Chicago, Ill. 60601
 French Quarter 910 Rue Royal #3, New Orleans, La. 70116
 French, Samuel, 25 W. 45th St., N.Y.C. 10036
 Fresco 729 Seventh Ave., N.Y.C. 10019
 Fulprod P.O. Box 10513, Tampa, Fla. 33609
 Funco Attn: Robie Robie Lester, 3456 Floyd Ter., Los Angeles, Calif. 90028
 Funt, Allen A., 60 West 55th St., N.Y.C. 10019
 Furey 6250 Leland Way, H'wood, Calif. 90028
 Futura 1648 Cherokee St., N.Y.C. 10019
 FWY c/o Filmways, Inc. 51 West 51st St., N.Y.C. 10019

G & C 609 Fifth Ave., N.Y.C. 10017
 G & F 316 West 79th St., N.Y.C. 10024
 G. I. c/o Jeno Bartal Orchs. 161 West 54th St., Rm. 602, N.Y.C. 10019
 GMA (GMA Pub. Div.) 230 N. Michigan Ave., Chicago, Ill. 60601
 Gables c/o J. Polack 300 East 46th St., N.Y.C. 10021
 Galaxy 2121 Broadway, N.Y.C. 10023
 Galbraith-Mareno 256 West Plumstead Ave., Lansdowne, Pa. 19050
 Gale (D.v. of Zephyr Productions, Inc.) Box 251 Austin, Minn.
 Gallegos P.O. Box 666, Montebello, Calif. 90641
 Galli 1619 Broadway, N.Y.C. 10019
 Galvo Music, Inc., 6290 Sunset Blvd., H'wood, Calif. 90028
 Galvo Pub. c/o Frank Woods, 2744 Seaton Pl., Bronx, N.Y. 10466
 Gamut c/o Cy Levitan, 9 Split Oak Dr., East Norwich, L.I., N.Y.
 Ganmore 1529 Pine St., Philadelphia 2, Pa.
 Gannon & Kent c/o Edward Traubner 132 S. Rodeo Dr., Beverly Hills, Calif.
 Inc., 132 S. Rodeo Dr., Beverly Hills, Calif.
 Gardner 164 Alex St., Bridgeport, Conn.
 Garnet 1690 Longfellow Ave., Apt. 6D, Bronx 60, N.Y.
 Garson-Hillard & Day c/o Mort Garson, 408 West 57th St., Apt. 1G, N.Y.C. 10019
 Garson 3175 Dona Cristina Pl., Studio City, Calif. 91604
 Gary 2326 Gales Court, Scotch Plains, N.J.
 Gate 117 West 48th St., N.Y.C. 10036
 Gateway Willow Park Center, Rt. 110, Farmingdale, L.I., N.Y.
 Gaumont c/o George P. Hill, 7830 Miami View Dr., North Bay Is., Miami Beach 41, Fla.
 Gavadima c/o Martin J. Machat, Esq. 1501 Broadway, Suite 406, N.Y.C. 10036
 Gayle, Tim c/o Tim Gayle, 6376 Yucca St. & Cahuenga Blvd., Hollywood, Calif. 90028
 Gazebo 9912 Taylorsville Rd., Louisville, Ky. 40299
 Geepio 815 Navaree Ave., New Orleans, La. 70124
 Geld-Udell 200 West 57th St., Rm. 301, N.Y.C. 10091
 GEM c/o Barney Young P.O. Box 340, Radio City P.O., N.Y.C. 10019
 Gemini c/o Mrs. Hank Fort, 2122 Massachusetts Ave., N.W., Washington 8, D.C.
 Gene and Mel 2307 Mack Ave., Detroit 7, Mich.
 General 53 East 54th St., N.Y.C. 10022
 General Words and Music c/o Neil A. Kjos, Jr., 525 Busse, Park Ridge, Ill.
 Genesis 36 West 74th St., N.Y.C. 10023
 Geneva 223 North Glenroy Ave., Los Angeles, Calif., 90049
 Genius 1841 Broadway, N.Y.C. 10019
 Genram 5330 Laurel Canon, No. H'wood, Calif. 91607
 Georasim c/o George Raymond Simon, 1200 39th St., Brooklyn, N.Y.
 Geordie 488 Madison Ave., N.Y.C. 10022
 George 8467 Beverly Blvd., Los Angeles, Calif. 90048
 Georgeoff, Evan, 5003 Ridgebury Blvd., Cleveland, Oh'o 44124
 Gerard c/o Jack Gerard, 1227 North La Cienaga, Los Angeles, Calif. 90069
 Geril 101 West 55th St., N.Y.C. 10019
 Gershwin 609 Fifth Ave., N.Y.C. 10017
 Gesner c/o Rosen, Seton & Sarbin 15 West 44th St., N.Y.C. 10036
 Giannini International 505 Liberty Trust Blvd., Philadelphia, Pa. 19107
 Gibbs 250 No. Canon Dr., Beverly Hills, Calif.
 Gibraltar c/o Bill Harrington 176 Kensett Rd., Manhasset, N.Y.
 Gibran c/o Andrew J. Feinman Esq., 424 Madison Ave., N.Y.C. 10017
 Gigson 1956 West 51st St., Chicago, Ill. 60609
 GIG c/o Martin Brooks, 5427 Carlton Way, Hollywood, Calif. 90027
 Gilbert, Ray c/o Robert H. Ginter & Company 120 El Camino Dr., Beverly Hills, Calif. 90210
 Gilead 3787 Amesbury Rd., H'wood 27, Calif.
 Giles 22047 Vanowen, La Jolla, Calif. 92037
 Gillam c/o David S. Gillam 8150 La Jolla Shores Dr., La Jolla, Calif. 92037
 Gillman, Wallace, Box 155, San Clemente, Calif. 92672
 Gilmar 5511 West Pico Blvd., Los Angeles, Calif. 90019
 Gilstro 1776 Broadway, N.Y.C. 10019
 Giovanni 157 West 57th Street, N.Y.C. 10019
 Gizmo 63 Amsden St., Arlington, Mass.
 Glad-Hamp c/o Gladys Hampton 1560 Broadway, N.Y.C. 10036
 Gladys 1619 B'way, 11th Floor, N.Y.C. 10019
 Glamford c/o Myron A. Mufts 282 Rochambeau Ave., Providence, R.I. 02906
 Glamorous c/o Klaus Ogermann 1619 B'way, N.Y.C. 10019
 Glaser, Sioma 99-46 64th Ave., Forest Hills, N.Y. 11375
 Glean c/o Bergstrom Friedman & Company, 1264 W. First St., Los Angeles, Calif. 90026
 Glenbrook 136 West 50th St., Rm. 1920, N.Y.C. 10019
 Glenden c/o Harvey G. Weiss, 401 Broadway, N.Y.C. 10013
 Global 211 West 58th St., N.Y.C. 10019
 GME 9134 Sunset Blvd., Los Angeles, Calif. 90046
 Gold, Jack 729 7th Ave., N.Y.C. 10019
 Gold Medal 13277 Via Madronas Dr., Saratoga, Calif. 95070
 Gold Seal 1612 Empire Way, Seattle, Wash.
 Golden Bell c/o Philip Becker, CPA, 545 5th Ave., N.Y.C. 10017
 Golden Day c/o Michael Manfredi, 832 South 19th St., Newark, N.J.
 Golden Eagle 1650 B'way, Rm. 301, N.Y.C. 10019
 Golden Music 1118 North Clark Dr., Los Angeles 48, Calif.
 Golden State (De Gar Music Dir.) 665 Harrison St., San Francisco, Calif. 94107
 Goldmine c/o Nick Kenny 2932 Greenbriar St., Sarasota, Fla. 33580
 Goldsen, Michael H., Inc., 6124 Selma Ave., Hollywood 28, Calif.
 Goldwyn, Samuel, 609 Fifth Ave., N.Y.C. 10017
 Goman 803 Baldwin Dr., Westbury, N.Y. 11590
 Good Foot c/o Frank Mikovich, 2934 Grand Route St. John, New Orleans, La.
 Goodman 825 West End Ave., Apt. 9A, N.Y.C. 10025
 Good-Will 145 4th Ave., N.Y.C. 10023

Goombay c/o Copyright Service Bureau Ltd. 221 West 55th St., N.Y.C. 10019
 Gor-Dan 256 West Plumstead Ave., Lansdowne, Pa. 19050
 Gordelys c/o Arthur A. Gordon 15 Abingdon Sq. N.Y.C. 10014
 Gordon, Kaufman & Real, Inc. c/o N. R. Real 14 Overlook Terrace, Nutley, N.J.
 Gould, Edward E., 407 No. Maple Dr., Beverly Hills, Calif.
 Grace c/o A. Morgan Maree, Jr. / Assoc. 6363 Wilshire Blvd., Los Angeles 48, Calif.
 Gradick 1650 Broadway #1005, N.Y.C.
 Grady 6380 Wilshire Blvd., Suite 804, Los Angeles, Calif. 90048
 Graham 1270 Sixth Ave., Suite 902, N.Y.C. 10020
 Gramophone 1140 South Robertson Blvd., Los Angeles, Calif. 90035
 Granadeane 555 Kapock St., Riverdale, N.Y. 10471
 Grand 1619 Broadway, N.Y.C. 10019
 Grandview 13349 Wentworth St., Arleta, Calif. 01332
 Granite 6124 Selma Ave., Hollywood 28, Calif.
 Gray, H. W., Co., Inc., 159 East 48th St., N.Y.C. 10017
 Great Lakes 138 Duffield, Detroit 1, Mich.
 Green & Brogdon 405 W. 54th St., Apt. 18, N.Y.C. 10019
 Green, Keith, 7926 Capistrano Ave., Canoga Park, Calif. 91304
 Greene Mort 5416 Amestoy Ave., Encino, Calif. 91316
 Green Wind c/o David Joseph & Co., 17 East 49th Street, N.Y.C. 10017
 Greene, Alan 25 W. 81st St., N.Y.C. 10024
 Greene c/o Copyright Service Bureau Ltd., 221 West 57th St., N.Y.C. 10019
 Greene, Walter 4802 Van Noord Ave., Apt. #1, Sherman Oaks, Calif. 91403
 Greenhaven c/o Orland & Chase 6 East 45th St., N.Y.C. 10017
 Greenhill 937 Edgemoor Rd., Cherry Hill, N.J. 08034
 Greenlake 109 S. Flores St., Los Angeles 48, Calif.
 Greenway (Dee Eldee Music Co. Div.) 10201 W. Pico Blvd., Los Angeles, Calif. 90064
 Greenwich 8300 Santa Monica Blvd., Hollywood 60, Calif.
 Gregar 8467 Beverly Blvd., Los Angeles, Calif. 90048
 Gregell (Gregell Music Co. Div.) 36-21 Utopia Parkway, Flushing, N.Y. 11358
 Gregory 17 West 60th Street, 2nd Floor, N.Y.C. 10023
 Greiner 7501 Buist Ave., Phila., Pa. 19142
 Gretavic 119 West 57th St., Suite 1108, N.Y.C. 10019
 Groham c/o Cecil Calvert, 450 Orlando St., El Cajon, Calif. 92021
 Grosvenor House P.O. Box 1563, Hollywood 28, Calif.
 Guardian 881 Tenth Ave., N.Y.C. 10019
 Guarneri 10425 Sarah St., No. H'wood, Calif. Guild 25 Central Park West, Apt. 10-T, N.Y.C. 10023
 Guild Pub. of Cal., Inc. 3929 Fredonia Dr., Hollywood 28, Calif.
 Gulfstream c/o Vincent Fiorino 5614 Taylor St., Hollywood, Fla.
 Gunston c/o Arnold Roseman, 9350 Wilshire Blvd., Suite 302, Beverly Hills, Calif.
 Gwen 11016 Kittridge St., No. Hollywood, Calif. 91606
 Gyrus 1631 Broadway, N.Y.C. 10019

H

H & R 8425 Melrose Ave., Hollywood 46, Calif.
 H.W.S. 1608 North Argyle Ave., Hollywood, Calif. 90028
 Haggart 191 Willis Ave., Wawthorne, N.Y.
 Half Moon 6290 Sunset Blvd., Hollywood, Cal. 90028
 Hall-Mack Winona Lake, Ind.
 Hal'Le'Lu'Jah Records, 1431 Addison Rd., Cleveland, Ohio
 Hallmark 626 North Rodeo Dr., Beverly Hills, Calif.
 Halrone 310 Livingston St., Brooklyn, N.Y. 11217
 Halseon c/o Edwin Abramson 60 Park Place, Rm. 418, Newark, N.J.
 Halsey 1674 Broadway, N.Y.C. 10019
 Hamar c/o John Redmond 109 Wilson St., Hackensack, N.J.
 Hamblen Attn: Larry Shayne 6290 Sunset Blvd., Suite 1003, Hollywood, Calif. 90028
 Ham'ltan 309 W. 57th St., N.Y.C. 10019
 Hamlet 101 So. Hayworth Ave., Los Angeles, Calif. 90048
 Hampshire House 10 Columbus Circle, Suite 2160, N.Y.C. 10019
 Hamusic, Inc., 9191 N. Broad St., Philadelphia, Pa. 19123
 Handman c/o Marshall & Vigoda 56 West 45th St., N.Y.C. 10036
 Handy Bros. 1650 Broadway, Rm. 501, N.Y.C. 10019
 Haney, Ray, Inc. (Carousel Music Pub. Co., Div.) P.O. Box 5635, Washington, D.C. 20016
 Hanger 2903 Park Ave., Minneapolis, Minn. 55407
 Hanley, James F., 237 Beverly Dr., Douglaston, N.Y. 11363
 Hanna-Barbera (Astral Music Div.) 3400 Cahuenga Blvd., Hollywood 28, Calif.
 Hanover c/o Larry Shayne Music 6290 Sunset Blvd., Suite 1003, Hollywood, Calif. 90028
 Hansen, Charles H., c/o Walter Hofer, 221 W. 57th St., N.Y.C. 10019
 Hap c/o Plummer, 145 Waverly Pl., N.Y.C. 10014
 Happiness 9428 Manor Rd., Leawood, Kansas
 Harbet 40 East 49th St., N.Y.C. 10017
 Harbor Lights c/o Lew Williams, 3928 S. Wisconsin Ave., Berwyn, Ill.
 Harding 1674 Broadway, N.Y.C. 10019
 Hargal 157 W. 57th St., N.Y.C. 10019
 Hargo c/o Harold Goldman 8278 Sunset Blvd., Los Angeles 46, Calif.
 Hark Inc. (Freestone Music Div.) Long Ford Terrace, Jensen Beach, Fla. 33454
 Harkinson 433 W. 44th St., N.Y.C. 10036
 Harlene c/o Al Simms 7165 West Sunset Blvd., Hollywood 46, Calif.
 Harmon, Larry 649 No. Bronson Ave., H'wood, Calif. 90004
 Harmony Nill 17 Minetta St., N.Y.C. 10012

(Continued on page 163)



SOUTHERN MUSIC PUB. CO. INC. PEER INTERNATIONAL CORPORATION

CHAS. K. HARRIS MUSIC PUBLISHING CO., INC.
 PEER SOUTHERN PRODUCTIONS, INC.
 LA SALLE MUSIC PUBLISHERS, INC.
 MELODY LANE PUBLICATIONS, INC.
 PANTHER MUSIC CORP.
 PERA MUSIC CORP.
 R.F.D. MUSIC PUBLISHING CO. INC.
 NEW YORK-CALIFORNIA
 TENNESSEE-FLORIDA

OFFICES IN MAJOR MUSIC CENTERS OF THE WORLD

ARGENTINA

—Buenos Aires

AUSTRALIA

—Sydney, N.S.W.

AUSTRIA

—Vienna

BELGIUM

—Brussels

BRAZIL

—Rio de Janeiro

CANADA

—Montreal, P.Q.

CHILE

—Santiago de Chile

COLOMBIA

—Bogota

FRANCE

—Paris

GERMANY

—Hamburg

GREAT BRITAIN

—London

HOLLAND

—Amsterdam

ITALY

—Milan

JAPAN

—Tokyo

MEXICO

—Mexico City

NEW ZEALAND

—Auckland

PUERTO RICO

—Santurce

SOUTH AFRICA

—Johannesburg

SPAIN

—Barcelona & Madrid

SWEDEN

—Stockholm

SWITZERLAND

—Zurich

VENEZUELA

—Caracas

MRS. MONIQUE PEER-MORRIS
 President

PROFESSIONAL DIVISION

LUCKY CARLE ROY HORTON



Meet The Family



Tree



LONDON TREE

Dumbarton House
68 Oxford Street
London W1, England
(covering the United Kingdom)



PARIS TREE

15 Rue Saussier Leroy
Paris 17, France
(covering France and Belgium)



ROME TREE

Via Virgilio, 8
Rome, Italy
(covering Italy)



FRANKFURT TREE

Gr. Friedberger Str. 23-27
6 Frankfurt 1, Germany
(covering Germany, Austria
and Switzerland)



STOCKHOLM TREE

Kommendorgatan 26
Stockholm O, Sweden
(covering Sweden, Denmark,
Norway and Finland)



MADRID TREE

Carmen 20
Madrid 13, Spain
(covering Spain and Portugal)



AMSTERDAM TREE

8-10 Kruisstraat
Haarlem, The Netherlands
(covering Holland & The Netherlands)



PRAGUE TREE

Gramophone Records and
Music Publishing House
Praha 1, Palackeho I
Czechoslovakia
(covering Czechoslovakia)



LATIN AMERICAN TREE

Paraguay 1583
Buenos Aires, Argentina
(covering Argentina)



LATIN AMERICAN TREE

Caixa Postal 5304
ZC-58
Rio de Janeiro, Gb., Brazil
(covering Brazil)



LATIN AMERICAN TREE

c/o Indica S. A.
Apartado 4093
San Jose, Costa Rica
(covering Costa Rica)



LATIN AMERICAN TREE

Mundo Musical S. A.
Puebla No. 286-301
Mexico 7, D. F., Mexico
(covering Mexico)

*We Are Looking Forward To Meeting With Our Friends In Asia
& Australia When We Come To Visit You This September. We'll
Be Contacting You In Sydney, Manila, Tokyo & Hong-Kong.*

TREE



PUBLISHING COMPANY INC.

905 SIXTEENTH AVENUE, SOUTH NASHVILLE, TENNESSEE 37202

JACK STAPP—PRESIDENT

W. D. (BUDDY) KILLEN—EXEC. V.P.

BMI PUBLISHERS

A

A & A 24-19 95th E. Elmhurst, N.Y.
 A & D 185 West End Ave., N.Y.C. Suite 9-C
 A.D.T. 250 W. 57 N.Y.C.
 A. E. B. 1041 North Formosa Hollywood
 A-1 Hotel Monterey Broadway & 94th N.Y.C.
 A-Z 2322 Vista Del Mar Hollywood
 Aaron 5759 Columbus Van Nuys, Cal.
 Abadan 2016 Terrace Pl. Nashville, Tenn.
 Abado 1851 Brunner St., Phila., Pa. 19140
 Bob Abbott c/o Roosevelt Music 1650 Broadway, N.Y.C.
 Abco P.O. Box 1224 Nashville, Tenn.
 Abel 507 Fifth N.Y.C.
 Abigail c/o Wm. Reynolds 2027 Parker Berkeley, Calif. 94704
 Abingdon Press 201-8th Ave. S., Nashville, Tenn.
 Abnak 40 W. 55, N.Y.C.
 Abner 12903 Brackland Cleveland, O.
 Academy 735 Santa Barbara Pasadena, Cal.
 Acama 1608 Argyle Hollywood
 Acapulco 2419 Burnside, L.A., Cal.
 Accent 306 Third Columbus, Ind.
 Acclaim, P.O. Box 128 Madison, Tenn.
 Ace 203 W. Capitol Jackson, Miss.
 Aceman 24-16 Bridge Plaza, N.Y.C.
 Acklen 617 Exchange Building Nashville, Tenn.
 Acme 1650 Broadway, N.Y.C.
 Acorn 10 Columbus Circle, N.Y.C.
 Acre 9171 Wilshire Blvd. Beverly Hills
 Act III 35 E. Wacker Dr., Chicago, Ill.
 Actual 1650 Broadway, N.Y.C.
 Acuff-Rose 2510 Franklin Nashville, Tenn.
 Adair 6154 Westminister, Houston, Texas
 Adams 1697 Broadway, N.Y.C.
 Adams-Ethridge Box 434 Galveston, Texas
 Adams-Vee & Abbott 216 S. Wabash Ave., Chicago
 Adanac (BMI Can.)
 Adaris see T. M.
 Addison see Trinity
 Adelphi Press Box 2045, Hollywood
 Adept 715 E. 111 Place, L.A., Cal.
 Larry Adler 145 W. 57, N.Y.C.
 Admiration 3432 Mentone, L.A., Cal.
 Adonis 10 Columbus Circle, N.Y.C.
 Adway, 1650 B'way, N.Y.C.
 Aero 2400 West Madison Chicago
 Affiliated 1619 Broadway, N.Y.C.
 Agard 247 West 46, N.Y.C.
 Agate 1650 Broadway, N.Y.C.
 Agatha 1619 Broadway, N.Y.C.
 Age (BMI Can.)
 Agean 195-40 E. Peck Fresh Meadow, N.Y.
 Agnola 507 Fifth, N.Y.C.
 Agon 2139 Daly, N.Y.C.
 Aikens & Lafayette 438 East 93 Chicago
 Aim 1776 Broadway, N.Y.C.
 Airbourne 1007 17 Ave S., Nashville, Tenn.
 Airedale 10859 Landale No. Hollywood, Cal.
 Airwaves 1619 Broadway, N.Y.C.
 Aisha, 120 E 56, N.Y.C.
 Ajay 150 West 58, N.Y.C.
 Ala King 3044 Taylor, Detroit, Mich.
 Alameda 136 West 52, N.Y.C.
 Alana 250 W 57, N.Y.C.
 Alanbo Box 38550 Hollywood
 Albania 6365 Selma Hollywood
 Albarbar 408 W 57, N.Y.C.
 Albi-Long 29 Murdock Court, Brooklyn
 Aldebaran Box 1223, N.Y.C.
 Aldrich 233 Pleasanton San Antonio, Texas
 Alert 1650 B'way, N.Y.C.
 Dick Ales R.D. 2 Geneva, Ohio
 Alfonso, 364 N. Madison, Pasadena, Calif.
 Alger 6201 Santa Monica Hollywood
 Algonquin 1650 Broadway, N.Y.C.
 Algowill 152 W. 49, N.Y.C.
 Alhambra 117 W 70, N.Y.C.
 Alhus 1307 1/2 Tamarind, L.A., Cal.
 Alibri 93 East Alexandrine Detroit, Mich.
 Alice 1465 Broadway, N.Y.C.
 Alicia 148 West 68 N.Y.C.
 Aljean 41-28 Case Elmhurst, N.Y.
 Aljo 1801 Ridge, Phila., Pa.
 Alki 3514 S. W. Manning Seattle, Wash.
 Allee 2119 Dowling Houston, Texas
 Allegheny 1650 Broadway, N.Y.C.
 Allen Intercollegiate (see Winneton)
 Thornton W. Allen (see Winneton)
 N.D. Allender & Sons 216 Denrock Box 1231 Dalhart, Texas
 Alley & Kirsch 1115 Bonner Houston, Texas
 Alliance 545 Fifth, N.Y.C.
 Allmac Route #1, Hermitage, Tenn.
 Allmine, 2453 Bedford, Bklyn, N.Y.
 Allrite 4718 W. Stanford Dallas, Texas
 Alltec 1164 74 St., Brooklyn, N.Y.C.
 Almimo 237 W 54, N.Y.C.
 Almor 850 Longwood, Bronx
 Alnur 129 Circle Dr, Teaneck, N.J.
 A Lot of Good Things 225 W 57, N.Y.C.
 Alpd Bankers Sec. Bldg. Walnut & Juniper Phila., Pa.
 Alpat 217 Kearny San Fran., Cal.
 Alpha Film 501 Madison, N.Y.C.
 Alpha 501 Madison N.Y.C.
 Alphony La Paz Hotel Palm Springs, Cal.
 Alrac 639 1/2 Hudson N.Y.C.
 Al-Ray 1851 Fifth, San Diego, Cal.
 Alrita 18 Sunnyfield Hicksville, N.Y.
 Alroy 1650 Broadway, N.Y.C.
 Alsi 8831 Sunset L.A., Calif.
 Alskip 1722 Washington St. Louis, Mo.
 Altair 5340 S. Fairfield Chicago
 Alton 157 W. 57, N.Y.C.
 Altoona 75-13th Wheeling, W. Va.
 Joe Altschuler 1501 Broadway, N.Y.C.
 Alvin 1650 Broadway, N.Y.C.
 Amano 608 Fifth, N.Y.C.
 Amaran 6 Deer Trail, Old Tappan, N.J.
 Amboy 168 Blake, Brooklyn, N.Y.
 American Composers Alliance 2121 Broadway, N.Y.C. New York, N.Y.
 American Jazz 2 W. 45, N.Y.C.
 American Melodies 4318 N. Monticello, Chicago
 American Metropolitan 135 W. 50, N.Y.C.
 American 9109 Sunset Hollywood
 American Performing Rights 1619 Broadway, N.Y.C.
 Americana House 18 E. Chestnut, Chicago
 Ames 134 Pinewood Teaneck, N.J.
 Amestoy 39 Forest Hills Woodland Hills, Cal.
 Amijo 6126 W. Belmont Chicago
 Amin 400 Central Park West, N.Y.C.

Amity 37 W 57, N.Y.C.
 Amor 233 E. 32, N.Y.C.
 Ampar, 101 W 55, N.Y.C.
 Ampen 8542 Benton Phila., Pa.
 Amphora 1727 Division Davenport, Iowa
 Ample 157 W. 57, N.Y.C.
 Amplified P.O. Box 125, Cambridge City, Ind.
 Ampolaires, 116 Virginia, Bridgeport, Conn.
 Amshel 1780 Broadway, N.Y.C.
 Amy 570 Fifth, N.Y.C.
 Ananga-Ranga 200 W. 57th St., N.Y.C.
 Anatole (see Premier Albums)
 Anbee 2135 Princeton, Bethlehem, Pa.
 And 15 W. 55 N.Y.C.
 Ander (BMI Can.)
 Andick 846 N. Cahvenga, Hollywood, Calif.
 Elizabeth Andis Morristown, Ind.
 Andon 605 Crest, Manhattan Beach, Cal.
 Andover 32436 Tarryton Farmington, Mich.
 Andrades 6511 England, Houston, Texas
 Andre 839-57th Brooklyn, N.Y.
 Andy Andrews Box 136 Kent, Conn.
 Annual, 2480 16 St. N.W., Wash., D.C.
 Anfil 1360 New York, Brooklyn, N.Y.
 Angel 756 7th Ave, N.Y.C.
 Angela-Ru 3529 Silsby Rd., Cleveland, O. 44118
 Angelique Wilton, Connecticut
 Johnny Angle 2224 Blevedere Jackson, Miss.
 Angle 117 W. 48 N.Y.C.
 Angle-Anderson Box 9156 Jackson, Miss.
 Anika 1359 Oak San Fran., Cal.
 Animation 4949 Hollywood, Hollywood
 Anita 14 W. 103rd St, N.Y.C.
 Annabelle 1048 N. Carol L.A., Cal.
 Annadale 1695 Clear View Beverly Hills, Cal.
 Ann-Dee 1133 Broadway, N.Y.C.
 Annette 1440 N. Highland Hollywood
 Annis 1323 S. Michigan Chicago
 Anode, 3974 McClung Dr, Los Angeles, Cal.
 Another, 200 W. 57, N.Y.C.
 Anthem 180 Route 17 Paramus, N.J.
 Anthony 1449 S. Michigan Chicago
 Anthor 7601 S. Stewart Chicago
 Antilleana 160 Broadway, N.Y.C.
 Antoine 565 Fifth, N.Y.C.
 Antupa 9600 Harvard, L.A., Cal.
 Apache 12517 Hortense, Studio City, Calif.
 Apex 2775 Lantz, San Jose, Cal.
 Apogee 424 S. Pearl Youngstown, O.
 Applejack 200 W. 57, N.Y.C.
 Apprentice 640 Fifth, N.Y.C.
 Apreco 2326 E. Side Johnson City, Tenn.
 Arc 1619 Broadway, N.Y.C.
 Arch-Tone P.O. Box 3296, Scottsdale, Arizona
 Arco 13500 Shaker Blvd, Cleveland
 Arcot 250 W. 57th St. N.Y.C.
 Arctic 415 S. New Hampshire L.A., Cal.
 Arda 186 Monroe Memphis, Tenn.
 Ardick 164 Waverly, N.Y.C.
 Ardleigh 4627 Morro Woodland Hills, Cal.
 Ar-Do Music (BMI Can.)
 Ar-Rex Berlin W 30, Taunzzen 16, Ger.
 Argo 1055 N. El Centro L.A., Cal.
 Argyle 30 W. 60 N.Y.C.
 Aries 3747 Ruthelen L.A., Cal.
 Aristokratt Hotel President 234 W. 48 N.Y.C.
 Ariston 1733 Broadway, N.Y.C.
 Arkay 5646 Lemona Van Nuys, Cal.
 Ark-La-Tex 1619 Broadway, N.Y.C.
 Arlington Place, 105 S. La Salle, Chicago
 Armada 1650 Broadway, N.Y.C.
 Armel 3343 W. Crystal, Chicago
 Armo see Lois
 Armond Hotel Shelton, 49th & Lexington, N.Y.C.
 Joseph L. Armstrong 1268 S. Bonsall Phila., Pa.
 Arness 1240 Yale, Santa Monica, Cal.
 Arnett 2825 Gay L.A., Cal.
 Arnold Music 850 7th Av, N.Y.C.
 Arren & Broderick 4149 N. Leanington Chicago
 Arrex (BMI Can.)
 Arrowhead See Golden West Melodies
 Arroyo 1646 Lucile, L.A. Calif. Art Audio 9706
 Art 1279 Queen Anne L.A., Cal.
 Cameron Ave. Detroit, Mich.
 Arta 1732 Amsterdam N.Y.C.
 Artemis 9151 Sunset Blvd, L.A., Cal.
 Edward Arthur 135 West 50th St, N.Y.C.
 Arthur 55 West 74th St. N.Y.C.
 Artia 1650 Broadway, N.Y.C.
 Artillery 235 W. 46 N.Y.C.
 Artist Band Composer 1149 W. Santa Ana, Fresno, Cal.
 Artistique 2881 Roosevelt Ave, Bronx, N.Y.C.
 Artrec Box 66 Miami, Fla.
 Arvee 7039 Sunset Hollywood
 Asbury 79 W. Monroe Chicago
 Ashland 136 E. 57th N.Y.C.
 Ashna 115-B Third Ave. N. Nashville, Tenn.
 Ashtown 1619 Broadway N.Y.C.
 Ashwood 617 Exchange Bldg. Nashville, Tenn.
 Asnes 217 125th, N.Y.C.
 Assembly 8 Westervelt, Tenafly, N.J.
 Associated Composers 630 Ninth Ave., N.Y.C.
 Associated 1 W. 47th N.Y.C.
 Aster 2415 So. Ridgeley L.A., Cal.
 Robert Astor 1650 Broadway, N.Y.C.
 Astro 785 De Soto Ypsilanti, Michigan
 At Last 2666 Ellendale Pl. L.A. Calif.
 Athens 1096 Lynwood Blvd. Nashville, Tenn.
 Athon 26 Benton Ave. Naperville, Illinois
 Atina 392 Central Park W., N.Y.C.
 Atlantic 6124 Selma Ave. Hollywood
 Atna Box 1707 Div. St. Nashville, Tenn.
 Atomic 14743 Saticoy, Van Nuys, Cal.
 Audicon 1674 B'way, N.Y.C.
 Audio-Master 17 E. 45th, N.Y.C.
 August 8732 Sunset, Hollywood
 Aurea 1697 Broadway, N.Y.C.
 Aurelio, 782 8th Av., N.Y.C.
 Aurora 614 W. 51st, N.Y.C.
 Austin 6124 Selma Av Hollywood
 Gene Autry 1556 North La Brea Hollywood
 Frankle Avalon 1320 Vine Phila., Pa.
 Avalon 6124 Selma, Hollywood
 Avenue See Lois
 Avon 130 W. 46th, N.Y.C.
 Award 3655 Berryman L.A., Cal.
 Aways 808 N. Linden Beverly Hills, Cal.
 Axis 4018 S. Lake Burbank, Cal.
 Aye & Bee 1819 Fairmount Phila., Pa.
 Azmort, 65 E 65th St, N.Y.C.
 Azure 422-18th Santa Monica, Cal.

B

B & B Box 7816 Detroit, Mich.
 B. & F. 1323 S. Michigan Chicago
 B. & S. 302 Exchange Bldg., Nashville, Tenn.
 BMI Canada 16 Gould Toronto, Can.
 BRC 445 Park Av, N.Y.C.
 B.M.S. 50 Lenox Rd. Brooklyn
 B.R.S. 527 Madison, N.Y.C.
 B-W Box 337 Wooster, O.
 Babb 48 & Tennessee Nashville, Tenn.
 Bach 135 Nassau Atlanta, Ga.
 Bachelor 430 N. Rodeo Beverly Hills, Cal.
 Back Beat 211 Spruce Newark, N.J.
 Backus 1270 6 Ave, N.Y.C.
 Backwoods Box #301 Nashville, Tenn.
 Bae N.W. Cor. 8 & Fitzwater Sts. Phila.
 Baha 4811 Laurel Canyon N Hollywood
 Baileys 1448 Denman Cincinnati, O.
 Bainbridge 971 Thomas St., Seattle, Wash. 98109
 Bais 50 So. Main Memphis, Tenn.
 Balare 1755 B'way, N.Y.C.
 Balboa 15038 Haynes Van Nuys, Cal.
 Baldwin 145 W. 45, N.Y.C.
 Bali Box 246, N.Y.C.
 Ballantyne (BMI Can.)
 Balleran 1812 Tammany Nashville, Tenn.
 Rambo 6515 Sunset, Hollywood
 Bandshell 1204 Kermit Nashville, Tenn.
 Bandstand 1650 Broadway, N.Y.C.
 Banff (BMI Can.)
 Banham 645 Madison, N.Y.C.
 Banks 1411 Walnut Phila., Pa.
 Bantron, 9649 Fern Ave., El Monte, Calif.
 Bar 11314 1/2 S. Main L.A., Cal.
 Barabash (BMI Can.)
 Barbary 4430 Santa Monica Blvd. L.A., Cal.
 Barbera-Hanna 3401 Cahuenga L.A., Cal.
 Barbison 2935 Fenton Bronx, N.Y.
 Barclay 972 Peninsula Woodmere, N.Y.
 Barcone, 150 W 55, N.Y.C.
 Bardell 370 Carlton Brooklyn, N.Y.
 Harry Bare 413 Race Cincinnati, O.
 Barham 1229 Olive Hollywood
 Bari 1700 Locust Phila., Pa.

Don Barksdale 138 Grand Oakland, Cal.
 Barlou 1428 N. Havenhurst, Hollywood
 Bar-Mar 2120 S. Michigan Chicago
 Barmour 8-16 43rd Ave., L.I.C., N.Y.
 Barnegat 1733 Broadway, N.Y.C.
 Barnhart Box 234, Vienna, Ohio
 Barroco 4421 Grimes Pl. Encino, Calif.
 Paul Barrett 709 Central Tower, San Francisco
 Ron Barrett 442 E. 93rd L.A., Cal.
 Barrister Box 2731 Long Beach, Cal.
 Barrisue 28 Pembroke Rd., Hamden, Conn.
 Barronette 3220 Audley Houston 6, Texas
 Barrow 201 W. 49th New York, N.Y.
 Bessie Barry 7192 Alaska, Detroit, Mich.
 Barry-Michael 200 W. 57 N.Y.C.
 Bart 548 Woodward Detroit, Mich.
 Earl Barton 1121 S. Glenstone, Springfield, Mo.
 Bass 418 Lake Dr., Hapeville, Ga.
 Batir 4050 Brick Church Pike Nashville, Tenn.
 Bay (BMI Can.)
 Bayberry 1730 Broadway, N.Y.C.
 Bayes 4233 Navajo St. N. H'wood, Calif.
 Johnny Baylor 850 7 Ave, N.Y.C.
 Bayou Box 115 Madison, Tenn.
 Bay-Tone 1509 Fillmore San Francisco
 Bayview Box 1373 Port Arthur, Texas
 Bayville 170 W. 74th, N.Y.C.
 Beach 149 E. 97th, N.Y.C.
 Beacon 25 Beacon Boston, Mass.
 Beacon Hill 150 W55, N.Y.C.
 Beak 5411 Lyford Memphis, Tenn.
 Beale Street Box 32014 L.A., Cal.
 Beam 414 W. 44th, N.Y.C.
 Beamark 3109 Mermajd, Brooklyn, N.Y.C.
 Be-Are 319 Seventh Ave. N. Nashville, Tenn.
 The Beat 3852 Grosvenor S. Euclid, O.
 Beatnick 686 Woodlawn Memphis, Tenn.
 Beaumont 4113 Dixie Canyon Sherman Oaks, Cal.
 Beau-Nichols 4836 Agneaux N. Hollywood
 Beau-Tex 4965 Bruce Dr. Beaumont, Texas
 Bebe 1650 Broadway, N.Y.C.
 (Continued on page 164)

RECORD PROMOTION & PUBLICITY OFFICES

(Continued from page 144)

SAN FRANCISCO

Samuel Berchloz
 P.O. Box 16052
 386-8988
 Bobby Chinn Associates
 P.O. Box 31349
 94131
 415-2680
 Kathy Furness & Assoc.
 703 Market St.
 PR 5-3905—DO 2-0106

SAN RAFAEL, CAL.

Ted Ponseti
 221 Knight Dr.
 453-4388

SCRANTON, PA.

Ladd & Associates
 401 Wintermantle Ave.
 18505
 (717) 343-6718

SEATTLE, WASH.

Record Artist Management
 971 Thomas St.
 98109
 (206) MA 2-0470
 SILVER SPRINGS, MD.
 Tri-Fi Productions
 Cal Hackett
 9419 Georgia Ave.
 587-3965

ST. LOUIS, MO.

Herbert Lutz
 4466 W. Pine 8'lvd.
 EM-3-6888

STRUTHERS, OHIO

Tony March Productions
 708 Fifth St.
 44471
 (216) 755-2773

SUMTER, S. CAR.

Trend Records
 Merrill Warner
 P.O. Box 1647
 773-7081

UPPER DARBY, PA.

Al Kelly
 255 Long Lane
 FI 2-2793

VIRGINIA BEACH, VA.

Creative Services
 Robert Gheza
 2022 Atlantic Ave.
 428-0548

RECORD PLATING PLANTS

(Continued from page 150)

Finebilt
 931 North Citrus Ave.
 Hollywood 38, Calif.

King Records
 1540 Brewster
 Cincinnati, Ohio

James G. Lee Record Processing
 145 W. 154th Rd.
 Los Angeles, Calif.

Long Wear Stamper Corp.
 36-41 36th St.
 Long Island City 6, N. Y.

Mastercraft Record Plating
 619 West 54th St.
 New York, N. Y.

MGM Record Mfg. Div.
 120 Arlington Ave.
 Bloomfield, N. J.

Monarch Record Mfg.
 4852 W. Jefferson Blvd.
 Los Angeles, Calif.

Plastic Products
 Memphis, Tenn.

RCA Custom Recordings
 155 East 24th Street
 New York 10, N.Y.

R. M. Record Matrix Co.
 546 N. Fair Oaks
 Pasadena, Calif.

Research Craft Plastics Corp.
 1011 N. Fuller
 Los Angeles, Calif.

Rite Record Productions, Inc.
 3930 Spring Grove Ave.
 Cincinnati, Ohio

Shaw Plating Corp.
 2604 Glendora Ave.
 Cincinnati, Ohio

Ultra Electroforming Co.
 110 Cedar Ave.
 Pitman, N. J.

**We speak
The Kings' English.**

MR. JACK MAGRAW
SCREEN GEMS-COLUMBIA MUSIC LTD
28/29 ST. JAMES'S SQUARE
LONDON S.W. 1, ENGLAND

MR. STIG ANDERSON
SCREEN GEMS
MUSIKFÖRLAG AB
BRAHEGATAN 24
STOCKHOLM, SWEDEN

MR. RUDI REVIL
EDITIONS SCREEN GEMS-COLUMBIA
71 RUE DE PROVENCE
PARIS 9E, FRANCE

MR. SHOICHI KUSANO
SHINKO MUSIC PUBLISHING CO., LTD.
13, 2-CHOME
TSUKASA-CHO, KANDA
CHIYODA-KU
TOKYO, JAPAN

MR. ROLAND KLUGER
EDITIONS SCREEN GEMS
COLUMBIA, S.P.R.L.
13 MADELEINE
BRUSSELS, BELGIUM

**Also Française,
Svensk, Deutsch,
日本語, Italiano,
Español, עִבְרִית,
Portuguese, and
'strian.**

MR. AMADO REQUEIRO
EDICIONES MUSICALES
HISPAVOX SA
CAMPOMANES NUM. 8
MADRID 13, SPAIN

DR. HANS GERIG
PAUL SCHMIDT MUSIKVERLAG GMBH
DRUSUSGASSE 7/11
COLOGNE, GERMANY

MR. FREDERICK REITER
MUNDO MUSICAL S.A.
PUEBLA 286
MEXICO D.F.

MR. LADISLAV SUGAR
EDIZIONI MUSICALI
SCREEN GEMS-COLUMBIA
GALLERIA DEL CORSO 4
MILAN, ITALY

STANKO JEREBIC
MELOGRAF, S.R.L.
PARAGUAY 1583
BUENOS AIRES, ARGENTINA

DR. OPHIRA BAR-BLAN
SUBAR MUSIC PUBLISHING CO., LTD.
RAMATH-HASHARON
1, ANY MA'AMIN STR.
ISRAEL

MR. ROSSINI PINTO
EDITORIA MUNDO MUSICAL LTDA. (BMI)
EDITORIA LATINO AMERICANA
DE MUSICA "ELAM" LTDA. (ASCAP)
CAIXA POSTAL 1940, ZC-00
RIO DE JANEIRO GB, BRAZIL

MR. JACK ARGENT
SCREEN GEMS/COLUMBIA MUSIC PTY. LTD.
UNIVERSAL HOUSE
PELICAN STREET
SYDNEY, AUSTRALIA

WHEREVER YOU ARE, **Screen Gems/Columbia Music** SPEAKS YOUR LANGUAGE!

EMIL LA VIOLA
VICE PRESIDENT IN CHARGE
COLUMBIA PICTURES/SCREEN GEMS TV MUSIC DIVISION
711 FIFTH AVENUE, NEW YORK 10022/(212) PLAZA 1-4400

BMI PUBLISHERS

(Continued from page 162)

Beckie 801 Dupont Bldg Memphis, Tenn.
 Beckwin 57 West 75th, N.Y.C.
 Beda c/o Bess Music, N.Y.C.
 Bedoc 200 W. 57th N.Y.C.
 Bee Cee Dee 507 S. Westgate, L.A., Cal.
 Bee Gee 616 Exchange Bldg, Nashville, Tenn.
 Bee Jay 100 W. 42nd N.Y.C.
 Bee 565 Fifth, N.Y.C.
 Beechmont 1650 Broadway, N.Y.C.
 Beechwood 1750 Vine, Hollywood, Cal.
 Begans 1674 B'way, N.Y.C.
 Begonia 4428 Calle Allagre, Phoenix, Ariz.
 Beige 1010 S. Robertson Blvd., L.A., Cal.
 Be-Jax 920 Walnut St., Phila., Pa.
 Bejo See Lois
 Bel Aire 10 S. La Salle St., Chicago, Ill.
 Bel Star Music P.O. Box 1763 Hollywood 28, Cal.
 Belfry 6363 Sunset Blvd., Hollywood 28, Cal.
 Belhaven 11920 S. Central, L.A., Cal.
 Bellage 15 E. 48th N.Y.C.
 Bellephon 1447 N. Gower Hollywood, Cal.
 Belleville 17 E. 45th St. N.Y.C.
 Bell-Kaye 1619 Broadway, N.Y.C.
 Bell-Tone 36 W. 44th N.Y.C.
 Belmar 565 West End Ave., N.Y.C.
 Belmont 823 S. Wabash Chicago, Ill.
 Belroy 56 W. 45th N.Y.C.
 Ben Hue 241 W. Florence L.A., Cal.
 Benbe 1762 W. 36th L.A., Cal.
 Benbolt 565 Fifth, N.Y.C.
 Benday 345 W. 58th N.Y.C.
 Bendig Suite 514, 6290 Sunset Blvd., Hollywood, Cal. 90028
 Beneficial 9151 Sunset Blvd. Hollywood, Cal.
 Benell 315 W. 47th St., N.Y.C.
 Bengal 2648 W. Grand Detroit, Mich.
 Ben-Ghazi 515 Madison Ave., N.Y.C.
 Benglo 250 East 4th N.Y.C.
 Ben-Lee 15th And Market Phila., Pa.
 Benmax 12202 Herbert L.A., Cal.
 Ben-Meyer 1595 Broadway, N.Y.C.
 Bob Bennett 1600 Chancellor St., Phila. 3, Pa.
 Benral 320 W. 76th, N.Y.C.
 Benson 11956 Riverside Dr., N. Hollywood, Cal.
 Benton 1010 S. Robertson Blvd., L.A., Cal.
 Benway 11815 Magnolia #1 N. Hollywood, Cal.
 E.M. 6117 Liebig Ave., N.Y.C.
 Bercon 6223 Selma Hollywood, Cal.
 Berkely 1650 Broadway N.Y.C.
 Berkshire 756 Seventh N.Y.C.
 Bernardo Belmont Plaza Lexington & 49th St., N.Y.C.
 Bernwood 1650 Broadway, N.Y.C.
 Berry 630 Fifth, N.Y.C.
 Bertgil 229 Park Ave. S. N.Y.C.
 Bertuccini 6221 Grays Phila., Pa.
 Beta 242 North Canon Dr. Beverly Hills, Ca.
 Betalbin 729 Seventh Ave. N.Y.C.
 Bette 200 W. 49th N.Y.C.
 Bettina 222 W. Rittenhouse Phila. Pa.
 Bibo 1619 Broadway, N.Y.C.
 Biernat & Dietz 19600 Rogge Ave. Detroit 3a, Mich.

Big Bopper Box 849 Beaumont, Texas
 Big Chief 618 Stahlman Bldg. Nashville 3, Tenn.
 Big "D" Music, Sportatorium, Dallas, Texas
 Big Jay Swings 2127 E. 110th St. L.A., Cal.
 Big Pack 37 W. 57th N.Y.C.
 Big Seven 1841 Broadway, N.Y.C.
 Big Star 4432 Prairie Chicago, Ill.
 Bigtop 1619 B'way, N.Y.C.
 Big Wedge Music 3101 Fleet St. Baltimore, Md.
 Big World 4601 Afton Dallas, Texas
 Bigareff 10 Columbus Circle, N.Y.C.
 Big-Ben Box 1571 San Francisco, Cal.
 Big Mack 12867 Livernoise, Detroit
 Billen 530 Carlton House Pittsburgh, Pa.
 Billie Fran 5219 Madella, Ft. Worth, Texas
 Billy, Jr. 1573 Sunset Plaza Dr. L.A., Cal.
 Bilya-Bah 130 South Breed L.A., Cal.
 Bimbo 5627 Klump Ave. N. Hollywood, Cal.
 Bingo 1774 North La Brea Hollywood, Cal.
 Birchdale 3007 Birchdale Dr. Memphis, Tenn.
 Birdsong 592 Farnsworth Detroit, Mich.
 Bishop 1650 Broadway, N.Y.C.
 Bittersweet, 70 Winding Wood Rd. South. Port Chester, N.Y.
 Blackburn 931 Alfred, L.A., Cal.
 Blackhawk 1800 N. Argyle Hollywood, Cal.
 Black Rabbit, 2221 W. Olive, Burbank, Cal.
 Blackthorn 7667 Fountain Hollywood, Cal.
 Blackwood 1650 B'way, N.Y.C.
 Blacron 10323 Santa Monica Blvd. L.A., Cal.
 Blair's 1906 Clemente, Detroit, Mich.
 Blanchard 1570 N. Gower Hollywood, Cal.
 Blane 949 No. Beverly Dr. Beverly Hills, Cal.
 Blanton 18459 Ryan Rd., Detroit, Mich.
 Blazon Box 35, Nashville, Tenn.
 Blecker 319 E. 8th St. N.Y.C.
 Blend 252 W. 149th St. N.Y.C.
 Bloor 1549 N. Vine Hollywood, Cal.
 Blue Bird 3901 E. Broadway, N. Little Rock, Ark. 72114
 Blue Blood 1780 Broadway, N.Y.C.
 Blue Book P.O. Box 2387 Bakersfield, Cal. 93302
 Blue Grass 157 W. 57th N.Y.C.
 Blue Indigo 3330 Barham Blvd. Hollywood, Cal.
 Blue Ridge 1540 Brewster, Cincinnati, O.
 Blue River 6223 Selma Hollywood 28, Cal.
 Blues Beat Box 464, N.Y.C.
 Bluff City 157 W. 57th N.Y.C.
 Bob & Jerry c/o Bob Feldman 165 End Ave., Brooklyn 35, N.Y.
 Boban 120 W. 57th N.Y.C.
 Bobber 4837 Mitchell Detroit, Mich.
 Bobby 1650 Broadway, N.Y.C.
 Bob-Dan 271 125th N.Y.C.
 Bobe Wes 4542 Live Oak, Mesquite, Tex.
 Bob-Len c/o Robt. Schwaid 3 E 57th St., N.Y.C. 10022
 Boblo 2056 Calvert Detroit, Mich.
 Bobrich 39 W. 60th N.Y.C.
 Bobwhite 6046 H'wood Blvd H'wood, Cal.
 Bodean 6720 S.W. 57th Terrace Miami, Fla.
 Boelsen, 608 Fifth Ave, N.Y.C.

Boka 1631 Broadway, N.Y.C.
 J. J. Bolen 1060 Crenshaw Blvd., L.A., Cal.
 Bolens 1405 E. Sixth St. Cleveland, O.
 Bolmin 1236-19th Ave., East Seattle, Wash.
 Bon Bon 59 Monroe St., Chicago 3, Ill.
 Bonatemp 1810 Dryades New Orleans, La.
 Bonnie Dee 920 3rd Ave. Seattle, Wash.
 Booker Ervin 480 W. Broadway, N.Y.C.
 Boras 1619 Broadway, N.Y.C.
 Bortoli 217 E. 115th St., Chicago, Ill.
 Boss 25 Somerset Newark, N.J.
 Bostill 3705 Palm Street St. Louis, Mo.
 Boulevard 46 E. Walton St., Chicago, Ill.
 Bourbon Street 2939 Serantine New Orleans, La.
 Boxer Music Co. c/o Blair House 445 N. Rossmore Ave. Hollywood 4, Cal.
 Boylston 1 Boylston Pl. Boston, Mass.
 Bradley 1433 Citadel Dr. N.E., Atlanta, Ga.
 Brad-Mar 6700 Laurel Grove, No. Hollywood, Cal.
 Brakenbury 1619 Broadway, N.Y.C.
 Bramble 913 17 Ave S., Nashville, Tenn.
 Bramco 6410 Madison Rd., Cincinnati, O.
 Brand 2 West 45th St., N.Y.C.
 Branix 710 Burdette, New Orleans, La.
 Branna 6087 Sunset, Hollywood, Cal.
 Branstro 56 W. 45, N.Y.C.
 Branwin 1619 Broadway, N.Y.C.
 Brasilero 2 W. 45th St., N.Y.C.
 Bre-Ho 408 W. 57th, N.Y.C.
 Brenda 1501 Broadway, N.Y.C.
 Bren-Lue Box 18882, Los Angeles, Cal.
 Brenner 1619 Broadway, N.Y.C.
 Brent 2 W. 45th, N.Y.C.
 Brentwood 3650 Watseka, L.A., Cal.
 Brennaham 6606 Sunset, Hollywood, Cal.
 Brewster 745 Fifth, N.Y.C.
 Brian 7611 S. Normal Blvd., Chicago
 Brianbert 4862 Parker St. Detroit
 Briarcliff 6365 Selma, Hollywood, Cal.
 Bric 801 16 Ave S., Nashville, Tenn.
 Brigaro 250 W. 57 St., N.Y.C.
 Bright Star 605 W. 156 St., N.Y.C.
 Bright-Tunes Brooklyn 17, N.Y.
 Brilliant 1438 N. Gower, Hollywood, Cal.
 Brindise 2500 N. Campbell, Chicago, Ill.
 Brio 6515 Sunset Blvd., Hollywood, Cal.
 Brittain 1619 Broadway, N.Y.C.
 Britton 1440 Broadway, N.Y.C.
 Broadset 1650 Broadway, N.Y.C.
 Broadstreet 1616 Western Sav. Fund Bldg., Broad & Chestnut St., Phila., Pa.
 Brockman-Schenck 1650 Broadway, N.Y.C.
 Brohun 437 Wilkins, Detroit, Mich.
 Brompton 50 Central Park W., N.Y.C.
 Bronjo Music Publishing Company, Inc. 89 West 60th St., New York 23, N.Y.
 Brookdale 756 Seventh Ave., N.Y.C.
 Brookville 345 W. 58th, N.Y.C.
 Alexander Provide, 120 W. 57th, N.Y.C.
 Brown and Crane 5113 St. Clair Cleveland, O.
 Brown & Green 9022 12th, Detroit, Mich.
 Brown 1650 Broadway, N.Y.C.
 Robert B. Brown 2320 Stanley Hills Dr., Hollywood, Cal.
 T. Brown & Sons 253 Merritts Ave., Atlanta, Ga.
 Brown-Regan 6356 De Longpre, Hollywood, Cal.
 Brownstone 417 E. 50th St., N.Y.C.
 Brownwood 1631 Broadway, N.Y.C.
 Bruder 625 Madison Ave., N.Y.C.
 Bruin 322 W. 48th, N.Y.C.
 Bruno & Son 1650 Broadway, N.Y.C.
 Brunswick 2334 S. Holt, L.A., Cal.
 Bryant House 3040 S. La Brea, L.A., Cal.
 Bryden 157 W. 57th St., N.Y.C.
 Brynor 392 Central Park W., N.Y.C.
 Al Bubis 8462 Sunset Blvd., L.A., Cal.
 Ruckeye 204 W. 8th St., Cincinnati, O.
 Buckhorn 1309 Hildreth Nashville, Tenn.
 Ruddy 135 W. 125th St., N.Y.C.
 Rudor P.O. Box 1385, Beverly Hills, Cal.
 Bugle Boy 185 N. Wabash, Chicago, Ill.
 Bumarack 1023 N. 67th, Phila., Pa.
 Runa 1707 Division, Nashville, Tenn.
 Bundle 1650 B'way, N.Y.C.
 Burden 201 W. 49th, N.Y.C.
 Burdette 6515 Sunset Blvd., Hollywood, Cal.
 Burdette 971 Thomas St., Seattle, Wash. 98109
 Burke-Fader 6727 First Ave. South. St. Petersburg, Fla.
 Johnny Burnette 6223 Selma, Hollywood, Cal.
 Burrows 284 Newbury, Boston, Mass.
 Busim 1422 E. 43 St., L.A., Cal.
 Buttercup 2817 Vanderbilt, Nashville, Tenn.
 Buttons 4922 Santa Monica, Hollywood, Cal.
 By-Nash 115 1/2 Third Ave., N. Nashville, Tenn.
 Ethel Byrd 205 W. 84th, N.Y.C.
 Byron 8330 W. Third, L.A., Cal.

Camrick 156 W. 44th, N.Y.C.
 Cana 1707 Division, Nashville, Tenn.
 Canard 1710 North La Brea, Hollywood
 Candid 110 MacDougal, N.Y.C.
 Candle-Glo 1124 Bennie Dillon Bldg., Nashville, Tenn.
 Candle-Light 4177 4th Ave., L.A., Cal.
 Canford 1619 Broadway, N.Y.C.
 Canjoco 511 Troy Drive, San Jose 28, Cal.
 Cannon Point 1841 Broadway, N.Y.C.
 Cannon 9837 Tabor, L.A., Cal.
 Cannon 222 Rittenhouse Sq. W., Phila., Pa.
 Canoga 20955 Elkwood, Canoga Pk., Cal.
 Cantata 235 W. 46th, N.Y.C.
 Canterbury 344 S. Serrano, L.A., Cal.
 Cantina 73 Newbury, Boston, Mass.
 Canuck 6605 Hollywood Blvd., Hollywood, Cal.
 Canyon 1501 Broadway, N.Y.C.
 Cape Ann 801 17th Ave. S., Nashville, Tenn.
 Capesana 2136 Laurel Canyon Blvd., Hollywood
 Capitol City Box 8061 Nashville, Tenn.
 Capizzi 618 S. Glenwood Pl., Burbank, Cal.
 Capri 145 W. 45th St., N.Y.C.
 Caprice 1104 N. Military, Detroit 9, Mich.
 Capricorn 1031 N. Lima St., Burbank, Cal.
 Car-Ano 10558 Lauriston Ave., W. Los Angeles, Cal.
 Cardinal 1587 Broadway, N.Y.C.
 Car-Gor 2207 N. Broad St., Phila. Pa.
 Carlot 6758 Colgate, L.A., Cal.
 Carlson 413 Race, Cincinnati, O.
 Carmel c/o Stanley Goldstein 122 E. 42nd St., N.Y.C.
 Carnegie 60 W. 68th, N.Y.C.
 Carney 2203 Spruce, Phila., Pa.
 Carolintone 1040 N. Las Palmas, Hollywood
 Carolyn 506 E. 35th, L.A., Cal.
 Ed Carrell 7123 Vivian, Dallas, Texas
 Carrowtown 6605 Hollywood Blvd., Hollywood
 Carsey 1560 N. La Brea, Hollywood
 Carson-Carrier 1608 N. Central, Knoxville, Tenn.
 Carte 6515 Sunset, Hollywood
 Carter 6000 Sunset, Hollywood
 Cascade 333 Sixth, N.Y.C.
 Johnny Cash 1619 Broadway, N.Y.C.
 Cash Songs 1065 E. Vernon Ave., L.A., Cal.
 Castle 6087 Sunset Blvd., Hollywood
 Catalina 1650 Broadway, N.Y.C.
 Cathy 9500 Goebel, L.A., Cal.
 Cattleman 200 W. 57th St., N.Y.C.
 Causeway 1441 Broadway, N.Y.C.
 Cave 817 16 Ave S., Nashville, Tenn.
 Cecere P.O. Box 9429, Rochester, N.Y. 14604
 Cedarlane 818 Kendall Drive, Nashville, Tenn.
 Cedarwood 815 16th Ave. S., Nashville, Tenn.
 Cee 1318 Poplar, Memphis, Tenn.
 Celann, 119 N. 9th, Minneapolis, Minn.
 Celebrity 6758 Colgate, L.A., Cal.
 Celebs 8848 Sunset, Hollywood
 Celeste 13209 Southview, Cleveland, O.
 Centella 6425 Hollywood Blvd., Hollywood
 Central 1483 N. Vine, Hollywood
 Century Songs 1483 N. Vine, Hollywood
 Ceola 510 N. 34th, Phila., Pa.
 Cepha 2146 West View, L.A., Cal.
 Cevet 130 Newark, Jersey City, N.J.
 Chador 4512 Chouteau, St. Louis, Mo.
 Challenge 157 57th, N.Y.C.
 Cham 565 Fifth, N.Y.C.
 Champion 322 W. 48, N.Y.C.
 Champlain 836 E. 63rd, Chicago, Ill.
 Chance 4324 Fourth, L.A., Cal.
 Chancel 1151 S. Broadway, L.A., Cal.
 Chandler 252 Main, Ansonia, Conn.
 Chant 11358 Asbury Park, Detroit, Mich.
 Chantex 10 Columbus Circle, N.Y.C.
 Chanto 1608 N. Argyle, Hollywood, Cal.
 Chardon 1650 B'way, N.Y.C.
 Charwood 1650 B'way, N.Y.C.
 Charchris 11937 Strathern, Hollywood, Cal.
 Charill 4461 Fulton, Sherman Oaks, Cal.
 Chariot 14 Main, Monsey, N.Y.
 Charkel 235 Brooklyn, Brooklyn, N.Y.
 Charlee 77 Crown, Milton 87, Mass.
 Charlene 493 Vista Drive, Falls Church, Va.
 Charles Bell 923 Adelaide, Pittsburgh 19, Pa.
 Charles Street 22 Charles N.Y.C.
 Charlested 7 John, Elmont, N.Y.
 Charleston 450 W. 24th, N.Y.C.
 Charlotte 307 E. 44th, N.Y.C.
 Charm 1619 Broad., N.Y.C.
 *Charran 7 Moreland, Roxbury, Mass.
 Charrich 545 Fifth, N.Y.C.
 Chart 1520 Archer Road, Bronx 62, N.Y.
 Chartbuster 1745 K St. N.W. Wash., D.C.
 Chas-Bon 3519 Kendrick Memphis, Tenn.
 Chase 8501 Remick, Sun Valley, Cal.
 Chateau 200 W. 57th, N.Y.C.
 Chat-Tone 6538 S. Evans, Chicago, Ill.
 Chaz-Mar 331 W. 51st, N.Y.C.
 Frederick C. Cheatham 1108 N. 27, Richmond, Va.
 Check Mark 1615 Bren Mar Drive, Alexandria, Va.
 Check 50 West 77th, N.Y.C.
 Check-Colt 1405 Locust, Phila., Pa.
 Checker 155 E. 76th, N.Y.C.
 Cheers 404 N. Roxbury Dr., Beverly Hills, Cal.
 Chelsea 1650 Broadway, N.Y.C.
 Cheltenham 212 N. 12th, Phila., Pa.
 Chelwood 48 W. 48th, N.Y.C.
 Chemistry 6330 Lindenhurst, L.A., Cal.
 Chenar 2914 N. Cicero, Chicago, Ill.
 Cherie 3621 Heath Lane, Mesquite, Texas
 Cherio 400 Madison, N.Y.C.
 Cher-Lo 701 Seventh, N.Y.C.
 Cherritown 1607 El Centro, Hollywood, Cal.
 Cherry Hill 6 Darby Lane, Cherry Hill, N.J.
 Cherry Valley 1302 Sigel, Phila., Pa.
 Jack Chertok Television 780 N. Gower St. Los Angeles
 *Chervain 1538 Senate, New Orleans, La.
 Cheryl 305 E. Mount Eden, Bronx 57, N.Y.
 David Cheskin 209 Sterling, Buffalo 16, N.Y.
 Albert Chesrow, 35 W. Jackson Blvd., Chicago
 Chevis 2120 S. Michigan, Chicago
 Chez 31 W. 71st, N.Y.C.
 Chicago Lake Villa, Ill.
 Chickadee 1912 Western, S. Greensburg, Pa.
 Chickasaw Music, Inc. P.O. Box 8332 Cross-town Station, Memphis, Tenn.
 Chicory 250 W 57, N.Y.C.
 Chicory 222 Rittenhouse Sq. W., Phila., Pa.
 Chontay 35 Ronald, Hicksville, N.Y.
 Chords Music Publishers, 160 W. 46th N.Y.C.

SOME GREAT COPYRIGHTS . . .

"I Will Wait For You"
 "Watch What Happens"
 "Have You Looked Into Your Heart"
 "Goin' Out of My Head"
 "Need You"
 "Diamond Head"
 "Blue Velvet"
 "Canadian Sunset"
 "Apples and Bananas"
 "I Want A Girl"
 "When My Baby Smiles At Me"
 "Row Row Row"
 "Blue Christmas"
 "Shutters and Boards"
 "Turn Back The Hands of Time"
 "You're The Reason"
 "Ko Ko Mo"
 "Pistol Packin' Mama"
 "Just The Way You Are"
 "The Wayward Wind"
 "Cinco Robles"
 "Suddenly There's A Valley"
 "Chanson D'Amour"
 "Wonderful Time Up There"
 "That's How Much I Love You"
 "To Know Him Is To Love Him"
 . . . and many others

BIBO MUSIC PUBLISHERS, INC. VOGUE MUSIC, INC.

New York Office
 Frank Abramson
 1619 Broadway
 New York, N.Y. 10019
 Lt-1-3197

California Office
 Paul Weirick
 2444 Wilshire Blvd.
 Santa Monica, Calif.
 Upton 0-7076

C

C And D 200 W. 57th, N.Y.C.
 C.A.M.-U.S.A. 370 Lexington Ave., N.Y.C.
 C. B. 1631 Broadway, N.Y.C.
 CCC 8136 Wortser N. Hollywood, Cal.
 C-11 9003 Dayton Way, Beverly Hills, Cal.
 C. J. 4803 S. Indiana, Chicago, Ill.
 Cable 744 Broad, Newark, N.J.
 Cactus Box 8626, L.A., Cal.
 Cadet 5757 Franklin, Hollywood, Cal.
 Cafe 1022 N. Croft, L.A., Cal.
 Cafun Box 1287, Shreveport, La.
 Cal 514 Franklin, Nashville, Tenn.
 Calaban 7966 Beverly Blvd., L.A., Cal.
 Calabar 4779 Whittier Blvd., L.A., Cal.
 Calagno 106 Southard Ave. Rockville Center, N. Y.
 Caldwell 2034 Ridge, Phila., Pa.
 Cal-Lee 3839 Sawtelle Blvd., L.A., Cal.
 Calliope 75 E. 55th, N.Y.C.
 Calumet 823 S. Wabash, Chicago
 Calvin 2 W. 45th, N.Y.C.
 Calyork 119 W. 57th, N.Y.C.
 Camad 79 W. Monroe, Chicago, Ill.
 Camarillo 6087 Sunset Blvd., Hollywood, Cal.
 Cambria 5224 Teesdale, N. Hollywood, Cal.
 Cambridge 565 Fifth, N.Y.C.
 Camden 6087 Sunset, Hollywood
 Camel 1697 Broadway, N.Y.C.
 Cameo-Parkway 1405 Locust, Phila.
 Camera 540 W. 123rd, N.Y.C.
 Camille 11314 1/2 S. Main, L.A., Cal.
 Camino 8321 Beverly Blvd, Los Angeles
 Camp And Canyon 1616 N. Argyle, Hollywood

(Continued on page 16)

1966
 a vintage year!



1967—
 INTOXICATING

23 CHART BREAKERS IN FIRST 6 MONTHS

THESE SONGS

"STANDING IN THE SHADOWS OF LOVE"
 "I'VE PASSED THIS WAY BEFORE"
 "YOU KEEP ME HANGIN' ON"
 "(I KNOW) I'M LOSING YOU"
 "A PLACE IN THE SUN"
 "IT TAKES TWO"
 "THE HUNTER GETS CAPTURED BY THE GAME"
 "LOVE IS HERE AND NOW YOU'RE GONE"
 "PUCKER UP BUTTERCUP"
 "THE LOVE I SAW IN YOU WAS JUST A MIRAGE"
 "JIMMY MACK"
 "TRAVELIN' MAN"
 "BERNADETTE"
 "GONNA GIVE HER ALL THE LOVE I'VE GOT"
 "IT'S SO HARD BEING A LOSER"
 "THE HAPPENING"
 "GOT TO HAVE YOU BACK"
 "ALL I NEED"
 "JUST LOOK WHAT YOU'VE DONE"
 "AIN'T NO MOUNTAIN HIGH ENOUGH"
 "7 ROOMS OF GLOOM"
 "I WAS MADE TO LOVE HER"
 "MORE LOVE"

THESE ARTISTS

FOUR TOPS
 JIMMY RUFFIN
 SUPREMES
 TEMPTATIONS
 STEVIE WONDER
 MARVIN GAYE & KIM WESTON
 MARVELETTES
 SUPREMES
 JR. WALKER & THE ALL STARS
 MIRACLES
 MARTHA & THE VANDELLAS
 STEVIE WONDER
 FOUR TOPS
 JIMMY RUFFIN
 CONTOURS
 SUPREMES
 ISLEY BROTHERS
 TEMPTATIONS
 BRENDA HOLLOWAY
 MARVIN GAYE & TAMMI TERRELL
 FOUR TOPS
 STEVIE WONDER
 SMOKEY ROBINSON & THE MIRACLES

THESE WRITERS

HOLLAND, DOZIER, HOLLAND
 JAMES DEAN & WM. WITHERSPOON
 HOLLAND, DOZIER, HOLLAND
 HOLLAND, WHITFIELD, GRANT
 DONALD MILLER, BRIAN WELLS
 WM. STEVENSON, SYLVIA MOY
 WILLIAM ROBINSON
 HOLLAND, DOZIER, HOLLAND
 H. FUQUA, D. COGGINS, J. BRISTOL
 W. ROBINSON, M. TARPLIN
 HOLLAND, DOZIER, HOLLAND
 BRIAN WELLS, RONALD MILLER
 HOLLAND, DOZIER, HOLLAND
 N. WHITFIELD, BARRETT STRONG
 J. DEAN, W. WITHERSPOON,
 S. McMULLEN
 HOLLAND, DOZIER, HOLLAND, DEVOL
 I. HUNTER, L. WARE, S. BOWDEN
 E. HOLLAND, F. WILSON,
 R. DEAN TAYLOR
 F. WILSON, R. DEAN TAYLOR
 NICKOLAS ASHFORD, VALERIE SIMPSON
 HOLLAND, DOZIER, HOLLAND
 H. COSBY, S. WONDER, L. HARDAWAY,
 S. MOY
 WILLIAM ROBINSON

JOBETE MUSIC COMPANY, INC.

2648 W. Grand Blvd., Detroit 8, Mich.

BMI PUBLISHERS

(Continued from page 164)

Beckie 80
Beckwin 1
Beda c/o
Bedoc 200
Bee Cee 1
Bee Gee 6
Bee Jay 1
Bee 565 F
Beechmon
Beechwood
Begans 14
Begonia 4
Beige 101
Be-Jax 9:
Bejo See
Bel Aire
Bel Star
Bel Cal.
Belfry 63
Belhaven
Bellage 1:
Bellerpho
Belleville
Bell-Kaye
Bell-Tone
Belmar 5
Belmont
Belroy 54
Ben Hue
Benbe 17
Benbolt 1
Benday 1:
Bendig 1:
wood, 1
Beneficia
Benell 3
Bengal 2
Ben-Gha
Benglo 2
Ben-Lee
Benmax
Ben-Mey
Bob Ben
Benral 3
Benson 1
Benton 1
Benway
E.M. 61
Bercon
Berkely
Berkshir
Bernard
N.Y.C
Bernwo
Berry 6
Bertgil
Bertucci
Beta 24
Betaltbr
Bette 2
Bettina
Bibo 16
Biernat
Mich.

Chrissay 1697 B'way, N.Y.C.
Chrismarc c/o Sonny Bono 7715 Sunset Blvd., L.A. 46, Cal.
Chuck Wagon 730 Fifth, N.Y.C.
Chuckaluck 324 S. Beverly Dr., Beverly Hills, Cal.
Chu-Fin 1808 West End Bldg., Nashville, Tenn.
Edwin T. Church 8029 Willon Glen Rd., Hollywood
Cigma Box 1202 Nashville, Tenn.
Cimarron 206 W. Walnut, Rogers, Ark.
Cindy 1650 Broadway, N.Y.C.
Cini 206 S. 13th, Phila., Pa.
Cireco 855 Treat, San Francisco
Citadel 8731 Sunset, Hollywood
City, 157 W. 57th, N.Y.C.
Claiborne Suite 615, 930 F St., N.W., Wash., D.C.
Clairwell 7319 S. Vernon, Chicago
Clamike 850 Seventh Ave, N.Y.C.
Clarama 200 W. 57th, N.Y.C.
Claridge 1841 Broadway, N.Y.C.
Clarity Box 66591 Houston 6, Texas
Clarose 1475 Broadway, N.Y.C.
Clasky 1510 S. Edris Drive, L.A., Cal.
Class 5707 Tenth, L.A., Cal.
Classic 521 Ave. N.Y.C.
Clayton 12020 Hoffman, Studio City, Cal.
Clef 1028 N. Western, Hollywood
Jack Clement 639 Madison, Memphis, Tenn.
Clifton 2 W. 45th, N.Y.C.
Climax 113 W. 57th, N.Y.C.
Clipper 500 Chesterfield, Nashville, Tenn.
Clock 946 W. Agarita, San Antonio, Texas
Clorvel 12020 Hoffman St., Studio City, Cal.
Clover 27 Spring, Elizabeth, N.J.
Club Miami P.O. Box 513, Middletown, O. 45047
Clydene 726 16 Ave S Nashville, Tenn.
Coda 19300 Ormiston, Cleveland, O.
Coad 1619 Broadway, N.Y.C.
Colby 250 E. 51st, N.Y.C.
Colca 7601 S. Stewart, Chicago
M. M. Cole, 823 S. Wabash, Chicago
Coleman-Secon 200 W. 57th, N.Y.C.
Colfranc 16 W. 61, N.Y.C.
Coliseum 1619 Broadway, N.Y.C.
Collins 1631 Broadway, N.Y.C.
Collwill 1819 Broadway, N.Y.C.
Colo 7515 W. Irving Park Road, Chicago
Colonial, 163 W. 23rd, N.Y.C.
Colorturnes 1041 N. Las Palmas, Hollywood
Colpert 1650 Broadway, N.Y.C.
Columbia Music 799 Seventh, N.Y.C.
Column 150 W. 55th, N.Y.C.
Combine 812-17th Ave. S., Nashville, Tenn. 37203
Combo 506 N. Virgil Ave., L.A., Cal.
Comma 18492 Indian, Detroit, Mich.
Command 36 W. 44th St., N.Y.C.
Commercial 565 Fifth, N.Y.C.
Concord 370 W. 35th, N.Y.C.
Condado 5812 Lemp, N. Hollywood

Congo 9528 S. Prairie, Chicago
Conley 1841 Broadway, N.Y.C.
Conmar 420-A Broadway, Nashville, Tenn.
Congressional 474 Ena Rd., Honolulu
Conmuse 1750 N. Vine, Hollywood
Mike Conner 1048 N. Carol, L.A., Cal.
Conrad 1449 S. Michigan, Chicago
Conroy 155 W. 46th, N.Y.C.
Constant 756 Seventh, N.Y.C.
Constellation 1619 Broadway, N.Y.C.
Conte 710 N. Maple Dr. Beverly Hills, Cal.
Contempo 50 W. 57th, N.Y.C.
Contemporary 8481 Melrose, L.A., Cal.
Continent 1651 Cosmo St., Hollywood
Continental 500 Fifth, N.Y.C.
Contour 150 W. 55th, N.Y.C.
Con-Trans 1650 Broadway, N.Y.C.
Contrast 11351 Burnham, L.A., Cal.
Cooga, 9033 Wilshire, Beverly Hills, Cal., 205 West End, N.Y.C.
Cool 1323 S. Michigan, Chicago
Co-Op Box 631, Elizabeth, N.Y.
Cooperative 21 W. Illinois St., Chicago
Co-Ordinated 160 W. 46th, N.Y.C.
Copar-Forrest, 1619 Broadway, N.Y.C.
Copley 1 Court, Boston, Mass.
Copper Penny c/o Howard B. Wolf, 6331 Hollywood Blvd., Suite 701, Hollywood, Cal.
Cord 2403 Hubbard, Brooklyn, N.Y.
Cordia 54 W. Randolph St., Chicago
Cordial 1926 N. St. Andrews Pl., Hollywood
Corelli-Jacobs 723 Seventh, N.Y.C.
Corette Box 4222, Houston, Texas
Corinthian 1697 Broadway, N.Y.C.
Cornball 1650 Broadway, N.Y.C.
Cornerstone 6920 Sunset Blvd., L.A., Cal.
Corona 1650 Broadway, N.Y.C.
Coronation 1619 Broadway, N.Y.C.
Cory-Richard 119 W. 57, N.Y.C.
Cotillion 1841 Broadway, N.Y.C.
Cotter 6201 Santa Monica, Hollywood
Countessa 409 S. Alandeale Ave., L.A., Cal.
Country, 20 E. Jackson Blvd., Chicago
Country 2 West 45th, N.Y.C.
Country Gentlemen 1631 B'way, N.Y.C.
Courien 119 W. 57th, N.Y.C.
Craft 1650 Broadway, N.Y.C.
Cragmoor 1472 Broadway, N.Y.C.
Cramart 1609 Hawkins, Nashville, Tenn.
Crane 1826 Jewett Drive, L.A., Cal.
Cranford 356 W. 40th N.Y.C.
Cranstone 4548 Irvine N. Hollywood, Cal.
Cravat 6124 Selma Ave, Hollywood
Creation 638 N. Westmount, Hollywood
Crep 1697 Broadway, N.Y.C.
Crestline 1587 Broadway, N.Y.C.
Crestwood 1650 Broadway, N.Y.C.
Cricket 9110 Sunset, L.A., Cal.
Cris Cross 659 Tenth, N.Y.C.
Cris 2680 Rochester, Detroit, Mich.
Crisstan 5215 De Longpre, Hollywood
Cristobel Carlton House Hotel, Pittsburgh
Al Crocker 1817 Brownell, Kansas City, Mo.
Cross Country 1014 Ellsworth St., Phila., Pa.
Crossbow 285 Madison, N.Y.C.

Crossroads 56 Ferry, Newark, N.Y.
Crosstown 157 W. 57th, N.Y.C.
Crow 100 S. Van Ness, L.A., Cal.
Crystal 1719 Poplar Memphis, Tenn.
Cuban 1733 Broadway, N.Y.C.
Cupid 1152 S. Hobart, L.A., Cal.
Curtain (BMI Canada)
Curtum 2203 Spruce, Phila., Pa.
Cynthia 1631 Broadway, N.Y.C.
Cyril 200 W. 57th, N.Y.C.

D

D And D 110 West 55th, N.Y.C.
Dadago 2827 Vineyard St. Los Angeles
Daisy's 135 W. 125th, N.Y.C.
Dak 200 W. 54th, N.Y.C.
Dakota 15 Brookwood, Wyandanch L.I., N.Y.
Dalton 3745 S. Dalton, L.A., Cal.
Damic 1650 B'way, N.Y.C.
Damita 56 W. 45th, N.Y.C.
Danbill Box 11152, Fort Worth, Texas
Danbury 2 West 45th, N.Y.C.
Danby 1619 Broadway, N.Y.C.
Dandelion 1919 N. Broad St., Phila, Pa.
Dan-John 1697 Broadway, N.Y.C.
Dantler's 2049 1/2 Burnside, L.A., Cal.
Dara 1619 Broadway, N.Y.C.
Darban 6700 Laurel Grove, N. Hollywood
Darrow N. E. Corner 19th And Ritner, Phila.
Dart 1453 N. Vine, Hollywood
Dartmoor 244 W. 48 St, N.Y.C.
Dark Horse 3009 Keeling Ave., Nashville, Tenn.
Dasher 65 W. 129th, N.Y.C.
Da-Tan 2726 S. Orange Drive, L.A., Cal.
Davcor Box 1183, Newburgh, N.Y.
David Music, Inc. 1650 Broadway, N.Y.C.
Davidson 101 W. 55th, N.Y.C.
Davilene 161 W. 54th St, N.Y.C.
Dale Davis P.O. Box 4273, Cleveland, Ohio 44132
Jimmie Davis 843 Delaware St., Shreveport, La.
Darl 111 W. 57 St, N.Y.C.
Davon 2101 Ivar, H'wood, Cal.
Davon Catalog 6290 Sunset Blvd., Hollywood, Calif.
Dayfield 3563 Jasmine, L.A., Cal.
Daylight Box 336 Burbank, Cal.
Dayroll Box 397, N.Y.C.
Daywin 250 N. Canon, Beverly Hills, Cal.
Dazzler 301 Academy, Newark, N.J.
De Vorzon 1606 N. Argyle, Hollywood
Deal 701 Seventh, N.Y.C.
Dearborn 54 W. Randolph, Chicago
Deaville 1650 Broadway, N.Y.C.
Deb 360 N. Michigan, Chicago
Deb-Ann 4041 N. 12th St., Phila., Pa.
Debin 315 W. 57th, N.Y.C.
Debra 4625 N. 50th Drive, Phoenix, Ariz.
Debron 1619 Broadway, N.Y.C.
Debrossard, 856 E. 95 St. Cleveland
Debutante 833 N. Cole, Hollywood
December 1697 Broadway, N.Y.C.

Decker 4123 Cole, Dallas, Texas
Dee Dee 318 78th, N.Y.C.
Dee 31 N. 13th, Allentown, Pa.
Deejay 227 1/2 S. Glenwood Pl., Burbank, Ca
Dee-La-Rue Corp. 1441 Broadway, N.Y.C.
Deep South Box 342, Birmingham, Ala.
Degree 2580 West Pico, L.A., Cal.
Deland 9110 Sunset Blvd., L.A., Cal.
Delanieur 2106 Fifth, L.A., Cal. 90016
Delgray Int. 1584 E. 31 St., Cleveland, (44114
Delhi 124 E. 4th, Cincinnati, O.
Delilah 6087 Sunset Blvd H'wood, Cal.
Delisse Publishing 514 Second Ave. So., Nashville
Delmar 8339 Loomis, Chicago
Delstone 1721 Broadway, N.Y.C.
Deluxe 3103 S. Delton, L.A., Cal.
Demar 1674 Broadway, N.Y.C.
Demeter 128 E. 41st, N.Y.C.
Den 930 F. Street, N.W., Washington, D.C.
Dennis 2435 South Reese, Phila., Pa.
Densue 5539 Sunset, Hollywood
Derry 240 Stockton, San Francisco
Desert Palms 3703 N. 7th St., Phoenix, Ariz
De-Shaf 2615 Nebraska, Detroit, Mich.
Desiard 250 W. 57th, N.Y.C.
Desmond 240 Stockton San Francisco
Devereaux 408 W. 57th, N.Y.C.
Devon 10 Columbus Circle, N.Y.C.
Devonshire 7000 Alceve, N. Hollywood
Dew 2020 Ridge, Phila., Pa.
Al Dexter General Delivery, Denton, Texas
Diadem 1619 Broadway, N.Y.C.
Dialogue 1619 Broadway, N.Y.C.
Diane 6223 Selma, Hollywood
Diary 166 Dreger Road, Memphis, Tenn.
Harold H. Dickinson 490 San Vincente Blvd. L.A., Cal.
Diddy Bop 427 Laurens St. Balt.
Diedre 951 E. 47th, Chicago
Dig 2077 S. Harvard Blvd., L.A., Cal.
Dijon (see Donna)
Dinah 1631 Broadway, N.Y.C.
Dinero 1535 N. Serrano, Hollywood
Ding Dong 1619 Broadway, N.Y.C.
Dinny 1619 Broadway, N.Y.C.
Dino 526 W. Lehigh, Phila., Pa.
Diplomacy 9229 Sunset Blvd., L.A., Cal.
Dirk c/o Russell Steagall 4012 Stone Canyon Ave., Sherman Oaks, Cal.
Discovery 203 N. Wabash Ave., Chicago, Ill
Disk 92 E. 19th, N.Y.C.
Distant 7514 H'wood Blvd., H'wood, Calif.
Diva 165 E. Erie, Chicago
Dixiana 888 Pearl St., Beaumont, Texas
Dixsil 6425 Hollywood Blvd., Hollywood
Docborg 40 W. 55, N.Y.C.
Doer 1650 Broadway, N.Y.C.
Doefeld 345 W. 58th, N.Y.C.
Dollar 333 E. 34th, N.Y.C.
Dolly Bee 1951 Holmby, L.A., Cal.
Dolly, 203 W. 81st, N.Y.C.

(Continued on page 168)

The April/Blackwood Music Publishing Companies present the faces behind the hits

NEIL ANDERSON
Vice-President

DAVID ROSNER
Professional Manager

CHIP TAYLOR
Associate
Professional Manager

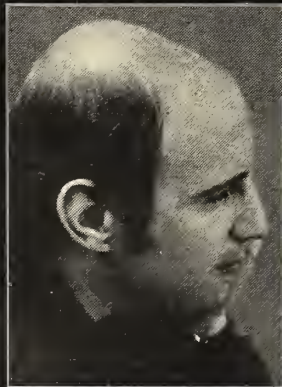

Al Gorgoni



John Hill



Estelle Levitt

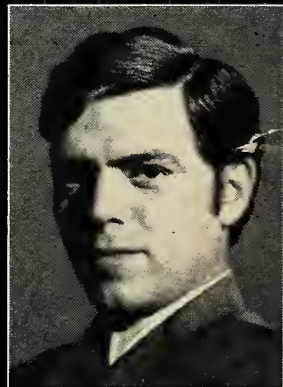

Tim Rose

Writing exclusively for April/Blackwood



Bill Soden



Lou Stallman



Billy Vera



Chip Taylor

Eddy's latest is the greatest!

Number 1 on the Country Charts
Number 34 on the Pop Charts

A powerhouse! Eddy's all-time greatest hits,
put together for the first time in an album
that's selling like wildfire.

LPM/LSP-3565

If it's happening...it's here!

RCA VICTOR 
The most trusted name in sound

THE BEST OF
EDDY ARNOLD

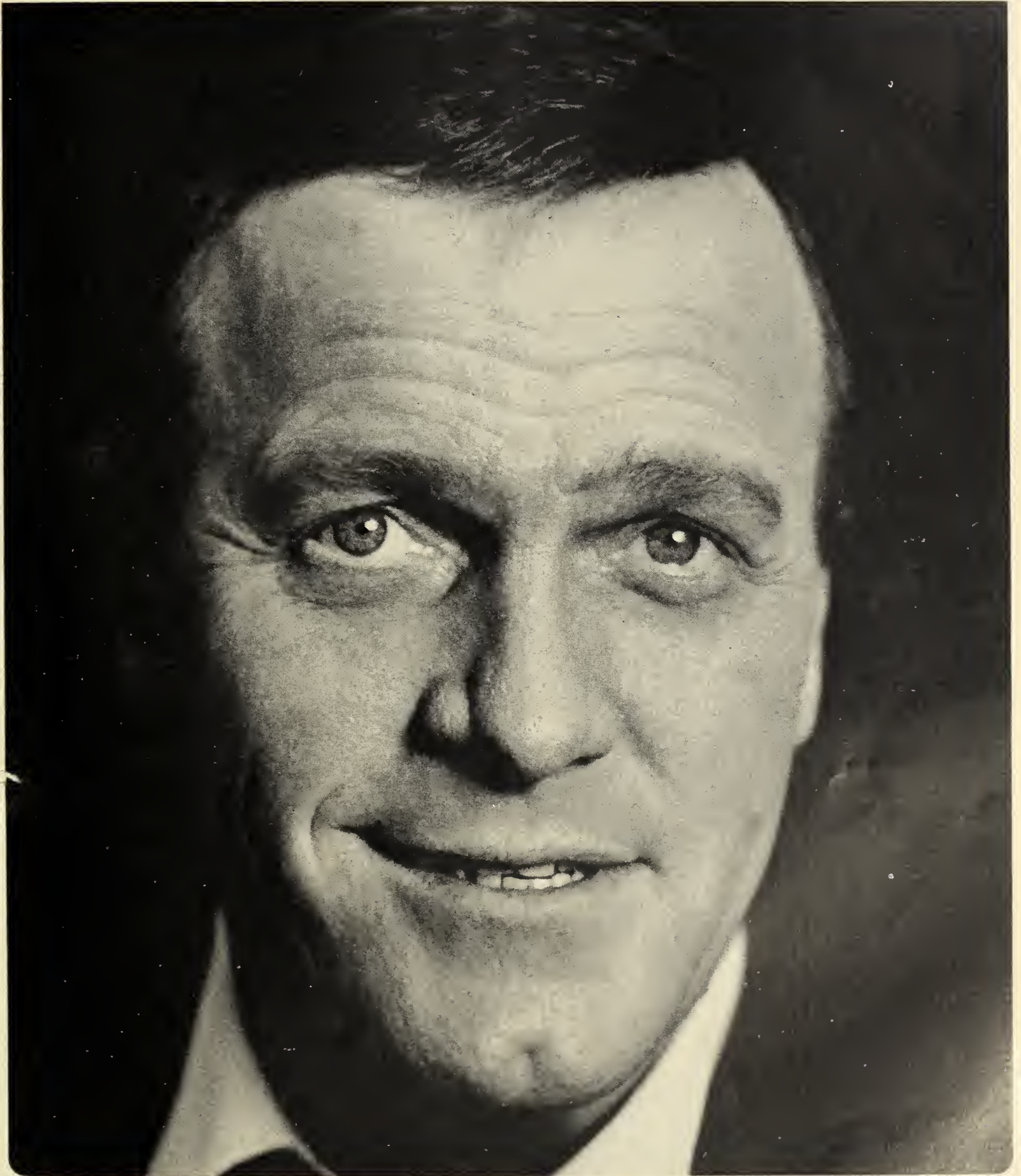

BMI PUBLISHERS

(Continued from page 166)

Domain 630 Fifth Av. N.Y.C.
 Dome 1959 Broadway, N.Y.C.
 Don c/o Duke-Peacock Records, 2809 Erastus,
 Houston, Texas
 Don Carlos 2534 West Pico, L. A., Cal.
 Don-Del 54 Randolph, Chicago, Ill.
 Donlou 55 East 93rd St. N.Y.C.
 Don-Michael 780 N. Gower, Hollywood, Cal.
 Donna, 7165 Sunset Blvd., L.A., Cal.
 Donna-Joan 101 W. 55th, N.Y.C.
 Donnawell 6124 Selma H'wood, Cal.
 Ral Donner 3322 W. Peterson, Chicago
 Donnymack 2636 S. Michigan, Chicago
 Donrey Box 359, N.Y.C.
 Don-Rob 1842 S. May, Chicago
 Doo Da 185 N. Wabash, Chicago
 Doraño 146 W. 54th, N.Y.C.
 Peter Doraine 3431 N.W. 169th Terrace,
 Opaolaka, Fla.
 Doral 14132 Runnymede, Van Nuys, Cal.
 Dorcas 6113 Dorcas Pl., L.A., Cal.
 Dorchester 756 Seventh Ave., N.Y.C.
 Dored 1875 S. Beverly Glen L.A., Cal.
 Doree, Johnny & Bill 12132 Hesby N. Holly-
 wood, Cal.
 Dorick 101 55th, N.Y.C.
 Lee Dorman 221 Ridgefield, Nashville
 Dormie 61 Broadway, N.Y.C.
 Dornix 1540 Brewster Cincinnati, O.
 D'oro 800 8th Ave., N.Y.C.
 Dorothy 240 W. 55th, N.Y.C.
 Dorrin Box 66134 L.A., Cal.
 Dot 3581 Milwaukee Chicago
 Dot 1206 Sudekum Bldg. Nashville, Tenn.
 Double O Box 1053, Beverly Hills, Cal.
 Douglas 1619 B'way, N.Y.C.
 Dougal 41 Central Park W., N.Y.C.
 Douglas & Collins 2033 Seventh Ave., N.Y.C.
 Dow 134 W. 87th, N.Y.C.
 Down South Lyle Lane, Nashville, Tenn.
 Downey 13117 Lakewood Downey, Cal.
 Doyle 1281 Monterey Ave., Berkeley, Cal.
 Draga 251 Fayette Ave. Buffalo 23, N.Y.
 Dragonwyck 2214 No. Canyon Hollywood, Cal.
 Drama 1650 Broadway, N.Y.C.
 Draper 724 W. Oakdale Chicago, Ill.
 Dreamland 40 W. 57th, N.Y.C.
 Dresden 25 C.P.W., N.Y.C.
 Drew 6025 Washington Phila., Pa.
 Drexall 2 W. 45th St., N.Y.C.
 Drive-In 7120 Sunset Hollywood, Cal.
 Druid P.O. Box 62 Atlanta, Ga.
 Drumadon 4610 Kester Sherman Oaks, Cal.
 Drummond 3766 Woodward Detroit, Mich.
 Drury Lane 1619 Broadway, N.Y.C.

Duane Box 174 Albany, Calif.
 Duarte 1432 E. Huntington Duarte, Cal.
 Dub 1270 Sixth Ave., N.Y.C.
 Dubarry 119 W. 57th, N.Y.C.
 Ducan 217 W. 25th, N.Y.C.
 Duchess 1777 Vine, Hollywood, Cal.
 Dueyees 235 W. 46th St., N.Y.C.
 Du-Faye 756 Seventh Ave., N.Y.C.
 Dumont 2805 Biscayne Blvd., Miami, Fla.
 Duncan & Johnson 6124 So. Parkway Chicago
 Dundee 1313 W. Seventh Clovis, N.M.
 Dunkirk 2120 Balsam, L.A., Cal.
 Duo 424 W. 49th N.Y.C.
 Duplex 1650 Broadway N.Y.C.
 Durham 310 Wilbert Wheeling, W. Va.
 Durson 928 N. Clark L.A., Cal.
 Dyche 1309 Walnut Cincinnati, O.
 Dynamic 1143 W. 17 St., Chicago
 Dynasty 1650 Broadway N.Y.C.
 Dynatone c/o King Records, 1540 Brewster
 Ave., Cincinnati 7, Ohio
 Dzona 1370 Fifth N.Y.C.

E

E & E 8604 S. Maryland Chicago
 E & M 2674 Steele Memphis, Tenn.
 Eagle 7002 Fifth N.W., Wash. D.C.
 Earl 2225 Fifth, N.Y.C.
 Walter Earle 126 W. 49th N.Y.C.
 Earth 1619 B'way, N.Y.C.
 East 926 E. Mc Lemore Memphis, Tenn.
 East End 3329 W. 6th Fort Worth, Texas
 East Side 2901 Nathan Memphis, Tenn.
 Eastern 554 Fifth N.Y.C.
 Eastwick 1332 Phila-Nad Bank Phila., Pa.
 Eb 4521 S. Western L.A., Cal.
 Ebony Box 542 San Antonio, Texas
 Eby 1650 Broadway, N.Y.C.
 Ecema 6407 Camelia N.O. Hollywood, Cal.
 Ec-lar 250 W. 57th N.Y.C.
 Electric 190 Waverly Place, N.Y.C.
 E-D Music 6124 Selma Hollywood, Cal.
 Edo 201 W. 49th N.Y.C.
 Edeejay 6381 Hollywood Blvd. Hollywood
 Eden 1697 Broadway, N.Y.C.
 Edgeline 1619 Broadway N.Y.C.
 Edgewater 1425 No. Dearborn Chicago
 Edi-Lou 200 West 57, N.Y.C.
 Edlee 1453 N. Vine Hollywood
 Edlock 1225 Sixth N.Y.C.
 Edlon 1650 Broadway N.Y.C.
 Edmy Box 4259 Phila. Pa.
 Edwin 719 Harvard Burbank, Cal.
 Edwina 789 Ponce De Leon Atlanta, Ga.
 Edwood 4615 Bellview Cincinnati, O.
 Efy-Lou 7 W. 45th N.Y.C.
 Efysee 161 W. 54th N.Y.C.
 Efta 608 Fifth Ave. N.Y.C.
 Egap 1270 Sixth N.Y.C.
 EJay 424 W. 49th N.Y.C.
 Ek 137 Riverside Dr. N.Y.C.
 Elbern 39 W. 55th, N.Y.C.
 Elbo Box 2968 Hollywood
 Eldor 33 W. 42nd N.Y.C.
 Eldorado 1717 N. Vine Hollywood
 Electron 6920 Sunset Hollywood
 Elegant 140 W. 57th N.Y.C.
 Elenda 6223 Selma Hollywood
 Elite 4818 Avalon L.A., Cal.
 Elizabeth 8831 Sunset L.A., Cal.
 Elk 1322 S. 13th Phila., Pa.
 Ellen 3010 14th N.W. Wash. D.C.
 Elmhurst 1697 Broadway N.Y.C.
 Elmtree 1270 Sixth Ave., N.Y.C.
 Elsher 250 S. Broad Phila. Pa.
 Elvira 125 W. 45th N.Y.C.
 Elvitruie 306 S. 16th Wilmington, N.C.
 Embassy 240 W. 55th N.Y.C.
 Ember 832 Kendall Dr. Nashville, Tenn.
 Emcee 1795 Riverside Dr. N.Y.C.
 Emelda 1427 Carondelet St. New Orleans
 Emerald 5425 W. Division Chicago
 Emerson 725 Riverside Dr. N.Y.C.
 Emit 165 W. 46th N.Y.C.
 Emkay 1619 Broadway, N.Y.C.
 Emorey 1650 Broadway, N.Y.C.
 Emperor 1650 Bway N.Y.C.
 Enak 1697 Broadway, N.Y.C.
 End 1650 Broadway, N.Y.C.
 Englewood 6650 Sunset Hollywood
 English 801 17th Ave S., Nashville, Tenn.
 Enrica 1697 Broadway, N.Y.C.
 Enright 1070 Howard San Francisco
 Ensign 1619 Broadway, N.Y.C.
 Entertainment 575 Madison N.Y.C.
 Epitome 7611 S. Normal Blvd., Chicago, Ill.
 Epps Box 4284 San Antonio, Texas
 Era 1065 Willow Glen Way San Jose, Cal.
 Ercolani 9614 Heather Road Beverly Hills, Cal.
 Eric 6425 Hollywood Blvd, Hollywood
 Ermont 800 Presido Ave, San Francisco
 Escapade 1650 B'way, N.Y.C.
 Esco 112 Nathan Road S.W. Atlanta, Ga.
 Escort 1724 1/2 W. 36th L.A., Cal.
 Esquire 400 Madison N.Y.C.
 Essay 238 S. Peck Dr. Beverly Hills, Cal.
 Essex 1619 Broadway N.Y.C.
 Esteem 488 Madison N.Y.C.
 Estella 235 W. 46th N.Y.C.
 Estey 5880 Hollywood Blvd. Hollywood
 Ethel Mae I and Schiller, Phila., Pa.
 Ettry 1619 Bway., N.Y.C.
 Eureka 115 E. 119th, L.A., Cal.
 Euterpe 4104 Witzel Dr. Sherman Oaks, Calif.
 Evar 5800 Third, L.A., Cal.
 Eve 700 S. Dearborn Chicago
 Evergreen 2001 Main Dallas, Texas
 Everlast 2294 8th, N.Y.C.
 Exbrook 9110 Sunset L.A., Cal.
 Excelloree 1011 Woodland St., Nashville, Tenn.
 37206
 Exchange 119 W 57, N.Y.C.
 Expansion 201 W. 49 N.Y.C.
 Explorer 239 Hillside Newark, N.J.
 Expo 4209 Parkmont Baltimore, Md.
 Extra 301 E 47th., N.Y.C.
 Ez-win 1681 Third N.Y.C.

F

F.A.A. 5019 Normandie L.A., Cal.
 F.M.E. 13842 Robson, Detroit, Mich.
 Fab 54 W. Randolph Chicago
 Fabur 2609 W. Olive Burbank, Cal.
 Fabulous 1320 Vine Phila., Pa.
 Fairbanks-Mellin 1650 Broadway N.Y.C.
 Fairfield 916 Kearny San Francisco
 Fairmount 1200 Walnut Phila., Pa.
 Fairview 511 Fifth N.Y.C.
 Faith 2081 Tennessee Dallas, Texas
 Faithful-Virtue 1650 Broadway, N.Y.C.
 Falart 1831 Waverly, Memphis, Tenn.
 Fall River 200 W. 57th N.Y.C.
 Falls City 9912 Taylorsville Rd., Louisville,
 Ky. 40299
 Falfstaff 7966 Beverly Blvd L.A., Cal.
 Fann 5880 Hollywood Blvd., Hollywood
 Fantastic 150 W46, N.Y.C.
 Faro 5004 Melrose, Hollywood
 Farout 64 E. 55th N.Y.C.
 Fashion 844 Thomas Memphis, Tenn.
 Fed 271 W. 126th N.Y.C.
 Ed Fay 4934 S. Wilton Place L.A., Cal.
 Fayhill 1650 Broadway N.Y.C.
 Fearless 4421 Van Horne, L.A., Cal.
 Feather 1271 Ave. of Americas, N.Y.C.
 February 13 E. 22nd N.Y.C.
 Fee Bee 4517 Wainwright Pitts., Pa.
 Gertrude Feith, Box 248, Pine Bluffs, Wyo.
 Felicia 1780 Broadway, N.Y.C.
 Fellows 1018 N. Watkins, Memphis, Tenn.
 Felsted 539 W. 25th N.Y.C.
 Fergus 18100 Greenlawn, Detroit, Mich.
 Fern 1650 Broadway N.Y.C.
 Fernelich 1829-12th St. N.W., Wash., D.C.
 Fernwood 1404 Hull So. Norfolk, Va.
 Jose Ferrer 375 Park N.Y.C.
 FI-Del 305 W. 52nd N.Y.C.
 Fidelity 5139 St. Antoine, Detroit, Mich.
 Fiesta Box 2471 Hollywood
 Fifty Third Street 315 W. 53rd, N.Y.C.
 Figure 1650 Broadway N.Y.C.
 Film & T.V. 11360 Dona Dorotea Dr. Studio
 City, Cal.
 Finch Box 48 Cincinnati, O.
 Fine Arts 1425 Broadway N.Y.C.
 Fine Songs 1501 Bway N.Y.C.
 Finnie 2078 Calvert, Detroit
 Fiore, 708 5th St Struthers, O.
 Fire 565 Fifth N.Y.C.
 Fireball 322 W 48, N.Y.C.
 Firefly 1674 Broadway N.Y.C.
 First Award 10724 Bloomfield St. N. H'wood,
 Calif.
 H B Fisher 54 W Randolph Chicago, Ill.
 Flair 9317 W. Wash. Blvd., Culver City, Cal.
 Flaka 511 Fifth N.Y.C.
 Flame 2611 E. 13th Brooklyn
 Flamingo Box 1732, Hollywood, Cal.
 Flanagan 1740 B'way, N.Y.C.
 Flatt & Scruggs 201 Donna Madison, Tenn.
 Ray Fleming 251 W. 42 St. N.Y.C.
 Fleet 1323 S. Michigan Chicago
 Flick 18559 Ryan Rd. Detroit, Mich.
 Flip and Skip 41 St. Nicholas Terrace, N.Y.C.
 Flipside 1607 N. El Centro Hollywood
 Florence 4215 W. Fifth Chicago
 Florida 1650 Broadway, N.Y.C.
 Floridian 407 Lincoln Road Miami Beach, Fla.
 Folk Songs 12021 1/2 Otsego, N. Hollywood
 Follways 10 Columbus Circle, N.Y.C.
 Fool Killer 25 W 56, N.Y.C.
 Footlight 729 Seventh N.Y.C.
 Ford 132 Nassau N.Y.C.
 Fore-Site 6365 Selma Hollywood
 Formation 324 W. 34th St. N.Y.C.
 Forrest Hills 1607 Hawkins Nashville, Tenn.
 Forshay 1631 Broadway, N.Y.C.
 Forty-Four 235 E. 45th N.Y.C.
 Fountainhead Box 1223, N.Y.C.
 Four Jays 9425 Sunset, Beverly Hills, Calif.
 Four Saints 1701 16th Ave., So. Nashville,
 Tenn.
 Four Star 9220 Sunset Blvd., Suite 312, L.A.,
 Cal.
 Four Star Television 4030 Radford Ave., No.
 Hollywood
 Wallace-Fowler 1556 No. La Brea, Hollywood
 Kim Fowley 6000 Sunset Blvd., Hollywood
 Ray Fox Music 1430 Spruce Phila. Pa.
 Francorp 401 Broadway, N.Y.C.
 Franco 1650 Broadway, N.Y.C.
 Franklin 163 W. 57th N.Y.C.
 Frannan 8983 Selmet Blvd. Hollywood
 Frauer 11936 Burbank Blvd. N. Hollywood
 Frazier & Godson 329 W. 60th L.A., Cal.
 Frederick 1323 S. Michigan Chicago
 Albert Edward Freeman 426 E. 58th N.Y.C.
 Fremart 1467 N. Vine Hollywood
 *Fremont 360 N. Michigan Chicago
 Friday Music 1549 N. Vine Hollywood
 Friendship 608 Fifth N.Y.C.
 Frigate 608 Fifth N.Y.C.
 Frisco 1140 N. Clairorne New Orleans, La.
 Frank I. Frish 2457 S. Central Park Chicago
 Frost 1631 Broadway N.Y.C.
 Fudduddudd Suite 705, 6363 Sunset Blvd.,
 Hollywood, Calif.
 Fuller P.O. Box 10513, Tampa, Fla.
 Fulton 530 Divisadero. San Fran., Cal.
 Fuqua 592 Farnsworth Detroit, Mich.
 Fury 5659 Heiskell Phila., Pa.

G

G & H 1510 Fairmount Phila., Pa.
 G and M 1220 S. Sunol Dr. L.A., Cal.
 G.G. 9460 Wilshire Beverly Hills, Cal.
 G-Note 1650 Broadway N.Y.C.
 Gabby 127 W. 70th St. N.Y.C.
 Gail Music Corp. 501 Madison, N.Y.C.
 Gala 55 W. 53rd N.Y.C.
 Gale & Gayles 250 W. 57, N.Y.C.
 Gallatin 9033 Wilshire, Beverly Hills, Cal.
 Gallery 850 Seventh N.Y.C.
 Al Gallico, 101 W. 55th St., N.Y.C.
 Gallo 8462 Sunset L.A., Cal.
 Galrek 756 Seventh Ave, N.Y.C.
 Gant 10606 Larchfield Dallas, Texas
 Garcliff 9808 Hillshire Beverly Hills, Cal.
 Garden of Allah 5548 S. Kildare, Chicago
 Garlock 475 Fifth N.Y.C.
 Garopa 3490 Wade L.A., Cal.

H

H & K 119 W. 57th N.Y.C.
 H & L 1631 Broadway N.Y.C.
 H & W 2817 W. Pico L.A., Cal.
 H. E. G. 1107 N. El Centro Hollywood
 Ha-So 13938 Vanowen, Van Nuys, Calif.
 Hackney 629 Waveland Chicago
 Haimish 1607 Vista Del Mar, Hollywood
 Frank J. Halama 2346 W. Thomas, Chicago
 Halbrook 1697 Broadway N.Y.C.
 Hall Clement 888 Pearl St., Beaumont, Texas
 Hall of Fame Box 921 Beverly Hills, Cal.
 Hallie 4736 Sanelca N. Hollywood
 Hal-Rudd 1607 El Centro Hollywood
 Hama and Rhodes 2339 So. Coutts, Los Angeles
 Hamblen 7740 Mulholland Dr., L.A., Cal.
 Hambone 2885 W. 14th Cleveland, O.
 Harpax Box 669 Hollywood
 Garrett 148 E. 47th N.Y.C.
 Gaslight 1650 Broadway N.Y.C.
 Gaviota 1515 Crossrds of World, Hollywood
 Gavy 915 Isabel L.A., Cal.
 Evelyn Gay 6544 Champlain Chicago
 Gay 1518 Pine, St. Louis, Mo.
 Gayjo 2526 W. Kiest Dallas, Texas
 Gaystar 1443 W. 64th, L.A., Cal.
 Gee-Clef 445 W. 50th N.Y.C.
 Geeting 117 17th Ave. So., Nashville, Tenn.
 Geezinslaw 480 Blecker, Mamaroneck, N.Y.
 Julius W. Geier 522 Fifth N.Y.C.
 Gele 3432 Mentone L.A., Cal.
 Genson 6425 Hollywood Blvd., Hollywood
 Gentry 140 W. 57th N.Y.C.
 Georgal 30 E. 60th N.Y.C.
 Georgette 16 W. 30th N.Y.C.
 Gerald 4308 N. Spaulding Chicago
 Gerson & Sullivan 743 Fifth N.Y.C.
 Ghana 5216 1/2 Calumet Chicago
 Giant 1617 N. El Centro Hollywood
 Gideon c/o Allen Klein, Time & Life Bldg.,
 Rockefeller Center, N.Y.C.
 Gil 1650 Broadway N.Y.C.
 Gilbert 1619 Bway, N.Y.C.
 Johnny Giles 6563 Barton Hollywood
 Gil-Kay 1326 Telford Cincinnati, O.
 Gillian 325 W. 45th N.Y.C.
 Al Gilray 6369 Delongpre, Hollywood
 Gil-Tone 5537 Irving Phila., Pa.
 Glad 314 E. Eleventh Houston, Texas
 Glaser 146 7th Ave., Nashville, Tenn.
 Glasgow Music Box 3103 Dallas, Texas
 Glen Cove 200 W. 58th N.Y.C.
 Glenayre 6 East Lake Chicago
 Jonathan Glenn 57 W. 56th N.Y.C.
 Glen-Regan 157 W. 57th N.Y.C.
 Glen-Ron 4729 N. Campbell Chicago
 Glenville 473 West End Ave., N.Y.C.
 Glenway 2308 W. 8th Cincinnati, O.
 Glenwood 1800 N. Argyle Hollywood
 Glick 1245 N. Vine Hollywood
 Glodis 1650 Broadway N.Y.C.
 Glo-Mac 6920 Sunset Blvd., Hollywood
 Gloreco 11558 La Salle Detroit, Mich.
 Glory 6421 Moore Dr. L.A., Cal.
 Glover 1697 Broadway N.Y.C.
 Glow 756 Seventh Ave, N.Y.C.
 Gobblers 7740 Mulholland L.A., Cal.
 Go-Go 11935 Bray Ave. L.A., Cal.
 Gold Clef 27 W. Chelton, Chester, Pa.
 Gold Cup 6920 Sunset Hollywood
 Gold Label 565 Fifth N.Y.C.
 Gold Tone 150 W. 46 N.Y.C.
 Goldband 1240 Hill Dr. L.A., Cal.
 Golden Gate 48 W. 48th N.Y.C.
 Jo Golden 101 S.W. 65th Miami, Fla.
 Golden Key 3456 Floyd Terrace L.A., Cal.
 Golden Rule 5353 Indiana Chicago
 Golden State Box 115 Madison, Tenn.
 Golden Tone Box 38502, Hollywood
 Golden Tune 12661 Tuller, Detroit, Mich.
 Golden West Melodies 1556 N. La Brea, Holly-
 wood
 Golden World 15004 Mack Ave. Detroit, Mich.
 Gold-Ridge 1556 N. La Brea Hollywood
 Jerry Goldstein c/o Mason & Co., 369 Lexing-
 ton Ave., N.Y.C.
 Gollatz 54 W. Randolph Chicago
 Good Sam 1416 N. LaBrea, Hollywood, Cal.
 90028
 Good Songs 150 W. 55th N.Y.C.
 Goose 3415 McKinley L.A., Cal.
 Gopam 119 W. 57th N.Y.C.
 Gopus 48 W. 48th N.Y.C.
 Gordon & Lefeur 66 W. 87th N.Y.C.
 Gordon 408 N. Rodeo Dr. Beverly Hills, Cal.
 Gorham 470 West End Ave., N.Y.C.
 Gorjay 335 W. 84th N.Y.C.
 Gospel 1619 Broadway N.Y.C.
 The Gospel Clef 320 Broadway N.Y.C.
 Gospeltone 1001 Capitol Access Rd., Baton
 Rouge, La.
 Gotham 2 W. 46th N.Y.C.
 Gotopro 521 W. 57 St. N.Y.C.
 Gott 101 W. 55th N.Y.C.
 Governor 15022 Ventura, Sherman Oaks, Cal.
 Gower 711 Fifth N.Y.C.
 Gralow 60 W. 46th N.Y.C.
 Granada 200 W. 57th N.Y.C.
 Grandye 117 17th Ave. S., Nashville, Tenn.
 Grange 831 S. Wabash, Chicago
 Granite 1651 Cosmo Hollywood
 Granson 1608 Argyle Hollywood
 Grant 1650 Broadway N.Y.C.
 Greenleaf Music 1619 Broadway N.Y.C.
 Green Water 420 E 55, N.Y.C.
 Gregmark 1610 N. Argyle Hollywood
 Greg-Moore 79 W. Monroe Chicago
 Greta 1619 Broadway N.Y.C.
 Greyco 640 Fifth N.Y.C.
 Griffith 608 Fifth Ave. N.Y.C.
 Grille 617 Exchange Bldg., Nashville, Tenn.
 Groove 43 W. 61st N.Y.C.
 Groovesville 517 Pavilion, 1 Lafayette Pl., De-
 troit, Mich.
 Groton 444 Madison Ave., N.Y.C.
 Guard 665 Harrison San Francisco, Calif.
 Guild 2511 Mayberry St., L.A., Cal.
 Guitar 6515 Sunset Blvd, H'wood
 Morris Gurlek 1631 Broadway, N.Y.C.
 Dan Guy 5607 Melrose Hollywood
 Gyro 873 Beecher Cincinnati, O.
 Gyurik 232 W. 48th St., N.Y.C.

(Continued on page 1)

Best Wishes!

TOMMY ROE

SANDY POSEY

BILLY JOE ROYAL

SWINGIN' MEDALIONS

THE TAMS

PAUL PEEK

THE ROEMANS

THE JAMES GANG

THE MOVERS

THE 4 CLASSICS

JUDY THOMAS

JOE SOUTH

RAY WHITLEY

Cotton Carrier, Mgr.

BILL LOWERY TALENT, INC.

P.O. Box 9687

Atlanta, Ga. 30319

404 233-3962

AL GALLICO MUSIC CORPORATION

101 West 55th Street • New York, N. Y. 10019 • JU 2-1368

Thank you
David Houston

For giving me 3 consecutive
#1 Records

"Almost Persuaded"
"Lovers Cathedral"
"With One Exception"

Thank you
- Jammy Wynette

For your 1st #1 Record

"You Good Girls Jump the Band"

Be Faithful

P.S. Also want to thank you
both for giving me a ride
on your first great smash.
"My Chinese Dreams"

SESAC PUBLISHERS

A

Abernathy, Briarcliff Hotel, 1050 Ponce de Leon Ave., N.E., Atlanta, Ga. 30383
 Accent Inc. (See Singspiration Inc.)
 Accord, Edition (See "IPA")
 Accordion (See Deiro, Pietro)
 Albright (See National)
 Amco, Div. of Music Sales, 33 W. 60th St., New York, N. Y. 10023
 Andrea, 925 N. 3rd St., Philadelphia, Pa. 19123
 Arct. M. (See "PWP")
 Arct. Wydawnictwo (See "PWP")
 Arima, 2945 Dona Susanna Dr., Studio City, Calif. 91604
 Augsburg, 426 So. Fifth St., Minneapolis, Minn. 55415 including Lutheran, Messenger, Wartburg
 Avalon (See Stirling)
 Aztec, 61 Church St., Malverne, L. I., N. Y. 11565

B

Babwin (See Pallma)
 Barnhouse, 110 B Ave. East, Oskaloosa, Iowa 52577
 Barlett (See Brumley)
 Bass (See King)
 Bava's, Davis, West Virginia 26260 including Musical
 Beazley (See Tennessee)
 Beirly (See Chart)
 Bendix (See National)
 Better Chords (See Singspiration Inc.)
 Better Chords Publications (See Singspiration Inc.)
 Bienstock, Siegfried (See "IPA")
 Birluth, 11 Riverside Drive, New York, N. Y. 10023
 Blackwood, Cecil, 209 North Lauderdale, Memphis, Tenn. 38105
 Blackwood, James, 209 North Lauderdale, Memphis, Tenn. 38105
 Blue Coast, 1401 Ave. Y, Brooklyn, New York 11235
 Brandwine, 705 North 12th St., Nashville, Tenn. 3720
 Braun, Hubert J. (See Braun Music, Inc.)
 Braun Music Co. (See Braun Music, Inc.)
 Braun Music, Inc., 33 West 60th St., New York, N. Y. 10023 including Braun, Hubert J., Braun Music Co., Braun Organization, The
 Braun Organization, The (See Braun Music, Inc.)
 Brenbar, Box 7007, Tampa, Fla. 33603
 Briar Hill, 630 West 246th St., Room 1431, New York, N. Y. 10471
 Broadcast Music Publishers (See National Music Company, Inc.)
 Broadman Press, 127 Ninth Ave., N., Nashville, Tenn. 37203 including: Coleman, Robert H., Coleman, Robert H., Pub. Co., Convention Press, Sunday School Board of the Southern Baptist Convention, The
 Bronze, 801 16th Ave., South, Nashville, Tenn. 37203
 Brumley, Powell, Missouri 65730 including: Bartlett, Moore

C

Capitol (See National Music Company, Inc.)
 Cardilli (See King)
 Carlton (See Ludwig)
 Carter, 106 Neverbreak Drive, Hendersonville, Tenn. 37075
 Castion, 555 Kappock St., Apt. 21D, Riverdale, N. Y. 10463
 Castlebrook, 8469 Hollywood Blvd., Los Angeles, Calif. 90069
 Catholic (See McLaughlin & Reilly)
 Central, 20209 Labrador St., Chatsworth, Calif. 91311 including: Ramsey, Will M.
 Century Music, 39 West 60th St., New York, N. Y. 10023 including Heritage, Keyboard
 Century Press, 412 N. Hudson, Oklahoma City, Okla. 73102
 Cerruti (See King)
 Chantry Music Press, Inc., Box 1101, Springfield, Ohio 45501 including: Chantry Music Press, Ltd.
 Chantry Music Press, Ltd. (See Chantry Music Press, Inc.)
 Charlie, 9028 Sunset Blvd., 2nd Floor, Los Angeles, Calif. 90069
 Chart, Inc., 1834 Ridge Ave., Evanston, Ill. 60204 including: Beirly, Alfred, Company, Coanacher, B., Huffer, Fred K., Littig, Frank, Warde, Harry, Warner, F. Eugene, Western Accordion
 Choral Press, 251 West 19th St., New York, N. Y. 10011
 Choral Services (See Singspiration)
 Church (See Singspiration)
 Clayton, Norman J. (See Clayton, Norman)
 Clayton, Norman, Winona Lake, Indiana 46590 including: Clayton Norman J.
 Clef (See King)
 Coanacher, B. (See Chart)
 Coleman, Robert H. (See Broadman Press)
 Coleman, Robert H., Publishing Co. (See Broadman Press)
 Colin, Charles, 315 West 53rd St., New York, N. Y. 10019
 Concord, Inc., P.O. Box 1391, Studio City, Calif. 91604 (Only compositions as per list issued)
 Concordia 3558 South Jefferson Ave., St. Louis, Mo. 63118
 Concourse, 630 West 246th St., Room 1431, New York, N. Y. 10471
 Convention Inc., 215 South Court St., Montgomery, Ala. 36104
 Convention Press, (See Broadman Press)
 Cooper, W. Oliver, (See Cooper, Wendell B., and Mrs. Camella)
 Cooper, Wendell B., and Mrs. Camella, RFD 1, Box 316, Cullman, Ala. 35055 including: Cooper, W. Oliver
 Copley, c/o Pryor, Braun, Cashman, & Sherman, 640 Fifth Ave., New York, N. Y. 10019
 Country Gentleman, Powell, Missouri 65730
 Crawford, Percy B., c/o The Crawford Broadcasting Co., P. O. Box 86, Flourtown, Pennsylvania 19031
 Cummings, M. Homer, 130 Cedar St., Huntington, W. Va. 25705
 Czyltelnik (See "PWP")

D

Daniel, John (See Stoker)
 Darom, Edition (See "IPA")

Dash, James Allan, 1834 Ridge Ave., Evanston, Ill. 60204
 Davis, Marion, Fayette, Ala. 35555
 Dawson, William L. (See Music Press)
 Dean, Emmet S., Box 610, Austin, Texas 78767
 Dean & Edmiston, Box 610, Austin, Texas 78767
 Dean & Evridge, Box 610, Austin, Texas 78767
 Dean & Franklin, Box 610, Austin, Texas 78767
 Dean & Hensley, Box 610, Austin, Texas 78767
 Dean & Morgan, Box 610, Austin, Texas 78767
 Dean & Segren, Box 610, Austin, Texas 78767
 Deiro, Pietro (See Deiro, Pietro)
 Deiro, Pietro, 133 Seventh Ave., So., New York, N. Y. 10014 including: Accordion, Deiro, Pietro, Frador, Mosti, Joe, Accordion, Viccas
 Delhi, 440 Main St., Cincinnati, Ohio 45201
 Denson-Parris (See Tennessee)
 Denson Trio (See Tennessee)
 Di Bella, O., 162 East 116th St., New York, N. Y. 10029
 D'amant, Abraham (See "IPA")
 Dickert, 62-33 Alderton St., Rego Park, L. I., N. Y. 11374

E

Edel, Yizchak (See "IPA")
 Ellis, 6233 South Utica, Tulsa, Okla. 74105 including: Ellis, V. B. (VEP)
 Ellis, V. B. (VEP) (See Ellis)
 Ellis, "VEP," Songs, Briarcliff Hotel, 1050 Ponce de Leon Avenue, N.E., Atlanta Georgia 30383
 Eulenburg Edition, GMBH., Adliswil-Zurich, Grutstrasse 68, Switzerland
 Eulenburg, Ernst, Ltd., 48, Gt. Marborough St., London, W.1, England

F

Fabian, Werner (See "IPA")
 Fairbank, H. W. (See National Music Company, Inc.)
 Faith Music, Briarcliff Hotel, 1050 Ponce de Leon Avenue, N.E., Atlanta, Georgia, 30383
 Ferrill, J. W. (See National Music Company, Inc.)
 Firm Foundation, P.O. Box 610, Austin, Texas 78767, including: Dean, Emmet S., Dean & Edmiston, Dean & Evridge, Dean & Franklin, Dean & Hensley, Dean & Morgan, Dean & Segren, Ramsey & Parker, Showalter G. H. P., Trio
 FitzSimons, H. T., 615 N. LaSalle St., Chicago, Ill. 60610
 Foray Music Inc., 812 17th Ave. S., Nashville, Tenn. 37203, 530 West Main St., Hendersonville, Tenn. 37075
 Forecast Music, (See National Music Company, Inc.)
 Foreststorn Music, 3788 Sixth Ave., Los Angeles, Calif. 90018
 Fouts, S. G., 428 12th St., Cookeville, Tenn. 38501, including: Fouts-Payne
 Fouts-Payne (See Fouts, S. G.)
 Frador (See Deiro, Pietro, Publications)
 Future Music (See National Music Company, Inc.)

G

Gaines, N. J., 143 Windsor Drive, Muskogee, Okla. 74401, including: Rainbow Music Company
 Gaither, William J., P.O. Box 143, Alexandria, Indiana 46001
 Gale (See Sage and Sand Music Publishers)
 Gebethner & Wolff (See "PWP")
 General Council of The Assemblies of God, (See Gospel Publishing House)
 Georgi & Vitak (See Vitak-Elsnic Company)
 Gil-Ron, Edition (See "IPA")
 Ginzburg, Dov, Publications (See "IPA")
 Glaco, 801 16th Ave., South, Nashville, Tenn. 37203
 Golden, 5653 1/2 Hollywood Boulevard, Hollywood, California 90028, including: Southern, Hal
 Gospel, (See Hathaway, Franklin Earl, Mus. Pub.)
 Gospel Publishing, 1445 Boonville Ave., Springfield, Missouri 65802, including: General Council of The Assemblies of God
 Gospel Quartet, P.O. Box, 6992, Nashville, Tenn. 37215
 Grabcewski, F., (See "PWP")
 Grammer, Frank (See Porter, Rue)
 Gregorian, 2130-32 Jefferson Ave., Toledo, Ohio 43624
 Gur-Ari, Hans (Horowitz) (See "IPA")
 Gurley, Robert G. (See Jusko, Ralph, Publications, Inc.)
 Gurley, (See Jusko, Ralph, Publications, Inc.)

H

Hackett Bobby, 34-21 84th St., Jackson Heights, N. Y. 11372
 Hall & McCreary Company (See Schmitt, Hall & McCreary Co.)
 Hall Music, P.O. Box 636, Maryville, Tennessee 37801
 Hall Music Company, The (See Tennessee)
 Hans, Willy (See "IPA")
 Hanson, Eddy (See National Music Company, Inc.)
 Harbor Music, 806 16th Ave., So., Nashville, Tennessee 37203
 Hartford, Powell, Missouri 65730
 Hart's (See National Music Company, Inc.)
 Harvest, 3217 Moorewood Drive, Nashville, Tenn. 37207
 St., Chicago, Ill. 60602, including: Gospel Hathaway, Franklin Earl, 77 West Washington St., Chicago, Ill. 60602, Gospel Music Publications
 Hawkins, Floyd W. (See Lillenas Publishing Company)
 Henson, J. M., Briarcliff Hotel, 1050 Ponce de Leon Avenue, N.E. Atlanta, Georgia 30383, including: Morris-Henson Music Company, Southern Music Plate Company
 Heritage (See Century Music Pub. Co., Inc.)
 Hess, W. Jake, 806 17th Avenue, South, Suite 203, Nashville, Tennessee 37203
 Highland 1311 N. Highland Ave., Hollywood, Calif. 90028
 Howlin, 10,000 Santa Monica Blvd., Suite 311, Los Angeles, Calif. 90067
 Huffer, Fred K. (See Chart Music Publishing House, Inc.)
 Huntzinger, R. L., Inc., Lawson Court, P.O. Box 854, Cincinnati, Ohio 45201
 Hymntime, 4308 Kirkland Drive, Fort Worth, Texas 76109, including: Stanphill IRA

I

Idzikowski, Leon (See "PWP")
 Idzikowski, M. (See "PWP")
 Imperial, 806 17th Avenue, South, Suite 203, Nashville, Tennessee 37203
 Inspiration, 1405 W. Backus, Springdale, Arkansas 72764, including: Paris, Oren, Rip-Chord Music Co.
 "IPA," Israel, P.O. Box 4345, Arlosoroff St., Tel-Aviv, Israel, including: Accord, Edition; Bienstock, Siegfried (Only compositions as per list issued); Darom, Edition; Diamant, Abraham; Edel, Yizchak; Fabian, Werner; Gil-Ron, Edition; Ginzburg, Dov, Publications; Gur-Ari, Hans (Horowitz); Hans, Willy; "Iscom," Israel Society of Composers, Authors & Music Publishers; Jimick, Harry; Samely, Sam; Tav-Rina, Edition; Winternitz, Chanani; Wohl, Jehuda; Wynert, Johnny
 "ISCAM," Israel Society of Composers, Authors & Music Publishers (See "IPA")
 Island Music, (See Zellner, Harry)
 IPES, David L., (See Lillenas Publishing Company)
 Ives Music Press, (See Lillenas Publishing Company)
 Ivory Publishing Co., Inc., 1422 Preston Drive, Nashville, Tenn. 37206

J

Jastrzab, Edition (See "PWP")
 Jaworski-Pandy, 179 Robert Drive, Wapping, Connecticut 06087
 Jayपाल, 540 West Broadway, New York, N. Y. 10012
 Jeffress, Crossett, Ark. 71635
 Jewell, Fred, Worthington, Ind. 47471
 Jimick, Harry (See "IPA")
 Jo-Mac Music, c/o Mr. Al Jones' 263 Delbarco Dr., Mobile, Ala.
 Jusko, Ralph, Editions (See Jusko, Ralph, Publications, Inc.)
 Jusko, Ralph, Publications, Inc., 440 Main St., Cincinnati, Ohio 45201 including: Gurley, Robert G.; Gurley, Music Company; Jusko, Ralph, Editions

K

Ka-Cov, c/o Harry Weber & Co., 271 Madison Ave., 19th Floor, New York, N.Y. 10016
 Kanner (See Top Music Publishers, Inc.)
 Keller, Hal (See Misty Music Publications)
 Kelman, 470 West End Ave., Apt. 1E, New York, N. Y. 10024
 Kendor, Delevan, N. Y. 14042
 Keyboard (See Century Music Pub. Co., Inc.)
 King, K. L., Fort Dodge, Iowa 50501
 King, 351 West 52nd St., New York, N. Y. 10019 including: Cardilli, M. V.; Cerruti, John M., Clef Music Corp.; Lane Publishing Co.; McKinley Publishers, Inc.; Roma Music Co.
 Kjos, Neil A., 525 Bussie Highway, Park Ridge, Ill. 60068
 Krachtus, John (See Vitak-Elsnic Company)
 Krone, Max T. & Beatrice P., Box 38, Idyllwild, Calif. 92349
 Kulka, 665 Harrison St., San Francisco, Calif. 94107
 Kuthan, E. (See "PWP")

L

Lair, John, Renfro Valley, Kentucky 40473
 Lane (See King Music Publishing Corp.)
 Langdon, Huntington, W. Va. 25704
 LeFevro Trio, The, Box 400, Atlanta, Georgia 30301
 Lena, Suite 507, 1619 Broadway, New York, N. Y. 10019
 Lillenas, Haldor (See Lillenas Publishing Company)
 Lillenas, Box 527, Kansas City, Missouri 64141 including Hawkins, Floyd W. (Only compositions as per list issued); Ives, David L. (Only compositions as per list issued); Ives Music Press (Only compositions as per list issued); Lillenas, Haldor (Only compositions as per list issued); Narzarene Publishing House
 Lister, Hovie, Briarcliff Hotel, 1050 Ponce de Leon Avenue, N.E. Atlanta, Georgia 30383
 Lister, Mosie (See Lister, Mosie, Publications)
 Lister, Mosie, Publications, P.O. Box 644, Tampa, Fla. 33601 including Lister, Mosie
 Lit, c/o Elgart, 55 East 74th St., New York, N. Y. 10021
 Littig, Frank (See Chart Music Publishing House, Inc.)
 Liturgical (See McLaughlin & Reilly Company)
 LLoyd, Suite 500, 301 E. Colorado Pasadena, Calif. 91101
 Lord, 806 16th Avenue, South, Nashville, Tenn. 37203
 Ludwig, 557-67 East 140th St., Cleveland, Ohio 44110 including: Carlton Music Pub.
 Lutheran (See Augsburg Publishing House)

M

Maciejowski, Zb. (See "PWP")
 Maltese, P.O. Box 12281, Norfolk, Va. 23502
 Maricopa, Inc. 713 18th Ave., South, Nashville, Tenn. 37203
 Mat-Co, 8890 N. Florida Ave., Tampa, Florida 33604 including: Mathews, John
 Mathews, John (See Mat-Co Publishing Co.)
 McKinley (See King Publishing Corp.)
 McLaughlin & Reilly, 67 Kingston St., Boston, Mass. 02111, including: Catholic Music Company; Liturgical Music Company
 McSpadden, Gary, 806 17th Avenue, South, Suite 203; Nashville, Tennessee 37203
 Melody-Aire (See Singspiration Inc.)
 Mercury, 17 West 60th St., New York, N. Y. 10023, including: Music Press, Inc.; Weaner-Levant Publications; Weaner, Maxwell
 Messenger Press (See Augsburg Publishing House)
 Ming, 806 16th Avenue, South, Nashville, Tennessee 37203
 Miracle, 220 71st Street, Miami Beach, Fla. 33141
 Misty, 6034 Vantage Ave., N. Hollywood, Calif. 91606, including: Keller, Hal
 Moore, David (See Brumley, Albert E., & Sons)
 Morales, Armond, 806 17th Avenue, South, Suite 203 Nashville, Tennessee 37203
 Morris-Henson (See Henson, J. M., Music Company)
 Moscheo, Joseph, II, 806 17th Avenue, South, Suite 203, Nashville, Tennessee 37203

Mosti, Joe, Accordion (See Deiro, Pietro, Publications)
 Music Press, P.O. Box 1052, Tuskegee Institute, Ala. 36088, including: Dawson, William L.
 Music Press, Inc. (See Mercury Music Corp.)
 Music Products (See Pallma Music Company)
 Musical Melody (See Bava's, John, Music)

N

National Music, Route 2, Box 193, Jefferson, Texas 75657, including: Ferrill, J. W., Quartet, Thomas, Alvis O., Thomas, J. E.
 National Music Co., Inc., 77 West Washington St., Chicago, Ill. 60602, including: Albright, Bendix, Broadcast, Capitol Fairbank, H. W., Forecast, Future, Hanson, Eddy. (Only compositions as per list issued), Hart's, Popular Select, Standard, Standard Songs, Windsor.
 Navigo, A Division of Disc. Inc., 2227 Fifth Avenue, Seattle, Washington 98121
 Nazarene (See Lillenas Publishing Company)
 Nemmers, M. L., 2936 N. Hackett Ave., Milwaukee, Wisc. 53211
 Network (See Top Music Publishers, Inc.)

O

Ortlund, Mrs. Anne, 1190 S. El Molino, Pasadena, Calif. 91106
 Ott, Doy, Briarcliff Hotel, 1050 Ponce de Leon Avenue, N.E., Atlanta, Georgia 30383

P

Pagani, O., & Bro., Inc., 289 Bleecker St., New York, N. Y. 10014
 Page Boy, 2805 Cooper Lane, Nashville, Tenn. 37216
 Pallma, P.O. Box 145, Beaumont, Calif. 92223, including: Babwin Publications, Music Products Corp., Pallma, Frank, Music Publisher, Pallma Music Products Corp., Quince, Walter A. (Only compositions as per list issued)
 Pallma Music Products Corp. (See Pallma Music Company)
 Pallma, Frank (See Pallma Music Company)
 Panella, 273 Clearview Ave., Pittsburgh, Pa. 15205
 Papa Joe's, 1007 17th Avenue, South Nashville, Tennessee 37212
 Paragon, 57 Third Ave., New York, N. Y. 10003
 Paris, Oren (See Inspiration Publishers)
 Parks, J. A., 525 Busse Highway, Park Ridge, Ill. 60068
 Parris (See Stamps Quartet Music Company)
 Parris, O. A. (See Stamps Quartet Music Company)
 Pawnee Rose, 806 16th Ave., South, Nashville, Tenn. 37203
 Peach, 806 16th Ave., S., Nashville, Tenn. 37203
 Perkins, 813 18th Avenue, South Nashville, Tennessee 37203
 Perry, F. Clark (See Tennessee Music & Printing Co.)
 Peterson, John F. (See Singspiration Inc.)
 Pioneer, 975 South West Temple, Salt Lake City, Utah 84101, including: Wheelwright, Lorin F.
 PJD Music, c/o Mr. Lawrence Uttal, 141 East 88th St., New York, N. Y. 10028
 Podgorski, I. (See Podgorski, I., Music)
 Podgorski, I., Music, 2233 Orthodox St., Philadelphia, Pa. 19137, including: Podgorski, I. Polskie Towarzystwo Muzyki, Wspolczesnej (See "PWP")
 Polskie Wydawnictwo Muzyki, Wspolczesnej (See "PWP")
 Pompano, c/o Jack Hooke, 1631 Broadway, New York, N. Y. 10019
 Poole, Inc., 11-A Lawyers Building, Greenville, South Carolina 29601
 Popular (See National Music Company, Inc.)
 Pound Ridge, 630 West 246th St., Room 1431, New York, N. Y. 10471
 "PWM," Polskie Wydawnictwo Muzyczne (See "PWP")
 "PWP," Przedstawicielstwo Wydawnictw Polskich (Association of Polish Publishers) Warsaw, Poland, including: Arct. M., Arct. Wydawnictwo Muzyczne, Czyltelnik, Gebethner & Wolff, Grabcewski, F., Idzikowski, Leon, Idzikowski, M., Jastrzab, Edition Kuthan, E., Maciejowski, Zb., Polskie Towarzystwo Muzyki Wspolczesnej, Polskie Wydawnictwo Muzyki Wspolczesnej, "PWM," Polskie Wydawnictwo Muzyczne, Rudnicki, Walery, Rynczak, J., Towarzystwo Wyda-wnicze Muzyki Polskiej, Uniwersum, Wyzsza Zymunt, "WJH," Wydawnictwo Muzyki "Synkopa," "Zaiki," Zwiasek Autorow, Kompozytorow I Wydawcow (Society of Polish Authors, Composers and Publishers), Zak, Czeslaw

Q

Quartet, (See National Music Company, Inc.)
 Quince, Walter A. (See Pallma Music Company)

R

Rainbow (See Gaines, N. J.)
 Ramola, 1615 Greenwood Place, Dallas, Texas 75224
 Ramsey, Will M. (See Central Music Company)
 Ramsey & Parker See Firm Foundation Publishing House)
 Revival, P.O. Box 16, Searcy, Ark. 72143, including: Walls, W. M.
 Ribbon Music, Inc., 806 16th Ave., South, Nashville, Tenn. 37203
 Rip-Chord (See Inspiration Publishers)
 River Rock, P.O. Box 7351, Nashville, Tenn. 37210
 Roma (See King Music Publishing Corp.)
 Rudnicki, Walery (See "PWP")
 Rynczak, J. (See "PWP")

S

Sacred (See Schmitt, Hall & McCreary Company)
 Sage and Sand Music, Inc., 5653 1/2 Hollywood Blvd., Hollywood, Calif. 90028, including: Gale Music, Sage and Sand Music Publishers
 Sage and Sand (See Sage and Sand Music, Inc.)
 Sajewski, W. H., 1227 Milwaukee Ave., Chicago, Ill. 60622
 Samely, Sam (See "IPA")
 Santeela, 806 16th Ave., South, N. Tenn. 37203 (Only composition issued)

(Continued on p

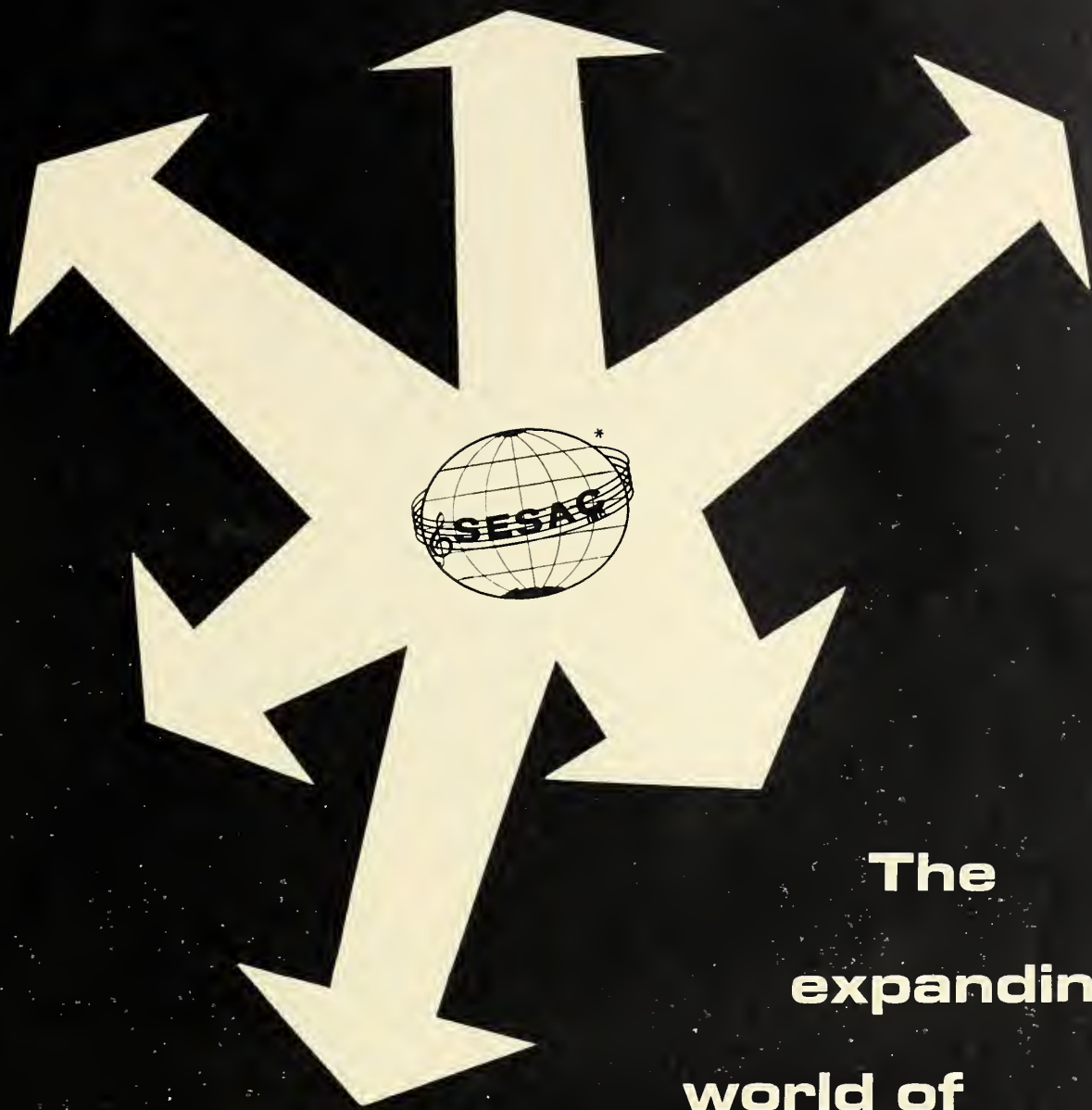

**The
expanding
world of
SESAC...**

representing a repertory that provides SESAC Licensees a constant source of new writers, composers and publishers.

As one of the world's foremost music licensing organizations, SESAC endeavors to provide its publishers with increased access to new audiences, and to add new vitality to the changing trends of today's music.

SESAC continues to expand its resources

for new composers and publishers seeking to showcase their works through performance and mechanical rights, programing and sales aids to the broadcaster and through its special projects department.

Both on the national and international scene, in every field of public performance, SESAC will continue to serve, to grow and to provide good music to the world's listening audience.

SESAC INC. /

NEW YORK: 10 COLUMBUS CIRCLE • NEW YORK, NEW YORK 10019 • 212-586-3450
NASHVILLE: 806 16TH AVENUE, SOUTH • NASHVILLE, TENNESSEE 37203 • 616-254-5703

• Trademark

SESAC PUBLISHERS

(Continued from page 170)

Schmidt, Arthur P., 1834 Ridge Ave., Evanston, Ill. 60204
 Schmitt, Hall & McCreary, 527 Park Ave., Minneapolis, Minnesota 55414, including: Hall & McCreary Company, Sacred Design Associates, Inc., Schmitt, Paul A., Music Company, Schmitt Publications, Inc., Selmer, H. & A., Inc. (Only compositions as per list issued)
 Schmitt, Paul A. (See Schmitt, Hall & McCreary Co.)
 Schmitt Publications (See Schmitt, Hall & McCreary Co.)
 Schubert, Edward, & Company, 39 West 60th St., New York, N. Y. 10023
 Sebnen, George W. (See Tennessee Music & Printing Co.)
 Select (See National Music Company, Inc.)
 Selmer, H. & A. (See Schmitt, Hall & McCreary Co.)
 Seyfarth, G. (See "PWP")
 Showalter, A. J. (See Tennessee Music & Printing Co.)
 Showalter, G. H. P. (See Firm Foundation Publishing House)
 Singspiration (See Singspiration Inc.)
 Singspiration, Inc., 4145 Kalamazoo, S.E., Grand Rapids, Michigan 49508, including: Accent Inc., Better Chords, Better Chords Publications Inc., Choral Services, Inc., Church Music Service Bureau, Melody-Are Press, Peterson, John W., Singspiration, Smith, Alfred B.
 Sioux Way, c/o Abe Turchin, 200 West 57th Street, New York, N. Y. 10019
 Sister, 10 Maple St., Brooklyn, N. Y. 11225
 Sizzle, 318 West 48th St., New York, N. Y. 10036, (Only compositions as per list issued)
 Skylite, 209 North Lauderdale, Memphis, Tenn. 38105
 Skylite Recording, P.O. Box 1502, Atlanta, Georgia 30301, including: Vaughan, James D., Music Publisher
 Slater, Will W. (See Slater Company, The)
 Slater Company, 3520 Boulder Drive, Dallas, Texas 75233, including: Slater, Will W.
 Slaughter, Henry T., 3217 Moorewood Drive, Nashville, Tenn. 37207
 Slip & Slide, 120 Belair Drive, Dobbs Ferry, N. Y. 10522
 Smith, Alfred B. (See Singspiration, Inc.)
 Smith, M. Lynwood, Wesson, Miss. 39191
 Southern, Hal (See Golden Valley Music)
 Southern Music Plate (See Henson, J. M.)
 Speer, Ben, P.O. Box 9201, Nashville, Tenn. 37204
 Spire (See World Library Publications)
 Stamps Quartet, Inc., P.O. Box 6992, Nashville, Tennessee 37215, including: Parris, Parris, O. A.
 Standard (See National Music Co., Inc.)
 Standard Songs (See National Music Co., Inc.)
 Stanphill, Ira (See Hymntime)

Stirling, 1650 Broadway, New York, N. Y. 10019, including, Avalon)
 Stoker, 4720 Benton Smith Rd., Nashville, Tenn. 37215 including: Daniel, John
 Sumner J. D., 720 17th Avenue, South, Nashville, Tennessee 37203
 Sunday School Board of the Southern Baptist Convention (See Broadman Press)
 Sword & Shield, Div. of Wills Family, Inc., 1417 East Abram Street, P.O. Box 211, Arlington, Texas 76011

T

Talent House, 1136 Sunnymeade Drive, Nashville, Tenn. 37216
 Tav-Rina Edition (See "IPA")
 Tennessee, Cleveland, Tenn. 37311 including: Beazley, Samuel W., & Son (Only compositions copyrighted up to and including 1924)
 Denson-Parris, Denson Trio, Hall (Only compositions as per list issued) Perry, F. Clark, Sebnen, George W., Showalter, A. J., Thomas, Alvis O. (See National Music Co., Inc.)
 Thomas, J. E. (See National Music Co., Inc.)
 Thompson, Route 5, Box 137B, Lake Charles, Louisiana 70601
 Top Music, 74 Riverside Drive, New York, N. Y. 10024 including: Kanner, Network
 Towarzystwo Wydawnicze Muzyki Polskiej (See "PWP")
 Traficante, 1834 Ridge Ave., Evanston, Ill. 60204
 Trio (See Firm Foundation Publishing House)

U

Universum (See "PWP")

V

Vaughan, James D. (See Skylite)
 Velva, c/o Henry Tobias, Room 1119, 1650 Broadway, New York, N. Y. 10019
 Viccas (See Deiro, Pietro)
 Vitak-Elsnic, 4815 South Ashland Ave., Chicago, Ill. 60609 including: Georgi & Vitak, Krachtus, John

W

Walls, W. M. (See Revival)
 Warde, Harry (See Chart, Inc.)
 Warner, F. Eugene (See Chart Inc.)
 Watburg (See Augsburg)
 WC Music, 116 S. Michigan Ave., Suite 903, Chicago, Ill. 60603 (Only compositions as per list issued)
 Weaner-Levant (See Mercury)
 Weaner, Maxwell (See Mercury)
 Wetherington, Jim, 1976 Oak Grove Rd., N.E., Atlanta, Georgia 30329
 Wescott, P.O. Box 7473, 316 East 11th Street, Houston, Texas 77008
 Western Accordion (See Chart Inc.)
 Western Swing, P.O. Box 242, Rogers, Ark. 72756
 Wheelwright, Lorin F. (See Pioneer)
 Wiehler, Zygmunt (See "PWP")
 Willis, 440 Main Street, Cincinnati, Ohio 45201
 Willis Publications, 211 East Liberty, Box 72, Farmington, Missouri 63640
 Windsor (See National Music Inc.)
 Winsett, R. E., 128 East 2nd Avenue, P.O. Box 327, Dayton, Tenn. 37321
 Wirtnitz, Chanan (See "IPA")
 WJB, 250 Tryon Ave., Teaneck, N.J. 07666
 "WJR" (See "PWP")
 Wohl, Jehuda (See "IPA")
 Wolfpack, 630 West 246th St., Room 1431, New York, N. Y. 10471 (Only compositions as per list issued)
 World Library of Sacred Music (See World Library Publications, Inc.)
 World Library Publications, 2145 Central Parkway, Cincinnati, Ohio 45214, including: Spire, World Library of Sacred Music
 Worrell, 1411 Walnut Street, Room 810-812, Philadelphia, Pennsylvania 19102
 Wydawnictwo Muzyczne "Synkopa" (See "PWP")
 Wynert, Johnny (See "IPA")

X

XIV, c/o Orenstein, Arrow & Lour'e, 119 West 57th Street, New York, N. Y. 10019

Z

"ZAIKS" (Society of Polish Authors, Composers and Publishers) (See "PWP")
 Zak, Czeslaw (See "PWP")
 Zellner, Harry, 210 West 101st Street, New York, N. Y. 10025 including: Island

NARAS Grammy Winners—1966

- 1 RECORD OF THE YEAR (Awards to the Artist and A & R Producer) STRANGERS IN THE NIGHT—Frank Sinatra—A & R Producer: Jimmy Bowen (REPRISE)
- 2 ALBUM OF THE YEAR (Awards to the Artist and A & R Producer) SINATRA: A MAN & HIS MUSIC—Frank Sinatra—A & R Producer: Sonny Burke (REPRISE)
- 3 SONG OF THE YEAR (This is a Songwriters' Award) MICHELLE—Songwriters: John Lennon, Paul McCartney (CAPITOL)
- 4 BEST INSTRUMENTAL THEME (This is a Composer's Award) BATMAN THEME—Composer: Neal Hefti (RCA)
- 5 BEST VOCAL PERFORMANCE—FEMALE—IF HE WALKED INTO MY LIFE (Single)—Eydie Gorme (COLUMBIA)
- 6 BEST VOCAL PERFORMANCE—MALE—STRANGERS IN THE NIGHT (Single)—Frank Sinatra (REPRISE)
- 7 BEST INSTRUMENTAL PERFORMANCE (OTHER THAN JAZZ)—WHAT NOW MY LOVE—Herb Alpert & the Tijuana Brass (A & M)
- 8 BEST PERFORMANCE BY A VOCAL GROUP—A MAN AND A WOMAN—Anita Kerr Singers (WB)
- 9 BEST PERFORMANCE BY A CHORUS—SOMEWHERE MY LOVE (Lara's Theme from "Dr. Zhivago")—Ray Conniff & Singers (COL)
- 10 BEST ORIGINAL SCORE WRITTEN FOR A MOTION PICTURE OR TELEVISION SHOW (This is a Composer's Award) DR. ZHIVAGO—Composer: Maurice Jarre (MGM)
- 11 BEST SCORE FROM AN ORIGINAL CAST SHOW ALBUM (This is a Composer's Award; plaque to the A & R producer; MAME (Original Cast)—Composer: Jerry Herman—A & R Producer: Goddard Lieberson (COL)
- 12 BEST COMEDY PERFORMANCE—WONDERFULNESS—Bill Cosby (WB)
- 13 BEST SPOKEN WORD, DOCUMENTARY OR DRAMA RECORDING—EDWARD R. MURROW—A REPORTER REMEMBERS—VOL. 1 THE WAR YEARS—Edward R. Murrow (COL)
- 14 BEST RECORDING FOR CHILDREN—DR. SEUSS PRESENTS: "IF I RAN THE ZOO" AND "SLEEP BOOK"—Marvin Miller (RCA-CAMDEN)
- 15 BEST ALBUM NOTES (This is an Annotator's Award) SINATRA AT THE SANDS—Frank Sinatra—Annotator: Stan Cornyn (REPRISE)
- 16 BEST INSTRUMENTAL JAZZ PERFORMANCE—GROUP OR SOLOIST WITH GROUP—GOIN' OUT OF MY HEAD—Wes Montgomery (VERVE)
- 17 BEST ORIGINAL JAZZ COMPOSITION (This is a Composer's Award) IN THE BEGINNING GOD—Composer: Duke Ellington (RCA)
- 18 BEST CONTEMPORARY (R & R) RECORDING (Award to the artist, plaque to the A & R Producer) WINCHESTER CATHEDRAL—New Vaudeville Band—A & R Producer: Geoff Stephens (FONTANA)
- 19 BEST CONTEMPORARY (R & R) SOLO VOCAL PERFORMANCE—MALE OR FEMALE (This category is for single records) ELEANOR RIGBY—Paul McCartney (The Beatles) (CAP)
- 20 BEST CONTEMPORARY (R & R) GROUP PERFORMANCE—VOCAL OR INSTRUMENTAL (This category is for single records) MONDAY, MONDAY—The Mamas & The Papas (DUNHILL)
- 21 BEST RHYTHM & BLUES RECORDING (Award to the artist, plaque to the A & R Producer) CRYING TIME—Ray Charles—A & R Producer: Tangerine Records (ABC-PARAMOUNT)
- 22 BEST RHYTHM & BLUES SOLO PERFORMANCE—MALE OR FEMALE (This category is for single records) CRYING TIME—Ray Charles (ABC-PARAMOUNT)
- 23 BEST RHYTHM & BLUES GROUP—VOCAL OR INSTRUMENTAL (This category is for single records) HOLD IT RIGHT THERE—Ramsey Lewis (CADET)
- 24 BEST FOLK RECORDING (Award to the Artist, plaque to the A & R Producer) BLUES IN THE STREET—Cortelia Clark—A & R Producer: Felton Jarvis (RCA)
- 25 BEST SACRED RECORDING (MUSICAL) (Non-Classical) (Award to the Artist, plaque to the A & R Producer) GRAND OLD GOSPEL—Porter Wagoner & the Blackwood Bros.—A & R Producer: Chet Atkins (RCA)
- 26 BEST COUNTRY & WESTERN RECORDING (Award to the Artist, plaque to the A & R Producer) ALMOST PERSUADED—David Houston—A & R Producer: Billy Sherrill (EPIC)
- 27 BEST COUNTRY & WESTERN VOCAL PERFORMANCE—FEMALE—DON'T TOUCH ME (Single)—Jeannie Seely (MONUMENT)
- 28 BEST COUNTRY & WESTERN VOCAL PERFORMANCE—MALE—ALMOST PERSUADED (Single)—David Houston (EPIC)
- 29 BEST COUNTRY & WESTERN SONG (This is a Songwriter's Award) ALMOST PERSUADED—Songwriters: Billy Sherrill, Glenn Sutton (EPIC)
- 30 BEST INSTRUMENTAL ARRANGEMENT (This is an Arranger's Award) WHAT NOW MY LOVE (Herb Alpert & the Tijuana Brass)—Arranger: Herb Alpert (A & M)
- 31 BEST ARRANGEMENT ACCOMPANYING A VOCALIST OR INSTRUMENTALIST (This is an Arranger's Award) STRANGERS IN THE NIGHT (Frank Sinatra)—Arranger: Ernie Freeman (REPRISE)
- 32 BEST ENGINEERED RECORDING—NON-CLASSICAL (This is an Engineer's Award) STRANGERS IN THE NIGHT (Frank Sinatra)—Engineer: Eddie Brackett (REPRISE)
- 33 BEST ENGINEERED RECORDING—CLASSICAL (This is an Engineer's Award) WAGNER LOHENGRIN—Leinsdorf cond. Boston Symphony, Pro Musica Chorus & Soloists—Engineer: Anthony Salvatore (RCA)
- 34 BEST ALBUM COVER, PHOTOGRAPHY (Award to the Art Director & Photographer) CONFESSIONS OF A BROKEN MAN—Porter Wagoner—Art Director: Robert Jones—Photographer: Les Leverette (RCA)
- 35 BEST ALBUM COVER, GRAPHIC ARTS (Award to the Art Director & Graphic Artist) REVOLVER—The Beatles—Graphic Artist: Klaus Voorman (CAP)
- 36 ALBUM OF THE YEAR (Awards to Artist and A & R Producer) IVES: SYMPHONY NO. 1 IN D MINOR—Morton Gould cond. Chicago Symphony Orchestra—A & R Producer: Howard Scott (RCA)
- 37 BEST PERFORMANCE—ORCHESTRA—MAHLER: SYMPHONY NO. 6 IN A MINOR—Erich Leinsdorf cond. Boston Symphony Orchestra (RCA)
- 38 BEST CHAMBER MUSIC PERFORMANCE—INSTRUMENTAL OR VOCAL—BOSTON SYMPHONY CHAMBER PLAYERS (Selections by Mozart, Brahms, Beethoven, Fine, Copland, Carter, Piston) Boston Symphony Chamber Players (RCA)
- 39 BEST PERFORMANCE—INSTRUMENTAL SOLOIST OR SOLOISTS (WITH OR WITHOUT ORCHESTRA)—BAROQUE GUITAR (Bach, Sanz, Weiss, Etc.)—Julian Bream (RCA)
- 40 BEST OPERA RECORDING (This is a Conductor's Award; special plaques to the Principal Soloists; plaque to the A & R Producer) WAGNER: DIE WALKURE—Georg Solti cond. Vienna Philharmonic Orchestra (Decca)

CONGRATULATIONS TO CASH BOX

"THAT'S HOW IT IS (WHEN YOU'RE IN LOVE)"

OTIS CLAY

ONE-DERFUL(!) 4848

"THE CHARGE"

B/W

"DIFF'RENT STROKS FOR DIFF'RENT FOLKS"

ALVIN CASH

MAR-V-LUS 6018

"JOEY"

THE YOUNG FOLK

MAR-V-LUS 6017

ONE-DERFUL (!) RECORDS

1829 S. Michigan Ave., Chicago 16, Ill.

TELS: 225-0583

SUBSCRIBE TO CASH BOX TODAY AND GET A COPY OF THIS DIRECTORY AS PART OF YOUR NEW SUBSCRIPTION

ED AMES / TIME, TIME



LPM/LSP-3834



LPM/LSP-3774 *



LPM/LSP-2781

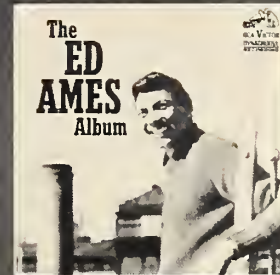

LPM/LSP-2944

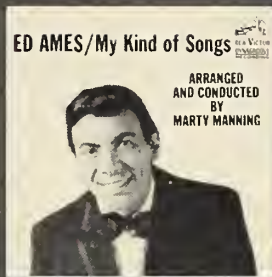

LPM/LSP-3390



LPM/LSP-3460



LPM/LSP-3636

Ed Ames offers music to please every musical taste with this strong lineup of albums featuring his new recording "Time, Time"—a perfect follow-up to his million-dollar seller "My Cup Runneth Over."

RCA VICTOR
The most trusted name in sound

Ames to please.



* Available on Stereo 8 Cartridge Tape

ASCAP PUBLISHERS

(Continued from page 160)

Harmony House of San Francisco P.O. Box 339, Mill Valley, Calif.
 Harmony c/o Lee Castle, 17 Longmeadow Rd., Yonkers, N.Y. 10704
 Harms Inc., Attn: Victor Blau, 488 Madison Avenue, N.Y.C. 10022
 Harms, T. B., 619 Fifth Ave., N.Y.C. 10017
 Hard 271 West 125th St., Suite 315, N.Y.C. 10017
 Harrel 71-017 Fairway Dr., Cathedral City, Calif. 92024
 Harratt 8815 Harratt St., Los Angeles, Calif.
 Harriet c/o Mort Becker, 305 Park Ave., N.Y.C. 10022
 Harris & Harris, 5327 Donna Ave., Tarzana, Calif. 91356
 Harris, Chas. K., 1619 Broadway, N.Y.C. 10019
 Harris, Henry 3231 Purdue Ave., Los Angeles 34, Calif.
 Harris, Jerome 21455 Highvale Tr. P.O. Box 104, Topanga, Calif. 90290
 Harrison 629 Sunset Blvd., Suite 1003, Hollywood, Calif. 90028
 Harsan 815 West 57th Street, N.Y.C. 10019
 Hart, Leo, 5928 Donna Ave., Tarzana, Calif.
 Hartley c/o Milan H. Hartz, 120 Cypress St., Millburn, N.J.
 Harvard Square 51 Leslie Rd., Belmont, Mass. 02178
 Harvest Hill 283 Chelsea St., Everett, Mass. 02149
 Harvest c/o Sy Mann 67-07 211th Street, N.Y.C. 11564
 Harw n 31 West 54th St., N.Y.C. 10019
 Haven House P.O. Box 454, La Crescenta, Calif.
 Haven c/o Harry Geller, 4225 Ethel Ave., Suite 32, Studio City, Calif.
 Haven c/o Maurice M. Kahn, 6381 Hollywood Blvd., Los Angeles, Calif. 90028
 Haven Press 545 Fifth Ave., N.Y.C. 10017
 Havenbrook c/o Charles R. Grean, 120 E. Hartsdale Ave., Hartsdale, N.Y.
 Havenhurst 71-017 Fairway Dr., Cathedral City, Calif. 92024
 Havenwood P.O. Box 128, 112 Broadway, Malverne, N.Y. 11555
 Haverford Music, 336 Central Park W., #4E, N.Y.C. 10025
 Wawaian P.O. Box 2061, Honolulu, Hawaii
 Haworth 185 W. End Ave., Apt. 20K, N.Y.C. 10023
 Hayes, Peter Lind and Mary Healy Hayes, 103 Mt. Tab Rd., New Rochelle, N.Y. 10805
 Hayton-Herre c/o Sidney Seid-nberg, 200 West 57th St., Rm. 607, N.Y.C. 10019
 Heartbeat c/o Seymour Schwartz, 9746 Crandon, Chicago, Ill. 60617
 Heartland 72 Maple (Box 429) West Des Moines, Iowa 50265
 Hefti, Neal 45 West 56th St., N.Y.C. 10019
 Helayne c/o Arthur Pine 515 Fifth Ave., N.Y.C. 10022
 Helena c/o Joe Darion, 110 Riverside Dr., N.Y.C. 10024
 Heller-Ferguson, Inc. 1666 No. Highland Ave., Hollywood, Calif. 90028
 Henderson 118 Belaire Ave., San Antonio, Tex. 78202
 Hendricks 45 Blauvelt Rd., Nanvet, N.Y. 10954
 Hendrix, James P.O. Box 1368, Nashville, Tenn.
 Henmar Press Inc., 373 Park Ave., So., N.Y.C. 10016
 Herry VIII c/o Steingarten, Wedeen & Weiss, 444 Madison Avenue, N.Y.C. 10022
 Hensley c/o Stanley L. Lefkowitz, 54 Second Ave., N.Y.C. 10003
 Herbec Inc., 9118 Sunset Blvd., Los Angeles 46, Calif.
 Herbert c/o Robert R. Kaufman, 51 Chambers St., N.Y.C. 10007
 Heritage House 10513 Santa Monica Blvd., Los Angeles, Calif. 90025
 Heritage 891 17th Ave., So., Nashville, Tenn.
 Heritage Square 1597 Post Road P.O. Box 266, Fairfield, Conn. 06430
 Herman 3561 Valley Meadow Rd., Sherman Oaks, Calif.
 Hicks 9922 Ostend Ave., Cleveland, Ohio 44108
 Hideout (Gear Pub. Div.) 15408 Mack Ave., Grosse Pointe Park, Mich. 48236
 Hi Fi 10999 Wilshire Blvd., Suite 410, Hollywood, Calif. 90024
 Highway 6526 Selma Ave., Hollywood, Calif.
 Hill, May 5216 So. Cornell, Suite 1 "E", Chicago, Ill. 60615
 Hillbron c/o Benjamin Starr, 161 West 54th St., N.Y.C. 10019
 Hillcrest c/o J. Robert Harris, 10 Marilyn Lane, Imperial Gardens, Westbury, L.I., N.Y.
 Hillsboro c/o Adonis Records, Inc. 200 W. 56th St., Suite 604, N.Y.C. 10019
 Hilltop c/o Jack Berch Box 273, RR 1, Yorktown Heights, N.Y. 10598
 Hillwood 2990 W. Pico Blvd., Los Angeles, Calif.
 Hinson, Robert 5318 Edgewater Dr., Orlando, Fla. 32810
 Hintz 850 Seventh Ave., N.Y.C. 10019
 Hi-Point c/o Edwin Greines, 3914 Hamilton Dr., Forth Worth, Tex.
 Hirt 150 East 52nd St., N.Y.C. 10022
 Hit 6533 Hollywood Blvd., Hollywood 28, Calif. 91607
 Hi-Ti 5437 Laurel Canyon Blvd., No. H'wood, Calif. 91607
 Hobby c/o Mrs. Eli Dawson 80-15 Grenfell St., Kew Gardens 15, N.Y.
 Hodon c/o Gordon & Miller 1619 Broadway, Rm. 813, N.Y.C. 10019

Hoffman, Al, c/o Alan Stein, Esq., 292 Madison Ave., N.Y.C. 10017
 Holford 9128 Sunset Blvd., Los Angeles, Calif. 90069
 Holliday 319 Lee Ave., Yonkers 5, N.Y.
 Holloway 8766 Holloway Dr., Hollywood, Calif. 90046
 Holly 836 W. 57th Ter., Kansas City, 13, Mo.
 Hollybrook 18 East 48th St., N.Y.C. 10017
 Holly-Hill 1744 No. Doheny Dr., Los Angeles 69, Calif.
 Hollyjo 1650 Broadway, Suite 1119, N.Y.C. 10019
 Holly-Pix 4931 Alcove Ave., No. Hollywood, Calif.
 Hollywood-Continental (Palomino Publishing Div.) 6208 Santa Monica Blvd., Hollywood, Calif. 90038
 Hollywood Hits 529 Elm P.O. Box 428, Carlsbad, Calif. 92008
 Holt, Rinehart and Winston, Inc., 383 Madison Avenue, N.Y.C. 10017
 Home Run 8859 So. Michigan, Chicago, Ill. 60619
 H metown c/o Sidney Prosen, 80-08 35th Ave., Jackson Heights, N.Y. 11372
 Homeyer, Charles W., & Co., Inc., 156 Boylston St., Boston, Mass.
 Honeycomb 9220 Sunset Blvd., Suite 330, Los Angeles, Calif. 90069
 Hope 5707 West Lake St., Chicago, Ill.
 Hopkins Syndicate, Inc., Hopkins Bldg., Mellett, Ind. 47958
 Horizon 118 N. Clark Dr., Los Angeles 48, Calif.
 Horn, Paul 2452 Horseshoe Canyon Dr., Los Angeles, Calif. 91364
 Hornblower 4742 Heaven Ave., Woodland Hills, Calif. 91364
 Horton, Vaughn, Inc. 1619 Broadway, N.Y.C. 10019
 Host 18 Berkley Lane, Syosset, N.Y. 11791
 House of James, Inc., 14738 Huston St., Sherman Oaks, Calif.
 House of Music Masters Pub. Co., 29 Pine St., Chelsea, Mass.
 House of Nacio Brown c/o Band of America—Trust Co. P.O. Box 810, Beverly Hills, Calif. 90216
 House of Zog 4813 Paradise Rd. #19, Las Vegas, Nev. 89109
 Howard, Beatrice Hotel Alvin, Rm. 605-B B'way & 52nd St., N.Y.C. 10019
 Howard, Joe c/o Mrs. Jos. E. Howard, P.O. Box 11144, Fort Lauderdale, Fla. 33306
 Howe-Lee c/o Milton Somerfield, Esq., 511 Fifth Ave., Rm. 704, N.Y.C. 10017
 Hub c/o Edward Traubner & Co., Inc., 132 So. Rodeo Dr., Beverly Hills, Calif. 90210
 Hudmar 24157 Lupin Hill Rd., Hidden Hills, Calif.
 Hudson c/o Kermit Goel, 440 West End Ave., N.Y.C. 10024
 Hul'abaloo 75 East 55th St., N.Y.C. 10022
 Humble 719 27th Ave., So., Nashville, Tenn. 39203
 Hummable c/o Vic Mizzy, P.O. Box 1792, Beverly Hills, Calif.
 Hunza Enterprises, 8440 Sunset Blvd., H'wood, Calif. 90069
 Hyacinth 10733 Stradella Ct., Los Angeles, Calif. 90024
 Hyman Helen 634 Elmcate Dr., Glenview, Ill. 60025

I.B.B. c/o Tanya Chaseman 845 W. End Ave., N.Y.C. 10025
 Icarus c/o Copyright Service Bureau Ltd., 221 West 57th St., N.Y.C. 10019
 Ice Follies Concession Co. (Ice Follies Music Div.), Winterland, Port & Steiner Sts., San Francisco, Calif.
 Idriss-Brown-Tibbles, Inc., 1951 Holmby Ave., Los Angeles 25, Calif.
 Ile-De-France Productions, Inc., 2 West 46th St., N.Y.C. 10019
 Image Music c/o March Fredericks, 46 Marlene Dr., Syosset, N.Y.
 Imogen 19 Tamara Lane, Cornwall, N.Y. 12518
 Imperial
 In P.O. Box 911, Hollywood Sta., H'wood, Calif. 90028
 Indano 6 East 45th St., N.Y.C. 10017
 Inge 4272 West Sta., Meridian, Miss.
 Instro c/o Laurel Record Co., 2314 86th St., Brooklyn, N.Y.
 Integrity 1050 Fifth Ave., Apt. 14A, N.Y.C. 10028
 Intercollegiate c/o Barney Young, P.O. Box 340, Radio City P.O. N.Y.C. 10019
 Interlochen Interlochen, Mich.
 Interlude P.O. Box 29151—Vermont Ave. Sta., Los Angeles, Calif. 90029
 International Artists, Ltd., 604 Taft Bldg., Hollywood, Calif.
 International Korwin Corp., 45 West 56th St., N.Y.C. 10019
 International Music Assoc., Inc. 140 S. Sepulveda Blvd., Los Angeles, Calif. 90049
 International Music Co., 509 Fifth Ave., N.Y.C. 10017
 International Music, Inc. Attn: Oscar Cohen, 445 Park Ave., 18th Floor, N.Y.C. 10022
 International Pauline Corp., 45 56th St., N.Y.C. 10019
 International Variety Associate 1513 North Cahuenga Blvd., Hollywood, Calif. 90028
 Intimate 1631 Broadway, N.Y.C. 10019
 Intino 1319 Rutgers St., Utica, N.Y. 13401
 Ipanema 1700 Rising Glen Road, Los Angeles, Calif. 90069

Irvick P.O. Box 979, El Monte, Calif. 91739
 Iryce 5041 1/2 Cahuenga Blvd., North Hollywood, Calif.
 Isabel 659 10th Ave., N.Y.C. 10036
 Italamerica 147 Mulberry St., N.Y.C. 10013
 Ivaloe 6311 Yucca St., Hollywood, Calif. 90028
 Ivanhoe 415 East 52nd St., N.Y.C. 10022
 Ivy 609 F 5th Ave., N.Y.C. 10017
 Izzo, Frank 5 Dover Rd., North Haven, Conn. 06473

J

J-B c/o Jack Romano 461 Dean St., Brooklyn 17, N.Y.
 J.B.J. 735 Morris St., Philadelphia, Pa. 19148
 JM 8910 Riggs Rd., Hyattsville, Mo. 20783
 J.P. c/o Mrs. Helen Weinberg, 65 1/2 East 12th St., Paterson, N.J. 07502
 JPB 1814 Broadway, Rm. 1205, N.Y.C. 10023
 JTH 9032 Wilshire Blvd., Suite 316, Beverly Hills, Calif. 90211
 J.V.P. 800 No. Argyle, Suite #303, Hollywood, Calif. 90028
 J & E c/o Dean-Altfield Associates, 15 West 55th St., N.Y.C. 10019
 J & R 25 Godwin Ave., Ridgewood, N.J. 07450
 Jabaron 110 Fisk St., Providence, R.I. 02905
 Jac c/o Hal David Elm Drive, East Hills, Roslyn, N.Y.
 Jack-Do c/o Jerome B. Lurie 717 Fifth Ave., N.Y.C. 10022
 Jack Sky c/o John M. Govsky, 7807 Farnsworth St., Philadelphia 15, Pa.
 Jaemel, Inc. 1141 South Beverly Dr., Los Angeles 35, Calif.
 Jacobs, Al. 535 N.E. 113th St., Miami, Fla. 33161
 Jacobs, Walter, Inc. 1350 Avenue of the Americas, N.Y.C. 10019
 Jacogg 54 Cleveland Ave., Hartford, Conn. 06120
 Jad 411 Dubois Ave., Dallas, Tex.
 Jade c/o Alan Gordon, 53 Boulevard, East Paterson, N.J. 07407
 Ja-Ma 2552 West Fifth St., Los Angeles 57, Calif.
 Jameco 870 A So. Broadway, Hicksville, N.Y.
 James, Billy Attn: R. P. Nicholas, Secy. & Treas. 4 Furness Lane, Wallingford, Chester County, Pa.
 James 1650 Broadway, N.Y.C. 10029
 Jana c/o Less McCann 6248 Scenic Ave., Hollywood, Calif. 90028
 Jandon 3942 Third Ave., Detroit, Mich. 48201
 Jandor c/o Kenneth Greenstein, 100 Park Ave., N.Y.C. 10017
 Janciro 1790 Rising Glen Rd., Los Angeles, Calif. 90069
 Janfra 135 West 59th St., Suite 1920 N.Y.C. 10019
 Janfred c/o George Kleinsinger, Hotel Chelsea, 200 West 23rd St., N.Y.C.
 Jan-Lee 269 El Camino Dr., Beverly Hills, Calif. 90212
 Janmur c/o George Mercaders & Co., 9171 Wilshire Blvd., Suite 404, Beverly Hills, Calif.
 Janon c/o Copyright Service Bureau Ltd., 221 West 57th St., N.Y.C. 10019
 Jarest 8676 Lookout Mountain Ave., H'wood, Calif. 90046
 Jarrard 145 West 71st St., N.Y.C. 10023
 Javel's 610 So. Verdugo Rd., Glendale, Calif. 91203
 Jay IV 39 Andover Rd., Roslyn Heights, N.Y.
 Jay Music 12236 Hesby St., No. H'wood, Calif.
 Jaybar c/o Louis P. Randell, 1501 Broadway, N.Y.C.
 Jay-Kay 150 West 55th St., N.Y.C. 10019
 Jaymar c/o Martin Mills Enterprises Inc. 1619 Broadway N.Y.C. 10019
 Jaytone 16386 Mandalay Dr., Encino, Calif. 91316
 Jeannie c/o David Shapiro 1129 E. 15th St., Tulsa, Oklahoma
 Jed 517 N. Main St., Sidney, O.
 Jefferson 1619 Broadway, N.Y.C. 10019
 Jeffrey 756 Seventh Ave., N.Y.C. 10019
 Jeje c/o Arnold H. Rosenthal 3343 Sedgwick Ave., Bronx 63, N.Y.
 Jemio 12201 Hillslope St., Studio City, Calif. 91604
 Jen D c/o Mrs. Jennie Dougherty, 540 East Walnut Lane, Philadelphia, Pa.
 Jenkins Gordon, Inc. c/o Praunstein, Chernin & Plant, 10,000 Santa Monica Blvd., Suite 311, Los Angeles, Calif. 90067
 Jenkins 1217-23 Walnut St., Kansas City 6, Mo.
 Jennings 4130 Main St., Kansas City, Mo.
 Jenny c/o Alouette Productions, Inc., 1619 Broadway Suite 914, N.Y.C. 10019
 Jerden (Marinwood Music Pub. Div.) 2227 Fifth Ave., Seattle, Wash. 98121
 Jericho 34 West 53rd St., N.Y.C. 10019
 Jerico 812 9th, Moultrie, Ga. 31768
 Jerryco c/o Edwin H. Morris & Co., Inc., 31 West 54th Street, N.Y.C. 10019
 Jerry 706 Union Ave., Memphis, Tenn.
 Jetset 800 Riverside Dr., N.Y.C. 10032
 Jett 1916 West 78th Pl., Los Angeles 47, Calif.
 Jewel 1619 Broadway, N.Y.C. 10019
 Jildana c/o Marion Weiss 27 Stegman Pl., Jersey City 5, N.J.
 Jillbern 39 W. 55th St., N.Y.C.
 Jilljan Attn: Al Schwartz 408 W. 57th St., Apt. 6-1, N.Y.C. 10019
 Jim Jon c/o Jimmy Saunders 1622 So. 9th St., Philadelphia 48, Pa.
 Jingle 130 Harrison St., Bloomfield, N.J.
 JKLM c/o Alters 411 West End Ave., N.Y.C. 10024
 JIJ (JLJ Music Co. Div.) 40 Central Park So., Suite 1 G, N.Y.C. 10019
 Jo-Al c/o Copyright Service Bureau Ltd., 221 West 57th St., N.Y.C. 10019
 Jo-Art c/o Joey Sasso 525 Lexington Ave., N.Y.C. 10017
 Jobel 22 Gary Rd., Syosset, N.Y. 11791
 Jodi c/o Stanley Applebaum 632 Winchester Ave., Union, N.J.
 Joeneil 1619 Broadway, N.Y.C. 10019

Joger 6311 Yucca St., Hollywood, Calif. 90028
 John Paul 2451 Nichols Canyon Rd., Hollywood 46, Calif.
 Jerry Johnson, Inc. c/o Jerry Johnson R.D. 1, Lebanon, N.J.
 Jo-Jon c/o Jonny Baron 1616 N. Argyle Ave., Suite 1, Hollywood, Calif. 90028
 Joleron 80 Fifth Ave., N.Y.C. 10011
 Joli Tinker 1619 Broadway, Suite 504A, N.Y.C.
 Joline c/o Jimmy McHugh 709 N. Sierra Dr., Hollywood, Calif. 90210
 Jolly 350 Fifth Ave., Suite 1535, N.Y.C. 10001
 Jolly c/o Archie Shipping, 3126A Easton Ave., St. Louis 6, Mo.
 Jonathan c/o Bud Granoff Assoc., 45 West 56th St., N.Y.C. 10019
 Jon-Tees c/o John T. Johnson 1614 Virginia Rd., Los Angeles 19, Calif.
 Jopell c/o Bert Pellish, 6944 Murietta Ave., Van Nuys, Calif.
 Jessie c/o Jerry Blaine 315 West 47th St., N.Y.C. 10036
 Joy 40 West 55th St., N.Y.C. 10019
 Joyson c/o Dunes Record Inc. 1619 Broadway, N.Y.C. 10019
 Jubilee 609 Fifth Ave., N.Y.C. 10017
 Juke Box Alley c/o Tin Pan Alley Records 1650 Broadway, N.Y.C. 10019
 Julesco 485 Fort Couch Rd., Pittsburgh, Pa. 15228
 Juli Attn: S. Glazier, 3300 Lake Shore Dr., Chicago 13, Ill.
 Julyry 1330 Avenue of the Americas, N.Y.C. 10019
 Jungnickel, Ross, Inc., 1619 Broadway, 11th Floor, N.Y.C. 10019
 July 235 West 46th St., N.Y.C. 10036

K

K & L 279 E. Warm Springs Rd., Las Vegas, Nev.
 Kady 12143 Buckeye, San Fernando, Calif.
 Kahal, Irving, c/o A. Halsey Cowan, Esq. 1740 Broadway, N.Y.C. 10019
 Kahanmoku, Duke, (Diamond Head Music Publishing Co.) International Market Place, Waikiki Beach, Hawaii
 Kahn, Gus, 6223 Selma Ave., Hollywood 28, Calif.
 Kalakaua P.O. Box 2547, Honolulu, Hawaii
 Kali c/o Robert B. Arkin, 5800 Arlington Ave., Riverdale, N.Y. 10471
 Kali Yuga 123 Medland Dr., Warrenton, D.C. 29851
 Kalman, Charles Emmerich, Inc. 1619 Broadway, 9th Floor, N.Y.C. 10019
 Kalmann 300 Farwood Rd., Philadelphia 51, Pa.
 Kalmus, Edwin F. 1345 New York Avenue, Huntington, N.Y. 11746
 Kanes c/o Hermankanes 143 Bruce Ave., Yonkers, N.Y.
 Kapralik c/o Copyright Service Bureau Ltd. 221 West 57th St., N.Y.C. 10019
 Karen c/o Larry Newton, 70-25 Yellowstone Blvd., Forest Hills, N.Y. 11375
 Karin 9341 1/2 Olympic Blvd., Beverly Hills, Calif.
 Karolyn 1650 Broadway, Suite 607, N.Y.C. 10019
 Kassel Airs 6934 Firmament Ave., Van Nuys, Calif.
 Kassner, Edward, 135 West 50th St., Rm. 1920, N.Y.C. 10019
 Kathie P.O. Box 262, Bound Brook, N.J. 08805
 Kat kris P.O. Box 834, Greenwood Lake, N.Y.
 Kay, Edward, c/o Abraham Marcus, Esq. 9250 Wilshire Blvd., Beverly Hills, Calif.
 Kearney P.O. Box 351, Bergenline Ave., No. Bergen, N.J.
 Keene c/o Skitch Henderson 234 East 61st St., N.Y.C. 10021
 Keepsake Serenades c/o Fay El Widen 7767 Hollywood Blvd., Suite 101, Hollywood, Calif. 90046
 Kehner, Clarence 242 Burns St., Camden, N.J. 08102
 Keith c/o Barney Fields 5750 Melrose Ave., Hollywood, Calif. 90038
 Keith-Valerie c/o Orland Chase & Mucci, East 45th St., N.Y.C. 10017
 Kellen, Milton 336 Central Park W., N.Y.C. 10025
 Kelton, Inc. 66 Mechanic St., New Rochelle, N.Y.
 Keltone International 7819 Noole Ave., Van Nuys, Calif. 91405
 Kenbob c/o Brunstein, Cherin & Plant, 10,000 Santa Monica Blvd., Suite 311, Los Angeles, Calif. 90067
 Kenco Enterprises, Inc. 382 Central Park W., Apt. 9W, N.Y.C. 10025
 Kendis c/o Mrs. James Kedis, 170-32 Cedarcroft Rd., Jamaica 3, N.Y.
 Kenmor c/o Dennis Day 2401 Mandeville Canyon Rd., Los Angeles, Calif. 90049
 Kennebek c/o Basil Bova, 250 Prospect Ave., Revere, Mass.
 Kennedy Songs 7 Pearl St., Montpelier, Vermont 05601
 Kent 242 Burns St., Camden, N.J.
 Kent, Walter 132 South Rodeo Drive, Beverly Hills, Calif. 90212
 Kenyon 501 Madison Ave., (24 Fl.) N.Y.C. 10022
 Kenyon c/o Albert De Vito 361 Pin Oak Lane, Westbury, N.Y. 11590
 Keyboard, Inc. c/o Laurence W. Beilenson 1946 N. Gramercy Pl., Los Angeles, Calif. 90028
 Keynote c/o Alfred W. Schlesinger, Esq. Crossroads of the World, Suite 1518, Hollywood 28, Calif.
 Keystone 9615 Helen Ave., Sunland, Calif.
 Kiele 5001 Palomar Dr., Tarzana, Calif. 91356
 K'm 288 Willow Dr., Levittown, Pa.
 Kimberly 211 West 58th St., N.Y.C. 10019
 Kimbill (New Way Products Co. Div.) 22 Fitting Pl., Box 2, Nutley 10, N.J.
 Kimura 6115 Selma Ave., Hollywood, Calif. 90028

(Continued on page 176)

FROM: YOU
 TO: SEVEN ARTS PRESS, INC.
 6365 Selma Avenue, Hollywood, California 90028
 Please send me _____ I'm enclosing payment in full _____ The following Walter E. Hurst—W. S. Hala books
 _____ Copies of THE RECORD INDUSTRY BOOK @ \$25.00
 _____ Copies of THE MUSIC INDUSTRY BOOK @ \$25.00
 _____ Copies of THE MUSIC PUBLISHERS OFFICE MANUAL @ \$25.00
 (California residents—please add 4% sales tax)

London Records, Inc.,
brings great English
and Continental hit-
makers to the U.S.A.
on these labels:

LONDON[®]



phase **4** stereo.

London Records, Inc., 539 W. 25 St., N. Y., N. Y.

London Records, Inc., offers
great U.S.A. hitmakers
to the rest of the world
on these labels:



ASCAP PUBLISHERS

(Continued from page 174)

King Brand c/o Westley Cowen 1595 B'way, N.Y.C. 10019
 King, Charles E. P.O. Box 2691, Pompano Beach, Fla.
 King, John 649 No. Bronson, H'wood, Calif.
 Kingsley c/o Edward Kassner 135 W. 50th St., Suite 1920, N.Y.C. 10019
 Kinlu 306 W. 51st St., Suite 4-G, N.Y.C. 10019
 Kips Bay 146 West 54th St., N.Y.C. 10019
 Kiss 4669 Arriba Dr., Tarzana, Calif.
 Kitty Anne 45 West 56th Street, N.Y.C. 10019
 Knollwood 15 East 48th St., N.Y.C. 10017
 Koff P.O. Box 1442, Studio City, Calif. 91604
 Kohn 1650 Broadway, Suite 1112, N.Y.C. 10019
 Koko 649 No. Bronson Ave., H'wood 38, Cal.
 Komotion R #1 Box 720, Stevensville, Mich. 49127
 Koty, Archie c/o Newmark 20 Woodruff Ave., Brooklyn, N.Y.C. 11226
 Kradar c/o Herman Krasnow 165 W. End Ave., N.Y.C. 10023
 Kramer-Whitney 1650 Broadway, N.Y.C. 10019
 Krasnow 435 1/2 S. Oakhurst Dr., Beverly Hills, Calif. 90212
 Krinch, Herman 113 Longvie St., W. Orange, N.Y. 07052
 Krieger 25205 Cypress St., Lomita, Calif. 90717
 Kuklaplitan 12 Beekman Pl., N.Y.C. 10022
 Kulma 305 W. 53rd St., Apt. 2J, N.Y.C. 10019

L

L & D 45 W. 56th St., N.Y.C. 10019
 LDJN c/o Leeds 322 W. 48th St., N.Y.C. 10036
 L & M 512 N. Roxbury Dr., Beverly Hills Calif. 90210
 La Forge c/o Jack La Forge 1500 Bay Rd., Miami Beach, Fla. 33139
 La-Mac The Sportorium Cadiz & Industrial, Dallas, Texas
 La Salle 1619 Broadway, N.Y.C. 10019
 La Vere 247 Fort Pitt Blvd., Pittsburgh 22, Pa.
 Labell 2065 Morris Ave., N.Y.C. 10053
 La Brea 1416 N. La Brea, Hollywood, Cal. 90028
 Lachambre 14100 Telegraph Rd., Detroit Mich. 48239
 Lady Mac 136 W. 52nd St., N.Y.C. 10019
 Laertes Box 265, Radio City Sta., N.Y.C. 10019
 Lake, Bonnie 310 E. 44th St., #2075 N.Y.C. 10017
 Lake Forest 1130 Green Bay Rd., Lake Bluff, Ill.
 Lake Shore c/o Bank of America Nat'l Trust Trust Dept. P.O. Box 1, Palm Springs, Calif. 192263
 Lamas P.O. Box 1273, Grand Central Sta., N.Y.C. 10017
 Landgold 6290 Sunset Blvd., H'wood, Cal. 90028
 Lane c/o Heritage House, Suite 7, 1346 N. Broad St., Phila., Pa. 19121
 Lange, John 6526 Selma Ave., H'wood 23, Cal.
 Lanlee 1607 El Centro, H'wood, Calif. 90028
 Lansdowne 1549 N. Vine St., H'wood 28, Calif.
 Lansing c/o Arthur Shinkin 15 Central Pk. W., N.Y.C. 10023
 Lantern c/o Arthur D. Schultz, 480 S. Oakhurst Dr., Los Angeles, Calif. 90035
 Lantz 6410 Willoughby Ave., H'wood, Calif. 90038
 Laren c/o Ross Jungnickel, Inc. 1619 B'way, N.Y.C. 10019
 Larilee 5642 Beck Ave., N. H'wood, Cal. 91601
 Larlita 607 W. 184th St., Apt. 2ER, N.Y.C. 10033
 Lassie 270 N. Canon Dr., Beverly Hills, Calif.
 Lasta P.O. Box 20004, Sta. N., Atlanta, Ga. 30325
 Laurel 22 W. 48th St., N.Y.C. 10036
 Lauriadell 881 7th Ave., N.Y.C. 10019
 Laurie 35 W. 45th St., N.Y.C. 10036
 Laurstedt c/o Edward Traubner & Co. 132 S. Rodeo Dr., Suite 501, Beverly Hills, Cal. 90212
 Lawrence c/o Lawrence Weitz Rt. 216, Stormville, N.Y.
 Lawson-Gould 609 5th Ave., N.Y.C. 10017
 Layne-Bosnick 1349 Cherokee Ave., Los Angeles, Calif. 90028
 Leajay 2724 Burton Ave., Las Vegas, Nev. 90028
 Leamay c/o Norris Chris Henson 1532 Wilcox, H'wood, Calif. 90028
 Lear 555 Madison Ave., N.Y.C. 10022
 Leblanc 7019 30th Ave., Kenosha, Wisc.
 Lednam c/o Johnny Mandell 8552 Appian Way, H'wood, Calif. 90046
 Lee-Jon 3580 Washington Blvd., Cleveland, O. 44118
 Lee, Janet 872 Marcella St., Phila., Pa. 19124
 Lee 165 W. 46th St., Rm. 411A, N.Y.C. 10036
 Leeds Attn: Mr. Hall Haas Music Corp. of America Universal Studios, Universal City, Calif. 91601
 Leevan 1631 B'way, N.Y.C. 10019
 Leeway c/o Hal Levy 4042 Benedict Canyon, Sherman Oaks, Calif.
 Leftwich 659 S. Orange Dr., Los Angeles, Cal. Legend 345 W. 58th St., 15F, N.Y.C. 10019
 Legendary 3322 Jerome St., Dallas, Tex. 75223
 Leigh 4046 Ingraham St., Los Angeles 5, Calif.
 Leigh, Mitch 32nd fl., 65 W. 54th St., N.Y.C. 10019
 Leilani Box 38713, H'wood, Calif. 90028
 Leipprandt 3864 N. Strum, Pigeon, Mich. 48975
 Lejo c/o Jr. Johnny Green 33 Riverside Dr., N.Y.C. 10023
 Lemon 1619 B'way, N.Y.C. 10019
 Le-Mor 823 S. Wabash Ave., Chicago, Ill.
 Lenore 2000 Glenview Ave., Park Ridge, Ill.
 Leon 2 Tudor City Pl., #3GN, N.Y.C. 10017
 Leonard, Hal 64 E. 2nd St., Winona, Minn.
 Leonora c/o Herb Reis 1619 B'way, N.Y.C.
 Leopold c/o Leopold Peter Karniol, 102 N. Westgate, Los Angeles 49, Calif.
 Lerner 3950 Vintage Ave., Studio City, Calif.
 Lerner, Samuel M. 1857 N. Wilton Pl., H'wood, Calif. 90028
 Lero 2990 W. Pico Blvd., Los Angeles 6, Calif.
 Lesjohn 6411 H'wood Blvd., H'wood, Cal. 90028
 Leslie, Edgar 59 W. 46th St., N.Y.C. 10019
 Leslie c/o Braunstein, Chernin & Plant 10,000 Santa Monica Blvd., Suite 311, Los Angeles, Calif. 90067
 Leslie c/o Mr. Paul Reif 57 W. 58th St., N.Y.C. 10019
 Levee 748 Camp St., New Orleans, La. 70130
 Levine, Joseph E. c/o Larry Shayne 6290 Sunset Blvd., Suite 1003, H'wood, Calif. 90028
 Levine-McHugh Time & Life Bldg., Rockefeller Center, N.Y.C. 10020
 Levine-McHugh 709 Sierra Dr., Beverly Hills, Calif. 90210

Lewandowski 2712 N. Woodward Ave., Royal Oak, Mich. 48073
 Lewis 39 W. 60th St., N.Y.C. 10023
 Lewki Attn: Gerard Purcell 150 E. 52nd St., N.Y.C. 10022
 Lew-Lou 10707 Camarillo St., N. H'wood, Cal. 91602
 Lexicon 5030 W. Waco Dr., Waco, Tex. 76703
 Lexington 670 N. Mich. Ave., Rm. 502, Chicago, Ill.
 Libby c/o Alex Beller 4311 Alceve Ave., Studio City, Calif. 91604
 Liberty State Box 192, Avery, Tex.
 Libreria Demartino 145-7 Mulberry St., N.Y.C. 10013
 Lida c/o Mr. Sidney G. Aron 39 B'way, N.Y.C. 10004
 Lilli c/o E. Jonny Graff, Pres. 2 Rochelle Rd., Larchmont, N.Y. 10538
 Lillimar c/o Alouette Prod., Inc. 1619 B'way, Suite 914, N.Y.C. 10019
 Lin 155533 Labrador St., Sepulveda, Calif.
 Linalan 618 S. Glenwood Pl., Burbank, Calif.
 Lincoln c/o Abner Silver 160 Central Pk. S., Suite 203, N.Y.C. 10019
 Lindabet 34 W. 53rd St., N.Y.C. 10019
 Lindel c/o Barnett & Willens 1180 Ave. of the Americas, N.Y.C. 10036
 Lindley 360 N. Camden Dr., Beverly Hills, Cal.
 Line and Stanza 62-11 Dieterly Crescent, Rego Pk., N.Y. 11374
 Linkletter 1800 Ave. of the Stars, Suite 210, Los Angeles, Calif. 90067
 Lion 1350 Ave. of the Americas, N.Y.C. 10019
 Lionel c/o William Riger, Esq. 1 Hanson Pl., Brooklyn, N.Y.
 Lisa-Ann 157 W. 57th St., N.Y.C. 10019
 Lisalee c/o Mr. Lee Coleman 37 W. 57th St., N.Y.C. 10019
 Listen & Learn 2050 Ludlow St., Phila., Pa. 19103
 Little Debbie 4314 N. Broad St., Phila. 40, Pa.
 Littlefield 408 N. Rodeo Dr., Beverly Hills, Cal. 90210
 Little Tor 95 Little Tor Rd., N.Y.C. 10056
 Living Legend 6365 Selma Ave., Suite 7, Los Angeles, Calif. 90028
 Livingston & Evans 6290 Sunset Blvd., H'wood, Calif. 90028
 Liza 150 W. 52nd St., N.Y.C. 10019
 Liz-Bet 315 W. 70th St., Apt. 3K, N.Y.C. 10023
 Lloyd's of H'wood Box 407, H'wood 28, Calif.
 LLSJ 2 Harriett La., Plainview, N.Y.
 Lock 6830 Pacific View, Los Angeles, Calif. 90028
 Loc-Lom 89 Oakland St., Berkeley Hgts, N.J.
 Loeb, John Jacob 42 Lafayette Pl., Woodmere, N.Y.
 Loma Vista c/o Mr. David Chudow 8330 W. 3rd St., Los Angeles 48, Calif.
 Lombard 1650 Broadway, N.Y.C. 10019
 Lombardo 1619 Broadway, N.Y.C. 10019
 Londontown 18 N. Clark Dr., Los Angeles, Calif. 90045
 Lone Star c/o Mrs. Joy Milane Box 1053, H'wood 28, Calif.
 Long Hair 151-14 Bayside Ave., Flushing, N.Y. 11354
 Longridge 6087 Sunset Blvd., H'wood 28, Cal.
 Longview 6087 Sunset Blvd., H'wood 28, Cal.
 Loop 525 Busse Hwy, Pk. Ridge, Ill.
 Lopez, V. 769 7th Ave., N.Y.C. 10019
 Lord and Leonard 56 Grand St., White Plains, N.Y. 10601
 Lord Music c/o Mr. Arthur Pine 515 Madison Ave., N.Y.C. 10022
 Lorenz 501 E. 3rd St., Dayton 1, Ohio
 Lorin Will 330 E. 46th St., N.Y.C. 10017
 Lorisel c/o Wladimir Selinsky 205 W. 57th St., N.Y.C. 10019
 Louwin 808 N. Broad St., 2nd fl, Phila., Pa. 19130
 Love 56 3rd St., Hoboken, N.J.
 Lowe 1411 Walnut St., Phila. 2, Pa.
 Lowe Charles 8749 Sunset Blvd., H'wood, Cal. 90069
 Lucianna 3581 Wood Hollow Rd., Northfield, O.
 Lugar c/o Mickey Garlock 475 5th Ave., N.Y.C. 10017
 Lu-Jac c/o Wattenberg & Wattenberg 609 5th Ave., N.Y.C. 10017
 Lu-Mel c/o Mr. Luther Henderson 124 W. 79th St., N.Y.C. 10014
 Lupercalia c/o Purcell 150 E. 52nd St., N.Y.C. 10022
 Luristan 723 7th Ave., N.Y.C. 10019
 Lute P.O. Box 1181, H'wood, Calif. 90028
 Luxcraft c/o Mr. Joseph Neglia 2358 4th St., Brooklyn 23, N.Y.
 Lyle 120 E. 34th St., N.Y.C. 10016
 Lynch Variety 8 Eatonton St., Monticello, Ga. 31064
 Lynnette c/o Bernard Cinelli 423 Highland Pl., Bound Brook, N.J. 08805
 Lynnstorm 9713 Santa Monica Blvd., Beverly Hills, Calif. 90210
 Lyra 43 W. 61st St., N.Y.C. 10023
 Lyric c/o Fred G. Moritt, Esq. 120 Schermerhorn St., Brooklyn, N.Y. 11201
 Lyrical Miracles 226 S. Beverly Dr., Beverly Hills, Calif.

M

M.A.B. 45 W. 56th St., N.Y.C. 10019
 M.K.T. 8410 Sunset Blvd., Los Angeles 69, Cal.
 M. L. 2473 Crestview Dr., Los Angeles, Calif. 90046
 M.Z.G. P.O. Box 38194, Los Angeles, Cal. 90038
 M.S.K. 1564 B'way, Suite 306, N.Y.C. 10019
 MCA Universal Studios, Universal City, Calif. 91608
 Mahreze c/o Richard Carpenter 372 Central Pk. W., Apt. #9B, N.Y.C. 10025
 MABS c/o Arnold Mills & Assoc. 8721 Sunset Blvd., Los Angeles, Calif. 90069
 MACAP 222 W. 83rd St., Apt. 11A, N.Y.C. 10024
 Mac Gibbon 1619 B'way, N.Y.C. 10019
 Macs-Sounds 325 W. 51st St., N.Y.C. 12019
 Madanson Box 2782 Grand Central Sta., N.Y.C. 10017
 Madrigal c/o Abraham Marcus, Esq. 9250 Wilshire Blvd., Beverly Hills, Calif.
 Magaska c/o Mr. Harry Ashburn 7773 Torreyson Dr., H'wood, Calif. 90046
 Magidson 10464 Lindbrook Dr., Los Angeles 24, Calif.
 Magnificent c/o Mr. Max J. Rosenberg 527 Madison Ave., N.Y.C. 10022
 Majestic c/o Mr. George Rosette 1240 Pk. Ave., N.Y.C. 10028

Makeba c/o Schward & Lewis Assoc. Inc. 345 W. 58th St., N.Y.C. 10019
 Malcom c/o Bobby Christian 703 N. East Ave., Oak Park, Ill.
 Malick 544 Fulmer Ave., Akron, Ohio 44312
 Malin 7 Patricia Dr., N.Y.C. 10056
 Malloy 6425 H'wood Blvd., H'wood 28, Calif.
 Malneck 508 N. Elm Dr., Beverly Hills, Calif.
 Maltby, Richard 220 Central Pk. S., N.Y.C. 10019
 Malvern Malvern, Chester County, Pennsylvania, Pa. 19355
 Malverne 4 Azalea Dr., Syosset, N.Y.
 Mona 835 Hamilton Ave., Fort Wayne, Ind. 46806
 Manchester 10 Columbus Cir., Suite 3160, N.Y.C. 10019
 Mandate 242 N. Conon Dr., Beverly Hills, Cal. 90210
 Mandolin 2216 Rogers Ave., Los Angeles, Calif. 90023
 Manhattan 565 W. End Ave., N.Y.C. 10024
 Manks, Chaw Drawer 30, Staunton, Ill.
 Mann, Herbie 300 Central Pk. W., N.Y.C. 10024
 Manners, Dudley 177 Beach 141st St., Bell Harbor, L.I.
 Manners 1229 N. Olive Dr., Los Angeles 69, Calif.
 Manning 10436 Eastborne Ave., W. Los Angeles 24, Calif.
 Manor 11 Rumsey Rd., Yonkers, N.Y.
 Manpine c/o Publishers' Licensing 40 W. 55th St., N.Y.C.
 Manseau c/o George J. Gottried, C.P.A. 9107 Wilshire Blvd., Suite 503, Beverly Hills, Cal.
 Mansfield Attn: Mr. Victor Blau 488 Madison Ave., N.Y.C. 10022
 Mansion 136 W. 52nd St., N.Y.C. 10019
 Mantovani c/o Ross Jungnickel, Inc. 1619 Broadway, N.Y.C. 10019
 Mappa 6087 Sunset Blvd., H'wood, Calif.
 Mara c/o Braunstein, Chernin & Plant 10,000 Santa Monica Blvd., Suite 311, Los Angeles, Calif. 90067
 Mara-Lane 609 5th Ave., N.Y.C. 10017
 Maral 6757 H'wood Blvd., H'wood 28, Calif.
 Marapunta Shayne 6290 Sunset Blvd., H'wood, Calif. 90028
 Maravilla 116 Central Pk. S., N.Y.C. 10019
 Mar-Ben 7931 Borcas St., Phila. 11, Pa.
 Marble 2065 Morris Ave., Bronx, N.Y. 10453
 Marchant c/o Kenneth D. Molloy, Attorney
 Mardel c/o Mr. J. Gotteried 1555 N. Bronson Ave., H'wood, Calif. 90028
 Ma-Ree Drawer 1, Madison, Tenn. 37115
 Maresca 2621 Palisade Ave., Riverdale, N.Y. 10463
 Margery c/o William W. Lazarow 119 W. 57th St., Suite 1106, N.Y.C. 10019
 Margin 6724 Allott Ave., Van Nuys, Calif.
 Marguerita 1650 B'way, Suite 403, N.Y.C. 10019
 Marian 135 W. 50th St., Suite 1920, N.Y.C. 10019
 Marimba 6 E. 45th St., N.Y.C. 10017
 Marina c/o Joe Jaros 29 Kralj Dr., Watsonville, Calif. 95070
 Marine 50 Broadway, Rm. 2701, N.Y.C. 10004
 Marinwood 971 Thomas St., Seattle, Wash. 98109
 Marjan c/o Harry Weinstein 2427 E. 29th St., Brooklyn, N.Y. 11235
 Marjon 7 W. Monroe St., Chicago, Ill. 60603
 Mark 56 P.O. Box 23, 424 N. Pine St., Anaheim, Calif.
 Mark-Jules c/o Adrian Greenberg 767 81st St., Miami Beach, Fla. 33141
 Markk VII P.O. Box 708, Encino, Calif. 91317
 Markell c/o Asher & Beldock & Kushnick 720 5th Ave., N.Y.C. 10019
 Marks, Gerald 140 W. 57th St., N.Y.C. 10019
 Marks Ted 13 Central Ave., Woodmont Milford, Conn.
 Marlen 408 N. Rodea Dr., Beverly Hills, Calif.
 Markwood 711 W. End Ave., Apt. 7A(s), N.Y.C. 10025
 Marlene 735 E. Rittenhouse St., Phila., Pa.
 Marlo c/o Mr. David W. Katz Attn: Mr. P. Plumer 10 E. 40th St., N.Y.C. 10019
 Marlong 11 Pk. Pl., N.Y.C. 10019
 Marmaduke c/o Walter Hofer 221 W. 57th St., N.Y.C. 10019
 Marnel c/o Copyright Service Bureau Ltd. 221 W. 57th St., N.Y.C. 10019
 Marpet 1777 N. Vine St., Suite 312, H'wood, Calif. 90025
 Marquetry c/o B. L. & H. Music Corp. 1650 Broadway, N.Y.C. 10019
 Marquis 4914 E. Horseshoe Rd., Scottsdale, Ariz. 85251
 Mars 10 Columbus Cir., Suite 2160, N.Y.C. 10019
 Marshall, David 911 Calle Refugio, Miramer, Banturee, P.R. 00371
 Marster-Sound c/o Mr. William Snyder 11 Riverside Dr., N.Y.C. 10023
 Marti 1520 N. Hayworth #6, H'wood 46, Calif.
 Martin, George & Sons 680 S. Crescent Ave., Cincinnati, Ohio 45229
 Martin, James H. 1341 S. Mich. Ave., Chicago, Ill.
 Martin, William 1865 N. Bay Causeway N. Bay Village, Fla. 33141
 Martin 9348 Santa Monica Blvd., Beverly Hills, Calif. 90210
 Marvin 1619 B'way, N.Y.C. 10019
 Marx, Josef 201 W. 68th St., N.Y.C. 10024
 Mary Jane c/o Albert R. Gaines 422 Madison Ave., N.Y.C. 10017
 Maryon 6207 N. Lundy Ave., Chicago, Ill. 60646
 Mastel c/o Weiss 1411 Hellenman St., Phila., Pa. 19149
 Mason 130 W. 56th St., N.Y.C. 10019
 Massey 1619 Broadway, N.Y.C. 10019
 Matador 607 Grant Bldg., Pittsburgh, Pa.
 Matas 321 N.W. 34th St., Miami, Fla. 33137
 Mathcar 90 Bayview Ave., S. I. N.Y. 10309
 Mattis, Johnny 1619 B'way, 11th fl., N.Y.C. 10019
 Maurice, Peter 10 W. 55th St., N.Y.C. 10019
 Maxana 606 Madison Ave., N.Y.C. 10022
 Maximum c/o Mr. Marion Evans 159 W. 49th St., N.Y.C. 10036
 Maxwell 119 W. 57th St., Suite 1108, N.Y.C. 10019
 May c/o Ross Jungnickel 1619 B'way N.Y.C. 10019
 Mayfair 31 W. 54th St., N.Y.C. 10019
 Mayoham c/o Copyright Service Bureau, Ltd. 221 W. 57th St., N.Y.C. 10019
 Maypole 200 W. 57th St., Rm. 710, N.Y.C. 10019
 Maysean c/o Mr. John A. Calabro 101-14 Ascan Ave., Forest Hills 75, N.Y.

Maytone 631 Knowles St., Royal Oak, Mich.
 Mc Dougle 2416 Hidalgo Ave., Los Angeles 39, Calif.
 McHugh 111 Main St., Salem, Va.
 McHugh & Adamson 609 5th Ave., N.Y.C. 10017
 McHugh, Jimmy 709 N. Sierra Ave., Beverly Hills, Calif. 90210
 McKinney's 56 W. 45th St., Suite 904, N.Y.C. 10036
 McPhail, Lindsay c/o Metl 135 E. 39th St., N.Y.C. 10036
 Mcon 515 W. End Ave., N.Y.C. 10024
 Meadow Crest 16065 Meadow Crest Rd., Sherman Oaks, Calif. 91403
 Meadowlark 1481 Vine St., H'wood, Calif.
 Medallion Songs 58 Market St., Newark 1, N.J.
 Mel-Pril 38 Donna Rd., Framingham, Mass.
 Melanie c/o Rosenberg & Rosenberg 430 Park Ave., N.Y.C. 10022
 Melbourne 352 Elm St., Manchester, N.H. 03101
 Meldan Lincoln Towers E. 160, E. End Ave., N.Y.C. 10023
 Melhead c/o Guardian Industries, Inc. Attn: H. L. Forghash 1250 E. 2nd St., Michigan City, Ind.
 Melissa c/o Mr. Ralph Kessler 8 Links Dr., Lake Success, N.Y.
 Mel-Joy c/o Ken Hecht 382 Central Pk. W., Apt. 9W., N.Y.C. 10025
 Melker 5343 Blackwelder S., Los Angeles, Cal. 90016
 Mellin, Judi 1650 B'way, N.Y.C. 10019
 Melo-Art 8983 Sunset Blvd., H'wood 69, Calif.
 Melodie 6708 Snider Plaza, Dallas 5, Tex.
 Melodie 85 Cooper St., Woodbury, N.J. 08096
 Melodies In Craft 32745 Taylor St., Winchester, Calif. 92396
 Melody P.O. Box 751, Evanston, Ill. 60204
 Melody 19 Colvin Rd., Scarsdale, N.Y. 10583
 Melomusic 1619 Broadway, N.Y.C. 10019
 Melrose 31 W. 54th St., N.Y.C. 10019
 Melrose, Walter 50 Old Barrington Rd., Barrington, Ill. 60010
 Mel & Sonance 150 W. Scott St., Fond Dulac, Wisc.
 Memory c/o Lanny Grey 108 E. 96th St., N.Y.C. 10028
 Memphis c/o R. Roy Coates 71 Union, Memphis, Tenn.
 Menorea 18 W. 70th St., N.Y.C. 10023
 Menclair (see Manpine)
 Merit c/o Mr. Roy Hillman 4124 Madilla Ave., Sherman Oaks, Calif.
 Merlin c/o Gregory & Howard 3438 S. Paradise Rd., Las Vegas, Nev. 89109
 Merrifield 134 N. Detroit St., Los Angeles, Cal.
 Merrell c/o Becker & Frank 545 5th Ave., N.Y.C. 10017
 Mesquite 31 W. 54th St., N.Y.C. 10019
 Met c/o Pulse Records Inc. 300 W. 55th St., N.Y.C. 10019
 Metropolitan 4900 Havenhurst Ave., Encino, Calif. 91316
 Mexical c/o Pryne, Braun, Cashman & Sherman 640 5th Ave., N.Y.C. 10019
 Mic 1776 Broadway, N.Y.C. 10019
 Michael Brent 70 Winding Wood Rd., Port Chester, N.Y.
 Mick-Da P.O. Box 1183, Newburgh, N.Y.
 Mick-Rick c/o Mr. Richard (Rick) Picone 928 51st St., Brooklyn, N.Y. 10019
 Midas 609 5th Ave., N.Y.C. 10017
 Middleton, Emanuel A., 1576 B'way, N.Y.C. 10036
 Midnight Sun 16027 Sunbuest St., Sepulveda, Calif. 91343
 Midway 157 W. 57th St., N.Y.C. 10019
 Miglo c/o Michael R. Collichio 520 Beech St., Haworth, N.J.
 Miladze 6245 Santa Monica Blvd., H'wood, Cal. 90038
 Milbee 6223 Selma Ave., H'wood, Calif.
 Milene 2510 Franklin Rd., Nashville, Tenn.
 Miljay c/o Edward M. Petty 854 Kelly St., Bronx, N.Y. 10459
 Miller 1350 Avenue of the Americas, N.Y.C. 10019
 Miller-Pearch 1916 Weepah Way, Los Angeles 46, Calif.
 Mills 1619 B'way, N.Y.C. 10019
 Milnac 1739 De Camp Dr., Beverly Hills, Calif.
 Mineo & Mineo 5620 N. Seaview, Tacoma, Washington
 Minerva 4124 Stansbury Ave., Sherman Oaks, Calif.
 Minette 11785 Laurelwood Dr., Studio City, Cal.
 Miracle 101 W. 57th St., Rm. 612A, N.Y.C. 10019
 Mirage c/o Owen Murphy 9100 1st Ave., Stone Harbor, N.J. 08247
 Miraka c/o Copyright Service Bureau Ltd. 221 W. 57th St., N.Y.C. 10019
 Miranda 105 York St., Lexington, Ken.
 Miriam c/o William Lazarow, Esq. 119 W. 57th St., Rm. 906, N.Y.C. 10019
 Mirich 1054 S. Robertson Blvd., #203, Los Angeles, Calif. 90035
 Miro 156 5th Ave., Suite 1036, N.Y.C. 10010
 Miron c/o Miron Mason Materials Co. 268 Johnson Ave., Brooklyn, N.Y.
 Mirror Lake c/o Edna Bettler 1674 Broadway, N.Y.C. 10019
 Mista 1631 Broadway, N.Y.C.
 Mitchell Attn: Jack Smolin 163-07 Depot Rd., N.Y.C. 11358
 Mivan 729 7th Ave., N.Y.C. 10019
 Mode c/o The Vincent Youmans Company, Inc. 157 W. 57th St., Suite 404, N.Y.C.
 Model P.O. Box 925, H'wood 28, Calif.
 Modern c/o Mr. Otto Gesana 45 E. 63rd St., N.Y.C. 10021
 Modern c/o Henry Gershwin Mazlen 1211 Ave., 1, Brooklyn, N.Y. 10030
 Moll, Ivan 33 W. 60th St., N.Y.C. 10019
 Mokell c/o Mr. Moe Preskill 62-60 99th St., Forest Hills, N.Y.
 Monaco, James V. c/o Mrs. James V. Monaco Rt. 1, Box 142, Lake Hamilton, Hot Springs, Ark.
 Monarch 8560 Sunset Blvd., Suite 806, Los Angeles, Calif. 90069
 Monfy c/o Ross Jungnickel, Inc. 1619 B'way, 11th fl., N.Y.C. 10019
 Monitor 1619 B'way, Rm. 901, N.Y.C. 10019
 Monnar c/o Samuel H. Lewis, Esq. 11 Beacon St., Boston 8, Mass.
 Monopoly 6515 Sunset Blvd., H'wood 28, Calif.
 Monroco 1440 Pacific Coast Hwy, Harbor City, Calif. 90028
 Monroe, Jack 354 Saratoga Ave., Brooklyn, N.Y. 11233

(Continued on page 178)

Mancini: More "Peter Gunn" Music

It's a direct hit! The legion of "Peter Gunn" fans who followed the long-run TV series will turn out big for this new Mancini movie score. Includes the "Peter Gunn" theme and "Dreamsville," plus some of Hank's most inventive writing to date. LPM/LSP-3840

RCA VICTOR 
The most trusted name in sound

Music from the Film Score
Composed and Conducted by
HENRY MANCINI



ASCAP PUBLISHERS

Monsour RCA Bldg., 6363 Sunset Blvd. Rm. 708, H'wood, Calif. 90028
 Montemar c/o Stahley Styne 1050 Park Ave., N.Y.C. 10028
 Montez 8943 Olin St., Los Angeles 34, Calif.
 Montefort 4 W. 58th St., N.Y.C. 10019
 Montoya, Carlos 345 W. 58th St., N.Y.C. 10019
 Mood 666 5th Ave., N.Y.C. 10019
 Moon Tunes 1744 N. Berendo St., H'wood, Cal.
 Moore, E. Barton 1124 Central Ave., SN.N., Albuquerque, N.M. 87010
 Moorpark 119 W. 57th St., N.Y.C. 10019
 Moosh 1207 Mopsick Ave., Linden, N.J.
 Moral Re-Armament 112 E. 40th St., N.Y.C. 10016
 Morella 11758 Blix St., N. H'wood, Calif.
 Moreno 1739 De Camp Dr., Beverly Hills, Cal.
 Morgan Manor 6223 Selma, H'wood, Cal. 90028
 Morgil c/o Morit Gilbert 1674 B'way, N.Y.C. 10019
 Morley 31 W. 54th St., N.Y.C. 10019
 Mormax c/o Mr. Leo Strauss, Jr. 60 E. 42nd St., N.Y.C. 10017
 Moross 610 W. End Ave., N.Y.C. 10024
 Morris, Edwin H. 31 W. 54th St., N.Y.C. 10019
 Morrisania 250 W. 57th St., Suite 2303, N.Y.C. 10019
 Morsam 210 Northview Dr., Canfield, Ohio
 Morite 1424 P St., Bakerfield, Calif. 93301
 Moss, Herbert M. 2 W. 46th St., N.Y.C. 10036
 Motola 6250 Lelandway, H'wood, Calif. 90028
 Mourbor 8-16 43rd Ave., Long Island City, N.Y. 11121
 Movietone 1844 Broadway, N.Y.C. 10028
 Mowbay P.O. Box 471 Cathedral Sta., N.Y.C. 10023
 Mozart-Editions 4 Mill La., Armonk, N.Y. 10504
 Muirfield Attn: Ivan Mogull 33 W. 60th St., N.Y.C. 10023
 Mulcaey 2700 Hollyridge Dr., H'wood 28, Calif.
 Mullens c/o Hoffman 64 W. 56th St., N.Y.C. 10019
 Mulligan c/o Pryor, Brown & Cashman 640 5th Ave., N.Y.C. 10019
 Multitone 117 W. 48th St., N.Y.C. 10036
 Murden 6350 St. Lawrence, Chicago, Ill. 60637
 Murry, Ted c/o Mr. Ted Murry 139 E. 35th St., N.Y.C. 10016
 Musetta 1048 N. Carol Dr., Los Angeles 69, Cal.
 Musette 113 W. 57th St., N.Y.C. 10019
 Musi-Chord c/o Al Stewart 2570 N. Beachwood Dr., H'wood, Calif. 90028
 Music American 6290 Sunset Blvd., Suite 1701, Sunset-Vine Tower, H'wood, Calif. 90028
 Music and Talent 80 B'way, #3510, N.Y.C. 10005
 Music Box 316 N. Citrus Ave., Covina, Calif. 91722
 Music City 812-17th Ave. S., Nashville, Tenn. 37203
 Music Exploitation 237 N. Mulberry St., Lancaster, Pa.
 Music Hall c/o Mr. Edward R. White 101 W. 55th St., N.Y.C. 10019
 Music Makers 1606 Vista Bel Mar, H'wood 28, Calif.

Music, Music, Music 509 Madison Ave., Suite 812, N.Y.C. 10022
 Music of Tomorrow c/o Phil Becker 545 5th Ave., N.Y.C. 10016
 Music Productions 6000 Sunset Blvd., H'wood, Calif. 90028
 Music Workshop 211 W. 53rd St., N.Y.C. 10019
 Musical Works 77 W. Washington St., Chicago, Ill. 60602
 Musicland California Bank Bldg., Suite 530, 9441 Wilshire Blvd., Beverly Hill, Calif.
 Musicville 130 W. 42nd St., #1302, N.Y.C. 10036
 Musifex 45 W. 45th St., N.Y.C. 10036
 Musitronics 230 Peck Dr., Beverly Hills, Calif.
 Mutual Entertainment Agency 65 E. South Water St., Chicago, Ill. 60601
 Mutual Music Society 609 5th Ave., N.Y.C. 10017
 Myers c/o Edward Kassner 135 W. 50th St., Suite 1920, N.Y.C. 10019
 Myra 15 Birchwood Ct., Blauvelt, N.Y.
 Myrow 1250 Sunset Plaza Dr., H'wood, Calif. 90069

N

NPP 575 Lexington Ave., N.Y.C. 10022
 Nacio P.O. Box 630, Beverly Hills, Calif.
 Nabor 243 S. Summit St., Indianapolis 1, Ind.
 Nala c/o Allan White 55 W. 89th St., #6, N.Y.C. 10024
 Namu c/o G. Ward Parsons 2910 Belden Dr., H'wood, Calif. 90028
 Nan c/o Kevin Knox Enterprises, Ltd. 1057 Hoe Ave., Suite 8B, N.Y.C. 10059
 Nan-Paul c/o Eli Parker & Company 315 S. Beverly Dr., Beverly Hills, Calif.
 Nancy Attn: Maurice "Bugs" Bower c/o Pickwick International, Inc. Pickwick Bldg., Long Island City, N.Y. 11101
 Naro 5371 W. Pico Blvd., Los Angeles, Calif. 90019
 Nascot 12610 Hortense St., Studio City, Calif.
 National General 6336 Sanvicente Blvd., Los Angeles, Calif. 90048
 National 56 Ferry St., Newark 5, N.J.
 Nationwide Songs 1674 B'way, Suite 606, N.Y.C. 10019
 Natson 161 W. 54th St., Suite 23, N.Y.C. 10019
 Nebam 200 W. 57th St., N.Y.C. 10019
 Nedloh 11905 Riverside Dr., N. H'wood Calif. 91609
 Neems c/o Copyright Service Bureau Ltd. 221 W. 57th St., N.Y.C. 10022
 Neiburg, Al J. 321 W. 78th St., N.Y.C. 10024
 Neila c/o Mr. Alfred W. Schlesinger 1619 N. Cherokee, H'wood, Calif. 90028
 Neilson 2 W. 45th St., N.Y.C. 10036
 Nelcor 1002 N. Alfred St., Los Angeles 69, Cal.
 Nelson 1717 N. Highland Ave., Suite 307 H'wood 28, Calif.
 Nemrac 6605, Los Angeles, Calif.
 Nena c/o Johnny Conquet, 1697 B'way, N.Y.C. 10019
 Nep Box 926-1321 W. 7th St., Clovis, N.M.

Network-Cheryl c/o Sean M. Downey, Jr. Canteer Corp. 1020-26 Thelia St., New Orleans, La. 70130
 Neuclear c/o Frank P. Warren 6027 H'wood Blvd., H'wood, Calif. 90028
 Nevalu 605 Artie St., Las Vegas, Nev. 89101
 Nevins-Kirshner c/o Kon Kirshner 711 5th Ave., N.Y.C. 10022
 New Age c/o Mr. Herbert Wasserman 875 W. End Ave., N.Y.C. 10025
 New Dawn c/o Don Goldie 2250 S.W. 21st Ter., Miami 45, Fla.
 New Dawn 609 5th Ave., N.Y.C. 10017
 New Folk World 1081 Crescent Heights, Los Angeles, Calif. 90035
 New Hampshire c/o Fong & Tong, Public Accountants 916 Kearney St., San Francisco, Calif.
 New Jupiter P.O. Box 1493, Hilo, Hawaii 96720
 New Line 7124 W. Sunset Blvd., L.A., Calif. 90046
 New Music c/o Scott & Know 6671 Sunset Blvd., Suite 1521, H'wood, Calif. 90028
 New Phoenix 2101 Lisbon Ave., Hartland, Wis.
 New Sounds c/o Mr. Charles Colin 315 W. 53rd St., N.Y.C. 10019
 New York S.E. Corner 16th, Pine, Phila, Pa. 19102
 New World Attn: Mr. Victor Blau 488 Madison Ave., N.Y.C. 10022
 Newburn c/o Samuel Berke & Co. 853 7th Ave., N.Y.C. 10019
 Newco c/o Samuel Berke & Co. 9350 Wilshire Blvd., Beverly Hills, Calif.
 Newman, Charles 328 S. McCarty Dr., Beverly Hills, Calif.
 Newman, Lee 11360 Dona Dorotea Dr., Studio City, Calif.
 Newport c/o Mr. Arthur Krob 1105 Little Bldg., 80 Boylston St., Boston, Mass. 02116
 Next Day 1631 Broadway, N.Y.C. 10019
 Nida 7251 L.A. 46, Calif.
 Nine Star c/o Mr. Victor Blau 488 Madison Ave., N.Y.C. 10022
 Nineteen Twenty 37 Saddle La., Cherryhill, N.J. 08034
 Nipper 1855 Broadway, N.Y.C. 10023
 Nob Hill Fairmont Hotel, Nob Hill, San Francisco, Calif. 94106
 Noel 1041 19th St., Apt. #6, Santa Monica, Calif. 90403
 Nomat 608 5th Ave., N.Y.C. 10020
 Norbett c/o Edward Traubaler & Co., Inc. 132 S. Rodeo Dr., Beverly Hills, Calif. 90022
 Norda 2279 17th Ave., San Francisco 16, Calif.
 Norhel c/o Morton A. Kaplan 1126 E. 59th St., Chicago 37, Ill.
 Norick c/o Morris Kritz, C.P.A. 127 Martin Dr., Harrington Park, N.J. 07640
 Norlan c/o Norman D. Ravis 21 Leonard Rd., Syosset, N.Y. 11791
 Norman c/o Frank Moore 977 Indian Creek Rd., Jenkintown, Pa.
 Nortac 800 E. Holt Ave., Pomona, Calif.
 Northern c/o MCA Inc. Universal Studios, Universal City, Calif. 91608
 North & Son 666 5th Ave., N.Y.C. 10019
 North House c/o Joe Caiani 1639 B'way, N.Y.C. 10019
 Northridge 6290 Sunset Blvd., H'wood, Calif. 90028
 Norwood 926 New Jersey Ave., N.W. Washington 1, D.C.
 Notable 161 W. 54th St., N.Y.C. 10019
 Noteworthy Radio City Music Hall, Rockefeller Center, N.Y.
 Nothing 9 Gay St., N.Y.C. 10014
 Novelty c/o Mr. John Redmond 199 Wilson St., Hackensack, N.J.
 November c/o Mellon 4 E. 77th St., N.Y.C. 10021

O

O'Conner and Miller c/o Mr. Sid Hershey 8779 W. Pico Blvd., L.A. 35, Calif.
 O'Flynn, Charles c/o Mr. Charles O'Flynn 200 Hillside Ave., Allendale, N.J.
 O-Ge c/o Gladys Patrick 143 W. 49th St., N.Y.C. 10019
 O'Henry's c/o Henry Otto Knutsen 2300 Brook Ave., Merrick, N.Y.
 O'Kay 77 W. Washington St., Chicago, Ill. 60602
 Oakland c/o Bourne Co., 136 W. 52nd St., N.Y.C. 10019
 Oberry 199 E. Blvd., S., Pontiac, Mich. 48058
 Occo 607 1/2 Selma Ave., H'wood, Calif. 90028
 Octave 520 5th Ave., N.Y.C. 10036
 Odeon 1031 Nol Lima St., Burbank, Calif.
 Odette c/o Mrs. Helene Blum 3900 Greystone Ave., Riverdale, N.Y. 10463
 Odin 1708 Pandora Ave., Suite C, L.A., Calif. 90024
 Official 27 Hickory Dr., Great Neck, N.Y. 11021
 Okeanos P.O. Box 3303, New Orleans, La.
 Okemo c/o Walter Gould 609 5th Ave., N.Y.C. 10017
 Okun c/o Mr. Lan Okun Dromore Rd., Scarsdale, N.Y. 10584
 Olenik c/o Nicholas H. Olejnic G-10282 N. Dixie Hwy, Clio, Mich.
 Oliver 200 W. 57th St., #1006, N.Y.C. 10019
 Olman, Abe 10 Columbus Cir., Rm. 2160, N.Y.C. 10019
 Olna c/o John C. McClellan 1650 B'way, N.Y.C. 10019
 Olympia 3005 Dudley Ave., Nashville, Tenn. 37212
 Olympus 345 W. 58th St., N.Y.C. 10019
 Omar c/o The Peter Frank Organization 9000 Sunset Blvd., L.A., Calif. 90069
 Omell P.O. Box 232, Radio City Sta., N.Y.C. 10019
 Omen c/o Mr. Norman F. Edge 2040 Kennedy Blvd., Jersey City, 97305
 On Broadway Tonight c/o Al Foster 756 7th Ave., Suite 401A, N.Y.C. 10019
 Oniram 13-40 137th St., College Pt., N.Y. 11356
 Opportunity P.O. Box 184, Haworth, N.J.
 Orange-Empire 10906 Fruit Land Dr., H'wood, Calif. 91604
 Orchesis c/o Daniel F. Jahn 200 W. 57th St., N.Y.C. 10019
 Orlob 636 W. 174th St., N.Y.C. 10033
 Orville 6380 Wilshire Blvd., Suite 1007, L.A., Calif. 90048
 Oso 9650 Oso Ave. Chatsworth, Calif.
 Ostrow, Herbert Ray 6620 Kindred St., Phila., Pa. 19142
 Our 5215 Raywood La., Nashville, Tenn. 37211

Oury, Mike 406 Brainedo, Libertyville, Ill. 60048
 Outfield c/o Ralph Carmichael 17820 Chatsworth St., Granada Hills, Calif.
 Overbrook Attn: Mr. Samuel D. Hodge 1314 S. Howard St., Phila., Pa. 19147
 Oviv c/o Mr. Arthur 240 W. 55th St., N.Y.C. 10019
 Owens-Kemp c/o Jack Owens 1518 E. Colter, #224, Phoenix, Ariz. 85014
 Oxford University Press, c/o John Onen Ward 417 5th Ave., N.Y.C. 10016
 Ozzie's 6875 Elcajon Blvd., San Diego, Calif. 92115

P

P. D. c/o Peter Doraine 1138 N.E. 2nd Ave., Miami, Fla.
 P.D.S. 1350 Ave., N.Y.C. 10019
 P.J.L.A. 8239 Webb Ave., N. H'wood, Calif. 91605
 P. and O. 921 E. Blithedale Ave., Mill Valley, Calif. 94043
 PM 11700 Valley Crest Rd., Studio City, Calif. 91604
 P. W. Attn: Peter G. Wright 185 N. Wabash Ave., Suite 2016, Chicago Ill.
 Packson c/o Lorenzo Pack 1408 N. Y. Ave., Apt. 2A, Brooklyn, N.Y. 11210
 Pasca 9713 Santa Monica Blvd., Beverly Hills, Calif. 90210
 Pageant 7270-B Sunset Blvd., H'wood 46, Cal.
 Palace 1619 B'way, Rm. 509, N.Y.C. 10019
 Paley c/o Mr. John Paley 7900 Willow Glen Rd., L.A. 46, Calif.
 Palm 333 Windsor Ave., L.A. 5, Calif.
 Palm Springs 1601 N. Gower St., H'wood 28, Calif.
 Palma 210 Lakeview Dr., Collingswood, N.J. 08108
 Palomar 601 Northwest 195th Ter., Miami, Fla.
 Pambill c/o Carlton Record Corporation 345 W. 58th St., N.Y.C. 10017
 Pamela 609 5th Ave., N.Y.C. 10017
 Pampall c/o Martel 155 E. 55th St., N.Y.C. 10022
 Panama Artists c/o Herbert Wolff, Jr. 2010 N. Greenway Dr., Coral Gables, Fla.
 Pandee P.O. Box 1270 San Pedro, Calif. 90733
 Panorama 250 W. 57th St., Suite 918, N.Y.C. 10019
 Panther c/o Southern Music 1619 Broadway, N.Y.C. 10019
 Pao 1650 B'way, Suite 907B, N.Y.C. 10019
 Paper Tiger 6063 Sunset Blvd., H'wood, Calif. 90028
 Par c/o Mr. Julius La Rosa 300 E. 51st St., N.Y.C.
 Par-Four 17310 Pancho St., Encino, Cal. 91316
 Paradise 6311 Yucca St., H'wood, Cal. 90028
 Parakeet 1650 B'way, Rm. 505, N.Y.C. 10019
 Paramount c/o Sidney Herman 1501 B'way N.Y.C. 10036
 Paris 1650 B'way, Rm. 1115, N.Y.C. 10019
 Park Ridge 200 E. 66th St., N.Y.C. 10021
 Parliament 619 B'way 11th fl., N.Y.C. 10019
 Parkland c/o N. Schwartz 161 W. 54th St., N.Y.C. 10019
 Patelson, Joseph 160 W. 56th St., N.Y.C. 10019
 Patrel 620 Hardin Dr., Inglewood, Calif. 90202
 Patric 19927 Ace St., Northridge, Calif.
 Pattern 7033 Sunset Blvd., Suite 308, H'wood 28, Calif.
 Patti 1428 N. Gower St., H'wood, Calif. 90028
 Pavanne 1619 B'way, Suite 514, N.Y.C. 10019
 Pawnbroker c/o Alouette Productions, Inc. 1619 Broadway, Suite 914, N.Y.C. 10022
 Paxton, George 1619 Broadway, N.Y.C. 10019
 Peder Frank
 Peero 3168 S. Shedley St., Phila, Pa.
 Pelew 315 W. 57th St., Suite 3F, Rear Bldg., N.Y.C. 10019
 Pell Mell 5053 Valjean Ave., Encino, Cal. 91316
 Penn-Franklin 150 W. 55th St., Suite 5B, N.Y.C. 10019
 Penn c/o Mr. Sammy Mysels 345 W. 58th St., N.Y.C. 10019
 Pennant Attn: Sidney F. Mobell 2 Geary St., San Francisco, Calif. 94108
 Penthouse c/o Cy Leonard 1320 Miller Dr., W. H'wood, Calif. 90069
 Pep 'n' Paul 2042 S. 18th St., Philadelphia 45, Pa.
 Pepamar Attn: Mr. Victor Blau 488 Madison Ave., N.Y.C. 10022
 Pepper, J. W. & Son 231 N. 3rd St., Phila. 2, Pa.
 Perevin c/o Mr. Harry Ashburn 7773 Torreyson Dr., H'wood, Calif. 90045
 Perma c/o Mr. Ronald Stein 17414 Devonshire St., Northridge, Calif.
 Persuasive 16 Canterbury Rd., Great Neck, N.Y.
 Petanden c/o Peter Van Steeden 748 Ponus Ridge, New Canaan, Conn. 06840
 Peters 6124 Selma Ave., H'wood 28, Calif.
 Petkere, Bernice 1416 N. Havenhurst Dr., L.A. 46, Calif.
 Pett 1697 B'way, Rm. 205D, N.Y.C. 10019
 Peyton 860 Shone Dr., Reno, Nev. 89502
 Phalanx c/o Pryor, Braun & Cashman 640 5th Ave., N.Y.C. 10019
 Phillips 300 W. 55th St., N.Y.C. 10022
 Phipps c/o International Korwin Corp. 57 W. 56th St., N.Y.C. 10019
 Photoplay c/o Mr. Allan Betzenberger, Pres. 117 4th St., Sladington, Pa. 18080
 Phyllis 1201 Taft Bldg., 1680 N. Vine St., H'wood 28, Calif.
 Piano Melodies 3 Kraft Ave., Bronxville, N.Y.
 Piantadosi c/o Adam J. Robinson 2100 Elsegundo Blvd., Gardena, Calif. 90249
 Pic 39 W. 54th St., N.Y.C. 10019
 Picture c/o Ross Jungnickel, Inc. 1619 B'way, N.Y.C. 10019
 Piedmont 136 W. 52nd St., N.Y.C. 10019
 Pierrette 2200 Beech Knoll Rd., L.A., Cal. 90046
 Pincus, George, & Sons
 Pine Hollow c/o Walter Hofer 221 W. 57th St., N.Y.C. 10019
 Pine Ridge 1350 Avenue of the Americas, N.Y.C. 10019
 Ping 1549 N. Vine St., H'wood, Calif. 90028
 Pinkard 211 W. 53rd St., Suite 2G, N.Y.C. 10019
 Pintoff, E. 64 E. 55th St., N.Y.C. 10022
 Pioneer Valley 29 Marquette St., Springfield, Mass.
 Piper c/o Mr. Irving Miller, Pres. 11449 Canton Dr., Studio City, Calif.
 Pirrotta, C. M. 121 Centre St., Roxbury, Mass.

HEAR THOSE

SOULFUL SIZZLING SOUNDS

FROM DETROIT

on

GROOVESVILLE REVILLOT SOLID HIT RECORDS

Artists

J. J. BARNES	THE PARLIAMENTS	PAT LEWIS
STEVE MANCHA	ROSE BATTISTE	JOHNNY GOODE
THE HOLIDAYS	JACKY BEAVER	THE DEBONAIRE
BENNY POOLE	JIMMY GILFORD	SHERRY PAYNE



SOLID Hitbound PRODUCTIONS INC.



Creators of Detroit's FORWARD Sound

8832 Puritan

Detroit, Michigan 48238

(313) 342-7206

EVERYDAY IS SATURDAY!

JUNE 1967						
SATURDAY	SATURDAY	SATURDAY	SATURDAY	SATURDAY	SATURDAY	SATURDAY
				1	2	3
				"A LOVER'S CONCERTO"	"RAG DOLL"	"CAN'T TAKE MY EYES OFF YOU"
4	5	6	7	8	9	10
"C'MON MARIANNE"	"SOCK IT TO ME!"	"CALIFORNIA NIGHTS"	"DAWN" (Go Away)	"THE SUN AIN'T GONNA SHINE ANYMORE"	"CONCRETE AND CLAY"	"JENNY TAKE A RIDE"
11	12	13	14	15	16	17
"LET'S HANG ON"	"NAVY BLUE"	"WORKIN' MY WAY BACK TO YOU"	"SILENCE IS GOLDEN"	"SUMMER AND SANDY"	"TELL IT TO THE RAIN"	"RONNIE"
18	19	20	21	22	23	24
Remind my wife that today is Father's Day!	Phillip's birthday!	"WALKIN' MY CAT NAMED DOG"	"OPUS 17"	"SAVE IT FOR ME"	"BEGGIN'"	"GOODBYE GIRL"
25	26	27	28	29	30	
	Betty's birthday!	"I'M GONNA CHANGE"	"BYE BYE BABY"		4 day weekend	



Saturday Music

Saturday Music, Inc. 1841 Broadway Suite 600 New York, N. Y. 10023 CI 5-3535

ASCAP PUBLISHERS

(Continued from page 178)

Pirus 12426 Landale, Studio City, Calif. 91604
 Pisa Box 104, Closter, N.J. 07624
 Pivot 76674 Latigo Shore Dr., Malibu, Calif. 90046
 Plan Two 1619 Broadway, N.Y.C. 10019
 Planetary 1631 Broadway, N.Y.C. 10019
 Platinum 1688 Meridian Ave., Miami Beach, Fla. 33139
 Players 609 5th Ave., N.Y.C. 10017
 Playhouse 1680 N. Vine St., Rm. 219, H'wood 28, Calif.
 Plaza 8833 Sunset Blvd., L.A. 69, Calif.
 Pleasant 66 Mechanic St., New Rochelle, N.Y.
 Plus-Minus 6124 Selma Ave., H'wood, Calif. 90028
 Plymouth 17 W. 60th St., 6th fl., N.Y.C. 10023
 Poe 500 5th Ave. N., Box 214 Metro Manor, Nashville, Tenn. 37219
 Polam P.O. Box 8148, 360 Tolland St., East Hartford, Conn. 06108
 Poly Tone 16027 Sunburst St., Sepulveda, Cal. 91343
 Ponzello 1412 23rd Ave., N. Nashville, Tenn.
 PONY (see Tim Gayle)
 POP (see Cenci)
 "Pops" c/o Mr. Alfred Eisenstein 94-30 59th Ave., Queens, N.Y. 11373
 Popular 165 W. 46th St., Rm. 411A, N.Y.C. 10036
 Port 1106 Madison Ave., Suite 7G, N.Y.C. 10028
 Portilla 18 Storms Ave., Park Ridge, N.J.
 Positive c/o Mr. Aaron Richards 300 E. 33rd St., Apt. 17J, N.Y.C. 10016
 Post 1556 North La Brea Ave., H'wood, Calif. 90028
 Pound Ridge 19 W. 44th St., #504, N.Y.C. 10036
 Poz 850 7th Ave., N.Y.C.
 Preferred 225 Broadway, N.Y.C. 10007
 Premium Stuff 14951 Schaefer, Detroit, Mich. 48227
 Prentice-Hall P.O. Box 900, Englewood Cliffs, N.J.
 Prentice Attn: Clyde Otis 1650 B'way, Suite 502, N.Y.C. 10019
 Prentiss 1697 Broadway, N.Y.C.
 Prentiss-Clark 644 Riverside Dr., #80, N.Y.C. 10031
 President 4 Mill La., Armonk, N.Y. 10504
 Presser, Theodore, Bryn Mawr, Pa.
 Prestige 2511 Mayberry St., H'wood, Calif.
 Pride 230 W. 41st St., N.Y.C. 10036
 Princess 1650 Broadway, N.Y.C. 10019
 Print c/o Japalana Productions 723 7th Ave., N.Y.C. 10019
 Priscilla 101 W. 57th St., Rm. 612A, N.Y.C. 10019
 Prize 517 16th Ave. S., Nashville, Tenn.
 Pro Art 469 Union Ave., Westbury, N.J. 11590
 Pro Musica 386 Fulton Ave., Jersey City, N.J.
 Prodrara 610 4th Ave., East Northport, N.Y.
 Producers c/o Mr. Jule Styne 237 W. 51st St., N.Y.C. 10019
 Prom 5404 Franklin Ave., H'wood 27, Calif.
 Promenade 6650 Sunset Blvd., H'wood 28, Cal.
 Promotion 26544 Bretton Woods, Madison Heights, Mich. 48071
 Prose 1697 B'way, Rm. 501, N.Y.C. 10019
 Protone 2534 West Pico Blvd., L.A., Calif. 9006
 Pryor 35 Pryor Pl., New Rochelle, N.Y. 10804
 Public International 1617 A. Herman St., Nashville, Tenn. 37208
 Purchase 1650 Broadway, N.Y.C. 10019
 Purple Turley 1204 Superior Blvd., Cleveland Ohio 44114
 Purple Sage 1912 Western Ave., S. Greenburg, Pa. 15601
 Putnam 609 5th Ave., N.Y.C. 10017
 Pyramid 6087 Sunset Blvd., H'wood 28, Calif.

Q

Quad P.O. Box 5265, Sherman Oaks, Calif.
 Quarter-Note 1045 W. 92nd St., L.A., Calif. 90044
 Quartet 1619 Broadway, N.Y.C. 10019
 Queen City Box 2588, H'wood 28, Calif.
 Quincy 131 Farrington St., Wollaston, Mass. 02170

R

R.C.N. 3120 O St., Sacramento, Calif. 95316
 R.F.D. 1619 Broadway, N.Y.C. 10019
 "R" 4257 Bakman Ave., North H'wood, Calif.
 R-J Concerts 5710 Wallis La., Woodland Hills, Calif. 91364
 R-Mor 2415 Jenkintown Rd., Glenside, Pa. 19038
 Rae-Cox & Cooke, 1674 B'way, Suite 908, N.Y.C. 10019
 Ragtime c/o George Scheck 161 W. 54th St., N.Y.C. 10019
 Raige (Griffon Publisher Div.) 110 Ocean Park Blvd., Santa Monica, Calif.
 Raimor c/o Jimmy McHugh Music, Inc. 709 No. Sierra Dr., Beverly Hills, Cal. 90210
 Rainbow c/o Diane Lampert 1326 Londonberry View, Apt. 4, Los Angeles, Calif. 90069
 Rabro P.O. Box 1254, Los Angeles, Cal. 90028
 Racer 2107 W. Washington Blvd., L.A., Cal. 90018
 Raines, Allen W., Inc. Box 148, Garden City, N.Y.
 Raintree 1619 B'way, Rm 501, N.Y.C. 10019
 Ramoria c/o Pryor, Braun & Cashman 640 5th Ave., N.Y.C. 10019
 Randall Box 158, Parkville, N.Y.
 Randolph c/o Jack Fulton 18263 Verano Dr., San Diego, Calif. 92128
 Randy-Smith 3941 Woodlawn Dr., Nashville, Tenn.
 Ranger 7 1530 Chestnut St., Suite 710, Phila., Pa. 19102
 Rann 15022 Ventura Blvd., Suite A, Sherman Oaks, Calif.
 Rap 7100 Hillside Ave., Apt. 208, H'wood 28, Calif.
 Raphael, Fred 6758 Colgate Ave., L.A. 48, Cal.
 Raphael Music 1041 19th St., (6), Santa Monica, Calif. 90403
 Rathvon 691 Highland Ave., Pelham Manor, N.Y. 10801

Raye c/o Frank Lavere 5425 W. Division St., Chicago 51, Ill.
 Raymak 568 Pepper Ridge Rd., Stamford, Conn.
 Raymor-McCollister 4059 N. Hydraulic, Wichita, Kan. 67219
 Rayster 1650 B'way, N.Y.C. 10019
 Reactors, Box 7088, Norfolk, Va. 23509
 Reade 119 W. 57th St., N.Y.C. 10019
 Realm (Rolls) 310 Madison Ave., Suite 1001, N.Y.C. 10019
 Realm c/o Richard Randall 1697 B'way, N.Y.C. 10019
 Rebb Wyncote House #628 Washington Lane & Township Line, Wyncote, Pa.
 Recherche 473 West End Ave., N.Y.C. 10023
 Recona 1175 Howard St., San Francisco, Calif. 94103
 Record Music 1650 B'way, Rm 605 N.Y.C. 10019
 Record Songs, Inc., 450 W. 24th St., Suite 4A, N.Y.C. 10011
 Red Balloon 150 W. 55th St., N.Y.C. 10019
 Red Hook 33 W. 60th St., N.Y.C. 10019
 Red River (Crazy Creek Music Div.) c/o S. Edward Katz, Esq., 1501 B'way, Suite 2004, N.Y.C. 10036
 Red Wing 631 20th St., Red Wing, Minn. 55066
 Reece 9301 Wilshire Blvd., Beverly Hills, Cal. 90212
 Reedlands c/o Werber/Cardenas S.A. 916 Kearny St., San Francisco 11, Calif.
 Regaldi 279 Warwick Ave., Teaneck, N.J. 07666
 Reinach 70 E. 77th St., N.Y.C. 10021
 Rejay 5052 Berkeley Ave., Westminster, Calif. 92683
 Reliable Colonnade W. 802-C 51 Clifton Ave., Newark, N.J. 07104
 Reliance 1619 B'way, N.Y.C. 10019
 Religious 199 Wilson St., Hackensack, N.J.
 Remick Attn: Victor Blau 488 Madison Ave., N.Y.C. 10022
 Rensen, Alice, Inc. 37 W. 88th St., N.Y.C. 10024
 Renaldo c/o Lawrence L. Lazar, Esq., 407 Lincoln Rd., Miami Beach, Fla.
 Renault 11360 Dona Dorotea Dr., Studio City, Calif.
 Rene, Leon 2124 W. 24th St., Los Angeles, Cal. 90018
 Renee c/o Scheiman, Albert & Maclean, Time & Life Bldg., N.Y.C. 10020
 Renball c/o Rene J. Hall 6365 Selma Ave., H'wood 28, Cal.
 Reo 3923 Jackson St., N.E., Minneapolis, Minn.
 Rep 2292 Bronson Hill Dr., L.A., Cal. 90028
 Rest-A-While c/o Sherman Ford, Jr. 1757 Pon-nus Ridge Rd., New Canaan, Conn. 06840
 Revel, Harry 155 W. 68th St., N.Y.C. 10023
 Revere 260 W. 72nd St., N.Y.C. 10023
 Rex 6381 H'wood Blvd., H'wood, Cal. 90028
 Reynard 1841 B'way, N.Y.C. 10023
 Reynolds & Anthony c/o Leo Anthony 2211 Belmont Dr., Beverly Hills, Calif. 90210
 Reynolds 901 Eighth Ave., N.Y.C. 10019
 Rhyme & Rhythm Inc., 144 Jolind Rd., Paoli, Pa.
 Rhythm Enterprises Inc. 2461 Creston Way, H'wood 28, Calif.
 Rhythm Roost 156 W. 44th St., N.Y.C. 10036
 Rialto 57 Third Ave., N.Y.C. 10003
 Ric Tic c/o Michael Sarivalas 15004 Mack Ave., Detroit, Mich.
 Riccardi 160 W. 73rd St., N.Y.C. 10023
 Richard Irwin c/o Joseph L. Kolsky, 1650 B'way N.Y.C. 10019
 Richard Music c/o Frank Brandt Assoc. 201 No. Occidental, L.A., Calif. 90022
 Richcrisand, Inc. 120 E. 56th St., N.Y.C. 10019
 Richards, Paul 75 Allen Rd., Rockville Centre, N.Y. 11570
 Richelieu c/o Leo Jacobs 220 N. Doheny Dr., Beverly Hills, Calif. 90210
 Richjon 250 S. Broad St., N. 201, Phila. Pa.
 Richter, William B., 1601 67th Ave., Phila 26, Pa.
 Richtree Attn: James Reichert 10 W. 10th St., N.Y.C. 10011
 Ricki c/o Don George 200 W. 54th St., N.Y.C. 10019
 Ricon 13063 Ventura Blvd., Studio City, Cal. 91604
 Rina 79 W. Monroe St., Chicago, Ill. 60603
 Ringle, Dave Rt. 4, Box 1564, Brooksville, Fla.
 Rinimer c/o Julius Lefkowitz & Co. 9171 Wilshire Blvd., Beverly Hills, Calif.
 Rick (Southgate Music Co. Div.) 1413 Dutch Valley Pl., N.E. Atlantic, Ga. 30324
 Rinn 328 Gerard Ave., Elkins Pk., Phila. 17, Pa.
 Ritchie 1619 B'way, Rm 412, N.Y.C. 10019
 Ritcali 1700 Rising Glen Rd., L.A., Calif. 90069
 Ritwell P.O. Box 142, Middle Haddam, Conn. 03456
 Ritter, Tex, 6124 Selma Ave., H'wood 28, Cal.
 Ritvale 608 Fifth Ave., N.Y.C. 10020
 Riverside c/o Jimmy Wakely, 4720 Forman Ave., N. Hollywood, Calif.
 Ro Jim 281 Grand Ave., Freeport, N.Y.
 Roann P.O. Box 748, Benton Harbor, Mich.
 Robar Howard J. Robbins c/o Stratford Music Corp., 237 W. 5th St., N.Y.C. 10019
 Robbee (Mary Jo Pub. Co. Div.) Carlton House -550 Grant St., Pittsburgh 19, Pa.
 Robbins, Howard Robbins c/o Startford Music Corp., 237 W. 51st St., N.Y.C. 10019
 Robbins, J. J., Inc., Howard Robbins, c/o Stratford Music Corp., 237 W. 51st St., N.Y.C. 10019
 Robbins 1350 Ave., of the Americas, N.Y.C. 10019
 Robert 1650 B'way, Suite 901, N.Y.C. 10019
 Roberts, Jeff 17 Longwood Rd., Quincy, Mass., 02169
 Robertson, Don Taft Bldg., H'wood & Vine, H'wood, Calif. 90028
 Roberty c/o Robert Roth 1608 Hillhurst Ave., Los Angeles 27, Calif.
 Robin-Styne 237 W. 51st St., N.Y.C. 10019
 Robinson, Russel, J., Inc. 18 E. 48th St., N.Y.C. 10017
 Roblu 11861 Reagan St., Los Anamitos, Calif.
 Robran c/o Randy Van Horne, 5951 Colfax Ave., N. Hollywood, Calif.
 Rochester 358 Aldrich Rd., Fairport, N.Y. 14450
 Rochester 6380 Wilshire Blvd., L.A., Cal. 90048
 Roddle-Miller P.O. Box 410, Hot Springs, Ark.

Rodenheaver Co., The Winona Lake, Indiana
 Rodeo c/o Charles O'Flynn 200 Hillside Ave., Allendale, N.J.
 Rober 449 S. Beverly Dr., Beverly Hills, Calif. 90212
 Rolls Royce c/o Copyright Service Bureau, Ltd. 221 W. 57th St., N.Y.C. 10019
 Romy c/o Dotty Wayne 1153 1/2 N. Edgemont, Los Angeles, Calif.
 Roncom 405 Park Ave., Suite 1602, N.Y.C. 10022
 Rondo 165 O'Farrell St., San Francisco, Calif. 94102
 Ronell, Ann c/o Sol A. Rosenblatt 630 Fifth Ave., N.Y.C. 10029
 Room At The Bottom 302 Twentieth St., Santa Monica, Calif. 90402
 Rork, Ernest, A., & Son 2281 De Soto Sta., Memphis 2, Tenn.
 Rosarita 1619 Broadway, 11th Fl. N.Y.C. 10019
 Rose, David c/o Gilbert & Levine 9601 Wilshire Blvd., Suite 229, Beverly Hills, Calif. 90210
 Rosemarie c/o Eli Parker & Co. 315 S. Beverly Dr., Beverly Hills, Calif. 90212
 Rosemeadow 1619 Broadway, N.Y.C. 10019
 Rosemond c/o Ramrod Productions, Inc., 221 W. 57th St., N.Y.C. 10019
 Rosenblatt 102 Whitman Rd., Yonkers, N.Y.
 Rosewood 136 E. 57th St., N.Y.C. 10022
 Ross, Allan 12841 Woodbridge, Studio City, Calif. 91604
 Ross, Charles 220 E. 60th St., Apt. 5L, N.Y.C. 10022
 Rossdon c/o Braunstein, Cherson & Plant, 10,000 Santa Monica Blvd., Suite 311, L.A., Calif. 90067
 Rossi c/o Mario Rossi 1955 W. 8th St., B'klyn, N.Y. 11223
 Rossiter, Will 173 W. Madison St., Chicago, Ill.
 Round Table 1434 N. Genesee Ave., Hollywood, Calif.
 Roundabout 729 Seventh Ave., N.Y.C. 10019
 Row, R. D., 62 Cooper Sq., N.Y.C. 10003
 Rowell-Kelly 7518 W. 121st St., Parma 30, O.
 Roxbury 77 Crown St., Milton, Mass.
 Roy c/o Oliver La Freniere 199 Botsford St., Hempstead, N.Y.
 Royal Coachman 11577 Dilling St., Studio City, Calif.
 Royal Music 14238 Sunset Blvd., Pacific Palisades, Calif.
 Royal Palm c/o Mrs. Thelma Butt, 300 Clarke Ave., Palm Beach, Fla.
 Rual 234 W. 55th St., 2nd Floor, N.Y.C. 10019
 Rubank, Inc. 5544 W. Armstrong Ave., Chicago 46, Ill.
 Rub-Hall c/o A. L. Silverman & Co. 12412 Ventura Blvd., Studio City, Calif.
 Ruby, Harry 10433 Wilshire Blvd., L.A., Cal. 90024
 Rubytone 10910 S.E. Foster Rd., Portland, Ore. 97266
 Ru Jac Attn: Willeam B. Blake P.O. Box 8684 Baltimore, Md. 21240
 Rulo 982 Boulevard, New Milford, N.J.
 Rumpel c/o Shearer & Fields, Jacob & Shearer, Esq., 9255 Sunset Blvd., Los Angeles, Calif. 90029
 Runnymede 6087 Sunset Blvd., Hollywood, Cal. 90028
 Rupel 158 E. 52nd St., N.Y.C. 10022
 Russ 217 Tiffany Rd., Oyster Bay, N.Y. 11771
 Russell-Cason 812 17th Ave., S. Nashville, Tenn. 37203
 Russlynn 3363 Bennett, Hollywood, Calif. 90023
 Russwilt c/o Wilbur Greenberg 1400 Bankers Securities Bldg., Philadelphia 7, Pa.
 Ruthsan 300 So. Rexford Dr., Beverly Hills, Calif.
 Rutland c/o Margaret Jones 75-01 141st Pl., Kew Gardens Hills 67, N.Y.
 Ruxton 10 Columbus Circle, Suite 2160, N.Y.C. 10019
 Ryan 2335 N. Lorel, Chicago, Ill. 61639
 Ryland c/o Phillip Becker, CPA 545 Fifth Ave., N.Y.C. 10017
 Rytvok Inc. 39 W. 54th St., N.Y.C. 10019

S

S.A.L. c/o Barry Levinson 640 Fifth Ave., 5th Fl., N.Y.C. 10019
 S & R 6533 H'wood Blvd., H'wood 28, Cal.
 S & J c/o Schwartz 35 W. 45th St., N.Y.C. 10036
 SCP c/o Carl Prayer 155 W. 47th Penthouse N.Y.C. 10017
 S.P.C. 86th St., Francis St., Newark, N.J. 07105
 SSS (Public Music Div.) 200 W. 57th St., N.Y.C.
 Sacred Music Press of the Hebrew Union College-Jewish Institute of Religion 40 W. 68th St., N.Y.C. 10023
 Saga c/o Ben Barton 1619 Broadway, Rm 412 N.Y.C. 10019
 Sage (Sage Music Co. Div.) Box 44, Universal City, Cal.
 Sahara 609 Fifth Ave., N.Y.C. 10017
 St. George 408 Hialeah Dr., Cherry Hill Estates, N.J. 08034
 St. Gregory Guild, Inc. 1705 Rittenhouse Sq., Phila. 3, Pa.
 St. James c/o Burke & Van Heusen, Inc., 250 West 57th St., N.Y.C. 10019
 St. Nicholas 1619 B'way, 6th Fl., N.Y.C. 10019
 Salter 3658 Woodhill Canyon Rd., Studio City, Cal.
 Salza 6410 Willoughby Ave., H'wood, Cal. 90038
 Sammary 101 W. 55th St., Suite 1E, N.Y.C. 10019
 Samson 400 East 59th St., N.Y.C. 10022
 San-Dan 608 Fifth Ave., N.Y.C. 10020
 San-Dee 1008 East Lycoming St., Phila, Pa. 19124
 San Dino 1619 Broadway, N.Y.C. 10019
 Sandbox 40 West 57th St., N.Y.C. 10019
 Sandman Rd. 1, #80 Morris Ave., Montville, N.J. 07045
 Sandra 1631 Broadway, 3rd Fl., N.Y.C. 10019
 Sands 116 Central Park So., N.Y.C. 10019
 Sandy 1631 Broadway, N.Y.C. 10019
 Sandysair c/o Richard Lewine 16 East 73rd St., N.Y.C. 10021
 Samson c/o Irwin Schlusell, Esq., 215 East 68th St., N.Y.C. 10021
 Santa Maria 113 S. Indian Ave., Palm Springs, Cal. 92262
 Santee 165 West Tenth St., N.Y.C. 10014

Sanvic 15 East 48th St., N.Y.C. 10017
 Sapphires 27 Hikory Dr., Great Neck, L.I., N.Y. 11020
 Sarah Ann's 6640 Gardena Ave., Long Beach, Cal.
 Sarah 1650 Broadway N.Y.C. 10019
 Saturn-Satellite 2428 So. Broad St., Phila, Pa. 19145
 Saunders 119 W. 57th St., N.Y.C. 10019
 Savon c/o Tony Savonne, 7100 Hillside Ave., #601, H'wood, Cal. 90046
 Savoy 130 W. 56th St., N.Y.C. 10019
 Sawtell & Herring 202 N. Canoi Dr., Beverly Hills, Cal. 90210
 Sawyer, Jean 256 W. Plumstead Ave., Lansdowne, Pa. 19050
 Sax 5th Ave., 8440 Sunset Blvd., Suite 1104, L.A., Cal. 90069
 Scarsdale 666 Fifth Ave., N.Y.C. 10019
 Schatzie 1919 West End Bldg., Suite 710, Nashville, Tenn. 37203
 Schein 211 W. 53rd St., N.Y.C. 10019
 Schirmer, E. C. 600 Washington St., Boston 11, Mass.
 Schirmer, G., Inc. 609 Fifth Ave., N.Y.C. 10017
 Schlepity c/o Dare Records P.O. Box 2056, Bell Gardens, Cal. 90201
 Schmitt 88 S. 10th St., Minneapolis 3, Minn.
 Schroeder c/o William Reynolds, 2027 Parker St., Berkeley, Cal. 94704
 Schroeder, D. L., 56 Biltmore Blvd., Massapequa, N.Y.
 Schubert, Franz 425 W. B'way, Ft. Worth 4, Tex.
 Sebumann c/o Bourne Co., 136 W. 52nd St., N.Y.C. 10919
 Schwartz c/o Laurie Records 35 W. 45th St., N.Y.C. 10036
 Schwartz, Merrel 36 E. 5th St., Cincinnati, O.
 Seacroft c/o KLM 1100 Doolittle Ave., Las Vegas, Nev. 89106
 Seacom 370 Fulton Ave., Hempstead, L.I., N.Y.
 Scott, Andrew Inc. 65 W. 54th St., 32nd Fl., N.Y.C. 10019
 Scott, Michael c/o Gary B. Altman 5900 N. Kentland, Woodland Hills, Cal.
 Scott, Tony, c/o Herbert Wasserman 875 West End Ave., N.Y.C. 10025
 Scroll 292 Madison Ave., Rm 1204, N.Y.C. 10017
 Sculpture 1 E. 57th St., N.Y.C. 10022
 Sea 1 Boylston Pl., Boston, Mass.
 Sebiniano c/o Michael P. Sebiniano 285 E. 49th St., Brooklyn, N.Y. 11203
 Second 1619 B'way, 11th Fl., N.Y.C. 10019
 Seesaw 241 1/2 E. 84th St., N.Y.C. 10028
 Select 40 W. 55th St., N.Y.C. 10019
 Selsom 43 Broad St., Red Bank, N.J. 07701
 Senator 210 W. 55th St., N.Y.C. 10019
 Seneca c/o Ellis L. Walsh 2329 W. 25th St., Apt. 204, L.A. 44, Cal.
 Senisa 511 Brooklyn Ave., San Antonio, Tex. 78215
 Sepe c/o Tony Sepe 5842 Camerford, Apt. #2, H'wood, Cal. 90048
 SER Productions, Inc. (Brochure Music Div.) 6000 Sunset Blvd., Suite 102, H'wood, Cal. 90028
 Serena 333 Sixth Ave., N.Y.C. 10014
 Sergeant c/o Sinatra Enterprises 4000 Warner Blvd., Burbank, Cal. 91505
 Serio 29 Livingston Pl.-Benskin, Teaneck, N.J. 07666
 Seton 1631 B'way, N.Y.C. 10019
 Seuffert 1666 Linden St., Ridgewood 27, Queens, N.Y.
 Sevarts 200 Park Ave., N.Y.C. 10017
 Sevberg c/o Tabak & Kurnit, 40 W. 55th St., N.Y.C. 10019
 Sevborg (see Manpine)
 Seven Arts Press, Inc. (Suite Seven Music Div.) 6365 Selma Ave., N.Y.C. 10017
 Sewan P.O. Box 323, Long Beach, N.Y.
 Sewanee 8763 Sunset Blvd., L.A. 69, Cal.
 Seydell, Gypsy 6239 N. Western Ave., Apt. 2A, Chicago, Ill. 60645
 Shale c/o Jack I. Aster, Esq., 1650 B'way, N.Y.C. 10019
 Shalomar 6 Beacon St., Boston, Mass. 02108
 Shamely c/o MCA, Inc. Accounting Dept. Universal City, Cal. 91608
 Shamrock c/o Dr. Lewis J. Franklin 149 Dean Terrace, Union, N.J., 07083
 Shank, Bud c/o Jimmy McHugh, 709 N. Sierra Dr., Beverly Hills, Cal. 90210
 Shapiro, J. W. 4300 Pulaski Hwy., Baltimore, Md. 21224
 Shapiro, Bernstein & Co., Inc. 666 Fifth Ave., N.Y.C. 10019
 Shapiro, Ted 695 N.E. 151st St., Miami 61, Fla.
 Shari 120 W. 57th St., N.Y.C. 10022
 Sharkey c/o Irving Cohen 505 Park Ave., N.Y.C. 10022
 Shattinger c/o Copyright Service Bureau Ltd. 221 W. 57th St., N.Y.C. 10019
 Shaw, Eddie 9220 Sunset Blvd., Suite 328, L.A., Cal. 90069
 Shawnee Press, Inc., Delaware Water Gap, Pa.
 Shay c/o Jimmy McHugh Music, Inc. 709 N. Sierra Dr., Beverly Hills, Cal. 90210
 Shayne, Larry 6290 Sunset Blvd., H'wood, Cal. 90028
 Shayne, Larry, 6290 Sunset Blvd., H'wood, Cal. 90028
 Shearing c/o Roseman & Stern 9350 Wilshire Blvd., Suite 302, Beverly Hills, Cal. 90212
 Sheenfeen c/o Alouette Productions, Inc. 1619 B'way, Suite 914, N.Y.C. 10019
 Shefter, Bert, 9255 Sunset Blvd., Suite 609, L.A. 69, Calif.
 Sheila 234 W. 56th St., N.Y.C. 10019
 Shelby 1153 1/2 N. Edgemont St., L.A. Cal. 90029
 Shelley, David 6124 Selma Ave., H'wood 28, Cal.
 Shelley 875 Fifth Ave., N.Y.C. 10021
 Shempire P.O. Box 1232, Evanston, Ill.
 Sheppard John 1107 Cedar Ave., Boulder, Colo. 80302
 Sheraton Box 4, Dedham, Mass.
 Sheratone P.O. Box 3119, Pittsburgh, Pa. 15230
 Sheriton 6223 Selma Ave., Suite 203, H'wood 28, Cal.
 Sherman, Al 700 S. Hobart Blvd., Apt. 305, L.A. 5, Cal.
 Sherwin c/o Robert Mellin 1650 B'way, Rm. 901, N.Y.C. 10019
 Sherwood Melodies Box 499, Bardonia, N.Y. 10954
 Shield, Roy, Mrs. Katherine W. Shield, P.O. Box 1736, Oakland, Cal. 94604

(Continued on page 182)

The "In" Campus Group The Youngbloods

Their album: "The Youngbloods" * Latest single: "Euphoria"



ESTABLISHED 1899



William Morris Agency

Herbert S. Gart Management, Inc.

RCA VICTOR

The most trusted name in sound



* Available on Stereo 8 Cartridge Tape

ASCAP PUBLISHERS

(Continued from page 180)

Shy-Hy 9158 Rundelay Way, P.O. Box 7123, Sacramento, Cal. 95826
 Shilkret, Nathaniel, Box 38, Malverne, L.I., N.Y.
 Shirlest Andrews Bldg., Rm 334 35 Court St., Buffalo 2, N.Y.
 Sho-Rae 8148 Mannix Dr., L.A., Cal. 90046
 Shoreham 6410 Willoughby Ave., H'wood, Cal. 90038
 Show Tunes, Inc. 1270 Sixth Ave., Suite 902, N.Y.C. 10020
 Shubert Attn: Syd Goldberg, 488 Madison Ave., N.Y.C. 10022
 Shuman, Alden, c/o Alden Shuman 302 E. 88th St., N.Y.C. 10028
 Siana (Eagle Hill Music Div.) 781 7th Ave., N.Y.C. 10019
 Sifer Paul J. 3947 Fredonia Dr., H'wood, Cal. 90028
 Sight & Sound 6404 H'wood Blvd., H'wood 28, Cal.
 Sigma 1619 B'way, 11th Fl., N.Y.C. 10019
 Sigmanson 27 Nassau Dr., Great Neck, N.Y. 11020
 Silent c/o Hardy Salwitz 2109 B'way, Suite 1177, N.Y.C. 10023
 Silhouette c/o Copyright Service Bureau Ltd., 221 W. 57th St., N.Y.C. 10019
 Silk City 432 E. 32nd St., Paterson, N.J.
 Silver Burdett Co., Columbia Rd., Morristown, N.J.
 Silver Cloud c/o Dita Bell, Porte Pestaute 33 Canon St., London, E.C. 4, England
 Silvertowne c/o Ross Jungnickel, Inc. 1619 B'way, N.Y.C. 10019
 Simon, George, Inc. c/o Larry Shayne Music, Inc., 1619 B'way, Rm. 516, N.Y.C. 10019
 Sing N' Dance 66 Mechanic St., New Rochelle, N.Y.
 Siras 39 W. 54th St., N.Y.C. 10019
 Sitara 1915 24th Rd., Astoria, N.Y.
 Six Iron Sunvine Tower, Suite 823, Sunset & Vine H'wood, Cal. 90028
 Sixty Two Revue 33 W. 60th St., N.Y.C. 10023
 Skidmore 666 Fifth Ave., N.Y.C. 10019
 Skinner Box 671, H'wood 28, Cal.
 Skip 4813 Paradise Rd. #19, Las Vegas, Nev. 89109
 Skokie 216 Hammond St., Westernport, Md. 21562
 Sky-Hi 1651 B'way Ave., Pittsburgh, Pa. 15216
 Skyline 81 Spring Valley Rd., Paramus, N.J.
 Skyrock 1651 B'way Ave., Pittsburgh, Pa. 15216
 Skyview 9165 Sunset Blvd., L.A. 69, Cal.
 Sleepy Hollow c/o Billy End Wheelie, Bee Tree Broad, Swannanoa, N.C. 28778
 Slen 818 6th St., Union Beach, N.J. 07735
 Slide 411 Gordon St., Reading, Pa. 1960
 Smith, Ethel, c/o Copyright Service Bureau Ltd. 221 W. 57th St., N.Y.C. 10019
 Smith-Foley c/o Syd Foley 610 Cathedral Parkway, N.Y.C. 10025
 Smith, William J. 254 W. 31st St., N.Y.C. 10001
 Snyder 1804 Ivar Ave., H'wood, Cal. 90028
 Society for the Publication of American Music, Inc., c/o Yale University, New Haven, Conn.
 Soifer c/o Soifer 2719 W. 33rd St., Bklyn, N.Y. 11224
 Soliloquy 1650 B'way, Suite 1203, N.Y.C. 10019
 Sollari 6290 Sunset Blvd., Suite 1003, H'wood, Cal. 90028
 Solo 9713 Santa Monica Blvd., Beverly Hills, Cal. 90218
 Solon 677 Sierra St., Porterville, Calif. 93257
 Somerset c/o Mr. Russ Black 4618 W. Dale Ave., L.A., Calif. 90041
 Sommer, Henry J. P.O. Box 322, Silver Spring, Md. 20907
 Son-Deane 25 Jennifer Lane, Hartsdale, N.Y. 10530
 Song Shop 173 West Madison St., Room 1208, Chicago 2, Ill.
 Song-Art c/o Robert Mellin, 1650 B'way, N.Y.C. 10019
 Song City 118 South Wetherly Drive, L.A., Calif. 90048
 Songfest 1650 B'way, No 1210 N.Y.C. 10019
 Song Mill c/o Milton Nelson 2816 Eighth Ave., N.Y.C. 10039
 Songs, c/o Mr. Walter Kent 4236 Alcoe, Studio City, Calif.
 Songs Box 102, Scarborough, N.Y.
 Songsellers 1619 B'way, No. 605, N.Y.C. 10019
 Songsmiths 1650 B'way, Rm. 906, N.Y.C. 10019
 Sonora 8464 Airline H'way, Baton Rouge, La.
 Soon 4055 Wilshire Blvd., L.A., Calif. 90005
 Soremy 521 5th Ave., Suite 1518, N.Y.C. 10017
 Soso 17130 S. Billings Dr., Gardena, Cal. 90247
 Sound & Light 35 W. 53rd St., N.Y.C. 10019
 Soundpost 221 West 57th St., N.Y.C. 10019
 Sounds 1619 B'way, Suite 1003, N.Y.C. 10019
 Sounds Unlimited 1 E. 57th St., N.Y.C. 10022
 South Sea 4948 Fulton Ave., Sherman Oaks, Calif.
 Southern 1619 B'way, N.Y.C. 10019
 Southdale 6290 Sunset Blvd., H'wood, Calif. 90028
 Southern 1100 B'way, P.O. Box 329, San Antonio 6, Texas
 Southwest 1951 Holmby Ave., L.A. 25, Calif.
 Souvenir, Box 1725, H'wood 28, Calif.
 Sovereign c/o Al Lewis 22 E. 49th St., N.Y.C.
 Spar c/o Bernard A. Lang 36 Central Park South, N.Y.C. 10019
 Sparrow 10513 Santa Monica Blvd., W. L.A., Calif. 90025
 Spear Jack 9931 Oak Park Ave., Northridge, Calif. 91324
 Spectacular 30 Rockefeller Plaza, Suite 962, N.Y.C. 10020
 Spectrum 242 East 87th St., N.Y.C. 10028
 Spence 825 N. W. Knoll Dr., L.A., Cal. 90069
 Spencer, Glenn, 2276 Lysander, Simi, Calif.
 Spencer c/o Spencer Prod. 507 Fifth Ave., N.Y.C. 10017
 Spier, Larry 1650 B'way, Suite 408, N.Y.C. 10019
 Spin 100 Cullum, Richland, Wash. 99352
 Spina, 2233 Vista Del Mar Pl., H'wood 28, Cal.
 Spinetti 4416 Bergline Ave., Union City, N.Y.
 Spinks 218 Frankford Road, Ronceverte, West Va. 24970
 Spital c/o Gladys Shelly 875 5th Ave., N.Y.C. 21, N.Y.
 Spitzer, Henry c/o Braunstein & Chornin 300 Madison Ave., N.Y.C. 10017

Spoone c/o Mr. Jack Spina 9033 Wilshire Blvd., Beverly Hills, Calif.
 Spotlight 6402 West Keefe Ave. Pkwy., Milwaukee, Wisc. 53216
 Springton 12 Palmer Mill Road, Media, Pa.
 Stada Copyright Service Bureau Ltd. 221 West 57th St., N.Y.C. 10019
 Staff 374 Great Neck Road Great Neck, N.Y.
 STAGE CRAFT c/o Herman Meltzer, Esq. 551 5th Ave., N.Y.C. 10017
 Stage Six 301 Richmond Ave., South Orange, N.J. 07079
 Standard 814 S.W. 18th St., Ft. Lauderdale, Fla. 33315
 Standish c/o Mary Mirenburg, Esq. 501 Madison Ave., N.Y.C. 10022
 Standley 24208 Alliene Ave., Lomita, Calif.
 Stanley 11420 Babbitt Ave., Granada Hills, Cal.
 Stanley & Livingston c/o Mr. William Livingston Box 855, Rocky Point, N.Y.
 Stanley Attn: Jerry K. Fields 9171 Wilshire Blvd., Beverly Hills, Calif. 90210
 Stan-Mar c/o Commander 1610 North Argyle Ave., H'wood 28, Calif.
 Stanwood Attn: Mr. Ben Barton 1619 B'way, Room 412, N.Y.C. 10019
 Stanyan 1777 N. Vine St., H'wood, Cal. 90028
 Star-Hit c/o Nelson Cogane 89 Merritt Ave., Massapequa, N.Y.
 Star-Fire A St. & B'way, Lenoir City, Tenn. 37771
 Starbright c/o Abner Silver 160 West 59th St., N.Y.C.
 Starfish 31941 Pacific Coast Hwy., So. Laguna, Calif. 92677
 Stargen 11 West 60th St., N.Y.C. 10023
 Starlight 9000 Sunset Blvd., Beverly Hills, Calif. 90069
 Starsun (Big "Y" Div.) 105 S. Cleveland Ave., Wilmington, Del. 19805
 Startime 6313 Peach Ave., Van Nuys, Calif. 91401
 Stasny 1619 Broadway, N.Y.C. 10019
 State 1619 B'way, N.Y.C. 10019
 Status 881 Seventh Floor, N.Y.C. 10019
 Stearns, Julian, Arena S. Rd., Harrison, N.Y.
 Steeple-Tone c/o Mr. Lee Russell 222 West 49th St., N.Y.C., 10019
 Stein & Van Stock 2648 West Grand Blvd., Detroit, Mich. 48208
 Stelzer 1732 Whitley Ave., H'wood 28, Calif.
 Stephens, Bob 54 West 58th St., N.Y.C. 10019
 Stepping Tones P.O. Box 64334, L.A. 64, Calif.
 Steps c/o Mr. James G. Rowles 638 N. Belair Drive, Burbank, Calif.
 Sterene 2637 N. 48th St., Milwaukee, Wisc. 53210
 Still, William Grant 1262 Victoria Ave., L.A., Calif. 90066
 Stitt 215 West Fifth St., No. 412, L.A. 13, Cal.
 Stock, Larry 2 Crosshill Rd., Tuckahoe 7, N.Y.
 Stokes 8255 Beverly Blvd., L.A., Calif. 90048
 Stooones, Harry 1721 Broadway, N.Y.C. 10019
 Stormont Music c/o David Joseph 1540 B'way, N.Y.C. 10036
 Storn, Harris & Jones 5372 Tampa Ave., Tarzana, Calif. 91356
 Stratford 609 Fifth Ave., N.Y.C. 10017
 Stroud 1650 B'way, Room 611, N.Y.C. 10019
 Stuart, Frank (Sal-Tor Division) 1721 B'way, N.Y.C. 10019
 Studio 115 Manhattan, Warwick, N.J. 07463
 Styne & Cahn c/o Edward Traubner 132 S. Rodeo Drive, Beverly Hills, Calif.
 Suchan P.O. Box 9391 Melrose Branch, Nashville, Tenn. 37204
 Sugarbush 6223 Selma Ave., H'wood, Cal. 90028
 Sujan 39 West 60th St., N.Y.C. 10023
 Sulky c/o G.L.G. 729 7th Ave., N.Y.C. 10019
 Summerhouse P.O. Box 919, New Britain, Ct.
 Summit c/o Herb Reis 1619 B'way, N.Y.C. 10019
 Summy-Birchard c/o David K. Sengstack 1834 Ridge Ave., Evanston, Ill.
 Sunburst P.O. Box 1721, Hobbs, New Mexico
 Sunflower c/o Mr. Gene Goodman 1619 B'way, N.Y.C. 10019
 Sunglow 117 So. Goldenrod Rd., Orlando, Fla.
 Sunland Box 1, Little River, Miami, Fla.
 Sunny Skies 1614 N. Argyle Ave., H'wood, Calif. 90028
 Sunnydale 17 Clover Pl., New Rochelle, N. Y.
 Sunset 1674 B'way, N.Y.C. 10019
 Sverb c/o Goldsund 1650 Broadway, #907B, N.Y.C. 10019
 Supersonic, Wold Lake, Ill. 62998
 Supreme 1619 B'way, N.Y.C. 10019
 Surrey 1674 B'way, Suite 514, N.Y.C. 10019
 Susaper 1630 N. Vine St., H'wood, Cal. 90028
 Sutton 415 East 52nd St., N.Y.C. 10022
 Swan, Don 5880 S.W. 94th St., Miami, Fla. 33156
 Swan c/o F. J. Rainer 135 Long Lane, Upper Barby, Pa.
 Swanson Robert (RSP Division) 689 Fifth Ave., N.Y.C. 10022
 Swarthmore 336 Central Park W., #4E, N.Y.C. 10025
 Sweatmen, Wilbur c/o Robert Sweeney 2821 Highland Ave., Kansas City, Mont. 64109
 Sweet 1852 West Drive, San Marino, Calif.
 Sweetums 45 West 56th St., N.Y.C. 10019
 Swing House, 12130 Sherman Way, N. H'wood, Calif. 91605
 Sybilla 111 W. 57th St., N.Y.C.
 Sylvan 323 Cedar St., N.W., Washington 12, D.C.
 Symphony House c/o Paul Siegel Tauntzienz Strasse 16, Berlin, W. 30, Germany
 Syndicate, 136 West 50th St., Room 1920, N.Y.C. 10019
 Syosset c/o Wallace J. Zober 15 Brookwood Drive, Wyandanch, L.I. N.Y.
 Systems For Educations 612 N. Michigan Ave., Chicago, Ill. 60611

Tad Copyright Service Bureau 221 West 57th St., N.Y.C. 10019
 Tadmud 490 Westend Ave., Suite 1C, N.Y.C. 10024
 Tahiti Musique 5810 So. Normandie, L.A., Calif. 90044
 Taj 1313 North Vine St., H'wood 28, Calif.
 Talent 2424 South Broad St., Phila., 45, Pa.
 Talent, Leo 1650 B'way, Rm. 906, N.Y.C. 10019
 Talisman c/o Judy Hicks 4450 Agnes Ave., North H'wood, Calif. 91607
 Talmadge 826 7th Ave., N.Y.C. 10019
 Talmay 875 Ave. Of Americas, N.Y.C. 10001
 Tamara 1777 N. Vine St., H'wood, Cal. 90028
 Tamarin 8 East 48th St., N.Y.C. 10017
 Tamarisk 1332 1/2 Miller Dr., L.A. 46, Calif.
 Tambilene 8324 Delgany Ave., Playa del Rey, Calif. 90291
 Tammy Lynn 17060 Mayall St., North Ridge, Calif. 91324
 Tandra c/o Nick Perito 10 East 49th St., N.Y.C. 10017
 Tanglewood c/o S. Goldstein, Esq. 295 Madison Ave., N.Y.C. 10017
 Tape 6051 Harold Way, No. 36, H'wood 28, Cal.
 Tara Adler Building 136 West 46th St., Adler, N.Y.C. 10036
 Tarcus c/o George Pincus 1650 B'way, N.Y.C. 10019
 Tarpon c/o Theodore S. Reig 1631 B'way, N.Y.C. 10019
 Tarto P.O. Box 254, Raritun, N.J. 08869
 Tascosa House 5529 1/2 Harold Way, H'wood, Calif. 90028
 Tate c/o Charles F. Webb 666 Hancock St., Apt. 3A, Brooklyn, N.Y. 11233
 Taubman, Paul, Penthouse Club 30 Central Park South, N.Y.C. 10019
 Taurus c/o Miss Bebe Blake L.A. Athletic Club, 431 W. 7th St., L.A. 13, Calif.
 Taylor, Larry 165 W. End Ave., N.Y.C. 10023
 Teardrop 2508 Franklin Rd., Nashville, Tenn. 37204
 Ted Jay 214 Clason St., Horicon, Wisc. 53032
 Teeger 165 East 32nd St., N.Y.C. 10016
 Tee Pee 1650 Broadway, Rm. 715, N.Y.C. 10019
 Teen Ed (Condro Div.) 13 Union St., Medford, N.J.
 Teeny Bopper 118 So. Wetherly Dr., #105, L.A., Calif.
 Tenna 15 East 18th St., N.Y.C. 10017
 Teesdale 1479 North Vine St., H'wood 28, Cal.
 Telen 5235 Cleveland, Skokie, Ill.
 Telerad (Bolinger Division) 1953 Pontius Ave., L.A., Calif. 90025
 Tema, 13310 Caine Ave., Cleveland, Ohio 44105
 Temple c/o Joe Shribman 449 South Beverly Drive, Beverly Hills, Calif. 90212
 Templeton c/o Shawnee Press, Delaware Water Gap, Pa.
 Tempo 52 West 58th St., N.Y.C. 10019
 Temponic 175th St. Francis Ave., Tiffin, Ohio 44883
 Tendril 6619 Cameron Ct., Bklyn, N.Y. 11204
 Tenley c/o Pryor & Braun 640 Fifth Ave., N.Y.C. 10019
 Tenuto Box 158 Southern Sta., Hattiesburg, Miss. 39401
 Tepper, Saul c/o Saul Tepper 79 Barrow St., N.Y.C. 10014
 Terell c/o R. Terry 32 W. 82nd St., N.Y.C. 10024
 Teri 1608 North Argyle, H'wood, Calif. 90028
 Terrace 173 West Madison, Chicago, Ill.
 Terry 220 Pharr Road, N.E. Atlanta 5, Ga.
 Terry c/o Ben Arrigo 157 W. 57th St., N.Y.C. 10019
 Terton 120 East 56th St., Suite 310, N.Y.C. 10022
 Tetra 120 West 57th St., N.Y.C. 10019
 Texoma Route 1, Box 74A, Park Hill, Okla.
 Thank P.O. Box 416, N.Y.C. 10019
 Theotig, Vahan 379 Santa Rita Place, Banning, Calif.
 Third Stream 200 West 57th St., N.Y.C. 10019
 Thirty Seven 5615 W. Olympic Blvd., L.A., Calif. 90048
 Thomas, John c/o Jack J. Katz Esq. 608 Fifth Ave., N.Y.C. 10020
 Thomason-Ray 6301 Coldwater Canyon Ave. #24, N. H'wood, Calif. 91606
 Thompson, Kay Palazzo Torlonia, Rome, Italy
 Thor 399 Fullerton Pkwy, Chicago, Ill. 60614
 Thornhill c/o Kastriner & Harris 19 W. 44th St., Room 318, N.Y.C. 10036
 Thornlee c/o Kastriner & Harris 19 West 44th St., Room 318, N.Y.C. 10036
 Three Arts 7233 1/2 Santa Monica Blvd., H'wood, Calif. 90046
 Three Dee 3205 Bonnie Hill Drive, H'wood 28, Calif.
 3 H's c/o Henry Oakes 315 Westfield Blvd., Indianapolis, Ind. 46220
 Three Minute c/o Beatrice Kornstein 2025 North Allen Ave., Altadena, Calif.
 Three Time 78 Spindle Rd., Hicksville, N.Y. 11801
 Threesome 12660 Mulholland Drive, Beverly Hills, Calif.
 Thru-Way 1228 East Gunhill Road, Bronx 69, N.Y.
 Thunderbird 1608 N. Argyle, H'wood, Calif. 90028
 Thru-Bil 1619 S. Orange Dr., L.A., Cal. 90019
 Tillbilly 5 West 86th St., N.Y.C. 10024
 Timber 6150 Lexington Ave., H'wood, Calif. 90028
 Timely 1650 Broadway, Rm. 701, N.Y.C. 10019
 Timsonac 1048 No. Carol Drive, L.A., 69, Cal.
 Tinker 2309 Knowles Road, Wilmington 2, Del.
 Tiny Tot c/o Robert Feldman 1619 B'way, N.Y.C. 10019
 Tiplot 200 W. 57th St., Rm. 607, N.Y.C. 10019
 Tipton, Blair 4709 Beethoven St., L.A., Calif. 90066
 Tivoli c/o Gilbert & Livine 9601 Wilshire Blvd., Suite 229, Beverly Hills, Calif. 90210
 Tohey 1650 Broadway, N.Y.C. 10019
 Tobias Henry 1650 Broadway, Room 604, N.Y.C. 10019
 Tod 632 Winchester Ave., Union, N.J. 07083
 Toman 2017 South Cedar St., Lansing, Mich. 48910
 Tomard 70 W. Monroe St., Chicago, Ill. 60603
 Tone 5 Tudor City Pl., Suite 209, N.Y.C. 10017
 Top-Hit 1120 N. Fuller Ave., L.A., Cal. 90046
 Top Notch 1619 B'way, N.Y.C. 10019
 Topik c/o Frances M. Gnass 631 Knowles, Royal Oak, Mich.

Topper 119 West 57th St., Room 610, N.Y.C.
 Tor 408 North Rodeo Drive, Beverly Hills, Cal.
 Torch c/o Monmouth-Lee 730 5th Ave., N.Y.C. 10019
 Totem P.O. Box 3194, Grand Central Station, N.Y.C. 10017
 Touring c/o Larry Elgart 55 East 74th St., N.Y.C. 10021
 Towne 1619 B'way, Room 906, N.Y.C. 10019
 Toy Town 17 W. 60th St., 8th fl., N.Y.C. 10023
 Trace 52-37 79th St., Elmhurst, N.Y.
 Tracer c/o Reco-Art 212 N. 12th St., Philadelphia 7, Pa.
 Tracie, P.O. Box 849, Beaumont, Texas
 Trafalgar c/o Nadel 200 West 57th St., N.Y.C. 10019
 Trajames 214 Roundhill Road, Ashland, N.J. 08002
 Trans American 1619 Broadway, N.Y.C. 10019
 Transcontinental 1674 B'way, N.Y.C. 10019
 Tray 135 W. 50th St., Suite 1920, N.Y.C. 10019
 Traylorm 515 Madison Ave., No. 3300, N.Y.C. 10022
 Treasure Aisle 711 North State St., Clarks Summit, Pa.
 Trenner 408 North Rodeo Dr., Beverly Hills, Calif. 90210
 Trevi c/o PGI 25 East 26th St., N.Y.C. 10010
 Tri-Music 6307 West Keefe Ave. Pkwy, Milwaukee, Wisconsin 53216
 Tri-Tone 7438 Craner St., Sun Valley, Calif. 91352
 Triana c/o Marc Fredericks 46 Marlene Drive, Syosset, N.Y. 11791
 Triangle 1619 B'way, N.Y.C. 10019
 Tribute Heller 345 East 52nd St., N.Y.C. 10019
 Tricky 1631 B'way, N.Y.C. 10019
 Trident 82 Forest Road, Allendale, N.J.
 Trinda c/o Phil Tucker 142 Fifth Ave., 5th fl., N.Y.C. 10011
 Trine c/o Charles Darwin 48 West 63rd St., N.Y.C. 10019
 Tropical Aptdo 3556, Caracas, Venezuela, S.A.
 Troubadour 345 W. 58th St., 15-F, N.Y.C. 10019
 True Blue c/o Larry Fontine 16027 Sunburst St., Sepulveda, Calif.
 Trulite c/o Alfred Tvellino 117 W. 70th St., N.Y.C. 10023
 Tru-Sound (Tru-Sound Div.) 203 S. Washington Ave., Bergenfield, N.J. 07621
 Tucker, Orrin 15475 Hamner Dr., L.A. 24, Cal.
 Tucker, Tommy 583 N. Edgemere Dr., W. Allenhurst, N.J. 07711
 Tuk c/o Robert Tulak 13522 Clinton St., Garden Grove, Cal.
 Tulip Attn: Clyde Otis 1650 B'way, Suite 502, N.Y.C. 10019
 Tune-House 1619 B'way, Suite 514, N.Y.C. 10019
 Turquoise 8455 Beverly Blvd., L.A. 48, Cal.
 Tuttle c/o Robert Mellin 1650 B'way, Rm 901, N.Y.C. 10019
 Twangy c/o Andrew J. Feinman 608 Fifth Ave., N.Y.C. 10020
 Twelve Stave 139 E. 33rd St., No. 1513 N.Y.C. 10016
 Twinchris 6290 Sunset Blvd., Suite 1003, H'wood Calif. 90028
 Twin Girl 1210 E. Cliveden St., Phila, Pa. 19119
 Two Dees c/o Dave Franklin P.O. Box 1383, Beverly Hills, Cal. 90213
 Two-Penny 1619 B'way, N.Y.C. 10019
 Tycorn 1674 B'way, Rm 316, N.Y.C. 10019
 Tylerson 6124 Selma Ave., H'wood 28, Cal.

U

U.S. Songs, c/o Quartet Music, Inc. 1619 B'way, N.Y.C. 10019
 Ulan 729 Seventh Ave., N.Y.C. 10019
 Unicorn 1841 B'way, N.Y.C. 10023
 Unilite 7322 19th Ave., Bklyn, N.Y.
 Union 14145 Dickens St., Sherman Oaks, Cal.
 Unison c/o Vic Mizzy, P.O. Box 1792, Beverly Hills, Cal.
 United Artists Attn: Sidney Shemel, Esq. 729 Seventh Ave., N.Y.C. 10019
 United Intl Copyright Representatives, c/o B. Stollman, Esq. 156 Fifth Ave., N.Y.C. 10010
 United 1631 B'way, N.Y.C. 10019
 University 1650 B'way, N.Y.C. 10019
 UPA 4440 Lakeside Dr., Burbank, Cal.
 Uptown 1145 E. 56th St., Bklyn 34, N.Y.
 Urban 1177 W. Jefferson, Blvd., L.A., Cal.
 Uzram 2201 Burr Oak Ave., N. Riverside, Ill.

V

Vado c/o Vincent Velardi, 2226 McDonald Ave., Bklyn, N.Y. 10023
 Valando 22 W. 48th St., N.Y.C. 10036
 Valbo c/o Martin J. Machat, 1501 B'way, N.Y.C. 10036
 Valada 1674 B'way N.Y.C. 10019
 Valencia 1650 B'way, Rm 408, N.Y.C. 10019
 Valenco 11332 Miles Ave., Cleveland, O. 44105
 Valentina Century City, Gateway East Bldg., Suite 500, L.A., Cal. 90067
 Valentine c/o Sebastian (Billy) Mure 1697 B'way N.Y.C. 10019
 Valentino, Thomas J., 150 W. 46th St., N.Y.C. 10036
 Valiant 1619 B'way, N.Y.C. 10019
 Valley Brook 2733 Kensington Ave., Phila 34, Pa.
 Valley Entertainment 11734 Wilshire Blvd. #C1415 L.A., Cal. 90025
 Valmount P.O. Box 324, N. Miami 61, Fla.
 Valry c/o Philip Becker, CPA 545 Fifth Ave., N.Y.C. 10017
 Vandie 2480 16th St., N.W., Washington, D.C. 20009
 Vanessa Attn: Clyde Otis, 1650 B'way, Suite 502, N.Y.C. 10019
 Van Heusen 250 W. 57th St., N.Y.C. 10019
 Van-Jak 2 Leone Close, Scarsdale, N.Y.
 Vanguard c/o Bryan Lindsay 250 W. 57th St., N.Y.C. 10019
 Vanilla 923 Gregory Ave., Valparaise, Fla. 32580

(Continued on page 184)

JERRYSON NIMPANE

THE WHITE RABBIT
RCA VICTOR



CONGRATULATIONS TO CASH BOX

on 25th Anniversary

MAHALIA JACKSON

Exciting New Album Release!

"IN CONCERT EASTER SUNDAY - 1967"

COLUMBIA RECORDS

PUT A PLUS IN YOUR PROMOTION

We aggressively PROMOTE & MERCHANDISE in Southern Ohio (Columbus, Dayton, Cincinnati & Louisville) AS WELL AS Illinois, Indiana & Wisconsin.

Chicago Promotion: Cincinnati Prom. & Sales:

**CHARLES "DEEK" ATKINS LEE FOGEL
TOM AMANN LARRY BLACKWELL**

WE WORK NEW ARTISTS & NEW RELEASES
NOT JUST CHART HITS

Labels we represent in Southern Ohio:

**AUDIO-FIDELITY, BRENT, CALLA, GAMBLE, EPIC,
LIL DARLIN', MAINSTREAM, MAYFIELD, OKEH,
ONE-DER-FUL, RIC-TIC, STOP & VAULT.**

As to Chicago—CHECK WITH:

**DANNY DAVIS
TED FIEGEN
DON GRAHAM
"D" KILPATRICK
BOB KRASNOW**

**LEE LASSEFF
DOUG MOODY
RUSS REGAN
LE BARON TAYLOR
IRWIN ZUCKER**

Jack White—Seymour Greenspan

Illinois & Indiana:

SUMMIT DIST., INC.,

7447 North Linder Ave.
Skokie, Ill. 60076
(312) 677-1621 (312) 463-1833

Ohio & Kentucky:

SUMMIT DIST., INC.

617 Central Trust Tower
Cincinnati, Ohio 45202
(513) 241-6361

ASCAP PUBLISHERS

(Continued from page 182)

Vanity Attn: Thomas Schifarella, P.O. Box 2484, Paterson, N.J.
Vanlee 101 W. 57th St., Rm. 612A, N.Y.C. 10019
Vannel Box 177, Somers, Conn. 06071
Vanno c/o Roulette Records 1631 B'way, N.Y.C. 10019
Vantage 4433 Vantage Ave., Studio City, Cal. 91604
Variety 1350 Ave. of the Americas N.Y.C. 10019
Varo c/o Nathaniel Hoffman 41 E. 42nd St., Suite 1717, N.Y.C. 10017
Varona 5400 Fieldstone Rd., N.Y.C. 10071
Veca 1025 Remington Rd., Wynnwood, Pa. 19096
Veda c/o William N. Collette 5177 Pickford St., L.A., Cal.
Vended 1122 N. Gordon #6, H'wood, Cal. 90038
Venus 1619 B'way, Rm. 404, N.Y.C. 10019
Venus Recording P.O. Box 1451, Beverly Hills, Cal. 90213
Vera Nova c/o Jack Fascinato 720 N. Roxbury Dr., Beverly Hills, Cal.
Verde Vista c/o White #4 2383 Union St., San Francisco, Cal. 94123
Verna 930 F. St., N.W. Rm. 615 Washington 4, D.C.
Vernon 1619 B'way, N.Y.C. 10019
Veronique 250 W. 57th St., N.Y.C. 10019
Versil c/o Bill Silva 4462 Murietta St., #10, Sherman Oaks, Cal. 94403
Vic Vegas 4813 Paradise Rd. #19, Las Vegas, Nev. 89109
Vibes c/o Terry Gibbs, 13414 Oxnard St., Van Nuys, Cal. 91401
Vical c/o Carlton C. Camarata 33 Chestnut Rd., Verona, N.J.
Vicar c/o K. Brassel, 90 Riverside Dr., N.Y.C. 10024
Vickers 6381 H'wood Blvd., L.A. 28, Cal.
Victoria c/o Rosenberg & Rosenberg 430 Park Ave., N.Y.C. 10022
Victoria Attn: Victor Blau 488 Madison Ave., N.Y.C. 10022
Videocraft Int'l. 116 E. 30th St., N.Y.C. 10016
Vido 292 Madison Ave., N.Y.C. 10017
Vi-Jim 150 W. 55th St., N.Y.C. 10019
Viking c/o Mrs. Rose Gwartz, 421 Burmont Rd., Drexel Hill, Pa. 19026
Villa Moret 785 Market St., San Francisco 3, Cal.
Vim 9 Rockefeller Plaza, Rm. 1533, N.Y.C. 10020
Vine St. 1549 N. Vine St., H'wood 28, Cal.
Vin-Sun 1507 N. Vine St., H'wood 28, Cal.
Vinrob 501 Madison Ave., N.Y.C. 10022
Virginia City 14 E. Jackson Chicago, Ill. 60604
Virtu 8500 Fayette St., Phila. 50, Pa.
Vista 309 W. 57th St., N.Y.C. 10019
Vitalent (Vitalent Div.) c/o Mary Small 165 W. 66th St., N.Y.C. 10023
Vitalfo Via Archimede, 175, Rome, Italy
Vito P.O. Box 105, Lodi, Cal.
Viv-O 1850 N. Harvard Blvd. #14 L.A., Cal. 90027
Vogel, Jerry 112 W. 44th St., N.Y.C. 10018
Volkwein Bros. 117 Sandusky St., Pittsburgh, Pa. 15212
Volta 333 S. Windsor Blvd. L.A. 5, Cal.
Vonnie c/o R. D. Giacomo Dee 1517 Kadel Dr. Bethlehem, Pa.
Voss 3100 Torreyson Pl., L.A. Cal. 90046

W

W.P.N. 10 Swirl Lane, Levitown, N.Y. 11756
WPVC 190 Waverly Pl., N.Y.C. 10019
Wakefield 1619 B'way, N.Y.C. 10019
Walck, Henry Z. 19 Union Sq. W., N.Y.C. 10003
Wald, Herb 6083 Sunset Blvd., H'wood, Cal.
Walden 1841 B'way, N.Y.C. 10023
Waldo Attn: Alfred A. Porgie 1619 B'way, Rm 1014, N.Y.C. 10019
Wallan, c/o Lawson-Gould 609 Fifth Ave., N.Y.C. 10017
Walmac c/o Irwin Roth 111 B'way, N.Y.C. 10006
Walter Cy 225 E. 73rd St., N.Y.C. 10021
Walters c/o Richard Shelton, Suite 712, 79 W. Monroe St., Chicago, Ill. 60603
Wanton c/o Edward Traubner 132 S. Rodeo Dr., Beverly Hills, Cal. 90212
Wanderlust (Wanderlust Div.) c/o Fay Widen 7767 H'wood Blvd., H'wood, Cal. 90028
Wangir 351 W. 52nd St., N.Y.C. 10019
Wah-Mar c/o George Brown 850 Seventh Ave., Suite 303, N.Y.C. 10019
Ward, Jay 8218 Sunset Blvd., H'wood, Cal.
Waredown 689 S. Bronson Ave., L.A., Cal. 90005
Warnow, Mark 4042 Benedict Canyon Dr., Sherman Oaks, Cal.
Warock 39 W. 54th St., N.Y.C. 10019
Warwick c/o Edward Traubner 132 S. Rodeo Dr., Beverly Hills, Cal. 90212
Washington & Lee 1712 Angelo Dr., Beverly Hills, Cal.
Watonga 2609 N. W. 36th St., Oklahoma City, Okla. 73112
Waverly, Jack Bahama Terrace, Treasure Rd., Stuart, Fla.
Wayfarer 580 W. End Ave., N.Y.C. 10024
Waygate c/o John J. Cevetello 1717 N. Vine St., Suite 20, H'wood 28, Cal.
Webster & Lee 980 S. Menlo Ave., L.A., Cal. 90006
Webster c/o Edward Traubner 132 S. Rodeo Dr., Beverly Hills, Cal.
Wedgewood c/o Gil Garfield 444 N. Camden Dr., Beverly Hills, Cal.
Weill-Brecht-Harms Attn: Victor Blau 488 Madison Ave., N.Y.C. 10023
Weintraub 30 W. 60th St., N.Y.C. 10023
Weiss, Mac 2175 Ryer Ave., Bronx 57, N.Y.
Weiss, Sam 6087 Sunset Blvd., H'wood 28, Cal.
Wells c/o Kastriner & Harris 19 W. 44th St., N.Y.C. 10036
Wells, O. J. 120 East Main Cross, Box 321, Taylorville, Ill. 62568
Welz Box 522, Salisbury, Md. 21801
Welzheim Attn: Jack Bregman 1619 B'way, N.Y.C. 10019
Wendy 1650 B'way, Rm 906, N.Y.C. 10019
Wentworth c/o Felix C. Ziffer, 641 Lexington Ave., 22nd Floor, N.Y.C. 10022
Wes Mar (Wes Mar Div.) 31 W. Market St., Akron, O. 44308
Wespo 392 Central Park West, Apt. 18M, N.Y.C. 10025
Wess, Richard c/o Farber, Cohen & Diamond, Esq. 608 Fifth Ave., N.Y.C. 10020
West End 1650 B'way, N.Y.C. 10019

Western 10000 Riverside Dr., Suite 8, N. H'wood, Cal.
West, Ray, c/o Ray West 2411 Webb Ave., Bronx 68, N.Y.
Westindy P.O. Box 2371, Charlotte Amalie, St. Thomas, Virgin Islands
Westmont 6290 Sunset Blvd., H'wood, Cal. 90028
Whale c/o Jack Lawrence 229 E. 52nd St., N.Y.C. 10022
Wharton c/o Nicholas A. Busillo 1023 W. 67th St., Phila., Pa. 19151
Wherefore 441 W. 49th St., N.Y.C. 10036
Whitecup, Leonard, Inc. 215 E. 68th St., N.Y.C. 10021
White Bear c/o Stephen Schmidt Box 51 Stinson Beach, Cal. 94976
White, Don 2020 Ridge Ave., Phila., Pa. 19121
White Heather 2631 Riverside Dr., Bellmore, N.Y. 11710
White Mountain c/o Robert J. Calilli, 1122 Rhinelander Ave., Bronx, N.Y. 10461
White Way c/o Edward R. White 101 W. 55th St., N.Y.C. 10019
Whiting 1619 B'way, No. 502, N.Y.C. 10019
Whitney-Kramer-Zaret 1650 B'way N.Y.C. 10019
Widco 9465 Wilshire Blvd., Suite 820, Beverly Hills, Cal. 90212
Wide World of Music 9000 Sunset Blvd., H'wood, Cal. 90069
Wildcat 1712 Farrell, Greenboro, N.C. 27405
Williamson 609 Fifth Ave., N.Y.C. 10017
Willing, Foy, c/o Robin 6915 Helen Ave., Sunland, Cal. 91040
Willow 384 Pinebrook Blvd, New Rochelle, N.Y. 10804
Willowgreen 451 Grand Ave., Palisades Park, N.Y. 07650
Wilshire 423 S. Reyford Dr., Apt. 201, Beverly Hills, Cal. 90212
Wilson Earl c/o Earl Wilson 340 W. 57th St., N.Y.C. 10019
Wilstan 178 Mission Ave., San Rafael, Cal. 94901
Winch (April) 760 N. Lacienea Blvd., L.A., Cal. 90069
Wimbleton c/o Lambro 1419 N. Fairfax, #3, L.A., Cal. 90046
Winchell, Danny 500 W. 235th St., Riverdale 68, N.Y.
Windsor 6725 Sunset Blvd. Suite 219, H'wood, Cal. 90028
Winslow c/o Lawrence 890 Sixth Ave., N.Y.C. 10001
Winston 315 N. Martel Ave., L.A. 36, Cal.
Wintersett c/o Valando Attn: Arthur Valando 22 W. 48th St., N.Y.C. 10036
Winton House, c/o Lenard H. Monroe, Esq., 1801 Ave. of the Stars, L.A., Cal. 90067
Wise 1650 B'way, N.Y.C. 10019
Witmark, M., & Sons Attn: Victor Blau 488 Madison Ave., N.Y.C. 10022
Wizel & Day c/o Robert Day 6 Northview Pl., White Plains, N.Y.
Wizel Murray 15 Central Park W., N.Y.C. 10023
Wolf E. 212 Wilsey Court, Paramus, N.J.
Wolf-Mills 8814 Skrak Ave., Playa Del Rey, Cal. 90292
Wolper (Wolper Div.) 6544 Sunset Blvd., L.A. Cal. 90069
Wood River 9008 Parrot Ave., Downey, Cal. 90240
Woodbine 11224 Bellagio Rd., L.A. 49, Cal.
Woodbury—Woodbury, Conn.
Woodrow 200 W. 57th St., N.Y.C. 10019
Woodvale c/o Edward Traubner 132 So. Rodeo Dr., Beverly Hills, Cal. 90210
Woodward c/o Martilla 381 Bleecker St., N.Y.C. 10014
Woofie c/o Ross Jungnickel, Inc. 1619 B'way, N.Y.C. 10019
Word (Sacred Songs Div.) 5030 W. Waco, Waco, Texas 76710
Words & Music 17 W. 60th St., 8th Floor, N.Y.C. 10023
Wordsworth c/o Lottie Biggs 115 W. 89th St., N.Y.C. 10024
World 13 E. 48th St., N.Y.C. 10017
Worth, Bobby 1320 Miller Dr., W. H'wood, Cal. 90069
Worthy 1009 Ave. K, Bklyn 30, N.Y.
Wright-Way c/o Milo Wright 2200 No. Roosevelt, Wichita, Kansas
Wyncoot c/o Cameo-Parkway 1405 Locust St., Phila., Pa.
Wynn, Charles, c/o Helen Weinberg 63 1/2 E. 12th St., Paterson, N.J. 07502
Wynnfield 3003 Ocean Front Walk, Venice, Cal. 90291

X

X.Y.Z. 535 N.E. 113th St., Miami 38, Fla.
Xina c/o Robt. Schwaid, 3 E. 57th St., N.Y.C. 10022

Y

Ybarra Box 665, Lemon Grove, Cal. 92045
Yellen & Fain c/o Jack Yellen, The Jack Yellen Farm, Springville, N.Y.
Yogar 1004 N.E. 26th Ave., Pampano Beach, Fla. 33064
Yorktown 33 W. 60th St., N.Y.C. 10023
Youmans, Vincent 157 W. 57th St., Suite 404, N.Y.C. 10019
Young, Victor 609 Fifth Ave., N.Y.C. 10017
Your Piano and Organ Studios 8840 So. Sep. Blvd., Los Angeles, Cal. 90045
Yukon 225 E. 57th St., #2, N.Y.C. 10022
Yula c/o Whitney 15 W. 55th St., N.Y.C. 10019
Yuvan 729 Seventh Ave., N.Y.C. 10019

Z

Zackary c/o George Roumanis, Futura 1717 N. Highland Ave., Ridgefield Park, N.J.
Zanata 1800 N. Argyle Ave., H'wood, Cal. 90028
Zeller 6223 Selma Ave., H'wood, Cal. 90028
Zenobi 162 Wilcox St., New Britain, Conn.
Zephyr c/o Allen Miller 565 Fifth Avenue, N.Y.C. 10017
Zimrog c/o Alfred N. Zimbalist 9715 Alcott St., L.A., Cal. 90035
Zizane c/o Stan Catron 237 W. 54th St., N.Y.C. 10019
Zizz 1639 B'way, Suite 310, N.Y.C. 10019
Zing 40 Maffett St., Plains, Pa. 18705
Zorich 8100 Harding Ave., Miami Beach, Fla. 33141
Zuma c/o Ben Melzer 609 N. Ditmar St., Oceanside, Cal. 92054

**DIAMOND RECORDS
AND
IT'S FAMILY
CONGRATULATES
CASH BOX
ON IT'S
25TH
ANNIVERSARY**

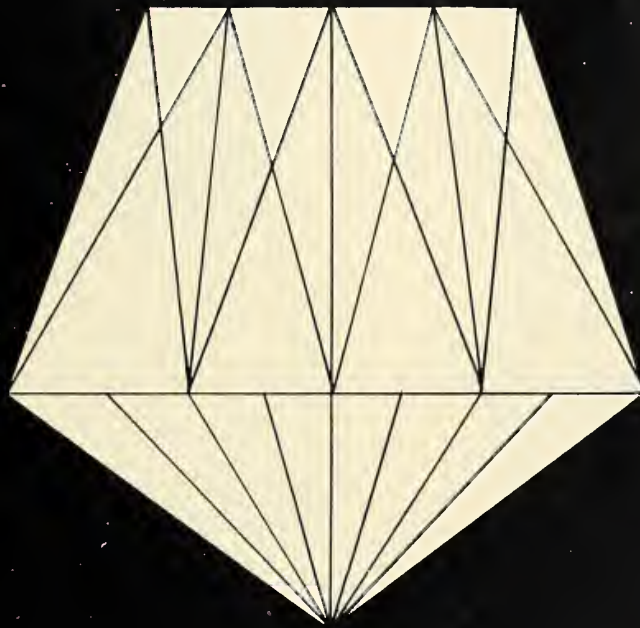

RONNIE DOVE
ETTORE CENCI
DAWN'S EARLY LIGHT
CARLTON EDWARDS

JOHNNY THUNDER
RUBY WINTERS
TOMMY DAE & THE HIGH TENSIONS
ANDY ROSE

Joe Kolsky

Phil Kahl

Diamond Records

1650 Broadway
New York, N.Y.
(212 Ju 6-3876)

BMI PUBLISHERS

(Continued from page 168)

Hammock 948 N. 4th Knoxville, Tenn.
 Hampton 136 W. 52nd N.Y.C.
 Hand Bennie Dillon Bldg., Nashville, Tenn.
 Hannibal Box 232 N.Y.C.
 Happy Hearts 1619 Broadway N.Y.C.
 Hara 632 Madison Memphis, Tenn.
 Har-Bock 8715 W. 3rd L.A., Cal.
 Harco 149 W. 48th N.Y.C.
 Louis Hardin 101 W. 44th N.Y.C.
 Franck Harding 136 W. 52nd N.Y.C.
 Harlan 1332 Phil. Nat. Bank Bldg. Phila., Pa.
 Harlequin 505 Ardmore Dr. Minneapolis, Minn.
 Harley 3432 Mentone L.A., Cal.
 Harold & Dimple 1241 W. 60th L.A., Cal.
 Harold 442 W. 57th N.Y.C.
 Harper & Brothers 49 E. 33rd N.Y.C.
 Harris & Vavrin 54 W. Randolph Chicago
 Harrose 12626 Kling N. Hollywood
 Hartsdale 2 W. 45th N.Y.C.
 Alan Hartwell 825 Madison N.Y.C.
 Harvard 1619 Broadway N.Y.C.
 Harvey 1518 No. Gower, Hollywood
 Hastings 1540 Broadway N.Y.C.
 Hawaii Revue Studios, Universal City, Cal.
 Hawk 1733 Broadway N.Y.C.
 Haymarket 6515 Sunset Hollywood
 Lee Hazlewood 6515 Sunset Hollywood
 Heatherfield 1697 Broadway N.Y.C.
 Heatherton 853 Seventh Ave., N.Y.C.
 Hebraica-Glantz 156 W. 44th St. N.Y.C.
 Hector 111 W. 57, N.Y.C.
 Heid 49 Heid Ave., Dayton, O.
 Heigh-Ho 507 Fifth Ave., N.Y.C.
 Heires 1631 Broadway, N.Y.C.
 Helios 1619 Broadway, N.Y.C.
 Hellock Box 2243 Nashville, Tenn.
 Henderson 125 Windemere Rd., Staten Island, N.Y.
 Hendricks 328 Ridgewood Ave., Homestead Hill Valley Cal. 94941
 Hennessey 1650 Broadway, N.Y.C.
 Henry 25 W. 56th N.Y.C.
 Henry-Wade 3941 Woodlawn Dr. Nashville, Tenn.
 Herb-Hunt 1032 Fourteenth Ave. N., Nashville, Tenn.
 Herb-Mor 1545 No. Las Palmas, Hollywood
 Ray Herbert 1650 B'way, N.Y.C.
 Hercules 1270 Sixth N.Y.C.
 Hermes 6408 1/2 Hollywood Blvd. Hollywood
 Hermosa 8715 W. Third L.A., Cal.
 Dolph Hewitt 1230 W. Washington, Chicago
 Ersel Hickey 1619 Broadway N.Y.C.
 Hickory Lake 905 16th Ave. Nashville
 Hidden Valley 292 Madison N.Y.C.
 Hilde 1600 N. La Brea Hollywood, Cal.
 Hi-Fi Songs 6376 Yucca St., Hollywood, Cal. 90028
 High Mountain 226 7th Ave. Nashville
 Highridge 916 Keamek San Francisco
 Hi-Hoss 1697 Broadway N.Y.C.
 Hildale 14801 Piedmont, Detroit, Mich.
 Hildy 1650 Broadway N.Y.C.
 Hill and Range 1619 Broadway N.Y.C.
 Mary Hill 8500 Fayette, Phila., Pa.
 Hillart 2854 W. Pico L.A., Cal.
 Hillary 1481 N. Vine Hollywood
 Hillbilly 14 E. 77th N.Y.C.
 Hilliard 1717 N. Highland Hollywood
 Hillsboro Box 275 Nashville, Tenn.
 Hillside 1626 No. Vine Hollywood
 Hi-Town 628 Exchange Bldg. Nashville Tenn.
 Hi-Lo 639 Madison Memphis, Tenn.
 Hilton-Gregg 1651 Cosmo Hollywood
 Hi-Mi 7750 S. Calumet Chicago
 Hinds, Hayden & Eldredge 589 Fifth, N.Y.C.
 Hinkle 1040 N. Las Palmas Hollywood
 Hirsch 6311 Yucca St., Hollywood, Cal. 90028
 His 19273 Warrington, Detroit, Mich.
 Hit Tunes 4211 Madison Culver City, Cal.
 Hi-Tone 1733 Broadway N.Y.C.
 Hits of Tomorrow Box 841, Hammond, Ind.
 Hitsville 1697 Broadway N.Y.C.
 Hob 111 Mack Detroit, Mich.
 Hob & Nob 158 W. 15th, N.Y.C.
 Hoffman House 1549 N. Vine Hollywood
 Hollenden 1631 Broadway N.Y.C.
 Hollis 10 Columbus Circle, N.Y.C.
 Holly House 1321 W. Seventh Clovis, N.M.
 Hollycrest 3058 Hollycrest Pl., Hollywood
 Hollyvale 1607 El Centro, Hollywood
 Hollywood 8597 Appian Way Hollywood
 Hollywood Star 557 N. Kenmore, L.A., Cal.
 Homer 3725 Woodward, Detroit, Mich.
 Homer & Jethro 3308 S Manor Drive, Lansing, Ill.
 Hood 12251 Crewe, N. Hollywood
 Hopewell 1619 Broadway N.Y.C.
 Horizon 1619 B'way, N.Y.C.
 Horn 962 N. Ardmore Hollywood
 Hornet
 Sampson Horton 1697 Broadway N.Y.C.
 House of Fior 6365 Selma Hollywood
 House of Fortune 6557 Barton Hollywood
 House of Sound 130 S. Breed L.A., Cal.
 Jack Howard 2733 Kensington, Phila., Pa.
 Hullabaloo 6223 Selma Hollywood
 Hummingbird 1612 Vista Del Mar Hollywood
 Ross Hunter 250 N. Canon Dr. Beverly Hills, Cal.
 Husky 806 16th Ave. S., Nashville, Tenn.
 Hut P.O. Box 6 Memphis 4, Tenn.
 Hutchinson 119 W. 57th N.Y.C.

Ivel 200 W. 57th N.Y.C.
 Ivy-Gee 1650 Broadway N.Y.C.
 Iza 1650 B'way, N.Y.C.

J

J. Little 1650 Broadway N.Y.C.
 J.V.B. 8620 12th Detroit Mich.
 Jack Box 2423 Beaumont, Texas
 Jacco 5 S. 60th Phila., Pa.
 JAEP 1780 Broadway, N.Y.C.
 L.B. Jaffe 14722 Broadway N.Y.C.
 Jaglea 1650 Broadway N.Y.C.
 Jaguar 8582 Sunset, Los Angeles
 Jalo 1916 Fairbank Rd., Baltimore, Md.
 Jalyne 2203 Spruce Phila., Pa.
 Ahmad Jamal 1525 E. 53rd Chicago
 Jamas 6223 Selma Hollywood
 Jambicor 236 7th Ave., N.Y.C.
 Jamboree 5050 W. Fletcher Chicago
 Dick James 1780 Broadway, N.Y.C.
 Jamie 919 N. Broad St., Philadelphia, Pa.
 Jandee 2124 Cahuenga Hollywood
 Jane 405 E. 54th N.Y.C.
 James-Robinson 1692 Madison Memphis, Tenn.
 Jania 1155 Milwaukee Chicago
 Janice 200 W. 57th N.Y.C.
 Janie 7947 S. Constance Chicago
 Janjo 54 W. Randolph Chicago
 January 25 W. 56, N.Y.C.
 Jaro 136 W. 52nd N.Y.C.
 Jason 157 W. 57th N.Y.C.
 Jat 1556 N. La Brea Hollywood
 Jay & Cee, see Lois
 Jay Jay 2452 S. Kedzie Chicago
 Joy Six 1136 Columbus Ave., Boston, Mass.
 Jaybee 40 E. 49th N.Y.C.
 Jay-Boy 1790 Broadway N.Y.C.
 Jayco 157 W. 57th N.Y.C.
 Jayde 36 W. Randolph Chicago
 Jay-El 1616 N. Argyle Hollywood
 Jaymond 222 E. 46th N.Y.C.
 Jayson 1650 Broadway N.Y.C.
 Jazz Standard 235 W. 46th N.Y.C.
 Jazz Workshop 2186 Fifth N.Y.C.
 Jeanick 1916 Fairbanks Rd., Baltimore, Md.
 Jec 308 Poplar Memphis, Tenn.
 Jecco 1650 B'way N.Y.C.
 Jeff-Paul Carlton House Pittsburgh, Pa.
 Jefmark 200 W. 57th N.Y.C.
 Jehad Productions 49 W. 19 St. N.Y.C.
 Jen-Shem 2640 S. Kildare Chicago
 Jepsalana 723 Seventh N.Y.C.
 Jess 369 Lexington Ave., N.Y.C.
 Jet 7322 S. Calumet Ave., Chicago
 Jet Star 1630 Live Bldg., Dallas, Texas
 Jetstar 40 W. 55, N.Y.C.
 Jember 8888 West Pico L.A. Cal.
 Jim-Jam 1650 Broadway N.Y.C.
 Jimskip 136 W. 52nd N.Y.C.
 Jitters 850 7th, N.Y.C.
 Joaneline 1619 B'way, N.Y.C.
 Jo-Bar 756 7 Ave., N.Y.C.
 Jobete 2648 West Grand Detroit, Mich. 48208
 Jodax 119 W. 57th N.Y.C.
 Joel 511 5th Av., N.Y.C.
 Jo-Genie Shelton Towers Hotel N.Y.C.
 John L. 1520 E. 67th Pl., Chicago
 Johnstone-Montet 6087 Sunset Hollywood
 Joi-See 1717 N. Vine Hollywood
 Joli 1619 Broadway N.Y.C.
 David Jones 345 W. 58th N.Y.C.
 Joni 1449 S. Michigan Chicago
 Jon-Jay 1619 Broadway N.Y.C.
 Jonware 515 Madison N.Y.C.
 Kappy Jordan 575 West End N.Y.C.
 Joseph 1207 E. 53rd Chicago
 Joshua 50 W. 57th N.Y.C.
 Joslow 131 South Croft, Los Angeles
 Jot 2208 Spruce Phila., Pa.
 Jowal 120 E. 56th N.Y.C.
 Jovall 1435 Haffine Nashville, Tenn.
 Joyce 6087 Sunset Hollywood
 Juarez 22821 Hayden Rd., Farmington, Mich. 48024
 Judre 232 W. 48th N.Y.C.
 Judoe 525 Lexington N.Y.C.
 Judson 1650 Broadway N.Y.C.
 Judy-Jim 2712 Hartford Dr. Nashville, Tenn.
 Julie 120 W. 57th N.Y.C.
 Julmer 521 Fifth N.Y.C.
 Juno 6734 1/2 Selma Hollywood
 Just 35 W. 45th N.Y.C.
 Justis 639 Madison, Memphis, Tenn.

K

K and G 200 W. 57th N.Y.C.
 K & S 1740 Broadway N.Y.C.
 K-M 19 E. 53rd N.Y.C.
 Kags c/o Time & Life Bldg., N.Y.C.
 Kags 6425 Hollywood Blvd., Hollywood, Cal.
 Kalet-Nelson 118 W. 57th St., N.Y.C.
 Kalin 333 E. 34th N.Y.C.
 Kalith 1619 Broadway, N.Y.C.
 Kam 410 Park, N.Y.C.
 Kamar Box 115, Madison, Tenn.
 Kamnus 616 S. Michigan, Chicago
 Les Kangas 7902 Dewey, San Gabriel, Cal.
 Kansoma 6418 Camrose Ter., Bethesda, Md.
 Kapa 3232 Clairmont, Detroit, Mich.
 Kapen 1485 N. Vine, Hollywood
 Karelo 3215 Ave H B'klyn, N.Y.
 Kari 3380 Pasadena, Detroit, Mich.
 Karlan 1449 S. Michigan, Chicago
 Karyn Helene 507 Fifth, N.Y.C.
 Kasen 461 8 Ave, N.Y.C.
 Katrina 1970 Laurretta, Memphis, Tenn.
 Kavelin 7250 Beverly, L.A., Cal.
 Kayak 207 E. 31st, N.Y.C.
 Kaybee 9100 Sunset, Hollywood
 Kayro, Revue Studios., Universal City, Cal.
 Kebo 1501 Broadway, N.Y.C.
 Keel 1595 Broadway, N.Y.C.
 Keetch, Caesar & Dino 1650 B'way N.Y.C.
 Kez 12762 Sherman Way, N. Hollywood
 Kelco Inc. 250 W. 57th., N.Y.C.
 Kelly 20 E. Jackson, Chicago
 Pete Kelly 4024 Radford, No. Hollywood
 Kemo 6087 Sunset, Hollywood
 Kenn 1165 Broadway, N.Y.C.
 Kempto 2 W. 45th St., N.Y.C.
 Ken Marlow 617 Exchange Bldg., Nashville, Tenn.
 Kendall 7732 Claremont Dr., Dallas, Texas
 Kennar 617 Exchange Bldg., Nashville, Tenn.
 Kennel 2218 S. 19th, Phila., Pa.
 Kennecott 1650 Broadway N.Y.C.
 Kenneth 4538 1/2 Russel, Hollywood, Cal.
 Kennetta 12118 Louis Ave., Whittier, Calif.
 Kenny 1674 Broadway, N.Y.C.
 Ken-Ricka 4965 Bruce, Beaumont, Texas
 Kensington 1501 Broadway, N.Y.C.
 Kenson 200 W. 57th, N.Y.C.
 Kentucky 1619 Broadway, N.Y.C.
 Kenwood 161 W. 54 St., N.Y.C.
 Bob Kerr 1270 6th., N.Y.C.

Ketchy 1697 Broadway, N.Y.C.
 Keva 604 Exchange Bldg., Nashville, Tenn.
 Keystone 1619 Broadway, N.Y.C.
 Kildare 35 E. Wacker Dr., Chicago, Ill.
 Kilt 150 W. 55th., N.Y.C.
 Kilynn 392 Central Park W., N.Y.C.
 Kimberly 686 W. 246th., Riverdale, N.Y.
 King Ring 150 W. 55th., N.Y.C.
 Kinglet 2211 Bowmont, Beverly Hills, Cal.
 Kingsland, 2742 E Tremont, N.Y.C.
 Kingston Int'l. 1927 Churchill, Trenton, Mich.
 Kingswood 1525 McGavock St. Nashville
 Jack Kinney 3349 Cahuenga Blvd., Hollywood
 Kips Bay 157 W. 57th., N.Y.C.
 James E. Kirchstein 123 Water., Sauk City, Wis.
 Kismet 131 W. 28th., N.Y.C.
 Klick 4828 Greenville Ave., Dallas, Texas
 Klive 6425 Hollywood, Hollywood
 Knightsbridge 1650 B'way, N.Y.C.
 Knob Hill 2609 N.W. 36 St., Oklahoma City, Okla.
 Buddy Knox 6920 Sunset, Hollywood
 Knox 639 Madison, Memphis, Tenn.
 Koe-Gray 2037 W. 79 L.A., Cal.
 Konvan 8605 So. Bennett, Chicago
 Kooba 45 W. 45th., N.Y.C.
 Koolwood 125 Addison, Chicago
 Koss 6012 1/2 Eleanor, Hollywood
 Kostate 119 W. 57th., N.Y.C.
 Kram 836 E. 63rd., Chicago
 Kreg-Lincoln 1626 North Vine, Hollywood
 Kryder 1790 Broadway, N.Y.C.

L

L and J. 527 E. 63rd Street, Chicago
 La Bina 12 W. Garfield, Chicago
 LaBlanch P.O. Box 3303, New Orleans, La.
 La Clave 1920 Chestnut, Phila., Pa.
 Lennie La Cour 3330 N. Lake Shore Dr., Chicago
 Edward La Mont 3254 W. Grace, Chicago
 Label 6500 Yucca, Hollywood
 Labeth 185-40 Ilion, St. Albans, L.I. N.Y.
 Labonte 5928 Melrose L.A. Cal.
 Lach 6223 Selma, Hollywood
 Ladnaret 101 W. 55 St., N.Y.C.
 Lador 1650 Broadway, N.Y.C.
 Laine-Simms 8983 Sunset., Hollywood
 Laka 6087 Sunset, Hollywood
 Lake Erie 2259 Brush Rd., Cleveland, O.
 Lakeside 8736 Sunset Blvd., L.A., Cal.
 Lamaja 4159 S. Ellis, Chicago
 Lana 1650 Broadway, N.Y.C.
 Lancaster 806-16th Ave. S., Nashville, Tenn.
 Lancelot, 6515 Sunset, Hollywood
 Lancer 1314 Hellerman St., Phila., Pa.
 Lanco 6636 Hollywood Blvd., L.A., Cal.
 Land Mark, 172 S. Military, Detroit, Mich.
 Lan-Den Box 8213, Memphis, Tenn.
 Lanfair 1501 S. Wooster, L.A. Cal.
 Langley 101 W. 55th., N.Y.C.
 Lanier 1225 Sixth, N.Y.C.
 Lansdale 1023 N. 67 St., Phila., Pa.
 Lar Jan 2817 West Pico, L.A., Cal.
 Lar-Bell 9110 Sunset, L.A., Cal.
 Larco 1650 Broadway, N.Y.C.
 Laredo 1001 N. Lincoln, Burbank, Cal.
 Lark 1650 Broadway, N.Y.C.
 Larrabee 6381 Hollywood Blvd., Hollywood
 Larrax Box 3368, El Paso, Texas
 Lash 1326 Kerper, Phila., Pa.
 Lasker 3300 Lake Shore Dr. Chicago
 Lasso 1306 S. Garnet, Phila., Pa.
 Lastar 1549 N. Vine St., Hollywood
 Laucan 12044 Chandler, No. Hollywood
 Lava 2102 W. 24th., L.A., Cal.
 Laval (BMI Canada)
 Lavalier 1556 No. La Brea, Hollywood
 Tony Lavelli 13 E. 55th., N.Y.C.
 Lawana 2549 S. Spaulding, L. A. Cal.
 Lawn 4008 S. Ellis, Chicago
 Le Bill Box 11152, Fort Worth, Texas
 Le Rage 1733 Broadway, N.Y.C.
 Le Rue 6404 Hollywood Blvd. Hollywood
 Lealan 618 S. Glenwood Pl., Burbank, Cal.
 Ernie Lee 36 E. Fifth, Cincinnati, O.
 Jay Lee 1650 Broadway, N.Y.C.
 Lee-Tea 118 W. 57th., N.Y.C.
 Lee-Wall 157 W. 57th., N.Y.C.
 Pinky Lee 262 N. Crescent Dr. Beverly Hills, Calif.
 Legion 1650 Broadway, N.Y.C.
 Leisure 5880 Hollywood Blvd., Hollywood
 Lejean 6110 Mayflower, Maywood, Cal.
 Lendrof 2105 N. Springfield, Chicago
 Lenelle 203 N. Wabash, Chicago
 Lenmar 6757 Hollywood Blvd., Hollywood
 Lennerts 16055 Warwick Rd., Detroit, Mich.
 Lenoir 1538 E. 62 St, Los Angeles
 Lenon 781 7th Ave. N.Y.C.
 Leonard 1650 Broadway, N.Y.C.
 Lerita, SEE January
 Lesay 1650 Broadway, N.Y.C.
 Lesgor 1619 B'way, N.Y.C.
 Levington 157 W. 57th., N.Y.C.
 William L. Lewis 2540 W. Pico Blvd., L.A., Cal.
 Lido 6266 Sunset, Hollywood
 Lighthouse 1650 Broadway, N.Y.C.
 Lightning 1248 S. Berendo, L.A., Cal.
 Li-Hess 1630 Broadway, N.Y.C.
 Liletta 5328 S. Central Ave. Los Angeles
 Lillian 2707 W. Pico, L.A., Cal.
 Lilly-Jo 2065 Union, Memphis, Tenn.
 Linton 485 Madison, N.Y.C.
 Lix 1501 Broadway, N.Y.C.
 Lmax 618 S. Ridzelev Dr., L.A., Cal.
 Lmro 1523 W. Flournoy Chicago
 Lmro Public Sq., Fayetteville, Tenn.
 Linden 1650 Broadway, N.Y.C.
 Lindone 240 Central Park S., N.Y.C.
 Linsider Ltd. 1577 Dixwell Ave., Hamden, Conn.
 Harry Link R.F.D. New Hyde Park, L.I., N.Y.
 Lion 2809 Erastus, Houston, Texas
 Lisa 9016 Roselawn, Detroit, Mich.
 Liscart 6626 Sunset, Hollywood
 Littlefield 6533 Hollywood Blvd., Hollywood
 Little Darlin' 7947 Fareholm Dr., L.A., Cal.
 Little Dinner 1631 Broadway, N.Y.C.
 Little M Box 73542, L.A., Los Angeles 3, Cal.
 Little Star Box 26141, Dallas, Texas
 Litzann 8983 Sunset, Hollywood
 Llord and Logan 608 Fifth, N.Y.C.
 Loadstone, 163 Orizaba, San Francisco, Calif.
 Lohar Music 155 W. 46th., N.Y.C.
 Lochmoor 43300 Capital Ave., Detroit, Mich.
 Lochrae 485 Madison, N.Y.C.
 Locomotive 620 Biscobel Nashville, Tenn.
 Locust 11 So. 56th., Phila., Pa.
 Lode 812-A N. Hobart, Hollywood
 Lods 1540 Brewster Cincinnati, O. 146 W 54th., N.Y.C.
 Lola 457 W. 45th., N.Y.C.

Lollipop 225 W. 36 St. N.Y.C.
 Lomer 25 Central Park West, N.Y.C.
 Lo-Mill 9224 Figueroa, L.A., Cal.
 Londonderry 275 W. 4th St. N.Y.C.
 Lonesome Pine Box 11, Vienna, Va.
 Lonette 6515 Sunset, Hollywood
 Longbow 1560 N. La Brea, Hollywood
 Longhorn 1902 Leeland, Houston, Texas
 Lonnie 45 W. 39th., N.Y.C.
 Lonzo and Oscar Box 64, Hendersonville, Tenn.
 Loom 200 W. 57th., N.Y.C.
 Lorelei 124 N. Naomi, Burbank, Cal.
 Lorin 1750 N. Vine, Hollywood
 Loring 1048 No. Carol Dr. L.A., Cal.
 Lorob South Road, Harrison, N.Y.
 Lorrac 5617 Brushton, L.A., Cal.
 Lost 1619 Broadway, N.Y.C.
 Loubarray 119 W. 57th., N.Y.C.
 Loudvay 6331 Hollywood Blvd., Hollywood
 Lovlee 408 W. 57, N.Y.C.
 Lovelane 15794 Steel, Detroit, Mich.
 Low-Ab Box 9687, Atlanta, Ga.
 Lowery Box 9687, Atlanta, Ga.
 Low-Ja Box 9687, Atlanta, Ga.
 Low-Sal P.O. Box 9687, Atlanta, Ga.
 Low-Twi Box 9687, Atlanta, Ga.
 Loyal 10410 Lagrange, L.A., Cal.
 Lucky Duck 826 7 Ave., N.Y.C.
 Lucky Hit 511 Fifth, N.Y.C.
 Luetta 156 W. 44th., N.Y.C.
 Lu-Mar 4755 S. Kenneth, Chicago
 Lupal 501 Madison, N.Y.C.
 Lupine 2930 Boston Blvd., W. Detroit, Mich.
 Lu-Tal 2605 Niles Street Bakersfield, Cal.
 Luther 200 East End Ave., N.Y.C.
 Lux 1619 Silverlake, L.A., Cal.
 Lyco 3903 Olive St. Louis, Mo.
 Lyeomung 101 W. 55th., N.Y.C.
 Lynbrook 105-24 63rd Dr., Forest Hills, N.Y.
 Kenny Lynch 1619 B'way, N.Y.C.
 Lynd 160 W. 46th., N.Y.C.
 Lyndale 101 W. 55th., N.Y.C.
 Lyneve Lewis Tower, 15th & Locust, Phila., Pa.
 Lynlu 1270 Sixth, N.Y.C.
 Lynn 100 W. 42, N.Y.C.
 Ly-Rann 4916 Franklin Rd., Nashville, Tenn.

M

M.J.Q. 881 Tenth, N.Y.C.
 MRC 35 E. Wacker Dr., Chicago
 MS 2017 No. Argyle, L.A., Cal.
 Mable 535 W. 44th., N.Y.C.
 Mac-Avery 1697 Broadway, N.Y.C.
 Macklin 1610 Camden, L.A., Cal.
 Maclen 1780 Broadway, N.Y.C.
 Macmar 3051 Kingston, Memphis, Tenn.
 Madchen 157 W. 57th., N.Y.C.
 Maddin 2426 Silverlake, L.A., Cal.
 Madelon 5607 Melrose, Hollywood
 Maestro 1467 N. Vine, Hollywood
 Magdon 1040 N. Las Palmas, Hollywood
 Maggie 1650 Broadway, N.Y.C.
 Magic Circle 604 Commercial Bldg., Shreveport, La.
 Magnifico 151 Gertrude Rd. Mamaroneck, N.Y.
 Magnolia 14155 Magnolia, Van Nuys, Cal.
 Main 589 Fifth, N.Y.C.
 Mainstay c/o Al Gallico 101 W. 55, N.Y.C.
 Main Street 322 W. 48th., N.Y.C.
 Major Melodies 1441 Broadway, N.Y.C.
 Major Minor 110 W. 55th., N.Y.C.
 Mal-Che 35-51 85th., Jackson Heights, N.Y.
 Malcom 1776 Broadway, N.Y.C.
 Malibu 10756 Wellworth, L.A., Cal.
 Mall 427 S. Broad, Phila., Pa.
 Malver 424 W. 49th., N.Y.C.
 Mammalen 1800 N. Argle, Hollywood
 Management 200 W. 57th., N.Y.C.
 Manger 200 West 57th St. N.Y.C.
 Manheim 146 E. 57, N.Y.C.
 Manistee 9110 Sunset, L.A., Cal.
 Manna 1595 Crossroads Of World, Hollywood
 Manny 1 E. 42nd., N.Y.C.
 Mansfield 1023 S. Mansfield, Los Angeles
 Manu 415 W. 52nd., N.Y.C.
 Maple Leaf 1650 Broadway, N.Y.C.
 Mar Cal 42 W. 76th., N.Y.C.
 Marathon 1607 N. El Centro, Hollywood
 Maravilla 6277 Selma, Hollywood
 J. T. Marble 1650 Broadway, N.Y.C.
 Marcel Box 19581, L.A., Cal.
 Marcella 20 W. Alexandrine, Detroit 1, Mich.
 Marchester 250 S. Broad, Phila., Pa.
 Marcia 1619 B'way, N.Y.C.
 Marc-Jean 8831 Sunset, L.A., Cal.
 Marcus 1600 N. La Brea, Hollywood
 Mardon 6367 Selma, Hollywood
 Maresh 3303 E. 55th, Cleveland, O.
 Marfan 1619 Broadway, N.Y.C.
 Margaret 1650 Broadway, N.Y.C.
 Margie Carol 2534 W. Pico, L.A., Cal.
 Margol 155 W. 46th, N.Y.C.
 Maribus 1780 Broadway, N.Y.C.
 Maricana 713 Eighteenth Ave., Nashville, Tenn.
 Marielle 119 W. 57th, N.Y.C.
 Marigold 35 W. 53rd, N.Y.C.
 Marinosa 713 18 Ave., S., Nashville, Tenn.
 Marizona 713 18th Ave., Nashville, Tenn.
 Marjay 1631 Broadway, N.Y.C.
 Mark Nine 1900 5th Ave, N.Y.C.
 Markham 408 N. Rodeo Dr., Beverly Hills, Cal.
 E. B. Marks 136 W. 52nd. N.Y.C.
 Marla 34 Leroy St., Tenafly, N.J.
 Marlane 52 Remsen Rd., Great Neck, N.Y.
 Marlboro 1619 Broadway, N.Y.C.
 Marlinda 27 Stegman Pl., Jersey City, N.J.
 Marlyn 550 Fifth, N.Y.C.
 Marmaduke, 8 & 48th, N.Y.C.
 Marna 12333 Ventura, Studio City, Cal.
 Marneshok 1650 Broadway, N.Y.C.
 Mar-Nick 1320 Vine, Phila., Pa.
 Marnat 200 W. 57th St., N.Y.C.
 Mar-Pet 1814-22 S. 11th, Phila., Pa.
 Marsal 518 2nd, Phila., Pa.
 Marsh 14637 Huston, Sherman Oaks, Cal.
 Marshall 565 Fifth, N.Y.C.
 Martel 24 Terrace Dr., Huntington Station, L.I., N.Y.
 Martin & Morris 4315 Indiana, Chicago
 Troy Martin, James Robertson, Seventh Ave. N., Nashville, Tenn.
 Martick 350 Madison, N.Y.C.
 Martyn 713 18th Ave., Nashville, Tenn.
 Marvella 408 W. 57th, N.Y.C.
 Mary 2456 Flood Terrace, L.A., Cal.
 Mary-June 7185 Sunset, Hollywood
 Maryland 5415 Inverview, Baltimore Md.
 Mason & Dixon 1557 W. 133rd, L.A., Cal.
 Mason 119 E. W-10th Pl., Chicago
 Mascarella 2440 S. Archer, Chicago

(Continued on page 188)

BERT KAEMPFERT



**Composer, Arranger, Orchestra Leader,
Top International Record-Selling Artist**

**VOTED ONE OF THE TOP
PROGRAMMED ORCHESTRAS - 1967**

(CASH BOX D.J. POLL)

Writer of such hits as:

“STRANGERS IN THE NIGHT”

“WONDERLAND BY NIGHT”

“AFRIKAAN BEAT”

“A SWINGIN’ SAFARI”

“DANKE SCHOEN”

“L - O - V - E”

“BLUE MIDNIGHT”

“SPANISH EYES”

“LADY”

“SWEET MARIA”

“MAGIC TRUMPET”

“WIEDERSEH’N”

ROOSEVELT MUSIC CO., INC.

America’s No. 1

Independent Publisher

Recent Hits:

“SPANISH EYES”

“THE WHEEL OF HURT”

“SWEET MARIA”

Coming Soon:

Great new singles with:

FRANK SINATRA

DEAN MARTIN

STEVE LAWRENCE

VIC DAMONE

NANCY WILSON

JOHNNY MATHIS

JACK JONES

... and many, many more

***ROOSEVELT MUSIC CO., INC.**

New York HAL FEIN • JERRY BROWN • MURRAY BAKER
Los Angeles AL FRIEDMAN

* Exclusive Publisher of Bert Kaempfert’s Compositions

BMI PUBLISHERS

(Continued from page 186)

Masterclasses 1529 N. Brood St., Phila.
 Masterworks 240 Cherokee Rd., Nashville, Tenn.
 Matador 768 Leventhal, N.Y.C.
 Mataram 4348 Lockwood, L.A., Cal.
 Maureen 1697 Broadway, N.Y.C.
 Maverick Box 669, Hollywood
 Maxine 1650 Broadway, N.Y.C.
 Ray Maxwell 6359 Selma Ave., Hollywood
 Mayco 225 Broadway, N.Y.C.
 Maygar 165 West End Ave., N.Y.C.
 Mayhew 8 E. 48th, N.Y.C.
 May-Loo 6087 Sunset, Hollywood
 Maytime 6087 Sunset, Hollywood
 Maywood 5499 Lime, Long Beach, Cal.
 Maze 6064 Hollywood, Hollywood
 Mazzan 1321 S. Michigan, Chicago
 McClellan 1650 Broadway, N.Y.C.
 McClure 626 Selma, Hollywood
 Walter Brownie McGhee 254 E. 125, N.Y.C.
 Jack Meakin 3338 Waverly Dr., Hollywood
 Medal 234 W. 56th, N.Y.C.
 Media 211 W. 58th, N.Y.C.
 Melba 200 W. 54th, N.Y.C.
 Mel-Hi 1650 Broadway, N.Y.C.
 Helhouse 119 W. 57th, N.Y.C.
 Melinda 60 W. 68th, N.Y.C.
 Melissa 1637 Vista Del Mar, Hollywood
 Robert Mellin 1650 Broadway, N.Y.C.
 Mellow 1650 Broadway, N.Y.C.
 Melmar 3017 Vista, Phila., Pa.
 Mel-Mat 215 Davis, Taylor Texas
 Melody House 958 W. Edgemont Dr., San Bernardino, Calif.
 Melody Lane 1619 Broadway, N.Y.C.
 Melody Trails 10 Columbus Circle, N.Y.C.
 Melotone Box 3194, N.Y.C.
 Melva 2148 S. St. Louis, Chicago
 Memo 157 W. 57th, N.Y.C.
 Mercedes 1554 N. Gower, Hollywood
 Merge 136 E. 57th, N.Y.C.
 Meridian 31 W. 54th, N.Y.C.
 Mermaid 200 W. 57th, N.Y.C.
 Merpine 40 W. 55, N.Y.C.
 Merrick 237 W. 51st, N.Y.C.
 Merrimac 1619 Broadway, N.Y.C.
 Merry Bell 1714 N. Ivar, Hollywood
 Merymount 47 W. 63rd, N.Y.C.
 Mesa 1151 S. Broadway, L.A., Cal.
 Mester Box 7753, Detroit, Mich.
 Met 1794 Chelsea, Memphis, Tenn.
 Meteor 6533 Hollywood Blvd., Hollywood
 Meteorion 117 W. 48th, N.Y.C.
 Metric 6920 Sunset, Hollywood; 1650 B'way, N.Y.C.
 Mezzo 7633 S. Indiana, Chicago
 Mia Sola 156 W. 44th St., N.Y.C.
 Miceli's 450 N. May, Chicago
 Michele 6724 Allott, Van Nuys, Cal.
 Michigan 1501 Broadway, N.Y.C.
 Midneys 393 Seventh, N.Y.C.
 Mid-West 667 W. Hancock, Detroit, Mich.
 Midwood 1619 Broadway, N.Y.C.
 Mighty Magie 9301 Wilshire Blvd, Beverly Hills, Calif.
 Miglow 130 W. 42nd., N.Y.C.
 Miken 516 Fifth, N.Y.C.
 Mikim 37 W. 57, N.Y.C.
 Milbern 723 Seventh, N.Y.C.
 Milky Way 608 Fifth, N.Y.C.
 Miller Songkraft 1597 Broadway, N.Y.C.
 Millie 8 E. 48th, Street, N.Y.C.
 Milma 788 Columbus, N.Y.C.
 Mileast 698 Fifth Avenue, N.Y.C.
 Mimosa 801-17th Ave. Nashville
 Minaret 200 W. 57th St., N.Y.C.
 Mindyl 624 S. Michigan, Chicago
 Mingo 756 Seventh, N.Y.C.
 Minit 6425 Hollywood Blvd., Hollywood
 Miraj 3322 W. Peterson, Chicago
 Miramar 6417 W. 84th., L.A., Cal.
 Mishawaka 920 S. Laurel, Mishawaka, Ill.
 Miss Marcie 15 W. 55th., N.Y.C.
 Mission 7936 Santa Monica, L.A., Cal.
 Missle 2428 S. Broad, Phila., Pa.
 Missouri 1650 Broadway, N.Y.
 Mist 108 E. 30th., N.Y.C.
 Miltoma 468 W. 58 St., N.Y.C.
 Mitti 104-20 Queens Blvd., Forest Hills, N.Y.
 Miv 1650 B'way, N.Y.C.
 Miyako 2186 5th Ave., N.Y.C.
 Mobile 1626 No. Vine, Hollywood
 Moccion 1637 Vista Del Mar, Hollywood
 Modern 5810 S. Normandie, Los Angeles, Cal.
 Mohawk 2741 Shacklett Dr., Nashville, Tenn.
 Mojo 2258 Monroe, Memphis, Tenn.
 Monitor 1337 Washington, Boston, Mass.
 Mono 4720 Forman, N. Hollywood
 Monocle 507 Fifth, N.Y.C.
 Monrovia 2058 Monterey Rd., South Pasadena, Cal.
 Montauk 1650 Broadway, N.Y.C.
 Montclare 1800 N. Argyle, Hollywood
 Monte Verde 5637 Monte Verde Dr., Santa Rose, Cal.
 Montecito Box 2471, Hollywood
 Monterey 1114 N. Sweetzer, Hollywood
 Monty 5209 Haverford, Phila., Pa.
 Moomoo 119 W. 57th., N.Y.C.
 Moon Mist 1697 Broadway, N.Y.C.
 Moonbeam 1614 N. Argyle, Hollywood
 Moonchild 211 W. 53rd., N.Y.C.
 Moonlight 9155 Sunset, Hollywood
 Jose Morand 1619 Broadway, N.Y.C.
 Morey 4724 W. Washington, L.A., Cal.
 Morgan 1529 Pine, Phila., Pa.
 Morgan-Shelley 226 Capitol Blvd., Nashville, Tenn.
 Morkane 3906 Mary Ellen, Studio City, Calif.
 Morning Sun 608 Fifth, N.Y.C.
 Morro 1733 Broadway, N.Y.C.
 Morton 565 Fifth, N.Y.C.
 Moss Rose 806—16th. Ave. So., Nashville, Tenn.
 Mother Bertha 440 E. 62nd, N.Y.C.
 Motion 1631 Broadway, N.Y.C.
 Mount Royal 1549 N. Vine, Hollywood
 Mount Rushmore 1607 N. El Centro, Hollywood
 Mountain City Dome Building, Chattanooga, Tenn.
 Mountain 1595 Crossroads of World, Hollywood
 Mr. Wigzles 1823 Hull St., Richmond, Va.
 Mundial 6710 Nordling St, Houston, Texas
 Munson 2 W. 45th., N.Y.C.
 Muse 1256 So. Orange, Glendale, Cal.
 Music Development 101 W. 55th., N.Y.C.
 Music International 1619 Broadway, N.Y.C.
 Music Maestro's 1674 Broadway, N.Y.C.
 Music Mill 5890 Hollywood Blvd., Hollywood
 Music Row 117 West 46 St., N.Y.C.
 Music of Today 119 W. 57th., N.Y.C.
 Music Products 1501 Broadway, N.Y.C.

Music World 6087 Sunset, Hollywood
 Musicians 6087 Sunset, Hollywood
 Musictime U.S.A. 9 Rockefeller Plaza, N.Y.C.
 Mueonic 458 Cornish Dr., Nashville, Tenn.
 Myto 2307 Edison, Detroit, Mich.

N

Nagy 785 West End Ave., N.Y.C.
 Najac 1631 Broadway, N.Y.C.
 Najo 5840 Second Blvd., Detroit, Mich.
 Nam 511 Fifth Ave., N.Y.C.
 Nancoz 1270 Sixth, N.Y.C.
 Narwood 40 E. 49th., N.Y.C.
 Nash-Beau 888 Pearl St., Beaumont, Texas
 Nasta 8497 Sunset, Hollywood
 Natchez Trace 2911 Harlin Dr., Nashville, Tenn.
 Nathan 1650 Broadway, N.Y.C.
 Navajo 1800 N. Argyle, Hollywood
 Navarre 1721 Broadway, N.Y.C.
 Near North 35 East Wacker Dr., Chicago
 Neenah Menasha 916 Kearny St., San Francisco, Cal.
 Neil 9165 Sunset Boulevard, Los Angeles, Cal. 90069 (see Purple Bottle)
 Herbert Nelson 250 W. 57th., N.Y.C.
 Nestor 156 W. 44th., N.Y.C.
 New Approach 40 W. 55, N.Y.C.
 New Chamber 461 Sixth Ave., N.Y.C.
 New Christy 1614 N. Argyle, Hollywood
 New Colony 630 Walden Rd., Winnetka, Ill.
 New Lyric 46 East Superior St., Chicago
 New Era 322 W. 48th., N.Y.C.
 New Hope 150 W. 58th., N.Y.C.
 New Keys Box 507, Nashville, Tenn.
 New Ventures 390 W. 57th., N.Y.C.
 New Wave 1619 B'way, N.Y.C.
 Bob Newhart 79 W. Monroe, Chicago
 Newmark 1639 Broadway, N.Y.C.
 Newroads 119 W. 57th., N.Y.C.
 Niagara 320 W. 55, N.Y.C.
 Nibs 1639 Broadway, N.Y.C.
 Tom Neilsen 1416 N. New Hampshire
 Nicolet 328 East 58th St., N.Y.C.
 Ninny 205 W. 84th., N.Y.C.
 Nite-Life 2090 Seventh, N.Y.C.
 Nobil 150 W. 58th., N.Y.C.
 Nocturne 1674 Broadway N.Y.C.
 Nola Box 52287, New Orleans, La.
 Nole 720 N. Michigan, Chicago
 Nom c/o Patricia Music, 1631 Broadway, N.Y.C.
 Noma 1619 Broadway, N.Y.C.
 Non-Stop 19 East 76th St., N.Y.C.
 Nor Va Jak Music, Inc., 1313 W. Seventh, Clovis, N.M. and 50 West 57th St., N.Y.C.
 Norad 3510 Hampton, Nashville, Tenn.
 Norbay 185 Wabash, Chicago
 Nor-Cliff 521 Fifth, N.Y.C.
 Norlam 9 E. 40th., N.Y.C.
 Norles 1501 Broadway, N.Y.C.
 Norman 1353 N. Highland, Hollywood
 Norman-Leonard 442 W. 57th., N.Y.C.
 North Star 1936 University, St. Paul, Minn.
 Northeastern 1650 Broadway, N.Y.C.
 Nosruc 140 E. 7th., N.Y.C.
 Nottingham 6381 Hollywood Blvd., Hollywood
 Novel 419 Boylston St., Boston, Mass.
 Nu-Dey Musical 17823 Collins, Encino, Cal.
 Nubia 616 Exchange Building, Nashville
 Nuca 1697 B'way, N.Y.C.
 Nugget 1414 Commerce Title Bldg., Memphis, Tenn.
 Numart 6757 Hollywood Blvd., Hollywood
 Nu-Star 298 Brown, Nashville, Tenn.
 Nu-Way 1650 Broadway, N.Y.C.

O

Oak Route #2, Box 60, Elm City, N.C.
 Oakcrest 1126 Jeanette St., Abilene, Texas
 Oakhurst 366 No. Camden Dr., Beverly Hills, Cal.
 Oakwood 2809 West Linden Ave., Nashville, Tenn.
 Obie 1650 Broadway, N.Y.C.
 Obyte 175 Fifth, N.Y.C.
 Oceanic 58 W. 48th., N.Y.C.
 Odeon 200 W. 57th., N.Y.C.
 Odile 1607 No. El Centro, Hollywood, Cal.
 Off Beat 146 Seventh Ave., Nashville, Tenn.
 Ogram 247 West 72nd. St., N.Y.C.
 Okra 35 W. 53, N.Y.C.
 Okun P.O. Box 2605, Hollywood, Cal.
 Olbert 1650 Broadway, N.Y.C.
 Old Beachcomber 6639 San Vicente, Compton, Cal.
 Old Judge 1458 Getwell, Memphis, Tenn.
 Old Lyne 101 W. 55th., N.Y.C.
 Oletto (see Blue Bird)
 Sy Oliver 400 Madison, N.Y.C.
 Olowola 664 West 163rd St., N.Y.C.
 Olrap 728 Camp St., New Orleans, La. 70130
 Otto Norman Olsen 1239 Gordon, Hollywood, Cal.
 Omanid 1952 South Muskego, Milwaukee, Wis.
 Omni 817 16th Ave. Sq, Nashville
 Omnibus 50 W. 8th., N.Y.C.
 One O'Clock 225 W. 57th., N.Y.C.
 One, Two, Three 128 Thompson, N.Y.C.
 One-Way 1206 Sudekum Bldg., Nashville, Tenn.
 Onko 6612 N. Lightfoot, Chicago, Ill.
 Opal 6308 Sunset Blvd., Los Angeles, Cal.
 Open Road P.O. Box 128, Madison, Tenn.
 Optimist 13325 Victory Blvd., Van Nuys, Cal.
 Opus 200 W. 57th., N.Y.C.
 Orange 18 E. 50th., N.Y.C.
 Orbe 3044 Winnemac Ave, Norridge, Ill.
 Orbit 4014 W. Olympic, L.A., Cal.
 Orchard Box 408, G.P.O., N.Y.C.
 Ordell 1619 Broadway, N.Y.C.
 Originales 10333 East Beach, Bellflower, Cal.
 Originals 1721 Broadway, N.Y.C.
 Orjae 6514 So. San Pedro St., L.A., Cal.
 Orman 1258 Gordon St., Hollywood, Cal.
 Orpheus 2 S. Clarks, N.Y.C.
 Orquidia 928 Orme, Los Angeles, Cal.
 Ortega 9034 Sunset Blvd., Los Angeles, Cal.
 Orvin 534 W. 150th., N.Y.C.
 Osborne 2076 Union Ave., Memphis, Tenn.
 Oscar 745 Fifth, N.Y.C.
 Othello 365 West 20th., N.Y.C.
 Johnny Otis 1631 Broadway, N.Y.C.
 Outpost 6277 Selma Avenue, Hollywood, Cal.
 Oval 15 Central Park West, N.Y.C.
 Ovation 2019 St. Charles, New Orleans
 Overland 2 West 45th St., N.Y.C.
 Overtone 119-33 147th., Jamaica, L.I., N.Y.
 Overture 428 Gretna Green, Los Angeles, Cal.
 Owaissa 14536 Roscoe, Panorama City, Cal.
 Owen P.O. Box 842, Bakersfield, Cal.
 Don Owens 219 Adams, Memphis, Tenn.
 Owl Music 32 West Randolph St., Chicago, Ill.
 Ozy 137 W 52, N.Y.C.

P

P & M 48 W. 53rd. St., N.Y.C.
 P-G 4648 S. Cottage Grove, Chicago, Ill.
 P.N.P. 1695 Broadway, N.Y.C.
 P.P.X. 1650 Broadway, N.Y.C.
 Paberne 756 7th. Ave., N.Y.C.
 Pace 117 W. 48, N.Y.C.
 Pacemaker 1780 Broadway, N.Y.C.
 Pacific Coast P.O. Box 38631, Hollywood, Cal.
 Pacific-International 16427 Harvard, Gardena, Cal.
 Padre 407 West 40th., St., N.Y.C.
 Padua 5004 Melrose Ave., Hollywood, Cal.
 Page 523 W. 6th., Los Angeles, Cal.
 Paget Time & Life Bldg., N.Y.C.
 Pagoda 6035 Le Doux Rd., Los Angeles, Cal.
 Painted 666 Fifth, N.Y.C.
 Pal 928 Western, Broad & Chestnut, Phila., Pa.
 Palisades 11 West 60th St., N.Y.C.
 Palladium 6229 Sunset, Hollywood, Cal.
 Tommy Palm 85 Second, Brooklyn, N.Y.
 Palmer 5101 Matilija, Sherman Oaks, Cal.
 Palmina 1703 Jackson St., Phila., Pa.
 Palmina N.W. Cor. 8th & Fitzwater Sts., Phila., Pa.
 Pam 1650 Broadway, N.Y.C.
 Pamasons 6022 Bay Parkway, Brooklyn, N.Y.
 Pamco 1330 Ave. of Americas, N.Y.C.
 Pamela 588 Alston, Memphis, Tenn.
 Pamlee 1323 S. Michigan, Chicago, Ill.
 Pamper 119 Two Mile Pike, P.O. Box 96, Goodlettsville, Tenn.
 Pan 242 N. Canon Drive, Beverly Hills, Cal.
 Pandora (See Lois)
 Panfa 1757 N. Serrano, Hollywood, Cal.
 Pan-World 1543 S. Canfield Dr., Los Angeles, Cal.
 Papaleo 1639 Broadway, N.Y.C.
 Paper 8462 Sunset Blvd. Los Angeles
 Parade 120 South Valley, Burbank, Cal.
 Param 1501 B'way, N.Y.C.
 Parasol 3011 Beach 40th B'klyn., N.Y.
 Park 351 East 58th., N.Y.C.
 Barry Parker 1710 Ave., Brooklyn, N.Y.
 Charlie Parker 8 East 48th., N.Y.C.
 Johnny Parker 15 W. 84th., N.Y.C.
 Park-Lane 2043 Wellington, Westbury, N.Y.
 Gene Parson 7023 Oxford, Oakland, Ill.
 Partita 1780 Broadway, N.Y.C.
 Pasadena 148 N. Pasadena, Pasadena, Cal.
 Pasca National Bank Bldg., Market St., Phila., Pa.
 Paskal 7561 Waring, Los Angeles, Cal.
 Paso 100 No. La Salle, Chicago, Ill.
 Pastel 112-25 34th., Corona, L.I.
 Paator 1790 Broadway, N.Y.C.
 Pat 2 Weyland Rd., Plainville, N.Y.
 Patlow 18475 Evergreen Rd., Detroit, Mich.
 Patmar 6233 Wilshire, Los Angeles, Cal.
 Patone 237 Chestnut St., Westville, N.J.
 Patricia 1631 Broadway, N.Y.C.
 Patsy Ann 224 West 49th., N.Y.C.
 Pattern 16 South Broad, Phila., Pa.
 Jack Patton 1924 W. 7, Hollywood, Cal.
 Paty 618 So. Western, Los Angeles, Cal.
 Paula 5420 Corbin, Tarzana, Cal.
 Paulette South Rd., Harrison, N.Y.
 Paulus 654-560 Chelsea, Memphis, Tenn.
 Paul-Marc 1607 North El Centro, H'wood, Cal.
 Paulric 6623 Ridge, Brooklyn, N.Y.
 Pavillion 1010 Cadillac Tower, Detroit, Mich.
 Pawnee 137 Riverside, N.Y.C.
 Paxwin 1619 Broadway, N.Y.C.
 Peach Box 115, Madison, Tenn.
 Peanuts 150 West 55th., N.Y.C.
 Pearyag 11622 Canton Pl., Studio City, Calif.
 Pearl 1619 Broadway, N.Y.C.
 Pearlford 4163 Central Ave., Los Angeles, Cal.
 Pearson 729 S. Western, Los Angeles, Cal.
 Peeler 1220 N. Broad, Phila., Pa.
 Peer Int'l. 1619 Broadway, N.Y.C.
 Peerless 3547 Dahlia, Los Angeles, Cal.
 Pegasus 1607 North El Centro, Hollywood, Cal.
 Pel Music 612 Patterson, Chicago, Ill.
 Pelican 912 Front St., P.O. Box 444, Morgan City, La.
 Pelton 1650 Broadway, N.Y.C.
 Pemora 1619 Broadway, N.Y.C.
 Pen 507 Fifth Ave., N.Y.C.
 Pendarvis P.O. Box 41, Old Town, Fla.
 Penululum 499 N. Canon, Beverly Hills, Cal.
 Penguin 210 W. 79th., N.Y.C.
 William Penn 150 W. 55th St., N.Y.C.
 Pennjag 3476 Amber, Phila., Pa.
 Penny 130 So. 4th., St., Las Vegas, Nev.
 Penobscot 250 Prospect, Revere, Mass.
 Penrose 5911 South Broadway, L.A., Cal.
 Pep 5462 Pelleur St., Compton 2, Cal.
 Perception 524 Poinsettia Place, L.A., Cal.
 Perdue & Perdue 1735 Seward 3D, Detroit, Mich.
 Perfection 1429 Hawthorne, Pittsburgh, Pa.
 Peri-Lee 22 W. 670 Sidney, Glen Ellyn, Ill.
 Periscope 89 Hollingsworth Boston, Mass.
 Pernie 11 East Delaware Pl, Chicago
 Perry P.O. Box 131, 500 Adams, Vidalia, Ga.
 Personality 1055 N. El Centro, L.A., Cal.
 Petal Pat 128 E. 65th., N.Y.C.
 C. F. Peters 373 Park Ave., S., N.Y.C.
 Petko 1141 North Highland Ave., H'wood, Cal.
 Petone 25 W. 56, N.Y.C.
 Max Pfeffer 45 W. 45th St., N.Y.C.
 Philadelphia 550 Fifth Ave., N.Y.C.
 Philaine 628 W., Los Angeles, Cal.
 Phoebe 1170 Broadway, N.Y.C.
 Phoenix 50 West 57th., N.Y.C.
 Piccadilly 135 W. 50, N.Y.C.
 Pickford 107 W. 43rd., St., N.Y.C.
 Pico 1332 S. Flower, L.A., Cal.
 Picturone 1650 Broadway, N.Y.C.
 Hilda Pihel 54 W. Randolph, Chicago, Ill.
 Pierre 2659 Milwaukee, Chicago, Ill.
 Pillittere P.O. Box 9429, Rochester, N.Y. 14604
 Pinebrook 1650 Broadway, N.Y.C.
 Pine Knob 45 W. 56, N.Y.C.
 Pinelawn 756 Seventh Ave., N.Y.C.
 Pink Lady 6235 N. Lowell, Chicago, Ill.
 Pinpoint Crestview, Nashville, Ind.
 Pioneer 8665 Wilshire, Beverly Hills, Cal.
 Piourette 2222 So. Western, Los Angeles, Cal.
 Pitfield See January
 Pitote c/o Richard H. Roemer, Esq., 400 Madison Ave., N.Y.C.
 P.S. Pitts 1415 E. 18th. St., Los Angeles, Cal.
 Pixie 123 Toluca Lake, Hollywood, Cal.
 Place 565 Fifth, N.Y.C.
 Plainview 119 West 57th St., N.Y.C.
 Platter 1650 Broadway, N.Y.C.
 Plaudit 1841 S.W. 29th Miami, Fla.
 Play 1501 Broadway, N.Y.C.
 Playette 401 West 42nd, N.Y.C.
 Playmate 616 Lavergne Wilmette, Ill.
 Play-Mor 52-87 79th Elmhurst, L.I., N.Y.
 Playnote 306 51st, N.Y.C.

Playrite 201 W. 49th, N.Y.C.
 Pleasant Valley 14143 Chandler Van Nuys, Cal.
 Pleasure 2936 Baker St., Baker, Ora.
 Plectrum 6087 Sunset Hollywood, Cal.
 Neely Plumb 6463 Firmament Van Nuys, Cal.
 Pluto 1518 Wilton Pl. Los Angeles, Cal.
 Podium 10935 Mc Vine Sunland, Cal.
 Podler 1104 Roscomare Los Angeles, Cal.
 Polka Towne 23 Marian La., Jericho, L.I., N.Y.
 Pokvan 150 W. 55th St., N.Y.C.
 Poochum 4515 W. 29th St., Los Angeles
 Poodle 161 W 54 N.Y.C.
 Practical 538 So. Berendo, #4, Los Angeles
 Potomac 2103 Penn. Ave. N.W., Wash. D.C.
 Power X Music 1650 Broadway, N.Y.C.
 John Lowell Pratt 232 Madison, N.Y.C.
 Premier Albums 356 West 40th St., N.Y.C.
 Premium 1600-10 S. LaSalle Chicago, Ill.
 Elvis Presley 1619 Broadway, N.Y.C.
 Press 827 Thomas Memphis, Tenn.
 Prestige 203 S. Washington Bergenfield, N.J.
 Presto 6223 Selma Ave. Hollywood, Cal.
 Pretty 611 South 11th Las Vegas, Nev.
 Price & Associates 48 W. 138th St., N.Y.C.
 Henry Price 2058 Watsonia Terrace Hollywood, Cal.
 Prigan 608 Fifth Ave., N.Y.C.
 Primary 1501 Broadway, N.Y.C.
 Prince 111-35 76th Forest Hills, N.Y.
 Princeton 4402 Vineland N. Hollywood, Cal.
 Prin-El 2639 East Broadway Long Beach, Cal.
 Pringle 11125 Sarah St., Hollywood, Cal.
 Prior 129 Front St., N.Y.C.
 Prism 6920 Sunset Hollywood, Cal.
 Pritchett P.O. Box 2908 Hollywood, Cal.
 Private Library 35 West 53rd St., N.Y.C.
 Prix 235 46th St., N.Y.C.
 Pro Musica 1215 Fifth Ave., N.Y.C.
 Process 114 N. Front Franklin, Pa.
 Profile 218 W. 47th N.Y.C.
 Progressive 1619 Broadway, N.Y.C.
 Prolific 841 E. 25th Los Angeles, Cal.
 Prologue 15 Park Row, N.Y.C.
 Promar 1842 Dudley Phila., Pa.
 Promotions Of Memphis 1496 Mink Memphis, Tenn.
 Prompt 5835 So. San Pedro Los Angeles, Cal.
 Pronto 1841 Broadway, N.Y.C.
 Prop-er 833 E. Parkway Brooklyn, N.Y.
 Prosser 768 Broad St., Newark 1, N.J.
 Proven 1585 Broadway, N.Y.C.
 Prytania P.O. Box 5053, Chicago, Ill.
 Pub 1650 Broadway, N.Y.C.
 Pulse 1360 North Lakeshore Chicago, Ill.
 Pure Gold 297 N. Main Memphis, Tenn.
 Pure 185 N. Wabash Chicago, Ill.
 Purple Bottle 9165 Sunset Boulevard, Los Angeles, Cal. 90069 (see Neil)
 Purple Flamingo 220 W. 13th St., N.Y.C.
 Pussy Cat P.O. Box 12281 Norfolk, Va. 23502

Q

Quan P.O. Box 42115 Los Angeles, Cal.
 Quasimodo P.O. Box 2122, Williamsburg, Va.
 Queensbury 1631 Broadway, N.Y.C.
 Quest 9 Lorraine New City, N.Y.
 Quilted 1755 York Memphis, Tenn.
 Quinn 5100 Calenda Woodland Hills, Cal.
 Quintet 1619 Broadway, N.Y.C.

R

R.A.O. 5420 Melrose Hollywood, Cal.
 R & R 214 Tower Life Bldg., San Antonio, Texas
 R & S 137-59 70th Flushing, N.Y.
 R & T 2341 18th Vero Beach, Fla.
 R.E.T.J. 121 E. Olive Monrovia, Cal.
 R.F.T. 150 W. 46th St., N.Y.C.
 R.G. 45 W. 45th N.Y.C.
 R.G.A. 410 1/2 N. Palm Beverly Hills, Cal.
 R.P.D. 100 W. 42nd N.Y.C.
 RSVP 1650 Broadway, N.Y.C.
 R-T (See Lois)
 RTD 537 Dunn Pittsburgh, Pa.
 RTLT 1962 West 29th Los Angeles, Cal.
 R-V 6600 N. Broad St., Phila., Pa.
 Rachel 8665 Wilshire Beverly Hills, Cal.
 Radcliffe 855 Treat San Francisco 10, Cal.
 Radiant 185 N. Wabash Chicago, Ill.
 Radio Active P.O. Box 558 N. Hollywood, Cal.
 Rador 150 W. 55th N.Y.C.
 Radon 173 W. Madison Chicago, Ill.
 Ragmar 41 W 72, N.Y.C.
 Rags 450 W. 24th N.Y.C.
 Rainbow 1975 Davidson, N.Y.C.
 Raleigh 345 W. 58th N.Y.C.
 Ra-Len 3021 Carmona Los Angeles, Cal.
 Rakelaw 4155 Mary Ellen Ave., N. Hollywood, Cal.
 Ralla 12 Warren St., N.Y.C.
 Ram 250 E. 116th N.Y.C.
 Rama 650 N. Bronson Ave., Hollywood, Cal.
 Ramed 1320 Vine St., Phila., Pa.
 Ramitary 1740 B'way, N.Y.C.
 Ramms Box 166 Mc Allen, Texas
 Rampart 902 Pine Winnetka, Ill.
 Al Randolph 2588 Seventh N.Y.C.
 Random 9350 Wilshire Beverly Hills, Cal.
 Rangel 505 W. Commerce San Antonio, Texas
 Ranger-Lee P.O. Box 322 N. Hollywood, Cal.
 Rapture 2943 Western Los Angeles, Cal.
 Rare 1716 Tisinger Dallas, Texas
 Raskind 155 W. 46th N.Y.C.
 Rave 1253 N. Laurel Los Angeles, Cal.
 Raybird 49 W. 57th N.Y.C.
 Rawson 4712 S. Penn., Okla. City, Okla.
 Ray-Dor 1153 1/2 N. Edgemont Los Angeles, Cal.
 Ray-Gee 1650 Broadway, N.Y.C.
 Raymar 345 W. 58th N.Y.C.
 Raymon 631 No. Morada West Covina, Cal.
 Raytray 9503 Broadmore Pleasanton, Cal.
 Rayven 1650 Broadway, N.Y.C.
 Razor Sharp, c/o Kenneth Gamble, 5412 Osage Ave., Phila., Pa.
 Reach 1528-30 Overington St., Phila., Pa.
 Reba
 Reben 60 E. 42nd Room 4106 N.Y.C.
 Rebus 335 West 11th St., N.Y.C.
 Rocco 320 E. 54th St., N.Y.C.
 Robert Recker (E.B. Marks)
 Recordo 6359 Selma Hollywood, Cal.
 Red Ball 3914 Hamilton Fort Worth, Texas
 Red River 1001 N. Lincoln Burbank, Cal.
 Red Seal 801 17 Ave. S., Nashville, Tenn.
 Red Stick 100 Spain P.O. Box 2306 Baton Rouge, La.
 Red, White & Blue P.O. Box 5314 San Diego, Cal.
 Reddev 801 N. Labrea, Los Angeles, Cal.
 Redheads 119 W. 57th St., N.Y.C.
 Redstone 9163 Sunset Blvd. Los Angeles, Cal.
 Redwal 535 Cotton Ave., Macon, Georgia
 (Continued on page 198)

Vogue Records
Congratulates
PET CLARK
For Her Selection As
No.1
FEMALE
VOCALIST
1966-67



WARNER BROS.
RECORDS

EXCLUSIVE REPRESENTATION



PUBLICITY: JAY BERNSTEIN

MONTHLY RECAP OF 1967's BIGGEST HITS

Because Cash Box is continually asked to supply a list of the year's leading hits to A&R men, producers, radio stations, etc., Cash Box is introducing a continuing feature that will list the year's Top 50 titles as of the date the feature appears. The feature will be published in the last issue of each month and is compiled from the Cash Box Top 100 Sales Chart. Point system operates as follows: For each week a song is #1 on the Top 100 it receives 136 points. Each #2 record is awarded 124 points. No. 3 gets 123. No. 4 gets 122. No. 5 gets 121. the line till the No. 50 song which gets 51 points. Only the top fifty titles of any given week are included in

stations, etc., Cash Box is introducing a continuing feature that will list the year's Top 50 titles as of the date the feature appears. The feature will be published in the last issue of each month and is compiled from the Cash Box Top 100 Sales Chart. Point system operates as follows: For each week a song is #1 on the Top 100 it receives 136 points. Each #2 record is awarded 124 points. No. 3 gets 123. No. 4 gets 122. No. 5 gets 121. the line till the No. 50 song which gets 51 points. Only the top fifty titles of any given week are included in

TOP HITS AS OF JAN.

	TOTAL POINTS
1. I'M A BELIEVER—Monkees—Colgems	540
2. SNOOPY VS THE RED BARON—Royal Guardsmen—Laurie	496
3. TELL IT LIKE IT IS—Aaron Neville—Parlow	491
4. GOOD THING—Paul Revere & Raiders—Columbia	475
5. SUGAR TOWN—Nancy Sinatra—Reprise	449
6. WORDS OF LOVE—Mamas & Papas—Dunhill	434
7. COMING HOME SOLDIER—Bobby Vinton—Epic	417
8. WINCHESTER CATHEDRAL—New Vaudeville Band—Fontana	412
9. GEORGY GIRL—Seekers—Capitol	404
10. THAT'S LIFE—Frank Sinatra—Reprise	397
11. WE AIN'T GOT NOTHIN' YET—Blues Magoos—Mercury	383
12. NASHVILLE CATS—Lovin' Spoonful—Kama Sutra	361
13. STANDING IN THE SHADOW OF LOVE—Four Tops—Motown	353
14. MELLOW YELLOW—Donovan—Epic	350
15. TELL IT TO THE RAIN—4 Seasons—Philips	348
16. EAST WEST—Herman's Hermits—MGM	330
17. I'VE PASSED THIS WAY BEFORE—Jimmy Ruffin—Soul	327
18. (I KNOW) I'M LOSING YOU—Temptations—Gordy	320
19. TRY A LITTLE TENDERNESS—Otis Redding—Volt	313
20. COLOR MY WORLD—Petula Clark—Warner Bros.	311
21. WHERE WILL THE WORDS COME FROM—Gary Lewis—Liberty	305
21. 98.6—Keith—Mercury	305
21. STAND BY ME—Spyder Turner—MGM	305
22. MUSTANG SALLY—Wilson Pickett—Atlantic	297
23. (I'M NOT YOUR) STEPPING STONE—Monkees—Colgems	291
24. TALK TALK—Music Machine—Original Sound	275
25. KNIGHT IN RUSTY ARMOUR—Peter & Gordon—Capitol	266
26. KIND OF A DRAG—Buckinghams—USA	257
27. HOW DO YOU CATCH A GIRL—Sam The Sham & Pharaohs—MGM	255
28. PAPA WAS TOO—James Brown—King	252
29. SINGLE GIRL—Sandy Posey—MGM	251
30. GOOD VIBRATIONS—Beach Boys—Capitol	234
31. MUSIC TO WATCH GIRLS BY—Bob Crewe Generation—DynoVoice	233
32. CRY—Ronnie Dove—Diamond	232
33. BORN FREE—Roger Williams—Kapp	223
34. A PLACE IN THE SUN—Stevie Wonder—Tamla	213
35. DEVIL WITH THE BLUE DRESS ON & GOOD GOLLY MISS MOLLY—Mitch Ryder & Detroit Wheels—New Voice	202
36. I NEED SOMEBODY—?(Question Mark) & Mysterians—Cameo	201
37. HELP ME GIRL—Animals—MGM	192
38. HELLO, HELLO—Sopwith Camel—Kama Sutra	180
39. BLUE AUTUMN—Bobby Goldsboro—United Artists	176
40. GALLANT MEN—Senator Dirksen—Capitol	169
41. I FOOLED YOU THIS TIME—Gene Chandler—Checker	164
42. ANOTHER NIGHT—Dionne Warwick—Scepter	161
43. THERE'S GOT TO BE A WORD—Innocence—Kama Sutra	159
44. WILD THING—Senator Bobby—Parkway	147
45. GREEN GREEN GRASS OF HOME—Tom Jones—Parrot	137
45. LADY GODIVA—Peter & Gordon—Capitol	137
46. MAME—Herb Alpert & Tijuana Brass—A&M	135
47. HAPPENINGS TEN YEARS AGO—Yardbirds—Epic	134

TOP HITS AS OF FEB.

	POSITION LAST MONTH	TOTAL POINTS
1. I'M A BELIEVER—Monkees—Colgems	1	1054
2. 98.6—Keith—Mercury	23	1018
3. GEORGY GIRL—Seekers—Capitol	10	911
4. SNOOPY VS. THE RED BARON—Royal Guardsmen—Laurie	2	909
5. TELL IT LIKE IT IS—Aaron Neville—Parlow	5	891
6. WE AIN'T GOT NOTHIN' YET—Blues Magoos—Mercury	12	837
7. GOOD THING—Paul Revere Raiders—Columbia	3	749
8. KIND OF A DRAG—Buckinghams—U.S.A.	30	745
9. STANDING IN THE SHADOWS OF LOVE—Four Tops—Motown	4	706
10. STAND BY ME—Spyder Turner—MGM	22	640
11. MUSIC TO WATCH GIRLS BY—Bob Crewe Generation—DynoVoice	34	630
12. NASHVILLE CATS—Lovin' Spoonful—Kama Sutra	13	616
13. SUGAR TOWN—Nancy Sinatra—Reprise	6	608
14. WORDS OF LOVE—Mamas & Papas—Dunhill	7	605
15. WINCHESTER CATHEDRAL—New Vaudeville Band—Fontana	9	551
16. KNIGHT IN RUSTY ARMOUR—Peter & Gordon—Capitol	27	537
17. GREEN GREEN GRASS OF HOME—Tom Jones—Parrot	47	533
18. RUBY TUESDAY—Rolling Stones—London	—	506
19. HELLO HELLO—Sopwith Camel—Kama Sutra	41	493
19. TELL IT TO THE RAIN—4 Seasons—Philips	15	493
21. LOVE IS HERE & NOW YOU'RE GONE—Supremes—Motown	—	492
22. COMING HOME SOLDIER—Bobby Vinton—Epic	8	483
23. THAT'S LIFE—Frank Sinatra—Reprise	11	464
24. COLOR MY WORLD—Petula Clark—Warner Bros.	21	456
25. WHERE WILL THE WORDS COME FROM—Gary Lewis—Liberty	24	443
26. GIMME SOME LOVIN'—Spencer Davis Group—United Artists	—	435
27. PRETTY BALLERINA—Left Banke—Smash	—	432
28. THE BEAT GOES ON—Sonny & Cher—Atlantic	—	423
29. THEN YOU CAN TELL ME GOODBYE—Casinos—Fraternity	—	410
30. I HAD TOO MUCH TO DREAM LAST NIGHT—Electric Prunes—Reprise	—	407
31. WILD THING—Senator Bobby—Parkway	46	403
32. SINGLE GIRL—Sandy Posey—MGM	16	395
33. I'VE PASSED THIS WAY BEFORE—Jimmy Ruffin—Soul	—	392
34. TRY A LITTLE TENDERNESS—Otis Redding—Volt	20	382
35. MERCY, MERCY, MERCY—Cannonball Adderley—Capitol	—	374
36. MELLOW YELLOW—Donovan—Epic	14	350
37. LET'S SPEND THE NIGHT TOGETHER—Rolling Stones—London	—	348
38. IT'S NOW WINTERS DAY—Tommy Roe—ABC	—	333
39. EAST WEST—Herman's Hermits—MGM	17	330
40. ARE YOU LONELY FOR ME BABY—Freddie Scott—Shout	—	327
41. HOW DO YOU CATCH A GIRL—Sam The Sham & Pharaohs—MGM	31	322
42. (I KNOW) I'M LOSING YOU—Temptations—Gordy	—	320
43. PAPA WAS TOO—Joe Tex—Dial	32	316
44. (I'M NOT YOUR) STEPPING STONE—Monkees—Colgems	25	301
45. MUSTANG SALLY—Wilson Pickett—Atlantic	26	297
46. BRING IT UP—James Brown—King	—	293
47. GO WHERE YOU WANNA GO—5th Dimension—Soul City	—	287
48. TALK TALK—Music Machine—Original Sound	28	275
49. INDESCRIBABLY BLUE—Elvis Presley—RCA	—	265
50. THERE'S GOT TO BE A WORD—Innocence—Kama Sutra	29	259

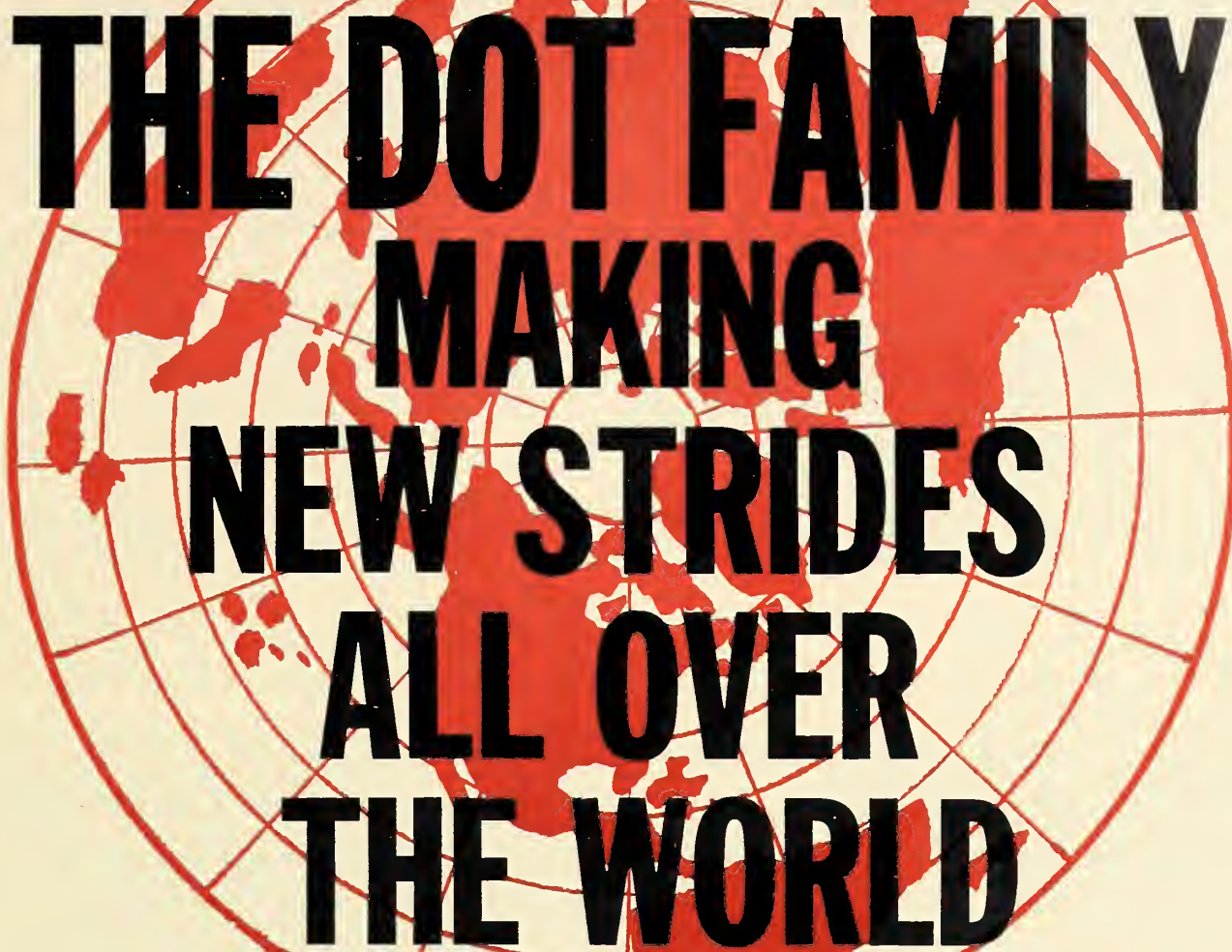

**THE DOT FAMILY
MAKING
NEW STRIDES
ALL OVER
THE WORLD**



*Congratulations Cash Box on your 25th Anniversary
From the Dot Family*

MONTHLY RECAP OF 1967's BIGGEST HITS

TOP HITS AS OF MARCH

	POSITION LAST MONTH	TOTAL POINTS
1. I'M A BELIEVER—Monkees—Colgems	1	1373
2. GEORGY GIRL—Seekers—Capitol	2	1259
3. KIND OF A DRAG—Buckinghams—U.S.A.	7	1149
4. WE AIN'T GOT NOTHIN' YET—Blues Magoos—Mercury	5	1059
5. RUBY TUESDAY—Rolling Stones—London	18	1010
6. SNOOPY VS. THE RED BARON—Royal Guardsmen—Laurie	3	972
7. LOVE IS HERE & NOW YOU'RE GONE—Supremes—Motown	21	963
8. TELL IT LIKE IT IS—Aaron Neville—Parlow	4	960
9. THEN YOU CAN TELL ME GOODBYE—Casinos—Fraternity	29	880
10. GREEN, GREEN GRASS OF HOME—Tom Jones—Parrot	17	862
11. 98.6—Keith—Mercury	8	856
12. THE BEAT GOES ON—Sonny & Cher—Atco	28	785
13. GOOD THING—Paul Revere & Raiders—Columbia	6	749
14. GIMME SOME LOVIN'—Spencer Davis Group—United Artists	26	725
15. STANDING IN THE SHADOWS OF LOVE—4 Tops—Motown	9	706
16. SOCK IT TO ME BABY—Mitch Ryder & Detroit Wheels—New Voice	—	703
17. MUSIC TO WATCH GIRLS BY—Bob Crewe Generation—DynaVoice	11	700
18. PRETTY BALLERINA—Left Banke—Smash	27	682
19. STAND BY ME—Spyder Turner—MGM	10	640
20. NASHVILLE CATS—Lovin' Spoonful—Kama Sutra	12	616
21. I HAD TOO MUCH TO DREAM LAST NIGHT—Electric Prunes—Reprise	30	611
22. SUGAR TOWN—Nancy Sinatra—Reprise	13	608
23. WORDS OF LOVE—Mamas & Papas—Dunhill	14	605
24. BABY I NEED YOUR LOVIN'—Johnny Rivers—Imperial	—	604
24. EPISTLE TO DIPPY—Donovan—Epic	—	604
26. MY CUP RUNNETH OVER—Ed Ames—RCA	—	602
27. MERCY, MERCY, MERCY—Cannonball Adderley—Capitol	35	577
28. THERE'S A KIND OF A HUSH—Herman's Hermits—MGM	—	572
29. WINCHESTER CATHEDRAL—New Vaudeville Band—Fontana	15	551
30. THE HUNTER GETS CAPTURED BY THE GAME—Marvelettes—Tamla	—	538
31. KNIGHT IN RUSTY ARMOR—Peter & Gordon—Capitol	16	537
32. I'VE BEEN LONELY TOO LONG—Young Rascals—Atlantic	—	536
33. PENNY LANE—Beatles—Capitol	—	530
34. HAPPY TOGETHER—Turtles—White Whale	—	495
35. TELL IT TO THE RAIN—4 Seasons—Philips	19	493
36. HELLO HELLO—Sopwith Camel—Kama Sutra	19	493
37. YOU GOT TO ME—Neil Diamond—Bang	—	489
38. COMING HOME SOLDIER—Bobby Vinton—Epic	22	483
39. FOR WHAT IT'S WORTH—Buffalo Springfield—Atlantic	—	482
40. LET'S SPEND THE NIGHT TOGETHER—Rolling Stones—London	37	469
41. THAT'S LIFE—Frank Sinatra—Reprise	23	464
42. INDESCRIBABLY BLUE—Elvis Presley—RCA	49	459
43. DARLIN' BE HOME SOON—Lovin' Spoonful—Kama Sutra	—	457
44. COLOR MY WORLD—Petula Clark—Warner Bros.	24	456
45. DEDICATED TO THE ONE I LOVE—Mamas & Papas—Dunhill	—	449
46. WHERE WILL THE WORDS COME FROM—Gary Lewis—Liberty	25	443
47. STRAWBERRY FIELDS FOREVER—Beatles—Capitol	—	405
48. WILD THING—Senator Bobby—Parkway	31	403
49. ARE YOU LONELY FOR ME BABY—Freddie Scott—Shout	—	395
49. SINGLE GIRL—Sandy Posey—MGM	32	395

TOP HITS AS OF APRIL

	POSITION LAST MONTH	TOTAL POINTS
1. I'M A BELIEVER—Monkees—Colgems	1	1373
2. GEORGY GIRL—Seekers—Capitol	2	1259
3. RUBY TUESDAY—Rolling Stones—London	5	1224
4. KIND OF A DRAG—Buckinghams—U.S.A.	3	1220
5. HAPPY TOGETHER—Turtles—White Whale	34	1133
6. THEN YOU CAN TELL ME GOODBYE—Casinos—Fraternity	9	1087
7. THERE'S A KIND OF A HUSH—Herman's Hermits—MGM	28	1062
8. WE AIN'T GOT NOTHIN' YET—Blues Magoos—Mercury	4	1059
9. LOVE IS HERE & NOW YOU'RE GONE—Supremes—Motown	7	1038
9. SOCK IT TO ME BABY—Mitch Ryder & Detroit Wheels—New Voice	16	1038
10. PENNY LANE—Beatles—Capitol	33	995
11. DEDICATED TO THE ONE I LOVE—Mamas & Papas—Dunhill	45	994
12. SNOOPY VS. RED BARON—Royal Guardsmen—Laurie	6	972
13. FOR WHAT IT'S WORTH—Buffalo Springfield—Atlantic	—	966
14. TELL IT LIKE IT IS—Aaron Neville—Parlow	8	960
15. MY CUP RUNNETH OVER—Ed Ames—RCA	26	954
16. I THINK WE'RE ALONE NOW—Tommy James & Shondells—Roulette	—	905
17. GREEN GREEN GRASS OF HOME—Tom Jones—Parrot	—	862
18. THE BEAT GOES ON—Sonny & Cher—Atco	—	585
19. 98.6—Keith—Mercury	11	856
20. THIS IS MY SONG—Petula Clark—Warner Bros.	—	800
21. I'VE BEEN LONELY TOO LONG—Young Rascals—Atlantic	32	760
22. CALIFORNIA NIGHTS—Leslie Gore—Mercury	—	756
23. GOOD THING—Paul Revere & Raiders—Columbia	13	749
24. STRAWBERRY FIELDS FOREVER—Beatles—Capitol	47	738
25. GIMME SOME LOVIN'—Spencer Davis Group—U.A.	14	725
26. JIMMY MACK—Martha & Vandellas—Gordy	—	718
27. STANDING IN THE SHADOWS OF LOVE—4 Tops—Motown	15	706
28. MUSIC TO WATCH GIRLS BY—Bob Crewe Generation—DynaVoice	17	700
29. I NEVER LOVED A MAN (THE WAY I LOVE YOU)—Aretha Franklin—Atlantic	—	687
30. PRETTY BALLERINA—Left Banke—Smash	18	682
31. A LITTLE BIT ME, A LITTLE BIT YOU—Monkees—Colgems	—	672
32. EPISTLE TO DIPPY—Donovan—Epic	24	670
33. SOMETHIN' STUPID—Frank & Nancy Sinatra—Reprise	—	666
34. BERNADETTE—4 Tops—Motown	—	651
35. STAND BY ME—Spyder Turner—MGM	—	640
36. WESTERN UNION—Five Americans—Abnak	—	636
37. NASHVILLE CATS—Lovin' Spoonful—Kama Sutra	20	616
38. I HAD TOO MUCH TO DREAM (LAST NIGHT)—Electric Prunes—Reprise	21	611
39. BEGGIN'—Four Seasons—Philips	—	608
39. SUGAR TOWN—Nancy Sinatra—Reprise	—	608
40. WORDS OF LOVE—Mamas & Papas—Dunhill	23	605
41. HUNTER GETS CAPTURED BY THE GAME—Marvelettes—Tamla	—	603
42. 59TH STREET BRIDGE SONG—Harpers Bizzare—Warner Bros.	—	595
43. MERCY, MERCY, MERCY—Cannonball Adderley—Capitol	27	577
44. WINCHESTER CATHEDRAL—New Vaudeville Band—Fontana	29	551
45. KNIGHT IN RUSTY ARMOUR—Peter & Gordon—Capitol	—	537
46. UPS & DOWNS—Paul Revere & Raiders—Columbia	—	527
47. RETURN OF THE RED BARON—Royal Guardsmen—Laurie	—	524
48. SWEET SOUL MUSIC—Arthur Conley—Atco	—	493
48. TELL IT TO THE RAIN—4 Seasons—Philips	—	493
48. HELLO HELLO—Sopwith Camel—Kama Sutra	36	493
49. YOU GOT TO ME—Neil Diamond—Bang	37	489
50. PUCKERUP BUTTERCUP—Jr. Walker—Soul	—	484

LPM/LSP-3727

Here is Jimmy's first RCA Victor album.
And this is his latest single: "Ninety
Days" c/w "In the Same Old Way" #9241

RCA VICTOR
The most trusted name in sound

JIMMY DEAN IS HERE!



Available on RCA Stereo 8 Cartridge Tape

Hear, Hear!

Jimmy Dean is here!



MONTHLY RECAP OF 1967's BIGGEST HITS

TOP HITS AS OF MAY

	POSITION LAST MONTH	TOTAL POINTS
1. HAPPY TOGETHER—Turtles—White Whale	5	1409
2. I'M A BELIEVER—Monkees—Colgems	1	1376
3. GEORGY GIRL—Seekers—Capitol	2	1259
4. I THINK WE'RE ALONE NOW—Tommy James & Shondells—Roulette	16	1257
5. RUBY TUESDAY—Rolling Stones—London	3	1224
6. KIND OF A DRAG—Buckingham—USA	4	1220
7. SOMETHIN' STUPID—Frank & Nancy Sinatra—Reprise	33	1124
8. THEN YOU CAN TELL ME GOODBYE—Casinos—Fraternity	6	1087
9. A LITTLE BIT ME, A LITTLE BIT YOU—Monkees—Colgems	—	1083
10. THERE'S A KIND OF A HUSH—Herman's Hermits—MGM	7	1062
11. WE AIN'T GOT NOTHIN' YET—Blues Magoos—Mercury	8	1059
11. DEDICATED TO THE ONE I LOVE—Mamas & Papas—Dunhill	11	1059
12. THIS IS MY SONG—Petula Clark—WB	—	1041
13. LOVE IS HERE & NOW YOU'RE GONE—Supremes—Motown	9	1038
14. SOCK IT TO ME BABY—Mitch Ryder & Detroit Wheels—New Voice	9	1038
15. PENNY LANE—Beatles—Capitol	10	995
16. JIMMY MACK—Martha & Vandellas—Gordy	26	982
17. SWEET SOUL MUSIC—Arthur Conley—Atco	48	978
18. SNOOPY VS THE RED BARON—Royal Guardsmen—Laurie	12	972
19. FOR WHAT IT'S WORTH—Buffalo Springfield—Atlantic	13	966
20. TELL IT LIKE IT IS—Aaron Neville—Parlow	14	960
21. MY CUP RUNNETH OVER—Ed Ames—RCA	—	954
22. THE HAPPENING—Supremes—Motown	—	874
23. GREEN GRASS OF HOME—Tom Jones—Parrot	17	862
24. BEAT GOES ON—Sonny & Cher—Atco	18	858
25. 98.6—Keith—Mercury	19	856
26. DON'T YOU CARE—Buckingham—Columbia	—	843
27. I NEVER LOVED A MAN (THE WAY I LOVE YOU)—Aretha Franklin—Atlantic	29	837
28. BABY I NEED YOUR LOVIN'—Johnny Rivers—Imperial	—	831
29. WESTERN UNION—Five Americans—Abnak	36	789
30. BERNADETTE—4 Tops—Motown	34	777
31. I'VE BEN LONELY TOO LONG—Young Rascals—Atlantic	21	760
32. CALIFORNIA NIGHTS—Lesley Gore—Mercury	22	756
33. GOOD THING—Paul Revere & Raiders—Columbia	—	749
34. STRAWBERRY FIELDS FOREVER—Beatles—Capitol	24	738
35. ON A CAROUSEL—Hollies—Imperial	—	731
36. GIMME SOME LOVIN'—Spencer Davis Group—UA	25	725
37. STANDING IN THE SHADOWS OF LOVE—Four Tops—Motown	—	706
38. MUSIC TO WATCH GIRLS BY—Bob Crewe Generation—Dynavoice	28	700
39. PRETTY BALLERINA—Left Banke—Smash	30	682
40. EPISTLE TO DIPPY—Donovan—Epic	32	670
41. BEGGIN—4 Seasons—Philips	39	668
42. I'M A MAN—Spencer Davis Group—UA	—	658
43. YOU GOT WHAT IT TAKES—Dave Clark Five—Epic	—	648
44. WITH THIS RING—Platters—Musicor	—	644
45. STAND BY ME—Spyder Turner—MGM	—	640
46. NASHVILLE CATS—Lovin' Spoonful—Kama Sutra	36	616
47. I HAD TOO MUCH TO DREAM (LAST NIGHT)—Electric Prunes—Reprise	38	611
48. SUGAR TOWN—Nancy Sinatra—Reprise	—	608
49. WORDS OF LOVE—Mamas & Papas—Dunhill	—	605
50. HUNTER GETS CAPTURED BY THE GAME—Marvelettes—Tamla	—	603

TOP HITS AS OF JUNE

	POSITION LAST MONTH	TOTAL POINTS
1. HAPPY TOGETHER—Turtles—White Whale	1	1409
2. I'M A BELIEVER—Monkees—Colgems	2	1373
3. GEORGY GIRL—Seekers—Capital	3	1259
4. I THINK WE'RE ALONE NOW—Tommy James & Shondells—Roulette	4	1257
5. SOMETHIN' STUPID—Frank & Nancy Sinatra—Reprise	7	1252
6. SWEET SOUL MUSIC—Arthur Conley—Atco	17	1232
7. RUBY TUESDAY—Rolling Stones—London	5	1224
8. KIND OF A DRAG—Buckingham—USA	6	1220
9. THE HAPPENING—Supremes—Motown	22	1138
10. THEN YOU CAN TELL ME GOODBYE—Casinos—Fraternity	8	1087
11. A LITTLE BIT ME, A LITTLE BIT YOU—Monkees—Colgems	9	1083
12. THERE'S A KIND OF A HUSH—Herman's Hermits—MGM	10	1062
13. WE AIN'T GOT NOTHIN' YET—Blues Magoos—Mercury	11	1059
13. DEDICATED TO THE ONE I LOVE—Mamas & Papas—Dunhill	11	1059
13. I GOT RHYTHM—Happenings—B. T. Puppy	—	1059
14. DON'T YOU CARE—Buckingham—Columbia	26	1056
15. THIS IS MY SONG—Petula Clark—WB	12	1041
16. GROOVIN'—Young Rascals—Atlantic	—	1038
16. LOVE IS HERE & NOW YOU'RE GONE—Supremes—Motown	13	1038
16. SOCK IT TO ME BABY—Mitch Ryder, Etc.—New Voice	14	1038
17. FOR WHAT IT'S WORTH—Buffalo Springfield—Atlantic	19	966
18. PENNY LANE—Beatles—Capitol	15	955
19. JIMMY MACK—Martha & Vandellas—Gordy	16	982
20. SNOOPY VS THE RED BARON—Royal Guardsmen—Laurie	18	972
21. TELL IT LIKE IT IS—Aaron Neville—Parlow	20	960
22. MY CUP RUNNETH OVER—Ed Ames—RCA	21	954
23. RESPECT—Aretha Franklin—Columbia	—	936
24. SOMEBODY TO LOVE—Jefferson Airplane—RCA	—	904
25. RELEASE ME—Englebert Humperdinck—Parrot	—	896
26. GREEN GRASS OF HOME—Tom Jones—Parrot	23	862
27. BEAT GOES ON—Sonny & Cher—Atco	24	858
28. 98.6—Keith—Mercury	25	856
29. I NEVER LOVED A MAN (THE WAY I LOVE YOU)—Aretha Franklin—Atlantic	—	837
30. BABY I NEED YOUR LOVIN'—Johnny Rivers—Imperial	—	831
31. CLOSE YOUR EYES—Peaches & Herb—Date	—	802
32. GIRL, YOU'LL BE A WOMAN SOON—Neil Diamond—Bang	—	797
33. ON A CAROUSEL—Hollies—Imperial	35	796
34. WESTERN UNION—Five Americans—Abnak	29	789
35. BERNADETTE—4 Tops—Motown	30	777
36. CREEQUE ALLEY—Mamas & Papas—Dunhill	—	772
37. I'VE BEEN LONELY TOO LONG—Young Rascals—Atlantic	31	760
38. CALIFORNIA NIGHTS—Lesley Gore—Mercury	32	756
39. GOOD THING—Paul Revere & Raiders—Columbia	33	749
40. STRAWBERRY FIELDS FOREVER—Beatles—Capitol	34	738
41. GIMME SOME LOVIN'—Spencer Group—UA	36	725
42. STANDING IN THE SHADOWS OF LOVE—Four Tops—Motown	37	706
43. HIM OR ME WHAT'S IT GONNA BE—Paul Revere & Raiders—Columbia	—	701
44. MUSIC TO WATCH GIRLS BY—Bob Crewe Generation—Dynavoice	38	700
45. HERE COMES MY BABY—Tremloes—Epic	—	694
46. HAPPY JACK—The Who—Decca	—	693

"We demand a recount!"

-Homer and Jethro

Now, now fellas! Look at the bright side: as Non-Winners for the second straight year you have chalked up an unrivalled record in the industry.

For personal appearances contact: Jimmy Richards Productions (312-MO 4-1552) 919 North Michigan Avenue, Chicago, Illinois 60611 (Private long-distance telephone; 312-MO 4-1646)

RCA VICTOR
The most trusted name in sound



THE BIG THREE

COUNTRY WINNERS IN EACH CATEGORY OF CASH BOX DISK JOCKEY POLL

MOST PROGRAMMED SINGLE

1. ALMOST PERSUADED—DAVID HOUSTON—
EPIC—AL GALICO—BMI
2. THERE GOES MY EVERYTHING—
JACK GREENE—DECCA—HUSKY, BLUE
CREST—BMI
3. DON'T COME HOME A-DRINKIN'—LORETTA
LYNN—DECCA—SURE FIRE—BMI

MOST PROGRAMMED ALBUM

1. YOU AIN'T WOMAN ENOUGH
LORETTA LYNN—DECCA
2. BUCK OWENS AT CARNEGIE HALL—
CAPITOL
3. TOUCH MY HEART—RAY PRICE—COLUMBIA

MOST PROGRAMMED MALE VOCALIST

1. BUCK OWENS—CAPITOL
2. DAVID HOUSTON—EPIC
3. EDDY ARNOLD—RCA VICTOR

MOST PROGRAMMED FEMALE VOCALIST

1. LORETTA LYNN—DECCA
2. CONNIE SMITH—RCA VICTOR
3. DOTTIE WEST—RCA VICTOR

MOST PROMISING MALE VOCALIST

1. JACK GREENE—DECCA
2. NAT STUCKEY—PAULA
3. WAYLON JENNINGS—RCA VICTOR

MOST PROMISING FEMALE VOCALIST

1. LYNN ANDERSON—CHART
2. TAMMY WYNETTE—EPIC
3. JEANNIE SEELY—MONUMENT

MOST PROGRAMMED VOCAL GROUP

1. BROWNS—RCA VICTOR
2. WILBURN BROS.—DECCA
3. HARDIN TRIO—COLUMBIA

MOST PROGRAMMED INSTRUMENTALIST

1. CHET ATKINS—RCA VICTOR
2. FLOYD CRAMER—RCA VICTOR
3. ROY CLARK—CAPITOL

MOST PROGRAMMED ORCHESTRAS

1. BUCKAROOS—CAPITOL
2. HANK THOMPSON'S BRAZOS VALLEY BOYS
—CAPITOL
3. TEXAS TROUBADORS—DECCA

MOST PROMISING INSTRUMENTALIST

1. LLOYD GREEN—LITTLE DARLIN'
2. JIMMIE BRYANT—IMPERIAL
3. JERRY REED—RCA VICTOR

BUCK "THE TIGER" OWENS

America's "NO. 1"
COUNTRY SINGER

4-BIG YEARS IN A ROW! *

1967 BIG HITS

① "WHERE DOES THE GOOD TIMES GO" and ② "SAM'S PLACE"

and his

BUCKAROOS

"NO. 1"
COUNTRY &
WESTERN BAND

3-BIG YEARS
IN A ROW! *

* IN THE 1967
CASH BOX
DJ POLL



DJ'S NEEDING RECORDS:
WRITE - EDDIE BRIGGS
405 CHESTER AVE., BAKERSFIELD,
CALIFORNIA 93301

FOR BOOKINGS...
CALL - WRITE OR WIRE TO:
JACK McFADDEN - 403 CHESTER AVE.
BAKERSFIELD, CALIF., 327-1000, 327-7201

BUCK OWENS
FAN CLUB
P.O.#128, EDISON,
CALIF., 93220

BMI PUBLISHERS

(Continued from page 188)

Reed's 54 W. 116th St., N.Y.C.
 Regal 1342 No. Orange Hollywood, Cal.
 Regency 1040 N. Las Palmas Hollywood, Cal.
 Regent 1619 Broadway, N.Y.C.
 Regina 507 Fifth N.Y.C.
 Regnis 201 W. 77th N.Y.C.
 Rego Park 61-15 98 St., Rego Park, N.Y.
 Rehmel 433 Savier Knoxville, Tenn.
 Herb Reis 1619 Broadway, N.Y.C.
 Release 450 W. 147th N.Y.C.
 Rell-Tom-Pol 1650 Broadway, N.Y.C.
 Remarque 180 W. 58th N.Y.C.
 Rembrandt 59 E. 54th N.Y.C.
 Renaldo's 46 W. 116th N.Y.C.
 Renato 4622 S. Mozart, Chicago
 Rencoll 18617 St. Aubin Detroit, Mich.
 Renda 3703 No. Seventh Phoenix, Ariz.
 Anthony Renfro 1895 W. 22nd St., Los Angeles, Cal.
 Reno 180 Bay 32 Brooklyn, N.Y.
 Renown P.O. Box 1674, Durham, N.C.
 Renraw 21617 Reynolds Torrance, Cal.
 Renrel 3351 N. Green Bay, Milwaukee, Wis.
 Rensark 1887 Bay Atlantic Beach, N.Y.
 Repeat 1050 S. Gramercy Los Angeles, Cal.
 Republic 1619 Broadway, N.Y.C.
 Reserve 6522 Tanglewood Seven Hills, Ohio
 Retta 9820 Yoakum Beverly Hills, Cal.
 G.M. Reuss 630 N. Columbia Naperville, Ill.
 Revilo 199 Botsford Hempstead, N.Y.
 George W. Rex 1107 Commerce Tacoma, Wash.
 Rexford 408 North Rodeo Beverly Hills, Cal.
 Rey 478 Central Park W., N.Y.C.
 Rey Reid 1697 Broadway, N.Y.C.
 Reynolds & Andrews 1816 W. Adams Los Angeles, Cal.
 Rhodes 8715 W. Third Hollywood, Cal.
 Rhombus P.O. Box 47 Hollywood, Cal.
 Rhoton, 439 Brewer, Nashville, Tenn.
 Rhythmetime 226 S. Beverly, Beverly Hills, Cal.
 Rhythm Int'l. 451 W. 47th N.Y.C.
 Rhythm Tamers 21834 Grace Torrance, Cal.
 Rhythms Of West 11 Palm Circle Rd., Redwood City, Cal.
 Mareno Ricci 934 Tree Phila., Pa.
 Rice Mill 1405 Locust Phila., Pa.
 Scott P.O. Box 6 Belen, N.M.
 Charles Rich 639 Madison, Memphis, Tenn.
 Bob Richards 116 W 45, N.Y.C.
 Richardson 1040 So. Curson, Los Angeles, Cal.
 Richben 1650 Broadway, N.Y.C.
 Richcraft 2314 63rd Brooklyn, N.Y.
 Richfield 206 12th Ave. San Francisco, Cal.
 Richtone Box 6081, Dallas, Texas
 Ricky 1501 Broadway, N.Y.C.
 Ric-O-Lac 3330 N. Lake Shore Dr., Chicago, Ill.
 G. Ricordi 16 W. 61st N.Y.C.
 Riddle 4819 Gentry N. Hollywood, Cal.
 Ridge 850 Seventh N.Y.C.
 Ridgefield 1619 Broadway, N.Y.C.
 Ridgeway 6087 Sunset Hollywood, Cal.
 Riff-Time 2706 Ford Brooklyn, N.Y.
 Rigmor 154 W. 106th N.Y.C.
 Rikpage 7417 Melrose Los Angeles 46, Cal.
 Riley 400 Madison N.Y.C.
 Rim 1293 Dean Brooklyn N.Y.
 Gene Ring Bank Of Galesburg Bldg. Galesburg, Ill.
 Charles Rinker 1610 N. Argyle Hollywood, Cal.
 Rinky Dink 1726 N. Occidental Los Angeles, Cal.
 Rio 28 E. 10th N.Y.C.
 Ripley 1776 Broadway, N.Y.C.
 Rittenhouse 1617 North Broad Phila., Pa.
 TexRiHev 6124 Selma Ave., H'wood, Calif.
 Rival 6240 A. Wilcox Bell, Cal.
 River 1323 So. Michigan Ave., Chicago, Ill.
 Riverdale 145 Linn Yonkers, N.Y.
 Johnny Rivers 1560 No. LaBrea, Hollywood, Cal.
 Roadside 151 East 49th St. N.Y.C.
 Ro-An 535 N.E. 113th St., Miami, Fla.
 Roar 2125 N. Commonwealth Hollywood, Cal.
 Roband 165 W. 46th N.Y.C.
 Rob-Ann 254 W. 54th N.Y.C.
 Robbie P.O. Box 117 Westminster, Cal.
 Robin Hood 5916 Carleton Way, Los Angeles, Cal.
 Floyd Robinson 154 Eighth N. Nashville, Tenn.
 Robinson 34-36 E. 32nd N.Y.C.
 Robinsounds 180 W. 58th N.Y.C.
 Roblar 8400 Sunset Hollywood, Cal.
 Robot 2095 San Jacinto Beaumont, Texas
 Robyn Renee 2016 Terrace Nashville, Tenn.
 Rock Masters 56 W. 45th N.Y.C.
 Rock 5244 Whitsett N. Hollywood, Cal.
 Rock 'N Roll 707 S. 55th Phila., Pa.
 Rockaway 1631 Broadway, N.Y.C.
 Rockford 149 W. 48th N.Y.C.
 Rockingham 12198 Ventura Studio City, Cal.
 Rockland 2 W. 45th N.Y.C.
 Rockville 1619 Broadway, N.Y.C.
 Rocky Hill 3435 Alta Vista Dr., Chattanooga, Tenn.
 Roc-Mar 193 Bay 40th Brooklyn, N.Y.
 F.W. Rode P.O. Box 430 Santa Cruz, Cal.
 Rodel 2615 Woodhill Cleveland, Ohio
 Gene Rodgers 134 W. 58th N.Y.C.
 Rodney 7619 Sunset Hollywood, Cal.
 Roe 60 E. Bellevue, Chicago, Ill.
 Roadway 748 S. 10th Newark, N.J.
 Rogelle 35 W. 45, N.Y.C.
 Rogers & Van Buren P.O. Box 64431. Los Angeles, Cal.
 Ro-Gor 5135 St. Antoine Detroit, Mich.
 Rojo 255 Crooks Clifton, N.J.
 Rolling Hills 2311 Gentry Houston, Texas
 Rollins 1619 Broadway, N.Y.C.
 Rollyn 1692 Madison Memphis, Tenn.
 Romance 154 W. 54th N.Y.C.
 Rome Rox 31 Sutton Place S., N.Y.C.
 Romeo 1047 1/2 W. 52nd Los Angeles, Cal.
 Romm 333 W. 56th N.Y.C.
 Romola 949 N. Clark Los Angeles, Cal.
 Ron P.O. Box 866 New Orleans 12, La.
 Rona 1799 De Camp Beverly Hills, Cal.
 Rondeau 254 W. 49th N.Y.C.
 Rondell 6515 Sunset Los Angeles, Cal.
 Rondo P.O. Box 2367 Hollywood, Cal.
 Rondon 1721 Broadway, N.Y.C.
 Romlor 461 Eighth Ave., N.Y.C.
 Rook 119 W. 57th St., N.Y.C.
 Room Seven 6365 Selma Ave., Hollywood, Cal.
 Roosevelt 1650 Broadway, N.Y.C.
 Rorlie 6061 Hollywood, Hollywood, Cal.
 Ror-Ron 2333 Marhurb Pittsburgh, Pa.
 Maria Rosa 7021 Hollywood, Hollywood, Cal.
 Rosarch 119 W. 57th N.Y.C.
 George F. Rosche 337 W. Madison St., Chicago, Ill.
 Fred Rose 2510 Franklin Nashville, Tenn.
 Martin Rose 123 W. Madison Chicago, Ill.
 Rose City 150 W. 55th N.Y.C.

Rose Hill 1780 Broadway, N.Y.C.
 David Rosen P.O. Box 94 Bloom Hall, Pa.
 Rosenberg 414 North Vista Los Angeles, Cal.
 Rosewood 254 W. 49th N.Y.C.
 Leo Ross 443 W. 50th N.Y.C.
 Ross 9222 Allwood Houston, Texas
 E. Rossi 127 Mulberry, N.Y.C.
 Rossmore 6241 Camellia No. Hollywood, Cal.
 Rossongs 1650 Broadway, N.Y.C.
 Rotine 2835 West Los Angeles, Cal.
 Rouge 218 W. 49th N.Y.C.
 Routeen P.O. Box 3267, Scottsdale, Ariz.
 Roxy 1619 Broadway, N.Y.C.
 Royal American 1200 Howard Bellaire, Texas
 Royal Crest 3919 Roxanne Los Angeles, Cal.
 Royal Crown 160 W. 46th N.Y.C.
 Rozell 605 S. Normandie Los Angeles, Cal.
 Rozzo 6087 Sunset Hollywood, Cal.
 Mark Rubens 1687 Broadway, N.Y.C.
 Rubill 295 Madison, N.Y.C.
 Paul Rubio 635 1/2 N. Sycamore, Hollywood, Cal.
 Rudder 15 J. Morrissey Teaneck, N.J.
 Rue 7436 Genesta Van Nuys, Cal.
 Rugby 1343 S. Michigan Chicago, Ill.
 Rujanart 5231 Biloxi No. Hollywood, Cal.
 Rumbalero 1619 Broadway, N.Y.C.
 Rumson 1426 N. Beechwood, Hollywood
 Rupert Music 1601 No. Gower, Hollywood, Cal.
 Rush 756 Seventh N.Y.C.
 Russell 1631 Broadway, N.Y.C.
 Russher 1650 Broadway, N.Y.C.
 Russ-Dale 155 W. 46th N.Y.C.
 Willard Russell 2130 Feger Fresno, Cal.
 Russ-Hix 121 Bank N.Y.C.
 Rusthoi Gospel P.O. Box 647, Pasadena, Cal.
 Rustic 5454 Mesmer Culver City, Cal.
 Ruth 3437A No. 24th Milwaukee, Wis.
 Ryerson 154 W. 14th N.Y.C.
 SAAB 850 Seventh Ave., N.Y.C.
 S & H 5143 W. 58th Pl., Los Angeles, Cal.
 S & J 35 W. 57, N.Y.C.
 S & S (See Lois)
 S And W P.O. Box 135, Riverside, Cal.
 SFO 916 Kearny St., San Francisco, Cal.
 SG 711 Fifth Ave., N.Y.C.
 S-G 90 Charles, N.Y.C.
 S N M 6940 Bay Miami Beach, Fla.
 S-P-R 1619 Broadway, N.Y.C.
 Sabra 109 South Flores Los Angeles, Cal.
 Sacramento 160 W. 46th N.Y.C.
 Sacred 1619 Broadway, N.Y.C.
 Sa-Day 247 W. 72nd N.Y.C.
 Sadie 505 Fifth N.Y.C.
 Safari 1234 N. June Hollywood, Cal.
 Sag Harbor 1619 Broadway, N.Y.C.
 Sagamore 1650 Broadway, N.Y.C.
 Saginaw 1619 Riverside Nashville, Tenn.
 Sahara 3570 Atlantic Long Beach, Cal.
 Saima 8831 Sunset Los Angeles, Cal.
 St. Lawrence 6087 Sunset Hollywood, Cal.
 St. Louis 1619 Broadway, N.Y.C.
 Salaam 4659 S. Drexel Chicago, Ill.
 Sally 101 W. 55th N.Y.C.
 Salm 1619 Broadway, N.Y.C.
 Saloon Sonos c/o Sinatra Enterprises, 4000 Warner Blvd., Burbank, Cal.
 Sam 96 Perry N.Y.C.
 Sambek 2928 Prospect Cleveland, Ohio
 Samba 145 W. 47th N.Y.C.
 Samchera 592 Lafayette St., Gretna, La.
 Sampson 155 E. 24th N.Y.C.
 San Juan 1650 Broadway, N.Y.C.
 San Remo 853 Seventh N.Y.C.
 Sanada 1631 B'way, N.Y.C.
 Sanama 8601 Lone Star Rd., Jacksonville, Fla.
 Sanco 1617 El Centro Hollywood, Cal.
 Sand & Surf 612 15th Belmar, N.J.
 San-Del 410 So. Michigan Ave., Chicago, Ill.
 L. O. Sanderson 1619 Broadway, N.Y.C.
 Sandette P.O. Box 664 Knoxville, Tenn.
 Sandole 229 W 52, N.Y.C.
 Sandra 297 N. Main Memphis, Tenn.
 Sandusky 12th & Walnut Bldg., Kansas City, Mo.
 Sanford 506 Seventh Buffalo, N.Y.
 Sanga 200 W. 57th N.Y.C.
 Santo Box 433 Memphis, Tenn.
 Sanwood 10 W. 74th St., N.Y.C.
 Sapphire 533 Canal New Orleans, La.
 Saracen 1607 North El Centro Hollywood, Cal.
 Saran 2631 Fonville Dallas, Texas
 Saratoga 150 W. 55th N.Y.C.
 Sardonyx 2648 Hillger Detroit 14, Mich.
 Sark Music 1270 Sixth St., Memphis, Tenn.
 Sar-Lib 107 Beale St., Memphis, Tenn.
 Art Satherlev 3507 Landa Los Angeles, Cal.
 Saturday 1841 B'way, N.Y.C.
 Saturn 1650 Broadway, N.Y.C.
 Satyr 3611 Buena Park Studio City, Cal.
 Sausalito 608 Fifth Ave., N.Y.C.
 Saxon 1697 Broadway, N.Y.C.
 Scale 120 E. 56th St., N.Y.C.
 Scarlet 307 South Wabash Chicago, Ill.
 Peter Scheffer's 756 Seventh N.Y.C.
 Scherer 1619 Broadway, N.Y.C.
 Max Schooner 6114 W. Vernor Highway, Detroit, Mich.
 Schonne 2942 Longwood Jacksonville, Fla.
 Schulman 2643 S. 3rd St., Phila., Pa.
 Wally Schuster 1650 Broadway, N.Y.C.
 Schoebert 431 S. 62 St., Phila., Pa. 19143
 Scope 157 W. 57th St., N.Y.C.
 Score 345 W. 58th St., N.Y.C.
 Scornio 6535 Wilshire Los Angeles, Cal.
 Jay Scott 2200 N. Glenoaks Burbank, Cal.
 Screen Gems, Columbia 711 5th Ave., N.Y.C.
 Sculptone 119 W. 57th St., N.Y.C.
 Sea Of Tunes 3701 W. 119th Hawthorne, Calif.
 Sea-Bee 2531 W. Broadway P.O. Box 24 Louisville, Ky.
 Seabreeze 2733 Kensington Phila., Pa.
 Sea-Lark 25 West 56th St. N.Y.C.
 Seaman 55 Liberty St., N.Y.C.
 Season's Four 1841 B'way, N.Y.C.
 Sebastian 25 E. 67th St., N.Y.C.
 Second Sound 1650 Broadway, N.Y.C.
 Secor 1841 Broadway, N.Y.C.
 Seeley 79 W. Monroe St., Chicago 3, Ill.
 Seemac 119 W. 67th St., N.Y.C.
 Dan Segal 915 Second N.Y.C.
 Segario 270 W. 123rd, N.Y.C.
 Senno 9729 Granger Garfield Hrts., O.
 Selbony 630 Lenox Ave., N.Y.C.
 Paul Selden 350 W. 55th N.Y.C.
 Sella 3236 Clarksville Highway Nashville, Tenn.
 Sellstar 2110 N. Main Fort Worth, Texas
 Selma 1650 Broadway, N.Y.C.
 Semerak 4327 S. Sacramento Ave., Chicago, Ill. 60632
 Semprini 1619 Broadway, N.Y.C.
 Senator 210 W. 55th N.Y.C.



COUNTRY POLL WINNERS

MOST PROGRAMMED SINGLE

ALMOST PERSUADED—DAVID HOUSTON—EPIC
 THERE GOES MY EVERYTHING—JACK GREENE—DECCA
 DON'T COME HOME A-DRINKIN'—LORETTA LYNN—DECCA
 Swinging Doors—Merle Haggard—Capitol
 Sweet Thang—Nat Stuckey—Paula
 Where Does The Good Times Go—Buck Owens—Capitol
 I'm A Lonesome Fugitive—Capitol
 Somebody Like Me—Eddy Arnold—RCA Victor
 Misty Blue—Wilma Burgess—Decca
 You Ain't Woman Enough—Loretta Lynn—Decca
 Lonely Again—Eddy Arnold—RCA Victor
 Sam's Place—Buck Owens—Capitol
 True Love's A Blessing—Sonny James—Capitol
 Walk Through This World With Me—George Jones—Musicor
 Touch My Heart—Ray Price—Columbia

MOST PROGRAMMED ALBUMS

YOU AIN'T WOMAN ENOUGH—LORETTA LYNN—DECCA
 BUCK OWENS AT CARNegie HALL—CAPITOL
 TOUCH MY HEART—RAY PRICE—COLUMBIA
 My World—Eddy Arnold—RCA Victor
 Swinging Doors—Merle Haggard—Capitol
 Best Of Jim Reeves—RCA Victor
 Open Up Your Heart—Buck Owens—Capitol
 There Goes My Everything—Jack Greene—Decca
 Downtown Country—Connie Smith—RCA Victor
 Best Of Sonny James—Capitol
 Born To Sing—Connie Smith—RCA Victor
 Somebody Like Me—Eddy Arnold—RCA Victor

(Continued on page 200)

BMI PUBLISHERS

Sencha 720 Riverside, N.Y.C.
 Sendme 1154 N. Wilton Los Angeles, Cal.
 Senut 56 W. 45th St., N.Y.C.
 Sepulveda 390 S. Hauser Blvd., Los Angeles, Cal.
 Sequoia 224 W. 49th N.Y.C.
 Serenade 1608 Hillhurst Los Angeles, Cal.
 Serendipity 640 Fifth Ave., N.Y.C.
 Session 1650 Broadway, N.Y.C.
 Seven Arts 200 Park Ave., N.Y.C.
 Seven Seas P.O. Box 564 Nashville, Tenn.
 Seven-Eleven 666 Fifth N.Y.C.
 Seven-Ten 17 Ellis St., Lincoln Park, N.J.
 Seventh Ave. 1650 Broadway, N.Y.C.
 Seventy Second 306 E. 72nd N.Y.C.
 Sewell 411 West End N.Y.C.
 Sexton 5308 Laurel Canyon N. Hollywood, Cal.
 Seymour Co. 119 57th N.Y.C.
 Shac 109 W. 42nd N.Y.C.
 Shadows 1619 Broadway, N.Y.C.
 Shag 1861 W. Adams Los Angeles, Cal.
 Shaggy 185 N. Wabash Chicago, Ill.
 Sha-Lee's 1578 Adelia Place N.W. Atlanta, Ga.
 Shalom 119 West 57th St. N.Y.C.
 Shane 1141 S. Beverly Los Angeles, Cal.
 Shannon 185 N. Wabash Chicago, Ill.
 Sharolyn 915 North Clark Los Angeles, Cal.
 Shasta P.O. Box 5203, Phoenix, Ariz.
 Shat-Shep 7215 Hillside Hollywood, Cal.
 Herman Shavers 5419 S. Michigan Chicago, Ill.
 C. Shaw 1674 Broadway, N.Y.C.
 Shaw Music 19 E. 48th N.Y.C.
 Shan-Todd 22821 Hayden Rd., Farmington, Mich. 48024
 Shaysee 1631 Broadway, N.Y.C.
 Shealy 240 W. 55th N.Y.C.
 Sheffield 666 Fifth N.Y.C.
 Vernon Shelby P.O. Box 423 Jacksonville, N.C.
 Sheldon-Mitchel 28 W. 38th N.Y.C.
 Shell 4333 Bakman N. Hollywood, Cal.
 Shelros 250 S. Broad St., Philadelphia, Pa.
 Shenan 13013 Venice Los Angeles, Cal.
 Jean Shepard 234 W. 48th N.Y.C.
 Sheplan P.O. Box 32114 Cincinnati, O.
 Shepley 150 W. 55th N.Y.C.
 Shepmike 8961 Sunset Hollywood, Cal.
 Sherco 230 Riverside Dr., N.Y.C.
 Sherbourne 8745 Sunset Hollywood, Cal.
 Sheridan 1650 Broadway, N.Y.C.
 Sherlyn 495 S.E. 10th Court Hialeah, Fla.
 Sherman 1650 Broadway, N.Y.C.
 Sherman 1606 Argyle Hollywood, Cal.
 Sherod 802 Linden Memphis, Tenn.
 Sherryvale 6124 Selma Ave. Hollywood
 Shidel 1740 Broadway, N.Y.C.
 Shields 54 W. Randolph Chicago, Ill.
 J. Shink 729 Seventh N.Y.C.
 Shirgus 5250 Appian Way Long Beach, Cal.
 Shoe 1741 Market Oakland, Cal.
 Shoe-String 1619 Broadway, N.Y.C.
 Shorn 1619 Broadway, N.Y.C.
 Short 101 W. 55th N.Y.C.
 Show Music 1619 Broadway, N.Y.C.
 Shuevitz 2077 So. Harvard Los Angeles, Cal.
 Shuler 607 Lauricella New Orleans, La.
 Shumac 224 Canon Beverly Hills, Cal.
 Shvanc Shutt 1333 Kansas Topeka, Kan.
 Shvanc 501 N. Sycamore Los Angeles, Cal.
 Sid-Lee 135 W. 50, N.Y.C.
 Sielver 239 Central Park W., N.Y.C.
 Siegel 7825 Ranchito Panorama City, Cal.
 Siegfried-Charles 357 W. 55th N.Y.C.
 Sierra 12824 Indianapolis Los Angeles, Cal.
 Signal 210 S. 95th Petersburg, Ind.
 Signature 4155 Mary Ellen N. Hollywood, Cal.
 Sienet 1674 Broadway, N.Y.C.
 Sikorski 250 W. 57th N.Y.C.
 Sildar 150 W. 55th N.Y.C.

Silken-Satin 155 W. 46th N.Y.C.
 Silmo 13618 Addison Sherman Oaks, Cal.
 Silver Screen 152 W. 49th N.Y.C.
 Silver Tone 213 East 6th Austin, Texas
 Silverbell Music 215 E. 68 St., N.Y.C.
 Silyn Music 1821 De Loz Hollywood, Cal.
 Simco 1630 Broadway, N.Y.C.
 Simeck 457 W. 54th N.Y.C.
 Simon House 250 W. 57th N.Y.C.
 Simon-Jackson 6920 Sunset Hollywood, Cal.
 Simplicity 1912 W. 138th Compton, Cal.
 Sinclair 745 Fifth N.Y.C.
 Singcoy 1650 Broadway, N.Y.C.
 Murray Singer 1674 Broadway, N.Y.C.
 Singleton 1650 Broadway, N.Y.C.
 Singsmo 916 Kearney St., San Francisco, Cal.
 Singular 250 S. Broad Phila., Pa.
 Sir Music 4861 Fulton Sherman Oaks, Cal.
 Siran 5840 Second Blvd., Detroit, Mich.
 Sitma 365 W. 125th N.Y.C.
 Six 1619 Broadway, N.Y.C.
 Sixty Six 660 N. Broad Phila., Pa.
 Jimmie Skinner P.O. Box 493 Cincinnati, O.
 Skinton 14958 Ardmore Ave., Detroit
 Skudrin 5417 Fleet Cleveland, O.
 Skylark P.O. Box 2837 Dallas, Texas
 Skyrocket 342 E. 9th N.Y.C.
 Skyway Box 133 Hollywood, Cal.
 Slacsar 444 Madison Ave., N.Y.C.
 Slag 1072-5 Lynch Jackson, Miss.
 Arthur Slater 1100 Glendale Los Angeles, Cal.
 Slo-Motion 161 Fifth Bethpage, L.I., N.Y.
 Slotkin 209 Glen Arbor Haverton, Pa.
 Small-Loft 260 W. 72nd N.Y.C.
 Smart 54 Wad Metuchen, N.J.
 Smash 313 Pecan Dr., Monroe, La.
 Harrison Smith 254 New York Brooklyn, N.Y.
 Solidarity 12254 Montana Los Angeles, Cal.
 Some 511 Fifth N.Y.C.
 Somerset 1617 El Centro Hollywood, Cal.
 Sonark 1606 North Argyle Hollywood, Cal.
 Sonata 554 Fifth N.Y.C.
 Song Craft 8564 Hillside Los Angeles, Cal.
 Sonny Smith 1544 W. York Philadelphia, Pa.
 Snapper 1631 Broadway, N.Y.C.
 Snav 1697 Broadway, N.Y.C.
 Snowflake Sound 410 Main St., W Orange, N.J.
 Hank Snow 1619 Broadway, N.Y.C.
 Rosina Sobek 210 W. 7th Los Angeles, Cal.
 Sobel 1 East 28th St., N.Y.C.
 Society Of Jewish Composers, Publishers And Songwriters 54 Second N.Y.C.
 Soland Music P.O. Box 78243 Los Angeles, Cal.
 Songbird P.O. Box 25133 Los Angeles, Cal.
 Song-Ranch P.O. Box 287, Hollywood, Cal.
 Songs Of Spain 38 E. 57th N.Y.C.
 Songs Of The Country 245 W. 51st N.Y.C.
 Songs Of The World 900 Sunset Blvd., Hollywood, Cal. 90069
 Sonlo (See Lois)
 Sonnet 3237 N.W. 47th Oklahoma City 12, Okla.
 Sonny Bov. 1616 Argyle, Hollywood
 Soul Sound 1812 Contantinople St., New Orleans, La. 70115
 Soulhouse 620 N. Maple Dr., Beverly Hills, Cal.
 Sound Lab 3030 Post St., Jacksonville, Fla.
 Sound 6533 Hollywood, Hollywood 28, Cal.
 Soundcraft 21300 Pacific Coast Highway Malibu, Cal.
 Source 916 Kearney San Francisco, Cal.
 South Eastern European 35 W. 92nd N.Y.C.
 South Mountain 237 W 54, N.Y.C.
 South Philadelphia 1549 Mc Kean Phila., Pa.
 Southeast 2712 Dickerson Rd., Nashville, Tenn.

(Continued on page 200)

The Recorded Artistry of Jim Reeves



LPM/LSP-3793



*LPM/LSP-2890



*LPM/LSP-2968

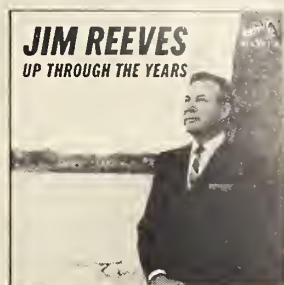

LPM/LSP-3427(e)



LPM/LSP-3482(e)



*LPM/LSP-3542

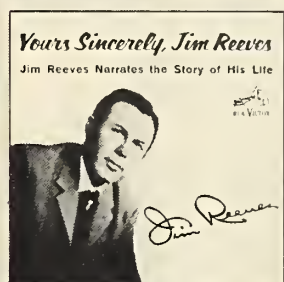

*LPM/LSP-3709(e)

Here are just 7 of the 23 albums in Jim Reeves' catalog, available only on



*Available on RCA Stereo & Cartridge Tape.

BMI PUBLISHERS

(Continued from page 198)

Southern Belle 3324 W. End Nashville, Tenn.
 Southland 2577 Oxford S., Memphis, Tenn.
 Southside 1650 Broadway, N.Y.C.
 Spangle 115-B Third Ave., N. Nashville, Tenn.
 Spanish 127 W. 48th N.Y.C.
 Spanka 119 W. 57th N.Y.C.
 Spare Rib 200 W. 57th N.Y.C.
 Spark 145 N. Canyon Monrovia, Cal.
 Sparkling 319 Seventh Ave., N. Nash., Tenn.
 Spartacus 150 W. 55th N.Y.C.
 Spartus 123 1/2 E. Tennessee St. P.O. Box 740
 Florence, Ala.
 Spearhead 370 W. 35th N.Y.C.
 Specialty 1453 N. Vine Hollywood, Cal.
 Spectorious 1780 Broadway, N.Y.C.
 Bill Spencer's 3759 Third Los Angeles, Cal.
 Spendel 305 E. 93rd N.Y.C.
 Spendo 3009 W. Vernon Los Angeles, Cal.
 Sphinx 6263 Saylin Los Angeles, Cal.
 Spindletop 157 W. 57th N.Y.C.
 Spinnet 1205 1/2 S. La Cienega Los Angeles, Cal.
 Spinnmill 15th & Locust Phila., Pa.
 Spinning Wheel 511 Fifth N.Y.C.
 Spiral 200 W. 57th N.Y.C.
 Spitzer 270 Madison N.Y.C.
 Ruth Spivak 806 Seventh N.Y.C.
 Spivey 443 Waverly Brooklyn, N.Y.
 Spook 815 Sixteenth S. Nashville, Tenn.
 Sportin Life 3606 1/2 Bagley Los Angeles, Cal.
 Spring Valley 659 Tenth N.Y.C.
 Sprite P.O. Box 38444 Hollywood Cal.
 Spur 10560 Wilshire Los Angeles, Cal.
 Square Deal 13027 Lorne, N. Hollywood, Cal.
 Square 1650 Broadway N.Y.C.
 Sta-ber 400 E. 33rd Chicago, Ill.
 Stacey 11016 Kirtzide N. Hollywood, Cal.
 Stadium 1601 N. Gower Hollywood, Cal.
 Staff Box 32, Steamboat, Nev.
 Stafford 4812 Carmen Las Vegas, Nev.
 Stagg 10 Marlo Belleville, Ill.
 Stahl 145 W. 57th N.Y.C.
 Stairway P.O. Box 1224 Mobile, Ala.
 Stami 1631 Broadway, N.Y.C.
 Stamps-Baxter (see Affiliated)
 Stan 1697 Broadway N.Y.C.
 Stand-Out 717 Washington Gary, Ind.
 Stanford 2 W. 45th N.Y.C.
 Stanger P.O. Box 297 Maple Shade, N.J.
 Stanrick 1569 Sunset Los Angeles, Cal.
 Stanson 165 N. Wabash Chicago, Ill.
 Staple 649 E. 39th Chicago, Ill.
 Star Tunes 1607 El Centro, Hollywood
 Starday Box 115 Madison, Tenn.
 Stardom 942 W. 32 Pl. Chicago, Ill.
 Stardust 1650 Broadway N.Y.C.
 Starfire 511 Fifth N.Y.C.
 Starfite 271 W. 125th N.Y.C.
 Starflower 1225 Sixth N.Y.C.
 Starmaker 4469 Charleswood Memphis, Tenn.
 Starrite 314 E. 11th Houston, Texas
 Stars P.O. Box 9687 N. Atlanta, Ga.
 Star-Shun Flood Bldg San Francisco, Cal.
 Starstan 742 South Hill Los Angeles, Cal.
 Milt Staviv 756 Seventh N.Y.C.
 Stazybo 1650 Broadway N.Y.C.
 Steary 1270 6th N.Y.C.
 Stebrita (see Lois)
 Ted Steele 1440 Broadway N.Y.C.
 Stefani 226 E. 36th N.Y.C.

Steinway 2 W. 45th N.Y.C.
 Stelen 8809 Oakwild Lane Hollywood, Cal.
 Steilee 139 E. 33rd N.Y.C.
 Stemar 7250 Beverly Los Angeles, Cal.
 Stemick 318 W. 48th N.Y.C.
 Stept Bros. 203 N. Wabash Chicago, Ill.
 Stereo 456 N. Mansfield Los Angeles, Cal.
 Jos. W. Stern & Co. (E. B. Marks)
 Stern 215 Banks San Francisco, Cal.
 Shepard Stern 823 S. Wabash Ave., Chicago
 Arthur Steven 1018 1/2 South Norton Los An-
 geles, Cal.
 Stevil 1650 Broadway N.Y.C.
 Stevo 308 Lenox Ave., N.Y.C.
 Stillman S 1715 Broadway N.Y.C.
 Stilran 134 N. 55th St., N.Y.C.
 Stinson 5966 Lakeview Detroit Mich.
 Stock 1619 Broadway N.Y.C.
 Stonestrow 17 Minetta St., N.Y.C.
 Stonewall 815 Sixteenth Nashville, Tenn.
 Stoneybrook 917 Sydney St., Philadelphia
 storm Jordan 1700 Broadway, N.Y.C.
 Storm King 121 47th N.Y.C.
 Straight Ahead 1650 Broadway N.Y.C.
 Strato-Muse 1650 Broadway N.Y.C.
 Street 185 N. Wabash Chicago, Ill.
 String 929 West End N.Y.C.
 Stringer 1204 Dallas Nashville, Tenn.
 Strobi 890 Sixth N.Y.C.
 Studio 157 W. 57th N.Y.C.
 Style and Song 291 Broadway N.Y.C.
 Style 20 E. Jackson Blvd., Chicago, Ill.
 styletone 1650 Broadway, N.Y.C.
 Su Mu Pub. 1041 N. Formosa, Hollywood, Cal.
 Suarez 6605 Hollywood Blvd., Hollywood, Cal.
 Suburban 550 Fifth N.Y.C.
 Sudbury 5224 Teesdale N. Hollywood, Cal.
 Suerob 1697 Broadway N.Y.C.
 Suffolk 10 Columbus Circle, N.Y.C.
 Sugar Ray 1475 Broadway, N.Y.C.
 Sugor 545 Fifth Ave., N.Y.C.
 Sulpat 1607 Broadway, N.Y.C.
 Sultan 255 West 55th St., N.Y.C.
 Suma 728 Texas St., Shreveport, La.
 Sun Valley 632 N. Dearborn, Chicago, Ill.
 Sunbeam 22 W. 48th N.Y.C.
 Sun-Crest 1614 N. Argyle Hollywood, Cal.
 Sunday 1 N. La Salle Chicago, Ill.
 Sundown 3035 W 38th Chicago, Ill.
 sunno 150 W. 58th N.Y.C.
 Sunny 439 S. Wabash, Chicago, Ill.
 Sunnyside 1619 Broadway, N.Y.C.
 Sunnyside 1650 Broadway N.Y.C.
 sunrise 1619 Broadway N.Y.C.
 Sunshine 408 N. Rodeo Beverly Hills, Cal.
 Sun-Vine 1507 N. Vine Hollywood, Cal.
 Sure 1619 Broadway N.Y.C.
 Sure-Fire 801 16th Ave. S., Nashville, Tenn.
 Surf Music 21 W. Illinois Chicago, Ill.
 Surimi 1479 Vine Hollywood, Cal.
 Susan 79 W. Monroe Chicago, Ill.
 Suto 1135 S. Beverly Dr. Los Angeles, Cal.
 Sutter 756 7 Ave., N.Y.C.
 Suwal 150 W. 55th N.Y.C.
 Sweco 1780 Broadway, N.Y.C.
 Sweet & Swing 9655 S. Prairie Ave., Chicago
 Sweeteen 1650 Broadway N.Y.C.
 Sweetheart 1650 Broadway N.Y.C.
 Swing & Tempo 1560 Broadway N.Y.C.
 Swingin 150 W. 55th N.Y.C.



COUNTRY POLL WINNERS

(Continued from page 198)

MOST PROGRAMMED MALE VOCALIST

BUCK OWENS—CAPITOL
 DAVID HOUSTON—EPIC
 EDDY ARNOLD—RCA VICTOR
 Merle Haggard—Capitol
 Jim Reeves—RCA Victor
 George Jones—Musicor
 Sonny James—Capitol

Jack Greene—Decca
 Bill Anderson—Decca
 Ray Price—Columbia
 Porter Wagoner—RCA Victor
 Willie Nelson—RCA Victor
 Waylon Jennings—RCA Victor

MOST PROGRAMMED FEMALE VOCALIST

LORETTA LYNN—DECCA
 CONNIE SMITH—RCA VICTOR
 DOTTIE WEST—RCA VICTOR
 Norma Jean—RCA Victor
 Kitty Wells—Decca

Wilma Burgess—Decca
 Jean Shepard—Capitol
 Wanda Jackson—Capitol
 Liz Anderson—RCA Victor
 Jeannie Seely—Monument
 (Continued on page 202)

BMI PUBLISHERS

Sycamore P.O. Box 1654 Hollywood, Cal.
 Sylvia 1650 Broadway N.Y.C.
 Symbol 1055 N. El Centro, Los Angeles, Cal.
 Symbolic 320 W. 76th N.Y.C.
 Syndicate 6869 1/2 Fountain, Hollywood, Cal.

Richard Tickin 501 Tenth N.Y.C.
 Tidal 2675 Federal, W. Los Angeles, Cal.
 Tideland 756 Seventh N.Y.C.
 Tiffany 3048 School, Oakland, Cal.
 Tiger 1841 Broadway N.Y.C.
 Tiki Music 616 Exchange Bldg., Nashville,
 Tenn.

T-C 1614 N. Cherokee Hollywood, Cal.
 T. M. 101 W. 55th N.Y.C.
 T N T 1422 W. Poplar San Antonio, Texas
 TPA 555 Madison N.Y.C.
 Tait 1644 Veteran Los Angeles, Cal.
 Taffy 1670 N. Gower Hollywood, Cal.
 Taggie 119 W. 57th N.Y.C.
 Tailormade 1788 S. La Cienega, Los Angeles,
 Cal.

Timbrea 1680 N. Vine Hollywood, Cal.
 Time 1790 Broadway N.Y.C.
 Timpkin 1405 E. Sixth Cleveland, O.
 Tin Pan Valley, 1508 Dickerson, Nashville,
 Tenn.
 Tinadele 13221 S. Avalon, Los Angeles, Cal.
 Tincalun 22821 Hayden Rd., Farmington,
 Mich. 48024

Tajal 200 W. 57th N.Y.C.
 Tal 1919 S. Tenth Phila., Pa.
 Talcoa Hollywood Knickerbocker Hotel, Holly-
 wood, Cal.
 Tallard 8303 Melrose Ave., Los Angeles
 Tallyrand c/o Marshall & Vigoda, 130 W. 57,
 NYC

Talmon 4411 Gra-Mar Dr., Nashville, Tenn.
 Tamasa 343 W. 58th N.Y.C.
 Tamkoda 5004 Melrose Hollywood, Cal.
 Tampico 1170 Broadway, N.Y.C.
 Tangerine 100 W. 42nd N.Y.C.
 Tangier 1674 Broadway N.Y.C.
 Tani-Lori P.O. Box 2331 Hollywood, Cal.
 Tannin 850 Seventh N.Y.C.
 Tarridge 850 Seventh N.Y.C.
 Irving Tanz 836 Eastern Pkwy., Bklyn., N.Y.
 Taps 1619 Broadway N.Y.C.

Tara Claire 154 Bristol Ave. N., L.A., Calif.
 Ta-Rah 3322 W. Peterson Chicago, Ill.
 Tarheel P.O. Box 15 Madison, Tenn.
 Tarry-Town 1819 Broadway N.Y.C.
 Tartan 573 Palm Dr., Glendale, Cal.
 Task 2300 N.W. 56 Terrace, W. H'wood, Fla.
 Tatlin 2959 4th Los Angeles, Cal.
 Taurus 301 E. 47th N.Y.C.

Tecumseh P.O. Box 9687, N. Atlanta, Ga.
 Teen Ager 6407 S. Kedzie Chicago, Ill.
 Tejas 5513 1/2 E. Grand, Dallas, Texas
 Telecast 69 W. Washington Chicago, Ill.
 Tele-Graff 3 Sheridan Sq. N.Y.C.
 Tele-Reco 3455 Cahuenga, Los Angeles, Cal.
 Temerity 1323 S. Michigan, Chicago, Ill.
 Tempoc Ent. S.A., 730 Gower, H'wood Cal.
 Temple 5 S. 60th Phila., Pa.
 Tempus 423 1st Natl. Bank Bldg., Peoria, Ill.
 Tenneva 300 W. 33rd, N. Little Rock, Ark.
 Tenn-Tex 319 Seventh Av. N., Nashville, Tenn.
 Tenor 248 Sherer Blvd., Franklin Sq., N.Y.C.
 Tentap 527 Madison N.Y.C.

Tepajo 19 Arlington St., Boston
 Teresa 1479 N. Vine Hollywood, Cal.
 Terese 200 E. Superior Chicago, Ill.
 Tereve-Laen 35 E. Wacker Chicago, Ill.
 Terp 1001 Garden Hwy., N. Sacramento, Cal.
 Terra-Orb 6064 Hollywood Blvd., H'wood, Cal.
 Lou Terrasi 254 W. 47th N.Y.C.
 Terry-Wilkins 152 W. 49th N.Y.C.

Tetlow 1243 N. Virgil Los Angeles, Cal.
 Tex 9028 Sunset Blvd., Los Angeles, Cal.
 Textical 962 N. Ardmore Hollywood, Cal.
 Thalia 804 E. Imperial Highway, L.A., Cal.
 Tharpe 1619 Broadway N.Y.C.
 Thayer 2031 Thayer Los Angeles, Cal.
 Theatre 1619 Broadway N.Y.C.
 Thelma's 8040 Dexter, Detroit, Mich.
 Thimble 200 W. 57th N.Y.C.

Ray J. Thomas 846 N. Cahuenga, H'wood, Cal.
 Thomas-Cole 117 W. 48th N.Y.C.
 Thompson 2836 W. Harrison Chicago, Ill.
 Thornwood 11 Charlton N.Y.C.
 Thoroughbred 2429 Hawthorne Ave., Louis-
 ville, Ky.

Three Boys 1270 Ave of Americas, N.Y.C.
 Three Speed 8 E. 48th N.Y.C.
 Three Star 143 W. 51st N.Y.C.
 Thrush 2991 Ingledeale, L.A., Cal.
 Thunder 3013 Wingate, Nashville, Tenn.
 Thunderbird 140 E. 56th N.Y.C.
 Thursday 1619 Broadway N.Y.C.
 Tiara 1650 Broadway N.Y.C.
 Tibor 200 W. 57th N.Y.C.

Tickson 9000 Sunset Blvd, Los Angeles

Toloca 10058 Valley Spring Lane, N. Holly-
 wood, Cal.
 Tomac 200 W 108, N.Y.C.
 Tom Cat P.O. Box 121 Abbeville, Ala.
 Tomahawk 98 Scobey Nashville, Tenn.
 Tomboy Petroleum Center San Antonio, Texas
 Tomkins 1075-5 Lynch Jackson, Miss.
 Tomm 2360 S. Beverly Glen Los Angeles, Cal.
 Tommy 15 W. 84th N.Y.C.
 Tomorrow's 353 E. 50th N.Y.C.
 Tom-Tom Post Office Box 4734 Compton, Cal.
 Tone 511 Fifth N.Y.C.

Tone-Craft 2709 Germantown Phila., Pa.
 Tonecraft 12412 Ventura Blvd, Studio City,
 Calif.

Tonto 11735 Hatteras, N. Hollywood, Calif.
 Toole 500 E. 33 1906 Chicago, Ill.
 Top Flight 3823 Grove Oakland, Cal.
 Top Talent 617 Exchange Building, Nashville
 Top Ten 231 Lincoln New Rochelle, N.Y.
 Topaz 9171 Wilshire Beverly Hills, Cal.
 Topper 6619 Northumberland, Pittsburgh, Pa.
 Tornado 525 W. Vernon Los Angeles, Cal.
 Torpedo 356 40th N.Y.C.

Torrington 88 Water Torrington, Conn.
 Torso 134 W. 58th N.Y.C.
 Toussaint 616 W. 116th N.Y.C.
 Herbert G. Tovey 1619 Broadway, N.Y.C.
 Tower Hill 305 W. 45th N.Y.C.
 Tower 3621 Floral Nashville, Tenn.
 Tower of Gold 2226 N. Alvarado Los Angeles,
 Cal.

Towles 367 E. Paces Ferry Rd., N.E., Atlanta,
 Ga.
 Town and Country 756 Seventh N.Y.C.
 Townsend-Shayne 1619 Broadway N.Y.C.
 Tracey 1451 Madison Memphis, Tenn.
 Trade Mark 4707 Broadway Chicago, Ill.
 Traff 916 Kearny San Francisco, Cal.
 Tragan 6332 Brynhurst Los Angeles, Cal.
 Trail 3921 McComas Fort Worth, Texas
 Trails End 146 7th Ave N., Nashville, Tenn.
 Tramer P.O. Box 5314 San Diego, Cal.
 Tranco 742nd Acwron, Zapata Afsta, Zapata,
 Texas

Trans-America 474 Daniels Beverly Hills, Cal.
 Trans-Music 1619 Broadway N.Y.C.
 Trans-Pacific 1619 Broadway N.Y.C.
 Trans-World 1719 W. End Nashville, Tenn.
 Transglobal 56 West 45th St., N.Y.C.
 Trauma 6122 Delongpre Hollywood, Cal.
 Travis 1556 No. LaBrea, L.A., Cal.
 Traydel 3511 DuPont Ave. Kensington, Md.
 20795

Traymore 1650 Broadway N.Y.C.
 Tredlew 200 W. 57th N.Y.C.
 (Continued on page 202)



I Promised You Records
 I Promised You Pictures
 I Promised You Promos
 and you voted me

"THE MOST PROMISING FEMALE OF THE YEAR"

(Country & Western—1967)

Now I Promise To Do My Best To Make
 Good Country Records

Thanks Fellas
LYNN ANDERSON

Tuneful Twosome

Connie's voice/Bill's music



Two of the top names in country music—Connie Smith and Bill Anderson—get together for this strong album entry which includes Connie's latest hit single "Cincinnati, Ohio" #9214.

LPM/LSP-3768

Exclusive Management:
Charlie Lamb Corporation
P. O. Box 396, Nashville,
Tennessee (615) 298-3348



RCA VICTOR



The most trusted name in sound



THANK YOU

"SWEET THANGS" (D.J.'s)

For Voting Me One Of The

MOST PROMISING

MALE VOCALISTS

(C&W)

1967



NAT STUCKEY

and for your Acceptance
of my latest Paula LP

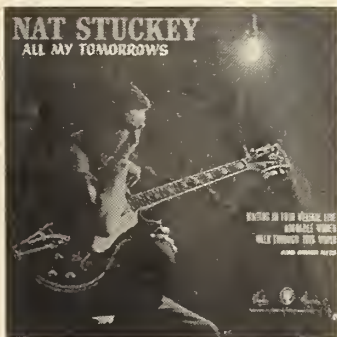

LP 2196

"ALL MY TOMORROWS"

Personal Manager:
FRANK PAGE
Box 271;
Shreveport, Louisiana,
(318) 422-8711



COUNTRY POLL WINNERS

(Continued from page 200)

MOST PROMISING MALE VOCALIST

JACK GREENE—DECCA
NAT STUCKEY—PAULA
WAYLON JENNINGS—RCA VICTOR
Charlie Pride—RCA Victor
Johnny Paycheck—Little Darlin'
Kenny Price—Boone

Johnny Darrell—United Artists
Van Trevor—Band Box
Bobby Wright—Decca
Bobby Lewis—United Artists
Ed Bruce—RCA Victor

MOST PROMISING FEMALE VOCALIST

LYNN ANDERSON—CHART
TAMMY WYNETTE—EPIC
JEANNIE SEELY—MONUMENT
Wilma Burgess—Decca
Lorene Mann—RCA Victor

Dolly Parton—Monument
Kay Adams—Tower
Cheryl Pool—Paula
Donna Fargo—Ramco

MOST PROGRAMMED VOCAL GROUPS

BROWNS—RCA VICTOR
WILBURN BROS.—DECCA
HARDIN TRIO—COLUMBIA
Stonemans—MGM
Statler Bros.—Columbia

Flatt & Scruggs—Columbia
Willis Bros.—Starday
Tompall & Glaser Bros.—MGM
Jim & Jesse—Epic
Carter Family—Columbia
(Continued on page 204)

BMI PUBLISHERS

(Continued from page 200)

Tree 905 16th Ave. So., Nashville, Tenn.
Trianon 3942 Third Detroit, Mich.
Tribute 250 W. 57th N.Y.C.
Tri-City 225 W. 57th N.Y.C.
Trickle 14812 Saticoy Van Nuys, Cal.
Tri-Dec State Bank-Haines City, Fla.
Tridon 237 West 54th St. N.Y.C.
Trigo 244 E. 13 N.Y.C.
Trim 81 Spring Valley Paramus, N.J.
Trinity (see T.M.)
Trio 1619 Broadway N.Y.C.
Tri-Park 101 W. 55th N.Y.C.
Triphi 588 Farnsworth Detroit, Mich.
Triple EEE 1619 Broadway N.Y.C.
Triplet 404 N. Roxbury, Beverly Hills, Cal.
Triple-Tone 1650 Broadway N.Y.C.
Tri-Staff 508 University Fairfax, Va.
Tri-State 1730 Eureka Way Redding, Cal.
Triumph 111 W. 57th N.Y.C.
Triumvirate 812 17 Ave. S., Nashville, Tenn.
Triway 224 N. Canon Beverly Hills, Cal.
Trojan 1356 W. San Madele, Fresno, Cal.
Tronic Box 115 Madison, Tenn.
Trophy 554 Fifth Ave. N.Y.C.
Tropical 2400 N.W. 27 St. Miami, Fla.
Trousdale 40 ABC Records, 1330 Ave. of Americas, N.Y.C.
Trubill 13019 Cordary Hawthorne, Cal.
Truman 65 W. 129th N.Y.C.
Trump 40 W. 55, N.Y.C.
Try Me 200 W. 57, N.Y.C.
Tryton 1650 Broadway N.Y.C.
Tisoris 224 W. 49th N.Y.C.
Ernest Tubb 1619 Broadway N.Y.C.
Tuckahoe P.O. Box 128 Madison, Tenn.
Tudor 1631 Broadway N.Y.C.
Tula 9033 Wilshire Beverly Hills, Cal.
Tulip Time 100 Seventh Pittsburgh, Pa.
Tulsa 747 E. Walnut Pasadena, Cal.
Tune-Art 156 W. 44th N.Y.C.
Tunecrafters 1607 El Centro, Hollywood
Tunetime 1650 Broadway N.Y.C.
Tuneville 3910 Baxter Nashville, Tenn.
Tu-Po 1604 E. 33rd Los Angeles, Cal.
Tupper 20 E. Tupper Buffalo, N.Y.
Turban 255 W. 55th N.Y.C.
Turntable 1697 Broadway N.Y.C.
Turvy 723 7th N.Y.C.
Twenty 420 E. 64th N.Y.C.
Twilight 223 W. 52nd N.Y.C.
Twin 1697 Broadway N.Y.C.
Twin Peaks 2166 Market San Francisco, Cal.
Twin-Star 2862 Horseshoe Drive S.E., Atlanta, Ga.
Twist P.O. Box 2921 Hollywood, Cal.
Two Jays 131 Garden Teaneck, N.J.
Two Minute 2025 N. Allen Altadena, Cal.
Two-Beat 445 Park N.Y.C.
Tybee 100 W. 42nd N.Y.C.
Tycora 134 W. 91, Los Angeles, Cal.
Tymena 430 Pearce Rd., Pittsburgh, Pa.
Typort 3 W. 57th N.Y.C.
Tyrol 1631 Broadway N.Y.C.
Tv-Tex P.O. Box 3321 Tyler, Texas
Uganda 40 W. 55, N.Y.C.
Una 206 1/2 Union Nashville, Tenn.
Unamic P.O. Box 8705 Nashville, Tenn.
Unart 729 7th N.Y.C.
Unbelievable 1650 Broadway N.Y.C.
Underwood 7155 Hawthorne, Hollywood, Cal.
Universal 4403 Sheridan Rd., Chicago, Ill.
Up 639 Madison Memphis, Tenn.
Up Town 1737 W. Monroe Chicago, Ill.
Upa 440 Lakeside Burbank, Cal.
Upam 119 W. 57th N.Y.C.
Up Tight 2109 Lake Ave., Baltimore, Md.
Uptrend 3020 Hollyridge Hollywood, Cal.
Uranus 7th Ave. & 50th St., N.Y.C.

Max Urban 1651 Cosmo Hollywood, Cal.
Urso 882 E. 57th Los Angeles, Cal.
Ursula P.O. Box 522, Salisbury, Md. 21801
V.I.P. P.O. Box 38444 Hollywood, Cal.
Vadim 13141 Oxnard St. Van Nuys, Calif.
Val-Art 1614 N. Cherokee, Hollywood, Cal.
Valbar 1650 Broadway N.Y.C.
Val-Dare 5743 Cahuenga, N. Hollywood, Cal.
Valjean 5136 W. 41 Denver 12, Col.
Valjo (see Lois)
Valley 1619 Broadway N.Y.C.
Valley 1740 Broadway N.Y.C.
Valley 6087 Sunset Hollywood, Cal.
Valleydale 1619 Broadway N.Y.C.
Valtone 910 N. Foothill Rd. Beverly Hills, Cal.
Vamp 963 First National Bldg., Detroit, Mich.
Van Brunt 6330 Sunset Blvd., Hollywood, Cal.
Van Doe 5909 Melrose Hollywood, Cal.
Van Houton 6500 Charlesworth, N. Hollywood
Van Lee 1343 E. Harvard St. Glendale, Cal.
Van Winkle & Darian 1549 N. Vine Hollywood, Cal.
Vanadore 1537 McGavock Pike Nashville Tenn.
Vanguard 6087 Sunset Hollywood, Cal.
Vanjo Box 516 Goodlettsville, Tenn.
Van-Nauert 1620 Margate Rd., Palos Verdes, Cal.
Vantim 4929 Morse Ave, Sherman Oaks, Cal.
Vapac 1829 S. Michigan Chicago, Ill.
Variety 145 Linn Yonkers, N.Y.
Varnes 3547 N. 21st Phila., Pa.
Varsity 2643 South Third Phila., Pa.
Vaughn 1692 Madison Memphis, Tenn.
Stuart Vavrin 2119 W. 54th Chicago, Ill.
Benjamin Veal 4209 Western Los Angeles Cal.
Vector 823 Cammack Court, Nashville, Tenn.
Veda 1724th N.Y.C.
Vedco 2721 A. E. 6th Long Beach, Cal.
Vedel 209 Fourth, W. Hendersonville, N.C.
Vegas 3788 Paradise Rd., Las Vegas, Nev.
Vejac 8462 Sunset, Hollywood, Cal.
Emil Velazco 723 Seventh N.Y.C.
Vellore P.O. Box 38530, Hollywood, Calif.
Venetia 1501 W. Cortland Chicago, Ill.
Venice 8300 Santa Monica Hollywood, Cal.
Verbo 2751 McConnell Los Angeles, Cal.
Vernal 240 Central Park So., N.Y.C.
Vertigo 727 N. Kedzie Chicago, Ill.
Vibra 1036 Hilldale Los Angeles, Cal.
Vicki 850 7th Ave., N.Y.C.
Videorama 156 W. 44th N.Y.C.
Vidor 1001 N. Lincoln Burbank, Cal.
Vier P.O. Box 723 Hollywood, Cal.
View 1570 N. Edgemond Los Angeles, Cal.
Vijay 2215 Edison Detroit, Mich.
Villa 1619 Broadway N.Y.C.
Village 37-11 87th Jackson Heights, N.Y.
Villanova 1619 Broadway N.Y.C.
Vincent 1323 S. Michigan Chicago, Ill.
Peter Vincent 250 N. Canon Beverly Hills.
Vince Rago P.O. Box 691, Wilmington, Del.
Vintage (see combine)
Viola 522 Patterson Nashville, Tenn.
Violet 4411 S. Mettler Los Angeles, Cal.
Vir-Cel 5938 Kimble Ave., Phila., Pa.
Virgo 2586 N. Beachwood Hollywood, Cal.
Viscount 1619 Broadway N.Y.C.
Vision 119 W. 57th N.Y.C.
Vista 1674 Broadway N.Y.C.
Viva 1800 N. Argyle, Hollywood, Cal.
Vir Music 185 N. Wabash Chicago, Ill.
Voca 1650 Broadway N.Y.C.
Vogue 1619 Broadway N.Y.C.
Vokes, P.O. Box 1203, New Kensington, Pa.
Vol 920 Sutton Hill Rd., Nashville, Tenn.
Volo 1650 Broadway N.Y.C.
Voltage 8230 Hollywood, Hollywood, Cal.
(Continued on page 204)

Constantly Voted #1 Girl Singer 1966-1967 (Cash Box D.J. Survey)



LORETTA LYNN

STEREO

YOU AIN'T WOMAN ENOUGH - LORETTA LYNN



**#1 MOST PROGRAMMED
ALBUM 1967**
CASH BOX D. J. SURVEY

STEREO



**ERNEST
TUBB and
LORETTA
LYNN
SINGIN'
AGAIN**

HER CURRENT HIT ALBUM



Direction: SMILEY WILSON / **THE WIL-HELM AGENCY**, 801 16th Avenue South, Nashville, Tennessee (615) 244-1403

BMI PUBLISHERS

(Continued from page 202)

Volunteer 56 Ferry Newark, N.J.
 Vondart 887 Chatwood Memphis, Tenn.
 Vonglo 1674 Broadway, N.Y.C.
 Vulcan 96 Ferry N.Y.C.

W. W. 11360 Dona Dorotea, Studio City, Cal.
 Wabbit 5880 Hollywood, Hollywood, Cal.
 Wade 20 Beekman N.Y.C.
 Wajoma 157 W. 57th N.Y.C.
 Wakabe 271 Madison N.Y.C.
 Walaine 8912 Firestone Plaza Los Angeles.
 Walbridge 154 W. 57th N.Y.C.
 Harold Wald 146 W. 54th N.Y.C.
 Ed Waller 13603 S. Avalon Los Angeles, Cal.
 Wallis 4450 N. Jefferson Miami Beach, Fla.
 Walnut 148 W. 125th N.Y.C.
 Wal-rich 3351 W. 43rd Pl. Los Angeles, Cal.
 Wanda 429 W. Hortter, Phila., Pa.
 Wanellen 850 7 Ave. N.Y.C.
 Wanessa 154 W. 54th N.Y.C.
 Ward & Sears 1790 Broadway N.Y.C.
 Billy Ward 6000 Sunset Hollywood, Cal.
 Clara Ward 3800 N. 18th Phila., Pa.
 Jay Ward 8218 Sunset Los Angeles, Cal.
 Warden Box 8061 Nashville, Tenn.
 Ward-Marks 1258 N. La Brea Hollywood, Cal.
 Ware's 6112 Selma Hollywood, Cal.
 Warren 349 E. 49th N.Y.C.
 Warwood, 2712 Dickerson Road, Nashville
 Waterfall 1208 Lee Ave., Morristown, Tenn.
 Waymore 1619 Broadway N.Y.C.
 Roger Wayne 1650 Broadway N.Y.C.
 Wee Dee Box 337, Wooster, Ohio
 We Three 1650 Broadway, N.Y.C.
 Web IV 1650 Broadway, N.Y.C.
 Weddington 14707 McCormick Van Nuys, Cal.
 Wedlaw 5606 Beer Ave, Los Angeles
 Weger 1650 Broadway N.Y.C.
 Weiss & Barry 1556 N. La Brea Hollywood.
 Nathan Weiss 1501 B'way, N.Y.C.
 Welcome Music 31 W. 54th N.Y.C.
 Welden and Weiss 8833 Sunset Blvd., L.A.
 Welland 6311 Yucca St, Hollywood
 Wellesley 1050 Fifth Ave, N.Y.C.
 Maurice O. Wells 3816 N. Clark Chicago, Ill.
 Welton Music 2847 Effie Los Angeles, Cal.
 Wemar 1619 Broadway N.Y.C.
 Wendell 9229 Sunset Blvd, Los Angeles
 Wensley 3 Wensley Ave, Great Neck, N.Y.
 Werber 608 Fifth Ave. N.Y.C.
 Bobe Wes 4542 Live Oak Mesquite, Tex.
 Weslu 1650 B'way, N.Y.C.
 West Coast 340 N. Camden Beverly Hills, Cal.
 Ted West 2809 W. Linden Nashville, Tenn.
 Westbury 2 W. 45th N.Y.C.
 Westex Box 6406, Odessa, Tex.
 Westfield 10859 Landale, N. Hollywood, Cal.
 Westgate 9350 Wilshire Blvd. Beverly Hills.
 West-Higgins 2930 Boston Detroit, Mich.
 Westlake 7190 Sunset Los Angeles, Cal.
 Westside 729 Seventh N.Y.C.
 Westwall Box 115 Madison, Tenn.
 Westwind 8510 Sunset Hollywood, Cal.
 Wheel of Fortune 6100 Afton Hollywood, Cal.
 Whimsy Box 1415 Hollywood, Cal.
 White Castle 1650 Broadway N.Y.C.
 Elmore White 1650 Broadway N.Y.C.
 Mack White 1026 Market San Francisco, Cal.

Whiteman 1520 N. Hayworth, Hollywood, Cal.
 Wian 511 Fifth N.Y.C.
 Wil 14318 Wilfred Detroit, Mich.
 Wilberton 203 W. 126th N.Y.C.
 Wilbur's 55 W. 19th N.Y.C.
 Wildcat 1619 Broadway N.Y.C.
 Wilderness 913-17th Ave, So. Nashville
 Wildon 2 Park N.Y.C.
 Wildrick & Miller 630 Fifth N.Y.C.
 Wildwood 30 W. 60th N.Y.C.
 Wiley 1650 Broadway N.Y.C.
 Wilkay 1650 Broadway N.Y.C.
 Slim Willet 9109 Sunset Hollywood, Cal.
 Dootsie Williams 9512 S. Central Los Angeles.
 Kae Williams 3214 W. York, Phila, Pa.
 Williams 46 E. Walton Chicago, Ill.
 Ralph Williams 203 N. Wabash Chicago, Ill.
 Richard M. Williams 4532 Cimarron L.A.
 Willin 553 W. 51st N.Y.C.
 Willis-Woodward (E. B. Marks)
 Willstar 521 East Fifth St., # 18, N.Y.C.
 Wilshire 10558 Lauriston W. Los Angeles, Cal.
 Wincop P.O. Box 972 Hollywood, Cal.
 Window 720 17th Ave. S., Nashville, Tenn.
 Wine & Roses 3529 Silsby Rd., Cleveland, O.
 44118
 Wing Ding 1650 Broadway N.Y.C.
 Winlyn 200 W. 57th N.Y.C.
 Winneton 1619 Broadway N.Y.C.
 Winona Box 7256, Nashville
 Winsor 1220 N. Gardner Hollywood, Cal.
 Winter 1650 Broadway N.Y.C.
 Wise-O-Man P.O. Box 7006 Nashville, Tenn.
 Wistadala 1546 29th Phila., Pa.
 Wisto (see Lois)
 Milton G. Wolf 25 E. Jackson Chicago, Ill.
 Wolverine Box 5054 Detroit, Mich.
 Wonderland 500 S. Buena Vista Burbank, Cal.
 Woodbury 6087 Sunset Hollywood, Cal.
 Woodman 2077 S. Harvard Los Angeles, Cal.
 Woodstock 1697 Broadway N.Y.C.
 Woolf 13304 S. Norfolk Detroit, Mich.
 Woolcott 8448 Ridpath Los Angeles, Cal.
 Worart 550 Grant St., Pittsburgh, Pa.
 Wormwood 812 17th Ave. S., Nashville, Tenn.
 Wow 505 E. 87th N.Y.C.
 Wrath 270 N. Canon Beverly Hills, Cal.
 Wren 715 E. 111th Pl. Los Angeles, Cal.
 Mac Wright 200 W. 57th N.Y.C.
 Peter Wright 143 W. 54th Los Angeles, Cal.
 Wright-Gerstl 7118 Coldwater Canyon, N. Hol-
 lywood, Cal.
 Wrist 8215 Romaine Los Angeles, Cal.
 Wyndham 200 W. 57th N.Y.C.
 Wynmar 114 W. 70th N.Y.C.
 Wynne 1619 Broadway N.Y.C.

The X Plus Y 271 W. 125th N.Y.C.
 X-L 607 S. Commonwealth Los Angeles, Cal.
 Xenophon 4264 S. Central Los Angeles, Cal.

Yanden 3494 Obion Dr., Memphis
 Yeldem 6359 Selma Ave., Hollywood, Cal.
 90028
 Yellow Sand 3852 N Euclid Tucson, Ariz.
 Yenom 1781 Hauser Blvd, Los Angeles, Calif.
 Yonah P.O. Box 425 Louisville, Ga.
 Bob Yorey, c/o Universal Attractions, 200 W.
 57, N.Y.C.



COUNTRY POLL WINNERS

(Continued from page 202)

MOST PROGRAMMED INSTRUMENTALISTS

CHET ATKINS—RCA VICTOR	Joe Maphis—Mosrite
FLOYD CRAMER—RCA VICTOR	Del Wood—Columbia
ROY CLARK—CAPITOL	Merle Travis—Capitol
Pete Drake—Smash	Lloyd Green—Little Darlin'
Boots Randolph—Monument	Bill Monroe—Decca
Jimmie Bryant—Imperial	

MOST PROGRAMMED ORCHESTRAS

BUCKAROOS—CAPITOL	Flatt & Scruggs—Columbia
HANK THOMPSON'S BRAZOS	Wagonmasters—RCA Victor
VALLEY BOYS—WARNER BROS.	Blue Boys—RCA Victor
TEXAS TROUBADORS—DECCA	Jones Boys—Musicor
Leon McAuliffe's Cimarron Boys— Capitol	Texas Playboys—Kapp

MOST PROMISING INSTRUMENTALIST

LOYD GREEN—LITTLE DARLIN'	Curly Chalker—
JIMMIE BRYANT—IMPERIAL	Glen Campbell—Capitol
JERRY REED—RCA VICTOR	Larry Butler—
Jerry Smith—	Weldon Myrick—RCA Victor
Phil Baugh—Longhorn	

Young Peoples 100 Sixth N.Y.C.	Zayo P.O. Box 1173 Hollywood, Cal.
Yucca 8134 S. Alameda Los Angeles, Cal.	Zelda 335 W. 78th N.Y.C.
Yuki 4182 Farndale, N. Hollywood, Cal.	Ze-rott 114-17 145 St., Ozon Park, N.Y.
Yvonne 9328 S. Parnell Chicago, Ill.	Bob Zieff 2477 Cheremoy Hollywood, Cal.
	Zim Music 236 W. 55th N.Y.C.
Z-12 5211 Santa Monica Hollywood, Cal.	Zira c/o I. La Charles Harper, P.O. Box 53, Manhattanville P.O., N.Y.
Zarak 501 E. 32 St., Chicago, Ill.	Zodiac 1733 Broadway N.Y.C.
Zarpac 11680 Pendleton Sun Valley, Cal.	Zondervan Music 1619 Broadway N.Y.C.
Zarr 1674 Broadway N.Y.C.	Zordun Music Co. 52 St. Nicholas, N.Y.C.
Zawinul 382 Central Pk West, N.Y.C.	

THANK
YOU



Management:
 Mrs. Earl Scruggs
 201 Donna Drive
 Madison, Tennessee
 Phone 615-895-2254

FLATT & SCRUGGS



LATEST
 ALBUM
 CL 2643
 CS 9443



PUBLISHED BY: NEWKEYS MUSIC, INC.



Floyd Cramer

PLAYS HITS



Current Hit Single:
"THEME FOR SAM"
 From the Movie **"GUN"**
 RCA 9237

LPM-2883

anywhere there's music, you'll
 find **ACUFF-ROSE** and its
 affiliated companies

ENGLAND



ACUFF-ROSE MUSIC, LTD.
 London, England

AUSTRALIA



ACUFF-ROSE PUBLICATIONS PTY. LTD.
 Melbourne, Australia

GERMANY



ACUFF-ROSE MUSIKVERLAGE K. G.
 Munich, Germany

SWITZERLAND

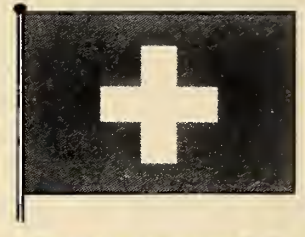

ACUFF-ROSE VERLAG A. G.
 Zurich, Switzerland

DENMARK

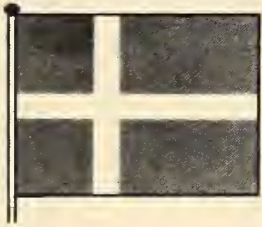

ACUFF-ROSE SCANDIA
 Copenhagen V. Denmark

UNITED STATES

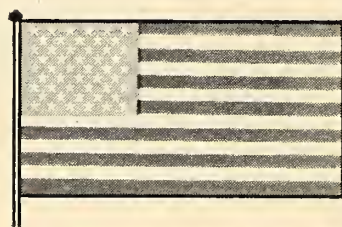

ACUFF-ROSE FAR EAST
 Nashville, Tennessee

SOUTH AFRICA



ACUFF-ROSE (S.A.) (Pty.) LTD.
 Johannesburg, South Africa

SPAIN



EDICIONES HISPAVOX
 Madrid, Spain

BELGIUM



EDITIONS ACUFF-ROSE BENELUX
 Brussels, Belgium

ARGENTINA



EDITORIAL JULIO KORN
 Buenos Aires, Argentina

ITALY



EDIZIONI ACUFF-ROSE S.r.l.
 Milan, Italy

BRAZIL

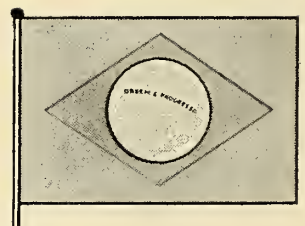

IRMAOS VITALE S.A.
 Sao Paulo, Brazil

FRANCE

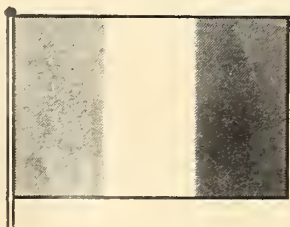

EDITIONS ACUFF-ROSE FRANCE
 Paris, France

JAPAN

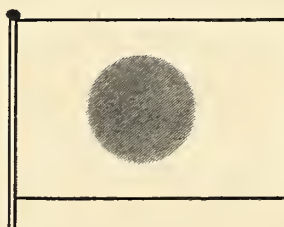

SHINKO MUSIC PUB. CO., LTD.
 Tokyo, Japan

ISRAEL



SUBAR MUSIC PUBLISHING CO.
 Ramath-Hasharon, Israel

UNITED STATES

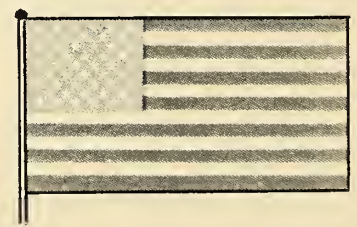

ACUFF-ROSE PUBLICATIONS, INC.
 Nashville, Tennessee



ANNUAL
World Wide
DIRECTORY

25th Anniversary Edition

1967-1968

INTERNATIONAL SECTION

*Day after day,
record men everywhere
are profiting from
Philips' experience*

ARE YOU ?

When the Philips trademark was first put on a record label, it already stood for decades of world-wide experience. This experience—in the field of sound as in many others—can be put at your disposal if you want records pressed, packaged, promoted or distributed. Whenever you have a sound to sell, Philips are the people to see.

EUROPE

AUSTRIA

Polyphon Schallplatten G.m.b.H.
Mariahilferstrasse 127
Vienna 6

BELGIUM

N.V. Polygram
Anderlechtstraat 37
Brussels

CYPRUS

Messrs. D. Ouzounian
M. Soutanian & Co.
P.O. Box 1775
Nicosia

DENMARK

Nordisk Polyphon AS
Empdrupvej 115
Copenhagen

FINLAND

Oy Finnlevy ab
P.O. Box 10 584
Helsinki

Fintone Oy

Munkisaarenkatu 2
Helsinki

FRANCE

Société Phonographique Philips
Rue Jenner 6-8
Paris, 13e

GERMANY

Philips Ton Gesellschaft G.m.b.H.
Mönckebergstrasse 7
Hamburg 1

**GREAT BRITAIN and
NORTHERN IRELAND**

Philips Record Ltd.
Stanhope House
Stanhope Place
London W. 2

GREECE

Helladisc S.A.
8, Hermes Street
Athens

ICELAND

Stál Ltd.
P.O. Box 737
Reykjavik

IRELAND

Irish Record Factors
34 Parnell Square, West
Dublin

ITALY

Phonogram S.p.A.
14, Via Benadir
Milan

THE NETHERLANDS

N.V. Phonogram
Singel 170-172
Amsterdam

NORWAY

Norsk Phonogram A/S
Kirkeveien 64 IV
Oslo 3

PORTUGAL

Philips Portuguesa S.A.R.L.
Rua Joaquim Antonio de Aguiar 66
Lisbon

SPAIN

Fonogram S.A.
Paseo de las Delicias 76
Madrid

SWEDEN

A.B. Philips Sonora
Postbox 5153
Stockholm

SWITZERLAND

Philips AG
Edenstrasse 20
Zürich

TURKEY

Grünberg Ticaret A.S.
P.O. Box 533
Istanbul

NORTH AMERICA

CANADA

London Records of Canada Ltd.
190, Graveline Street
St. Laurent P.O.

U.S.A.

Philips Records
35, East Wacker Drive
Chicago, 1, Illinois - 60601

CENTRAL AMERICA

BARBADOS

West Indies Records (Barbados) Ltd.
P.O. Box 176
Bridgetown

COSTA RICA

Indica
Industria de Discos Centroamericana
Apartado 4093
San José

GUATEMALA

Dideca
Discos de Centroamerica
Apartado Postal 1792
Ciudad de Guatemala

JAMAICA

Sound, Tape and Records Ltd.
Orange Street at Eve Lane
Kingston

MEXICO

Dusa Discos Universales S.A.
Rio Tiber 58
Mexico, 5 D.F.

NETHERLANDS ANTILLES

Philips Antillana N.V.
P.O. Box 523
Willemstad - Curaçao

PANAMA

Messrs. Internacional S.A.
P.O. Box 417
Colon

SURINAME

C. Kersten & Co. N.V.
P.O. Box 1808
Paramaribo

SOUTH AMERICA

ARGENTINA

Phonogram S.A.I.C.
Córdoba 1351 - 9 piso
Buenos Aires

BOLIVIA

Philips Sudamericana S.A.
Cajon Postal 2964
La Paz

BRAZIL

Companhia Brasileira de Discos
Caixa Postal no. 93
Rio de Janeiro

CHILE

Philips Chilena
Avda Santa Maria 0760
Casilla 2687
Santiago de Chile

COLUMBIA

Philips Colombiana S.a.
Division Discos
Apartado Aéreo 4282
Bogota

ECUADOR

Philips Ecuador
Casilla 343
Quito



PARAGUAY
Philips del Paraguay S.A.
Casilla Correo 605
Asunción

PERU
„El Virrey” Industrias Musicales S.A.
Casilla no. 6191
Lima

URUGUAY
Philips del Uruguay S.A.
Avenida Uruguay 1287
Montevideo

VENEZUELA
Siemens Venezolana S.A.
Apartado Postal 3616
Caracas

MIDDLE EAST

THE HASJEMITE KINGDOM OF JORDAN
Transjordan Engineering Co. Ltd.
P.O. Box 1
Amman

ADEN
Messrs. Besse & Co. (Aden) Ltd.

ARABIA
Messrs. Yusuf A. Alghanim
P.O. Box 223
Kuwait

SAUDI ARABIA
Messrs. A. Rajab & A. Silsilah
P.O. Box 203
Jeddah

SYRIA
Ets. Chanine & Fils
Rue du Parlement
Damas

FAR EAST

CEYLON
Messrs. Maurice Roche Ltd.
P.O. Box 61
Colombo

HONG KONG
Messrs. Moutrie & Co. Ltd.
Alexandra House
7, Des Voeux Road C.

INDIA
Philips India Ltd.
Philips House
7, Justice Chandra Madhab Road
Calcutta 20

JAPAN
PHILIPS RECORDS LTD.
Kotani Building 6th Floor
1-4 Yurakucho, chiyoda -ku
Tokyo

PHILIPPINES
Home Industries Inc.
P.O. Box 170
Quezon City

SINGAPORE
Phonogram Far East
P.O. Box 1117
Singapore 9

THAILAND
Philips Electrical Co.
of Thailand Ltd.
282, Silom Road
Bangkok

VIETNAM
Messrs. Tan Viet-Nam Thuong-Xa
183, Rue Tu Do
Saigon

AFRICA

CONGO
Philips Congo S.C.R.L.
137, Boulevard du 30 Juin
P.O. Box 1798
Leopoldville

EAST AFRICA
Associated Sound
(East Africa) Ltd.
P.O. Box 3695
Nairobi

ETHIOPIA
Philips Ethiopia
(Priv. Ltd. Co.)
P.O. Box 659
Addis Abeba

GHANA
Messrs.
Philips (Ghana) Ltd.
P.O. Box M 14
Accra

LIBERIA
Messrs. Oost. Afrikaanse Compagnie
P.O. Box 281
Monrovia

LIBYA
Messrs. W. Buzaeik Radio House
P.O. Box 156
Benghazi

NIGERIA
Philips (West African) Records Ltd.
P.O. Box 2997
Lagos

SIERRA LEONE
Messrs. Freetown Cold Storage Ltd.
P.O. Box 99
Freetown

SOUTH AFRICA
Trutone (Pty) Ltd.
P.O. Box 9299
Johannesburg
Ophirton

SUDAN
Messrs. Electrohouse
P.O. Box 823
Khartoum

OCEANIA

AUSTRALIA
Philips Electrical
Industries Pty. Ltd.
Philips House
Box 2703, G.P.O.
Sydney

NEW ZEALAND
Philips Records
(New Zealand) Ltd.
Philips House
P.O. Box 3517
Wellington



Address all general enquiries to Philips' Phonographic Industries Central Offices: Baarn, The Netherlands



PHILIPS GROUP RECORDS (London)

are not happy
just making all the
big waves on the
pop music scene.

NOW they're setting
the pace with
musicassettes, too.



PHILIPS



Artistes include:— John Walker · Scott Walker · Harry Secombe · Dusty Springfield · Robert Farnon & his Orchestra · The Four Pennies · Errol Garner · The Modern Jazz Quartet · The Spencer Davis Group · Dave Dee, Dozy, Beaky, Mick & Tich · Wayne Fontana · Manfred Mann · Julie Felix · Julie Rogers · New Vaudeville Band · The Mindbenders and many, many others.

Philips Records Limited, Stanhope House, Stanhope Place, London W.2.

GREAT BRITAIN—THE PAST 12 MONTHS

During its 25 years' existence, *Cash Box*—like the music industry it serves—has grown from strength to strength, and many changes and advances have been made.

Nowhere have the changes been more sweeping than in the international field, which *Cash Box* entered in 1959. The timing was right. *Cash Box*, and the music industry in Britain and in Europe, was raring to go—able and willing to experiment and expand. Much has been achieved in the ensuing years. The countries of Europe, far from losing their individuality, have preserved and protected it. By creating their own artists and sounds, they have contributed much to the previously American-dominated scene.

All in all, the first half of the decade has seen a tremendous advance internationally, thus bringing nearer and nearer the realization of a "one world concept." Few will deny that Britain and The Beatles will go down in history as the trend-setters of the sixties—leading and revolutionizing the musical world over the past five years. However, as the hysteria of Beatlemania dies away, and the group scene begins to fade, the time is ripe to take a general look at the British market as it is today.

Dramatic Changes

The shape of Britain's record industry is changing dramatically as the second half of the decade develops. At every level there are signs of new techniques, new personalities, new processes and, not least, new major manufacturing forces.

EMI and Decca continue to control the largest shares of the market, but their pre-eminent positions are slowly decreasing. First it was Philips Records and then Pye Records that became substantial rivals. CBS, after purchasing Oriole, launched its own British operation two years ago. Though its progress—particularly in the areas of chart records has been slower than many industry personalities expected, its vast American catalogues of classical and show material, plus such world "greats" as Andy Williams and Tony Bennett, have brought it far more business than the hit parade would suggest.

Label Standings

Despite an expensive excursion into the British talent market by securing Georgie Fame, it has been the recent success of the Tremeloes, four years on the scene as a backing group, which has brought CBS its first real singles chart excitement. This, coupled with the British original cast album of "Fiddler on the Roof", has created the sales impact which the business expected CBS to generate.

More spectacular has been the recent emergence of Polydor, the British arm of the German giant Deutsche Grammophon. For some years, its great classical catalogue had given the firm a small but respected place on the British market. Two years ago a decision was made to widen the scope of the British operation. Roland Rennie was brought back from New York as its head. It has now been set up as a widely-based operation involved in every field of record activity.

A great part of Polydor's success has been due to the acquisition of the Atlantic line. This coincided with a great awakening interest in soul music, which also showed in EMI's great success with the Tamla-Motown catalogues.

Although continuing within the terms of its licensing deal with Decca, RCA has expanded its own interests substantially. It now has a record operation in miniature functioning in the creative and marketing areas backing Decca's efforts and paving the way for possible new forms of trading on the British market.

The second half of 1967 sees the launching of independent marketing operations by both Liberty and MGM,

who had previously licensed through EMI. Disney broke away similarly at the turn of the year.

Coupled with these manufacturer-licensee upheavals, have been the emergence of successful independent labels, breaking the long-held belief that individuals could not compete in this area in Britain. The Andrew Oldham/Tony Calder Immediate operation, now nearly two years old, repeatedly makes its presence felt. So does Chris Blackwell's Island Records. Dick James and Larry Page have successfully launched Page One, and Robert Stigwood the Reaction label. Latest in the line is Phil Solomon's Major-Minor Records and Kit Lambert and Chris Stamp's Track label.

While all these changes have been vastly increasing the competition among manufacturers, there have been even bigger and more fundamental marketing changes. Until the summer of 1966, dealers had a vast choice of source of supply at distributor level. For many years both EMI and Decca were supplying dealers with not only each other's product, but that of other manufacturers, too.

Pye had pioneered direct distribution of much of its product, and in 1965 Philips decided that it would supply its whole range direct. EMI and Decca followed last summer, ending a vast area of wasteful competition. CBS chose to use EMI's distribution, and Polydor shared Philips'. Most independents aligned with one or the other of the majors, often supplementing them by using the remaining handful of independent wholesalers whose main business remained specialist lines.

At the same time, most majors reinstated applying surcharges to small orders to meet fast-rising distribution costs. This placed a greater onus on to record dealers to maintain closer stock control.

With returns generally limited to five per cent of turnover, careful ordering became more essential than ever. Tax, which was raised from 25% to 27½% of wholesale price, had to be paid by the dealer on delivery and also inhibited over-ordering.

Stocking Problem

All sections of the industry have been looking at this stocking problem. Manufacturers want the greater part of their catalogues in the shops. Retailers, though more heavily penalized than ever before for over-stocking, still want to be able to supply from their shelves. Greatest hope lies in the elimination of the need to stock both stereo and mono LPs. Over the year, it has become accepted that there is no possibility of a compatible disk. Therefore, the standard disk must become the stereo one. Britain has been slow to adapt the stereo concept, even though disks are sold for the same price as mono. The problem has been to convince the equipment industry that it should make pick-ups suitable for stereo disks, even on otherwise mono equipment. This is gradually becoming a reality. In the past year both Pye and the Saga budget line experimented with stereo-only releases and abandoned them. Philips and Polydor have had some success with limited releases. The biggest lead came this summer from EMI, which has decided, with the knowledge that some sales may be lost temporarily, though not it expects, in the long term, to issue classical releases in stereo only. It is felt that classical buyers are likely to have the best playback equipment, even if mono-only. If successful, this move will have wide-reaching effects on production and distribution as well as stocking at both manufacturer and retailer level. However, Britain's manufacturers rely extensively on export sales (about 15 per cent in 1966) and mono pressings may have to continue for some time to meet demands of

slower developing overseas countries and the territories where stereo brings a premium.

Price Maintenance

As it adjusts to these changes and opportunities, the British industry is faced with the possible end of fixed retail prices. Price maintenance as such, has already been abolished, but a special case can be made out for continuance by application to the High Court. The record industry has taken that course, but until the case is heard—perhaps late in 1968—it is able to maintain fixed prices. The case is being led by EMI and Decca, with support from Philips and Pye. Saga is making its own application.

There is considerable hope that a case will be established following the precedent set by the book trade, with which the record industry has many similarities, including the creative, manufacturing, distributing, marketing and retailing functions.

These fundamental changes have been taking place in a period of general economic depression, brought about by the national balance of payment crisis of 1964, and the stringent measure taken by the Government in the summer of 1966 to counter it.

These included both a prices and wages freeze, and the imposition of a selective employment tax, which, though benefiting manufacturing enterprises, has penalized the vast majority of the industry. It has been a severe handicap to retailers, particularly those relying on part-time staff.

While increasing costs, these economic measures have undoubtedly lessened consumer demand. Capital equipment sales were badly hit, but record sales have been hurt too. On the first half year's performance it seems unlikely that the 1967 figures will be maintained.

Manufacturer sales to the home market reached a peak of \$63 million in 1964. This was on the crest of the boom instituted by the Beatles. As production dropped back, it was felt that domestic demand was adjusting to a more normal level. The 1966 home sales reached almost \$60 million, which was 11% ahead of 1963, and 2.8 times that of ten years earlier.

Exports worth 10.5 million in 1966 were the highest ever recorded. The previous peak was \$10.2 million of 1957 after which they fell to a low of \$7.5 million in 1961 and have since been steadily climbing back.

Although the total number of disks produced by manufacturers, 84.9 million, showed a substantial drop compared with the 93.7 million of 1965, and the peak 101.3 million of 1964, it was in a large degree made up by LP production which reached an all-time high of 33.3 million. Album production is growing rapidly, being double that of 1960 and nearly triple that of 1956.

British manufacturers continue to produce a small number of 78s (400,000 in 1966). These are virtually all for export, mainly to Africa and Asia. Taking production of 78s and 45s together (51.6 million in 1966) this section of the market is at about the level of ten years ago in unit turnover.

The EP, which though never a big item, had been responsible for a substantial amount of turnover, has virtually died away. Its death was hastened by the introduction in 1965 of budget albums selling at about \$1.75 (almost the same as EPs) by EMI, Pye and Philips who joined such budget manufacturers as Saga and Pickwick. The budget album is now accepted as part of the British record business. Many dealers stock them, although most lines are racked, usually by the manufacturer.

One of the more controversial changes of the year was EMI's decision to introduce a full-price racking operation. This began with a handful of outlets in the fall of 1966. Although it has been expanded now, it is still regarded as an experimental

operation. It introduced for the first time in Britain, heat-shrunk film wrapping of records.

In the classical field, the revival in interest of baroque music has continued, and Decca has imported from Teldec, Germany, a notable series "Das Alte Werk". Decca has also finished its recording of "The Ring" cycle. EMI is placing great faith in its recording of a new pianist, Daniel Barenboim.

Classical recordings have greatly increased their share of the market according to many industry figures, but the basis of the record business remains in the "pop" and popular fields.

The "pop" market is undoubtedly handicapped by the lack of suitable exposure media. The TV miming ban sponsored by the Musicians' Union in the summer of 1966 had the effect of enormously increasing the budgets of television beat show productions. Only the larger stations could afford to continue and most of these cut back. For most of this year there has not been a program on network featuring new records.

Pirate Broadcasters

The pirate broadcasters face the threat of elimination by the Government. Legislation before Parliament will make it difficult for them to continue. The shipborne stations in particular, feel it will be possible although they will have to go outside Britain for support and sustenance.

Though most industry leaders feel that the pirates have helped reduce singles sales, the offshore broadcasters have undoubtedly been a big influence in the introduction and development of new artists. Most of the stations operate on a playlist formula. This year it became possible for time to be bought on Radio Caroline for the promotion of disks outside the station's playlist. The pirate broadcasters have undoubtedly won themselves big audiences. The Government has authorized the BBC to begin a new radio network which will carry a national pop music program. This will start in the autumn, and will cover most of the country from the outset.

However, the BBC's contract with the record companies both limits the amount of time given to airplay of disks and the frequency of broadcasting of an individual disk. So Top 40 broadcasting, as developed in America and used by several of the pirate broadcasters, will not be possible. Most of the air time will have to be filled by live broadcasts by pop artists and groups, dancebands and orchestras, presented in a disk jockey format. This technique has been thoroughly developed by the BBC which increasingly subjected it to scientific audience research and application.

Little of the broadcasting is truly "live"—most of it is pre-recorded and the opportunity is usually taken for a second take if the artist or producer is dissatisfied with the sound obtained. So there is opportunity for disk promotion without disk play by local artists. It will become even more important for the successful introduction of American artists for them to visit this country for in-person promotion, to take advantage of this type of broadcasting as well as television and club and theatre dates which may be available.

Cassettes

The biggest technical innovation of the year has undoubtedly been the introduction by Philips of the Musicassettes. After two years' experience on the continent, the system was launched here last fall with what was probably the biggest marketing campaign ever mounted for a record project in this country.

The launch began with stereo cassettes. As they are suitable for play-

(Continued on page 8)

ELECTRIC & MUSICAL
INDUSTRIES LTD



Aucune autre société de disques ne peut se vanter d'un marché mondial aussi étendu que EMI. Das internationale Netz umfasst alle Sparten der Schallplatten-Industrie. Dalla fabbricazione e l'incisione al "marketing", la pubblicità e la promozione di artisti. Deze catalogus bevat een bijzonder groot gedeelte van wereldberoemde klassieke en "Pop" artiesten. Ella posee muchas de las marcas más famosas en el mundo del disco. De njuter av verkligt internationellt utbyte av skiv-nyheter on information.

同社は有望な音楽家の録音、接待ならびに促進をする設備をいたる所に持っています。 اہم خوردہ فروش اداروں کے ساتھ ان کے بیے مثل رابطے بھی قائم ہیں - تمام دنیا میں ریکارڈ کے بڑے بڑے

which, translated into plain English or, if you prefer it—American—means EMI is the most international of all Record organisations. Whether it be Manufacturing, Recording, Marketing or Selling—you will find EMI at the top of the Record business everywhere from Tonga to Timbuktu—from Alice to Albuquerque.



THE GREATEST RECORDING ORGANISATION IN THE WORLD

E. M. I. LTD. HAYES - MIDDLESEX - ENGLAND.

GREAT BRITAIN—THE PAST 12 MONTHS

(Continued from page 5)

back with mono equipment, they became the first true compatible sound carriers yet seen in this country. Early this year, Philips' London duplicating plant came fully into production.

The economic recession handicapped sales of equipment but the concept is already widely accepted. CBS and Pye assigned both their catalogue and licensed repertoires to Philips for distribution. EMI and Polydor are marketing their own musicassettes. Several independent labels, including Immediate and Page One, have also arranged for their repertoire to be available on musicassettes.

The only major firm not active in marketing the concept is Decca, which has always avoided becoming involved in tape records in this country, although its repertoire is available in tape form in the U.S. and many other countries.

There has now been some activity by RCA, Muntz and ITCC preparatory to launching the cartridge systems here, but so far there has been no substantial campaign. So much for the general scene, now let's examine more closely the activities of Britain's record companies and music publishers over the past twelve months.

RECORD COMPANIES

EMI

For EMI, one of the major events of the year under review, came at the very beginning, when in July 1966 the company commenced sole distribution for its own labels, and those it represents in the United Kingdom. The results have brought a better control over promotional and advertising activities from factory to consumer. It also enabled the sales force to devote all their energy to the EMI lines, and to speed up delivery which has benefited the dealer by faster turnover of stock.

Overall, U.K. and Northern Ireland distribution is now undertaken from three major depots—Hayes, Manchester and Belfast. At the beginning of 1965, the company's interim report for the half year ending 31st December 1966 announced group profits before taxation of £5,767,000 as against £7,307,000 for the same period the previous year. During the half year, 65% of the profits before tax were earned by EMI's overseas companies, compared with 75% for the corresponding period in 1965.

A successful year is assured, due to the hits by The Seekers, Vince Hill, Lulu, Cliff Richard, The Hollies, Cilla Black, The Easybeats, Herman's Hermits, Rolf Harris, Ken Dodd, and of course, bringing this year to an exciting climax, The Beatles burst on the scene again with their latest album, "Sargeant Pepper's Lonely Hearts Club Band". The album sold 130,000 in its first day on release, excluding export orders. During the year, the Beatles also renewed their contract with EMI for a further nine years.

The year has been notable for EMI chart successes, with many American artists including the final tremendous breakthrough of the Tamla-Motown sound. Palpable hits were scored by The Four Tops, The Supremes, The Temptations, Jimmy Ruffin, and Marvin Gay and Kim Weston.

Other Americans to do well in the singles charts were Gene Pitney, Lee Dorsey and the Royal Guardsmen. In the album field, one of the year's biggest hits was the "Zivago" sound track LP, selling around 70,000 copies. Amongst the many artists who enjoyed LP chart entries during the year were The Beach Boys, The Beatles, Georgie Fame, The Seekers, Cliff Richard and The Four Tops.

New talents to emerge during 1966/67 included The Pink Floyd with "Arnold Laine", Jeff Beck with "Hi

Ho Silver Lining", Australian group The Easybeats with "Friday On My Mind" which was also a resounding hit in the United States. New signings included Billy Fury and Kathy Kirby, both ex Decca, Lulu ex Decca, who went straight into the charts with "The Boat that I Row".

In the classical field, turnover to June 1967 showed an increase of approximately 8% on the same period last year. Highlights of the year's classical sales included Klemperer's "Missa Solemnis", an album of popular Sibelius works conducted by Sir John Barabroli, and an album by the Menuhin family of "Mozart's Triple Concerto". Another good classical seller was Mahler's "Song of the Earth" which sold 5,500 copies within three months of release, the album conducted by Klemperer. Another outstanding record was Sir Adrian Boult's recording of Holst's "Planets" selling 4,300 in its first month. Another highlight was the Gerald Moore "Farewell Concert" at the Festival Hall.

Major classical signings of the year included soprano Janet Baker, pianist Daniel Barenboim, and cellist Jacqueline du Prez.

Breaking through the sound barrier, EMI announced that as from 1st July new classical albums would be issued in stereo only, thus becoming the first British company to follow the trend already set by Germany and Scandinavia.

New labels acquired during the year include Jubilee and Associated labels, and contracts were renewed with ABC Paramount until 1971 and EMI also renewed their Tamla-Motown contract. During the year, Liberty went independent, and later this year it is expected that MGM will follow suit.

In April this year, EMI acquired majority interest in Gerry Oord's Bovema record company of Holland. Also during the year EMI appointed Jugoton of Yugoslavia as their licensee in that territory, thus gaining an entry into the vast market in Eastern Europe.

The major organizational changes within EMI came early in 1967 with the appointment of Ken East as Managing Director of EMI Records.

During the year, EMI Chairman Sir Joseph Lockwood, visited South Africa, United States and Mexico. Another major event of the year was the takeover of the Grade organization.

The EMI-Paul Hamlin "Music for Pleasure" series of budget price LPs sold over 5 million records from the commencement in October 1965 to March 1967, thus exceeding all expectations. The year has also seen EMI's entry into the field of Musicassettes, and a considerable amount of EMI repertoire is now available on the Philips' system.

Decca

For Decca Records, the highlight of the year has undoubtedly been the launching of the Deram label, primarily promoted and guided to success by Exploitation Manager Tony Hall. The label, launched in October 1966 had an immediate hit with Cat Stevens' "I Love My Dog", followed by "Mathew & Son", "Gonna Get Me a Gun", and his first album which also rated chart success "Mathew & Son". Cat Stevens has also emerged as a prolific songwriter, penning not only his own material, but supplying hits for other artists as well. He gave "The Move" two chart entries on Deram with "Night of Fear" and later, "I Can Hear the Grass Grow". The label also scored with "I Was Kaiser Bill's Batman" by Whistling Jack Smith. The most recent Deram success has been the Number One Smash "A Whiter Shade of Pale" by Procul Harum, which turned out to be Deram's first big international success. Other artists for whom Tony Hall and Deram have high hopes are Denny Laine (ex Moody Blues mem-

ber) and The Warm Sounds, who made a promising debut with "Birds and Bees". Most of the Deram material comes from indie producers New Breed Productions headed by Denny Cordell, and Smash Productions headed by Mike Hurst. Deram is the first major label to open its doors to indie producers and release masters within the confines of a major label. On the Decca label, the company had huge success via Tom Jones' "Green Green Grass of Home" and Engelbert Humperdinck's "Release Me". These two artists held the Number One spot for eleven weeks, and during the year under review the Decca Group held the Number One spot for no less than twenty-three weeks. Other artists to boost the Decca year have been The Small Faces, Val Doonican, and Alan Price, as well as Americans, Ike & Tina Turner, The Monkees, Jim Reeves, The Mamas & Papas, and The Turtles. In the album charts, "The Sound of Music" is still riding high, with sales rapidly approaching 2,000,000 copies. Other LP charters of the year have been albums by Tom Jones, The Monkees, Jim Reeves, Val Doonican and The Rolling Stones.

Good sales have also been notched up with Phase Four stereo albums and John Mayall's Bluesbreaker albums.

In the classical field, the most important issue has been the complete recording of Wagner's "Die Walkure" issued in September 1966 to complete the Vienna Philharmonic-Solti-Decca recording of the Ring cycle. Other operatic highlights have been Gounod's "Faust" with Sutherland and Corelli, and the first recording of Benjamin Britten's "Midsummer Night's Dream" conducted by the composer. During the year, Decca launched the "Grand Opera Series" featuring re-issues of famous Decca recordings on the low-priced Ace of Diamonds label. Eleven operas have been issued. Additions have been made to the Phase Four concert series devoted to popular classics which will be extended still further in the coming year. Four special albums devoted to Toscanini recordings have been issued by RCA on the Victrola label, to tie in with the centenary celebrations in March. The year also saw the introduction of the Victrola "Legacy" series, devoted to great recordings of artists of the past.

The year has seen an increase in the importation of continental disks, and Decca's Turnabout label, retailing at 17/8d featuring Baroque music has been very successful, as has "Das Altwerk" catalogue from the Telefunken label which retails at 42/-d. Since Decca undertook their own distribution just a year ago, service to retailers has been speeded-up and they now give a twenty four hour service from their four depots at London, Birmingham, Manchester and Glasgow.

During the year, Decca acquired several new labels, including the White Whale catalogue which has given them the turtles' hits. Other label acquisitions were Hickory, Mira, Lee Hazelwood Inc. and Impact. Monument, distributed here by Decca for some time, was given its own logo.

Philips-Fontana

For Philips and Fontana, it has been another highly successful year. Following the fantastic success of 1966 when the group had 20% of the entire singles market, their share for the first four months of 1967 fell slightly to around 15%. As previously, folk has been on the up and up, with a strong rostra of artists including Joan Baez and British singles, Julie Felix, Martin Carthy and The Corrie Folk Trio.

In the "pop" singles field, one of the company's greatest assets has been the enormous success all over the world of the New Vaudeville Band with "Winchester Cathedral." "Peek A Boo," and "Finchley Central" all

on Fontana. It has in fact, been a remarkably successful year altogether with Fontana, particularly in the singles field. In addition to the New Vaudeville Band, chart entries have been registered by The Troggs "With A Girl Like You," The Mind Benders "Ashes To Ashes," Manfred Mann "Just Like A Woman," "Semi-Detached Suburban Mr. James" and "Haha Said The Clown," Wayne Fontana had a hit with "Pamela Pamela" whilst Dave Dee, Dozey, Beaky, Mick & Tich have emerged as a top international group with major chart success entries throughout Europe, notably with "Bend It" and "Hideaway" and "Touch Me, Touch Me."

On the Philips label, Dusty Springfield further consolidated her previous chart successes and established herself in the world markets with hits such as "All I See Is You," "Going Back," "I'll Try Anything" and her latest triumph "Give Me Time."

The Walker Brothers (John Scott now solo artist with Philips), had a couple of hits with "You Don't Have To Tell Me" and "Another Tear Falls." Spencer Davis chalked up a succession of hits with "When I Come Home," "Give Me Some Loving" and "I'm A Man." The Spencer Davis Group have now split, but Davis and his new group have signed with Fontana, and ex-member Stevie Winwood's new group Traffic, had their first record on Island "Paper Sun" issued in May, which immediately became a chart best seller. Harry Secombe—always a powerful LP seller—made a surprise entry into the singles charts this year, selling over 300,000 copies with his version of "This Is My Song." In the LP field, April this year was Harry Secombe month, marked by the issue of a special double-pack album "Secombe's Personal Choice." Album sales have been good, particularly "popwise," with Dusty Springfield's "Golden Hits" topping the list. Other big album sellers have come from The Walker Brothers and The Troggs. The company has cut down on budget line releases, but is issuing stronger material by top names such as Basie, Vaughn, Brook Benton and Dizzie Gillespie.

A classical highlight of the year was the release in May of the much-praised "St. Luke Passion"—a two record set by the contemporary Polish composer Penderecki.

The Philips Musicassettes, introduced in October 1966, have been a tremendous success, and eighteen major companies have now accepted the Philips' system. At the time of writing, taking all the repertoire available, there are some 150 cassette titles on the market, and this will be doubled by the Autumn to over 300. July is to be declared Musicassette Month, with concentrated activity by Sales and Promotional forces backed by consumer advertising. In the Autumn Philips plan to strengthen their classical catalogue of Musicassettes, with highlights from "The Messiah" recording, and the first releases of chamber music and concertos. Around the world there are sixty three equipment manufacturers who are manufacturing for the Philips' system, and close on 100 labels on which repertoire is being issued.

Pye

For Pye records, the year got off to a slow start in January, but February started to point the way for Pye in 1967. March saw an increase in volume of 28% and April 35% over the same month a year earlier. This was not taking into account the phenomenal sales of Sandie Shaw's Eurovision Winner "Puppet On A String" throughout Europe.

Having terminated distribution through EMI Wholesalers last July, Pye terminated its long-standing association with Selecta early this year. At the end of June, Pye concluded its arrangements with independent factors, thus controlling its U.K. dis-

(Continued on page 10)

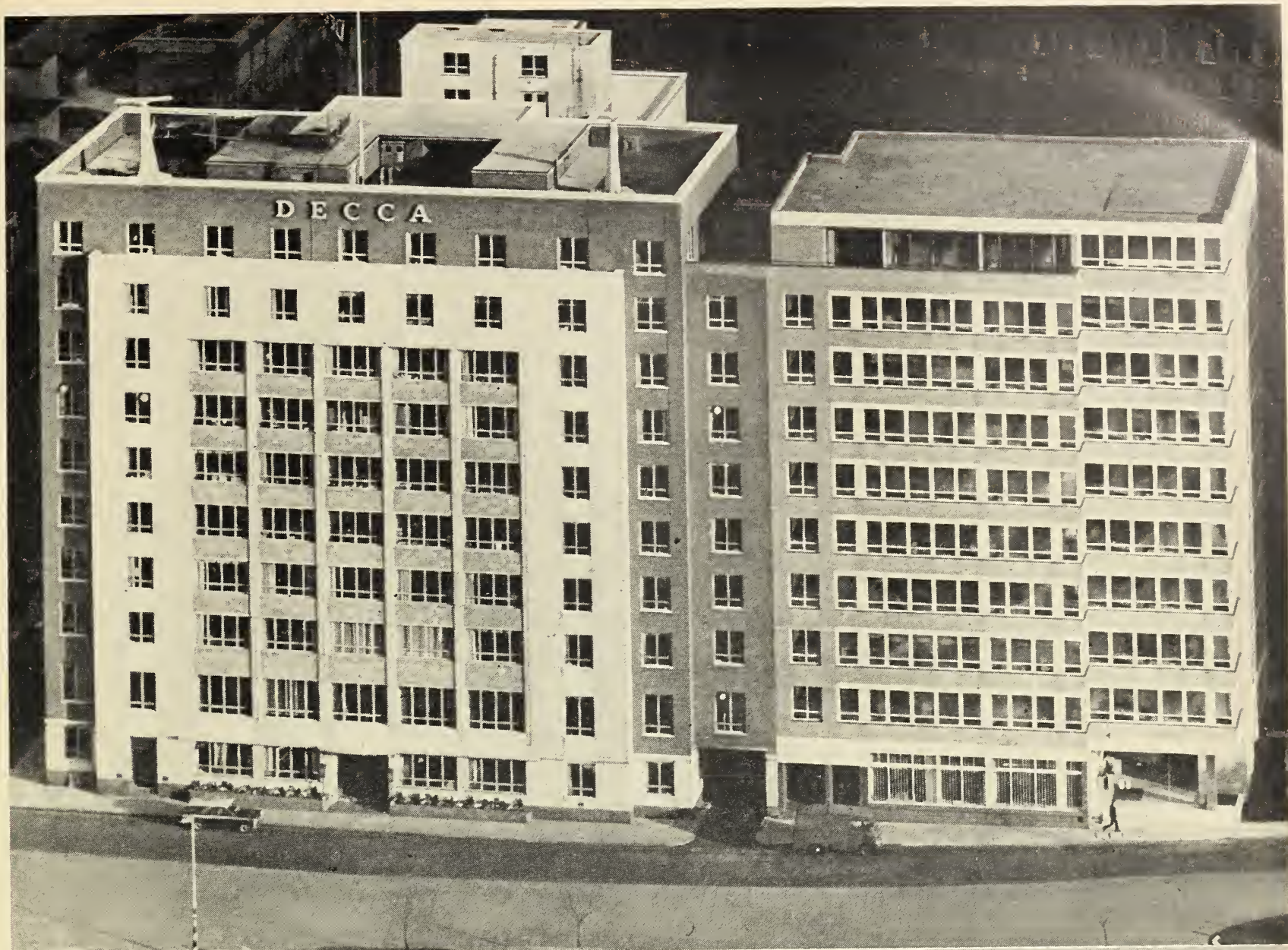

Decca offices: 9 Albert Embankment London SE1 England

The
Decca Record
Company Limited
of England
and its USA subsidiary
London Records Inc
offer American record labels a first-class
world-wide distribution service

For distribution outside of the U.S.A. write or call Mimi Trepel London Records Inc. 539 West 25th St. New York 1, N.Y. Oregon 5-6060

GREAT BRITAIN—THE PAST 12 MONTHS

(Continued from page 8)
tribution 100%. During the transitional period ending June 1967, the sales and distribution forces have been expanded proportionately, and on July 1st the sixth and latest depot opens at Bristol to cover the west country and South Wales. This blanket coverage and emphasis on distribution is part of Pye's overall policy to combat the stiff competition that lies ahead as more and more American companies set up independent operations in this country.

Pye is confident that its 100% distribution system is as effective as possible, and together with their studio and pressing facilities, places them in a very strong position.

Pye's chart successes over the past twelve months can be gauged by the fact that by May 1967 the company had held the Number One slot no less than eight times. Their share of the LP charts has been equally impressive.

In the singles field "Guantanamera" by The Sandpipers gave Pye a chart entry for ten consecutive weeks. British artists The Kinks had a tremendous year in the singles charts with "Sunny Afternoon" and "Dead End Street," culminating in their latest smash "Waterloo Sunset." They also hit hard in the album charts with "Well Respected Kinks." Donovan had a couple of blockbusters with "Sunshine Superman" and "Mellow Yellow," and of course Petula Clark maintained her hold with "I Couldn't Live Without Your Love" and gave the company a Number One hit with "This Is My Song." Another Number One came from Sandie Shaw with her Eurovision winner "Puppet On A String" which turned out to be the biggest international hit of the year. Following their individual solo successes, Frank Sinatra with "Strangers In The Night" and Nancy Sinatra with "These Boots Were Made For Walking," the duo teamed up to give Pye another Number One with their Reprise single "Something Stupid." In the album field, Geno Washington and the Piccadilly label a resounding hit with "Hand Clappin' Foot Stompin' Funky But Live." American Herb Alpert achieved popularity and gained album placings with "Going Places," "Whipped Cream And Other Delights" and "S.R.O." The comedy highlight of the year came from Napoleon XIV with "They're Coming To Take Me Away, Ha Ha."

A highlight of Pye's year was the international look given to their 7th Annual Sales Conference in October 1966, which was attended by delegates from sixteen overseas territories.

Pioneers in the field of low priced albums via Golden Guinea, Pye's latest low priced series "Marble Arch" has been an unqualified success. Since September 1966 nearly 1½ million LPs have been sold, including "Well Respected Kinks" which sold a quarter of a million, and the Searchers' Smash Hits" sold over 100,000. Sixteen other albums have sold over 100,000 copies each.

It has also been a year of enormous expansion and improvement for Pye's studios, which are used for recording major artists from companies other than Pye, such as The Rolling Stones, Spencer Davis, Nancy Sinatra etc. The factor has also been further developed by the addition of new presses and can now produce over 100,000 albums and 2,500 singles per week.

CBS

Ken Glancy, Managing Director of CBS, reports that progress during the company's first twelve months in their new headquarters has exceeded expectations. CBS have increased their penetration into both popular and classical markets. In the "pop" field, major acquisitions have included such talents as Georgie Fame and The Tremeloes. Fame's first CBS single to make the charts, "Because I Love You" was launched by a unique and massive promotional campaign. Fame

has also had an EP and an LP released. The Tremeloes, in their first six months with CBS, achieved two smash hits, first with the transatlantic charter "Here Comes My Baby," followed and climaxed by "Silence Is Golden," giving CBS their first British-oriented Number One, (and incidentally, the first British group to top the charts in 1967.) Other British signings included Gerry Marsden, The Zombies, Anita Harris, and Brian Poole.

Amongst the classical highlights were the releases of "Wozzeck" conducted Pierre Boulez (awarded the Grand Prix de Disque of France as the best operatic recording of 1966-67). Leonard Bernstein consolidated his reputation with his best-selling version of Mahler's "Eighth Symphony" with the London Symphony Orchestra (the first time CBS have used a British Orchestra). Another major release in the operatic field was the highly successful "Falstaff" with Dietrich Fischer Dieskau and Leonard Bernstein conducting. CBS also hit the jackpot with the original cast album of "Fiddler On The Roof" starring Topel—which hit the singles and LP charts. Bob Dylan's "Greatest Hits Volume 1" also proved to be a consistent LP chart entry.

Visiting CBS artists during the year have included Tony Bennett, who also collected a silver disk for his "San Francisco," Simon & Garfunkel, Woody Herman, Dave Brubeck, The Byrds, The Clancy Brothers, The Brothers Four, Carolyn Hester, Eugene Ormondy, Leonard Bernstein, Isaac Stern, Pierre Boulez, Rudolph Ferkin. In the music cassette field, CBS' repertoire has been made available to Philips, and to date some twenty music cassettes ranging from Bob Dylan to West Side Story, are on the market.

Polydor

Polydor's new streamlined policy, launched in the fall of 1965 when Roland Rennie took over the directorship, has paid handsome dividends, as results for the past twelve months will testify. During this period, production and sales at all speeds, have matched the enthusiasm initially shown by the Polydor team. In May this year, the Top Twenty charts showed five placings for products distributed by Polydor. Reviewing the company's progress, Roland Rennie pinpointed the gratifying success and development of the Atlantic and Associated labels' repertoire.

Progress has also been achieved in the international field with artists such as Bert Kaempfert and James Last. Both have been widely accepted in Great Britain and Polydor look forward to a much broader international development in the future. On the home front Polydor's success has been equally rewarding, through their association with such talents as The Who, The Cream, Jimi Hendrix and The Experience, whilst The Bee Gees are rapidly establishing themselves as a major force in the record markets of the world. Whilst progress in the "pop" field has been particularly strong, this has in no way affected the still growing appreciation for the company's incomparable classical repertoire.

Over the last year the United Artists Organization in London, which includes the publishing, film, record, and music division, has extended enormously. Due to the increased activity in all branches, the company will be moving to larger premises later this year. Some of the most prominent albums have been the James Bond album "Thunderball," and the latest in the series, "You Only Live Twice," in which Nancy Sinatra sings the title song. Frank Cordell's score for "Khartoum" was one of the best sound track albums of the year. Ken Thorne won an Oscar for the best adaptation of an original music score for "A Funny Thing Happened On The Way To The Forum."

United Artists

The United Artists record label in Great Britain has had one of its biggest successes with the Easybeats' recording of "Friday On My Mind" which was a world hit, climbing high in the American charts. An album is also on current release. "A Man And A Woman" composed by Francis Lai, was one of the biggest selling sound track albums, and another film with music by the same composer, is now being completed and promises to be an even bigger success. Shirley Bassey's first album for United Artists "I've Got A Song For You," and more recently, "And We Were Lovers," were successful in all parts of the world. Bassey will undertake an European tour this summer, to promote the recordings and appear in major television shows and galas throughout Europe. Among the most successful British artists to be acquired for the United Artists American label are the Spencer Davis Group, one of the biggest names in the American record business. Now Stevie Winwood's new group called Traffic, already launched in this country, will also be distributed in America on the United Artists label. Vera Lynn had her most successful single release in America for some years with a song called "It Hurts To Say Goodbye," and an album by Vera is also on release in America. Another contract artist, Samantha Jones, looks like her first really big hit with "Ray Of Sunshine." In preparation are the first recording sessions with The Fortunes, already internationally successful, and whose first single release will be early this summer.

A new film, produced by United Artists and directed by Clive Donner, who was responsible for "What's New Pussycat," will include songs written and performed by the Spencer Davis Group and Stevie Winwood, in an exciting new-style movie "Around The Mulberry Bush." There will be at least ten songs in the picture, which should prove to be one of the most exciting film albums of the year. United Artists also report that Lionel Bart has been commissioned to write the title songs for two important British productions. Frank Cordell has just completed his first orchestral album for United Artists, to be released shortly.

Italian artists, Mina and Domenico Modugno, will be coming to London in the next few weeks to make their first English recordings for United Artists. Noel Rogers, Managing Director, is satisfied with the company's progress during the past year, and predicts considerable expansion in the months to come.

Delyse

For Delyse, the past twelve months have seen a great diversification of their activities. The crowning achievements came with the company's nomination for the "Grammy" award for their much-praised recording of Mahler's "Des Knaben Wunderhorn" album, featuring Janet Baker and Geraint Evans, conducted by Win Morris. The album is now released in the United States on Angel. In the "pop" field, progress has been particularly marked, with their Irish repertoire, which also gave Delyse its major chart entry with "The Merry Ploughboy" by Dermot O'Brien—a Number One in Ireland for eight weeks. The company's successful Childrens' catalogue has been increased by 90% and was the biggest selling children's series in the United Kingdom. The year has also seen the introduction of the new Envoy International series, which includes repertoire drawn from all over the world. Turnover for the year ending March 1967 was 200% up on the previous year. During the past twelve months, Isabella Wallich, the company's dynamic founder-director, has travelled considerably throughout Europe and earlier this year, visited America. Future plans are basically, to de-

velop both the Delyse and Envoy labels, and expand into independent record production in the classical field.

Elektra

For Elektra, the year has seen a tremendous increase both in output and sales of their budget line "Bounty" Elektra have concentrated on building up a roster of British talent with marked success. High on the list is the Scottish Folk group, The Incredible String Band, whose first album tagged after them went to Number One in the British folk charts and has now been released in the United States. Their second album "The 5000 Spirits Or The Layers Of The Onion" is also on release.

The year has also seen an impressive entry into the "pop" field by the parent American company with artists such as The Doors and The Love both making the United States charts and notching up impressive U.K. sales. Singles by the groups have also been issued in the U.S. and in this country. A notable event of the year was the arrival of Judy Collins for a recording session at the end of 1966. She cut an album entitled "In My Life" tagged after one of the tracks by Lennon & McCartney. For the LP the artist broke away from her strictly folk idiom and went "a la Beatles."

Elektra stars to visit the United Kingdom in 1966/67 included Tom Paxton and Judy Collins (both with SRO concerts at the Royal Albert Hall), and Tom Rush.

Elektra's concert promotion activities have also achieved phenomenal popularity and success with international artists such as Jacques Brel, and Simon & Garfunkel who had a concert at the Royal Albert Hall.

Some notable Nonesuch releases have also been issued, the most important being "The Haydn Paris Symphonies," set of three LPs by Leslie Jones.

Transatlantic

Transatlantic Records report a highly successful 1966 with an even brighter 1967 in prospect. The year ending 31st December 1966 saw a rise in turnover of 28% and a further increase of 40% for the first four months of 1967. The addition of the Audio Fidelity and Prestige catalogues contributed considerably to this increase. Transatlantic have issued over thirty Audio Fidelity LPs since taking on the line just over a year ago, and a special promotion in January this year tied in with Kodak's cameras, resulted in the sale of some 14,000 Audio Fidelity LPs in the month.

Transatlantic's first release from the Prestige catalogue came out in November 1966. Prestige items are released under the Transatlantic label on a special "PR" series at 35/6d and older material from the line comes out on Transatlantic's highly successful 21/6d XTRA label. Popular LPs from Prestige have included albums by Richard "Groove" Holmes, the jazz organist Eric Dolphy, Mose Allison, and the Modern Jazz Quartet.

In April 1967 Transatlantic started a new pop single label BIG T on which singles by a number of new artists including The Purple Gang as well as established LP sellers from Transatlantic such as Bert Jansch be issued.

Transatlantic has continued to enjoy a major share of the domestic folk market, consistently having four or five LPs in the Top Ten Folk LP Charts. Bert Jansch, John Renbourn, and The Young Tradition—a comparatively new group, have all topped the folk LP charts for at least two months during the year, and the Dubliners and the Ian Campbell Folk Group have been well represented. The Young Tradition climaxed a successful first year with an invitation to the Newport Folk Festival in the U.S.A. in July.

For Transatlantic the year has seen a considerable increase in exports (Continued on page 12)

DECLARATION OF INDEPENDENCE!

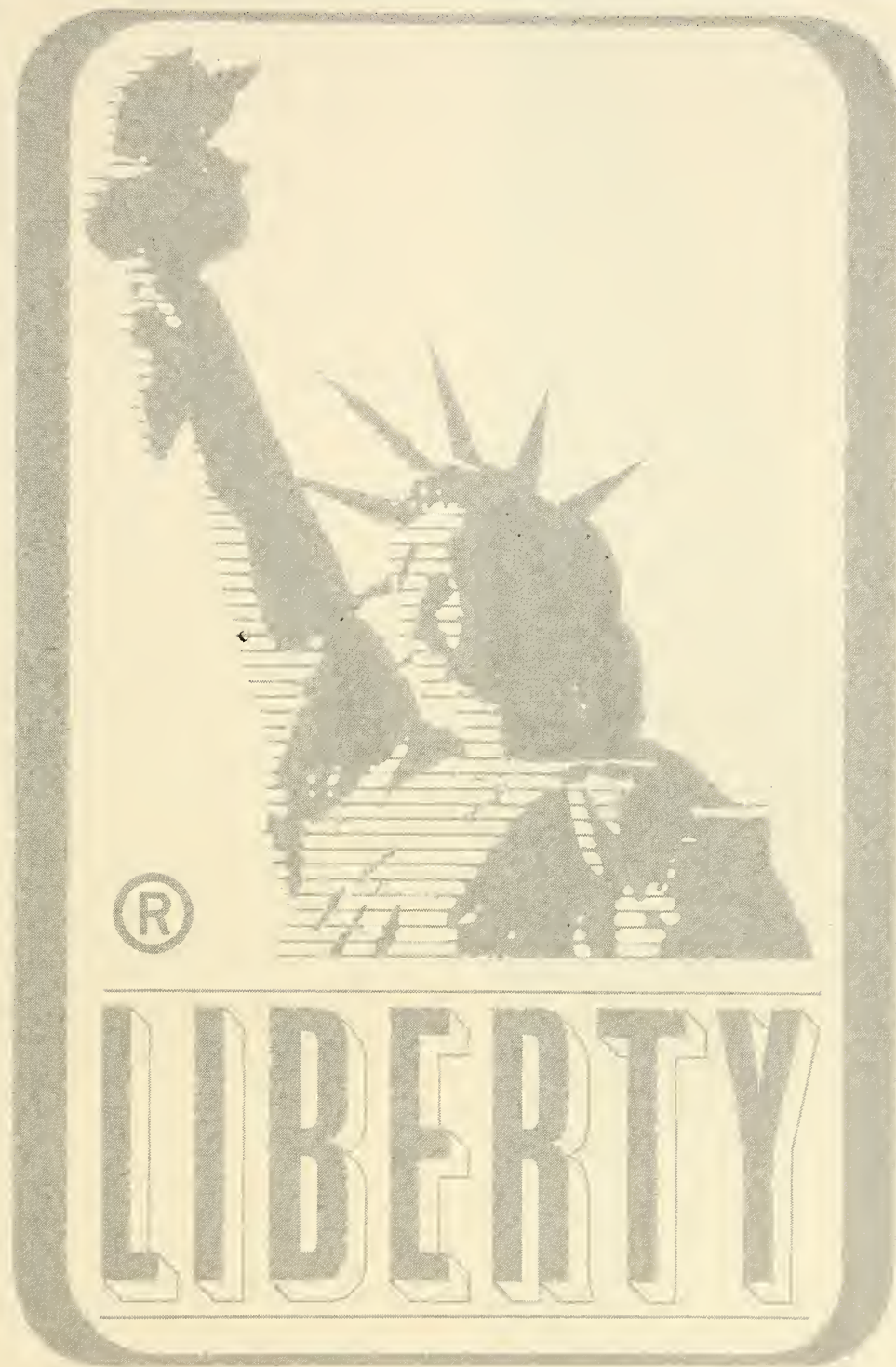

Now dynamically on its own

IN GREAT BRITAIN

Bob Reisdorff (Managing Director)
Liberty Records Limited, 11 Albemarle Street, London W1. Telephone: Mayfair 7362

IN WEST GERMANY

Siegfried Loch (Managing Director)
Liberty Records G.M.B.H. 1 Saerbergraben, Munich 33. Telephone: Munich 54-7022. Cables: Librecord Munich

LEASE MASTER DEALS INVITED

DELYSE

RECORDING COMPANY

"This Company has now broken
into the International market
with a Bang"

THE GRAMOPHONE.
MAY 1966.

25-27 MARYLEBONE RD.
LONDON N.W.1.

"The fastest growing
Independent in Great Britain"

RECORD RETAILER.

ENVOY

GR. BRITAIN—THE PAST 12 MONTHS

(Continued from page 10)
which at times have run as high as 18% of the total turnover. During the year the company have acquired agreements for export products with the Barclay Company in Holland and Belgium, and with Solive Karakos in France. Consistent export business has also been maintained over the year with the Vogue Company in Germany and Switzerland, and the Sonet Group in Scandinavia. Skandinavisk Grammophon in Denmark, Iverson in Norway, and Westerlund in Finland, have become agents in their territories for the Prestige material released by Transatlantic. An increased amount of overseas licensing has also taken place with EMI in Australia, New Zealand, South Africa and the West Indies, with Vanguard in the USA and with Astor Electronics PTY in Australia and New Zealand.

Transatlantic's associate publishing company, Heathside Music Limited, shows a year of considerable growth. Records of Heathside songs have been obtained by artists such as The Brothers Four, Bobby Bare, Judy Collins, Robin Hall & Jimmy McGregor and Julie Felix.

Island

For Island records, the year has seen an extension of the success of their product around the world, especially in the United States where it is released by United Artists. In fact it has been the company's best and most productive year to date.

A major event of Island's year has been the "parting of the ways" between Stevie Winwood and the Spencer Davis Group, which has given Island a string of chart successes over the past two years. Stevie Winwood, having formed his new group Traffic, remains under contract to Island's chief, Christopher Blackwell. During the year, Blackwell brought over indie American producer Jimmy Miller, who produced the "I'm A Man" single for the Spencer Davis Group and Traffic's first single, "Paper Sun" which was an immediate chart success. Other Island groups, the V.I.P.'s, the Smoke, and Jimmy Cliff, have enjoyed success on the continent where they have toured extensively. Jackie Edwards and Wynder K. Frog have both made promotional tours of the United Kingdom and Wynder K. Frog's "Green Door" has been issued in United States by United Artists.

Argo

This year, Argo not only celebrates its tenth year as a member of the Decca Group, but emerges once and for all, as a major label in its own right, and the leading company for spoken word recordings, not only in the United Kingdom but throughout the world. Considerable progress has been made with Argo's major project—"The English Poet" (from Chaucer to Yates) series of albums now nearing completion, with forty five out of an estimated sixty five LPs already on release on both sides of the Atlantic. Argo now has nine LPs completed in their "The Poet Speaks" series, in which about sixty contemporary poets talk about and read their own works. Undoubtedly the most comprehensive collection of the younger poets ever recorded, the series claims such well known names as Auden, Graves, Betjeman and the American poetess Sylvia Plath. In the realm of "conceptual" recordings, Argo recently embarked upon a twelve record anthology devoted to The Ballad entitled "The Long Harvest," which traces the development of famous Scottish ballads in their native English and North American versions. The series, which has been researched, produced and performed by Ewan McColl and Peggy Seeger.

In the musical field, Argo has boadened its catalogue internationally with recordings by Haydn, Mozart, and Rameau etc. taking their place alongside British composers. Harley Usill, the presiding genius behind Argo Records, and the newly ap-

pointed director of Decca Educational Service, paid a visit to the U.S. earlier this year.

Page One

Page One Records was formed in July 1966 and released its first record on the Page One label in September of the same year. Success was immediate with smash hits by The Troggs, "I Can't Control Myself," "Any Way That You Want It" and "Give It To Me" all of which were resounding international hits. Latest in line of Trogg successes is "Night Of The Long Grass" which emphasizes the prolific songwriting talent of group member Reg Presley and the creative ability of Larry Page in the recording studio. The Troggs' album "Troglodynamite" gave the label its first entry into the U.K. album charts. Second album success came via the Larry Page Orchestra with "Waltzing To Jazz" which was issued in the States on the Calla label. Following the Troggs came The Loot, who achieved chart success via "Baby Come Closer." Page's overseas trips have proved very successful with the acquisition of Italian singing star Bobby Solo, who makes his debut on the label in July, which will be backed by an extensive promotion campaign. Top Spanish group Los Brincos have been signed by Larry Page and they were launched on the U.K. market in May with "Lola." Early in 1967 Page acquired the services of Adrian Rudge (formerly with EMI) to head the marketing and promotional aspects of the company. Rudge also leases with foreign companies regarding the scheduling of the Page One product and it is the Larry Page policy to negotiate separate deals for each artist in each country. On a world basis Page One has sold close on nine million units in its one year of operation. In May 1967 Page One acquired rights to the Pic and Bill R & B catalog from Chardy in Fort Worth, Texas. Page One is anxious in the future to conclude more deals of this nature, whether they be in the R & B, Pop or specialised classical, stereo or instrumental fields.

Immediate

Just twelve months ago, a small independent record company topped the charts for the first time. The record was "Out Of Time" by Chris Farlowe. The record company was Immediate. During the past twelve months Immediate has grown immensely. After the successes of Chris Farlowe, there followed a small lull, during which the company's executive looked for new talented people. One of them was P. P. Arnold, former lead singer with The Ikettes, whose first debut single "The First Cut Is The Deepest" quickly gave her a Top Twenty chart entry. The Small Faces have not joined Immediate although established as a top group in Britain they have yet to achieve international success overseas. Immediate's plan is to launch the group not only in this country but throughout the world. Immediate have acquired the rights to the Beach Boys' music for publication in this country, and enjoyed a considerable success with "Good Vibrations." Immediate, together with Mike Hurst and Chris Brough have a company "Smash" with Mike Hurst in charge of the production side, and Smash Music Ltd, which publishes the work of new writers. Immediate Productions maintains an open door policy towards independent producers, ensuring that each record is treated individually.

Track

One of the major breakthroughs of the year came with the launching of Track records headed by Kit Lambert and Chris Stamp, who discovered The Who in 1964 and who have since become regular chart entrants. Track came into being in March this year, and their first single "Hey Joe" by Jimi Hendrix was rush released on Polydor and paved the way for the
(Continued on next page)

GR. BRITAIN—THE PAST 12 MONTHS

(Continued from preceding page)

follow-up "Purple Haze" which was released on Track and went straight into the charts, as did "The Wind Cries Mary" which, together with "Pictures Of Lily" by The Who, gave Track three chart entries in one week. The Hendrix album, "Are You Experienced" also featured prominently in the LP charts. Track have set up an office in New York for the promotion of their artists, and will continue their policy of concentrating on few releases in order to get maximum exploitation and sales. In future, they aim to set up a European jazz label to be headed by Pete Townsend.

Ember Records have stepped up their activity in the singles field. The company has established Tommy Drennan and The Monarchs on the charts, and had good selling singles by James Brown, Charles Aznavour, and also launched top model Twiggy worldwide on records. The Company had a very successful year in the U.S.A. under their deal with Capitol which saw three best selling albums with sales running close to half a million units by Chad & Jeremy, and John Barry & His Orchestra, the winner of the 1967 Academy Award for "Born Free."

A concentrated effort has been made by Ember to bring them closer to their overseas distributors, and over 90% of all products released have been licensed in overseas territories where they are particularly strong. Every European licensee was visited at least twice during the year.

Ember launched their LP Playhouse presentations with an original recording of The Critic, bringing together Noel Coward, Mel Ferrar and Barbara Jefford, and licensed this to American Decca. They increased their share of the market with the "Famous Artists" Budget series which now total 50 LPs at 10/-d each.

Major Minor

For Philip Solomon's Group of Companies, the event of the year has been the launching in November 1966 of the indie "Major Minor" record company, distributed by Selecta and six other independent distributors. The label's first major hit came in March of this year with "The Seven Drunken Nights" by The Dubliners. The LP "A Drop Of The Hard Stuff" also made the charts. Pat Campbell (formerly with RCA and Decca) joined Major Minor in March as Managing Director. In April, Solomons further strengthened his copyright department, now in charge of Margaret Brace (formerly with Ember). Another new member of staff is Ron Algar (ex Assistant Dick Rowe, Decca's A & R Department) and now Personal Assistant to Philip Solomon. Solomon completed a deal with CBS to distribute Major Minor in the United States, on Epic. His affiliation with Decca in certain territories including Australia, New Zealand, Belgium etc. continues. New signings for Major Minor include Peter Lawlor (to be released in United States by London) and singer-composer David McWilliams. Solomon emphasizes that although future plans call for an output of folk and country and western, all tastes will be catered for despite the success of The Dubliners. A good promotional outlet for Major Minor results from Solomon's link with Radio Caroline. British group The Bachelors, managed by Solomon, maintained their chart status during the year and in September 1966 won a Silver Disk for their quarter million selling album "The Bachelors' 16 Great Songs."

Planet

It can be said that Shel Talmy of Planet Records is one of Britain's most prolific independent producers and during the year he has continued his onslaught in the British charts with more hits by The Kinks "Dead End Street," "Sunny Afternoon" and their current smash "Waterloo Sunset." He took Manfred Mann into the charts with "Just Like A Woman"

and "Semi Detached Suburban Mr. James" and was responsible for The Easybeats first major British hit "Friday On My Mind" which also achieved international success and notched up another million seller for Talmy. In his five year career as an independent producer Talmy has acquired 10 Gold Singles and 1 Gold L.P., 11 Silver Singles and 2 Silver L.P.s and has sold over 33 million records. All the above mentioned singles were released on major labels and the first success for his own Planet label came with "Painter Man" and "Make Time" by The Creation—a group which also proved very popular in Germany. In the film sphere Talmy is busy working on Thom Keyes book "All Night Stand" which starts shooting in the autumn.

Pickwick Int'l

Pickwick International achieved their expected increase in sales. The company turnover was substantiated in common with its parent company in the States which has resulted in a record year for the group. Some indication of this increase can be gauged by the fact that recent shares in the American parent company rose on the American stock exchange by 40 per cent. For Pickwick International in Great Britain the year has seen an increase in retail distribution outlets of some 450-500 over a year ago mostly in supermarket and other non-record type outlets throughout the country. Pickwick negotiated a distribution arrangement in Scotland with Clyde factors resulting in the Allegro product being carried by almost every regular record dealer in Scotland. Allegro is now sold in more than 500 outlets in Scotland including general stores and supermarkets and it has proven in the last year to be a very successful operation. The Allegro catalogue has increased by a further 50 titles. The highly successful "Alf Garnet Sings Songs Of World War One" L.P. has given the company an entre into many regular record outlets which had not previously stocked budget line records and many of them are now taking the entire range. Six weeks after the release of the Alf Garnet record additional distribution was gained by CBS in London who pressed the album for Pickwick and distributed it via their own sales force. The past twelve months has seen an increase of over 20 per cent in Pickwick's export business. Long term contracts for distribution have been made in many countries, perhaps the most important of all in Australia with Basic Books Ltd.

Emerald

Across the Irish sea in Belfast Northern Ireland, Emerald Records have gone from strength to strength, particularly late in 1966 and early 1967. They have licensed the Tradition catalogue of America which includes L.P.s of The Clancy Brothers and Tommy Makem and already four records have been issued from this catalogue. Emerald's own production of L.P.s includes new records by Bridie Gallagher, James Young, The Go Lucky Four, Erin Go Brass and Frankie McBride. All their L.P.s are proving to be large sellers throughout the British Isles and in overseas territories as well. Festival Records of Australia have licensed quite a lot of Emerald's catalogue and currently three American major record companies are negotiating for the rights of this label for the United States and Canada.

Melodisc

Melodisc, Britain's No. 1 Bluebeat and R & B company have had a very successful year. Their big hit came with "Al Capone" by Prince Buster which sold almost a quarter million copies and proved a worthy follow-up to his previous best seller "The Ten Commandments of Man." Prince Buster came to Britain during the year for a six-week tour. EMI is releasing the single in Belgium, Holland, France and Sweden. Prince Buster's latest single is "Cincinnati Kid" and all his material is published by

(Continued on page 16)

POLYDOR GROUP RECORDS FOR THE BEST OF TWO WORLDS IN RECORD ENTERTAINMENT



Distributed in the U.K. by Polydor Records Ltd, 17-19 Stratford Place London W1

Depots In
 London Bristol
 Leeds Manchester
 Dublin Glasgow
 And Birmingham



100% Direct Distribution Throughout The U.K.

HEAD OFFICE

A.T.V. House
 Gt. Cumberland Place
 London W.1.
 Tel. AMBassador 5502

CUSTOM PRESSING FACILITIES

Transcription Manufacturing And Recording Co.
 James Estate
 Western Road, Mitcham, Surrey
 Tel. Mitcham 7000

RECORDING STUDIOS

A.T.V. House
 Gt. Cumberland Place
 London W.1.
 Tel. AMBassador 5502

MELODY

POP 30

MAKER

- 1 (1) SOMETHING STUPID Frank and Nancy Sinatra, Reprise
- 2 (3) PUPPET ON A STRING Sandie Shaw, Pye
- 3 A LITTLE BIT ME A LITTLE BIT YOU Mr. RCA



BRITAIN'S TOP 40 ALBUMS

THIS WEEK	LAST 3 WEEKS' POSITIONS	Weeks in Chart	TITLE	Artist	Label	Numbers (stereo followed by mono)	Producer
							John Schroeder
8	8 7 5 13		HAND CLAPPIN'—FOOT STOMPIN', etc.	Geno Washington	Piccadilly	NSPL/NPL 38026	Alpert
9	5 6 7 6		S.R.O.	Herb Alpert	Pye	NSPL/NPL 28088	Larry Page
10	10 13 20 4		TRUCK DRIVERS	Herb Alpert	Pye	NSPL/NPL 28065	Herb Alpert/Jerry Moss
11	7 5 6 31		GOING PLACES	Herb Alpert	Pye	NSPL/NPL 18171	Tony Hatch
19	17 16 18 5		COLOUR MY WORLD	Petula Clark	Pye	—/NPL 18159	Tony Hatch
22	18 20 22 7		HIT PARADE	Petula Clark	Reprise	RSLP/RLP 1020	Jimmy Bowen
29	25 23 31 4		THAT'S LIFE	Frank Sinatra	Marble Arch	—/MAL 612	Shel Talmy
32	35 29 30 28		WELL-RESPECTED KINKS	Kinks			

UNITED ARTISTS SERIES

World Selling Artistes
On
The International Label
Single and Album Releases By:

THE EASYBEATS
THE FORTUNES
SHIRLEY BASSEY
DOMINICO MODUGNO
BOBBY GOLDSBORO
JAY & THE AMERICANS
JIMMY McGRIFF
GARNETT MIMMS
FRANK CORDELL
MINA
RAPHAEL

MOTION PICTURE ALBUMS

"RED, WHITE AND ZERO"
(Vanessa Redgrave)

"A MAN AND A WOMAN"
(Music by Frances Lai)

"YOU ONLY LIVE TWICE"
(John Barry)
(Title song by Nancy Sinatra)

"THE WAY WEST"
(Bronislaw Kaper)

"AFRICA ADDIO"
(Music by Riz Ortolani)

"THE WHISPERERS"
(John Barry)

FLAT 5 ALBERT GATE COURT
124 KNIGHTSBRIDGE, LONDON S.W.1.
Telephone KNIGHTSBRIDGE—9383-5

GR. BRITAIN—THE PAST 12 MONTHS

(Continued from page 13)

Melodisc Music. In addition Emil Shalit, Managing Director of Melodisc is Prince Buster's manager for all territories. Melodisc's newest label Stardust, specialising in Irish material, was launched in May this year. Shalit reports that for Melodisc the year 1966/67 has been one of the best the company has ever experienced mainly due to Prince Buster's releases.

For King and R&B Records the year has seen the setting up of King Records (Ireland) Ltd. headed by Larry Cunningham and the signing of Irish artistes; The Royal Waterford Showband, Nita Lorry and folk group The Dragoons. Mr. King visited Jamaica during the year seeking masters and catalogues to build up the Ska Beat label. King Records has entered into an agreement to have all its material to be distributed throughout Europe on the Polygram label but in the U.K. they remain entirely independent.

Marquis

Joe Roncoroni and Ken Jones of Marquis Enterprises have further consolidated their success over the past twelve months. Artistes recorded by Marquis include Jonathan King, The Zombies (now released by CBS) and a promising new singer Tony Kingston, whose first release "Mama Come On Home" on Decca has evoked great interest in the U.K. and will soon get U.S. release on the London label. The company's American offshoot Mainstay Music Inc. recently concluded a five year deal with the Peter Walsh Organisation by which they have the right to all original songs recorded by The Tremeloes and other Peter Walsh artistes throughout the world, excluding Great Britain and Eire. This includes the flip side of their "Here Comes My Baby" smash and two tracks from their first album.

Contemporary

For Don Arden's independent Contemporary Records the year has been the most successful in the company's five year existence. Much of the credit lies with Arden himself and his ability to select his records and artistes i.e. "All Or Nothing" and "My Mind's Eye" by The Small Faces on Decca. Arden has also formed a new company "With It" Records for the sole purpose of launching and building up new artistes. First signings are The Rush whose first single "Happy" was issued on Decca. On the publishing side Contemporary had a major triumph with "Hi Ho Silver Lining" by Jeff Beck and The Attack.

AIR

AIR (London) Ltd., one of Britain's major independent production companies under the direction of George Martin, Ron Richards, John Burgess and Peter Sullivan, this year has furthered its reputation in both the U.K. and overseas markets. In addition to recording such talent as The Beatles, David and Jonathan, Tom Jones, The Hollies, Peter and Gordon, Cilla Black and Matt Monro (U.K. only) the year has seen the addition of Englebert Humperdinck whose latest single "There Goes My Everything" was produced by Peter Sullivan. Kathy Kirby and Spencer Davis are now also signed to AIR for recording. The year culminated in The Beatles latest smash album "Sgt. Pepper's Lonely Hearts Club Band" which was, of course, produced by George Martin.

For Norman Newell it has been quite a year. After a long association with EMI he set up his own independent production company and his first recordings were with Italian singer Rita Pavone. He scored a double triumph by getting her into the British charts with "Heart" and "You Only You" thus establishing himself on the independent scene. He was also responsible for Topol's chart success with "If I Were A Rich Man" from "Fiddler On The Roof" and also produced the CBS London Cast

album which is now a consistent album charter. At the time of writing Newell is busy working on lyrics to songs by Belgian singer Adamo whom he records in Britain as well as Germany's Roy Black and Udo Jurgens of Austria. During the year he recorded an album in Paris with Franck Pourcell. Norman Newell is represented in America by George Greif who is also setting up a publishing company on Newell's behalf.

For Micky Most and Rak Records it has been a most productive year in which Herman's Hermits recording of "There's A Kind Of Hush" sold a million copies and won a Gold Disk (the 22nd Golden Disk awarded to a Micky Most production). His first recording with Lulu "The Boat That I Row" achieved immediate chart success as did Donovan with "Sunshine Superman," "Mellow Yellow" and "Epistle To Dippy" and Jeff Beck's "Hi Ho Silver Lining." During the year Most completed the soundtrack for Herman's film "Mrs. Brown You've Got A Lovely Daughter" and produced new albums for The Yardbirds and Donovan. Most commutes between London and New York regularly acquiring material for his artistes.

Independent record producer/arranger/composer Charles Blackwell has, over the past four years, built himself a reputation in the U.K. for writing and producing top chart material. Success first came to him with John Leyton's recording of "Johnny Remember Me" which he arranged and produced and Mike Sarne's "Come Outside" which he composed and produced. Both hit the No. 1 slot. More recently his successes have included "Hold Me" and "Together" two big hits for P.J. Proby and very recently the Englebert Humperdinck single "Release Me" which he produced and arranged. Blackwell has also been responsible for producing all British hits of French recording star Francoise Hardy including "All Over the World."

For New Breed Productions formed barely 12 months ago and headed by Denny Cordell the year under review has been more than a little exciting. They produced one of the first recordings for the new Deram label with new singer Beverley and The Pyramid but really came to the forefront with The Move's waxing of "Night Of Fear" which led to their recent smash "I Can Hear The Grass Grow." Their latest triumph is Procul Harum's "A Whiter Shade Of Pale" which achieved international status within three weeks of release. It is expected to top a million in the very near future giving Deram their first Gold Disk.

Orlake Ltd., Britain's No. 1 independent processing and pressing plant has, during the past twelve months, implemented 22 new presses thus virtually doubling its production capacity. If necessary Orlake provides a 24-hour round-the-clock-service including shipping and delivery. Mr. Clark, Managing Director of Orlake feels that with the infiltration of more American labels operating in Britain in the coming months his pressing capacity will be fully utilised. The Orlake plant situated at Dagenham in Essex is just 30 minutes from the center of London. Additional facilities carried out by Orlake include production of labels, sleeves, catalogues and promotional material.

Publishers

From record manufacturers to music publishers for whom it has been another very good year. British songwriters and artistes have maintained their hold both in the United Kingdom and United States markets—although to a slightly lesser degree than in the previous year. The year under review has seen a resurgence in the popularity of American artistes and copyrights with an increasing number of covers by British talent. Nevertheless, British publishers concentrating on British material have

(Continued on page 18)

Plain cookin's for the birds!



It's amazing what people will swallow before they get around to tasting the real thing. Likewise with showbiz; ninety per cent of current acts are mere stuffing – just to make the individual record company's (or agent's) menu seem more impressive.

Not so Island Records; who are successful because they are *selective*.

Above, you have all the essential ingredients that go to make up Island's recipe for success; each one carefully selected and prepared to make the kind of entertainment that has the customers asking for more . . . care for a taste?

P.S. Just to add some spice, we also manage the best of Britain's Disc-jockeys.



ISLAND RECORDS, 155-157 Oxford Street, London, W.1, England.

Telephone: 01-734 6228 Cables: ACKEE—LONDON

GR. BRITAIN—THE PAST 12 MONTHS

(Continued from page 16)

increased their percentage of entries into the American Top 100 (58 British copyrights entered the American charts in 1965-66 and 65 in 1966-67). They have also increased their hold on the European charts via a number of British spawned international hits notably "Winchester Cathedral" by The New Vaudeville Band published by Southern Music and "Puppet On A String" by Sandie Shaw published by K.P.M. Sheet music sales have maintained a steady level during the year and it is still possible for a really big hit to sell up to 50,000 copies. All in all the year has been a healthy one for the occupants of Tin Pan Alley which along with Carnaby Street is a 'must' for visitors to 'Swinging London'.

Beatles

"It's All Happening" continues to be the theme for Britain's ace publisher Dick James and his group of associated companies. The year has brought further expansion and continuing success for all the companies. Underlying the success of Northern Songs, The Beatles publishing company, is the fact that on the London stock exchange shares are standing considerably higher than at this time last year. Approximately 20 songs by John Lennon and Paul McCartney together with George Harrison have been added to the catalogue. With the purchase of the Dave Toff catalogue earlier this year something like 400 titles were incorporated into the Northern catalogue. The success of the Beatles album "Revolver" all over the world brought forth innumerable cover recordings and resulted in world wide chart singles such as "Yellow Submarine" and "Eleanor Rigby"—both Ivor Novello Award Winners as top selling singles of the year. Another Ivor Novello Award came for "Michele" for "The Most Performed Work of the Year."

"Penny Lane" and "Strawberry Fields" reaped two more hits for the group's fantastic crop of world wide hits. More recently The Beatles latest L.P. "Sgt. Pepper's Lonely Hearts Club Band" has been hailed as another outstanding contribution to the record and publishing markets of the world and is already getting a multitude of cover recordings. Paul McCartney added his personal contribution to the profits of Northern Songs via his memorable and outstanding background score for The Boulting Brothers film "The Family Way" arranged and orchestrated by the group's A & R Manager George Martin. Lennon, McCartney and Harrison continued their writing activities after they had met the requirements of the Sgt. Pepper L.P. by composing and recording with The Beatles several original songs which are to be used in a full length colour cartoon entitled "Yellow Submarine" produced by Al Brodax for King Features now in production and scheduled for screening in 1968. This production will also incorporate many of the earlier Northern Song hits. Other expanding and interesting activities include the development of Maribus Music as an associate group of companies which includes Galto Music Ltd. in association with Graham Nash, Alan Clarke and Tony Hicks, the writing team of The Hollies who, with the enthusiasm and encouragement of Dick James, has progressed from writing "B" sides and occasional album tracks to all songs for The Hollies resulting in world hits such as "Stop Stop Stop" and "On A Carousel." Galto Music have signed several talented writers who are now being developed. The most recent addition to the Maribus group of companies is the incorporation of Spencer Davis Music. On the record side with Page One firmly established Dick James has set up This Record Company Ltd. under the management of Stephen James and Denis Berger. In

the last few months recordings have been made by The Living Daylights—a group already enjoying sales success in the U.S. where they are released on Kama Sutra's Buddah label. Finally, Dick James has built a recording studio within his suite of offices and has developed and expanded world representation of recordings created by Page One and This.

Southern

For Southern Music it has been another year of pro-British activity which has been gathering momentum ever since Bob Kingston became Managing Director seven years ago. Under his aegis Southern has achieved many world wide hits with British material recorded by British artistes. Contract writers include Geoff Goddard, Carter-Lewis and Geoff Stephens. The Carter-Lewis team this year were responsible for "Semi Detached Suburban Mr. James" by Manfred Mann and gave Australian singer Normie Rowe a chart entry with "Ooh La La" and Peter and Gordon "Sunday for Tea." However, it fell to Geoff Stephens to give Southern its biggest international smash of the year with the million selling "Winchester Cathedral" by The New Vaudeville Band. The number won a Grammy Award in the U.S. and an Ivor Novello Award in the U.K. and was one of the year's most multi covered recordings. "Winchester Cathedral" was followed by "Peek-A-Boo" and more recently "Finchley Central." During the year Southern also scored heavily with three Donovan releases "Epistle to Dippy," "Mellow Yellow" and "Sunshine Superman." Publishing companies have also been set up with film production companies such as Anglo-Amalgamated and Monarch Film Corporation Ltd. for the publishing of film scores. Southern's Iver Recording Company with studios in their Tin Pan Alley building have also been producing disks for release by major companies.

FD&H

For Francis Day & Hunter, Robbins

and Feldmans 1966-67 has brought its rewards consistent with the world wide success of the Big Three. Topping the year's hits for F. D. & H. was undoubtedly "There's A Kind Of Hush" by Herman's Hermits written by F. D. & H. contract writer Les Reed in association with Geoff Stephens. Other Les Reed hits have included Wayne Fontana's "24 Sycamore" and "Tabatha Twitchet" by Dave Clark Five—both published by Reed's own Donna Music company. Reed also wrote the music with lyrics by Barry Mason for "A Man Alone"—a tribute to Sir Francis Chichester recorded by the Morrisgion Orpheus Choir on Columbia. During the year F. D. & H. acquired The Beach Boys catalogue for continental Europe and had a major hit with "Good Vibrations" in the Italian charts published by Edizione Musicale Francis Day. Another major continental hit for Francis Day & Hunter was in Germany where their company had the James Last composition "Games That Lovers Play." For Robbins Music the year under review has been their best ever as far as pop singles are concerned. Always strong in the film theme "Dr. Zhivago" now entering its second year in London's West End has sold over 80,000 soundtrack albums (MGM) and "Lara's Theme" has been multi-recorded. The Koppelman-Rubin team have provided Robbins with much catalogue material via The Faithful Virtue and Chardon publishing companies from which came The Turtles big international hit "Happy Together." They also have all material from The Lovin' Spoonful. Contract writer Tim Hardin penned material for many artistes and Crispian St. Peters had a big hit with "Pied Piper." The Small Faces "Hey Girl" was a big charter as was "All Or Nothing." At the beginning of the year Young Music Enterprises was formed and General Manager Ian Ralfini and Martin Wyatt visited the States for talks with American agents. Wyatt is personal representative in the U.K. for such artistes as

(Continued on page 21)

Firmly established and operating independently, Elektra Records (U.K.) Ltd. means much more than Elektra's outstanding records or Elektra's trend-setting Nonesuch label: we mean BOUNTY business, too, for BOUNTY is becoming increasingly a productive member of Elektra's family of labels. BOUNTY is preparing an exciting jazz series 'Bounty Jazz', and has released already a superb selection of authentic Blues records, albums produced independently and recordings drawn from numerous international sources. A new BOUNTY catalogue is available on request. Bright business begins when you contact BOUNTY. The telephone number is REGent 6466.

Cable address: FOLKMUSIC LONDON

ELEKTRA RECORDS (U.K.) LTD, 2 DEAN STREET, LONDON, W.1

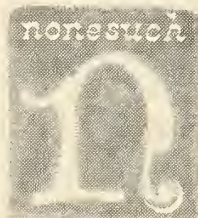



CREATED BY

NORTHERN SONGS LIMITED

JAEP MUSIC LIMITED · MARIBUS MUSIC LIMITED

GRALTO MUSIC LIMITED · PACERMUSIC LIMITED

NUOVA MUSIC LIMITED · LORDS MUSIC Co. LIMITED

DICK JAMES MUSIC LIMITED · METRO MUSIC LIMITED

PAGE ONE RECORDS LIMITED · THIS RECORD Co. LIMITED

FOR USA, CANADA, MEXICO & THE PHILIPPINES

Administration Management: WALTER HOFER, 22 1, WEST 57 th. STREET, NEW YORK, N.Y. 10019

Music Management LEONARD HODES, Suite 1200 , 1780, BROADWAY, NEW YORK, N.Y. 10019

THE WORLD WIDE ORGANISATION OF

DICK JAMES MUSIC LIMITED

JAMES HOUSE, 71 -75 , NEW OXFORD STREET, LONDON, W.C.1. ENGLAND.

Telephone:- 01-836-4864 (5 Lines) Cables ; DEJAMUS, LONDON, W.C.1. Telex; 27135

TRACK RECORDS LIMITED

58 Old Compton Street
London W1
01-347-9506

The Who

The Jimi Hendrix Experience

John's Children

NEW ACTION LIMITED NEW YORK

TRACK RECORDS LIMITED

888 Eighth Avenue
New York NY10019

(212) 581-3257

promotion and publicity
(Nancy Lewis)

BRITISH RECORD MANUFACTURERS

ARGO RECORD COMPANY
115, Fulham Road, London, S.W.3.
Tel: 01-589-5293
Managing Director: H. J. Usill
Label: Argo.

CBS RECORDS LTD.
28-30, Theobalds Road, London, W.C.1.
Tel: 01-242-9000
Managing Director: Ken Glancy
Labels: CBS, CBS-Realm.

THE DECCA RECORD COMPANY LTD.
Decca House,
9, Albert Embankment, London, S.E.1.
Tel: 01-735-8111
Chairman: Sir Edward Lewis
Director & Commercial Manager: W. W. Townsley.

Labels: Decca, Deram, Ace of Clubs, Ace of Diamonds, London, Monument, London-Globe, LHI, RCA Victor, RCA Victorola, RCA Camden, Brunswick, Ace of Hearts, Editions de L'Oiseau Lyre, Vox, Turnabout, Argo, Telefunken, Coral, Vocalion, Emerald, Contemporary, Good Time Jazz, Beltona, Rex.
Distributors of: Bigtop, Carlton, Challenge, Era, Kapp, Sun, Starday, American Decca Group, American London Group, Congress, Phyllis, White Whale, Impact, Mira, Valiant, Bang, Jamie, Hickory, Garrison.

DELYSE-ENVOY RECORDS LTD.
25, Marylebone Road, London, N.W.1.
Tel: 01-486-4266
Managing Director: Mrs. Isabella Wallich.
Labels: Delyse, Envoy.

ELEKTRA RECORDS
2, Dean Street, London, W. 1.
Tel: 01-734-6466
Managing Director: Donald Johnston
Labels: Elektra, Bounty, Nonesuch.

EMBER RECORDS
York House, Empire Way,
Wembley, Middlesex.
Tel: 01-903-1077
Managing Director: Jeffrey Kruger
Labels: Ember, Famous Artists, Speciality.
Distributors of: Circa, Ambassador, Sun, Aravel, LMI, Barclay, Kapp, Palette, Davon, Bethlehem, King, Starday, Rondo, Flip, Everest, Kent, Crown, Roulette, Tico, Festival, Roost, Nashville, P. S. Speciality.

EMERALD RECORDS LTD.
67-69 Ann Street,
Belfast 1, Northern Ireland.
Tel: 31616
President: Mervyn A. Solomon.
Label: Emerald.

E.M.I. RECORDS
EMI House,
20, Manchester Square, London, W. 1.
Tel: 01-486-4488
Managing Director: K. East
Labels: HMV, Capitol, Columbia, Parlophone, Impulse, Regal-Zonophone, Encore, State-side, Command, United Artists, Waverley, Tamla-Motown.
Distributors of: ABC Records Inc. (USA), Ascot (USA), Apollo (USA), Bell, Diamond, Epic, Global, Laurie, Metronome (Denmark), Musicor, Okeh, Swan, Tower, Twentieth Century Fox, Westminster, Institute for Language Study.

ESQUIRE RECORDS (LONDON) LTD.
76, Bedford Court Mansions,
Bedford Avenue, London, W.C.1.
Tel: 01-687-1810
Director: Carlo Krahmer.
Labels: Esquire, Starlite, Faith.

EVEREST PLASTICS LTD.
Victoria Works,
Edgware Road, Cricklewood, N.W.2.
Tel: 01-450-7746
Managing Director: Monty Lewis.
Labels: Rainbow, Instant Learning.

IMMEDIATE RECORDS CO. LTD.
Immediate House,
63-69, New Oxford Street, London, W.C.1.
Tel: 01-240-3377
Managing Directors: Tony Calder & Andrew Oldham
Label: Immediate.

ISLAND RECORDS LTD.
155-157, Oxford Street, London, W. 1.
Tel: 01-734-6228
Sales Office: 108, Cambridge Road, N.W.8.
Tel: 01-545-1921
Managing Director: Christopher Blackwell
Labels: Island, Sue, Surprise, Black Swan, Aladdin, Jump-Up

JUPITER RECORDINGS LTD.
140, Kensington Church Street, London, W. 8.
Tel: 01-229-9531
Directors: V. C. Clinton-Baddeley, Wallace Southam, Edgar Vetter
Label: Jupiter.

LEOMARK LTD.
Winchester House,
77, London Wall, London, E.C.2.
Tel: 01-588-1815

LIBERTY RECORDS LTD.
11, Albermarle Street, London, W. 1.
Tel: 01-629-7362
Managing Director: Bob Reisdorf
Labels: Liberty, Bluenote.
Distributors of: Dolton, Imperial, Minit, Pacific Jazz, Soul City, Sunset, World Pacific.

MAJOR MINOR RECORDS LTD.
71-75, New Oxford Street, London, W. C. 1.
Tel: 01-836-1801
Managing Director: Philip Solomon
Label: Major Minor.

MUSIC FOR PLEASURE
Drury House,
Russell Street, London, W.C.2.
Tel: 01-405-3434
Managing Director: Richard Baldwin.
Label: Music for Pleasure.

MELODISC RECORDS LTD.
12, Earlam Street, London, W.C.2.
Tel: 01-405-2848
Managing Director: Emil Shalit
Labels: Melodisc, Bluebeat, Dice, Kalypso

PAGE ONE RECORDS LTD.
71-75, New Oxford Street, London, W. C. 1.
Tel: 01-493-4864
Managing Director: Larry Page
Label: Page One

PHILIPS RECORDS LTD.
Stanhope House,
Stanhope Place, London, W. 2.
Tel: 01-262-7788
Managing Director: Leslie Gould
Labels: Philips, Fontana, Mercury, Wing, Caedmon, Riverside, Limelight.
Distributors of: Vanguard, Smash, Vee Jay, Mainstream, Barclay, World Pacific, Page One, Island, Roulette.

PICKWICK INTERNATIONAL INC. (GREAT BRITAIN) LTD.
Victoria Works, Edgware Road,
Cricklewood, London, N.W.2.
Tel: 01-450-7746
Managing Director: Monty Lewis
Labels: Happy Time, Allegro, Bravo.

PLANET RECORDS
10, Albert Gate Court,
124, Knightsbridge, London, S.W.1.
Tel: 01-589-5350
Managing Director: Shel Talmy
Label: Planet.

POLYDOR RECORDS LTD.
17-19, Stratford Place,
London, W. 1.
Tel: 01-493-7401
Managing Director: Roland Rennie
Labels: Deutsche Grammophon, Archive Production, Heliodor, Polydor, Atlantic.

PRESIDENT RECORDS LTD.
25, Denmark Street,
London, W. C. 2.
Tel: 01-405-3026
Director: D. A. Dane
Label: President.

PYE RECORDS LTD.
A.T.V. House,
Great Cumberland Place,
London, W. 1.
Tel: 01-262-5502
Managing Director: Louis Benjamin
Labels: Cameo-Parkway, Sacred, Golden Guinea, Red Bird, Piccadilly, Pye, Pye International, Pye Jazz, Reprise, Warner Bros., Vogue, Durium, Marble Arch, Chess, Kama Sutra, Hispavox, Century 21, Hanna-Barbera.
Distributors of: A & M, Checker, Cadet, Wyn-cote, Crusader, Charzer, Try, Blue Masque, Jerden, Paula, Joda, Jocida, King, Blue Cat, Scepter/Wand, Mode, Somerset.

RCA GREAT BRITAIN LTD.
50-52, Curzon Street,
London, W. 1.
Tel: 01-629-8541
Deputy Managing Director: Bernard T. Ness
Label: RCA.

R & B DISCS LTD.
176-178, Clapton Common,
Stamford Hill,
London, E. 5.
Tel: 01-800-9061
Managing Director: Mrs. R. Isen-King
Labels: King, R & B, Panda, Carnival, Ska-Beat.
Distributors of: Seeco, Panda, Carnival, Kent, Modern, Buhl International.

RECORDS FOR PLEASURE
Drury House,
Russell Street,
London, W.C.2.
Tel: 01-405-3434
Director: Richard Baldwin
Label: Supraphon.

ROULETTE RECORDS (LONDON) LTD.
71-75, New Oxford Street,
London, W.C.1.
Tel: 01-836-1801
Managing Director: Philip Solomon
Label: Roulette.

SAGA RECORDS LTD.
326, Kensal Road,
London, W. 10.
Tel: 01-523-6651
Managing Director: Marcel Rodd
Labels: Saga, Pan, Eros, Society, Fidelity, Presto, Lyrique, Opus, Heritage, Dandy, Language Records.

SPOT RECORDS LTD.
64, South Molton Street,
London, W. 1.
Tel: 01-499-7173
Managing Director: Norman Austin
Labels: Spot, Ryemuse.

STRIKE RECORDS LTD.
Suite 15,
43, Upper Berkeley Street,
London, W. 1.
Tel: 01-262-0563
Director: Lionel Segal
Label: Strike.

SPIN RECORDS LTD.
Dunville Buildings,
Adelaide Street,
Belfast, 2.
Tel: Belfast 21939
Managing Director: Gordon Smyth

(Continued on next page)

BRITISH RECORD MANUFACTURERS

(Continued from preceding page)

77 RECORDS

77, Charing Cross Road,
London, W.C.2.
Tel: 01-580-4197
Managing Director: Doug Dobell
Labels: 77, Folklore.

TALENT RECORDS LTD.

76, Bedford Court Mansions,
Bedford Avenue, London, W.C.1.
Tel: 01-636-1810
Managing Director: Carlo Kramer
Label: Talent.
Distributors of: Delmark.

TRACK RECORD RECORDS

6, Chesterfield Gardens,
London, W. 1.
Tel: 01-629-4726
Managing Director: Kit Lambert
Label: Track.

TOPIC RECORDS LTD.

27, Nassington Road,
London, N.W.3.
Tel: 01-435-9983
Managing Director: G. Sharp
Label: Topic.

TRANSATLANTIC RECORDS LTD.

120-122, Marylebone Lane,
London, W. 1.
Tel: 01-486-4353
Managing Director: Nathan Joseph
Labels: Transatlantic, Xtra, Audio Fidelity,
Prestige.
Distributors of: Folkways, M.K.(USSR), Con-
versaphone.

RALPH TUCK PROMOTIONS LTD.

Reydon, Southwold,
Suffolk.
Tel: Southwold 2231
Managing Director: Ralph Tuck
Label: RTP.

UNITED ARTISTS RECORDS LTD.

5, Albert Gate Court,
124, Knightsbridge,
London, S.W.1.
Tel: 01-589-9383

WORLD RECORD CLUB

Parkbridge House,
Little Green,
Richmond, Surrey.
Tel: 01-940-8331
Chairman: Norman Lonsdale
Labels: World Record Club, Conquest.

BRITISH GRAMOPHONE RECORD DISTRIBUTORS

ASSOCIATED RECORDINGS COMPANY

326, Kensal Road,
London, W. 10.

E.M.I. RECORDS

(THE GRAMOPHONE CO. LTD.)

80, Blyth Road, Hayes, Middlesex.
Regent House, 39, Canon Street, Manchester.
West Wear Street, Sunderland, Co. Durham.
10, Musters Road, West Bridgeford,
Nottingham.
4a, Ford Park Lane, Mutley, Plymouth, Devon.
Bayliss & Houme, Hurst Street, Birmingham.

KEITH PROWSE & CO. LTD.

Wholesale Record Division,
117, Fulham Road,
London, S.W.3.

KING RECORDS

(R & B DISCS)

176-178, Clapton Common,
Stamford Hill, London, E. 5.

LUGTON & CO. LTD.

P.O. Box 2BN,
209-212, Tottenham Court Road,
London, W. 1.

PHILIPS RECORDS (SALES) LTD.

P.O. Box 90, 17 Beddington Farm Road,
Croydon, Surrey.
18, Lloyd Street, Manchester 2.
Floodgate Street, Digbeth, Birmingham.
Highland House, 58 Waterloo Street, Glasgow
C.2, Scotland.

POLYDOR RECORDS LTD.

17-19, Stratford Place,
London, W. 1.

PYE RECORDS (SALES) LTD.

132, Western Road, Mitcham Surrey.
Ralli Buildings, Salford 3.
9a, Upper Accommodation Road, Leeds 9.
80, York Street, Glasgow 2.
1a, Dora Road, Small Heath, Birmingham.
Symphola Ltd. 19, Adelaide Street, Belfast 2.
24, Mountjoy Square, Dublin.

SELECTA

(A Division of Decca Record Co. Ltd.)
50, Southwark Bridge Road, S.E.1.
Pollokshaws, Glasgow S.3.
Failsworth, Manchester.
Earl Shilton, Leicester.

SOLOMON & PERES

67-69, Ann Street, Belfast 1, Ireland.
2, Dame Street, Trinity Lane, Eire, Ireland.

H. R. TAYLOR (BIRMINGHAM) LTD.

34, Pershore Street,
Birmingham 5.

GR. BRITAIN—THE PAST 12 MONTHS

(Continued from page 18)

Petula Clark, Kenny Ball, The Young Idea etc. Recently Jamarnie Music was formed as a subsidiary company to Young Music Enterprises and publishes all material from Zoot Money including "Knick Knack." Other hits of the year have included "Hi-Lili Hi-Lo" by The Alan Price Set and Bobby Darin's "If I were A Carpenter." For Feldmans it has been a very successful year with hit singles by Bob Dylan "Just Like A Woman" whilst Paul Jones made a very successful debut as a solo singer with "High Time." Georgie Fame hit with "Because I Love You" and Peter and Gordon gave the company two very big international hits with "Lady Godiva" and "Knight In Rusty Armour." Dusty Springfield hit the big time with "You Don't Have To Say You Love Me" and The Yardbirds scored on both sides of the Atlantic with "Over Under Sideways Down." During the year Feldmans entered into a contract whereby Dean Street Music acquired publishing rights for all Bob Dylan material. The company's General Manager Ben Nisbet visited the U.S. during the year.

Ardmore & Beechwood

The past year has seen the removal of Ardmore & Beechwood back to 363 Oxford Street above the HMV record store. At the end of his second year as General Manager of Ardmore & Beechwood Harry Lewis reports that progress has been up to the expected standard. In the coming year the growth of the company both at home and abroad is scheduled for even further expansion. EMI now take their music publishing division very seriously and it is already taking its place as a major part of the group's world wide organisation. The years biggest hits have included the estab-

lishment in the U.K. of Lee Dorsey as a major seller culminating in his latest release "My Old Car." A & B also published Neil Diamond's "Girl You'll Be A Woman Soon." Two of the pubbery's greatest hits of the year came very recently firstly with the No. 1 smash by The Tremeloes "Silence Is Golden" (CBS) and "The Boat That I Row" by Lulu (Columbia).

Burlington

Burlington Music have had their best year to date achieving the maximum number of hits with the minimum number of copyrights. Their two biggest hits have been Tom Jones' "Green Green Grass Of Home" and "Release Me" by Englebert Humperdinck—both on Decca. "Green Green Grass" held the No. 1 position for six consecutive weeks with a total of 15 weeks in the charts. "Release Me" was a No. 1 for five consecutive weeks and chalked up 15 weeks on the charts. Another single which achieved chart status was "I Don't Care" by Los Bravos. Burlington also made a healthy profit by acquiring "Old Tige" the flip side of Jim Reeves massive hit "Distant Drums" which was in the British charts for 18 weeks with four weeks at No. 1. Burlington has several tracks on both the "Green Green Grass" and "Release Me" albums. During the year the company also acquired the American Edquinox pop and r & b catalogue from the U.S.A.

Chappells

For Chappells the year has had its triumphs and its tragedies. The triumph came in February this year with the opening of the new Chappell building replacing the one destroyed by fire in 1965. The tragedy came with the death of Louis Dreyfus in
(Continued on page 28)

A LABEL OF
INFINITE VARIETY

argo

SPOKEN WORD

The only complete and uncut
WORKS OF SHAKESPEARE

7 CENTURIES OF ENGLISH POETS
Top Artistes, Superb Recording

CHORAL AND INSTRUMENTAL

World's finest choirs includes
King's College, Cambridge
St. John's College, Cambridge

A Superb catalogue of early
Classical and 20th Century music
Folk Song • Ballad • Jazz and Documentary

argo

A LABEL OF
INFINITE VARIETY

A DIVISION OF THE DECCA GROUP

Distributed in U.S.A. by *LONDON*

NORMAN NEWELL
INTERNATIONAL
RECORDING PRODUCER
for

- ROY BLACK — GERMANY
- RITA PAVONE — ITALY
- ADAMO — BELGIUM
- TOPOL — ISRAEL
- UDO JURGENS — AUSTRIA

NORMAN NEWELL ORGANISATION
66, MONTAGUE MANSIONS
BAKER STREET, LONDON, W. 1.

Tel: 935-4133

BRITISH ARTISTS & COPYRIGHTS TO ENTER AMERICAN TOP 100

JUNE 1966 TO JUNE 1967



CBS are proud to announce their CUSTOM PRESSING and STUDIO SERVICES in England

CUSTOM PRESSING all sizes and speeds. Finest quality Processing and Pressing

STUDIOS The most up-to-date in England 1, 2, 3 & 4—Tracks STUDER and AMPEX machines AKG and NEUMANN microphones Full Echo and Equalisation facilities

MASTERING ORTOFON and NEUMANN systems—Mono & Stereo

Enquiries welcomed at CBS RECORDS LTD. 28-30 Theobalds Road, London, W.C. 1 Telephone: CHancery 9000 Telex: 263349 CBSR London Cables: Colrecord London, W.C. 1

Title	Artiste	British Publisher	American Publisher	British Label	American Label
Ashes to Ashes	The Mindbenders	Screen Gems	Screen Gems	Fontana	Fontana
*All I See Is You	Dusty Springfield	Belinda	Ann-Rachel	Philips	Philips
Bus Stop	The Hollies	Hournew	Manken	Parlophone	Imperial
Bend It	Dave Dee, Dozy, Beaky, Mick and Tich	Lynn	Spectorious	Fontana	Fontana
Born Free	Roger Williams	Screen Gems	Screen Gems	London-American	Kapp
Black Is Black	Los Bravos	Mellin	Elmwin	Decca	London
*Changes	Crispian St. Peters	Essex	Barricade	Decca	Jamie
Can I Trust You	The Bachelors	Robbins	Miller	Decca	London
Colour My World	Petula Clark	Welbeck	Northern	Pye	Warner Bros.
*Dandy	Herman's Hermits	Carlin	Noma	Columbia	MGM
*Distant Shores	Chad & Jeremy	Carlin	Wama	CBS	Columbia
Dead End Street	The Kinks	Davray	Mondvies Noma	Pye	Reprise
*Detroit City	Tom Jones	Southern	Cedarwood	Decca	Parrot
Eleanor Rigby	The Beatles	Northern	Maclen	Parlophone	Capitol
East West	Herman's Hermits	Hournew	Manken	Columbia	MGM
Epistle To Dippy	Donovan	Southern	Peer Int.	Pye	Epic
Friday On My Mind	Easybeats	United Artists	United Artists	United Artists	United Artists
*Funny Familiar Forgotten Feelings	Tom Jones	Acuff Rose	Acuff Rose	Decca	Parrot
*Games That Lovers Play	Mantovani	F. D. & H.	Miller	Decca	London
Get Away	Georgie Fame	Gunnell	Noma	Columbia	Imperial
*Girl On A Swing	Gerry & Pacemakers	Bright Tunes	Bright Tunes	Columbia	Laurie
Gimme Some Lovin'	Spencer Davis	Island	Essex	Fontana	United Artists
Green Grass Of Home	Tom Jones	Burlington	Tree	Decca	Parrot
Georgie Girl	The Seekers	Springfield	Chappell	Columbia	Capitol
Have You Seen Your Mother Baby	The Rolling Stones	Mirage	Gideon	Decca	London
Have You Ever Loved Somebody	The Searchers	Gralto	Maribus	Pye	Kapp
Here There And Everywhere	The Fourmost	Northern	Maclen	Parlophone	Capitol
Happenings Ten Years Ago	The Yardbirds	Robbins	Leo Feist	Columbia	Epic
Help Me Girl	The Animals	Anim	Helios	Decca	MGM
*Here Comes My Baby	The Tremeloes	Ardmore & Beechwood	Mainstay	CBS	Epic
I Can't Control Myself	The Troggs	Dick James	Dick James	Fontana	Fontana
I Couldn't Live Without Your Love	Petula Clark	Welbeck	Duchess	Pye	Warner Bros.
*I've Got To Have A Reason	Dave Clark	Branston	Columbia	Epic
I'll Try Anything	Dusty Springfield	Raintree	Pambar	Philips	Philips
I'm A Man	Spencer Davis	Island	Essex	Fontana	United Artists
I Was Kaiser Bill's Batman	Whistling Jack Smith	Mills	Mills	Deram	Deram
*Just Like A Woman	Manfred Mann	Feldman	Dwarf	H.M.V.	Mercury
Knight In Rusty Armour	Peter & Gordon	Feldman	Dean Street	Columbia	Capitol
Lady Jane	The Rolling Stones	Mirage	Gideon	Decca	London
Lady Godiva	Peter & Gordon	Dean Street	Regent	Columbia	Capitol
Let's Spend The Night Together	The Rolling Stones	Mirage	Gideon	Decca	London
Little Games	Yardbirds	Mills	Mills	Columbia	Epic
Mellow Yellow	Donovan	Southern	Donovan	Pye	Epic
Mother's Little Helper	The Rolling Stones	Mirage	Gideon	Decca	London
Morningtown Ride	The Seekers	Compass	Amaedo	Columbia	Capitol
Matthew & Son	Cat Stevens	Cat	Cat	Deram	Deram
New York Mining Disaster	The Bee Gees	Abigail	Abigail	Polydor	Atco
19th Nervous Breakdown	The Rolling Stones	Mirage	Gideon	Decca	London
Not Responsible	Tom Jones	Leeds	Northern	Decca	Parrot
Nineteen Days	Dave Clark	Pall Mall	Branston	Columbia	Epic
No Milk Today	Herman's Hermits	Hournew	Manken	Columbia	MGM
On A Carousel	The Hollies	Gralto	Maribus	Parlophone	Imperial
Over Under Sideways Down	The Yardbirds	Yardbird	Leo Feist	Columbia	Epic
Paperback Writer	The Beatles	Northern	Maclen	Parlophone	Capitol
Paint It Black	The Rolling Stones	Mirage	Gideon	Decca	London
*Pied Piper	Crispian St. Peters	Robbins	Chardon	Decca	Jamie
*Pretty Flamingo	Manfred Mann	Shapiro Bernstein	Ponderosa	H.M.V.	United Artists
*Please Tell Me Why	Dave Clark	Spurs	Branston	Columbia	Epic
Peek-a-Boo	The New Vaudeville Band	Meteor	Southern	Fontana	Fontana
Penny Lane	The Beatles	Northern	Maclen	Parlophone	Capitol
**Portrait Of My Love	The Tokens	Kassner	Picadilly	—	Warner Bros.
Rain	The Beatles	Northern	Maclen	Parlophone	Capitol
**Red Rubber Ball	The Cyrkle	Lorna	Ecletic	Parlophone	Columbia
Ruby Tuesday	The Rolling Stones	Mirage	Gideon	Decca	London
*Release Me	Engelbert Humperdinck	Burlington	Four Star	Decca	Parrot
*Satisfied With You	Dave Clark	Sphere	Branston	Columbia	Epic
*See See Rider	Eric Burdon & Animals	Leeds	Leeds	Decca	M.G.M.
Sittin' On A Fence	Twice As Much	Mirage	Gideon	Immediate	M.G.M.
Stop Stop Stop	The Hollies	Gralto	Maribus	Parlophone	Imperial
Sunny Afternoon	The Kinks	Belinda	Noma	Pye	Reprise
Sunshine Superman	Donovan	Southern	Southern	Pye	Epic
Strawberry Fields Forever	The Beatles	Northern	Maclen	Parlophone	Capitol
Sunday For Tea	Peter & Gordon	Southern	Southern	Columbia	Capitol
Tc Show I Love You	Peter & Gordon	Welbeck	Leeds	Columbia	Capitol
This Door Swings Both Ways	Herman's Hermits	Dick James	Blackwood	Columbia	M.G.M.
The Kids Are Alright	The Who	Fabulous	Devon	Decca	London
Turn Down Day	The Cyrkle	Leeds	Northern	Parlophone	Columbia
There's A Kind Of Hush	Herman's Hermits	F. D. & H.	Leo Feist	Columbia	M.G.M.
*This Is My Song	Petula Clark	Leeds	Shamley	Pye	Warner Bros.
**Tell Me To My Face	Keith	Gralto	Maribus	Philips	Mercury
Who Am I	Petula Clark	Welbeck	Duchess	Pye	Warner Bros.
Winchester Cathedral	The New Vaudeville Band	Meteor	Southern	Fontana	Fontana
Wild Thing	The Troggs	Dick James	Blackwood	Fontana	Fontana
With A Girl Like You	The Troggs	Dick James	James-Blackwood	Fontana	Fontana
Walk With Faith In Your Heart	The Bachelors	F. D. & H.	TeePee	Decca	London
When I Was Young	Eric Burdon & Animals	Yameta	Yameta	Decca	M.G.M.
Yellow Submarine	The Beatles	Northern	Maclen	Parlophone	Capitol
*You Got What It Takes	Dave Clark	Leeds	Fidelity	Columbia	Epic

*British artistes with American copyrights **American artistes with British copyrights



HEAD OFFICE

363, OXFORD STREET, LONDON, W. 1. ENGLAND

FRANCE

Les Editions et Productions
Musicales Pathe Marconi
19, Rue Lord Byron
Paris 8e

BELGIUM

Ardmore & Beechwood,
Belgium
72, Quai des Charbonnages
Brussels

ITALY

Edizioni Musicali La Voce
Del Padrone
Piazza Cavour 1
Milan

GERMANY

Edition Accord
Hohenstaunfenring 63/1
Cologne 5

HOLLAND

Anagon Music Publishers N.V.
Heemsteedse Dreef 287
Heemstede

SWEDEN

Edition Odeon
Oxenstiernsgatan 37
Stockholm No.

DENMARK

Imudico A/S
Colbjornsensgade 19
Copenhagen V

AUSTRALIA

Castle Music Pty. Ltd.
301, Castlereagh Street
Sydney

SPAIN

Ediciones Gramofono Odeon
Urgel 234
Barcelona

U.S.A.

Beechwood Music Corporation
1750, Vine Street
Hollywood 90028
California

MEXICO

Beechwood de Mexico
Ayuntamiento No. 54
Mexico 1, D.F.

GREECE

Arion Greek Music Co. Ltd.
P.O. Box 287
Athens

SOUTH AFRICA

Ardmore & Beechwood (South
Africa) (Pty) Ltd.
P.O. Box 11254
Johannesburg, Transvaal

ARGENTINE

Editorial Musical Odeon
Moreno 2038
Buenos Aires

JAPAN

Toshiba Music Publishing Co.
Ltd.
17, Akasaka 2-2
Minato-Ku
Tokyo

HONG KONG

Pathe Publications (Far East)
Ltd
4th Floor
MacDonald House
Orchard Road
Singapore 9



Nelson Has Trafalgar Square

ARDMORE & BEECHWOOD

HAS

THE LION'S SHARE

OF

INTERNATIONAL HITS!!!

BRITISH ARTISTES TO ENTER TOP 100 LP CHARTS

The Animals	Animalism The Best Of The Animals	MGM
The Beatles	Animalization Rubber Soul Yesterday and Today	Capitol
Eric Burdon & Animals Chad And Jeremy	Eric Is Here The Best Of Chad And Jeremy	MGM Capitol
Dave Clark Five	Distant Shores Try Too Hard Satisfied With You Dave Clark Five's Greatest Hits 5 x 5	Epic
Petula Clark	More Great Hits Color My World /Who Am I I Couldn't Live Without Your Love	Warner Bros.
Donovan	Sunshine Superman Mellow Yellow	Epic
Herman's Hermits	The Real Donovan The Best of Herman's Hermits The Best of Herman's Hermits Vol: 2	MGM
The Hollies	Both Sides Of Herman's Hermits There's A Kind Of Hush Hold On	Imperial
Englebert Humperdinck Tom Jones The Kinks	Bus Stop The Hollies Greatest Hits Stop Stop Stop Release Me Green Green Grass Of Home	Parrot Parrot Reprise
Mantovani	The Kinks Greatest Hits Face To Face Mr. Music Mantovani Music	London
The Mindbenders New Vaudeville Band Peter And Gordon	Golden Hits Of Mantovani A Groovy Kind Of Love Winchester Cathedral Lady Godiva	Fontana Fontana Capitol
Chrispian St. Peters The Rolling Stones	The Best Of Peter And Gordon The Pied Piper Between The Buttons Big Hits Aftermath Got Live If You Want It Gimme Some Lovin'	Jamie London
Spencer Davis Group	Born Free	United Artists
Soundtrack Album Dusty Springfield	You Don't Have To Say You Love Me	MGM Philips
The Seekers The Troggs The Yardbirds	Golden Hits Georgy Girl Wild Thing The Yardbirds Greatest Hits Over Under Sideways Down	Capitol Fontana Epic

BRITISH INDEPENDENT RECORD PRODUCERS

ANDES SOUND LTD. Immediate House, 63-69, New Oxford Street, London, W. C. 1. Tel: 01-240-3377 Directors: Andrew Oldham & Tony Calder	NOEL BROWN PRODUCTIONS LTF. 26, D'Arbly Street, London, W. 1. Tel: 01-437-3745 Noel Brown
BRON ASSOCIATED PUBLISHERS LTD. 29-31, New Oxford Street, London, W. 1. Tel: 01-437-5063 Gerry Bron	NEW BREED PRODUCTIONS LTD. Dumbarton House, 68, Oxford Street, London, W. 1. Tel: 01-636-7906 Denny Cordell
CEE CEE PRODUCTIONS 10, Denmark Street, London, W. C. 2. Tel: 01-493-1653 Roy Berry and Mike Collier	NEMS ENTERPRISES LTD. Sutherland House, 5-6, Argyll Street, London, W. 1. Tel: 01-734-3261
CONTEMPORARY RECORDS LTD. 52-55, Carnaby Street, London, W. 1. Tel: 01-437-9602 Hope Levy	ODDBALL RECORDS LTD. 22, Kingly Street, London, W. 1. Tel: 01-437-5953 Grenville Collins Robert Stigwood
CITY MUSIC 8, Radnor House, 93-97, Regent Street, London, W. 1. Tel: 01-734-5351 B. A. Palmer	RAK RECORDS LTD. 155-157, Oxford Street, London, W. 1. Tel: 01-437-6671 Micky Most & Peter Grant
DERRY TONE RECORDS 45-46, Chandos Place, London, W. 1. Tel: 01-240-2907 Drew Harvey	RECORD SUPERVISION LTD. Lansdowne House, Lansdowne Road, London, W. 11. Tel: 01-727-0041 Denis Preston
DOUBLE-R PRODUCTIONS LTD. Kent House, 87, Regent Street, London, W. 1. Tel: 01-589-3847 Steve Rowland	RITZ RECORDS Flat 6, Albert Gate Court, 124, Knightsbridge, London, S.W.1. Tel: 01-589-8801 Bunny Lewis
ALAN A. FREEMAN & ASSOCIATES LTD. 145, Oxford Street, London, W. 1. Tel: 01-437-5362 Alan Freeman	SCOTT-SOLOMON PRODUCTIONS LTD. 73-75, New Oxford Street, London, W. C. 1. Tel: 01-493-1801 Tommy Scott & Philip Solomon
FXB PRODUCTIONS LTD. 100, Nightingale Lane, London, S.W.12. Tel: 01-673-3189 Eddie Jarrett & Tom Springfield	STRAND RECORDS LTD. 41, Kingsway, London, W.C.2. Tel: 01-405-0411 Peter Walsh
HANSA PRODUCTIONS LTD. 5, Denmark Street, London, W. C. 2. Tel: 01-240-0674 Steve Rowland	SMASH PRODUCTIONS LTD. 26, Kingly Street, London, W. 1. Tel: 01-437-8512 Mike Hurst & Christopher Brough
IVER RECORDING COMPANY LTD. 8, Denmark Street, London, W. C. 2. Tel: 01-836-4524 Bob Kingston	STANLEY SCHOFIELD PRODUCTIONS LTD. 6-8, Old Bond Street, London, W. 1. Tel: 01-629-4642 Stanley Schofield
LINDON RECORDS LTD. 235-241, Regent Street, London, W. 1. Tel: 01-734-7961 Tito Burns, Mike Hurst & Chris Curtis	TRACK RECORDS LTD. 58, Old Compton Street, London, W. 1. Tel: 01-437-9506 Chris Stamp
MARQUIS ENTERPRISES LTD. 37, Soho Square, London, W. 1. Tel: 01-437-9405/6 Joe Roncoroni & Ken Jones	VOX PRODUCTIONS (GB) LTD. 11, Elgood House, Wellington Road, London, N.W.8. Tel: 01-774-1208 P. Fejer

INT'L ARTISTES TO ENTER TOP 100 LP CHARTS

Bert Kaempfert	Strangers In The Night Bye Bye Blues Bert Kaempfert's Greatest Hits	Decca
Los Bravos Horst Jankowski Soundtrack	Black Is Black So What's New A Man And A Woman	Press Mercury United Artists

LONDON
138-140, Charing Cross
Road,
London, W. C. 2.

PARIS
Publications-Francis Day,
S.A.
5, Avenue de l'Opera

AMSTERDAM
Francis-Day
Muziekuitgevers N.V.
Amstel 52

HAMBURG
Francis Day & Hunter
GBH
Mittelweg 149,
2000, Hamburg

ZURICH
Francis-Day Produktion
Brunnwiesenstrasse 26

MADRID
Canciones Francis-Day
Carmen 20

COPENHAGEN
Francis Day & Hunter
Scandinavia A/S,
Gothersgade 9-11,
Copenhagen K.

THE

INTERNATIONAL PUBLISHERS

FRANCIS DAY & HUNTER

B. FELDMAN

ROBBINS MUSIC

NEW YORK

Francis Day & Hunter Inc.
745, Fifth Avenue

BRUSSELS

Editions Francis-Day S.A.
25, Place Saint-Géry

MILAN

Edizioni Musicali
Francis-Day S.R.L.
Piazza Del Liberty 2

JOHANNESBURG

Francis Day (S. Africa)
Pty Ltd.
Suite 901-4, 9th Floor,
Silvern House,
139, Commissioner Street

Agents

AUSTRALIA

J. Albert & Son Pty Ltd.
137-9, King Street,
Sydney.

JAPAN

Eastern Music Pub. Co.
Kyowa Building,
34, Kotochira-cho,
Shiba, Minato-ku,
Tokyo.

INTERNATIONAL REPRESENTATION

THROUGH

**THE BURLINGTON-PALACE
MUSIC GROUP**

BRITISH ISLES

BURLINGTON MUSIC CO. LTD.
9 Albert Embankment,
London, SE 1.

and

PALACE MUSIC CO. LTD.
9 Albert Embankment,
London, SE 1.

U.S.A.

BURLINGTON MUSIC CORPORATION
539 West 25th Street
New York 1, N.Y.

and

FELSTED MUSIC CORPORATION
539 West 25th Street
New York 1, N.Y.

CANADA

BURLINGTON MUSIC OF CANADA
190 Graveline Road,
St. Laurent, P.Q.

LTD. and

FELSTED MUSIC OF CANADA, LTD.
190 Graveline Road,
St. Laurent, P.Q.

AUSTRALASIA

PALACE MUSIC (PTY) LIMITED
299-301, Castlereagh Street,
Sydney, N.S.W.

SOUTH AFRICA

BURLINGTON MUSIC (AFRICA)
a division of:
MUSIC PUBLISHING CO. OF AFRICA
(PTY) LIMITED
GALLO CENTRE
Cor. Kerk & Gold Streets,
Johannesburg, S. Africa

BENELUX COUNTRIES

N.V. PALACE MUSIC HOLLAND
Vondelstraat 90,
Amsterdam-W

GERMANY & AUSTRIA

BURLINGTON MUSIKVERLAG GmbH.
Hoehenweg 22,
8211 Rimsting (Chiemsee),
Bavaria, Germany.

SCANDINAVIA

PALACE MUSIC (SWEDEN) A.B.
Jungfrugatan 18,
Stockholm. O.

ITALY

EDIZIONI MUSICALI PALACE Srl.
Piazzetta Pattari 1/3,
Milano.

**FRANCE &
FRENCH UNION**

EDITIONS MUSICALES PALACE Sarl.
8 Rue Saint Marc,
Paris, 2

THE TRANSATLANTIC GROUP • THE TRANSATLANTIC GROUP

THE TRANSATLANTIC GROUP • THE TRANSATLANTIC GROUP

BRITAIN'S FOREMOST
INDEPENDENT RECORD CO.
WE PRESENT

AUDIO FIDELITY • CONVERSAPHONE
FOLKWAYS • TRANSATLANTIC • XTRA
PRESTIGE



**TRANSATLANTIC
RECORDS, LTD.**

120-122, MARYLEBONE LANE,
LONDON, W.1. ENGLAND.
Telephone: 01-486-4353
Telegrams: XTRA, LONDON, W.1.

THE TRANSATLANTIC GROUP • THE TRANSATLANTIC GROUP

THE TRANSATLANTIC GROUP • THE TRANSATLANTIC GROUP

BEST SELLING SINGLES FROM PHILIPS

All I See Is You
Any Way That You Want Me
Ha! Ha! Said The Clown
Hold Tight
Just Like A Woman
98.6
This Is My Song
Wild Thing
Winchester Cathedral
You Don't Have To Say You Love Me

Dusty Springfield
The Troggs
Manfred Mann
Dave Dee, Dozy, Beaky, Mick & Tich
Manfred Man
Keith
Harry Secombe
The Troggs
New Vaudeville Band
Dusty Springfield

Philips
Fontana
Fontana
Fontana
Fontana
Mercury
Philips
Fontana
Fontana
Philips

BEST SELLING L.P.s FROM PHILIPS

Autumn
Best Of Bassey
Best Of Los Paraguayos
Favourites
From Nowhere
Golden Hits
Second Album
Portrait
Sing Again
Take It Easy With The Walker Brothers
Personal Choice

The Spencer Davis Group
David Bassey
Shirley Bassey
Trio Los Paraguayos
Frankie Vaughn
The Troggs
Dusty Springfield
Spencer Davis Group
The Walker Brothers
The Walker Brothers
The Walker Brothers
Harry Secombe

Fontana
Wing
Wing
Philips
Fontana
Philips
Fontana
Philips
Wing
Philips
Philips

BEST SELLING PHILIPS MUSICASSETES

Everything's Coming Up Dusty
First L.P.
Golden Hits
Show Souvenirs
Take It Easy
Volume Five

Dusty Springfield
Spencer Davis Group
Los Paraguayos
Harry Secombe
The Walker Brothers
Joan Baez

BEST SELLING SINGLES FROM PYE

Dead End Street
Dear Mrs. Applebee
59th Street Bridge Song
Guantanamo
It's A Man's Man's Man's World
I Couldn't Live Without Your Love
Mellow Yellow
Nothing Comes Easy
Puppet On A String
Run To The Door
Muirsheen Durkin
Somethin' Stupid
Sunshine Superman
Sunny Afternoon
Summer In The City
Sugar Town
Strangers In The Night
This Is My Song
The More I See You
They're Coming To Take Me Away Ha-Ha!
Zorba's Dance

The Kinks
David Garrick
Harpers Bizarre
The Sandpipers
James Brown & The Famous Flames
Petula Clark
Donovan
Sandie Shaw
Sandie Shaw
Clinton Ford
The Rambler
Frank & Nancy Sinatra
Donovan
The Kinks
The Lovin' Spoonful
Nancy Sinatra
Frank Sinatra
Petula Clark
Chris Montez
Napoleon XIV
Marcello Minerbi

Pye
Piccadilly
Warner Bros.
Pye Internat'l
Pye Internat'l
Pye
Pye
Pye
Pye
Pye
Reprise
Pye
Pye
Kama Sutra
Reprise
Reprise
Pye
Pye Internat'l
Warner Bros.
Durium

BEST SELLING L.P.s FROM PYE

A Golden Age of Donegan
The Best Of Ball, Barber & Bilk
Chuck Berry
Hand Clappin' Foot Stompin'
Funky But Live
Face To Face
Going Places

Lonnie Donegan
Kenny Ball, Chris Barber and Acker Bilk
Chuck Berry
Geno Washington and the Ram Jam Band
The Kinks
Herb Alpert and the Tijuana Brass
Dingo Garcia Y Sus Carios
The Hamburg Student Choir
Frank Sinatra
Petula Clark
Joe Henderson
Kenny Ball and his Jazzmen
Miki And Griff
Alexander Brothers
The Danube Strings
Petula Clark
Gustav Holst
Hugo Rignold conducts London Philharmonic Orchestra
The Searchers
Frank Sinatra
Irish Showbands
Adam Singers
Los Norte Americanos
Alexander Brothers
The Kinks
Herb Alpert and the Tijuana Brass
David Haines Piano with the Paris Theatre Orchestra

Marble Arch
Marble Arch
Marble Arch
Piccadilly
Pye
Pye Internat'l
Pye
Marble Arch
Reprise
Pye
Marble Arch
Marble Arch
Marble Arch
Pye Golden Guinea
Marble Arch
Pye
Marble Arch
Marble Arch
Marble Arch
Pye Golden Guinea
Marble Arch
Pye Internat'l
Marble Arch

BEST SELLING E.P.s FROM PYE

Black And Tan Gun
Come Back To Stay
Dedicated Kinks
The Daleks
Did You Ever Have To Make Up Your Mind
F.A.B.
Forty Shades Of Green
Getting Sentimental
Strangers In The Night
Thunderbird 1
Thunderbird 2
Two Of A Kind
The Sea Around Us
This Is My Song
So What's New
This Is My Song
Tell The Boys

Sean Dunphy
Dickie Rock & the Miami Showband
The Kinks
TV Puppets
Lovin' Spoonful
TV Puppets
Jim MacLeod and his Band
Herb Alpert and the Tijuana Brass
Frank Sinatra
TV Puppets
TV Puppets
Joe Dolan and the Drifters Showband
The Ludlows
Herb Alpert & The Tijuana Brass
Petula Clark
Sandie Shaw

Pye
Pye
Pye
Pye
Century 21
Kama Sutra
Century 21
Pye
Pye Internat'l
Reprise
Century 21
Century 21
Pye
Pye
Pye Internat'l
Pye
Pye

BEST SELLING SINGLES FROM CBS

Because I Love You
I Left My Heart In San Francisco
If I Were A Rich Man
I Want You
Here Comes My Baby
Music To Watch Girls By
Rainy Day Woman Nos: 12 & 35
Silence Is Golden

Georgie Fame
Tony Bennett
Topol
Bob Dylan
The Tremeloes
Andy Williams
Bob Dylan
The Tremeloes

CBS
CBS
CBS
CBS
CBS
CBS
CBS
CBS
CBS

(Continued on next page)

BEST SELLING L.P.s FROM CBS

Almost There	Andy Williams	CBS
Bringing It On Home To Me	Bob Dylan	CBS
Bob Dylan Greatest Hits Volume One		CBS
Blonde On Blonde	Bob Dylan	CBS
Great Movie Themes	Andy Williams	CBS
Greatest Hits	Tony Bennett	CBS
Here Come The Tremeloes	The Tremeloes	CBS
Hi Fi Companion	Ray Conniff	CBS
In The Arms Of Love	Andy Williams	CBS
If I Ruled The World	Tony Bennett	CBS
My Name Is Barbra Too	Barbra Streisand	CBS
My Fair Lady	Soundtrack & Broadway Cast	CBS
	Album	
Mary Poppins	Soundtrack	CBS
Sounds Of Silence	Simon & Garfunkel	CBS
Somewhere My Love	Ray Conniff	CBS
Tony Bennett Is San Francisco		CBS
Super Stereo Sampler Album		CBS
The Boys Won't Leave The Girls Alone	Various Artists	CBS
The Best Of Frankie Laine	Clancy Brothers	CBS
West Side Story	Soundtrack	RealM
Younger Than Yesterday	The Byrds	CBS

BEST SELLING SINGLES FROM POLYDOR

Bye Bye Blues	Bert Kaempfert	Polydor
Happy Jack	The Who	Reaction
Hey Joe	Jimi Hendrix	Polydor
I'm A Boy	The Who	Reaction
I Can't Turn You Loose	Otis Reading	Atlantic
I Feel Free	The Cream	Reaction
Little Man	Sonny & Cher	Atlantic
Land of a Thousand Dances	Wilson Pickett	Atlantic
Knock On Wood	Eddy Floyd	Atlantic
Mustang Sally	Wilson Pickett	Atlantic
New York Mining Disaster 1941	Bee Gees	Polydor
Purple Haze	Jimi Hendrix	Track
Pictures of Lilly	The Who	Track
Sweet Soul Music	Arthur Conley	Atlantic
Substitute	The Who	Reaction
The Beat Goes On	Sonny & Cher	Atlantic
The Wind Cries Mary	Jimi Hendrix	Track
Warm and Tender Love	Percy Sledge	Atlantic
When a Man Loves a Woman	Percy Sledge	Atlantic

BEST SELLING L.P.s FROM POLYDOR

Are You Experienced	Jimi Hendrix	Track
A Quick One	The Who	Reaction
Bye Bye Blues	Bert Kaempfert	Polydor
Best of Bert Kaempfert	Bert Kaempfert	Polydor
Fresh Cream	The Cream	Reaction
Annie Fischer Plays Beethoven's Concerto No. 3		
Swinging Safari	Bert Kaempfert	Polydor
Strangers In The Night	Bert Kaempfert	Polydor
Stereo Musicale	Various Artists	Polydor
This Is James Last	James Last	Polydor
The World of Sonny & Cher	Sonny & Cher	Atlantic

BRITISH TAPE MANUFACTURERS

AMPEX LTD.
72, Berkeley Avenue
Reaking
Berks

AGFA LTD.
27, Regent Street
London, W. 1

SASF UNITED KINGDOM LTD.
5a, Gillespie Road
London, N. 5.

BRAND FIVE FERRODYNAMIC
101, Leadenhall Street
London, E.C.4

E.M.I. TAPE LTD.
Blyth Road
Hayes
Middlesex

GEVASNOR LTD.
Great West Road
Brentford
Middlesex

KODAK LTD.
Victoria Road
Ruislip
Middlesex

MASTER MAGNETIC TAPES
Colnbrook
Buckinghamshire

BRITISH LABEL & SLEEVE MFRS

GARROD & LOFTHOUSE LTD.
5, Langley Street
London, W.C.2

GRAPHIS PRESS LTD.
1-3, Highbury Station Road
London, N. 1

HAYCOCK PRESS LTD.
2, Exmoor Street
London, W. 10

L. HANNIBAL & CO. LTD.
Pinfold Street
Thurmaston, Leicester

HARRISON & SONS LTD.
Printing House Lane
Hayes, Middlesex

ROBERT STACE & CO. LTD.
Industrial Estate
Tunbridge Wells, Kent

ST. JAMES PRESS
326, Kensal Road
London, W. 10

WEST BROTHERS PRINTERS LTD.
186-190, Streatham Road
Mitcham, Surrey

BRITISH PRESSING PLANTS

ALLIED RECORDS LTD.
326, Kensal Road,
London, W. 10.

BRITISH HOMOPHONE CO. LTD.
Excelsior Works,
Rollins Street,
London, S.E.15.

CBS RECORDS LTD.
Chamberlain Road,
Aylesbury,
Bucks.

THE DECCA RECORD CO. LTD.
Albert Road,
New Malden,
Surrey.

E.M.I. RECORDS
(THE GRAMOPHONE CO. LTD.)
Blyth Road,
Hayes,
Middlesex.

ORLAKE LTD.
Sterling Works,
Rainham Road South,
Dagenham,
Essex.

PHILIPS RECORDS LTD.
Record Works,
Walthamstow Avenue,
London, E. 4.

SECOL FAIRCHILD LTD.
Woolpack Lane,
Braintree,
Essex.

TRANSCRIPTION & MANUFACTURING & RECORDING CO. LTD.
James Estate,
Western Road,
Mitcham,
Surrey.

PHILIPS LTD.
Century House
Shaftesbury Avenue
London, S.W.1

TELEFUNKEN
AEG (Great Britain) Ltd.
27, Chancery Lane
London, W. C. 2

SCOTCH
Minnesota Mining & Manufacturing Co. Ltd.
3M House
Wigmore Street
London, W. 1

EMERALD RECORDS LTD.

On the Irish Charts 52 weeks of the Year

The Hottest and Biggest Selling Irish Record Label in Europe. We are always interested in leasing good C & W masters from overseas to issue over here.

Mervyn A. Solomon, 67/69, Ann Street, Belfast 1, Northern Ireland
Member of I.F.P.I.

CHAPPELLS
ARE HOME AGAIN
AT

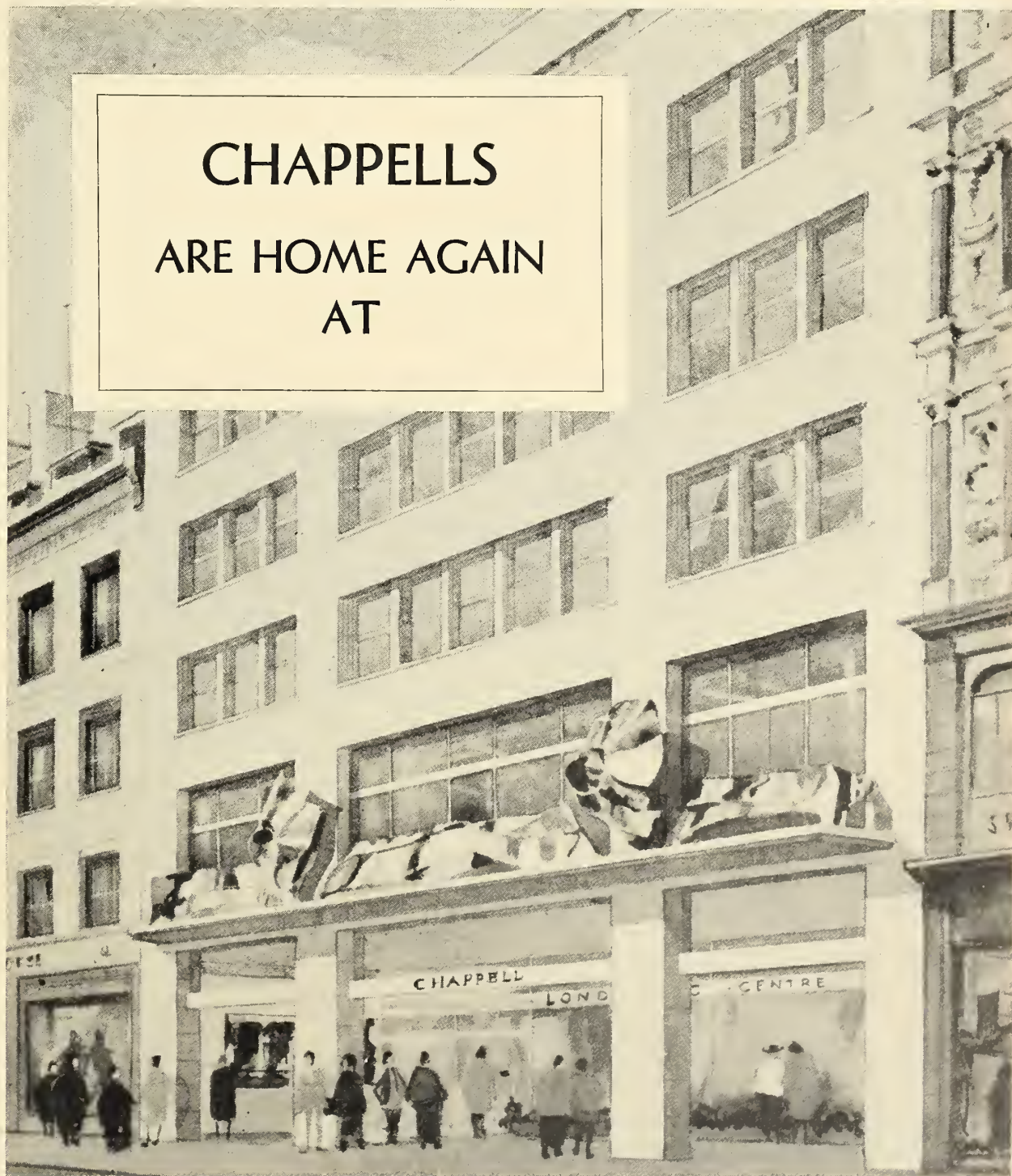

50 NEW BOND STREET, LONDON W.1.
TEL:-MAYFAIR: 7600. CABLE-"SYMPHONY" LONDON

BRITISH MUSIC PUBLISHERS

AIRBORNE MUSIC LTD.
26, D'Arblay Street,
London, W. 1.
Tel: 01-437-3745

AMBASSADOR MUSIC LTD.
(Ambassador Seven Arts)
(Cash Songs Pub. Co.)
(Davyon Music)
(Gil Music)
(George Pineus & Sons Music)
(In Music)
(Pin-Tar Music Inc.)
23-24, Greek Street,
London, W. 1.
Tel: 01-437-7053

APEX MUSIC COMPANY,
33, D'Arblay Street,
London, W. 1.
Tel: 01-629-0686

APOLLO MUSIC LTD.
(Solihull Music Ltd.)
(Trelion Music Co. Ltd.)
164, Shaftesbury Avenue,
London, W.C.2.
Tel: 01-240-0022

ARCADIA MUSIC PUBLISHING CO. LTD.
(Polyphone Music Co. Ltd.)
(Swan & Co. Ltd.)
10, Sherlock Mews,
London, W. 1.
Tel: 01-935-5469

APRIL MUSIC LTD.
28-30, Thebolads Road,
London, W. C. 1.
Tel: 01-242-9000

ARDMORE & BEECHWOOD LTD.
(Black Swan Music)
(Coppa Music Ltd.)
(Hunter Music Ltd.)
(Mutual Music Ltd.)
(Manhattan Music Ltd.)
(Pepe Music Ltd.)
(Westside Music Ltd.)
363, Oxford Street,
London, W. 1.
Tel: 01-486-4531

ASCHERBERG, HOPWOOD & CREW LTD.
(Bayley & Ferguson Ltd.)
(L. J. Cary & Co. Ltd.)
16, Mortimer Street,
London, W. 1.
Tel: 01-687-3562

EDWIN ASHDOWN LTD.
P.O. Box No: 4DR,
19, Hanover Square,
London, W. 1.
Tel: 01-629-1184

FRED BENSON LTD.
33, Crawford Street,
London, W. 1.
Tel: 01-723-6752

CARLIN MUSIC CORP.
(Alan Price Music Ltd.)
(Anita Music Ltd.)
(Benday Music Ltd.)
(Cardinal Music Ltd.)
(Chad & Jeremy Music Ltd.)
(Coronet Music Ltd.)
(Davray Music Ltd.)
(Design Music Ltd.)
(Enquiry Music Ltd.)
(Escort Music Ltd.)
(Fabienne Music Ltd.)
(Fiesta Music Ltd.)
(Jack Good Music Pub. Co. Ltd.)
(Joaneline Music Ltd.)
(Johnny Mathis Music Ltd.)
(Kalmann Music Ltd.)
(Kenmoss Music Ltd.)
(Kenny Lynch Music Ltd.)
(Kieron Music Ltd.)
(Knox Music Ltd.)
(Lark Music Ltd.)
(Leiber-Stoller Songs Ltd.)
(Linvoy Music Ltd.)
(Ludix Music Ltd.)
(Manor Music Co. Ltd.)
(Marlyn Music Co. Ltd.)
(Mayercroft Music Ltd.)
(Miracle Songs Ltd.)
(Miranda Music Ltd.)
(Park Lane Music Co. Ltd.)
(Peterman & Co. Ltd.)
(Riverdale Music Ltd.)
(Robert Vinton Music Ltd.)
(Rondoe Music (London) Ltd.)
(Semprini Music Ltd.)
(Shadows Music Ltd.)
(Shadam Music Ltd.)
(Slamina Music Ltd.)
(Smooth Music Ltd.)
(S.P.R. Music Ltd.)
(Starfire Music Ltd.)
(Stork Music Pub. Co. Ltd.)
(Swansong Music Ltd.)
(T.M. Music Ltd.)
(Tollak Music Co. Ltd.)
(Tomlin Music Ltd.)
(Tollie Music Ltd.)
(Vicki Music Ltd.)
(Vincent Shepherd Enterprises Ltd.)
(Vivace Music Ltd.)
(Warland Music Ltd.)
(Johnny Devlin Music (London) Ltd.)
(Belinda (Recordings) Ltd.)

17, Savile Row,
London, W. 1.
Tel: 01-734-3251

BOOSEY & HAWKES MUSIC PUBLISHERS LTD.
(Anglo-Soviet Music Press Ltd.)
(Boosey & Co. Ltd.)
(Cavendish Music Co. Ltd.)
(Edition A. Guthell)
(Editions Russe de Musique)
(Hawkes & Son (London) Ltd.)
(J. R. Lafleur & Son Ltd.)
(Rudall, Carte & Co. Ltd.)
(Winthrop Rogers)
(P.O. Box 1 BR)
295, Regent Street,
London, W. 1.
Tel: 01-580-2060

BOSWORTH & CO. LTD.
14-18, Heddon Street,
London, W. 1.
Tel: 01-734-4961

BOURNE MUSIC LTD.
(Aeolian Music Ltd.)
34-36, Maddox Street,
London, W. 1.
Tel: 01-493-6412

BOX & COX (PUBLICATIONS) LTD.
(Bocu Music Ltd.)
(Mello Music Co.)
7, Denmark Street,
London, W. C. 2.
Tel: 01-836-9869

BRON ASSOCIATED PUBLISHERS LTD.
(B.V.F. Anglo-Continental Music Co. Ltd.)
(Sydney Bron Music Co. Ltd.)
(Carrie Music Ltd.)
(Debmarr Pub. Co. Ltd.)
(Hit Songs Ltd.)
(Mann Music Pub. Ltd.)
(Marklon Music Ltd.)
(Sheridan Music Co. Ltd.)
(Song Favourites Ltd.)
(Yale Music Corp. Ltd.)
29-31, Oxford Street,
London, W. 1.
Tel: 01-437-5063

BURLINGTON MUSIC CO. LTD.
(Palace Music Co. Ltd.)
9, Albert Embankment,
London, S.E. 1.
Tel: 01-735-2692 & 01-625-7507

THE CAMPBELL CONNELLY GROUP
(Berry Music Ltd.)
(Cinephonic Music Co. Ltd.)
(Cross Music Ltd.)
(Dash Music Co. Ltd.)
(Evergreen Music Co. Ltd.)
(Harrison Music Co. Ltd.)
(Hournew Music Ltd.)
(Gauntlet Music Ltd.)
(Ivy Music Ltd.)
(Montclare Music Co. Ltd.)
(Hans Sikorski Ltd.)
(Show Music, Ltd.)
(Starlite Music Pub. Co. Ltd.)
(Vince Music Ltd.)
10, Denmark Street,
London, W. C. 2.
Tel: 01-836-3941

FRANK CHACKSFIELD MUSIC LTD.
(Eros)
(Medway)
(Senlac)
"Allegro", Elm Walk,
Farnborough, Kent.
Tel: Farnborough 55509

CONTEMPORARY MUSIC LTD.
52-55, Carnaby Street,
London, W. 1.
Tel: 01-437-9602

CHAPPELL & CO. LTD.
(Acuff-Rose Music Ltd.)
(Anglo-Pic Music Co. Ltd.)
(Larry Adler Music Ltd.)
(Avenue Music Pub. Co. Ltd.)
(Britannia Music Co. Ltd.)
(Irving Berlin Ltd.)
(Bradbury Wood Ltd.)
(Bregman, Vocco & Conn Ltd.)
(Chalet Music Ltd.)
(Clarence Music Ltd.)
(Compass Music Ltd.)
(Commair-Chappell Ltd.)
(Walt Disney Music Co. Ltd.)
(Delfont Music Ltd.)
(Empire Consul Music Ltd.)
(Erle Music Ltd.)
(E.F.D.S. Publications Ltd.)
(Famous-Chappell Ltd.)
(Frank Music Co. Ltd.)
(Ipanema Music Ltd.)
(Jewel Music Pub. Co. Ltd.)
(Joseph E. Levine Music Co. Ltd.)
(Lowery Music Ltd.)
(Le Vien Music Ltd.)
(Maddox Music Co. Ltd.)
(Majority Music Ltd.)
(Magic Music Ltd.)
(Michele Music Ltd.)
(Minstrel Music Ltd.)
(Edwin H. Morris & Co. Ltd.)
(Paxwin Music Ltd.)
(P.K. Music Ltd.)
(New World Music Ltd.)
(Patricia Music Ltd.)
(Terry Oates (Publishing) Ltd.)
(Sterling Music Pub. Co. Ltd.)
(Springfield Music Ltd.)
(Stratford Music Ltd.)
(Ben Selvin Music Ltd.)
(Metric Music Ltd.)
(Valando Music Co. Ltd.)
(Victoria Music Pub. Co. Ltd.)
(Walton Music Ltd.)
(Williamson Music Ltd.)
(York Music Ltd.)
50, New Bond Street,
London, W. 1.
Tel: 01-629-7600

J. & W. CHESTER LTD.
Eagle Court,
London, E. C. 1.
Tel: 01-253-6947

CONTACT MUSIC LTD.
23, Denmark Street,
London, W.C.2.
Tel: 01-240-2816

EDWARD COX MUSIC CO. LTD.
142, Charing Cross Road,
London, W.C.2.
Tel: 01-240-3917

J. B. CRAMER & CO. LTD.
99, St. Martin's Lane,
London, W.C.2.
Tel: 01-629-3456

CRANZ & CO. LTD.
1, Montague Street,
London, W. C. 1.
Tel: 01-687-5171

(Continued on next page)

WE ARE ONLY ONE YEAR OLD THIS MONTH AND WE'VE MANAGED TO PRODUCE

GETAWAY No.1 (June '66)

SUNNY No.10 (Sept. '66)

SITTING IN THE PARK No. 8 (Dec. '66)

BECAUSE I LOVE YOU No.14 (Mar. '67)

For Georgie Fame

and

NIGHT OF FEAR No.2 (Feb. '67)

I CAN HEAR THE GRASS GROW No.5 (Apr. '67)

For The Move

and

A WHITER SHADE OF PALE No.1 (June '67)

For Procol Harum

and

HAPPY NEW YEAR (Sept. '66)

For Beverley

and

SAY YOU DON'T MIND (Released this week)

For Denny Laine

and

SUMMER OF LAST YEAR (Jan. '67)

For The Pyramid

BUT FEW CAN HOLD A CANDLE TO US

Produced by **Denny Cordell**
For **NEW BREED PRODUCTIONS**
68 Oxford Street London W.1.



JOE RONCORONI

and

KEN JONES

of

Marquis Music Ltd.

Verulam Music Ltd.

Jonjo Music Ltd.

on behalf of their artistes

JONATHAN KING

TONY KINGSTON

JAMIE POWER

URSULA SANDS

THE ZOMBIES

Recorded exclusively by

MARQUIS

ENTERPRISES LTD.

Send Greetings to all their friends
in the Recording & Music Industries.

37, SOHO SQUARE
LONDON, W. 1, ENGLAND.
Telephone: Gerrard 9405/6
Cables: MARQUIMUS

CUSTOM PRESSING

If you want to best
and who doesn't?

contact

ORLAKE

BRITAIN'S

NO: 1 INDEPENDENT

FULL

PROCESSING & PRESSING
FACILITIES

Also producing

ALBUM SLEEVES

CATALOGUES

LABELS

PROMOTIONAL MATERIAL

ORLAKE LTD

STERLING WORKS

RAINHAM ROAD SOUTH

DAGENHAM, ESSEX, ENGLAND

Tel: DOMINION 7700, 8430.

BRITISH MUSIC PUBLISHERS

(Continued from preceding page)

DANVER MUSIC LTD.
(Joper Music Ltd.)
(Tomorrow Music Co.)
Suite 34, Evelyn House,
62, Oxford Street, W. 1.
Tel: 01-580-8251

HAROLD DAVISON LTD.
(Cat Music)
(Toby Music)
(Sphere Music)
Regent House,
235-241, Regent Street,
London, W. 1.
Tel.: 01-589-7961

DISC MUSIC LTD.
23, Denmark Street,
London, W.C. 2
Tel: 01-240-2816

DOUGLAS MUSIC COMPANY
(Anglia Music)
18, Broadlands Avenue,
Streatham, S.W.16.
Tel: 01-769-1437

DUNRAVEN MUSIC PUBLISHING CO. LTD.
28-30, Market Place,
London, W. 1.
Tel: 01-580-9694

ESSEX MUSIC LTD.
(Allegro Music Ltd.)
(Coda Music Ltd.)
(Concord Music Ltd.)
(Cromwell Music Ltd.)
(Greenwich Music Ltd.)
(Harmony Music Ltd.)
(Kensington Music Ltd.)
(Key Music Ltd.)
(Lakeview Music Pub. Co. Ltd.)
(London Tree Music Ltd.)
(Majestic Music Ltd.)
(Musical Comedy Productions Ltd.)
(New Breed Productions)
(Romney Music Ltd.)
(Horizon Music Ltd.)
(Tyler Music Ltd.)
Dumbarton House,
68, Oxford Street,
London, W. 1.
Tel: 01-636-7906

B. FELDMAN & CO. LTD.
(Beacon Music Ltd.)
(British & Continental Music Agencies)
(Charter Film Music Ltd.)
(Dean Street Music Ltd.)
(Dix Music Ltd.)
(The Dreamers Music Co. Ltd.)
(Gerrard Music Ltd.)
(Henrees Music Ltd.)
(Hermusic Ltd.)
(Jade Music Ltd.)
(Kennedy Street Music Ltd.)
(Manchester Music Ltd.)
(Roar Music Ltd.)
(Yardbirds Music Ltd.)
64, Dean Street,
London, W. 1.
Tel: 01-437-9336

JOHN FIELDS MUSIC CO. LTD.
(Ashley-Fields Music)
(Phoenix Music Pub. Co. Ltd.)
(Primrose Music Co. Ltd.)
(Roncom Music Ltd.)
63, Frith Street,
London, W. 1.
Tel: 01-734-7462

FILMUSIC PUBLISHING CO. LTD.
(Debonaire Music)
(Medallion Music)
(Pall Mall Music)
(Tudor Music)
110, New Bond Street,
London, W. 1.
Tel: 01-493-7633

FLAMINGO MUSIC LTD.
Stanhope House,
Stanhope Place,
London, W. 2.
Tel: 01-262-7788

FLORIDA MUSIC COMPANY LTD.
(Angel Music Co.)
(Ember Mood Music Library)
(Gloucester Music Pub. Co.)
(Lorraine Music Co.)
(Mark Music Pub. Co.)
(Monshana Music Pub. Co.)
(Mood Music Pub. Co.)
(Metropole Music Pub. Co.)
(Sharon Music Pub. Co.)
York House, Empire Way,
Wembley, Middlesex.
Tel: 01-903-1077

FORTITUDE MUSIC LTD.
17, Savile Row,
London, W. 1.
Tel: 01-493-5351

FRANCIS DAY & HUNTER LTD.
(Bluebird Music Co.)
(Donna Music Ltd.)
(Magna Music Co. Ltd.)
(Sun Music Pub. Co. Ltd.)
138-140, Charing Cross Road,
London, W.C.2.
Tel: 01-836-9351

FURSTNER LTD.
40, Hyde Park Gate,
Flat 6, London, S.W.7.
Tel: 01-536-4383

GABRIEL MUSIC GROUP
(Gabriel Music Co.)
(Diamond Music Co.)
(Eddie Calvert Music Ltd.)
(Bryanston Music)
24, Bryanston Street,
London, W. 1.
Tel: 01-835-3722

GALLIARD LTD.
(Augener Ltd.)
(Joseph Williams Ltd.)
(Weekes Music Ltd.)
Barith Works, Queen Anne's Road,
Great Yarmouth, Norfolk.

NOEL GAY MUSIC CO. LTD.
(Clover-Conway Music Co.)
(Felicia Gay Music Co. Ltd.)
(P & G Music)
(Plantagenet Music Co. Ltd.)
(Two Four Music Publishers Ltd.)
(Warden Music Co. Ltd.)
24, Denmark Street,
London, W. C. 2.
Tel: 01-836-3941

GOOD MUSIC
Dumbarton House,
68, Oxford Street,
London, W. 1.
Tel: 01-636-7906

HEATHSIDE, MUSIC.
120-122, Marylebone Lane,
London, W. 1.
Tel: 01-486-4353

ISLAND MUSIC LTD.
155-157, Oxford Street,
London, W. 1.
Tel: 01-734-6220

IMMEDIATE (LONDON) MUSIC LTD.
(Avakak Music)
(James Page Music)
(Immediate (London) Music Ltd.)
(Nice Songs and Lovely Music)
(Nicolson Music)
(Smash Music)
Immediate House,
63-69, New Oxford Street,
London, W.C.1
Tel: 240-3377

DICK JAMES MUSIC LTD.
(G.M. Music Ltd.)
(Gralto Music Ltd.)
(Gwyneth Music Ltd.)
(Jaep Music Ltd.)
(Lords Music Co. Ltd.)
(Maribus Music Ltd.)
(Melcher Music Ltd.)
(Metro Music Ltd.)
(Northern Songs Ltd.)
(Nuova Music Ltd.)
(Pacermusic Ltd.)
James House,
71-75, New Oxford Street,
London, W.C.1.
Tel: 01-836-4864

KASSNER ASSOCIATED PUBLISHERS LTD.
(American Metro Music Ltd.)
(Bens Music Ltd.)
(City Music Ltd.)
(Coslow-Kassner Music Ltd.)
(Cumberland Music Ltd.)
(Denmark Productions Ltd.)
(First Music Ltd.)
(Grosvenor Music Co. Ltd.)
(Gale & Gayles Ltd.)
(Edward Kassner Music Co. Ltd.)
(Cecil Lennox Ltd.)
(Myers Music Ltd.)
(J. Norris Music Pub. Co. Ltd.)
(Rush Music Ltd.)
(Success Music Ltd.)
(Schaeffers-Kassner Music Ltd.)
(Unit Productions Ltd.)
(Welbeck Productions Ltd.)
(Yukon Music Ltd.)
Kassner House, 25, Denmark Street,
London, W.C.2
Tel: 01-405-3026

KING MUSIC PUBLISHING CO. LTD.
Clifford House,
15, Clifford Street,
London, W. 1.
Tel: 01-734-6579

K.P.M. MUSIC LTD.
(Budd Music Ltd.)
(Cooper Music Ltd.)
(Clinton Music Co.)
(Sam Fox Pub. Co. Ltd.)
(Garnett Music Ltd.)
(Gallico Music Ltd.)
(Imperial Music Co. Ltd.)
(Keith Prowse Music Pub. Co. Ltd.)
(Macmelodie Ltd.)
(Mariboro Music Ltd.)
(Melita Music Ltd.)
(Peter Maurice Music Co. Ltd.)
(Musieville Ltd.)
(Boss Rose Music Ltd.)
(Baintree Music Ltd.)
(Reynolds Music)
(Television Music Ltd.)
(World Copyrights Ltd.)
(World Wide Music Co. Ltd.)
(Villager Music Ltd.)
21, Denmark Street,
London, W.C.2.
Tel: 01-836-3856

LEEDS MUSIC LTD.
(Blossom Music Ltd.)
(Challenge Music Ltd.)
(Duchess Music Ltd.)
(Elstree Music Ltd.)
(Eugene Music Ltd.)
(Harms-Witmark Ltd.)
(Joy Music Ltd.)
(Kags Music Ltd.)
(Pickwick Music Ltd.)
(Rawlson Music Ltd.)
(Revue Music Ltd.)
(Spone Music Ltd.)
(Tangerine Music Ltd.)
(Valley Music Ltd.)
(Welbeck Music Ltd.)
139, Piccadilly,
London, W. 1.
Tel: 01-629-7211

(Continued on next page)

FREDDIE POSER

Group of Companies

Freddie Poser Music Ltd.

Glissando Music Ltd.

Fortissimo Music Ltd.

Darren Music Ltd.

Blue Blood Music Ltd.

Red Blood Music Ltd.

46, MADDOX STREET,
LONDON, W. 1.
Tel: 01-629-1735/6

Congratulations
from

LEN TAYLOR

of

BOURNE MUSIC LTD.

34-36 MADDOX STREET
LONDON W.1. ENGLAND

Telephone: 01-493-6412/6583

Cables: BOURNEMUSIC,
LONDON, W.1.

YOU CAN'T GO WRONG
WITH A WRIGHT SONG

OVER HALF A CENTURY OF WORLD HITS

Including World Copyrights—
THE DREAM OF OLWEN
THEME FROM
THE APARTMENT
AMONG MY SOUVENIRS
etc. etc.

LAWRENCE WRIGHT MUSIC COMPANY LTD.

Associated companies:
ELIZABETHAN MUSIC CO. LTD.
VOCABLE MUSIC CO. LTD.

54, GREEK STREET,
LONDON W.1.



CYRIL GEE

and

TONY HILLER

of

MILLS MUSIC LONDON

and their hit songwriting
teams of:

Roger Greenaway—Roger Cook
Jimmy Stewart—Jerry Langley
Harold Spiro—Phil Wainman

congratulate Cash Box
on its
25th Anniversary Edition

GREAT BRITAIN'S MUSIC PUBLISHERS

(Continued from preceding page)

LORNA MUSIC CO. LTD.
(Cinderall Music Ltd.)
(Charlie Parker Music Co. Ltd.)
(Laurel Music Co. Ltd.)
(Speedee Music Ltd.)
(Woodside Music Ltd.)
5, Denmark Street,
London, W. C. 2.
Tel: 01-836-4741

LYNN MUSIC LTD.
142, Charing Cross Road,
London, W.C.2.
Tel: 01-836-0827

MAESTRO MUSIC
7-8, Norfolk Street,
Strand, W.C.2.
Tel: 01-836-8570

MARQUIS MUSIC CO. LTD.
(Marquis Enterprises Ltd.)
(Mistletoe Melodies Ltd.)
(Jonjo Music Co. Ltd.)
(Verulam Music Co. Ltd.)
37, Soho Square,
London, W. 1.
Tel: 01-437-9405

MEDIANT MUSIC LTD.
(Active Music Ltd.)
(Audio Ads Ltd.)
(Douglas Music Ltd.)
(Everest Music Ltd.)
(Peak Music Ltd.)
(Pop Music Ltd.)
(Matchless Music Ltd.)
(Movie Music Ltd.)
(Viking Music Ltd.)
5, Wardour Street,
London, W. 1.
Tel: 01-734-6311

ROBERT MELLIN LTD.
(Admiration Music Ltd.)
(Alger Music Ltd.)
(Barton Music Co. Ltd.)
(CMP (Music Publishing) Ltd.)
(Franco-London Music Ltd.)
(Harriet Music Ltd.)
(Lloyd Logan Ltd.)
(Leeann Music Ltd.)
(Margaret Music Ltd.)
(Nevins-Kirschner Music Ltd.)
(Pamper Music (London) Ltd.)
(Roxborough Music Ltd.)
(Singular Music Ltd.)
64, New Bond Street,
London, W. 1.
Tel: 01-629-3272

MILLS MUSIC LTD.
(B. F. Wood Music Co.)
(Henderson Music Co.)
(Mervyn Music Co.)
(Paradise Music Ltd.)
20, Denmark Street,
London, W.C.2.
Tel: 01-629-1745

MUSICUS LTD.
74, Newman Street,
London, W. 1.
Tel: 01-580-0074

NOVELLO & CO. LTD.
(Elkin & Co. Ltd.)
Borough Green,
Seven Oaks, Kent.
Tel: Borough Green 3261
London Showroom:
27, Soho Square,
London, W. 1.
Tel: 01-437-1222

ONE FOUR TWO MUSIC LTD.
(Anglo Irish Artistes Ltd.)
(Belgravia Music Co. Ltd.)
(Derry Music Ltd.)
(Favourite Music Ltd.)
(Hyde Park Music Ltd.)
(Jasol Music Ltd.)
(Pagsol Music Ltd.)
(Pat Music Ltd.)
(Tee Pee Music Ltd.)
73-75, New Oxford Street,
London, W.C.1.
Tel: 01-836-1801

ORBIT UNIVERSAL MUSIC CO.
10, Albert Gate Court,
124, Knightsbridge,
London, S.W.1.
Tel: 01-589-6293

OXFORD UNIVERSITY PRESS
44, Conduit Street,
London, W. 1.
Tel: 01-734-5364

PAN-MUSIK LTD.
23, Denmark Street,
London, W.C.2.
Tel: 01-405-2816

PEERS MUSIC LTD.
6, Denmark Place
London, W.C.2.
Tel: 01-405-0891

PLANETARY-NOM LONDON LTD.
London Pavillion Chambers,
Great Windmill Street,
London, W. 1.
Tel: 01-734-3424

FREDDIE POSER MUSIC LTD.
(Blue Blood Music Ltd.)
(Darren Music Ltd.)
(Fortissimo Music Ltd.)
(Glissando Music Ltd.)
(Red Blood Music Ltd.)
46, Maddox Street,
London, W. 1.
Tel: 01-629-1735

R & B MUSIC LTD.
176-178, Clapton Common,
Stamford Hill,
London, E. 8.
Tel: 01-800-9061

G. RICORDI (LONDON) LTD.
The Bury,
Church Street,
Chesham, Bucks,
Tel: Chesham 3311

ROBBINS MUSIC CORPORATION LTD.
(Leo Feist Ltd.)
35, Soho Square,
London, W. 1.
Tel: 01-437-0068

SCHAUER & MAY
239, Shaftesbury Avenue,
London, W.C.2.
Tel: 01-836-3349

SCOTT-SOLOMON LTD.
73-75, New Oxford Street,
London, W.C.1.
Tel: 01-836-1801

SCHOTT & CO. LTD.
48, Great Marlborough Street,
London, W. 1.
Tel: 01-437-1246

SCREEN GEMS-COLUMBIA MUSIC LTD.
(Colgems Music Corp.)
28-29, St. James Square,
London, S.W.1.
Tel: 01-944-6881

SOULSATIONAL SOUNDS LTD.
2, Lennox Gardens,
London, S.W.1.
Tel: 01-589-3336 Ex 5.

A. SCHROEDER MUSIC PUBLISHING CO. LTD.
(Anim Publishing Ltd.)
(Bibo Music)
(Englewood Publications)
(Kim Fowley Music)
(Isalee Music)
(Lar-Bell Music)
(Lassie Publishing)
(Living Legend Music)
(Promenade Music)
(Vogue Music)
(Woldox Music)
(Wolper Music)
(Wrather Publishing)
(Yameta)
15, Berkeley Street,
London, W. 1.
Tel: 01-493-2506

SHAPIRO BERNSTEIN & CO. LTD.
(Aviva Music Ltd.)
(Glad Music Ltd.)
(Skidmore Music Ltd.)
(Twangy Music Ltd.)
38, Soho Square,
London, W. 1.
Tel: 01-437-3493

SOUTHERN MUSIC PUBLISHING CO. LTD.
(Anglo-Southern Film Music Pub. Co. Ltd.)
(Bluebell Music Pub. Co. Ltd.)
(Carter-Lewis Music Pub. Co. Ltd.)
(Cedarwood Music Ltd.)
(Donovan (Music) Ltd.)
(Dunmo Music Pub. Co. Ltd.)
(Iver Recording Co. Ltd.)
(Jamie Music Pub. Co. Ltd.)
(Latin American Music Pub. Co. Ltd.)
(Liber-Southern Ltd.)
(Meridian Music Pub. Co. Ltd.)
(Meteor Music Pub. Co. Ltd.)
(Monique Music Ltd.)
(Most Music Pub. Co. Ltd.)
(Mirror Music Pub. Co. Ltd.)
(Southern Library of Recorded Music Ltd.)
(South Eastern Music Pub. Co. Ltd.)
(White Lodge Music Pub. Co. Ltd.)
(Southern-Monarch Film Music Pub. Co. Ltd.)
8, Denmark Street,
London, W. C. 2.
Tel: 01-836-4524

SPARTA MUSIC LTD. & ASSOCIATED COMPANIES
(Ember-Sparta Mood Music)
(Hal Shaper)
(Halmusic Ltd.)
(Noble-Arts Film Music Ltd.)
(The Moody Blues)
(Soul Music & Soul Records)
(Surefire Music & Surefire Records)
(Totem Pole Music)
155-157, Oxford Street,
London, W. 1.
Tel: 01-437-2468

77 MUSIC
77, Charing Cross Road,
London, W. C. 2.
Tel: 01-437-4197

THAMES MUSIC LTD.
39-41, New Bond Street,
London, W. 1.
Tel: 01-499-5961

DAVID TOFF MUSIC PUBLISHING CO. LTD.
(Abbey Music Ltd.)
(Celestial Music Co. Ltd.)
(Era Music Co. Ltd.)
(Italian Music Co. Ltd.)
74, Newman Street,
London, W. 1.
Tel: 01-580-6641

TOBY MUSIC LTD.
Regent House,
235-241, Regent Street,
London, W. 1.
Tel: 01-734-7961

UNITED ARTISTS MUSIC LTD.
(Alexis Music Co. Ltd.)
(Cambridge Music, Ltd.)
(Dominion Music Co. Ltd.)
(Dorafo Music Ltd.)
(Grand Canyon Music Ltd.)
(Galahad Music Ltd.)
(Jack Gold Music Ltd.)
(Kama-Sutra Music Ltd.)
(Osbit Music Co. (Publishing) Ltd.)
(Parnes Music Ltd.)
(P.S. Music Ltd.)
(Prestige Artists Ltd.)
(Rogers Music Ltd.)
(Soho Music Ltd.)
(Trio Music Co. Ltd.)
(Urug Music Ltd.)
5, Albert Gate Court,
124, Knightsbridge,
London, S.W.1.
Tel: 01-589-9383

UNITED MUSIC PUBLISHERS LTD.
(Montague Street)
1, Montague Street,
Russell Square,
London, W.C.1.
Tel: 01-636-5171

UNIVERSAL EDITION (LONDON) LTD.
(Alfred A. Kalmus Ltd.)
2-3, Fareham Street,
London, W. 1.
Tel: 01-437-5203

PETER WALSH MUSIC LTD.
(Jimbo Music Co. Ltd.)
(Tremeloes Music Ltd.)
(Wilmington Music Ltd.)
6, Southampton Place,
London, W. C. 1.
Tel: 01-405-0943

JOSEPH WEINBERGER LTD.
(Glocken Verlag Ltd.)
(Inter-Art Music Publishers)
33, Crawford Street,
London, W. 1.
Tel: 01-723-6752

LAWRENCE WRIGHT MUSIC CO. LTD
(Elizabethan Music Co. Ltd.)
(Vocable Music Co. Ltd.)
54, Greek Street,
London, W. 1.
Tel: 01-589-7111-3

Congratulations to Cash Box
on its 25th Anniversary

from

HAROLD FIELDS

★ ★ ★

RONCOM MUSIC LTD.

ASHLEY FIELDS

PRIMROSE MUSIC CO. LTD.

(Bill Bramwell)

63, FRITH STREET
LONDON, W. 1.
Tel: 01-734-7462

GREETINGS FROM

**AMBASSADOR
MUSIC
LTD.**

23-24, GREEK STREET
LONDON, W.1. ENGLAND

CABLES:- AMBAMUSIC
Telephone (01) 437-7053

**SPARTA
MUSIC LTD.**
Europe's youngest
established Publishing House

HAL SHAPER

Janie Palmer—Mike Berry
and our staff
Thank all the artists, record
companies & our overseas
publishers for our current
International hits
WORLDWIDE HITS

No: 1 "GROOVIN"
by The Young Rascals

"PUT YOUR HEAD ON
MY SHOULDER"

The million selling standard
recorded by Richard Anthony
**THE BACHELORS,
HERMAN etc.**

The R & B "Smash"
"TRAMP" by OTIS & CARLA
also Bobby Johnson & The
Atoms

**EDDIE FLOYD'S R & B
"Biggies"**

"SET MY SOUL ON FIRE"
& "CAN'T GET ENOUGH
OF YOUR LOVE"

B. B. KING'S "THE JUNGLE"
& forthcoming smash by
**THE TREMELOES
"RUNNING OUT"**

155-157 OXFORD STREET
LONDON W.1. ENGLAND
Cables: HALMUSIC-LONDON

PHONE: GERRARD 2468

THE
SYDNEY BRON

Group of Companies
LONDON

Publishing • Record Production
and
Artistes Management & Agency
Representing

**MANFRED MANN • GENE
PITNEY**

**THE BONZO DOG DOO-DAH BAND
THE EASYBEATS**

29-31, OXFORD STREET, LONDON, W. 1.

"HOLD TIGHT"

for yet more

HOWARD-BLAIKLEY

hits

Published by

HAROLD GELLER

of

LYNN MUSIC

142, CHARING CROSS ROAD,
LONDON, W.C. 2. ENGLAND
Tel: 01-836-0827/8

THE CAMPBELL CONNELLY

WORLD-WIDE GROUP OF COMPANIES
MANAGING DIRECTOR • ROY BERRY

LONDON

10, DENMARK STREET,
LONDON W.C.2.

Branches in:

NEW YORK • PARIS • HAMBURG
COPENHAGEN • AMSTERDAM • BRUSSELS
MILAN • BARCELONA • BRAZIL • SYDNEY
BUESNOS AIRES • JOHANNESBURG

CHARLES BLACKWELL

FREELANCE ARRANGER
PRODUCER
COMPOSER
LYRIC-WRITER

A HOST OF **No. 1** HITS IN EVERY FIELD

PHONE: 01-504-8609

1, LICHFIELD ROAD
WOODFORD GREEN,
ESSEX. ENGLAND

PICKWICK INTERNATIONAL INC. (G.B.) LTD.
BRITAIN'S LEADING MANUFACTURER OF

QUALITY L. P. RECORDS

REQUIRE

RECORDED MATERIAL

OF ALL TYPES BUT PARTICULARLY
CLASSICAL MATERIAL WITH TOP NAME
ARTISTES. MONO OR STEREO.

OFFERS TO:

MONTY LEWIS,
MANAGING DIRECTOR,
PICKWICK INTERNATIONAL INC. (G.B.) LTD.,
VICTORIA WORKS, EDGWARE RD.,
LONDON, N.W. 2, ENGLAND.
TEL: 01-450-7746

THE ROBERT MELLIN LTD.

GROUP OF COMPANIES

64, NEW BOND STREET,
LONDON W.1. ENGLAND

Telephone: 01-629 3272/3 Cables: MELLINMUS—LONDON W. 1.

**Cash Box—The International Music
and Record Weekly**

BRITAIN'S MILLION SELLERS PRE-1961 GOLD DISK AWARDS

Diana
Let's Have A Party
Petite Fleur
Mary's Boy Child
O Mein Papa
Limelight
What Do You Want To Make
Those Eyes At Me Fo
Rock Around The Clock
We Will Make Love
Harry Lime Theme
He's Got The Whole World In His Hands
Auf Wiedersehen
Charmaine
It's Now Or Never
Living Doll
Freight Train
Cara Mia

Paul Anka
Winifred Atwell
Chris Barber
Harry Belafonte
Eddie Calvert
Frank Chacksfield
Emile Ford

Columbia
Philips
Pye
RCA
Columbia
Decca
Pye

Bill Haley
Russ Hamilton
Anton Karas
Laurie London
Vera Lynn
Mantovani
Elvis Presley
Cliff Richard
Nancy Whiskey
David Whitfield

Brunswick
Oriole
Decca
Parlophone
Decca
RCA
Columbia
Oriole
Decca

1961-1962

Apache
Are You Sure
Does Your Chewing Gum Lose Its Flavour
Midnight In Moscow
Stranger On The Shore
The Young Ones

The Shadows
The Allison
Lonnie Donegan
Kenny Ball
Acker Bilk
Cliff Richard

Columbia
Fontana
Pye
Pye
Columbia
Columbia

1962-1963

I Remember You
Telstar
Lovesick Blues

Frank Ifield
The Tornados
Frank Ifield

Columbia
Decca
Columbia

1963-1964

A World Without Love
Bachelor Boy/The Next Time
Bits & Pieces
Can't Buy Me Love
Diane
Glad All Over
I Want To Hold Your Hand
Lucky Lips
Lovesick Blues
Little Children
Needles And Pins
She Loves You

Peter & Gordon
Cliff Richard
Dave Clark Five
The Beatles
The Bachelors
Dave Clark Five
The Beatles
Cliff Richard
Frank Ifield
Billy J. Kramer
The Searchers
The Beatles

Columbia
Columbia
Columbia
Parlophone
Decca
Columbia
Parlophone
Columbia
Columbia
Parlophone
Pye
Parlophone

L.P. awarded to The Beatles for million sales of their Parlophone L.P. "With The Beatles."

1964-1965

Do Wah Diddy Diddy
Downtown
Have I The Right
I'll Never Find Another You
I Feel Fine
My Boy Lollipop
You Really Got Me

Manfred Mann
Petula Clark
The Honeycombs
The Seekers
The Beatles
Millie
The Kinks

H.M.V.
Pye
Pye
Columbia
Parlophone
Fontana
Pye

1965-1966

Glad All Over
Tears
The Carnival Is Over
We Can Work It Out

Dave Clark Five
Ken Dodd
The Seekers
The Beatles

Columbia
Columbia
Columbia
Parlophone

1966-1967

A Groovy Kind of Love
Bend It
Green Green Grass of Home
Puppet on a String
Release Me
Send It On Home To Me
Wild Thing
Winchester Cathedral
You Don't Have to Say You Love Me

The Mindbenders
Dave Dee, Dozy, Beaky,
Mick and Tich
Tom Jones
Sandie Shaw
Engelbert Humperdinck
Spencer Davis
The Troggs
New Vaudeville Band
Dusty Springfield

Fontana
Fontana
Decca
Pye
Decca
Fontana
Fontana
Fontana
Philips

GR. BRITAIN—THE PAST 12 MONTHS

(Continued from page 28)
Continental chart entries included "Heart" by Rita Pavone. The emphasis placed on British recordings and material by Screen Gems is underlined by the fact that in 1966 50 per cent of the 300 titles handled were of British origin. The year finished with the release of "To Sir With

Love" the Columbia picture starring Sydney Pottier and Lulu for which Screen Gems have the score. The coming year will see the company move into larger premises to be shared with Columbia Pictures.

Freddie Poser

For Freddie Poser's group of companies the highlight of the year was "What Would I Be" (Darrin) recorded by Val Doonican on Decca and composed by Jackie Trent. The number also won an Ivor Novello Award as the Second Best Selling British Copyright of 1966. It was also the year that Sandie Shaw broke in a big way in Italy and Spain with two Top Ten entries "Girl Don't Come" and "Tomorrow." Amongst the latest releases handled by Freddie Poser have been the Chris Andrews compositions "Two Stretes" by Val Doonican and "Our Love Has Gone" by The Fortunes—both on Decca. Poser also published "A Thousand Times A Day" waxed by a new duo Chris and Maxime on Philips discovered and recorded by Chris Andrews. The company also published "Somewhere In A Rainbow" recorded by Paul Arnold on Pye. During the year Poser had a U.S. number originally cut by Jay and the Americans and covered in the U.K. on an L.P. track by The Walker Bros. entitled "Living Above Your Head." The biggest hit in the publishing (Continued on page 34)

Congratulations

from

CYRIL SHANE

and

THE STAFF

SHAPIRO BERNSTEIN

and Company Ltd.

WARWICK HOUSE
38, SOHO SQUARE
LONDON W.1. ENGLAND

ELVIS

New
Soundtrack
Album

RCA VICTOR presents **ELVIS** IN THE ORIGINAL SOUNDTRACK ALBUM FROM THE MGM PICTURE

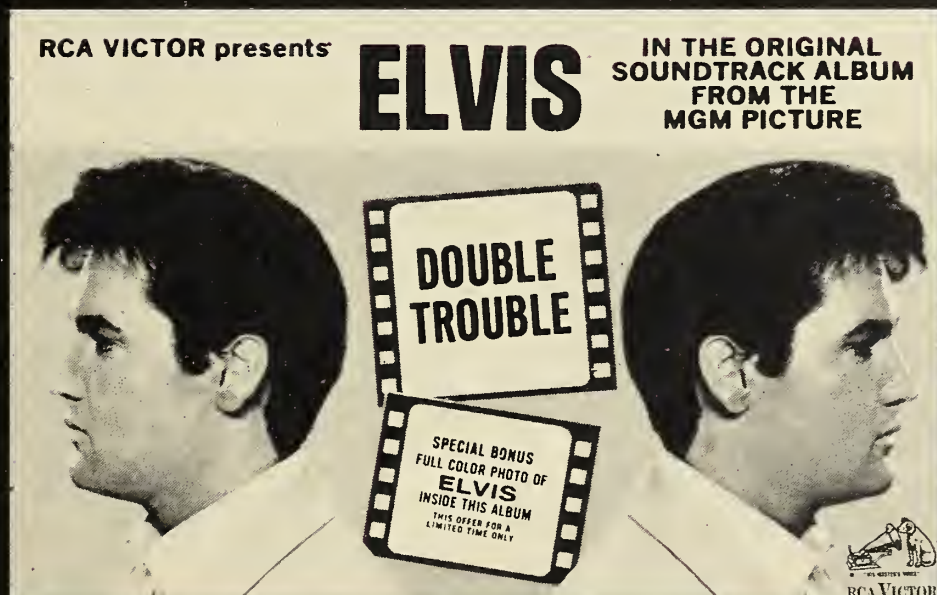

DOUBLE TROUBLE

SPECIAL BONUS
FULL COLOR PHOTO OF
ELVIS
INSIDE THIS ALBUM
THIS OFFER FOR A LIMITED TIME ONLY

METRO-GOLDWYN-MAYER Presents **ELVIS PRESLEY**
DOUBLE TROUBLE

Co-starring **JOHN WILLIAMS** **YVONNE ROMAIN** **THE WIERE BROS.** And Introducing **ANNETTE DAY**

Screen Play by **JO HEIMS** Based on a Story by **MARC BRANDEL** Directed by **NORMAN TAUROG** Produced by **JUDD BERNARD** and **IRWIN WINKLER** In **PANAVISION** and **METROCOLOR**

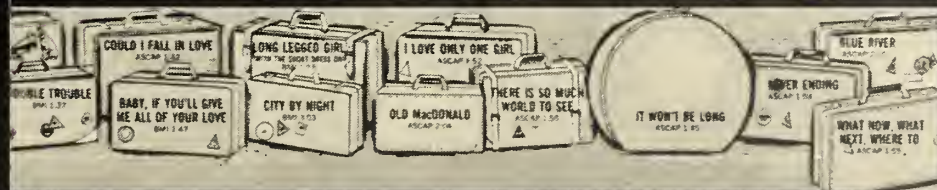

DOUBLE TROUBLE
COULD I FALL IN LOVE
LONG LEGGED GIRL
I LOVE ONLY ONE GIRL
BLUE RIVER
BABY, IF YOU'LL GIVE ME ALL OF YOUR LOVE
CITY BY NIGHT
OLD MacDonald
THERE IS SO MUCH WORLD TO SEE
IT WON'T BE LONG
NEVER ENDING
WHAT NOW, WHAT NEXT, WHERE TO

LPM/LSP-3787 Elvis sings all the songs from his new MGM movie plus Four Bonus Selections.

RCA VICTOR
The most trusted name in sound

GR. BRITAIN—THE PAST 12 MONTHS

(Continued from page 32)

activities of Robert Mellin has been the British composition "Black Is Black" recorded by Spanish group Los Bravos which became an international hit throughout the world. Mellin has expanded still further in the field of film and TV series acquiring a considerable number of soundtracks and publishing rights in major themes and background music. The most recent being the U.A. release "A Fistful of Dollars" the film which broke all box office records in the U.S. and the continent and released in the U.K. in May. Mellin has the soundtrack album recorded by Ennio Enricoe who has also recorded a single of the title song coupled with the second theme "The Man With No Name." A vocal single of both titles has been released on Fontana by The Dalys. During the year Robert Mellin acquired the Pamper Music country & western catalogue. Their film activities extend throughout Europe with affiliations in France, Italy, Rumania and Czechoslovakia. Mellin is personally devoting more of his time to composing for and supervising his film activities.

Campbell-Connelly

The year has seen a still further increase in profits for the Campbell Connelly group of companies which has been steadily rising for the past four years. During the year Managing Director Roy Berry made a round-the-world tour. In America he signed a catalogue deal with indie producers Charles Green and Brian Stone for representation in the U.K. The first release being the Buffalo Springfield group "For What It's Worth" and their first album "Buffalo Springfield" both on Atlantic. Chart-wise one of Campbell Connelly's biggest hits has been "Something Stupid" by Frank and Nancy Sinatra on Reprise. Other hits have included "Sunny" with disks by Bobby Hebb, Georgie Fame and Cher, "Bus Stop" by The Hollies, "No Milk Today" and "East West" both by Herman's Hermits and "Pamela Pamela" by Wayne Fontana. Further additions to the Campbell Connelly writing team have been Brian Morris and The Dead Sea Fruit.

KPM

For the K.P.M. group of companies it has been a very good year which finished in a wave of glory in Vienna when Sandie Shaw won the Eurovision Song Contest with "Puppet On A String" which turned out to be a million seller and a No. 1 practically all over Europe. The song firmly established two of KPM's contract writers Phil Coulter and Bill Martin. Cover records were made in Holland, France, Spain, Germany, Norway and Belgium. KPM also had a big hit with Ken Dodd's "It's Love" the Italian song with English lyrics by Norman Newell. Other hits included Dusty Springfield's "Little By Little," "A Walk In The Black Forest" by Horst Janowski, "The Work Song" by Herb Alpert and more recently a major chart entry by The Mamas and Papas on RCA "Dedicated to the One I Love." During the year KPM has acquired new catalogues notably Forest Hills Music Inc., Combine Music Inc., (a subsidiary of Monument Records). The KPM recorded library has also grown and now represents some 30 hours of new and modern music.

Mills

Cyril Gee of Mills Music reports that the year 1966/67 has seen considerable expansion in all fields of the Mills Organisation. In the "pop" field, the company has enjoyed more chart successes than ever before including such numbers as "Lovers Of The World Unite" by Peter & Gordon, "I Was Kaiser Bill's Batman" by Whistling Jack Smith, "Little Games" by The Yardbirds, "You've Got Your Troubles" by Nancy Wilson, "Green Grass" by Gary Lewis and "Happiness Is" by Ray Coniff.

In the educational field, Mills made great strides, specially in music for

the piano, guitar and recorder. British sales represented a 70% increase on the previous year.

Sparta

Hal Shaper of Sparta Music reports that the Modern Music Catalogue acquired eighteen months ago, has been virtually responsible for an album of material per week. Sparta has this year revived "Put Your Head On My Shoulder" the Paul Anka million-seller which will have at least eight new versions out in 1967. Sparta also revived two other Anka hits "Steel Guitars And A Glass Of Wine" and "Lonely Boy." From the American Hit Parade Sparta had "Tramp" by Otis Reading and Carla Thomas, and a whole selection of singles and LP tracks by Eddie Floyd, Wilson Pickett and Percy Sledge. As producers, Sparta had "The Incredible New Liverpool Scene" being released by CBS—a live album of jazz poetry from Liverpool. The company also has LPs scheduled by The Halliard Folk Group (Decca) and the new Martin Carthy Folk LPs and EPs on Fontana. Both previous albums have made the Top Ten folk charts.

Production-wise Sparta are also recording the Beechwoods and a new group The Mellow Yellow from Fontana.

Bourne

Len Taylor of Bourne Music reports that during the past twelve months the company has had a number of new recordings by established artists such as Nina & Frederick, Andy Williams, Tony Bennett and Jack Jones. Bourne's catalogue of early Sacred & Secular music has been extended, and a second album of this material has been recorded by John McCarthy and The Ambrosian Singers, for release here later this year.

Mrs. Bonnie Bourne paid her usual visit to the London office, followed by a tour of the continent, visiting her affiliates in Holland, France, Germany and Italy.

Lawrence Wright

Bill Ward, Managing Director of Lawrence Wright, reports that during the last twelve months the company has been completely re-organised and re-vitalised, by the incorporation of young personnel to cater for today's demands. Parallel with this, Lawrence Wright has activated its recording activities under the direction of Professional Manager Len Beadle, resulting in a number of master tapes being successfully leased to major recording companies. In the past twelve months Lawrence Wright has set up Summit Artists (Ltd) an artists' agency organisation incorporating a personal management department. Another company, Lawrence Wright Entertainments Ltd., has also been reactivated, and will result in stage productions at Blackpool etc.

Lynn

Lynn Music, the three and a half year old company under the direction of Harold Geller, was voted by Record Retailer the 8th Most Successful Publisher in the United Kingdom for 1966/67. The past twelve months has seen some major chart entries, notably by Dave Dee, Dozy, Beaky, Mick and Tich, including "You Make It Move" "Hold Tight," "Hideaway," "Bend It," "Touch Me," and more recently, "Okay." Credit for this string of successes is due to the working collaboration between Harold Geller of Lynn Music, and Ken Howard and Alan Blaikley, Manager and writers for Dave Dee, Dozy, Beaky, Mick & Tich. The amazing success of this combination in Germany, working with Minerva Music, has produced in the last twelve months, seven Number One's. Lynn Music also had the film score, "Dalek Invasion Earth" by Bill McGuffie, and a single by the same artist entitled "Fugue For Thought" on Philips.

Shapiro, Bernstein

Cyril Shane of Shapiro Bernstein

has had the best year for the past four years. Many of the company's biggest successes have been English versions of Italian numbers, picked up by Shane on his travels abroad. These include, "Don't Answer Me" and "A Fool Am I" both by Cilla Black, with English lyrics by Bernstein's contract writer Peter Callander, who also penned for another Italian song entitled "Once There Was A Time" recorded by Tom Jones. Other hits of the year have included "Pretty Flamingo" by Manfred Mann, and Sounds Orchestral who also had another charter with "Image." Another hit for Bernstein was Sandie Posy's "Born A Woman." More recently, the pubby had the Mitch Murray-Peter Callander composition "Mr. Abbercrombie Taught Me" recorded on Clan by Lady Murray alias Grezina Frame, and the latest Dusty Springfield single "Give Me Time," another Italian copyright which was in fact the winning song from the Festival of Roses in Rome 1967.

Bron

It has been an above-average year for the Bron Associated Publishing Company, and a year of great expansion on their artists, agents and management side. It has also brought about the increasing success of Manfred Mann and Gene Pitney. The success of these two artists has been brought about by the assiduous application of their interests by the recently-formed Bron Artists Management Company, under the direction of Gerry Bron. Recent acquisitions have been the Australian group The Easybeats, and the outstanding comedy group, The Bonzo Dog Doo Dah Band. The expansion of the company has caused Bron to considerably rebuild and modernise their premises. Alongside this has been the reorganisation of staff to cope with the company's diverse activities. One of the company's biggest international successes of the year has been with "Ha Ha Said the Clown" by Manfred Mann. This record was produced by Gerry Bron & it is the company's intention to expand its record production activities in the future.

Major hits of the past year have also included "Backstage" by Gene Pitney, "Lightnin' Strikes" by Lou Christie, "You're A Better Man Than I" by the Yardbirds, "You Won't Be Leaving" by Herman's Hermits, "Cold Light Of Day" by Gene Pitney, and of course "Ha Ha Said The Clown" by Manfred Mann. The year has also seen the formation of Mann Music Publishers Ltd., in association with Manfred Mann.

Harold Fields

During the year Harold Fields has further developed and consolidated the promotion of their instruction books for use in music colleges throughout Europe where they are distributed by Ashley Fields. The Porter Heaps Hammond Organ Catalogue, already a terrific seller in the United States, is now the accepted tutor for this instrument in the U.K. Perry Como is to step-up his recording activities, which will benefit his publishing company Roncom Music Ltd., handled in this country by Harold Fields.

For Leeds Music, the year under review started well with "Strangers In The Night," followed by a recession until "This Is My Song" gave them a double success with versions by Petula Clarg and Harry Secombe. Paul Jones's solo disk "I've Been A Bad Bad Boy" notched up good sales, and more recently Petula Clark gave the Welbeck catalogue a boost with her "Don't Sleep In The Subway" single.

The year has seen a consolidation of the tie-up between Leeds Music and Universal Pictures, giving them the film scores of such box office successes as "Deadlier Than The Male," "Privilege," "A Man And a Woman," "Countess From Hong Kong" and "The Jokers."

Ambassador

"A Taste Of Honey" still continues to be a good source of revenue for Ambassador Music, and during the year Tom Jones, Peter & Gordon, Vince Hill and Anita Harris covered

the number, bringing the total number of recordings to 500.

French singing star Mireille Mathieu waxed "Rusty Bells" which was also included on her album. Ambassador Music acquired the John Lee Hooker catalogue and will be publishing all future Hooker material.

The new Tarzan TV series gave Ambassador "Tarzan March" with six recordings, including the latest one on Columbia by Acker Bilk, which promises to be an international success. Indie producer Drew Harvey entered into a publishing agreement with parent company Gil Music, and Harvey Block Gil Music was formed. George Pincus paid several of his periodical visits to Britain.

Lorna

Lorna Music continued to profit from "Someday-Oneday" by The Seekers and "Sounds of Silence" by The Bachelors. Unhappily the Simon & Garfunkel composition "59th Street Bridge Song" by Harpers Bizarre, a hit in America, failed to take off in this country. During the year, Lorna acquired the rights to the Joey Brooks catalogue (writer of the Walker Brothers' hit "My Ship Is Coming In"). Lorna's General Manager Alan Paramour expects considerable success with this material in the coming months. Lorna's independent record production activities have resulted in an album called "Suburban Serenades" by a new artist, Partridge Green Esq., released by CBS. Green is contracted to Lorna as a writer and an artist. Lorna also has the publishing rights to the score by Loe Hoyer for the Danish film "Seventeen," the sound track album issued in this country on Columbia.

Fanfare

Fred Jackson's Fanfare Music has been very successful with indie productions, mainly via "Freeloader" by the Pussyfoot, which become an international success and has been released world wide.

Jackson also started up new companies in various overseas territories, one of the most successful being Editions Fanfare in Stuttgart, Germany. The company had three big hits, "Ha Ha Said The Clown" by Manfred Mann, "Here Comes My Baby" by The Tremeloes, and "Western Union" by The Searchers. Fanfare in England also had a good seller with Tony Osborne's "Blue Bolero" which now has 25 covers, including versions in Turkish and Japanese. During the year, Fred Jackson made a very successful tour of the United States and Canada. The company also had a Canadian hit with "His Girl" by The Guess Who.

Aaron Schroeder

Since setting up his British operation, American publisher Aaron Schroeder has achieved international success with his contract writer Randy Newman via such compositions as "My Ship Is Coming In" by The Walker Brothers, Gene Pitney's "Nobody Needs Your Love" and "Simon Smith and His Amazing Dancing Bear" by The Alan Price Set. Price's new single is also a Randy composition "The Biggest Night Of Her Life" released on Decca. Aaron Schroeder also has a world wide representative deal with Jimi Hendrix and has had major successes with "Purple Haze" and "The Wind Cries Mary."

Cavendish & La Fleur

For Cavendish & La Fleur it has been another year of success with their vast catalogue of standard evergreens, and the company's revenue continues to be largely derived from broadcast material. However, during the year subsidiary company, Boosey & Hawkes, have had a CBS single release of "Danny Boy" by C/W singer Ray Price, which figured in the United States' C/W charts for several weeks.

Planetary-Nom

Planetary-Nom (London) Ltd., a subsidiary of Big Seven Music Cor-

(Continued on page 60)

We're so big we can afford to think small.

We'll handle your littlest request.

We'll press your records, do your distributing. Record, merchandise, promote, advertise, publicize your artists. Our highly equipped studios are yours to rent. And our publishing companies are at your disposal.

We have what you might call a musical valet service. Handling each project with kid gloves. And style. And *ne plus ultra* attention.

You can sit back and leave all the work to us. Just license your entire catalog, or even a single song. Pick one country, or the globe. We'll take over. Brilliantly. Imaginatively. And do such a top-notch job that you'll think CBS stands for Certain Business Success.

One thing for sure, we do mean business. Big business and small business.

Our affiliates are bursting with energy. And ideas. And resources. Because they export to other countries, it gives us nearly 100 national markets. One hundred excellent reasons for making CBS Records the world's largest—and most comprehensive—music services operation.

We're so big-small it makes our competitors gasp.

Try us for size.

CBS Records 
Entertaining the Entire World

CBS International: 51 West 52 Street, New York, New York 10019.
(212) 765-4321. Cable COLRECORD; Telex 421782



artists of world renown
music in the great tradition
outstanding quality

Deutsche Grammophon Gesellschaft, Address:



worldwide distribution
foremost in service
internationally acclaimed

GERMANY—THE PAST 12 MONTHS

HIGHLIGHTS

- Total sales for 1966 were about 400 million DM (\$100 million), an increase of about 20 million DM (\$5 million) over the previous year.
- Although single sales were slightly down, the 12" LP jumped 16.6% and the Pop LP sales rose a tremendous 37.5%.
- Classical sales were 31.5% compared to 40% for the previous year but still well above the world

market average.

- Export rose 7.6% while import rose 14%.
- Production went down by 2.6% for singles and 14.5% rise for LP's.
- EP sales dropped 30%.
- Low priced records (\$2.50 or below) accounted for about 1/3 of total LP sales.
- Almost all LP's are now stereo compatible which can also be played on a monoaural system.

The last 12 months saw many changes in the record business in Germany. As statistics show, the market is going more and more in the direction of LP's with the low priced LP market growing day by day. It is now possible to buy good quality stereo LP's for as little as DM 5 (\$1.25) while the single record sells for DM 4.75 (\$1.19). The singles business saw 109 songs enter the top 10 with 50 German copyrights making the grade.

Of the 109 songs, 46 were in the original English language and 5 instrumental hits made the top 10 charts. In actual sales, the balance was even stronger for English and U.S. hits but the juke box business still favored the German language hit. The large cities were also heavily dependent on English and U.S. records with good sales on some French product while the smaller cities and towns continued to sell mainly German language product mixed with good reports on foreign material.

A breakdown on top 10 product according to label is also included in this section and shows an amazing breakthrough especially for Vogue with its strong single repertoire from the U.S. and England. LP sales are still mainly concentrated on the big four with Philips, Teldec, Electrola and Polydor accounting for well over 80% of total LP business. Ariola is also very strong in the LP field with their strong classical label Eurodisc and artists Rudolf Schock, operetta king of Germany and Peter Alexander leading the way for the label's strong LP representation.

A strong tendency has also been shown in the last 12 months to independent production and even indie labels handled by major distributors here.

This is especially in the singles field. Strongest of the indies is Hansa Records owned by Peter Meisel and

distributed by Ariola who not only have strong local artists but have also been successful in buying masters from top foreign artists such as The Hollies and The Troggs. Germany has also developed strong export artists lead off by Bert Kaempfert and closely followed by The Ofarims, Udo Jurgens, Horst Jankowski and James Last with tunes written by Mr. Kaempfert also finding a strong place in the U.S. hit parade. James Last also contributed "Games That Lovers Play" to the charts.

The main problem that has faced the singles business for German productions has been the fact that the A&R men have been unable to develop local artists and the writers have been unable to come up with original material of the type that has dominated the charts in England and the U.S. The two top beat bands selling records here both record in the English language and even some pop artists have turned to recording in English from this market and for this market. Main examples here are The Lords from Electrola The Rattles from Philips and Andy Fisher from Vogue. Top selling single artist is now Polydor's Roy Black who has never failed to top the charts with his singles in the past year and also won the Bravo Magazine and Radio Luxemburg award as the most popular artist in Germany. Dave Dee, Beaky, Dozy, Mick and Tich have also done tremendously well for Philips and even took first place in popularity polls ahead of The Beatles who continue to have a tremendous turnover here along with the Rolling Stones.

A major battle between the record industry and the broadcasting industry in Germany lead to a complete stop for several months of airplay of record product and resulted in lower record sales. The fight which has been

(Continued on page 42)

SALES

Category	1966 in millions	1965 in millions	% change
singles	23.9	25.4	- 5.9
EP	5.3	7.5	-29.3
10" LP	0.7	1.2	-41.7
12" LP	17.6	15.1	+16.6

CLASSICAL & SPOKEN WORD

singles	0.5	0.7	-28.6
EP	1.9	2.8	-32.1
10" LP	0.3	0.6	-50.0
12" LP	5.5	6.3	-12.7

POP SALES

singles	23.4	24.7	- 5.3
EP	3.4	4.7	-27.7
10" LP	0.4	0.6	-33.3
12" LP	12.1	8.8	+37.5

EXPORT

singles	4.4	4.3	+ 2.3
EP	0.9	1.2	-25.0
10" LP	0.1	0.2	-50.0
12" LP	7.3	6.1	+19.7

IMPORT

singles	0.32	0.28	+14.3
EP	0.22	0.31	-29.0
10" LP	0.02	0.02	—
12" LP	1.90	1.55	+22.6

PRODUCTION

singles	29.8	30.6	- 2.6
EP	6.9	9.9	-30.3
10" LP	1.0	1.6	-37.5
12" LP	27.6	24.1	+14.5

The other publishers say that "they try harder"
May we tell you why we're Number 1?

For 8 years now, we've lead the list of publishers in the top 10 and top 3.

The reason is great foreign and local material and

Service!

GERIG's got promotion service

GERIG's got contact service

GERIG's got organizational service.

They try harder, we work harder and bring results!

GERIG's got it!

GERIG Musikverlage, Cologne, Germany, Drususgasse 7-11

TELDEC

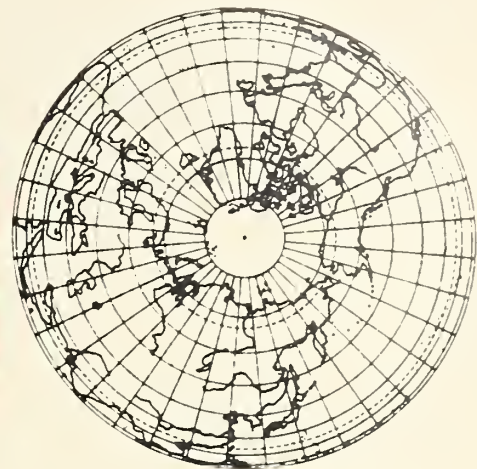

REPRESENTING THE WORLD'S MOST IMPORTANT RECORD LABELS AND INTERNATIONALLY FAMOUS ARTISTS IN GERMANY

Ed Ames
Paul Anka
Eddy Arnold
Bobby Bare
Len Barry
Harry Belafonte
Perry Como
Bing Crosby
James Darren
Sammy Davis jr.
Val Doonican
Buddy Holly
Engelbert Humperdinck
Tom Jones
Mario Lanza
Trini Lopez
Dean Martin
Billy Mo
Chris Montez
Roy Orbison
Crispian St. Peters
Elvis Presley
Jim Reeves
Ronny
Willy Schneider
Ricky Shayne

Frank Sinatra
Frank Sinatra jr.
Cat Stevens
Whistling Jack Smith

Herb Alpert & the Tijuana Brass
Count Basie
Xavier Cugat
Don Kosaken Chor
Original Egerländer
Musikanten Ernst Mosch
Duke Ellington
Arthur Fiedler
(Boston Pops Orchestra)
Will Glahé
Ted Heath
Henry Mancini
Mantovani
Glenn Miller
Mitch Miller
Werner Müller
Original Oberkrainer
Quintett Avsenik
Nelson Riddle

Edmundo Ros
Wiener Sängerknaben

Chet Atkins
Don Cherry
Floyd Cramer
Duane Eddy
Horst Fischer
Pete Fountain
Al Hirt
Jacques Loussler
Peter Nero
Boots Randolph
Klaus Wunderlich

France Gall
Eartha Kitt
Hildegard Knef
Brenda Lee
Miriam Makeba
Manuela
Peggy March
Odetta
Rita Pavone

Nina Simone
Nancy Sinatra
Caterina Valente

The Association
City Preachers
The Electric Prunes
Everly Brothers
The Gibsons
Harpers Bizarre
Los Indios Tabajaras
Jefferson Airplane
Kingston Trio
Los Machucambos
The Mamas & The Papas
Sergio Mendes & Brazil '66
The Monkees
The Move
Peter, Paul & Mary
Alan Price Set
The Rolling Stones
The Sandpipers
The Small Faces
Ike & Tina Turner
The Turtles



DECCA



RCA VICTOR

LONDON



reprise:

CORAL

DERAM

monument

TELDEC

Schallplatten-Gesellschaft mbH. Hamburg/Germany

GERMANY'S BEST SELLERS (TOP 10 TUNES) OF THE LAST YEAR (JULY-JUNE) BY DISTRIBUTOR IN ORDER OF APPEARANCE ON CHARTS, NOT IN ORDER OF SALES

ARIOLA-EURODISC SCHALLPLATTEN

Title	Artist	Label	Publisher
Juanita Banana	The Peels	Hansa	Edition Intro/Meisel
★Ich liebe das Leben (I love this life)	Peter Alexander	Ariola	Hans Gerig Music
★Nur wenn Du bei mir bist (only when you are with me)	Elisa Gabbai	Hansa	Edition Tutti
With a girl like you I can't control myself	The Troggs	Hansa	Rolf Budde Music
★Moderne Romanzen (modern romances)	The Troggs	Hansa	Rolf Budde Music
Augen wie zwei Sterne (that's nice)	Peter Alexander	Ariola	Hans Gerig Music
★Ich hab einen guten Freund gehabt (I had a good friend)	Rex Gildo	Ariola	Edition Belmont
La Montanara	Marion	Hansa	Edition Intro/Meisel
★Zehn Kosaken, kein Gewehr (ten kosaks, no rifle)	Nini Rosso	Hansa	Bosworth Music
Snoopy Vs. the red Baron	Sigi Hoppe	Ariola	Edition Maxim
Spanisch war die Nacht (Spanish night)	Royal Guardsmen	Ariola	Fuller-Sanphil-Windsong
★Ein Ring aus Gold (a golden ring)	Peter Alexander	Ariola	Hans Gerig Music
Wild Thing	Rex Gildo	Ariola	Edition Intro/Meisel
	The Troggs	Hansa	April Music

CBS SCHALLPLATTEN

Title	Artist	Label	Publisher
★der neue Tag beginnt (the new day begins)	Bernd Spier	CBS	Melodie der Welt/Michel
Fremde in der Nacht (strangers in the night)	Peter Beil	CBS	Hans Gerig Music
Over under sideways down	The Yardbirds	Epic	Francis Day & Hunter
Alle meine Träume (all my dreams)	Peter Beil	CBS	Hans Gerig Music
Sunshine Superman	Donovan	Epic	Peer Music/T. Seeger

DEUTSCHE VOGUE SCHALLPLATTEN

Title	Artist	Label	Publisher
Something on my mind	Chris Andrews	Vogue	Edition Intro/Meisel
Sunny Afternoon	The Kinks	Pye	Aberbach Music
Early bird	Andre Brasseur	Vogue	Edition Trumpf/Arends
Hanky Panky	Tommy James & the Shondelles	Vogue	Ralph M. Siegel Music
Komplimente (compliments)	Pat Simon	Vogue	Belmont Music/Yaskiel
★Sag mir wie (tell me how)	Udo Juergens	Vogue	Montana Music/Beierlein
So wunderbar verliebt zu ein (so wonderful to be in love)	Petula Clark	Vogue	Edition Belmont/Yaskiel
Mr. Cannibal	Andy Fisher	Vogue	Nero/Edition Intro/Meisel
Dandy	The Kinks	Vogue	Aberbach Music
Dear Mrs. Applebee	David Garrick	Pye	Rolf Budde Music
Deadend street	The Kinks	Vogue	Aberbach Music
★Geh vorbei (pass on by)	Udo Juergens	Vogue	Montana Music/Beierlein
★Capito	Vera Palm	Hit Ton	Minerva Music/von der Dovenmühle
A man in the woods	Andy Fisher	Vogue	Belmont Music
Puppet on a string	Sandie Shaw	Hit Ton	Hans Gerig Music
Please Mr. moving man	David Garrick	Vogue	Melodie der Welt/Michel
★Das schönste Mädchen der Welt (the prettiest girl of the world)	Larry Finnegan	Vogue	Hans Gerig Music

ELECTROLA SCHALLPLATTEN

Title	Artist	Label	Publisher
Sloop John B	The Beach Boys	Capitol	Francis Day & Hunter
Paperback Writer	The Beatles	Odeon	Rolf Budde Music
Du bist mein erster Gedanke (yours)	Cliff Richard	Columbia	Ralph Maria Siegel Music
Michelle	The Beatles	Odeon	Rolf Budde Music
Super Girl	Graham Bonny	Columbia	Morris Music
Yellow submarine	The Beatles	Odeon	Rolf Budde Music
★Man muss schliesslich auch mal nein sagen können (a girl has to know how to say no)	Gitte	Elektrola	Hans Gerig Music
★Rosen brauchen Sonnenschein (roses need sunshine)	Rex Gildo	Elektrola	Hans Gerig Music
(Dandy)	Herman's Hermits	Columbia	Aberbach Music
★Wenn der Abschied kommt (when we say goodbye)	Wanda Jackson	Capitol	Melodie der Welt
★Ich mach Protest (I protest)	Gitte	Elektrola	Hans Gerig Music
★Das Glück ist rosarot (luck is red like roses)	Cliff Richard	Columbia	Edition Accord
★Wenn die bunten Fahnen wehen (the coloured flags are flying)	Heino	Elektrola	Schott-Soehne Music
Penny Lane	The Beatles	Odeon	Northern Songs Ltd.

METRONOME SCHALLPLATTEN

Title	Artist	Label	Publisher
Little Man	Sonny & Cher	Atlantik	Edition Intro/Meisel
★French geküsst ist halb gewonnen	Siw Malmkvist	Metronome	Minerva Music/Dovenmühle
Barcarole 66	Jan Gorissen	Golden 12	Metorion
★Ein neues Spiel, ein neues Glück (another game, another chance)	Siw Malmkvist	Metronome	Edition Intro/Meisel
My friend Jack	The Smoke	Metronome	Metorion Music
★Dein Herz das muss aus Gold sein (your heart must be made of gold)	Anna-Lena	Metronome	Edition Intro/Meisel

PHILIPS - TON SCHALLPLATTEN

Title	Artist	Label	Publisher
Monday, Monday	The Mamas & the Papas	Philips	Edition Intro/Meisel
The sun ain't gonna shine any more	The Walker Brothers	Star Club	Edition Accord/Dehmler
★Wenn du gehn willst (if you want to go)	Vicky	Philips	Ralf Arnie Music
★Morgen ist der schönste Tag (tomorrow is the best day)	Nana Mouskouri	Fontana	Ralf Arnie Music
Hold tight	Dave Dee, Dozy, Beaky, Mick & Tich	Philips	Minerva Music/von der Dovenmühle
Hideaway	Dave Dee, Dozy, Beaky, Mick & Tich	Philips	Minerva/von der Dovenmühle
Bend it	Dave Dee, Dozy, Beaky, Mick & Tich	Star Club	Minerva Music/von der Dovenmühle
Hard to love you	Dave Dee, Dozy, Beaky, Mick & Tich	Star Club	Minerva Music/Dovenmühle
Save me	Dave Dee, Dozy, Beaky, Mick & Tich	Star Club	Minerva Music/Dovenmühle
Touch me, touch me	Dave Dee, Dozy, Beaky, Mick & Tich	Star Club	Minerva Music/Dovenmühle
Ha Ha, said the clown	Manfred Mann	Fontana	Edition Fanfare/Kirsten

(Continued on next page)

THANKS
for your faith and confidence

PLEASE
continue to give us your
faith and confidence.

MINERVA MUSIC
Rudi Von Der Dovenmühle
Nord Str. 17 a **Cologne, Germany**



Germany

is one of the leading record-markets in the world

Philips Ton

is one of the leading record-companies in Germany

YOU

are interested in this big market, looking for a partner

WE

are interested in you, looking for new material and talent

Let us join for big business



Please write, phone or cable if you have a sound to offer. There will always be the right man for you at:

PHILIPS TON GESELLSCHAFT M. B. H.
2 Hamburg 1, Postbox 1093
Telephone: (0411) 33 92 21
Telegramm: Phihag Telex: 02 - 161587 a DPU d

GERMANY'S BEST SELLERS (TOP 10 TUNES) OF LAST YEAR (JULY-JUNE)

(Continued from preceding page)

POLYDOR SCHALLPLATTEN

Title	Artist	Label	Publisher
100 Mann und ein Befehl (Ballad of green berets)	Freddy Quinn	Polydor	Francis Day & Hunter
Juanita Banana	Mal Sondock	Polydor	Edition Intro/Meisel
★Müssen Frauen einsam sein (must women be lonely)	Peter Alexander	Polydor	Hans Gerig Music
★Der Mond war schuld daran (the moon is to blame)	Connie Francis	MGM	Francon/Schneider
★Leg dein Herz in meine Haende put your heart in my hands	Roy Black	Polydor	August Seith Music
★Beiss nicht gleich in jeden Apfel (don't bite into every apple)	Wencke Myhre	Polydor	Minerva Music/von der Dovenmühle
★Irgendjemand liebt auch dich (somebody loves you too)	Roy Black	Polydor	Edition Intro/Meisel
★Unverstanden (not understood)	Sascha Distel	Polydor	Hans Gerig Music
★Meine Reise ist zu Ende (my journey is over)	Connie Francis	MGM	Francon/Schneider
★Summer in the city	The Lovin' Spoonful	Kama Sutra	Hans Gerig Music
★Eine Handvoll Reis (a hand full of rice)	Freddy Quinn	Polydor	Edition Esplanada
★Du allein (you alone)	Franz Beckenbauer	Polydor	Radio Music Int.
★Lass den dummen Kummer (stop that worrying)	Renate Kern	Polydor	Edition Maxim
★Good night my love	Roy Black	Polydor	August Seith Music
★Wer hat ihn gesehn (who has seen him)	Wencke Myhre	Polydor	Aberbach Music
★Frag nur Dein Herz (ask your heart only)	Roy Black	Polydor	Hans Gerig Music
★Es ist so schoen dass es Dich gibt (it's wonderful, that you exist)	Connie Francis	MGM	Francon/Schneider
★Happy Jack	The Who	Polydor	Hans Gerig Music
★Alle Männer alle (all men, all)	Wencke Myhre	Polydor	Aberbach Music
★Schiwago Melodie	Maurice Jarre	MGM	Hans Gerig Music
★Morgen beginnt die Welt (tomorrow starts the world)	Freddy Quinn	Polydor	Edition Doma/B. Kaempfert
★Meine Liebe zu Dir (my love to you)	Roy Black	Polydor	Riva Music

TELDEC SCHALLPLATTEN GmbH.

Title	Artist	Label	Publisher
Paint it Black	The Rolling Stones	Decca	Hans Gerig Music
How does that grab you darling	Nancy Sinatra	Reprise	Belmont Music/Yaskiel
★Honey Bee	The Magics & Drafi	Decca	Edition Intro/Meisel
★Hundert Jahre und noch mehr (100 years and more)	Peggy March	RCA Victor	Edition Bellevue
★Strangers in the night	Frank Sinatra	Reprise	Hans Gerig Music
★Mother's little helper	The Rolling Stones	Decca	Hans Gerig Music
★Black is black	Los Bravos	Decca	Ralph Maria Siegel Music
★Dunja Du	Ronny	Telefunken	Idee Music
★Dumme sterben niemals aus (some people never learn)	Manuela	Telefunken	Edition Intro/Meisel
★Wenn Du einsam bist (when you are lonely)	Ronny	Telefunken	Edition Marbot
★Have you seen your mother baby, standing in the shadow	The Rolling Stones	Decca	Hans Gerig Music
★Sweetheart schenk mir einen Ring (sweetheart give me a ring)	Peggy March	RCA Victor	Rolf Budde Music
★I am a believer	The Monkees	RCA Victor	Hans Gerig Music
★Memories of Heidelberg	Peggy March	RCA Victor	Melodie der Welt
★Lass die Sonne wieder scheinen (let the sun shine again)	Ronny	Telefunken	Edition Maxim
★Let's spend the night together	The Rolling Stones	Decca	Mirage Music
★Mal nichtgleich den Teufel an die Wand (don't paint the devil on the wall)	Peggy March	RCA Victor	Rolf Budde Music
★Lord Leicester aus Manchester Release Me	Manuela Engelbert Humpert	Telefunken Decca	Edition Intro/Meisel Paul C.R. Arends Music
★Somethin' Stupid	Frank Sinatra & Nancy	Reprise	Chappell Music/Seith
★I was Kaiser Bill's Batman	Whistling Jack Smith	Deram	Mills Music
★A little bit me, a little bit you	The Monkees	RCA Victor	Hans Gerig Music

GERMANY—The Past 12 Months

(Continued from page 38) settled was basically over royalties that broadcasting stations should pay for artists and musicians for the use of their talents through recordings. The fight started exactly one year ago and lasted until the end of 1966. As of January, records were once again aired and record sales on the singles level picked up but the results of the fight which left the listeners dependent on foreign radio stations, AFN (Armed Forces Radio) BFN (British Forces Network) and Radio Luxem-

burg lead to a tremendous popularity for foreign product which has not diminished to this day. On July 1st last year, of the 16 records listed in the 2 top ten lists, 8 of the records were German language and 8 were of U.S.-English origin and on June 9th of this year again 16 records were listed and 9 were of German origin with 7 being U.S.-English product.

The German pop music festival accounted for two records moving well over 100,000 with the Roy Black disc (3rd place) accounting for over 1/2

million sales and the winning entry from Wencke Myhre doing over 100,000 and secondplace tune from Elisa Gabbai selling over 50,000. About a million records were sold of festival songs. This year, the festival was cancelled accounting for a drop in German product as well. Next year, the festival will be held once again.

GEMA, the German collection agency came up with the whopping sum of 127 million German marks income last year which was an increase of 11.7% over the year before. The development of German composers and authors income can be seen in 10 year jumps as in 1953

GEMA took in about 6 million marks. In 1943 the sum jumped to 14.5 million marks, in 1953 the sum was 27 million marks and in 1963 the GEMA income was 105.8 million. A profitable business for the writers of German music.

A very popular and profitable new concept in the classical LP field has been the special subscription offers of major firms on major classical recordings. The subscriptions start usually about a month or two before release of the product and end about 5 to 6 months later with lower prices offered to subscribers. This service is especially popular in Germany. (Continued on page 47)

FRANCIS, DAY & HUNTER GMBH MOVES!

We move with **Top Promotion • Top Hits • Top Artists**



Now movin' into brandnew offices!

Move with

**FRANCIS, DAY & HUNTER GMBH
MITTELWEG 149, HAMBURG 13 - GERMANY**

THANKS!

LOCAL ARTISTS

anna-lena
fred bertelmann
gerd boettcher
drafi deutscher
suzanne doucet
elisa gabbai
georgio
rex gildo
michael holm
siw malmkvist
manuela
marion
peter moesser's music
ricky shayne
mal sondock



HANSA RECORDS INTRO PUBLISHING

INTERNATIONAL ARTISTS

Nini Rosso
The Hollies
The Troggs
The Young Idea
The Count Five
The Loot
The Herd

PETER MEISEL
THOMAS MEISEL
HANS BLUME
GUNTER HENNE
TRUDY SENNERT

BERLIN-WILMERSDORF WITTELSBACHER STR. 18

TEL: 8814057

AUGUST SEITH

Music Publishers



FOR GERMANY'S TOP POP HITS!

EXCLUSIVE WHOLESALE SHEET MUSIC DISTRIBUTION
FOR LEADING INTERNATIONAL PUBLISHERS!

SENDLINGERTOR PLATZ 10 • MUNICH 2, GERMANY



HE FEELS SAFE WITH HIS PUBLISHER IN GERMANY



ABERBACH (HAMBURG) GMBH.

2 HAMBURG 36 · WARBURGSTR. 22 · TEL. 44 20 02-04

GERMANY'S Music Publishers

ABERBACH MUSIKVERLAGE
Herr Otto Demler
Warburgstrasse 22
2 Hamburg 36
Telephone: 44 20 02

EDITION ACCORD
Hohenstaufen Ring 63
Cologne
Telephone: 23 80 67

AME MUSIKVERLAG EDWARD KASTNER
Frau Barbara Kist
Uhlhornstr. 1
3 Hannover-Kleefeld
Telephone: 55 52 62/55 62 32

APRIL MUSIKVERLAG
Herr Bernhard Mikulski
Palmengartenstrasse 4
6 Frankfurt/Main
Telephone: 77 55 44

PAUL C. R. ARENDS MUSIKVERLAGE
Herr Michael Arends
Rimsting/Bavaria
(Edition Trumpf—Burlington Musik)
Telephone: 08151/634

RALF ARNIE MUSIKVERLAGE
Star Musikproduktion
Herr Ralf Arnie
Wrangelstrasse 5
Hamburg 20
Telephone: 46 40 41

ATRIUM MUSIKVERLAG
Herr Felix Stahl
Rothenbaumchaussee 191
Hamburg 13

ROLF BUDDÉ MUSIKVERLAGE
Herr Rolf Budde
Hohenzollern Damm 54a
1 Berlin 33
Telephone: 88 650 51

CHAPPELL & CO.
August Seith Musikverlag
Herr August Seith
Sendlinger Tor 10
8 München 15
Telephone: 59 68 28

CAPRICCIO MUSIKVERLAG
Herr Peter Lach
Monckebergstrasse 5
Hamburg 1
Telephone: 33 40 96

EDITION DOMA
Herr Bert Kaempfert
Inselstrasse 4
Hamburg 20
Telephone: 51 68 29

EDITION ESPLANADE
Herr Teubig
Rathenau Strasse 25
Hamburg 39
Telephone: 51 82 11

FRANCIS DAY & HUNTER
Frau Bornemann
Mittelweg 149
Hamburg 13
Telephone: 41 03 084

HANS GERIG MUSIKVERLAGE
Herr Hans Gerig
Drususgasse 7/11
Cologne
Telephone: 23 48 33

GLOBAL MUSIKVERLAG
(Altus Musikverlag,
Minor Musikproduktion
Fanfare Musikproduktion)
Herr Peter Kirsten
Moerike Strasse 32
7 Stuttgart
Telephone: 64 56 79

OTTO KÜHL MUSIKVERLAGE
Herr Jack Joseph
Am Hof 34/36
Cologne
Telephone: 21 22 76

WILL MEISEL MUSIKVERLAGE
Herr Rudolf Schroder
Wittelsbacher Strasse 18
Berlin-West
(Meisel, Monopol)
Telephone: 88 32 345

PETER MEISEL MUSIKVERLAGE
(Intro, Nero, Augustin)
Herr Peter Meisel
Wittelsbacherstr. 18
Berlin-West
Telephone: 88 14 057

MELODIE DER WELT MUSIKVERLAGE
Herr Michel
Grosse Friedberger Strasse 23-27
Frankfurt/Main
Telephone: 28 78 47

EDITION MIKADO
Herr Charly Niessen
Belgrad Strasse 86
Munich
Telef: 34 23 59

MINERVA MUSIK
(Tequila Musik)
Herr Rudi von der Dovenmühle
Nordstrasse 17 a
Cologne-Nippel
Tel.: 73 39 61

MONTANA MUSIKVERLAGE
Herr Hans R. Beierlein
Neuhäuserstrasse 3
Munich 2
Telephone: 26 10 96

EDITION MODERN
Herr Hans Wewerka
Franz Josefstrasse 2
Munich
Tele: 33 86 88

EDITION MARBOT
Frau Ernie Bilkenroth
Bronstrasse 12
Hamburg 13
Telef.: 44 66 06

PEER MUSIKVERLAGE
(Southern Music)
Herr Theodor O. Seeger
Klaerchenstr. 11
Hamburg
Telef.: 48 86 45

QUINT MUSIKVERLAG
Herr Dr. Stein
Nymphenburgerstr. 38
Munich 2
Telephone: 55 06 85

EDITION ROYAL
Herr Hans Lang
Nikolai Platz 6
Munich 23
Telephone: 36 15 77

PETER SCHAEFFERS MUSIKVERLAGE
Sendlinger Strasse 23
Munich 2
Tele: 26 20 91

RALPH MARIA SIEGEL MUSIKVERLAGE
Herr Ralph Maria Siegel
Am Biederstein 7
Munich
Telephone: 47 68 20

ALFRED SCHACHT MUSIKVERLAGE
Adolfsstr. 45
Hamburg
Tele: 23 35 26

PAUL SIEGEL MUSIKVERLAGE
Mr. Paul Siegel
Tuentzien 16
Berlin-West
Telef: 24 70 29

HANS SIKORSKI MUSIKVERLAGE
Herr Gunther Gayer
Johnsallee 23
Hamburg 13
Tele: 45 07 77

SONG EDITION
Herr Heino Gaze
Gustav Freytag Strasse 9
Berlin-West
Telef.: 89 39 71

TUTTI MUSIKVERLAG
Frau Gamber
Eschersheimer Landstrasse 12
Frankfurt/Main
Telephone: 59 29 96

UFATON MUSIKVERLAGE
Herr Rudolf Foerster
Sonnenstrasse 19
Munich
Telef: 55 79 57

FOREIGN RADIO STATIONS IN GERMANY

AMERICAN FORCES NETWORK, EUROPE (AFN)
US Army Element,
APO 757
Burggraben 1
6 Frankfurt/Main
Telephone 0611/314800

BRITISH BROADCASTING CORPORATION
German Service
Bayerischer Platz 1
1 Berlin 30
Telephone 0311/935277

BRITISH FORCES NETWORK (BFN)
British Forces Post Office 19
5 Cologne
or: Parkstrasse 61
5 Cologne Marienburg
Telephone: 0221/381757

RADIO FFB
(Radio Station of French Forces in Berlin)
Kurt Schumacher Damm
Quartier Napoleon
1 Berlin 52

RADIO FREE EUROPE
Englischer Garten 1
8 Munich 22
Telephone: 0811/229921

RADIO EUROPA NO. 1
Europäische Rundfunk und Fernseh AG
Dudweiler Strasse 57-59
66 Saarbrücken
Telephone: 0681/24162

RADIOSTANZIJA SWOBODA—Radio Liberty
Lilienthalstr. 2
2 Munich 19
Telephone: 0811/68931

VOICE OF AMERICA
Radio-Station in Germany
Koeniginstr. 5
8 Munich 22
Telephone: 0811/228931

GERMANY'S Radio & TV Stations

BAYERISCHER RUNDFUNK
 Rundfunkplatz 1
 8 Munich 2
 Telephone 0811/59001
 Telex 05-23428
 General Manager: Christian Wallenreiter
 Press Department: Arthur Bader
 Music Program Director: Dr. Rolf Dideczuh
 Pop Programming: Carl Michalski
 TV Studios: Munich-Freimann
 Telephone 0811/38061
 Telex 05-23551
 Unterfoehring/Munich
 Telephone: 0811/36701
 Department III, Music and Entertainment:
 Hans Stephan

DEUTSCHE WELLE
 Brüderstrasse 1
 5 Cologne
 Post Box 344
 Telephone 0221/20301
 Music Programs: Erich Winkler

DEUTSCHLANDFUNK
 Lindenallee 7
 5 Cologne-Marienburg
 Telephone 0221/380161
 Telex 08881262/63
 Music Department: Walter Jellinek
 Entertainment: Gerd Beines

HESSISCHER RUNDFUNK
 Bertramstrasse 8
 6 Frankfurt/Main
 Post Box 32 94
 Telephone 0611/59051
 Telex 0411127, 0411583
 General Manager: Werner Hess
 Press Department: Richard Weigand
 Entertainment Department: Werner Jaspert
 Music Production: Peter Backhaus
 Orchestra: Willy Berking
 TV Program Director: Hans Otto Grünefeldt
 Entertainment: Alexis Neve
 Music Production: Gotthard Welker

NORDDEUTSCHER RUNDFUNK
 Rothenbaumchaussee 132
 2 Hamburg 13
 Telephone: 0411/441931
 Telex: 0211793
 General Manager: Gerhard Schröder
 Press Department: Manfred Jenke
 Entertainment: Henri Regnier
 TV Studio:
 Gazellenkamp 57
 2 Hamburg-Lokstedt
 Telephone 0411/441931
 Telex 0214646
 Entertainment Dept. I: Harald Vock
 Entertainment Dept. II: Henri Regnier

RADIO BREMEN
 Henrich-Hertz-Strasse 13
 28 Bremen
 Telephone 0421/444041
 Telex 024761
 General Manager: Heinz Kerneck
 Press Department: Gerd Wulff
 Entertainment: Dieter Rohkohl
 TV Program Director: Hans Abich

RIAS—Radio Station in the American Sector of Berlin
 Kufsteiner Strasse 69
 1 Berlin 62
 Telephone: 0311/21301
 Telex 0183790
 General Manager: Robert H. Lochner
 Program Director: Herbert Kundler
 Press Department: Dr. Horst Kirstaedter
 Entertainment and Light Music: Prof. Hans Carste
 Music Programs: Rüdiger Piesker/Eduard Poetter

SAARLANDISCHER RUNDFUNK
 Studio Halberg
 66 Saarbrücken
 Post Box 1050
 Telephone 0681/6021
 Telex 0442353
 General Manager: Dr. Franz Mai
 Press Department: Klaus Altmeyer
 Music Department: Richard H. Krueger
 Music Programs: Rosemarie Jungk/Manfred Minnich
 TV
 Musical Entertainment: Dr. Peter Rocholl
 Entertainment and Show: Albert C. Weiland
 Director for Shows: Truck Branss

SENDER FREIES BERLIN
 Masurenallee 8-14
 1 Berlin 19
 Telephone: 0311/92031
 Telex 0183767
 General Manager: Walter Steigler
 Press Department: Wilfried Zierke
 Program Director: Eberhard Schütz (radio and TV)
 Music Department: Alfred Jack
 Entertainment Director: Erich Koberling
 Orchestra: William Greihs
 TV entertainment: Dieter Finner

SÜDDEUTSCHER RUNDFUNK
 Neckarstrasse 145
 7 Stuttgart 1
 Post Box 837
 Telephone 0711/299701
 Telex 0723456
 General Manager: Dr. Hans Bausch
 Press Department: Heinz Rudolf Fritsche
 Musical Entertainment: Wolfram Roehrig
 TV
 General Manager: Horst Jaedicke

SÜDWESTFUNK
 Hans Bredow Strasse
 757 Baden-Baden
 Post Box 820
 Telephone 07221/761
 Telex: 0784381
 General Manager: Helmut Hammerschmidt
 Press Department: Hans Roland Froebel
 Musical Entertainment: Oskar Haaf
 TV Entertainment: Fritz Aeckerle
 TV Productions: Walter Huhn

WESTDEUTSCHER RUNDFUNK
 Wallrafplatz 5
 5 Cologne
 Post Box 1850
 Telephone: 0221/20701
 Telex 8882575
 General Manager: Dr. Klaus von Bismarck
 Press Department: Josef Rick
 Musical Entertainment: Oskar Reisinger
 Entertainment Department: Heinz Schroeter
 Orchestra: Kurt Edelhagen
 TV General Management: Dr. Hans-Joachim Lange
 TV Entertainment: Hannes Hoff

ZWEITES DEUTSCHES FERNSEHEN
 (Second German TV Program)
 Grosse Geiche
 65 Mainz
 Post Box 343
 Telephone: 06131/2051
 Telex 04187661
 General Manager: Prof. Dr. Karl Holzamer
 Entertainment, Music: Dr. Hans Peter Rischel
 Foreign Radio Stations in Germany

WE'RE ON A FRENCH KICK IN GERMANY



POLNAREFF PUSH PLATTERS!

LA POUPEE QUI FAIT NON
(MEINE POPPE SAGT "NON")

LOVE ME, PLEASE LOVE ME

L'AMOUR AVEC TOI (ICH WILL DICH LIEBEN)

TA TA TA TA

MICHAEL'S MONEY MAKERS FOR



MARBOT

EDITION MARBOT, HAMBURG 13, BORNSTRASSE 12

PHONE: 44 66 06

PAUL C. R. ARENDS

MUSIC PUBLISHERS

Germany— 8211 Rimsting
 P.O. Box 20
 (Write to Mr. Michael Arends)

PAUL C. R. ARENDS VERLAG
 BURLINGTON MUSIKVERLAG
 EDITION TRUMPF
 EDITION SHIRLEY
 EDITION ITALMELODIE
 EDITION HAZYLAND

Switzerland— 8001 Zurich
 Schifflande 26
 (Write to Mr. Hazy Osterwald)

EDITION HAZYVILLE



GIVES THE FINEST
 RECORD AND ARTIST
 PROMOTION IN GERMANY?
 JUST ASK
 THE BEE GEES-THE WHO
 JIMI HENDRIX EXPERIENCE
 CREAM—THE EASY BEATS...
 THEY'LL ALL SAY—

Stigwood Yaskiel International
 GmbH

2000 Hamburg 39 · Körnerstr. 13

Tel. 2792081/2

CABLES: NEMSENT HAMBURG

KURT FELTZ MUSIK PRODUKTION

PETER ALEXANDER
(SPANISH NIGHTS)

RALF BENDIX

SACHA DISTEL

GITTE

HAZY OSTERWALD

MARTIN LAUER

WILLY SCHNEIDER

PETER RUBIN—(REPRESENTING

GERMANY AT THE 7TH INTERNATIONAL

FESTIVAL OF LIGHT MUSIC SONGS)

AN INTERNATIONAL THANKS!

KOLON, GERMANY
TEL: 215723

DRUSUS GASSE 7-11
TELEX: 8881673

EUROPEAN COLLECTING SOCIETIES

AUSTRIA

Staatlich Genehmigte Gesellschaft der Autoren,
Komponisten und Musikverleger
A.K.M.
Vienna
Gesellschaft zur Verwaltung und Auswertung
mechanisch-musikalischer Urheberrechte
Austro Mechana
Vienna

BELGIUM

Societe Belge des Auters, Compositeurs et
Editeurs
Sabam
Brussels

DENMARK

Internationalt Forbund til Beskyttelse af
Komponistrettigheder in Danmark
Koda
Copenhagen
Nordisk Copyright Bureau
N.C.B.
Copenhagen

FINLAND

Saveltajain Tekijanoikeustoimisto
Teosto
Helsinki

FRANCE

Societe pour l'Administration du Droit de
Reproduction Mecanique des Auteurs, Com-
positeurs et Editeurs
S.D.R.M.
France
Societe des Auteurs, Compositeurs et Editeurs
de Musique
Sacem
Paris
Organisation des Nations Unies pour l'Educa-
tion, la Science et la Culture
Unesco
Paris
Association Litteraire et Artistique Interna-
tionale
Paris
Bureau International de l'Edition Mecanique
B.I.E.M.
Paris

GERMANY

Gesellschaft fur Musikalische Auffuhrungs und
Mechanische Vervielfaltigungsrechte
GEMA
Germany

HOLLAND

Het Bureau voor Muziek-Auteursrecht
BUMA
Marius Bauerstraat 30
Amsterdam
Stichting tot Exploitatie van Mechanische Re-
productierechten der Auteurs
STEMRA
Marius Bauerstraat 30
Amsterdam

ITALY

Societa Italiana degli Autori ed Editori
SIAE
Rome
Societe Esercizio Diritti Riproduzione Mec-
canica
SEDRIM
Rome

HUNGARY

Bureau Hongrois pour la Protection des Droits
d'Auteurs
ARTISJUS
Budapest

NORWAY

Norsk Komponistforenings Internasjonale Mu-
sikkbyra
Tono
Oslo

POLAND

Stowarzyszenie Autorow
ZAIKS
Warsaw

PORTUGAL

Sociedad de Escritores e Compositores Teatrais
Portugueses
S.E.C.T.P.
Lisbon

SPAIN

Sociedad General de Autores de Espana
SGAE
Madrid

SWEDEN

Forenningen Svenska Tonsattaers Interna-
tionella Musikgyra
STIM
Stockholm

SWITZERLAND

Societe Suisse pour les Droits de Reproduction
Mecanique
MECHANLIZENZ
Bern
Societe Suisse des Auters et Editeurs
SUISA
Bern

UNITED KINGDOM

Mechanical Copyright Protection Society
380, Streatam High Road
London, S.W. 16
Performing Right Society Ltd.
29, Berners Street
London, W. 1

THE GUARANTEE
FOR THE BEST
EXPLOITATION
OF YOUR SONGS



ROLF BUDDER
MUSIKVERLAGE

1 Berlin 33

Hohenzollerndamm 54a

Publishers of Songs in the German Top 10 Over the Past 12 Months

5 OR MORE SONGS

Hans Gerig Musikverlage — 23 songs
Intro Musikverlage/Meisel — 13 songs
Rolf Budde Musikverlage — 10 songs
Minerva Music/R. Von Der
Dovenmühle — 9 songs
Edition Belmont — 5 songs
Aberbach Music — 5 songs

MORE THAN ONE SONG

Chappell/August Seith
Musikverlage — 4 songs
Melodie Der Welt/Michel — 4 songs
Francis Day & Hunter — 3 songs
Ralph Maria Siegel Musikverlage — 3 songs
Edition Maxim — 3 songs
Francon/Schneider — 3 songs
Ralf Arnie Music — 2 songs
Metorion Music/A. Schacht — 2 songs
Paul C.R. Arends Musikverlage — 2 songs
Edition Montana/Beierlein — 2 songs
Edition Accord — 2 songs

ONE SONG

Peer Musikverlage
Fanfare Musikverlage/Global/P. Kirsten
Riva Music
Mills Music
Doma Musikverlag/Kaempfert
Schott & Soehne
Fuller-Sanphil-Windsong BMI
Bosworth Music
Edition Marbot
Edition Esplanade
Radio Music Int.
Idee Musikverlag
Tutti Musikverlag
Bellevue Musikverlag

OUR ACTIVITY = YOUR SUCCESS

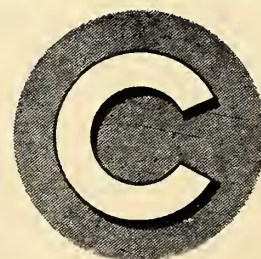

CAPRICCIO

managed by Peter Lach

Capriccio Musikverlag — 2 Hamburg I
Mönckeberg Str. 5 Tel: 334096 Cable: Caprimusik-Hamburg

GERMANY'S Record Producers, Mfrs. And National Distributors

ARIOLA SONOPRESS GMBH
433 Guetersloh, Post Box 835
Telephone 05251/234 27
(Ariola, Athena, Baccarola, Bertelsmann
Schallplattenring, Cameo, Classique, Eurodisc,
Manhattan, Parkway, Starday, Cetra, Hispano-
vox, Carusell, Hansa, Colpix, Kapp, Everest,
Bel Air, Fonit Fast, C. N. Rood, Russian
General Manager: Dr. Werner Vogelsang
Assistant Gen. Manager and Distribution
Chief: Friedrich Schmidt
Import/Export: Hans Georg Ehmke, Press
Dept. (Classic) Carl Wilhelm Cuerten, Public
Relations, artist Promotion: Wilhelm Klofat

EURODISC MUSIKPRODUKTION
Landwehrstrasse 33
8 München 15
Telephone: 0811/59 10 21
Telex: 05 234 87
General Manager: Egmund Lueftner, Pop
Repertory Dept. Rolf Benecke and Wolfgang
Renk

AUSTROTON RECORDS
Diepholz/Hannover
(Austroton, Elite Special, Triola, Ricordi)

DEUTSCHE GRAMMOPHON GMBH
Rothenbaumchaussee 4
2 Hamburg 13
Telephone: 44 17 91
Telex: 02 156 69
(Archiv Produktion, Deutsche Grammophon,
Heliodor, United Artists, MGM, Cub, Cantate,
Command, Italdisc, Verve, Polydor, Musicor,
Big Top, Command, Dart Sales)

Manager of the German department: Richard
Busch. Distribution Chief: Heinz Holle, Pro-
duction Manager (Polydor) Oskar Drechsler,
Press Department: Klaus Reimann, Artist Pro-
motion: Hanna Reinecke

CBS SCHALLPLATTEN
Palmengartenstrasse 4
Frankfurt/Main
Telephone: 77 08 61
Telex: 01 31 66
(Linda, CBS, Blue Note, Artone, Hickory, Ca-
dance, Carina, Funckler, Palette, Candid,
Taml, Motown, Gordy, Peacock, Duke, Back
Beat)
General Manager: Bernhard Mikulski, Distri-
bution: Herbert Giesewetter, Production: Ru-
dolf Kreuzer, Press Dept: Herbert W. Müller

CORNET SCHALLPLATTEN
5062 Fornsbach b. Cologne
Sonnenweg 9
Telephone: 02205/2930
General Manager: Heinz Gietz/Günther Ilgner,
Distribution: Rolf Engleder, Press und Public
Relations: Günther Ilgner

DEUTSCHE VOGUE RECORDS
Zur Mühle 2
5021 Grosskoenigsdorf b. Cologne
Telephone: 02234/39 61
(Vogue, Pye, Durium, Seeco Music, Clan, Red
Bird, Chess, Checker, Cadet, Dot, Roulette)
General Manager: Jean-Jacques Finsterwald,
Assistant Gen. Manager: Roger Lilla, Distri-
bution and Press: Heinz Jürgens, Production
Dept.: J.-J. Finsterwald, Press: Gerdi Bartelt,
Doris Wagner, Walter Jansen, Gerd Rehn

ELECTROLA GMBH
Maarweg 149
5 Cologne-Braunsfeld
Telephone: 0221/49 31 31
Telex: 08 8812 90
(Electrola, Columbia, Capitol, HMV, Odeon,
Parlophone, Pathe, EMI, Epic)
General Manager: Dr. L. Veder, Distribution,
Marketing: W. Jung, Press: H. Kier, Artist
Promotion: W. Friedrich, Export: A. Batzen

KURT FELTZ MUSIKPRODUKTION
Drususgasse 7-11
Cologne
Telephone: 0221/21 57 23

HANSA MUSIKPRODUKTION
Wittelsbacher Strasse 18
Berlin 31
Telephone: 881 40 57
General Manager: Peter Meisel, foreign con-
tacts: Irmstrud Sennert Press: Hans Blume,
Artist Promotion: Heidi Merensky, Produc-
tion: Christian Bruhn/Peter Meisel, Produc-
tion "Berlin Musik Produktions GmbH" Thom-
as Meisel/Günter Henne

JUPITER RECORDS
Am Biederstein 7
8 München 23
Telephone: 33 56 17
(Jupiter, Stellina)

METRONOME RECORDS GMBH
Heidenkampsweg 76 b
2 Hamburg 1
Telephone: 0411/24 12 61
Telex: 02 138 09
(Metronome, Atlantic, Barclay, Golden 12,
Atco, Prestige, Simon)
General Manager: Leif E. Kraul, Distribution:
Leif Kraul, Reinhard Streit (Klaus Lehfeldt)
Import/Export: Ursula Bull, Helge Wagner
Production: Edmund Schaeffler, Public Rela-
tions: Gisela Kremin, Helga Reis

MILLER INTERNATIONAL
Spalding Str. 160
Hamburg
Telephone: 54 30 31
(Somerset, Sonodor)

MONOPOL RECORDS
Wittelsbacher Str. 18
Berlin 31
Telephone: 881 2345
(Monopol)

OSKAR RECORDS
Rotwandstrasse 16
Munich-Grosshesselohe
Telephone: 79 42 66
(Oscar, Tempo)

PHILIPS TON GMBH
Moenekebergstr. 7
2 Hamburg 1
Telephone: 33 92 21
Telex: 02 15 288
(Philips, Fontana, Pergola, ABC Paramount,
Contemporary, Goodtime, Jazz, Riverside,
World Pacific, Interdisc, Mercury)
General Manager: Hans Nitschke, Marketing:
Constantin Th. Metaxas Distribution: Georg
Augustin, Administration: Hans Böhme
Production: Wolfgang Kretzchmar
Public relations: Hannes Flessner

RECO RECORDS
Jahnstr. 61
Frankfurt/Main
Telephone: 59 58 58
(Oriole, Embassy, Norman Petty Productions)

777 RECORDS
Im Kirling 11, Rheinhausen
Post Box 36
(777)

TEFI WERKE GMBH
Koelner Strasse 8/12
Porz b. Cologne
(Tefi tapes)

SABA MUSIKPRODUKTION
Post Box 69
773 Villingen/Schwarzwald
Telephone: 07721/33 51
Telex: 07 92 8 18
General Manager: Hans Georg Brunner-
Schwer, Distribution: Michael Pfeiffer, Radio
and press: Ernst Salvermoser

STIGWOOD YASKIEL INTERN. GmbH
Koernerstr. 13
Hamburg 39
Telephone: 279 20 80
General Manager: Lawrance M. Yaskiel
Catalogue Management: Peter Knight, Press:
Juergen Otterstein,
Promotion: Daniela Holubowski

TELDEC SCHALLPLATTEN GMBH
Heussweg 25
Hamburg 19
Telephone: 40 191
Telex: 02 13545
(Telefunken, Decca, London, Warner Bros,
RCA, Sun, Monument Coral, Brunswick, Re-
prise)
General Manager: Hans Lieber/Kurt Richter,
Arthur Weizenegger
Pop Production: Günter Borchert, Press, pro-
motion: Günther Bräunlich

**SCHALLPLATTENFABRIK
SPECIAL RECORD GMBH**
Rotwandstrasse 16
Grosshesselohe b. Munich
Telephone: 79 42 86
Telex: 05 22235
General Manager: Oscar Meissner, Distribu-
tion: Fritz Walter, Press: Philipp Stoecklein

TONSTUDIO CASTON
Liebigstrasse 10 a
Munich 22

BELLAPHON RECORDS
Zeil 123
Frankfurt/Main
Telephone: 28 71 14

MAL SONDOCK MUSIC PRODUCTIONS
Joseph-Raps Str. 1
Munich 23
Tel: 326410

MUSIC PUBLISHING?

YES: EDITION MODERN
Musik- und Bühnenverlag
Hans Wewerka
München-Wein-Zürich

MUSIC PRODUCTION? TAPE DISTRIBUTION?

YES: INMUS
International Music Service
Hans Wewerka
München-Berlin
Wien-Zürich-London

PROMOTION?

YES: INTERARTIST
International Artists Agency
Hans Wewerka

LOOKING FOR A PACKAGE DEAL OF ACTION?

Contact: Mr. Hans Wewerka
or: Mr. Eckart Rahn
8000 München 13/Germany
Franz-Josef-Strasse 2
Tel.: 0811-34 63 08/33 86 88
Cable: Modernmusic München

WE'RE IN THE BUYIN' & SELLIN' BUSINESS!

PLENTY OF LOCAL HITS!
TOP STARS
ADAM & EVE

Not overloaded with foreign
catalogues!
Plenty of great Hit-masters for
foreign territories.

WANT A HIT IN GERMANY?
WANT A HIT FROM GERMANY?

CONTACT:

YOUNG MODERN ACTIVE
BELLAPHON RECORDS

Zeil 123 Frankfurt/Main, W.-Germany

Tel. 287114

GERMANY—THE PAST 12 MONTHS

(Continued from page 42)
cially popular about Xmas time when
the delivery of the product is guaran-
teed in time for the holiday and gift
packages are offered ranging in prices
up to about \$40 for 11 or 12 LP pack-
ages, a substantial reduction over
normal prices.

A tremendous change has also taken
place in the personal appearance field
in Germany. The days of tours packed
with local pop stars is over. Not one
single tour of German pop artists has
toured Germany this year with success

and top pop acts from abroad have
dominated the scene with more or less
success. The concert halls have switch-
ed to a place for good music and folk
acts with The Ofarims, Hildegard
Knef, Charles Aznavour, Gilbert
Beaud, etc. doing tremendous busi-
ness. The pop fans have switched to
the discoteque where not only do pop
records get tremendous exposure but
also the discoteques have been book-
ing top pop acts from here and abroad
to draw crowds into their clubs. Top
(Continued on page 48)

GERMANY—The Past 12 Months

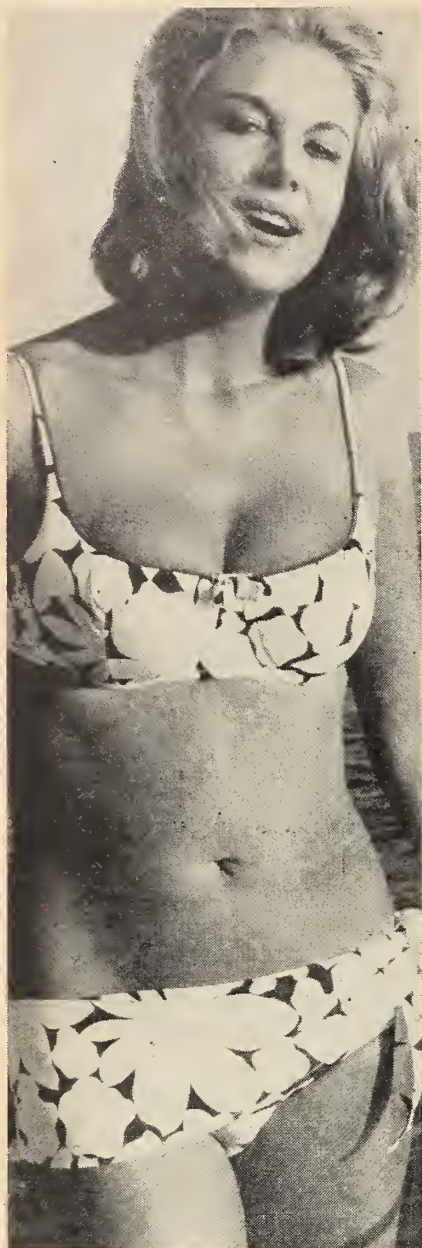

(Continued from page 47)
artists now do the discoteque circuit either appearing with a band or even with tapes or acetates of their tracks which they use for their show. German radio and TV continue to ignore teen-oriented tastes and broadcast a minimum of straight pop shows. The only beat shows in Germany on TV are monthly and there are only 3 of these which also feature fashion and other aspects of teen life and are limited to Saturday afternoon broadcasts. The two radio stations broadcasting German pops are Radio Luxemburg and Radio Saarbrücken which have the bulk of the day taken up by pop programming while the other German stations do very little for their pop fans. Exposure is a major problem in Germany these days.

An interesting development of the last year was a strong tie between the major magazines in Germany and the record industry. About 10 major magazines arranged with local record firms to have a joint label with the magazine pushing the product and the record companies selling over normal distribution channels.

Record manufacturers moved more and more into the publishing field in the last year with Philips closely tied to the Capriccio Musikverlag, Polydor bought the Aberbach organization, Electrola is represented by Edition Accord, Metronome has their Meteorion Music handled by Alfred Schacht Vogue has Belmont Music, CBS has their April Music and only Teldec, Ariola and Hansa is of course tied with Intro Music. Almost all major A&R men also have publishing ties and radio Luxemburg also has their own publishing outlet handled by Peter Meisel.

The first publicity outfit opened their doors in Germany this year. Larry Yaskiel joined forces with Robert Stigwood who is tied with Brian Epstein to open the Stigwood-Yaskiel Ent. with the firm heavily loaded with British product. The firm also now has ties with Polydor and Philips for many changes took place on the executive level in the record business this past year. At Philips, Director Hans Schrade left the firm to take over the D.G.G. in Mexico with Hans Nitschke moving in as new director. C. TH. Metaxas left D.G.G. Mexico to go to Philips as marketing director in Germany. Production chief of Polydor Gunter Ilgner and Electrola producer Heinz Gietz left their firms to form their own Coronet Record label with distribution handled by Electrola.

Dieter Weindenfeld took over as production chief of Electrola from his D.J. post at radio Luxemburg but left a few months later to go to Edition Montana with Hans Beierlein. Erich Offierowski then took over the post at Electrola. Nils Nobach returned to Electrola as A&R man. A report of the record firms showed that 74 records have reached the 1/2 million sales mark from 1945-1966 and 36 LP's reached the 100,000 mark. Only 15 of the single records were foreign discs and 10 of the singles were instrumentals. Leading the list was Freddy Quinn of Polydor with 9 singles and 3 LP's. LP wise, 9 classical records made the LP 100,000 list and My Fair Lady in the original German cast version did over 1/2 million LP sales with the German film soundtrack on CBS racking up another 100,000 sales. 8 foreign LP's made the magic circle.

The German record industry came together in a new public relations capacity with the 7 major firms joining forces. The organization will sponsor the first Grand Gala du Disque in Berlin for the Radio-TV fair and have put together the first color TV show to be shown in Germany. The group will also sponsor a pop music festival next year. In addition, the record industry now has their own trade paper having taken over the old "Music" and making a new magazine called "Schallplatte". After U.S. Columbia opened their CBS offices here, Liberty became the 2nd U.S. controlled disc operation to open offices in Germany. Distribution will

be handled by a major label here but promotion and production will be done by a special staff. Siegfried Loch left Philips to take over direction chores for Liberty.

The major teen paper "Eravo" had their readers poll and the results showing male honors going to Polydor's Roy Black followed by Electrola star Graham Bonney and Ariola artist Udo Jurgens. Distaff honors went to Polydor's Wencke Myhre followed by Teldec's Manuela and Hansa's Marion.

The beat band winner was Dave Dee, Dozy, Beaky, Mick and Tich with the Beatles and The Beach Boys following.

Bert Kaempfert became the first German composer to receive the Hollywood journalist award for the best film song of the year. Of course, the song was "Strangers in the Night".

Germany now has three major trade papers with 2 smaller ones and every hit parade gives a completely different picture of the market. The Automatenmarkt is the most informative hit parade as far as juke box plays are concerned although sales and radio play are also considered by the paper. The "Schallplatte" is basically the official organ of the record industry and reflects manufacturers sales to distributors and shops with a notary public qualifying the results sales as their major factor in sales for the hit parade. It seems impossible that a country about 1/2 the size of Texas should have such problems getting together on a hit list but that's how things are here.

GEMA came to an agreement with the five major tape recorder manufacturers for a set royalty of a million dollars for the use of their material on tapes. The manufacturers who bought the deal now give their customers the right to tape radio broadcasts and records which they did not legally have before.

Record prices are in danger of rising in this country due to a 5% tax increase as the year reaches the half way mark.

The humorous note of the year was reached as the county of Bavaria gave a court decision officially declaring "beat" music as no music at all! The tax authorities have said that all music concerts of any type will not be subject to entertainment tax but the ruling by the court means that a 20% from gross tax will be placed on beat shows. That means that a major city of Munich will be basically beat-less until this decision is changed as promoters cannot afford to book top foreign acts and pay the tremendous tax on concert tickets.

A last note on the exposure scene found that teen oriented magazines were folding. The only one left is "Bravo" as Musik Parade closed their doors and "OK" went into the hands of "Bravo". The sales of "Bravo" were also off 1/3 over the previous year.

These were the main stories of the last 12 months concerning the German music industry. The next 12 should be just as different and exciting in this ever changing world of entertainment. Cash Box will be on hand to give a first hand report on the events and people that make up the record industry in this important market—Germany.

GLOBAL MUSIK

GERMANY

Peter Kirsten has formed the following firms swinging under the Global Banner:

ALTUS MUSIKVERLAG

swinging with local copyrights from famous writers such as:

HORST JANKOWSKI
HELMUT ZACHARIAS
KAY FARMER

FANFARE MUSIKVERLAG

swinging with top hits such as:

HA! HA! SAID THE CLOWN
WESTERN UNION
HERE COMES MY BABY

MINOR MUSIK PRODUKTION

important indie record production swinging with exclusive artists such as:

PETER HORTEN
JANINE BERNARD
ANNY MICHAELIS

We've placed masters from companies such as:

FESTIVAL RECORDS
CBS-ENGLAND
ASTOR RECORDS

with major German record companies

WANNA PLACE YOUR
MASTERS IN GERMANY?

WANNA HAVE ACTION ON
YOUR COPYRIGHTS?

CONTACT

PETER KIRSTEN

by Telex: 07-21573
by Phone: 641626-27

GLOBAL MUSIK

7 STUTTGART 1
Moerikestrasse 32
Cable Address: Globalmusic

THE FASTEST GROWING COMPANY
IN GERMANY'S MUSIC BUSINESS!

WE LOVE

INDIES

EVEN MORE!

SO IF YOU HAVE

REPERTOIRE

FREE FROM GERMANY

Please contact:

NOBBY VARENHOLZ

of

BERTELSMANN

GUTERSLOH

MUSIC INTERNATIONAL

for

ARIOLA & EURODISC

GERMANY'S LARGEST

RECORD CLUB

and

PUBLISHING HOUSE

Tel: Gutersloh 25811

Cables: Bertelsmann-Gutersloh

TELL THE
ADVERTISER
YOU SAW IT
IN
CASH BOX

The happiest sound in all the world



AN ORIGINAL SOUNDTRACK RECORDING

RODGERS ²⁰and HAMMERSTEIN'S

ROBERT WISE Presents **THE SOUND OF MUSIC**

JULIE ^{and} CHRISTOPHER
ANDREWS-PLUMMER
conducted by
IRWIN KOSTAL

LOCD/LSOD-2005



Available on Stereo 8 Cartridge Tape

Original Sound Track on **RCA VICTOR**
The most trusted name in sound

RCA VICTOR ARGENTINA

PRESENTS
ITS INTERNATIONAL ARTISTS

PALITO ORTEGA
LOS CHALCHALEROS
JUAN RAMON
LOS IRACUNDOS
BARBARA & DICK
JUAN D'ARIENZO
LOS DE SALTA
GINETTE ACEVEDO

RCA VICTOR ARGENTINA SA

CASILLA DE CORREO 4400 BUENOS AIRES — ARGENTINA

BEST WISHES FROM TROVA!

WE REPRESENT

CONTEMPORARY—COUNTERPOINT ESOTERIC
MOONGLOW—SAVOY—WORLD PACIFIC
GOOD TIME JAZZ—FOLKWAYS
PACIFIC JAZZ—CONCERT DISC—ELENCO

And Are Interested in Additional Lines

CORRIENTES 2434

BUENOS AIRES, ARGENTINA

TROVA 



CONGRATULATIONS FROM SURCO

SURCO INDUSTRIAS MUSICALES

TUCUMAN 439

BUENOS AIRES, ARGENTINA



Industrias

alanicky

Fonograficas

we represent

WAND - KUBANEY - SCEPTER - KRISTAL - DISCORICO
QUALITY

And Are Interested in Additional Lines

ALA NICKY SRL—ALSINA 1535—BUENOS AIRES—ARGENTINA

Export Import Corporation

ARGENTINA—

THE MARKET: The past twelve months marked changing trends that made rather difficult to establish the real and the potential size of the market, since there were alternative periods of strong and low sales, in some cases without specific reasons, although, of course, many explanations were given. In general, it may be said that the year '66/'67 was weaker than the previous one, with a general slump in April/May '67, when sales man 40% below the previous year marks, but with a reaction expected for the end of June and early July.

The exact amount of records sold is established monthly by the Chamber of Record Producers; due to a much criticized decision, these figures are not published, but it may be supposed that the monthly sales volume is about 350 million pesos, or \$1 million at the new exchange rate of 350 pesos to the dollar. Last year we estimated the sales volume at \$1.2 million a month; the difference may be due to the variability in the exchange rate (at that time there was an exchange rate of 189 pesos to a dollar, meaning a 80% devaluation in twelve months) and the already mentioned sales slump. Incidentally, some of the companies affiliated with the Chamber of Record Producers have objected to the figures produced by this organization, which creates a confusion that shouldn't exist.

Prices of records have also increased, but the current price in dollars is somewhat lower because of the above mentioned devaluation. There is no fixed price and there are some variations between the different labels, but it could be said that regular LP's cost \$4.30 (versus \$4.95 last July) and singles \$.90 to \$.95. There are several lower priced series, offering classical and pop music at prices of less than \$2. A change of the structure of the sales tax has also taken place, and the discount to the dealer ranges from 28 to 32%, depending on the form it is calculated. There are a few "distributors" who handle the accounts of hundreds of small dealers, who find it more practical to buy their records from one place instead of about twenty record companies. According to estimations from the diskeries, the "distributors" account for about 30 to 40% of the whole volume, and receive extra discounts from the manufacturers, although lately this practice has been discontinued by some of the companies, at least partially. During the past months, an experiment on "rack jobbing" has also taken place, generating contempt from regular dealers and manufacturers because of the location of the racks. However, it may be considered that more projects of this sort will be launched in '67/'68, because of the need of more points of sale for the industry, suffocated by the inability of the regular dealers to sell the production.

This problem leads, of course, to a trend towards record clubs, but only CBS has organized such a club up to now. The other companies have been studying the possibilities of this way of sales, but CBS' Special Products Division has been the only one to run it regularly, with reportedly good results. There are also several packages available, in a market started years ago by the Reader's Digest with surprisingly good results. Recently CBS celebrated the sale of its 100,000th package of the "Tango And Folk Music" production, and Phonogram has been also selling strongly its "Argentina Sings This Way" set, and is preparing the second one. As in other countries, RCA presses the Reader's Digest sets, and there is a new Italian Music package offering several RCA artists, but there is no direct relation, saleswise.

A more simple way, widely used by local company Sicamericana and EMI affiliate Odeon is the budget priced series, called "Difusión Musical" and "Colección Musical." Half royalty agreements have been made previously, and the results were so interesting that other companies have followed the move, among them CBS with its

"Harmony" label. RCA has its Camden logo and a promotional line under the main logo, but the difference in prices is much less important than in the Sicamericana or Odeon cases, whose DM and CM LP's are sold at 50 to 60% of the regular albums' prices. Phonogram is using a somewhat different policy, offering a two record set at the price of one regular LP. Results have been also good in this case, and further releases were being planned at presstime.

Another important change that took place during this period was the suppression of all the exchange restrictions that made difficult the remittance of funds to foreign countries. Under current regulations, royalties and other financial payments may be paid freely, although import duties have been increased for some items. Previously, all remittances had to be approved by the Central Bank, which meant a delay of several months for most operations.

Regarding the distribution of the market, about 55% to 60% of the sales correspond to Buenos Aires and its outskirts (about 6,500,000 in total population). Since there are 22,340,000 inhabitants in the whole country, this means a strong sales concentration in the city of Buenos Aires. Some of the reasons are lower income in the provinces, weaker facilities (e.g. lack of electric power in some rural parts) and less promotion. This point will be discussed later, and has been already commented on in the Argentine column of the May 13, 1967 issue of Cash Box.

PRODUCTION: Because of the lack of data it is difficult to establish the percentage of sales belonging to international music and the amount corresponding to local production. The proportion varies for each company, but the reports received by this representative estimated the average at 50-50. Some years ago the proportion was higher for local music, due to a local pop and folk bonanza, but more recently foreign music recovered part of the field. As in many other markets, the biggest problem is caused by the limited means of promotion and the excess of releases, which means that many new singles and LP's are marketed with little promotion and their sales potential is seriously endangered. The variety of catalogs represented by most of the companies ranks second among the difficulties, and the lack of appropriated talent for executive posts is also important.

Under a recent realignment, RCA separated its A&R in classical-folk-tango, local pop and international pop, with further divisions from the promotion point of view. Odeon has three A&R toppers and CBS a sort of A&R council, while Sicamericana and Phonogram have one A&R man each, with cooperation of other people for classical music releases, which means little saleswise. Independent production is practically nonexistent, but almost surely in the next months there will be moves in this field, since several companies have been studying the legal aspects of the I.P. contracts and the possibilities of this type of arrangement. It may be foreseen that I.P.'s will become popular in the near future.

In fact, there are producers that work with their own label (e.g. Fermata, distributed by Odeon, and Microfon, distributed by RCA), but the type of contract makes them owners of practically everything, with the distributing company limiting its work to the pressing, sales and accounting phases. There are also some composers and arrangers working on royalty bases, but the real indie producer, who brings in his own ideas, is yet to come. Some experiments made years ago in this field didn't give good results, but apparently the system will be tried again soon.

During the past twelve months several new companies started operating, adding some interesting catalogs to the market. One of them is BGM,

(Continued on next page)

THE PAST 12 MONTHS

(Continued from preceding page)

representing several European diskeries and managed by the people also owning one of the pressing outfits, Milan; however, both companies work independently. Also in action is the Belter-Quinto group, owned by the Spanish diskery with the same name and members of the Cinco Latinos group. Trova, although founded nearly three years ago, expanded its activities strongly during this period, and started recording locally; so did Fermata, although presenting only one record, the "14 With Tango Music," LP, about which there was much comment.

Among the bigger companies, there was the usual label mobility. Following an international agreement, CGD passed from Sicamericana to CBS, while United Artists, acquired a year ago, gave top results with "A Man And A Women." Sicamericana got several new labels, among them Hispavox, for which highly successful chanter Raphael sings. Also arriving were Festival of France, Everest from the States and Italian Durium. RCA tried Tamla-Motown with good results, obtaining several good selling records, while Microfon started Kama-Sutra, Seeco and Bang. Surco obtained French Vogue, while Producciones Fermata started with Valiant and Ariston.

PROMOTION: There are 16 radio stations in Buenos Aires and about 30 more in the rest of the country, with a few FM outlets. Most of the stations are administered by the State through a special branch of the Government, but advertising is accepted by nearly all of them, excepting Radio Nacional, its affiliated stations, and two more. There are nine private outlets and the commercial stations administered by the Government should be licensed soon. In Buenos Aires there are five TV channels, and some fifteen more (all private) operate in the rest of the country. There is a project for a color TV channel, which would also be state-owned. Records are widely played by all stations, but the programming idea is applied by very few of them. It is more usual to sell the space to advertising agencies and producers, who afterwards decide what records they will play. There are no regulations regarding type of music to be aired.

Promotion through other means is scarcely used. Festivals are applied only to folk music, and some 40 of them are scheduled yearly; the most important ones are located in Cosquin, in the Province of Cordoba, Baradero and Salta, with tango Festivals in La Falda and some other cities. There is also a yearly TV Song Festival sponsored by a private company, which generally results in interesting songs. Up to now, however, results from the Festival are far from those obtained in countries like Italy.

Night life, both in Buenos Aires and the rest of the country, isn't so strong as to help in selling a song or an act. Most of the night-clubs work as discotheques, and personal appearances are scarce, although some years ago they were usual. The lack of good impresarios and booking agents, and the complete absence of organizations devoted to this, are also affecting this aspect of the trade. During the past twelve months, there were few good tie-ins between visiting artists and record companies, the best of them being the one arranged by Spanish artist Raphael and Sicamericana. In other cases, diskeries worked in a more or less disconnected way, with little or no contact with the impresario.

One of the interesting aspects is the growing export of music to countries like Japan, Italy, Spain and most of the Latin America area, and even the States. Folk artists made frequent visits to Japan, appearing also in the States; this was the case of Atahualpa Yupanqui, Eduardo Falu and several tango musicians. Recordings made here by Malvicino were released in the States, and waxings by local artists Barbara & Dick, Palito Ortega and Juan Ramon were

marketed in certain European areas. Ortega also recorded an album in Nashville, seeking the peculiar sound obtained in that city, and Uruguayan group Los Iracundos waxed an LP in Italy.

After a long-lasting crisis, the local cinema industry entered the scene as another strong promotion means. Palito Ortega, Leo Dan and Juan Ramon ranked best among the screen stars, and Dan's latest production, "La Muchachada de a Bordo", gave bright boxoffice results. In June '67 Palito Ortega was shooting a film in Spain, with cinematress Ricio Durcal, while Juan Ramon was in Chile finishing "Bye, Love" with TV starlet Erika Wallner and several local artists.

Most important of all are the musical programs on TV, with "Carrousel" (TV 13), "El Special" (TV 9) and "Comienza el Show" (TV 11) the most important ones. In April TV 11 started its daily program, "Tele-música", emceed by Chilean deejay Raul Matas, presenting new songs in a tie with radio program "Discomanía", aired also daily by Radio Splendid. A good song on TV may mean strong sales, but the best results were achieved years ago when Monday sales were directly connected with weekend program "Club del Clan". This effect hasn't been repeated-yet.

ARTISTS: Few new artists have appeared this year: Palito Ortega, Juan Ramon and Yaco Monti are still at the top, with Barbara & Dick, a duet, following them. In general, there has been a decrease in the popularity of local talent, Palito Ortega (who started singing in 1962) being a very special case. Among tango music orksters, the names of Juan D'Arienzo (since 1935), Anibal Troilo, Atilio Stampone, Horacio Salgan and Leopoldo Federico are still tops; modern tango directors Astor Piazzolla and Osvaldo Piro also have good prestige. Among the singers Edmundo Rivero and Nestor Fabian have the highest ratings, folk singers Atahualpa Yupanqui, Eduardo Falu, and Jorge Cafrune, and folk groups Los Chachaleros, Los Fronterizos, Los De Salta and Los Huanca Hua are also very popular, with newcomers Miguel Saravia, Mercedes Sosa and Ramon Navarro gaining force. Female stars include Ramona Galarza, Ginette Acevedo and Marian Farias Gomez, all in the folk field.

There were several important visitors during these twelve months, with French star Gilbert Becaud, vocal group the Swingle Singers, Italian lark Milva, Puerto Rican Jose Feliciano, French teen idol Johnny Hallyday and Sacha Distel being the top attractions.

Sales figures remained conservative, although several records passed the 100,000 mark, and albums the 50,000 level. A good hit single sells about 30,000 and 10,000 is a good figure for an album. Vocal records gained force, although one of the biggest hits ("Un Homme Et Une Femme") was instrumental. The Beatles kept selling, but overall results were affected by their small output during this period. The Rolling Stones, the Monkees and more recently Herman's Hermits took their place. Tropical music, represented by the Wawanco group ("La Banda Borracha"), The Cuarteto Imperial and Los Cinco del Ritmo, also had a good share of the market.

PUBLISHERS: It has been a hard year for the publishers, due mainly to the delay in payments by the only collecting society, SADIAC. At press-time SADIAC was paying phonomenal royalties corresponding to the end of 1965 and first three months of 1966, and there was no information about the performance rights. This meant that many publishers received practically no revenues during more than a year, having to pay salaries and expenses from their own funds. (Continued on next page)

INTERNATIONAL ARTISTS REACH ARGENTINE CHARTS THROUGH



RAY CONNIFF (U. S. A.)

LOS PANCHOS (MEXICO)

ROBERTO CARLOS (BRASIL)

THE BLUE COMETS (JAPAN)

DONOVAN (U. S. A.)

CARAVELLI (FRANCE)

BOBBY SOLO (ITALY)

DISCOS CBS S. A. - Paraguay 1583, Buenos Aires, Argentina.

THESE ARE SOME OF OUR OUTSTANDING ARTISTS:

ROSAMEL ARAYA—LUCIO MILENA
RICARDO REY—ALBERTO MARINO
LOS VENETO'S—PEPITO PEREZ
BINGO REYNA

DISC JOCKEY SAIC

PEDRO GOYENA 72 BUENOS AIRES
ARGENTINA

IN ARGENTINA

Microfon MEANS ACTION

TANGO-FOLK-DANCE-INTERNATIONAL MUSIC
SUITABLE FOR YOUR MARKET

LAVALLE 1759 BUENOS AIRES

Where the action is!

ARGENTINA'S BEST SELLERS

Title	Artist
CBS Un Homme Et Une Femme Winchester Cathedral El Rey del Rio* La Banda Il Diritto D'Amare	Soundtrack UA Film The New Happiness Cuarteto Imperial Cuatro Voces Wilma Golch
DISC JOCKEY Apasionado* Avec Dos Años Little Man Monsieur Cannibale	Rosamel Araya Charles Aznavour Pepito Perez Dalida Bingo Reyna
MICROFON Campanas de Navidad* Entre Hombres* Hang On Sloopy Yo Soy Aquel Rondando tu Esquina*	Los Cinco del Ritmo Chacho Santa Cruz Mc Coys Jose Antonio Nestor Fabian
MUSIC HALL Strangers in The Night These Boots Are Made for Walkin' Nuestro Juramento Cuando Tu No Estas Hablemos del Amor	Frank Sinatra Nancy Sinatra Julio Jaramillo Raphael Raphael
ODEON Siempre Te Recordaré* La Banda Borracha El Conductor Mes Mains Sur Tes Hanches Yellow Submarine	Yaco Monti Los Wawancó Los Wawancó Adamo The Beatles
PHILIPS Black is Black Brava Una Casa in Cima al Mondo Winchester Cathedral La Vaca Blanca	Johnny Hallyday Mina Mina New Vaudeville Band Los de Colombia
RCA Funeral del Labrador Solo* Mamita, Mama* Sin Fe La Felicidad* *Local copyright	Barbara y Dick Palito Ortega Palito Ortega Jose Feliciano Palito Ortega

BEST SELLING E.P.s FROM RCA

1. Sin Final—Brass Ring—RCA
2. El Despertar—Marco Antonio Muñoz—RCA
3. La Novicia Rebelde—Julie Andrews—RCA
4. El Brindis del Bohemio—Manuel Bernal—RCA
5. El Toro y la Luna—Joselito—RCA

BEST SELLING L.P.s FROM RCA CAMDEN

1. Benny Moré—Benny Moré—RCA Camden
2. Lupita Palomera—Lupita Palomera—RCA Camden
3. Movie Themes—Gil Bowen—RCA Camden
4. Los Bribones—Los Bribones—RCA Camden
5. Son Clave de Oro—Son Clave de Oro—RCA Camden

"14 CON EL TANGO"

(Fourteen With The Tango)

The biggest painters, poets and
musicians of Argentina, together

in an LP awarded by the

ARGENTINE INSTITUTE OF PUBLIC
OPINION

as the "boom" of the year

AND THE

INTERNATIONAL RECORD FESTIVAL OF
MAR DEL PLATA — 1st PRIZE

released by

FERMATA

RECORD PRODUCERS—MUSIC PUBLISHERS

San Martin 640 — Bs. Aires

Argentina

Wire: Fermata Baires

ARGENTINA MUSIC PUBLISHERS

ALA-NICKY

Manager: Alaide Gorostiza
Alsina 1535, Buenos Aires
Tel: 494218

EDITORIAL JULIO KORN SRL

Manager: Ricardo Korn
Moreno 2034, Buenos Aires
Tel: 487709
(Julio Korn, Vitale, Mundo Musical, Odeon, Ramar, Europa, Tierra Linda, Sucesos, Iadarola, Latin Must)

EDICIONES INTERNACIONALES

FERMATA SRL
Manager: Mauricio Brenner
San Martin 640, Buenos Aires
Tel: 319330
(Fermata, Novel, Roma)

EDITORIAL EDAMI

Manager: Alberto Martinez
Lavalle 1494, Buenos Aires
(Edami, Acorde)

ESTABLECIMIENTO MUSICAL

NEUMANN SRL
Manager: Carlos Di Liscia
Maipu 235, Buenos Aires
Tel: 465343
(Neumann, Downey, Apolo)

SMART EDICIONES MUSICALES SRL

Manager: Momiglio Giacompol
Santa Fe 1552, Buenos Aires
Tel: 445796
(Smart)

EDITORIAL LAGOS

Manager: A. Lagos
Talcahuano 638, Buenos Aires
Tel: 403746
(Lagos)

EDITORIAL PERROTI

Manager: Maximo Perroti
Virrey Cevallos 1152, Buenos Aires
(Perroti)

EDICIONES MUSICALES RELAY

Paroissien 3960, Buenos Aires
(Relay)

MELOGRAF

Manager: Stanko Jerebic
Charcas 1422, Buenos Aires
(Melograf)

MILROM SRL

Manager: Lucio Milena
Rodriguez Peña 36, Buenos Aires

EDITORIAL PIROVANO

Manager: Vda de Pirovano
Pasco 1267, Buenos Aires
(Pirovano)

COMAR

Montevideo 641, Buenos Aires

RICORDI AMERICANA SA

Cangallo 1570, Buenos Aires

EDITORIAL BEMOL

Alsina 3089, Buenos Aires

EDITORIAL SELECT

Manager: O. Rubinstein
Callao 420, Buenos Aires

EDITORIAL ESCALA

Juncal 2535, Buenos Aires

EDITORIAL EMBA

Talcahuano 395, Buenos Aires

EDITORIAL TALENT

Lavalle 1759, Buenos Aires
Manager: Mario Kaminsky
Tel: 496128

DISCOS BELTER ARGENTINA

S.A.C.I.

RODRIGUEZ PENA 40
BUENOS AIRES,
ARGENTINA



Industrias del Disco SA
Representing
DEUTSCHE TEMPO—FONIOR
DEUTSCHE VOGUE—SOBEDI
LE CHANT DU MONDE—TONO
SONET—MANU—HED ARZI
TRANSATLANTIC—PALACIO
Lavalle 1546—Bs Aires
Argentina

ARGENTINA THE PAST 12 MOS.

(Continued from preceding page)

The fact that the Argentine contracts allow the publishers only 25% of the royalties (vs 50% in most of the countries) and that SADAIC charges about 60% for administration expenses doesn't help, either. There are also difficulties with collecting societies of other countries, who feel unwilling to pay until SADAIC sends them their money from this market. At presstime it was reported that elections would take place no sooner than in six to nine months, and there were seventeen candidates for the presidency of the society. The prevailing opinion was that more than a year will be needed to straighten out the situation.

CASH BOX

DEVOTES

MORE

SPACE

TO

THE

INTERNATIONAL

MUSIC

MARKET

THAN

ALL

OTHER

MUSIC

TRADE

PAPERS

COMBINED

— THE LASTEST ONE... —
WITH THE BEST MUSIC!

ACCENT
DIAL
FANTASY
GNP-CRESCENDO
MAINSTREAM
TIME



PASTEUR 341—5° Piso—Of. 1
BUENOS AIRES • ARGENTINA

ARGENTINA RECORD COMPANIES

ALA-NICKY SRL

Alsina 1535, Buenos Aires
Manager: Alaide Gorostiza
Tel: 494218
Labels: Ala Nicky-Scepter-Kubaney

DISC JOCKEY SAIC

Manager: Manuel Rodriguez Luque
Pedro Goyena 72, Buenos Aires
Tel: 92-9090
Labels: Disc Jockey, Palette, Continental,
Meazzi, Barclay, Artone, Chantecler

BELTER ARGENTINA SRL

Rodriguez Peña 36, Buenos Aires
Label: Belter
Manager: Ricardo Romero

BGM S.A.

Lavalle 1546, Buenos Aires
Tel: 468576
Labels: BGM, Galatea, Magenta, Deutsche
Vogue, Metronome, Le Chant du Monde,
Sonet
Manager: Miguel Benitez

DIAL SRL

Manager: Carlos
Pasteur 341, Buenos Aires
Tel: 470145
Labels: Dial, Fantasy

DISCOS CBS S.A.

Paraguay 1583, Buenos Aires
Manager: Armando Di Guglielmo
Commercial Director: Douglas Taylor
Labels: CBS, Columbia, United Artist, CGD
Tel: 412341

DISCOS QUINTO

Rodriguez Peña 36, Buenos Aires
Label: Quinto, Sono Play, Velvet
Manager: Ricardo Romero

EDITORIAL JULIO KORN SRL

Moreno 2034
Tel: 487709
Labels: Diskornamount, Musidisc, Ariel

FAMOUS SRL

Manager: Ian Morris
Peru 1511, Buenos Aires
Peru 1511, Buenos Aires
Labels: Ariel, ABC Paramount, Musidisc,
Nilser
Tel: 263306

H y R

Manager: H. Maluf
Lavalle 653, Buenos Aires
Label: HyR

INDUSTRIAS ELECTRICAS Y MUSICALES ODEON S.A.

Manager: Edward Insley
Corrientes 485, Buenos Aires
Tel: 496651
Labels: Odeon, Odeon Pops, London, Decca,
Liberty, Capitol, Angel

MICROFON SRL

Manager: Mario Kaminsky
Lavalle 1759, Buenos Aires
Tel: 496128
Labels: Microfon, Audio Fidelity, Chencellor,
Cadence, Coral, Durium, Secco, Supraphon

PHONOGRAM S.A.

Manager: Hugo Persichini
Cordoba 1351, Buenos Aires
Tel: 419442
Labels: Philips, Polydor, Mercury, MGM, DGG,
Archiv, Heliodor, Novola

PRODUCCIONES FERMATA (Discos) SRL

Manager: Mauricio S. Brenner
San Martin 640, Buenos Aires
Tel: 319330
Labels: Fermata, RGE, Cameo-Parkway

RCA VICTOR ARGENTINA S.A.

President: Robert Cook
Paroissien 3960, Buenos Aires
Labels: RCA, Vik, Camden, Victrola

SICAMERICANA SACIFI

Pres.: Nestor Selasco
VP: Luis Calvo
José E. Uriburu 40, Buenos Aires
Tel: 469808
Labels: Music Hall, Demon, Reprise, Fonit,
Gamma, Roulette, Vanguard, Fuentes, Dot,
Copacabana, Festival, Durium, Kapp, Warner
Bros.

SURCO IND. MUSICALES SRL

Tucuman 431, Buenos Aires
Managers: Enrique Iriberry and Atilio Suva
Tel: 32-3143
Labels: Opus, Vox, Atlantic, Telefunken,
Vogue, Vergara

SVELT SRL

Corrientes 2322, Buenos Aires
Label: Svelt

TONODISC SRL

Manager: Jorge Esperon
15 de Noviembre 1287, Buenos Aires
Labels: Command, Tonodisc, Westminster

TROVA SRL

Corrientes 2434
Tel: 479996
Buenos Aires, Argentina
Labels: Folkways, Pacific Jazz
Manager: Alfredo Radoszynski

ARGENTINA'S TRADE ASSOCIATIONS

AMPRODIS, A.C.
Asociación Mexicana de Productores de Discos
President: Eduardo L. Baptista
Guanajuato 65
México 7, D.F.

SACM, S. de A.
Sociedad de Autores y Compositores de Música
S. de A.
General Director: Carlos Gómez Barrera
Ponciano Arriaga 17
México 1, D.F.

AMPEM
Asociación Mexicana de Productores y Editores
de Música
President: Rogelio Brambila
Av. Cuñiláhuac 2305
México, D.F.

ANDA
Asociación Nacional de Actores
General Secretary: Jamie Fernández
Altamirano 126 y 128
México, D.F.

ARGENTINA'S RECORDING STUDIOS

INDUSTRIAS ELECTRICAS Y MUSICALES
ODEON SA
Corrientes 485, Buenos Aires

DISCOS CBS SA
Paraguay 1583, Buenos Aires

ESTUDIOS GUEMES
Lavalle 655, Buenos Aires

ESTUDIOS SAN MARTIN
Tucuman 451, Buenos Aires

ESTUDIOS ION
Hipolito Yrigoyen 2512, Buenos Aires

ESTUDIOS PHONOGRAM
Belgrano 1666, Buenos Aires

SICAMERICANA SA
Jose E. Uriburu 40
Buenos Aires

ESTUDIOS T.N.T.
Santa Fe 1050, Buenos Aires

ESTUDIOS PHONAL
Santa Fe 3117, Buenos Aires

ARGENTINA'S PRESSING PLANTS

INDUSTRIAS ELECTRICAS Y MUSICALES
ODEON SA
Corrientes 485, Buenos Aires

RCA VICTOR ARGENTINA SA
Paroissien 3960, Buenos Aires

DISCOS CBS SA
Paraguay 1583, Buenos Aires

MILAN & CIA
Perito Moreno 235
Temperley, Prov de Buenos Aires

GALVADISC
Once de Setiembre 481
Ciudadela, Pcia de Buenos Aires

CONTINENTAL
Superi 3530, Buenos Aires

PLASTIGAL SA
Francisco Bilbao 2248
Tel: 636534
Buenos Aires

ARGENTINA'S Jacket Manufacturers

ALPHA SA
Ecuador 935, Buenos Aires

IMPRIMEX SRL
Gascon 1437, Buenos Aires

D'ARRUDA DEL PUP SA
Velez Sarsfield 101, Buenos Aires

BERKO FINKEL
Mercedes 2168, Buenos Aires

LAGENHEIM HNOS
Pichincha 1484, Buenos Aires

SERRATORE
Azara 496, Lomas de Zamora
Pcia Buenos Aires

CURT LATTE
Ereznano 3021, Buenos Aires

DISCOS QUINTO

S.A.C.I.

RODRIGUEZ PENA 40
BUENOS AIRES,
ARGENTINA

ARGENTINA'S Widest Catalog of Folklore-Tango-Pop Music

Is On

PHONOGRAM

LOS FRONTERIZOS • ASTOR PIAZZOLLA
LOS QUILLA HUASI • LOS CLAUDIOS
EDMUNDO RIVERO • ARIEL RAMIREZ
HORACIO SALGAN • MERCEDES SOSA
ANDRE • LOS CANTORES DEL ALBA
JAIME TORRES and many others

PHONOGRAM S. A. I. C.

CORDOBA 1351 • BUENOS AIRES • ARGENTINA



MUSIC HALL

RECORDS

OF

ARGENTINA

WITH THE MOST IMPORTANT ARTISTS
OF THE WORLD

SALUTES

CASH BOX

AND WISHES IT A

HAPPY ANNIVERSARY

SICAMERICANA S.A.C.I.F.I.

J. E. Uriburu 40-42

Buenos Aires

AUSTRALIA—THE PAST 12 MONTHS

The twelve months period ended June 30th, 1967 (which is also the conclusion of the Australian financial year) has seen little real fluctuation in the industry one way or the other in the matter of new representation and development of new ideas; but there have been some significant trends that could result in big changes by this time next year.

Record production figures for the nine months period ended March 31, 1967 (the latest available at this stage) show a strong upward move in favour of album production.

Period	7" product	Album product
Nine months ended March, 1967.	5,197,000	5,393,000
Nine months ended March, 1966.	4,491,000	3,789,000

While these figures don't show a breakdown of albums (low-priced as against regular-priced) in categories, it is known that the best gains have been in economy priced lines.

Most record companies have albums that retail at (Aust) \$2.95 (there are some selling at a little more, and some at a little less) and their stiffest competition isn't necessarily from other domestic product in the same price groupings—but rather from the big range of fully imported albums that are retailing for as little as (Aust) \$1.50, with a huge variety being offered at \$1.99, retail.

This makes it rough on the locally manufactured article, but the local product has the advantage of name talent and they are being given top promotion and marketing... they are not just being 'DUMPED' on the Australian market.

The low-priced locally manufactured disk is also in competition with the Record Club operators. Among these are World Record Club (associated with the EMI organisation); Australian Record Club which is op-

erated by Australian Record Company (the only major label in this country without a low-priced line of albums on the open market); and the Universal Record Club which is closely affiliated with Festival Records, Universal offers a broad catalogue of name talent discs to its subscribers. There are other Clubs in business here; but the three mentioned are considered to be the Big Three in Australia.

Pre-recorded Tapes & Cartridges

There is constant activity with all labels in this territory in the field of pre-recorded reel-to-reel and cartridge tapes. The action in capital expenditure on new plant for duplicating, manufacturing processes for blank reels and cartridges, packaging, etc., is more than sufficient to indicate that there is a big future in these taped products.

The big market is still a fair way off for all pre-recorded taped goods, but it is obviously destined to become an important feature of the record industry of Australia. There are those people in the trade who believe that the cassette system will 'make the reel-to-reel method obsolete overnight'. Many doubt that this will be so, because there are thousands upon thousands of top-quality domestic tape recorders in use here that have years of life left in them.

The economics of tape, which is still in a relative stage of infancy in comparison to disks—especially in relation to locally duplicated goods—are such that pre-recorded tapes are being marketed at prices that are greater than the identical performance on stereo disk. The average retail price of 4-track (7" reel) pre-recorded stereo tapes is around (Aust) \$7.25; as against an average of around \$5.00 for the same music on a conventional pressing.

However, as the market expands and the local know-how and experience in duplicating, packaging, and

marketing broadens, it is confidently expected that tapes will sell at close to the same price as disks; this is happening in a couple of instances at the moment, but the bulk of the pre-recorded tapes are retailing way above records.

Cartridge tapes are just coming into their own in this country, and there is still a great deal to be done by the industry to 'sell' the cassette system. It was only a few weeks ago that EMI made its first release of Musicassettes, and these were all fully imported.

Philips is now marketing four different models in cassette playback units, and they also have a fairly extensive range of imported Musicassettes on the market... Philips are also running ads in the daily press to familiarize the public with these products.

So far, there is no local duplicating being done. However, it is known that several major companies are presently tooling-up in preparation for the manufacture of cassette components and playback units. It seems that Australia will almost exclusively adopt the Philips C.60 cassette system. This time next year we will have a much clearer picture on the cartridge products.

One interesting aspect that is emerging as a result of the increasing activity in tapes is the fact that it is bringing with it many new retailers apart from the regular record dealers.

The pattern seems to be that camera stores in this country almost invariably sell tape playback units also (but do not handle disks); and where a unit is being sold it opens the way to sell tapes. So we have a situation where many such stores are now stocking large ranges of pre-recorded tapes.

It seems certain that many businesses now specializing in the marketing and installation of car radios will offer the same services for cassette units—this makes them ideal retailers of Musicassettes.

Rack Sales

Rack-jobbing, in the sense that we know it in the United States, has been virtually non-existent in this territory. Sure, there is plenty of selling from racks which are in ever-increasing use by retailers, but in such cases the retailer himself simply fills and services his own racks.

Whereas in the United States these functions are all attended to by the independent rack-jobber who actually owns the stock until it is sold by the retailer; and the rack man makes sure that rack stocks in stores are kept up-to-date by constantly changing disks.

There are a couple of organizations now showing a greater interest in rack-jobbing than ever before. If these companies continue to pursue their initial interest, their first moves will surely be to the big retail chain-stores such as Coles, Woolworths, etc., and possibly some of the more progressive super-market and grocery chain groups.

There is a huge potential for rack-jobbing in these stores if only consumer interest can be tempted. Cash Box believes there is nothing surer than that rack-jobbing will become an essential part of the record industry of Australia during the immediate future years. This may not be to the liking of the regular manufacturer/distributor/retailer set-up; but if the rack man cannot get supplies of locally pressed disks he won't hesitate to start importing low-priced brands and eventually undersell the local product.

Local Disks And Talent

Whilst quite a number of locally produced records and artists have scored pretty well since this time last year; there is little doubt that the local business has lost a great deal of the excitement it had always generated in past years.

Perhaps this is a sign that the Australian record business is coming-of-age, and that this maturity brings

with it a more studied and sober appraisal of the scene... in other words they are now taking the local industry for granted.

However, it is just great to see that at long last more and more Australian pop artists are being accepted and appreciated on an international scale... this is something that has only happened in the last few years to Australia... even then it didn't happen often. One of the first to breakthrough to the big-time was Frank Ifield, who is now a 'name' artist anywhere in the world. Then comes Rolf Harris, a fine Australian talent who is now one of the big stars of English television today.

There is no doubt that our most successful pop export is The Seekers; who have achieved more than anyone else in proving to the world that Australia possesses some excellent natural talent. The Seekers must definitely rate in the best and most successful top five recording acts in the business. Their personal triumphs during their last visit home (a couple of months ago) had to be seen and heard to be believed. It is generally agreed in Australia that there is still plenty of untapped talent in The Seekers that is sure to come to the fore when they are given an opportunity in films.

One of the hottest domestic properties of all time in Australia is a young man by name of Normie Rowe. He built a personal following with teenagers in this country that was akin to the early swooning days of the great Sinatra.

Unfortunately, Normie Rowe hasn't been able to emulate his Australian feats in England, where (apart from a brief visit home) he has been for something like the past twelve months.

However, this type of 'run-of-outs' that is handicapping Normie has been overcome by plenty of other artists in the past... and we believe that Normie will do likewise.

Local girl Lana Cantrell continues to score well in the United States, especially in the realm of clubs and television. We have always admired Lana's talent going way back to the early days when she was first appearing on "Bandstand" with her "refreshingly different" performances. Lana hasn't as yet hit the top in the disk stakes... but with talent such as hers it's only a matter of time.

The Easybeats left this country less than one year ago following a whole series of national smash singles in Australia. Today The Easybeats are one of the brightest disk-attractions in the business, thanks to their smash, "Friday On My Mind." The five-piece group was back here recently for a lightning concert-tour which was a riotous success. The multi-talented Easybeats (they write the majority of the material they record) are heading towards even bigger things than "Friday On My Mind" during the years ahead.

Another Australian outfit obviously creating a terrific impression overseas are The Bee Gees, who are now in the management hands of Brian Epstein. They are on their way to world stardom with "New York Mining Disaster 1941," and are getting action on the Continent with "Spicks And Specks," which was a giant national hit for the boys in Australia before they left for greener pastures overseas. There is plenty of talent in The Bee Gees, they are wonderful composers in addition to their performing ability.

Despite this drain on some of the best and most exciting talent from Australia, we still have many acts of good potential... some of whom are on the brink of big things.

In the solo field, young artists like Cheryl Gray, Johnny Young (heading for England soon), Lynne Randell (currently on an overseas trip); Robbie Snowden, Sandy Scott, Grantley Dee, Bev Harrell, Ronnie Burns, etc., are all making consistent headway in the domestic market, and with a little luck this success could spill-over to embrace overseas markets also. In the group field there are young acts who have the ability to win international (Continued on next page)

For ACTIVE and EFFICIENT NATIONAL PROMOTION and DISTRIBUTION throughout

AUSTRALIA

Call—write—phone—cable

PHONO - VOX of AUSTRALIA PTY. LTD.

155 Sydney Road

Brunswick

Victoria. 3056. Australia

Phone: 38-9517. Cables: Phonovox, Melbourne

(The independent company that gets things done in a BIG WAY... DOWN UNDER)

Already distributing these famous labels and artists; Vogue—Pop—Mode—Vogue & Mode International—Pacific Deutsche Vogue—Vogue Belgium—Marfer—Az Disc—Style—Phonocolor—Italdisc—Ducale—Sonet; Antoine, Françoise Hardy, Michel Polnareff, etc.

We also have masters available to overseas companies by top Australian talent such as Tony Barber, Pauline Dee, the Clefs, Denise Drysdale, etc.

AUSTRALIAN MUSIC PUBLISHERS

ABIGAIL MUSIC (AUSTRALIA) PTY. LTD.
4th Floor, London Textiles House,
127 York Street, Sydney. New South Wales,
2000.

Phone: 291050.
Managing Director: Mr. Norman Whiteley.
(associated companies)
Nemsongs (Australia) Pty. Ltd.
Norman Whiteley (Australia) Pty. Ltd.
Pamper Music (Australia) Pty. Ltd.

ACCOLADE MUSIC CO. PTY. LTD.
83 Miller Street, North Sydney.
New South Wales 2060.
Manager: Mr. Robert Iredale.
Phone: 920722.

J. ALBERT & SON PTY. LTD.
137-139 King Street, Sydney.
New South Wales 2000.
Director: Mr. Edward (Ted) F. Albert.
Phone: 282141.
Cables: Music, Sydney.

ALLANS MUSIC (AUSTRALIA) PTY. LTD.
276 Collins Street, Melbourne.
Victoria 3000.
Director: Mr. Rudolph E. Bare.
Phone: 630451.
Cables: Pianoforte, Melbourne.
Associated Companies, Acuff-Rose Publications,
D. Davis & Co. Pty. Ltd.

APOLLO PUBLISHING COMPANY, PTY. LTD.
161-173 Sturt Street, South Melbourne.
Victoria 3205.
Director: Mr. Neville Smith.
Phone: 690300.
Cables: Schuh, Melbourne.

ASSOCIATED MUSIC PTY. LTD.
221 Elizabeth Street, Sydney.
New South Wales 2000.
Manager: Mr. Bill Donaldson.
Phone: 618541.
Cables: Radiointer, Sydney.

BELINDA MUSIC (AUSTRALIA) PTY. LTD.
"Whitehouse"
403 George Street, Sydney.
New South Wales 2000.
General Manager: Mr. Ray Walter.
Phone: 291195.
Cables: Belmusic, Sydney.
(Associated companies)

T. M. Music (Australia) Pty. Ltd.
A. Schroeder Music (Australia) Pty. Ltd.
Rondor Music (Australia) Pty. Ltd.
Benday Music (Australia) Pty. Ltd.
George Weiner Music (Australia) Pty. Ltd.
Kalmann Music (Australia) Pty. Ltd.
Johnny Devlin Music Pty. Ltd.
Lionie Lee Music Pty. Ltd.
Williams-Conde Music Pty. Ltd.
Progressive Music (Australia) Pty. Ltd.
Belcas Music Ltd, New Zealand, in conjunc-
tion with Castle Music Pty. Ltd.

BOOSEY & HAWKES (AUSTRALIA) PTY. LTD.
National Building,
250 Pitt Street, Sydney.
New South Wales 2000.
Director: Mr. George S. Cooper.
Phone: 619046.
Cables: Sonorous, Sydney.
Jewel Music (Australia) Pty. Ltd.

CASTLE MUSIC PTY. LIMITED
301 Castlereagh Street, Sydney.
New South Wales 2000.
Manager: Mr. Phil Matthews.
Phone: 20912.
Cables: Emitron, Sydney.
Managing agents for Walt Disney Mickey
Mouse (A'sia) Pty. Ltd.
Palace Music Pty. Ltd.
Ivan Mogull Music (Australia) Pty. Ltd.
Belcas Music Ltd, New Zealand, in conjunc-
tion with Belinda Music (Aust.) Pty. Ltd.

CHAPPELL & CO. LTD.
68-70 Clarence Street, Sydney.
New South Wales 2000.
Manager: Mr. Basil Ahrens.
Phone: 294681.
Cables: Symphony, Sydney.
Edwin H. Morris & Co. Ltd.
The Sterling Music Publishing Company.
Aberbach (Australia) Pty. Ltd.
Comet Music (Australia) Pty. Ltd.
Five Continents-Chappell Pty. Ltd.
Robert Mellin Pty. Limited.
Planetary-Nom (Australia) Pty. Ltd.
Wallaby Music Pty. Limited.

WALT DISNEY MICKEY MOUSE (A'SIA) PTY. LTD.
149 Castlereagh Street, Sydney.
New South Wales 2000.
Director: Mr. Walter A. Granger.
(Managing agents, Castle Music Pty. Limited)
Phone: 618942.
Cables: Mickmouse, Sydney.

ESSEX MUSIC OF AUSTRALIA PTY. LIMITED.
Suite 1. 8th Floor,
King York House,
32-34 York Street, Sydney.
New South Wales 2000.
General Manager: Mr. Barry Kimberley.
Phone: 298595.
Cables: Semus, Sydney.
Cromwell Music of Australia Pty. Ltd.
Arwin Music of Australia Pty. Ltd.
Barton Music (Australia) Pty. Ltd.

LEEDS MUSIC PTY. LIMITED
Universal House,
Pelican Street, Darlinghurst,
New South Wales 2010.
General Manager: Mr. Jack Argent.
Phone: 616088.
Cables: Leedsmusic, Sydney.
Tu-Con Music Pty. Ltd.
Tangerine Music Pty. Ltd.
Spoon Music Pty. Ltd.
Pincus-Gil Pty. Ltd.
Cricknet Music Pty. Ltd.
Victoria Music Company.
Northern Songs Pty. Ltd.
Dick James Music Pty. Ltd.
Jaep Music Pty. Ltd.
Pacer Music Pty. Ltd.
Screen Gems-Columbia Music Pty. Ltd.
Crown Music Pty. Ltd.

W. H. PALING & CO. LTD.
338 George Street, Sydney.
New South Wales 2000.
Nicholson's Pty. Ltd.

SOUTHERN MUSIC PUBLISHING CO. (AUSTRALASIA) PTY. LTD.
38-40 York Street, Sydney.
New South Wales 2000.
Managing Director: Mr. Chris Vaughan-Smith.
Phone: 292547.
Cables: Southmusic, Sydney.
Peer International Pty. Ltd.
Music Publishing Co. of Australia Pty. Ltd.
Sam Fox Publishing Co. (Australia) Pty. Ltd.
World Music Publishing Co. Pty. Limited.

WOOMERA MUSIC PTY. LTD.
185-187 A'Beckett Street, Melbourne.
Victoria 3000.
Managing Director: Mr. Ron Gillespie.
Phone: 3297255.
Cables: Dualscale, Melbourne.
Spanka Music Pty. Ltd.

YELDAH MUSIC
15 Verdun Street, Mowbray Heights,
Launceston.
Tasmania 7250.
Manager: Mr. Eric W. Scott.
Phone: 262197.

AUSTRALIAN RECORD COMPANIES

ASTOR ELECTRONICS PTY. LTD.
161-173 Sturt Street
South Melbourne
VICTORIA. 3205.
Phone: 690300
Manager Record Division: Mr. Neville Smith
Cables: Schuh, Melbourne
Labels: Astor, Go 11, Red Bird, Vanguard,
Kama-Sutra, Hi-Fi, Elektra, Nonesuch, Ka-
rate, Scope, Audio-Fidelity, Century 21
Distributors of Pye (England), Hanna-Barbera,
Tradition, MTA, Crown, Budget Sound

AUSTRALIAN RECORD COMPANY LTD.
11-19 Hargrave Street
East Sydney
NEW SOUTH WALES. 2010.
Phone: 314111
Managing Director: Mr. A. W. T. Smith
Cables: Colerecord, Sydney
Labels: CBS, Reprise, Warner Bros, Chess,
Kapp, Hickory, Epic

EMI (Australia) LTD.
301 Castlereagh Street
Sydney
NEW SOUTH WALES. 2000.
Phone: 20912
Cables: Emitron, Sydney
Manager Record Division: Mr. Cec Barlow
Labels: HMV, Columbia, Capitol, Decca (Eng-
land), Parlophone, London, Vocalion, Disney-
land, Stateside, Cameo-parkway, Vista, Tam-
la-Motown
Distributors of many, many overseas labels in
this area

FESTIVAL RECORDS PTY. LTD.
223-229 Harris Street
Pyrmont
NEW SOUTH WALES. 2009.
Phone: 684021
Managing Director: Mr. Frederick C. Marks
Cables: Festival, Sydney
Labels: Festival, 20th Century-Fox, A & M,
United Artists, Liberty, World-Pacific, Pa-
cific Jazz, Imperial, Dolton, Sunset, Ampar,
Atlantic, Command, Coral, Dot, Impulse,
Monument, Scepter, Stax, A.T.A., Clarion,
Leedon, Spin, Sunshine, Calendar, Brunswick
Distributors of America Decca, King (Japan)
King (U.S.A.), and others

HADLEY RECORDS
15 Verdun Street
Mowbray Heights
Launceston
TASMANIA 7250
Manager: Mr. Eric W. Scott
Phone: 262197
Label: Hadley (C & W)

MINSTREL RECORDS CO. PTY. LTD.
467 Parramatta Road
Leichardt
NEW SOUTH WALES 2040
Phone: 564383
Manager: Mr. Tony D'Ambr
Cables: Minstrel, Sydney
Labels: Minstrel, Durium. Also importers of
Continental records

PHONOGRAM RECORDINGS PTY. LTD.
69 Clarence Street
Sydney
NEW SOUTH WALES 2000
Phone: 20223
General Manager: Mr. Arthur Major
Cables. Phonorec, Sydney
Labels: Philips, Polydor, Fontana, Mercury,
Riverside, Wing, Zodiac, Deutsche Gramm-
phon, Limelight, Surrey, Smash, MGM,
Verve

PHONO-VOX OF AUSTRALIA PTY. LTD.
155 Sydney Road
Brunswick
VICTORIA 3056
Phone: 389517
Manager: Mr. Tony Tromeros
Cables: Phonovox, Melbourne
Labels distributed: Phono-Vox, Vogue, Pop,
Mode, Vogue & Mode International, Pacific
Deutsche Vogue, Vogue Belgium, Marfer,
Az Disc, Style, Phonocolor, Italdisc, Ducale,
Sonet

RCA OF AUSTRALIA PTY. LTD.
221 Elizabeth Street
Sydney
NEW SOUTH WALES 2000
Phone: 618541
General Manager Record Division:
Mr. W. J. (Bill) Walsh
Cables: Radiointer, Sydney
Labels: RCA, Vik, RCA Victrola, RCA
Camden

W & G RECORD PROCESSING CO. PTY. LTD.
185-187 A'Beckett Street
Melbourne
VICTORIA 3000
Phone: 3297255
Managing Director: Mr. Ron Gillespie
Cables: Dualscale, Melbourne
Labels: W & G, Diaphon, In, Gem, W & G
International, Word, Swaggie

DELTRON RECORDS
10-14 West Parade
West Ryde
NEW SOUTH WALES 2114
Phone: 806334
Manager: Mr. Brian Flaherty
Cables: Delron, Sydney

DELTRON RECORDS
10-14 West Parade
West Ryde
NEW SOUTH WALES 2114
Phone: 806334
Manager: Mr. Brian Flaherty
Cables: Delron, Sydney

DELTRON RECORDS
10-14 West Parade
West Ryde
NEW SOUTH WALES 2114
Phone: 806334
Manager: Mr. Brian Flaherty
Cables: Delron, Sydney

DELTRON RECORDS
10-14 West Parade
West Ryde
NEW SOUTH WALES 2114
Phone: 806334
Manager: Mr. Brian Flaherty
Cables: Delron, Sydney

DELTRON RECORDS
10-14 West Parade
West Ryde
NEW SOUTH WALES 2114
Phone: 806334
Manager: Mr. Brian Flaherty
Cables: Delron, Sydney

DELTRON RECORDS
10-14 West Parade
West Ryde
NEW SOUTH WALES 2114
Phone: 806334
Manager: Mr. Brian Flaherty
Cables: Delron, Sydney

DELTRON RECORDS
10-14 West Parade
West Ryde
NEW SOUTH WALES 2114
Phone: 806334
Manager: Mr. Brian Flaherty
Cables: Delron, Sydney

DELTRON RECORDS
10-14 West Parade
West Ryde
NEW SOUTH WALES 2114
Phone: 806334
Manager: Mr. Brian Flaherty
Cables: Delron, Sydney

DELTRON RECORDS
10-14 West Parade
West Ryde
NEW SOUTH WALES 2114
Phone: 806334
Manager: Mr. Brian Flaherty
Cables: Delron, Sydney

DELTRON RECORDS
10-14 West Parade
West Ryde
NEW SOUTH WALES 2114
Phone: 806334
Manager: Mr. Brian Flaherty
Cables: Delron, Sydney

DELTRON RECORDS
10-14 West Parade
West Ryde
NEW SOUTH WALES 2114
Phone: 806334
Manager: Mr. Brian Flaherty
Cables: Delron, Sydney

DELTRON RECORDS
10-14 West Parade
West Ryde
NEW SOUTH WALES 2114
Phone: 806334
Manager: Mr. Brian Flaherty
Cables: Delron, Sydney

DELTRON RECORDS
10-14 West Parade
West Ryde
NEW SOUTH WALES 2114
Phone: 806334
Manager: Mr. Brian Flaherty
Cables: Delron, Sydney

DELTRON RECORDS
10-14 West Parade
West Ryde
NEW SOUTH WALES 2114
Phone: 806334
Manager: Mr. Brian Flaherty
Cables: Delron, Sydney

DELTRON RECORDS
10-14 West Parade
West Ryde
NEW SOUTH WALES 2114
Phone: 806334
Manager: Mr. Brian Flaherty
Cables: Delron, Sydney

DELTRON RECORDS
10-14 West Parade
West Ryde
NEW SOUTH WALES 2114
Phone: 806334
Manager: Mr. Brian Flaherty
Cables: Delron, Sydney

DELTRON RECORDS
10-14 West Parade
West Ryde
NEW SOUTH WALES 2114
Phone: 806334
Manager: Mr. Brian Flaherty
Cables: Delron, Sydney

DELTRON RECORDS
10-14 West Parade
West Ryde
NEW SOUTH WALES 2114
Phone: 806334
Manager: Mr. Brian Flaherty
Cables: Delron, Sydney

DELTRON RECORDS
10-14 West Parade
West Ryde
NEW SOUTH WALES 2114
Phone: 806334
Manager: Mr. Brian Flaherty
Cables: Delron, Sydney

DELTRON RECORDS
10-14 West Parade
West Ryde
NEW SOUTH WALES 2114
Phone: 806334
Manager: Mr. Brian Flaherty
Cables: Delron, Sydney

DELTRON RECORDS
10-14 West Parade
West Ryde
NEW SOUTH WALES 2114
Phone: 806334
Manager: Mr. Brian Flaherty
Cables: Delron, Sydney

DELTRON RECORDS
10-14 West Parade
West Ryde
NEW SOUTH WALES 2114
Phone: 806334
Manager: Mr. Brian Flaherty
Cables: Delron, Sydney

DELTRON RECORDS
10-14 West Parade
West Ryde
NEW SOUTH WALES 2114
Phone: 806334
Manager: Mr. Brian Flaherty
Cables: Delron, Sydney

AUSTRALIA—The Past 12 Months

(Continued from preceding page)
fame; The Twilights, The Groop, The
Loved Ones, The Masters Appren-
tices, The Cherokees, The Vibrants,
etc.

Publishing

There have been few changes or
trends as a result of the years trad-
ing in the publishing wing of the
music industry of Australia. Most of
the top hit songs during the past year
have been of either English or Ameri-
can origin; and sub-publishing rights
to them for this territory have gen-
erally been assigned to one of the
old-established music publishers in
this country.

It is encouraging to report that
music publishers in general; and in
particular those that are wholly-
owned and operated in Australia; are
showing a much keener desire to pub-
lish and promote sheet copies on lo-
cal pop compositions.

Full credit must go to the publisher
who has the foresight and initiative to
do this. Because, whilst the imme-
diate results from Australian composi-
tions may be small; looking at it on
a long-term basis those who help the
Australian publishing business to get
on its feet and stand with the rest of
the world, must benefit from helping
our writers develop to the stage

where they can compete with the best
of the recognized international writers.

For some reason or other very few
songs of Australian origin have been
given the chance to score on a world-
wide level. We believe the time isn't
too far distant before local composi-
tions will reach the stage of interna-
tional recognition—and with them will
develop the local publisher who will
have a new bargaining power for over-
seas placement on Australian songs.

A couple of members of The Easy-
beats have a world hit with their own
song ("Friday On My Mind"), and
they and their publisher (J. Albert &
Son) are now reaping some of the re-
wards that go hand-in-hand with their
efforts.

The biggest single hazard that the
Australian music publisher has to
face in relation to the local song, is
the reluctance of most of his overseas
affiliates and/or record companies to
accept an Australian pop composition
for consideration . . . even though in
many cases such a song may have en-
joyed chart ratings in this country on
a national scale.

But now that some of the world
spotlight is reflecting on the Aus-
tralian scene through the efforts of
such people as The Seekers, The Easy-
beats, The Bee Gees, and others; may-

(Continued on page 57)

A POWERFUL NEW FORCE IN THE AUSTRALIAN RECORD INDUSTRY

PHONOGRAM RECORDINGS PTY. LIMITED

PHILIPS — FONTANA — DEUTSCHE GRAMMOPHON
GESELLSCHAFT — POLYDOR — ARCHIV — HELIODOR
MERCURY — CAEDMON — ZODIAC — MGM — VERVE

TOP FLIGHT PROMOTION & SALES TEAMS
SPEEDY DISTRIBUTION CENTRES

IN ALL CAPITAL CITIES

PHONOGRAM RECORDINGS PTY. LIMITED
69 CLARENCE STREET, SYDNEY, AUSTRALIA

AUSTRALIA'S BEST SELLING RECORDS DURING THE PAST 12 MONTHS

This list comprises the best-selling records, listed by companies in alphabetical order, in each category; Album, E.P., single; over the past twelve months. Locally produced records are marked with asterisk.

BEST SELLING SINGLES FROM ASTOR

This Is My Song	Petula Clark	Astor
Puppet On A String	Sandie Shaw	Astor
*Undecided	The Masters Apprentices	Astor
*Oh Monah	The Cherokees	Go!!
Why Don't Women Like Me	Clinton Ford	Astor
*Minnie The Moocher	The Cherokees	Go!!
Sunny Afternoon	The Kinks	Astor
I Couldn't Live Without Your Love	Petula Clark	Astor
Daddy	Pebbles & Bamm Bamm	Astor
Colour My World	Petula Clark	Astor

BEST SELLING ALBUMS FROM ASTOR

Love And Harold Steptoe	Steptoe & Son	Astor
Kink Kontroversy	The Kinks	Astor
Lawrence Of Arabia	Soundtrack	Colpix
My Love	Petula Clark	Astor
Joan Baez In Concert (Vol 1)	Joan Baez	Vanguard
Daydream	The Lovin' Spoonful	Kama-Sutra
Fairytale	Donovan	Astor
Face To Face	The Kinks	Astor
Petula Clark's Hit Parade	Petula Clark	Astor
Me	Sandie Shaw	Astor

BEST SELLING E.P.s FROM ASTOR

Kinksize Hits	The Kinks	Astor
Downtown	Petula Clark	Astor
Lawrence Of Arabia	Soundtrack	Colpix
Kwyet Kinks	The Kinks	Astor
*Little Boy Sad	MPD Limited	Go!!
My Love	Petula Clark	Astor
Universal Soldier	Donovan	Astor
There's Always Something There	Sandie Shaw	Astor
Michelle	The Overlanders	Astor
*The Cherokees	The Cherokees	Go!!

BEST SELLING SINGLES FROM EMI

Green, Green Grass Of Home	Tom Jones	Decca
Yellow Submarine	The Beatles	Parlophone
No Milk Today	Herman's Hermits	Columbia
Friday On My Mind	The Easybeats	Parlophone
Good Vibrations	The Beach Boys	Capitol
The Carnival Is Over	The Seekers	Columbia
Georgy Girl	The Seekers	Columbia
Tar And Cement	Verdelle Smith	Capitol
Born Free	Matt Monro	Capitol
Penny Lane	The Beatles	Parlophone

BEST SELLING ALBUMS FROM EMI

Rubber Soul	The Beatles	Parlophone
Mary Poppins	Soundtrack	Buena Vista
Revolver	The Beatles	Parlophone
Doctor Zhivago	Soundtrack	MGM
Big Hits	The Rolling Stones	Decca
Help!	The Beatles	Parlophone
Shirley Bassey's Greatest Hits	Shirley Bassey	Columbia
Aftermath	The Rolling Stones	Decca
The Best Of Al Martino	Al Martino	Capitol
The Beatles Greatest Hits (Vol 1)	The Beatles	Parlophone

BEST SELLING E.P.s FROM EMI

*Easyfever	The Easybeats	Parlophone
Hits From The Seekers	The Seekers	Columbia
Further Requests	The Beatles	Parlophone
*Easy As Can Be	The Easybeats	Parlophone
*She's So Fine	The Easybeats	Parlophone
The Animals Are Back	The Animals	Columbia
Route 66	The Rolling Stones	Decca
Not Fade Away	The Rolling Stones	Decca
The Rolling Stones	The Rolling Stones	Decca
Jake The Peg	Rolf Harris	Columbia

BEST SELLING SINGLES FROM FESTIVAL

Snoopy Versus The Red Baron	Royal Guardsmen	Festival
Ooh La La	Normie Rowe	Sunshine
*Step Back/Cara-Lyn	Johnny Young	Clarion
Mama	B. J. Thomas	Scepter
*Spicks And Specks	The Bee Gees	Spin
Sweet Pea	Tommy Roe	Ampar
*Pride And Joy/Stones That I Throw	Normie Rowe	Sunshine
Return Of The Red Baron	Royal Guardsmen	Festival
*Wallpaper Roses	Sandy Scott	A.T.A.
Gimme Some Lovin'	Spencer Davis Group	Festival

BEST SELLING ALBUMS FROM FESTIVAL

Going Places	Herb Alpert & Tijuana Brass	A & M
Whipped Cream & Other Delights	Herb Alpert & Tijuana Brass	A & M
The Lonely Bull	Herb Alpert & Tijuana Brass	A & M
South Of The Border	Herb Alpert & Tijuana Brass	A & M
Zorba The Greek	Soundtrack	Festival
What Now My Love	Herb Alpert & Tijuana Brass	A & M
S.R.O.	Herb Alpert & Tijuana Brass	A & M
*Johnny Young	Johnny Young & Kompany	Clarion
I Got You Babe	Sonny & Cher	Atlantic
The Very Best Of Roy Orbison	Roy Orbison	Monument

BEST SELLING E.P.s FROM FESTIVAL

*Let It Be Me	Johnny Young & Kompany	Clarion
Spanish Flea	Herb Alpert & Tijuana Brass	A & M
*All My Lovin'	Johnny Young & Kompany	Clarion
Tijuana Taxi	Herb Alpert & Tijuana Brass	A & M
Zorba The Greek	Herb Alpert & Tijuana Brass	A & M
Zorba The Greek	Soundtrack	Festival
A Taste Of Honey	Herb Alpert & Tijuana Brass	A & M
*Pride & Joy	Normie Rowe	Sunshine
Only The Lonely	Roy Orbison	Monument
Sweet Pea	Tommy Roe	Ampar

BEST SELLING SINGLES FROM PHONOGRAM

(formerly Philips)

Winchester Cathedral	New Vaudeville Band	Philips
Pamela Pamela	Wayne Fontana	Philips
You Don't Have To Say You Love Me	Dusty Springfield	Philips
Happy Jack	The Who	Polydor
Bend It	Dave Dee, Dozy, Beaky, Mick & Tich	Philips
I'm A Boy	The Who	Polydor
Substitute	The Who	Polydor
The Sun Ain't Gonna Shine Anymore	The Walker Brothers	Philips
This Is My Song	Harry Secombe	Philips
Peek-A-Boo	New Vaudeville Band	Philips

BEST SELLING ALBUMS FROM PHONOGRAM

Swingin' Safari	Bert Kaempfert	Polydor
Trumpet A Go Go	James Last	Polydor
The Best Of Bert Kaempfert	Bert Kaempfert	Polydor
Roger Miller—Golden Hits	Roger Miller	Philips
Dusty Springfield's Golden Hits	Dusty Springfield	Philips
Elizabeth Serenade	Gunter Kallman Chorus	Polydor
Encore Of Golden Hits	The Platters	Philips
Portrait	The Walker Brothers	Philips
Percussion Parisienne	David Carrol Orch.	Philips
You Won't Believe Your Ears	Wes Harrison	Philips

BEST SELLING E.P.s FROM PHONOGRAM

Substitute/I'm A Boy	The Who	Polydor
The Wedding	Julie Rogers	Philips
I Need You	The Walker Brothers	Philips
Morgen/Sailor	Lolita/Robie	Philips
The Sun Ain't Gonna Shine Anymore	The Walker Brothers	Philips
The Platters	The Platters	Philips
Ready Steady Who	The Who	Polydor
I Only Want To Be With You	Dusty Springfield	Philips
Lover's Concerto	Sarah Vaughan	Philips
Winchester Cathedral	New Vaudeville Band	Philips

BEST SELLING SINGLES FROM RCA

I'm A Believer	The Monkees	RCA
A Little Bit Me, A Little Bit You	The Monkees	RCA
Ballad Of The Green Berets	S/Sgt. Barry Sadler	RCA
Monday, Monday	Mamas & Papas	RCA
Dancing In The Street	Mamas & Papas	RCA
Dedicated To The One I Love	Mamas & Papas	RCA
Tell Me Why	Elvis Presley	RCA
Distant Drums	Jim Reeves	RCA
(It's A) Long Lonely Highway	Elvis Presley	RCA
Spinout	Elvis Presley	RCA

BEST SELLING ALBUMS FROM RCA

The Sound Of Music	Soundtrack	RCA
South Pacific	Soundtrack	RCA
Blue Hawaii	Elvis Presley	RCA
More Of The Monkees	The Monkees	RCA
Paradise Hawaiian Style	Elvis Presley	RCA
The Monkees	The Monkees	RCA
G. I. Blues	Elvis Presley	RCA
Always In My Heart	Los Indios Tabajaras	RCA
A Christmas Treasure	Julie Andrews	RCA
The Student Prince	Mario Lanza	RCA

BEST SELLING E.P.s FROM RCA

Jailhouse Rock	Elvis Presley	RCA
Elvis By Request	Elvis Presley	RCA
Follow That Dream	Elvis Presley	RCA
Tickle Me	Elvis Presley	RCA
Old Shep	Elvis Presley	RCA
The End Of The World	Skeeter Davis	RCA
Have Nageela	Harry Belafonte	RCA
My Last Date	Skeeter Davis	RCA
Love In Las Vegas	Elvis Presley	RCA
Ave Maria	Mario Lanza	RCA

BEST SELLING SINGLES FROM W & G

*The Loved One	The Loved Ones	In
*Ever Lovin' Man	The Loved Ones	In
*Sad Dark Eyes	The Loved Ones	In
*A Love Like Ours	The Loved Ones	In
Morningtown Ride	The Seekers	W & G
A World Of Our Own	The Seekers	W & G
I'll Never Find Another You	The Seekers	W & G
*The Purple Petrol Eater	Webb Brothers	W & G
*I'll Go Crazy	Merv Benton	W & G
*Big Jack	Merv Benton	W & G

(Continued on next page)

JEWEL MUSIC

(AUSTRALIA) PTY. LIMITED

offers complete representation,
promotion, exploitation and
protection in

AUSTRALIA AND NEW ZEALAND

• • •

Contracts negotiated on a catalogue
basis or for single songs

JEWEL MUSIC (AUSTRALIA) PTY. LIMITED

George S. Cooper (President)
National Building, 250 Pitt Street,
Sydney, Australia

SPAIN'S Music Publishers

EDICIONES ARMONICO—Rambla de Cataluña, 10—(Barcelona, 7)
 EDICIONES CARCELLE—Farrell, 4—Hostafranch (Barcelona, 14)
 EDICIONES CLIPPER'S—Rambla de Cataluña, 10—(Barcelona, 7)
 EDICIONES GRAMAFONO ODEON—Urgel, 234—(Barcelona, 11)
 EDICIONES HISPANIA—Av. José Antonio, 31—(Madrid, 13)
 EDICIONES MUSICA DEL SUR—Diputación, 337—(Barcelona, 9)
 EDICIONES MUSALES CALIPSO—Alcalá, 70—(Madrid, 9)
 EDICIONES MUSALES CLAVE—Alcalá, 70—(Madrid, 9)
 EDICIONES MUSALES HISPANOX, S.A.—Campomanes, 8—(Madrid, 13)
 EDICIONES MUSALES LUIS ARAQUE—Rios Rosas, 28—(Madrid, 3)
 EDICIONES MUSALES MADRID—Mayor, 27—(Madrid, 13)
 EDICIONES MUSALES PUERTA DEL SOL—Alcalá, 70—(Madrid, 9)
 EDICIONES MUSALES R.C.A. ESPANOLA—Edificio Torre de Madrid—Planta 7ª n° 8—(Madrid, 13)
 EDICIONES MUSALES UNIVERSAL—Chinchilla, 2—(Madrid, 13)
 EDICIONES MUSALES "ZAFIRO"—Campomanes, 10—(Madrid, 13)
 EDICIONES QUIROGA—Alcalá, 70—(Madrid, 9)
 EDITORIAL ALIER—Carmen, 27—(Madrid, 13)
 EDITORIAL CANCIONES DEL MUNDO—Carmen, 20—(Madrid, 13)
 EDITORIAL FIESTA EN TRIANA—Niebla, 35—Apartado Correos, 493—(Sevilla)
 EDITORIAL MILLS MUSIC ESPANOLA, S.L.—Alcalá, 70—(Madrid, 9)
 EDITORIAL MUSICA DE ESPANA—Cuesta de Santo Domingo, 11—(Madrid, 13)
 EDITORIAL MUSICA MODERNA—Marqués de Cubas, 6—(Madrid, 14)
 EDITORIAL MUSICAL IBERO AMERICANO (EMIA)—Diputación, 337—(Barcelona)

AUSTRALIA—The Past 12 Months

(Continued from page 55)

be overseas parties may now be interested in making a closer and more thorough assessment of Australian songs.

Finale

One of the most important matters over the next twelve months to both record companies and music publishers throughout Australia will be the

expected widespread changes to the Copyright laws of this country. The suggested changes are to be considered by all interested parties, and it is expected that the Bill of changes will be introduced to Federal Parliament during the August session. More will be reported on this vital matter during the months ahead in our regular weekly columns.

AUSTRALIA'S TRADE ORGANIZATIONS

MUSIC LICENSING

A.P.R.A. (AUSTRALASIAN PERFORMING RIGHT ASSOCIATION LTD.)
 208 Clarence Street,
 Sydney, New South Wales 2000.
 Phone: 293713.
 General Manager: Mr. John Sturman,
 Cables: APRA, Sydney.

C.O.R.S. (COPYRIGHT OWNERS REPRODUCTION SOCIETY)
 8th Floor, Wynyard House,
 291 George Street, Sydney.
 New South Wales 2000.
 Phone: 296033.

RECORD ASSOCIATION
 ASSOCIATION OF AUSTRALIA RECORD MANUFACTURERS
 103-105 Oxford Street Sydney.
 New South Wales 2000.
 Phone: 312041
 Secretary: Miss V. Green.
 Cables: Fonocord, Sydney.

BROADCASTERS

FEDERATION OF AUSTRALIAN COMMERCIAL BROADCASTERS
 47 York Street, Sydney.
 New South Wales, 2000.
 Phone: 291738.
 Federal Director: Mr. E. L. Sommerland,
 Cables: AFOBS, Sydney.

MUSICIANS

MUSICIANS' UNION OF AUSTRALIA (Federal Office).
 61 Queens Road, Melbourne.
 Victoria 3000.
 Phone: 512110.
 General Secretary: Mr. C. Wheatland.
 Cables: Musun, Melbourne.

RECORD LABEL SUPPLIERS

H. CLARK PTY. LTD.
 19-23 Sydenham Road, Marrickville,
 New South Wales 2204.
 Phone: 513218.

MILAN SPECIALTY PRINTER CO. PTY. LTD.

291 Bell Street, Preston.
 Victoria 3072.
 Phone: 441594
 Manager: Mr. Len Dyson.

VICTORIAN PRINTING WORKS PTY. LTD.

Wills Street, Melbourne.
 Victoria 2000.
 Phone: 3297744.
 Manager: Mr. Fred Tucker.

RECORD COVER SUPPLIERS

F. H. BOOTH & SON PTY. LTD.
 31 Burton Street, Darlinghurst,
 New South Wales 2010.
 Phone: 318017.

MILAN SPECIALTY PRINTER CO. PTY. LTD.

291 Pall Street, Preston.
 Victoria 3072.
 Phone: 441594.
 Manager: Mr. Len Dyson.

Z. NOSEK & CO. PTY. LTD.

170 Botany Street, Waterloo,
 New South Wales 2017.
 Phone: 695723.

VICTORIAN PRINTING WORKS PTY. LTD.

Wills Street, Melbourne,
 Victoria 2000.
 Phone: 3297744.
 Manager: Mr. Fred Tucker.

SHEET MUSIC PRINTERS

F. H. BOOTH & SON PTY. LTD.
 31 Burton Street, Darlinghurst,
 New South Wales 2010
 Phone: 318017.

A. KYNOCH & CO. PTY. LTD.

18 Ireland Street, West Melbourne.
 Victoria 3003.
 Phone: 630451.

MOCKRIDGE BULMER PTY. LTD.

259 Penshurst Road, Willoughby,
 New South Wales 2068
 Phone 412168.

VAN DYKE MUSIC AGENCIES

3 West Street, Paddington,
 New South Wales 2021.
 Phone: 311805.

AUSTRALIA'S BEST SELLERS (Con't)

BEST SELLING ALBUMS FROM W & G

*The Seekers Sing Their Big Hits
 *Introducing The Seekers
 Hide And Seekers
 *Kevin Shegog's Greatest Hits
 *Old Time Ballroom
 *Folk Songs
 From A Jack To A King
 In The Cocktail Bar
 It's Honky Tonk Time
 *Bill McCormack Sings The Big Songs

The Seekers W & G
 The Seekers W & G
 The Seekers W & G
 Kevin Shegog W & G
 William Flynn W & G
 Denis Gibbons W & G
 Ned Miller W & G
 Eddy Young W & G
 Martin Gale W & G
 Bill McCormack W & G

BEST SELLING E.P.s FROM W & G

*The Loved Ones
 A World Of Our Own
 Morningtown Ride
 I'll Never Find Another You
 *Bush Songs
 *The Best Of Kevin Shegog
 Nursery Rhymes

The Loved Ones In W & G
 The Seekers W & G
 The Seekers W & G
 The Seekers W & G
 Denis Gibbons W & G
 Kevin Shegog W & G
 Elizabeth Humphries/Charles Young W & G
 Glenda Raymond W & G
 Elizabeth Humphries/Charles Young W & G
 The City Slickers W & G

*When We Were Very Young
 17 Favourite Nursery Rhymes

*Discotheque Dance Party

Cash Box—July 8, 1967

MARISOL



CAMPOMANES 10, MADRID 13, SPAIN

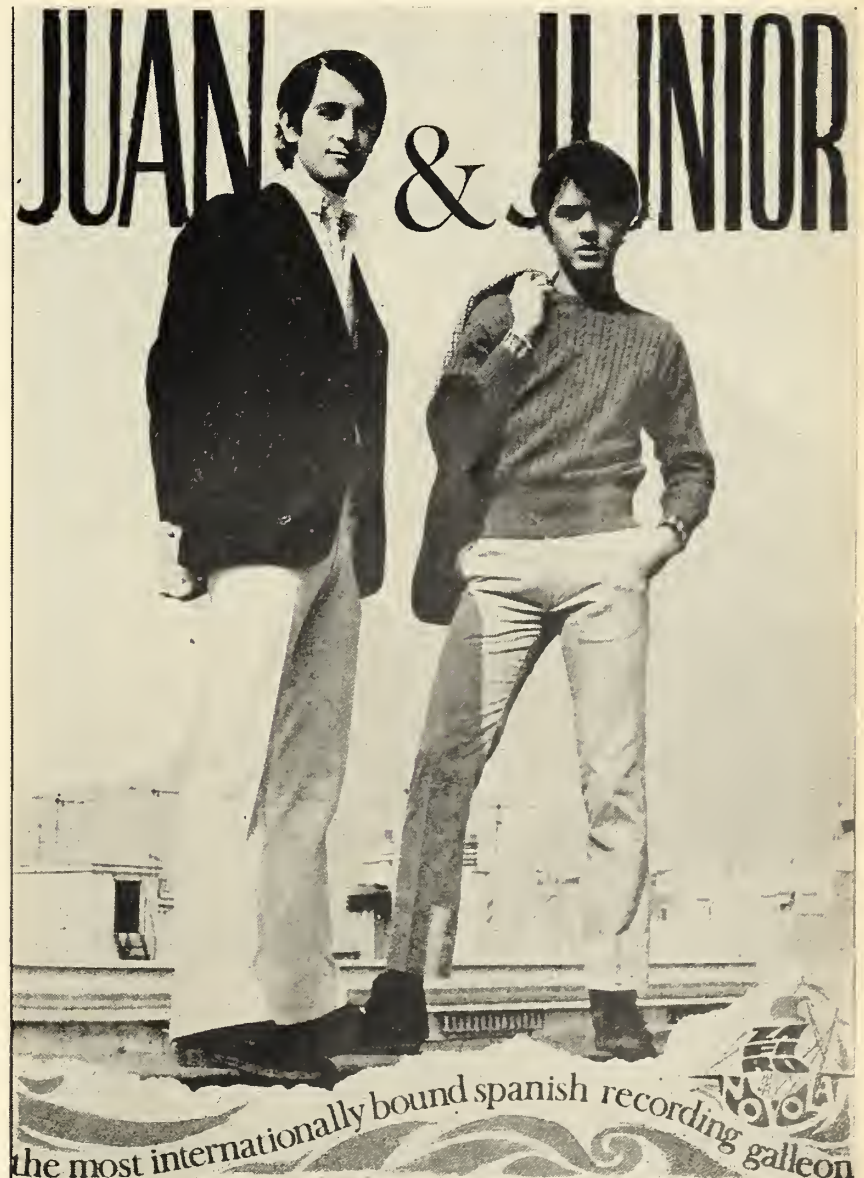

CAMPOMANES 10, MADRID 13, SPAIN

SPAIN—THE PAST 12 MONTHS

The two-year boom (1965-1966) in the Spanish record industry has very largely come to an end. This is due to the general economic situation, whose trend is now towards stabilization. In the record business, as in many other fields, the past two years were years of optimism. Sales increased highly, and the quality, technically and artistically, increased as well. Some new companies (both little and big ones) entered the market in competition with the already established, which increased the volume of work considerably.

In order to get information about the development of the market, Cash Box spoke with Julio Sampedro, president of the Spanish Group of the International Federation of Phonographic Industries. This is the main trade organisation in Spain. There are two other organisations. One of them is the "subgroup of music over plastic materials" of the Instituto Espanol del Libro (Spanish Book Institute). The other is the "subgroup of editors of records" of the Syndicate of Paper and Graphic Arts. Publishers and authors are affiliated with the SGAE (Sociedad General de Autores de Espana) "Spanish General Society of Authors," a member of BIEM.

As Sampedro told us, the Spanish group of the IFPI does not deal with commercial affairs, and their meetings (generally one every three months) are held for a discussion of impressions and general considerations about the business. For example, the last meetings were given over to a discussion of author royalties, which are calculated from the global price of the record. As this price includes the price of the cover (a fifth of the total in some cases), the group is going to present a proposal to ask that the authors' 8% should be calculated only from the price of the record.

As far as we know, there are no

official figures of record sales in Spain, but the approximate estimations are that last year about six million records were sold. To increase this figure a great deal is really difficult if you consider that there are no more than a million record players in the country. The figure does increase about 75,000 every year, which is not too much according to the medium economic level. What is the reason? Sampedro pointed out that Spain is a sunny country with good weather almost the whole year. In winter, young people (most of the record buyers are youngsters) are inside studying or working, and they buy records constantly, with highest figures in December. But as soon as the spring comes people prefer the open air activities. Beside this, record players are not as essential to life as washing machines, cars, refrigerators, etc., so a record player is almost the last thing a family buys. We can be optimistic, because the increase of sales of record players is constant if not spectacular. Sampedro thinks that sales will be stabilized in one or two years after the boom of 1965-1966.

Another question is the price of records. While most other consumer products have been increasing their prices, record prices have remained the same for almost four years. On the other hand, costs are higher: salaries, higher publicity. The moment for the increase of prices has come. It is not yet confirmed, but it is very probable that most of the companies are going to sell the EP at 115 pesetas (they are now sold at 95 pesetas), singles at 75 pesetas (now 65), (60 pesetas equals a dollar). No increase is expected in LP's. Spain was in past years a definitive EP market, but now things have changed. More singles and LPs are sold now. The EP will remain, but singles and LP's will continue to take a bigger part of the market.

Another question is taxes. The Spanish record industry is hoping for an exemption from taxes. They say that since books, as a cultural product, have no taxes, records should have none either. For the time being, records are charged with a 15% "luxury tax," and a 2.70% "enterprises traffic tax," as well as the 8% that has to be paid to the SGAE as "author rights."

As a result of the bigger promotion given to certain records, the past 12 months saw more of them pass the 100,000 mark. This is not too usual, but every time there is a bigger difference in the figures of hit records and those of the records nobody knows. Some Spanish artists are consistent best sellers. Among them we can mention Raphael. A two time Spanish singer in the Eurovision song contest, he has appeared on English TV and in almost all South American countries. There are groups that hit with almost every record they produce. This is the case with the Pekenikes, an instrumental group whose records appear in England and the USA (through Pye and United Artists) and whose self-composed tunes have had a good reception here and abroad. Also we should mention Los Brincos, who recently recorded in England for Page One records (the Larry Page label). Their records appeared in England, France and Italy. Los Bravos are the best internationally-known Spanish group, due to the big success of "Black Is Black," that also sold very well in Spain, (number one for more than two months). Juan & Junior, former members of the Brincos, are also planning to do international business. Their records are going to be released on the CBS label in England). Joan Manuel Serrat is the big surprise of the year. He is a young singer and sings his own songs in "catalan" (a language spoken in the North East, the part of Spain of a higher level economically). Massiel is the most outstanding female artist. She sings songs of a new "author-singer," Luis Eduardo Aute, as well as her own songs. Two other groups among the best sellers are Los Sirex and Los Mustang. In the folk field, Manolo Escobar and Peret are generally accepted as the artists that sell the most records. Other artists that sell well are Bruno Lomas, Duo Dinámico, Los 3 Sudamericanos, Los Pasos, Luis Aguilé, Micky y Los Tonys, Los Relámpagos, Los Salvajes, Lone Star, Los Angeles and Luis Eduardo Aute.

Beside domestic disks, foreign records sell well here if they have a big promotion or have been recently in the USA or English top ten. The Four Tops, Nancy and Frank Sinatra, The Beatles, The Rolling Stones, The Turtles, Adamo, The Troggs, The Spencer Davis Group, The New Vaudeville Band, The Monkees, Iva Zanicchi, Little Tony, Donovan, Wilson Pickett, Manfred Mann, The Who, Herman's Hermits, James Brown, Michel Polnareff, and Tom Jones have been in the best sellers lists, among others.

A number of new record companies began to operate here during the past 12 months: Ekipo Records, with a folklore catalogue; Sesión Records, with different artists (domestic); Sonoplay (with domestic artists and foreign labels); Fidiás and CEM, the newest of them all.

In distribution, some foreign labels have changed representatives and some labels with no distribution here are now handled by Spanish companies. Atlantic, previously represented by Belter, is now represented by Hispavox. Festival and CGD, previously represented by Hispavox, are now represented by Tempo. Tamla Motown, whose releases appeared in the Stateside label, are now represented here by RCA. Liberty, previously represented by Odeon (EMI) is now represented by Hispavox. Verve, previously represented by Odeon, is now represented by Fono-

SPAIN'S RECORD COMPANIES

FABRICA DE DISCOS COLUMBIA
Address: Libertad 24 (Madrid)
Phone: 2211093; 2211095
Director: D'Enrique Inurrieta
Labels (domestic): Columbia, Alhambra
Labels (distributed): Decca, Decca (American Series), London, Barclay, Kama Sutra etc.

BERTA
Address: Preciados 29 (Madrid)
Phone: 2315967
Director: D. Marcial Hita Castillo
Labels (domestic): Berta

FONOGRAM
Address: Av. de America y Hdez. de Tejada s/n (Madrid)
Phone: 2674200
Labels: Philips, Fontana, DGG, Polydor, Mercury, MGM, Heliodor, Riverside, Verve, Folklore de España, (Verve to be distributed in July)

Compañía del Gramófono ODEON (EMI)
Address: Urgel 234 (Barcelona)
Director: D. René Maget
Phone: 2302205
Labels: Voz de Su Amo (HMV), Odeon, Capitol, Pathé, Liberty, Regal, Stateside, Angel, Verve, Immediate

RCA Española
Address: Torre de Madrid, P-7, Of. 8 y 9 (Madrid)
Phone: 2484913
Director: D. Gil Beltran
Labels: RCA Victor, Vik, Victrola, Tamla Motown, Dot

EKIPO
Address: Valencia 229 (Barcelona)
Phone: 2153704
Director: D. Arturo Mas Aguado
Labels: Ekipo

EDIGSA
Address: Av. de José Antonio 654 (Barcelona)
Phone: 2316950
Director: D. José M^a Macip Gich.
Labels: Edigsa

Discos VERGARA
Address: Paseo General Mola 4 (Barcelona)
Phone: 2571200
Labels: Vergara, Angelicum, Ariola, Ariston, B&M, CAM, Cetra, Clan Celentano, Club Francaise du disque, Durium, Eurodisc, Melodia, IFI, Kapp Records, Musica Sacra, Ricordi, Scepter, Studio SM, Style, Time Records, Vox
Director: D. Alberto Serra

SONOPLAY
Address: Av. América (Estudios Moro) (Madrid)
Phone: 2457600
Labels: Sonoplay, Miller International, Cantagallo, Tiffany, Disques President, GO Records, Major Minor, Cameo Parkway, Knig Records, Budget Sounds, Jubilee Records, B. T. Puppy Records
Director: D. Pedro Mengibar

Discos FIDIAS
Address: Claudio Coello 76 (Madrid)
Phone: 2764209
Director: Erich Ruiz Albrecht
Labels: Fidiás

MARFER
Address: Paseo Alto de la Virgen del Puerto 7 (Madrid)
Phone: 2657800
Director: D. Emilio Fernández
Labels: Artone, Bellaphone, Cisne, Combo, Le club Francaise du Disque, Emporio, Music-disc, Negram, Palacio, Turicaphon

ZAFIRO
Address: Campomanes 10 (Madrid)
Phone: 2415004
Director: D. Esteban García Morencos
Labels: Zafiro, Novola, Saar, Musart

Discos TEMPO
Address: Goya 99 (Madrid)
Phone: 2762645
Director: D. Alfredo García Segura
Labels: Tempo, Riviera, President (England), Festival, CGD

DISCOPHON
Address: Valencia 288 (Barcelona)
Phone: 2151370
Director: D. Francisco Ortega
Labels: Discophon, Epic, CBS

BELTER
Address: Gomis 1 (Barcelona)
Phone: 2481754
Director: D. Joaquín Alfonso Navas
Labels: Belter, Metronome, Ri Fi etc.

SESION
Address: Garcia de Paredes 78 (Madrid)
Phone: 224812
Labels: Sesión, GTA
Director: D. Francisco Sanz

CEM
Address: Guzmán el Bueno 123 (Madrid)
Phone: 2541155
Director: D. Enrique Martín Garea
Labels: CEM, Copacabana, Disc-Jockey, Microphon, North, Parade, Robinson, Equipe

HISPAVOX
Address: Torrelaguna 104
Phone: 2152304
Director: D. José Manuel Vidal
Labels: Hispavo, ABC Paramount, Atlantic, Reprise, Warner Bros, Pye, Vogue, Bluebell, Cadet, Canadian American, Carish, Command, AZ, Disneyland, Ducretet-Thomson, Erato, Gamma, Impulse, Le chant du Monde, Marcal, Music-Hall, Peerless, United Artists, Liberty, Imperial





DISCOS VERGARA SPAIN

The famous firm who introduced to the world of records the most acclaimed of prima donnas

MONTSERRAT CABALLE

is preparing to launch throughout the world and especially in America a wide and very complete

PANORAMA OF THE SPANISH SCENIC MUSIC

ranging from XVIIIth Century songs to modern opera.

This really ambitious programme of recordings includes the most representative musical comedies, a genre which enjoys maximum popularity in America as well as in most other parts of the world.

Available recordings: The Doge's Wife; The Song of Forgetfulness; Dona Francisquita; The Moorish Queen; Moors and Christians; Maruxa; Those from Aragon; Soul of God. To be released shortly: El Bateo; The Bolero Jacket; Bohemians; The Farmhouse; The Swallows; Marina; The Mischievous One; The Saffron Flower; The Feast of La Paloma and many others.

PRINCIPAL ARTISTS

Angeles Chamorro (soprano); Isabel Penagos (soprano); Mary Carmen Ramirez (soprano); Pilar Torres (soprano); Ines Rivadeneyra (mezzo-soprano); Bernabe Marti (tenor); Carlo del Monte (tenor); Francisco Saura (tenor); Cesar Ponce de Leon (baritone); Vicente Sardinero (baritone); Raimundo Torres (baritone); Miguel Aguerri (bass); Rafael Campos (bass).

Groups, Choirs, Barcelona Philharmonic Orchestra.
Directors: Rafael Ferrer, Eugenio M. Marco, Enrique Ribo, Antonio Ros Marba and others.



FLAMENCO SONG ARCHIVE

A collection of 6 L.P.s of "in situ" recordings and interpretations of the most genuine "cantaos" giving the chief "hondo" songs with their most genuine variations. A real "corpus" which can be considered as a monument to the very distinctive Spanish "folk."

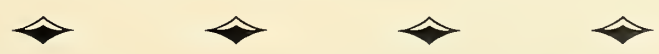

For commercial and artistic information please contact

DISCOS VERGARA

Paseo General Mola, 9 Barcelona, Spain
Branches in Madrid, Valencia, Bilbao, Sevilla,
Palma de Mallorca, Las Palmas de Gran Canaria
Affiliated firms in Mexico, Venezuela,
Colombia, Uruguay and Argentina



SPAIN'S BEST SELLERS DURING THE PAST 12 MONTHS

ODEON (EMI)

EP's or Singles
 "Mis Manos en tu Cintura" (Adamo) HMV
 "Submarino Amarillo" (Los Mustang) HMV
 "Good Vibrations" (Beach Boys) Capitol
 "Como Ayer" (Dúo Dinámico) HMV
 "Como Ayer" (Bruno Lomas) Regal
 "Tu Nombre (Adamo) HMV
 "Yellow Submarine" (Beatles) Odeon
 "Todo Negro" (Los Salvajes) Regal
 "Juanita Banana" (Georgie Dann) HMV
 "Paperback Writer" (Beatles) Odeon

LP's

"Revolver" (Beatles)
 "Adamo al Olympia"
 "Adamo en Espanol"
 "Exitos del 66" (Alfredo Domenech)
 "Los Javaloyas en Palma"
 "Amor, Baile y Violines" (Frank Pourcel)
 "Rubber Soul" (Beatles)
 "Mi Cristo Roto" (P. Cué)
 "Recital de éxitos" (Various artists)
 "La Rosa del Azafrán" (Marcos Dedondo)

FONOGRAM

EP's or Singles
 "Dr. Zhivago" (Original soundtrack) MGM
 "Black is Black" (Johnny Hallyday) Philips
 "Winchester Cathedral" (New Vaudeville Band)
 Fontana
 "Wit A Girl Like You" (Troggs) Fontana
 "I Can't Control Myself" (Troggs) Fontana
 "Cartagenera" (Beatles de Cádiz)
 "Gimme Some Loving" (Spencer Davis)
 Fontana
 "I'm A Man" (Spencer Davis) Fontana
 "Peek A Boo" (New Vaudeville Band)
 Fontana
 "I'm A Boy" (The Who) Polydor
 "Happy Jack" (The Who) Polydor
 "Another Tear Falls" (Walker Brothers)

FONOGRAM

LP's
 Paul Mauriat/Philips
 Paul Mauriat/Philips
 Paul Mauriat/Philips
 Paul Mauriat/Philips
 Paul Mauriat/Philips
 "Doctor Zhivago" (Original Soundtrack) MGM
 Helmut Zacharias/Polydor
 James Last
 Werner Muller/Polydor
 Connie Francis/MGM
 "Siete Novias Para Siete Hermanos" (Original Soundtrack) MGM

VERGARA

EP's
 "L'Emigrant" (Rudy Ventura)
 "Yo Grito" (Los Sirex)
 "Un Hombre Ilorará" (Jose Guardiola)
 "Els Savis" (Juan Capri)
 "Cadillac" (Los Gatos Negros)
 "Yo Soy Napoleón" (Los Sirex)
 "Bang Bang" (Equipo 84)
 "No Pensare a Me" (Claudio Villa)
 "Un Hombre y Una Mujer" (Tenor—Herederó)
 "Cuore Matto" (Little Tony)

Singles

"Nostalgia" (Ninni Rosso)
 "Primer Amor" (Herederó)
 "Juanita Banana" (The Peels)
 "El Mundo en Navidad" (Los Sirex)
 "Septiembre" (Jose Guardiola)
 "La Tierra de las Mil Danzas" (Los Gatos Negros)
 "Brindis" (Los Sirex)
 "Un Hombre Y Una Mujer" (Jose Guardiola)
 "Acto di Forza No. 10" (I Ragazzi Del Sole)

LP's

Flamenco Hits
 Montserrat Caballe
 Equipo 84
 Antonio Machin
 Roger Williams
 Marujita Diaz
 Hits Primavera—66
 Hits Verano
 España Hits
 Pasodobles
 España Hits—2

DISCOPHON

Singles
 "Belen Belen" (Peret)
 "Yo Soy Aquel" (Emilio El Moro)
 "El Monkey" (Hnas. Benitez)
 "El Muerto Vivo" (Peret)
 "Dr. Zhivago" (Ray Conniff)
 "The Sounds of Silence" (Simon & Garfunkel)
 "Like a Rolling Stone" (Bob Dylan)
 "Besame Mucho" (Ray Conniff)
 "El Cant Dels Ocells" (Pablo Casals)
 "Sunshine Superman" (Donovan)

LP's

"Say It With Music" (R. Conniff)
 "West Side Story" (Soundtrack)
 "My Fair Lady" (Soundtrack)
 "Please Love Me" (Caravelli)
 "Guitarras de Medianoche" (Cuco Sanchez)
 "Concierto en la Casa Blanca" (Palo Casals)
 "J'Aime" (Caravelli)
 "Agrup. Roque Nublo" (Canarias)
 "Cobia La Principal de La Bisbal" (Sardanas)
 "Mexico" (Varios Artistas)

SONOPLAY

EP's or Singles
 "Miguel e Isabel" (Luis Aguilé)
 "Tema de Lara" (Roy Etzel)
 "It's a Man's Man's Man's World"
 (James Brown)
 "La Guitarra" (Miguel Rios)
 "Taxi" (Los Impala)
 "Eres un Vago" (Los Botines)
 "Lady Jane" (Glyn Johns)
 "La Banda" (Luis Aguilé)
 "But It's Allright" (J. J. Jacson)
 "Why" (The End)

LP's

"Rueda de Canciones Navidenas"
 (Various Artists)
 "Vales Vieneses"
 "Dance Party" (The Gisha Brothers)
 "Million Seller Hits of 1966" (101 Strings)
 "Soul of Spain" (101 Strings)
 Antonio Gades
 "La Biblia" (Original Soundtrack)
 "The Best of Chris Barber"
 "Hawaii" (Original Soundtrack)

EDIGSA

EP's
 "Ara Que Tinc Vingt Anys"
 (Joan Manuel Serrat)
 "La Moral" (Francesco Pi de la Serra)
 "Inici de Cantic" (Raimon)
 "L' hora dels Adeus" (Coral Sant Jordi)
 "Cançons de Peliculas" (Nuria Feliú)
 "Cant dels Ocells" (Lou Bennet)
 "Nadales" (Coral Sant Jordi)
 "Canço de la Matinada" (Joan Manuel Serrat)
 "La Santa Espina"
 (Mauné i els seus Dinamics)
 "Quan Surti el Sol" (Jacinta)

LP's

Nuria Feliú/Tete Montoliú
 Nuria Feliú/Lou Benet
 "Disc d'or de la Sardane"
 "Raimon-Espriu"
 "Raimon al Palau"
 Contes de Grimm
 Contes d' Andersen
 Frederic Mompou
 Robert Gerhard

MARFER

EP's
 "Cucurucucú Paloma" (Los Tres Paraguayos)
 "Recuerdos de Ypacarai"
 (Los Tres Paraguayos)
 "Malaguena" (Los Tres Paraguayos)
 "Granada" (Los Tres Paraguayos)
 "Non Pensare a Me" (Renata)
 "Vuelo 502" (Santy Castellanos)
 "Me Perdi en la Serrania" (Flor de Cordoba)
 "Viva el Pasodoble" (Mariano Matabuena)
 "En Una Flor" (Cuarteto Maranatha)
 "La Pulga de Tijuana" (Claudia)

MARFER

LP's
 Los Tres Paraguayos
 "Fiesta de Espana"
 "Marfer Parade No. 5"
 "Espana y Sus Canciones" (Various Artists)
 "Sol y Alegria de Espana"
 "Bailes Flamencos"
 "Tablas y Cante" (El Charro)
 "Puerto de La Cruz"
 "Marfer Parade No. 4"
 "Pasodobles al Acordeon"
 (Mariano Matabuena)

EKIPO

EP's
 El Pasodoble
 El Flamenco
 Maria Dolores
 Vicent
 Ramon Calduch
 Los Tres Hernández
 Manolo del Rio
 José Luis Campoy
 Chus Martinez
 Los Wikingos

LP's

"Espana es Diferente"
 "La Espanola"
 "Guitarra Flamenca"
 "Sangre y Arena"
 Quinto de Sevilla
 Chus Martinez
 Los Tres Hernández
 "La Sardana"
 "Tuna Universitaria de Barcelona"
 "Hits para Bailar"

RCA

LP's
 The Mama's and the Papa's
 Los Indios Tabajaras
 La Muerte Tenia un Precio
 (Original Soundtrack)
 Sonrisas y Lágrimas
 Las 14 Canciones de Este Año (Various)
 Los Indios Tabajaras
 Concierto No. 1 Brahms (Rubinstein)
 Esquivel y su Orquesta
 Fiesta en México
 Nelsen Eddy y Jeanette McDonald

EP's

"Ultimo Tren a Clarksville" (The Monkees)
 "Standing In the Shadows of Love"
 (The Four Tops)
 "Look Through My Window"
 (The Mama's and the Papa's)
 "Me he de Comer esa Tuna" (Jorge Negrete)
 "La Muerte Tenia un Precio"
 Del film "Puños y Lágrimas" (Elvis Presley)
 "Sonrisas y Lágrimas"
 "Arenas Arrastran los Rios" (José Menese)
 "Hojita Verde" (Miguel Aceves Mejia)
 "La Llorona" (Chavela Vargas)

RCA

Singles
 "Monday Monday"
 (The Mama's and the Papa's)
 "Reach Out I'll Be There" (The Four Tops)
 "I Saw Her Again"
 (The Mama's and the Papa's)
 "Balada para una Sonrisa" (Sylvie Vartan)
 "Cuando Digo que te Amo" (Tony Remis)
 "I'm a Believer" (Los Monkees)
 "Words of Love"
 (The Mama's and the Papa's)
 "A Little Bit Me, A Little Bit You"
 (The Monkees)
 "Dedicated to the One I Love"
 (The Mama's and the Papa's)
 "Tema de Lara" (Al Korvin)

EP's

"Un Beso en el Puerto" (Manolo Escobar)
 "Juanita Banana" (Los 3 Sudamericanos)
 "La Banda Borracha" (Los 3 Sudamericanos)
 "Vuelo 502" (Los de la Torre)
 "La Guapa de Cadiz" (Lola Flores)
 "Guantanamo" (Los 3 Sudamericanos)
 "Septiembre" (Magdalena Iglesias)
 "Non Pensare a Me" (Iva Zanicchi)
 "Malrecida Ma del Carmen" (Manolo Escobar)
 "El Sartenero" (Conchita Bautista)

LP's

"Todo San Remo" (Various Artistas)
 Festival Mallorca 1966
 "Exitos de Peliculas" (Manolo Escobar)
 "Los 3 Sudamericanos"

Mina

Exitos a Go-Go
 "Ronda de España" (Antoñita Moreno)
 "La Guapa de Cadiz" (Lola Flores)
 "Carmen de España" (Carmen Sevilla)

HISPAVOX

EP's
 "Yo Soy Aquel" (Raphael—Hispavox)
 "Extraños En La Noche" (Frank Sinatra—
 Reprise)
 "Marionetas En La Cuerda" (Sandie Shaw—
 Pye)
 "Hablemos Del Amor" (Raphael—Hispavox)
 "Estas Botas Son Para Caminar" (Nancy
 Sinatra—Reprise)
 "Cuando Tu No Estas" (Raphael—Hispavox)
 "Estuve Enamorado" (Raphael—Hispavox)
 "Un Hombre Y Una Mujer" (Soundtrack—
 United Artists)
 "Love Me, Please Love Me" (Michel Pol-
 Nareff—Az)
 "Mañana" (Sandie Shaw—Pye)

LP's

"Mi Vida" (Raphael—Hispavox)
 "Cuando Tu No Estas" (Raphael—Hispavox)
 "Extraños En La Noche" (Frank Sinatra—
 Reprise)
 "Hilo De Seda" (Los Pekenikes—Hispavox)
 "Lo Mejor Del Año" (Vol. 3—Varios)
 "Katuska" (Varios)
 "La Del Manojó" (Varios)
 "Un Hombre Y Una Mujer" (Soundtrack—
 United Artists)
 "Taste Of Honey" (Herb Alpert—A & M)
 "Lo Mejor De Joan Baez" (Joan Baez—
 Amadeo)

Singles

"Lady Pepa" (Los Pekenikes—Hispavox)
 "Hilo De Seda" (Los Pekenikes—Hispavox)
 "Guantanamo" (The Sandpipers—A & M)
 "Frente A Palacio" (Los Pekenikes—His-
 pavox)
 "La Banda Borracha" (Alberto Cortez—His-
 pavox)
 "La Moto" (Los Pasos—Hispavox)
 "Ojos De España" (Kuldip)
 "Anouschka" (Los Pasos—Hispavox)
 "When A Man Loves A Woman" (Percy
 Sledge—Atlantic)
 "Land Of 1,000 Dances" (Wilson Pickett—
 Atlantic)

ENGLAND— THE PAST 12 MOS.

(Continued from page 34)

poration of New York, previously handled in the U.K. by Chappells, opened its own independent office in London in March 1967, under the management of Andrew Heath. Since that date, the catalogue has seen its single releases become more frequent, with records such as "I Think We're Alone Now" by Tommy James, and The Shandelles on Major-Minor, "Too Much Of A Good Thing" by the Shirellas on Pye, and "I Like The Way" by Simon on RCA. Also a lot of Planetary titles have been recorded in England with releases scheduled for later in the year. This new activity in the singles market augments the consistent releases of album material that the company enjoys. Some of the artists to have released Planetary-Nom titles in the past few months include Herb Alpert, Zoot Sims, Lulu, Peaches & Herb, Margaret Whiting, The Searchers, The Righteous Brothers and Ike & Tina Turner. Andrew Heath is optimistic about the year ahead now that the new set-up is firmly established and a regular flow of material being received from the States and from young English writers.

**CASH BOX
DEVOTES MORE
SPACE TO THE
WORLD MARKET
EACH WEEK THAN
ALL OTHER MUSIC
TRADES COMBINED**

LOS BRINCO



the most internationally bound spanish recording galleon
 CAMPOMANES 10, MADRID 13, SPAIN

KEY TO THE SPANISH MARKET



FOR A LABEL OF QUALITY

THE BEST
COMMERCIAL
ORGANIZATION



THE HIGHEST
QUALITY
PRODUCT

FONOGRAM, S. A.

AVDA. DE AMERICA Y HERNANDEZ DE TEJADA - APDO. DE CORREOS 35019 - TEL. 2674200. DIR. TELEGRAF. FONOGRAM
MADRID-17

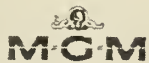

SPAIN—The Past 12 Months

(Continued from page 58)
gram. Kama Sutra and Deram (without representation here before) are now handled by Spanish Columbia. Vergara has the representation of the official Russian catalogue, Melodia. Sonoplay represents King, Jubilee, Cameo/Parkway (previously represented by Hispavox), Disques President B. T. Puppy, Budget Sound, Go, Major Minor and Tiffany, as well as Miller and Cantagallo. GTA, previously represented by RCA, is now represented by Sesion. President Records represented by Tempo. Artone is represented by Marfer. Vergara represents Kapp and Discophon handles CBS.

Technically, the quality of records produced in Spain is now better than ever. There are good recording studios that belong to the main companies (Fonogram, Hispavox, Odeon, Belter, Discophon and Columbia). There are independent studios such as Estudios Celada and Eustudios Cima S.A., both in Madrid. Pressing plants are modernized and belong to record companies (except Iberofon, which is independent).

There are many song festivals in Spain. The main ones are at Mallorca, Benidorm, Aranda (which this year will be held in Oporto), Barcelona, Menorca, Canarias, León, Orense, Gijón and others.

There are many radio programs dedicated to records. Main disc jockeys, are Tomás Martín Blanco, Angel Alvarez, Pepe Palau, Mariano Mendez Vigo, Carlos Marimón, Joaquín Prat, and Raul Matas. Almost every radio station has a program devoted to records.

Record reviews in magazines and papers have increased since last year.

Almost every newspaper in Barcelona has a record section that appears weekly. The main one is "El Noticiero Universal" written by Carlos Marimón. In Madrid, ABC (one of the

most serious papers) has a record section by Mariano Mendez Vigo. We should also mention "Pueblo" by Pepe Palau, "Ya" by Juan Maria Mantilla and "Alcaázar" by Miguel delos Santos. There are more teen papers this year. "Tele Guía," "Alta Fidelidad," "Fans," "Fonorama" and "Discobolo" (the veteran one, now five years old) are mostly dedicated to records and music slanted toward young people. "Aria Jazz" and "Ritmo" cover smaller markets.

Spanish TV has a regular program every week devoted to records, and it is one of the best loved programs in Spain. It is Fernando Garcia de la Vega's "Escala en Hi-Fi." The big shows of Spanish TV usually present world famous artists. These shows are "Noche del Sábado" and "Gran Premio." There are two other musical shows, "Tele Ritmo" (emceed by J. M. Quero) and "Musical 14'05" (emceed by Martin Maqueda).

In the summer season, almost every company takes a special interest in folklore records because of the more than 15 million tourists that come to Spain every year. In the summer therefore, sales of pop and classical records are lower in this period.

The trend for the near future, as far as we can see, is a regular but not too spectacular increase in sales. Most of these sales will come from records by Spanish artists (those that are really important are very few) and by foreign best sellers. Some foreign artists have a big success here due to the fact that they record in Spanish (this is the case with Adamo, whose records sung in Spanish always are near the 100,000 mark in sales).

Discotheques are becoming more and more popular every day. Those on the coast will be playing in August the records that will have success in October. The juke box has relatively little importance in Spain.

The Record Scene in Greece

Despite the increasing number of tourists finding their way to Greece, the record market is still primarily concerned with local repertoire performed by local artists. There are three major kinds of Greek music—traditional folksong, popular songs, and light music.

Popular songs are divided into two categories, which loosely, could be described as ancient and modern. The former, oriental in style with its roots in Byzantine music, although highly popular in Greece, is unsuitable for export (in the same way that outside Spain the demand for authentic flamenco music is limited). The modern category of light music, such as "Never On Sunday" and "Syrtaki" is popular with the younger and more sophisticated Greek, and also suitable for export. Greek light music, although modern in style is definitely Grecian in character, and entirely different from international "pop" music—therefore, the appeal is largely local. A festival of Greek light music takes place every year in September at Thessaloniki.

Int'l Artists

Generally speaking, artists specializing in traditional folksong are unsuited for modern music or song, and therefore are seldom known outside their own country—it is artists of the "Never on Sunday" and light music schools who display international potential. One such artist, Lola Tsakiris, came to England last year to record an LP for the Decca record company, for issue in Europe, the Middle East and the United States, as well as in Greece. Another artist, Zoitsa Kouroukli who carried off the first prize at the Mediterranean Festival at Barcelona in 1965 with "Min Les Tipota" is another Greek artist with international potential who has appeared in numerous festivals throughout Europe, including those in Majorca and Poland. The artist sings in English and French, and records both for Martin Th. Gesar's Pan Vox label and on the CBS label. Another Greek artist well known at interna-

tional festivals is Yovanna. She has won prizes at festivals in Poland, Switzerland and Germany, where she was recently on tour with French singing star Sacha Distel. As well as Greek, she sings in French and Italian, and like Zoitsa Kouroukli, she records both for Pan Vox and CBS.

Until two or three years ago, Greek teenagers, who are the principal buyers of Greek light music and international "pop" music, were reluctant to accept local cover recordings by Greek artists of their favourite British and American originals. More recently, however, tastes have changed, largely due to the emergence of such young Greek groups as The Fourmix, who with their best-selling Decca single "Jeronimo Yanka" paved the way for other groups, amongst them The Charms. Like the singers mentioned above, both these groups are contracted to Martin Th. Gesar.

GREECE'S RECORD COMPANIES

GREEK PHONOGRAPH RECORD HOUSE

Platia Kolokotroni 3, Athens
Phone: 231.533, 233.069
Cable: GEORPH ATHENS
Pres.: Mr. Georgios Orphanidis
Labels (domestic): RCA Victor
Labels (others): Aristocrat, Carisch, Dot, Hickory, Melophone, Pathé, Telefunken.

HELLADISC S.A. GRAMOPHONE RECORDS CO.

Ermou Street 8, Athens
Phone: 238.291/3
Cable: HELLADISC ATHENS
Pres.: Mr. Nikolas Antipapas
Labels (domestic): Fidelity, Philips, Polydor
Labels (others): Archiv-Produktion, Audio, Fidelity, Barclay, Cameo/Parkway, Deutsche Grammophon, Fontana, Mercury, Polydisc, Riverside, Roulette, United Artists.

LAMBROPOULOS BROS., LTD.

8B Lykourgou Street, Athens
Phone: 527.168, 527.287
Cable: ADELAMBRO ATHENS
Pres.: Mr. Xenophon Lambropoulos
Labels (domestic): Columbia, His Master's Voice
Labels (others): ABC-Paramount, Capitol.

MELODY RECORDS CORP.

11 Aristidou, Athens
Phone: 227.329
Cable: MELODY ATHENS
Pres.: Mr. Anthony Plomaritis
Labels (domestic): Athenee, Melody, Popular
Labels (others): Artone, Combo, Embassy, Everest, Festival, Meazzi, Pacific, Rifi, Ronnex, Simco, Sonet, Teeny, Variety, Vedette, Zafiro.

MINOS MATSAS & SON

48 Stadiou Street Athens
Phone: 288.660
Cable: ODEOPARLOPHONE ATHENS
Pres.: Dr. Minos Matsas
Labels (domestic): Odeon, Parlophone
Labels (others): Motown-Tamla.

MUSIC-BOX

2 Nikis Street, Athens 126
Phone: 221.574-225.921-235.391
Cable: THOMS ATHENS
Pres.: Mr. Martin Th. Gesar
Labels (domestic): CBS, Decca, Music-Box, Pan-Vox
Labels (others): Cetra, Clan, Decca Records Inc., New York, Durium, Epic, Hispavox, Imperial, Liberty, Dolton London, Markal, Palette, Pye, Quality, Société Decca Française du Son, Stateside, Vogue.

Los Grandes Exitos de la Musica Espanola:

"FRENTE A PALACIO"	(Los Pekenikes)
"YO SOY AQUEL"	(Raphäel)
"HABLEMOS DEL AMOR"	(Raphäel)
"ESTUEVE ENAMORADO"	(Raphäel)
"AMOR FINGIDO"	(Don Felipe)
"UNA CALLE CUALQUIERA"	(Don Felipe)
"VOLVERAS OTRA VEZ"	(Raphäel)
"TIENE LA TARARA"	(Marisol)
"TRAPOS VIEJOS"	(Los Pekenikes)

HAN SIDO PUBLICADOS POR:

Ediciones Quiroga Alcalá, 70 — Madrid (España) Cables: QUIROGAMUSIC	Ediciones Música de España — Cuesta de Santo Domingo, 11 Madrid (España)
--	---

START A NEW
SUBSCRIPTION TO
CASH BOX TODAY
AND GET A COPY
OF THIS INT'L
DIRECTORY FREE

GREECE'S MUSIC PUBLISHERS

GRECOPHON
3 Karageorgis Servias Street, Athens
Phone: 225921
Cable: GRECOPHON ATHENS
Pres.: Mrs. Marika Gesar

MAISON DE MUSIQUE PHILIPPE NAKAS
2 Rue Harilaou Trikoupis, Athens
Phone: 612.720
Cable: NAKASFIL ATHENS
Pres.: Mr. Philippe Nakas

MICHAEL GAETANOS
10 Stoa Arsakiou, Athens
Phone: 222.876
Cable: MIGAETANOS ATHENS
Pres.: Mr. Michael Gaetanos

POPULAR MUSIC AND RECORDS
Themistocleous Aristidou, Athens
Phone: 843.230
Cable: POPULARECORD ATHENS
Pres.: Mr. Evans Plomaritis

GREECE'S COLLECTION AGENCY

A.E.P.I. SOCIETE ANONYME HELLENIQUE POUR LA PROTECTION DE LA PROPRIETE INTELLECTUELLE
7 Botassi Street, Athens
Phone: 629.730
Cable: DAX ATHENS
Pres.: Mr. Gregoire Constantinides
Collecting Society for Mechanical Licenses

GRECO *phon*
editions musicales

PUBLISHER

3, KARAGEORGIS SERVIAS STREET

ATHENS

Telephone: 225921

Cable: GRECO Phone ATHENS

President: MARIKA GESAR



Jim Reeves sings "The Storm"

c/w "Trying to Forget" #9238 RCA VICTOR

RCA The most trusted name in sound



CANADA—THE PAST 12 MONTHS

The record business in Canada from the point of view of a purely Canadian business is stronger now than it has ever been before. Moreover, it grows stronger with each passing month. However, the big money in record sales in Canada, and it has been unofficially estimated that total annual record sales in this country are in the neighborhood of fifty million dollars, is still earned by records produced in the United States, and to a lesser degree, in Great Britain. The slice of the Canadian market that not so long ago increased sharply in favor of Great Britain has now fallen off to a noticeable degree, but that is pretty much the case in all of North America. That is the key to the whole Canadian record scene. It is not so much a Canadian record market as it is a North American record market. It is impossible to be so close to an industrial colossus such as the United States, a country whose overall entertainment industry—records included—ranks as one of its major exporters, and not be sharply influenced by trends and developments in the U. S. Canada reflects, on a smaller scale, all the influences and developments that apply in any given year on the American record market.

If the figures mentioned above are the least bit accurate (50 million dollars resulting from the sale of records in a year) and the quote appeared very recently in a nationally syndicated newspaper story and one considers that figure in respect to the Canadian population figures, 20 million in round figures, it appears that the potential volume in Canada is most encouraging. Unit price structure on Canadian records is very similar to that of the United States. Singles, EP's and LP's are within a few cents either way of the American price on the same item. The American dollar does have a slight monetary advantage over its Canadian counter-

part. The rate of exchange hovers between seven and eight per cent in favour of the U. S. dollar.

Detailed sales figures on any individual record product are nearly impossible to get hold of. Such figures are seldom made public by record companies. Experience indicates that total sales on hit singles in Canada have increased to the point that a "hot" single can now expect to bring home something on the order of 50,000 plus sales. That is up sharply from the 20,000 to 30,000 Canadian sales a hit could be expected to accrue only two or three years ago. A notable exception has always been the French language market that geographically pretty well confines itself to the Province of Quebec.

Expo '67 Ties

Canada's slice of the record sales pie in Canada has never been bigger than it is now. That was the substance of the opening line of this piece, and proof of that statement follows now: although Canada's Centennial year is not quite half over as this is written, world-wide interest generally centres on this country due to a great extent to the way that our country's fabulous World's Fair, "Expo '67" has far upstaged anything similar that has gone before. Directly tied to Canada's Centennial celebrations is the song, "Canada," written by Bobby Gimby and recorded by the composer with a kid's chorus. The song is now nudging the 200,000 sales mark, and there is still six months selling time left in Canada's one hundredth birthday celebrations. It would be fair to say that Quality has in this record the all time best seller in Canada, certainly in so far as a Canadian production is concerned. Released in the U. S. on MGM, it has contributed to the interest that already runs high where Canada is concerned throughout the World. It

is significant to note that only upon its release in the U. S. did full page trade ads appear. This may be one shortcoming of record producers in Canada, they don't believe they have a hit until they get their product released in the U. S. Generally speaking though, Canadians just don't seem to have the ability to thump the old publicity tub for anything made in Canada, as they do for product originating anywhere else in the world, and this lack of enthusiasm is not confined only to the record business.

Songs and Artists

There have been other very big sellers in Canada, and by that one means Canadian produced records in the period covered by this review. Notable among them was a beer commercial that became a very big selling record hit for two companies. Quality was first to recognize the potential in a Casl release by The Carlton Showband of "The Merry Ploughboy." Shortly after, the actual group that did the song on the Carling's Breweries TV commercial appeared on an Arc outing. The Abbey Tavern Singers called their version of the song "Off To Dublin In The Green." American releases were obtained for both, Quality's through Bell and Arc's through HBR. Perhaps the most consistent artist from a point of view of sales was Gordon Lightfoot. He had several U.A. releases that all did top ten business in most Canadian centres. These included "Spin Spin," "Go Go Round" and "The Way I Feel." Lloyd Leipzig, Director Of Creative Services for United Artists Records in the U. S., told a gathering of Compo men at their National sales meeting that Lightfoot was highly thought of by American toppers of the firm. If ever the time comes when a reversal of the product flow across the 49th parallel occurs, and Canadian

record product starts moving in quantity to the U. S., Gordon Lightfoot will be one of the pace setters.

Another consistently successful group on the Canadian scene over the past year has been The Guess Who. Recording for Quality the group went through a change in personal management over the course of the year as Bob Burns was replaced by Ray Levin. Big sellers for the group included "And She's Mine," "His Girl" and "Pretty Blue Eyes." "His Girl" was a very big item in Great Britain, scoring heavily on airplay with the "private" stations, and selling in large quantity into the bargain. It was written by vet Canadian musician-composer, Johnny Cowell. Two of the best coast to coast promotion undertakings were those of the RCA Victor Company in support of girl chanter, Marti Shannon, and Hal Ross' colorful coast to coast junket on behalf of the debut rock record on K-R by the Toronto group, The Mandala. Marti's RCA album and single came in for much attention from Canadian deejays and Hal's visit to most of the major Canadian markets had "Opportunity" by The Mandala on practically every play list in the Country.

The Staccatos from Ottawa, managed by Sandy Gardiner of Desanda Productions, scored for Capitol on several important releases. Moreover, careful management has groomed this vocal-instrumental group into one of the most demanded acts in Canada, with much business in the U. S. as well. Deejays in the major Canadian centres are now not only playing Canadian records, they are booking the Canadian artists for P. A.'s in their cities. Dave Boxer has staged several important Canadian-content shows in Montreal. The CFCF spinner, in promoting his various shows, has been a key factor in the promotion of Canadian talent in that City in general. Expo '67 is booking many of the top Canadian recording acts into various attractions at the fair. Bob Mac-

(Continued on next page)

LONDON

RECORDS

SELLS

CANADA

BRANCHES COAST TO COAST

FAST, AGGRESSIVE, EFFECTIVE,
DISTRIBUTION AND PROMOTION

PHONE, WIRE, TELEX OR WRITE

LONDON RECORDS OF CANADA 1967 LTD.

190 GRAVELINE RD.

PHONE 631-2061

ST. LAURENT, P.Q.

TELEX: 012384

CANADA—THE PAST 12 MONTHS

(Continued from preceding page)
Adorey of Toronto's CHUM has been booking top Canadian attractions at his location. Dave Charles, CJBQ Belleville, sets the Canadian P. A. pace for smaller centers. The arrival of a second pop-oriented station on the Toronto scene, geared to Canadian talent to a great extent, has been very important in exposure of Canadian records in the Toronto market. Foster Hewitt's CKFH has even gone so far as to hire one of the most promising femme singers in Canada as Librarian. She is Susan Taylor, winner of the Toronto Telegram's popularity poll even before her debut record, "Don't Make Promises" was released on Yorkville. She, like many young and promising Canadians, has benefited from heavy TV exposure of Canadian pop record acts by several important network shows on both the CBS and CTV nets. These shows are important exposure vehicles for pop artists with new releases. These, together with numerous local bandstand-type shows in markets across the Country are key factors in the breaking of a hit nationally in Canada.

Regional Aspects

One major problem that confronts Canadian record men is the very strong regional aspects that prevail on the pop music scene in Canada. If it's tough to get a California-originated record played in New York in the U. S., you should try and get record product originating on Canada's west coast, or for that matter mid-west, played in key eastern centres. The reverse is also true on records that are produced in Toronto and Montreal. Notable exceptions have been releases by Gordon Lightfoot, The Guess Who and The Mandala. But, I have already referred to the

full fledged promo campaigns that have been planned around most of this product. The National Promotion Man is a rare item in Canadian record circles, that is to say the successful one is. For the most part, promotion is a side line for the sales department on the national level, and left to affiliated distributors and company-owned branches in the larger cities across the country.

Two firms that make an all-out national promotion effort are Compo, through the activities of Al Mair, and Quality through Harold Winslow and Ed Lawson. Paul White at Capitol is one of the most promotion-oriented sales executives on the national record scene in Canada, while another Sales exec that not only thinks and talks promotion, but gets out on the road frequently to see his contacts is Paul Clark from Caravan. Top local promo men are Quality's Liam Mullan in Montreal and another Montrealer, Barry Paine at Compo. Air play is still the key to breaking any given record in Canada. However, even this is considerably complicated by Canada's proximity to the U. S. Many important American radio stations have signals that penetrate the most important Canadian markets. As a result a new release is heard in saturation quantities in Canada well before product is available in this Country. This review refers now to American, and frequently British record product. To counteract this early exposure of new record product on American outlets in their own markets, many Canadian radio men have made arrangements for immediate service on important American records from several independent operators in the U. S. As a result of this development many Canadian radio stations are obtaining and playing important American hits even before

they reach the Canadian record company concerned, and certainly well before they can go to the pressing plants for manufacture and retail sale. Irresponsible, pre-release exposure by broadcasters is, happily, at a minimum in Canada. Most music directors and program directors do their best to guard against destroying the demand for a given release by too heavy pre-release broadcasting of the record in question. American releases are manufactured in Canada by branches of the American firm concerned, or by a licensed affiliate.

Highlights By Headline

1966-67 Canadian record business highlights by headline: Independent producer Marshall Shapiro forms own recording and production facility, "Company Of Broadcast Producers," "They're Coming To Take Me Away," Warner Bros. release by Napoleon XIV, soars to the top of most Canadian charts, Quality realigns national executive, appointing Montreal and becomes centre of controversy over lyrics. Winnipeg Branch Managers, Reg Ayres and Clyde MacGregor respectively to National Sales top spots for various of the Quality lines. David Clayton Thomas and the Bossmen score heavily on Canadian chart scene with home grown R&B sounds on "Brainwashed." All-girl radio station, CHIC, debuts in Brampton. Very few Canadian broadcasters react to "ban the Beatle" craze following supposed "anti-Christ" remarks by John Lennon, bit proves to be tempest in tea pot. Allan Slight exits top programming spot at Toronto's CHUM to form independent programming consultant firm based in Canada and England.

Distrib switches in Winnipeg takes Phonodisc's mid west operation to

Laurel, while Corrine Burke takes over Columbia lines in same area. Long time record retail man, Alex "Mr. Records" Sherman debuts own label, Excellent Records, based in Ottawa. TJB packs 'em in at Toronto O'Keefe Centre, Herb Alpert and Jerry Moss receive plaques from Quality for outstanding achievements and contributions to Canadian record industry. Monkees take country by storm riding "Last Train To Clarksville" to the top of everybody's chart. Gaiety's Don Grashey closes production deal for Jerry Palmer with Epic. Gerry Young replaces Mark Anderson as Manager at London's Winnipeg branch. Mark moves over to Muis-mart's mid-west branch as Manager. Dean Hagopian debuts new Montreal TV seg, "Teen 66," now presumably "Teen 67."

General increase, a sharp one, for R&B records on the air waves of Canadian pop stations begins to show up in increased sales in this area all across Country.

Tony Choma debuts new label in Montreal market, Tempo Records. Vet Record Man Harold Pounds ankles Sparton after over 20 years in same post. He is replaced on the Sparton Record scene by Larry Page. Joe Pareiselli becomes National Sales Promotion Manager. Harold moves over to a partnership in Bob Stone's Stone label, "Winchester Cathedral" develops into monster chart item for Fontana's New Vaudeville Band. Spencer Davis releases acquired for Canada by Stone Records. Heavy air play and sales for James Last music on Polydor spreads across Country. "Toronto Sound" show spotlights wide array of Canadian artists and groups. Many American record men scout the lengthy scene at Maple Leaf Gardens. Montreal continues to lead the way in Canada for the development of soul hits, giving heavy air play to Ben E. King outing, "What Is Soul." Side be-

(Continued on page 71)

Why

set up an office,
whip up a sales force,
woo thousands
of dealers,
learn French,
promote,
distribute,
advertise—
why bother
to manufacture?



If you want to
sell records
in Canada,
let us get your
ulcers
for you.

**Only RCA Victor has COMPLETE
facilities for manufacturing and
marketing records in Canada.**

RCA VICTOR COMPANY, LTD. 1001 Lenoir St., Montreal, Canada
514-933-7551

CANADIAN MUSIC PUBLISHERS

A & B SYME (BMI)
Box 383
Salmon Arm, B.C.

ABC MELODY PUBLICATIONS (CAPAC)
Ste. 1103, 1449 St. Alexander St.,
Montreal, P.Q.

ABERBACH (CANADA) LTD. (CAPAC)
58 Advance Road,
Toronto 18, Ontario

ADOLPHE TAIGI MUSIC PUBLISHERS
(CAPAC)
2161 Jolicoeur,
Montreal 20, P.Q.

ALFREDO MARCHITTO MUSIC (CAPAC)
17 Egan Ave.,
Toronto, Ontario

ALLEGRO, HENRY VARTAS MUSIC
(CAPAC)
113 Winston Park Blvd.,
Downsview, Ontario

ANDER SONGS (BMI)
20 Cranfield Road,
Toronto 16, Ontario

ANGLO-CANADIAN MUSIC (CAPAC)
58 Advance Road,
Toronto 18, Ontario

AR — DO MUSIC (BMI)
1356 Eglinton Ave. W.
Toronto 10, Ontario

AUBADE INC. (CAPAC)
Box 46 NDG
Montreal, P.Q.

BALLANTYNE MUSIC (BMI)
6 Orkney Cres.
Islington, Ontario

BANFF MUSIC (BMI)
4828 Cote Des Neiges Road,
Montreal 28, P.Q.

BARABASH MUSIC (BMI)
11335-84th St.,
Edmonton, Alberta

BAY MUSIC (BMI)
20 Cranfield Road,
Toronto 16, Ontario

BELINDA (CANADA) LTD. (CAPAC)
58 Advance Road,
Toronto 18, Ontario

BEN KERR MUSIC (BMI)
52 Springhurst Ave.,
Toronto 3, Ontario

BICKFORD MUSIC (BMI)
195 Carlton St.,
Toronto, Ontario

BIGLAND MUSIC (CAPAC)
1940 Yonge St.,
Toronto 7, Ontario

BOOSEY & HAWKS (CANADA) (CAPAC)
209-13 Victoria St.,
Toronto, Ontario

BRAVA MUSIC (CAPAC)
58 Advance Road,
Toronto 18, Ontario

BRILL MUSIC (CAPAC)
58 Advance Road,
Toronto 18, Ontario

BURLINGTON OF CANADA (CAPAC)
190 Graveline Road,
St. Laurent, P.Q.

CANADA WIDE MUSIC (BMI)
362 Langdon Cres.,
Moose Jaw, Sask.

CANADIAN ITALIAN (CAPAC)
3669 rue Fenelon,
Ville St. Michel, P.Q.

CANADIAN MUSIC SALED LTD. (CAPAC)
58 Advance Road,
Toronto 18, Ontario

CANINT MUSIC (CAPAC)
20 Cranfield Road,
Toronto 16, Ontario

CANUCK MUSIC CORP. (CAPAC)
309 Grosvenor Ave.,
Montreal 6, P.Q.

CAPORAL MUSIC (BMI)
5207 Durocher Ave.,
Montreal, P.Q.

CHAPPEL & CO. LTD. (CAPAC)
14 Birch Ave.
Toronto 7, Ontario

CHINGUACOUSEY MUSIC (BMI)
Post Office Box 703
Oshawa, Ont.

CLARENDON HOUSE LTD. (BMI)
5567 Queen Mary Road,
Montreal, P.Q.

COLONEL WALT MUSIC (BMI)
1560 Bayview Ave.,
Toronto 1, Ontario

CREATIONS DE QUEBEC (CAPAC)
1143 rue St. Jean,
Quebec 4, P.Q.

CURTAIN MUSIC (BMI)
66 Wellington St. W.,
Toronto, Ontario

DASANDA PRODUCTIONS
19 Hexham Road,
Ottawa 14, Ontario

DEE BEE MUSIC (CAPAC)
Ste. 503, 701 Don Mills Road,
Don Mills, Ontario

DENSTA MUSIC (BMI)
10290 Terasse Fleury,
Montreal, P.Q.

DORTON MUSIC (BMI)
33 Regency Square,
Scarborough, Ontario

EASTMAN PUBLISHERS (CAPAC)
32 Alcorn Ave.,
Toronto, Ontario

ED ARCHAMBAULT (CAPAC)
500 St. Catherine St. E.,
Montreal, P.Q.

EDITIONS ADAGIO (BMI)
5727 Delorimier,
Montreal, P.Q.

EDITIONS ANDRE (BMI)
353 Rachel St. E.,
Montreal, P.Q.

EDITIONS ANDRE ROUSSELL (CAPAC)
Ste. 10, 6 Wellington St. S.,
Sherbrooke, P.Q.

EDITIONS BIJOU (BMI)
309 Grosvenor Ave.,
Montreal, P.Q.

EDITIONS CAPRICE (BMI)
4824 Cote Des Neiges Road,
Montreal, P.Q.

EDITIONS CHANSONIA (BMI)
1482 St. Catherine St. W.,
Montreal, P.Q.

EDITIONS DE L'ETOILE (CAPAC)
8359 Place Chanceaux
Ville d'Anjou, P.Q.

EDITIONS DULAU (CAPAC)
Ste. 44, 4824 Cote Des Neiges,
Montreal, P.Q.

EDITIONS DU PASSE TEMPS (BMI)
Box 906, Stn. B,
Montreal, P.Q.

EDITIONS FRANCO (CAPAC)
189 Rockland Road,
Mont Royal, Montreal, P.Q.

EDITIONS FRANCO CANADIENNES
(CAPAC)
Box 127, Stn. N,
Montreal, P.Q.

EDITIONS GEORGES GIGUERE (CAPAC)
17 St. Francoise-Xavier,
Terrebonne, P.Q.

EDITIONS JAQUES LABREZQUE (CAPAC)
Box 116, NDG,
Montreal 28, P.Q.

EDITIONS JEROME (CAPAC)
6341 Goncourt Ave.,
D'Anjou, P.Q.

EDITIONS LA CLAIRIE FONTAINE (BMI)
Box 116, NDG,
Montreal 28, P.Q.

EDITIONS MADELEINE (CAPAC)
7611 Louis Hebert St.,
Montreal, P.Q.

EDITIONS MODELES (BMI)
65, 53rd Ave.,
Pointe-Aux Trembles, P.Q.

EDITIONS MUSECALES DE LA BONNE
(CAPAC)
Box 150
La Mannais Laprairie, P.Q.

EDITIONS MUSECALES DE MONTREAL
(CAPAC)
5382 St. Andre,
Montreal, P.Q.

EDITIONS MUSECALES G. PANDO (CAPAC)
Apt. 6915, 10th Ave.,
Rosemont, P.Q.

EDITIONS MUSECALES LYRA (CAPAC)
3669 Fenelon St.,
Montreal, P.Q.

EDITIONS MUSECALES METRO (BMI)
189 Rockland, Mont Royal,
Montreal, P.Q.

EDITIONS MUSECALES QUINN-MARAI
(BMI)
7147 17th Ave.,
Ville St-Michel, P.Q.

EDITIONS MUSIQUEBEC (CAPAC)
1405 Bishop St.,
Montreal, P.Q.

EDITIONS PALMARES (CAPAC)
Ste. 424, 1396 St. Catherine W.,
Montreal, P.Q.

EDITIONS PRIMA (CAPAC)
165 St. Joseph Blvd. W.,
Montreal, P.Q.

EDITIONS PURLENNE (CAPAC)
Box 72, Delorimier Stn.,
Montreal 34, P.Q.

EDITIONS RUSOIS
Ste. 301, 26 Wellington St.,
Sherbrooke, P.Q.

EDITIONS SOMMETT (BMI)
202 Castlefield Rd.,
Dorval, P.Q.

EDITIONS TROUBADOUR (BMI)
7656 Henri Julien,
Montreal, P.Q.

EDITIONS VENUS (CAPAC)
5727 Delorimier St.,
Montreal 35, P.Q.

EDITIONS VILEEMARIE (CAPAC)
2213 Wellington,
Montreal, P.Q.

EMPIRE MUSIC LTD. (BMI)
934 Twelfth St.,
New Westminster, B.C.

ENID MUSIC CO. (BMI)
1356 Eglinton Ave. W.,
Toronto, Ontario

ESSEX MUSIC LTD. (CAPAC)
32 Alcorn Ave.,
Toronto, Ontario

EVANS MUSIC (CAPAC)
Mascouche, P.Q.

FALCON MUSIC CO. (BMI)
Enderby, B.C.

FAMOUS-CHAPPEL LTD. (CAPAC)
14 Birch Ave.,
Toronto 7, Ontario

FAVOURITE MUSIC (BMI)
47 Westleigh Cres.,
Toronto 14, Ontario

FELSTED MUSIC LTD. (BMI)
190 Groveline Road,
St. Laurent, P.Q.

FIRESIDE MUSIC (CAPAC)
Box 181,
Fort William, Ontario

FIVE CONTINENTS CHAPPEL (CAPAC)
14 Birch Ave.,
Toronto 7, Ontario

FRANK MUSIC LTD. (CAPAC)
14 Birch Ave.,
Toronto 7, Ontario

FREDERICK HARRIS LTD. (CAPAC)
Box 670,
Oakville, Ontario

FRED NOSWORTHY (BMI)
110 Patricia Ave.,
Willowdale, Ontario

FRONTIER MUSIC CO. (BMI)
928 Glencairn Ave.,
Toronto 19, Ontario

GAUDAIN PUBLISHING (CAPAC)
Ste. 400, 2015 Drummond St.,
Montreal 25, P.Q.

GERRY MYERS CO. (BMI)
Ste. 202, 1001 O'Connor Dr.,
Toronto, Ontario

GONDOLA MUSIC (BMI)
1818 Bickford Dr.,
Clarkson, Ontario

GORDON V. THOMPSON LTD. (CAPAC)
32 Alcorn Ave.,
Toronto 7, Ontario

GREAT WEST MUSIC (BMI)
91 Cottonwood Dr.,
Don Mills, Ontario

HALBEN PUBLISHING (CAPAC)
531 Chomeday Blvd.,
Chomeday, P.Q.

HILLCO MUSIC (BMI)
167 Mt. Royal E.,
Montreal, P.Q.

HURDON MUSIC (BMI)
383 College St.,
Port Arthur, Ontario

INTER QUEBEC (BMI)
1143 St. Jean St.,
Quebec, P.Q.

IRVING BERLIN (CAPAC)
14 Birch Ave.,
Toronto 7, Ontario

JARMAN PUBLICATIONS (BMI)
80 Richmond St. E.,
Toronto, Ontario

JERY'S MUSIC (CAPAC)
649 Beaumont St.,
Montreal, P.Q.

KALAMALKA MUSIC SALES (BMI)
2305-27th St.,
Vernon, B.C.

KEENOTE MUSIC
14886 Prospect Ave.,
White Rock, B.C.

KIN-GAR PUBLICATIONS (BMI)
Box 6,
Kinnaird, B.C.

LAURENTIAN MUSIC (BMI)
61 Dablia,
Dorval, P.Q.

LAVAL MUSIC (BMI)
649 Beaumont St.,
Montreal, P.Q.

LEEDS MUSIC (CANADA) (CAPAC)
215 Victoria St.,
Toronto, Ontario

L'INDUSTRIE MUSICALE (BMI)
500 St. Catherine St. E.,
Montreal, P.Q.

LOUIS GOSSO PUBLISHING (BMI)
25 Mountain Ave., N.,
Stoney Creek, Ontario

MATCH MUSIC CORP.
6 Wellington St. S.,
Sherbrooke, Quebec

(Continued on next page)



QUALITY RECORDS LIMITED

380 BIRCHMONT ROAD
TORONTO, ONTARIO, CANADA
PHONE: 698-5511

FOR THE FASTEST, MOST EFFICIENT
COAST TO COAST
CANADIAN DISTRIBUTION

CONTACT US FOR YOUR
TAPE DUPLICATING NEEDS TO!

SALES DEPARTMENTS & WAREHOUSES
IN THE SEVEN MAJOR CANADIAN MARKETS
VANCOUVER—CALGARY—EDMONTON—WINNIPEG—TORONTO—MONTREAL—HALIFAX

NUMBER ONE PUBLICITY & PROMOTIONS
STEREO TAPE DUPLICATION SYSTEMS

U.S. OFFICE — 130 WEST 57th ST.
NEW YORK, NEW YORK

c/o MARSHAL & VIGODA

Phone JU 2-1122

CANADIAN MUSIC PUBLISHERS (Con't)

(Continued from preceding page)

M. C. MUSIC (BMI)
2496 W. Broadway NDG,
Montreal, P.Q.

M. J. S. PUBLISHERS (BMI)
115 Royal Ave., S.W.,
Calgary, Alberta

MANITOBA MUSIC (BMI)
Box 1113,
Winnipeg, Manitoba

MANOR MUSIC (BMI)
4565 4th St.,
L'Abord A Plouffe, P.Q.

MARKSON MUSIC (BMI)
21 Wonderland Dr.,
Scarborough, Ontario

MARTELLO MUSIC (BMI)
455 Chatonplain St.,
Lancaster, New Brunswick

MELBOURNE MUSIC (CAPAC)
4824 Cote Des Neiges Rd.,
Montreal, P.Q.

MELLOCHORD PUBLISHING (CAPAC)
1316 Edward St.,
Fort William, Ontario

MELLO-MUSIC (BMI)
988 Waterford Ave.,
Fort Garry, Wpg. 19, Manitoba

MOGA MUSIC (BMI)
21 Larose St.,
Hull, P.Q.

MOHICAN MUSIC (BMI)
104 Bank St.,
Ottawa, Ontario

MONTINA MUSIC (BMI)
2955 Fendall St.,
Montreal 26, Que.

MUIR PUBLISHING (BMI)
888 Yonge St.,
Toronto 5, Ontario

19TH MUSIC (BMI)
Ste. 15, 2159 Elmira Dr.,
Ottawa, Ont.

NORMAN SPUNT (BMI)
4565 4th St.,
L'Abord A Plouffe, P.Q.

NORTHERN LIGHT (BMI)
340 North Isle Highway,
Victoria, B.C.

NOTEWORTHY MUSIC (CAPAC)
Ste. @ 352 W. Mall,
Eitbicoke, Ontario

NOWAR PUBLISHERS (BMI)
475 Selkirk Ave.,
Winnipeg 4, Man.

OXFORD UNIVERSITY PRESS (CAPAC)
70 Wynford Dr.,
Don Mills, Ontario

POLAR MUSIC (BMI)
9 Northampton Dr.,
Islington, Ontario

QUEST MUSIC (BMI)
9 South Drive
Toronto, Ontario

RAIDER-LONDON (BMI)
5902 Bessborough,
Montreal, P.Q.

RAY BROWN MUSIC (BMI)
99 Park Road,
Toronto 5, Ontario

ROBERT MELLIN (CAPAC)
58 Advance Road,
Toronto, Ontario

ROCHFORD PATRICE
650 Westview Ave.,
Ottawa 3, Ontario

RODEO MUSIC (BMI)
4824 Cote des Neiges Road,
Montreal, P.Q.

RONNIE HAWKINS (BMI)
331 Yonge St.,
Toronto 2, Ontario

ROYAL CANADIAN (BMI)
2163 Woodlawn Ave.,
Windsor, Ontario

RUDY'S SONG (BMI)
1-360 Red Creek Road,
Grosmere, B.C.

SCARF MUSIC (BMI)
258 Dion St.,
Pont Viau, P.Q.

SCHMIDT MUSIC (CAPAC)
258 Dion St.,
Pont Viau, P.Q.

SENRAP MUSIC (BMI)
742 Bay St.,
Toronto, Ontario

SEVERN MUSIC (CAPAC)
780 Eglinton Ave. W.,
Toronto 10, Ontario

SHEFFARD MUSIC (BMI)
Box 489,
Waterloo, P.Q.

SHELDON MUSIC (CAPAC)
14 Birch Ave.,
Toronto 7, Ontario

SHOWTUNE MUSIC CO. (BMI)
425 University Ave.,
Toronto, Ontario

SINGER SONGS (BMI)
108 Anthony Road,
Downsview, Ontario

SOCIETE AMICALE (CAPAC)
1480 St. Catherines St. W.,
Montreal, P.Q.

SOL EDITIONS MUSICALES (CAPAC)
2085 Scott St.,
St. Laurent, P.Q.

SOUND ADVERTISING (BMI)
1220 St. Matthew,
Montreal, P.Q.

SOUTHERN MUSIC (CANADA) (CAPAC)
1405 Bishop St.,
Montreal, P.Q.

SPELLBINDER MUSIC (BMI)
223 Joicey Blvd.,
Toronto 12, Ontario

STARR FIELD MUSIC (CAPAC)
29 Colbourne St.,
Toronto, Ontario

SYMBOLIC MUSIC (BMI)
Box 58,
Ottawa, Ontario

TP MUSIC (BMI)
1356 Eglinton Ave. W.,
Toronto, Ontario

THAMES MUSIC (BMI)
Box 4034, Stn. C.,
London, Ontario

TOMI MUSIC (BMI)
19 Park Road,
Toronto, Ontario

TORRES MUSIC (BMI)
851 Liverpool,
Montreal, P.Q.

TRANS CANADA (CAPAC)
Ste. 203, 27 Carlton St.,
Toronto, Ontario

TRENTON MUSIC (BMI)
102 Carlton St.,
Toronto, Ontario

TRI-LITE MUSIC (BMI)
675 W. Hastings St.,
Vancouver 2, B.C.

VANCOUVER PUBLISHING (BMI)
3826 W. 26th Ave.,
Vancouver 8, B.C.

VAN ROME PUBLISHING
40 High Park Blvd.,
Toronto, Ontario

WATERLOO MUSIC (BMI)
3 Regina St. N.,
Waterloo, Ontario

WENTWORTH MUSIC (BMI)
22 Woodland Ave.,
St. Catherines Ont.

WESTERN MUSIC (CAPAC)
570 Seymour St.,
Vancouver, B.C.

WEXFORD MUSIC (CAPAC)
32 Alcorn Ave.,
Toronto, Ontario

WHALEY ROYCE (CAPAC)
310 Yonge St.,
Toronto 2, Ontario

WILCONDON MUSIC (BMI)
1350 Alberni St.,
Vancouver, B.C.

WILLOW MUSIC (CAPAC)
Box 181,
Fort William, Ontario

CANADIAN RECORDING STUDIOS

ARAGON ENTERPRISES
615 W. Hastings St.,
Vancouver 2, B.C.

W. ARBUTHNOT RECORDING STUDIOS
322 Tache Ave.,
St. Boniface 6, Manitoba

AUDPRO RECORDING STUDIO
1 Waterman Ave.,
Toronto 16, Ontario

BAY MUSIC CO LTD.
5 Waterman Street,
Toronto 16, Ontario

CALART RECORDING STUDIOS LTD.
Box 1262,
Regina, Sask.

DOWNTOWN SOUND STUDIOS
10534 — 109 St.,
Edmonton, Alberta

EAGLE RECORDING STUDIOS
475 Selkirk Ave.,
Winnipeg 4, Manitoba

EKO-PHON RECORDING STUDIO
Bield, Manitoba

HALLMARK STUDIOS LTD.
22 Sackville St.,
Toronto 2, Ontario

MONTICANA RECORDS
2955 Fendall St.,
Montreal 26, Que.

RCA VICTOR RECORDING SERVICES
1241 Guy St.,
Montreal, P.Q.

RCA VICTOR RECORDING SERVICES
225 Mutual St.,
Toronto, Ontario

want Canada?

HERE!



Get *ALL* of it with

COMPO + CANADA

Contact: LEE ARMSTRONG or BOB CHISLETT
PHONE 514-637-2561 TELEX 01-20122 TWX 610-422-3064

The Compo Company Ltd., 2377 Remembrance St., Lachine, Quebec, Canada

want Facts?

1. We're Canada's OLDEST record company, GROWING since 1922
2. Canada's LARGEST manufacturer: 78 presses, 2 plants, (most modern in Canada)
3. Canada's TIGHTEST promotion team
 - 10 full-time swingers
4. Canada's MOST EFFECTIVE sales force
 - 21 full-time go-getters
5. Canada's MOST COMPLETE distribution set-up: ware-houses in the 7 major markets ●

INDEPENDENT RECORD COMPANIES

ACADIA RECORDS
Box 400
Toronto 19, Ontario

ADOLPHE TAIGI MUSIC INC.
2161 Jolicoeur
Montreal 20, P.Q.

ALOUETTE RECORDS
500 St. Catherines St. E.
Montreal 24, P.Q.

AMROUX ENTERPRISES
104-10120 Jasper Ave.
Edmonton, Alberta

ARAGON ENTERPRISES LTD.
615 West Hastings St.
Vancouver 2, B.C.

ARC SOUND LTD.
20 Cranfield Road
Toronto 16, Ontario

ED ARCHAMBAULT INC.
500 St. Catherines St. E.
Montreal 24, P.Q.

BEN KAYE ASSOCIATES INC.
4824 Cote Des Neiges Road
Montreal 26, P.Q.

BISON RECORDS
Box 430
Aylmer, Ontario

BRAVO RECORDS
58 Advance Road
Toronto 18, Ontario

BROADCAST PRODUCERS LTD.
Ste. 1108, 55 Isabella St.
Toronto 18, Ontario

CANADIAN AMERICAN RECORDS LTD.
Box 1113
Winnipeg 1, Manitoba

CENTENNIAL RECORDS
1054-109 St.
Edmonton, Alberta

CHARADE PRODUCTIONS
8 Belsize Drive
Toronto 7, Ontario

CLIP RECORDS
1940 Yonge St.
Toronto 6, Ontario

DASANDA PRODUCTIONS
116 O'Connor St.
Ottawa 4, Ontario

DISQUES METEOR RECORDINGS LTD.
6 Wellington St. S.
Sherbrooke, P.Q.

DRAM PRODUCTIONS
261 Wellington St. S.
Kitchener, Ontario

EAGLE RECORDS
475 Selkirk St.
Winnipeg 4, Manitoba

EKO-PHON RECORDS
Bield, Manitoba

FI-SOUND CORPORATION LTD.
4359 Montrose Ave.
Montreal 6, P.Q.

FONORAMA RECORDS INC.
258 Dijon St.
Pont Viau, P.Q.

FORWILL PRODUCTIONS
10534-109 St.
Edmonton, Alberta

FRONTIER RECORDS
Box 489
Waterloo, P.Q.

GAMMA RECORDS
589 St. Paul St. W.
Montreal, P. Q.

GAIETY RECORDS LTD.
232 Lincoln St.
Port Arthur, Ontario

HAWK RECORDS
331 Yonge St.
Toronto 2, Ontario

H-BRO PRODUCTIONS
167 Mont Royal Ave.
Montreal, P.Q.

JAGUAR ENTERPRISES LTD.

5550 Fraser St.
Vancouver, B.C.

MATCH MUSIC CORP.
6 Wellington St. S.
Sherbrooke, P.Q.

MONTICANA ENTERPRISES
2955 Fendall St.
Montreal 26, Que.

NOTEWORTHY MUSIC
McCaucherty Farm,
Streetsville, Ontario

PAGE RECORD CO.
13907 Buena Vista Road
Edmonton, Alberta

PLAZA MUSIC LTD.
649 Beaumont St.
Montreal 15, P.Q.

POSTERITY RECORD CO.
77 Sparks St.
Ottawa 4, Ontario

REM RECORDS
Ste. 503 701 Don Mills Road
Don Mills, Ontario

RODEO RECORDS LTD.
4824 Cote Des Neiges Road
Montreal 26, P.Q.

SELECT RECORDS
500 St. Catherines St. E.
Montreal 24, P.Q.

SOTAN RECORDS
2327 Richmond Road S. W.
Calgary, Alberta

SOUNDAROUND RECORDS
Box 1262
Regina, Sask.

SPOTLIGHT RECORDS
528 McLeod St.
Ottawa 4, Ontario

TAMARAC RECORD PRODUCTIONS
1940 Yonge St.
Toronto 7, Ontario

TARTAN RECORDS LTD.
Box 898
Port Arthur, Ontario

VILLA RECORDS
401 Carlton St.
St. Catherines, Ontario

WILLOW MUSIC
R. R. 1
Fort William Ontario

WORTH RECORDS
6 Wellington St. S.
Sherbrooke, P.Q.

CANADIAN PRESSING PLANTS

PRECISION RECORD PRODUCTION LTD.
1 Waterman Ave.,
Toronto 16, Ontario

QUALITY RECORDS OF CANADA LTD.
380 Birchmount Rd.,
Scarborough, Ontario

RCA VICTOR LTD.
Hannibal St.,
Smith Falls, Ont.

SPARTON OF CANADA LTD.
Box 2125,
London, Ontario

THE COMPO COMPANY LTD.
Lachine, Quebec

THE COMPO COMPANY LTD.
Cornwall, Ontario

CANADA'S BEST SELLING RECORDS (66-67)

CARAVAN

Best Selling LP's

Cafe Au Go Go
Et Maintenant
Francoise Hardy
Mod Is The British Mod Beats
Petula Clark 65
Projections
This Land Is Your Land
Tim Hardin #1

Blues Project
Les Classels

Blues Project
Mickey & Bunny

45's

Any Other Way
If I Call You By Some Name
Looking At A Baby
Simple Deed
Somebody Help Me
Yellow Balloon

Jackie Shane
Paupers
The Collectors
Paupers
British Modbeats
Yellow Balloons

COLUMBIA

Singles

Almost Persuaded
Backstage
Hey Joe
Him or Me
Jackson
Lets Fall in Love
Mellow Yellow
My Back Pages
Somewhere My Love
Tell It Like It Is
Walk Through This World With Me

David Houston
Gene Pitney
Tim Rose
Paul Revere & The Raiders
Johnny Cash & Pearl Butler
Peaches & Herb
Donovan
Byrds
Ray Conniff
Aaron Neville
George Jones

Bob Dylan
Original Broadway Cast

Peaches & Herb

Gilles Vigneault
Simon & Garfunkel
Eugene Ormandy
Ray Price
Donovan

Epic
Musicor
Columbia
Columbia
Columbia
Columbia
Date
Epic
Columbia
Columbia
Columbia
Musicor

Columbia
Columbia
Columbia
Columbia
Date
Columbia
Columbia
Columbia
Columbia
Columbia

GAIETY

Singles

Cerina
"I'll Know Better" (Next Time)
Love That's True
Love and Obey

Laborer
No Love Like Mine
Promise Her Love
Shake Yourself Down
The Dreamer
The Face of Time
The Heart You Break
Your Special Day

Jerry Palmer
Sandi Shore
White Nights
The Plague

49th Parallel
Myrna Lorrie
White Nights
Checkerlads
Checkerlads
The Plague
Jerry Palmer
Myrna Lorrie

Gaiety
Gaiety
Gaiety
Reo
RCA
International
Columbia
Gaiety
Gaiety
Gaiety
Reo
Gaiety
Gaiety

LONDON

Singles

Ain't Gonna Lie
Baby I Need Your Lovin
Beggin
Black Is Black
California Nights
Can't Take My Eyes Off You
Detroit City
Girls in Love
Go Where You Wanna Go
Green, Green Grass Of Home
Have You Seen Your Mother Baby
Standing in the Shadow
I Was Kaiser Bills Batman
Lady Jane
Let's Spend The Night Together
My Girl Josephine
Niki Hoeky
Paint It Black
Paint Me A Picture
Poor Side Of Town
Pretty Ballerina
Release Me
Ruby Tuesday
Sunday Will Never Be The Same
Tell It To The Rain
The Loser
The Pied Piper
The Tracks Of My Tears
Walk Away Renee
Walkin In The Sunshine
We Ain't Got Nothin' Yet
Where Will The Words Come From
Wild Thing
Winchester Cathedral
With A Girl Like You
98.6

Keith
Johnny Rivers
The 4 Seasons
Los Bravos
Leslie Gore
Franki Valli
Tom Jones
Gary Lewis
The 5th Dimension
Tom Jones

The Rolling Stones
Whistling Jack Smith
The Rolling Stones
The Rolling Stones
Jerry Jaye
P. J. Proby
The Rolling Stones
Gary Lewis
Johnny Rivers
The Left Banke
Engelbert Humperdinck
The Rolling Stones
Spanky And Our Gang
The 4 Seasons
Gary Lewis
Crispian St. Peters
Johnny Rivers
The Left Banke
Roger Miller
The Blues Magoos
Gary Lewis
The Troggs
The New Vaudeville Band
The Troggs
Keith

Mercury
Imperial
Philips
Press
Mercury
Philips
Parrot
Liberty
Soul City
Parrot

London
Deram
London
London
Hi
Liberty
London
Liberty
Imperial
Smash
Parrot
London
Mercury
Philips
Liberty
London
Imperial
Smash
Mercury
Liberty
Fontana
Fontana
Fontana
Mercury

Albums

Aftermath
Between The Buttons
Big Hits (High Tide and Green Grass)
Changes
Dusty Springfield's Golden Hits
Electric Comic Book
Golden Greats
Green, Green Grass Of Home
Greatest Hits From England
Guitar Freakout
Johnny Rivers' Golden Hits
Mantovani's Golden Hits
Original Golden Hits
Psychedelic Lollipops
Super Psychedelics
The Rolling Stones
The Very Best of Roy Orbison
Up Up And Away
Walk Away Renee
Wild Thing
Wild Thing
Winchester Cathedral
Words And Music by Roger Miller
You Don't Have to Paint Me A Picture
2nd Vault Of Golden Hits

The Rolling Stones
The Rolling Stones
The Rolling Stones
Johnny Rivers
The Blues Magoos
Gary Lewis
Tom Jones
Various Artists
The Ventures

Various Artists
The Blues Magoos
The Ventures
Live

The 5th Dimension
The Left Banke
The Troggs
The Ventures
The New Vaudeville Band

Gary Lewis
The 4 Seasons

London
London
London
Imperial
Philips
Mercury
Liberty
Parrot
Parrot
Dolton
London
London
Liberty
Mercury
Liberty
London
Monument
Soul City
Smash
Fontana
Dolton
Fontana
Smash
Liberty
Philips

(Continued on next page)

Caravan Record Sales Ltd.

The New House of Hits in

CANADA

NATIONWIDE DISTRIBUTION
CONTACT: FRANK P. SWAIN

117 Midwest Rd.
Scarborough, Ont.
Phone 416-757-2455

CANADIAN RECORD MANUFACTURERS

ALLIED RECORD CORPORATION
110 Barbados Boulevard,
Scarborough, Ontario
(416) 267 4460
Bruce Beatty
Bang, Compass, Elektra, Nonesuch, President,
Pye, Roulette, Time, Gateway-Dyno, Recoton
Needles-Accories
Branches:
124 Ronald Drive,
Montreal West, Quebec
George Spencer,
3285 Dutch Village Rd.,
Halifax, Nova Scotia

ARC SOUND LTD.,
20 Cranfield Road,
Toronto 16, Ontario
751 1613
President: Phil G. Anderson, Vice President:
Bill Gilliland, National Sales Mgr.: Tom
Burney
Branches:
1436 Erin Street, Winnipeg, Manitoba
6511-104th Street, Edmonton, Alberta
Distributors:
R. W. Crawford Ltd.,
152 Albert Street, Moncton, N.B.
Emerson Record Sales Ltd.,
1859 West Fourth Ave., Vancouver 9, B.C.
R.M.P. Sales Ltd.,
183 Bates Road, Montreal 26, Quebec

**CANADIAN MUSIC SALES COR-
PORATION LIMITED**
58 Advance Road,
Toronto 18, Ontario
239 2361
T. St. Clair Low, President
Alma, Alto, Ariola-Eurodisc, Baccarola, Beav-
er, Blue Star, Bravo, Bruno, Budapest, Domin-
ion, Educo, Folkcraft, 49th. State, Hazam,
Lloyd Shaw, MacGregor, Music Minus One,
Old Timer, Sets In Order, Universal

CARAVAN RECORD SALES LTD.,
117 Midwest Road, Scarborough, Ontario
(416) 757 2455
Frank P. Swain, President
Distributors:
Wholesale Appliances,
8401 Fraser Street, Vancouver, B.C.
Transworld Record Company Inc.,
1180 St. Antoine Street, Montreal, Quebec
George Spencer,
Halifax, Nova Scotia
Walco Needles and Accessories, Stone Records,
V Records Uke, Design, Muza, Vogue, Greco-
phone, Merry Disc, Riverside, Mainstream,
New Syndrome, Eagle, Red Leaf, Fiesta, Mur-
ray Banks, Carinia, Qualitone, Trans-Canada,
Caravan, Verve Folkways, Sue, Folkways,
Spoken Arts, Franklin Records.

CAPITOL RECORDS (Canada Ltd.)
Head Office: 3109 American Drive, Malton
P.O., Ont. Telephone (416) 677-5050
Ontario Branch: 3109 American Drive, Mal-
ton, P.O., Ont. Telephone (416) 677-5050

Quebec Branch: 155 Port Royal West, Mon-
treal 11, P.Q. Telephone (514) 389-3588

Distributors: Select Music Company, 1803
Commercial Dr., Vancouver, B.C. Van Dusen
Brothers Ltd., 10528-123rd St., Edmonton,
Alta. Grosvenor Distributors, c/o Van Dusen
Brothers—Edmonton, Alta. Electrical Supplies,
312 William Ave., Winnipeg, Man.

Record Labels: Capitol, Angel, Serapim,
Melodiya, Pathe, Imported Odeon, Imported
Parlophone, Studio Two, Waverley, 20th Cen-
tury-Fox, Pickwick/33, Disneyland, Buena
Vista

Executive Personnel: Executive Vice-President
—G. Edward Leatham, Vice-President & Di-
rector of Sales—E. Taylor Campbell, Treas-
urer & Controller—Brian J. O'Shea, National
Advertising & Promotion Manager—Gord Ed-
wards, Director of A & R—Paul White, Di-
rector of Operations—Harold F. Burr

**COLUMBIA RECORDS OF CANA-
DA, LTD.,**
1121 Leslie Street,
Don Mills 5, Ontario
447 3311
R. R. Pampe, Vice President & Managing
Director
Columbia, Epic, Okeh, Harmony, Barclay
Labels, Ode, Starday, Nashville, Odyssey, Go
Go, Rojac, Date, Disques Canetti, Licensee Of
Musicor
Columbia Records Distributors Canada Ltd.,
1113 Leslie Street, Don Mills, 5, Ontario
Columbia Records Distributors Canada Ltd.,
1168 Montee De Liesse, Montreal, Quebec
550 Cambie Street, Vancouver, B.C.
Canadian Electronics Ltd.,
10552 A 114th Street, Edmonton, Alberta

THE COMPO COMPANY LIMITED
2377 Remembrance Street,
Lachine, Quebec
Telephone: 637 2561 Area Code: 514 Cable
Address: Compoco
R. A. Chislett, Vice President and General
Manager
S. D. Roberts, Vice President and Sales
Manager
A&R Popular: Lee Armstrong; Publicity and
Promotion: Roy Smith; Compo Field Promot-
ion Manager: Al Mair
Affiliated labels (owned or distributed)
DECCA DIVISION: Decca, Coral, Brunswick,
Vocalion, Caedmon, LHI, APEX DIVISION:
Abnak, Accent, Apex, Carnaval, Challenge,
Crescendo, Damon, Diamond, Lero, Point,
Soma, United Artists, Double Shot, UNI,
Project 3
Alberta: Calgary, area code 403
Acklands, 4124 Ninth Street, S.E. 243 4291
Manager: Wayne Langton
Edmonton, area code 403
Acklands, 10304-108 Street 429 1781 Man-
ager: Wayne Langton, Rep. Jack Williams
British Columbia:
Vancouver, area code 604
Johnston Appliances, 5239 Victoria Drive,
Zone 16 FA 5 3261 Manager: Miss Pat van
Kleeck
Manitoba: Winnipeg, area code 204
Thomas Rathwell, 575 Roseberry Street, St.
James SP 4 4561 President: Thomas Rathwell
Nova Scotia: Amherst, area code 902
Waldale, Station Street 667 3308 President:
W. S. A. Daley
Ontario: Toronto and Area, area code 416
Apex, 76 Colville Road, Zone 15 249 7551
Manager: George Offer
Quebec: Lachine, area code 514
Compo, 2377 Remembrance Street 637 2561
R. A. Chislett, V. P. & General Manager:
S. D. Roberts

GAIETY RECORDS LTD.,
232 Lincoln Street,
Port Arthur, Ontario
(807) 345 6298
President: Don Grashey, Vice-President,
Charles Williams
Gaiety
Distributed in Canada by RCA Victor

**LONDON RECORDS OF CANADA
(1967) LTD.,**
190 Graveline Street,
St. Laurent, Quebec
631 2061, Cable 01-2384
President: F. C. Jamieson; National Sales
Manager: Adrian Bilodeau
Argo, Ace Of Clubs, Ace Of Diamonds,
Argo, Aura, Backbeat, Banff, Belair, Beltone,
Caprice, Celtic, Click, Cobra, Canusa, Das
Alte Werke, Dolton, Deram, Duke, Durium,
disco-Prestige, Elysee Europa, Era, Fontana,
France-Canada, Galaxy, Hi, Imperial, Jamie,
Jupiter, Liberty, Limelight, M.S.L. Series,
Oiseau-Lyre, Pacific Jazz, Parrot, Pergola,
Philips, Philles, Press, Phil-L.A., of Soul,
Rodeo, Rusticana, Smash, Societe Francaise
du Son, Sun, Sunset, Soul City, Sound Stage
7, Telefunken, Saturne, Tempo, Viva, Velvet,
Wing, World Pacific.
Branches:
1630 Midland Ave.,
Scarborough, Ontario 755 3373 Cable 02-2830
Manager: Gilles Aubin
654 King Edward Street,
Winnipeg, Manitoba 772 4305 Cable 03-5364
Manager: Gerry Young
628 11th Ave., S. W.,
Calgary, Alberta 264 5605 Cable 032-2272
Manager: John Toews
3166 Lake City Way,
Lake City Industrial Park,
Burnaby, B. C. 298-6471 Cable 04-5503 Man-
ager: Ormond Jones
Monticana Records (SEE BELOW)
Musimart Ltd.,

MONTICANA RECORDS,
2955 Fendall Street,
Montreal 26, Quebec
(514) 739 8935 737 9200
Dave Leonard, President and Director Of
A&R
Monticana Records
Branches: #824 4 West 31st Street, New
York, N. Y., 10001

PHONODISC LTD.,
355 King Street West,
Toronto, Ontario
366 8744
President: D. A. McKim, National Sales
Manager: Hal Ross
Audio-Fidelity, Chess-Checker-Cadet, Kapp,
Tamla/Motown, Delta, Regency, King, Paula.
Branches:
Phonodisc Ltd.,
809 William Street, Montreal, Quebec
861 5891 Manager: Jim Corbett
Phonodisc Ltd.,
3931 East Hastings Street,
Burnaby 2, B. C. 298 2611 Manager:
Frank Weaver
Phonodisc Ltd.,
P.O. Box 1021,
Winnipeg, Manitoba, 783 0436 Manager:
Wally Sokulsky
Central Record Co., Ltd.,
4511 Manitoba Road, S. E.,
Calgary, Alberta, 243 2586 Manager:
Dave Jones

QUALITY RECORDS LTD.,
380 Birchmount Rd.,
Scarborough, Ontario
698 5511
Mr. G. L. Keane, Vice President and Manag-
ing Director; Mr. W. R. Bays, Vice President,
Finance; Mr. G. R. Struth, Production Co-
ordinator
Branches and Distributors:
Taylor Pearson And Carson (B.C.) Ltd.,
2182 West 12th Ave., Vancouver, B.C.
Manager: Mr. R. Ayres
Quality Records Ltd.,
Mid-West Sales Division,
4th Floor—Galt Bldg., Winnipeg, Manitoba.
Manager: Mr. C. Porter

QUALITY (Con't)
Quality Records Ltd.,
Quebec Sales Division,
2215 Beaconsfield Ave.,
Suite 4,
Montreal 28, Quebec Manager: Mr. L. Mullan
Taylor Pearson And Carson (Alta.) Ltd.,
4340-4th Street, S.E., Calgary, Alberta
Manager: Mr. John Watson
Quality Records Ltd.,
Ontario Sales Division,
130 Mack Ave.,
Scarborough, Ontario Manager: Mr. C. Mc-
Gregor
Canadian Assemblies,
Station Street, Amherst, Nova Scotia Man-
ager: Mr. T. Evans
Labels:
A&M, Atlantic/Atco, Barry, Bell, Dot, Hick-
ory, Jubilee, Kama Sutra, Quality, Reo,
Sceptre, Verve, MGM

RCA VICTOR COMPANY, LTD.
1001 Lenoir Street
Montreal 30, Canada. Telephone: WE 3-7551
Gen. Mgr.: G. I. Harrison; Sales Manager:
Knox Coupland
Lines: RCA Victor, RCA Camden, Dunhill,
Gaiety, Request, Elite, Heartwarming, Sir
John A

Branches and Distributors:
RCA VICTOR CO. LTD.
3611-3619 Commission St.
Halifax, Nova Scotia
Mr. H. Josey

RCA VICTOR CO. LTD.
1450 Castlefield Ave.
Toronto, Ontario
J. R. Feeney

RCA VICTOR CO. LTD.
4120 6th Street, S.E.
Calgary, Alberta
Clark

A.A. MURPHY & SONS LTD.
216 First Ave. No.
Saskatoon, Sask.
J. Smith

RCA VICTOR CO. LTD.
5575 Royalmount Ave.
Montreal, Quebec
J. G. Bergeron

RCA VICTOR CO. LTD.
2070 Notre Dame Ave.
St. James 21, Manitoba
D. Anderson

RCA VICTOR CO. LTD.
2876 Rupert St. at Grandview Blvd.
Vancouver, British Columbia
Ray Lavasseur

RODEO RECORDS LIMITED,
4824 Cote des Neiges Road,
Montreal 26, Quebec
(514) 731 0889
George Taylor, President
Banff, Campus, Caprice, Celtic, Europa,
Melbourne, Rodeo International
Distributed by: London Records Of Canada
(1967) Ltd., 190 Graveline Street, St. Laurent,
Que.

SPARTON OF CANADA LIMITED,
100 Elm Street, P.O. Box 2125, London,
Ontario
455 6320
W. L. Page, Vice President and Manager
Record Division
ABC Records, Command, Impulse, Westmin-
ster, Whitehall, Senate, Tangerine, Simon Says,
Bluesway, HiFi Records, Life, Contemporary,
Good Time Jazz, Eurotone, Mira, Mirwood,
Surrey, Boone, Sparton, Tiffany, Grand
Award, Colortone, MTA, Summit, Repeat.
Distributors:
Sparton Of Canada Ltd.,
200 Bates Road, Montreal 16, Quebec
Sparton Of Canada Ltd.,
57 Ingram Drive, Toronto, Ontario
Mr. Keith Olafson,
1440 Bannatyne Ave., Winnipeg, Manitoba
Wholesale Appliances,
8401 Fraser Street, Vancouver, B.C.

**ROBERT J. STONE ASSOCIATES
A DIVISION OF ROBERT J. STONE
OF CANADA LTD.**
Post Office Box 703,
Oshwa, Ontario
(416) 723 0898
Bob Stone: President
Branch:
Post Office Box 4245
London "C", Ontario
(519) 432 6575
Vice President: Harold Pounds
Stone, Thames, Island, Redoe, Listen and
Learn, Chart, Supraphon, Artia
Caravan Record Sales Ltd.,
117 Midwest Road, Scarborough, Ontario
Wholesale Appliances
8401 Fraser Street, Vancouver, B.C.
Robert J. Stone Associates (continued)
Trans World Records Inc., Montreal, Quebec
George Spencer, Halifax
Chart label, distributed exclusively by Col-
umbia Records of Canada Limited for Robert
J. Stone Associates.
Supraphon; distributed exclusively by Sparton
Of Canada Ltd., for Robert J. Stone Associ-
ates

(Continued on next page)

COLUMBIA RECORDS OF CANADA, LTD.

1121 Leslie St., Don Mills 5, Ont. Canada
Telephone: 447-3311
Mr. R. R. Pampe: Vice President & Managing Director

Manufacturers & Distributors of
**COLUMBIA, EPIC, OKEH, HARMONY,
BARCLAY LABELS, ODE, STARDAY, NASHVILLE,
ODYSSEY, GO GO, ROJAC, DATE,
DISQUES CANETTI—LICENSEE OF MUSICOR**

**COLUMBIA RECORDS DISTRIBUTORS
CANADA, LTD.**
1113 Leslie St., Don Mills 5, Ontario

**COLUMBIA RECORDS DISTRIBUTORS
CANADA LTD.**
1168 Montee de Liesse, Montreal, Quebec

VAN HORNE ELECTRIC SUPPLY CO.
550 Cambie Street, Vancouver, B.C.

CANADIAN ELECTRONICS LTD.
10552-A 114th St., Edmonton, Alberta

WE SPECIALIZE IN PREMIUM RECORDS



CANADA—THE PAST 12 MONTHS

(Continued from page 65)
comes a best seller on Atco in the Montreal area.

Pop format broadcasters appear on the Montreal scene in force as Gord Sinclair's CFOX adopts 'round the clock rock, and other City outlets, CFCF and CKGM lengthen pop air stanzas. David Grief named Montreal branch manager for Sparton. "His

Girl" by The Guess Who on Quality shows well on British charts as well as Canadian lists. The Ugly Ducklings and The Stich 'n Tyme score on air play and sales scenes with debut releases on fledgling Yorkville label. "Arm Full Of Teddy Bears" sells arm fulls of records for Barry Allen on Capitol. Debbie Lori Kaye, cute C&W chanter signs management contract

with Sol Holliffe. John Pozer debuts new Sir John A label in Ottawa. The Classels, top French-Canadian act for years, sign for American distribution of English-language record product with Main Line of Cleveland. Al Mair named National Field Promotion Manager for Compo.

Monkee record product snows under RCA Victor plant in Smiths Falls. National newspaper coverage reports greatest production quantities ever at RCA plant. Frank Weaver is named Manager of new Phonodisc branch in Vancouver. Capitol picks up Disneyland and Buena Vista lines for Canada. Sandy Posey cited for 50,000 Canadian sales on "Born A Woman." Monkees appear on two Canadian P.A.'s, Toronto and Winnipeg. "Half Past Midnight" tears up the chart scene for The Staccatoes on Capitol. Exec realignment at RCA Victor puts Andy Nagy and Bill Paterson in top national sales posts for various RCA lines. Al Boliska, long time Toronto radio man heals for early-morning spot on Montreal's CFCF. Grahme Richards' stay in top programming post at CHUM, shortlived. Vet U.S. broadcaster heads back Stateside. Canada scoops the world on release of new Monkee single, "A Little Bit Me."

Gamma Records of Montreal scores heavily in Quebec album sales. Guy Bertrand becomes National Sales Manager for Musimart. Ian and Sylvia score with Canadian hit on MGM, "Lovin' Sound," get much American air play as well. Big Town Boys change billing to B.T.B-4, score with Yorkville outing, "Do It To 'em." Stone Records switch national distribution from Sparton to Caravan. Warner Brothers-Reprise announces formation of a totally separate Canadian sales and distribution organization to be established in the Fall of 1967.

CANADIAN RECORD MANUFACTURERS (Con't)

(Continued from preceding page)
TRANS WORLD RECORD CO. INC.
1180 St. Antoine Street
Montreal, P.Q.
514-866-2884
President: Arthur Young

BRANCH
TRANS WORLD RECORD CO. INC.
117 Midwest Road
Scarboro, Ont.
416-759-1638

BRANCH
TRANS WORLD RECORD CO. INC.
1299 Strachona
Winnipeg, Man.
204-503-0436

Distributors of: Blanche Neige (French), Canterbury, Fiesta, Folkways, Grecophon, Jazzland, La Voix de L'Auteur Mainstream, Montagnard (French), Murry Banks, Riverside, Spoken Arts, Spoken World, Trans World, Stone, Tag Ltd., Verve Forecast, Wonderland, Dover, Listen and Learn, Oak Publications and others.

SOUTH AFRICA'S MUSIC PUBLISHERS

ABERBACH (S.A.) (PTY.) LTD.
c/o Southern Music Publishing Co. S.A.)
(Pty.) Ltd., 601/603 Silbro House, 225
Jeppe Street, Johannesburg

ARDMORE & BEECHWOOD (S.A.) (PTY.) LTD.
P. O. Box 11254, Johannesburg
(32 Steele Street, Steeldale, Johannesburg, Transvaal)
Phone: 869-2661
Cable: ABEMUSIC JOHANNESBURG
Pres.: Mr. W. F. Fraser

ARWIN MUSIC OF SOUTH AFRICA (PTY.) LTD. (MPA)
P.O. Box 6216, Johannesburg
(161 President Street, Johannesburg)
Phone: 23-2111
Cable: GALLOTONE JOHANNESBURG
Pres.: Mr. Martin Melcher, Mr. W. F. Lyons, Mr. A. Delmont, Mr. Ralph Trehwela

BANDSTAND PUBLICATION (PTY.) LTD.
P. O. Box 10217, Johannesburg
(21a Plein Street, Johannesburg)
Phone: 23-7169
Cable: BANDSTAND POSTBOX 10217 JOHANNESBURG
Pres.: Mr. Mervyn F. John

BELINDA (JOHANNESBURG) (PTY.) LTD.
304/5 His Majesty's Building, Eloff Street, Johannesburg
Phone: 834-8208
Cable: BELINDSONG JOHANNESBURG
Gen. Mgr.: Mr. Ray Walter

BOOYSEY & HAWKES (S.A.) (PTY.) LTD.
P. O. Box 3966, Johannesburg
Phone 838-7548
Cables: SONOROUS JOHANNESBURG
Mng. Director: Mr. A. G. Kilby

BREVE (PTY.) LTD.
5th Floor, Time House
3 Stephenson Street, Eloff Street Extension
Johannesburg
Mng. Director: Mr. G. J. Wallis

BROWNHUT MUSIC PUBLISHING CO. (PTY.) LTD.
P. O. Box 1225 Johannesburg.
Phone: 24-6512
Cables: TROUBADOR JOHANNESBURG
Mng. Director: Mr. I. Katz

CARSTENS-DE WAAL PUBLICATIONS
P. O. Box 9973, Johannesburg, Transvaal
(605/606 Bradford House, 116 President Street, Johannesburg)
Phone: 22-8146
Pres.: Mr. Anton de Waal

DEE JAY MUSIC CO
P. O. Box 7186, Johannesburg
(605/606 Bradford House, 116 President Street, Johannesburg)
Phone: 22-8146
Pres.: Mr. Louis Combrinck

FILMUSIC (PTY.) LTD.
304 His Majesty's Building,
Eloff Street, Johannesburg
Phone: 834-8208
Cable: BELINDSONG JOHANNESBURG
Gen. Mgr.: Mr. Ray Walter

FRANCIS DAY (S.A.) (PTY.) LIMITED
Suite 901/4—9th floor
Silvern House
139 Commissioner Street
Johannesburg S.A.
Cable: ROFEDA
Phone: 23-4492
Gen. Mgr.: Kim Bennet

GOLD MUSIC (MPA)
P. O. Box 6216
Johannesburg
Director: A. Delmont

G.R.P.C. MUSIC (MPA)
Newkirk
132, Kerk St.
Johannesburg
Director: A. Golembó

TEDDIE GARRAT (PTY.) LTD.
P. O. Box 5828, Johannesburg
(6th Floor, Time House, 3 Stephenson Street, Johannesburg)
Cables: SYNCOPATE JOHANNESBURG
Director: A. G. Garrat

GOOD MUSIC AFRICA (PTY.) LTD. (MPA)
P. O. Box 6216, Johannesburg
(161 President Street, Johannesburg)
Phone: 23-2111
Cable: GALLOTONE JOHANNESBURG
Pres.: Mr. Felix Faecq, Mr. A. Delmont, Mr. John Rose

H.A.U.M.
P. O. Box 1371, Cape Town
(Monach House, 58 Long Street, Cape Town)
Cables: HAUM CAPE TOWN
Manager: G. D. Steenekamp

IMPALA MUSIC CO
P. O. Box 9973, Johannesburg
(Bradford House, 116 President Street, Johannesburg)
Phone: 22-8146
Pres.: Mr. Anton de Waal

LAETREC MUSIC LTD.
304/5 His Majesty's Building,
Eloff Street, Johannesburg
Phone: 834-8208
Cable: BELINDSONG JOHANNESBURG
Pres.: Mr. A. G. J. McGrath

MELODY MUSIC (PTY.) LTD. (MPA)
P. O. Box 9299, Johannesburg
(161 President Street, Johannesburg)
Phone: 23-2111
Director: Mr. David G. Fine

**MELOTOONGOLWE MUSIEKUITGEWERS
MELOTONE WAVES MUSIC PUBLISHERS**
P. O. Box 11070, Johannesburg
(12—8th Avenue, Houghton, Johannesburg)
Pres.: Mr. Olaf Andresen

MUSIC PUBLISHING CO. OF AFRICA (PTY.) LTD.
P. O. Box 6216, Johannesburg
(161 President Street, Johannesburg)
Phone: 23-2111
Cable: MUSIPUB JOHANNESBURG
Director: Mr. Ralph Trehwela

MIMOSA MUSIC PUBLISHERS (PTY.) LTD.
P. O. Box 173, Bergvlei, Johannesburg
Man. Director: Mr. E. L. Olivier

PLANETARY-NOM AFRICA (PTY.) LTD. (MPA)
P. O. Box 6216, Johannesburg
(161 President Street, Johannesburg)
Cable: GALLOTONE JOHANNESBURG
Pres.: Mr. Morris Levy, Mr. Morris Gurlek

PLYMOUTH MUSIC (PTY.) LTD.
304/5 His Majesty's Building,
Eloff Street, Johannesburg
Phone: 834-8208
Cable: BELINDSONG JOHANNESBURG
Pres.: Mr. Ray Walter

PROGRESSIVE AFRICA MUSIC (PTY.) LTD.
c/o Belinda (Jhb) (Pty.) Ltd., 305 His Majesty's Building, Eloff Street, Johannesburg
Cable: BELINDSONG JOHANNESBURG
Pres.: Mr. Ray Walter

PROTEA MUSIC
c/o Carstens-De Waal Publications, P. O. Box 9973, Johannesburg, Transvaal
(605 Bradford House, 116 President Street, Johannesburg)
Phone: 22-8146
Pres.: Anton de Waal

SEGAL'S PUBLISHING CO
19 Riebeeck St., Cape Town
Phone: 3-7743
Director: Mr. Charles Segal

SOUTHERN MUSIC PUBLISHING CO. (S.A.) (PTY.) LTD.
P. O. Box 10274, Johannesburg, Transvaal
Phone: 23-6222
Cable: SOUTHMUSIC JOHANNESBURG
Gen. Manager: Mr. G. Taylor

SUN-PACIFIC MUSIC
P. O. Box 17004, Johannesburg
(608 Hunstanton, Twist St., Hillbrow, Johannesburg)
Phone: 724-8278
Cable: REKLAMA JOHANNESBURG
Pres.: Mr. Gilbert Gibson

CANADA

Arc Record Distributors

AGGRESSIVE
DISTRIBUTION—
MERCHANDISING,
PRESSING
and PROMOTION
FROM COAST
TO COAST

Contact: **PHIL ANDERSON**
or **BILL GILLILAND**
ARC SOUND LTD.
20 Cranfield Road
Toronto 16, Ontario
Phone-416-751-1613

Want to know about the many faces
of the Record Business in Canada

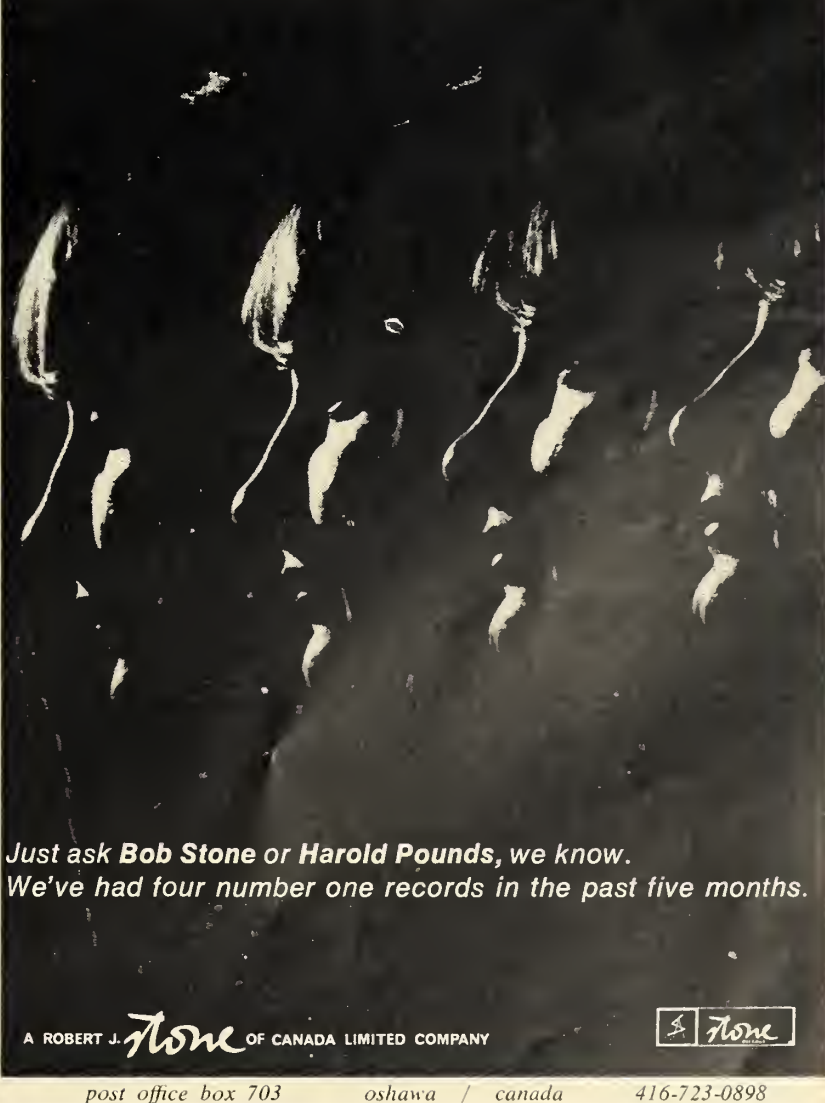

Just ask Bob Stone or Harold Pounds, we know.
We've had four number one records in the past five months.

A ROBERT J. Stone OF CANADA LIMITED COMPANY

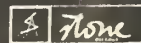

post office box 703 oshawa / canada 416-723-0898

*You want
active promotion
of your songs?*

it's

NEW ORIENT

MUSIC INC

in
Japan

Akasaka Mantion, 16-5-7 Akasaka, Minatoku, TOKYO, Japan
TEL: Tokyo 583-8718, 8719, 2898 Cable: NEWORIMUS, TOKYO

JAPAN— THE PAST 12 MONTHS

During the latter half of 1966, the share percentage of total record sales of Japan's seven leading record companies here was 25.2% for Nippon Victor, 21.5% for Toshiba Records, 19.7% for Nippon Columbia, 15% for King Records, 7.17% for Teichiku Records and 5.2% for Crown Records, among which Toshiba's sales achievement is notable. Nippon Columbia, all-time second-ranker, dropped to the third position. Toshiba's favorable achievement resulted from good sales of The Ventures, The Beatles, Karajan and Yuzo Kayama. Gross sales of the seven companies was 15.3 billion yen, 1.46 billion yen increase (some 10% increase), over that of the first half of 1966, while the population of music lovers has been increasing these years at a high rate of 7% per year, the Tax Administration Agency reported.

Characteristics of the past one year: Interchange of artists occurred, especially Japanese hits, which were put on the overseas market more often than last year, starting with "Furi Furi" by The Spiders, released on Philips, "Kimito Itsumademo" by Yuzo Kayama on U.S. Capitol, "Blue Eyes" by Blue Comets on CBS and "Sad Sunset" by The Spiders on London Philips. On the other hand, many foreign artists played Japanese originals not only in Japanese but also in foreign tongues. In fact, Bert Kaempfert, Xavier Cugat, Carmen Cavallaro, Andy Williams, Billy Vaughn, Duane Eddy and George Hamilton IV put newly adapted Japanese originals in their repertoires this year.

Partly due to the help of the popularity of the Italian Western movie, King Records on Seven Seas, RCA Victor, and Columbia Records on United Artists put a strong stress on the sales promotion of these western records and made consecutive hits

every month. Within this year, some 20 Western films are scheduled to be released, therefore several of Western disks are expected to be hits. Among the past releases the following were hits:

"Riffifi In Paris" (Seven Seas), "Back Home Someday" (Seven Seas), "For The Taste Of Killing" (Seven Seas), "Home To My Love" (Seven Seas), "Where The Bullets Fly" (Seven Seas), "Thema Di Arizona" (RCA), "Return Of The Seven" (United Artists), "The Magnificent Seven" (United Artists), "The Man Who Came To Kill" (Globe).

Teichiku Records and Nippon Gramophon started to release pop originals at the beginning of this year, stimulated by the series of big hits made by Toshiba on Capitol, Columbia on CBS, King Records on Seven Seas, and Victor on Philips. Thus, six leading record companies added pop artists to their rosters. Nippon Columbia had Jacky Yoshikawa and His Blue Comets, and Village Singers. Blue Comets are most popular with big hits such as "Blue Eyes," "My Lonely First Love," "Where" and recent hit "Blue Chateau." Toshiba Records holds a million smash hit maker Yuzo Kayama, and Kabuki artist, Somegoro Ichikawa, the Wild Ones, and a new lark Jun Mayuzumi. Philips of Nippon Victor has the world-famous Spiders, solo singer Mike Maki and lark Ryoko Moriyama who is called a Joan Baez of Japan. King Records has Sharp Five, The Rising Sun Trio, and Four Nine Aces and Teichiku Records has Kinya Kitahoji, and Van Dogs, while Gramophon Records has The Tigers. The rise of these good selling records by Japanese artists has been a big breakthrough for the Japanese record industry. (Continued on page 74)

THROUGHOUT JAPAN!

well-established publisher

ONGAKU-NO-TOMO SHA

and the active affiliates

SUISEI-SHA

TOA MUSIC CO.

6-30 Kagurazaka, Shinjuku-ku, Tokyo

MOST PROGRESSIVE RECORD COMPANY IN JAPAN

DISTRIBUTOR OF THESE
WORLD-FAMOUS LABELS

KING RECORDS



● **GREAT BRITAIN**

DECCA / LONDON
ACE OF DIAMONDS
ACE OF CLUBS
REX
DERAM
ARGO

● **FRANCE**

DECCA
BARCLAY
RIVIERA

● **GERMANY**

TELEFUNKEN
DECCA
ARIOLA / EURODISC
HARMONIA MUNDI
HANSA

● **ITALY**

RICORDI
C. G. D.
JUKE BOX
S. A. A. R.
CETRA
TELEDISC

● **SPAIN**

COLUMBIA
ZAFIRO

● **HUNGARI**

QUALITON

● **U.S.A.**

HI
CHALLENGE
JAMIE / GUYDEN
ABNAK
COLLISEUM
WHITE WHALE
VAULT
WAIKIKI

ABC-PARAMOUNT
IMPULSE
TANGERINE
BLUESWAY
JERDEN
COMMAND
GRAND AWARD
WESTMINSTER
VANGUARD

BACH GUILD
A & M
PROJECT 3
CONTEMPORARY
GOOD TIME JAZZ
G.N.P. CRESCENDO
STARDAY
FANTASY
PARROT

● **MEXICO**

ORFEON

● **ARGENTINA**

MUSIC HALL
DISC JOCKEY

● **AUSTRALIA**

FESTIVAL

KING RECORD CO., LTD.

12-13, 2-CHOME OTOWA-CHO, BUNKYO KU, TOKYO, JAPAN
Cable Address: KING RECORD TOKYO, Tel. 941 3111



THE WORLD IS WAITING FOR "BIG HITS"

from

SEVEN SEAS MUSIC CO., LTD.

12-13, 2-CHOME, OTOWA-CHO, BUNKYO-KU, TOKYO, JAPAN Cable Address: SEVENMUSIC, TOKYO

The Leading Publisher
of
JAPAN

EASTERN MUSIC

PUBLISHING COMPANY LTD.

KYOWA BLDG., 34 SHIBA KOTOHIRA-CHO, MINATO-KU, TOKYO. Cable : EASTMUS

JAPAN—The Past 12 Months

(Continued from page M-575)
dustry. For this new trend, Japanese publishers are largely responsible. For example, Shinko Music was the key factor in creating the 1966 "folk song" fad as well as bringing such groups as the Spiders and the Savages to a sudden national fame with hit after hit aimed on the teen market. Eight out of the twelve singles the company produced last year were smash hits, which surpass the past performance by any record company or production firm.

Further, Watanabe Music contributed a great deal to the increase in Toshiba Record's sales with, Yuzo Kayama, a film star, emerging as a big record artist. Other artists, the Tigers (Polydor), the Bunnys (King), The Wild Ones (Toshiba), all rock'n' roll groups, sold well.

It is felt that Japanese pop will more and more expand its shares in the Japanese record world and will function as a new source of fad.

Sales plans of Each Record Company:

World Group of Nippon Victor has conducted a sales campaign on its LP lines to make them constant sellers. Another policy was to choose the artists who were considered high promotions were mainly conducted on Nini Rosso, Billy Vaughn, partly with the help of local promoters. Among more than 30 labels, releases were made most on Reprise with Dot and Motown following: In jazz, promotion was made on Prestige and among European labels, attention was put on Durium, Sprint and Vogue chiefly. World Group of Nippon Victor has scheduled promotions for Rhythm & Blues with Supremes, Four Tops and the Temptations as leading artists.

RCA of Nippon Victor has conducted sales promotions in the past year on such artists as Monkees, Mamas & Papas, Elvis Presley, and Peggy March. First, The Monkees who made debut here with "The Last Train To Clarksville" made a 2nd hit with "I'm A Believer" and new re-

lease "A Little Bit Me, A Little Bit You." The Monkees will get more popular with the release of the TV program, "The Monkees," scheduled this September on TBS TV in Tokyo.

Mamas & Papas had hits with "I Saw Her Again," "Monday, Monday," Presley with "Love Letter" and Peggy March with "Rain In Rome," which was recorded in Japan.

RCA Victor of Japan will go further with Italian Westerns on RCA Italiana. The sales policy the department will take on "Mexican Rock": With the Mexico Olympic next year, things Mexican are taken up by various business circles such as fashion, magazines, movie, and music. The first release will be "Go-Go Mexico" by Sagrario Baeva of Mexico RCA. The tune was composed by Kunihiko Suzuki, a noted composer. Another sales policy the RCA Victor of Japan will take is to conduct a sales promotion on the Jefferson Airplane, who debuted with "Somebody To Love."

Philips department of Nippon Victor has conducted a sales promotion on the British Sound with The Walker Brothers and Spencer Davis Group, Troggs and produced several hits such as "Land Of 1000 Dances," "In My Room" and others. Sales policy taken in the future: Philips will conduct the sales promotion on American Sound with Manfred Mann, Tommy James and the Shondels and Keith. However, The Walker Brothers' break-up is a big headache for Philips because it came when the artists' popularity had reached its peak.

King Records' sales policy was chiefly conducted on the release of Italian Western disks, of The Rolling Stones, of Tijuana Brass, of San Remo Award disks, of Marjolie Noel, and of Joan Baez. The Rolling Stones made 3 or 4 hits, while Tijuana Brass, having visited here this April for a tour, is becoming popular with a recent hits, "Mame," "Taste Of Honey,"

(Continued on page 76)



Victor Publishing Co., Ltd. of Japan

12-6-3 Chome, Misaki-cho, Chiyoda-ku
Tokyo, Japan

Tel; (262) 1320, 2558, 6717, 0239, 6403

Cable Address; Victpublish Tokyo

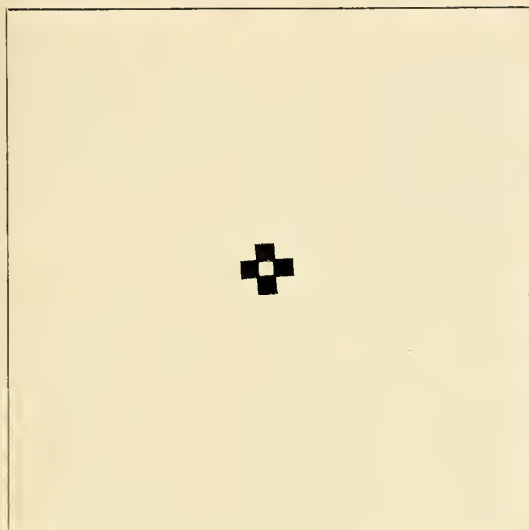
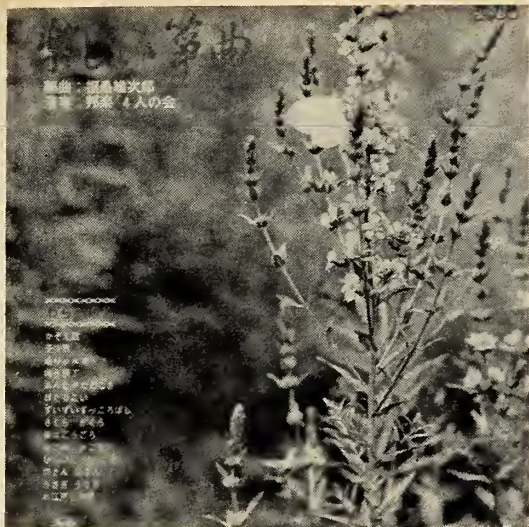

MANUFACTURED BY
Toshiba Musical Industries Ltd.
IN JAPAN

DELIGHTFUL 'KOTO' MUSIC . . .

*Toshiba So-kyoku (koto music) Series are
winning a great reputation!*

HOGAKU QUARTET'S DELIGHTFUL SO-KYOKU SERIES

1. warabe-uta album: counting
song, lullaby and other
japanese children's songs.

2. Nippon Min-yo album: Awa-
odori, Kiso-bushi and other
japanese traditional folk songs
& dances.
(available on CAPITOL in U.S.A.)

3. Nippon Ka-kyoku album: Hana,
Yoimachi-gusa and other
modern japanese songs.

JAPANESE MUSIC FOR SHAKU- HACHI and KOTO

1. roku-dan no shirabe
2. hachi-dan no shirabe
3. Okayasu-kinuta

TOSHIBA MUSICAL INDUSTRIES LTD.

Chairman: MOTOJI KUNO

TOSHIBA MUSIC PUBLISHING CO., LTD.

President: NORIICHIRO ISHIZAKA

Leading music publisher of Japan!

Address: 17, AKASAKA, 2-2 MINATO-KU TOKYO, JAPAN

CABLE: TOSHIBA PUBLISH TOKYO

Three Leading Firms Backed By
The Business Leaders of Japan



**NIPPON BROADCASTING
SYSTEM, INC.**

- Japan's largest radio station with a nation-wide network.
- Owns Fuji Telecasting Co. for television broadcasts.
- Leads the popular music world of Japan.

Cables: NBSINC TOKYO



**NIPPON BROADCASTING
SYS. SERVICE, CO.**

- Produces and sells PONY label 4- & 8-track cartridges, cassettes and open reels.
- Largest music center in the Orient.
- Largest duplicating center in the Orient.



**PACIFIC MUSIC
PUBLISHING CO., LTD.**

- Music publishing firm and record producer.
- Agent for foreign publishing rights.
- Consistent producer of hit songs.

Main Office:

Yurakucho, Chiyoda-ku
Tokyo, Japan
Tel: 281-5251

Cables: PACIFIC MUSE

JAPAN—The Past 12 Months

(Continued from page 74)

"Work Song" and others. With Mexico Olympic next year, the TJB will figure strongly. Joan Baez performances were held at the beginning of year, with LP's of the lark selling more than singles. Takeshi Terauchi & The Bunnys, a new electric guitar group, had "Let's Go Shake," which sold 150 thousand copies in one month since its release. As new sales promotion, the firm will promote Sergio Mendes and Brazil '66 made debut here with "Mas Que Nada." Besides Sergio Mendes, the firm will conduct a sales push on the Turtles who had a hit with "Happy Together" and Chanson Larks, Charles Aznavour, and Mirielle Matheieu.

Toshiba Record's sales promotions were conducted chiefly on The Beatles, The Ventures, Peter, Paul & Mary and Wild Ones. Claude Chiari toured here in April and Adamo came here in June, arousing much popularity. Adding to the artists above, the firm will conduct promotion on Twiggy and the Knack. The top ten LP's of Toshiba for the past one year are as follows: Revolver (The Beatles-Odeon), Ventures In Japan (Liberty), Best Of Peter, Paul & Mary (Warner Brothers), Nat King Cole Deluxe (Capitol), Claude Chiari Deluxe (Odeon), Best Of Ventures (Liberty), Oldies But Goldies (The Beatles-Odeon), Beach Boys Deluxe (Capitol), Best Of Peter, Paul & Mary, Vol. 2 (Warner Brothers), Franck Pourcel Deluxe (Odeon).

Nippon Columbia has made a strong sales promotional campaign on Donovan, Simon & Garfunkle, Paul Revere & The Raiders and The Brothers Four. Among recent hits, The Rainbows attracted attention with a smash hit, "Balla Balla" and the follow-up of the artists, "It Must Be Love," sold well. Andy Williams is the artist for Nippon Columbia whose disks, both in LP and singles, made big hits. He

toured Japan recently. Blue Comets is also a top act for the firm, with their consecutive smash hits. "Wednesday's Child" (Soundtrack) is a recent smash hit of the firm.

As for the artists on whom Nippon Grammophon has conducted sales promotions, Johnny Tillotson, and The Spotnicks are the best and they have become well-known with the help of successful performances here. From now on, sales promotion will chiefly be conducted on The Who, The Rubies, The Tigers, Gus Bachus Singers, all on Polydor, and Sam The Sham and Pharaohs on MGM and The Lovin' Spoonful on Kama Sutra and Wilson Pickett, Sonny & Cher, The Young Pascals on Atlantic.

Recent top ten best selling records are "Country Boy" (Johnny Tillotson-MGM) "Beat Goes On" (Sonny & Cher-Atlantic), "Happy Jack" (The Who-Polydor), "How Do You Catch A Girl" (Sam The Sham & Pharaohs-MGM), "Sayonara Natari" (The Rubies-Polydor), "The Monx Man" (The Spotnicks-Polydor), "Theme Of Grand Pri Film" (Soundtrack-MGM), "Nashville Cats" (The Loving Spoonful-Kama Sutra), "Everybody Needs Somebody To Love" (Wilson Pickett-Atlantic).

**JAPAN'S TRADE
ASSOCIATIONS**

*THE JAPANESE SOCIETY OF RIGHTS OF
AUTHORS AND COMPOSERS (JASRAC)
Tameike Meisan Bldg.
30 Tameikemachi Akasaka, Minatoku, Tokyo

*N O S K (NIPPON ONGAKU
SHUPPANSHA KYOKAI)
(Japan's Publisher Association)
Kyowa Bldg.
34 Kotohiracho, Shiba, Minatoku, Tokyo

*NIPPON CHIKUONKI RECORD KYOKAI
(Japan's Record Company Association)
9-8-2 Tsukiji, Chuoku, Tokyo

DON HO

Sings

Japanese Hit!!

"All That's Left Is The Lemon Tree"

(黄色いレモン)



Available on Reprise Records



Loads and Loads of Original Japanese Hits!!

NICHION

- Subsidiary of TBS (The Foremost National Radio & TV Network)
- Representative for Music Publishers Holding Corporation of U. S. A.
- Full Promotion of Foreign Songs
- Music Publications
- Musical Instruments
- President: SHIGERU AKIMOTO
- Address: Matsudaira Bldg. 3-4-1, Akasaka, Minato-ku, Tokyo
- Cable: PUBLISHMUSIC TOKYO
- Phone: Tokyo (584) 4722-4

THE GREATEST MUSIC ORGANIZATION IN THE FAR EAST

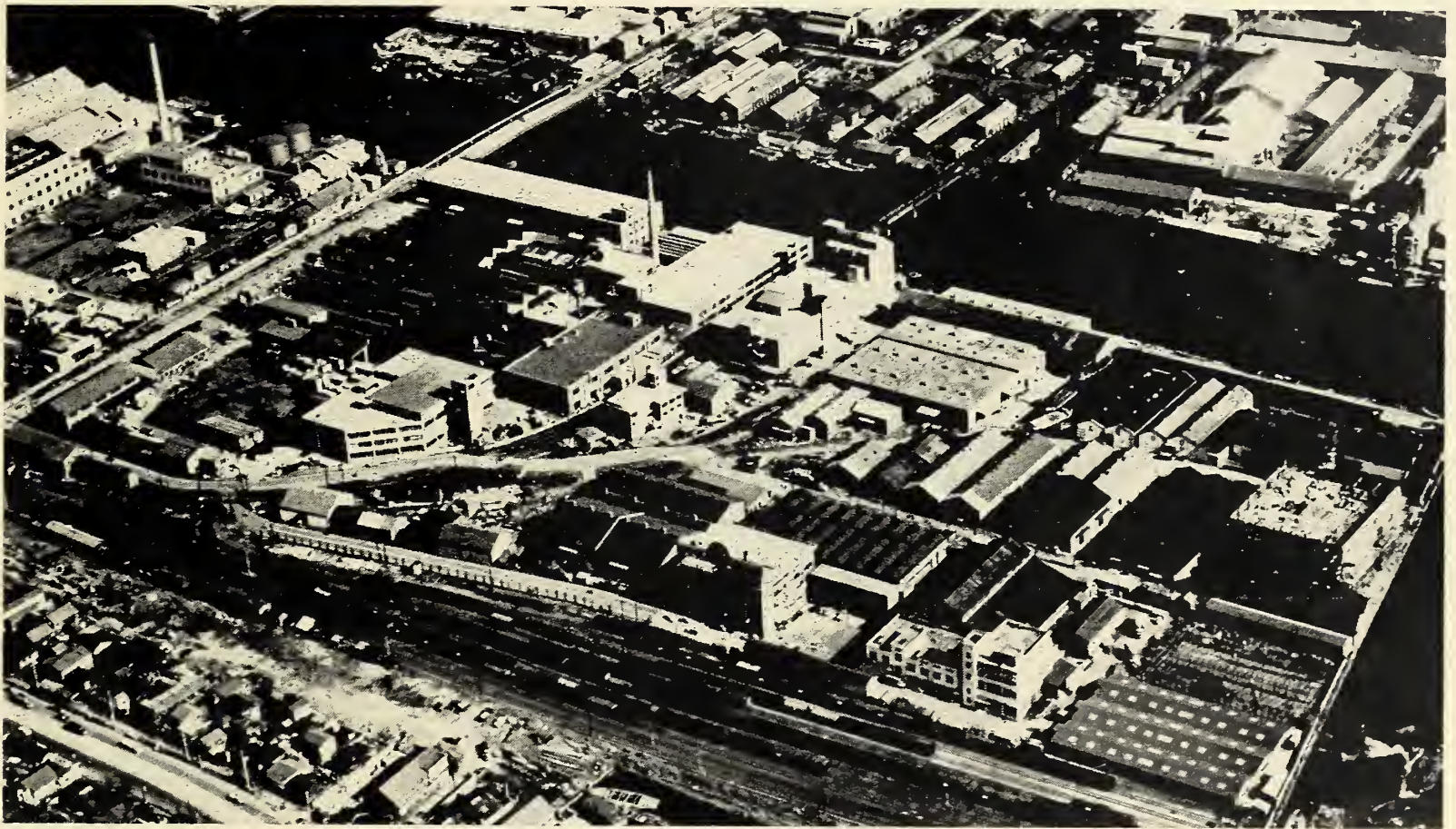

VICTOR COMPANY OF JAPAN LTD.

MAIN OFFICE

4-1 NIHONBASHI-HONCHO CHUO-KU TOKYO

RECORD DIVISION

13-2 TSUKIJI CHUO-KU TOKYO

40 YEARS

OF HISTORY

IN THE INDUSTRY



CHAIRMAN: KŌNOSUKE MATSUSHITA



PRESIDENT: HITOSHI MOMOSE

◀ AFFILIATE COMPANY ▶

VICTOR MUSIC SUPPLY COMPANY LTD.
VICTOR PUBLISHING COMPANY LIMITED.

6-3 TSUKIJI
CHUO-KU TOKYO

13-2 MISAKI-CHO
KANDA TOKYO

World-Wide Hits are on

GMIP

*in
Japan*

GEI-EI MUSIC PUBLISHERS

Nakamura Bldg., 3-13-13 Shinmachi
Akasaka, Minato-ku, Tokyo, Japan
Tel: 584-0901 · 0902 · 0943 · 0944

JAPAN'S Record Manufacturers

TEICHIKU RECORDS CO., LTD.
1-2 Nishi Shinbashi, Minatoku, Tokyo
President: Toyoji Nanko
Telephone: 502-6651
Label: Decca, Scepter, Union, Coral, Brunswick, Teichiku

NIPPON GRAMMOPHON CO., LTD.
6-6-1 Shinbashi Minatoku, Tokyo
President: Shinken Izawa
Telephone: 401-4131
Label: Archiv, Polydor, MGM, Atlantic, Verve, Heliodor, Kama Sutra, Grammophon

MINOLPHONE K. K.
Daiichi Taihei Bld.
45-2 Tsunohazu Shinjuku, Tokyo
President: Koichi Nakayama
Telephone: 343-1111
Label: Minolphone

NIPPON COLUMBIA CO., LTD.
4-14 Akasaka Minatoku, Tokyo
President: George Kanzaki
Telephone: 584-8111
Label: CBS, Epic, United Artists, Vee Jay, Desney Land, Time Mainstream, Audio Fidelity, Pye, Barenreiter, Columbia

VICTOR COMPANY OF JAPAN LTD.
4-1 Nihonbashi-Honcho, Chuoku, Tokyo
President: Hitoshi Momose
Telephone: 241-7811
Label: RCA Victor, Victrola, Camden, 23th Century Fox, Philips Fontana, Mercury, Riverside, Colgems, Dot, Vogue, World Pacific

TOSHIBA MUSICAL INDUSTRIES LTD.
12, 2, 2 chome, Akasaka, Minatoku, Tokyo
President: Motoharu Kuno
Telephone: 583-1111
Label: Toshiba, Angel, Odeon, Capitol, Kapp, Liberty, Warner Bros., Stateside

NIPPON CROWN CO., LTD.
Shinwa Bldg.
8-10-2 Akasaka, Minatoku, Tokyo
President: Kazuhisa Arita
Telephone: 582-4741
Label: Crown

KING RECORDS
12-2 chome Otowa, Bunkyo, Tokyo
President: Kazumitsu Machijiri
Telephone: 941-3111
Label: London, Argo, Telefunken, ABC, Paramount, Impulse, Westminster, Command, Vanguard, Bach Gulde, Contemporary, Good Time Jazz, Seven Seas

JAPAN'S Tape Manufacturers

VICTOR PUBLISHING CO., LTD. OF JAPAN
12-6-3 Chrome Misakicho, Chiyodaku, Tokyo
262-1320

WATANABE MUSIC PUBLISHING CORP.
Matsui Bldg. 4 Fl.
4-1 Rurakucho, Chiyodaku, Tokyo
502-0037

WALT DISNEY ENTERPRISES OF JAPAN LTD.
Kanesaka Bldg. 6 Fl.
4-5-2 Shinbashi, Minatoku, Tokyo
591-5886

ZEN-ON MUSIC PUBLISHING CO., LTD.
25 Higashi Gokencho, Shinjuku, Tokyo
269-0121

YAMADA MUSIC CORPORATION
618-2- Hatanodai, Shinagawa-ku, Tokyo
784-1033

K. K. MAINICHI MUSIC SYSTEM
Shindai Bldg.
25 1-chome, Hamadori, Dojima, Kitaku, Osaka, Japan

K. K. TBS MUSIC
c/o Nippon Hoso,
36 Hitotsugicho, Akasaka, Minatoku, Tokyo

TOYO ONGAKU HOSO K. K.
Meito Bldg.
4 16 1-chome, Jingumae, Shibuyaku, Tokyo

ASAHI HOSO K. K.
2 2-chome Minami, Oyodocho, Oyodoku, Osaka, Japan

TEIKOKU DENPA K. K.
New Kojimachi Bldg.
23 3 5-chome, Kojimachi, Chiyodaku, Tokyo

K. K. NIPPON HOSO SERVICE
c/o Nippon Hoso
7 1-chome, Yurakucho, Chiyodaku, Tokyo

MECCA RECORD PACK K. K.
Rosei Bldg.
4 1-chome, Higashi Azabu, Minatoku, Tokyo

TOKYO DENKI KAGAKU KOGYO K.K.
311 Ichinotsubo, Kawasaki, Japan

TOKYO ROKUON K. K.
6 59 Masagocho, Kitaku, Osaka, Japan

SUMITOMO 3M K. K.
3M Bldg.
21 1 7-chome, Akasaka, Minatoku, Tokyo

K. K. FUJI SOUND
Asanumagumi Bldg.
5 Arakicho, Shinjuku, Tokyo

K. K. TAIKO DENKI SEISAKUSHO
13 10 6-chome, Nakanobe, Shinagawaku, Tokyo

TOYO TANSHI K. K.
2 3-chome, Edobashi, Nihonbashi, Chuoku, Tokyo

CHUO ROKUON K. K.
Tone Bldg.
2 6-chome, Nishi Ginza, Chuoku, Tokyo

THE SPIDERS, "SAD SUNSET" "FURI FURI"



YOUR IDEAL AGENCY IN JAPAN

TOP MUSIC PUBLISHING CO., LTD.

Room #4-A Mitoko Bldg.
6-2-4 Akasaka, Minato-ku, Tokyo
Tel: (584) 7581~3 Cable: HORIPROMUSIC TOKYO

HORI PRODUCTION INC.

Room #304 Peak Akasaka
2-13-12 Akasaka, Minato-Ku, Tokyo
Tel: (582) 2853~7 Cable: HORIPROMUSIC TOKYO



MARI SONO



THE PEANUTS
(World Famous Twin Sisters)



KOSAKU DAN
(YUZO KAYAMA)
(Composer & Singer of
"Forever With You," Capitol)



YUKARI ITO



MICHIYO AZUSA

Top Entertaining Organization in Japan

WATANABE

PRESENTS

MORE THAN 500 POPULAR ARTISTS, COMPOSERS & LYRICISTS

ARTIST PROMOTING

TV, RADIO, MOVIE, SHOW
& RECORD PRODUCING

MUSIC PUBLISHING



MIE NAKAO

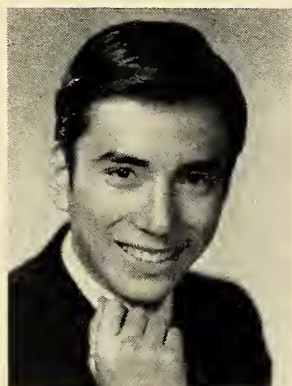

AKIRA FUSE

WATANABE PRODUCTION CO., LTD.

President: SHIN WATANABE

WATANABE MUSIC PUBLISHING CORP.

President: MISA WATANABE

4TH FLOOR MATSUI BLDG. #4 1-CHOME YURAKUCHO
CHIYODA-KU, TOKYO, JAPAN TEL.: 502-0541 CABLE PROWATANABE

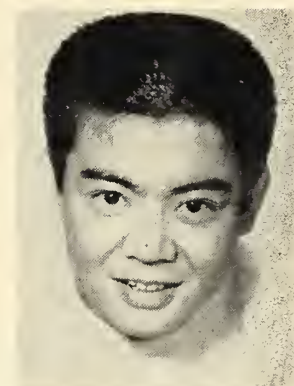

YASUO TANABE



TOMOKO KEI



KIYOKO ITO



NANA KINOMI



Japan's
SHINKO
MUSIC PUBLISHING CO., LTD.

Music Publishing
Musical Books Publication
Instrument Deals
Monthly Popular Music Magazine
"THE MUSIC LIFE"
And Active Record Master Production

Address: Wako Bldg., 2-chome, Tsukasa-cho, kanda,
Chiyoda-ku, Tokyo, Japan
Cable: Shinko Music Tokyo
TEL. (292) 2861 ~ 2868

**YOUR WORLDWIDE
HIT FROM EXOTIC
JAPANESE POP TUNE**



THE MOST ACTIVE independent PUBLISHER
WRITE IMMEDIATELY



NIPPON COLUMBIA MUSICAL ENTERPRISES, LTD.
14-14, AKASAKA 4-CHOME, MINATOKU, TOKYO
cable NICOLME telex TK 2951

president TETSUO MARUYAMA
vice president JUN IMAHORI

JAPAN'S Music Publishers

ABERBACH TOKYO KABUSHIKI KAISHA
Zenkoyoren Bldg.
409, 7-2 Hirakawa-cho, Chiyodaku, Tokyo
265-3291

AKABOSHI MUSIC PUBLISHERS
Shinjuku Daiichi Mansion, 124-1 Kashiwagi,
Shinjukuku, Tokyo
361-8901

BIG-HILL MUSIC PUBLISHERS
Yayoikan, 5-7 Nishi, Ginza, Chuoku, Tokyo
573-5983

CROWN MUSIC PUBLISHER, INC.
Shinwa Bldg.
8-10-2 Akasaka, Minatoku, Tokyo
582-4741

DAIICHI MUSIC PUBLISHER
Ito Bldg.
16-6-3 Kasumigaseki, Chiyodaku, Tokyo
580-0551

EASTERN MUSIC PUBLISHING CO., LTD.
Kyowa Bldg.
34 Kotohira-cho, Shiba, Minatoku, Tokyo
501-0344

FAR EAST MUSIC PUBLISHING CORP.
c/o Mr. Sadao Ochiai
9-3-3 Kamirenjyaku, Mitakashi, Tokyo
(Musashino) 43-4016

FRIENDSHIP MUSIC, INC.
20-7-7 Minami Aoyama, Minatoku, Tokyo
400-9773

FUJI MUSIC INC.
3-4-2 Mukohara, Itabashiku, Tokyo
328-4781 (Kimura)

FURUKAWA MUSIC PUBLISHERS
c/o Tokyo Ongaku,
8-3 Kyobashi, Chuoku, Tokyo
281-7770

**GRAMMOPHON PUBLISHING &
PROMOTION K. K.**
6-6-1 Shinbashi, Minatoku, Tokyo
571-6509

GEI-EI MUSIC PUBLISHERS
Nakamura Bldg. 3Fl.
13-13-3 Akasaka, Minatoku, Tokyo
584-0901

**INTERNATIONAL MUSIC PUBLISHERS
CO., LTD.**
Mansui Bldg.
14-3 Ogawacho, Kanda, Chiyodaku, Tokyo
292-7256

ISHIHARA MUSIC PUBLISHING CORP.
40 Kotohira-cho, Shiba, Minatoku, Tokyo
501-7747

JAPAN C.A.M. LIMITED
Playguide Bldg.
2-2 Ginza, Chuoku, Tokyo
562-0111

KAMINARI MUSIC PUBLISHER INC.
c/o Big Hill K. K., Yayoikan
5-7 Nishi, Ginza, Chuoku, Tokyo
573-5983

KAWAI GAKUFU CO., LTD.
321-2 Komagome, Toshimaku, Tokyo
983-7428

KANAI MUSIC PUBLISHERS
Shin Kokusai Bldg. 8Fl.
828-ku, 4-3 Marunouchi, Chiyodaku, Tokyo
211-7826

KOKUSAI MUSIC PUBLISHERS
Nippon Chusha Bldg.
43 Toyamacho, Shinjukuku, Tokyo
293-7672

KUSANO MUSIC INC.
Wako Bldg.
13 2-chome, Tsukasacho, Kanda, Chiyodaku,
Tokyo
292-2867

**MAHINA MUSIC PUBLISHING
CORPORATION**
Daihachimori Bldg.
4-20-3 Shimbashi, Nishi, Minatoku, Tokyo
433-5321

MUSIC PUBLISHER HIT MAKER, LTD.
c/o Tokyo Gakki Shoka, Mansui Bldg.
14-3 Ogawacho, Kanda, Chiyodaku, Tokyo
291-9100

MUSICAL RIGHTS (TOKYO) K. K.
Zenkoyoren Bldg. 409
7-2 Hirakawa-cho, Chiyodaku, Tokyo
265-3291

MUSIC FRIEND PUBLISHER
Murata Bldg. 8 Fl.
27-4 Yoyogi, Shibuyaku, Tokyo
379-1431

MUSIFON, INC. OF JAPAN
c/o FM Tokai, Hatsumei Kaikan
17 Akefuneco, Nishikubo, Shiba, Minatoku
Tokyo
502-0481

NEW ORIENT MUSIC INC.
Akasaka Mansion 201
16-5-7 Akasaka, Minatoku, Tokyo
538-2898

**NEW-SOUND MUSIC PUBLISHERS CO.,
LTD.**
Nakane Bldg.
29-62 Tansucho, Azabu, Minatoku, Tokyo

**NICHION, INC. (NIHON ONGAKU
SHUPPAN K. K.)**
Matsudaira Bldg.
3-4-1 Akasaka, Minatoku, Tokyo
584-4722

**NIPO-AMERICANA MUSIC PUBLISHING
CO., LTD.**
2-20-4 Imakawa, Suginamiku, Tokyo
271-2170

**NIPPON COLUMBIA MUSICAL
ENTERPRISES LTD.**
14-14-4 Akasaka, Minatoku, Tokyo
584-8111

**NIPPON KAYO MUSIC PUBLISHING CO.,
LTD.**
6-2 Yoyogi, Shibuyaku, Tokyo
379-1411

(Continued on next page)

So. AFRICA - Record Manufacturers

E.M.I. (SOUTH AFRICA) (PTY.) LTD.
P. O. Box 11254, Johannesburg, Transvaal
(32 Steele Street, Steeldale, Johannesburg)
Phone: 869-2661
Cable: **SOUNDBOX JOHANNESBURG**
Pres.: Mr. W. J. Richmond
Labels (domestic): Angel, Uitspan, Odeon,
Umsakazo, Capitol, Columbia, Mis Master's
Voice, Parlophone.
Labels (others): Liberty, M.G.M., Odeon,
Stateside, Barclay, Tamla-Motown, Immedi-
ate, Ember, Waverly.

GALLO (AFRICA) LTD.
P. O. Box 6216, Johannesburg, Transvaal
(Gallo Centre, Corner Kerk & Gold St., Jo-
hannesburg)
Phone: 23-2111
Cable: **GALLOTONE JOHANNESBURG**
Pres.: Mr. Eric Gallo; managing director:
Alec Dumont
Labels (domestic): Continental, Gallotone,
Welkom, New Sound, Motella, Kiddie Klub.
Labels (others): Archiv-Produktion, Audio,
Fidelity, Brunswick, Cameo, Coral, Decca,
Deutsche Grammophon, Heliodor, Murray
Banks, Parkway, Polydor, Somerset, Tele-
funken, Disneyland, London, Savoy, Buena
Vista, Chantecler, Prestige, Swingsville.

GRAMOPHONE RECORD CO., LTD.
P. O. Box 2445, Johannesburg, Transvaal
(cor. Fox and Gold Streets, Johannesburg)
Phone: 23-0546
Cable: **AFRICORD JOHANNESBURG**
Pres.: Mr. Arnold Golemo
Labels (domestic): Kiddie Sound, Tropik,
Unika.
Labels (others): Caedmon, CBS, Mercury,
Philips, Riverside.

METEOR RECORDS (PTY.) LTD.
P. O. Box 6640, Johannesburg, Transvaal
(187 President Street, Johannesburg)
Phone: 22-6403, 22-8851
Cable: **METEORDISC JOHANNESBURG**
Pres.: Mr. R. R. Moskovitz
Labels (domestic): Big Beat, Big Eight, Jazz,
Kristal, Meteor, Saffier.
Labels (others): Ad-Lib, Candid, CGD, Em-
bassy, Hispavox, Lenox, Lusidisc, Oriole,
Prima-Magnagroove.

SUN-PACIFIC MUSIC
P. O. Box 17004, Hillbrow, Johannesburg
(608 Hunstanton, cor. Twist & Kotze Streets,
Hillbrow, Johannesburg)
Phone: 724-8278, 724-8279
Cable: **REKLAMA JOHANNESBURG**
Pres.: Mr. Gilbert Gibson, Mr. Taffy Kikillus
Labels (domestic): Sun-Pacific, Unika

TEAL RECORD CO. LTD.
P. O. Box 4105, Johannesburg, Transvaal
(124, President Street, Johannesburg)
Phone: 22-0355
Cable: **TEALREC JOHANNESBURG**
Pres.: Mr. A. G. J. McGrath
Labels (domestic): Drum, Teal
Labels (others): Durium, Cadet, Monument,
Liberty, King, World Pacific, Teal, Presi-
dent, Reprise.

TELSTAR RECORDS (PTY.) LTD.
304/5 His Majesty's Building
Eloff Street, Johannesburg
Phone: 834-8208
Cable: **BELINDSONG JOHANNESBURG**
Pres.: Mr. Ray Walter
Labels (domestic): Ray, Telstar.

TROUBADOR RECORDS (PTY.) LTD.
P. O. Box 1225, Johannesburg, Transvaal
(1-5, Browning Street, Wolhuter, Johannes-
burg)
Phone: 24-1787, 24-9157, 24-9158
Cable: **TROUBADOR JOHANNESBURG**
Joint Man. Dir.: Mr. M. Fagin & Mr. I. Katz
Labels (domestic): Church, FM, Gaza, Goli,
Hit, Manzini, Troubador.
Various foreign Franchises pressed under the
Troubador label

TRUTONE (PTY.) LTD.
P. O. Box 9299
5th Floor, "Nukirk"
132, Kerk St. (Cor. Nugget)
Phone: 23-0791/2/3/4/5
Cable: **TRUTONE JOHANNESBURG**
Man. Dir.: Mr. D. G. Fine
Labels (domestic): Envee, Juweel, Perel, Pret,
Quality, Rave, Renown, Ridge, Winner.
Labels (others): Dot, MGM, Roulette, Somer-
set, United Artists, Verve, Vox.

WORLD RECORD COMPANY
President: Mr. A. G. J. McGrath
P. O. Box 4105, Johannesburg, Transvaal,
South Africa
124 President Street, Transvaal, South Africa
Labels (Domestic): Kalahari
Labels (Others): Hickory, Imperial, ABC-
Paramount, Pye, Warner Bros., Eurodisc,
Atlantic, A & M Records, Crescendo,
Palette, Impulse, Command, Ariola, Vogue,
Hanna Barbera, Starday, Kama Sutra.

JAPAN'S MUSIC PUBLISHERS

(Continued from preceding page)

ONGAKUNOTOMOSHA CORP.
30-6 Kagurazaka, Shinjuku, Tokyo
268-6151

ONGAKU-SHUNJUSHA LTD.
30-1 Jimbocho, Kanda, Chiyodaku, Tokyo
291-0360

ORIENTAL MUSIC CO.
13-22-2 Daisawa, Setagayaku, Tokyo
421-4123

OVERSEAS MUSIC PUBLISHERS CO., LTD.
25 Higashi Gokencho, Shinjuku, Tokyo
260-5430

PACIFIC MUSIC PUBLISHING CO., LTD.
c/o Nippon Hoso
7-1 Yurakucho, Chiyodaku, Tokyo
281-5251

RHYTHM MUSIC PUBLISHER, INC.
18 Sarugakucho, Shibuyaku, Tokyo
461-6945

REVUE JAPAN, LTD.
Hotel New Japan 881
29-2 Nagatacho, Chiyodaku, Tokyo
581-2143

SHINKYO MUSIC PUBLISHING CO., INC.
c/o Mr. Teruchiyo Miyamoto
602-3 Nishi Sugamo, Toshimaku, Tokyo

SHINKO MUSIC PUBLISHING CO., LTD.
Wako Bldg.
2-chome, Tsukasache, Kanda, Chiyodaku, Tokyo
292-2861

SUISEISHA
30-6 Kagurazaka, Shinjuku, Tokyo
268-6151

SEVEN SEAS MUSIC CO., LTD.
13-12-2 Otowa, Bunkyo, Tokyo
941-3111

TAIYO MUSIC, INC.
Central Apt. 335
313-6-30-4 Jingumae, Shibuyaku, Tokyo
403-3763

TOA MUSIC CO.
30-6 Kagurazaka, Shinjuku, Tokyo
268-6151

TONE MUSIC CO., LTD.
Daisan Mori Bldg. 3 Fl.
10-4-1 Shinbashi, Nishi, Minatoku, Tokyo
502-8214

TOP MUSIC PUBLISHING CO., LTD.
Mitoko Bldg. 4-A
4-2-6 Akasaka, Minatoku, Tokyo
582-5046

TOKYO MUSIC PUBLISHING CO., LTD.
Kokusai Bldg.
12-3 Marunouchi, Chiyodaku, Tokyo
213-6765

TOKYO MUSIC PUBLISHING CO.
23-7-2 Kameidocho, Kotoku, Tokyo
682-8255

TOSHIBA MUSIC PUBLISHING CO., LTD.
17-2-2 Akasaka, Minatoku, Tokyo
583-1131

TOKYO-KIKAKU MUSIC PUBLISHING CO., LTD.
6-6 Nishi Ginza, Chuoku, Tokyo
572-0712

JAPAN'S INDEPENDENT RECORD PRODUCERS

SHINKO MUSIC PUBLISHING CO., LTD.
Wako Bldg.
2-chome, Tsukasacho, Kanda, Chiyodaku, Tokyo

WATANABE MUSIC PUBLISHING CORP.
Matsui Bldg. 4th Fl.
1-4 Yurakucho, Chiyodaku, Tokyo

AUSTRALIA'S BEST SELLING SHEET MUSIC

Best-selling sheet music for past twelve months. Listed by publisher in alphabetical order. Asterisk indicates local composition.

Best-selling sheet music from Accolade

Bend It
Save Me
I Will Wait For You
*Roundabout

Best-selling sheet music from J. Albert & Son

Somewhere My Love
Tar And Cement
Somethin' Stupid
*Friday On My Mind
Lady Godiva
*Sorry
The Pied Piper
*Step Back
A Walk In The Black Forest
The Knight In Rusty Armour
Good Vibrations
Second Hand Rose
Those Magnificent Men

Best-selling sheet music from Allans music

Puff The Magic Dragon
(Allans)
Blowing In The Wind
(Allans)
What Now My Love
(Allans)
I Believe
(Davis)
Leaning On A Lamp Post
(Davis)
Release Me
(Davis)
Li'l Red Riding Hood
(Acuff-Rose)
Hair On My Chinay Chin Chin
(Acuff-Rose)
Twinkle Toes
(Acuff-Rose)
Communication Breakdown
(Acuff-Rose)

Best-selling sheet music from Belinda group

Spanish Flea
Tijuana Taxi
So What's New
Mexican Shuffle
Spanish Eyes
In The Country
Hanky Panky
Sunny Afternoon
Mexican Road Race
Cinco De Mayo

Best-selling sheet music from Boosey & Hawkes

These Boots Are Made For Walkin'
(Boosey & Hawkes)
The Wedding
(Jewel Music)
Pearly Shells
(Boosey & Hawkes)
Summer Wine
(Boosey & Hawkes)
How Does That Grab You Darlin'
(Boosey & Hawkes)
Sugar Town
(Boosey & Hawkes)
Work Song
(Jewel Music)
Music To Watch Girls By
(Jewel Music)
I'm A Man
(Jewel Music)
Roadrunner
(Jewel Music)

Best-selling sheet music from Castle group

Green, Green Grass Of Home
(Palace Music)
Hitch Hiker
(Palace Music)
*Rolf Harris Song Book
(Castle Music)
Roger Miller Song Book
(Palace Music)
So Much Love In The World
(Castle Music)
Lies
(Palace Music)
You Got Soul
(Castle Music)
*9-50
(Castle Music)
Ivan Mogull Hits
(Ivan Mogull Music)
Cherish
(Castle Music)

Best-selling sheet music from Chappell & Co. group

Edelweiss
Georgy Girl
Pretty Flamingo
Wallpaper Roses
Elusive Butterfly
Born A Woman
Black Is Black
Walk With Me
Sweetheart Tree
Alfie

Best-selling sheet music from Essex group

Lady Jane
Mother's Little Helper
Ruby Tuesday
Guantanamera
GiGimme Some Lovin'
Happy Jack
Fly Me To The Moon
March Of The Mods
I Am A Rock
Out Of Time

Best-selling sheet music from Southern Music group

Winchester Cathedral
Ooh La La
Mellow Yellow
Peek-A-Boo
Semi-Detached Suburban Mr. Jones
Sunshine Superman
Sunday For Tea
Detroit City
Look At My Baby
*Keep Me Satisfied

Best-selling sheet music from Leeds Music

Strangers In The Night (Leeds)
Born Free (Tu-Con)
Yellow Submarine (Northern)
Penny Lane (Northern)
Eleanor Rigby (Northern)
Let It Be Me (Leeds)
I'm A Believer (Tu-Con)
Strawberry Fields Forever (Northern)
Colour My World (Leeds)
On A Carousel (Leeds)

ZENONGAKU
Z
SHUPPANSHA

ZEN-ON

THE GREATEST & OLDEST MUSIC PUBLISHERS IN JAPAN

Since its first publication of musical scores in 1931, ZEN-ON has become very popular as the best musical scale publisher in Japan. Its repertory ranges widely from modern popular songs to classical.

Address: No. 25 Higashigoken-cho, Shinjuku-ku, TOKYO JAPAN
Phone: (269) 0121-0127
Affiliated: OVERSEAS MUSIC PUBLISHERS Co., Ltd.

When dealing with Japan
Always remember the name of

TONE MUSIC CO., LTD.

The most reliable and progressive
music publisher in Japan

Address: Dai-San Mori Bldg., 4-10, 1-chome,
Nishi-Shimbashi, Minato-ku, Tokyo, Japan
Telephone: 502-8214, 8215

TOKYO MUSIC

provides you with an extensive and effective
promotion of your music.

TOKYO MUSIC PUBLISHING CO., LTD.

KOKUSAI BLDG., 7TH FLOOR

3-12, MARUNOUCHI
CHIYODA-KU, TOKYO

TEL: (213) 6765

CABLE: MUSICATO

SWITZERLAND—THE PAST 12 MONTHS

In Switzerland the record industry has had a good year, with an increase in annual turnover from 35 million Swiss francs to around 40 million.

Generally speaking, although the level of single, EP and LP sales has remained steady, there have been some changes in the overall scene.

For instance, from the 1st April this year, fixed prices for single and EP records were abolished. Singles, which were previously 'pegged' at 4.75 Swiss francs, now sell from 3.90 to 4.40. EP's which used to cost 7.90 can now be bought from 5.90 to 6.90.

The abolition of RPM (Resale Price Maintenance) as far as records are concerned, follows abolition of fixed prices for other labelled articles such as food, cigarettes, household goods etc. Although the record industry is far from happy with the change, it is generally regarded as an economical necessity—a sign of the times, along

with the development of the consumer and wholesale market.

Although LP's are unaffected by the abolition of RPM, the standard price has been reduced from 21.50 to 19 Swiss francs for "pop" albums, and classical prices have been reduced from the standard 27 francs to 24 francs. However, the price for luxury class albums remains unchanged at 27 francs.

An upsurge in LP sales generally is expected as a result of the change in price structure, as the record dealer is no longer so interested in selling singles due to reduced profit margin. Stereo is still the order of the day and no new Mono albums are being produced in Switzerland.

One of the reasons given for the overall rise in turnover for the past twelve months is the increased activity of clubs such as Ex Libris, who also maintain their own chain of

shops and act as rack-jobbers for the Megros Organisation. The Ex Libris product is sold via three methods. Firstly, by direct mailing to consumers. Secondly, through their own chain of shops (approximately thirty), and thirdly, rack-jobbing. Nevertheless, rack-jobbing is not prevalent in Switzerland, and the usual method of selling is through dealers and chain stores in the traditional way.

Switzerland, and its five million inhabitants, still suffers from a shortage of labour. There has been little change in the number of guest workers from Italy, Germany, Spain, Austria and Greece, which now total some 800,000. The Government's ruling on the matter has not been as drastic as was at first expected, and workers with 10-year working permits may now take up permanent residence in Switzerland. There is still a big demand for more workers.

The year has seen the introduction of the first Swiss "Pop" TV Showcase, "Hits A Go Go". The program, screened once every six weeks on Swiss and German television, and presented by Mal Fondock, has definitely benefited "pop" record sales.

Int'l Artist Popularity

The past year has also seen a tremendous upsurge in the popularity of recordings by British and American artists, whilst French and German material has been less in demand. This has certainly been the case of Musikvertrieb A.G. headed by Maurice Rosengarten, who reports an excellent year for his record, publishing and coin machine interests. The year has seen an increase in both single and LP sales. With single sales generally down, Musikvertrieb attributes its success at this speed to the tremendous number of hits from Britain and the United States, one of the biggest hits of the year being "Strangers in the Night" by Frank Sinatra on Reprise, the label which Musikvertrieb acquired from Switzerland in 1966. This was followed by the Frank and Nancy Sinatra "Something Stupid". Also from America, the Beach Boys' "Good Vibrations" sold heavily on Capitol. From Britain, the Rolling Stones hit the jackpot, first with "Mother's Little Helper" and later with "Have You Seen your Mother Standing in the Shadows". The Rolling Stones' popularity was boosted in Switzerland by a personal visit to Zurich in April this year at the Sports Stadium, with a capacity of 10,000 people. During their visit, the group were presented with The Golden Stone of Zurich to mark their outstanding Swiss sales of singles and LP's. Other best sellers of the year have also been by groups, such as The Troggs, and starting in September 1966, The Monkees.

Musikvertrieb's classical best seller of the year was the five-record boxed set of Beethoven's Piano Concertos by Arthur Rubinstein, which was sold at a special price of 10.95 francs per disc (54 francs for the set). The success of this package encouraged Musikvertrieb to bring out a similar set of Toscanini. Operatic recordings are still very popular in Switzerland, and for Musikvertrieb it was a Wagner year, with the "Gottterdammerung" set on Decca. The company reports that the 8 track cassettes of RCA have started to sell well, and are now put out by the company alongside the cassettes of Telefunken and Decca, for use on Grundig and Telefunken tape players.

Label & Publisher Details

The Musikvertrieb Publishing Company is still very active, and during the last twelve months has notched up many hits, including the winning song from the Baden-Baden festival "Beiss Nicht Gleich In Yaden Opsel" which became a major hit and a sheet music best seller.

Philips A.G. have also had some very good hits by British groups, particularly Dave Dee, Dozy, Beaky, Mick & Tich with "Bend It" selling some 14,000 copies, plus some EP's. This was achieved without a personal visit from the group. Another strong

hit from Britain was "Winchester Cathedral" by the New Vaudeville Band. The Walker Brothers and Manfred Mann were also big sellers. However, Philips report a slight drop, approximately 10%, in single sales over the past twelve months, which they attribute to the falling-off in the appeal of French artists, in which the company is particularly strong. Nevertheless, Philips' artists such as Johnny Halliday, Claude Francais, Herve Villard and Sheila, continue to sell well.

Philips' classical best sellers included Handel's "Messiah" with Colin Davis conducting (a three-record set). The Philips' cassette introduced to Switzerland in the Autumn of 1965 has proved popular with rising sales, despite the fact that the cassettes are more expensive at 24 francs as opposed to 21.50, than the LP's from which the material is taken. However, for Philips, despite the 10% drop in single sales the overall volume for the year has remained satisfactorily stable.

E.M.I. A.G. headquartered at Zug have continued to flourish under the direction of Mr. Bevierre, who during the year has travelled extensively, particularly in the Middle East.

However, a fuller report of E.M.I.'s activities comes from Jecklin & Company in Zurich, who promote and distribute the E.M.I. product in Switzerland. July this year will see the formation of a new E.M.I.—Jecklin company, to be called E.M.I. Records Switzerland. The Company will handle all E.M.I. material except Capitol, including the H.M.V. label previously handled in Switzerland by Hug. The company will operate out of Zurich, using the extensive Jecklin H.Q. The Managing Director of the new company will be Mr. Bevierre who will remain with E.M.I. A.G. at Zug. It is expected that Jecklin as a record distributor will cease to function, but the Jecklin chain of record stores will continue to operate as before and possibly expand. Jecklin reports that sales for 1966-67 to date, have not been as good as the previous year. Contributory causes include the new single and EP price structure and the increased popularity of budgetline albums, which has reduced somewhat the sales of higher-priced LP's. Best sellers in the "Pop" field have been the Beatles once more with numbers such as "Penny Lane" and "Yellow Submarine". Herman's Hermits too have been big sellers with "No Milk Today" and "Super Girl". The Hollies had a hit with "Stop, Stop, Stop", whilst the Four Tops enjoyed considerable success with all their releases, particularly "Reach Out, I'll be There". Other chart successes have come from Twice as Much and Cliff Bennett & The Rebel Rousers. TV appearances in Switzerland have also been made by Graham Bonney, Georgie Fame and Chris Farlowe. During the year, the local Swiss group, Les Sauterelles, launched a year ago by Jecklin and now recording for E.M.I. Italiana, have established themselves on the market with numbers such as "Hong Kong", "I'm a Prisoner" and the American composition "I Love How You Love Me".

In the classical field, best sellers for Jecklin have included Klemperer's "Don Giovanni" on Angel, and the same conductor's "Missa Solemnis". Record of the Month promotion on the Vox and Harmonia Mundi labels have been very successful, particularly with Baroque Concertos. Jecklins have entered the cassette market with Metronome, Columbia and Parlophone material for the Philips' system. To date, between thirty and forty cassettes have been issued, and Jecklin see a reasonably large future for them as an additional market, but not to the detriment of the gramophone record.

Phonag A.G. During the past twelve months the company has completed its contract with CBS. CBS is now handled independently by its own newly-formed CBS Schalplatten A.G. company, based in Zug and headed up

(Continued on next page)

P

WE PROMOTE IN ORDER TO SELL

WE SELL IN ORDER TO MAKE A PROFIT

WE MAKE A PROFIT IN ORDER TO PROMOTE

SOME PEOPLE THINK WE ARE RIGHT

WE THINK THEY ARE RIGHT IN THINKING WE ARE RIGHT

WE ARE PHONAG IN WINTERTHUR

PHONAG A.G. IS AN INDEPENDENT COMPANY IN SWITZERLAND

NOT THE ONE BUT SOME PEOPLE SAY A GOOD ONE

WE THINK THEY ARE RIGHT

PHONAG A.G. STADTHAUSSTRASSE 69 POSTFACH 66

8401 WINTERTHUR, SWITZERLAND

Telephone: 052-23-62-31

EDITION HELBLING

We are one of the most active and largest publishers in Switzerland and represent many major catalogues of the world.

IF YOU HAVE A HIT OR A WHOLE CATALOGUE

YOU WANT US TO WORK ON PLEASE WRITE TO US:

HAUS MELODIE, VOLKETSWIL—ZURICH

SWITZERLAND

Cables: HELBLINGMUSIC, ZURICH

Tel: (051) 86 43 93

Switzerland—The Past 12 Mos.

(Continued from page 82)

by Managing Director Mr. Wijngaard.

During the year, Phonag has acquired several new and important labels for representation in Switzerland, including the Czechoslovakian classical label Supraphon. One of the label's top artists Karel Ancerl visited Switzerland during the year for a series of concerts, resulting in excellent sales for his recordings with the Czech Philharmonia Orchestra. Other labels acquired during the year were Fonit-Cetra of Italy, with its considerable repertoire of "pop" and classics—the latter being particularly strong in the operatic field. Top Fonit-Cetra star Claudio Villa with his winning song from San Remo, "No Pensare A Me" turned out to be Phonag's best-selling top single of the year. Villa's Eurovision song, "Non Andare Piu Lontana" has also been issued in Switzerland by Phonag. Another Italian label acquisition was Vedette, again with a "pop" and classical catalogue, the latter specialising in old baroque and renaissance material. Vedette "pop" artist Gian Pieretti also made a promotional visit to Switzerland for radio and television, with considerable success. From Germany, Phonag acquired Belaphon, a label especially strong in "pop" music. Other new label acquisitions during the year have included the French "Belvedere" label, G.T.A. from Italy, and Eurocord from Germany. Phonag have also taken the new Cornet label from Germany, recently formed by A.&R. Managers, Ilgner & Gietz.

The Finsterwald & Cantacuzene, Vogue S. A. and Belmont S.A. group of companies enjoyed considerable success in Switzerland during 1966/67. Apart from the labels represented by the firm, such as Vogue, Deutsche Vogue, Pye, Durium, Saar, AZ, Dot, Kapp, Scepter, and Roulette, Finsterwald & Cantacuzene has taken over the distribution of Hispavox (Spain), Star (Swiss folklore), Ember (Great Britain), Joker (a budget line label) and The Schwann-Music Sacra repertoire from Germany. Innumerable

chart successes during the year included "To Whom It Concerns" by Chris Andrews, "Ridera" by Little Tony, "My Love" by Petlua Clark, "La Poupee Qui Fait Non" by Michel Polnareff, "Sunny Afternoon" by The Kings, "Love Me" by Michel Polnareff, "Hanky Panky" by Tommy James, "Les Play-Boys" by Jacques Dutronic, "Merci Cherie" by Udo Jurgens, "Mr. Cannibal" by Andy Fisher, "Dandy" by The Kinks, "Tata Ta Ta" by Michel Polnareff, "Dear Mrs. Applebee" and "Please Mr. Movingman" by David Garrick, "Un homme une femme" by Pierre Barouh.

This series of successes allowed Finsterwald & Cantacuzen to remain a first rank organisation, both on the national and international levels. Their success was further enhanced by the achievements at San Remo of "Cuore Matto" by Little Girl, "Pietre" by Antoine, and by the two first winners of the Eurovision contest, "Puppet on a String" by Sandie Shaw, and "If I could Choose" by Sean Dunphy. Sales reached a new record in 1967.

The Finsterwald & Cantacuzene group also participated in the Midem international meeting at Cannes.

Another advantage for the firm is that most of its artists are able to sing in several languages, thus allowing a larger diffusion of success in the international field. These artists include Petula Clark, Francoise Hardy, Michel Polnareff, Udo Jurgens, Antoine, Christophe, etc. Finsterwald & Cantacuzene also specialise in the Swiss market with different "Budget line" labels, such as Mode, Joker, Marble Arch and Pop.

Due to the installation of new electronic record presses, and to certain rationalisations made in their factory, Turicaphon A.G. was able to increase their yearly capacity of records from 3 million to 4 million during the past year. Turicaphon A.G.'s label, Elite Special distributed over the whole world, made an exclusive contract with Boris Rubaschkin, a Russian singer who is living in Vienna and has released two of his records "Russische Volkslieder" and "Alte Russische Soldatenlieder" with great

success in Europe, U.S.A. and Canada. The artist's third 12" LP will be available during the next few weeks entitled "Russische Strassenlieder".

At present the Elite special 12" LP catalogue comprises more than 350 stereo recordings. In the classical field the following original Spanish organ recordings have sold well— "Alt-Spanische Orgelmusik" Auf Spanischen Orgeln

Another successful record, combining both piano and guitar entitled "Kammermusik Fuer Gitarre Und Klavier" has already been pressed in different countries of the world. Two notable additions have been made during the year to Turicaphon's Swiss Jazz label, started a few years ago. These were "The Golden Swing Years" and "Teddy Stauffer's original Teddies". The recordings were actually made in the years 1940/41.

Elite Special's best selling album in the past year has been "Froehliche Weihnacht Ueberall" which has notched up European sales of over 100,000 records.

On the publishing side, Turicaphon's group of companies has had another highly successful year, with the following best sellers:—Edition Annabella has had "Balla Balla" by The Rainbows, and "N'Avoue Jamais" by Guy Mardel. Another of their companies, Flora Musikverlags enjoyed considerable success with Beatles' material, notably "Yesterday" "Michelle" and "Revolver". Musikus had their biggest hits with "Sorry Little Baby" by Hans-Jurgen Baumler and "Es Ist So Schoen, Dass Es Dich Gibt" by Connie Francis. For Edition Turicaphon AG, it was a year of evergreens, notably "Blauer Himmel" and "Tango Bolero".

The year also saw the foundation of a new music publishing company, called Arena Verlag GmbH. This company's best seller was "Einsamer Boy" by Wencke Myhre".

For Siemens E.A.G. it has been a satisfactory year, with particularly good results from the company's three budgetline album series, Heliodor retailing at 10.95 francs, the classical

DGG "Privilege" series selling at 17 francs, and the "Pop" Privilege" selling at 15 francs. DGG's top classical Archive series remains at the old selling price of 27 francs. Commenting on the new price structure, a spokesman for Siemens said that it is generally agreed that record prices were too high before the abolition of RPM.

The company's biggest success of this year, and in fact of any year, has been with the MGM "Zhivago" film sound track. Approximately 15,000 copies were sold in nine months—something like four times the sales figure for an average best selling LP. The film is still running in Zurich and playing to capacity after seven months. The original single "Lara's Theme" is released by Siemens on MGM, but the best selling version in the singles field has been the French version "Chanson de Lara" by John William on Polydor, with sales exceeding 35,000 in the short time of eight months. Additionally, a host of instrumental and cover versions are also notching up good sales. Roy Black continues to be a major selling artist, with two big hits in the past year, "Irgend Jemand Liebt Auch-dich" and his latest release, "Good-night My Love". His album, "Roy Black" has been a best seller as was his first Italian single recording, "Voglio Dirti Grazie".

In the Italian field, major hits have come from Orietta Berti, notably with her San Remo song, "Io Tu E Le Rose". Connie Francis also enjoyed considerable success with her Italian version of the "Zhivago" theme.

Among the American best sellers for Siemens were The Loving Spoonful and the Easy Beats, and from England, The Who and The Cream. In the instrumental field, James Last has proved a major seller with his singles "Lara's Theme" and "This is My Song" from the film The Countess of Hong Kong. He has also enjoyed good album sales. Bert Kaempfert continues to maintain his popularity in the best seller lists.

The Philips cassettes have been

(Continued on page 86)

In Switzerland

The centre of the Record Industry is

MUSIKVERTRIEB AG

8040 Zurich, Badenerstrasse 555

Telephone: 051/54.97.54 Cable: Musikvertrieb Zurich

DISTRIBUTING THE TOP LABELS
IN THE WORLD OF
MUSIC

Argo		
Ariola	Bluebell	Capitol
Cameo Parkway	Colgems	Coral
Decca	Deram	Dunhill
Elite-Special	Eurodisc	Festival



Hansa	London
Hickory (London)	Monument
L'Oiseau-Lyre	RCA-Victor
Reprise	Ricordi
Telefunken	Vega
Warner-Bros.	White Whale

THE SOUND OF ATLANTIC



AROUND THE WORLD!

Foreign Licensees and Distributors of Atlantic Recording Corporation

ARGENTINA:

SURCO INDUSTRIAS MUSICALES
Tucuman 439
Buenos Aires, Argentina
Mr. Enrique Iriberry
phone: 32-0123

AUSTRALIA:

FESTIVAL RECORDS PTY. LTD.
223-229 Harris Street
Pyrmont, N.S.W., Australia
Mr. Frederick C. Marks
phone: 68-4021

BELGIUM:

COMPAGNIE PHONOGRAPHIQUE
FRANCO-BELGE BARCLAY
31, Rue du Lombard
Brussels 1, Belgium
Mr. V. Bral
phone: 11 81 97

BRAZIL:

COMPANHIA BRASILEIRA DE DISCOS
Caixa Postal 4082-ZC-05
Av. Rio Branco 311, 4° Andar
Rio de Janeiro, Brazil
Mr. Alain Trossat

CANADA:

QUALITY RECORDS, LTD.
380 Birchmount Road
Scarborough, Ontario
Canada
Mr. George Kean
phone: OX 8-5511

CHILE:

PHILIPS CHILENA S.A.
Casilla 2687
Santiago de Chile, Chile
Mr. Hernan Serrano

COLOMBIA:

PHILIPS COLOMBIANA S.A.
Apartado Aereo 4282
Bogota, Colombia
Mr. Alfonso Escolar Nieto

COSTA RICA:

INDUSTRIA DE DISCOS
CENTROAMERICANA
P.O. Box 4093
Avenida 8, Calles 11/13
San Jose, Costa Rica
Mr. Jose Tassis
phone: 21-31-22

DENMARK:

Metronome Records A/S
31 Vibevej
Copenhagen, Denmark
Mr. Bent Fabricius-Bjerre
phone: AEGir 8112

ENGLAND:

POLYDOR RECORDS LTD.
17-19 Stratford Place
Oxford Street
London, W.1., England
Mr. Roland Rennie
phone: HYDe Park 7401

FRANCE:

DISQUES BARCLAY
143 Avenue de Neuilly
Neuilly sur Seine, France
Mr. Eddie Barclay
phone: 722-60-30

GERMANY:

METRONOME RECORDS G.m.b.H.
Heidenkampsweg 76 B
Hamburg, Germany
Mr. Leif Kraul
phone: 24 12 61

GREECE:

DIONYSOS
GENERAL PUBLISHING CO. LTD.
11, Kriezotou Street
Athens 134, Greece
Mr. Alexander Patsifas
phone: 616 716

HOLLAND:

POLYDOR NEDERLAND N.V.
Piet Heinplein 5
Den Haag, Holland
Mr. E. Garretsen
phone: 63 49 55

HONG KONG:

COSDEL (HONG KONG) LTD.
1331-2 Prince's Building
Hong Kong, B.C.C.
Mr. T. K. Whang
phone: 24 08 23

ITALY:

RIFI RECORD CO.
77 Corso Buenos Aires
Milan, Italy
Mr. Giovanni Battista Ansoldi
phone: 27.36.41

JAPAN:

NIPPON GRAMMOPHON CO. LTD.
6-6, 1-chome Shinbashi
Minato-ku
Tokyo, Japan
phone: 572 6451
Mr. Gunter Hellgardt

MEXICO:

DISCOS UNIVERSALES S.A.
Rio Tiber No. 58
Mexico 5, D.F.
phone: 25 29 89
cables: GRAMMOPHON
Mr. Hans Schrade

PERU:

EL VIRREY INDUSTRIAS MUSICALES S.A.
Avenida Panamericana 3551
San Isidro, Peru
Mr. Polidoro Garcia

PHILIPPINES:

MARECO, INC.
131 Del Monte Avenue
Quezon City, Philippines
Mr. Luis Villar

SINGAPORE:

COSDEL (SINGAPORE) LTD.
P.O. Box 2659
General Post Office
Singapore
telephone: 35 0 47
Mr. S. P. Sim

SOUTH AFRICA:

TEAL RECORD CO. LTD.
124 President Street
Johannesburg, South Africa
telephone: 22-0355
Mr. A. G. J. McGrath

SPAIN:

HISPAVOX S.A.
Torrelaguna 102
Madrid 17, Spain
telephone: 215 2304
cables: VOX
Mr. Luis Calvo

SWEDEN:

METRONOME RECORDS AB
Storangsavagen 27
Stockholm, No., Sweden
telephone: 61 06 16
Mr. Borje Ekberg

SWITZERLAND:

BARCLAY RECORDS S.A.
14, Rue du Roveray
Geneva, Switzerland
Mr. Claude Aubert

TURKEY:

MELODI RECORDS
Istiklal Cad. Lion Magazasi Yani
Istanbul, Turkey
Mr. Kayihan Caglayan

VENEZUELA:

SIEMENS VENEZOLANA S.A.
Apartado 3616
Caracas, Venezuela
Mr. Harry Alex

ATLANTIC Records, 1841 Broadway,

THE SOUND OF ATLANTIC AROUND THE WORLD!

- ★ THE YOUNG RASCALS
- ★ ARETHA FRANKLIN
- ★ SONNY & CHER
- ★ HERBIE MANN
- ★ BOBBY DARIN
- ★ WILSON PICKETT
- ★ JOE TEX
- ★ BUFFALO SPRINGFIELD
- ★ ARTHUR CONLEY
- ★ CHARLES LLOYD
- ★ SOLOMON BURKE
- ★ ESTHER PHILLIPS
- ★ PERCY SLEDGE
- ★ THE MODERN JAZZ QUARTET
- ★ BEN E. KING
- ★ DAVE PIKE
- ★ THE CAPITOLS
- ★ BARBARA LEWIS
- ★ BENNY LATIMORE
- ★ KEELY SMITH
- ★ DON COVAY
- ★ ROY AYERS
- ★ KING CURTIS
- ★ THE DRIFTERS
- ★ DON VARNER
- ★ CHICK COREA
- ★ ART FREEMAN
- ★ FLIP WILSON
- ★ TOM SANKEY
- ★ PERCY WIGGINS
- ★ TED TAYLOR
- ★ DEON JACKSON
- ★ AL JOHNSON
- ★ ROBIN KENYATTA
- ★ DEE DEE SHARP
- ★ MARY WELLS
- ★ FREDDIE HUBBARD
- ★ CLARENCE CARTER
- ★ BYARD LANCASTER
- ★ HUBERT LAWS
- ★ YUSEF LATEEF
- ★ CLARENCE "FROGMAN" HENRY
- ★ JEAN BONNARD
- ★ DARRELL BANKS
- ★ JUNIOR MANCE
- ★ JIMMY HUGHES
- ★ SHELLY MANNE
- ★ JOE ZAWINUL
- ★ THE VAGRANTS
- ★ CARMEN McRAE
- ★ CLAY TYSON
- ★ IRA SULLIVAN
- ★ BOOKER T. & THE MG'S
- ★ SOUL BROTHERS SIX
- ★ ROLAND KIRK
- ★ EDDIE HARRIS
- ★ PATTI LABELLE & THE BLUEBELLES
- ★ VANILLA FUDGE
- ★ RUFUS HARLEY
- ★ HANK CRAWFORD
- ★ LESLIE UGGAMS
- ★ MOSE ALLISON
- ★ SWEET INSPIRATIONS
- ★ BROTHER JACK McDUFF
- ★ NAT ADDERLEY



New York 10023 (212) PL 7-6306

SWISS Record Manufacturers

ALBERT ACHERMANN A.G.

Höhner Schallplatten,
Telstrasse 21,
8026 Zurich.
Tel: 051-25 03 09

BARCLAY RECORD S.A.

Rue du Roveray 14,
1200 Geneva.
Tel: 022-36 17 41
Labels: Ateo, Atlantic, Barclay, Bravo, Erato,
Iag, Ricolo, Riviera, Tempo (Germany).

BARENREITER-VERL A.G.

Neuweilerstrasse 15,
4000 Basel 15.
Tel: 061-39 58 99
Labels: Barenreiter-Musicaphon, Calig, Da Ca-
mera, Cantante, Laudinella.

CBS SCHALLPLATTEN A.G.

Unter Alstadt 10,
6300 Zug.
Tel: 042-4 62 22
Labels: Artone, CBS, Date, Epic, Funckler,
Hickory, Musicor, Okeh, Oldtown, Tamla
Motown, Temporel, Westminster.

DISQUES-OFFICE,

188, Rue Pierre Aebly,
1700 Frigourg.
Tel: 037-2 62 61
Labels: Ades, Atlantic, Alpha, Barque, Musi-
disc, National, Ocora, Pacific-Orpheo, Petit
Menstrel, Bam, President, Supradisc, Visa-
disc, Vista, Discophiles

ELECTROMUSIC A.G.

Nauenstrasse 71,
4002 Basel.
Tel: 061-34 92 50
Labels: Alpina, Alpha, Discaphon, Holidays,
Juke Box, Special Record (Tempo), Tell, Sa-
brina.

EDITION EULENBURG GmbH,

Grutstrasse 28,
8134 Adliswil.
Tel: 051-91 36 81
Labels: MMO (Classic Edition)

FONO-GmbH,

Seidenhofstrasse 14,
6002 Luzern.
Tel: 041-22 22 88
Labels: FGL, Fono.

HUG & CO.

Lindenhofstrasse 16,
4001, Basel.
Tel: 061-35 10 77
Labels: Bartok, Electrola/HMV, Encore, Ency-
clopedia Sonore, Hor-Zu, Jupiter, La Voce
Del Padrone, Liberty, Linguaphone, Monitor,
Plaisir Musical.

JECKLIN & CO.

Ramistrasse 42,
8024 Zurich.
Tel: 051-34 52 77
Labels: Choir, CCA, Ducretet-Thomson, Har-
monica Mundi, Immediate, Luna, Studio 2
Stereo, Tamla Motown, Angel, Cabaret Aus
Wien (Preisler), Carish, CGD, Columbia,
Contemporary, Die Prominente Stimme, Im-
perial, Metronome, Odeon, Parlophone,
Pathe, Preisler, Quadrigo-Ton, Regal, State-
side, Stereo, Super Majestic, Tamla Motown,
Turnabout, Volksplatte.

JOHN LAY,

Bundesstrasse 13,
6002 Luzern.
Tel: 041-3 44 55
Labels: Bellaphon, Balex, Everest, Starlett,
Superton, Tempo Vedette, Welt Melodie,
Amati, Apex, Arc, Bluesville, Carneval, Cor-
sair, Embassey, Melody, Moodsville, Musica
et Litera, Layola, New Jazz, Orchestola,
Pilatus, Premiere, Prestige, Ronnex, Saga,
Society, Sphinx, Swiss Sound, Teeny, Unesco,
Valois.

LA LIBRAIRE NOUVELLE

18, Rue de Carouge,
1200 Geneva.
Tel: 022-25 98 76
Labels: Chant du Mond, Folkways.

MUSIKVERTRIEB A.G.

Badenerstrasse 555,
8040 Zurich.
Tel: 051-34 54 97 54
Labels: A & M, Bluebell, Bentler, Cameo-
Parkway, Canadian, Capitan, CMS, Con-
stanze, Deram, Hickory London, Interrecord,
Impact Festival, Mignon, Monument, Bacca-
rola, Ace of Clubs, Ace of Diamonds, Ace of
Hearts, Argo, Ariola, Athena, Bluebell,
Brunswick, Capitol, Century, Colgems, Coral,
Decca, Dunhill, Elite Special, EMAG, Euro-
disc, Festival, GR, Hansa, Hed Arzi, Hor
Zum, Jaguar, Junior, L'oiseau-Lyre, Loma,
London, MRC, Monlondji, North, Niagra,
PINKA, Piper, RCA (Arc), RCA Camden,
RCA Victor, RCA Victrola, Reprise, Ricordi,
River, Sidewalk, Starlet, Swizz-Jazz, Tele-
funken, Tower, Triola, Uptown, Vega, War-
ner Bros., Superton, White Wahle, Ace.

ORBEXIS A.G.

Angensteinstrasse 15,
4000 Basel 20,
Tel: 061-41 18 29
Labels: Design, Grand Prix, Happy Time, Pax-
ton, Pickwick, Presto.

OVERSEAS RECORDS A.G.

Alte Zurcherstrasse,
8154, Oberglatt.
Tel: 051-94 71 50
Labels: Carosello, Pergola, Starlette (Italy),
Vergara (Spain), Anstraphon, Allas-Fidelio,
Ciau Ragazzi, Clan Celentano, Curci, Delta,
DNG Cantastorie, Embassy, Folkpop, IPM,
Italmusica, Kansas, Kappao, Las Vegas,
Level, Maietti, Mazzi, Mondial, Ole, Oversea,
Panorama, Pig, Pleint Vent, President, Pri-
mary, Ribalta, Roman, Said, Silver, Sonor,
Sunstar, Syr, Tauro, Togo, Topas, Variety,
Wergo.

PELIKAN MUSIKVERLAG.

Bellerivestrasse 22,
8034, Zurich.
Tel: 051-32 57 90
Labels: Harmonica Mudi, Camerata, Concentus
Musicus, Iramac, Schwann, Pelca.

PHILIPS A.G.

Raffelstrasse 25,
8027 Zurich.
Tel: 051-44 22 11
Labels: Musica Antiqua, Pergola, Battle, Caed-
mon, Carvel, Cynus, Fidelity, Fontana,
Jazzland, Melodicon, Orpheus, Star-Club,
Veejay, Wing, World Pacific.

PHONAG SCHALLPLATTEN A.G.

Stadthausstrasse 69,
8401 Winterthur.
Tel: 052-23 62 31
Labels: Bellaphon, Cetra-Fonit, Cornet, Ero-
vox, Eurocord, Finale, GTA, Marfer, Pips-
Elle, Supraphon, Tempo Vedette, Amadeo,
Amanda, Belvedere, Bluenote, Center, Eureka,
MPS, Phonga, Phonocolor, Popular, Primavera,
Quodlibet, Saba, Style, Symco, Van-
guard.

PICK RECORDS.

Schallplatten Vertrieb,
Brunnwiesenstrasse 26,
8049 Zurich.
Tel: 051-56 70 60
Labels: Amalthea.

A. ROTH LISBERGER.

Schallplattenvertrieb,
Dufourstrass 4,
2500 Biel.
Tel: 032-3 01 11
Labels: Marfer, Ariston, CDI, Ciak, Combo,
Discollino, Italsud, Phonotyp, Rotberg, Uni-
versal, Vis Zeus.

SIEMENS EAG.

Lowenstrasse 35,
8021, Zurich.
Tel: 051-27 26 52
Labels: Adria, Archiv Produktion, Brunswick,
Polydor, Command, DGG, Heliodor, Hit
House, Italdisc, Kama Sutra, King, MGM.

TURICAPHON A.G.

Schweizer Schallplatten-Fabrik,
8611 Riedikon.
Tel: 051-87 43 11
Labels: Asmahan, Baidaphon.

VOGUE S.A.

70, Avenue des Alpes,
1820 Montreux.
Tel: 021-62 45 55
Labels: Adventure, Electra, Ember, Epidaure,
Hispanvox, Hanna Barbera, Jolly, Jocker, Lu-
men, Laurie, Markal, Mainstream, MKN,
Mondiophone, Pacific-Orpheo, Palette, Star-
bestgen, Stella, Strike, A.Z. Belter, Calig,
Cam, Charlin, Christophorus, Circus, Clate,
Collector, Contrepoint, Diademe, Dixieland,
Donnia, Durium, Epsilon, Gene Norman, Si-
mon, Spoken Arts, Time, Transatlantic, Hit-
Ton, Jericho, Kapp, Mode, Musica Sacra, Or-
feon, Piccadilly, Pastorale et Musique, Pop,
Pye, Roulette, Royal, Scepter, Schwann,
Somerset, Sprint, Storyville, Studio SM,
Sonet-Chancellor, Tico, Titanus, Tono, Typic,
Unidisc.

WASSERTURM STIFTUNG

Chorknaben St. Paul,
Moosmattstrasse 28,
6000 Luzern.
Tel: 041-41 24 21

SWITZERLAND

MUSIC PUBLISHERS

ALPANA ABERBACH GMBH

c/o Hans Jecklin,
Ramistrasse 42,
8000 Zurich 1.
Tel: 24 39 41

EDITION ANNABELLA

Weidstrasse 11,
8610, Uster, Zurich.
Tel: 87 30 72

EDITIONS DE BELMONT S.A.

Avenue des Alpes 70,
1820, Montreux.
Tel: 62 45 55

WILLY BESTGEN

Postfach 25,
7270 Davos 2.

EDITION CODA

Brunnenwiesenstrasse 26,
8049, Zurich, 10/49.
Tel: 56 70 60

EDIFO S.A.

Badenerstrasse 334,
8000 Zurich 4.
Tel: 54 64 77

FLORA GMBH

Weidstrasse 11,
8610 Uster, Zurich.

HELBLING & CO.

8604, Volketswil/Zurich.
Tel: 86 43 93

EDITION MELODIE

Brunnenwiesenstrasse 26,
8049, Zurich 10349.
Tel: 56 70 60

MUSIKUS GMBH

Weidstrasse 11,
8610, Uster, Zurich.
Tel: 87 30 72

SIDEM

8, Rue de Hesse,
1200, Geneva.
Tel: 25 59 55

SOUTHERN MUSIC A.G.

Hauptpostfach 617,
8000 Zurich.
Tel: 42 31 38 (Brunner)

ED. TURICAPHON A.G.

8611, Riedikon Bei Uster, Zurich.
Tel: 87 43 11

WALTER WILD

Aehrenweg 11,
8056 Zurich 56.
Tel: 48 45 66

CADENZA EDITION

8, Rue de Hesse
1200 Geneva.
Tel: 25 59 55

MONDIA MUSIC

8, Rue de Hesse
1200 Geneva.
Tel: 25 59 55

SWITZERLAND

SUPPLIES & SERVICES

PRESSING PLANT

TURICAPHON A.G.
Schweizer Schallplattenfabrik
8611 Riedikon/Uster, Zurich.
Tel: 87 43 11 Telex: 52645

MUSIC LICENSING ASSOCIATIONS

SUISA (Societe Suisse des Auteurs et Editeurs)
General Guisan Quai 38, 8027 Zurich 27.
Tel: 25 77 00

RECORDING STUDIOS

TONSTUDIO HUG & CO.
Fusslistrasse 4, 8000 Zurich 1.

ALFRED LUSSI

Disco-Ton Wettsteinall 21,
4000 Basle.

MAX LUSSI

Tonstudio,
Leimenstrasse 76,
4000 Basle.

STUDIO D'ENREGISTREMENT DE DISQUES

B.V.M.
32, Rue de St. Jean,
1200 Geneva.

W. A. WETTLER

Bachtelstrasse 16,
8304 Wallisellen.

Switzerland—The Past 12 Mos.

(Continued from page 86)

highly successful, and in some cases have outsold the LP's from which they were taken. So far, 100 cassettes have been released (including about 60 stereo), with material from all the DGG labels and MGM, Kama-Sutra, Verve and U.A. DGG is now planning to release classical cassettes. In the classical field, Philips were again very successful, specially with the subscription line in which "Missa Solemnis" two-record set was way up front as far as sales were concerned. Second came the Handel Concertos for Organ, a five-record set conducted by Von Karajan. Third came Beethoven's Piano Sonatas (eleven record set), and fourth "Tristan & Isolde" (five record set). A major feature of the classical releases has been the tremendous success of the low priced Heliodor label, selling at 10.95 francs. In two years, Heliodor has built up a repertoire of approximately 100 releases.

As far as the publishing scene in Switzerland is concerned, the past year has brought its problems. For instance, as a result of the German I.F.P.I. and T.V.L. strike, the number of sub-publishing copyrights has been drastically cut. Another difficulty for publishers in an essentially importing country is the popularity of 'beat' music, and the fact that many of the top artists in this field not only record and write their own material, but publish it as well—thus cutting the potential royalties normally enjoyed by established publishers. The last twelve months has seen a vast up-trend in the popularity of British and American material. Again, many of the hits being independently published by the artists. On the other hand, sheet music sales are better in Switzerland than in Germany.

For Editions Coda it has been another good year. Highlights have been the success of the standard catalogue of Evergreens, plus 'pop' music titles such as "The Green Beret", "Spanish Eyes" and "Little Man", Editions Coda also publishes—together with Editions Baur—the score of Switzerland's smash-hit stage musical, "Golden Girl" by Hans Moeckel, Hans Gmuier and Hans Suter, currently touring Switzerland. The original cast recording is released on the Pick label. Pick enjoyed large sales also with its catalogue of Swiss Folklore Music. Other Coda hits include The Wild Gentlemen's single, "Gilly Gilly" and their album of the same title. The Wild Gentlemen are now embarking on an international career with TV appearances in France and Germany.

Editions Melodie have expanded in the field of educational music, and amongst the most popular material has been that written by Hans Bodemann for recorder and guitar. During the year, a new publishing company has been formed between Ringier S.A. and Peterers—Editions Televox Gmph.

Editions Helbling. Already the Swiss Representative for Chappells, and Southern, as well as World Music of Brussels, including Zodiac Music of America, have during the past twelve months, added yet two other catalogues to its repertoire, Campbell Connelly of Gt. Britain and Edward B. Marks of the United States. The Campbell Connelly deal gave Helbling a major hit with "No Milk Today" by Herman's Hermits. Edward Marks gave them the Irish song, "The John F. Kennedy March". From Southern Music Helbling had many English-produced hits, including "Winchester Cathedral", "Superman" and "Mellow Yellow" etc. etc. Chappells brought them two new musical scores, "Mame" and "Georgy Girl". Mr. Brunner of Editions Helbling was also responsible for promoting a new instrumental group, "Cappelletti" who recorded ten singles for release by Tell Records. Early in 1967 Helbling found a new and important group of singers, Eugster, who although well known on radio and television, had not previously recorded. Brunner signed them up and will record them for the local and international markets, singing in French, Italian, German and English. A new recording contract was also signed with Anita Traversi.

FIRST IN MUSIC— FIRST IN RECORDS!



EDITION CODA PICK RECORDS OF SWITZERLAND



The Active Publishing Company With Its Own Record Affiliation

EDITION CODA • POSTFACH 260 • 8049 ZURICH
PICK RECORDS • POSTFACH 198 • 8049 ZURICH

In A Word... A WORLD OF MUSIC

I
T

F S
R O
A U G
N T E H

S
C
A
A
N

S
O
U
T
H
H
A
F

A. SCHROEDER

L P E A M L A I N I
Y A M A L S N G C
I E N A T A L A
N R Y N V A
I D I N
C A D
A

And In Two Words...

JOIN US!

ABBY STEINBERG-WALLY GOLD
25 W. 56th St.,
NEW YORK, N.Y. 10019
(212) JU 2-8810
CABLE: SCHROMUS, N.Y.

DAVID MOOK
9000 SUNSET BLVD.
LOS ANGELES, CALIFORNIA 90069
(213) 274-7351

A. SCHROEDER MUSIC CORPORATION



disques
vogue

VOGUE INTERNATIONAL INDUSTRIES

FRANCE

HAS THE WORLD



PETULA CLARK



AIMABLE



LES CHARLOTS

ANTOINETTE



disques
vogue

VOGUE INTERNATIONAL INDUSTRIES

AND THEIR N°1 HIT BY THE VOGUE

BRANCHES

VOGUE P.I.P.
PARIS—VILLETANEUSE (Seine) FRANCE
Tel: 752.73.00 / Telex: VOGDISC 28.493

VOGUE BELGIUM
VOGUE P.I.P. BELGIQUE / VOGUE S.A.
35 Bld Barthelemy - BRUXELLES (BELGIUM)

VOGUE GERMANY
DEUTSCHE VOGUE
SCHALLPLATTEN
VOGUE SCHALLPLATTEN
GMBH
ZUR MUHLE 2
5021 Grosskonigsdorf bei
Köln (GERMANY)

VOGUE SWITZERLAND
VOGUE S.A.
70, Avenue des ALPES
MONTREUX (SWITZERLAND)

DISTRIBUTED THROUGHOUT THE WORLD

A Hc Te 80 Tc
B Rn 12 Tc L
B N 40 Tc L
C U 6 Tc L
D I 1 Tc L
E N 4 Tc L
I C E T I I C E T I I

N°1 RECORD COMPANY

N°1 ARTISTS



**FRANÇOISE
HARDY**



**JACQUES
DUTRONC**

**PIERRE
PERRET**

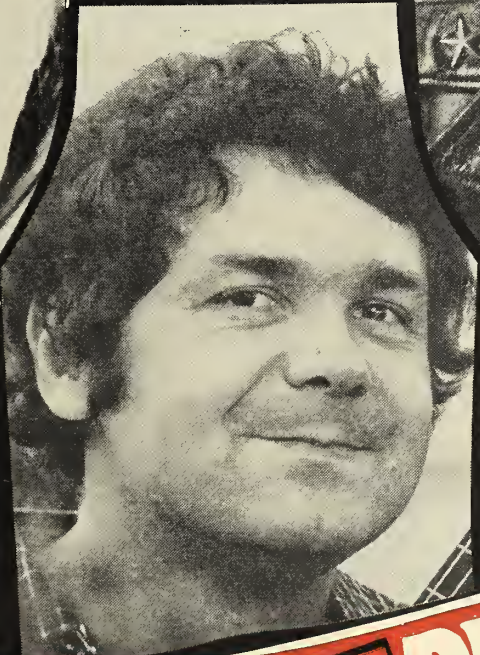

SULLIVAN

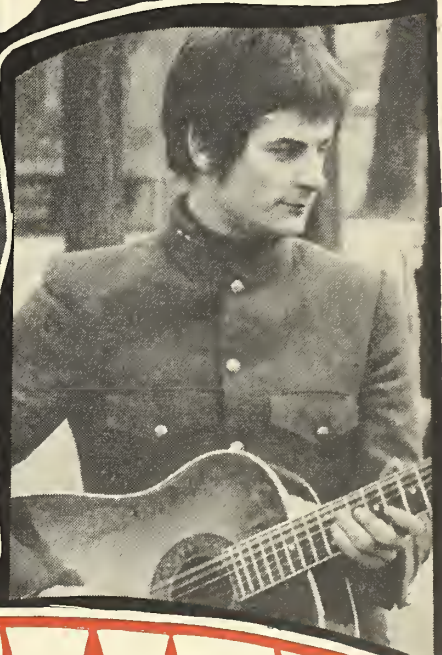

ARE ALSO PUBLISHED

THE VOGUE GROUP

ASSOCIATED PUBLISHING COMPANIES

VOGUE INTERNATIONAL
20, Bis Rue Louis PHILIPPE
NEUILLY-sur-SEINE (Seine)
FRANCE
TEL: 722.05.30

EDITIONS GERARD CALVI
54, Rue d'Hauteville
PARIS (Seine)
FRANCE
TEL: 824.93.83

EDITIONS DU CARROUSEL
20 Bis, Rue Louis PHILIPPE
NEUILLY-sur-SEINE (Seine)
FRANCE
TEL: 722.05.30

VOGUE INTERNATIONAL
BELGIQUE
35 Bid Barthelemy
BRUXELLES
BELGIUM

EDITIONS ALPHA
54, Rue d'Hauteville
PARIS (Seine)
FRANCE
TEL: 824.93.83

EDITIONS BELMONT
70, Avenue des ALPES
MONTREUX SWITZERLAND

EDITIONS BELMONT
ZUR MUHLE 2
5021 Grosskonigsdorf bei
Köln GERMANY

**VOGUE INTERNATIONAL—
HOLLAND**
Heemsteedse dreef 287
HEEMSTEDE
HOLLAND
TEL: (02500) 83654-81445

NEW YORK OFFICE
C/O IRVING CHEZAR
555 MADISON AVENUE
NEW YORK

FRANCE—THE PAST 12 MONTHS

It is impossible to deny that the situation of the French record industry has been worrisome for the twelve past months. The French companies' turnover has been 17% lower in 1966 than in 1965. The fall reached 20% for the first three months of 1967 compared to the same period in 1966. First, this drop is the consequence of the general economic recession. Another reason is the greater and greater importance of clothes in the teenagers budget. But the most important fact is the difficulties the producers have in finding new stars. This season, for the first time since the beginning of the Yéyé period eight years ago, we did not see the birth of a big star. The last important revelations have been Michel Polnareff (AZ) and Jacques Dutronc (Vogue) last year.

This season began with a two-month strike by the musicians. The crisis has been really serious and artists had to go and record secretly in the different European countries. The end of 1966 also showed a new trend among the publishers. More and more they want to be independent producers.

In France the present year began with a fantastic event. The first international record and music publishing market, M.I.D.E.M., took place in Cannes from January 30th to February 4th. The market organized by Bernard Chevy has been a very great success, and it certainly began a very long career. This market offers an excellent opportunity to bring together the greatest possible number of music men from all over the world: A&R men, international music publishers, impresarios, agents and managers, broadcasting and TV executives, producers, deejays, composers and authors. All the participants during or after the market expressed delight at the contacts they made and the good deals they closed. Several really important French per-

sonalities are members of the MIDEM International Sponsorship Committee. They are: Charles Meri, president of S.D.R.M.; Georges Auric, president of S.A.C.E.M. and president of académie du disque Français; Henri Froment, president of SNICOP; and, since last month, president of the IFPI, Rolf Marbot; president de la chambre syndicale des Editeurs de Musique, Marc Pincherle; president de l'académie Charles Cros; and Paul Pisson, president of FNICM.

During that period we heard from Jacques Brel, who is one of the top French artists. He has decided to stop his stage appearances. He is tired, and wants to be free and do what he wants. It is a very bad and very important fact for French showbusiness. That is not the only drama among the stars. In May and June French showbusiness lost three important people. Ted Moura, general manager of President Records was killed in a car crash in Paris. A few days later, the charming girl deejay Frédérique who worked for Europe 1 suddenly died. She was twenty-five years old. Three days later, excellent artist René Louis Lafforgue was killed in a car crash. He was cut by Pathé Marconi, and managed a famous Parisian night-club, l'Ecole Buissonnière.

Just after MIDEM, Petula Clark came back to town. She came back from the States with her extraordinary recordings, the French treatment of "This Is My Song." French title is "C'est ma chanson". With that song Petula immediately reached first place on the chart and kept that position for three months. In February, Chappell publishing company presented its first record production. It is a new trio, the Hamsters. They recorded a French treatment of "Georgy Girl," the Seekers' hit. They have been distributed in France, Belgium, Holland and Germany by CBS Records. This winter CBS worked hard to promote

Caravelli. Records of that excellent orchestra director have been released in 37 different countries.

After Petula Clark and her song "C'est ma chanson," the most important successes since the beginning of the year are: "Inch Allah," by Adamo (EMI), Pathé Marconi publishing; "Paris en Colère," by Mireille Mathieu (Barclay), Salabert publishing; "Les Playboys," by Jacques Dutronc (Vogue), Alfa publishing; "L'heure de la Sortie" by Sheila (Philips), Carrère and Breton publishing. In the meantime Sheila finished her first movie, "Bang Bang." It should be a great success.

It is a fact movie songs are important in the French market this season. "A Man and A Woman" by Pierre Barouh and Nicole Croisille (AZ); "La Chanson de Lara," by the Compagnons-de la Chanson (CBS) or by John William (Polydor); "C'est ma chanson" by Petula Clark (Vogue); and, of course, the excellent Michel Legrand's music for Jacques Demy's musical, "Les Demoiselles de Rochefort," have been among the greatest successes of the past 12 months.

In February CBS did a special promotion job on Donovan. The British artist is getting stronger and stronger in France, and his success in Cannes at MIDEM contributed to make the CBS Show one of the most appreciated by the trade and the press. Donovan made a TV appearance in "Têtes de bois et Tendres Années." He was on stage for a one-man Show at the Olympia on March 1st. On the same date CBS released the "Mellow Yellow" LP. Festival artist Marie Laforêt is the leading star of the film "Le 13ème Caprice," directed by Roger Boussinot. The music from the film is published by Editions Derby.

The United Artists label is now distributed by Philips. In the first days of March, Eddie Adamis, who man-

ages this publishing company, presented his own first production. He recorded twin girls, Les Chéries. Their main title is "Le Fox Trotte," by Burt Baccarah and Eddie Marnay. Les Nouvelles Editions' Eddie Barclay has completed a deal with Columbia Screen Gems for musical themes in original version and French treatment to be published in France. First has been from the Matt Helm film, "Murderers' Row."

During the last week in March, the "Grands Prix Internationaux du Disque de l'Académie Charles Cros" were awarded. Prix Pierre Brive went to Régine (Pathé) and Jacques Dutronc (Vogue). Prix Chanson went to Nana Mouskouri (Philips) and Gilbert Grenier (Pathé Marconi). Prix Revelation went to Patrick Abrial (CBS), and the Prix du Premier Disque to the Poliakov sisters (Voix de son maitre) and J. Bertin (BAM).

The promotion show of the American company, Stax, featuring Otis Redding, Booker T. and the MG's, Sam and Dave, Eddie Floyd, Arthur Conley, and the Markeys was a very great success on the Olympia Stage. The Compagnie Européenne du Disque, which distributes Stax records in France, released at this occasion a promotion LP album entitled "Rhythm and Blues Panorama." It is interesting to note that in France American records are gaining a more and more important position. The losers appears to be the English groups. The Beatles, Rolling Stones and the Kinks are still very strong, but the American upswing seems to be irresistible.

Raymond Legrand created a special producing department for Decca. Vogue artist Colette Renard was the first to join him. In the meantime a new record label debuted in France. Its name is Disques "R." Its first artist is Milord who released an EP with four of his own songs. A few

(Continued on page 93)

MIREILLE MATHIEU

* LATEST RELEASE *

ADIEU A LA NUIT • NOUS ON S'AIMERA • POUR UN CŒUR SANS AMOUR • QUAND ON REVIENT

71.163 M

mireille
mathieu



★ A BARCLAY RECORDING ARTIST ★

MIREILLE MATHIEU
*
AROUND
THE WORLD

MAY/JUNE

GERMANY
CANADA
SOVIET UNION

JULY/AUGUST

BELGIUM
ENGLAND

SEPTEMBER

SPAIN
ENGLAND
USA

OCTOBER
NOVEMBER

ENGLAND
PORTUGAL

FROM
NOVEMBER 29 TH 67
TO JANUARY 7 TH 68

SPAIN
OLYMPIA
OF PARIS

EXCLUSIVE BOOKING
JOHNNY STARK



FRANCE — Music Publishers

AGEL L.
94, rue Boulanger, Paris 10e. COM 59-86 BOT 17-77

ALLELUIA
10 rue Saint Florentin, Paris 1er. 073-85-05

ALPHA
54, rue d'Hauteville, Paris. TAI 93-82

AMOUR
24, rue P. Semard, Paris 9e. TRU 56-39

ANDORRA
52, Faubourg St. Martin, Paris. NOR 45-91

APRIL MUSIC
3 rue Freycinet, Paris 16e. 727 26-45

ARC DE TRIOMPHE
2 bis, rue Sainte-Genevieve, Courbevoie. DEF 54-54

ARLEQUIN
12, boulevard Poissoniere, Paris 9e. PRO 86-03

ARMAGNAC
12, boulevard Poissoniere, Paris 9e. PRO 86-03

ARPEGE
25, boulevard Beaumarchais, Paris 6e. TUR 09-03

ASSOCIEES (les Editions), United Artists
7, rue de la Pepiniere, Paris 8e. 387.35-85 49-06

AZNAVOUR (Charles): Editions musicales
124 rue La Boetie, Paris 8e. BAL 80-30

BAETZ PH et Cie
52, rue du Faubourg St. Martin, Paris 10e. NOR 45-91

BAGATELLE
10, rue Washington, Paris 8e. ALM 17-99

BALS DE FRANCE
94, rue du General de Gaulle, Rosny-Sous-Bois.

BARCLAY (les Nouvelles Editions Eddie)
44, rue de Miromesnil, Paris 8e. ANJ 87-80

BAUDOIN
91, rue de Rome, Paris 8e. EUR 20-95

BAXTER Francis
6 avenue Parmentier, Sevran. AVR 51-02

BESSEL W et Cie
78, rue de Monceau, Paris 8e. LAB 02-13

BEUSCHER
25, Boulevard Beaumarchais, Paris 4e. TUR 09-03

BILLAUDOT
14, rue de l'Echiquier, Paris 10e. PRO 13-77

BOOSEY AND HAWKES
4, rue Drouot, Paris 9e. PRO 73-44

BORNEMANN et EDITIONS P. DECOURCELLE
15, rue de Tournon, Paris 6e. DAN 05-88

BOURCIER
12, boulevard Poissoniere, Paris 9e. PRO 86-03

BOUSQUET
61, faubourg St. Denis, Paris 10e. PRO 15-35

BRETON
3, rue Rossini, Paris 9e. TAI 86-19 TAI 53-64

CALIFORNIA
2 Avenue de Messine, Paris 8e. LAB 06.03

CALVI Gerard
54, rue d'Hauteville, Paris 10e. TAI 93-82

CAMIA (France Continentale)
80, rue Rene Boulanger, Paris 10e. NOR 06-54

CARAVELLE (voir PLANTE)

CARROUSEL
54, rue d'Hauteville, Paris 10e. TAI 93-82

CAYLA
33, faubourg St. Martin, Paris 10e. BOT 91-66

CHANTALINE
187, avenue Paul; Doumer, Triel (Set 0)

CHANT DU MONDE 1e
32, rue Beaujon, Paris 8e. WAG 67-73

CHAPPELL
4, rue d'Argenson, Paris 8e. ANJ 56-05

CHOUDENS
38, rue Jean Mermoz, Paris 8e. BAL 17-21

COLBY
87, 89, rue La Boetie, Paris 8e. ELY 76-54

COLIBRI
19A, rue Caumartin, Paris 9e. OPE 54-48

COMTESSE
44, rue de Miromesnil, Paris 8e. ANJ 87-80

COMUFRA (M. Legrand)
252, faubourg St. Honore, Paris. MAC 50-16 MAC 55-69

CONTINENTA LES
17, rue Monsigny, Paris 2e. RIC 05-23

COSTALLAT
60, Chaussee d'Antin, Paris 9e. TRI 78-71

CONTEMPORAINES
99, avenue Simon Bolivar, Paris 19e. BOL 68-19

COURCELLES
49, avenue Montaigne, Paris 8e. ALM 10-98

D'ANELLA
7, rue St. Lazare, Paris 9e. TRU 76-96

DEL CLERCQ (France Vedettes)
44, rue du Colisee, Paris 8e. BAL 69-83

DECURCK MAURICE,
61, avenue Raymond Poincaré, Paris 16e. PAS 69-69

DERBY
95 Boulevard Beaumarchais, Paris 3e. 272 37-98

DIGOUDE DIODET
39, faubourg St. Martin, Paris 10e. BOT 28-61

D.M.F.
14, avenue Hoche, Paris 8e. WAG 81-93

DO RE MI
5, rue Lincoln, Paris 8e. ELY 50-90

DORSAY
69, faubourg St. Martin, Paris 10e. NOR 61-50

DREJAC
60, rue Francois 1er, Paris 8e. ELY 62-36

DURAND ET CIE
4, place de la Madeleine, Paris 8e. OPE 45-74

ECO MUSIC
19, rue Lord Byron, Paris 8e. BAL 53-00

ENOCH
27, boulevard des Italiens, Paris 2e. RIC 69-95

ESCHIG (Max)
48, rue de Rome, Paris 8e. LAB 66-64

ESSEX
28, boulevard Poissoniere, Paris 9e. PRO 25-28

EUROPA
27, rue de l'Echiquier, Paris. PRO 19-45

FANTASIA
3, rue de Gramont, Paris 2e. RIC 61-23, RIC 96-10

FELDMAN
5, avenue de l'Opéra, Paris 1er. OPE 37-37

FESTIVAL
3, rue de Gramont, Paris 2e. RIC 61-23, RIC 96-10

FIESTA
87-89, rue La Boetie, Paris 8e. ELY 76-54

FORTIN
4, cité Chaptal, Paris 9e. TRI 58-34

FRANCE MELODIE
5, avenue de l'Opéra, Paris 1er. OPE 33-11, OPE 37-37

FRANCE VEDETTES
voir P. de Clerq.

FRANCIS DAY
5, avenue de l'Opéra, Paris 1er. OPE 33-11, OPE 37-37

FRANCE RECORD
33, rue Marc Séguin, Paris 18e. 206 71-08

FRENCH MUSIC
124, rue de La Boetie, Paris 8e. BAL 80-30

FRIZZA
56, rue de Paradis, Paris 10e. PRO 19-64

GARZON J.
13, rue de l'Echiquier, Paris. PRO 39-15

GASTE L.
5, rue du Bois de Boulogne, Paris 16e. POI 53-53

GOLF
8, boulevard Julien-Potin, Neuilly.

HAMELLE ET CIE
24, boulevard Malesherbes, Paris 8e. ANJ 36-39

HARMONIA
35, boulevard Malesherbes, Paris 8e. ANJ 08-93

HELIAN
252, faubourg St. Honoré, Paris 8e. MAC 50-16

HEUGEL
2 bis, rue Vivienne, Paris 2e. GUT 43-53

HOHNER
19, rue Van Loo, Paris 16e. BAG 63-50

HORTENSIA
46, rue de Douai, Paris 9e. TRI 52-64

IMPERIA
14, avenue Hoche, Paris 8e. WAG 01-46, WAG 01-13

JOBERT
44, rue du Colisée, Paris 8e. ELY 26-82

JOUBERT
25, rue d'Hauteville, Paris 10e. PRO 15-73

LABRADOR
29, cité d'Antin, Paris 9e. 874 05-06

LASRY A.
62, boulevard de Clichy, Paris 18e. MON 53-00

LEDUC A.
175, rue St. Honoré, Paris 1er. OPE 12-80

LEMOINE ET CIE
17, rue Pigalle, Paris 9e. TRI 09-25
(Continued on page 92)

HIT...CH-HIT with us to success

DECCA FRANCE

• MAURICE CHEVALIER •
• FERNANDEL • JACQUES LOUSSIER •
• COLETTE RENARD • BERNARD LAVILLIERS •
• ERIC CHARDEN • LES MACHUCAMBOS • • •
• MAURICE LARCANGE • JACK DIEVAL •

j.c. trambouze

FRANCE—RECORD MANUFACTURERS

BAM
133, bd Raspail.
Paris 6e.
LIT.16.12.
Managing director: A. Levi Alvarez.

BARCLAY
143, avenue de Neuilly.
Neuilly/Seine.
SAB.60.30.
Managing director: Eddie Barclay.
Labels distributed: Hispavox, Atlantic, 20th Century Fox, Aristocrat, Bang, B. T. Puppy, Valiant, Elenco, Monument, Ri-Fi.

COMPAGNIE EUROPEENNE DU DISQUE
5, rue Geoffroy-Marie.
Paris 9e.
TAL.71.66.
Managing director: Eddie Barclay.
Labels domestic: Erato, Riviera.
Labels distributed: Amadeo, Jag, Atco, Rigolo, Stax, Chess, Tempo.

CHANT DU MONDE
32, rue Beaujon.
Paris 8e.
WAG.67.73.
Managing director: Jean Roire.
Labels distributed: Valois, Enfance.

CLUB NATIONAL DU DISQUE
12, rue du Croissant.
Paris 2e.
GUT.18.67.
Managing Director: René Nicolé.

C. B. S.
3, rue Freycinet
Paris 16e.
PAS. 26-45.
Managing Director: Jacques Souplet.

DECCA
30, rue Beaujon.
Paris 8e.
WAG. 19.01.
Managing Director: Henri Froment.
Labels domestic: Twist.
Labels distributed: London, CID.

FESTIVAL
3, rue de Gramont.
Paris 2e.
RIC.96.10.
Managing Director: P. G. Duprat.
Labels Domestic: Impact, Jonquille, Totem.
Labels distributed: Mouloudti, Orly, Temporel, Cbarlin, Deesse, Palette, Mirwood, Artone, Canusa, C & D, Ricordi, C.A.M., Palette, R.S.C., Emir.

PATHE MARCONI EMI
19, rue Lord Byron.
Paris 8e.
BAL.53.00.
Managing Director: Francois Minchin.
Labels domestic: La Voix De Son Maitre, Columbia, Pathe, Ducretet-Thomson, Les Discobiles Français.
Labels distributed: Capitol, Odeon, Command, Liberty, Telefunken, Tamla Motown, Trianon, Cairophon, La Voix De L'Orient.

PANORAMA
18, avenue Daumesnil,
Paris 3eme.
278.37.98
Managing Director: Robert Lotrouse.

PHILIPS
6, rue Jenner,
Paris 13eme.
POR. 75.28
GOB. 48.90
Managing Director: Georges Meyerstein-Maigret.
Labels domestic: Fontana Pergola, Critere, Oiseau-Lyre.
Labels distributed: Mercury, Smash, World Pacific, Pacific Jazz, United Artists, Viva Records, Island Records, Page one Records.

POLYDOR
2, rue Cavalotti,
Paris 18eme.
LAB. 05.39
Managing Director: Marcel France.
Labels domestic: Disques Jacques Canetti.
Labels distributed: Deutsche Grammophon, Archiv-Production, Brunswick, M.G.M., Capri, Verve, VSP Verve, SABA, Kama Sutra.

PRESIDENT
Commercial service: 21, rue Pierre Sénard,
Paris 9eme.
TRU. 02.28
Artistic service: 30, rue Pierre Sénard.
LAM. 49.20
Managing Director: Jean Moura.

R.C.A.
52, avenue Hoche,
Paris 8eme.
WAG. 33.60
Managing Director: Henri Froment.

UNIDISC
31, 33, rue de Fleurus,
Paris 6eme.
548.41. 61
548.49.95
Managing Director: Roger Payen.

VEGA
49, avenue Hoche,
Paris 8eme.
CAR. 16.34
Managing Director: M. Darpin.
Labels distributed: ABC Paramount, Impulse, Cetra.

VOGUE
82, rue M. Grandcoing,
Villetaneuse/Seine.
PLA. 73.00
Managing Director: Léon Cabat.
Labels domestic: Pacific, Number One, Monte-Carlo, Mode, Disques AZ.
Labels distributed: Durium, Elektra, Laurie, Premier, Pye, Reprise, Warner Bros, Kapp, Dot, Roulette, Scepter Red Bird Clan GNP, Gurtler Jolly Music, Miller International, Mocambo, Time Mainstream, Duke Peacock, Glad Hamp, Joda, Jubilee, Kenwood.

FRANCE—Music Publishers

(Continued from page 91)

LIDO
85 bis, avenue de Wagram, Paris 17e. MAC
26-98

MALESHERBES
11, boulevard Malesherbes, Paris 8e. ANJ
77-33

MARINE
44, rue de Miromesnil, Paris 8e. 265 87-80

MASSPACHER
39, passage du Grand Cerf, Paris 2e. GUT
02-02

MAX ESCHIG
48, rue de Rome, Paris 8e. LAB 66-64

MERIDIAN
5, rue Lincoln, Paris 8e. ELY 10-81

METROPOLITAINES
3, rue Rossini, Paris 9e. TAI 83-94, PRO
21-78

MICRO
14, rue Washington, Paris 8e. BAL 43-03

MONDE MELODIE
20, rue R. Poincaré, Paris 16e.

MONDIA
46, rue Laffitte, Paris 9e. TRU 07-75

MONTE BELO
33, rue Le Peletier, Paris 9e. PRO 08-53

OUVRIERES
12, avenue Soeur Rosalie, Paris 13e. GOB
29-07

PARES PH
46, rue Laffitte, Paris 9e. LAM 40-42, TRU
07-79

PARIS ETOILE
17, rue Montigny, Paris 2e. 742 05-23

PARIS MELODIES
76, Cbamps-Elysées, Paris 8e. BAL 49-80

PATHE MARCONI
19 rue Lord Byron, Paris 8e. BAL 53-00

PATRICIA
5, rue Lincoln, Paris 8e. ELY 06-22

PEPE LUIZ (Editions Musicales)
14, rue Cbaptal, Paris 9e. 744 24-03

PHILIPPO
24, boulevard Poissonnière, Paris 9e. TAI
89-24

PLANTE
35, boulevard Malesherbes, Paris 8e. ANJ
08-93

PLEINS FEUX
12, boulevard Poissonnière, Paris 9e. PRO
25-02, PRO 86-04

PRESENCE
33, faubourg St. Martin, Paris 10e. NOR
89-05

PRISMA MUSIC
40, faubourg St. Martin, Paris 10e. PRO
53-01

**PROCURE GENERALE DES PAROISSES
DES COMMUNATES ET DUNCLERGE**
76, bis, rue des St. Pères, Paris 4e. LIT
70-50

PROSADIS
14, avenue Hoeche, Paris 8e. 622-45-00

RAILLET
12, passage de l'Industrie, Paris 10e. TAI
44-55

REVIL
71, rue de Provence, Paris 9e. TRI 90-76

RHODANIA
4, rue Juste Mévier, Paris 18e. ORN 84-30

RICORDI
3, rue Roquepine, Paris 8e. ANJ 94-15, ANJ
51-47

LE RIDEAU ROUGE
26, rue de Longchamp, Paris 16e. 704 52-37

ROMANS
1, bis, avenue Victor-Hugo, Chatou (S. et O.).
37, rue Boursault, Paris 17e. LAB 42-17

ROYALTY
25, rue d'Hauteville, Paris 10e. PRO 67-26

SACHA
11, avenue Delcassé, Paris 8e. BAL 91-51

SALABERT
22, rue Cbauchet, Paris 9e. TAI 55-60

SALVADOR
6, place Vendome, Paris 1er. OPE 87-05

SALVET-ASSOCIEES
89, rue La Boétie, Paris 8e. ELY 76-54

SANDRA-MUSIC
44, rue du Coisée, Paris 8e. 359 70-82

SCHOLA-CANTORUM
269, rue St. Jacques, Paris 5e. 033 56-74

**SEMI (Société d'Editions Musicales Inter-
nationales)**
5, rue Lincoln, Paris 8e. ELY 10-81

TOURNIER GERARD (Sociétés Associees)
67, rue de Provence. 874 26-16
Paris 9e. 874 19-41

TROPICALES
28, boulevard Poissonnière, Paris 9e. PRO
25-28

TUTTI
15, rue Saussier-Leroy, Paris 17e. WAG 91-00

UNIVERSELLES
52, faubourg St. Martin, Paris 10e. NOR
45-91

VIANELLY
voir Breton.

VENDOME
5, rue Lincoln, Paris 8e. ELY 10-81

VENTURA
14, avenue Hoche, Paris 8e. WAG 23-20.

VERSAILLES
42, rue Paradis, Paris 10e. 523 09-00

ZURFLUH A.
73, boulevard Raspail, Paris 6e. BAB 29-26,
LIT 68-60

**A POPULAR
PHRASE IN
THE INTERNATIONAL
MUSIC INDUSTRY
LANGUAGE:**

**I READ IT
IN
CASH BOX**

Editions TUTTI

"NE ME QUITTE PAS" (Jacques Brel)

(If You Go Away)

Editions Musicale

PETER MAURICE

"PUPPET ON (Bill Martin)
A STRING" (Phil Couter)

"Un Tout Petet Pantin" (P. Delanoe)

SANDIE SHAW

PARIS TREE MUSIC

"GREEN GREEN (Putman, Reed)
GRASS OF HOME" (& Sullivan)

"Les Grilles de ma Maison" } J. Chaumelle
"Le Toit de ma Maison" }

DALIDA NANA MOUSKOURI
LES COMPAGNONS DE LA CHANSON

General Manager Jean PIERARD
International Manager Claude PASCAL

15 RUE SAUSSIER-LEROY, PARIS XVII^{eme}
Telephone: 924 83-89

FRANCE—THE PAST 12 MONTHS

(Continued from page 90)

weeks later AZ artist Danyel Gérard announced he will create his own record label, "P.D.G." ("Production Danyel Gérard").

The Eurovision song contest in Vienna presented two surprises. Everybody was very happy when third place was taken by the French song "Il doit faire beau la bas," by Pierre Delanoé and Hubert Giraud (SEMI Publishing). The French representative Noëlle Cordier was a great success for the way she interpreted that song. A few hours after the contest, the Barclay artist signed contracts for TV programs in Germany and Sweden. On the contrary "Quel coeur vas tu briser," by Gérard Gray and Daniel Faure, was a surprising failure. However this song, a Tutti original copyright, is quite good, but Geraldine who recorded it through the Polydor label, was not at her best during the contest.

Italian film Elsa Martinelli released her first EP record in March through the AZ label. Lyrics of three songs were written by Jacques Lanzmann who writes all the Jacques Dutronc songs. At the same time, EMI artist Salvatore Adamo left Paris to do a movie in Aix en Provence. It will be his first appearance on screen as an actor.

Beuscher A&R man René Desmarty, signed a contract with Hubert E. Marks. The Beuscher Publishing company now represents E. B. Marks, Alameda Music Corp. and Piedmont Music Corp. for France, Belgium, Luxembourg and all Francophone countries. Alain Boubllil, Vogue publishing company manager, personally directed the recording of the French treatment of Sandie Shaw's "Puppet On a Strong." French title is "Un tout petit pantin" (Tutti publishing).

This treatment has been much appreciated in Franch but it could not beat the original version. It is an important fact because the French public now prefers songs in their original language.

Philippe Boutet (CBS A&R) signed a contract with Maurice Chevalier this winter. CBS will produce an LP with 12 new songs for Chevalier's 80th birthday. Six will be written by US composers and six by French. Chappell named a new A&R man: Michel Larmand. A few days later Frank and Nancy Sinatra's fabulous hit "Somethin' Stupid" was recorded in French by Sacha Distel and Johana Shimkus. Maurice Tézé wrote French lyrics. Success was immediate.

Ray Charles was a great success in Paris in his one night appearance at the Salle Pleyel in April. At this occasion the first Stateside LP album was released in France. Percy Sledge also came to Paris in April to appear at the fête du Muguet de Chaville. To tie-in with his appearance, Barclay released his new EP "Out Of Left Field." A new independent producing company was created in April: Productions Musicales SIBECAR. Manager is Gilles Bleiveis. First artists are Pascal Bilat (Festival) and Marcel Hurten (AZ). Another new label appeared on the market at the same time: Relax. Its first release is an album by the Dutch group, the Outsiders. Relax is distributed by Iramac France which releases the Iramac and Pelca labels.

Barclay artist Jean Ferrat, who is produced by Gérard Meys (Productions Alleluia), left France on May 18th to present ten one man shows in Cuba. After that he took a vacation tour through Mexico, Brazil, etc. Ferrat will be back in Paris for the first days of 1968 only. This season was really good for the international careers of French artists. Enrico Ma-

cias, who is cut by EMI, was a great success in the USSR. Three other great artists have sung in that country since October: Juliette Gréco, Rosy Armen and recently Mireille Mathieu, who has been the lead of the first official French show on tour in Russia. Charles Aznavour, Gilbert Beaud and, of course, Petula Clark performed in the United States. During his tour Charles Aznavour wrote his last hit, "Je Reviens Fanny." With the opening of the International Film Festival in Cannes, there were several releases of movie themes. Among them, RCA Victor presented the soundtrack of "Mouchette," by Robert Bresson which was offered at the Festival. Sarava published music from "Mon Amour Mon Amour," directed by Nadine Trintignant, and Labrador published the music from the Robert Hossein movie "J'AI Tué Raspoutine."

This season a lot of things were reported concerning the war between the radio stations. For the first time ORTF and Radio Télé Luxembourg are working very hard to compete with the successful Europe No. 1 station. In May Radio Télé Luxembourg published a memo to prove "President" Rosko is the Deejay of the Year. Rosko joined this broadcast last November. Within six months the gallup soundings went up from 5% to 40%. Presently Rosko has 76.6% in the popularity polls as well.

The Philips turnover for the first four months of this year is exactly the same as for the same period last year. However, January and March were better than January and March figures for 1966. February, on the other hand, was down, but April 1966 and 1967 are parallel. Louis Hazan, Philips general manager, reports that sales of 45 r.p.m. disks this year are 20% lower than in 1966. He points

out that this is in line with the general slackening off of the French record market. Philips maintains its turnover because of the success of its L.P. price policy of 19.95 NF instead of 21 or 23NF.

Vogue's turnover for the year 1966 showed an increase of more than 37% compared with 1965. Turnover for the first four months of the current year is reported to be about 30% up on the same period last year. This shows that 1966-1967 has been a great period for Vogue. In 1965 Vogue was a good, but not very important record company. Suddenly the Cabat company has become the most successful company. In 1966 this firm and the labels it represents had most of the top hits. Vogue A&R man Christian Fehner discovered Antoine. Three months later it was Wolfson's turn. He launched Jacques Dutronc. Vogue distributes Michel Polnareff records; Petula Clark and Pierre Perret who are cut by Vogue sold more and more records. Frank Sinatra was No. 1 with "Strangers In The Night." The same was true for Pierre Barouh and Nicole Croisille with the "A Man And A Woman" theme. Françoise Hardy was still very strong and Vogue, which distributes Pye records, released English and French treatments of Sandie Shaw's "Puppet On A String": A Great Year for the Cabat team.

The season ended with the IFPI triennial council. At this occasion Henri Froment, Decca and RCA prexy in France, as named IFPI president. Next year will hopefully see gains for the record industry because SNI-COP is planning a big promotion campaign in the months ahead.

CASH BOX
THE
INTERNATIONAL MUSIC WEEKLY

LOOKING FOR FRENCH HITS FESTIVAL'S GOT THEM



ANDRE VERCHUREN
MARIE LAFORET
MICHEL DELPECH
JACQUELINE TAIEB
MICHEL FUCAIN
LES SURFS



THE SMOKE
ACKER BILK
BOBBY SOLO
NINA & FREDERIK
GIGLIOLA CINQUETTI
JEAN-CLAUDE DECAMP

LOOKING FOR HITS PROMOTION FESTIVAL'S GOT IT

France Best Sellers

VOGUE

- 1 LES PLAYBOYS (Jacques Dutronc)
- 2 ET MOI ET MOI ET MOI (Jacques Dutronc)
- 3 CANELLE (Antoine)
- 4 C'EST MA CHANSON (Petula Clark)
- 5 STRANGERS IN THE NIGHT (Frank Sinatra)
- 6 LES JOLIES COLONIES DE VACANCES (Pierre Perret)
- 7 THESE BOOTS ARE MADE FOR WALKING (Nancy Sinatra)
- 8 LA MAISON OU J'AI GRANDI (Françoise Hardy)
- 9 UN TOUT PETIT PANTIN (Sandie Shaw)
- 10 CHAUFFE MARCEL (Les Charlots)

POLYDOR

- 1 LA CHANSON DE LARA (John William)
- 2 DOCTEUR JIVAGO (Soundtrack)
- 3 IT'S A MAN'S MAN'S WORLD (James Brown)
- 4 MIREILLE (Marcel Amont)
- 5 SUMMER IN THE CITY (Lovin' Spoonful)
- 6 C'EST MA CHANSON (John William)
- 7 DAYDREAM (Lovin' Spoonful)
- 8 BABY STONE (Stone)
- 9 HAPPY JACK (The Who)
- 10 LES GRILLES DE MA MAISON (John William)

FESTIVAL

- 1 MANCHESTER ET LIVERPOOL (Marie Laforet)
- 2 LES PORTECLES (André Verchuren)
- 3 MY FRIEND JACK (The Smoke)
- 4 INVENTAIRE 66 (Michel Delpech)
- 5 PRENDS TA GUITARE (Michle Fugain)
- 6 LA TABLE DE MULTIPLICATION (Jacques Bodoïn)
- 7 GUANTANAMERA (Digno Garcia)
- 8 LES AVENTURES D'ASTERIX LE GAULOIS
- 9 AHHH! APRES TOUT (Jean Claude Decamp)
- 10 7 HEURES DU MATIN (Jacqueline Taieb)

EMI PATHE MARCONI

- 1 INCH ALLAH (Adamo)
- 2 J'AI PEUR (Enrico Macias)
- 3 L'INCENDIE A RIO (Sacha Distel)
- 4 COEUR EN BANDOULIERE (Adamo)
- 5 PENNY LAINE (The Beatles)
- 6 NO MILK TODAY (Herman's Hermits)
- 7 GOOD VIBRATIONS (Beach Boys)
- 8 FILLE SAUVAGE (Richard Anthony)
- 9 MORTE SAISON (George Chelon)
- 10 REACH OUT I'LL BE THERE (The Four Tops)

PHILIPS

- 1 L'HEURE DE LA SORTIE (Sheila)
- 2 BANG BANG (Sheila)
- 3 NOIR C'EST NOIR (Johnny Hallyday)
- 4 LA NON DEMANDE EN MARRIAGE (George Brassens)
- 5 J'ATTENDRAI (Claude François)
- 6 SI J'ETAIS CHARPENTIER (Johnny Hallyday)
- 7 AMOUREUX DU MONDE ENTIER (Claude François)
- 8 ET SI C'ETAIT VRAI (Georgette Lemaire)
- 9 HEY JOE (Johnny Hallyday)
- 10 TOUTE LA VIE (Claude François)

BARCLAY

- 1 PARIS EN COLERE (Mireille Mathieu)
- 2 QU'ELLE EST BELLE (Mireille Mathieu)
- 3 MON CREDO (Mireille Mathieu)
- 4 CELINE (Hughes Aufray)
- 5 BLACK IS BLACK (Los Bravos)
- 6 BAISSÉ UN PEU LA RADIO (Dalida)
- 7 L'EPERVIER (Hughes Aufray)
- 8 POTEKINE (Jean Ferrat)
- 9 LES EMANCIPATIONS D'ALPHONSE (Jacques Martin et Jean Yanne)
- 10 LES ENFANTS QUI JOUENT (Erik Saint Laurent)

RCA

- 1 PAR AMOUR, PAR PITIE (Sylvie Vartan)
- 2 MISTER JOHN B (Sylvie Vartan)
- 3 2'35" DE BONHEUR (Sylvie Vartan)
- 4 I'M A BELIEVER (Monkees)
- 5 MONDAY, MONDAY (Mamas & Papas)
- 6 DEDICATED (Mamas & Papas)
- 7 LAST TRAIN TO CLARKSVILLE (Monkees)
- 8 LORSQU'ON EST HEUREUX (Jacqueline Dulac)
- 9 OH! LA HEY (Noel Deschamps)
- 10 NOTTE DI FERRAGOSTO (Gianni Morandi)

DECCA

- 1 PAINT IT BLACK (Rolling Stones)
- 2 RUBY TUESDAY (Rolling Stones)
- 3 Y PUT A SPELL ON YOU (Alain Price Set)
- 4 HAVE YOU SEEN YOUR MOTHER (Rolling Stones)
- 5 HAPPY TOGETHER (Turtles)
- 6 A WHITER SHADE OF PALE (Procol Harum)
- 7 (NOUVEAUTE SORTIE DEPUIS 10 JOURS)
- 8 GREEN, GREEN GRASS OF HOME (Tom Jones)
- 9 NOT RESPONSIBLE (Tom Jones)
- 10 MY MIND'S EYE (The Small Faces)
- BD DE LA MADELINE (Moody Blues)

FRANCE—Recording Studios

ACOUSTI STUDIOS
(Projections 16mm)
54, rue de Seine,
Paris 6^e.
MED. 53.30

A.I.R. PRODUCTION
(enregistrement, mixage, montage, repiquage)
134, boulevard Haussmann
CAR. 64.53

APSOME STUDIOS
(mixage, montage, repiquage)
80, rue Cardinet
Paris 17^e.
WAG. 89.21

ARSONOR
19, rue Burg
Paris 18^e.
CLI. 37.06

BARCLAY HOCHÉ ENREGISTREMENT,
9, avenue Hoche,
Paris 8^e.
WAG. 81.30

**CENTRE D'ENREGISTREMENT DES
CHAMPS-ELYSEES**
(direction technique André Charlin),
15 avenue Montaigne,
Paris 8^e.
BAL. 01.37

COMEDIE DES CHAMPS-ELYSEES,
15, avenue Montaigne.
Paris 8^e.
BAL. 05.06

COTY ET Co,
177, avenue de Neuilly,
Neuilly/Seine.
MAL. 07.74
MAL. 37.75

DAVOUT Studios,
73, boulevard d'Avout.
PYR. 53.39

D. M. S.
(diffusion magnétique sonore)
15, rue Saussier-Leroy,
Paris 17^e.
WAG. 91.00
WAG. 77.32
WAG. 40.55

E. T. A.
35, bis rue de l'Abbé Grégoire
Paris 6^e.
222 49-29

EUROPA SONOR,
15, rue Charcot,
Paris 13^e.
20 bis, rue de la Gaité.
JUS. 33.83
MED. 53.55

GANARO
27, boulevard de Courcelles
Paris 8^e.
522 80-28

GANDIA FILMS,
4, avenue Estienne d'Orves,
Nice (A.M.)
88.27.86

GENEIX René,
6, rue Jouvenet,
Paris 16^e.
AUT. 08.52

JOUVE Studios,
99, avenue du Général Michel Bizot
Paris 12^e.
DOR. 60.39

INTERSONOR,
55, rue de la Croix Nivert,
Paris 15^e.
SUF. 57.31

MARIGNAN Studios
(directeur Gérard: René Louge)
15, rue Forest,
Paris 18^e.
LAB. 58.32

PALAIS ROYAL
27, rue de Richelieu
Paris 1^e.
RIC. 39.98

PATHE MARCONI,
62, rue de Sèvres,
Boulogne.
VAL. 01.66

PHILIPS,
94, boulevard Blanqui,
Paris.
KLE. 07.89

POLYDOR,
44, rue des Dames,
Paris 17^e.
LAB. 55.90

PROGRAMMES DE FRANCE (Les),
22, rue Bayard,
Paris 8^e.
ELY. 20.31

PUBLI-ONDES,
28, boulevard Haussmann,
Paris 9^e.
PRO. 78.03

PUBLI-SONOR,
1 et 3, rue du Départ,
Paris 14^e.
DAN. 28.20

S. E. M.
1, avenue Cagnoli
06-Nice
88 23-84

S.G.P.,
28, boulevard Haussmann,
Paris 9^e.
PRO. 78.03

**SOCIETE INDUSTRIELLE DE
SONORISATION (S.I.S.),**
22, avenue de la Porte de Champerret,
Paris 17^e.
GAL. 96.11

TECHNISONOR,
12, rue Magellan,
Paris 8^e.
BAL. 96.60

VOGUE
54, rue d'Hauteville
Paris 10^e
TAL. 93.82

VOXIGRAVE,
6, rue de Lisbonne,
Paris 8^e.
LAB. 66.84

EUROPEAN MUSIC ORGANISATIONS

AUSTRIA
Bundesgremium des Handels mit Burchern,
Kunstblättern, Musikalien und Zeitschriften
Wien 1
Bauernmarkt 13 Austria
Verband der Bühnenverleger Österreichs
Wien X11
Kiningergasse 6, Austria

BELGIUM
Chambre Syndicale des Editeurs de Musique de
Belgique
13, Rue de la Madeleine
Brussels, Belgium

DENMARK
Dansk Musikforlaeggerforening
Borgergade 3
Copenhagen K, Denmark

FRANCE
Union Internationale des Editeurs, Section des
Editeurs de Musique
1, Rue de Courcelles
Paris 8^e eme, France
Chambre Syndicale des Editeurs de Musique,
1, Rue de Courcelles,
Paris 8^e eme, France
Chambre Syndicale des Editeurs de Musique
Legrere
117, Boulevard Saint-Germain
Paris 6^e eme, France

FINLAND
Musiiikkikustantajain Yhdistys
Aleksanterinkatu 11
Helsinki, Finland

HOLLAND
Vereniging van Muziekhandelaren en Uitgevers
in Nederland
Amstel 52
Amsterdam C, Holland
London, W. 1, England

ITALY
Union Editori Musicali Italiani
Via Francesca Sforza No. 1
Milan, Italy

NORWAY
Norsk Musikkforleggerforening
Karl Johansgate 45
Oslo, Norway
Nordisk Musikkforleggerunion
Postboks 1466
Vikta, Oslo, Norway
(Including Denmark, Finland, Norway &
Sweden)

SPAIN
Instituto Nacional del Libro Espanol
Sub-Section Editores de Musica
Ferraz 13, Madrid 8, Spain

SWEDEN
Svenska Musikforleggarforeningen UPA
Drottninggatan 81A
Stockholm, Sweden

SWITZERLAND
Verband der Musikalien-Handler und Verleger
in der Schweiz
Limmatquai 26/28
Zurich 1, Switzerland
Schweizerischer Bühnenverleger-Verband
Utoquai 41
Zurich, Switzerland

UNITED KINGDOM
The Music Publishers' Association Ltd.
73-75, Mortimer Street

N.Y. MASSES MAD FOR 'CASINO'

VARIETY

PICTURE GROSSES

PICTURE GROSSES

'Casino' Boffo News in Philly, Huge \$50,000; 'Man' Sock 22G; 'Seasons' Smash 31G, 6th; 'Flint' Bangup 35G

CAP, CINEMA 1, GIGANTIC 1 1/2

Wednesday, May 3, 1967

'Casino' Wham \$20,000, D.C.; 'Hombre' Cant 14G, 3d; 'Alamo' Bright 10G
Chi Biz Still Smash; 'Casino' Terrif 90G, 'Alamo' Strong 20G, 'Women' 'Hombre' Boffola 42G, 2d

'Casino' Smash \$30,000, St. Loo; 'Hotel' Is Lofty 8 1/2G, 3d; 'Seasons' 13G

L.A. Climbs; 'Casino' Royal \$55,000, 'Summer' Lush 16G, 'Man' Sturdy 11G, 18th Wk.; 'Prix' Grand 25 1/2G

'Casino' Boff 45G Pacing Toronto

'CASINO' MIGHTY 18G, 'L'VILLE; 'FLINT' 7 1/2G

'Casino' Boffola \$18,000 in Denver

'Casino' Cool 100G In Det.; 'Bible' Rich 17G, 13th; 'Prix' Hot \$12,000

'Casino' Topper In Mpls., \$16,000

CHARLES K. FELDMAN'S COLGEMS CASINO ROYALE



Music Composed and Conducted by **BURT BACHARACH**

"Casino Royale Theme" played by **HERB ALPERT & the TIJUANA BRASS**

"The Look of Love" sung by **DUSTY SPRINGFIELD**



A COLUMBIA PICTURES RELEASE / PANAVISION® / TECHNICOLOR®

Action Album Now **COMO/COSO-5005**

COLGEMS®

Manufactured and Distributed by RCA

Available soon on Stereo 8 Cartridge Tape and 3 3/4 ips reel tape.

Chicago, May 2. Windy City deluxer situations are continuing their fast pace this frame, as newcomers and holdovers register fat lallies. "Casino Royale" is bowing to a terrific \$90,000 at the State-Lake, and reth a slick \$20,000 at the Orient. "Night Women" is rated ght \$8,500 or over at the World. proe combo of "Weekend At kirk" and "Rapture" looks in first. "Hombre" is nabbing a great ad canto at the Chicago. lea Addio" is excellent in its evelt second. "In Like Flint" illing a hearty fourth frame at United Artists.

'Casino' Sock 18G, Cincy Standout

Cincinnati, May 2. "Casino Royale" rules the first-a roost here currently, being a xeko Albee entry. Other bright nes are "Sound of Music" in sec-nd-week advance at the Prince- n Cinema and "Man For All h- d cantos at the

'Casino' Smash \$32,000 In Balto; 'Hombre' Wow 47G; 'Oh Dad' 12G, 2d

Baltimore, May 2. "Casino Royale" opened with a ng at Boulevard and Westview ema. "Hombre" is strong on in five locations. "Coal" looks in first at Seven East. "The o" is okay at the Town on re- l opener. "Man For All Sea- continues sock in ninth ses- the Charles. and a Woman" is boffo in nd at the Five West. "Oh (20th r Dad" is nice in second t the Northwood and Gle otel" is pleasing in fifth "Taming of Shrew" in sixth at the Up-

Trans-Beacon Sand Pebbles" Sound \$9,700.

SWEDEN—Music Publishers

A. SCHROEDER MUSIKFORLAG—P.O. Box 5265—STOCKHOLM 5
(Jungfrugatan 18—Stockholm O)
Phone: 61 75 30
Cable: SWEDENMUSIC STOCKHOLM
President: Mr. Stig Anderson

ABR. LUNDQUIST AB—Surbrunnsgatan 30—STOCKHOLM Va
Phone: 34 55 20
President: Mr. Einar Hylin

AHLINS MUSIKFORLAG AB—Kungsholmsgatan 20—STOCKHOLM K
Phone: 51 63 86
Cable: AHLINMUSIK STOCKHOLM
President: Mr. Ernfrid Ahlin

AMERICAN SONGS AB—Drottninggatan 55—STOCKHOLM C
Phone: 21 69 97
Cable: STOCKHOLMSMUSIK STOCKHOLM
President: Mr. Felix Stabl

AMIGO MUSIKPRODUKTION AB—Atlasgatan 14—STOCKHOLM Va
Phone: 31 67 10
President: Mr. P. A. Boquist

ANDERSSONS MUSIKFORLAG AB—Sodra Forstadsgratan 6—MALMO C
Phone: 75 210
President: Mr. Stig Anderson

BARTON (SCANDINAVIA) AB—Drottninggatan 65—STOCKHOLM C
Phone: 11 62 40
President: Mr. Ake Gerhard-Larsson

BLINDA (SCANDINAVIA) AB—Drottninggatan 65—STOCKHOLM C
Phone: 11 62 40
Cable: BELINDSONG STOCKHOLM
President: Ake Gerhard-Larsson

BENS MUSIC AB—P.O. Box 5265—STOCKHOLM 5
(Jungfrugatan 18—Stockholm O)
Phone: 61 75 30
Cable: SWEDENMUSIC STOCKHOLM
President: Mr. Stig Anderson

BROADWAY MUSIC AB—P.O. Box 5265—STOCKHOLM 5
(Jungfrugatan 18—Stockholm O)
Phone: 61 75 30
Cable: SWEDENMUSIC STOCKHOLM
President: Mr. Stig Anderson

CEDARWOOD (SCANDINAVIA) AB—Drottninggatan 65—STOCKHOLM C
Phone: 11 62 40
President: Mr. Ake Gerhard-Larsson

DER MUSIKUS—Farkostvagen 8—LIDINGO 1
Phone: Stockholm 765 12 30
President: Mr. Hans Busch

DOLLAR MUSIC—c/o Sohr—Folkungagatan 136—STOCKHOLM So
Phone: 43 90 93
President: Mr. Ake Sohr
Outside Sweden represented by Globe Music—P. O. Box 40139—Stockholm 40

DOMINION AB—Storangsavagen 27—STOCKHOLM No
Phone: 61 13 16
Cable: MULTITONE STOCKHOLM
Presidents: Mr. Borje Ekberg & Mr. Anders Burman

EDITION CITY—Drottninggatan 65—STOCKHOLM C
Phone: 11 62 40
President: Mr. Ake Gerhard-Larsson

EDITION LIBERTY AB—P.O. Box 1178—SOLNA 1
(Ankdammgatan 5 G—Solna 1)
Phone: Stockholm 82 04 80
Cable: TEFUNK SOLNA
President: Mr. Sixten Eriksson
Professional manager: Mr. Hans Englund

EDITION LUNDEN—Bromsvagen 25—

ALVSJO
Phone: 47 35 46
President: Mr. Walter Cohn

EDITION ODEON—Oxenstiernsgatan 37—STOCKHOLM No
Phone: 60 53 53, 22 45 80
Cable: TURNTABLE STOCKHOLM
Managing director: Mr. Kjell Wigren

EDITION SYLVAIN AB—Linnegatan 9-11—STOCKHOLM O
Phone: 62 05 30
President: Mr. Thore Ehrling

EHRLING & LOFVENHOLM AB—P.O. Box 8—STOCKHOLM TuH
(Pipersgatan 29—Stockholm K)
Phone: 54 32 13
Cable: KAYTONE STOCKHOLM
President: Mr. Leif Kronlund

EHRLINGFORLAGEN—Linnegatan 9-11—STOCKHOLM O
A concern of music publishers. For information see:
Edition Sylvain
Nils-Georges Musikforlags AB
Thore Ehrling Musik AB

EUROPA-PRODUKTION—Drottninggatan 65—STOCKHOLM C
Phone: 11 62 40
Cable: EUROPASONG STOCKHOLM
President: Mr. Ake Gerhard-Larsson

FLAMINGO MUSIKFORLAG AB—Bergslagsvagen 260—BROMMA
Phone: Stockholm 87 33 00
Presidents: Mr. Roland Ferneberg & Mr. Sture Wahlberg

FORLAGET FILADELFIA AB—P.O. Box 6082—STOCKHOLM 6
(Dobelnsgatan 52—Stockholm Va)
Phone: 34 93 80
Cable: PINGSTYRKAN STOCKHOLM
Manager: Mr. Sven Lindahl
Religious music:—The Pentecostal Movement

FORLAGET VISOR & LATAR—P.O. Box 194—AERLA (ARLA in Swedish writing) (Olstorp—Arla)
Phone: Eskilstuna (016) 700 16
President: Mr. Gunnar Olsson

GAVOTTE MUSIC AB—P.O. Box 27199—STOCKHOLM 27
(Invernessvagen 16—Stockholm 27)
Phone: 85 50 50
Cable: GAVOTTEMUSIC STOCKHOLM
President: Mr. Pierre Westerman

GEHRMANS MUSIKFORLAG AB—P.O. Box 505—STOCKHOLM 1
(Vasagatan 46—Stockholm C)
Phone: 10 09 52
Cable: MUSIKGHERMAN STOCKHOLM
President: Lennart Bagger-Sjoberg
Professional manager: Mr. Bernt Baune

GLOBE MUSIC—P. O. Box 40139—STOCKHOLM 40
Phone: Uppsala 13 50 50
President: Mr. Thomas Nordlund

GRONSTETS MUSIKFORLAG—Borgargatan 4—STOCKHOLM Sv
Phone: 69 22 07
President: Mr. Karl Gronstedt

KARIN AB—Storangsavagen 27—STOCKHOLM No
Phone: 61 13 16
Cable: MULTITONE STOCKHOLM
Presidents: Mr. Borje Ekberg & Mr. Anders Burman

KASSNER MUSIK AB—Drottninggatan 55—STOCKHOLM C
Phone: 21 69 97
Cable: STOCKHOLMSMUSIK STOCKHOLM
President: Mr. Felix Stabl

KEWE MUSIC—Vikingavagen 15—DAN-

DERYD
Phone: Stockholm 755 78 99
President: Mr. Kewe Wickman

LANI MUSIC AB—Hantverkargatan 54—STOCKHOLM K
Phone: 53 53 00
President: Mr. Yngve Stoor

LOIS (SCANDINAVIA) AB—Drottninggatan 65—STOCKHOLM C
Phone: 11 62 40
President: Mr. Ake Gerhard-Larsson

MODERN MUSIC AB—Valhallavagen 16—STOCKHOLM O
Phone: 30 20 36
Director: Mr. Felix Stahl

MOONLIGHT MUSIC—Vackra vagen 14—SUNDBYBERG
Phone: Stockholm 29 15 36
President: Mr. Ake Oquist

MORGONSTJARNANS FORLAG—Kungsholmsgatan 20—STOCKHOLM K
Phone: 51 63 87
Cable: AHLINMUSIC STOCKHOLM
President: Mrs. Marta Ahlin

MULTITONE AB—Storangsavagen 27—STOCKHOLM No
Phone: 61 13 16
Cable: MULTITONE STOCKHOLM
Presidents: Mr. Borje Ekberg & Mr. Anders Burman

MUSIKALISKA KNUTEN—P.O. Box 733—STOCKHOLM 1
(Idrottsvagen 52—Norviken)
Phone: 714 06 77
President: Mr. Uno Ullven

MUSIKALISKA MAGAZINET—Drottninggatan 65—STOCKHOLM C
Phone: 11 62 40
President: Mr. Ake Gerhard-Larsson

MUSIKFORLAGET ESSEX AB—Regeringsgatan 45—STOCKHOLM C
Phone: 23 49 85
Cable: NOMECO STOCKHOLM
President: Mr. Lennart Reuterskiold

NILS-GEORGS MUSIKFORLAGS AB—Linnegatan 9-11—STOCKHOLM O
Phone: 62 05 30
Cable: NILSGEORGMUSIK STOCKHOLM
President: Mr. Thore Ehrling

NORDISKA MUSIKFORLAGET AB—P.O. Box 8—STOCKHOLM TuH
(Pipersgatan 29—Stockholm K)
Phone: 54 19 00
Cable: MUSICALIA STOCKHOLM
President: Mr. Leif Kronlund

PALACE MUSIC (SWEDEN) AB—P.O. Box 5265—STOCKHOLM 5
(Jungfrugatan 18—Stockholm O)
Phone: 61 75 30
Cable: SWEDENMUSIC STOCKHOLM
President: Mr. Stig Anderson

PLATINA MUSIKFORLAG—c/o Edition Odeon—Oxenstiernsgatan 37—STOCKHOLM No
Phone: 60 53 53
Cable: TURNTABLE STOCKHOLM
Managing director: Mr. Kjell Wigren

POLAR MUSIC AB—P.O. Box 5265—STOCKHOLM 5
(Jungfrugatan 18—Stockholm O)
Phone: 61 75 30, 60 22 87
Cable: SWEDENMUSIC STOCKHOLM
President: Mr. Stig Anderson

PROGRESSIVE AB—Storangsavagen 27—STOCKHOLM No
Phone: 61 13 16
Cable: MULTITONE STOCKHOLM
Presidents: Mr. Borje Ekberg & Mr. Anders Burman

REUTER & REUTER FORLAGS AB—Regeringsgatan 45—STOCKHOLM C
Phone: 23 49 85
Cable: NOMECO STOCKHOLM
President: Mr. Lennart Reuterskiold

ROBERT MELLIN (SCANDINAVIA) AB—Drottninggatan 65—STOCKHOLM C
Phone: 11 62 40
President: Mr. Ake Gerhard-Larsson

RYMUS AB—Kungsgatan 56—STOCKHOLM C
Phone: 20 06 97
President: Mr. Henry Fox

SCALA MUSIFORLAG AB—Regeringatan 45—STOCKHOLM C
Phone: 23 49 85
Cable: NOMECO STOCKHOLM
President: Mr. Lennart Reuterskiold

SCHLAGERFORLAGET MUSIK AB—Hantverkargatan 62—STOCKHOLM K
Phone: 53 53 00
President: Mr. Yngve Stoor

SCREEN GEMS MUSIKFORLAG AB—P.O. Box 5265—STOCKHOLM 5
(Jungfrugatan 18—Stockholm O)
Phone: 61 75 30
Cable: SWEDENMUSIC STOCKHOLM
President: Mr. Stig Anderson

SEVEN BROTHERS MUSIC INC.—c/o Edition Odeon—Oxenstiernsgatan 37—STOCKHOLM No
Phone: 60 53 53
Cable: TURNTABLE STOCKHOLM
Managing director: Mr. Kjell Wigren

THE SHADOWS MUSIC (SCANDINAVIA) AB—Drottninggatan 65—STOCKHOLM C
Phone: 11 62 40
President: Mr. Ake Gerhard-Larsson

SONET MUSIC AB—P.O. Box 39062—STOCKHOLM 39
(Artemisgatan 8—Stockholm No)
Phone: 67 05 40
Cable: SCANDICORD STOCKHOLM
President: Mr. Rune Ofwerman

SONORA MUSIKFORLAGS AB—P.O. Box 5153—STOCKHOLM 5
(Kommendorgatan 26—Stockholm O)
Phone: 63 54 00
Cable: SONORA STOKHOLM
President: Mr. Eddie Landqvist
Professional manager: Mr. Sture Borgedahl

SOUTHERN MUSIC AB—Grevturegatan 38—STOCKHOLM O
Phone: 67 99 10
Cable: SOUTHMUSIC STOCKHOLM
President: Mr. Ronald Sjogren

SPANKA MUSIC—P.O. Box 5265—STOCKHOLM 5
(Jungfrugatan 18—Stockholm O)
Phone: 61 75 30
President: Mr. Stig Anderson

STARTON AB—Bondegatan 4—STOCKHOLM So
Phone: 23 30 55
President: Helge Roundqvist

STOCKHOLMS MUSIKPRODUKTION—Drottninggatan 55—STOCKHOLM C
Phone: 21 69 97
Cable: STOCKHOLMSMUSIK STOCKHOLM
President: Mrs. Felix Stabl

SUCCEMELODIER AB—Drottninggatan 55—STOCKHOLM C
Phone: 21 69 97
Cable: STOCKHOLMSMUSIK STOCKHOLM
President: Mr. Felix Stabl

AB SVENSKA MANU-MUSIC—Blekingegatan 61—STOCKHOLM So
Phone: 43 80 12
President: Mr. Per Nystrom

SWEDEN MUSIC AB—P.O. Box 5265—STOCKHOLM 5
(Jungfrugatan 18—Stockholm O)
Phone: 61 75 30
Cable: SWEDENMUSIC STOCKHOLM
President: Mr. Stig Anderson

TAGEMUSIK—c/o Edition Odeon—Oxenstiernsgatan 37—STOCKHOLM No
Phone: 60 53 53
Cable: TURNTABLE STOCKHOLM
Managing director: Mr. Kjell Wigren

THORE EHRLING MUSIK AB—Linnegatan 9-11—STOCKHOLM O
Phone: 62 05 30
Cable: EHRLINGMUSIK STOCKHOLM
President: M. Thore Ehrling

UNITED ARTISTS MUSIKFORLAG AB—P. O. Box 5265—STOCKHOLM 5
(Jungfrugatan 18—Stockholm O)
Phone: 61 75 30
Cable: SWEDENMUSIC STOCKHOLM
President: Mr. Stig Anderson

WESSMAN & PETERSSON—Adelsgratan 5—VISBY
Phone: 101 11
President: Mr. Hans Pettersson

SWEDEN GALVANIC INDUSTRIES

AB EUROPA FILM—Annedalsvagen 29—SUNDBYBERG
Phone: Stockholm 28 58 00
Cable: europafilm sundbyberg
President: Mr. Gustav Scheutz

AB SVENSK GRAMMOFONINDUSTRI—Sveavagen 17—STOCKHOLM C
Phone: 10 63 67
President: Mr. Tage Anderson

AB J. G. SODERQUIST—Idungatan 3—STOCKHOLM Va
Phone: 33 63 80
Cable: galvanomatris stockholm
President: Mr. J. G. Soderberg

SWEDEN PRESSING PLANTS

AB ALPHA
P.O. Box—Sundbyberg 1
(Esplanaden 10—Sundbyberg)
Phone: Stockholm 28 26 00
Cable: aktialpha stockholm
President: Mr. S. Jacobsson

AB CHAMPION RADIO
P.O. Box 21028—Stockholm 21
(Rörstrandsgatan 37—Stockholm Va)
Phone: 22 78 20
Cable: championradio stockholm
President: Mr. Olof Bengtson

MEKANISKA VERKSTADEN REKORD AB
Norrbäckgatan 1—Stockholm Va
Phone: 23 42 15
Cable: recopress stockholm
President: Mr. Knut Vestman

AB SVENSK GRAMMOFONINDUSTRI
Sveavägen 17—Stockholm C
Phone: 10 63 67
President: Mr. Tage Andersson

SWEDEN COLLECTING SOCIETIES

S.T.I.M.
Tegnarlunden 3—Stockholm C
Phone: 24 29 50
Cable: stim stockholm
President: Dr. Sven Wilson
The Swedish Performing Rights Society/
Föreningen Svenska Tonsättares Internationella Musikbyrå.

SWEDEN MUSIC AB

Jungfrugatan 18
STOCKHOLM · SWEDEN

Cable address:
SWEDEN MUSIC · STOCKHOLM

Phone:
61 75 30 · 60 22 87 · 63 79 70

STIG ANDERSON

Publisher Of The Big Hits

Musikförlaget ESSEX AB

Regeringsgatan 45 Stockholm C Sweden

SCANDINAVIA — 1967

January:

As the year started, Fintone Oy in Finland (the Siemens group) moved over to Oy Finnlevy. Henrik von Denffer, former head of Fintone Oy, remained head of all former Fintone labels. . . . Belgian producer Peter Plum came to Stockholm for business talks. . . . The M.I.D.E.M. Festival was held in Cannes. Scandinavian artists attending included Kirsti Sparboe of Norway, Sven Ingvars of Sweden, and Caesars of Denmark. . . . Stig Anderson of Sweden Music AB (Stockholm) left for a round-the-world business trip, which took him to Tokyo, Honolulu and the United States. . . . In Denmark "Oh, Oh What A Kiss" (Über die Wellen) by the Rocking Ghosts on Metronome topped the charts. Finland preferred "Little Man" with Sonny & Cher on Atlantic. Herman's Hermits on Columbia topped in Norway with "No Milk Today," while in Sweden the Hep Stars on Olga topped with "Consolation."

February:

Just back from a business trip around Europe, Simon Brehm, 47, died of a heart attack on Feb. 11th. For many years he had been the head of Karusell Grammofon AB. . . . Local song festivals began to take place in Scandinavia in order to get a song for the Song For Europe Fest in Vienna in April. Finland was first with its local festival on Feb. 11th. . . . Denmark had announced that they intended to stay outside the Song For Europe spectacle this year. . . . Lennart Reuterskiöld, head of Swedish publishing house Reuter & Reuter AB and Musikförlaget Essex AB made business visits to England and the United States. . . . Sweden's local song festival took place Feb. 24th. . . . "Oh, Oh What A Kiss" (Über die

Wellen) continued topping the Danish charts for a second month, and so did "Little Man" in Finland. In Norway and Sweden "I'm A Believer" by the Monkees on RCA Victor topped the charts.

March:

The Beatles on Parlophone began moving up the charts here with "Penny Lane," just released all over Scandinavia. . . . Film themes and songs were strong sellers, both as far as "Dr. Zhivago" and the new Chaplin movie "The Countess From Hong Kong" were concerned. . . . In Sweden, a newcomer on records, Mats Olin, recorded "Jag Tror På Sommaren" (I Believe In The Summer), penned by his father Stig Olin, and got an immediate hit on the Polar label. . . . The Monkees on RCA Victor with "I'm A Believer" topped the Danish charts, as well as the Finnish and Swedish, while in Norway the Beatles on Parlophone with their "Penny Lane" took the jackpot.

April:

Musichouse Westerlund in Helsinki, Finland, took over all EMI labels in Finland. Some of them, such as Columbia, MGM, Odeon and Parlophone, had been handled by Pohjoismainen Sähkö-Oy (PSO). . . . Three gold disks were presented in Sweden to the Hep Stars, Olga recording group and to Sven Ingvars, now with Svensk-American. . . . Sandie Shaw of Britain, won the Eurovision Song Contest in Vienna at the beginning of April and started moving high on the charts here with her "Puppet On A String" single. . . . Nalen, famous jazz and dance spot in Stockholm for decades, finally closed—a victim of the rebuilding plan for central Stockholm. . . . "Penny Lane" by the Beatles on Parlophone, topped the

charts in Denmark, Norway and Sweden. A local song, "Elsa, Kohtalon Lapsi" with Martti Innanen on Safir, was the most popular in Finland.

May:

Jan Malmsjö, CBS recording artist in Sweden went to the United States for a short visit. . . . Cyril Shane of Shapiro Bernstein (London) was in Stockholm for biz talks. . . . The Beach Boys, Capitol recording group were in Sweden and Finland for concerts. . . . Sammy Davis, Jr., gave highly appreciated concerts in Scandinavia during his European concert tour. . . . CBS started doing local recordings in Denmark, Norway and Finland. . . . "Penny Lane" by the Beatles on Parlophone topped the Danish charts again, "Elsa, Kohtalon Lapsi" by Martti Innanen on Safir topped the charts in Finland, also for the second month. Norwegians preferred "Puppet On A String" with Sandie Shaw on Pye, while the Swedes went for "A Little Bit Me, A Little Bit You" by the Monkees on RCA Victor.

June:

Bengt Sundström returned to Swedish EMI, now as producer. During his previous session with the same company, he was with the EMI publishing house, Edition Odeon. . . . Swedish EMI is moving its record dept. to a new office in central town. . . . Sandie Shaw, the sensation of the year after winning the Eurovision Song Festival in Vienna in April, journeyed to Sweden for concerts, and so did the Troggs. EMI sales convention was arranged in Stockholm with executives from London, Copenhagen, Helsinki and Oslo. . . . Ivan Nordström, former producer at Swedish EMI, will go to Karusell Grammofon AB as president of the company after July 1st. . . . A local oldie, "Du Skal Ikke Gi' Mig Roser" by Björn Tidmand on Odeon topped the Danish charts, "Elsa, Kohtalon Lapsi" topped in Finland for the third month, Nancy & Frank Sinatra on Reprise were on the top in Norway and Sweden with "Somethin' Stupid."

DENMARK—Music Publishers

ACUFF-ROSE SCANDIA—Vesterport 247—
COPENHAGEN V
Phone: 11 50 00
Cable: MUSICMORK COPENHAGEN
President: Mr. Knut Mørk

DACAPO MUSIKFORLAG—Pilestraede 2—
COPENHAGEN K
Phone: Central 9549
Cable: DACAPOMUSIC COPENHAGEN
President: Mr. Henry Andersen

DGF MUSIC—Dortheavej 39—COPENHAGEN
NV
Phone: TAga 8505
Cable: WINCKLERMUSIC COPENHAGEN
President: Gustav Winckler, Karl Emil
Knudsen

EDITION STAR—Dortheavej. 39—COPEN-
HAGEN NV
Phone: TAga 2282
Cable: WINCKLERMUSIC COPENHAGEN
President: Mr. Gustav Winckler

FRANCIS, DAY & HUNTER SCANDINAVIA
A/S—Gothersgade 9—COPENHAGEN K
Phone: Minerva 7888
Cable: MUSICHANSEN COPENHAGEN
Presidents: Mrs. Hanne & Lone Wilhelm
Hansen
Professional mgr.: Mr. Arne Spliid

IMUDICO A/S (International Musical Dis-
tributing Co.)—Colbjørnsensgade 19—COPEN-
HAGEN V
Phone: Hilda 5625
Cable: IMUDICO COPENHAGEN
President: Mr. Albert Kleinert

MELCHER MUSIK-FORLAG A/S—Gothers-
gade 9—COPENHAGEN K
Phone: Minerva 7888
Cable: MUSICHANSEN COPENHAGEN
Presidents: Mrs. Hanne & Lone Wilhelm
Hansen
Professional mgr.: Mr. Arne Spliid

MØRKS MUSIKFORLAG—Vesterport 247—
COPENHAGEN V
Phone: 11 50 00
Cable: MUSICMORK COPENHAGEN
President: Mr. Knut Mørk

MULTITONE A/S—Vibevej 31—COPENHA-
GEN NV
Phone: 34 21 28
Cable: MULTITONE COPENHAGEN
President: Mr. Harry Jensen

MUSIKPRODUKTION WINCKLER — Dorth-
eavej 39 COPENHAGEN NV
Phone: TAga 2282
Cable: WINCKLERMUSIC COPENHAGEN
Presidents: Mr. Gustav Winckler & Mr. Karl
Emil Knudsen

OKTAV MUSIK—Helleruplund Alle 4—HEL-
LERUP
Phone: HELrup 9305 & 7690
President: Mr. Børge Binderup
Professional mgr.: Mr. Jørgen Kleinert

PRESTO MUSIKFORLAG—Vesterport 247 —
COPENHAGEN V
Phone: 11 50 00
Cable: MUSICMORK COPENHAGEN
Mr. Knut Mørk

REG CONNELLY MUSIK-FORLAG A/S —
Gothersgade 9—COPENHAGEN K
Phone: Minerva 7888
Cable: MUSICHANSEN COPENHAGEN
President: Mrs. Hanne & Lone Wilhelm Han-
sen
Professional mgr.: Mr. Arne Spliid

TEMPO MUSIKFORLAG—Vesterport 247 —
COPENHAGEN V
Phone: 11 50 00
Cable: MUSICMORK COPENHAGEN
President: Mr. Knut Mørk

WILHELM HANSEN, MUSIK-FORLAG —
Gothersgade 9—COPENHAGEN K
Phone: Minerva 7888
Cable: MUSICHANSEN COPENHAGEN
Presidents: Mrs. Hanne & Lone Wilhelm
Hansen
Professional mgr.: Mr. Arne Spliid

DENMARK—Recording Studios

BIGOS STUDIO—Polensgade 7— COPEN-
HAGEN S
Phone: Sundby 716
President: Mr. Børge Jensen

METRONOME STUDIOS A/S—Vibevej 31—
COPENHAGEN NV
Phone: AEGir 8112
Cable: METRORECORDS COPENHAGEN
President: Mr. Bent Fabricius-Bjerre

TONO GRAMMOFONPLADER A/S—Dorth-
eavej 1-3—COPENHAGEN NV
Phone: AEGir 9680
Cable: TONORECORDS COPENHAGEN
President: Mr. Harry Larsen

WIFOS INGENIØRSFIRMA—Nyvej 6 —
COPENHAGEN V
Phone: EVa 5814
President: Mr. G. P. Foss

Sub-publishing in Scandinavia?

Action . . .
Promotion . . .

EDITION
ODEON
STOCKHOLM

OXENSTIERNSGATAN 37, STOCKHOLM No
Telephone: 22 45 80 — 60 53 53
Cables: TURNTABLE Stockholm
Managing director: Kjell Wigren

The Hottest Independent Label In

Scandinavia

is

POLAR RECORDS AB

P.O. Box 5265 Jungfrugatan 18 Stockholm 5 Sweden

Cable: SWEDENMUSIC STOCKHOLM

Phone: 63 79 70 & 60 22 87

SWEDEN—Record Manufacturers

AMIGO MUSIKPRODUKTION AB—Atlasgatan 14—STOCKHOLM Va
Phone: 31 67 10
President: Mr. P. A. Boquist
Labels (domestic): Amigo, Team

ARKENS RUNDRADIO—c/o Ljusterdal—Murargatan 2C—UPPSALA
Phone 11 62 60
Presidents: Mr. Ake Ljusterdal, Mr. Stig Holtzberg & Mr. Gunnar Olsson
Labels (domestic): Arr
Records distributed by GDC

ARNE BILL PRODUKTION AB—P.O. Box 953—HAGERSTEN 9
(Blommensbergsvagen 140—Hagersten 9)
Phone: Stockholm 18 18 44
President: Mr. Arne Bill
Labels (domestic): Bill Records
Records distributed by GDC

BOKFORLAGET LIBRIS—P.O. Box 330—OREBRO 1
(Orebro Missionsforenings Forlag—Skolgatan 11—Orebro 1)
Phone: (019) 11 93 60
Cable: OREBROMISSIONEN OREBRO
Manager: Mr. Wimar Hansson
Labels (domestic): Jubilate
Religious music.

AB CLAVICORD—Post Box 35—BOLLNAS 1
Phone: 52 122
President: Mr. Evald Sonefors
Labels (domestic): Clavicord
Records distributed by GDC

***CUPOL GRAMMOFON & MUSIK AB**—Katarina Bangata 17—STOCKHOLM So
Phone: 23 30 55
Cable: CUPOL STOCKHOLM
President: Mr. Helge Roundqvist
Labels (domestic): Cupol, Nashville, Reprise, Labels (others): Ariola, Baccarola, Cantio, Cetra, Contemporary, Efel, Eurodisc, Europa, Festival, Fonit, Good Time Jazz, Hansa, Hep House, JD, JF, Lyra, Melodia, MMO, Olga, Palette, Parodisc, Playtone, Pop Hat, Sveriges Radio, Swe-Tone, Toni, Time, Troll, Vega.

DOLLAR MUSIC—Folkungagatan 136—STOCKHOLM So
Phone: 43 90 93
President: Mr. Ake Sohr
Labels (domestic): Dollar
Records distributed by Cupol

E.M.I. LTD. SVENSKA AB—Fack—STOCKHOLM 10
(Kommendorgatan 44—Stockholm O)
Phone: 22 45 80
Cable: GRAMMOPHON STOCKHOLM
President: Mr. Anders Holmstedt
A & R man: Mr. Bengt Sundstrom
Labels (domestic): Columbia, His Master's Voice, Odeon, Sakral, Svensk-American, Labels (others): Amy, Angel, Artist, Barnparaden, Benita, Biphon, Blue Note, Capitol, Delyse, Dolton, Dynavoice, Electrola, Ember, Encore, Envoy, Epok, Erato, Gloria, Immediate, Imperial, Kurre Smack, Laurie, Liberty, MGM, Parlophone, Pathe, Rasp, Regal, Select, Stateside, Tamla/Motown, Tivoliophone, Tower, Uptown, Volksplatte, Waverly, Wergo.

ERNST WESTERBERGS FORLAGS AB—Post Box—STOCKHOLM 6
(Norrullsgatan 10—Stockholm Va)
Phone: 24 16 50
Cable: BAPTIST STOCKHOLM
President: Mr. Zeth Abrahamsson
Labels (domestic): Cantus
Religious music—The Baptists

EUROPA-PRODUKTION—Drottninggatan 65—STOCKHOLM C
Phone: 11 62 40
Cable: EUROPASONG STOCKHOLM
President: Mr. Ake Gerhard-Larsson
Labels (domestic): Efel, Europa, Olga
Records distributed by Cupol

FRALSNINGARMENS FORLAGS AB—P.O. Box 5090—STOCKHOLM 5
(Ostermalmsgatan 71—STOCKHOLM O)
Phone: 63 17 00
Cable: FRALSNING STOCKHOLM
Manager: Mr. Harry Floby
Labels (domestic): Festival
Labels (others): Regal
Religious music—The Salvation Army

FORLAGET FILADELFIA AB—P.O. Box 6082—STOCKHOLM 6
(Dobelnsngatan 52—Stockholm Va)
Phone: 34 93 80
Cable: PINGSTKYRKAN STOCKHOLM
President: Mr. Sven Lindahl
Labels (domestic): Hemmets Harold
Religious music—The Pentecostal Movement

***GRAMMOFON AB ELECTRA**—P.O. Box 1178—SOLNA 1
(Ankdammsgatan 5G—Solna 1)
Phone: Stockholm 82 04 80
Cable: TEFUNK SOLNA
President: Mr. Sixten Eriksson
A & R man: Mr. Mats Olsson
Labels (domestic): RCA Victor
Labels (others): Colgem, Dunhill, RCA Camden, RCA Victorola

HELLBERG-PERLITZ PRODUCTION—Lilla Nygatan 16—STOCKHOLM C
Phone: 11 42 84
President: Mr. Franklin Perlitz
Labels (domestic): Rasp
Records distributed by Skandinaviska Gram-mophon AB

IBRA RADIO AB—P.O. Box 821—STOCKHOLM 1
(Sveavagen 34—Stockholm C)
Phone: 24 01 30
President: Mr. Hans Carlsson
Labels (domestic): Ibra
Religious music

JAZZ RECORDS—Nynasvagen 333—ENSKEDE
Phone: Stockholm 39 29 88
President: Mr. Gunnar Lindqvist
Labels (domestic): Jazz Records

JET RECORDS—P.O. Box 14068—STOCKHOLM 14
(Grevgatan 3—Stockholm O)
Phone: 60 61 50
President: Mr. Ove Sloor
Labels (domestic): Jet
Records distributed by GDC

KARUSELL GRAMMOFON AB—Post Box—SOLNA 1
(Framnasbacken 4B—Solna 1)
In middle of Aug. moving to Karlavagen 81—Stockholm O

New address and phone number will be given in the Scandinavian column later.
Phone: Stockholm 27 26 70
Cable: KARUSELL STOCKHOLM
Presidents: Mr. Ivan Nordstrom & Mr. Klaus Holler
Labels (domestic): Joker, Karusell, Polydor
Labels (others): ABC-Paramount, Archiv-Produktion, Bounti, Cameo/Parkway, Command, Deutsche Grammophon, Elektra, Folkways, Heliodor, Impulse, Kama Sutra, Lani, Midnight Sun, Nonesuch, Swe-Disc, Tip, United Artists, Verve, Westminster.
Records distributed by GDC.

KASKAD RECORDS—P.O. Box 3134—STOCKHOLM 3
(Solvagen 8—Trollbacken)
Phone: 44 40 87
President: Mr. Lennart Broberg
Labels (domestic): Kaskad

KEWE MUSIC—Vikingavagen 15—DANDERYD
Phone: Stockholm 55 78 99
President: Mr. Kewe Wickman
Labels (domestic): Wide World Records

AB KNAPPUPP—P.O. Box 3073—STOCKHOLM 3
(Kungsgatan 19—Stockholm C)
Phone: 24 07 20
Cable: RALVOPRO STOCKHOLM
President: Mr. Felix Alvo
Labels (domestic): Knappupp, Triola
Labels (others): Dot, Hamilton, Kapp
Records distributed by GDC

LIDOPRODUKTION—Fack 131—LIDKOPING
Phone: 23 125
President: Mr. Ejnar Svensson
Labels (domestic): Anette
Records distributed by GDC

MEGAFON—Goteborgsvagen 28—GOTHENBURG C
Phone: 20 60 96
President: Mr. Lars-Gunnar Andersson
Labels (domestic): Chalmers, Megafon.
Records distributed by GDC

***METRONOME RECORDS AB**—Storangs-vagen 27—STOCKHOLM No
Phone: 61 06 16
Cable: METROREC STOCKHOLM
President: Mr. Mats Bjerke
Export manager: Mr. Borje Ekberg
Labels (domestic): Metronome, Snurrskivan
Labels (others): ATCO, Atlantic, Bang, Barclay, Dial, Shout, Stax, Volt
Records distributed by GDC

MOONLIGHT MUSIC—Vackra vagen 14—SUNDBYBERG
Phone: Stockholm 29 15 36
President: Mr. Ake Oquist
Labels (domestic): Midnight Sun Records
Records distributed by GDC

MORGONSTJARNANS FORLAG—Kungsholmsgatan 20—STOCKHOLM K
Phone: 51 63 87
Cable: AHLINMUSIK STOCKHOLM
President: Mr. Marta Ahlin
Labels (domestic): Morgonstjarnan
Labels (others): Ansgar
Religious music.

NORDISKA MUSIKFORLAGET AB—P.O. Box 8—STOCKHOLM Tull
(Pipersgatan 19—Stockholm K)
Phone: 54 19 00
Cable: MUSICALIA STOCKHOLM
President: Mr. Leif Kronlund
Labels (domestic): Artist, Barnparaden
Records distributed by Skandinaviska Gram-mophon AB

NYA BOKFORLAGS AB—P.O. Box 5020—STOCKHOLM 5
(Sibyllegatan 18—Stockholm O)
Phone: 67 01 55
President: Mr. Karl-Erik Hellberg
Labels (domestic): Angelica
Religious music—The Methodists

***AB PHILIPS-SONORA**—P.O. Box 5153—STOCKHOLM 5
(Kommendorgatan 26—Stockholm O)
Phone: 63 54 00
Cable: SONORA STOCKHOLM
President: Mr. Eddie Landqvist
Labels (domestic): CBS, Conserton, Dux, Fontana, Oktav, Philips, Sonata, Sonora, Svenska Ljud.
Labels (others): Amadeo, Date, Golden Guinea, Harmony, Limelight, Marble Arch, Mercury, Mira, Musicor, Page One, Piccadilly, Pye, Smash, Vanguard, World Pacific.
Records distributed by GDC.

POLAR RECORDS AB—P.O. Box 5265—STOCKHOLM 5
(Jungfrugatan 18—Stockholm O)
Phone: 63 79 70
Cable: SWEDENMUSIC STOCKHOLM
President: Mr. Bengt Bernhag
Labels (domestic): Polar
Records distributed by GDC

POPULAR MELODI—Norrbackagatan 5, 1—STOCKHOLM Va
Phone: 30 16 96
President: Mr. Allan Ehwert
Labels (domestic): Pop

AB RECORD-MATERIEL—Norrbackagatan 1—STOCKHOLM Va
Phone: 23 42 15
Cable: RECOPRESS STOCKHOLM
President: Mr. Knut Vestman
Labels (domestic): Onskesagan

SCAN-DISC RECORDING CO. AB—Gre-vturgatan 38—STOCKHOLM O
Phone: 67 99 14
Cable: SCANDISCO STOCKHOLM
President: Mr. Ronald Sjogren
Labels (domestic): Polka, Scan-Disc
Labels (others): Kenwood, Primary, Rifi, Roost, Roulette, Squire, Tico, Tono.
Records distributed by GDC

SEPTIMA RECORDS AB—P.O. Box 5265—STOCKHOLM 5
(Jungfrugatan 18—Stockholm O)
Phone: 63 79 70
Cable: SWEDENMUSIC STOCKHOLM
President: Mr. Bengt Bernhag
Labels (domestic): Septima
Records distributed by GDC

***SONET GRAMMOFON AB**—P.O. Box 39062—STOCKHOLM 39
(Artemisgatan 8—Stockholm No)
Phone: 67 05 40
Cable: SONETMUSIC STOCKHOLM
President: Mr. Gunnar Bergstrom
Int'l & Sales mgr: Mr. Dag Haggqvist
Labels (domestic): Gazell, Grand Prix, Sonet, Storyville
Labels (others): Cadet, Checker, Chess, Durium, Epic, GNP Crescendo, Go Go, Island/Sue, Major Minor, Moonglow, Okeh, Palette, Pickwick 33, Planet, Riviera, Scepter, Super Majestic, Supraphon, Transatlantic, Xtra.
Records distributed by GDC.

SUNSET RECORD—P.O. Box 40139—STOCKHOLM 40
Phone: Uppsala 13 50 50
President: Mr. Thomas Nordlund
Labels (domestic): Sunset Records
Records distributed by GDC

AB SVENSKA MANU-MUSIC—Blekingegatan 61—STOCKHOLM So
Phone: 43 07 55
President: Mr. Per Nystrom
Labels (domestic): Manu
Labels (others): Junior Records
Records distributed by GDC

SVENSKA MISSIONSFORBUNDETS FORLAG—Tegnergatan 8—STOCKHOLM Va
Phone: 34 96 80
President: Mr. Bertil Johansson
Labels (domestic): Sirius, Solist
Records distributed by GDC—Religious music

SVERIGES RADIO AB—P.O. Box 955—STOCKHOLM 1
(Oxenstiernsgatan 2—Stockholm No)
Phone: 63 10 00
Cable: BROADCAST STOCKHOLM
Manager of record dept.: Mr. Manne Ginsburg
Labels (domestic): Sveriges Radio
Records distributed by Cupol and by Skandinaviska Grammophon AB.

SWE-DISC GRAMMOFON AB—Islandstorget—BROMMA
Phone: Stockholm 87 33 00
Cable: SWEDISC ISLANDSTORGET BROMMA
Presidents: Mr. Roland Ferneberg Mr. Sture Wahlberg
Labels (domestic): Swe-Disc
Records distributed by GDC

SWERECO AB—Post Box—JOHANNESHOV
(Huvudskarsvagen 16—Johanneshov)
Phone: Stockholm 39 32 00
President: Mr. Arne Setterwall
Labels (others): AZ, Crown, Eros, MK, Mode, Monitor, Pop, Saga, Sidney Bechet, Vogue.

SWE-TONE RECORDS—c/o Pergeman—Snickarvagen 25—BRO
Phone: Staket 40 533
President: Mr. Alf Pergeman
Labels (domestic): Swe-Tone
Records distributed by Cupol

***TELEFUNKEN FORSALJNING AB**—P.O. Box 1178—SOLNA 1
(Ankdammsgatan 5 G—Solna 1)
Phone: Stockholm 82 04 80
Cable: TEFUNK SOLNA
President: Mr. Sixten Eriksson
Musical director: Mr. Mats Olsson
A & R man: Mr. Sven Agren
Labels (domestic): Decca, Reprise, Sagoton, Swedish Society Discofil, Telefunken, Teles-tar, Warner Bros.
Labels (others): Ace of Clubs, Ace of Diamonds, Ace of Hearts, Brunswick, Coral, Deram, Loma, London, Monument, L'Oiseau-Lyre, Turnabout, Vocalion.

WILLIAMS FORLAGS AB—P.O. Box 315—BROMMA 3
(Holbergsgatan 95—Bromma)
Phone: Stockholm 37 27 40
Cable: ILLKCLASS STOCKHOLM
President: Mr. Bo All
Labels (domestic): Kurre Smack
Records distributed by Skandinaviska Gram-mophon AB.

*Refer to members of Swedish Association of Record Suppliers.

CUPOL AB—Katarina Bangata 17—STOCKHOLM So
Phone: 23 30 55
Cable: CUPOL STOCKHOLM
President: Mr. Helge Roundqvist
Distributes the products of the following manufacturers: Cupol Grammophon & Musik AB, Dollar Music, Europa-Produktion, Sveriges Radio AB and Swe-Tone Records.

GDC/GRAMMOFONBOLAGENS DISTRIBUTIONSCENTRAL—P.O. Box 5153—STOCKHOLM 5
(Jungfrugatan 19—Stockholm O)
Phone: 63 54 00
President: Mr. Eddie Landqvist
Distributes the products of the following manufacturers: Arkens Rundradio, Arne Bill Produktion AB, AB Clavicord, Jet Records, Karusell Grammophon AB, AB Knappupp, Lidoproduktion, Megafon, Metro-nome Records AB, Moonlight Music, Pan Records, Pandoree, AB Philips-Sonora, Polar Music AB, Scan-Disc Recording Company AB, Septima Records AB, Sonet Grammophon AB, Sunset Records, AB Svenska Manu-Music, Svenska Missionsforbundets Forlag, Swe-Disc Grammophon AB.

SKANDINAVISKA GRAMMOFON AB—P.O. Box 27053—STOCKHOLM 27
(Sandhamnsgratan 39—Stockholm No)
Phone: 22 45 80
Cable: GRAMMOFON STOCKHOLM
President: Mr. Anders Holmstedt
Distributes the products of the following manufacturers: Hellberg-Perlitz Produktion, Jazz Records, Nordiska Musikforlaget AB, Skandinaviska Grammophon AB, Sveriges Radio AB and Williams Forlags AB.

SWEDEN RECORDING STUDIOS

COMO STUDIO—Karlbergsvagen 57—STOCKHOLM Va
Phone: 30 96 00
Cable: METROREC STOCKHOLM
Studio manager: Mr. Rune Persson

EUROPA FILM AB—Annedalsvagen 29—SUNDBYBERG
Phone: Stockholm 28 28 00
Cable: EUROPFILM STOCKHOLM
Studio manager: Mr. Bjorn Bergqvist

SVENSKA AB PHILIPS—P.O. Box—STOCKHOLM 27
(Lidingovagen 50—Stockholm No)
Phone: 63 50 00
Cable: PHILAMP STOCKHOLM
Studio manager: Mr. Dag Secher
Studio technician: Mr. Gert Palmcrantz

SELA STUDIO—Stortorget 5—STOCKHOLM C
Phone: 10 31 34
President: Mr. Lennart Ljungberg
Studio manager: Mr. Sten Hagberg

**YOUR AMIGOS
IN SCANDINAVIA
CAN DO
SOMETHING
FOR YOU!**



RECORDS • PUBLISHING

AMIGO
MUSIKPRODUKTION AB

Atlasgatan 14 Stockholm Va
SWEDEN

Jan and Per-Anders Boquist

THE Publisher In Scandinavia

REUTER & REUTER

Regeringsgatan 45

Stockholm C

Sweden

SWEDEN'S BEST SELLERS

Listed below are records appearing at first, second and third spot in the charts month-by-month during the first six months, 1967:

- January:**
- *Consolation (Hep Stars/Olga) Hep House AB, Sweden
 - *Vid din sida (Sven Ingvars/Svensk-American) Seven Brothers Music Inc./Edition Odeon, Sweden
 - Alex Is The Man (Ola & Janglers/Gazell) Sonet Music AB, Sweden
- February:**
- I'm A Believer (Monkees/RCA Victor) Screen Gems Musikförlag AB, Sweden
 - I natt jag dromde (Last Night I Had A Strangest Dream) (Hep Stars/Olga) Musikförlaget Essex AB, Sweden
 - Green, Green Grass Of Home (Tom Jones/Decca) Palace Music (Sweden) AB, Sweden
- March:**
- I'm A Believer (Monkees/RCA Victor) Screen Gems Musikförlag AB, Sweden
 - I natt jag dromde (Last Night I Had A Strangest Dream) (Hep Stars/Olga) Musikförlaget Essex AB, Sweden
 - Bucket T. (Who/Polydor) Screen Gems Musikförlag AB, Sweden
- April:**
- Penny Lane (Beatles/Parlophone) Sonora Musikförlags AB, Sweden
 - En sang en gang for langsen (Green, Green Grass Of Home) (Jan Malmsjö/CBS) Palace Music (Sweden) AB, Sweden
 - A Little Bit Me, A Little Bit You (Monkees/RCA Victor) Screen Gems Musikförlag AB, Sweden
- May:**
- A Little Bit Me, A Little Bit You (Monkees/RCA Victor) Screen Gems Musikförlag AB, Sweden
 - En sang en gang for langsen (Green, Green Grass Of Home) (Jan Malmsjö/CBS) Palace Music (Sweden) AB, Sweden
 - Penny Lane (Beatles/Parlophone) Sonora Musikförlags AB, Sweden
- June:**
- Somehin' Stupid (Nancy & Frank Sinatra/Reprise) Thore Ehrling Musik AB, Sweden
 - Ha! Ha! Said The Clown (Manfred Mann/Fontana) Sonora Musikförlags AB, Sweden
 - Puppet On A String (Sandie Shaw/Pye) Thore Ehrling Musik AB, Sweden
- *Local copyright.

The year has been comparatively good for local tunesmiths, with a large number of their songs appearing among the top ten. Monkees, of course, have done very good here, as in other countries, and offered a very strong competition to the British wave, which is still strong here.

FINLAND'S BEST SELLERS

Listed below are records appearing at first, second and third spot in the charts month-by-month during 1967:

- January:**
- Little Man (Sonny & Cher/Atlantic) Oy R. E. Westerlund Ab, Finland
 - No Milk Today (Herman's Hermits/Columbia) Scandia-Musiikki Oy, Finland
 - Keltainen jaansakia (Yellow Submarine) (Simo & Spede/Scandia) Scandia-Musiikki Oy, Finland
- February:**
- Little Man (Sonny & Cher/Atlantic) Oy R. E. Westerlund Ab, Finland
 - I'm A Believer (Monkees/RCA Victor) Screen Gems Musikförlag AB, Sweden
 - No Milk Today (Herman's Hermits/Columbia) Scandia-Musiikki Oy, Finland
- March:**
- I'm A Believer (Monkees/RCA Victor) Screen Gems Musikförlag AB, Sweden
 - Hiljainen kitara (Gringo's Guitar) (Danny/Scandia) Scandia-Musiikki Oy, Finland
 - Little Man (Sonny & Cher/Atlantic) Oy R. E. Westerlund Ab, Finland
- April:**
- *Elsa kohtalon lapsi (Martti Inanan/Safir) Erik Lindström Music, Finland
 - I'm A Believer (Monkees/RCA Victor) Screen Gems Musikförlag AB, Sweden
 - *Sua kutsun, Maarit (Danny/Scandia) Edition Coda, Finland
- May:**
- *Elsa, kohtalon lapsi (Martti Inanan/Safir) Erik Lindström Music, Finland
 - *Sua kutsun, Maarit (Danny/Scandia) Edition Coda, Finland
 - On ihmeen hyva tulla kotiin (Green, Grass Of Home) (Lasse Martensson/RCA Victor) Palace Music (Sweden) AB, Sweden
- June:**
- *Elsa, kohtalon lapsi (Martti Inanan/Safir) Erik Lindström Music, Finland
 - *Iltatuulen viesti (Aikamiehet/Finlandia) Levysävel Oy, Finland
 - *Sua kutsun, Maarit (Danny/Scandia) Edition Coda, Finland
- *Local copyright.

The general trend is still obvious; there's a great market for either local songs, or foreign songs sung in Finnish, but of course, with Finland becoming more and more a teenagers' market, also foreign artists in foreign languages are taking over a greater part of the record market.

DENMARK'S BEST SELLERS

Listed below are records appearing at first, second and third spot in the charts month-by-month during 1967:

- January:**
- Oh, Oh What A Kiss (Uber die Wellen) (Rocking Ghosts/Metronome) Multitone A/S, Denmark
 - En tusindfyrd i min hand (En prästkrage i min hand) (Keld & Donkeys/HMV) Imudico A/S, Denmark
 - *Jeg har aldrig faet noget (Defenders/Sonet) No publisher
- February:**
- Oh, Oh What A Kiss (Uber die Wellen) (Rocking Ghosts/Metronome) Metronome A/S, Denmark
 - *Jeg har aldrig faet noget (Defenders/Sonet) No publisher
 - *Sad'n var det ikke i halvfemserne (Matadorerne/Metronome) No publisher
- March:**
- I'm A Believer (Monkees/RCA Victor) Screen Gems Musiförlag AB, Sweden
 - Oh, Oh What A Kiss (Uber die Wellen) (Rocking Ghosts/Metronome) Multitone A/S, Denmark
 - Let's Spend The Night Together (Rolling Stones/Decca) Musikförlaget Essex AB, Sweden
- April:**
- Penny Lane (Beatles/Parlophone) Multitone A/S, Denmark
 - *Sidste dans (Keld & Donkeys/HMV) Imudico A/S, Denmark
 - Let's Spend The Night Together (Rolling Stones/Decca) Musikförlaget Essex AB, Sweden
- May:**
- Penny Lane (Beatles/Parlophone) Multitone A/S, Denmark
 - *Sidste dans (Keld & Donkeys/HMV) Imudico A/S, Denmark
 - Du skal ikke gi' mig roser (Björn Tidmand/Odeon) Musikproduktion Winckler, Denmark
- June:**
- Du skal ikke gi' mig roser (Björn Tidmand/Odeon) Musikproduktion Winckler, Denmark
 - Puppet On A String (Sandie Shaw/Pye) Imudico A/S, Denmark
 - Nu tar jeg til Dublin (Björn Tidman/Odeon) Imudico A/S, Denmark
- *Local copyright.

The year has been very good also for local tunesmiths, who have noted a number of best sellers, particularly with some oldies (for some reasons they are called "evergreens" here in Scandinavia).

DENMARK PRESSING PLANTS

FABRIKEN PLASTICA A/S—Dortheavej 1-3—COPENHAGEN NV
Phone: AEGir 9680
Cable: TONORECORDS COPENHAGEN
Mr. Harry Larsen President:

SKANDINAVISK BAKELITE INDUSTRI A/S—Provnsvej 35—COPENHAGEN-VAN-LOSE
Phone: 70 15 21
President: Mr. Marius Sørensen

SKANDINAVISK GRAMMOPHON A/S—Høffdingsvej 18—COPENHAGEN-VALBY
Phone: 30 67 11
Cable: GRAMMOPHON COPENHAGEN
President: Mr. S. L. G. Gottlieb

DENMARK COLLECTING SOCIETIES

K. O. D. A.—Kronprinsessegade 26—COPENHAGEN NV
Phone: Central 2277
Cable: INTERKODA COPENHAGEN
President: Mr. Svend Erik Tarp
International Forbund till Beskyttelse af Komponistrettigheder i Danmark/International Association for Protection of Composer's Rights in Denmark.

N. C. B.—Upsalagade 24—COPENHAGEN Ø
Phone: TRianon 3660
Cable: COPYRIGHT COPENHAGEN
President: Mr. Karl Nielsen
Nordisk Copyright Bureau—Mechanical licenses in Scandinavia.

DENMARK—Record Manufacturers

AEG DANSK ELEKTRISITETS A/S—Nyropsgade 18—COPENHAGEN V
Phone: Central 5000
Cable: ELEKTRONGEA COPENHAGEN
President: Mr. John L. Bryholt
Assistant mgr.: Mr. Vilhelm Høy
Labels (others): Cupol, Efel, Europa, Nashville, Olga, Swedish Society Discofil, Telefunken

I. S. DANSK GRAMMOPHONPLADEFORLAG—Dortheavej 39—COPENHAGEN NV
Phone: TAGA 8505
Cable: DANRECORD COPENHAGEN
President: Mr. Karl Emil Knudsen
Publicity: Mr. Poul Bach
A & R man: Mr. Gustav Winckler
Labels (domestic): Ecco, Life, Mascot, Sonet, Storyville
Labels (others): Amigo, Artone, Baronet, Blue Note, Cadet, Canadian-American, Charlie Parker, Checker, Chess, Colpix, Epic, Folkways, Funckler, Gazell, Grand Prix, Island Records, Kenwood, MK, Monitor, Moonglow, Musidisc, Nashville, Okeh, Palette, Pickwick 33, Planet, Red Bird, Roulette, Roost, Saga, Scan-Disc, Society, 77/Folklore, Starday, Status, Supraphon, Transatlantic, Xtra.

FELIX FILM OG GRAMMOPHON—Bernstoffs-gade 21—COPENHAGEN K
Phone: MInerva 2543
Presidents: Mr. Ejnar Christensen
Labels (domestic): Felix
Labels (others): Cantate

GRØNLANDS INKØBSRING A/S—Vesterbrogade 60—COPENHAGEN V
Phone: EVa 1561
Cable: RINGBUY COPENHAGEN
President: Mr. Olle Flønsted
Labels (domestic): Kajak
Manufacturer of records by and for local consumption at Greenland

HEDE NIELSENS FABRIKKER A/S—Grundtvigsvej 10A—COPENHAGEN V
Phone: EVa 4120
Cable: HENIGRAM COPENHAGEN
President: Mr. Ove Hede Nielsen
General manager: Mr. Leif Risell
Publicity: Mr. Leif Risell
Labels (domestic): RCA Victor
Labels (others): RCA Camden, RCA Victrola, Reprise, Warner Bros.

KORSETS EVANGELIUMS FORLAG—Kronprinsesgade 7—COPENHAGEN K
Phone: PAlea 3808
Manager: Mr. Sv. Aage Svendsen & Mr. W. Hagstrom
Labels (domestic): Korsets Evangelium
Labels (others): Hemmets Harold, Klango
Religious music—The Pentecostal Movement

METRONOME RECORDS A/S—Vibevej 31—COPENHAGEN NV
Phone: AEGir 8112
Cable: METRORECORDS COPENHAGEN
President: Mr. Bent Fabricius-Bjerre
Labels (domestic): Anders And, Metronome
Labels (others): ABC-Paramount, Ariola, Athena, Ateo, Atlantic, Baccarola, Bang, Cameo/Parkway, Carla, Clarion, Dial, Don, Elektra, Eurodisc, Golden 12, Hansa, Impulse, Joker, Karusell, Midnight Sun Records, Nonesuch, Shout, Snurrskivan, Stax, SweDisc, Troubadour, Volt, Westminster.

MØRKS MUSIKFORLAG—Vesterport 247—COPENHAGEN V
Phone: 11 50 00
Cable: MUSICMORK COPENHAGEN
President: Mr. Knut Mørk
Publicity: Mr. Ivan Meldgaard
Labels (domestic): Triola
Labels (others): Austroton, CGD, Derby, Dot, Elite Special, Golden Guinea, Hickory, Jewel, Kapp, Knäppupp, Paula, Piccadilly, Pye, Whit.

NORDISK POLYPHON AKTS.—Emdrupvej 115—COPENHAGEN NV
Phone: 69 25 22
Cable: POLYPHON COPENHAGEN
Managing director: Mr. Werner Hamburger
A & R manager: Mr. Bruno Henriksen
Labels managers (including publicity): Mr. Andreas Arffmann, Mr. H. Rosenløv Jensen, Mr. Ove Wiisholm
Labels (domestic): Philips, Polydor, Polyphon
Labels (others): Ace of Clubs, Ace of Diamonds, Ace of Hearts, Archiv-Produktion, Brunswick, CBS, Decca, Deram, Deutsche Grammophon, Fontana, London, Mercury, Riverside, Turnabout, United Artists, Verve, Vocalion.

OKTAV MUSIK—Helleruplund Alle 4—HELLERUP
Phone: HELrup 9305 & 7690
President: Mr. Borge Binderup
Publicity: Mr. Jørgen Kleinert
Labels (domestic): Oktav
Labels (others): ZAC

SKANDINAVISK GRAMMOPHON A/S—Høffdingsvej 18—COPENHAGEN-VALBY
Phone: 30 67 11
Cable: GRAMMOPHON COPENHAGEN
President: Mr. S. L. G. Gottlieb
Publicity: Mr. Kurt Hviid-Mikkelsen
Labels (domestic): Columbia, His Master's Voice, Odeon
Labels (others): Capitol, Dolton, Electrola, Ember, Encore, Gloria, Immediate, Imperial Laurie, Liberty, Metro, MGM, Parlophone, Pathe, Regal, Stateside, Svensk-American, Tamla/Motown.

TIVOLIPHON—Fredriksberg Alle 25—COPENHAGEN V
Phone: HILda 2768
President: Mr. Asger Lund-Christensen
Labels (domestic): Tivoliphon

TONO GRAMMOPHONPLADER A/S—Dortheavej 1-3—COPENHAGEN NV
Phone: AEGir 9680
Cable: TONORECORDS COPENHAGEN
President: Mr. Harry Larsen
Label managers: Mr. E. Øllgaard, Mr. Svend Hansen
Labels (domestic): Teener, Tono
Labels (others): Amadeo, Audio Fidelity, Barclay, Bel Air, Contemporary, Durium, Embassy, Fonit, GNP, Good Time Jazz, Jazz Selection, Josie, Jubilee, Mainstream, Majestic, Mode, Oriole, Pop, Ronnex, Swing, Time, Vogue.

FINLAND—COLLECTING SOCIETIES

T.E.O.S.T.O.
Hietaniemenkatu 2—Helsinki
(Tekijanoikeustoitomisto/Tonsattarnas Copyright Byra/Finnish Copyright Bureau)
Phone: 44 85 09
Cable: Teosto Helsinki
President: Mr. Martti Turunen

FINLAND—GALVANIC INDUSTRIES

AKKUTEOLLISUUS OY
Neitsytpolku 1 B—Helsinki
Phone: 11 912
Cable: Nife Helsinki
President: Mr. Ernst Wallner

FINLAND—PRESSING PLANTS

Oy AIRAM Ab
Pursimiehenkatu 29-31—Helsinki
Phone: 11 431
Cable: Airam Helsinki
President: Mr. Henrik Bergroth

AKKUTEOLLISUUS OY
Sahatie 2—Helsinki
Phone: 11 912
Cable: Nife Helsinki
President: Mr. Ernst Wallner



manufacturing, sales
and distribution in
Sweden/Scandinavia,
contact

Cupol AB, Kat. Bang.,
17, Stockholm, Sweden.
Also music pub. comp.

STOCKHOLMS MUSIKPRODUKTION

Always open for interesting material and catalogue deals for all Scandinavian countries.

Management: Felix & Lisbeth Stahl
Drottninggatan 55, Stockholm C / Sweden

LOTS SHOWBIZ UNDER ONE HAT

(in fact the biggest independent hat in Norway)

Record Dept. Publishing Concert Agency

Looking for a good connection in Scandinavia? May we offer you our services: record dept. (the definite leading on locally produced single hits), concert agency, background music, publishing, sound equipment, recording facilities.

Local recording on Triola and Sonet-label (constantly on the charts).

Distribution: Allegro — Argo-Artone — Bel Air — Cadet — Checker — Chess — Colpix — Dimension — Disques — Dot — Durium — Elite Special — Epic — Funcler — Gazal — Hickory — Island Records — Joy — Kapp — Knappupp — Loma — MK — Omega — Palette — Prima — Red Bird — Reprise — RIC — Rifi — Roulette — Saba — Scandisc — Selec — Show — Sone — Specialty — Storyville — Sue — Super Majestic — Symbol — Tempo — Tiger — Tip — Transatlantic — Triola — Valiant — Vox — Warner Bros. — Vogue.



ARNE BENDIKSEN AS
NORSK MUSIKK PRODUKSJON
Grammofonplateavd./record dept.
Østerdalsgaten 1—OSLO 6
TLF. 67 67 90, CABLEADR: "BENDIKMUSIC"

Now in our own building with 1000 sq. metres for our use.

— the progressive and trusted firm that's setting the trend in Scandinavian showbiz.

NORWAY—Record Manufacturers

ANSGAR FORLAG A/S—Møllergaten 26—OSLO 1
Phone: 42 07 47
President: Mr. Tormund Torgussen
Labels (domestic): Ansgar
Religious music.

ARNE BENDIKSEN A/S—Østerdalsgaten 1—OSLO 6
Phone: 67 67 90
Cable: BENDIKMUSIC OSLO
President: Mr. Arne Bendiksen
Labels (domestic): Hjemmets Toner, Lorne Records, Sonet, Triola.
Labels (others): Allegro, Argo, Artone, Bel Air, Cadet, Checker, Chess, Colpix, Dimension, Disques AZ, Dot, Durium, Elite Special, Epic, Funcler, Gazal, Hickory, Island Records, Joy, Kapp, Knappupp, Loma, MK, Omega, Palette, Prima, Red Bird Reprise, RIC, Rifi, Roulette, Saba, Scan-Disc, Select, Show, Specialty, Storyville, Sue Records, Super-Majestic, Symbol, Tempo, Tiger, Tip, Transatlantic, Valiant, Vox, Warner Bros. Vogue.

BRØDRENE JOHNSEN A/S—P.O. Box 251—OSLO 1
(Nedre Slottsgate 11—Oslo 1)
Phone: 42 09 93
Cable: BRODEKJOHN OSLO
President: Mr. Peer Johnsen
Labels (domestic): Rondo
Labels (others): Amadeo, Cetra, Fonit, Pye, Tono, Vox.
Records distributed by Norsk Phonogram A/S.

CARL M. IVERSEN A/S—P.O. Box 191—OSLO 1
(Youngsgate 1—Oslo 1)
Phone: 41 39 60, 41 38 67
Cable: PLANOREFLEX OSLO
Supervisor: Mr. S. L. G. Gottlieb
Manager: Mr. Hans Roo
A & R man: Mr. Rolf Syversen
Labels (domestic): Columbia, His Master's Voice, Odeon
Labels (others): Angel, Capitol, Dolton, Electrola, Ember, Encore, Gloria, Immediate, Imperial, Laurie, Liberty, MGM, Parlophone, Pathe, Platina, Regal, Stateside, Svensk-American, Tamla/Motown.

FILADELFAFORLAGET A/S—S:t Olavs gate 24—OSLO 1
Phone: 33 61 27
President: Mr. Kjell Ruud
Labels (domestic): Klango
Labels (others): Hemmets Harold
Religious music—The Pentecostal Movement.

JØRG-FR. ELLERTSEN A/S—Jernbanetorget 4—OSLO 1
Phone: 41 26 09
Cable: TROLLMUSIC OSLO
President: Mr. Jørg-Fr. Ellertsen
Labels (domestic): Kristine Toner (religious), Troll (pop)
Labels (others): Crescendo
Records distributed by A/S Nera.

MANU MUSIC A/S—Tolbugaten 12—OSLO 1
Phone: 42 72 12
President: Mr. Per Gunnar Jensen
Manager: Mr. Per-Arne Knobelauch
Labels (domestic): Emanuel, Manu

A/S NERA—P.O. Box 7033 Homansbyen—OSLO 3
(Pilestredet 75c—Oslo 3)
Phone: 46 19 50
Cable: MUSICA OSLO
President (record section): Mr. Eilif Meyer
Labels (domestic): Musica, RCA Victor.
Labels (others): Colgem, Cupol, Dunhill, Efel, Europa, Kristine Toner, Nashville, Olga, RCA Camden, RCA Victor, Sveriges Radio, Telefunken, Troll.

A/S NOR-DISC—P.O. Box 1384—OSLO 1
(Rosenborggaten 19—Oslo 3)
Phone: 33 78 70
Cable: PROTON OSLO
President: Mr. Sigurd Johannessen
Labels (domestic): Karusell, Metronome, Nord-Disc, Polydor, Decca.
Labels (others): ABC-Paramount, Ace of Clubs, Ace of Diamonds, Ace of Hearts, Archiv-Produktion, Atco, Atlantic, Beltona, Brunswick, Cameo/Parkway, Command, Commodore, Coral, Deram, Deutsche, Gramophon, Felsted, Heliodor, Impulse, Joker, London, New Jazz, L'Oieau-Lyre, Prestige, Starday, Swe-Disc, Turnabout, United Artists, Verve, Vocation, Whitehall.

NORSK GRAMMOFONKOMPANI A/S—Wergelandsveien 1—OSLO 1
Phone: 33 40 18
Cable: NOGRAKO OSLO
President: Mr. Odd Roar Knudsen
Labels (domestic): Barneplaten, Harmoni.
Labels (others): Embassy, Music Minus One, Speed-Up, Manhattan.

NORSK-LUTHERSK MISSIONSSAMBAND—Grensen 19—OSLO 1
Phone: 41 76 40
Cable: NORSKLUTH OSLO
President: Mr. Tormond Vaagen
Labels (domestic): Norea
Religious music.

NORSK PHONOGRAM A/S—P.O. Box 5325—OSLO 3
(Kirkeveien 64—Oslo 3)
Phone: 69 59 02
Cable: PHILIPS OSLO
President: Mr. Haakon Tveten
Labels (domestic): CBS, Cue, Fontana, Philips
Labels (others): Amadeo, Audio Fidelity, Cetra, Jazzland, Mercury, Nonesuch, Piccadilly, Polar, Pye, Riverside, Rondo, Sonata, Sonora, Tono.

NORWAY COLLECTING SOCIETIES

T. O. N. O.—Klingenberggate 5—OSLO 1
Phone: 42 18 08
President: Mr. Ragnar Kjerrulf
Norsk Komponistforenings Internasjonale Musikbyrå/The Norwegian Copyright Bureau.

NORWAY GALVANIC INDUSTRIES

NORSK RIKSKRINGKASTING—Bjørnstjerne Bjørnsons Plass 1—OSLO NV
Phone: 46 38 20
Cable: STUDIO OSLO
Manager: Mr. Rolf Glosly

A/S RADIO INDUSTRI—Sandakerveien 16—OSLO 4
Phone: 37 56 80
President: Mr. D. W. van der Sijde

NORWAY MUSIC PUBLISHERS

ARNE BENDIKSEN A/S—Østerdalsgaten 1—OSLO 6
Phone: 67 67 90
Cable: BENDIKMUSIC OSLO
President: Mr. Arne Bendiksen

CARL M. IVERSEN A/S—P.O. Box 191—OSLO 1
(Youngsgate 1—Oslo 1)
Phone: 41 38 67
Cable: CEMIYOUNG OSLO
President: Mr. Hans Roo

EDITION LYCHE—Kongens gate 2—OSLO 1
Phone: 41 44 85
Cable: EDILYCH OSLO
General manager: Mr. Philip Kromer

JØRG-FR. ELLERTSEN A/S—Jernbanetorget 4—OSLO 1
Phone: 41 26 09
Cable: TROLLMUSIC OSLO
President: Mr. Jørg-Fr. Ellertsen

MANU MUSIC A/S—Tollbugaten 12—OSLO 1
Phone: 42 72 12
President: Mr. Per Gunnar Jensen

MUSIKK-HUSET A/S—P.O. Box 1459—OSLO 1
(Karl Johans gate 45—OSLO 1)
Phone: 42 17 03
President: Mr. Sigurd Kjielland
Publicity: Mr. Arne Damsgaard

NORSK MUSIKFORLAG A/S—P.O. Box 1499—OSLO 1
(Karl Johans gate 39—OSLO 1)
Phone: 41 49 03
Cable: MUSIKFORLAGET OSLO
President: Mr. Fridtjof Backer-Grondahl

SKANDIA MUSIKPRODUKSJON A/S—Pilestredet 9—OSLO 1
Phone: 33 44 53
President: Mr. Finn Eriksen

VIKING MUSIC A/S—Pilestredet 9—OSLO 1
Phone: 33 44 53
President: Mr. Kjell Karlson

NORWAY RECORDING STUDIOS

ARNE BENDIKSEN A/S—Østerdalsgaten 1—OSLO 6
Phone: 67 67 90
Cable: BENDIKMUSIC OSLO
President: Mr. Arne Bendiksen

CARL M. IVERSEN A/S—P.O. Box 191—OSLO 1
(Youngsgate 1—Oslo 1)
Phone: 41 38 67
Cable: PLANOREFLEX OSLO
President: Mr. Hans Roo

NORSK GRAMMOFONKOMPANI—Wergelandsveien 1—OSLO 1
Phone: 33 40 18
Cable: NOGRAKO OSLO
President: Mr. Odd Roar Knudsen

DENMARK RECORD DISTRIBUTORS

FAELLESEKSPEDITIONEN—Vibevej 31—COPENHAGEN NV
Phone: AEGIR 8112
Cable: METRORECORDS COPENHAGEN
Managing Director: Mr. Bent Fabricius-Bjerre
This distributor handles the products of Metro-nome Records A/S and Tono Grammofonplader A/S.

FINLAND MUSIC PUBLISHERS

EDITION CODA—Ritokallontie 8/16 P—HELSINKI 33
Phone: 45 16 27
President: Mr. Johan Vikstedt

ERIK LINDSTROM MUSIK—Simonkatu 10B—HELSINKI
Phone: 64 48 77
Cable: FINNDISCOY HELSINKI
President: Mr. Rolf Kronqvist

LEVYSAVEL OY—Vuorikatu 14—HELSINKI
Phone: 12 651
Cable: LEVYSAVEL HELSINKI
President: Mr. Lauri Rokkanen
Publicity: Mr. Martti Piha

LEVYTUKKU OY—P. O. Box 178—HELSINKI
(Fredrikinkatu 45—Helsinki)
Phone: 38 149
Cable: LEVYTUKKU HELSINKI
President: Mr. Niilo Erik Saarikko

Oy MUSHIKKI-FAZER-MUSIK Ab—P.O. Box 260—HELSINKI
(Aleksanterinkatu 11—Helsinki)
Phone: 10 751
Cable: MUSICFAZER HELSINKI
President: Mr. Roger Lindberg
Publicity: Mr. Osmo Ruuskanen

SCANDIA-MUSIIKKI Oy—Hietalahdenranta 11a—HELSINKI
Phone: 64 20 05
Cable: SCANDIAMUSIC HELSINKI
President: Mr. Paavo Einio
Publicity: Mr. Antti Einio

Oy R. E. WESTERLUND Ab—Pohjoinen Esplanadikatu 37—HELSINKI
Phone: 10 396
Cable: PIANOWESTERLUND HELSINKI
President: Mr. Robert Westerlund
Professional manager: Mr. Björn Björklöf

X-SAVEL—Humalistonkatu 17 A 5—HELSINKI
Phone: 49 49 87
President: Mr. Toivo Kärki

FINLAND RECORDING STUDIOS

ELECTRO-VOX STUDIO
Neitsytpolku 1 B—Helsinki
Phone: 11 912
Cable: Nife Helsinki
President: Mr. Ernst Wallner

FINNVOX OY
Arinatie 8—Helsinki 37
Phone: 45 45 21
President: Mr. Kurt Juuranto

POHJOISMAINEN SAHKO OY
Vuorikatu 14—Helsinki
Phone: 12 651
Cable: Nea Helsinki
Manager: Mr. Martti Piha

SCANDIA STUDIO
Sturenkatu 4—Helsinki
Phone: 76 86 36
Manager: Mr. Jaakko Salo

Oy R. E. WESTERLUND Ab
Pohjoinen Esplanadikatu 37—Helsinki
Phone: 10 396
Cable: Pianowesterlund Helsinki
President: Mr. Robert Westerlund
Studio manager: Mr. Reino Backman

NORWAY PRESSING PLANTS

HEGER PLASTICS A/S—Kjelsasveien 141—OSLO 4
Phone: 21 72 17
Cable: HEPLAST OSLO
President: Mr. Ragnar Heger

NORSK PHONOGRAM A/S—P.O. Box 5325—OSLO 3
(Kirkeveien 64—OSLO 3)
Phone: 69 59 02
Cable: PHILIPS OSLO
President: Mr. Haakon Tveten

NORSK GRAMMOFONKOMPANI A/S—Wergelandsveien 1—OSLO 1
Phone: 33 40 18
Cable: NOGRAKO OSLO
President: Mr. Odd Roar Knudsen

NORSK TEKNISK PORSELEN-FABRIKK—Seiersborg—FREDRIKSTAD
Phone: 5900
President: Mr. Peter Barfoed

looking for an efficient
nation-wide distribution
in Denmark—contact

own studio

own processing
and pressing plant

biggest independent
company in Denmark
for more than 30 years

TONO, Copenhagen NV.
1 Dortheavej, Phone: Aegir 9680



FINLAND MANUFACTURERS RECORD

AKKUTEOLLISUUS Oy—Neitsytpolku 1 B—HELSINKI
 Phone 11 912
 Cable: NIFE HELSINKI
 President: Mr. Ernst Wallner
 Publicity: Mr. Harald Stahle
 Labels (domestic): Corona
 Labels (others): Cupol

Oy DISCOPHON Ab—Takomontie 3—HELSINKI 37
 Phone: 45 16 27
 Cable: DISCOY HELSINKI
 President: Mr. Bengt G. Liljeroth
 A & R man: Mr. Johan Vikstedt
 Labels (domestic): RCA Victor
 Labels (others): RCA Camden, RCA Victrola.

Oy FINNDISC Ab—Simonkatu 10—HELSINKI
 Phone: 64 48 77, 64 49 66
 Cable: FINNDISCOY HELSINKI
 President: Mr. Rolf Kronqvist
 Labels (domestic): Safr
 Labels (others): Blue Note, Nashville.

FINNLEVY Oy—Valimontie 2—HELSINKI 37
 Phone: 45 31 36
 Cable: FINNLEVY HELSINKI
 President: Mr. Roger Lindberg
 A & R and Sales managers: (former Fazer group) Mr. Osmo Ruuskanen, (former Fintone group) Mr. Henrik von Denffer.
 Labels (domestic): CBS, Decca, Fontana, Philips, Polydor, Rytmi, Savel
 Labels (others—former Fazer group): Artone, Barclay, Brunswick, Coral, Deram, Felsted, London, Mercury, Pye.
 (former Fintone group): ABC—Paramount, Amadeo, Archiv-Produktion, Cameo/Parkway, Capri, Command, Deutsche Grammophon, Elektra, Heliodor, Impulse, Joker, Kama Sutra, Karusell, Nonesuch, Olga, Primula, Riverside, Swedisc, United Artists, Vee Jay, Verve, Westminster, Whitehall.

FORSAMLINGSFORBUNDET SIRIUS—Ratakatu 29—HELSINKI
 Phone: 58 177
 President: Mr. Bjarne Boije
 Labels (others): Sirius
 Religious Music.

IBRA RADIO LAHETYS R. y.—Pengerkatu 9—HELSINKI
 Phone: 77 98 54
 President: Mr. Kaj Antturi
 Labels (domestic): Ibra
 Religious Music.
LEVYTUKKU Oy—P. O. Box 178—HELSINKI
 (Fredrikinkatu 45 a—Helsinki)
 Phone: 63 81 49

Cable: LEVYTUKKU HELSINKI
 President: Mr. Niilo Erik Saarikko
 Labels (domestic): Broadway, Manhattan, Triola.

MUSIIKITALO WESTERLUND Oy/MUSIC-HOUSE WESTERLUND—Pohjoinen Esplanadikatu 37—HELSINKI
 Phone: 10 396
 Cable: PIANOWESTERLUND HELSINKI
 President: Mr. Robert Westerlund
 Production manager: Mr. Reino Backman
 Labels (domestic): Columbia, HMV, Odeon, Parlophone
 Labels (others): Blue Note, Buena Vista, Capitol, Disneyland, Dolton, Electrola, Immediate, Imperial, Liberty, MGM, Pathe, Platina, Prestige, Regal, Stateside, Svensk-American, Tamla/Motown, Tower.

PELASTUSARMEIJAN KAUPPAOSASTO—City-kaytava 16-17—HELSINKI
 Phone: 62 57 52
 President: Mr. Hellin Lindström
 Labels (domestic): Pelastussointuja
 Labels (others): Festival
 Religious music—Salvation Army.

POHJOISMAINEN SAHKO-Oy—Vuorikatu 14—HELSINKI
 Phone: 12 651
 President: Mr. Oskar Rokkanen
 Manager, Music Dept.: Mr. Martti Piha
 Labels (domestic): Blue Master, Finlandia, Top Voice
 Labels (others): Elite Special, Erato, Reality, Saga, Vogue.

SCANDIA-MUSIIKKI Oy—Hietalahdenranta 11—HELSINKI
 Phone: 64 20 05
 Cable: SCANDIAMUSIC HELSINKI
 President: Mr. Harry Orvomaa
 A & R man: Mr. Jaakko Salo
 Publicity: Mr. Paavo Einio
 Labels (domestic): Scandia, Metronome, Sonet
 Labels (others): Argo, Ariola, Athena, Atlantic, Baccarola, Chess, Checker, Cadet, Durium, Ember, Epic, Eurodisc, Gazell, Grand Prix, Hansa, Hep House, Kapp, Knappupp, Megafon, Pickwick, Roulette, Scan-Disc, Snurrskivan, Specialty, Storyville, Supraphon.

SAHKOLIHKEDEN Oy—Takomontie 3—HELSINKI 37
 Phone: 45 44 01
 Cable: SLOY HELSINKI
 President: Mr. Eino Hietanen
 Publicity: Mr. Johan Vikstedt
 Labels (domestic): Telefunken
 Labels (others): Reprise, Warner Bros.

NORWAY'S BEST SELLERS

Listed below are records appearing at first, second and third spot in the charts month-by-month during 1967:

- | | | |
|-----------|---|---|
| January: | 1 | No Milk Today (Herman's Hermits/Columbia) Reg Connelly, Musik-Förlag A/S Denmark |
| | 2 | Green, Green Grass Of Home (Tom Jones/Decca) Palace Music (Sweden) AB, Sweden |
| | 3 | Dead End Street (Kinks/Pye) Belinda (Scandinavia) AB, Sweden |
| February: | 1 | I'm A Believer (Monkees/RCA Victor) Screen Gems Musikförlag AB, Sweden |
| | 2 | Green, Green Grass Of Home (Tom Jones/Decca) Palace Music (Stockholm) AB, Sweden |
| | 3 | Mellow Yellow (Donovan/Epic) Southern Music AB, Sweden |
| March: | 1 | Penny Lane (Beatles/Parlophone) Sonora Musikförlags AB, Sweden |
| | 2 | I'm A Believer (Monkees/RCA Victor) Screen Gems Musikförlag AB, Sweden |
| | 3 | Let's Spend The Night Together (Rolling Stones/Decca) Musikförlaget Essex AB, Sweden |
| April: | 1 | Penny Lane (Beatles/Parlophone) Sonora Musikförlags AB, Sweden |
| | 2 | I'm A Believer (Monkees/RCA Victor) Screen Gems Musikförlag AB, Sweden |
| | 3 | Vandra vidare (Gunnar Wiklund/HMV) Edition Odeon, Sweden |
| May: | 1 | Puppet On A String (Sandie Shaw/Pye) Musikk-Huset A/S, Norway |
| | 2 | Somethin' Stupid (Nancy & Frank Sinatra/Reprise) Thore Ehrling Musik AB, Sweden |
| | 3 | A Little Bit Me, A Little Bit You (Monkees/RCA Victor) Screen Gems Musikförlag AB, Sweden |
| June: | 1 | Somethin' Stupid (Nancy & Frank Sinatra/Reprise) Thore Ehrling Musik AB, Sweden |
| | 2 | Puppet On A String (Sandie Shaw/Pye) Musikk-Huset A/S, Norway |
| | 3 | A Little Bit Me, A Little Bit You (Monkees/RCA Victor) Screen Gems Musikförlag AB, Sweden |

The year so far has not been very promising for local tunesmiths. Apart from appearing among the top three during 1967, one of the hottest top sellers here has been Hep Stars' Swedish recording of "Last Night I Had A Strangest Dream," on the charts not less than 29 weeks.

RECORDS SINCE 1929

strong domestic production on
 BLUE MASTER - FINLANDIA - TOP VOICE

Finnish distributor of
 VOGUE - ERATO - SAGA - REALITY
 ELITE SPECIAL

Music Publisher: **LEVYSAVEL OY**
 Vuorikatu 14, Helsinki



POHJOISMAINEN SÄHKÖ-OSAKEYHTIÖ
 Musical Department
 Helsinki • Vuorikatu 14 • Finland

A STATISTICAL LOOK AT NORWAY

Area: 124,064 sq. miles (mainland—323,917 sq. kilometres) to which is added Spitsbergen (Svalbard), a group of mountainous islands in the Arctic Ocean of 23,957 sq. miles (62,050 sq. kilometres) and some mainly uninhabited Arctic possessions.

Population: 3,700,000 inhabitants.
Record market: Norway is an importing market, now slowly shifting from mainly an adult's market to a teenager's market. According to trade people, record sales seems to have

been most satisfactory. As in most countries, a growing LP sale is reported, while EPs have a limited market in Norway compared with singles.

Language: Local language is Norwegian, but foreign-language records in particular and English-language records in general have no difficulty in the competition.

Radio & TV: Broadcasts and TV are handled by non-commercial government-controlled stations.

A STATISTICAL LOOK AT DENMARK

Area: 16,619 sq. miles (43,044 sq. kilometres), to which is to be added the Faroe Islands in the North Atlantic, about 300 miles northwest of the Shetlands (540 sq. miles), and Greenland, a huge island between the North Atlantic and the Polar Sea (827,300 sq. miles)—making the total area of Denmark 844,459 sq. miles (2,200,000 sq. kilometres).

Population: (Incl. Faroe Islands and Greenland).

Record market: Denmark is mainly an importing market, and also a teenager's market. Sales of LPs is going up, there is a limited market for EPs, while singles are dominant.

ing. Stereo is doing very good, and if both stereo and mono versions are available, only stereo is released in most cases.

Language: Local language is Danish, which does not hurt the sale of foreign-language records, preferably those in English language. For the native population at Greenland, a certain production of records in the Eskimo language exists.

Radio & TV: Broadcasts and TV are government-owned non-commercial stations. Special radio stations at Greenland offers programs in Danish as well as Eskimo language.

A STATISTICAL LOOK AT FINLAND

Area: 130,165 sq. miles (337,009 sq. kilometres)

Population: 4,600,000 inhabitants.

Record market: Finland is an importing market, and also an adult's market, while it seems to becoming more and more of a teenager's market in those days. LP sales, usually of less importance, has been going up while EPs are still of less importance compared with the singles. Record sale in general went down in 1965, but has since then been steadily going up. As major problems is mentioned "too much pop music being aired over local radio stations" as well as a growing sale of tape recorders.

Language: Local language is Finnish, but great parts of the country, particularly in southern and western

Finland are both Finnish and Swedish speaking territories. Recordings in Finnish are still offering strong, perhaps sometimes too strong, competition to foreign-language records. However, during the last two years more and more artists, particularly the teenage-groups, are recording also local songs in English with a good sales result.

Radio & TV: Broadcasts are non-commercial via the government controlled stations. As far as TV is concerned, a private-operated commercial station competed with the government-controlled non-commercial stations. The other year, the government station bought the private company and has since then continued operation of both stations.

the sonet group

OF INDEPENDENT RECORD COMPANIES OF SCANDINAVIA

WHY NOT JOIN THIS HAPPY FAMILY OF LABELS
 TO GET THE MOST EFFICIENT PROMOTION AND
 DISTRIBUTION OF YOUR PRODUCT BY LEADING
 INDEPENDENT RECORD COMPANIES

EPIC	OKEH
CADET	PALETTE
CHECKER	PLANET
CHESS	RIVIERA
DURIUM	SCEPTER
GAZELL	SONET
GNP CRESCENDO	SPECIALTY
GO GO	STORYVILLE
GRAND PRIX	SUPRAPHON
ISLAND	TRANSATLANTIC
MAJOR MINOR	WAND
MOONGLOW	XTRA



SWEDEN **Sonet Grammofon AB** Artemisgatan 8 Stockholm No

NORWAY **Arne Bendiksen AIS** Østerdalsgaten 1 Oslo 6

DENMARK **Dansk Grammofonpladeforlag** Dortheavej 39 Copenhagen

FINLAND **Scandia Musiikki** Hietalahdenranta 11 Helsingfors

BELGIUM — THE PAST 12 MONTHS

For Belgium the year has not been either exciting or remarkable. The market has remained fairly static but like most European countries sales of singles have fallen but album sales have increased and continue to do so. Stereo sales of both pop and classical records have forged ahead by 100 per cent. While a very good single smash can sell up to 100,000 copies an average worth while hit notches up around 50,000 copies. Again, as in other European countries, British and American artists have returned to favor and staked a healthy claim to the charts. Record prices have not been increased despite the fact that import tax has gone up from 20 per cent to 23 per cent (an increase of 11 per cent in the past two years). The two pack-jobbing operations De Pelgrims' Maison Bleu and Philips-Barclay Cogedep have continued to vie with each other in acquiring new outlets.

EMI

For EMI's S.A. Gramophone Company the year has seen a lessening off in the single sales but an increase in L.P.s which are becoming more and more important in Belgium. British

and American artists have sold very well during the past twelve months aided and abetted by the British pirate radio stations which are received clearly in Belgium. Although the company's best selling artist is still the Belgian star Adamo, The Beatles, Herman's Hermits and Cliff Richard are close runners-up. The Shadows, too, remain consistently good but are strongest in the album field. During the year S. A. Gramophone acquired the Cameo-Parkway and BlueBeat labels. A major boost to the company's catalog was the recent acquisition of the German label Cornet which is expected to sell extremely well particularly in the Flemish section of Belgium. EMI's publishing company Ardmore & Beechwood, under the experienced guidance of Jeff de Boeck has continued to secure more than its fair share of chart successes and several new contracts have been signed including one with Cyril Shane of Shapiro Bernstein in London.

Inelco & Polygram

Although record sales generally were down, Inelco, which handles the RCA catalogue, report that figures were up on the previous year thanks to the fantastic success of The Monkees helped by their TV series which began in May; The Mamas and the Papas and, of course, the stalwart Elvis Presley. Presley's single sales fell slightly but he continues to sell more and more albums. British artists, too, have been very successful including a new group The Frugal Sound with "Reason to Believe". Pierre J. Goemaere, managing director of Inelco also reports that cartridge sales are climbing slowly as instruments are being made available to manufacturers. The company's publishing outlet Universal Songs grows from strength to strength. The American Millbridge catalogue (managed by Gerry Purcell, manager of Al Hirt and Eddy Arnold) has given the company many hits. Universal Songs also has a publishing agreement with RCA Italiana. Universal enjoyed success with Toni Witt and his Orchestra not only in Belgium but also in Germany, Scandinavia, U.S.A. and Canada.

Polygram Records, the Philips company in Belgium, report that single and EP sales have remained stable while LP sales have continued to rise. The company enjoyed tremendous success via British artists and high on the list was Harry Secombe whose version of "This is My Song" sold over 2000 copies. Secombe's LP's also sell well in Belgium. Other British artists to notch up good sales for Polygram include The Troggs, Spencer Davis, Dave Dee, Dozy, Beaky, Mick and Tich and Manfred Mann. The Philips Cassettes got off to a bumper start in the fall of 1966 and then levelled off. However, sales are expected to gather momentum once again when the price of equipment falls. Polygram's publishing outlet Primavera, under the direction of Mr. Vandenhout, has also benefitted considerably from the success of British talent.

Palette & Vogue

Palette Records this year celebrated their 45th Anniversary and continued to flourish and forge ahead with energy and drive. The company has Belgian's top Flemish singer Will Tura who, during the year, celebrated his 10th Anniversary in show business and collected a Gold Disk for 100,000 copies of his "El Bandido" single. Tura also records in German, French and English. Earlier this year he toured Germany and France and enjoyed chart success via his "De Zigeuner" single. Another big seller for Palette came with the Teddy Merrens version of Sandia Shaw's Eurovision songwinner "Puppet on a String" which was released in 16 countries. Other Palette artists to enjoy chart success during the year have been Los Mayas, The Klan and Andre Brasseur. During the year Palette chiefs Roland Kluger and Jacques Faecq undertook an extensive tour of the Far East. In Japan a

number of copyrights were exchanged and visits were made to their licensees Nippon Columbia. Kluger and Faecq also visited America.

For Vogue it has been one of their best years ever. Managing director Roger Meylemans reports an increase in turnover of over 30 per cent on the previous year. The company has claimed more than 50 chart entries during the past twelve months and high on the list of best sellers has been Petula Clark with one hit after another. However, it was with Sandie Shaw's Eurovision winner "Puppet on a String" that Vogue had its biggest hit of the year and, indeed in the history of the company. At one point the number sold 45,000 in three days.

N.V. Fonior & Anvers

Another good year for N.V. Fonior with some big selling chart entries. The company launched a large scale promotional campaign for the A & M label and had a big hit with Herb Alpert's "Casino Royale". Fonior also introduced a new promotional label for deejays which was well received. A new and important acquisition to the Decca label was Tonia (Belgian's 1966 Eurovision entry) and her latest single "Tommy Jones" sold well. A new group The New Inspirations got under way and backed such well known artists as Dave Berry and Englebert Humperdinck. From Britain the company completed a deal to lease Philip Solomon's British label Major Minor in Belgium.

For Anvers Radio the year has been a profitable one under the direction of W. Goldschmidt. The company handles many important labels including ABC Paramount, Telefunken, Elite, Impulse, Ducretet-Thompson, Hebra, Audio Fidelity and Command etc. More recently they acquired the latter's subsidiary label Grand Award. Another addition to the roster has been added in the past twelve months, Fonit-Cetra of Italy, thus giving Anvers the San Remo hit "Non Pensare A Me" by Claudio Villa. Via Telefunken, the low-priced Starlet label also came to Anvers. Goldschmidt reports that some of his biggest successes over the past twelve months have come from fellow-Belgian label Hebra via their young duo Karini and Rebecca—Anvers distribute the Hebra product. Other best sellers were Americans Frankie Laine and Della Reese and German artistes Ronny and Manuela. Very good results have also been received by a recent dealer promotional campaign.

Editions Brauer & Barclay Disques

For Madame Brauer and M. Darliere of Editions Brauer and their record label Hebra (distributed by Anvers) it has been another successful year both in the record and publishing fields. The popular duo Karini

and Rebecca collected a Gold Disk in May this year for 100,000 sales of their records. A new group The Mec-Op Singers made their debut with "Dies Irae" in English which was a big success. Another best seller was Belgian pianist-arranger Roland Thyssen. On the publishing side Brauer acquired the Mark Music catalogue of America publishers of "This is my Song" and "The Telephone". Another company New Music of Holland was formed with Mr. Portengen.

Barclay Disques continue to establish itself on the Belgian market. Considerable credit for their success is due to their deal with American labels such as Atlantic, 20th Century Fox, Monument, Jubilee and the newly acquired Buddah label (subsidiary of Kama Sutra). The year has also seen the acquisition of Ariola of Germany which they handle from September this year. Barclay have also enjoyed chart success with artistes such as Percy Sledge, Sonny and Cher, Los Bravos, Tom Jones and Bobby Darin. Barclay's French star Mireille Mathieu has also achieved considerable popularity and success in Belgium while Charles Aznavour continues to be a big seller.

Sobedi continues to press for many companies including Artone, CBS, S. A. Gramophone, Polydor and Palette. Their record company, Sobedi had some excellent sales from The Black Snakes with "My Only Love".

Discobel

For Discobel, one of Belgium's oldest companies, the year has been an important one during which organizational changes have taken place. In January this year the 41 year old administration was given a new look with the injection of new and younger blood. Decca's promotion and public relations manager Werner Huys (well known in the music publishing world—Disco Music/Sorbet Music Corporation) took over the responsibility of running Discobel together with Jacques Bentinx. During the year the Impact and President (France) labels were taken over and Discobel also started their own productions. Discobel looks to the future with confidence.

Arcade

In the singles field Arcade Records scored big hits with "Rio de Janeiro" (Anneke Soetaert) and "Verlangen" (Anita). Mainly an L.P. label Arcade achieved international success with 6 L.P.s by The Jokers. Over 250,000 copies of these recordings were sold in eleven countries and 2 L.P.s by The Hammond Brothers were sold in 14 countries. The firm owns a complete tape library of mood music for international consumption. Also a mobile studio for location recordings.

BELGIUM'S BEST SELLERS—THE PAST 12 MONTHS

BEST SELLING SINGLES FROM CBS

1. Ce M'Avance A Quoi—Comme La Lune (Joe Dassin)
2. Excuse Me Lady (Joe Dassin)
3. Here Comes My Baby (The Tremeloes)
4. Just One Smile (Gene Pitney)
5. Le Sous-Marin Vert/La Chanson (Les Compagnons de la Chanson)
6. Flowers Never Bend (Simon & Garfunkel)
7. Rainy Day Women (Bob Dylan)
8. Somewhere My Love (Ray Conniff)
9. Silence Is Golden (The Tremeloes)
10. Till/Autumn Leaves (Tony Bennett)

BEST SELLING E.P.s FROM CBS

1. Ce M'Avance A Quoi/Comme La Lune (Joe Dassin)
2. C'est Ma Chanson (This Is My Song) (Les Compagnons de la Chanson)
3. Excuse Me Lady (Joe Dassin)
4. Lara's Theme (Les Compagnons de la Chanson)
5. Non C'est Rien/Les Enfants Qui Pleurent (Barbra Streisand)
6. Ray Conniff Plays Mary Poppins
7. Somewhere My Love (Ray Conniff)
8. Volume One (Bonhomme & Tilapin)
9. Volume Two (Bonhomme & Tilapin)
10. Volume Three (Bonhomme & Tilapin)

BEST SELLING L.P.s FROM CBS

1. A Bobino (Les Compagnons de la Chanson)
2. Ray Conniff's Marvelous
3. Please Love Me (Caravelli)
4. Greatest Hits (Frankie Lane)
5. My Fair Lady (Soundtrack)

CBS LP's (Con't)

6. Somewhere My Love (Ray Conniff and Singers)
7. West Side Story (Soundtrack)
8. We Shall Overcome (Pete Seeger)
9. World of Hits (Ray Conniff)
10. Vive la Rose (Guy Beart)

BEST SELLING SINGLES FROM S.A. GRAMOPHONE

1. Ces Mots Stupides (Sacha Distel and Joanna Shimkus)
2. Ballade en Novembre (Anne Vanderlove)
3. Et Apres et Fille Sauvage (Richard Anthony)
4. Edelweiss (Vince Hill)
5. Evelynne (Georges Chelon)
6. High Time/I've Been A Bad Bad Boy (Paul Jones)
7. In The Country/It's All Over (Cliff Richard)
8. Inch Allah (Adamo)
9. L'Important C'est la Rose (Gilbert Becaud)
10. Mijn Lied Voor Jou (This Is My Song) (Lize Marke)
11. No Milk Today/There's A Kind of Hush (Herman's Hermits)
12. My Friend Jack (The Smoke)
13. On A Course! (The Hollies)
14. Penny Lane (The Beatles)
15. Sunday for Tea (Peter and Gordon)
16. Sock It To Me Baby (Mitch Ryder)
17. J'ai Peur, Jamais Deux Sans Trois (Enrico Macias)
18. Western Union (The Five Americans)

(Continued on next page)
Cash Box—July 8, 1967

ANVERS RADIO
Place de l'Yser, 10
Brussel 1,
Phone: 18 74 00

is one of the Belgians leading record-distributing-companies with active people in their Service.

We distribute exclusively important labels as:

ABC-Paramount
Telefunken
Elite • Impulse
Ducretet-Thomson
Ember • Arsa • Hebra
Command
Audio-Fidelity
Fonit-Cetra

Editions
JEAN KLUGER
Galeries du Centre,
Bloc 3, App. 339
Brussels 1.
Phone: 12 92 38

BELGIUM — RECORD COMPANIES

ANVERS RADIO S.A.

Place de l'Yser 10, Brussels 1. Phone 187400.
 Director: W. Goldschmidt.
 Sales manager: A. Jenty.
 Labels: ABC Paramount, Telefunken, Elite, Impulse, Ducretet-Thomson, Ember, Arsa, Hebra, Command, Audio Fidelity, Fonit-Cetra.

ARCADE RECORDS (P.M.P.)

Kastanjelaan 1, Aartselaar, Belgium. Phone 03-782926.
 President: L. Van Rymentant.
 Sales manager: Rudy Witt.
 Labels: Dino, Cannon, Memo.

ARTONE

Boulevard Baudouin 21, Brussels 1. Phone 191170.
 Managing director: Mrs. P. Robiefroid.
 Labels: Apex, Artone, Barebreiter, CGD, Chess, Cadet, Checker, Epic, Go-Go, Memory Lane, Okeh, Festival, Deese, Funckler, Hanna Barbera, Hansa, Hickory, Joda, Jocida, Jomada, Palette, Ricordi, Speciality, Supraphon (Artia), Tamlamotown, Gordy, Melody, VIP, United Artists, Ascot, DCP, Solid State, Veep, Westminster.

BARCLAY

rue de Lombard 31, Brussels 1. Phone 118171.
 Managing director: V. Bral.
 A&R manager: Peter Plum.
 Labels: Barclay, Atlantic, Rigolo, Hispavox, 20th Century, MK, Monument, Jubilee, Budda.

CARDINAL

Belgielei 143, Antwerp. Phone 304943.
 Managing director: Rocco Granata.

CANDLE

Bolwerklaan 19, Brussels 1. Phone 780683.
 Managing director: Camille Saye.
 Labels: Whamm, Basart, Europhon, Christoforus.

CBS

Boulevard Baudouin 21, Brussels 1. Phone 191170.
 Managing director: Pascal Robiefroid.
 Labels: CBS, Critere, Date, Harmony, Musicor, Ode, Odissey, Rajac, Temporel.

DISCOBEL S.A.

Lombardstraat 31, Brussels 1. Phone 133945.
 Director: Werner Huys.
 Sales manager: Jacques Buntinx.
 Labels: Ariola, Baccarola, Cantate, Charlin, Corsair, Cycnus, Discostar, DRM, Eurodisc, Hansa, Impact, Lumen, Memo, Mondiphonie, President, Prestige, Qualiton, Rsaissi, SM, Vedette, Vergara, Viva.

DISCOLIVRET S.A.

4a, Quai du Commerce, Brussels 1. Phone 177678.
 Managing director: Mr. Delanoet.

FONIOR S.A.

Quai des Charbonnages 26-28, Brussels 8. Phone 254010.
 Managing director: Pelgrims de Bigard.
 Sales manager: Albert de Reuck.
 A&R manager: Achille Palmans.
 Labels: Telstar, Vega, Musique Pour Tous, Saga, Omega, Week-End, London, Decca Inc., Coral, Top, Major-Minor, CID, Blue-Beat, Lyrique Pour Tous.

GRAMOPHONE S.A.

Quai des Charbonnages 72, Brussels 8. Phone 274390
 Managing director: John Kirsch.
 Sales manager: Emil Garin.
 Artistic director: Jeff de Boeck.
 Labels: HMV, Columbia, Pathe, Capitol, Gloria, Parlophone, Odeon, Trianon, Liberty, Mondiphonie, Carlin, Stateside, Encore, Angel Markal, Cameo-Parkway, Cornet, Immediate, Dispres Line.

HEBRA

rue St. Christophe 30, Brussels 1. Phone 129375.
 Manager directors: Mrs. Brauer and J. Darlier.

INELO BELGIUM S.A.

rue de l'Hopital 24, Brussels 1. Phone 112220.
 Managing director: P. J. Goemaere.
 Sales manager: Mr. Colpin.
 Labels: RCA Victor, Dunhill, Colgems, Strike, Amadeo, Iramac-Relax, Tania, RCA Victor Stereo 8.

PALETTE

rue de la Madeleine 13, Brussels 1. Phone 115120.
 Directors: F. Faecq and R. Kluger.
 A&R manager: Roland Kluger.

POLYGRAM

rue d'Anderlecht 37, Brussels 1. Phone 134444.
 Managing director: Mr. P. J. Lebbink.
 Sales manager: C. Licoppe.
 Labels: Phillips, Fontana, Mercury, Smash, Limelight, Riverside, Pacific Jazz, World Pacific, Mira, Mirwood, Pergola, Oiseau Lyre, Starclub.

SHOW RECORDS

Steenweg op Diest 69, Aarschot (Brabant). Phone 66999.
 General manager: Jules Nijs.

SCHOTT-FRERES

rue Saint-Jean 30, Brussels 1. Phone 112122.
 Manager director: J. J. Junne.

POLYDOR

116, Chaussee de Charleroi, Brussels 6. Phone 373100.
 Managing director: Walter Holzapfel.
 A&R manager: Mich Mertens.
 Labels: DGG, Archiv Produktion, Polydor, MGM, Verve, Verve Folkways, Metronome, Heliodor, Kama Sutra, Golden 12, Swedisc, Privilege, Storyville, Belevedere.

RANCH RECORDS

rue Gallait 90, Brussels. Phone 412280.
 Labels: Ranch, Micro.

SOBELI

20, Boulevard Maurice Lemonnier, Brussels 1. Phone 131307.
 General manager: Fernand Janssens.
 Executive manager: Georges Martens.

SONOBEL

rue Rouppe 4, Brussels 1. Phone 120928.
 Managing director: Mr. Borzee.

VOGUE INTERNATIONAL

35, Boulevard Barthelemy, Brussels. Phone 115417.
 President: Leon Cabat.
 General manager: Roger Meylemans.
 Labels: Vogue, Swing, Mode, A.Z., Monte Carlo, Lou, Line, Number One, May, Diadem, Epsilon, Pacific, Orphee, Chanson D'Orphee, Pye, Marble Arch, Golden Guinea, Piccadilly, Tono, Sprint, Saar, Music, Jolly, Orfeu, Belter, Mocambo, Orfeon, Maya, Warner Bros., Reprise, Loma, Dot, Hamilton, Gene Norman, Crescendo, Autumn, Back Beat, Jay Gee, Time, Mainstream, Premier, Scepter, Wand, Elektra, Kapp, Medaillon, Guardian, Laurie, Miller, Legend, Somerset, Red Bird, Blue Cat, Brent, Hispavox, Puppy, Roulette, Durium, Negram, Delta.

BELGIUM'S BEST SELLERS—THE PAST 12 MONTHS

(Continued from preceding page)

BEST SELLING L.Ps FROM S.A. GRAMOPHONE

1. Surtout le Recital Adamo a l'Olympia '67 (Adamo)
2. Le Recital "Toon" (Toon Hermans)

BEST SELLING SINGLES FROM FONIOR

1. Cherie (Eddy Wally)
2. Dans je de Hele Nacht Met Mij (Karin Kent)
3. Dommage Dommage (Engelbert Humperdinck)
4. Green Green Grass of Home (Tom Jones)
5. Je Te Donne Mon Coeur (Claude Sylva)
6. Lana (Roy Orbison)
7. Lady Jane (The Rolling Stones)
8. Mama (Dave Berry)
9. Paint It Black (The Rolling Stones)
10. The Pied Piper (Crispian St. Peter)

BEST SELLING E.Ps FROM FONIOR

1. As Tears Go By (The Rolling Stones) ...
2. Theo En Zijn Auto (Theo Van Den Bosch)
3. Thunderball (Tom Jones)
4. The Strangerstinnen (The Strangers)
5. Un Pen de Poivre Un Peu Desel (Tonia)

BEST SELLING L.Ps FROM FONIOR

1. Aftermath (The Rolling Stones)
2. Grije Haren (Bobbjeaan Schoepen)
3. Going Places (Herb Alpert)
4. Les Disque a La Carte (Lilly Vincent)
5. Souviens-Toi (Lilly Vincent)
6. The Strangers 1 & 2 (The Strangers)
7. 15 Jaar Strangers (The Strangers)
8. Whipped Cream (Herb Alpert)
9. What Now My Love (Herb Alpert)
10. TV Truut (The Strangers)

BEST SELLING SINGLES FROM VOGUE S.A.

1. Dandy (The Kinks)
2. C'est Ma Chanson (This Is My Song) (Petula Clark)
3. Kilimandjaro (Pascal Danel)
4. Les Elucubrations d'Antoine (Antoine)
5. La Maison Ou J'ai Grandi (Francoise Hardy)

VOGUE (Con't)

6. Les Play-Boys (Jacques Dutronc)
7. Puppet On A String (Sandie Shaw)
8. Strangers In the Night (Frank Sinatra)
9. Somethin' Stupid (Frank and Nancy Sinatra)
10. Ne Jouez Pas Au Soldats (Les Sunlight)

BEST SELLING E.Ps FROM VOGUE S.A.

1. C'est Ma Chanson (Petula Clark)
2. Les Play-Boys (Jacques Dutronc)
3. Les Elucubrations D'Antoine (Antoine)
4. La Maison Ou J'ai Grandi (Francois Hardy)
5. Les Jolies Colonies de Vacances (Pierre Perret)
6. Ne Jouez Pas Aux Soldats (Les Sunlight)
7. Robin Des Bois (Jean Claude Darnal)
8. Strangers In the Night (Frank Sinatra)
9. Un Homme et Une Femme (Pierre Barouh et Nicole Croisille)
10. These Boots Are Made for Walking (Nancy Sinatra)

BEST SELLING L.Ps FROM VOGUE

1. C'est Ma Chanson (Petula Clark)
2. Kyrieleys (The Bob Boon Singers)
3. La Maison Ou J'ai Grandi (Francois Hardy)
4. Le Disque D'or de Sidney Bechet
5. Next Summer (Roger Mores)
6. Strangers In the Night (Frank Sinatra)
7. That's Life (Frank Sinatra)
8. These Boots Are Made for Walking (Nancy Sinatra)
9. Toccata et Fugues de Jes Bach (Michael Schneider aux Grandes Orgues)
10. Une Homme et Une Femme (Pierre Barouh & Nicole Croisille)

BEST SELLING SINGLES FROM PALETTE

1. Arriverderci Maria (Will Tura)
2. Already Mine (The Klan)
3. De Zigeuner (Will Tura)
4. El Bandido—De Fanfare (Will Tura)
5. Guantanamera (Digno Garcia)
6. Holliday—The Kid (Andre Brasseur)
7. La Poupée Qui Fait Non (Michel Polnareff)
8. L'Amour Avec Toi (Michel Polnareff)
9. Puppet On A String (Teddy Mertens)
10. Ta Ta Ta (Michel Polnareff)

(Continued on next page)

CONGRATULATIONS TO CASH BOX ON ITS

25th ANNIVERSARY

BUT

WORLD MUSIC

IS

CELEBRATING ITS



45th ANNIVERSARY

DO YOU WONDER HOW WE HAVE LASTED SO LONG?

- ★ WELL IT'S AS SIMPLE AS THIS: BEING 45 YEARS OLD WORLD MUSIC KNOWS THE MEANING OF TRADITION.
- ★ PALETTE THEIR RECORD AFFILIATE IS NOW ONE OF THE MOST ACTIVE PRODUCERS IN THE EUROPEAN MARKET.
- ★ THE PRESIDENT OF THE COMPANY, F. R. FAECQ, WAS ALSO THE FOUNDER AND IN 1945 WITH THE LATE JACQUES KLUGER MADE WORLD MUSIC ONE OF THE MOST IMPORTANT INTERNATIONAL PUBLISHERS. MR. FAECQ IS ONE OF THE MOST EXPERIENCED MEN IN TODAY'S MUSIC BUSINESS & COPYRIGHT FIELDS.
- ★ ROLAND KLUGER IS STILL VERY YOUNG & LOVES ACTION. WHAT BETTER EXPLOITATION COULD YOU GET THAN A YOUNG AND ACTIVE ONE. BY THE WAY—THREE MORE FACTS.
- ★ SOME PEOPLE LIKE PRECISE & ORGANISED BUSINESS. WELL FROM 1st JANUARY 1968 OUR COPYRIGHT DEPARTMENT WILL BE COMPLETELY MECHANISED.
- ★ SOME PEOPLE LIKE A YOUNG THINKING BUSINESS. WELL COME AND MEET OUR EXPLOITATION STAFF AND YOU'LL BE CONVINCED.
- ★ SOME PEOPLE LIKE INTERNATIONALLY MINDED BUSINESS WELL OUR INTERNATIONAL REPRESENTATIVES AROUND THE WORLD WILL BE PLEASED TO MEET YOU DURING ONE OF YOUR TRIPS.

Holland: I.M.C. Mr. & Mrs. Steen-Bergen	Italy: World Music Italy—Mr. A. Rotelli
Luxembourg: Luxembourg Music—Mrs. Wenandy	U.S.A.: Zodiac Music—Mrs. Sandra Hammond
England: Good Music—Mr. Geoffrey Heath	Hammond; Compton Music—Oenstein, Arrow & Lourie
France: Ed. Vendome—Mr. Douville Ed. Magellan—Mr. R. Dorsay	Canada: Transcanada & Zodiac Music
Germany: Trumpf—Mrs. Arends Ton Und Kunst—Mr. Hoen	Australia: Mrs. Chris Vaughan
Scandinavia: INTRECO	Argentina: World Music—Mr. Korn
Spain: World Music Espana.—Mr. Salinger	Brazil: World Music—Mr. Vitale.

IN BRUSSELS F. R. FAECQ—R. KLUGER AND THE WORLD MUSIC TEAM WILL BE MOST PLEASED TO WELCOME YOU. HOPE TO SEE YOU VERY SOON. AT: 13, MADELEINE, BRUSSELS TEL: 11.51.20.

BELGIAN MUSIC PUBLISHERS

IF YOU ARE LOOKING FOR

 **STRONG DISTRIBUTION**

 **EFFICIENT PROMOTION**

You are making a wise choice
in selecting:

DISCOBEL. SA

LOMBARDSTRAAT 31

BRUSSELS 1

BELGIUM.

Contact Mr. Werner HUYS.

Phone: 13.39.45

ARDMORE AND BEECHWOOD
Quai des Charbonnages, 72, Brussels 8. Phone 274390
Managing director Belgium: Jeff De Boeck

EDITIONS BASART-BELGIUM
Maurice Lemonnierlaan 20, Brussels 1. Phone 02/125034
Managers: A. Strengholt, H. Gomperts, Guus Jansen Jr.

EDITIONS CHARLES BENS
rue Gallait, 90 Brussels 4. Phone 412280
Managing director: Mrs. J. Bosmans
Artistic director: Harry Frekin
Press and publicity: Pierre Vandendries

EDITIONS HERMAN BRAUER
rue St. Christophe, 30 Brussels 1. Phone 129375-127361
Managing directors: Mrs. Brauer and Jean Darlier

BELGA MUSIC
Steenweg op Diest, 69, Aarschot (Brabant). Phone 016/66999
Managing director: Jules Nijs

DISCO MUSIC
Dascottelei, 34 Deurne—Antwerp. Phone 03/367597
Managing director: Werner Huys

IDEAL MUSIC
Cederlaan, 48, Wilrijk (Antwerp) Phone 03-382309
Managing director: Jean Van Horn

BELINDA
Boulevard Anspach, 155, Brussels 1. Phone 118313
Managing director: Edgard Plumart

CHAPPELL
Galerie du Centre, 218 Brussels 1. Phone 127348
Managing director: Mr. De Coene-Dom

CLASS MUSIC
Goudbloemstraat, 17, Antwerp. Phone 03-329990

DISCO MUSIC
Dascottelei 34, Deurne, Antwerp. Phone 03-367597
Managing director: Werner Huys

PASSE-PARTOUT AND DANCING
Vroenhofstraat, 13, Deurne-Antwerp. Phone 03-396320
Managing director: Leo Lambrechts
Executive manager: Frank Hermans

EDITIONS FONIOR
Quai des Charbonnages, 26, Brussels 8. Phone 254010
Managing director: Pelgrims de Bigard
Music director: Georges Delfosse
Artistic director: Achille Palmans

FONOGRAM
Boulevard Maurice Lemonnier, 20 Brussels 1. Phone 131307-131306
Managing director: Fernand Janssens

FRANKIE MUSIC
Greinstraat, 74, Antwerp. Phone 03-322485
Managing director: Jean Meeusen

DERBY MUSIC
rue de la Pepiniere, 1, Brussels 1. Phone
Managing director Belgium: Lise Rollan

JOKERS A.G.C. MUSIC
Olmenlaan 4, Antwerp L.O., Belgium
Phone: 32.68.58.
Director: J. Blanckaert

MODERNY
97 rue de la Marliere Mouscron. Phone 056/31539
Managing director: Marcel de Keukeleire

PETER PLUM PUBLICATIONS
rue des Teinturiers 18 Brussels 1. Phone 115229-114743
Managing director: Peter Plum

SAB MUSIC
41 boul. De l'Abbattoir, Brussels 1. Phone 110252
Managing director: A. Pletinck

PRIMAVERA
Boulevard M. Lemonnier 22, Brussels 1. Phone 133789
Managing director: Lammy Vandenhout
Press and Publicity: Hans Custers

SCHOTT FRERES
rue Saint Saint-Jean, 30, Brussels 1. Phone 112122
Managing director: J. J. Junne

EDITIONS TEMPO
rue du Lombard 60 Brussels 1
Managing director: M van Elewijck

INTERVOX MUSIC
Boomssesteeuweg 376 Wilrijk-Antwerp. Phone 03-388600
Managing director: L. J. Van Rymenant

JEAN KLUGER MUSIC
Galerie du Centre, Bloc 3, App. 339, Brussels 1. Phone 129238
Director: Jean Kluger

WORLD MUSIC-SOUTHERN MUSIC
rue de la Madeleine, 13 Brussels 1. Phone 115120
Managing directors: F. Faecq and Roland Kluger

GRANATA MUSIC
Collegalaan, 108 Deurne-Antwerp. Phone 03-365646
Managing director: Rocco Granata

GOLD CROWN MUSIC
26 Avenue des Buissonets, Brussels 2. Phone 787416
Managing director: Roger Feinberg

SILVER STAR
Terdonk, Ghent. Phone 09-518950
Managing director: F. Boone

BELGIUM'S BEST SELLERS—THE PAST 12 MONTHS

(Continued from preceding page)

BEST SELLING E.B.'S FROM PALETTE

1. Arriverderci Maria (Will Tura)
2. Ballade On the Beach (Andre Brasseur)
3. El Bandido (Will Tura)
4. C'est Parti Mon Kiki (Kiki)
5. De Zigeuner (Will Tura)
6. Guantanamo (Digno Garcia)
7. Love Me Please Love Me (Michel Polnareff)
8. La Poupee qui fait non (Michel Polnareff)
9. Sous quelle etoille suit-je ne? (Michel Polnareff)
10. Ta Ta Ta (Michel Polnareff)

BEST SELLING L.Ps FROM PALETTE

1. Early Bird (Andre Brasseur)
2. Guantanamo (Digno Garcia)
3. Medley Moods—Made in France (Jo Heyne & Eddy Green)
4. Multi Organ Sound (Andre Brassuer)
5. Michel Polnareff
6. Kreuder Spielt Peter Kreuder (Peter Kreuder)
7. Will Tura Hits (Will Tura)
8. Will Tura No. 3 (Will Tura)
9. Tura Toppers No. 4 (Will Tura)
10. Uit Het Hart (Will Tura)

BEST SELLING SINGLES FROM ARTONE

1. Bernadette (The Four Tops)
2. Friday On My Mind (The Easybeats)
3. Lara's Theme (Garry Sherman)
4. Reach Out I'll Be There (The Four Tops)
5. Sunshine Superman (Donovan)
6. Standing In the Shadow Of Love (The Four Tops)
7. Summertime (Billy Stewart)
8. Who'll Be The One (The Easybeats)
9. You Keep Me Hangin' On (The Supremes)
10. Yellow Mellow (Donovan)

BEST SELLING E.Ps FROM ARTONE

1. Bonne Chance mon Garcon (Michel Delpech)
2. Epistle To Dippy (Donovan)
3. Le Sous-marin Vert (Andre Verchuren)
4. Le Chant des Clochettes (Andre Verchuren)
5. Mon Amour, Mon Ami (Marie Laforet)
6. Manchester & Liverpool (Marie Laforet)
7. Prends ta Guitare (Michel Fugain)
8. Sunshine Superman (Donovan)
9. Inventaire 66 (Michel Delpech)
10. Tete de Turc (Michel Delpech)

BEST SELLING L.Ps FROM ARTONE

1. Asterix Le Gaulois For Children (In French)
2. Asterix et la Serpe D'or For Children (In French)
3. A Go Go (The Supremes)
4. Le Petit Prince Literature (In French)
5. Live (The Four Tops)

ARTONE (Con't)

6. La Chanson de Lara (Andre Verchuren)
7. Les Porte-Cles (Andre Verchuren)
8. Peter en de Wolf For Children (In Dutch)
9. Road Runner (Junior Walker)
10. Sunshine Superman (Donovan)

BEST SELLING SINGLES FROM POLYDOR

1. Abschied Vom Meer (Freddy)
2. Du Bist Nicht Allein (Roy Black)
3. Ganz in Weiss (Roy Black)
4. Leg Dein Hertz (Roy Black)
5. Gut Night My Love (Roy Black)
6. Il Silenzio (H. Schachtner)
7. Rot Ist Der Wein (Ivo Robic)
8. 5000 Miles Von Zuhause (Freddy)
9. Tief in Deinen Augen (Rene Carol)
10. Wolly Bully (Sam The Sham & The Pharos)

BEST SELLING E.Ps FROM POLYDOR

1. Daydream (The Lovin' Spoonful)
2. Costa Brava (Compagnons de la Chanson)
3. La Chanson de Lara (Soundtrack)
4. Le Mexicain (Marcel Amont)
5. Paloma (Freddy)
6. Pax Hominibus (John William)
7. Ring Dang Doo (Sam The Sham & The Pharos)
8. Unsere Sonntagkonzert
9. Wolly Bully (Sam The Sham & The Pharos)
10. La Chanson de Lara (John William)

BEST SELLING L.Ps FROM POLYDOR

1. Bert Kaempfert Bestseller (Bert Kaempfert)
2. An Der Sconen Blauen Donau (Kaiserwalzer)
3. Blue Midnight
4. Heut' Spielt Der Strauss (Helmut Zacharias)
5. Freddy Auf Hoher See (Freddy)
6. Hammon A GoGo
7. Pax Hominibus e.o. (John William)
8. Poppourris der schonsten Melodien (Berliner Luft)
9. Strangers In the Night (Bert Kaempfert)
10. Seine Grosse Erfolge (Freddy)

BEST SELLING SINGLES FROM CANDLE RECORDS

1. Darling (Serge)
2. Camarera De Mi Amor (Alberto Cortez)
3. Het Mini Rokje (Tony Corsari)
4. Het Leven is een Hitparade (Jan Theys)
5. Oh Oh What A Kiss (Micky Day)
6. Oh I Love You (Micky Day)

BEST SELLING L.Ps FROM CANDLE

1. De Zandvoortse Vissertjes
2. Kees Pruis
3. Willy Derby
4. We Vliegen er In

(Continued on page 106)

IN BELGIUM

GO.

GO..

GO...with

polygram

and

SELL!

SELL!!

SELL!!!

like **PHILIPS**  **fontana**
already do---

37ANDERLECHTSTREET - BRUSSELS 1



Available on Stereo 8 Cartridge Tape COM/COS-103

Hey, Hey Here's The Monkees' Third Album. It's ready for you now.



COLGEMS[®]
Manufactured and
Distributed by RCA



HOLLAND — THE PAST 12 MONTHS

Phonogram told Cash Box that its management was happy to report a steadily growing turnover in Musicassettes. Among new labels in the Phonogram catalogue over the past year are Deram and President. With both popular labels considerable successes were booked on the Dutch record-market. All other labels showed top-sales during the intensive winter and spring selling-campaigns and the general market-position has been improved again. The introduction of the classical "Grandioso" LP-series (Fontana) and "Boutique de Musique" (Philips), stereo mostly, had remarkable sales results. These series do not only include re-releases of earlier best sellers, but also a great number of new and even exclusive productions. Phonogram maintains a strong and consistent policy in the production of home-talents. Excellent figures resulted from the Beat and Cabaret genres again. (Golden Records for Wim Sonneveld on Philips and Boudewijn de Groot on Decca, while a half dozen of other artists in these fields, recorded after July 1966, are approaching the Golden Figure.)

In Dutch beat-music a change is taking place to preferences for Rhythm & Blues, on the analogy of the American and English examples. Lyrics in the English language seem to be preferred; however, also Dutch lyrics of beat-songs on singles and LPs reached impressive turnover-figures. Growing acknowledgment is shown from abroad for the merits of Dutch popular musical talents. Some Dutch artists have found recognition in very "difficult" countries like France and England. In England: Boudewijn de Groot ("Land of Rainbow's End" a hit-parade climber) and Coby + Blizzards, Holland's best r & b group. In America: The R-d-ys. In France: Liesbeth List and Ramses Shaffy. Miss List was also to come to LP-cooperation with the Greek composer Theodorakis, a plan which was detained because of political circumstances. Originals by Ramses Shaffy were translated into the French and a chanson entitled "Tou-tankhamon" was composed by Shaffy in Paris and released by S.P.P. as feature-chanson on EP. In the classical field the tremendous success of the Concertgebouw Orchestra (Bernard Haitink conducting) touring the USA and Canada, ending in Montreal at the Holland Day, May 18th, was a regular triumph for musical life in Holland. It is interesting to mention that the Bruckner-project by Holland's leading orchestra is nearing its completion. An attempt to enlarge the turnover in the Jazz-field (US material) was fully honored by means of releases in lesser expensive LPs in attractive presentations. Contacts with Dutch dealers (1100) and the Dutch press were consolidated firmly and the influences were deepened and widened. Various publicity-stunts and dealer-service activities resulted in excellent

sales. Phonogram's share in the TV and radio-world (general promotion and personal appearances) increased considerably. Also the cooperation with theatre-bureaus, agents and publishers was very satisfying.

For Bovema the second half of 1966 was highly dominated by ample preparations for the new repertoires in the new season and, of course by the celebration of a double anniversary: 20 years of Bovema in the Dutch record industry, founded by its President Gerry Oord, who himself, took a look back at 35 successful years of perseverance, commercial spirit and craftsmanship. Altogether an important milestone, the impact of which has made itself felt since many years in the Benelux-area. An almost endless stream of guests—many from abroad—attended the festivities on 19th September at the Amsterdam-Hilton Hotel. Almost at the same time Bovema hit the market with 9 series of 12" albums, featuring each a particular kind of music (such as "beat," folklore, chansons, entertainment also), the whole package covering a total of more than 70 LP-records, the promotion of which ran off with a nation-wide string of sales meetings with dealers. The company took its usual share in Hit parade-items, among them The Beatles' "Yellow Submarine" and a breakthrough for such young coming men as Chris Farlowe, Twice as Much and Paul Jones. Bovema was also traditionally represented in October's Grand Galas du Disque, this time with the Peanuts, Georgie Fame and Richard Anthony, while 3 classical albums were awarded Edisons. Big names like Sinatra, the Beatles and The Beach Boys were blown up even more commercially by either TV-films or special releases (Pet Sounds). In November '66 a couple of young Dutch artists were introduced to the local press: The Cats, Patricia, John Lamers and Dimitri van Teren. From these, the Cats had one of their first hit singles released through EMI in Great Britain, while Patricia will join the Dutch vocal-team for The Knokke-Festival this summer. The biggest stunt in December was HMV's release of a new magnificent Gré Brouwensteyn album with operatic arias on the occasion of the singer's concert-visit to the USSR. HMV/Angel's Klemperer-recording of Mahler's "Song of the Earth" hit the local classical market in January '67. Bovema promoted sales by extensive advertising campaigns in the country's leading magazines.

Capitol launched a special Buck Owens-month in April, while Columbia released a new Benedetto Marcello-album early this year. April was also dedicated stereo-month. A country-wide sales campaign was developed, featuring 60 of the company's most prominent stereo-albums. Columbia-Holland recorded and released initial albums by "Syntagma Musicum" (a Dutch ensemble specializing

in ancient music from the Middle Ages) and "The Robber's Symphony," the latter project being a highlight on Dutch TV during Easter. Both c&w- and r&b-material have been collected into a series of singles, subtitled "Country Giants" and "Soul Supply." In May 1967 Gerry Oord and EMI's Bill Stanford finished ample negotiations resulting in EMI's official take-over of the majority of Bovema-shares. Both companies are cheering this development, which will strengthen and increase their mutual activities in the European Common Market. Bovema removed its record stores and forwarding depts. to a new larger place in Heemstede not far from its headquarters, and also worked out a rather unique collaboration with another Dutch record company N.V. Negram-Haarlem, thus economizing the storage, bookkeeping and supplies of records. The first half of 1967 there have been regular TV-gigs for Bovema-artists: among them were Adamo, Vera Lynn, Twice as Much, The Pink Floyd, Vic Dana, Fran Jeffries, P. P. Arnold and Jeff Beck. Very recently Gramophonehouse launched 9 beat albums and Bovema is sure to do big business with the sensational new Beatles-album "Sgt. Pepper's Lonely Hearts Club Band."

Over the last year the total sales of Negram-Delta went up with more than 45%. This because of their still expanding LP market; the sales of the marvelous Eurodisc operetta records and their fabulous position in the local charts. No wonder that the management of Negram-Delta is very satisfied with the tremendous successful season of 1966/67. July '66 The Kinks made it big with "Dedicated Follower of Fashion." Frank Sinatra had his greatest hit ever, "Strangers In The Night," and the Dutch Motions were very successful with "My Love Is Growing," later in '66 covered by the Walker Brothers. The same month David Garrick entered the Dutch charts for the first time with "Lady Jane." Since then he has not been out of the charts for one single week. "Lady Jane" was followed by "Mrs. Applebee," "I Found A Love" and "A Certain Misunderstanding." Udo Jürgens scored a hit in July with "Merci Cherie" his third and winning entry to the Eurovision Songfestival.

In August '66, the first record by the TeeSet caused a sensation in the nation. A track of the LP "Emotion"

was released as a single and reached the top 5: "Don't You Leave." Since then all TeeSet singles became hits. In September '66 Negram-Delta took over the Roulette-label and gained two hits at the same moment with "Hanky Panky" and "Say I Am" by Tommy James & the Shondells. Sales of Roulette LP's have been very satisfying. Also in September Negram-Delta introduced the Elektra label to the Dutch market. Albums by Tom Paxton, Marc Spoelstra, Judy Collins and others have been very successful. Sales of the LP's by the Doors, Love and Paul Butterfield Blues Band, however, surprised everybody. The press is raving about those three groups. Negram is still continuing a special promotion campaign and expects to gain even better results of these artists in the second half of '67. October '66, Robert Stolz was received as a special guest at the Grand Gala Du Disque 1966 and was honored for his musical merits. Also in October, Negram-Delta released the new Kinks album "Face To Face." Although "Sunny Afternoon" was still in the charts and their budget LP "Well Respected Kinks" was a chart buster, Negram released one of the tracks, "Dandy," as a single. The Kinks version as well as a version by Clinton Ford made the top ten. Later on in the season the Kinks made it big with "Dead End Street," "Mr. Pleasant" and "Waterloo Sunset." In October N.C.R.V.-TV screened "A Man And His Music," dedicated to the one and only Frank Sinatra. Of the other Reprise and Warner Brothers artists especially Dean Martin could be seen quite regularly on TV. Reprise and Warner Brothers are two of Negrams most important LP labels; albums by Nancy and Frank Sinatra, Sammy Davis, Peter, Paul & Mary, and The Everly Brothers sold even better than singles. November '66, The Motions had their greatest hit since "Wasted Words," a revival of the Motown-evergreen "It's The Same Old Song." At that time the second album by the Motions was still one of the best-selling LP's in the nation. Later in this season the Motions scored a hit with "I Want You, I Need You" while Rudy Bennett hit the charts twice with his records "How Can We Hang On To A Dream" and "Amy." In December '66 Negram-Delta concentrated more on selling successful (Continued on page 108)

BELGIUM'S BEST SELLERS—THE PAST 12 MONTHS

(Continued from page M-607)

BEST SELLING SINGLES FROM INELCO

1. Blue River (Elvis Presley)
2. Distant Drums (Jim Reeves)
3. If Every Day Was Like Christmas (Elvis Presley)
4. I Saw Her Again (The Mamas & Papas)
5. Love Letters (Elvis Presley)
6. Monday Monday (The Mamas & Papas)
7. Spinout (Elvis Presley)
8. Torna A Sorrento (The Chakachas)
9. The Last Train To Clarksville (The Monkees)
10. We Shall Overcome (Joan Baez)

BEST SELLING E.P.s FROM INELCO

1. Ave Maria (Mario Lanza)
2. Adios Amigo (Jim Reeves)
3. L'Air qui Balance (Sylvie Vartan)
4. Les Guinguettes (Alan Barriere)
5. Night Rider (Elvis Presley)
6. Mr. John B (Sylvie Vartan)
7. Pourquoi (Le Double Cinq)
8. Sound of Music (Julie Andrews)
9. Deux Filles en Moi (Sylvie Vartan)
10. We Shall Overcome (Joan Baez)

BEST SELLING L.P.s FROM INELCO

1. Belafonte's Golden Record (Harry Belafonte)
2. Cocktail Party (Roger Danneels)
3. Elvis For Everyone (Elvis Presley)
4. Frankie and Johnny (Elvis Presley)
5. Farewell Angelina (Joan Baez)
6. Glenn Miller Story (Glenn Miller & His Orchestra)
7. Joan Baez No. 5 (Joan Baez)
8. Jeannette Macdonald & Nelson Eddy
9. Martine Bijl (Martine Bijl)
10. Sp'out (Elvis Presley)
11. The Sound of Music (Julie Andrews)
12. You Do Something To Me (Mario Lanza)

BEST SELLING SINGLES FROM POLYGRAM

1. A Worried Man (Ferre Grignard)
2. Car . . . tout le monde a Besoin d'Amour (Claude Francois)
3. Give It To Me (The Troggs)
4. Ik Geelof (Jimmy Frey)
5. Ik Woot Het Wel (Jimmy Frey)

6. Ha Ha Said The Clown (Manfred Mann)
7. Hey Joe (Johnny Hallyday)
8. Qu'est ce que tu Deviens (Claude Francois)
9. Touch Me (Dave Dee, Dozy, Beaky, Mick & Tich)
10. This Is My Song (Harry Secombe)

BEST SELLING E.P.s FROM POLYGRAM

1. Give It To Me (The Troggs)
2. Hey Joe (Johnny Hallyday)
3. J'ai Trop de Peine (Herve Vilard)
4. La Famille (Sheila)
5. Leoise (Robert Cogoi)
6. La Petite (France Gall)
7. Nest ce pas Etrange (Claude Francois)
8. Signe Alouette (TV Soundtrack)
9. Tr . . . Partir ou tu Voudras (Annie Philips)
10. Winchester Cathedral (Claude Francois)

BEST SELLING L.P.s FROM POLYGRAM

1. Aventures D'Estherix
2. Claude Francois
3. Dance With Dave Dee, Dozy, Beaky, Mick & Tich
4. Ferre Grignard
5. Georges Brassens No. 9
6. Johnny Hallyday
7. Les Demeiselles de Rochefort
8. The Troggs
9. Wannes Van de Velde No. 1 and No. 2

BEST SELLING SINGLES FROM DISCOBEL

1. Avez-vous Vu Mirza (Non Ferrer)
2. Heb Je De Sleutel v.d. Juke Box Gezien? (Cocktail Trio Imperial)
3. Ik Bewonder Jou (John Lamers)
4. Ik Heb Me Weer Vergist (Bob Smit)
5. I'm Gone (Red Sheldon)
6. Shotgun Wedding (Roy C.)
7. Shapes of Things (The Yardbirds)
8. Teddy Bear (Peggy Vander Buzht)
9. That's Nice (Neil Christian)
10. Venex donc Dhez Moi (Harry Dungen)

BEST SELLING L.P.s FROM DISCOBEL

1. Der Vogelhandler (R. Schock)
2. Land des Lachels (R. Schock)
3. Rocking Tenor Sax (Eddie Chamblee)
4. Twisting Tenor Sax (Gene Ammons)
5. Wiener G'schichten (Peter Alexander)
6. Wleter Folge (Paul Lincke)

SHARP UPWARD MOVE

is always the trend of our company

In the past FIVE MONTHS we had "SEVEN NUMBER ONES" in the charts of Holland and Belgium.

Your material will be given a 1A-plug—

We are specialised in obtaining local recordings.

EDITIONS ALTONA

—Symphony House—VONDELSTRAAT 90 AMSTERDAM—W.

Same company handles: U.A. MUSIC NEDERLAND
PALACE MUSIC HOLLAND
KASSNER ALTONA

Managing Director: Wim van Vught

Phones: (020) 18.63.24 (3 lines)
Cables: ALTONMUSIC—Amsterdam

IN HOLLAND...

negram presses pure profit!

NEGRAM: HOLLANDS
GREATEST INDEPENDENT
RECORD COMPANY
HERENWEG 101 HEEMSTED
PHONE 02500 - 87350

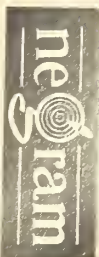

hans kellerman



bob oeges

HOLLAND—The Past 12 Months

(Continued from page 106)

records than on new releases, this because of the Santa Claus (Dec. 5) and Xmas season. Best selling records this month were the albums by Robert Stolz, Margitt Schramm and Rudolf Schock; albums by Dean Martin; "The Very Best Of The Everly Brothers" and the budget LP's in the Marble Arch series; records by Petula Clark, Jacques Dutronc and of course the Kinks.

Early '67, Negram introduced Jimmy James and Geno Washington to the Dutch market. An LP by Sammy Davis and Laurinda Almeida was released as well as an album by the very successful French pop singer Jacques Dutronc on Vogue. Special promotion campaigns were being held for Baccarolo and Marble Arch records. Jacques Dutronc entered for the third time the top 40 with "Les Cactus" and two LP's were released by the Paul Butterfield Blues Band. Petula Clark reached the number one position on the Dutch charts in March '67 and stayed there with "This Is My Song" for almost two months. Robert Stolz, Rudolf Schock and Margitt Schramm toured this month in the Netherlands. The tour was very successful and stimulated the sales of the beautiful Eurodisc operetta records quite a lot. Sandie Shaw reached the top of the charts in April with the winning song of the Eurovision Song Festival, "Puppet On A String." Due to TV and live performances, the record has been in the top ten for three months, five weeks at nr. 1!!!! Important LP releases this month were an album by the most famous Dutch brass band The Amsterdam Politie Kapel and "That's All," a new double LP by Sammy Davis. Peter Alexander's single "Spanisch War Die Nacht" did not reach the charts, but sales were higher than those of many hits. Sammy Davis visited the Netherlands in May for a live-show, broadcasted directly by A.V.R.O.-TV. This month was Negram-Delta's most successful month, up to date, in the popular field; company had eleven hits on hand, of which four in the top ten, six in the top 20. The management of Negram-Delta, Mr. Hans I. Killerman and Mr. Robert Oeges are proud of the results reached in the season 66/67 and will try to make the season 67/68 even better. In August Negram-Delta are moving into the new offices, where the circumstances are very good for the best possible results.

During 1966 the Atlantic label was put up in the house of Polydor. Since then much attention has been paid to this label. The biggest hit of 1966 "Little Man" (Sonny and Cher) was released under it. Besides, the growing interest in R and B put "Atlantic" in the news regularly (Wilson Pickett, Otis Redding a.o.). From Polydor England with Jimi Hendrix quickly gained an obviously fixed place in the hit-parade. From time to time two numbers are among the top 40 and his LP, which has just been released, reaches big sales. There seems to be

no end to the sales of records with the Bee Gees. This group has several numbers in the top 40. An LP is on the way. Polydor Germany came on the market with a large number of new records from the Kaempfert and Last repertory, all of which were received enthusiastically by thousands of buyers. Furthermore there were Roy Blacks' hit successes, which keep their place on the hitparade, particularly in the Southern part of Holland. His new LP is much in demand. The MGM label, represented by Polydor, released among others the famous LP Dr. Schivago, one of the top selling LP's in Holland. The single from this LP regularly appeared on the top 40 list. Verve—also represented by Polydor—made some brilliant LP's with Astrud Gilberto, Stan Getz, Oscar Peterson and others, all quickly gaining their place in the market. Record sales were reached on the Kama Sutra label with "The Lovin' Spoonful," first class hitmakers, now also with a new LP. Holland's fast-growing record company also developed their own great activities in recording. Several hits were created with beat groups such as the Golden Earrings and The Shoes. The Golden Earrings were also released in America.

In Polydor's famous special series a great number of new Dutch productions appeared, which all became top-sellers. Dutch Singer number one: Corrie Brokken, signed a contract with Polydor; her productions have a great future before them, especially in Germany, where she is going to produce a number of TV shows for the next season. Jacco van Renesse made his first recording and singer Bojoura soon saw her first record among the top 40. In the classical sector great successes were scored thanks to one of the world's best labels for classical music: D.G.G. Thousands of albums were sold after a strong subscription-campaign in 1966. The well-introduced DGG "stable" was distributed over a broad front and reached the best sales-figures ever gained. Polydor Nederland in time adapted her organization to this fast growth, reorganized, enlarged its facilities and is ready for the coming season to be and to remain: one of Holland's fastest growing record companies.

For Inelco season '66/'67 started with signing the contract for the Dutch Record Club. Mama's and Papa's hit the top in Holland with "Monday Monday" in July '66. Elvis Presley was again on the hitparade with his "Love Letters" and Jim Reeves' "Distant Drums" was a best-seller in the Netherlands. Inelco signed the contract for the Dutch version of "Fiddler On The Roof," titled "Anatevka." Rita Pavone again was in Holland August '66 on the television screen and also The Peter Nero Show from the Amsterdam Carré theatre. The Hunters "bombed" with their "political song": "The Russian Spy And I." Peter Serkin performed with the Concert Gebouw Orchestra and he made the audience

very enthusiastic with his piano-playing. Jazz Star Series was a big success and it was the beginning of the "revival of Jazz". The title "With God On Our Side" of Joan Baez, the strongest title from her last television show is (now on EP) also a big success. Inelco started the Monkees' publicity campaign in September, and also the "Al Hirt Grand Gala Bomber Campaign" started same month. Inelco started its own Publishing Company by the name of Universal Songs by contracting Wim Landman, one of our national publishing specialists. October '66 was Inelco's month for the Monkees . . . Monkees' Sensation in Holland! One of the stars on the popular Grand Gala was without any doubt: Al "He Is The King" Hirt and his band. One of the stars of The Grand Gala Classique '66: Van Cliburn. "Lucia Di Lammermoor" with Anna Moffo and Carlo Bergonzi in the leadin' roles, has got the best critics of the year.

"The Sound Of Music" got an Edison-award popular and "Othello" with Sir Laurence Olivier a classical Edison. Inelco released the Santa Claus and Christmas LP of the winning Dutch "Familie von Trapp": Familie Kortekaas. Enormous reactions on the release of "L'Enfance du Christ", the first Christmas Oratorio in the low price series. November was Inelco's Monkee-LP-Month pre-eminently! Also long expected: "Il Barbiere di Siviglia" conducted by popular Erich Leinsdorf came on the Dutch market. Mama's and Papa's scored again with "Look Through My Window". Jim Reeves was Inelco's "best-selling artist" of the Santa Claus sales in Holland. Fats Waller was growing much more popular in Holland and even beatbands started playing old songs and special contests were held. Monkees' "I'm A Believer" jumped into the Top Ten. Sylvie Vartan was on television on her visit in Holland and she sang a Dutch title: "Ballade voor een Glimlach." "Anatevka" (Fiddler On The Roof) started their "Victory Tour" in the theatres and on the RCA Victor label. The Country Clarinet of mister "Pee Wee Spitelera" received very fine critics. "The Sound Of Music" was the best sold LP of 1966, Jim Reeves the best bought artist of 1966, and The Monkees were the biggest sensation of 1966!!!!!!

In January of this year Inelco started its "Local Record Production Company" with several free lance producers and a new label: "Tania." Again Mama's and Papa's attention for their: "Words Of Love." Elvis' Golden records were received with big enthusiasm and an Elvis Day was organized in Amersfoort. In January, Mr. Leinsdorf visited Amsterdam. Piet Beishuizen, Director of the C.C.G.C. and Pierre Dam, Inelco's publicity manager, handed the classical Edison Award to Sir Laurence Olivier in London. The Inelco staff went to Hamburg in February to have the half yearly meeting with the other companies. New Elvis hit: "Indescribably Blue"; "Yours Sincerely" of the late Jim Reeves was the most requested record for collectors. All the Dutch "Anatevka-Artists" received a record out of the hands of mgr. Wim Brandsteder. Malcolm Frager was in Amsterdam; also Richard Lewenthal. "Relaxing with the Ad Vanderhood Quartet" was a soft swing local production and requested by all the other companies too. Mr. Friedberg, director of the Amadeo Company, visited Inelco in March. This was also the month of the birth of a very good English group: "The Frugal Sound." A big "Old Jazz Press Conference" in March was the beginning of a number of old jazz festivities and RCA was the organizer. March 7 will be the "Jazzday" in the future.

Mama's and Papa's were here again with "Dedicated To The One I Love." Leonard Pennario in Holland; also Charles Münch. Monkees had another smash hit with their "Little Bit Me A Little Bit You." Artur Rubinstein was on tour in Holland in April. Inelco released the sensational LP: "Mama's and Papa's Deliver". Conny Vink, Inelco's trump for the coming Knokke-Song-Festival, released her

hit: "Bossa Nova Boy". Inelco released "Toscanini In Memoriam" with a special small in-memoriam-campaign. On television were four Nashville Shows: Jim Reeves, Chet Atkins, Bobby Bare, a.o. Simon Carmiggelt, our national "Small-joke-tales-specialist", was contracted for the RCA-label. "Lucrezia Borgia" in a three-record-album was released in April. Joan Baez on television in May. Country and Western is "future music" and that's why Inelco is preparing big campaigns for the promotion of this music in Holland, also for Jazz and Victrols. Inelco prepares its "10th year anniversary." In May Mr. Wim Brandsteder went on business-trip to the States and Canada. He got "The Golden Record" for the "Sound Of Music" LP.

CBS Gramofoonplaten Holland started 1967 with an extensive local production; the new set-up is headed by producer Cees de Man and involved a scheme of new material which so far proved to be a huge success in the low countries as well as abroad.

One of the most important releases of last season has been the second album by The Kilima Hawaiians, entitled "Moonlight Over Hawaii". No doubt The Kilima Hawaiians by now have reached an almost world-wide audience with their first CBS album "Farewell Hawaii." Albums have been issued in U.S., Japan, Mexico, Great Britain, Australia, Israel, most European countries and many others. Albums by Trio Antoine Mommers and Die Harmonika Paraders with Accordion music and Tony Eyk's Bar Quartet's "Hey Mr. Hammond" still are very successful and sales are increasing in Belgium, Germany, Austria and Switzerland, not to mention Holland. The first CBS Barrel-organ Album, entitled "International Melodies" by the Bruderorgelwaldkirch, including selections from "Mary Poppins", LP-recording, entitled "Caribbe Souvenirs" (The Sound Of The West-Indies), and an album by The "Snuffy" King Trio, entitled "Wack Wack" and many other albums to come, were made for the international market in the first place. New CBS groups, such as The Stax with "Gone Gone Gone", the fourth single by popular group Les Cruches: "Will You Always Love Me"/"Mum and Dad", Sweet Nothing and The Blues Group Five proved to be quite successful on the local market. Especially J. B. Euson, who made quite some noise with his tremendous first CBS single "Amen" c/w "Where Can My Lover Be" is one of the artists, whom CBS is proud to have on its label. CBS' most promising British group of last season were The Tremeloes, who rapidly made the charts with their second single "Silence Is Golden," after their first success "Here Comes My Baby." No doubt their first album, entitled "Here Comes The Tremeloes" will become a blockbuster on the local market. Ray Conniff and the Singers' "Somewhere My Love," as well as their album with the same title still is one of the best-selling singles and albums in Holland. Other artists who made quite an impact on the local market were: The Byrds ("My Back Pages" and album "Younger Than Yesterday"), the French Orchestra of Caravelli, Gene Pitney, Andy Williams' "Music To Watch Girls By" and Bob Dylan.

During the '66-'67 season Artone and its subsidiary Funkler Records managed to further expand their activities in the Benelux as well as in the international markets. Many new artists, both in the pop and the classical fields, were signed for recordings released in the company's international catalogue, which now boasts such bestselling items as the packages by The Reunion Jazz Band, The New Orleans Syncopators, Los Tenientes, Piano team Martin Gale & Cor Coles and Willy Schobben, who scored locally with "Somewhere, My Love." Artone's locally produced classical line continued to receive rave reviews for newly recorded LP's such as the highly successful first volume of Handel's Organ Works as performed by renowned Albert de Klerk. Artone as distributor for ABC Records scored

(Continued on page 110)

BASART

in

BENELUX

NUMBER ONE MUSIC PUBLISHER

LEIDSEGRACHT 11—AMSTERDAM—HOLLAND

Phone: 222626

MAURICE LEMONNIERLAAN 20—BRUSSELS—BELGIUM
Phone: 125034

DUTCH Record Manufacturers

ARTONE GRAMOPHONE N.V.
Kruisstraat 8-10
Haarlem
Tel.: 17476
Telex: 41051 Argram
Managing Directors: Bill C. Slinger & Casper D. Slinger
Sales Director: John J. Vis
Labels: United Artists, Tamla-Motown, Chess, ABC, Epic, Prestige (U.S.A.), Festival (France), Palette (Belgium), Ricordi (Italy), Bärenreiter (Germany)

BARCLAY NEDERLAND N.V.
Singel 104
Amsterdam
Tel.: 234361
Telex: 13013
Managing Director: B. R. Maessen
Labels: Barclay, Riviera, Erato
Distributors of: 20th Century Fox, Jubilee, Josie, B. T. Puppy Valliant, Ashley, Bud-dah, Transatlantic, Rigolo, Rifi, Tempo (Sp), Saba

BASART GRAMMOFOONPLATENMAAT-SCHAPPIJ N.V.
Houtmankade 20
Amsterdam
Tel.: 63209—222192—241260
Managing Director: F. Basart
Labels: Whamm, Europhon, Vox, Turnabout, Pelca, Da Camera, Camerata, Christophorus, Amalthea, President, Folkways, Stibbe, Durium, Disc, Français
Distributors of: Super Majestic, Sprint

BOVEMA VERKOOPMAATSCHAPPIJ N.V.
Bronsteeweg 49
Heemstede
Tel.: 80750
Telex: 41257
President: G. M. Oord
Labels: Columbia, Capitol, His Master's Voice, Imperial, Liberty, Pathé, Stateside, Parlophone, Odeon, Monument, Immediate, Ember, Gloria, Regal, Die Volksplatte

CBS GRAMMOFOONPLATEN
(a division of Interphone Industrie N.V.)
Kruisstraat 8-10
Haarlem
Tel.: 17476
Telex: 41051 Argram
Managing Directors: Bill C. Slinger & Casper D. Slinger
Label: CBS

CNR GRAMMOFOONPLATENMAATSCHAP-PIJ N.V.
Gevers Deynootplein 40
(Postbox 5075)
Scheveningen
Tel.: 559500
Managing Director: J. W. van Zeeland
Labels: CNR, Jubilate
Distributors of: Telefunken, Melodia, Cetra, Harmonia Mundi

N.V. DURECO
Beursstraat 21
Amsterdam
Tel.: 242288
Telex: 14409
Managing Director: A. de Reuck
Labels: Omega, Telstar, Te Deum, Metronome, Golden 12, Dureco, Ojee, Cid/Zafiro, Show Records

INELCO HOLLAND N.V.
A. J. Ernststraat 801
Amsterdam
Tel.: 421722
Tel.: 14622
Managing Director: W. Brandsteder
Labels: RCA Victor, RCA Camden, RCA Victrola, Amadeo, Vanguard, Elite-Special

IRAMAC N.V.
Brediusweg 43
Bussum
Tel.: 18285—19546
Managing Director: Willem Duys
Labels: Iramac, Relax
Distributors of: Dover Publications, Wergo, Diskanto, Disco Nederland, Starday, Nashville

B. MUNNIKENDAM
Kromme Waal 18-19
Amsterdam
Tel.: 248994
Managing Director: B. Munnikendam

N.V. NEGRAM-DELTA
Herenweg 101
Heemstede
Tel.: 87350
Managing Directors: Robert Oeges & Hans I. Kellerman
Labels: Delta, Negram, Havoc
Distributors of: Ariola, Eurodisc, Roulette, Vogue, Mode, Elektra, Pye, Marble Arch, Golden Guinea, Piccadilly, Reprise, Warner Bros., Dot, Kapp, Scepter, Wand, Lema, Hansa, Cornet, Hitton, Major Minor, Bounty, Baccarola

N.V. PHONOGRAM
Singel 170-172
Amsterdam
Tel.: 245588
Alb. Perkstraat 35
Hilversum
Tel.: 13455
Telex: Phonogram ASD-12038
Managing Director: J. Haslinghuis
Labels: Philips, Fontana, Mercury, Decca, London, Brunswick
Distributors of: Almo, Challenge, Coliseum, Contemporary, Coral, Fantasy, Good Time Jazz, Hi, Hollywood, Jamie/Guyden, Jazzland, Josie, Jubilee, Mira, Mirwood, Pacific, Parrot, Phillies, Riverside, Smash, Starday, Sue, Sun, Symbol, Tribe, Vee-Jay, White Whale, World Pacific (U.S.A.), Ace Of Clubs, Ace Of Hearts, Argo, Beltona, Caemdon, Deram, L'Oiseau Lyre, Page One, President, Vocalion (England), Star-Club (Germany), etc.

POLYDOR NEDERLAND N.V.
Piet Heinplein 5
Den Haag
Tel.: 634955
Telex: 31481
Managing Director: E. Garretsen
Labels: Deutsche Grammophon Gesellschaft, Archiv, Heliodor, M.G.M., Verve, Atlantic, Command, Belvédère, Kama Sutra, Storyville, Polydor

DUTCH Record Manufacturers

EDITIONS ALTONA
(Palace Music Holland)
(U.A. Music Nederland)
(Kassner-Altona)
Vondelstraat 90
Amsterdam-W
Tel.: 186324
Cables: Altonmusic
Managing Director: Wim van Vught

ANAGON MUSIC PUBLISHERS N.V.
Melody House
Heemsteedse Dreef 287
Heemstede
Tel.: 83654—81445
Managing Director: Jan van Schalkwijk

ATLANTIC
(Scherzando/Harm Fanfare, Pacific)
Wilgenplaslaan 230
Rotterdam 12
Tel.: 226669
Managing Director: Chr. Th. Back

LES EDITIONS INTERNATIONALES BASART N.V.
Leidsegracht 11
Amsterdam
Tel.: 222626
Managing Director: Guus Jansen Jr.

BELNDA (AMSTERDAM) N.V.
(Hill And Range Songs, Inc.)
Leidsegracht 1
Amsterdam
Tel.: 220162
Managing Director: E. van Zoeren

BENELUX MUSIC
(Benelux Music)
(Funny Music)
(Charly Music)
St. Maartenslaan 1-3
Weert (L)
Tel.: 2620
Telex: 51285
Managing Director: Johnny Hoes

BOSEPEL MUSIC N.V.
(Ed. Musicales Bens)
(Ed. Ponior)
Warmoesstraat 86
Amsterdam
Tel.: 226394
Telex: 14409
Managing Directors: A. E. Palmans, J. Bosmans, Joop Gerrits

CHAPPELL & CO. HOLLAND N.V.
Weteringschans 35
Amsterdam
Tel.: 64664—64790
Managing Director: Mrs. A. Nagel-Van Zwi-ten

FREETONE N.V.
Brediusweg 43
Bussum
Tel.: 18285—19546
Managing Director: Willem Duys

HOLLAND MUSIC N.V.
(Peer-Southern Organization, New York)
(Cedarwood Pub. Co. Inc., Nashville, Ten-nessee)
(Helios Music Corp., New York)
(Glamorous Music Inc., New York)
Singel 500
Amsterdam
Tel.: 231163
Managing Director: Han Dunk

INTERNATIONALE MUZIEK CO.
(World Music)
(Screen Gems)
(Acuff Rose)
Burg. Hoggwerstraat 1159
Amsterdam
Tel.: 110660
Managing Director: Jan Steenberg

INTERNATIONALE MUZIEKUITGEVERIJ DE KRUYFF
Rijksstraatweg 115
Gaanderen
Doetinchem
Tel.: 4181
Managing Director: J. de Kruyff

MUZIEKUITGAVEN MELODIA
(Francis, Day & Hunter Ltd.)
(Robbins Music Corp.)
Amstel 52
Amsterdam
Tel.: 238800
Managing Director: C. Smit Jr.

METRO MUZIEK
Bern. Zweepskade 18
Amsterdam Z2
Tel.: 723116
Managing Director: Mrs. C. A. J. Antoni-Schoonenburg

MUZIEKUITGEVERIJ J. POELTUYN
Deurlostraat 18
Amsterdam
Tel.: 722827

MUZIEKUITGEVERIJ J. PORTINGEN N.V.
(April Music Inc., New York)
(Blackwood Music Inc., New York)
(Tree Publ. Comp. Inc., Nashville, Tenn.)
(Sparta Music Ltd., London)
(Edition Meteorion, Fribourg)
(Ed. Jean Kluger, Brussels)
(New Music Corporation, Brussels)
(Editions Malando)
Kruisstraat 8-10
Haarlem
Tel.: 12277
Managing Director: J. Portengen

UNIVERSAL SONGS HOLLAND N.V.
(Universal Songs, Brussels)
(Millbridge-Polaris)
(Millbridge-Daedalion)
(Millbridge-Elbee)
A. J. Ernststraat 801
Amsterdam-Z.
Tel.: 421722
Telex: 14622
Managing Director: W. Brandsteder

If you are looking

for a hard-working, inventive, enthusiastic,
versatile, young-but-experienced
promotion-team,
anxious and able
to get American records on the highest spots
of the Dutch hitparade,

write or call

N.V. PHONOGRAM

Singel 170-172/Amsterdam/Holland/phone 020-245588

The company that dominates the Dutch record market

HOLLAND—The Past 12 Months

(Continued from page 108)

with Tommy Roe's "Sweet Pea" as well as with LP recordings by such prominent artists as Ray Charles and John Coltrane. Funckler's relentless promotion of the Tamla-Motown label thru the years this season resulted in breaking open the local market for Rhythm & Blues, with such artists as Stevie Wonder, The Four Tops, The Supremes, Jr. Walker and Marvin Gaye strongly hitting the charts. Most of these now have already several hits to their credit in Benelux, as much as they continue to be successful. The Chess line offered Billy Stewart's Hit reading of "Summertime", whereas many names from the label's jazz roster received plenty of attention thru the specially designed "I Love Jazz On Chess" series. Further additions to Prestige's unique "Modern Jazz Giants" series scored heavily in the same field.

Donovan's "Sunshine Superman" and "Mellow Yellow", both on single as well as on LP, proved to be blockbusters for the diskery's Epic line. Further cause for satisfaction provided the sales-results to two Glen Miller Orchestra albums released on the same label. Artone's United Artist dept. managed to bring The Easybeats' recording of "Friday On My Mind" in the No. 1 slot of the local charts for several weeks, long before record started climbing in England and the United States. Hits on the Palette label this season included: Michel Polnareff's "La Poupee", "Love Me Please Love Me" and "Ta, Ta, Ta," whereas Digno Garcia's version of "Guantanamera" proved a strong competitor to the original hit recording. Now that Monaural recording appears to be heading into its final stages, Artone successfully completed the switching over to Stereo of the majority of its current releases.

CNR, which already has some stakes in the classical fire with labels

as Harmonia Mundi, Telefunken and Cantate, expects a very great deal from the Russian Melodia-label, which will be introduced with a big publicity campaign in the autumn. The Melodia catalog is considered as one of the most important in the entire world with artists like David Oistrakh, Sviatoslav Richter and Constantin Ivanov, CNR-artist Gert Timmerman got a trophy at the Cannes "Midem" trade fair as the best sold Dutch recording artist of the past year. Same artist gets a 1,000,000 trophy in the fall. One of the most interesting CNR-discoveries of last season was girl singer Reggie v.d. Burgt who scored on the Dutch Hitparade. CNR also expects a lot of new Dutch group "Daddy's Act".

Basart's record department, representing among others the important Italian Durium-label in Holland, reports 200,000 sales of the Nini Rosso-hit "Il Silenzio", thus having the best selling foreign record of all times for this company. Other highlights of the Durium-label were the Nini Rosso album "La Montanara" and "Cuore Matto" by Italy's eternal chartrider Little Tony. Recently Mrs. Mintangian of Durium and Mr. Frans Basart signed the extension of their present agreement. An agreement was reached with the Folkways-label for European releases of their folklore catalog. Activity on local talent includes Dutch topgroup Les Baroques, whose "Such A Cad" and "I Know" have been released in the U.S. and all Europe, and whose latest single "Bottle Party" just entered the charts two weeks after release. Other successful items were Caroline Kaart, whose folksong-album sold 10,000 copies. R&B-talent John "King Size" Russell with "Oh Monah," "One Plus One Makes Two" and his album "Rhythm & Blues," just released; Basart recently introduced talented Israelian singer David, who made his successful debut with "The Oriental

Beat Goes On." About to be released is the Dutch version of "Er Und Ich" by German Hansa-label's most important artist Marion. Latin music in the Basart catalog is represented by Los Aventureros, Aruba-originated group, who recently recorded their first album. Increased activity on the record-field in the near future will help to boost the already established force of the Basart group in the Dutch music industry.

For Iramac 1966/67 season started off with the first big hit of the Outsiders "Lying All The Time," after which same group stayed in the Dutch hit parade one year without any interruption with numbers like "Keep On Trying," "Touch," "Monkey On Your Back" and "Summer Is Here." Iramac's Martine Bijl was one of the sensations of Dutch Knokke-song contest team. In September Iramac organised a dealers-meeting in cooperation with CNR. Famous Chinese bass, Yi-Kwei Sze got an Edison for his Iramac-LP with songs of Tcherenine and Moussorgsky, and in Paris the "Grand Prix Du Disque Lyrique" for his Iramac-record with songs of Brahms and Moussorgsky. Beat groups Outsiders and Zipps made appearances in Paris during the month of December. Dutch version of "Yellow Submarine" entitled "Jelle Zal Wel Zien" became one of the biggest carnival hits of the year. In February Iramac got the Dutch representation of the American C&W label "Star-day," in March of the label of sacred music "Diskanto" and the German progressive-classical label "Wergo." in April the label "Disco Nederland" with recordings of known and rare organs and in June the Soul Sound-label with recordings of B.B. King, Little Richard, John Lee Hooker, Lowell Fulson, Mary Love and Ike & Tina Turner. In April the first LP of the Outsiders came on the market; in 3 days time 10,000 copies were sold, which was a record for Dutch beat LP's. In May, Chinese bass Yi-Kwei Sze got, for the second time, the "Grand Prix Du Disque Lyrique" for an Iramac-recording and in the same

month Dutch group The In-Crowd came under contract with Iramac for their Relax-label. In June the Outsiders got their Golden Record for 100,000-sales.

PUBLISHERS

Holland Music N.V. (Peer-Southern Organization) Amsterdam, had a good season with the top Artists Donovan and Michel Polnareff. Their outstanding Hitparaders, such as: "Mellow Yellow," "Sunshine Superman," "Epistle To Dippe," "Ta Ta Ta Ta," "Love Me, Please Love Me" and "Le Pauv' Guitariste" all made a good show in the charts. And then of course the phenomenal rise to success of the New Vaudeville Band with "Winchester Cathedral," "Peek-A-Boo" and "Finchley Central," Manfred Mann with "Semi-Detached Suburban Mr. Jones" and Peter & Gordon with "Sunday For Tea."

Apart from vast activities with their immense catalogue of standard numbers appearing in the repertoires of all local artists, orchestras, etc. three main objects were vastly intensified by Chappell-Holland. The whole repertoire of Tom Springfield was paid a lot of attention to and was further established (Georgy Girl; Morningtown Ride), the already sensational sales of records and sheet-music of "The Sound of Music" reached its peak in the season 1966-1967, and the glorious triumph of the Dutch stage-version of the musical "Fiddler on the roof," staged in Holland as "Anatevka," now having finished the first series of performances in Amsterdam, and touring the country now. Numerous "Chappell"-copyrights have been recorded as local versions by Dutch talent, culminating in "Something Stupid." Dutch Television presented three big productions of musical works controlled by Chappell-Holland: "Kiss Me Kate," "The Mikado" and "Robber Symphony."

Les Editions Internationales Basart N.V. has been extremely successful (Continued on next page)

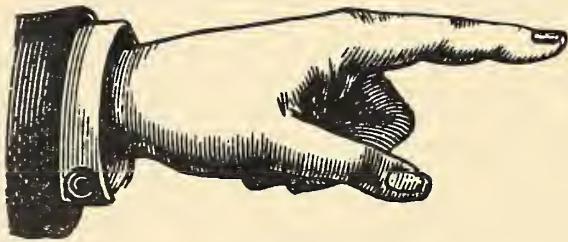

THIS HAND POINTS TO THE RIGHT COMPANY

**FOR NATION-WIDE DISTRIBUTION OF YOUR RECORDS IN HOLLAND.
THE COMPANY WITH THE GRIP ON THE MARKET**

N.V. GRAMMOFOONPLATENMAATSCHAPPIJ CNR
POSTBOX 5075 - SCHEVENINGEN - HOLLAND

● OWN PRESSINGPLANT ●
INDEPENDENT AND RELIABLE

DUTCH TRADE ASSN.'S

C.C.G.C. (COMMITTEE COLLECTIVE GRAM-

OPHONE CAMPAIGN)

Nwe. Keizersgracht 52
Amsterdam
Tel.: 241032

N.V.G.D. (NETHERLANDS ASSOCIATION
OF GRAMOPHONERECORDS DEALERS)

Nieuwe Binnenweg 132
Rotterdam
Tel.: 251660-252472

N.V.G.I. (NETHERLANDS ASSOCIATION OF
RECORD COMPANIES)

Nieuwe Binnenweg 132
Rotterdam
Tel.: 251660-252472

DUTCH RECORDING STUDIOS

ARTISOUND

Doelenzaal
Groenburgwal 24
Amsterdam
Tel.: 66679

BAVOHUIS

Sumatrastraat 2
Amsterdam
Tel.: 740499

GELUIDSTECHNISCHBUREAU GTB

Jan van Nassastraat 67
The Hague
Tel.: 244555

N.V. BOVEMA

Overboslaan 6
Heemstede
Tel.: 80750

BOSEPEL MUSIC N.V.

Warmoesstraat 86
Amsterdam
Tel.: 226394

L. LUDOLPH

P. de Hooghlaan 11
Nw. Loosdrecht
Tel.: 3744

N.V. PHONOGRAM

Honingstraat 14 A
Hilversum
Tel.: 14956

"SOUND PUSH"

Huizerweg 13
Blaricum
Tel.: 6050

STUDIO SONORA

Heemsteedse Dreef 287
Heemstede
Tel.: 83654

DUTCH MUSIC LICENSING ORGANIZATIONS

STEMRA

Marius Bauerstraat 30
Amsterdam
Tel.: 156822

BUMA

Marius Bauerstraat 30
Amsterdam
Tel.: 156822

DUTCH PRESSING PLANTS

ARGRAM

(a division of Interphone Industrie N.V.)
Kruisstraat 8-10
Haarlem
Tel.: 17476
Factory: Nijverheidsweg, Haarlem

N.V. BOVEMA

Bronsteeweg 49
Heemstede
Tel.: 80750
Factory: Blekersvaartweg 45, Heemstede

PHILIPS PHONOGRAFISCHE INDUSTRIE

N.V. (P.P.I.)
G. v.d. Veenlaan 4
Baarn
Tel.: 3551

N.V. TELCAP

Cort v.d. Lindenstraat 13
Rijswijk (ZH)
Tel.: 985223

DUTCH MATRIX COMPANIES

ARMETAL

(a division of Interphone Industrie N.V.)
Kruisstraat 8-10
Haarlem
Tel.: 17476
Factory: Nijverheidsweg, Haarlem

N.V. BOVEMA

Blekersvaartweg 45
Heemstede
Tel.: 80750

PHILIPS PHONOGRAFISCHE INDUSTRIE

N.V. (P.P.I.)
G. v.d. Veenlaan 4
Baarn
Tel.: 3551

N.V. TELCAP

Cort v.d. Lindenstraat 13
Rijswijk (ZH)
Tel.: 985223

LABEL & SLEEVE MFRS.

ARPRINT

(a division of Interphone Industrie N.V.)
Kruisstraat 8-10
Haarlem
Tel.: 17476
Factory: Nijverheidsweg, Haarlem

HABO

Valsbermkade 27
Amsterdam
Tel.: 155259

HOLLAND— THE PAST 12 MONTHS

(Continued from preceding page)

this past year. This is most clearly shown by the fact that 31 Basart-controlled copyrights figured among the top-5 of the Dutch charts during this period, of which we name such strong chart riders as "Yesterday," "Sunny," "Stranger In The Night," "No Milk Today" and—more recently—"I Was Kaiser Bill's Batman," "This Is My Song" and this year's Eurovision Contest-winner, "Puppet On A String." The toplists show a regular 15 to 20 songs controlled by Basart and its affiliates each week. Of the all-time Lennon-McCartney hit "Yesterday" eleven cover versions were obtained, a very remarkable achievement in this small territory. Basart almost monopolizes the publishing of Dutch beatwriters, among which there are several highly talented young people, who have been equally successful in other countries. Songs and original recordings by local composers and groups like Les Baroques, The Golden Earrings, The Motions, The Outsiders and The Ro-d-ys have found their way to many countries all over the world. Various important catalog deals were set during this period either for Holland or for Benelux. Basart now represents such important publishers as Jobete Music Co. and the Big 7 Companies. With Deutsche Grammophon Gesellschaft Basart formed the Edition Arena-Holland Company, the Dutch affiliate of Aberbach G.m.b.H. This company handles the original material of Aberbach-Hamburg in Holland and furthermore acts as the publishing department for Polydor-Nederland. From M.U. Artemis, Publishing department of Philips International, Edition Arena-Holland obtained the rights to the Cotillion, East and Pronto catalogs for Holland. This remarkable expansion required important reinforcement of staff personnel, while the firm turned to further mechanization of their operations. Total mechanization is expected to be introduced before the end of this year. Another important move in the expansion program of Basart has been the installation of a Belgian office in Brussels, where Mr. Alain Lelievre heads the exploitation of all Basart's world copyrights and Benelux acquisitions. Agreements were reached with three very important German publishers, which in alphabetical order are Rolf Budde, Dr. Hans Gerig and Peter Meisel, regarding the representation of their interests through jointly owned companies for the Benelux territory. The German market still has a strong influence on the Benelux countries and after the recess caused by the struggle in the German music industry last year, business is picking up fast and good results are to be expected shortly.

Manager Wim van Vught of Altona informed Cash Box about a most successful year for his pubbery and affiliations. In this year the pubbery handled three times as much copyrights as the year before and therefore the internal organization was extended with strong elements as Willy Rex and young Peter Koelwijn in the promotion and A & R-field. Biggest successes were the original Dutch recordings as Boudewijn De Groot with the Number-One title "Welterusten Mr. President" (Sleep Well, Mr. President) and songstress Conny van de Bos with "Ik Ben Gelukkig Zonder Jou" (I'm Happy Without You). Biggest title of the year was the Dutch version on the United Artists copyright "Dance Mamma Dance Pappa" sung by Karin Kent: "Dans je de hele Nacht met mij." Since long years it happened for the first time that a Dutch version became a new Number One in the Dutch charts. Even in Belgium this title obtained the Number-One position. Also a big success was the Dutch version "Als Ik De Golven Aan Het Strand Zie" sung by famous songstress Ria Valk on the Burlington/Herb Alpert title: Surfin' Senor.

(Continued on next page)

SONGS



UNIVERSAL SONGS
MUSIC PUBLISHERS



THIS
is our phonenumber

020-421722

HOLLAND

ask for Wim Landman

02-112220

BELGIUM

ask for Ivon de Bie

THIS is our telex

HOLLAND 14622 BELGIUM 22090

THIS
is our address

HOLLAND · ARENT JANSZON ERNSTSTRAAT 801
AMSTERDAM

BELGIUM · RUE DE L'HOPITAL 20-24

BRUXELLES

HOLLAND'S Gold Records — 1966/67

Title	Artist(s)	Label
Cherie	Eddy Wally	Telstar
Dans Je De Hele Nacht Met Mij	Karin Kent	Decca
En Van Je Hoempa!	Johnny Hoes	Telstar
Frater Venantius	Wim Sonneveld	Philips
Glaasje Op . . . Laat Je Rijden	Sjake Schram	Artone
Green Green Grass Of Home	Tom Jones	Decca
Het Land Van Maas En Waal	Boudewijn De Groot	Decca
Il Silenzio	Nini Rosso	Stibbe/Sprint
In Der Mondhelle Nacht	Gert & Hermien Timmerman	CNR
Jongens Van 18 Jaar	Zangeres Zonder Naam	Telstar
La Danse De Zorba	Trio Hellenique	CNR
Little Man	Sonny & Cher	Atlantic
No Milk Today	Herman's Hermits	Columbia
Outsiders	Outsiders	Relax
Release Me	Engelbert Humperdinck	Decca
The Sound Of Music	Julie Andrews, etc.	RCA Victor
Waarem Heb Jij Me Laten Staan?	De Heikrekeis	Telstar

HOLLAND—The Past 12 Months

(Continued from preceding page) ita. The strong position in Dutch recordings of Altona was further more emphasized by Top Ten titles as "You're The Victor" by Dutch beat-group Q'65 and "Tjing-A-Ling" by well-known Johnny Lion. Also in foreign titles, Altona had a strong year. With the Kassner catalog they exploited such titles as "Bang Bang" by Sonny & Cher, "Bald Headed Woman" received four local covers, "It is Really Worth Your While" by The Fortunes. Own successful sub-publications were a.o. "Ganz In Weiss" by Roy Black, successfully covered by Hermien Timmermans and "As Tears Go By" by The Rolling Stones. Beginning of the year 1967 brought Altona a lot of Number-One Titles: "Friday On My Mind"—The Easybeats (U.A. Music); "Green Green Grass Of Home" (Palace Music)—Tom Jones; "Release Me"—Engelbert Humperdinck (Palace Music); "Ha

Ha Said The Clown"—Manfred Mann (Bron Music); "Land Van Maas en Waal"—Boudewijn De Groot (own copyright); and "Ben Ik Te Min" Armand (own copyright). All together also the year 1967 will be a continuation of the strong position Altona kept on the Dutch market during the past years.

Anagon music publishers had a very good season with the acquisition of the Walt Disney catalog. Anagon, before long independently working together with the E.M.I.-publishing companies, now is an affiliate of E.M.I. "Merci Cherie" was one of the most successful titles of this puberty.

Belinda (Amsterdam) N.V.—former representative of the Jobete catalog—concentrated its promotion activities on introducing R&B-music in Holland, resulting in such big hits as: "River deep, mountain high" (Ike and Tina Turner), "You Can't Hurry Love," "You Keep Me Hangin' On" (Supremes) and "Reach Out I'll Be There," "Standing in the Shadow of Love" (Four Tops) etc. However, a look in the follow-up of the Dutch charts shows a remarkable change from American to European Artists going on: In the second part of 1966 Belinda noted a 50/50 quotation, but in the first part of 1967 this changed up to 75% European (for the main part English) and 25% American releases. Big sales were achieved by the Kinks (Pye) with their "Sunny Afternoon," "Dandy," "Deadend Street" and "Mr. Pleasant." On this very moment again the Kinks have a new tremendous bestseller with "Waterloo Sunset." As for the future Belinda expects a steady progress of European Beat and Popmusic.

J. Portengen Muziekuitgeverij N.V. enjoys an important expansion. Besides an intensive own local production, new catalog deals and new-formed subsidiaries caused a healthy growth. We mention the following deals: April and Blackwood Inc. ("Wild Thing"); Tree Publ. Co.; (Continued on page 114)

REMEMBER the name of HOLLAND'S TOP PUBLISHER

BELINDA
BELINDA
BELINDA
BELINDA
BELINDA
BELINDA
BELINDA
BELINDA
BELINDA

(AMSTERDAM) N.V.
LEIDSEGRACHT 1
AMSTERDAM, HOLLAND

For your Representing in the Benelux

CONTACT MUSIC PUBLISHING ATLANTIC

WILGENPLASLAAN 230 • ROTTERDAM 12 • TEL. (101) 22 66 69

Dir. Chris Back

POLYDOR
NEDERLAND NV

THE HOUSE OF HITS IN HOLLAND

polydor nederland nv
piet heinplein 5 the Hague holland

HOLLAND'S BEST SELLERS

BEST SELLING SINGLES FROM PHONOGRAM

Land Van Maas On Waal	Boudewijn de Groot	Decca
Green Green Grass Of Home	Tom Jones	Decca
Sammy	Ramses Shaffy	Philips
Let's Spend The Night Together	Rolling Stones	Decca
Dan Je De Hele Nacht Met Mij	Karin Kent	Decca
Paint It Black	Rolling Stones	Decca
Release Me	Engelbert Humperdinck	Decca
With A Girl Like You	The Troggs	Fontana
Lady Jane	Rolling Stones	Decca
Ben Ik Te Min	Armand	Fontana

BEST SELLING EP's FROM PHONOGRAM

Ben Ik Te Min	Armand	Fontana
Croquetten	Wim Sonneveld	Philips
Hard Of Stone	Rolling Stones	Decca
Boudewijn de Groot	Boudewijn de Groot	Decca
Sammy	Ramses Shaffy	Philips

BEST SELLING LP's FROM PHONOGRAM

Wim Sonneveld	Philips
Boudewijn de Groot	Decca
Marianne Faithfull	Decca
Rolling Stones (3 LPs)	Philips
"Ja Zuster, Nee Zuster"	Decca
Them	Decca

BEST SELLING SINGLES FROM BOVEMA

No Milk Today	Herman's Hermits	Columbia
Sloop John "B"	The Beach Boys	Capitol
Yellow Submarine	The Beatles	Parlophone
Penny Lane	The Beatles	Parlophone
Good Vibrations	The Beach Boys	Capitol
Paperback Writer	The Beatles	Parlophone
Stop! Stop! Stop!	The Hollies	Parlophone
Sunny	Cher	Liberty
God Only Knows	The Beach Boys	Capitol
What A Crazy Life	The Cats	Imperial

BEST SELLING LP's FROM BOVEMA

Revolver	The Beatles	Parlophone
"Toon"	Toon Hermans	H.M.V.
Best Of The Beach Boys	Beach Boys	Capitol
Hemeltje Lief	Fons Jensen	Columbia
Sunny	Cher	Liberty

BEST SELLING SINGLES FROM NEGRAM/DELTA

This Is My Song	Petula Clark	Vogue
Strangers In The Night	Frank Sinatra	Reprise
Sunny Afternoon	Kinks	Pye
Puppet On A String	Sandie Shaw	Pye
Somethin' Stupid	Nancy & Frank Sinatra	Reprise
Mr. Pleasant	Kinks	Pye
Waterloo Sunset	Kinks	Pye
Mrs. Applebee	David Garrick	Pye
It's The Same Old Song	Motions	Havoc
Don't You Leave	Tee-Set	Delta

BEST SELLING LP's NEGRAM/DELTA

Well Respected Kinks	Kinks	Pye
Emotion	Tee-Set	Delta
Their Own Way	Motions	Havoc
Welterfolge	Robert Stal	Ariola
Strangers In The Night	Frank Sinatra	Reprise

BEST SELLING SINGLES FROM POLYDOR

Little Man	Sonny and Cher	Atlantic
Summer In The City	Lovin Spoonful	Kama Sutra
When A Man Loves A Woman	Percy Sledge	Atlantic
Daddy Buy Me A Girl	Golden Earrings	Polydor
I'm A Boy	The Who	Polydor
Born A Woman	Sandy Posey	M.G.M.
Standing And Staring	The Shoes	Polydor
Hey Joe	Jimi Hendrix	Polydor
NaNaNa	The Shoes	Polydor
Spicks And Specks	The Beegees	Polydor

BEST SELLING LP's FROM POLYDOR

Winter Harvest	Golden Earrings	Polydor
Dr. Schiwago	James Last	M.G.M.
Trumpet A Go Go	Jimi Hendrix	Polydor
Are You Experienced	Astrud Gilberto	Polydor
The Shadow Of Your Smile		Verve

BEST SELLING SINGLES FROM INELCO

I'm A Believer	The Monkees	RCA Victor
Distant Drums	Jim Reeves	RCA Victor
Monday Monday	Mama's and Papa's	RCA Victor
A Little Bit Me, A Little Bit You	The Monkees	RCA Victor
Last Train To Clarksville	The Monkees	RCA Victor
Edelweiss	Julie Andrews & Christopher Plummer	RCA Victor
I Saw Her Again	Mama's and Papa's	RCA Victor
Adios Amigo	Jim Reeves	RCA Victor
Love Letters	Elvis Presley	RCA Victor
Dedicated To The One I Love	Mama's and Papa's	RCA Victor

BEST SELLING EP's FROM INELCO

The Monkees	The Monkees	RCA Victor
Sound Of Music	Julie Andrews	RCA Victor
With God On Our Side	Joan Baez	Amadeo
Christmas Songs	Jim Reeves	RCA Victor
Adios Amigo	Jim Reeves	RCA Victor

BEST SELLING LP's FROM INELCO

The Sound Of Music	Julie Andrews	RCA Victor
The Country Side	Jim Reeves	RCA Camden
Songs To Warm The Heart	Jim Reeves	RCA Victor
Joan Baez V	Joan Baez	Amadeo
Good'n Country	Jim Reeves	RCA Camden

BEST SELLING SINGLES FROM CBS

Somewhere My Love	Ray Conniff	CBS
My Back Pages	The Byrds	CBS
Nobody Needs Your Love	Gene Pitney	CBS
I Want You	Bob Dylan	CBS
Just Like A Woman	Bob Dylan	CBS
So You Want To Be A Rock'n Roll Star	The Byrds	CBS
We Shall Overcome	Pete Seeger	CBS
Silence Is Golden	The Tremeloes	CBS
Here Comes My Baby	The Tremeloes	CBS
I'm A Rock	Simon & Garfunkel	CBS

BEST SELLING EP's FROM CBS

Great New Sound	Bob Dylan	CBS
West Side Story	Original Soundtrack	CBS
We Shall Overcome	Pete Seeger	CBS
Somewhere My Love	Ray Conniff	CBS
Free Again	Barbra Streisand	CBS

HOLLAND'S BEST SELLERS

BEST SELLING LP's FROM CBS

West Side Story
Invisible Tears
Bonde On Blonde
Rhapsody In Blue
Beethoven Violinconcerto

Original Soundtrack
Ray Conniff & Singers
Bob Dylan
Leonard Bernstein
Francescatti/Bruno Walter

CBS
CBS
CBS
CBS
CBS

BEST SELLING SINGLES FROM ARTONE/FUNCKLER

Sunshine Superman
Friday On My Mind
Reach Out, I'll Be There
Blowin' In The Wind
La Poupee Qui Fait Non
The Happening
Summertime
Ta, Ta, Ta, Ta
It Takes Two
Sweet Pea

Donovan
The Easybeats
The Four Tops
Stevie Wonder
Michel Polnareff
The Supremes
Billy Stewart
Michel Polnareff
Marvin Gay & Kim Weston
Tommy Roe

Epic
United Artists
Tamla-Motown
Tamla-Motown
Palette
Tamla-Motown
Chess
Palette
Tamla-Motown
ABC-Records

BEST SELLING LP's FROM ARTONE FUNCKLER

Reunion
The Four Tops Live
Choice!
Mazzel
Händel Organ Concertos

Reunion Jazz Band
The Four Tops
The Ramsey Lewis Trio
Leo Fuld
Albert de Klerk

Artone
Tamla-Motown
Chess Int.
Artone
Artone

BEST SELLING SINGLES FROM CNR

Danse de Zorba
Corsica d'Amore
Ave Maria no Morro
Rode Anemomen
Fernando en Filippo
Teddybear
Juanita Banana
Ella Ella
Oh What A Kiss
Klein Annabell

Trio Hellénique
Gert en Hermien Timmerman
Gert Timmerman
Hermien Timmerman
Milly Scott
Reggy v.d. Burgt
The Peels
Trio Hellénique
Will Andy
Ronny

CNR
CNR
CNR
CNR
CNR
CNR
Karate
CNR
CNR
Telefunken

BEST SELLING EP's FROM CNR

Danse de Zorba
Dikkertje Dap
Strosse To Stroma Sou
Zingen in de Kring I
Zingen in de Kring IV

Trio Hellénique
De Leidse Sleuteltjes
Trio Hellénique
Kinderkoor Jacob Hamel
Kinderkoor Jacob Hamel

CNR
CNR
CNR
CNR
CNR

BEST SELLING LP's FROM CNR

Gert en Hermien
Trio Hellénique
De Gert Timmerman Show
Spotlight On Trio Hellénique
Gert Timmerman

Gert en Hermien Timmerman
Trio Hellénique
Gert Timmerman
Trio Hellénique
Gert Timmerman

CNR
CNR
CNR
CNR
CNR

BEST SELLING SINGLES FROM BASART

Il Silenzio
Such A Cad
Eenmaal Komt De Tijd
Geef Mij Maar Een Haring
Conversation
Cuore Matto
Ridera
Bottle Party
Working On A Tsjing Tsjang
I Know

Nini Rosso
Les Baroques
2 kleintjes pils
2 kleintjes pils
John Russell
Little Tony
Little Tony
Les Baroques
Les Baroques
Les Baroques

Stibbe/Sprint
Whamm
Europhon
Europhon
Whamm
Durium
Durium
Whamm
Whamm
Whamm

BEST SELLING LP's FROM BASART

Les Baroques
Herinneringen aan Willy Derby
Silenzio
Remember Holland
Jugoslavia

Les Baroques
Willy Derby
Nini Rosso
Draaiorgel De Klok
Ensemble Dragan Beljin

Whamm
Stibbe
Stibbe/Sprint
Europhon
Europhon

BEST SELLING SINGLES FROM IRAMAC

Touch
Monkey On Your Back
Summer Is Here
Lying All The Time
Keep On Trying
Mensen Geeft Elkaar Een Hand
Jelle Zal Wel Zien
You Go Your Way
Makelaar van Scaagen
Bloemendaalse Bos

Outsiders
Outsiders
Outsiders
Outsiders
Outsiders
Lily Kok
Albert Brosens
Davy Jones
Martine Bijl
Martine Bijl

Relax
Relax
Relax
Relax
Relax
Relax
Relax
Relax
Relax
Relax

BEST SELLING EP's FROM IRAMAC

Kapelletje
Jack Diéval Plays The Beatles
In Memoriam
St. Bavokerk, Haarlem
Cabaret By Candlelight

Kees Vick
Jack Diéval
Anneke Visser
KlaasBolt (Müllerorgel)
Lily & Leo Kok

Relax
Relax
Relax
Disco-Nederland
Relax

BEST SELLING LP's FROM IRAMAC

Outsiders
Martine Bijl Zingt
Martine
Hoboconcerten
Popular Musical and
Operetta Melodies

Outsiders
Martine Bijl
Martine Bijl
Hans de Vries
Johnny Wolfers

Relax
Relax
Relax
Iramac
Relax

BEST SELLING SINGLES FROM DURECO

Jongens Van 18 Jaar
Oh What A Kiss
Waarom
Jij Bent Voor Mij Alleen
Frech Gekusst
De Poedelwals
Klokkenwals
Eduard en Helena
Jelle Zal Wel Zien
Komkommertje

Zangeres Zonder Naam
Mickey Day
De Heikrekels
De Heikrekels
Siw Malmkvist
De Marjando's
Jan Gorissen
Zangeres Zonder Naam
Johnny Hoes
Betsie en Jo

Telstar
Omega
Telstar
Telstar
Metronome
Omega
Telstar
Telstar
Telstar
Ojee

BEST SELLING LP's FROM DURECO

Tropical
Jongens Van 18 Jaar
Los Machucambos Zingen Pepito,
La Bamba Enz.
48 Kinderliedjes
28 Suksessen Zangeres
Zonder Naam

Luis Borden & sa
Harpa Paraguya
De Zangeres Zonder Naam
Kinderkoor "Pippeloentje"
Jan Gorissen, Jean Kraft
accordeon

Metronome
Telstar
Omega
Dureco
Telstar



THE GREATEST RECORDING ORGANISATION IN THE WORLD





"TIMES MAY CHANGE
BUT GERRY OORD'S
BOVEMA CHANGES
WITH THE TIMES
AND IS STILL THE NO:1
COMPANY IN HOLLAND
EUROPE'S MOST
PROGRESSIVE
RECORD
MARKET"





BOVEMA HEEMSTEDÉ-HOLLAND



ITALY — THE PAST 12 MONTHS

As our review for this 25th edition of Cash Box begins, there are difficulties, as every year, in obtaining real figures.

It is our principal interest, to report to our readers positive facts and to prove them with real figures, concerning the total of disks sold in our territory and the real potential of our music market. Unfortunately, as we reported many times we can speak about facts, but the figures we will report are only inductive, since until now, it has been impossible to get real data concerning the total turnover of our industry.

Maybe this fact will surprise people who are not informed about the situation in Italy; we wish therefore to explain that this situation derives directly from our fiscal system. By the way we have to report that there is a project for the reform of our fiscal administration, and maybe this will give us definitive positive data concerning sales and production on our market in years to come.

And now we wish to start our report: as in the last editorial, we have to state that Italy is a country with 55 million inhabitants. The music products are supplied to these people via a total of 5230 music and record retailers located all throughout the peninsula and in the two islands of Sicily and Sardinia.

These shops are selling the products offered by 26 Italian record firms, or better by 26 Italian record sales organizations, which are selling their own products, or the products made in Italy and abroad and distributed by them.

Really Italian record firms who are producing records are much more than 26; precisely the number of record producers organized under a firm name are, in our country, 166 but record sales organizations are only 26, who also distribute the products of other record producers.

The number of existing shops, together with the number of existing

sales organizations operating on our market, can easily give an idea of what will be the total turnover on our record market. It is interesting to note that, examining the situation of the Italian market in order to fix approximate figures of total sales during the past twelve months, we have to take into consideration only the record sales organizations and not the record firms. If we consider the number of the record firms, which are as above reported more than 160, we have to state that this is an impossible figure for our record market.

Fortunately only record sales organizations have a direct influence on the market.

The record shops existing on our market shall be classified as follows: 250 (5% of total) are very big; 1,750 (35%) are to be considered of medium size; while 3,230 (60%) are small shops. This classification is fixed according to the average of purchases effected by each retailer.

It's easy to derive inductive figures, either taking into consideration the average of sales supposed to be effected by the retailers, or taking into account the average of records supposed to be sold during the twelve month period by the record sales organizations. Also it is possible to take into consideration an average of profit to be assigned to each record retailer, considering them all of little size, and fixing it in about 1,500,000 liras per year. To reach such a profit they have to sell an average of 6,000 units per year (singles and LPs together). This means that the records sold during a 12 month period should be of about 30,000,000 units.

On the other hand one can fix the average of units sold by a middle-sized record organization in Italy at the very minimum of 1,000,000 units per year. In this case, the record sales organization will just cover the costs of the organization itself. It is easy to derive therefore that total record sales in Italy shall in any case overpass the 26,000,000 unit mark in twelve months.

Last year, according to our inquiries, taking into account the average of production of each single record industry in our country, we fixed a total of 28,000,000 disks sold in one year. In the latest twelve months we have noted an expansion of the Italian record market, and a consecutive increase in record sales. In regard to this increase, it is interesting to note that during the twelve month period taken into consideration, 284 new record shops have entered into activity, while for the same period, only 62 retailers have closed their shops. Therefore there has been an increase in the number of record shops of about 4.5%.

This increase already justifies a supposed increase on total sales during the same period. This increase, adopting the criterion expressed above, shall be fixed at 2,000,000 units.

We have of course made a comparison of this inductive data with the production of each record firm during the past twelve months. Being inductive data, we can't report them separately, but we wish to mention the result, and we are able to fix as a prudent estimation an increase on the total record production in respect to the same period of last year, of 2,500,000 units as minimum.

The percentage of increase is, therefore in respect always to the same period of last year, 9%. This data can be assumed as true if squared with the aforementioned data concerning the retail trade.

As a conclusion we can state that during the previous twelve month period, total record sales on the Italian record market have surpassed the 30,000,000 unit mark, with an increase of 9% in respect to the same period of the past year.

We indicate as follows the supposed subdivision among the various classes of disks indicating also the

percentage on the total reserve to each class:

SINGLES	24,850,000	(82.82%)
E.P.	650,000	(2.18%)
L.P. 12'	4,440,000	(14.80%)
L.P. 10'	60,000	(0.20%)

Total 30,000,000 (100.00%)

According to the above figures we have the following changes in respect to the past year: SINGLES have increased by 1,220,000 copies, with a decrease in percentage in total sales in respect to the past year of—1.57%.

EP sales have decreased by 80,000 units, with a decrease in percentage in respect to the last year of—0.43%.

LP 12' sales have increased in respect to last year by 870,000 units, with an increase in percentage on the total in respect to the same period of the past year of +2.06%. The sales of LP 10' have decreased by 10,000 units, with a decrease of —0.6% in respect to total sales of last year.

Therefore as indicated by the above data, the greatest increase is the LP sales which have increased from 12.74% (percentage on total sales reported in our Directory 1966) to 14.80% (percentage on total sales as reported this year). Their share on the total market has increased by 24.36% the total volume of sales.

The increase in sales for units of single disks has been for the same period 5.16%; and, therefore (considering the expansion of our record market) indicates as reported 9% of the total. There has been a decrease in respect to the total number of singles sold.

There are therefore two different events that come to our attention: on

one hand the increase of the total record market (9%) which is demonstrating that really the Italian market is fast developing; and on the other, the sliding of the market towards the LP products.

Concerning the increase of the total market, we reported in last year's editorial that according to our data we foresaw an increase of about 10% of total sales for each year. This year we have quoted as a prudent figure a 9% increase, which is very near to our expectations, if we consider the total increase in units (this means about two records sold to every three Italian people). The increase is really about 13% if the calculation is made on value and not on units.

The second event mentioned is the sliding of the record market towards the LP releases. This means that our market is becoming mature little by little. This not only depends on the record buyers, but first of all is connected with the best policy of our record firms who seem to be capable of profiting from the potential of our record market.

Now it is time to take a deep look into our record organization, examining the various record firms under two main aspects, industrial production and distribution. In the record field, even if often forgotten, the wellknown economic law applies also to this industry—production and distribution have a direct influence on the market which derives directly from the organization of these two big sections of the record enterprises.

INDUSTRIAL PRODUCTION

As we reported opening this article, (Continued on page 116)

HOLLAND—The Past 12 Months

(Continued from page 112)

Sparta-Holland (Moody Blues—songs); Meteorion-Benelux (Nina and Frederik—songs); Music rights society—Holland (Robert Mellin repertoire); New Music—Holland ("Kilimandjaro"); Jean Kluger—Holland ("Guantanamera"); etc., etc.

Francis-Day Muziekuitgevers/Melodia reported to Cash Box that analyzing the music scene in Holland it stands out that beat is less dominating and the music more friendly than during last season, that the protest song was soon forgotten, but from it developed "the song to listen to" whereby the lyrics, the story are predominant. Filmmusic may enter the top-lists easily and stay there for many weeks. Dutch groups were successful in their effort to produce a more personal sound, now called "Nederbeat."

Bospel Music started its activities on December 8, 1966, although the new publishing company was founded in July of that year already. A. E. Palmans and Mrs. J. Bosmans, respectively a&r manager of Decca-Belgium (N. V. Fonior) and owner of Ed. Musicales Bens, Brussels, took the initiative. Joop Gerrits, formerly with Holland Music (Southern Peer) was appointed to managing director of Bospel Music, which pubbery is a part of an organization of several record companies and music-publishers with offices in Amsterdam, Brussels, Paris, Stockholm, etc. Although this pubbery is working now for only half a year, it already had very big hits like "Dear Mrs. Applebee," "Cuore Matta" (San Remo '67), "Words Of Love" (Mama's & Papa's), "Hablemos Del Amor," "Land Of 1000 Dances" etc. Most titles had cover versions, released by Phonogram, Duraco, Bovema, etc. Bospel Music is an independent publishing company and is not connected with any record company.

As stated before, Inelco started its own publishing company by the name of Universal Songs by contracting Wim Landman, one of Hollands national publishing specialists. Landman already acquired most important copyrights like "Blue Side Of Lonesome," the song that gave the last Jim Reeves LP its name, "Rose Of

Washington Square," to be issued on the LP "Thoroughly Modern Millie" with Julie Andrews, "The Russian Spy And I," an original copyright recorded in Finland, Brasil, Spain and other countries. Many Dutch writers took faith in the pubbery and assigned their material to the company. Very good contracts have been established by personal visits to London and Germany.

Benelux Music is cooperating closely with their record company, Telstar, and both firms have been extremely successful, especially in the production of Dutch songs. 4 Golden records have been awarded during this period to Telstar-artists and publisher Benelux Music for the wonderful sales (More than 100,000 singles) of their golden hits "Jongens Van Achttien Jaar," "Waarom Heb Jij Laten Staan," "Cherie" and "En Van Je Hoempa." Three of the above-mentioned songs were original Benelux Music copyrights, the fourth is an original German copyright "Das Humbta Taterä" written by Toni Hämmerle and published by Melodie der Welt, Frankfurt. Unfortunately Mr. Hämmerle's disease prevented him from coming to Holland to receive his golden record but, together with his active publisher Melodie der Welt, attend the next dealers meeting of Telstar records and both will receive their golden records on that occasion. Both Telstar and Benelux Music were successful in placing their songs and records abroad: "Cherie" has been number 1 in the Belgian hit parade for months, "Barcelora '67" by Jan Gorissen and his wonder accordion hit the German charts and the recordings by famous Vienna artists Jean and Willy (Die Limburger) were released in 7 countries. Both firms have been working on new projects to raise sales. Benelux Music printed 2 hits in mini-size with low selling-price especially for young musicians (lead-line, symbols and words). Telstar produced a large number of cheap 30 cm. long-playing records in their Piccolo and Festival series. Sales have been enormous and both firms are very happy with the results. On the whole both firms are very proud of the results and have high hopes for the next season.



if you are interested
in the italian market
you should know that



SAAR means:
JOLLY RECORDS
leading independent
recording and publishing
company



SAAR owns its:
6 tracks
recording studio
modern automatic
pressing plant



SAAR distributes:
az - contact - dot
everest - joker
roulette - vogue - zafiro



SAAR srl - VIALE PORTA VERCELLINA, 14
MILAN - ITALY

DURIUM IS PROUD TO PRESENT ITALY'S 1967
"HIT ARTIST"

LITTLE TONY

HEAR AND ENJOY THE BIGGEST HIT
OF THE 1967 SAN REMO FESTIVAL

CUORE MATTO



RECORDED BY DURIUM:
VIA MANZONI 40 · 42 · MILAN

PUBLISHED BY EDIZIONI MUSICALI DURIUM
VIA MANZONI 40 · 42 · MILAN
TEL. 701008 · 701705





a
new
link
to
our
chain

we are glad to
inform that
the **ADRIANO
CELENTANO's**
publishing firm



Edizioni Musicali

is now associated
to

**GRUPPO EDITORIALE
LEONARDI**

**Corso Europa 5
Milano (Italy)
phone: 702094**

STUDIO M

ITALY'S BEST SELLERS OF THE PAST 12 MONTHS

TITLES	ARTISTS	LABELS	PUBLISHERS
1 Cuore Matto	Little Tony	Durium	Durium
2 Strangers In The Night	Frank Sinatra	CGD	Sugarmusic
3 Bang Bang	Equipe 84	Ricordi	Ariston
4 Tema	I Giganti	RiFi	La Cicogna
5 Un Mondo D'Amore	Gianni Morandi	RCA	Mimo
6 Pietre	Antoine	Saar	Sciascia
7 29 Settembre	Equipe 84	Ricordi	Ricordi
8 Notte Di Ferragosto	Gianni Morandi	RCA	RCA
9 La Fisarmonica	Gianni Morandi	RCA	RCA
10 L'Immensita'	Johnny Dorelli	CGD	Clan— Sugarmusic
11 A Chi	Fausto Leali	RiFi	Curci
12 Lara's Theme	Bob Mitchell	RiFi	Curci
13 Ridera'	Little Tony	Durium	Durium
14 Il Geghege'	Rita Pavone	RCA	RCA—Curci
15 Stasera Mi Butto	Rocky Roberts	Durium	Curci
16 Winchester Cathedral	The New Vaude- ville Band	Phonogram	Southern
17 Penny Lane	The Beatles	Carisch	Ricordi
18 Se Mao	Adamo	Emi Italiana	EMI Italiana
19 Amo	Adamo	Emi Italiana	EMI Italiana
20 Paint It Black	The Rolling Stones	Decca	Southern
21 Michello	The Beatles	Carisch	Curci
22 Che Colpa Abbiamo Noi	The Rokes	RCA	Ricordi
23 Sognando La Cali- fornia	I Dik Dik	Ricordi	Ricordi
24 Ciao Amore Ciao	Luigi Tenco	RCA	RCA
25 Proposta	I Giganti	RiFi	La Cicogna
26 E'La Pioggia Che Va	The Rokes	RCA	RCA
27 Il Mondo In Mi 7a	Adriano Celen- tano	Clan	Clan—Curci
28 Yellow Submarine	The Beatles	Carisch	Ricordi
29 Una Ragazza In Due	I Giganti	RiFi	La Cicogna
30 Let's Spend The Night Together	The Rolling Stones	Decca	Sugarmusic

ITALY—The Past 12 Months

(Continued from page 114)

record products in Italy are presented under 350 different marks owned by the 166 record firms existing here. Of course not all these record firms have their own pressing plant: if we consider industrial production we see that only 16 record firms have their own factory. These are: Audio Edizioni Paoline of Rome, Cellograf Simp of Milano, Durium of Milano, Fonit Cetra of Torino, Fonocrom of Como, Fonola of Milano, Ariston of Milano, Industria Italiana Lingue Vive Nel Mondo of Milano, Italmusica of Milano, EMI Italiana of Milano, Phonogram of Milano, RCA Italiana of Rome, Saar of Milano, Bentler Records of Milano, CGD/CBS Italiana of Milano, Ri-Fi of Milano.

Of the above mentioned 16 firms, only 9 presently have real weight on the Italian market, representing almost 75% of total record production; these are: RCA Italiana, EMI Italiana, Phonogram, CGD/CBS Italiana, Durium, Ri-Fi, Saar, Fonit-Cetra, Ariston Records, Cellograf Simp.

The other ones are mainly producing for third parties, and just a little percentage of the total production is devoted to their own labels.

Of course, all pressing plants are also generally working for third parties, but in the case of the above mentioned 9 firms, their activity is first of all devoted to their production.

The pressing plants existing in Italy presently number 30. As we reported, 16 are owned by the same record firms; 14 have been created only for production for third parties. Some of these have a very considerable production. We wish to mention in this regard Ambrosio Discografica of Milano, which with 30 presses is the biggest pressing plant in Italy not owned by record firms.

We think it is also interesting to know the potential of the pressing plants owned by the record firms: The biggest factory is owned by RCA Italiana in Rome, owning a total of 36 presses, and a total of 280 workers are employed.

Second on the list is EMI Italiana, within the new factory at Caronno Pertusella has 34 presses (10 of them modern injection machines) and 94 workers. Fonit Cetra owns 30 presses and employs 99 workers. Durium has 30 presses too, and 60 workers. Saar has 20 presses and 100 workers; Ri-Fi employs 14 presses (8 injection machines and 6 compression machines) with 45 workers. Ariston has 18

presses with 100 workers; Italmusica has 8 presses and 14 workers; Bentler has 6 presses and 25 workers.

By the way it is necessary to specify in order to give a real value to this classification that injection machines have a higher rate of production of about 1/3 in respect to the usual compression presses.

With this report we have concluded our report concerning industrial production on the Italian record market. There is just one last consideration: with the exceptions of the Rome-based RCA Italiana and Edizioni Paoline (whose potential is very low), the biggest part of the record industry is mainly located in Milan and in the surroundings of this town.

Now we can take into consideration the other second important section which constitutes the backbone of the record industry: distribution.

RECORD SALE ORGANIZATION

As reported, record firms total 166 in Italy. This is really a big number in comparison with yearly total sales of our record market. But, as we opened this review, only 26 record distributing organizations exist in Italy. All these sales organizations are directly or indirectly involved with a record firm. There is no completely independent record distribution company in Italy.

For some commercial reasons, some record sales organizations also being directly associated with record firms, have been structured as an independent company.

First one of these is Messaggerie Musicali (sales manager Sergio De Gennaro) which is the sales organization of CGD and CBS Italiana, and constitutes an essential part of these record firms.

C & C, the commercial organization formed by Curci (Cemed Carosello) and Clan Celentano for the distribution of the products of both firms. They represent also a lot of other catalogs. Sales Manager is Giovanni Formento.

D.D.R. (Distributori Discografici Riuniti), which is the sales organization of Bruber Records. Sales manager is Carlo Fausti.

MPM, a new record sales organization, owned by Tiffany Records and Italmusica. Sales manager will be Pino Paschetto.

Other data concerning the above mentioned sales organizations: Mes-

(Continued on page 118)



DISCHI RICORDI S.p.A.

Via Berchet, 2 - Milano (Italy)

**GRUPPO RICORDI
MUSICA LEGGERA**

Galleria del Corso, 2 - Milano (Italy)

Record and Publishing companies

*Subsidiaries of G. RICORDI & C. S.p.A. established in 1808

≡
the

YOUNG
companies
with an

OLD
tradition
≡

STUDIO M

EVERY SEASON IS ALWAYS

CURCI SEASON

Publishing Group — Galleria del Corso 4 Milano — Tel. 79.47.46

**CURCI • D'ANZI • ACCORDO
ITALCANTO • CERVINO
SPANKA ITALIANA • ARIETE
MUSIC UNION • ITALIAN YANK
DUCALE • ORCHESTRALMUSIC
RTV • FAST • STAR**

.... and of its sister firm

CAROSELLO GEMED

Via Beccaria, 5 — Milano

**CAROSELLO • CURCI
ERATO • DISNEYLAND
ARIETE • BUENA VISTA
TOPOLINO • TRIOLA
ITALIAN YANK
MUSTANG • UNITED ARTISTS**

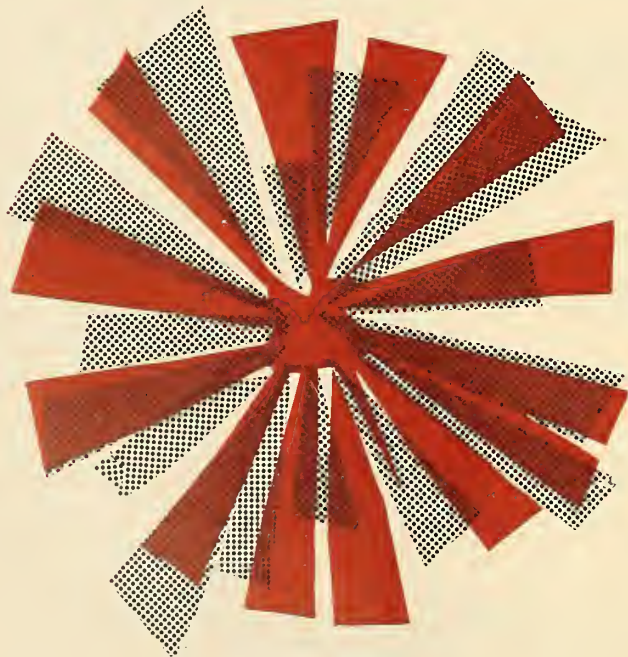

ITALY—The Past 12 Months

(Continued from page 116)

saggerie Musicali has 35 sales agents and 7 stores located in the principal Italian towns.

C & C has 33 sales agents and 8 stores.

DDR has 12 agents and 2 stores.

MPM has 11 sales agents and 3 stores.

Now the inside sales organization of each record firm:

RCA Italiana's sales organization is by far the largest existing organization on the Italian market, including 80 sales agents and 20 executives. Stores total 12, located all throughout Italy.

EMI Italiana is the second in the list: the sales agents of their commercial organization total 30 with 5 different stores.

Ri-Fi Records has also 30 agents with two stores, one in Milan and one in Rome.

Dischi Ricordi has 22 sales agents and one store in Rome and one in Milan.

Saar has 20 sales agents with 20 stores.

Ariston Records has 20 sales agents and 4 stores.

Det Records has 18 sales agents and one store in Rome.

Vedette Records has 17 sales agents and 2 stores in Rome and in Milan.

Carsich S.p.A. has 15 agents and 15 stores all throughout Italy.

Durium has 15 sales agents and 7 stores.

Decca Italiana has also 15 agents and 7 stores.

Vis Radio has 14 agents and 3 stores.

Phonogram has 14 agents and 2 stores.

GTA Records has 14 agents and one store in Milan.

Dischi Bluebell has 13 sales agents with two stores, one in Milan and another in Rome.

Cellograf Simp has 12 sales agents and two stores, in Milan and Rome.

CDI, has 12 sales agents with one store only.

Fonit Cetra has 10 sales agents with 4 stores.

Societa' Trevisan Combo has 7 sales agents and one store in Milan.

Saint Martin Records has 3 sales agents only, with one store in Milan.

As we said above, the record sales organization represents the backbone of each company: of course, the data we reported shall be examined not only taking into account the number of agents or stores owned by each firm, but this data have to be considered together with other elements such as the quantity of repertoire offered in sales or produced, and the quality and classes of the same (classic, pop, folk etc., and LPs, singles or others). Also to be taken into consideration is the inside organization of each firm, which is also one of the most important elements for the estimation of potential in the market.

In any case, the potential of each record firm is associated to the industrial producing power of the firm. As further data, it is interesting to note that among the 166 record firms existing on the Italian market, only 10 of them have at the same time a pressing plant and a sales organization: Ariston Records, CBS Italiana/CGD, Durium, EMI Italiana, Fonit Cetra, Italmusica, Phonogram, RCA Italiana R.I.F.I. and SAAR.

These firms, with the exception of Ariston and Italmusica, also own recording facilities. Their organizations can be considered complete under every point of view and as a matter of fact they can be considered the leading firms on the Italian market.

Coming back to the sales organization we have to stress that a good part of the 26 existing organizations have been created or reinforced recently. Such is the case of Messaggerie Musicali, sales organization of CGD/CBS Italiana, which has increased the number of its agents from 14 to 35.

The increases of the record mar-

ket, registered in the past twelve month period, is also partly a consequence of the sales organizations of our industry.

Perhaps more appropriately, it is to be ascribed to the new power of the sales organizations the shifting of the market toward the LP production.

Let's consider the various reasons for this increase of LP sales, how this phenomenon has been revealed and how it is directly connected with the increase of the sales organization potential.

It is also interesting to examine this point, since it is directly connected with the increase of demand for foreign products on our market.

As we had the occasion to report in our review of last year, the inside organization of each record firm has to take care of the distribution of the products directly to the retailers, without any other intermediary. In case of a strong record sales organization, it is obvious, that each sales agent will drive the attention of the retailers from the singles production (which is a repertoire that can be sold in a limited period of time, according to the success obtained, the actual trend, the quality of the production) to the albums which repertoire can be sold over a larger period of time, and with its bigger value, increases the total volume of sales of each agent.

The executives of record production, following demand, are giving more attention to LP releases. LP production cannot be improvised, and it is the LP releases which demand stronger investments. This is the reason why with the improvement of sales organizations, the consequent increase of LP sales, Italian record firms are obliged to tap to foreign catalog and repertoires to feed the distribution chain. Consequently this is one of the reasons for the increasing demand of foreign repertoires on our record market after the crisis of 1964 and 1965.

The Production and the Present Trend

This increase in the demand of foreign product, of course, which can be directly connected to the request of LP products created on the market, on the other hand, is also due to the actual success that foreign recordings and artists are obtaining on our market.

First on the list among foreign names there are English artists, followed by the Americans and by French talents.

Individually, only Englishmen are first on the list, because of the present "beat" trend, but the biggest number of releases devoted to foreign artists for this twelve months period has been devoted to the American talents. In fact, the biggest number of catalogs represented comes from the States.

This situation we think will be even more strengthened in the near future, since it is for certain that new record companies will organize their own distribution, and they will need material to feed their own sales organizations that can't depend, at least at the start, only on the domestic production.

We now wish to take into consideration the real trend of Italian record production during the twelve past months. It is necessary to state that domestic artists and domestic production have always had the biggest share of the Italian market.

At the end of 1966, a progressive shift towards the foreign products was noted. Progressively Italian copyrights and original Italian recordings were disappearing from our charts. For instance, on the top fifteen best selling disks reported on our charts at the end of December only 6 were domestic copyrights, while 9 were foreign tunes, and 7 of them in the original recorded version.

Superficially, this is connected with the "beat" fashion which has reached

(Continued on page 125)

WHERE THERE ARE HITS THERE IS THE TRADEMARK

OF

RIFFI
RECORD COMPANY

1966: Radio TV contest
"Un disco per l'estate"
3rd price to I GIGANTI
5th price to IVA ZANICCHI

1965: Golden Record of
the Italian press
to MINA's first LP

1966: Golden Record to
I GIGANTI's single
"Tema"

1967: Golden Record of
the Italian press
to MINA's second LP

1966: Golden Record of
the Italian press
to TERESA STICH RANDALL's
album (Westminster)

1967:

Festival of Sanremo
First price to IVA ZANICCHI

1966: Festival of Sanremo
2nd price ex-aequo to
IVA ZANICCHI

for Non Pensare a Me.
2nd price ex-aequo to
I GIGANTI and
GIORGIO GABER

1966: Golden Record of
the Italian press
to IVA ZANICCHI's first LP

1966: Festival of Naples
2nd price to GIORGIO GABER
5th price to IVA ZANICCHI

PREMIO
DELLA CRITICA
DISCOGRAFICA
ITALIANA

ITALY'S Music Publishers

A
ABERBACH—Via Lazio 9, Roma
ACAMPORA MICHELE—Corso Vittorio Emanuele 26, Avellino
ACCADEMIA—(Ariston) P.ta Pattari 1/3, Milano
ACCORDO (Curci)—Galleria del Corso 4, Milano
ACUFF ROSE—(Messaggerie Mus.) Galleria del Corso 4, Milano
ADAM—Mirandola (Moderna)
ADMIRAL—Via Veruda 58, Trieste
ADRIA—Via Modenella 64, Modena
ADRIATICA—(Messaggerie Musicali) Galleria del Corso 4, Milano
ADRIATICA FILM—P.le Giulio Cesare 19 b, Milano
AIDA—Via G. Avezzana 45—Roma
A.I.E.M.—Viale Regina Margherita 111/A, Rimini (Forlì)
ALBA—Via P. Colletta 18, Milano
ALFA—(Leonardi) Corso Europa 5, Milano
ALFIERE—P.ta Pattari 2, Milano
ALFON—Via Cavallotti 4, Milano
ALLEGRO—(Bixio) Via Borgogna 7, Milano
ALLELUJA—Via dei Quintili 245, Roma
ALLIONE—Via E. Toti 4, Milano
ALMA—Via Michelangelo 18, Torino
ALT—Via Ciro Menotti 12, Milano
AMAZONA—(Messaggerie Mus.) Galleria del Corso 4, Milano
AMBROSIANA—(Nazionale) Corso V. Emanuele 30, Milano
AMERICA—Galleria del Corso 4, Milano
AMETISTE—Gall. del Corso 4, Milano
ANCORA—Via Nicolini 8, Milano
APES—Via S. Alessio 7, Roma
APOLLO—(Messaggerie Musicali) Galleria del Corso 4, Milano
APPLAUSO—(Southern) P.ta Pattari 2, Milano
APRIL MUSIC—(Messaggerie Mus.) Galleria del Corso 4, Milano
AQUILA—Via Parmigianino 10, Parma
ARALDO—(Messaggerie Musicali) Galleria del Corso 4, Milano
ARCOBALENO—Via Pirandello 60, Roma
ARCOPHON—C.so Europa 16, Milano
ARDENS—(Eridania) Piazza Cavallotti 11, Mantova
ARETUSA—Via Tolstoi 51, Milano
ARGO—Piazza Augusto Imperatore 32, Roma
ARGOSS—Via Arte della Lana 26, Napoli
ARIETE—(Curci) Galleria del Corso 4, Milano
ARION—(Messaggerie Musicali) Galleria del Corso 4, Milano

ARISTON—P.ta Pattari 1/3, Milano
ARK—Via Solferino 51, Brescia
ARLECCHINO—Via della Torre 11, Milano
ARLEM—Via S. Liborio 1, Napoli
AROMANDO—(Messaggerie Musicali) Galleria del Corso 4, Milano
ARPA—Via Matteotti 37, Lugo di Romagna (Ravenna)
ARSON—Via Po 3, Torino
ASSO—Galleria del Corso 2, Milano
ASTORIA—Via Baracchini 2, Milano
A.T.A.—Piazza d'Ara Coeli 1, Roma
AUGUSTA—Via Po 3, Torino
AVIETTA—Viale Giustiniano 274, Roma
AZALEA—Via S. Martino 65/3, Genova

B
BAMA—(Messaggerie Musicali) Galleria del Corso 4, Milano
BARAGIOLA & ZEPPI—Via Indipendenza 9, Como
BARBATI FAUSTO—Via Venturi 5, Modena
BARRACUDA—Via Guattani 8, Roma
BARTON—(Aberbach) Via Lazio 9, Roma
BASSETTI DI DALL'ARGINE—Via A. Mazza 6, Parma
BDM—Via S. Petronio Vecchio 17/19, Bologna
B.D.S. Company—Galleria del Corso 4, Milano
BEL RIVER—Galleria del Corso 4, Milano
BELATI TITO—(Vidale) Galleria del Corso 4, Milano
BELLA CIAO—Via Cernaia 5, Milano
BELTRAMO—Via Roma 179, Sanremo (Imperia)
BEMOLLE—Via Bessarione 14, Milano
BERBEN—Via Redipuglia 65, Ancona
BEST SELLER—Torre Montello, P.le Gramsci, Mantova
BIANCHI Casa Musicale—Via Manzoni 13 B, Gallarate (Milano)
BIDERI—Via S. Pietro a Majella 17, Napoli
BISIO—Via Piranesi 37, Milano
BIXIO SAM—(Bixio) Via Borgogna 7, Milano
BLUE SKY—(Clan) Corso Europa 5, Milano
BOA—Via Soresina 12, Milano
BOLERO—Via F. Baracchini 1, Milano
BONAGURA—Via Anglona 9, Roma
BONGIOVANNI—Via Rizzoli 28 E, Bologna
BOSCHETTI MARIA—Corso Perticari, Savignano (Forlì)
BOSTON—Corso Repubblica 33, Forlì
BOTTEGA DELLA CANZONE—Viale Piceno 14 A, Milano
BRIDGE—Galleria del Corso 4, Milano
BRIEFTE—Via del Faro 5, Anzio (Roma)
BROSIO—Corso Vinzaglio 117, Torino

BRUBER—Piazza Duomo 31, Milano

C
CAESAR—(Nazionalmusic) Corso Vittorio Emanuele 30, Milano
CALDERAZZI—Via Scarlatti 188, Napoli
CALIFORNIA—(C.A. Rossi) Galleria del Corso 2, Milano
C.A.M.—(Campi) Via Virgilio 8, Roma
CAMBI—Via Albalonga 40, Roma
CAMPANIA—Villaggio UNRRA 34, Salerno-Pastena
CAMPI EDITORE—Via Virgilio 8, Roma
CAMPIDOGGIO—Via G. Pisanelli 2, Roma
CANARIA—Via Altamura 22, Napoli
CANASTA—Via Vincenzo da Seregno 4, Milano
CANTANAPOLI—(Leonardi) Corso Europa 5, Milano
CANTICO—(Vidale) Galleria del Corso 4, Milano
CANZONI E MELODIE—Via Castelli 17, Marghera (Venezia)
CANZONI MODERNE—(Messaggerie Musicali) Galleria del Corso 4, Milano
CAPODANNO ANTONIO—Piazza Esquilino 29, Roma
CARFOR—Via S. Brigida 16, Napoli
CARILLO—(Camhi) Via Albalonga 40, Roma
CARISCH—Via General Fara 39, Milano
CARONA—Corso Buenos Ayres 77, Milano
CARRARA—Via A. da Calepio 4, Bergamo
CARUSO—Via Rasori 2, Milano
CASADEI SECONDO—Via Perticari 88, Savignano sul Rubicone (Forlì)
CASA DELLA MUSICA—(Bixio) Via Veneto 108, Roma
CASA ED. MUS. C. LOMBARDO—Via Torchio 4, Milano
CASA NOSTRA—Casella Postale 619, Firenze
CASIMIRI—Via S. Caterina da Siena 61, Roma
CASIROLI—(Leonardi) Corso Europa 5, Milano
CASTELLI LUIGI—Corso Lamarmora 10, Alessandria
CAVALLARI—Via Galleria 50, Bologna
C.D.R.—(Compagnia Discografica Romana) Via Guidobaldo del Monte 13, Roma
C.E.D.I.—Via Bruno Buozzi 10, Torino
CEMBALO—Via Bonito 27 B, Napoli
CEMED CAROSELLO—Via Beccaria 5, Milano
CEMI—Via Goethe 18, SANREMO (Imperia)
CERVINO—(Curci) Galleria del Corso 4, Milano
CHANT DU MONDE—(Nazionalmusic) Corso Vittorio Emanuele 30, Milano
CHAPEL—Galleria del Corso 4, Milano
CHENNA—Via Piave 3, Torino
CHIAPPO—(Nazionalmusic) Corso Vittorio Emanuele 30, Milano

CHICANORA—Via Dacia 18, Roma
CHI-GI—Via Bitinia 19, Roma
CHILLIN—Via Martorelli 18, Torino
CICERO MUSIC—Corso Europa 5, Milano
CICHELLERO—(GTA Music) Galleria del Corso 2, Milano
CICOGNA—Via Morozzo della Rocca 6, Milano
CIDEM—Via Volturmo 7, Bologna
CIELO—Galleria del Corso 2, Milano
CILIBERTI—Villaggio UNRRA 34, Salerno-Pastena
CINQUE CONTINENTI—Largo Messico 6, Roma
CIOFFI—Corso Europa 5, Milano
CIPRIANI—Via Lagrange, 47, Torino
CIRCE—Via E. Filiberto 10/A, Gaeta (Latina)
CLAN—Corso Europa 5, Milano
CLUB—Via Luchino del Maino 12, Milano
COBRA—(Messaggerie Musicali) Galleria del Corso 4, Milano
CODEVILLA—Galleria del Corso 2, Milano
COLOMBI—Via della Maddalena 26, Genova
COLORADO—Via Inama 17, Milano
CONCENTUS—Viale Parioli 55, Roma
CONCHIGLIA—Via Firenze 15, Roma
CONNELLY—Galleria del Corso 2, Milano
CONTINENTAL—Galleria del Corso 2, Milano
CORA—Via Hajeck 34, Milano
CORALLO—Piazza Ferretto 14, Mestre (Venezia)
CORSO—Via E. Monaci 21, Roma
CO-THI—Via Francesco Arese 7, Milano
CRISOPOLI—Via Farini 5, Parma
CROMA—Galleria del Corso 2, Milano
CROMAPHON—Via Benevento 34, Torino
CUCCILO—Galleria del Corso 2, Milano
CURCI—Galleria del Corso 4, Milano

D
DAMASO—Via Po 29, Torino
DANIELE—(Sidet) P.ta Pattari 4, Milano
D'ANZI—(Curci) Galleria del Corso 4, Milano
DA ROVERE—Piazza S. Maria Novella 5, Firenze
DEA—(Curci) Galleria del Corso 4, Milano
DE ANGELIS MARIO—Via Romana 162, Roma
DE FILIPPI BRUNO—Via Almerigo da Schio 3, Milano
DEGA—Via Pontida 16, Alessandria
DEL PIAZZO—C.so Stazione Spigno Monferato (Alessandria)
DEL SECOLO—Via S. Felice 28, Bologna
D.E.M.—Via Riva Reno 60, Bologna
DE PALMA—Via Renzo da Ceri 145, Roma
DE SANTIS—Via Cassia Antica 13, Roma
DIAMANTE—(Sidet) P.ta Pattari 4, Milano

(Continued on page 122)

**ADVANCED DESIGN
 FAST PRODUCTION
 EASY OPERATION
 LOWER UNIT COST**

The new fully automatic injection moulding machine models 1967

**17 SR - RECORD
 30 SR - RECORD**

**PROVIDED WITH SPECIAL
 PRESSURE COMPENSATORS
 GUARANTEE HIGH-PRECISION
 MICROGROOVES, HENCE PERFECT
 RECORDS OF STEREO
 AND CLASSICAL MUSIC**

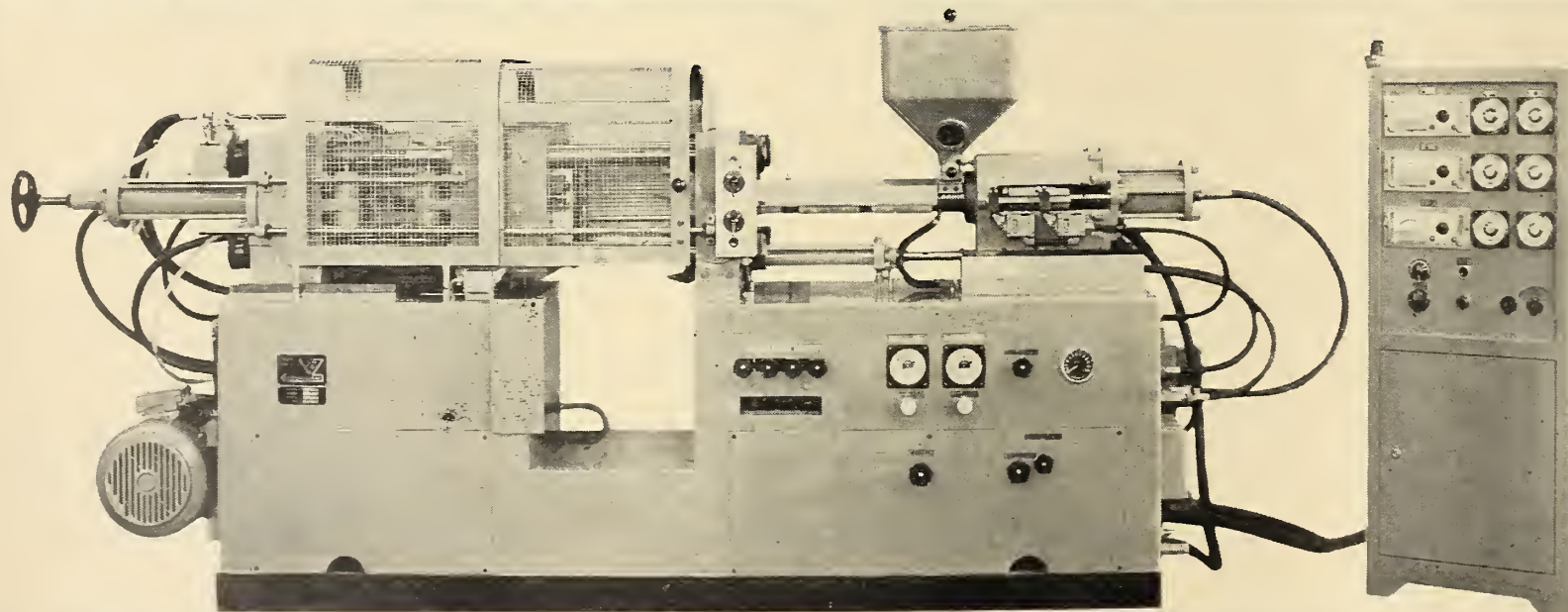

Ask for our leaflet "May 1967" which illustrates our machines and ancillary equipment for injection moulding of gramophone records.

METALMECCANICA
 S.A.S.
 PIZZI PODESTA' & C.
 MILANO
 CORSO MAGENTA 44



IN ITALY ON CASH BOX DESK



wherever
music is
Phonogram
is

PHONOGRAM S.P.A.

CAP. SOC. L. 700.000.000 (VERS. L. 500.000.000) - C.C.I.A. MILANO 427772
SEDE SOCIALE, DIREZIONE, UFFICI, MAGAZZINI E FABBRICA: MILANO, VIA BENADIR, 14
TELEFONI: 2826.241 (5 LINEE URBANE)
STUDI DI REGISTRAZIONE: MILANO, PIAZZA CAVOUR 2 - TELEFONO: 790.071
INDIRIZZO TELEGRAFICO: COMINFON MILANO
ROMA - UFF. PROMOZIONE: VIA PASUBIO 4 - TEL. 354.423



CASH BOX
2, Galleria Passerella
M i l a n o
f.a.o. Mr. Panvini-Rosati

VS. RIF.
VS. DEL
NS. REP. UP.
NS. RIF. DP/Bed
PROT. N. 538
MILANO, il 30.5.67

We are pleased to communicate the new inside organisation of our Society:

PHONOGRAM S.p.A.

Head-Offices:
Management, Offices, Factory:
Recording Studios:

Milano - via Benadir, 14- tel. 2826.241
Milano - via Benadir, 14- tel. 2826.241
Milano - piazza Cavour, 2- tel. 790.071

Publishing House:
Alfiere - Esedra:

Milano - via Benadir, 14- tel. 2826.241
Roma - via Pasubio, 4 - tel. 354.423

Branch-Office: Rome -

Managing Director -	Mr. Manlio BARON
General Manager and A&R Manager -	Mr. Mario CORSI
Financial Manager -	Mr. Luigi SANVITO
Sales Manager -	Mr. Franco PARADISO
A&R Classical Dept. -	Mr. Helmut EBNET
Advertising Dept. -	Mr. Dario POGLIANI
Press & P.R. Officer -	Mr. Maso BIGGERO

With kind regards, we remain

Yours faithfully

PHONOGRAM S.p.A.

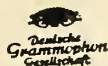



mascotte

a hit for every
season

LAST WINTER:

NON PENSARE A ME

by Testa - Sciorilli

winner of the San Remo Song Festival

THIS SUMMER:

L'ULTIMO GIORNO

by Testa - Sciorilli

finalist of the contest «A Disc for the Summer»

EDIZIONI MUSICALI MASCOTTE

Galleria del Corso 2

Milano (Italy) ph:793601

ITALY'S MUSIC PUBLISHERS

(Continued from page 120)

DIAPASON—Via delle Vite 41, Roma
DIESIS—Via F. Baracchini 2, Milano
DI GIANNI—Corso Trieste 65, B, Roma
DI LAZZARO—(Messaggerie Musicali) Galleria del Corso 4, Milano
DINO—Via Pontina Km. 23,270 Roma
DIONISO—Via Avezzana 45, Roma
DIOR—Corso Europa 5, Milano
DISCO—Via delle Fratte di Trastevere 42, Roma
DIVI INTERNATIONAL—Via Nuova Olivella 9, Nocera Inferiore (Salerno)
DOMUS—R'iva Reno 60, Bologna
DONNARUMMA—(Bideri) Via S. Pietro a Majella 17, Napoli
DORA—Via S. Giulia 83, Torino
DRAGO—Via Roma 42, Magenta (Milano)
DUCALE—Via Beccaria 5, Milano
DUE TORRI—Via Emilia Ponente 169/4, Bologna
DUOMO—(Durium)—Via Manzoni 40/42, Milano
DURIUM—Via Manzoni 40/42, Milano

E

EAR—(Nazionalmusic) Corso Vittorio Emanuele 30, Milano
EBE—(Nazionalmusic) Corso Vittorio Emanuele 30, Milano
ECO—Via S. Antonio 5, Milano
EDEN—(Nazionalmusic) Corso Vittorio Emanuele 30, Milano
EDERA—Via P. Liberi 28, Padova
EDICOMO—(Guerrini) Galleria del Corso 2, Milano
EDIEMME—Galleria del Corso 4, Milano
EDIFILM—Via Manfredi 19, Roma
EDI NUFA—Galleria del Corso 4, Milano
EDIR—(Ricordi) Galleria del Corso 2, Milano
ELDORADO—(Guerrini) Galleria del Corso 2, Milano
ELECTA—Via Tommaso Grossi 8, Torino
ELITE—(Leonardi) Corso Europa 5, Milano
ELUGI—Via Sampiero di Bastelica 38, Roma
EMANUELA—Corso Unione Sovietica 28, Torino
E.M.I.—Galleria del Corso 4, Milano
EMILIANA—Via Romagnoli 49, Bologna
E.M.I.R.A.—Via Appia Nuova 359, Roma
EMS—Via Galileo Galilei 28, Alessandria
EPIDI—Piazza Belgioioso 1, Milano
EPIFANI—Via Veneto 14, Roma
ERIDANIA—(Omonimo) Piazza Cavallotti 11, Mantova
ESEDRA—P.tta Pattari 2, Milano
ESSE—Via Ciro Menotti 12, Milano
EST—Via Monte Magno 15, Torino
ESTER MUSIC—Via Mirabello 19, Roma
EURASIA—(Nazionalmusic) Corso Vitt. Emanuele 30, Milano
EUREKA—Via Piave 24, Roma
EUTERPE—Casella Postale 596, Genova
EUTERPE—Vico Corrieri S. Brigida, Napoli
EVA—Via S. Lucia 107, Napoli
EVEREST—Corso Umberto I° 132, Napoli

F

FABBRI—Via F. Venezian 24, Trieste
FALCOCCHIO—Galleria del Corso 2, Milano
FAMA—(Ricordi) Galleria del Corso 2, Milano
FANEL—Via Camilla 66, Roma
FANTASIA—(Messaggerie Musicali) Galleria del Corso 4, Milano
FANTIN—Via Ciro Menotti 12, Milano
FANTUZZI—(Nazionalmusic) Corso Vitt. Emanuele 30, Milano
FARIL—Mirandola (Modena)
FASFILMS—Via Berthollet 37, Torino
FAST—(Curci) Galleria del Corso 4, Milano
FAUNO—Viale Ludovico Ariosto 7 A, Firenze
FESTA—Via Torino 30, Napoli
FIERA—(Messaggerie Musicali) Galleria del Corso 4, Milano
FILMER—Piazza 8 Agosto 6, Bologna
FILM MELODIA—(Nazionalmusic) Corso Vitt. Emanuele 30, Milano
FILMUSIC—(Nazionalmusic) Corso Vitt. Emanuele 30, Milano
FIRST MUSIC Co.—(Ariston) P.tta Pattari 1/3, Milano
FLAG—Galleria del Corso 4, Milano
FLAMINIA—(Messaggerie Musicali) Galleria del Corso 4, Milano
FLASH—Galleria del Corso 2, Milano
FONIT-CETRA—Via Gonzaga 4, Milano
FONO CINE—Via S. Paolo 15, Milano
FONOFILM RICORDI—(Ricordi) Galleria del Corso 2, Milano
FONORITMI—Piazza Grandi 11, Milano
FONOS—Via Volturmo 7, Bologna
FONO STAR—Via Cardinal Federico 7, Milano
FORLIVESI—Via di Borgo S. Giacomo 20, Firenze
FORMIDABLE MUSIC Co.—(Ariston) P.tta Pattari 1/3, Milano
FORTISSIMO—(Southern) P.tta Pattari 2, Milano
FORTUNA—(Curci) Galleria del Corso 4, Milano
FOX—(Southern) P.tta Pattari 2, Milano
FRANCHI CARLO—Via Propaganda 16, Roma
FRANCIS DAY—Piazza del Liberty 2, Milano
FRANK MUSIC—(Messaggerie Musicali) Galleria del Corso 4, Milano
FRATTALI UMBERTO—P.zza S. Maria Maggiore 12, Roma
FULGINEA—(Campi) Via Virgilio 8, Roma

G

GALATEA—Via Lorenzo Bolano 2, Catania
GALLAZZI—(Francis Day) Piazza del Liberty 2, Milano
GALLETTI & BOSTON—Corso G. Mazzini 38, Faenza (Ravenna)
GALUPPO—Viale Marche 43, Milano
GARDENIA—Via Bonoini 16, Firenze
GARDINO LORENZO—Via Guttuari 14, Asti
GARISENDA—Corte Galluzzi 1, Bologna
GEA—(Messaggerie Musicali) Galleria del Corso 4, Milano
GENERAL MUSIC—Viale Liegi 41, Roma
GENNARELLI—(Bideri) Via S. Pietro a Majella 17, Napoli
GENOVA—Via S. Martino 37, Genova
GESA—Angiporto Galleria Umberto I° 7, Napoli
GHERDEN MUSIC Corporation—Galleria del Corso 2, Milano
GIADA—Galleria del Corso 4, Milano
GIANCA—Via Siligardi 48, Modena
GIBA—Angiporto Galleria 7, Napoli
GIP—Via Isonzo 39, Cosenza
G.I.R.A.—Via Mazzini 114 B, Roma
GIRAFFA—Via Oslavia 12, Roma
GIRL—Via Palestrina 2, Milano
GIULIANA—Via F. Venezian 24, Trieste
GLOBO—Via Duomo 326, Napoli
GLOBUS—Corso Garibaldi 67, Fiorenzuola d'Arda (Piacenza)
GOLD—Galleria del Corso 4, Milano
GOLFO—Rettifilo 311, Napoli
GONG—(Campi) Via Virgilio 8, Roma
GORI—(Francis Day) P.tta Liberty 2, Milano
GRANDI FIRME DELLA CANZONE—Via Gregoriana 12, Roma
GRIDENIS—Piazza Zama 37, Roma
GTA MUSIC—Galleria del Corso 2, Milano
GUANDA—Via Cantelli 13, Parma
GUERRINI—Galleria del Corso 2, Milano
GUIDOBONO—Via Ugone Visconti 3, Tortona

H

HEFLIN—(Eridania) Piazza Cavallotti 11, Mantova

I

ILLER—Barco (Reggio Emilia)
IL MANDOLINO—Via Martiri della Libertà 16, Torino
IL PAPIRO—Via Malaspina 8, Pavia
I.M.I.—International Music of Italy—Corso Europa 5, Milano
INDIOS—Via Arnaldo Lucci 130, Napoli
INTERLANCIO—Via Guglielmotti 43, Roma
INTERNATIONAL TV RECORD—Via Bergamo 12, Milano
INTERNAZIONALI—Viale Piceno 14 A, Milano
I.S.A.—Via E. Quirino Visconti 11, Roma
ITALCANTO—(Curci) Galleria del Corso 4, Milano
ITALCARISCH—(Southern) P.tta Pattari 2, Milano
ITALIA CANTA—Va Ara Coeli 3, Roma
ITALIAN YANK—(Curci) Galleria del Corso 4, Milano
ITALMARLETTA—Via Oslavia 12, Roma
ITALMUSICA—Corso Genova 22, Milano
ITALO SVIZZERE—Besozzo (Varese)
IVANA—(Messaggerie Mus.) Galleria del Corso 4, Milano
IZZO—(Curci) Galleria del Corso 4, Milano

K

KANSAS—Galleria del Corso 4, Milano
KARIM—Piazza della Vittoria 11 A, Genova
KASSNER EDWARD—(Ariston) P.tta Pattari 1/3, Milano
KORAL—Via Caboto 16, Modena
KRAMER—(Southern) P.tta Pattari 2, Milano

L

LA BUSSOLA—(Ariston) P.tta Pattari 1/3, Milano
LA CANZONE—(Connelly) Galleria del Corso 2, Milano
LA CANZONETTA—Vicoletto Berio 2, Napoli
LA CICALA—(Messaggerie Musicali) Galleria del Corso 4, Milano
LADY MELODY—Galleria del Corso 4, Milano
LA FALENA—(Messaggerie Musicali) Galleria del Corso 4, Milano
LA FENICE—Via Guerrazzi 30, Bologna
LA MIA CANZONE—Via Pandosia 21, Roma
LA TURRITA—Via S. Stefano 13, Bologna
LA VESUVIANA—(Diapason) Via della Vite 41, Roma
LA VOCE DEL PADRONE—Galleria del Corso 4, Milano
LE CANZONI DEL TEVERE—Via Cola di Rienzo 162, Roma
LE GRANDI FIRME DELLA CANZONE—(Bixio) Via Borgogna 7, Milano
LE MONDE—Via Teulada 71, Roma
LEOFILM—Via Montello 32, Roma
LEONARDI—Corso Europa 5, Milano
LEON MUSIC—(Leonardi) Corso Europa 5, Milano
LES COPAINS—Piazza Liberty 2, Milano
LIBERTY—(Messaggerie Mus.) Galleria del Corso 4, Milano
(Continued on next page)

ITALY'S MUSIC PUBLISHERS

(Continued from preceding page)

LOI—Spilamberto (Modena)
L'ORA MIA—Via Ara Coeli 11, Roma
LORD—Galleria del Corso 4, Milano
LOTUS RECORD—Corso Europa 5, Milano
LOUISIANA—(Leonardi) Corso Europa 5, Milano

M

MAESTRI—Via Calcamuggi 15, Alessandria
MAESTRO—Via Areifice 2, Milano
MAGISTRAL RECORD MUSIC—Via Martinetti 10, Milano
MAIETTI—Via Palmi 20, Milano
MAJESTIC ITALIANA—Via Morozzo della Rocca 6, Milano
MANLIO—Via Alessandria 129, Roma
MARECHIARO—Via E. De Marinis 4, Napoli
MARECO—Via Modenella 64, Modena
MARES—Via S. Francesco a Porta Capuana, Napoli
MARI GIOVANNI—Via Dante 19, Cesena (Forlì)
MARIO E.A.—Via Benedetto de Falco 5, Napoli
MARLETTA—Via Settembrini 8, Roma
MAS—(SAAR) Via S. Vittore 40, Milano
MASCHERONI—(Messaggerie Musicali) Galleria del Corso 4, Milano
MASCHIO—Via Carlo Alberto 43, Torino
MASCOTTE—Galleria del Corso 2, Milano
MASSARA—Via Palma 7, Ivrea (Torino)
MAURRI—Via del Corso 1/17 r, Firenze
MAZZONI—Corso 2° Garibaldi 98, Grammichele (Catania)
MEBEL—Casella Postale 73, Marghera (Venezia)
M.E.C. (Music European Co.)—(Ariston) P.tta Pattari 1/3, Milano
MEDANA—Galleria Subalpina, Torino
MEDIOLANA—(Connelly) Galleria del Corso 2, Milano
MELODI—(Messaggerie Musicali) Galleria del Corso 4, Milano
MENESTRELLO—(Messaggerie Musicali) Galleria del Corso 4, Milano
MERCURIO—Via Stoppani 10, Roma
MESTRINA—Via Caneve 23, Mestre (Venezia)
METRON—Via F. Baracchini 2, Milano
M.I.A.—Galleria Umberto 1° 83, Napoli
MICHELI—Piazza Scipione Ammirato 3, Roma
MICROFON—Via Casaregis 52, Firenze
MILLELUCI—Via Giusti 39, Ragusa
MILLEN—Via Luigi Vischi 14, Spilamberto (Modena)
MILLENOTE—(Sidet) Piazzetta Pattari 4, Milano
MINSTREL—Via Bruno Buozzi 89, Roma
M.M.M. Mondo Musicale Milano—Via Boccaccio 24, Milano
MOCCHI—Galleria del Corso 4, Milano
MONDIA MUSIC—Via F. Baracchini 2, Milano
MORQUIN—Via Africa Italiana 19, Bari
MUSICA—Via Luccoli 56/r, Genova
MUSICA E DISCHI—Via Carducci 8, Milano
MUSICAL CINE—Galleria del Corso 4, Milano
MUSICAL FILM—(Leonardi) Corso Europa 5, Milano
MUSICALGLOBE—Via Villa Emiliani 10, Roma
MUSICALIA—Via Malatesta 20, Napoli
MUSIC HALL—Via Romagna 14, Roma
MUSICHOUSE—Via Ponte Seveso 22, Milano
MUSIC UNION—(Curci) Galleria del Corso 4, Milano

N

NABEDA—Via Ara Coeli 11, Roma
NAPOLI CANORA—Vicoletto Berio 2, Napoli
NAZIONALE—(Nazionalmusic) Corso Vitt. Emanuele 30, Milano
NEW YORK MUSIC EDIZIONI MUSICALI U.S.A.—Sede: Casella Postale 1157, Milano—Ufficio legale: Via Boryazzi 50, Monza
NIDO—Via Gregoriana 50, Roma
NINFEA—Corso Francia 102, Torino
NORD SUD—Via Fasana 21, Roma

O

ODES—Via Trieste 7, Foggia
ODORICI—Via Luigi Vischi 16, Spilamberto (Modena)
OKLAHOMA—Voc. Scetelle 46, Terni
OLIMPIA—Via Ugone Visconti 3, Tortona (Alessandria)
OLONA—(GTA) Galleria del Corso 2, Milano
OMAC—Via Cagliari 15, Roma
OMEGA—Via Coluccio Salutati 5, Firenze
ONDA—(Diapason) Via della Vite 41, Roma
ORCHESTRAL MUSIC—(Curci) Galleria del Corso 4, Milano
ORFEO—(Zanibon) Piazza dei Signori 24, Padova
ORSA MAGGIORE—(GTA) Galleria del Corso 2, Milano
ORTIPE—Via dei Gracchi 58, Roma
OTOS—Borgognissanti 98, Firenze
OTTO TEMPI—Via Po 28, Torino

P

PALACE—(Ariston) P.tta Pattari 1/3, Milano
PALLADIUM—(Southern) P.tta Pattari 2, Milano
PALMA—Piazza Cavalletto 2/2, Genova

(Continued on next page)



ESTABLISHED IN

1887

THE MOST PROGRESSIVE IN

1967

80 years of activity in the music field. 80 years of hits. We can be considered as one of the oldest music organizations in the world. But we still are the most progressive. Our activity is the best known in the classical field. We represent the catalogues of BOOSEY & HAWKES, DURAND, SALABERT and many others. We published works of world famous composers as PIZZETTI, MALIPIERO, DALLAPICCOLA. We were the first publishing firm starting an independent record production in 1928.

We introduced on the music scene top talents as LUCIANO TAJOLI, CLAUDIO VILLA, GORNI KRAMER, ARMANDO TRAVAJOLI, PEPPINO DI CAPRI.

We introduced THE BEATLES in Italy. We published such evergreens like MUSICA PROIBITA and CIRIBIRIBIN.

We have one of the largest and dynamic organization in the music field in Italy. If you are looking for good connections we offer you our services. We need new material for our publishing firm. Give us your repertoires. These will be our tomorrow hits.

Carisch S.p.A.
Via Fara 39
Milano, Italy
tel. 650741 | 2 | 3

STUDIO M

ITALY'S Music Publishers

(Continued from preceding page)

PANAGINI—Via G. Ferrari 2, Novara
PANDORA—Via Rolli 15, Roma
PANZUTI—Galleria del Corso 2, Milano
PARISI—Via XX Settembre 76, Torino
PARVIS—Piazza S. Simone, Tortona (Alessandria)
PATTACINI—Via XXIV Maggio 22, Barco (Reggio Emilia)
PEDROTTI F.lli—Trento
PEER ITALIANA—(Southern) P.tta Pattari 2, Milano
PALLEGRINO—Via dei Gracchi 58, Roma
PENTAGRAMMA—Via Tolmino 5, Roma
PERI—Via G. Avezzana 45, Roma
PETER MAURICE—(Messaggerie Musicali) Galleria del Corso 4, Milano
PETRONIANA—Via Frassinago 15, Bologna
PETTIROSSO—(Ariston) P.tta Pattari 1/3, Milano
PICCOLA VELA—Via E. De Marinis 4, Napoli
PICKWICK—(Messaggerie Musicali) Galleria del Corso 4, Milano
PIERROT—Via Spartaco, 27, Milano
PIGINI—(Italmusica) Corso Genova 22, Milano
PINO ASTI di Asti Giuseppe—Via Rondizzoni 12, Parma
PIPER Club—(Ariston) P.tta Pattari 1/3, Milano
PO—Via S. Giulia 83, Torino
POLARIS—(Messaggerie Mus.) Galleria del Corso 4, Milano
PORTOFINO—(GTA Music) Galleria del Corso 2, Milano
PROGRESSIVE—(Aberbach) Via Lazio 9, Roma
PUBLIMUSIC—Galleria del Corso 2, Milano
PUBLIVOX—Via Romagna 14, Roma
PUCCI—Via della Libertà 75, Portici-Napoli
PUCCIO—Via Fieno 6, Milano

Q
QUAGLIA FRANCESCO—Via Caraglio 61, Torino

R
RADIO—(Sidet) P.tta Pattari 4, Milano
RADIOFILMUSICA—Galleria del Corso 2, Milano
RADIOMELODIE—(Diapason)—Via della Vite 41, Roma
RADIO RECORD RICORDI—Galleria del Corso 2, Milano
RAIMONDO—Via Porpora 100, Milano
RAMPOLDI—(Guerrini) Galleria del Corso 2, Milano

RASCCEL—(Messaggerie Musicali) Galleria del Corso 4, Milano
RATTAZZI—Via S. Michele del Carso 20, Milano
RAVASINI—Galleria del Corso 2, Milano
RCA ITALIANA—Via Tiburtina Km. 12, Roma
REBER—Piazza S. Francesco 6, Bologna
REDI—Via Cernaia 5, Milano
REGENT—(Ariston) P.tta Pattari 1/3, Milano
RENDINE—Galleria Umberto I° 27, Napoli
RESOLUTE—(Messaggerie Musicali) Galleria del Corso 4, Milano
RETE—Via degli Scipioni 167, Roma
RIAS—(Messaggerie Musicali) Galleria del Corso 4, Milano
RICORDI G. & C.—Via Berchet 2, Milano
RIGEL—Fraz. Torre Orsina, Via Villa Margine 14, Terni
RIMI—Galleria del Corso 2, Milano
RITMI E CANZONI—(Ricordi) Galleria del Corso 2, Milano
ROBINSON MUSIC—Via Caneve 23, Mestre (Venezia)
ROCCHI—Via Cervia 296, Cesena (Forli)
ROMA—Largo Oragi e Curiazi 9, Roma
ROMANA FILM—Galleria del Corso 4, Milano
ROMEO—Viale Parioli 41, Roma
RONDINELLA—Via del Seminario 91, Roma
ROOSVELT—(Aberbach) Via Lazio 9, Roma
RORAM—Galleria del Corso 4, Milano
ROSALPINA—Piazzetta della Mostra 2/3, Bolzano
ROSSI ALFREDO—P.tta Pattari 1/3, Milano
ROSSI C. A.—Galleria del Corso 2, Milano
ROTELLINI ASSUNTO—Via Vitt. Emanuele 13, ALBA (Cuneo)
R.T.V.—(Curci) Galleria del Corso 4, Milano
RUBENA—Via Porta d'Archi 8/2, Genova
RUCCIONE—Via Guidobaldo del Monte 13, Roma
RUSCONI—Via De Sanctis 4, Milano
RUSSO—Via S. Teresa al Museo, Napoli

S
S.A.A.R.—Viale di Porta Vercellina 14, Milano
SABAUDA—Via Tommaso Grossi 8, Torino
SABRINA—Via Ariosto 21, Milano
SACHA ITALIANA—(Southern) P.tta Pattari 2, Milano
SAGITTARIO—(GTA) Galleria del Corso 2, Milano
SAINT MARTIN RECORD—Via Lambertenghi 34, Milano
SANTORO GIOVANNI—Via Cavour 238, Roma

SAINT TROPEZ—Corso Europa 5, Milano
SALVATI—Corso Cavour 58, Bari
SAN GIUSTO—(Guerrini) Galleria del Corso 2, Milano
SAN PAOLO—(GTA Music) Galleria del Corso 2, Milano
SANTA CECILIA—(Ariston) P.tta Pattari 1/3, Milano
SANTA LUCIA—(Bideri) Via S. Pietro a Majella 17, Napoli
SANTILLO—Corso Vitt. Emanuele 38, Nocera Inf. (Salerno)
SANTOJANNI—(Bideri) Via S. Pietro a Majella 17, Napoli
SAPHOX—Scalinata L. Montaldo 5/1, Genova
SAPORETTI & CAPPELLI—Via dei Conti 12 r, Firenze
SARDAMUSIC—Bosa (Nuoro)
SAVIO—Via Dante 19, Cesena (Forli)
SCANZONATISSIMO—Rione Lauro 82, Napoli
SCIACCA—Via Frattina 89, Roma
SCIASCIA—Corso Europa 5, Milano
SCIASCIA SALVATORE—Corso Umberto 117, Caltanissetta
SCREEN GEMS—COLUMBIA—(Messaggerie Musicali) Galleria del Corso 4, Milano
SELEMUSICA—(GTA) Galleria del Corso 2, Milano
SENZA FINE—Galleria del Corso 4, Milano
SERMI FILM—Via Cesare Beccaria 24, Roma
SERRA LUIGI—Via Luccoli 56, Genova
SETTEBELLO—Corso Europa 5, Milano
SETTENOTE—(Southern) P.tta Pattari 2, Milano
SFINGE MANZONIANA ENIGMISTICA—Via Antonio Ghislanzoni 25, Lecco (Como)
SIBILIO—Spalto Gamondio 11, Alessandria
SIBILLA—Via Albalonga 40, Roma
SIDERAL—Via Città di Castello 14, Roma
SIDET—P.tta Pattari 4, Milano
S.I.G.E.M.—Viale Risorgimento 10, Agropoli (Salerno)
SILMAR—Via F. da Paola 2, Torino
SIMEOLI SALVATORE—Via S. Pietro a Majella 5, Napoli
SIMPHONY—Via Monteverde 11, Roma
SIRENA (La)—Via E. De Marinis 4, Napoli
SIRIO—Via S. Giacomo 6, Napoli
SISTINA—(Messaggerie Musicali) Galleria del Corso 4, Milano
SISTRO—(GTA Music) Galleria del Corso 2, Milano
SMART—Galleria del Corso 2, Milano
SMERALDO—Via Giuseppe Rosso 5, Roma
SOFIA—(Messaggerie Musicali) Galleria del Corso 4, Milano
SOLARE—Via Vezzani 2, Reggio Emilia
SOMBRERO—Corso Europa 5, Milano
SONEM—Via Madama Cristina 11, Torino
SONG—Via Bigli 11, Milano

SONORA—Via Perticari 88, Savignano sul Rubicone (Forli)
SONORFILM—(Nazionalmusic)—Corso Vitt. Emanuele 30, Milano
SONZOGNO—Via Bigli 11, Milano
SORANO—Via De Amicis 123, Firenze
SORRISI E CANZONI—(Campi) Via Virgilio 8, Roma
SOUTHERN MUSIC—P.tta Pattari 2, Milano
SOUVENIR—(Leonardi) Corso Europa 5, Milano
SPANKA ITALIANA—(Curci) Gall. del Corso 4, Milano
SPRINT—(Durium) Via Manzoni 40/42, Milano
STAR—(Clan) Corso Europa 5, Milano
STEITEL—Via Ugone Visconti 3, Tortona (Alessandria)
STELLA—Piazzale Velasquez 9, Milano
STELLA ROMANA—Corso Vittorio Emanuele 22, Milano
STEM—Via Fratelli Bandiera 10, Torino
STOP—Galleria del Corso 4, Milano
STRADIVARIUS—(C. A. Rossi) Galleria del Corso 2, Milano
STUDIO MUSICALE ROMANO—Via Alpi 15 d, Roma
SUCCESSO—(Messaggerie Musicali) Galleria del Corso 4, Milano
SUPERBA—Piazza Castello 9, Torino
SUPERSONIC—(Messaggerie Musicali) Galleria del Corso 4, Milano
SUSY—Via Piatti 4, Milano
SUVINI-ZERBONI—(Messaggerie Musicali) Galleria del Corso 4, Milano
SWEET MELODY—Via Guastalla 5, Milano

T
TABU—Via Erbe 2, Milano
TALENTO—Via Nazionale 64, Moschiano (Avellino)
TANK—(Campi) Via Virgilio 8, Roma
TARQUINIA—Piazza S. Simeone, Tortona (Alessandria)
TELEMONDO—Via Monte Santo 10 A, Roma
TELESTAR—Via Turati 28, Milano
T.E.M.I.—Via G. B. Tiepolo 36, Roma
TEMPO—Via Porta d'Archi 8/6, Genova
TERME—Via Aurelia 69, Vado Ligure (Savona)
TEVERE—(Messaggerie Musicali) Galleria del Corso 4, Milano
TIBER—(Messaggerie Musicali) Galleria del Corso 4, Milano
TIGRE—Piazza Medaglie d'Oro 4, Milano
TORNADO—(Sidet) P.tta Pattari 4, Milano
 (Continued on next page)

the hits maker place
 while milan is sleeping CGD
 is working for you



Caterina Caselli
 gigliola cinquetti
 johnny dorelli
 betty curtis
 tony del monaco

EXCLUSIVE DISTRIBUTORS OF:
 (alphabetical order)

A & M - AUDIO FIDELITY - CRESCENDO -
 FESTIVAL - MUSICOR - PROJECT 3 - REPRISÉ
 RIVIERA - SCEPTER - WARNER BROS.

ITALY—The Past 12 Months

(Continued from page 118)

the highest success at the end of 1966, but this is not the real reason. The "beat" fashion served to create a new interest on the part of record operators towards foreign products which were clearly declining in 1963 and 1964.

The new demand of foreign releases pushed the Italian record companies in a new campaign for the acquisition of foreign labels: it is interesting to note that all new agreements concerning distribution or introduction of foreign catalogs in our territory were signed or discussed or renewed just during this twelve months period. It started with the pact signed between Cemed Carosello and United Artists, followed with the formation of Dischi MGM, a joint venture between Ricordi and MGM Records, and has been just recently concluded with the pact between R.I.F.I. and Atlantic.

Profiting from a new interest by part of customers toward foreign releases, the Italian record companies have welcomed the situation, and have opened all doors to these products with small investments, without direct production problems. Hence, they have resolved the problem of feeding their record sales organizations.

In our weekly column we have reported our negative opinion concerning, generally, the song contests. Even in the case of San Remo our opinion was negative because the total sales of the festival releases do not always compensate for the loss of four months of usual sales.

But we have to recognize the value of the San Remo song contest and other top contests such as "A Disk For Summer" and "Cantagiro".

These contests are the last bulwark in defense of the Italian domestic product. Reserved for original Italian songs they oblige the Italian companies to make an effort in producing and releasing suitable Italian recordings.

At the end of December 1966 only 25% of disks listed in our hit parades were of Italian origin. Four weeks later, immediately after the San Remo contest, more than 80% of the best selling disks were of Italian origin, and this percentage remained un-

ITALY'S MUSIC PUBLISHERS

(Continued from preceding page)

TRE GOLFI—Traversa Altamura, Parco Mele, Napoli

TRE STELLE—(C.A. Rossi) Galleria del Corso 2, Milano

U

ULPIA—Via Montello 32, Roma

ULTRA—Via Volturna 7, Bologna

UNIDEAR—Galleria del Corso 4, Milano

UNIONE—Via Nuova, Meldola (Forlì)

UNIVERSAL EDITION—Via A. Doria 16, Milano

URAGANO—Galleria del Corso 4, Milano

USIGNOLO—(Fonit-Cetra) Via Mazzini 15, Milano

V

VARESE L. di Pietro Varese—Via Garibaldi 22, Parma

VARIETASALOTTO—Via Francesco Datini 3, Roma

VENTRELLA—Via S. Tomaso 22, Cosenza

VESCOVI—(Italmusica) Corso Genova 22, Milano

VESUVIO—Via L. F. De Magistris 10, Roma

VIDALE—Galleria del Corso 4, Milano

VIDIO—Galleria del Corso 2, Milano

VIS RADIO—Corso Umberto I° 132, Napoli

VULCANIA—Piazza S. Simone, Tortona (Alessandria)

W

WORLD MUSIC—(Messaggerie Musicali) Galleria del Corso 4, Milano

Y

YES—Via Anguissola 21, Milano

Z

ZA BUM—Galleria del Corso 4, Milano

ZANIBON—Piazza dei Signori 24, Padova

ZANONI—Via Ciro Menotti 12, Milano

ZIG ZAG—(Guerrini) Galleria del Corso 2, Milano

ZITA—Via Flaminia 36, Roma

Cash Box—July 8, 1967

changed until four months after the conclusion of the festival. Then, little by little, the percentage dropped to 60% of the total. We hope that this percentage will again be increased thanks to introduction of the "Disk For Summer" hits.

The taste of the public influences the product issued by the record firms and vice versa.

We wish to stress therefore, that the shifting of record production in Italy toward foreign product during the past twelve months was not mainly due to fashion but principally to the policy of the record companies, who immediately after the economical slump of 1964 and 1965, found in foreign product the way to satisfy the increasing record demand on our domestic market.

The "contest" organizations, demanding original Italian product, defend and protect the Italian musical industry, which otherwise, in our opinion, would have become a satellite of the foreign industries.

And not only do the contests defend the domestic product on the inside market; they also help to increase the market for Italian product abroad.

It is well known that in the case of the San Remo Festival all finalist songs are automatically licensed throughout the world (firstly in the European and Latin American countries).

This urges Italian record firms to introduce their artists and products abroad.

Of course the penetration of the Italian record product into the international market is not easy. Complete representation of our lines is generally possible only in Spain, Portugal and in South America. In the Latin countries, a great part of the Italian record product is automatically released. In other countries the release of original Italian recordings is very limited.

For this reason there are very few Italian record firms represented and distributed all around the world. There are a few international organizations such as Phonogram, RCA and EMI or recently also CBS and MGM, which from time to time release original Italian material, but the only Italian companies who have world distribution are Durium, Ricordi, Saar, Ri.Fi., CGD, Ariston, Fonit Cetra and Carisch.

We don't have to put the accent on special results obtained by our companies abroad; we can speak about isolated initiatives taken by different record firms in order to introduce on foreign markets top Italian talents. This is the case with Durium, Ri.Fi., Ariston and CGD. The Italian market is devoted more to the importation than to the exportation, and there is great interest in obtaining shares of the international market.

Durium has conducted a promotional campaign abroad on behalf of Little Tony and Nini Rosso; Dischi Ricordi has strongly promoted Milva and Equipe 84. Ariston Records is introducing their top star Ornella Vanoni; CGD is working on Gigiola Cinquetti, Ri.Fi. Records is promoting Mina and Iva Zanicchi. But with very few exceptions, mainly Spain, Argentina and Brazil, Italian artists do not appear on the charts of foreign countries. Italian companies never make definite decisions concerning a concrete program for the introduction abroad of their products and their artists. This is perhaps because of the increased interest in the importation and the release of foreign recordings on our market during the past twelve months. With very few exceptions, we have noted a lack of interest in the exportation and promotion of our domestic products abroad.

Italian enterprises usually have international departments organized or administered in an embryonic way, or devoting their activity, in great part, toward importation.

This causes great damage to our industry, whose artists could so easily have international exposure, and bring a part of the world record market into our hands, as is the case

(Continued on page 127)

CHART BREAKING ARTISTS:

caterina valente
le gemelle kessler
riki maiocchi
i camaleonti
il quartetto cetra
tony dallara
i profeti
i roll's 33

last new born of a wonderful and perfect mosaic

CBS ITALIANA

ITALY'S RECORD MANUFACTURERS

STUDIO M

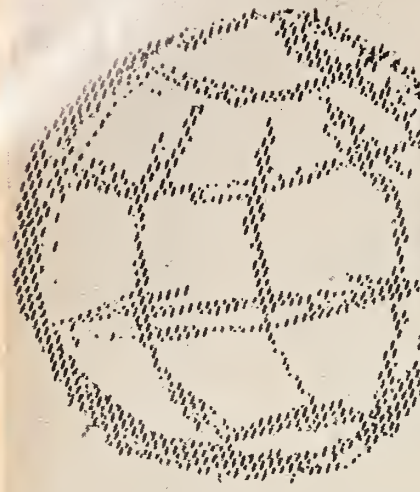

**the
only
country
in the
world...**

**where
BANG BANG
has had 15 cover
recordings 5 of which
within the top 15 is
Italy...**

**...and you are not wrong
if you think
that we were
responsible
for this!**



edizioni musicali
E. KASSNER
**gruppo editoriale
ARISTON**
piazetta Pattari 1/3 Milano (Italy)
phone 897745

ARISTON RECORDS
Piazzetta Pattari 1/3, Milano
Tel. 897745
Telegraphic Address: Aristonrecords
President: Alfredo Rossi
General Manager: Alfredo Rossi
A/R Manager: Gianni Guarnieri
Sales Manager: Amleto Silvestri
International Dept: Ernesto Re
Domestic labels: Ariston Records
Foreign labels: Ariston Records
Pressing Plant: Via Massimo Gorki, San
Giuliano Milanese, Milano (18 Presses 100
workers)
Sales Agents: 20
Stores: 3

BENTLER RECORDS
Galleria del Corso 2, Milano
Tel. 780103
President: Gualtiero Guerrini
A/R Manager: Maria Luisa Guerrini
Sales Manager: Dolores Miglio
Domestic labels: Bentler
Pressing plant: Via Goldoni 14, Trezzano,
Milano (6 presses, 25 workers)
Distributed by Vedette

DISCHI BLUEBELL S.r.L.
Via Filippo Turati 28, Milano
President: and General Manager: Antonio
Casetta
A/R Manager: Federico Montearduini
Sales Manager: Arturo Malcotti
Domestic labels: Bluebell, Mini
Foreign labels: Somerset, Hanna Barbera,
Colpi, Esp Disc, Canadian, American, Vee
Jay
Sales Agents: 13
Stores: 1

BRUBER S.p.A.
Piazza Duomo 31, Milano
Tel. 897097
General Manager: Carlo Pome'
A/R Manager: Bruno Burattini
International Dept: Rosa Maria Cantoni
Domestic labels: River, Capitan, Interrecord,
Mignon
Distributed by DDR

CAR DISCHI JUKE BOX
Via Barletta II, Milano
Tel. 5392392
President: Carlo Alberto Rossi
A/R Manager: Luciano Zotti
Domestic Labels: Car, Dischi Juke Box
Recording Studio: Via Barletta II, Milano
Distributed by Ariston

CARISCH S.p.A.
Via Genral Fara 39, Milano
Tel. 650741
President: Sandro Galli
Vice president: Gino Mazzocchi
Domestic labels: Carisch
Foreign labels: Parlophon, Odeon
Recording Studio: Via Monviso 17, Milano
Sales Agents: 15
Stores: 15

CBS ITALIANA S.p.A.
Galleria del Corso 4, Milano
Tel. 794841
President: Ladislao Sugar
Vice President: Jero Sugar
Managers: Franco Crepax, Sandro Delor,
Giuseppe Giannini
A/R Manager: Gianfranco Mondaldi
International Dept: Johnny Porta
Domestic and Foreign labels: CBS
Pressing plant: Via Moretto 9, Milano
Recording Studio: Galleria del Corso 4, Milano
Distributed by Messaggerie Musicali

**CDB DISCOGRAFIA ITALIANA E INTER-
NAZIONALE**
Piazzetta Pattari 2, Milano
Tel. 878472
Telegraphic Address: CDB Italiana Milano
President: Carmine De Benedittis
Domestic Labels: CDB
Distributed by Messaggerie Musicali

CELLOGRAK SIMP S.p.A.
Via Maffucci 18, Milano
Tel. 3763141
President: Natale Sciascia
General Manager: Riccardo Rota
A/R Manager: Gino Mescoli
International Dept: Riccardo Rota
Sales Manager: Giovanni Albani
Domestic labels: Style, Big Ben, Phonocolor,
Primavera
Pressing plant: Via Maffucci 18, Milano
Sales Agents: 12
Stores: 2

**CEMED CAROSELLO EDIZIONI MUSICALI
E DISCOGRAFICHE S.r.L.**
Via Beccaria 5 Milano
Tel. 793008
Telegraphic Address: Curcimusic Milano
Managing Director: Giuseppe Gramitto Ricci
Domestic Labels: Carosello, Curci, Costanza,
Curci Erato, Italian Yank, Paperino, Topo-
lino
Foreign Labels: Disneyland, Buena Vista,
United Artists, Erato
Distributed by CEC

CINEVOX
Via Borgogna 7
Milano
Tel. 701107
President: Cesare Andrea Bixio
Vice President: Pasquale Coliman
General Manager: Carlo Bixio
Domestic labels: Cinevox
Distributed by CEC

CLAN CELENTANO
Corso Europa 7, Milano
Tel. 704261
President: Adriano Celentano
General Manager: Corrado Pintus
A/R Manager: Miki del Prete
International Dept: Gabriella Zanotti
Domestic labels: Clan, Clao Ragazzi, Totem
Distributed by CEC

COMPAGNIA DISCOGRAFICA ITALIANA
Via Balilla 36, Milano
Tel. 8472672
Telegraphic Address: Cempadisc
President: Pierquinto Cariaggi
Vice President: Alberto Cariaggi
General Manager: Antonio Cariaggi
A/R Manager: Renato Serio
Sales Manager: Antonio Cariaggi
Domestic labels: CDI, BCD, Discolino, Disco-
mecc
Sales Agents: 12
Stores: 1

COMPAGNIA GENERALE DEL DISCO S.p.A.
Galleria del Corso 4, Milano
Tel. 794841
President: Ladislao Sugar
Vice President: Piero Sugar
Managers: Franco Crepax, Sandro Delor,
Giuseppe Giannini
A/R Manager: Renato Angiolini
International Dept: Johnny Porta
Domestic labels: CGD
Foreign labels: Reprise, Warner Bros., ASM,
Audio Fidelity, Pricject, Musicor, Festival,
Riviera, Scepter
Pressing Plant: Via Moretti 9, Milano (14
presses, 60 workers)
Recording Studio: Galleria del Corso 4, Milano
Distributed by Messaggerie Musicali

DECCA DISCHI ITALIA S.p.A.
Via Brisa 3, Milano
Tel. 891848
Telegraphic Address: Deccital Milano
President: Sir Edward Lewis
General Manager: Romano Bacchini
A/R Manager: Paolo Tosi
Sales Manager: Luigi Negro
Domestic labels: Jaguar, Edig
Foreign labels: Decca, London, Telefunken,
Argo, Vega', Oiseau Lyre, Brunswick, Coral,
Deram, Decca American Serie.
Sales Agents: 15
Stores: 6

**DET DISCOGRAFICA EDITRICE TIRRENA
S.p.A.**
Via Virgilio 8 Roma
Tel. 314341
Telegraphic Address: Camusic Roma
President: Giuseppe Campi
A/R Manager: Ezio Leoni
Domestic labels: DET Records, DET Interna-
tional Records, CAM Records, Campi Rec-
ords, Tank Records
Distributed by Campi Distribuzione

DISCHI PARADE S.r.L.
Viale Bruno Buozzi 3, Roma
Tel. 805109
Managing director: Vincenzo Micocci
A/R Manager: Vincenzo Micocci
International department: Bruno Pozza
Domestic labels: Parade, Eureka
Distributed by C e C

DISCHI RICORDI S.p.A.
Via Berchet 2, Milano
Tel. 891848
Telegraphic Address: Ricordisc
President: Gianni Babini
Vice President: Eugenio Clausetti
Managing Director: Guido Rignano
A/R Manager: Sandro Colombini
Sales Manager: Renzo Venini
International Dept: Mimma Guastoni
Domestic labels: Dischi Ricordi, International,
Classici della Musica Classica, 1 best Seller,
Club, Tavola Rotonda
Foreign labels: Amadeo Vanguard, Bang
Shout, Cameo Parkway ars Polona Epic,
Impact (France), Kama Sutra, Major Minor,
Mgm Verve Metro Vsp Verve Forecast,
Mira Mirwood Surrey, Pacific Jazz World
Pacific, Page one
Recording Studio: Via dei Cinquecento 1,
Milano
Sales Agents: 22
Stores: 2

**DUCALE EDIZIONI MUSICALI E DISCO-
GRAFICHE S.r.L.**
Via Beccaria 5, Milano
Tel. 791440
Telegraphic Address: Fonorecord
President: David Matalon
A/R Manager: Renato Vantellini
Domestic labels: Italdisc, Ducale, Broadway
Foreign labels: Discophon, Panorama, Qualiton
Distributed by DDR

DURIUM S.p.A.
Via Manzoni 40 42, Milano
Tel. 701008
Telegraphic Address: Durium Milano
President: Krikor Mintangian
A/R Managers: Aurelio Ajroldi, Giampiero
Scussel, Felice Piccaredda
Sales Manager: Pino Paschetto
International Dept: Elisabel Mintangian
Domestic labels: Durium, Sprint, Royal
Foreign labels: Prestige, Chess, Checker,
Cadet, King
Pressing Plant: Via Trieste, Erba, Come
(30 presses, 60 workers)
Recording Studio: Via Carlo Troia 7, Milano
Sales Agents: 15
Stores: 7

EMI ITALIANA
Piazza Cavour 1, Milano
Tel. 652577
Telegraphic Address: Emigram Milano
General Manager: George Charles Alexander
A/R Manager: John Lee
Sales Manager and International Dept: Carlo
Barbareschi
Domestic labels: Voce del Padrone, Columbia,
Pathe', Regal
Foreign labels: Paramount, Liberty, Tower,
Command, Electrola, Columbia, Angel,
Pathe', Capitol, Dolton, Stateside, Uptown,
Impulse
Pressing plant: Caronno Pertusella, Milano
(24 presses, 94 workers)
Recording studio: Piazza Cavour 1, Milano
Sales agents: 30
Stores: 5

(Continued on next page)

ITALY'S RECORD MANUFACTURERS

(Continued from preceding page)

FONIT CETRA

Via Bertola 34, Torino
Tel. 5753
Telegraphic Address: Fonit Cetra Torino
President: Enrico Carrara
Vice president: Renato Zaccone
A/R Manager: Mario Zanoletti
Sales Manager: Luigi Arduino
International Dept: Maurizio Golla
Domestic labels: Fonit Cetra, Cricket, Excelsius
Foreign labels: Ariola, Congress, Cricket, Encyclopedie Sonore Hachette, Eurodisc, Excelsius, International Hi Fi, Kapp Records, Musicdisc, Musicdisc Savoy, President
Pressing plant: Via Meda 45, Milano (30 Presses, 99 workers)
Recording Studio: Via Meda 45, Milano
Sales Agents: 10
Stores: 4

GTA RECORDS S.p.A.

Corso Europa 5, Milano
Tel. 782296
Telegraphic Address: Gtarecords
President: Luigi Sampietro
Managing Director: Gigi Cichellero
A/R Manager: Giulio Libano
International Dept: Piero Gallotti
Domestic labels: GTA Records, Brio Records
Sales Agents: 14
Stores: 1

ITALMUSICA

Corso Genova 22, Milano
Tel. 854641
President: Luciano Pigini
A/R Manager: Giovanni Moretto
Domestic labels: Silver record, Sir IPM, Pig.
Pressing plant: Ripa Ticinese 65, Milano (8 Presses, 14 workers)
Sales Agents: 7
Stores: 2

MEAZZI S.r.L.

Via dei Piatti 4, Milano
Tel. 867361
Telegraphic Address: Megrafom
President and General Manager: Enrico Meazzi
A/R Manager: Gianni Fallabrino
International Dept: Andrea Casale Rossi
Domestic labels: Meazzi, Hollywood, Meazzi Classica, Astraphon, Baby Record, Panoramic, Arpeggio, Humourplay, Baby lingue, GBC
Distributed by C e C

PHONOGRAM S.p.A.

Via Benadir 14, Milano
Tel. 2826241
Telegraphic Address: Comingan Milano
Managing Director: Manlio Baron
General Manager: Mario Corsi
A/R Manager: Mario Corsi
Sales Manager: Franco Paradiso
International Dept: Dario Pogliani
Domestic labels: Melodicon
Foreign labels: Adria, Archiv, Critere, Cyrus, Deutsche, Grammophon Gesellschaft, Fontana, Heliodor, Jazzland, Mercury, Pacific, Jazz Pergola, Philips, Polydor, Riverside, Wing, World Pacific
Pressing Plant: Via Benadir 14, Milano (24 Presses, 90 workers)
Recording Studio: Piazza Cavour 2, Milano
Sales Agents: 14
Stores: 2

RCA ITALIANA S.p.A.

Via Tiburtina Km. 12, Roma
Tel. 416041
Telegraphic Address: Radiointer, Roma
President: Enrico Galeazzi
Vice President: Carlo Ciulli Ruggeri
Managing Director: Giuseppe Ornato
Assistant Manager: Ennio Melis
A/R Manager: Ettore Zeppegno
Sales Manager: Luciano Bernacchi
International Dept: Francesco Fanti Salvoni
Domestic labels: RCA Italiana, Arc
Foreign labels: Barclay, Discophile Francais, Ducretet Thompson, Pye, RCA Custom, RCA Victor, RCA Victrola, Vik, Tamla Motown
Pressing Plant: Via Tiburtina Km. 12, Roma (36 Presses, 280 workers)
Recording Studio: Via Tiburtina Km. 12, Roma
Sales Agents: 100
Stores: 12

RIFI RECORDS Co. S.p.A.

Corso Buenos Aires 77, Milano
Tel. 273641
Telegraphic Address: Rifirecord Milano
President: Giampiero Rossi
Managing Director: Giovanbattista Ansoldi
Sales Manager: Piero La Salce
A/R Managers: Bruno Martelli, Gianfranco Intra
International Dept: Giuseppe Velona
Domestic labels: Rifi, Primary
Foreign labels: Atlantic, Monument, Variety, Westminster, Vox
Pressing plant: Via Vespolate 22 Confienza, Milano (14 Presses, 45 workers)
Recording Studio: Play-Co, Via Stromboli 18, Milano
Sales Agents: 30
Stores: 2

SAAR S.r.L.

Viale Porta Vercellina 14, Milano
Tel. 4696251
Telegraphic Address: Saar Milano
President: Walter Guertler
General Manager: Italo Brandin
Sales Manager: Sergio Balloni
International Dept: Giuseppe Di Gioia
Domestic labels: Jolly, Stella, Music
Foreign labels: Atlantic, Concert Disc, Contact, Dot, Everest, Folkways, Red Bird, Roulette, Vogue, AZ
Pressing Plant: Via Gramsci 20, Pero, Milano (20 Presses, 100 workers)
Sales Agents: 20
Stores: 20

SAINT MARTIN RECORDS s.a.s.

Via Porro Lambertenghi 34, Milano
Tel. 6884434 680679
General Manager: Gino Caselli
A/R Manager: Jeon Langosz
Sales Manager: Lucio Panicchi
International Dept: Primo del Comune
Domestic labels: Sain Martin
Sales Agents: 3
Stores: 1

SOCIETA' TREVISAN COMBO RECORD

Corso Europa 16, Milano
Tel. 799158
Telegraphic Address: Trevisancombo Milano
President: Aldo Speriani
General Manager: Mario Trevisan
Domestic labels: Saint Martin
Sales Agents: 7
Stores: 7

TIFFANY RECORDS

Galleria del Corso 2, Milano
Tel. 793896
Telegraphic Address: Mariart
President: Anna Scotta
General Manager: Marino Marini
A/R Manager: Beppe Cardile
Sales Manager: Pino Paschetto
International Dept: Maurizia Foladore
Domestic labels: Tiffany
Distributed by MPM

VEDETE RECORDS EDIZIONI FONOGRAFICHE

Corso Europa 5, Milano
Tel. 780046
General Manager: Armando Sciascia
A/R Manager: Armando Sciascia
Sales Manager: Sergio Sciascia
International Dept: Aliko Andris Mikalaros
Domestic labels: Corsair, Tempo, Vedette
Foreign labels: Ember Record
Sales Agents: 17
Stores: 2

VIS RADIO

Corso Umberto 1 132, Napoli
Tel. 322705
Telegraphic Address: Vis Radio Napoli
President: Aldo Scopa
A/R Manager: Gino Conte
Domestic labels: Vis Radio, Dominator
Recording Studio: Via Pupa Caiafa 36, Napoli
Sales Agents: 14
Stores: 2

ITALY—The Past 12 Mos.

(Continued from page 125)

with the American and now the English companies.

Continuing our report, we have noted an increasing interest by part of the Italian record industry in the classical field, which of course, consists entirely of LP's.

We have also noted that the greatest interest in classical recordings is shown by those firms who have a big distribution. They build up a classical catalog which sells constantly throughout the year.

We should also mention the increasing interest by part of the Italian public in classical disks. As we reported in our review last year this interest has been awakened by special

initiatives taken by different record firms.

Record companies that have taken special initiative in the classical field are (in alphabetical order): Bluebell, CBS Italiana, Cemed Carosello, Clan Celentano, CDI Compagnia Discografica Italiana, Decca Dischi, EMI Italiana, Fonit Cetra, Meazzi, Phonogram, RCA Italiana, Ricordi, Ri.Fi., Saar and Vedette.

Particular attention has to be paid to the classical releases originally made in Italy. This is because with the lifting of customs in 1968 for the countries in the European Common Market, there will be a larger market for these disks. Classical products are the only ones that can be easily and directly exported in all the countries and are not subjected to local releases and local promotion. Companies that

(Continued on page 128)

in the bag of Tiffany
a new discovery:
NIKY



TIFFANY Records
Galleria del Corso 2
Milano (Italy)
phone 793.896

WE ARE BUILDING A NEW HOUSE

A new house for a new record firm

A new record firm associated to an old publishing firm

An old publishing firm known all over the world

known all over the world thanks to this hits

«Mamma» «Vivere» «Violino Tzigano»

«Portami tante rose» and others

The name of this firm is

BIXIO

The name of the record firm is

CINEVOX

We produce pop music and film soundtracks
You will ear a lot about us!

CINEVOX Records

associated to Edizioni Musicali BIXIO

**Via Borgogna 7
Milano (Italy)**



STUDIO M

ITALY—The Past 12 Months

(Continued from page 127)

have an original product in hand will take advantage of this new situation. We have to mention in this case Saar and Vedette. They have already attentively examined the whole situation and have already produced a line that is destined to be exported directly in the Common Market area.

Saar has pressing plant facilities and this represents a further aid in meeting the particular requirements of this new market.

The opening of the Common Market area presents the Italian industry with new problems, which are not limited to the classical lines, but will be extended more or less to the entire LP field. Because importation will now be as easy as exportation, wholesalers can create on the inside market direct competition with every record sales organization.

Italy is considered the fourth market on the European continent, and while England, Germany and France, are already stable, we are still developing.

The strong inside competition has already created some troubles in our record industry, and as a first consequence the retail prices of LP's, especially classical ones, have slid down, reducing subsequently the profits of our industry. What will happen when the market is open to external competition?

As far as the low-priced series are concerned, there has been a tendency to standardize the price of mono and stereo albums. Last year we quoted for the albums a minimum price of Lit. 1.650 (\$2.66) and a maximum of Lit. 4.400 (\$7.10). This year the minimum retail selling price for albums is Lit. 1.500 (\$2.27) with a maximum price of Lit. 3.300 (\$5.32). We have noted a dangerous tendency on the part of some retailers to sell LP's at Lit. 1.200 (\$1.93). This price is actually reserved for a restricted class of disks, without peculiar artistic or technical characteristics.

This sinking of prices is not yet alarming, but it will become serious, when the really big competition arrives from the other members of the European Common Market.

It is to be noted that the price of Lit. 1.500 for classical albums has already been assumed as a definitive price by some record firms, and this is also the price fixed by CBS Italiana during their latest convention in Riccione, at the beginning of June, for their low-priced series.

The competition is expected to be even stronger when other firms enter the classical LP production. We know that five other Italian record firms are preparing to start classical music lines and are looking for classical material. These firms are Ariston, Det Record, Bentler, GTA, and Tiffany.

The situation in the pop album field is less difficult. During the past 12 months, we have noted on the part of the top Italian record firms a tendency toward more coordinated activity in releasing LP's. In many cases a prepared schedule of production is followed.

The success of an artist on LP's usually follows his success on singles. The coordination of releases depends on able A&R managers. Among the best-known are Ettore Zeppegno of RCA Italiana, and Giampiero Ricci, who is responsible for the Tamla Motown success here, Aurelio Ajroldi and Giampiero Scussel of Durium and Enrico Piccaredda. We wish to stress that Giampiero is responsible for the big success here of Rocky Roberts. Also to be mentioned are Franco Crepax and Giuseppe Giannini of CGD/CBS Italiana and Sandro Colombini, who recently joined Dischi Ricordi after a former association with Clan Celentano. Responsible for the Ri.Fi product are Tonino Ansoldi, Bruno Martelli and Gianfranco Intra. Also to be noted is Luigi Negro of Decca Italiana, who is responsible for the release of some pop LP's derived from the Decca repertoire. We wish to con-

clude the list by mentioning Sergio Bono of EMI Italiana.

These gentlemen are responsible for the 30 best selling singles in Italy during the past twelve months.

Now we wish to examine these disks. It is interesting to note that among these 30 top hits, only fifteen are in the "beat" or "rhythm & blues" style. Also it is interesting to consider that the "beat" hits listed on our charts were for the most part released in 1966, while the R&B hits have all been released during the past twelve months. It is a clear symptom that rhythm & blues has many fans on our market.

By the way, even if it is not derived from the examination of the top 30 charts, we have to take the view that there are clear signs also of the return of Latin-American music on the hit scene. Some promotions which are in effect during the summer of 1967 are clearly demonstrating a certain tendency toward the Latin style. Some top new releases are directly devoted to Italian versions of South American original copyrights.

Going on with a study of this top 30 chart, it is necessary to stress that it is again confirmed that Italy is the country of the melody, in spite of fashion or trend: Fifteen of the 30 best sellers are flowing melodies, some of them International standards like "Strangers In The Night" (Frank Sinatra/CGD), others like "Un Mondo D'Amore" (Gianni Morandi/RCA) are in typical Italian style. Top position on the chart, with few exceptions, are covered by melodic releases.

There is also another consideration which will also serve as a confirmation of what we stated before on the San Remo song Festival: 5 of the 30 releases listed on the charts derive from the San Remo contest. Three of them are listed among the top 10 and the first, "Cuore Matto" by Little Tony (Durium) has sold over one million copies.

One also has to thank this contest as we have on the list 16 original Italian copyrights, while the other 14 are of foreign origin. 20 of the 30 releases are of Italian originals and only 10 of foreign origin.

The various record companies represented among this top 30 chart are: RCA Italiana, 7 releases; Ri.Fi, 5 releases; Durium, 3 releases; Ricordi, 3 releases; Carisch, 3 releases; CGD, 2 releases; EMI Italiana, 2 releases; Decca Italiana, 2 releases; Phonogram, 1 release; Saar, 1 release; and Clan, 1 release.

Another interesting consideration is that 13 of the 30 numbers listed on this hit parade are performed by groups and this is the most glaring sign shown by the "beat" fashion, which, by the way, has helped record firms reduce their investments in recording sessions, and making pass, quite unobserved, the musicians strike we had during the months of March and April.

This list can also indicate who have been the most successful artists on the Italian market during the past twelve months: Gianni Morandi (RCA Italiana) is listed with three disks among the top 30. Also I Giganti (Ri.Fi) has three records among the 30 best sellers, together with The Beatles (Carisch) with three records, too. Little Tony (Durium) is present with two disks, followed by Equipe 84 (Ricordi), also with two records, and by Adamo (EMI Italiana) and The Rolling Stones (Decca), also with two releases listed among the top 30.

Another consideration derives directly from the examination of this best sellers list: while until the last year, we had to put an accent on the activity of the indie record producers, we have to note now that this phenomenon is tending to disappear. This is directly connected with the improvement of the internal organization of each record firm: among the artists listed on our best sellers list, only Gianni Morandi and Rita Pavone (both of RCA Italiana) have been released through an indie record producer, who in the case of Gianni Morandi is Franco Migliacci, and

(Continued on next page)

ITALY—The Past 12 Months

(Continued from preceding page)
in the case of Rita Pavone, Teddy Reno.

Of course, the success of these disks does not only depend on the production departments, but it is also directly connected with the promotion activity developed by each record firm. In this connection we wish to conclude our review, as fast look into the promotional activity of our record market.

Promotion and Promotional Media

It is interesting to note the great importance that is attached by the record companies to the promotional department. All Italian record firms have a promotional department. Promotion, together with artistic production, seems to be the principal pitch of the record activity.

Top promotional media are of course TV and Radio. This media in Italy are in the hands of Rai Radiotelevisione Italiana, a unique monopolistic company directly controlled by the state.

We do not have particular changes to report in the general policy of our Radio TV Company during the past twelve month period. After the "changing of the guard" reported last year, when a young, dynamic executive took over the reins of the monopolistic organization, we have had TV and Radio programs more suitable to the taste of the public and in the case of musical programs, closer to the real trend of the market.

For the past twelve month period, we have to mention two TV programs which have been organized, taking into direct consideration the trend of the music market: a series called "Settevoci" and another weekly called "Diamoci Del Tu" conducted by two top young talents Giorgio Gaber (Ri.Fi) and Caterina Caselli (CGD).

Speaking about radio broadcastings, radio here is having a second youth. Record production is addressed to young people. After the big success

of the weekly transmission "Bandiera Gialla" (Yellow Flag), which was the first program entirely devoted to youth, other similar programs have been organized. The Italian Radio has discovered the disk-jockey and has created new broadcasts entirely devoted to pop talents and pop music.

Among the most popular of these young Italian disk jockeys are Gianni Boncompagni, conceiver and producer of "Bandiera Gialla," Renzo Arbore, Adriano Mazzeletti, and Sergio Gigli.

This change of policy of our Radio Monopoly was more forced than desired. Two radio stations immediately near to the Italian borders started two years ago a series of daily transmissions devoted to the Italian public (in Italian language). We refer to Radio Montecarlo and Radio Capodistria, both located in the resort towns. First station is covering the Tirrenic coast, while the second one is heard along the Adriatic coast. Particularly interesting is their activity during the summer season, when radio programs are specially followed. Both stations are commercial and for this reason they have established direct connections with Italian record firms, offering a strong promotional media.

This competition to our Radio TV organization becomes stronger every day, and our Radio TV setup was compelled to renew its programs and productions. We have to thank this competition for having brought about an improvement of our radio transmissions.

Of the other branch of the promotional organization and of the promotional media, there is not too much to say: Jukes have increased again during the past twelve months. In four years the number of units has quite doubled. This is also a further confirmation of the expansion of our record market. Juke boxes have of course developed their weight as promotional media.

A reason of the increase of the

number of juke boxes existing on our market, is due to the special organizations that have been created with the purpose of distributing records only to juke box operators. These facilities have convinced many of them, to enter the field, or to increase the number of sets. We wish to mention two of these organizations: ODJB and Jukebox Service, both located in Milan.

The price of a single disk to be sold to these organizations has been generally fixed in Lit. 350 (\$0.56). Further discounts are only granted in case of special promotional campaigns, but, in this field, with a direct contact between record firm and the organizations of distribution there are not special problems involving this promotional media.

As far as press-oriented promotion is concerned, there are no special problems. Particular interest is shown by part of the record industry to the trade press which can directly influence the distribution organizations such as wholesalers or retailers, as well as to the specialized press.

Particularly during the period we examine (three magazines already mentioned in our past copy) have acquired a particular weight on the music market. These magazines are Ciao Amici, Big and Giovani. Ciao Amici and Giovani started as monthly magazines, but they have been changed, into weekly editions. These magazines have all an average circulation of about 150,000 copies per week, they have a considerable promotional power. Record firms are giving particular attention to them, especially in case of promotional campaign on new talents or for some particular releases.

A place completely apart is reserved to the weekly magazine "Sorrisi E Canzoni" published by Campi. This magazine is one of those with a biggest circulation in Italy: 1,000,000 copies per week. This magazine is devoting a great part of the space to musical events, and as a matter of fact, even though not directed to a specified section of the public, has a considerable promotional power, with an average circulation of 150,000

copies per week. There is also another magazine which (more or less) is of the same category of Sorrisi E Canzoni, this magazine is called "Settimana Radio E TV". As indicated by the title this magazine is devoted principally to top events of Radio and TV.

Please note that all these magazines, with the only exception of Settimana Radio E TV, are publishing record charts. Another magazine, also being not specialized in music and record arguments, is devoting a good part to the musical life: this is Bolero Film, which also sports a record chart. This weekly magazine has an average circulation per week of about 250/300,000 copies.

Going back to the trade press, we have to mention two magazines devoted to the Italian market: they are Musica E Dischi published monthly, and Discografia Internazionale published twice per month. Discografia Internazionale started its publication in Nov. 1966.

International press is represented in Italy by Cash Box.

Publishing Activity

As we had the occasion to state many times in our editorials, the record industry is playing a prominent role on the musical market. The real industrial activity is concentrated in the hands of phonographic producers, while the publishing activity shall (here) be considered as a subsidiary of the record industry.

This phenomenon is similar in all countries, but we think is particularly emphasized in Italy. All top musical enterprises, with only one or two exceptions who have born firstly as music publishing companies, have shifted little by little towards record production and have now made of this their main activity. Outstanding cases are those of Ricordi and Sugarmusic which (born as music publishers) are listed now among the prominent record industries; particularly in this case Sugarmusic who started producing records with the associated record

(Continued on next page)

CAMPI editore

ESTABLISHED SINCE 1898

IS

WHERE

ACTION

IS

IN MUSIC

BUSINESS IN ITALY

ROME ■ VIA VIRGILIO. 8
ITALY

THE NEW RECORD COMPANY OWNED LABELS



DET-DET INTERNATIONAL
CAM. TANK
INDEPENDENT DISTRIBUTION

THE SOUND TRACKS PRODUCTION AND PUBLISHING FIRM



OVER 700 SOUND TRACKS
RELEASED IN 5 YEARS INCLUDING:
FELLINI 8½, MONDO CANE,
DIVORCE ITALIAN STYLE,
JULIET OF SPIRITS AND OTHERS

THE MUSIC AND ENTERTAINMENT WEEKLY MAGAZINE



VIA VIRGILIO, 8 - TELEFONO. 314-341
ROMA

SOLD OVER 1,200,000 COPIES
WEEKLY

* INTERNATIONAL AGENCIES

C.A.M. U.S.A., INC.

370 LEXINGTON AVENUE
SUITE 2208, NEW YORK, N.Y. 10017
U.S.A.

JAPAN C.A.M.

c/o TOWA CO., LTD.
PLAYGUIDE BLDG. NO. 2, 2-CHOMEGINZA
CHUO-KU, TOKYO, JAPAN

CAMPANA

8 RUE de HESSE
1211 GENEVA
SWITZERLAND

ITALY— THE PAST 12 MONTHS

(Continued from preceding page)

company CGD/Compagnia Generale Del Disco, and have established a pressing plant and a complete record sales organization. They are also associated with CBS Italiana.

Having lost its industrial characteristics (with the complete discontinuance of the sheet music sales) and being considered as subsidiary to the principal activity of record production, music publishing still covers a prominent role in the economical cycle of the musical industries. This is the reason that has pushed most of the top record firms to start an activity in the publishing field.

During the period in which the record activities passed from an "artisan" stage to a real industry (in years from 1958 to 1963) it seemed that the publishing activity should have been destroyed by the new enterprises, but now, that the record industry has reached (in Italy) a maturity point, and also a point of stability, the publishing enterprises seem to have found a new position in the musical creations. Now that the record producers are looking for highest qualities in their product, the cooperation of the music publishers that have to supply to them with the raw materials for their releases, seems to be indispensable, even if at this stage the demand should have been satisfied directly by the inside publishing organization of the record firms. As a matter of fact, the record producers prefer (in order to be sure to create a better production) to extend their researches on all available repertoires.

Of course first in taking advantage of this state of things, are the large publishing groups, with a great number of repertoires at their disposal: these big publishing organizations have recently reinforced their influence on the music market, but at the same time also emphasized the artisan activity of little pubberies able to deliver to the record industries, the particular tune they need.

In the present organization of the record market, the promotional help with which the publisher was able to contribute to the success of a disk has lost much of its importance in view of the big promotional organization of each record enterprise.

Thus, the record producer's concern for the artistic and commercial value of the material, seems to exceed his interest in cooperating with the publisher for the success of the release.

This of course has, as an automatic result, a reduction of the share of profit of the publishers, who, in the case of little enterprises always have to transfer a share of their profits to the record enterprises. This, which in the past was considered as a lamentable state of affairs, is now quite accepted, and it finds justification in a rising economy of the market.

We have noted, by the way, during the twelve month period on which we are reporting, an increase in the initiatives taken in the publishing field on the part of single persons (authors or composers, for instance) who prefer to act independently as publishers even if submitted to the range of influence of some record firms, who, by the way, without any beaucocratic or financial engagement, can obtain what they need for their production, still maintaining their share of profits.

We have noted a development of this phenomenon mostly in Rome which is the second musical center of Italy, after Milan. Of course these are only embryonic symptoms, but in our opinion they are destined to develop further in the future.

Big publishing groups, especially with the representation of top foreign catalogues, are reinforcing their position, but this is justified by the fact, that through their own organizations, they participate directly in the promotion of record product, and, in this case, are partly responsible in the final success of the disk.

We can underscore this conclusion by examining the already mentioned Top 30 list of the past twelve months. Of the 30 hits listed, 13 are owned by top publishing groups (Ariston one

ITALIAN RECORDING STUDIOS

A
ACUSTICA ITALIANA—Via XX Settembre 122, Roma—Tel. 474,139—489,761
ANGELICUM—Piazza S. Angelo 2, Milano—Tel. 654,610
AUDIO EDIZIONI PAOLINE—Via Castro Partico 21, Albano (Roma)

B
B D M—Via S. Petronio Vecchio 27, Bologna

C
CARISCH—Via Monviso 17, Milano—Telefono 389,317
CINEVOX—Via Gregoriana 16, Roma—Telefono 686,486

D
DAUNIA—Via Lecce 31, Foggia—Tel. 23,632
DIRMAPHON—Via Pola 15, Roma—Telefono 84,44,002
DISCHI RICORDI S.p.A.—Piazzini dei Cinque-Cento 1, Milano—Tel. 530,394
DISCOGRAFICA ROLFILM MUSICALE—Corso Valdocco 11, Torino—Tel. 511,719
DURIUM S.p.A.—Via Troya 7, Milano—Tel. 470,778

E
EUPHON—Via Principe Amedeo 12, Torino—Tel. 541,441

F
FONIT-CETRA S.p.A.—Via Bertola 34, Torino—Tel. 57,53; Via Meda 45, Milano—Telefono 84,32,551; Via Nicola de' Cesarini (P.zza Argentina), Roma—Tel. 565,451
FONOLA—Via Leopardi 25, Milano—Telefono 872,882
FONOLUX—Piazza Cinecittà, Roma
FONORAMA—DI C.A. ROSSI—Registrazioni e doppiaggio—Via Barletta 11, Milano—Tel. 53,92,392—53,92,215
FONO ROMA—Via Maria Cristina 5, Roma—Tel. 382,051; Via Lumière 4, Cologno Monzese (Milano)—Tel. 91,23,073/4/5

I
INTERNATIONAL RECORDING S.p.A.—Via Urbana 172, Roma—Tel. 480,667—481,926

K
KRITES STUDIO—Via Biancamano 31, Roma—Tel. 753,850

L
LA VOCE DEL PADRONE—COLUMBIA—MARCONIPHONE S.p.A.—Via S. Eufemia 25, Milano—Tel. 802,622

title, Curci 6 titles, Ricordi 3 titles, Southern 2 titles, Sugarmusic one title), and have been recorded by labels not associated with the pubberies.

In this connection we have ascertained a decrease in the number of copyrights recorded by the record firms and owned by publishers associated with these firms.

In the Italian column in the 1966 Directory, we reported that 40% of the total tunes recorded in 1965/1966 were owned by publishing firms not associated with the record companies who released the disks, while 60% of copyrights recorded were owned by pubberies directly associated or connected with the record producers. This year the percentage of non-affiliated copyrights recorded has increased 4%, while of course the number of copyrights recorded belonging to the record firms has decreased 6%. The 2% difference indicates copyright owned by small independent publishing firms.

Although these changes are not startling, they may indicate a growing trend.

The increase in the percentage of recorded copyrights belonging to the big publishing groups is partially due to the fact that for most of the foreign releases copyrights are automatically assigned to publishers not associated with the record firms who release the disks. This is because of previous agreements, or because the top publishing groups, which existed on the market before the younger record organizations, are still preferred by the original owner of the copyrights; he still assigns his copyrights to them, even if his works initiated on disks.

There will be a change in this field in the near future, when contracts will be renewed, and the record firms will claim the assignment of sub-publishing rights for our country.

At this moment, it looks as though the labels will win their claim.

M
MEAZZI s.r.l.—Via Piatti 6, Milano—Telefono 867,361
MESSAGGERIE MUSICALI—Galleria del Corso 2, Milano—Tel. 794,841
MICROPHONE RECORD—Via Mantova 10, Milano—Tel. 593,053

P
PHONODORICA—Corso C. Alberto 58, Ancona
PHONOGRAM S.p.A.—Piazza Cavour 2, Milano—Tel. 790,071
PHONOTYPE RECORDS—Via E. De Marinis 4, Napoli—Tel. 322,694

R
RADIO VATICANA—Città del Vaticano, Roma
R.A.I.D.—Via Giolitti 10, Torino—Tel. 512,062
RAIFON—Viale XX Settembre 17, Trieste
RCA ITALIANA S.p.A.—Via Triburtina Km. 12, Roma—Tel. 416,041
RECORDING CENTER—Via Ampère 1, Milano—Tel. 23,66,146
RIVEL RECORD—Via Risorgimento is. 66 n. 23, Messina

S
SAAR—Via Gramsci 20, Pero (Milano)—Telefono 35,30,564
SAID RECORD—Via C. Battisti 67, Palmi (Reggio Calabria)—Tel. 209
SALAMONE F.—Via Frinco 30, Torino—Telefono 390,763
SAX RECORDS—Via Pietro Borsieri 41, Milano—Tel. 68,84,423
SELESPETTACOLO—Via Rovello 3, Milano—Tel. 865,747
SONIC—Via Gabriele Camozzi 1, Roma—Tel. 318,519
STEREO s.r.l.—Via Stromboli 18/20, Milano—Tel. 463,257
STUDIO ARLECCHINO—Corso Vittorio Emanuele 11, Milano—Tel. 799,690
STUDIO REGSON—Via Ludovico il Moro 57, Milano—Tel. 42,24,620
STUDIO 7—Corso Venezia 7, Milano—Telefono 700,027—782,407

T
TECNIPHON—Sala Barozzi—Via Vivaldo 7, Milano—Tel. 794,164
TITANUS—Via Sommacampagna 28, Roma—Tel. 471,741

V
VIS RADIO—Via Cupa Caiafa 36, Napoli—Tel. 386,184

ITALIAN RECORD PRESS MANUFACTURERS

G.B.F. COSTRUZIONI MECCANICHE—Via Vittorio Veneto 12, Bresso (Milano)

METALMECCANICA s.a.s.—Corso Magenta 44, Milano

NEGRI BOSSI & C. S.p.A.—Viale Europa 64, Cologno Monzese (Milano)

TCS—Via Fratelli di Dio 9, Novate Milanese (Milano)

TRIULZI S.p.A.—Via Vialba 56, Novate Milanese (Milano)

CANADIAN TRADE ORGANIZATIONS

AMERICAN FEDERATION OF MUSICIANS
17 Queen St. E.,
Toronto, Ontario

BMI (CANADA)
41 Valley Brook Drive,
Don Mills, Ontario

CANADIAN MUSIC CENTRE
559 Avenue Road,
Toronto 7, Ontario

ITALY'S PRESSING PLANTS

AMBROSIO DISCOGRAFICA s.a.s.—Via Brasile 9, Limito (Milano)—Telefono 90.46.185/6
AUDIO EDIZIONI PAOLINE—Via Castro Partico 21, Albano (Roma)

BELLU' F.lli s.n.c.—Via per Seregno 114, Seregno (Milano)

CALYPSO s.a.s.—Via Quintino Sella 91, Busto Arsizio (Varese)

CELLOGRAF SIMP—Via Maffucci 18, Milano—Tel. 371.130—371.171

C G D—Via Moretto 9, Milano—Tel. 712.497—714.370

CONDORELLI FRANCESCO—Via Maniace 11, Catania

DURIUM S.p.A.—Via Trieste, Erba (Como)—Tel. 61.426

EDISC—Vicolo Monte delle Capre, Roma
E.F.D.—Via D. da Settignano 10, Milano—Tel. 467.482—Stab. in Cambiagio

FONIT-CETRA S.p.A.—Via Meda 45, Milano—Tel. 84.32.551

FONOCROM—Via Martiri della Libertà, Bellano (Como)—Tel. 81.434

FONOLA—Via Leopardi 25, Milano—Telefono 872.882

INDUSTRIA FONOGRAFICA ITALIANA (I.F.I.)—Massimo Gorki—Strada per Zivido, San Giuliano Milanese (Milano)—Tel. 98.45.501

INDUSTRIA ITALIANA LINGUE VIVE NEL MONDO—Via IV Novembre 5, San Colombano al Lambro (Milano)

ITALMUSICA—Ripa Ticinese 75, Milano—Tel. 84.86.270

LA VOCE DEL PADRONE—Via Domenico 14, Milano—Tel. 434.041; Viale Umbria 37, Milano—Tel. 540.526/7

MAPLAST—Via Teocrito 23, Telefono 25.76.586

MICROWATT DI CAGNOLA CLEMENTE—Via Principato 2, Vignate (Milano)—Tel. 62.209 Dischi normali e su laminato plastico—Cartoline sonore.

NOVOPOL—Via Chioggia 10, Milano
NUOVA ENIGMISTICA TASCABILE—Via Massaia 98, Firenze

PHONOGRAM S.p.A.—Via Benadir 14, Milano—Tel. 28.26.241

PHONOTYPE RECORDS—Vicoletto S. Giovanni Maggiore 5-6, Napoli

RAIFON—Viale XX Settembre 17, Trieste
RCA ITALIANA S.p.A.—Via Tiburtina km. 12, Roma—Tel. 416.041

RI-FI RECORD CO.—Via Durazzo 2, Milano—Tel. 293.953

SAAR—Via Gramsci 20, Pero (Milano)—Telefono 35.30.564

SIRONI ANGELO—Via Cavour 65, Novate Milanese (Milano)

ITALIAN CARTRIDGE REPRODUCTION STUDIOS

DUREMA S.p.A.—DUPLICAZIONI E REGISTRAZIONI MAGNETICHE—Via Marsala 7, Milano—Telefono 664.161

S.I.L. S.p.A.—Via Giannone 10, Torino—Telefono 535.304

**SUBSCRIBE TO CASH BOX
TODAY
AND GET A COPY OF
THIS DIRECTORY
AS PART OF YOUR SUBSCRIPTION**

GROWING GROWING GROWING

ALL AROUND THE
WORLD



DISNEYLAND RECORDS INTERNATIONAL MANUFACTURERS AND DISTRIBUTORS

ARGENTINA
AUSTRALIA
BRAZIL
CANADA

CHILE

COLOMBIA
DENMARK
EL SALVADOR
ENGLAND

FINLAND
FRANCE

GERMANY

GREECE
ISRAEL
ITALY
JAPAN
MEXICO
NETHERLANDS
NEW ZEALAND

NORWAY
PERU
PHILIPPINES
SOUTH AFRICA
SPAIN
SWEDEN
VENEZUELA
YUGOSLAVIA

PHONOGRAM S.A.I.C.
E.M.I. AUSTRALIA LTD.
RCA ELECTRONICA BRASILEIRA
WALT DISNEY MUSIC OF CANADA
LIMITED
Distributor: Capitol Records (Canada) Ltd.
CORPORACION DE RADIO DE CHILE
S.A.

DISCOS ORBE LTDA.
SKANDINAVISK GRAMMOPHON
DISCOS CENTROAMERICANOS S.A.
WALT DISNEY PRODUCTIONS, LTD.
Distributor: E.M.I. RECORDS
(The Gramophone Co. Ltd.)

OY R. E. WESTERLUND AB
WALT DISNEY PRODUCTIONS
(FRANCE)

Distributor: A.D.E.S., S.A.
WALT DISNEY MICKY MAUS G.m.b.H.
Distributor: Electrola Gesellschaft m.b.H.
GENERAL PUBLISHING CO., LIMITED
HATAKLIT LIMITED

Distributor: CAROSELLO C.E.M.E.D.
Nippon Columbia Company Ltd.
RCA VICTOR MEXICANA
BOVEMA
HIS MASTER'S VOICE (N.Z.) LTD.
(E.M.I. Manufacturing Limited)

CARL M. IVERSEN A/S
EL VIRREY S.A.
DYNA PRODUCTS, INC.
GALLO (AFRICA) LTD.
HISPAVOX S.A.
SKANDINAVISKA GRAMMONPHON
VENEVOX, C.A.
GRAMMOPHONE RECORD
PRODUCTION

BUENOS AIRES
SYDNEY
SAO PAULO
TORONTO

SANTIAGO

BOGOTA
COPENHAGEN
SAN SALVADOR
LONDON

HELSINKI
PARIS

FRANKFURT

ATHENS
HAIFA
MILAN
KAWASAKI
MEXICO D.F.
HEEMSTED
WELLINGTON

OSLO
LIMA
MANILA
JOHANNESBURG
MADRID
STOCKHOLM
CARACAS
BELGRADE

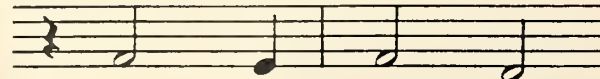
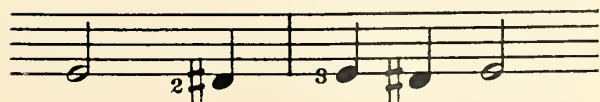

© 1967 Walt Disney Productions

These are!
our Artists

Discos



**LORENZA LORY
CHUCHO RINCON
LUIS PEREZ MEZA
GUSTAVO PIMENTEL
GINA MORET
ENRIQUE RAMBAL
VERDAGUER
LOS DELFINES
TRIO ROMANTICO
LOS DUENDES**



**ENRIQUE GUZMAN
SILVIA PINAL
ARTISTS:**



Distributed by
Discos Cisne, S. A.

**IF YOU ARE INTERESTED IN
DISTRIBUTION WRITE NOW!**

**Discos Cisne, S. A.
Carracci No. 64
México, D. F. - México**

GENERAL POINT OF VIEW:—No big changes have happened in the last 12 months in the record industry. After more than ten years, the ghosts of the dead idols are still alive in the mind of the people. Mexican idols like Jorge Negrete, Pedro Infante (the biggest of all of them) and the recently deceased Javier Solís, still have enviable record sales. The new Mexican talents, some of them who have quality and projection, don't mean much to the people and their sales are irregular. Maybe this is because the foreign recordings have taken an important place in the Mexican record market.

As was the case some years ago, the bolero rhythm and the trios (traditional music and singers) are still out of favor with the public and only the bolero ranchero (a modern style of Mexican folk music) is really strong, as is tropical music, folk music and old catalogs. Foreign music in foreign and domestic versions is on the upswing and is taking an important part in the selling budgets of the record companies.

Nevertheless, the situation in the record industry is not bad at all. The sales averages have been increasing and plans for the future are rosy.

POPULATION:—México has a population of 40,000,000 people and the city of México has six and a half million inhabitants. The minimum salary is \$60 a month and we may consider that an average family income in the big cities of the 28 states of the republic is around \$100. And the prices of the records in single, extended play and long play are much like those in the United States, while the record players are much more expensive. So, with these statistics, a big hit in México may sell between 20,000 and 25,000 copies and when it passes 100,000 copies, as very few did, it is considered a golden record. All these things may be of interest to an American or European label who wants to ask a guarantee of 10, 20 or 30 thousand dollars for the distribution of its label in México. It is simply impossible.

FUTURE OF THE RECORD BUSINESS IN MEXICO:—As previously noted, perhaps the main problem Mexico has always had has been the high prices of the record players which are prohibitive to the masses. This problem is being studied very seriously by the members of The Amprodis (Mexican Association of Record Producers) to find a record player with quality but with a cheap price that could increase the selling volume.

Another interesting point is record distribution through the whole nation and foreign countries. It is getting better each day and the relations with record people in the countries of Latin America, the United States and parts of Europe and the Orient are better than ever and, therefore, the sales are increasing.

Very interesting are the facilities that the government has provided to promote the artistic life in México, especially in the capital, where the new regent has given facilities to open new entertainment places, even promoting concerts and auditions in public places, that have opened new working mediums for the artists and the new talents that indirectly benefit the recording companies. In the city of México there are more than 30 first class night clubs, besides the second and third class places, which all have many artists constantly working.

Besides the radio stations (more than 500 in the country), the TV channels cooperate to promote the record business through their musical shows. By the end of the year, two new channels will be operating in the

city of México and that obviously will help to create, popularize and promote talents, with the help of the four channels already in the Mexican capital.

The self-promotions of the record companies are operating more professionally now. The budgets of the advertising and promotion departments have increased and the artists receive more and better attention than before. The newspapermen now have better information to promote artists and to provide more information about their jobs. The deejays are more conscious now of the labor of the recording companies and their artists and are cooperating wonderfully with all of them.

Many companies are working now in special surveys to discover what the people like best, what they would like to listen to and to buy, their preferences and what they dislike, the advertising and promotion for definite areas of the best consumer country; the public relations between record agents and record sellers, between promoters and deejays, the incentives for their best selling artists, and so forth. México does not have the perfect system or selling, promotion and distribution, but it is doing its best, that is the most important thing. Perhaps México has just started, but the first step has been taken.

All these things sound good, because mainly, there is enthusiasm to work for a better future in the record field. There are still many things to do and Mexico is conscious of this, but it is ready to work for them. Perhaps one of Mexico's dreams is to want to be the leader of Latin America in the music and record field, and it will try hard to get there.

GENERAL GLANCE AT THE RECORD COMPANIES IN MEXICO:

RCA:—This company is looking for new A&R elements, preferably new in the music field. Names like Eduardo Magallanes, Maricarmen Cirici, Okamura and others, are under the direction of Rubén Fuentes to invigorate the music production. In the advertising field, this department is split now by Guillermo Infante, who also is general sales manager and who has under his direction Raul del Valle and Federico Gutierrez. Louis Couttolen, Jr., president of RCA, wants to renew the company in some departments and he is demonstrating it. RCA is still the number one record company in México.

CBS:—As with RCA, Manuel Villarreal, president and General director of this company, is creating new administrative and production ideas to increase sales. Luis Bastón has been named coordinator of the A&R department, while Armando de Llano, vice president and general manager, is in charge of the administrative work of this important label, where Raul Bejarano is handling the sales department.

MUSART:—Eduardo L. Baptista, president of this company, has put special attention on foreign distribution and has created offices in Miami and some parts of Central and South America. This company has lately contracted several Central and South American artists, who are recording in México under the direction of Guillermo Acosta. Luis Gil, who is the vice president of this company, has given special attention to the promotion and advertising department. He has a most valuable collaborator in the person of Jesus Acosta, who also is directing their TV shows. The sales department under Jose Luengo, is working as well as always.

CAPITOL:—With less than two years in the Mexican music market, Andre Midani, general manager of

this company, has done a great job in the music industry. He started this company with new elements in this field and names like Alfredo Gil, Jr., in the A&R department, René Leon in the international catalogue, Miguel Delgado in the advertising department, Sergio Nuñez Flacón in the promotion and public relations jobs, and Arturo Valdéz, who has become a good sales manager. This company is already figuring as one of the most important in México.

ORFEON:—This is a 100% Mexican company which began to build a Mexican catalog without the help of any foreign catalog to distribute. Its dynamic president and owner, Rogerio Azcárraga, and its general director, Alejandro Siegrist, have created a new factory with the most modern equipment with 24 record presses and the newest models of machinery required for the recording process. They also handle the Motorola radio and TV industry and the cartridge assemble, all of them costing many million pesos. Porfirio Reyna is doing a nice job in the Orfeon's speciality of new wave recordings, and Paco de la Barrera is working hard on the standard catalogs.

PEERLESS:—The great experience of its president Heinz Klinckwort, and the hard work of its general manager Leo Porias, maintain this company's good sales, especially in the interior cities of the country. Two new and young A&R men are now in charge of the new Peerless music production and they are doing their jobs well. Roberto Salinas is promoting and advertising in the right way, and Bruno Vogt is directing his efforts to the province, the Latin sections of the United States and Latin America, in addition to the Mexican capital.

GAMMA:—This is the case of a "small" record company that became in a short time a "big" label due to the distribution of foreign records, thanks to the labor of one man, Tomás Muñoz, who with wonderful vision and intelligent work, has made this a most profitable business. Now, Muñoz is in the United States in a study plan and the company is now in the hands of Carlos Camacho, who has been named assistant general manager, and who is a man of great experience and will continue the labor of Muñoz, assisted by the young executive Luis Moyano.

DUSA:—This is the company that handles the catalog of Philips, Polydor, Deutsche Grammophon, Verve, MGM, Mercury and many other labels. Dusa, a new organization commanded by its new general manager, Hans Schrade, is described in another part of this Mexican Review. Meanwhile Agustin Hernández is the sales and promotion department, Edgardo Obregón and Salvador Arreguin in the A and R department, are working closely with him.

TIZOC:—This is also a relatively new company directed by a dynamic young man, Mario Freidberg, who is the vice president of the label. He is now in the process of enlarging the company. Several new executives will definitely give this company the importance of the big ones.

CISNE:—This is the newest record company in México City, but also the biggest in plans for the future. This company has presses and machines, and its artistic catalog has been going well. Rafael Ficacchi is the owner and president of this company and has chosen dynamic people to augment an important catalog for the future.

RCA VICTOR MEXICANA S.A. DE C.V.



MARCO ANTONIO MUÑIZ JOSE ALFREDO JIMENEZ SONIA "LA UNICA" MIGUEL ACEVES MEJIA LOS HERMANOS CASTRO PABLO BELTRAN RUIZ HERMANOS RIGUAL IMELDA MILLER ROSA DE CASTILLA



HUGO AVENDAÑO SAGRARIO BAENA AMALIA MENDOZA LIBERTAD LAMARQUE PEDRO VARGAS LA RONDALLA TAPATIA CESAR COSTA LOS TRES DIAMANTES



MAYTE GAOS LA PRIETA LINDA ALEJANDRO ALGARA LOS DANDYS PEPE JARA MANUEL BERNAL LOS CUATRO HERMANOS SILVA VIRGINIA LOPEZ



MARIACHI VARGAS DE TECALITLAN LOS VIOLINES DE VILLAFONTANA ALVARO CARRILLO MARIA VICTORIA ARMANDO MANZANERO LUPITA PALOMERA FERNANDO VALADES GILBERTO VALENZUELA



YOLANDA Y SU TRIO PERLA NEGRA CARMELA Y RAFAEL BENITO HERNANDEZ LAS CHIC'S LOURDES BALEDON ESTRELLITA NUÑEZ MARIO MAYITA Y KIKO



COMPARSA UNIVERSITARIA DE LA LAGUNA ROBERTO JORDAN MARIA LUISA LANDIN LOS TRES ASES LOS MOONLIGHTS LUPE Y RAUL



REBECA JOSEFINA Y JOAQUIN LOS BRILLOS LOS ZIGNOS HERMANITAS JIMENEZ MARIANO MERCERON



CARLOS AMADOR JR. HERMANAS HERNANDEZ LOS BRIBONES TOMMY LOPEZ DARIO SOTELO CHUCHO ZARZOSA PANCHO PANTERA JUAN ANTONIO

MEXICO — MUSIC PUBLISHERS

AMPEN-MEXICAN ASSOCIATION OF PROMOTERS AND PUBLISHERS OF MUSIC, S.C.
 President: José Márquez
 Address: Av. Chapultepec #43
 Public Relations: Rogelio Brambila

BRAMBILA MUSICAL MEXICO, S.A.
 President: Rogelio Brambila P.
 Address: Av. Cuiclahuac, 2305
 México, D.F.
 Phone: 27-66-67

Affiliated to:
 USA: Ardome & Beechwood, Morris Music, Moonlight Music, Central Songs, Walt Disney, Zodiac Music, Walter Hoser, Harros Interprice and Montlare Music.
 Argentina, Chile and Uruguay: Julio Korn, Alfredo Perrotti, Ricordi Brasilena and Editorial Lagos.
 Columbia: Ecomus.
 Ecuador: Sadram and Mel, Ecuatorianas, S.A.
 Brasil: Irmaos Vitale y Euterpe
 Venezuela: Evmi.
 Spain: Canciones del Mundo, Hispa-Vox
 Gramofono Odeon, Luis Araque, Quiroga and Universal Jazz.
 Germany: Edition Accord, Edition Montana.
 France: Pathe Marconi, Eddi Barclay
 Italy: Voce del Padrone.
 England: Ardmore and Beechwood, Good Music.
 Japan: Toshiba Music Publishing.
 Australia: Castle Music Publishing.

CAMPEI (CORPORATION ARTISTICA MUSICAL, PRODUCCIONES Y EDICIONES INTERNACIONALES)
 General Manager: Javier Ochoa Valle
 Cumbres de Maltrata #375-A
 México 12, D.F.
 Phone 43-71-40
 General Manager: Javier Ochoa Valle
 Artistic Representations: Alfredo Marcelo Gil, (Gil and Gil)
 Professional Dept. Alfredo Gil Jr.
 President: Alfredo Gil
 General Director: Leodegario Hernández Campos
 Consolidated Music Publishers Inc.
 Music Publishers Holding Corp.
 Mills Music, Inc.
 Japan: Kusano Music, Inc. and Shinko Music Publishers Co.
 Larry Shaye Music Inc.
 Music Samous Corp.
 Sam Fox Publishers Co. Inc.

COMPAS-EDICIONES COMPAS, S.A.
 Av. Insurgentes Sur #300-Condominio
 México, D.F.
 General Manager: Jesús Martínez Ross

EMMI (EDITORIAL MEXICANA DE MUSICA INTERNACIONAL, S. A.)
 Manager: Mario Alvarez
 Address: Dr. Valenzuela #10
 México, D.F.
 P.O. Box 1465
 Phone: 21-03-31
 Affiliated to:
 USA: Southern Music Publishing Co., Inc.
 Peer International Corporation.
 Argentina: Editorial Argentina de Música Internacional, S. de R. L. (EDAMI)
 Brasil: Editorial de música Brasileira e Internacional, S.A. (EMBI)
 Chile: Southern Music International
 Columbia: Peer de Columbia, Ltda.
 Dominican Republic: Peer International Dominicana
 Ecuador: Emporia Musical, S.A.
 Puerto Rico: Peer International Corp. de Puerto Rico
 Venezuela: Peer International de Venezuela

(EMMI—Continued)
 France: Societe D'editions Musicales Internationales (S.E.M.I.)
 Germany: Peer Musikverlag G.m.b.h.
 England: Southern Music Publishing Company Ltd.
 Italy: Edizione Southern Music S.R.L.
 Spain: Editorial Musical Ibero Americana, S.A. Southern Music Española, S.A.

GREVER (GREVER INTERNACIONAL, S.A.)
 Address: Londres, 179
 México, D.F.
 General Manager: Teodoro A. Dehesa
 Assistant Manager: Enrique Márquez

MARQUEZ (HNOS. MARQUEZ, S.A.)
 Address: Av. Chapultepec, 43
 México, D.F.
 Phone: 12-02-28
 Managers: José and Ramón Márquez

MUNDO MUSICAL (EDITORIA MUNDO MUSICAL, S.A.)
 Address: Puebla 282-301
 México 7, D.F.
 Phone: 25-10-42
 General Manager: Mario de Jesús

PHAM (PROMOTORA HISPANO AMERICANA DE MUSICA, S.A.)
 General Manager: Luis Martínez Serrano
 Address: Dr. Valenzuela, 10
 México 7, D.F.
 P.O. Box 542
 Phone: 21-79-45 and 12-96-50

MEXI-MUSIC, S.A.
 Address: Av. División del Norte, 31
 México, D.F.
 General Manager: Mario Freidberg
 Affiliated to:
 Gene Autrey Four Stars Sales Co. U.S.A.
 Golden West Melodies Inc. U.S.A. Jat Music Inc. U.S.A.
 Weiss and Barry U.S.A. Western Music Publishing Co. U.S.A. Taj Music, U.S.A.
 Dick Yames Music Limited and Associated Companies (England)
 Seven Seas Publishing Co. Pty. Ltd (New Zealand)

FERMATA MEXICANA, S.A.
 Address: Av. División del Norte, 31
 México, D.F.
 General Manager: Mario Freidberg
 Representants:
 Ediciones Internacionales Fermata (Argentina S.R.L.)
 Editora e Importadora Musical Fermata Brasil Ltda.
 Commander Publications (U.S.A.)
 Editoriale Star. S.R.L. (Italy); Editoriale Clan S.R.L. (Italy); Edicione Leonardi S.R.L. (Italy)
 Charles Brull Ltd. (England); Keith Bros. Music Publishing Co. Ltd. (England)
 Peter Maurice Music Co. Ltd. (England)

EDITORIAL TEOCALI, S.A.
 Address: Av. División del Norte #31
 México, D.F.
 General Manager: Mario Freidberg
 Woomera Music Pty. Ltd. (Australia)
 Almo Music Corp. (U.S.A.); Irving Music Corp. (U.S.A.)

BEECHWOOD DE MEXICO, S.A.
 Address: Ayuntamiento #54
 México 1, D. F.
 Phone: 18-13-20
 Manager: René León
 Cable: Beechwoodmex.
 Catalogos: Beechwood, U.S.A.
 Ardmore & Beechwood (World Wide)
 Odeón, Pathé, etc.
 Beechwood de México

MEXICO RECORD MANUFACTURERS

RCA VICTOR MEXICANA, S.A. DE C.V.
 Av. Cuiclahuac 2519
 México 16, D.F.
 Phone: 27-60-20
 President: Louis Couttolenc, Jr.
 General Record Sales Manager: Guillermo Infante
 Labels: (Domestic) RCA Victor and RCA Camden
 Labels (Others) Dot, Walt Disney, Elenco and Buenavista.

DISCOS MUSART, S.A.
 Av. Cuiclahuac, 2327
 P.O. Box 17503
 México, 16 D.F.
 Phone: 27-00-20
 President: Eduardo L. Baptista.
 Chairman of the Board: Eduardo C. Baptista
 Vice President: Luis A. Gil
 Labels: (Domestic) Musart
 Labels: (Others) United States, Liberty, World Pacific, Prestige, Tempo, Time, Mainstream, Pacific Jazz, Colonial, Discuba, Brasil, Music Disc, RGE Colombia: Zeida, Venezuela: Fonograma, Spain: Zafiro, Germany: Arliola (Probable)

ORFEON VIDEO-VOX, S.A.
 Av. Universidad, 1273
 México, D.F.
 Phone: 24-25-01
 President: Rogerio Azcarraga
 General Director: Alejandro Siegrist
 Labels: (Domestic) Orfeón, Maya, Dimsa and Ariel
 Labels: (Others) Westminster, Whit Hall, King Records, Tico, Music Hall Artones Gramophone, National Records Library Inc., Roulette, Metronome, Barclay, Japan and U.S. Orion, Alambra.

PEERLESS DE MEXICO, S.A.
 Laguna Mayran 232
 México 17, D.F.
 Phone 45-63-40
 President: Heinz Klinckwort
 General Manager: Leo Porias
 Labels: (Domestic) Peerless and Eco
 Labels: (Others) London, Telefunken, Richmond, Vox, Del Norte, Seeco and Falcón.

DISCOS TIZOC, S.A. (Before Disco Importadora, S.A.)
 Av. División del Norte, 31
 México 12, D.F.
 Phone 43-72-41
 General Manager: Mario Freidberg
 Labels: (Domestic) Tizoc, Advanced
 Labels: (Others) A&M, Hi-fi, Fantasy, Life, GNP Crescendo, Challenge, Folkways, Monitor, Colpix, Elektra, Viking, Disk, Jokey, Nilser, Contemporary, Vedette, WG, Fuentes, Bluebell, Style fono color, Ri-Si Vault, Prosadis.

DISCOS UNIVERSALES, S.A.
 Río Tiber, 58
 México 5, D.F.
 Phone 14-34-72
 General Manager: Hans Schrade
 Labels: DGG, Polydor, Philips, MGM, Mercury, Verve, Fontana Archive Atco, Atlantic, Kamasutra.

DISCOS CAPITOL DE MEXICO, S.A.
 Ayuntamiento #54.
 México 1, D.F.
 Phone: 18-13-20
 General Manager: André Midani
 Labels: All the EMI Catalogue.
 Distributors in U.S. and Puerto Rico: Records Distributors of America; Central America: Dideca; Colombia: Codiscos; Perú: Industrias Electronicas y Musicales Peruanas, S.A.M.; Chile: Odeon; Brazil: Disco RCE; Venezuela: La Discoteca C.A.

CBBS COLUMBIA DE MEXICO, S.A.
 16 de Sept. No. 51
 San Bartolo Naucalpan, Edo. de México
 Phone: 33-20-80 and 27-62-20
 President of CBS Mexicana: J. Manuel Villareal
 Vice-Presidente and General Manager: Armando de Llano
 Commercial Manager: Raul Bejarano
 Labels (Domestic) CBS and Harmony
 Labels: (Others) Columbia, Harmony and Montilla.

DISCOS GAMMA, S.A.
 Ejercito Nacional 167
 México 5, D.F.
 Phone: 45-73-60
 President: Manuel Vidal Zapater
 General Director: José Tomás Muñoz
 General Assistant Manager: Carlos Camacho
 Labels: (Domestic) Gamma
 Labels: (Others) Hispa Vox, Warner Bros., Reprise, Pye, Chess Checker, Cadet, United Artist, ABC-Paramount, Imperial, Vanguard, Ducrette Thompson, Festival, Supraphon, Erato, Vogue and Command, Clan Celentano, Fonit Cetra, Proyecto III, Durium, Double Shot, Everest Alvorada, BWD productions.

DISCOS CISNE, S.A.
 Carracci #64
 México 19, D.F.
 Phone: 24-52-11 and 24-57-53
 President: Rafael Ficachi
 Labels: Cisne.
 Distributors of: Puchito, Marsers, Crown, Decca, HIR, Adria Acuario.

COMPANIA IMPORTADORA DE DISCOS S.A.
 Tenayuca, 475-F
 México, D.F.
 Phone 24-46-79
 President: Gabriel Mendóza
 Labels: Decca, Coral, Audio Mex, Brunswick.

SUSCRIBE TO CASH BOX TODAY AND GET A COPY OF THIS DIRECTORY AS PART OF YOUR NEW SUBSCRIPTION

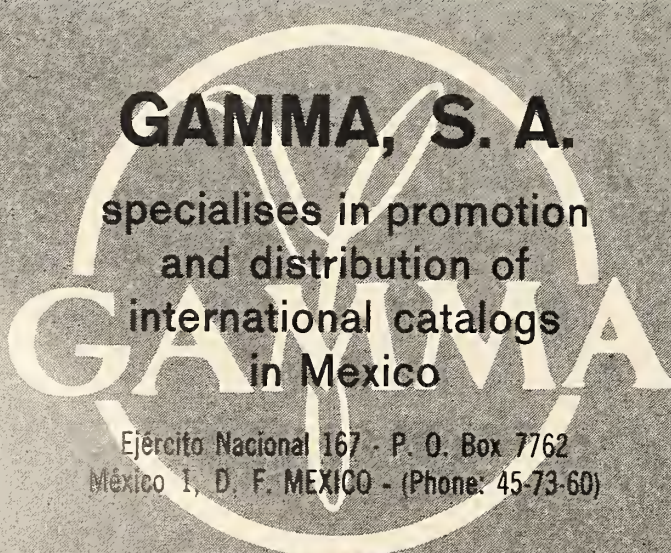

GAMMA, S. A.
 specialises in promotion and distribution of international catalogs in Mexico
 Ejército Nacional 167 - P. O. Box 7762
 México 1, D. F. MEXICO - (Phone: 45-73-60)

WHAT HAPPENS IN DISCOS UNIVERSALES S. A. ?



Everything began with Mr. Hans Schrade's arrival to Mexico City, who came directly from Germany to take over the General Management of that Company. In the new reorganization of Schrade's management the almost radical change of executives team was observed. Now there is a new group and some of them well-known in the industry for its capacity. They are developing the projects outlined by the company. On the other side, there is an immediate purpose, the expansion of their international activities, a better progress of the levels represented and also a radical change of their offices. But all of this are only conjectures eventhough its activities are known, they have been very discreet by not telling a word yet, that may be published regarding all mentioned above.

Meanwhile, the Mexican record industry in general, as well as the press, radio, discoteques and all the world regarding that business makes themselves the question: What happens in Discos Universales S. A. A light veil of mystery covers the true, so it's very transparent to see it over.

Dared reporters have made some versions about it but not yet an official one. And also there is a question, what great meaning has the visit to Mexico City, several weeks ago, of the General Administrative of the Philips and Deutsche Grammophon and Mr. Brakema's visit, the representative of Latin American of Philips International. Up to date they have not given information about their talks to the press.

Suspense is about to finish in Discos Universales S. A., the company which represents Philips and Deutsche Grammophon here in Mexico, and many other known labels in the world and it has realizing enough activities within its organization.

However, their actitud, optimism and cordiality of their meeting, make us think that there will be many surprises in the future and meanwhile rumors continue and all over the question: ...What happens in Discos Universales...? What is their purpose...?

ENRIQUE ORTIZ

your music

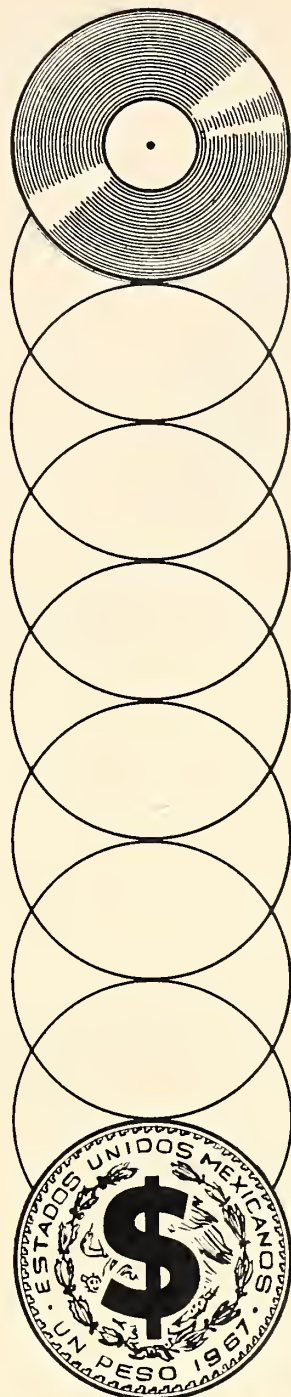

is money
in

MEXICO

We sell your records in Mexico and Central America throughout the most active distribution and advertising company. Send us your records and music and receive MUCHOS PESOS from:

DISCOS TIZOC, S. A.

Office: Av. División del Norte 31 México 12, D. F., México Phone: 43-72-40

Mail: P. O. Box 11-620 México 11, D. F., México

MUCHAS GRACIAS to all our affiliates through the years.



FOLKWAYS RECORDS

HIFIRECORD

monitor

GRUPO FREY

FOR BEST PUBLISHING & COLLECTING IN MEXICO

MEXIMUSIC, S. A.

FERMATA MEXICANA, S. A.

EDITORIAL TEOCALI, S. A.

We represent some of the world's leading publishers in Mexico & Central America including:

The Beatles Publishing Companies; Fermata Group; Venice Music; Burlington Music; Clan Group; Rideau Rouge; Charles Bull; Illian Melody Press; Leonardi Music and Aznavour's Publishing Companies.

THE BEST



**ORFEON
VIDEOVOX
S. A.**



Alce Blanco No. 26
Esq. Ave. 8
Naucalpan de Juárez,
Estado de México

STOP the best

MODERN RECORD PLANT
COMPLETE CUSTOM SERVICE
DISTRIBUTION NETWORK
NEW INTEGRAL BUILDING
RECORDING STUDIOS

The Best
Mexican Artists

The Best
Represented
Foreign Labels

JORGE NEGRETE
PEDRO INFANTE
CHARRO AVITIA
HNAS. AGUILA
HNOS. MARTINEZ GIL
HERNANDO AVILES
HNOS. CARRION
ROCKING DEVIL'S
HITTERS
TOÑO QUIRAZCO
HNAS. NUÑEZ
ACERINA
CHAVELA VARGAS
MA. ELENA SANDOVAL
JORGE FERNANDEZ
ROBERTO CANTORAL
JULIAN BERT

BARCLAY
DALIDA
CHARLES AZNAVOUR
MIRELLE MATHIEU
ROULETTE
TOMMY JAMES
SARAH VAUGHN
TICO
CELIA CRUZ
JOE CUBA SEXTET
KING
JAMES BROWN
KING(JAPAN)
TOKYO CUBAN BOYS
NOBUO HARA
METRONOME
BENT FABRIC
THE PALS & GALS
BODGET SOUND
101 STRINGS

MEXICO'S BEST SELLING RECORDS

BEST SELLING SINGLES OF MUSART

1—De Colores	Estudiantina de Guanajuato	Musart
2—Brasilia	Los Aragón	Musart
3—El Traje de Baño	Mike Laure	Musart
4—Bravo	Olga Guillot	Musart
5—Dame un beso	Mike Laure	Musart
6—Hay ojitos	Los Relámpagos	Musart
7—Te traigo en mi Cartera	Antonio Aguilar	Musart
8—El Cable	Los Aragón	Musart
9—Teresa	Torrebruno	Musart
10—No	Angélica María	Musart

BEST SELLING LP's FROM MUSART

1—Mi Cristo Roto	Jose Antonio Cossio	Musart
2—Organo Melódico	Juan Torres	Musart
3—Los Aragón	Los Aragón	Musart
4—De Colores	Estudiantina de Guanajuato	Musart
5—Al Ritmo de Mike Laure	Mike Laure	Musart
6—Torrebruno, con los hits de Europa	Torrebruno	Musart
7—Ven, Amorcito Ven	Alberto Vázquez	Musart
8—Bravo	Olga Guillot	Musart
9—Rancheras Inolvidables	Antonio Aguilar	Musart
10—Los Grandes Exitos Internacionales	Luis Arcaez	Musart

BEST SELLING E.P.'s FROM MUSART

1—Tierra Mala	Antonio Aguilar	Musart
2—Ven, Amorcito Ven	Alberto Vázquez	Musart
3—De Colores	Estudiantina de Guanajuato	Musart
4—Brasilia	Los Aragón	Musart
5—Dame un Beso	Mike Laure	Musart
6—Amor y Traición	Flor Silvestre	Musart
7—Capri C'est Fini	Gloria Lasso	Musart
8—Teresa	Torrebruno	Musart
9—Mas Fuerte que tu Amor	Angélica María	Musart
10—Bravo	Olga Guillot	Musart

BEST SELLING SINGLES OF CBS

1—Se te Olvida (La Mentira)	Javier Solís	CBS
2—Es Lupe	Los Johnny Jets	CBS
3—Mi Razón	Sonora Santanera	CBS
4—Las Rejas no Matan	Javier Solís	CBS
5—El Vicio	Jorge Valente	CBS
6—Espumas	Javier Solís	CBS
7—La Mentira (Se te olvida)	Los Panchos	CBS
8—Batijugando	Sonia López	CBS
9—Celoso	Los Panchos	CBS
10—La Martina	Irna Serrano	CBS

BEST SELLING L.P.s FROM CBS

1—Sombras	Javier Solís	CBS
2—Viajando y Bailando	Sonora Santanera	CBS
3—Epoca de Oro	Los Panchos	CBS
4—La Chamaca de Oro	Sonia López	CBS
5—Canción de Un Preso	Irma Serrano	CBS
6—Johnny Jets a Go-Go	Los Johnny Jets	Harmony
7—El Organo Melódico	Ken Griffin	Harmony
8—Et Maintenant	Caravelli & Percy Faith	CBS
9—Eydí Gorme & Los Panchos en español	Eydí Gorme & Los Panchos	CBS
10—Ray Conniff en Español	Ray Conniff	CBS

BEST SELLING E.P.s FROM CBS

1—Payaso	Jvier Solís	CBS
2—Tema de Lara	Los Panchos	CBS
4—4 Hits de Javier	Sonora Santanera	CBS
3—Mi Razón	Javier Solís	CBS
5—Volverás	Sonora Santanera	CBS
6—Canciones de la película "Amor a Ritmo a Go-Go"	Javier Solís	CBS
7—Mas Exitos de los Johnny Jets	Los Johnny Jets	CBS
8—El Puente Roto	Irma Serrano	CBS
9—Eydí Gorme y Los Panchos	Eydí Gorme y Los Panchos	CBS
10—Hambre	Magda Franco	CBS

BEST SELLING SINGLES FROM PEERLESS

1—Rondando tu Esquina	Julio Jaramillo	Peerless
2—Fuiste a Acapulco	Los Apson Boys	Peerless
3—El Ultimo Beso	Polo	Peerless
4—Siempre te Amare	Los Reno	Peerless
5—El Cable	Mario y sus Diamantes	Peerless
6—La Chispita	Hugo Blanco	Peerless
7—Noche Callada	Marco Antonio Vázquez	Peerless
8—Ruby Tuesday	The Rolling Staones	London
9—Me Piden	Los Babys	Peerless
10—Guantanamera	Sextette La Plata	Peerless

BEST SELLING L.P.s FROM PEERLESS

1—Rondando tu Esquina	Julio Jaramillo	Peerless
2—Fuiste a Acapulco	Los Apson Boys	Eco
3—El Ultimo Beso	Polo	Eco
4—El Cable	Mario y sus Diamantes	Peerless
5—Siempre en el corazón de México	Pedro Infante	Peerless
6—CARTAS a Mi Hijo	Enrique Rambal	Peerless
7—Triunfamos	Los Tecolines	Peerless
8—La Chispita	Hugo Blanco	Peerless
9—A Gu Gu	Los Xochimilcas	Peerless
10—Ecos de Yucatán	Herman's Michel	Peerless

BEST SELLING E.P.s FROM PEERLESS

1—El Ultimo Beso	Polo	Peerless
2—Rondando tu Esquina	Julio Jaramillo	Peerless
3—Fuiste a Acapulco	Los Apson Boys	Peerless
4—El Cable	Mario y sus Diamantes	Peerless
5—La Chispita	Hugo Blanco	Peerless
6—Paint it Black	The Rolling Stones	London
7—Muchacha	Los Ovnis	Peerless
8—I Wish You Love	The Bachelors	London
9—Muñecas del Cha Cha Cha	Celia Cruz	Peerless
10—Te Deseo Amor	Marco Antonio Vázquez	Peerless

BEST SELLING SINGLES FROM CAPITOL

1—Help	The Beatles	Capitol
2—Teresa	Los Yaki	Capitol
3—María no Mas	Cliff Richard	Capitol
4—The Last Round Up	Cliffie Stone	Capitol
5—Sonny	Los Yaki	Capitol
6—Arráncame	Hnos. Arriagada	Capitol
7—Noche Callada	Los Huasos Quincheros	Capitol
8—Silhouettes	Herman's Hermit	Capitol
9—I'll Never Find Another You	The Seekers	Capitol
10—No	Carlos Lico	Capitol

BEST SELLING L.P.'s FROM CAPITOL

1—Mi Cristo Roto	Padre Ramón Cué	Capitol
2—Help	The Beatles	Capitol
3—Rubber Soul	The Beatles	Capitol
4—Yeah, Yeah, Yeah	The Beatles	Capitol
5—The Eddy Duchin Story	Harry Celler	Capitol
6—Et Maintenant	Gilbert Beaud	Capitol
7—Los Yaki en Vivo	Los Yaki	Capitol
8—Tres Corazones hechos Canción	Hnos. Arriagada	Capitol
9—Capri C'est Fini	Andrik	Capitol
10—Bossa Tres	Leny Andrade, Pery Ribeiro y Gemini V	Capitol

(Continued on page 138)



THE BEST LABEL
from SOUTH OF THE BORDER

...with

The Best **Mexican** Talents!

ANTONIO AGUILAR ★ ANGELICA MARIA ★
LOS ARAGON ★ LUIS ARCARAZ ★ CARLOS
CAMPOS ★ OLGA GUILLOT ★ GLORIA LASSO
★ MIKE LAURE ★ LENA Y LOLA ★ FLOR
SILVESTRE ★ TORREBRUNO ★ ALBERTO
VAZQUEZ ★ LUCHA VILLA, *etc.*

DISCOS MUSART, S. A. - APDO. POSTAL 17503 - MEXICO 17, D. F. - MEXICO
U.S.A. Distributor: MUSICAL RECORDS CO. ■ P. O. Box 75 ■ Tel. 887-2638 ■ Hialeah, Fla.

THE LEADING LABELS IN THE MEXICAN MARKET



LONDON

RICHMOND



PEERLESS DE MEXICO, S. A.
APDO. 1657 MEXICO, D. F.

MEXICO'S BEST SELLING RECORDS

(Continued from page 136)

BEST SELLING E.P.s FROM CAPITOL

1—Help	The Beatles	Capitol
2—Auxilio	Los Yaki	Capitol
3—Michelle-Girl	The Beatles	Capitol
4—If I Fell	The Beatles	Capitol
5—No Milk Today	Herman's Hermit	Capitol
6—The Last Round Up	Cliffe Stone	Capitol
7—Teresa-Sonia	Los Yaki	Capitol
8—Sigamos Pecando	Hnos. Arriagada	Capitol
9—Because	Dave Clark Five	Capitol
10—Good Vibrations	Beach Boys	Capitol

BEST SELLING SINGLES FROM TIZOC

1—Guantanamera	The Sandpipers	Tizoc
2—A Taste of Honey	Herb Alpert	Tizoc
3—What Now My Love	Herb Alpert	Tizoc
4—Mas que Nada	Sergio Mendes	Tizoc
5—La Mula Bronca	Al Hurricane	Tizoc
6—Malvada	Trio Sensación	Tizoc
7—El Mundo	Archibald & Tim	Tizoc
8—Spanish Flea	Herb Alpert	Tizoc
9—The Shadow of Your Smile	Billy Strange	Tizoc
10—Whipped Cream	Herb Alpert	Tizoc

BEST SELLING L.P.s FROM TIZOC

1—Mas que Nada	Sergio Mendes	Tizoc
2—Guantanamera	The Sandpipers	Tizoc
3—What Now My Love	Herb Alpert	Tizoc
4—The More I See You	Chris Montez	Tizoc
5—Going Places	Herb Alpert	Tizoc
6—Zorba The Greek	Original Sound Track	Tizoc
7—Whipped Cream	Herb Alpert	Tizoc
8—Bahia	Arthur Lyman	Tizoc
9—Beto Bermúdez	Beto Bermúdez	Tizoc
10—Mariachi Fox	Rafael Palomar	Tizoc

BEST SELLING E.P.s FROM TIZOC

1—Guantanamera	The Sandpipers	Tizoc
2—Mas Que Nada	Sergio Mendes	Tizoc
3—Zorba The Greek	Original Sound Track	Tizoc
5—What Now My Love	Herb Alpert	Tizoc
5—Lo que mas me Gusta de Ti	Chris Montez	Tizoc
6—A Taste of Honey	Herb Alpert	Tizoc
7—El Mundo	Archibald & Tim	Tizoc
8—Tijuana Taxi	Herb Alpert	Tizoc
9—Batman	Original Sound Track	Tizoc
10—Whipped Cream	Herb Alpert	Tizoc

BEST SELLING SINGLES FROM GAMMA

1—Brazilia	Tony Mottola	Command
2—Strangers In The Night	Frank Sinatra	Reprise
3—Zorba The Greek	Trio Ateniense	Vogue
4—Sugar Town	Nancy Sinatra	Reprise
5—Yo Soy Aquel	Raphael	Hispavox
6—96 Tears	Question Mark and The Mysterious	Cameo Parkway
7—Cafe Express	Leiber and Stoller	United Artists
8—Winchester Cathedral	John Smith	Top Six
9—These Boots Are Made For Walkin'	Nancy Sinatra	Reprise
10—No Hay que Ceder	Karina	Hispavox

BEST SELLING L.P.s FROM GAMMA

1—Brazilia	Tony Mottola	Command
2—Strangers In The Night	Frank Sinatra	Reprise
3—A Man and A Woman	Original Sound Track	United Artists
4—Strangers In The Night	Santo & Johnny	Canadian American
5—Lara's Theme	Ferrante & Teicher	United Artists
6—Venus	Santo & Johnny	Canadian American
7—Yo Soy Aquel	Raphael	Hispavox
8—Servidumbre Humana	Movie Themes	United Artists
9—Zorba The Greek	Trio Ateniense	Vogue
10—El Mundo	Monna Bell	Hispavox

BEST SELLING E.P.s FROM GAMMA

1—Brazilia	Tony Mottola	Command
2—Strangers In The Night	Frank Sinatra	Reprise
3—A Man and A Woman	Original Sound Track	United Artists
4—Susie "Q"	Johnny Rivers	Imperial
5—Zorba The Greek	Trio Ateniense	Vogue
6—These Boots Are Made For Walkin'	Nancy Sinatra	Reprise
7—A Man and A Woman	Ferrante & Teicher	United Artists
8—Cafe Express	Leiber and Stoller	United Artists
9—Yo Sol Aquel	Raphael	Hispavox
10—And I Love Her	Santo & Johnny	Canadian American

BEST SELLING SINGLES FROM ORFEON

1—La Hora del Jerk	Los Hitter's	Orfeon
2—Amarrado	Los Belmont's	Orfeon
3—La Banda Borracha	Los Polivoces	Orfeon
4—Probemos otra Vez	Los Americans	Orfeon
5—El Mundo está Loco	Toño Quirazco	Orfeon
6—Juanita Banana	Los Hooligans	Orfeon
7—Susie "Q"	Los Sputniks	Orfeon
8—Caperucita Roja	Los Rockin' Devils	Orfeon
9—El Despertar	Irma Dorantes	Orfeon
10—125 Pecas	Toño Quirazco	Orfeon

BEST SELLING L.P.s FROM ORFEON

1—Aguinaldo	Dueto Aguila y Sol	Orfeon
2—Bule Bule	Various Artists	Orfeon
3—Desde Ayer	Hnos. Carrión	Orfeon
4—Toda una Vida	Chabela Vargas	Orfeon
5—Todos Queremos a Lupe	Los Rockin' Devils	Orfeon
6—La Banda Borracha	Marimba Orq. La Perla de Soconusco	Orfeon
7—Voy a Quitarme el luto	Toño La Negra	Orfeon
8—El Mundo está Loco	Toño Quirazco	Orfeon
9—Juanita Banana	Various Artists	Orfeon
10—Amanecí en tus Brazos	Francisco "Charro" Avitia	Orfeon

BEST SELLING E.P.s FROM ORFEON

1—Los Hijos de Sanchez	Francisco "Charro" Avitia	Orfeon
2—Hey Lupe	Los Rockin' Devils	Orfeon
3—Un Hombre Respetable	Los Hitter's	Orfeon
4—La Banda Borracha	Los Polivoces	Orfeon
5—Brinquen	Los Belmont's	Orfeon
6—Juanita Banana	Los Hooligans	Orfeon
7—Susie "Q"	Los Sputniks	Orfeon
8—Cumbia Ballenata	Toño Quirazco	Orfeon
9—El Despertar	Irma Dorantes	Orfeon
10—Caperucita Roja	Los Rockin' Devils	Orfeon

BEST SELLING L.P.s FROM DIMSA

1—Pancha Ska	Toño Quirazco	Dimsa
2—Un hombre Respetable	Los Hitter's	Dimsa
3—Amarrado	Los Belmont's	Dimsa
4—Juanita Banana	Los Hooligans	Orfeon
5—Probemos otra Vez	Los Americans	Orfeon

(Continued on next page)

MEXICO'S BEST SELLING RECORDS

(Continued from preceding page)

BEST SELLING SINGLES FROM DUSA

1—Capri C'est Fini	Hervé Vilard	Philips
2—Mas que Nada	Los Dominic's	Polydor
3—Winchester Cathedral	New Vaudeville Band	Philips
4—Acompañame	Rocio Dúrcal	Philips
5—Perdámomos	Chucho del Muro	Philips

BEST SELLING L.P.s FROM DUSA

1—Dr Zhivago	Original Sound Track	Philips
2—La Revelación Mundial de 1967	Hervé Vilard	Philips
3—Acompañame	Rocio Dúrcal	Philips
4—Jazz Sebastian Bach	The Swingle Singers	Philips
5—Noches en la Posada Vallarta	Victor Iturbe "Piruli"	Philips

BEST SELLING E.P.s FROM DUSA

1—Winchester Cathedral	Various Artists	Philips
2—Capri C'est Fini	Hervé Vilard	Philips
3—Dr. Zhivago	Original Sound Track	Philips
4—Acompañame	Rocio Dúrcal	Philips
5—Invierno Triste	Connie Francis	MGM

BEST SELLING SINGLES FROM CISNE

1—Algo Tonto	Enrique Guzmán & Silvia Pinal	Aquarium
2—Duraznos con Crema	Las Ikettes	Cisne
3—Hanky Panky	Los Pankys	Cisne
4—Roberta	Pimentel y sus Panorámicos	Cisne
5—Jorge	Lorenza Lori	Cisne
6—Es Solo Amor	Los Pankys	Cisne
7—Decepcionada	Los Dos Luceros	Cisne
8—La Pelicula	Lorenza Lori	Cisne
9—Culpable	Los Picapiedra	Cisne
10—Primero yo que Tu	Chucho Rincón	Cisne

BEST SELLING L.P.s FROM CISNE

1—Fascinación	Pimentel y sus Panorámicos	Cisne
2—Tiempo Tempestuoso	Cuerdas Románticas	Cisne
3—Tema del Dr. Zhivago	Rita Infante	Cisne
4—Al morir la Tade	Enrique Rambal	Cisne
5—La Amada Inmóvil	Various Artists	Cisne
6—Poemas para Mamá	Enrique Rambal	Cisne
7—Rimas de Gustavo A. Becquer	Verdaguer	Cisne
8—Prohibido en TV	Los Sonorámicos	Cisne
9—Rosas Rojas para una Dama Triste	Los Delfines	Cisne
10—Viaje por la América		Cisne

BEST SELLING SINGLES FROM RCA

1—Sin Final	Brass Ring	RCA
2—El Despertar	Marco Antonio Muñoz	RCA
3—Cuando Vivas Conmigo	Jose Alfredo Jiménez	RCA
4—Rondando tu Esquina	Sagrario Baena	RCA
5—Rosa María	Los Moonlights	RCA

BEST SELLING L.P.s FROM RCA

1—Rondalla Tapatia, Vol. I	Rondalla Tapatia	RCA
2—Ballet Folklórico de México	Ballet Folklórico	RCA
3—El Despertar	Marco Antonio Muñoz	RCA
4—El Brindis del Bohemio	Manuel Bernal	RCA
5—Rondalla Tapatia Ranchera	Rondalla Tapatia	RCA

VICTOR YTURBE "THE BOHEME"



The debut of Victor Iturbe, known as "piruli" and also as "The Bohemian," in the bar of a Mexico City Hotel, was a great success. A new voice, fresh with bohemian tonalities, was presented in a place in harmony with his interpretative style. Victor Iturbe performs bohemian songs, romantics, deep Mexican flavor, accompanied by his guitar, showing that his success with records is fully backed with its personal performance. In his short career as a singer, he has been presented in several cities in the United States, he has performed throughout all the north of the Mexican Republic, but his place of performances is in "Puerto Vallarta Hotel," located near the coast of Jalisco, a resort vacationists place.

Being a singer of traditional and modern

romantic performances, he is being hailed, due to his youth and good looks, as a new idol in this style.

Among other songs he has interpreted stand out "NO" actually success, of Armando Manzanero, "ELIA" of Fuentes and Roth composers, and naturally "CONFIDENCIAS DE AMOR," a record that is being listened to on the radio very frequently.

Right after his debut, Victor Iturbe signed a contract for television continuing on his way. Other presentations on TV included one that has pleasant memories for him were "THE ED SULLIVAN SHOW," and very soon the Record Company will release an L.P. with the title of "CELOSO" containing his most popular repertory.

ENRIQUE ORTIZ

THERE ARE FIVE REASONS

WHY



IS A

REVOLUTIONARY COMPANY.

* Because its Mexican artists and recordings have been favorites in American trade magazines.

* Because the most important Mexican radio stations dedicate 20% of their time to our records.

* Because we rank among the first record companies in the Mexican market after only one and a half year of activities.

* Because Discos Capitol de Mexico is a young and happy family . . . it represents the Mexico of tomorrow.

And essentially

* Because we try harder.

If you want the best of Mexican music for your territory, call on us.

If you want to have your catalogue well distributed in Mexico, call on us.



BRAZIL — THE PAST 12 MONTHS

NOW CHANTECLER

is present
in 13 countries

RELEASING
GREAT HITS!



THE BEST MUSICS FOR
1967 CHRISTMAS



OUR DISTRIBUTORS
THROUGHOUT THE WORLD: -

CYRIL STEVENS (AUSTRALIA), GALLO (SOUTH AFRICA), METRONOME (GERMANY), FESTIVAL (FRANCE), MARFER (SPAIN), ALVORADA and ORFEU (PORTUGAL), KUBANEY RECORDS and EPIC RECORDS (U.S.A.), PEERLESS (MEXICO), ONDINA (NICARAGUA), ORBE (VENEZUELA), FUENTES (COLOMBIA), VIRREY (PERU), MARPAR and DISC JOCKEY (ARGENTINA).



CHANTECLER

P.O. Box 478 SAO PAULO BRASIL
EXCLUSIVE DISTRIBUTOR IN
BRAZIL OF THE FOLLOWING
LABELS:

FESTIVAL (FRANCE), RICORDI (ITALY), DECCA and ROULETTE (U.S.A.), PEERLESS (MEXICO), VIRREY (PERU), FUENTES (COLOMBIA).

Although Brazil is larger in area than the United States, the country's population is as low as 80 million inhabitants—of these, and although this condition is improving every year, a great number are still living in a rather primitive habitat, sometimes having to fight against long periods of drought, or unexpected and devastating floods, as is so frequent in such a tropical zone, which is not yet prepared to face it all financially and technically. We can consider that the record market is concentrated in the larger capitals such as Rio de Janeiro, São Paulo, Belo Horizonte, Porte Alegre, Recife, etc. although other markets are constantly being opened; In spite of the highly musical standards of the Brazilian people, we can consider that the customary record buyer still belongs to a privileged class. But more and more people are getting familiar with the record industry, through a well directed radio promotion.

Although Brazil is going through a new and important phase of political stability and relative satisfaction in this field, the average Brazilian is facing a period of financial sacrifice, which is needed to put back in place what was out of order for so many years. In spite of a price contention policy of the Government (decree 71), many prices are still going up constantly and this affects the record industry or any other that is considered still a luxury; however, and although record prices went up over 30% this past year, the companies cannot raise them in spite of the higher prices of everything that is connected with the recordings (studio hour, musicians, sound technicians, recording material, etc.), because they know that this would probably mean that their production would remain on the shelves. . . . And in spite of it all, the companies are aggressively cutting more disks, concentrating in new promotions (unfortunately they do not seem to realize how important it would be for the industry and the Brazilian music in general to do it on a more international basis . . .), launching new labels, new artistes, new groups, new names.

Up to this moment, we have been hesitant to publish any figures, because of the difficulty to have figures one can trust, and because of the fear to compare them with those of other countries. . . . The first difficulty was solved through the cooperation of the "Brazilian Association of Record Producers" who gave us the year's statistics; as for the second reason, we think that it is about time that the world knows with what difficulties we all work here in this field. So here are Production, Sales and releases statistics, on a month to month basis and that portrays in figures what is said above: although the public's acceptance and the companies' willingness show that the Brazilian record industry is going ahead, numbers are not allowed to get bigger.

As we wrote before, this was Brazil's Festival Year! While for many years there was not a single important music festival here, in spite of the musical richness of the country, dur-

ing these past twelve months we had three. . . . The two National Festivals were organized by two of the most important TV stations (TV Excelsior and TV Record) and were partly responsible for a new era in the Brazilian popular music: from the first one, one of the hits of the year emerged, "Porta-Estandarte," and from the second a couple of numbers that became all time standards appeared, "A Banda" and "Disparada." Through these festivals three names attained top credits in the Brazilian musical field: Chico Buarque De Hollanda, composer and interpreter of "A Banda," Jair Rodrigues, interpreter of "Disparada" and Geraldo Vandré, who in spite of not being entirely responsible for this latest number—Theo (Theofilo de Barros Filho) was the composer, and the same happened with the winner of the other festival, "Porta-Estandarte," whose composer Fernando Lona, remained unknown—took advantage of it to project himself nationally. . . . Songstress Nara Leão, who also appeared as interpreter of "A Banda," also saw her popularity raised through it. The Modern Popular Music suffered two important influences during this year: first from the folk-music of the North and Northeast, where Vandré finds motives for practically all his compositions—besides him other pure composers of the Bahia school, such as Gilberto Gil, Caetano Veloso, Sidney Miller, and others, brought new blood to the country's pop music; the other influence was due to a sort of one-man movement, with Chico Buarque de Hollanda, an excellent poet and inspired composer, who modernized the spirit of the old traditional "samba" of late Noel Rosa. His style is pure, simple and romantic and all lyrics are real poems. After his first numbers to become hits—"Pedro Pedreiro" and "Ole Ola"—Chico saw his career go up immediately; then came the musical score of theater play "Vida E Morte de Severina," which gained top acclaim in France; finally came the winning song of the festival, "A Banda," which Chico was forced to play in the Rio International Fest by insistence of a crowd of about 10,000 people, and that would make him "the man of the year" in the Brazilian popular music field. It is said that, last year another great Brazilian composer Antonio

Carlos Jobim was drinking his beer in Copacabana, when a friend went by and greeted in the usual way: "Hi, Tom, what's new?" and Jobim answered: Chico Buarque de Hollanda?"

Back to our Festivals: in Rio de Janeiro we had the "First International Festival of Popular Song." Although musically it was not a strong competition, it is very possible that through its social success, it may become one of the most important such manifestations of the years to come. Important personalities were present, coming from all over the world, either to be members of the Jury [or panel of judges] (Henry Mancini, Soloviov Sedoi, Amalia Rodrigues, Pedro Vargas, Julio De Caro, Yma Sumac, Jean Sablon, Host Jankowsky), as guests of honour (Jay Livingston and Ray Evans, Les Baxter, Hachidai Nakamura, Nelson Riddle, David Raskin, Mich Murray and Les Reed, Helmut Zacharias, John Mandel, and many others), as well as famed interpreters (Udo Jurgens, Inge Brueck, Wayne Fontana, Gogy Grant, Guy Mardel, Edoard Khil, Chiemi Eri and others such as Irena Santor, Simone De Oliveira, Lill Lindfors and Brazilians Claudia, Elis Regina, Nana Caymmi, Tuca, Maysa, Paulinho Nogueira, Tito Madi, Doris Monteiro, Claudette Soares, Miltoninho, Gal Costa, Helena De Lima and others).

After this period which gave new hopes to the modern popular music of Brazil and which helped to bring it back with new strength and different aspects, the teen-music started again to bore into the large public's preference—both local and imported recordings started to appear more and more in the charts as we approached the end of this twelve months period. Incontestible king is still Roberto Carlos (CBS) who is an absolute hit maker, not only as an interpreter but also as a composer—his position as Brazil's Teen Star is still solid and as time goes by he is becoming a legend, more than an idol! Erasmo Carlos (RGE) and Wanderlea (CBS) kept their position as the immediate followers of RC. But this year a new name appeared to form with them the cream of the teen music in this country—his name is Ronnie Von (Poly-

(Continued on next page)

BRAZIL'S DOMESTIC & FOREIGN RELEASES

	POPULAR MUSIC		CLASSIC MUSIC	
	national	foreign	national	foreign
May 66	66	63	2	8
June	100	88	4	7
July	110	58	2	11
Aug.	105	67	2	8
Sept.	126	75	3	20
Oct.	110	65	3	17
Nov.	148	69	—	14
Dec.	72	57	—	—
Jan. 67	85	46	—	9
Feb.	66	49	—	4
Mar.	86	75	3	10
Apr.	100	52	—	15

BRAZIL'S SALES AND PRODUCTION FIGURES 1966-1967

	Number of records pressed all 33 1/3 R.P.M.				Value of sales (in New Cruzeiros)*
	singles	doubles	LP Mono	LP Stereo	
1966					
May	219,201	114,389	271,450	9,928	NCr\$ 1,969,215
June	255,453	138,552	294,470	11,168	2,153,866
July	272,599	125,490	286,573	13,800	2,219,195
Aug.	384,210	159,150	318,669	12,605	2,742,335
Sept.	373,766	123,040	294,250	10,777	2,537,671
Oct.	437,795	108,813	286,186	11,482	2,641,208
Nov.	470,147	134,476	451,395	13,931	3,303,248
Dec.	338,878	152,706	457,854	25,350	3,792,323
1967					
Jan.	261,872	138,640	299,071	3,355	2,598,065
Feb.	237,851	105,787	201,965	8,360	1,793,478
March	247,272	99,354	298,615	8,882	2,599,429
April	341,501	101,489	268,926	9,191	2,804,014

Note: In May both Production and Sales as well as Value of sales is going up but figures are not available as yet.
* The New Cruzeiro (NCr\$) is worth 1,000 old Cruzeiros (Cr\$) or 2,70 to the US Dollar.

BRAZILIAN RECORD COMPANIES

CBS DO BRAZIL S.A., INDUSTRIA E COMERCIO
Rua Visconde Rio Branco, 53—Rio de Janeiro (Guanabara) phone: 31, 40 40
General Manager: Evandro Ribeiro
Labels: CBS, Columbia, Epic, Date, Musicor, Harmony, Okeh, Odyssey, Oriole, Embassy, Plaza, Entre

COMPANHIA BRASILEIRA DE DISCOS
Avenida Rio Branco, 311—Rio de Janeiro (Guanabara) phones: 42.09.64—42.8 95—52, 61 95

General Manager: Alain Trossat
Labels: Philips, Polydor, Fontana, Deutsche Grammophon, Warner Bros., Reprise, Ato, MGM, Mercury, Fantasia, Heliodor, Archiv

DISCOS CHANTECLER (CASSIO MUNIZ S.A.)
Rua Aurora, 1050—Sao Paulo (Sao Paulo) phones: 37, 13 77—37, 40 80
General Manager: J. Rahmi
Labels: Decca, Roulette, Peerless, Ricordi, Festival, Virrey, Fuentes

DISCOS ELENCO

Rua Visconde da Gávea, 125—5°.andar—Rio de Janeiro (Guanabara)
President: Aloisio de Oliveira
Label: Elenco

FABRICA DE DISCOS ROZENBLIT, LTDA.

Rua Conselheiro Nébias, 662—Sao Paulo (Sao Paulo)

Phones: 52.52 20—51.01 77—51.01 78

Board of Directors: José, Isaac and Adolfo Rozenblit, Kurt and Bernardo Sondermann

Labels: Mocambo, AU (Aartistas Unidos), Kapp, Jubilee, B. T. Puppy, Lyrichord, Motown/Tamla, Time, Vogue Mode, Deutsche Vogue, Supraphon, Italdisc, Carrossello

FERMATA DO BRASIL LTDA.

Labels: A&M, Cameo/Parkway, Durium, Jolly, Disques AZ
RGE DISCOS LTDA.

Labels: Barclay, Dot, CGD, Ariston, Musart, Page One

DISCOS Som/Maior LTDA.

Labels: Som/Maior, Valliant, Interecord
Avenida Ipiranga, 1123—Sao Paulo (Sao Paulo)

Phones: 35.28 32—34.89 90—37.26 60

President: Enrique Lebendiger

GRAVACOES ELECTRICAS S.A.

Rua 7 de Abril, 59—8°.andar—Sao Paulo (Sao Paulo)

Phones: 37.32 15—37.54 39

General Manager: Lourenço Sampaio Góes
Labels: Continental, Disquenho, Discao, Caboclo, Sertanejo, Colpix, W&G's, Ducretet-Thomson, Telefunken

GGRAVACOES MUSIDISC LTDA.

Rua da Lapa, 120—Rio de Janeiro (Guanabara)

President: Nilo Sérgio Pinto
Labels: Musidisc, Nilser, Command, Masterpiece, Vox, Audiola, Hi-Fi Jazz

INDUSTRIAS ELECTRICAS E MUSICAIS

FABRICA ODEON S.A.

Avenida Rio Branco, 99—Rio de Janeiro (Guanabara)

Phone: 22.98 87

General Manager: Henry Jessen

Labels: Odeon, London, Capitol, Angel, Parlophon

RCA ELECTRONICA BRASILEIRA S.A.

Avenida Ipiranga, 1097—Sao Paulo (Sao Paulo)

Phones: 32.91 02—37.47 19—35.01 78/79/70

President: Douglas Reid

General Manager record division: Eric Skinner

Labels: RCA Victor, Dunhill, Liberty, RCA Camden, Soul City, Victrola, Dolton, Disneyland, Buena Vista

SOM INDUSTRIA & COMERCIO S.A.

Rua Cáspero Libero, 58—Sao Paulo (Sao Paulo)

Phone: 35.81 97

President: Emilio Vitale

Labels: Copacabana, Verve, Westminster, Seeco, Montilla, Palette, Orpheon, Videovox, Music-Hall

BRAZIL—THE PAST 12 MONTHS

(Continued from preceding page)

dor) and his disks are among the best-sellers of the year; he created a new style, a more intellectualized type which is of great appeal to an older line of teeners—his striking looks help a lot! In a more romantic line another top teen artist is flying high in the public's preference, young and handsome Wanderley Cardoso (Copacabana). This year still another name can be mentioned in the front line of teen-music, Eduardo Araujo, (Odeon) who also interprets some of his own compositions and hit the charts a few times. New names appear all the time and some can also be mentioned as today's favorites, such as Bobby De Carlo (Mocambo), Marcos Roberto (Continental), Sergio Reis (Odeon) (also an excellent composer), Dori Edson (Continental), Jerry Adriani (CBS), two-some "Os Vips" (Continental), Deny & Dino (Odeon), Leno & Lilian (CBS), etc. Besides the exclusive groups who accompany the top stars, such as "RC Septet," "OS Tremendões," "OS Vandecos," etc.

some good instrumental (sometimes vocal also) groups have top billing in the country, such as "Os Jordans" (Copacabana), "Os Jet Blacks" (Chantecler), "Renato & Seus Blue Caps" (CBS), "Os Incriveis" (Continental), and last year a new important group appeared specially supported by young trumpet player Ronaldo (AU) who unfortunately separated from "Os Versateis" (AU). An interesting new angle in the teen music was brought by a young (17), fascinating looking girl mysteriously called De Kalafe (AU) who, accompanied by new instrumental group "A Turma" stirred curiosity and comments of all kinds—she sings a sort of protest song in a strong and aggressive way, mostly compositions of one of the young components of the group. There are of course many other chanters and groups of importance in the present teen-music scene, but we couldn't possible mention them all. The imported teen-music came in strong during these past twelve months, specially at this end of the period. Besides "The Beatles"

(Odeon), who here too are constantly heading the charts, others conquered the public's choice, specially "The Mama's & The Papa's" (RCA), who are also present in the charts constantly, "The Rolling Stones" (Odeon), "Sam The Sham & The Pharaohs" (MGM), "Gary & The Pacemakers," "The Happenings" (Mocambo), "The Sandpipers" (Fermata), "Los Bravos" (Odeon), and many others; also from Europe, Johnny Holliday (Philips), Michel Polnareff (first Mocambo then Fermata), Christophe (Mocambo), etc. In our opinion, teen-music is here to stay for many years still . . .

In a traditional pop music, including balads and romantic songs, the most important local artist this year was no doubt Agnaldo Rayol (Copacabana), who was crowned "Rei da Voz" (King of the Voice) a title once owned by one of the most popular Brazilians of all time, Francisco Alves. Another great chanter, Agnaldo Rayol did not appear as much this year because he is concentrating in his international career and has many records cut in other South American countries which even gained chart credit (sung in spanish); Lindomar Castilho (Continental) also had a

good year and appeared a couple of times in the charts. In the "bolero" line, king is still Carlos Alberto (CBS) who is an absolute best seller in Rio and provinces; also from CBS Carlos Jose appeared well. Other names of importance this year are Barros De Alencar (Chantecler), Luiz Aguiar (AU), Ary Sanches (Continental), Oslain Galvão and comediant Moacyr Franco (Copacabana).

Wilson Simmonal (Odeon) deserves a chapter by himself—he does not belong to any of those schools; he is a versatile showman, who created the new "teen-samba" and can sing any kind of music he wants. He also appeared as a composer with an interesting number called "Tribute To Martin Luther King" and is one of the top TV stars of the moment.

Other artists still on top are chanters Elis Regina (Philips), in a new and better phase of the MPM, old-time and still the queen Elizete Cardoso (Copacabana), new-comer Claudia (RGE), the "swingest" Elza Soares (Odeon), Agostinho Dos Santos who is coming back, Helena De Lima (RGE), Giane, Joelma (both Chantecler), Angela Maria, Miltoninho and others.

(Continued on page 143)

Fermata Group

ESTABLISHED IN SOUTH AMERICA SINCE 1936

FOR YOUR BUSINESS IN SOUTH AMERICA CONTACT FERMATA

ALWAYS IN THE SPOTLIGHT READY FOR NEW BUSINESS

WE COVER ALL LATIN AMERICA

LABELS:

**RGE
FERMATA
SOM/MAIOR**

PUBLISHING GROUP:

**Fermata do Brasil Ltda.
Edicoes Musicais Seresta Ltda.
Melodias Americanas Ltda.
Editora Musical Arlequim Ltda.
Editora Musica Brasileira Moderna Ltda.
Editora Musical Arapua Ltda.
Editora Musical Sonata Ltda.
Musiclave Ltda.
Disparada Edicoes Musicais Ltda.**

CENTRAL OFFICES:

Avenida Ipiranga 1123

Sao Paulo

BRASIL

Phones: 37-2660 / 34-8990 / 35-2832 / 36-0878



Cables: FERMATABRASIL

(DO YOU REMEMBER THESE SONGS?)

- 1 girl from ipanema
 - 2 quiet nights of quiet stars
 - 3 meditation
- * They are brazilian

FÁBRICA DE DISCOS ROZENBLIT

can offer you, many other great successes,

through  and  records, two of the most famous brazilian labels.

FÁBRICA DE DISCOS *Rozenblit* LTDA

Estrada dos Remédios, 855 - Recife-Pe.
 FILIAIS: SÃO PAULO - Rua Cons. Nebias, 662
 RIO - Av. Rio Branco, 14 - 15.0

BRAZIL'S BEST SELLERS

CBS DO BRASIL S. A. INDUSTRIA E COMERCIO

TITLE	ARTIST	PUBLISHER	LABEL
BEST SELLING SINGLES (7"—33 1/3 RPM)			
Esqueca (Forget Him)	Roberto Carlos	Fermata	CBS do Brasil
Quero Que Vá Tudo Pro Inferno	Roberto Carlos	Vitale Mellin	CBS do Brasil
Pobre Menina/Devolva-Me	Roberto Carlos	Fermata	CBS do Brasil
Namoradinha De Um Amigo	Roberto Carlos	Fermata	CBS do Brasil
Meu Só Vou Gostar De Quem Gosta De Mim	Roberto Carlos	Ed. RCA	CBS do Brasil
Somewhere My Love	The Ray Conniff Singers	Todamerica	CBS do Brasil
Para O Casamento	Wanderléa	Aberbach	CBS do Brasil
Até O Fim	Renato & Seus Blue Caps	Fermata	CBS do Brasil
Ninguém Poderá Julgar-Me	Jerri Adriani	Ed. RCA	CBS do Brasil
Lar Doce Lar	Renato & Seus Blue Caps	Fermata	CBS do Brasil
BEST SELLING LP's			
Roberto Carlos	Roberto Carlos		CBS do Brasil
Jovem Guarda	Roberto Carlos		CBS do Brasil
As 14 Mais, Vol. 19	Several Brazilian Artistes		CBS do Brasil
Um Embalo	Renato & Seus Blue Caps		CBS do Brasil
A Ternura	Wanderléa		CBS do Brasil
BEST SELLING DOUBLE-COMPACTS			
Jovem Guarda	Roberto Carlos		
Roberto Carlos	Roberto Carlos		
Tempo Do Amor	Wanderléa		
Jovem Guarda, Vol. 3	Roberto Carlos		
Um Embalo	Renato & Seus Blue Caps		

COMPANHIA BRASILEIRA DE DISCOS			
BEST SELLING SINGLES (7"—33 1/3 RPM)			
Tristeza	Jair Rodrigues	Fermata	Philips
A Praça	Ronnie Von	Ed. Clava	Polydor
Disparada	Jair Rodrigues	Ed. Disparada	Philips
A Catedral	Ronnie Von	E.M.B.I.	Polydor
Winchester Cathedral	New Vaudeville Band	E.M.B.I.	Philips
A Banda	Nara Leao	Fermata	Philips
Strangers In The Night	Frank Sinatra	Fermata	Reprise
Meu Bem (Girl)	Ronnie Von	Fermata	Polydor
Noir C'est Noir	Johnny Halliday	Fermata	Philips
Ole Ola	Nara Leao	Fermata	Philips
Smethin' Stupid	Nancy & Frank Sinatra	Ed. RCA	Reprise
BEST SELLING LP's			
Dr. Zhivago	Original Soundtrack		MGM
Ronnie Von	Ronnie Von		Polydor
Dois Na Bossa No. 2	Elis Regina & Jair Rodrigues		Philips
Francis Albert Sinatra & Antonio Carlos Jobim			Reprise
O Sorriso De Jair	Jair Rodrigues		Philips
BEST SELLING DOUBLE-COMPACTS			
Meu Bem	Ronnie Von		Polydor
Noir C'est Noir	Johnny Halliday		Philips
Pede Passagem	Nara Leao		Philips
Luar De Nappes	Bert Kaempfert		Philips
I've Got You Under My Skin	4 Seasons		Philips

DISCOS CHANTECLER (CASSIO MUNIZ S. A.)			
BEST SELLING SINGLES			
Chapeuzinho Vermelho	The Jet Black's	Fermata	Chantecler
Porta-Estandarte	Tuca & Geraldo Vandré	Ed. Disparada	Chantecler
Suzie Q	The Jet Black's	Fermata	Chantecler
A Banda/Disparada	Ely Camargo	Fermata Disparada	Chantecler
Hanky Panky	Tommy James & The Shondells	Fermata	Roulette
Perdimentamente Te Amarei	Joelma	Notas Mágicas	Chantecler
Io Ti Daró Di Piu	Ornella Vanoni	Notas Mágicas	Ricordi
Olhos Tristes	Giane & Barros de Alencar	n.p.	Chantecler
The Virginian	Stanley Wilson	Fermata	Decca
E O Amor	Nalva de Aguiar	Fermata	Chantecler
BEST SELLING LP's			
The Jet Black's	The Jet Black's		Chantecler
Disco De Ouro	Teixeirinha		Chantecler
A Harpa E A Cristandade	Luis Bordon		Chantecler
Flores Perfumadas Para Alguem	Waldik Soriano		Chantecler
Festival De San Remo 67	Several Italian Artists		Ricordi
BEST SELLING DOUBLE-COMPACTS			
Sonho Dos Meus Sonhos	The Jet Black's		Chantecler
Furacao	Joelma		Chantecler
Waldik Soriano	Waldik Soriano		Chantecler
Teixeirinha	Teixeirinha		Chantecler
A Harpa E A Cristandade	Luis Bordon		Chantecler

FABRICA DE DISCOS ROZENBLIT LTDA. (MOCAMBO)			
BEST SELLING SINGLES			
See You In September	The Happenings	Fermata	B.T. Puppy
Tijolinho	Bobby de Carlo	Vitale	Mocambo
Aline	Christophe	Vitale	Vogue
Mascara Negra	Zé Ketí	Arlequim	Mocambo
Jogo De Roda	Elis Regina	Fermata	AU
A Banda	Meninos Cantores de Sao Paulo		AU
A Boneca Que Diz Nao	Bobby de Carlo	Embi	Mocambo
Barra Limpa	Martinha	Fermata	AU
Merci Cherie	Udo Jurgens	Ed. RCA	Vogue
This Is My Song	Petula Clark	Fermata	Vogue
BEST SELLING LP's			
Bobby De Carlo	Bobby de Carlo		Mocambo
Born Free	Roger William		Kapp
Viva O Festival	Several Brazilian Artists		AU
Lara's Theme	Roger William		Kapp
Uma Noite No Urso Branco	Os Versateis		AU
BEST SELLING DOUBLE-COMPACTS			
Love Me Please Love Me	Michel Polnareff		Disques AZ
Lara's Tbeme	Roger William		Kapp
Le ler, Bonheur Du Jour	Françoise Hardy		Vogue
Downtown	Petula Clark		Vogue
Four Hits	New Zago		Mocambo

(Continued on page 144)

DISCOS COPACABANA

WHERE GREAT BRAZILIAN ARTISTS RECORD... SUCH AS:

- ANGELA MARIA—AGNALDO RAYOL—WANDERLEY CARDOSO
 WALDIK SORIANO—TEIXEIRINHA—MOACYR FRANCO—
 ELIZETH CARDOSO—THE JORDANS—JOHAN DALGAS FRISCH
 JEAN CARLO—CAREQUINHA—ROBERTO SILVA

Representatives for Brazil of such famous labels as:
VERVE — UNITED ARTISTS — WESTMINSTER

SOM INDUSTRIA & COMERCIO S. A.

Rua Franca Pinto, 70 and Avenida Paulista, 900—4º
 P.O. BOX 3336
 SAO PAULO, S.P.—Brasil

IRMÃOS VITALE S/A

INDUSTRIA E COMÉRCIO
MUSIC PUBLISHERS

Providing the best in music for the past half century.
 We have the biggest musical catalog in Latin America.

Rua Franca Pinto, 42—P.O. BOX 380
SÃO PAULO, S.P.—Brasil

ARGENTINA'S MUSIC PUBLISHERS

Represented by S.B.A.C.E.M.—Rua Buenos Aires, 58-A—Rio de Janeiro (GB)

EDICOES EUTERPE LTDA.—Avenida Rio Branco, 108—Rio de Janeiro

EDICOES MANGIONE LTDA.—Rua 13 de Maio, 13—Rio de Janeiro

EDITORA MUSICAL CARLOS GOMES LTDA.—Rua 24 de Maio, 476—Sao Paulo
COOPERATIVA DOS AUTORES MUSICAIS

AQUARELA DO BRASIL
BRAZANO EDITORA MUSICAL

EDITORA MUSICAL IRACEMA
EDITORA MUSICAL ARARIBOIA
EDITORA MUSICAL ILHABELA
EDITORA MUSICAL SIDERAL
EDITORA MUSICAL SERENATA
EDITORA MUSICAL PARAIZO
EDITORA MUSICAL TROPICAL
EDITORA MUSICAL CASABLANCA
EDITORA MUSICAL PANAMERICANA

Represented by U.B.C.—Rua Visconde de Inhauma, 134—Rio de Janeiro (GB)

EDITORA NOSSA TERRA—Rua Visconde de Inhauma, 134—Rio de Janeiro
EDITORA MUSICAL TODAMERICA—Rua Santa Luzia, 799—Rio de Janeiro
EDICOES SAMBA—EDICOES CLAVE—Rua Selva, 70 (Usina-Tijuca)—Rio de Janeiro

BANDEIRANTE EDITORA MUSICAL—Rua do Seminario, 165—Sao Paulo
EDITORA MUSICAL PAO DE ACUCAR LTDA.—Rua Rosa Silva, 18—Rio de Janeiro
EDITORA CRUZEIRO MUSICAL—Rua Visconde de Janiro—Rio de Janeiro
EDITORA RIO MUSICAL LTDA.—Rua Visconde de Inhauma, 134—Rio de Janeiro
EDITORA MUSICAL COPACABANA
EDITORA MUSICAL CORCOVADO
EDITORA MUSICAL ROMANCE
EDITORA MUSICAL TIGER
EDITORA MUSICAL S. JORGE
EDITORA MUSICAL FILETOS
EDITORA MUSICAL RITMO MOURA
EDITORA MELODIAS POPULARES

Fermata do Brazil Affiliated Group—Avenida Ipiranga, 1123—Sao Paulo

FERMATA DO BRAZIL LTDA.
EDITORA MUSICAL SERESTA LTDA.
MELODIAS AMERICANAS LTDA.
EDITORA MUSICAL ARLEQUIM LTDA.
EDITORA MUSICAL BRASILEIRA MODERNA LTDA.
EDITORA MUSICAL ARAPUA LTDA.
EDICOES MUSICAIS SONATA LTDA.
MUSICLAVE LTDA.
DISPARADA EDICOES MUSICAIS

Irmaos Vitale Affiliated Group—Rua Franca Pinto, 42—Sao Paulo

IRMAOS VITALE EDITORES
EDITORA MUSICAL CEMBRA LTDA.
EDITORA MUSICAL ACUFF ROSE LTDA.
EDITORA MUSICAL CENTRAL SONGS LTDA.
EDITORA MUSICAL ZODIAC MUSIC LTDA.
EDITORA MUSICAL WORLD MUSIC LTDA.
EDICOES MUSICAIS UNITED ARTISTS

EDICOES MUSICAIS RCA LTDA.—EDICOES MUSICAIS VICTOR LTDA.—Avenida Ipiranga, 1097—Sao Paulo

EDITORA DE MUSICA BRASILEIRA & INTERNACIONAL LTDA.—(EMBI)—Avenida Almirante Barroso, 91—Rio de Janeiro

NOTAS MAGICAS EDITORA MUSICAL LTDA.—SMART EDITORA MUSICAL LTDA.—Avenida Ipiranga, 1123—Sao Paulo

RICORDI BRASILEIRA S.A.—Rua Quintino Bocaiuva, 22—Sao Paulo

MUNDO MUSICAL EDICOES LTDA.—Rua Visconde Rio Branco, 53—Rio de Janeiro

CASA CARLOS WEHRS PIANOS S.A.—Rua da Carioca, 47—Rio de Janeiro

EDITORA ARTUR NAPOLEAO LTDA.—Rua Juan Pablo Duarte, 46—Rio de Janeiro

EDITORA MUSICAL BRASILEIRA—Rua Santa Luzia, 799—Rio de Janeiro

A GUITARRA DE PRATA INSTRUMENTOS DE MUSICA LTDA.—Rua da Carioca, 37—Rio de Janeiro

MUSICAS & INSTRUMENTOS CASA MANON LTDA.—Rua 24 de Maio, 476—Sao Paulo

BRAZIL—THE PAST 12 MONTHS

(Continued from page 141)

From the international field the most important of the year was no doubt Frank Sinatra (Reprise) in his spectacular come back to the charts here; but several others have had significant penetration this year, such as Matt Monro (Odeon), Jack Jones, (Mocambo), naturally Herb Alpert & Tijuana Brass, (A&M) Nancy Sinatra, Trini Lopez (both Reprise), and several others. French and Italian music was much weaker this year, but still several artists appeared strong, some of which came through the San Remo Festival.

A new rhythm from Brazil made news in the United States and other countries through recordings of several top artistes, as was largely publicized here: "Jequibau", is a serious and conscientious work of maestros Mario Albanese and Ciro Monteiro; young guitarists Macumbinha and Santisteban are active in the promotion of the new haunting rhythm and a trip to the US is planned. At this time we can say that Antonio Carlos

Jobim reached the top of his international career, recording with Frank Sinatra what we consider one of the best records of the year and which is a chart album—this was the most important means of promotion for the Brazilian popular music this year and more results are to be expected, after other recordings made there by the young and talented composer. Besides "Tom", Astrud Gilberto and specially Sergio Mendes helped put Brazilian music in a high position internationally. This year a new addition to the great promo of Brazilian pop music appeared strong in the US—organist-composed-arranger Walter Wanderley who also had some chart disks. Luiz Bonfa, Laurindo de Almeida, Bola Sete, Doum, are other names now familiar in the North American territory. Top chantress Maysa is also in California and it is possible that we may hear from her soon. Many other Brazilian artists were requested to visit South American and European countries, such as Edu Lobo, Elis Regina, Zimbo Trio, Peri Ribeiro, Tamba Trio, Eliana Pitt-

man, Altamar Dutra, Miltoninho, Chico Buarque de Hollanda, Roberto Carlos, etc.

Besides those who attended the Rio Intl. Fest, very few foreign artists were in this country during these past twelve months, among them: Caterina Caselli, French teen star Johnny Halliday, Mexican Trio Los Panchos, Italian chantress Milva and lately Israel international chantress Hanna Ahroni; other important international stars are scheduled to come soon, such as the Happenings, Chris Montez and once again it is talked about Frank Sinatra and daughter Nancy. . . . This is partly due to the efforts of artists' agent Waldomiro Saad, who is doing an excellent work of international exchange.

Two important facts connected with show business and disk happened during the past twelve months: the launching of new label "AU" (Artistas Unidos), with an excellent promo background which include several TV and radio stations and has plant and promotion of "Fabrica de Discos Rozenblit" working for it; besides, such old and experienced disk pros as Bob Corte-Real (A&R) are active assuring a good production of

the new-born label; the other happening was the opening of a new TV channel in São Paulo (TV Bandeirantes, Channel 13) which is presenting new musicals local and VT importations.

Considering all difficulties that Brazil is going through, we can honestly affirm that this was a year of victories to the record industry in general, although figures do not represent it for the mentioned reasons. There is a definite public acceptance for the record and a special artists' promotion, through improved TV programs, higher salaries, competition and better understanding of the markets. Local artists and companies are looking ahead to the future with high hopes, knowing that the movement is being understood and appreciated, and optimistically based in the idea that the financial situation will improve through a better government, which is the thing that was needed to allow the record industry in Brazil to reach the deserved and wished for position in the country's activities. And soon we will be also talking of important facts related with tape cartridges and juke-boxes!

(Continued on page 146)

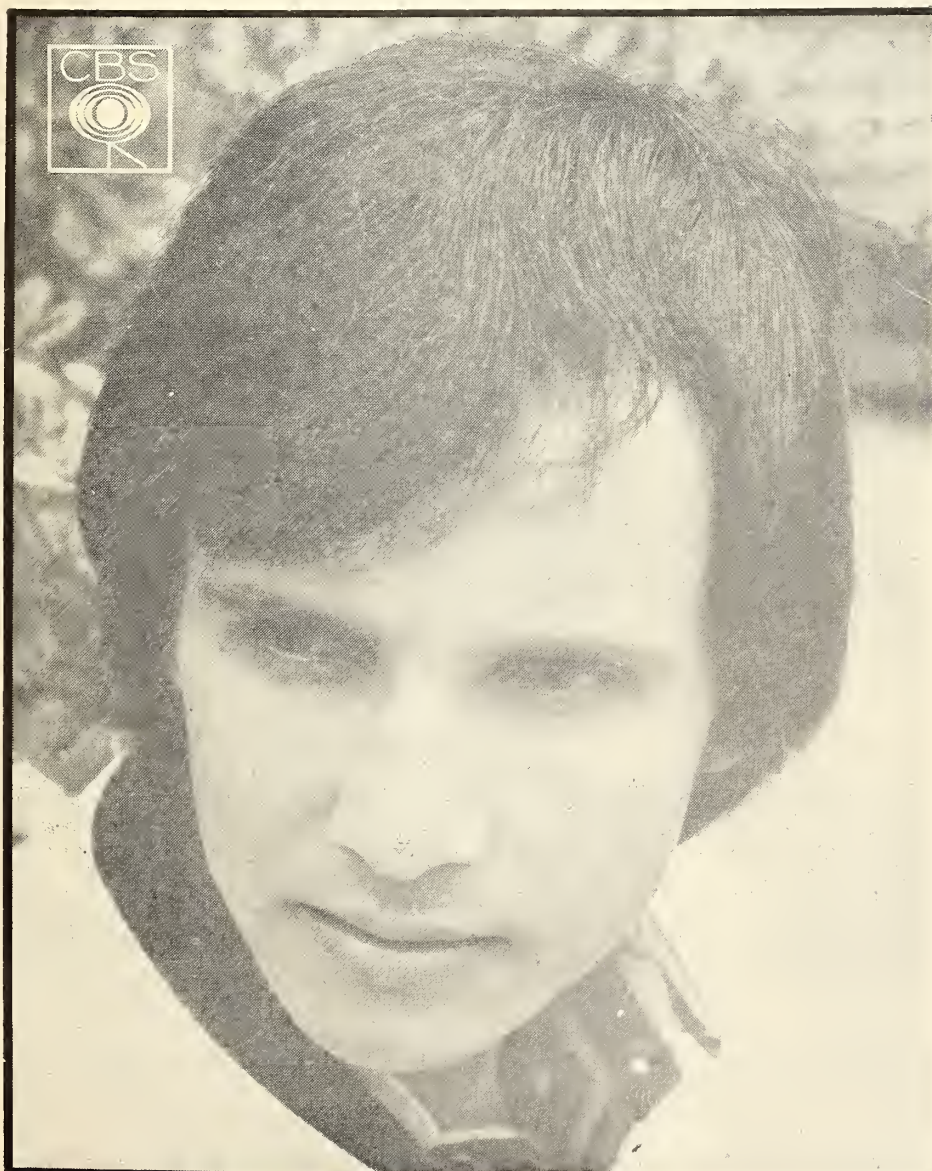

The Latin American Idol
of the
Teen-Agers Music

**Roberto
Carlos**

Awarded Brazilian Artist
in the
First Midem Festival
(Cannes, France)

DISCOS CBS S.A.
BRAZIL

FERMATA GROUP

Sweeps

34 AWARDS

Biggest First-half Year in FERMATA History!

Rights now available for publishing and/or recording in the United States and Canada to many outstanding tunes from FERMATA's world-acclaimed Latin American catalogue.

FERMATA INT'L. MELODIES, Inc.
A.S.C.A.P.
BENDIG MUSIC CORP.
B.M.I.

D. FRENKIEL, Mgr.
6290 Sunset Blvd.,
Hollywood, Calif., 90028
PHONE: (213) 462-7473

(See our "AWARDS AD" . . . Part 1, page 64 this issue)

EDITORA DE MÚSICA BRASILEIRA E INTERNACIONAL S/A — "EMBI"

Editôra de Música Lyra Ltda. — Editôra de Música Indus Ltda.
Avenida Almirante Barroso, 91/401
Rio de Janeiro — Brasil

Associated to the Southern-Peer group of New York
SOME OF OUR SUCCESS:

SI MANDA, MAS QUE NADA e CHOVE CHUVA—Jorge Ben; TIM DOM DOM—Joao Mello/Codó; MAR DE JANAÍNA—Codó; MARIA NINGUÉM—Carlos Lyra; É LUXO SÓ—Ary Barroso/Luiz Peixoto; O BOM RAPAZ—Geral do Nunes.

THE MOST ACTIVE PUBLISHERS IN BRAZIL PRESENT THEIR 1967 HITS:

EBRIO DE AMOR
CARANGO
SÓ VOU GOSTAR DE QUEM GOSTA DE MIM
CIAO AMORE, CIAO (Tchau amor, adeus)
PIANGI CON ME
SOMETHIN' STUPID (Cosinha estúpida)
QUANDO DICO CHE TI AMO

they are

EDIÇÕES MUSICAIS RCA LTDA.
&
EDIÇÕES MUSICAIS VICTOR LTDA.

Av. Ipiranga, 1.097-11° and.
Sao Paulo — Brasil
cable address: RADIOINTER SPAULO



INTERNACIONAL REPUTATION

Chico Buarque de Hollanda and Antonio Carlos Jobim have achieved for themselves an international reputation as leaders of Brazilian modern music.

Messias, one of the very best Brazilian guitar players and personal friend of Chico, interprets twelve of the most recent and popular tunes of this accomplished young composer in this album.

BRAZIL'S BEST SELLERS

(Continued from page 142)

FERMATA DO BRASIL, LTDA.

TITLE	ARTIST	PUBLISHER	LABEL
BEST SELLING SINGLES			
Whipped Cream	Herb Alpert's Tijuana Brass	Fermata	A&M
The More I See You	Chris Montez	Todamerica	A&M
Lara's Theme	Al Korvin	Fermata	Fermata
Dollaro Bucato Theme	Gianni Ferrio	Fermata	Fermata
Guantanamera	The Sandpipers	Fermata	Fermata
Never Never	Billy Vaughn	Fermata	Fermata
Michelle	Claudio Villa	Fermata	Fermata
Non Pensare A Me	Michel Polnareff	Fermata	Disques AZ
Love Me Please Love Me	Chris Montez	Embi	A&M
Sunny		Fermata	
BEST SELLING LP's			
Whipped Cream	Herb Alpert's Tijuana Brass		A&M
The More I See You/Call Me	Chris Montez		A&M
San Remo 67	Several Italian Artists		Fermata
Herb Alpert Presents	Sérgio Mendes & Brasil 66		A&M
Guantanamera	The Sandpipers		Fermata
BEST SELLING DOUBLE-COMPACTS			
El Presidente	Herb Alpert's Tijuana Brass		A&M
Monsieur Cannibale	Sacha Distel		Fermata
The Shakers	The Shakers		Fermata
Love Me Please Love Me	Michel Polnareff		Disques AZ
The More I See You	Chris Montez		A&M

GRAVAÇÕES ELETRICAS S. A. (CONTINENTAL)

BEST SELLING SINGLES			
Ebrio De Amor	Lindomar Castilho	Ed. RCA	Continental
Faça Alguma Coisa Pelo A Praça	Os Vips	Ed. Genial	Continental
Nao Presto Mas Te Amo	Francisco Petronio	Ed. Clave	Continental
O Adeus	Demetrius	Ed. Genial	Continental
Vai Embora Daqui	Ary Sanches	Fermata	Continental
Submarino Amarelo	Marcos Roberto	Fermata	Continental
Os Milionarios	Os Vips	Fermata	Continental
Veja Se Me Esquece	Os Incriveis	Vitale	Continental
Terezinha	Dori Edson	Fermata	Continental
	Gilberto Lima	Vitale	Continental
BEST SELLING LP's			
Escuta Minha Oração	Lindomar Castilho		Continental
Somente Boleros Vol. 2	Poly		Continental
Os Vips, Vol. 2	Os Vips		Continental
Abisco De Rosas	Dilermano Reis		Continental
Festival De San Remo	Several Italian Artists		Continental
BEST SELLING DOUBLE-COMPACTS			
Pathinho Feio	Children's story		Disquinho
A Baratinha	Children's story		Disquinho
Dori Edson	Dori Edson		Continental
Ciro Aguiar	Ciro Aguiar		Continental
"Os Brazas"	Os Brazas		Continental

INDUSTRIAS ELETRICAS & MUSICAIS FABRICA ODEON S. A.

BEST SELLING SINGLES			
Bus Stop	The Hollies	Fermata	Odeon
Pensando Nela	Golden Boys	Fermata	Odeon
Michelle	Beatles	Fermata	Odeon
Michelle	Golden Boys	Fermata	Odeon
A Praça	Wilson Simonal	Ed. Clave	Odeon
Coruja	Deny & Dino	Fermata	Odeon
Yesterday	Matt Monro	Fermata	London
Yesterday	The Beatles	Fermata	London
Satisfaction	Rolling Stones	Vitale	London
Mascara Negra	Dalva de Oliveira	Arlequim	Odeon
Mamae Passou Açucar	Wilson Simonal	Ed. Samba	Odeon
Goiabao	Eduardo Araujo	Ed. Clave	Odeon
Coração De Papel	Sérgio Reis	Fermata	Odeon
BEST SELLING LP's			
Rubber Soul	The Beatles		Odeon
Revolver	The Beatles		Odeon
Help!	The Beatles		Odeon
O Bom	Eduardo Araujo		Odeon
Alguem Na Multidao	Golden Boys		Odeon
BEST SELLING DOUBLE-COMPACTS			
Wilson Simonal	Wilson Simonal		Odeon
Altamar Dutra	Altamar Dutra		Odeon
Elza Soares	Elza Soares		Odeon
Sérgio Reis	Sérgio Reis		Odeon
Rolling Stones	Rolling Stones		London

RCA ELETRONICA BRASILEIRA S. A.

BEST SELLING SINGLES			
California Dreamin'	The Mama's & The Papa's	Vitale	Dunhill
Monday Monday	The Mama's & The Papa's	Vitale	Dunhill
Last Train To Clarksville	The Monkees	Mundo Musical	RCA Victor
See You In September	The Mustangs	Fermata	RCA Victor
Ciao Amore Ciao	Luigi Tenco	Ed. RCA	RCA Victor
Escureceu	Carlos Gonzaga	Fermata	RCA Victor
Piangi Con Me	The Rokes	Ed. RCA	RCA Victor
Si Fa Sera	Gianni Morandi	Ed. RCA	RCA Victor
A Partida	Os Iguais	Ed. RCA	RCA Victor
Disparada	Geraldo Vandrê	Ed. Disparada	RCA Victor
BEST SELLING LP's			
If You Can Believe	The Mama's & The Papa's		Dunhill
The Sound Of Music	Original Soundtrack		RCA Victor
The Monkees	The Monkees		RCA Victor
The Mama's & The Papa's	The Mama's & The Papa's		Dunhill
Vou Sair Dos Labios Teus	Adilson Ramos		RCA Victor
BEST SELLING DOUBLE-COMPACTS			
California Dreamin'	The Mama's & The Papa's		Dunhill
Last Train To Clarksville	The Monkees		RCA Victor
I Saw Her Again	The Mama's & The Papa's		Dunhill
Piangi Con Me	The Rokes		RCA Victor
Dr. Zhivago	The Brass Ring		RCA Victor

(Continued on page 146)

**For 1968,
save running around the world
do all your business in one week
in sunny cannes**

MEET AT THE MIDEM

29 JANUARY

3 FEBRUARY

1968

**PALAIS DES FESTIVALS
CANNES FRANCE**

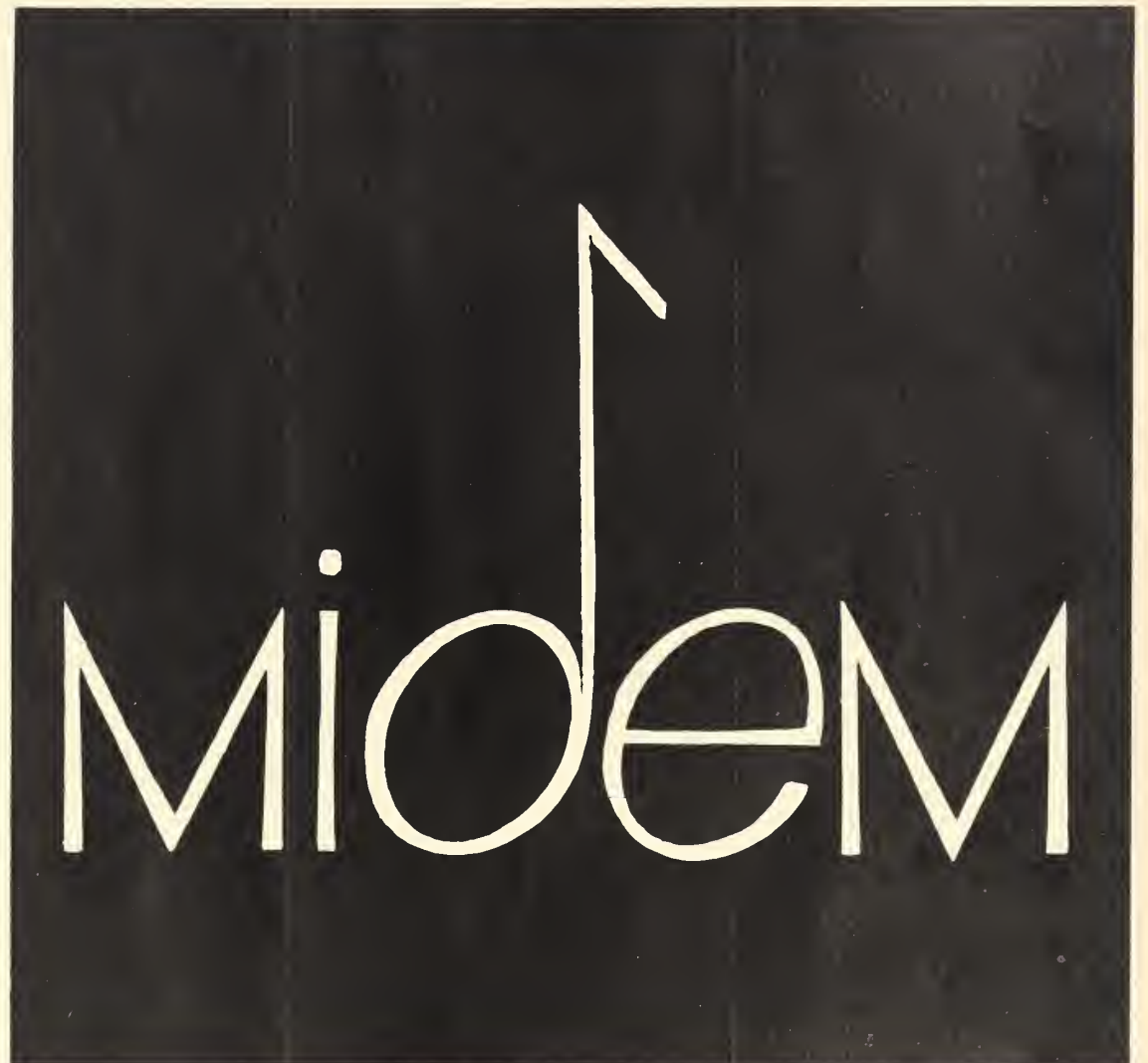

**MARCHÉ INTERNATIONAL DU DISQUE ET DE L'ÉDITION MUSICALE
INTERNATIONAL RECORD AND MUSIC PUBLISHING MARKET**

**MIDEM GENERAL MANAGEMENT : 9 Rue Magellan, 75 PARIS 8^e FRANCE
Telephone : 359.35-35 - Cable : MIDEM PARIS 042**

**U.S. REPRESENTATIVE : REN GREVATT, 200 West 57th Street, Suite 910, NEW YORK CITY,
N.Y. 10019. U.S.A.
Telephone : (212) 582-0252, -0253**

EMI:
In its 10th year of operation in South Africa E.M.I. has gone from strength to strength and is very optimistic about new artists now making the grade. A good example has on the local scene been the fantastic reception accorded two young men, Sias Reinecke and Gert van Tonder, known as Group 2, who's first recording, a single titled "Die Ou Kraaliedjie" quickly established them on the South African Hit Parade. A new Afrikaans label "Uitspan" was introduced during the year and Nico Carstens, South Africa's foremost Band Leader and Composer (who is known Internationally via his Hit compositions "Zambizi" and "Sadies Shawl") headed up this operation and this label has already made its mark in this highly competitive industry.

Artists who toured South Africa during the past 12 months included Capitol's master balladeer Matt Monro and Trumpet Maestro Ray Anthony with his full show: Australia's gift to the Pop World The Seekers had a smash reception whilst that ageless Frenchman Maurice Chevalier showed he was still a master entertainer.

E.M.I. South Africa was also honoured during this year with a visit by Sir Joseph Lockwood, Chairman of the E.M.I. Group of companies, accompanied by another E.M.I. Top Executive, Mr. J. G. Stanford.

In April of this year a visit was made by Ron Kass, the director of overseas operations for Liberty Records. From the Liberty stables riding high on the charts were the Ventures and Gary Lewis & The Playboys. Both of these artists continue to impress teenagers, while the Johnny Mann Singers and the 50 Guitars of Tommy Garrett also increased in popularity. Overall, the local Hit Parades were still dominated by overseas talent with the beat, particularly the Detroit Sound, making itself felt, but by no means keeping out the ballads. The biggest selling 7 single of the year was undoubtedly MGM's Sandy Posey's debut record "Single Girl". Also from MGM the incomparable film soundtrack of "Dr. Zhivago" further enhanced that company's image in this country with both the mono and stereo versions selling extremely well. The Surfing Sound was truly established by the Beach Boys, and every one of their singles released topped the Hit Parades. Capitol continued to dominate the 'good music' market with singers such as Al Martino, Nancy Wilson and Peggy Lee, while sales returns for the New Classic Singers were particularly impressive. Also from the U.S.A. and released on the company's Stateside label the Royal Guardsmen topped the charts with their "Snoopy" records and the Five Americans showed they were here to stay with "Western Union". The popularity of Neil Diamond continued to grow and The Buckingham were quickly established with a "Kind Of A Drag". Whilst the Bob Crewe Generation created an overnight sensation with their single "Music To Watch Girls By". The follow-up LP appears destined to become a best seller. On the Tamla-Motown scene, the Supremes showed they were still leaders in this field, but Martha & The Vandellas especially with their hit "Jimmy Mack" proved they were not far behind, as indeed did the Four Tops and the Marvelettes. Undoubtedly the Detroit Sound will grow in stature over the next 12 months and many promotions to encourage this are now in the planning stage.

From Immediate came several hits by Chris Farlowe particularly his "Ride On Baby", which stayed on the charts for some three months. Also establishing themselves well were the Twice As Much.

From the British labels, H.M.V., Columbia, Parlophone, Ember, the Beatles were still the top pon group, with Herman's Hermits, the Shadows and The Hollies as close contenders. Cliff Richard maintained his popularity and was constantly on the Hit Parades, his two biggest numbers be-

ing "In The Country" and "Time Drags By". Male duo's were dominated by Columbia's Peter & Gordon with such hits as "Lady Godiva", though in this field Liberty's Jan & Dean provided tough competition.

A young mademoiselle from France proved to be particularly successful on the Barclay label. Her name is Mireille Mathieu and she was undoubtedly the top newcomer on the Barclay label where Dalida and Charles Aznavour continued to lead the field. Their type of singing continued to increase in popularity as indeed did the records on H.M.V. of Gilbert Beaud, who will be touring the Republic shortly.

GALLO:

Gallo (Africa) Limited moved to their newly built offices in September. Occupying one complete block, the modern skyscraper incorporates luxurious offices, a showroom floor, three levels of underground garage space, and a lush executive floor which leads via french doors to a large paved roof garden. In a setting of tropical plants and fountains stands The Rotunda, an enormous circular glass-enclosed room designed for the entertaining of VIP's and for the launching of promotional campaigns.

The Studio Complex forms the heart of the building. It was designed by Gallo's Chief Recording Engineer Geoff Tucker in conjunction with the C.S.I.R. (South African Council for Scientific and Industrial Research). Although many new and unorthodox ideas and devices are features, all planning was in strict accord with Mr. Tucker's principle of "straight-forward and uncluttered."

Comprising two main studios (52 x 32 and 44 x 23) in addition to Speech Studios for radio programme recording, Audition Studios, Re-Mix Studios, offices and reception rooms, the entire Complex is floated on a deep base of fibre-glass. Mixing Desks in the two large studios are fully transistorized, were locally built (entirely to Mr. Tucker's design), and record direct mono, or two- or three-track stereo.

In keeping with the streamlining of the Company generally, the Gallo record factory at Roodepoort is being modernized and enlarged to meet greater demand, particularly that in the Coloured and Bantu markets. It is of interest to note that South Africa is one of the few countries still pressing 78 r.p.m. records in quantity: the 78 r.p.m. is a major part of the Bantu trade in records.

Of importance on the local recording scene, little could exceed that at present of young Record Producer Grahame Beggs. He joined the Gallo Group in June 1966 and since then, of the many dozens of disks he has produced, less than ten percent have failed to reach local charts. Not only has Grahame Beggs (who is 23) produced hits: in most cases he has himself discovered the artists and found the songs as well. His greatest successes are undoubtedly the Dream Merchants' recordings—Love Minus Zero, Land Of Milk And Honey, and Time And The River. These as well as their first LP Predictions And Things reached high places on Hit Parades, and it was only four months after their disk debut that they won the coveted Golden S.A.R.I. Award. In March the two Dream Merchants (Billy Forrest who won last year's C & W/S.A.R.I., and Billy Andrews) flew to London, and are now busy recording for Decca. Their second LP is to be released there shortly. Seven-single number four is titled Rattler, was written specially for them by Seeker Bruce Woodley (composer of Red Rubber Ball) when the Seekers were on tour here last year, and has earned extravagant predictions from overseas and local pundits.

TRUTONE:

A number of highly successful sales drives were launched by this company, with their Xmas Promotion being the talking point not only of the trade, but also of the buying public. Trutone has grown by a per-

BRAZIL'S BEST SELLERS

(Continued from page 144)

RGE DISCOS LTDA.

TITLE	ARTIST	PUBLISHER	LABEL
BEST SELLING SINGLES			
Voce Me Acende	Erasmio Carlos	Fermata	RGE
A Banda	Chico Buarque de Hollanda	Fermata	RGE
Dio Come Ti Amo	Gigliola Cinquetti	Fermata	RGE
Michelle	Billy Vaughn	Fermata	RGE
Wild Thing	The Troggs	Fermata	RGE
La Banda Borracha	Mike Laure	Ed. RCA	RGE
A Carta	Erasmio Carlos	Fermata	RGE
Un Homme Et Une Femme	Mireille Mathieu	Fermata	RGE
O Tremendao	Erasmio Carlos	Fermata	RGE
Quem Te Viu, Quem Te Ve	Chico Buarque de Hollanda	Fermata	RGE

BEST SELLING LP'S

Voce Me Acende	Erasmio Carlos	RGE
A Banda	Chico Buarque de Hollanda	RGE
Os Grandes Sucessos De Billy Vaughn		RGE
Mireille Mathieu	Mireille Mathieu	Barclay
Aos Seus Amigos	Helena de Lima	RGE

BEST SELLING DOUBLE-COMPACTS

Paris Em Agosto	Charles Aznavour	Barclay
La Paloma	Billy Vaughn	RGE
Alain Barriere	Allain Barriere	RGE
Erasmio Carlos	Erasmio Carlos	RGE
Paulinho Nogueira	Paulinho Nogueira	RGE
Chico Buarque De Hollanda		RGE

SOM INDUSTRIA & COMERCIO S. A. (Copacabana)

BEST SELLING SINGLES

A Praia	Agnaldo Rayol	Vitale	Copacabana
Te Esperarei	Wanderley Cardoso	Vitale	Copacabana
Eu Nasci P'ra Voce	Giancarlo	Notas Mágicas	Copacabana
Eu Te Darei Bem Mais	Moacyr Franco	Fermata	Copacabana
A Tua Voz	Agnaldo Rayol	Ed. RCA	Copacabana
Amor Criança	Wanderley Cardoso	Vitale	Copacabana
Cinderella	Angela Maria	Vitale	Copacabana
Vem Chegando A Madrugada	Elizete Cardoso	Nossa Terra	Copacabana
Lara's Theme	The Jordan's	Todamerica	Copacabana
O Chorao	Paulo Diniz	Vitale	Copacabana

BEST SELLING LP'S

Quando O Amor Te Chama	Agnaldo Rayol	Copacabana
A Bossa Eterna	Cardo-o & Monteiro	Copacabana
Perdamente Apaixonado	Wanderley Cardoso	Copacabana
Studio 17	The Jordans	Copacabana
Eu Te Darei Bem Mais	Moacyr Franco	Copacabana

BEST SELLING DOUBLE-COMPACTS

Minha Serenata	Wanderley Cardoso	Copacabana
Falaste Coração	Angela Maria	Copacabana
Rosa De Ouro	Elizete Cardoso	Copacabana
Doce Amargura	Moacyr Franco	Copacabana
Pombinha Branca	Silvana	Copacabana

DISCOS SOM/MAIOR LTDA.

BEST SELLING SINGLES

7 Uomini D'Oro	Orch. Armando Trovajoli	Som/Maior
Cherish	The Association	Som/Maior
Mascara Negra	Mário Zan	Som/Maior
That's The Way It's Gonna Be	Lee Mallory	Som/Maior
Stop The Music	The Hitmakers	
Esqueça Nao	Tito Madi	
Porta Estandarte	Geraldo Vandrê	
La Banda Borracha	Sansa Cinco	
A Banda	Mário Zan	
Fica Mal Com Deus	Geraldo Vandrê	

BEST SELLING LP'S

7 Uomini D'Oro	Original Soundtrack (Armando Trovajoli)	
12 Temas De Cinema		
30 Cancoes De San Remo 67		
Shelby Flint		
The Association		

BEST SELLING DOUBLE-COMPACTS

4 Sucessos Vol. 2	Tullio Gallo & Tom Patrick
4 Temas de Cinema	The Association
The Association	
4 Sucessos, Vol. 1	
Mario Zan & Sua Bandinha	

centage not only unprecedented in the annals of its own history, but possibly even in that of the whole South African record industry.

Pop record stars, released by Trutone, whose records featured most prominently for many months on the local charts were—The Troggs, Dave Dee, Dozy, Beaky, Mick & Tich, Manfred Mann and The New Vaudeville Band.

L.P. artists who made a strong impact on the buying public were The Korean Orphan Choir, Walter Wanderley, Astrud Gilberto, Shirley Bassey, Billy Vaughn, Ferranti & Teicher, The Troggs, Brook Benton. In their own particular spheres, such giants as, Joan Baez, Jimmy Smith, and Richter and Rostropovitch, dominated the market.

The Trutone A & R team heard a Korean Orphan Choir record sample. Realising the group's potential, the distributorship of the Word Label was obtained, and a recompiled LP released. The LP was an immediate success and many thousands have been sold.

Two Trutone artists won 1966/67 S.A.R.I. Awards (the South African equivalent of the U.S. Grammy Award)—Julia Mann as South Africa's Best Female Vocalist, and George Hayden (Saxophone) as South Africa's Best Instrumentalist.

Tremendous progress has also been made by Trutone in the manufacture and distribution of African material.

BRAZIL—THE PAST 12 MOS.

(Continued from page 143)

To finalize this report, we wish to ask forgiveness of local firms and artists who were not mentioned in this review, although having been connected with important events of the Brazilian scene, but we can assure them that this was completely unintentional. We would also like to take this opportunity to thank all diskeries and pubberies for their cooperation during this year of hard work for the good Brazilian popular music in all its aspects and wish them all luck in this next year.

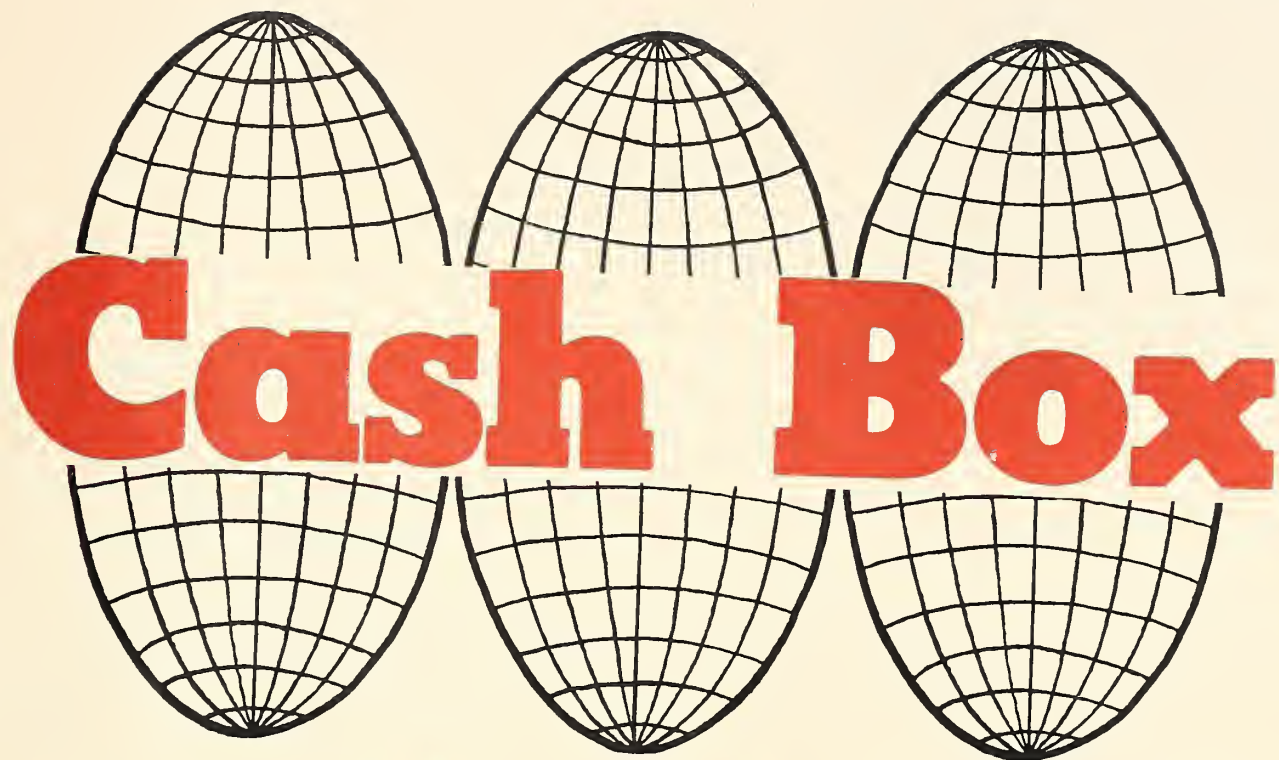

ANNUAL

World Wide

**COIN MACHINE
and VENDING**

DIRECTORY

1967-1968

25th Anniversary Edition



Attention. Calling all music operators. Calling all music operators. Are your location profits in trouble?

Better call in *Super Jukebox*, otherwise known as the mighty "Music Merchant" (MM).

Faster than a mint at making money... more powerful than a magnet at getting customers over to play. Listen to these music operators who've seen the mighty Rowe AMI Music Merchant in action. "Amazing." "Incredible." "Fantastic."

Super Jukebox changes right on the spot (Change-A-Scene), and really comes on... talking it up for more, more music ("Play-Me Records").

If you're having location profit problems, why not call in *Super Jukebox* to the rescue?

Rowe[®]
MANUFACTURING

75 Troy Hills Road • Whippany, New Jersey 07981

R-36

THE SUPER JUKEBOX

Get ready for fantastic profits with...

THE FABULOUS

PhonoVue



IT'S HERE...
AUDIO-VISUAL
ENTERTAINMENT
EVERY OPERATOR
CAN AFFORD!

(It's the first audio-visual
that works with a jukebox.)

PhonoVue is a companion piece for Rowe AMI's Music Merchant jukebox. It accompanies the latest chart records with exciting Super-8 mm films in dazzling color on a giant 14" x 23" screen.

All you do is choose one of the 20 premium-price movie-record selections on the Music Merchant jukebox . . . the PhonoVue and the record (coordinated in time, tempo and mood to the movie) swing into simultaneous action. Your locations' customers will go into action too . . . digging deep for more money!

No additional floor space is needed . . . PhonoVue can be located away from the Music Merchant on a back-bar, wall or even in an adjoining room. (If the location has more than one room for entertainment, you can install additional PhonoVues.)

With each PhonoVue, you get a guaranteed film supply from Rowe AMI's swinging, up-to-date

film library. Rowe is your most reliable source for audio-visual entertainment . . . we're the only jukebox manufacturer in the field, and we know your needs.

All PhonoVue Super-8 mm films come in pocket-size Technicolor® Magi-Cartridges.™ Changing films is simple . . . you take cartridge out, snap new one in place.

If you're in the mood for double profits at low cost, see your Rowe AMI distributor. He'll show you the winning combination—PhonoVue & Music Merchant.

Rowe®
MANUFACTURING
75 Troy Hills Road
Whippany, New Jersey 07981



from the desk of . . .

GEORGE ALBERT
OF



July, 1967

Dear Friends:

An enormous sense of satisfaction accompanies the presentation of our 1967-68 Coin & Vending Directory. More than simply the completion of one more annual, this 25th "silver anniversary" edition marks a proud hurdle in the world of international commerce and we are as prone to tradition as the next.

Twenty-five directories, each a barometer of the health of this business of operating and selling coin equipment, each a valid reflection of the growing vitality of the industry, each and every one proud to serve the thousands of tradesmen of many languages in the daily concourse of business.

The coin machine industry is essentially a buy and sell business . . . whether it be the purchase of a new pool table, the teenager selecting his favorite tune from one of our thousands of phonographs or the sale of a refreshing can of cold soda to a weary traveler at a service station vendor. But in the last analysis, the coin industry is the business of selling entertainment. It can be seen in the satisfied face of the truckdriver working out his nervous energy on the pinball machine and winning a free game, heard in the staccato clanging of the arcade as children run to their parents for one more nickle for the hockey machine, and actually felt through the pounding base speakers of today's advanced phonograph sound systems.

This industry has carved a necessary niche wherever folks have leisure time to expend, not only in America but in such overseas markets as Europe and Japan where prosperity has offered people a chance for more recreational fun than ever before (in 1966, the dollar volume of exported coin equipment shattered the previous year's record by \$5 million). To the trade, this 25th Annual Directory is one more instrument to be used in the quest for financial success. Speaking on my own behalf and for the entire staff at Cash Box, may I thank you once again for making it possible to serve you.

George Albert

President and Publisher

AGAIN, I WANT TO BUY YOUR USED MACHINES

I need the following equipment immediately to fill overseas orders:

AMI

F120	J100M/120	N200
G120	J200	O200
G200	K200	WQ200-1
H120	Cont. 200-1	WQ200
H100M	Cont. 100-2	CGA str.
H200	Cont. 200-2	Hideaway
I100M	J.A.L. 200	200 selec.
I200	M200	

SEEBURG

R100	161	LPC-480
V200	222	3WI-100 WB.
VL200	AQ160	160 WB
KD200	DS160	200 WB
L100	AY160	
201	LPC-1	

ROCKOLA

1455	1485	404	426
1465	1488	408	429
1464	1494	414	
1475	1495	418	
1484	1496	425	

WURLITZER

2300	2600	2810	3000
2400	2610	2800	3010
2500	2710	2900	5250 WB
2510	2700	2910	

SHUFFLES

U. Gypsy	U. Crest
U. Stardust	U. Bank Pool
U. Viking	U. Topper
U. Embassy	U. Tempest
U. Sparky	U. Pacer
U. Astro	U. Tiger
U. Ultra	U. Orbit
U. Skippy	U. Mambo
U. Playboy	U. Cheetah
U. Rumpus	U. Pyramid
U. Caravelle	

ARCADE EQPT.

Auto Photo 14	So. Time Trial
Auto Photo 11	M. Joker Ball
W. Roadracer	So. Little Pro
CC Pro Basket.	B. All Star Del
CC Pro Hockey	WM TENPin
Mid. Red Ball	Wm. Teestrike
Wm Mini Golf	CC Pop Up
So. Speedway	Standard Met. Typer

GUNS

CC Riot	CC Ponyexp
CC Shootclown	CC Raygun

CC Longrange

CC Playland
CC Champion
CC Texas Rang.
Wm Vanguard
Wm Hercules
W. Crusader
W. Titan
W. Spaceglider.

CC Wildwest

CC Worldfair
M. Bazooka
M. Rifle Gall
M. Rifle Rge.
M. Trophy
M. Rifle Chp.
M. Monster
S. Shootbear

BASEBALL (F.P.)

W. Grandslam
W. Worldseries
M. Slugger
CC All Star
W. Major Lg.
M. Tophit
B. Ballpark
W. Double Plays (new Playfields)

B. Target
M. Playball
M. Little Lg.
CC Big Lg.
CC TV B.B.
Wm Pitch Bat
M. 57 Baseball
W. Magic City
W. Magic Town
Bus Stop '65
Mad World '64
Monte Carlo '64
Sky Diver '64
Two in One '65
Hootenanny '63
Cross Country '63
Cue Tease '63
Moon Shot '63
Star Jet '63
Diskotex '65
Fifty Fifty '65

MIDWAY

1. Pl. Target
2. Pl. Target
Carnivals.
Raceways

Flying Turns
Winners
Citamp.
Mystery Score

ADDABALLS

G. Flipper Parade
G. Fl. Fair
G. Fl. Clowns
G. Fl. Cowboys
G. Majorette
G. Cowpokes
G. Bigtops
G. Flipper Pool
G. Ice Show

W. Vagabond
W. Swingtime
Wm. Palookas
Wm. WingDings
Wm. Ski Clubs
B. Happy Tour
B. Hayride
B. Trios
B. Gold Rush

PIN BALLS

G. Gauchos '62
G. Swingalong '63
G. Shipmates '63
G. Bonanza '64
G. Happy Clown '64
G. World Fair '64
G. Bowling. Queen '64
G. North Star '64
G. Seashore '64
G. Dodge City '64
G. Masquerade '65
G. Bankaball '65
G. SkyLine '65
G. Ice Review '65
G. Buckaroo '65
G. King & Queen '65
G. Paradise '65
G. Central Park '66
G. Crosstowns '66

G. Thorobread '66
G. Mayfair '66
G. Hi Dolly '66
G. Subway '66
G. Dancing Lady '66
Wm. Mardigras '62
W. Tom Tom '63
W. Bigdaddy '63
W. Merry Widow '63
W. Bigdeal '63
W. El Toro '63
W. Jumping Jack '63
W. Beat the Clk '64
W. Heat Wave '64
W. Riverboat '64
W. Soccer '64
W. Whoopee '64
W. Ohboy '64
W. Sanfrancisco '64

W. StopNGo '64

W. Eagerbeaver '64
W. Prettybaby '65
W. ZigZag '65
W. Moulin Rouge '65
W. Teacher Pet '65
W. Lucky Strike '65
W. Bigchief '65
W. Alpine Club '65
W. Pot Gold '65
W. Fullhouse '66
W. Top Hand '66
W. Eightball '66
W. Ago go '66
W. Hot Line '66
W. Big Strike '66
W. Casanova
W. Magic City
W. Magic Town
Bus Stop '65
Mad World '64
Monte Carlo '64
Sky Diver '64
Two in One '65
Hootenanny '63
Cross Country '63
Cue Tease '63
Moon Shot '63
Star Jet '63
Diskotex '65
Fifty Fifty '65

Sheba '65

Blue Ribbon '66
Gold Rush '66
Wild Wheels '66
Campus Queen '66
Loop The Loop '66
Bazaar '66
Capersville
B. Three in line '63
B. Grand Tour '64
B. Harvest '64
B. Bongo '64
B. Bullfight '64
B. Magiccircle '64
B. Trio '65
B. Six Sticks '66
B. Big Day '65
B. Aces High '65
B. Bandwagon '65
K. Poker Face
K. Colorama
K. CoCart
CC Sunvalley
CC Bronco
CC Firecrker
CC Royalflash
CC Mustang
CC South Pacif
CC Kicker
CC Festival
CC Beatnick

Parade

Keywest
Doubleheader
Beach Beauty
Sun Valley
Miss America
Cyp. Gardens
Beachtime
Carnival Queen
Sea Island
Ballerina
County Fair
Laguna Beach
Rollerderby

Circus Queen

Acapulco
Bikini
Can Can
Lido
Twist
Golden Gate
Silver Sails
Bounty
Beauty Beach
Border Beauty
Follies Br.
Bahama
Zodiac

BALLY ONE BALLS

Beauty Contest
Beach Queen

BALLY HOLLY COMO

MODEL CRANES

(one motor models only!)

Bally Rotarys

BALL BOWLERS

Untd Bwlaramas '60
Un Polaris '64
Bally Bowler '64
Un Tornado '64
Un Matador '64
Bally '65

United Galleon '65
Wm Oasis '65
Wm Maverick '65
Un Amazon '66
Un Aztec '66

GOTTLIEB

Britestar
Crisscross
Contest
Gondolier
Picnic
Rocket ship
Sitting Pretty
Sunshine
Capt. Kidd
Dancing Doll
Kewpie Doll
Lite a card
Melody Lane
Seven seas
Spot a card
Texan
World Beauty
Cover Girl
Egghead reply
Fashion show
Olympic
Preview
Sunset
Tropic Isle

Atlas
Around the world
Double Action
Hi Diver
Liteaball
Miss Annabelle
Madamoiselle
Queen of Diamonds
Racetime
Straightshooter
Sweet Sioux
Universe
Wagon Train
Aloha
Big Casino
Corral
Foto Finish
Flying Circus
Lancer
Oklahoma
Showboat
Flying Chariot
Sweetheart

UPRIGHTS

B. Jumbo
B. Spr Jumbo
B. Jamboree
K. Red Arrow
K. Sweet Shaw.
K. Black Dragon
K. Flashback
K. Twin Red Ar
K. Wild Arrw

KEENEY PINS

Venus
El Rancho
Startime
Old Plant.
Rainbow
Hacienda

BALLY SIX CARDS

Lotta Fun
Barrel Fun
Barrel Fun, 61
Barrel Fun, 62

Litealine
Shootaline
Funways

BINGOS

Frolics
Beauty
Miami Beach
Nightclub
Broadway
Big Show
Showtime
Touchdown

- If quantity is involved, we are willing to negotiate a deal based on picking up with our own truck, unpacked.
- M.S.I. wants to know if you have other used machines not listed above? Chances are good we can move it.
- Get on our mailing list. We send you offerings listing what machines we need and prices we'll pay.

MYRON SUGERMAN
INTERNATIONAL

Phone: 201-642-7177
744 Broad Street Newark, N.J. 07102
Cable: PRINCECHARMING, NEWARK, N. J.

Gentlemen:

- Please contact me. I have machines I want to sell.
 Please put me on your mailing list.

Co. _____

Address _____

City _____

State _____

Phone _____

Your Name _____

INTERNATIONAL : NEWSLINE

A LOOK BACK AT 1967 A.T.E.

LONDON—Since our Annual Review last July, one of the most important events has been the 23rd Amusement Trades Exhibition and the second to be held in the new venue, Alexandra Palace, London.

Unfortunately, the experiment of holding the event in November was theoretically sound, but proved in practice to be rather less successful than the Organisers had hoped.

As for the first Alexandra Palace show in January 1966, attendance figures were again way above the normal, but the sad fact was that Operators generally, while showing considerable interest in the exhibition, were reluctant to place firm orders.

No doubt the prevailing uncertainty resulting from the credit squeeze and wages freeze was partly responsible, and there is little doubt in the Organisers' minds that the main reasons were, (a) that the season had just finished and operators seem to think it too early to think about the next one, which lay a winter and a spring away, and (b) that since everyone hopes to start the season with the very latest equipment available, there was a fear that by placing orders too soon there might be no cash left for new equipment which might appear on the market later.

In the light of this experience, and after consulting other interested parties, manufacturers etc. the organisers came to the conclusion that the original date was, after all, the most suitable, and their plans for holding another exhibition in November 1967 were abandoned in favour of early 1968.

The 24th A.T.E. will therefore, take place again at the Alexandra Palace on 16th, 17th and 18th January 1968. From enquiries already made, there is little doubt that the whole of the 26,000 sq. ft. of actual stand area will again be taken up, and that new financial and attendance records will be created.

As we reported last year, the import surcharge which had been inflicted upon us soon after the present Government came into power, was abolished at the end of October 1966. However, the surcharge had little effect on business during its currency and therefore, it seems unlikely that its removal will noticeably increase business.

Arising out of the U.K. balance of payments problem, members of Parliament have suggested from time to time that it might not be a bad thing to ban or curtail the import of Fruit Machines, but the Chancellor has so far declined to take such action, chiefly on the grounds that it would invite retaliatory action by other countries with nothing to be gained by it.

As forecast a year ago, the so-called Gaming Machine License Duty was introduced on 1st October 1966, and has already resulted in quite a useful contribution to the Revenue. (A licence duty of £75 (\$210) for each coin-operated gaming machine operated by a 6d coin, and a tax of £37.10.0. (\$104) for machines operated by coins of less value than 6d.)

As mentioned in the last report, it was not intended that the duty should apply to amusement machines giving modest prizes, and on the whole this is the position. There is however, a strong difference of opinion between the trade and the Customs & Excise Authorities as to the liability of certain types of machines, and as after six months' of argument it has been impossible to solve the situation by negotiation, it would seem that sooner or later a test case will have to be brought before the courts to get an authoritative and decisive ruling.

During the past few months, the Government has finally reached a decision as to the basis for the new system of decimal currency scheduled to come into force in 1971.

In the face of tremendous opposition, not only on the machine side, but from all sorts of other businesses and organisations, it has been decided to retain the pound as the new major unit, and this for the coin machine business will have two very unfortunate consequences. Firstly, the decimal equivalent of the present penny which is the coin most widely used in coin-operated circles, will be so small and insignificant in size that a large proportion of existing machines cannot be adapted to accept it, and will therefore have to be scrapped.

Secondly, we shall lose entirely our second most popular coin, the six-penny piece, and the machines concerned will also have to be adapted. Barring a change in the law, which makes sixpence the maximum, they will have to convert to a new decimal coin valued at 4.8 pence representing a 20% cut in earnings. The trade and other interests are continuing to make strong protests, but it is unlikely that these will have any effect as the Government seems determined to have its own way despite anything else we might have to say.

Looking ahead, it is not easy to forecast business trends whilst the credit squeeze and the wage freeze remain in force, but so far as one can judge, they have not had any undue effect on business so far.

As far as seaside business is concerned. Takings have admittedly shown some drop on figures for the previous year, but it is thought this is due more than anything else to the exceptionally bad weather experienced during the early part of the season, and there is every indication that if we get better weather, losses can be recovered.

The Government did announce some time ago that they intended to take an early opportunity to review the present gaming laws, and a new Bill is likely to be introduced into Parliament towards the end of the year. The original intention was to deal only with so-called 'Big Time' gaming in casinos etc. but there is now reason to think that they may make rather more extensive changes in the law and that machine interests will also be affected. It is not possible to say at this stage just what is proposed, but needless to say, the trade are keeping a very watchful eye on the proceedings, and can be relied upon to take whatever steps may be necessary in order to protect their interests.

RUFFLER & WALKER IS PICTURE OF SUCCESS WITH AMERICAN MACHINES

BRITAIN—Ruffler & Walker continue to enjoy considerable success with the Rock-Ola phonographs, for which they are sole importers and distributors. The latest models have been the luxury Imperial 433, 160 Selection, introduced to Britain at the end of 1966, which has become the outstanding machine of 1967 and is especially suitable for high class locations.

The Grand Prix GP 160 Model 432, 160 Selection, has also been introduced during the past twelve months and the machine is proving very popular for general use and siting. The Concerto model 434, 100 Selection took the place of the very popular 'Starlet', and was the most popular machine of the year 1965/66. A very good machine for the fast-increasing "pub" and cafe location businesses. In addition to these machines, Ruffler & Walker have enjoyed success with the Wall phonograph Model 430, 100 Selection, which has the same mechanism as the Concerto, and is available for wall-fixing or on a chromium stand which is available as an 'extra'.

SEGA PLANS A NEW LINE OF AMUSEMENT GAMES FOR EXPORT

TOKYO—Sega Enterprises will produce for export a new line of low priced quality amusement machines at their newly expanded multimillion dollar Tokyo Plant, according to a recent company announcement. Four or five new novelty amusement machines

disappearing."
"Sega is not trying to compete with major American manufacturers." "Our purpose is to make available quality equipment that is too expensive to engineer and produce in limited quantity in the United States."



This panoramic view reveals Sega's servicemen repairing flipper machines in their well organized service area.

will be introduced each year to meet the growing international demand for attractive moderately priced arcade equipment.

During a recent interview, David Rosen, Managing Director of Sega stated: "For some time now the industry has been a victim of a price squeeze." "The price of amusement equipment has steadily risen because of increased labor, material and transportation costs." "As most operators find it difficult or impossible to raise prices above the traditional five cents or dime plays, the U.S. manufacturers have had to be satisfied with passing on only a part of their added cost." "Several manufacturers have also compensated for this by discontinuing certain low run models, cutting back expenses for research and development of new equipment, and building many models along similar lines in order to achieve increased use and value from production tools, jigs and facilities."

"While this is all very understandable, it has resulted in a void or vacuum in new, reasonably priced novelty equipment." "Game Centers thruout the world are starting to appear monotonously similar—innovation, the life blood of the industry is "Our goal is to complement the role

of U.S. manufacturers and thereby render a service to the industry." "As the largest distributor/operator of coin operated amusement machines and arcades in the Pacific area, we feel that if arcades are to become more varied and interesting, everyone will benefit—manufacturers, distributors and operators." "CSOI, the worldwide agents of Sega products will be firming distributorships within the next several months."

PHONOGRAPHIC EQUIP., LTD. MOVING TO NEW SHOWROOM

BRITAIN—For Phonographic Equipment (Distributors) Ltd. it has been another year of expansion and, at the time of writing, the company is within a month of moving into vast new premises at Cricklewood where they will have the most lavish showroom of any coin machine distributor in the world. The premises will include large storage and service departments together with palatial offices and display facilities. They will house the largest permanent collection of machines ever to be seen under one roof.

Phonograph Equipment's Directors announced a pre-tax profit for the six months ending 31st October 1966 of £378,000. The Directors feel confident that despite hazardous trading conditions and the severe credit squeeze profits will be more than maintained for the second half of the year. Phonographic are U.K. distributors for Bally, Williams and Sega and distribute the American Rolls Royce of juke boxes Seeburg as well as the continental Jupiter boxes.

A major event of the year has been Phonographic's entry into the vending industry. This came when they acquired control of the Quick M Vending Co. Ltd. which deals in beverage machines and quick snack. More recently Quick Maid acquired the sole distribution of Choice-Vend an American manufactured range of cold drink vending machines. This acquisition is likely to play an important part in the continued growth of the Phonographic group.

Phonographic and its subsidiary companies make up one of the most formidable and successful coin machine and vending groups in the world today. Quick Maid's deal with Choice-Vend and their subsequent American programme has been a break-through in British vending where previously there were virtually no installations of soft drink vending machines. Orders placed with Choice-Vend in the first two months of the new operation amounted to over 400 machines.

\$56,068,875 GROSS DOLLAR VOLUME 1966 COIN MACHINE EXPORT SALES

1966 WAS A RECORD YEAR FOR COIN MACHINE EXPORT SALES. TOTAL SALES FOR THE YEAR REACHED \$56,068,875 FOR PHONOGRAPHS, VENDING AND AMUSEMENT MACHINES. FOLLOWING IS A COMPLETE BREAKDOWN FOR 1966.

DIVISION BREAKDOWN

PHONOGRAPHS		VENDING		AMUSEMENTS
Units	Dollars	Units	Dollars	Dollars
29,567	\$14,212,121	50,052	\$12,409,470	\$29,438,284

TOP TEN IMPORT COUNTRIES

PHONOGRAPHS

COUNTRY	Units	Dollars
WEST GERMANY	6681	\$3,788,267
BELGIUM	3789	2,447,556
JAPAN	4672	1,986,181
UNITED KINGDOM	5334	840,089
CANADA	1531	638,172
ITALY	944	526,967
FRANCE	565	470,094
GREECE	1247	340,493
HONG KONG	675	316,776
PERU	1662	296,952

VENDING

COUNTRY	Units	Dollars
CANADA	12,837	\$3,742,246
WEST GERMANY	12,620	2,991,414
MEXICO	2286	1,632,763
UNITED KINGDOM	1882	628,334
PHILIPPINE REP.	800	594,924
BELGIUM	6289	430,126
FRANCE	2550	323,554
VENEZUELA	577	288,002
SWEDEN	1522	223,096
NETHERLANDS	334	165,163

AMUSEMENTS

COUNTRY	Dollars
UNITED KINGDOM	\$5,891,068
SWITZERLAND	5,299,611
WEST GERMANY	4,767,586
FRANCE	3,784,127
ITALY	3,238,869
BELGIUM	1,155,353
JAPAN	944,884
DENMARK	564,110
CANADA	525,821
VIETNAM	401,487

REFER TO FOLLOWING
PAGES FOR QUARTERLY
BREAKDOWN OF
ANNUAL EXPORT
FIGURES



Japan's Leading
Distributors and
Importers of:

Coin Phonographs and
Amusements of all kinds

Sole Distributors for Japan

SEEBURG CORP.
D. GOTTLIEB & CO.

Manufacturers of:

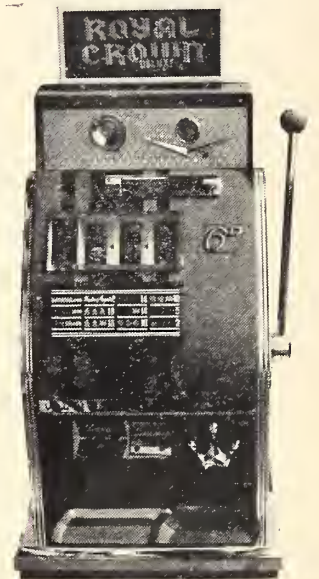

Royal Crown
720mm high, 480mm wide, 470mm deep



Basket Ball
1,300mm high, 800mm wide, 1520mm deep

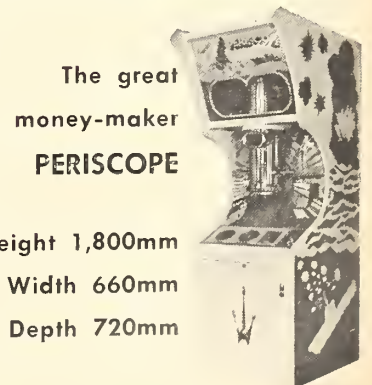

The great
money-maker
PERISCOPE

Height 1,800mm
Width 660mm
Depth 720mm

Three games thoroughly
tested throughout Japan
World Inquiries Welcomed

TAITO TRADING CO., LTD.

HEAD OFFICE
812 Fukoku Bldg., Uchisaiwaicho
Chiyoda-ku, Tokyo, Japan
Tel: 591-6858 Tokyo
Cable: EPTRA Tokyo

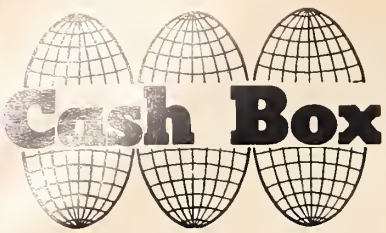

ANNUAL EXPORT VOLUME REPORT

Phonographs

Amusement

COUNTRY	1st Quarter Volume (Jan.-Mar. 1966)		2nd Quarter Volume (April-June 1966)		3rd Quarter Volume (July-Sept. 1966)		4th Quarter Volume (Oct.-Dec. 1966)	
	No. of Units	Dollar Volume	No. of Units	Dollar Volume	No. of Units	Dollar Volume	No. of Units	Dollar Volume
NO. and CENTRAL AMERICA								
Bahamas	22	\$ 13,635	15	\$ 13,321	4	\$ 4,050	27	\$ 13,010
Barbados	—	—	—	—	—	—	—	—
Bermuda	—	—	—	—	—	—	—	—
British Honduras	—	—	—	—	—	—	—	—
Canada	585	140,216	346	151,026	296	138,030	309	208,900
Costa Rica	22	19,227	2	1,649	5	4,189	15	15,390
Dom. Rep.	102	15,235	58	9,720	18	3,440	16	3,289
El Salvador	—	—	7	5,193	5	4,525	6	5,666
Fr. West Indies	—	—	—	—	—	—	—	—
Greenland	—	—	—	—	—	—	—	—
Guatemala	—	—	4	3,507	8	7,008	2	1,882
Haiti	—	—	—	—	—	—	—	—
Honduras	28	11,655	42	17,978	39	12,501	37	25,085
Iceland	—	—	—	—	—	—	—	—
Jamaica	148	52,197	45	29,320	17	6,618	7	2,885
Lw. Wv. Is.	—	—	—	—	—	—	—	—
Mexico	192	33,977	165	19,093	430	39,821	162	24,727
Neth. Antilles	—	—	—	—	—	—	—	—
Nicaragua	48	18,189	38	24,640	20	13,487	106	24,625
Panama	30	29,823	21	18,045	124	36,676	107	57,176
Trinidad	16	11,838	3	1,150	8	4,650	—	—
TOTAL	1,193	\$ 345,992	746	\$ 294,639	974	\$ 274,995	794	\$ 382,635
SOUTH AMERICA								
Argentina	16	\$ 4,740	—	—	15	\$ 15,150	19	\$ 19,917
Bolivia	—	—	—	—	—	—	—	—
Brazil	—	—	—	—	—	—	—	—
Br. Guiana	—	—	4	2,218	—	—	—	—
Chile	—	—	—	—	—	—	—	—
Colombia	—	—	—	—	—	—	—	—
Ecuador	—	—	—	—	—	—	—	—
Peru	347	146,171	542	88,938	528	92,001	245	69,842
Surinam	—	—	—	—	—	—	—	—
Uruguay	—	—	—	—	—	—	—	—
Venezuela	130	10,684	54	80,867	23	31,080	383	33,527
TOTAL	493	\$ 161,595	600	\$ 172,023	566	\$ 138,231	647	\$ 123,286
EUROPE								
Austria	114	\$ 81,020	28	\$ 17,950	59	\$ 39,805	37	\$ 27,828
Azores	—	—	—	—	—	—	—	—
Belgium	1,178	837,661	890	451,230	657	454,736	1,064	703,929
Cyprus	5	4,498	6	4,387	12	4,550	5	2,265
Denmark	114	102,850	190	151,458	1	680	16	11,025
Finland	209	170,977	—	—	—	—	166	147,659
France	423	122,315	295	82,430	269	70,522	260	65,626
Gibraltar	—	—	—	—	—	—	—	—
Greece	—	—	—	—	—	—	—	—
Hungary	—	—	—	—	—	—	—	—
Ireland	40	34,807	244	194,826	491	175,953	165	121,381
Italy	—	—	—	—	—	—	—	—
Malta	99	80,015	74	47,755	75	28,512	148	114,612
Netherlands	10	7,120	17	2,237	8	3,074	—	—
Norway	7	3,915	—	—	—	—	—	—
Portugal	40	36,264	47	30,485	24	16,389	2	1,631
Spain	—	—	275	203,198	24	21,107	166	88,929
Sweden	—	—	—	—	—	—	—	—
Switzerland	124	96,064	—	—	—	—	—	—
Trieste	—	—	—	—	—	—	—	—
Turkey	—	—	—	—	—	—	—	—
United Kingdom	365	265,310	307	253,566	1,276	210,852	146	110,261
West Germany	1,772	1,041,506	1,874	1,015,998	1,528	873,980	1,507	856,783
Yugoslavia	—	—	—	—	—	—	—	—
TOTAL	4,500	\$ 2,884,322	4,247	\$ 2,455,520	4,424	\$ 1,900,160	3,622	\$ 2,251,929
ASIA								
Arabia	—	\$ —	—	\$ —	—	\$ —	—	\$ —
Bahrain	—	—	—	—	—	—	—	—
Ceylon	—	—	—	—	—	—	—	—
Fed. Malaya	32	7,595	284	23,985	7	2,860	18	6,900
Hong Kong	117	71,686	262	131,285	120	13,692	176	100,113
India	—	—	—	—	—	—	—	—
Iran	—	—	—	—	—	—	—	—
Israel	—	—	—	—	—	—	—	—
Jordan	—	—	—	—	—	—	—	—
Japan	1,265	446,898	1,275	522,789	1,034	482,699	1,098	533,795
Korean Rep.	—	—	—	—	—	—	—	—
Kuwait	—	—	—	—	—	—	—	—
Lebanon	—	—	—	—	—	—	—	—
Macao	—	—	—	—	—	—	—	—
Nansei Is.	117	98,348	151	98,047	93	64,686	37	21,655
Pakistan	—	—	—	—	—	—	—	—
Philippine Rep.	—	—	111	37,397	49	16,257	62	12,221
Singapore	—	—	—	—	—	—	—	—
Syria	—	—	—	—	—	—	—	—
Taiwan	—	—	—	—	—	—	—	—
Thailand	—	—	26	5,600	9	3,703	39	20,790
Vietnam	—	—	—	—	—	—	—	—
TOTAL	1,531	\$ 624,527	2,109	\$ 819,103	1,312	\$ 583,897	1,430	\$ 695,474
AUSTRALIA								
Australia	4	\$ 3,060	46	\$ 15,079	30	\$ 6,059	37	\$ 8,206
New Zealand	—	—	—	—	—	—	—	—
Fr. Pac. Is.	—	—	—	—	—	—	—	—
T. Pac. Is.	—	—	—	—	—	—	—	—
TOTAL	4	\$ 3,060	46	\$ 15,079	30	\$ 6,059	37	\$ 8,206
AFRICA								
Algeria	—	\$ —	—	\$ —	—	\$ —	—	\$ —
Angola	—	—	—	—	—	—	—	—
Br. East Africa	—	—	—	—	—	—	—	—
Canary Is.	—	—	—	—	—	—	—	—
C. Af. Rep.	—	—	—	—	—	—	—	—
Egypt	17	5,758	8	3,785	—	—	—	—
Ethiopia	—	—	—	—	—	—	—	8,500
Fr. Somaliland	—	—	—	—	—	—	—	—
Gabon	—	—	—	—	—	—	—	—
Ghana	—	—	—	—	—	—	—	—
Kenya	36	10,597	70	18,397	16	4,299	8	5,607
Liberia	—	—	—	—	—	—	—	—
Libya	—	—	—	—	—	—	—	—
Malagas	—	—	—	—	—	—	—	—
Mauritania	—	—	—	—	—	—	—	4,014
Morocco	—	—	—	—	—	—	—	—
Mozambique	—	—	—	—	—	—	—	—
Nigeria	83	8,200	—	—	—	—	—	4,290
O. W. Africa	—	—	—	—	—	—	—	—
Rep. Congo	—	—	—	—	—	—	—	—
Rhod. NY	—	—	—	—	—	—	—	—
Senegal	—	—	—	—	—	—	—	—
Som. Rep.	—	—	—	—	—	—	—	—
Span. Af.	—	—	—	—	—	—	—	—
Tanzania	20	17,843	—	—	4	3,500	—	5,370
Tunisia	—	—	—	—	—	—	—	—
Uganda	—	—	—	—	—	—	—	—
Un. So. Africa	—	—	—	—	—	—	—	16,322
Z. Rh. Ma.	—	—	—	—	—	—	—	—
TOTAL	156	\$ 42,398	78	\$ 22,182	20	\$ 7,799	8	\$ 5,607
GRAND TOTAL	7,877	\$ 4,064,294	7,826	\$ 3,778,549	7,326	\$ 2,911,141	6,538	\$ 3,467,137

COUNTRY	1st Qtr. 1966 (Jan.-Mar.) Dollar Volume
NO. and CENTRAL AMERICA	
Bahamas	\$ 14,891
Barbados	—
Bermuda	15,420
British Honduras	—
Canada	118,382
Costa Rica	—
Dom. Rep.	—
El Salvador	—
Fr. West Indies	—
Greenland	—
Guatemala	—
Haiti	—
Honduras	—
Iceland	—
Jamaica	—
Lw. Wv. Is.	—
Mexico	—
Neth. Antilles	—
Nicaragua	—
Panama	14,905
Trinidad	—
TOTAL	\$ 162,998
SOUTH AMERICA	
Argentina	\$ —
Bolivia	—
Brazil	—
Br. Guiana	—
Chile	—
Colombia	—
Ecuador	—
Peru	—
Surinam	—
Uruguay	—
Venezuela	69,618
TOTAL	\$ 69,618
EUROPE	
Austria	\$ 21,082
Azores	6,482
Belgium	323,689
Cyprus	—
Denmark	192,300
Finland	8,873
France	1,400,291
Gibraltar	—
Greece	—
Hungary	—
Ireland	22,130
Italy	367,786
Malta	—
Netherlands	39,435
Norway	10,131
Portugal	—
Spain	15,651
Sweden	85,561
Switzerland	353,575
Trieste	—
Turkey	17,660
United Kingdom	1,758,536
West Germany	1,527,560
Yugoslavia	—
TOTAL	\$ 6,150,742
ASIA	
Arabia	\$ —
Bahrain	—
Ceylon	—
Fed. Malaya	5,300
Hong Kong	64,024
India	—
Iran	—
Israel	—
Jordan	—
Japan	227,530
Korean Rep.	3,980
Kuwait	—
Lebanon	—
Macao</	

FOUR QUARTERLY REPORTS FOR 1966



Machines

Vending Machines

2nd Qtr. 1966 (April-June) Dollar Volume	3rd Qtr. 1966 (July-Sept.) Dollar Volume	4th Qtr. 1966 (Oct.-Dec.) Dollar Volume	COUNTRY	1st Quarter Volume (Jan.-Mar. 1966)		2nd Quarter Volume (April-June 1966)		3rd Quarter Volume (July-Sept. 1966)		4th Quarter Volume (Oct.-Dec. 1966)	
				No. of Units	Dollar Volume	No. of Units	Dollar Volume	No. of Units	Dollar Volume	No. of Units	Dollar Volume
			NO. and CENTRAL AMERICA								
\$ —	\$ 10,609	\$ 17,046	Bahamas	14	\$ 4,895	40	\$ 11,680	24	\$ 5,385	45	\$ 19,687
5,539	4,904	21,174	Barbados	—	—	—	—	—	—	16	10,820
184,673	91,403	131,273	Bermuda	27	11,234	22	7,980	25	10,416	27	11,473
—	3,882	1,146	British Honduras	—	—	—	—	—	—	—	—
—	54,150	—	Canada	2,455	750,010	4,549	1,224,700	3,036	779,422	2,797	988,114
—	—	—	Costa Rica	—	—	—	—	—	—	—	—
—	—	—	Dom. Rep.	10	4,530	—	—	—	—	—	—
—	—	—	El Salvador	—	—	—	—	—	—	—	—
—	—	—	Fr. West Indies	—	—	—	—	19	16,331	1	671
—	—	—	Greenland	—	—	—	—	—	—	—	—
—	—	—	Guatemala	—	—	—	—	—	—	—	—
—	—	—	Haiti	—	—	—	—	—	—	—	—
—	—	—	Honduras	99	38,347	11	5,633	18	7,073	16	8,013
—	—	—	Iceland	—	—	—	—	—	—	—	—
—	—	—	Jamaica	—	—	25	11,304	4	2,227	2	996
—	—	—	Lw. Wv. Is.	23	4,873	—	—	3	1,350	—	—
11,506	—	2,100	Mexico	260	101,329	316	104,995	1,594	1,415,790	118	10,649
27,640	31,931	14,252	Neth. Antilles	—	—	—	—	—	—	—	—
—	—	—	Nicaragua	—	—	—	—	—	—	—	—
—	—	—	Panama	13	5,267	62	20,801	67	18,661	77	40,083
—	—	—	Trinidad	25	4,380	—	—	—	—	—	—
\$ 229,358	\$ 196,879	\$ 186,991	TOTAL	2,926	\$ 924,865	5,025	\$ 1,387,093	4,790	\$ 2,256,655	3,099	\$ 1,090,506
			SOUTH AMERICA								
\$ —	\$ —	\$ —	Argentina	—	—	—	—	—	—	—	—
—	—	—	Bolivia	—	—	—	—	—	—	—	—
—	—	—	Brazil	—	—	—	—	—	—	—	—
—	—	—	Br. Guiana	—	—	—	—	—	—	—	—
—	—	—	Chile	—	—	—	—	—	—	—	—
—	—	—	Colombia	—	—	—	—	—	—	—	—
—	—	—	Ecuador	200	3,150	—	—	—	—	—	—
—	—	—	Peru	—	—	—	—	—	—	—	—
—	—	—	Surinam	—	—	—	—	—	—	—	—
—	—	—	Uruguay	—	—	—	—	—	—	—	—
83,457	93,841	27,133	Venezuela	168	82,234	135	84,775	53	32,883	221	88,130
\$ 83,457	\$ 93,841	\$ 27,133	TOTAL	368	\$ 85,384	135	\$ 84,775	53	\$ 32,883	221	\$ 88,130
			EUROPE								
\$ 35,285	\$ 16,399	\$ 27,797	Austria	104	\$ 34,260	12	\$ 5,728	1	\$ 1,085	—	\$ —
2,204	5,800	—	Azores	—	—	—	—	—	—	—	—
297,573	168,203	365,888	Belgium	950	116,736	3,775	54,899	345	139,124	1219	119,367
156,849	73,528	138,443	Cyprus	—	—	—	—	—	—	—	—
9,838	2,028	17,941	Denmark	56	5,053	1	560	—	—	—	—
885,126	477,567	1,021,143	Finland	14	7,715	74	16,450	41	16,533	339	13,287
—	—	—	France	693	86,692	635	82,226	182	67,082	1040	87,554
—	—	44,478	Gibraltar	—	—	—	—	—	—	—	—
—	—	—	Greece	—	—	—	—	—	—	—	—
4,811	13,339	1,450	Hungary	—	—	—	—	—	—	—	—
1,025,752	684,998	1,160,333	Ireland	—	—	—	—	—	—	—	—
—	—	—	Italy	985	45,416	370	107,766	359	35,227	422	40,751
—	—	—	Malta	—	—	—	—	—	—	—	—
22,323	33,093	271,705	Netherlands	83	31,178	95	95,125	104	16,909	52	21,951
47,418	4,469	5,676	Norway	—	—	28	7,284	20	6,160	23	6,351
40,459	12,188	45,326	Portugal	—	—	—	—	—	—	—	—
33,585	46,876	41,131	Spain	36	31,074	165	74,091	164	63,366	44	23,968
1,839,411	1,681,836	1,424,789	Sweden	77	10,520	1,286	118,434	156	94,142	—	—
—	—	—	Switzerland	82	30,472	22	8,326	17	6,214	18	6,701
—	—	—	Trieste	—	—	—	—	—	—	—	—
—	—	—	Turkey	—	—	—	—	—	—	—	—
1,389,324	1,236,691	1,506,517	United Kingdom	348	141,644	854	295,592	256	67,433	424	123,665
929,932	1,830,859	479,235	West Germany	2989	758,909	5,756	1,074,455	1,938	590,453	1,937	567,597
51,681	—	36,200	Yugoslavia	—	—	—	—	—	—	—	—
\$ 6,771,527	\$ 6,287,874	\$ 6,660,852	TOTAL	6417	\$ 1,299,699	13,073	\$ 1,940,936	3,583	\$ 1,103,728	5,518	\$ 1,011,192
			ASIA								
\$ —	\$ —	\$ —	Arabia	—	—	—	—	—	—	—	—
—	—	—	Bahrain	—	—	—	—	—	—	—	—
6,140	—	1,069	Ceylon	—	—	—	—	—	—	—	—
135,527	30,911	25,340	Fed. Malaya	—	—	—	—	—	—	—	—
—	—	1,020	Hong Kong	—	—	—	—	—	—	—	—
—	—	—	India	—	—	—	—	—	—	—	—
—	—	—	Iran	—	—	—	—	—	—	—	—
—	—	—	Israel	—	—	—	—	—	—	—	—
141,816	299,560	275,978	Jordan	—	—	—	—	—	—	—	—
—	59,320	119,020	Japan	295	42,568	1,242	55,327	811	21,631	239	7,243
—	—	—	Korean Rep.	—	—	—	—	—	—	—	—
—	—	82,249	Kuwait	—	—	—	—	—	—	—	—
—	—	—	Lebanon	109	54,432	50	757	55	5,550	—	—
52,222	26,043	21,995	Macao	—	—	—	—	—	—	—	—
3,840	30,695	1,600	Nansei Is.	51	11,148	70	12,360	151	13,280	28	11,110
—	—	—	Pakistan	—	—	—	—	—	—	—	—
—	—	—	Philippine Rep.	138	87,548	51	42,153	308	230,994	303	234,229
—	—	—	Singapore	6	3,048	—	—	—	—	—	—
—	—	—	Syria	—	—	—	—	—	—	—	—
7,260	5,498	12,020	Taiwan	—	—	—	—	—	—	—	—
22,164	62,062	28,947	Thailand	—	—	201	4,204	250	3,500	—	—
100,860	114,877	27,971	Vietnam	—	—	2	6,400	3	1,155	—	—
\$ 469,829	\$ 628,066	\$ 597,209	TOTAL	599	\$ 198,744	1,616	\$ 121,201	1,578	\$ 276,110	570	\$ 252,592
			AUSTRALIA								
\$ 41,505	\$ 13,074	\$ 53,244	Australia	—	—	576	\$ 45,349	576	\$ 41,289	603	\$ 39,377
—	—	—	New Zealand	—	—	—	—	—	—	—	—
—	—	—	Fr. Pac. Is.	—	—	—	—	—	—	—	—
—	—	—	T. Pac. Is.	—	—	—	—	—	—	—	—
\$ 41,505	\$ 13,074	\$ 53,244	TOTAL	—	\$ —	576	\$ 45,349	576	\$ 41,289	603	\$ 39,377
			AFRICA								
\$ —	\$ —	\$ —	Algeria	—	—	—	—	—	—	—	—
—	—	—	Angola	—	—	—	—	—	—	—	—
14,779	3,928	21,305	Br. East Africa	—	—	—	—	—	—	—	—
—	—	—	Canary Is.	—	—	—	—	—	—	—	—
—	—	—	C. Af. Rep.	—	—	—	—	—	—	—	—
1,790	600	—	Egypt	—	—	—	—	—	—	—	—
—	—	—	Ethiopia	15	10,240	—	—	—	—	—	—
—	—	—	Fr. Somaliland	—	—	—	—	—	—	—	—
—	—	—	Gabon	—	—	—	—	—	—	—	—
—	—	7,186	Ghana	—	—	—	—	—	—	—	—
—	—	—	Kenya	—	—	—	—	—	—	—	—
—	—	—	Liberia	3	4,610	—	—	—	—	—	—
—	—	—	Libya	—	—	—	—	—	—	—	—
9,750	4,200	11,189	Malagas	—	—	—	—	—	—	—	—
—	—	—	Mauritania	—	—	—	—	—	—	—	—
—	—	—	Morocco	—	—	—	—	—	—	—	—
—	—	—	Mozambique	—	—	—	—	—	—	—	—
—	—	—	Nigeria	—	—	—	—	—	—	—	—
—	—	—	O. W. Africa	—	—	—	—	—	—	—	—
—	—	—	Rep. Congo	—	—	—	—	—	—	—	—

ANALYSIS OF THE ANNUAL COIN MACHINE EXPORT VOLUME REPORT FOR 1967

SHIPPING
THE
FAR EAST
DAILY!



JOE
DUARTE

MANILA
TOKYO
HONGKONG
NAHA
BANGKOK
KUALA LUMPUR
SINGAPORE
AUSTRALIA
SAIGON
PORT SWETTENHAM

We specialize in shipping juke boxes and games to the Far East. May we serve YOU?

DUARTE INTERNATIONAL

835 East 31 St.
Los Angeles 11, Calif. U.S.A.

CABLE:
DUARTEX, Los Angeles

TOUSJEUX & NOUVEAUTES

S. A.
GENEVA, SWITZERLAND

We are the oldest manufacturers of football games, trade mark "LE NATIONAL," the best European game known.

We are also

Operator and Distributor for Switzerland of Bally, Chicago.

THE ORIGINAL!!

KICKER and CATCHER
the COUNTER GAME with
BUILT-IN-PROFITS



J. F. FRANTZ MFG. CO.
1940 W. Lake St., Chicago 12, Ill.
Tel: Taylor 9-2399

GENERAL

1966, in keeping with tradition, was another record breaking year for American coin machine trade exports. An increase from the 1965 total of \$51,000,197 to this year total of \$56,068,875, proves a more aggressive foreign interest in American made machines. The jump in total export sales is attributed primarily to amusement machines. Phonographs and vending machines held fairly close to their 1965 totals. The 1966 increase in amusements were well over \$5 million, to be precise, \$5,239,651, total for last year was \$24,135,633 as compared to \$29,375,284 for this year. Europe seems to be the center attraction for American amusement games as indicated by the 1966 import figure, well over \$25 million, an increase of approximately \$5 million over the 1965 total of over \$20 million. Although phonographs and vending exports held close par to their 1965 figure, it is expected, with the new and improved equipment lines, to be a very promising future for American manufacturers.

PHONOGRAPHS

As in 1965, no violent surges, up or down, were recorded in phonographs this year. Most of the countries held fairly close to their 1965 figures with the big exception of Belgium. Their imports for 1966 were up over \$1 million from last year, while Canada lost one-half million in trade. Italy was down \$300,000 from 1965. In 1966, total phonograph units exported were 29,567, and in 1965, there were 34,206. The drop of five thousand or so accounts for the dollar volume drop. The top countries for 1966 were: West Germany, with 6,681 units for a dollar total of \$3,788,267; Belgium, with 3,789 units imported and a dollar volume of \$2,447,556; and the usual Japan figures of 4,672 for \$1,986,181. 1965 phonograph machine exports were \$15,608,865 while registering a slight decline for 1966 with \$14,212,121.

AMUSEMENT

As we predicted last year, amusement machine exports are well above the 1965 volume. Italy, as a result of the relaxed laws to allow regular games and add-a-balls, increased their previous volume to \$3,238,869. This represents an over-all increase of nearly \$3 million dollars. The United Kingdom, last years leading importer of games, declined in the dollar race but still managed to maintain their lead as the leading importer of games from America. Their drop to \$5,891,068 in 1966 from \$7,160,859 in 1965 can be attributed to the increased tax requirements imposed upon operators last year. Switzerland upped their imports by nearly \$4 million from 1965 to become the second leading importer of amusements. One of the largest declines among the smaller countries was Nansei Islands, in 1965, they imported nearly \$450,000 worth of games while in 1966, it dropped downward to \$110,000. The war torn nation of Vietnam showed a serious upward movement, as they purchased nearly \$220,000 in 1965 for games, and \$401,000 in 1966. This increase is apparently due to the U.S. Government's policy of providing entertainment for American servicemen in foreign countries. Despite the ups of some countries and the downs of others, this was a tremendous year for American manufacturers of games.

VENDING

In 1965, vending export volumes was tagged, "the happiest sales story in the history of coin machine exports." Well, its lost some of the glamour but not enough to hurt export sales, as indicated by \$2 million dollar gain over last year. Mexico, seems to be the deciding factor, with their increase over last years figure of \$83,779 by \$1.5 million dollars. This is a fantastic increase and Mexico has now proved to be one of the leading markets for vending machines. The United Kingdom registered a slight drop as did Switzerland. The small but industrious country of Venezuela registered a \$200,000 dollar gain over 1965, while purchasing 577 vending machines. Total sales for 1966 was \$12,409,470 for 50,052 machines exported. The 1965 figures for a comparison were, 32,614 units exported for \$10,527,468 dollars. It was an extremely good year and this year is expected to be an even greater one.

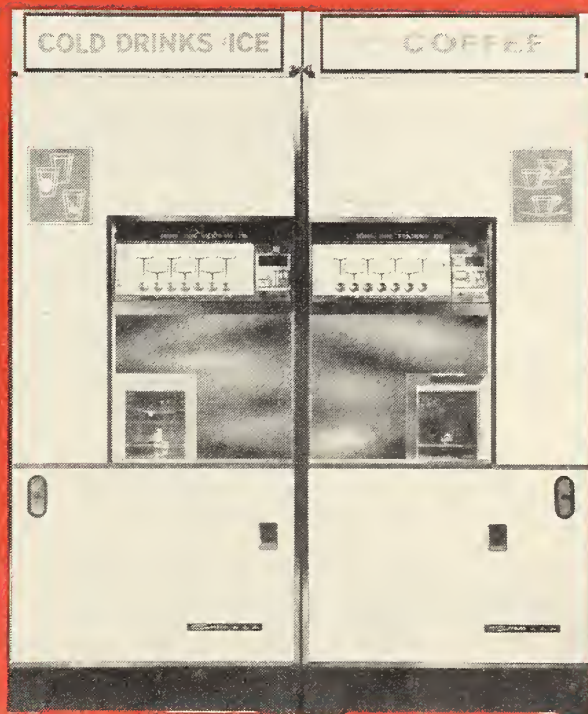
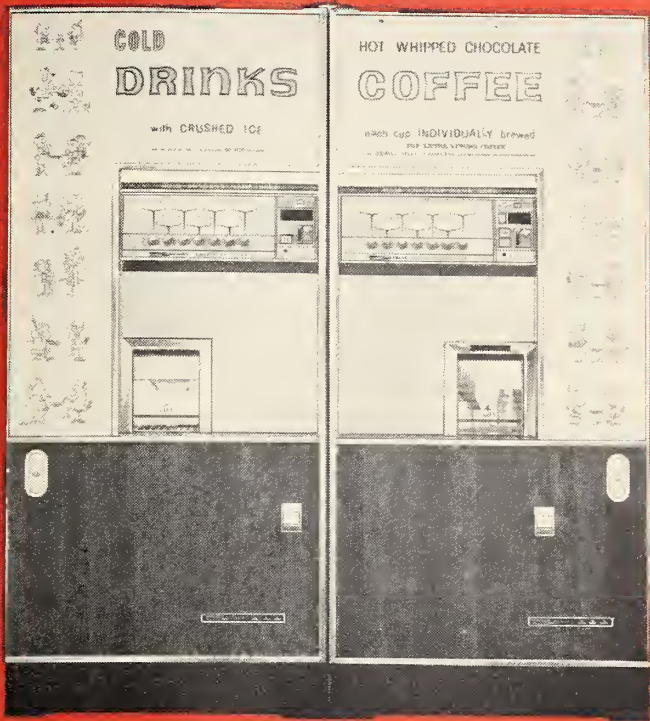

Around the world, Seeburg is the preferred name in music and vending.

Beverage Venders. Seeburg "Marquee", "Top Hat" and Williamsburg venders actively promote business. Attractive, modern front panels merchandise top-quality products. Seeburg's complete vending line is designed for dependable operation.

Coin Phonographs. Seeburg Stereo Showcase. Combines the finest in stereo sound with an exclusive rotating display of album covers, color and light. All transistorized. 160 selections. Plays Little LP albums and single records in 33 and 45 rpm speeds. Optional Dollar Bill Acceptor.

Income Totalizing. Exclusive Seeburg built-in totalizing systems, tamperproof, totalize all coins accepted. They provide visual and/or printed collection slips for complete audit and control. Optional equipment.

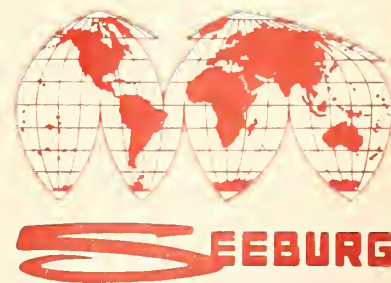

Seeburg equipment is built, not adapted, for use anywhere in the world, for any voltage or coinage. *World-wide service.* Seeburg distributors provide new equipment, parts, service. Address: The Seeburg Sales Corp., Chicago 60622. Cables: SEEBUR, CHICAGO.



Two of the modern, well equipped Arcade Centres of the Belgian Amusement Company in Belgium



BELGIAN AMUSEMENT COMPANY

IMPORTERS

&

EXPORTERS

of

AMUSEMENT EQUIPMENT

•

ARCADE SPECIALIST

•

EXCLUSIVE SEGA and AMF
DISTRIBUTORS IN BELGIUM

BELGIAN AMUSEMENT COMPANY

Langeleemstraat 187

ANTWERP—BELGIUM

Tel: 39 30 79—39 72 01 ANTWERP

European Trade Organizations

AUSTRIA

Verband des Osterreichischen Automaten-Gewerbes, Brucknerstrasse 4/8
Wien IV, Dr. Rudolph Rampf.

BELGIUM

U.B.A. UNIE VAN DE BELGISCHE AUTOMATENBRANCHE
UNION BELGE DE L'AUTOMATIQUE,
228, Rue Theodore Verhaegenstraat,
Brussels 6, Belgium

DENMARK

Foreningen AF Fabrikanter Og Opstillere AF Musikautomater
I Danmark
Lyskaer, 8, Herlev-Copenhagen. Mr. Edwin Jensen.

FRANCE

SYNDICAT NATIONAL DES FABRICANTS D'ELECTROPHONES
AUTOMATIQUES
72, Boulevard De Montparnasse, Paris, Mr. Bouzanquet.
Federation Francaise Des Exploitants et Commerçants de L'Automatique.
38bis, Rue Vivienne, Paris (2e). Mr. Jean Faraut.
Syndicat National Des Professionels De L'Automatique
104, Boulevard de Clichy, Paris. Mr. Charlot.
Syndicat National Des Importateurs-Exjortateurs D'Appareils Auto-
matiques.
1, Quai de Grenelle, Paris 15e. Mr. Gaillard.

GERMANY

V.D.A.I. Verband der Deutschen Automatenindustrie eV, Koln-Lindenthal,
Aachner Strasse 199, Cologne. and W 15, Lietzenburger Strasse 36,
Berlin. Contact Dr. Jutzi, Bad Kreuznach, First Chairman; Herr Gunter
Wulff, Vice-Chairman, Berlin. (Assoc. of German manufacturers of
automatic machines)

ZOA

Zentralverband der Organisationen des Deutschen Automaten

Aufstellgewerbes

Koeln, Kaiser-Wilhelm-Ring 6—8

President: Mr. Hasso Loeffler, Cologne

(Central Organization for German operators with association in the 11
countries of the German Federal Republic).

DAGV

Deutscher Automaten-Grosshandels-Verband eV

Hamburg 1, Gross Baeckerstrasse 3

President: Mr. Heinz Kaestner, Rothelmshausen Bez. Kassel

(Association of the German wholesalers of automatic machines)

Grosse Baeckerstrasse, 3, Hamburg 1. Mr. Helmut Neuberg.

GREAT BRITAIN

AMUSEMENT CATERER'S ASSOCIATION

Gloucester House 19, Charing Cross Road, London W.C.2. Mr. John
Singleton.

Amusement Trades Association

72a, Walton Road, East Molesey, Surrey.

P.O.A. The Phonograph Operators Association

76B. Rochester Row. S.W.1. Mrs. L. Shaw.

IRELAND

Amusement Caterers Association of Northern Ireland.

6, Carlisle Circus, Belfast. 14. Mr. J. H. A. Swinson.

ITALY

S.A.P.A.R. Associazione Nazionale Noleggiatori Apparecchi Automatici.

Via di Villa Patrizi 10, Roma. Mr. A. Ricardi.

ASSOCIAZIONE NATIONALE NOLEGGIATORI APPARECCHI
AUTOMATICI

Pza Buonarotti 24, Milano. Mr. F. de Fendi.

NETHERLANDS

A.U.T.E.X. Bond Van Muziek En Amusementsapparaten.

2e Westewagenhot k, St. Laurenshuis, Rotterdam. Mr. P.H.M. Hoogen-
bergh.

Music Co-Operation

Rechthuisstraat 8, Rotterdam. Mr. H. J. de Groot.

Prof. Dr. Schuk Foundation, P.O. Box 4, Bergen Op Zoom, Holland,

Pres. J. F. Vale

SWEDEN

Sveriges Automatagares Riksförbund

Vanadisplan 5, Stockholm 21, Mr. Van Gyllenpalm.

EUROPEAN MANUFACTURERS

■ Coin-Operated Phonographs and Amusement Machines ■

Phonographs

Belgium

BELGIUM

DISCOMATIC
Lange Kievitstraat 83,
Antwerp.

ETS. RENNOTTE
83, Rue Gustave Masset,
Gembloux.

N.V. SUGGEST-TOEBOSCH
Lange Leemstraat 113-116,
Antwerp.

France

SOCIETE BAL-AMI.
40, Rue Saint-Amand,
Le Touquet, Paris-Plage.

ETS. BONZINI.
34-36, Rue Desirie Vienot,
Bagnole/Seine.

CAMECA.
103, Boulevard Saint-Denis,
Courbevoie.

CIFA
72, Bd. du Montparnasse,
Paris 14.

CITEP.
44, Rue du Colisee,
Paris 8.

S.A. ELECTRONIQUE & MECANIQUE,
Rue Bol Respiro,
Monte Carlo/Monaco.

ELECTRO-KICKER SA,
Baume Les Dames,
Doubs, Charles Gosteli

FLESH EDITIONS VOG,
Palais Berliz,
Paris.

INTER FRANCO-SUISSE
79, Bd. du Montparnasse,
Paris.

ETS. MARCHANT.
7-9, Rue Voltaire,
Levallois.

C. MARTINA.
22, Avenue Jean Jaures,
Paris.

MARCEL AUTOMATIQUE EUROPEEN,
7, Rue de Tournus,
Paris 15e.

STE. MATEBOIS,
39, Avenue du General Leclerc,
Chalette sur Loing.

SCOPITONE (Cameca)
103 Blvd. St. Denis,
Courbevoie

SOCIETE MIAMI.
13, Rue P. Lafargue,
Putteaux (Seine)

MICRO MUSIU.
47, Bis Rue de Bellevue,
Creteil (Seine)

MUSIMATIC.
8, Rue du Mont Thabor,
Paris 1e.

MAURICE PLOTCHENKO,
60, Rue de Provence,
Paris 9c.

ETS. RENE PIERRE RANCHOT,
18, Rue Mazagran,
Paris 10e.

SOCIETE SECEMAU (STELLA)
4, Rue Scipion,
Paris 6e.

SEME AUTOMATIC,
17, Rue de Marignan,
Paris.

STE. SMAME
45, Rue des Boulets,
Paris.

**SOCIETE INTERNATIONALE DE
PHONOVISION**
60, Rue de Provence,
Paris 9me.

ETS. RENE WOLFF,
141, Ave. de Verdun,
Iss-les-Moulineaux.

Germany

TH. BERGMANN & CO.
Eimbteler Str. 45a,
Hamburg-Altona

BEROMAT GMBH.
Tauentzienstr. 6,
Berlin. W.30.

CANTEEN AUTOMATENBAU, GMBH,
Neu-Isenberg/Frankfurt
Hathenastrasse 53.

DEUTSCHE WURLITZER GMBH.
Krs. Lubbecke (Westf)
Hullhorst.

EICHHOFF-WERKE GMBH.
Und Schlitz in Hessen,
Ludenscheid i. W.

ELTEC
Nollendorfstr. 11-12,
Berlin, W. 30.

HEINRICH HECKER
Kapellendorfstr. 4,
Paderborn.

LOEWEN-AUTOMATEN,
Bingen/Rhein.

NOVA-APPARATE GMBH.
Semperstrasse 24
Hamburg

NSM APPRTEBAU
Alzeyer Str. 51,
Bingen/Rhein.

L. ROHDE
Neuer Wall 38,
Hamburg 36.

TONO-AUTOMATEN
Rathenastrasse 53,
Neu Isenburg bei
Frankfurt/Main.

**TREFF SPEIL UND
WARENVERKAUFSAUTOMATEN**
Meinekestr. 3.
Berlin. W. 15.

UTA-ELEKTROAKUSTIK
Magstadt bei Stuttgart.

GEORG WIEGANDT & SOHNE,
Ziegrastr. 15-19,
Berlin-Neukolin.

WULFF APPARATEBAU,
Tauentzienstrasse 6,
Berlin W. 30.

Great Britain

CHANTAL LTD.
Station Road
Kingswood, Bristol

Holland

JOS. VAN OSCH.
Kerkstraat A55,
Kerkdriel.

Italy

S.I.F. CINEBOX
Filmshows for Cinebox
Brevetti Mondiali Cinebox
Via Marco Polo 7, Milano

SOCIETE INTERNATIONALE SONOVISIONE.
Via Torino 40,
Rome.
Corso Matteotti, 8, Milano.

CINEBOX INTERNATIONAL S.P.A.
Via Marco Polo 7
Milano, Italy
(manufacturer, world dist., license holder of
Cinejukebox)

Spain

GEDASA
Valderribas 52,
Madrid.

SINFONOLA
San Quintin, 10,
Madrid.

Cleveland Coin International

We sell only the best money-making equipment in the United States and Abroad

CUSTOMER SATISFACTION GUARANTEED

You can be sure that every piece of equipment is thoroughly shopped. Or, if you prefer, equipment is available in a complete and clean condition.

Cleveland Coin International always has in stock a complete selection of every make of phonographs, games, arcade and vending equipment. YOU NAME IT, WE'VE GOT IT!

PHONOGRAPHS

ALL-TECH Kiddie Rides
AMERICAN Hand Dryers
(electric)
AMERICAN shuffleboards &
Pool Tables
AUTOMATIC PRODUCTS
Smokeshop & Candyshop
COIN-OPERATED Parking
Meters
KLOPP Coin Sorters &
Counters

AMUSEMENT GAMES

AMERICAN MACHINE & FOUNDRY
American Speedway
FISCHER Pool Tables
GOTTLIEB Pin Games
HAND DRYERS
HARMON Package
Vendors
IRVING KAYE Pool
Tables

ARCADE EQUIPMENT

MIDWAY Baseball
Games
MUTOSCOPE
Photo Machines
NATIONAL Shuffleboards
& Pool Tables
NORTHWESTERN
Vendors

VENDING EQUIPMENT

VALLEY Pool Tables
**WESTINGHOUSE-
UNIVERSAL**
Candimat
WILLIAMS
Amusement Games
WURLITZER
Music Machines
Remote Wallboxes

FACTORY DISTRIBUTORS FOR:

We can supply you with parts for all the machines we handle. For prompt and dependable service, place your export or domestic orders with

Cleveland Coin International

2029 Prospect Ave., Cleveland, Ohio 44115 Cable: CLECOIN (216) TO 1-6715

WRITE FOR OUR NEW
EXPORT CATALOGUE
AND PRICE BULLETIN

The only satisfactory **VOICE RECORDER**
produced in the world today **VENDING**
permanent high quality **DISCS**



- ★ Modern and very substantial cabinet.
- ★ High quality — distortion free reproduction on long lasting all plastic 6" discs.
- ★ No swarf or cuttings.
- ★ Simplified maintenance free mechanism ensures long life and good profits.

Write, Wire or 'Phone for full information:—

C.W.C. EQUIPMENT LIMITED

Kings Grove, Maidenhead, Berkshire, England

phone: 20411

Telegram: DURAUQIP

Ets. **RENE PIERRE** Automatic Games Manufacturer
39 Ranchot, Jura, France

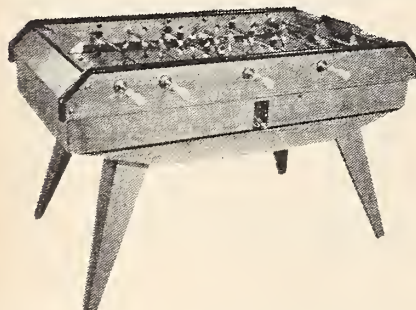

FOOT-BALL DERBY

*Competition
Lux
Standard*

*Tam-Tam
Billiards
American Golf*

EMPIRE FOR EXPORT

SHIPMENTS MADE ALL OVER

THE WORLD—FROM THE

PORT OF CHICAGO

→ NO INLAND FREIGHT ←

- SPECIAL CHUTES
- SPECIAL PACKING
- COMPLETE SERVICE FACILITIES

THE WORLD'S LARGEST DISTRIBUTOR OF COIN MACHINES

EMPIRE INTERNATIONAL

DOMESTIC DISTRIBUTORS FOR:

Rock-Ola • Midway
Gottlieb • Chicago Coin

CABLE: EMCOMACH
Call-Write-Cable

Division of **EMPIRE DISTRIBUTING, INC.**
Formerly Empire Coin Machine Exchange, Inc.

CHICAGO: 1012 N. Milwaukee • EV 4-2600

DETROIT: 7743 Puritan • DI 1-5800

EUROPEAN AMUSEMENT MFR'S.

■ Coin-Operated Gaming & Arcade Equipment

Belgium

AUTOMATENFABRIEK JODEK
Koophandelstraat 2
Wetteren

BELGEX AUTOMATIC LTD.
Rue Capouillet 37,
Brussels 6.

Denmark

DANOMAT
Falkoner Alle 66,
Copenhagen.

PAUL KRISTENSEN
Damhus Boulevard 55,
Copenhagen-Valby.

O & E STEFANSEN,
Bogholder Alle 40,
Copenhagen-Vanlose.

BRDR. STEFANSEN,
Broholms Alle 5a,
Copenhagen-Charlottenlund.

TESTO A/S.
Frederikberggade 3,
Copenhagen.

TRITA TRADING CO.
Falkoner Alle 66,
Copenhagen.

**ESBJERG UNDERHOLDING
AUTOMATENFABRIK**
Gamie Faergevej,
Esbjerg.

HANS ZIRSEN
Steen Blichersvej 22,
Copenhagen.

England

AINSWORTH CONSOLIDATED (G.B.) LTD.

ARISTOCRAT HOUSE
2a, Kimberley Gardens,
Harringay,
London, N. 4.

AUTOMATIC MACHINE SALES LTD.
147, Perry Vale,
London, S.E. 23.

AUTOMATEN DISTRIBUTORS LTD.
46, Mostyn Street,
Llandudno,
Wales.

BELL FRUIT MANUFACTURING CO. LTD.
Leen Gate, Lenton,
Nottingham.

BRYANS WORKS
Kegworth,
Derby.

CROMPTON & BATES
166-172 High Street,
Ramsgate, Kent.

CHICAGO AUTOMATIC SUPPLY CO.
218, Shaftesbury Avenue,
London, W.C.2.

DITCHBURN EQUIPMENT LTD.
Dock Road,
Lytham, Lancashire.

GOLDING AUTOMATICS LTD.
37, London Road,
Marks Tey, Colchester,
Essex.

K. & R. EDWARDS
28, James Street,
Bath, Somerset.

EDWIN HALL & CO.
67, Besey Street,
London, S.W. 16.

France

SOCIETE ALEBN
43, Rue d'Enghien,
Paris 10.

ETS. BONZINI
34-36, Rue Desire Vienot,
Bagnole/Seine.

ETS. BUSOZ
79, Rue de Clignancourt,
Paris 18.

ETS. CLERGE
12, Rue de Girondis,
Lyon/Rhone.

ETS. PIERRE MAILLARD
20, Rue Jules Grosjean,
Montbeliard.

ETS. RALLY
98, Ave. St. Lambert,
Nice.

ETS. V. SALMON
108, Bd. de Courcelles,
Paris 17.

STE. SECEMAU (STELLA)
4, Rue Scipion,
Paris 6.

SOPIMA
16, Rue Thiers,
Grenoble/Isere.

SOFRADIC
35, Rue Croix-Nivert
Paris 15.

UNIMECA
11 bis, Avenue Kleber,
Paris.

Germany

AUTOMATENBAU FOERSTER GMBH
Lange Strasse 87.

TH. BERGMANN & CO.
Eimsbutteler Str. 45a,
Hamburg-Altona.

DR. HANSBERG.
Bliesmuhle,
Neunkirchen/Saar.

HOFFMANN (PAY-OUTS)
Hellenthal.

**IMO-AUTOMATENFABRIK HELM
JENTZSCH GMBH.**
Bielefelder Str. 76,
Nielefeld-Brackwede.

HANS JOHANNSEN
Battenberg/Eder

KICKER GMBH.
Niederbardenberg/Aachen.

A. KOSTER
Schwarzbach 130,
Wuppertal-Oberbarmen.

LOWEN-AUTOMATEN
Am Freidhof,
Bingen/Rhein.

BILLARDFABRIK NOBILING
Bismarckstr. 65,
Berlin-Charlottenburg.

RUDOLF NAUDASCHER
Moslestr. 17,
Freiburg I. Br.

K. MOSCHKE
Klinikstrasse 16,
Wurzburg.

N.S.M. APPARATEBAU
Alzeierstrasse 51,
Bingen/Rhein.

HELMUT REHBOCK
Alter Teichweg 19,
Hamburg 22

SCHMIDTZ UND GERDES
An der Botmuhle 5,
Cologne.

P. W. WENZEL
Sternstrasse 3,
Gelsenkirchen.

WESTAUTOMATEN G. HILTGENS K.G.
Krefelder Str. 65,
Moers.

WESTAV
Rothelmshausen,
Post Wabern bez. Kassel

**WINKLER AUTOMATEN GMBH.
(PAY-OUTS)**
Hohenzollernring 2-10,
Cologne.

GEORG WIEGANDT & SOHNE
Ziegrastrasse 15-19,
Berlin-Neukolin.

WULFF-APPARATEBAU
Tauentzienstrasse 6,
Berlin W. 30.

Sega Enterprises Distributor Network

BELGIAN AMUSEMENTS
187 Langeleem Street
Antwerp, Belgium

OSCAR SIESBYE A/S
5, Palaigade
Copenhagen K. Denmark

PHONOGRAPHIC EQUIPMENT (DIST) LTD
Exmoor Street, Barby Road
London W. 10, England

RUFFLER & WALKER
33-37, St. John's Hill
Clapham Junction
London S.W. 11, England

NORDATOR CO.
Kalevastreet 27A
Helsinki, Finland

A/B FREUIS DANNEMAN & CO.
Grenstigen 9
Lidingo 5
Stockholm, Sweden

ESTABLISHMENT GARLAN
Int'l P.O. Box 1252
Seoul, Korea

AMERICAN VENDORS, INC.
P.O. Box 238
Naha, Okinawa

SEVEN SEAS ENTERPRISE
#20, 3rd Street
Gilmore Avenue
Quezon City, P.I.

JUKEBOXES, INC.
119A Chatham Road (6/Flr)
Kowloon, Hong Kong

SARL ELECTRONICS LTD
Boite Postale 957
Saigon, South Vietnam

TAIWAN SERVICE CO., LTD
P.O. Box 3266
Taipei, Taiwan

SIAM AMUSEMENTS CO.
G.P.O. Box 1872
Bangkok, Thailand

European Vending Machine Manufacturers

BELGIUM

DYNAVEND
66, Bd. de l'Imperatrice,
Brussels.

DENMARK

AUTOMATFABRIK DANSK
AUTOMATFABRIK
Wilders Plads,
Copenhagen.

ESBJERG UNDERHOLDING
AUTOMATFABRIK
Gamle Faergevej,
Elsbjerg

PAUL KRISTENSEN
Damhus Boulevard 55,
Copenhagen-Valby.

INTERNATIONAL VIBRATOR COMPANY
Dyrehovegaarsvg 2,
Lyngby.

SOREN WISTOFT & COMPANY A/S.
Nikolajvej 4-6,
Copenhagen.

FRANCE

ETS. BONNET
Villefranche Sur Saone.

ETS. BONZINI
34-36, Rue Desire Vienot,
Bagnolet/Seine

D.E.M.
34, Rue Lebour,
Montreuil.

ETS. DRANCY
72, Rue Jean Legalleux,
Ivry (Seine)

SOCIETE INDUSTRIELLE D'APPAREILS
AUTOMATIQUES
10, Rue Leontine,
Paris.

GERMANY

TH. BERGMANN & COMPANY
Eimsbuttelestrasse 64-66,
Hamburg-Altona.

HENRICH BRUNSWIG
Sternstrasse 117,
Hamburg.

FERDINAND FLORSTEDT
Flottenstrasse 57,
Berlin-Reinickendorf.

GLOBUS-AUTOMATEN GMBH
Schleusenstrasse 18,
Frankfurt am Main.

MAKO APPARATEBAU
Frankfurterstrasse 74,
Offenbach/Main.

GREAT BRITAIN

ALDEBERT ENGINEERING CO. LTD.
Aldebert Works,
Aldebert Terrace,
London, S.W. 8.
(Cigarette & Confectionery Machines)

AUTOBARS CO. LTD.
4-6, High Street,
Brentford,
Middlesex.
(Change-Givers, Hot & Cold Drink Machines)

AUTOMAT LTD.
173, Elmers End Road,
Beckenham, Kent.
(All Types)

BIRMINGHAM AUTO VENDERS LTD.
24, Station Road,
Erdington, Birmingham 23.
(All Types)

BRECKNELL, DOLMAN & ROGERS LTD.
Pennywell Road,
Bristol 5.
(Cigarette & Confectionery Machines)

BRITISH AUTOMATIC CO. LTD.
14, Appold Street,
London, E.C. 2.
(All Types)

BURT. J. (CHISWICK) LTD.
93, High Road,
Chiswick W. 4.
(Cigarette Machines)

CHADBURNS (LIVERPOOL) LTD.
Vender Sales Division,
Park Lane Works,
Netherton,
Bootle 10, Lancashire
(Cold Drink Machines)

DEAN BROS. (ENGINEERS) LTD.
Haydn Road,
Nottingham.
(Confectionery & Match Machines)

DITCHBURN VENDING MACHINES LTD.
Dock Road,
Lytham,
Lancashire.
(Hot & Cold Drink Machines)

ELECTRIC SHOP DEVELOPMENTS LTD.
22, High Street,
Fulham, S.W. 6.
(Universal Venders)

FISHER & LUDLOW LTD.
Vending Division,
Bordesley Works,
Clyde Street,
Birmingham 12.
(All Types)

GIBECO (ENGLAND) LTD.
175 Kilburn High Road,
London, N.W. 6.
(Beveridge & Food)

GLOSTER EQUIPMENT LTD.
Hucclecote,
Gloucester.
(All Types)

THE RANK ORGANISATION
Kershaw Division,
200, Harehills Lane,
Leeds 8.
(All Types)

NATIONAL AUTOMATIC MACHINES LTD.
54/56, Minerva Road,
Park Royal,
London, N.W. 10.
(All Types)

PHOTO-ME STUDIOS LTD.
Lyon Road,
Hersham Factory Estate,
Hersham,
Surrey.
(Photographic Machines)

ROLLASON AEROCESSORIES LTD.
Croydon Airport,
Surrey.
(Hot & Cold Drink Machines)

SANKEY, JOSEPH & SONS LTD.
Vendo Division,
Hadley Castle Works,
Wellington,
Shropshire.
(All Types)

W. M. STILL & SONS LTD.
29-31, Greville Street,
London, E.C. 1.
(Hot & Cold Drink Machines)

HOLLAND
MACHINEFABRIEK COULIN
Vlaardingen.

DESCO (VAN DESSEL)
Rechthuislaan 8,
Rotterdam.

N. V. HANDEL MAATSCHAPPIJ HOLDEEN
Willem Buijwechstraat 65,
Rotterdam.

ITALY

BREVETTI F.A.S.N.A.
Via Monte Rosa 35,
Turin

FIDAM
Via Senato 24,
Milan.

GAETANO SPATAFINA
Via Maso Di Bianco 10,
Florence.

SIDAM,
Via RuBiana 52,
Turin

E. BIANCHI VELO
Linea Primato
Automatic Vendors Div.
Offices: Via Fantoli, 11
Milano, Italy
Phone 503441
Factories: Via Alessandria, 1
Pontecurone (Alessandria)
Italy

BELAM

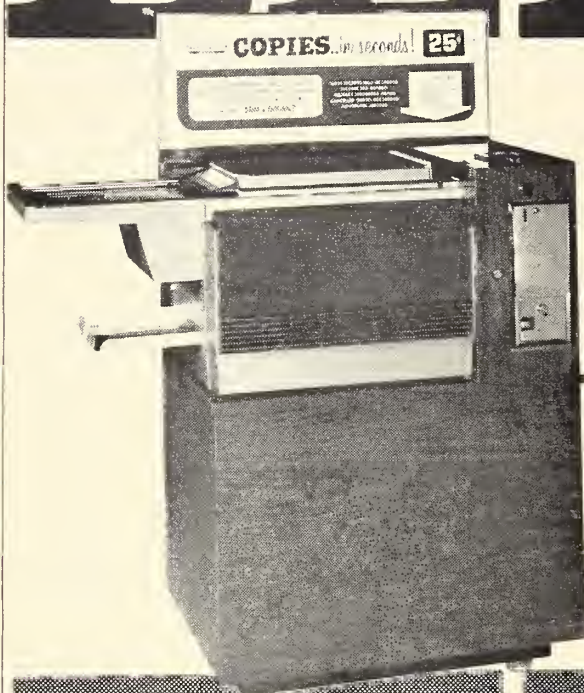

Exclusive Export Agents for the
U. S. Coin-A-Copy

the perfect photocopy machine

WRITE FOR DETAILS

BELAM

Export Agents for
**U.S. BILLIARDS
POOL TABLES**

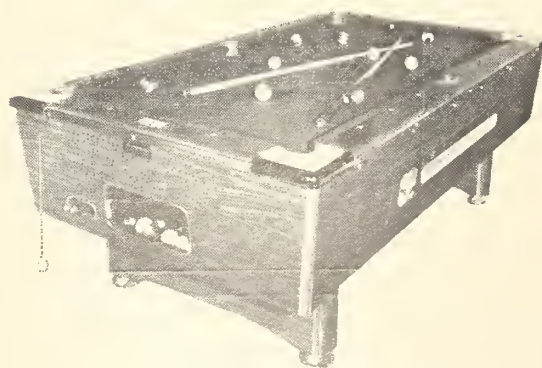

Write for Prices and Literature

FOR PRICES AND LITERATURE

Write or Cable

R.H. BELAM COMPANY, INC.

51 Madison Ave., N.Y., N.Y. 10010 • Murray Hill 9-5633-4-5

and, as always

NUMBER ONE

In Export
In Service
in lowest price

PHONOGRAPHS

Seeburg—Wurlitzer
AMI—Rock-Ola

FLIPPERS

Gottlieb—Williams

BALLY BINGOS

UNITED SHUFFLES

BOWLERS

United—Bally—Chicago Coin

FRUIT (SLOT) MACHINES

Jennings—Mills



EXPORTERS
IMPORTERS

Cable Address
"BELAMEX" NEW YORK

Immediate delivery anywhere in Europe or Asia from our warehouse stocks in Antwerp and New York.

EUROPEAN Importers: For latest inventory information contact our European office:

Paul Schmit
R. H. Belam Company (overseas), Inc.
17A Korte Winkelstraat Antwerp, Belgium
Telephone 03/32.59.46

U. S. MANUFACTURERS

with

WORLD WIDE REPRESENTATIVES

AMERICAN

AMERICAN SHUFFLEBOARD CORPORATION
210 Patterson Plane Rd.
Union City, N.J.

Write for foreign representatives

AUTO-PHOTO

AUTO-PHOTO COMPANY
3300 Central Avenue
Los Angeles, California
(Subsidiary of Photo-Me Int'l.)

PHOTOME LIMITED
Hersham Trading Estate
Hersham, Surrey, England

PORTEX, S.A.R.L.
4, Square Rapp
Paris VII, France

SCHNELLPHOTOAUTOMATEN G.m.b.H.
47 Viersener Strasse
Krefeld, West Germany

FOTOFIX SCHNELLPHOTO-AUTOMATEN, G.m.b.H.
Praterstrasse 36, Door 6
Vienna, Austria

NIPPON AUTO-PHOTO K.K.
3 Enokizaka-machi
Akasaka, Minato-ku
Tokyo, Japan

BALLY

BALLY MANUFACTURING COMPANY
2640 Belmont Avenue
Chicago 18, Illinois 60618
Write for Foreign Distributor Information

CHICAGO COIN

CHICAGO DYNAMIC INDUSTRIES,
1725 W. Diversey Blvd.
Chicago, Illinois 60614
Write for Foreign Distributor Information

CINEBOX

(Licensee For Filmotheque-Discotheque)
DAVID ROSEN INC.
855 No. Broad St.
Philadelphia, Pa. 19123

DUNCAN

DUNCAN SALES
737 Carnegie Ave.
Cleveland, Ohio
(Licensee For Th. Berman)

EXHIBIT

EXHIBIT SUPPLY CO.
4218-30 W. Lake St.
Chicago, Ill.

GOTTLIEB

D. GOTTLIEB & CO.
1140-50 North Kostner Avenue
Chicago, Illinois 60651

FRANCE, NORTH AFRICA, BENE-LUX, BRITISH ISLES, ITALY AND SPAIN

Mondial Commercial Corp.
Empire State Building
350 Fifth Avenue
New York, N. Y.

GERMANY AND AUSTRIA
Nova Apparate GmbH & Co.
Semperstrasse 24
Hamburg 39, Germany

SWITZERLAND
Eric de Stoutz
1 Avenue du Mail
Geneva, Switzerland

SCANDINAVIA
Aktiebolaget Freius Danneman
Grenstigen 9
Lidingo 5, Sweden

PUERTO RICO

All Coin
Amusement Company
2495 N. W. 77th Terrace
Miami, Florida

QUEBEC, CANADA

Laniel Amusements, Inc.
151 Rockland Avenue
Town of Mont Royal
Montreal, Quebec, Canada

WINNIPEG, MANITOBA, CANADA

Monarch Coin Machine Co.
211 Rupert Avenue
Winnipeg, Manitoba, Canada

AUSTRALIA

Goddard Novelty Co. Pty. Ltd.
257 Groadway
Sydney, Australia

JAPAN

Taito Trading Co., Ltd.
207 Fukoku Bldg.
Uchisaiwai-cho, Chiyoda-ku
Tokyo, Japan

JENNINGS

JENNINGS MANUFACTURING CO.

Contact: Mar-Matic Sales, Inc.
1140 E. Cold Spring Lane
Baltimore, Md. 21212
or
General Sales Co. Ltd.
Ireland Ireland, Bermuda

MIDWAY

MIDWAY MFG. CORP.
10136 Pacific Ave.
Franklin Park, Ill.

Foreign Representative:

MONDIAL COMMERCIAL CORP.

350 Fifth Ave.
New York, N.Y.

MUTOSCOPE

International Mutoscope Corp.
11-12 44th Avenue, Long Island
City, N.Y.
International Distributors
Belamex Vending Intl.
51 Madison Ave., New York City

PATTERSON

PATTERSON INTERNATIONAL CORP.

Patrus Alms Building
Cincinnati, Ohio 45206
(Licensee)

ROWE

ROWE MANUFACTURING
Troy Hills Rd.
Whippany, New Jersey

All requests for information concerning export of Rowe equipment and export distributorships, licensees and branches should be addressed to: J. Morfin, Ass't. Director Export Sales, Rowe Manufacturing, 75 Troy Hills Road, Whippany, New Jersey. Cable address: Rovend Whippany.

(Continued)



THE WORLD'S LARGEST DISTRIBUTORS
OF
COIN OPERATED AMUSEMENT MACHINES
FOR
THE WORLD'S LEADING MANUFACTURERS.

WILLIAMS - BALLY - SEEBURG.

SEGA - JUPITER - UNITED.

MIDWAY - MAYFIELD - WHITTAKER.

Phonographic Equipment (Distributors) Ltd.

North Block, Cricklewood Trading Estate
Claremont Road, London N.W.2

Telephone: 01-450-5251 (10 lines)
01-450-5221 (4 lines)

EXPORT

One of the West Coast's largest, oldest and dependable exporters of all types of new and reconditioned coin operated games and phonographs.

WRITE FOR PRICE LIST

Simon Distributing Co.

2833 W. Pico Blvd., Los Angeles, Calif. A. C. 213 737-0104. Cable: Simondist

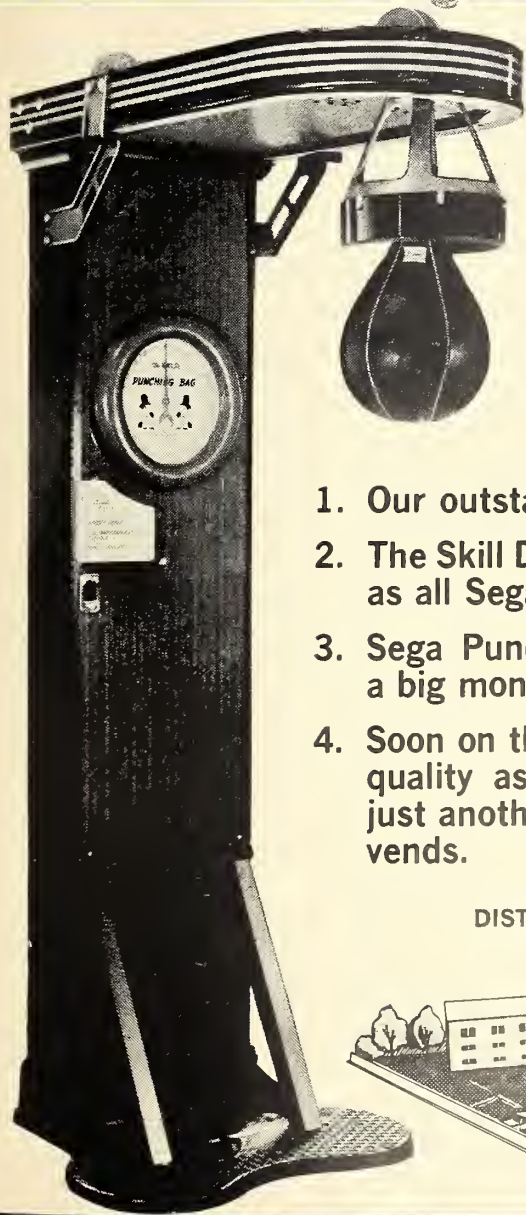
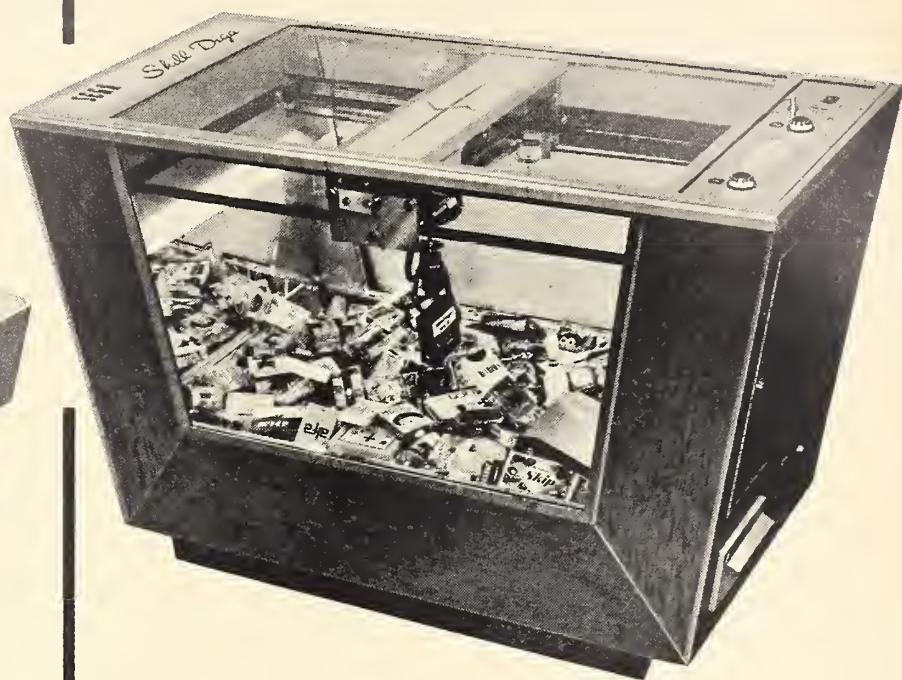
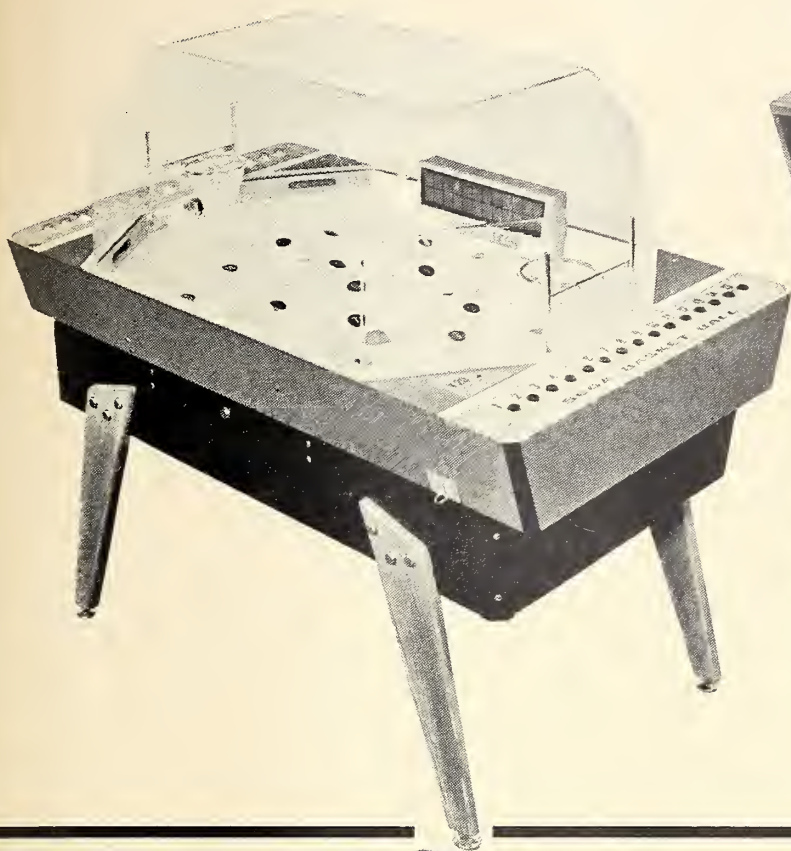

FOUR games
that cheer imagineers
and gives a deep glow
of satisfaction
to budgeteers

1. Our outstanding quality built Sega Basketball.
2. The Skill Diga built to U. S. standards the same as all Sega games.
3. Sega Punching Bag, an old favorite and still a big money earner, made to last a lifetime.
4. Soon on the scene, with the same outstanding quality as all Sega games, "Rifleman"—not just another gun. After each firing your target vends.

DISTRIBUTORSHIP INQUIRIES INVITED

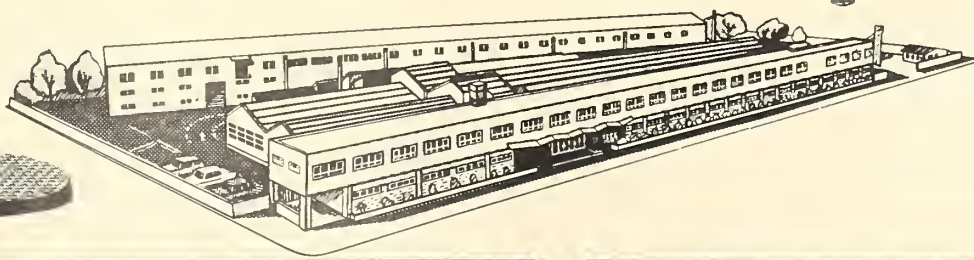

MANUFACTURED BY
SEGA enterprises Ltd.
HANEDA AIRPORT P.O. BOX 32
TOKYO, JAPAN

WORLDWIDE DISTRIBUTOR
Club Specialty Overseas Inc.
APARTADO 133 PANAMA 1, R. de P.

U.S. MANUFACTURERS WITH WORLD WIDE REPRESENTATIVES

ROCK-OLA

ROCK-OLA MANUFACTURING CORPORATION

800 North Kedzie Ave.
Chicago, Illinois

Foreign Representatives:

Brabo Corporation
Kronenburgstreet 55
Antwerp, Belgium
(Benelux Countries)

Capitol Enterprises
P. O. Box 253
Monrovia, Liberia
West Africa

Compania Comercial Curacao de
Honduras, S.A.
Apartado 353
Tegucigalpa, Honduras

Companhia Ultramarina de
Comercio, Lda.
Avenida Da. Republica No. 27
Lourenco Marques, Portuguese
East Africa

Duarte International Sales Co.
835 East 31st Street
Los Angeles 11, California

Esteve International Corp.
Ponce de Leon No. 724
Hato Rey, Puerto Rico

Goddard Novelty Co. Pty. Ltd.
257 Broadway
Sydney, Australia

Guam Music, Inc.
Blake Bldg.
P. O. Box 631
Agana, Guam

Isthmian Amusement Corporation
P. O. Box 465
Curundu, Canal Zone

K. I. D. Inc.,
Knickerbocker Industries
395 Broadway
New York 13, New York

Laniel Automatic Machines, Inc.
151 Rockland Road
Town of Mount Royal
Montreal 16, Quebec, Canada

Industrias Nacionales De Sonida,
SA
Calzada Mexico Xochim Ilco
#4861
Mexico 22, D.F. Mexico

J. Milhem & Sons
P. O. Box 20
24 Easy Street
Freetown, Sierre Leone

Morcoin Co., Ltd.
564 Interior-1
Echague Street
Manila, Philippines

New-Way Sales Company
1257-61 Queen St. W.,
Toronto, Ontario, Canada

Nova Apparate
24 Semperstrasse
Hamburg 39, Germany

(Novomat A. G.
Pfeffingerstr. 104
Basel, Switzerland

(Grommer & Co.,
Taborstreet 25
Vienna II, Austria

(Mepadi S. A.
Rue de La Grange Aux Ormes
Marly-Haute Par Metz
Boîte Postale No. 191
France

(Ruffler & Walker
33-37 St. John's Hill
Clapham Junction
London S. W. 11, England

Manitoba
Via Meravigli 16
Milano, Italy

Geourguen Abrahamian
63, Route Mantab
Bahar Street
Teheran, Iran

W. E. van Romondt's Handel
Maatschappy N.V.
Postbus 168
Paramaribo, Surinam Z.A.M.
Netherland Guina

Ross Distributors of Puerto Rico,
Inc.
215 Eleanor Roosevelt Avenue
Hato Rey, Puerto Rico

Sega Enterprises, Ltd.
Tokyo International Airport
Haneda P. O. Box 63
Tokyo, Japan

Establishment Garlan
International P. O. Box 1252
Seoul, Korea

American Vendors, Inc.
P. O. Box 238
Naha, Okinawa

Club Specialty Inc.,
Apartado 133
Panama, R. de Panama

Gande, Price, Ltd.,
G. P. O. Box 2621,
Gloucester Bldg.
Hong Kong

Wh. J. Crum
Gande, Price, Ltd.
Boite Postale 872
Saigon, Vietnam

Juke-Boxes Inc.
119B Chatham Road, 7/Floor
Kowloon, Hong Kong

Pacific Entertainments Ltd.
Rm. 228 Wang Hing Building
#10 Queen's Road Central
Hong Kong

Van Dusen Brothers
10528-123rd Street
Edmonton, Alberta, Canada

(Van Dusen Brothers
723-10th Avenue, S. W.
Calgary, Alberta, Canada

(Select Music Company
1803 Commercial Drive
Vancouver 10, B. C., Canada

Raymond Weir
Regent Street West
Belize, British Honduras

Winnipeg Coin Machine Co.,
768 Notre Dame Avenue
Winnipeg, Man., Canada

Stim Bottling Factory
P.O. Box 277
Bahrain, Arabian Gulf

SEEBURG

SEEBURG INTERNATIONAL INC.
1500 N. Dayton St.
Chicago, Illinois

Cable Address
Seevend Chicago

Seeben, N. V.
203 Mechelsesteenweg
Antwerpen, Belgium

Seeburg Great Britain Ltd.
430 Edgeware Road
London W. 2, England

Stockdale Industrial Venders Ltd.
Heachman, King's Lynn
Norfolk, England

Phonographic Equipment
(Distributors) Ltd.
316-320 Ladbroke Grove
London W 10, England

Seevend Automaten Vertriebs,
G.M.B.H.
Seevend Automation
Carl-Petersen
Strasse 70-76
2 Hamburg 26, Germany

Seerome S.P.A.
Viale Lombardia 72
Milan, Italy

Seerome S.P.A.
Via Gadames 44-46
Rome, Italy

A & D Christoff O. H. G.
Stubenring 16
Vienna 1, Austria

Nordatoy Oy
Sahaajankatu 7
Helsinki, Finland

Socodimex S. A.
1, Quai de Grenelle
Paris 15, France

General Espanola de Automaticos
S. A.
Calle Valderribas 73
Madrid 7, Spain

Manufacturera de Sinfonolas
S. A.
Avenida Jardin 330
Mexico 15, D. F., Mexico

(Continued)

EUROPE'S LARGEST DISTRIBUTORS OF PLEASURE PRODUCTS



33-37, ST. JOHN'S HILL, CLAPHAM JUNCTION, LONDON, S.W.11.

WORKS, ALTENBURG GARDENS, S.W.11.

TELEPHONE BATTERSEA 8626-7-8-9 CABLES RUFFWALK LONDON

IMPORTERS AND SOLE U.K. DISTRIBUTORS OF THE WORLD FAMOUS

ROCK-OLA

for reliability

MAIN U.K. DISTRIBUTORS SEGA FRUIT MACHINES

WE ALSO CARRY A FULL RANGE OF

JENNINGS - KEENEY - GAMES - GOTTLIEB - CHICAGO COIN PRODUCTS



Exclusive Distributors: **Rowe** MUSIC SYSTEMS & VENDING MACHINES

Exports The  World's Needs
In Music, Games and Vending

Fischer - Bally - Irving Kaye - Gottlieb

offices: Los Angeles • Honolulu • Tokyo

2401 S. Hill St., Los Angeles, Calif. 90007 • Phone: A.C. 213-749-7405

Cable: CIRCLEINT

The No.1 money makers are from

United

BILLIARDS, INC.



*Pool tables with
the Velvet Touch*

The complete coin-table line
of unparalleled excellence!

DOZENS OF TOP FEATURES

"Bulldog" collection security • Metered collections

**WATCH UNITED FOR THE BIGGEST
SURPRISES EVER SEEN IN THE
POOL TABLE & AMUSEMENT TRADE**

SEE YOUR LOCAL DISTRIBUTOR OR
WRITE FOR FREE COLOR BROCHURE

SIZE TO FIT
EVERY LOCATION
UNITED

"100" .. (78" x 46")
"200" .. (88" x 51")
"300" .. (93" x 53")
"400" .. (103" x 58")
"500" .. (114" x 64")

plus

Model 55 Rebound Table

United **BILLIARDS, INC.**

51 PROGRESS ST., UNION, N. J. 07083

(201) 686-7030

U.S. MANUFACTURERS WITH WORLD WIDE REPRESENTATIVES

Seeburg (cont'd)

Philippine Amusement Enterprises, Inc.
731 Aurora Blvd.
Quezon City, Philippines

Musikvertrieb A. G.
Badenerstrasse 555
Zurich, Switzerland

Distribuidoras Unidas C. A.
Avenida Mexico No. 229
Caracas, Venezuela

Markie Johns Agency
Frisco Junction
Port Fortin
Trinidad, West Indies

Inversiones Samoa S.A.
Av. Limatambo 3581
(CDA. 35 Av. Panamericana Sur)
San Isidro
Lima, Peru

Taito Trading Co., Ltd.
Central P. O. Box 1164
Tokyo, Japan

Pan Nordic Automation
P. O. Box 18
Saro, Sweden

Mr. Peter Thomas
Avenida Universitaria
San Salvador, El Salvador

Seeburg (Aust.) Pty. Ltd.
136 Nelson Street
Annandale, Sydney, Australia

Compania Columbiana
De Discos S. A.
Apartado Aereo No. 14-28
Medellin, Columbia

Laniel Automatic Machines, Inc.
151 Rockland, Mount Royal
Montreal, Quebec, Canada

Taylor Ven-Equipment, Ltd.
45 Crockford Boulevard
Toronto, Ontario, Canada

Osvaldo Pares Inc.
Calle Post 17
Mayaguez, Puerto Rico

Punater Sons (A) Ltd.
Punater House
Grogan Road West
Nairobi, Kenya

Maharlika Corporation
731 Aurora Blvd., Quezon City
P.O. Box 2952, Manila

Layla Trading Company
Bank of Pars Building
Saadi Avenue
Tehran, Iran

Disco Centro Ltda.
Apartado 4580
San Jose, Costa Rica

Caribbean Motors Co., C. Por A.
Apartado #52
Santo Domingo, Dominican Republic

A.M.I.C.A.
Apartado 1052
Calle Benalcazar No. 511
Quito, Ecuador

Casa Edison
9a. Av. Sur y Calle Ruben Dario
606
San Salvador, El Salvador

N.A.M. Nacional
P. O. Box 196
6a. Ave. y 24 Calle, Zona 4
Guatemala, Guatemala

Curacao Trading Co., Inc.
P. O. Box 368
Port-au-Prince, Haiti

Alix E. Garnier & Cia.
P. O. Box 124
Tegucigalpa, D.C., Honduras

Fernando Horvilleur & Cia. Ltda.
405 Calle Central Oeste
Managua, Nicaragua

Curaco Trading Co., Inc.
P. O. Box 368
Guatemala, Guatemala

Industrias Riojas, S.A.
Rosas Moreno 97
Mexico 4, D.F., Mexico

Daniel Genest
755 Montfort
Jonquiere, Que., Canada

William Pound Agencies Ltd.
P. O. Box 1173
St. John's, Nfld., Canada

C. J. Sheils Ltd.
1760 Midland Avenue
Scarborough, Ont., Canada

Curacao Trading Co.
(Surinam), Inc.
P. O. Box 1819
Paramaribo, Surinam

J. A. Nieuw
P. O. Box 84
Oranjestad, Aruba, N.W.I.

Guardia & Cia., S.A.
Apartado Postal 481
Panama City, Panama

Manufacturas Peru Ltda.
Apartado #4124
Lima, Peru

Borinquen Wholesale & Finance Corp.
Calle Comercio 400
P.O. Box 3089
San Juan, Puerto Rico

Elias V. Siutto
Yl 1599
Montevideo, Uruguay

Intervenca
Apartado del Este 5125
Caracas, Venezuela

Alouette Amusement Quebec, Ltee.
1807 Notre Dame St., W
Montreal 3, Que., Canada

Dale Distributing (B.C.) Ltd.
1110 Homer Street
Vancouver 2, B.C., Canada

J. E. (Holdings) Ltd.
c/o John Elliott Ltd.
144 King St.
Kingston, Jamaica

State Sales and Service Corporation

SAMUEL A. WEISMAN
1825 GUILFORD AVENUE

DAVID KOENIGSBERG
BALTIMORE 2, MD.

Phones: 837-7177

THE WURLITZER COMPANY

BALLY MFG. CO.

MIDWAY MFG. CO.

TAPE-ATHON CORP.

DITCHBURN VENDING MACHINES, INC.

EXCLUSIVE
FACTORY
DISTRIBUTORS

IRVING KAYE SALES CORP.

UNIVERSAL VENDORS, INC.

JOHNSON FARE BOX CO.

ATTENTION: WORLD BUYERS:

WE ARE EXPERTS IN
RECONDITIONING,
CRATING AND SHIPPING
TO ALL PARTS OF THE WORLD
FROM THE GREAT PORT OF
BALTIMORE.

TRY US FOR PRICE

TRY US FOR QUALITY

- Bingo Games
- Shuffle Alleys
- Bowling Alleys
- Arcade Equipment
- Phonographs
- Pin Ball Machines
- Cigarette Machines

Satisfaction Guaranteed



THE OLDEST and LARGEST DISTRIBUTOR

ON THE PACIFIC COAST

Exclusive Distributors for:

SEEBURG CORP.

GOTTLIEB MFG. CO.

UNITED MFG. CO.

CHICAGO COIN

IRVING KAYE CO.

WILLIAMS MFG. CO.

MIDWAY MFG. CO.

We have substantial inventories at all times of:

- ✓ PHONOGRAPHS
- ✓ SHUFFLE ALLEYS
- ✓ GAMES
- ✓ ARCADE EQUIPMENT
- ✓ BOWLERS

Write or Wire for Information:

Cable Address: PINGAME

Phone: HEMlock 1-1750

ADVANCE AUTOMATIC SALES CO.

1350 HOWARD STREET, SAN FRANCISCO, CALIF. HE 1-1750

COIN-OPERATED PHONOGRAPHS

ROCK-OLA Mfg. Corp.

800 N. Kedzie Ave.
Chicago, Ill.

1954 — 1967

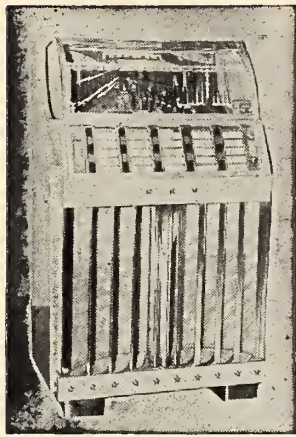

Rock-Ola 1442
(1954—120 Sel.—45 rpm)

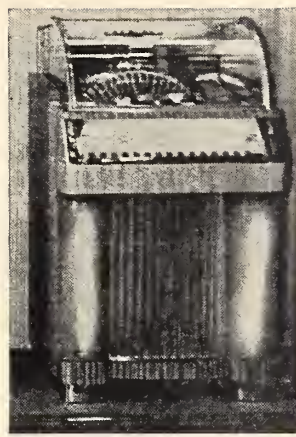

Rock-Ola 1446
(1954—120 Sel.—45 rpm)



Rock-Ola 1448
(1955—120 Sel.—45 rpm)

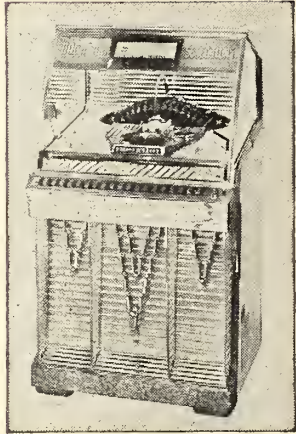

Rock-Ola 1452
(1956—50 Sel.—45 rpm)

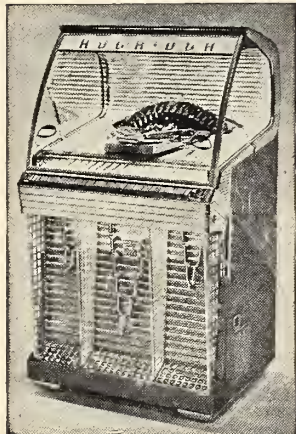

Rock-Ola 1454
(1956—120 Sel.—45 rpm)

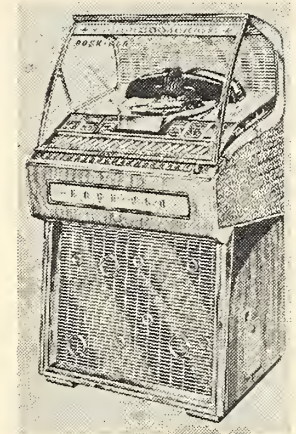

Rock-Ola 1455
(1957—200 Sel.—45 rpm)

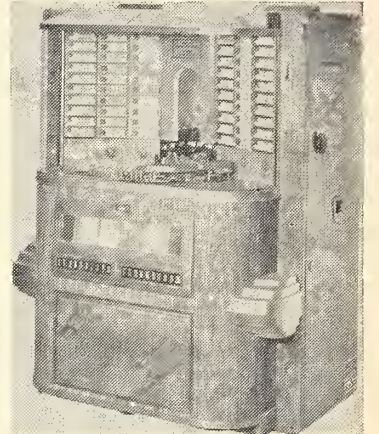

Rock-Ola 1464
(1958—Wall Type Phono)

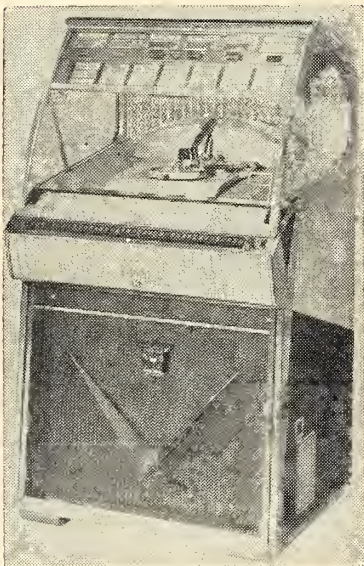

Rock-Ola 1465
(1958—200 Sel.—45 rpm)
1462—100 Sel., 1458—50 Sel.

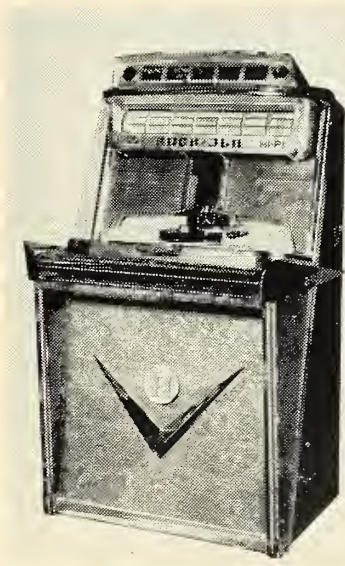

Rock-Ola 1475
(1959—St. or Mon. 200 Sel.)
Model 1468—120 Sel.

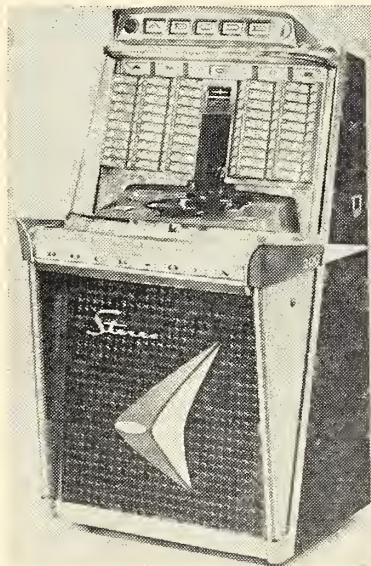

Rock-Ola 1485
(1960—200 Sel.)
Model 1478—120 Sel.

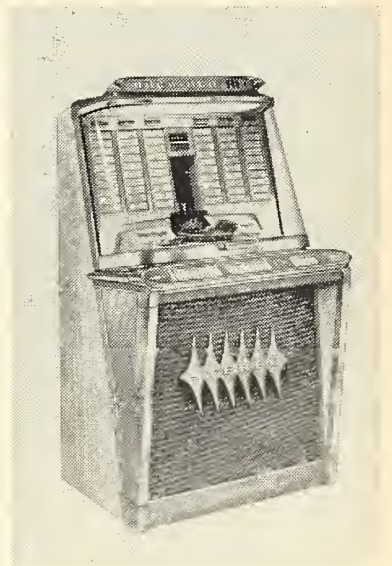

Rock-Ola 1495
(1961—200 Sel.)
Model 1488—120 Sel.

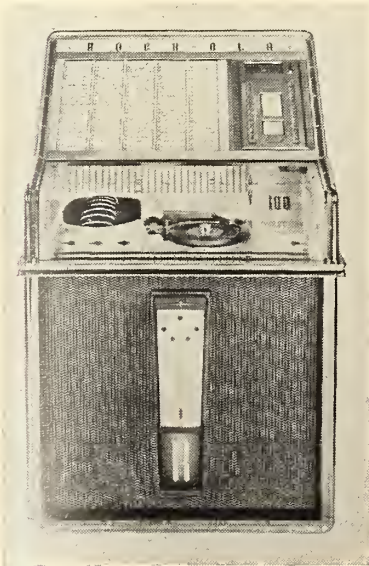

Rock-Ola 1493
(1962 Princess—100 Sel.)
45-33 rpm, and Wall Mdl. Avail.



Rock-Ola 1497
(1962 Empress—200 Sel. 45-33)
Model 1496—120 Sel.

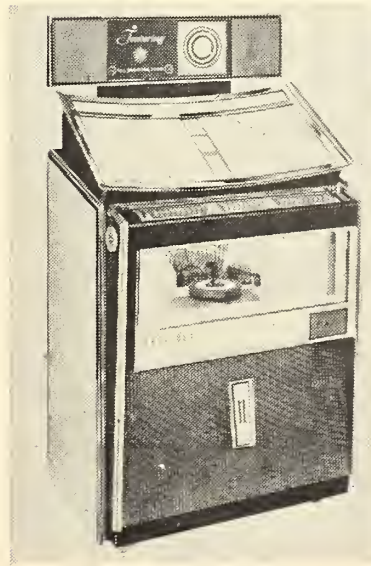

Rock-Ola 408
(1963 Rhapsody—160 Sel.)
Capri-404—100 Sel., 45-33 rpm

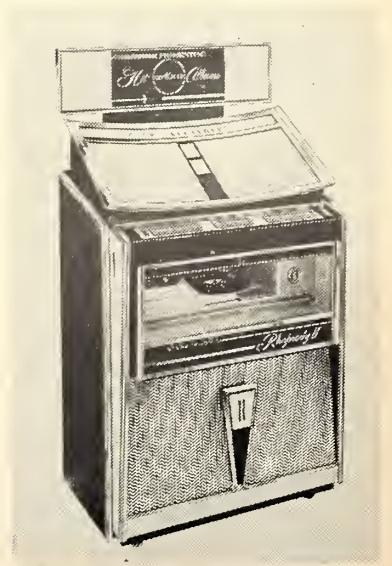

Rock-Ola 418 SA
(1964 Rhapsody II—160 Sel.)
Capri-414—100 Sel., 45-33 rpm

COIN-OPERATED PHONOGRAPHS

Rock-Ola —
— Rowe

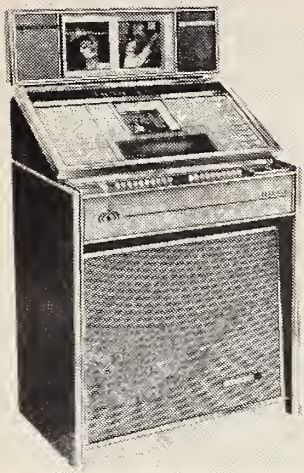

Rock-Ola 424
(1964 Princess Royal St—Mon)
100—Sel. 33—45—7" LP Intermix

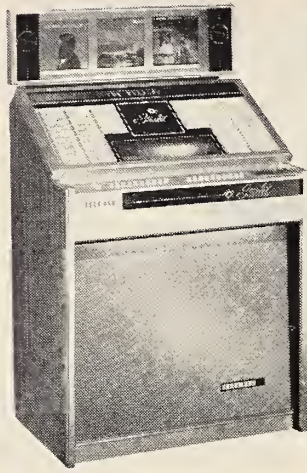

Rock-Ola 429
(1965 Starlet St—Mon)
100—Sel. 33—45—7" LP

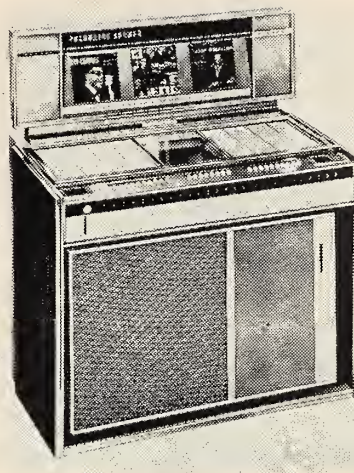

Rock-Ola 425
(1964 Grand Prix 160—Sel.)
33—45 rpm

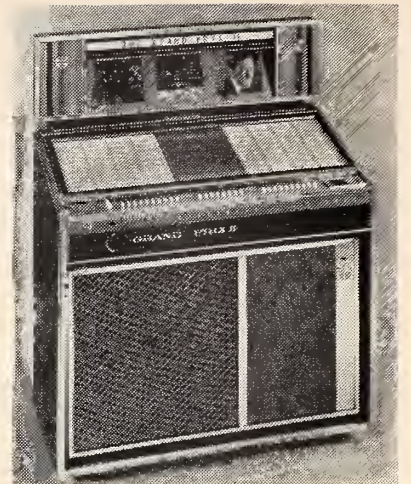

Rock-Ola 426
(1965 Grand Prix II 160—Sel.)
St—Mon. 33—45 rpm

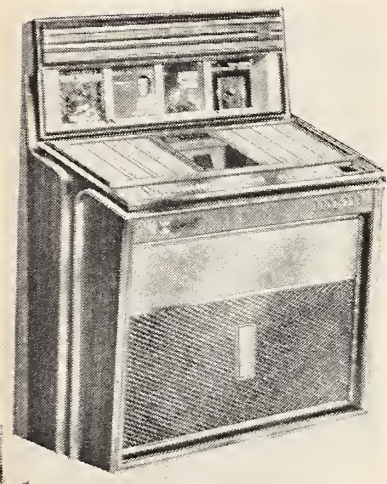

Rock-Ola 433
(1966 GP/Imperial St—Mon)
160 Sel. 33—45 rpm

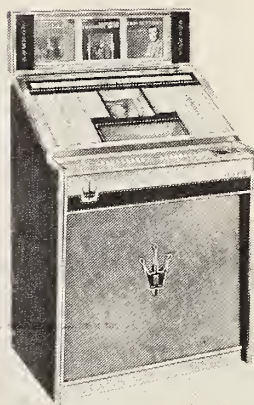

Rock-Ola 431
(1966/67 Coronado St—Mon)
100 Sel. 33—45 rpm

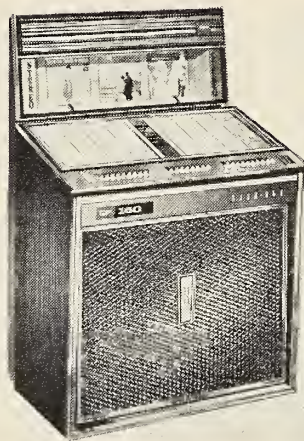

Rock-Ola 432
(1966/67 GP/160 St—Mon)
160 Sel. 33—45 rpm

ROWE MANUFACTURING

Troy Hills Road
Whippany, N. J.

1955 — 1967

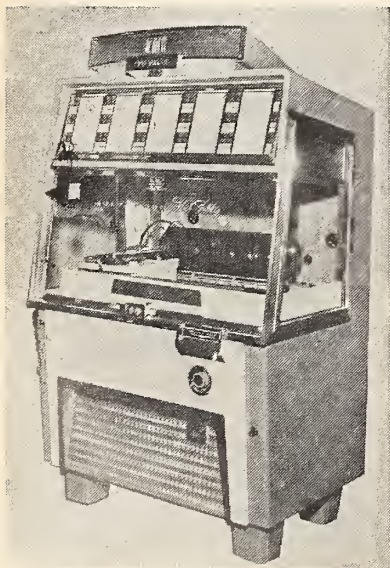

Rowe "G"
(1955 80 or 120—Sel.)
45 rpm

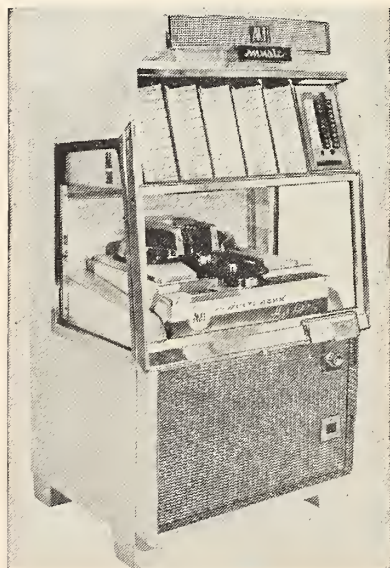

Rowe "G—200"
(1956 200—Sel. 45 rpm)

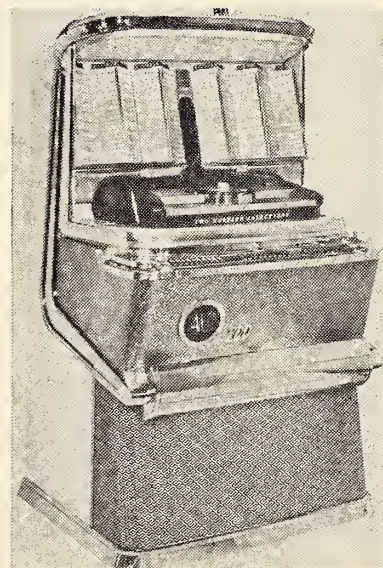

Rowe "H—200"
(1957 200—Sel. 45 rpm)
Model H—120 120 Sel.
(100 Sel. available)

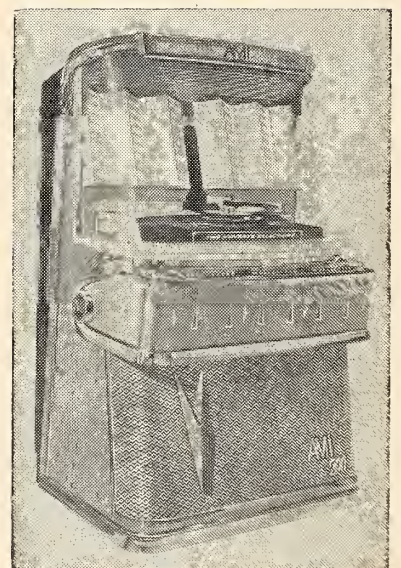

Rowe "I—200"
(1958 200 Sel. 45 rpm)

ROCK-OLA MEANS

"MONEY MAKERS" regardless of location. Phonographs...coffee machines... can vendors...they all net more dollars when they're ROCK-OLA coin-operated equipment.

Phonographs and Vendors alike are designed with the operator in mind...designed to attract the most money from the public and use the least money for service and maintenance. This year, more than ever, ROCK-OLA has gone all-out, all the way, to assure greater accessibility, for greater operator convenience and service ease. There's a size and type of phonograph, coffee machine or can cold drink vendor to assure maximum profits from any location.

Look to

ROCK-OLA

All-out, all the way, for profits!

ROCK-OLA MANUFACTURING CORPORATION
800 North Kedzie Avenue • Chicago, Illinois 60651

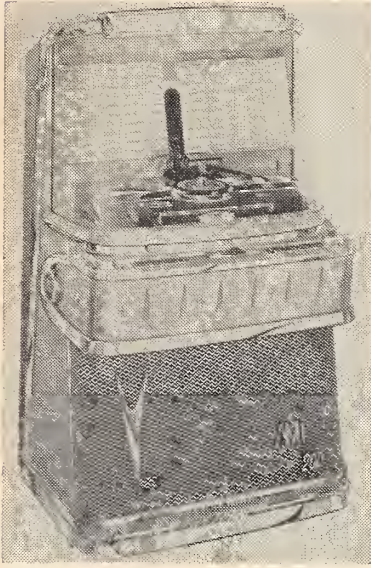

Rowe "1-200M"
(1958 200 Sel. 45 rpm)

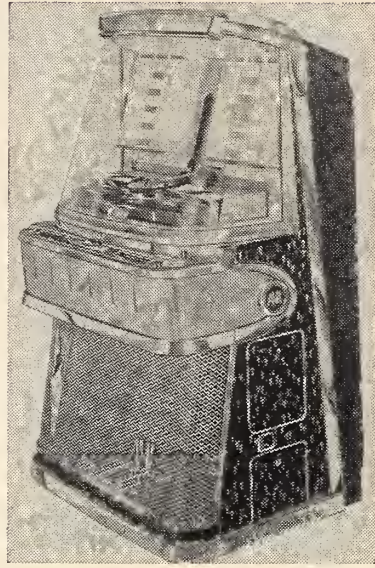

Rowe "1-200"
(1958 120 Sel. 45 rpm)
Model "1-100"
(1958 100 Sel. 45 rpm)

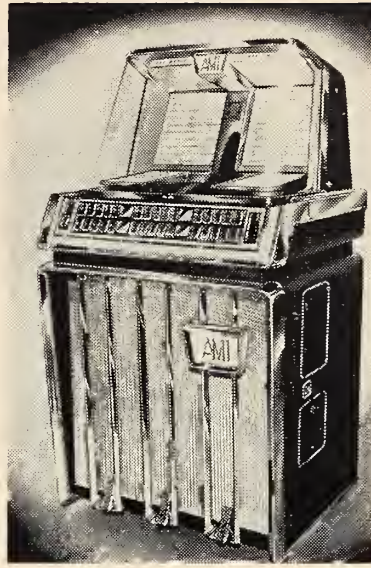

Rowe "J"
(1959 St-Mon. 200 Sel.)
Elec. or Man.
(120 Sel.) (100 Sel.)

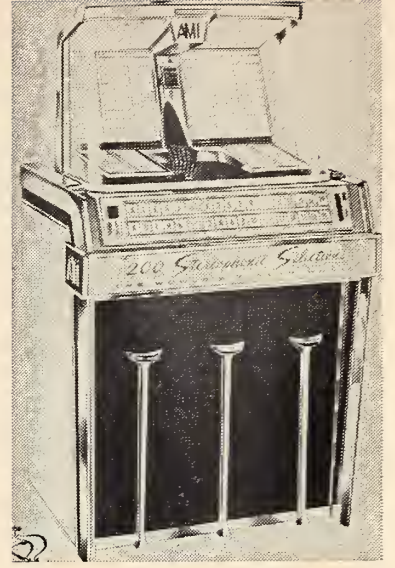

Rowe "K"
(1960 200, 120 or 100 Sel.)

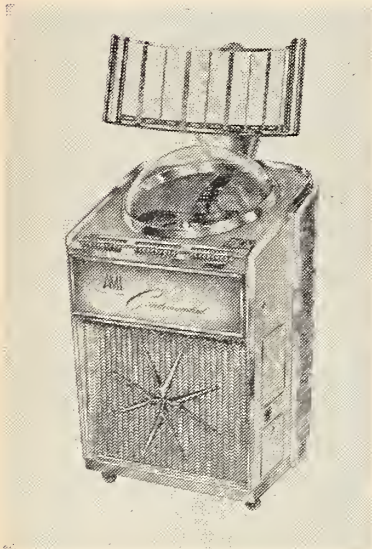

Rowe "Continental 200"
(1960 200—Sel. Lyric 100—Sel.)

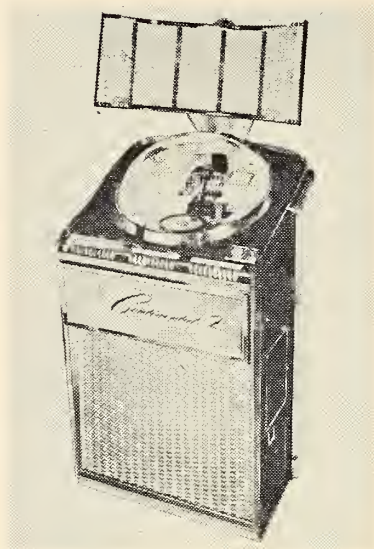

Rowe "Continental 2"
(1961 200 or 100—Sel. 45—33)

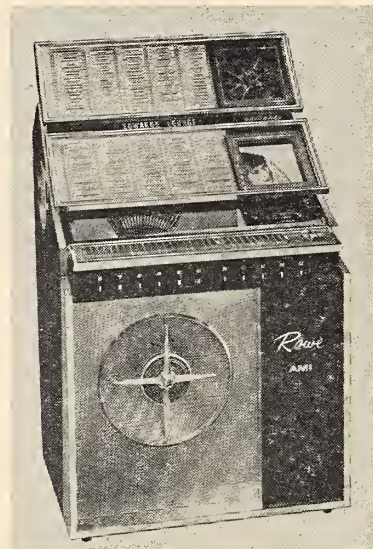

Rowe-AMI
(1962-63 200, 160 or 100—Sel. 45—33)

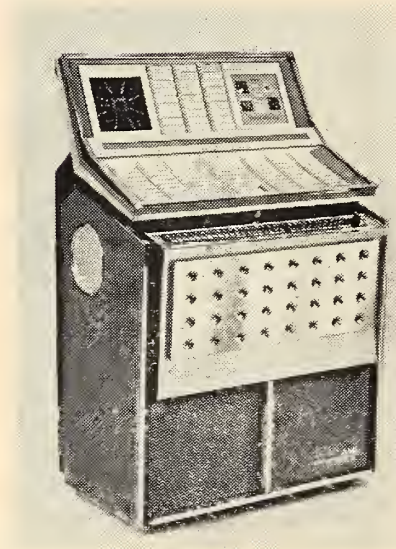

Rowe "Tropicana"
(1963-64 200, 160 or 100—Sel. 45—33)

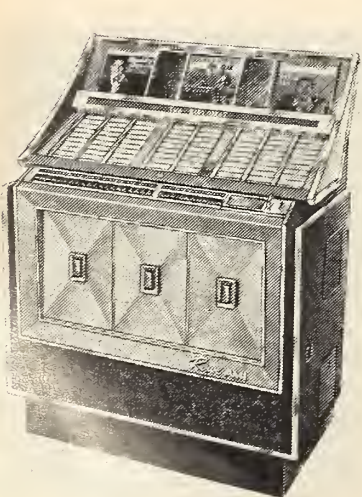

Rowe "Diplomat"
(1965 200, 160 or 100—Sel. 45—33)



Rowe "Band Stand"
(1966 Model JAO 200 Sel.)
33—45 rpm



Rowe AMI MM-1
(1966/67 100-160-200 Sel)
optional dollar bill acceptor
33—45 rpm

TIRED OF HOPELESSLY
SEARCHING FOR THAT
BIT OF COIN MACHINE
INFORMATION?

READ



AND PEOPLE WILL
BE CALLING YOU FOR
INFORMATION



EXCLUSIVE DISTRIBUTORS for the BEST-SELLING LABELS

- ABC
- AWARD ARTISTS
- BETHLEHEM
- BLUESWAY
- BOOM
- CADET
- CHECKER
- CHES
- CHISA
- COMMAND
- CONGRESS
- COTIQUE
- DADDY BEST
- DELUXE
- DUNHILL
- FOUR CORNERS
- GOLDEN
- GOLDEN AWARD
- HICKORY
- IMPULSE
- JERDEN
- KAPP
- KENT
- KING
- LOMA
- MODERN
- MONUMENT
- MOVIE TONE
- MUSIC GUILD
- MUSICOR
- POST
- REPRIS
- SOMA
- SOUND STAGE 7
- SURE
- TANGERINE
- TUFF
- TWENTIETH CENTURY-FOX
- VEEP
- WARNER
- WESTMINSTER

CINEJUKEBOX

The only 2-in-1 machine that combines movies and juke box in a single unit

THE MOST COMPLETE LINE OF COIN OPERATED EQUIPMENT

HOT DRINKS	HOT DRINKS	FACTORY	CANDY	HOT FOODS	FRESH FOODS	CIGARETTES	COLD DRINKS
★ ROWE AMI	★ IRVING KAYE	★ AUTO PHOTO	★ BALLY	★ U.S. BILLIARDS	★ FILMOTHEQUE-DISCOTHEQUE	★ PHOTO-VOICE	
★ MIDWAY PRODUCTS	★ ALL-TECH	★ CINE-JUKEBOX					

★ WE STOCK THE WORLD'S LARGEST INVENTORY

DAVID ROSEN inc.

amusement vending * music machines * record dist.

**855 NORTH BROAD STREET
PHILADELPHIA, PA., 19123
Phone: (215) CENter 2-2900**

SEND FOR COMPLETE COIN MACHINE LIST

COIN OPERATED PHONOGRAPHS

Seeburg

SEEBURG SALES CORP.

1500 N. Dayton

Chicago, Ill.

1953 — 1967

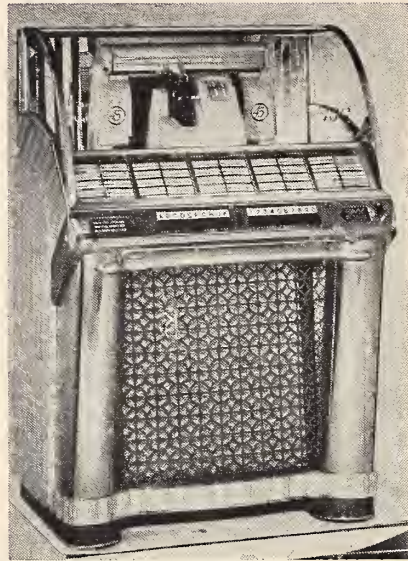

Seeburg HF-100G
(1953 100—Sel. 45 rpm)

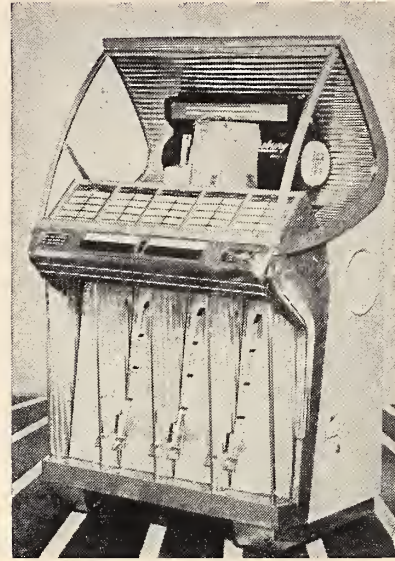

Seeburg HF-100R
(1954 100—Sel. 45 rpm)

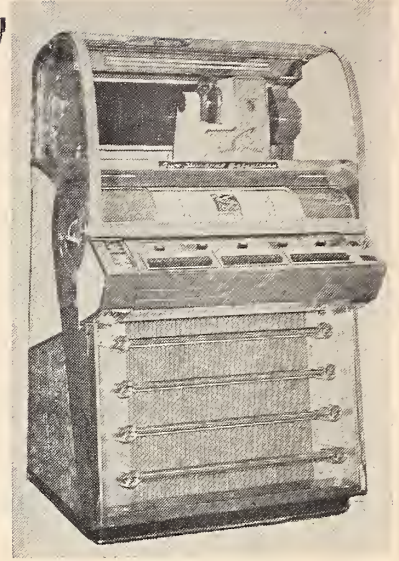

Seeburg V-200
(1955 200—Sel. 45 rpm)



Seeburg KD-200
(1957 200—Sel. 45 rpm)

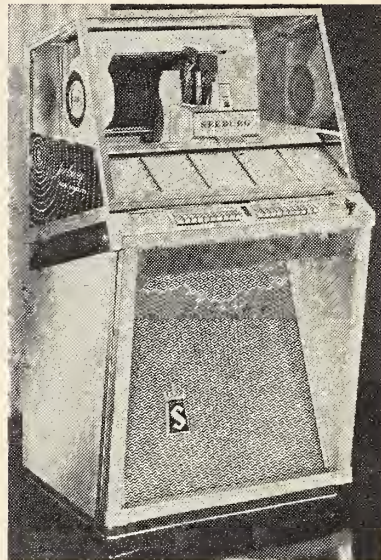

Seeburg L-100
(1957 100—Sel. 45 rpm)

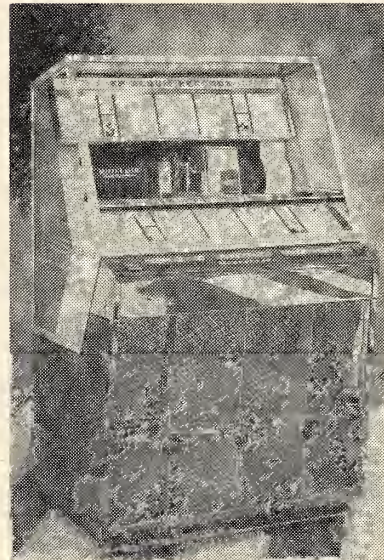

Seeburg "201"
(1958 200—Sel. 45 rpm)

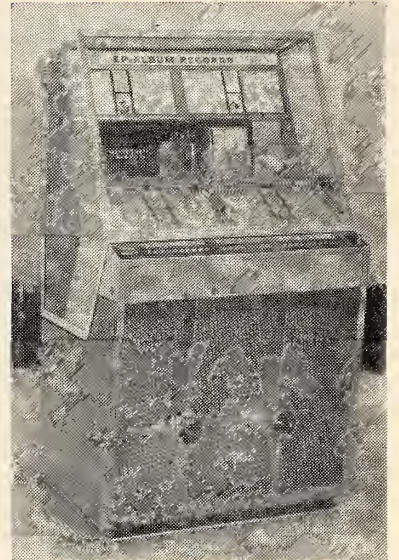

Seeburg "161"
(1958 160—Sel. 45 rpm)

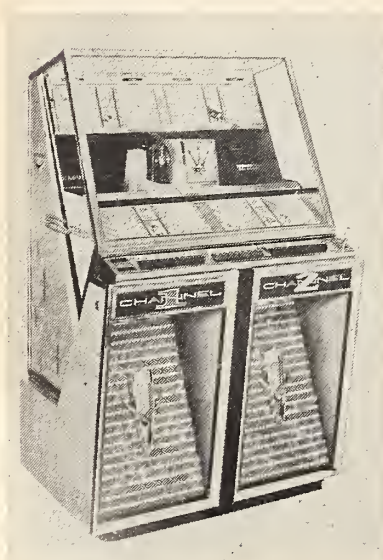

Seeburg "222"
(160—Sel., "220" 100—Sel.)

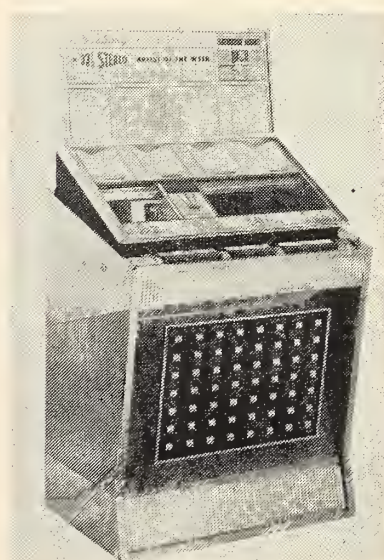

Seeburg "AQ160S"
(1960—160 Sel. 45—33)

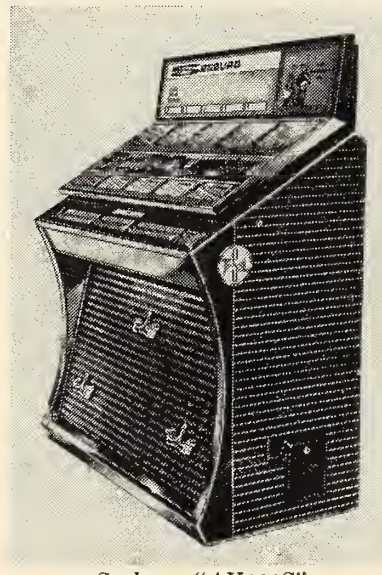

Seeburg "AY160S"
(1961 160—Sel. 45—33)
Model "AY100S" 100—Sel.

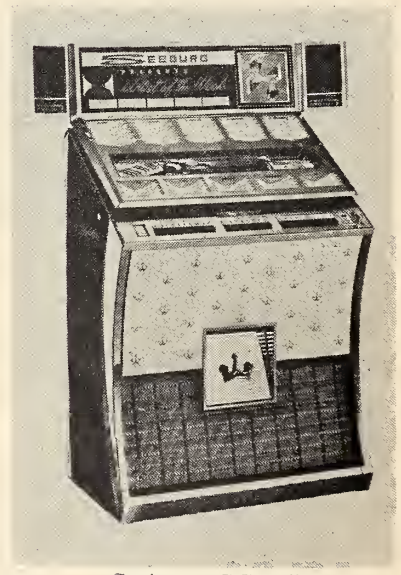

Seeburg "DS160"
(1962 160—Sel. 45—33)
Model "DS100" 100—Sel.



**you
hold
all the
aces
with...**

JUPITER

the money making sound of music!

Styled with the continental touch to do an all-American profit job in your area! Swiss precision engineering makes this one of the finest juke box lines ever produced... with a rich mono-stereo sound system that rivals its smart Parisian appearance. Jupiter looks like a million but is remarkably economic in price... to make it the most important price breakthrough in years for both distributors and operators. May we suggest you jump on the Jupiter bandwagon now... **while a few choice distributorships are still available in the United States, Canada, and the Caribbean!**

JUPITER Sales of America
Division of Taran Enterprises, Inc.

3401 N.W. 36th Street, Miami, Florida 33142 • (305) 635-2531

- ♥ available in 80, 100, or 120 selection models. Model 120 Concorde (picture above) represents the finest in stereo sound.
- ♠ a maintenance man's dream, with finger-tip accessibility to all parts.
- ♦ accent on durability. Simplicity of design means less opportunity for breakdown, less servicing, higher net profit per machine.
- ♣ proved economy and trouble-free operation has sold over 35,000 Jupiters, now coining money throughout the world.
- ♥ true, rich sound reproduction that means increased play.
- ♠ priced to save, built to last, designed to catch eyes and coins, destined to become the star of the juke-box field.

COIN-OPERATED PHONOGRAPHS

Seeburg-
Wurlitzer

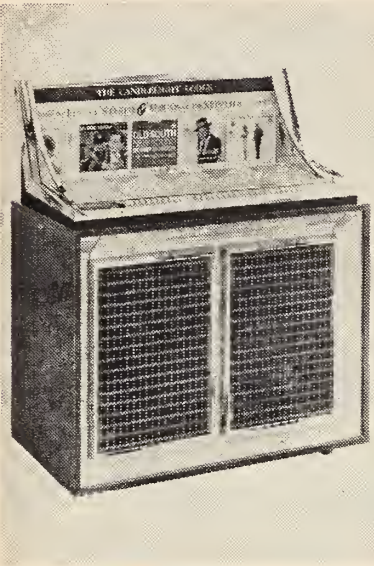

Seeburg LPC-1
(1963-64 160—Sel. 45—33)

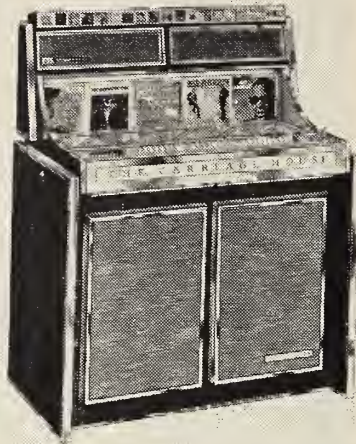

Seeburg LPC 480
45—33 rpm

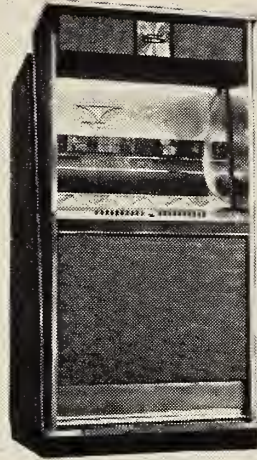

Seeburg "Mustang"
(1965-1966 100—Sel. 45 rpm)

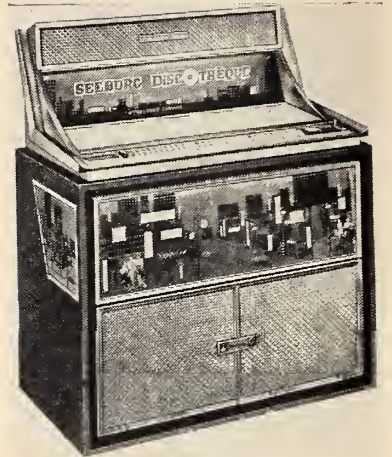

Seeburg "Electra"
(1965-66 160—Sel. 33—45 rpm)



Seeburg Stereo Showcase
(1966/67 160 Sel. St. Mon.)
33—45 rpm
optional dollar bill acceptor

THE WURLITZER CO.
N. TONAWANDA, N.Y.

1953 — 1967

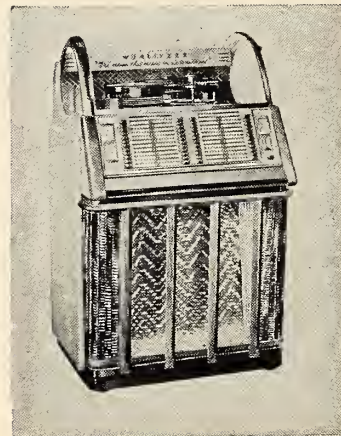

Wurlitzer 1600—1650
(1953 48—Sel. 78 rpm)

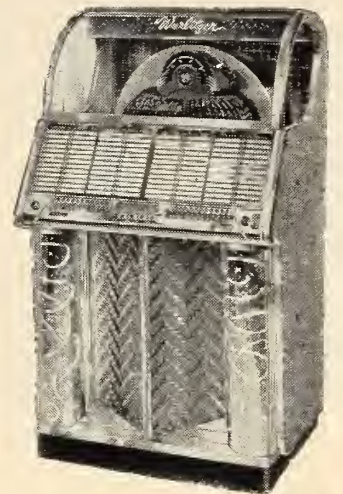

Wurlitzer 1700
(1954 104—Sel. 45 rpm)

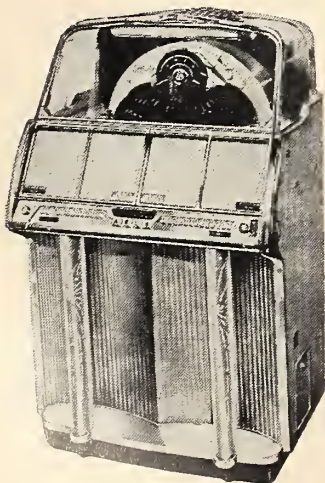

Wurlitzer 1800
(1955 104—Sel. 45 rpm)

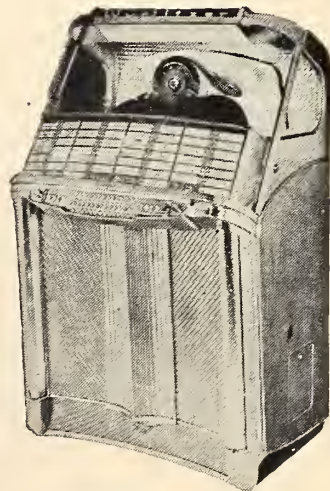

Wurlitzer 1900
(1956 104—Sel. 45 rpm)

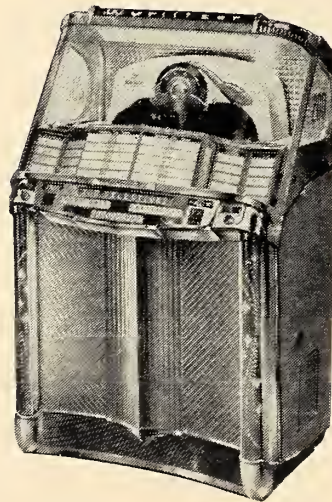

Wurlitzer 2000
(1956 200—Sel. 45 rpm)

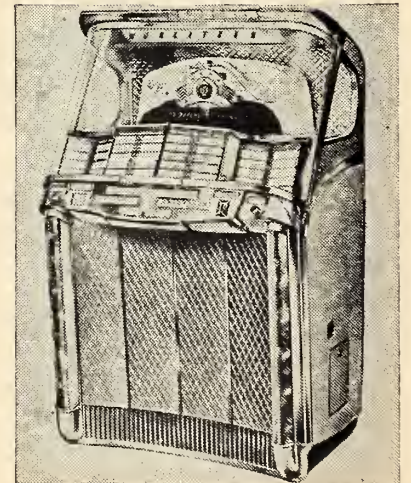

Wurlitzer 2100
(1957 200—Sel. 45 rpm)

ONLY WURLITZER OFFERS THE BEST A National Dollar Bill Acceptor

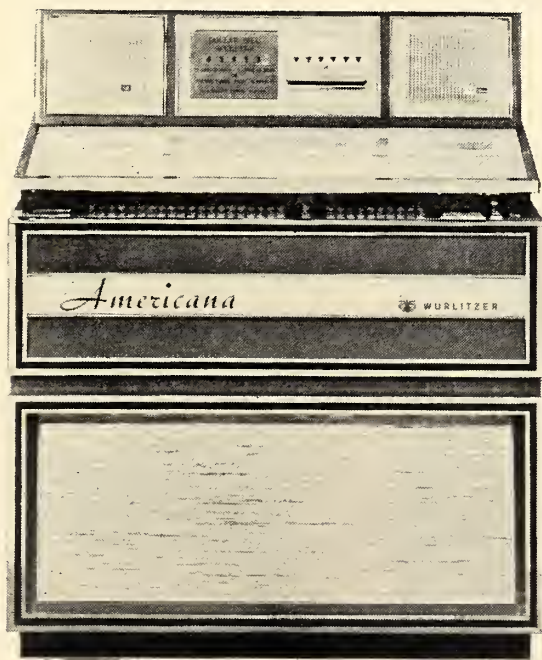
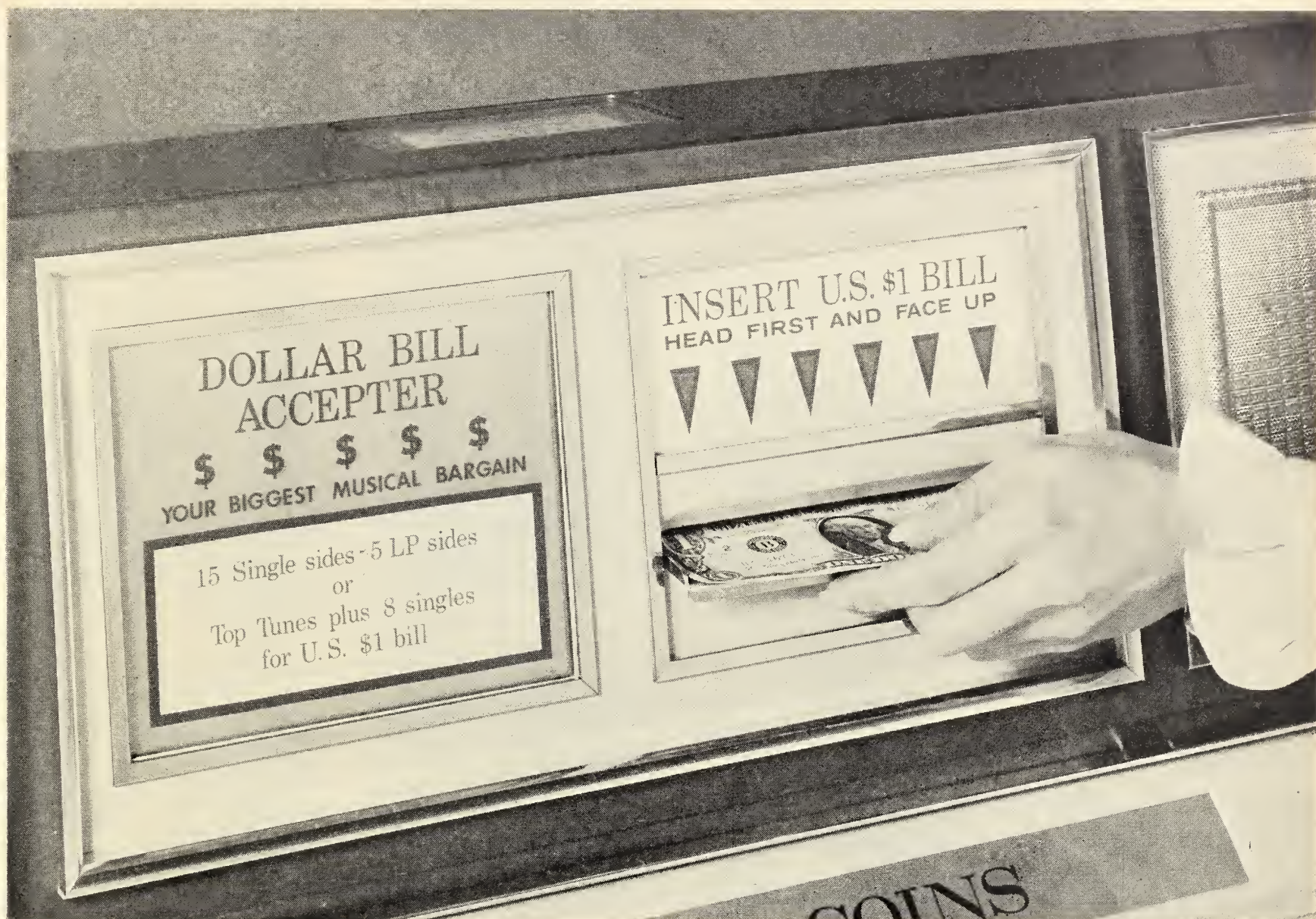

When you go for a Dollar Bill Acceptor, you want a sure-fire, fool-proof mechanism. National makes it. You can have it as an optional extra — but only on the new WURLITZER AMERICANA Phonographs.

The Acceptor is positioned in the center of the dome display panel for eye-attracting play appeal. It accepts only U.S. Dollar Bills.

Take a new look at your locations that really move. Put a WURLITZER AMERICANA with a National Bill Acceptor in the swinging spots . . . you'll make money as you never have before!

Wurlitzer Americana

BIG in Sound...BIG in Beauty...

BIG in Money-Making Features

THE WURLITZER COMPANY · NORTH TONAWANDA, NEW YORK

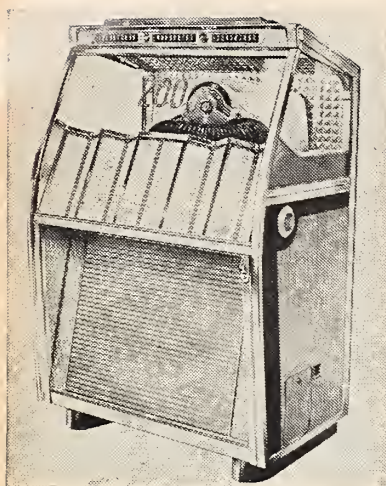

Wurlitzer 2150
(1957 200—Sel. 45 rpm)

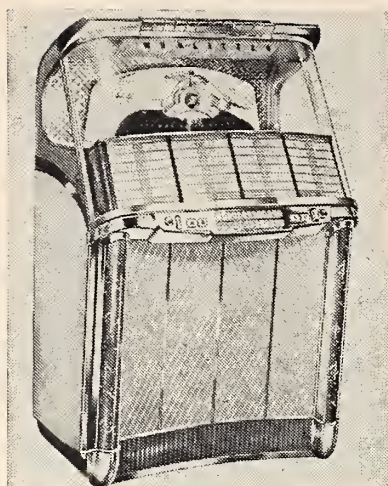

Wurlitzer 2104
(1957 104—Sel. 45 rpm)

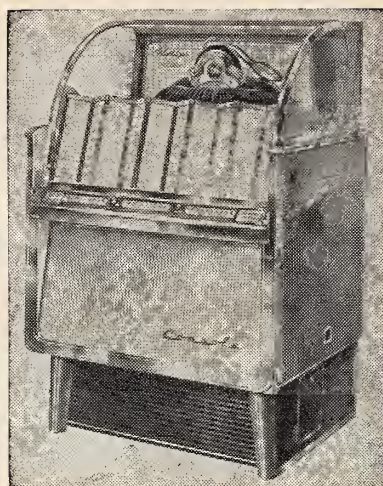

Wurlitzer 2200
(1958 200—Sel. 45 rpm)

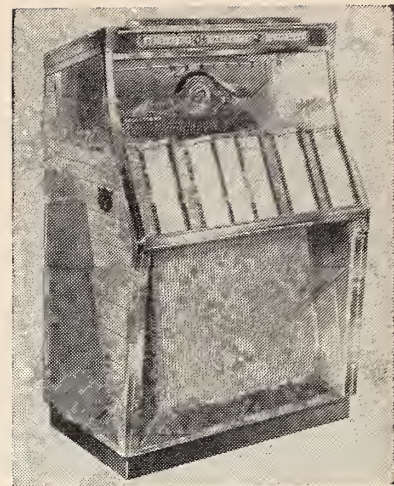

Wurlitzer 2250
(1958 200—Sel. 45 rpm)



Wurlitzer 2300
(1959 200—Sel. St—Mon)
2304—104—Sel., 2310—100—Sel.

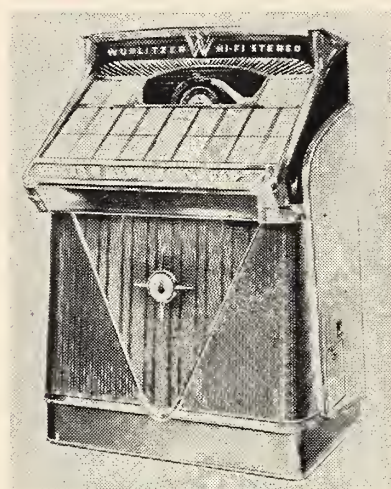

Wurlitzer 2400
(1960 200—Selections)
2404—104—Sel., 2410—100—Sel.

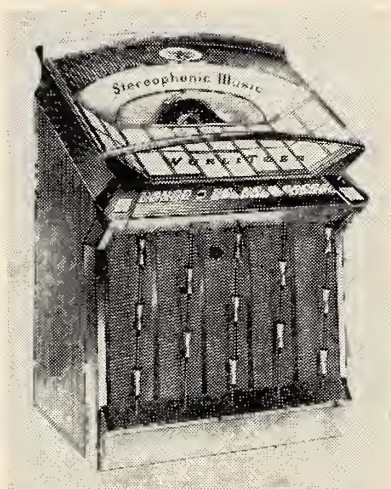

Wurlitzer 2500S
(1961 200—Sel. 45-33 Avail)
2504—104—Sel., 2510—100—Sel.

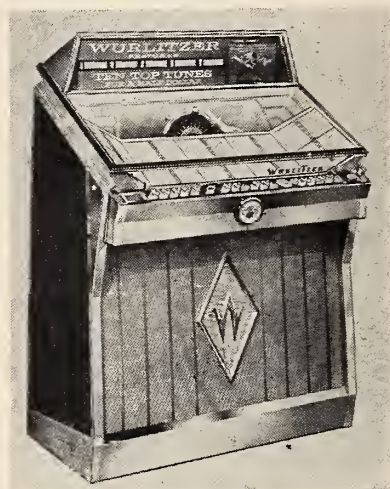

Wurlitzer 2600
(1962 200—Sel. 45-33)
Model 2610 100—Sel.

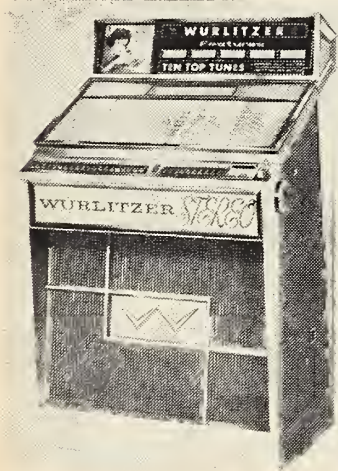

Wurlitzer 2700
(1963 200—Sel. 45-33)
Model 2710 100—Sel.

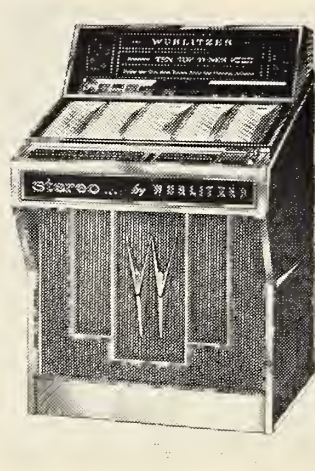

Wurlitzer 2800
(1964 200—Sel. 45-33)
Model 2810 100—Sel.

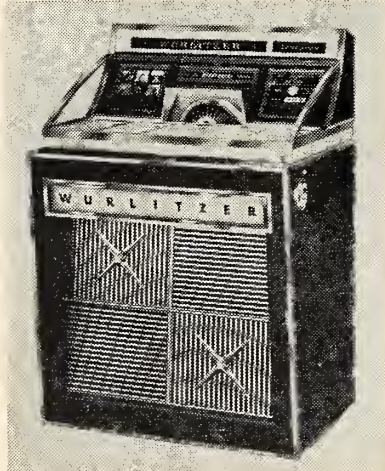

Wurlitzer 2900
(1965 200—Sel. 45-33)
Model 2910 100—Sel.



Wurlitzer 3000
(1965-1966 200 Sel. w/Top Tunes
and little LP albums)

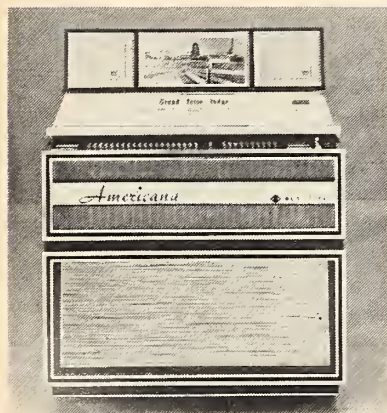

Wurlitzer Americana 3100-3110
160-200 Sel. Models
(1966/67 stereo-mono 33—45 rpm)
optional dollar bill accepter



**United
Mfg. Co.**
1957 — 1961

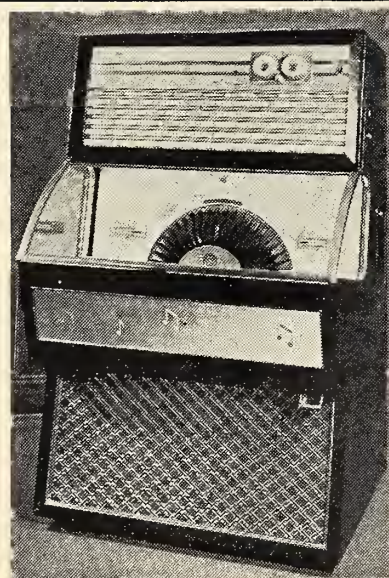

United UPA—100
(1957 100—Sel. 45 rpm)

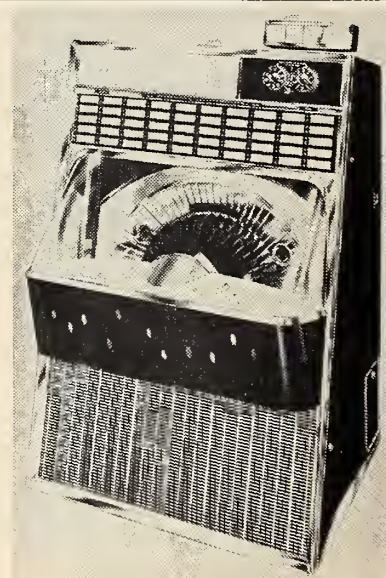

United UPC—100
(1960 100—Sel.)

COIN-OPERATED PHONOGRAPHS

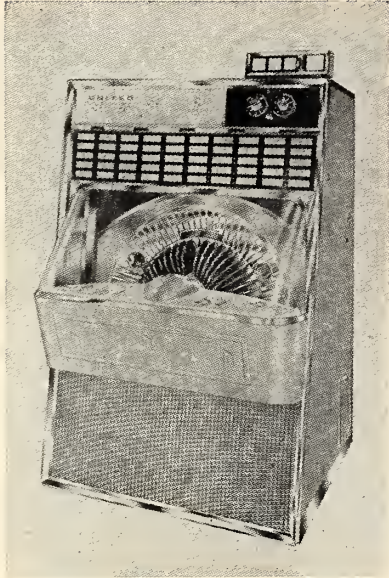

United UPD-100
(1961, 62, 63-100 Sel.)

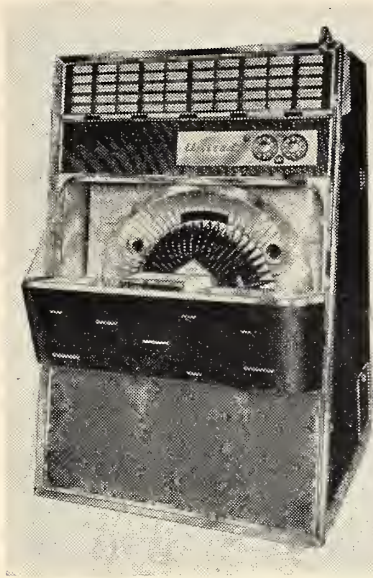

United UPB-100
(1959 100-Sel. St-Mon)

**JUPITER SALES
OF AMERICA**
DIVISION OF TARAN
ENTERPRISES, INC.
3401 N.W. 36th. Street
Miami, Florida
33142



Jupiter E 80
(1967-80 Sel.)
33-45 rpm

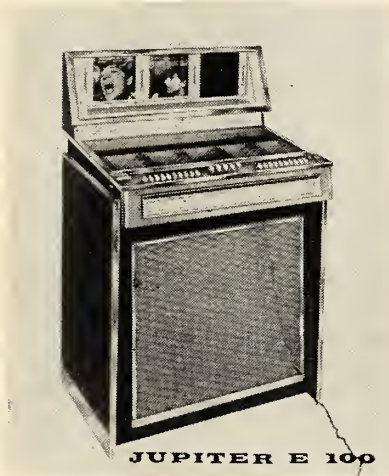

JUPITER E 100

Jupiter E 100
(1967-100 Sel.)
33-45 rpm



JUPITER 120 C

Jupiter 120 C
(1967-120 Sel.)
33-45 rpm

REMOTE SELECTOR UNITS

—
Under current
production

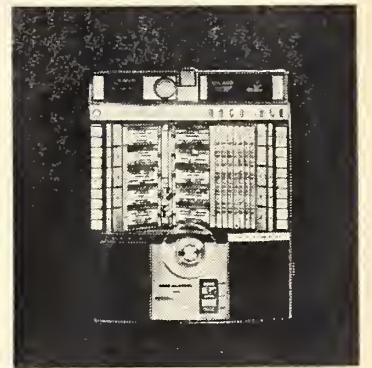

Rock-Ola Phonette
(Remote Wallbox 160 Sel. Twin st.
speakers Model 503.
Model 504 100 sel.)



Rowe AMI Wall-Ette
(#WRA, WRB remote 200 Sel.
Push-button volume control,
twin st. speakers)



Seeburg Consolette
(Remote, 160 Sel., Push-button
volume control, Twin st. speakers)

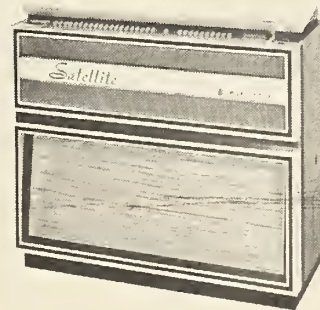

Wurlitzer Satellite
(Model 5131, 100 Sel.
Remote speaker console
Model 5132 200 Sel. Identical
to companion Americana, in
lower design)

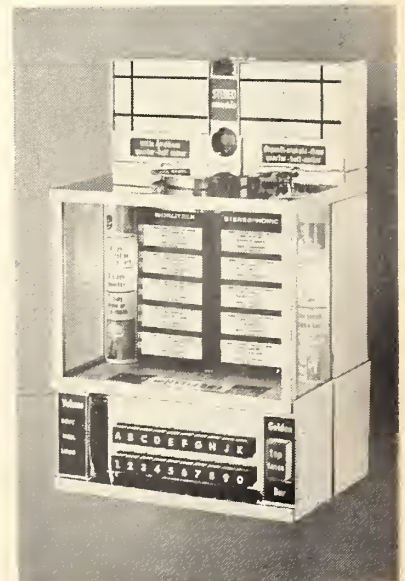

Wurlitzer Model 5220
(200 Sel. W/twin
speakers, push-button
volume control)

AMUSEMENT MACHINES

Produced July '66—June '67 U.S. Factories

Pingames



Bally BAZARR 1P

Pingames



Bally FUN CRUISE 2P

Pingames

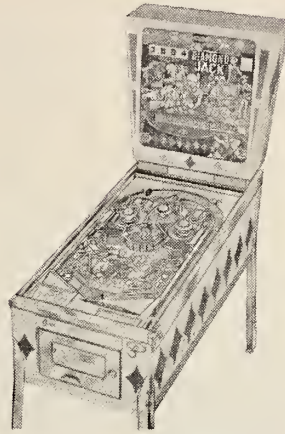

Gottlieb "DIAMOND JACK"

Pingames

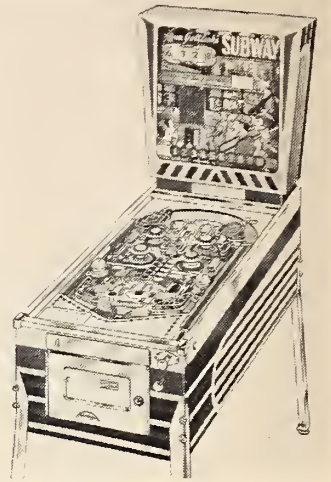

Gottlieb 'SUBWAY' 1P

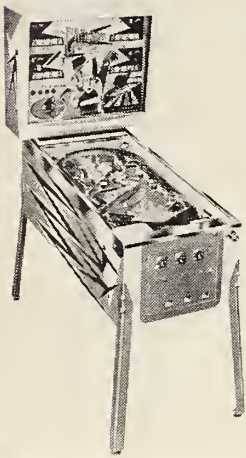

Bally CAPERSVILLE 4P



ChiCoin BEATNIKS 2P



Gottlieb DANCING LADY



Gottlieb KING OF DIAMONDS 1P



Bally "CAMPUS QUEEN" 4P

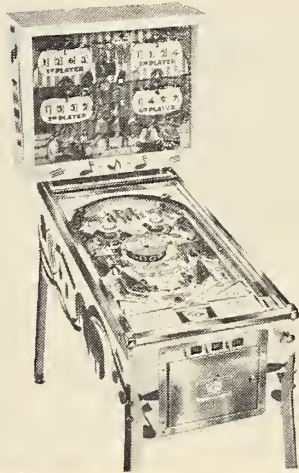

ChiCoin FESTIVAL 4P

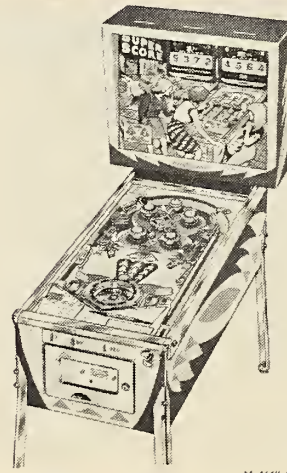

Gottlieb SUPER SCORE 2P



Gottlieb MAYFAIR 2 PL

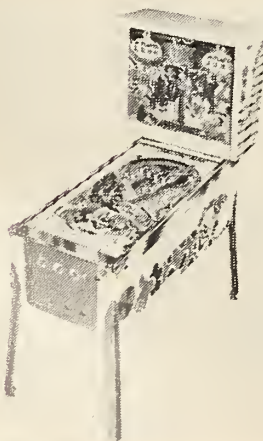

Bally 'LOOP-THE-LOOP' 2P

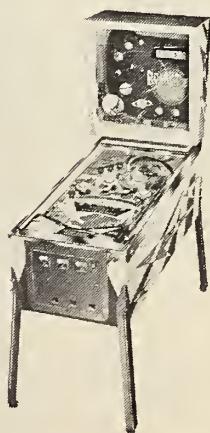

Bally "Rocket III," Add-A-Ball

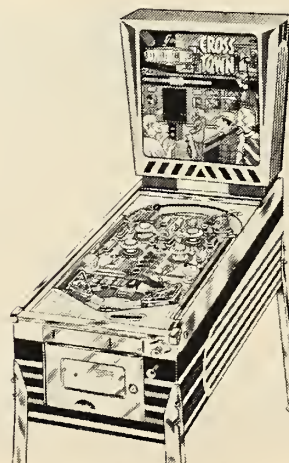

Gottlieb CROSS TOWN



Gottlieb Hi-Score 4-Pl.

AMUSEMENT MACHINES

Produced July '66—June '67 U.S. Factories

Pingames

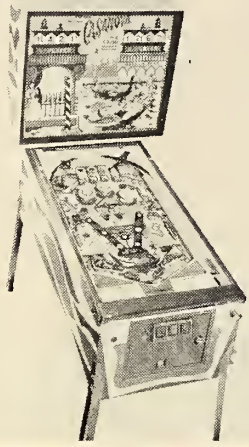

WILLIAMS' 'CASANOVA' 2P

Pingames



Williams MAGIC CITY 1P

Shuffleboard

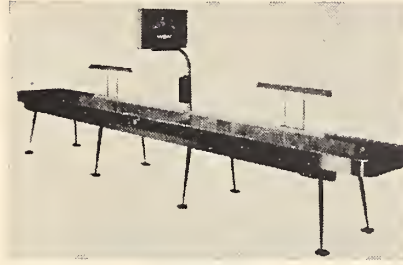

NATIONAL
Professional Model

Shuffle Alleys

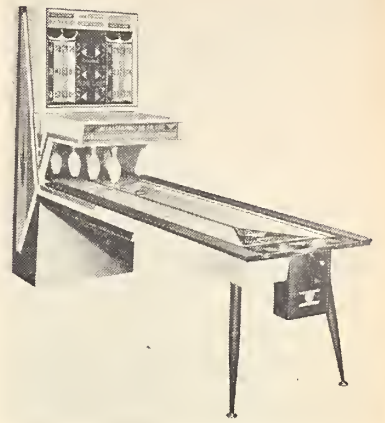

ChiCoin PARK LANE 6P

Scoreboards

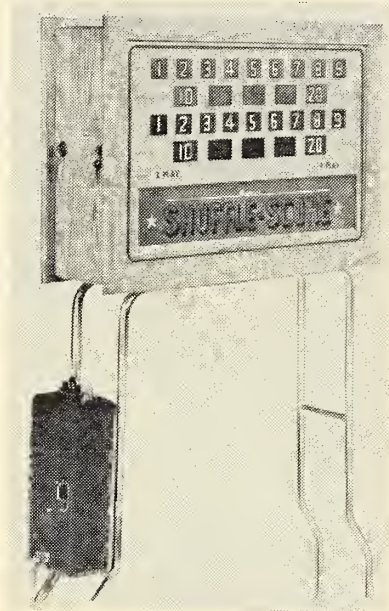

MARVEL
Shuffleboard Scoreboard

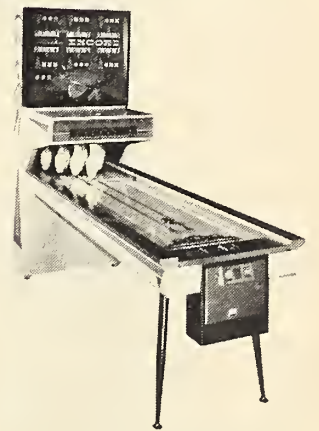

UNITED 'ENCORE' 6P



Wms. LUCKY STRIKE 1PL

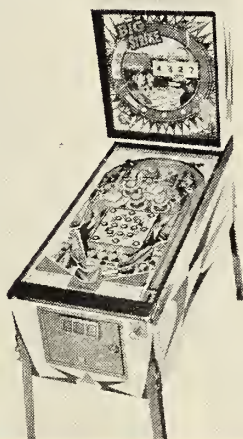

BIG STRIKE Add-A-Ball 1P



WILLIAMS 'A-GO-GO' 4PL

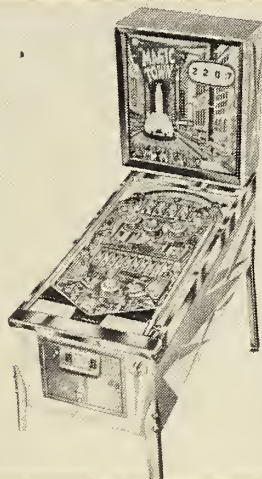

Williams MAGIC TOWN 1P

Song Machine

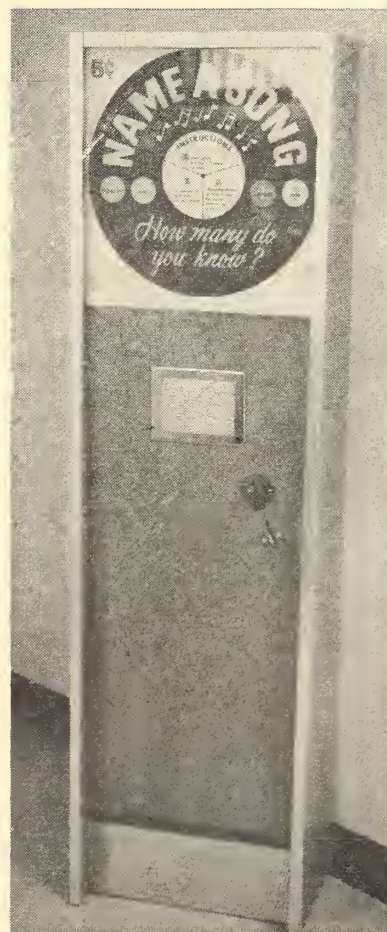

URBAN INDUSTRIES
"Name-A-Song"

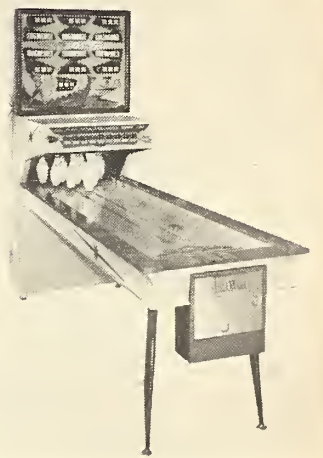

Williams ALTAIR 6P

Shuffleboard

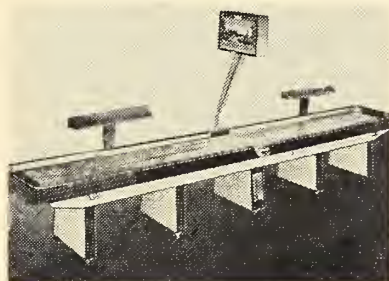

American IMPERIAL



Wms. SHANGRI LA 4P



ChiCoin IMPERIAL

Shuffle Alleys



MIDWAY 'CORBA' SHUFFLE

Bowlers

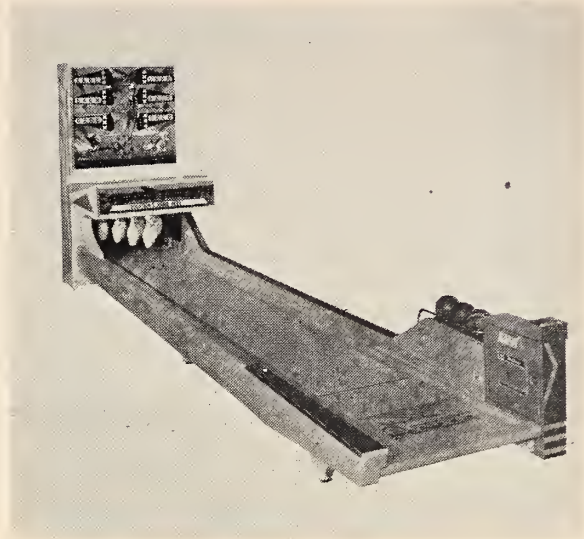

UNITED "AMAZON" BOWLER

Bowlers

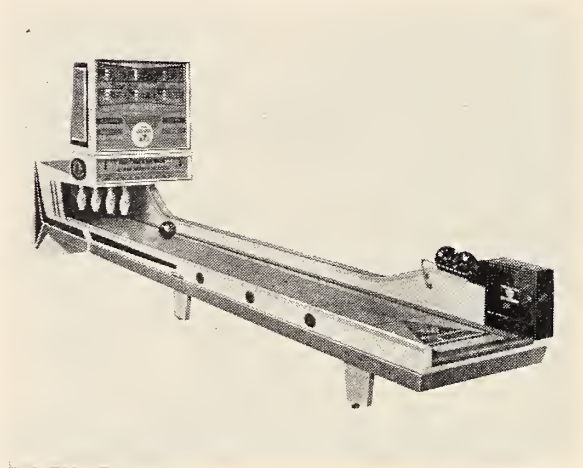

CHICOIN FESTIVAL BOWLER

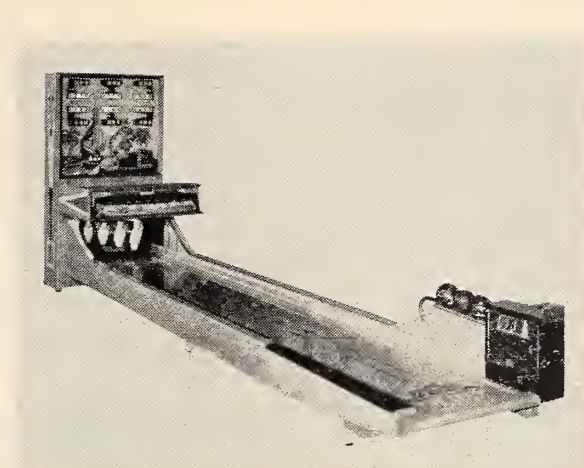

UNITED CORONADO BOWLER

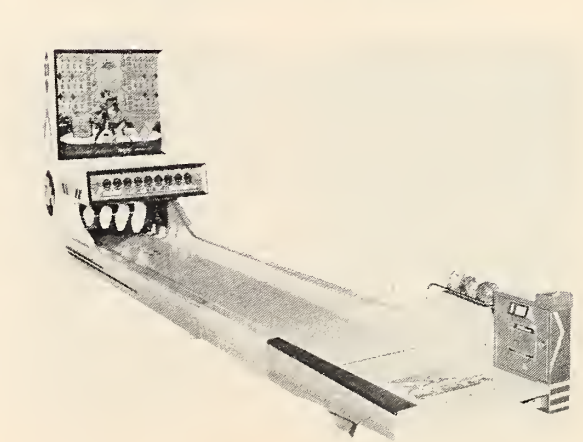

UNITED "AZTEC"

Baseball Games

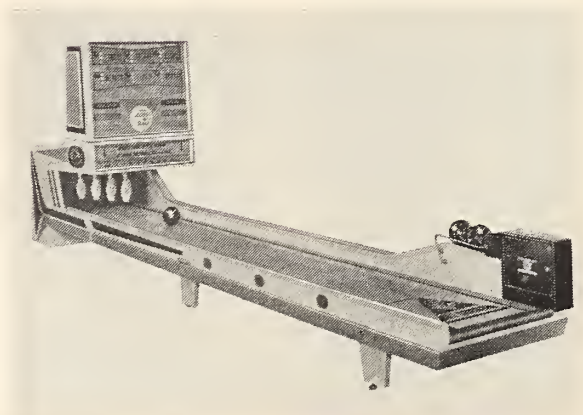

CHICOIN FLAIR BOWLER



ChiCoin BULLSEYE 2P



Wms. BASE HIT 2P

U.S. BILLIARDS
NUMBER 1 NAME
in POOL TABLES



'67 "PRO" SERIES

FINEST COIN-OPERATED POOL TABLES

- PRO-1 (one piece slate).....78 x 46
- PRO-2 (one piece slate).....86 x 50
- PRO-3 (one piece slate).....93 x 53
- PRO-4 (one piece slate).....103 x 58
- PRO-5 (three piece slate).....114 x 64

Professional K-66 Cushions

Acknowledged the "World's Finest"

USED ON PRO-3 - 4 - 5 POOL TABLES

TOPS IN QUALITY, DURABILITY, AND DESIGN

All pool tables manufactured by U.S. Billiards feature genuine solid slate — with rugged "H"-Frame leg construction. Simple to set up with adjustable leg levelers. Easy maintenance too... access to runways without removing slate... adjustable bolt and t-nut cushion moulding attachment. Cabinets, legs, and rails of genuine mica maintain their beauty under the toughest conditions. Tamper-Proof Meter on all Coin Tables.

U.S. CLUB POOL

WITH SPLIT BALL RETURN

Coin-Operated.

Available in 55½ x 39½.



U S BILLIARDS, Inc.
 Amityville, New York 11701

for information call 516-798-2626

EXCLUSIVE NEW YORK AREA DISTRIBUTOR

ALBERT SIMON INC. • 587 TENTH AVE. • NEW YORK, N.Y. 10036

U.S. BILLIARDS CONVERTIBLE TIME POOL

PROVEN ON LOCATIONS



REGULATION SIZE CUE BALL 2 1/4"
PROFESSIONAL K-66 CUSHIONS
USED ON ALL TIME POOL TABLES

TIME POOL MODELS

T86	86" x 50"
T93	93" x 53"
T106	106" x 60"
T106 SNOOKER	106" x 60"
T114	114" x 64"
T114 SNOOKER	114" x 64"



- First all-purpose coin pool table
- Permits all types of regulation 6-pocket play
- Operates on timer as set by operator — 50¢ (2 quarter operation)
- Converts in seconds to regular lock-in coin operated table
- Adapts to all location requirements

for information call 516-798-2626

COPIES EVERYTHING EVERYTIME

U S COIN-A-COPY copies everything — colors, photos, ballpoint, crayon — yes everything! It even copies pages from bound books and 3D items. Because the original never enters the unit, there is no chance of damage to even the most delicate original.

ANYONE CAN OPERATE IT

U S COIN-A-COPY is push-button automatic. Just lay any original, up to 8 1/2" x 14" on the "travelling copy top," press a button. Copies are produced automatically, in seconds.

ENDS HIGH COPY COSTS

U S COIN-A-COPY is today's lowest priced 3D electrostatic copier. No meters, no minimum copying requirements. You only pay for copies you use, and the cost is less per copy.

LIGHTWEIGHT, Compact

U S COIN-A-COPY requires just 2 feet x 4 feet area, and plugs into any normal 110V outlet. In fact, it is priced so a number of units may be strategically located throughout location for greater efficiency.

DRY COPIES 100% ACCURATE

U S COIN-A-COPY copies are produced dry. Write on them, stack them, file them, or mail them immediately. Every copy is an accurate, legally accepted reproduction of the original. There is no 6% or 20% copy reduction as in other copying devices.

MILLION COPY GUARANTEE

The rugged, reliable, superbly-built U S COIN-A-COPY is guaranteed to produce at least One Million Copies, provided authorized U S COIN-A-COPY Service and supplies are used.



U. S. COIN-A-COPY

Division of U. S. BILLIARDS, INC.

EXCLUSIVE NEW YORK AREA DISTRIBUTOR

ALBERT SIMON INC. • 587 TENTH AVE. • NEW YORK, N.Y. 10036

Baseball Games



Midway FUN BALL 1P

Auto-test Game

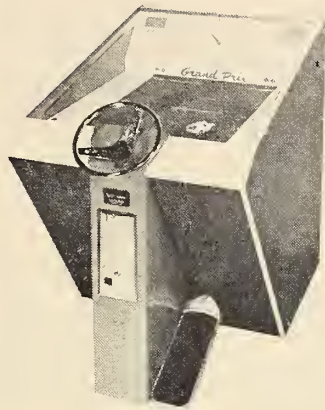

DuKone GRAND PRIX

Film Machines



URBAN Model AP-10

Gun Games



ChiCoin 'SUPER-SCOPE'

Balloon Machine



INTERNATIONAL MUTOSCOPE BALLOON-O-MAT

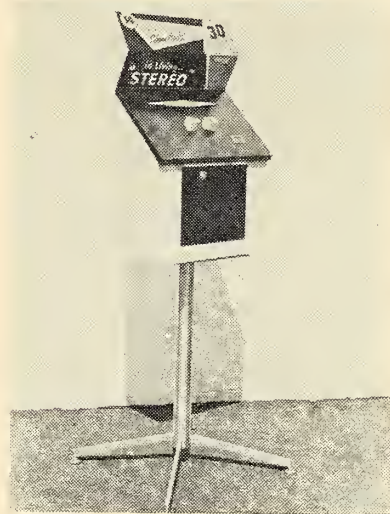

Urban 3D STEREO

Foosball Game

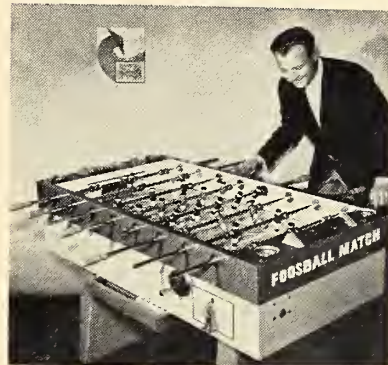

PATTERSON INT'L FOOSBALL

Gun Games

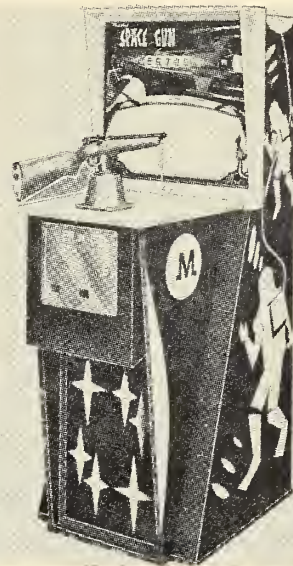

Midway SPACE GUN



ChiCoin WILD WEST

Bingo Machine

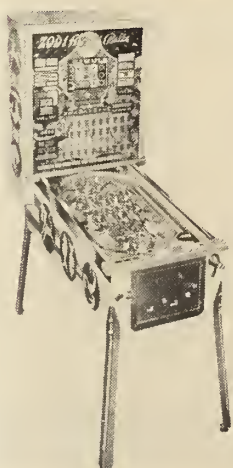

BALLY "ZODIAC"

Coin Box

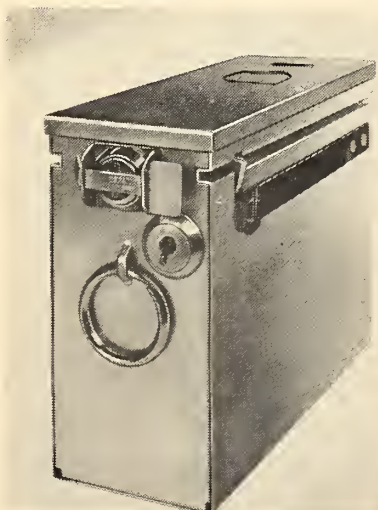

INTER-COUNTY INDUSTRIES Security Coinbox. Wide Variety Available for Amusement, Music, Vending Equip.



Midway 'CAPTAIN KID'

Kiddie Rides

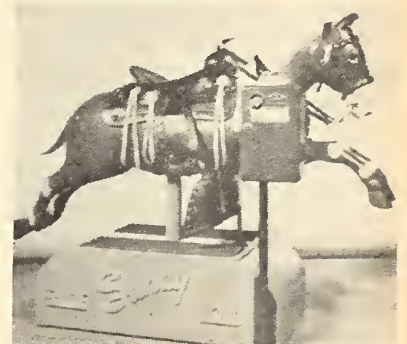

United Tool and Engineering "Sondy Pony"



Williams ARCTIC GUN



ALL-TECH Highway Patrol

Kiddie Ride



Al Fischer Co.
Flipper Ride

Kiddie Rides

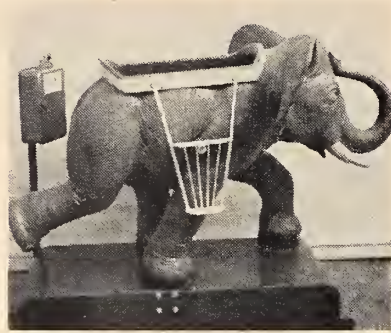

HAWKINS JUMBO
(Hawkins rides not shown)

RODEO PONY, DONNIE DUCK, LEO
THE LYON, DERBY PONY JR., MUS-
TANG and BEN HUR CHARIOT

Metal Typer

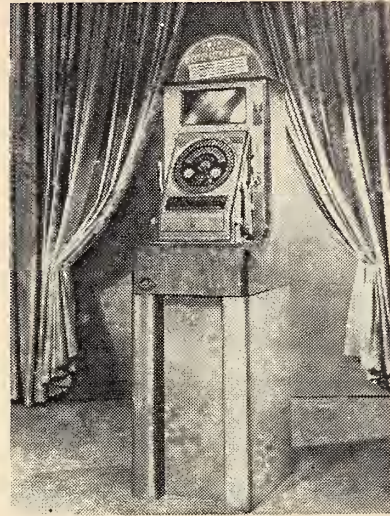

STANDARD HARVARD

Plastic Label Machine



DUKANE TAG-IT

Seal-In Plastic Units



Exhibit KLEER SEAL VENDER

Photo Copy Machine

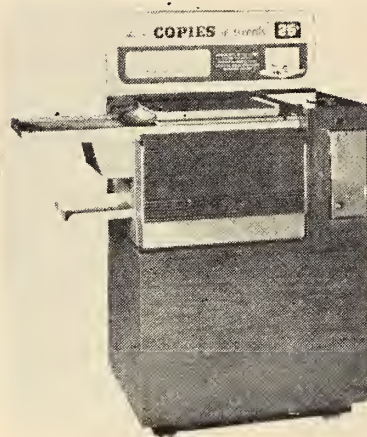

U.S. Coin-A-Copy

Photo Machines

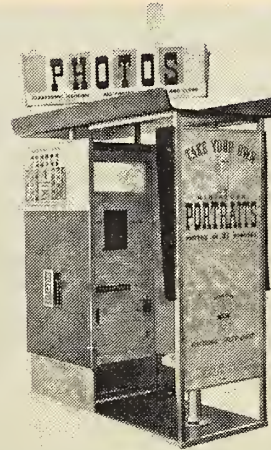

AUTO-PHOTO STUDIO



PERMA-SEND MODEL 66

Shoeshine Machines



MONDIAL SHOESHINE

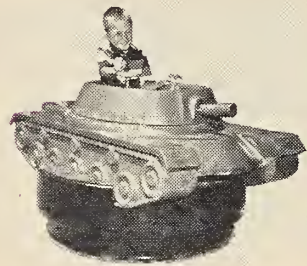

UNIVERSAL MFG. CORP.
Army Tank

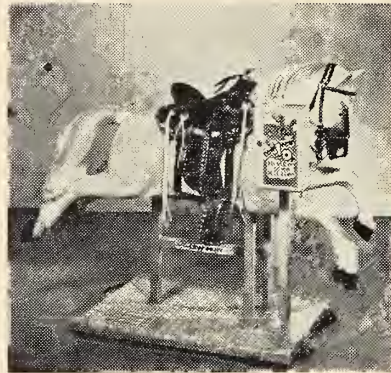

ALL-TECH
Cow Pany

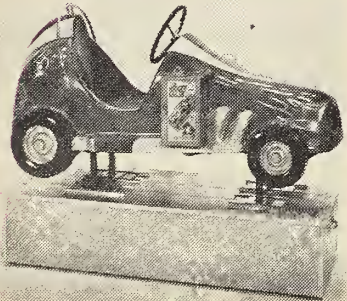

ALL-TECH
Midget Racer

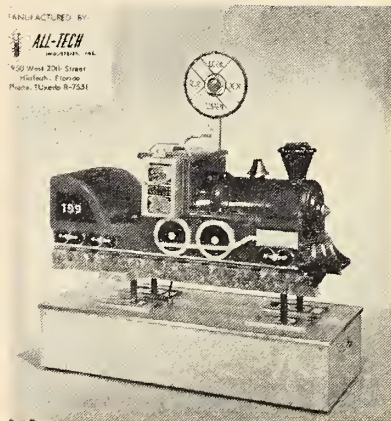

ALL-TECH
Sante Fe Express

(All-Tech models not shown)

STAGE COACH, CHUCK WAGON,
FIRE ENGINE, INDIAN SCOUT,
HELICOPTER and SATELLITE EX-
PLORER



Hawkins
TWIN QUARTERHORSE

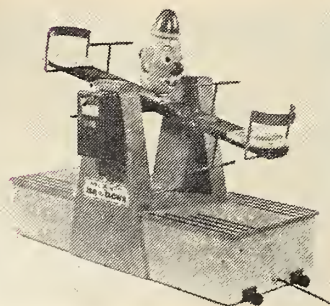

Hawkins SAM THE CLOWN



UNIVERSAL MFG. CORP.
The Satellite



INTERNATIONAL MUTOSCOPE

★ Two steps to Higher Profits
and Additional Locations
from **MONDIAL**

★ *Automatic Shoe Polisher*

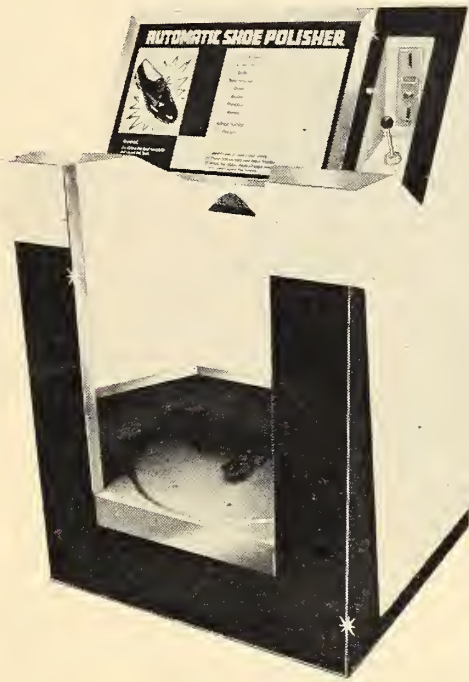

A FULLY AUTOMATED AND PATENTED SHOE SHINE MACHINE THAT SHINES A SHOE LIKE A PROFESSIONAL BOOTBLACK.

- 1500 shines per tankfull.
- Shines any color shoe with exclusive neutral wax supplied by Johnsons Wax Co.
- Customer's foot remains stable while rotating polishing brushes do all the work.
- Gives a professional shine from heel to tip without touching socks.
- Available with 10¢ or 25¢ rejectors.

★ *Flash Soccer*

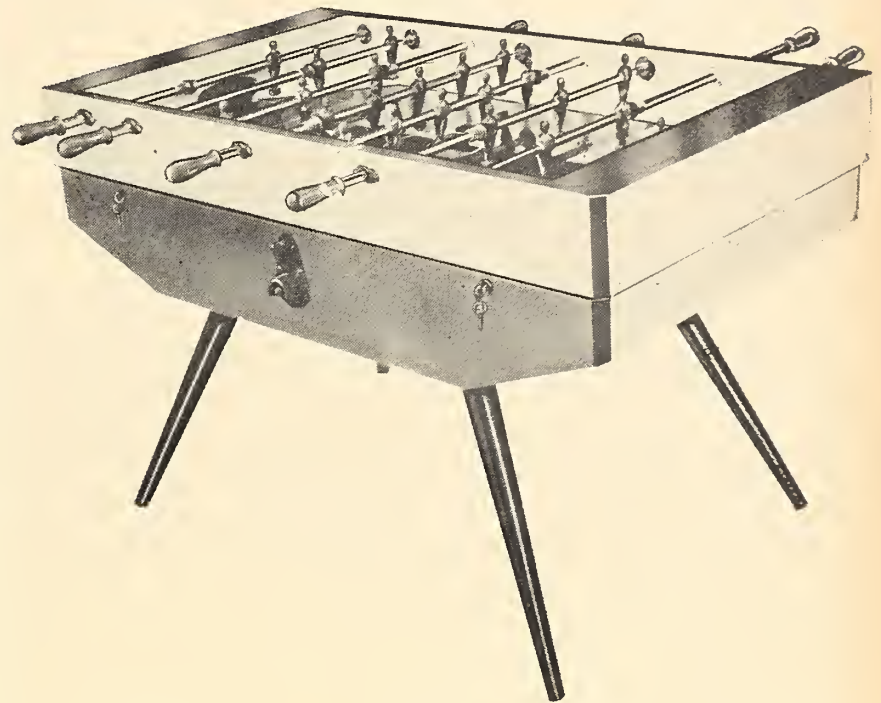

THE ONLY COIN-OPERATED SOCCER TABLE SPECIFICALLY PRICED AND DESIGNED FOR THE TASTES OF THE AMERICAN OPERATOR.

- Two or four can play.
- Strictly mechanical—no service calls.
- Utilizes either A.B.T. or Heath push type coin chute.
- Price per-game is set by the operator.
- Covered playfield.
- Leg levelers.
- Telescoping rods allow a minimum of location space.
- Immediate delivery on all parts guaranteed.

DISTRIBUTOR TERRITORIES AVAILABLE.
INQUIRIES WELCOMED — FAST DELIVERY



MONDIAL INTERNATIONAL, INC.

350 FIFTH AVE.
NEW YORK CITY
(212) WI 7-5661

AMUSEMENT MACHINES

Seal-in Plastic Units

LOOK IT'S EASY!
SEAL IN PLASTIC

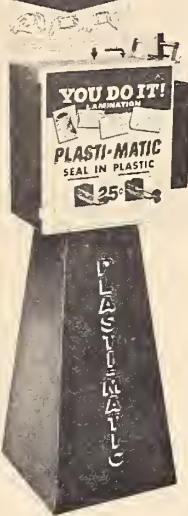

INTERNATIONAL MUTOSCOPE
Plasti-Matic
Seal-In Unit

Slot Machines

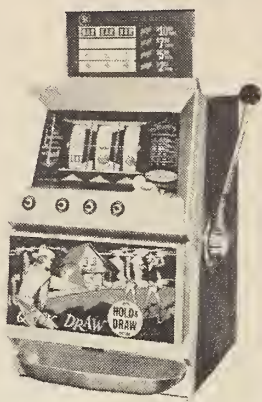

BALLY HOLD & DRAW

Shuffle Boards



AMERICAN SHUFFLE 88

Speedways



LITTLE INDY

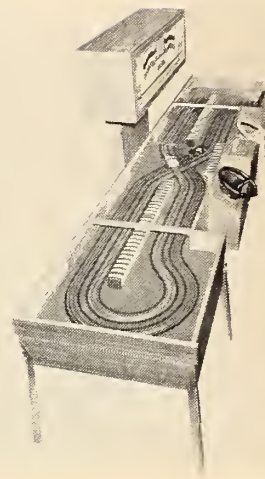

AMERICAN SPEEDWAY

Foosball Games

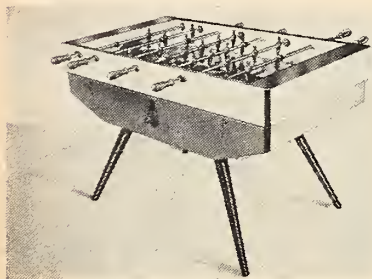

MONDIAL "FLASH" SOCCER

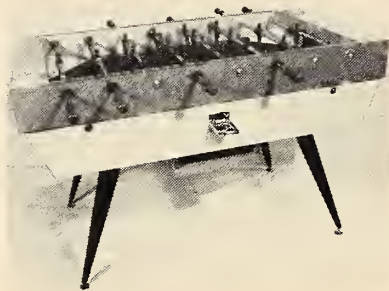

PZP "KICK-IT" SOCCER

ALL-TECH

serves the COIN MACHINE INDUSTRY

THE WORLD OVER

GANG BUSTER

A fast moving coin snatcher that'll give action on any location and years of profitable operation.

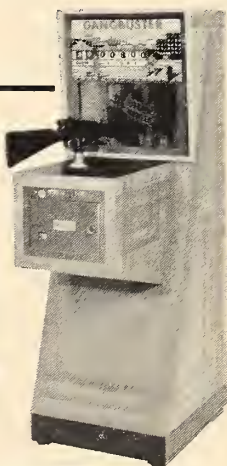

GRIP TEST

The favorite of generations brought up to date with sleek, modern lines, flawless mechanism and unlimited earning capacity.



BATTY CAR

The latest in our long line of Kiddie Ride winners.

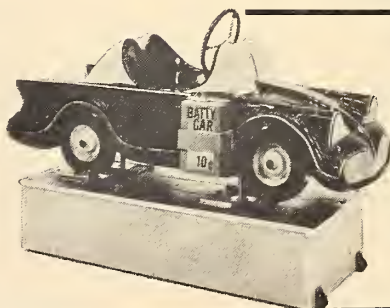

TITAL - 220 SLOT CAR TRACK

This thrilling championship course is a big 55½ feet long and 18 feet wide. No other track in the world has the thrills and challenges of the 220. The 44 foot high speed straightaway going into an amazing 50 degree bank offers thrills and chills never before seen in slot car racing. The 220 is equivalent to one mile long based on a 1/24" scale model.

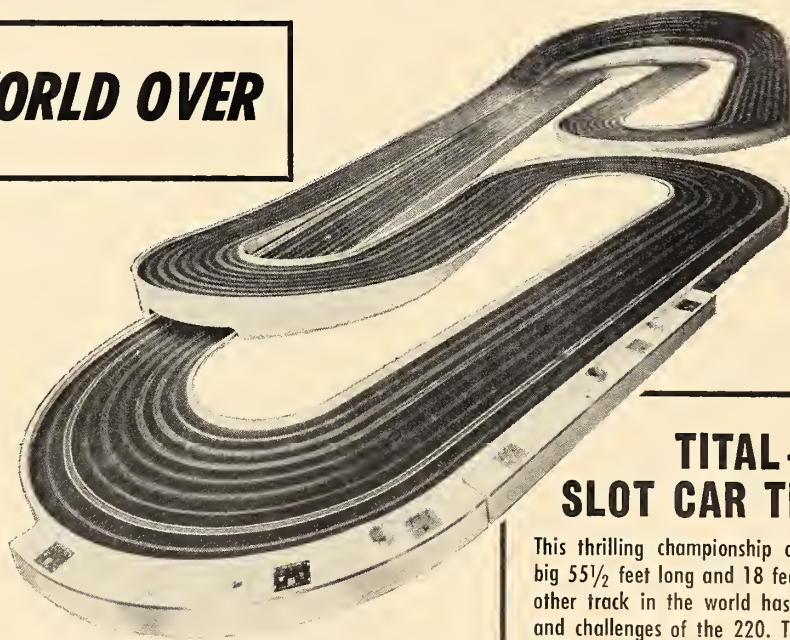

WRITE! WIRE!

PHONE for complete information on our complete line of slot car race tracks, games, kiddies rides and pool tables.

ALL-TECH INDUSTRIES, INC.
P.O. Box 1416—950 West 20th Street, Hialeah, Florida 33010
Phone: (305) 888-7551

cue
your
sales
with

ALL-TECH's

**COMPLETE
DELUXE
LINE OF
QUALITY
COIN-OPERATED
TABLES**

ALL-TECH
is the largest
KIDDIE RIDE
manufacturer
in the world
with an
assortment of
14
Diversified rides
Distributors!
Phone for
Latest Brochures
and Price List.

WRITE!
WIRE!
phone your orders!

IMMEDIATE
DELIVERY!

ALL-TECH

INDUSTRIES, INC.

P. O. Box 1416—950 West 20th Street • Hialeah, Florida 33010 • Phone: (305) 888-7551

The New "EBONY BLACK BEAUTY"



Gold Crest 6
46" x 78"
3 ft. x 6 ft.
One piece 3/4 slate bed

Gold Crest New Yorker
49" x 85"
One piece 3/4 slate bed

Gold Crest 7
52" x 92"
3 1/2 ft. x 7 ft.
One piece 3/4 slate bed

Gold Crest 8
57" x 101"
4 ft. x 8 ft.
One piece 7/8 slate bed

Gold Crest tables are all constructed with impregnated decrolite fiberglass panel skirt. Ebony Black Beauty makes friends readily because it's smart, distinctive, rich looking and enhances play in the most discriminating locations. Gold Crest tables are also available in white.

SILVER CREST NEW YORKER

49" x 85"
One piece 3/4 slate bed



Silver Crest 8
57" x 101"
4 ft. x 8 ft.
One piece 7/8 slate bed

Silver Crest 7
52" x 92"
3 1/2 ft. x 7 ft.
One piece 3/4 slate bed

Patented super construction for utmost rigid strength, trueness to prevent sagging or warpage. Finest quality, modern design, new in appearance. Sturdy, adjustable metal leg levelers in bright gold anodized. Genuine Italian cured slate bed.

The New DOLPHIN HOME TABLE

AT18—Model #718 (4 x 8)
AT17—Model #717 (3 1/2 x 7)



One-piece genuine Italian slate bed, honed to 1/5000ths inch. 7/8" thick on 8 ft. model; 3/4" thick on 7 ft. model.

**Standard Accessories
for All Tables**

4 cues, complete set of grade A balls, chalk, chalk holder, shaker bottle and pills, triangle, bridge, cut tip repair kit.

AMUSEMENT MACHINES

Produced July '66—June '67 U.S. Factories

Pool Tables

ALL-TECH



REGULATION MODEL
Coin-Operated
4½ feet by 9 feet

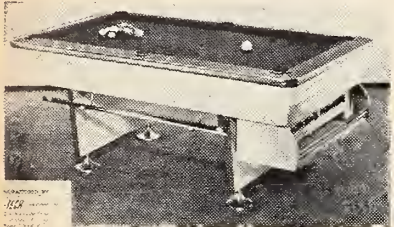

GOLD CREST MODEL
Coin-Operated
46 inches by 78 inches

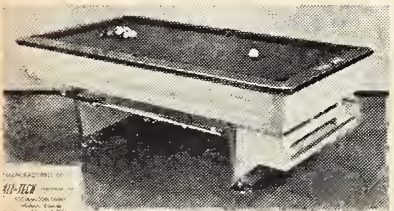

GOLD CREST MODEL
Coin-Operated
4 feet by 8 feet



REGULATION MODEL
Non-Coin-Operated
4½ feet by 9 feet



GOLD CREST DELUXE
Coin-Operated
46 inches by 78 inches

AMERICAN

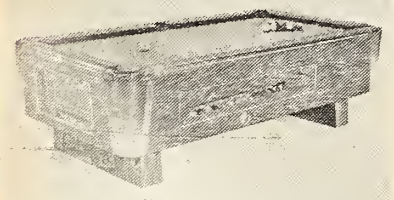

CLASSIC MODEL
Coin-Operated
6', 7' and 8' Models

Pool Tables

AMERICAN



ELECTRA
6', 7' and 8' Models
Coin-Operated
(battery-operated
drop coin mechanism)

FISCHER



EMPRESS SERIES
Coin-Operated
Model: 105C (105")
Model: 92C (91")

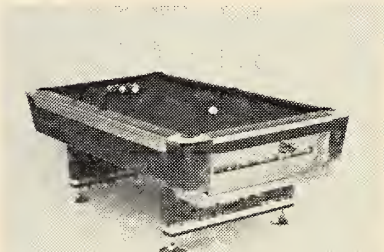

REGENT SERIES
Coin-Operated
Models 101C, 86C and 91C

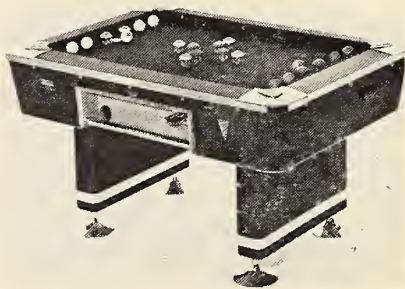

FIESTA 58 (REBOUND)
Coin-Operated
31½ by 42 by 58"

IRVING KAYE

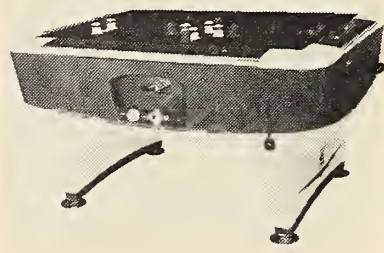

DELUXE KLUB POOL
Coin-Operated
Regular 56" by 40"

Pool Tables

IRVING KAYE

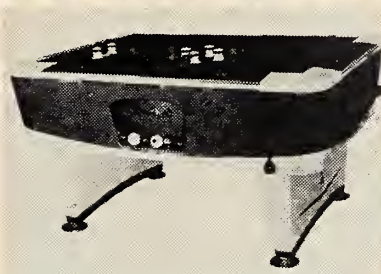

DELUXE KLUB POOL
Coin-Operated
Jumbo 75" by 43"

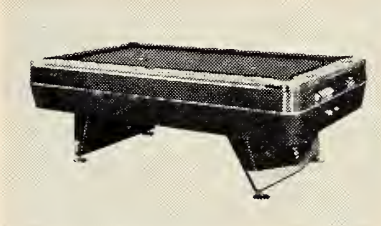

AMBASSADOR
Non-Coin Operated
(Available in 7, 7½,
8 and 9 foot sizes)

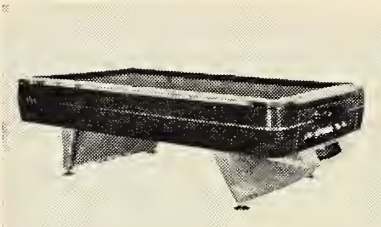

DELUXE ELDORADO '66
Coin-Operated
(Mark I) 77" by 45"

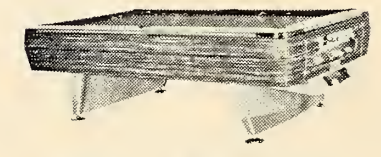

DELUXE ELDORADO
Coin-Operated
Mark II 85" by 47"

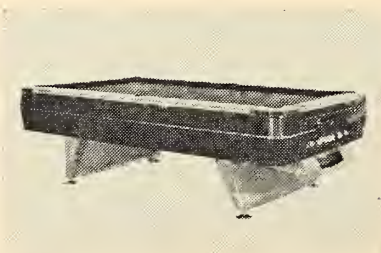

DELUXE ELDORADO
Coin-Operated
Mark III 92" by 52"

Pool Tables

IRVING KAYE

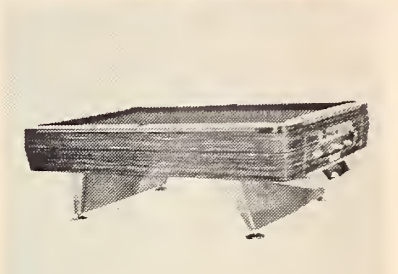

DELUXE ELDORADO
Coin-Operated
Mark IV 106" by 58"

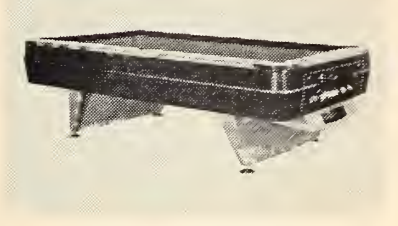

DELUXE ELDORADO
Coin-Operated
Mark V 114 by 64"



Irving Kaye Jr.
Mark IV

NATIONAL

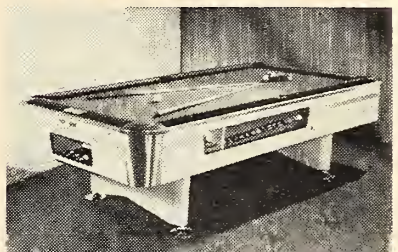

CORONET LINE
Coin Operated
Model I (45 by 77"),
II (52 by 92"),
Model III (59 by 105"),
IV (63 by 113")

UNITED BILLIARDS

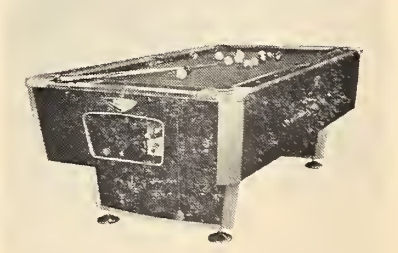

UNITED 300
93 X 53 inches

Deluxe Eldorado "67"

OPERATOR'S DREAM COME TRUE



Cushion moldings are held to top frame by machine screws. No more slipping wood or broken screws. Spin tight provided with each table. Aluminum molding between cabinet and top frame hides all screws.

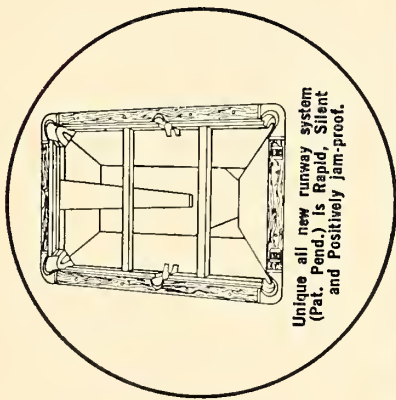

Unique all new runway system (Pat. Pend.) is Resper, Silent and Positively Jam-proof.

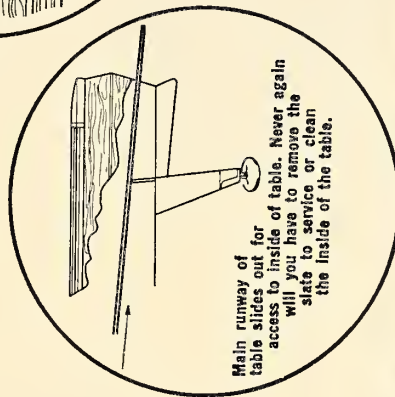

Main runway of table slides out for access to inside of table. Never again will you have to remove the slate to service or clean the inside of the table.

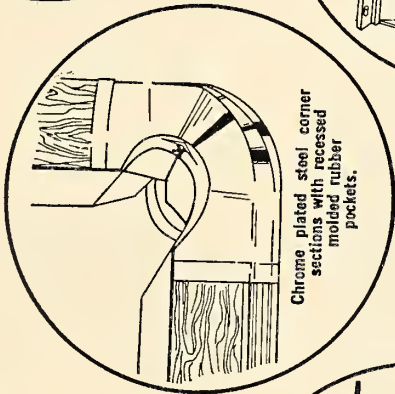

Chrome plated steel corner sections with recessed molded rubber pockets.

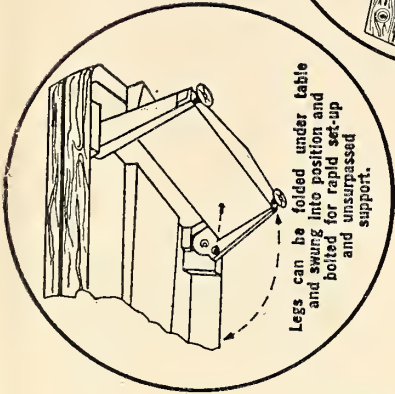

Legs can be folded under table and swung into position and bolted for rapid set-up and unsurpassed support.

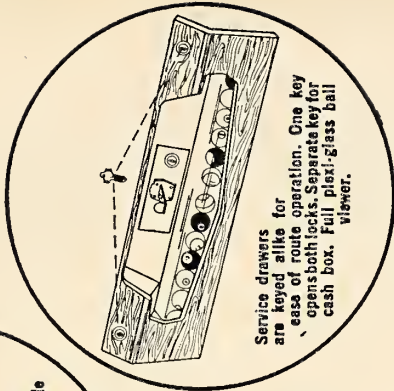

Service drawers for ease of route operation. One key opens both locks. Separate key for cash box. Full plexi-glass ball viewer.

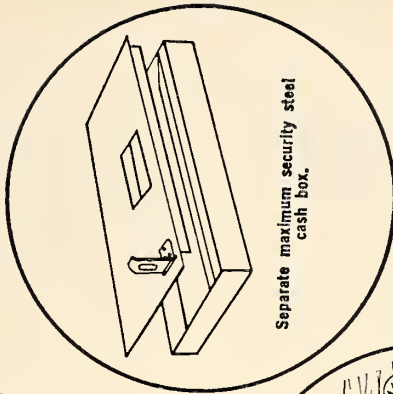

Separate maximum security steel cash box.

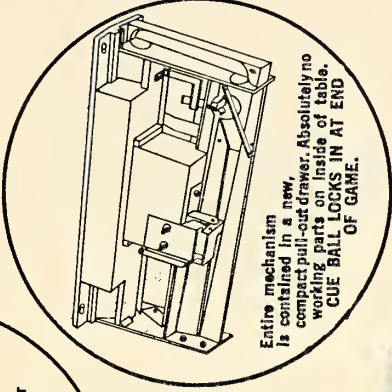

Entire mechanism is contained in a new, compact pull-out drawer. Absolutely no working parts inside of table. CUE BALL LOCKS IN AT END OF GAME.

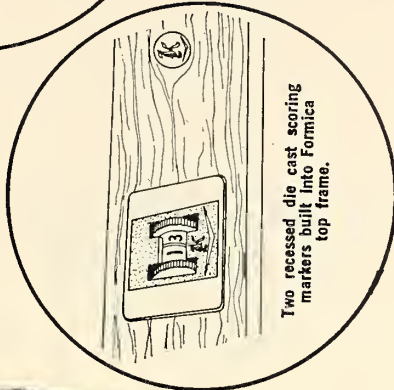

Two recessed die cast scoring markers built into Formica top frame.

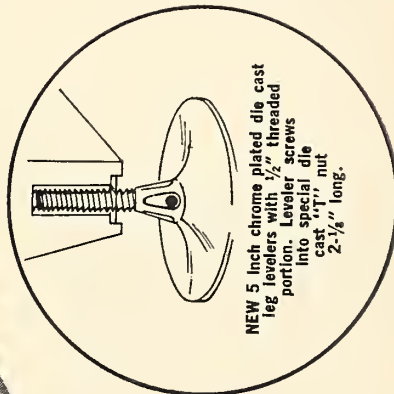

NEW 5 inch chrome plated die cast leg levelers with 1/2" threaded portion. Leveler screws into special die cast 1/2" nut 2-1/4" long.

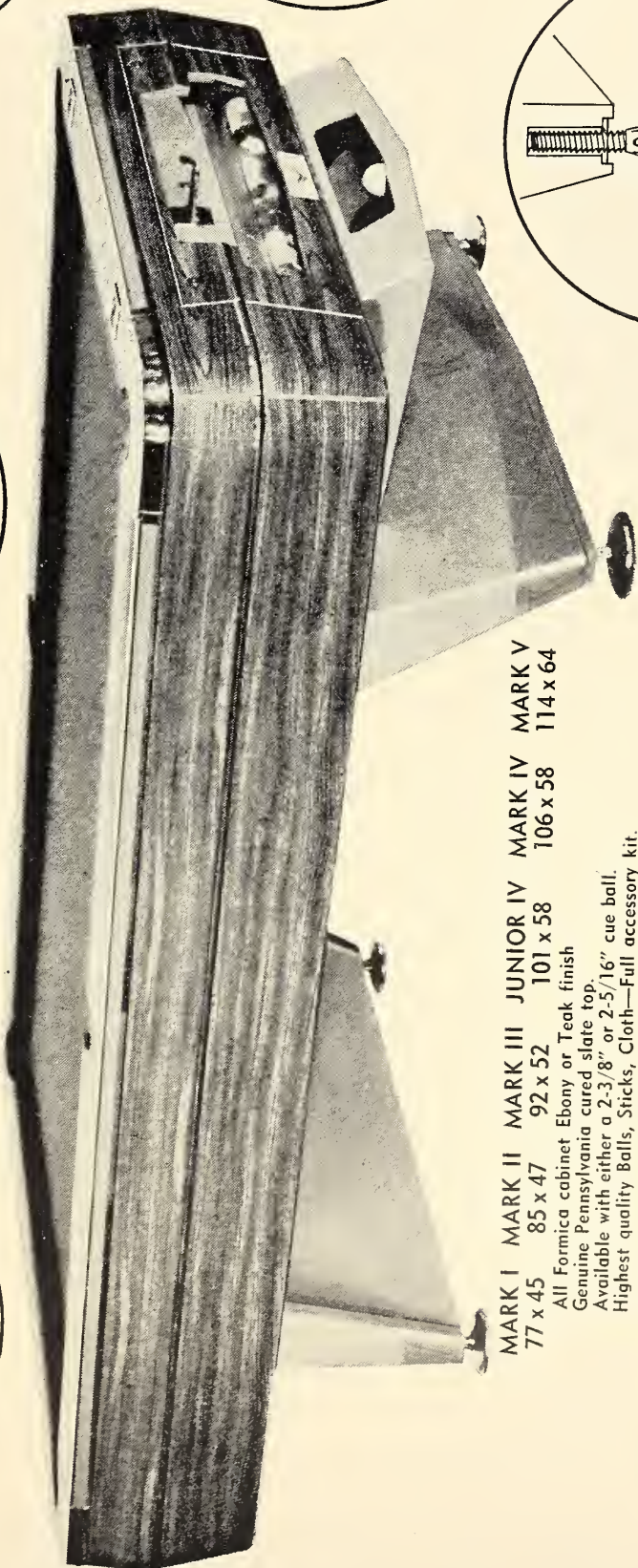

MARK I 77 x 45 MARK II 85 x 47 MARK III 92 x 52 MARK IV 101 x 58 MARK V 106 x 58 JUNIOR IV 101 x 58 MARK V 114 x 64

All Formica cabinet Ebony or Teak finish
Genuine Pennsylvania cured slate top.
Available with either a 2-3/8" or 2-5/16" cue ball.
Highest quality Balls, Sticks, Cloth—Full accessory kit.

Irving Kaye Co. Inc.

363 Prospect Place Brooklyn 38, N. Y. STerling 3-1200

Pool Tables
UNITED BILLIARDS



UNITED 400
103 X 58 inches
Also comes in United 100, 200
and 500 series

U.S. BILLIARDS



U. S. Club Pool

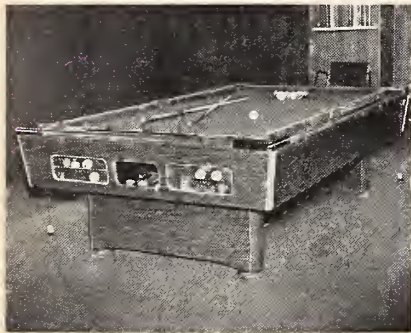

Professional Model®

Pool Tables
U.S. BILLIARDS



U.S. BILLIARDS, 1967
Snooker 106, 106X60 inches
Snooker 114, 114X64 inches



U.S. BILLIARDS, 1967
Pro-4 Home Model
106X60 inches

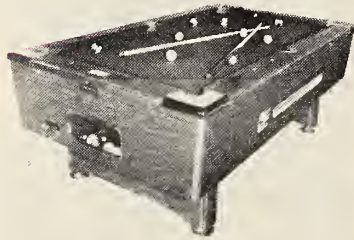

U.S. BILLIARDS 1967
Pro-3, 93X53 inches

Pool Tables
U.S. BILLIARDS

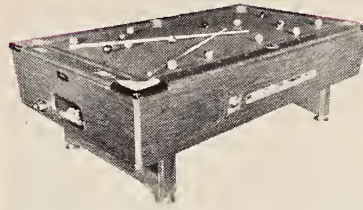

U.S. BILLIARDS, 1967
Pro-4, 103X58 inches
Pro-5, 114X64 inches



U.S. BILLIARDS, 1967
Convertible Time Pool
Models, T-86, T-93, T-106, T-114

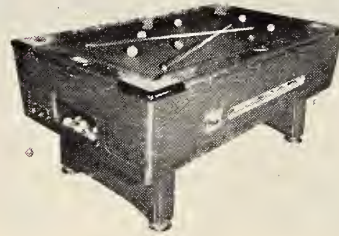

U.S. BILLIARDS, 1967
Pro-1, 78X46 inches
Pro-2, 86X50 inches

Pool Tables
VALLEY

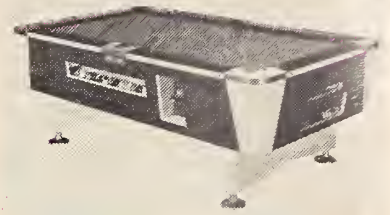

VALLEY
MODELS 1785, 1885 and 1935
Measuring 78 by 45 by 31,
88 by 50 by 31 and
93 by 53 by 31 inches

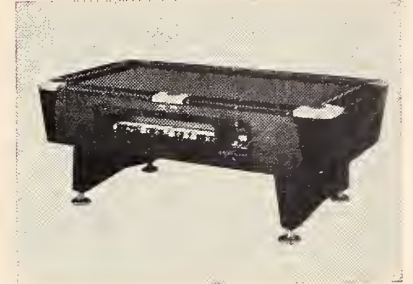

VALLEY
MODELS 785A, 875A and 935A



VALLEY
Bumper Pool® Model 565

**ALL
POOL TABLE
SUPPLIES**



The IMPERIAL Line

**UNDER
1
ROOF!**

*from America's
largest pool table supply house
catering to the coin machine industry!*

● "IMPERIAL" CUE STICKS

Wood Cues. Complete exclusive line of fine wood cues. Wide range of models and prices.—UNMATCHED IN PRICE AND QUALITY. All lengths—48", 52", 57"—one piece and jointed.

Fiberglass Cues. Our Imperial Fiberglass are the best in the business. Available fully tapered and untapered—48", 52" and 57" lengths with Brad Tip.

Aluminum Cues. A brand new line of cues with wood butt and aluminum shafts make these the best in their class.

● SLATES

In ALL sizes! For tables requiring one-piece slates or three-piece slates for larger tables.



FULL LINE OF ACCESSORIES

Complete Catalog Available on Request

Distributor and Manufacturer Inquiries Invited!

eastern

NOVELTY DISTRIBUTORS, INC.

● "IMPERIAL" CLOTH

OUR OWN EXCLUSIVE LINE OF IMPORTED QUALITY CLOTH. And available ONLY from Eastern Novelty Distributors, Inc.!

Also a complete line of the Finest Domestic Cloths

Highest quality . . . rubber-backed with cotton or rayon, or unbacked. Sold by the bolt or pre-cut to any size. Variety of colors always available!

● BALLS

The finest IMPORTED Belgian balls, designed to last a lifetime. Complete sets (1-15), cut balls or odd replacements.

MAIN OFFICE
3726 Tonnele Avenue
(Routes #1 and #9)
North Bergen, New Jersey
Telephone (201)
UNion 4-2424
Member BBIA

WEST COAST BRANCH
2939 E. 11th Street
Los Angeles, California
Telephone (213)
269-5979

GUARANTEED SATISFACTION

American Amusement Machine Manufacturers

TYPE OF EQUIPMENT PRODUCED

ALL-TECH

ALL-TECH INDUSTRIES, INC.
950 West Twentieth St.
HIALEAH, FLORIDA

(Coin-operated pool tables, home tables, kiddie rides, coin and non coin-op slot car units)

AMERICAN MACHINE & FOUNDRY

Westbury, New York
(Coin-Op Car Games)

(Write For Distributor Information)

AMERICAN

AMERICAN SHUFFLEBOARD CO.
210 Paterson Plank Rd.
UNION CITY, N.J.

(West Coast)

1423 So. Western Ave.
LOS ANGELES, CALIF.

(Coin-operated pool tables, home tables, shuffleboards, bank shuffleboards, novelties)

AUTO-PHOTO

U. S. SALES OFFICE
AUTO-PHOTO CO.
3300 Central Ave.
LOS ANGELES, CALIF.

(Coin-operated Photo Studios)

Write for Distributor Information

BALLY

BALLY MANUFACTURING CO.
2840 Belmont Ave.
CHICAGO, ILL.

(Pingames, Bingos, Uprights,
Fruit Machines)

(Write Direct For Distributor Information)

CAMPBELL

CAMPBELL MANUFACTURING
CORP.

242 Eleanor Street
KALAMAZOO, MICH. 49006

(Coin-operated pool tables, home tables)

(Write For Distributor Information)

CHICOIN

CHICAGO DYNAMIC
INDUSTRIES, INC.

1725 Diversey Blvd.
CHICAGO, ILL.

(Pingames, Shuffle Alleys, Big Ball Bowlers,
Baseball Machines, Arcade Novelties)

(Write For Distributor Information)

COLOR-SONICS

COLOR-SONICS, INC.

724 5th Ave.
NEW YORK CITY

(Film Juke Box)

(write for distributor information)

DALE

DALE ENGINEERING CORP.
6744 Orizaba Ave.
LONG BEACH, CALIF.

(Arcade equipment)

(Write For Distributor Information)

DUFFY

DUFFY PLAYER PIANOS

408 Broad Ave.
PALISADES PARK, N.J.

(Coin-operated player pianos)

DUNCAN

DUNCAN SALES CORP.

737 Carnegie Ave.
CLEVELAND, OHIO

(License of Th. Bergmann
Novelty Machines)

DUKANE

GAMES DIVISION DUKANE
CORP.

ST. CHARLES, ILLINOIS
Raceway Game,
Embossed Name Vendor)

(Write For Distributor Information)

EXHIBIT

EXHIBIT SUPPLY CO.

4218-30 W. Lake St.
CHICAGO, ILL.

(Photo Card Vendors)

(Write For Distributor Information)

AL FISCHER

AL FISCHER & CO.

37 Lafayette Ave.
FORT THOMAS, KY.

(Kiddie rides)

FISCHER

FISCHER SALES COIN DIVISION

TIPTON, MISSOURI

(Coin-Operated Pool Tables, Home Tables)

(Write For Distributor Information)

FRANTZ

J. F. FRANTZ MFG. CO.

1940 W. Lake St.
CHICAGO, ILL.

(Counter Games)

(Distributor List Available On Request)

(Continued)

Gottlieb's New 4-Player

HI-SCORE



New illuminated score-card holder.

Hi-Score spinner scores up to 2000 points with suspenseful action.

2 holes and 4 bottom rollovers light to activate spinner.

4 bulls-eye targets and 2 side rollovers build up values of spinner holes.

4 reel scoring vastly expands player-appeal.

Star hole in spinner scores "shoot again" feature.

Delivered with triple-chute combinations.

New electric auto-ball lift speeds play.

Location-tested and proven for long-time earning power.

Spinner hole values indicated in all new eye-catching light-box glass.

1927 1967

our motto for 40 years — There's No Substitute for QUALITY

D. Gottlieb & Co. 1140 N. Kostner Ave., Chicago, Ill. 60651

GOLD STAR

GOLD STAR DIST. LTD.
5025 S.E. POWELL BLVD.
PORTLAND, OREGON 97206
(Coin-Op Football Game)

GOTTLIEB

D. GOTTLIEB & CO.
1140-50 N. Kostner Ave.
CHICAGO, ILL.
(Pin Games)

(Distributors)

ACTIVE AMUSEMENT MACHINES CO.
666 N. Broad St.
PHILADELPHIA, PA.

ADVANCE AUTOMATIC SALES CO.
1105 West Pico Boulevard
LOS ANGELES, CALIFORNIA

ADVANCE AUTOMATIC SALES CO.
1350 Howard St.
SAN FRANCISCO, CALIF.

ALL COIN AMUSEMENTS CO.
2495 N.W. 77th Terrace
MIAMI, FLA.

BANNER SPECIALTY CO.
1508 Fifth Ave.
PITTSBURGH, PA.

BILOTTA DIST. CO.
224 N. Main St.
NEWARK, N.Y.

BIRMINGHAM VENDING CO.
540 Second Ave.
BIRMINGHAM, ALA.

CLEVELAND COIN MACHINE EXCH.
2029 Prospect Ave.
CLEVELAND, O.

CULP DIST. CO.
614 W. Sheridan
OKLAHOMA CITY, OKLA.

EMPIRE DISTRIBUTING COMPANY
6100 West Bluemount Road
MILWAUKEE, WISCONSIN

FRANCO DIST. CO.
24 No. Perry St.
MONTGOMERY, ALA.

GARRISON SALES CO.
1000 W. Washington
PHOENIX, ARIZ.

GENERAL VENDING SALES CORP.
245 W. Biddle St.
BALTIMORE, MD.

H. Z. VENDING & SALES CO.
1205 Douglas St.
OMAHA, NEB.

R. F. JONES CO.
240 Shotwell St.
SAN FRANCISCO, CALIF.

R. F. JONES CO.
2930 W. 9th Ave.
DENVER, COLO.

DIAMOND DIST.
375 South 2nd West
SALT LAKE CITY, UTAH

B. D. LAZAR CO.
1635 Fifth Ave.
PITTSBURGH, PA.

LIEBERMAN MUSIC CO.
257 Plymouth Ave., N.
MINNEAPOLIS, MINN.

MILLER-NEWMARK DIST. CO.
5743 Grand River Ave.
DETROIT, MICH.

MILLER-NEWMARK DIST. CO.
3767 28th St. S.E.
GRAND RAPIDS, MICH.

IRVING MORRIS, INC.
145 Frelinghuysen Ave.
NEWARK, N.J.

MORRIS NOVELTY CO.
3007 Olive St.
ST. LOUIS, MO.

MUSIC VEND DIST. CO.
100 Elliott Ave., West
SEATTLE, WASHINGTON 98119

MUSIC VEND DISTRIBUTING CO.
1140 S.E. 7th Ave.
PORTLAND, OREGON

MUSIC VEND DISTRIBUTING CO.
West 811 Second
SPOKANE 4, WASHINGTON

NATIONAL COIN MACHINE EXCH.
1411 W. Diversey Pkwy.
CHICAGO, ILL.

NEW ORLEANS NOVELTY CO.
1055 Dryades St.
NEW ORLEANS, LA.

ROYAL DISTRIBUTING COMPANY
1112 North High Street
COLUMBUS, OHIO

ROYAL DIST. CO.
1210 Glendale-Milford Rd.
CINCINNATI, OHIO

SANDERS DIST. CO.
612—8th Ave. So.
NASHVILLE, TENN.

SEABOARD, N. Y. CORPORATION
171 Park Avenue
EAST HARTFORD, CONN.

STATE MUSIC DISTRIBUTORS
3100 Main Street
DALLAS, TEXAS

STATE MUSIC DISTRIBUTORS
3438 Leeland
HOUSTON, TEXAS 77003

SOUTHERN AMUSEMENT CO.
628 Madison Ave.
MEMPHIS, TENN.

S. L. STIEBEL GAMES CO., INC.
635 West Main St.
LOUISVILLE, KENTUCKY

TRIMOUNT AUTOMATIC SALES
40 Waltham St.
BOSTON, MASS.

W. B. MUSIC CO.
2900 Main St.
KANSAS CITY, MO.

Export
JUDD DISTRIBUTING CO.
1140-50 N. Kostner Ave.
CHICAGO, ILL.

HAWKINS

PAUL HAWKINS CO.
3119 E. Pennsylvania Ave., Rt. 7
TUCSON, ARIZONA
(Kiddie Rides)

IRVING KAYE

IRVING KAYE CO., INC.
363 Prospect Place
BROOKLYN, N. Y.
(Coin-operated Pool Tables, Home Tables,
Cue Sticks and other accessories)
(Write For Distributor Information)



17 YEARS OF
PROVEN SUPERIORITY

Here's What You Get When You Select a Table From Fischer

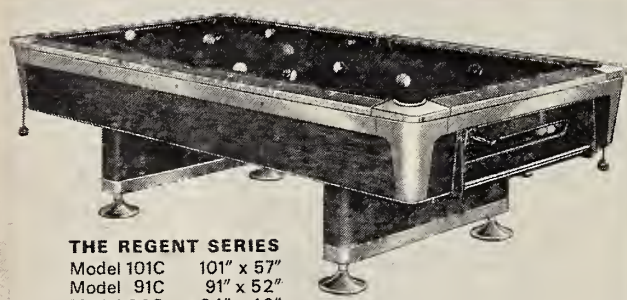

THE REGENT SERIES
Model 101C 101" x 57"
Model 91C 91" x 52"
Model 86C 84" x 48"

Compact companion to Empress line. Long-lived beauty of Walnut-look vinyl Clad-on, high-lighted by chrome plated cast pocket fittings.

Fischer Tables provide all the fine features you expect from the ultimate in coin-op billiard equipment. Included are such outstanding features as: New, field tested, trouble free mechanism drawer • One piece side and end panels for easy replacement in case of damage • New die cast leg saddle for easy installation • New pebbled chrome corner caps • Die cast leg levelers require no lifting when leveling table • Exclusive wedge-lock and cushion assembly • Burn-proof top rail • Finest all-wool felt covering • 2 $\frac{5}{8}$ " cue ball for the advanced players and many, many more.

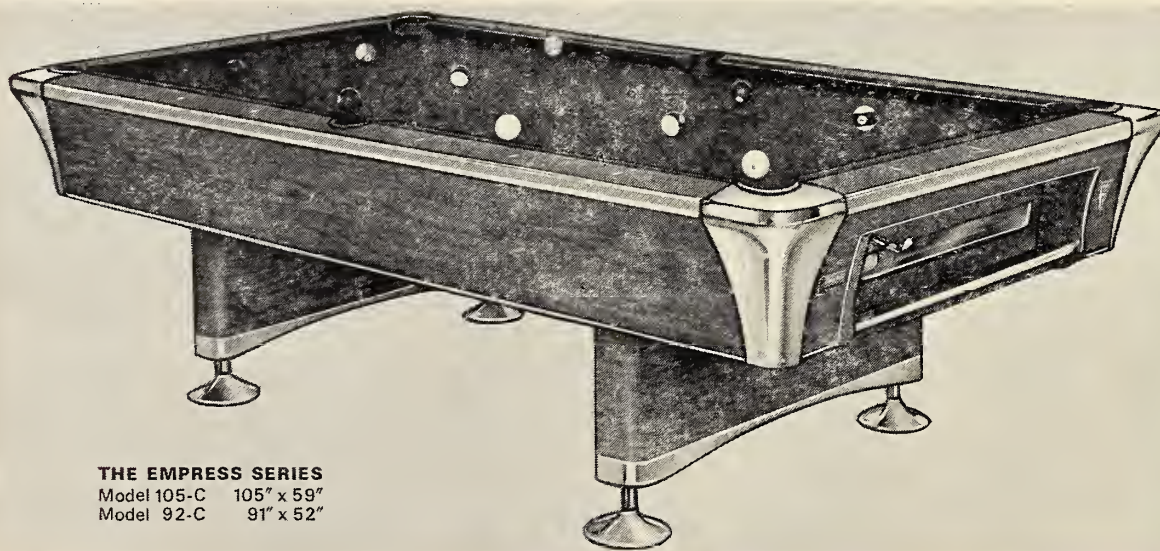

THE EMPRESS SERIES
Model 105-C 105" x 59"
Model 92-C 91" x 52"

Available in: Walnut-grained Satin finish. Luxuriously styled and precision crafted throughout to please even the most serious players. Durability-designed to provide many extra years of use.



Patented Exclusive Fischer Feature: WEDGE-LOCK and Cushion assembly. 12 unit-lock clamps replace more than 50 wood screws . . . Wedge-lock cushions locks top rail, playfield and frame together in a single, perfectly rigid unit.

See your Distributor or write for further information and prices.

Fischer **MANUFACTURING CO., INC., TIPTON, MO. 65081**

AMERICAN AMUSEMENT MANUFACTURERS — Type of Equipment Produced

JUPITER SALES

OF AMERICA
(Div. Taran Enterprises)
3401 N.W. 36th St.

MIAMI, FLORIDA
(Importers of Jupiter phono for U.S.,
Canada and Caribbean)

MARVEL

MARVEL MANUFACTURING CO.
2849 West Fullerton
CHICAGO, ILLINOIS
(Wide Variety of Scoreboard Units)

MIDWAY

MIDWAY MFG. CO.
10136 Pacific Ave.
FRANKLIN PARK, ILL.
(Baseball Games, Arcade Novelties,
Shuffle Alleys)
(Write For Distributor Information)

MONDIAL

350 Fifth Ave.
New York, N.Y.
(Football & Shoeshine Units)

MUNVES

MIKE MUNVES CORP.
577 Tenth Ave.
NEW YORK CITY
(Arcade Equipment)

MUTOSCOPE

INTERNATIONAL
MUTOSCOPE CORP.
11-12 44th Avenue
LONG ISLAND CITY, NEW YORK
(Photo Studio, Balloon Vendor, Seal-In Unit)
(Write For Distributor Information)

NATIONAL

NATIONAL SHUFFLEBOARD
CORP.
31 Main St.
EAST ORANGE, N.J.
(Coin-operated Pool Tables, Home Tables,
Shuffleboards)
(Write For Distributor Information)

PATTERSON

PATTERSON INTERNATIONAL
Patrus Alms Bldg.
(Football, Card Vendor, Novelty Games)

ROSEN

DAVID ROSEN, INC.
855 N. Broad St.
PHILADELPHIA, PA.
(Cinebox Licensee For
Cinejukebox)

STANDARD

STANDARD-HARVARD
METALTYPER
1318 North Western Ave.
CHICAGO, ILL.
(Coin-operated Metaltyper)

UNITED BILLIARDS

UNITED BILLIARDS, INC.
52 Hunter St.
NEWARK, N.J.
(Coin-operated Tables)

UNITED TOOL

UNITED TOOL &
ENGINEERING C.
705C Transportation Bldg.
CINCINNATI, OHIO
(Kiddie Rides)

UNIVERSAL

UNIVERSAL PRODUCTS, INC.
410 West High St.
JEFFERSON CITY, MO.
(Kiddie Rides)

URBAN

URBAN INDUSTRIES INC.
4708 Pinewood Rd.
LOUISVILLE, KENTUCKY 40218
(Panorams, Movie Theaters)
(Write For Distributor Information)

U.S. BILLIARDS

U. S. BILLIARDS INC.
AMITYVILLE, N.Y.
(Coin-operated Pool Tables,
Novelty Games, Photocopy Machine)
(Write For Distributor Information)

VALLEY

VALLEY SALES CO
333 Morton St.
BAY CITY, MICH.
(Coin-operated Pool Tables and accessories)
(Write For Distributor Information)

WILLIAMS

WILLIAMS ELECTRONIC
MANUFACTURING CORPORATION
3401 No. California Ave.
CHICAGO, ILL. 60618
(Div. of Seeburg)

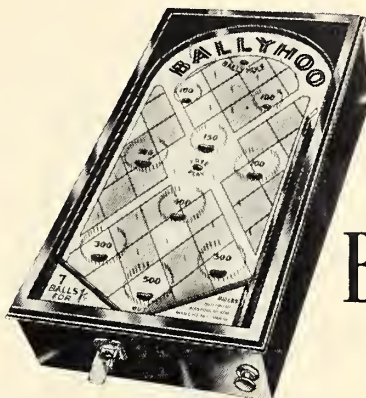

Since 1931 and **BALLYHOO**

millions of *Bally* games prove

you can bank on a *Bally* game

get on the Air Special List!

As the world's only producer of all types of coin-operated games... Bingo Pinballs... Flipper Pinballs... Ball Bowlers... Shuffle Alleys... Arcade Games... Slot-Machines and other Automatic-Award Games... Bally invites you to add your name to the Bally Air Special List to receive air-mailed bulletins of every new Bally game. Write today.

BALLY MANUFACTURING COMPANY
2640 BELMONT AVENUE
CHICAGO 18, ILLINOIS

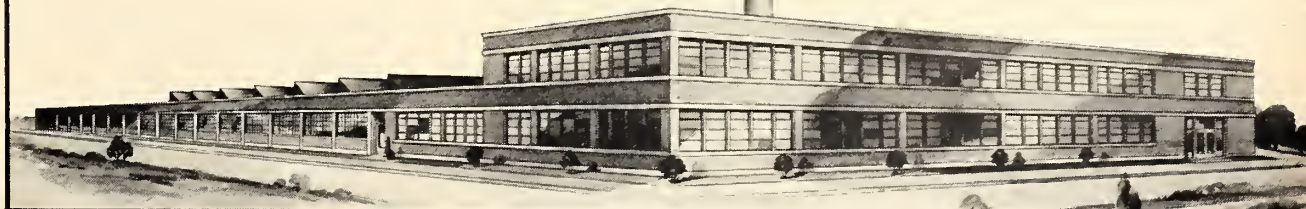

CIGARETTE MACHINE MANUFACTURERS CURRENT MODELS

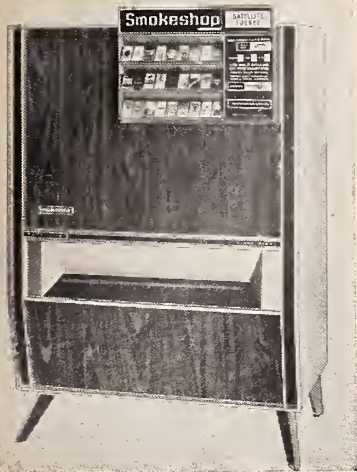

AUTOMATIC 'SATELLITE'

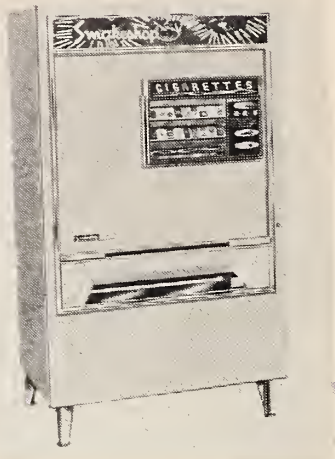

AUTOMATIC PRODUCTS
Smokeshop Modulator '900'



FEDERAL
The President 084. 20 columns.

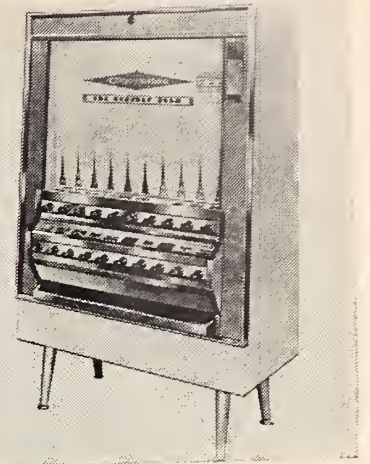

NATIONAL
Crown Series 800—20 cols. 10 front cols.; max. cop. 52; 10 rear max. cop. 33; total 850. Takes all sizes. Mechanical.

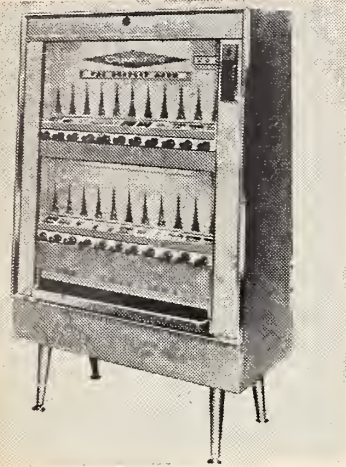

NATIONAL
Crown Series 222; 22 cols.; 11 upper cols.; max. cop. 33; 11 lower max. cop. 23; total 616. Takes all sizes. Mechanical.

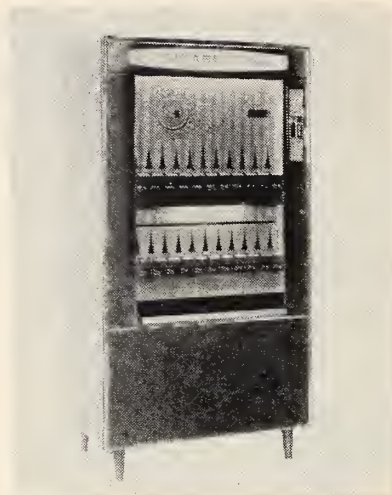

NATIONAL
22M-72 Cigarette, Manual; 22 sel.; 616 cop.; 72 inches.

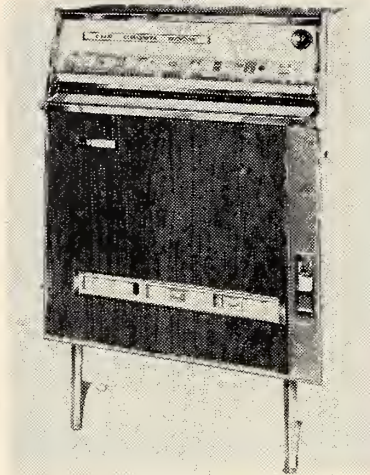

NATIONAL
Crowe 880; electric; top pock delivery; 22 selections; 880 pock copacity.

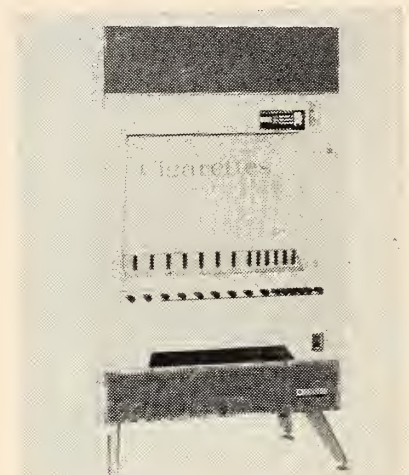

ROWE MANUFACTURING
Model 86; 510 copacity; 14-sel.; manual coin mech; vends of three different prices up to 50¢.

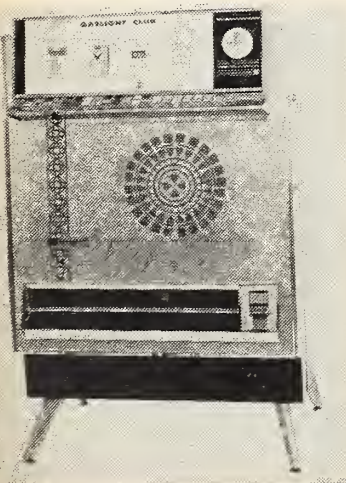

ROWE MANUFACTURING
Riverio Model; 20 selections; vends of four different prices to 50¢. Avail. w/100 MM columns.

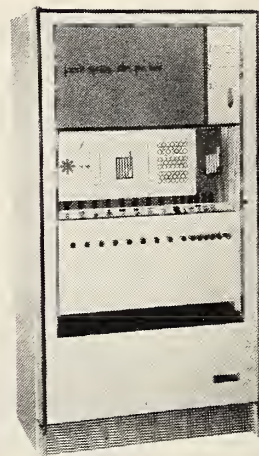

ROWE
Model 286 Celebrity Cigarette Vendor; 14 Sel.; Manual.

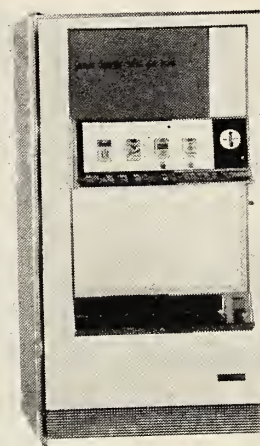

ROWE
Model 260 Celebrity Cigarette Vendor; 21 Sel.; Electric.

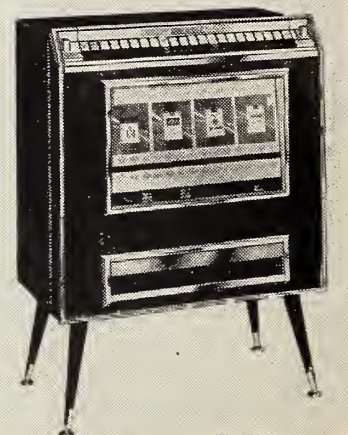

SEEBURG
Model 4E5; elec.; top-load; 11 cols. with 20-pock cop.; 11 cols. with 55 pock cop.; 825 copacity; 22 cols. all sizes; personalized.

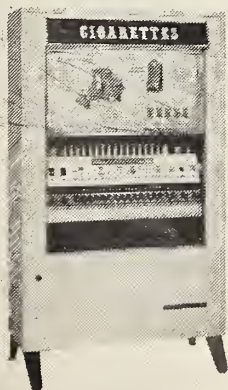

SEEBURG
Williamsburg Line
Models 14T1 and 14T1G; 4 cols. of 60 pock; 10 cols. of 27; 510 cop. Models W20T1 and W20T1G; 4 cols. of 60 pock; 16 cols. of 27; 672 cop.

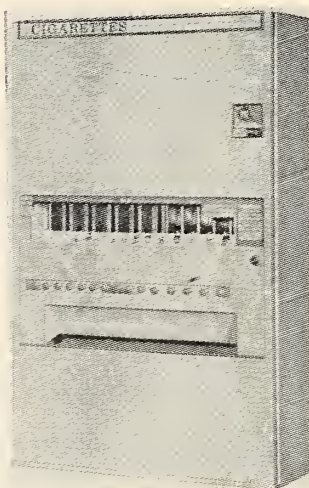

VENDO
520 Cigarette Vendor; 15 Sel.; 79 inches.

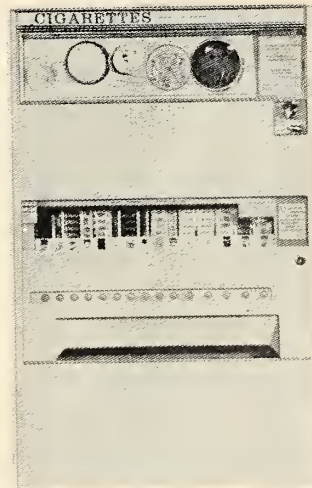

VENDO
520 Cigarette Merchandiser; 63 inches; 520 Copacity; 15 Sel.



VENDO
Electric Cigarette Vendor; 30 Sel.

CIGAR & CANDY UNIT MFR'S CURRENT MODELS

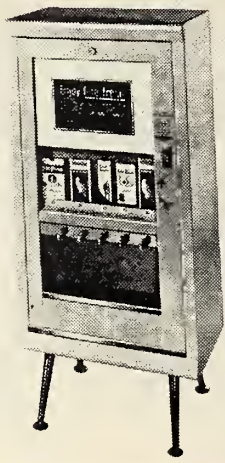

GENERAL CIGAR
5-col.; also available 7 cols.

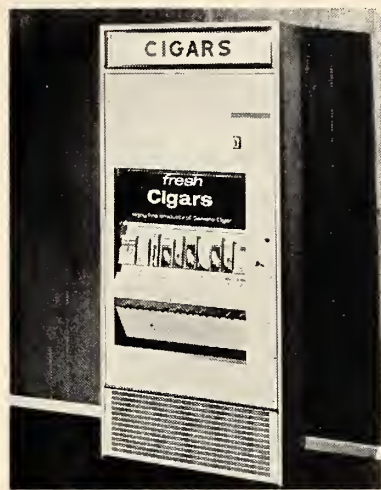

GENERAL CIGAR
Cigar vendor; 10 selections, 395 capacity.



GENERAL CIGAR
Cigar vendor; 10 selections, storage space available.

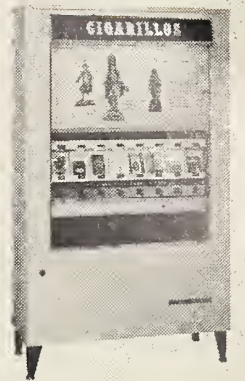

SEEBURG
Williamsburg line: cigarillos; Model W8C01; 8-sel.; 200 cap.

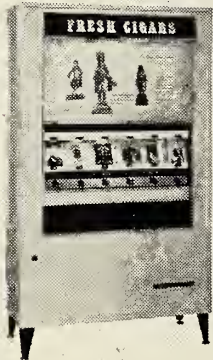

SEEBURG
Williamsburg line: cigar vendor Model W6CR1; 6-sel.; 114 cap.

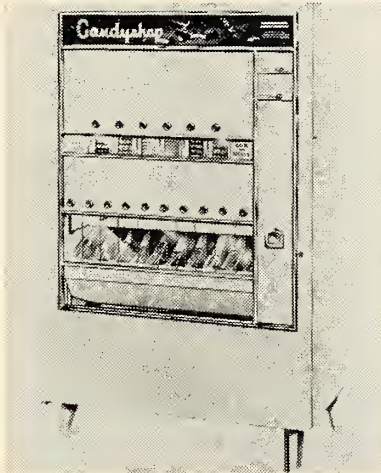

AUTOMATIC PRODUCTS
Candyshop Model; 10 candy columns with 400 bar capacity; 6 gum-mint columns with 200 capacity; first in/first out.

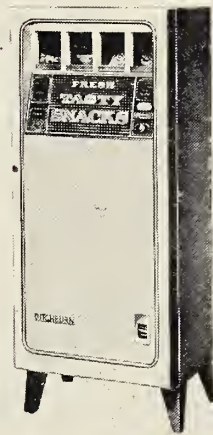

DITCHBURN
Minisnack 770; 4 columns; 100 snack capacity; first in/first out.

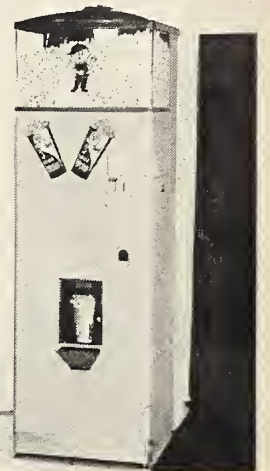

FEDERAL
Cup drop popcorn vendor; Model CD-130; 130 cup capacity; 10¢ vend.



FEDERAL
Secretary 270; 6-col. pastry vendor.



GOLD MEDAL
Model 200 popcorn vendor; 120 10¢ sale capacity; 100 sale storage; electronic system; National Rejector; 110 volt.



GOLD MEDAL
Model 300 drop-cup popcorn vendor



INTER-COUNTY IND.
PEZ candy vendor

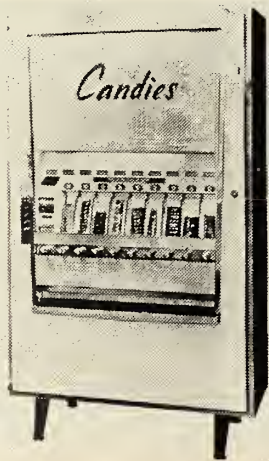

NATIONAL
Consoline candy vendor; 14 selections; 9 bar and 5 gum or mint; maximum 416 units; nickel changemaker; variable shelving.

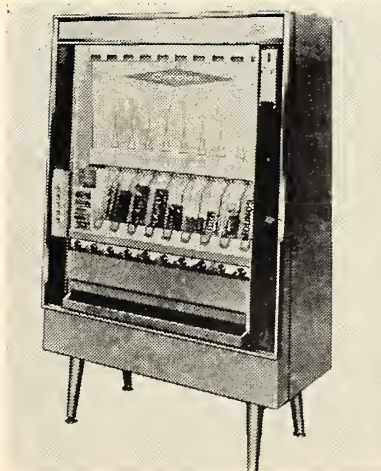

NATIONAL
Series CC Crown Line DeLuxe; 14 selections; Max. capacity 416 units; 9 bar plus 5 gum or mint; coin mechanism; set price selector; variable shelving.

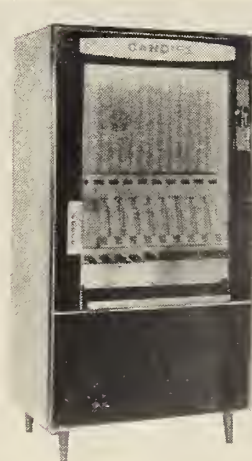

UNIVERSAL
CM-72 Manual candy merchandiser. 10 candy sel.; 5 gum & mint sel.; 72 inches.

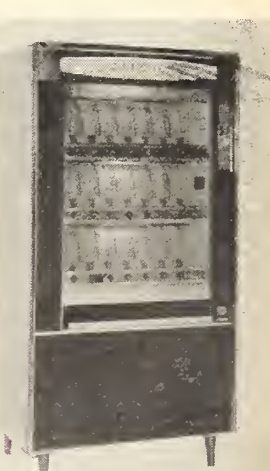

NATIONAL
21CE-72 Electric candy merchandiser. 21 sel. 72 inches

CANDY, AND COLD CAN DRINK UNIT MFR'S CURRENT MODELS

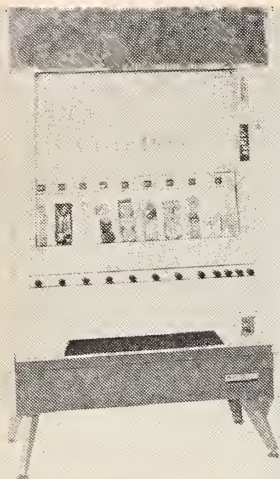

ROWE MFG.

Model 77; 11 cal.; 340 capacity; manual coin mech.; 190 candy; 4 gum/mint.

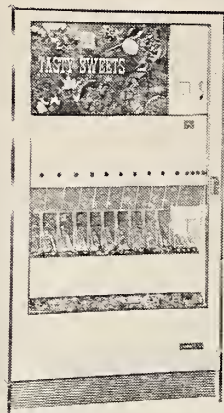

ROWE MFG.

Fifa model; bar displayed in bar vended; 14 column cap.; 10 candy, 4 gum/mint; makes change without purchase.

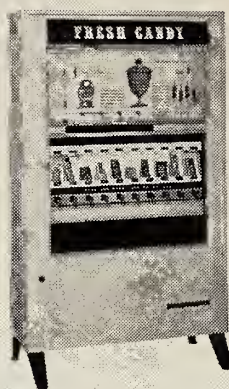

SEEBURG

Williamsburg Line; models W10CN1-10C, W10CN1-5/10C, W10CN1G-10C and W10CN1G-5/10; 10 selections; 2 or 3 cal., adjustable; cap. 220.



UNIVERSAL VENDORS

Candimat made by Westinghouse; 7 columns of 24 shelves & 2 for 100 5¢ gum or 68 10¢ gum-mint; maximum capacity 268 items; manual operation.

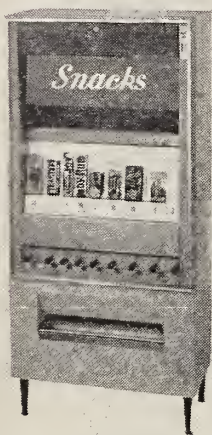

UNIVERSAL

Snack machine; 9 columns; Manual operation.

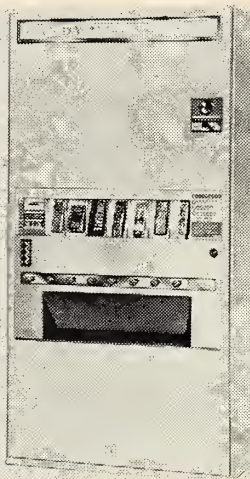

VENDO

Staner Model FA2A candy with gum-mint unit; variable shelf sizes; 7 cal. 20 shelves; 2 cal. 24 shelves; 4 cal. variable gum-mint.

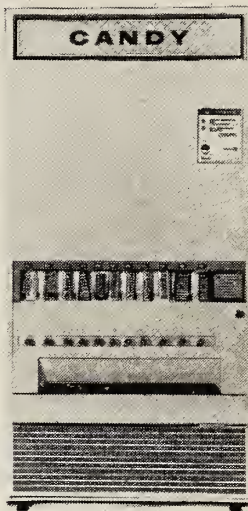

VENDO

Model FB2(B) Candy merchandiser; 63 inches; 246 cap.; 14 sel.

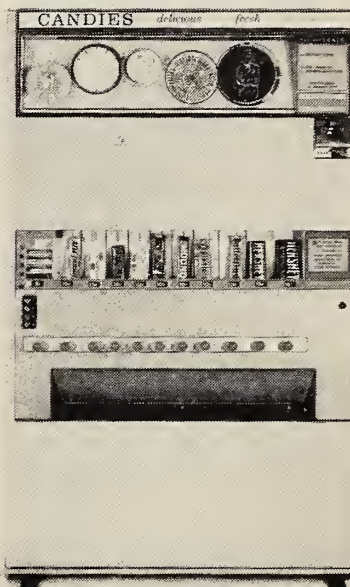

Model FB-6A Candy vendar; 63 inches; 160 cap.; 11 sel.

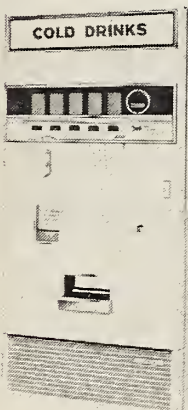

Rack-Ola 3304 MODULAR

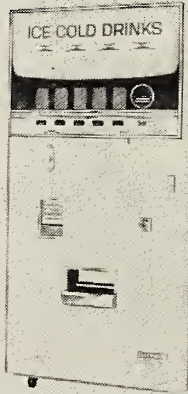

Rack-Ola 3304 STANDARD

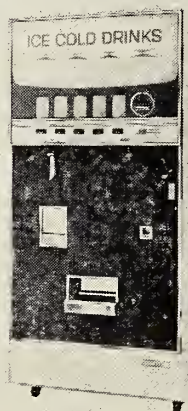

Rack-Ola 3304 DELUXE



SEEBURG Cold Drink Unit

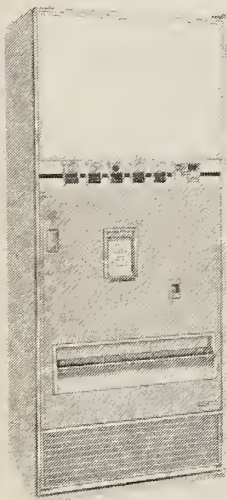

ROCK-OLA

Cold can vendar; 5 Sel.; Electric operation.

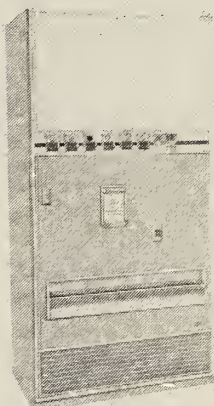

ROCK-OLA

Cold can vendar; 6 Sel.; Electric Operation.

MICHIGAN OPERATORS

We are still your distributors for
D. Gottlieb & Co. Pinballs
American Shuffleboard Co. Pool Tables, Shuffleboards & Accessories
ChiCoin Bowlers, Shuffle Alleys & Pingames
Jupiter Phonographs

MILLER-NEWMARK DIST. CO.

Home Office
GRAND RAPIDS
 3767 E. 28th St.
 949-2030

WURLITZER

Detroit Office
 5743 Grand River Ave.
 TY 8-2230

Call us for any of the following products:
 Bally, All-Tech, Irving Kaye, U. S. Billiards, United & Fischer
 AMF Home & Professional Standard Changers
 Also: Oak Bulk Vendors, Charms & Ballgums
 Ditchburn Vendors, Penny King Co., Leaf Brand, Carl Guggenheim & Paul Price, Knight Toy & Novelty

VENDING MACHINE MFRS.—TYPE EQUIP. PRODUCED

THE ALASKAN CO., INC.
1140 Kirkland Ave
Nashville, Tenn.
Ice

ALCO COIN LOCK CO.
82a Harvard St.
Brookline, Mass. 02146
Toilet Locks

ALD, INC.
7045 North Western Avenue
Chicago, Illinois
Dryclnrs, dryers, washers, extractors, coin
changes, laundry supplies

ALGAS INDUSTRIES
3951 South Capital Ave
City of Industry Calif. 95610
Candy bars, cigarettes, soft drinks

ALLEN ELECTRONICS, INC.
2260 Avenue A
Bethlehem, Pa. 18001
Coffee, instant packet, hot chocolate, soft
drinks, pre-mix, soup (cup), tea

A.M.M. MANUFACTURING CORP.
1400 Rahway Ave
Avenue, N. J. 07001
Ice cream, milk

AMERICAN CLEANING EQUIPMENT CORP.
5024 Rose St.
Schiller Park, Ill. 60176
Vacuum cleaner for cars

AMERICAN COIN LOCK COMPANY, INC.
453 Cottage Street
Pawtucket, Rhode Island
Toilet locks

AMERICAN HYGIENIC CORPORATION
(Division of Delicate Corporation of America)
717 Pine St.
Camden, N.J.
Sanitary napkin

AMERICAN LOCKER COMPANY, INC.
Jones & Gifford Ave.
Jamestown, N.Y. 14709
Lockers for checking parcels

AMERICAN SCIENCE CENTER, INC.
5700 Northwest Highway
Chicago, Illinois 60646
Telescope

AMERICAN UNIVEND CORPORATION
405 Lexington Ave
New York, New York 10017
Candyroll items, supplies.

AUTOMATIC PRODUCTS COMPANY
(Division of Gross-Given Manufacturing Com-
pany)
301 Chestnut Street
St. Paul, Minn. 55102
Cigarettes, candy units and component parts

AUTO-POP MFG. CO., INC.
14 North Ninth Street Building
St. Louis, Mo. 63101
Fresh popped corn

AUTOVEND CORP.
1275 Bloomfield Ave.
Fairfield, New Jersey
Candy, shopping bags

**AVENCO (ADVANCE ENGINEERING COM-
PANY)**
5001 Boone Ave., North
Minneapolis, Minn. 55428
Instant and fresh brew coffee, hot choc.,
canned food, tea, soup, coin changers, cold
drinks

BEAUTY AID HAIR DRYERS
(Div. of Helene Curtis Ind., Inc.)
4401 West North Ave.
Chicago, Illinois 60639
Hair Dryers

BEL-CAL CORPORATION
602 South Bridge Street
Visalia, California 93277
Coin changers, paper currency changers, paper
currency handling venders

BEST PLASTIC PRODUCTS INC.
(Subsidiary of Marlen Co.)
325 West 25 Pl.
Chicago, Ill. 60616
Laminators, parts and supplies

K. G. BROWN MFG. CO., INC.
Wickham Avenue
Mattituck, Long Island, New York 11952
Charcoal, ice, milk, ice cream, bait, groceries,
hosiery, soap

CACO MFG. CORP.
5816 Heiser St.
Houston, Texas 77032
Hair dryers

CAVALIER CORPORATION
(Division of Seeburg)
1100 East 11th Street
Chattanooga, Tennessee 37043
Drinks, canned & bottled

CHANGE BANK
P.O. Box 1000
11711 Chillicothe Road
Chesterland, Ohio 44026
Changers for dollar bills; combination bill and
coin changers

CHECKMATE BATTERY VENDING
4853 Joyce Drive
Dayton, Ohio 45439
Batteries

CHIP-A-MATIC SALES CO.
1470 S. Michigan Ave.
Chicago, Ill. 60605
Potato chips, snack vendors

CHOICE-VEND CORPORATION
(A Division of the Seeburg Corporation)
Turn Pike Rd.
Windsor Locks, Conn. 06096
Bottled soft drinks, milk, can drinks

COAN MANUFACTURING CO.
2070 Helena Street
Madison, Wisc. 53704
Candy, gum, cookies, crackers, cigarettes,
instant coffee, hot chocolate, aoup, pastry

COPIA MFG. CORP.
1055 Stewart Ave.
Garden City, N.Y. 11534
Vico photo copier

COFFEE-MAT CORP.
251 S. 31st St.
Kenilworth, N. J.
Coffee vendors

COFFEE TIME OF AMERICA, INC.
314 S. 12th St.
Omaha, Nebraska 68102
Hot drink vendors

COIN ACCEPTORS, INC.
4946 Daggett Ave.
St. Louis, Mo. 63110
Currency and coin changers, components

COIN-TROLLED EQUIPMENT CORP.
11486 Hart Street
North Hollywood, California 91605
Newspapers & magazines

JOHN F. COLBERT CO.
612 Kahl Building
Davenport, Iowa 52801
Car wash equipment

COLMA, INC.
70 Piedmont Street
Worcester, Mass. 06110
Cologne spray, lotions, supplies products

COMMERCIAL MECHANISMS
218 Sandy Spring, Place N.E.
Atlanta, Ga. 30328
Soft drinks, plastic bottles, sanitary napkins,
juice, milk

CONTINENTAL-APCO, INC.
(Division of The Vendo Co.)
(Subsidiary of Continental Vending Machine
Corp.)
956 Brush Hollow Road
Westbury, Long Island, N. Y.
Cigarettes, post-mix soft drinks, post-mix soft
drinks with ice, pre-mix soft drinks, pre-mix
soft drinks with ice, batch fresh-brew and
instant coffee, hot chocolate, soup, popcorn,
ice cream, hot and cold prepared food, also
supplies vendible products and vending ma-
chine components and supplies.

**CONTINENTAL MANUFACTURING CO.,
INC.**
1213 First Ave.
Conway, Pa. 15027
Exercise equipment

THE CORNELIUS COMPANY
2727 North Ferry Street
Anoka, Minn. 55303
Bottled soft drinks

COUNCIL MANUFACTURING COMPANY
420 North Second Street
Fort Smith, Ark.
Ice, charcoal, vending machine components &
supplies

DELICATE CORP.
717 Pine St.
Camden, N. J. 08103
Sanitary napkins vending machine

DEMAC INC.
2641 Decatur Avenue
New York, N.Y. 10058
Single cup fresh brew, tea, hot choc., soup

DIAL-A-SHAKE INC.
Route 30 & Oak Ave
New Lenox, Illinois 60451
Milkshake vendor

DITCHBURN VENDING MACHINES, INC.
(Div. of The Ditchburn Org. Ltd., England)
1826 North Elston Ave.,
Chicago, Ill. 60622
Instant coffee, cookies, crackers, hot choc.,
pastry, tea, soft drinks, laundry supplies

DIVIDENDS DISPENSER, INC.
1115 Main Street
Bridgeport, Connecticut 06603
Tickets

DOCUMAT, INC.
84 Fourth Avenue
Waltham, Mass. 02154
Photo copy machines

E. B. METAL PRODUCTS CO.
P. O. Box 149
Whitehall, New York 12887
Bags, bait, books, cookies, crackers, handker-
chiefs, hosiery, food, insurance, laundry, pens
& pencils, napkins

EASTERN SPECIALTY PRODUCTS, INC.
83 Zeigler Street
Boston, Massachusetts 02119
Milk, supplies

ELECTROWARE CORPORATION
5350 Rondeau St.
Toledo, Ohio 43615
Popcorn

ELECTRONIC SHINE BOY COMPANY
mid-western division
2016 South Faris Avenue
Sioux Falls, South Dakota 57105
Coin-operated shoe shine machines

EM-RO DISTRIBUTORS
6355 North Broadway
Chicago, Illinois 60626
Parking lot gates

ENVIRO EQUIPMENT CORPORATION
369 Linden Street
Brooklyn, N.Y. 11227
Ice

THE EXHIBIT SUPPLY COMPANY
4719-21 West Lake Street
Chicago, Ill. 60644
Post cards, coin-operated plastic laminating
machines

FAWN SALES, INCORPORATED
Box 1333
8000 University Avenue
Des Moines, Iowa 50305
Cigarettes, hot beverage (coffee, chocolate,
soup), pastry, snack (cookies), candy, popcorn
(sack or cup drop), canned drink.

FEDERAL MACHINE CORPORATION
100-104 S.W. Fourth St.,
P.O. Box 1713
Des Moines, Iowa 50506
Popcorn (cup drop or sack), hot drink (coffee,
chocolate, soup), cigarette, Candy Gum/mint,
Pastry.

**FEDERAL DIV., THE VICTOREEN IN-
STRUMENT CO.**
1055 Stewart Ave.
Garden City, N.Y. 11534
Photo copy machines

FERROMATIC PRODUCTS
(Division of Ferro Stamping Company)
1367 Franklin Street
Detroit, Mich. 48207
Canned soft drinks

FLATTO MANUFACTURING COMPANY
P. O. Box 623
Brownsville, Texas 78520
Stamps, stamp folders, Model 35

THE FLEXIBLE COMPANY
326-332 North Water Street
Loudonville, Ohio 44842
Lockers

FOLLETT CORPORATION
99 Broad Street
Phillipsburg, New Jersey 08862
ice

(Continued)

Your 1-2 punch for higher
collections and more dependable
equipment!

Seeburg
Music

Seeburg Stereo Showcase

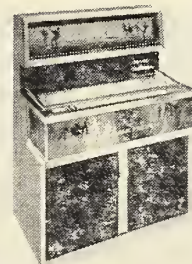

Seeburg
Vending

Full Line Available

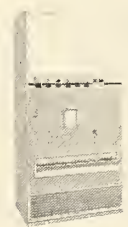

WHERE QUALITY COUNTS

SEEBURG-BUILT! SEEBURG SOUND! SEEBURG MUSIC!

Southeastern Vending Distributors, Inc.

601 WOODIS AVE.
NORFOLK, VA.
(703) 622-0811

1010 S. SAUNDERS ST.
RALEIGH, N.C.
(919) 833-1633

716 HUGER ST.
COLUMBIA, S.C.
(803) 253-7565

VENDING MACHINE MFRS.—TYPE EQUIP. PRODUCED

FORD GUM AND MACHINE COMPANY, INC.
Hoag and Newton Street
Akron, N.Y. 14001
Ball gum, candy

FRUIT-O-MATIC MANUFACTURING COMPANY
P.O. Box 551
7856 Sepulveda Boulevard
Van Nuys, Calif. 01408
Refrigerated fresh fruit

GARDNER MANUFACTURING COMPANY
263 Kansas Street
Horicon, Wisc. 53032
Hot canned food, soup

GARWOOD METAL, INC.
231 North Ave.,
Garwood, N. J.
Cigarette and cigar vendors

GENERAL CIGAR CO., INC.
605 Third Ave.
New York, New York 10016
Cigars, supplies vendible products, cigar vendors

GENERAL VENDING CORP.
(Subsidiary of Mr. Hot Cup, Inc.)
29 Terminal Way
Pittsburgh, Pa. 15219
Books, coffee, newspapers, magazines

GIEPEN ASSOCIATES, INC.
8538 West Grand Ave.
River Grove, Illinois 60171
Instant coffee, hot choc., soft drinks, soup, tea
Comic books

GLASCO CORPORATION
(Subsidiary of U.M.C. Industries)
P. O. Box 97
Barnhart, Mo.
Instant coffee, bottled & canned soft drinks,
pre-mix drinks

GLOEKLER REFRIGERATOR CO.
3950 W. 20th St.
Erie, Pennsylvania 16512
Pizza, component & supplies, french fries, hot
dogs, hamburgers

GOLD MEDAL PRODUCTS COMPANY
1825-39 Freeman Avenue
Cincinnati, Ohio 45214
Pre-popped popcorn, pre-packaged detergents,
Peanuts

ANDREW GORRETTA & COMPANY
5209 Euclid Avenue
Cleveland, Ohio 44103
Cigarettes

GRISWOLD VENDING COMPANY
(Division of Northwest Automatic Products
Corporation)
1212 Chestnut Avenue
Minneapolis, Minn. 55403
Pre-brew coffee, bulk milk, packaged merchan-
dise

G.S.W. COIN-OP SUPPLY INC.
310 North Austin
Dallas, Texas 75202
Bags, laundry supplies, popcorn

HAIRDRI VALETING, INC.
725 Columbia Ave.
Belvidere, Ill. 61008
Hairdryers

HAMILTON SCALE COMPANY
3350 Secor Road
Toledo, Ohio 43606
Scales, coin changers, stamps, tickets

HARBY INDUSTRIES
14753 Arminta St.
Van Nuys, Calif.
General merchandise

THE HEINZ MANUFACTURING COMPANY
P.O. Box 524
Bristol, Conn. 06012
Bulk products, cartoned milk, bottled milk,
newspapers, magazines, fruit juice, groceries,
eggs, bottled & canned soft drinks

HILSON INDUSTRIES, INC.
5300 Vine Street
Cincinnati 17, Ohio 45217
Ice

HILSUM SALES CORPORATION
(Subsidiary of American Sumatra Tobacco
Corporation)
344 North East 61st Street
Miami, Fla. 33137
Stamps, cigars, cigarettes, newspapers, maga-
zines, post cards

HOSPITAL SPECIALTY CO.
(Div. of American Automatic Vending Corp.)
1991 East 66 St.
Cleveland, Ohio 44103
Sanitary napkins

HYPRESSURE JENNY
(Div. of Homestead Valve Mfg. Co.)
Box 348
Coraopolis, Pa. 15108
Car wash equipment

HYPRO ENGINEERING, INC.
700-39 Ave. N.E.
Minneapolis, Minn. 55421
Car wash equipment

ICE ALL-O-MATIC MFG., INC.
4081 S. State St.
Salt Lake City, Utah 84107
Ice vendors

ICE-LEASING CORP.
98-11 178 Place
Jamaica 33, N.Y.
Bagged ice

ICE PLANT EQUIPMENT CO., INC.
2543 Frankford Ave.
Phila., Pa. 19125
Bait, ice

**INTER-AMERICAN STAMP VENDING
CORP.**
45 Bergen St.
Brooklyn, N.Y. 11201
Cards, Postage stamps

**INTERNATIONAL BALLY COFFEE VEND-
ING CORP.**
(Div. of Seeburg Corporation)
6119 Howard Street
Niles, Illinois 60648
Fresh-brew coffee, hot choc., soup, tea

**INTERNATIONAL MUTOSCOPE CORPORA-
TION**
11-12 44th Ave.
Long Island City, New York 11101
Auto, photo, voice recordings, books, magazines,
laminating machines, handkerchiefs, sanitary
napkins, insurance

JENNINGS AND COMPANY
(Division of Hershey Manufacturing Com-
pany)
4307 West Lake Street
Chicago, Ill. 60624
Canned, cartoned, bottled milk, canned drinks,
groceries, specialty items, supplies

JOHNSON FARE BOX
(Subsidiary of Bowser, Inc.)
4619 Ravenswood Avenue
Chicago, Ill. 60640
Coin changers, components

KIMBERLY-CLARK CORP.
One East Wacker Drive
Chicago, Ill.
Sanitary napkins

K-WAY DISPENSING EQUIPMENT CO.
812 Huron Road
Cleveland, Ohio 44115
Post-mix vending machines

**KWIK KAR WASH & KWIK KAR DRIVE-
THRU INC.**
147 Parkhouse
Dallas, Texas 75207
Car wash equipment

L & A PRODUCTS INC.
369 Hersey St.
St. Paul, Minn.
Car wash equipment

LA CROSSE COOLER CO.
2809 Losey Boulevard, South
La Crosse, Wisc. 54602
Bottled soft drinks

LEKTRO-VEND CORP.
P. O. Box 649
Sullivan Rd.
Aurora, Ill. 60507
Candy bars, cookies, crackers, gum, hosiery,
handkerchiefs, lipstick, lotion, pastry, per-
fume, potato chips, pretzels, general purpose
venders

LENNOX MANUFACTURING COMPANY
(Div of UMC Industries, Inc.)
5002 South Halsted Street
Chicago, Illinois 60609
Beverage vending and vending components

LEONARD SALES CO.
(Subsidiary of Vecco Beauty Equipment Mfg.
Co.)
167 North Racine
Chicago, Illinois 60607
Hair dryers

EDW. LIVINGSTON & SONS, INC.
1735-39 Walnut St.
Kansas City, Mo. 64108
Car wash equipment

MAGIC BAY CAR WASH SALES, INC.
306-12 Ave. So.
Nashville, Tenn. 37203
Car wash equipment

MALKIN-ILLION COMPANY
400 Coit Street
Irvington, N.J. 07111
Cigars

W. MANNHARDT & SON, INC.
7916 West Grand Avenue
Chicago 35, Ill.
Ice

THE MARTIN BROS. ELECTRIC CO.
3620 Perkins Ave.
Cleveland, Ohio 44114
Hair dryers

MARVEND, INC.
1242 Hayse Industrial Drive
P.O. Box 6006, Sta A
Marietta, Ga. 30062
Instant coffee, soup, tea, candy, potato chips,
note book paper, pretzels

MAYVILLE METAL PRODUCTS COMPANY
First and Highland
Mayville, Wisc. 53050
Contract mfrs., also components

MECHANICAL SERVANTS, INC.
6610 North Clark Street
Chicago, Ill. 60626
Combs, sanitary napkins, lipstick, ball pens,
toys, perfume, souvenirs, razors, razor blades,
gum, pencils, hand lotion

METERFLO DISPENSERS, INC.
4201 West Peterson Ave
Chicago, Ill. 60646
Juices, bulk milk

MICRO-MAGNETIC INDUSTRIES INC.
951 Commercial St.
Palo Alto, California 93400
Money changing equipment, ticket vendors

MICRO VEND, INC.
303 West 42nd Street
New York, New York 10036
Hot and cold packaged vendors

MILLER INDUSTRIES
(Division of Guardian Ind., Inc.)
180 East Sixth St.
Dubuque, Iowa
Hair dryers, vending machine components &
supplies

MISTER MAGIC, INC.
(Div. of Self Service Equipment Co., Inc.)
2501 Hawn Freeway
Seagoville, Texas 75159
Car wash equipment, truck mobile, power wash
equipment

JOHN E. MITCHELL COMPANY
3800 Commerce St.
Dallas, Texas 75221
Car wash cabinet

MODEL VENDING CONTROLS INC.
11711 Chillicothe Rd.
Chesterland, Ohio 44026
Money changing equipment

MODERN PRODUCTS COMPANY
Route 6
Box 365A
Yakima, Wash 98901
Refrigerated fresh fruit

MORTON LAMM & ASSOCIATES
1017 Oak Lane
Phila., Pa. 19126
Cigarettes, cookies, crackers, currency vendors,
hot & cold packaged food, groceries, bottled &
cartoned milk, pretzels, bottled & canned
drinks

MOYER & DIEBEL METALCRAFTS LTD.
Jordan Station
Ontario, Canada
Hot drink, cold drink, sundries

NARCO
(Subsidiary of the Navarre Corporation)
Pioneer Bank Building, Suite 600
Chattanooga, Tennessee 37402
Bottled and pre-mix soft drink machines

NATIONAL REJECTORS, INC.
(Subsidiary of Universal Match Corporation)
5100 San Francisco Avenue
St. Louis, Mo. 63115
Currency changers, coin changers, cup vendors,
components

**NATIONAL SALES OFFICES MARKETERS,
INC.**
41 E. 42 St.
New York, N.Y. 10017

**NATIONAL SANITARY LABORATORIES,
INC.**
6652 North Western Avenue
Chicago, Ill. 60645
Sanitary napkins, combs, razor blades, pens &
pencils

NATIONAL UNI-PAC, INC.
5154 Peachtree Industrial Boulevard
Chamblee, Georgia 30005
Instant coffee, crackers, hot drinks, pastry

NATIONAL VENDORS, INC.
(Subsidiary of Universal Match Corporation)
5055 Natural Bridge Avenue
St. Louis, Mo. 63115
Cigarettes, candy, gum, mints, cookies, crack-
ers, pastry, refrigerated sandwiches, hot cans,
genl. mchdse.

**TAP THE
TERRIFIC
TAG-A-LONG
CHILDREN'S
MARKET with**



**CANDY
DISPENSERS**

Now you can DIVERSIFY . . .

- make more profit with no more effort!
- made more productive use of sales time!
- reduce operating costs!

**PEZ comic strip candy
dispensers plus the new PEZ
VENDING MACHINE offer . . .**

- the bright gay colors and ACTION of nationally-advertised PEZ comic strip character candy dispensers.
- design created especially for children—coin slots and selection levers at child level.
- simple, "foolproof" design with only 2 moving parts.
- uninterrupted sales—4 coin "mechs".
- anybody can replace "mechs" without tools.

Write or telephone for full information.
Start picking up these extra profits NOW!

**INTER-COUNTY
INDUSTRIES, INC.**

809 Walnut Street, Reading, Pa. 19601
Area 215; 375-2722

VENDING MFR. LIST (Continued)

NEDACO, INC.
13747 So. Western Ave.
Blue Hills, Ill.
Carded merchandise, handkerchiefs hoslery

RAM JET CAR WASH DIV.
2527 Second Ave, North
Leeds, Alabama 35094
Car wash equipment

NEWSPAPER ENTERPRISE ASSOC.
(Div. of Scripps-Howard Newspapers)
1200 West Third St.
Cleveland, Ohio 44113
Newspapers & magazines

REDWOOD MACHINE CO., INC.
1703 Peoria Rd.
Springfield, Ill. 62700
Notebook paper, pens & pencils

THE NIK-O-LOK CO., INC.
422 East New York Street
Indianapolis, Ind. 46202
Toilet locks, lease only

REED ELECTROMECH CORP.
340 Blackhawk Park Ave.
Rockford, Ill.
Changemakers, vending components

NORRIS DISPENSERS, INC.
2720 Lyndale Avenue, South
Minneapolis, Minn. 55408
Cartoned-bottled milk

ROBCO MFG. CORPORATION
235 West Main Street
Patchogue, Long Island, New York
Dryclnrs., washers, extractors, packaged gum,
laundry supplies, contract work

**NORTH AMERICAN VENDING MACHINES,
LTD.**
63 Whitburn Crescent, Downsview
Ontario, Canada
Ultra-violet lamps

ROCK-OLA MFG CORPORATION
800 North Kedzie Avenue
Chicago, Ill. 60651
Fresh brew coffee, hot choc., bulk soup, tea,
books, cigarettes, canned soft drinks

THE NORTHWESTERN CORP.
1006 East Armstrong Street
Morris, Ill. 60450
Bulk nuts, gum, candy, stamps

ROWE MFG.
75 Troy Hills Rd.
Whippany, N.J. 07981
Cigarettes, post-mix drinks, batch fresh brew-
single cup fresh brew coffee, hot choc., tea,
soup, candy, pastry, hot and cold pkgd. food,
sandwiches, pkgd. gum, bill changer, coin
handling equipment, components

NU-PROCESS INDUSTRIES, INC.
13374 Farmington Rd.
Livonia, Mich. 48150
Car wash equipment

RUDD-MELIKIAN, INC.
300 Jacksonville Road
Warminster, Pa. 18974
Single cup fresh brew, liquid concentrate, pow-
dered coffee, tea, soup, hot choc., cartoned
milk, hot-cold pkgd. food, pastry, cookies,
crackers, fruit, post mix drinks.

OAK MFG. CO., INC.
650 South Ave 21
Los Angeles, Calif. 90031
Bulk products, cards, gum, sanitary vendors

S. MFG. CO., INC.
314 S. Twelfth St.
Omaha, Nebraska
Potato chips, snacks

OMNIVEND METALAB EQUIPMENT CO.
270 Duffy Ave
Hicksville, N.Y. 11801
Bottled & canned milk, soft drinks

PACIFIC NIK-O-LOK CO., INC.
2421 South Yates Avenue
Los Angeles, Calif. 90022
Toilet locks, change makers

S & L SALES, INC.
314 S. Twelfth St.
Omaha, Nebraska
Coffee vendors

**PARAMOUNT ALL-PURPOSE VENDING
EQUIPMENT INC.**
1470 South Michigan Ave
Chicago, Ill. 60605
General purpose vendors

S AND S PRODUCTS, INC.
West Grand Avenue
Lima, Ohio 45802
Bottled-canned drinks,

PARRISH METAL-CRAFT CO.
1 East State Street
Geneva, Ill. 60134
Pens, pencils, sanitary napkins, contract work
Bulk, cookies, candy, gum

S AND S VENDING MACHINE CO.
670 Lincoln Avenue
San Jose, Calif. 95126
Ice

PATTERSON INT'L INC.
10 Roakwood Bldg.
Cincinnati, Ohio 45202
Postcards

SAHARA PRODUCTS
(Division of McGraw-Edison Corp.)
3736 N. Booth St.
Milwaukee, Wis. 53201
Laundry supplies

PEN-MAR VENDING, INC.
Box 2142
Hagerstown, Md.
Sundries

SCHERMACK PRODUCTS CORP.
1164 West Baltimore Avenue
Detroit, Mich. 48202
Stamps

PERK-ETTE, INC.
1470 South Michigan Avenue
Chicago, Ill. 60605
Fresh brew coffee

SCHOENBACH COMPANY
715 Lincoln Place
Brooklyn, N.Y. 11216
Stamps, combs, handkerchiefs, napkins, coin
operated scales

POLICY-MATIC CORPORATION
P.O. Box 1163
1168 Atlanta St.
Marietta, Georgia 30062
Insurance

SCRIBE INTERNATIONALE
3166 Des Plaines Ave.
Des Plaines, Ill. 60018
Postage stamps

POLYCO INC.
(Div. of Fullview Ind.)
3602 South Jason
Englewood, Colorado 55429
Bags, wire garment hangers

THE SEEBURG CORPORATION
1600 North Dayton Street
Chicago, Ill. 60622
Cigarettes, single cup fresh brew, soup, tea,
hot choc., post mix drinks, bottled and canned
soft drinks, candy, cookies, cartoned milk,
pastry, components, crackers

J. B. POST CO.
66 Oxford Street
Wilkes-Barre, Pennsylvania
Ice

SELECTIVEND CORPORATION
1111 South 12th Street
Kansas City, Kans. 66105
Bottled & canned soft drinks

POSTAGE STAMP MACHINE CO., INC.
2008 Utica Avenue
Brooklyn, New York 11234
Stamps, post cards

SERV-O-MATIC, INC.
P.O. Box 663
Des Moines, Iowa 50303
Instant coffee (bulk), hot chocolate

POSTAGE STAMP VENDOR CO.
4750 N. Ronald St.
Harwood Heights, Ill. 60656
Postage stamps

WILLIAM F. SHEPHERD, INC.
1747 Central Avenue
Cincinnati, Ohio 45214
Candy, cookies, detergent, bleach, contract
work

PRISCILLA ALLEN COSMETICS, INC.
422 Main St.
Clifton, N. J.
Lipstick, perfume, combs, sundries

SHIPMAN MANUFACTURING CO.
1326 South Lorena Street
Los Angeles, Calif. 90023
Cigarettes, candy, cookies, gum, stamps, in-
surance, contract work

PUBLISHERS VENDING SERVICES, INC.
250 East Fifth Street
St. Paul, Minnesota 55101
Newspapers, magazines, books, sundries

When you're looking for the
best in coin-operated
MUSIC & VENDING
look to your *Seeburg* distributor—
LOOK TO LONDON

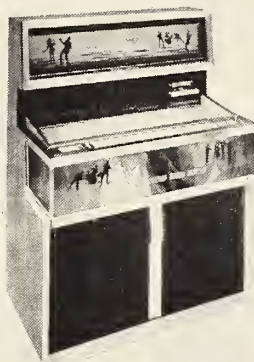

*And
Look
at these
Great
Seeburg
Products!*

S. L. London Music Co., Inc.

3130 W. Lisbon Ave., Milwaukee, Wisconsin
Tel: (414) 344-3220

Nate Victor • Carl Betz • Walter Koelbl • Don Emery

For The **FINEST** New
MUSIC and **VENDING**
in
OHIO, MICHIGAN, KENTUCKY
and **WEST VIRGINIA**
it's
SHAFFER DISTRIBUTING CO.

Distributing **ROWE-AMI** Equipment
For The **FINEST** Used
MUSIC and **VENDING** Equipment
anywhere in the world
it's also

SHAFFER DISTRIBUTING CO.

Columbus, Ohio, 849 North High St. (614) 294-4614
Cincinnati, Ohio, 51 Novner Drive (513) 771-6170
Cleveland, Ohio, 2126 E. 21st Ave. (216) 241-2651
Detroit, Mich., 300 E. Milwaukee (313) 873-4200

VENDING MACHINE MANUFACTURERS

The operator **1** stop for your
Number **1** equipment lines

Wurlitzer Americana Phonograph

- Big Sound
- Beauty
- Dependability

Automatic Products Company

- Smokeshop
- Candyshop
- Snackshop

Dollar for dollar—the most profitable
music and vending lines available today!

BILOTTA Enterprises
224 N. Main St., Newark, N.Y.

The Most Reputable Distributor
on the West Coast

C. A. ROBINSON and Company

2301 W. PICO BLVD. • LOS ANGELES, CAL. 90006
Telephone (213) 385-7318

Serving operators in the West for 27 Years

Charlie Robinson - Al Bettelman -
Hank Tronick—Representing
100 yrs. of experience in the
coin machine business.

Distributors for:
MIDWAY MFG. CO.
VALLEY MFG. & SALES CO.

MANUFACTURER INQUIRIES INVITED

Early Summer Money-Makers

from **DAVIS**

PERFECT FOR THE

★ TWO PLAYS FOR 25¢ ERA ★

Seeburg LPC-480 **\$895**
(with or without bonus feature)

SPECIALS for JULY

RECONDITIONED and REFINISHED

Seeburg Electra	\$995
Seeburg DS160	575
Seeburg AY160	475
Seeburg AQ160	375

WALLBOXES

Seeburg S-160 ... 160 Sel.	\$95
3WA ... 160 or 200 Sel.	39
3WI ... 100 Sel.	15

WORLD EXPORT
Davis **Corp.**
DISTRIBUTING
Exclusive Seeburg Distributors
738 EAST ERIE BOULEVARD
SYRACUSE, NEW YORK 13210
PHONE GRanite 5-1631
AREA CODE 315

SHUFORD ENTERPRISES, INC.
P.O. Box 1742
Hickory, North Carolina 28601
Return bottles vender

E. J. SHURTZ MFG. CO.
240 West Tenth Street
Wichita 2, Kans. 67201
Ice

SIDEWALK VENDING
45 Bergen St.
Brooklyn, N.Y. 11201
Plastic laminating & post cards

SKILL VENDING SALES, INC.
440 West Ontario St.
Chicago, Ill. 60610
Shoe shine machine

MATT SKOREY, INC.
2118 S. Bellaire
Denver, Colorado 80203
School supplies

SOLUPAK COMPANY
5727 West 36th Street
Minneapolis, Minn. 55416
Laundry supplies, foot vibrators, car wash
machine

SONDO ENTERPRISES
2107 Bellevue Ave.
Los Angeles, Calif. 90026
Fresh-brew coffee, instant coffee

SPECIALTY ENGINEERING CORP.
9030 Premier Row
Dallas, Texas 75207
Pre-mix drink, vending machine components
& supplies

SPEEDEE CAR KLEEN
(Div. of Rexarc, Inc.)
East Third St.
West Alexandria, Ohio 45381
Car wash equipment

STAMPAK
(Div. of Inter-American Stamp Vending
Corp.)
45 Bergen
N.Y., N.Y.
Postage stamps

STANCRAFT
(Division of Standard Packaging Corporation)
250 West 57 St.
New York, N.Y. 10019
Greeting cards, hosiery

STANDARD CHANGEMAKERS, INC.
422 East New York Street
Indianapolis, Indiana 46202
Coin changers, currency changers

STANDARD-HAVARD METAL TYPER, INC.
1318 North Western Avenue
Chicago, Ill. 60622
Identification discs, name plates

STEELMADE, INC.
155 East Main Street
Lomira, Wisconsin
Hot canned foods, cartoned milk, canned
drinks, can opener kits

STEEL PRODUCTS, CO.
40 Eighth Ave., S.W.
Cedar Rapids, Iowa
Paper cups

L. STEINER MFG. CO.
45 Bergen Street
Brooklyn N.Y. 11201
Stamps, post cards

STONER MFG. CO.
(Division of the Vendo Company)
328 Gale Street
Aurora, Illinois 60506
Candy, mints, gum, cookies, cigarettes, pastry,
instant coffee, hot chocolate, tea, hot canned
food

SUPERIOR MFG. CO.
P.O. Box 262
9110 Terminal Ave
Skokie, Ill. 60078
Cigarettes, cigars, gum, hot dogs

U.S. AUTOMATIC SALES, INC.
1400 Rahway Avenue
Avenel, New Jersey 07001
Ice cream, cartoned milk, vending machine re-
pair service

U. S. VENDING CORPORATION
140 53rd Street
Brooklyn, N.Y. 11232
Ice cubes

UNEEDA SHOE SHINE MACHINE CO.
(Subsidiary of Acme Sales Co.)
552 West 53rd Street
New York, N.Y. 10019
Shoe Shine Machines

UNITED JET WASH
(Div. of United Rent-Alls, Inc.)
2605 North 27 St.
Lincoln, Nebraska 68503
Car wash equipment

UNIVERSAL METAL PRODUCTS
(Div. of Universal Match Corp.)
5661 National Bridge Ave
St. Louis, Mo. 63120
Vending machine components & supplies

UNIVERSAL VENDORS, INC.
1616 Walnut St.
Philadelphia, Pa. 19103
Candy bars, cookies, crackers, gum, cigar,
cigar packs, snacks

VACMANCO
97 Main St.
Schwenksville, Pa. 19473
Car wash equipment

VAC-UR-CAR, INC.
8337 North Christiana
Skokie, Ill. 60076
Vacuum cleaner for cars & trucks

VEND-A-BOX, INC.
321 York St.
Newport, Ky. 41071
Popcorn

VEND-A-MATION, INC.
3745 Spaeth St.
Cincinnati, Ohio 45223
Coin changers

THE VENDO COMPANY
7400 East 12th St.
Kansas City, Mo. 64126
Pre-mix & bottled soft drinks, cartoned milk,
juices, ice cream novelties, coffee (instant &
fresh brew), hot chocolate, hot & cold pack-
aged food, cookies, crackers, nuts, currency
changers

VEND-O-MATIC SALES, INC.
6401 Goodrich Ave.
Minneapolis, Minn. 55426
Hot canned foods, canned soft drinks, vending
machine components & supplies

VENDOR MFRS., INC.
R-457 Chestnut St.
P.O. Box 7307
Nashville, Tenn 37203
Bulk products

VENDORLATOR MFG. CO.
(Div. of the Vendo Co.)
7400 E. 12th St.
Kansas City, Mo. 64126
Bottled, canned & pre-mix soft drinks

VENDOTRONICS CORP.
572 Merrick Rd.
Lynbrook, N.Y. 11563
Popcorn

VEND-RITE MFG. CO.
(Div. of R. J. Tennes & Co., Inc.)
1536 North Halsted St.
Chicago, Ill. 60622
Laundry supplies, laundry bags, pens, pencils,
sanitary napkins, cookies, crackers, packaged
gum, insurance, coin changers

VICTOR PRODUCTS CORP.
901 Pope Ave
Hagerstown, Maryland 21740
Pre-mix, post-mix, bottled and canned soft
drinks, instant coffee, hot chocolate, soup, tea,
canned & bulk juice, coin changers

VICTOR VENDING CORP.
5701 West Grand Ave.
Chicago, Ill 60639
Bulk candy, nuts, ball gum, pens & pen re-
fills, coin changers

WEBEN PRODUCTS, INC.
(Div. of Weben Industries, Inc.)
1616 Anson Rd.
Dallas, Texas 75235
Car wash equipment

**WESTERN INDUSTRIES, INC. PARKING
CONTROLS DIVISION**
2744 West 36th Place
Chicago, Ill. 60632
Tickets, coin-operated parking gates

WESTINGHOUSE ELECTRIC CORP.
(Automatic Merchandising Division)
653 Page Boulevard
Springfield, Mass. 01102
Bottled & canned soft drinks, coffee (fresh-
brew, single cup) hot chocolate, soup (cup),
tea

WOODMASTER
P.O. Box 3161
Madison, Wisconsin 53704
Firewood, Charcoal, press-to-logs, other bulky
items (packaged or loose)

COIN-OPERATED

AUDIO VISUAL MACHINES

Rowe AMI PhonoVue companion film projection unit for Music Merchant Phonograph. 20 sel., cartridge load. Super 8 mm film.

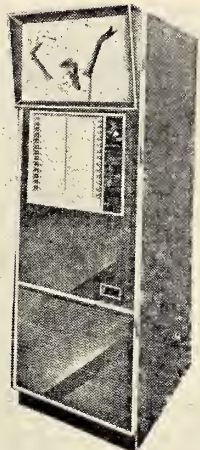
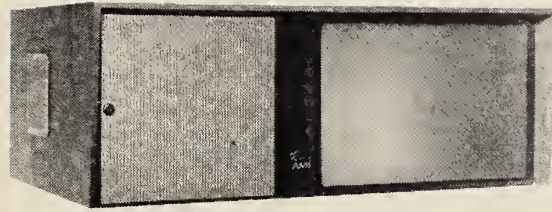

COLOR-SONICS
Color-Sonics Video Jukebox (26 selections, 8 mm. loop-cartridge).



David Rosen, Inc. Cinejukebox
Combination audio-visual, 16mm film/40 sel., 200 recordings, 9 color slides. (#250)



SCOPITONE
Tel-A-Sign Corp. 3401 West 47 St., Chicago, Ill. 16 mm film 36-sel.

PHONOGRAPHS GAMES

We make the best deals in Indiana

Exclusive Distributors for
**Seeburg—Williams
Bally—Chicago Coin**

IMPORTERS

*Big Supply
of Games and
Music Always in Stock.*

Write for List.

Contact Al Calderon

**CALDERON
DISTRIBUTING, INC.**

433 N. Alabama St.
Indianapolis, Ind.
Phone: (317) 634-8468

COLOR-SONICS COIN-OPERATED AUDIO-VISUAL THEATRE

THE MOST ADVANCED COIN-OPERATED THEATRE

★ FEATURING SIMPLICITY OF DESIGN

★ CARTRIDGE LOADED FILM

★ LARGE SCREEN OPERATION

Model 2600, 26 play film only machine
for cocktail lounges,
bus terminals and restaurants.

Model Combi 150, 24 film selections
plus 128 record selections
for bars and cocktail lounges.

CALL, WRITE, WIRE

COLOR SONICS, INC.

724 Fifth Avenue
New York, N. Y. 10019
212-Plaza 7-0106
Cable Address
Colorsonic NY



DISTRIBUTORSHIPS AVAILABLE IN SOME TERRITORIES.

RUNYON

**SERVING THE OPERATOR ...
SERVING THE INDUSTRY ...
ALWAYS WITH A SMILE!**

Distributors for the finest
Coin-Operated Equipment:

**MUSIC AMUSEMENT
FULL LINE VENDING
POOL TABLES**



The Rowe AMI MUSIC MERCHANT
Phonograph
Stereo-Round Sound
Breathtaking Design



The Rowe AMI PHONOVue
The sensational companion
piece to the Music Merchant
that's making location history!

Rowe FULL-LINE Vendors
A Vending Machine for every
location!

**TOP AMUSEMENT LINES!
BALLY
IRVING KAYE
WILLIAMS
MIDWAY
GOTTLIEB
CHICAGO COIN
UNITED**

**ONE-STOP SHOPPING
AT RUNYON!**

SHUFFLES — PINS — GUNS — KIDDIE RIDES
— PARTS & SERVICE — RECORD DEPT. —
SHOPS — SPRAYROOMS — LUXURIOUS SHOW-
ROOMS — VISIT US!

RUNYON SALES CO. INC.

U.S. Route 22, Fadam Road, Springfield, N.J.
Tel Drexel 6-8720

593 Tenth Avenue, New York, N.Y.
Longacre 4-1880

306 Tolland St., East Hartford, Connecticut
Butler 9-4303

U.S. PHONOGRAPH MANUFACTURERS AND DISTRIBUTORS

ROCK-OLA

**ROCK-OLA MANUFACTURING
CORP.**

800 North Kedzie Ave.
CHICAGO, ILL.

(Distributors)

ARIZONA

VALLEY VENDORS CORP.
1145 W. Hilton Ave.
PHOENIX, ARIZONA 85003

ALABAMA

FRANCO DISTRIBUTING CO., INC.
24 North Perry Street
MONTGOMERY, ALABAMA 36104

CALIFORNIA

ADVANCE AUTOMATIC SALES COMPANY
1105 W. Pico Boulevard
LOS ANGELES, CALIF. 90015

M D R DISTRIBUTORS, INC.
363 Clementina St.
SAN FRANCISCO, CALIF.

COLORADO

MOUNTAIN DISTRIBUTORS
3630 Downing Avenue
DENVER, COLORADO 80205

FLORIDA

ELI ROSS DISTRIBUTORS, INC.
90 Riverside Avenue
JACKSONVILLE, FLORIDA 32202

ELI ROSS DISTRIBUTORS, INC.
852 N. W. 71st Street
MIAMI, FLORIDA 33150

GEORGIA

GREATER SOUTHERN DISTRIBUTING
COMPANY
321 Edgewood Avenue, S.E.
ATLANTA, GEORGIA 30312

ILLINOIS

EMPIRE COIN MACHINE EXCHANGE
1012 N. Milwaukee Avenue
CHICAGO, ILLINOIS 60622

KANSAS

BIRD MUSIC DISTRIBUTORS, INC.
124-126 Poyntz Avenue
MANHATTAN, KANSAS 66503

KENTUCKY

S. L. STIEBEL COMPANY
635 West Main Street
LOUISVILLE, KENTUCKY 40202

LOUISIANA

A.M.A. DISTRIBUTORS, INC.
1711 St. Charles Avenue
NEW ORLEANS, LA. 70130

MARYLAND

GENERAL VENDING SALES CORP.
239-245 W. Biddle Street
BALTIMORE, MARYLAND 21201

MASSACHUSETTS

GLOBE AUTOMATIC VENDING MACHINE
CO., INC.
378 Granite Street
QUINCY, MASSACHUSETTS 02169

MICHIGAN

EMPIRE COIN MACHINE EXCHANGE
7743 Puritan Avenue
DETROIT, MICHIGAN 48238

EMPIRE COIN MACHINE EXCHANGE
1955 South Division Street
GRAND RAPIDS, MICHIGAN 49507

RONDEAU SALES—(DIVISION OF
EMPIRE COIN MACHINE EXCHANGE)
102-20th Street
MENOMINEE, MICHIGAN

MINNESOTA

ADVANCE MUSIC, INC.
7600 Wayzata Blvd.
MINNEAPOLIS, MINN. 55426

MISSOURI

MUSICAL SALES, INC.
2920 Locust Street
ST. LOUIS, MISSOURI 63103

MONTANA

H. B. BRINCK
825-827 East Front Street
BUTTE, MONTANA 59701

NEBRASKA

H. Z. VENDING & SALES CO., INC.
1201-1207 Douglas Street
OMAHA, NEBRASKA 68102

NEW JERSEY

SEACOAST DISTRIBUTORS
1200 North Avenue
ELIZABETH, NEW JERSEY 07201

NEW YORK

GRECO BROS. AMUSEMENT CO., INC.
1288 Broadway Avenue
ALBANY, NEW YORK

GRECO BROS. AMUSEMENT CO., INC.
Main Street—Box G
GLASCO, NEW YORK 12432

ACE-HI DISTRIBUTORS
1286 Electric Ave.
LACKAWANNA, N.Y. 14219

ALBERT SIMON, INC.
587-9 Tenth Avenue
NEW YORK, NEW YORK 10036

FLOWER CITY DISTRIBUTORS, INC.
389 Webster Avenue
ROCHESTER, NEW YORK 14609

VICTOR CONTE (SALES, INC.)
1001 Lansing Street
UTICA, NEW YORK 13501

NORTH CAROLINA

LESTOURGEON DISTRIBUTING CO.
2828 South Boulevard
P. O. Box 641
CHARLOTTE, NORTH CAROLINA 28201

OHIO

MONROE COIN MACH. EX.
2423 Payne Ave.
CLEVELAND, OHIO 44114

OKLAHOMA

TULSA AUTOMATIC MUSIC COMPANY
739 West 5th Street
TULSA, OKLAHOMA 74127

PENNSYLVANIA

ACTIVE AMUSEMENT MACHINES CO.
666 N. Broad Street
PHILADELPHIA, PENNA. 19130

B. D. LAZAR COMPANY
1635 Fifth Avenue
PITTSBURGH, PENNA. 15219

ACTIVE AMUSEMENT MACHINES CO.
1101 Pittston Avenue
SCRANTON 5, PENNA.

TENNESSEE

S & M DISTRIBUTING CO., INC.
1074 Union Avenue
MEMPHIS, TENNESSEE 38104

SANDERS DISTRIBUTING COMPANY
612 Eighth Avenue, South
NASHVILLE, TENNESSEE 37203

TEXAS

STATE MUSIC DISTRIBUTORS, INC.
3100 Main Street
DALLAS, TEXAS 75226

AMUSEMENT DISTRIBUTORS, INC.
1615 St. Emanuel Street
HOUSTON, TEXAS 77003

UTAH

BEST DISTRIBUTING, INC.
53 N. Angelo Ave.
SALT LAKE CITY, UTAH

VIRGINIA

VENDING MACHINE EXCHANGE
63 Commonwealth Avenue
BRISTOL, VIRGINIA 24201

WASHINGTON

M. J. STANLEY COMPANY
309-112th N.E.
BELLEVUE, WASHINGTON

WEST VIRGINIA

WALLACE & WALLACE MUSIC, INC.
401 Jones Avenue
OAK HILL, WEST VIRGINIA 25901

WISCONSIN

EMPIRE COIN MACHINE EXCHANGE
(c/o HASTINGS DISTRIBUTORS)
6100 W. Bluemond Road
MILWAUKEE, WISCONSIN

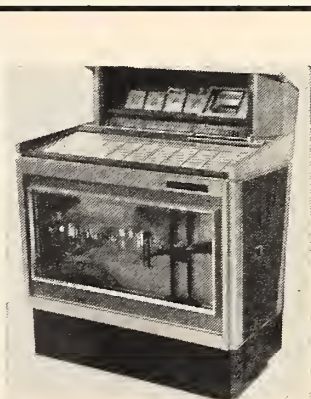

DISTRIBUTORS OF ROWE FULL-LINE
VENDING AND FOR

**THE ROWE-AMI MUSIC
MERCHANT & PHONOVue**

IN VIRGINIA AND W. VIRGINIA

**ROANOKE
VENDING EXCHANGE, INC.**

4930 WEST BROAD STREET
RICHMOND, VA. TEL.: (703) 282-4221

JACK G. BESS HARRY D. MOSELEY W. DAVID STREET

Chairman of the Board

President

Vice-President

M. L. MUNDIE Director of Sales

SALESMEN

E. W. BISHOP State of Virginia
E. T. (A1) MATTHEWS State of West Virginia

DISTRIBUTORS FOR:—

Rowe Manufacturing

Irving Kaye Sales Co.

Klopp Engineering, Inc.

Valley Sales Company

American Shuffleboard Co.

Williams Electronic

Manufacturing Corp.

Watling Mfg. Co.

ROWE AMI

ROWE MANUFACTURING
Troy Hills Road
WHIPPANY, NEW JERSEY

(Distributors)

ALABAMA

JOHNNY ROWELL DISTRIBUTING CO.,
INC.
1631 1st Avenue
NORTH BIRMINGHAM

ARIZONA

GARRISON SALES CO.
1000 W. Washington St.
PHOENIX

CALIFORNIA

R. F. JONES CO.
240 Shotwell St.
SAN FRANCISCO

CIRCLE INTERNATIONAL
2401 South Hill Street
LOS ANGELES

U.S. PHONOGRAPH MANUFACTURERS AND DISTRIBUTORS

ROWE AMI

ALABAMA

HERMITAGE MUSIC CO.
1631 First Ave., N.
BIRMINGHAM

COLORADO

DIAMOND DIST. CO.
2830 West Ninth St.
DENVER

CONNECTICUT

RUNYON SALES CO.
306 Tolland St.
E. HARTFORD

DISTRICT OF COLUMBIA

DAVID ROSEN, INC.
855 N. Broad St.
PHILADELPHIA, PENNSYLVANIA

FLORIDA

BUSH INTERNATIONAL, INC.
60 Riverside Ave.
JACKSONVILLE
286 N.W. 29th St.
MIAMI
1725 W. Cypress
TAMPA

GEORGIA

PEACH STATE MUSIC CO., INC.
624 New Street
MACON

PEACH STATE DISTRIBUTING
1040 Boulevard, S.E.
ATLANTA

HAWAII

CIRCLE INTERNATIONAL
849 Halekauwila Street
HONOLULU

ILLINOIS

ATLAS MUSIC CO.
2122 N. Western Ave.
CHICAGO

INDIANA

J & J DISTRIBUTORS, INC.
1661 W. 16th Street
INDIANAPOLIS

LOUISIANA

J. H. LYNCH CO., INC.
1601 S. Gayoso
NEW ORLEANS

MASSACHUSETTS

TRIMOUNT AUTOMATIC SALES CORP.
40 Waltham St.
BOSTON

MICHIGAN

SHAFFER MUSIC CO.
300 East Milwaukee St.
DETROIT

MINNESOTA

K. C. SALES AND SERVICE
1926 University Ave.
ST. PAUL

MISSOURI

W. B. MUSIC CO., INC.
2900 Main St.
KANSAS CITY

ADVANCE DIST. CO.
4710 Delmar Blvd.
ST. LOUIS

NEW JERSEY

RUNYON SALES CO.
U.S. Route 22 and Fadam Rd.
SPRINGFIELD

NEW YORK

ROWE MANUFACTURING
31 E. 17th St.
NEW YORK CITY

RUNYON SALES CO.
593 Tenth Ave.
NEW YORK CITY

SHELDON SALES DIST. CORP.
881 Main St.
BUFFALO

OHIO

SHAFFER MUSIC CO.
849 North High St.
COLUMBUS
51 Novner Dr.
CINCINNATI
2126 E. 21st St.
CLEVELAND

OKLAHOMA

AUTOMATIC MUSIC DISTRIBUTORS
900 N. Western Ave.
OKLAHOMA CITY

PENNSYLVANIA

BANNER SPECIALTY CO.
1508 Fifth Ave.
PITTSBURGH

DAVID ROSEN, INC.
855 N. Broad St.
PHILADELPHIA

SOUTH CAROLINA

PEACH STATE TRADING CO.
729 Lady Street
COLUMBIA

TENNESSEE

SOUTHERN AMUSEMENT DIST. CO.
628 Madison Ave.
MEMPHIS

HERMITAGE MUSIC CO.
469 Chestnut Street
NASHVILLE

TEXAS

CENTRAL SALES CO.
91 Dennis
HOUSTON

SANTONE SALES CO.
121 Navarro St.
SAN ANTONIO
1405 Turtle Creek Blvd.
DALLAS

UTAH

DIAMOND DIST. CO.
375 South Second St., W
SALT LAKE CITY

VIRGINIA

ROANOKE VENDING EXCHANGE, INC.
4930 W. Broad St.
RICHMOND

WASHINGTON

R. F. JONES CO.
309 Ninth Ave., N.
SEATTLE

WISCONSIN

PIONEER SALES & SERVICE, INC.
3110 W. Fond du Lac Ave.
MILWAUKEE

CANADA

GILCHRIST VENDING, LTD.
5796 Ferrier St.
TOWN OF MOUNT ROYAL, MONTREAL
76 Densley Ave.
TORONTO
2089 W. Fourth Ave.
VANCOUVER
265 Princess St.
WINNIPEG
7221 104th St.
EDMONTON

PUERTO RICO

DIMSIA, INC.
P.O. Box 8582, Fdez, Juncos Sta.
SANTURCE

(Continued)

International Distributors of All Makes
and Types of Coin Operated Equipment

As Is Or Completely Reconditioned

MUSIC AMUSEMENT VENDING

SUTHERLAND DISTRIBUTING CO.

Exclusive Seeburg Dist.

2710 McGee Trafficway, Kansas City, Missouri

HA 1-7466

705 N.W. 4th St., Oklahoma City, Oklahoma 73102

CE 6-3691

226 South Flores St., San Antonio, Texas

CA 6-0305



ACTIVE'S THE CHOICE FOR

THE LOWEST PRICES and BEST EQUIPMENT ALWAYS

Exclusive Gottlieb, Rock-Ola, Fisher and Chicago
Coin Distributor for Eastern Penn-
sylvania, South Jersey and Delaware.
Reconditioned Equipment for Export.

ACTIVE

AMUSEMENT MACHINES CO.

666 N. Broad St., Philadelphia 30, Pa.
POplar 9-4495

1101 Pittston Ave., Scranton 5, Pa.
Write or wire for prices.

You can ALWAYS depend
on **JOE ASH** ALL WAYS

31 years

of honest, dependable service
to the coin machine trade...

...and through the years with

SEEBURG

the industry's finest name!



DISTRIBUTORS FOR

WILLIAMS ☆ BALLY ☆ CHICAGO COIN

ATLAS MUSIC CO.

2231 Fifth Ave.

Pittsburgh, Pennsylvania

Tel. 471-1704

U.S. PHONOGRAPH MANUFACTURERS AND DISTRIBUTORS

SEEBURG

THE SEEBURG CORPORATION
1500 N. Dayton St.
CHICAGO, ILL.

(Distributors)

ARIZONA

STRUVE DISTRIBUTING COMPANY
1900 East McDowell Road
PHOENIX, ARIZONA 85006

CALIFORNIA

STRUVE DISTRIBUTING COMPANY
1403 West Boulevard
LOS ANGELES, CALIFORNIA 90015

ADVANCE AUTOMATIC SALES CO.
1350 Howard Street
SAN FRANCISCO, CALIFORNIA 94103

COLORADO

STRUVE DISTRIBUTING COMPANY, INC.
OF COLORADO
50 Rio Grande Boulevard
DENVER, COLORADO 80023

CONNECTICUT

ATLANTIC CONNECTICUT CORP.
171 Park Avenue
EAST HARTFORD, CONN. 06108

FLORIDA

FLORIDA MUSIC & VENDING CO.
310 Riverside Avenue
JACKSONVILLE, FLORIDA

FLORIDA MUSIC & VENDING CO.
1100 Northwest 163rd Drive
MIAMI, FLORIDA 33169

GEORGIA

G. K. GABRIELSON & CO., INC.
724 Memorial Drive, S. E.
ATLANTA, GEORGIA 30316

SOUTH ATLANTIC DISTRIBUTING CO.
763 Trabert Avenue N.W.
ATLANTA, GEORGIA 30318

ILLINOIS

WORLD WIDE DISTRIBUTORS
2730 West Fullerton
CHICAGO, ILLINOIS 60647

INDIANA

CALDRON DISTRIBUTING CO., INC.
423 North Alabama Street
INDIANAPOLIS, INDIANA 46204

IOWA

PHILIP MOSS AND COMPANY
1420 Locust Street
DES MOINES, IOWA 50309

KANSAS

SUTHERLAND DISTRIBUTING CO. OF
WICHITA
1135 North Washington Street
WICHITA, KANSAS 67214

KENTUCKY

SOUTHERN AUTOMATIC MUSIC CO., INC.
735 South Brook Street
LOUISVILLE, KENTUCKY 40203

LOUISIANA

OPERATORS SALES, INC.
4122 Washington Avenue
NEW ORLEANS, LOUISIANA 70125

MARYLAND

EASTERN DISTRIBUTORS, INC.
1812 Worcester Street
BALTIMORE, MARYLAND 21230

MASSACHUSETTS

W. S. DISTRIBUTING, INC.
126 Lincoln
BRIGHTON, MASSACHUSETTS 02135

MICHIGAN

MARTIN AND SNYDER COMPANY
13200 West Warren
DEARBORN, MICHIGAN 48126

MINNESOTA

LIEBERMAN MUSIC COMPANY
VIKING VENDING, INC.
9549 Penn Avenue South
MINNEAPOLIS, MINNESOTA 55411

MISSOURI

SUTHERLAND DISTRIBUTING CO. OF
JOPLIN
501 Wall Street
JOPLIN, MISSOURI 64801

SUTHERLAND DISTRIBUTING CO., INC.
1920 McGee Trafficway
KANSAS CITY, MISSOURI 64108

L & R DISTRIBUTING, INC.
1901 Delmar Boulevard
ST. LOUIS, MISSOURI 63103

NEBRASKA

PHILIP MOSS AND COMPANY
309 North 16th Street
OMAHA, NEBRASKA 68110

NEW JERSEY

ATLANTIC NEW JERSEY CORP.
730 Division Street
ELIZABETH, NEW JERSEY 07201

NEW YORK

DAVIS DISTRIBUTING CORPORATION
1056 Broadway
ALBANY, NEW YORK 12204

DAVIS DISTRIBUTING CORPORATION
1231 Main Street
BUFFALO, NEW YORK 14209

ATLANTIC NEW YORK CORPORATION
843 Tenth Avenue
NEW YORK, NEW YORK 10019

DAVIS DISTRIBUTING CORPORATION
56 N. Union Street
ROCHESTER, NEW YORK 14604

DAVIS DISTRIBUTING CORPORATION
738 Erie Boulevard, East
SYRACUSE, NEW YORK 13210

NORTH CAROLINA

SOUTHEASTERN VENDING DIST., INC.
1010 South Saunders Street
RALEIGH, NORTH CAROLINA 27603

OHIO

MARTIN AND SNYDER OF OHIO
5091 West 164th Street
CLEVELAND, OHIO 44142

SEE VEND, INC.
457 Neilston Street
COLUMBUS, OHIO 43215

OKLAHOMA

SUTHERLAND DISTRIBUTING CO., INC.
Northwest Fourth & Lee Streets
OKLAHOMA CITY, OKLAHOMA 73102

OREGON

DUNIS DISTRIBUTING COMPANY
1140 Southeast 7th Avenue
PORTLAND, OREGON 97214

PENNSYLVANIA

EASTERN MUSIC SYSTEMS CORP.
EASTERN VENDING DISTRIBUTORS, INC.
334 North Broad Street
PHILADELPHIA, PENNSYLVANIA 19102

ATLAS MUSIC COMPANY
2231 Fifth Avenue
PITTSBURGH, PENNSYLVANIA 15219

SOUTH CAROLINA

SOUTHEASTERN VENDING DIST., INC.
716 Huger Street
COLUMBIA, SOUTH CAROLINA 29201

TENNESSEE

SAMMONS-PENNINGTON COMPANY
440 Monroe Avenue
MEMPHIS, TENNESSEE 38104

SAMMONS-PENNINGTON-NASHVILLE,
INC.
214 Sixth Avenue South
NASHVILLE, TENNESSEE 37203

TEXAS

SUTHERLAND DISTRIBUTING CO., INC.
1343 South Staples
CORPUS CHRISTI, TEXAS 78404

O'CONNOR DISTRIBUTING CO., INC.
9030 Directors Row
DALLAS, TEXAS 75247

SUTHERLAND DISTRIBUTING CO., INC.
3902 Pershing Street
EL PASO, TEXAS 79903

H. A. FRANZ & CO.
606 Dennis
HOUSTON, TEXAS 77006

SUTHERLAND DISTRIBUTING CO., INC.
226 South Flores Street
SAN ANTONIO, TEXAS 78204

UTAH

STRUVE DISTRIBUTING CO., INC.
276 West First Street
SALT LAKE CITY, UTAH 84101

VIRGINIA

SOUTHEASTERN VENDING DIST., INC.
601 Woodis Ave. (P.O. Box 87)
NORFOLK, VIRGINIA 23510

WASHINGTON

MUSIC-VEND DISTRIBUTING CO.
100 Elliott, West
SEATTLE, WASHINGTON 98119

WISCONSIN

S. L. LONDON MUSIC COMPANY, INC.
S. L. LONDON VENDING CO., INC.
3130 W. Lisbon Avenue
MILWAUKEE, WISCONSIN 53208

PUERTO RICO

LONDON DISTRIBUTING CORP.
757 Calle Figueroa, Stop 18 1/2
SANTURCE PUERTO RICO
Mr. Max Groso
Mail: P. O. Box 8471
Fernandez Juncos Station
San Juan, Puerto Rico 00910

(Continued)

In the Tulsa, Oklahoma Area Check First With

TULSA AUTOMATIC MUSIC CO.

(Established in 1952)

739 W. 5th TULSA, OKLAHOMA Phone: LU. 4-4775
HEADQUARTERS FOR ALL TYPES OF USED COIN MACHINES

Write for Complete List of Current Equipment Prices

ASK FOR

R. C. HOGARD, President DALE RORIE, Mgr.

Exclusive Distributors for:

ROCK-OLA MFG. VALLEY SALES CO.
AMERICAN SHUFFLEBOARD BALLY MFG. CO.

LIEBERMAN MUSIC CO.

9549 Penn Ave., South
Minneapolis, Minnesota 55431

Exclusive Factory Distributors

(612) 888-5521

SEEBURG SALES CORP.
D. GOTTLIEB & CO.
FISCHER MFG. CO.
WILLIAMS ELECTRONICS, INC.

VIKING VENDING CO.

9549 Penn Ave., South
Minneapolis, Minnesota 55431

(612) 888-5521

SEEBURG VENDING MACHINES
CONEX CUPS

WESTINGHOUSE CANDI MAT
Full Line Vending Machine Parts

HAROLD N. LIEBERMAN CO.
9549 Penn Ave., South

(612) 888-5521

Exclusive Distributor For
The Following Record Mfrs.:

BANG
BEAR
BHUDDA
CAMEO-PARKWAY
CANTERBURY
DOT
FOUR CORNERS
KAPP
LONDON & GROUP
MGM
MONUMENT
PHILLIES
ROULETTE
SWAN
TOWER
VANGUARD
VERVE

3 ONE-STOPS TO SERVE YOU

ACME MUSIC CO.

Sam Sales

9549 Penn Ave., South
Minneapolis, Minnesota

(612) 888-5521

LIEBERMAN'S ONE-STOP RECORDS—SAM SALES

809 So. 25th St.

Omaha, Nebraska

(402) 341-3056

SUSAN DIST. CO.—

SAM SALES

1410 So. Michigan Ave.

Chicago, Ill.

(312) 922-2517

U.S. PHONOGRAPH MANUFACTURERS & DISTRIBUTORS

WURLITZER

THE WURLITZER CO.

NORTH TONAWANDA, N.Y.

(Distributors)

ARIZONA

VALIANT AMUSEMENT, INC.
3129 East McDowell Road
PHOENIX, ARIZONA 85008

ARKANSAS

GODWIN DISTRIBUTING COMPANY, INC.
2116 West 38th St.
NORTH LITTLE ROCK, ARKANSAS 72118

CALIFORNIA

THE WURLITZER COMPANY
2920 West Pico Blvd.
LOS ANGELES, CALIFORNIA 90006

THE WURLITZER COMPANY
154 South Van Ness Avenue
SAN FRANCISCO, CALIFORNIA 94703

COLORADO

DRACO SALES COMPANY
2005 West Alameda
DENVER, COLORADO 80223

FLORIDA

SOUTHERN MUSIC DISTRIBUTING CO.
INC.
2465 Harper Street
JACKSONVILLE, FLORIDA 32204

SOUTHERN MUSIC DISTRIBUTING CO.
INC.
503 West Central Avenue
ORLANDO, FLORIDA

F.A.B. DISTRIBUTING COMPANY, INC.
3721 Navy Boulevard
PENSACOLA, FLORIDA 32503

GEORGIA

THE WURLITZER COMPANY OF GEORGIA
1761 Tully Circle, N.E.
ATLANTA, GEORGIA 30329

HAWAII

NATIONAL AMUSEMENTS, INC.
3018-A Waialae Avenue
HONOLULU, HAWAII 96816

ILLINOIS

NATIONAL COIN MACHINE EXCHANGE
1411-13 Diversey Boulevard
CHICAGO, ILLINOIS 60614

INDIANA

LEW JONES DISTRIBUTING CO., INC.
1311 North Capitol Avenue
INDIANAPOLIS, INDIANA 46202

KANSAS

UNITED DISTRIBUTORS, INC.
902 West Second Street
WICHITA, KANSAS 67201

KENTUCKY

CO-OPERATIVE DISTRIBUTING COMPANY
221 East Market Street
LOUISVILLE, KENTUCKY 40202

LOUISIANA

THE WURLITZER COMPANY
832 Baronne Street
NEW ORLEANS, LOUISIANA 70113

MARYLAND

STATE SALES AND SERVICE
CORPORATION
1825 Guilford Avenue
BALTIMORE, MARYLAND 21202

MICHIGAN

ANGOTT DISTRIBUTING COMPANY, INC.
2616 Puritan Avenue
DETROIT, MICHIGAN 48238

MINNESOTA

SANDLER DISTRIBUTING COMPANY
236 Girard Avenue North
MINNEAPOLIS, MINNESOTA 55405

MISSOURI

MID-WEST DISTRIBUTORS
709 Linwood Blvd.
KANSAS CITY, MISSOURI

BRANDT DISTRIBUTING COMPANY, INC.
1809-11 Olive Street
ST. LOUIS, MISSOURI 63103

NEBRASKA

CENTRAL DISTRIBUTING COMPANY
1209 Douglas Street
OMAHA 2, NEBRASKA

NEW MEXICO

HARPER'S CONSOLIDATED MUSIC COM-
PANY, INC.
1062 North Seventh Street
LAS CRUCES, NEW MEXICO

NEW YORK

BILOTTA ENTERPRISES, INC.
1226 Broadway
ALBANY 4, NEW YORK

MUSICAL DISTRIBUTORS CORPORATION
2714 Beverly Road
BROOKLYN 25, NEW YORK

STEWART-MILFORD CORPORATION
777 Main Street
BUFFALO, NEW YORK 14203

BILOTTA ENTERPRISES, INC.
224 North Main Street
NEWARK, NEW YORK 14513

MUSICAL DISTRIBUTORS CORPORATION
841 Tenth Avenue
NEW YORK, NEW YORK

NORTH CAROLINA

BRADY DISTRIBUTING COMPANY
1900 West Morehead Street
CHARLOTTE, NORTH CAROLINA 28208

OHIO

ROYAL DISTRIBUTING, INC.
1210 Glendale-Milford Road
CINCINNATI, OHIO 45215

CLEVELAND COIN MACHINE EXCHANGE
INC.
2029 Prospect Avenue
CLEVELAND, OHIO 44115

ROYAL DISTRIBUTING, INC.
1112 N. High Street
COLUMBUS 1, OHIO

CLEVELAND COIN MACHINE EXCHANGE,
INC.
1827 Adams Street
TOLEDO, OHIO

OKLAHOMA

CULP DISTRIBUTING COMPANY
614 West Sheridan Avenue
OKLAHOMA CITY 2, OKLAHOMA

OREGON

NORTHWEST SALES COMPANY OF
OREGON
1040 S. W. Second Avenue
PORTLAND, OREGON 97204

PENNSYLVANIA

MICKEY ANDERSON AMUSEMENT CO.
314 East 11th Street
ERIE, PENNSYLVANIA 16503

BANNER SPECIALTY COMPANY
1213 W. 5th Street
PHILADELPHIA, PENNSYLVANIA 19122

MUSIC DISTRIBUTING COMPANY
1945 Fifth Avenue
PITTSBURGH 19, PENNSYLVANIA

ROTH NOVELTY COMPANY
54 North Pennsylvania Avenue
WILKES-BARRE, PENNSYLVANIA 18701

SOUTH CAROLINA

THE WURLITZER COMPANY OF GEORGIA
2005 State Street
Cayce, South Carolina 29033

TENNESSEE

ROCK CITY DISTRIBUTING CO., INC.
615 Murfreesboro Road
NASHVILLE, TENNESSEE 37210

GODWIN DISTRIBUTING CO., INC.
518 S. Main St.
MEMPHIS, TENNESSEE 38103

TEXAS

COMMERCIAL MUSIC COMPANY, INC.
1550 Edison Street
DALLAS, TEXAS 75207

GULF COAST DISTRIBUTING CO.
6205 Gulf Freeway
HOUSTON, TEXAS 77023

GULF COAST DISTRIBUTING CO.
75 El Paso Street
SAN ANTONIO, TEXAS 78207

WASHINGTON

NORTHWEST SALES COMPANY
3150 Elliott Avenue
SEATTLE, WASHINGTON 98121

WEST VIRGINIA

CRUZE DISTRIBUTING COMPANY, INC.
1101 West Washington Street
CHARLESTON 2, WEST VIRGINIA

WISCONSIN

UNITED, INC.
1907 North Third Street
MILWAUKEE, WISCONSIN 53212

ADD-A-BALL

GOTTLIEB

FLIPPER	\$125.00
FLIPPER PARADE	\$160.00
FLIPPER FAIR	\$160.00
FLIPPER CLOWN	\$175.00
FLIPPER COWBOY	\$195.00
SQUARE HEAD	\$175.00
BIG TOP	\$250.00
MAJORETTE	\$250.00
COWPOKE	\$325.00
FLIPPER POOL	\$375.00
ICE SHOW	\$375.00
HURDY GURDY	\$375.00
SUBWAY	\$395.00
PLEASURE ISLE	\$375.00

CHICAGO COIN

SUN VALLEY	\$175.00
FIRECRACKER	\$150.00
BRONCO	\$175.00
ROYAL FLASH	\$200.00
MUSTANG	\$200.00
HULA HULA	\$375.00

WILLIAMS

SKILL BALL	\$125.00
JOLLY JOKER	\$125.00
FRIENDSHIP 7	\$160.00
VAGABOND	\$175.00
SWINGTIME	\$175.00
PALOOKA	\$225.00
WING DING	\$250.00
SKI CLUB	\$275.00
BOWL A STRIKE	\$350.00
TOP HAND	\$375.00
BIG STRIKE	\$395.00
CASANOVA	\$495.00
MAGIC TOWN	\$445.00

BALLY

HAPPY TOUR	\$175.00
HAY RIDE	\$175.00
TRIO	\$225.00
GOLD RUSH	\$275.00

ALL PRICES QUOTED ARE FOR COMPLETELY SHOPPED EQUIPMENT, F.O.B. CLEVELAND, OHIO.

TERMS: 1/3 DEPOSIT, BALANCE C.O.D. OR SIGHT DRAFT.

EXPORT TERMS: LETTER OF CREDIT THROUGH UNION COMMERCE BANK, 917 EUCLID AVENUE, CLEVELAND, OHIO 44114

IF YOU ARE NOT ON OUR MAILING LIST, SEND US YOUR LETTERHEAD AND WE WILL INCLUDE YOU IN OUR NEXT MAILING.

DIRECT ALL INQUIRIES TO: 2423 PAYNE AVENUE ADDRESS.

MONROE COIN MACHINE EXCHANGE

HOME OFFICE

2423 Payne Avenue
Cleveland, Ohio 44114
Phone: (216) 781-4600

BRANCH OFFICE

844 Hall Avenue
Dayton, Ohio 45404
Phone: (513) 222-4005

M
U
S
I
C
A
L
D
I
S
T.
C
O
R
P.

Offering the most complete package in the amusement line

MUSICAL DISTRIBUTORS CORP.

(FASTEST GROWING DISTRIBUTOR IN THE EAST)

FRANCHISED FACTORY DISTRIBUTORS FOR

WURLITZER CHICAGO COIN UNITED BILLIARDS

EXPERT
RECONDITIONING
ON
PREMISES

Complete 1-Stop Shopping For
NEW AND USED EQUIPMENT

Yes, we have
the sensational
HELICOPTER TRAINER

MUSICAL DIST. CORP.

841 10th Ave. • N.Y., N.Y. JU 6-7782

2714 Beverly Rd. • Bklyn, N.Y. UL 6-7720

DuKane's Grand Prix

A PROVEN
MONEY-MAKER

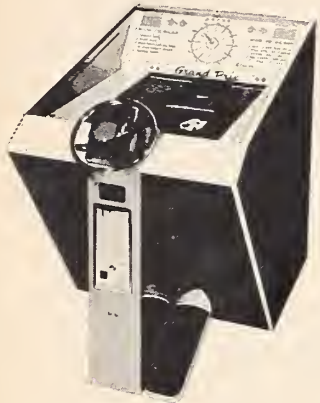

FEATURES:

- ★ 5 month field testing
- ★ 10 cents play—one minute
- ★ Sealed counter
- ★ Standard slot-track car
- ★ Solid state electronics
- ★ Plug-in assemblies
- ★ Complete rear panel removable for access
- ★ Standard 110V. system
- ★ Wood-grain finished sides
- ★ Coin acceptors unit—separately keyed
- ★ Rugged, tamper-proof construction

and



DuKane's TAG-IT

11" wide, 11" deep, 18" high
Pedestal available

Location studies prove machine will pay for itself in one year. Ideal for Discount stores, Drug stores, Arcades, Variety stores and Supermarkets.

WRITE DEPT. CMD-7

GAMES
DIVISION OF DUKANE CORPORATION
St. Charles, Illinois 60174

U.S. Jobbers & Distributors Listed By State

ALABAMA

N. Birmingham
Johnny Rowell Dist. Co., 1631 First Ave.
Birmingham
Birmingham Vending Co., 540 2nd Ave., N.
Jefferson Music Co., 19th & 7th
Southern Amusement Dist., 3606 6th Ave. S.
Montgomery
Franco Distribution Co., P.O. Box 927 or 24 N. Perry St.

ALASKA

Anchorage
M. J. Stanley Co., P.O. Box 256
Fairbanks
Alaska Music Co., Box 1234
Dunis Dist. Co.

ARIZONA

Casa Grande
Pinal Music Co., 1319 N. Pinal Ave.
Phoenix
Amco Leasing, Inc., 2040-B North 16th St.
Copper State Amusements, 921 N. 6th St.
Jim Finnerty, 2051 27th Place
Garrison Sales Co., Inc., 1000 W. Washington
Minthorne Music Co., Inc., P.O. Box 16170
Struve Dis. Co. Inc., 1902 E. McDowell Rd.
Valiant Amuse. Inc., 3129 E. McDowell Rd.
Safford
Gila Elec. & Music Co., 406 Main St.
Tucson
Arizona Amusement & Vending Co., 848 No. 4th Ave.
Falcon Automatic, 727 So. Campbell Ave.
Paul W. Hawkins, Route 7—Box 974-L, 3119 East Pennsylvania

ARKANSAS

Fayetteville
Tri-State Sales Co., 315 Rollston St.
Hope
Arkansas Distributing Co., 316 W. 2nd St.
Little Rock
Little Rock Amusement Co., 105 W. 13th St.
Standard Aut. Dist. Co., 805 Broadway
Godwin Dist. Co., 2116 W. 38th St.
Pine Bluff
Wilcox Amusement Co., 318 W. 2nd St.

CALIFORNIA

Los Angeles
Amco Music & Vending, Inc., 2251 West Pico Blvd.
American Shuffleboard Co. Inc., 1423 S. Western Ave.
Associated Coin Amusement Co., Inc., 1126 E. 14th St.
Badger Sales Co., Inc. 2251 W. Pico Blvd.
Circle International, 2401 S. Hill St.
Coin Machine Service Co., 2809 W. Pico Blvd.
Eastern Novelty Co., 2939 E. 11th St.
Irving Bromberg Co., 8313½ W. 3rd St.
Kings Dist. Co., 2712 West Pico Blvd.
Duarte Int. Sales Co., 835 E. 31st St.
C. A. Robinson & Co., 2301 W. Pico Blvd.
Pacific Coin Machine Dist. 2712 W. Pico Blvd.
Paul A. Laymon, Inc., 1429 W. Pico Blvd.
Simon Dist. Co., 2831-35 W. Pico Blvd.
E. F. Stantone & Co., 2736 W. Pico Blvd.
Struve Dist. Co. Inc., 1403 West Pico Blvd.
The Wurlitzer Co., 2920 W. Pico Blvd.
Weymouth Dist. Co., 2525 W. Pico Blvd.
Fresno
Kings Dist. Co., 1031 Belmont Ave., P.O. Box 4334
Modesto
Patton Music Co., 611 Eye St.
San Francisco
Advance Automatic Sales Co., 1350 Howard St.
Golden Gate Novelty Co., 2293 Mission St.
Huber Dist. Co., 1118 Howard St.
R. F. Jones Co., 240 Shotwell St.
Nobro Novelty Co., 142 Dore St.
Charles I. Perry Co., 15 Harriet St.
The Wurlitzer Co., 154 South Van Ness Ave.
Santa Rosa
Coin Machine Service, Inc., 322 Wilson St.
Sacramento
Valley Dist., 710 12th St.
Turlock
Patton Music Co., 132 So. Center St.
Visalia
Kings Dist. Co., 330 N. Johnson St.
Pacific Coin Machine Dist., 330 N. Johnson St.
Oakland
A.S.S. Co. of No. Calif., 911—53rd Ave.
Associated Coin Amusement Co., Inc., 2230 E. 14th St.

COLORADO

Denver
Draco Sales Co., 2005 W. Alameda Ave.
Diamond Distributing Co., 2830 W. 9th Ave.
Midwest Music Co., 3850 Mariposa St.
Modern Dist. Co., 3222 Tejon St.
Mountain Distributors Co., 3630 Downing St.
Struve Distrib. Co. Inc., 50 Rio Grand Blvd.
Lakewood
McKee Sales Co., 2095 Newcom Dr.

CONNECTICUT

Hartford
General Amusement Game Co., 187 Park St.
East Hartford
Atlantic New York Corp., 171 Park Ave. P.O. Box 806
Runyon Sales Co., 306 Tolland St.
New Britain
PZP Associates Inc., 257 Slater Rd.

FLORIDA

Jacksonville
Bush International, 60 Riverside Ave.
S. L. London Distributing Co. of Jacksonville, 90 Riverside Ave.
Southern Music Dist. Co. Inc., 2465 Harper St.
Eli Ross Distributors, 90 Riverside Ave.
Miami
All coin Amusements Co., 2495 N.W. 77th Terrace
Bush International, 286 N.W. 29th St.
London Dist. Co., 1100 Northwest 163 Dr.
Eli Ross Dist. Inc., 852 N.W. 71st St.
Cesar R. Sandoval & Co., P.O. Box 7305
Orlando
Southern Music Dist. Co. Inc., 503 W. Central Ave.
Pensacola
F.A.B. Dist. Co., Inc., 3721 Navy Blvd.
Tampa
Bush Dist., 1723 West Cypress
Southern Music Co., 2209 E. Broadway

GEORGIA

Atlanta
Friedman Amusement Co., 739 Lambert Dr. N.E.
G. K. Gabrielson & Co. Inc., 724 Memorial Dr. S.E.
Greater Southern Dist. Co., 321 Edgewood Ave., S.E.
National Uni-Pak, 534 Armour Circle
Peach State Music Co., 1040 Blvd. S.E.

(Continued)

NEW SURE-TRACK
MECHANISM WITH
2 5/16" CUE BALL

"CORONET"™



Write for FREE Color
Brochure or Phone
201-228-2700

4 SIZES
AVAILABLE
4 x 8 PRO.
4 1/2 x 9 PRO.
52" x 92"
46" x 78"

NATIONAL
Shuffleboard & Billiard Co.

1275 BLOOMFIELD AVE., FAIRFIELD, N. J. 07006

Facilities now TRIPLED...
note NEW address and
phone number.

(Georgia, continued)

Robinson Dist. Co., 321 Edgewood Ave. S.E.
 South Atlantic Dist. Co., 763 Traybert
 Sparks Specialty Co., 842 N. Highland Ave. N.E.
 Variety Dist. Co., 585 Grant St. S.E.
Macon
 Heath Dist. Co., 655 Second St., P.O. Box 4145
 Peach State Music Co., 624 New St. Rome
 Tri-State Dist. Co., Box 615

HAWAII

Honolulu
 Circle International, 849 Halekauwila St.
 Hawaiian Amusement Ltd., 505 Kamanani St.
 National Amuse., 3018-A Waiialea Ave.
 Playland Coin Machine Co., 239 S. Hotel St.
 Service Games, Inc., 210 Mokaewa St. Wahiawa, Oahu
 Auto. Vend. Mach. Co., P.O. Box 186

IDAHO

Pocatello
 Dan The Music Man, 1229 N. Main St.

ILLINOIS

Belleville
 Taylor Sales Co., 120 & 325 West Main St.
Chicago
 Atlas Music Co., 2122 N. Western Ave.
 Champion Dist. Co., 3451 N. Milwaukee
 Color-Sonics of Illinois, Inc., 2606 West Peterson
 Empire Coin Machine Co., 1012 N. Milwaukee Ave.
 Globe Dist. Co., 2330 N. Western Ave.
 King & Co., 2700 Lake St.
 Merit Industries, 7312 So. Halstead St.
 National Coin Machine Exch., 1411-13 Diversey Boulevard
 O. O. Mallegg Co., 400 West Madison St.
 Purveyor Shuffleboard Co., 4322 N. Western Ave.
 Seeburg International, 1500 N. Dayton St.
 Trans-World Trading Corp., 6445 North Central Ave.
 Western Trails Amuse. Co., 3249 No. Broadway
 World Wide Dist., 2732 West Fullerton Ave.
Moline
 Hallgren Dist Co., 1626 3rd Ave.
Peoria
 American Shuffleboard Sales Co., 101 S. Goodwin St.
Rockford
 Midwest Dist. Co., 208 N. Madison St.

INDIANA

Evansville
 Automatic Amusement Co., 1000 Pennsylvania St.
 Carl J. Speis Co., P. O. Box 3133
 S & S Dist. Co., 1000 Pennsylvania St.
Fort Wayne
 Antoine & Bechtel, 2101 Weisser Park
 Jack Eiser Sales, 820 Shick St.
Indianapolis
 Associated Dist., 150 E. 16th St.
 Calderon Dist. Inc., 423 N. Alabama St.
 Evans Music Co., 1150 Banta Rd.
 Lew Jones Dist. Co., Inc., 1311 North Capital Ave.
 J. & J. Dist., Inc., 1661 W. 16th St.
 Siler Sales Co., 5955 Cooper Rd.
 Southern Automatic Music Co. of Indiana, Box 422

IOWA

Ankeny
 Lamberti Music Co., 605 Walnut St.
Des Moines
 Philip Moss & Co., 1420 Locust St.
 Superior Sales Co., 1337 2nd Ave.
Dubuque
 Dubuque Coin Machine Co., 1456 O'Hagen St.

KANSAS

Manhattan
 Bird Music Co., Inc., Box 290
Wichita
 Southerland Dist. Co. of Wichita, 1135 Washington St.
 United Dist. Inc., 902 W. Second St.

KENTUCKY

Covington
 Donaldson Distributing Co., 329 W. 9th St.
 Lew Jones Dist. Co. Inc., 329 W. 9th St.
Louisville

Automatic Sales Co., Inc., 1012 Barrett
 B. B. Novelty Co. Inc., 715 W. Main St.
 Co-operative Dist. Co., 221 E. Market St.
 Southern Automatic Music Co., Box 834

A SERVICEMAN'S DREAM

MIDWAY'S

Cobra

SHUFFLE ALLEY

**...JUST ANOTHER SHUFFLE ALLEY?
 NOT ON YOUR LIFE!**

**BEFORE YOU BUY...
 COMPARE THESE FEATURES...**

- ★ **6 WAYS TO PLAY**
- ★ **1500 LESS SOLDER CONNECTIONS!**
- ★ **400 LESS SWITCHES!**
- ★ **SCORING REELS—3 TIMES FASTER & QUIETER!**
- ★ **ABSOLUTELY NO PIN SWITCHES!**
- ★ **3 MINUTE CHANGE-OVER OF REBOUND RUBBER!**
- ★ **SHIPMENT PACKED 50 LBS. LIGHTER!**
- ★ **MANY MORE REVOLUTIONARY CHANGES!
 DESIGNED TO CUT OPERATING COSTS!**

MANY OF ABOVE FEATURES APPLY TO SPACE GUN

MIDWAY MANUFACTURING COMPANY
 3750 RIVER ROAD • SCHILLER PARK, ILLINOIS

U.S. Distributors and Jobbers

LISTED BY STATES

NEW HAMPSHIRE

Manchester
Tri-State Amusement Co., Bedford St.

NEW JERSEY

Belleville
Sun-Glo Dist.
113 Heckel Street
Elizabeth
Atlantic N.Y. Corp., 730 Division St.
Seacoast Dists. Inc., 1200 North Ave.
Newark
Irving Morris, Inc., 145 Frelinghuysen Ave.
Phil Gould, 224 Market St.
No. Bergen
Betson Enterprises, 3726 Tonnelles Ave.
Eastern Novelty Distributors, 3726 Tonnelles Ave.
Springfield
Runyon Sales Company, U.S. Route 22 & Fadarm Road
Union City
American Shuffleboard Co. Inc., 210 Patterson Plank Rd.

NEW MEXICO

Albuquerque
Border-Sunshine Nov. Co., 2919 4th St., N.W.
Las Cruces
Consolidated Music Co., Box 86
Roswell
Ginsberg Music Co., 205 No. Main St.

NEW YORK

Albany
Bilotta Enterprises, Inc., 1226 Broadway
Davis Dist. Co., 1056 Broadway
Greco Bros. Amuse. Co. Inc., 1288 B'way Ave.
Universal Vendors, 788 Broadway
Binghamton
Binghamton Amusement Co. Inc., 4 Florence St.
Brooklyn
American Vending Co., 2684 Coney Island Ave.
Herman Dist. Co. Inc., 1505 Coney Island Ave.
Musical Distributors Corporation, 2714 Beverly Road
Buffalo
Clare Enterprises, Inc., 5939 Main St.
Davis Dist. Corp., 1231 Main St.
Sheldon Sales, Dist. Corp., 881 Main St.
Stewart-Milford, 777 Main St.
Superior Distributing, 1395 Clinton St.
Elmira
Joy Automatic, 108 E. Church St.
Glasco
Greco Bros., Box 94
Great Neck
L.I. National Sales, 243 N. Blvd.
Hudson Falls
Henry C. Knoblauch & Sons, 7 Broad St.
Lackawanna
Ace-Hi Dist. Co., 1286 Electric Ave.
Newark
Bilotta Enterprises, 224 N. Main St.
New York
Atlantic New York Corp., 843 Tenth Ave.
R. H. Belam, 51 Madison Avenue
Leonard Haimas Co., Inc., 35 Mercer St.
Lipsky Dist. Corp., 607 Tenth Ave.
Mike Munves Corp., 577 Tenth Ave.
Mondial Comm. Corp., 350 5th Ave.
Musical Distributors Corp., 841 Tenth Ave.
One-Stop Coin, 646 Tenth Ave.
Runyon Sales Co., 593 Tenth Ave.
Seaboard New York Corp., 843-849 Tenth Ave.
Albert Simon, Inc., 587 Tenth Ave.
United East Coast Corp., 583 10th Ave.
West Side Coin Machine Corp., 636 Tenth Avenue
Nyac Slate Co., 112 Railroad Ave.
Rochester
Davis Dist. Corp., 56 No. Union St.
Flower City Dist., Inc., 389 Webster Ave.
Rockville Centre
Active Automatic Sales, 891 Coleridge Rd.
Scotia
Mohawk Skill Games, 67 Swaggetown Road

Syracuse
Advance Vending, 123 Falso
Davis Corp., 738 Erie Blvd., E.
E. M. House Sales, 1051 S. Salina St.
Utica
Victor Conte, 1001 Lansing St.

NEVADA

Las Vegas
Atomic Coin, Box 4321
Reno
Bally Dist. Co., 44 W. Liberty St.

NORTH CAROLINA

Charlotte
Brady Dist. Co., 1900 W. Moorehead St.
LeSturgeon Dist. Co., 3100 S. Tryon St., P.O. Box 641
Roanoke Vending, Franklin 7-1310
The Seeburg Dist. Co., 801 S. Cedar St.
Southeastern Vending Distributing, Inc., 801 S. Cedar St.
Greensboro
National Products Corp., 2416½ High Point Rd.
Raleigh
Bishop Music Co. P.O. Box 2168
Pierce Music Co., 415 East Martin
South Eastern Vend. Dist., Inc., 1010 S. Saunders St.

Reidsville
Trents Record Center, P.O. Box 475

NORTH DAKOTA

Bismarck
Dakota Music Corp., 912 Arthur Dr.

OHIO

Byesville
Vernon Yontz Sales Co., 140 Second St.

Canton
Stark Novelty Co., 239—30th St., N.W.

Cincinnati
Alvend Co., 4003 Hamblen Dr.
Bigner Music, Inc., 2345 Quebec Rd.
Pioneer Vending, 3726 Kessen Ave.
Royal Dist. Inc., 1210 Glendale-Milford Rd.
Shaffer Music Co., 1889 Central Parkway

Cleveland
Cleveland Coin Mach. Exch., 2021-25 Prospect Ave.
Lake City Amusement Co., 4531-4533 Payne Ave.
Martin & Snyder, 5091 W. 164th St.
Monroe Coin Machine Exchange, 2423 Payne Ave.
Shaffer Music Co., 2126 E. 21st St.

Columbus
Royal Dist. Inc., 1112 North High St.
See Vend Inc., 457 Neilstone St.
Shaffer Dist. Co., P.O. Box 160 Station "A"

Dayton
Monroe Coin Machine Exch., 844 Hall Ave.

Medina
Reinhardt Co., 734 E. Smith Rd.

Toledo
Cleveland Coin Ex., 1827 Adams St.
Toledo Coin Machine Exch., 814 Summit St.

Youngstown
J. & M. Novelty Co., 5555 Mahoning Ave.

OKLAHOMA

Oklahoma City
Atkins Music Co., 233 S. W. 20th St.
Automatic Music Dist. 900 N. Western Ave.
Boyle Amusement Co., 522 N.W. Third St.
Culp Dist. Co., 614-16 W. Sheridan Ave.
Dickson Dist. Co., 631 W. California Ave.
Rice Music Co., 611 N. Hudson
Sutherland Distrib. Co., Northwest Fourth & Lee Sts.
Sutherland Dist. Co., 709 N.W. 4th St.
Tulsa
H. W. Dolph Dist. Co., 2239 E. 6th St.
Tulsa Automatic Music Co., 739 West 5th St.
C. and C. Amusement Co., 1511 S. Trenton

OREGON

Portland
Dunis Dist. Co., 1003 S.W. Front Ave.



OUT OF THIS WORLD  Williams®

APOLLO

SINGLE PLAYER
ADJUSTABLE 3-5 BALL PLAY



1. Two, 300 When Lit Lanes, Allow Back Up To The Top Of The Playfield Action.
2. Completing Countdown Lites Center Target To Score 300 Points.
 - A. Hitting Center Target When Lit, Opens "Free Ball" Gate And Increases Scoring Value Of Bottom Targets and Out Lanes.
 - B. Out Lanes Score Special When Lit.
3. Ball Leaving Playfield, With Countdown Completed, Launches Rocket In Back Box To Score 50 Points, 300 Points Or Special.
4. Match Feature.

OPTIONAL —
Single, double or triple chutes
Individual lift-out coin trays

NOW
DELIVERING
ALTAIR
CORONADO
ARTIC GUN



Williams® ELECTRONICS, INC.

3401 NORTH CALIFORNIA AVENUE • CHICAGO, ILLINOIS 60618

CABLE ADDRESS WILCOIN CHICAGO

AVAILABLE FOR IMMEDIATE DELIVERY THROUGH YOUR WILLIAMS DISTRIBUTOR

SERVICE is MORE than a word at

WORLD WIDE ... YOUR ONE-STOP

SUPERMARKET for MUSIC—VENDING—GAMES

WORLD WIDE'S more than a quarter century of export experience is your assurance that you can buy with confidence. Every machine location-proved with our unique "Continuous-Play Testing."

• CLEAN AND COMPLETE • EXPERT REFINISHING • PROTECTIVE PACKING

BALL BOWLERS

CHICAGO COIN

UNITED

17' CORVETTE	\$695	16' AMAZON	\$725
17' PREVIEW	595	16' MAVERICK	625
16' SUPERSONIC	525	13' & 16' OASIS	525
16' TOURNAMENT	425	13' & 16' MATADOR	375
13' & 16' MAJESTIC	395	16' POLARIS	325
13' & 16' CADILLAC	295	16' FUTURA	250

DISTRIBUTORS FOR: SEEBURG • UNITED • WILLIAMS

TERMS: 50% deposit, Bal. Sight Draft or confirmed letter of credit. We carry the most complete line of Phonographs, Games, Arcade and Vending Equipment. Write for Complete List!



WORLD WIDE distributors

2730 WEST FULLERTON AVE., CHICAGO 47, ILL.
EVerglade 4-2300 CABLE: GAMES - CHICAGO

USED BALLY

SLOT MACHINES..... WRITE

Mills Bellomatic—Front End Open, less than two years old, like new \$495.00

Mills Hi Top, very clean, 21 bell \$295.00

Black Beauty, hand load and automatic load, Jack Pot ... \$295.00

Jennings Galaxie, electric automatic, late style \$495.00

Jennings El Dorado \$295.00

Jennings Standard Sun Chief, front load \$195.00

Bally Bingos—Old, free play—Beauties & up, etc. \$95.00

WRITE—WIRE—FOR INFORMATION

BALLY DISTRIBUTING CO.

P.O. Box 7457 44 West Liberty St.
Reno, Nevada Tel: 702-323-6157

ARCADES

ARE PROFITABLE

Munves Can Give You Complete Installation

Of

**ARCADE
BILLIARD ROOMS
GROUP GAMES**

Write For Arcade Catalogue
Parts & Supplies For All
Billiard—Amusement Machines

MIKE MUNVES CORP.

577 Tenth Ave., New York 36, N.Y.
BRyant 9-6677

Contact The Greatest... **THE GRECO BROS.**

★ For ALL Of Your ★
Domestic and Export Needs

Any Machine That Operates

With A Coin — We Got.

If We Don't — We'll Get It!

Season's Greetings

GRECO BROS. AMUSEMENT CO.

MAIN STREET, GLASCO, N.Y.
CHerry 6-8700

1288 BROADWAY, ALBANY, N.Y.
HO 5-0228

U.S. Distributors & Jobbers

Listed by State

Northwest Sales Co. of Oregon, 1040 S.W. 2nd Ave.
Western Dist., 1226 S.W. 16 Ave.

PENNSYLVANIA

Erie
Mickey Anderson, 314 E. 11th St.
Harrisburg
D & L Coin Mach. Co., 414 Kelker St.
Moosic
Sterling Service, Rocky Glen Park
Philadelphia
Active Amusement Machine Co., 666 N. Broad St.
American Shuffleboard Sales Co., 1511-13 Spring Garden Ave.
Banner Specialty Co., 1641 N. Broad St.
Block Marble Co., 2929 W. Cheltenham Ave.
Central Vend. Mach. Ser. Co. 6011 Baltimore
James Clement Mfg. Co., 3301 Frankford Ave.
Eastern Music Systems Corp., 334 N. Broad St.
General Coin Machine Co., 929 Spring Garden St.
International Amusement Co., 3810 Dorchester Rd.
Lehigh Special Co., 826 N. Broad St.
Model Vending, 4830 No. Front St.
Rake Coin Machine Exch., 609 Spring Garden St.
David Rosen, 2451 N. 56th St.
Scott-Crosse Co., 1732-42 Fairmont Ave.
S & K Dist. Co., 3608 Powelton Ave.
Steppin' Sam Co., 1439 Higbee St.
Veeco Sales Co., 2125 Market St.
Pittsburgh
Atlas Music Co., 2231 Fifth Ave.
Banner Specialty Co., 1508 Fifth Ave.
B. D. Lazar Co., 1635 Fifth Ave.
Music Dist. Co., 1945 Fifth Ave.
Oak Sales Co., 2033 Fifth Ave.
Pittsburgh Coin Machine Exch., 2203 Fifth Ave.
RayCar, Inc., 7812-14 Hamilton Ave.
Reading
Klopp Novelty Co., 312 No. 9th St.
Scranton
Active Amuse. Machines Co., 1101 Pittston Ave.
Leonard's Novelty Co., 1317 Prospect Ave.
Wilkes-Barre
Roth Novelty Co., 54 N. Pennsylvania Ave.
Williamsport
Williamsport Electronics and Television Co., 233-35 W. Third St.
York
Crosse Dunham Co., 350 Greendale Rd.

SOUTH CAROLINA

Columbia
G. K. Gabrielson & Co., 2608 Main St.
Peach State Music Co., 729 Lady St.
So. Eastern Vend. Dist. Corp., 1506 Taylor St.
Sparks Specialty Co., 1820 Sumter St.

SOUTH DAKOTA

Pierre
Gordon Stout, Co., Box 4

TENNESSEE

Chattanooga
Chattanooga C. M. Co., 1820 Rossville Ave.
Dixie Amusement Co., 912 Houston St.
Shearer Amusement Co., 11 West Peak
Knoxville
Central C.M. Exchange, 2422 North Central
Roanoke Vend. Exch. Inc., 313 W. Depot Ave. N.W.
Triangle Music Co., 206 W. Magnolia
Memphis
Consolidated Amuse. Co., 1269 Madison Ave.
Game Sales Co. Inc., 262 South Camilla
S&M Sales Co. Inc., 462 N. 2nd St.
Sammons Pennington Co., 440 Monroe Ave.
Southern Amusement Dist., 628 Madison Ave.

Standard Aut. Dist. Co. Inc., 1269 Madison Ave.
Williams Dist. Co., 1117 Union Ave.
Nashville
H. & N. Dist. Co., 313 Seventh Ave. So.
Hermitage Music Co., 469 Chestnut Parker Dist. Co., Box 1281
Rock City Dist. Co. Inc., 615 Murfreesboro Rd.
Sammons-Pennington-Nashville, Inc., 214 Sixth Ave. South
Sanders Dist. Co., 612 Eighth Ave. S.
T. W. Amusement Co., 3104 Clarksville H'way
Triangle Music Co., 206 W. Magnolia

TEXAS

Corpus Christi
Southland Dist. Co., 1343 Staples
Dallas
A's Vending, 2910 Commerce
Southland Dist. Co., 1405 Turtle Creek Blvd.
Commercial Music Co., 1550 Edison St.
O'Connor Co. Inc., 9030 Directors Row
Southern Vending Co., 1405 Turtle Creek Blvd.
State Music Co., 3100 Main St.
El Paso
Sutherland Dist. Co., 3904 Pershing
Fort Worth
Fort Worth Amusement Co., 309 Ellison Bldg., 103 Main St.
Sun Refinishing Co., 201 E. Daggett
Houston
American Shuffleboard Sales Co., 254 W. Gray
Amusement Distributors, Inc., 1615 St. Emanuel St.
Central Sales, 91 Dennis
H. A. Franz & Co., 606 Dennis
Gulf Coast Distributing Co., 6205 Gulf Freeway, Houston, Texas
H & H Dist. Co., 3016 Polk St.
Southern Vending Company, 1 Main St., Room 376
Steele Dist. Co. Inc., 2617 Leeland
R. Warncke Co., 3445 Leeland Ave.
Bill Williams Distributing Co., 91 Dennis St.
Mineral Wells
Wallace Dist. Co., P.O. Box 75
Odessa
Sheffield Music Co., 1401 Maple St.
San Antonio
A's Vending, 913 S. St. Mary's
Gulf Coast Dist. Co., 75 El Paso
Sutherland Dist. Co., 226 So. Flores St.
Santone Sales Co., 121 Navarro St.
R. Warncke Co., 121 Navarro St.

UTAH

Salt Lake City
Dan Stewart Co., 140 E. Second South Ave.
Diamond Dist. Co., 375 South Second West
Interstate Dists. 917 So. State St.
R. F. Jones Co., 375 So. 2nd West
P. D. Struve, Struve Dist. Co, 276 West First St.
Thompson Dist. Co., 127 E. Second South

VIRGINIA

Bristol
Roanoke Vend. Exch. Inc., 63 Commonwealth Ave.
Norfolk
Diamond Coin Machine Exch. Inc., 609 Woodis Ave.
O'Connor Dist. Inc., 1611 Virginia Beach Blvd.
Southeastern Dist. Inc., 601 Woodis Ave. (P.O. Box 87)
Portsmouth
O'Connor Vending Machine Co., 624 Crawford St.
J. A. Woodard Co., 13 Oakcrest St.
Richmond
Allen Dist. Co., 3409 West Leigh St.
O'Connor Vending Machine Co., 2318 W. Main St.
Roanoke Vend. Exch. Inc., 4930 W. Broad St.

(Continued)

U.S. Distributors & Jobbers Listed by States

WEST VIRGINIA

Charleston
Cruze Dist. Co. Inc., 1101 W. Wash-
ington St.
Roanoke Vending Ex. Inc., 625 Ohio
Ave.
Fairmont
Mid-State Dist., 1909 Locust Ave.
Martinsburg
Hutzler Vend. Mach. Co., 1301 Win-
chester Ave.
Oak Hill
Allied Sales, Inc., 928-930 Market St.
Tri-State Amusement, 149 18th St.,
Rear
Wallace & Wallace Music, Inc., 401
Jones Ave.
Wheeling
Allan Sales, Inc., 928-930 Market St.
Tri-State Amusement, 149 18th St.,
Rear
Wheeling Coin Machine Exch., 2829
Loff St.

WISCONSIN

Beloit
Dan Savage Nov. Co., 628 Third St.
Green Bay
Bookmeier Sales Co., 148 No. Chestnut
St.
Feel Coin Mach. Exch., 245 Summit
St.
Forst Dist. Co., 201 So. B'way
H & L Sales Co., 1337 Velp Ave.
Union Sales Co., 409 N. Adams St.
Lake Geneva
H & M Sales Co., Box 414
Milwaukee
Badger Novelty Co. Inc., 3957 N. 35th
St.
General Novelty Co., 519 N. 16th St.
Hastings Dist. Co., 6100 W. Blue-
mound Rd.
Mitchell Novelty Co., 3506 W. Na-
tional Ave.
Paper Dist. Co., 3601 W. Fond du lac.
Pioneer Sales & Service, 3110 W.
Fond du lac Ave.
Summerfield Inc., 2736 W. Tutonia
S. L. London Music Co. Inc., 3130 W.
Lisbon Ave.
United Inc., 1907 North 3rd St.
Sheboygan
Anthony Hirt, 2420 No. 8th St.

GUAM

Agana
Austin Shelton Music Co., Agana

PUERTO RICO

San Juan
London Dist. Co., P.O. Box 8471
C. Hermanez
1816 Loiza St.
Santurce, P.R.

CANADA

Ontario
Lewis Music Sales Ltd., 361 Main E.,
Hawkesbury
Quebec
Jos. Lipari Dist. Inc., 7111 St. Denis
St., Montreal
Vancouver
Western Atom. Vending Ltd. 499
Commercial Dr.
St. John's,
Newfoundland
Gus Winter Limited, Portugal Cove
Road
Gilchrist Vending Ltd.
Edmonton, Alberta
Montreal, Quebec
Vancouver, B.C.
Toronto, Ontario
Winnipeg, Manitoba

WASHINGTON

Bellvue
N. J. Stanley Co., 309 112th St. NE.
Mercer
Michael J. Stanley Co., 7600 S.E. 24th
Ave. POB 177
Seattle
Acme Amusement Co., Inc., 211 Sec-
ond Ave.
American Shuf. Sales Co. of Seattle,
3144 Elliott Ave.
R. F. Jones Co., 309 9th Ave. North

Michael Dist. Co., 100 Elliott, W.
Music-Vend Dist. Co., 100 Elliott,
West.
Northwest Sales Co., 3150 Elliott Ave.
Puget Sound Novelty Co., 114 Elliott
Ave. W.
Western Dists., 3126 Elliott Ave.
Spokane
Western Dists. Inc., 1007 W. Wash. St.

**JOBBER AND
DISTRIBUTORS
LIST BEGINS
ON PAGE 57**

NATIONAL COIN

Authorized Wurlitzer Distributor

Exporting to all parts of the world
for a quarter of a century!
All Types Coin-Operated Equipment
New and Used.

Completely Reconditioned

GOTTLIEB 5-BALL PIN GAMES
PHONOGRAPHS—all makes and models
KIDDIE RIDES • BOWLERS, etc.

Send for literature and price list

NATIONAL COIN MACHINE EXCH.
1411-13 Diversy, Chicago 14, Ill., U.S.A.
Phone: BUckingham 1-8211

CABLE: "NATCOINCO"—CHICAGO

DYNAMIC DYNABALL!

A special thanks to
you that we are still
the fastest growing
parts supplier for dis-
tributors on all coin
machine and billiard
supplies on the world.



MOSCONI

So that we always are the best we have
added to our sales staff the world's
greatest billiard player—the one and
only Willie Mosconi—who has a com-
plete line of billiard accessories.

DISTRIBUTORS WRITE TODAY FOR YOUR
COMPLETE SET OF CATALOGS. INTERNA-
TIONAL DISTRIBUTORS INVITED.

DYNABALL COMPANY

8040 RIDGEWAY AVE., SKOKIE, ILL.
677-0773 549-5100

CONGRATULATIONS CASH BOX

A Magazine With
Faith In The Future
Of Our Trade

MAR-TAB VENDING

Pres. Sol Tabb
Miami, Florida

**SACRIFICING!
17 COLORAMA
AUDIO-VISUAL JUKE BOX THEATRE
LOW, ROCKBOTTOM PRICE
INCLUDING
40 THRILLING
FEATURE FILMS / \$1250⁰⁰
CALL - WIRE - or WRITE
LARRY KAGHAN
COLOR-SONICS OF ILLINOIS, INC.
2606 W. Peterson, Chicago, Illinois 60645 Phone: (312) RO. 4-5025**

CHICAGO COIN . . . Diversified Mfgr. of Coin - Operated Amusement Games

**NOW
IN
PRODUCTION**

4-Player

**CRISS CROSS
SKI-BALL**

2 GAMES IN ONE!

6-Player

**RIVIERA
PUCK BOWLER**

6-Player

**VEGAS
17' BALL BOWLER**

WILD WEST RIFLE GALLERY
Acclaimed Best Gun of the Year!

2-Player

BULLSEYE BASEBALL

2-Player

BEATNIKS

4-Player

FESTIVAL

Complete Line of
1, 2 and 4-Player PIN GAMES

Mrs.
of
PROVEN
PROFIT MAKERS
Since
1931

CHICAGO COIN MACHINE DIV.

CHICAGO DYNAMIC INDUSTRIES, INC.

1725 W. DIVERSEY BLVD., CHICAGO, ILLINOIS 60614

We Extend to

"CASH BOX"

Our very sincere congratulations on
your 25th Anniversary

We of the Westchester Operators Guild are very proud and happy
to have Cash Box as our friend.

Our Best Wishes For Your Continued Success.

Westchester Operators Guild Inc.

125 NORTH MAIN STREET
PORT CHESTER, NEW YORK

Sincerest Congratulations

on your 25th Anniversary

PHONOGRAPH SERVICE CORP.

2436 N. CICERO AVE., CHICAGO 39, ILL.
TEL: NA-2-4100

CONGRATULATIONS

to

CASH BOX

on its

25th Anniversary

Thanks for all your achievements
in behalf of the Coin-Machine Operators

Amalgamated Machine Operators Ass'n.

8163 N.E. 2nd Ave. • Miami, Fla.
James I. Mullins, Pres.

Happy Anniversary

Sincerest and Best Wishes

to

CASH BOX

On It's 25th Anniversary

MUSIC OPERATORS of NEW YORK, Inc.

NEW YORK, N. Y.

AL DENVER, Pres.

SINCEREST BEST WISHES TO

CASH BOX

on its 25th Anniversary

ILLINOIS COIN MACHINE OPERATORS ASSN.

2436 NO. CICERO AVE., CHICAGO, ILL. 60639

COIN-MACHINE INDUSTRY

July 1966 June 1967
YEAR IN REVIEW



JULY

134 companies prepared for NAMA's 30th Annual Convention. ★ An anti-corrosion spray for vendors was developed by the Rocket Chemical Corp. ★ NAMA was given the Nolan Award for Public Health Service. ★ The Treasury Dept. resumed regular yearly dating, indicating the coin shortage was finally over. ★ New Jersey saw bootlegging of contraband cigarettes as a result of the cigarette tax. ★ Conn. and Jersey NAMA Councils elected officers and directors. ★ Empire's, Robbins proposed O. J. T. to relieve mechanic shortage. ★ N. Y. Supreme Court upheld Buffalo vending laws. ★ Louis

Nicastro was appointed Seeburg president. ★ H. Blotner was appointed chairman of the 30th NAMA Convention. ★ Hank Leyser accepted distributorship of Color-Sonics Audio-Visual for California. ★ Dynaball opened a Chicago branch. ★ H. La Foille passed away at age 54. ★ Tom Buckley wrote pin game article, "Mother is a Pinball Machine" for Esquire Mag. ★ Snodgrass and Montooth were appointed MOA district chairmen. ★ United Billiards added second plant in Newark. ★ Wagner Van Vlack was elected president of the Vendo Co.

AUGUST

Gov. Rockefeller killed New York State pingame license bill. ★ NAMA kicked off 30th Anniversary membership drive. ★ Robert Dunlap, Seeburg V. P., passed away in London at age 54. ★ Patterson International introduced "Emadis" postcard vendor. ★ Briton's House of Commons vetoed fruit machine licensing bill by a vote of 178-119. ★ Rock-Ola premiered Coronado and GP-160 compact phonos.

★ Rowe appointed Rowell distributors for Alabama. ★ Rock-Ola displayed vending products at Belgian coin show. ★ Midway appointed Art Rapacz treasurer. ★ Bally revealed "Campus Queen" pinball. ★ ChiCoin released "Kicker." ★ Electric stamp unit was released by Scribe. ★ Gottlieb released "Crosstown". ★ Fred Pliner appointed field/sales representative at Williams.

SEPTEMBER

Rowe released its Music Merchant phonograph. ★ Midway Mfg. introduced "Captain Kid" gun game. ★ United released "Aztec" big ball bowler. ★ House Judiciary Committee offered royalty proposal to the MOA. ★ Color-Sonics held national open house for model 2600 audio-visual unit. ★ Seeburg introduced "Stereo Showcase" phono graph. ★ Seeburg's sales skyrocketed by seven million. ★

George Arneson was elected to presidency of Vendo. ★ Williams released "Hot Line". ★ MOA's hospitalization plan was introduced. ★ Patterson International appointed Milne Denny as exec. VP and director. ★ Missouri Supreme Court cleared Vendo on trade secrets case. ★ House Judiciary Committee appointed general revision of copyright laws HR 4347.

OCTOBER

Bally introduced "Loop-the-Loop". ★ United revealed "Encore". ★ Bill Adair was elected president of Seeburg Sales Corp. ★ Model Vending changed name to "Changebank." ★ Coin Acceptors appointed D. D. Landahl head of advertising. ★ Chicago Dynamics appointed Ross Scheer Dir. of field/customer relations. ★ Acute shortage of 50¢ pieces was noted. ★ Seeburg named George Gilbert as international chief. ★ ChiCoin released "Super Scope" game. ★ Gottlieb announced "Subway" game. ★ Bill Adair promoted operators on two for a quarter play a good way to offset rising costs. ★ Kaye Co. announced

"Junior IV" table. ★ Fred Granger announced that the MOA convention was the best ever, 2500 delegates attended, with 311 new members signing up. ★ 1967 roster of MOA officials announced, James Tolisano, pres., John Wallace, chairman of the board, Bill Cannon, sec., Howard Ellis, treasurer, and John Trucano, sgt.-at-arms. ★ Jupiter Corp. launched French juke in USA. ★ 11,000 attended NAMA's 1966 Exposition. ★ Gottlieb released "Dancing Lady". ★ Color-Sonics announced "Combo 150". ★ Fun Cruise and "Bazaar" was released by Bally. ★ NCMOA president announced new officers and directors.

COIN-MACHINE INDUSTRY

July 1966 June 1967
YEAR IN REVIEW



NOVEMBER

NAMA review claimed 3.8 billion in goods sold thru vendors in 1965. ★ James McGuire was named NAMA president. ★ ICMOA elected new officers. ★ Sol Mollengarden was appointed regional supervisor for All-Tech. ★ Al Denver was re-elected

president of MONY. ★ Color-Sonics named H. Schwartz to top post. ★ Coffee vendor "Jet" was introduced by Seeburg. ★ John O'Hea was named V-P of Rudd-Melikian. ★ Annual amusement trade exhibition was held at the Alexandra Palace.

DECEMBER

Jack Gordon was elected Scorpitone president. ★ Williams released "Casanova". ★ Music operators of Virginia celebrated their 8th. year. ★ Coin snooker table was premiered by U. S. Billiards. ★ National Coin Carwash Council formed its executive committee. ★ Fire devastated the building housing J. F. Frantz Mfg. Co. ★ Singleton said no ATE will be held in 1967, will revert to old schedule. ★ Great Britain decided to switch to the decimal system in grading its coinage. ★ South Carolina's Supreme Court pool table decision was re-

vealed. ★ Bob Richards was elected chief of NCA. ★ ARA announced two new wall box Consolettes. ★ Fred Walters was named General Sales Mgr. for Philly American Shuffle-school in Houston. ★ E. H. Ide was appointed west coast sales representative of U. S. Billiards. ★ Wurlitzer held first American factory service school in Houston. ★ E. H. IDE was named V-P for Central Division of Interstate United. ★ Max Jaeger was appointed president of Automatique. ★ Rowe AMI's "PLAY-ME" promotion took root.

JANUARY

Bureau of the Census reported \$200 million worth of vending machines were shipped in 1965. ★ Chi-Coin released "Festival" 4-player game. ★ Nat Solow resigned as head of Eastern Music Systems. ★ Gottlieb opened the new year with "King of Diamonds" pin. ★ 1967 March of Dimes got underway for coinbiz. ★ Rowe released new coffee brewing vendor model 212. ★ Nathan Hockman was named Wurlitzer N. E. sales mgr. ★ Midway released "Fun Ball" baseball game. ★ The MOA legislative committee met to outline strategy for their fight against Section 116 in Wash., D. C. ★ Leo Pacanowski was appointed assistant credit head at Wurlitzer. ★ National Vendors created a new distributorship in Canada. ★ Chicago Coin unveiled its

"Park Lane" 6-player shuffle game. ★ Williams presented "Magic City" to the industry. ★ Jack Rose staged AECOM show. ★ Seeburg revealed their sales were up \$11 million. ★ Long time coin machine associate Barney Ross, died of cancer at his Lake Shore Dr. home. ★ Frank Finneran was appointed V-P Vending Div. of Seeburg Corp. ★ Bert Jacob was appointed sales representative of Canada for Wurlitzer. ★ The Commerce and Industry Asso. of N. Y. offered a new management service to trade asso. ★ McCormick Place was destroyed by fire. ★ N. J. Vending Operators won a 6-month tax stay. ★ Rock-Ola presented their 100 selection, "Concerto" phono. ★ Williams released "Artic Gun" game. ★ Teddy Blatt was named UJA honor guest.

FEBRUARY

Losses suffered by vending operators thru theft of cash and products, totaled \$241,610 during previous 12 month period, according to a national survey released. ★ Colorado vending operators organized NAMA state council. ★ The NAECOME trade exhibition was held in London. ★ R. H. Belam was named export sales agent for U. S. Coin-a-Copy photocopy machine. ★ David Smith, president of NCCOA called for combined effort to help North Carolina Operators. ★ Bally unveiled "Capersville" pin. ★ MOA announced a new program of greater cooperation and membership in the asso. for onestops. ★ Phonographs mfgs. mailed operator's questionnaire for economic survey by Price

Waterhouse. ★ AMF created a new vending div. offering three new water filters for vending machines. ★ N. Y. State Supreme Court heard the sales tax case between Bathrick and the State Attorney's office. ★ Canteen Corp. reported first quarter earnings up \$8 million. ★ NAMA reported its membership up 23% since 1964. ★ Color-Sonics signed contract for exclusive American rights to NSM's juke box record mechanism. ★ Chicago Coin released "Beatniks" 2-player. ★ Gene Daddis resigned his post at American Shuffle and took up a similar position with United Billiards. ★ Williams released "Magic Town".

Thank you for your continued support . . .



New York State Coin Machine Association Inc.

Millie McCarthy, Pres.
Mac Douglas, Treas.
Jack LaHarte
HURLEYVILLE, NEW YORK

IMPORTERS

ATTENTION!

For Best Prices
Coin-Operated
Equipment

Contact:
PURVEYOR DIST. CO.

4322 N. Western Ave., Chicago, Ill.
PHONE: JUniper 8-1814

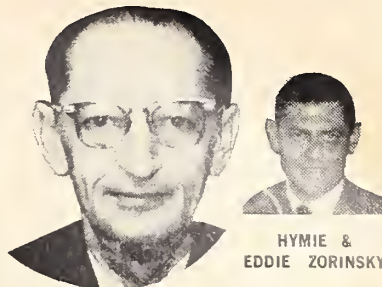

HYMIE & EDDIE ZORINSKY

Representing:

**ROCK-OLA
GOTTLIEB
CHICAGO COIN
FISCHER**

WRITE—WIRE—or CALL

Phone: 341-1121

H.Z. Vending & Sales Company

1201-03-05-07 Douglas St.
Omaha, Nebr. Ph. 341-1121

When It Comes To Reconditioned Equipment
Operators always come to

LIPSKY DISTRIBUTORS CORP.

607 Tenth Ave., New York, N.Y. • (212) LO 3-4028

Exclusive New York distributor for Jupiter Phonographs and All-Tech Pool Tables.
All types of New and Used PHONOGRAPHS, POOL TABLES, CIGARETTE, CANDY and SODA Machines.

Get Ready For Fantastic Profits With THE FABULOUS AMI PHONOVUE

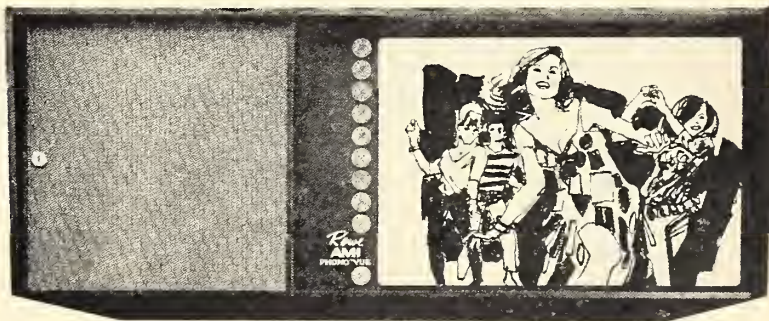

it's here . . . Audio Visual Entertainment
Every Operator Can Afford!

A Companion Piece For
**ROWE AMI
MUSIC MERCHANT**
An Unbeatable Combination



TRIMOUNT AUTOMATIC SALES CO.

40 Waltham St., Boston, Mass., 02118 Tel. 542-9480
Cable: TricoIn, Boston

Now Delivering
100 mm.

CIGARETTE VENDERS

BANNER

Specialty Company

1213-31 N. 5th St.
Philadelphia, Pa.
(215) 236-5000

1508 Fifth Ave.
Pittsburgh, Pa.
(412) 471-1373

EXHIBIT'S X500 TWIN 2¢ CARD VENDERS

PROVEN PROFIT PRODUCERS
(For Counter or Stand)

1500 FREE CARDS included with
purchase of every X500 Card Vender.
Write for complete details.

THE EXHIBIT SUPPLY CO.

4719 W. LAKE ST.
CHICAGO, ILL. 60644

PHONE ES 8-9070 ES 8-9071
AREA CODE 312

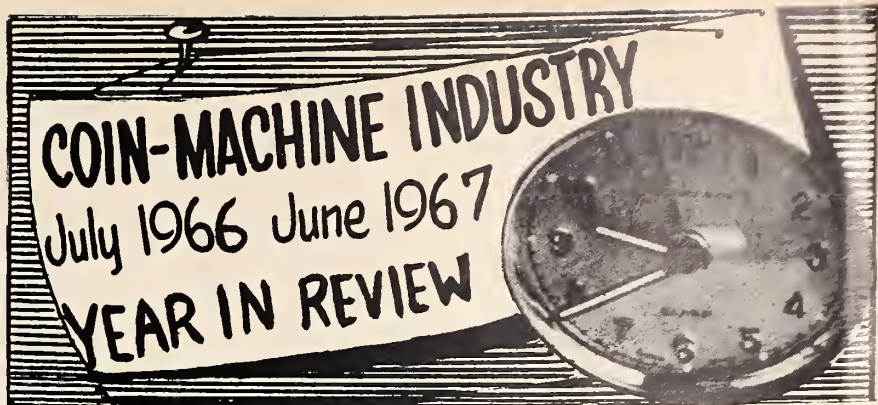

FOR THE BEST IN MUSIC AND GAMES

IT'S

STRUVE

STRUVE DISTRIBUTING CO.

1403 W. PICO BLVD.

LOS ANGELES, CALIFORNIA

Phone 213-748-8641

SOCCER is now BIG TIME!

Follow the lead of CBS—Cash in on big profits—Here is the newest amusement game in America that is spreading like WILDFIRE—it's moving so fast that we need agents and distributors all over the U.S. We need you to sell

KICK-IT

Table Soccer Game

The new 1968 design — completely mechanical with telescoping rods and Heath Mechanism.

List price \$295.00
FOB, New Britain, Conn.

PZP Associates, Inc.
257 Slater Rd., New Britain, Conn. 06053
Tel.: 203-223-6578

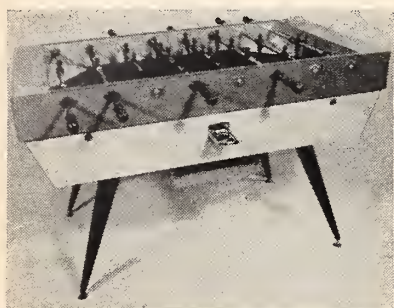

Congratulations to Cash Box
on its help to all in our industry

COIN-OPERATED INDUSTRIES OF NEBRASKA

(Formerly Music Guild of Nebraska)

1208 FARNAM STREET

OMAHA, NEBRASKA

TERRIFIC OFFER!

6 SCORPITONE

AUDIO VISUAL MACHINES

Like new — complete and ready
to go on location \$2500.00

WRITE WIRE CALL

JOEL KLEIMAN SAM COOPER
PIONEER SALES & SERVICE, INC.

3110 W. Fond Du Lac, Milwaukee, Wisc. 414-HI 5-9340

BEST WISHES

To

CASH BOX

ON YOUR 25th ANNIVERSARY

HASTINGS DISTRIBUTING COMPANY, INC.

(Since 1932)

6100 W. BLUEMOUND ROAD, MILWAUKEE 13, WISCONSIN

MARCH

Chi-Coin introduced "Vegas" bowling game. ★ Taran Enterprises signed an exclusive contract for Jupiter Juke distribution. ★ PhonoVue production got in full swing as AMI geared for heavy operator demand. ★ Bally returned to the vending business, with Dave Howle in the drivers seat. ★ NAMA released its annual vending income survey. ★ MOA board met in Washington for the Jukebox Royalty Bill. ★ Ewald Fischer presented a new administration and service building to the Boy Scouts of America. ★ Williams introduced "Altair" 6-player shuffle game. ★ John "Tac" Elms celebrated his 35th year

in the coin machine business. ★ Illinois State Legislators began pressing for passage of a bill that would ban all pin ball machines. ★ Appellate Div. of the N. Y. State Supreme Court overturned a decision of the State Supreme Court, and ruled jukebox receipts not taxable under Article 28 of the state sales tax law. ★ MOA testified before the Senate. ★ Small Business Administration published vending manual, describing how to start and manage a small vending firm. ★ Robert Nims testified for NSBA at the Senate Copyright Hearings.

APRIL

Chicago Coin released "Bullseye" 2-player baseball game. ★ Williams introduced "Shangri-La" to the industry. ★ Fred Granger announced the show committee rosters for 1967 MOA convention. ★ NAMA dispensed 103,000 "Alert" decals for cigarette machines. ★ Midway introduced new "Cobra" shuffle game. ★ The Ill. Senate Legislative Committee passed out Bill S376, tailored to outlaw all pingames as gambling devices. ★ Chicago Coin named Empire Dist. Co. as Ill. distributor. ★ The House Rules Committee met to consider debate on HR 2512, which included Section 116. ★ The House Rules Committee adapted the revised Section 116 by a voice vote. They then voted on the entire bill, passing it by a vote of 379 to 29. ★ United Billiards added model 55, rebound pool table, to their line of coin operated pool tables. ★ Rock-Ola introduced three new cold can vendors to the trade. ★ ICMOA retained prominent law firm to meet

anti-pinball bill. ★ Chicago truck transportation was crippled when a strike-lockout occurred in the windy City. ★ Coffee-Mat Corp. made application for listing its common shares on the American Stock Exchange. ★ MOA membership drive reached 250. ★ Mondial revealed plans to market shoeshine machine. ★ AMF entered coin machine game field with "American Speedway." ★ United Billiards celebrated its first anniversary as a coin operated pool table mfg. ★ Fischer displayed new "Empress" pool table. ★ America's new "Shuffle 88" was bowed at MOA convention. ★ NAMA issued booklet on labor negotiations. ★ Rudd-Melikian opened a warehouse in Atlanta. ★ "Big Strike" was released by Williams. ★ "Imperial" was introduced by ChiCoin. ★ Wurlitzer Co. introduced the "Americana" phonograph series. ★ Walter Kovalik was appointed head of Seeburg's Chicago Div.

MAY

Attorneys, King-Winning-Burditt presented substitute pin bill to the Illinois House. ★ Scorpitone Corp. became Theatre 16 Int'l. ★ Illinois Vending Council re-elected Matthew Cockrell as president. ★ Attorney Nick Allen presented MOA's opposition to Section 117 to the Senate Judiciary Committee. ★ The Stroud Jordan Award was presented to Jay Musser. ★ Chicago Coin presented "Wild West" gun game. ★ Willie

Mosconi joined the Dynaball staff. ★ The second Illinois pin game hearing was set for May 17th. ★ Substitute section in HB2410 to allow flippers, was announced. ★ Bally began construction of a new engineering addition. ★ President Johnson named a panel to study silver pricing and coinage. ★ Valco bought out Seeburg's Kay Div. ★ NCAWA-NCCC merged to form a stronger organization.

JUNE

Kaye named Bally Dist. Nevada distributors of their pool tables. ★ Millie McCarthy entered Horton Memorial Hospital. ★ Radio station WINS issued an editorial on "cigarette smuggling." ★ Midway released "Space Gun." ★ N.Y. Attorney General Appeal Application was denied by the Appellate. ★ Gottlieb unveiled "Hi-Score" 4-player. ★ Texas Senate allows tavern curfew extension. ★ Seeburg selected a new Canadian distrib. for their machines. ★

Rock-Ola appoints Advance Auto. exclusive distrib. for music and vending in Southern Calif. ★ Rowe named Peach State as distributors in North Carolina. ★ D. O. Thoms was elected president of MAMA. ★ Alabama operators form organization and joins NAMA. ★ Cigarettes prices rise. ★ U.S. silver prices faced a threat. ★ Bally introduced "Rocket 111" to the trade. ★ New York UJA victory dinner held at NY Statler Hilton. ★ New York UJA fund amounts to \$46,850.

COIN MACHINE PARTS & SUPPLIES

ABBOTT COIN COUNTER CO.
P.O. Box 1341
Greenwich, Conn.
Coin bags, handling & wrapping equipment

ALD, Inc.
7045 N. Western Avenue
Chicago, Illinois
Coin tabulating equipment

AMERICAN SHUFFLEBOARD CO.
210 Paterson Plank Rd.
Union City, N.J.
Complete line of shuffleboard supplies.

AQUALARM
14238 So. Prairie Ave.
Hawthorne, Calif.
Burglar alarm

ARDMORE PRODUCTS INC.
Aldene Rd. & First Ave.
Roselle, N.J.
Vending machine fronts (conversion kit).

AUTOMATIC PRODUCTS CO.
301 Chestnut St.
St. Paul, Minn.
Coin changers.

BABACO ALARM SYSTEMS INC.
723 Washington St.
New York, N.Y.
Burglar alarms.

BANNER SPECIALTY CO.
1641 N. Broad St.
Philadelphia, Pa.
Parts & supplies outlet.

BEMIS COMPANY INC.
850 North Star Center
Minneapolis, Minn.
Coin bags.

BLOCK MARBLE
2929 Cheltenham Ave.
Philadelphia, Pa.
Parts and supplies outlet.

BRAD, INC.
24011 Talbot St.
St. Clair Shores, Mich.
Cue tips.

BRANDT AUTOMATIC CASHIER
515-517 So. First St.
Watertown, Wis.
Coin counters, sorters, and wrappers.

CAN PRO CORP.
19 E. McWilliams St.
Fond Du Lac, Wis.
Coin bags.

CHICAGO LOCK CO.
33 W. Belmont Ave.
Chicago, Ill.
Machine locks & burglar alarms.

COIN ACCEPTORS, INC.
4946 Daggett Ave.
St. Louis, Mo.
Coin changers, acceptors, repair & accumulating devices.

COIN MACHINE IMPROVEMENT
2365 Old Bridge Rd.
Dallas, Tex.
Wallbox kits.

COUNTEX CORP.
World Trade Center
San Francisco, Calif.
Coin sorters, counters & wrappers.

D & R INDUSTRIES
3323 West Foster Ave.
Chicago, Ill.
General parts & supplies outlet.

DYNABALL COMPANY
8040 N. Ridgeway
Skokie, Ill.
Coin machine & billiard supplies.

EASTERN NOVELTY DIST. INC.
3726 Tonnele Ave.
N. Bergen, N.J.
Complete line of billiard accessories.

EASTERN NOVELTY DIST. INC.
(West Coast Branch)
2939 E. 11th St.
Los Angeles
Billiard accessories

GLOBE DIST. CO. INC.
2330 N. Western Ave.
Chicago, Ill.
Coin handling equipment.

HAMILTON SCALE CORP.
3350 Secor Rd.
Toledo, Ohio
Coin changers.

H. GREENWALD CO. INC.
1340 Metropolitan Ave.
Brooklyn, N.Y.
Coin meters, timers, chutes & locks.

ILLINOIS LOCK CO.
303-313 W. Hintz Rd.
Wheeling, Ill.
Locks and leg levelers.

INTER-COUNTY INDUSTRIES INC.
809 Walnut St.
Redding, Pa.
Cash boxes and color-code decals.

ITT GENERAL CONTROLS INC.
200 S. Wolf Rd.
Des Plaines, Ill.
Coin counters.

JOHNSON FARE BOX CO.
4619 N. Ravenswood
Chicago, Ill.
Coin handling equipment.

IRVING KAYE CO. INC.
363 Prospect Place
Brooklyn, N.Y.
Billiard cues & racks.

KLOOP ENGINEERING INC.
25551 Schoolcraft
Livonia, Mich.
Coin handling equipment.

LEWIS MERCANTILE CO.
40 Great Jones St.
New York, N.Y.
Coin bags.

MAJOR METALFAB INC.
812 N. Orleans St.
Chicago, Ill.
Coin changers, counters & wrappers.

MARVEL MFG. CO.
2847 W. Fullerton Ave.
Chicago, Ill.
Score boards & billiard supplies.

MATUDA ENTERPRISE
P.O. Box 509, Astor Station
Boston, Mass. 02123
Voice and piano tapes

MICRO-MAGNETIC INDS. INC.
951 Commercial St.
Palo Alto, Calif.
Complete line of coin changers & supplies.

MIKE MUNVES CORP.
577 Tenth Ave.
New York, N.Y.
Complete coin machine parts & supplies.

NATIONAL REJECTORS INC.
5100 San Francisco Ave.
St. Louis, Mo.
All types of slug rejectors & coin handling accessories.

NEW ORLEANS NOVELTY CO.
1055 Dryades St.
New Orleans, La.
Coin handling equipment.

NYACK SLATE CO.
Railroad Ave.
Nyack, N.Y.
Billiard accessories.

PEACH STATE DIST. CO.
1040 Boulevard S.E.
Atlanta, Ga.
Complete coin machine parts & supplies.

PRECISION NOVELTY
11532 S. Mayfield
Worth, Ill.
Shuffle pucks.

RANDEL LOCK SERVICE CO.
21 Primrose Lane
Valley Stream, L. I.
Locks

REED ELECTROMECH CORP.
340 Black Hawk Ave.
Rockford, Ill.
Slug rejectors, coin changers, meters and dispensers.

STANDARD CHANGE-MAKERS INC.
422 E. New York St.
Indianapolis, Ind.
Coin sorters & counters.

SUN-GLO SHUFFLEBOARD SUPPLIES, INC.
111-113 Heckel St.
Belleville, N.J.
Complete line of shuffleboard supplies.

VALLEY MFG. & SALES CO.
333 Morton St.
Bay City, Michigan
Billiard accessories

THE VENDO CO.
7400 E. 12th St.
Kansas City, Missouri 64126
Slug rejectors

WICO CORP.
2913 N. Pulaski Ave.
Chicago, Ill.
Complete coin machine parts & supplies.

DISCOUNT HOUSE

for all types of
coin machine
parts and supplies.

Please write for the
1966-67 D&R Catalog.



3420 W. IRVING PARK ROAD
CHICAGO, ILLINOIS 60618
PHONE: (312) 478-2700

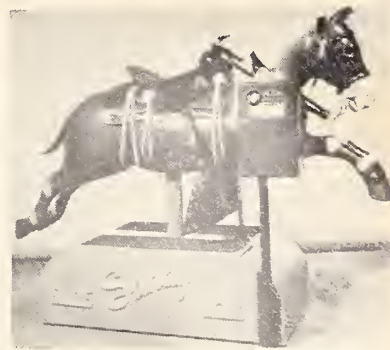

**SANDY PONY
PORKY PIG
KIDDIE BOAT
RUDY DEER**

Aluminum bodies for lasting beauty and durability. Underwriters Laboratories re-examination service.

Manufacturers of sturdy kiddie rides since 1952

UNITED TOOL & ENGINEERING CO.

9970 Springfield Pike
Cincinnati, Ohio 45215
(513) 771-3790

Manufacturers of
**COIN-OPERATED
MOVIE THEATERS**
'PANORAMS'
Write for brochure describing all available models and film.

URBAN INDUSTRIES INC.
P. O. Box 31
LOUISVILLE, KENTUCKY 40201
AC 502-969-3227

WISCONSIN'S LEADING DISTRIBUTOR
Celebrating Our 27th Year
SPECIALIZING
Buying-Selling-Trading
New and used phonographs-games
Exclusive distributors for Wisconsin and Upper Michigan

**THE WURLITZER COMPANY
VALLEY SALES COMPANY
TAPE-ATHON CORPORATION
AMERICAN SHUFFLEBOARD
UNIVERSAL VENDORS
DITCHBURN EQUIPMENT LTD.**
Write for current price lists or call for the best deal.

HARRY JACOBS RUSS TOWNSEND
united INC.
1907 N. Third St., Milwaukee, Wis. 53212
(414) 372-9272

AMERICA'S LEADING MANUFACTURER



SUN-GLO



Pucks
Products
for
Shuffleboards



SEE YOUR LOCAL DISTRIBUTOR TODAY!
Sun-Glo Shuffleboard Supplies, Inc.

111-113 HECKEL ST. BELLEVILLE, N. J. 07109
(201) 759-4474



Also Available
Sidemount
Scoreboard,
15-21 Pts.,
\$249.50

electric scoreboard

FOR SHUFFLEBOARDS

Natural Finish Hardwood Cabinet

- Two-faced
- Fits any shuffleboard
- Scores 15-21 and/or 50 points
- Large metal coin box holds \$500 in dimes
- Coin-operated
- 10c 1 player or 10c 2 player by simple plug switchover
- Aluminum button scoring blocks
- Chrome tube supports

IMMEDIATE DELIVER \$169.50

Terms: 1/3 Dep., Bal. C.O.D. or S.D.

MARVEL MANUFACTURING CO.

2849 W. Fullerton Ave., Chicago 47, Ill.
Phone: DI 2-2424

Directory Of U.S. Coin Machine Trade Associations

NATIONAL

Music Operators of America
228 N. LaSalle St.
Chicago, Ill. 60601
Exec. V.P. Fred Granger

National Automatic Merchandising Association
7 S. Dearborn St., Chicago, Ill.
Thomas B. Hungerford, Executive Director

National Coin Machine Distributors Assn.
30 N. LaSalle St., Chicago, Ill.
Bob Slifer, Executive Director

ALABAMA

Alabama Amusement Assn.
224 Dexter
Montgomery, Ala. 36104
Isaac Cohen

ARIZONA

Arizona Music Guild
P.O. Box 14011
Phoenix, Arizona
Exec. Sec. John Hourihan

ARKANSAS

Arkansas Music Operators Assn.
609 Rector Bldg.
Little Rock, Ark. 72201
Charles Stewart, Exec. Sec'y.

CONNECTICUT

Bridgeport Coin Machine Operators Assn.
520 Success Ave.
Bridgeport, Conn. 06610
James V. Fitzpatrick

Eastern Conn. Music Operators Assoc.
Box 522
Norwich, Conn. 06360
Marvin M. Horwitz, Counsel

Music Operators of Connecticut
242 Trumbull St.
Hartford, Conn. 06103
Pres.

CALIFORNIA

California Music Merchants Assoc.
128 E. 14th St.
Oakland, Calif. 94606
Pres. Henry Leyser

FLORIDA

A.M.O.A. of Florida
8163 N.E. 2nd Ave.
Miami, Fla. 33138
Pres. James I. Mullins

Florida Amusement & Music Assn.
101 Pepper Bldg.
Box 3122
Tallahassee, Fla. 32303
Exec. Dir., Julius Sturm

ILLINOIS

Associated Buyers Club
4206 N. Western Ave.
Chicago, Ill. 60618
Wayne Hesch, Pres.

Central States Phono. Oprs. Asso.
204 W. First Ave.
Peoria, Ill. 61605
John R. Bush

Illinois C. M. Operators Assoc.
101-18th St.
Rock Island, Ill. 61201
Pres. Lou Casolia

Music Operators of No. Illinois
8020 Lincoln Ave.
Skokie, Ill. 60076
Pres. Robert Lindelof

Recorded Music Service Asso.
188 Randolph St.
Chicago, Ill. 60601
Earl Kies

National Coin Machine Distributors Assn.
30 N. LaSalle St.
Chicago, Ill. 60602
Exec. Dir. Orville L. Slifer
312-STate 2-6096

INDIANA

Music Operators Society of St. Jos. Valley
130 N. Ironwood Dr.
Mishawaka, Ind. 46544
Pres. Frank R. Fahiano

IOWA

Iowa Music Operators Assn.
Osceola, Iowa 50213

MARYLAND

Amusement Machine Oprs. Assn.
2441 N. Charles St.
Baltimore 18, Md.
Pres. Irv Goldner

MASSACHUSETTS

Mass. Coin Machine Asso.
116 Race St.
Holyoke, Mass. 01040

Western Mass. Music Guild
116 Race St.
Holyoke, Mass. 01040
Russel Mawdaley

MINNESOTA

Minnesota Amusement Games Assn., Inc.
601 Central Ave.
Farihault, Minn. 55021

MISSOURI

Missouri Amusement Machine Assn.
705 Olive St., Rm. 1420
St. Louis, Mo. 63101
Dewey S. Godfrey Jr.

Missouri Coin Machine Council
205 W. 10th
Trenton, Mo. 64683

MONTANA

Coin Machine Operators Assn.
815 So. Central Ave.
Malta, Mont. 59588

NEBRASKA

Coin Operated Industries of Neb.
1208 Farnam St.
Omaha, Neb. 68102
Howard Ellis, Sec'y.-Treas.

NEW JERSEY

South Jersey Coin Machine Assn.
805 Hopkins Road
Haddonfield, N. J. 08033
Pres. Bill Cannon

N. J. Council of Coin Machine Ops.
1175 Broad St.
Newark, N. J. 07114
D. M. Steinherg

Vending Guild of N. J.
1175 Broad St.
Newark, N. J. 07114
Pres. Allen Waldor

NEW MEXICO

New Mexico Music Guild
P. O. Box 86
Las Cruces, N. M. 88001
Alfred Harper, Pres.

NEW YORK

Coin Mach. Ops. of Onondaga County
340 Roxford Road, S.
Syracuse, N. Y. 13208
Chas. M. Keppler, Pres.

Music Oprs. of New York, Inc.
250 W. 57th St.
New York, N. Y. 10019
Pres. Al Denver

New York State Coin Machine Assn.
Box 204
Hurleyville, N. Y. 12747
Pres. Millie McCarthy

New York State Operators Guild Inc.
P. O. Box 371
Beacon, N. Y. 12508
Pres. Mike Mulqueen

Westchester Oprs. Guild Inc.
125 N. Main St.
Port Chester, N. Y. 10573
Pres. Carl Pavesi

NORTH CAROLINA

N. Carolina Ops. Assn.
534 Hay St.
Box 406
Fayetteville, N. C. 28302

OHIO

Automatic Phonograph Owners Assn.
432 Walnut St.,
Cincinnati, Ohio 45202
Pres. Nat Bartfield

Northwestern Ohio Music Ops., Inc.
511 S. Canal St.
Delphos, Ohio 45833
Wm. E. Hullinger

Phonograph Merchants' Asso. Hdqtrs.
928 Leader Bldg.
Cleveland, Ohio 44114
Miss Virginia Holcomb, Sec'y.-Treas.

Summit County Music Ops. Asso.
471½ S. Main St.
Akron, Ohio 44311
Charles Marvin, Pres.

Tri-County Phonograph Operators Assn.
Canton Area
127 Tremont St., S.W.
Massillon, Ohio 44646
Edward Elum

PENNSYLVANIA

AMOA of Pennsylvania
Suite 400
Blackstone Bldg.
Harrisburg, Pa. 17101
Joseph LaSala, Exec. Sec'y.

Amusement Machine Assn. of Philadelphia
850 N. Broad St.
Philadelphia, Pa. 19130
Joseph Silverman, Bus. Mgr.

Anthracite Music Oprs. Assoc.
P.O. Box 348
Scranton, Pa. 18501
Ben Sterling, Pres.

Eastern Penn. Amuse. Machine Asso.
10 East Main St.
Norristown, Pa. 19401
J. J. Smith, Jr., Pres.

Lancaster Music Association
20 S. Third Street
Columbia, Pa. 17512
John Myers, Pres.

SOUTH CAROLINA

S. C. Coin Ops. Assn., Inc.
2005 State
Cayee, S. C. 29033
Mrs. Erby Campbell, Sec'y.-Treas.

SOUTH DAKOTA

Music & Vending Assoc. of S. D.
901 E. 7th Ave.
Mitchell, S. D. 57301

TENNESSEE

Memphis Music Association
462 N. Second Street
Memphis, Tenn. 38105
Alan Dixon, V.P.

Tenn. Music Ops. Assn.
210 Highland Avenue
Jackson, Tenn. 38301
H. A. Waller, Pres.

TEXAS

Jefferson Coin Machine Council
1323 Magnolia St.
Beaumont, Texas 77701
Hugh G. Freeland

San Antonio Music Ops. Assn., Inc.
909 E. Houston St.
San Antonio, Texas 78205

VERMONT

Vermone Coin Operators Assn.
S. Main
Chester, Vt. 05143

VIRGINIA

Music Operators of Virginia
129 Thompson St.
Ashland, Va. 23005
W. R. Lumpkin, Pres.

WASHINGTON

Bremerton Mutual Amusement Assn.
223 Second Ave.
Bremerton, Wash. 98310
George Dexter

WASHINGTON, D.C.

Washington Music Guild
2932 12th St., N.W.
Washington, D. C.

WEST VIRGINIA

West Virginia Music & Vending Assn.
401 Jones Ave.
Oak Hill, W. Va. 25901
John A. Wallace, Pres.

WISCONSIN

Milwaukee Music Ops. Assn.
6100 W. Bluemound Road
Milwaukee, Wisc. 53213
Samuel Hastings, Pres.

Wisconsin Music Merchants Assn.
115 Smythe Ct.
Beaver Dam, Wisc. 53916
E. D. Dowe, Sec'y.-Treas.

Credit Life Insurance

All risk insurance for vending, games and music equipment on location.

SPECIALISTS

Fire — Casualty —
Bonds — Automobile — Group
— Life — Pension Trust —
Profit Sharing

DID YOU KNOW that the Spindel Insurance Agency, Inc., paid death claims to distributors on the lives of operators who died during 1966 in excess of \$400,000?

DID YOU KNOW that the GM&V Corporation, a division of the Spindel Insurance Agency, Inc., provides operators with all risk policies in the event of equipment theft, fire, vandalism on location, and while equipment is in transit?

FOR COMPLETE INFORMATION, WRITE OR CALL TODAY.

Representing America's Leading Companies Nationally

— Serving distributors for over 25 years —

SPINDEL INSURANCE AGENCY, INC.

8551 S. Stony Island Avenue, Chicago, Illinois 60617

Phone (Area Code 312) 374-3700

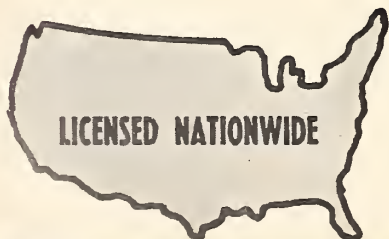

1966-67 Coin & Vending Directory
Part III—INDEX TO FEATURES

International Newslines 6

Top Ten 1966 Import Nations 7

1966 Export Statistics 8,9

European Trade Associations 12

European Phonograph and Amusement
Manufacturers 13,14

European Vending Manufacturers 15

U.S. Manufacturers with World Wide
Distributors 16-20

Coin Phonograph Photo Gallery 21-31

Pingames, arcade and pool table
photo gallery 32-38

U.S. Amusement Manufacturers and
Type of Equipment Produced 45-47

Cigarette, Candy and Can Drink
Vending Machine Photo Gallery 48-50

U.S. Vending Manufacturers 51-54

Audio-Visual Machines 55

U.S. Franchised Phonograph
Distributors 56-59

Distributors and Jobbers Listed by
State 60-65

Coin Machine History 66-68

Parts and Supplies Houses 69

U.S. Trade Associations 72

a name
you can
rely on

American ★

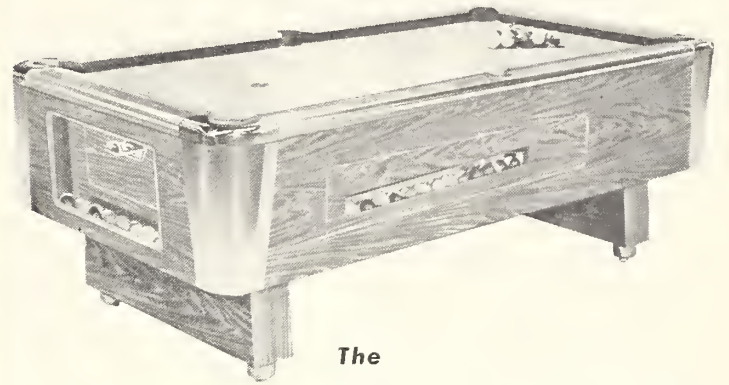

The
CLASSIC
with cheat proof "Feather Touch"
coin mechanism.

for Shuffleboards . . .

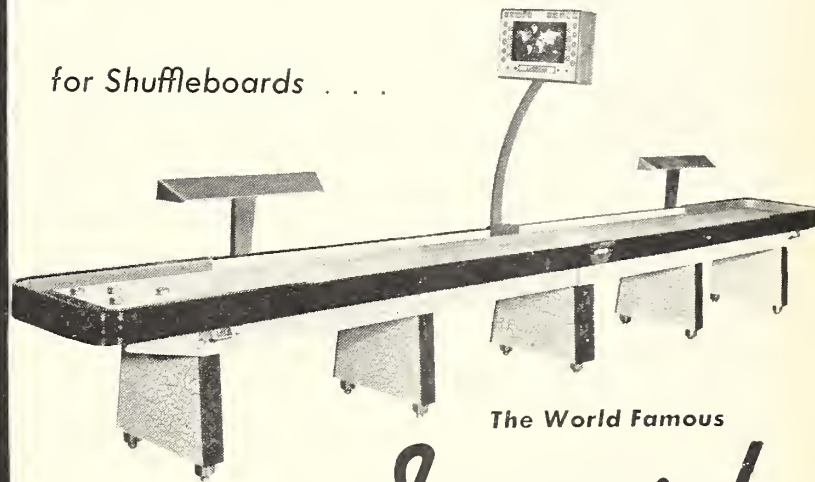

The World Famous

Imperial



...**SHUFFLE 88**...

American ★
SHUFFLEBOARD
COMPANY

210 Paterson Plank Road Union City, N. J. (201) UNion 5-6633
1423 S. Western Avenue, Los Angeles, Calif. (213) REpublic 3-3724

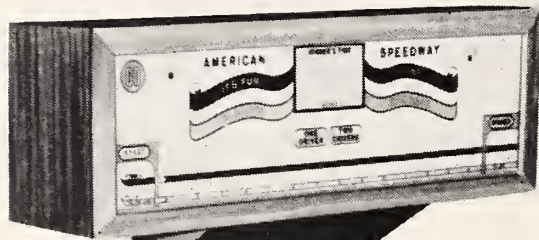

AMERICAN SPEEDWAY

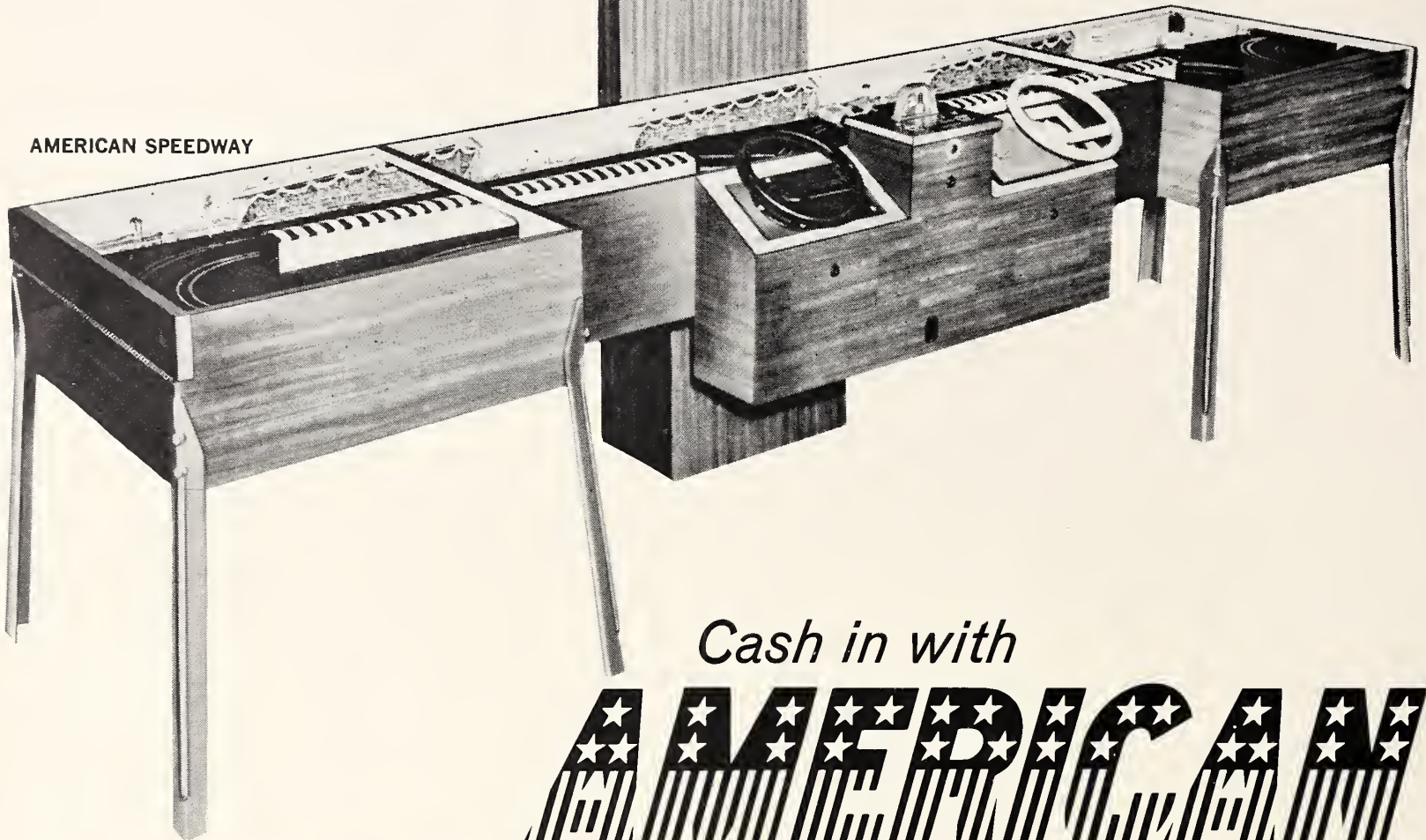

Cash in with

AMERICAN

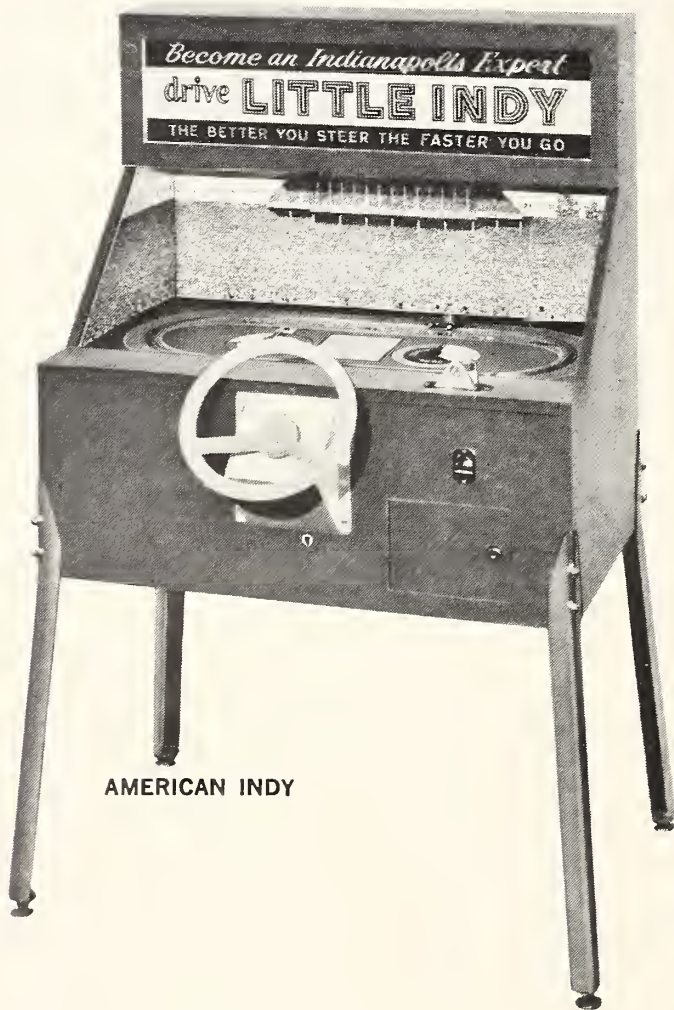

AMERICAN INDY

Profit from today's tremendous popularity of model car racing with the first new game ideas in a decade!

AMERICAN INDY, a one-player, 30-second version of America's most famous speedway, Indianapolis. Packs one of the industry's biggest coin potentials per square foot into a 36" X 30" floor space.

AMERICAN SPEEDWAY, all the thrills, excitement and skill of auto racing. For one or two players. An average game is completed in well under 60 seconds, a single machine can take in up to \$12 an hour.

Keep your eyes peeled for these and other profitable innovations from American.

AMERICAN MACHINE & FOUNDRY COMPANY
WESTBURY, NEW YORK 11590