

Billboard®

\$75

INTERNATIONAL BUYER'S GUIDE

T H I R T Y - T H I R D E D I T I O N

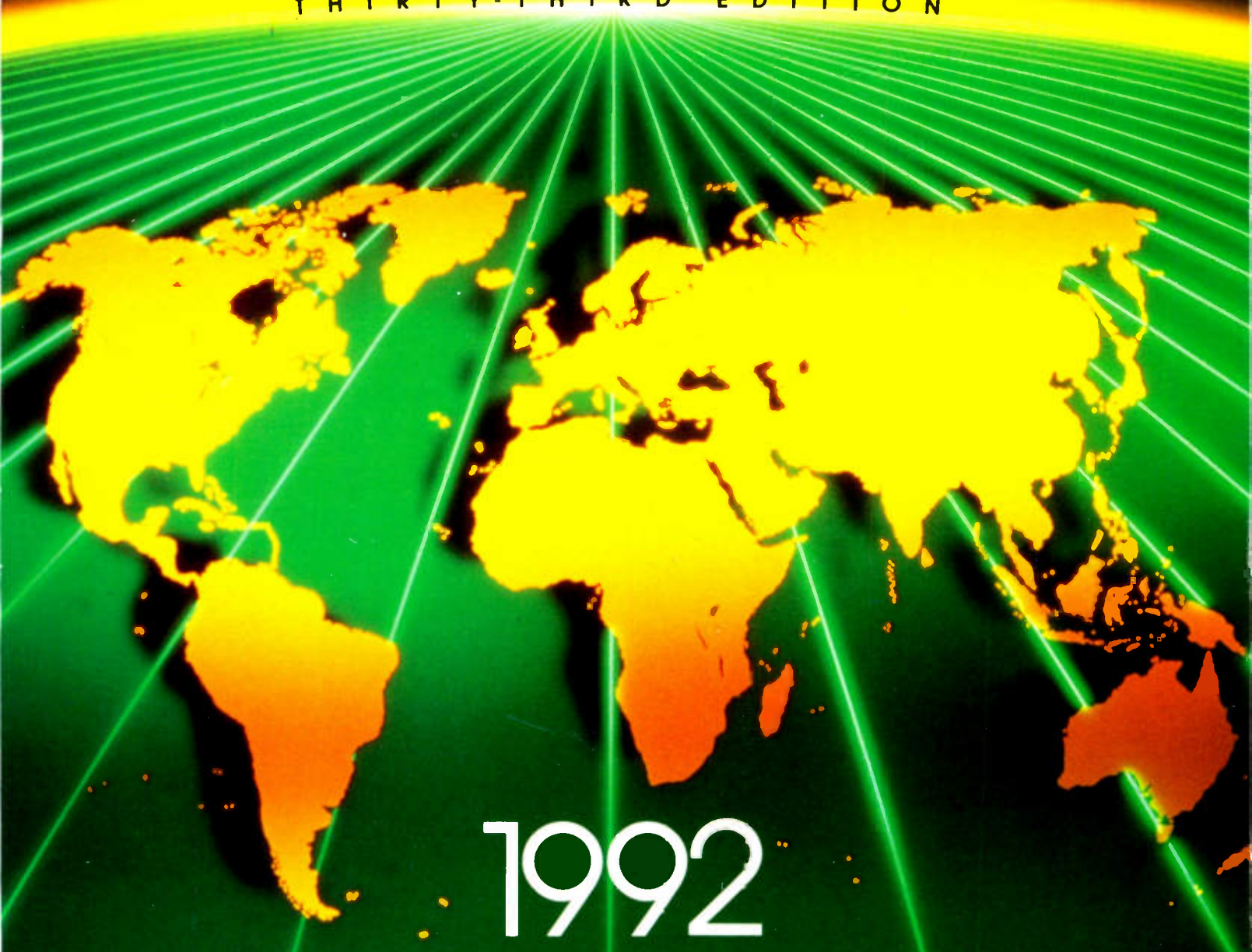

1992

THE ONLY WORLDWIDE REFERENCE SOURCE TO:

RECORD LABELS & HOME VIDEO COMPANIES • MUSIC PUBLISHERS • WHOLESALERS
ACCESSORY MANUFACTURERS • INDUSTRY SERVICES & SUPPLIERS • RAW MATERIALS
CD REPLICATORS • TAPE DUPLICATORS • EUROPEAN & INTERNATIONAL SECTIONS



PERFECT EXECUTION EVERY TIME

For flawless form and performance, add SHAPE to your team this year. Whatever grade, color or design you specify, SHAPE will execute it more consistently—time after time. Your products last longer and lead more profitable lives inside SHAPE shells and packaging. Smoother passes, longer hits, fewer bogies—play after play. That's SHAPE.

SHAPE Inc, PO Box 366, Biddeford, Maine 04005, USA
 Toll Free: 800/462-4165, Tel: 207/282-6155,
 Fax: 207/283-9130.



SHAPE

Quality—Time and Time Again

Publisher—Directories:
Ronald E. Willman

Director of Sales:
Norm Berkowitz

Directory Sales Staff:
Lidia Bonguando, Christine Chinetti,
Marv Fisher, Linda Hersch, Aki Kaneko,
Mike Lewis, Lee Ann Pack, Pat Rod,
Angela Rodriguez

Sales-Pacific Rim
Neutral Distributing Services Inc.
Grace Ip
(310) 330-7888, Fax: (310) 330-7889

Director of Data Base Services:
Ray Heitzman

Data Base Operations Manager:
Daniel Bale

Directories Coordinator:
Gayle Cotham

Cover Photo:
Comstock, N.Y.C.

Art & Design:
Jeff Nisbet

Production Manager:
Len Durham

Production Coordinator:
Lydia Mikulko

**Associate Publisher & Director
of Marketing & Sales:**
Gene Smith

Group Publisher:
Howard Lander

Offices:
1515 Broadway
New York, NY 10036
Tel.: (212) 764-7300. Telex: (710) 581-6279
Cable: Billboy NY. Fax: (212) 536-5358
9107 Wilshire Blvd.
Beverly Hills, CA 90210
Tel.: (213) 273-7040. Telex: 66-4969
Cable: Billboy LA. Fax: (213) 859-5302
49 Music Square West
Nashville, TN 37203
Tel.: (615) 321-4240. Fax: (615) 320-0454
Telex: 4900008016 LCS UI
31 Meagher St.
Chippendale, NSW, 2008
Australia
Tel.: 61-2-699-6995. Fax: 61-2-699-1093.
402 Utsunomiya Building
6-19-16 Jingumae, Shibuya Ku
Tokyo 150, Japan
Tel.: 81-3-498-4641. Fax: 81-3-499-5905
Via Umberto I, 13
20039 Varese (MI)
Italy
Tel.: 362-58-44-24. Fax: 362-58-44-35
23 Ridgmount St.
London, WC1E 7AH
United Kingdom
Tel.: 44-71-323-6686. Fax: 44-71-323-2314

© Copyright 1991 BPI Communica-
tions, Inc., a subsidiary of Affiliated
Publications, Inc. No part of this
publication may be reproduced, stored
in retrievable system, or transmitted in
any form by any means, electronic,
mechanical, photocopying, recording,
or otherwise, without the prior written
permission of the publisher.

Single copy price \$75.00
ISBN 8230-8044-7

BPI Communications, Inc.

© Billboard's

1992 INTERNATIONAL BUYER'S GUIDE TABLE OF CONTENTS

Publisher's Letter	4
Keyword Index	6
How to Use this Directory	8
Music and Video Companies	10
Record Labels	11
Home Video Companies (Theatrical, Music & Special Interest)	38
Music Publishers	44
Sheet Music & Folio Suppliers	65
Distribution & Consumer Product Manufacturers ..	66
Wholesalers & Distributors Index	67
Wholesalers & Distributors	70
Music & Video Accessory Manufacturers	108
Audio Accessory Manufacturers	110
Manufacturers: Retail Merchandising Products	111
Industry Services & Suppliers	113
Store Fixture Manufacturers	114
Security & Surveillance Systems Manufacturers	115
Computer Systems & Services	115
Associations & Professional Organizations	117
Entertainment Attorneys	118
International Business Agents of Music/Video	119
Performing & Mechanical Rights Organizations	119
Music Libraries	120
Public Relations	120
Record Promotion	121
Schools & Instruction	123
Materials & Supplies	124
Blank & Bulk Tape Manufacturers	125
Blank Tape Loaders	126
Consumer Tape Product Charts	127
Pro Tape Product Charts	130
Cartridges, Cassettes, Reels & Other Parts	139
Jewel Box Manufacturers	144
Raw Materials	145
Envelopes & Mailers	145
Jackets & Sleeves	146
Labels	180
Polybags & Shrinkwrap	311
Manufacturing Plants, Services & Equipment	147
Tape Custom Duplicators	149
Compact Disc Manufacturers & Videodisc Manufacturers	160
Plating & Pressing Plants	168
Mastering Facilities	169
Packaging & Labeling Services	172
CD Replicating Systems Equipment Manufacturers	174
Tape Duplicating & Processing Equipment Manufacturers	175
Tape Equipment Manufacturers	177
Tape Packaging & Labeling Equipment Manufacturers	178
European Listings	181
International	272
Advertisers Index	313

Dear Industry Executive:

Welcome to our 33rd edition of Billboard's International Buyer's Guide (IBG). Within these pages, you will find detailed information to assist you in your everyday business operations in the music and home video fields.

Billboard's basic mission, with its directories, is to supply executives and managers with the most useful information and opportunities for reaching those most important in their day-to-day operations.

Please note that this year we have made a few changes which will make it easier for you to locate information. For example, our European section contains all European countries including those formerly in the Eastern Block. There is also a separate International Section containing over 40 countries. The Keyword Index, on pages 6 & 7, will help you to locate a country or category throughout the directory.

Our listings are compiled by responses from past years and current respondents. Each year, thousands of questionnaires are sent from our Nashville and Amsterdam offices, and we encourage everyone to respond.

We believe there is no existing directory which fills your needs as does IBG and are confident this directory will help you, the manager/executive, in making decisions for reaching the sellers in the marketplace.

Thank you for your participation and readership. If you have any questions, please do not hesitate to contact me.

Cordially yours,

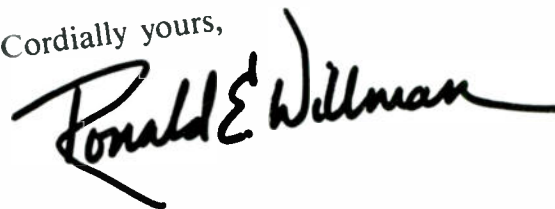

Ronald E. Willman
Publisher - Directories

Put the Lock on Pre-Recorded Software Theft with Sentry™ Security Devices



Tampered EAS and price tags are a thing of the past with ALPHA Sentry™ Security Devices. Because the Sentry package encloses the EAS tag, there's no longer any need to worry about shoplifters tearing it away with the shrinkwrap and walking out with your merchandise — and your profits.

The Sentry is also designed to allow the customer an unobstructed view of the graphics for increased impulse buying. Plus its convenient unlocking device makes it easy for the cashier to retrieve the software from the package at the counter, making it ready to reuse — time and time again with the same EAS tag.

ALPHA'S entire line of Sentry security packages is compatible with all types of EAS systems and store fixtures.*

*Shelving display shown by Lift Display, Inc.



The CD Sentry™

The CD Sentry is available in two styles — one for standard compact discs and one for double CDs



The Audio Sentry™

All Sentry security packages use the same locking mechanism, including this package for music cassettes.

Unlocking the Sentry at the counter is simple—just slide it into the opening device and press the handle down. The same opening device is used for all the different styles of Sentry packaging.

ALPHA SENTRY™ SECURITY DEVICES



The Video Sentry™

Capitalize on the explosive growth of sell-through video movies with the ALPHA Video Sentry.

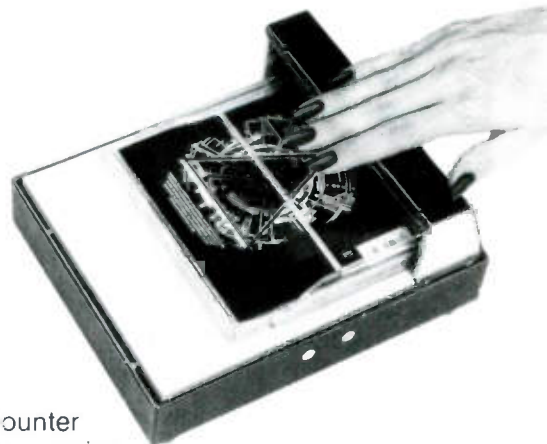

Call or write ALPHA, a leading worldwide supplier of security, storage and packaging of software products, for more information or samples of this and our other products.

ALPHA

ALPHA Enterprises, Inc.
330 South Wood Street • East Canton, Ohio USA 44730
216-488-0361 Fax: 216-488-0312

Keyword Index

Accessories, Music & Video	108	Home Video Companies	38
Accessory Mfrs., Audio	110	Hong Kong	291
Advertisers Index	313	Hungary	216
Argentina	303	Iceland	217
Associations	117	Importers (See Wholesalers)	70
Attorneys, Entertainment	118	India	281
Audio Accessory Mfrs.	110	Indonesia	275
Audio Cassette Shells & Parts	139	Industry Services & Suppliers	114
Audio Tape Duplication Services	149	Instruction	123
Audio Tape Mfrs.	125	Int'l Business Agents, Music & Video	119
Audio Tape Product Charts (Consumer)	127	Ireland	217
Audio Tape Product Charts (Pro)	130	Israel	282
Australia	276	Italy	217
Austria	183	Jackets & Sleeves	146
Badges, Buttons, Promo Items	111	Jackets, T-Shirts, Promo Items	111
Bahamas	310	Jamaica	310
Baltics	185	Japan	293
Barbados	310	Jewel Box Mfrs.	144
Belgium	189	Kenya	272
Bermuda	310	Labeling Equipment Mfrs.	178
Blank & Bulk Tape Mfrs.	125	Labeling Services	172
Blank Tape Product Charts (Consumer)	127	Labels	180
Blank Tape Loaders	126	Legal Services	118
Blank Tape Product Charts (Pro)	130	Libraries, Music	120
Bolivia	304	Luxembourg	228
Brazil	305	Mailers	145
Bulgaria	189	Malaysia	299
CD Replicating Systems Equipment Mfrs.	174	Manufacturers, Audio Accessories	110
Canada	284	Manufacturers, Blank & Bulk Tape	125
Cartridges	139	Manufacturers, Jewel Box	144
Cartridges, Cassettes & Other Parts	139	Manufacturers, Labeling Equipment	178
Cassette Shells, Parts	139	Manufacturers, Merchandising Products	111
Chile	306	Manufacturers, Packaging Equipment	178
China	291	Manufacturers, Security Systems	115
Coatings, Tape	145	Manufacturers, Store Fixtures	114
Colombia	306	Manufacturers, Tape Duplicating Equipment	175
Compact Disc Mfrs.	160	Manufacturers, Tape Equipment	177
Computer Systems & Services	115	Manufacturers, Tape Processing Equipment	175
Costa Rica	281	Manufacturers, Video & Music Accessories	108
Czechoslovakia	189	Manufacturers, Video Disc	160
Denmark	190	Manufacturing Plants	149
Display Fixtures & Dividers	111	Manufacturing Services & Equipment	149
Distributors/Wholesalers, Listings	70	Mastering Facilities	169
Distributors/Wholesalers, Index	67	Materials, Raw	145
Duplicating Equipment, Tape	175	Mechanical Rights Organizations	119
Duplicating Services, Custom Tape	149	Mexico	289
Ecquador	307	Music & Video Accessory Mfrs.	108
Egypt	272	Music & Video Int'l Business Agents	119
El Salvador	281	Music Libraries	120
Entertainment Attorneys	118	Music Publishers	44
Envelopes & Mailers	145	New Zealand	280
Exporters (See Wholesalers)	70	Nigeria	272
Finland	192	Norway	234
Folio & Sheet Music Suppliers	65	One-Stops (See Wholesalers)	70
France	193	Packaging & Labeling Equipment Mfrs.	178
Germany	203	Packaging & Labeling Services	172
Greece	215	Pakistan	282
Guatemala	281	Panama	281

Keyword Index

Parts: Cassette, Reel, etc.	139	Store Fixture Mfrs.	114
Performing Rights Organizations	119	Suppliers, Pre-Recorded Video	38
Peru	308	Suppliers, Sheet Music & Folio	65
Philippines	275	Sweden	240
Plating & Pressing Plants	168	Switzerland	243
Poland	235	T-Shirts, Promo Items	111
Polybags & Shrinkwrap	311	Taiwan	303
Portugal	236	Tape Custom Duplicators	149
Posters, Promo Items	111	Tape Duplicating & Processing Equipment	175
Pressing Plants	168	Tape Equipment Mfrs.	177
Processing Equipment, Tape	175	Tape Loading Services	126
Professional Organizations	117	Thailand	303
Promotion, Record	121	The Netherlands	228
Public Relations	120	Trinidad & Tobago	310
Publishers, Music	44	Turkey	283
Rackjobbers (See Wholesalers)	70	U.S.S.R. - Soviet Union	271
Raw Materials	145	United Arab Emirates	283
Record Compounds	145	United Kingdom	246
Record Labels	11	Uruguay	308
Record Promotion	121	Venezuela	309
Reels & Other Parts	139	Video & Music Accessory Mfrs.	108
Retail Merchandising Products Mfrs.	111	Video & Music Int'l Business Agents	119
Romania	237	Video Cassette Shells, Parts	139
Schools & Instruction	123	Video Disc Mfrs.	160
Security & Surveillance Systems Mfrs.	115	Video Program Suppliers/Buyers	38
Sheet Music & Folio Suppliers	65	Video Tape Duplication Services	149
Shrinkwrap	311	Video Tape Mfrs.	125
Singapore	299	Video Tape Product Charts (Consumer)	128
Sleeves	146	Video Tape Product Charts (Pro)	134
South Africa	272	Wholesalers/Distributors, Listings	70
South Korea	302	Wholesalers/Distributors, Index	67
Spain	237	Yugoslavia	271

DATA DISKETTES or MAILING LABELS PRESSURE SENSITIVE or CHESHIRE

Specialized mailing labels will allow you to target potential customers. Labels are available from any category listed in the following Billboard Directories:

Record Retailing Directory
Tape/Disc Directory
Country Music Sourcebook
International Buyer's Guide
International Talent & Touring Directory
International Recording Equipment & Studio Directory

For complete details and information please contact:

Directories Central, Billboard
PO Box 24970, Nashville, TN 37202
 or call **615-321-4282**

How To Use This Directory

As a guide to locating specific listings, the following explanations are presented for each major section. As a first step for finding any listing, refer to the Contents page or Keyword Index page for the first page of the particular section desired and note whether the listings are arranged by state or alphabetically.

UNITED STATES

MUSIC & VIDEO COMPANIES

Record Labels

Finding a record label is straightforward since listings in this section are in alphabetical order by company name. Record labels are cross referenced back to their parent companies.

Home Video Companies (Theatrical, Music, & Special Interest)

The Video section includes alphabetically sequenced listings for video program suppliers and buyers.

Music Publishers

Music Publishers are listed in alphabetical order by company name. Affiliates and administered companies are cross referenced back to their primary company listings.

Sheet Music & Folio Suppliers

These listings are in alphabetical order by company name.

DISTRIBUTION & CONSUMER PRODUCT MANUFACTURERS

Wholesalers & Distributors Index

Alphabetical listing by company name indicating the states in which listings appear in the 'Wholesalers & Distributors' section.

Wholesalers & Distributors

These listings are in alphabetical order by state. Listings include distributors, one stops, rackjobbers, importers, and exporters of audio/video products.

Music & Video Accessory Manufacturers

Audio Accessory Manufacturers

Manufacturers: Retail Merchandising Products

Each section is arranged alphabetically by company name or by state.

INDUSTRY SERVICES & SUPPLIERS

Store Fixture Manufacturers

Security & Surveillance Systems Manufacturers

Computer Systems & Services

Associations & Professional Organizations

Entertainment Attorneys

International Business Agents of Music/Video

Performing & Mechanical Rights Organizations

Music Libraries

Public Relations

Record Promotion

Schools & Instruction

Each section is arranged alphabetically by company name or by state. Company listings are limited to those services and supplies done in-house and provided to outside clients.

MATERIALS & SUPPLIES

Blank & Bulk Tape Manufacturers

Blank Tape Loaders

Blank & Bulk Tape Manufacturers Charts

These charts of audio/video blank and bulk raw tape should be used in conjunction with the listings for manufacturers of tape products which precede the charts and present the addresses, telephone numbers and personnel of the companies.

Cartridges, Cassettes, Reels & Other Parts

Jewel Box Manufacturers

Raw Materials

Envelopes & Mailers

Jackets & Sleeves

Labels

Polybags & Shrinkwrap

Each section is arranged in alphabetical order by company name.

MANUFACTURING PLANTS, SERVICES AND EQUIPMENT

Tape Custom Duplicators

Companies providing duplicating services for tape audio/video products.

Compact Disc Manufacturers &

Videodisc Manufacturers

Plating & Pressing Plants

Mastering Facilities

Packaging & Labeling Services

CD Replicating Systems Equipment Manufacturers

Tape Duplicating & Processing Equipment Manufacturers

Tape Equipment Manufacturers

Tape Packaging & Labeling Equipment Manufacturers

Each section is arranged alphabetically by company name or by state.

EUROPEAN LISTINGS SECTION

INTERNATIONAL SECTION

Refer to International section.

ADVERTISERS INDEX

To quickly locate an advertiser within the International Buyer's Guide, turn to the Advertisers Index. Companies are listed in alphabetical order and page number(s) are indicated on which their advertisement(s) appear.

GENERAL INFORMATION ABOUT LISTINGS

The listings contained in this publication are based solely upon information supplied to Billboard as of presstime. All information is checked for accuracy as of that time. However, Billboard is not responsible for changes in management or any other related business associations that may supersede the listings contained herein. Efforts are made by questionnaire mailings and phone calls to obtain information on companies which should be listed. If you would like to be listed in the next issue of the International Buyer's Guide please send the relevant information in the format of the section under which it should appear. Information should be addressed to: Daniel Bale, Operations Mgr., BPI Communications, Inc., Directory Central, P.O. Box 24970, Nashville, TN, 37202.

SOUND ADVICE!

DISCTRONICS

CALIFORNIA

Our New National Sales Office
3800 Barham Boulevard, Suite 102
Los Angeles, CA 90068
Phone: (213) 851-7300
FAX: (213) 851-7579
Mort Weiner
Cal Roberts

TEXAS

2800 Summit Avenue
Plano, TX 75074
Phone: (214) 881-8800
FAX: (214) 881-8500
Ian Cameron

UNITED KINGDOM

Europe Ltd.
Glenthorne House
Hammersmith Grove,
London W6 OLC
Phone: (44) 81-741-9192
FAX: (44) 81-748-2106
James Mitchell

AUSTRALIA

9 DeHavilland Road
Braeside,
Victoria Australia 3195
Phone: (613) 587-2633
FAX: (613) 614-3711
Doug Bell

MASTERING/REPLICATION/PACKAGING/QUALITY/SERVICE

In this section...

- Record Labels
- Home Video Companies
(Theatrical, Music & Special Interest)
- Music Publishers
- Sheet Music & Folio Suppliers

Music & Video Companies

RECORD LABELS

A

AAA Ltd., (See O.K. Records).
ABC Video Ent's., Inc., (See Creav, Inc. U.S.A.).
ABKCO Records (Div. ABKCO Music & Records, Inc.), 1700 Broadway, 41st Floor, New York, NY, 10019, (212) 399-0300. Fax: (212) 582-5090. Pres.: Allen Klein; Vice Pres.: Ken Salinsky; Iris Kaital; Vice Pres. A & R: Jody Klein. Label(s): (Owned) ABKCO, Cameo Parkway, SAR/Derby, (Distributed) Phil Spector.
A.B. Records, PO Box 5649, Hollywood, FL, 33083, (305) 962-0551. Pres.: Alford Brown. Label(s): (Owned) A.B.
ABX Records, PO Box 122, Main St., Bellwood, AL, 36313, (205) 588-2546. Pres.: Danny Bryan; Vice Pres. A & R: Michael Bryan. Label(s): (Owned) ABX, A-Lab. US Reps.: Futuristic South (AL).
A.J.K. Music, (See K-tel Int'l (USA), Inc.).
AJ Records, 1755 York Ave., Ste. 21F, New York, NY, 10128, (212) 860-3023. Fax: (212) 831-0906. Pres.: Jane Peterer; Vice Pres.: A.C. Thompson. Int'l Reps.: GlobeArt (Switzerland).
AKO Records, 20531 Plummer St., Chatsworth, CA, 91311, (818) 998-0443. Fax: (818) 998-2537. Pres./Gen. Mgr.: A.E. Sullivan; A & R: Don Tunnell. Label(s): (Owned) AKO, Aztec, Dorn.
A-Lab. (See ABX Records).
A.M.I. Records/American Music Inc., 3840 Dickerson Rd., Nashville, TN, 37207, (615) 868-2356. Fax: (615) 868-2356. Pres.: Michael R. Radford; Vice Pres. A & R: Harold Hodges; Vice Pres.: Richard Johnson. Label(s): (Owned) Tamara.
AMP (See Alternative Music Prodns., Inc.).
AM-PM, (See Trend/Discovery Records).
A & M Records, Inc., 1416 N. LaBrea Ave., Hollywood, CA, 90028, (213) 469-2411. Fax: (213) 856-2600. Chrmn., Pres.: Jerry Moss; Sr. Vice Pres., Gen. Mgr.: Al Cafaro; Sr. Vice Pres., Promos.: Charlie Minor; Vice Pres., Sales: Bill Gilbert; Vice Pres. A & R: David Anderle. Branch(es): 595 Madison Ave., New York, NY, 10022, (212) 826-0477. Fax: (212) 838-8786, Exec/Vice Pres., Publicity: Wayne Issacs. Label(s): (Distributed) Delos, Denon, Shoreline, Twin Tone, Word.
ASV, (See Creav, Inc. U.S.A.).
A.V., (See SoundMasters).
AVC Entertainment Inc., 6201 Sunset Blvd., Ste. 200, Los Angeles, CA, 90028, (213) 461-9001. Fax: (213) 874-7525. Chrmn./Pres.: James A. Warsinske; Gen. Mgr.: Andrew Kaulkin; Promo. Dir.: Greg Bell; Vice Pres. A & R: Jay Warsinske. Label(s): (Owned) AVC, Solid.
AVI Record Prodns., Inc., 10116 Riverside Dr., Ste. 200, Toluca Lake, CA, 91602, (818) 752-9080. Fax: (818) 752-9817. Pres.: Raymond Harris; Gen. Mgr.: William James Calder. Label(s): (Owned) A V I, (Distributed) Creed, Excello, Nashboro. US Reps.: Rhino Records (CA); Mesa/Bluemoon Records (CA). Int'l Reps.: BMG Arista/Ariola (Australia).
ABC, (See MCA Special Markets & Products).
Aaron, (See Rock-A-Billy Records).
Abee Cake Records, PO Box 117, New Berlinville, PA, 19545, (215) 367-0335. Pres.: Dave Stahl.
Absolute Records, 3378 W. Harvard, Santa Ana, CA, 92704.
Accent Records, 71906 Hwy. 111, Rancho Mirage, CA, 92270, (619) 346-0075. Fax: (619) 346-0075. Pres./CEO: Scott B. Seely; Vice Pres.: Delores L. Seely; Vice Pres. A & R: Buddy Merrill. Label(s): (Owned) Accent, Coachella. US Reps.: GNP Crescendo (CA). Int'l Reps.: Festival (Australia); Vogue (France).
Acclaim Music, div. of The Spoken Word, Inc., PO Box 7269, Oxnard, CA, 93031, 3645 Saviers Rd., Ste. 9, Oxnard, CA, 93033, (805) 483-6707. Fax: (805) 483-6707. Exec. Dir.: John O. Lundy; Mgr.: Ellen Hardin. Label(s): (Owned) Acclaim Music. US Reps.: Chapel Records (ID).
Accord, (See Musidisc S.A.).
Ace Records, PO Box 9341, Jackson, MS, 39206, 103 Fairmont Lane, Pearl, MS, 39208, (601) 939-6868. Fax: (601) 932-3038. Pres.: John Vincent. Label(s): (Owned) Ace, Vin, (Distributed) Ocean Blue.
Acid Jazz, (See Ex Urbana, Inc.).
Acoustic Disc, 7957 Nita Ave., Canoga Park, CA, 91304, (818) 704-7800. Fax: (818) 704-0185. Pres.: Craig R. Miller; Vice Pres./A & R Rep.: David J. Grisman. Branch(es): PO Box 4143, San Rafael, CA, 94903, (415) 499-0365. Fax: (415) 492-9602, Dir. Sales & Distribution: Harriet Rose, Dir. Mktg. & Promos.: Arthur Rose. US Reps.: I.D.C.(CA); Rounder (MA); Harbor (NY); Record De-

pot (VA); Gemini (GA); East Side Digital (Ryko) (MN); Encore (CO).
Acoustic Sounds, PO Box 2043, 146 S. Santa Fe, Salina, KS, 67401, (913) 825-8609. Fax: (913) 825-0156. Pres.: Chad Kassem. Label(s): (Owned) Analogue Prodns.
Acrecko, (See Starman Records).
Action Records, 1616 Park Place Ave., Ft. Worth, TX, 76110, (817) 923-1111. Owner/Pres.: Marvin Moore; Producer: Bill White. Label(s): (Owned) Action.
Active, (See Select Records).
Adelphi Records, Inc., PO Box 7688, Silver Spring, MD, 20907, (301) 434-6958. Fax: (301) 434-3056. Pres., Gen. Mgr.: Gene Rosenthal; Vice Pres. Mktg., Sales: Howard Rosenthal; Vice Pres. Promo.: Jon Curlin; Vice Pres. Spec. Projects: Hap Passman; Vice Pres. A & R: Jon Curlin. Label(s): (Owned) Sunsplash, (Distributed) Genes Compact Disc.
Adirondack, (See Michele Audio Corp.).
Adobe Records, PO Box W, Shallowater, TX, 79363, (806) 873-3537. Pres.: Tom Woodruff; Assoc.: Sue Swinson.
Advantage Records, 1018 17th Ave. S., #11, Nashville, TN, 37212, (615) 329-9093. Fax: (615) 329-9094. Pres.: Mick Lloyd; Legal Counsel: Hugh Entekin; Vice Pres.: Bev Landstreet Jr.; Vice Pres. A & R: Mike Daniel. Int'l Reps.: Quality Special Products (Canada).
Afterschool Publishing Co., PO Box 14157, Detroit, MI, 48214, (313) 571-0363. Pres.: Herman Kelly; Mgr./Vice Pres. A & R: Luke Peters. Label(s): (Owned) Afterschool, Feel Prodns. Int'l Reps.: RCA Records (Brazil).
Age of Aquarius, (See American Music Co.).
Airborn Records, PO Box 3064, Flint, MI, 48502, (313) 736-5191. Pres.: Ron Moore. Label(s): (Owned) Airborn Communications, Airborn Prodns.
Airwax Records Prodns., PO Box 288291, Chicago, IL, 60628, (312) 779-2384. Pres./A & R Rep.: Casey Jones; Mgr.: B. Jones. Label(s): (Owned) Airwax, Delta City. US Reps.: Collecto's Choice, Wax Museum (NC); Phone Booth Records (OR); Plan 9 Records Distr. (VA).
Airway, (See Earwig Music Co., Inc.).
Akasha Records, PO Box 2033, Secaucus, NJ, 07096, (201) 864-4034. Pres.: G.F. Antanies; Vice Pres.: J. Coen. Label(s): (Owned) Akasha.
Akros, (See Clone Records).
Alacazam, (See Alcazar Prodns., Inc.).
Alamo Records, 324 Broadway, Nashville, TN, 37201, (615) 244-3803. Fax: (615) 255-2629. Contact: Tony Alamo.
Alarma, (See Frontline Records).
Alavox, (See International Record Corp.).
Albatross, (See Lucifer Records, Inc.).
Albradella, (See Soul-Po-Tion Records).
Alcarm Record Co., PO Box 070796, E.N.Y. Sta., 655 Wyona St., Brooklyn, NY, 11207, (718) 272-1200. Fax: (718) 649-1280. Pres./CEO: Alfred McCarther; Sr. Exec. Vice Pres.: Laura Gubern.
Alcazar Prodns., Inc., PO Box 429, S. Main St., Waterbury, VT, 05676, (802) 244-8657, (802) 244-7845. Fax: (802) 244-6128. CEO: Joan Pelton; Pres.: Paul Smith; A & R/Label Mgr.: Lafe Sutton. Label(s): (Owned) Alacazam, (Distributed) Fogarty's Cove, Pax, Round River, Mark Rubin Prodns., Singing Toad, True North. US Reps.: Bayside Dist. (CA); Rounder Records (MA); Old Fogey Dist. (MI); Richman Bros. (NJ); Action Music Sales, Inc. (OH); Silo, Inc (VT). Int'l Reps.: Int'l Record Dist. (Italy); Munich Records (The Netherlands); Gramophone HEEB AG (Switzerland).
Alfalfa, (See King Walk, Inc.).
Alias Records, Inc., 374 Brannan St., San Francisco, CA, 94107, (415) 546-1863. Fax: (415) 546-1433. Prodn/A & R: Lorry Fleming; Tour Promo./A & R: Suzie Racho; Radio Promo.: Giana Bernardini; Sales & Mktg.: Debbie Wilk. Branch(es): 2815 W. Olive Ave., Burbank, CA, 91505, (818) 566-1034. Fax: (818) 566-6623. Pres.: Delight Jenkins; Business Opns.: A.J. Strauber; Publicity: Brett Milano; Video/Retail Sales Promo.: Jill Emrick; Advertising: Robb Moore. Int'l Reps.: Virgin Records (France); Revolver Records (U.K.).
Aljean Records, 7 Colonial Ave., Myerstown, PA, 17067, (717) 866-5067. Pres.: Al Shade.
All American Composers Library, (See D.S.M. Producers, Inc.).
All Art Jazz, (See Jazz Alliance).
All Star Promos., PO Box 37612-Gold Tree Station, Sarasota, FL, 34278, (813) 377-1877. Fax: (813) 377-1877. Pres.: Rob Russen; Exec. Vice Pres.: Lynn N. Russen; Vice Pres.: Eric Russen; Janice Russen; Vice Pres. A & R: Bob Francis. Label(s): (Owned) Castle, Jade, Rock Island, TCB.
Allegiance Records Ltd., 620 Hampshire, Ste. 6, Westlake Village, CA, 91362, CEO: Bill Valenziano; Pres.: Marty Goldrod; Pres. Label Group: Michael Dion; Vice Pres./Gen. Mgr.: Stan Layton. Label(s): (Owned) ITI, Takoma, (Distributed) Sphere, RTV,

GMS, Forever Gold, Beyond, Valley Vue, Voss, Who's Who in Jazz, Windstar.
 US Reps.: Encore (Boulder, CO); Rock Bottom (Norcross, GA).
 Int'l Reps.: Alta Records (Canada); Trend Records (Canada); Best US Dist. (The Netherlands); In Akustic (West Germany).
Allegro, (See Moss Music Group, Inc.).
Alluia! Music, (See Integrity Music, Inc.).
Alleysound, 548 Broadway, Macon, GA, 31201, (912) 742-1049. Pres.: Alan Walden.
Alligator Records & Artist Mgmt., Inc., PO Box 60234, 1441 W. Devon, Chicago, IL, 60660, (312) 973-7736. Fax: (312) 973-2088. Pres.: Bruce Iglauer; Sales Mgr.: Kerry Pearce; Retail Promo Mgr.: Chris Young; Dir. Artist Relations: Nora Kinnally. Label(s): (Owned) Alligator. US Reps.: Action Music Sales (OH-MI-NY); Associated Dist. (AZ); Bayside (CA); Big State Dist. (TX); California Record Dist. (CA-WA); Encore (CO); Landmark (FL); M.S. Dist. (IL-MN); Music Craft (HI); Old Fogey (MI); Record Depot (VA); Richman Bros. (NJ-MD); Rounder (MA-NY-LA); Silo (VT); Selecto (TN); Tant (MI). Int'l Reps.: WEA (Canada).
Almighty, (See Refuge Music Group).
Alpha Int'l, (See Sigma Alpha Entertainment Group).
Alpine, (See JR Sound Prodns., Inc.).
Alshire Int'l, Inc., 1015 Isabel St., Burbank, CA, 91516, (213) 849-4671. Fax: (818) 569-3718. Pres.: Al Sherman; Vice Pres.: Richard Sherman. Label(s): (Owned) Alshire, Audio Fidelity, Exact, Grit, Somerset, Stereo Fidelity.
Altered, (See Multi-Sound Records Int'l).
Alternative Music Prodns., Inc., 7188 Sunset Blvd., Ste. 204, Los Angeles, CA, 90046, (213) 969-2109. Fax: (213) 876-2552. Pres./CEO: John M. Brock, Jr.; Vice Pres.: Christy Binder; Opns. Mgr.: Jeff Cayton; Creative Consultant: Raul Duran; Vice Pres. A & R: Byll Lyons. Label(s): (Owned) AMP.
Alternative Records, 1610 Riverview, Eugene, OR, 97403, (503) 344-5716. Fax: (503) 485-0654. Pres.: Randy Layton; Mktg./Int'l Dir.: Richard Sellens; Vice Pres. A & R: Kevin C. Restiaux. Label(s): (Distributed) Seven And Seven Is Mine.

The Best of East Europe Music
and Productions in the West

No. 1 rock group from the
war-torn Yugoslavia

First European world wide album release

E A S T E U R O P E A N

World wide licensing & distribution
of this and other excellent
music product from
Eastern Europe
available exclusively through

EAST EUROPE RECORDS & MUSIC

Divisions of EAST EUROPE VENTURES, Inc.
246 East Eau Gallie Blvd.
Indian Harbour Beach, Florida 32937, U.S.A.

International Licensing: (407) 779-3410
U.S. Distribution & Promotion: 1-800-940-9846
U.S. Direct Sales: 1-800-940-EAST
Fax: (407) 773-3783

- US Repts.: Spring Arbor Dist. (MI).
Int'l Repts.: Spark Music (The Netherlands).
- Alternative Tentacles**, PO Box 11458, San Francisco, CA, 94101, (415) 541-5303. Fax: (415) 243-0599.
- Alva**, (See Golden Boy Records).
- Alyssa Records**, PO Box 133, Farmingville, NY, 11738, (516) 472-1219. Pres.: Andy Marvel; Vice Pres. A & R: Alyssa Marvel.
- Amadeo**, (See Apon Record Co., Inc.).
- Amazing Grace**, (See Fred Rice Prods., Inc.).
- Amazing Records**, PO Box 2164, 501 N. Interregional Hwy., Austin, TX, 78768, (512) 477-7055. Fax: (512) 477-7057. Owner/Mgr.: Jim Yanaway; CEO: Harry Friedman; Gen. Mgr.: Becki Tooley; Acct. Mgr.: David Palsce; Promos.: Jim Geisler.
- US Repts.: Rounder Dist. (MA); Bayside (CA); Austin (TX); Midnight (NY).
Int'l Repts.: IRD (Italy); Semaphore (Holland); Witness (France); Roadhouse (Norway).
- Ambassador Recording Corp.**, PO Box 31112, Seattle, WA, 98103, (206) 937-5703, (206) 525-2199. Fax: (206) 933-8011. Pres.: Chris Kamila; Vice Pres./Artistic Dir.: Steven Novacek; Gen. Mgr.: Gayle Novacek.
- Label(s): (Owned) Ambassador, (Distributed) Overture (Canada).
- Ambient Sound**, 404 Annapolis Ave., West Saint Paul, MN, 55118, (612) 552-1426. Owner/Pres.: Robert Cain.
- Ame. Records (Amentia)**, PO Box 7910, New York, NY, 10116, (718) 836-4107. Pres.: Yasmainy E. Soya; Dance A & R: Khaldah Brode; Exec. Producer: Yasmainy Soya.
- Label(s): (Owned) Ame. Records (Amentia).
- America**, (See Musidisc S.A.).
- American Cowboy Songs, Inc.**, 3015 Leeville Rd., Mount Juliet, TN, 37122, (615) 444-8431. Fax: (615) 443-3211. CEO: Alfred LeDoux; Pres.: Chris LeDoux; Sec./Treas.: Bonnie LeDoux.
- US Repts.: Paradgm (CA); High Altitude (MT); KTI (NE); Barstow Pro Rodeo, Western Merchandisers (CA); KSG Dist. (UT); Record Depot (VA).
- American Gramophone Records**, 9130 Mormon Bridge Rd., Omaha, NE, 68152, (402) 457-4341. Fax: (402) 457-4332. Exec. Vice Pres.: Stephen Kalhorn; Nat'l Sales Dir.: Michael Delich; Chief Financial Officer: Kevin Clognan; Int'l Bus. Devel. Dir.: Terry Cadmus.
- Branch(es): 16830 Ventura Blvd., Ste. 515, Encino, CA, 91436, (818) 907-8516, Western Region Mgr.: Dan Davis; 81 Skyland Dr., Roswell, GA, 30075, (404) 642-5497, Southeast Region Mgr.: Barry Racoff; 41A Queen Catherine Way, Chester, MD, 21619, (301) 643-8649, East Coast Region Mgr.: Cliff Schultz; 4595 Forestview Lane N., Plymouth, MN, 55442, (612) 550-0988, Contact: Dwight Montijar.
- Label(s): (Owned) American Gramophone, (Distributed) Erdenklang, Living Music, Windstar.
- US Repts.: Assoc. Dist. (AZ); Big State Dist. (TX); Encore Int'l (MD); Eurpac East (VA); Herrington Co. (NH); Mill City Music (MN); Music Design, Inc. (WI); Navarre Corp. (MN); Northward Press, Inc. (WI); Precision Sound Mktg. (WA); Pyramid Dist. (CA); Real to Reel (CA); Rivertown Trading Corp. (MN).
- American Melody Records**, PO Box 270, 102 Wheeler Path, Guilford, CT, 06437, (203) 457-0881. Pres.: Phil Rosenthal; Vice Pres.: Beth Sommers.
- Label(s): (Owned) American Melody.
- US Repts.: Silo, Inc. (VT); Landmark Dist. (NY); Direct Co. (CT); Rounder Dist. (MA).
Int'l Repts.: Waterlily Music (Canada).
- American Music Co.**, 3830 Hwy. 78, Mt. Horeb, WI, 53572, (608) 437-8970. Pres.: Jim Kirchstein.
- Label(s): (Owned) Age of Aquarius, American Music, Cuca Records, Jolly Dutchman, Night Owl, Psalms, Sara Records.
- American Pie**, PO Box 66455, Los Angeles, CA, 90066, 13381 Beach Av., Marina Del Rey, CA, 90292, (213) 821-4005. Fax: (213) 823-3389. Pres.: Wayne Volat.
- Label(s): (Owned) American Pie.
- American Radio**, (See Caprice Int'l Records and Canadian American Records).
- American Voices Record Co., Inc.**, 3205 Blue Ridge Ct., Virginia Beach, VA, 23452, (804) 340-8374. Pres.: Heath Webb; Gen. Mgr./Sec.: Jean Webb.
- Americanate Records, Int'l**, 1817 Loch Lomond Way, Las Vegas, NV, 89102, (702) 384-0030. Fax: (702) 382-1926. Pres.: Joe Jan Jaros; Vice Pres.: Pauline Jaros; Gen. Mgr.: Ken Brown.
- Label(s): (Owned) Americanate, Christy, (Distributed) Multisonic.
- Int'l Repts.: Multisonic (Czechoslovakia).
- AmeriSong Records**, 8727 E. Girard Ave., Denver, CO, 80231, (303) 695-8628. Pres.: Randi Perkins; A & R/Producer: Mike Crowley.
- Label(s): (Owned) AmeriSong.
- Amherst Records, Inc.**, 1800 Main St., Buffalo, NY, 14208, (716) 883-9520. Fax: (716) 884-1432. Pres.: Leonard Silver; Exec. Vice Pres.: Larry Silver; Vice Pres./Gen. Mgr.: David E. Parker; Vice Pres./Sales/Mktg.: David Colson; Vice Pres. A & R: Rose Rupert.
- US Repts.: California (CA); Navarre (MN); Malverne (NY); Action Music (OH); Big State (TX).
Int'l Repts.: A & M Records (Canada); Polygram Int'l (United Kingdom, Europe, Japan).
- Analog Records**, 4212 Wyldwood Rd., Austin, TX, 78739, (512) 282-5682. Fax: (512) 479-0910. Owner/CEO: Tom Roubesh; Promo/Mktg. Dir.: Ric Shreves; Contact: James Harvey.
- Analogue Prods.**, (See Acoustic Sounds).
- Anamaze Records**, 4110 McKinley St., Hollywood, FL, 33021, (305) 964-7300. Fax: (305) 599-9001. Pres., A & R Dir.: Cosmo Ohms; Legal Advisor: Jeff Jacobson; Mktg., Research: Peter Crockford; Vice Pres. Artist Rel.: Mike Tubin.
- Branch(es): 150 Fifth Ave. Ste. 1103, New York, NY, 10011.
- US Repts.: Pickwick (FL); Jem (NJ); Benel (NY).
- Ancient of Days Gold**, (See Kison Elyon Records).
- Anello/Cexton Prodn. Group**, (See Cexton Records).
- Angel**, (See Capitol-EMI Music, Inc.).
- Angel Records**, 810 7th Ave., New York, NY, 10019, (212) 462-6252. Pres.: Steve Murphy; Vice Pres. Eastern Opns.: Tony Caronia; Vice Pres. Sales & Mkt. Devel.: Gilbert Hetherwick; Vice Pres. A & R: Elizabeth Ostrow.
- Branch(es): 1750 N. Vine St., Hollywood, CA, 90028, (213) 462-6252.
- US Repts.: CEMA Distribution.
- Angel Records (Div. of Capitol EMI)**, 1750 N. Vine St., Hollywood, CA, 90028. Pres.: Steve Murphy; Vice Pres. Eastern Opns.: Tony Caronia; Dir. Creative Serv.&Opns.: Barry Golin; Dir. Mktg.: Linda Sterling; Vice Pres. A & R: Elizabeth Ostrow.
- Angelsong**, 2714 Westwood Dr., Nashville, TN, 37204, (615) 297-2246. Pres.: Mabel H. Birdsong.
- Anla**, (See Goldband Recording Corp.).
- Ansonia Records, Inc.**, 750 Paterson Ave., East Rutherford, NJ, 07073, (201) 470-0301. Fax: (201) 470-8274. Pres.: Mercedes Glass; Promo: Lori Glass; Henry Glass; Vice Pres. A & R.
- Label(s): (Owned) Ansonia.
- Antenna Records/Cornerstone Mgmt.**, 148 E. Lancaster Ave., Wayne, PA, 19087, (215) 687-8800. Fax: (215) 971-0646. Pres.: Steve Mountain.
- Label(s): (Owned) Antenna.
- Antilles/Mango Records**, 14 E. 4th St., 3rd Floor, New York, NY, 10012, (212) 995-0202. Fax: (212) 477-5918.
- Antique-Catfish Records**, PO Box 192, 708 W. Euclid, Pittsburg, KS, 66762, (316) 231-6443. Owner/Pres.: Gene Strasser; Vice Pres. A & R: John Poznich; Shawn Strasser.
- Label(s): (Owned) Antique, Catfish.
- Antiquity**, (See Narada Prods., Inc.).
- Antone's Records & Tapes**, 2928 Guadalupe St., Austin, TX, 78705, (512) 322-0617. Fax: (512) 477-2930. Gen. Mgr.: Susan Piver; Sales Dir.: Connie Johns; Comm. Radio & Press: Sally King; Non Comm. Radio: Tracy O'Quinn.
- US Repts.: Bayside (CA); California Record (CA); Encore (CO); Landmark (GA); MS (IL); House (KS); Rounder (MA); Tant Enterprises (MI); Richman Bros. (NJ); Important (NY); Action Music Sales (OH); Select-O-Hits! (TN); Silo (VT).
Int'l Repts.: P. Vine (Japan); Sonet (United Kingdom); ATM Canada (Canada).
- Apollo Jazz**, (See Athena Prods.).
- Apollo Music**, (See Athena Prods.).
- Apollo Theatre Records**, 60 E. 42nd St., Ste. 1336, New York, NY, 10017, (212) 370-1302. Vice Pres. A & R: Voca Rivers.
- Apon Record Co., Inc.**, PO Box 3082, Steinway Sta., Long Island, NY, 11103, (718) 721-5599. Fax: (718) 721-5599.
- Label(s): (Owned) Amadeo, Apon, Discapon, Love, Ukraine, (Distributed) Supraphon.
- Apostle-Rosiland Records**, PO Box 1862, Hollywood, CA, 90028, (818) 896-5346. Pres.: R. J. Anthony Smith; Vice Pres.: Rosiland Smith.
- Label(s): (Owned) Arnesia, Caelyn, Rosiland.
- US Repts.: R. P. Communications (CA).
- April River**, (See Stanyan Record Co.).
- Arcade & Arzee Record Co.**, 3010 N. Front St., Philadelphia, PA, 19133, (215) 426-5682. Pres.: Rex Zario; Gen. Mgr.: Lucky Taylor.
- Label(s): (Owned) Arzee.
- Archive of Folk & Jazz Music**, (See Everest Record Group).
- Arctic**, (See Jamie/Guyden Dist. Corp.).
- Ardavan Records**, PO Box 2512, Hollywood, CA, 90078, (213) 464-8163. Fax: (818) 905-5014. Pres.: Ardie Bryant; Vice Pres.: Anne Bryant; Vice Pres. A & R: David P. Bryant.
- Arena**, (See RCI Records, Inc.).
- Arhoole Prods., Inc.**, 10341 San Pablo Ave., El Cerrito, CA, 94530, (415) 525-7471. Fax: (415) 525-1204. Pres.: Chris Strachwitz; Mgr.: Tom Diamant.
- Label(s): (Owned) Arhoole, Folklyric.
- US Repts.: Bay Side Record Dist. (CA); Rounder Dist. (MA); The House Dist. (KS); Floyd's Wholesale (LA); Encore Dist. (CO); Gemini Dist. (GA); Richman Bros. (NJ); Silo, Inc. (VT); Record Depot (VA); Old Fogey Dist. (MI); Landmark Dist. (IL); Rangel Dist. Co. (TX).
- Int'l Repts.: Tempo (Australia); Dist. Fusion (Canada); UK-Topic Records (England); Fennica-Keskus (Finland); Media 7 (France); IMS/PolyGram (Germany); IRD (Italy); Vivid/Blues Int'l (Japan); Enrique Llerenas (Mexico); Munich Records (Netherlands); Solo Blues (Spain); Amigo (Sweden); Plainisphere (Switzerland).
- Arista Records, Inc.**, 6 W. 57th St., New York, NY, 10019, (212) 489-7400. Fax: (212) 830-2222. Pres., New York: Clive Davis; Exec. Vice Pres.: Bill Berger; Exec. Vice Pres. Opns.: Roy Lott; Sr. Vice Pres. Sales: James Cawley; Vice Pres./Gen. Mgr.: Tim DuBois; Publicity Contact: Merissa Ide; A & R Contact: Anthony Von Dolien; Promo. Contact: Allen Butler.
- Branch(es): 8370 Wilshire Blvd., Beverly Hills, CA, 90211, (404) 452-2320, Promo: Jon Klein; 3395 Northeast Expressway, Ste. 360, Atlanta, GA, 30341, (404) 452-2320, Promo: Linda Alter; 1 Music Cir. North, Nashville, TN, 37203, (615) 780-9100, Fax: (615) 780-9190, Vice Pres./Gen. Mgr.: Tim DuBois.
- Aristo**, (See Creav, Inc. U.S.A.).
- Ark Record**, PO Box 100743, Nashville, TN, 37224, (615) 355-6772. Contact: Everett Faulker.
- Arlic Record Co.**, PO Box 100743, Nashville, TN, 37210, (615) 833-1955.
- Arnesia**, (See Apostle-Rosiland Records).
- Arnold**, (See Carrie Records).
- Aroun' Town Prodn. Inc.**, 2312 San Jose, Las Vegas, NV, 89104, (702) 457-3875. Pres.: Gloria F. Copeland; A & R Vice Pres.: Clarence Ross.
- Label(s): (Owned) Rap Attack.
- Arrival, (See K-tel Int'l (USA), Inc.).
- Art Sublime**, PO Box 473, Gardena, CA, 90248, (213) 329-7254. Fax: (213) 515-0840. Pres.: David Overstreet.
- Label(s): (Owned) Art Sublime.
- US Repts.: Wayside Music (MD).
Int'l Repts.: Musea (France); Edison (Japan); Semaphore (Netherlands).
- Artful Balance**, (See JCI).
- Artifex Records, Inc.**, 604 Overview Ln., Franklin, TN, 37064, (615) 794-3349. Fax: (615) 791-0298. Pres.: Peter Miller; Dir. of Sales & Mktg.: Gina Cossey.
- Label(s): (Distributed) Earth Tone, Fortress, Freshwater, Oak Leaf, Tonewheel.
- US Repts.: Malverne Dist. (NY); Music Distributors Inc. (Dallas, TX); Music Design (Milwaukee, WI); New Leaf (Atlanta, GA); ARP (Japan).
- Arway Records & Ents., Inc.**, PO Box 584, Marion, AR, 72364, (501) 732-6454. Pres./CEO: Marion "Mikii" Hooper; Exec. Vice Pres.: Cleophas Cash; Vice Pres./Controller: Percy Hooper; Sec./Treas.: Betty Reese.
- Arzee**, (See Arcade).
- Ashby Park**, (See Smarty Pants Audio & Video).
- Ashley Records**, PO Box 567, Log Shival Dr., Hendersonville, TN, 37075, (615) 824-3573. Pres.: Leon Ashley; Vice Pres.: Margie Singleton; Gen. Mgr.: Linda Denny; A & R Dir.: L.S. Walton.
- Asylum**, (See Warner Music Int'l).
- Atch Records & Prods.**, 10103 Fondren Ste. 380, Houston, TX, 77096, (713) 981-6540. Pres.: Charles Atchison; Vice Pres.: Broderick Atchison; Studio Dir.: Rick Lauderdale; Promotional Dir.: J. T. Jennings.
- Atco Records**, 1290 Ave. of the Americas, 4th Floor, New York, NY, 10104, (212) 484-6400. Fax: (212) 484-8119. Chrmn.: Derek Shulman; Pres.: Harry Palmer; Exec. Vice Pres./Opns.: Ted Green; Vice Pres. Promos.: Craig Lambert; Dir. Int'l: Marggi Vangeli; Dir. A & R: Derek Oliver; Int'l Press & Promo. Coord.: Gaby Sappington.
- Branch(es): 9255 Sunset Blvd., Ste. 1122, Los Angeles, CA, 90069, (213) 285-9556, Fax: (213) 285-9834, Dir. Nat'l Promo.: Mark Gorlick, Dir. A & R: Karen Dumont.
- US Repts.: WEA Int'l.
Int'l Repts.: WEA Int'l.
- Athens Prods.**, 311 Willowbrook Rd., Staten Island, NY, 10314, (718) 698-2280. Fax: (718) 761-6411. Gen. Mgr.: Robert Marino.
- Label(s): (Owned) Apollo Jazz, Apollo Music, Athena Jazz, Pallas Athenna, (Distributed) Athena.
- US Repts.: East Coast Music Distrib. (NY).
Int'l Repts.: Connaissance Musik (Germany); Audio By Design Ltd. (England).
- Atlla Records**, 63 Dixie Hwy., Rossford, OH, 43460, (419) 666-2019. Fax: (419) 666-3141. Pres.: John Pockis; Vice Pres.: Mary Pockis; Sec.: Joe Manera; A & R Dir.: Johnny Paris; Business Affairs: Jean Hoover.
- Int'l Repts.: East West Records (Germany).
- Atlanta Assoc.**, (See Soul-Po-Tion Records).
- Atlanta Int'l Record Co., Inc.**, 881 Memorial Dr., SE, Atlanta, GA, 30316, (404) 577-5728. Fax: (404) 223-0144. Pres.: S. R. Freeman, Jr.; Vice Pres.: Alan Freeman; Sales Mgr.: Geri L. Jenkins; Nat'l Promo. Dir.: Juandolyn B. Stokes.
- Label(s): (Distributed) Gospearl Records.
- Atlantic**, (See Warner Music Int'l).
- Atlantic Recording Corp.**, 75 Rockefeller Plaza, New York, NY, 10019, (212) 484-6000. Chrmn./CEO: Ahmet Ertegun; Co-Chrmn. & Co-CEO: Doug Morris; Sr. Vice Pres./Gen. Mgr.: Mark Schulman; Sr. Vice Pres. & SFO: Mel Lewinter; Vice Pres. Int'l: Fran Lichtman; Dir. Int'l Art Rel./Publ.: Janis Maiello; Int'l Prod. Mgr.: John Walker; East West U.K. Prod. Mgr.: Vicky Germaise.
- Branch(es): 1025 16th Ave. S., Nashville, TN, 37212, (615) 327-9394, Fax: (615) 329-2008, Admin. Coord.: Joya Caryl.
- Label(s): (Owned) Charisma, East West America, Es Paranza, Finnadar, First Priority, Megaforce Worldwide, Modern, Titanium, Virgin, A Vision Entertainment (Video).
- US Repts.: WEA.
Int'l Repts.: Warner Music Int'l.
- Atlantic Recording Corp.**, 9229 Sunset Blvd., Ste. 710, Los Angeles, CA, 90069, (213) 205-7450. Fax: (213) 205-7475. Sr. Vice Pres. & Gen. Mgr.: Paul Cooper; West Coast Reg'l Mktg. Dir.: Tom Davies; Office Services Coord.: Melonie Lewis; West Coast Publicity Dir.: Laura Gold.
- Atmosphere Records**, (See Northcott Productions, Ltd.).
- Atreus Records**, 331 W. 57th St., Ste. 111, New York, NY, 10019, (212) 320-9180. Pres.: Joseph H. Bernard; A & R Rep.: Lisbeth Bernard; Angel Mercado.
- Auburn Records & Tapes**, PO Box 96, 6223 N. 51st Ave., Glen-dale, AZ, 85311, (602) 435-0314. Owner: Frank E. Koehl.
- Label(s): (Owned) Auburn.
- Audax**, (See Music & Arts Productions of America, Inc.).
- Audio Arts Records**, 3420-3C Calle Azul, Laguna Hills, CA, 92653, (714) 770-6162. Owner/Mgr.: Madelon Baker.
- Label(s): (Owned) Audio Gospel.
- Audio Fidelity**, (See Alshire Int'l, Inc.).

- Audio Gospel**, (See Audio Arts Records).
- Audio Lab**, (See Creav, Inc. U.S.A.).
- AudioLoft Recording Studios**, PO Box 7-11, Old Hwy 54 W., Macks Creek, MO, 65786, (314) 363-5432. Fax: (314) 363-5820. Pres./Owner: B. J. Carnahan; Gen. Mgr.: Brad Edwards. Label(s): (Owned) BOC, History.
- Audiophile Records**, 1206 Decatur St., New Orleans, LA, 70116, (504) 525-1776. Pres.: George H. Buck, Jr.; A & R: Gus Stafiras; Jon P. Pult; Vice Pres. A & R: Wendel Echols. US Reps.: City Hall (CA); Rounder (MA); North County, Zim (NY).
- Int'l Reps.:** Jazzology Dist. (Australia); Phoenix Trading Co. (Japan); Adlib (Sweden); Jakob Etter, Planisphere (Switzerland); Jazz Music, Swift (United Kingdom).
- Audiorama Records Corp.**, 658 Tenth Ave., New York, NY, 10036, (212) 246-9858, (212) 246-9859. Fax: (212) 459-8949. Pres.: Raael Diaz; Vice Pres.: Hilda Diaz; Music Mgr.: Angel Nieves; Promo. Mgr.: Hilda Lueiano. Label(s): (Owned) Sonomax, (Distribu:ed) Musical Prodn.s., Th-Rodven, Velvet, B & B, Bronco, Gad, Libertad.
- August Records, Inc.**, PO Box 438, Lahaska, PA, 18931, (215) 862-3012. Fax: (215) 862-9145. Vice Pres.: Beryl Handler.
- Auriga**, (See Christmas Records, Prince/SF Publications).
- Auspex Records**, PO Box 1666, Studio City, CA, 91614, (213) 877-1078. Fax: (818) 763-1955. Owner: Jules Chaikin.
- Avalanche Records**, 413 S. 25th St., Blair, NE, 68008, (402) 426-4508. CEO: Clifton R. Johnson; Pres.: Stafford Johnson; Vice Pres.: Don Johnson. Label(s): (Owned) Avalanche.
- Avant-Garde Records Corp.**, 12224 Avila Dr., Kansas City, MO, 64145, (816) 942-8859. Fax: (816) 942-8988. Pres.: Scott W. Smith; Vice Pres.: Louis Teicher; Sec.: Arthur Ferrante; Mgr. Mktg.: Brad K. Brann. US Reps.: Intersound Int. (GA).
- Avatar Prodn.s.**, 6290 Sunset Blvd., Los Angeles, CA, 90028, (213) 464-1593. Pres.: Reggie Brown. Label(s): (Owned) Crazy Hype!
- Avatar Records Inc.**, 7831 S.E. Stark, Ste. 207, Portland, OR, 97215, (503) 252-6033. Pres./CEO: M. chael Berkley; Vice Pres. A & R: Robert (Bobo) Roth; Marc Immerman; Midwest Vice Pres. A & R: Ian Maikes.
- Award**, (See RCI Records, Inc.).
- Awesome Records**, 102 D St., Clinton, SC, 29325, CEO/Pres.: Julian L. Dillard; Vice Pres. A & R: David L. Dillard.
- Axbar Records**, 5230 San Pedro Ave., San Antonio, TX, 78212, (512) 829-1909. Owner/Gen. Mgr.: Joe L. Scates; A & R: Jerry Blanton; Mktg. Mgr.: George Chambers; Dir. Radio Promos.: Gary Bradshaw. Label(s): (Owned) Axbar, Charro, Gringo, Jato, Prince, Trophy. US Reps.: Daro Exports (NY); Curtis Wood, Dixi-Raks (TN); Flying Book Service (TX).
- Int'l Reps.:** Western Songs (Sweden).
- Azra Int'l**, PO Box 459, 4343 E. 58th St., Maywood, CA, 90270, (213) 560-4223. Fax: (213) 560-1240. Pres.: D.T. Richards; Artist Relations: Al Martinez; Mktg.: Theo Thrasher; Publicity: Sheri Sigler; Vice Pres. A & R: David Richards. Label(s): (Owned) Condor Classix, Iron Works, Metal Storm, World Metal, (Distributed) Stardust, Masque. US Reps.: Performance (NJ); Kand America (CA); Important (CA); Caroline (NY); Azra (CA).
- Aztec Corp.**, 6 S. 230 Cohasset Rd., Naperville, IL, 60540, (708) 961-3559. Pres./Sales Mgr.: Allan Shaw; Vice Pres. Opns.: Lisa Holmes. Label(s): (Owned) Folk Era Prodn.s., (Distributed) Homecoming, Hoot Mon, Kenebunk River, MTA, SGB, West Knoll, Tranquilla, Cross Country, Dark Angel, Depot, Dooley, Eastwind, Fannigan's, Ball Bearing, Borderline, Brandywine, Cactus, Cief, Cooper, BG. US Reps.: RM Distrib. (IL).
- B**
- BAL Records**, PO Box 369, La Canada, CA, 91012, (818) 548-1116. Pres.: Adrian P. Bal; Sec./Treas.: Berdella M. Bal.
- B-Atlas & Jody Records Co.**, 2557 E. First St., Brooklyn, NY, 11223, (718) 339-8047. Vice Pres., A & R Dir.: Vincent Vallis; Pres. Sales: Ron Alexander; Vice Pres., A & R Sales: Gloria Black; Vice Pres. Sales: Tom Peci. Label(s): (Owned) G Co, Jody. US Reps.: Schwartz Bros. (MD, NJ); Rounder (MA); Malverne (NY); Universal (PA).
- BGM Records**, 4265 Gate Crest, San Antonio, TX, 78217, (512) 654-8773. Fax: (512) 654-8895. Gen. Mgr.: Bill Green; Promo. Dir.: Debbie Green. Label(s): (Owned) BGM, Rain Forest.
- BHJ**, (See Seaside Records).
- BMG/RCA Record Labels**, 1 Music Cir. N., Nashville, TN, 37203, (615) 664-1200. Pres./Gen. Mgr.: Joe Galante.
- BMJ**, (See Southern Sound Prodn.s.).
- BMX Records**, 4882 McPhenson Dr., PO Box 698, Roswell, GA, 30075, (404) 594-0669. Fax: (404) 250-9036. Pres.: Mauris Griffin, II.
- BOC**, (See AudioLoft Recording Studios).
- BSW Records**, PO Box 2297, Universal City, TX, 78148, (512) 653-9899. CEO/Pres.: Frank Williams; Mgr. Europe Office: Willy Seidel; Dir. Publicity: Frank Weatherly; Vice Pres. A & R: Del Richerson; Pub.: Frank Weatherly; Sec.: Regina Halamuda. Label(s): (Owned) BSW. US Reps.: Sabine River Music (TX). Int'l Reps.: Hee Jee Record Co. (Korea).
- BVM Records**, 2253 Kingsland Ave., New York, NY, 10469, (212) 515-9700. Fax: (212) 881-0501. Pres./CEO: Louis S. Filardi; Producer: Don Anthony; Recording Artists Rep.: Joe Petralia; Pub. Rel. Exec. Dir.: Anthony F. Staino; Vice Pres. A & R: Marie A. Cartica. Label(s): (Owned) BVM. US Reps.: One World Records (NJ).
- Baby Doll**, (See Sugarfoot Prodn.s.).
- Bachats**, (See Kubaney Publishing Corp.).
- Bad Boys**, (See Christmas Records).
- Baddest Of The Bad Posse Records**, PO Box 464, RCS, New York, NY, 10185, (212) 777-0442, (718) 712-2224. Pres./CEO: Leslie Williams; Gen. Mgr./Creative Arts: Tony Dunmore; Gen. Mgr./Business Affairs: Rebecca Williams; Dir. Publicity & Promos.: Wayne Cochrane; Vice Pres. A & R: Andre James. Label(s): (Owned) Baddest Of The Bad Posse, Rebel Rock. US Reps.: Rebel Rock Records (NY).
- Bah Humber Records**, 1722 S. Carson, Ste. 2607, Tulsa, OK, 74119, (918) 585-5050. Pres./Gen. Mgr.: Dick Loftin; Project Coord./Exec. Prod.: Lee Ann Loftin.
- Baila**, (See Worldwide Entertainment).
- Bainbridge Entertainment Co., Inc.**, PO Box 8248, 2507 Roscomare Rd., Los Angeles, Van Nuys, CA, 91409, (213) 476-0631. Fax: (213) 472-4190. Pres.: Harlene Marshall; Vice Pres.: P.J. Littleton. Label(s): (Owned) Bainbridge, Darksilver, Time, (Distributed) Quartet.
- Baja**, (See TSR Records).
- Billy Baker & Assoc.**, 3345 Hollins Ferry Rd., Baltimore, MD, 21227, (301) 247-7446, (301) 247-7447. Fax: (301) 247-7445. Pres./CEO/Personal Mgr.: William E. Baker; Promos. & Mktg.: Lisa King; Sales/Promos./Mktg.: Ernest W. Cash; Vice Pres. A & R: Michael E. Szymanski. Label(s): (Owned) Go, Infinity.
- Bald Headed**, (See Winners Circle Records).
- Ball Record Mfg. & Distribution Co.**, 355 S. Mansfield St., Los Angeles, CA, 90036, (213) 936-1032. Fax: (213) 937-8728. Owner/Pres.: Jim L. Ball, Ph.D. Label(s): (Owned) Savior.
- Bandstand U.S.A.**, (See Goldwax Record Co. Inc.).
- Bang Zoom Records**, PO Box 1045, Long Island City, NY, 11101, (718) 786-7951. Pres./Owner: Ilze Lemesis. US Reps.: Important Dist. (Hollis, NY).
- Banjar Records, Inc.**, PO Box 32164, Minneapolis, MN, 55432, (612) 755-9829. Pres.: LeRoy Larson. US Reps.: Old Fogey (MI); Mill City Music (MN).
- Barnett Prodn.s., Inc.**, 2305 Dickey Ave., Chicago, IL, 60664, (708) 689-2726. Pres.: Walter Mae Barnett; Vice Pres.: Walter T. Barnett; A & R Dir.: T. Young; Sec.: Clara Weldon.
- Barquet**, (See Westwood Entertainment Group).
- Basement Records**, 234 Christopher Columbus Dr., Jersey City, NJ, 07302, (201) 963-1560. Fax: (201) 963-1560. Int'l Vice Pres.: Craig Bevan; Vice Pres. Sales: Barry Zeger; Promo. Dir.: Terry Selders; A & R Dir.: Kent Frederick. US Reps.: JFL, (FL); Encore, Unique (NY).
- Batish Records**, 1310 Mission St., Santa Cruz, CA, 95060, (408) 423-1699. Chrmn.: S. D. Batish; Vice Pres.: Ashwin Batish; Gen. Mgr.: Ravi Batish; A & R: Surendra Batish.
- Battery Records, Inc.**, 74-09 37th Ave., Ste. 420, Jackson Heights, NY, 11372, (718) 898-6964. Pres.: Ben Bagley.
- Bay City**, (See Victory Media Group).
- Bay Port**, (See Fink/Pinewood Records).
- Bay Records**, 1741 Alcatraz Ave., Berkeley, CA, 94703, (510) 428-2002. Owner: Michael Cogan.
- Bayou Classics**, (See Master-Trak Ent.s.).
- Beach**, (See Extra Sensory Prodn.s.).
- Beale Street Records, Inc.**, PO Box 1618, Memphis, TN, 38101, (901) 725-9303. Fax: (901) 725-9303. Pres.: Dan Greer.
- Beale Street U.S.A.**, (See Goldwax Record Co. Inc.).
- Bear Creek Entertainment Group**, 19 Music Sq. W., Nashville, TN, 37203, (615) 255-5740. Pres.: John Young; Vice Pres.: Valerie Graham. Label(s): (Owned) Bear.
- Bearsville Records**, PO Box 135, Bearsville, NY, 12409, (914) 679-7303. Fax: (914) 679-5731. Owner/Pres.: Sally A. Grossman; Controller/Gen. Mgr.: Willis Vermilyea; Dir. of A & R: Ian Kimmel. Label(s): (Owned) Bearsville. US Reps.: Rhino Records (CA).
- Beat**, (See The Orange Record Co., Inc.).
- Beat Street Records**, 850 Seventh Ave., Ste. 901, New York, NY, 10019, (212) 245-9835. Fax: (212) 245-9836. Branch(es): 129 Devonshire St., Surry Hills, 2010, Australia, (071) 794-4904, Fax: (612) 699-1537; 74A Belsize Lane, London, NW35B, United Kingdom, (071) 794-4904, Fax: (071) 433-3710.
- Beatlefest, Inc.**, PO Box 436, 15 Charles St., Westwood, NJ, 07675, (201) 666-5450. Fax: (201) 666-8687. Pres.: Mark Lapidos; Vice Pres.: Carol Lapidos. Label(s): (Owned) Caromar.
- Beau-Jim Records, Inc.**, PO Box 2401, Sarasota, FL, 34230, (813) 746-3905. Pres.: Buddy Hooper.
- Beck Records**, 2503 W. Fullerton Ave., Chicago, IL, 60647, (312) 489-6032. Contact: Kimmo Williams; Carol Williams. Label(s): (Owned) Beck. US Reps.: Musicraft (HI); MDI (TX); Landmark (GA); Impact (IL).
- Bed of Roses Records**, 4217 Highland Ave., Ste. 128, Waterford, MI, 48328, (313) 673-6460. Pres./Owner: Debbi Combs; Promos. Dir.: Dave Mielke.
- Bee Gee Records Inc.**, 1012 S. Fair Oaks Ave., South Pasadena, CA, 91030, (818) 405-0356. Pres.: Byron Spears, Jr.; Vice Pres.: Leroy L. Lovett.
- Beechwood**, (See Little Giant Records).
- Beggars Banquet**, 274 Madison Ave., Ste. 804, New York, NY, 10016, (212) 889-9595. Fax: (212) 889-3641.
- Bellaire Records**, PO Box 125, Bellaire, TX, 77401, (713) 667-9196. Owner: Don Janicek. Label(s): (Owned) Chapel, Fun-E, Guide.
- Belle**, (See La Louisianne Records).
- Belly Dance**, (See Rashid Sales Co.).
- Belmont Records**, 484 Lexington St., Waltham, MA, 02154, (617) 891-7800. Pres.: John Penny. Label(s): (Owned) Belmont, Waverly.
- Beni Mer**, (See Kison Elyon Records).
- Benson Co.**, 365 Great Cir. Rd., Nashville, TN, 37228, (615) 742-6800. Fax: (615) 742-6911. Pres.: Jerry Park; Vice Pres., Sales: Allan Hardin; Vice Pres., Mktg.: Dan Lynch; Int'l Sales Exec.: Scott Harvey; Vice Pres. A & R: Ken Pennell. Label(s): (Distributed) Fore Front, Giant, Maranatha, Urgent.
- Ben Records, Inc.**, PO Box 9, Willow, NY, 12495, (212) 233-3353. Pres.: Baird Hersey; Promo/Sales: Jude Sillato.
- Beracah Records** (div. of Beracah Ministries, Inc.), 6855 Jimmy Carter Blvd., Ste. 2100, Norcross, GA, 30071, (404) 446-0588. Fax: (404) 446-0120. Pres.: Rev. John M. Sussewell; Vice Pres.: Canzetta S. Sussewell; Treas.: Cassandra Hightower; Vice Pres. Sales & Mktg.: Terrence E. Williams. US Reps.: Schwartz Bros. (MD); Central South Music Sales (TN); Malverne Dist., Inc. (NY); Select O Hits (TN). Int'l Reps.: Magnum Music Ltd. (England).
- Bermuda Dunes Records**, 40-655 Jefferson, Bermuda Dunes, CA, 92201, (619) 345-2851.
- Bernstein Corp.**, 2170 S. Parker Rd., Ste. 115, Denver, CO, 80231, (303) 755-2546, (800) 783-4487. Fax: (303) 755-2617. Pres./CEO: Richard J. Bernstein; Chrmn.: Morris Bernstein; Sr. Vice Pres.: Allen Bernstein; Vice Pres.: Neil Bernstein; Vice Pres. A & R: R. S. Miller. Label(s): (Owned) Finer Arts, Strummin, Transworld, Wee Bee.
- Int'l Reps.:** BYG Records (France).
- Berry Hill**, (See Track America).
- Bert & I, Inc.**, PO Box 666, Ipswich, MA, 01938, (508) 356-0151. Pres.: Robert A. Bryan; Vice Pres./Mgr.: Faith L. Bryan.
- Bestway Group, Inc.**, c/o Pearce Massler, 25 Main St., Hackensack, NJ, 07601, (908) 753-6548. Fax: (908) 755-8664. Pres.: Howard A. Massler. Label(s): (Owned) Merry, Wonderland.
- Big**, (See Hometown Music Co.).
- Big Bear Music**, 22 Circle Dr., Fairview Heights, IL, 62208, (618) 397-3701. Pres.: Robert D. Schirmer.
- Big Blue Dolphin Records & Tapes**, 760 W. Sample Rd., Pompano Beach, FL, 33064, (305) 943-9865. Fax: (305) 943-9865. President: Josh Noland; Vice-President: Mike Cotton; Vice Pres. A & R: Mike Cotton. US Reps.: H & L Dist. (FL).
- Big K Records**, PO Box 3500, 17 Sachem St., Pawtucket, RI, 02861, (401) 728-1689. Fax: (508) 399-6380. Pres./Gen. Mgr. Karen Pady.
- Big Money, Inc.**, PO Box 2483, Loop Stn., 2900 James Ave. S., Ste. F, Minneapolis, MN, 55402, (612) 827-7500. Fax: (612) 827-7507. Pres.: Chris Johnson; Second In Command: Scott Hull. Label(s): (Owned) Big Money, Ruthless. US Reps.: Dutch East (NY); T.C.I. (MN); Cargo (IL); Revolver (CA); Godd Guise (IL).
- Big Prodn.s. & Publishing Co., Inc.**, 37 E. 28th St., Ste. 308, New York, NY, 10016, (212) 447-6000. Fax: (212) 447-6003. Pres.: Paul Punzone; Gen. Mgr. A & R: Bruce B. Fisher. Label(s): (Owned) Big Prodn.s. US Reps.: JFL (FL); Justin (GA); JJ (NY); Liaison (MO); Unique (NY); Vista (NJ); WIN (NY); Record Imports (NY); S.&L. (NY).
- Big Records**, 80-08 35th Ave., Jackson Heights, NY, 11372, (718) 651-8213. Pres.: Sidney Prosen; Music Coord.: Phil Prosen; Country Rep.: Wanda Helm. Branch(es): PO Box 90575, Nashville, TN, 37209, (615) 989-2450, Nat'l Country Rep.: Wanda Helm.
- Big Sky**, (See SCP Records (Div. of The Sound Column Companies)).
- Big Sound**, (See TNA Records).
- Big Tap Records c/o Jacobson & Colfin, P.C.**, 156 Fifth Avenue, Suite 434, New York, NY, 10010, (212) 691-5630. Fax: (212) 645-5038. Pres.: Gerald Tapper; Business Affairs: Jeffrey E. Jacobson.
- Big Time Records (America), Inc.**, 9903 Santa Monica Blvd., #472, Beverly Hills, CA, 90212, (213) 465-9527. Fax: (213) 286-0824. Pres.: Fred Bestall. Label(s): (Distributed) D'tat.
- Int'l Reps.:** D'tat (Australia).
- Biograph Records, Inc.**, 16 River St., Chatham, NY, 12037, (518) 392-3400. Fax: (518) 392-2666. Pres./A & R Dir.: Arnold S. Caplin; Vice Pres.: Barbara Caplin; Exec. Asst.: Debra C. Rath; Computer Graphic/Art Dir.: Alan D. Caplin. Label(s): (Owned) Biograph, Center, Dawn, Melodeon, (Distributed) Historical. US Reps.: Encore Dist. (CO); Precision Sound (WA), Rounder (MA). Int'l Reps.: Media 7 (France); IRD (Italy); Topic Records (England).
- Biography In Music**, (See Lyric Distribution, Inc.).
- Birch Records**, PO Box 92, Wilmette, IL, 60091, (312) 292-0988, (708) 251-7037. Pres.: Dave Wylie; Vice Pres.: June Wylie. Label(s): (Owned) Birch. US Reps.: Old Homestead (MI).

- Birch Tree Group, Ltd.**, 180 Alexander St., Princeton, NJ, 08540, (609) 683-0090.
- Bird Prods.**, 1946 N. Hudson Ave., Chicago, IL, 60614, (312) 787-6060. Pres.: Robin McBride.
Label(s): (Owned) VU.
- Bizarre/Straight Records**, 740 N. La Brea Ave., 2nd Floor, Los Angeles, CA, 90038, (213) 935-4444. Fax: (213) 936-6354. Pres.: Herb Cohen; Vice Pres., Bus. Affairs: Evan Cohen; Vice Pres. A & R: Robert Duffey.
Label(s): (Owned) Bizarre/Straight.
US Reps.: Rhino Records (CA).
- Bizz-E Prods.**, c/o Jacobson & Colfin, P.C., 156 Fifth Ave., Ste. 434, New York, NY, 10010, (212) 691-5630. Fax: (212) 645-5038. Pres.: Everett Ramos.
- Black Diamond Records Inc.**, PO Box 222, Railroad Ave., Pittsburg, CA, 94565, (510) 779-4341, (213) 748-6549. Fax: (510) 779-7253. Dir. Promos: David Norwood; Mktg. Dir.: Jamal Outlaw; Dir. Sales: Nik DePaulo; Asst. Dir. Sales: Lenna Bellucci; Vice Pres. A & R: Joe Brown.
- Black Dimond Records**, PO Box 8073, Pittsburg, CA, 94565, (510) 779-4341, (213) 748-6545. Fax: (510) 779-7253. Asst. Dir. Promos.: Mary Johnson; Mgr. Mktg. Dept.: Mike Adams; Mgr. A & R Dept.: Stan Williams; Mgr. of Sales: Jody Johnson; Vice Pres. A & R: Art Jackson.
Label(s): (Distributed) D. City.
- Black Dog Records**, 1156 Park Lane, W. Palm Beach, FL, 33417, (407) 686-1354. Exec. Dir.: Marian Joy Ring; A & R Dir.: Ron Caruso; Prodn. Consultant: Rusty Gordon.
Branch(es): 1156 Park Ln., West Palm Beach, FL, 33417, (407) 686-1354, A & R Dir.: Rusty Gordon.
Label(s): (Owned) Black Dog.
- Black Hat Records**, PO Box 4088, Austin, TX, 78765, (512) 452-9411. Pres.: Larry Watkins.
- Black Sun**, (See Celestial Harmonies).
- Black Top Records**, 1313 W. Cornelia Ave., Chicago, IL, 60657, (312) 477-9224. Fax: (312) 929-0181.
- Blackball Line Recordings**, PO Box 265, Gracie Sta., New York, NY, 10028, (212) 288-3832. Pres.: Sailorman Jack; Vice Pres.: Pat Smith; A & R: Lulu Kobak; Promo: Benny Katzinski.
- Blackberry Way Records**, 606 13th Ave., SE, Minneapolis, MN, 55414, (612) 378-2466. Owners: Mike Owens & Kevin Glynn.
- Blas First Records**, 262 Mott St., Ste. 324, New York, NY, 10012, (212) 941-9560. Fax: (212) 941-9383. U.S. Label Mgr.: Reyne Occuro.
- Blaster Boxx Hits**, 519 N. Halifax Ave., Daytona Beach, FL, 32118, (904) 252-0381. Fax: (904) 252-0381. CEO: Bobby Lee Cude.
Label(s): (Owned) Blaster Boxx Hits.
- Blind Pig Records**, PO Box 2344, San Francisco, CA, 94126, (510) 526-0373. Fax: (510) 526-9095. Pres.: Edward Chmielewski; Mktg. & Sales Dir.: Jerry DelGiudice.
Branch(es): 3022 N. Allen, Chicago, IL, 60618, (312) 772-0043, Fax: (312) 772-2115, Mktg. & Sales Dir.: Jerry DelGiudice.
Label(s): (Owned) Blind Pig.
US Reps.: Rounder (MA); Silo (VT); Richman Bros. (NJ); Record Depot (VA); Rock Bottom Dist. (FL); Action Music Sales (OH); Old Fogey Dist. (MI); Encore Dist. (CO); M.S. Dist. (IL); Michael Ginsburg Dist. (TN); Precision C/O The Culver Co. (TX); Bayside Dist. (CA); CRD (CA); Select-O-Hits (TN).
Int'l Reps.: Parsifal (Belgium); Festival, Trend (Canada); FMS Music Service (Germany); Music & Words (Holland); I.R.D. (Italy); Amigo Musik (Sweden); Blues Interactions (Japan); Topic (United Kingdom); Be Bop (Switzerland); Dixie Frog (France).
- Blue Brass**, (See Release Records).
- Blue Canyon Records**, PO Box 6622, Santa Fe, NM, 87502, (505) 989-9298. Owner: Jim Terr.
- Blue Earth Records**, PO Box 1515, West Caldwell, NJ, 07007, (201) 226-3863. Pres.: Herbie Pabst; Vice Pres./A & R: Julie Tucker; Vice Pres./Prods.: Glenn Taylor.
- Blue-Eyed-Blues**, (See Claiming Race Records).
- Blue Flame Records**, 209 Lenox Ave., Providence, RI, 02907, (401) 941-6649. Fax: (401) 467-4305. Pres.: Bob Bell.
Label(s): (Owned) Blue Flame, Roomtoons.
- Blue Gem Records**, PO Box 29688, Hollywood, CA, 90029, (213) 664-7765. Pres.: Pete Martin.
Label(s): (Distributed) Hi-Lite.
- Blue Jay**, (See Stark Records & Tape Co.).
- Blue Note**, (See Capitol-EMI Music, Inc.).
- Blue Orchid**, (See DA Music USA).
- Blue Plate**, (See Al Bunetta Mgmt.).
- Blue Ridge**, (See Stark Records & Tape Co.).
- Blue Rock 'It Records**, PO Box 383, 1375 Road B, Redwood Valley, CA, 95470, (707) 485-8308. Pres.: Patrick Ford.
US Reps.: Bayside Dist. (CA); Tant Ents. (MI); North Country (NY).
Int'l Reps.: Crosscut (W. Germany); IRD (Italy); Bodacious (United Kingdom).
- Blue Sun Prods.**, PO Box 67, Covina, CA, 91723, 978 Amelia, San Dimas, CA, 91723, (714) 592-3098. Pres.: Steve Mortensen.
Label(s): (Owned) Single Phase.
- Blue Wave Records**, 3221 Perryville Rd., Baldwinville, NY, 13027, (315) 638-4286. Fax: (312) 635-4757. Pres.: Greg Spencer; Vice Pres.: Sue Spencer.
Label(s): (Owned) Blue Wave, Horizon.
US Reps.: Select-O-Hits (TN); Important (NY); Bayside (CA); Encore (CO); Midnight (NY).
- Blues Unlimited**, (See Master-Trak Ents.).
- Blythwood Records, Inc.**, 8008 Georgetown Pike, McLean, VA, 22102, (703) 893-6848. Pres.: Johnny Maddox; Vice Pres.: Fredette Eagle.
US Reps.: Blythwood (VA).
- Bobkat Records**, 50 Spring City Rd., Phoenixville, PA, 19460, (215) 948-5096. Pres.: Robert Benedetto; Vice Pres., Gen. Mgr.: Vincent Benedetto; Sec.: Kathleen Benedetto.
- Boddie Recording**, 12202 Union Ave., Cleveland, OH, 44105, (216) 752-3440. Pres.: Louise Boddie; Eng. Pres.: Thomas Boddie; Mgr.: Dennis Boddie; Sec.: Jeanette Boddie.
Label(s): (Owned) Bounty, Luau, Soul Kitchen.
- Bold 1 Records**, 2124 Darby Dr. NW, Massillon, OH, 44646, (216) 833-2061. Owner/Producer: Nick Bold; Promos: Dave Myers.
Label(s): (Owned) Bold One, Roxtown.
US Reps.: Caprice Int'l (PA).
- Bolivia**, (See Known Artist Records).
- Bonaire Records**, 7774 Torreyson Dr., Los Angeles, CA, 90046, (213) 876-4160. Fax: (213) 876-0476. Pres./A & R Rep.: Clive Corcoran.
Int'l Reps.: BMG Dist. (Germany); Electra AB Dist. (Denmark).
- Bonfire**, (See Jay Jay Record & Tape Co.).
- Bonnet**, (See Country Stream Records).
- Boo**, (See Ron-Dom Prods., Inc.).
- Boom/Powerplay Records**, 200 Regent Dr., Winston-Salem, NC, 27103, (919) 768-1881. Fax: (919) 768-8315. Pres./A&R Rep.: Dave Passerallo; Sec.: Linda Stilson.
Label(s): (Owned) Boom, Powerplay.
- Borinquen**, (See Studios Borinquen, Inc.).
- Boss**, (See Pegasus Records).
- Boston Skyline Records**, 73 Hemenway St., #508, Boston, MA, 02115, (617) 536-5464. Fax: (617) 266-1575. Owner: Wayne Wadhams.
US Reps.: Silo Records (VT); Trip (Tower Records) (CA); Rizzoli Int'l (NY).
- Bounty**, (See Boddie Recording).
- Bouquet-Orchid Ents.**, Box 11686, 97 Peachtree Park Dr., Ste. M-3, Atlanta, GA, 30355, (404) 355-7635. Pres.: Bill Bohannon; Vice Pres./Mktg.: Ed Neeley; Dir. Promo.: Coy Bohannon; Dir. Promos.: Sharon Wells; Vice Pres. A & R: Scott Smith.
Label(s): (Owned) Bouquet.
US Reps.: Handleman Co. (MN); Nat'l Independent Record Dist. (CA); Malverne (NY); Select-O-Hits (TN).
- Bourne Co.**, 5 W. 37th St., New York, NY, 10018, (212) 391-4300. Fax: (212) 431-4306.
Label(s): (Owned) Murbo.
- Bouvier**, (See Credence Records).
- Bradley Brothers Records & Tapes**, PO Box 2144, Winnetka, CA, 91306, (805) 522-6045. Fax: (805) 522-8329. Owner: Don Bradley; Vice Pres.: Hal Bradley; A & R: Darren Thomas; Nat'l Promos.: Debbie Lee.
Label(s): (Owned) Cobra Country, Tex Mex.
US Reps.: Curtis Wood (TN); Country Music Int'l (WA).
- Branchchild**, (See Dean Whitney Music Ents.).
- Branch Int'l Records**, PO Box 671008, 11347 Park Central Pl., Dallas, TX, 75367, (214) 750-0720. Fax: (214) 987-4638. Mgr.: Pat McKool; A & R: Mike Anthony; Publicity: Dolores Pittman; Record Producer: Bart Barton.
- Brand X Records**, PO Box 14438, South Lake Tahoe, CA, 95702, (916) 542-1403. Owner/Producer: Bob Cole; Pub. Rel.: Pat Murphy.
- Brandywine Prods.**, PO Box 413, Durham, NH, 03824, (603) 749-2811. Vice Pres.: Richard R. Shaw; Ronald B. Shaw.
- Brat Records**, PO Box 157, Richmond, VA, 23201, (804) 359-0001. Pres.: Barry Gottlieb.
- Braziloid**, (See Celluloid Records).
- Bread 'N Honey, Inc.**, PO Box 3391, Ventura, CA, 93006, (818) 781-3492. Fax: (818) 781-3495. Pres.: Declan Kavanagh; Vice Pres. Sales/Creative: Wil Evans; Vice Pres./Gen. Mgr.: Roderic Kavanagh.
Label(s): (Owned) Bread 'N Honey.
- Break Time**, (See Creav, Inc. U.S.A.).
- Breakthru' Records, Inc.**, 2 Lincoln Sq. 24 E., New York, NY, 10023, (212) 362-1689. Pres.: Robert Silverstein.
US Reps.: Oxymorom P & D (CA).
- Brentwood Jazz**, (See Brentwood Music, Inc.).
- Brentwood Kids Company**, (See Brentwood Music, Inc.).
- Brentwood Music, Inc.**, 316 Southgate Ct., Brentwood, TN, 37027, (615) 373-3950. Fax: (615) 373-0386. Pres.: Jim Van Hook; Creative Dir.: Ed Kee; Dir. of Mktg.: Glenn Wagner; Dir. of Sales: Don Noes.
Label(s): (Owned) Brentwood Jazz, Brentwood Kids Company, Smoky Mountain Music.
Int'l Reps.: Christian Mktg. (Canada); Work U.K. (United Kingdom); Alpha & Omega (Australia).
- Briarhead Records**, PO Box 1875, Gretna, LA, 70054, (504) 392-4615. Fax: (504) 392-4512. Pres.: Ken Keene; Vice Pres.: Frankie Ford.
Label(s): (Owned) Keeta, Sonor, (Distributed) Stardust.
- Brick City Records**, PO Box 4291, 500 North St., Ste. 10, Springfield, IL, 62708, (217) 523-2262. CEO/Pres.: Robert D. Adams, Sr.; Exec. Vice Pres./W. Coast Office: Damong Webb; V.P. Admin/Personnel: Doris Smith; Vice Pres. Mktg.: Annette M. Fleming; Vice Pres. A & R: Robert D. Adams, Jr.
Label(s): (Owned) Brick City.
- Bridge Records, Inc.**, GPO Box 1864, New York, NY, 10116, (516) 487-1662. Fax: (516) 773-3397. Managing Dir.: Becky Starobin; Pres.: David Starobin.
US Reps.: KOCH Int'l (US).
Int'l Reps.: IMS Polydor (Japan), (Holland), (Luxembourg), (Belgium); Media 7 (France); Trubach Digital (Austria), (Germany); Taifu Electronics (Taiwan); Albany Dist. (United Kingdom).
- Brier Patch Records**, 3825 Meadowood Ln. SW, Grandville, MI, 49418, (616) 534-6571. Pres.: Ken Medema; Manager: Beverly Vander; Bus. Mgr.: Linda Hoogerhyde; Assoc.: Sharon Knott.
- British Overseas Airways Music**, (See Trend Recording & Distributing Co.).
- British Records**, 1015 Gayley Ave., Los Angeles, CA, 90024, Contact: Geoff Gibbs.
- Broadbeach Records**, 3464 Encinal Canyon Rd., Malibu, CA, 90265, (310) 457-4405. Pres.: Randy Nauert.
Label(s): (Owned) Peaceable, (Distributed) Great Northern Arts.
- Broadway**, (See Old Homestead Records).
- Broadway Baby**, (See Original Cast Records).
- Brofeel Records, Inc.**, 12103 Clark, Santa Fe Springs, CA, 90670, (213) 941-4940. Pres.: Kirk Tyler; Exec. Vice Pres.: Joanne Tyler; Vice Pres./Promo.: Count Fisher.
- Brunswick Records**, 640 Monarch Plaza, 3414 Peachtree Rd., Atlanta, GA, 30326, (404) 266-8990. Fax: (404) 266-8683. Pres.: Robert A. May; Legal & Business Affairs: Amy F. Davis.
Label(s): (Distributed) Brunswick.
- Buckhead Music & Film**, (See Score Prods., Inc.).
- Buckshot**, (See Jerce Records).
- Buddah**, (See Essex Entertainment, Inc., The Special Music Co., Pair Records).
- Buena Vista**, (See Walt Disney Records).
- Bug Records, Inc.**, 6777 Hollywood Blvd., 9th Floor, Hollywood, CA, 90028, (213) 466-4352. Fax: (213) 466-2366. Dir.: Dan Bourgoise; Fred Bourgoise.
Label(s): (Owned) Mole Hole.
- Buldogg Records**, 8 Mark Lane, New City, NY, 10956, (914) 634-8282. Fax: (914) 634-5888. Pres.: Jeffrey Kruger; Vice Pres.: Leslie Lewis; Copyright & Licensing: Mervyn Pugh; Vice Pres. A & R: Roland Rogers.
Label(s): (Owned) Ember, Great Voices of the Century.
Int'l Reps.: Bulldogg Records (England).
- Bullseye Blues Records**, One Camp St., Cambridge, MA, 02140, (617) 354-0700. Fax: (617) 491-1970. Pres.: Marian L. Levy; Vice Pres.: Ken Irwin; Clerk of Corp.: Bill Nowlin.
Int'l Reps.: Munich Records (Netherlands); Americana Records (Japan).
- Al Bunetta Mgmt.**, 4121 Wilshire Blvd., Ste. 204, Los Angeles, CA, 90010, (213) 858-0882. Contact: Al Bunetta; Dan Einstein.
Label(s): (Owned) Blue Plate, Oh Boy, Red Pajamas.
- Bunjak Records/Acres of Talent**, 900 Westgate Ln., Ste. C-8, Bossier City, LA, 71112, (318) 742-5777. Pres.: Lillian Mills.
- Dave Burgess Ents.**, PO Box 40929, Nashville, TN, 37204, (615) 370-3002. Fax: (615) 329-2078. Publishing Admin.: Deon Robb Burgess.
- Burgundy Records**, div. of Henry Prods., Ltd., PO Box 909, Grapevine, TX, 76051, (817) 481-4261, (214) 790-3238. Fax: (214) 259-2781. Dir., Sales/Promos.: Joe Gibson.
Branch(es): 1012 18th Ave., South, Nashville, TN, 37212, (615) 327-7988, Contact: Joe Gibson.
- Burlap**, (See Sea Cruise Productions, Inc.).
- Buttilla**, (See Raina Recording Co.).
- Buy Our Records**, PO Box 363, 1401 Springfield Ave., Irvington, Vauxhall, N.J., 07088, (201) 373-2626. Pres.: James Dunley; Vice Pres.: Christopher G. Friar; Sec.: Domenick Moccia; Treas.: Leonard J. Sblendorio.

C

- CASON Records & Tapes**, 8127 Eirita Dr., Hollywood, CA, 90046, (213) 650-8891. Fax: (213) 654-3908. Pres.: Richard Cason; CEO: Richard Deluy.
- C.B.F.**, (See Charlie Fields Prodn.).
- CBO**, (See True Records, Inc.).
- CDE Records & Tapes**, PO Box 310551, 2740 Greenbriar Pkwy., Ste. 110, Atlanta, GA, 30331, (404) 349-5224. Pres.: Charles Edwards; Vice Pres.: Michelle Stephens; Vice Pres. Mktg. & Promos.: Akeem Elijah Edwards.
Label(s): (Owned) Nationwide Black Radio, TBS, Toll Free.
- C.D. Presents, Ltd.**, 1317 Grant Ave., Ste. 531, San Francisco, CA, 94133, (415) 641-7775. Fax: (415) 641-7889. Pres.: David H. Ferguson.
US Reps.: Important (CA); Caroline (NY).
- CDX (Compact Disc Express/Country Express**, 1018 17th Ave. S., Nashville, TN, 37212, (615) 321-0800.
- CGD**, (See Warner Music Int'l).
- CITA Communications, Inc.**, 676 Pittsburgh Rd., Butler, PA, 16001, (412) 586-6552. Fax: (412) 586-6552. Pres./Producer: Michael Paul Taimuty, II; Vice Pres.: Richard K. Clark; Dir. A & R/Producer: Mickie E. Taimuty.
Label(s): (Owned) Phunn!, Trope.
- CMC Prods.**, 106 W. Horton St., Zebulon, NC, 27597, (919) 269-5508. Fax: (919) 269-7217. Pres.: Bill Cain; Publicity: Tom Lipsky.
Branch(es): 1226 17th Ave., South #3, Nashville, TN, 37212, (615) 327-1632, Fax: (615) 726-3299, Contact: Maurice Godwin.
- CMH Records, Inc.**, PO Box 39439, 2380-B Glendale Blvd., Los Angeles, CA, 90039, (213) 663-8073. Fax: (213) 669-1470. Pres.: David Haerle.
- CMP Records, Inc.**, 155 W. 72nd St., Ste. 704, New York, NY, 10023, (212) 769-9362. Fax: (212) 580-3604. Pres.: Paul Schulman; Promos. Dir.: Joe Pignato.

- CPI Records**, PO Box 7320, 12220 Tiara St., Beverly, CA, 90212, (818) 762-7417. Principal: Franz B. Swegal.
- CRS Inc.**, 724 Winchester Rd., Broomall, PA, 19008, (215) 544-5920. Pres.: John Russo; Vice Pres.: Lydia Walton Ignacio; Admin. Asst.: Caroline Hunt; Rep.: Jack M. Shusterman.
- Label(s): (Owned) Capra, Contemporary Record Society, Contemporary Recording Studio, (Distributed) Crystal Records, Orion Master Recordings.
- CSA**, (See Country Showcase America Records).
- C S I**, (See Country Star Int'l).
- CTR**, (See Hallways To Fame Prodn., Inc.).
- C.W.S.**, (See Rock-A-Billy Records).
- CA-Song Music**, 1697 Broadway, Ste. 1409, New York, NY, 10019, (212) 333-3239, (212) 586-3700. Owner: Mike Cassone. Label(s): (Owned) Como, Rialto, Rollins, Roman.
- Cabaret DRG**, (See DRG Records, Inc.).
- Cabletown**, (See Dagenie Corp.).
- Cactus Records**, PO Box 270802, 180 Wallace Rd., #K-20 (37211), Nashville, TN, 37227, (615) 781-6118. Owner/Artist: Butch Baldassari.
- US Reps.: Record Depot (VA); Lifedance (OR); Silo, Inc. (VT); Music Design (WI); New Leaf (GA).
- Cadence Jazz Records, Ltd.**, Cadence Bldg., Redwood, NY, 13679, (315) 287-2852. Fax: (315) 287-2860. Pres.: Robert D. Rusch; Promo.: Dave Bernstein; Advertising: Larry Raye; Sales: Slim.
- Int'l Reps.: Cadillac Dist. (UK).
- Cadet Records**, PO Box 36, 221 E. Main St., Burnett, WI, 53922, (414) 689-2320.
- Label(s): (Owned) Cadet.
- Caedmon**, (See Harper Audio).
- Caelyn**, (See Apostle-Rosiland Records).
- Cafe**, (See Mobile Fidelity Sound Lab).
- California Gold Record Co.**, 2680 Walnut Ave., Ste. A, Tustin, CA, 92680, (800) 448-0384. Fax: (714) 730-3924. Pres.: Lee McGloin; Sales Mgr.: Scott Kelly; Sales Rep.: Julie Ritter.
- California Int'l Records**, PO Box 2818, Newport Beach, CA, 92659, (714) 494-0181. Fax: (714) 494-0982. Consultant: Al DeLory.
- Label(s): (Owned) California Int'l, Creative Network Co., Global Village.
- Calvary Records, Inc.**, 142 Eighth Ave., North, Nashville, TN, 37203, (615) 244-8800.
- Calvert Street Records, Inc.**, 6126 Chinquapin Pkwy., Baltimore, MD, 21239, (301) 323-2563. Fax: (301) 366-3565. Pres./A & R: Stephen Janis; Vice Pres./Mktg. & Promo.: Stephen Bowen; A & R Coord.: Michael Willis; Vice Pres. Licensing & Publish: Julie Higgins.
- Label(s): (Owned) Calvert Street.
- US Reps.: SOH Dist. Network (TN).
- Camden Soul**, (See Castile Records).
- Cameo Classics**, (See Moss Music Group, Inc.).
- Cameo Parkway**, (See ABKCO Records (Div. ABKCO Music & Records, Inc.)).
- Can-Score Prodn.**, (See Factory Beat Records, Inc.).
- Canaan**, (See Word, Inc.).
- Canada**, (See Rock-A-Billy Records).
- Canadian American**, (See Caprice Int'l Records and Canadian American Records).
- Candy Records**, 2716 Springlake Ct., Irving, TX, 75060, (214) 790-5172. Owner/Gen. Mgr.: Kenny Wayne; Promo. Coord.: Candy Renee Hagler; Asst. Promo. Coord.: Hollis Hagler; Warehouse Mgr.: Ronnie Hart; Vice Pres. A & R: Elvis Dristopher Hagler.
- Label(s): (Owned) Hollis, Kamotion, Lil' Possum, Sweet Tooth.
- Caney**, (See Guajiro Records, Inc.).
- Canyon Creek Records, Inc.**, PO Box 671008, 11347 Park Central Pl., Dallas, TX, 75367, (214) 750-0720. Fax: (214) 987-4638. CEO/Pres.: Bart Barton; Sec./Treas.: Pat McKool; A & R: Mike Anthony.
- Label(s): (Owned) Canyon Creek, (Distributed) Branch Int'l, Lemon Square.
- Int'l Reps.: BMT (Canada).
- Canyon Records Prodn., Inc.**, 4143 N. 16th St., Ste. 4, Phoenix, AZ, 85016, (602) 266-7835. Pres.: Raymond A. Boley; Sec./Treas.: Mary E. Boley; Vice Pres. A & R: Robert Doyle.
- Cap**, (See Cha-Cha Records).
- Capetown Records**, PO Box 207, 772 S. Kingshighway, Cape Girardeau, MO, 63701, (314) 335-0100, (314) 335-7327. Pres./Gen. Mgr.: Fred J. Horrell; A & R: Scott L. Horrell.
- Capitol-EMI Music, Inc.**, 1750 N. Vine St., Hollywood, CA, 90028, (213) 462-6252. Fax: (213) 467-6550. Pres.: Joe Smith; Exec. Vice Pres.: Neil McCarthy; SVP Catalog & Video Planning: Bud O'Shea; Vice Pres. & Gen. Counsel: Bob O'Neill; Vice Pres. Human Resources & Admin.: Rayna Brown; Vice Pres. Information Technology: Don Dentzer; Pres./Mfg.: Vic Beretta; Sr. Dir. Pub. Rel./Corp. Comm.: Bob Bernstein.
- Label(s): (Owned) Angel, Chrysalis, Blue Note, SBK, Enigma, EMI, IRS, (Distributed) Gold Castle/Cypress, Rhino, Curb, Bellmark, Alpha Int'l, Barking Pumpkin.
- US Reps.: CEMA Distribution.
- Capitol Nashville**, 1111 16th Ave. S., Nashville, TN, 37212, (615) 320-5009. Fax: (615) 321-0158. Pres.: Jimmy Bowen; Exec. Vice Pres.: Jerry Crutchfield; Vice Pres. Promos.: Bill Catino; Vice Pres. Mktg. & Sales: Joe Mansfield; Dir. Bus. Affairs: Wayne Halper.
- Capitol Records**, 1750 N. Vine St., Hollywood, CA, 90028, (213) 462-6252. Pres.: Hale Milgrim; Exec. Vice Pres.: Art Jaeger; Vice Pres. Creative Svcs.: Marcia Ecelstein; Sr. Vice Pres. Promos.: John Fagot; Sr. Vice Pres./GM Black Music Div.: Step Johnson; Sr. Vice Pres. Sales: Lou Mann; Vice Pres. Mktg.: Jeremy Hammond; Sr. Vice Pres. A & R: Simon Potts; Vice Pres. Promo/Black Music: Barbara Lewis.
- Branch(es): 810 7th Ave., New York, NY, 10019, (212) 603-8700. Capitol East Coast G.M.: Bruce Lundvall.
- Capra**, (See Contemporary Recording Studios, CRS, Inc.).
- Capriccio**, (See Delta Music, Inc.).
- Caprice Int'l Records and Canadian American Records**, PO Box 808, Litzitz, PA, 17543, (717) 627-4800. Fax: (717) 626-0395. C.O.B.: Gerry Granahan; Leonard Zimmer; Pres.: A & R/Gen. Mgr.: Joey Welz; Nat'l Promo. Dir.: Butch Paulson; Professional Mgr.: James E. Myers; Exec. Sec.: Linda Dee.
- Label(s): (Owned) American Radio, Canadian American, Caprice Int'l, American Radio, Canadian American, Caprice Int'l, (Distributed) Music City, Scal, Bold-1, Music City, Scal, Bold-1.
- US Reps.: Dixi Raks (TN); Handleman Co. (MI).
- Int'l Reps.: Two Marie Music, Bison Bop, Hydra Records (West Germany).
- Capricorn Records, Inc.**, 120 30th Ave. N., Nashville, TN, 37203, (615) 320-8470. Fax: (615) 320-8476. Pres.: Phil Walden; Vice Pres./Gen. Mgr.: Don Schmitzerle; Vice Pres. Promos & Mktg.: Jeff Cook; Vice Pres. Publicity/Media Rel.: Mark Pucci.
- Label(s): (Owned) Capricorn.
- Capstan Records**, PO Box 211, East Prairie, MO, 63845, (314) 649-2211. Pres.: Tommy Loomas; Vice Pres.: Joe Silver; A & R: Alan Carter.
- Captain Records**, 3809 Plaza Dr., Ste. 107-183, Oceanside, CA, 90056, (215) 253-1705. Fax: (215) 258-5757.
- Captain Records**, PO Box 535, Boothbay Harbor, ME, 04538, (215) 253-1705.
- Cardiac Records, Inc.**, 1790 Broadway, 6th Floor, New York, NY, 10019, (212) 977-8020. Fax: (212) 977-8042. Pres.: Cathy Jacobson; Vice Pres. A & R: Bob Ghossen; Promo. Dir.: Ray Caviano; Sales & Mktg. Dir.: Jim Parham.
- Carlen**, (See Ripete Records, Inc.).
- Carlyle Records, Inc.**, 1217 16th Ave. S., Nashville, TN, 37212, (615) 327-8129. Fax: (615) 321-0928. Pres.: Laura Fraser; Vice Pres.: Preston Sullivan; Dir. Promo.: Keith Coes; Dir. Retail: Kelly Coplin.
- US Reps.: Important Records (NY); Select-O-Hits (TN); Caroline Records (CA).
- Carman Prodn.**, 15456 Cabrillo Rd., Van Nuys, CA, 91406, (213) 873-7370. Fax: (818) 787-3981. Pres.: Tom Skeeter; Vice Pres./Treas.: Joe Gottfried; Dir.: John Campagna; Vice Pres. A & R: Joey D. Vieira.
- Carmel Records**, PO Box 50353, Palo Alto, CA, 94303, (415) 856-3650. Fax: (415) 856-0371. Exec. Producer: Donald Groshart; Artist Relations: Jeanette Avenida; Mktg. Mgr.: Prescott Thompson; Admin. Asst.: Tracy Evans.
- Label(s): (Owned) Carmel, (Distributed) Fountain Prodn., KS, Mog, Acoustic Moods, Asian Improv.
- Carolina Records Co.**, 1605 Park Dr., Raleigh, NC, 27605, (919) 833-6694. Owner: Ethel Laughlin Casey.
- Caroline Records**, 114 W. 26th St., New York, NY, 10001, (212) 989-2929. Fax: (212) 989-9791. Pres.: Keith Wood; Gen. Mgr.: Duncan Hutchison; Dir.: Janet Billig; Label Mgr.: Gerard Talbot.
- Label(s): (Owned) Caroline, Primo Scree, (Distributed) Sub Pop. EG. Play It Again Sam, Antler Subway.
- Caromar**, (See Beatlefest, Inc.).
- Carousel**, (See W. W. Associates, Inc.).
- Carthage**, (See Rykodisc, Inc.).
- Mark Carvel Ents., Inc.**, 70 W. 95th St., Ste. 12-G, New York, NY, 10025, (212) 666-6454. Fax: (212) 634-2583. CEO: Mark Carvel.
- Label(s): (Owned) Mighty Soul Sonic.
- Casa Grande Records**, PO Box 113, 6 Carter Pl., Woburn, MA, 01801, (617) 933-1474. Gen. Mgr.: Frank Paul; Pub. Rel.: Rita Daniels; Vice Pres. A & R: Frank Paul.
- Label(s): (Owned) Don-Mar, Shawmut.
- Cascade Mountain Records**, 2370 W. Carson St., Ste. 150, Torrance, CA, 90501, (213) 320-9396. Contact: William J. Wickline.
- Ernie Cash Ents.**, 744 Joppa Farm Rd., Joppatowne, MD, 21085, (301) 679-2262. Owner-A & R: Ernest W. Cash.
- Label(s): (Owned) Continental.
- Casino Record, Inc.**, PO Box 43659, Las Vegas, NV, 89116, (702) 794-4588. Pres.: Lou Ragland; Gen. Mgr.: Fannie L. Gorman; Sr. Consultant: C. Holly Atkins; Vice Pres. A & R: Rudolph Jackson; Vice Pres. Artist Mgmt.: Bobby Wade.
- Label(s): (Owned) Great Lakes, Spirit Records of Nevada, (Distributed) Gold Sound.
- Buzz Cason Prodn.**, PO Box 40764, Nashville, TN, 37204, (615) 383-8682. Fax: (615) 383-8696. Owner/Pres.: Buzz Cason.
- Label(s): (Owned) Track.
- Castillo Int'l Inc.**, 500 Greenwich St., New York, NY, 10013, (212) 941-5800. Fax: (212) 941-8340. Pres.: Fred Newman; Exec. Vice Pres./Gen. Mgr.: Gabrielle Kurlander; Vice Pres./A & R: Tony Rose.
- Label(s): (Owned) Castillo Int'l.
- Castle Records**, PO Box 37612, Gold Tree Sta., Sarasota, FL, 34237, (813) 377-1877. Fax: (813) 377-1877. Pres.: Rob Russen; Exec. Vice Pres.: Lynn N. Russen; Vice Pres. A & R: Eric Russen; Vice Pres. A & R: Rodney K. Russen.
- Label(s): (Owned) Camden Soul, Jade, Phoenix, Pyramid, Rock Island, TCB.
- Catfish**, (See Antique-Catfish Records).
- Catman**, (See Mirror Records, Inc.).
- Catskill Mountain Records**, Red Kill Rd., Fleischmanns, NY, 12430, (914) 254-4565. Pres.: Barry Drake; Gen. Mgr.: Patricia Padir.
- Cavalcade**, (See Westwood Entertainment Group).
- Celestial Harmonies**, PO Box 30122, 4549 E. Ft. Lowell, Tucson, AZ, 85751, (602) 326-4400. Fax: (602) 326-3333. Pres.: Eckart Rahn; Vice Pres.: Kathryn A. Riser; Acct. Mgr.: Ann Kilby.
- Label(s): (Owned) Black Sun, Celestial Harmonies, MonteVideo, (Distributed) Kuckuck, Fortuna.
- US Reps.: Action Music Sales (OH); Banyen Sound/Landmark Dist., Inc. (NY); CD One Stop (CT); DeVors & Co., Paradigm Dist., Pyramid Dist., Real To Reel (CA); Lifedance (OR); Music Design (WI); New Leaf Dist. Co., Rock Bottom, Inc. (GA); Precision Sound Mktg. (WA); Silo, Inc. (VT); Encore Dist. (CO).
- Int'l Reps.: 38 C Audio, Eastern Pacific Sounds (Taiwan); Chacra Alternative Music, Inc., Dist. Fusion III, Inc., ERA Int'l Ltd., Sounds of Noor (Canada); HNH Int'l Ltd. (Hong Kong); Larrikin Records Pty, Ltd. (Australia); Ode Record Co., Ltd. (New Zealand); Producciones Lubata, S.A. (Mexico).
- Celluloid Records**, 330 Hudson St., #FL4, New York, NY, 10013, (212) 633-2100. Fax: (212) 633-2700. Pres.: John Matarazzo; Promo. A & R Dance Music: Ted Esposito; A & R Rock: Jim Fourniadi; Press & Promo. Dir.: Viola Galway; A & R World Music: Robert Soares.
- Label(s): (Owned) Braziloid, Celluloid, Hudson Canyon, Hudson Van Dam, Mercenary, Moving Target, Skaloid.
- Int'l Reps.: MCR Prod. (Holland).
- Celtoid**, (See DNA Records).
- Centaur Prodn., Inc.**, 12220 Tiara St., North Hollywood, CA, 91607, (818) 762-7417. Pres.: Franz B. Swegal.
- US Reps.: Forerunner Dist. (Studio City, CA).
- Centaur Records**, PO Box 19630, 82 Aldine St., Rochester, NY, 14619, (716) 328-4649. Pres.: Martha Pitoni; Mgr./A & R: Ven Pitoni; Publicity: Marvin Steffy.
- Label(s): (Owned) Sea King.
- Centaur Records, Inc.**, 8867 Highland Rd., Ste. 206, Baton Rouge, LA, 70808, (504) 336-4877. Fax: (504) 336-9678. Pres.: Victor E. Sachse; Vice Pres.: Clyde P. Rolston.
- Label(s): (Owned) Centaur.
- US Reps.: Harmonia Mundi (US).
- Int'l Reps.: EBS (Canada); Oh Musik (Denmark); TMS (France); Music Tokyo (Japan); Clavicentre (Holland); Gamut (United Kingdom); Disco Center (Japan); Shun Cheong (Hong Kong, Singapore).
- Center**, (See Biograph Records, Inc.).
- Century Records, Inc.**, 1429 Hawthorne St., Pittsburgh, PA, 15201, (412) 782-4477. Pres.: Edward J. Moschetti; A & R: Matt Edwards.
- Label(s): (Owned) Star.
- Century 21**, (See Random Ents., Inc.).
- Cerebral Records**, 1236 Laguna Dr., Carlsbad, CA, 92008, (619) 434-2497. Pres.: Lincoln A. Kroll; Vice Pres./Accounting: Laura Maher.
- Label(s): (Owned) Cerebral.
- Cexton Records**, 2740 S. Harbor Blvd., Ste. K, Santa Ana, CA, 92704, (714) 641-1074. Fax: (714) 641-1025. Pres.: John Anello, Jr.; Vice Pres./Promo.: Christine Thompson; Vice Pres. A & R: J. Anello/C. Thompson.
- Label(s): (Owned) Anello/Cexton Prodn. Group, (Distributed) Triangle, Wildcard.
- US Reps.: Precision Sound (WA).
- Cha-Cha Records**, 902 N. Webster St., Port Washington, WI, 53074, (414) 284-3279. Pres./Gen. Mgr.: Joseph C. Delucia.
- Label(s): (Owned) Cap, Cha Cha, Debby.
- Challedon**, (See Rob-Rik Inc., t/a Challedon Record Co.).
- Chameleone Music Group, Inc.**, 3355 W. El Segundo Blvd., Hawthorne, CA, 90250, (213) 973-8282, (800) 444-6044. Fax: (213) 679-3395. Pres.: Stephen Powers; Vice Pres./Gen. Mgr.: Andy Frances; Vice Pres. Sales: Bill Meehan; Chief Financial Officer: Al F. Sanda.
- Branch(es): 114 West 70th St., Ste. 3D, New York, NY, 10023, (416) 588-3913. Contact: Bob Lau; 65 Jefferson Ave., Ste. 205, Toronto, ON, M6K 1Y3, Canada, (416) 588-3913. Gen. Mgr.: Ashley Hillman.
- Label(s): (Owned) Dali, Mountain Railroad, (Distributed) Innovative Communications, Posh Boy, Sierra, Vee Jay, Youngheart, Beachwood, Independent Project.
- Int'l Reps.: A & M (Canada).
- Chapel**, (See Bellaire Records).
- Charade Records**, 1384 Sequoia Ave., Tulare, CA, 93274, (209) 688-2533. Pres.: Raymond A. Baradat; Vice Pres.: Sandra G. Baradat; Promos.: Bob Dennison; Mktg.: Kristi Ingram; Vice Pres. A & R: Art Stewart.
- Label(s): (Owned) Charade, Faux Pas, Taradab, (Distributed) Rooster Fish.
- Charburn**, (See Charlie Fields Prodn.).
- Charisma Records**, 1790 Broadway, 20th Floor, New York, NY, 10019, (212) 586-7700. Fax: (212) 765-0989. Pres.: Phil Quarataro; Vice Pres. Sales: Jerre Hall; Vice Pres. Promo.: Bob Catania; Vice Pres. Press & Artist Dev.: Audrey Strahl; East Coast Vice Pres. A & R: Jeff Fenster; Vice Pres. Nat'l Pop Promo: Al Moinet (Los Angeles).
- Branch(es): 335 N. Maple Dr., Ste. 260, Beverly Hills, CA, 90210, (213) 275-9071. Fax: (213) 275-9148. Vice Pres. West Coast A & R: Danny Goodwin, Vice Pres. Album Promo: Lenny Bronstein.
- Label(s): (Owned) Charisma, (Distributed) Point Blank.
- US Reps.: Distrib. by Atlantic through W.E.A. (NY).
- Charro**, (See Axbar Records).

Cosmotone Records, PO Box 71988, Arco Plaza, Los Angeles, CA, 90071.
Branch(es):
Label(s): (Owned) Cosmotone Music, (Distributed) Center For The Queen Of Peace.

Cotton Row Recording dba New Memphis Music, Inc., 1503 Madison Ave., Memphis, TN, 38104, (901) 276-8518. Co-Owner: Ward Archer, Jr.; Nikos Lyras; Studio Mgr.: Melanie W. Hunolt.

Cougar Records, 3125 19th St., Ste. 217, Bakersfield, CA, 93307, (805) 831-2165. Owner: Lillian M. Richardson; Pub. Rel.: Gerald O. Stuckey.

Counterpoint, (See Everest Record Group).

Country Boy, (See Vokes Record Co.).

Country Bump, (See Ric Rac Records/Div. of Ric Rac, Inc.).

Country Harvest Records, PO Box 473, Brentwood, TN, 37027. Pres.: Thomas Gramuglia.
Branch(es): PO Box 566, Andrew Street Rd., Massena, NY, 13662, (315) 769-2448. Fax: (315) 764-0182. Pres.: Thomas Gramuglia.

Country Int'l Records, 23 Music Cir. E., Nashville, TN, 37203, (615) 327-4656. Fax: (615) 327-0035. Pres.: Sherman Ford; Vice Pres.: J.G. Ford; Vice Pres. Sales & Promo.: Jake Payne. Label(s): (Owned) Emkay, Ford, Merry-Go-Round, (Distributed) Tree Top.

Country-King, (See Sid Kleiner Music).

Country Life Records, PO Box 467, Berea, KY, 40403, (606) 986-8111. Exec. Dir.: Raymond W. McLain; Mktg. Dir.: Betty McLain; Sales Mgr.: Connie McLain.

Country Road, (See Scene Prodn.).

Country Showcase America Records, 385 Main St., Laurel, MD, 20707, (301) 725-7712. Fax: (301) 470-6035. Pres./A & R: Francis Gosman; Vice Pres./A & R: LeRoy Vauge; Promo.: Paul White; Bob Teaff.
Label(s): (Owned) CSA, Country Showcase America.

Country Star Int'l, PO Box 569, 439 Wiley Ave., Franklin, PA, 16323, (814) 432-4633. Pres.: Norman Kelly; Sec./Treas.: Junie Lou Kelly; Vice Pres.: Oliver Mersley.
Label(s): (Owned) C S I, Country Star, Mersey, Process.

Country Stream Records, 5053 Tholozan Ave., Saint Louis, MO, 63109, Vice Pres. A & R: Rita Champain.
Label(s): (Owned) Bonnet.

County, (See Rebel Records).

County Records, PO Box 191, Floyd, VA, 24091, (703) 745-2001. Fax: (703) 343-3240. Owner: Dave Freeman; Promo./Prodn.: Gary B. Reid.
Label(s): (Owned) Rebel.

Courier Recording, (See Conarch Prodn.).

Cousins Music, 836 Darwin St., Charleston, SC, 29412, (803) 795-5612. Mgr.: Lou Cicchetti.
Label(s): (Owned) Daisy, West End.

Covenant Recordings, Inc., PO Box 416, 920 E. State Rd., Am. Fork, UT, 84003, (801) 756-9966. Fax: (801) 756-1049. Pres./Chrmn. Board: Lewis Kofford; Vice Pres. Sales/Mktg.: Robby Nichols; Vice Pres. Mfg.: Paul Lee; Vice Pres. A & R: Daria Isackson.
US Reprs.: BMG (NY).

Cowboy Junction Flea Market & Publishing Co., Hwy. 44 W., Jct. 490, Lescanto, FL, 32661, (904) 746-4754. Pres.: Buddy Max.
Label(s): (Owned) Cowboy Junction.
US Reprs.: Cowboy Junction (FL).

Cowgirl Records, PO Box 6085, Burbank, CA, 91510. Pres.: M. Kaye; Vice Pres. A & R: A. Zedalis; Mktg.: M. Fitzgerald; Promos: O. Cunningham, N. Day; Sales: A. Andrews.
Label(s): (Owned) Cowgirl.
Int'l Reprs.: Kingsport Creek (CA).

Cozetta, (See Soul-Po-Tion Records).

Crazy Cajun Prodn., 5626 Brock St., Houston, TX, 77023, (713) 926-4438. Fax: (713) 926-8303. Owner/Prod.: Huey P. Meaux; Admin. Asst.: Kim Andriser.
Label(s): (Owned) Tribe.

Crazy Hypel!, (See Avatar Prodn.).

Creative Network Co., PO Box 2818, Newport Beach, CA, 92659, (714) 494-0181. Fax: (714) 494-0982. Consultant: Al DeLory.
Label(s): (Owned) California Int'l, Global Village.

Creative Sound Corp., PO Box 755, Malibu, CA, 90265, (310) 456-5482, (800) 323-7225. Fax: (310) 871-2266. Pres.: Bob Cotterell; Opns. Mgr.: Sally Rosikranz; Mktg. Mgr.: Dave Peters. Branch(es): 725 Market St., Wilmington, DE, 19801.
Label(s): (Owned) Sunrise, Trend Assoc.

Creative World, (See GNP Crescendo Record Co., Inc.).

Creav, Inc. U.S.A.

345 N. Maple Dr., Ste. 284, Beverly Hills, CA, 90210, (213) 273-8812, (213) 273-8813. Fax: (213) 273-7487. Vice Pres.: Tokukazu Sonoyama; Contact: Harumi Nishikawa.
Label(s): (Owned) ABC Video Ents., Inc., ASV, Aristo, Audio Lab, Break Time, Crown, Crown Classics, Enja, Granada Video, Hathut, Hi Blite, J.A.P., Koh Hak, LWT Int'l RPTA, Meldac, Muse, Ninety-One, Novalis, Palette Acanta, Panam, Arthur Rank, Sacis Int'l Dist.
Int'l Reprs.: Nippon Crown Co., Ltd. (Japan).

Credence Records, PO Box 8442, Universal City, CA, 91608, (818) 506-8533. Pres.: Jaeson Effant; Chrmn.: Jaeson James Jarrett; Vice Chrmn.: Samuel Z. Goldblack; Exec. Vice Pres.: Gip Noble, Jr.; Maxx Diamond; Vice Pres. A & R: Patrick Bouvier.
Label(s): (Owned) Bouvier, (Distributed) Home, Oaktree.

Int'l Reprs.: CBS (United Kingdom).
Creo, (See Pathways of Sound, Inc.).
Criket, (See Sunny Day Prodn., Inc.).
Crimson Records, 614 San Vicente, Ste. F, Santa Monica, CA, 90402, (310) 395-0984. Contact: Jay Westlin.
Criterion Music Corp., 6124 Selma Ave., Hollywood, CA, 90028, (213) 469-2296. Fax: (213) 962-5751. Pres.: Michael H. Golden.
Branch(es): 1025 17th Ave. S., Ste. C, Nashville, TN, 37212, (615) 327-2146. Rep.: Elizabeth Hudson; 38 rue de Bassano, Paris, 75008, France, (615) 327-2146. Fax: 01133140700130. Rep.: Eileen Chamussy.
Label(s): (Owned) Criterion, Granite Music Corp., Palm, Prince, Reo Tahiti, Tahiti, Tiare Tahiti.
Critical, (See Urgent! Records, Inc.).
Critique Records, Inc., 800 W. Cummings Park, Ste. 2500, Woburn, MA, 01801, (617) 935-7540. Fax: (617) 935-6866. Pres.: Carl Strube; A & R: Harry King; Dir. Alternative Promo.: Jon Lev.
US Reprs.: BMG (NY).

Eddie Crook Co., PO Box 989, 814 Wren Rd., Goodlettsville, TN, 37072, (615) 851-1360. Fax: (615) 851-7755. Pres.: Eddie Crook; Vice Pres.: Janice Crook; Mktg., A & R: Dave Wilcox; Sales: Cyndi Harp.
Label(s): (Owned) Harvest, MorningStar.

Crossfire, (See Oakridge Music Recording Service).

Crossover, (See Concord Jazz, Inc.).

Crown, (See Creav, Inc. U.S.A.).

Crown Classics, (See Creav, Inc. U.S.A.).

Crown Music Group, Inc., 1015 16th Ave. S., Nashville, TN, 37212, (615) 327-8100. Fax: (615) 327-7963. Pres.: Morris Thurman; Vice Pres.: James McKay; Vice Pres. Admin.: Lee Bach; Vice Pres. A & R: Eddie Burton.

Crush Music, (See K-tel Int'l (USA), Inc.).

Crux Star Int'l, Inc., PO Box 280385, 4005 Covington Pike, Memphis, TN, 38168, (901) 386-3115. Pres./CEO: Bob Holden; Vice Pres. Prof. Mgr.: Bill Hale; Gen. Mgr.: Becky Jernigan; Promo. & Mktg.: Fran Johnson; Vice Pres. A & R: Mike Pulido.

Crystal Records, Inc., 2235 Willida Ln., Sedro-Woolley, WA, 98284, (206) 856-4779. Fax: (206) 856-4989. Pres./A & R: Peter Christ; Vice Pres.: Linda Felver; Adv. Dir.: Sam Mundy; Sam Mundy.
Label(s): (Owned) Crystal, Poseidon, (Distributed) Grenadilla, Genesis.
Int'l Reprs.: Wind Song (Taiwan); Sam Joo (Korea); Music Press (Netherlands); LJM (Australia).

Crystal Sea, (See Lillenas Publishing Co.).

Cuca Records, (See American Music Co.).

Cuneiform Records, PO Box 6517, Wheaton, MD, 20916, (301) 589-6047. Fax: (301) 589-1819.
Label(s): (Owned) Cuneiform, (Distributed) Linden Music. RE.

Int'l Reprs.: ADN (Italy); Impetus (United Kingdom); Zero Communications (Japan); Cargo (Canada).

Curb Records, 3907 W. Alameda Ave., 2nd Floor, Burbank, CA, 91505, (818) 843-2872. Fax: (818) 846-8435. Chrmn.: Mike Curb; Pres./Curb Int'l: Carole Curb; Pres./Country Div.: Dick Whitehouse; Vice Pres./Gen. Mgr.: Joe Simone; Dir. Int'l Sales & Mktg.: Sarita Martin.
Branch(es): 23200 Chagrin Blvd., #3-820, Beachwood, OH, 44122, (216) 464-8020. Fax: (216) 464-9351. Gen. Mgr.: Steve Simone; 47 Music Square East, Nashville, TN, 37203, (615) 321-5080. Fax: (615) 327-3003. Vice Pres. Nat'l Promos.: Mike Borchetta.

Curtain Call, (See Music & Arts Programs of America, Inc.).

Curtiss Universal Record Masters, PO Box 1622, Hendersonville, TN, 37077, (615) 822-1044. Pres.: Wade T. Curtiss; Sales Mgr.: Dick Derwald; Gen. Mgr.: S. D. Neal; Vice Pres. A & R: Dick Daniels.
Label(s): (Owned) Terock, (Distributed) Licenses/Leases. Master Tapes.

Cutting Records, 104 Vermilyea Ave., Ste. B-2, New York, NY 10034, (212) 567-4900. Fax: (212) 304-3470. Pres.: Amado Marin; Mktg./Promos.: Louie Garcia; Asst. Mgr./Int'l: Ernie Nieves; Retail/Club Promos.: Danny Morales; Vice Pres. A & R: Aldo Marin.
Label(s): (Owned) Cutting, (Distributed) Lumar Musica, Sand Castle, Shocking.

Cybernavc Prodn., Inc., PO Box 2893, 158 South Fir St., Ventura, CA, 93002, (805) 641-3105. Fax: (805) 653-0106. CEO/Pres.: John Markovich; Vice Pres./Mktg. & Sales: Craig Markovich; Promo. Dept./Sales Rep.: Gary Romero; Vice Pres. A & R: Craig Markovich.
Branch(es): 230 East 87th St., Ste. 3-B, New York, NY, 10128, (212) 360-6746. Fax: (805) 653-0106. Contact: Gary Romero.

Cyclops Records, Inc., 273 Central Ave., c/o B. Eisenberg, Esq., White Plains, NY, 10606, (914) 946-7735. Pres.: Robert Fish.

Cypher, (See Lucifer Records, Inc.).

D

D, (See Paid Records).

DA Music USA, 362 Pinehurst Ln., Marietta, GA, 30068, (404) 977-4172. Fax: (404) 977-4173. CEO: Herb Heldt; Pres.: Achim Neumann; Promo. Dir.: Susan Swain.
Branch(es): PO Box 3, Little Silver, NJ, 07739, (201) 530-6887. Fax: (201) 842-5041. Pres.: Achim Neumann.
Label(s): (Owned) Blue Orchid, Night Sky.
US Reprs.: Importaciones Dome (CA); P/P! (NJ).
Int'l Reprs.: Trend (Canada).

DB Records, 432 Moreland Ave., NE, Atlanta, GA, 30307, (404) 521-3008. Fax: (404) 659-2876. Pres.: Danny Beard; Gen. Mgr.: Randy Crittenton; Mktg. Dir.: Steve Pilon.
Label(s): (Distributed) Safety Net.
US Reprs.: Caroline (CA); Dutch East India Trading, Import-ant (NY).

DCC Compact Classics, 8300 Tampa Ave., Ste. G, Northridge, CA, 91324, (818) 993-8822. Fax: (818) 993-0605. Pres.: Marshall Blonstein; Sr. Vice Pres./Gen. Mgr.: Stan Layton; Vice Pres./New Prod. Devel.: Del Costello; Int'l Coord.: Jerry Tolmich; Vice Pres. A & R: Steve Hoffman.
Label(s): (Owned) DCC, Garland, Sandstone, Shelter.
Int'l Reprs.: Navarre Corp. (MN); Schwartz Bros. (MD); Gemini (GA); Select-O-Hits (TN); Encore (CO).

D C Sound, PO Box 45, Bolivia, NC, 28422, (919) 253-5534. Owner/A&R Rep.: Stan Knowles.
Label(s): (Owned) DC Sound, DC Sound Country.

D & D Records, 1006 E. Vernon St., Los Angeles, CA, 90011, (213) 232-8803. Contact: David Moses.

DGC Records, 9130 Sunset Blvd., Los Angeles, CA, 90069, (213) 278-9010. Pres.: Ed Rosenblatt; Gen. Mgr.: Marko Babineau; Nat'l AOR Promo. Dir.: Hugh Surratt; Alternative Promo. Dir.: Mark Kates.
DJO, (See Daran Records).

DLM Records, 1722 S. Carson Ave., Tulsa, OK, 74119, (918) 585-5050. Pres./Gen. Mgr.: Dick Loftin.
Label(s): (Owned) Playground.

DNA Int'l, Inc., PO Box 314, New York, NY, 10037, (2-2) 694-1234. CEO: D.N.A.; Dir. Promo.: Hank Love; Dir. Sales: D. Great; Dir. Record: Reg Brown.
Label(s): (Owned) On Time, (Distributed) Majestic Control, Solid Goals, Yenom.

US Reprs.: Elektra, Tommy Boy, Warner Bros. (NY).

DNA Records, 725 Pomona Ave., Albany, CA, 94706, (5-0) 525-4773. Pres.: Danny Carnahan; Dir. A & R: Robin Petrie; Promo. Dir.: Allen Linnell.
Label(s): (Owned) Celtoid, DNA.

US Reprs.: Bayside Dist. (CA); Precision Sound Mktg. (WA); Silo (VT).
Int'l Reprs.: Festival (Canada).

DRG Records, Inc., 130 W. 57th St., Lte. 60, New York, NY, 10019, (212) 582-3040. Fax: (212) 459-9437. Pres.: Hugh For- din; Controller: Iris Russell; Prodn. Mgr.: Tricia Lutz; Licen- sing Admin.: Louisa Siouka; Vice Pres. A & R: Rich Brandt; Shipping: Jose Guizarro.
Label(s): (Owned) Cabaret DRG, DRG, DRG Archiv, Disques Swing, (Distributed) Stet, Swing.

US Reprs.: Rounder (MA), (NY); Landmark Dist. (NY), (LA), (GA), (CA).

Int'l Reprs.: WEA (Australia, New Zealand); Dist. Fusion (Canada); R.D.C. Records (France); TMS (France); Ethnic World Music (Germany); Conifer (Great Britain); IRDg (Japan); Music Dist. (Norway); Amigo Musikprodukt (Italy); King Record Co. (Japan); Music Dist. (Norway); Amigo Musik Produktion (Sweden).

D.S.M. Producers, Inc., 161 W. 54th St., New York, NY, 10019, (212) 245-0006. Fax: (212) 265-5726. Pres.: Suzan Bader; Vice Pres. Sales Dir.: Doris Kaufman; Vice Pres., Bus. Affairs: Kenneth R. Wiseman; Attorney, Legal Affairs: Jules I. Kurz; Vice Pres. A & R: Elba T. Toast.

Label(s): (Owned) All American Composers Library.

Da Mon Records, 646 E. Madison St., Lancaster, PA, 17602, (717) 393-1113, (717) 393-9079. Contact: Daoud Balewa.

Dagene/Cabletown Corp., PO Box 410851, San Francisco, CA, 94141, (415) 822-1530. Owner/Pres.: David Alston.
Label(s): (Owned) Cabletown, Dagene, Mahogany.
US Reprs.: Music People (CA).

Daisy, (See Cousins Music).

Dali, (See Chameleon Music Group, Inc.).

Dallian Records, 449 Anderson Dr., Wilmington, DE, 19801, (302) 654-0142. Contact: Johnnie Norwood.

Damabi, (See TSR Records).

Dance-A-Thon, (See Hottrax Records).

Dance Floor, (See Echo Records, Inc.).

Dancin' Machine Music, 256 S. Robertson, #1775, Beverly Hills, CA, 90211, (213) 274-0676. Pres.: Jeff Kutash.

Dancin' On Air Prodn., Inc., 413 Cooper St., Camden, NJ, 08102, (609) 963-6473. Fax: (609) 964-3291. Pres.: Michael Nise; Controller: Frank Nise.
Label(s): (Owned) Power Up.

US Reprs.: Sutra Records (New York, NY).

Dancing Tarantula, (See Darksilver Records & Filmworks, Inc.).

Dandray Records, 11 Fidelian Way, Lincoln Park, NJ, 07035, (201) 402-7978. Fax: (212) 465-9803. President: Angelo Badalamenti.

Danskdisk, (See Lindbergh Records).

Daran Records, 4148 S. King Dr., Chicago, IL, 60653, (312) 624-4811.
Label(s): (Owned) DJO, Ja-Wes, O'retta, Randan, Rap.

Dark Heart Records, 1236 S. Staples St., Corpus Christi, TX, 78404, (512) 884-4633. Owner/Pres.: Arnold Garcia.

Dark Horse Prodn., 1729 N. Third, Upland, CA, 91786, (714) 946-1398. Pres.: Bill Huff; Vice Pres./A & R: David J. Alver- son; Vice Pres./Finance: Ronald D. Schrock.

US Reprs.: Navarre Corp. (MN, CA); Gemini Dist. (GA); House Dist. (KS); Select-O-Hits (TN); Associated Dist. (AZ); Har- bor (NY).

Dark Side, (See More Music Records, Inc.).

Darksilver Records & Filmworks, Inc., PO Box 6397, 2507 Roscomare Rd., Burbank, CA, 91510, (213) 476-0631, (818) 841-8332. Fax: (213) 472-4190. Pres.: Michael Lee Thomas;

- Vice Pres.: David Altmanaver; Vice Pres./Texas Opns.: L. L. Thomas; Legal/Bus. Affairs: Robert S. Greenstein; Vice Pres. A&R: Curtis R. Weaver.
Label(s): (Owned) Dancing Tarantula, Realdream.
- Darva Records**, 8914 Georgian Dr., Austin, TX, 78753, (512) 836-3194. Pres.: Rickey C. Montgomery; Gen. Mgr.: Shirley Montgomery; Promo. Dir. & Mktg.: Michelle Montgomery; A & R Dir.: Joe Montgomery.
Label(s): (Distributed) Road.
- DataVoice Communications**, 366 N. Broadway, Ste. 310, Jericho, NY, 11753, (516) 486-8699. Pres.: Jay Gold; Vice Pres.: Gail Gold.
Label(s): (Owned) Turbo.
- Daucy Recording Co.**, 4372 Daucy, Flatrock, MI, 48134, (313) 782-0103. Pres.: Richard Johnson; Vice Pres./Sec. Diana Johnson.
Label(s): (Distributed) Sunray.
- Dauphne**, (See Dellwood Music Co., Inc.).
- Dawn**, (See Biograph Records, Inc.).
- Dayspring**, (See Word, Inc.).
- Deadwood**, (See Dynamite Records).
- Dearborn**, (See M S K Prods., Inc.).
- Death**, (See Metal Blade Records, Inc.).
- Debby**, (See Cha-Cha Records).
- Debut**, (See Fantasy, Inc.).
- Decca**, (See MCA Special Markets & Products).
- Deep Roots**, (See Koala Records, Inc.).
- Def American Records**, 3500 W. Olive Ave., Ste. 1550, Burbank, CA, 91505, (818) 973-4545. Fax: (818) 973-4571. Pres./Owner: Rick Rubin; Gen. Mgr.: Molk DiDid; Vice Pres. Media Relations: Heidi Ellen Robinson; Artist Relations: Renay Palome.
Int'l Reps.: Phonogram Ltd. (England).
- Def Wish Wax**, (See SLAMDEK/Scramdown).
- Delicious Vinyl, Inc.**, 6607 Sunset Blvd., Los Angeles, CA, 90028, (213) 465-2700. Fax: (213) 465-8926. Co-owner: Michael Ross; Gen. Mgr.: Rick Ross; A & R: Orlando Aguilian.
Int'l Reps.: Phonogram Ltd. (England).
- Dellwood Music Co., Inc.**, 87 Norwalk Ave., Whiting, NJ, 08759, (908) 350-4273. Pres. Int'l & Mktg.: Woodrow C. Gardella; Vice Pres. Sales & Promo.: Robert Gardella.
Label(s): (Owned) Dauphne, Dellwood, Woodvale.
- Delmark Records**, 4121 N. Rockwell, Chicago, IL, 60618, (312) 539-5001. Fax: (312) 539-5004. Pres.: Robert G. Koester; Opns. Mgr.: Steve Wagner; Admin. Dir.: Susan Koester.
Label(s): (Owned) Delmark, Pearl.
US Reps.: Bayside (CA); Campus Records (OH); Encore Dist. (CO); Hits Unlim. (IL); Master Takes (MI); MS Dist. (IL); Music Dist. (TX); North Country Dist. (NY); Old Fogey (MI); Performance, Richman Bros. Dist. (NJ); Rock Bottom (FL); Rounder Dist. (KS); Select-O-Hits (TN); Silo (VT).
- Delos Int'l, Inc.**, 1032 N. Sycamore Ave., Hollywood, CA, 90038, (213) 962-2626. Fax: (213) 962-2636. Pres.: Amelia S. Haygood; Dir. Int'l Sales: Catharine Jaap; Vice Pres. Mktg. & Media: Rudi Simpson.
Label(s): (Owned) Delos, Facet.
US Reps.: Allegro Imports (OR).
- Delta City**, (See Airwax Records Prods.).
- Delta Music, Inc.**, 2275 S. Carmelina Ave., Los Angeles, CA, 90064, (213) 826-6151. Fax: (213) 826-6927. Pres.: Michael McClain; Nat'l Sales Mgr.: Kirk Anderson; Dir. of Licensing: Jerome Stine.
Label(s): (Owned) Capriccio, Laser Light.
Int'l Reps.: Delta Music (West Germany); Trend Records (Canada); Judy S.A. (Mexico).
- Demon**, (See Titan Records).
- Denco**, (See Terock Records).
- Denon Records**, Nippon Columbia Co., Ltd., 135 W. 50th St., Ste. 1915, New York, NY, 10020, (212) 581-2550. Fax: (212) 581-2591. Gen. Mgr.: Toshio Kitatate; Opns. Mgr.: Ken Yoshimura; Nat'l Promo., Jazz: Jennifer Phelps; Nat'l Promo., Classical: Melanne Sacco.
Label(s): (Owned) Denon.
- Denver/Big Scott Records**, PO Box 871832, New Orleans, LA, 70287, (504) 246-9269. A&R Dir.: L. Dean; Vice Pres. Mktg.: James C. Scott Jr.; Dir. Sales/Promotion: James Mcgee.
- Desert Morning**, (See House of Knox Music Publishing).
- The Designer Music Group**, 308 Southgate Ct., Brentwood, TN, 37027, (615) 373-0122. Fax: (615) 373-0386. Director: Mark Cabaniss.
US Reps.: Brentwood Music (TN).
- Destiny Records**, PO Box 2162, 4354 E. Lake Rd., Sheffield Lake, OH, 44054, (216) 949-7113. Pres.: Robert Sellers; Prod.: Bob Jeffries; Vice Pres. A&R: David Sprouse.
Label(s): (Owned) Destiny, Rambo.
- Destiny Records**, 491 Hollyberry Ct., San Jose, CA, 95129, (408) 996-7560. Pres.: Don Gaynor.
- Detra**, (See Makedwde Records).
- Devil Wind**, (See Music Craftshop, Inc.).
- Dharma Records**, PO Box 615, 117 W. Rockland Rd., Libertyville, IL, 60048, (312) 362-4060. Pres.: Perry Johnson; Vice Pres.: Rick Johnson.
Label(s): (Owned) Future, Rockland.
- Diablo Records**, 3518 Champlain Ave., Youngstown, OH, 44502, (216) 755-7794. Owner/Pres./A & R: Bill Schaffert.
- Diadem Music Group**, 3310 West End Ave., 5th Floor, Nashville, TN, 37203, (615) 385-0079. Fax: (615) 383-2947. Pres.: George W. King, III; Exec. Vice Pres.: Larry Day; Vice Pres.: Ben Tankard; Dir. of Promo.: Mark Sorensen.
Label(s): (Owned) Diadem, Royal Tapestry Music, Tribute.
- Dial Records, Inc.**, PO Box 1374, Miami, FL, 33165, (305) 261-0000. Pres.: Joe Alonso; Vice Pres./Bus. Affairs: George L. Moneo; Admin. Dir.: Greg Winters; A & R: Michael J. McNamee.
Label(s): (Owned) Pisces.
- Didacek Records**, 652 Huntington Pkwy., #A, Nashville, TN, 37211, (615) 331-0734. Managing Dir.: Hans Strohmeyer.
Label(s): (Owned) Mo-wood.
- Digital to Disc**, (See Pet Records).
- Digital Music Products, Inc.**, PO Box 15835, Park Sq. Sta., Stamford, CT, 06901, (203) 327-3800. Fax: (203) 323-9474. Pres.: Tom Jung; Vice Pres.: Jean Jung.
US Reps.: Allegro Imports (OR).
Int'l Reps.: In Akusik (Germany); PolyGram Records (Hong Kong); Nippon Phonogram (Tokyo).
- Digitrax**, (See Hottrax Records).
- Dina**, (See Joey Records, Inc.).
- Dionn**, (See Jamie/Guyden Dist. Corp.).
- DiPOP Records**, 13B Franklin Dr., Maple Shade, NJ, 08052, (609) 48275224. Vice Pres., Label Opns.: Pierre Domenico; Vice Pres., Pub. Rel.: Joann Archer; Vice Pres. A&R: Pierre Domenico.
- Disappear Records**, 778 Waugh Ln., Ukiah, CA, 95482, Owner: Rick Ruststein; Mktg. & Sales: Brenda Chaffin.
Label(s): (Owned) Disappear.
- US Reps.:** Ladyslipper, Inc. (NC); Goldenrod Dist. (MI).
- Disc Trophy**, (See PXP Ents., Inc.).
- Discapop**, (See Apon Record Co., Inc.).
- Discos CBS Int'l**, 2190 NW 89th Place, Miami, FL, 33172, (305) 592-0045. Fax: (305) 591-1508. Vice Pres./Gen. Mgr.: Frank Welzer; Dir. Nat'l Sales/Promo.: George Zamora; Dir. A & R/West Coast: Jose Behar; Dir. A & R/East Coast: Angel Carrasco.
Branch(es): 1646 S. Vermont Ave., Los Angeles, CA, 90006, (213) 732-8265. Contacts: Jose Behar/Ruben Espinosa; 6322 Sovereign Dr., Suite 110, San Antonio, TX, 78229, (213) 732-8265. Contact: Ray Martinez.
Label(s): (Distributed) Cara, Orfeon, Profono.
- Discos Monica**, (See Peer-Southern Organization).
- Discovery Music**, 5554 Calhoun Ave., Van Nuys, CA, 91401, (818) 782-7818. Fax: (818) 782-7817. Pres.: David Wohlstadter; Ellen Wohlstadter; Dir. Publicity: Kym Pahoundis; Dir. of Sales: Tonya Sqaor.
Label(s): (Owned) Discovery Music.
US Reps.: BMG Dist., (USA).
- Discus**, (See Stanyan Record Co.).
- Walt Disney Records**, 500 S. Buena Vista St., Burbank, CA, 91521, (818) 567-5325. Fax: (818) 953-9910. Dir. of Sales: Jim Gentry; Mgr. Live Artist Series: Torrie Dorrell; Mktg. Mgr.: Peter Boucaud; Dir. Product Devel.: Harold Kleiner; Vice Pres.: Mark Jaffe.
Label(s): (Owned) Buena Vista, Walt Disney.
- Disneyland Vista**, (See Mena Ents., Inc.).
- Disques Dual**, PO Box 4395 Sta. A, Portland, ME, 04101, (207) 799-8711. Pres.: John Etnier; Mgr.: Nancy Caragol.
Label(s): (Owned) The Same Record Co.
- Disques Swing**, (See DRG Records, Inc.).
- Distinct**, (See Westwood Entertainment Group).
- Diversion Records**, 6134 Woodman Ave., Ste. 202, Van Nuys, CA, 91401, (818) 909-02*3. Owner: James Slater; Pres./CEO: Christian Slater.
- Dixiland Jubilee**, (See GNP Crescendo Record Co., Inc.).
- Doc Records Ltd./City Slicker Prods.**, PO Box L, Inwood Sta., New York City, NY, 10034, (212) 567-0411. Fax: (212) 304-2702. CEO/A & R Dir.: Dennis Bell; Vice Pres.: Claudette Washington.
- Doctor Dream Records**, 60 Plaza Sq., Orange, CA, 92666, (714) 997-9387. Fax: (714) 997-0184.
- Dr. Jazz**, (See Sony Records, Inc.).
- Dog Gone Records**, PO Box 1742, Athens, GA, 30603, (404) 549-8279. Contact: Jefferson Holt.
- Doghhouse Prods.**, (See Godwin Music Group).
- Dollie Records**, 3325 Fairmont Dr., Nashville, TN, 37203, (615) 269-4847. Pres.: John E. Denny; Gen. Mgr.: Jane L. Martin; Promo.: Charlie Lamb; Prodn.: Michele Bowery.
- Dominion**, (See K-tel Int'l (USA), Inc.).
- Domino Records**, 4209 NW 49th Dr., Tamarac, FL, 33319, (305) 484-6636. Pres./A & R: Joe Bollon.
Label(s): (Owned) Domino.
- Don-Mar**, (See Casa Grande Records).
- Door Knob**, (See Gene Kennedy Ents., Inc.).
- Dootone Records**, 121 S. Hope St., #334, Los Angeles, CA, 90012, (213) 628-7768. Pres.: Dootsie Williams.
- Dore Records**, 1608 Argyle, Hollywood, CA, 90028, (213) 462-6608. Pres.: Lew Bedell; Vice Pres.: Dore Bedell.
- Doric**, (See The Organ Literature Foundation).
- Dorn**, (See AKO Records).
- Dot**, (See MCA Special Markets & Products).
- Double A**, (See SARG Records).
- Double Feature**, (See Musicor Records).
- Down A Dusty Road**, (See Hummingbird Recording Co., Inc.).
- Down South**, (See King Walk, Inc.).
- Dragon Records, Inc.**, 872 Morris Park Ave., Bronx, NY, 10462, (212) 792-2198. Pres.: Vincent J. Gagliano; A & R Dir.: Joyce Hoath; Talent/Creative Coord.: Mike Semos.
Label(s): (Owned) Dragon, Mohawk, (Distributed) Agon.
- Dream Makers**, (See Survivor Records).
- Dream Sequence Music, Ltd.**, PO Box 2194, Charlottesville, VA, 22901, (804) 295-1877. Pres.: Kevin McNoldy.
Branch(es): PO Box 218155, Nashville, TN, 37221, (800) 637-3261.
Label(s): (Owned) Dream Sequence Music, Ltd.
- Dreamstreet Records**, PO Box 193, Ho Ho Kus, NJ, 07423, (201) 337-1869. Pres.: Howard S. Kenyon.
- US Reps.:** City Hall (CA); Harbor Record Export, Northcountry Dist. (NY).
- Driftwood Records**, PO Box 1928, Kingsport, TN, 37662, (615) 349-6860. Pres.: Margaret Yednak; Vice Pres./A & R: Peter Kobal; Sales: N.S. Kobal.
Label(s): (Owned) Driftwood, Illuminati.
- Drivin' Records**, PO Box 3343, Glendale, CA, 91201, (818) 764-6490.
- Drum-Boy**, (See Jay Jay Record & Tape Co.).
- Dum Beat Recordings**, 231 E. 29th St., #113, New York, NY, 10016, (212) 683-3774.
- Charles Dumont & Son, Inc.**, 1085 Dear Mont Dr., Voorhees, NJ, 08043, (609) 346-9100. Pres.: Charles J. Dumont; Gen. Mgr.: Michael S. Dumont.
- Dunhill**, (See MCA Special Markets & Products).
- Durban**, (See Sugarfoot Prods.).
- Dyer-Bennet Records**, 792 Columbus Ave., New York, NY, 10025, (212) 866-3673. Gen. Mgr.: Harvey Cort.
Label(s): (Owned) Dyer Bennet.
- Dynamite Records**, 5 Aldom Cir., West Caldwell, NJ, 07006, Branch(es): 151 Sherman St., Rochester, NY, 14606, (716) 254-6719. Rep.: George La Flame.
Label(s): (Owned) Deadwood, Dynamite, Tar Heel.
- Dynamo**, (See Musicor Records).
- Dynasty**, (See West Records).

E

- EDLOS**, (See Christmas Records).
- EG Records**, 9157 Sunset Blvd., # 215, Los Angeles, CA, 90069, (213) 274-2814. Fax: (213) 274-3976. Pres.: Linda Komorsky.
Label(s): (Owned) Editions EG.
- E.L.J. Records**, 1344 Waldron, Saint Louis, MO, 63130, (314) 863-3605. Pres.: Eddie L. Johnson; Prof. Mgr.: William Johnson.
- EMI Records U.S.A.**, 810 7th Ave., 8th Floor, New York, NY, 10019, (212) 603-8600. Fax: (212) 603-8681. Pres. & CEO: Sal Licata; Exec. Vice Pres./Gen. Mgr.: Ron Urban; Sr. Vice Pres. Mktg.: Jim Cawley; Sr. Vice Pres. Promo.: Jack Satter; Sr. Vice Pres. A & R: Ron Fair; Vice Pres. Sales: Ken Antonelli; West Coast Vice Pres. A & R: Mitchell Leib; Vice Pres. A & R: Michael Barackman; Vice Pres. AOR Promos.: Norm Osborne; Vice Pres. Promos.: Ron Geslin; West Coast Vice Pres. Promo.: Mark Kargol; Vice Pres. Urban Promo.: Glynice Coleman; Vice Pres. Bus. Affairs: Tim Mandelbaum; Vice Pres. Creative Svcs.: Henry Marquez; Vice Pres. Int'l: J.P. Bommel; Sr. Dir. Mktg.: Howie Gabriel; Sr. Dir. Publicity: Kim Akhtar; Sr. Dir. Finance: Dean Broadhead; Nat'l Dir. Sales: Phil Blume; Nat'l Dir. Urban Promo.: Bobby Bennett; Dir. Int'l Artist Devel.: Paul Donahoe; Dir. Video Promo & Mktg.: Lou Robinson.
Label(s): (Distributed) Capitol, Chrysalis, Curb, Enigma, Rhino, SBK.
US Reps.: CEMA (CA, DC, GA, IL, NC, OH, TX).
"E" Records, (See West Records).
- ESA Assoc.**, 72 E. 400 S., #355, Salt Lake City, UT, 84111, (801) 532-7202. Fax: (801) 322-4645. Pres.: Eric Claymaker; Vice Pres.: Martin Malmrose.
- ESB Records**, PO Box 6429, Huntington Beach, CA, 92615, (714) 962-5618. Exec. Prod.: Eva Bonn; Stan Bonn.
Label(s): (Owned) ESB.
- ESP-Disk' Ltd.**, PO Box 3968, Kingston, NY, 12401, (914) 657-7120. Pres.: Maria Stollman.
Label(s): (Owned) ESP Disk', United Int'l Copyright Reps.
- ETR**, (See Euro Tec Records).
- ETS Record Co.**, PO Box 932, Honolulu, HI, 96808, 264 Kaliahi St., Honolulu, HI, 96819, (808) 847-4300. Owner: Richard Riccio; Gen. Mgr.: Ed Dorman.
- Eagle**, (See Pet Records).
- Eagle Int'l Records**, 4416 Eatons Creek Rd., Nashville, TN, 37218, (615) 876-1729. Owner/A & R Rep.: D.M. Haddock.
US Reps.: Curtis Wood Dist. (TN).
Int'l Reps.: Cottage Records (U.K.).
- Eagle Mt. Int'l Church**, PO Box 699, Newark, TX, 76179, (817) 489-2226. Label Head: Win Kutz; Mktg. Dir.: Loren Johnson.
Label(s): (Owned) Heirborne, KCP, Sozo.
- The Early Morning**, (See Hummingbird Recording Co., Inc.).
- Earth Beat! World Music**, (See Music For Little People).
- Earth Records & Video**, Rt. 3, Box 57, Troy, AL, 36081, (205) 566-7932. Contact: Eddie Toney.
- Earth Station Records**, 143 Ave. B, Ste. 5A, New York, NY, 10009, (212) 529-5881. Fax: (212) 529-5882. Dirs.: Goran Andersson, Maria Jimenez.
Label(s): (Owned) Space Station.
US Reps.: Oxyomoron (CA).
- Earthbeat Records**, PO Box 1460, Redway, CA, 95560, (800) 346-4445. Fax: (707) 923-2590. Pres.: Leib Ostrow; Sec./Treas.: Linda Dillon-Ostrow; Vice Pres. Finance: Jimmy Durchslag; Vice Pres. Sales: Stuart Schonfield.
- Earwig Music Co., Inc.**, 1818 W. Pratt Blvd., Chicago, IL, 60626, (312) 262-0278. Fax: (312) 262-0278. Pres.: Michael Robert Frank.
Label(s): (Owned) Airway, Earwig.
Int'l Reps.: Parsifal (Belgium).

East Europe Records & Music

246 E. Eau Gallie Blvd., Indian Harbor Beach, FL, 32937, (800) 940-9846. Fax: (800) 940-0829. Contact: Maria Hernandez.

East West Records America, 75 Rockefeller Plaza, New York, NY, 10019, (212) 399-3300. Fax: (212) 399-3279. Pres./CEO: Sylvia Rhone; Exec. Asst.: Mae Attaway; Pres./COO: Vince Faraci; Sr. Vice Pres. A & R: Merlin Bobb; A & R Coord.: Jerome Sydenham; Vice Pres. Nat'l Promos.: Charley Lake; Nat'l Dir. Mktg. & Promo.: Jodi Williams; Nat'l Dir. Sales/Mktg.: Mike Carden; Nat'l Dir. Publicity: Lisa Barbaris.

Easy Day Records, 3190 Mackall Way, Palo Alto, CA, 94306, (415) 858-2548. Fax: (415) 856-6909. Owner/Producer: Drew Youngs; Producer: Piers Lawrence; Mgr.: Elisabeth Stearns.

Echo Mountain, (See Galaxy Mountain Music & Publishing).

Echo Records, 824 83rd St., Miami Beach, FL, 33141, (305) 865-8960, (305) 861-1216. Pres.: Walter Dana; Vice Pres.: Gus Dana.

Label(s): (Owned) Echo.

Echo Records, Inc., 215 Englewood Ave., Englewood, NJ, 07631, (201) 568-0040. Fax: (201) 568-2599. Pres.: Jeffrey Collins; A & R Mgr.: Paul Kyser; Promo. Mgr.: George Kerr; Co. Sec.: Nida Ross.

Label(s): (Owned) Dance Floor, Echo USA, Hangman, Proton Dance, (Distributed) Out Cold, Brooklyn Groove Prods. US Reps.: Vista Sounds Int'l, Inc. (NJ).

Eden, (See Jukebox Records).

Edible Records, 802 E. California, Urbana, IL, 61801, (217) 344-1721, (217) 387-7227. Pres.: Phil Strang; Vice Pres.: Chris Stefan.

Branch(es): 1264 N. Sweetzer, #202, West Hollywood, CA, 90069, (213) 656-9302. Contact: Chris Stefan.

Label(s): (Owned) Milk & Cookies, (Distributed) Record Service.

Editions EG, (See EG Records).

Effect, (See Luke Records, Inc.).

Eggplant Records, 3008 Belden Dr., Los Angeles, CA, 90068, (213) 469-2719. Fax: (213) 464-2272. Owners: Nick Thery, Sharon Thery.

Label(s): (Owned) Spinlet.

EI-Colbert, (See Kison Elyon Records).

Electric, (See Peak Records, Inc.).

Electricity Enterprises, Inc., PO Box 3764, 1300 SW 74 Ct., Miami, FL, 33152, (305) 268-4433. CEO/A & R: Bibi A. LaRed. Label(s): (Distributed) Chester, Quakette.

Elegance & Zesty Records Co., 8027 Thurston Dr., Cicero, NY, 13039, (315) 699-5613, (315) 699-7918. Pres.: Sylvester L. Wallace, Sr.; Asst. Mgr.: Arsenio D. Wallace; Creative Mgr.: Alicia Elluke Demps.

Label(s): (Owned) Elegance & Zesty.

Elektra Entertainment, 75 Rockefeller Plaza, New York, NY, 10019, (212) 484-7200. Fax: (212) 459-0346. Chrmn.: Bob Krasnow; Exec. Vice Pres.: Aaron Levy; Sr. Vice Pres. Bus. Affairs: Gary Casson.

Branch(es): 345 N. Maple Dr. Ste. 123, Beverly Hills, CA, 90210, (213) 288-3800. Vice Pres. A & R: Carole Childs; 83 Baker St., London, W1M 1AU, United Kingdom, 44-71-486-1414. Fax: 44-71-486-6892. Vice Pres. Elektra U.K.: Annie Roseberry, A & R Mgr.: Dave Field.

Label(s): (Owned) Elektra Nonesuch.

Elektra Int'l Classics, 75 Rockefeller Plaza, New York, NY, 10019, (212) 399-6945. Fax: (212) 399-8830. Vice Pres./Gen. Mgr.: Kevin Coppers; Dir. U.S. Opns./Teldec: Bob Goldfarb; Dir. U.S. Opns./Erat: Arthur Moorhead.

Elektra Nonesuch, 75 Rockefeller Plaza, New York, NY, 10019, (212) 484-7275. Fax: (212) 459-0346. Sr. Vice Pres./Gen. Mgr.: Bob Hurwitz; VP Mktg. & Creative Svcs.: Peter Clancy; Dir. Publicity & Promos.: Carol Yapple; Prod. Mgr.: Albert Lee; Prod. Asst.: Carla Capretto; Mktg. Asst.: Juana Simons.

Elemental Music, (See T.E.C. Tones/Ralph Records).

Elevation Ents., Inc., PO Box 8435, Boston, MA, 02114, (617) 547-2557. Pres.: Geraldine Hamlin; Vice Pres./Treas.: Michael Gallie; Vice Pres. A & R: John Thomas.

Elite Records, (See Thomas Wiggins Associates).

Elite, (See No-Bull Records).

Ember, (See Bulldog Records).

Emerald Records, 830 Glastonbury Rd., Ste. 614, Nashville, TN, 37217, (615) 361-7902. Pres.: Cliff Ayers Ostermeyer; Vice Pres./ Mktg.: Buddy Preston; Vice Pres./Sec.: Yvonne Mathews; Vice Pres. A & R: Buddy Preston. US Reps.: Music Town Record Dist. & Promos.(TN).

Emergo, (See Roadrunner Records & Music Publishing Co., Inc.).

Emkay, (See Country Int'l Records).

Empire Entertainment, (See State of Fresh American Entertainment).

Empty Sky Records, PO Box 626, 14th St., Verplanck, NY, 10596. Promo. Mgr.: Lisa Lancaster; Producer: Rick Carbone.

Label(s): (Owned) Verplanck, Yankee, (Distributed) Pumpkin.

Endeavor Starstrong Records, 30064 Annapolis Cir., Inkster, MI, 48141, (313) 729-7836. Pres.: Hardie W. Daniel; Vice Pres./Gen. Mgr.: Clark Daniel; Public Relations: Mary J. Hill; Promos.: Michelle Daniel; Vice Pres. A & R: Adrienne Daniel.

Label(s): (Owned) Endeavor, Endeavor Starstrong. US Reps.: Intersound Int'l (GA); One Stop Record Dist. (TN).

Enigma Entertainment, 11264 Playa Ct., Culver City, CA, 90231, (213) 390-9969. Fax: (213) 391-4561. Pres.: William Hein; CEO: Joe Regis; Vice Pres. A & R: John Guarnieri. Branch(es): 2nd Fl., 136 W. 18th St., New York, NY, 10011, (212) 741-1255. Contacts: M. Zukowski, Mark Diller; 2183 Dunwin Dr., Mississauga, ON, L5L 3S3, Canada, (212) 741-1255. Contacts: Derrick Ross, Mark Smith.

Label(s): (Owned) Intima, Medusa, Restless, (Distributed) Mute, Metal Blade.

Int'l Reps.: Liberation (Australia, New Zealand); EMI (South America); Pacific Music (South East Asia); EMI, Demon, Roadrunner (Germany, Austria, Switzerland, France, Benelux, Italy, Portugal, Israel, Iceland, Greece, United Kingdom); Sonet Rec. (Scandinavia); DRO (Spain); Alfa, Pony Canyon (Japan).

Enja, (See Creav, Inc. U.S.A.).

Ensign, (See Chrysalis Records, Inc.).

Entertainment Mgmt. Records, 454 Alps Rd., Wayne, NJ, 07470, (201) 694-3333. Pres.: Richard Zielinski; Vice Pres.: Martin Kopec; Treas.: Sonia Mallet.

Label(s): (Owned) Unicorn.

Entr'Acte, (See Fifth Continent Music Corp.).

Environments, (See Syntonic Research, Inc.).

Epic Records, 666 5th Ave., New York, NY, 10103, (212) 445-4321. Fax: (212) 445-7339. Pres.: Tommy Mottola; Pres. Epic/Associated: Dave Glew; Vice Pres. Admin.: Marty Greenfield; Vice Pres. Sales: Pete Anderson; Sr. Vice Pres. Mktg.: Larry Stessel; Sr. Dir. A&R: Kenny Komisar.

Episode, (See T.E.C. Tones/Ralph Records).

Epoch Universal Publications, 10802 N. 23rd Ave., Phoenix, AZ, 85029, (602) 864-1980. Fax: (602) 944-7378. Pres.: Ray Bruno; Exec. Vice Pres.: David Serey; Sales Mgr.: Bruce Bruno; Mktg. Dir.: Rick Hardy.

Label(s): (Owned) Livingsong, NALR, Sounds of Hope.

Equa Records, 1800 Mowry Ave., Fremont, CA, 94538, (415) 794-6637. Pres.: Dr. Warren M. Johnson; Promo. Dir.: Bob Jackson.

Label(s): (Owned) Equa.

Era, (See K-tel Int'l (USA), Inc.).

Eric Records, PO Box 287, 1120 Crown Point Rd., Westville, NJ, 08093, (609) 848-1900. Fax: (609) 848-0808. Pres./Buyer: William R. Buster, Jr.; Vice Pres.: Antony W. Colombet.

Es Paranza, (See Atlantic Recording Corp.).

Esar, (See Bill Rise Prods., Inc.).

Esquire Records, 177 E. Second St., Hunting Station, NY, 11746, (213) 876-9355. Fax: (213) 876-9365. Chrmn.: Gerald Laufer; Pres.: Arnold Orleans; Vice Pres. Promos.: Ronnie Jones; Vice Pres. A & R: Andy Janis.

Essence Records, Inc., 112-32 179th St., Saint Albans, NY, 11433, (718) 657-5821. Contact: Cory Lynch.

Essex Entertainment, Inc., 560 Sylvan Ave., Englewood Cliffs, NJ, 07632, (201) 894-8700. Fax: (201) 894-8630. Managing Partners: Sam Goff, Richard Greener; Nat'l Dir. Sales: Ted Wolf, Mike Cave, Martin Basart; Dir. A & R/Mktg.: Doug Friedman.

Label(s): (Owned) Buddha, Stradivari, Maestro, Project 3, (Distributed) PolyGram Special Products, RCA Special Products, Moss Music, Pair, Special Music, Warner Bros. Special Products, CBS Special Products, Camden, Capitol Special Products, Commodore, MCA Special Products, Arista Special Products.

Estate, (See Heath & Associates).

Estate Records, 1106 E. Ste. Catherine St., Louisville, KY, 40204, (502) 637-2877. Pres.: John V. Heath, II; Vice Pres.: John V. Heath, III.

Label(s): (Owned) Hillview.

Euro Tec Records, 231 Glencrest Ct., Ventura, CA, 93003, (805) 658-2488. Fax: (805) 658-8241. Pres.: Bruce Caplin.

Label(s): (Owned) ETR.

The Frank Evans Record Group, PO Box 6025, Newport News, VA, 23602, (804) 595-9000. Pres.: Frank Evans; Exec. Vice Pres.: Chase Von Fremd; Dir. A & R Rel.: Brian Norcross; Gen. Mgr.: Bruce Rader.

Label(s): (Owned) Continental Artist, Parquet, Peninsula Artist, Premiere Artist.

Everest Record Group, PO Box 6999, Beverly Hills, CA, 80212, (213) 557-0309. Fax: (213) 557-2662. Pres.: BC. Solomon.

Label(s): (Owned) Archive of Folk & Jazz Music, Concert-Disc, Counterpoint, Hi-Fi, Legacy, Olympic, Period, Tradition.

Evergreen Records, 1021 16th Ave. S., Nashville, TN, 37212, (615) 327-3213. Pres.: Johnny Morris.

Everland, (See Word, Inc.).

Every Seat In The House, PO Box 621, Radio City, NY, 10019, (813) 841-6155. Pres.: Don Seat; Vice Pres.: MacMillan Johnson; Gen. Mgr.: Amy Polan; Sec./Treas.: Donna Seat. US Reps.: The Maximus Companies (NY).

Everything, (See Virtue Records & Studios).

Ex Urbana, Inc., 222 W. 14th St., New York, NY, 10011, (212) 727-1360. Fax: (212) 366-5979. Pres.: Jared Hoffman; Vice Pres.: Dave Brubaker.

Label(s): (Owned) Acid Jazz, Instinct, Liquid Music, Low Spirit USA, Sonix.

Exact, (See Alshire Int'l, Inc.).

Executive Suite Records, 6922 Hollywood Blvd., #220, Hollywood, CA, 90028, (213) 463-0056. Gen. Mgr.: M. Kelly; Opns. Mgr.: D. Collins; A & R Coord.: M. Johnson; A & R Asst.: F. liams.

Label(s): (Owned) Rhapsody, (Distributed) Message.

Expanding Kingdom Records & Media Works, 4002 Liggitt Dr., San Diego, CA, 92106, (619) 226-4152. Fax: (619) 566-5637. CEO/Pres.: Douglas Foxworthy.

Extra Sensory Prods., PO Box 11377, Richmond, VA, 23230, (804) 285-8588. Fax: (804) 264-2479. Pres.: Martin Gary; Sec./Treas.: Kathleen Gary.

Label(s): (Owned) Beach, Groove, (Distributed) Short Stack. US Reps.: Schwartz Bros. (MD); Deans One Stop (VA); Landmark (GA).



F & L Records, 1618 16th Ave. S., Nashville, TN, 37212, (615) 292-3611. Contact: Bobby Fischer.

Label(s): (Owned) F & L, Progress.

FM, (See Sony Records, Inc.).

FSM Pantheon, (See Random House Mail Order).

FSR, (See Fidelity Sound Recordings).

FWP, (See Fred Weinberg Prods., Inc.).

FXL Sound Studios, PO Box 16540, 10244 NW 47th St., Plantation, FL, 33318, (305) 741-7766. Pres.: Frank Loconto; Exec. Vice Pres.: Phyllis Loconto; Vice Pres.: Bill Dillon.

Label(s): (Owned) F X L, True Friends.

Facet, (See Delos Int'l, Inc.).

Factory Beat Records, Inc., 521 Fifth Ave., 17th Floor, New York, NY, 10175, (212) 757-3638. Pres./Prod.: Rena L. Feeney; Dir./Prod.: Billy Nichols; Sales/Mktg. Mgr.: Chris S. Feeney; Promo.: Valerie A. Gills; Vice Pres. A & R: Billy Nichols. Label(s): (Owned) Can-Score Prods., R & R, R&R Mus c. Ren Maur Music Corp.

Family Records, 910 Hester, Memphis, TN, 38116, (901) 396-9952. Pres.: Earl Randle.

Famous Door Prods., 1-A-1 Estate St. Peter, Saint Thomas, VI, 00802, (809) 775-7428. Fax: (809) 775-7428. Owner: Harry Lim.

Label(s): (Owned) Famous Door.

US Reps.: Mobile Fidelity (CA); Harbor Record Export (NY).

Fantasy, Inc.

2600 Tenth St., Berkeley, CA, 94710, (510) 549-2500. Fax: (510) 486-2015. Pres.: Ralph Kaffel; Board Chrmn.: Saul Zaentz; Exec. Vice Pres.: Philip R. Jones; Exec. Vice Pres. Finance: Frank Noonan; Exec. Vice Pres./Bus. Affairs: Albert M. Bendich; Press/Publicity Dir.: Terri Hinte; Sales Mgr.: Kirk Roberts; Promo./Jazz: John Rogers; Prodn. Mgr.: Vickie Hellweg; Art Dir.: Phil Carroll; Dir. of Int'l Licensing: Bill Belmont; U.S. Licensing Admin.: Pamela Bendich.

Label(s): (Owned) Contemporary, Debut, Fantasy, Galaxy, Good Time Jazz, Milestone, Original Jazz Classics, Original Blues Classics, Pablo (Pablo Live, Pablo Today), Prestige (New Jazz, Bluesville, Swingville, Moodsville, Tru Sound), Riverside (HRS, Jazzland) Specialty, Stax (Enterprise), Volt, (Distributed) HDH, Landmark, Music Merchant.

Int'l Reps.: Australia & New Zealand: Festival. Austria: Mikulski. Brazil: Barclay. Canada: A & M. Denmark: Sonet, Finland: Euros, France: Carrere, Germany: Mikulski, Greece: CBS, Hong Kong: Pacific, Israel: MCI Inc., Italy: Om Disc, Japan: Victor Musical Inds.: Roots, Mexico: EMI, Portugal: Dargil, South Africa, Spain: Nuevos Medios, Sweden & Norway: Amigo, Switzerland: Mikulski, Thailand: Butterfly, United Kingdom: Ace, Yugoslavia: Jugoton.

Farview Records, 701 N. Graycroft, Madison, TN, 37115, (615) 865-2639. Pres.: Tony Farr; Sec.: Mary Farr.

Fast Track Records, 264 Tosca Dr., Stoughton, MA, 02072, (617) 821-0507.

Faux Pas, (See Charade Records).

Fayette, (See Virtue Records & Studios).

Fee Bee Record Co., 4517 Wainwright Ave., Pittsburgh, PA, 15227, (412) 884-4727. Mgr.: Joe Averbach; Asst. Mgr.: Alma Averbach; Promo.: Glen Phillips.

Label(s): (Owned) Fee Bee, Goodie, (Distributed) Petite, Star Joe Fee, (See Sharon Prods., Inc.).

Feel Prods., (See Afterschool Publishing Co.).

Festivo, (See The Organ Literature Foundation).

Fidelity Sound Recordings, 23 Don Ct., Redwood City, CA, 94062, (415) 366-3173. Owner: Reginald McGovern; Promo.: Jim Gallagher; Mktg.: Mo Rudick.

Label(s): (Owned) FSR, Five Star, Five Star Recordings of NZ.

Int'l Reps.: Five Star Recordings (New Zealand).

Charlie Fields Prodn., PO Box 145, Pleasant View, TN, 37146, (615) 746-8608. Fax: (615) 746-2758. Pres.: Charlie Fields; Gen. Mgr.: Bernice Fields, Pub. Rel.: Debbie Dean.

Label(s): (Owned) C.B.F., Charburn.

Fiesta Record Co., Inc.

PO Box 6, 251 Broadway, Lynbrook, NY, 11563, (516) 599-5522. Fax: (516) 599-8766. Pres./A & R: Jose Morand.

Sales Mgr.: Edward Kleinbaum, Opns Mgr.: Pauline Bomzer; Sec.: Lillian Morand.

Label(s): (Owned) Europa, Fiesta, Grecophone, (Distributed) EMI (England, France, Germany, Ireland, Italy), Castle Communications (Scotland), Emerald (Ireland), Turcaphon (Germany).

Fifth Continent Music Corp., 1931 San Miguel Dr., Ste. 200, Walnut Creek, CA, 94596, (510) 939-8161. Fax: (510) 939-8247.

Pres.: John Steven Lasher.

Label(s): (Owned) Entr'Acte, Label 'X', Preamble, S.C.S.E., Southern Cross, (Distributed) Move.

US Reps.: Albany Music Dist. (NY).

Int'l Reps.: Sonart Meca (Australia); Fenn Music/Proton (Germany); Meilleure Electronics (Singapore); Polydor IMS (Japan); Trend Records (Canada).

Film Score, (See Original Cast Records).

Filmtrax Copyright Holdings, Inc., 3808 Riverside Dr., #408, Burbank, CA, 91505, (818) 846-1400. Fax: (818) 846-7585. Gen. Mgr.: Barry Veverka-Brownlie.

Finer Arts, (See Bernstein Corp).

Fink/Pinewood Records, PO Box 5241, Chesapeake, VA, 23324, (804) 627-0957. Pres./Exec. Prod.: Bill Johnson. Label(s): (Owned) Bay Port, Pine Wood, Yard Bird. US Reprs.: Bay Port Records (VA); Pine Wood Records (VA).

Finnadar, (See Atlantic Recording Corp.; Warner Music Int'l).

Fireball Records, PO Box 803, 200 Perry St., Tazewell, VA, 24651, (703) 988-6267. Pres.: H.R. Cook. Label(s): (Owned) Fireball, Nightwind.

FireDragon Phonorecord Prods., 1826 Poplar Ln. SW, #4, Albuquerque, NM, 87105, (505) 243-2881. Pres.: Ginny Driskill; Vice Pres. Prodn.: Tony Polidori; Vice Pres. Licensing: Walter T. Priest; Video Dir.: Robert H. Henry. Label(s): (Distributed) Aerolite Int'l, Atterrack, Budari, FMC Ltd., Great West Ents, Icefire Int'l, Shan Int'l, Suddath Int'l, Vador Int'l, White Wolf Int'l, Inc., Juke, Kalyx (Chalice) Int'l, Maxima, Peony Int'l, Sell Pictures. Int'l Reprs.: Bobby Farrell, Vador Music Group (MN).

First Amendment, (See Jamie/Guyden Dist. Corp.).

First Coast Posse, (See Hallways To Fame Prods., Inc.).

1st Generation Records, PO Box 186, Brentwood, TN, 37204, (615) 371-9556. Fax: (615) 371-8638. Owner: Rose Drake. Label(s): (Owned) First Generation.

First Priority, (See Atlantic Recording Corp.).

Fishtracks Communications Group, Inc., 62 Congress St., Portsmouth, NH, 03801, (603) 431-5492. Managing Dir.: Thomas A. Daly.

516 Records, Inc., PO Box 518, Bethpage, NY, 11714, (516) 822-6312. Contact: George Hignell.

Five Star Recordings of NZ, (See Fidelity Sound Recordings).

Fixit Records, Inc., PO Box 656, Pomona, NY, 10470, (914) 362-2000. Fax: (914) 362-9233. Pres./CEO: Raina Bundy; Vice Pres.: Robert Bundy; Mgr. Corp. Planning: Irwin S. Zeldman; Mgr. Sales: Jeff Chandler; Vice Pres. A & R: Raina Bundy. Label(s): (Owned) Fixit. US Reprs.: Star Song Communications (TN).

Flambo, (See King Walk, Inc.).

Flat Town Music Co., PO Drawer 10, 434 E. Main St., Ville Platte, LA, 70586, (318) 363-2139. Fax: (318) 363-5622. Pres.: J. Floyd Soileau; Vice Pres.: Jiver Soileau; Sec.: Catherine S. Sylvester. Label(s): (Owned) Jin, Kom-A-Day, Maison de Soul, Swallow, (Distributed) ZBC, Monte! Michelle, RZ, La Louisiane, Great Southern. US Reprs.: Action Music Sales (OH); Bay Side Records (CA); Big State Dist. (TX); Floyd's Wholesale (LA); MS Distrib. Co. (IL); Old Foggy Distrib. (MI); Record Depot (VA); Richman Bros. (NJ); Rock Bottom (FL); Rounder Distrib. (MA); Select-O-Hits (TN); Silo Inc. (VT). Int'l Reprs.: Avan-Guard (Australia); Trend (Canada); Dixiefrog (France); Swift Record Dist., Ace Records Ltd. (England); Vivid Sound Corp. (Japan); Music & Words (Holland); Trikont (Germany).

Flip Flop Records, PO Box 1154, Evanston, IL, 60202, (312) 864-1383. Pres.: Brian Alexander; Mktg. Dir.: Daron Malkumson; A & R: Joey Maybein.

Florida Gospel Train, (See Florida Swamper Records).

Florida Melody Train, (See Florida Swamper Records).

Florida Swamper Records, 6415 Spring Hill Dr., Spring Hill, FL, 34606, (813) 868-5339. Pres.: Donald Marcum; Vice Pres.: Dennis Marcum; Arron Hale. Label(s): (Owned) Florida Gospel Train, Florida Melody Train.

Flying Fish Records, 1304 W. Schubert, Chicago, IL, 60614, (312) 528-5455. Fax: (312) 528-8262. Pres.: Bruce Kaplan; Vice Pres. Manufacturing: James Netter; Vice Pres. Promos & Adv.: Mike Fleischer; Vice Pres. Sales: Jean Lyons; Vice Pres. A & R: Seymour Guenther. Label(s): (Owned) Flying Fish, (Distributed) Blind Pig, Greenhays, Atomic Theory, Rooster Blues, Temple. US Reprs.: Bayside (CA); Rounder (MA); Silo (VT); Landmark, Precision, Rock Bottom, Indie. Int'l Reprs.: Temple Records (Scotland); American Records (Japan); Amigo (Sweden); FMS (Germany); IRD (Italy).

Flying High, (See Richey Records).

Folk Era Prods., (See Aztec Corp.).

Folk-Star, (See Goldband Recording Corp.).

Folklyric, (See Arhoolie Prods., Inc.).

Folkraft/Dance Record Dist., PO Box 404, Florham Park, NJ, 07932, Pres.: Gail Shifrin. Label(s): (Owned) Folkraft, (Distributed) Kimbo, Educational Activities.

Ford, (See Country Int'l Records).

Fortress, (See Refuge Music Group).

Fortune Records, PO Box 904, Royal Oak, MI, 48068, (313) 545-2146. Promo/A & R: Devora Brown; Mktg./Sales: Ted Mcquisten; Asst. Promo. A & R: Cindy Mandy. Label(s): (Owned) Fortune, Hi-Q, Strate 8.

Forum Records, Inc., PO Box 692, Middleton, WI, 53562, 1627 Troy Dr., Madison, WI 53704, (608) 241-0051. Pres.: Bill Schereck; Vice Pres., Gen. Mgr.: Jeff Ross.

Fossil Records, 808 S. Alkire St., Lakewood, CO, 80228, (303) 986-7309. Fax: (303) 986-0072. Pres.: William L. Fowler; Vice Pres.: Beatrice C. Fowler. Label(s): (Owned) Fossil.

Fountain Records, 1203 Billmore Ave., High Point, NC, 27260, (919) 882-9990. Pres.: Doris W. Lindsay. US Reprs.: Ernest Tubb (TN); Music Mood Ents. (IN); Dixie Rocks (TN).

Fountainhead Records, PO Box 40128, San Francisco, CA, 94140, (415) 641-6235. Gen. Mgr.: Trevor Levine. Label(s) (Owned) Fountainhead

4 AD Records, 611 Broadway, Ste. 311, New York, NY, 10012, (212) 353-3773. Fax: (212) 505-9314.

Four Flags, (See Spotlite Records).

4 Fruch Music Publishing Co., 1108 N. Sherbourne Dr., West Hollywood, CA, 90069, (213) 652-5603. Fax: (213) 652-3951.

415 Records, Ltd., 888 Seventh Ave., 37th Floor, New York, NY, 10106, (212) 841-8102, (212) 541-9666. Fax: (212) 841-8144. Owner: Steve Schenck; Sandy Pearlman. Label(s): (Owned) Popular Metaphysics.

14 Karat Records, PO Box 37040, Raleigh, NC, 27627, (919) 831-9212. Pres./Owner: Donne Weaver.

4th & Broadway/Great Jones Records, 14 E. 4th St., 3rd Floor, New York, NY, 10012, (212) 995-7800. Fax: (212) 477-5918.

Fourth Floor, (See Northcott Productions, Ltd.).

Fox Farm Recording, 2731 Saundersville Ferry Rd., Mount Juliet, TN, 37122, (615) 754-2444. Vice Pres. A & R: Kent Fox. Frame House. (See Top's Records).

Fraternity Recording Corp., 3744 Applegate Ave., Cincinnati, OH, 45211, (513) 661-5451.

Fre-Eco, (See Freddie Records, Inc.).

Freddie Records, Inc., 6118 S. Padre Island, Corpus Christi, TX, 78412, (512) 992-8411. Pres.: Freddie Martinez; Prodn. Mgr.: Jessie Salcedo; Gen. Mgr.: Lee Martinez. Label(s): (Owned) Fre-Eco, Rosita.

Frøjo, (See Fred Weinberg Prods., Inc.).

Frko Records, 417 E. Crosstimbers, Houston, TX, 77022, (713) 694-2971. Pres.: Freddie Kober. Label(s): (Owned) Contage'us, Honey Bee.

Fresh Air, (See Moseka Records & Tapes).

Frisco Records, Inc., PO Box 15094, New Orleans, LA, 70175, (504) 822-7037. Fax: (504) 866-0502. Pres.: Connie Larocca; Vice Pres./Gen. Mgr.: Earl King; Music Dir.: Curtis Mitchell. Label(s): (Owned) Lakeside, (Distributed) Pelican State.

Frog Work Records, (See Lite Album Publishing Co.).

Front Hall Ents., Inc., PO Box 307, Wormer Rd., Voorheesville, NY, 12186, (518) 765-4193. Fax: (518) 765-4193. Pres.: Kay L. Spence; Vice Pres.: William J. Spence. Label(s): (Owned) Front Hall. US Reprs.: Rounder (MA); Old Foggy Dist. (MI); Silo (VT).

Frontier Jamboree, (See Stardust/Wizard/Doss Records).

Frontier Prods., (See Heritage Records).

Frontier Records, PO Box 22, Sun Valley, CA, 91353, (818) 506-6886. Fax: (818) 506-0723. Pres.: Lisa Fancher; Vice Pres./Mktg.: Thames Sinclair. Label(s): (Distributed) Dangerhouse, Limited Potential, Popilama. US Reprs.: BMG (US).

Int'l Reprs.: Revolver (West Europe); Mushroom (Australia); Cargo (Canada).

Frontline Records, 4041 MacArthur Blvd., Ste. 300, Newport Beach, CA, 92660, (714) 660-3888. Fax: (714) 660-3899. Owner/Pres.: James Kempner; Exec. Vice Pres.: Brian Tong; Vice Pres. Corp. Media: Mike MacLane; Creative Dir.: Ed McTaggart. Branch(es): 365 Great Cir. Dr., Nashville, TN, 37228, Vice Pres. Mktg., Sales: Kent Songer. Label(s): (Owned) Frontline Kids, Graceland, Intense, Alarna. US Reprs.: Benson Co. (TN). Int'l Reprs.: Christian Mktg. (Australia); Mainroads Music (Canada); Concorde (New Zealand); Kingsway Pub., Word UK, Ltd., Music For Nations, Word Ltd., (United Kingdom); Fun House (Japan); GMI/Flava (The Netherlands).

Fun-E, (See Bellaire Records).

Funky Records, 244 Lyle Ave., Rochester, NY, 14608, (716) 458-5610. Owner/Pres.: Boyd McCoy; Vice Pres. A&R: Steve McNally.

Future, (See Dharma Records).

Future Shock Records, 101 Alder St., Ste. 2, West Babylon, NY, 11704, (516) 249-4941. Fax: (516) 249-0156.

Fuzzy Bugger Records, PO Box 68, Main St., Landingville, PA, 17942, (717) 366-0703. Label(s): (Owned) Fuzzy Bugger, (Distributed) Mountain Laurel.

G

G Co., (See B-Atlas & Jody Records).

G Fine Sounds, PO Box 180, Cooper Sta., 2 Washington Sq., Village, Ste. 13G, New York, NY, 10276, (212) 995-1608. Fax: (203) 334-6218. Pres.: Jonathan P. Fine; Vice Pres.: Lyvio G; Vice Pres., Legal Affairs: Jeffrey Siegel, Esq.; Vice Pres., Finance: Bernie Finegold.

GHB, (See Jazzology Records, Inc.).

GNP Crescendo Record Co., Inc.
8400 Sunset Blvd., Ste. 656-A, Los Angeles, CA, 90069, (213) 656-2614. Fax: (213) 656-0693. Pres.: Bob Norman; Creative Dir.: Jordana Von Spiro; Comptroller: Gene Pasta; Pub. Rel. Dir.: Randi Hill. Label(s): (Owned) Creative World, Dixieland Jubilee, GNP Crescendo. US Reprs.: Associated (AZ); CRD (CA); Encore (CO); Gemini (GA); Landmark (IL); St. Expedite (LA); Mill City (MN); Malverne (NY); Action (OH); MDI (TX); Ed Richter (WA); Richman (PA); Select-O-Hits (TN); Surfside (HI). Int'l Reprs.: Trend (Canada); Vogue (France, Belgium); Bernhard Mikuslji (Germany, Austria, Switzerland); Music Box (Greece); IRD (Italy); King Record Co., Ltd. (Japan); Polskie Nagrania (Poland); Sonet Grammofon AB (Sweden, Norway, Denmark); Chiang Huat (Singapore); Festival Records

(Australia, New Zealand); Alldisc (Brazil); Musicavision (Chile, Argentina); Silva Screen (U.K.).

GPH Music, (See Gospel Publishing House).

GRP, (See MCA Special Markets & Products).

GTP, (See Pop Record Research).

Gabriel Records, One Bala Place, Ste. LL-40, Bala Cynwyd, PA, 19004, (215) 668-9043. Vice Pres. A & R/Promo: Gerard N. Mainardi; Vice Pres. A & R/Mktg.: Michael J. Mainardi; Mktg. Mgr.: Sandy A. Martin.

Galaxy, (See Fantasy, Inc.).

Galaxy Mountain Music & Publishing, PO Box 4212, Reseda, CA, 91337, (213) 464-8382. Pres.: Cheryl Roth; Gen. Mgr.: Linda D. Milne; Mktg. Mgr.: Patsy A. Brown. Label(s): (Owned) Echo Mountain.

Galaxy Records & Tapes, 2400 Josephine St., Pittsburg, PA, 15203, (412) 371-0371. Fax: (412) 481-8693. Pres.: Eugene Jakiela; Vice Pres.: Carol Jakiela; Buyer: Kevin Jakiela.

Gallery II Records/CA, 2301 W. 59th St., Los Angeles, CA, 90043, (213) 294-7286. Fax: (213) 291-7709. Pres.: Johno Waller; Vice Pres.: Horace Hall, Jr.; Sec.: Wazir A. Aziz. US Reprs.: Wax-Trax (IL).

Gallery II Records, Inc., PO Box 630755, Miami, FL, 33163, (305) 935-4880. Fax: (305) 933-4007. Pres.: Jack Gale. Label(s): (Owned) Playback, Ridgewood.

Gallo, (See The Organ Literature Foundation).

Gamble & Huff, (See Philadelphia Int'l Records).

Gark Records, 4100 44th Ave. S., Minneapolis, MN, 55406, (612) 721-7945. Owner: Dave Pinsky; Vice Pres.: Jay Leigh; Ezra Gold; Vice Pres. A & R: Jay Leigh. Label(s): (Owned) Krag.

Garland, (See DCC Compact Classics).

Martin Gary Prods., PO Box 11377, Richmond, VA, 23230, (804) 285-8588. Fax: (804) 264-2479. Pres.: Martin Gary; Sec./Treas.: Kathleen Gary. Label(s): (Distributed) Short Stack. US Reprs.: Schwartz Bros. (MD); Deans One Stop (VA); Landmark (GA).

Gasparo Records, PO Box 600, 15 Fitzgerald Dr., Unit 7, Jaffrey, NH, 03452, (603) 532-8821. Fax: (603) 532-8841. Pres.: Roy Christensen; Contact: Virginia Christensen. Label(s): (Owned) Gasparo. US Reprs.: Allegro Imports (OR).

Gay 90's Village, Inc., PO Box 569, 2107 E. Malone Rear, Sikeston, MO, 63801, (314) 471-1347. Pres./Treas.: Laura L. Eakins; Vice Pres.: Randy A. Eakins; Sec.: Patty Newman. Label(s): (Owned) Gold 20.

Gear, (See Stairias Records).

Geffen Records, 9130 Sunset Blvd., Los Angeles, CA, 90069, (213) 278-9010. Fax: (213) 271-4358. Pres.: Ed Rosenblatt; Gen. Mgr.: Al Coury; Vice Pres. Nat'l Sales: Eddie Gilreath; Dir. Mktg.: Robert Smith. Branch(es): 75 Rockefeller Plaza, New York, NY, 10019, (212) 484-7170, A & R: Michael Rosenblatt. Label(s): (Distributed) Def American, Geffen.

David Geffen Co., 9130 Sunset Blvd., Los Angeles, CA, 90069, (213) 278-9010. Fax: (213) 271-4563. Gen. Mgr.: Marko Babineau. Branch(es): 75 Rockefeller Plaza, New York, NY, 10019, (212) 484-7170, Fax: (212) 484-8930.

Gente Wind Recording, (See Conarch Prods.).

Get Hip, Inc., PO Box 666, Canonsburg, PA, 15317, (412) 231-4766. Fax: (412) 231-4777. Co-Owner, A & R: Greg Kostelich; Michael Kastelic; Promo, A & R: Scott Warner.

Ghetto Farms, (See Trix Records, Inc.).

Ghost Records, 1905 Pesos Pl., Kalamazoo, MI, 49008, Pres.: Don Jobe; Vice Pres.: Jim Hallberg; A & R: Pete Lazaroff; Producer: Dan Steric. Label(s): (Owned) Ghost.

Giant Records, 345 N. Maple Dr., Ste. 205, Beverly Hills, CA, 90210, (213) 288-5500. Fax: (213) 288-5515. Chrmn.: Irving Azoff; Head of Finance: Kendall Barclay; Head of Promos/Mktg.: John Brodey; Mktg.: Bill Burks; West Coast A & R: Danny Keaton; Bob Cornick; Wendall Green; Head of Merch.: Peter Lubin; Dir. of Int'l: Susan Markheim; West Coast A & R Black Music: Cassandra Mills; Asst. to Chrmn.: Irene Fukunaga. Branch(es): 729 Seventh Ave., 12th Floor, New York, NY, 10219, (212) 704-4489, Fax: (212) 704-7011, East Coast A & R: Brian Koppelman, East Coast A & R Black Music: Gary Harris.

Gift, (See Track America).

Glad Hamp Records, Inc., 575 Laramie Ln., Mahwah, NJ, 07430, (201) 934-5665. Fax: (201) 934-1679. Pres.: Lionel Titone; Vice Pres.: Bill Titone; Gen. Mgr.: Charlie Mack. US Reprs.: Western Record Co. (CA).

Glitch Records, PO Box 4429, 600 W. 28th St., Ste. 105, Austin, TX, 78765, (512) 477-3909. Pres.: Keith A. Ayers.

Glo, (See B-Atlas & Jody Record Co.).

Global Musician, (See Global Records & Tapes).

Global Pacific Records, 270 Perkins St., Sonoma, CA, 95476, (707) 996-2748. Fax: (707) 996-2658. Pres.: Howard L. Sapper; Sr. Vice Pres.: Howard L. Morris; Vice Pres. Promo: Neal B. Sapper; Dir. Sales & Mktg.: Tom E. Sapper. Label(s): (Owned) Global Pacific, (Distributed) Heru. US Reprs.: Rhino (CA).

Int'l Reprs.: Bellaphon (Germany); Lubata (Mexico); Around the World (Singapore).

Global Records & Tapes, 1345 Avenue of the Americas, Ste. 3300, New York, NY, 10105, (212) 830-9520. Fax: (212) 586-8657. Pres.: Peter Kirsten. Branch(es): 171 Southgate Rd., London, N1 3LE, United

Kingdom, (089) 15 10 63, Gen. Mgr.: Peter Knight, Jr.; Nederlingstrasse 21, 8 Munchen 19, West Germany, (089) 15 10 63, Pres.: Peter Kirsten.
Label(s): (Owned) Global Musicon, Global Satellite.

Global Satellite, (See Global Records & Tapes).

Global Theater Records, 15456 Cabrito Rd., Van Nuys, CA, 91406, (213) 873-7370. Fax: (818) 787-3981. Pres.: Joe Gottfried; Vice Pres.: Tom Skeeter; Dir.: John Campagna.
Int'l Reps.: Fun House (Japan); Active Records (Sweden).

Global Village, (See Joseph Nicoletti Music Co., California Int'l Records, Creative Network Co.).

Go, (See Billy Baker & Assoc.).

Go 4 It, (See Megalodon Ent., Inc.).

Godwin Music Group, 1226 17th Ave. S., Ste. 2, Nashville, TN, 37212, (615) 327-1632. Fax: (615) 292-9752. Pres.: Hal Godwin; Gen. Mgr., A & R: Maurice Godwin.
Label(s): (Owned) Doghouse Prodn.

Gold Castle Records, 3575 Cahuenga Blvd. W., #470, Los Angeles, CA, 90068, (213) 850-3321. Fax: (213) 874-0266.

Gold Dust Records, PO Box 84, Strasstown, PA, 19559, (215) 488-1782. Contact: Patrick Sickafus.
Label(s): (Owned) Gold Dust.

Gold Nuggets, (See Ripete Records, Inc.).

Gold Records, 304 N. Point Dr., Stevens Point, WI, 54481, (715) 344-8156. Pres.: Norm Dombrowski.

Gold 20, (See Gay 90's Village, Inc.).

Goldband Recording Corp., PO Box 1485, Lake Charles, LA, 70602, (318) 439-4295. Fax: (318) 436-7585. Pres.: Eddie Shuler; Chief Engineer: Jeff LeJeune; Financial Sec.: M. Holt.
Label(s): (Owned) Anla, Folk-Star, Tic-Toc, (Distributed) Tek, Jador.
Int'l Reps.: Charly (United Kingdom).

Golden Boy Records, PO Box 5218, 16311 Askin Dr., Pine Mountain Club, CA, 93222, (805) 242-0125. Fax: (805) 242-4313. Owner: Eddie Gurren
Label(s): (Owned) Alva, Golden Boy, Golden Boy Jazz.

Golden Gate Records, PO Box 5215, 19 Coopers Hawk, Santa Cruz, CA, 95063, (408) 429-6880. Fax: (408) 438-8796. Pres./Owner: Gary Lamb; Vice Pres./Promos. Dir.: Adrienne Biliske; Regional Sales Dir.: Sue Meachen; Dir. of Opns.: Denise Davidson; Vice Pres. A & R: Adrienne Biliske; Nat'l & Int'l Dir. Sales: Forrest Meaches; Sales: Claudia Kraft; Acct.: Jill Haahein; Inventory Mgr.: Linda Koepfer
US Reps.: Incore (CO); Rock Bottom (FL); Navarre (MN); Precision Sound (WA); Silo (VT); Back Roads (CA); Music Design (WI); MDI (TX); Reel to Reel (CA); One World of Music (CA); Valley Record Dist. (CA).

Golden Horse Records, 90 Youmans Ave., Washington, NJ, 07882, (201) 689-1372. Contact: Earl E. Kelson.

Goldisc, (See Timeless Entertainment Corp.).

Goldust Records Co., 115 E. Idaho Ave., Las Cruces, NM, 88005, (505) 524-1889. Owner/Gen. Mgr.: Emmitt H. Brooks.
Label(s): (Owned) Goldust, (Distributed) Red Barn.

Goldwax Record Co. Inc., PO Box 30166, 3181 Poplar Ave., Ste. 325, Memphis, TN, 38130, (901) 458-2285. Fax: (901) 458-2476. Pres.: Quinton M. Claunch; Vice Pres./Sec.: S.D. Burks; Nat'l Promo. Dir.: Bernard Roberson; Chairman of the Board: E.W. Clark; Vice Pres. A & R: R.D. Clark.
Label(s): (Owned) Bandstand U.S.A., Beale Street U.S.A., Goldwax, (Distributed) Abec.

Good Time Jazz, (See Fantasy, Inc.).

Goodie, (See Fee Bee Record Co.).

Gordo Ent's., 255 N. New Hampshire Ave., Los Angeles, CA, 90004, (213) 384-9586. Fax: (213) 384-0411. Owner: Edward L. Davis; A & R: Harry Scorzo.
Label(s): (Owned) Rampart.
US Reps.: California Record Dist. (CA, WA); JFL Dist. (FL); Landmark (GA); Great Bay Dist. (MD); Landmark (IL); Music Dist. (TX); Motor City Music Dist. (MI); California Record Dist., JOC Records (CA); Select-O-Hits (TN); Landmark Dist (NY); Distribuidora Nacional (PR).

The Gordy Co., 6255 Sunset Blvd., 18th Floor, Hollywood, CA, 90028, (213) 461-9954. Fax: (213) 261-9526.

GosPearl Record Co., 337 Hospital Dr., Ste. A2, Glen Burnie, MD, 21061.

Gospel Publishing House, 1445 Boonville, Springfield, MO, 65802, (417) 862-2781. Fax: (417) 863-8558. Gen. Mgr.: Joe Kilpatrick; Mgr. Mktg. & Dist.: Tom Sanders; Mgr. Advertising: Carol Ball; Mgr. Merchandise Sales: Dan Johnston.
Label(s): (Owned) GPH Music, Melody Music, Radiant Music.

Gothic Records, Inc., PO Box 1576, Tustin, CA, 92681, (714) 998-2493. Pres.: George Dickcy.
Label(s): (Owned) Gothic.
US Reps.: Koch Int'l (NY).
Int'l Reps.: Koch Records (Germany), (Austria), (Switzerland); Koch Benelux (Netherlands); Koch Int'l Ltd. (England).

Gotown, (See Kilgore Records Co.).

Graceland, (See Frontline Records).

Graduation Records, Inc., PO Box 31519, Saint Louis, MO, 63131, (314) 432-7600. Pres.: Julian H. Miller II; Gen. Mgr.: Karen Willenberg.
Label(s): (Owned) Graduation.

Gramavision Records, Inc., 55A Katonah Ave., Katonah, NY, 10536. Pres.: Jonathan Rose; Managing Dir.: Joanna Fitzpatrick.
US Reps.: Mesa Bluemood Dist. (CA).
Int'l Reps.: GRP (Switzerland); Tokuma Japan Corp. (Japan).

Gramophone Records, PO Box 910, Beverly Hills, CA, 90213, (310) 276-2726. Gen. Mgr.: Oliver Berliner.

Granada Video, (See Creav, Inc. U.S.A.).

Grand Marshall, (See King Walk, Inc.).

Grand Slamm Records, Inc., 6 Valley Brook Dr., Middlesex, NJ, 08846, (212) 334-2187. Fax: (212) 334-2178. Contacts: Brian McEvoy, Dave Hall.

Grandi Voci, (See Random House Mail Order).

Granite Music Corp., (See Criterion Music Corp.).

Granite Records & Tapes, PO Box 24066, Nashville, TN, 37202, 108 Joyce Ln., Ashland City, TN, 37015, (615) 792-4468. Owner/Mgr.: Thomas Boyles; Surf Label A & R: Jeff Boyles; Promos. Mgr.: Carol Delaney.
Label(s): (Owned) Granite, Skip-The-Hype, Surf.

Graphite Records, 6101 Melrose Ave., Hollywood, CA, 90038, (213) 465-8164. Pres.: Adrian Anghel; Sr. Vice Pres.: Richard Kline; Gen. Mgr.: Lucian Anghel; Vice Pres. A & R: Constantin Ivanovici.
Label(s): (Owned) Graphite.
US Reps.: Select-O-Hits (TN); Navarre Corp. (MN); Great Bay Dist. (MD); Music Dist. (TX).

Grass Mountain, (See Richey Records).

Grass Roots Records, PO Box 532, Malibu, CA, 90265, (310) 463-5998. Fax: (310) 457-8891. Pres.: Lee Magid.
Label(s): (Owned) LMI.

Gravex, (See International Record Corp.).

Great American Music Hall, 859 O'Farrell St., San Francisco, CA, 94109, (415) 885-0750. Fax: (415) 885-5452. Pres.: Tom Bradshaw.

Great American Song Machine, (See Spanda Records).

Great Expectations, (See I AM Records).

Great Lakes, (See Casino Record, Inc.).

Great Southern Record Co., Inc., PO Box 13977, New Orleans, LA, 70185, (504) 482-4211. Pres.: John Berthelot.
Label(s): (Owned) Great Southern, New Orleans Sound.
US Reps.: Bayside Dist. (CA); M.S. Dist. (IL); Richmond Bros. (NJ); Floyd's Wholesale (LA); St. Expedite (LA); Action Music (OH); Rock Bottom (GA); Rounder Dist. (MA); Old Fogey (MI); Select-O-Hits (TN); Silo Record Dist. (VT).
Int'l Reps.: Avan-Guard (Australia); Trend (Canada); Witness (France); I.R.D. (Italy); Vivid Sound (Japan).

A Great Variety, (See Jay Jay Record & Tape Co.).

Great Voices of the Century, (See Bulldog Records).

Greek Repertoire, (See Rashid Sales Co.).

Green Dog Prodn., 1311 Candlelight Ave., Dallas, TX, 75116, (214) 298-9576. Pres.: Paul S. Ketter; Vice Pres. A & R: Joe Johnson.
Branch(es): PO Box 8074, Bossier City, LA, 71113, (318) 742-5777. Contact: Lillian Mills
Label(s): (Owned) Green Dog, Sagittar

Green Dolphin, (See Jeree Records).

Green Linnit Records, Inc., 43 Beaver Brook Rd., Danbury, CT, 06810, (203) 730-0333. Pres. & CEO: Wendy Newton; Managing Dir.: Steve Katz; Gen. Mgr./Sales & Promo Mgr.: Chris Tesky; Prod. Mgr.: Bill Verdier.

Green Menu, (See Henry Jerome Music, Inc.).

Gresham Prodn. Int'l, Inc., 13534 Preston Rd., Ste. 100, Dallas, TX, 75240, (214) 239-0323. Pres.: David Gresham; Vice Pres.: Phil Samuels.

David Gresham Records, Inc., 12424 Wilshire Blvd., Ste. 1120, Los Angeles, CA, 90025, (213) 207-3694. Fax: (213) 207-0855. Pres.: David Gresham; Vice Pres.: Allan Goldswain; Professional Mgr.: Kim Guggenheim.

Gretto, (See Moss Music Group, Inc.).

Gringo, (See Axbar Records).

Grit, (See Aishire Int'l, Inc.).

Groove, (See Extra Sensory Prodn.).

Guajiro Records, Inc., 10441 NW 28th St., Ste. 106, Miami, FL, 33172, (305) 592-1931. Fax: (305) 592-1932. Pres.: Roberto Torres; Vice Pres.: Marlen Torres.
Label(s): (Owned) Caney, Guajiro, Neon, SAR, Toboga.

Guide, (See Bellaire Records).

Guitar Recordings, Inc., 10 Midland Ave., Port Chester, NY, 10573, (914) 937-8601. Fax: (914) 937-0614. Pres.: Peter Primont; A & R: John Stix.

Gule Records, Inc., 7046 Hollywood Blvd., #611, Hollywood, CA, 90028, (213) 462-0502. Pres.: Linda Gordon.

Gunsmove Entertainment Inc., 2523 Roosevelt Hwy., Ste. D-3, College Park, GA, 30337, (404) 768-0488. Fax: (404) 768-0569. Pres.: Barbara A. Thomas; Vice Pres./A & R Rep.: James McClelland; Prodn. Admin.: Stan McClelland.
Label(s): (Owned) Gunsmove.

Gutu Corp./Parrot Fish Records, PO Box 12210, #2 Store Tvaer Gade, Saint Thomas, VI, 00801, (809) 776-4514. Fax: (809) 776-4514. Pres.: Larry D. Braga.
Label(s): (Owned) Parrot Fish.

Guyden, (See Jamie).

H

HKE, (See Pegasus Records).

Ha Surfside, (See Hula Records, Inc.).

Hacksney, (See LBI).

Hall Of Famers, (See Hard Hat Records).

Hallways To Fame Prodn., Inc., 8010 Int'l Village Dr., Jacksonville, FL, 32211, (904) 745-0897, (904) 768-4211. Pres.: Al Hall, Jr.; Vice Pres. A & R: Ronnie Hall.
Label(s): (Owned) First Coast Posse, Hallway Int'l, CTR, (Distributed) Brownstone West, Cosmik Eye.

Ham-Sem Records, Inc., 727 S. Spring St., #8, Los Angeles, CA, 90013, (213) 627-0557.

Hangman, (See Echo Records, Inc.).

Hannibal, (See Rykodisc, Inc.).

Happy Hour Music, 5206 Benito St., Montclair, CA, 91763, (714) 621-9903, (800) 252-5169. Fax: (714) 621-2412. Pres.: Judith M. Wahnon.
Label(s): (Owned) Happy Hour Music, (Distributed) Som Da Gente.
US Reps.: Laurie Records (NJ); Rock Bottom (FL); Silo Systems, Inc. (VT); Music New Hampshire (NH).

Hard Hat Records, 519 N. Halifax Ave., Daytona Beach, FL, 32118, (904) 252-0381. Fax: (904) 252-0381. CEO: Bobby Lee Cude; Vice Pres.: Watie Riley Pickens.
Label(s): (Owned) Hall Of Famers, Hard Hat, Maricao.

Hardly, (See Third Story Records, Inc.).

Hardway Record Co., PO Box 540, Dearborn Heights, MI, 48127, (313) 278-6068. Owner/CEO: Mark Shearer.

Harmony, (See Sound Image Entertainment, Inc.).

Harper Audio, 10 E. 53rd St., New York, NY, 10022, (212) 270-7000. Vice Pres. Sales/Mktg.: Brenda Marsh; Vice Pres. Audio Pub.: Susan Knopf; Mktg. Dir.: Ken Holland; Assoc. Editor: Anne Gaudinier.
Label(s): (Owned) Caedmon, TDM.
Int'l Reps.: Collins (United Kingdom).

Harvard Sq. Records, PO Box 1926 Harvard Sq. Sta., Cambridge, MA, 02238. Contact: George Kuczewicz.

Harvest, (See Eddie Crook Co.).

Hathut, (See Creav, Inc. U.S.A.).

Haven, (See Tuneworks Records, Inc.).

Hawaii Calls, Inc., 2290 Alahua Place, Honolulu, HI, 96819, (808) 847-4608. Fax: (808) 847-4609. Pres.: Donald P. McDiar-mid, III.

He Rose Records, 1098 Rose Ave., El Centro, CA, 92243, (619) 352-5774. Pres.: Danny Berg.

Head Chunk Records, PO Box 2087, Pawtucket, RI, 02861, 28 Toledo Ave., Pawtucket, RI, 02860, (401) 726-5843. Owner/Pres.: David Deschenes; Promos/Designer: Deborah Richardson; Finance/Bookkeeping: Manuel Silva.
Label(s): (Owned) Head Chunk.

Headfirst, (See K-tel Int'l U.S.A., Inc.).

Headliner Stars, (See Robbins Records, Inc.).

Heartake Songs, PO Box 621, Madison, TN, 37116, (615) 859-3682. Owner/Mgr.: Robert W. Stamper.

Heartbeat Records, One Camp St., Cambridge, MA, 02140, (617) 354-0700. Fax: (617) 491-1970. Pres.: Duncan Browne; Vice Pres.: Ken Irwin; Marian Levy; Clerk: Bill Nowlin; Vice Pres. A & R: Chris Wilson.
US Reps.: Bayside, CRD (CA); Richman (DC); Jerry Bassin (FL); MS (IL); House (KS); Rounder (MA, NY); Action (OH); Big State (TX).
Int'l Reps.: Larrikin (Australia); Parsifal (Belgium); Amatheia (Denmark, Sweden); Media Sept (France); Teldec (Germany); General (Greece); IRD (Italy); Americana (Japan); Munich (Netherlands); Music Dist. (Norway); Bebo (Switzerland); Charly, Greensleeves, Jet Star, Topic (United Kingdom).

Hearts of Space, Inc., PO Box 31321, San Francisco, CA, 94131, 1324 Noriega St., San Francisco, CA, 94122, (415) 759-1130. Fax: (415) 759-1166. Pres./Producer: Stephen Hill; Vice Pres./Gen. Mgr.: Leyla Rael Hill; Vice Pres. Sales/Mktg./Promos: Chris Stimson.
Label(s): (Owned) Hearts of Space.
US Reps.: Associated Distributors (AZ); Encore (CO); Navarre Corp. (MN-NY-IL-CA-WA); Rock Bottom (FL-GA-TX); Select-O-Hits (TN).

Heath & Associates, 1058 E. Saint Catherine, Louisville, KY, 40204, (502) 637-2877. Fax: (502) 637-6199. Pres.: John V. Heath II; Vice Pres.: John V. Heath III; Vice Pres. A & R: Mae Heath.
Label(s): (Owned) Estate, Hillview.

Heckel Records, 5160 Rice Rd., Ste. 384, Nashville, TN, 37013, (615) 331-0734. Managing Dir.: Harold Skelton.

Heirborne, (See Eagle Mt. Int'l Church, KCP Records).

Hello, (See Stark Records & Tape Co.).

Help Records & Tapes, 49 W. 76th St., New York, NY, 11023, (212) 877-4800. Pres.: Doug Wyles; Vice Pres./Dir. A & R: Wayne Vican.
Branch(es): 1110 E. Missouri, Ste. 400, Phoenix, AZ, 85014; 23365 Sandalwood St., Canoga Park, CA, 91307.

Hendersonville, (See Rock-A-Billy Records).

Carrie Records, PO Box 90639, 902 42nd Ave. N., Nashville, TN, 37209, (615) 321-3319. Exec. Dir.: James Hendrix; A & R (R&B & Pop): Arnold Blair; A & R Dir. (Gospel): Charles Mason; Contact: Edward Hamilton.
Label(s): (Owned) Arnold, Carrie, Lanrod, Ricare, Tribal.

Heritage Records, Rt. 3, Box 290, Galax, VA, 24333, (703) 236-9249. Owner: Bobby F. Patterson.
Label(s): (Owned) Frontier Prodn., Mountain.

Hermes, (See Nimbus Records, Ltd.).

Herrick Stone Prodn., (See Moseka Records & Tapes).

Herschel Records, 610 10 Fairbanks Ct., Chicago, IL, 60611, (312) 664-4354. Fax: (312) 664-8252. Pres.: Paul David Wilson.

Hi Blite, (See Creav, Inc. U.S.A.).

Hi-Fi, (See Everest Record Group).

Hi-Q, (See Fortune Records).

High Rockets, (See Dick Michaels Prodn.).

High Sky, (See Dick Michaels Prodn.).

High Street, (See Windham Hill Prodn., Inc.).

High Water Recording Co., CFA 232 MSU, 3750 Norriswood, Memphis, TN, 38152, (901) 678-2350. Fax: (901) 678-5118. Gen. Mgr./Exec. Prod.: Richard R. Ranta; Prod.: David Evans; Studio Mgr.: Larry Lipman; Asst. Gen. Mgr.: Mariyln Adams.
Label(s): (Owned) High Water.
Int'l Reps.: Vogue (France); Zu Zazz (England); Disques Black & Blue (France).

Higher Octave Music, 8033 Sunset Blvd., #41, Los Angeles, CA, 90046, (213) 856-0039. Fax: (213) 656-6490. Pres.: Matt

Marshall; Sr. Vice Pres.: Scott Bergstein; Vice Pres. Creative Ser.: Dee Westlund.
 Branch(es): 1187 Coast Village Rd., #1, Ste. 192, Santa Barbara, CA, 93108, (805) 565-1353, Chrmn.: Dan Seleen; 3-3-14 Shinbashi, Minato-ku, Tokyo, Japan, 3501 6411, Fax: 3504 0300, Chrmn.: Taro Tanabe.
 Label(s): (Owned) Higher Octave, (Distributed) Nightingale.
 US Reps.: Gourd Dist., Paradigm, Pyramid, Real To Reel, Zango (CA); Encore, White Swan (CO); Rock Bottom, Reyes (FL); New Leaf (GA); Motor City Music (MI); Navarre (MN); Cassette Masters (IL); Sound Traveler, Twinbrook (NY); Silo (VT); Precision (WA); Music Design (WI); Michael Ginsburg Dist. (TN).
 Int'l Reps.: Able Music (Philippines); Around The World (Singapore); Auco Disco (Costa Rica); Hæ Dongo Mulshan Co. (Korea); Importaciones Domi (Mexico); Incognito (Australia); Remzi Kamman (Turkey); Samuel B. Wilson (Argentina); Sonet UK (England); Trend Music Group (Canada); Nova Electronics (PR); Teichiku (Japan).
 Highland Music, Inc., 3 Parklane Blvd., Ste. 1020, Dearborn, MI, 48126, (313) 271-9795. Fax: (313) 271-3144. Pres.: Stephen A. Hawkins.
 Label(s): (Distributed) Deluxe, Gusto, Hollywood, King, Richmond, Starday.
 Hightone Records, 220 Fourth St., #101, Oakland, CA, 94607, (510) 763-8500. Fax: (510) 763-8558. Partner: Larry Sloven; Bruce Bromberg; Nat'l Dir. Promo.: Darrell Anderson; Mktg. Dir.: Woody Chancy.
 Label(s): (Owned) Hightone.
 US Reps.: CRDI (LA); MS (IL); Rounder (MA); Select-O-Hits (TN); Big State (TX); Landmark (GA); Action (OH).
 Hillview, (See Estate Records, Health & Assoc.).
 Bob Hinkle Mgmt., Inc., 17 Cadman Plaza W., Brooklyn, NY, 11201, (718) 858-2544. Fax: (718) 858-8976. Pres.: Bob Hinkle; Vice Pres.: John Scilipote.
 Label(s): (Owned) Zoom, Inc.
 History, (See AudioLoft Recording Studios).
 Hit Records/U.S.A. Entertainment, 349 S. Lafayette Pk. Pl., #323, Los Angeles, CA, 90057, 880 Front St., #661, Lahaina, Maui, HI, 96761, (808) 667-5150. Fax: (808) 667-5150. Pres.: Jason Rider; Vice Pres. A & R: Sandra Kay; Promos.: Kekaa Kaopulki.
 Label(s): (Owned) Maui Country.
 Hitstown-Disko Record Corp., 327 Upshur St., NW, Washington, DC, 20011, Pres.: Clifton Thomas; Vice Pres/Gen. Mgr.: Charles Farmer.
 Hollis, (See Candy Records).
 Hollowbody, (See Sundazed Music).
 Hollywood Maxy Wax, (See Mystic Records, Inc.).
 Hollywood Records of California, 603 First St., Ste. 138, Oceanside, CA, 92054, (619) 757-7446. Pres./Gen. Mgr.: William Bellman; Vice Pres./Mktg.: Myral Bellman; Special Products Mgr.: Lee Forman; Vice Pres. A & R: Bill Bellman.
 Label(s): (Owned) Hollywood, Hollywood Recorders, Mirror Ball.
 Homeland Recording & Publishing, 1011 16th Ave. S., Nashville, TN, 37212, (615) 327-1240. Fax: (615) 327-1346. Pres.: Bill Traylor; Vice Pres., Publishing: Terry Exley; Dir. of Publicity: Bethni Memphis; Dir. Radio Promo.: Kathy Fleming; Sales Mgr.: Diane Bell.
 Label(s): (Owned) Homeland, Hometown, Welcome Home, (Distributed) Shiloh, Jim.
 Hometown Music Co., 80-08 35th Ave., Jackson Heights, NY, 11372, (718) 651-8213. Pres.: Sidney Prosen; Vice Pres.: Philip Prosen; Coordinator: Wanda Helm.
 Branch(es): PO Box 90575, Nashville, TN, 37209, (615) 383-2450, Country Rep.: Wanda Helm.
 Label(s): (Owned) Big, Sleeping Giant.
 Honey Bee, (See Feko Records).
 Hook, (See Fred Rice Prods., Inc.).
 Horizon, (See Blue Wave Records).
 Hortor Universal Music Co., 313 El Tejon Ave., Oildale, CA, 93308, (805) 399-9028. Owner: Robert L. Horttor.
 Label(s): (Owned) Humco.
 Hosanna! Music, (See Integrity Music, Inc.).
 Hot Hits, 2505 Chamblee-Tucker Rd., #326, Chamblee, GA, 30341, (404) 452-0494. Pres.: Alan White; Vice Pres.: Michelle Johnson.
 Hottrax Records, 1957 Kilburn Dr., Atlanta, GA, 30324, (404) 662-6661. Pres.: Aleck Janoullis; Vice Pres./A & R: Oliver Cooper; Vice Pres. Finance, Sales: George Burdell; Mgr. Record Promos.: Teri Blackman.
 Label(s): (Owned) Dance-A-Thon, Digitrax, Lasertrax.
 US Reps.: Action Dist. (MD).
 House of Guitars, (See Mirror Records, Inc.).
 House of Knox Music Publishing, 4844 Seda Dr., San Diego, CA, 92124, (619) 569-4563. Owner/Gen. Mgr.: Robert B. Knox.
 Label(s): (Owned) Desert Morning.
 House of Orange, (See Jamie/Guyden Dist. Corp.).
 Hudson Canyon, (See Celluloid Records).
 Hudson Van Dam, (See Celluloid Records).
 Hula Records, Inc., 2290 Alahao Place, Honolulu, HI, 96819, (808) 847-4608. Fax: (808) 847-4609. Pres.: Donald P. McDiarmid, III.
 Label(s): (Owned) Ha Surfside, Hawaii Calls.
 Humco, (See Horttor Universal Music Co.).
 Hummingbird Recording Co., Inc., Rt. 3, Box 648, West Jefferson, NC, 28694, (919) 246-6431. Pres.: Louise P. Taylor; Prof. Mgr.: Ronnie Ray Taylor; Asst. Mgr.: Greathel T. Coldiron.
 Label(s): (Owned) Down A Dusty Road, The Early Morning, The Stars Are Matter.
 US Reps.: Canoe Gap (West Jefferson, NC).

Hybrid Records, 1320 Sherman, Evanston, IL, 60201, (708) 328-0400. Fax: (708) 328-1700. CEO: Graham Carlton.
 Label(s): (Owned) Hybrid.

I

IAI Records, Improvising Artists Records & Video, PO Box 4, 33 Lancaster St., Cherry Valley, NY, 13320, (607) 264-3785. Fax: (607) 264-3476. Pres.: C. Goss; Vice Pres.: P. Bley; Gen. Mgr.: D.S. Good.
 Label(s): (Owned) Improvising Artists.
 Int'l Reps.: IREC S.p.A., Soul Note Records (Italy).
 I AM Records, 610 N. Fairbanks, Chicago, IL, 60611, (312) 944-8426. Fax: (312) 944-8426. Pres.: Jun Mhoon; Exec. Dir.: Tracy Peterson; Mktg. Dir.: Freida Curry; Vice Pres. A & R: Curbe Mhoon.
 Label(s): (Owned) Great Expectations, Myriah Jun Publishing.
 US Reps.: Word Records (TX).
 IHS, (See LWV Entertainment).
 IMC, (See Refuge Music Group).
 IQ Records, Inc., PO Box 8161, New York, NY, 10116. Pres.: Branson Belchie; Vice Pres.: Jacques Battel.
 IRS, (See Capitol-EMI Music, Inc.).
 IRS Records, 3105 N. Wilke Rd., #A, Arlington Heights, IL, 60004.
 US Reps.: MCA Distributing Corp.
 I.R.S. Records, 3939 Lankershim Blvd., Universal City, CA, 91604, (818) 508-3130. Fax: (818) 373-7173. Chrmn.: Miles Copeland; Pres.: Jay Boberg; Sr. Vice Pres. Mktg.: Barbara Bolan; Vice Pres. Promo.: Barry Lyons; Vice Pres. A & R: Steve Giendinning.
 Branch(es): 594 Broadway, Ste. 901, New York, NY, 10012, (212) 334-2170, Fax: (212) 334-2178, Nat'l Sales Dir.: Derek Graham.
 Label(s): (Owned) No Speak, IRS Metal, (Distributed) Grand Stamm, Network, Pangaea.
 Int'l Reps.: EMI (Europe, United States, United Kingdom); Liberation (Australia, New Zealand); JVC (Japan).
 ITI, (See Allegiance Records Ltd., In The Interest Prods./ITI Records).
 Ice Records, Inc./Horizon Prods., 435 Main St., NY Penn Trade Ctr., Johnson City, NY, 13790, (607) 729-2291, (607) 729-4342. Fax: (607) 797-6007. Pres./CEO: Larry G. Lupole; Vice Pres. A & R: Michael C. English.
 Ichiban Records, Inc., PO Box 724677, Atlanta, GA, 30339, (404) 926-3377. Fax: (404) 926-2774. Pres.: John E. Abbey; Exec. Vice Pres.: Nina K. Easton.
 Branch(es): Research House, Fraser Rd., Perivale, Middx, UB674Q, United Kingdom, (081) 991-5990, Fax: (081) 991-9504.
 Label(s): (Owned) Wrap, Wild Dog, Miracle, (Distributed) Peachtowne Ents., Power Hse., Bandit, Cutrom, Gospel Capital, Urgent!, After Hours.
 Icon Records, 95 Greene St., New York, NY, 10012, (212) 925-2121. Pres.: Yale Evelev.
 US Reps.: New Music Dist. (New York, NY); Nonesuch (New York, NY).
 Idaho Records & Cassettes, PO Box 474, Clayton, ID, 63227, (208) 879-4677. Pres.: Muzzle Braun.
 Ideal, (See Record-Rama Sound Archives).
 Illuminati, (See Driftwood Records).
 Imaginary Entertainment Corp., 332 N. Dean Rd., Auburn, AL, 36830, (205) 821-7156. Proprietor: Lloyd E. Townsend, Jr.
 Label(s): (Owned) Imaginary.
 Immigrant City Records, 231 Sutton St., Ste. 2C, North Andover, MA, 01845, (508) 686-9811. Pres.: Ralph A. Barbaggio, Jr.; Gen. Mgr.: Sandra L. M. Scala.
 Impact Records, 6255 Sunset Blvd., Ste. 917, Hollywood, CA, 90028, (213) 466-6900. Fax: (213) 466-0303. CEO: Allen Kovac; Pres.: Jeffrey Sydney; Vice Pres. Fin./Admin.: Mark Sullivan; Sr. Vice Pres. Promos.: Bruce Tenenbaum; Vice Pres. Mktg.: Gilles Gauthier; Vice Pres. A & R: Randy Nicklaus; Dir. Publicity/Art. Rel.: John Lappen; Dir. Int'l: Lisa Oxman.
 Improvising Artists, (See IAI Records, Improvising Artists Records & Video).
 In-Effect, (See Relativity/Combat/In-Effect).
 In-House Recording, Inc., 146-05 130th Ave., South Ozone Park, NY, 11436.
 In The Interest Prods./ITI Records, PO Box 56204, Sherman Oaks, CA, 91413, (818) 842-0722. Fax: (818) 842-1441. Pres.: Michael Dion.
 Label(s): (Owned) ITI.
 Incentive Prods., div. of Jevart Music, 639 Bulen Ave., Columbus, OH, 43205, (614) 258-7112. Pres.: Jeffrey V. Smith.
 Label(s): (Owned) Incentive.
 Increase, (See Quicksilver/Increase).
 Infinity, (See Billy Baker & Assoc.).
 Infinity Series, (See Scarlet Records, Inc.).
 Inner Spirit, (See Wilson Okulolu, Inc.).
 Innova Recordings, (See Minnesota Composers Forum).
 Insomniac Records, PO Box 408, Tomkins Cove, NY, 10986, (914) 429-9500. Fax: (914) 429-7163. Pres.: Edward Tarsio; Gen. Mgr.: Louis Ragusa; Dir. Sales: Dennis Daulilo.
 Instinct, (See Ex Urbana, Inc.).
 Integrity Music, Inc., PO Box 16813, 1000 Cody Rd., Mobile, AL, 36616, (205) 633-9000. Fax: (205) 633-5202. Pres.: Michael Coleman; Exec. Vice Pres.: Ed Lindquist; Creative Dir.: Don Moen; Int'l Coord.: Joyce Smith.
 Label(s): (Owned) Alleluia! Music, Hosanna! Music, Interludes, Renewal! Music.

Int'l Reps.: Integrity, Christian Mktg. (Australia, Canada, New Zealand), Jenesco (Hong Kong), Salvation Book Center (Malaysia); Praise (Philippines); Christian Growth (Singapore); New Covenant Ministries (South Africa); Integrity, Word (United Kingdom).
 Intense, (See Frontline Records).
 Interludes, (See Integrity Music, Inc.).
 International Record Corp., PO Box 920658, Houston, TX, 77292, (713) 957-8398. Corp. Affairs Exec./Ofc.: Raul Rodriguez; Finance Mgr.: Blanca Lozano; Int'l Mgr.: D. Escobedo.
 Label(s): (Owned) Alavox, Intre, Gravex, Obsolete, Rapido, (Distributed) Artesia.
 Interplay Records, Inc., PO Box 11117, San Bernardino, CA, 92423, 26200 Redlands Blvd. #75, San Bernardino, CA, 92373, (714) 796-6110. Pres.: Toshiya Taenaka; Sales Mgr.: John Brechler.
 Label(s): (Owned) Interplay.
 US Reps.: Bayside Dist. (CA); Master Takes (MI); North Country Dist. (CA).
 Interscope Records, 10900 Wilshire Blvd., Ste. 1230, Los Angeles, CA, 90024, (213) 208-6547. Fax: (213) 208-7343.
 Intersound, Inc., PO Box 1724, 11810 Willis Rd., Roswell, GA, 30077, (404) 664-9262. Fax: (404) 664-7316. Pres.: Don Johnson; Nat'l Sales Mgr.: Bryan Hadley.
 Label(s): (Owned) Maxiplay, Pro Jazz, Proarte, Quintessence, (Distributed) DPI, Intersound.
 Intima, (See Enigma Entertainment).
 Intre, (See International Record Corp.).
 Iron Works, (See Azra Int'l).
 Ironbound, (See Peter Pan Industries).
 Island Records, 14 E. Fourth St., New York, NY, 10012, (212) 995-7800. Fax: (212) 477-5918. Chrmn.: Chris Blackwell; Pres.: Mike Bone; Vice Pres., Promos.: Lisa Velasquez; Vice Pres. A & R: Kevin Patrick.
 Label(s): (Distributed) 4th & Broadway, Antilles, Great Jones, Mango.
 Ivy Jazz, 599 N. Darwin St., #5, Salt Lake City, UT, 84103, (801) 575-6227. Owner: Paul Ellingson.

J

JAJ, (See J & J Musical Entcs., Ltd.).
 J.A.P., (See Creav, Inc. U.S.A.).
 JB, (See Joey Boy Records, Inc.).
 JCI, 21550 Oxnard St., Ste. 920, Woodland Hills, CA, 91367, (818) 593-3600. Fax: (818) 593-3610. Pres.: Jerome Bowie; Vice Pres. Sales: Jim Newhouse; Dir. Publicity: Adriene Bowles; Lynda Solomon; Vice Pres. A & R: Gino Cunico.
 Label(s): (Owned) Artful Balance.
 JDC Records, Inc., 567 W. Fifth St., San Pedro, CA, 90731, (310) 519-7393. Fax: (310) 519-1614. Owner: Jim Callon; Sr. Sales Officer: Eddie Fonseca; Credit Mgr.: Jody Ness; Int'l Sales: Mark Donnelly.
 JED Records, 3325 Fairmont Dr., Nashville, TN, 37203, (615) 269-4847. Pres.: John E. Denny; Gen. Mgr.: Jane L. Martin; Promo.: Charlie Lamb; Prodn.: Bil Vorndick.
 J & J Musical Entcs., Ltd., 156 Fifth Avenue, Suite 434, New York, NY, 10010, (212) 691-5630. Fax: (212) 645-5038. Pres.: Jeneane Claps; Vice Pres. A & R: Marc D. Moel.
 Label(s): (Owned) JAJ.
 J/L Entertainment Group, 8730 Sunset Blvd., #200 A, Los Angeles, CA, 90069, (213) 657-1836. Fax: (213) 859-9319. Pres.: Rise A. Heller; Managing Dir.: Jack B. Heller; Consultant: Mildred Heller.
 Label(s): (Distributed) Crown, NEC Avenue, Tokyo Agencies.
 J.L.I. Records, PO Box 74-R, Romeoville, IL, 60441, (815) 886-1160. Pres.: Julian Leal; Vice Pres. A & R: Sharon Matyue.
 Label(s): (Owned) J.L.I., (Distributed) Target.
 US Reps.: Crow's Nest, Pravda, Rose, Sound Warehouse, Wax Trax (IL).
 J & M Promo. & Public Relations, 10556 Arnwood Rd., Lake View Terrace, CA, 91342, (818) 890-0730, (818) 890-0977. Fax: (818) 899-4457.
 J. R. Records, 3081 NW 24th St., Miami, FL, 33142, (305) 635-5588. Fax: (305) 633-7427. Pres.: Allen L. Johnston; Vice Pres.: Jose Armada, Jr.; Vice Pres. Promo.: Rod Kenny, Sr.; Vice Pres. Mktg.: George Chavous; Vice Pres. A & R: Lynn Young.
 Label(s): (Distributed) Benz Records, New Records.
 JR Sound Prods., Inc., PO Box 158611, 1025 17th Ave., S., Nashville, TN, 37215, (615) 327-2227. Pres.: Johnny Rutenschroer.
 Label(s): (Owned) Alpine.
 JVC Musical Industries, Inc., 6363 Sunset Blvd., Ste. 500, Hollywood, CA, 90028, (213) 878-0101. Fax: (213) 467-7957.
 Ja-Wes, (See Daran Records).
 Jabala, (See Spanda Records).
 Jack's Records, 44 Strawberry Hill Ave., #1P, Stamford, CT, 06902, (203) 358-9898. Chrmn./Pres./CEO: Jack Althansen.
 Jacksons Record Corp., 18321 Ventura Blvd., Encino, CA, 91356, (818) 344-7117. Fax: (818) 344-7295. Pres.: Joe Jackson; Exec. Vice Pres.: Ben Brown; Bus. Affairs: Jerome Howard.
 Jade, (See All Star Promos., Castle Records).
 Jakiela Entcs., Inc., 2400 Josephine St., Pittsburgh, PA, 15203, Fax: (412) 481-8693. Pres.: Eugene T. Jakiela; Buyer: Kevin C. Jakiela; Co-Mgr.: Wayne T. Jakiela; Timothy M. Jakiela.
 Jalyn, (See Jack Lynch Music Group, Nashville Country Prods.).

- Jam-Power, Inc.**, 8756 Amigo Ave., Northridge, CA, 91324, (818) 701-0375, (818) 701-6624. Fax: (818) 701-5913. Chief Exec. Officer: Geraldine A. Berry; Pres.: Steven C. Berry. Label(s): (Owned) KMA, Take-Over. **Jamarc**, (See Pandisc Records).
- Jambros Records**, 5120 Walnut St., Philadelphia, PA, 19139, (215) 747-1201, (215) 747-1200. Pres.: Scott Herzog.
- Jamie/Guyden Dist. Corp.**, 2055 Richmond St., Philadelphia, PA, 19125, (215) 426-4384. Fax: (215) 426-2667. Pres.: Harold B. Lipsius; Gen. Mgr.: Paul Fien. Label(s): (Owned) Arctic, Dionn, First Amendment, Phil-L.A. of Soul, Silver Dollar, Vent, Volume. Guyden, House of Orange, Jamie, Landa, (Distributed) Montel, Olympia, Philomega, Dome.
- Janell**, (See Tiki Ent's., Inc.).
- Janet Marie Records/King Eugene Prodn.**, 14016 Evers Ave., Compton, CA, 90222, (615) 635-8522. Pres./Opns. Dir.: Robert E. Pullen Miles; Asst. to Pres.: Brian Murphy; Consultant: Tyrone Johnson; Asst. Producer: Sean Taylor.
- Jansco Records**, 10755 Bachelor Valley Rd., Witter Springs, CA, 95493, (707) 275-2777. Pres.: Jan Scobey; Gen. Mgr.: Eugene Paleno. Label(s): (Owned) Ragtime.
- Janus Records, Inc.**, PO Box 5188, 321 Ski Way, #177, Incline Village, NV, 89450, (702) 831-1582. Pres.: Thomas Bonetti. US Reps.: Celebrity Licensing, Inc. (CA).
- Jato**, (See Axbar Records).
- Jay Jay Record & Tape Co.**, 35 NE 62nd St., Miami, FL, 33138, (305) 758-0000. Owner & Buyers-Pres.: Walter E. Jagiello; Owner & Vice Pres.: Jeanette Jagiello. Label(s): (Owned) Bonfire, Drum-Boy, A Great Variety, Jay Jay. US Reps.: Specialty Dist. (FL); Seebro Products (IL); Singer One Stop (IL); Action Dist. (MD).
- Jazz Alliance**, PO Box 515, Concord, CA, 94522, (510) 682-6770. Fax: (510) 682-3508. Pres.: Carl E. Jefferson; Vice Pres./Gen. Mgr.: Phil Sheridan. Label(s): (Owned) All Art Jazz.
- Jazz Anthology**, (See Musidisc S.A.).
- Jazzand Records**, 12 Micieli Place, Brooklyn, NY, 11218, (718) 972-1220. Pres.: Rick Stone; Publicity Dir.: Idelle Nissila. Label(s): (Owned) Jazzanna. US Reps.: Harbor Record Export, North Country, Zim (NY).
- Jazzology Records, Inc.**, 1206 Decatur St., New Orleans, LA, 70116, (504) 525-1776. Pres.: George Buck. Label(s): (Owned) Solo Art, Southland, Stairas, American Music, Circle, GHB, Progressive. US Reps.: Rounder (MA); Rounder, Zim, Northcountry (NY); City Hall (CA).
- Jazzy Toy & Record Co.**, PO Box 1137, Concord, MA, 01742, (508) 371-3198. CEO: Bruce E. Carroll. US Reps.: Artec (VT).
- Jefferson Jazz**, (See Sony Records, Inc.).
- Jeree Records**, 1469 Third Ave., New Brighton, PA, 15066, (412) 847-0111. Owner/Engineer: Jerry Reed; Chief Engineer: Don Garvin; Staff Engineer: Mike Anderson. Label(s): (Owned) Buckshot, Candy, Green Dolphin, Jeree.
- Jerma Records Co.**, 1410 E. 72nd St., Chicago, IL, 60619, (312) 752-2755. Pres./Gen. Mgr.: Ulysses Warren. Label(s): (Owned) Chytowns.
- Henry Jerome Music, Inc.**, 5 Van Eiten Blvd., New Rochelle, NY, 10804, (914) 632-1270. Fax: (914) 235-5790. Pres.: Miriam Jerome; Gen. Mgr./Dir. A & R: Henry Jerome; Promo/Sales: Don Castaldi. Label(s): (Owned) Green Menu.
- Jet-Eye Record Prod. Inc.**, 7405 Crissman St., Utica, MI, 48317, Pres.: Johnny Powers; Vice Pres.: Alfred Cardillo; Gen. Mgr.: Del Pavlik. Label(s): (Owned) Jet Eye. US Reps.: Harmony House Records & Tapes (MI). Int'l Reps.: SunJay Records (Sweden); Rollercoaster Records (England).
- Jewel Records**, 1594 Kinney Ave., Cincinnati, OH, 45231, (513) 522-9336. Fax: (513) 522-9915. Pres.: Rusty York; Vice Pres.: Jr. Bennett; Linda York; Sales Mgr.: Sharon Woods. Label(s): (Owned) Log Cabin, Rye.
- Jewish Family Prodn.**, PO Box 19968, San Diego, CA, 92120, (619) 582-5696. Fax: (619) 582-5696. Pres.: George Fogelman. Label(s): (Owned) Jewish Family Prodn.. US Reps.: Tara Prodn. (NY); Silo, Inc. (VT); Sounds Write Prodn. (CA); One World Records (NJ).
- Jhuggernaut & Family Corp.**, 222 S. Fourth Ave., Mount Vernon, NY, 10550, (914) 668-0133. Fax: (914) 668-1768. Contact: Clifford O. Rodway.
- Jin**, (See Flat Town Music Co.).
- Jive**, (See Zomba Recording Corp.).
- Jody**, (See B-Atlas & Jody Records).
- Joey Boy Records, Inc.**, 3081 NW 24th St., Miami, FL, 33142, (305) 635-7469. Fax: (305) 633-7127. Pres.: Jose Armada, Jr.; Allen L. Johnston; Vice Pres. Promos. A & R: Rod Kenney, Sr.; Gen. Mgr.: Luz Marina Fernandez; Nat'l Promos. Mgr.: Karin F. Evertz. Label(s): (Owned) JB, JR. US Reps.: CRD (CA); Bassin (FL); Schwartz (MD); Big State (TX); Select-O-Hits (TN).
- Joey Records, Inc.**, 6703 W. Commerce St., San Antonio, TX, 78227, (512) 432-7893. Fax: (512) 436-1511. Chairman: Joe S. Lopez; Pres.: Joey M. Lopez; Vice Pres.: Raquel V. Lopez. Label(s): (Owned) Dina, Joey, Joey Universal, Moni, Omega, SAS. Int'l Reps.: Discos Joey de Mexico (Mexico). **Joker**, (See Lifetime Recordings).
- Jolly Dutchman**, (See American Music Co.).
- Jondi Records**, 130 W. 42nd St., #1106, New York, NY, 10036, (212) 819-0920. Fax: (212) 768-7822. Pres.: Dick Charles; Vice Pres.: Jon Soleather.
- Jennifer Jones Prodn. Co.**, 2635 De Soto St., New Orleans, LA, 70119, (504) 944-7747. Fax: (818) 899-4457. Pres./Gen. Mgr.: Jennifer Jones; Gen. Mgr.: Joe Jones, Sr. US Reps.: Theatrical Mgmt. Consultant (CA).
- Joe Jones & The Reynosa Bros. Records**, 10556 Arnwood Rd., Lake View Terrace, CA, 91342, (818) 890-0730, (818) 890-0977. Fax: (818) 899-4457. CEO/Opns. Mgr.: Joe Jones; Vice Pres./Gen. Mgr.: Marion Jones; Professional Mgr.: Dwayne Jones. Label(s): (Owned) Joe Jones & Reynosa Bros.. US Reps.: M&J Record Dist. (CA); KEWDE Record Dist. (CA).
- Ronald Jones, Jingles & Commercial Prodn. Co.**, 2114 New Orleans St., New Orleans, LA, 70119, (504) 944-6075, (504) 283-8459. Fax: (504) 288-8199. Pres./CEO & Opns. Mgr.: Ronald Jones; Mgr. Mktg. & Sales: Jennifer Jones; Creative A & R Prod.: Ronald Jones; Agent: Joe Jones, Sr. US Reps.: Theatrical Mgmt. Consultant (CA).
- Joseyimo Records**, PO Box 446, North Hollywood, CA, 91603, (818) 766-6146, (818) 761-5284. Pres.: Joseph Modeliste; Vice Pres. A & R/Promo.: April Modeliste
- Joyce Records**, PO Box 66666, Los Angeles, CA, 90066, 13381 Beach Av., Marina Del Ray, CA, 90292, (213) 821-4005. Fax: (213) 823-3389. Pres.: Wayne Volat.
- Juggler Records Ltd.**, 1101 SW Washington, Ste. 134, 408 SW Second, Ste. 228, Portland, OR, 97205, (503) 223-9419. Fax: (503) 243-2787. Vice Pres., A & R: Ronnie Noize. Label(s): (Distributed) Audio Addict, Satyricon, Schizophonic, TIK. US Reps.: Caroline (CA/NY).
- Juke**, (See Vendor Motion Pictures, Phonorecords & Music Publishing Group).
- Jukebox Records**, 207 Winding Rd., Friendswood, TX, 77546, (713) 482-2346. Partner: Buz Hart; Lonnie Wright. Label(s): (Owned) Eden, Quasar.
- Jumpin' Jack Records**, 2301 W. 59th St., Los Angeles, CA, 90043, (213) 294-7286. Fax: (213) 291-7709. Pres.: Johnno Waller; Sec.: Wazir A. Aziz; CFO: Leonardo Wilborn.
- June Appal Recordings**, 306 Madison St., Whitesburg, KY, 41858, (606) 633-0108. Fax: (606) 633-1009. Dist. Mgr.: Carolyn H. Sturgill. Label(s): (Owned) June Appal Recording.
- Jungle Productions/Records**, PO Box 3034, Austin, TX, 78764, (512) 443-7444. Pres.: Bruce Sheehan.
- Just US Records**, PO Box 691068, Los Angeles, CA, 90069, (213) 274-1900. Owner: Michele Elyzabeth; Pres.: Otis Stokes.
- Justice Record Co.**, 3100 Alabama Ct., Houston, TX, 77027, (713) 520-6669. Fax: (713) 526-7045. Pres.: Randall Hage Jamail; Dir. of Adv. & Promo.: Gary Moore; Sales Dir.: Connie Bambace; Distribution Dir.: Amy Cooper; Vice Pres. A & R: David A. Thompson. Label(s): (Owned) Justice. Branch(es):

K

- KCP Records**, PO Box 699, 777 Glory Rd., Newark, TX, 76071, (817) 489-2226. Fax: (817) 489-2098. Pres.: Win Kutz; Mktg. Mgr.: Loren Johnson; Prod. Coordinator: Jill Barnes; Vice Pres. A & R: Vince Collins. Label(s): (Owned) Heirborne. US Reps.: Spectra (TN).
- K-Dee-Dee**, (See Sharon Prodn., Inc.).
- KLW Int'l, Inc.**, PO Box 806, Marmora, NJ, 08223, (609) 391-0872. Pres.: Kevin L. Weakland.
- KMA**, (See Jam-Power, Inc.).
- KMAR**, 2301 W. 59th St., Los Angeles, LA, 90043, (213) 294-7286. Fax: (213) 291-7709. Pres.: Johnno Waller; CFO: Leonardo Wilborn; Sec.: Wazir A. Aziz.
- KMC Records**, 220 W. Mercer St., Ste. 409, Seattle, WA, 98119, (206) 285-8926. Pres.: Kelly M. Christensen; Vice Pres. Admin.: Julie Christensen. Branch(es): 4-5-12-204 Kamiosaki, Shinagawa-ku, Tokyo, 141, Japan, 03-490-0534, Mgr.: Shingo Kasumata.
- KM Records, Inc.**, 2980 N. Ontario St., Burbank, CA, 91504, (818) 841-3400. Fax: (818) 845-6478. Vice Pres./Gen. Mgr.: Jim Auchterlonie; Vice Pres./Sales Mgr.: Bill Riley. K.O., (See O.K. Records).
- K.R.C.**, (See Ozark Opry Records).
- KSS**, (See Kennett Sound Studios, Inc.).
- K-tel Int'l (USA), Inc.**, 15535 Medina Rd., Plymouth, MN, 55447, (612) 559-6800. Fax: (612) 559-6848. Pres.: Mickey Eifenbein; Vice Pres./A & R Mktg.: Owen Husney; Sr. Vice Pres. Sales: Tom Lenaghan; Mgr. Entertainment Mktg.: Bill Hallquist; Mgr. Product Development: Steve Wilson. Branch(es): 10 Grenoble Dr., #1516, Don Mills, ON, M3C 1C7, Canada, (416) 423-0210, Nat'l Sales Mgr.: Lorne Lichtman; Hameentie 157A, Helsinki, 00560, Finland, 35807571522, Fax: 3580790653, Managing Dir.: Jorma Kosonen; 30/32 Sir John Rogers's Quay, Dublin 2, Ireland, 3537114011, Fax: 3537170426, Managing Dir.: Shay Hennessy; 47 Brown St., Ponsonby, Auckland 1, New Zealand, 649787561, Fax: 649780452, Managing Dir.: Diana Creighton; Windmill Court, 192 Windmill Ln., Greenford, Middlesex, UB6 9DW, United Kingdom, 44815666789, Fax: 44815752264, Managing Dir.: Pat Broderick; Ramonville Strasse 2, 3. Stock, Karben 1, 6367, West Germany, 4960393335. Fax:
- 49603943332, Managing Dir.: Conni Stephan. Label(s): (Owned) A.J.K. Music, Arrival, Cold Front, Crush Music, Dominion, Era, Headfirst, K-tel, Nouveau, (Distributed) Kapone & Film Works, Copperfield.
- Kado**, (See Nesak Int'l).
- Kaizan Music**, 156 Fifth Avenue, Suite 434, New York, NY, 10010, (212) 691-5630. Fax: (212) 645-5038. Pres.: John Neptune; Vice Pres. A & R: Marc D. Moel.
- Kajun**, (See Master-Trak Ent's.).
- Kaleidoscope Records, Inc.**, PO Box O, El Cerrito, CA, 94530, (510) 845-9200. Fax: (510) 845-9248. Pres.: Jeff Alexson; A & R: Tom Diamant; Promo: Eric Froyd. US Reps.: Action Music Sales (OH); Backroads (CA); Bayside Record Dist. (CA); California Records Dist. (CA); Encore (CO); Goldenrod Dist., Inc. (MI); Impact (IL); Ladyslipper Music (NC); Mill City Music (MN); Old Fogey Dist. (MI); Paradigm (CA); Record Depot (VA); Richmond Bros. (NJ); Rounder Dist. (MA).
- Kamotion**, (See Candy Records).
- Kan II**, (See Kansa Records Corp.).
- Kansa Records Corp.**, PO Box 1014, 116 Countrywood Dr., Lebanon, TN, 37088, (615) 444-3865. Pres.: Chester E. Johnson; Sec./Treas./Gen. Mgr.: Kit Johnson. Label(s): (Owned) Kan II.
- Allan Kaplan Ent's.**, #6 Parkview Circle, Corte Madera, CA, 94925, (415) 927-7757. Fax: (415) 927-4637. Pres.: Allan Kaplan. Label(s): (Distributed) Music South.
- Kaupp Records**, PO Box 5474, Stockton, CA, 95205, 12112 Norman Ave., Stockton, CA, 95215, (209) 948-8186, (209) 942-2129. Fax: (209) 942-2163. Pres.: Nancy L. Merrihew; Gen. Mgr.: Robert Merrihew; Prodn. Mgr./Vice Pres. A & R: Rick L. Webb. Label(s): (Owned) Kaupp.
- Kazually Def Records**, 112 A Schley Blvd., Bremerton, WA, 98310, (206) 479-8885. Contact: Kurtis D. Nelson.
- Keeny/York**, (See TMA Records).
- Keeta**, (See Briarmead Records).
- Kellit-Aurora Record Corp.**, 241 W. 18th St., New York, NY, 10011, (212) 898-7200. Fax: (212) 633-8022.
- Gene Kennedy Ent's., Inc.**, 3950 Mt. Juliet Rd., Mount Juliet, TN, 37122, (615) 754-0417. Pres./Owner: Gene Kennedy; Vice Pres./Owner: Karen Jeglum Kennedy. Label(s): (Owned) Door Knob, Society.
- Kennett Sound Studios, Inc.**, PO Box 602, 2000 S. ByPass, Kennett, MO, 63857, (314) 888-2995. Pres.: Joe Keene; Vice Pres.: Fred Rigdon; Sec./Treas.: Kent Sexton. Label(s): (Owned) Cone, KSS.
- Kenning Prodn./Kenning Records**, PO Box 1084, Newark, DE, 19715, (302) 292-1445. Pres.: Kenny Mullins; Vice Pres.: Florence Doloughan.
- Kerrville Folk Festival**, (See Kerrville Music Foundation, Inc.).
- Kerrville Music Foundation, Inc.**, PO Box 1466, Kerrville, TX, 78029, (512) 257-3600. Exec. Dir.: Rod Kennedy; Bus. Mgr.: Andrea LedBlanc. Label(s): (Owned) Kerrville Folk Festival.
- Kether Elyon**, (See Kision Elyon Records).
- Kicking Mule Records, Inc.**, PO Box 158, 10 Springs Ranch, Alderpoint, CA, 95411, (707) 926-5312. Fax: (707) 926-5250. CEO: Ed Denson; Mktg.: Mary Alice Denson. Int'l Reps.: Festival (Canada); Topic (United Kingdom).
- Kid Cuz'n Records**, PO Box 182, Midwood Sta., Brooklyn, NY, 11230, Gen. Mgr.: Dick Alexander; Sales: Art Wayne.
- Kidco Music**, 1327 Cabrillo Ave., Torrance, CA, 90501, (213) 533-9514. Pres.: Madeleine Smith.
- Kilgore Records Co.**, PO Box 1700, 706 W. Mechanic St., Leesville, LA, 71496, (318) 239-2850. Fax: (318) 239-2850. Pres./Gen. Mgr./Promos.: John E. Kilgore; Vice Pres. A & R: L. Kilgore. Branch(es): Rt. 1, Box 95, Dry Prong, LA, 71423, (318) 640-4992. Fax: (318) 640-4992. Pres.: Dennis Murdock, Vice Pres./Sec.: Mary Murdock. Label(s): (Owned) Gotown, Kilgore.
- Killer**, (See Little Giant Records).
- Kimblon**, (See Stardust/Wizard/Doss Records).
- Kinetic**, (See Penguin Records, Inc.).
- King of Kings Int'l Records**, 38603 Sage Tree St., Palmdale, CA, 93551, Pres.: LeRoy Pritchett; Gen. Mgr.: Harold Dunklin; Pro. Mgr. A & R/Rec'd Artist: Charles Vickers. Label(s): (Owned) King of Kings, King of Kings Int'l.
- King Walk, Inc.**, PO Box 15094, New Orleans, LA, 70175, (504) 891-8485, (504) 822-7037. Fax: (504) 866-0502. Pres.: Earl K. Johnson; Vice Pres.: Erroll Johnson; Gen. Mgr.: Charles Daniels; Vice Pres. A & R: Tad Jones. Label(s): (Owned) Proud Cock, Alfalfa, Down South, Flambro, Grand Marshall, King Walk, New Orleans Soul.
- Kingdom Come Prodn.**, PO Box 14073, Cincinnati, OH, 45214, (513) 761-1045. Pres.: Steven M. Hill; Sales/Mktg.: Yvonne McCurdy; Vice Pres. A & R: Charles Davis. Label(s): (Owned) Sweet Tree.
- Kision Elyon Records**, PO Box 19215A, Los Angeles, CA, 90019, (213) 737-6196. Pres.: Tommy Colbert; Creative Mgr.: Yeshayah Tishbash. Label(s): (Owned) Ancient of Days Gold, Beni Mer, El-Colbert, Kether Elyon, Malache Elyon, Mit Abul-Kom, Nasser-El-Sadat.
- Sid Kleiner Music**, 10188 Winter View Dr., Naples, FL, 33942, (813) 566-7701. Fax: (813) 566-7702. Owner A & R: Sid Kleiner; Vice Pres.: Trudy Kleiner; Sec.: Mark Kleiner; Treas.: David Kleiner. Label(s): (Owned) Country-King, Musi-Poe, This Is It, Top-Star.

Known Artist Records, 1219 Kerlin Ave., Brewton, AL, 36426, (205) 867-2228. Pres.: Roy Edwards; Sales: Bobbie Robertson; Mgr.: Shannon Edwards; A & R: Gus Grice. Label(s): (Owned) Bolivia.

Koala Records, Inc., 6513 S. Broadway, Los Angeles, CA, 90003, (213) 750-0436. Pres./Treas.: Irv Kessler; Vice Pres., Sec.: Mary Kessler. Label(s): (Owned) Deep Roots, Koala, Lamb & Lion.

Koch Int'l Corp., 177 Cautiague Rock Rd., Westbury, NY, 11590, (516) 938-8080. Fax: (516) 938-8055. Pres.: Michael Koch; A & R Dir.: Michael Fine; Mktg. & Sales: Michael Rosenberg. Label(s): (Owned) Koch Int'l Classics, (Distributed) Kotch Int'l, Koch Schwann, CPO, Chandos, Essay, Mainstream, Melodiya, Orfeo, Prime Time, Shanachie, Silva America, Bridge, Smithsonian, Supraphon, Yazoo.

Koh Hak, (See Creav, Inc. U.S.A.).

Kom-A-Day, (See Flat Town Music Co.).

Krag, (See Gark Records).

Kraze, (See Maze Records).

Kristal Int'l, (See Stargem Records, Inc.).

Krystal Records, 50 St. Paul's Ave., Boston, MA, 02130, (617) 522-8911.

Kubaney Publishing Corp., 8000 NW 31st, Ste. 17, Miami, FL, 33122, (305) 591-7684. Fax: (305) 477-0789. Pres.: Tonyh San Chartin; Asst. Pres.: Gladys Aquilera; Chrmn.: Rosita A. Don; Mgr. Orders Dept.: Joaquin Diaz. Label(s): (Owned) Bachats, Don Chateau, Mate, (Distributed) Sonomundi (Panama), Sovisa (Spain), Columbia, Dideca (Guatemala), Discorona (Venezuela), Divucsa, Durium (Italy), Fonomusic. US Reps.: Kubaney (NY).

L

The LIND Institute, PO Box 14487, 584-B Castro St., San Francisco, CA, 94114, (415) 864-3396. Fax: (415) 864-1742. Gen. Partner: Ole Andersen; Dr. Charles Schmid; Mgr., Sales/Mktg.: Timothy S. Tattan. US Reps.: Backroads Dist., Devorss & Co., Pyramid, Real to Reel, Zango (CA); Chidvilas (CO); New Leaf (GA); Goldenrod/Horizon (MI); Mill City (MN); Lifedance (OH); Silo (VT), Music Design (WI).

LIRS Classics, 72 Orange St., Brooklyn, NY, 11201, (718) 875-6193. Owner: Ernest W. Ucko. Label(s): (Owned) LIRS Classics.

LMI, (See Grass Roots Records).

L & R, (See Optimism Incorporated).

LRJ Records, Box 3, 318 Horizon Vista Blvd., Belen, NM, 87002, (505) 864-7441. Fax: (505) 864-7442. Mgr.: Tony Palmer. Label(s): (Owned) Chuckie, Little Richie, Vantage.

L. S. Records, 120 Hickory St., Madison, TN, 37115, (615) 868-7171. Fax: (615) 860-3843. Publisher: Kevin L. Stoller.

LWV Entertainment, 5934 Blairstone Dr., Culver City, CA, 90230, (213) 558-8168. Vice Pres./Mktg./Promo.: Isaac Robinson; Vice Pres. Controller: Walter Giles; Vice Pres., Gen. Mgr.: Leonardo Wilborn. Label(s): (Owned) IHS. US Reps.: W & W Wholesalers (CA); Skippy Whites (MA). Int'l Reps.: About Time Rec. (England).

LWT Int'l RPTA, (See Creav, Inc. U.S.A.).

La Louisianne Records, 711 Stevenson St., Lafayette, LA, 70501, (318) 234-5577. Pres./Gen. Mgr.: David M. Rachou. Label(s): (Owned) Belle, La Louisianne, Tamm. US Reps.: Bayside Record Dist. (CA); Floyd's Wholesale (LA); Rounder Records (MA).

LaVal Records, 1327 Cobb St., Kalamazoo, MI, 49007, (616) 342-5328. Owner: Vic La Val. Label(s): (Owned) La Val.

Label "X", (See Fifth Continent Music Corp.).

Lakeside, (See Frisco Records, Inc.).

Lamar Music Co., PO Box 412, Bronx, NY, 10462, (914) 668-0383. Fax: (914) 668-3119. Pres.: Darlene Barkley; Vice Pres. A & R: Rick Robinson. Label(s): (Owned) Lamar Music Co., MelVern, (Distributed) Macola.

Lamb & Lion, (See Koala Records, Inc.).

LBI, PO Box 328, Jericho, VT, 05465, (802) 899-3787. Pres.: Bobby Hackney. Label(s): (Owned) Hackney, LBI.

L'AME, (See Wood'n Music, Inc.).

Lamon Records, 7017 Harris Blvd., Charlotte, NC, 28215, (704) 535-7263. Fax: (704) 537-0133. CEO: Dwight L. Moody, Jr.; Pres.: Carlton L. Moody; A & R: Wayne Moody; Mktg.: Mike Evans; Vice Pres. A & R: T. Moody. Label(s): (Owned) Lamon, Panhandle, (Distributed) Antler, Colonial.

Land O' Jazz Records, PO Box 26393, New Orleans, LA, 70186, (504) 482-3072. Owner: Plato Smith. Label(s): (Owned) Land O' Jazz.

Larry Land, (See SK Prodn's).

Landi, (See Jamie/Guyden Dist. Corp.).

Landmark Communications Group, PO Box 148296, Nashville, TN, 37214, (615) 889-4977. Pres.: Bill Anderson, Jr.; Vice Pres.: Dr. Harry Yates. Label(s): (Owned) Landmark, (Distributed) Jana.

Landside Records, Inc., 1800 Peachtree St. NW (333), Atlanta, GA, 30309, (404) 355-5580. Fax: (404) 351-2786. Pres.: Michael Rothschild. Label(s): (Owned) Landside.

Lane, (See West Records).

Lanor Records, PO Box 233, 329 N. Main St., Church Point, LA, 70525, (318) 684-2176. Fax: (318) 684-2176. Owner: Lee Lavergne. Label(s): (Owned) Lanor.

Lanrod, (See Carrie Records).

Lantana, (See Twister Records).

Lark Record Prodn's, Inc., 4815 S. Harvard, Ste. 520, Tulsa, OK, 74135, (918) 749-1648. Fax: (918) 749-1697. Pres.: Janae; Sales Mgr./Mktg. Dir.: Sue Teaff.

Laser, (See Statiras Records).

Laser Light, (See Delta Music, Inc.).

Lasertrax, (See Hottrax Records).

Laurie, (See Continental Communications Corp., Sony Records, Inc.).

Laurie Records/A div. of 3C Sales Corp., 450 Livingston St., Norwood, NJ, 07648, (201) 767-5551. Fax: (201) 767-8977. Pres.: Bob Schwartz; Exec. Vice Pres.: Gene Schwartz; Vice Pres.: Ernie Maresca; Vice Pres. Sales: Ron Bollon. Label(s): (Owned) Laurie, (Distributed) Nalli, Order Prodn's, Planetary Prodn's, Playback, Happy Hour, TMC. US Reps.: Richmand Bros. (NJ); Music City Record Dist. (TN); Big State Dist. (TX); Palustar Ent's. (MN); Action Music (MI); Jerry Bassin Dist. (FL); Justin Records (GA); Select-O-Hits (TN); Assoc. Dist. (AR); Great Bay Dist. (MD),(NJ); Universal Record Dist. (PA); California Record Dist. (CA).

LaVal Records, (See Vic Records).

Le Cam Records, PO Box 11152, Fort Worth, TX, 76110, Pres.: Major Bill Smith. Label(s): (Owned) Christi, Le Cam, Memphis Mystery.

LeFrak-Moelis Records, 40 W. 57th St., Ste. 1510, New York, NY, 10019, (212) 586-3600. Fax: (212) 307-7027. Pres.: Herb Moelis; Vice Pres. Promos/Mktg.: Randi Moelis Kantor; Vice Pres. Opns.: Larry Moelis; Dir. Publishing & License: Raven Mednis. Label(s): (Distributed) RCA.

Jimmy Joe Lee Prodn's.

PO Box 827, 13117 Hwy. #9, Boulder Creek, CA, 95006, (408) 338-2184. Fax: (408) 338-2749. Pres.: Jimmy Joe Lee. Label(s): (Owned) Monogram.

Legacy, (See Everest Record Group).

Legato Classics, (See Lyric Distribution, Inc.).

Legends, (See Random House Mail Order).

Legrand Records Int'l, 5736 Shenandoah Ave., Norfolk, VA, 23509, (804) 623-5565. Fax: (804) 640-1402. CEO Dir.: Frank J. Guida; Vice Pres.: Joseph F. Guida, Esq.; Treas.: Carmela T. Guida; Gen. Mgr. Acctg.: Rosetta G. Burns. Label(s): (Owned) S.P.Q.R., Soap Opera, Norfolk Int'l, Peanut Country. US Reps.: Readers Digest (NY); Rhino Records (CA). Int'l Reps.: Line Music (Germany); SV Music (Germany); Epic Sony (England).

Legs Label Records, 825 Fifth St., Menasha, WI, 54952, (414) 725-4467. Exec. Pres.: Lori Lee Woods; Promos.: Jean M. Wilson; Vice Pres. A & R: Rebekah A. Pierce; Sales Dir.: Darrell E. Akers; Asst. Sales Mgr.: Cheryl Akers. Label(s): (Owned) Legs, Sand Dollar.

Leonarda Prodn's, Inc., PO Box 1736, New York, NY, 10025, (212) 666-7697. Fax: (212) 662-0210. Exed. Dir./Producer: Mar-nie Hall. Label(s): (Owned) Leonarda. US Reps.: Albany Music Distr. (NY). Int'l Reps.: Albany Records U.K. (England).

Leprechaun, (See M S K Prodn's, Inc.).

Leverage Mgmt. Co., Inc., 477 82nd St., Brooklyn, NY, 11209, (718) 745-2537. Pres.: Philip Barry; Vice Pres.: Anthony Fischette; Sec./Treas.: Robert Lundberg; Mktg./Promo. Mgr.: Ziad Ojakli.

Library of Congress Broadcasting & Recorded Sound Div., 101 Independence Ave. SE, Washington, DC, 20540, (202) 707-5705. Public Services Coord.: Dina T. Fleming. Label(s): (Owned) L.C. "Our Music Past" Series, (Distributed) Koch Int'l. US Reps.: Koch Int'l Corp. (NY).

Life & Death Records, PO Box 3654, 6718 Leland Way, Hollywood, CA, 90078, (213) 465-7086. Fax: (213) 465-9622. Pres.: Kim Kruger; Sales Contact: Honey Davis. Int'l Reps.: Semaphone (Amsterdam, Holland).

Lifesong Records, PO Box 5807, Englewood, NJ, 07631, (201) 568-3996. Fax: (201) 569-9580. Pres.: Philip S. Kurnit; Vice Pres.: Terry Cashman; Tommy West. Label(s): (Owned) Lifesong.

Lifetime Recordings, 170 Sylvan Rd., Rochester, NY, 14618, (716) 244-7526. Owner: Lester W. Osband. Label(s): (Owned) Joker, Lyndell.

Lift Him Up Music, 156 Fifth Avenue, Suite 434, New York, NY, 10010, (212) 691-5631. Fax: (212) 645-5036. Pres.: Paul Ferrar; Vice Pres./Gen. Counsel: Jeffrey E. Jacobson; A & R Dir.: Marc D. Moel; Vice Pres. Bus. Affairs: Bruce E. Colfin. Label(s): (Owned) Praise.

Ligosa, (See Warlock Records).

Lil' Possum, (See Candy Records).

Lilac, (See Musica Femina Flute-Guitar Duo).

Lilenas Publishing Co., PO Box 419527, 2923 Troost Ave., Kansas City, MO, 64141, (816) 931-1900. Fax: (816) 753-4071. Mgr.: Robert L. Foster; Dir.: Harlan Moore; Mktg.: John Mathias; Advertising: Kelly Gallagher. Label(s): (Owned) Crystal Sea, Lilenas. US Reps.: Royal Mktg. (MO). Int'l Reps.: Beacon Dist. (Canada).

Lincoln Records, 23 Valentine St., Cambridge, MA, 02139, (617) 491-7780. Pres.: John Lincoln Wright.

Lindbergh Records, 1445 Sunset Ridge Rd., Glenview, IL, 60025, (708) 729-2047. Pres.: Sven Lindberg; Vice Pres., Mktg.: Frank Littlelow; Int'l Dir.: Bjorg Larsen. Label(s): (Owned) Danskisk, Norskisk, Scandinavian, Svenskisk.

Line Records, PO Box 402088, Austin, TX, 78704, (512) 448-1591. Contact: Heinz Geissler.

Lion Hunter Music, PO Box 11078, Anchorage, AK, 99511, (907) 349-2456. Pres.: Dave Connett; Vice Pres. A & R: Clive Lock. Label(s): (Owned) Lion Hunter Music. Int'l Reps.: Lion Hunter (United Kingdom).

Liquid Music, (See Ex Urbana, Inc.).

Lite Album Publishing Co., 2260 El Cajon Blvd., Ste. 161, San Diego, CA, 92104, (619) 282-0317. Fax: (619) 295-5036. Pres.: D. Rivers. Label(s): (Owned) Frog Work Records, New Style.

Little Giant Records, PO Box 205, Beechwood Club Rd., White Lake, NY, 12786, (914) 583-4471. Pres.: Mickey Barnett; A & R: Mike Pell. Label(s): (Owned) Beechwood, Killer, Little Giant, School Days.

Little Major Record Distributors, Inc., 244 W. 54th St., New York, NY, 10019, (212) 757-7222. Fax: (212) 757-7567. Pres.: Mel Fuhrman; Dir., Int'l Lic., A & R: Ron Eyrer; Dir., Mktg.: Rich Fuhrman; Dir., A & R: Michael Closter. Label(s): (Owned) Soundscreen, (Distributed) Se-Ya, Mixed Emotion, Aegis, Esquire. US Reps.: Associated Dist. (AZ); California Record Dist. (CA); Jerry Bassin, JFL Dist., Schwartz Brothers (FL); Schwartz Brothers (GA); Music Craft Dist. (HI); MS Dist. (IL); Schwartz Brothers (MD); MS Promos (MN); Schwartz Brothers (NJ); Encore Dist., (NY); Schwartz Brothers (NC); Schwartz Brothers (OH).

Little Richie, (See LRJ Records).

Living Music Records, Inc., PO Box 68, Litchfield, CT, 06759, (203) 567-8796. Fax: (203) 567-4276. Pres.: Paul Winter; Vice Pres.: Kathy Cowels. US Reps.: Moss Music Group (New York, NY). Int'l Reps.: Pony/Canyon Records (Japan).

Livingston, (See Epoch Universal Publications).

Loadstone Record & Music Co., 163 Orizaba Ave., San Francisco, CA, 94132, (415) 334-2247. Pres./Gen. Mgr.: Walter C. Stone; Regional Promo.: Lillie C. Moore; Local Promo.: Goyotte Williams; A & R: WC Stone. Label(s): (Owned) Loadstone, Lock, Open. Lock, (See Loadstone Record & Music Co.).

Log Cabin, (See Jewel Records).

Longhorn Records, PO Box 93457, Hollywood, CA, 90093, (213) 850-0986. Owner: Harvey Appell. Label(s): (Owned) Club of Spade.

Love, (See Apon Record Co., Inc.).

Low-Flying Angels Music, c/o Jacobson & Colfin, P.C., 156 Fifth Ave., Ste. 434, New York, NY, 10010, (212) 651-5630. Fax: (212) 645-5036. Pres.: Beth Travers; Business Affairs: Jeffrey E. Jacobson.

Low Spirit USA, (See Ex Urbana, Inc.).

Luaka Bop, Inc., PO Box 47, Prince St. Station, New York, NY, 10012, (212) 941-6866. Fax: (212) 219-8664. Chairman: David Byrne; Pres.: Yale Eveler; Mgr.: Brenda Dunlap. US Reps.: Warner Bros. (NY).

Lusa, (See Boddie Recording).

Lucifer Records, Inc., PO Box 263, Brigantine, NJ, 08203, (809) 266-2623. Pres.: Ron Luciano; Vice Pres.: Dana Luciano; A & R Dir.: Jerry Denton; Dir./Mgmt. of Arts: Bobby Fisher. Label(s): (Owned) Albatross, Cypher. Int'l Reps.: Michel Meyer & Co. (France).

Luckie Street Records, Inc., 1422 W. Peachtree St., Ste. 707, Atlanta, GA, 30309, (404) 876-8446. Fax: (404) 874-5558. Pres.: Dan R. Nolan; Vice Pres.: Michael E. Reeves; Promo.: Tracy Ritchey; Asst.: Esta Love.

Luke Records, Inc., 8400 NE Second Ave., Miami, FL, 33138, (305) 757-1969. Fax: (305) 757-3456. Pres./Owner: Luther Campbell; COO: Wayman "Slack" Johnson; Nat'l Promos Coord.: Gynne Daniels; Vice Pres. A & R: Michael Hopkins; Contact: Debbie Bennett. Label(s): (Owned) Effect, Luke, Skyline, (Distributed) Nautica, Crew-La Pool.

Lummtone Records, 2209 Crenshaw Blvd., Los Angeles, CA, 90016, (213) 734-4459. Pres.: Lummie J. Fowler.

Lunatunes Records, 8323 Justin Ave., Baton Rouge, LA, 70809, (504) 928-3902. Gen. Mgr.: Dudley-Brian Smith.

Jack Lynch Music Group, 306 Millwood Dr., Nashville, TN, 37217, (615) 366-9999. CEO: Col. J. D. Lynch. Label(s): (Owned) Jalyn, Nashville Bluegrass, Nashville Country Prodn's. US Reps.: Nashville Music Sales (TN).

Lyndell, (See Lifetime Recordings).

Lyric Distribution, Inc., PO Box 235, Roslyn Heights, NY, 11577, (516) 652-0588. Fax: (516) 621-8006. Pres.: Ed Rosen; Vice Pres. Sales/Mktg.: Steven Striffler. Label(s): (Owned) Biography in Music, Legato Classics, Standing Room Only 800, Standing Room Only 500.

Lyrichord Discs, Inc., 141 Perry St., New York, NY, 10014, (212) 929-8234. Fax: (212) 929-8245. Pres.: Nick Fritsch; Owner: Peter Fritsch; Gen. Mgr.: Greg Sandberg. Label(s): (Owned) Lyrichord Discs, Inc. US Reps.: Rounder (MA); Silo Systems (VT); City Hall (CA); Creative Music Mktg. (NH).

M

- MAC/VISOP** (See Michele Audio Corp.).
- MBTM Records**, PO Box 38624, 1008 Tenth St., Ste. 399, Sacramento, CA, 95838, (916) 537-7224. Gen. Partner/A & R: Clyde Anthony; Gen. Partner: Dwayne A. Polk.
- MCA Records**, 70 Universal City Plaza, Universal City, CA, 91608, (818) 777-4000. Chrmn./MCA Music Group: Al Teller; Pres., MCA Records: Richard Palmese; Pres./Black Music Div.: Ernie Singleton; Vice Pres., Mktg. MCA: Geoff Bywater; Exec. Vice Pres., A & R, MCA Rec.: Paul Atkinson. Branch(es): 100 N. First St., 4th Floor, Burbank, CA, 91502, (818) 845-0365, Fax: (818) 845-2564, Regional Sales & Mktg.: Cameron Smith; 5275 Triangle Pkwy., Ste. 100, Norcross, GA, 30092, (404) 447-6405, Fax: (404) 263-8132, Regional Sales & Mktg.: John Barnes; 1360 N. Wood Dale Rd., Ste. A, Wood Dale, IL, 60191, (708) 860-3733, Fax: (708) 860-0353, Regional Sales & Mktg.: Mick Stevanovich; 1775 Broadway, 8th Floor, New York, NY, 10019, (212) 841-8000, Vice Pres./Mktg.: Randy Miller, Vice Pres./A & R: Bruce Dickinson; 1514 South St., Nashville, TN, 37212, (615) 244-8944, Fax: (615) 259-9504, Pres.: Bruce Hinton, Exec. Vice Pres. A & R: Tony Brown. Label(s): (Distributed) B. Brown Prods., Bon Ami, Comptown, Curb, Future Entertainment, Gasoline Alley, Impact, MCA, Storefront Entertainment, Magnolia Sound, Mechanic, O'Farrell Entertainment, Radioactive. S.O.U.L., Savage. US Reps.: UNI Dist. (US).
- MCA Special Markets & Products**, 70 Universal City Plaza, Universal City, CA, 91608, (818) 777-4000. Fax: (818) 777-8264. Sr. Vice Pres.: Bruce Resnikoff; Vice Pres. Sales MCA Spec.Prods.: Bob Zipkin. Label(s): (Owned) ABC, Brunswick, Chess, Decca, Dot, Dunhill, GRP, Geffen, MCA.
- MCR** (See Charta Records/Delux Records).
- M&J** (See Sharon Prods., Inc.).
- MMG** (See Moss Music Group, Inc.).
- MMO Music Group/Pocket Songs**, 50 S. Buckhout St., Irvington, NY, 10533, (914) 591-5100. Fax: (914) 591-5103. Pres.: Irv Kratka; Vice Pres.: Dave Kratka; Adv./Publicity: Neil Mednick; Nat'l Acct. Exec.: Chris Reising. Label(s): (Owned) Music Minus One, Pocket Songs.
- MOR Records**, 17596 Corbel Ct., San Diego, CA, 92128, (619) 485-1550. Fax: (619) 485-1883. Pres./Owner/Prod.: Stuart L. Glassman; Engineer: Dan Milner. Label(s): (Owned) MOR, MOR Jazz.
- MP** (See Musical Prodn., Inc., Nota (Note) Publishing).
- MPI Music Group** (See Master Projects, Inc.).
- M. R. C.** (See Major Recording Studio).
- M-S** (See M S K Prods., Inc.).
- MSB** (See The Sonic Group Ltd.).
- M S K Prods., Inc.**, 15401 Tiramem Ave., Dearborn, MI, 48126, (313) 581-8100. Pres.: Chet Kajeski. Label(s): (Owned) Dearborn, Leprechaun, M-S.
- MTE** (See Master-Trak Ent.).
- MZA Records** (Children's Cassettes), 2878 Bayview Ave., Wantagh, NY, 11793, (516) 781-7826. Owner: Al Rubin.
- Macola Record Group, Inc.**, 8831 Sunset Blvd, Ste. 202, West Hollywood, CA, 90069, (310) 659-6036. Fax: (310) 659-6039. Pres.: Donald MacMillan; Ops. Mgr.: James Takeda. Label(s): (Owned) Macola, (Distributed) Hootlum, Techno Hop. Int'l Reps.: Rams Horn (Netherlands).
- Macola Records**, PO Box 412, New York, NY, 10462, (212) 613-9049. Pres.: Vernon Wilson; A & R Dir.: Rick Robinson; Mktg. Dir.: Darlene Barkley.
- Madison Station Prods.**, PO Box 853, 953 Highway 51, Ridgeland, MS, 38158, CEO/Producer: Jason S. Wooten. Label(s): (Owned) Madison, Madison Station, Ridgeland.
- Maestro** (See The Special Music Co., Pair Records, Essex Entertainment, Inc.).
- Maggie's Music, Inc.**, PO Box 4144, 940 Bay Ridge, Annapolis, MD, 21403, (301) 268-3394. Fax: (410) 267-7061. Pres./A & R: Maggie Sansone; Vice Pres./Ops. Mgr.: Richard Crenshaw. Label(s): (Owned) Maggie's Music. US Reps.: Landmark (NY); New Leaf (GA); L'lfedance (OR); Silo (VT); Music Design (WI).
- Lee Magid Mgmt.**, PO Box 532, Malibu, CA, 90265, (310) 463-5998. Contact: Lee Magid.
- Magnet** (See Warner Music Int'l).
- Mahdi** (See York's Prods.).
- Mahogany** (See Dagene/Cabletown Corp).
- Maison Record Co.**, PO Box 1029, 14065 Olive Meadows Pl., Poyay, CA, 92074, (619) 486-1318. Owner: Mike Maison; Promo. Dir.: Tinamarie Maison.
- Maison de Soul** (See Flat Town Music Co.).
- Majega Records**, 240 E. Radcliffe Dr., Claremont, CA, 91711, (714) 624-0677. Pres.: Gary K. Buckley.
- Majestic Control Records**, PO Box 330-568, Brooklyn, NY, 11233, (718) 919-2013. Pres./Promo. Dir.: Hank Loves. Pres./Sales Dir.: Half Pint; Asst. Dir. of Pub. Rel.: Jay Surgeon; Vice Pres. A & R: Alan Aleemo. US Reps.: Gemini (GA); Music Craft (HI); Impact (IL); Universal (PA); Select-O-Hits (TN).
- Majji** (See Cheetah Records Inc.).
- Major** (See Valentino Music & Sound Effects).
- Major Music Records, Inc.**, PO Box 2803, Hollywood, CA, 90078, (213) 281-3045. Pres.: Paul Korda.
- Major Recording Studio**, PO Box 2072, Waynesboro, VA, 22980, (703) 949-0106. Owner: John H. Major. Label(s): (Owned) Lark, M. R. C.
- Makedwde Records**, 10556 Arnwood Rd., Lake View Terrace, CA, 91342, (818) 890-0730, (818) 890-0737. Fax: (818) 899-4457. Pres.: Marion Coleman; CEO/Ops. Mgr.: Joe Jones, Sr.; Mgr. of A & R: Dwayne Jones; Mgr. of Mktg. & Sales: Keith Jones; Vice Pres. & Dir.: Detra Jones. Label(s): (Owned) Coleman, Detra, Marion, Trell. US Reps.: M & J Record Dist. (CA); KEDWDE Record Dist (CA).
- Makin' Music, Inc.**, 1230 17th Ave. S., Nashville, TN, 37212, (615) 269-6770. Pres.: Chris Dodson; Vice Pres.: Sandra Johnson.
- Malache Elyon** (See Kison Elyon Records).
- Malaco Records**, PO Box 9287, Jackson, MS, 39286, (601) 982-4522. Fax: (601) 982-4528. Pres.: Thomas J. Couch; Sr. Vice Pres.: Dave Clark; Vice Pres.: Wolf Stephenson; Dir. Nat'l Promos.: Wayman Johnson. Label(s): (Owned) Chimneyville, Malaco Jazz, Savoy, Slik, (Distributed) Muscle Shoals Sound, Avenue.
- Mammoth Records**, Carr Mill, Second Floor, Carboro, NC, 27510, (919) 932-1882. Fax: (919) 932-1885. Pres.: Jay Fairles. Label Mgr.: Steve Balcon; Publicity: Julia Carr Bayler. Retail: Don Gill; Radio & Video: Sean Maxon. US Reps.: Relativity Entertainment Dist.(NY). Int'l Reps.: Real Time (England); Revolver (United Kingdom); Rough Trade (Germany); Contempo (Italy); Play It Again Sam (Holland).
- Mansion** (See Sweetsong Prods.).
- Mar-Kay Record Co.**, 100 Oak Lawn Rd., Edwardsville, IL, 62025, (618) 288-9435. Pres.: Mary A. Joyce; Vice Pres.: Ron Allen; A & R/Promo: Phyllis Neely.
- Marc** (See Titan Records).
- Maria Records Co.**, PO Box 295, Riverdale, NY, 10463, (212) 549-0502. Pres./Owner: John Clark.
- Mariah Records**, PO Box 310, Carmichael, CA, 95609, (916) 485-3554. Pres.: Mari Minick. Vice Pres. A & R Myra Westervelt.
- Maricao** (See Hard Hat Records).
- Marion** (See Makedwde Records).
- Mktg.** (See More Music Group, Inc.).
- Marvelle Music Co.**, PO Box 532, Malibu, CA, 90265, (310) 463-5998. Fax: (310) 457-8891. Pres.: Lee Magid.
- Marilyn** (See Ron-Dom Prods., Inc.).
- Marz Records**, 2602 NW Fifth Ave., Miami, FL, 33127, (305) 573-5400. Fax: (305) 573-1006. Pres.: Jerry Suarez; Label Mgr.: Joe Alonso; A & R/Dance: Bibi. Label(s): (Owned) Marz, (Distributed) Kinetic US Reps.: Caroline (NY); CARGO (IL); JFL (FL); Justin Ent. (GA); MDI (TX); Navare Corp. (MN).
- Massa Records**, Cond. Las Torres Sur 10E, Bayamon, PR, 00619, (809) 780-3867. Fax: (809) 780-3867. Pres.: German W. Velez; Sales/Mktg.: Sandra Barbeito; Int'l Promo: German Velez Forester. Label(s): (Distributed) Atlantic, Elektra, Warner.
- Maske Records**, 3600 Trail Dairy Cir., North Fort Myers, FL, 33917, (813) 731-2276. Pres.: Salvatore Guerreri; Vice Pres.: Maichael White; Promo/Mktg.: Barbara White; Music Dir.: Ernie White. US Reps.: Natowide Sound (Nashville, TN).
- Massmedia**, 7105 Reynolds St., Pittsburgh, PA, 15208, (412) 247-1301. Pres.: Jon Gorr, Vice Pres.: Rebecca Ogan. Label(s): (Owned) Massmedia. US Reps.: Rounder (MA).
- Master** (See Skylite-Sing, Inc.).
- Master Grip Record Co.**, 21 Joyce St., Bloomfield, CT, 06002, (203) 242-1690. Pres.: Joseph O. Pritchett, Sr.; Sr. Vice Pres.: Eric T. Pritchett; Dir. Mktg. & Promo: Joseph O. Pritchett, Jr.; Vice Pres. A & R: Eric T. Pritchett.
- Master Projects, Inc.**, 387 Ivy St., San Francisco, CA, 94102, (415) 554-3720. Pres.: Daniel Jsel; Vice Pres./A & R: Udi Shanker; Mktg. Dir.: Azadeh Lumiere. Branch(es): 2301 W. Nichols, Ste. E, Arlington Heights, IL, 60004, (312) 577-7982. Gen. Mgrs.: Ed & Mary O'Mara; 832 North 24th St., Philadelphia, PA, 19130, (312) 577-7982. Contact: Kathy Howard. Label(s): (Owned) MPI Music Group, White Wings Int'l.
- Master-Trak Ent.**, 413 N. Parkerson Ave., Crowley, LA, 70526, (318) 788-0773. Fax: (318) 788-0776. Owner: J.D. Miller; Gen. Mgr.: Mark Miller; Chief Engineer: Bobby Terry; Promo: Leslie K. Hill. Label(s): (Owned) Bayou Classics, Blues Unlimited, Kajun, MTE, Showtime.
- Masterworks** (See Sony Records, Inc.).
- Mate** (See Kubaney Publishing Corp.).
- Maui Arts & Music Assoc.** (See Survivor Records/Dream Makers, Inc.).
- Maui Country** (See Hit Records/U.S.A. Entertainment).
- Max Entertainment, Inc.**, 76-05 51st Ave., Elmhurst, NY, 11373, (718) 335-2112. Fax: (718) 335-2184. Pres.: Michael Weiss; Gen. Mgr.: Sam Weiss, Dir. of A & R: Gladys Pizarro; Tina Bennet. Label(s): (Owned) Nervous, Sam.
- Maxiplay** (See Intersound, Inc.).
- Maxx Records**, 50 Music Sq W., Ste. 207, Nashville, TN, 37203, (615) 329-2591. Pres.: Fred Morris; Vice Pres.: Peggy Bradley; Dir., Promos.: Bob Ham. Label(s): (Owned) Rite Turns.
- Maxxum Music, Inc.**, PO Box 50, Nashville, TN, 37202, (615) 321-5050. Fax: (615) 329-0593. Pres.: Gary McSpadden. Vice Pres. Greg McNeay. US Reps.: Spring Arbor (MI).
- Maycon Records Co.**, 5306 W. Columbia Ave., Philadelphia, PA, 19131, (215) 877-8760. Pres.: Mae Connelly; Vice Pres.
- Creative Serv./A & R: Earl Connelly; Promo Dir.: James Brooks; Sec./Treas.: Charmelle Connelly.
- Maze Records**, 29 Willett Ave., Port Chester, NY, 10573, (914) 934-1313. Fax: (914) 934-2428. Pres.: Zoran Busic; Vice Pres./A & R: Jim Matthews, Dir. Promos: Stewart Morales. Label(s): (Owned) Kraze, Maze. US Reps.: Important (NY).
- Mazel** (See Periscope Record Co.).
- Tim McCabe Prods.**, 325 Rolling Rock Rd., Marietta, GA, 30067, (404) 952-2012. Fax: (404) 850-0024. Pres.: Tim McCabe. Label(s): (Owned) Planet Earth.
- Meadowlark** (See The Sparrow Corp.).
- Mean Mountain Music**, 926 W. Oklahoma Ave., Milwaukee, WI, 53215, (414) 483-6500. Owner: Michael J. Muskovitz; Business Mgr. & Acct.: Mary Ann Muskovitz; Store Mgr.: Edd Grider. Label(s): (Owned) Mean Mountain Music. Int'l Reps.: KOP'S Records (Canada).
- Mechanic Records, Inc.**, 6 Greene St., 2nd Fl., New York, NY, 10013, (212) 226-7272. Fax: (212) 941-9409. Pres.: Steve Sinclair; Vice Pres.: Holly Lane; Dir. Radio Promo: Chanty Kurz; Dir. Retail Promo: Maureen Cole; Dir. Publicity: Chip Ruggier. Label(s): (Owned) Sinclair, World Of Hurt. US Reps.: UNI Dist. Co. (CA), Important Record Dist. (NY).
- Meda Records, Inc.**, PO Box 21748, 19457 Shrewsbury Rd., Detroit, MI, 48221, (313) 862-5880. Pres.: Mertis John; Sr. Vice Pres./Vice Pres. Mktg.: Mable John; Dir. Promo/East Coast: Ernie Durham; Vice Pres. A & R: Joseph E. Hunter. Label(s): (Owned) Olmer. US Reps.: W&W Wholesale (CA); Gemini (IL).
- Medusa** (See Enigma Entertainment).
- Megaforce Worldwide** (See Atlantic Recording Corp.).
- Megajam Records, Inc.**, 1639 Madison Ave., Memphis, TN, 38104, (901) 272-9380. Fax: (901) 272-2734.
- Megalodon Ent.**, Inc., 5600 N. Dixie Hwy., Ste. 703, West Palm Beach, FL, 33407, (407) 844-6721. Pres.: Bennie L. Herring II; Vice Pres. A & R: Matthew Russell, Jr. Label(s): (Owned) Go 4 It, Yoybe.
- Megatone Records, Inc.**, 2261 Market St., #315, San Francisco, CA, 94114, (415) 621-7475. Fax: (615) 621-0121. Pres.: John Hedges; Gen. Mgr.: David Diebold. Label(s): (Owned) Megatone. Megatone House.
- MelVern** (See Lamar Music Co.).
- Meldac** (See Creav, Inc. U.S.A.).
- Melodeon** (See Biograph Records, Inc.).
- Melodia** (See Polish Record Center of America).
- Melody Music** (See Gospel Publishing House).
- Memphis Mystery** (See The Cam Records).
- Mena Ent., Inc.**, 606 Hipodromo Ave., Santurce, PR, 00909, (809) 723-1764. Gen. Mgr.: Ignacio Mena; Sales Mgr.: Daniel Mena; Promo. Mgr.: Carlos Villanueva. Label(s): (Owned) Chemo, Disneyland Vista, (Distributed) Disneyland Vista.
- Mentor Music Group, Inc.**, PO Box 2392, Woburn, MA, 01888, (617) 728-1463. Fax: (617) 932-8520. Pres.: Joseph A. Viglione; Vice Pres. A & R: Janis Reed, Vice Pres.: Harvey Wharfield; A & R: Mike Gordy, Mgmt. Jim Tirabassi. Label(s): (Owned) VAR Int'l, Varulven, ZZAJ. US Reps.: WGE (NH). Int'l Reps.: New Rose Records (France).
- Mercantile Records**, 2731 Saundersville Ferry Rd., Mt Juliet, TN, 37122, (9615) 754-2444. Owner: Kent Fox.
- Mercenary** (See Celluloid Records).
- Mercury/PolyGram Records**, 901 18th Ave. S., Nashville, TN, 37212, (615) 320-0110. Fax: (615) 327-4856. Vice Pres./Gen. Mgr.: Paul Lucks; Vice Pres./Nat'l Promos.: Bobby Young; Dir. Sales & Mktg.: Steve Miller, Dir. of Communications: Sandy Neese, Vice Pres. A & R: Harold Shedd.
- Merry** (See Bestway Group, Inc.).
- Merry-Go Round** (See Country Int'l Records).
- Merry Marilyn Music**, 301 Carriage Dr., Ste. F, Santa Ana, CA, 92707, (714) 957-3275. Pres.: Marilyn Hendricks. Vice Pres./Gen. Mgr. James Hendricks. Vice Pres./A & R: Josephine Sullivan.
- Mersey** (See Country Star Int'l).
- Mesa Records**, PO Box 25066, Nashville, TN, 37202, (615) 269-0593, (615) 262-9417. Gen. Mgr.: Taylor Sparks. US Reps.: Nationwide Dist.
- Metal Blade Records, Inc.**, 18653 Ventura Blvd., #311, Tarzana, CA, 91356, (818) 981-9050. Fax: (818) 981-9050. CEO: Brian Stigel, Pres.: Michael Faley; Dir. Sales: Catherine Sigler; Dir. Mktg.: Michael Jones; Vice Pres. A & R: Niels Schroeter. Branch(es): 1133 Broadway, #826, New York, NY, 10010, (212) 645-6208, Fax: (212) 242-7359, Chairman/CEO: Brian Stigel. Label(s): (Owned) Death. Int'l Reps.: Music for Nations (United Kingdom).
- Metal Magic Records**, 2210 Raper Blvd., Arlington, TX, 76013, (817) 461-8481. Owner/Pres.: Jerry Abbott, Gen. Mgr./Mktg. Dir.: Vinnie Paul, Sales/Promo Mgr.: Darrell Lance; Acct. Exec.: Rex Browning, Vice Pres. A & R: Vinne Paul/Darrell Lance. Label(s): (Owned) Cosmopolitan Country.
- Metal Storm** (See Azra Int'l).
- Meteor Records**, 830 Fesslers Pkwy., Ste. 106, Nashville, TN, 37210, (615) 747-4565. Vice Pres. Hal Bishop. Label(s): (Owned) Meteor, Saturn.
- Metropolis Records/S.M.D. Music Corp.**, 350 Fifth Ave., Ste. 3304, New York, NY, 10001, (212) 971-1322. Fax: (212) 564-1135. Pres.: Steven E. Marder, Esq., Vice Pres. A & R: Mark Levine, Dir. Video Prods.: Drew Stone, Dir. Mktg. & Promo.

- Kimberly Grunbaum; Dir. Special Markets: Alice Slater.
- Metropolitan Recording Corp.**, 900 Passaic Ave., East Newark, NJ, 07029, (201) 483-8080. Fax: (201) 483-0031. Pres.: Jerry R. Salerno; Promos. Dir.: Jason McFadden; Vice Pres. A & R: Joey Gold.
Label(s): (Owned) Metropolitan. Kaleidoscope, (Distributed) Digital Dungeon.
US Reps.: Malverne, Unique (NY); Universal (PA); JFL, Bassin (FL); Landmark (IL, CA, GA).
- Metrostar Records**, PO Box 5807, Englewood, NJ, 07631, (201) 568-3996. Fax: (201) 569-9580. Gen. Mgr.: Philip S. Kurnit. Label(s): (Owned) Metrostar.
- Dick Michaels Prods.**, 11311 Audelia Rd., #283, Dallas, TX, 75243, (214) 348-4151. Pres.: Dick Michaels.
Label(s): (Owned) High Rockets, High Sky.
- Niche Audio Corp.**, PO Box 566, Andrew St. Rd., Massena, NY, 13662, (315) 769-2448. Fax: (315) 764-0182. Pres.: Tom Gramuglia; Vice Pres.: Ginette Cormier.
Label(s): (Owned) Adirondack, N.Y. B.S.P.
- Mickey Records**, 810 Wateroak Dr. NE, Palm Bay, FL, 32905, (407) 723-1741. Pres.: Michael F. Matushin, Sr.
Label(s): (Owned) Mickey.
- Micon Recordings/Micon Entertainment West**, PO Box 48023, 14016 Evers Ave., Los Angeles, CA, 90222, (213) 769-7628. CEO/A & R Dir/Exec. Prod.: Shon Taylor; A & R Rep./Staff Prod.: Melvin B. Childs, III; Artist Dev. Rep.: Rakaa W. Taylor.
- Midnight Int'l Records, Inc.**, PO Box 390, New York, NY, 10011, (212) 675-2768. Fax: (212) 741-7230. Pres./Sales Dir.: J.D. Martignon; Promo.: Ron Bally.
US Reps.: Important (East), Midnight, Performance.
Int'l Reps.: Semaphore Amsterdam (Netherlands); Wind-song (U.K.); Heltet Skelter (Italy); Rockin' Berry (Greece).
- Mighty Soul Sonic**, (See Mark Carval Ent's., Inc.).
- Mighty Tiger**, (See Chase Music Group).
- Milan America, Inc.**, 635 Madison Ave., New York, NY, 10022, (212) 688-9090. Fax: (212) 754-9590. Pres.: Emmanuel Cham-boredon; Sec./COO: Toby Pieniek; Vice Pres./Mktg.: Charlie Jarzabek; Dir. Prod. Mgmt.: Dana Renert.
Label(s): (Owned) Milan.
US Reps.: RCA Records (NY).
Int'l Reps.: JVC (Japan), (Korea), (Taiwan), (Hong Kong).
- Miles Ahead Records**, PO Box 35449, Los Angeles, CA, 90035, (213) 281-8599. Pres.: Miles Grayson; A & R: Lermon Horton; Promo.: Charles Marcus; Sales: Brenda English.
Milestone, (See Fantasy, Inc.).
- Milestone Music Corp.**, PO Box 618, Lenox Hill Sta., New York, NY, 10021, (212) 689-0859. Pres.: B. Stone.
- Milk & Cookies**, (See Edible Records).
- Miller & Kreisel Sound Corp.**, 10391 Jefferson Blvd., Culver City, CA, 90232. Pres.: Ken Kreisel; Exec. Vice Pres.: Charles Back; Nat'l Sales Mgr.: John Arce.
Label(s): (Owned) RealTime, (Distributed) Perpetua.
- Minnesota Composers Forum**, 26 E. Exchange St., Ste. 200, Saint Paul, MN, 55101, (612) 228-1407. Fax: (612) 223-8619. Exec. Dir.: Linda Hoehschler; Managing Composer: Fritz Bergmann; Artistic Prod.: Jeffrey Brooks; Communications Dir.: Karen Nelson.
Label(s): (Owned) Innova Recordings.
- Minstrel**, (See Collegium Sound, Inc.).
- Miracle**, (See Ichiban Records, Inc.).
- Mirror Ball**, (See Hollywood Records of California).
- Mirror Records, Inc.**, 645 Titus Ave., Rochester, NY, 14617, (716) 544-9928. Pres./Treas./A & R: Armand Schaubroeck; Vice Pres./Sec.: Bruce Schaubroeck; Promo.: Candy Melons.
Label(s): (Owned) House of Guitars, Mirror, Catman.
Int'l Reps.: Semaphore Records (Netherlands); Important Dist., Dutch East, Get Hip Midnight Records, Caroline Record Dist., Cargo Record Dist. (Canada).
- Mr. Wonderful Prods., Inc.**, 1730 Kennedy Rd., Louisville, KY, 40216, (502) 774-1066. Vice Pres./Exec. Producer: Jerry Green; Vice Pres./Pub. Rel. Dir.: Erma Bush; Talent Agent: Arthur Williamson.
Label(s): (Owned) Wonderful, (Distributed) Ham-Sem.
US Reps.: Jewel/Paula (LA).
Int'l Reps.: Oluade Music (Nigeria); Caribbeat Comm. Ltd. (Dominican Republic).
- Mit Abul-Kom**, (See Kison Elyon Records).
- Mo-wood**, (See Didaczeck Records).
- Mobile Fidelity Sound Lab**, 1260 Holm Rd., Petaluma, CA, 94954, (707) 778-0134. Fax: (707) 778-6328. Pres.: Herbert A. Belkin; Sr. Vice Pres. Sales: James G. Benz; Vice Pres., Finance: Rose MacKinnon; Dir., Mktg.: Phyllis Schwartz; Vice Pres. A & R: Michael Grantham.
Label(s): (Owned) Cafe, Original Master Recording, (Distributed) Melodiya, Gostelradio.
Int'l Reps.: In-Akustik (Germany); TMS (France); Ettol Imports (Denmark); K-Tel Int'l (Switzerland); Radtone Music Systems (United Kingdom); Zhure Ltd. (Hong Kong).
- Modern Records**, 9111 Sunset Blvd., Los Angeles, CA, 90069, (213) 273-8111. Contact: Paul Fishkin.
US Reps.: WEA Int'l.
Int'l Reps.: WEA Int'l.
- Modern Wig Music**, (See Toddlin' Town Recording Studio).
- Mohawk**, (See Dragon Records, Inc.).
- Mole Hole**, (See Bug Records, Inc.).
- Len Monahan Prods.**, 9967-US-A20, Delta, OH, 43515, (419) 822-5242. Promo. Dir.: Kathy Gillen.
Label(s): (Owned) Red Dog, World Airwave.
- Mondo Music**, (See Select Records).
- Moneytree**, (See Pet Records).
- Moni**, (See Joey Records, Inc.).
- Monique Music Library**, (See Peer-Southern Organization).
- Monitor Collectors**, (See Monitor Recordings, Inc.).
- Monitor Music of the World**, (See Monitor Recordings, Inc.).
- Monitor Recordings, Inc.**, 10 Fiske Pl., Mount Vernon, NY, 10550, (914) 667-2020. Fax: (914) 667-2072. Pres.: A & R: Michael Stillman; Vice Pres., Sales Mgr.: Rose N. Rubin.
Label(s): (Owned) Monitor Collectors, Monitor Music of the World.
- Monogram**, (See Jimmy Joe Lee Prods.).
- MonteVideo**, (See Celestial Harmonies).
- Moon Records Phase II**, (See Moon Records).
- Moon Records**, 3333 Scenic Hwy., Memphis, TN, 38128, (901) 386-8102. Pres.: Cordell Jackson.
Label(s): (Owned) Moon, Moon Records Phase II.
- Moon Records Phase III**, 3333 Scenic Hwy., Memphis, TN, 38128, (901) 386-8102. Pres.: Dana Jackson; Vice Pres.: Janice Jackson.
Label(s): (Owned) Moon.
- Moonlight Records**, PO Box 184, Chapel Hill, NC, 27514, (919) 967-6666. Pres.: David C. Robert; Sec.: Bill Smith.
- Moose Records**, 480 Lytton St., Troutman, NC, 28166, (704) 528-4843. Vice Pres.: Stan Baits.
Label(s): (Owned) Moose Label, Sueno Label.
- More Music Records, Inc.**, 250 W. 57th St., Ste. 2413, New York, NY, 10019, (212) 586-6811. Contact: Michael "Kidd" Gomez; Promos.: John Jay.
Label(s): (Owned) Dark Side, Mktg.
- Morgan Creek Music Group**, 1875 Century Park E., Ste. 700, Los Angeles, CA, 90067, (213) 284-8282. Fax: (213) 788-9428. Co-Pres.: Jim Mazza; David Kershbaum; Vice Pres./Promo.: Walter Lee; Vice Pres./Mktg.: Colin Stewart; Vice Pres./Business Affairs: Mark Berger; Vice Pres./Publicity: Cary Baker.
Branch(es): 1875 Century Park E., Ste. 700, Los Angeles, CA, 90067, (213) 551-9785. Fax: (213) 788-9428, Vice Pres. Promo.: Walter Lee; 319 Townsend St., M-100, San Francisco, CA, 94107, (415) 957-5867. Fax: (415) 957-9553. Promo.: Bob Osborn; 2161 Newmarket Pkwy., Ste. 262, Marietta, GA, 30067, (404) 916-7340. Fax: (404) 984-8872. Promo.: Brad Moss; 2800 River Rd., #120, Des Plaines, IL, 60018, (708) 803-7432. Fax: (708) 298-9711. Promo.: Ric Lippincott; 7701 Greenbelt Rd., Ste. 520, Greenbelt, MD, 20770, (301) 220-1171. Fax: (301) 441-2871. Promo.: Fred Traube; 97-77 Queens Blvd., Rego Park, NY, 11374, (718) 793-6868. Fax: (718) 793-0094. Promo.: Bruce Brody; 5000 Quorum Dr., Ste. 200, Dallas, TX, 75240, (214) 381-2797. Fax: (214) 387-8730. Promo.: Laurie Morgan.
Label(s): (Owned) Morgan Creek.
Int'l Reps.: Polydor (London).
- MorningStar**, (See Eddie Crook Co.).
- Morrhythm**, (See Outstanding Records).
- Mosaic Records, Inc.**, 35 Melrose Pl., Stamford, CT, 06902, (203) 327-7111. Fax: (203) 323-3526. Co-Chrmn.: Charlie Lourie; Co-Chrmn.: Michael Cuscuna.
Label(s): (Owned) Mosaic, Mosaic Editions, True Blue Music.
- Moseka Records & Tapes**, PO Box 217, New Riegel, OH, 44853. Pres.: Ron Hanson; Vice Pres.: Rex H. Felton.
Label(s): (Owned) Fresh Air, Herrick Stone Prods.
- Mosrite Records**, PO Box 40013, Nashville, TN, 37204, (615) 292-2047. A & R: Mark Moesley; Gen. Mgr.: Andy Moesley.
- Moss Music Group, Inc.**, 75 Essex St., Hackensack, NJ, 07601, (201) 489-6313. Fax: (201) 489-7893. Gen. Mgr.: Ira Moss; Special Market: Gordon Stringer.
Label(s): (Owned) Allegro, Cameo Classics, Gretto, MMG, Vox.
- Motette**, (See The Organ Literature Foundation).
- Mother Records**, 5159 Wheelis Dr., Ste. 10, Memphis, TN, 38117, (901) 683-1933. Pres.: Celia McRee.
- Motown Record Co./L.P.**, 6255 Sunset Blvd., 17th Floor, Los Angeles, CA, 90028, (213) 468-3500. Fax: (213) 856-0341. CEO/Pres.: Jherly Busby; Sr. Vice Pres. Sales/Dist.: Oscar Fields; Sr. Vice Pres. Admin.: Shelley Fowler; Sr. Vice Pres. R&B Promo.: Paris Eley; Vice Pres. A & R: Zak Vaz.
Branch(es): 729 7th Ave., 12th Floor, New York, NY, 10019, (212) 704-4440. Fax: (212) 704-4470, Regional Mktg. Rep.: Suzette Provost, Dir. A & R (East Coast): Nadine Baker.
Label(s): (Distributed) Polygram.
- Mountain**, (See Heritage Records).
- Mountain Ghost Music**, PO Box 1291, 1130 Everett Memorial Hwy, Mt. Shasta, CA, 96067, (916) 926-2197. Pres.: Rick Johnson.
- Mountain Railroad**, (See Chameleon Music Group, Inc.).
- Moving Target**, (See Celluloid Records).
- Multi-Sound Records Int'l**, 150-34 14th Ave., Whitestone, NY, 11357, (718) 767-4452. CEO & Head of Promo.: Dave Weiner; Vice Pres. Opns.: Joe Salvatto; Vice Pres. A & R: Steve Romero.
Branch(es): 10 Tahoe Circle, Pittsburg, CA, 94565, (415) 427-6858. Opns. Mgr.: Sandy Santers.
Label(s): (Owned) Altered, Multi-Sound, Nitro.
- Murbo**, (See Bourne Co.).
- Muscle Shoals Sound Studios**, PO Box 915, 1000 Alabama Ave., Sheffield, AL, 35660, (205) 381-2060. Fax: (205) 381-6813. Pres.: Jimmy Johnson; Vice Pres.: Bill Issacs.
Branch(es): 47 Music Sq., East, Nashville, TN, 37203, (615) 327-0440. Contact: Bill Issacs.
- Muse Records (A div. of Blanchrist, Inc.)**, 160 W. 71st St., New York, NY, 10023, (212) 873-2020. Pres.: Joe Fields; Sales Mgr./Mktg.: Renne Steele; Promo. Mgr.: Barney Fields.
- Musi-Poe**, (See Sid Kleiner Music).
- Music & Arts Programs of America, Inc.**, PO Box 771, Berkeley, CA, 94701, (510) 525-4583. Fax: (510) 524-2111. Pres.: Frederick J. Maroth; Vice Pres.: Dr. Douglas Giancoli; Sec./Treas.: Marsha Berman; Sales Mgr.: Mark Freeman.
Label(s): (Owned) Audax, Crutain Call, Recital, Bruno Walter Society.
US Reps.: Allegro Imports Dist. (OR).
Int'l Reps.: Teldec Import Service (West Germany); Music Tokyo (Japan); New Trade Int'l (France); Florence Int'l (Italy); Baltic (Belgium).
- Music Box/Pan Vox**, (See Rashid Sales Co.).
- Music Craftshop, Inc.**, PO Box 22325, 1012 18th Ave. S., Nashville, TN, 37212, (615) 327-7988. Fax: (615) 321-0464. Pres.: David N. Gibson; A & R/Publicity: Brenda L. Madden.
Label(s): (Owned) Devil Wind, Phase II, Phono.
US Reps.: Nationwide Sound Dist.
- Music For Little People**, PO Box 1460, 1144 Redway Dr., Redway, CA, 95560, (707) 923-3991. Fax: (707) 923-3241. Pres.: Leib Ostrow; Vice Pres. Sales: Stuart Schonfield; Vice Pres. Mktg.: Ron Jones; Promo.: Anna Cherekovsky; Vice Pres. Record Div.: Jim Deerhawk.
Label(s): (Owned) Earth Beat! World Music, Music For Little People, (Distributed) Lemonstone, Robogie, Tickletune Typhoon.
Int'l Reps.: MSI, Inc. (Japan); Zhure Ltd. (Hong Kong).
- Music House Records**, 23 Maureen Dr., Mount Sinai, NY, 11766, (516) 928-2425. Fax: (516) 698-0152. Pres./A & R Rep.: Michael Dominic; Vice Pres./A & R Rep.: Cathy Giampietro.
Label(s): (Owned) Music House Prods.
- Music Minus One**, (See MMO Music Group/Pocket Songs).
- Music Services Of America**, 429 S. Lewis Rd., Royersford, PA, 19468, (215) 948-8228. Fax: (215) 948-4175. Pres.: Jim Femino; Dir. Sales & Mktg.: Tom Simpson; Vice Pres. A & R: Paul Zotter; A & R Rep.: John Fairhead.
Label(s): (Owned) Road.
- Music West Records**, PO Box 9429, San Rafael, CA, 94912, (415) 459-6800. Fax: (415) 459-4801. Pres./CEO: Allan Kaplan; Sales Mgr.: Anthony King.
Label(s): (Owned) Music West.
US Reps.: Navarre Corp. (MN); Rock Bottom (FL); Select-O-Hits, Inc. (TN); Encore Dist. (CO); Pyramid (CA); Real to Reel (CA); Silo (VT); New Leaf (GA); True Sound (WA).
Int'l Reps.: Aquamarin Verlag (W. Germany); Fonix Music (Denmark); Arpa Folk (Spain); Judy S.A. (Mexico); Chiang Huat Co. Pte. Ltd. (Singapore); Octo Arts Int'l, Inc. (Philippines); Oreade (Holland); Les Folies Art (Italy); Musicavision (Chile); Nature & decouvertes Air Park (France); Attic Records Ltd. (Canada).
- Music Workx Recording Corp.**, PO Box 684, Boston, MA, 02112, (617) 288-6003. Fax: (617) 282-6988. Pres. & CEO: Cassandra S. Cooper; Exec. Vice Pres.: Lawrence E. Blick; Dir. Southern Region: LaWanda C. Marshall; Vice Pres. A & R: Darrel S. Clay.
Branch(es): 210 Sullivan Dr., Memphis, TN, 38109, (901) 332-1200, Dir. Southern Region: LaWanda C. Marshall; PO Box 39, c/o Smash Sound, 4 Weber St., Pottersville, Dominican Repub, (809) 44-84134. Fax: Same. Contact: Chris Seraphine.
US Reps.: Music Workx (MA, TN).
- Music World**, (See Ralph L. Seltzer).
- Music Of The World, Ltd.**, PO Box 3620, Chapel Hill, NC, 27515, (919) 932-9600. Fax: (919) 932-9700. Pres./Producer: Bob Haddad; Art Dir.: Martha Lorantos.
Label(s): (Owned) Music Of The World.
US Reps.: Zango (CA); Rounder (MA); Silo (VT); Precision (WA); New Leaf (GA); Old Fogey Dist. (MI); Paradigm (CA).
Int'l Reps.: Dist. Fusion (Canada); Hieronymus (Finland); Bellaphon (Germany); Bomga (Japan); Music Consort AG (Switzerland); Music & Worlds (Holland); D A M (France); I R D (Italy); Comus (New Zealand).
- Musica Femina Flute-Guitar Duo**, PO Box 15121, 1718 SE 42nd St., Portland, OR, 97215, (503) 233-1206. Sole Proprietor/Artist: Kristian Aspen; Artist: Janna MacAustan.
Label(s): (Owned) Lilac.
US Reps.: Paradigm (CA); Goldenrod/Horizon (MI); Ladysliper, Inc. (NC); Lifedance (OR).
- Musical Heritage Society**, 1710 Hwy. 35, Asbury Park, NJ, 07712, (201) 531-7000. Fax: (201) 531-9686. Pres.: Albert Nissim; Exec. Vice Pres.: Jeffrey Nissim.
- Musical Prodn., Inc.**, 1472 NW 78th Ave., Miami, FL, 33126, (305) 592-4836. Fax: (305) 592-4828. Pres.: Antonio Moreno; Vice Pres.: Julia Moreno; Gen. Mgr. & Promo.: Carlos Paez; Sales Mgr.: Pedro Hereu; Vice Pres. A & R: Julio Gunda Merced.
Label(s): (Owned) MP, (Distributed) FM.
US Reps.: MP (NY), (CA), (PR).
- MusicaMaker**, (See Southern Sound Prods.).
- MusicaMasters**, 1710 Hwy. 35, Ocean, NJ, 07712, (908) 531-3375. Fax: (908) 531-9686. Pres.: Jeffrey Nissim; Dir.: Larry Palmacci; Prod. Mgr.: Alex Demidenko; Contract Admin.: Maryann Rogica.
Label(s): (Distributed) Hardtucket Entertainment.
Int'l Reps.: Nippon Phonogram (Japan); PolyGram Jazz (Netherlands).
- Musicoor Records**, PO Box 240H, Scarsdale, NY, 10583, (212) 246-9600. Pres.: Arthur Talmadge.
Label(s): (Owned) Double Feature, Dynamo, Musicoor, Skokie.
- MusicaTrac**, (See Trend/Discography Records).
- MusicaCrafters**, PO Box 1061, Willow Grove, PA, 19090, (215) 657-8863. Pres./Creative Dir.: Lou deLise; Vice Pres./Sales: Elena Marino.

- Int'l Repts.: The Music People, Ltd. (Toronto, ON, Canada).
Musidisc S.A., 143 Ave. B, #5A, New York, NY, 10009, (212) 529-5881. Fax: (212) 529-5882. Gen. Mgr., Bus. Affairs: Goran Andersson; A & R, Promos.: Maria Jimenez. Label(s): (Owned) Accord, America, Jazz Anthology.
Must Rock Prodn., c/o Jacobson & Cofin, P.C., 156 Fifth Ave., Ste. 434, New York, NY, 10010, (212) 691-5630. Fax: (212) 645-5038. Pres.: Ivan "Doc" Rodriguez; Business Affairs: Jeffrey E. Jacobson.
Myriah Jun Publishing, (See I AM Records).
Myrrh, (See Word, Inc.).
Mystery Music Inc., 2520 Cedar Elm, Plano, TX, 75075, (214) 867-6656. Fax: (214) 867-6657. Pres.: Michael M. Murphey; Vice Pres.: P.L. Murphey.
Mystic Records, Inc., PO Box 1596, 333 Via Vera Cruz, San Marcos, CA, 92069, (619) 945-2412. Fax: (619) 729-6760. Owner: Doug Moody. Label(s): (Owned) Clock, Hollyweird Maxy Wax, Mystic, Mystic CD, Mystic Cassettes, Thrash, Super Seven Seven Inch. US Repts.: Doug Moody Prodn. (CA).
Mystique, (See Rising Star Prodn.).
- N**
- NALR**, (See Epoch Universal Publications).
N.A.M.E. Brand Records, PO Box 26034, Richmond, VA, 23260, 2218 Rosewood Ave., Richmond, VA, 23220, (804) 355-3586. Fax: (804) 359-8901. Pres.: J. Plunky Branch; Vice Pres.: P. Muzi Branch; Gen. Mgr.: Khari Branch. Label(s): (Distributed) BlackFire.
NFS Records, Inc., 502 Park Ave., Ste. 9-D, New York, NY, 10022, (212) 223-3871. Chrmn./Theodore B. Shapiro; Pres.: Lloyd Price; Promo. Dir.: Cathy Bergman.
NMI, (See 3 G's Industries, Inc.).
NSD Records, PO Box 23262, 1012 18th Ave. S., Nashville, TN, 37202, (615) 327-7988. Fax: (615) 321-0464. Pres.: Joe Gibson; Vice Pres.: Noel Gibson; Promo. Dir.: Betty Gibson; Office Mgr.: Brenda L. Madden.
NSD Records, (See Nationwide Sound Distributors).
N.S.O. Records, 267 E. Township Line Rd., Upper Darby, PA, 19082, (25) 449-7130. Pres.: Nicholas Stoios.
Napu Records Int'l, PO Box 1036, 213 Hessler Place, Agana, GU, 96910, (671) 472-1600, (671) 472-3303. Fax: (671) 477-6860. Chrmn./Pres/CEO: Jimmy Dee; Vice Pres./Gen. Mgr.: Jackie Flores. Label(s): (Owned) Napu.
Narada Prodn., Inc., 1845 N. Farwell Ave., Milwaukee, WI, 53202, (414) 272-6700. Fax: (414) 272-6131. Pres: John Morey; Dir. Artist Development: Diane Almond; Dir. Int'l Sales/Mktg.: John Azzaro; A & R Dir.: Michael Sullivan; A & R: Dan Chase. Branch(es): Jacobus Pennweg 2, Hilversum, 1217 JH, Netherlands, 0113135238462, Fax: 011313542090, Dir. of Sales Mktg.: Jaap Houtingh. Label(s): (Owned) Antiquity, Narada, Sona Gaia.
Nashville Allstar, (See Rains Recording Co.).
Nashville Bluegrass, (See Jack Lynch Music Group; Nashville Country Prodn.).
Nashville Country Prodn., 306 Millwood Dr., Nashville, TN, 37217, (615) 366-9999. Pres.: Jack Lynch. Label(s): (Owned) Jaly, Nashville Bluegrass. US Repts.: Nashville Music Sales (TN).
Nashville Int'l Music Group, PO Box 121076, Nashville, TN, 37212, (615) 244-5357. Fax: (615) 383-9181. Pres.: Reggie M. Churchill; Vice Pres. A & R: Mark Churchwell; Sec./Treas.: Laurie Stephens. Label(s): (Owned) Nashville Int'l, (Distributed) Phoenix.
Nasser-El-Sadat, (See Kison Elyon Records).
Nasymix Records, 1809 Seventh Ave., 800 Tower Bldg., Seattle, WA, 98101, (206) 292-8772. Fax: (206) 292-8727. Pres.: Ed Locke; Vice Pres. Sales & Mktg.: Bernie Horowitz; Vice Pres. Nat'l Promos.: Ramon Wells; Dir. Nat'l Radio Promo.: Nes Rodriguez. Int'l Repts.: Festival (Australia); A & M (Canada); BCM (Germany); Oct Arts (Philippines).
Nationwide Black Radio, (See CDE Records & Tapes).
Nationwide Sound Distributors, 1012 18th Ave. S., Nashville, TN, 37212, (615) 327-7980. Pres.: Joe F. Gibson; Vice Pres.: David N. Gibson. Label(s): (Owned) NSD Records.
Natural Visions, (See SOAR Sound of America Records).
Nebula Records, 8867 Highland Rd., Ste. 206, Baton Rouge, LA, 70808, (504) 336-4877. Fax: (504) 336-9678. Pres.: Victor E. Sachse; Vice Pres. A & R: Clyde P. Rolston. Label(s): (Owned) Nebula. US Repts.: Twinbrook, Precision Sound, Encore, Action, Rock Bottom, Music Craft, Paulstarr.
Needle-Mate, (See Rains Recording Co.).
Neon, (See Guajiro Records, Inc.).
Neptune, (See Philadelphia Int'l Records).
Nerve-c/o Jacobson & Cofin, P.C., 156 Fifth Ave., Ste. 434, New York, NY, 10010, (212) 691-5630. Fax: (212) 645-5038. Counsel: Jeffrey E. Jacobson.
Nervous, (See Max Entertainment, Inc.).
Nesak Int'l, PO Box 588, Florham Park, NJ, 07932, 460 Ridgedale Ave., East Hanover, NJ, 07932, (201) 808-9776. Fax: (201) 808-9664. Pres.: Martin Kasen; Gen. Mgr.: Doris Chodoroff. Label(s): (Owned) Kado. Nesak.
New Act, (See QL Records).
- New Gramophone**, (See Stanyan Record Co.).
New Orleans Records, 733 1/2 Touro St., New Orleans, LA, 70116, (504) 949-2911. Contact: Clive Wilson; Partners: Paige Van Vorst.
New Orleans, (See Sharon Prodn., Inc.).
New Orleans Soul, (See King Walk, Inc.).
New Orleans Sound, (See Great Southern Record Co., Inc.).
New Renaissance Records, PO Box 11372, Burbank, CA, 91510, (213) 913-7135. Fax: (213) 465-9802. Pres.: Ann Boleyn; Nat'l Mktg. Dir.: Brad Roberts; Nat'l Customer Serv. Dir.: Brenda Umbrell; Nat'l Radio Dir.: Kim Russo; Nat'l Promos. Dir.: Braulio Luna. Label(s): (Owned) Colossal, (Distributed) Embalming, Rocking Horse. Int'l Repts.: Semaphore (Netherlands); Cargo (Canada).
New World Records, 2309 N. 36th St., #11, Milwaukee, WI, 53210, (414) 445-4872. Pres.: Marvell Love; Exec. Sec. Sales: Bettie R. Holt; Promo. Dir. Mktg.: Tony Washington. US Repts.: Dairyland Prodn., Inc. (WI).
New World Records—Recorded Anthology of American Music Inc., 701 Seventh Ave., 7th Floor, New York, NY, 10036, (212) 302-0460. Fax: (212) 944-1922. Pres.: Herman Krawitz; Dir. Mktg.: Paul Marotta; A & R Admin.: Fredrick Lonberg-Holm.
Newport Classic Ltd., 106 Putnam St., Providence, RI, 02909, (401) 421-8143. Fax: (401) 421-8154. Pres.: Lawrence J. Kramen; Vice Pres.: Shelley Kraman; Vice Pres. A & R: Jackson Braider. Label(s): (Owned) Newport Classic, Newport Classic Premier. US Repts.: Allegro Imports (OR). Int'l Repts.: Rare Records (Canada).
Next Plateau Records, Inc., 1650 Broadway, Ste. 1103, New York, NY, 10019, (212) 541-7640. Fax: (212) 315-0286. Pres.: Eddie O'Loughlin; Exec. V. Pres./Gen. Mgr.: Jenniene Leclercq; Vice Pres. Osns.: Dale Roadcap; Comptroller: Michael Healy; Sales & Prodn. Mgr.: Judy Herman; Promo Mgr.: Heidi Spiegel. Label(s): (Owned) Next Plateau, (Distributed) Soundcheck. US Repts.: Accoc. Distributors (AZ); CRD (CA); JFL Distributors (FL); Music Craft (HI); M.S. Distributors (IL); Frankie's Music (LA); Schwartz Brothers (MD); Malverne Distributors (NY); Select-O-Hits (TN); Music Craft Distributors (HI).
Next Step Records, 912 E. Third St., Ste. 104, Los Angeles, CA, 90013, (213) 617-3362. Fax: (213) 617-1544. Pres.: Barbara Wright.
Nickel Records Int'l, 753 Capitol Ave., Hartford, CT, 06106, (203) 951-8175. Pres./Producer: Jack Stang; Studio Mgr./Engineer: Jon Bolduc; Engineer: Jeff Anderson; Vice Pres. A & R: Barbara Ginsberg. US Repts.: Associated Independent's.
Joseph Nicoletti Music Co., PO Box 2818, Newport Beach, CA, 92659, (714) 494-0181. Fax: (714) 494-0982. Consultant: Al DeLory. Label(s): (Owned) California Int'l, Creative Network Co., Global Village.
Night Life, (See Sea Breeze Record Co.).
Night Owl, (See American Music Co.).
Night Sky, (See DA Music USA).
Nighthawk Records, PO Box 15856, Saint Louis, MO, 63114, 12643 Redcoat, Saint Louis, MO, 63043, (314) 576-1569. Fax: (314) 576-6960. Dir./Pres.: Robert Schoenfeld; Vice Pres. A & R/Creative Dir.: Leroy Pierson; Promo. Dir.: Patty St. John. US Repts.: Action Music (OH); Chin-Randy's, V.P. Records (NY); City Hall (CA); Gemini (GA); House (KS); Landmark (IL); Old Forge, Tant Ent. (MI); Performance, Richman Bros. (NJ); RAS (MD); Rounder (MA); Silo (VT); Music Craft Dist. (HI). Int'l Repts.: Amigo Musik (Sweden); Melodie (France); DownBeat, Fotofon, Garageland, Irie Records (Germany); Fat Shadow, Jet Star Phonographics, Topic Records (England); Groovy Music, Munich Records, Semaphore (The Netherlands); Int'l Record Dist. (Italy).
Nightingale, (See Open Sky Records).
Nightly Records, 230 Fifth Ave., Ste. 1818, New York, NY, 10010, (212) 684-7723. Fax: (212) 684-7748. Pres./Gen. Mgr.: Philippe Pigot; Sales & Mktg. Mgr.: Rick Fuhrman; Distribution Mgr.: Mel Fuhrman; Promo. Dept.: Pierre Zonzon. Label(s): (Owned) Nightly. US Repts.: Schwartz Bros. (GA); Unique (NY); J.F.L. (FL); Select-O-Hits (TN); Encore (CO); M.S. (IL). Int'l Repts.: Nightly France (France).
Nightstar Records, Inc., PO Box 602, 20 Longfellow Dr., Yarmouthport, MA, 02675, (508) 385-2199. Fax: (508) 398-2866. Pres./A & R Person: David M. Robbins; Vice Pres. Sales: Deborah Thatcher; Mktg. Mgr.: Sarah White; Vice Pres. Label: Daniel Reid. Label(s): (Owned) Nightstar. US Repts.: Select-O-Hits (TN); Rock Bottom (FL); Associated (AZ); New Leaf (GA); Music N/H (NH).
Nightwind, (See Fireball Records).
Nimbus Records, Ltd., PO Box 7427, Charlottesville, VA, 22906, Rt. 629 Guildford Farm, Ruckersville, VA, 22968, (804) 985-1100. Fax: (804) 985-3953. Vice Pres. Sales/Mktg.: Peter Elliott; Pres./Promos Mgr.: Sharon McCord; Mktg. Asst.: Deborah Plummer; Customer Service Asst.: Sarah Fears. Label(s): (Owned) Hermes, Prima Voce.
Nineveh, (See Thomas Wiggins Associates).
Nirvana Records, PO Box 285, Westfield, NJ, 07091, (908) 664-6505. Pres./Gen. Mgr.: Marc Zydiak.
Nise Prodn., Inc., 413 Cooper St., Camden, NJ, 08102, (609) 963-6400. Fax: (609) 964-3291. Controller: Frank Nise; Pres.: Michael Nise; Exec. Vice Pres.: Sandy Perchetti; Vice Pres. Mktg.: Aaisha Ali. Label(s): (Owned) Power Up.
Nite Records, PO Box 46666, 8287 Grand View Dr., Los Angeles, CA, 90046, (213) 650-7474. Pres.: Randy K. Nite; A & R Dir.: Edith Kiss; A & R: Cheri Tschannel; Publicity/Admin.: Dayna Colvin.
Nitro, (See Multi-Sound Records Int'l).
No-Bull Records, PO Box 21118, 22221 Cynthia Ct., Castro Valley, CA, 94546, (415) 538-6195. Fax: (415) 889-8533. CEO/Producer Mktg. Dir.: Thomas Wiggins; Producer Country Music: Pete Dracopoulos; Gospel Music Producer: Emmit Powell. Label(s): (Owned) Elite.
No Loose Change Music, 70 Carmine St., #2F, New York, NY, 10014, (212) 741-3968. Managing Dir.: Dennis Morouse.
No Speak, (See I.R.S. Records).
Noazart Prodn., 15920 177th Ave. NE, Woodinville, WA, 98072, (206) 485-5357. Pres.: Creed Noah. Vice Pres. Fin. & Admin.: Susan Day; Sec./Treas.: Mary Noah; Artist: Tim Noah; Vice Pres. A & R: Creed Noah. US Repts.: A & M (CA).
Noise Int'l, 5 Crosby St., 5th Floor, New York, NY, 10013, (212) 334-9268. Fax: (212) 925-4745. Pres./CEO: Karl Walterbach; Label Mgr.: Dean Brownrot. US Repts.: BMG, EPIC, RCA (NY).
Nonesuch, (See Warner Music Int'l).
Norfolk Int'l, (See Legrand Records Int'l).
Norskdisk, (See Lindbergh Records).
North Star Records, Inc., 95 Hathaway St., Providence, RI, 02907, (401) 785-8400, (800) 346-2706. Fax: (401) 785-8404. Founder/Pres.: Richard Waterman; Exec. Vice Pres.: Bruce Foulke; Vice Pres. Promos./Pub.: Virginia E. Shea; Vice Pres. Direct Mktg.: Paul Mason; Sales Mgr.: Jim Landis. US Repts.: Encore (CO); Lifedance Dist. (OR); Music Design (WI); Old Forge Dist. (MI); Paradigm (CA); Precision Sound Mark (LA); (TX); Richman Bros. (NJ); (MD); Rock Bottom, Inc. (GA); (FL); (TX); Rounder (CO); (NY); (MD); (GA); (TN); Silo (VT). Int'l Repts.: C.M. Dist. (North Yorkshire); Festival (Canada), Moth Group (England); Twinbrook Music (West Europe).
Northcott Productions, Ltd., 972 Lexington Ave., New York, NY, 10021, (212) 472-7975. Fax: (212) 904-1737. Pres.: Silvio Tancredi; Vice Pres.: Tommy Musto; Promo: Damon Wilde. Label(s): (Owned) Atmosphere Records, Fourth Floor, (Distributed) Fokus.
Northeastern Records, PO Box 3589, Saxonville, MA, 01701, (508) 820-4440. Fax: (508) 820-7769. Pres./Dir. A & R: Lynn Joiner; Promos. Dir.: Bill Ewing. Label(s): (Owned) Northeastern, (Distributed) Gagliano. Kochlen. US Repts.: Rounder Dist. (MA); Popular Arts Dist. (KS); Precision Sound Mktg. (WA); Rock Bottom Dist. (FL). Int'l Repts.: EBS Recording & Mgmt., Inc. (Canada); Koch Int'l (Amsterdam), (Austria), (London), (Australia); Music Tokyo Co. (Japan); Chiang Huat Co. (Singapore), Festival Records (Canada).
Not Yet, (See Winners Circle Records).
Nota (Note) Publishing, 1472 N.W. 78th Ave., Miami, FL, 33126, (305) 592-4836. Fax: (305) 592-4828. Pres. Antonio Moreno; Vice Pres./Gen. Mgr.: Julia Moreno, Promotor Carlos Paez. Mgr.: Pedro Huru. Label(s): (Owned) MP, (Distributed) FM.
Nouveau, (See K-tel Int'l (USA), Inc.).
Nova Records, Inc., 1730 Olympic Blvd., Santa Monica, CA, 90404, Pres.: David B. Gimpel; Dir. Radio Prmo.: Ross Harper; Dir. Mktg.: Lue Cuellar, Customer Relations Dir.: Fred Benner; Prod. & Int'l A & R: Mike Shapiro. Label(s): (Owned) Nova, (Distributed) Lipstick, Branchid, Taylor Made, White Light Prodn. Int'l Repts.: Navarre Corp., Twinbrook Music, Rock Bottom, Inc., Precision Sound, JVC Majors (Japan); IMS (Holland); IMS (Germany); Schuttfreer (France); Incognito Records (Australia); Chiang Huat. (Singapore & Malaysia), Hae Doney (Korea); Enfasis (Spain).
Now and Then Records, 412 E. 78th St., #2-A, New York, NY, 10021, (212) 879-4667. Pres.: Shane Faber.
Nowo USA, 67 Henry St., Englewood, NJ, 07631, (201) 568-8186. Pres.: Marco Rho, Exec. Vice Pres.: Barbara Borghi.
Nu-Kountry Records, 56 Ravenscroft Dr., Asheville, NC, 28801, (704) 254-8000. Contact: Ron Weathers, Eddie Swann.
Nucleus, (See Roots Music).
Nucleus Records, PO Box 111, Sea Bright, NJ, 07760, (201) 823-8718. Pres.: Robert Bowden; Vice Pres.: Gloria Bowen. Label(s): (Owned) Nucleus. US Repts.: Nucleus (NJ).
- O**
- OJL**, (See Origin Jazz Library).
O.K. Records, PO Box 95413, Seattle, WA, 98145, (206) 547-7434. Pres.: Michael Cox; A & R Dir.: Jock Scott; Prodn. Dir.: Mick Edwards; Promo. Dir.: Kip Martin. Label(s): (Owned) AAA Ltd., K.O.
O.L. Records, 42 Music Sq., W. Ste. 133, Nashville, TN, 37203, (213) 946-1524. Fax: (213) 946-8039. Dir.: Overton Lee; Mktg./Promo./A & R: Willi Beery; Sales/Mktg.: Jim Chadick. Label(s): (Owned) New Act, O.L. OT, (See On Top Records, Inc.).
Oak Lawn Records Co., Inc., 3810 Congress Ave., #115, Dallas, TX, 75219, (214) 520-2855. Pres.: Raymond C. Cooper, Vice

- Pres.: David Hilzendager; Promo: Jimmy Bartlett.
US Reps.: J.D.C. (CA); Jerry Basin, JFL (FL); Justin, Nova Dist., Hits Unlimited (IL); R.T.I. (NE); Unique Record, Watts Music (NY); Select-O-Hits (TN); Big State (TX).
- Oakridge Music Recording Service**, 2001 Elton Rd., Hallam City, TX, 76117, (817) 838-8001. Owner: Homer Lee Sewell. Label(s): (Owned) Crossfire.
- Obscure**, PO Box 19384, 4805 Baudin St., New Orleans, LA, 70179, (504) 482-6922. Pres.: John G. Aulin; Vice Pres.: Nora Wixted; Prod./Promo: Louie Ludwig.
- Observer Records**, 156 Fifth Ave., Ste. 434, New York, NY, 10010, (212) 691-5630. Fax: (212) 645-5038. Pres.: Winston "Ninety" Holness; Business Affairs: Bruce E. Coffin. US Reps.: Shanachie (NJ); ROIR (NY); Rounder (MA).
- Obsolete**, (See International Record Corp.).
- Oceana Records Ltd.**, 2700 N. 29th Ave., #200-S, Hollywood, FL, 33020, (305) 921-5555. Fax: (305) 921-5688. Pres.: Carl Maduri; Vice Pres. Sales/Mktg.: Gene Mahler; Nat'l Promos. Dir.: Debra Teague; Publicity Dir.: Violet Szilvas. US Reps.: BMG Dist. (NY).
- Oh Boy Records**, PO Box 36099, Los Angeles, CA, 90010, (213) 385-0882. Fax: (213) 385-3424. Pres.: Al Bunetta; Vice Pres.: Dan Einste'n.
- Old Homestead Records**, Box 100, Brighton, MI, 48116, (313) 227-1997. Pres.: John Morris; Exec. Asst.: Wilma Gray. Label(s): (Owned) Broadway, Rutabaga. US Reps.: Record Depot (VA); Rounder Records (MA).
- Olivia Records**, 4400 Market St., Oakland, CA, 94608, (510) 655-0364. Fax: (510) 655-4334. Pres.: Judy Diagacz; Mktg.: Andrea Personette; Promo/Record Dev.: Annice Jacoby. Label(s): (Owned) Olivia, Second Wave.
- Olmer**, (See Meda Records, Inc.).
- Olympic**, (See Everest Record Group).
- Olympus Records**, 1559 W. Fifth St., Brooklyn, NY, 11204, (718) 837-7335. Pres.: Steve Camhi; Vice Pres.: Joe Badlotto; Victor Carew.
- Omega Record Group**, 27 W. 72nd St., New York, NY, 10023, (212) 769-3060. Fax: (212) 769-3195. Pres./Mng. Dir.: Seymour Solomon; Opns. Mgr.: Wendy Simon; Controller: Fred Passick. US Reps.: Encore (CO), M.S. (IL); Schwartz Bros. (MD); Malverne (NY); Big State (TX). Int'l Reps.: Arcade Benelux (The Netherlands); King (Japan).
- Omni Records, Inc.**, PO Box 917, Bala Cynwyd, PA, 19004, (215) 828-7030. Pres.: Steve Bernstein. Label(s): (Owned) WMOT.
- On Time**, (See DNA Int'l, Inc.).
- On Top Records, Inc.**, 3081 NW 24th St., Miami, FL, 33179, (305) 635-7469. Fax: (305) 633-7127. Pres.: Jose Armada, Sr.; Allen L. Johnston; Vice Pres. Promos. A & R: Rod Kenney, Sr.; Gen. Mgr.: Luz Marina Fernandez; Nat'l Promo. Mgr.: Karin F. Evertz. Label(s): (Owned) OT. US Reps.: CRD (CA); Bassin (FL); Schwartz (MD); Big State (TX); Select-O-Hits (TN).
- 109 Records, Inc.**, 115 St. Mark's Place, New York, NY, 10009, (212) 363-3105. Fax: (212) 363-3105. Pres./A & R: Steven Jay Gabe; Publicity/Promo: Kristen Johnson. US Reps.: Caroline Records (NY); Dutch East India Trading Dist. (NY). Int'l Reps.: Semaphore (Netherlands).
- Onna Roll Records, Inc.**, 92-40 Queens Blvd., Ste. 3B, Forest Hills, NY, 11374, (718) 424-8562. Fax: (718) 587-5516. Pres.: Al Jankowsky; Vice Pres.: Eugene Colza; Asst. Vice Pres.: Javier Valdes, Jr.; Promos.: Gabriel Ortiz; Vice Pres. A & R: Javier Valdes, Jr. US Reps.: CRD (CA); Malverne (NY); Music Dist., Inc. (TX).
- The Onyx Star**, PO Box 434, Madison, AL, 35758, (205) 656-0426. Pres.: Clifford M. VanBuren; Vice Pres.: Donna M. VanBuren.
- Oopst!**, (See Pandisc Records).
- Open**, (See Loadstone Record & Music Co.).
- Open Door Record, Inc.**, 322 T St., NW, Washington, DC, 20001, (202) 483-1290. Pres.: David L. Sweeney; Vice Pres.: Anthony E. Daughtry; A & R Dir.: Harold Sweeney; Mktg./Sales Dir.: Brian Green.
- Open Sky Records**, 10735 Vernon, Huntington Woods, MI, 48070, (313) 546-7558. Pres.: Martin Scott Kosins; Chief Engineer: Danny Dallas; Vice Pres. A & R: Joyce Jerow. Label(s): (Owned) Nightingale, Open Sky. US Reps.: Harmony House (MI).
- Optimism Incorporated**, 6355 Topanga Canyon Blvd., Ste. 309, Woodland Hills, CA, 91367, (818) 346-6286. Fax: (818) 346-2968. Pres. Mktg./Sales: David Drozen; Vice Pres. Radio Promo.: Kathy McQuade; Brenda Winfield; Vice Pres. A & R: Sheryl Kay. Label(s): (Owned) L & R, (Distributed) Silver Wave.
- The Orange Record Co., Inc.**, 2166 W. Broadway, Ste. 119, Anaheim, CA, 92804, (714) 525-5223. Pres.: Maxwell Edison; Assoc. Dir. A & R: Tracy Sands; Vice Pres. A & R: Harold Shmouquet. Label(s): (Owned) Beat, Orange, Pastel, Phuktup, Swak. US Reps.: TSMS/SWAK (CA).
- Orange Records**, 156 Fifth Avenue, Suite 434, New York, NY, 10010, (212) 691-5630. Fax: (212) 645-5038. Pres.: David Peel; Business Affairs: Jeffrey E. Jacobson.
- Orbit Records**, PO Box 120675, 1300 Division St., Ste. 100, Nashville, TN, 37212, (615) 255-1068. Pres.: Ray McGinnis; A & R: Chuck McGinnis.
- O'retta**, (See Daran Records).
- The Organ Literature Foundation**, 45 Norfolk Rd., Braintree, MA, 02184, (617) 848-1388. Pres.: Henry Karl Baker.
- Label(s): (Owned) Dorc, Festivo, Gallo, Motette, (Distributed) Pape Verlay, Piccadilly.
- Orient**, (See Rashid Sales Co.).
- Origin Jazz Library**, PO Box 85, 330 Calif, #302, Santa Monica, CA, 90406, (213) 395-5739. Owner/Dir.: Bill Givens. Label(s): (Owned) OJL, (Distributed) Sunbeam, Testament, Texas Rose. US Reps.: City Hall (CA); Rounder Dist. (MA); More Records (CA).
- Original Cast Records**, PO Box 496, 5 Catoonah, Georgetown, CT, 06829, (203) 438-2663. Pres.: Bruce Yeko; Sales: Jennifer Yeko. Label(s): (Owned) Broadway Baby, Film Score, Original Cast, Take Home Tunes.
- Original Jazz Classics**, (See Fantasy, Inc.).
- Original Master Recording**, (See Mobile Fidelity Sound Lab).
- Original Sound Record Co., Inc.**, 7120 Sunset Blvd., Hollywood, CA, 90046, (213) 851-2500. Fax: (213) 851-8162. Pres.: Art Laboe; Gen. Mgr.: Nanette Leone; Vice Pres.: Paul Politi; Dir. A & R/Sales/Promos: Steve Pina. Label(s): (Owned) Original Sound.
- Orinda Records**, 111 Deerwood Place, Ste. 200, San Ramon, CA, 94583, (415) 831-4890. Fax: (415) 831-9278. Chrmn.: Michael Robert Phillips; Pres.: C.J. Black; A & R Dir.: Harry Balk; Technical Dir.: Joe Tarantino.
- Orleans Records**, 828 Royal St., #536, New Orleans, LA, 70116, (504) 361-1643. Fax: (504) 361-1643. Pres.: Carlo Ditta; Mktg. & Promo. Dir.: Russell Protti. US Reps.: Rounder Record Dist. (MA); North Country Dist. (NY); Pualstarr Dist. (MN); United Record Dist. (TN); I.D.C. (CA); Bayside Record Dist. (CA); Rock Bottom, Inc. (GA). Int'l Reps.: Festival Records (Canada); Spin Off (England); Vivid Sound Corp. (Japan).
- Other World Records**, 203 Chapel Ave., Nashville, TN, 37206, (615) 226-4240. Pres.: C. Floyd; Vice Pres./Dir. Promo.: Nathan Hill; Vice Pres./Dir. A & R: V. A. Smith; Vice Pres./Dir. Mktg.: N. F. Rau.
- Outer Limits**, (See Quark, Inc.).
- Outstanding Records**, PO Box 2111, Huntington Beach, CA, 92647. Owner: Earl Beecher. Label(s): (Owned) Morphym, Outstanding.
- Oxymoron P & D, Inc.**, PO Box 3366, Lynnwood, WA, 98046, (206) 787-1037. Fax: (206) 787-1039. Vice Pres. Domestic Sales: David Love; Vice Pres. Int'l Sales: Doug Lexa. Branch(es): 9532 Quaker Town Ave., Chatsworth, CA, 31311, (818) 886-2650. Fax: (818) 886-6079. Vice Pres. Int'l Sales: Doug Lexa.
- Ozark Opry Records**, PO Box 242, Osage Beach, MO, 65065, (314) 348-3383. Pres.: Joyce Mace; Chief Engineer: Jim Phinney. Label(s): (Owned) K.R.C.

P

- PDS-Universal Entertainment Group, Inc.**, PO Box 412477, Kansas City, MO, 64141, (800) 473-7550, (816) 823-5100. Pres./CEO: Pete Shivers; Vice Pres. A & R: Derrick Peters. Label(s): (Owned) PDS, PDS Associated, Universal Jazz, (Distributed) Pryme Tyne, Paradigm. US Reps.: PDS Dist. (MO).
- P.M. Records, Inc.**, 20 Martha St., Woodc iff Lake, NJ, 07675, (201) 930-9149. Fax: (201) 391-2486. Pres.: Gene A. Perla. Label(s): (Owned) P.M., Plug.
- PPX Ents., Inc.**, 300 W. 55th St., New York, NY, 10019, (212) 247-6010. Pres.: Ed Chalpin. Label(s): (Owned) Disc Trophy.
- PWL America Records Ltd.**, 117 W. 26th St., 5th Floor, New York, NY, 10001, (212) 741-0007. Fax: (212) 243-2603. Pres.: Robert John Jones; Gen. Mgr.: Marthe Reynolds; Nat'l Mgr./Rap & Club Promo: JC Hairston; Dir. of Artist Dev.: Leslie Drye; Dir.: Brian Chin. US Reps.: Mercury Records (NY).
- Pablo**, (See Fantasy, Inc.).
- Paid Records**, 3409 Brinkman St., Houston, TX, 77018, (713) 861-4824. Fax: (713) 861-2951. Contact: H. W. "Bud" Daily; Don Daily. Label(s): (Owned) D, Paid, (Distributed); Kikr.
- Pair Records**, 560 Sylvan Ave., Englewood Cliffs, NJ, 07632, (201) 894-8700. Fax: (201) 894-8630. Managing Partner: Sam Goff; Nat'l Dir. Sales/Mktg.: Ted Wolff; Dir. A & R/Mktg.: Doug Friedman. Label(s): (Owned) Maestro, Project 3, Stradivari, Buddah, (Distributed) Arista Special Products, CBS Special Products, Camden, Capitol Special Markets, Commodore, RCA Special Products, MCA Special Products, PolyGram Special Products, Warner Bros. Special Products.
- Pallas Athehna**, (See Athena Prods.).
- Palm**, (See Criterion Music Corp.).
- Palmico Sound**, (See Sugar Hill Records, Inc.).
- Palo Alto**, (See TBA Records, Inc.).
- Palomar Records**, PO Box 1233, Santa Monica, CA, 90406, (310) 410-4951. Pres.: Bobby Manrique; Vice Pres., A & R: Kris Manrique.
- Pan-Trax Records**, 112 E. Main St., Dickson, TN, 37055, (615) 255-4606.
- Pandisc Records**, 38 NE 167th St., Miami, FL, 33162, (305) 948-6466. Fax: 305 945-1055. Pres.: Bo Crane; Dir. Finance: Gail Porter; Nat'l Mktg. Dir.: Lydia Ojeda; Nat'l Publicity Dir.: Rona Sackson; Nat'l Club Promos: Anthony Frazier. Label(s): (Owned) Jamarc, Oopst!, Pandisc, (Distributed) Rascal, Breakaway, Cut-It-Up, Def.
- Pandora/Synthe Records**, PO Box 2281, Westover, WV, 26505. Pres.: Gilbert Trythall. Label(s): (Owned) Pandora/Synthe.
- Panhandle**, (See Lamor Records).
- Papin Records**, 1020 Keeaumoku St., Honolulu, HI, 96814, (808) 523-6880. Contact: Imelda Papin.
- Parallax Records**, PO Box 16387, Jackson, MS, 39236, 123 E. State St., Ridgeland, MS, 39157, (601) 856-2525. Fax: (601) 856-9462. Pres.: James A. Griffin. Label(s): (Owned) Parallax, Patmos.
- Parc Records, Inc.**, 3016 Dade Ave., 2nd Fl., Orlando, FL, 32714, (407) 894-0021. Fax: (407) 896-4597. Pres.: Patrick J. Armstrong; Vice Pres.: Jack Armstrong; Vice Pres. Parc Studios: Andy de Ganah; Admin. Asst./Office Mgr.: Gayle K. Boulware. US Reps.: Capitol (CA); CBS/EPIC/Portrait (NY).
- Paradise Records, Inc.**, PO Box 917, Bala Cynwyd, PA, 19004, (215) 828-7030. Chairman: Steve Bernstein; Co-Chairman: Nick Martinelli.
- Paris Records**, PO Box 22502, 22512 Criswell St., West Hills, Canoga Park, CA, 91307, (818) 883-8224. Owner: Jeffrey Gordon; A & R Dir.: Champ Gordon; A & R: Irene Dayton; Robert White. Label(s): (Distributed) Paj, Polo.
- Park J Tunes**, (See TMA Records).
- Parquet**, (See The Frank Evans Record Group).
- Parrot Fish**, (See Gutu Corp./Parrot Fish Records).
- Pasado Prods.**, 3378 W. Harvard, Santa Ana, CA, 92704, (714) 957-3073. Owner: Bill Laster; Office Mgr.: Monique Merritt.
- Pasha Music Organization, Inc.**, 5615 Melrose Ave., Los Angeles, CA, 90038, (213) 466-3507. Fax: (213) 469-0122. Pres.: Spencer D. Proffer; Vice Pres./Gen. Pres.: Carol N. Peters. Label(s): (Distributed) Pasha/CBS.
- Pastel**, (See The Orange Record Co., Inc.).
- Pathways of Sound, Inc.**, 6 Craigie Cir., Cambridge, MA, 02138, (617) 354-6190. Pres.: Joe Berk; Mktg. Dir.: D. C. Littlefield. Label(s): (Owned) Credo, Pathways Of Sound.
- Patmos**, (See Parallax Records).
- Paula**, (See Sue Records, Inc.).
- Paylo**, (See Comstock Records, Ltd.).
- Payola**, (See Traditional Music Record Co.).
- Peaceable**, (See Broadbeach Records).
- Peach Town Record Co., Inc.**, PO Box 492215, 3625 Sulene Dr., College Park, GA, 30349, (404) 761-8626. Pres./A & R Rep.: Bill Freeman; Vice Pres.: Mike Freeman; Sec./Treas.: Doris Freeman.
- Peak Records, Inc.**, PO Box 24281, Nashville, TN, 37202, (615) 661-5808. Fax: (615) 661-5905. Pres.: Jerry West; Vice Pres.: Mike Young; Prof. Mgr.: Gene Michale; Vice Pres. A & R: Gary Campbell. Label(s): (Owned) Electric, Maze, Peak, Police.
- Peanut Country**, (See Legrand Records Int'l).
- Pearl**, PO Box 412, New York, NY, 10462, (212) 613-9049. Pres.: Vernon Wilson; A & R Dir.: Rick Robinson; Mktg. Dir.: Darlene Barkley.
- Peer-Southern Organization**, 810 Seventh Ave., New York, NY, 10019, (212) 265-3910. Chrmn.: Monique I. Peer; Pres.: Ralph Peer II; Vice Pres.: Mario Conti. Branch(es): 6777 Hollywood Blvd., Los Angeles, CA, 90028, (213) 469-1667, Mgr.: Ray Kohn; 7 Music Circle North, Nashville, TN, 37201, (213) 469-1667. Label(s): (Owned) Discos Monica, Monique Music Library, Spark.
- Pegasus Records**, 1609 Congress Rd., Eastover, SC, 29044, (803) 776-8397. Pres./A & R: Howard A. Knight, Jr.; Vice Pres.: Robert A. Knight. Label(s): (Owned) Boss, Colonial, Wago, HKE, (Distributed) Grape. US Reps.: Action Dist. (MD).
- Penguin Records, Inc.**, 303 SE Fifth St., Dania, FL, 33004, (305) 925-1975, (305) 573-5400. Pres.: Joe Alonso; Opns Mgr.: Greg Winters; A & R/Product Mgr.: Michael J McNamee. Label(s): (Owned) Kinetic. US Reps.: Marz Records (FL).
- Peninsula Artist**, (See The Frank Evans Record Group).
- Perfect**, (See Timeless Entertainment Corp.).
- Perfect Pitch**, (See Score Prods., Inc.).
- Period**, (See Everest Record Group).
- Periscope Record Co.**, 129 Bishop St., Brockton, MA, 02402, (508) 588-6348. Pres.: Edward M. Hurvitz; Gen. Mgr.: Linda Berman; A & R: Ed Michaels. Label(s): (Owned) Mazel, Streke.
- Permian Records, Inc.**, 3122 Sale St., Dallas, TX, 75219, (214) 522-8874. Pres.: Charles A. Robinson; Vice Pres. Promo.: Ralph Witsell.
- Perpetua Records**, 10391 Jefferson Blvd., Culver City, CA, 90232. Pres.: Ken Kreisel.
- Persepolis**, (See Thomas Wiggins Associates).
- Perspective Prods.**, 35 Forest View Dr., Providence, RI, 02904, (818) 763-2028. Pres.: Richard Doyle.
- Pet Records**, PO Box 1102, Burbank, CA, 91507, (213) 874-7656. Owner: Peter Tevis. Label(s): (Owned) Digital to Disc, Eagle, Moneytree.
- Peter Pan Industries**, 88 St. Francis St., Newark, NJ, 07105, (201) 344-4214. Fax: (201) 344-0465. Pres./CEO: Donald Kasen; Sr. Vice Pres. Product: Joseph Porrello; Vice Pres. Nat'l Sales: Shelly Rudin; Int'l Sales Mgr.: Howard Shiman. Label(s): (Owned) Compose, Ironbound. Int'l Reps.: Rainbow Music Group (Australia); Wienerworld, Interceptor Group (United Kingdom).

- Peters' Records, Inc.**, 20217 NE 15th Ct., Miami, FL, 33177, (305) 573-8750. Fax: (305) 573-9187.
- Phantom Prodn., Inc.**, PO Box 90936, 701 Brazos, Ste. 500, Austin, TX, 78709, (512) 288-1044. Fax: (512) 288-4748. Dir.: Martin Theophilus; Chris Theophilus. Label(s): (Owned) Phantom. Int'l Reprs.: IRD Int'l (Italy).
- Phase II**, (See Music Craftshop, Inc.).
- Phil-L.A. of Soul**, (See Jamie/Guyden Dist. Corp.).
- Philadelphia Int'l Records**, 309 S. Broad St., Philadelphia, PA, 19107, (215) 985-0900. Fax: (215) 985-1195. Chrmn.: K. Gamble; Vice Chrmn.: L. Huff; Exec. Vice Pres. Finance: V. Wilson; Dir. A & R: E. Johnson. Label(s): (Owned) Gamble & Huff, Neptune, TSOP, Thunder, (Distributed) House Jam. US Reprs.: Action Music (Cleveland, OH); R&B (Columbus, OH); Bassin, Jerry (Miami, FL); Big State (Dallas, TX); CA Record (San Fernando, CA); Cleveland One-Stop (Cleveland, OH); Eastern Music (Philadelphia, PA).
- Philles**, (See Phil Spector Records, Inc.).
- Philo Records**, 1 Camp St., Cambridge, MA, 02140, (617) 354-0700. Fax: (617) 491-9170. Int'l Reprs.: Topic Records (United Kingdom); Larrikin Records (Australia).
- Phoenix Records, Inc.**, PO Box 121076, Nashville, TN, 37212, Pres./Gen. Mgr.: Reggie M. Churchwell; Vice Pres. A & R: Mark Churchwell.
- Phono**, (See Music Craftshop, Inc.).
- Phukup**, (See The Orange Record Co., Inc.).
- Phunn!**, (See CITA Communications, Inc.).
- Pilot**, (See Stark Records & Tape Co.).
- Pine Wood**, (See Fink/Pinewood Records).
- Pink Street Records, Inc.**, 1830 Spruce Ave., Highland Park, IL, 60035, (708) 831-1028. Fax: (708) 831-1029. Pres.: Nick Bakulinski; Vice Pres.: Chip Altholz.
- Pioneer**, (See Sivatt Music Prodn.).
- Piper Disc, Inc.**, 29 Borage Pl., Forest Hills, NY, 11375, (212) 398-9225. Pres.: Mario A. Varoli; Vice Pres.: Beverly Brown-Varoli.
- P.I.R.A.T.E. Records**, PO Box 2712, 1222 S. Sycamore Ave., Beverly Hills, CA, 90213, (213) 938-1536. Fax: (213) 965-0601. CEO: Tony Haynes.
- Pisces**, (See Dial Records, Inc.).
- Placenta Music, Inc.**, 314 Woodward Way, NW, Atlanta, GA, 30305, (404) 355-8810. Fax: (404) 355-0795. Pres.: Fred Schwartz; Nat'l Sales Dir.: Lisa Roggow; Int'l Sales: Burt Wolff; Vice Pres. A & R: Joe Wolff. Label(s): (Owned) Placenta Music. US Reprs.: American Baby Concepts (IA); New Leaf (GA); Music For Little People (CA); Music Design (WI); Justin (GA). Int'l Reprs.: Skyhigh Music (China); Nippon Television (Japan); Jigu Records (Korea); Swissteo Enterprise (Singapore); Sony Music Int'l (South America); New World Prodn. (Australia, New Zealand); Records Mktg. Benelux (Europe); Music India (India).
- Plain Wrap**, (See Top's Records).
- Planet Earth Records**, 325 Rolling Rock Rd., Marietta, GA, 30067, (404) 952-2012. Fax: (404) 850-0024.
- Plantation**, (See Shelby Singleton Entls., Inc.).
- Platinum Int'l Music**, 2 Music Cir. S., Nashville, TN, 37203, (615) 242-0900. Fax: (615) 255-7303. CEO: Norman Ratner; Gen. Mgr.: Marcia Flowers.
- Playback Records**, PO Box 630755, Miami, FL, 33163, (305) 935-4880. Fax: (305) 933-4007. Pres.: Jack Gale. Label(s): (Owned) Gallery II, Ridgewood. US Reprs.: Laurie Records (NJ).
- Playground**, PO Box 133, Ojai, CA, 93024, Pres.: Jim Pewter; Gen. Mgr.: Judy Pewter. Label(s): (Owned) Playground. Int'l Reprs.: The Image Music Group Pty Ltd. (Australia).
- Pleason Records**, 1727 Roanoke Ave., Sacramento, CA, 95838, (916) 925-4886. Owner: Jerry Parker. Label(s): (Owned) Pleason.
- Plug**, (See P.M. Records, Inc.).
- Pocket Songs**, (See MMO Music Group/Pocket Songs).
- Poison Ring**, (See TNA Records).
- Polaris Record Co., Inc.**, 1414 Montreal Rd., Atlanta, GA, 30084, (404) 938-1998. Fax: (404) 938-2193. Pres.: Ricky Stephenson; Vice Pres.: Marc T. Boyd; Sec.: William Robinson; Vice Pres. A & R: Diya Nabawi. US Reprs.: Landmark Dist. (GA, NY); Big State Dist. (TX).
- Police**, (See Peak Records, Inc.).
- Polish Record Center of America**, 3069 Milwaukee Ave., Chicago, IL, 60618, (312) 539-9898. Owner: Jan Wojewodka; Mgr.: Joseph Zielinski; Sales Mgr.: Alex Switaj. Label(s): (Owned) Melodia, (Distributed) Muza, Pronit, Veriton.
- Polka Towne Music**, 211 Post Ave., Westbury, NY, 11590, (516) 334-6228. Pres.: Teresa Zapolska.
- PolyGram Classics/PolyGram Records, Inc.**, 810 Seventh Ave., New York, NY, 10019, (212) 333-8100. Fax: (212) 333-8402. Pres.: Guenter Hensler; Vice Pres. DG: Nancy Phillips; Vice Pres. London: Lynne Hoffman; Vice Pres.: Nancy Zannini. Label(s): (Distributed) Black Saint/Soul Note, ECM, Gramavision, Watt.
- PolyGram Mercury—Nashville**, 901 18th Ave. S., Nashville, TN, 37212, (615) 320-0110. Fax: (615) 329-9619. Vice Pres./Gen. Mgr.: Paul Lucks; Vice Pres. Promo.: Ed Mascolo; Bobby Young; Vice Pres. Creative: Harold Shedd; Mgr. A & R: Buddy Cannon; Dir. Communications: Sandy Neese. Label(s): (Owned) Mercury.
- PolyGram Records (Country Div.)**, 901 18th Ave. S., Nashville, TN, 37212, (615) 320-0110. Fax: (615) 327-4856. Creative Vice Pres.: Harold Shedd; Vice Pres./GM Nash. Opns.: Paul Lucks; Nat'l Dir./Sales & Mktg.: Steve Miller; Dir./Communications: Sandy Neese; Mgr./A & R: Buddy Cannon.
- Pop Record Research**, 17 Piping Rock Dr., Ossining, NY, 10562, (914) 762-8499. Pres.: Gary Theroux; Sales Mgr.: Joan Holpuch; Vice Pres. A & R: Richard James. Label(s): (Owned) Surf City, GTP, (Distributed) Bob.
- Pops Neon Entls.**, PO Box 4125, West Hills, CA, 91308, (818) 887-2248. Dir./Gen. Mgr.: Steve Hobson.
- Popular Metaphysics**, (See 415 Records, Ltd.).
- Popular Records**, 888 Seventh Ave., #401, New York, NY, 10019, (212) 246-5520. Fax: (201) 836-0661. Pres.: Jurgen Korduletsch. Label(s): (Owned) Radikal. US Reprs.: RCA/BMG (NY); Cardiac Records (NY); Hot. Prod. (FL).
- Poseidon**, (See Crystal Records, Inc.).
- Positive Music Records Inc.**, PO Box 1521, Columbia, MD, 21044, (301) 750-3813. Fax: (301) 750-3813. Pres./A & R Man: Ken Navarro; CEO: Joseph Navarro; Vice Pres. Sales & Promo.: Kristin Leonhard. Label(s): (Owned) Positive Music. US Reprs.: Navarre Corp (MN & CA), Rock Bottom Dist. (FL, TX, GA), Action Music Sales (OH, MI), Motor City Dist. (MI), Associated Dist. (AZ), Twinbrook Music (NY, DC), Casa de los Lopes (PR).
- Pow Wow Records, Inc.**, 225 W. 57th St., Ste. 404, New York, NY, 10019, (212) 245-3010. Fax: (212) 956-2326. Pres.: Herb Corsack; Vice Pres.: Judy Cacase; Mktg. Dir.: Olga Dedulin. Label(s): (Owned) Pow Wow. US Reprs.: Action Music Sales (OH); Big State (TX); California Record Dist. (CA); Great Bay Dist. (MD); M.S. Dist. (IL); Malverne Dist. (NY); Schwartz Bros. Dist. (MD); Select-O-Hits (TN); Universal Dist. (PA).
- Power Up**, (See Dancin' On Air Prodn., Inc.; Nise Prodn., Inc.).
- Powerplay**, (See Boom/Powerplay Records).
- Prairie Fire, Inc.**, PO Box 9278, 5616 Dearborn, Mission, KS, 66201, (913) 831-3225. Fax: (913) 831-0199. Pres.: Chris Stout; Vice Pres. A & R: Rob Arnold.
- Prairie Music Ltd.**, PO Box 438, Walnut, IA, 51577, (712) 784-3001. Fax: (712) 784-2010. Pres.: Robert Everhart. Label(s): (Owned) Prairie Music.
- Praise Records, c/o Jacobson & Colfin, P.C.**, 156 Fifth Avenue, Suite 434, New York, NY, 10010, (212) 691-5630. Fax: (212) 645-5038. Pres.: Paul Ferrar; Business Affairs: Jeffrey E. Jacobson.
- Pray Virtue**, (See Virtue Records & Studios).
- Preamble**, (See Fifth Continent Music Corp.).
- Precision Records Corp.**, PO Box 322, Ingomar, PA, 15127, (412) 364-8660. Fax: (212) 628-9147. Pres.: Charles Surman.
- Prelude Records**, PO Box 93, 157 Chestnut Hill Rd., Trumbull, CT, 06611, (203) 261-5216. Fax: (203) 268-9124. Pres.: Armando Sciascia; Mgr.: Tom Morrison; Vice Pres. A & R: Alikli Andris.
- Premiere Artist**, (See The Frank Evans Record Group).
- Prescription Co.**, 70 Murray Ave., Port Washington, NY, 11050, (516) 767-1929. Pres.: David F. Gasman; Vice Pres. Manufacturing: John Bradley; Tour Coord.: Bill Fearns; Dist. Mgr.: Bruce Brennan; Vice Pres. A & R: Kirk Nordstrom. Label(s): (Owned) Prescription.
- President Music Corp.**, 220 Mineola Blvd., c/o Rubin & Levin, Mineola, NY, 11501, (516) 747-5190. Contact: J. E. Zerga.
- Prestige**, (See Fantasy, Inc.).
- Presto Records**, PO Box 1081, Lowell, MA, 01853, 198 River St., Ste. 1, Waltham, MA, 02154, (617) 893-2144. Pres.: Christopher Porter; Promo Dir.: Adam Boc. Label(s): (Owned) Presto. US Reprs.: Caroline, Dutch East India (NY); Twin Cities Imports (MN). Int'l Reprs.: Semaphore (The Netherlands).
- Pretty One**, (See S.W. & A. Assoc., Co.).
- Price-Less Premium**, (See Random House Mail Order).
- Prima Voce**, (See Nimbus Records, Ltd.).
- Prime Sound Recordings**, 1056 Beach & 20th St., Far Rockaway, NY, 11691, (718) 327-2091. Fax: (718) 327-2091. CEO/Pres.: Bernard Salvant; Vice Pres.: Luc E. Salvant. Label(s): (Owned) Studip Fresh.
- Primo Scree**, (See Caroline Records).
- Prince**, (See Axbar Records, Criterion Music Corp.).
- Prince/SF Publications**, 1135 Francisco St., #7, San Francisco, CA, 94109, (415) 775-9627. Artists Rep: Ken McClucelli. Label(s): (Owned) Auriga, Christmas.
- Priority Records, Inc.**, 6430 Sunset Blvd., #800, Hollywood, CA, 90028, (213) 467-0151, (800) 235-2300. Fax: (213) 856-8796. Pres.: Bryan Turner; Sr. Vice Pres.: Mark Cerami; Exec. Vice Pres. Int'l: Stephen Drath; Vice Pres. Special Mkts: Bonnie Pritchard; Vice Pres. Sales: Robert Grossi. Label(s): (Owned) Priority Rocks, (Distributed) Nu-Beat, Big League, Rap-A-Lot, Rhythm Safari.
- Private Music**, 9014 Melrose Ave., Los Angeles, CA, 90069, (213) 859-9200. Fax: (213) 859-7408. Pres./CEO: Ron Goldstein; Vice Pres. Mktg./Sales: Steve Macon; Vice Pres. Finance: Julio Proietto; Vice Pres. A & R: Jamie Cohen; Vice Pres. Publicity/Artist/Rel.: Karen Johnson.
- Pro Jazz**, (See Intersound, Inc.).
- Proart**, (See Intersound, Inc.).
- Process**, (See Country Star Int'l).
- Profile Records, Inc.**, 740 Broadway, 7th Floor, New York City, NY, 10003, (212) 529-2600. Fax: (212) 420-8216. Pres.: Cory Robbins; Vice Pres.: Steven Plotnick; Vice Pres./Black/Urban Promos.: Manny Bella. Branch(es): 8730 Sunset Blvd., Ste. 270, Los Angeles, CA, 90069, (213) 659-7999. Fax: (213) 659-3516, A & R Mgr., West Coast: Dave Moss; 10 Tech, West, Warple Way, London, W3 0RQ, United Kingdom. (44) 749-8777. Fax: (44) 749-3703. Managing Dir.: Andrew Cleary.
- Progress**, (See F & L Records).
- Progressive**, (See Jazzology Records, Inc.).
- Project 3 Records**, 211 W. 56th St., New York, NY, 10019, (212) 247-4422. Fax: (212) 262-3105. Pres.: Herbert A. Linsky. Label(s): (Owned) Seagull.
- Proton Dance**, (See Echo Records, Inc.).
- Protone Records**, 970 Bel Air Rd., Los Angeles, CA, 90077, (213) 472-5344. Dir.: Jane Courtland Welton; Assoc. Dir.: Laila Padorr Nilles.
- Proud Cock**, (See King Walk, Inc.).
- Psalms**, (See American Music Co.).
- Psychoacoustic Sound**, (See T.E.C. Tones/Ralph Records).
- Pure Metal**, (See Refuge Music Group).
- Pure & Simple Records**, PO Box 563, 6 Rosario Shores Rd., Eastsound, WA, 98245, (206) 376-5230. Fax: (206) 376-4894. Pres.: Christopher Peacock; Vice Pres. A & R: Jaylin Chung. Label(s): (Owned) Pure & Simple. US Reprs.: Precision Sound (WA); Navarre Corp. (MN); Action Music Sales (OH); Rock Bottom (FL); Music Design (WI); Backroads Dist., Real to Reel, Pyramid Dist. (CA); New Leaf (GA); Mill City Music (MN); Litledance Dist. (OR); Assoc. Dist. (AZ); Encore Dist. (CO).
- Pyramid Records**, PO Box 140316, Nashville, TN, 37214, Owner: Jimmy Kish.

Q

- Q-Rap**, (See Quark, Inc.).
- Qmark Records**, 1201 Carlisle Rd., York, PA, 17404, (717) 757-4934. Pres.: Lewis Quintin; Vice Pres./A & R: Mark Barkan; Mktg.: Lillian McHugh. Branch(es): 150 W. 55th St., New York, NY, 10019.
- Quadrant Records**, 9430 Live Oak Pl., #308, Fort Lauderdale, FL, 33324, (305) 472-7757. Pres.: Jack P. Bluestein. Label(s): (Owned) Quadrant, Twister.
- Quadraphonic Sound**, (See Twister Records).
- Quadraphonic Talent, Inc./V.E.N., Inc./Lantana Music**, PO Box 630175, 9430 Live Oak Pl., #308, Miami, FL, 33163, (305) 472-7757. Pres.: Jack P. Bluestein. Label(s): (Owned) Twister.
- Quark, Inc.**, 1650 Broadway, #1212, New York, NY, 10019, (212) 489-7260. Fax: (212) 489-7267. Pres.: Curtis Urbina; Vice Pres.: Mara Freedman. Label(s): (Owned) Outer Limits, Q-Rap, (Distributed) Minimal.
- Quasar**, (See Jukebox Records).
- Quicksilver/Increase**, 6860 Canby Ave., Reseda, CA, 91335, (818) 342-2880. Fax: (818) 342-4029. Pres.: Howard L. Silvers; Dir., Mktg.: Len Chapman; Dir., Promo.: David Greenman; Dir., Advertising: Deena Schwartz. Label(s): (Owned) Increase, Quicksilver, Quicksilver Gospel, Quicksilver Jazz, (Distributed) Bulldog. Int'l Reprs.: Attic & Trend Records (Canada).
- Quickway Recording**, (See Revonah Records).
- Quintessence**, (See Intersound, Inc.).
- Qwest Records, Inc.**, 3800 Barham Blvd., Ste. 503, Los Angeles, CA, 90068, (213) 874-3028. Fax: (213) 874-5049. Dir., Artist Relations: Joann Tominaga; Dir. A & R, East Coast: Lisa Morris; Vice Pres. A & R: Raoul Roach. US Reprs.: Warner Bros. Records (CA).

R

- RAJ Records**, PO Box 584, Marion, AR, 72364, (501) 732-6454. Pres./Chrmn.: Marion "Mikki" Hooper; Vice Pres./Dir.: Cleophas Cashe, Vice Pres./Comptroller: Percy Hooper; Sec./Tres. Dir.: Betty Reese.
- RC**, (See Roadrunner Records & Music Publishing Co., Inc.).
- RCA Records**, 1133 Avenue of the Americas, New York, NY, 10036, (212) 930-4000. Fax: (212) 930-4512. Pres.: Bob Buziak; Exec. Vice Pres.: Rick Dobbs; Sr. Dir. A & R: Wendy Ishkhans; Vice Pres. Prod. Devel.: Randy Goodman; Pres. Records Labels US: Joe Galante; Vice Pres./Gen. Mgr.: Jack Weston; Publicity: Brenna Davenport-Leigh; A & R: Josh Leo; Promo.: Eddie Mascolo. Branch(es): 6363 Sunset Blvd., Hollywood, CA, 90028, (213) 468-4000. Fax: (213) 468-4073, Sr. Dir. A & R (West Coast): Bennett Kaufman; 1 Music Cir. N., Nashville, TN, 37203, (615) 664-1200. Fax: (615) 664-1237. Asst., Media Relations: Greg McCarn. Label(s): (Distributed) Beggars Banquet, Jive/RCA, Simmons.
- RCI Records, Inc.**, PO Box 110802, Nashville, TN, 37222, (615) 833-2052. Pres.: Ray Roberts. Branch(es): 405 Terrytown Rd., Ste 335, White Plains, NY, 10607, (914) 592-7983. Label(s): (Owned) Arena, Award, Thomas, 21st Century.
- RCM Records, Inc.**, 810 Cardinal Ln., Hartland, WI, 53029, (414) 367-3021. Pres./Dir.: Donald F. Radtke; Vice Pres.: Michael Radtke; Sec./Dir.: Robert S. Radtke; Treas./Dir.: Mary Nancy Radtke.
- REF Records**, 404 Bluegrass Ave., Madison, TN, 37115, (615) 865-6380. Pres.: Bob Frick; Vice Pres.: Shawn Frick, Scott Frick.

- RFA Records (Radio Free America)**, PO Box 2398, Corrales, NM, 87048, (505) 897-0770. Pres.: Kenneth Pushkin; Vice Pres. Mktg.: Jim Voeck; Comptroller: Kit Walker; Producer: Marilyn Pittman.
- RJD Records**, PO Box 12239, Las Vegas, NV, 89112, (702) 456-7724. Pres./CEO: Robert J. DiMaggio.
Label(s): (Owned) RJD, Slack.
- R M M Records & Video Corp.**, 568 Broadway, Ste. 806, New York, NY, 10012, (212) 925-2828. Fax: (212) 925-6154. Pres.: Ralph Mercado; Vice Pres.: Carlos Mario Gutierrez; Dir. of Prodn.: Elena Martinez; Mktg. & Promo.: Ralph Verde.
Label(s): (Distributed) Bat (Spain); Combo Venezuela, Famoso Ecuador, SonoLux, Sony (Mexico), Sony Int'l.
Int'l Reps.: SonoLux Records (Columbia); Combo Records (Venezuela); Bat Records (Spain); Sony Discos (Mexico); Famoso Records (Ecuador).
- R-M Records**, 920 McArthur Blvd., Warner Robins, GA, 31093, (912) 923-6533. Owner/Mgr.: Ray H. Melton; Prof. Mgr.: George Lovell.
Label(s): (Owned) R-M.
- RMS/Triad Records**, 6267 Potomac Cir., West Bloomfield, MI, 48322, (313) 661-5167. Gen. Mgr.: Bob Szajner; Prof. Mgr.: Laura Holiday.
- ROAR Rap of America Records**, (See SOAR Sound of America Records).
- R.O.I.R./Reachout Int'l Records, Inc.**, 611 Broadway, Ste. 411, New York, NY, 10012, (212) 477-0563. Fax: (212) 505-9908. Pres./Managing Dir.: Neil S. Cooper; Office Mgr.: Anne Doran; A & R, Retail, Radio: Val Bracken; Press: Ingrid Tejada.
Int'l Reps.: Danceteria (France); Windsong, Pinnacle (United Kingdom); Semaphore (Germany); Wide (Italy); Multirock (Spain); Rec Rec (Switzerland).
- ROM Records div. of Treasure Trove, Inc.**, PO Box 491212, Los Angeles, CA, 90049, (213) 471-5000. Fax: (213) 472-6367. Pres.: Keith Holzman.
Label(s): (Owned) ROM.
- R & R Records, Inc.**, 521 Fifth Ave., New York, NY, 10175, (212) 757-3638. Pres.: Rena L. Feeney; Vice Pres.: William F. Feeney; Sec.: William A. Feeney; Treas.: Chris S. Feeney.
Label(s): (Owned) Factory Beat.
US Reps.: Win Record (Long Island City, NY); Pearl Record Dist. (Brooklyn, NY).
- RSO Records, Inc.**, 1775 Broadway, New York, NY, 10019, (212) 975-0700. Chrmn.: Robert Stigwood; Dir./A & R: James Dayley.
- R.T.P. Int'l**, PO Box 311, Cohasset, MA, 02025.
Label(s): (Owned) R.T.P. Int'l. Sequel.
- Rabadash Records, Inc.**, PO Box 19384, New Orleans, LA, 70119, (504) 482-6922, (504) 482-4649. Fax: (504) 488-4481. Pres.: John G. Autin; Vice Pres.: Nora Wixted.
Radiant Music, (See Gospel Publishing House).
- Radikal**, (See Popular Records).
- Radio Doctors Records Ltd.**, 240 W. Wells St., Milwaukee, WI, 53203, (414) 276-6422. Pres./Owner/A & R: Stuart L. Glassman.
- Radio Records div. of Mel Tillis Ent.**, 48 Music Sq. E., Nashville, TN, 37203, (615) 255-2300. Pres.: Mel Tillis; Contact: Ben Payne.
- Radiola/Sandy Hook Records**, PO Box C, Sandy Hook, CT, 06482, (800) 243-0987. Fax: (203) 797-0819. Sales Mgr.: Jon Sonneborn.
Label(s): (Owned) Radiola, Sandy Hook.
US Reps.: Rounder Dist. (MA); City Hall Records (CA).
- Radium 226-05 Records**, 143 Ave. B, 5th Floor, New York, NY, 10009, (212) 529-5881. Fax: (212) 529-5882. Bus. Affairs: Goran Andersson; Mgr.: Maria Jimenez; Int'l: Ulrich Hildebrand, Micke Von Hausswolff.
Branch(es): Sodra Allegatan 3, Göteborg, 41301, Sweden, Fax: (031) 139039. Pres.: Ulrich Hildebrand.
- Rag Baby Records**, PO Box 3316, San Francisco, CA, 94119. Co-Owners: Bill Belmont, Joe McDonald.
Label(s): (Owned) Tape Talk.
Int'l Reps.: Festival (Australia); OM Disc (Italy); Live (Germany).
- Ragtime**, (See Jansco Records).
- Raider Records**, 102 N. Washington Ave., Dunellen, NJ, 08812, (201) 968-4084. Pres.: Helen Majeski.
- Rain Forest**, (See BGM Records).
- Rainbird**, (See Cimiron/Rainbird Records).
- Rainbow Planet Songs, Inc.**, 5110 Cromwell Dr., Gig Harbor, WA, 98335, (206) 265-3758. Pres.: Jim Valley; Gen. Mgr.: Judy Valley.
- Rains Recording Co.**, 1092 Flanagan Sta. Rd., Winchester, KY, 40391, (606) 744-7921. Owner/Mgr.: Jack O. Rains; Prod.: Mary B. Rains; Prod. Promos.: L. Hodges; Vice Pres. A & R: Claude C. Frisby.
Label(s): (Owned) Buttilla, Nashville Allstar, Needle-Mate, Reka.
- Ralph**, (See T.E.C. Tones/Ralph Records).
- Rampart**, (See Gordo Ent.).
- Ranbo**, (See Destiny Records).
- Randall Records**, 29 Elaine Rd., Milford, CT, 06460, (203) 878-7383. Pres.: Gerald R. Randall; Vice Pres.: Howard Randall; A & R: Gerald B. Randall, Cathy Nani Randall.
- Randan**, (See Daran Records).
- Random Ent., Inc.**, 825 Madison Ave., New York City, NY, 10021, (212) 734-4000. Pres./CEO: Savina Hartwell; Vice Pres./COO: Alan Hartwell; Vice Pres. A&R: Allison Hartwell.
Label(s): (Owned) Century 21, Solid Brass, (Distributed) Sylvania, Zenith, Love, Random, Rave.
- Random House Mail Order**, 201 E. 50th St., New York, NY, 10022, (212) 572-2621. Pres.: Scott Robins.
Label(s): (Owned) FSM Pantheon, Grandi Voci, Legends, Price-Less, Price-Less Premium, (Distributed) Murray Hill.
- Range Buster**, (See Stardust/Wizard/Doss Records).
- Ranwood**, (See Welk Music Group).
- Rap**, (See Daran Records).
- Rap Attack**, (See Aroun' Town Prodn. Inc.).
- Rapido**, (See International Record Corp.).
- Bill Rase Prodn., Inc.**, 955 Venture Ct., Sacramento, CA, 95825, (916) 929-9181. Fax: (916) 929-4751. Pres.: Bill Rase; Vice Pres.: Lori Rase Hall; Sec./Treas.: Shirley Rase; Prodn. Mgr.: Esther Marcroit; Chief Recording Eng.: Wayne Johnson.
Label(s): (Owned) Esar.
- Rashid Sales Co.**, 191 Atlantic Ave., Brooklyn, NY, 11201, (718) 852-3298. Fax: (718) 643-9522. Gen. Mgr.: Stanley K. Rashid.
Label(s): (Owned) Belly Dance, Greek Repertoire, Music Box/Pan Vox, Orient, (Distributed) Greek Repertoire, EMI, Regal, Relax-In-Soute, Serios, Sono Cairo, Soutel Phan, Voice of Lebanon, Voix du L'Orient, Cairophone.
- Rattler**, (See SARG Records).
- Raven Music Co.**, 6123 139th Pl. SW, Edmonds, WA, 98020, (206) 632-0887.
- Raw Records**, 215 Englewood Ave., Englewood, NJ, 07631, (201) 871-6909. Fax: (201) 871-6879. Partner/A & R Dir.: Steve Oaklander; Partner/Bus. Mgr.: Charles Laliberte; Nat'l Retail Mktg. Dir.: Jeff Krupczyn.
- Razor Edge**, (See Razor & Tie Music).
- Razor Records**, 2623 N. Bosworth, Chicago, IL, 60614, (312) 549-3227. Owner: Mark Lefens.
- Razor & Tie Music**, 214 Sullivan St., Ste. 5A, New York, NY, 10012, (212) 473-9173. Fax: (212) 473-9174. Principal: Craig Balsam; Cliff Chenfeld.
Label(s): (Owned) Razor Edge, Razor & Tie.
US Reps.: Caroline Records Dist. (NY).
- Ready To Rock Records**, 760 Quail Tail Trail, Sedona, AZ, 86336. Pres.: P.J. Biorosi; Mktg. Dir.: Larry Napieralski.
Label(s): (Distributed) Azra Records, Crypt Kicker Records.
- Real Live Records**, 112 W. Boston Post Rd., Mamaroneck, NY, 10543, (914) 698-0443. Fax: (914) 381-4543. Pres./A & R Dir.: Joe Ferry; Vice Pres./Gen. Mgr.: Peter Denenberg.
US Reps.: Chase Music Group, Rhino (CA).
- Real Music**, 85 Libertyship Way, Ste. 207, Sausalito, CA, 94965, (415) 331-8273. Fax: (415) 331-8278. Vice Pres./Sales/Mktg.: Terence Yallop; Sales/Opns. Mgr.: Gary L. Chappell; Dir. Promo.: Rick Jeffery; Contact: Kenny Altman.
US Reps.: Associated (AZ); Devorss Co, Paradigm, Pyramid, Zango (LA); Encore (CO); Rock Bottom (FL); New Leaf (GA); Schwartz Bros. (MD); Navarre Corp, Mill City (MN); Lifedance (OR); Silo (VT); Precision Sound (WA); Music Design (WI).
- Realdream**, (See Darksilver Records & Filmworks, Inc.).
- RealTime**, (See Miller & Kreisel Sound Corp.).
- Rebel Records**, PO Box 3057, Roanoke, VA, 24015, (703) 343-5355. Fax: (703) 343-3240. Owner: Dave Freeman; Promo/Prodn.: Gary B. Reid.
Label(s): (Owned) County.
- Rebel Rock**, (See Baddest Of The Bad Posse Records).
- Rebirth, Inc./Wenha Prodn.**, 81 Chandler, Detroit, MI, 48202, (313) 875-0289. Fax: (313) 543-3948. Exec. Prod./Artistic Dir.: Wendell Harrison; Exec. Dir./Promo.: Pamela Wise.
Label(s): (Owned) Rebirth, Wenha.
- Rebo**, (See Rego Irish Records, Tapes & Videos).
- Recital**, (See Music & Arts Programs of America, Inc.).
- The Record Co.**, PO Box 35022, Los Angeles, CA, 90035, (213) 655-9461. Pres.: Steve Angelica.
- Record Co. of the South**, PO Box 14685, 5220 Essen Ln., Baton Rouge, LA, 70809, (504) 766-3233. Fax: (504) 766-4112. CEO: Cyril E. Vetter; Pres.: Courtney Westbrook; Gen. Mgr.: Johnny R. Palazzotto.
Label(s): (Owned) Record Co. of the South.
- Record Masters**, PO Box 1622, Hendersonville, TN, 37077, (615) 822-1044. Pres.: Wade T. Curtiss.
- Record-Rama Sound Archives**, 4981 McKnight Rd., Pittsburgh, PA, 45237, (412) 367-7330. Fax: (412) 367-7388. Owner: Paul C. Mawhinney.
Label(s): (Owned) Ideal, VAL.
- Record Records**, PO Box 13603, 4805 Baudin St., New Orleans, LA, 70185, (504) 482-6922, (504) 866-5745. Pres.: Steve Winn; Vice Pres.: Nora Wixted; Prodn/Promo: Louie Ludwig.
- Recording Cooperative**, (See S.W. & A. Assoc., Co.).
- Red Beans Records**, 2240 N. Magnolia, Chicago, IL, 60614, (312) 472-4787, (312) 463-4441. Pres.: Peter Crawford; Vice Pres.: Erwin Helfer.
Label(s): (Owned) Red Benas.
US Reps.: North Country Dist. (NY); TANT (MI); Mastertakes (MI).
Int'l Reps.: SteepleChase (Denmark).
- Red Dog**, (See Len Monahan Prodn.).
- Red Dot Records**, 1121 Market St., Galveston, TX, 77550. Pres.: A. W. Marullo, Sr.; Vice Pres.: A.W. Marullo, Jr.; Gen. Mgr.: Johnny Marvilo; Mktg. Promo.: Don Ferguson; Vice Pres. A & R: Don Westmoreland.
Label(s): (Owned) Red Dot.
- Red Horse Prodn./Revolver Records**, PO Box 158304, Rt. 2, Box 267-C, Nashville, TN, 37215, (615) 670-6129. Fax: (615) 670-6703. Mgr./Promo.: Jean Cramer.
Label(s): (Owned) Red Horse, Revolver.
Int'l Reps.: Hitsounds Records (Netherlands); Bear Family (Germany); Silversounds (England).
- Red House Records, Inc.**, PO Box 4044, 720 Washington Ave. SE, #202, Saint Paul, MN, 55104, (612) 379-1089. Fax: (612) 379-0945. Pres.: Robert M. Feldman; Opns. Mgr.: C.W. Frymyre.
Label(s): (Owned) Red House.
US Reps.: Americana Records (CA); Big State (TX); Educational Record (GA); Edward Grant (MI); Encore (CO); Gail Mayer (MI); Hear Music (MA); Landmark (NY); Music Design (WI); Music For Little People (CA); Paradigm (CA); Pricerite Entertainment (NY); Rivertown Trading (MN); Audio Buff (OH); June Appal (KY).
Int'l Reps.: B.O.M. (Japan); Int'l Record (Italy); Van Record (Netherlands).
- Red Onion Records**, PO Box 366, Dayton, OH, 45401, (513) 222-2413. Fax: (513) 223-1018. Pres.: Gene Mayl; Vice Pres.: Sharon Mayl; Sales Mgr.: Kevin Mayl.
- Red Pajamas**, (See Al Bunetta Mgmt.).
- Redeye Records**, PO Box 62, Saint Joseph, MO, 64502, (816) 233-8778, (816) 593-2355. Pres.: W.D. Morgan; Vice Pres.: Jeffrey Battle; A & R: Robert B. "Buck" Orr; Mktg./Admin. Asst.: Cecelia Sten.
Label(s): (Owned) Redeye.
- Redstone Records**, PO Box 300717, 900 Lincoln, Denver, CO, 80203, (303) 831-9340. Pres.: Jan Kovdelka; Opns. Mgr.: Richard Sallee.
- Redwood Cultural Work**, PO Box 10408, 1222 Preservation Park Way, Oakland, CA, 94606, (510) 835-1445. Fax: (510) 835-1459. Exec. Dir.: Joanie Shoemaker; Sales Mgr.: Cynthia Frenz; Promos Mgr.: Karen Hester.
Label(s): (Owned) Redwood.
- Reel-1-Records, Inc.**, PO Box 3457, Rockefeller Ctr. Sta., New York, NY, 10185, 401 East 23rd St., New York, NY, 11226, (212) 330-0952. Pres., Gen. Mgr.: David King; Vice Pres. A & R: L.C. Hamilton; Vice Pres./Business Affairs: Jeanette Mata.
Label(s): (Owned) Reel 1.
US Reps.: American Music Errands, Inc. (NY).
- Reference Recordings Ltd.**, PO Box 77225X, 580 Crespi Dr., Unit 1, San Francisco, CA, 94107, (415) 355-1892. Fax: (415) 355-1949. Pres.: J. Tamblin Henderson, Jr.; Mktg. Dir.: Marcia Gordon Martin; Tech. Dir.: Keith O. Johnson; Sales Promo. Dir.: Janice Mancuso.
Label(s): (Owned) Reference Recordings.
- Refuge Music Group**, PO Box 2048, Lehigh Valley, PA, 18001, (215) 391-0900. Sr. Vice Pres.: Gavin Morke.
Label(s): (Owned) Almighty, Fortress, IMC, Pure Metal, (Distributed) Narrow, Royal Music.
US Reps.: Spectra.
- Rego Irish Records, Tapes & Videos**, 64 New Hyde Park Rd., Garden City, NY, 11530, (800) 854-3746. Fax: (516) 354-7768. Pres.: Patrick Noonan; Sales & Promos. Dir.: Sharrin Murphy; Mgr.: Vincent Mitchell.
Label(s): (Owned) Colleen, Rebo.
US Reps.: P.P.I. (NJ).
- Reiter Records, Ltd.**, PO Box 216, 454 Main St., Cold Spring Harbor, NY, 11724, (516) 367-8544. Fax: (516) 367-8507. Pres.: Andrea B. Reiter; Vice Pres. A & R: Tko Batista; Vice Pres. Business Aff.: Stewart Rosenblum.
- Reks**, (See Rains Recording Co.).
- Relativity/Combat/In-Effect**, 187-07 Henderson Ave., Hollis, NY, 11423, (718) 740-5700. Relativity Prod. Mgr.: David Counter; In-Effect Prod. Mgr.: Howie Abrams; Combat Prod. Mgr.: Jim Welch; Vice Pres. A & R: Cliff Cuitreni.
Label(s): (Owned) Combat, In-Effect, Relativity, (Distributed) Earache, MMC, Clappers.
- Release Records**, PO Box 234, Saint Louis, MO, 63166. Pres.: Bob J. Bax.
Label(s): (Owned) Blue Brass, Release.
- Relic Record Prodn., Inc.**, PO Box 572, Hackensack, NJ, 07602, (201) 342-6475. Fax: (201) 342-5954. Co-Owner: Donn Fileti; Edward Gries.
Label(s): (Owned) Relic, Times Square, (Distributed) Crstal Ball, Clifton.
- US Reps.: Rounder Dist. (MA); CRDI (CA).**
Int'l Reps.: Swift Dist. (England); Bear Family (Germany); Vivid Sound, Blues Interactions (Japan).
- Relix Records**, PO Box 92, Brooklyn, NY, 11229, (718) 258-0009. Pres.: Leslie D. Kippel; Vice Pres.: Toni A. Brown; A & R: Gary Saunders.
US Reps.: Important Records (NY).
- Ren Maur Music Corp.**, (See Factory Beat Records, Inc.).
- Rendee**, (See True Records, Inc.).
- Rendezvous Entertainment**, 1133 Avenue of the Americas, 3rd Floor, New York, NY, 10036, (212) 930-4760. Fax: (212) 930-4767. Pres./CEO: Jimmy Jenner; A & R Coordinator: Althea Vigilio.
- Renewal! Music**, (See Integrity Music, Inc.).
- Reo Tahiti**, (See Criterion Music Corp.).
- Reptar**, (See Warner Bros. Records, Inc.; Warner Music Int'l).
- Reptile Records**, PO Box 121213, Nashville, TN, 37212, (615) 331-7400. Pres./A & R: Scott Tutt; Promo: Sunny Richards; Accts.: Lou Rosenthal; Promo: Robbie Henry.
Label(s): (Owned) Reptile.
US Reps.: Select-O-Hits (TN); Music City Rec. Dist. (TN); Action Dist. (OH); Midnight Int'l (NY).
- Requestline Records, Inc.**, 204 Grove St., Clifton, NJ, 07013, (201) 777-9100. Fax: (201) 777-2640. Pres.: John Laskowski; Sales Mgr.: Jay Pacheco, Jr.; Mktg. Dir.: Ralph DeWail.
- Resilient Records**, 220 Concord Dr., Paramus, NJ, 07652. Pres.: Tom Gervat; Bus. Mgr.: Ruth Kahrs.
Restless, (See Enigma Entertainment).
- Retrieve Records**, PO Box 1002, Asbury Park, NJ, 07712, (201) 223-6676. Pres.: David H. Miller.
- Retroactive**, (See Ripete Records, Inc.).

Reup Records, 5120 Walnut St., Philadelphia, PA, 19139, (215) 747-1200. Owner/Pres.: Scott Herzog; Owner/Vice Pres.: Franklin Rorer Jr.; A & R: Sam Suber.

Revelation, (See Survivor Records/Dream Makers, Inc.).

Revere Records, PO Box 10461, 3479 NW Yeon Ave., Portland, OR, 97210, (503) 228-9430. Fax: (503) 228-5039. Pres.: Morris McClellan; Vice Pres.: Lewis Ross; Sec./Treas.: Eleanor Ross.

Label(s): (Owned) Revere.

US Reps.: Encore (CO); Gail Mayer (MI); Gourds Music, Paradigm, Pyramid, Real to Reel (CA); Michael Ginsburg (TN); Lifedance (OR); Mill City (MN); Music Design (WI); Music Dist. Inc., Regina (TX); New Leaf (GA); Notably Yours (OH); Rounder (MA); Silo (VT); Phillips Ents. (NC); Sound Traveller (NY); Surfside (HI).

Int'l Reps.: Midsummer Music (Canada).

Revolver, (See Red Horse Prodn./Revolver Records).

Revonah Records, Box 217, Ferndale, NY, 12734, (914) 292-5965. Fax: (914) 292-2313. Owner/Chief Engineer: Paul Gerry; Mgr.: Patricia Gerry.

Label(s): (Owned) Quickway Recording, Revonah, Studio 17, Tel-EVue.

Rexius, (See Sunny Day Prodn., Inc.).

Rhapsody, (See Executive Suite Records).

Rhino Inc., 2225 Colorado Ave., Santa Monica, CA, 90404, (310) 828-1980. Fax: (310) 453-5529. Pres.: Richard Fooks; Gen. Mgr.: Harold Bronson; Exec. Vice Pres. Bus./Legal: Robert Emmer; Vice Pres. Mktg.: Chris Tobey; Vice Pres. A & R: Gary Stewart; Vice Pres. Sales: Keith Altomare; Vice Pres. Product Mgmt.: Garson Fooks; Dir. Promos.: Thomas Kenney; Int'l Mktg.: Peter Pasternak.

Label(s): (Owned) Rhino New Artists, Word Beat.

US Reps.: CEMA (CA-GA-MN-NJ).

Rhythm, (See Terock Records).

Rhythms Prodn., PO Box 34485, 8869 Venice Blvd., Los Angeles, CA, 90034, (213) 836-4678. Pres.: Ruth S. White; Vice Pres.: David O. White; Gen. Mgr.: Marjory W. Gandelman; Art Dir.: Lotte Cherin.

Label(s): (Owned) Rhythms Prodn., Tom Thumb, Watch Me Grow.

US Reps.: Cheviot Corp. (CA); Sparrow Corp. (CA).

Int'l Reps.: Marqfed Int. Trading Corp. (Philippines).

Rialto, (See CA-Song Music).

Ric Rac Records div. of Ric Rac, Inc., PO Box 712, Nashville, IN, 47448, (812) 837-9569. Pres.: R.L. Hanson; Vice Pres./Publicity: Tina B. Hanson.

Label(s): (Owned) Country Bump.

Ricare, (See Carrie Records).

Rice Records, PO Box 121656, 1808 West End Bldg., Ste. 825, Nashville, TN, 37212, (615) 242-2461. Fax: (615) 329-8111. Pres. & CEO: E. Jimmy Key.

Fred Rice Prodn., Inc., PO Box 643, 48-780 Eisenhower Dr., La Quinta, CA, 92253, (619) 564-4823. Pres.: Fred Rice; Sec./Treas.: Dorothy Rice; Sales Mgr.: Robert Rice.

Label(s): (Owned) Amazing Grace, Hook, Startime Music, Western Americana, Yo-Yo.

Richardson Records, 1938 Baltimore Annapolis Blvd., Annapolis, MD, 21401, (301) 757-3733. Pres.: Charles A. Richardson.

Label(s): (Owned) Richardson.

Richey Records, PO Box 122115, 7121 Vickery Blvd., Fort Worth, TX, 76121, (817) 731-7375. Owners: Slim Richey/Fran-cie White.

Label(s): (Owned) Flying High, Grass Mountain, Ridge Runner, Tex Grass.

Ricochet Records Ltd., PO Box 133, Farmingville NY, 11738, (516) 472-1219. Pres.: Andy Marvel; Vice Pres. A & R: Alyssa Marvel.

Ridge Runner, (See Richey Records).

Ridgeland, (See Madison Station Prodn.).

Ridgewood, (See Gallery II Records, Inc., Playback Records).

Rim, (See Urgent! Records, Inc.).

Ripete Records, Inc., 1111 S. Main St., Elliott, SC, 29046, (803) 428-3358. Fax: (803) 428-6434. Pres.: Marlon E. Carter; Vice Pres.: Peter N. Smolen; Business Affairs/Accounts: Karen F. Carter; Mgr.: Michael A. Farver.

Label(s): (Owned) Carlen, Gold Nuggets, Retroactive, (Distributed) Red Dog Express, Rockin Robin, Gold Coast.

US Reps.: Selecto Hits (TN); Gemint Dist. (GA); Justin Entertainment (GA); Rock Bottom (FL).

Ripsaw Record Co., 4545 Connecticut Ave. NW, #805, Washington, DC, 20008, (202) 362-2286. Pres.: Jonathan Strong.

Label(s): (Owned) Ripsaw.

US Reps.: Roundup Records (MA); Collectors Choice (NC); Phone Booth Records (OR); DixiRaks Mail Order (TN); Richman Bros. Records, Inc. (NJ).

Rising Star Prodn., 3665 Hughes Ave., #210, Los Angeles, CA, 90034, (615) 327-8036. Pres./Dir. A & R Mktg.: Gerald A.D. Brown; Vice Pres. A & R Mktg.: David M. Tucker; Dir. Promo.: Ross Fleming, III.

Label(s): (Owned) Mystique, Satin Sound.

Rising Sun, (See Scene Prodn.).

Riske Records, PO Box 3381, Teaneck, NJ, 07666, (201) 837-5550.

Rite Turns, (See Maxx Records).

River Music, Rt. 175, Blue Hill Falls, ME, 04615, (207) 374-2208. Fax: (207) 374-2082. Pres.: Paul D. Sullivan; Vice Pres.: Jillson Knowles; Promos.: Lisa M. Farrar.

Label(s): (Owned) River Music.

River Records, 3705 N. Sterling, Peoria, IL, 61615, (309) 686-7664. Fax: (309) 686-7664. Pres.: Ronald C. Volz; Mktg.

Dir.: Becky Volz; A & R: Greg X. Volz; Radio Promo: Jennifer Florida.

US Reps.: Spectra, Inc. (TN).

Int'l Reps.: Christian Mktg. Ltd. (Canada); GMI Music Partners BV (Europe); Christian Mktg. (New Zealand); Christian Mktg. (Australia); Maranatha Record Co. CC (South Africa).

Riverside, (See Fantasy, Inc.).

Riverview, (See Rockland Records).

Road Records, 429 S. Lewis Rd., Royersford, PA, 19468, (215) 948-8228. Fax: (215) 948-4175. Pres.: Jim Femino; Vice Pres.: Leslie Holcomb; Artist Rel.: Tom Simpson; Mktg.: Bette Malone; A & R: Jamie Lewis.

Label(s): (Distributed) Shadow Hill.

Roadracer, (See Roadrunner Records & Music Publishing Co., Inc.).

Roadrunner Records & Music Publishing Co., Inc., 225 Lafayette St., Ste. 407, New York, NY, 10012, (212) 219-0077. Fax: (212) 219-0301. Pres.: Cees Wessels; Gen. Mgr./V.P. A & R: Douglas Keogh; Mktg. Dir.: Jonas Nachsin; Promo. Dir.: Scott Givens; A & R Label Mgr.: Monte Conner; Sales Mgr.: Don Brady.

Branch(es): 9157 Sunset Blvd., Ste. 310, Hollywood, CA, 90069, (213) 859-2402. Fax: (213) 859-0570. Contact: Bob Nalbandian; 3/5 Rue Albert De Vativesnil, Levallois, 92300, France, 0147581227. Fax: 0147581226. Contact: Pamela Lynch; Sudermanstrabe 5, Koln 1, 5000, Germany, 0221720921. Fax: 0221726387. Contact: Frank Stroebel; Baarsjesweg 273, Amsterdam, 1058, Netherlands, 0206169921. Fax: 0206160776. Contact: Cees Wessels; First-Second Floor, 387 Harrow Rd., London, W9 3NA, United Kingdom, 0819699099. Fax: 0819688388. Contact: Mark Palmer.

Label(s): (Owned) Emergo, Roadracer, RC, (Distributed) Magna Carta, Third Mind.

US Reps.: Relativity Entertainment Dist. (NY).

Rob-Rik Inc. /a Chaledon Record Co., Pembroke One Bldg., 281 Independence Blvd., 5th Floor, Virginia Beach, VA, 23462, (804) 499-8971. Fax: (804) 456-5445. Pres. & Gen. Counsel: Richard N. Shapiro.

Label(s): (Owned) Chaledon.

Robbins Records, Inc., HC80 Box 5B, Leesville, LA, 71446, Pres.: Sherre V. Stephens; A & R: Angel Stephens; Nat'l Promo.: Darrell Scott.

Label(s): (Owned) Headliner Stars, Robbins.

Rock-A-Billy Records, PO Box 1622, Hendersonville, TN, 37077, (615) 822-1044. Pres.: Wade T. Curtiss; Vice Pres.: Dick Derwald; Gen. Mgr.: Don Rowlett; Sales Mgr.: Dick Danleis; Vice Pres. A & R: S.D. Neal.

Label(s): (Owned) Aaron, CWS., Canada, Hendersonville, R.M., Record Masters, Rock-A-Nash-A-Billy.

Rock-A-Nash-A-Billy, (See Rock-A-Billy Records).

Rock Dreams, 1635 Rt. 33, Hamilton Square, NJ, 08690, (609) 890-0808. Fax: (609) 588-8945. Promo. Dir.: John Cardarelli; Mktg.: James Minelli; Sales: John Bates.

Rock Island, (See All Star Promos.; Castle Records).

Rock 'N' Roll, (See Scotti Brothers Records).

Rockit Records, Inc./Rockit Ent., Ltd., Inc., 35918 Union Lake Rd., Ste. 306, Mount Clemens, MI, 48043, (313) 792-8452. Music Dir./Chariman/Pres.: Joseph Trupiano; Prod./Sec.: John Dudick; A & R Rep.: Michael Wright; A & R Vice Pres.: Mark Jowett.

Label(s): (Owned) Rockit.

US Reps.: IHR, Inc. (NY); McCartney Menagerie (FL); Keep On Tracking (GA); Important Record Dist. (NY).

Rockland Records, PO Box 615, 117 W. Rockland, Libertyville, IL, 60048, (312) 362-4060. Pres./Gen. Mgr.: Perry Johnson; Vice Pres.: Rick Johnson.

Label(s): (Owned) Riverview.

Rockville Prodn., 3050 Biscayne Blvd., Miami, FL, 33137, (305) 573-0599. Contact: Rege Howard.

Rockville Records, PO Box 800, 81 N. Forest Ave., Rockville Centre, NY, 11571, (516) 764-7938. Fax: (516) 764-6315. Vice Pres. A & R/Label Mgr.: Debbie Southwood-Smith; Retail Dir.: Jeff Pachman.

Rodven, Inc., 3191 Coral Way, Ste 110, Miami, FL, 33145, (305) 442-7273, (305) 592-7055. Fax: (305) 445-7434. Pres.: Rodolfo Rodriguez; Dir.: Peter Cernik; Nat'l Sales Coord.: Lazaro Fernandez; Vice Pres.: Jose Martinez.

Label(s): (Distributed) Love, Sonorodven, WEA Int'l Latin.

Rokk Steady Records, PO Box 40124, San Francisco, CA, 94140, (415) 641-8414. Fax: (415) 821-0416. Pres.: Nathan Malbrue; Prod/J A & R: Bobby Scott; Mktg. & Pub. Rel.: David Gross.

Label(s): (Owned) Rokk Steady.

Roll On Records, 112 Widmar Pl., Clayton, CA, 94517, (510) 672-8201. Contact: Edgar J. Brinca.

Roll Records, Inc., PO Box 1081, Miami, FL, 33243, (305) 667-2757. Fax: (305) 667-7651. Pres.: Linda Fine; Vice Pres.: Ish.

Rollins, (See CA-Song Music).

Roma Records, PO Box 2183, Brentwood, TN, 37024, (615) 373-0986.

Roman, (See CA-Song Music).

Rome Romare, (See Sabteca Records).

Ron-Dom Prodn., Inc., 2114 New Orleans St., New Orleans, LA, 70119, (504) 283-8459, (818) 944-6075. Fax: (504) 288-8199. Pres./Gen. Mgr.: Ronald Jones; Professional Mgr.: Marilyn Jones; A & R Sound Mixer: Anatole Domino; Agent: Joe Jones, Sr.

Label(s): (Owned) Boo, Clinky Top, Marylin.

US Reps.: M&J Dist. (CA).

Ronn, (See Sue Records, Inc.).

rooArt, 850 Seventh Ave., New York, NY, 10019, (212) 245-9835. Fax: (212) 245-9836. Pres. North America: Sean Coakley. Branch(es): 70 Judge St., Woolloomooloo, NSW, 2011, Australia, (612) 357-1599. Fax: (612) 357-1841. Pres.: C.M. Murphy, Head of Australian Branch: Kim Frankiewicz; 22A Lambolie Place, London, NW34HP, United Kingdom, (071) 483-4020. Fax: (071) 483-4060. Pres.: C.M. Murphy, Head of U.K. Branch: Paul Craig.

Label(s): (Distributed) Mercury/PolyGram.

US Reps.: Mercury/Polygram Records (NY).

Roomtoons, (See Blue Flame Records).

Rooster Blues Records, 232 Sunflower Ave., Clarksdale, MS, 38614, (601) 627-2209. Owner/Producer: Jim O'Neal; Partner/Prodn. Coord.: Patricia Johnson; Vice Pres. Mail Order Sales: Julie Buchanan; Artist Rep.: Colin Buchanan.

Label(s): (Owned) Rooster Blues, (Distributed) Airwax, Southern Culture, Wilco.

US Reps.: Flying Fish (IL).

Int'l Reps.: Bedrock (England); P-Vine Special (Japan).

Roots Music, PO Box 111, Sea Bright, NJ, 07760. Pres.: Robert Bowden.

Label(s): (Owned) Nucleus.

US Reps.: Nucleus (NJ).

Roper Records, Inc., 45-15 21st St., Long Island City, NY, 11011, (718) 786-2401. Pres.: Franc Peri.

Rosemary Melody Line Records, PO Box 1078, Vineland, NJ, 08360, (609) 696-0943. Pres.: Dennis Link; A & R: Greg Giannascol; Mktg.: Jay Wilson.

Label(s): (Owned) Wind Rose.

Rosiland, (See Apostle-Rosiland Records).

Rosita, (See Freddie Records, Inc.).

Rotten Records, PO Box 2157, Montclair, CA, 91763, (714) 621-2410. Fax: (714) 621-2410. Pres.: Ron Peterson; Vice Pres.: Pete Cassidy.

Rough Diamond, (See Survivor Records/Dream Makers, Inc.).

Rough Luxury, 1156 Forest Ave., New York, NY, 10456, (212) 617-4783. A & R: C. McRae.

Rough Trade, Inc., 611 Broadway, #311, New York, NY, 10012, (212) 777-0100. Fax: (212) 505-9314. CEO: Robin Hurley; CFO: Tom Bogan; Label Mgr.: Nick Cucci; Nat'l Sales Mgr.: Shari Wilkins.

Branch(es): 326 Sixth St., San Francisco, CA, 94103, (415) 621-4307. Fax: (415) 864-6942. Wholesale Mgr.: Skip Hewitt.

Label(s): (Distributed) Alchemy, Apocalypse, Genies, Heyday, Pitch-A-Tent, Twin Tone.

Int'l Reps.: Rough Trade Ltd. (United Kingdom).

Round Robin Records, 101 Hurt Rd., Hendersonville, TN, 37075, (615) 824-5900. Fax: (615) 824-8800. Pres.: Jim Pierce.

Label(s): (Owned) Strawberry, Strawboss.

Rounder Records Corp., 1 Camp St., Cambridge, MA, 02140, (617) 354-0700. Fax: (617) 491-1970. Pres.: Marian Leighton Levy; Treasurer: Ken Irwin; Clerk of Corp.: Bill Nowlin; Dist. Mgr.: Duncan Browne; Vice Pres. A & R: Riley Puckett.

Label(s): (Owned) Varrick, (Distributed) Clean Cuts, Daring.

US Reps.: Bayside, CRD (CA); Richmond (DC); Jerry Basin (FL); MS (IL); House (KS); Rounder (MA, NY); Action (OH); Big State (TX).

Int'l Reps.: Larrikin (Australia); Parsifal (Belgium); Amalthea/Denmark, Sweden); Media Sept (France); Teldec (Germany); General (Greece); IRD (Italy); Americana (Japan); Munich (Netherlands); Music Dist. (Norway); BeBob (Switzerland); Charly, Topic (United Kingdom).

Rowena, (See Tiki Ent., Inc.).

Roxtown, (See Bold 1 Records).

Royal Tapestry Music, (See Diadem Music Group).

J. Ruby Prodn. Inc., dba Slash Records, PO Box 48888, Los Angeles, CA, 90048, 7381 Beverly Blvd., Los Angeles, CA, 90036, (213) 937-4660. Fax: (213) 933-7277. Pres.: Bob Biggs; Vice Pres.: Mark Trilling; Mktg. Dir.: Kio Novina; Promo. Dir.: Michelle Zichella; A & R Dir.: Randy Kaye.

Label(s): (Owned) Ruby, Slash.

US Reps.: WEA Corp. (CA).

Int'l Reps.: London Records (England); Mushroom Records (Australia).

Rumpelstiltskin, (See Wood'n Music, Inc.).

Rumrunner Records, Inc., 3406 N. Ocean Blvd., Fort Lauderdale, FL, 33308, (305) 561-4880. Fax: (305) 537-9048. Pres.: Greg Aliferis.

Rune, (See Cleverland Records).

Rural Rhythm Records, PO Box A, 135 W. Foothill Blvd., Ste. C, Arcadia, CA, 91066, (818) 359-6061. Fax: (818) 303-4323. Pres.: Sam Passamano, Jr.

Label(s): (Owned) Rural Rhythm.

US Reps.: More Records, Uncle Jim's (CA); Old Homestead (MI); Record Depot (VA); DCC Compact Classics (CA).

Rustron Music Prodn., 1156 Park Ln., West Palm Beach, FL, 33417, (407) 686-1354. New Product & Song Review: Florida Office Only; Exec. Dir.: H. Rusty Gordon; Mktg. Admin.: Davilyn Whims.

Branch(es): 33 Whittier, Poets Corner, Hartsdale, NY, 10530, (914) 761-3025, Only Commercial & Tech'l: New York Office, Creative Dir.: Ronald Caruso.

Label(s): (Owned) Whimsong, Rustron, (Distributed) RVP, Silver Stream, Montana Blake, PRM, RCP (Rick Carson Prodn.), Catalyst, Circle & Star, Florida Daze, GBP (Gary Barth Prodn.), GJP (Gordon Johnson Prodn.), Mermaid, Soul Inspiration, Working Hand, Akasha, Benthic, Black Dog, CBR.

US Reps.: Lady Slipper Distributors (NC); Alhambra Int'l Distribution (FL).

Int'l Reps.: Sono Exit Cintas & Discos Ltda., FM Cintas & Discos Ltda. (Colombia).

Rutabaga, (See Old Homestead Records).

Ruthless. (See Big Money, Inc.).
Ruthless Records, 21860 Burbank Blvd., Ste. 100, Woodland Hills, CA, 91367, (818) 710-0060. Fax: (818) 710-1009. Contact: Eric Wright.
Rutledge Records, PO Box 526, Ft. Lauderdale, FL, 33302. Contact: Johnnie Rutledge.
Rye. (See Jewel Records).
Rykodisc, Inc., Pickering Wharf Bldg., C-3, Salem, MA, 01970, (508) 744-7678. Fax: (508) 741-4506. Pres.: Don Rose; Dir. Mktg.: John Hammond; Dir. Promos.: Jim Neill; Dir. Publicity: Carrie Svengen; Dir. Altern. Mktg./Sales: Cheryl McEnaney.
 Branch(es): 530 N. Third St., Minneapolis, MN, 55401, (612) 375-9162, Fax: (612) 375-0272, CFO & V.P. Sales/Distrib: Rob Simonds, A & R Dir.: Jeff Rougviue; 20-22 N. Third St., 6th Floor, Philadelphia, PA, 19106, (215) 629-0030, Fax: (215) 629-0034, Vice Pres. Bus. Affairs: Arthur Mann, Dir. Bus. Affairs: Paul Dickman; P.O. Box 2401, London, England, W2 5SF, United Kingdom, 44/71-727-7480, Fax: 44/71-229-4190, Dir. Rykodisc Europe: Joe Boyd, A & R Dir.: Jeff Rougviue.
 Label(s): (Owned) Carthage, Hannibal, Ryko Analogue, Rykodisc, (Distributed) Tried & True.

S

SAB. (See Shake & Bake Records, Inc.).
SAC Records, PO Box 2706, Elizabeth, NJ, 07207, (201) 755-0836. Pres.: Seymour Kurke; Vice Pres.: Wendy Oldham.
SAR. (See Guajiro Records, Inc.).
SAR/Derby. (See ABKCO Records (Div. ABKCO Music & Records, Inc.)).
SARG Records, 311 E. Davis St., Luling, TX, 78648, (512) 875-3350. Pres./Gen. Mgr.: Charlie Fitch; Asst. Mgr.: Sharon Seaman; Promo/Pub. Rel.: Denise Fitch; Sales Mgr.: Celeste Niederhofer; Vice Pres. A & R: Ben W. Fitch.
 Branch(es): 116 S. Cypress St., Luling, TX, 78648, (512) 875-3350, Owner: Charlie Fitch.
 Label(s): (Owned) Double A, Rattler, SARG.
SAS. (See Joey Records, Inc.).
SBK. (See Capitol-EMI Music, Inc.).
SBK Records, 1290 Avenue of the Americas, New York, NY, 10104, (212) 492-1200. Fax: (212) 245-4115. Chrmn./CEO: Charles Koppelman; Pres./COO: Martin Dandier; Sr. Vice Pres.: Arma Andon, Arthur Moguli; Sr. Vice Pres.: A & R: Don Rubin; Sr. Dir. Nat'l Album Prom: Neil Lasher; Sr. Dir. New Music: Michael Mena.
SBS/Confidential Records, 478 Ballard Dr., Ste. 26, Melbourne, FL, 32935, (407) 242-9933. Contact: Drazen Premate; David Pensado.
SCP Records (Div. of The Sound Column Companies), PO Box 20784, 342 W. 200 S., Ste. 160, Salt Lake City, UT, 84170, (801) 355-5327. Pres.: Ron Simpson; Prof. Mgr.: Jennifer Johnson; Publicity: Clive Romney.
 Branch(es): 27 Music Sq. E., Ste. 258, Nashville, TN, 37203, (615) 244-4331, Pres.: Ron Simpson.
 Label(s): (Owned) Big Sky.
 US Reprs.: Embryo Music (UT).
S.C.S.E. (See Fifth Continent Music Corp.).
S.F.L. Tapes & Discs, PO Box 120316, 757 Brownlee Dr., Nashville, TN, 37212, (615) 356-4684. Pres.: John Lomax III; Vice Pres. Sales: F.M. Wells; Promo.: John Lomax IV.
 Label(s): (Owned) S.F.L..
 US Reprs.: Bayside, Gourd Music (CA); Lifedance (OR); Select-O-Hits (TN); Silo (VT); Navarre Corp. (MN); Rock Bottom (FL).
SGP. (See Solid Ground Prods.).
S & H. (See Sun-Glo Records, Inc.).
SK Prods., 1302 Hwy. 143, Cedarburg, WI, 53012, (414) 375-1991. Owner: Jay Rossmann; Sec.: Debbie Rossmann.
 Label(s): (Owned) Larry Land.
SLAMDEK/Scramdown, PO Box 43551, Louisville, KY, 40253, (502) 244-0068. Label Coord.: K. Scott Ritcher; Dist. Dir., Sales: Hank Moody; Promo.: Joey Mudd; Artistic Dir.: John F. Kampschaeffer; Vice Pres. A & R: Kelly Kemper.
 Label(s): (Owned) Def Wish Wax, City of Louisville, (Distributed) A, Desoto, Ricky!
 US Reprs.: Blacklist Mailorder (CA); Desoto (DC); New World Records (NY).
SME Records (dba Stubble Mac Ents.), 963 Franklin Ave., Columbus, OH, 43205, (614) 365-9000. Pres.: Malcolm Stubblefield; Dir. Sales/Mktg.: J. Delassautos; Dir. Mktg./Promo.: Charles Christian.
SOAR Sound of America Records, PO Box 8606, Albuquerque, NM, 87198, (505) 268-6110. Pres.: Tom Bee; Vice Pres. A & R: Robby Bee.
 Label(s): (Owned) Natural Visions, ROAR Rap of America Records, Souled Out.
SOR-Step One Records, 1300 Division St., #304, Nashville, TN, 37203, (615) 255-3009. Fax: (615) 255-6282. Pres./Producer: Ray Pennington; Dir. of Sales: Ronald P. Elliott; Bookkeeper/Sec. to Pres.: Leslie Ann Elliott; Office Mgr.: Lynn Pennington.
 Label(s): (Owned) S O R.
SPI. (See Smarty Pants Audio & Video).
S.P.Q.R., (See Legrand Records Int'l).
S.R.C., 11300 West Olympic Blvd., #610, Los Angeles, CA, 90064, (301) 445-5529. Fax: (301) 445-5534. Pres.: Tim O'Brien; CFO: Michael Mesnick; Dir. Mktg. & Sales: Mike Missile; A & R: Gary St. Clair; Dir. Studio Opns.: Steve McDonald.
S.R.I., (See Surprise Records, Inc.).

SSS Int'l. (See Shelby Singleton Ents., Inc.).
SUS Americana Records, 300 Linfield Dr., Vallejo, CA, 94590, (707) 645-1615. Fax: (707) 553-7773. Pres.: Jack Walker; Vice Pres./A & R: Tom Kawai.
 Branch(es): 5-3-11 Nakakasai, Edogawa-Ku, Tokyo, 134, Japan, (03) 3878-6041, Fax: (03) 3878-6578, Pres.: Terry Kuroda, Gen. Mgr.: Tom Kawai.
 Label(s): (Owned) SUS Americana.
S.W. & A. Assoc., Co., PO Box 802, Madison Sta., 953 Highway 51, Ste. A, Madison, MS, 39130, (601) 856-7468. Pres./A & R: Style Wooten.
 Label(s): (Owned) Pretty One, Recording Cooperative, Style, Styleway, Thee One, Wooten.
Swak. (See The Orange Record Co., Inc.).
Sabteca Records, PO Box 10286, 712 Longridge Rd., Oakland, CA, 94610, (415) 465-2805. Pres.: Bernard Duane Herring Sr.; Gen. Mgr.: Bernard Duane Herring Jr.; Promo./Sales: Sean Aubrey Herring.
 Label(s): (Owned) Andre Romare.
Sagittar. (See Green Dog Prods.).
Sahara Dance Tracks. (See Sahara Records & Filmworks Int'l).
Sahara Jazz. (See Sahara Records & Filmworks Int'l).
Sahara Records & Filmworks Int'l, 117 W. Harrison Bldg., Dept. S-627, Chicago, IL, 60605, (800) 874-5799. Fax: (317) 549-9007. Pres./CEO: Edward De Miles; A & R Dir.: Greg Payne; Vice Pres./Mktg.: Dwayne Woolridge; Vice Pres./Admin.: Ron Miles.
 Branch(es): 4475 Allisonville Rd., 8th Floor, Indianapolis, IN, 46205, (317) 546-2912, Fax: (317) 549-9006.
 Label(s): (Owned) Sahara, Sahara Dance Tracks, Sahara Jazz.
 US Reprs.: EDM-Sahara (IN).
Sam. (See Max Entertainment, Inc.).
The Same Record Co. (See Disques Dual).
San Juan Record & Tape Club Ltd., 499 Erneston Rd., Parlin, NJ, 08859, (908) 727-7200. Fax: (908) 727-7240. Pres.: Jay Chernow; Sec. & Treas.: Eileen Chernow; Vice Pres.: Michael Chernow.
Sand Dollar. (See Legs Label Records).
Sand Hand Jazz, Ltd. (See Sand Hand Records, Inc.).
Sand Hand Records, Inc., 3703 Edgewood Rd., Baltimore, MD, 21215, (301) 542-2583, (301) 466-0188. CEO, Pres.: D. Christopher Johnson; Vice Pres.: Dana Johnson; P.R. Pres.: Avis Johnson; A & R Pres.: Brad C. Kapton; Vice Pres. A & R: Christopher David.
 Label(s): (Owned) Sand Hand Jazz, Ltd., (Distributed) Unisex + 6, Christopher David III Prods.
Sandstone. (See DCC Compact Classics).
Sansu Ents., Inc., 3809 Clematis Ave., New Orleans, LA, 70122, (504) 949-8386. Fax: (504) 948-3105. Pres.: Marshall E. Sehorn; Vice Pres.: Allen Toussaint.
Sara Records. (See American Music Co.).
Satelite. (See State of Fresh American Entertainment).
Satin Sound. (See Rising Star Prods.).
Saturn. (See Meteor Records).
Savior. (See Ball Record Mfg. & Distribution Co.).
Savoy Records, 611 Broadway, Ste. 428, New York, NY, 10012, (212) 529-3155. Exec. Dir.: Rev. Milton Biggum; Dir. Nat'l Promos.: Teresa Hairston.
Sazz. (See Cheetah Records).
Scandinavian. (See Lindbergh Records).
Scaramouche Recordings, PO Box 7018, 406 Tharpe Rd., Warner Robins, GA, 31095, (912) 953-2800. Pres.: Robert R. Kovach.
 Label(s): (Owned) Scaramouche Recordings.
Scarface Records, 1716 Ocean Ave., #45, San Francisco, CA, 94112, (415) 586-3524. Pres./Owner: Oscar Jackson, Jr.; Vice Pres.: Marcus E. Clemmons; Mktg. Mgr.: Mark Jones.
 US Reprs.: Associated (AZ); Abbey Road, CA Record (CA); Aquarius Dist. (CT); Jerr Bassin (FL); Justin Entertainment (GA); Music Craft (HI); M.S. (IL); Great Bay (MD); Motor City Music (MI); Navarre Corp. (MN); Dutch East India Trading (NY); Big Dist. (NC); Action Music (OH); Universal (PA); Select-O-Hits (TN).
Scart Records, Inc., 605 Ridgefield Rd., Wilton, CT, 06897, (203) 762-2102. Fax: (203) 762-5081. Pres.: Ruby McFarland Rahn.
 Label(s): (Owned) Infinity Series.
 US Reprs.: Backroads, Eastern Pacific, Real Music (CA); Action Music Sales (OH); Precision Sound Mktg. (TN).
Scene Prods., PO Box 1243, Beckley, WV, 25802, (304) 252-4836. Pres.: Richard L. Petry; A & R Dir.: Carol Lee.
 Label(s): (Owned) Country Road, Rising Sun.
Scepter. (See Sony Records, Inc.).
Don Schafer Promos., Inc., PO Box 57291, Dallas, TX, 75207, (214) 339-5891, (214) 339-0358. Fax: (214) 333-0203. Pres.: Don Schafer; Vice Pres.: Rob Landrum; Sec.: Dianna Littlepage; Vice Pres. A & R: Ron Condrum.
 Label(s): (Owned) Texas.
School Days. (See Little Giant Records).
Scorchor. (See Clay & Clay, Inc.).
Score Prods., Inc., 3414 Peachtree Rd., Ste. 640, Atlanta, GA, 30326, (404) 266-8990. Fax: (404) 266-8683. Pres.: Robert A. May; Exec. Vice Pres.: Michael Mjehovich; A & R: Amy Davis; Products: Travis Broch.
 Label(s): (Owned) Buckhead Music & Film, The Comedy Label, Perfect Pitch, Small Wonder.
Scorpemgi Records, Inc., 888 Seventh Ave., Ste. 401, New York, NY, 10019, (212) 265-4300. Pres.: Lonnie Johnson; Vice Pres.: Michele Olivio; Gen. Mgr.: D. Johnson; Asst. Gen. Mgr.: G. Jones.
 Label(s): (Owned) Skyview, (Distributed) Stupid Fresh.

Scorpio Music, Inc., 2500 E. State St., Trenton, NJ, 08619, (609) 890-6000. Fax: (609) 890-0247. Pres.: Ger Vasoni; Gen. Mgr.: Steven Parelman; Promo.: Patricia Pagnani; A & R Dir.: Frank Nelson.
Scott Assoc., 7 Linda Ln., Plainview, NY, 11803. Pres.: Scott Edward.
Scotti Brothers Records, 2114 Pico Blvd., Santa Monica, CA, 90405, (310) 450-3193. Fax: (310) 452-9053. Chrmn.: Tony Scotti; Vice Chrmn.: Ben Scotti; Pres.: Johnny Musso; Vice Pres. Black Music: Ronnie Jones.
 Label(s): (Owned) Rock 'N' Roll.
Scrutchings Music, 429 Homestead St., Akron, OH, 44306, (216) 733-8529.
 US Reprs.: Nova (GA).
Sea Breeze Record Co., PO Box 11267, Glendale, CA, 91226, (818) 242-2093. Fax: (818) 242-7704. Owner: Danny Behrer; Prodn. Mgr.: Robert Coomber; Promo. Mgr.: Alex Iles.
 Label(s): (Owned) Night Life, Walrus, (Distributed) Jazz Mind.
Sea Cruise Productions, Inc., PO Box 1875, Gretna, LA, 70054, (504) 392-4615. Fax: (504) 392-4512. Pres.: Ken Keene; Vice Pres.: Frankie Ford.
 Label(s): (Owned) Briarmeade, Burlap, (Distributed) Stardust.
Sea King. (See Centaur Records).
Seagull. (See Project 3 Records).
Seaside Records, 100 Labon St., Tabor City, NC, 28463, (919) 653-2546. Pres.: Elson H. Stevens; Gen. Mgr.: F.L. Jones; Prof. Mgr.: Reth A. Stevens; Promos.: Diane Jones.
 Label(s): (Owned) BHH.
Second Wave. (See Olivia Records).
Dave Segel Promos., 1304 Cranwood Sq. S., Columbus, OH, 43229, (614) 885-2789. Pres.: Dave Segel.
Select Records, 16 W. 22nd St., 10th Floor, New York, NY, 10010, (212) 691-1200. Fax: (212) 691-3375. Pres.: Fred Munao; Sales/Mktg.: Lou DeBiase; Creative Svcs.: Amy Bennick; Bus. Affairs: Harry Getzov.
 Label(s): (Owned) Active, Mondo Music.
Ralph L. Seltzer, 1751 Draper Valley Rd., Selma, OR, 97538. Owner: Ralph Seltzer; Mgr.: M. Walther.
 Label(s): (Owned) Music World.
Senator Records, 818 18th Ave. S., Nashville, TN, 37203, (615) 242-1511. Fax: (615) 255-7200. Chrmn./CEO: Jack McFadden; Pres.: Stan Barnett; Vice Pres./Sec. & Treas.: V.J. McFadden.
September Music Co., 250 W. 57th St., New York, NY, 10107, (212) 581-1338. Fax: (212) 686-2182. Pres.: Stanley Mills.
Sequel. (See R.T.P. Int'l).
Serenity Records, 180 W. 25th St., Upland, CA, 91786, (714) 981-2318. Fax: (714) 981-6986.
Shadowland Recording. (See Conarch Prods.).
ShadowLight Records, 9900 Tagus St., Ste. 25, Pico Rivera, CA, 90660, (310) 699-2450. Pres./Owner: Ron Hart.
 Label(s): (Owned) ShadowLight.
 US Reprs.: New Leaf Dist. (GA).
Shake & Bake Records, Inc., PO Box 214, Queens, New York, NY, 11420, (718) 659-9631. Fax: (718) 659-6121. Pres.: Darnell Aiken; Exec. Vice Pres.: Anthony Anderson; Vice Pres. A & R: Cynthia Aiken; Cynthia Aiken.
 Label(s): (Owned) SAB, Shake and Bake.
 US Reprs.: Malverne (NY).
Shanachie Records Corp., 37 E. Clinton St., Newton, NJ, 07860, (201) 579-7763. Fax: (201) 579-7083. Pres.: Richard Nevins; Vice Pres./A & R: Randall Grass; Dir. Mktg.: Lee Goldstein; Dir. Publicity: Andrew Seidenfeld.
 Label(s): (Owned) Shanachie, Yazoo, (Distributed) Message, Solomonic, Spirit Feel, Tara.
 US Reprs.: Koch Int'l (NY).
Shaolin Film & Records, PO Box 387, Hollywood, CA, 90028, (818) 506-8660. Pres./Producer: Richard O'Connor; Vice Pres. A & R: Damien Hunter; Pres./Promos: Craig Shuey; Vice Pres. A & R: Michelle McCarty.
Sharon Prods., Inc., 10556 Arnowood Rd., Lake View Terrace, CA, 91342, (818) 890-0730, (818) 890-0977. Fax: (818) 899-4457. Pres./CEO: Joe Jones, Sr.; Mgr/Mktg. Sales: Jennifer Jones; Mgr/A & R: Ronald Jones; Dir.: Keith Jones.
 Branch(es): 2114 New Orleans St., New Orleans, LA, 70119, (504) 944-6075, Contact: Deborah Jones; 2635 DeSoto St., New Orleans, LA, 70119, (504) 944-7447, Contact: Jennifer Jones.
 Label(s): (Owned) Joe Fee, Joe Jones, K-Dee-Dee, M & J, New Orleans, You Talk Too Musch.
 US Reprs.: Jennifer Jones Records (LA).
Shawmut. (See Casa Grande Records).
Sheffield Lab, Inc., PO Box 5332, Santa Barbara, CA, 93150, (805) 969-4744. Fax: (805) 969-5640. Pres.: Doug Sax; Vice Pres.: Lincoln Mayorga; Mgr.: Andrew Teton; Nat'l Sales: Robert Pfeiffer.
 Label(s): (Owned) Sheffield Lab.
Shelter. (See DCC Compact Classics).
Sheperd Records, PO Box 20570, Columbus Cir. Sta., New York, NY, 10023, (212) 724-8404. Owner: Daniel McGlynn.
Shikata Records, 4921 Leesa Ann Ln., Hermitage, TN, 37076, (615) 889-8534. Pres.: Keishi Shikata; Contact: Mayumi Shikata.
Shining Star Music, 417 Tamal Plaza, Corte Madera, CA, 94925, (415) 924-4848. Pres.: Lloyd Barde; Sales/Mktg.: Darlene Johnson.
Shoestring Records. 1907 Central, Alton, IL, 62002, (618) 465-5619. Pres.: Howard E. Neal.
 Label(s): (Owned) Shoestring.
Showboat Records & Tapes, PO Box 613329, 476 Lido Dr., South Lake Tahoe, CA, 95761, (916) 542-4444. Pres.: Casey

- Anderson; Vice Pres./Sec./Treas.: Liz Anderson; Vice Pres. A & R: Casey & Liz Anderson.
Showtime, 513 14th St., NE, Washington, DC, 20002, (202) 397-6952. Exec. Pres.: C. Ables; Gen. Mgr.: B. Salles.
Sierra Classical, (See Sierra Records).
Sierra Records, PO Box 5853, Pasadena, CA, 91117, (818) 355-0181. Fax: (818) 793-5753. Pres.: John M. Delgatto. Label(s): (Owned) Sierra, Sierra Classical.
 US Reps.: Oxymoron P & D (CA); Precision Sound (WA); Landmark Dist. (NY).
Sigma Alpha Entertainment Group, 1080 N. Delaware Ave., Philadelphia, PA, 19125, (215) 425-8682. Fax: (215) 425-4376. Pres./CEO: Peter S. Pelullo; Chariman: Joseph Tarsia; Vice Pres./Lic./Pub.: Mike Forte; Vice Pres. A & R: Rick Winward; R & B: Primus Robinson.
 Label(s): (Owned) Alpha Int'l.
Signature, (See Sony Records, Inc.).
Silk/Cut Records, PO Box 1148, 900 Cedar Ln., Atlantic City, NJ, 08404, (609) 641-3316. Pres.: Keni Applewhite; Vice Pres.: Gail Jasper; Asst. Vice Pres.: Corace Jasper; Productional Mgr.: Sting Ray; Vice Pres. A & R: Keni Applewhite.
Silver Blue Records, 220 Central Park S., New York, NY, 10019, (212) 586-3535. Pres.: Joel Diamond.
 US Reps.: Silver Blue Records (CA).
Silver Dollar, (See Jamie/Guyden Dist. Corp.).
Silver Loomas Prods., 38 Music Sq. E., Nashville, TN, 37203, (615) 255-8005. Pres.: Tommy Loomas; Vice Pres.: Joe Silver; A & R: Alan Carter.
Silver Thunder Records, 2712 Larmon Dr., Nashville, TN, 37204, (615) 292-2204. Pres.: Rusty Budde; Vice Pres.: David W. Cronan.
SilverFlash Records, Inc., 3455 E. 81st St., New York, NY, 10028, (212) 517-9538. Sales/Promo/Int'l: Bonnie Abrams, A & R/Mktg. Dir.: Isaac Ferruson.
 Int'l Reps.: J. U. C. Music (Japan).
Silvertone Records, 6777 Hollywood Blvd., 6th Floor, Hollywood, CA, 90028, (213) 464-7409. Fax: (213) 464-7144.
Silverwave Records, 6355 Topanga Canyon Blvd., Ste. 309, Woodland Hills, CA, 91367, (818) 346-6286. Fax: (818) 346-2968. Pres. Mktg./Sales: David Drozen, Vice Pres./Dir. A & R: Sheryl Kay; Dir./Nat'l Promo.: Brenda Winfield.
 Int'l Reps.: Bellaphon Int'l Sound Service (West Germany); Merit Music (Hong Kong); Virgin Records (Australia, New Zealand).
Sinclair, (See Mechanic Records, Inc.).
Sing, (See Skylite-Sing, Inc.).
Single Phase, (See Blue Sun Prods.).
Shelby Singleton Ents., Inc., 3106 Belmont Blvd., Nashville, TN, 37212, (615) 385-1960. Fax: (615) 385-1964. Pres.: Shelby S. Singleton, Jr.; Vice Pres.: John A. Singleton; Vice Pres., Sales: Col. Jim Wilson.
 Label(s): (Owned) Plantation, SSS Int'l, (Distributed) Sun.
Sire Records, 75 Rockefeller Plaza, 20th Floor, New York, NY, 10019, (212) 484-6830. Fax: (212) 581-6416. Pres.: Seymour Stein; Vice Pres. A & R: Joe McEwen; Dir. A & R: Shirley Divers; New York Gen. Mgr.: Karen Rooney; Label Mgr.: Sandy Aloute.
 Branch(es): 3300 Warner Blvd., Burbank, CA, 91505, (071) 487-5066. Fax: (818) 953-3306. Managing Dir.: Howie Klein; 83 Baker St., London, W1M 1AJ, United Kingdom, (071) 487-5066. Fax: (071) 935-3837, Asst. to Pres.: Geraldine Oakley.
Sirr Records, PO Box 58116, Philadelphia, PA, 19102, (215) 927-3328. Pres.: Rodney Jerome Keitt; Dir.: Edward Jones, Jr.
Sisapa Records Co., 6200 Eiterman Rd., Amlin, OH, 43002, (614) 764-4777. Fax: (614) 764-7463.
Sivatt Music Prods., PO Box 7172, 10 Michael Dr., Greenville, SC, 29610, (803) 295-3177. Pres.: Jesse B. Evatte; Vice Pres.: Derek Evatte.
 Label(s): (Owned) Pioneer, SoundSouth, Tribute.
Six-One-Five Records, PO Box 110829, 2473 Rocky Fork Rd., Nashville, TN, 37222, (615) 776-2060. Fax: (615) 776-2181. Owner: Bill Wence; Vice Pres.: Nedria Wence; Promo.: Kris Wence.
 Label(s): (Owned) Six One Five, Skyway.
16th Avenue Records, 65 Music Sq. W., Nashville, TN, 37203, (615) 321-5000. Fax: (615) 321-5655. Pres./Gen. Mgr.: Jerry Bradley; Nat'l Dir. Sales & Mktg.: B.J. McElwhee; Reg. Dir. Promo.: John Mitchell; Geno Rumpel, Ed Kelley.
Skaloid, (See Celluloid Records)
Skill Record Co., PO Box 653, Highland, TX, 77562, (713) 424-4235. Pres./A & R/Promo.: Slick Norris.
Skip-The-Hype, (See Granite Records & Tapes).
Skokie, (See Musicor Records).
Skylark Records, 204 Dalton Dr., Raleigh, NC, 27615, (919) 870-1109. Fax: (919) 870-0720. Owner/Gen. Mgr.: Donald J. Grantham; Promo. Mgr.: Lenore Grantham.
 Label(s): (Owned) Skylark.
Skyline, (See Luke Records, Inc.).
Skyline Contemporary, (See Skylite-Sing, Inc.).
Skyline Country, (See Skylite-Sing, Inc.).
Skyline-Sing, Inc., 58 Music Sq. W., Nashville, TN, 37203, (615) 327-4557. Pres.: Joel Gentry; Sales Dir.: Carl Gentry; Sec./Treas.: Lill A. Gentry.
 Label(s): (Owned) Master, Christian Folk, Temple, Sing, Skyline Contemporary, Skyline Country, (Distributed) Nonlie, Peaceful Stream, New Haven, Calvary.
Skyview, (See Scorpem Records, Inc.).
Skyway, (See Six-One-Five Records).
Slack, (See RJD Records).
Slash, (See J. Ruby Prods. Inc., dba Slash Records).
Slave Raider Records, 1800 Calafia St., #B, Glendale, CA, 91208, (612) 432-3102.
Sleeping Giant, (See Hometown Music Co.).
Silk, (See Malaco Records).
Sling Shot, (See Sonic Atmospheres).
Small Wonder, (See Score Prods., Inc.).
Smarty Pants Audio & Video, 15104 Detroit Ave., Ste. 2, Lakewood, OH, 44107, (216) 221-5300. Fax: (216) 221-5348. CEO/Pres.: S. Trirk; Vice Pres., Creative Svc.: Andrea Blain; Dir., Order Dept.: Leann Sullivan.
 Label(s): (Owned) Ashby Park, SPI, (Distributed) Nat'l Film Board of Canada.
Smithsonian Collection of Recordings, 470 L'Enfant Plaza, Ste. 7100, Washington, DC, 20560, (202) 287-3738. Fax: (202) 287-3184. Dir.: Felix C. Lowe; Exec. Dir.: Bruce Talbot, Assoc. Prod.: Dennis Britton; Editorial & Design Coord.: Jane Sapp; Prod. Coord.: Kathy Kim.
 US Reps.: KOCH Int'l Corp. (NY).
Smithsonian Folkways Records, 1 Camp St., Cambridge, MA, 02140, (617) 354-0700. Fax: (617) 491-1970. Dir. Mktg.: Matt Walters; Curator: Anthony Seeger; Special Markets: Justin "Bing" Broderick.
 US Reps.: Bayside, CRD (CA); House (KS); Rounder (NY); Action (OH); Richman (PA/DC); Big State (Texas).
 Int'l Reps.: Larrikin (Australia); Teldec (Germany). IRD (Italy); Munich (Netherlands); Music Dist. (Norway); Amalthea (Sweden); BeBop (Switzerland); Americana (Tokyo); Topic (United Kingdom).
Smoky Mountain Music, (See Brentwood Music, Inc.).
Sneak Tip Records, 102-40 62nd Ave., Forest Hills, NY, 11375, (718) 459-0334. Pres.: Gerald Famolari.
Soap Opera, (See Legrand Records Int'l).
Soaring Records, PO Box 1075, 7474 Ne 8th Ct., Boca Raton, FL, 33429, (407) 391-0255. Pres./Sec./Treas.: Marianne Stander, Vice Pres. A & R: M. Scott Stander.
Social Records, 3175 Mt. Vernon Ave., Riverside, CA, 92507, (714) 788-8327. Pres.: Marshall Heaney.
Society, (See Gene Kennedy Ents., Inc.).
Solid, (See AVC Entertainment Inc.).
Solid Brass, (See Random Ents., Inc.).
Solid Ground Prods., PO Box 2146, 16056 E. Amar Rd., Hollywood, CA, 90078, (818) 330-6920. Fax: (800) 779-1524. Owner: Michael Quick.
 Label(s): (Owned) SGP.
Solo Art, (See Jazzology Records, Inc.).
Sombrero Records, PO Box 121561, Nashville, TN, 37212, (615) 269-5523. Pres.: Emily Cantrell; Vice Pres.: Al Cantrell.
Somers, (See Alshire Int'l, Inc.).
Sona Gaia, (See Narada Prods., Inc.).
Sonata Records Co., 4304 Del Monte Ave., San Diego, CA, 92107, (619) 222-3346. Radio & TV Promos.: Dean Logo; Sales Dir.: Phil Jones; Distribution Mgr.: Helen Di Lella; Finance Dir.: George Lahoud; Vice Pres. A & R: Joseph Di Lella.
 Label(s): (Owned) Sonata.
Songs & Creations, Inc., PO Box 7, 64 Nokomis, San Anselmo, CA, 94979, (800) 227-2788. Fax: (415) 258-4755. Pres./Owner: Yohann Anderson; Office Mgr.: Anne Mallory; Mktg. Mgr.: Robin Somers.
 Label(s): (Owned) Songs & Creations, Songs & Creations. Sonic, (See Ex Urbana, Inc.).
Sonic Atmospheres, 14755 Ventura Blvd., #1776, Sherman Oaks, CA, 91403, (818) 505-6003. Fax: (818) 505-6006. Pres.: Craig Huxley; Gen. Mgr./A & R: Hyman Katz; Promos Dir.: Bill Clodfelter.
 Label(s): (Owned) Sling Shot, Sonic Edge.
 US Reps.: Backroads, City One-Stop (CA); Encore (CO); Jerry Bassin's (FL); Schwartz Bros. (MD); Rounder (MA), Navarre Corp. (MN); Silo (VT); Precision Sound Mktg. (WA); Music Design (WI).
Sonic Edge, (See Sonic Atmospheres).
The Sonic Group Ltd., 1204 Ave. U, Ste. 1235, Brooklyn, NY, 11229, (718) 646-8969. Fax: (718) 648-6575. Pres./A & R: Mark S. Berry.
 Label(s): (Owned) MSB.
Sonomax, (See Audiorama Records Corp.).
Sonor, (See Biarmade Records).
Sonority Records, Inc., 7701 Jervis St., Springfield, VA, 22151, (703) 354-1557. Pres.: Ray Disney.
Sonotone Music Corp., 1535 NW 79th Ave., Miami, FL, 33126, (305) 477-5999. Fax: (305) 477-8996. Gen. Mgr.: Oscar Liord; Nat'l Sales Mgr.: Nelson Abreu.
 Label(s): (Distributed) Discos Victoria, Musical Prods., Sonoartist, Sonografica, Velvet de Venezuela, AKC, Codiscos, Dideca, Disco Fuentes, Discomoda, Discomoda.
Sonrise Records, Inc., PO Box 755, Malibu, CA, 90265, (310) 456-5482. Pres.: Bob Cotterell.
Sony Records, Inc., PO Box 4450, New York, NY, 10101, (212) 445-4321. Fax: (212) 445-9619. Pres./CEO: Walter R. Yetnikoff; Pres./CBS Records Div.: Tommy Mottola, Mgr. A & R Admin.: Elaine Trettle; Pres.: Sony Records-Nash.: Roy Wunsch; Dir. Media Development: Fletcher Foster; Vice Pres./A & R, Columbia: Steve Buckingham; Vice Pres./A & R, Epic: Bob Montgomery; Promo. Contact, Columbia: Joe Casey; Promo. Contact, Epic: Jack Lameier; Publicity, Columbia: Jules Wortman, Publicity-Epic: Cheryl Lindsey Branch(es) 1801 Century Park West, Los Angeles, CA, 90067, (213) 556-4700. Sr. Vice Pres./Gen. Mgr.: Myron Roth; Columbia/Epic Records, 34 Music Sq. E., Nashville, TN, 37203, (615) 742-4321. Fax: (615) 244-2549.
 Label(s): (Owned) Laurie, Masterworks, Musicor, Scepter, Signature, WTG, Bulldog, Columbia, Dr Jazz, Epic, FM, Jefferson Jazz, Wand.
Soul Kitchen, (See Boddie Recording).
Soul-Po-Tion Records, 313 Highland Ave., Albany, GA, 31701, (912) 438-8497. Pres.: Jesse Boone; Vice Pres.: Eric Boone. Label(s): (Owned) Albradella, Atlanta Assoc., Cozette, Soul-Po-Tion, Vanity.
 US Reps.: Gwen Soul City, Justin Entertainment (GA); Central South Dist. (TN); Jerry Bassin (FL).
Souled Out, (See SOAR Sound of America Records).
Soulstreet Records, Inc., 265 Main St., E. Rutherford, NJ, 07073, (201) 933-2297. Fax: (212) 655-3581. Pres.: Glenn Larusso; Club Promos. Dir.: Batcho Manguel.
 Label(s): (Owned) Soulstreet, (Distributed) In Groove.
 Int'l Reps.: Disques Vogue (France); YZY (West Germany).
Sound Development Releasing Group, Ltd., PO Box 5052, Evanston, IL, 60204, (708) 328-0400. Fax: (708) 328-1700. CEO: Graham Carlton.
Sound Feelings Records, 24266 Walnut St., Newhall, CA, 91321, (805) 254-4938. Pres.: Howard Richman; Mktg. Dir.: Jackie Adair.
 Int'l Reps.: Voice Co. (Japan).
Sound Image Entertainment, Inc., 6556 Wilkinson, North Hollywood, CA, 91606, (213) 762-8881. Pres./CEO: Marty Eberhardt; Vice Pres./Gen. Mgr.: Dave Chatfield; Vice Pres./Bus. Affairs: John Bishop; Vice Pres./Sales: Chuck Kopp.
 Label(s): (Owned) Harmony.
Sound of Los Angeles Records (Solar Records), 1635 N. Cahuenga Blvd., Hollywood, CA, 90028, (213) 461-0390. Fax: (213) 461-9032. Chrmn.: Dick Griffey; Pres./Gen. Counsel: Virgil Roberts; Vice Pres./Asst. Gen. Co.: Peter Van Brunt, Dir. A & R: Glen Davis.
 Label(s): (Owned) Solar.
 US Reps.: Sony Music, Vogue Records (CA).
Sound Rx, 212 Van Tassel Ct., San Anselmo, CA, 94960, (415) 485-5321. Fax: (415) 485-1312. Pres./Owner: Steven Halpern, Sales Mgr.: Emil Sobylak; Andrea Heath; Business Mgr. Al Evers; Personal Mgr.: Melanie Jordan.
 Label(s): (Owned) Sound Rx, Sound Wave 2000, Sound Wave 2000, Sound Rx.
Sound of the Sphinx, 198 Hope St., Providence, RI, 02906, (401) 751-6316. A & R: Richard C. Famiglietti.
Sound Wave 2000, (See Sound Rx).
SoundSouth, (See Sivatt Music Prods.).
Soundbox Records, 345 Riverside Dr., Ste. 6-A, New York, NY, 10025, (212) 864-0073. Pres. & Dir. Distribution: Carolyn Sachs; Vice Pres./Dir. Radio Promo: Adam Lewis; Dir. Artist Rel. & Devel.: Greg M.; Dir. Publicity: Jim Matus.
 Label(s): (Owned) Soundbox.
 US Reps.: Dutch East (NY).
 Int'l Reps.: Semaphore (The Netherlands); Dutch East (Japan).
Soundings Of The Planet, PO Box 43512, Tucson, AZ, 85733, (602) 792-9888.
SoundMasters, 9717 Jensen Dr., Houston, TX, 77093, (713) 695-3648. Pres.: J.D. Johnson; Vice Pres.: A.V. Mittelstedt; Treas.: Lola Mason.
 Label(s): (Owned) A.V. Cherry.
SoundPoint Recordings, Inc., 5311 W. Judy Ct., Visalia, CA, 93277, (209) 739-3412. Fax: (209) 739-1580. Chrmn.: George S. Lavenson, Jr.; Pres.: Robert J. Geide, Sr.; Treas.: Thomas L. Volk; Vice Pres. Artist Relations: Joe Eick.
Sounds Of Gospel, (See Westbound Records, Inc.).
Sounds of Hope, (See Epoch Universal Publications).
Sounds-Vision Music, PO Box 3691, La Mesa, CA, 91944, (800) 447-1322. Owner/Gen. Mgr.: Rod Hollman; Owner: Aleandra Hollman; Mktg & Sales: Albert Hollman.
 Label(s): (Owned) Sounds-Vision Music, (Distributed) ARO, Hannibal, Hepcat, Sirocco.
 US Reps.: Sounds-Vision Music (CA); Tower Records Int'l (CA); Lyricord Discs (NY).
 Int'l Reps.: Roblan Dist. (Canada).
Soundscreen, (See Little Major Record Distributors, Inc.).
Soundwaves Records, PO Box 22325, 1012 18th Ave., S., Nashville, TN, 37202, (615) 327-7980. Fax: (615) 321-0464. Pres.: Noel Gibson; Vice Pres.: Joe Gibson; Promo.: Betty Gibson; Office Mgr.: Brenda L. Madden.
Soundwings, Inc., 1299 Ocena Ave., Ste. 800, Santa Monica, CA, 90401, (310) 394-2528. Fax: (310) 394-4148. Pres.: Patrick Williams; Vice Pres./Gen. Mgr.: Catherine Williams; Dir. Promo.: Doc Remer, Dir. Publicity/A & R: Adam Ward Seligman.
 Label(s): (Distributed) Soundwings/Duke Street.
 Int'l Reps.: Fun House (Japan), Virgin Records (New Zealand), Virgin Records (Australia); Merit Music (Hong Kong).
Source Records, Inc., 39 S. LaSalle St., Ste. 825, Chicago, IL, 60603, (312) 280-0808. Fax: (312) 280-9191. Pres.: John Bellamy; Vice Pres.: Anthony Stephens; A & R Rep.: John Bellamy.
 Label(s): (Owned) Source, (Distributed) Brackett Int'l Reps.: Trulove Records (England).
Source Unlimited Records & Tapes, Inc., 331 E. Ninth St., New York, NY, 10003, (212) 473-7833. Pres.: Santo Mollica.
 Label(s): (Owned) Source Unlimited.
Soustreet Records, Inc., 928 Broadway, Ste. 205, New York, NY, 10010, (212) 460-8677. Fax: (212) 614-0166. Pres.: Glenn LaRusso; Vice Pres. Robert Melzer, Club Promo: Bacho Manguel.
 Label(s): (Owned) Street Soul.
Southern Cross, (See Fifth Continent Music Corp.).
Southern Sound Prods., 100 Labin St., Tabor City, NC, 28463, (919) 653-2546. Pres.: Elson H. Stevens.
 Label(s): (Owned) BMJ, Musicmaker, Seaside.
Southern Tracks Record Co., 3051 Clairmont Rd., NE, Atlan-

ta, GA, 30329, (404) 325-0323. Fax: (404) 325-1075. Mgr.: Butch Lowery.
Label(s): (Distributed) Southern Tracks.

Southern Wing Records, 13710 Steele Creek Rd., Charlotte, NC, 28217, (704) 588-3998. Owner: J. R. Branch.
Southland. (See Jazzology Records, Inc.)

Southland Records, Inc., PO Box 1547, Arlington, TX, 76004, (817) 461-3280. CEO/Pres.: Steve Reed.

Sovereign Records, (div. of Aloft Music Entns., Inc.), 1697 Broadway, Ste. 903, New York, NY, 10019, (212) 247-2904. Pres.: Ruby Fisher.
US Reps.: North Country (NY); Serendipity (CT); Walrus (CA). Sozo. (See Eagle Mt. Int'l Church).

Space Records, 2037 Alvarado Dr., NE, Albuquerque, NM, 87110, (505) 268-8405. Pres./Gen. Mgr.: A. Medley.
Label(s): (Owned) Space.

Space Station. (See Earth Station Records).

The Spacex Co., PO Box 741506, Dallas, TX, 75374, (214) 340-7600. Fax: (214) 644-0555. Contact: Ed Spacex.

Spanda Records, 155 B. Quincy Court, Bloomingdale, IL, 61008, (708) 529-7127. Pres.: Carolyn P. Ford; Gen. Mgr.: Karen Di Renzo; A & R Dir.: Jabala Ford.
Label(s): (Owned) Great American Song Machine, Jabala Spark. (See Peer-Southern Organization).

The Sparrow Corp., PO Box 5010, 101 Winners Cir., Brentwood, TN, 37204, (615) 371-6800. Fax: (615) 371-6697. Pres.: Billy Ray Hearn; Sr. Vice Pres./Mktg.: Bill Hearn; Vice Pres./A & R: Peter York; Vice Pres./Sales: Danny McGuffey. Branch(es): 54 Music Sq., East, Suite 306, Nashville, TN, 37203, (615) 327-3800. Gen. Mgr./Vice Pres., A & R: Peter York.
Label(s): (Owned) Meadowlark, (Distributed) Pretty Good, Star Song, Ark. Birdwing, Integrity's Hosanna Music.
Int'l Reps.: Alpha & Omega (Brisbane, Australia); Word Records (Richmond, BC, Canada); Concorde (Havelock North, New Zealand); Praise (Quezon City, Philippines); Word U.K. (United Kingdom).

Speak No Evil Records, 5751 Rodeo Rd., Los Angeles, CA. Contact: Sheryl Monaghan-Carr

The Special Music Co., 560 Sylvan Ave., Englewood Cliffs, NJ, 07632, (201) 894-8700. Fax: (201) 894-8630. Managing Partner: Richard Greener; Dir. A & R/Mktg.: Doug Friedman. Branch(es): 1785 Shaker Heights Dr., Bloomfield Hills, MI, 48304, (313) 852-6288. Fax: (313) 852-6410. Nat'l Sales Dir.: Mike Cave.
Label(s): (Owned) Buddah, Maestro, Project 3, Special Music, Stradivari, (Distributed) PolyGram Special Products, RCA Special Products, Commodore, Camden, CBS Special Products.

Specialty Stax. (See Fantasy, Inc.)

Phil Spector Records, Inc., 686 S. Arroyo Pkwy., Penthouse Ste., Pasadena, CA, 91105, (818) 846-9900. Fax: (818) 799-1241. Professional Mgr.: Harold Esposito; Gen. Mgr./A & R: Thomas Mix; Admin. Dir.: Janis Zavla.
Label(s): (Owned) Phillies

Spectrum, Inc., 751 Laurel St., San Carlos, CA, 94070, Pres.: Paul Weaver

Spindletop Records, Inc., 4015-A Magnolia Blvd., Burbank, CA, 91505, (818) 842-0722. Fax: (818) 842-1441. Pres.: W. Barry Wilson, Vice Pres./Gen. Mgr.: Michael Dion; Publicity Dir.: Tracy Daniello; Warehouse Supervisor: Tony Valenziano. Label(s): (Distributed) Bons Ritmos, ITI, Reiter.
US Reps.: LaCalifusa (CA); Twinbrook (NY).
Int'l Reps.: Trend (Canada); Chaing Huat (Singapore).

Spinit. (See Eggplant Records).

Spirit Music, Inc., PO Box 2240, Boulder, CO, 80306, (303) 443-8181. Pres.: Jonathan S. Goldman; Vice Pres.: Karen Anderson; A & R: Steve Stone; Mktg.: Debi Elliott.
Label(s): (Owned) Spirit Music.
US Reps.: Music Design (WI); Pyramid (CA); New Leaf (GA).
Int'l Reps.: Oreade (The Netherlands).

Spirit Records, 1818 Lennox Ave., Charlotte, NC, 28203, (704) 375-0654. Pres.: William R. Bradford, III.

Spirit Records of Nevada. (See Casino Record, Inc.)

Spoken Arts, Inc., 310 North Ave., New Rochelle, NY, 10801, (914) 636-5482. Fax: (914) 636-1539. Chrmn.: Arthur L. Klein. Ph.D. Pres.: Susan Kline; Corp. Dir.: Ernest B. Schnell; Purchasing: Lisa Somners.

Spotlite Records, PO Box 875, 311 1/2 E. Main, Niles, MI, 49120, (616) 684-0653. Fax: (616) 683-4415. Pres.: Gary Shinholt; Vice Pres.: Larry Clymer; Dir. of Promos.: Grover Garges, Talent Coord. Sandra Brown; Vice Pres. A & R: Larry Clymer.
Label(s): (Owned) Four Flags.

Staccato Sounds Ltd., PO Box 1002, Pearl River, NY, 10965, (914) 735-0605. Pres.: John Parrick; Vice Pres.: Robert Rizzuto; Vice Pres./Sales: John J. Maggio; Vice Pres. A & R: Peter Soho.

Standing Room Only 800. (See Lync Distribution, Inc.).

Standing Room Only 500. (See Lync Distribution, Inc.).

Stanyan Record Co., PO Box 2783, Hollywood, CA, 90028, (213) 657-7311. Owner: Rod McKuen; Pres./Gen. Mgr.: Wade Alexander.
Label(s): (Owned) April River, Discus, New Gramophone Star. (See Century Records, Inc.).

Star Image. (See Starworld Corp.).

Star Vision Int'l Records, 23 Ivy St., Stamford, CT, 06902, (203) 358-9948. Pres.: James Dockett; Dir./Admin. & A & R: Barbara Dockett

Starborn Records, 3884 Franklin Ave., Los Angeles, CA, 90027, (213) 662-3121. CEO: Brian Ross; Business Affairs: Aaron Anthony.

Stardust/Wizard/Doss Records, PO Box 13, Rt. 2, Box 2512, Estill Springs, TN, 37330, (615) 649-2577. Pres.: Col. Buster Doss; Vice Pres.: Kimberlee Doss; Bo Doss; Sec./Treas.: Barbara Doss.
Label(s): (Owned) Doss, Frontier Jamboree, Kimbolon, Range Buster, Stardust, Wizard.

Stargem Records, Inc., 43 Music Sq. E., Nashville, TN, 37203, (615) 244-1025. Pres.: Wayne Hodge; A & R: Donna Adwell; Creative Dir.: Debbie Moore.
Label(s): (Owned) Kristal Int'l, Timestar.

Stark Records & Tape Co., 628 S. South St., Mount Airy, NC, 27030, (919) 786-2865. Pres./Owner: Paul E. Johnson; Mgr. Mktg. & Sales: Gertrude B. Johnson.
Label(s): (Owned) Blue Jay, Blue Ridge, Sugarbear, Stark, Tornado, Colonial, Hello, Pilot, (Distributed) Modern, Joy Broadcast, E.K.O., Tchiban, Spinn.

Starline Records, 310 Sepulveda, Palm Springs, CA, 92263, (619) 327-7947. Contact: Jon Kodi.

Starman Records, PO Box 245604, 675 Third Ave., Sacramento, CA, 95824, (916) 448-1080. Pres.: Almeritt V. Covington; Vice Pres. Sales/Mktg.: Marsha Covington; Promo. Dir.: Diana L. Curry; A & R: Nathan Curry.
Label(s): (Owned) Acrecko, North Star, (Distributed) Diana.

Starr Record Co., PO Box 1, Florida, NY, 10921, (914) 651-4266. Pres.: James Sturr; Vice Pres.: Edward Kosior.

The Stars Are Maller. (See Hummingbird Recording Co., Inc.).

Startime Music. (See Fred Rice Prods., Inc.).

Starway Records, Inc., 7600-B Leesburg Pike, Ste. 400, Falls Church, VA, 22043, (703) 821-0500, (800) 782-7929. Fax: (703) 442-7545. Pres.: Guy Beatty; Mktg. & Promo. Dir.: Arman Taheri.

Starwest Records, 6808 Willow Grove, Longview, WA, 98632, (206) 577-6558. Contact: Mike Poe.

Starworld Corp., PO Box 22653, Nashville, TN, 37202, (615) 822-6119. Pres./CEO: David W. Mathes; Vice Pres./Sales Dir.: Sam Lewis; Sec.: DeAnna Mathes.
Label(s): (Owned) Star Image.

Stash Daybreak. (See Stash Records, Inc.).

Stash Records, Inc., 611 Broadway, New York, NY, 10012, (212) 477-6277. Fax: (212) 477-6398. Vice Pres./A & R: Fred Brightman; Vice Pres.: Natasha Brightman; Will Friedwald; Contact: Jim Eigo.
Label(s): (Owned) Stash, Stash Daybreak, (Distributed) Vintage Jazz Classics, Jass.

US Reps.: City Hall (CA); Landmark (GA); Rounder (MA); Action (OH).

State of Fresh American Entertainment, 250 W. 57th St., Ste. 1527, New York, NY, 10107, (212) 713-5530. Fax: (212) 582-0593. Pres./CEO: Dwayne Haywood; Vice Pres. Mktg.: Bob Goldberg; Vice Pres. Bus. Affairs: Steve Rabinowitz; Sr. Vice Pres. Custom Label Grp.: Bruce Levine; Vice Pres. A & R: Dave Anderson.
Label(s): (Owned) Empire Entertainment, Satellite, State Of Fresh, Sun Music Sales, (Distributed) Mahogany Entertainment, Def Control.
US Reps.: Indy Network.

Statiras Records, 1304 Fletcher Rd., Tifton, GA, 31794, (912) 382-6257, (912) 382-7916. Fax: (912) 382-6761. Pres.: Gus P. Statiras; Vice Pres. A & R: Perry Statiras.
Label(s): (Owned) Gear, Laser, Statiras, Statur.
Int'l Reps.: Cottage Records Ltd. (England).

Statue Records, 2810 McBain St., Redondo Beach, CA, 90278, (213) 371-5793. Fax: (213) 371-5686. Pres.: Jim Monroe; Chairman: Anthony Remonal; Vice Pres. A & R: Brian Gunther; Gen. Mgr.: Lisa Raven.
Label(s): (Owned) Statue, (Distributed) DH.

Statur. (See Statiras Records).

Stecker Communications, PO Box 100581, Denver, CO, 80250, (303) 756-2726. Pres.: Robert B. Stecker.

Stelltown. (See Supergold Prods.).

Stepping Stone. (See Trend Recording & Distributing Co.).

Stereo Fidelity. (See Alshire Int'l, Inc.).

Stinson Records, PO Box 3415, Granada Hills, CA, 91344, (818) 709-3640. Fax: (818) 709-7722. Pres.: Jack M. Kall.

Stone Drunk Records, PO Box 242, Woodland, PA, 16881, Owner: John Maines, Jr.; Vice Pres.: Jack Maines; Mgr.: Tim Schodol; A & R: John Wesley.

Stone Records Ltd., PO Box 1917, Venice, CA, 90924, (213) 391-8009. Fax: (213) 390-0140. Pres.: Richard Egizi; Gen. Mgr.: Brett Pollak.
US Reps.: Navarre (CA, MN); Select-O-Hits (TN); MDI (TX); Action Music (OH).

Stradivari. (See The Special Music Co.; Pair Records; Essex Entertainment, Inc.).

Strafe Entertainment/New Medium Records, 140 Lawrence St., Brooklyn, NY, 11201, (718) 625-2838. Pres.: Steven W. Standard; Vice Pres.: Sharon Taylor; Admin.: Kathy Waters.
Label(s): (Owned) New Medium.

Straight-Up Prods., PO Box 78617, Seattle, WA, 98178, (206) 228-7307. Fax: (206) 226-4812. CEO/Opns. Mgr.: Rachelle Smith-Byers; CEO/Prod.: Andre L. Sterling.
Label(s): (Owned) Straight-Up Sound Recordings.
US Reps.: Hits Unlimited (IL).

Strangeland Records, 11846 Balboa Blvd., Ste. 135, Granada Hills, CA, 91344, (818) 377-4752, (818) 362-3550. Fax: (818) 361-2389. Pres.: Ray Soular.
Label(s): (Owned) StrangeLand.

Strata-East Records, PO Box 36 GCS, New York, NY, 10163. Chief Officer: Charles Tolliver.
Label(s): (Owned) Strata East.
Int'l Reps.: Bellaphon (Germany).

Strate 8. (See Fortune Records).

Strawberry. (See Round Robin Records).

Strawboss. (See Round Robin Records).

Street Soul. (See Soustreet Records, Inc.).

Street Street Communications, Inc., 9377 Lincoln Blvd., Ste. 2269, Los Angeles, CA, 90045, (213) 568-8952. Exec. Dir./CEO: Mark St. Juste; A & R Dir.: Margie St. Juste; Jessica St. Paul; Mktg. Dir.: Robert Roundtree; Sales Dir.: Cindy Brown.
Label(s): (Owned) Street Street Music, (Distributed) BBD AITP.

Streke. (See Periscope Record Co.).

Strong City Records, 759 Allerton Ave., Bronx, NY, 10467, (212) 519-6018. Pres.: Rocky Bucano; Vice Pres./A & R Dir.: Jazzy Jay; Art Dir.: Eric Orr; Gen. Mgr.: Skeff Anselm.
US Reps.: Landmark (Long Island City, NY); Great Bay (Baltimore, MD); M. S. Atlanta (Atlanta, GA); Action Music, Music Distributors, Inc., California Record Distributor.
Int'l Reps.: London Records (London, England).

The Strugglebaby Recording Co., PO Box 8385, 2612 Erie Ave., Cincinnati, OH, 45208, (513) 871-1500. Fax: (513) 871-1510. Pres.: Stan Hertzman; A & R: Charlie Fletcher; Vice Pres. A & R: Sam Richman.
Label(s): (Owned) Strugglebaby.

Strummin. (See Bernstein Corp.).

Studio B Records, PO Box 295, Atco, NJ, 08004, (609) 767-4225. Mgr.: Bob Thomas; Mktg.: Bob Fitzpatrick; Asst. Dir.: Mark Daniel.
Label(s): (Owned) Studio B.
US Reps.: Rosemark Pub. (NJ).

Studio 805, 805 18th Ave. S., Nashville, TN, 37203, (615) 329-9204. Mgr.: Butch Carr.

Studio 17. (See Revonah Records).

Studios Borinquen, Inc., G.P.O. Box 364785, San Juan, PR, 00936, (809) 731-2088. Fax: (809) 720-3726. Vice Pres.: Raul Aguayo; Gen. Mgr.: Bendito Valdes.
Label(s): (Owned) Borinquen.

Stupid Fresh. (See Prime Sound Recordings).

Style. (See S.W. & A. Assoc., Co.).

Styleway. (See S.W. & A. Assoc., Co.).

Sue Records, Inc.

PO Box 1125, Shreveport, LA, 71163, 1700 Centenary Blvd., Shreveport, LA, 71101, (318) 227-2228. Fax: (318) 227-0304. Pres.: Stanley J. Lewis; Sr. Vice Pres.: Susan Lewis; Vice Pres.: Ann Stuckey.
Label(s): (Owned) Jewel, Paula, Ronn, (Distributed) USA, Job, Artistic.

Sueno Label, (See Moose Records).

Sugar Hill Records, Inc., PO Box 4040, Duke Sta., Durham, NC, 27706, (919) 489-4349. Fax: (919) 489-6080. Pres.: Barry Poss; Mktg. & Promos. Dir.: Penny Parsons; Radio Promos.: Betsy Heady.
Label(s): (Owned) Palmico Sound, Sugar Hill.
US Reps.: Action Music Sales (OH); Associated Dist. (AZ); Bayside, California Record Dist. (CA); Big State Dist. (TX); Encore Dist. (CO); Landmark Dist. (IL); Music City Dist., Select O Hits (TN); Old Fogey (MI); Record Depot (VA); Richman Bros., Schanachie (NJ); Rock Bottom (GA); Rounder (MA); Silo (VT).
Int'l Reps.: Amthalta (Scandinavia); Americana, B.O.M. Services (Japan); King Records, Pooh Yokochi, Bebop (Switzerland); CM, Topic Records (England); Comus (New Zealand); East West (West Germany); Int'l Record Dist. (Italy); Larrikin (Australia); Media Sept (France); Mike's Country Music Room (Scotland).

Sugarbear, (See Stark Records & Tape Co.).

Sugarfoot Prods., PO Box 1065, Joshua Tree, CA, 92252, (619) 366-9539. Pres.: Dewey Dobson; Vice Pres./Prod. Mgr.: Sheila Dobson.
Label(s): (Owned) Baby Doll, Durban, (Distributed) Southern Music.
Int'l Reps.: Sugarfoot (Europe, Africa).

Sugo Records, Inc., PO Box 1196, El Granada, CA, 94018, (415) 726-0696. Fax: (415) 726-0698. Pres.: Stevan Pasero; Vice Pres.: Jeremy Hale; Dir.: Digeann Cabrelli.
Label(s): (Owned) Sugo, (Distributed) Fireworks, MMM Music.
Int'l Reps.: Festival (Australia); Attic (Canada); Alfa (Japan); Jigu (Korea).

Sun Entertainment Corp., 3106 Belmont Blvd., Nashville, TN, 37212, (615) 385-1960. Fax: (615) 385-1964. Pres.: Shelby S. Singleton, Jr.; Exec. Vice Pres.: John A. Singleton; Vice Pres., Sales: Col. Jim Wilson.
Label(s): (Owned) Sun, (Distributed) Plantation, SSS Int'l.
Int'l Reps.: Bellaphon (West Germany); Charly (United Kingdom); EMI (Australia); PolyGram (Canada); Sonet Gram-mofon (Sweden).

Sun-Glo Records, Inc., PO Box 557851, Miami, FL, 33255, (305) 262-7300. Pres.: Samuel Solomon, Jr.; Mktg./Dist. Vice Pres.: Darnell Johnson; Vice Pres. Pub. Rel.: Frank Solomon.
Label(s): (Owned) S & H, Tempus.
US Reps.: Florida Rock (Miami, FL).

Sun Music Sales. (See State of Fresh American Entertainment).

Sun-Ray & Sky-Vue Records, 1662 Wyatt Pkwy., Lexington, KY, 40505, (606) 254-7474. Owner/Pres.: James T. Price; A & R: Kevin Rawlins; Sec.: Rose Powers.
Label(s): (Owned) Sun Ray, Sky Vue, (Distributed) Duncely.
Int'l Reps.: Brian Taylor, Egleton & Chalmers, Record Mart.

- The Bop Shop (England); Scorpio Patrice Barbat (France).
Sunbonnet Records, 3316 Cocoa Dr., Nashville, TN, 37218, (615) 254-8712. Fax: (615) 254-8712. Pres./Gen. Mgr.: Earl Lett; Vice Pres. A & R: Lamar Lett; Promos. Mgr.: Mattie Swain. Label(s): (Owned) Sunbonnet.
- Sundance Records**, 907 Baltimore St., Mobile, AL, 36605, (205) 432-1023. Pres.: Antonio Pritchett; Promo./Mktg.: Vernon Clemons; Sales Rep.: Robert Goodwill; Int'l Sales: Nancy Pritchett. Label(s): (Distributed) T.P.
- Sundazed Music**, PO Box 85, 228 Mansion St., 2nd Floor, Coxsackie, NY, 12051, Pres./Vice Pres.: Bob Irwin; Sec./Treas.: Mary Irwin. Label(s): (Owned) Hollowbody, Sundazed, Whos Driving My Plane. US Reps.: Skyklad, Performance (NJ); Important (CA, NY); Caroline (CA, NY); Dutch East India, Venus, Midnight (NY); Get Hip (PA); Big State Dist. (TX); Music (NH). Int'l Reps.: Back to the Rock (Japan); Vicious Sluth (Australia).
- Sundown Records, Inc.**, PO Box 241, 3694 Spanish Gate Dr., Newbury Park, CA, 91320, (805) 499-9912. Fax: (805) 499-9047. Pres.: Gilbert V. Yslas; Sec.: Richard L. Searles. Sunn. (See Terock Records).
- Sunny Day Prods., Inc.**, 1931 SE Morrison, Portland, OR, 97214, (503) 238-4525. Fax: (503) 236-8347. Pres.: Russ Gorsline; Vice Pres.: Greg Branson. Label(s): (Owned) Criket, Rexius.
- Sunrise Communications**, PO Box 755, Malibu, CA, 90265, (310) 456-5482. Pres.: Robert C. Cottler.
- Sunshine Entertainment Corp.**, 627 N. Rossmore Ave., Ste. 312, Hollywood, CA, 90028, (213) 465-5050. Fax: (213) 466-1629. Pres./CEO: Walter Kahn; A & R Coord.: Mauro Monteiro. Label(s): (Owned) Sunshine.
- Sunsplash**, (See Adelphi Records, Inc.).
- Super Seven Seven Inch**, (See Mystic Records, Inc.).
- Supergold Prods.**, 9016 Wilshire Blvd., Beverly Hills, CA, 90211, (213) 674-7855. Pres.: Ben Brown. Label(s): (Owned) Steeltown.
- Supreme Record Co.**, PO Box 150394, 602 W. Iris Dr., Nashville, TN, 37215, (615) 298-3824. Partner/Mgr.: Tom Walls; Office Mgr.: Jean Walls. Label(s): (Owned) Timberhill.
- Sureshot Records**, PO Box 1345, 7915 Forest Glenn Dr., Kings Beach, CA, 96143, (916) 546-5381. Owner/Pres.: Alan Redstone; Office Mgr.: Rene Randall. Label(s): (Owned) Sureshot.
- Surf**, (See Granite Records & Tapes).
- Surf City**, (See Pop Record Research).
- Surge**, (See Wan Star Entertainment Group).
- Surprise Records, Inc.**, PO Box 42707, Philadelphia, PA, 19101, 7231 Mansfield Ave., Philadelphia, PA, 19138, (215) 276-8861. Pres./CEO: W. Lloyd Lucas; Vice Pres./Mktg. Sales Mgr.: Adele J. Lucas; Dir. Promo Activity: Brian L. Lucas; Dir. Int'l Affairs: Karen Mabry-Lucas; Vice Pres. A & R: Darryl L. Lucas. Label(s): (Owned) S.R.I., Surprise. US Reps.: Universal Record Dist. (PA).
- Survival Records**, PO Box 7032, Marietta, GA, 30065, (404) 436-8631. Pres.: Jeff Higgins. US Reps.: Important Record Dist. (NY).
- Survivor Records/Dream Makers, Inc.**, 880 Front St., Ste. 661, Lahaina, Maui, HI, 96761, (808) 661-5151. Fax: (808) 661-5154. Pres./CEO: Jason W. Schwartz; Contact: Anita Kagan; Vice Pres.: Publishing: Bonnie Fredericks; Artist Relations: Vice Pres.: Romeo Folvarko. Label(s): (Owned) Dream Makers, Maui Arts & Music Assoc., Revelation, Rough Diamond, Survivor.
- Susan**, (See Terock Records).
- Svenskdisk**, (See Lindbergh Records).
- Swallow**, (See Flat Town Music Co.).
- Swampstone Records**, PO Box 441388, West Somerville, MA, 02144, (617) 926-8953. CEO: Peter Wetherbee. Label(s): (Owned) Swampstone. US Reps.: Rounder Records Corp.
- Sweet Tooth**, (See Candy Records).
- Sweet Tree**, (See Kingdom Come Prods.).
- Sweetson Prods., Rt. #9**, Box 332 A, Parkersburg, WV, 26102, (304) 428-7773. Owner: Roger L. Hoover; Mktg.: Dave Fore; Promo/Sales: Windy Winn; Publicity: Carol Prunty. Label(s): (Owned) Mansion.
- Syntonic Research, Inc.**, 5 Barranca Cr., Austin, TX, 78731, (512) 459-4345. Fax: (512) 459-4346. CEO: I. S. Teibel; Vice Pres. Mktg.: Michael Kron; Vice Pres./Comptroller: R. Aarons; Vice Pres. Sales: R. Gallo. Label(s): (Owned) Environments. US Reps.: Backroads, Devors & Co., Pyramid, Real to Reel, WEA (CA); Mind Flight Corp. (CO); New Leaf (GA); Atlantic Records (NY); Institute for Earth Education (WA); Music Design (WI). Int'l Reps.: Sounds of Noor (Canada); Fonx Musik (Denmark); Musiques du Monde (Holland); Sunray Yamakou (Japan).
- T**
- TBA Records, Inc.**, 11026 Ventura Blvd., Ste. 3, Studio City, CA, 91604, (213) 877-5106. Fax: (818) 506-5207. Pres.: Don Mupo; Vice Pres., Int'l. Jennifer Bensi. Label(s) (Owned) Palo Alto, Tall Tree.
- US Reps.: Assoc. (AZ); Encore (CO); Gemini (GA); Music Craft (HI); Great Bay (MD); Navarre (MN); Action, ARC, (OH); Universal (PA); Select-O-Hits (TN); Big State (TX). Int'l Reps.: Trend (Canada); BMG Aris/Ariola (Germany, Australia, Switzerland); Les Folies Art (Italy); Victor Musical Ind. (Japan); Ivory Rec. (Philippines); Chiang Huat Co. (Singapore, Malaysia, Thailand, Hong Kong, Taiwan); Roots Record (South Africa).
- TBS**, (See CDE Records & Tapes).
- TCB**, (See All Star Promos, Castle Records).
- TD Hype**, Cio Trotman-Dofat Prods., 710 East 236th St., Bronx, NY, 10466, (914) 664-6021. Pres.: Greg Trotman; Vice Pres.: Tony Dofat.
- TDM**, (See Harper Audio).
- T.E.C. Tones/Ralph Records**, 109 Minna St., Ste. 391, San Francisco, CA, 94105, (415) 585-4379. Fax: (415) 584-8126. Dir.: Thomas J. Timony; A & R/Mktg.: Sheenah Fair. Label(s): (Owned) Elemental Music, Episode. Psychoacoustic Sound, Ralph, T.E.C. Tones. US Reps.: Trip Dist. (Tower Records); East Side Digital (MN). Int'l Reps.: Boudisque Dist. (Holland).
- TJ Records**, PO Box 8443, Stanford, CA, 94309, Contact: Tom Boyd; Collin Robert. Label(s): (Owned) TJ.
- T-Jaye Records**, PO Box 60412, 923 Main St., Nashville, TN, 37206, (615) 226-1004. Fax: (615) 226-1004. Owner & Pres.: Ted Jarrett. Label(s): (Owned) T-Jaye.
- US Reps.: Jerry Bassin, Inc. (FL); One Stop Record House (GA); Frankie's Music Dist. (LA); M.S. Dist. (IL).
- TMA Records**, 29 S. Erie St., Toledo, OH, 43602, (419) 243-5300. Fax: (419) 255-2231. Pres.: Michael Drew Shaw; Vice Pres. Int'l Opls.: J. Knorr. Label(s): (Owned) Heritage, Keeny/York, Park J Tunes, TMA.
- TNA Records**, PO Box 57, 10 George St., Wallingford, CT, 06492, (203) 269-4465. Fax: (203) 294-1745. Exec. Dir.: Thomas Cavalier; Exec. Sec.: Edyth Mercier; Technical Sec.: Richard Robinson; Dir. Master Placement: Darlene Cavalier. Label(s): (Owned) Big Sound, Poison Ring.
- T.O.M. Records**, PO Box 487, Novato, CA, 94948, (415) 898-1609. Fax: (415) 457-0780. Contact: Reynold Brown.
- TRF Music Company**, 1619 Broadway, New York, NY, 10019, (212) 265-8090. Fax: (212) 956-3039. Pres.: Michael Nurko; Vice Pres.: John Bienstock; Gen. Mgr.: Allan Tepper; Sales Mgr.: Norman Dozier. Label(s): (Distributed) Black Rock, Bosworth, Carlin, Montparnasse.
- TSOP**, (See Philadelphia Int'l Records).
- TSR Records**, 18653 Ventura Blvd., #513, Tarzana, CA, 91356, (818) 705-3512. Fax: (818) 705-3403. Pres.: Tom Hayden; Vice Pres.: Suzanne Hayden. Label(s): (Owned) Baja, Damabi.
- US Reps.: City Hall, JDC (CA); Bassin, JFL (CA); Action (OH); Big State (TX).
- Tahiti**, (See Criterion Music Corp.).
- Take Home Tunes**, (See Original Cast Records).
- Take-Over**, (See Jam-Power, Inc.).
- Takoma**, (See Allegiance Records Ltd.).
- Tall Tree**, (See TBA Records, Inc.).
- Tamara**, (See A.M.I. Records/American Music Inc.).
- Tamm**, (See La Louisiana Records).
- Tandem Records**, 1300 Old Baysshore, # 191, Burlingame, CA, 94010, (415) 344-3640. Fax: (415) 344-3670. Vice Pres. A & R: Bill B. Label(s): (Distributed) Speed.
- Tantulus Records, Inc.**, 6420 Wilshire Blvd., Ste. 1400, Los Angeles, CA, 90048, (213) 653-2321. Fax: (213) 653-4164. Pres./Gen. Mgr.: Peter S. Burke; Sec.: Averill C. Pasarrow. Label(s): (Owned) Tantulus.
- Tape Talk**, (See Rag Baby Records).
- Tar Heel**, (See Dynamite Records).
- Taradab**, (See Charade Records).
- Target Records**, 308 Munger Ln., Bethlehem, CT, 06751, (203) 266-7411. Pres.: Paul Hotchkiss. Label(s): (Owned) Target, (Distributed) Roto-Noto.
- Tawas Records**, 1376 Ready Ave., Burton, MI, 48529, (313) 742-0770. Pres.: Harry F. Chester; Mgr.: Cindy Braun; Mktg./Sales: Dennis Braun; Promo: Hank Chess; Vice Pres. A & R: Willard Groff.
- Mick Taylor Music**, 156 Fifth Avenue Suite 434, New York, NY, 10010, (212) 691-5630. Fax: (212) 645-5038. Pres.: Mick Taylor; Business Affairs: Bruce E. Colfin.
- Techsonic Prods.**, PO Box 8451, 1025 W. MacArthur Blvd., Emeryville, CA, 94662, (415) 653-5811. Fax: (415) 652-5058. Owner: Jason Blaine.
- Telarc Int'l Corp.**, 23307 Commerce Park Rd., Cleveland, OH, 44122, (216) 464-2313. Fax: (216) 464-4108. Chrmn./CEO: Jack Renner; Pres.: Robert Woods.
- Teldec**, (See Warner Music Int'l).
- Telemark Dance Records**, PO Box 55, McLean, VA, 22101, (703) 450-7760. Pres.: Richard S. Mason; Vice Pres.: Sheila M. Mason; Office Mgr.: Josephine Vooght; Research Dir.: Marion Stranoh. Label(s): (Distributed) Dansan, Tema, Sydney Thompson.
- Tel-E-Vue**, (See Revonah Records).
- Temple**, (See Skylite-Sing, Inc.).
- Tempus**, (See Sun-Glo Records, Inc.).
- Ten**, (See Virgin Records).
- Ten Squared, Inc.**, PO Box 865, North Hollywood, CA, 91603, (818) 506-3143. CEO/Pres.: Michael Wenslow; Vice Pres./Audio Recording: John Rando. Label(s): (Owned) Ten Squared.
- Terock Records**, PO Box 1622, Hendersonville, TN, 37077, (615) 822-1044. Pres.: Wade T. Curtiss; Vice Pres.: Dick Derwald; Gen. Mgr.: Don Rowlett; Sales Mgr.: Dick Daniels. Vice Pres. A & R: S.D. Neal. Label(s): (Owned) Curtiss, Denco, Rhythm, Sunn, Susan, Toronto.
- Tex Grass**, (See Richey Records).
- Tex-Lou Records**, 15502 Wildwood Lake, Houston, TX, 77083, (713) 933-1250. Pres.: Isaac Sweat; Vice Pres.: Sharon Lang.
- Tex Mex**, (See Bradley Brothers Records & Tapes).
- Texas**, (See Don Schafer Promos, Inc.).
- Texas Archive-Gulf Coast Recordings**, PO Box 17132, Austin, TX, 78760, (512) 288-7288. CEO: Dough Hanners.
- Texas Opry Records**, 32243 Old Hempstead Rd., Magnolia, TX, 77355, (713) 356-6779. Pres.: Cookie Douglas; Vice Pres.: Mike Kelly; Dir.: Steve Douglas.
- Thee One**, (See S.W. & A. Assoc., Co.).
- Theresa Records**, 2006 Carquinez, El Cerrito, CA, 94530, (415) 524-4908. Contact: Allen G. Pittman; Co-Owners: Betty K. Ishida. US Reps.: Rounder (MA); Richman Bros. (NJ). Int'l Reps.: Bellaphon (West Germany); Crown (Japan). Thin Lyne Records, 1012 E. Pacific Coast Hwy., Long Beach, CA, 90806, (310) 591-4731. Contact: Kelvin Anderson.
- Third Story Records, Inc.**, 5120 Walnut St., Philadelphia, PA, 19139, (215) 747-1201, (215) 747-1200. Pres.: John Wicks; Vice Pres.: Scott Herzog; Sales Dir.: Rod Burton. Label(s): (Owned) Hardly, Jambros, Reup.
- 37 Records, Inc.**, PO Box 34, East Irvine, CA, 92650, (714) 891-0258. Fax: (714) 897-4613. Pres.: Steven M. McClintock; Vice Pres./A & R: Tim James; Mgr.: Valerie Raedel; Promos.: Catherine Enny.
- This Is It**, (See Sid Kløner Music).
- Thomas**, (See RCI Records, Inc.).
- Thoroughbred Records**, 6503 Wolfcreek Pass, Austin, TX, 78749, (512) 288-3370. Owner/Professional Mgr.: Rex T. Sherry.
- Thrash**, (See Mystic Records, Inc.).
- 3 C**, (See Continental Communications Corp.).
- 3 G's Industries, Inc.**, 6015 Troost, Kansas City, MO, 64110, (816) 361-8455. Pres./Gen. Mgr.: Eugene Gold; V.P./Promos. & Sales: Chris King; Chief Engineer: Michael Green; Mktg.: Roy Boy Skins; Vice Pres. A & R: Jeff Lucas. Label(s): (Owned) Chris C. Cory, NMI, Three G.
- Thrival Prods., Inc.**, 20310 Western Rd., Deephaven, MN, 55331, (612) 470-9249. Fax: (612) 470-1275. Pres.: Marnie Jones; Mgr.: Anthony Benson; Promotions: Mike Fleisher.
- Tom Thumb Music (Div. of Rhythms Prods.)**, PO Box 34485, 8869 Venice Blvd., Los Angeles, CA, 90034, (213) 836-4678. Pres.: R. S. White; Vice Pres.: David O. White. Label(s): (Owned) Tom Thumb.
- Thumbs-Up Records, Inc.**, 3343 NW 68 Ct., Ft. Lauderdale, FL, 33309, (305) 972-0066. Pres.: Stuart M. Cox; Vice Pres.: Robert Gonzales; Sec./Treas.: Francine Priddy.
- Thunder**, (See Philadelphia Int'l Records).
- Tiare Tahiti**, (See Criterion Music Corp.).
- Tic-Toc**, (See Goldband Recording Corp.).
- Tiki Entis, Inc.**, 195 South 26th St., San Jose, CA, 95116, (408) 286-9840. Fax: (408) 286-9845. Pres.: Gracie J. O'Neal; Producer, Mktg.: Jeannine O'Neal; Promo.: Ron Akin. Label(s): (Owned) Janell, Rowena. US Reps.: Go Jo Prods. (CA).
- Timberhill**, (See Supreme Record Co.).
- Time**, (See Bainbridge Entertainment Co., Inc.).
- Time-Life Music**, 777 Duke St., Alexandria, VA, 22314, (703) 838-7000. Fax: (703) 838-6915. Chrmn.: Paul Stewart; Pres.: John Hall; Vice Pres.: Fernando Pargas; Exec. Producer: Charles McCardell.
- Timeless Entertainment Corp.**, 10 Pebblewood Dr., Irvine, CA, 92714, (714) 552-5231. Gen. Mgr./Vice Pres. A & R: Fred Bailin; Artist Relations Dir.: Marci Lynn; Promotion Dir.: Seth Joseph; Business Affairs: Francine Rae. Label(s): (Owned) Goldisc, Perfect. US Reps.: Big State (TX), (OK); Schwartz Bros. (MD), (DC), (GA); Action Music Sales (OH), (PA); Landmark (LA), (NY), (NJ); Navarre (MN), (WI), (ND), (SD), (IA).
- Times Square**, (See Relic Record Prods., Inc.).
- Timestar**, (See Stargem Records, Inc.).
- Titan Records**, 1389 Primavera Dr. E., Palm Springs, CA, 92262, (619) 323-9880. Owner/Gen. Mgr.: George R. Brown. Label(s): (Owned) Demon, Marc, Tri-Disc.
- Titanium**, (See Atlantic Recording Corp.).
- Tobago**, (See Guajiro Records, Inc.).
- Toddlin' Town Recording Studio**, 1304 N. Broadway, Melrose Park, IL, 60160, (312) 865-7749. Owner/Producer: Dan DePirro Jr.; Arranger: Kevin Simon; Asst.: Frank Dellegge. Label(s): (Owned) Cheetah Club, Modern Wing Music.
- Toll Free**, (See CDE Records & Tapes).
- Tom Thumb**, (See Rhythms Prods.).
- Tommark Records**, 7560 Woodman Pl., #G-3, Van Nuys, CA, 91405, (818) 994-4862. Owner: Mark Thornton; Tom Willitt.
- Tommy Boy Music Inc.**, 1747 First Ave., New York, NY, 10128, (212) 722-2211. Fax: (212) 289-3708. Chrmn.: Tom Silverman; Pres.: Monica Lynch; Sr/Vice Pres. Bus. Affrs./Int'l: Dan Hoffman; Vice Pres. Sales/Mktg.: Steve Knutson; Vice Pres. Art Devel./Media Rel.: Laura Hynes; A & R: Kevin Maxwell.
- Tomorrow's Gold Records**, PO Box 4670, Wilmington, DE, 19807, (302) 652-2888. Contact: Monique & Troy Husser.
- Tomorrow River Music**, PO Box 165, 9126 S. Cedar Rd., Madison, WI, 53701, (608) 423-3095. Owner/Pres.: Robbie Clement. Label(s): (Owned) Tomorrow River. US Reps.: Silo (VT).

Tomydon Records, 912 Chadford Rd., Irmo, SC, 29063, (803) 732-3430. Gen. Mgr.: Tommy Greene.
Top Dog, (See Continuum Records, Inc.).
Top-Star, (See Sid Kleiner Music).
Top's Records, 9015 Owensmouth Ave., #106, Canoga Park, CA, 91304, (818) 341-7125. Fax: (818) 709-5050. CEO: Linda Revel; Gary Revel; Pres.: A & R Dept.: Mary Revel; Nat'l Promo. Dir.: Hal Jon Norman.
 Label(s): (Owned) Frame House, Plain Wrap, (Distributed) Star City.
Tornado, (See Stark Records & Tape Co.).
Toro'na Int'l, 2525 E. 38th St., Indianapolis, IN, 46208, (317) 252-9286. Pres.: Inga D. McDaniel; Int'l Promos.: Josetta Claudell; Exec. Mktg.: Denise Parks; Vice Pres.: Anthony Wiggins; Vice Pres. A & R: Landrum Shields.
 Label(s): (Owned) Toro'na Int'l, (Distributed) DeeKisha, McCastle Studio.
 US Reps.: Mr. Wonderful (KY).
 Int'l Reps.: Wailer (Japan).
Toronto, (See Terock Records).
Torrid, (See Clay & Clay, Inc.).
Town Crier Recordings, 29 W. 17th St., New York, NY, 10011, (212) 255-0553. Fax: (212) 645-0287. Pres.: Claudia Marx; Promo. Dir.: Laurel Jacobs.
 Label(s): (Owned) Town Crier.
 US Reps.: One World Records (NJ).
TownHall Records, PO Box 5332, Santa Barbara, CA, 93150, (805) 969-4744, (800) 235-5737. Fax: (805) 969-5640. Owner: Lincoln Mayorga; Mgr.: Linda Jones.
Toy Records, PO Box 219, New York, NY, 10101, (212) 695-6995.
Track, (See Buzz Cason Prodn.).
Track America, PO Box 40764, 2804 Azalea Pl., Nashville, TN, 37204, (615) 383-8682. Fax: (615) 383-8696. Pres.: Buzz Cason; Vice Pres.: Peggy Cason; Vice Pres. Artist Dev.: Richard E. Carpenter; Vice Pres. A & R: Buzz Cason.
 Label(s): (Owned) Berry Hill, Gift, Track.
Tractor Records, (See Claiming Race Records).
Tradition, (See Everest Record Group).
Traditional Music Record Co., PO Box 438, 230 Central, Walnut, IA, 51577, (712) 784-3001. Fax: (712) 784-2010. Pres.: Sheila Armstrong.
 Label(s): (Owned) Payola, Prairie Music, Traditional Music.
Traditional Records, PO Box 8, Cosby, TN, 37722, (615) 487-5543. Pres.: Jean Schilling; Vice Pres.: Lee Schilling.
Transworld, (See Bernstein Corp.).
Trebas Institute of Recording Arts of the U.S.A., Inc., 6464 Sunset Blvd., The Penthouse, Hollywood, CA, 90028, (213) 467-6800. Pres.: David P. Leonard.
 Branch(es): 290 Nepean St., Ottawa, ON, K1R 5G3, Canada, (514) 845-4141; 1435 Bleury, Suite 301, Montreal, PQ, H3A 2H7, Canada, (514) 845-4141.
Trell, (See Makedwde Records).
Trend Assoc., (See Creative Sound Corp.).
Trend/Discovery Records, 117 N. Las Palmas Ave., Los Angeles, CA, 90004, (213) 938-5482. Fax: (213) 933-1903. Pres.: Albert Marx; Mgr.: Lee Carubo.
 Label(s): (Owned) AM-PM, Discovery, Musicraft.
 US Reps.: CRD, Inc. (CA); Malverne Dist., North Country Dist., (NY).
 Int'l Reps.: DAM (France); Ariola Import Service (West Germany); AD Lib Dist. (Sweden); Flexitron, Ltd. (United Kingdom).
Trend Recording & Distributing Co., PO Box 201, Smyrna, GA, 30081, (404) 432-2454. Pres.: Tom Hodges; Exec. Vice Pres.: Rick Hodges; Vice Pres.: Frank Brannon.
 Label(s): (Owned) British Overseas Airways Music, Stepping Stone, Trend, Trend Setter, (Distributed) Bunjac, Caprice Int'l.
 US Reps.: Caprice Int'l (PA); One Stop Records (TN).
Trend Setter, (See Trend Recording & Distributing Co.).
Tri-Disc, (See Titan Records).
Tribal, (See Carrie Records).
Tribe, (See Crazy Cajun Prodn.).
Tribute, (See Diadem Music Group, Sivatt Music Prodn.).
Tried & True Music, PO Box 39, Austin, TX, 78767, (512) 288-1695. Fax: (512) 288-5301. Pres.: Susan Walker; Business Mgr.: Ron Shelley; Promos. Dir.: Jill McGuckin; Publicist: John T. Davis.
 US Reps.: Rykodisc (MA).
Triple Nixxon, (See Triple X Entertainment).
Triple X Entertainment, PO Box 862529, 2020 N. Main St., Ste. 240, Los Angeles, CA, 90086, (213) 221-2204. Fax: (213) 221-2778. Owner/Partner: Peter Heur; Dean Naleway; Accts.: Tomoko Brooks; Publicity: Bruce Duff; Prodn. Mgr.: Jeffrey Zimmitt.
 Label(s): (Owned) Triple Nixxon, Triple X.
 US Reps.: Important Records (NY).
 Int'l Reps.: Roadrunner (Amsterdam).
Trix Records, Inc., PO Drawer 493, Cottick Rd., Rosendale, NY, 12472, (914) 687-9573. Pres.: Peter B. Lowry; Vice Pres.: Robbie Casey.
 Label(s): (Owned) Ghetto Farms, Trix.
Trope, (See CITA Communications, Inc.).
Trophy, (See Axbar Records).
Tropical Storm, (See WEA Latina Inc.).
Tropicana Records, PO Box 910, Beverly Hills, CA, 90213, (213) 276-2726. Gen. Mgr.: Oliver Berliner.
Tru-Gems Records, PO Box 3683, Beverly Hills, CA, 90212, (213) 273-1986. Owner: Lee Silver.
True Blue Music, (See Mosaic Records, Inc.).
True Friends, (See FXL Sound Studios).
True Records, Inc., Rt. 2 Ash St. Box 466B, Central City, KY,

42330, (502) 754-5050. Fax: (502) 754-4466. Co-Owner: Bobby D. Reed; Paul C. Hayes; Clyde Brown, Jr.
 Branch(es): Rt. 2, Box 466-B, Central City, KY, 42330, (502) 754-5050. Fax: (502) 754-4466. Contact: Paul Hayes.
 Label(s): (Owned) CBO, Rendee.
Trusty Records, 8771 Rose Creek Rd., Nebo, KY, 42441, (502) 249-3194. Owner: Elsie Childers.
Tuff City Records, 161 W. 54th St., New York, NY, 10019, (212) 262-0385. Fax: (212) 541-5068. Pres.: Aaron Fuchs; Controller: Jesse Maltbrey; Promo. Dir.: Jeff Trotter.
 Int'l Reps.: Wotie Music (France); BCM Records (Germany).
Tuneworks Records, Inc., 4433 Petit Ave., Encino, CA, 91436, (213) 278-8970. Fax: (818) 907-7664. Pres.: Dennis Lambert.
 Label(s): (Owned) Haven.
 US Reps.: CEMA (CA).
Turbo Records, PO Box 409, East Meadow, NY, 11554, (516) 486-8699. Fax: (516) 564-1217. Pres.: Jay Gold; Vice Pres.: Gail Guld; Dir. A & R: Robyn Michelle.
Turne Round Prodn., 6470 Eighth Ave., Grandville, MI, 49418, (616) 457-2172. Pres.: Jay Round; Vice Pres.: Betty Round.
Turquoise Records Inc., PO Box 947, Hwy. 931, Whitesburg, KY, 41858, (606) 633-0485. Fax: (606) 633-0493. Pres.: Pat Martin.
 US Reps.: Old Fogey Dist. (MI); Record Depot (VA); Silo, Inc. (VT); Folk Craft (CT); Ladyslipper Dist. (NC); Tant Ents. (MI); MS Dist. Co. (IL); Richman Bros. Dist. (NJ); Rounder Dist. (MA); Bayside Dist. (CA); M. Ginsburg Dist. (TN); Lifedance Dist. (OR); Gail Mayer Dist. (MI).
21st Century, (See RCI Records, Inc.).
Twin/Tone Records, Inc., 2541 Nicollet Ave. S., Minneapolis, MN, 55404, (612) 872-0646. Fax: (612) 872-9326. Pres./Legal & Bus.: Paul Stark; A & R: Dave Ayers; Distribution: Chris Osgood; Promo/Publicity Dir.: Jill Fonass.
 Label(s): (Distributed) Anphetamine Reptile, Coyote, Red Decibel.
Twinbrook Music, Inc., 227 W. 29th St., 5th Floor, New York, NY, 10001, (212) 889-8900. Fax: (212) 725-1538. Pres.: Jay Baney; Vice Pres.: Dan Moretti; Sales Mgr.: Dale Ashley.
Twist Records, 4111 Lincoln Blvd., Ste. 621, Marina Del Rey, CA, 90292, (213) 306-1116. Fax: (213) 822-0693. Owner, A & R: David Lumnian; Owner: Phil Cramer; Assoc.: Noel Stephens.
 US Reps.: Enigma (CA).
 Int'l Reps.: CBS Sony (Japan).
Twister Records, 9430 Live Oaks Place, #308, Fort Lauderdale, FL, 33324, (305) 472-7757. Pres.: Jack P. Bluestein.
 Label(s): (Owned) Lantana, Quadraphonic Sound, Quadraphonic Talent, Quadraphonic Talent.
Tye, (See Wan Star Entertainment Group).
Tyscot Records, Inc., 3532 N. Keystone Ave., 3403 N. Ralston Ave., Indianapolis, IN, 46218, (317) 926-6271. Fax: (317) 924-4689. Pres.: Leonard Scott; Nat'l Promo. Dir.: Stephen Thompson; Retail Promo. Dir.: Elizabeth Edwards; Asst. Gen. Mgr.: Lisa Pierce; Vice Pres. A & R: Bryant S. Scott.
 Label(s): (Owned) Circle City, (Distributed) Suite Nine.

U

USA Music Group, 11496 Burbank Blvd., North Hollywood, CA, 91601, (818) 505-0855. Fax: (818) 505-0626. Pres.: Martin Braude; Vice Pres. Oons.: Orville Kelman; Oons. Mgr.: Anne Hischar; Vice Pres. A & R: Leslie Brander.
US Records Inc., 535 Fifth Ave., New York, NY, 10017, (212) 682-8400. Pres.: Victor Benedetto; Prodn. Mgr./A & R Rep.: Alex Benedetto; Bus. Affairs Mgr.: Wallace Collins.
Ukraine, (See Apon Record Co., Inc.).
Ultimate Records, 917 Larabee St., Ste. 10, West Hollywood, CA, 90069, (213) 652-3636.
Ultra Records, PO Box 29722, Los Angeles, CA, 90029, (213) 913-9100. Mktg. Dir.: Lili Paul; Promo. Mgr.: Frank Rodriguez; Sales Mgr./Exec. Vice Pres.: Jim Anderson; Int'l Relation: Matthew Bowman; Vice Pres. A & R: Marcelo Brown.
 US Reps.: Macola Dist. (CA); Pearl Dist. (NY); Brown & Blue (CA).
Unicorn, (See Entertainment Mgmt. Records).
United Int'l Copyright Reps., (See ESP-Disk' Ltd.).
United Sound Arts, PO Box 477, Long Branch, NJ, 07740, (800) 631-2187. Fax: (908) 870-3340. CEO: Robert Kimble; Pres.: Gertrude Kimble; Admin. Vice Pres.: James Kimble; Sales/Mktg. Dir.: Elaine Rauff.
 Label(s): (Distributed) Kimbo Educational.
Universal-Athena Records, PO Box 1264, Peoria, IL, 61654, (309) 673-5559. Owner: Jerry Hanlon.
Universal Jazz, (See PDS-Universal Entertainment Group, Inc.).
UnLtd. Inspiration Records, PO Box 614, Santa Cruz, CA, 95061, (408) 458-3022. Owner: Larry Leeder.
 Label(s): (Owned) UnLtd. Inspiration.
 US Reps.: Backroads (CA); New Leaf (GA); Music Design (WI); Silo, Inc. (VT).
 Int'l Reps.: New Age Media (Australia).
UpBeat Music/Records, 360 S. Euclid Ave., #316, Pasadena, CA, 91101, (818) 577-3978. Pres.: Brett W. Perkins.
Urgent Records, Inc., PO Box 16591, 485 N. Canton Club Circle, Jackson, MS, 39236, (601) 957-7027. Fax: (601) 981-8241. Pres.: Tim Whitsett; Gen. Mgr.: Janis Harper; Press: Goring Heath.
 Label(s): (Owned) Critical, Rim, Urgent!, Vitall, Vital Arts.
 US Reps.: Ichiban (GA).

V

VAL, (See Record-Rama Sound Archives).
VAR Int'l, (See Mentor Music Group, Inc.).
V. C. Records, 541 Main St., Danville, VA, 24541, (804) 792-3129. Owner: Roy Roberts.
VU Records & Bird Prodn., 1946 N. Hudson Ave., Chicago, IL, 60614, (312) 787-6060. Pres.: Robin McBride.
Valentino Music & Sound Effects, 151 W. 46th St., New York, NY, 10036, (212) 869-5210. Fax: (212) 869-6259.
 Label(s): (Owned) Major, Valentino Music, Valentino Sound Effects, Major, Valentino Music, Valentino Sound Effects.
Valentino Sound Effects, (See Valentino Music & Sound Effects).
Vandor Int'l, (See Vandor Motion Pictures, Phonorecords & Music Publishing Group).
Vandor Motion Pictures, Phonorecords & Music Publishing Group, 1826 Poplar Ln., SW, Albuquerque, NM, 87105, (505) 243-2881. Fax: (505) 247-4843. Chairman: Gen. Bobby Farrell; Pres.: Lois T. Cunningham; Vice Pres., Oons.: Dale H. Oldham; Vice Pres., Licensing: Matt L. Lucas; Vice Pres. A & R: Ginny Driskill.
 Label(s): (Owned) Juice, Vandor Int'l, (Distributed) Suddath Int'l, Icefire Int'l, FMC Ltd., Kalyx, Peony Int'l, Shan Int'l, Aerolite Int'l.
 US Reps.: Bobby Farrell, Int'l (NM).
Vanguard, (See Welk Music Group).
Vanity, (See Soul-Po-Tion Records).
Vantage, (See LRJ Records).
Varese Sarabande Records, Inc., 13006 Fatico St., North Hollywood, CA, 91605, (818) 764-1172. Fax: (818) 765-7801. Pres.: Chris Kuchler; Vice Pres. A & R: Robert Townson.
 Label(s): (Owned) Varese Sarabande.
 US Reps.: UNI Dist. Corp. (CA).
Varrick, (See Rounder Records Corp.).
Varulven, (See Mentor Music Group, Inc.).
Vent, (See Jamie/Guyden Dist. Corp.).
Verplanck, (See Empty Sky Records).
The Versa Record Co., 2033 Dorst St., Toledo, OH, 90016, (419) 537-0225. Contacts: Tom Noble, Keith Noble.
Vic Records, 1327 Cobb St., Kalamazoo, MI, 49007, (616) 342-5328. Owner: Vic La Val.
 Label(s): (Owned) LaVal Records, (Distributed) Vic.
Victori Promos. & Mktg., Inc., 23494 Lahser Rd., Southfield, MI, 48034, (313) 948-9787. Fax: (313) 948-1093. Pres.: Jerome Cunningham, Sr.; Vice Pres. Oons.: Mertas D. Cunningham; Promo: Michele A. Cunningham; Mktg.: Jerome Cunningham, Jr.; Vice Pres. A & R: Brian K. Cunningham.
 Label(s): (Owned) Z-Hot, (Distributed) Torrid, CS, Hitline, Morning Glory.
Victory Media Group, 1054 Conifer Ln., Petaluma, CA, 94954, (707) 762-4858. Owner/Gen. Mgr.: G. W. Daniel; Dir. of A & R: Shelly Holling; Dir., Oons.: Mark Holling.
 Label(s): (Owned) Bay City, Victory.
Vin, (See Ace Records).
Vineland, (See Welch Grape Records).
Virgin, (See Atlantic Recording Corp.).
Virgin Boy Records & Publishing, PO Box 542792, 2613 Castle, Dallas, TX, 75354, (214) 257-1510. Pres./A & R Rep.: James Yarborough; Gen. Mgr.: Becky Buchanan.
 Label(s): (Owned) Virgin Boy.
Virgin Records, 9247 Alden Dr., Beverly Hills, CA, 90210, (213) 278-1181. Fax: (213) 278-6231. Sr. Vice Pres./Gen. Mgr.: Jim Swindel; Vice Pres., Promos./Mktg.: Sharon Heyward; Vice Pres., Artist Dev.: Jacquie Perryman; Vice Pres. Publicity: Sue Sawyer.
 Label(s): (Owned) Ten, (Distributed) Real World, Night, Circa.
Virginia Arts Records, 512 Stewart St., Charlottesville, VA, 22901, (804) 971-1411. Owner, Gen. Mgr.: R. Paul Brier.
 Label(s): (Owned) Virginia Arts.
 US Reps.: Ladyslipper, Inc. (NC).
Virginia Records Co., 217 Main St., Fort Lee, NJ, 07024, (201) 974-3900. Pres.: Al Thomas; Vice Pres. A & R: Tom Argiro.
 Label(s): (Owned) Virginia.
Virtue Records & Studios, 8809-11 Rising Sun Ave., Philadelphia, PA, 19115, (215) 763-2825. Pres.: Frank Virtue; A & R: Mary Ann Lanciano; Mgr.: Mary Buzzi; A & R Dir.: Landay Lanciano; Promos.: Linda Vitacolona.
 Label(s): (Owned) Everything, Fayette, Pray Virtue, Rising Star.
A Vision Entertainment (Video), (See Atlantic Recording Corp.).
Vision Records, Inc., 13385 W. Dixie Hwy., North Miami, FL, 33161, (305) 893-9191. Fax: (305) 895-2647. Pres.: Steve Alaimo; Vice Pres.: Ron Albert; Treas.: Howard Albert; Vice Pres. A & R: Ron Albert.
 Label(s): (Owned) Vision, (Distributed) Cliff Sounds & Films, Gold Hill, Ms. B.
 US Reps.: Schwartz Bros. (MD); Landmark (GA); Big State (TX); M.S. (IL).
Vital!, (See Urgent! Records, Inc.).
Vital Arts, (See Urgent! Records, Inc.).
Viva La Musica, (See Fred Weinberg Prodn., Inc.).
Vokes Record Co., PO Box 12, New Kensington, PA, 15068 (412) 335-2775. Pres./A & R: Howard Vokes.
 Label(s): (Owned) Country Boy, Woodpecker, Vokes (Distributed) Traveler, Wiley, Morgan of Clover, Rave, Sac, Colt, Century II, Elayne, Fox Fire, Missile, Blue Ridge, Bunjak.
Volt, (See Fantasy, Inc.).
Volume, (See Jamie/Guyden Dist. Corp.).

Worldwide Entertainment, 134 W. 32nd St., Ste. 602, 1 W. 28th St., 2nd Floor, New York, NY, 10001, (212) 613-9053. Fax: (212) 779-1854. Pres.: Darrin McGillis.
Label(s): (Owned) Baila.
Would'n Shoe Records, 780 Utica Ave., Boulder, CO, 80304, CEO: Stephen Bond Garvan.
Label(s): (Owned) Would'n Shoe, (Distributed) Greenpeace, Hatch.
Wrap. (See Ichiban Records, Inc.).
Wreck-Creation. (See Cleverland Records).

X

XLNT Music, 38-62 240th St., Little Neck, NY, 11363, (718) 279-4139. Pres./A & R Dir.: James Cohn; Vice Pres.: Eileen Cohn.
Label(s): (Owned) XLNT Music.
US Reps.: Albany Music Dist., Inc. (NY).
Xanadu Records Ltd., 3242 Irwin Ave., Kingsbridge, NY, 10463, (212) 549-3655. Pres.: Don Schlitten.
Int'l Reps.: EPM Musique (France); Crown Records (Japan).
Xtrawatt. (See WATT Works, Inc.).

Y

YZA Records, 2200 Risa Dr., Glendale, CA, 91208, (818) 548-0850. Fax: (818) 240-5660. Pres./Chairman: Jose Silva; Gen. Mgr.: Zulma A. Jimenez; Concept Promos.: Ian Hill Presents/England; Latin America/Promos.: Jaime Roman/Chile.
Yankeé. (See Empty Sky Records).
Yard Bird. (See Fink/Pinewood Records).
Yazoo. (See Shanachie Records Corp.).
Yellow Jacket Records, 10303 Hickory Valley Dr., Fort Wayne, IN, 46835, (219) 627-5168. Pres.: Allan R. Straten; Vice Pres./A & R: Sylvia K. Grogg.
Yellowstone Records, 1108 Moorehead, Miles City, MT, 59301, (406) 232-1683. Pres.: Burch Ray; Vice Pres.: Linda Palmer; Mgr.: Ray Palmer.
YesYes Records, PO Box 32031, 12909 Copperas Ln., Richmond, VA, 23294, (804) 796-9983. Pres.: David L. Esleick; Gen. Mgr.: Elizabeth B. Cherry.
Label(s): (Owned) Yesyes.
Yo-Yo. (See Fred Rice Prods., Inc.).
YoYibe. (See Megalodon Ent., Inc.).
York's Prods., PO Box 540, Parksville, NY, 12768, (914) 292-5738. Fax: (914) 292-5738. Pres.: Dr. York.
Label(s): (Owned) Mahdi.
Int'l Reps.: Jimco Records (Japan).
You Talk Too Much. (See Sharon Prods., Inc.).
Youngheart Music, Inc., PO Box 6017, 10701 Holder St., Cypress, CA, 90630, (800) 444-4287, (714) 995-7888. Fax: (714) 995-3548. Pres.: Jim Connelly.
Label(s): (Owned) Youngheart Video, Youngheart.

Z

Z-Hot Records, 23494 Lahser Rd., Southfield, MI, 48034, (313) 948-9787. Fax: (313) 948-1093. Pres.: Jerome Cunningham, Sr.; Vice Pres. Opns.: Mertas D. Cunningham; Vice Pres. Mktg.: Jerome Cunningham, Sr.; Promo: Michele A. Cunningham; Vice Pres. A & R: Brian K. Cunningham.
US Reps.: Victori Promos. (MI).
ZZAJ. (See Mentor Music Group, Inc.).
ZZYZX Records, PO Box 23, Sun Valley, CA, 91352, (818) 982-2174. Owner: J. Eric Freedner; A & R: Lawrence Treadwell.
Label(s): (Owned) ZZZYX.
Zeca, Inc., 27 Music Sq. E., Ste. 171, Nashville, TN, 37203, (615) 331-1003. Pres.: Michael Z. Dandwicz; Vice Pres. A & R: Lisa Dauwalder.
Branch(es): 33200 Bainbridge Rd., Ste. 32, Cleveland, OH, 44139, (216) 893-2596. Contact: Lisa Dauwalder.
Zip Kid Records, PO Box 8161, New York, NY, 10116, (908) 229-9422. Fax: (212) 643-8469. Owner: Jacques Battel.
Zoe Records, 2980 W. 28th St., Brooklyn, NY, 11224, (718) 946-0840. Fax: (718) 266-3972. Pres.: Robert Taylor; Vice Pres.: Kirk Harris.
Zomba Recording Corp., 137-139 W. 25th St., 8th Floor, New York, NY, 10001, (212) 727-0016. Fax: (212) 645-3783. Chrmn.: Clive Calder; Sr. Vice Pres. Artist Devel.: Ann Carli; Sr. Vice Pres./Gen. Mgr. Record Group: Barry Weiss; Sr. Vice Pres. Bus. Affairs: Paul Katz.
Label(s): (Owned) Jive, Silvertone, US Reps.: BMG Music (NY).
Zoo Entertainment, 6363 Sunset Blvd., Hollywood, CA, 90028, (213) 468-4200. Fax: (213) 468-4207. Pres.: Lou Maglia; Office Mgr.: Sandy McKinney; Sr. Vice Pres./Gen. Mgr.: George Gerrity; Dir. Opns.: Bennett Zimmerman; Vice Pres. A & R: George Daly; Vice Pres. Mktg. & Sales: Jayne Neches Simon.
Zoom, Inc.. (See Bob Hinkle Mgmt., Inc.).

HOME VIDEO COMPANIES

(Theatrical, Music & Special Interest)

A.I.P. HOME VIDEO, 10726 McCune Ave., Los Angeles, CA, 90034, (213) 559-8805. Contact: Patricia Pawlok.
AMI ENTERTAINMENT, 12500 Riverside Dr., Ste. 207, North Hollywood, CA, 91607, (818) 762-3455. Pres.: Raj Mahotra. Supplies: Feature Films, How-To.
Formats: VHS.
A & M VIDEO, 1416 N. La Brea Ave., Hollywood, CA, 90028, (213) 469-2411. Fax: (213) 871-0467. Vice Pres. Bus. Dev.: Mill Olin; Video Sales/Mktg. Dir.: Steve Macon.
Supplies: Instructional, Music Long Form, Children's, Special Interest.
Formats: VHS.
A*VISION ENTERTAINMENT, 75 Rockefeller Plaza, New York, NY, 10019, (212) 484-6000. Fax: (212) 765-0899. Video Mktg. Mgr.: Julie Smith.
ACADEMY ENTERTAINMENT, 1 Pine Haven Shore Rd., Shelburne, VT, 05482, (802) 985-2060. Fax: (802) 985-3403. Pres.: Donald E. Chatham; Vice Pres. Sales: Jules Abramson; Program Buyer: Robert E. Baruc; Dir. Bus. Affairs: Susan Luksik.
Supplies: Feature Films.
Formats: VHS.
Seeking: Feature Films.
ACTIVE HOME VIDEO, 12121 Wilshire Blvd., Ste. 200, Los Angeles, CA, 90025, (213) 447-6131. Fax: (213) 207-0411. Pres.: Ron Levanson; Sales Mgr.: Alice DeBurr; Contact: Juanita Weber.
Supplies: Feature Films, Soft Adult.
Formats: VHS.
Seeking: Feature Films.
AIMS MEDIA, 6901 Woodley Ave., Van Nuys, CA, 91406, (818) 785-4111. Fax: (818) 376-6405. Pres./Program Buyer: Jeffrey M. Sherman; Dir. Int'l Sales: David Cohen.
Supplies: Instructional, Special Interest Only.
Formats: VHS, Beta, S-VHS, LaserVision.
Seeking: Instructional.
AMAZING HORIZONS, INC., PO Box 61662, Sunnyvale, CA, 94088, (408) 947-5857. Pres.: Ernest A. Montiel; Sec./Treas.: Gienna Dancer Montiel.
Supplies: Documentary.
Formats: VHS, Beta.
AMERICAN SPORTS NETWORK, PO Box 6100, Rosemead, CA, 91770, (818) 572-4727. Pres.: Louis Zwick; Program Buyer: Scott Hlcken.
Supplies: Exercise, Instructional, Special Interest Only, Sports.
Formats: VHS, Beta.
Seeking: Exercise, Instructional, Special Interest Only, Sports.
Distribution of clips for clubs and venues.
APPALSHOP FILMS/VIDEO, 306 Madison St., Whitesburg, KY, 41858, (606) 633-0108. Fax: (606) 633-1009. Sales Mgr./Program Buyer: Carolyn H. Sturgill.
Supplies: Sports, Documentary-Appalachian Region.
Formats: VHS, Beta.
AQUATIC EXERCISES BY BILLIE C. LANGE, PO Box 822, 37 Cayman Cir., Umatilla, FL, 32784, (904) 483-0606. Pres.: Richard Feirs; Sales Mgr.: Randall Freeman; Owner: Billie C. Lange.
Supplies: Exercise, Instructional, Health & Fitness.
Formats: VHS.
ARISTA RECORDS, 6 W. 57th St., New York, NY, 10019, (800) 443-0857, (212) 830-2330, Mktg. Contact: Dave Santaniello.
ARISTO VIDEO PROMOS., PO Box 22765, Nashville, TN, 37202, 1620 16th Ave. S., Nashville, TN, 37212, (615) 269-7071. Fax: (615) 269-0131. Pres.: Jeff Walker.
Supplies: Video Short Form.
Formats: VHS, Beta, 3/4", 1".
ATLAS VIDEO INC., 4915 St. Elmo Ave., Ste. 305, Bethesda, MD, 20814, (301) 907-0030. Fax: (301) 907-9049. Pres.: Peter Edwards; Dir. Opns.: Marsha Oden; Sales Mgr.: Elizabeth Martin; Program Buyer: John Lorenz.
Supplies: Instructional, Sports, Historical Documentaries.
Formats: VHS.
Seeking: Exercise, Instructional, Music Long Form, Special Interest Only, Sports.
AURORA HOME VIDEO—DIV. OF NORTHERN ARTS ENTERTAINMENT, Northern Arts Studios, Williamsburg, MA, 01096, (413) 268-9301. Fax: (413) 268-9309. Chrmn.: John Lawrence Re'; Pres.: David Mazar.
Supplies: Music Long Form.
Formats: VHS.
Seeking: Music Long Form.
BASTET PRODS., PO Box 77029, Tucson, AZ, 85703, (602) 293-8088. Pres.: Gerald Harwood.
Supplies: Exercise, Special Interest Only, Dance & Video Art.
Formats: VHS, Beta.
NORMAN BEERGER PRODS., 3217 S. Arville St., Dept. F, Las Vegas, NV, 89102, (702) 876-2328. Pres./Program Buyer: Norman Berger; Sales Mgr.: Kenny Beerger.
Supplies: Visual Music, Wilderness, Space, Docum..
Formats: VHS, Beta.
Distribution of clips for clubs and venues.
BENNETT MARINE VIDEO, 730 Washington St., Marina Del

Rey, CA, 90292, (213) 821-3329. Fax: (213) 306-3162. Pres./Prog. Buyer: Michael Bennett; Sales Mgr.: James Johnston.
Supplies: Instructional, Special Interest Only, Sports.
Formats: VHS, SECAM, PAL.
Seeking: Instructional, Special Interest Only.
BENNU PRODS., INC., 171 Madison Ave., New York, NY, 10016.
Supplies: Exercise, Feature Films, Instructional.
Formats: VHS, Beta, S-VHS.
Seeking: Exercise, Feature Films, Instructional.
BEST FILM & VIDEO CORP., 98 Cutter Mill Rd., Great Neck, NY, 11021, (516) 487-4515. Fax: (516) 487-4834. Pres./Program Buyer: Roy B. Winnick; Sales Mgr.: Ben M. Tenn.
Supplies: Exercise, Instructional, Special Interest Only, Sports, Children's.
Formats: VHS, Beta.
Seeking: Exercise, Instructional, Special Interest Only, Sports.
THE BLACKHAWK CATALOG, C/O REPUBLIC PICTURES, 12636 Beatrice St., Los Angeles, CA, 90066, (213) 306-4040. Fax: (213) 301-0142. Vice Pres.: Philip J. Kromnick; Opns. Coord.: Kimberly Baker.
Supplies: Feature Films.
Formats: VHS.
BREGER VIDEO INC., 915 Broadway, New York, NY, 10010, (212) 254-3900. Pres.: Sue Breger; Sales Mgr.: Barbara Prisco.
Supplies: Instructional, Cooking Videos.
Formats: VHS, Beta.
BRENTWOOD HOME VIDEO/SPORTSMEN ON FILM, 5740 Corsa Ave., #102, Westlake Village, CA, 91362, (818) 879-9090. Fax: (818) 879-9101. Pres./Program Buyer: David Catlin; Sales Mgr.: (Brentwood) Steve Eckles; Sales Mgr.: (Sportsmen) Greg Summit.
Supplies: Exercise, Instructional, Music Long Form, Sports, Hunting & Shooting, Documentaries.
Formats: VHS.
Seeking: Exercise, Feature Films, Music Long Form, Sports.
BRIDGESTONE MGMT. GROUP, 2091 Las Palmas Dr., Carlsbad, CA, 92009, (619) 431-9888. Fax: (619) 431-0489. Pres.: Robert Campbell, Jr.; Sr. Vice Pres.: Conrad I. Homishak.
Supplies: Exercise, Feature Films, Instructional, Special Interest Only, Sports, Religious & Family.
Formats: VHS.
Seeking: Exercise, Feature Films, Instructional, Special Interest Only, Sports.
BUENA VISTA/TOUCHSTONE/WALT DISNEY HOME VIDEO, 500 S. Buena Vista St., Prodn. Bldg., Burbank, CA, 91522, (818) 560-1000, (818) 562-3770. Dir. Mktg.: Robert J. Marick.
Supplies: Exercise, Feature Films, Animated.
Formats: VHS, Beta, LaserVision.
CBS/FOX VIDEO, 1330 Avenue of the Americas, New York, NY, 10019, (212) 737-4816. Fax: (212) 737-4802. Pres.: George Krieger; Mktg.: Mindy Pickard.
CBS MUSIC VIDEO ENTS., 51 W. 52nd St., New York, NY, 10019, (212) 445-5295. Fax: (212) 445-1662. Pres.: Jon Peisinger; Vice Pres.: Jerry Durkin; Contact: Deborah Newman.
CABIN FEVER ENTERTAINMENT, INC., 100 W. Putnam Ave., 1 Sound Shore Dr., Greenwich, CT, 06830, (203) 863-5200. Fax: (203) 863-5258. Pres.: Thomas Molito; Sales Mgr.: Richard Margolis; Dir. Bus. Development: Robert C. Banre.
Supplies: Instructional, Music Long Form, Special Interest Only, Sports.
Formats: VHS, Beta.
Seeking: Special Interest Only, Sports.
CABLE FILMS & VIDEO, PO Box 7171, Kansas City, MO, 64113, 2026 W. 63rd St., Shawnee Mission, KS, 66208, (913) 362-2804. Fax: (816) 531-2271. Pres.: Herbert Miller; Program Buyer: Marc Stevens; Gen. Mgr./Sales Mgr.: Todd Randall.
Supplies: Feature Films, Cartoons, Short Features.
Formats: VHS, U-matic, 16mm, 1".
Seeking: Feature Films.
CAMP VIDEO, 8841 Wilbur Ave., Northridge, CA, 91324, (818) 349-2267. Fax: (818) 349-2464. Pres.: Salvatore Richichi; Sales/Gen. Mgr.: Dusty Urban.
Supplies: Feature Films.
Formats: VHS, Beta.
Seeking: Feature Films.
CANNON VIDEO, 8670 Wilshire Blvd., Beverly Hills, CA, 90211, (213) 967-2226. Fax: (213) 652-3397. Vice Pres.: Evan Fisher; Dir. of Sales: Jim Ward.
Supplies: Feature Films.
Formats: VHS, LaserVision.
CELEBRITY HOME ENTERTAINMENT/JUST FOR KIDS HOME VIDEO, 6320 Canoga Ave., Ph. Ste., Woodland Hills, CA, 91365, (818) 715-1980. Fax: (818) 716-0168. Pres.: Noel Bloom.
Supplies: Children's Videos.
Formats: VHS.
CENTERPOINT COMMUNICATIONS GROUP, INC., 434 S. First St., San Jose, CA, 95113, (408) 993-9368. Fax: (408) 993-1056. Pres.: Tim Blake; Dir. Mktg./Program Buyer: Dee Alexander.
Supplies: Instructional, Special Interest Only, Children's.
Formats: VHS.
CENTRAL PARK MEDIA (CPM), 301 W. 53rd St., 13th Floor, New York, NY, 10019, (212) 977-7456. Managing Dir.: John O'Donnell.
CHERRY LANE VIDEO, PO Box 430, 10 Midland Ave., Port

The listings contained in this publication are based solely upon information supplied to Billboard as of press time. All information is checked for accuracy as of that time. However, Billboard is not responsible for changes in management or any other related business associations that may supersede the listings contained herein.

- Chester, NY, 10573, (914) 935-5200, Fax: (914) 937-0614, Pres.: Peter Primont.
Supplies: Instructional.
Seeking: Instructional.
- CHILDREN'S CIRCLE HOME VIDEO**, 389 Newtown Tpk., Weston, CT, 06883, (203) 222-0002, Fax: (203) 226-3818, Pres.: Morton Schindel; Sales Mgr.: Linda Griffin; Program Buyer: Cari Best; Mktg. Asst.: Jill Perlstein.
Supplies: Children's Programming.
Formats: VHS.
- CINEVISTA VIDEO**, 560 W. 43rd St., Ste. 8-J, New York, NY, 10036, (212) 947-4373, Pres.: Mr. Rene Fuentes-Chao.
- CLASSIC FAMILY ENTERTAINMENT**, 6649 Odessa Ave., Van Nuys, CA, 91406, (818) 789-9000, Pres.: Sidney Niekerk; Sales Mgr.: Jack Gallagher.
Supplies: Feature Films.
Formats: VHS, Beta.
- COLE ENTS., INC.**, 2127 E. Speedway, Ste. 215, Tucson, AZ, 85719, (602) 322-9055, Fax: (602) 327-9461, Pres.: Cary Cole.
Supplies: Instructional, Special Interest Only.
Formats: VHS.
- COLISEUM VIDEO**, 430 W. 54th St., New York, NY, 10019, (212) 489-8130
Supplies: Wrestling.
- COLOSSAL HOME ENTERTAINMENT, INC.**, 500 Sugar Mill Rd., Ste. 100A, Dunwoody, GA, 30350, (404) 992-8065, Fax: (404) 565-5912, Pres.: Pat McGonigle; Exec. Vice Pres.: Stephen McGonigle.
Supplies: Exercise, Instructional, Special Interest Only, Sports, Children's Programming.
Formats: VHS, Beta.
Seeking: Exercise, Sports.
- COMPLETE ENTERTAINMENT, INC.**, 9650 Desoto Ave., Unit C, Chatsworth, CA, 91311, (818) 718-0366, Fax: (818) 718-8536, Pres./Program Buyer: Dean Goldfarb; Sales Mgr.: Rose Campas.
Supplies: Feature Films, Sports.
Formats: VHS, Beta.
Seeking: Feature Films, Special Interest Only, Sports.
- CONGRESS VIDEO**, 1776 Broadway, Ste. 1010, New York, NY, 10019, (212) 581-4880, (800) 847-8279, Chrmn./CEO: Richard E. Burke; Pres.: Robert W. Sigman; Sales Mgr.: Charles Staley; Program Buyer: Hubert Bush.
Supplies: Exercise, Feature Films, Instructional, Music Long Form, Special Interest Only, Sports, Educational.
Formats: VHS, Beta.
Seeking: Exercise, Feature Films, Instructional, Music Long Form, Special Interest Only, Sports.
- CONNOISSEUR VIDEO COLLECTION**, 8436 W. 3rd St., Ste 600, Los Angeles, CA, 90048, (213) 553-8873, Fax: (213) 651-0555, Pres.: Peter Marai; Sales Mgr.: Bill Kruger.
Supplies: Feature Films, Performance, Foreign.
Formats: VHS.
Seeking: Feature Films.
- CONVERSA-PHONE INSTITUTE, INC.**, 2101 9th Ave., Ronkonkoma, NY, 11779, (516) 467-0600, Fax: (516) 467-0602, Pres.: Edmund L. Owen; Vice Pres. Sales/Program Buyer: Bruce A. Owen.
Supplies: Instructional.
Formats: VHS.
Seeking: Instructional.
- CORINTH VIDEO**, 34 Gansewoort St., New York, NY, 10014, (212) 463-0305, Pres.: John M. Poole; Exec. Vice Pres.: Peter J. Meyer.
Supplies: Feature Films, Opera, ballet, classic films.
Formats: VHS.
Seeking: Feature Films.
- CROCUS ENTERTAINMENT, INC.**, 630 Twelve Oaks Center, Wayzata, MN, 55391, (612) 473-9002, Fax: (612) 473-0648, Sales Mgr.: Ward K. Rose; Pres./CEO: Henry T. Morrison, Jr.
Supplies: Exercise, Feature Films, Instructional, Special Interest Only, Sports.
Formats: VHS.
Seeking: Exercise, Feature Films, Instructional, Music Long Form, Special Interest Only, Sports.
- CROWN VIDEO**, 225 Park Ave. S., New York, NY, 10003, (212) 254-1600, Program Buyer: Linda Morgenstern; Program Buyer: Kathryn Mintz; Mktg. Mgr.: Chuck Lang.
Supplies: Exercise, Instructional, Special Interest Only.
Formats: VHS.
Seeking: Exercise, Instructional, Special Interest Only.
- CYCLE VISION TOURS, INC.**, 440 Charrelton, Ste. 220, Eugene, OR, 97401, (503) 345-9635, (800) 624-4952, Fax: (503) 345-2977, Pres.: Mark Lange.
Supplies: Exercise.
Formats: VHS.
Distribution of clips for clubs and venues.
- DCI MUSIC VIDEO**, 541 Ave. Of The Americas, New York, NY, 10011, (212) 691-1884, Fax: (212) 691-3547, Pres.: Paul Siegel; Sales Mgr.: David Hakim; Program Buyer: Rob Wallis.
Supplies: Instructional.
Formats: VHS.
Seeking: Instructional, Music Long Form.
- DIAMOND ENTERTAINMENT**, PO Box 695, New Canaan, CT, 06840, (203) 327-2740
- DIAMOND TIME LTD.**, 270 Lafayette St., Ste. 903, New York, NY, 10012, (212) 274-1006, Fax: (212) 274-1938, Pres.: Bruce Higham; Vice Pres. Opns.: Cathy Carapella.
Supplies: Music Long Form, Compilation Music Videos.
Formats: VHS, Beta, LaserVision.
Seeking: Music Long Form.
- DO IT YOURSELF, INC./DN VIDEO CORP.**, Windmill Point, Oriental, NC, 28571, (919) 249-0063, Fax: (919) 249-2552, Pres.: Robert Roskind.
Supplies: Instructional, Special Interest Only.
Formats: VHS.
Seeking: Instructional, Special Interest Only.
Distribution of clips for clubs and venues.
- DOLPHIN PRODS., PO Box 23**, Harrison, NY, 10528, (212) 628-5930, Pres.: Allan Stanley; Prodn. Mgr.: Bruce Davis; Creative Dir.: Bob Blansky.
Supplies: Exercise, Feature Films, Instructional, Sports.
Formats: VHS, Beta.
- DOUGLAS VIDEO, INC.**, 13659 Victory Blvd., Ste. 133, Van Nuys, CA, 91401, (818) 700-6975, Fax: (818) 998-6032, Pres.: Barry Simon; Sales Mgr.: Rick Bassman.
Supplies: Feature Films, Sports.
Formats: VHS, Beta, LaserVision.
Seeking: Exercise, Feature Films, Sports.
- ESPN**, 605 Third Ave., New York, NY, 10158, (212) 916-9200, Vice Pres. & Gen. Mgr.: William Ketcham; Mgr./Sales Mgr.: Grace McGahren.
Supplies: Exercise, Special Interest Only, Sports.
Formats: VHS.
Seeking: Sports.
- EAST MEDIA GROUP/DMS EXPORT IMPORT**, 1810 W. Burbank Blvd., Burbank, CA, 91605, (818) 567-1212, Fax: (818) 567-1410, Pres.: J.S. Lee; Sales Mgr.: Larry Fine; Program Buyer: Larry Fine; Program Buyer: Mariusz Sosnowski.
Supplies: Exercise, Feature Films, Instructional, Music Long Form, Sports, Kid's Speciality Programs.
Formats: VHS, Beta, 1", 3/4".
Seeking: Feature Films, Instructional, Music Long Form, Special Interest Only, Sports.
- EASTMAN KODAK CO.**, 343 State St., Rochester, NY, 14650, (716) 724-4482, Sales Mgr.: Thomas Van Wert.
Supplies: Exercise, Special Interest Only, Sports, Photography, Hobbies etc..
- EASY RIDER HOME VIDEO & TELEVISION**, 28210 Dorothy Dr., Agoura Hills, CA, 91301, (818) 889-8740, Fax: (818) 889-4726, Pres.: Joe Teresi; Exec. Vice Pres.: Mark Seigfried.
Supplies: Special Interest Only, Sports.
Formats: VHS.
- EMPEROR ENTERTAINMENT, INC.**, 271 Bolinas Rd., Fairfax, CA, 94930, (415) 456-7807, Pres.: Mark Bredt; Vice Pres. Acquisitions: Roger Ellman (815)569-7144; Fax: (805) 687-4247.
Supplies: Feature Films, Music Long Form, Special Interest Only.
Formats: VHS, LaserVision.
Seeking: Feature Films, Music Long Form, Special Interest Only.
- ERGO HOME VIDEO**, PO Box 2037, 668 Front St., Teaneck, NJ, 07666, Pres.: Dr. Eric Goldman; Mktg. Dir.: Jane Zylberman.
Supplies: Feature Films, Jewish Oriented, 100+ titles.
Formats: VHS, Beta, PAL, SECAM.
- ESCO MEX VIDEO PRODS.**, 441 S. Beverly Dr., Ste. 6, Beverly Hills, CA, 90212, (213) 556-3606, Sales Mgr.: Amanda Escobar; Pres./COF: Oscar Escobar.
Supplies: Feature Films, Spanish Feature Films.
Formats: VHS, Beta.
Seeking: Feature Films.
Distribution of clips for clubs and venues.
- EUROPEAN VIDEO DISTR.**, 2321 W. Olive St., Ste. C, Burbank, CA, 91506, (818) 848-5902, Fax: (818) 848-1965, Pres.: Bela Bunyik; Opns./Sales Mgr.: Bonnie Anderle.
Supplies: Feature Films, Instructional, Music Long Form, Foreign.
Formats: VHS.
Seeking: Feature Films.
- EXPRESS VIDEO PRODUCTS**, 2496 64th St. N., Saint Petersburg, FL, 33710, (813) 381-2557, Pres.: Michael E. Davis.
Supplies: Instructional.
Formats: VHS.
Seeking: Instructional.
- FAMILY FILMS**, 3558 S. Jefferson, St. Louis, MO, 63118, (314) 268-1000, Mktg. Mgr.: Dave Henrichs.
Supplies: Feature Films, Religious, Religious-Oriented Children's.
Formats: VHS.
- FEELING FINE PROGRAMS, INC.**, 3575 Cahuenga Blvd. W., Ste. 440, Los Angeles, CA, 90068, (213) 851-1027, Fax: (213) 850-0395, Pres.: N. Douglas Mazza; Sales Mgr./Program Buyer: Kristen Houghton; Contact: Laura Kawaguchi.
Supplies: Exercise, Instructional, Special Interest Only.
Formats: VHS.
- FILM CLASSIC EXCHANGE**, Film House, 143 Hickory Hill Cir., Osterville, MA, 02655, (508) 428-7198, Fax: (508) 428-7198, Pres.: Jeffrey H.J. Aikman; Sales Mgr.: Elsie Aikman; Program Buyer: Violet Atkins.
Supplies: Exercise, Feature Films, Instructional, Music Long Form, Special Interest Only, Sports.
Formats: VHS, Beta, 8mm, S-VHS, LaserVision.
Seeking: Exercise, Feature Films, Instructional, Music Long Form, Special Interest Only, Sports.
- FIRST VIDEO EXCHANGE**, 17503 S. Figueroa, Gardena, CA, 90248, (310) 516-6422, Pres.: Jeff Layton.
- FLOWER FILMS**, 10341 San Pablo Ave., El Cerrito, CA, 94530, (415) 525-0942, Fax: (415) 525-1204, Pres.: Les Blank; Sales Mgr.: Laura Schultz.
Supplies: Feature Films, Music Long Form, Special Interest Only, Cooking.
Formats: VHS, Beta, 16mm, PAL.
- FRIES HOME VIDEO**, 6922 Hollywood Blvd., Hollywood, CA, 90028, (213) 466-2266, Sr. Vice Pres.: Len Levy; Vice Pres. Mktg.: Cathy Mantegna.
- FRONT ROW ENTERTAINMENT**, 195 Campus Plaza I, Edison, NJ, 08837, (908) 225-8896, (800) 666-2800, Fax: (908) 228-8286, Pres.: David Sutton; Vice Pres./Program Buyer: Robert E. Janeczek; Sales Mgr.: Jim Preslon.
Supplies: Exercise, Sports, Children's Educational, "B" Movies.
Formats: VHS.
Seeking: Special Interest Only, Sports.
- FRONTLINE VIDEO & FILM**, 243 12th St., Del Mar, CA, 92014, (619) 481-5566, Fax: (619) 481-4189, Co-Pres./Program Buyers: Jim Marino & Ira Oppen; Sales Mgr.: Bonnie Kristell.
Supplies: Special Interest Only, Sports.
Formats: VHS.
Seeking: Special Interest Only, Sports.
- FULL THROTTLE FILMS**, 450 S. Central Ave., Glendale, CA, 91204, (818) 956-1444, Pres.: Scott Dundee.
Supplies: Feature Films.
Formats: VHS, Beta.
Seeking: Feature Films.
- GME PIANO VIDEO**, PO Box 7562, 4150 Chestnut Ave., Long Beach, CA, 90807, (213) 424-5177, Fax: (213) 424-5177, Owner/Pres.: Dr. Allen Giles.
Supplies: Instructional.
Formats: VHS.
- GERMAN LANGUAGE VIDEO CENTER**, 7625-27 Pendleton Pike, Indianapolis, IN, 46226, (317) 547-1257, Fax: (317) 547-1263, Pres./Program Buyer: Juergen Jungbauer; Sales Mgr.: Gabi Jungbauer.
Supplies: German Language.
Formats: VHS.
Seeking: Feature Films.
- GESSLER PUBLISHING CO.**, 55 W. 13th St., 5th Floor, New York, NY, 10011, (212) 627-0099, (212) 627-3323, Fax: (212) 627-5948, Pres.: Seth C. Levin; Sales Mgr.: Paula Dunn.
Supplies: Feature Films, Instructional, Special Interest Only.
Formats: VHS.
Seeking: Feature Films, Instructional, Special Interest Only.
- GLOBAL VIDEO DISTRIBUTORS, INC.**, 8181 NW 91 Terrace, Ste. 7, Medley, FL, 33166, (305) 887-1986, Fax: (305) 887-2000, Pres.: Angel Tomongo; Sales Mgr.: Vincente Fernandez.
Supplies: Exercise, Feature Films, Instructional, Music Long Form, Sports, Spanish movies.
Formats: VHS, Beta.
- GOODTIMES/KIDS KLASSICS VIDEO**, 401 Fifth Ave., 6th Floor, New York, NY, 10016, (212) 889-0044, Fax: (212) 213-9319, Pres.: Joe Cayre; Sr. Vice Pres.: Michael Kirsch; Non-Theatrical Acquisition: Sr. Vice Pres. Andy Greenberg; Theatrical Acquisitions: Sr. Vice Pres. Jeff Baker.
Supplies: Exercise, Feature Films, Instructional, Music Long Form, Sports, Children's, Documentaries.
Formats: VHS.
Seeking: Exercise, Feature Films, Instructional, Music Long Form, Sports.
- GREAT CHEFS VIDEO— GSI, INC.**, PO Box 56757, New Orleans, LA, 70156, 421 Frenchmen At Esplanade, New Orleans, LA, 70116, (504) 943-4343, Fax: (504) 943-3381, Pres.: Nick Kokoron; Exec. Producer/Sales Mgr.: John Shoup.
Supplies: Special Interest Only.
Formats: VHS.
Seeking: Feature Films.
- HBO VIDEO**, 1100 Avenue of the Americas, New York, NY, 10036, (212) 512-1000, Pres.: Eric Kessler.
Supplies: Exercise, Feature Films, Instructional, Animated.
Formats: VHS, Beta.
- HPG HOME VIDEO**, 400 S. Houston, Ste. 230, Dallas, TX, 75202, (214) 741-5544, Fax: (214) 742-8423, Pres.: Mickey Holden; Mktg. Dir./Sales Mgr.: Karlene Lewis; Dir. New Product Div.: Paige Flink.
Supplies: Exercise, Instructional, Special Interest Only, Sports.
Formats: VHS.
Seeking: Special Interest Only.
- HALMAR VIDEO**, PO Box 474, Lewiston, NY, 14092, (416) 356-6865, Pres.: Harold Cosgrove.
Supplies: Sports, Motorcycle.
Formats: VHS, Beta.
Seeking: Sports.
- HANNA BARBERA HOME VIDEO**, 2400 Cahuenga Blvd., Hollywood, CA, 90068, (213) 969-1246, Fax: (213) 969-1238, Sr. Vice Pres./Gen. Mgr.: Wendy Moss; Sales Mgr.: Nan Halperin; Program Buyer: Kaaren Brown.
Supplies: Instructional, Children's.
Formats: VHS, Beta, LaserVision.
- HARTLEY FILM FOUNDATION**, 59 Cat Rock Rd., Cos Cob, CT, 06807, (203) 869-1818, Pres./Sls. Mgr./Pgm. Buyer: E da Hartley; Mgr.: Lisa Corbo.
Supplies: Special Interest Only, Holistic Health, Transpersonal Religious.
Formats: VHS.
- HEALING ARTS HOME VIDEO**, 1229 Third St., Santa Monica, CA, 90401, (310) 458-9795, Fax: (310) 458-0939, Pres.: Steven Adams; Gen. Mgr./Sales Mgr.: Melinda Walker.
Supplies: Exercise, Instructional, Special Interest Only, International.
Formats: VHS, Beta, 8mm, PAL.
Seeking: Exercise, Instructional, Special Interest Only.
- HEMDALE HOME VIDEO**, 7966 Beverly Blvd., Los Angeles, CA, 90048, (213) 966-3700, Pres.: Eric Parkinson.

HEN'S TOOTH VIDEO, 1124 S. Solano, Las Cruces, NM, 88001, (505) 525-8233, Pres.: Steve Newmark. Supplies: Foreign Films. Formats: VHS.

HIGHLIGHT PRODNs., Pier 27, Admin. Bldg, San Francisco, CA, 94111, (415) 989-9134, Fax: (415) 989-3063, Pres./Program Buyer: Greg Becker; Sales Mgr.: Kevin Campbell. Supplies: Feature Films, Special Interest Only. Formats: VHS.

HOME & INDUSTRIAL VIDEO, 100 28th St., Fairlawn, NJ, 07410, (201) 777-4700, Fax: (201) 778-1257, Pres.: Jonathan Coffino; Sales Mgr.: Stu Sable; Program Buyer: Tom Croghan. Supplies: Exercise, Feature Films, Instructional, Music Long Form, Sports.

IMAGE ENTERTAINMENT, 9333 Oso Ave., Chatsworth, CA, 91311, (818) 407-9100, Fax: (818) 407-9111, Pres.: Martin Greenwald; Vice Pres. Sales: Steve Garwood; Program Buyer: Bruce Venezia; Nat'l Sales Mgr.: Alan Ostroff. Supplies: Laser Discs. Formats: LaserVision. Seeking: Exercise, Feature Films, Instructional, Music Long Form, Special Interest Only, Sports.

IMPERIAL ENTERTAINMENT CORP., 4640 Lankershim Blvd., 4th Floor, North Hollywood, CA, 91602, (818) 762-0005, Fax: (818) 762-0006, Pres.: Sunil R. Shah; Exec. Vice Pres./Program Buyer: Sundip R. Shah; Sales Mgr.: Sue Cunningham. Supplies: Feature Films. Formats: VHS, Beta, LaserVision. Seeking: Feature Films.

IMPROVISING ARTISTS RECORDS & VIDEO, PO Box 4, 83 Alden St., Cherry Valley, NY, 13320, (607) 264-3785, Fax: (607) 264-3476, Pres.: Carol Goss; Sales Mgr.: D.S. Good. Supplies: Music Long Form, Special Interest Only, Contemporary American Poets, Video & Computer Animation. Formats: VHS.

INCREASE VIDEO, 6860 Canby Ave., Ste. 117, Reseda, CA, 91335, (818) 342-2880, Fax: (818) 342-4029, Pres./Program Buyer: Howard L. Silvers; Sales Mgr.: Len Chapman. Supplies: Exercise, Instructional, Special Interest Only, Sports. Formats: VHS. Seeking: Exercise, Instructional, Special Interest Only, Sports.

INT'L PROGRAM CONSULTANTS, INC., 200 E. 24th St., New York, NY, 10010, (212) 685-4619, Fax: (212) 755-4734, Pres.: Russell Kagan; Dir. Opns.: JoAnn Zumba. Formats: VHS.

INT'L VIDEO NETWORK, 2242 Camino Ramon, San Ramon, CA, 94583, (510) 866-1121, Fax: (510) 866-9262, Pres.: James R. Conner; Vice Pres. Sales & Mktg.: Michael Pritt; V. Pres. Prodn./Pgm.Buyer: Kim Thomas. Supplies: Special Interest Only, Travel. Formats: VHS, Beta, 8mm, S-VHS, LaserVision. Seeking: Special Interest Only.

INTROPICS VIDEO, 7131 Owens Mouth Ave., Canoga Park, CA, 91303, (818) 348-1555, Contact: Dick Miller.

IYV CLASSICS, INC., 725 Providence Rd., Charlotte, NC, 28207, (704) 333-3991, Fax: (704) 335-0672, Sales Mgr.: Jim Broome; Pres./Program Buyer: Joshua Tager. Supplies: Feature Films, Special Interest Only, Sports, Documentaries. Formats: VHS, S-VHS. Seeking: Feature Films, Instructional, Music Long Form, Special Interest Only, Sports. Distribution of clips for clubs and venues.

JCI VIDEO, 21550 Oxnard St., Ste. 920, Woodland Hills, CA, 91367, (818) 593-3600, Fax: (818) 593-3610, Pres.: Jerome Bowie; Vice Pres. Sales: Jim Newhouse. Supplies: Exercise, Feature Films, Instructional, Sports, Childrens. Formats: VHS. Seeking: Exercise, Feature Films, Instructional, Music Long Form, Sports.

J2 COMMUNICATIONS/NATIONAL LAMPOON, 10850 Wilshire Blvd., Ste. 1000, Los Angeles, CA, 90024, (213) 474-5252, Fax: (213) 474-1219, Pres.: James P. Jimirro; Sales Mgr.: Alan Benjamin; Dir. Prgmng./Pgm. Buyer: Patti Jackson. Supplies: Exercise, Feature Films, Instructional, Music Long Form, Sports, Kids, Sports, Nat'l Lampoon Comedy. Formats: VHS, Beta, 8mm, S-VHS, LaserVision. Seeking: Exercise, Feature Films, Music Long Form, Sports.

KVC ENTERTAINMENT/BARR VIDEO & AUDIO, 12801 Schabarum Ave., Irwindale, CA, 91706, (800) 582-2000, Fax: (818) 814-2672, Vice Pres. Sales: Timothy Ackerman; Program Buyer: Mark Gilula. Supplies: Exercise, Feature Films, Instructional, Sports. Formats: VHS. Seeking: Exercise, Feature Films, Instructional, Sports.

K-VIDEO PRODNs., 157 Wiltshire Rd., Claymont, DE, 19703, (302) 798-2229, Fax: (302) 798-7359, Pres.: John Kay; Mktg. Dir./Sales Mgr.: Charmaine Imburgia. Supplies: Instructional. Formats: VHS, S-VHS, 3/4" U-Matic SP.

KINO ON VIDEO, 353 W. 39th St., Ste. 503, New York, NY, 10018, (212) 629-6880, Fax: (212) 714-0871, Pres./Program Buyer: Donald Krim; Sales Dir.: Laurence Lerman. Supplies: Feature Films, Music Long Form. Formats: VHS, LaserVision. Seeking: Feature Films.

KULTUR INT'L FILMS, 121 Hwy. 36, West Long Branch, NJ, 07764, (908) 229-2343, Fax: (908) 229-0066, Pres.: Dennis M. Hedlund; Sales Mgr.: Johanna Kelly; Program Buyer: Ronald F. Davis; Nat'l Mktg. Dir.: Brad Carly. Supplies: Feature Films, Instructional, Music Long Form, Special Interest Only. Formats: VHS, Beta, LaserVision. Seeking: Feature Films, Instructional, Music Long Form, Special Interest Only.

LASERDISC CORP. OF AMERICA, 2265 E. 220th St., Long Beach, CA, 90801, (310) 835-6177

LEARNING THROUGH ENTERTAINMENT INC., 40 Dixie Village Shopping Center, Gastonia, NC, 28052, (704) 867-3330, Contact: Ms. Leslie Dale.

LEGACY HOME VIDEO, 15904 Strathern St., #23, Van Nuys, CA, 91406, (818) 781-3492, Vice Pres.: Ron Cavanagh. Supplies: Feature Films, Instructional, B-Titles, Foreign, Self-Help, Anti-Drug. Formats: VHS.

LEISURE JAZZ VIDEO

PO Box 56757, New Orleans, LA, 70156, 421 Frenchmen At Esplanade, New Orleans, LA, 70116, (504) 943-4343, Fax: (504) 943-3381, Pres.: Nick Kokoron; Exec. Producer/Sales Mgr.: John Shoup. Supplies: Music Long Form. Formats: VHS.

LIGHTHOUSE HOME VIDEO, 510 SW Third Ave., Ste. 400, Portland, OR, 97205, (503) 248-6366, Contact: Don Gronquist.

LIVE HOME VIDEO INC., 15400 Sherman Way, Van Nuys, CA, 91410, (818) 908-0303, Fax: (818) 908-9539, Pres.: David Mount; Sales Mgr.: Stuart Snyder; Sr. Vice Pres. Programming/Program Buyer: Ronna Wallace. Supplies: Exercise, Feature Films, Instructional, Music Long Form, Sports. Formats: VHS, Beta, LaserVision. Seeking: Exercise, Feature Films, Instructional, Music Long Form, Sports.

LIMIVISION CORP., 1490 Lafayette St., Ste. 305, Denver, CO, 80218, (303) 860-0400, Fax: (303) 860-0425, Pres./Prog. Buyer: Jamie White; Sales Mgr.: Tim Miller; Dir. Mktg./Pub. Rel.: Anne Fitzgibbon. Supplies: Feature Films, Instructional, Music Long Form, Documentaries, Classic Films, Animation. Formats: LaserVision.

MCA HOME VIDEO, INC., 70 Universal City Plaza, Universal City, CA, 91608, (818) 777-4300, Fax: (818) 777-4318, Pres.: Robert Blattner; Contact: Louis Feola. Supplies: Exercise, Feature Films, Instructional, Music Long Form, Sports. Formats: VHS, Beta, LaserVision. Seeking: Feature Films, Music Long Form.

M.C.E.G. VIRGIN HOME ENTERTAINMENT, 2400 Broadway, Santa Monica, CA, 90404, (310) 315-7800, Fax: (310) 315-7850, Chrmn./CEO: Jonathan Crane; Pres.: Kathleen Callahan; Vice Pres. Sales: Vickie Barber. Supplies: Feature Films. Formats: VHS, Beta, LaserVision. Seeking: Feature Films.

MPI HOME ENTERTAINMENT, 5439 Chauenga Blvd., North Hollywood, CA, 91601, (818) 760-7778, Fax: (818) 760-7883, Vice Pres./Program Buyer: Richard Shenson. Supplies: Exercise, Feature Films, Instructional, Music Long Form, Special Interest Only, Documentary. Formats: VHS.

Seeking: Feature Films, Music Long Form. Distribution of clips for clubs and venues.

MPI HOME VIDEO, 15825 Rob Roy Dr., Oak Forest, IL, 60452, (312) 687-7881, Fax: (312) 687-3797, Pres.: Waleed B. Ali; Exec. V. Pres./Sales Mgr.: Sam Citro. Supplies: Instructional, Music Long Form, Special Interest Only, Documentaries, Biographies. Formats: VHS, Beta, LaserVision. Seeking: Instructional, Music Long Form, Special Interest Only.

MADERA CINEVIDEO INC., 620 E. Yosemite Ave., Madera, CA, 93638, (209) 661-6000, Fax: (209) 674-3650, Pres./Program Buyer: Jess Rodriguez; Sales Mgr.: Connie Pascolati. Supplies: Feature Films, Spanish language. Formats: VHS. Seeking: Feature Films, Instructional. Distribution of clips for clubs and venues.

MADISON SQUARE GARDEN HOME VIDEO, 2 Pennsylvania Plaza, 14th Floor, New York, NY, 10121, (212) 465-5927, Vice Pres. Mktg.: Lee Berke.

MAGNUM ENTERTAINMENT, INC., 9301 Wilshire Blvd., Ste. 602, Beverly Hills, CA, 90230, (213) 278-9981, Fax: (213) 278-4429, Sales Mgr.: Cheryl L. Gersch; Dir. of Acquisitions: Leslie Buhler. Supplies: Exercise, Feature Films, Music Long Form, Sports. Formats: VHS, Beta. Seeking: Feature Films.

THE MAIER GROUP, 235 E. 95th St., New York, NY, 10128, (212) 534-4100, Fax: (212) 410-2145, Pres.: Howard S. Maier; Vice Pres. Sales: Candace Barth; Program Buyer: John Cox; Mktg. Dir.: Melissa Berman. Supplies: Exercise, Instructional, Sports, Kid-Vid, Dance. Formats: VHS. Seeking: Exercise, Instructional, Sports.

MAIN EVENT ENTERTAINMENT, PO Box 449, 5520 Sunrise Hwy., Sayville, NY, 11782, Pres.: Dean George Papadeas; Sales Mgr.: Angela Sabato; Consigliere: Kenny Youngblood. Supplies: Sports, Motorsports. Formats: VHS.

MARTINF. WEBER CO., 2727 Southampton Rd., Philadelphia, PA, 19154, (215) 677-5600, Fax: (215) 677-3336, Pres.: Mike Gorak; Sales Mgr.: Al Cooper. Supplies: Instructional. Formats: VHS, Beta.

MASTERVERSION, 969 Park Ave., New York, NY, 10028, (212) 879-0448, Pres.: Richard Stadin. Supplies: Feature Films, Instructional, Music Long Form, Special Interest Only, Sports, y. Formats: VHS, LaserVision. Seeking: Feature Films, Instructional, Music Long Form, Special Interest Only, Sports.

MEDIA HOME ENTERTAINMENT, 5730 Buckingham Pkwy., Culver City, CA, 90230, (213) 216-7900, Fax: (213) 216-7851, Pres.: Glenn Greene; Program Buyer: John Turtle; Vice Pres./Sales Mgr.: Ted Rosenthal; Program Buyer: Nancy Steingars. Supplies: Exercise, Feature Films, Sports, Childrens. Formats: VHS, Beta, LaserVision. Seeking: Exercise, Feature Films, Sports.

MEDIA MASTER'S MKTG., 3840 Dickerson Rd., Nashville, TN, 37207, Vice Pres.: Harold Hodges.

MEDIA WEST HOME VIDEO, PO Box 1563, Lake Grove, OR, 97035, (503) 624-8008, Fax: (503) 598-9176. Supplies: Instructional, Special Interest Only. Formats: VHS. Seeking: Special Interest Only.

MERIDIAN FILMS, PO Box 5917, Columbia, SC, 29250, 4328 Jackson Blvd., Columbia, SC, 29205, (803) 782-9941, Fax: (803) 782-7857, Pres.: Anna Benson; Program Buyer: Mark Henriksen; Exec. Producer/Sales Mgr.: Cynthia Benson. Supplies: Exercise. Formats: VHS. Distribution of clips for clubs and venues.

METACOM, INC., 1401-B W. River Rd. N., Minneapolis, MN, 55411, (612) 588-2781, Fax: (612) 588-2913, Pres.: Dennis Levin; Sales Mgr.: Walt Rapacz; Mktg. Vice Pres.: Karen Lansing. Supplies: Feature Films, Instructional, Cartoons, comedy shorts. Formats: VHS. Seeking: Feature Films.

MEXCINEMA VIDEO CORP., 7231 Santa Monica Blvd., West Hollywood, CA, 90046, (213) 874-1112, Fax: (213) 874-4987, Pres./Program Buyer: Alberto Blasco; Gen. Sales Mgr.: Sonia L. Hernandez; Sales Mgr.: Armando Gomer Farias. Supplies: Feature Films. Formats: VHS. Seeking: Feature Films.

MID-COM, INC., PO Box 15771, Evansville, IN, 47715, 5555 Byerson Dr., Newburgh, IN, 47630, (812) 473-0533, Pres.: Jack A. Fenimore; Sales Mgr.: Kay Kirkland. Supplies: Instructional. Formats: VHS, Beta. Seeking: Feature Films.

MILESTONE FILM & VIDEO, 279 W. 96th St., Ste. 28-C, New York, NY, 10025, (212) 865-7449, Fax: (212) 222-8952, Pres.: Amy Heller; Vice Pres.: Dennis Doros. Supplies: Art Documentary. Formats: VHS.

MILLION DOLLAR VIDEO CORP., 5900 Wilshire Blvd., Ste. 500, Los Angeles, CA, 90036, (213) 933-1616, Contact: Gerardo Dominguez.

MODERN SOUND PICTURES, INC., 1420 Howard St., Omaha, NE, 68102, (402) 341-8476, Fax: (402) 341-8487, Pres.: Keith T. Smith; Sales Mgr.: Sandra L. Smith. Supplies: Feature Films, Religious, childrens. Formats: VHS, Beta.

MONTEREY MOVIE CO., 5142 N. Claretton St., Agoura Hills, CA, 91301, (818) 597-0047, Fax: (818) 597-0105, Pres.: Scott Mansfield; Exec. V. Pres./Sales Mgr.: Jere Mansfield. Supplies: Exercise, Feature Films, Instructional, Music Long Form. Formats: VHS, 8mm. Seeking: Special Interest Only.

MORRIS TELEVISION & VIDEO, 2730 Monterey St., #105, Torrance, CA, 90503, (213) 533-4800, Fax: (213) 533-1993, Pres.: Dawn Morris; Sales Mgr.: Roger Casas; Vice Pres. Mktg./Program Buyer: Bruce Barton. Supplies: Exercise, Feature Films, Instructional, Sports. Seeking: Exercise, Feature Films, Instructional, Sports.

MULTI-VIDEO, INC., PO Box 35444, Charlotte, NC, 28235, (704) 536-6928, Contact: Tommie Espin.

MY BABY CAN READ, 12021 Wilshire Blvd., Ste. 522, Los Angeles, CA, 90025, (213) 826-1619, Pres.: Jack St. Onge. Supplies: Pre-School Children's. Formats: VHS.

MYSTIC FIRE VIDEO, 225 Lafayette St., #1206, New York City, NY, 10012, (212) 941-0999, Fax: (212) 941-1443, Pres.: Sheldon Rochlin; Exec. Vice Pres./Program Buyer: Bill Breeze; Sales Mgr.: Nancy Riggins. Supplies: Feature Films, Special Interest Only, Documentary. Formats: VHS, LaserVision.

NSI VIDEO, PO Box 895, Hermosa Beach, CA, 90254, (213) 374-7476, Pres.: Gerard Ravel. Supplies: Sports.

NEW ERA MEDIA, PO Box 410685, 425 Alabama St., San Francisco, CA, 94141, (415) 863-3555, Pres.: Allan R. Kesler.

- Supplies: Music Long Form, Special Interest Only.
Formats: VHS, S-VHS, LaserVision.
Seeking: Music Long Form, Special Interest Only.
- NEW LINE HOME VIDEO**, 575 Eighth Ave., 16th Floor, New York, NY, 10018, (212) 239-8880, Vice Pres. Mktg.: Michael Karaffa.
- NEW WORLD VIDEO**, 1440 S. Sepulveda Blvd., Los Angeles, CA, 90025, (213) 444-8100, Fax: (213) 444-8460, Pres.: Paul Culberg; Sales Mgr.: David Pierce; Program Buyer: Walter Calmette; Int'l Pres.: Bill Shields; Int'l Sales Mgr.: Jonathan Weisgal.
Supplies: Feature Films, Instructional, Sports.
Formats: VHS, Beta, LaserVision.
Seeking: Feature Films.
- NEW YORKER VIDEO**, 16 W. 61st St., New York, NY, 10023, (212) 247-6117, Fax: (212) 307-7855, Pres.: Daniel Talbot; Vice Pres./Sales Mgr.: Jose A. Lopez.
Supplies: Feature Films, Foreign.
Formats: VHS.
- NOAZART PRODN., INC.**, 15920 177th Ave., NE, Woodinville, WA, 98072, (206) 485-5357, Pres.: Creed Noah; Sales Mgr.: Susan Day.
Supplies: Childrens.
Formats: VHS.
- OCEAN VIDEO, INC.**, 1515 W. Glenoaks Blvd., Glendale, CA, 91201, (818) 547-2001, Fax: (818) 547-2009
Supplies: Instructional, Martial Arts & Kung Fu.
Formats: VHS.
- OPTICAL DATA**, 30 Technology Dr., Warren, NJ, 07060, (201) 668-0022, Fax: (201) 668-1322, Pres.: William Clark; Vice Pres.: Betty Paxton; Sales Mgr.: James Donatelli
Supplies: Instructional, Special Interest.
Formats: LaserVision.
- ORION HOME VIDEO**, 9 W. 57th St., New York, NY, 10019, (212) 980-1117, Pres.: Leonard White; Sales Mgr.: Gene Silverman; Program Buyer: Susan M. Blodgett
Supplies: Feature Films, Non-Theatrical.
Formats: VHS, Beta, CED, LaserVision.
Seeking: Feature Films.
- PHD VIDEO**, Film House, 143 Hickory Hill Cir., Osterville, MA, 02655, (508) 428-7198, Fax: (508) 428-7198, Pres.: J.H. Aikman; Sales Mgr.: Janie Barber; Program Buyer: Joseph Polak.
Supplies: Exercise, Instructional, Special Interest Only, Sports.
Formats: VHS, Beta, 8mm, S-VHS, LaserVision, Super Beta.
PAL, SECAM.
Seeking: Exercise, Instructional, Special Interest Only, Sports.
- PPI ENTERTAINMENT GROUP/PARADE VIDEO**, 88 Saint Frances St., Newark, NJ, 07105, (201) 344-4214, Fax: (201) 344-0465, Pres.: Donald Kasen; Sales Mgr.: Shelly Rudin; Program Buyer: Joey Porrello.
Supplies: Exercise, Instructional, Special Interest Only.
Formats: VHS, Beta.
Seeking: Exercise, Feature Films, Instructional, Special Interest Only, Sports.
- PACIFIC ARTS VIDEO/PBS HOME VIDEO**, 11858 La Grange Ave., Los Angeles, CA, 90025, (213) 820-0991, Fax: (213) 826-4779, Pres.: George Steele III; Vice Pres. Sales: Joanne Held.
Supplies: Feature Films, Instructional, Music Long Form, Special Interest Only, PBS Home Video.
Formats: VHS, LaserVision.
Seeking: Exercise, Feature Films, Instructional, Music Long Form, Special Interest Only, Sports.
- PARAMOUNT HOME VIDEO**, 5555 Melrose Ave., Hollywood, CA, 90038, (213) 956-5000, Vice Pres.: Eric Doctorow.
- PARENTS APPROVED VIDEO**, 212 NW Fourth Ave., Hallandale, FL, 33009, (305) 458-7505, Fax: (305) 458-8554, Pres.: Mike Rubin.
- PERFORMANCE VIDEO**, 7 N. Mountain Ave., Montclair, NJ, 07042, (201) 744-0770, Fax: (201) 744-1054, Pres.: John Scher; Dir.: Holly St. Lifer.
Supplies: Music Long Form.
Formats: VHS.
- PHOENIX DISTRIBUTORS**, 6253 Hollywood Blvd., #818, Hollywood, CA, 90028, (213) 469-0553, Fax: (213) 462-0137, Pres./Program Buyer: Michael Shoel; Sales Mgr.: John Stegan.
Supplies: Feature Films.
Formats: VHS, Beta.
Seeking: Feature Films.
- PIONEER ARTISTS**, 2265 E. 220th St., Long Beach, CA, 90801, (310) 818-0556, Fax: (310) 816-0420, Pres.: T. Kudo; Sales Mgr.: Rick Buehler; Mgr./Acquisitions: Steve Galloway, Prodn. Coord.: Donna Watson.
Supplies: Music Long Form.
Formats: LaserVision.
Seeking: Music Long Form.
- PLAYBOY VIDEO ENTERTAINMENT GROUP**, 8560 Sunset Blvd., Los Angeles, CA, 90069, (213) 654-4080, Fax: (213) 652-4481
- POLA PRODN., INC.**, 18662 Mac Arthur Blvd., Ste. 200, Irvine, CA, 92715, (714) 752-5700, Pres.: James Polakof; Program Buyer: Gloria Jean.
Supplies: Feature Films, Instructional, Special Interest Only.
Formats: VHS.
Distribution of clips for clubs and venues.
- POLYGRAM MUSIC VIDEOS**, 825 Eighth Ave., New York, NY, 10019, (212) 333-8414, (800) 223-7781, Pres.: Joe Shults; Vice Pres.: Jim Caparro; Vice Pres. Video Promos.: Randy Roberts.
- POTENTIALS UNLIMITED, INC.**, 4025 Broadmoor, SE, Grand Rapids, MI, 49518, (616) 949-7894, Pres.: Barrie Konicov; Sales Mgr.: Tim Kelly
Supplies: Instructional, Motivational Subliminal.
Formats: VHS, Beta.
- POWERSPORTS AMERICAN VIDEO**, 8444 Reseda Blvd., Ste. M, Northridge, CA, 91324, (818) 407-0590, Fax: (818) 407-0598, Pres.: William Moabian; Vice Pres./Sales Mgr./Prog. Buyer: Joe Levin
Supplies: Exercise, Feature Films, Instructional, Special Interest Only, Sports, Documentary.
Formats: VHS, Beta.
Seeking: Special Interest Only, Sports.
- PREMIER PROMOS., INC.**, PO Box 19022, 1420-B.S. Mint St., Charlotte, NC, 28219, (704) 334-1111, Fax: (704) 334-3833, Pres.: J.M. Pettus.
Supplies: Special Interest Only
Formats: VHS.
Seeking: Special Interest Only.
Distribution of clips for clubs and venues.
- PREMIERE HOME VIDEO**, 755 N. Highland Ave., Hollywood, CA, 90038, (213) 934-8903, Fax: (213) 934-8910, Pres./Program Buyer: Robert Coleman; Sales Mgr./Mktg.: Cynthia M. Geske
Supplies: Feature Films, Instructional, Special Interest Only, Sports, Children.
Formats: VHS, Beta.
Seeking: Feature Films.
- PRICE STERN SLOAN, INC.**, 11150 Olympic Blvd., Ste. 650, Los Angeles, CA, 90064, (213) 447-4118, Fax: (213) 445-3933, Pres.: Charles Gates; Sales Mgr.: Steve Wallace; Video Div./Program Buyer: Claudia Sloan.
Supplies: Instructional, Special Interest Only, Children's.
Formats: VHS.
- PRISM ENTERTAINMENT**, 1888 Century Park E., Ste. 350, Los Angeles, CA, 90067, (213) 277-3270, Fax: (213) 203-8036, Pres.: Barry Collier; Vice Pres. Sales & Mktg.: Joe Petrone; Vice Pres. Acquisitions: Barbara Javitz.
Supplies: Feature Films.
Formats: VHS, Beta.
Seeking: Feature Films.
- PUBLIC MEDIA VIDEO/HOME VISION CINEMA**, 5547 N. Ravenswood Ave., Chicago, IL, 60640, (312) 878-2600, (800) 826-3456, Fax: (312) 878-8648, Pres.: Wes Monty; Vice Pres.: Ellen Lasser; Sales Mgr.: Jeff McGuire; Program Buyer: Joanna Greene; Adv. Dir.: Ellen Weiskopf.
Supplies: Music Long Form, Special Interest Only, Fine arts, documentary.
Formats: VHS, Beta.
Seeking: Music Long Form, Special Interest Only.
- RCA/COLUMBIA PICTURES HOME VIDEO**, 3500 W. Olive Ave., Ste. 300, Burbank, CA, 91505, (818) 953-7900, Fax: (818) 953-7864, Pres.: Patrick Campbell; Vice Pres. Sales: David Pierce; Program Buyer: (Int'l) Linda Gamble; Mktg. Mgr.: Elaine Perliss.
Supplies: Feature Films, Childrens programs
Formats: VHS, Beta, CED, LaserVision.
- RDK PRODN., INC.**, 4446 Stern Ave., Sherman Oaks, CA, 91423, (818) 907-8900, Fax: (818) 986-2189, Pres.: Richard Klinger.
Supplies: Exercise, Instructional, Music Long Form, Sports, Original Children's Entertainment.
Formats: VHS, Beta.
- RH J HOME VIDEO**, PO Box 2830, Palm Springs, CA, 92263, (619) 323-9315
- RKO PICTURES**, 1801 Avenue of the Stars, Ste. 448, Los Angeles, CA, 90067, (213) 277-3133
Supplies: Exercise, Feature Films, Instructional.
Formats: VHS, Beta.
Seeking: Feature Films.
- RM FILMS INT'L INC.**, PO Box 3748, Hollywood, CA, 90078, (213) 466-7791, Pres.: Russ Meyer; Sales Mgr.: Janice Cowart.
Supplies: Adult Comedies.
Formats: VHS, Beta.
- RVI—ROTFIELD VIDEO INC.**, PO Box #220, 347 Montgomery Ave., Bala Cynwyd, PA, 19004, (215) 664-9882, (800) 962-2092, Fax: (215) 660-9479, Vice Pres.: Kara Ferber.
Supplies: Exercise, Special Interest Only, Political, Children's.
- RADIO VISION INT'L**, 7060 Hollywood Blvd., Ste. 525, Hollywood, CA, 90028, (213) 469-5750, Fax: (213) 469-5599, Pres./Program Buyer: Kevin Wall; Sr. Vice Pres. Sales: David Wyler.
Supplies: Music Long Form.
Formats: 1" U-Matic.
- READER'S DIGEST**, Pleasantville, NY, 10570, (914) 241-5771, Fax: (914) 238-7605, Pres.: James Schadt; Dir.: Edward J. Murphy.
Supplies: Special Interest Only, Scen c/Travel, Mood Music.
Formats: VHS, LaserVision
Seeking: Exercise, Music Long Form, Special Interest Only.
- RED ONION RECORDS**, PO Box 366, Dayton, OH, 45401, (513) 222-2413, Fax: (513) 223-1018, Pres.: Gene Mayl; Vice Pres./Program Buyer: George Ellis.
Supplies: Instructional, Music Long Form, French & German Films.
Formats: VHS, Beta, CED.
Seeking: Instructional, Music Long Form.
- REGO IRISH RECORDS, TAPES & VIDEO**, 64 New Hyde Park Rd., Garden City, NY, 11530, (516) 328-7800, (800) 854-3746, Fax: (516) 354-7768, Pres.: Paddy Noonan; Sales/Promos. Dir.: Sharin Murphy.
Supplies: Irish Music, Drama, Travel & Gen. Int.
Formats: VHS.
Seeking: Feature Films.
- REPUBLIC PICTURES HOME VIDEO**, 12636 Beatrice St., Los Angeles, CA, 90066, (213) 306-4040, Fax: (213) 301-0221, Pres.: Vallery Kountze, Vice Pres., Sales: Gary Jones; Vice Pres., Acquisitions: Mel Layton.
Supplies: Feature Films, Special Interest Only.
Formats: VHS, LaserVision.
Seeking: Feature Films.
- RHAPSODY FILM INC.**, PO Box 179, 30 Charlton St., New York, NY, 10014, (212) 243-0152, Fax: (212) 645-9250, Pres./Program Buyer: Bruce Ricker.
Supplies: Feature Films, Music Long Form, Jazz, Blues, Third World Music Programs.
Formats: VHS, LaserVision.
Seeking: Feature Films, Music Long Form.
- RHINO HOME VIDEO**, 2225 Colorado Ave., Santa Monica, CA, 90404, (310) 828-1980, Fax: (310) 453-5529, Sales Mgr.: Steve Garwood; Vice Pres./Gen. Mgr./Pgm. Buyer: Army Schorr.
Supplies: Feature Films, Music Long Form, Special Interest Only, Classic Television, Children's.
Formats: VHS, LaserVision.
Seeking: Feature Films, Music Long Form, Special Interest Only.
- RICON ENTS.**, 5863 Village Forest Ct., Houston, TX, 77092, (713) 683-0105, Pres.: Richard C. Colton.
Supplies: Special Interest Only, Space Shuttle Mission Documentaries.
Formats: VHS, Beta.
- ROCK AMERICA**, 27 E. 21st St., New York, NY, 10010, (212) 475-5791, Fax: (212) 674-0788, Pres.: Ed Steinberg; Sales Mgr.: Bob King.
Supplies: Music Long Form, Music Video Clips.
Formats: VHS, Beta, S-VHS, 3/4".
Seeking: Music Long Form.
Distribution of clips for clubs and venues.
- RODEO VIDEO, INC.**, PO Box G, 412 S. Main, Snowflake, AZ, 85937, (602) 536-7111, Fax: (602) 536-7120, Pres.: Lynda Flake; Sales Mgr.: Reed Flake; Program Buyer: Keith Flake.
Supplies: Sports.
Formats: VHS, Beta.
Seeking: Feature Films, Instructional, Sports.
- SVS**, 1700 Broadway, 16th Floor, New York, NY, 10019, (212) 757-4990, Fax: (212) 956-3792, Pres.: Michael Holzman; Sales Mgr.: Jeff Rabinovitz; Program Buyer: Ron Gell.
Supplies: Feature Films, Sports, Childrens, music short form.
Formats: VHS, Beta, some titles available in 8mm.
Seeking: Feature Films, Sports.
- SATURN PRODN., INC.**, 1697 Broadway, Ste. 1105, New York, NY, 10019, (212) 489-2460, Fax: (212) 397-0665, Pres.: Tom Ward.
Supplies: Feature Films.
Formats: VHS.
- SELECT VIDEO PUBLISHING/THE TRAVELOGUER COLLECTION**, 3301 W. Hampden Ave., Ste. N, Englewood, CO, 80110, (303) 781-0679, Fax: (303) 761-8556, Pres.: Rick Pinkham; Dir. Sales: Joanne O'Keefe.
Supplies: Special Interest Only, Travel.
Formats: VHS.
- SHAPEWORKS +**, PO Box 340451, Tampa, FL, 33694, (813) 968-9379, Pres.: Angela Hillemann; Gen. Mgr./Sales Mgr.: Robert Hillemann
Supplies: Exercise.
Formats: VHS, Beta.
- SHAPIRO-GLICKENHAUS H. VIDEO**, 12001 Ventura Pl., Studio City, CA, 91604, Contact: Jacque Palmiere.
- SHOWCASE PRODN., INC.**, 140 Parkhouse St., Dallas, TX, 75207, (214) 653-8352, Fax: (214) 742-4190, Pres.: Jim Appleton; Sales Mgr.: Daryl Haynes.
Supplies: Instructional.
Formats: VHS.
- SHOWCASE PRODN., INC.**, 50 Mildred Dr., Ste. B, Fort Myers, FL, 33901, (813) 278-4800, Fax: (813) 275-6126, Pres.: Donald J. Pasin.
Supplies: Feature Films, Cartoons, Collectors' Editions, Westerns.
Formats: VHS.
Seeking: Feature Films.
- SIERRA HOME VIDEO**, PO Box 5853, Pasadena, CA, 91117, (818) 355-0181, Fax: (818) 793-5753, Pres.: John M. Delgato.
Supplies: Music Long Form, Vintage TV Music Performances.
Formats: VHS.
Seeking: Music Long Form.
- SILVERMINE VIDEO**, 6860 Canby Ave., Ste. 117, Reseda, CA, 91335, (818) 342-2880, Fax: (818) 342-4029, Sales Mgr.: Len Chapman; Pres./Program Buyer: Howard L. Silvers.
Supplies: Exercise, Instructional, Special Interest Only, Sports.
Formats: VHS.
Seeking: Exercise, Instructional, Special Interest Only, Sports.
- SIMITAR ENTERTAINMENT, INC.**, 3850 N. Annopolis Ln., Plymouth, MN, 55447, (612) 559-6660, Fax: (612) 559-0210, CFO: Richard Rice; Pres./Program Buyer: Ed Goetz; Sales Mgr.: Joel Smetanka.

Supplies: Exercise, Feature Films, Instructional, Sports, Military, Automotive.

Formats: VHS.

Seeking: Exercise, Feature Films, Instructional.

SKYFIRE, PO Box 9900, 1775 Kuenzli Ln., Reno, NV, 89507, (702) 323-0965, Fax: (702) 323-1099, Pres.: Jim Mitchell; Mktg. Dir./Sales Mgr.: Mitch Larson.

Supplies: Special Interest Only, Sports, Aviation Entertainment.

Formats: VHS, Beta.

SMARTY PANTS AUDIO/VIDEO, 15104 Detroit Ave., Ste. 2, Lakewood, OH, 44107, (216) 221-5300, Fax: (216) 221-5348, Pres.: S. Tirk; Sales Mgr.: R.G. Korp; Program Buyer: Andrea blain; Asst. to Pres.: Leann Sullivan.

Supplies: Children's, Family.

Formats: VHS.

Seeking: Exercise.

SOLO SPORTS VIDEO, PO Box 357, Dana Point, CA, 92629, (714) 240-6778, Pres.: Craig Peterson; Sales Mgr.: Margaret Erkneff.

Supplies: Instructional, Sports.

Formats: VHS, Beta.

Seeking: Sports.

SOUTH GATE ENTERTAINMENT, 7080 Hollywood Blvd., #307, Hollywood, CA, 90028, (213) 962-8530, Fax: (213) 962-2416, Pres.: Joram Pelman; Vice Pres. Int'l Sales: Lisa Wilson-Deitell; Program Buyer: Cindi Zale.

Supplies: Feature Films.

Formats: VHS.

Seeking: Feature Films.

SOUVENIRS OF HAWAII, PO Box 2457, Honolulu, HI, 96805, 2290 Alahao Pl., Honolulu, HI, 96819, (808) 847-4608, Fax: (808) 847-4609, Pres.: Donald McDiarmid III.

Supplies: Feature Films, Instructional.

Formats: VHS, Beta.

SPECIAL INTEREST VIDEO, 553 Mendocino Ave., Santa Rosa, CA, 95401, (707) 579-3936, Fax: (707) 544-0449, Pres.: Michael Heumann; Sales Mgr.: Craig Little; Program Buyer: Marcia Ludwig.

Supplies: Instructional, Special Interest Only, Sports, Travel.

Formats: VHS, Beta.

SPECTACOR VIDEO, 7920 Sunset Blvd., 4th Floor, Los Angeles, CA, 90046, (213) 871-2777, Contact: Kimberly Goldstein.

SPORTS BOOKSHELF, PO Box 392, Ridgefield, CT, 06877, (203) 438-3055, Pres.: R. Cohen.

Supplies: Instructional, Sports.

Formats: VHS, Beta.

Seeking: Sports.

SPORTS WORLD CINEMA, PO Box 17022, Salt Lake City, UT, 84117, (801) 266-9300, Pres.: Gary Ewing.

Supplies: Exercise, Instructional, Sports, Entertainment & Instruction.

Formats: VHS.

Seeking: Exercise, Sports.

STAR CLASSICS, INC., 4301 Glenwood Rd., Brooklyn, NY, 11210, (718) 434-1100, Fax: (718) 859-0759, Pres./Program Buyer: Martin Chopp; Sales Mgr.: Gerald Schwebel.

Supplies: Exercise, Feature Films, Instructional, Sports.

Formats: VHS.

STARMAKER ENTERTAINMENT, 151 Industrial Way E., Eatontown, NJ, 07724, (908) 389-1020, Fax: (908) 389-1021, Pres./Program Buyer: Ken Plamer; Exec. Vice. Pres./Sales Mgr.: Al Schiefelbein.

Supplies: Feature Films, Special Interest Only, Children's Product.

Formats: VHS.

STONEWOLF VIDEO PRODNS., PO Box 459, Lolo Shopping Center, Lolo, MT, 59847, (406) 273-0060, Fax: (406) 273-0879, Pres./Sales Mgr.: Tony A. Schoonen; Program Buyer: Gary D. Holmes; Office Mgr.: Lorie Tripp.

Supplies: Instructional, Special Interest Only, Sports, Outdoor Recreation.

Formats: VHS, Beta, 8mm.

Seeking: Instructional, Special Interest Only, Sports.

SYBERVISION SYSTEMS, INC., 7133 Koll Center Pkwy., Pleasanton, CA, 94566, (510) 846-2244, Fax: (510) 426-0256, Pres.: J. Gary Shansby; Sales Mgr.: Don Abbott; Wholesale Acct. Rep.: Joyce Hansen.

Supplies: Exercise, Instructional, Sports.

Formats: VHS, Beta.

SYNERGY HOME ENTERTAINMENT, 858 12th St., Ste. #8, Santa Monica, CA, 90403, (310) 451-2513, Contact: Adriana Shaw.

TAM PRODNS., Film House, 143 Hickory Hill Cir., Osterville, MA, 02655, (508) 428-7198, Fax: (508) 428-7198, Sales Mgr.: Janie Barber; Program Buyer: Jordy Watson; Pres./CEO: Jeffrey H. Aikman.

Supplies: Exercise, Feature Films, Instructional, Music Long Form, Special Interest Only, Sports, Television Prodns.

Formats: VHS, Beta, 8mm, S-VHS, LaserVision, Super Beta, 16mm, 35mm.

Seeking: Exercise, Feature Films, Instructional, Music Long Form, Sports.

TAMARILLE'S FOREIGN FILMS, 110 Cohasset Stage Rd., Chico, CA, 95926, (916) 895-3429, Sales Mgr.: Patrick Colton.

Supplies: Feature Films, Instructional, Foreign, performing & fine arts.

Formats: VHS, Beta.

TAPESTRY VIDEO, 702 N. Maple Dr., Beverly Hills, CA, 90210, (213) 278-8090, Fax: (213) 471-6400, Pres.: Dann Moss; Sales Mgr./Program Buyer: Charles Douglass.

Supplies: Exercise, Feature Films, Music Long Form.

Formats: VHS, Beta, LaserVision.

Seeking: Exercise, Feature Films, Music Long Form, Special Interest Only.

TELE-STORY (DIV. OF FUN DISCOVERY, INC.), PO Box 3998, 20525 Nordhoff St., Chatsworth, CA, 91313, (818) 998-9333, Contact: Thomas West.

THOMSON PRODNS., INC., PO Box 1225, Orem, UT, 84058, (801) 226-0155, Fax: (801) 375-6880, Pres.: Linda Thomson; Sales Mgr.: Pamela Jensen; Program Buyer: Linda Neilsen.

Supplies: Exercise, Feature Films, Instructional, Music Long Form, Special Interest Only, Sports.

Formats: VHS.

3M/LEISURE TIME PRODUCTS, 3M Center, Bldg. 225-3N-04, Saint Paul, MN, 55144, (612) 733-2665, Fax: (612) 736-7479, Sales Mgr.: Tom Diehl.

Supplies: Instructional.

Formats: VHS.

Seeking: Instructional, Sports.

THRESHOLD RELEASING, INC., PO Box 47440, Seattle, WA, 98146, (800) 225-2376, Pres.: Richard Russell; Sales Mgr.: Marcy Benham Bliss.

Supplies: Special Interest Only, Aviation.

Formats: VHS, Beta, PAL.

TIME-LIFE VIDEO & TELEVISION, 777 Duke St., Alexandria, VA, 22314, (703) 838-7000, Pres.: Candice Carpenter; Vice Pres. Development & Prod'n: Marion Lear Swaybill.

TOUCHSTONE HOME VIDEO, 500 S. Buena Vista, Burbank, CA, 91521, (818) 562-3712, Contact: Kim Thomas.

TRI-COAST INT'L, INC., 1020 Pico Blvd., Santa Monica, CA, 90405, (310) 452-1181, Fax: (310) 452-2432, Pres.: C.A. Malugen; Sales Mgr.: Wendy Brickman; Dir. of Development: Jay A. LeBow.

Supplies: Instructional, Music Long Form.

Formats: VHS.

Seeking: Feature Films, Instructional, Music Long Form.

TRYLON VIDEO, INC., 1370 Avenue of the Americas, New York, NY, 10019, (212) 767-0500, Fax: (212) 767-0125, Pres.: Nicholas P. Santrizos; Exec. Vice Pres., Sales/Mktg.: Jay Press; Vice Pres., Adv./Promo.: Catherine McAdam.

Supplies: Feature Films.

Formats: VHS.

Seeking: Feature Films.

TURNER HOME ENTERTAINMENT, 5 Penn Plaza, New York, NY, 10001, (212) 714-7991, Fax: (212) 714-7801, Vice Pres.: Martin Weinstein.



MONTPELIER, MONTPELIER STATION VA

A NATIONAL TRUST PROPERTY

PRESERVATION...PLAN ON IT

Planning on restoring a house, saving a landmark, reviving your neighborhood?

Gain a wealth of experience and help preserve our historic and architectural heritage. Join the National Trust for Historic Preservation and support preservation efforts in your community.

Make preservation a blueprint for the future.

Write:

**National Trust
for Historic Preservation
Department PA
1785 Massachusetts Ave., N.W.
Washington, D.C. 20036**

- Supplies: Feature Films, Instructional.
Formats: VHS, Beta.
- 21ST GENESIS HOME VIDEO, INC.**, 15820 Arminta St., Van Nuys, CA, 91406, (818) 787-0660, Pres.: Jerry Tenebaum; Vice Pres.: Paul Hillson.
Supplies: Feature Films.
Formats: VHS, Beta.
- TWIN TOWER ENTS., INC.**, 18720 Oxnard St., Ste. 101, Tarzana, CA, 91356, (818) 344-8424, Fax: (818) 344-8474, Pres./Program Buyer: Michael Swartz; Sales Mgr.: Jim Brown.
Supplies: Instructional, Special Interest Only, Sports.
Formats: VHS, Beta.
Seeking: Exercise, Instructional, Music Long Form, Special Interest Only, Sports.
- TYNDALE HOUSE PUBLISHER, 351 Executive Dr.**, Wheaton, IL, 60189, (708) 668-8300, Fax: (708) 668-8905, Development Mgr.: Philip L. Spegren.
- UNICORN VIDEO, INC.**, PO Box 1086, Reseda, CA, 91337, 9811 Independence Ave., Chatsworth, CA, 91311, (818) 407-1333, Fax: (818) 407-8246, Pres.: Joanne Goldstein; Sales Mgr./Program Buyer: Keith Goldstein.
Supplies: Feature Films, Instructional, Special Interest Only, Spanish.
Formats: VHS.
Seeking: Feature Films, Instructional, Special Interest Only.
- UNITED AMERICAN VIDEO**, 2100 Carolina Pl., Fort Mill, NC, 29715, (803) 548-7300, Fax: (803) 548-3335, Pres.: Vernon Brannon; Vice Pres. Purchasing: Greg Taylor; Sales Mgr.: Don Matthews.
Supplies: Exercise, Feature Films, Instructional, Sports.
Formats: VHS.
Seeking: Exercise, Feature Films, Instructional.
- V C I (VIDEO COMMUNICATIONS, INC.)**, 6535 E. Skelly Dr., Tulsa, OK, 74145, (918) 622-6460, (800) 331-4077, Fax: (918) 665-6256, Pres./Program Buyer: Bob Blair; Sales Mgr.: Creighton Fross.
Supplies: Feature Films, Instructional, Religious/Inspirational.
Formats: VHS, LaserVision.
Seeking: Feature Films.
- V.I.E.W. VIDEO INC.**, 34 E. 23rd St., New York, NY, 10010, (212) 674-5550, Fax: (212) 979-0266, Pres.: Bob Karcy.
Supplies: Exercise, Instructional, Music Long Form, Special Interest Only, Sports, Opera, Dance, Art.
Formats: VHS, Beta, 8mm, LaserVision, PAL.
Seeking: Exercise, Instructional, Music Long Form, Special Interest Only, Sports.
- VIP VIDEO**, Film House, 143 Hickory Hill Cir., Osterville, MA, 02655, (508) 428-7198, Fax: (508) 428-7198, Pres./Program Buyer: Jeffrey H. Aikman; Program Buyer/Sales Mgr.: JoAnne Polak.
Supplies: Exercise, Feature Films, Instructional, Music Long Form, Sports.
Formats: VHS, Beta, 8mm, S-VHS, LaserVision.
Seeking: Exercise, Feature Films, Instructional, Music Long Form, Special Interest Only, Sports.
- VESTRON VIDEO**, 1010 Washington Blvd., Stamford, CT, 06901, (203) 978-5585, Fax: (203) 978-5811, Sales Mgr.: Michael Karaffa.
Supplies: Exercise, Feature Films, Instructional, Music Long Form, Special Interest Only, Sports.
Formats: VHS, Beta, LaserVision.
Seeking: Exercise, Feature Films, Instructional, Music Long Form, Sports.
Distribution of clips for clubs and venues.
- VIDAMERICA**, 60 Madison Ave., 12th Floor, New York, NY, 10010, (212) 685-1300, Fax: (212) 685-1603, Pres.: Alfred Markim; Exec. Vice Pres./Program Buyer: Gary Needle; Sales Mgr.: Albert Price.
Supplies: Exercise, Feature Films, Music Long Form, Special Interest Only, Sports.
Formats: VHS.
Seeking: Exercise, Feature Films, Music Long Form, Special Interest Only, Sports.
- VIDCO INDUSTRIES**, 7900 Alabama Ave., Canoga Park, CA, 91304, (818) 715-9411
- VIDEO AIDED INSTRUCTION, INC.**, 182 Village Rd., Roslyn Heights, NY, 11577, (516) 621-6176, Fax: (516) 484-8785, Pres.: Peter Lanzer; Sales Mgr.: Mona E. Lanzer.
Supplies: Instructional, Academic/Educational.
Formats: VHS.
- VIDEO BROKERS INT'L**, 95 Seaview Blvd., Port Washington, NY, 11050, (800) 666-8433, Fax: (516) 625-9406, Pres.: Shep Alster; Sales Mgr./Program Buyer: Stuart Cohen.
Supplies: Pre-Viewed.
Formats: VHS.
- THE VIDEO CONNECTION**, 3123 W. Sylvania Ave., Toledo, OH, 43613, (419) 472-7727, Fax: (419) 472-2655, Pres.: John Day.
Supplies: Exercise, Feature Films, Instructional, Music Long Form, Special Interest Only.
Formats: VHS, LaserVision.
- VIDEO DIMENSIONS**, 530 W. 23rd St., New York, NY, 10011, (212) 929-6135, Fax: (212) 929-6135, Pres./Program Buyer: Allan Greenfield; Sales Mgr.: M. Finger.
Supplies: Feature Films.
Formats: VHS, S-VHS, 3/4".
Seeking: Feature Films.
- VIDEO MUSIC, INC.**, PO Box 1128, Norristown, PA, 19404, 500 E. Washington St., Norristown, PA, 19401, (215) 278-7240, Fax: (215) 272-6074, Pres.: Thomas Scamen; Promo/Publicity: Eve Seaman.
Supplies: Music Long Form.
Formats: VHS.
Seeking: Music Long Form.
- THE VIDEO NATURALS CO.**, 1833 Lemoine St., Los Angeles, CA, 90026, (213) 667-2966, (800) 950-5545, Owner: Steven Siporin.
Supplies: Special Interest Only.
Formats: VHS.
- VIDEO SAFARIS INT'L**, PO Box 50859, Tucson, AZ, 85703, (602) 293-8088, Pres.: Gerald Harwood, Vice Pres.: Sarajejan Allen Harwood.
Supplies: Travel-Mideast & Africa.
Formats: VHS, Beta, PAL.
- VIDEO TREASURES, INC.**, 1055 W. Maple Rd., Clawson, MI, 48017, (313) 280-1010, Fax: (313) 280 0237, Pres./Program Buyer: George Port; Vice Pres. Sales: Fred Traub.
Supplies: Exercise, Feature Films, Instructional, Special Interest Only, Sports.
Formats: VHS, LaserVision.
Seeking: Exercise, Feature Films, Instructional, Music Long Form, Sports.
- VIDEO YESTERYEAR/VIDEO IMAGES**, PO Box C, Sandy Hook, CT, 06482, (203) 744-2476, (800) 243-0987, Fax: (203) 797-0819, Pres.: Jon Sonneborn.
Supplies: Feature Films, Nostalgia, Documentary, TV, Cartoons.
Formats: VHS, Beta, 8mm.
- VIDEOTOURS, INC.**, 300 Winding Brook Dr., Glastonbury, CT, 06033, (203) 659-8687, Fax: (203) 657-3334, Pres.: J.R. Johnson; Vice Pres./Program Buyer: Kathryn Deyerle; Sales Mgr.: Sandra Lee Marella.
Supplies: Special Interest Only.
Formats: VHS, PAL.
- VIDEOVISA, INC.**, 12901 Coral Tree Pl., Los Angeles, CA, 90066, (213) 478-6868, Contact: Marco Bracamontes.
- VIDMARK CORP.**, 2901 Ocean Park Blvd., Ste. 213, Santa Monica, CA, 90405, (310) 399-8877, Fax: (310) 399-3828, Pres.: Mark Amin; Vice Pres.: Barry Barnholtz; Vice Pres. Sales/Mktg.: Robert Wittenberg.
Supplies: Feature Films, Instructional, Sports.
Formats: VHS, Beta.
Seeking: Feature Films.
- VISION ENTERTAINMENT**, 18662 Mac Arthur Blvd., Irvine, CA, 92715, (714) 752-0741, (714) 752-5700, Pres./Program Buyer: Gloria J. Polakof.
Supplies: Feature Films, Special Interest Only.
Formats: VHS.
- THE VOYAGER CO.**, 1351 Pacific Coast Hwy., Santa Monica, CA, 90401, (213) 451-1383, Fax: (213) 394-2156, Partners: Bob Stein & Aileen Stein; Sales Mgr.: Todd Wade; Mktg./Pub. Rel.: Elizabeth Collumb.
- XENON HOME VIDEO, INC.**, 211 Arizona Ave., Santa Monica, CA, 90401, (310) 451-5510, Fax: (310) 395-4058, Pres.: S. Leigh Savidge; Sales Mgr.: Douglas Coleman; Program Buyer: Arnie Lakey; Dir. of Special Projects: Patrick Sierchio.
Supplies: Feature Films, Instructional, Music Long Form.
Formats: VHS.
Seeking: Feature Films, Music Long Form.
- ZANE ENTERTAINMENT GROUP**, PO Box 39437, Rochester, NY, 14604, (800) 843-0345, Contact: Chuck Zane.
Supplies: Feature Films, Instructional, Music Long Form, Videodisc-based computer programs.
Formats: VHS, LaserVision.
Seeking: Feature Films, Instructional, Music Long Form.
- WARNER ELEKTRA ATLANTIC CORP.**, 111 N. Hollywood Way, Burbank, CA, 91505, (818) 843-6311, Pres.: Henry Droz; Dir. Video Sales: Gary Rautenberg.
Supplies: Music Long Form, Special Interest Only, Sports.
Formats: VHS, LaserVision.
- WARNER HOME VIDEO**, 4000 Warner Blvd., Burbank, CA, 91522, (818) 954-6000, Fax: (818) 954-6544, Pres.: Warren Lieberfarb; Sales Mgr.: Frank Kraus; Sales Vice Pres.: John Quinn; Vice Pres. WorldwideVideo: Elyse Eisenberg.
- Supplies: Exercise, Feature Films, Instructional, Music Long Form, Sports.
Formats: VHS, Beta, CED, LaserVision, 8 MM.
Seeking: Exercise, Feature Films, Instructional, Music Long Form, Special Interest Only, Sports.
- WARNER REPRIS VIDEO**, 3300 Warner Blvd., Burbank, CA, 91505, (818) 953-3467, Fax: (818) 953-3797
Supplies: Music Long Form.
Formats: VHS.
- WESTERN PUBLISHING CO., INC./GOLDEN BOOK VIDEO**, 1220 Mound Ave., Racine, WI, 53404, (414) 633-2431, Fax: (414) 631-5035, Pres.: Joseph Marino; Sales Mgr.: Robert Komisar; Mktg. Mgr.: William Reitman.
Supplies: Children's programming.
Formats: VHS.
- WHAM! USA**, 1600 Falmouth Rd., Ste. 113-1980, Centerville, MA, 02632, (508) 420-0121, Fax: (508) 428-7198, CEO: Jeffray H. Aikman; Pres.: Violet Atkins; Sales Mgr.: John Wilson; Program Buyer: Janie Barber.
Supplies: Exercise, Feature Films, Instructional, Music Long Form, Special Interest Only, Sports, Made-For-Video Features.
Formats: VHS, Beta, 8mm, S-VHS, LaserVision.
Seeking: Exercise, Feature Films, Instructional, Music Long Form, Special Interest Only, Sports.
- WHITE JANSSEN, INC.**, 604 Davis St., Evanston, IL, 60201, (312) 328-2221, Pres.: Stefaan Janssen; Program Buyer: Matthew White.
Supplies: Exercise, Feature Films, Instructional, Special Interest Only, Popular Culture, Non-theatrical.
Formats: VHS.
Seeking: Exercise, Feature Films, Instructional, Music Long Form, Special Interest Only, Sports.
- WILD WING PRODN.**, 3601 Deilvate Pl., Encino, CA, 91436, (818) 990-1421, Fax: (818) 981-7749, Pres.: Drew Michaels; Sales Mgr.: Kathryn Grossman.
Supplies: Special Interest Only, Documentary.
Formats: VHS, Beta.
Seeking: Special Interest Only.
- WOLFRAM VIDEO**, 1700 S. 60th St., West Allis, WI, 53214, (800) 433-1652, Fax: (414) 546-4654, Pres./Program Buyer: Wolf Zimmermann; Mktg. Dir./Sales Mgr.: Bob Huntington.
Supplies: Music Video.
Formats: VHS, Beta, S-VHS.
Distribution of clips for clubs and venues.
- WOOD KNAPP VIDEO**, 5900 Wilshire Blvd., Los Angeles, CA, 90036, (213) 965-3500, Fax: (213) 930-2742, Pres.: Betsy Wood Knapp; Sales Mgr.: Harold Weitzberg; Exec. Asst.: Pam Miller.
Supplies: Exercise, Instructional, Special Interest Only.
Formats: VHS.
Seeking: Exercise, Instructional, Special Interest Only.
Distribution of clips for clubs and venues.
- WORLDVISION HOME VIDEO, INC.**, 1700 Broadway, New York, NY, 10019, (212) 261-2700.
- WORLDWIDE ENTERTAINMENT MKTG.**, 1133 Avenue of the Americas, 6th Floor, New York, NY, 10036, (212) 930-4500, Fax: (212) 930-4734, Pres.: Michael L. Omansky; Dir. Project Mgmt. & Opns.: Anne V. Vessio.
Supplies: Special Interest Only, Sports, Nostalgia, Children's.
Formats: VHS.
Seeking: Special Interest Only, Sports.
- XTC VIDEO**, 143 Hickory Hill Cir., Osterville, MA, 02655, (508) 428-7198, Pres.: Jeffrey H. Aikman; Sales Mgr.: Janie Barber; Program Buyer: JoAnne Polak.
Supplies: Feature Films.
Formats: VHS, Beta, 8mm, S-VHS.
Seeking: Feature Films.
- XENENEX INC.**, 300 Brickstone Sq., Andover, MA, 01810, (508) 475-3000, Fax: (508) 475-0909, Pres.: Christopher T. Jenny; Sls/Mktg. Dir./Pgm. Buyer: Thomas Uzso; Mktg. Mgr.: Joshua Shapiro.
Supplies: Exercise, Instructional, Health.
Formats: VHS.
Seeking: Exercise, Instructional.

Billboard's 1992 International Buyer's Guide

Your indispensable industry reference source.
Make it work for you every day!

To order call (800) 223-4156, (outside NY), (212) 536-5174
or (800) 344-7119, (outside NJ), (201) 363-4156

Or send check for \$75 plus \$3 S&H (for international orders please add \$8 for S&H) to:
Billboard Directories, P.O. Box 2016, Lakewood, NJ 08701

BDDS5125

MUSIC PUBLISHERS

A

- ABC Music Co.**, (ASCAP) (See Bourne Co.).
- ABD Music**, (ASCAP) (See Southern Melody Publishing Co.).
- ABKCO Music Inc.**, 1700 Broadway, New York, NY, 10019, (219) 399-0300. Fax: (212) 582-5090. Pres.: Allen Klein; Vice Pres.: Iris Keitel; Sr. Dir.: Alisa Ritz.
- ACE Publishing Co.**, (BMI) PO Box 9341, Jackson, MS, 39206, 103 Fairmont Ln., Jackson, MS, 39208, (601) 939-6868. Fax: (601) 932-3038. Pres.: John Vincent.
- ACF Music Group**, 1025 16th Ave. S., Ste. 201, Nashville, TN, 37212, (615) 321-5511. Fax: (615) 321-0453. Professional Mgr.: Bonita Allen; Professional Mgr.: Michael Montgomery.
- ADRA Music**, (BMI) 16 W. 22nd St., 10th Floor, New York, NY, 10010, (212) 691-1200. Fax: (212) 691-3375. Pres.: Fred Munao.
- AMCORP Group**, 827 Meridian St., Nashville, TN, 37207, (615) 226-1122. Publishing Admin.: Brenda Bridges.
- A & Mc Publishers**, (ASCAP) (See Torona Music).
- APRS**, (BMI) 810 Seventh Ave., New York, NY, 10019, (212) 265-3910.
- ARAL Music**, (ASCAP) (See Raybird Music).
- A Street Music**, (ASCAP) 701 Seventh Ave., Ste. 9W, New York, NY, 10036, (212) 764-3872. Fax: (212) 730-2206. Pres.: Bill Grabowski; Gen. Mgr.: Terry Sellers.
- The A Team Music**, (ASCAP) PO Box 613329, 476 Lido Dr., South Lake Tahoe, CA, 95761, (916) 542-4444. Pres.: Liz Anderson; Gen. Mgr./Professional Mgr.: Liz Anderson.
- AVC Music**, (ASCAP) 6201 Sunset Blvd., Ste. 200, Hollywood, CA, 90028, (213) 461-9001. Fax: (213) 874-7525. Pres.: James Warsinske; Gen. Mgr.: Greg Bell; Professional/Creative Mgr.: Jay Warsinske.
- AVI Music Publishing Group, Inc.**, (BMI/ASCAP) 10116 Riverside Dr., #200, Toluca Lake, CA, 91602, (818) 752-9080. Fax: (818) 752-9817. Pres.: Raymond Harris; Gen. Mgr.: W. James Sterling Calder.
- Aaychdee Music**, (ASCAP) (See Raybird Music).
- Abe Music**, (SESAC) (See MMO Music Group).
- Aberdeen Music, Inc.**, (See Plymouth Music Co., Inc.).
- Abnak Music c/o Publishers' Licensing Corp.**, (BMI) PO Box 5807, Englewood, NJ, 07631, (201) 568-3996. Fax: (201) 569-9580. Pres.: John Abdnor.
- Above & Beyond Music**, (ASCAP) (See The Sparrow Corp.).
- Accabonac Music**, (ASCAP) (See Cherry Lane Music Publishing Co., Inc.).
- Accumulated Copy Rights**, (BMI) (See Doug Moody Music).
- Act III Music Group**, (See BMG Music Publishing Inc.).
- Acuff-Rose Music, Inc.**, (BMI) (See Opryland Music Group, Inc.).
- Acutone Music**, (ASCAP) (See Harmony Gold).
- Adams Communications, Inc.**, (BMI) (See Almo Music Corp.).
- Addax Music Co., Inc.**, (ASCAP) (See Famous Music Corp.).
- Addmore Music**, (ASCAP) (See Hitage Music).
- Admiration Music Pub.**, (BMI) (See Brunswick Music Publishing).
- Advanced Music Co.**, (See Walrus Music Publishing).
- Afterschool Publishing Co.**, (BMI) PO Box 14157, Detroit, MI, 48214, (313) 571-0363. Pres./Professional Mgr.: Herman Kelly; Gen. Mgr.: Luke Peters.
- Agarita Music**, (ASCAP) (See The Walt Disney Co.).
- Agoth**, (BMI) (See Vin-Joy Music, Inc.).
- Fred Ahlert Music Corp.**, (ASCAP) 8425 W. Third St., Ste. 300, Los Angeles, CA, 90048, (213) 651-0471. Fax: (213) 651-0477. Pres.: Fred E. Ahlert, Jr.
- Air Rifle Music**, (ASCAP) (See Jaelius Ents., Inc.).
- Airdrome Music & Stonewood Lane Music**, 9157 Sunset Blvd., Ste. 215, Los Angeles, CA, 90069, (213) 274-2814. Fax: (213) 274-3976. Pres./Professional/Creative Mgr.: Linda Komorsky.
- Akasha Records & Mgmt., Inc.**, PO Box 2033, 312 Born St., Secaucus, NJ, 07094, (201) 864-4034. Fax: (201) 666-2790. Pres.: Gerald F. Antanies; Gen. Mgr.: Jerry Coen; Professional Mgr.: Bob O'Brien.
- Al-Bo Music Co.**, (ASCAP) 4209 NW 49th Dr., Tamarac, FL, 33319, (305) 484-6636. Pres./Gen. Mgr.: Joe Bollon.
- Al Marie Music**, (BMI) 1300 Division St., Ste. 304, Nashville, TN, 37203, (615) 255-3009. Fax: (615) 255-6282.
- Alabama Band Music**, (ASCAP) (See Maypop Music Group).
- Albet Music Corp.**, (ASCAP) (See Fourth Floor Music/Fiction Music, Inc.).
- Albradella Music**, (BMI) (See Bruboon).
- Alcazar Prodn.s.**, PO Box 429, S. Main St., Waterbury, VT, 05676, (802) 244-7845. Fax: (802) 244-6128. Pres.: Paul Smith; Professional Mgr.: Lefe Dutton.
- Alexis Music, Inc.**, (ASCAP) PO Box 532, Malibu, CA, 90265, (310) 463-5998. Fax: (310) 456-5109. Pres.: Lee Magid.
- Alfred Publishing Co.**, (ASCAP) PO Box 10003, Van Nuys, CA, 91410, 16380 Roscoe Blvd., Ste. 200, Van Nuys, CA, 91406, (818) 891-5999. Fax: (818) 891-2812. Pres.: Morton Manus; Gen. Mgr.: John Handlos; Professional/Creative Mgr.: John O'Reilly. Branch(es): 1305 Pickering Pkwy., Suite 300, Pickering, ON, L1V 3P2, Canada, (416) 839-8541.
- Alhart Music Publishing**, (BMI) PO Box 1593, Lakeside, CA, 92040, (619) 443-2170. Pres./Gen. Mgr.: Richard C. Phipps, Sr.
- Aliben Music**, (BMI) (See Skinny Zach Music).
- Aljoni Music Co.**, (BMI) 8010 Int'l Village Dr., Jacksonville, FL, 32211, 4037 Josephine St., Lynnwood, CA, 90262, (904) 745-0897. Gen. Mgr.: Al Hall, Jr.; Professional/Creative Mgr.: Ronnie Hall.
- Alkatraz Corner Music**, (BMI) PO Box 193316, San Francisco, CA, 94119, (510) 486-2052. Owner: Joe McDonald; Gen. Mgr.: Bill Belmont.
- All Beats Music**, (ASCAP) (See Terrace Entertainment Corp.).
- All Boys USA Music**, (BMI) (See Terrace Entertainment Corp.).
- All Ear's Music**, (ASCAP) (See Amadeus Music Co., c/o Franklin, Weinrib, Rudell & Vassallo).
- All Jams Music**, (BMI) (See Terrace Entertainment Corp.).
- All Nations Music Publishing**, (ASCAP) 8857 W. Olympic Blvd., Ste. 200, Beverly Hills, CA, 90210, (213) 657-9814. Fax: (213) 657-2331. Pres.: Billy Meshel; Professional Mgr.: Chris Mancini; Dir.: John Massa.
- All Night Music**, (BMI) (See The Ted Jarrett Music Group).
- Alladrane Music**, (ASCAP) (See Malaco Music Group).
- Allans Music Pty. Ltd. (Australia)**, (See E.C. Schirmer Music Co., Inc.).
- Alleluia! Music**, (SESAC) (See Integrity Music, Inc.).
- Alley Music Corp.**, 1619 Broadway, New York, NY, 10019, (212) 489-8170. Fax: (212) 956-3039.
- Jimmy Allison Music**, (BMI) (See Cactus Music/Gidget Publishing).
- Jimmy Allison Music**, (ASCAP) 5 Aldom Circle, W. Caldwell, NJ, 07006. Pres.: Tar Heel Pete.
- Almaviva Music, Ltd.**, (BMI) (See Live Music Pub. Corp.).
- Almitra Music c/o Publishers' Licensing Corp.**, (ASCAP) PO Box 5807, Englewood, NJ, 07631, (201) 568-3996. Fax: (201) 569-9580.
- Almo Music Corp.**, (ASCAP) 1358 N. La Brea Ave., Los Angeles, CA, 90028, (213) 469-2411. Fax: (213) 469-4302. Pres.: Lance Freed; Gen. Mgr.: Allan Rider; Vice Pres.: Brenda Andrews. Branch(es): 1904 Adelicia, Nashville, TN, 37212, (615) 321-0820. Vice Pres.: David Conrad.
- Alpenglow Publishing**, (BMI) 4837 Mokry, Corpus Christi, TX, 78415, (512) 991-8486. Pres.: Rick Garcia; Professional Mgr.: M. Lee Gunter.
- Alpha Music, Inc.**, (BMI) 1619 Broadway St., New York, NY, 10019, (212) 265-8090. Fax: (212) 956-3039. Pres.: Michael Nurko; Gen. Mgr.: Allan Tepper.
- Altrac Music**, (BMI) (See Walt Works, Inc.).
- Alshire Publishing Companies**, 1015 Isabel St., Burbank, CA, 91506, (213) 849-4671. Fax: (818) 569-3718. Pres.: Al Sherman; Gen. Mgr.: Faye Frankbe.
- Alva Music**, (BMI) PO Box 5218, 16233 Mil Potrero Rd., #203, Pine Mountain, CA, 93222, (805) 924-0125. Fax: (805) 242-4313. Pres.: Eddie Gurren.
- Amachrist Music**, (ASCAP) (See Funky but Music, Inc., dba Morningstar).
- Amadeo Music**, (ASCAP) (See Funky but Music, Inc., dba Morningstar).
- Amadeus Music Co., c/o Franklin, Weinrib, Rudell & Vassallo**, (ASCAP) 488 Madison Ave., 8th Floor, New York, NY, 10022, (212) 935-5500. Fax: (212) 308-0642. Pres.: Earl Rose.
- Ruben Amado S.R.L.**, (SADAIC) (See Telearte Florida, Inc./Music Publishing Co.).
- Amanda Rose Publishing**, (BMI) 20217 NE 15th Ct., North Miami Beach, FL, 33179, (305) 770-0011. Fax: (305) 770-4475. Pres.: Steve Peters; Gen. Mgr.: Andrew Korge; Professional Mgr.: Audrey Chin.
- Amazing Grace Music**, (BMI) (See Startime Music).
- American Gramophone Publishing**, (SESAC) (See Dots & Lines Ink).
- American League Music**, (BMI) 3500 W. Olive Ave., Ste. 950, Burbank, CA, 91505, (818) 955-7060. Fax: (818) 955-7059. Pres.: Jay Warner; Gen. Mgr.: Stu Ric; Professional Mgr.: Pasqual Pace.
- American Made Music**, (BMI) (See Little Big Town Music Group).
- American Music Erands, Inc.**, (BMI) PO Box 5457, Rockefeller Ctr. Sta., New York, NY, 10185, (212) 330-0952. Pres./Gen. Mgr.: David S. King.
- Americana Music Publishing, Inc.**, (JASRAC) (See Fulltilt Music).
- Americatone Int'l USA**, (BMI) (See The Rambolt Music Publishers).
- AmeriSong, Inc.**, (BMI) 8727 E. Girard Ave., Denver, CO, 80231, (303) 695-8628. Pres.: Randi C. Perkins; Professional Mgr.: Mike Crowley.
- Amerlot Music**, (ASCAP) 488 Madison Ave., Ste. 1710, New York, NY, 10022, (212) 223-0044. Fax: (212) 223-4531. Pres.: John E. Nathan.
- Amicos Two Music, c/o Jacobson & Collin, P.C.**, (ASCAP) 156 Fifth Ave., Ste. 434, New York, NY, 10010, (212) 691-5630. Pres.: Hector "Ziggy" Gonzales; Gen. Mgr.: Jeffrey E. Jacobson.
- Amida Music, Inc.**, (ASCAP) 1845 N. Farwell Ave., Milwaukee, WI, 53202, (414) 272-6700. Fax: (414) 272-6131. Pres.: John Morey.
- Amiron Music**, (ASCAP) 20531 Plummer St., Chatsworth, CA, 91311, (818) 998-0443. Fax: (818) 998-2537. Gen. Mgr.: A. Sullivan.
- Ammeth Publishing**, (BMI) PO Box 1029, Poway, CA, 92074, (619) 486-1318. Fax: (619) 486-1318. Pres.: Mike Maison; Gen. Mgr.: Tinamarie Maison.
- Amore Music Co.**, (BMI) (See Alan Hartwell Music).
- John Anderson Music**, (See Al Gallico).
- Andsome Music**, (BMI) (See Shelby Singleton Music, Inc.).
- Andustin Music**, (ASCAP) 34 Ratterman Rd., Woodstock, NY, 12498, (914) 679-6000. Fax: (914) 679-9022. Pres.: Harris Goldberg.
- Anello/Cexton Music Co.**, (ASCAP) 2740 S. Harbor, Ste. K, Santa Ana, CA, 92704, (714) 641-1074. Fax: (714) 641-1025.
- Pres./Gen. Mgr.: John Anello, Jr.; Gen. Mgr.: Christine Thompson.
- Johnny Angel Music**, (BMI) PO Box 295, Riverdale, NY, 10463, 6601 Broadway, Riverdale, NY, 10471, (212) 549-0502. Pres.: John Clark.
- Angela Music**, (SAMRO) (See Fruit Music).
- Angelsong Publishing**, (BMI) 2714 Westwood Dr., Nashville, TN, 37204, (615) 297-2246. Pres./Gen. Mgr.: Mabel H. Bridson.
- Anghel & Son Publishing**, 5020 Bilmoro Ave., Tarzana, CA, 91356, (818) 708-9557. Pres.: Adrian Anghel; Gen. Mgr.: Luciano Anghel.
- Animal Logic**, (ASCAP) (See First Release Music Publishing).
- Ankh Music**, (ASCAP) (See The Ted Jarrett Music Group).
- Anlon Music Co.**, (ASCAP) 11 Fidelian Way, Lincoln Park, NJ, 07035, (201) 402-7978. Fax: (212) 465-9803. Contact: Anglo Badalamenti.
- Anode Music**, (BMI) 417 E. Crosstimbers, Houston, TX, 77022, (713) 694-2971. Pres.: Freddie Kober.
- Ansonia Records, Inc.**, 750 Paterson Ave., East Rutherford, NJ, 07073, (201) 470-0702. Fax: (201) 470-8274. Pres.: Mercedes Glass.
- Antlers Music**, (BMI) (See Kenny O'Dell Music).
- Anton Music**, (ASCAP) (See Neil Music, Inc.).
- Any Kind of Music, Inc.**, (ASCAP) 888 Seventh Ave., Ste. 401, New York, NY, 10019, (212) 246-5520. Fax: (212) 836-0661. Pres.: Jurgen Korduletsch.
- Aoudad Music Co.**, (ASCAP) (See Major Bob Music).
- Apollo Music**, (See Athena Music Publishers).
- Apon Publishing Co.**, (ASCAP) PO Box 3082, Steinway Station, Long Island, NY, 11103, (718) 721-5599. Pres.: Daria I. Poncic; Professional/Creative Mgr.: Andrew M. Poncic, Jr.
- Apple Butter Music Co.**, (ASCAP) (See Hal Bernard Ents., Inc.).
- Arc Music Corp.**, (BMI) (See The Goodman Group Music Publishers).
- Archer Music Co.**, (See Conarch Prodn.s.).
- Arcola Music Co.**, (BMI) (See Cromma Music Co.).
- Ardayan Music**, (ASCAP) PO Box 2512, Hollywood, CA, 90078, (213) 464-8163. Fax: (818) 905-5014. Pres.: Ardie Bryant; Gen. Mgr.: Anne Bryant; Professional/Creative Mgr.: David P. Bryant.
- Argyle Music**, (ASCAP) (See Spina Music).
- Arisav Music**, (SESAC) (See Malaco Music Group).
- Tom C. Armstrong, Writer**, (See Tandem Tunes, Inc.).
- Around The World Music**, (ASCAP/BMI) 17208 Braxton St., Granada Hills, CA, 91344, (818) 360-8088. Fax: (818) 366-8353. Pres.: Bob Weiss.
- Arpell/Pinellas Music Publishing**, (ASCAP/BMI) 1614 N. Fairfax Ave., Los Angeles, CA, 90046, (213) 874-0147. Fax: (213) 874-7171. Pres.: R. Hitchcock; Gen. Mgr.: G. Newman.
- Art of Concept Music**, (BMI) PO Box 40128, San Francisco, CA, 94140, 3603 23rd St., San Francisco, CA, 94110, (415) 641-6235. Gen. Mgr.: Trevor Levine; Professional/Creative Mgr.: Trevor Levine.
- Art/Speak Publishing**, (ASCAP) PO Box 180, Woodland Hills, CA, 91365, (818) 715-0404. Pres.: David Evans.
- Artal Music**, (BMI) (See Catalogue Music).
- Artemis Music**, (BMI) (See Ultima Thule Music).
- Articulate Music**, (BMI) PO Box 1117, San Bernardino, CA, 92423, 26200 Redlands Blvd., #715, Redlands, CA, 92373, (714) 796-6110. Pres.: John Brechler.
- Artrec Publishers**, (BMI) PO Box 15032, Fort Lauderdale, FL, 33318, 5800 SW 17th Ct., Plantation Isles, FL, 33317, (305) 584-1904. Pres.: Harold E. Doane.
- Ashley Publications, Inc.**, PO Box 337, 133 Industrial Ave., Hasbrouck Heights, NJ, 07604, (201) 288-8080. Fax: (201) 288-0389. Pres.: Al Ashley; Gen. Mgr.: Monroe Gumer; Professional Mgr.: Herbert Leventhal.
- Ashmar Music**, (BMI) PO Box 567, Hendersonville, TN, 37077, (615) 824-3573. Pres./Gen. Mgr.: Margie Singleton.
- Associated Music Publishers**, (BMI) 225 Park Ave. S., 18th Floor, New York, NY, 10003, (212) 254-2100. Fax: (212) 254-2013. Copyright Dir.: Yolanda Blum.
- Associated Music Publishers, Inc.**, (BMI) (See G. Schirmer, Inc.).
- Assorted Music**, (BMI) (See The Mighty 3 Music Group).
- Astron Music Publishing**, (BMI) PO Box 22174, Pittsburgh, PA, 15222, 4746 Bowes Ave., West Mifflin, PA, 15122, (412) 462-3691. Pres./Professional/Creative Mgr.: Renee Asher; Asst. Mgr.: Kevin Amos. Branch(es): 7219 Hampton Ave., Ste 4, West Hollywood, CA, 90046. Contact: Rossi Dudrick.
- Astronette Publishing Co.**, (BMI) 2037 Alvarado Dr., NE, Albuquerque, NM, 87110, (505) 268-8405. Pres./Gen. Mgr.: A. Medley.
- Athena Music Publishers**, 311 Willowbrook Rd., Staten Island, NY, 10314, (718) 698-2280. Fax: (718) 761-6411. Gen. Mgr.: Robert Marino.
- Atherton Music**, 1300 Old Bayshore Blvd., #191, Burlingame, CA, 94010, (415) 344-3640. Fax: (415) 344-3670. Pres.: Haim Zion.
- Atlantic Music Corp.**, (BMI) (See Criterion Music Corp.).
- Atrous Publishing**, 331 W. 57th St., Ste. 111, New York, NY, 10019, (212) 320-9180.
- Attid Music**, (ASCAP) 828 Royal St., Ste. 536, New Orleans, LA, 70116, (504) 361-1643. Fax: (504) 361-1643. Pres./Gen. Mgr.: Carlo Ditta.
- Audible Music Publishing Co.**, (ASCAP) 4110 McKinley St., Hollywood, FL, 33021, (305) 964-7300. Pres.: Cosmo Ohms; Gen. Mgr.: Jeff Jacobson; Professional Mgr.: David Tubin.
- Audio Arts Publishing Co.**, (ASCAP) 3420-3C Calle Azul,

Laguna Hills, CA, 92653, (714) 770-6162. Pres./Gen. Mgr.: Madelon Baker.
Audway Music, (BMI) (See Tenalina Music).
Auntie Argon Music, (BMI) PO Box 4125, West Hills, CA, 91308, (818) 887-2248. Dir.: Steve Hobson.
Auspeck Music, (ASCAP) PO Box 1740, Studio City, CA, 91614, (213) 877-1078. Fax: (818) 763-1955. Pres.: Jules Chaiklin.
Austin Music, (BMI) (See Tex Ritter Music Publishing).
Australian Mushroom Music, (ASCAP) (See Bob-A-Lew Music).
Autopower, (BMI) (See Danvo Songs; Espy Music Group).
Avant Music, (ASCAP) (See Western Int'l Music Publishing).
Avatar Publishing Group, (ASCAP/BMI) 6290 Sunset Blvd., Ste. 605, Los Angeles, CA, 90028, (213) 464-1593. Fax: (213) 464-0204. Pres.: Rodney Gordy.
Avision Music, (ASCAP) (See Lindseyanne Music, Inc.).
Avon Gate Music, Inc., (BMI) (See Filmtrax Copyright Holdings, Inc.).
Axbar Prodn's., (BMI) PO Box 12353, 5230 San Pedro Ave., San Antonio, TX, 78212, (512) 829-1909. Pres./Gen. Mgr.: Joe L. Scates; Professional/Creative Mgr.: Jerry Blanton.
Axe Handle Music, (ASCAP) (See Axbar Prodn's).
Azinda Publications, (BMI) 325 Rolling Rock Rd., Marietta, GA, 30067, Pres./Gen. Mgr.: Tim McCabe.

B

BGM Network, (BMI/ASCAP) 4265 Gate Crost, San Antonio, TX, 78217, (512) 654-8773. Fax: (512) 654-8895. Gen. Mgr.: Bill Green.
BLA Music, Inc., (ASCAP) (See Castle Publishing, Inc.).
BLC Music Co., (BMI) (See Lowery Music Co., Inc.).
B.L. & H. Music, (ASCAP) (See H/B Webman & Co.).
BMG Music Publishing Inc., 8370 Wilshire Blvd., Beverly Hills, CA, 90211, (213) 651-3355; Fax: (213) 655-8535. Sr. Vice Pres./Gen. Mgr.: Danny Strick; Sr. Dir. Creative Affairs: Deborah Dill; Sr. Dir. Admin.: Judy Hicks; West Coast Creative Mgr.: Margaret Mittleman.
 Branch(es): 1133 Ave. of Americas, 8th Floor, New York, NY, 10036, (212) 930-4000. Fax: (212) 930-4263, Dir. East Coast Creative Svcs: Jon Bonci, Dir. of Royalty: Barbara Gardner, 1 Music Circle N., Ste. 380, Nashville, TN, 37203, (615) 780-5420. Fax: (615) 780-5430. Vice Pres./Gen. Mgr.: Henry Hurt, G.M. Gospel Music Div.: Elwyn Raymer.
BMG Music Publishing Worldwide, 1133 Ave. Americas, 8th Floor, New York, NY, 10036, (212) 930-4000. Fax: (212) 930-4263. Pres.: Nicholas L.D. Firth; Vice Pres./Finance & Admin.: Carol Lipkin; Vice Pres. Int'l: Ron Solvold; Vice Pres. Legal & Bus. Affairs: Stanley Schneider, Esq.
BMI, (See TEK Publishing).
B.O.A.M., (ASCAP) (See Mimic Music).
BTX Music, (ASCAP) (See Highest Praise Publishing Co.).
BMG Songs Inc., (ASCAP) (See BMG Music Publishing Inc.).
Baby Raquel Music, (ASCAP) 1204 Ave. U, Ste. 1235, Brooklyn, NY, 11229, (718) 646-8969. Fax: (718) 648-6575. Pres./Professional Creative Mgr.: Mark S. Berry.
Baby Tate Music Corp., (BMI) PO Box 493, Rosendale, NY, 12472, Cottekill Rd., Cottekill, NY, 12419, (914) 687-9573. Pres.: Peter B. Lowry.
Back On The Block Music, (BMI) (See Qwest Music Publishing).
Back In The Day Music Co., (ASCAP) PO Box 59114, Philadelphia, PA, 19102, (215) 438-5853. Partner: Jeanne Brewer.
Backbone Publishing, (BMI) PO Box 845, 2888 Willow Pass Rd., Concord, CA, 94522, (510) 682-6770. Fax: (510) 682-3508. Pres.: Carl E. Jefferson; Professional Mgr.: Patricia Phillips.
Bad Grammer Music, Inc., (BMI) 35918 Union Lake Rd., Ste. 306, Mount Clemens, MI, 48043, (313) 792-8452. Pres./Creative Mgr.: Joseph Trupiano; Gen. Mgr./Creative Mgr.: John Dudick.
Bada Music, (BMI) (See MGM-Path Communications Co.).
Baddest Of The Bad Posse Records, (BMI) PO Box 464, Rockefeller Center Station, New York, NY, 10185, (212) 777-0442, (718) 712-2224. Pres.: Leslie Williams; Gen. Mgr.: Rebecca Williams; Professional/Creative Mgr.: Tony Dunmore.
Bah Humbug Music, (BMI) 1722 S. Carson, Ste. 2607, Tulsa, OK, 74119, (918) 585-5050. Pres./Gen. Mgr.: Dick Loftin; Professional Mgr.: Lee Ann Loftin.
Baitstring Music, (ASCAP) (See Cheavoria Music Co.).
Bal & Bal Music Publishing Co., (ASCAP) PO Box 369, La Canada, CA, 91012, (818) 548-1116. Pres.: Adrian P. Bal.
Bal West Music Publishing Co., (BMI) (See Bal & Bal Music Publishing Co.).
Bamboo Music, Inc., (BMI) (See K-tel Int'l, Inc.).
Banjar Publications, PO Box 32164, Minneapolis, MN, 55432, (612) 755-9829. Pres.: LeRoy Larson.
Bar-None Music, (BMI) 6777 Hollywood Blvd., 9th Floor, Hollywood, CA, 90028, (213) 466-4352.
Baradat Music, (BMI) 1384 Sequoia Ave., Tulare, CA, 93274, (209) 686-2533. Pres.: Raymond A. Baradat; Gen. Mgr.: Bill Ingram; Professional/Creative Mgr.: Ray Baradat, Jr.
"Barkin' for the Master's Bone", (BMI/ASCAP) PO Box 2790, 100 E. 5th St., Fountain Sq., Cincinnati, OH, 45201, Pres.: Kevin Barr; Gen. Mgr.: Sean Steward; Professional/Creative Mgr.: Shonda R. Barr.
C. L. Barnhouse Co., (SESAC) PO Box 680, 205 Cowan Ave. W., Oskaloosa, IA, 52577, (515) 673-8397. Fax: (515) 673-4718. Pres.: Robert Barnhouse Sr.; Gen. Mgr.: Robert Barnhouse; Professional/Creative Mgr.: Charles Barnhouse.

Barry & Cia, (Buenos Aires), (ASCAP) (See Boosey & Hawkes, Inc.).
Barwin Music Co., (ASCAP) (See MPL Communications, Inc.).
Bash Music, (ASCAP) (See Bluewater Music Corp.).
Basil Music, (ASCAP) (See Anlon Music Co.).
Basilikos Music, (ASCAP) (See Don King Music Group, Inc.).
Basin Street Music, (ASCAP) (See Stainless Music Corp.).
Bastion Music, (BMI) (See Tracy Sands Music).
Batish Records, (ASCAP) 1310 Mission St., Santa Cruz, CA, 95060, (408) 423-1699. Pres.: S.D. Batish; Gen. Mgr.: Ravi Batish; Professional Mgr.: Ashwin Batish.
Bay City Music, (ASCAP) (See Victory Media Group).
Beachcomer, (BMI) (See Caprice Int'l Records/Canadian American Records).
Bean Jammin' Music, (See ABKCO Music Inc.).
Beau-Jim Music, Inc., (ASCAP) PO Box 2401, Sarasota, FL, 34230, (813) 846-3905. Pres./Gen. Mgr.: Buddy Hooper.
Beau Music Catalog, (BMI) (See Henry Jerome Music, Inc.).
Beaver Music, (ASCAP) (See H/B Webman & Co.).
Bed of Roses Records, (BMI) 4217 Highland Rd., Ste. 128, Waterford, MI, 48328, (313) 673-6460. Pres.: Debby Combs.
Bee Bee Gun Music Co., (BMI) (See Jaelius Ent's., Inc.).
Bee Cool Publishing Co., (BMI) (See Jamie Music Publishing Co.).
Earl Beecher Publishing, (BMI) PO Box 2111, 7072 Blue Salls Dr., Huntington Beach, CA, 92647, (714) 842-8635.
BeeF Songs, (ASCAP) (See Fruit Music).
Beginner Music, (ASCAP) PO Box 2532, Muscle Shoals, AL, 35662.
Bekool Music, (ASCAP) PO Box 671008, Dallas, TX, 75367, 11347 Park Central Pl., Dallas, TX, 75230, (214) 750-0720. Fax: (214) 987-4638. Pres./Gen. Mgr.: Pat McKool; Professional/Creative Mgr.: Belinda Tanner.
Bel Canto Music, (ASCAP) (See AVI Music Publishing Group, Inc.).
Belaieff, Bros., (ASCAP) (See C.F. Peters Corp.).
Bellamy Music, (ASCAP) 1102 17th Ave. S., Ste. 401, Nashville, TN, 37212.
Steven Bellamy, (ASCAP) (See Crimson Publishing).
Bellboy Music, (BMI) (See The Mighty 3 Music Group, Warner/Chappell Music, Inc.).
Belle Creole Music, (ASCAP) 9330 Beach 20th St., Far-Rockaway, NY, 11691, (718) 327-2091. Fax: (718) 327-2091. Pres.: Bernard Salvant; Gen. Mgr.: Luce E. Salvant; Professional/Creative Mgr.: Peter Francis.
Bellhouse Music, (ASCAP) (See Warner/Chappell Music, Inc.).
Belmont Music Publishers, (ASCAP) PO Box 231, Pacific Palisades, CA, 90272, (213) 454-1867. Fax: (213) 573-1925. Gen. Mgr.: Anne Wirth.
Belwin Mills Publishing Corp., (ASCAP) (See CPP/Belwin, Inc.).
Benefit Music, (BMI) (See Fitzgerald Hartley Co.).
Benson Company, 365 Great Cir. Rd., Nashville, TN, 37228, (615) 742-6800. Fax: (615) 742-6911. Pres.: Jerry Park; Gen. Mgr.: Jerry Park.
Bent Cent Publishing, Inc., (BMI) (See World Wide Music, Inc.).
Benton Music, (BMI) (See Neil Music, Inc.).
Benyard Music Co., (BMI) PO Box 298, Kew Gardens, NY, 11415, (718) 657-5363. Pres.: Kevin Benyard; Gen. Mgr.: Lor-na Dance.
Beracah Publishing Co., (ASCAP) 6855 Jimmy Carter Blvd., Ste. 2100, Norcross, GA, 30071, (404) 446-0588. Fax: (404) 446-0120. Pres.: Rev. John M. Susselwell; Gen. Mgr.: Terrence Williams.
Berdoe Music, (BMI) PO Box 8875, Universal City, CA, 91608, (818) 506-4956. Fax: (818) 506-6355. Pres.: Boots Clements; Gen. Mgr.: Jim McGuckin; Professional/Creative Mgr.: Eric Lamart.
Berekley Music, (ASCAP) (See Get Rich Music/Stay Rich Music).
Bergstrom Music Ltd. c/o Publishers' Licensing Corp., (ASCAP) PO Box 5807, Englewood, NJ, 07631, (201) 568-3996. Fax: (201) 569-9580.
Berjac Publishing Co., (ASCAP) (See Mary Williams Music Clearance Corp.).
Hal Bernard Ent's., Inc., PO Box 8385, 2612 Erie Ave., Cincinnati, OH, 45208, (513) 871-1500. Fax: (513) 871-1510. Pres.: Stan Hertzman; Professional/Creative Mgr.: Pepper Bonar.
M. Bernstein Music Publishing Co., (ASCAP) 2170 S. Parker Rd., Ste. 115, Denver, CO, 80231, (303) 755-2546. Fax: (303) 755-2617. Pres.: Richard J. Bernstein; Gen. Mgr.: R.J. Miller; Professional/Creative Mgr.: Beth Payne.
Berry Hill Songs, (BMI) (See Southern Writers Group, USA).
Bert & I, Inc., PO Box 666, 35 Mill Rd., Ipswich, MA, 01938, (508) 356-0151. Pres.: Rev. Robert A. Bryan; Gen. Mgr.: Faith Bryan.
Bertam Publishing Co., (ASCAP) (See Jobete Music Co., Inc.).
John Berthelot & Assoc., (ASCAP) PO Box 13977, New Orleans, LA, 70185, (504) 482-4211. Pres.: John Berthelot.
Bess Music, (BMI) (See Malaco Music Group).
Best of all Music, (ASCAP) (See Bestall & Reynolds).
Bestall & Reynolds, 9003 Santa Monica Blvd., #472, Beverly Hills, CA, 90212, (213) 465-9527. Fax: (213) 286-0824. Pres.: Fred Bestall.
Bethlehem Music, (BMI) 2709 Hemingway Dr., Nashville, TN, 37215, (615) 298-4410.
Bethlehem Publishing, (See Conarch Prodn's).
Better Half Music Co., (ASCAP) (See Bourne Co.).
Better Times Publishing, (BMI) 1203 Biltmore Ave., High Point, NC, 27260, (919) 882-9990. Pres.: Doris W. Lindsay.
Bexley Publishing Co., (BMI) 3333 Scenic Hwy., Memphis,

TN, 38128, (901) 386-8102. Pres./Professional/Creative Mgr.: Cordell Jackson; Gen. Mgr.: Bexley Jackson.
Bianca Music, (BMI) PO Box 30166, Memphis, TN, 38130, 3181 Poplar Ave., Memphis, TN, 38111, (901) 458-2472. Fax: (901) 458-2476. Pres.: S.D. Burks; Gen. Mgr.: A. Presley; Professional/Creative Mgr.: A. Presley.
Bibo Music Publishers, (ASCAP) (See Welk Music Group).
The Bicycle Music Co., (ASCAP/BMI) 8075 W. Third St., Ste. 400, Los Angeles, CA, 90048, (213) 938-2265. Fax: (213) 938-5357. Pres.: David Rosner.
Bienstock Publishing Co., (ASCAP) (See Alley Music Corp).
Freddy Bienstock Music Co., (BMI) (See Alley Music Corp).
Big Accumulator Music, (ASCAP) (See Zerkal Music, Inc.).
Big Blue Dolphin Music Publishing, (BMI) 760 W. Sample Rd., Pompano Beach, FL, 33064, (305) 943-9865. Fax: (305) 943-9865. Pres., Gen. Mgr.: Josh Noland.
Big City Music, Inc., (BMI) 15 Gloria Ln., Fairfield, NJ, 07004, (201) 808-8280. Pres.: Gary J. Rottger; Gen. Mgr.: Cynthia Cooper.
Big Ears Music, 4121 Wilshire Blvd., Ste. 204, Los Angeles, CA, 90010, (213) 385-0882. Fax: (213) 385-3424. Pres.: Al Bunetta.
Big Fat Music, (BMI) (See Lindseyanne Music, Inc.).
Big Heart Music, Inc., (BMI) 804 N. Crescent Dr., Beverly Hills, CA, 90210, (213) 275-7020. Fax: (213) 275-0447. Pres.: Sherwin Bash; Gen. Mgr.: Randy Bash.
Big Music, (BMI) (See Linesider Prodn's., Rohm Music).
Big Prodn's. & Publishing Co., Inc., (ASCAP) 37 East 28th St., Ste. 308, New York, NY, 10016, (212) 447-6000. Fax: (212) 447-6003. Pres.: Paul Punzone; Gen. Mgr.: Bruce B. Fisher.
Big State Music Publishing, (BMI) 1311 Candlelight Ave., Dallas, TX, 75116, (214) 298-9576. Pres.: Paul S. Ketter.
Big 3, (ASCAP/BMI) (See CPP/Belwin, Inc.).
Big Thrilling Music, (ASCAP) (See Slash Music).
Bill-Lee Music, (BMI) (See Ren-Maur Music Corp.).
Biograph Records, Inc., (ASCAP/BMI) 16 River St., Chatham, NY, 12037, (518) 392-3400. Fax: (518) 392-2666. Pres.: Arnold S. Caplin.
Birch Island Music Press, (ASCAP) (See C. L. Barnhouse Co.).
Bird Seed Music, (BMI) 1946 N. Hudson Ave., Chicago, IL, 60614, (312) 787-6060. Pres.: Robin McBride.
Birdsong Harmony, (BMI) (See Angelsong Publishing).
Birdwing Music, (ASCAP) (See Cherry Lane Music Publishing Co., Inc.).
Bislar Music Publishing, (BMI) 240 S. Carter Ave., Louisville, CO, 80027, (303) 673-0466. Pres.: Ed Bislar.
Bizarre Music, (BMI) (See Third Story Music Inc.).
Black Coffee Music, Inc., (BMI) (See Prophecy Publishing, Inc.).
Black Hat Music, (ASCAP) PO Box 4088, Austin, TX, 78765, (512) 452-9411. Pres./Gen. Mgr.: Larry Watkins.
Black Stallion Country Publishing, (BMI) PO Box 368, 9741 Commerce Ave., Tujunga, CA, 91043, (818) 352-8142.

Jewel... Paula RONN RECORDS
 P.O. Box 1125
 Shreveport, LA 71163-1125
 (800) 446-2865 (318) 865-5318
 (318) 227-2228 FAX: (318) 227-0304
 Stan Lewis, President

SU-MA PUB.	COBRA RECORDS
POLLYDAY PUB.	SOUL POWER REC.
LENNY & LITTLE PUB.	USA RECORDS
LAWN-FREDERICK- BRANDON PUB.	WHIT RECORDS
AGE RECORDS	JOB RECORDS
	CHIEF RECORDS

Full service manufacturer of Pop, C&W, R&B, Gospel & Jazz!

Contact your independent distributor & one-stop for catalog and product info or call direct. Foreign distribution open.

Movie, TV Packages & Special Promotions call: Tom Bonetti 213-876-1097 Stan Lewis 318-227-2228

★ ★ MOVIE PRODUCERS CONTACT TOM BONETTI FOR PROMOTIONAL KIT.

- Pres./Gen. Mgr.: Kenn E Kingsbury, Jr.
Blackheart Music, PO Box 15856, Saint Louis, MO, 63114, 12643 Redcoat, Saint Louis, MO, 63043, (314) 576-1569. Fax: (314) 576-6960. Pres.: Robert Schoenfeld.
Blackwood Music, Inc., 1290 Avenue of the Americas, New York, NY, 10104, (212) 492-1200.
Blanchris Music, 160 W. 71st St., New York, NY, 10023, (212) 873-2020. Fax: (212) 877-0407. Gen. Mgr.: Renee Walden.
Bleecker Street Music, (BMI) (See Rose Hill Group).
Blen Music Pub., (ASCAP) 4527 #3 Allia Rd., Marina Del Rey, CA, 90292, (213) 821-0545. Fax: (213) 823-1594. Pres.: Ben Weisman; Gen. Mgr.: Elsie Weisman.
Blendingwell Music, Inc., (ASCAP) PO Box 5807, Englewood, N.J., 07631, (201) 568-3996. Fax: (201) 569-9580. Pres.: Phiip S. Kurnit; Gen. Mgr.: Terry Cashman.
Bleu Disque Music Co. Inc., (See Warner/Chappell Music, Inc.).
Blind Basement Music, PO Box 7688, Silver Springs, MD, 20907, (301) 434-6958. Fax: (301) 434-3056.
Blitrate Music, (ASCAP) (See Joel S. Turtle).
Blockbuster Music Co., (BMI) (See Jamie Music Publishing Co.).
Ben Bloom Music Corp., (ASCAP) (See Bourne Co.).
Bloomfield Music, (SESAC) (See Bridgeport Music, Inc., Globe Art, Inc.).
Blue Canyon Music, (BMI) PO Box 6622, Santa Fe, NM, 87502, (505) 989-9298. Pres.: Jim Terr.
Blue Counterpoint Music, (BMI) (See Palo Publishing).
Blue Earth Music, Inc., (ASCAP) PO Box 1515, W. Caldwell, N.J., 07007, (201) 226-3863. Pres.: Herbie Abast; Gen. Mgr.: Julie Tucker.
Blue Gas Music, (BMI) (See Palo Publishing).
Blue Gate Publishing, 116 Chestnut St., Providence, RI, 02903, (401) 274-4119. Fax: (401) 272-0501. Pres.: Richard R. Waterman; Exec. Vice Pres.: Bruce Foulke.
Blue Hill Music, (BMI) (See Tutch Music).
Blue Lake Music, (BMI) (See Terrace Entertainment Corp.).
Blue Menu Music Catalog, (BMI) (See Henry Jerome Music, Inc.).
Blue Monday Music, (BMI) (See Garrett Music Ents.).
Blue Moon Music/Zomba Enterprises, Inc., (ASCAP) 1114 17th Ave. S., Ste. 105, Nashville, TN, 37212, (615) 321-4850. Gen. Mgr.: Michael Hollandsworth; Professional Mgr.: Than Tallemot.
Blue Prairie Music, (BMI) (See RCI Music Group).
Blue Sky Rider Songs, (See Willin' David Music Group).
Blue Turtle Music, (ASCAP) (See Int'l Record Syndicate Music, Inc.).
Blue Umbrella Music Publishing Co., (ASCAP) 3011 Beach 40th St., Brooklyn, NY, 11224, (718) 372-6436. Pres.: Kadish Millet.
Blueford Music, (ASCAP) (See Mercantile Music).
Bluwater Music Corp., (BMI/ASCAP) PO Box 120904, 1114 17th Ave. S., Ste. 202, Nashville, TN, 37212, (615) 329-0777. Fax: (615) 329-0779. Pres.: Brownlee Ferguson; Professional/Creative Mgr.: Frank Liddell.
Bob-A-Lew Music, (ASCAP) PO Box 8649, Universal City, CA, 91608, (818) 506-6331. Fax: (818) 506-4735. Pres.: Ronda Espy.
Bobbing Heads Music, (ASCAP) (See Zerkall Music, Inc.).
Bobby O Music, (ASCAP) (See Orbob Music Inc. c/o Lipservice).
Bocage Music, (ASCAP) PO Box 1061, Willow Grove, PA, 19090, (215) 657-8863. Pres.: Louis A de Lise; Professional Mgr.: Elena Marino.
Bocephus Music, Inc., (BMI) (See Dave Burgess Ents.).
Boggy Depot Publishing, (BMI) 10051 Greenleaf, Santa Fe Springs, CA, 90670, (213) 946-3193. Fax: (213) 946-8039. Pres.: Overton Lee.
Bold Gold Pub., (BMI) 50 Spring City Rd., Phenixville, PA, 19460, (215) 948-5096. Pres.: Robert Benedetto. Gen. Mgr.: Vince Benedetto.
Bolnik Music, (BMI) 2124 Darby Dr., NW, Massillon, OH, 44646, (216) 833-2061. Pres./Professional Mgr.: Dick Boldi.
Bonaire Songs, (ASCAP) 7774 Torreyson Dr., Los Angeles, CA, 90046, (213) 876-4160. Fax: (213) 876-0476. Pres./Gen. Mgr.: Clive Corcoran.
Johnny Bond Publications, 1815 Division St., Nashville, TN, 37203, (615) 327-8436. Pres.: Sherry Bond.
Bonfire Publishing, (ASCAP) PO Box 6429, Huntington Beach, CA, 92615, 19931 Gloucester Ln., Huntington Beach, CA, 92646, (714) 962-5618. Pres.: Eva Bonn; Gen. Mgr.: Stan Bonn.
Bonnyview Music/Drive-In Music, (ASCAP) 7120 Sunset Blvd., Hollywood, CA, 90046, (213) 851-2500. Fax: (213) 851-8162. Pres.: Art LaBoe; Exec. Vice Pres.: Paul Polit.
Boo Bear Publishing, (ASCAP) (See Avatar Publishing Group).
Boomerang Music, (BMI) (See S & R Music Publishing Co.).
Boosey & Hawkes, Inc., (ASCAP) 24 W. 57th St., New York, NY, 10019, (212) 757-3332. Fax: (212) 262-2012. Gen. Mgr.: James M. Kendrick; Professional Mgr.: David Huntley.
Branch(es): 52 Cooper Sq., 10th Floor, New York, NY, 10003, (212) 979-1090. Gen. Mgr./Printed Music: Michael Murray.
Boots & Spurs Music, (BMI) (See Garrett Music Ents.).
Bob Talk Music, (ASCAP) PO Box 566, Massena, NY, 13662, (315) 769-2448. Fax: (315) 764-0182. Pres.: Tom Gramuglia.
Boss Tweed Music, (BMI) PO Box 23, Sun Valley, CA, 91352, (818) 982-2174. Pres.: J. Eric Freedner.
Boston Skyline Music, (ASCAP) 73 Hemenway St., #508, Boston, MA, 02115, (617) 536-5464. Fax: (617) 266-1575. Pres.: Wayne Wadhams.
Bosworth & Co., Ltd., (PRS) (See Alpha Music, Inc.).
Bote & Bock Musikverlag, (GEMA) (See G. Schirmer, Inc.).
Bourne Co., (ASCAP) 5 W. 37th St., New York, NY, 10018, (212) 391-4300. Fax: (212) 391-4306. Pres.: Mrs. Bonnie Bourne; Gen. Mgr.: Mr. Robert Frisby; Professional Mgr.: Mr. Peter Myers.
Branch(es): PO Box 975, North Hollywood, CA, 91603, (818) 788-6438. Rep.: George Perl.
Brainstorm Music, Inc., (ASCAP) 599 Broadway, 5th Floor, New York, NY, 10012, (212) 226-9595. Fax: (212) 213-9598. Pres.: Eiichi Naito.
Brandsme Music Corp., (BMI) (See Music Sales Corp.).
Branch Int'l Music, (See Lemon Square Music).
Brandwood Music, (BMI) (See Malaco Music Group).
Brandy River Music Co., PO Box 413, Durham, NH, 03624, (603) 749-2811. Pres.: Richard R. Shaw; Gen. Mgr.: Ronald B. Shaw.
Brantford Music, (BMI) (See Southern Melody Publishing Co.).
Brat Music, (BMI) PO Box 157, Richmond, VA, 23201, (804) 359-0001. Pres.: Barry Gottlieb.
Bread 'N Honey, (ASCAP) PO Box 3391, Ventura, CA, 93006, (818) 781-3492. Fax: (818) 781-3495. Pres.: Declan Kavanach; Gen. Mgr.: Roderic Kavanach; Professional/Creative Mgr.: Will Evans.
Breakaround Music, (BMI) (See Whooping Crane Music).
Breezeaway Publishing Co., (BMI) (See N2D Publishing Co.).
Breitkopf & Haertel, (GEMA) (See G. Schirmer, Inc.).
Brentwood Music, Inc., 316 Southgate Cir., Brentwood, TN, 37027, (615) 373-3950. Fax: (615) 373-0386. Pres.: Jim Van Hook; Creative Dir.: Ed Kee.
Briarhead Music Unlimited, (ASCAP) (See Sea Cruise Music).
Bridge Bldg. Music, (BMI) (See Brentwood Music, Inc.).
Bridgeport Music, Inc., 21348 Telegraph Rd., Ste. 200, Southfield, MI, 48034, (313) 355-1540. Pres.: Armand Boladian.
Brier Patch Music, 3625 Meadowood Ln. SW, Grandville, MI, 49418, (616) 534-6571. Pres.: Ken Medema; Gen. Mgr.: Beverly Vander Molen.
Bright Sky Music, (ASCAP) (See Opryland Music Group, Inc.).
Brio Music, (BMI) (See Funky but Music, Inc., dba Morningstar).
Bristol Music Co., (ASCAP) 614 S. St. Andrews Pl., #108, Los Angeles, CA, 90005, (213) 252-1709. Pres.: Jamie Rounds.
Bro 'N Sis Music, Inc., (BMI) (See Alley Music Corp.).
Broadbeach Music, (ASCAP) (See Peaceable Kingdom Publishing).
Broadway Sound, (ASCAP) (See DiMaggio Publishing Co.).
John Brock Publishing, (ASCAP) 7188 Sunset Blvd., Ste 204, Los Angeles, CA, 90046, (213) 969-2109. Pres.: John Brock; Gen. Mgr.: Christy Binder.
Brogue, (BMI) 64 New Hyde Park Rd., Garden City, NY, 11530, (800) 854-3746. Fax: (516) 354-7768.
Broken Songs, (ASCAP) PO Box 28450, Santa Ana, CA, 92799, (714) 751-2242. Fax: (714) 755-6236. Pres.: James Kempner; Gen. Mgr.: Brian Tong; Professional Mgr.: Ed McTaggart.
Bronjo Music, 499 Erneston Rd., Parlin, NJ, 08859, (908) 727-7200. Fax: (201) 727-7240. Pres.: Jay Chernow.
Brooks & Assoc., (See Prince/SF Publications).
Brooks Brothers, (BMI) (See Enchantment Music Co.).
Brookside Music Corp., (ASCAP) 159 W. 53rd St. c/o Reid Whitelaw, New York, NY, 10019, (212) 541-7761. Fax: (212) 956-5761. Pres.: Reid Whitelaw.
Brooky Bear Music, (ASCAP) (See Dave Burgess Ents.).
Broozbee Music, Inc., (ASCAP) 37 E. 28th St., Ste. 308, New York, NY, 10016, (212) 447-6000. Fax: (212) 447-6003. Pres.: Bruce B. Fisher; Gen. Mgr.: Gene Scard.
Brother Bear Music, (BMI) (See DeWhit Music).
Brother Bills Music Co., (ASCAP) (See Lowery Music Co., Inc.).
Brown/Feldman Publishing, (ASCAP) PO Box 4044, St. Paul, MN, 55404, 720 Ave. SE, #202, Minneapolis, MN, 55414, (612) 379-1089. Fax: (612) 379-0945. Pres.: Robert M. Feldman; Gen. Mgr.: C.W. Frymire.
Brown Street Music, (ASCAP) (See Brown/Feldman Publishing).
Bruboon, (BMI) 313 Highland Ave., Albany, GA, 31701, (912) 436-6508, (912) 438-8497. Pres./Professional-Creative Mgr.: Jesse Boone, Sr.; Gen. Mgr.: Eric Boone; Professional/Creative Mgr.: Austin Hall.
Bruin Music Co., (BMI) (See Famous Music Corp.).
Brunswick Music Publishing, PO Box 3683, Beverly Hills, CA, 90212, (213) 273-1986.
Lionel Bruton Publishing, (BMI) (See Wajji Music Group).
Nathan Bryden Music Co., (BMI) PO Box 10574, Portland, OR, 97210, (503) 243-2634. Pres.: Nathan Bryden.
Buckaroo Music, (BMI) PO Box 150272, Nashville, TN, 37215.
Buckhorn Music Publishers, Inc., (BMI) PO Box 120547, 1009 17th Ave. S., Nashville, TN, 37212, (615) 327-4590. Fax: (615) 327-4639. Pres.: Marjohm Wilkin; Gen. Mgr.: Sherrill Blackman.
Bud-Don Music, (ASCAP) (See Glad Music Co.).
Budd Music Corp., (ASCAP) 75 Palma Dr., Rancho Mirage, CA, 92270, (619) 323-1097. Pres.: Buddy Kaye; Gen. Mgr.: Richard Kaye.
Buena Vista Music, (BMI) (See The Walt Disney Co.).
Buffalo Bill Music, (BMI) PO Box 414314, 1520 Daytonia Rd., Miami Beach, FL, 33141, (305) 865-0363. Fax: (305) 865-0344. Pres.: Bob Taran; Gen. Mgr.: Adam Taran; Professional Mgr.: Mickey Novack.
Bug Music, (BMI/ASCAP) 6777 Hollywood Blvd., 9th Floor, Hollywood, CA, 90028, (213) 466-4352. Fax: (213) 466-2366.
CEO: Dan Bourgoise; Pres.: Fred Bourgoise; Gen. Mgr.: Beth Allison; Professional/Creative Mgr.: Mara Bruckner.
Bugle Songs, Ltd., (PRSUK) (See First Release Music Publishing).
Bull-Kent Music, (ASCAP) (See Mercantile Music).
Bullfrog Ballads, (ASCAP) (See Folklore Music).
Bull's Creek Publishing, (BMI) 11 Music Circle S., Nashville, TN, 37203, (615) 242-7410. Pres.: Phyllis Austin; Gen. Mgr.: Micki Foster.
Bull's Gap Music, (ASCAP) (See Homeland Recording & Publishing).
Bull's Run Publishing, (ASCAP) (See Bull's Creek Publishing).
Bullwhip Publishing Co., (ASCAP) (See Jam-Power, Inc.).
Bumpershot Music, Inc., (BMI) (See Hal Bernard Ents., Inc.).
Bunzo Music Co., (BMI) 153 Stevens Ave., Mount Vernon, NY, 10550, (914) 699-6052. Fax: (914) 699-1769. Pres./Gen. Mgr.: Peter Lane.
Burbank Plaza Music, Inc., (ASCAP) (See Filmatrx Copyright Holdings, Inc.).
Dave Burgess Ents., (BMI/ASCAP) PO Box 40929, Nashville, TN, 37204, (615) 370-3002. Fax: (615) 329-2078. Gen. Mgr.: Dave Burgess.
Joe Burke Music Co., (ASCAP) (See Fred Ahlert Music Corp.).
Burke & Van Heusen, (ASCAP) (See Bourne Co.).
Burrin Ave. Music, (BMI) (See 337 Music).
Bill Butler Music, (BMI) PO Box 20, 2006 Ave. E, Hondo, TX, 78861, (512) 426-2112. Fax: (512) 426-2112. Pres./Gen. Mgr.: Bill Butler; Professional/Creative Mgr.: Max Gardener.
Larry Butler Music, (See NEM Entertainment Corp.).
Buttala Publishing Co., (ASCAP) 1092 Flanagan Sta. Rd., Winchester, KY, 40391, (606) 744-7921. Pres.: Mary B. Rains; Gen. Mgr.: Jack O. Rains.
Buzzart Ents., Inc., (BMI) 169 Pier Ave., Top Floor, Santa Monica, CA, 90405, (213) 392-3088. Fax: (213) 392-0931.
Buzzerb Music, (BMI) (See Scott Tutt Music).
By Ear Music Co., (BMI) PO Box 78617, Seattle, WA, 98178, 2020 Grant Ave. S., Apt. D-105, Renton, WA, 98055, (206) 228-7307. Fax: (206) 226-4812. Pres.: Andre L. Sterling; Gen. Mgr.: Rachelle Smith-Byers.
Byrm Records, (SOCAN) (See Astron Music Publishing).

C

- CDT Prods.**, (ASCAP) (See Laymond Publishing Co.).
C.P.I. Music, (ASCAP) PO Box 7320, 12220 Tiara St., Beverly Hills, CA, 90212, (818) 762-7417. Pres.: Franz Swegal.
CPP/Belwin, Inc., (ASCAP/BMI) 15800 NW 48th Ave., Miami, FL, 33014, (305) 620-1500, (800) 327-7643. Fax: (305) 621-4869.
Pres.: Sandra Feldstein; Sales: E. Gutstein, T. Proctor.
Cabin Fever Music, (BMI) 100 W. Putnam Ave., Greenwich, CT, 06830, (203) 863-5200. Fax: (203) 863-5258. Pres.: Thomas A. Molito; Gen. Mgr.: William C. Doble; Professional Mgr.: Pat Halverson.
Cactus Industries Music, (ASCAP) PO Box 322, Ingomar, PA, 15127, (412) 364-8660. Fax: (212) 628-9147. Pres.: Charles W. Surman.
Cactus Music/Gidget Publishing, (ASCAP) 5 Aldom Cir., West Caldwell, NJ, 07006. Pres.: Tar Heel Pete.
Cadet Polka Records, PO Box 36, Burnett, WI, 53922, (414) 689-2320. Pres.: Don Peachy.
Cadillac Baby Prods., (BMI) (See Earwig Music Co., Inc.).
Cahn Music Co., (ASCAP) (See Warner/Chappell Music, Inc.).
John Cale Music, Inc., (BMI) 270 Madison Ave., Ste. 1410, New York, NY, 10016, (212) 683-5320. Fax: (212) 686-2182. Pres.: John Cale; Gen. Mgr.: Christopher Whent.
Calente Music, (ASCAP) (See Ray Ruff).
Calhoun Street Music, (BMI) 220 Fourth St., Ste. 101, Oakland, CA, 94607, (510) 763-8500. Fax: (510) 763-8558. Pres.: Larry Sloven.
California Country Music, (BMI) 112 Widmar Pl., Clayton, CA, 94517, (510) 672-8201. Pres.: Edgar J. Brincat.
California Flight/Just Write Music Co., (BMI/ASCAP) PO Box 222, Pittsburg, CA, 94565, (510) 779-4341. Fax: (510) 779-7253. Pres.: Jerry L. Johnson; Gen. Mgr.: Joseph R. Brown.
California Int'l, (ASCAP) (See Joseph Nicolletti Music Co.).
Callee Music Corp., (ASCAP) (See Fourth Floor Music/Fiction Music, Inc.).
Callon-Love Music, (BMI) 567 W. Fifth St., San Pedro, CA, 90731, (310) 519-7393. Fax: (310) 519-1614. Pres.: Jim Callon; Gen. Mgr.: Dale Love Callon.
Calvary's Shadow Publications, (See Conarch Prods.).
Camelback Mountain Music Corp., (ASCAP) (See Shapiro, Bernstein & Co., Inc.).
Camera Music, (See US Music).
Camex Music, (BMI) (See US Music).
Campbell Connolly, Inc., (ASCAP) (See Music Sales Corp.).
Glen Campbell Music Group, (BMI/ASCAP) 10351 Santa Monica Blvd., #300, Los Angeles, CA, 90025, (213) 552-0960. Fax: (213) 557-3468. Pres.: Glen Campbell; Copyrights/Licenses: Francesca DeAngelis.
Branch(es): PO Box 158717, Nashville, TN, 37215, (615) 385-9875. Fax: (615) 385-9186. Professional/Creative Mgr.: Marty Gamblin, Professional/Creative Mgr.: Cherie Gamblin.
Canaanland Music, (BMI) (See Word Music).
Canal Street Music, (BMI) (See Stainless Music Corp.).
Canadaigua Music, (See You Heard It—Hear!).
Candantino Music, (ASCAP) (See MGM-Pathe Communications Co.).
Cannon Film Music, (BMI) (See MGM-Pathe Communications Co.).
Canoe Gap Pub. Co., (See Hummingbird Recording Co., Inc.).
Canpic Music, (ASCAP) (See MGM-Pathe Communications Co.).

- Canterbury Music**, (ASCAP) (See David Rubinson Publishing).
Canzone Music, (BMI) (See MGM-Pathe Communications Co.).
Capano Music, (ASCAP) 237 Chestnut St., Westville, NJ, 08093, (609) 456-4402. Pres.: Anthony J. Capano; Gen. Mgr.: Pasquale Capano; Professional Mgr.: Brian Alan Capano.
Capo Ann Music, (BMI) (See Darcy Music).
Capo May Music, (BMI) (See Darcy Music).
Capo Rock Music, (ASCAP) PO Box 207, 772 S. Kings Hwy., Cape Girardeau, MO, 63701, (314) 335-0109, (314) 335-7327. Pres.: Fred J. Horrell; Gen. Mgr.: Scott L. Horrell.
Caplin Music, (BMI) (See Biograph Records, Inc.).
Cappy Music, (ASCAP) (See Cherry Lane Music Publishing Co., Inc.).
Caprice Int'l Records/Canadian American Records, Postal Suite 808, Lititz, PA, 17543, (717) 627-4800. Fax: (717) 626-0395. Pres./Gen. Mgr.: Joey Welz; Professional/Creative Mgr.: James E. Myers; Exec. Sec.: Linda Dee.
Captain Crystal Music, (BMI) 6986 El Camino Real, #B-412, Carlsbad, CA, 92008, (619) 931-9256. Pres.: Charls Senter.
Cara Publications, (ASCAP) (See C. L. Barnhouse Co.).
Lance Cara Publishing Co., (BMI) PO Box 5542, Mission Hills, CA, 91395, (818) 367-8519. Pres.: Irene Lamothe; Gen. Mgr.: Phillip Couture.
Caramba Edizioni Musicali, (SIAE) (See Alpha Music, Inc.).
Carb Music Co., (ASCAP) (See Hal Bernard Ents., Inc.).
Carbert Music, Inc., (BMI) (See Alley Music Corp.).
Rick Carbone Music, (BMI) (See Empty Sky Music Publishing Co.).
Careers-BMG Music Publishing, (BMI) (See BMG Music Publishing Inc.).
Carers Music, Inc., (BMI) 8370 Wilshire Blvd., Beverly Hills, CA, 90211, (213) 655-9222.
Caribbean Wave Music, (ASCAP) 568 Broadway, Ste. 806, New York, NY, 10012, (212) 925-2828. Fax: (212) 925-6154. Pres.: Ralph Mercado; Gen. Mgr./Professional-Creative Mgr.: Carlos Mario Gutierrez.
Carimusic Corporation, PO Box 52-7950, 8000 NW 31st, Ste. 19, Miami, FL, 33152, (305) 591-7685. Fax: (305) 477-4431. Pres.: Mateo San Martin; Professional Mgr.: Gloria Patricia Jaramillo.
Carlanta Music, (ASCAP) (See G. Schirmer, Inc.).
Carlin Music, Ltd., (PRS) (See Alpha Music, Inc.).
Carlotta Publishing, (BMI) (See Broken Songs).
Graham Carlton Music Co., (BMI) PO Box 333, Evanston, IL, 60204, 1320 Sherman, Ste. 3, Evanston, IL, 60201, (708) 328-0400. Fax: (708) 328-1700. Pres.: Graham Carlton.
Carlyle Music, (ASCAP) (See H/B Webman & Co.).
Carole Marie Music, (BMI) (See Comet-Tale).
Carolights Music, (ASCAP) (See Peaceable Kingdom Publishing).
Carolina Publishing Co., 1605 Park Dr., Raleigh, NC, 27605. Professional/Creative Mgr.: Ethel Laughlin Casey.
Carolina Songs, (ASCAP) 1208 Charles Blvd., Greenville, NC, 27834, (919) 355-4633. Pres./Gen. Mgr.: Nicky Harris.
Richard E. Carpenter Publications, (ASCAP) (See Southern Writers Group, USA).
Carreau Music, (BMI) (See Funky but Music, Inc., dba Morningstar).
Carvon Music, Inc., (BMI) (See Cromia Music Co.).
Casa Musicale Sonzogno, (ASCAP) (See Theodore Presser Co.).
Don Casale Music, (BMI) 377 Plainfield St., Westbury, NY, 11590, (516) 333-7898. Pres./Gen. Mgr.: Don Casale; Professional/Creative Mgr.: Don Casale.
Cases Music, (SESAC) (See The Goodman Group Music Publishers).
Ernie Cash Music, (BMI) 744, Joppa Farm Rd., Joppatowne, MD, 21085, (301) 679-2262. Professional/Creative Mgr.: Ernest W. Cash.
Cashflow Publishing, (ASCAP) PO Box 11377, Richmond, VA, 23230, (804) 285-8588. Fax: (804) 264-2479. Pres.: Martin Gary; Gen. Mgr.: Kathleen Gary.
Buzz Cason Pub. Co/Southern Writers Group, PO Box 40764, 2804 Azalea Pl., Nashville, TN, 37204, (615) 383-8682. Pres.: Buzz Cason; Professional Mgr.: Richard E. Carpenter.
Casting Publishing, (ASCAP) 21 Joyce St., Bloomfield, CT, 06002, (203) 242-1690. Pres.: Joseph O. Pritchett, Sr.; Professional/Creative Mgr.: Eric T. Pritchett.
Castle Publishing, Inc., (BMI) 1393 Old Hillsboro Rd., Franklin, TN, 37064, (615) 791-0810. Fax: (615) 791-1324. Pres./Gen. Mgr.: Jozef Nuyens.
Catalogue Music, (BMI) PO Box 240H, Scarsdale, NY, 10583, (212) 246-9600. Pres.: Arthur Talmadge; Gen. Mgr.: George Stone.
Caution Music, (BMI) 432 Moreland Ave., NE, Atlanta, GA, 30307, (404) 521-3008. Fax: (404) 521-3008. Pres.: Danny Beard.
Cavesson Music Enterprises Co., (ASCAP) (See Merit Music Corporation).
Cayuga Music, (See You Heard It—Hear!).
Ceberg Music, (ASCAP) (See Brookside Music Corp.).
Cedar Valley Publishing, (BMI) (See Dusty Rose Music).
Centerpoint Music Co., (BMI) (See Rontom Music Co.).
Central Songs, (BMI) (See Screen Gems-EMI Music, Inc.).
Century Music Publishing Co., Inc. (See Ashley Publications, Inc.).
Century 22 Publishing, (ASCAP) (See Palo Publishing).
Challeidon Publishing Co., (BMI) Pembroke One Bldg., 5th Floor, 281 Independence Blvd., 5th Floor, Virginia Beach, VA, 23462, (804) 499-8971. Fax: (804) 456-5445. Pres.: Richard N. Shapiro.
Champagne Music Corp., (ASCAP) (See Welk Music Group).
Championship Tundra Music, (BMI) (See Darksilver Music Ltd.).
Chancellor Music Ltd., (BMI) (See Folkbird Music).
Chandos Music, (ASCAP) (See Foiklore Music).
Mike Chapman Publishing, (ASCAP) (See All Nations Music Publishing).
Chappell Music Co., (ASCAP) (See Warner/Chappell Music, Inc.).
Chapter IV, (ASCAP) (See Glen Campbell Music Group).
Charbuz Music Co., (BMI) 5306 W. Columbia Ave., Philadelphia, PA, 19131, (215) 877-8760. Pres.: Mae Connelly; Gen. Mgr./Professional-Creative Mgr.: Earl Connelly.
Charisma Music Publishing USA, Inc., (ASCAP) 1841 Broadway, Ste. 411, New York, NY, 10023, (212) 956-2880. Fax: (212) 956-2114. Pres.: Julie Lipsius; Professional Mgr.: Joey Gmerek.
Charmlee Music, (BMI) (See Peaceable Kingdom Publishing).
Charo Publishing, (ASCAP) (See Mary Williams Music Clearance Corp.).
Chatawa Music, (ASCAP) (See Malaco Music Group).
Cheavoria Music Co., (BMI) 1219 Kerlin Ave., Brewton, AL, 36426, (205) 867-2228. Pres.: Roy Edwards; Gen. Mgr.: Bobbie Robertson; Professional/Creative Mgr.: Shannon Edwards.
Chela Music, (BMI) (See Out On A Limb Publishing).
Chelsea Avenue Film Publishing, (ASCAP) (See SB Publishing).
Chelsea Music, (PRS) (See Airdrome Music & Stonewood Lane Music).
Cherio Corp., (BMI) 39 W. 54th St., New York, NY, 10019, (212) 246-5757. Fax: (212) 977-8408. Professional Mgr.: Robert Jones.
Cherith Publishing Co., (ASCAP) PO Box 72, Placentia, CA, 92670, (714) 751-6736. Fax: (714) 751-6715. Pres.: Bernice Dietz.
Cherolyne Music Co., (BMI) (See Darren Music Co.).
Cherry Lane Music Publishing Co., Inc., (ASCAP) PO Box 430, 10 Midland Ave., Port Chester, NY, 10573, (914) 937-8601. Fax: (914) 937-0614. Pres.: Peter W. Primont; Gen. Mgr.: Mike Connelly.
Cherry Mountain Music, (ASCAP) (See Cherry Lane Music Publishing Co., Inc.).
Cherry River Music, (BMI) (See Cherry Lane Music Publishing Co., Inc.).
Chervalin Music Publishing Co., (See Joe Jones Copyright Mgmt.).
Chessal Music Co., (BMI) (See Alishire Publishing Companies).
Chessford Music Publications, (BMI) (See C. L. Barnhouse Co.).
Chestler Publishing Co., (BMI) 1376 Ready Ave., Burton, MI, 48529, (313) 742-0770. Pres.: Harry F. Chestler; Gen. Mgr.: Cindy Braun; Professional/Creative Mgr.: Dennis Braun.
Chestnut Mound Music Group, PO Box 989, 814 Wren Rd., Goodlettsville, TN, 37072, (615) 851-1360. Fax: (615) 851-7755. Pres.: Eddie Crook.
Chetkay Music Pub., 15401 Tireman, Dearborn, MI, 48126, (313) 581-8100. Pres.: Chet Kajeski.
Chex Music, (BMI) (See AMCORP Group, AVC Music).
Chi-Chava Music Publishing Co., (JMPCPW) (See Melder Publishing Co., Joe Jones Copyright Mgmt.).
Children's Musical Plays, (ASCAP) (See Popular Music Co.).
Chip 'N' Dale Music Publishers, Inc., (ASCAP) 3950 N. Mt. Juliet Rd., Mount Juliet, TN, 37122, (615) 754-0417. Pres.: Gene Kennedy; Gen. Mgr./Professional Mgr.: Karen Jeglum Kennedy.
Chock Music Co., (BMI) (See Henry Jerome Music, Inc.).
Choctaw Music Co., (BMI) (See Blackwood Music, Inc.).
Choral Art Publications, (ASCAP) (See Sam Fox Publishing Co., Inc.).
Choudens, (ASCAP) (See C.F. Peters Corp.).
Christian Joy Music, (BMI) PO Box 17188, Cincinnati, OH, 45217, (513) 242-0721. Fax: (513) 351-6775. Contact: Dale J. Kelly.
Chriswald Music, (ASCAP) (See De Walden Music Int'l, Inc.).
Chriswald Music, (ASCAP) 6255 Sunset Blvd., Ste. 915, Hollywood, CA, 90028.
Chrysalis Music Group, Inc., 9255 Sunset Blvd., Los Angeles, CA, 90069, (213) 550-0171. Fax: (213) 550-0785. Gen. Mgr.: S/Rvice Pres: Tom Sturges; Professional Mgr.: Peter Castrow; Dir. Talent: Russell Ziecker. Branches: 12 Stratford Pl., London, W19AF, England, 011-4414082355. Contacts: Doug D'Arcy, Roy Eldridge.
Chu Fin Music, Inc., (BMI) (See Shelby Singleton Music, Inc.).
Chu Teh Music, 330 Hudson St., 4th Floor, New York, NY, 10013, (212) 633-2100. Fax: (212) 633-2700. Pres.: John Matarazzo; Gen. Mgr.: Ted Esposito.
Clara Church Publishing, (SESAC) (See FXL Sound Studios).
Ciano Publishing, (BMI) PO Box 263, Brigantine, NJ, 08203, (609) 266-2623. Pres.: Ron Luciano; Gen. Mgr.: Jerry Denton; Professional/Creative Mgr.: Bobby Fisher.
Cimiron Music, (BMI) 607 Piney Point Rd., Yorktown, VA, 23692, (804) 898-8155. Pres.: Lana Puckett; Gen. Mgr.: Kim Penson.
Cinder Cat Music, (ASCAP) 912 E. Third St., Studio 104, Los Angeles, CA, 90013, (213) 617-3362. Fax: (213) 617-1544. Pres.: Barbara Wright.
Circle Hwy. Music, (ASCAP) (See Song Source, Inc.).
Cireco, (See Fantasy, Inc.).
Citko-Slott Publishing, (ASCAP) 100 Merrick Rd., Ste. 200, Rockville Centre, NY, 11570, (516) 536-8341. Fax: (516) 536-8852. Pres./Professional/Creative Mgr.: James Citkovic; Gen. Mgr.: Edward Slott.
City Farmer Music, (BMI) (See Anlon Music Co.).
Claire Music Co., (ASCAP) (See Alfred Publishing Co.).
Claridge Music Co., (ASCAP) (See MPL Communications, Inc.).
Guy & Suzanne Clark, (ASCAP) Rt. 4, Crosswinds, Mount Juliet, TN, 37122.
Clarus Music, Ltd., (ASCAP) 340 Bellevue Ave., Yonkers, NY, 10703, (914) 591-7715. Fax: (914) 591-5082. Pres.: Selma Fass; Gen. Mgr.: Bernie Fass.
Class Action Music, (ASCAP) (See Dave Burgess Ents.).
Clauda B Music, (ASCAP) (See Anode Music).
Al Clauser, (BMI) 426 S. Broadway, Skiatook, OK, 74070, (918) 396-1333. Gen. Mgr.: Jim Clauser; Pres./Professional Mgr.: Al Clauser.
Clays Ferry Music, (BMI) PO Box 100743, Nashville, TN, 37224, (615) 355-6772. Pres.: Everett Faulkner.
Norman Clayton Publishing, (SESAC) (See Word Music).
Geo. Clemons Publishing, (ASCAP) (See Berdo Music).
Clessidra Music Publishing Co., (BMI) (See Prelude Music Publishing).
Clock Music, (BMI) (See Doug Moody Music).
Clockwork Music Co., (BMI) 23663 Country Villa Rd., Ramona, CA, 92065, (619) 789-4965. Owner: Ed Marmor.
Co-Heart Music Group, (BMI) 1103 17th Ave. S., Nashville, TN, 37212, (615) 327-0031. Fax: (615) 327-4175. Pres.: Glenn Martin.
Co-Inside, (See Own Write Music).
Co-Jac Music, (BMI) (See AVI Music Publishing Group, Inc).
Coal Dust Music, (SESAC) (See Coal Miners Music).
Coal Dust West Music, (BMI) (See Ziffren Brittenham & Branca).
Coal Miners Music, (CMI) 1010 18th Ave. S., Nashville, TN, 37212, (615) 329-2220. Pres.: O. V. Lynn, Jr.; Vice Pres.: Lorene Allen.
Coast Music, (BMI) 117 N. Las Palmas Ave., Los Angeles, CA, 90004, (213) 938-5482. Fax: (213) 933-1903. Pres.: Albert L. Marx; Gen. Mgr.: Patricia Nickerson.
Cojamo Music, (BMI) (See Highest Praise Publishing Co.).
Cold Chillin Music Publishing, Inc., 1995 Broadway, Ste. 1800, New York, NY, 10023, (212) 724-5500. Fax: (212) 724-6018. Pres.: Len Fichtelberg; Tyrone Williams; Gen. Mgr.: Dee Joseph Garner.
Decarlo Coley Publishing, (SESAC) (See Waji Music Group).
Colgems/EMI Music Publishing, (ASCAP) 8730 Sunset Blvd., Penthouse E, Los Angeles, CA, 90069, (213) 652-8078. Branches: 1207 16th Ave., South, Nashville, TN, 37212, (615) 320-7700.
Collins Court Music, Inc., (ASCAP) (See Tom Collins Music Corp.).
Tom Collins Music Corp., (BMI) 25 Music Sq. W., Nashville, TN, 37202, (615) 255-5550. Fax: (615) 256-6467. Pres.: Tom Collins; Professional Mgr.: Lynn Gann.
Franco Colombo, Inc., (ASCAP/BMI) (See CPP/Belwin, Inc.).
Columbia Pictures Music Group, Columbia Plaza E., Ste. 242, Burbank, CA, 91505, (818) 954-3272. Pres.: Bob Holmes.
Column One Ltd. Music Group, (ASCAP) 3555 Mernter Rd., Springfield, MO, 65804, (417) 881-5015. Pres.: Elizabeth M. Martin; Gen. Mgr.: Lou Whitney; Professional Mgr.: Ron Butler.
Column Two Music, (BMI) (See Column One Ltd. Music Group).
Comet-Tale, (ASCAP) Postal Ste. 808, 14 Raspberry Ln., Lititz, PA, 17543, (717) 627-4800. Fax: (717) 626-0395. Pres.: Joey Welz; Gen. Mgr.: Joey Welz; Professional Mgr.: James E. Myers.
Commodores/Hanna Music, (ASCAP) (See American League Music).
Company Store Music, (BMI) (See Jack Music, Inc.).
Complete Music USA, Inc., (ASCAP/BMI) (See Lipservices).
Composers, (See Fantasy, Inc.).
Con Brich Music, (BMI) (See Marco Music Group, Inc.).
Conarh Prodn., PO Box 201, Tecumseh, OK, 74873, (405) 598-6379. Pres.: Darrell Archer; Gen. Mgr.: Randy Lack; Professional/Creative Mgr.: Starla Armitage.
Concorde Publishing Co., (SESAC) (See Marco Music Group, Inc.).
Condominium Publishing Group, (BMI) PO Box 32 GCS, New York, NY, 10163. Pres.: Charles Tolliver.
Cone Music Co., (BMI) (See Joe Keene Music Co.).
Conedisa, (See Latin American Music Co., Inc.).
Tommy Connors Music, (BMI) (See Dave Burgess Ents.).
Conrad Music/div. Arc Music Corp., (BMI) (See The Goodman Group Music Publishers).
Consolidated Music Publishers, (ASCAP) (See Music Sales Corp.).
Contemporary, (See Fantasy, Inc.).
Coolwell Music, (ASCAP) (See Criterion Music Corp).
Martin Cooper Music, (ASCAP) PO Box 131, Malibu, CA, 90265, (213) 275-4508. Fax: (213) 456-1499. Pres.: Marty Cooper.
Copenco, (ASCAP) (See Tandem Tunes, Inc.).
Copper Basin Music, (BMI) (See Coal Miners Music).
Coraven C.A., (SACVEN) (See Telearte Florida, Inc./Music Publishing Co.).
Cordova Publishing Co., (BMI) (See Alishire Publishing Companies).
CORE Entertainment Corp., (BMI/ASCAP) 21724 Ventura Blvd., Ste. 242, Woodland Hills, CA, 91364, (818) 883-1413. Fax: (818) 716-9493. Pres.: Keith Dressel; Gen. Mgr.: Audrey Osborne.

Cornerstone Mgmt., 148 E. Lancaster Ave., Wayne, PA, 19087, (215) 687-8800. Fax: (215) 971-0646. Pres.: Steve Mountain.

Cosmotone Music, (ASCAP) PO Box 71988, Arco Plaza, Los Angeles, CA, 90071. Pres.: Rafael Brom.

Cota Music, Inc., (BMI) (See Warner/Chappell Music, Inc.).

Cotillion Music, Inc., (BMI) 9000 Sunset Blvd., Penthouse, Los Angeles, CA, 90069, (213) 273-3323.

Cotton Moon Music, (BMI) PO Box 132, Boston, MA, 02123, (617) 965-9765. Fax: (617) 965-6714.

Colton Row Recording, (BMI) (See New Memphis Music, Inc.).

Council Rock Music, Inc., (BMI) (See K-tel Int'l, Inc.).

Country Classics Music Publishing Co., (BMI) PO Box 15222, Oklahoma City, OK, 73155, 105 Burk Dr., Oklahoma City, OK, 73115, (405) 677-6448. Pres.: Yvonne McKowan DeVaney; Gen. Mgr.: Sonny Lane; Professional/Creative Mgr.: Jean Dee.

Country Mile Music, Inc., (BMI) (See World Wide Music, Inc.).

Country Music Group, 23 Music Cir. E., Nashville, TN, 37203, (615) 327-4656. Pres.: Sherman Ford; Gen. Mgr./Professional Mgr.: Jake Payne.

Country Music News, 305 Washington Ave., Cincinnati, OH, 45217, (513) 242-2248. Publisher/Editor: Will Mason.

Country Music Reporter Magazine, (See California Country Music).

Country Party Music, (BMI) PO Box 192, 708 W. Euclid, Pittsburg, KS, 66762, (316) 231-6443. Pres.: Eugene Strasser.

Country Showcase, (BMI) 385 Main St., Laurel, MD, 20707, (301) 725-7713. Fax: (301) 470-6035. Pres.: Frances Gosman.

Country Star Music, PO Box 569, 439 Wiley Ave., Franklin, PA, 16323, (814) 432-4633. Pres.: Norman Kelly.

Country Stream Music, (BMI) 5053 Tholozan Ave., Saint Louis, MO, 63109, (314) 352-4741. Pres.: Anthony Mazzola; Gen. Mgr.: Toni Gibbons; Professional/Creative Mgr.: Tina Mazzola.

County, Rt. 13, Box 362, Easley, SC, 29640, (803) 859-6551. Pres./Gen. Mgr.: Larry Orr.

County Line Music, (ASCAP) (See Skinny Zach Music).

Covina High Music, (BMI) PO Box 4474, Palm Desert, CA, 92261, (619) 341-8264. Fax: (619) 340-0644. Pres.: Robbie Fields.

Cow Cents Music, (BMI) (See Muy Bueno Music Group).

Cow Cuts Publishing, (ASCAP) (See Muy Bueno Music Group).

Cowabonga Music, Inc., (ASCAP) PO Box 630755, Miami, FL, 33163, (305) 935-4880. Fax: (305) 933-4007. Pres.: Jack Gale.

Cowboy Junction Publishing Co., Hwy. 44 W., Jct. 490, Lecanto, FL, 32661, (904) 746-4754. Pres.: Buddy Max.

Cozumel Music, (See La Rana/El Porto Music).

Crazy Cajun Music, (BMI) 5626 Brock St., Houston, TX, 77023, (713) 926-4438. Fax: (713) 926-8303.

Creative Concepts Publishing Corp., (ASCAP) 406 Bryant Circle, Box 848, Ojai, CA, 93024, (805) 646-4811, (800) 222-9745. Fax: (805) 646-2621. Pres.: John L. Haag; Gen. Mgr.: Matt Haag.

Creative Network, (ASCAP) (See Joseph Nicoletti Music Co.).

Creature Comfort Music, (BMI) (See Valand Publishing Group).

Creedside Music Pub. Co., 100 Labor St., Tabor City, NC, 28463, (919) 653-2546. Pres.: Elson H. Stevens; Gen. Mgr.: F.L. Jones; Professional Mgr.: Retha Stevens.

Crimson Publishing, (ASCAP) 614 San Vicente, Ste. F, Santa Monica, CA, 90402, (213) 395-0984. Pres.: Jay Westin.

Criterion Music Corp., (ASCAP) 6124 Selma Ave., Hollywood, CA, 90028, (213) 469-2296. Fax: (213) 962-5751. Pres.: Michael H. Goldsen; Professional/Creative Mgr.: Bo Goldsen.

Critique Music Pub. Co. Inc., (BMI) 800 W. Cummings Park #2500, Woburn, MA, 01801, (617) 935-7540. Fax: (617) 935-6866. Pres.: Carl Strube; Professional Mgr.: Harry King.

Croma Music Co., (ASCAP) 130 W. 57th St., #11-E, New York, NY, 10019, (212) 246-5031. Pres.: Patricia Rankin; Gen. Mgr.: Dwight Frye; Contact: The Harry Fox Agency.

Cromwell Music, Inc., (ASCAP) (See TRO (The Richmond Organization)).

Crooked Fingers Music, (ASCAP) PO Box 2454, Austin, TX, 78765.

Cross Keys Publishing Co., Inc., (ASCAP) PO Box 1273, Nashville, TN, 37202.

Mike Cross Music, (ASCAP) (See Southern Melody Publishing Co.).

Crosseyed Bear Music, (BMI) (See Harlem Music, Inc.).

Crossing Borders Music, (BMI) (See Caribbean Wave Music).

Crown Music Group, Inc., 1015 16th Ave. S., Nashville, TN, 37212, (615) 327-8100. Fax: (615) 327-7963. Pres.: Morris Thurman, Jr.; Gen. Mgr.: Eddie Binton.

Crux Star Int'l, Inc., (BMI) 4005 Covington Pk., Memphis, TN, 38135, (901) 386-3115. Pres.: Bob Holden; Gen. Mgr.: Bill Hale; Professional/Creative Mgr.: Mike Pulido.

Crying Creek Publishers, PO Box 8, Cosby, TN, 37722, (615) 487-5543. Pres.: Jean Schilling.

Crystal Music Publishers, Inc., (ASCAP) 6420 Wilshire Blvd., Ste. 1400, Los Angeles, CA, 90048, (213) 653-2321. Fax: (213) 653-4164. Pres.: Peter S. Burke; Gen. Mgr.: Averil C. Pasarow; Professional/Creative Mgr.: Peter S. Burke.

Cubason Music, (BMI) 740 Broadway, 5th Floor, New York, NY, 10003, (212) 674-5496. Fax: (212) 674-4614. Pres.: Michael Krinsky; Vice Pres.: David Golove.

Cude & Pickens Music Publishing, (BMI) 519 N. Halifax Ave., Daytona Beach, FL, 32118, (904) 252-0381. Fax: (904) 252-0381. Pres./Professional/Creative Mgr.: Bobby Lee Cude.

Cuetone Music, (BMI) (See Harmony Gold).

Cundy-Bettoney Co., (ASCAP) (See Carl Fischer, Inc.).

Jerome Cunningham Music, (BMI) 23494 Lahser Rd., Southfield, MI, 48034, (313) 948-9787. Fax: (313) 948-1093. Pres.: Jerome Cunningham, Sr.; Gen. Mgr.: Brian K. Cunningham; Professional/Creative Mgr.: Jerome Cunningham, Jr.

Cyclops Music, a div. of Cyclops Records, Inc., (ASCAP) 273 Central Ave., c/o B. Eisenberg, White Plains, NY, 10606, (914) 946-7735. Gen. Mgr.: Robert Fish.

Czech Music Fund (Prague), (ASCAP) (See Boosey & Hawkes, Inc.).

D

DACT Prodn., (BMI) PO Box 602, 20 Longfellow Dr., Yarmouthport, MA, 02675, (508) 385-2199. Fax: (508) 398-2866. Pres.: Deborah Thatcher Robbins; Gen. Mgr.: David M. Robbins.

DA Music Publishing, 362 Pinehurst Ln., Marietta, GA, 30068, (404) 977-4172. Fax: (404) 977-4173. Pres.: Herb Heldt; Gen. Mgr.: Achin Neumann; Professional Mgr.: Susan Swain.

D L M Publishing, (See Dick Loftin Music).

D L M Songs, (See Dick Loftin Music).

DMJ Music, 3333 Scenic Hwy, Memphis, TN, 38128, (901) 386-8102. Pres.: Dana Jackson.

DMP Publishing, Inc., (BMI) 175 Dolphin Cove Quay, Stamford, CT, 06902, (203) 327-3800. Fax: (203) 323-9474. Pres.: Tom Jung.

DRG Music, (ASCAP) 130 W. 57th St., Ste. 6D, New York, NY, 10019, (212) 582-3040. Fax: (212) 459-9437. Pres.: Hugh Fordin.

D.S.M. Producers, Inc., (ASCAP) 161 W. 54th St., New York, NY, 10019, (212) 245-0006. Fax: (212) 265-5726. Pres.: Suzan Bader; Gen. Mgr.: Kenneth R. Wiseman; Professional/Creative Mgr.: Elba T. Toast.

D'Accord Music, Inc. c/o Publishers' Licensing Corp., (ASCAP) PO Box 5807, Englewood, NJ, 07631, (201) 568-3996. Fax: (201) 569-9580. Pres.: Lis Jones.

Dagene Music, (ASCAP) PO Box 410851, San Francisco, CA, 94141, (415) 822-1530. Pres./Professional Mgr.: David Alston.

Dana Publishing Co., (BMI) 824 83rd St., Miami Beach, FL, 33141, (305) 865-8960, (305) 861-1216. Pres.: Walter Dana; Gen. Mgr.: Gus Dana.

Dancing Tarantula Music, (BMI) (See Darksilver Music Ltd.).

Dandelion Music Co., (BMI) (See Jamie Music Publishing Co.).

Danvo Songs, (ASCAP) 300 Esplanade Dr., Ste. 760, Oxnard, CA, 93030, (805) 988-1661. Fax: (805) 988-1658. Pres.: Ernie Campagna.

Darbone Publishing Co., (BMI) Rt. 3, Box 172, Haynesville, LA, 71036, (318) 927-5253. Pres.: Edward Dettenheim.

Darcy Music, (BMI) 10136 Idlewood Pl., River Ridge, LA, 70122, (504) 738-9363. Fax: (504) 948-3105. Pres.: Barbara Darcy; Gen. Mgr./Professional Mgr.: Marshall E. Sehorn.

Darjess Music, (ASCAP) (See Song Source, Inc.).

Dark Heart Music, (BMI) 1236 S. Staples St., Corpus Christi, TX, 78404, (512) 884-4633. Fax: (512) 883-9786. Pres.: Arnold Garcia.

Dark Wings Music, 5 Crosby St., Fifth Floor, New York, NY, 10013, (212) 334-9268. Fax: (212) 925-4745. Pres.: Karl Walterbach.

Darksilver Music Ltd., (BMI) PO Box 6397, 2507 Roscomare Rd., Burbank, CA, 91510, (213) 476-0631, (818) 8418332. Fax: (213) 472-4190. Pres.: Michael Thomas; Gen. Mgr.: Curtis R. Weaver; Professional Mgr.: Karl Kizine.

Darren Music Co., (ASCAP) PO Box 2144, Winnetka, CA, 91306, (805) 522-6045. Fax: (805) 522-8329. Pres.: Don Bradley; Gen. Mgr./Professional Mgr.: Darren Thomas.

Dartmoor Music, (ASCAP) (See The Bicycle Music Co.).

Dasta Music, (ASCAP) PO Box 117, New Berlinville, PA, 19545, (215) 367-0335. Pres.: Dave Stahl.

Dauncy Music Publishing, 4372 Dauncy, Flatrock, MI, 48134, (313) 782-0103. Pres.: Richard Johnson.

Daval Music Co., (ASCAP) (See Alshire Publishing Companies).

David/Sarah Music Inc., (BMI/ASCAP) 1560 Broadway, Ste. 1210, New York, NY, 10036, (212) 247-2159. Fax: (212) 302-5364. Pres.: Morton Wax.

David 'n' Will Music, (ASCAP) (See Willin' David Music Group).

Davike Music Co., (ASCAP) (See Fricon Music Co.).

Dawg Music, (BMI) 7957 Nita Ave., Canoga Park, CA, 91304, (818) 704-7800. Fax: (818) 704-0185. Pres.: Craig R. Miller.

Dawnbreaker Music, (BMI) 1290 Avenue of the Americas, New York, NY, 10104, (212) 492-1200.

Daydreams Music, (ASCAP) (See Mad Monkey Music).

Daymaker Music, (BMI) (See Berdoo Music).

Dayspring Music, (BMI) (See Word Music).

Jeff Dayton Music, (BMI) PO Box 9296, Scottsdale, AZ, 85252, (602) 837-8650. Pres.: Jeff Dayton.

The Edward DeMiles Music Co., (BMI) 4475 Allisonville Rd., 8th Fl., Indianapolis, IN, 46205, (317) 546-2912, (317) 549-9006. Fax: (317) 549-9007. Pres.: Edward De Miles; Gen. Mgr.: Greg Payne; Professional/Creative Mgr.: Steven L. Page.

Branches: 117 W. Harrison Bldg., Dept. S627, Chicago, IL, 60605, (800) 874-5799. Contact: Greg Payne.

De Walden Music Int'l, Inc., (BMI) 6255 Sunset Blvd., Ste. 1911, Hollywood, CA, 90028, (213) 462-1922. Fax: (213) 462-2407. Pres.: Christian De Walden; Professional Mgr.: Debra Holland.

Dedan Music, (BMI) 200 Regent Dr., Winston-Salem, NC,

27103, (919) 768-1881. Fax: (919) 768-8315. Pres.: Dave Passerallo; Gen. Mgr.: Linda Stillson; Professional Mgr.: Otis Henry.

Dee Joy Musical Works Publishing Co., (BMI) PO Box 3398, Los Angeles, CA, 90051, (213) 930-0930. Pres.: Frank Foulk.

Jason Dee Music, Inc., (BMI) 44 Music Sq. E., Nashville, TN, 37203, (615) 255-2175. Fax: (615) 244-4314. Pres.: Charles Fields; Gen. Mgr.: Bernice Fields.

Deejay Music, (BMI) (See Empire Songs).

Def Jam Music, (ASCAP) (See Hitstage Music).

Def Wish Trax, (See Nov. 17th Music).

Del Bon, (BMI) (See The Music Group).

Don Del Music, 902 N. Webster, Port Washington, WI, 53074, (414) 284-3279. Pres.: Joseph C. DeLucia.

Delaray Publishing Co., (BMI) PO Box 492251, 3625 Sulene Dr., Atlanta, GA, 30349, (404) 761-8626. Pres.: Bill Freeman; Gen. Mgr.: Mike Freeman; Professional/Creative Mgr.: Sebernia Freeman.

Delev Music Co., (BMI) PO Box 42707, Philadelphia, PA, 19101, 7231 Manstfield Ave., Philadelphia, PA, 19136, (215) 276-8861. Pres.: W. Lloyd Lucas; Gen. Mgr.: Adele J. Lucas; Professional/Creative Mgr.: Darryl L. Lucas.

Delhi Publications, (See Willis Music Co.).

Delicate Music Co., (BMI) (See Surrey Music Co.).

Delicious Music, (See S H R Publishing).

Delightful Music, (See Warner/Chappell Music, Inc.).

Delpha's Music Publishing, (BMI) PO Box 329, Mulberry, AR, 72947, (501) 997-1557.

Delrieu Editions (France), (See E.C. Schirmer Music Co., Inc.).

Delta Music, (ASCAP) (See Meadowlark Music Co.).

Delta R & E, (See Fantasy, Inc.).

Richard Delvy Ents., Inc., (ASCAP) (See Miraleste Music Co.).

Demain Music, (BMI) (See Larry Spier, Inc.).

DenJac Music Co., (See S H R Publishing).

Denjac, (ASCAP) (See Saja Music Co.).

Denny Music, Inc., (ASCAP) (See John E. Denny).

John E. Denny, (BMI) 3325 Fairmont Dr., Nashville, TN, 37203, (615) 269-4847. Pres.: John E. Denny; Gen. Mgr.: Jane L. Martin.

Derglenn Music Publishing Co., (BMI) (See Jobete Music Co., Inc.).

Desert Moon, (See J.D. Music/Frankly Music).

Desert Rain, (ASCAP) (See J.D. Music/Frankly Music).

Deshon Music, (BMI) (See CPP/Belwin, Inc.; Columbia Pictures Music Group).

Deshufflin, Inc., (ASCAP) (See Ridge Music Corp.).

Designer Music Group, (ASCAP/BMI) 308 Southgate Ct., Brentwood, TN, 37027, (615) 373-0122. Fax: (615) 373-0386. Pres.: Mark Cabaniss.

Desilu Music Corp., (ASCAP) (See MPL Communications, Inc.).

Detrimental Music, (See La Rana/El Porto Music).

Deviny James Music, (ASCAP) (See Playground Music).

Devon Music, Inc., (BMI) (See TRO (The Richmond Organization)).

DeWhit Music, (ASCAP) PO Box 106, Lake Arrowhead, CA, 92352, (714) 337-5161. Gen. Mgr.: Dean Whitney.

Dhanus Music Publishing, (BMI) PO Box 2147, Sioux City, IA, 51104, Professional/Creative Mgr.: Morrie Miller.

Diadem, Inc., 3310 West End Ave., 5th Floor, Nashville, TN, 37203, (615) 385-0079. Fax: (615) 383-2947. Pres.: George W. King III; Gen. Mgr.: Larry Day.

Diadem Sky, (ASCAP) (See Diadem, Inc.).

Diamond Back Music Co., (BMI) PO Box 347008, San Francisco, CA, 94134, (415) 753-2306. Gen. Mgr.: Joe Buchwald.

Diamond Dog Music, (ASCAP) (See Little Big Town Music Group).

The Diamond Music Cos., (ASCAP/BMI) (See The Bicycle Music Co.).

Diamond Tape Corp., (BMI) (See Ray of Hope Publishing).

Didaczech Come In Publishing, 652 Huntington Pkwy., Nashville, TN, 37211, (615) 331-0734. Pres.: Hans Strommeyer; Gen. Mgr.: Mo-wood Kindog.

Different Stokes, (ASCAP) (See Otis Stokes Publishing).

Digby Music, (SOCAN) (See Airdrome Music & Stonewood Lane Music).

Dillard Music, (See Gopam Ents., Inc.).

DiMaggio Publishing Co., (ASCAP) PO Box 12239, Las Vegas, NV, 89112, (702) 456-7724. Pres.: Robert J. DiMaggio.

Dipop Music, (ASCAP) 13 B Franklin Dr., Maple Shade, NJ, 08052, (609) 482-7522. Pres.: Pierre Domenico; Gen. Mgr.: Joann Archer; Professional Mgr.: Pierre Domenico.

Disapop Publishing Co., (ASCAP) (See Apop Publishing Co.).

Disc-Tinct Echo Music, Inc., (ASCAP) (See Disc-Tinct Music, Inc.).

Disc-Tinct Music, Inc., (BMI/NMPA) 215 Englewood Ave., Englewood, NJ, 07631, (201) 568-0040. Fax: (201) 568-2599. Pres.: Jeffrey Collins; Gen. Mgr.: Paul Kysner; Professional/Gen. Mgr.: George Kerr.

Discovery Music, 5554 Calhoun Ave., Van Nuys, CA, 91401, (818) 782-7818. Fax: (818) 782-7817.

Diskmakers Publishing Co., (ASCAP) (See Alan Hartwell Music).

The Walt Disney Co., 500 S. Buena Vista St., Burbank, CA, 91521, (818) 567-5307. Fax: (818) 953-9910.

Disnote Music, Inc., (ASCAP) 7701 Jarvis St., Springfield, VA, 22151, (703) 354-1557. Pres.: Ray Disney.

Distressing Music, 310 Greenwich St., 4B, New York, NY, 10013, (212) 285-5543. Pres./Gen. Mgr.: Vito Ray.

Diversified Sound Innovators, (BMI) 131 Elm Rd., 2nd Floor, Pittsburgh, PA, 15237, (412) 486-9485. Pres./Gen. Mgr.: David S. Irish.

Diversion Music, (BMI) 6134 Woodman Ave., Ste. 202, Van Nuys, CA, 91401, (818) 909-0213. Pres.: Christian Slater.

Dixie Stars Music, (ASCAP) (See HoriPro Entertainment Group).

Do-Tel Music Pub., (ASCAP) (See Jack Music, Inc.).

Doc Ron Publishing, (BMI) PO Box 1075, Boca Raton, FL, 33429, (305) 391-0255. Pres.: Marianne Stander; Gen. Mgr.: M. Scott Stander.

Dr. Canada Music, (ASCAP) (See Heavy Jamin Music).

Dr. York Prods., Inc., 548 Hart St., Brooklyn, NY, 11221, (718) 443-4417. Pres.: Isa Muhammad.

Dolly Bee Music, (BMI) (See Titan Records).

Don & Willie Music, (SESAC) (See Marullo Music Publishers).

Donna Music Publishing Co., (BMI) PO Box 113, 6 Carter Pl., Woburn, MA, 01801, (617) 933-1474. Pres.: Frank Pappalardo; Gen. Mgr./Professional Mgr.: Frank Paul.

Door Knob Music Publishing, Inc., (BMI) (See Chip 'N' Dale Music Publishers, Inc.).

Dora Music, (BMI) PO Box 995, Norfolk, VA, 23501, (804) 627-0957. Pres.: Bill Johnson

Dorian Music Publishers Corp., (ASCAP) (See Alpha Music, Inc.).

Dorsey Bros. Music, (ASCAP) (See Music Sales Corp.).

Col. Buster Doss Music, (BMI) PO Box 13, Estill Springs, TN, 37330, (615) 649-2577. Pres.: Col. Buster Doss.

Dots & Lines Ink, (SESAC) 9130 Mormon Bridge Rd., Omaha, NE, 68152, (402) 457-4341. Fax: (402) 457-4332. Pres.: Chip Davis; Gen. Mgr.: Steve Kalthorn; Pro/essional/Creative Mgr.: Erin Hughes.

Branch(es): 16830 Ventura Blvd., Ste. 515, Encino, CA, 91436, (818) 907-8516, Western Region Mgr.: Dan Davis; 81 Skyland Dr., Roswell, GA, 30075, (404) 642-5497, SE Region Mgr.: Barry Racoff; 41A Queen Catherine Way, Chester, MD, 21619, (301) 643-8649, East Coast Region Mgr.: Cliff Schultz; 4595 Forestview Lane N., Plymouth, MN, 55442, (612) 550-0988, Contact: Dwight Montjar.

Dovecot Music, (ASCAP-FOX) (See Fuente Music Co.).

Downstairs Music, (BMI) (See The Mighty 3 Music Group; Warner/Chappell Music).

Drake Music Group, (BMI/ASCAP) PO Box 186, Brentwood, TN, 37024, (615) 371-9556. Fax: (615) 371-8638. Pres.: Rose Drake.

Dream City Music, (BMI) (See AMCORP Group).

Dream Makers, (BMI) (See Ten of Diamonds Music).

Dream Sequence Music Ltd., (BMI) PO Box 2194, 2333 Whip-poorwill Rd., Charlottesville, VA, 22902, (804) 295-1877. Pres.: Kevin McNoldy; Sec.: Kathy McNoldy.

Branch(es): PO Box 218155, Nashville, TN, 37221, (800) 637-3261.

Drive-In Music, (BMI) (See Bonnyview Music/Drive-In Music).

Drop Top Music, (BMI) 232 Sunflower Ave., Clarksdale, MS, 38614, (601) 627-2209. Pres.: Jim O'Neal

Dropkick Music, (BMI) 810 Seventh Ave. 36th Floor, New York, NY, 10019, (212) 492-1200

Droz Music, (BMI) 6355 Topanga Canyon Blue #309, Woodland Hills, CA, 91367.

Duane Music, Inc., 382 Clarence Ave., Sunnyvale, CA, 94086, (408) 739-6133. Pres.: Garrie Thompson.

Dub Notes, (ASCAP) (See Cornerstone Mgmt.).

Charles Dumont & Son, Inc., 1085 Dumont Dr., Voorhees, NJ, 08043, (609) 346-9100. Fax: (609) 346-3452. Pres.: Charles J. Dumont; Gen. Mgr.: Michael S. Dumont.

Dune Grass Music, Inc., (ASCAP) PO Box 400, Gainesville, VA, 22065, (703) 754-2400. Fax: (703) 754-2400. Pres./Gen. Mgr.: Joseph J. Contrucci.

Duraud, S.A., (ASCAP) (See Theodore Presser Co.).

Styly Rose Music, (BMI) PO Box 45, Bolivia, NC, 28422, (919) 253-5534. Pres.: Stan Knowles.

Dutchess, (BMI) (See MCA Music Publishing).

Dutchy Publishing BV, (ASCAP) (See Mateo San Martin Agency, Inc.).

Dy-Cor, (BMI) (See Dyer Bennet Records).

Dyer Bennet Records, (BMI) 792 Columbus Ave., New York, NY, 10025, (212) 866-3675. Pres./Gen. Mgr.: Harvey Cort.

E

E.D.M. Music Publishers, (ASCAP) (See Clockus Music Co.).

EMI Music Publishing Worldwide, 1290 Ave. of the Americas, 42nd Floor, New York, NY, 10104, (212) 492-1200. Fax: (212) 245-4115. Chrmn./CEO: Charles Koppelman; Vice Chrmn.: Martin Bandier.

Branch(es): 8730 Sunset Blvd., P.H. East, Los Angeles, CA, 90069, (213) 652-8078, Vice Pres. West Coast: Pat Lucas; 35 Music Square E., Nashville, TN, 37203, (615) 742-8081, Vice Pres./Gen. Mgr. Southern Region: Delia Froehlig.

Eagle Ear Music, Inc., (ASCAP) PO Box 5807, Englewood, NJ, 07631, (201) 568-0050. Fax: (201) 569-9580. Pres.: Paul Colby; Professional/Creative Mgr.: Ken Gorka.

Earshot Music Co., (ASCAP) (See Hal Bernard Ents., Inc.).

Earth Dance Music, (ASCAP) 3694 Spanish Gate Dr., Newbury Park, CA, 91320, (805) 499-9912. Fax: (805) 499-9047. Pres.: Gilbert Ysias; Professional/Creative Mgr.: Richard Seales.

Earth Music, (ASCAP) (See Qwest Music Publishing).

Earwig Music Co., Inc., (BMI) 1818 W. Pratt Blvd., Chicago, IL, 60626, (312) 262-0278. Fax: (312) 262-0278. Pres.: Michael Frank

Eastern Keyboard Music, (BMI) PO Box 7313, 16 Pine Radial Dr., Ocala, FL, 32672, (904) 687-3040. Pres.: Reginald E. Blackman

Easy Listening Music, Div. of Columbia Pictures Industries, Inc., (ASCAP) (See Columbia Pictures Music Group).

Eau D Yeah Music, (ASCAP) (See Joel S. Turtle).

Eddie & The Cruisers Publishing, (BMI) (See SB Publishing).

Eddie Music, (BMI) PO Box 27, Brooklyn, NY, 11223, (718) 339-8047. Pres.: Tom Bosco; Professional Mgr.: Ron Alexander.

Eden Music Corp., (BMI) (See Clyde Otis Music Group).

Don Edgar Music Co., (BMI) 2312 Jasper St., Fort Worth, TX, 76106, (817) 626-3448. Professional Mgr.: Darwin Edgar; Pres./Gen. Mgr.: Don Edgar.

Edge Of Fluke Music, (ASCAP) (See Fitzgerald Hartley Co.).

Edimusic, (See Latin American Music Co., Inc.).

Edimusic LTDA, (SAYCO) (See Telearte Florida, Inc./Music Publishing Co.).

Ediprom, (BMI/ASCAP) (See Mateo San Martin Agency, Inc.).

Edisa, (BMI) (See Mateo San Martin Agency, Inc.).

Editio Musica Budapest, (ASCAP) (See Boosey & Hawkes, Inc.).

Edition Helios, (See Mark Foster Music Co.).

Edition Pleasure Point Music, (See Zerkall Music, Inc.).

Edition Salabert, (SACEM) (See G. Schirmer, Inc.).

Edition Sunset Publishing Inc., (ASCAP) (See BMG Music Publishing Inc.).

Edition Wilhelm Hansen AS, (See G. Schirmer, Inc.).

Editions Billaudot, (ASCAP) (See Theodore Presser Co.).

Editions Jobert, (ASCAP) (See Theodore Presser Co.).

Editions Lemoine, (ASCAP) (See Theodore Presser Co.).

Editorial Borinquen, GPO Box 34785, San Juan, PR, 00936, (809) 731-2088. Fax: (809) 720-3726. Pres./Gen. Mgr.: Raul Aguayo.

Edizioni Musicali Sciascia, (SIAE) (See Preludium Music Publishing).

Edizioni Suvini Zerboni (Milan), (ASCAP) (See Boosey & Hawkes, Inc.).

Edson Publishing Co., (ASCAP) PO Box 845, 2888 Willow Pass Rd., Concord, CA, 94522, (510) 682-6770. Fax: (510) 682-3508. Pres.: Carl E. Jefferson; Professional Mgr.: Patricia Phillips.

Egg Ink Music, 156 Fifth Avenue, Suite 434, New York, NY, 10010, (212) 691-5630. Fax: (212) 645-5038. Pres.: Daniel Egink; Vice Pres.: Abigail Storm; Bus. Affairs: Jeffrey E. Jacobson.

Egghead & Boogee Ltd., 710 West End Ave., Ste. B, New York, NY, 10025, Contact: Ellie Ellsworth.

Eifell Music, Inc., (BMI) (See Zerkall Music, Inc.).

Eight-O-Five Music, (ASCAP) 1710 Roy Acuff Place, Nashville, TN, 37203, (615) 254-5925.

El Zaz Music Publishing, 6703 W. Commerce St., San Antonio, TX, 78227, (512) 432-7893. Fax: (512) 436-1511. Pres./Gen. Mgr.: Joey M. Lopez.

Elasac Music, (ASCAP) (See Don Casale Music).

Elcasc Music Publishing Co., (BMI) PO Box 22, Underhill, VT, 05489, (802) 899-3787. Pres./Professional-Creative Mgr.: Bobby Hackney.

Elevation Publishing, PO Box 8435, Boston, MA, 02114, (617) 547-2557. Pres.: Geraldine Hamlin.

Eleven East Corp., (BMI) 11 E. 86th St., New York, NY, 10028, (212) 722-8300. Fax: (212) 534-4211. Pres.: Ivan Mogull.

Eleventh Avenue Theatricals, (ASCAP) (See Larry Spier, Inc.).

Eliseo Edizioni Musicali, srl, (SIAE) (See Preludium Music Publishing).

Elizabeth Music, (BMI) (See Titan Records).

Elkan Vogel, (ASCAP) (See Theodore Presser Co.).

Price Elkins & Elkins, (BMI) 15830 Venture Blvd., #300, Encino, CA, 91436, (818) 990-6910.

Elliot/Jacobsen Music Publishing Co., (ASCAP) (See Great Honesty Music Co.).

Ellipsis Music Corp., (ASCAP) (See Jamie Music Publishing Co.).

Elrta Music, (ASCAP) (See Miraleste Music Co.).

Embassy Music Corp., (BMI) (See Music Sales Corp.).

Emile Music, (ASCAP) (See Stainless Music Corp.).

Empire Songs, (ASCAP) 3008 Belden Dr., Los Angeles, CA, 90068, (213) 469-2719. Fax: (213) 464-2292. Pres./Gen. Mgr.: Nick Thery; Professional/Creative Mgr.: Bud Mathis.

Empty Sky Music Publishing Co., (ASCAP) PO Box 626, 14th St., Verplanck, NY, 10596, Gen. Mgr.: Lisa Lancaster.

Emu Music, (BMI) (See Bob-A-Lew Music).

Enchantment Music Co., (BMI) 115 E. Idaho Ave., Las Cruces, NM, 88005, (505) 524-1889. Pres.: Emmit H. Brooks.

Encino Music, (See Warner/Chappell Music, Inc.).

Endless Frogs Music, (ASCAP) PO Box 7072, Corte Madera, CA, 94976, (415) 924-6867. Pres.: Andre Pessis.

Englishtown Music, (BMI) 9200 Sunset Blvd., Ste. 706, Los Angeles, CA, 90069.

Engstrom & Sodering, (KODA) (See C.F. Peters Corp.).

Ensemble Music Press, (ASCAP) (See Carl Fischer, Inc.).

Ensign Music Corp., (BMI) One Gulf & Western Plaza, New York, NY, 10023, (212) 373-7433. Contact: Sidney Herman.

Enter-Prizin Music, (ASCAP) 4950 Wilshire Blvd., Ste. 4000, Los Angeles, CA, 90010, (213) 937-2202. Fax: (213) 937-1875. Pres.: Alfred Scaife, Jr.; Professional Mgr.: Alfred Scaife, Jr.

Epoch Universal, 10802 N. 23rd Ave., Phoenix, AZ, 85029, (602) 864-1980. Fax: (602) 944-7378. Pres.: Ray Bruno; Gen. Mgr.: David Serey; Professional Mgr.: Rick Hardy.

Branch(es): 4226 Bridgetown Rd., Cincinnati, OH, 45211.

Equa Music, (ASCAP) 1800 Mowry Ave., Fremont, CA, 94538, (415) 794-6637. Pres.: Dr. Warren Johnson; Gen. Mgr.: Sandra Johnson; Professional/Creative Mgr.: Bob Jackson.

Equinox Music, (BMI) (See AVI Music Publishing Group, Inc.).

Erikanian Music, Inc., (ASCAP) PO Box 16264, 853 W. University Pkwy., Baltimore, MD, 21210, (301) 467-4231. Fax: (301) 467-4642. Pres.: Jack Heyrman.

Sharon Erman Assoc. (See Prince/SF Publications).

Ertis Music, (ASCAP) (See RCS Music Co.; Vetter Music Publishing Co.).

Ertolajay Musique, Ltd., (ASCAP) (See H.E.G. Music).

Espy Music Group, (ASCAP/BMI) 11684 Ventura Blvd., #509, Studio City, CA, 91614, (818) 760-2299. Fax: (818) 506-4735. Pres.: Kim G. Espy.

Essex Music Int'l, Inc., (ASCAP) (See TRO (The Richmond Organization)).

Eternal Candle Music, (ASCAP) (See Quill & Keyboard Music Publishing).

Ethnic Music Pub. Corp., (ASCAP) (See Ashley Publications, Inc.).

Euro Tec, 231 Glencrest Cr., Ventura, CA, 93003, (805) 658-2488. Fax: (805) 658-8241. Gen. Mgr.: Sybil Edwin

Even Safer Music, (ASCAP) (See Very Safe Music).

Evertunes Publishing, (ASCAP) (See World Music).

Evil Eye Music, Inc., (BMI) 11 W. 19th St., Ste. 711, New York, NY, 10011, (212) 627-4646. Fax: (212) 633-1233. Pres.: Howard S. Richmond; Gen. Mgr./Professional Mgr.: Larry Richard.

Evoke Music, (BMI) (See 23rd Street Publishing/Listening Room Music, Inc.).

Excellorec Music, (BMI) (See AVI Music Publishing Group, Inc.).

Expanding Nebula Music, (BMI) 8867 Highland Rd., Ste. 206, Baton Rouge, LA, 70808, (504) 336-4877. Fax: (504) 336-9678. Pres.: Victor E. Sachse; Gen. Mgr.: Clyde P. Rolston.

Expanding Universe Music, (BMI) 4002 Liggitt Dr., San Diego, CA, 92106, (619) 226-4152. Fax: (619) 566-5637. Pres.: Douglas Foxworthy; Gen. Mgr.: Philip A. Groves; Professional/Creative Mgr.: Carl Allen.

Eye Kill Music, PO Box 242, Woodland, PA, 16881, Pres.: John Maines, Jr.; Gen. Mgr.: Jack Maines; Professional Mgr.: Mark Suica.

Eyeball Music, (BMI) PO Box 60234, 1441 W. Devon, Chicago, IL, 60660, (312) 973-7736. Fax: (316) 973-2088. Pres.: Bruce Iglauer; Gen. Mgr.: Bob DePugh.

F

FXL Sound Studios, PO Box 16540, Plantation, FL, 33318, 10244 NW 47th St., Sunrise, FL, 33351, (305) 741-7766. Pres.: Frank X. Loconto; Exec. Vice Pres./Gen. Mgr.: Phyllis Finney Loconto.

Faith & Hope Music, (ASCAP) 3479 NW Yeon Ave., Portland, ME, 07210, (503) 228-9430. Fax: (503) 228-5039. Pres./Professional Mgr.: Morris McClellan; Gen. Mgr.: Eleanor Ross.

Falferious Music, (BMI) (See The Walt Disney Co.).

Fame Publishing Co., Inc., (BMI) PO Box 2527, 603 E. Avalon Ave., Muscle Shoals, AL, 35662, (205) 381-0801.

Family Affair Music, (ASCAP) (See Respect Music Co.).

Famous Door Prods., 1A-1 Estate St. Peter, Saint Thomas, VI, 00802, (809) 775-7528. Fax: (809) 775-7428. Pres.: Linca Lim.

Famous Music Corp., (ASCAP) 15 Columbus Cir., New York, NY, 10023, (212) 373-7433. Fax: (212) 373-7488. Pres.: Robert D. Fead; Professional Mgr.: Jim Vellutato; Exec. Vice Pres.: Sidney Herman.

Fantasy, Inc.

2600 Tenth St., Berkeley, CA, 94710, (510) 549-2500. Fax: (510) 486-2015. Chrmn.: Saul Zaentz; Pres.: Ralph Kaffel; Exec. Vice Pres. Finance: Frank Noonan; Exec. Vice Pres./Bus. Affairs: Albert M. Bendich; Dir. of Int'l Licensing: Bill Belmont; U.S. Licensing Admin.: Pamela Bendich.

Farm Hand Music, (BMI) (See Little Big Town Music Group).

Farmer & Thomas Music, 327 Upshur St. NW, Washington, DC, 20011, Pres.: Clifton Thomas; Vice Pres./Gen. Mgr.: Charles Farmer.

Faro Music Publishing, (BMI) 255 N. New Hampshire Ave., Los Angeles, CA, 90004, (213) 384-9586. Fax: (213) 384-0411. Owner: Edward L. Davis.

Farr-Away Music, (BMI) 701 N. Graycroft, Madison, TN, 37115, (615) 865-2639. Pres./Gen. Mgr./Professional Mgr. Tony Farr.

Bobby Farrell Int'l Music Publishing Co., (BMI) (See Vando Motion Pictures, Phonorecords & Music Publishing Corp.).

Father Thunder Publishing Co., (BMI) (See Jam-Power, Inc.).

Fee Bee Music Co., (BMI) 4517 Wainwright Ave., Pittsburg, PA, 15227, (412) 884-4727. Pres.: Joe Averbach; Gen. Mgr.: R. Averbach.

Feesongs, (BMI) (See Fitzgerald Hartley Co.).

Felstar Music, (BMI) (See American League Music).

Ferry Boat Music, (ASCAP) 24707 Wax Orchard Rd., Rt. 4, Box 428, Vashon Island, WA, 98070, (206) 463-2712. Pres.: Robert Krinsky.

Fez Music, (BMI) (See Third Story Music, Inc.).

Fezsongs, (ASCAP) 429 S. Lewis Rd., Royersford, PA, 19468, (215) 948-8228. Fax: (215) 948-4175. Pres./Gen. Mgr.: Jim Femino; Professional/Creative Mgr.: Tom Simpson.

Fiddleback Music Co., Inc., (BMI) (See Valand Publishing Group).

Fields & Lance Music, (BMI) (See Country Music Group).

Fifth Floor Music, (ASCAP) (See Third Story Music, Inc.).

Fifty Seven Varieties Music, (BMI) (See Palo Publishing).

Figgy Music, (BMI) (See Peter Teuis Music).

Fillmore Music House, (ASCAP) (See Carl Fischer, Inc.).

Filmtrax Copyright Holdings, Inc., 3808 Riverside Dr., Ste. 408, Burbank, CA, 91505, (818) 846-1400. Fax: (818) 846-7585. Pres.: Bruce M. Theriot; Professional Mgr.: Kevin Odegard.

Final Touch, (ASCAP) (See Avatar Publishing Group).

- Finger-Poppin' Music, (BMI) PO Box 2512, Austin, TX, 78768, (512) 440-1956. Pres.: Jim Yanaway.
- Finnegan Assoc., (ASCAP) (See Fricon Music Co.).
- William Finnegan Prodn., (BMI) (See Fricon Music Co.).
- Fireball Music, (ASCAP) 2807-6 Oceanfront Walk, Venice, CA, 90291, (213) 301-0705.
- Firedragon Music Publishing Co., (ASCAP) (See Vando Motion Pictures, Phonorecords & Music Publishing Corp.).
- Fire drum Music Publishers, (ASCAP) PO Box 8207, Albuquerque, NM, 87198, (505) 268-6110. Fax: (505) 256-7735. Pres./Gen. Mgr.: Tom Bee; Gen. Mgr./Professional Mgr.: Robert Bee.
- First Million Music, Inc., (ASCAP) 50 Music Sq. W., Ste. 207, Nashville, TN, 37207, (615) 329-2591. Gen. Mgr.: Peggy A. Bradley; Professional Mgr.: Karen Morris.
- First Monday Music, (ASCAP) (See Word Music).
- First Release Music Publishing, (BMI) 6124 Selma Ave., Hollywood, CA, 90028, (213) 469-2296. Fax: (213) 962-5751. Pres.: Dan S. Howell.
- Branch(es): 1025 17th Ave. S., Nashville, TN, 37203, (615) 327-2146.
- First Word Music, (ASCAP) (See Last Word Music).
- Firststars Music, (ASCAP) (See Int'l Record Syndicate Music, Inc.).
- Fischbach & Fischbach PC, (ASCAP) 1925 Century Park E., Ste. 1260, Los Angeles, CA, 90067, (213) 556-1956.
- Bobby Fischer Music Group, (ASCAP) 1618 16th Ave. S., Nashville, TN, 37212, (615) 292-3611. Pres.: Bobby Fischer.
- Carl Fischer, Inc., (ASCAP/BMI) 62 Cooper Sq., New York, NY, 10003, (212) 777-0900. Fax: (212) 477-4129. Pres.: Walter F. Connor.
- Fish Head Music, Inc., (BMI) PO Box 15220, New Orleans, LA, 70175, (504) 897-3627. Pres.: Edward L. Volker; Gen. Mgr./Creative Mgr.: Tad Jones.
- Fishin Fool Music, (BMI) (See Price Elkins & Elkins).
- Fishtunes, (BMI) (See TADM).
- Charlie Fitch Music, (BMI) 311 E. Davis St., Luling, TX, 78648, (512) 875-3350. Pres./Gen. Mgr.: Charlie Fitch.
- Fitzgerald Hartley Co., 7250 Beverly Blvd., Ste. 200, Los Angeles, CA, 90036, (213) 934-8002. Fax: (213) 934-5506. Professional/Creative Mgr.: David Dillon.
- Five & A-Half B Music, (BMI) PO Box 932, Honolulu, HI, 96808, 264 Kaili St., Honolulu, HI, 96819, (808) 847-4300. Pres.: Richard Riccio; Gen. Mgr.: Ed Dorman.
- Five Towers Music, (BMI) (See Castle Publishing, Inc.).
- Five West Music, (BMI) (See Ten-East Music Co.).
- Harold Flammer, Inc., (ASCAP) (See Shawnee Press, Inc.).
- Flat River Music, (BMI) (See Crazy Cajun Music).
- Flat Town Music Co., (BMI) PO Drawer 10, 434 E. Main St., Ville Platte, LA, 70586, (318) 363-2139. Fax: (318) 363-5622. Pres.: J. Floyd Soileau.
- Flojan Music Co., (ASCAP) (See Fred Ahlert Music Corp.).
- Florentine Music, (BMI) (See Comet-Tale).
- Florida Melody Train, (BMI) (See Florida Swamper).
- Florida Swamper, (BMI) 6415 Spring Hill Dr., Spring Hill, FL, 34606, (813) 868-5339. Pres.: Donald Marcum; Gen. Mgr.: Aaron Hale.
- Flowering Stone Music, (ASCAP) (See SB Publishing).
- Flying Fish Music, (BMI) 1304 W. Schubert, Chicago, IL, 60614, (312) 528-5455. Fax: (312) 528-8262. Pres.: Bruce Kaplan; Gen. Mgr.: Mike Fleischer.
- Flying Jalopy Music, (See Nova Records, Inc.).
- Focal Point Music, (BMI) 920 McArthur Blvd., Warner Robins, GA, 31093, Pres./Gen. Mgr.: Ray H. Melton; Professional/Creative Mgr.: George Lovell.
- Carl Foley, Inc., (ASCAP) (See Carl Fischer, Inc.).
- Folklore Music, (ASCAP) 1671 Appian Way, Santa Monica, CA, 90401, (310) 451-0767. Fax: (310) 458-6005. Pres.: Manuel Greenhill; Gen. Mgr./Professional Mgr.: Mitchell Greenhill.
- Folkways Music Publishers, Inc., (BMI) (See TRO (The Richmond Organization)).
- Folsom Prodn., Inc., 43 McKee Dr., Mahwah, NJ, 07430, (800) 631-7123. Contact: Ed Feldsott.
- Fono Music Publishing, (BMI) 6206 Chandler Dr., San Diego, CA, 92117, (619) 569-8464. Pres.: Ronnie C. Seville; Gen. Mgr.: Neon Seville.
- Fonotalento, (SACUEN) (See Telearte Florida, Inc./Music Publishing Co.).
- Forbeerg, (ASCAP) (See C.F. Peters Corp.).
- Ford Music Publishing Co., (ASCAP) (See Country Music Group).
- Carroll W. Ford Music, (SESAC) (See Country Music Group).
- Malcolm Ford Music Publishing Co., (BMI) (See Country Music Group).
- Forest Creek Music, (BMI) (See Bekool Music).
- Forestbrook Music, (ASCAP) PO Box 875, 311 1/2 E. Main, Ste. 3, Niles, MI, 49120, (616) 683-1554. Fax: (616) 683-4415. Pres.: Gary Shinholt; Gen. Mgr.: Sandra Brown; Professional Mgr.: Larry Clymer.
- Forge Seat, (SESAC) (See Southern Writers Group, USA).
- Formula Music, (ASCAP) (See Malaco Music Group).
- Forsythe Music, (ASCAP) (See AVI Music Publishing Group, Inc.).
- Fort Knox Music, Inc., (BMI) (See Alley Music Corp.).
- 49th Street Music, (See Pow Wow Music, Inc.).
- 42nd Street Music, (ASCAP) (See Joel S. Turtle).
- 40 West Music Corp., (See SHR Publishing).
- Fostco Music Press, (See Mark Foster Music Co.).
- Mark Foster Music Co., PO Box 4012, 28 E. Springfield, Champaign, IL, 61824, (217) 398-2760. Fax: (217) 398-2791. Pres.: James McKelvy; Gen. Mgr.: Jane Menkhous.
- Four Seasons Music, (ASCAP) (See Nashville Int'l Music Group).
- XIV Music, (SESAC) (See Print Music Co., Inc.).
- Fourth Floor Music/Fiction Music, Inc., (ASCAP/BMI) PO Box 135, Rt. 212, Wittenberg Rd., Bearsville, NY, 12409, (914) 679-7303. Fax: (914) 679-5731. Pres.: Sally Grossman; Gen. Mgr.: Willis Vermilyea; Professional/Creative Mgr.: Ian Kimmet; Admin.: Warner/Chappell Music.
- Fowler Music Ents., 808 S. Alkire St., Lakewood, CO, 80228, Pres.: William L. Fowler; Gen. Mgr.: Beatrice C. Fowler.
- Sam Fox Publishing Co., Inc., (ASCAP) 5276 Hollister Ave., Ste. 251, Santa Barbara, CA, 93111, (805) 683-9003. Pres.: Frederick W. Fox; Gen. Mgr./Professional/Creative Mgr.: Harry Fox, Jr.
- Branch(es): 170 NE 33rd St., Fort Lauderdale, FL, 33334, (305) 563-1844, Contact: Bernard Fisher; 810 Seventh Ave., 9th Floor, New York, NY, 10019, (212) 265-3910, Contact: Cecile Russo; 127 Charing Cross Rd., London, WC2HOEA, United Kingdom, (01) 434-2131, Fax: (01) 434-3531.
- Fradale Songs, (BMI) PO Box 121015, Nashville, TN, 37212, 502 E. Iris Dr., Nashville, TN, 37204, (615) 385-3408. Fax: (615) 297-2186. Pres.: David Leone; Gen. Mgr.: Reesha Leone.
- Framedrum Music, (BMI) (See Zerkall Music, Inc.).
- Frاندoro Music, Inc., (BMI) 8 Heather Dr., St. Louis, MO, 63123, (314) 843-9142. Pres.: Frank Daniels; Gen. Mgr.: Dorothy Daniels; Professional/Creative Mgr.: Shawn Daniels.
- Frank Music Corp., (ASCAP) (See MPL Communications, Inc.).
- Free & Show, (ASCAP) 903 Via Mill Cumbres, #12, Solana Beach, CA, 92075, (619) 792-8144. Professional Mgr.: Laurie Roberts; Pres./Gen. Mgr.: Ronald G. Patton.
- Freedrum Music, (ASCAP) (See Quark, Inc.).
- Freeman & Company Music Publishing Co., (SESAC) (See Int'l Atlanta Music).
- Fresh Memory Music, (ASCAP) (See Songs For Today).
- Fretboard Publishing, (BMI) PO Box 40013, Nashville, TN, 37204, (615) 292-2047. Gen. Mgr.: Andy Moseley; Professional Mgr.: Mark Moseley.
- Frick Music Publishing Co., (BMI) 404 Bluegrass Ave., Madison, TN, 37115, (615) 865-6380. Pres.: Bob Frick.
- Fricon Music Co., (BMI) 1048 S. Ogden Dr., Los Angeles, CA, 90019, (213) 931-7323. Fax: (213) 938-2030. Pres.: Terri Fricon; Vice Pres.: Gay DiFusco.
- Fricon Music Co., (ASCAP) (See Fricon Music Co.).
- Friendly Finley Music, (BMI) (See Shelby Singleton Music, Inc.).
- Friends of the General Music, (BMI) (See Lemon Square Music).
- Donnie Fritts Music, (BMI) (See Southern Writers Group, USA).
- Front Hall Ents., Inc., PO Box 307, Wormer Rd., Voorheesville, NY, 12186, (518) 765-4193. Pres.: Kay L. Spence.
- Front Room Music, (BMI) 2506-A Audubon Pl., Austin, TX, 78741, (512) 441-7139. Owner: Jim Stricklan.
- Fronto Music, (BMI) 444 Brickell Ave., Ste. 650, Miami, FL, 33131, (305) 661-7818. Fax: (305) 665-4170. Pres.: Marc Buoniconti.
- Frozen Inca Music, (BMI) 1800 Peachtree St. NW, #333, Atlanta, GA, 30309, (404) 355-5580. Fax: (404) 351-2786. Pres.: Michael Rothschild; Professional/Creative Mgr.: Eddie Cleveland.
- Fruit Music, (BMI) PO Box 121771, Nashville, TN, 37212, (615) 298-5260. Pres.: Curtis Allen.
- Fuente Music Co., (BMI-HARRY FOX) PO Box 1233, Santa Monica, CA, 90406, (213) 410-4951. Pres.: Bobby Manrique; Gen. Mgr.: Theresa Tapia; Professional/Creative Mgr.: Kris Manrique.
- Fujippastic Music, (See Funky but Music, Inc., dba Morningstar).
- Full Armor Publishing Co., (ASCAP) (See Songs For Today).
- Fulfillit Music, (BMI) 300 Linfield Dr., Vallejo, CA, 94590, (707) 645-1615. Fax: (707) 553-7773. Pres.: Jack B. Walker II.
- Fully Conscious Music Pub., (ASCAP) (See First Release Music Publishing).
- Fulmore Music Prodn., (SESAC) 4031 Forni Rd., Placerville, CA, 95667, (916) 622-5166. Pres.: Charles Fulmore; Gen. Mgr.: Dona Fulmore.
- Funky but Music, Inc., dba Morningstar, PO Box 1770, 153/155 Sanders Ferry Rd., Hendersonville, TN, 37077, (615) 824-9439. Fax: (615) 824-6691. Pres.: Kyle Lehning; Gen. Mgr.: Tony Gottlieb.
- Funky Flamenco Music, (BMI) (See Peter Teuis Music).
- Funky Music, (BMI) 244 Lylel Ave., Rochester, NY, 14608, (716) 458-5610. Pres./Gen. Mgr.: Boyd McCoy; Professional/Creative Mgr.: Steve McNally.
- Futuristic South, (BMI) PO Box 122, Bellwood, AL, 36313, (205) 588-2546. Pres./Pro-Creative Dir.: Danny Bryan; Gen. Mgr.: Michael Bryan.
- Fydaq Music, (BMI) 240 E. Radcliffe Dr., Claremont, CA, 91711, (714) 624-0677. Pres.: Gary K. Buckley.
- G & W Publishing Corp. c/o Publishers' Licensing Corp., (ASCAP) PO Box 5807, Englewood, NJ, 07631, (201) 568-3996. Fax: (201) 569-9580. Pres.: Sid Woloshin.
- GPH Music, (ASCAP) (See Gospel Publishing House).
- Gabal Music Co., (SESAC) (See Alexis Music, Inc.).
- Galahad Music, Inc., (BMI) (See September Music Corp.).
- Galaxy Mountain Music & Publishing, (BMI) PO Box 427, Reseda, CA, 91337, (213) 464-8382. Pres.: Cheryl Roth; Professional/Creative Mgr.: Linda D. Milne.
- Galaxy Music Corp., (ASCAP) (See E.C. Schirmer Music Co., Inc.).
- Galleria Press, (See Plymouth Music Co., Inc.).
- Al Gallico, 9301 Wilshire Blvd., Ste. 311, Beverly Hills, CA, 90210, (213) 274-0165.
- Branch(es): 711 5th Ave., New York, NY, 10022, (212) 702-2941, Fax: (212) 688-2738.
- Al Gallico Music, A Division of Columbia Pictures Industries, Inc., (BMI) (See Columbia Pictures Music Group).
- Gamble-Huff Music, (BMI) (See The Mighty 3 Music Group).
- Garrett Music Ents., 14660 Hiawatha St., Mission Hills, CA, 91345, (818) 8994467. Pres.: Thomas L. Garrett; Gen. Mgr./Professional Mgr.: James Cornelius.
- Gate Music Co., (ASCAP) (See Sam Fox Publishing Co., Inc.).
- Gather' Round Publishing, (BMI) (See Bonfire Publishing).
- Gatewisk Music Co., (BMI) (See Surrey Music Co.).
- Gavdia Music Arts, (See E.C. Schirmer Music Co., Inc.).
- Gaviota Music, (BMI) (See Manna Music, Inc.).
- Gay 90's Village, Inc., PO Box 569, 2107 E. Malone, Rear, Sikeston, MO, 63801, (314) 471-1347. Pres./Gen. Mgr.: Laura L. Eakins; Creative Mgr.: Patty Newman.
- Gee Money Music, (ASCAP) (See Get Rich Music/Stay Rich Music).
- Geffen Music, 9130 Sunset Blvd., Los Angeles, CA, 90069, (213) 285-2713. Fax: (213) 271-4358. Pres.: Ronny Vance; Gen. Mgr.: Lisa Wells; Professional Mgr.: Jaymes Foster-Levy.
- Carl Gehrmans Musikforlag (Stockholm), (ASCAP) (See Boosey & Hawkes, Inc.).
- Gele Music Pub., (BMI) (See Brunswick Music Publishing).
- Gelfand, Rennett & Feldman, (ASCAP) 1025 16th Ave. S., #202, Nashville, TN, 37212, (615) 329-3333.
- Gemini Lady Music, (SESAC) (See Delev Music Co.).
- Gen-Jan Music, (BMI) (See Pollybyrd Publications Ltd.).
- Larry Gene Music, (BMI) (See J-Paul Music).
- Genelle Music Co., (BMI) 1304 Fletcher Rd., Tifton, GA, 31794, (912) 382-6257. Fax: (912) 382-6257. Pres.: Gus P. Stataras; Gen. Mgr.: Genelle D. Stataras; Professional/Creative Mgr.: Perry G. Stataras.
- Gentle Wind Prodn., (See Conarch Prodn.).
- Get Rich Music/Stay Rich Music, (BMI/ASCAP) PO Box 314, New York, NY, 10037, (212) 694-1234. Pres.: Ms. Nelson.
- Getloadoffatso Music, (BMI) (See ADRA Music).
- Gibson Davidsong Publishing, (ASCAP) (See Rushwin Publishing).
- Gift, (ASCAP) (See Southern Writers Group, USA).
- Gil Gad Music Co., (ASCAP) 6015 Troost, Kansas City, MO, 64110, (816) 361-8455. Pres.: Eugene Gold; Professional/Creative Mgr.: Chris King.
- Givemetunes Music, (ASCAP) PO Box 1154, Evanston, IL, 60202, (312) 864-1383. Pres.: Brian Alexander; Gen. Mgr.: Jerry Aleson.
- Giving Music, (ASCAP) 910 Hester Rd., Memphis, TN, 38116, (901) 396-9952. Pres./Professional/Creative Mgr.: Edward Earl Randle.
- Glad Hamp Music, (ASCAP) (See Swing & Tempo Music, Inc.).
- Glad Music Co., (BMI) 3409 Brinkman St., Houston, TX, 77018, (713) 861-3630. Fax: (713) 861-2951. Pres.: Donald M. Daily.
- Glasscat Music, (ASCAP) (See Almo Music Corp.).
- Global Music Inc., (ASCAP) 1345 Avenue of the Americas, New York, NY, 10105, (212) 830-9396. Fax: (212) 586-8657. Pres.: Peter Kirsten.
- Branch(es): Niederlangerstrasse 21, 8 Munchen, 19, Germany, (089) 151-063, Fax: (089) 151-060. Pres.: Peter Kirsten; 171 Southgate Rd., London, N1 3LE, United Kingdom, (071) 359-2974, Gen. Mgr.: Peter Knight, Jr.
- Global Pacific Pub., (BMI) 180 E. Napa St., Sonoma, CA, 95476, (707) 996-2748. Fax: (707) 996-2658. Pres.: Howard Sapper; Gen. Mgr.: Shelia Adams; Professional Mgr.: Josh Duckworth.
- Global Village Music Co., (ASCAP) (See Joseph Nicoletti Music Co.).
- GlobeArt, Inc., (BMI) 1755 York Ave., Ste. 21F, New York, NY, 10128, (212) 860-3023. Fax: (212) 831-0906. Pres./Gen. Mgr.: Jane Peterer; Professional/Creative Mgr.: Jane Peterer.
- GlobeSound Publishing, (See GlobeArt, Inc.).
- Glorysound, (ASCAP) (See Shawnee Press, Inc.).
- Gnostic Music Co., (ASCAP) (See Henry Jerome Music, Inc.).
- Go-Gio Music, (ASCAP) (See MGM-Pathe Communications Co.).
- GoStar Music, (BMI) 3345 Hollins Ferry Rd., Baltimore, MD, 21227, (301) 247-7446. Fax: (301) 247-7445. Gen. Mgr.: Mike Szymanski; Pres./Professional Mgr.: William E. Baker.
- Gold Horizon Music Group, (BMI) (See Columbia Pictures Music Group).
- Gold Horizon Music Corp., (BMI) (See Filmtrax Copyright Holdings, Inc.).
- Gold Plate Music, (BMI) PO Box 288291, Chicago, IL, 60628, 1041 W. 108th Pl., Chicago, IL, 60643, (312) 779-2384. Pres.: Casey Jones.
- Gold Screen, Inc., (ASCAP/BMI) 7655 Sunset Blvd., Los Angeles, CA, 90046, (213) 851-9000. Fax: (213) 854-3480. Music Dir.: Randall Ramage.
- Gold Sovereign Music, (BMI) (See Fred Ahlert Music Corp.).
- G. Golden Clef Music, (See SoulStreet Music, Inc.).
- GPL Music, (ASCAP) (See Diamond Back Music Co.).
- G.S.C. Music, (ASCAP) (See Guy & Suzanne Clark).
- GTP Music, (BMI) (See Pop Record Research).
- GUTU Corp., PO Box 12210, 2 Store Tvaer Gade, Saint Thomas, VI, 00801, (809) 776-4514. Fax: (809) 776-4514. Pres.: Larry D. Braga.
- G W M Inc., (ASCAP) (See Neil A. Kjos Music Co.).

- Eugene Gold Music, (BMI) (See Gil Gold Music Co.).
Jay Gold Music Publishing, (BMI) PO Box 409, East Meadow, NY, 11554, (516) 486-8699. Fax: (516) 564-1217. Pres./Professional/Creative Mgr.: Jay Gold; Gen. Mgr.: Gail Gold.
Manny Gold Music Publisher, (ASCAP) 895 McDonald Ave., Brooklyn, NY, 11218, (718) 435-1918. Pres.: Manny Gold.
Golden Boy Music, (BMI) (See Country Stream Music).
Golden Boy Rock Music, (See La Rana/El Porto Music).
Golden Bridge Music, (ASCAP) (See Song of the World, Inc.).
Golden Group Music, (BMI) (See Harmony Gold, Gold Screen, Inc.).
Golden Guitar Music, (BMI) PO Box 40602, Tucson, AZ, 85717, (602) 795-0350. Pres.: Jeff Johnson; Gen. Mgr.: Jeff Johnson, Jr.
Golden Reed Music, Inc., (ASCAP) (See New Clarion Music Group).
Golden Torch Music Corp., (ASCAP) (See Filmtrex Copyright Holdings, Inc.).
Golden Torch Music Group, (ASCAP) (See Columbia Pictures Music Group).
Goldline Music, (ASCAP) (See Warner/Chappell Music, Inc.).
Goldmine Music, (ASCAP) (See Bourne Co.).
Michael H. Goldsen, Inc., (ASCAP) (See Criterion Music Corp).
Gone Gator Music, (ASCAP) (See Zeiderman, Oberman & Assoc., Inc.).
Good Heart Music, (SESAC) (See Co-Heart Music Group).
Good Life Publications, (ASCAP) (See CPP/Beilwin, Inc.).
Good Token Music, (ASCAP) (See Scott Tutt Music).
Goodland Publishing, (ASCAP) (See Marco Music Group, Inc.).
The Goodman Group Music Publishers, 488 Madison Ave., 5th Floor, New York, NY, 10022, (212) 751-7300. Fax: (212) 486-6687. Pres./Gen. Mgr.: Gene Goodman.
Goosebump Music, (BMI) Box 35022, Los Angeles, CA, 90035, (213) 655-9461. Pres.: Steve Angelica.
Goosepile Music, (BMI) 7 Colonial Ave., Myerstown, PA, 17067, (717) 866-5067. Pres.: Jean Shade.
Gopam Entis., Inc., 11 Riverside Dr., #13C-W, New York, NY, 10023, (212) 724-6120. Fax: (212) 580-9456. Pres.: John Levy; Gen. Mgr.: Laurie Goldstein.
Gordon Music Co., (ASCAP) PO Box 2250, Canoga Park, CA, 91306, (818) 883-8224. Pres./Professional-Creative Mgr.: Jeffrey Gordon; Gen. Mgr.: Irene Dayton.
Steve Gordon Music, (BMI) (See Lindseyanne Music, Inc.).
David Gornton, (BMI) (See Sam Fox Publishing Co., Inc.).
Gospel Publishing House, (ASCAP/SESAC) 1445 Boonville Ave., Springfield, MO, 65802, (417) 862-2781. Fax: (417) 862-8558. Gen. Mgr.: Joe Kilpatrick.
Gospel Rock Music, (BMI) 8027 Thurston Dr., Cicero, NY, 13039, (315) 699-5613. Pres.: Sylvester L. Wallace, Sr.; Gen. Mgr.: Arsenio D. Wallace; Professional/Creative Mgr.: Alicia Elaine Demps.
GoTown Publishing Co., (BMI) PO Box 1700, Leesville, LA, 71496, 706 W. Mechanic St., Leesville, LA, 71446, (318) 239-2850. Fax: (318) 239-2850. Pres./Gen. Mgr.: John E. Kilgore; Professional/Creative Mgr.: Marvin E. Haynes.
Gracious Music, (BMI) (See Faith & Hope Music).
Graduation Music, Inc., (ASCAP) PO Box 31519, Saint Louis, MO, 63131, (314) 432-7600. Pres.: Julian H. Miller II; Gen. Mgr.: Karen Willenberg.
Gramophone Music Co., (ASCAP) PO Box 921, Beverly Hills, CA, 90213, (213) 276-2726. Gen. Mgr.: Oliver Berliner; Professional/Creative Mgr.: G.O. Hernandez.
Grand Pasha Publishing, (BMI) 5615 Melrose Ave., Los Angeles, CA, 90038, (213) 466-3507. Fax: (213) 469-0122. Pres.: Spencer Proffer; Gen. Mgr.: Carol Peters.
Grand Prize Music, (BMI) (See Crazy Cajun Music).
Grand Staff Music, Inc., (SESAC) (See New Clarion Music Group).
Granite Music Corp., (ASCAP) (See Criterion Music Corp).
Justin Grant Music, (BMI) (See Sephra Music c/o Publishers' Licensing Corp.).
Don Grantham Music, (BMI) 204 Dalton Dr., Raleigh, NC, 27615, (919) 870-1109. Fax: (919) 870-0720. Gen. Mgr.: Donald J. Grantham.
Grass Mountain Publishing, (BMI) PO Box 122115, Fort Worth, TX, 76121, (817) 731-7376. Pres.: Slim Richey.
Gravenhurst Music, (BMI) 1469 Third Ave., New Brighton, PA, 15066, (412) 847-0111. Pres.: Jerry Reed.
Grawick Music Publishing, (BMI) (See James Hendrix, Composer & Publisher).
Gre-Jac Music, (BMI) PO Box 1618, Memphis, TN, 38101, (901) 725-9303. Fax: (901) 725-9303. Pres.: Dan Greer.
Great American Publishing Co. (GAP), (BMI) 576-B Goldsboro Rd. NE, Atlanta, GA, 30307, (404) 688-0799. Pres.: Al Harris.
Great American Song Machine, (See Spanda Music).
Great Honesty Music, (BMI) PO Box 547, Larkspur, CA, 94939, (415) 924-4976. Pres.: Erik Jacobsen.
Great Leawood Music, Inc., (ASCAP) (See Twinsong Music).
Great Pyramid Music, (BMI) (See Diamond Back Music Co.).
Great Walrus Ltd., (ASCAP) (See Third Story Music, Inc.).
Green Apple Music Co., (BMI) (See Fricon Music Co.).
Green Door Music, (BMI) 1616 Park Pl. Ave., Fort Worth, TX, 76110, (817) 923-1111. Pres./Gen. Mgr.: Marvin Moore; Professional/Creative Mgr.: Bill White.
Green Hills Music, (ASCAP) (See Little Big Town Music Group).
Green Linnet Music, Inc., (ASCAP) 43 Beaver Brook Rd., Danbury, CT, 06810, (203) 703-0333. Fax: (203) 730-0345. Pres.: Wendy Newton; Professional Mgr.: Steve Katz.
Green Menu Music Catalog, (ASCAP) (See Henry Jerome Music, Inc.).
Green Room Music, (ASCAP) (See Little Big Town Music Group).
E. J. Green Music, (ASCAP) (See Alva Music).
David Gresham Music, (ASCAP) 12424 Wilshire Blvd., Ste. 1120, Los Angeles, CA, 90025, (213) 207-3694. Fax: (213) 207-0855. Pres.: David Gresham; Professional Mgr. & Bus. Affairs: Mr. Kim Guggenheim.
Greystone Press, (See Plymouth Music Co., Inc.).
Grog Kill Music, (ASCAP) (See Watt Works, Inc.).
Groper Music, (BMI) Rt. 6, Box 41-L, Austin, TX, 78737, (512) 288-1695. Fax: (512) 288-5301. Pres.: Susan Walker; Gen. Mgr.: Ron Shelley.
Frank Guida Prod., (BUMA) (See Rockmasters Int'l Network).
Guinea Farm Music, (BMI) (See ADRA Music).
Gulf Bay Publishing, (SESAC) (See Marco Music Group, Inc.).
Gull Songs, (BMI) (See Terrace Entertainment Corp.).
E.J. Gurren Music, (ASCAP) PO Box 5218, 16311 Askin Dr., Pine Mountain Club, CA, 93222, (805) 242-0125. Fax: (805) 242-4313. Pres.: Eddie Gurren.
Gypsy Joker Music, (BMI) (See 23rd Street Publishing/Listening Room Music, Inc.).
- ## H
- H.E.G. Music, 6381 Hollywood Blvd., Ste. 775, Hollywood, CA, 90028, (213) 465-9814. Fax: (213) 465-5646. Vice Pres./Gen. Mgr.: Wendi Cartwright.
Hakuhodo Music Publishing Co., Ltd. (See Amida Music, Inc.).
Hall-Clement Publications, (BMI) (See Welk Music Group).
Hall of Fame Music Co., (BMI) PO Box 921, Beverly Hills, CA, 90213, (310) 276-2726. Gen. Mgr.: Oliver Berliner; Professional Creative Mgr.: G.O. Hernandez.
Rick Hall Music, Inc., (ASCAP) PO Box 2527, 603 E. Avalon Ave., Muscle Shoals, AL, 35660, (205) 381-0801. Fax: (205) 381-6337. Pres.: Rick Hall; Gen. Mgr.: Mark Hall; Professional Mgr.: Mickey Buckins.
Halmirque Musical Works, Ltd., (ASCAP) (See Aljoni Music Co.).
Halwill Music, Inc., (ASCAP) (See Harlem Music, Inc.).
Hampshire House Publishing Corp., (ASCAP) (See TRO (The Richmond Organization)).
Hampstead Heath Music Publishers, (ASCAP) 6986 El Camino Real, #B-412, Carlsbad, CA, 92008, (619) 931-9256. Pres.: Charls Senter.
Hank's Cadillac Songs, (BMI) (See Fruit Music).
Hanlit Publications, Inc., 270-272 West 19th St., New York, NY, 10011, (212) 675-3619. Fax: (212) 633-8022. Pres.: Ervin Litke; Gen. Mgr.: Ethel Gabriel; Professional/Gen. Mgr.: Don Tannen.
Jeffrey R. Hanna, (ASCAP) 2410 Blair Blvd., Nashville, TN, 37203.
Hanover Music Group, (ASCAP) PO Box 6296, Beverly Hills, CA, 90212. Fax: (818) 347-4892. Pres.: Paul Weston; Professional/Creative Mgr.: Tim Weston.
Happy Day Music Co., (BMI) (See Joe Keene Music Co.).
Happy Trails Music, (BMI) (See Garrett Music Entis.).
Happy Valley Music, (BMI) 1 Camp St., Cambridge, MA, 02140, (617) 354-0700. Fax: (617) 491-1970. Pres.: Bill Nowlin; Gen. Mgr.: Jake Guralnick; Professional Mgr.: Ken Irwin.
Harbor Record Export, (See Famous Door Prods.).
Harbot Music, (SESAC) (See Peer-Talbot Music Group).
Hardie Daniel Music, (ASCAP) 30064 Annapolis Cir., Inkster, MI, 48141, (313) 729-7836. Pres.: Hardie W. Daniel; Gen. Mgr.: Clark Daniel; Professional/Creative Mgr.: Adrienne Daniel; Mary J. Hill.
Hardstone Music, (ASCAP) (See American League Music).
Harlem Music, Inc., (BMI) 1800 Main St., Buffalo, NY, 14208, (716) 883-9520. Fax: (716) 884-1432. Pres.: Leonard Silver; Gen. Mgr.: David E. Parker.
Harmonious Music, (BMI) (See AVC Music).
Harmony Gold, (ASCAP/BMI) 7655 Sunset Blvd., Los Angeles, CA, 90046, (213) 851-4900, (213) 271-9752. Fax: (213) 851-5599. Music Dir.: Randall Ramage.
T. B. Harms Co., (ASCAP) (See Welk Music Group).
Alan Hartwell Music, (BMI) 825 Madison Ave., New York, NY, 10021, (212) 734-4000. Pres.: Alan Hartwell; Gen. Mgr.: Savina Hartwell; Professional Mgr.: Allison Hartwell.
Harvard Music, Inc., (BMI) (See Eleven East Corp.).
Harwin Music Co., (ASCAP) (See MPL Communications, Inc.).
Hauser Artists, (See Prince/SF Publications).
Havana-New York Music Co. c/o Publishers' Licensing Corp., (BMI) PO Box 5807, Englewood, NJ, 07631, (201) 568-3996. Fax: (201) 569-9580. Gen. Mgr.: Paquito D'Rivera; Professional/Creative Mgr.: Brenda Feliciano.
F. B. Haviland Publishing Co., Inc., (ASCAP) (See Jerry Vogel Music Co., Inc.).
Havre Music Services, (See Prince/SF Publications).
Hayes Street Music, (ASCAP) (See Almo Music Corp.).
Haynestrom Music, (ASCAP) (See H.E.G. Music).
He Rose Publishing, (BMI) 1098 Rose, El Centro, CA, 92243, (619) 352-5774. Pres.: Danny Berg.
Headless Horseman, (BMI) 1716 Ashwood Ave., Nashville, TN, 37212, (615) 298-4286.
Headliner Stars Music, (BMI) GC80 Box 5B, Leesville, LA, 71446. Pres.: Sherre V. Stephens; A & R: Angel Stephens.
Hear Music, (ASCAP) (See Nunifunt Music).
Hear No Evil Music Co., (BMI) (See Espy Music Group).
Heartake Songs, (ASCAP) PO Box 621, Madison, TN, 37116, (615) 859-3682. Pres./Professional Mgr.: Robert W. Stamper.
Heath Music Pub., (ASCAP) (See Two John's Music).
Heavy Jamin' Music, (ASCAP) PO Box 1622, Hendersonville, TN, 37077, (615) 822-1044. Fax: (615) 822-1044. Pres.: Wade Curtiss; Gen. Mgr.: S.D. Neal; Professional/Creative Mgr.: Dick Daniels.
Heavy Weather Music, (BMI) (See Rob-Lee Music).
Hee Bee Dooinit Music, (ASCAP) (See Qwest Music Publishing).
Heinrichshofen Edition (West Germany), (BMI) (See C.F. Peters Corp.).
Heircraft Music, (ASCAP) (See Kel-Jon Publishing).
Heleriqui, (BMI) 2209 Crenshaw Blvd., #107, Los Angeles, CA, 90016, (213) 734-4459. Pres./Gen. Mgr.: Lummie J. Fowler.
Hello There! Music Publishing, Inc., (ASCAP) (See Frec Ahlert Music Corp.).
Heip Me Rhonda Music, (ASCAP) (See Brookside Music Corp.).
Hendon Music, Inc., (BMI) (See Boosey & Hawkes, Inc.).
Hendricks Music, Inc., (ASCAP) (See Almo Music Corp.).
James Hendrix, Composer & Publisher, PO Box 90639, 902 42nd Ave. N., Nashville, TN, 37209, (615) 321-3319. Pres./Gen. Mgr.: James Hendrix.
Henmar Press, Inc., (ASCAP) (See C.F. Peters Corp.).
Henry Prods., Ltd., (BMI) PO Box 909, 3107 Mustang Dr., Ste. 32, Grapevine, TX, 76051, (817) 481-4261, (214) 790-3238. Fax: (214) 259-2781. Pres.: C. Henry Lewis.
Henstooth Music, (BMI) (See The Music Group).
Herald Square Music, Inc., (ASCAP) (See Alley Music Corp.).
Herb-Hunt Music, (BMI) (See The Ted Jarrett Music Group).
Hereford Music, (ASCAP) 1222 Preservation Pkwy., Oakland, CA, 94612, (415) 763-2034. Fax: (415) 835-1459. Pres.: Jo Lynne Worley; Gen. Mgr.: Bryan Welland; Professional/Creative Mgr.: Holly Near.
Heritage Music Pub. Co., Inc., (See Ashley Publications, Inc.).
Mark Herman & Ronnie Apter, (BMI) 5748 W. Brooks Rd., Shepherd, MI, 48883, (517) 828-6987. Pres.: Mark Herman.
Hermosa Music, (BMI) (See Ultima Thule Music).
Hi-Bi Publishing Co., Inc., (ASCAP) PO Box 5457, Rocketteller Ctr. Sta., 401 East 23rd St., New York, NY, 10185, (212) 330-0952. Pres./Gen. Mgr.: David King; Professional/Creative Mgr.: Jeanette Rapersad-Mata.
Hi-Cue Prods., (ASCAP) (See Irving Mills Music, Publishers Representative).
Hickory Valley Music, (ASCAP) 10303 Hickory Valley Dr., Fort Wayne, IN, 46835, (219) 627-5168. Pres.: Allan Straten; Gen. Mgr.: Allan Straten; Professional Mgr.: Sylvia Grogg.
Hidden Lake Music, (BMI) 111 Hatcher Lake Ln., Hendersonville, TN, 37075, (615) 822-4582.
Hidden Pun Music, Inc., (BMI) (See Lipservices).
High Seas Music, (BMI) (See Fitzgerald Hartley Co.).
Highest Praise Publishing Co., PO Box 1869, Hollywood, CA, 90078, 6922 Hollywood Blvd, Ste. 720, Hollywood, CA, 90028, (213) 466-3199. Fax: (213) 466-3974. Gen. Mgr.: Kent Washburn.
Highgate Press, (BMI) (See E.C. Schirmer Music Co., Inc.).
Hillwheel Pub, (BMI) (See Little Richie Johnson Music).
Hill Country Publishing, (BMI) (See Bill Butler Music).
Mary Hill Music, (BMI) (See Virtu Music).
Rose Hill Group, (ASCAP) 1326 Midland Ave., Syracuse, NY 13205, (315) 475-2936. Pres.: Z. Taft; Professional/Creative Mgr.: Vincent Taft.
Hillbrow Music, (ASCAP) (See Songs For Today).
Hillgreen Music, (BMI) (See Folklore Music).
Hinrichsen London, (PRS) (See C.F. Peters Corp.).
Hip-Bone Music, (ASCAP) (See Danvo Songs).
His Eye Music, (SESAC) (See The Sparrow Corp.).
History Publishing Co., (BMI) PO Box 7-11, Old Hwy 54 W., Macks Creek, MO, 65786, (314) 363-5432. Fax: (314) 363-5820. Pres.: B.J. Carnahan; Gen. Mgr.: Brad Edwards.
Hit & Run Music Publishing, Inc., (ASCAP) (See Lipservices).
Hitkit Music, (BMI) (See Music Craftshop, Inc.).
Hittage Music, (ASCAP) 16 W. 22nd St., 10th Floor, New York, NY, 10010, (212) 691-1200. Fax: (212) 691-3375. Pres.: Frec Munao.
Hitzgalore Music, (BMI) (See Jaellus Entis., Inc.).
Hobsongs, (ASCAP) (See Almo Music Corp.).
Al Hoffman Songs, Inc., (ASCAP) (See Music Sales Corp.).
Holiday Music Services, (See Prince/SF Publications).
James Hollihan Music, (ASCAP) (See Skinny Zach Music).
Hollis Music, Inc., (BMI) (See TRO (The Richmond Organization)).
Hollybrook Music Co., (ASCAP) (See Big Heart Music, Inc.).
Hollyville Music, (SESAC) (See Manna Music, Inc.).
Hollywood Ave. Music, (BMI) 8306 Appalachian Dr., Austin, TX, 78759, (512) 338-1991. Fax: (512) 338-1808. Pres.: Carlyne Majer; Gen. Mgr.: Tammy Moore.
Hollywood Music Service, (See Prince/SF Publications).
Hollywood Pictures Music, (ASCAP) (See The Walt Disney Co.).
HolPic Music, Inc., (BMI) (See The Walt Disney Co.).
Holy Grail Publishing, (BMI) 12609 Dessau Rd., Ste. A222, Austin, TX, 78753, (512) 251-0375. Pres.: Gary A. Coll; Gen. Mgr.: Brad L. Silverlight; Professional Mgr.: Ben Blank.
Holy Moley Music, (BMI) (See SB Publishing).
Hombre Del Mundo Music, (See ASB Publishing) (See Whooping Crane Music).
Home Recker Music, (BMI) (See Jonco Music).
Homeland Recording & Publishing, 1011 16th Ave. S., Nashville, TN, 37212, (615) 327-1240. Fax: (615) 327-1346. Pres.: William W. Traylor; Gen. Mgr.: Terry Exley; Professional/Creative Mgr.: Terry Exley.
Homestead Press, (SESAC) (See Homeland Recording & Publishing).

Hometown Music Co., (ASCAP) 80-08 35th Ave., Jackson Heights, NY, 11372, (718) 651-8213. Pres./Gen. Mgr.: Sidney Prosen.

C. W. Homeyer, (ASCAP) (See Carl Fischer, Inc.).

HoneyMaker Music. (BMI) (See Free & Show).

Hook Music. (BMI) (See Startime Music).

Hook Records, (BMI) (See Yo-Yo Music).

Hook Up Music. (ASCAP) (See Droz Music).

Hookem Music. (ASCAP) (See Terrace Entertainment Corp.).

Hookit Music. (BMI) (See Terrace Entertainment Corp.).

Hoosier Music. (ASCAP) (See Malaco Music Group).

Hopi Sound Music. (ASCAP) (See De Walden Music Int'l, Inc.).

Hopscotch Army. (BMI) (See Nov. 17th Music).

HoriPro Entertainment Group. (ASCAP) 1819 Broadway, Nashville, TN, 37203, (615) 329-0890. Fax: (615) 329-1874. Pres.: Robert J. Beckham; Gen. Mgr.: Ronnie Gant; Professional/Creative Mgr.: Norman DeVASURE.

Horror Music Co., (BMI) 313 El Tejon Ave., Oildale, CA, 93308, (805) 399-9028. Owner/Gen. Mgr.: Robert L. Horror.

Hosanna Music. (ASCAP) (See Integrity Music, Inc.).

Hot Knobs. (BMI) 607 Piney Point Rd., Yorktown, VA, 23692, (804) 898-8155. Gen. Mgr.: Kim Person; Pres./Professional Mgr.: Lana Puckett.

Hot Lips Music Co., (BMI) 498 West End Ave., New York, NY, 10024, (212) 580-9065. Pres.: Randy Klein.

House Of Gemini. (BMI) (See Sign Of The Twins c/o Publishers' Licensing Corp.).

House of Joy Music. (ASCAP) 7904 Mason Ave., Canoga Park, CA, 91306, (818) 341-0542. Fax: (818) 341-0543. Pres.: Ken Joy.

House of Knox Music Publishing. (ASCAP) 4844 Seda Dr., San Diego, CA, 92124, (619) 569-4563. Owner: Robert Knox.

House of Rock Music. (BMI) (See Melody House Music Publishers).

How The West Was Sung Music. (BMI) (See White Cat Music).

How Ya Doin'? (BMI) (See Kiva Voices).

Randy Howard Music. (ASCAP) PO Box 150584, Rt. 1, Box 610-A, Nashville, TN, 37215, (615) 759-4703. Pres./Gen. Mgr.: Randy L. Howard; Professional/Creative Mgr.: Randy L. Howard.

Hudmar Publishing Co., Inc., (ASCAP) (See Fitzgerald Hartley Co.).

Hudson Bay Music, Inc., (BMI) (See Alley Music Corp.).

Hulex Music. (ASCAP) (See Bob-A-Lew Music).

Human Boy. (ASCAP) (See Cornerstone Mgmt.).

Hummingbird Recording Co., Inc., Rt. 3, Box 648, West Jefferson, NC, 28694, (919) 246-6431. Pres.: Louise P. Taylor; Gen. Mgr.: Ronnie R. Taylor; Professional Mgr.: Greathel T. Coliron.

Humongous Music. (ASCAP) (See Big Prodn. & Publishing Co., Inc.).

Hungry Mountain Music. (BMI) (See Kenny O'Dell Music).

Huntzinger Publications. (See Willis Music Co.).

Debbie Hupp Music. (ASCAP) (See Southern Writers Group, USA).

Husky Music. (BMI) (See Southern Arts Music).

I

I Love Music. (BMI) PO Box 66666, Los Angeles, CA, 90066, 13381 Beach Ave., Marina Del Rey, CA, 90292, (310) 821-4005. Fax: (310) 823-3389. Pres.: Wayne Volat.

IPFS Rejected Youth. (See La Rana/El Porto Music).

I. R. S. Music. (BMI) (See First Release Music Publishing).

I. R. S. Songs. (ASCAP) (See First Release Music Publishing).

IRS Songs, Inc., (ASCAP) (See Int'l Record Syndicate Music, Inc.).

Ibex Publishing Co., (BMI) (See Major Bob Music).

Ideas of March Music Div., (ASCAP) 1136 Gateway Ln., Nashville, TN, 37220.

Ideas Unlimited. (ASCAP) (See Magnemar Publishing).

Iddris-Brown-Tibbles. (ASCAP) (See Titan Records).

Iffin Music. (BMI) 38 Music Sq. E., Ste. 215, Nashville, TN, 37203, (615) 254-0825. Pres.: Heath Webb; Gen. Mgr.: Jean Webb.

Illegal Songs Inc., (BMI) (See First Release Music Publishing; Int'l Record Syndicate Music, Inc.).

Imaginary Music. 332 N. Dean Rd., Auburn, AL, 36830, (205) 821-5277. Gen. Mgr.: Lloyd E. Townsend, Jr.

Impulsivo Music. (ASCAP) (See RCS Music Co., Vetter Music Publishing Co.).

In-House Publishing, Inc., 146-05 130th Ave., South Ozone Park, NY, 11436, (718) 322-8258. Pres.: Barry Jones.

In-The-Pocket Music Pub., (ASCAP) (See Rendezvous Entertainment).

Indian Forest Music. (SESAC) (See Chestnut Mound Music Group).

Indian Hills Music. (BMI) (See Darksilver Music Ltd.).

Inorbit Music, Inc., (BMI) (See All Nations Music Publishing; Carers Music, Inc.).

Instant Flight Music. (BMI) (See The Ted Jarrett Music Group).

Institute of American Music. (ASCAP) (See Carl Fischer, Inc.).

Integrity Music, Inc., PO Box 16813, 1000 Cody Rd., Mobile, AL, 36695, (205) 633-9000. Fax: (205) 633-5202. Pres.: Michael Coleman; Exec. Vice Pres.: Ed Lindquist.

Int'l Atlanta Music. (BMI) 881 Memorial Dr., SE, Atlanta, GA, 30316, (404) 577-5728. Fax: (404) 223-0144. Pres.: S. R. Freeman, Jr.; Gen. Mgr.: Alan Freeman.

Int'l Forecast Music. (BMI) PO Box 14073, Cincinnati, OH, 45214, (513) 561-1269. Pres.: Charles Davis; Professional Mgr.: Steven M. Hill.

Int'l Music Co., (BMI) (See Bourne Co.).

Int'l Music Services, 9376 Airdrome St., Los Angeles, CA, 90035, (213) 839-8340. Fax: (213) 202-7675. Pres.: Linda Komorsky.

Int'l Record Syndicate Music, Inc., (BMI) 6124 Selma Ave., Los Angeles, CA, 90028, (213) 469-2296. Fax: (213) 962-5751. Pres.: Miles Copeland; Gen. Mgr.: Jay Boberg; Professional Mgr.: Dan Howell.

Interplay Music Publishing Co., (ASCAP) PO Box 9135, Calabasas, CA, 91302, (714) 796-6110. Fax: (818) 887-4164. Pres./Gen. Mgr.: Toshiya Taenaka.

Intersong Music. (See Warner/Chappell Music, Inc.).

Intertrax Music, Inc. (BMI) (See Filtrax Copyright Holdings, Inc.).

Ione Press. (BMI) (See E.C. Schirmer Music Co., Inc.).

Irving Mills Music, Publishers Representative. PO Box 10372, 370 Concord Dr., Sedona, AZ, 86336, (602) 282-4394. Pres./Gen. Mgr.: Paul Mills; Professional/Creative Mgr.: Paul Mills.

Irving Music, Inc., (BMI) (See Rondor Music, Int'l, Almo Music Corp.).

C. Isaak Music Publishing. (ASCAP) (See Great Honesty Music).

Isa De Canciones. (BMI) PO Box 920658, Houston, TX, 77292, (713) 957-8398. Pres./Gen. Mgr.: Paul Rodriguez.

Island Music, Inc., (BMI) 6525 Sunset Blvd., Los Angeles, CA, 90028, (213) 469-1285. Fax: (213) 460-4966.

Marc Isle Music. (BMI) (See Marco Music Group, Inc.).

Israel Music Institute (Tel Aviv), (ASCAP) (See Boosey & Hawkes, Inc.).

Israel Vibration Music c/o Jacobson & Colfin, P.C., (BMI) 156 Fifth Ave., Ste. 434, New York, NY, 10010, (212) 691-5630. Fax: (212) 645-5038. Pres.: Spence; Gen. Mgr.: Jeffrey E. Jacobson; Professional/Creative Mgr.: Apple.

It Ain't Easy. (See J.D. Music/Frankly Music).

It's Really Rob Music. 14016 Evers Ave., Compton, CA, 90222, (213) 635-8522. Pres.: Robert E. Pullen-Miles.

Ivory Palaces Music. (ASCAP) 3141 Spottswood Ave., Memphis, TN, 38111, (901) 323-3509. Pres.: Jack Abell; Professional/Creative Mgr.: Keith Solitsy.

Ivy Jazz. (BMI) 599 N. Darwin St., #5, Salt Lake City, UT, 84103, (801) 575-6227. Pres.: Paul Ellingson.

Iza Music Corp., (BMI) (See Clyde Otis Music Group).

J

JASAM Music. (ASCAP) (See Print Music Co., Inc.).

J.D. Music/Frankly Music, (ARISTA) PO Box 8958, Jacksonville, FL, 32239, (904) 744-7774. Pres./Gen. Mgr.: Fred Frank.

J & J Kamman Music Co., (See Ashley Publications, Inc.).

J & J Musical Entertainments. 156 Fifth Avenue, Suite 434, New York, NY, 10010, (212) 691-5630. Fax: (212) 645-5038. Pres.: Jeneane Claps; Professional/Creative Mgr.: Jeffrey E. Jacobson.

J-K Keys Music. (ASCAP) (See Southern Arts Music).

JLI Music. (BMI) PO Box 74-R, Romeoville, IL, 60441, (815) 880-1160. Pres.: Julian Leal; Gen. Mgr.: Sharon Matyus.

J-Paul Music. (ASCAP) 435 Main St., S-211A, Johnson City, NY, 13790, (607) 729-2291. Fax: (607) 797-6007. Pres.: Larry Lupole; Gen. Mgr.: Michael C. English; Professional Mgr.: L. Lupole, M. English.

J. R. Publications. (See Music for Percussion, Inc.).

JSH Music. (ASCAP) (See Big Heart Music, Inc.).

JTL Publications. 14505 Fox Knoll Dr., Colonial Heights, VA, 23834, (804) 458-2024. Pres.: James T. Lester.

J&W Chester Music Ltd., (PRS) (See G. Schirmer, Inc.).

Ja Nikki Songs. (BMI) (See Pollybird Publications Ltd.).

Jaba Music Co., (BMI) 153 Stevens Ave., Mount Vernon, NY, 10550, (914) 699-6052. Fax: (914) 699-1769. Pres.: Jack Adesso; Gen. Mgr.: Alan McDovitch.

Jack & Bill Music Co., (ASCAP) (See Welk Music Group).

Jack Music, Inc., (BMI) PO Box 120477, Nashville, TN, 37220, (615) 383-0330. Pres.: Jack H. Clement; Vice Pres.: Bob Webster.

Jaclyn Music. (BMI) 306 Millwood Dr., Nashville, TN, 37217, (615) 366-9999. Pres.: Jack Lynch.

Jaelius Ents., Inc., 14660 Hiawatha St., Mission Hills, CA, 91345, (818) 899-4446. Pres.: James Cornelius.

Jatamal Music. (ASCAP) (See Zerkall Music, Inc.).

Jalius Music. (ASCAP) (See Jaelius Ents., Inc.).

Jam-Power, Inc., 8756 Amigo Ave., Northridge, CA, 91324, (818) 701-0375, (818) 701-6624. Fax: (818) 701-5913.

Jamaica Joe Music. (BMI) (See Berdoo Music).

Fred James Music. (BMI) (See Southern Writers Group, USA).

Rick James/Stone City Music. (ASCAP) (See American League Music).

Jamie Music Publishing Co., (BMI) 2055 Richmond St., Philadelphia, PA, 19125, (215) 426-4384. Fax: (215) 426-2867. Pres.: Harold B. Lipsius; Gen. Mgr.: Paul Flan.

Jamil Music. (BMI) 413 N. Parkerson Ave., Crowley, LA, 70526, (318) 783-1601. Fax: (318) 788-0776. Owner: J.D. Miller.

Jana Music. (BMI) (See Newcreature Music).

Jando Music, Inc., (ASCAP) (See Jack Music, Inc.).

Jandon Music. (ASCAP) (See Trianon Publications).

Janel Music. (BMI) 195 S. 26th St., San Jose, CA, 95116, (408) 286-9840. Fax: 9408 286-9845. Pres.: Gracie O'Neal; Gen. Mgr.: Jeannine O'Neal; Pres./Gen. Mgr.: Gracie O'Neal.

Janon Music. (ASCAP) (See AMCORP Group).

Jaramex Publishing Corporation. (ASCAP) (See Mateo San Martin Agency, Inc.).

The Ted Jarrett Music Group. PO Box 60412, 923 Main St., Nashville, TN, 37206, (615) 226-1004. Pres./Gen. Mgr.: Ted

Jarrett; Professional/Creative Mgr.: George Gray.

Jesepny Music. (ASCAP) (See Espy Music Group).

Jatap Publishing Co., (BMI) (See Irving Mills Music, Publishers Representative).

Jay Jay Publishing Co., (BMI) 35 NE 62nd St., Miami, FL, 33138, (305) 758-0000. Pres.: Walter E. Jagiello.

Jay Six Publishing Co., (BMI) 26 Northern Ave., Harwich Port, MA, 02646, (508) 432-9070. Pres.: Jack Sager.

Jay-Tam Music Div., (BMI) 676 Pittsburgh Rd., Butler, PA, 16001, (412) 586-6552. Fax: (412) 586-6642. Pres.: Michael Paul Taimuty, II; Gen. Mgr.: Mickii E. Taimuty.

Jaymar (Canada), (ASCAP) (See Oxford University Press, Inc.).

Jaymore Music. (BMI) Box 100, Brighton, MI, 48116, (313) 227-1997. Pres.: John Morris.

Jazz Fund Music. (BMI) (See Raybird Music).

Jazzand. (BMI) 12 Micieli Pl., Brooklyn, NY, 11218, (718) 972-1220. Pres.: Rick Stone; Professional Mgr.: Idelle Nissila.

Jed's Tunes. (SESAC) (See John E. Denny).

Jeff Who Music. (ASCAP) (See Jeffrey R. Hanna).

Jen-Ga-Matt Music. (ASCAP) (See Jimmy Swaggart Ministries).

Jeneane & Jude Music. (ASCAP) c/o Jacobson & Colfin, 156 Fifth Ave., New York, NY, 10010, (212) 691-5630. Fax: (212) 627-3025. Pres.: Jeneane Claps; Gen. Mgr.: Jennie Claps.

Jennifer Music, Inc., (ASCAP) (See Cromma Music Co.).

Waylon Jennings Music. (ASCAP) 1117 17th Ave. S., Nashville, TN, 37212, (615) 329-9180.

Jepalana Music. (ASCAP) (See Print Music Co., Inc.).

Jer Joy Music. (BMI) PO Box 1264, Peoria, IL, 61654, (309) 673-5755. Pres.: Jerry Hanlon.

Jero Limited Music. (BMI) 2309 N. 36th St., #11, Milwaukee, WI, 53210, (414) 445-4872. Pres.: Marvell Love; Gen. Mgr.: Bettie R. Holt; Professional Mgr.: Tony Washington.

Henry Jerome Music, Inc., 5 Van Etten Blvd., New Rochelle, NY, 10804, (914) 632-1270. Fax: (914) 235-5790. Pres.: Miriam Jerome; Gen. Mgr.: Henry Jerome; Professional/Creative Mgr.: Donald Castaldi.

Jerryco Music Co., (ASCAP) (See MPL Communications, Inc.).

Jet-Eye Music, Inc., (BMI-HARRY FOX) 7405 Crissman St., Utica, MI, 48317, (313) 731-8277. Pres.: Johnny Powers; Gen. Mgr.: Del Pavlik.

Jetstar Publishers, Inc., (BMI) (See Abnak Music c/o Publishers' Licensing Corp.).

Jevrt Music. (BMI) 639 Bulen Ave., Columbus, OH, 43205, (614) 258-7112. Pres.: Jeffrey V. Smith.

Jewel Music Publishing Co., Inc., (ASCAP) (See The Goodman Group Music Publishers).

Jewish Family Prodn. Publishing. (ASCAP) (See Jewish Music).

Jewish Music. (BMI) 8116 Aedan Ct., San Diego, CA, 92120, (619) 582-5696. Pres.: George Fogleman.

Jilean Music. (See Gopam Ents., Inc.).

Jim Boy Music. (ASCAP) 1307 Lone Oak Cir., Nashville, TN, 37215.

Jimerlean Music Publishing. (BMI) (See James Hendrix, Composer & Publisher).

Jimpire Music. (BMI) 5 Decker Ct., Mahwah, NJ, 07430, (201) 825-9043. Pres.: John Pruitt; Gen. Mgr.: James Castor.

Jingle Bells Publishing. (ASCAP) (See Crimson Publishing).

Jo Jo April Publishing Co., (BMI) (See Jomod Music).

Jo-Rae Music. (BMI) (See Montgomery Publishing).

Jobete Music Co., Inc., (ASCAP) 6255 Sunset Blvd., Los Angeles, CA, 90028, (213) 856-3507. Fax: (213) 461-2785. Pres.: Lester Sill; Gen. Mgr.: Frank F. Banyai.

Lockey Music, Inc., (ASCAP) (See Cromma Music Co.).

Jodax Music Co., (See Gopam Ents., Inc.).

Jodi-Pat Music. (BMI) (See Kingston Int'l Publishing Co.).

Joe Lu Publishing Co., (BMI) (See Jomod Music).

Joey Boy Publishing. (BMI) 3081 NW 24th St., Miami, FL, 33142, (305) 635-7469. Fax: (305) 633-7127. Pres.: Jose Armada, Jr.; Allen L. Johnston; Gen. Mgr.: Luz Marina Fernandez; Professional/Creative Mgr.: Rod Kenney.

Richard E. Johnson. 4372 Dauncy, Flat Rock, MI, 48134.

Little Richie Johnson Music. (BMI) PO Box 3, 1700 Plunkett Ct., Belen, NM, 87002, (505) 864-7441. Fax: (505) 864-7442. Pres.: Little Richie Johnson; Gen. Mgr.: Tony Palmer.

Jokay Music. (BMI) 18321 Ventura Blvd., Tarzana, CA, 91356, (818) 344-7117. Fax: (818) 344-7295. Pres.: Joe Jackson; Gen. Mgr.: Ben Brown.

Jomod Music. (BMI) PO Box 446, North Hollywood, CA, 91603, (818) 786-6146. Pres.: Joseph Modeliste; Gen. Mgr.: Ziggy Modeliste.

Jon Music. (BMI) PO Box 233, 329 N. Main St., Church Point, LA, 70525, (318) 684-2176. Fax: (318) 684-2176. Pres./Gen. Mgr.: Lee Lavergne; Professional/Creative Mgr.: Lee Lavergne.

Jonan Music. (ASCAP) (See Malaco Music Group).

Jonathan Mark Music. (ASCAP) (See The Sparrow Corp.).

Jonathan Three Music Co., (See S H R Publishing).

Jonco Music. (ASCAP) 7105 Reynolds St., Pittsburgh, PA, 15208, (412) 247-1301. Pres.: Jon Gorr; Gen. Mgr.: Rebecca Ogan.

Jondi Music. (BMI) 130 W. 42nd St., #1106, New York, NY, 10036, (212) 819-0920. Fax: (212) 768-7822. Gen. Mgr.: Jon Soleather.

Jondil. (ASCAP) 306 Millwood Dr., Nashville, TN, 37217, (615) 366-9999. Pres.: Jack Lynch.

Jondora Music. (See Fantasy, Inc.).

Deborah Jones Publishing Co., (See Joe Jones Copyright Mgmt.).

Jennifer Jones Music Publishing Co., (See Joe Jones Copyright Mgmt.).

Joe Jones Copyright Mgmt., (JJMPCV) 10556 Arnwood Rd., Lake View Terrace, CA, 91342, (818) 890-0730, (818) 890-0977. Fax: (818) 899-4457. Pres.: Joe Jones, Sr.; Gen. Mgr.: Dwayne Jones; Professional/Creative Mgr.: Marion Jones.

Jongleur Music, (ASCAP) 9015 Owensmouth Ave., #106, Canoga Park, CA, 91304, (818) 341-0454. Pres.: Gary Revel.

LoRo Music Corp., (ASCAP) (See Larry Spier, Inc.).

Josena Music, (SESAC) PO Box 566, Los Altos, CA, 94022, (408) 746-3555. Pres.: Joe Nardone.

Joshada Music, (BMI) (See Jokay Music).

Josie Cracks Gum, (BMI) (See CORE Entertainment Corp.).

Jowat Music, (See Gopam Entns., Inc.).

Mary Joyce Publishing Co., 100 Oak Lawn Rd., Edwardsville, IL, 62025. Pres.: Mary Joyce.

Joye Music, (BMI) (See Around The World Music).

Joyful Wisdom Music, (BMI) (See Alkatraz Corner Music).

Ju-Bop/Meshvagh Music, (ASCAP/BMI) (See Raybird Music).

Jubilation Music, (BMI) (See Fydek Music).

Juju Raga Music, (BMI) (See Shkere Music).

Jump Edizioni Musicali, (SIAE) (See Alpha Music, Inc.).

Jumpin' Off Music, (BMI) (See Avatar Publishing Group).

Jury, (See Fantasy, Inc.).

Jusko Publications, (See Willis Music Co.).

Just A Note, (BMI) (See Two John's Music).

K

KLW Int'l, Inc., PO Box 806, Marmora, NJ, 08223, (609) 391-0872. Pres.: Kevin L. Weakland.

K-tel Int'l, Inc., 15525 Medina Rd., Plymouth, MN, 55447, (612) 559-6800. Fax: (612) 559-6815. Pres.: Mickey Elfenbein; Professional/Creative Mgr.: Owen Husney. Branch(es): 10 Grenoble Dr., #1516, Don Mills, ON, M3C 1C7, Canada, (416) 423-0210. Fax: (416) 423-0210. Nat'l Sales Mgr.: Lorne Lichtman; Hameentie 157A, Helsinki, 00560, Finland, (358) 07571522. Fax: (358) 07906653. Managing Dir.: Jorma Kosonen; Ramonville Strasse 2, 3 Stock, Karben, 6367, Germany, 49-6039-3335. Fax: 49-6039-43332. Managing Dir.: Conni Stephan; 30/32 Sir John Rogerson's Quay, Dublin, 2, Ireland, 353-1-714011. Fax: 353-1-770426. Managing Dir.: Shay Hennessy; 47 Brown St., Ponsonby, Auckland, 1, New Zealand, 64-9-787-561. Fax: 64-9-780-452. Managing Dir.: Diana Creighton; Windmill Ct., 192 Windmill Ln., Greenford, Middlesex, UB6 9DW, United Kingdom, 44-81-566-6789. Fax: 44-81-575-2264. Managing Dir.: Pat Broderick.

Kack Klick Publishing, Inc., (BMI) 645 Titus Ave., House of Guitars, Rochester, NY, 14617.

Kadoc Music, (BMI) (See ADRA Music).

Kae-Lyn Music, (See Gopam Entns., Inc.).

Kahana Music Pub. Co., (BMI) (See Crystal Music Publishers, Inc.).

Kaizan Music c/o Jacobson & Colfin, (ASCAP) 156 Fifth Avenue, Ste. 434, New York, NY, 10010, (212) 691-5630. Fax: (212) 645-5038. Pres.: John Kaizan Neptune; Gen. Mgr.: Jeffrey E. Jacobson.

Edwin F. Kalmus Music Publications, (See CPP/Belwin, Inc.).

Kamaaina Music, Inc., (ASCAP) (See Crystal Music Publishers, Inc.).

Kamalar Publishing, (ASCAP) (See David Rubinson Publishing).

Kamishi Publishing (div. Arway Records & Ents., Inc.), (ASCAP) PO Box 584, Marion, AR, 72364, (501) 732-6454. Pres.: Marion "Mikii" Hooper; Gen. Mgr.: Cleo Cashe.

Kander & Ebb, Inc., (BMI) (See Valand Publishing Group).

Kansas By The Sea, (ASCAP) 270 N. Canon Dr., Ste. 1057, Beverly Hills, CA, 90210.

Karefree Music Publishing Co., (ASCAP) (See The Fred Morris Music Group, First Million Music, Inc.).

Karjan Music Publishing Co., (SESAC) PO Box 205, Beechwood Club Rd., White Lake, NY, 12786, (914) 583-4471. Pres.: Mickey Barnett; Gen. Mgr.: Mike Pell.

Karlamar Music Publishing Co., (BMI) (See The Fred Morris Music Group).

Katch Nazar Music, (ASCAP) (See Rose Hill Group).

Kaupp's & Robert Publishing Co., (BMI) PO Box 5474, 3274-C Tomahawk Dr., Stockton, CA, 95205, (209) 948-8186. Fax: (209) 942-2163. Pres.: Nancy L. Merrihew; Gen. Mgr.: Robert Merrihew; Professional/Creative Mgr.: Rick Webb.

Kayman Music Co., (BMI/ASCAP) (See Crown Music Group, Inc.).

Ke-Dw-De Music Publishing Co., (See Joe Jones Copyright Mgmt.).

Joe Keene Music Co., (BMI) PO Box 602, 200 S. Bypass, Kennett, MO, 63857, (314) 888-2995. Pres./Gen. Mgr.: Joe Keene.

Keeta Music Co., (BMI) (See Sea Cruise Music).

Kel-Jon Publishing, (ASCAP) PO Box 699, Newark, TX, 76071, (817) 489-2226. Fax: (817) 489-2098. Pres./Gen. Mgr.: Win Kutz; Professional/Creative Mgr.: Loren Johnson.

Kelins Craft Music Co., (ASCAP) PO Box 801, Beverly Hills, CA, 90213, 6922 Hollywood Blvd., Ste. 220, Beverly Hills, CA, 90028, (213) 463-0056. Gen. Mgr.: M. Kelly.

Katie Kelley Music, (ASCAP) (See Faro Music Publishing).

Kellijai, (ASCAP) (See Pollybyrd Publications Ltd.).

Kelling Kraft Music, (ASCAP) 6922 Ho lywood Blvd., Ste. 220, Hollywood, CA, 90028, (213) 463-0056. Gen. Mgr.: M. Kelly; Professional Mgr.: Demetric Collins.

Kells, (ASCAP) 64 New Hyde Park Rd., Garden City, NY, 11530, (800) 854-3746. Fax: (516) 354-7768.

Kelly Music Publications, (BMI) (See Country Star Music).

Kenning Prods., (BMI) PO Box 1084, Newark, DE, 19715, (302) 292-1445. Pres.: Kenny Mullins.

Keno Publishing, (BMI) PO Box 4429, 600 W. 28th, Ste. 105, Austin, TX, 78765, (512) 477-3909. Pres.: Keith A. Ayers.

Kentucky Colonel Music, (BMI) PO Box 5853, Pasadena, CA, 91117, (818) 355-0181. Fax: (818) 793-5753. Pres.: John M. Delgato.

Kentucky Sweetheart Music, (BMI) PO Box 17087, Nashville, TN, 37217, 40 Fiberglass Dr., Mount Juliet, TN, 37122, (615) 754-6100. Fax: (615) 754-8007. Gen. Mgr.: Martha Taylor; Melissa Hill.

Kentucky Wonder Music, (BMI) 1027 Swathmore Ave., Ste. 138, Pacific Palisades, CA, 90272, (213) 454-0306. Fax: (213) 459-8185. Pres.: Michael P. Reilly; Professional/Creative Mgr.: Michael E. Conroy.

Kenwall Publishing, (ASCAP) (See Chip 'N' Dale Music Publishers, Inc.).

Kenwood Music, (BMI) (See Songs For Today).

Kenyon Publications, 361 Pin Oak Ln., Westbury, NY, 11590, (516) 333-3236. Owner: Alberto DeVito.

Keristene Music, Ltd., 919 South E. St., Oxnard, CA, 93030, (805) 487-7140. Pres.: Kenneth Howard Smith; Professional Mgr.: Kristine J. Smith; Vice Pres.: Irene J. Tarbell.

Keuka Music, (See You Heard It—Hear!).

Key of B Music, (ASCAP) (See HoriPro Entertainment Group).

Keymary Music, (BMI) (See Southern Arts Music).

Keytekey Music, (ASCAP) (See Glen Campbell Music Group).

Kicking Mule Publishing, Inc., (BMI) PO Box 158, 10 Springs Ranch, Alderpoint, CA, 95411, (707) 926-5312. Fax: (707) 926-5250. Pres.: Ed Denson; Mktg.: Mary Alice Denson.

Kid and the Squid Music, (ASCAP) (See The Sparrow Corp.).

Kidada Music, (BMI) (See West Music Publishing).

Kidco Music, (ASCAP) 1327 Cabrillo Ave., Torrance, CA, 90501, (213) 533-9514. Pres.: Madeleine Smith.

Kinectic Collections Songs, (ASCAP) (See Int'l Record Syndicate Music, Inc.).

Kinetic Kolections Songs, (ASCAP) (See First Release Music Publishing).

King Coal Music, Inc., (ASCAP) (See Coal Miners Music).

King Eugene Production, (See It's Really Rob Music).

King Kozmo Music, (See Randy Klein Music).

Don King Music Group, Inc., PO Box 110911, Nashville, TN, 37222, 19 Music Sq. W., Nashville, TN, 37203, (615) 256-0580. Pres.: Don King.

Earl King Music, (BMI) (See Shirley's Music).

K. L. King Music House, (SESAC) (See C. L. Barnhouse Co.).

Kingsport Creek Music, (BMI) PO Box 6085, Burbank, CA, 91510. Pres.: M. Kaye; Gen. Mgrs.: A. Zedalis; Professional Mgr.: M. Fitzgerald.

Kingston Int'l Publishing Co., (BMI) 9 Cygnat Dr., Smithtown, NY, 11787, (516) 724-7644. Gen. Mgr.: Bob Szilagy; Professional/Creative Mgr.: Ima Harrison.

Kips Bay Music, (ASCAP) (See Raybird Music).

Kipteez Music, (ASCAP) (See Avatar Publishing Group).

Jimmy Kish Music Publishing Co., (BMI) PO Box 140316, Nashville, TN, 37214, (615) 889-6675. Professional/Creative Mgr.: Jimmy Kish.

Kiva Voices, (ASCAP) 904 Rayner, Memphis, TN, 38114, (901) 278-1888. Fax: (901) 725-1983. Pres.: Gary R. Belz.

Kjos West, (ASCAP) (See Neil A. Kjos Music Co.).

Neil A. Kjos Music Co., 4382 Jutland Jr. Dr., San Diego, CA, 92117, (619) 270-9800. Fax: (619) 270-3507. Pres.: Neil A. Kjos, Jr.; Sales Mgr.: Donald Minaglia.

Randy Klein Music, (BMI) 498 West End Ave. #1B, New York City, NY, 10024, (212) 580-9065. Pres.: Randy Klein.

Klesmer Music, (ASCAP) (See Mary Williams Music Clearance Corp.).

Klickitat Music, (BMI) 1931 SE Morrison, Portland, OR, 97214, (503) 238-4525. Fax: (503) 236-8347. Gen. Mgr.: Russ Gorsline.

Night After Knight Music, (BMI) (See Malaco Music Group).

Michael Knight Music, (BMI) (See Tenalina Music).

Knight Music Publishers, (BMI) (See Firedrum Music Publishers).

Howard Knight Music, (SESAC) (See Tenalina Music).

Kobal Music, (BMI) PO Box 1928, Kingsport, TN, 37662, (615) 349-6860. Pres.: Peter Kobal; Gen. Mgr.: Nicholas Kobal; Professional/Creative Mgr.: Margaret Kobal; Suzanne Kobal.

Koch Int'l Corp., 2700 Shames Dr., Westbury, NY, 11590, (516) 333-4800. Fax: (516) 333-4818. Pres.: Michael Koepfle; A & R: Michael Fine.

Ted Koehler Music Co., (ASCAP) (See Fred Ahlert Music Corp.).

Kohaw Music, Inc., (ASCAP) (See The Bicycle Music Co.).

Koke Moke & Noke Music, (BMI) PO Box 724677, Atlanta, GA, 30339, (404) 926-3377. Fax: (404) 926-2774. Pres.: John Abbey; Gen. Mgr.: Bryan Cole.

KoKoMo Music, (ASCAP) (See Bob-A-Lew Music).

Konitz Music, (BMI) (See Raybird Music).

Koscusko Music, (SESAC) (See Malaco Music Group).

Krandon Music, (BMI) (See AMCORP Group).

Krismik Music, (ASCAP) (See De Walden Music Int'l, Inc.).

Kristal Int'l Music, (SESAC) (See Newwriters Music).

Kubaney Publishing Corporation, (BMI) (See Carimusic Corporation).

Kunstler Music, (BMI) (See Music For Life Publishing).

Kuper-Lam Music, (BMI) PO Box 66274, Houston, TX, 77266, (713) 520-5791. Fax: (713) 661-4357. Pres.: Ivan Kuper; Gen. Mgr.: Hank Lam.

L

L.C. Kat, (See Own Write Music).

LITA Music, (ASCAP) 3609 Donna Kay Dr., Nashville, TN, 37211, (615) 331-6056. Fax: (615) 831-0991. Pres./Gen. Mgr.: Benjamin Peters.

L & N Music, (See Al Gallico).

LaBell Music Pub., (ASCAP) (See Brunswick Music Publishing).

Morgan La Fey Music, (BMI) PO Box 11372, Burbank, CA, 91570, (213) 913-7135. Fax: (213) 962-9176. Pres.: Ann Boleyn.

La Jolla Music Co., (BMI) (See Neil A. Kjos Music Co.).

La Lou Music, (BMI) 711 Stevenson St., Lafayette, LA, 70501, (318) 234-5577. Pres./Gen. Mgr.: David Rachou.

La Papaya Music, (BMI) (See De Walden Music Int'l, Inc.).

La Rana/El Porto Music, PO Box 3628, 11264 Playa Ct., Culver City, CA, 90231, (213) 390-9969. Fax: (213) 391-8356. Pres.: William Hein; Professional Mgr.: Brian Fukuji; Vice Pres.: James McCarthy.

Labirt Music Publishing, (BMI) (See James Hendrix, Composer & Publisher).

Lakesound Music, (ASCAP) (See American League Music).

Lamasco Music, (BMI) 4416 Eatons Creek Rd., Nashville, TN, 37218, (615) 876-1729. Pres./Professional/Creative Mgr.: D.M. Haddock; Gen. Mgr.: D.E. Bolling.

Lambert & Potter Music, (BMI) (See Rent-A-Song).

Dennis Lambert Music, (BMI) (See Rent-A-Song).

Lambros Music, (BMI) (See Rent-A-Song).

Lamoka Music, (See You Heard It—Hear!).

Lang Percussion, Inc., (See Music for Percussion, Inc.).

Language of Sound, Inc., (ASCAP) (See Fricon Music Co.).

Largo Music, Inc., (ASCAP) 425 Park Ave., New York, NY, 10022, (212) 371-9400. Gen. Mgr.: John Murro; Creative Dir.: Eddie Lambert. Branch(es): 606 N. Larchmont Blvd., Los Angeles, CA, 90004, (213) 464-8322.

Larrabee Publications, (See Ashley Publications, Inc.).

Larsongs, (BMI) (See Highest Praise Publishing Co.).

Laser Beam, (BMI) 812 W. Darby Rd., Havertown, PA, 19083, (215) 446-7100. Fax: (215) 446-7721. Pres./Gen. Mgr.: Denny Somach.

Last Word Music, (BMI) PO Box 692, 1627 Troy Dr., Madison, Middleton, WI, 53562, (608) 241-0051. Pres.: Bill Schereck; Gen. Mgr.: Jeff Ross.

Latin American Music Co., Inc., PO Box 1844 Cathedral Sta., New York, NY, 10025, (212) 993-5551. Fax: (212) 993-5553. Pres.: L. Raul Bernard; Gen. Mgr.: Dolores Vera; Professional/Creative Mgr.: Mary Huertas.

Latin Records Publishing, (ASCAP) (See Mateo San Martin Agency, Inc.).

Latter End Music, (BMI) (See Glen Campbell Music Group).

Latter Rain Music, (ASCAP) (See The Sparrow Corp.).

Laurmack Music, (ASCAP) 655 Wyona St., Brooklyn, NY, 11207, (416) 597-0066. Pres.: Alfred McCarther.

Laymond Publishing Co., (BMI) PO Box 25371, Charlotte, NC, 25371, 7017 Harris Blvd., Charlotte, NC, 28215, (704) 535-7263. Fax: (704) 537-0133. Pres.: Carlton Moody; Gen. Mgr.: David Moody.

Lazer Songs, (SAMRO) (See Fruit Music).

Le Bill Music Inc., (BMI) PO Box 1152, Ft. Worth, TX, 76110, (817) 738-8843. Pres.: Major Bill Smith.

Le Mango Music, (ASCAP) (See De Walden Music Int'l, Inc.).

Leacom Publishing, (BMI) (See Tandem Tunes, Inc.).

Leah Music Catalog, (ASCAP) (See Henry Jerome Music, Inc.).

Leaning Mirror, (BMI) (See Pure & Simple Prods.).

Lease-A-Tune, (ASCAP) (See Rent-A-Song).

Least of All Music, (BMI) (See Bestall & Reynolds).

Norman Lee Publishing, (ASCAP) (See C. L. Barnhouse Co.).

Leeds Music, (ASCAP) (See MCA Music Publishing).

LeFrak Moelis Music Co., (See SHR Publishing).

LeFrak Moelis Record Co., (ASCAP) (See Saja Music Co.).

LeFrank Entertainment Music Pub., (See SHR Publishing).

Legs Music Inc., (See ABKCO Music Inc.).

Legz Music, (BMI) (See Ciano Publishing).

Lehrae Music, (BMI) (See Malaco Music Group).

Leiber-Stoller, (ASCAP) 9000 Sunset Blvd., Ste. 1107, Los Angeles, CA, 90069, (213) 273-6401. Fax: (213) 273-1591. Exec. Vice Pres./Gen. Mgr.: Randy Poe.

Leiber-Stoller Songs, Inc., (ASCAP) (See Leiber-Stoller).

Jerry Leiber Music, (ASCAP) (See Leiber-Stoller).

Ty Lemley Music, (ASCAP) 100 S. Crestline Dr., Ste. 47, Las Vegas, NV, 89107, (702) 878-3476. Pres.: Ty Lemley; Gen. Mgr.: Bud Lemley; Professional Mgr.: Tolmena Lemley.

Lemon Square Music, (ASCAP) PO Box 671008, Dallas, TX, 75367, 11347 Park Central Pl., Dallas, TX, 75230, (214) 750-0720. Fax: (214) 987-4638. Pres./Gen. Mgr.: Bart Barton; Professional/Creative Mgr.: Mike Anthony.

Len-Johns Pub., (BMI) (See Ragland Publications).

Leo-Vincent Music, (ASCAP) 5934 Blairstone Dr., Culver City, CA, 90230, (213) 558-8168. Gen. Mgr.: Leonardo V. Wilborn.

Leona Music Publishing Co., 239 W. 18th St., New York, NY, 10011, (212) 989-7200. Fax: (212) 633-8022. Pres.: Ervin Lutkei; Gen. Mgr.: Donald Tannen; Professional/Creative Mgr.: Ethel Gabriel.

Hal Leonard Publishing Corp., (ASCAP/BMI) PO Box 13819, 7777 W. Bluemound Rd., Milwaukee, WI, 53213, (414) 774-3630. Fax: (414) 774-3259. Pres.: Keith Mardak; Vice Pres. Bus. Affairs: Mary Bultman.

Leonarda Productions, Inc., (ASCAP) PO Box 1736, Cathedral Sta., New York, NY, 10025, (212) 666-7697. Pres./Gen. Mgr.: Marnie Hall.

Leonbea, (SESAC) (See Tyscot Publishing).

Leslie Music, (ASCAP) (See Neil Music, Inc.).

Let Cord Music, (SESAC) (See Mick Lloyd Prods.).

Let There Be Music, (ASCAP) (See Southern Writers Group, USA).

Let's Shine Music. (ASCAP) (See David Rubinson Publishing).
 Wayne Leupold Editions. (See E.C. Schirmer Music Co., Inc.).
 Levelland Publishing Co., (BMI) (See Crazy Cajun Music).
 Lew-Bob Songs, (BMI) (See Bob-A-Lew Music).
 Lewis Music Publishing Co., Inc., (ASCAP) (See Ashley Publications, Inc.).
 Lexy Girl Music. (ASCAP) (See Joel S. Turtle).
 Liaison II Publishing. (BMI) (See American League Music).
 Liberator Music. (BMI) (See Brat Music).
 Lichelle Music Co., (ASCAP) 4215 Hood Ave., Burbank, CA, 91505, (213) 849-7409. Fax: (818) 845-4995. Pres.: Dean Kay, Vice Pres.: Michelle Kay.
 Lienau, (ASCAP) (See C.F. Peters Corp.).
 Life and Death Music. (BMI) PO Box 3654, 6716 Zeland Way, Hollywood, CA, 90078, (213) 465-7086. Fax: (213) 465-9622. Pres.: Kim Kruger; Gen. Mgr.: Honey Davis.
 Life Fantasy Music. (BMI) (See Life of the Record Music, Inc.).
 Life of the Record Music, Inc., (ASCAP) PO Box 158611, 1025 17th Ave. S., Nashville, TN, 37215, (615) 327-2457, (615) 327-2227. Pres./Gen. Mgr.: Johnny Rutenschroer; Professional Mgr.: Debra Rogers.
 Lifestream. (ASCAP) (See Songs of Calvary).
 Lift Him Up Music, c/o Jacobson & Colfin, P.C., (ASCAP) 156 Fifth Ave., Ste. 434, New York, NY, 10010, (212) 691-5630. Fax: (212) 645-5038. Pres.: Paul Ferrar; Gen. Mgr.: Jeffrey E. Jacobson.
 Light & Sound Music Inc., (ASCAP) (See Tri-She Kieta Publishing Inc.).
 Lightforce Music. (ASCAP) 1054 Conifer Ln., Petaluma, CA, 94954, (707) 762-4858. Pres./Gen. Mgr.: G.W. Daniel; Professional/Creative Mgr.: Shelly Holling.
 Lightning Creek Music. (BMI) PO Box 192, Pittsburg, KS, 66762, (316) 231-6443. Pres.: John Poznich; Gen. Mgr.: Gene Strasser.
 Lil Bo-Dean Music. (ASCAP) (See DeWhit Music).
 Lillenas Publishing Co., (SESAC) PO Box 419527, Kansas City, MO, 64141, 2923 Troost Ave., Kansas City, MO, 64109, (816) 931 1900. Fax: (816) 753-4071. Pres.: Robert L. Foster; Gen. Mgr.: Harlan Moore.
 Lily Pond Music. (BMI) (See Cherie Corp.).
 Lincoln Lines Publishing. (BMI) 23 Valentine St., Cambridge, MA, 02139, (617) 491-7780. Pres.: John Lincoln Wright.
 Lincoln Road Music Co., (BMI) (See Joe Keene Music Co.).
 Dennis Linde Music. (BMI) (See SBK Entertainment World, Inc.).
 Doris Lindsay Publishing. (ASCAP) (See Better Times Publishing).
 Lindseyanne Music, Inc., (BMI) 13385 W. Dixie Dr., North Miami, FL, 33161, (305) 893-9191. Fax: (305) 895-2647. Pres.: Steve Alaimo; Gen. Mgr.: Howard Albert; Professional/Creative Mgr.: Ron Albert.
 Lineage Pub. Co., (BMI) PO Box 211, East Prairie, MO, 63845, (314) 649-2211. Pres.: Tommy Loomas; Gen. Mgr.: Joe Silver; Professional Mgr.: Alan Carter.
 Linesider Prods., (BMI) PO Box 57, 10 George St., Wallingford, CT, 06492, (203) 269-4465. Fax: (203) 294-1745. Pres.: Thomas "Doc" Cavalier, Gen. Mgr.: Edyth Mercier.
 Lin's Lines, c/o Jacobson & Colfin, P.C., (ASCAP) 156 Fifth Ave., Ste. 434, New York, NY, 10010, (212) 691-5630. Fax: (212) 645-5038. Pres.: Linda Jacobson; Gen. Mgr.: Marc Moel; Professional/Creative Mgr.: Jeffrey E. Jacobson.
 Lion Hunter. (BMI) Box 110678, Anchorage, AK, 99511, (907) 349-2456. Pres.: David C. Connert, Jr.
 Lipservices. (ASCAP/BMI) 1841 Broadway, Ste. 411, New York, NY, 10023, (212) 956-2880. Fax: (212) 956-2114. Pres.: Julie Lipsius; Professional Mgr.: Joey Gmerek; Contact: Jonathan Mann.
 Lipstick Traces Music Publishing. (BMI) (See Tracy Sands Music).
 Little Big Town Music Group, 303 18th Ave. S., Nashville, TN, 37203, (615) 321-5286. Fax: (615) 329-4128. Pres./Gen. Mgr.: Woody Bomar.
 Little Cowboy. (ASCAP) (See Little Richie Johnson Music).
 Little Darlin' Music. (BMI) (See Martin Cooper Music).
 Little M Publishing Co., (BMI) (See Su-Ma Publishing Co.).
 Little Pumpkin Music c/o Publishers' Licensing Corp., (ASCAP) PO Box 5807, Englewood, NJ, 07631, (201) 568-3996. Fax: (201) 569-9580. Pres.: Lis Jones.
 Live Music Pub. Corp., (BMI) 793 Bingham Rd., Ridgewood, NJ, 07450, (201) 447-4700. Fax: (704) 447-4708. Pres.: Ed Newmark.
 Living Song Records. (See Epoch Universal).
 Llee Corp., (BMI) (See Cherie Corp.).
 Mick Lloyd Prods., 1018 17th Ave. S., #11, Nashville, TN, 37212, (615) 329-9093. Fax: (615) 329-9094. Pres.: Mick Lloyd.
 Loaves & Fishes Music Co., Inc., (BMI) (See The Bicycle Music Co.).
 Locked Up Music, Inc., (BMI) 800 Tower Bldg., 1809-Seventh Ave., Seattle, WA, 98101, (206) 292-8772. Fax: (206) 292-8727. Pres.: Ed Locke.
 Lodestar Music. (SESAC) (See Chip 'N' Dale Music Publishers, Inc.).
 Lodge Hall Music Inc., (ASCAP) (See BMG Music Publishing Inc.).
 Dick Loftin Music. (BMI) 1722 S. Carson Ave. Ste. 2607, Tulsa, OK, 74119, (918) 585-5050. Pres./Gen. Mgr.: Dick Loftin.
 Loftunes. (See Dick Loftin Music).
 Londontown Music. (ASCAP) (See Garrett Music Ents.).
 Lone Lake Songs, Inc., (ASCAP) (See RCI Music Group).
 Loney Tunes Music. (ASCAP) (See Solid Smoke Songs).
 Long Tooth Music. (BMI) 15250 Ventura Blvd., Ste. 900, Sherman Oaks, CA, 91403, (818) 990-0550.

Longhorn Records. PO Box 93457, Hollywood, CA, 90093.
 Lonn' Vanessa Songs. (SESAC) (See Pollybrd Publications Ltd.).
 Lookout Music. (ASCAP) (See AVI Music Publishing Group, Inc.).
 Loose Ends Music. (ASCAP) (See Don King Music Group, Inc.).
 Lord Burgess Music Publishing Co., (ASCAP) (See Cherry Lane Music Publishing Co., Inc.).
 Lord Hume Music. (ASCAP) (See Dhanus Music Publishing).
 Lorenz Creative Svcs., (ASCAP) (See BMG Music Publishing Inc.).
 Lorimar Music Publishing, Inc., (See Warner/Chappell Music, Inc.).
 Lovville Music. (SESAC) (See Terrace Entertainment Corp.).
 Lou-Lee Music Co., (BMI) (See Alexis Music, Inc.).
 Lou de Lis Prods., (BMI) (See Bocage Music).
 Love Music Co., (ASCAP) (See Alan Hartwell Music).
 Love Street Publishing. (BMI) PO Box 35001, 5311 SW Ninth St., Ste. E, Des Moines, IA, 50315, (515) 285-6564. Fax: (515) 285-2333. Pres.: Art Stenstrom.
 Love Thing. (ASCAP) (See Cornerstone Mgmt.).
 Love This Town Music. (ASCAP) (See Little Big Town Music Group).
 Lovely Sorts of Death. (See La Rana/El Porto Music).
 Lyle Lovett Music. (ASCAP) (See Criterion Music Corp).
 Lovey Music, Inc., (BMI) PO Box 630755, Miami, FL, 33163, (305) 935-4880. Fax: (305) 933-4007. Pres.: Jack Gate.
 Low Dog Music Co., (ASCAP) (See Major Bob Music).
 Low-Flying Angels Music, c/o Jacobson & Colfin, P.C., (BMI) 156 Fifth Ave., Ste. 434, New York, NY, 10010, (212) 691-5630. Fax: (212) 645-5038. Pres.: Beth Travers; Business Affairs: Jeffrey E. Jacobson.
 Low-Sal Music Co., Inc., (BMI) (See Lowery Music Co., Inc.).
 Low-Twi Music Co., Inc., (BMI) (See Lowery Music Co., Inc.).
 Lowery Music Co., Inc., (BMI) 3051 Clairmont Rd. NE, Atlanta, GA, 30329, (404) 325-0832. Fax: (404) 325-1075. Pres.: Bill Lowery; Professional Mgr.: Joseph Carrier; Professional/Creative Mgr.: Butch Lowery.
 Ludlow Music, Inc., (BMI) (See TRO (The Richmond Organization)).
 Lurch Music. (BMI) Rt. 1, Box 2273, Miles City, MT, 59301, (406) 232-1683. Pres.: Burch Ray.
 Lusi-Fun-Fun/Zomba Ents. Inc., 1114 17th Ave. S., Nashville, TN, 37212, (615) 321-4850. Fax: (615) 321-4616. Gen. Mgr.: Michael Hollandsworth; Professional Mgr.: Thad Tarleton.
 Lusty Laura Music. (BMI) (See Heartake Songs).
 Luverne Publications. (See Southern Music Co.).
 Luxikon Music. (BMI) PO Box 2281, Westover, WV, 26505, Pres.: Gilbert Trythall.
 Lyn Pen Publishing. (BMI) (See Al Marie Music).
 Lynclay Publications. 19938 Patton, Detroit, MI, 48219, (313) 533-4506. Fax: (313) 533-6226. Pres.: Charles Clay; Gen. Mgr.: Lynette Clay.
 Lynstorm Publishing Co., (ASCAP) (See Irving Mills Music, Publishers Representative).

M

MAJ Music Corp., (ASCAP) (See Larry Spier, Inc.).
 MAM, (ASCAP) (See Chrysalis Music Group, Inc.).
 MBS Publishing Int'l, (BMI) (See Ten-East Music Co.).

MCA Music Publishing

(ASCAP) 70 Universal City Plaza, Universal City, CA, 91608, (818) 777-4550. Fax: (818) 777-6218. Pres.: Leeds Levy; Vice Pres./Film-TV Music: Scott James; Vice Pres./Creative Services: Carol Ware; Sr. Dir./Creative Services: Betsy Anthony, Branches: 1755 Broadway, New York, NY, 10019, (212) 841-8000, Fax: (212) 582-7340, Exec. Vice Pres.: John McKellen, Vice Pres.: Mark Koren, Vice Pres./Talent Acquisition: John Alexander, Vice Pres./Int'l Acquisition: Merrill Wasserman; 1114 17th Ave. S., Nashville, TN, 37212, (615) 327-4622, Fax: (615) 320-7639, Vice Pres./Gen. Mgr.: Steve Day, Dir./Creative Services: Dave Loggins.

M.E.G., (BMI) (See Vossword Songs).
 MGM-Pathé Communications Co., 10000 West Washington Blvd., Culver City, CA, 90232, (213) 280-6250. Fax: (213) 558-5993. Dir.: Joachim H. Hansch; Licensing Mgr.: Ron Duverny.
 MHZ Publishing. (BMI) (See Ten-East Music Co.).
 MJQ Music, Inc., (BMI) 1697 Broadway, New York, NY, 10019, (212) 582-6667. Fax: (212) 582-6667. Pres.: John Lewis; Gen. Mgr.: Paul Schwartz.
 MMO Music Group, 50 S. Buckhout St., Irvington, NY, 10533, (914) 591-5100. Fax: (914) 591-5103. Pres./Professional Mgr.: Irv Kratka; Gen. Mgr.: David Kratka.
 MPL Communications, Inc., (ASCAP) 39 W. 54th St., New York, NY, 10019, (212) 246-5757. Fax: (212) 977-8408. Gen. Mgr.: Thomas W. McCade; Contact: Joseph Weiss.
 M.S.J. Publishing Co., (BMI) 9377 Lincoln Blvd., Ste. 2269, Los Angeles, CA, 90045, (213) 568-8952. Pres.: Mark St.Justice; Gen. Mgr.: Robert Roundtree; Professional/Creative Mgr.: Bonnie Berry.
 Ray Mack Music. (ASCAP) (See National Music Co.).
 Macolia Music. (BMI) 8831 Sunset Blvd., Ste. 202, West Hollywood, CA, 90069, (310) 659-6036. Fax: (310) 659-6039. Pres.: Don MacMillan; Gen. Mgr.: Lee Denton; Professional/Creative Mgr.: James Takeda.

Macy Place Music. (ASCAP) 228 Bermuda Dr., Nashville, TN, 37214, (615) 889-0229.
 Mad Monkey Music. (ASCAP) 11231 Otsego St., #114, North Hollywood, CA, 91601, (818) 980-4385. Pres.: Mark W. Vidito.
 Madelon Music. (BMI) (See Audio Arts Publishing Co.).
 Madrak Music. (ASCAP) (See WestTunes Music c/o Westwood Entertainment Group).
 Magic Castle. (See NEM Entertainment Corp.).
 Magic Fleet Music. (BMI) (See Brookside Music Corp.).
 Magic Light Music. (BMI) (See Miraleste Music Co.).
 Magic Message Music. (ASCAP) PO Box 1345, 7915 Forest Glenn Dr., Kings Beach, CA, 96143, (916) 546-5381. Pres.: Alan Redstone; Gen. Mgr.: Rene Randell.
 Magic Rainbow Music. (ASCAP) 330 E. 91st St., New York, NY, 10128, (212) 996-0666. Pres.: Marty Dunayer; Gen. Mgr.: Melinda Dunayer.
 Magic Touch Music. (ASCAP) (See Miraleste Music Co.).
 Magnamar Publishing. (BMI) 900 W. Gate Ln., C-8, Bossier City, LA, 71112, (318) 742-5777. Pres.: Lillian Mills; Gen. Mgr.: Bonnie Mills; Professional Mgr.: James W. Dalphonse.
 Main Mansfield Assoc., 50 Music Sq. W., Ste. 200, Nashville, TN, 37203, (615) 329-2020.
 Mainstay Music, Inc., (BMI) (See Al Gallico).
 Majestic Control. (BMI) PO Box 330-568, Brooklyn, NY, 11233, (718) 919-2013. Pres.: Hank Love; Gen. Mgr.: Alan Alemo; Professional Mgr.: Half Pint.
 Major Bob Music. (ASCAP) 1109 17th Ave. S., Nashville, TN, 37212, (615) 329-4150. Pres.: Robert W. Doyle; Gen. Mgr.: Robert M. Frye; Professional Mgr.: Lana Wood.
 Makedwed Publishing Co., (JMPPCPW) 10556 Arnowood Rd., Lake View Terrace, CA, 91342, (818) 890-0730, (818) 890-0977. Fax: (818) 899-4457. Pres.: Marion Coleman; Gen. Mgr.: Joe Jones, Sr.; Professional/Creative Mgr.: Dwayne Jones.
 Makin' Music, Inc., 1230 17th Ave. S., Nashville, TN, 37212, (615) 269-6770. Pres.: Chris Dodson; Gen. Mgr.: Sandra Johnson.
 Makin' Songs Music, Inc., (ASCAP) (See Makin' Music, Inc.).
 Makin' It Up Music, Inc., (BMI) (See Makin' Music, Inc.).
 Malaco Music Group. (BMI) PO Box 9287, Jackson, MS, 39286, (601) 982-4522. Fax: (601) 982-4528. Pres.: Thomas J. Couch; Gen. Mgr.: Stewart Madison.
 Malcolm Music. (BMI) (See Shawnee Press, Inc.).
 Mammoth Music. Carr Mill, Second Floor, Carboro, NC, 27510, (919) 932-1882, ext. 204. Fax: (919) 932-1885. Pres./Creative Mgr.: Jay Fairtex; Gen. Mgr.: Steve Balcon.
 Management Agency Music. (BMI) (See Chrysalis Music Group, Inc.).
 Management III Music. (BMI) (See Cherry Lane Music Publishing Co., Inc.).
 Henry Mancini Ents., (ASCAP) (See All Nations Music Publishing).
 Majack Music. (ASCAP) (See Lipservices).
 Manna Music, Inc., (ASCAP) 25510 Avenue Stanford, Ste. 101, Valencia, CA, 91355, (805) 257-1191. Pres.: Hal Spencer; Gen. Mgr.: Hal Spencer; Professional Mgr.: Arletta J. Klar.
 Mapa Mundi (United Kingdom). (See E.C. Schirmer Music Co., Inc.).
 Marbill Music. (BMI) (See Le Bill Music Inc.).
 Marble Music. (ASCAP) (See Brunswick Music Publishing).
 Marc-Jean Music. (BMI) (See Titan Records).
 March 9. (ASCAP) (See Almo Music Corp.).
 Marchael Music. (ASCAP) PO Box 43135, Upper Montclair, NJ, 07043, (201) 857-2935. Pres.: Richard Reiter; Gen. Mgr.: Susan Feldman.
 Marco Music Group, Inc., PO Box 24454, 1620 16th Ave. S., Nashville, TN, 37202, (615) 269-7074. Fax: (615) 269-0131. Pres.: Jeff Walker; Gen. Mgr.: Terri Walker; Professional/Creative Mgr.: Clayton Cooper.
 Margenia Music. (See Gopam Ents., Inc.).
 Margol Music Co., (BMI) (See Country Music Group).
 Marielle Music Corp., (BMI) PO Box 621, New York, NY, 10019, (813) 841-6155. Pres.: Don Seat; Gen. Mgr.: Amy Polan; Professional Mgr.: Seat.
 Branches: PO Box 14324, Clearwater, FL, 34629.
 Marisamric Music. (BMI) (See We-Us & Co.).
 Mark of Arles Music. (BMI) PO Box L, Inwood Sta., New York, NY, 10034, (212) 567-0411. Fax: (212) 304-2702. Pres./Professional-Crea. Mgr.: Dennis Bell; Gen. Mgr.: Claudette Washington.
 Marko Press. (See Mark Foster Music Co.).
 Marks Central Publishing. (BMI) PO Box 540, Dearborn Heights, MI, 48127, (313) 278-6068. Pres.: Mark S. Shearer.
 Edward B. Marks. (BMI) (See Alley Music Corp.).
 Markyle Music. (BMI) PO Box 3057, Roanoke, VA, 24015, (703) 343-5355. Fax: (703) 343-3240. Pres.: David Freeman; Gen. Mgr.: Gary B. Reid.
 Marlen Music Co., (ASCAP) (See Gordon Music Co.).
 Bob Marley Music Ltd., (ASCAP) (See Almo Music Corp.).
 Marmaduke Music. (ASCAP) (See AMCORP Group).
 Marmor Music Co., (BMI) (See Clockwork Music Co.).
 Marsaint Music, Inc., (BMI) 3809 Clematis Ave., New Orleans, LA, 70122, (504) 949-8386. Fax: (504) 948-3105. Pres./Gen. Mgr.: Marshall E. Sehorn.
 Marshall Songs Music. (BMI) 3175 Mt. Vernon Ave., Riverside, CA, 92507, (714) 788-8327. Pres.: Marshall Heaney.
 Pete Martin Music. (BMI) (See VAAM Music Group).
 Martu Music. (ASCAP) (See Rhineland Music).
 Marullo Music Publishers. (BMI) 1121 Market St., Galveston, TX, 77550, (409) 762-4590. Pres.: A. W. Marullo, Sr.; Gen. Mgr.: A. W. Marullo, Jr.; Professional/Creative Mgr.: Johnny Marullo.
 Andy Marvel Music. (ASCAP) PO Box 133, Farmingville, NY, 11738, (516) 472-1219. Pres.: Andy Marvel.

- Marvel Music Co., (BMI) (See Alexis Music, Inc.).
 Marz Needs Music, (BMI) 2602 NW Fifth Ave., Miami, FL, 33127, (305) 573-5400. Fax: (305) 573-1006. Pres.: Jerry Suarez; Gen. Mgr.: Joe Alonso.
 Master Copy, (See Nathan Bryden Music Co.).
 Masterlease Music Publications, (BMI) PO Box 234, Saint Louis, MO, 63166, (314) 296-9526. Pres.: Bob J. Bax; Gen. Mgr.: Paul J. Bax.
 Mateoconk Music Corp., (BMI) (See Marielle Music Corp.).
 Mateo San Martin Agency, Inc., PO Box 52-7950, 8000 NW 31st, Ste. 17, Maimi, FL, 33152, (305) 591-7684. Fax: (305) 477-4431. Pres.: Mateo San Martin; Professional Mgr.: Gloria Patricia Jaramillo.
 Matra Music, (See SoulStreet Music, Inc.).
 Mattie Ruth Music, (ASCAP) (See Glen Campbell Music Group).
 Maui No Ka Oi Music, (ASCAP) (See Ten of Diamonds Music).
 Mavid Music Publishing Co., (ASCAP) (See Mertis Music Co.).
 Maxim Music, Inc., (ASCAP) (See Cromma Music Co.).
 Maxjacker Music, (BMI) (See Anna Teresa Music Ltd.).
 Mayflower Music Corp., (ASCAP) PO Box 30122, Tucson, AZ, 85751, 4549 E. Fort Lowell, Tucson, AZ, 85712, (602) 326-4400. Fax: (602) 326-3333. Pres.: Eckart Rahn; Vice Pres.: Kathryn A. Riser.
 Mayhow Music, (BMI) (See AMCORP Group).
 Maypop Music, div. of WildCountry Inc., (BMI) PO Box 121192, Nashville, TN, 37212, Contact: Kevin Lamb.
 Maypop Music Group, PO Box 12192, 702 18th Ave. S., Nashville, TN, 37212, (615) 254-8800. Fax: (615) 255-0706. Vice Pres./Gen. Mgr.: Kevin Lamb; Professional Mgr.: Cliff Williamson.
 Mayumi Music, 276 Fifth Ave., Ste. 603, New York, NY, 10001, (212) 889-3226. Fax: (212) 889-3225. Pres.: Teruo Nakamura.
 Delbert McClinton Music, (BMI) (See Bob-A-Law Music).
 Don McLean Music, (BMI) (See Dave Burgess Ent's.).
 McGinnis & Marx Music Publishers, (BMI/ASCAP) 236 W. 26th St., #11S, New York, NY, 10024, (212) 675-1630. Partner: Angelina Marx; Paul Sadowski.
 McLain Family Music, PO Box 467, Berea, KY, 40403, (606) 986-8111. Gen. Mgr.: Betty McLain; Pres./Professional Mgr.: Raymond W. McLain.
 Blake McRae Publishing, (ASCAP) 1156 Forest Ave., Bronx, NY, 10456, (212) 617-4783. Pres.: Crispin Blake McRae.
 Meadowee Music, (BMI) 1727 Roanoke Ave., Sacramento, CA, 95838, (916) 925-4886. Owner: Jerry Parker.
 Meadowlark Music, (ASCAP) 1608 Argyle, Hollywood, CA, 90028, (213) 462-6608. Pres.: Ned Bedell.
 Media Arts Center, (BMI) (See Nickel Records Int'l).
 Mary Megan Music, (ASCAP) (See Newcreation Music).
 Melder Publishing Co., (JMMPCPW) 10556 Arnowood Rd., Lake View Terrace, CA, 91342, (818) 890-0730, (818) 890-0977. Fax: (818) 899-4457. Pres.: Joe Jones; Gen. Mgr.: Marion Jones; Professional/Creative Mgr.: Dwayne Jones.
 Melody House Music Publishers, (BMI) 910 N. Pacific St., #29, Oceanside, CA, 92054, (619) 757-7447. Fax: (619) 757-3128. Pres.: William Bellman; Gen. Mgr.: Bill Bellman; Professional/Creative Mgr.: Myral Bellman.
 Melody Music, (SESAC) (See Gospel Publishing House).
 Melody Trails, Inc., (BMI) (See TRO (The Richmond Organization)).
 Melstep Music, (BMI) (See Woodrich Publishing Co.).
 Memo Music, (ASCAP) (See Orbob Music Inc. c/o Lipservice).
 Memory Lane Music Corp., (BMI) (See Larry Spier, Inc.).
 Meray Music Co., Inc., (ASCAP) (See Mertis Music Co.).
 Mercantile Music, (BMI) 2731 Saundersville Ferry Rd., Mount Juliet, TN, 37122, (615) 754-2444. Pres.: Kent Fox.
 Mercury Music, (SESAC) (See Theodore Presser Co.).
 Meredith Music Publications, (ASCAP) (See Music for Percussion, Inc.).
 Merion Music, (BMI) (See Theodore Presser Co.).
 Merit Music Corporation, 66 Music Sq. W., Nashville, TN, 37203, (615) 327-4494. Fax: (615) 327-4498. Pres.: Guy Beatty; Gen. Mgr./Profession Mgr.: Mike Whelan.
 Mernee Music, (ASCAP) (See Woodrich Publishing Co.).
 Merri Mike Publishing, (See Welch Grape Publishing).
 Merrie Olde Christmas Carolers, (See Prince/SF Publications).
 Merry-Go-Round Melody Co., (BMI) (See Country Music Group).
 Merry Marilyn Music, (BMI) 33717 View Crest Dr., Lake Elsinore, CA, 92530, (714) 245-2763. Pres.: Marilyn Hendricks; Gen. Mgr./Professional Mgr.: Jim Hendricks.
 Mertis Music Co., (BMI) PO Box 21748, 19457 Shrewsbury Rd., Detroit, MI, 48221, (313) 862-5880. Pres.: Mertis John; Gen. Mgr.: Mable John.
 Mester Music Publishing, (BMI) (See James Hendrix, Composer & Publisher).
 Metal Blade Music, 18653 Ventura Blvd., Ste. 311, Tarzana, CA, 91356, (818) 981-9050. Fax: (818) 981-9095. Pres.: Brian Slagel; Gen. Mgr.: Michael Faley.
 Meteor Music, (BMI) (See S & R Music Publishing Co.).
 Frank Metis Music, (ASCAP) 1650 Broadway, New York, NY, 10019, (212) 246-3869. Pres.: Frank Metis.
 Metisse Music, (See Pablo Music).
 Metrolina Publishing Co., (BMI) 13710 Steele Creek Rd., Charlotte, NC, 28217, (704) 588-3998. Pres.: J. R. Branch.
 Metrostar Music, (ASCAP) PO Box 5807, Englewood, NJ, 07631, (201) 568-3996. Fax: (201) 569-9580. Gen. Mgr.: Philip S. Kurnit.
 Mexican Music Copyright, Inc., (BMI) (See Mateo San Martin Agency, Inc.).
 Mia Mind Music, (ASCAP) 500 1/2 E. 84th St., Room 4B, New York, NY, 10028, (212) 861-8745. Fax: (212) 439-9106. Pres.:
 Michael Brooks; Gen. Mgr.: Michael Yonkom; Professional/Creative Mgr.: Steven Bentzel.
 Michele Record Ediciones, (See Telearte Florida, Inc./Music Publishing Co.).
 Mickey Records, (BMI) 127 Monroe Trail, Hopatcong, NJ, 07843, (201) 398-1489. Pres.: Michael F. Matushyn, Sr.
 Mideb Music, (ASCAP) (See Mismam Music).
 Midge's Fist Music, (ASCAP) 22533 Jameson Dr., Woodland Hills, CA, 91364, (818) 222-2169.
 Mighty Nice Music, (BMI) (See Bluewater Music Corp.).
 Mighty Pretty Music, (SESAC) (See Song of the World, Inc.).
 Mighty Ring Music, (BMI) PO Box 862529, Los Angeles, CA, 90086, 2020 N. Main St., Ste. 240, Los Angeles, CA, 90031, (213) 221-2204. Fax: (213) 221-2778. Pres.: Peter Heur; Dean Naleway; Gen. Mgr./Professional/Crea.Mgr.: Linda Trudnick.
 Mighty "T" Music, (ASCAP) (See Highest Praise Publishing Co.).
 The Mighty 3 Music Group, 309 S. Broad St., Philadelphia, PA, 19107, (215) 546-3510. Fax: (215) 985-1195. Vice Pres.: Constance Heigler.
 Milan America, Inc., 635 Madison Ave., New York, NY, 10022, (212) 935-5810. Fax: (212) 754-9590. Pres.: Emmanuel Chamboredon; Gen. Mgr./Professional-Crea.Mgr.: Toby Pieniek.
 Milbern Music, (ASCAP) (See Print Music Co., Inc.).
 Mild Ones Music, (BMI) (See The Bicycle Music Co.).
 Milene Music, Inc., (ASCAP) (See Opryland Music Group, Inc.).
 Miles Ahead Music, (BMI) (See Joel S. Turtle).
 Milkman's Chivalree, Inc., (ASCAP) (See Fourth Floor Music/Fiction Music, Inc.).
 Miller's Daughter Music, (ASCAP) 1229 17th Ave. S., Nashville, TN, 37212.
 Millhouse Music, (BMI) 1710 Roy Acuff Pl., Nashville, TN, 37203, (615) 255-0428. Fax: (615) 244-5928. Pres.: Harold Shedd; Gen. Mgr.: Russ Zavitson; Professional/Creative Mgr.: Russ Zavitson.
 Mills Music, Inc., (ASCAP) (See Filmax Copyright Holdings, Inc.).
 Millstone Music Co., (ASCAP) (See Al Marie Music).
 Milsap Music Inc., (BMI) (See BMG Music Publishing Inc.).
 Mimic Music, (BMI) PO Box 201, Smyrna, GA, 30081, (404) 432-2454. Pres./Gen. Mgr.: Tom Hodges; Professional/Creative Mgr.: Richard Hodges.
 Minds Eye Music, (BMI) PO Box 37040, Raleigh, NC, 27627, (919) 831-9212. Pres.: Donne Weaver.
 Tim Miner Music, Inc., (ASCAP) (See The Sparrow Corp.).
 Minnewaska Music Co., (BMI) (See RCI Music Group).
 Miquick Music, (ASCAP) PO Box 2146, Hollywood, CA, 90078, 16056 E. Amar Rd., La Puente, CA, 91744, (818) 330-6920. Fax: (800) 779-1524. Pres.: Michael Quick.
 Miracle Mile Music, (BMI) (See Respect Music Co.).
 Miracle Music, (ASCAP) (See Blen Music Pub.).
 Miraleste Music Co., (BMI) 8127 E. Lirita Dr., Hollywood, CA, 90046, (213) 650-8891. Fax: (213) 654-3908. Pres./Professional/Creative Mgr.: Richard Delvy; Gen. Mgr.: Tammy Cohen.
 Mismam Music, (ASCAP) 76-05 51st Ave., Elmhurst, NY, 11373, (718) 335-2112. Fax: (718) 335-2184. Pres.: Sam Weiss; Gen. Mgr.: Michael Weiss.
 Misirlou Corporation, (See Ashley Publications, Inc.).
 Miss Hazel Music, (BMI) 100 W. Putnam Ave., Greenwich, CT, 06830, (615) 370-0616. Professional Mgr.: Ron Cornelius; Administrator: Pat Halverson.
 Miss Mischief Music, (BMI) 912 E. Third St., Studio 104, Los Angeles, CA, 90013, (213) 617-3362. Fax: (213) 617-1544. Pres.: Barbara Wright.
 Mississippi River Publishing Co., (ASCAP) (See Music River Publishing).
 Mr. Bones Music Publishing, Inc., (BMI) (See Fred Ahert Music Corp.).
 Mr. Mort Music, Inc., (ASCAP) PO Box 145, Pheasant View, TN, 37146, (615) 746-8608. Fax: (615) 746-2758. Pres.: Charlie Fields; Gen. Mgr.: Bernice Fields.
 Ron "Mister Wonderful's" Music, (BMI) 1730 Kennedy Rd., Louisville, KY, 40216, (502) 774-1066. Pres.: Ronald C. Lewis.
 Mitchell Music Catalog, (ASCAP) (See Henry Jerome Music, Inc.).
 Mobile Fidelity, (See Famous Door Prodn's.).
 Modern Love Songs, (ASCAP) (See Joel S. Turtle).
 Modern Music, (See NEM Entertainment Corp.).
 Modern World Music, (ASCAP) 143 Ave. B, New York, NY, 10009, (212) 529-5881. Fax: (212) 529-5882. Pres.: Gioran Andersson; Gen. Mgr.: Maria Jimenez.
 Moe Jams, (ASCAP) (See Avatar Publishing Group).
 Mole End Music, (ASCAP) (See The Sparrow Corp.).
 Mom Bell Music Publishing Co., (BMI) PO Box 2280, Bala Cynwyd, PA, 19004, (215) 664-1895. Fax: (215) 664-1283. Pres.: Anthony S. Bell; Gen. Mgr./Professional Creative Mgr.: David J. Steinberg, Esq.
 Momentum Music Ltd., (BMI) 4170 Kraft Ave., Studio City, CA, 91604, (818) 762-8271. Fax: (818) 762-7782. Pres.: Andrew Heath; Professional/Creative Mgr.: Charly Prevost. Branch(es): 17-19 Alma Rd., London, SW181AA, United Kingdom, (081) 871-2121. Fax: (081) 871-1766.
 Monitor Recordings, 10 Fiske Pl., Mount Vernon, NY, 10550, (914) 667-2020. Fax: (914) 667-2072. Pres.: Michael Stillman; Gen. Mgr.: Rose N. Rubin.
 Charlie Monk Music, (ASCAP) 3991 Hobbs Rd., Nashville, TN, 37215.
 Monster Music, (ASCAP) (See Bob-A-Law Music).
 Montgomery Publishing, (BMI) 8914 Georgian Dr., Austin, TX, 78753, (512) 836-3194. Pres.: Roy J. Montgomery; Gen. Mgr.:
 Michelle Montgomery; Professional Mgr.: Shirley Montgomery.
 Montparnasse, (SACEM) (See Alpha Music, Inc.).
 Moo Moo Music Corp., (BMI) (See Marielle Music Corp.).
 Mood Music Co., Inc., (ASCAP) (See Shapiro, Bernstein & Co., Inc.).
 Doug Moody Music, (BMI) PO Box 6271, 333 Via Vera Cruz, Oceanside, CA, 92058, (619) 945-2412. Fax: (619) 729-6760. Pres.: Doug Moody; Gen. Mgr.: Eva Watts.
 Moon Hill Mgmt. Inc., (BMI) (See Prophecy Publishing, Inc.).
 Moon June Music, (BMI) 4233 SW Marigold, Portland, OR, 97219, (503) 777-4622. Pres.: Bob Stoutenburg.
 Moon Rock Records, (BMI) (See Ray of Hope Publishing).
 Moon & Stars Music, (BMI) (See Screen Gems-EMI Music, Inc.).
 Moona Music Co., (BMI) PO Box 16367, Jackson, MS, 39236, 123 E. State St., Ridgeland, MS, 39157, (601) 856-2525. Fax: (601) 856-9462. Pres.: James Griffin.
 Moonbow Music, 306 Madison St., Whitesburg, KY, 41858, (606) 633-0108. Pres.: Carolyn H. Sturgill.
 Moonlight Two Music, (BMI) (See Fricon Music Co.).
 Moorpark Music Corp., (ASCAP) (See Marielle Music Corp.).
 Mooter Music Co., (ASCAP) (See Moona Music Co.).
 Mopape Music, (BMI) 334 Third Ave. S., Franklin, TN, 37064, (615) 794-9611.
 More Great Music, (BMI) PO Box 9429, San Rafael, CA, 94912, (415) 459-6800. Fax: (415) 459-4801. Pres.: Allan Kaplan.
 More of the Same Music, (SESAC) (See Malaco Music Group).
 Morganactive Songs, Inc., (ASCAP) 1800 Grand Ave., Nashville, TN, 37212, (615) 383-7970.
 Morhits Publishing Co., (See Duane Music, Inc.).
 Morley Music Co., (ASCAP) 39 W. 54th St., New York, NY, 10019, (212) 246-5757. Fax: (212) 977-8408. Professional Mgr.: Robert Jones.
 Mormon Bridge Music, (BMI) (See Dots & Lines Ink.).
 Morning Dew Publications, (See Conarch Prodn's.).
 Giorgio Moroder Pub., 9348 Civic Center Dr., #101, Beverly Hills, CA, 90210, (818) 761-6906.
 Edwin H. Morris & Co., (ASCAP) (See MPL Communications, Inc.).
 The Fred Morris Music Group, 50 Music Sq. W., #207, Nashville, TN, 37203, (615) 329-2591. Artist Dev. Dir.: Peggy Bradley.
 Most Urgent! Music, (BMI) PO Box 16591, Jackson, MS, 39236, 485 N. Canton Club Circle, Jackson, MS, 39211, (601) 957-7027. Fax: (601) 981-8241. Pres.: Tim Whitsell; Gen. Mgr.: Janis Harper; Professional/Creative Mgr.: Goring Heath.
 Mother Bertha Music, Inc., (BMI) 686 S. Arroyo Pkwy., Penhouse Ste., Pasadena, CA, 91105, (818) 846-9900. Fax: (818) 799-1241. Pres.: Phil Spector; Gen. Mgr.: Janis L. Zavala; Professional Mgr.: Harold Esposito.
 Mountain Empire Music, (BMI) PO Box 3161, Roanoke, VA, 24015, (703) 563-5937. Pres.: Gary B. Reid.
 Mountain Flower Music, (SESAC) (See Maypop Music Group).
 Mountain Ghost Music, (BMI) PO Box 1291, Mount Shasta, CA, 96067, (619) 926-2197. Pres.: Rick Johnson.
 Mountain Green Music, (BMI) (See Sound Column Companies).
 Mountain Heritage Music Co., (BMI) Rt. 3, Box 280, Galax, VA, 24333, (703) 236-9249. Pres.: Bobby Patterson.
 Movietone Music Corp., (ASCAP) (See Sam Fox Publishing Co., Inc.).
 Mudosa, (See Latin American Music Co., Inc.).
 Mudslide Music, (BMI) (See Varry White Music).
 Muffin Stuffin Music, (See La Rana/EI Porto Music).
 Muhlenberg Music, Inc., (BMI) (See World Wide Music, Inc.).
 Multi-Ti Hit Music, (BMI) 50 Music Sq. W., 604, Nashville, TN, 37203, (615) 329-4487. Pres./Gen. Mgr.: Frank Mull.
 Multisongs, (SESAC) (See BMG Music Publishing Inc.).
 Mumbo Jumbo Music, (BMI) (See Slash Music).
 Munificent Music, (BMI) PO Box 2512, Austin, TX, 78768, (512) 250-0392. Pres.: Cass Hook.
 Murbo Music Publishing, (BMI) (See Bourne Co.).
 Murphy Music, (BMI) (See Ultima Thule Music).
 Muscle Shoals Sound Music Publishing Co., (BMI) (See Malaco Music Group).
 Music As Software, Inc., (BMI) (See DMP Publishing, Inc.).
 Music of Calvary, (SESAC) (See Songs of Calvary).
 Music City Music, (ASCAP) (See SBK Entertainment World, Inc.).
 Music Corp. of America, (BMI) (See MCA Music Publishing).

Good things come in small packages.

The Lowery Group is small in size compared to the conglomerates, but we can & do give personal attention to our songs & our writers.



The Good Music Group
LOWERY
 3051 Clairmont Road, N.E.
 Atlanta, GA 30329
 404/325-0832
 FAX 404/325-1075

- Music Craftshop, Inc.**, PO Box 22325, Nashville, TN, 37202, 1012 18th Ave. S, Nashville, TN, 37212, (615) 327-7980. Fax: (615) 321-0464. Pres.: Noel Gibson.
- Music Enterprise Inc.**, (BMI) (See Crazy Cajun Music).
- Music For Life Publishing, (BMI)** PO Box 2803, Hollywood, CA, 90078, (213) 281-3045. Pres./Professional/Creative Mgr.: Paul Korda; Gen. Mgr.: Fred Stevenson.
- Music For Little People, (BMI)** PO Box 1460, 1144 Redway Dr., Redway, CA, 95560, (707) 923-3991. Fax: (707) 923-3241. Pres.: Leib Ostrow; Gen. Mgr.: Jim Deerhawk; Vice Pres. Sales: Stuart Shonfield.
- Music From Now On, (ASCAP)** (See More Great Music).
- Music General Corp. (ASCAP)** 818 18th Ave. S, Nashville, TN, 37203, (615) 327-1700. Fax: (615) 255-7200. Pres.: Jack McFadden; Gen. Mgr.: Jo McFadden; Professional/Creative Mgr.: Stan Barnett.
- The Music Group, (BMI)** 16161 Ventura Blvd., Encino, CA, 91436, (818) 342-1385. Fax: (818) 990-5078. Pres.: Danny Sheridan; Gen. Mgr.: Bonnie Bramlett; Professional/Creative Mgr.: Gene Adams.
- Music Lane Prodn.s., (BMI)** 1100 Music Ln., Ste. 5, Austin, TX, 78704, (512) 447-3988. Pres.: Wayne Gathright; Gen. Mgr.: Bill Munyon.
- Music Makers Pub. Co., (ASCAP)** (See H/B Webman & Co.).
- The Music Office, (BMI)** PO Box 2392, Woburn, MA, 01888, (617) 728-1463. Fax: (617) 932-8520. Pres.: Joseph A. Viglione; Gen. Mgr.: Harvey Wharfright; Professional/Creative Mgr.: Janis Reed.
- Music for Percussion, Inc., (BMI)** PO Box 24330, Fort Lauderdale, FL, 33307, 170 NE 33rd St., Fort Lauderdale, FL, 33334, (305) 563-1844. Fax: (305) 563-9006. Gen. Mgr.: Bernard Fisher.
- Music River Publishing, (BMI)** CFA 232, MSU, 3750 Norriswood, Memphis, TN, 38152, (901) 678-2350. Fax: (901) 678-5118. Pres.: V. Lane Rawlins; Gen. Mgr.: Richard R. Ranta; Professional/Creative Mgr.: David Evans.
- Music Sales Corp., (ASCAP)** 225 Park Ave. S., 18th Floor, New York, NY, 10003, (212) 254-2100. Fax: (212) 254-2013. Pres.: Barrie Edwards; Copyright Dir.: Yolanda Blum; Professional/Creative Mgr.: Phillip Black.
- Music 70 Music Publishers, (See Plymouth Music Co., Inc.).**
- Music Umbrella, (ASCAP)** PO Box 1067, Santa Monica, CA, 90406, (310) 452-0116. Pres.: Glenn H. Friedman; Gen. Mgr.: Zeilina Munoz; Professional/Creative Mgr.: Patches Friedman.
- Music of the World, (BMI)** (See All Nations Music Publishing).
- Music and More Publishing, (BMI)** (See Malaco Music Group).
- Tony Music & Assoc., (BMI)** 809 S. Damen Ave., Ste. 602A, Chicago, IL, 60612, (312) 413-4471, (312) 684-0081. Pres.: Tony Music.
- Muscabana, (SACEM)** (See Hall Of Fame Music Co.).
- Musical Comedy Prodn.s., Inc., (BMI)** (See TRO (The Richmond Organization)).
- Musicanza Corp. Pub., (ASCAP)** 2878 Bayview Ave., Wantagh, NY, 11793, (516) 781-7826. Pres.: Al Rubin.
- Musikverlage Hans Sikorski, (GEMA)** (See G. Schirmer, Inc.).
- Must Rock Prodn.s., (BMI)** (See ADRA Music).
- Musycal, (See Latin American Music Co., Inc.).**
- Muy Bueno Music Group, (BMI)** 1000 18th Ave. S., Nashville, TN, 37212, (615) 329-2402. Fax: (615) 327-4917. Pres.: Connie Woolsey; Professional/Creative Mgr.: Bobby Cottle.
- Muzzle Music, (ASCAP)** PO Box 474, Clayton, ID, 83227, (208) 879-4677. Pres.: Muzzle Braun.
- James E. Myers Ent.s., (ASCAP)** 1607 E. Cheltenham Ave., Philadelphia, PA, 19124, (215) 288-7824. Owner: James E. Myers; Gen. Mgr.: Catherine L. Brookshaw; Professional/Creative Mgr.: Richard P. Colanzi.
- Myriad Music, (ASCAP)** (See H/B Webman & Co.).
- Myrna's Music, (SESAC)** (See Magmaster Publishing).
- Mystic Sound Music, (BMI)** (See Doug Moody Music).
- Mystiklos Music, (BMI)** PO Box 90938, 701 Brazos, Ste. 500, Austin, TX, 78709, (512) 288-1044. Fax: (512) 288-4748. Pres.: Chris Theophilus; Gen. Mgr.: Martin Theophilus.
- N**
- NEM Entertainment Corp.**, 1209 16th Ave. S., Nashville, TN, 37212, (615) 329-1100. Pres.: Ira Jaffe; Contacts: Chuck Bedwell, M. Thomas.
- NES/Brett, (BMI)** (See Locked Up Music, Inc.).
- NRP Music Group, (BMI/ASCAP)** 10 Pebblewood Dr., Irvine, CA, 92714, (714) 552-5231. Gen. Mgr.: Fred Bailin.
- N2D Publishing Co., PO Box** 121682, Nashville, TN, 37212, (615) 329-9945. Fax: (615) 321-3457. Pres.: Douglas P. Casmus.
- Nada Music, (See Spanda Music).**
- Nalim Music, (BMI)** (See Milan America, Inc.).
- Namrac Music, (BMI)** 15456 Cabrillo Rd., Van Nuys, CA, 91406, (213) 873-7370. Fax: (818) 787-3981. Pres.: Tom Skeeter; Professional/Creative Mgr.: Shivaan O'Brien.
- Napuamusic Pub. Co., (ASCAP)** (See Henry Jerome Music, Inc.).
- Nara Music, (BMI)** 1845 N. Farwell Ave., Milwaukee, WI, 53202, (414) 272-6700. Fax: (414) 272-6131. Pres.: John Morey; Professional/Creative Mgr.: Michael Sullivan.
- Nashcal Music, (BMI)** (See Bobby Fischer Music Group).
- Nashville Int'l Music Group, (ASCAP)** PO Box 121076, Nashville, TN, 37212, (615) 244-5357. Fax: (615) 244-4466. Pres./Gen. Mgr.: Reggie M. Chruchwel.
- Nashville Title Wave Music, Inc., (BMI)** (See Crown Music Group, Inc.).
- Nashwood Music, (ASCAP)** (See Manna Music, Inc.).
- Nathaniel Music, (BMI)** (See Songs For Today).
- Natl' League Music, (ASCAP)** (See American League Music).
- Natural Songs, Inc., (ASCAP)** (See Rent-A-Song).
- Nautical Music Co., PO Box** 120675, Nashville, TN, 37212, (615) 255-1068. Pres.: Ray McGinnis.
- Neck Bone Music, (BMI)** (See Sugar Mama Music).
- Nehemiah Publishing Co., (BMI)** (See Shop Dat Music).
- Neil Music, Inc., (BMI)** 8400 Sunset Blvd., Ste. 4A, Los Angeles, CA, 90069, (213) 656-2614. Fax: (213) 656-0693. Pres.: Gene Norman.
- Neon Sky Music, (ASCAP)** (See Muy Bueno Music Group).
- Nerve Music c/o Jacobson & Coffin, (ASCAP)** 156 Fifth Ave., Ste. 434, New York, NY, 10010, (212) 691-5630. Fax: (212) 645-5038. Pres.: Marc Moel; Gen. Mgr.: Jeffrey Jacobson.
- New Albany, (BMI)** (See Malaco Music Group).
- New Clarion Music Group, (BMI/ASCAP)** PO Box 121081, 1233 17th Ave. S., Nashville, TN, 37212, (615) 321-4422. Fax: (615) 321-5369. Pres.: Sue K. Patton; Office Mgr.: A. Farron McAdams; Professional/Creative Mgr.: Mike Sebastian.
- New East Music, (ASCAP)** (See Fitzgerald Hartley Co.).
- New Ideas Music Co., (BMI)** (See NRP Music Group).
- New Image, (See SoulStreet Music, Inc.).**
- The New Irving Kahal Music Co., (ASCAP)** (See Fred Ahlert Music Corp.).
- New Memphis Music, Inc., (ASCAP/BMI)** 1503 Madison Ave., Memphis, TN, 38104, (901) 276-8518. Pres.: Nikos Lyras; Gen. Mgr.: Tamara Frost; Professional/Creative Mgr.: Nikos Lyras.
- New Spring, (ASCAP)** (See Brentwood Music, Inc.).
- New Start, Inc., (BMI)** (See Valand Publishing Group).
- New Town Music, Inc., (ASCAP)** (See Cromia Music Co.).
- New Turquoise Music, (BMI)** PO Box 947, Hwy. 931, Whitesburg, KY, 41858, (606) 633-0485. Fax: (606) 633-0493. Pres.: Pat Martin.
- New & Used Music, (ASCAP)** (See Fischbach & Fischbach PC).
- New York Voices Music, (ASCAP)** (See David Rubinson Publishing).
- NewBag Music, (BMI)** PO Box 11377, Richmond, VA, 23230, (804) 285-8588. Fax: (804) 264-2479. Pres.: Martin Gary; Gen. Mgr.: Kathleen Gary.
- Newcreature Music, (BMI)** PO Box 148296, Nashville, TN, 37214, (615) 889-4977. Pres.: Bill Anderson; Professional/Creative Mgr.: Dr. Harry Yates.
- Newkeys Music, Inc., (BMI)** (See Southern Arts Music).
- Newmarket Music, (ASCAP)** (See Most Urgent! Music).
- Newwriters Music, (BMI)** 43 Music Sq. E., Nashville, TN, 37203, (615) 244-1025. Pres.: Wayne Hodge.
- Next Plateau Music, Inc., (ASCAP)** 1650 Broadway, Ste. 1103, New York, NY, 10019, (212) 541-7640. Fax: (212) 315-0286. Pres.: Eddie O'Loughlin; Exec. Vice Pres./Gen. Mgr.: Jenniene Leclercq; Business Affairs: Hal Webman.
- Nickel Records Int'l, (BMI)** 753 Capitol Ave., Hartford, CT, 06106, (203) 951-8175. Pres./Producer: Jack Stang; Gen. Mgr.: Bobbi Ginsberg.
- Joseph Nicoletti Music Co., (ASCAP)** PO Box 2818, Newport Beach, CA, 92659, (714) 494-0181, ext. 22. Fax: (714) 494-0982. Pres.: J. Nicoletti.
- Nida Music Publishing Co., (ASCAP)** 4014 Murieta Ave., Sherman Oaks, CA, 91423, (818) 981-5331. Pres./Gen. Mgr.: Nicholas S. Carras; Professional/Creative Mgr.: Nicholas S. Carras.
- Nikeda Music, (BMI)** 1907 Central, Alton, IL, 62002, (618) 465-5619. Pres.: Howard E. Neal.
- 1956 Music, (ASCAP)** (See Dagene Music).
- Nise Productions, Inc., 413 Cooper St., Camden, NJ, 08102,** (609) 963-6400. Fax: (609) 964-3291. Pres.: Michael Nise; Gen. Mgr.: Sandy Perchetti.
- No Tomato Music, (ASCAP)** (See Fitzgerald Hartley Co.).
- Nolen/Reeves Music, Inc., (BMI/ASCAP)** 1422 W. Peachtree St., #707, Atlanta, GA, 30309, (404) 876-8436. Fax: (404) 874-5558. Pres.: Michael Reeves; Gen. Mgr./Professional Mgr.: Dan Nolen.
- Norbay Music, (BMI)** (See Catalogue Music).
- Norfolk Music, (BMI)** (See AVI Music Publishing Group, Inc.).
- Slick Norris Pub. Co., (BMI)** PO Box 653, Highlands, TX, 77562, (713) 424-4235. Pres.: Slick Norris.
- North American Liturgy Resources, (See Epoch Universal).**
- North Bay Music Services, (See Prince/SF Publications).**
- North Mountain Music, (BMI)** (See Brookside Music Corp.).
- North & Son Music Inc., (ASCAP)** (See Shapiro, Bernstein & Co., Inc.).
- Northcott Music, (BMI)** 972 Lexington Ave., New York, NY, 10021, (212) 472-7975. Fax: (212) 904-1737. Pres.: Silvio Tancredi; Professional/Creative Mgr.: Tommy Musto.
- Northern Rose Publishing aka Skyhook Prodn.s., (ASCAP)** PO Box 5133, 357 Yale Ave., Hillside, NJ, 07205, (908) 686-3670. Pres.: E. Scott Hook.
- Northern Sierra Music (div. of Exit Records), (ASCAP)** 9844 Business Park Dr., Sacramento, CA, 95827, (916) 361-3652. Pres.: Mary Neely; Gen. Mgr.: Jan Volz.
- Northridge Music Co., (ASCAP)** (See All Nations Music Publishing).
- Northvale Music Publishing Co., (BMI)** (See 3 Seas Music, a div. of Continental Communications Corp.).
- Nortness & Sons Music Publishing, (BMI)** 3310 NE Ainsworth, Portland, OR, 97211, (503) 288-4076. Pres.: Casey Nortness; Gen. Mgr.: Dennis Allen Jones.
- Not Yet Music, (BMI)** (See Jeff Dayton Music).
- Nota (Note) Publishing, Inc., 1472 NW 78th Ave., Miami, FL, 33126,** (305) 592-4836. Fax: (305) 592-4828. Pres.: Antonio Moreno; Gen. Mgr.: Julia Moreno.
- Notable Music, (See Warner/Chappell Music, Inc.).**
- Notegun Music, (BMI)** (See Virginia Arts).
- Nova Records, Inc., 1730 Olympic Blvd., Santa Monica, CA, 90404,** (310) 392-7445. Fax: (310) 396-2889. Pres.: David B. Gimpel.
- Novello & Co., (PRE/ASCAP)** (See Theodore Presser Co.).
- Nov. 17th Music, (BMI)** PO Box 43551, Louisville, KY, 40253, (502) 473-0068. Pres.: Charles Allan Ritcher, Jr.; Gen. Mgr.: K. Scott Ritcher; Professional Mgr.: Jesus Rosebud.
- Now & Then Music, (BMI)** 412 E. 78th St., #2A, New York, NY, 10021, (212) 879-4667. Pres.: Shane Flare.
- Nucleus Records, (BMI)** PO Box 111, Sea Bright, NJ, 07760, Pres.: Robert Bowden; Gen. Mgr.: Robert Bowden.
- Nujac Publishing Co., Inc., (BMI)** (See Jamie Music Publishing Co.).
- Nymph Music, Inc., (BMI)** (See Virgin Music, Inc.).
- O**
- OAQ Music, (See Chu Teh Music).**
- O.A.S. Music Publishing Inc., (ASCAP)** 3251 W. Shadowlawn Ave. NE, Atlanta, GA, 30305, (404) 231-9888. Pres.: Keith C. Andrews.
- O.C.P.-Oregon Catholic Press, 5536 NE Hassalo, Portland, OR, 97213,** (800) 547-8992, (503) 281-1191. Fax: (503) 282-3486.
- O-Heart Music, Inc., (ASCAP)** (See Co-Heart Music Group).
- OKI, (See Country Music News).**
- O'Neal & Friend, (ASCAP)** (See Janell Music).
- O Songs, (ASCAP)** (See J.D. Music/Frankly Music).
- O-TeX Music, (BMI)** (See Muy Bueno Music Group).
- OU Percussion Press, (See Music for Percussion, Inc.).**
- Obsessive Songs, (BMI)** (See Linesider Prodn.s.; Rohm Music).
- Ocean Drive Music, (BMI)** (See Brookside Music Corp.).
- Ocean Walk Music, (BMI)** 13159 Glenoaks Blvd., Sylmar, CA, 91342, (818) 364-2464. Pres./Gen.Mgr./Professional Mgr.: Mark Thornton.
- Ocmulgee Music, (BMI)** (See Randy Howard Music).
- Oconomowoc Music, (See You Heard It—Hear!).**
- Octa Music, Inc., (ASCAP)** (See Warner/Chappell Music, Inc.).
- Octave Higher Music, (BMI)** 11208 N. 38th Pl., Phoenix, AZ, 85028, (602) 953-1671. Fax: (602) 946-3957. Pres.: Peter Damian; Gen. Mgr./Professional/Cre. Mgr.: Phillip Kelly.
- October's Child Pub., (ASCAP)** (See Azinda Publications).
- Kenny O'Dell Music, (BMI)** PO Box 219, Nolensville, TN, 37135, (615) 776-5126. Pres./Gen. Mgr.: Kenny O'Dell.
- Of Music, (ASCAP)** 550 Harding Place, #C108, Nashville, TN, 37211, (615) 333-2872. Pres./Gen. Mgr.: Tom Oteri; Professional/Creative Mgr.: Richard Fagan.
- Oh Bobby Music, (BMI)** (See Orbob Music Inc. c/o Lipservice).
- Oh Boy Music, (ASCAP)** (See Great Honesty Music).
- Oh My Gosh Music, (BMI)** 5146 Hill Dr., Memphis, TN, 38109, (901) 789-5296. Pres.: Gerald McDade; Gen. Mgr.: Eddie Ruth; Professional Mgr.: Gerald McDade.
- Old Boston Publishing, (BMI)** PO Box 311, Cohasset, MA, 02025, Gen. Mgr.: Rik Tinory.
- Old Brompton Road, (ASCAP)** (See Jobete Music Co., Inc.).
- Old Empress Music, (BMI)** 1226 17th Ave. S., Ste. 3, Nashville, TN, 37212, (615) 327-1632. Fax: (615) 292-9752. Pres.: Hal Godwin; Gen. Mgr.: Hal Godwin; Professional Mgr.: Maurice Godwin.
- Old Empress Music, (BMI)** (See Un-Der 16 Songs).
- Old Friends Music, (BMI)** (See Song of the World, Inc.).
- Old Guide Music, Inc., (BMI)** (See First Million Music, Inc.; The Fred Morris Music Group).
- Old Home Place Music, (BMI)** 10005 Banner Country Ct., Gaithersburg, MD, 20882, (301) 540-3895. Pres./Gen. Mgr.: Wayne Busbice.
- Old Wolf Music, (BMI)** (See Little Big Town Music Group).
- Olde Clover Leaf Music, (ASCAP)** (See Fred Ahlert Music Corp.).
- Olenik Records, (ASCAP)** G-10282 N. Saginaw Rd., Clio, MI, 48420, (313) 686-9644. Pres.: Nicholas Olejnik.
- Omni-Praise Music, (BMI)** (See Leo-Vincent Music).
- One Eye Soul Publishing Co., (BMI)** (See Jamie Music Publishing Co.).
- One Hot Note Music, Inc., (BMI)** PO Box 216, 454 Main St., Cold Spring Harbor, NY, 11724, (516) 367-8544. Fax: (516) 367-8507. Pres.: Tito Batista; Gen. Mgr.: Stewart Rosenblum; Professional/Creative Mgr.: Andrea Reiter.
- One Of A Kind Music, (BMI)** (See Rent-A-Song).
- One Note Beyond Music, (ASCAP)** PO Box 120037, Nashville, TN, 37212, (212) 586-0382. Pres.: John Weaver; Gen. Mgr.: Russell Barnard; Professional Mgr.: Helen Hudson.
- One Step To Happiness Music, 156 Fifth Ave., Ste. 434,** New York, NY, 10010, (212) 691-5630. Fax: (212) 645-5038. Pres.: Andrew Tosh; Gen. Mgr.: Bruce E. Colfin, Esq.
- Onelda Music, (See You Heard It—Hear!).**
- Onny-Sary Publishing Co., (BMI)** PO Box 9154, Knoxville, TN, 37940, (615) 970-2327. Pres./Gen. Mgr.: H.S. Watson.
- Onondaga Music, (See You Heard It—Hear!).**
- Onyx, (See Fantasy, Inc.).**
- Onyx Star Music, (BMI)** PO Box 434, Madison, AL, 35758, (205) 656-0426.
- Oozle Music, (BMI)** (See Andustin Music).
- Open Sky Music Publishers, (ASCAP)** 10735 Vernon, Huntington Woods, MI, 48070, Pres.: Martin Scot Kosins; Gen. Mgr.: Laurie Wein; Professional/Creative Mgr.: Joyce Jerow.
- Opri Music, (BMI)** 584 61st St., Oakland, CA, 94609, Pres.: J.G. Wilson; Gen. Mgr./Professional/Creative Mgr.: K.A. Okulolo.
- Opryland Music Group, Inc., 65 Music Sq. W., Nashville, TN,**

LOS ANGELES • NEW YORK • NASHVILLE • SAN FRANCISCO • BUENOS AIRES • SYDNEY • VIENNA

• HILVERSUM • SINGAPORE • TALLIN • MEXICO CITY • JOHANNESBURG • MADRID • STOCKHOLM • ZURICH • SAN JUAN •



peermusic

Your Local Sub-publisher...Worldwide

• HILVERSUM • SAO PAULO • RIO DE JANEIRO • TORONTO • SANTIAGO • PARIS • HAMBURG • LONDON • MILAN • TOKYO •

LOS ANGELES • NEW YORK • NASHVILLE • SAN FRANCISCO • BUENOS AIRES • SYDNEY • VIENNA

- 37203, (615) 321-5000. Fax: (615) 327-0560. Professional Mgr.: Charlie Monk; Pres./Gen. Mgr.: Jerry O. Bradley.
- Orange Bear Music Co., (BMI)** (See Scully Music Co.).
- Orange Peel, (BMI)** 156 Fifth Ave., Ste. 434, New York, NY, 10010, (212) 691-5630. Fax: (212) 645-5038. Pres.: David Peel; Gen. Mgr.: Marc D. Moel; Professional Mgr.: Maria Cradle.
- Orange Skies Music, (BMI/ASCAP)** 2225 Colorado Ave., Santa Monica, CA, 90404, (310) 828-1980. Fax: (310) 453-5529. Pres.: Bob Emmer; Gen. Mgr.: Harold Bronson.
- Walter Orange Music, (ASCAP)** 10960 Willshire Blvd., #938, Los Angeles, CA, 90024, (213) 473-2266. Professional Mgr.: Jo-Ann Geffen.
- Orbob Music Inc. c/o Lipservice, (ASCAP)** 1841 Broadway, Ste. 411, New York, NY, 10023, (212) 956-2880. Fax: (212) 956-2114. Pres.: Bobby Orlando; Admn.: Julie Lipsius.
- Orchid Publishing, PO Box 11686, 97 Peachtree Park Dr., #M-3, Atlanta, GA, 30355, (404) 355-7635.** Pres.: Bill Bohannon; Gen. Mgr.: Ed Neeley; Professional/Creative Mgr.: Coy Bohannon.
- Order Publishing, (ASCAP)** 6503 York Rd., Baltimore, MD, 21212, (301) 377-2270. Fax: (301) 377-2281. Pres.: Jeff Order; Gen. Mgr.: Joyce Klein; Professional Mgr.: Jay G. Grubb.
- The Organ Literature Foundation, 45 Norfolk Rd., Braintree, MA, 02184, (617) 848-1388.** Pres.: Henry Karl Baker.
- Orpheum, (See Fantasy, Inc.).**
- Otis Music Co., (BMI)** (See Mertis Music Co.).
- Clyde Otis Music Group, (BMI/ASCAP)** PO Box 325, Englewood, NJ, 07631, (201) 567-7538. Fax: (201) 567-5948. Pres.: Clyde Otis; Vice Pres.: Isidro Otis.
- Otto Publishing, (See FXL Sound Studios).**
- Our Jam Music, (BMI)** (See Whooping Crane Music).
- Out On A Limb Publishing, (BMI)** PO Box 6283, 38 A St. Margaret St., Charleston, SC, 29405, (803) 722-4548. Pres.: Samuel W. Colston, III; Gen. Mgr.: Lisa A. Ratner.
- Out Time Music, (ASCAP)** (See Fitzgerald Hartley Co.).
- Over The Rainbow Music, Inc., (ASCAP)** (See K-tel Int'l, Inc.).
- Overdue Music, (ASCAP)** (See Fitzgerald Hartley Co.).
- Overpriced Music, (BMI)** (See Cornerstone Mgmt.).
- Owasco Music, (See You Heard It—Hear!).**
- Owl's Head Publishing Co., (BMI)** PO Box 3667, Chapel Hill, NC, 27515, (919) 932-9600. Fax: (919) 932-9700. Pres.: Bob Haddad.
- Own Write Music, (ASCAP)** PO Box 33541, Cleveland, OH, 44133, (216) 237-8303. Fax: (216) 237-1352. Professional Mgr.: Diane Endres; Pres./Gen. Mgr.: Dennis Kraynik.
- The Oxbridge Pub. Co., 15720 Ventura Blvd., Ste. 419, Encino, CA, 91436, (818) 784-3661.** Pres.: Forrest Norman Weiss.
- Oxford University Press, Inc., (ASCAP)** 200 Madison Ave., Music Dept., New York, NY, 10016, (212) 679-7300. Fax: (212) 725-2972. Pres.: E.W. Berry; Professional/Creative Mgr.: Susan Brailove.
- P**
- PDS Music Publishing, (ASCAP/BMI)** PO Box 412477, Kansas City, MO, 64141, (800) 473-7550, (816) 523-5100. Pres./Gen. Mgr.: Pete Shivers.
- PKM Music, (ASCAP)** PO Box 5807, Englewood, NJ, 07631, (201) 568-3996. Fax: (201) 569-9580. Gen. Mgr.: Philip S. Kurnit.
- P King Music, (ASCAP)** (See Belle Creole Music).
- P.M. Records, Inc., (ASCAP)** 20 Martha St., Woodcliff Lake, NJ, 07675, (201) 930-9149. Fax: (212) 757-5679. Pres.: Gene A. Perla.
- PRI Songs, Inc., (See The PRI Music Publishing Companies).**
- The PRI Music Publishing Companies, 810 Seventh Ave., New York, NY, 10019, (212) 333-8300.** Fax: (212) 333-8160. Admn. Dir.: Larry L. Lash.
- Branch(es): 3800 W. Alameda Ave., Suite 1500, Burbank, CA, 91505, (818) 848-7530. Creative Mgr.: West Coast: Loraine Rebidas; 901 18th Ave South, Nashville, TN, 37212, (615) 320-0180. Professional Mgr.: Buddy Cannon.
- PRI Songs, Inc., (BMI)** (See The PRI Music Publishing Companies).
- PRI Tunes, Inc., (SESAC)** (See The PRI Music Publishing Companies).
- PSO, Ltd., (See Peer-Southern Organization, Peer-Talbot Music Group).**
- Pa'amoni, (ACUM)** (See Arpelli/Pinellas Music Publishing).
- Pablo Music, (BMI)** PO Box 4, 33 Lancaster St., Cherry Valley, NY, 13320, (607) 264-3785. Fax: (607) 264-3476. Pres.: Paul Bley; Gen. Mgr.: Carol Goss.
- Pace Music Co., (BMI)** (See Sam Fox Publishing Co., Inc.).
- Pacific Island Publishing, (BMI)** (See All Nations Music Publishing).
- Package Good Music, (BMI)** PO Box 285, Westfield, NJ, 07091, (908) 654-6505. Pres./Gen. Mgr.: Marc Zydjak.
- Pacca Music Publishers, (ASCAP)** (See Irving Mills Music, Publishers Representative).
- Padua Music Co., (BMI)** (See Faro Music Publishing).
- Pady Music Publishing Co., (ASCAP)** PO Box 3500, 17 Sachem St., Pawtucket, RI, 02861, (401) 728-1689. Fax: (508) 399-8380. Pres./Gen. Mgr.: Karen Pady.
- Page Mill Publishing, (BMI)** (See Palo Publishing).
- Paint the Town Music, (SESAC)** (See Little Big Town Music Group).
- Painted Desert Music Corp., (BMI)** (See Shapiro, Bernstein & Co., Inc.).
- Pallas Athena Music, (See Athena Music Publishers).**
- Palmerton, (BMI)** (See Caprice Int'l Records/Canadian American Records).
- Palo Publishing, (ASCAP)** 11026 Ventura Blvd., Ste. #3, Studio City, CA, 91604, (213) 877-5106. Fax: (818) 506-5207. Pres.: Don Mupo; Gen. Mgr.: Jennifer Bensi.
- Pamadash Music Co., (ASCAP)** (See Hal Bernard Ent's., Inc.).
- Pamasons Music, (BMI)** (See Blen Music Pub.).
- Pants Down Music, (BMI)** (See American League Music).
- Parachades Music Co., (BMI)** (See Moona Music Co.).
- Paradise Cove Music, (BMI)** (See Dave Burgess Ent's).
- Paragold, (BMI)** (See Far-Away Music).
- Paramount Music Corp., (ASCAP)** (See Famous Music Corp.).
- Parasol Music Publishing Co., (BMI)** (See Blue Umbrella Music Publishing Co.).
- Parker, (See Fantasy, Inc.).**
- Charlie Parker Music, (BMI)** (See AMCORP Group).
- Parrot Fish Records, (See GUTU Corp.).**
- Party Central, (See Prince/SF Publications).**
- Passado Music, (ASCAP)** 3378 W. Harvard, Santa Ana, CA, 92704, (714) 957-3073. Fax: (714) 957-3254. Pres.: Bill Laster; Gen. Mgr.: Betty Roberts; Professional/Creative Mgr.: Monique Merritt.
- The Pasha Music Co., (ASCAP)** (See Grand Pasha Publishing).
- Patchcord Music, (ASCAP)** 1 Thompson Sq., Ste. 501, Boston, MA, 02129, (617) 241-5150. Pres.: Daniel Flynn; Gen. Mgr.: Robert E. Rose.
- Patchwork Music, (ASCAP)** PO Box 120475, Nashville, TN, 37212.
- Paterson's Pub., Ltd., (ASCAP)** (See Carl Fischer, Inc.).
- Pathe Entertainment Music, Inc., (ASCAP)** (See MGM-Pathe Communications Co.).
- Pattern Music, Inc., (ASCAP)** (See K-tel Int'l, Inc.).
- Paulb Music Publishing Co., (BMI)** 3518 Champlain Ave., Youngstown, OH, 44502, (216) 755-7794. Pres./Gen. Mgr.: Bill Schaffert.
- Paw Paw Music, (BMI)** (See Bob-A-Lew Music).
- Paw Print Music, (ASCAP)** (See Old Empress Music; Un-Der 16 Songs).
- Pawnbroker Music, (ASCAP)** (See Qwest Music Publishing).
- Payton Place, (BMI)** 15502 Wildwood Lake Dr., Houston, TX, 77083, (713) 933-1250. Pres.: I. P. Sweat; Gen. Mgr.: Sharon Lang; Professional Mgr.: Danny Coker.
- Peace Pipe Music Publishing, (BMI)** (See Firedrum Music Publishers).
- Peaceable Kingdom Publishing, (ASCAP)** 3464 Encinal Canyon Rd., Malibu, CA, 90265, (310) 457-4405. Pres./Professional Mgr.: C.R. Nauert.
- Pechybo Int'l Music Publishing Co., (ASCAP)** (See Vandor Motion Pictures, Phonorecords & Music Publishing Corp.).
- Pecot Music Co., (ASCAP)** (See Avatar Publishing Group).
- Peel Publishing Co., (BMI)** 156 Fifth Avenue, Suite 434, New York, NY, 10011, (212) 691-5630. Fax: (212) 645-5038. Pres.: David Peel; Gen. Mgr.: Jeffrey E. Jacobson.
- Peer Int'l Corp., (See Peer-Southern Organization, Peer-Talbot Music Group).**
-
- Peer-Southern Organization**
- 810 Seventh Ave., 9th Floor, New York, NY, 10019, (212) 265-3910. Fax: (212) 489-2465. Pres./CEO: Ralph Peer, II; Vice Pres. Copyright & Licensing: Cecile Russo; Int'l Mgr., Latin American Div.: Provi Garcia; Dir. of Creative Services: Amber Fayyaz.
- Branch(es): 8159 Hollywood Blvd., Los Angeles, CA, 90069, (213) 656-0364, Fax: (213) 656-3298, Vice Pres.: Kathy Spanberger, Mgr., Latin Div.: Catherine Schindler, Dir. of Creative Services: Nanci M. Walker, Professional Mgr.: Gigi Gerard; 2 Music Cir. S., Nashville, TN, 37203, (615) 244-6200, Fax: (615) 726-0423, Mgr.: Jana Talbot; Cobian's Plaza, Ave. Ponce De Leon 1603, Orlicina 205 Parada 23, Santurce, PR, 00909, (809) 723-4381, Fax: (809) 723-4381, Mgr.: Hiram Negron.
-
- Peer-Talbot Music Group, 2 Music Cir. S., Nashville, TN, 37203, (615) 244-6200.** Fax: (615) 726-0423. Gen. Mgr.: Jana Talbot.
- Peermusic, (BMI)** (See Peer-Talbot Music Group).
- Peermusic Ltd., (See Peer-Southern Organization).**
- Pejjo Music, (BMI)** (See Tarpell Music).
- Pelton Publishing, (BMI)** PO Box 182, Midwood Sta., Brooklyn, NY, 11230, (718) 339-3536. Gen. Mgr.: Dick Alexander.
- Pembroke Music Co., Inc., (BMI)** (See Carl Fischer, Inc.).
- Pemora Music Publishing Co., Inc., 251 Broadway, Lynbrook, NY, 11563, (516) 599-5522.** Fax: (516) 599-8766. Pres.: Jose Morand.
- Penny Thoughts Music, 484 Lexington St., Waltham, MA, 02154, (617) 891-7800.** Pres.: John Penny.
- Pentagon Music Co., (BMI)** (See Jamie Music Publishing Co.).
- Perfect Blend Publishing, (BMI)** (See Diadem, Inc.).
- Perfect Circle Publishing, (ASCAP)** (See Funky but Music, Inc., dba Morningstar).
- Perfection Music Publications, (BMI)** 1429 Hawthorne St., Pittsburgh, PA, 15201, (412) 782-4477. Pres.: Edward J. Moschetti; Professional Mgr.: Gail P. Gray.
- Periscope Music Co., (BMI)** 129 Bishop St., Brockton, MA, 02402, (508) 588-6348. Pres.: Edward M. Hurvitz; Gen. Mgr.: Linda Berman; Professional/Creative Mgr.: Ed Michaels.
- Periterra Music, (BMI)** PO Box 4368, Long Island City, NY, 11101, (718) 786-2401. Pres.: Franc Peri.
- Perla Music, (See P.M. Records, Inc.).**
- Perspective Music Co., (BMI)** (See NRP Music Group).
- Perumusica E.I.R.L., (See Telearte Florida, Inc./Music Publishing Co.).**
- Peso Music, (BMI)** (See Garrett Music Ent's).
- Peters Edition Ltd. (London), (BMI)** (See C.F. Peters Corp.).
- Ben Peters Music, (BMI)** 900 Old Hickory Blvd., Rt. 6, Brentwood, TN, 37027, (615) 373-5530.
- C.F. Peters Corp., (BMI)** 373 Park Ave. S., New York, NY, 10016, (212) 686-4147. Fax: (212) 689-9412. Pres.: Stephen Fisher.
- Justin Peters Music, (BMI)** 3609 Donna Kay Dr., Nashville, TN, 37211, (615) 331-6056. Fax: (615) 831-0991. Pres.: Justin Peters.
- Petrals Soul Music, PO Box 5215, Santa Cruz, CA, 95063, 19 Coopers Hawk, Scotts Valley, CA, 95066, (408) 429-6880.** Fax: (408) 438-8796. Pres.: Gary Lamb; Gen. Mgr.: Adrienne Biliske.
- Pewter Pal Music, (BMI)** (See Playground Music).
- Phantom Music, (BMI)** (See Mystikos Music).
- Philella Music, (BMI)** (See Playground Music).
- Phoenix Music, (BMI)** (See Rob-Lee Music).
- Phoenix Music Service, (See Prince/SF Publications).**
- Phono Music, (SESAC)** (See Music Craftshop, Inc.).
- Piano Music, (BMI)** (See The Mighty 3 Music Group, Warner/Chappell Music, Inc.).
- Pic Corp., (ASCAP)** (See Cherio Corp.).
- Pickering Music Publishers, (BMI)** (See Irving Mills Music, Publishers Representative).
- Picks & Strings Music c/o Jacobson & Colfin, (BMI)** 156 Fifth Ave., Ste. 434, New York, NY, 10010, (212) 691-5630. Fax: (212) 645-5038. Pres.: Walter Morris; Gen. Mgr.: Jeffrey Jacobson.
- Phil Pigot Organization, Inc. (P.P.O., Inc.), (BMI)** 230 Fifth Ave., Ste. 1818, New York, NY, 10001, (212) 684-7723. Fax: (212) 684-7748. Pres./Gen. Mgr.: Phillippe Pigot.
- Pilot Point, (ASCAP)** (See Lilenas Publishing Co.).
- Pimpin' Tunes, (ASCAP)** (See H.E.G. Music).
- Pine Island Music, (BMI)** 9430 Live Oak Pl., #308, Fort Lauderdale, FL, 33324, (305) 472-7757. Pres./Professional/Creative Mgr.: Jack P. Bluestein.
- Pineapple Music Pub., (ASCAP)** (See Big State Music Publishing).
- Pinellas Music, (BMI)** (See Arpelli/Pinellas Music Publishing).
- Pink Hill Publishing, (BMI)** (See American League Music).
- Pink Pig Music, (BMI)** (See Funky but Music, Inc., dba Morningstar).
- Pinnacle Entertainment, (BMI)** 217 Dorsey Ave., Penthouse, Cincinnati, OH, 45210, (513) 579-8418. Pres.: Khalid D. Nurredin; Gen. Mgr.: Roger L. Gresham; Professional Mgr.: Marilyn K. David.
- Pipeline Music, (P.R.S.)** (See Bonaire Songs).
- Pitch Pipe Music, (BMI)** 3414 Peachtree Rd. NE, Ste. 640, Atlanta, GA, 30326, (404) 266-8990. Fax: (404) 266-8683. Pres.: Robert A. May.
- Platinum Bullet Int'l Music, (BMI)** PO Box 75793, Salt Lake City, UT, 84107, (801) 486-5546. Pres.: Cindy Kay Skinner; Gen. Mgr.: Laurie Forsman; Professional Mgr.: Dana Pelittier. Branch(es): PO Box 23284, Nashville, TN, 37202.
- Platinum Gold Music, (ASCAP)** 9200 Sunset Blvd., #1220, Los Angeles, CA, 90069, (213) 275-7329. Fax: (213) 275-7371. Pres.: Steve Cohen; David Cook.
- Playground Music, (BMI)** PO Box 133, Ojai, CA, 93024, Pres.: Jim Pewter; Gen. Mgr.: Judy Pewter.
- Playin' Tag Music, (ASCAP)** (See Homeland Recording & Publishing).
- Playnote Music Publishing, PO Box 219, Radio City Sta., New York, NY, 10101, (212) 695-6995.** Pres.: Lawrence Lucie; Professional Mgr.: N.L. King.
- Playthematic, (ASCAP)** 900 Passaic Ave., East Newark, NJ, 07029, (201) 483-8080. Fax: (201) 483-0031. Pres.: Jerry R. Salerno.
- Pleasant Hill Music, (BMI)** (See Diadem, Inc.).
- Pleasant View Music, (ASCAP)** (See Chestnut Mound Music Group).
- Plurb On Music, Inc., (ASCAP)** (See Fourth Floor Music/Fiction Music, Inc.).
- Plymouth Music Co., Inc., (ASCAP)** PO Box 24330, Fort Lauderdale, FL, 33307, 170 N.E. 33rd St., Fort Lauderdale, FL, 33334, (305) 563-1844. Fax: (305) 563-9006.
- Pocket Music, (SOCAN)** (See Bonaire Songs).
- Poco Loco Music Co., (BMI)** (See Faro Music Publishing).
- Point Music Ltd., (ASCAP)** (See BMG Music Publishing Inc.).
- Poleski Pub., (ASCAP)** (See Harlem Music, Inc.).
- Polka Towne Music, (BMI)** 211 Post Ave., Westbury, NY, 11590, (516) 334-6228. Pres.: Teresa Zapolska.
- Pollyann Music, (ASCAP)** (See Pollybyrd Publications Ltd.).
- Pollybyrd Publications Ltd., (ASCAP/BMI)** 4210 Lankershim Blvd., Universal City, CA, 91602, (818) 505-1125. Fax: (818) 505-1129. Pres.: Denise M. Gauthier; Gen. Mgr.: Max Diamond; Professional Mgr.: Ronnie Cele.
- Pollyday Publishing Co., (BMI)** (See Su-Ma Publishing Co.).
- PolyGram Music Publishing, (ASCAP)** 810 Seventh Ave., New York, NY, 10019, (212) 333-8000. Contact: Brian Kelleher.
- Pomona Music Corp., (BMI)** (See Shapiro, Bernstein & Co., Inc.).
- Poncello Music, (ASCAP)** (See The Ted Jarrett Music Group).
- Poncho Case Music, (ASCAP)** (See Malaco Music Group).
- Ponderosa Music Co., Inc., (BMI)** (See Shapiro, Bernstein & Co., Inc.).
- Pop Record Research, 17 Piping Rock Dr., Ossining, NY, 10562, (914) 762-8499.** Pres.: Gary Theroux.
- Pops Neon Ent's., PO Box 4125, West Hills, CA, 91308, (818) 887-2248.** Contact: Steve Hobson.
- Popular Music Co., (ASCAP)** PO Box 1221, Hollywood, FL, 33022, Pres./Gen. Mgr.: Mort Browne; Professional/Creative Mgr.: Addy Browne.
- Positif Press, (See The Organ Literature Foundation).**
- Potable Music, (See Warner/Chappell Music, Inc.).**

Pow Wow Music, Inc., 225 W. 57th St., Ste. 404, New York, NY, 10019, (212) 245-3010. Fax: (212) 956-2326. Pres.: Herb Corsack; Professional/Creative Mgr.: Judy Cacase.

Power Force, (See NEM Entertainment Corp.).

Power Metal Music, Inc., (BMI) 2210 Raper Blvd., Arlington, TX, 76013, (817) 461-8481. Pres.: Jerry Abbott.

Power Play Music, (BMI) 1900 Elm Hill Pike, Nashville, TN, 37210, (615) 889-8001. Pres.: Moe Lytle.

Prairie Music Ltd., (BMI) PO Box 438, Walnut, IA, 51577, (712) 784-3001. Pres.: Robert Everhart; Gen. Mgr.: Sheila Armstrong.

Prairieville, PO Box 0, El Cerrito, CA, 94530, (415) 845-9200. Fax: (415) 845-9248. Pres.: Jeff Alexson.

Praise c/o Jacobson & Coffin, (ASCAP) 156 Fifth Ave., Ste. 434, New York, NY, 10010, (212) 691-5630. Fax: (212) 645-5038. Pres.: Paul Ferrar; Gen. Mgr.: Jeffrey Jacobson.

Praise! Music, (BMI) (See Integrity Music, Inc.).

Prelude Music Publishing, (ASCAP) PO Box 93, 157 Chestnut Hill Rd., Trumbull, CT, 06611, (203) 261-5216. Fax: (203) 268-9124. Pres.: Armando Sciacia.

Prentice Music, Inc., (ASCAP) (See Clyde Otis Music Group).

Prescription Co., (BMI) 70 Murray Ave., Port Washington, NY, 11050, (516) 767-1929. Pres.: David F. Gasman; Gen. Mgr.: Paul Jonath; Professional/Creative Mgr.: Arthur M. Gasman.

Theodore Presser Co., (ASCAP) Presser Pl., Bryn Mawr, PA, 19010, (215) 525-3636. Fax: (215) 527-7841. Pres.: Arnold Broido; Professional/Creative Mgr.: Thomas Broido.

Prestige, (See Fantasy, Inc.).

Jimmy Price Music Publisher, (BMI) 1662 Wyatt Pkwy., Lexington, KY, 40505, (606) 254-7474. Pres./Professional Mgr.: James T. Price; Gen. Mgr.: Rose Powers.

Pricption Co., (BMI) 70 Murray Ave., Port Washington, NY, 11050, (516) 767-1929. Pres.: David F. Gasman; Gen. Asst.: Kirk Nordstrom.

Prince of the Bronx, (See La Rana/El Porto Music).

Prince/SF Publications, 1135 Francisco St., Ste. 7, San Francisco, CA, 94109, (415) 775-9627. Gen. Mgr.: Ken Malucelli.

Princess Music Pub. Corp., (ASCAP) (See H/B Webman & Co.).

Print Music Co., Inc., (ASCAP) 10 Swirl Ln., Levittown, NY, 11756, (516) 796-3698. Pres./Gen. Mgr.: Nat Schnapp; Professional/Creative Mgr.: Jerry Samuels.

Pritchett Publications, (BMI) 38603 Sage Tree St., Palmdale, CA, 93551, (805) 947-4657. Pres./Creative Mgr.: LeRoy Pritchett; Gen. Mgr.: Charles Vickers. Branch(es): 171 Pine Haven, Daytona Beach, FL, 32014.

Prize Music, Inc., (ASCAP) (See Shelby Singleton Music, Inc.).

Process Music Publications, (BMI) (See Country Star Music).

Prodigal Son Music, (BMI) (See Mary Williams Music Clearance Corp.).

Promiseland Music, (SESAC) (See Word Music).

Pronto Music, (BMI) (See Cotillion Music, Inc., Warner/Chappell Music, Inc.).

Prophecy Publishing, Inc., (ASCAP) PO Box 4945, Austin, TX, 78765, (512) 459-6036. Pres.: Tom White.

Prophet Music, Inc., (ASCAP) (See The Bicycle Music Co.).

Prosperous, (ASCAP) (See Angelson Publishing).

Prostyhtunes, (BMI) (See H.E.G. Music).

Protons, Inc., (ASCAP) 740 Broadway, 7th Floor, New York, NY, 10003, (212) 529-2600. Fax: (212) 420-8216. Pres.: Steven Plotnick.

PsalmSinger, (BMI) (See Lilienas Publishing Co.).

Pubco Music Publishing, (BMI) 20 North Third St., Daniel Bldg., 6th Floor, Philadelphia, PA, 19106, (215) 629-0030. Fax: (215) 629-0034. Pres.: Arthur M. Mann.

Pure Prairie League Music, (ASCAP) (See Kentucky Wonder Music).

Pure & Simple Island Music, (BMI) (See Pure & Simple Prods.).

Pure & Simple Prods., (ASCAP) PO Box 563, 6 Rosario Shores Rd., Eastsound, WA, 98245, (206) 376-5230. Fax: (206) 376-4894. Pres.: Christopher Peacock.

Purple Haze Music, (BMI) PO Box 1243, Beckley, WV, 25802, (304) 252-4836. Pres.: Richard L. Petry; Professional/Creative Mgr.: Carol Lee.

Pushcart Music, (See Bronjo Music)

Q

QVQ Music, (ASCAP) (See Linesider Prods.; Rohm Music).

Qmark Music Corp., (BMI) 1201 Carlisle Rd., York, PA, 17404, (717) 843-4228. Fax: (717) 852-0554. Pres.: Lewis Quintin; Professional/Creative Mgr.: Mark Barkan.

Quark, Inc., 1650 Broadway, Ste. 1212, New York, NY, 10019, (212) 489-7260. Fax: (212) 489-7267. Pres.: Curtis Urbina; Gen. Mgr.: Mara Freedman.

Quarkette Music, (BMI) (See Quark, Inc.).

Quartet Music, Inc., (ASCAP) (See Laiber-Stoller).

Quicksand Music, (BMI) (See Qwest Music Publishing).

Quill & Keyboard Music Publishing, (ASCAP) PO Box 4172, Ocala, FL, 32678, (904) 732-7038. Pres./Professional/Creative Mgr.: Robin MacBlane; Gen. Mgr./Professional/Creative Mgr.: Larry Whittler.

Charlie Quintal Music, (ASCAP) (See Comet-Tale).

Quisqueya Publishing, (ASCAP) (See Carimus Corporation).

Qwest Music Publishing, 3800 Barham Blvd., Ste. 503, Los Angeles, CA, 90068, (213) 874-2829. Fax: (213) 874-4236. Pres.: Louise A. Velazquez.

R

RCI Music Group, 405 Tarrytown Rd., Ste. 335, White Plains, NY, 10607, (914) 592-7983. Pres.: Ron Carpenter.

RCS Music Co., (ASCAP) PO Box 14685, Baton Rouge, LA, 70898, 5220 Essen Ln., Baton Rouge, LA, 70809, (504) 766-3233. Fax: (504) 766-4112. Pres.: Cyril E. Vetter; Gen. Mgr.: Courtney Westbrook; Professional Mgr.: Johnny R. Palazzotto.

R.D. Row Music Co., (ASCAP) (See Carl Fischer, Inc.).

RFT Music Publishing Corp., (BMI) (See Thomas J. Valentino, Inc.).

RGS Music Co., (ASCAP) 488 Madison Ave., Ste. 1710, New York, NY, 10022, (212) 223-0044. Fax: (212) 223-4531. Pres.: John E. Nathan.

R.L. August Music Co., (See SHR Publishing).

RMO Music, (BMI) (See Songs For Today).

Rabadash Music, (ASCAP) PO Box 19384, New Orleans, LA, 70119, (504) 482-6922. Fax: (504) 488-4481. Pres.: John G. Autin; Gen. Mgr.: Nova Wixted; Professional Mgr.: Louie Ludwig.

Eddie Rabbitt Music Publishing, (BMI) (See All Nations Music Publishing).

Racerex Music, (ASCAP) (See Avatar Publishing Group).

Radio Thunder Music, (ASCAP) (See Darksilver Music Ltd.).

Ragland Publications, (BMI) PO Box 43659, Las Vegas, NV, 89116, (702) 794-4588. Pres.: Cozetta Ragland; Gen. Mgr.: Marcietta Ragland; Professional Mgr.: Lou Ragland.

Rainbow Planet Songs, Inc., (ASCAP) (See Ferry Boat Music).

Raindrop Publications, (See Conarch Prods.).

Raintree Music, (ASCAP) (See Budd Music Corp.).

Raku Records, 91 Newbury St., Boston, MA, 02116, Contact: David Kowal.

Ram Shack Music, (BMI) (See Jonco Music).

Ramapo Music, (BMI) (See MMO Music Group).

The Rambol Music Publishers, (ASCAP) 1817 Loch Lomond Way, Las Vegas, NV, 89102, (702) 384-0030. Fax: (702) 382-1926. Pres.: Joe Jan Jaros; Gen. Mgr.: Ken Brown; Professional/Creative Mgr.: Ken Brown.

Ranchette Music Publishing, (BMI) 11311 Audelia Rd., #283, Dallas, TX, 75243, (214) 348-4151. Pres.: Dick Michaels.

Range Road Music, Inc., (ASCAP) (See Alley Music Corp.).

Ranger Bob Music, (ASCAP) C/O Polygram/Island Music Publishing, 54 Music Sq. E., Nashville, TN, 37203, (615) 256-7648.

Ranlar Music, (See Espy Music Group).

Rap Alliance, (ASCAP) PO Box 180, Cooper Station, 2 Washington Sq. Village, Ste. 13G, New York, NY, 10276, (212) 995-1608. Fax: (203) 334-6218. Pres.: Jonathan P. Fine; Professional/Creative Mgr.: Lyvio G.

Fred Raphael Music, (ASCAP) 319 Via Don Benito, Cathedral City, CA, 92234, (619) 328-0170. Pres.: Hermione Greene.

Rapture Publishing, (See Conarch Prods.).

Raquel's Songs, (BMI) (See Baby Raquel Music).

Rare Blue Music, (ASCAP) (See Chrysalis Music Group, Inc.).

Rashida Music, (BMI) (See Qwest Music Publishing).

Rattlesnake Ridge, (BMI) (See John E. Denny).

Raven Music, (BMI) PO Box 77011, 12055 First Ave. NW, Seattle, WA, 98177, (206) 367-0736. Pres.: Ron Ellis.

Ravenswood Music, (BMI) (See Rondell Music).

Ray-Dee, (SESAC) (See Glad Music Co.).

Ray of Hope Publishing, (BMI) 209 Trade Wind Ln., Plymouth, MA, 02360, (508) 759-3256. Pres.: Fred Kussman; Gen. Mgr.: Robin Chlasson; Professional Mgr.: Ray Fournier.

Raybird Music, (BMI) 457 W. 57th St., New York, NY, 10019, (212) 245-2299. Pres.: Ray Passman; Gen. Mgr.: Teddy Charles.

Clifton Rayburn Music Co., (ASCAP) (See Hal Bernard Ents., Inc.).

Ready To Rock Music, (BMI) 760 Quail Tail Trail, Sedona, AZ, 86336. Pres.: P.J. Biorisk; Gen. Mgr.: Larry Napieralski.

Real Zeal Music, (See Randy Klein Music).

Rear Window Music, (ASCAP) (See Solid Smoke Songs).

Rebel Heart Music, Inc., (ASCAP) 54 Music Sq. W., 2nd Floor, Nashville, TN, 37203, (615) 256-3644.

Rebel/Rock Records, (BMI) (See Baddest Of The Bad Posse Records).

Record Rama Sound Archives, (BMI) 4981 McKnight Rd., Pittsburgh, PA, 15237, (412) 367-7330. Fax: (412) 367-7388. Pres.: Paul C. Mawhinney.

Record, Video & Film Music Publishing, (ASCAP) 3884 Franklin Ave., Los Angeles, CA, 90027, (213) 662-3121. Pres.: Brian Ross; Gen. Mgr.: Ian Anthony Ross; Professional Mgr.: DiDi Anthony.

Recordo Music Publishers, (BMI) (See Leon Rene Publications).

Red Admiral, (BMI) (See Chrysalis Music Group, Inc.).

Red Barn Farm Pub., (BMI) PO Box 84, Strausstown, PA, 19559, (215) 488-1782. Pres.: Patrick N. Sickafus.

Red Diaper Music, (BMI) (See Alkatraz Corner Music).

Red Linnet Music, (BMI) 43 Beaver Brook Rd., Danbury, CT, 06810, (203) 730-0333. Fax: (203) 730-0345. Pres.: Wendy Newton; Professional/Creative Mgr.: Steve Katz.

Red Pelican, (ASCAP) 576-B Goldsboro Rd. NE, Atlanta, GA, 30307, (404) 688-0799. Pres.: Al Harris.

Red Rock Music Co., (BMI) PO Box 871832, New Orleans, LA, 70187, (504) 246-9269. Pres.: Beatrice James; Gen. Mgr.: Yvonne Gates; Professional/Creative Mgr.: James C. Scott, Jr.

Red Zone Music, (BMI) PO Box 62, St. Joseph, MO, 64502, (816) 233-6778. Pres./Professional Mgr.: W.D. Morgan; Gen. Mgr.: C. Stien.

Reesha Music, (BMI) (See Fradale Songs).

Regal Music Publications, (ASCAP) (See Perfection Music Publications).

Regatta Music, Ltd., (BMI) (See Int'l Record Syndicate Music, Inc., First Release Music Publishing).

Regent Music Corp., (BMI) (See The Goodman Group Music Publishers).

ReignInMe Music, (SESAC) (See Josena Music).

Relix Magazine, PO Box 94, Brooklyn, NY, 11229, (718) 258-0009. Fax: (718) 692-4345. Pres.: Toni A. Brown.

Ren-Maur Music Corp., (BMI) 521 Fifth Ave., 17th Floor, New York, NY, 10175, (212) 757-3638. Pres.: Rena L. Feeney; Gen. Mgr.: Maureen Gills; Professional/Creative Mgr.: Billy Nichols.

Rendezvous Entertainment, 1133 Avenue of the Americas, New York, NY, 10036, (212) 930-4760. Fax: (212) 930-4767. Pres.: Jimmy Ienner.

Leon Rene Publications, (ASCAP) 2124 W. 24th St., Los Angeles, CA, 90018, (213) 737-5125. Pres.: Irma Rene; Gen. Mgr.: Rafael Rene; Professional/Creative Mgr.: Tony Jones.

Rent-A-Song, (BMI) 4433 Petit Dr., Encino, CA, 91436, (213) 278-8970. Fax: (818) 907-7664. Pres.: Dennis Lambert; Gen. Mgr.: Ali Adiwaya.

Republic Music Corp., (BMI) (See World Music, Inc.).

Republic of Texas, (ASCAP) (See Bill Butler Music).

Requested Songs, (ASCAP) PO Box 120603, Nashville, TN, 37212, (615) 298-1694.

Respect Music Co., (BMI) PO Box 35449, Los Angeles, CA, 90035, (213) 281-8599. Pres.: Miles Grayson; Gen. Mgr.: Tracy Moore.

Rest-A-While Music Co., (ASCAP) (See Country Music Group).

Revel Music, (BMI) (See Don King Music Group, Inc.).

Gary Revel Music, (ASCAP) (See Jongleur Music).

Revelation Music Publishing Corp., (ASCAP) (See Valand Publishing Group).

Reynsong Music, (BMI) 1229 17th Ave. S., Nashville, TN, 37212, (615) 321-4487.

Rhineland Music, (BMI) 3809 Clematis Ave., New Orleans, LA, 70122, (504) 949-8386. Fax: (504) 948-3105. Pres./Gen. Mgr.: Marshall E. Sehorn.

Rhythm Wrangler Music, (BMI) Rt. 6, Box 41-L, Austin, TX, 78737, (512) 288-1695. Fax: (512) 288-5301. Pres.: Susan Walker; Gen. Mgr.: Ron Shelley.

G. Ricordi & Co. (Milan), (BMI) (See Boosey & Hawkes, Inc.).

Ridge Music Corp., (BMI) 38 Laurel Ledge Ct., Stamford, CT, 06903, (203) 322-1496. Fax: (203) 322-8201. Pres.: Paul Tannen.

Ridge Runner Publishing, (ASCAP) PO Box 122115, Fort Worth, TX, 76121, (817) 731-7375. Pres.: Slim Richey.

Right Key Music, (BMI) (See Horipro Entertainment Group).

Righthouse Music, (ASCAP) (See W. Packhouse Music Publishing, Inc.).

Rightsong Music, (BMI) (See Warner/Chappell Music, Inc.).

Riffing Music, Inc., (ASCAP) (See Valand Publishing Group).

RingHouse Publishing Co., (ASCAP) 5600 N. Dixie Hwy., #703, West Palm Beach, FL, 33407, (407) 844-6721.

Rio Bravo Music Co., (BMI) (See Major Bob Music).

Rittke Int'l Co., (See Fuente Music Co.).

Tex Ritter Music Publishing, (ASCAP) 6124 Selma Ave., Hollywood, CA, 90028, (213) 469-2296. Pres.: Dorothy Ritter; Gen. Mgr.: Michael H. Goldsen.

Roadblock Music, Inc., (ASCAP) 225 Lafayette St., Ste. 407, New York, NY, 10012, (212) 219-0077. Fax: (212) 219-0301. Pres.: Cees Wessels; Gen. Mgr.: Douglas Keogh; Administrator: Joan Bolvin.

Rob-Lee Music, (BMI) PO Box 37612, Gold Tree Sta., Sarasota, FL, 34278, (813) 377-1877. Fax: (813) 377-1877. Pres.: Rod Russen; Gen. Mgr.: Lynn Schuette; Professional/Creative Mgr.: Eric Russen.

Robadon Music, (BMI) PO Box 2162, 4354 E. Lake Rd., Sheffield Lake, OH, 44054, (216) 949-7113. Pres./Gen. Mgr.: Robert Sellers; Professional/Creative Mgr.: David Sprouse.

Kent Robbins Music, (BMI) (See Southern Writers Group, USA).

Robin Hood Music Co., (BMI) 5531 Tuxedo Terrace, Hollywood, CA, 90068, (213) 465-9758. Pres.: John Marascalco.

Rock Force, (BMI) (See Lindseyanne Music, Inc.).

Rock Island Music, (ASCAP) (See Rob-Lee Music).

Rock 'n Roland, (ASCAP) (See Joel S. Turtle).

Rocket & Space Music, (ASCAP) (See Short & Sweet Music).

NOTICE!

The listings contained in this publication are based solely upon information supplied to Billboard as of presstime. All information is checked for accuracy as of that time. However, Billboard is not responsible for changes in management or any other related business associations that may supersede the listings contained herein.

S

- Rockmasters Int'l Network**, 5736 Shenandoah Ave., Norfolk, VA, 23509, (804) 623-5565. Fax: (804) 640-1402. Pres.: Frank J. Guida; Gen. Mgr.: R.G. Burns; Professional/Creative Mgr.: Joseph Da Vinci Guida.
- Rockwood Music**, (BMI) (See American League Music).
- Rocky Bell Music**, (BMI) (See White Cat Music).
- Rodanca Music**, (ASCAP) (See Bianca Music).
- Rodeheaver Co.**, (ASCAP) (See Word Music).
- Rodney Friend Music**, (BMI) (See Highest Praise Publishing Co.).
- Rodsongs**, (ASCAP) (See Almo Music Corp.).
- Rogan Publishing**, (BMI) (See Malaco Music Group).
- Rohm Music**, (BMI) PO Box 57, 10 George St., Wallingford, CT, 06492, (203) 269-4465. Fax: (203) 294-1745. Pres.: Thomas "Doc" Cavalier; Gen. Mgr.: E. Mercier.
- Roll On Records**, (See California Country Music).
- Ron "Mister Wonderful" Music**, (BMI) 1730 Kennedy Rd., Louisville, KY, 40210, (502) 774-1066. Pres.: Ronald C. Lewis. Ronarte Pub., (ASCAP) (See Sound Column Companies).
- Ronatote Music Publishing Co. Inc.**, (JMP/CPW) 2114 New Orleans St., New Orleans, LA, 70119, (504) 944-6075, (504) 283-8459. Fax: (504) 288-8199. Pres.: Ronald Jones; Gen. Mgr.: Marilyn Jones; Professional/Creative Mgr.: Joe Jones Sr. Branch(es): 10556 Arnwood Rd., Lake View Terrace, CA, 91342, (818) 890-0730, Contacts: Joe Jones Sr. Dwayne Jones.
- Rondell Music**, (BMI) PO Box 827, 13117 Highway #9, Boulder Creek, CA, 95006, (408) 338-2184. Fax: (408) 338-2749. Pres./Gen. Mgr.: Jimmy Joe Lee.
- Rondo Music Co.**, (ASCAP) PO Box 6785, San Mateo, CA, 94403, (415) 574-5398. Gen. Mgr.: Jack Sharpe.
- Rondor Music, Int'l**, 1358 N. LaBrea, Hollywood, CA, 90028, (213) 856-2699. Fax: (213) 469-4302. Pres.: Lance Freed; Gen. Mgr.: Allan Rider; Sr. VP: Brenda Andrews.
- Rontom Music Co.**, (ASCAP) PO Box 150394, Nashville, TN, 37215, 602 W. Iris Dr., Nashville, TN, 37204, (615) 298-3824. Pres.: Tom Walls; Gen. Mgr.: Jean Walls.
- Room Full of Music**, (BMI) (See Manna Music, Inc.).
- Room Seven Music**, (BMI) 6253 Hollywood Blvd., #1100, Los Angeles, CA, 90028, (213) 469-1095. Fax: (213) 469-7901. Pres.: Walter E. Hurst.
- RoomToons Music**, (BMI) 209 Lenox Ave., Providence, RI, 02907, (401) 941-6649. Fax: (401) 467-4305. Pres.: Bob Bell.
- Rooster Music**, (BMI) 80 S. Washington St., #200, Seattle, WA, 98104, (206) 624-7688. Pres.: Wall Wagner.
- Roots Music**, (BMI) PO Box 111, Sea Bright, NJ, 07760, (201) 823-8718. Pres./Professional/Creative Mgr.: Robert Bowden; Gen. Mgr.: Gloria Bowden.
- Rose Canyon Music Co.**, (SESAC) (See Neil A. Kjos Music Co.).
- Rose Tree Music**, (ASCAP) (See The Mighty 3 Music Group; Warner/Chappell Music, Inc.).
- Rosebud Publishing Co. Inc.**, (BMI) Rt. 5, Box 1635, Henderson, TX, 75652, (214) 889-2724. Pres./Gen. Mgr.: Frank C. St. Clair.
- Rosemark Publishing Co.**, (BMI) 12 Lorkim Ln., Atco, NJ, 08004, (609) 767-8037. Pres.: Robert Thomas; Gen. Mgr.: Bob Fritzpatrick.
- Rosemary Melody Line**, (BMI) (See Windrose, Inc.).
- Rosey Red**, (BMI) (See Music General Corp.).
- Rosker Music**, (BMI) 8306 Appalachian Dr., Austin, TX, 78759, (512) 338-1991. Fax: (512) 338-1808. Pres.: Carlyne Majer; Gen. Mgr.: Tammy Moore.
- Brian Ross Music**, (BMI) 3884 Franklin Ave., Los Angeles, CA, 90027, (213) 662-3121. Pres.: Brian Ross; Gen. Mgr.: Aaron Anthony; Professional/Creative Mgr.: Ian Anthony Ross.
- Rough Diamond**, (BMI) (See Ten of Diamonds Music).
- Rounder Music**, (ASCAP) (See Happy Valley Music).
- James Rounds Music**, (ASCAP) (See Bristol Music Co.).
- Royal Flair Music**, (BMI) PO Box 438, 203 Central, Walnut, IA, 51577, (712) 784-3001. Fax: (712) 784-2010. Pres.: Robert Everhart. Branch(es): A.P. 1050, Veracruz, Mexico, Contact: Sheila Armstrong.
- Royal Tapestry Music**, (ASCAP) (See Diadem, Inc.).
- David Rubinson Publishing**, (ASCAP) PO Box 411197, San Francisco, CA, 94141, (415) 777-1212. Fax: (415) 931-5002. Pres.: David Rubinson; Professional Mgr.: Kathy Horton.
- Ray Ruff**, (ASCAP) 156 Carlin Dr., Columbia, SC, 29169.
- Randall Ramage Music**, (BMI) 906 N. Doheny Dr., Ste. 302, Los Angeles, CA, 90069, (213) 271-9752. Fax: (213) 271-4842. Pres.: Randall L. Ramage.
- Rumble Seat Music**, (BMI) (See Why Any Luck).
- Rumrunner Music, Inc.**, 3406 N. Ocean Blvd., Fort Lauderdale, FL, 33308, (305) 561-4880. Fax: (305) 537-9048. Pres.: Greg Aliferis.
- Rural Hip Music**, (ASCAP) 1025 16th Ave. S., Ste. 202, Nashville, TN, 37212, (615) 320-5291.
- Rushwin Publishing**, (BMI) PO Box 1150, Buna, TX, 77612, (409) 423-2521. Gen. Mgr./Professional Mgr.: James Gibson.
- Rustron Music Publishers/Rustron Music Prods.**, (BMI) 1156 Park Lane, West Palm Beach, FL, 33417, (407) 686-1354. Admin./Submission Review: Florida Office Only; Exec. Dir.: H. Rusty Gordon; Professional Mgr.: Davilyn Whims. Branch(es): 33 Whittier, Poets Corners, Hartsdale, NY, 10530, (914) 761-3025. Gen. Mgr./Professional Mgr.: Ronald Caruso.
- Ryan's Songs**, (ASCAP) 18653 Ventura Blvd., Ste. 513, Tarzana, CA, 91356, (818) 705-3512. Fax: (818) 705-3403. Pres.: Suzanne Hayden.
- Rye Boy Music**, (ASCAP) (See Joel S. Tuttle).
- Rytvoc, Inc.**, (ASCAP) (See Cheri Corp.).
- SBK Entertainment World, Inc.**, 1290 Avenue of the Americas, New York, NY, 10104, (212) 492-1200.
- SB Publishing**, (ASCAP/BMI) 2114 Pico Blvd., Santa Monica, CA, 90405, (213) 450-3193. Fax: (213) 452-9053. Pres.: Tony Scotti; Gen. Mgr.: Mara Perez.
- SHR Publishing**, 40 W. 57th St., Ste. 1510, New York, NY, 10019, (212) 586-3600. Fax: (212) 307-7027. Pres.: Herb Moelis; Gen. Mgr.: Raven L. Mednis.
- SK Prods. Publishing**, 1302 Hwy. 143, Cedarburg, WI, 53012, (414) 375-1991. Pres.: Jay Rossman; Gen. Mgr.: Debbie Rossman; Professional Mgr.: Bruce Colfin.
- S.L.H. Music Publishers**, (ASCAP) (See Cape Rock Music).
- SMD Publishing**, (See La Rana/El Porto Music).
- SRF Publishing**, (ASCAP) (See Int'l Atlanta Music).
- S & R Music Publishing Co.**, (ASCAP) 71906 Hwy. 111, Rancho Mirage, CA, 92270, (619) 356-0075. Fax: (619) 346-0075. Pres.: Scott B. Seely; Gen. Mgr.: Dolores L. Seely.
- S.T.D. Music Publishing**, 140 Lawrence St., Brooklyn, NY, 11201, (718) 625-2838. Pres.: Steven W. Standard; Gen. Mgr.: Kathy Waters; Professional/Creative Mgr.: Sharon Taylor.
- STM Music**, (BMI) (See Next Plateau Music, Inc.).
- SACM Latin Copyright, Inc.**, (ASCAP) (See Mateo San Martin Agency, Inc.).
- Sabertooth Music**, (BMI) (See SB Publishing).
- Sabteca Music Co.**, (ASCAP/BMI) PO Box 10286, 712 Longridge Rd., Oakland, CA, 94610, (415) 465-2805. Pres.: Bernard D. Herring; Gen. Mgr.: Bernard D. Herring, Jr.; Professional/Creative Mgr.: Sean A. Herring.
- Sadram**, (See Latin American Music Co., Inc.).
- Safe Return Music**, (BMI) PO Box 7032, Marietta, GA, 30065, (404) 436-8631. Pres.: Jeff Higgins.
- Sage Brush Music**, (BMI) PO Box A, Arcadia, CA, 91066, 135 W. Foothill Blvd., Ste. C, Monrovia, CA, 91016, (818) 359-6061. Fax: (818) 303-4323. Pres.: Sam Passamano, Jr.
- Sage & Sand Music**, (SESAC) (See HoriPro Entertainment Group).
- Saheedron Music Publishing, Inc.**, (ASCAP) (See Peer-Talbot Music Group).
- Saiko Music Co.**, (ASCAP) (See Hal Bernard Entns., Inc.).
- St. Michael's Music Publishing**, (ASCAP) PO Box 1862, Hollywood, CA, 90028, (818) 896-5346. Pres.: James Wesley Smith.
- Saira Music**, (ASCAP) (See 23rd Street Publishing/Listening Room Music, Inc.).
- Saja Music Co.**, (BMI/ASCAP) 40 W. 57th St., Ste. 1510, New York, NY, 10019, (212) 586-3600. Fax: (212) 307-7027. Pres.: Herb Moelis; Professional Mgr.: Melinda Meals.
- Sallgood Music**, (See La Rana/El Porto Music).
- Salmo Music**, 331 E. Ninth St., New York, NY, 10003, (212) 473-7833. Professional/Creative Mgr.: Santo Mollica.
- Salt Creek Music**, (ASCAP) (See Salt Works, Inc.).
- Salt Works, Inc.**, (BMI-ASCAP) 21 Fleetwood Ave., Jackson, OH, 45640, (614) 286-3420. Pres.: R.J. Elliott; Gen. Mgr.: M.A. Morgan.
- Samfred Music, Inc.**, (BMI) (See Sam Fox Publishing Co., Inc.).
- Sand Hand, Inc.**, (BMI) 3703 Edgewood Rd., Baltimore, MD, 21215, (301) 466-0188. Pres.: D. Christopher Johnson; Gen. Mgr.: Dana Johnson.
- Tracy Sands Music**, (BMI) 2166 W. Broadway, Ste. 119, Anaheim, CA, 92804, (714) 525-5223. Pres.: Tracy Sands; Gen. Mgr.: Robert Wahlsteen; Professional Mgr.: Herb G. Wahlsteen.
- Saran Music Co.**, (BMI) (See Bob-A-Lew Music).
- Sasha Songs Unlimited**, (BMI) (See Grand Pasha Publishing).
- Savgo Music**, (BMI) (See Malaco Music Group).
- Scarlet Scarlet Music, Inc.**, (BMI) 605 Ridgfield Rd., Wilton, CT, 06897, (203) 762-2102. Fax: (203) 762-5081. Pres.: Ruby McFarland Rahn.
- Scarlet's Mate Music**, (ASCAP) (See Song Source, Inc.).
- Scarsdale Music Corp.**, (ASCAP) (See Shapiro, Bernstein & Co., Inc.).
- Scates & Blanton**, (BMI) (See Axbar Prods.).
- Richard Schaver**, (PRS/BMI) (See Theodore Presser Co.).
- E.C. Schirmer Music Co., Inc.**, (ASCAP) 138 Ipswich St., Boston, MA, 02215, (617) 236-1935. Fax: (617) 236-0261. Pres./Professional/Creative Mgr.: Robert Schuneman.
- G. Schirmer, Inc.**, (ASCAP) 225 Park Ave. S., 18th Floor, New York, NY, 10003, (212) 254-2100. Fax: (212) 254-2013. Pres.: Barrie Edwards; Vice Pres./Promo. Dir.: Susan Feder.
- Schmerdel Music**, (BMI) 7560 Woodman Pl., #G3, Van Nuys, CA, 91405, (818) 994-4862. Owner: Tom Willett.
- Schnorr Music**, (BMI) (See Mary Williams Music Clearance Corp.).
- Edward Schuberth & Co., Inc.**, (SESAC) (See Ashley Publications, Inc.).
- Schumann Music Co.**, (ASCAP) (See Bourne Co.).
- Scoba One Music**, (BMI) (See Faro Music Publishing).
- G. Scott Music Publishing Co.**, (See JTL Publications).
- Gregg Scott Music**, (BMI) 16 Dundee Rd., Stamford, CT, 06903, (203) 322-5778. Fax: (203) 329-7838. Pres.: Fred Weinberg; Gen. Mgr./Professional/Creative Mgr.: Gregg Scott Weinberg.
- Scotti Bros. Film Publishing**, (BMI) (See SB Publishing).
- Scottone Music**, (ASCAP) (See SB Publishing).
- Scott's Residence Dist.**, (BMI) (See Tyscot Publishing).
- Scramblers Knob Music**, (ASCAP) 1000 Scramblers Knob, Franklin, TN, 37203, (615) 742-8081.
- Scramrock Music Co.**, (BMI) 139 E. Harding Rd., Springfield, OH, 45504, (513) 399-6708. Professional/Creative Mgr.: Robert T. "Dusty" Jones.
- Screen Gems-EMI Music, Inc.**, (BMI) 6920 Sunset Blvd., Hollywood, CA, 90028, (213) 469-8371. Branch(es): 16th Ave. S., Nashville, TN, 37212, (615) 320-7700.
- Scrutchings Music**, (BMI) 429 Homestead St., Akron, OH, 44306, (216) 773-8529. Pres.: Walter E.L. Scrutchings.
- Scully Music Co.**, (ASCAP) 627 N. Rossmore Ave., Ste. 312, Hollywood, CA, 90028, (213) 465-5050. Fax: (213) 466-1629. Pres./Gen. Mgr.: Walter Kahn; Professional/Creative Mgr.: Mauro Monteiro.
- Sea Cruise Music**, (BMI) PO Box 1875, Gretna, LA, 70054, (504) 392-4615. Fax: (504) 392-4512. Pres./Gen. Mgr.: Ken Keene; Professional/Creative Mgr.: Frankie Ford.
- Seaneen Music**, (ASCAP) (See DeWhit Music).
- Seaside Publishing**, (BMI) PO Box 357, Ridgefield Park, NJ, 07660, (201) 641-5749. Pres.: C.A. Pruitt.
- Second Serve Music**, (BMI) (See Mick Lloyd Prods.).
- Secret Affair Music**, (BMI) (See Any Kind of Music, Inc.).
- See No Evil Music Co.**, (ASCAP) (See Espy Music Group).
- See Strait Music**, (ASCAP) (See My Bueno Music Group).
- See This House Music**, (ASCAP) (See All Nations Music Publishing).
- Anthony Seigler Publishing**, (SESAC) (See Wajji Music Group).
- Ralph Seltzer Music**, (ASCAP) 1751 Draper Valley Rd., Selma, OR, 97538, (503) 597-2161. Pres.: Ralph L. Seltzer; Gen. Mgr.: M. Walther.
- Semenya Music**, (See Gopam Entns., Inc.).
- Seneca Music**, (See You Heard It—Hear!).
- The Sengstack Group, Ltd.**, (ASCAP) PO Box 2072, 100 Thanet Circle, Princeton, NJ, 08540, (609) 497-3900. Fax: (609) 924-1618. Pres.: David K. Sengstack; Pub. Administrator: Kate Chen.
- Senior Music**, (ASCAP) (See Garrett Music Entns.).
- Sephra Music c/o Publishers' Licensing Corp.**, (ASCAP) PO Box 5807, Englewood, NJ, 07631, (201) 568-3996. Fax: (201) 569-9580. Pres.: Kenny Burrell.
- September Music Corp.**, (ASCAP) 250 W. 57th St., New York, NY, 10107, (212) 581-1338. Fax: (212) 765-6703. Pres.: Stanley Mills.
- Serenity Manor Music**, (ASCAP) 1470 Old Hillsboro Rd., Franklin, TN, 37064, (615) 794-7154.
- Service Winner Music**, (ASCAP) (See Mick Lloyd Prods.).
- Seven Arts Press, Book & Music Publishers**, (ASCAP) 6253 Hollywood & Vine, #1100, Los Angeles, CA, 90028, (213) 469-1095. Fax: (213) 469-7901. Pres.: Walter E. Hurst.
- Seven of Us Music**, (BMI) 810 Wateroak Dr. NE, Palmbay, FL, 32905, (407) 723-1741. Pres.: Michael F. Matushin, Sr.
- 17th Ave. Music**, (ASCAP) (See Buchhorn Music Publishers, Inc.).
- Seventh Son Music, Inc.**, (ASCAP) (See Glen Campbell Music Group).
- Sforzando (Tele Music)**, (SACEM) (See Alpha Music, Inc.).
- Shade Tree Music, Inc.**, (BMI) (See All Nations Music Publishing).
- Shades Music Co.**, (ASCAP) 14755 Ventura Blvd., #1776, Sherman Oaks, CA, 91403, (818) 506-6003. Fax: (818) 505-6006. Pres.: Craig Huxley; Gen. Mgr./Professional Mgr.: Hyman Katz.
- Shadowland Prods.**, (See Conarch Prods.).
- ShadowLight Music**, (ASCAP) 9900 Tagus St., Ste. 25, Pico Rivera, CA, 90660, (310) 699-2450. Pres.: Ron Hart.
- Shan-Darlyn Publishing Corp.**, HCR 1, Box 732, Banning, CA, 92220, (714) 849-6064. Pres.: Darlene Shanklin; Gen. Mgr.: Justis Van Tyler.
- Shaolin Music**, (ASCAP) PO Box 387, Hollywood, CA, 90078, (818) 506-8660. Pres./Gen. Mgr.: Richard O'Connor; Professional/Creative Mgr.: Michelle McCarty.
- Shapiro, Bernstein & Co., Inc.**, (ASCAP) 10 E. 53rd St., 19th Floor, New York, NY, 10022, (212) 751-3395. Fax: (212) 319-8769. Pres.: Richard M. Voltger; Gen. Mgr.: Leon J. Bretler; Professional/Creative Mgr.: Michael S. Brettler.
- Sharkey Music, Inc.**, (ASCAP) (See Cromma Music Co.).
- Sharon**, (ACUM) (See Arpell/Pinellas Music Publishing).
- Shawnee Press, Inc.**, (ASCAP) 225 Park Ave. S., 18th Floor, New York, NY, 10003, (212) 254-2100. Fax: (212) 254-2013. Pres.: Barrie Edwards; Copyright Dir.: Yolanda Blum; Professional Mgr.: Philip Black.
- Shayna Music**, (BMI) (See Periscope Music Co.).
- Sheddhouse Music**, (ASCAP) (See Millhouse Music).
- Billy Sheehan Music**, (ASCAP) (See Cherry Lane Music Publishing Co., Inc.).
- Sheffield Music Corp.**, (BMI) (See Shapiro, Bernstein & Co., Inc.).
- Shekere Music**, (BMI) PO Box 26034, Richmond, VA, 23260, 2218 Rosewood Ave., Richmond, VA, 23220, (804) 355-3586. Fax: (804) 359-8901. Pres.: James Branch; Gen. Mgr./Professional/Creative Mgr.: Philip Branch.
- Shelbyville Songs**, (BMI) (See CORE Entertainment Corp.).
- Shell Music Publishing**, (BMI) (See Jimpire Music; Larry Spier, Inc.).
- Shelwin Publication Co.**, (BMI) 4148 S. King Dr., Chicago, IL, 60653, (312) 624-4811. Pres.: James W. Shelton; Gen. Mgr.: Diana Echols; Professional Mgr.: Randall A. Shelton.
- Shenandoah Music**, (ASCAP) (See Terrace Entertainment Corp.).
- Shepard Music**, (BMI) PO Box 20570, Columbus Cir. Sta., New York, NY, 10023, (212) 724-8404, (717) 347-5573. Pres.: Daniel McGlynn.
- Sheridan Songs**, (BMI) (See The Music Group).
- Bonnie Sheridan Tunes (BST)**, (BMI) (See The Music Group).
- Shinowal Songs**, (BMI) (See G & W Publishing Corp. c/o Publishers' Licensing Corp.).

Shirley's Music, (BMI) PO Box 15110, New Orleans, LA, 70175, (504) 822-7037. Fax: (504) 866-0502. Pres.: Earl K. Johnson; Gen. Mgr.: Shirley Johnson; Vice Pres.: Jo Ann Robinson.

Shop Dat Music, (ASCAP) 302 Rembrandt Dr., Old Hickory, TN, 37138, (615) 754-4288. Pres.: David A. Vaughn; Gen. Mgr.: Regina Vaughn.

Shoptim Music, (ASCAP) (See Shop Dat Music).

Short Rose Music, (ASCAP) PO Box 120536, Nashville, TN, 37212, (615) 331-7400. Pres.: Scott Tutt; Gen. Mgr.: Sunny Richards.

Short & Sweet Music, (BMI) 70 W. 95th St., New York, NY, 10025, (212) 666-6454. Fax: (212) 534-2583. Pres./Gen. Mgr.: Mark Carvel.

Shownote Music Co., (See Showpiece Prodn.).

Showoff Pub. Co., (See Showpiece Prodn.).

Showpiece Prodn., (BMI) PO Box 813, Main St., Yonkers, NY, 10702, (914) 965-0801. Pres.: Robert B. Schoen.

Showplace, Inc., (BMI) PO Box 2183, Brentwood, TN, 37024, (615) 373-0986. Pres.: Norma Jean Taylor; Gen. Mgr./Professional Mgr.: George Riddle.

Showtime, (BMI) 513 14th St. NE, Washington, DC, 20002, (202) 397-6952. Pres.: Charles A. Ables; Gen. Mgr.: Berch L. Sallies.

Sign Of The Twins c/o Publishers' Licensing Corp., (ASCAP) PO Box 5807, Englewood, NJ, 07631, (201) 568-3996. Fax: (201) 569-9580. Pres.: Gerry Thomas.

Sign of the Ram Music, (ASCAP) (See Delev Music Co.).

Silhouette Music, (ASCAP) (See Owest Music Publishing).

Silk Purse, (BMI) 1741 Alcatraz Ave., Berkeley, CA, 94703, (510) 428-2002. Pres.: Michael Cogan.

Silly Love Songs, (BMI) Box 2, Palo Cedro, CA, 96073, (916) 222-8129. Pres.: Ruben Lopez, Jr.

Silver Blue Music/Oceans Blue Music, (ASCAP/BMI) 220 Central Park S., Penthouse, New York, NY, 10019, (212) 586-3535. Fax: (212) 822-2497. Pres.: Joel Diamond.

Silver Dollar Music, (ASCAP) (See Jack Music, Inc.).

Silver Dust Music, (ASCAP) 3840 Dickerson Rd., Nashville, TN, 37207, (615) 866-2312. Pres./Gen. Mgr./Professional Mgr.: Michael R. Radford.

Silver Fiddle, (ASCAP) (See Airdrome Music & Stonewood Lane Music).

Silver Note, (SESAC) (See The Ted Jarrett Music Group).

Silver Ridge Music, (ASCAP) (See Silverhill Music).

Silver Thunder Music Group, (BMI) c/o Larry Butler Prodn., 2 Music Cir. S., Ste. 100, Nashville, TN, 37203, (615) 292-2204. Fax: (615) 269-0767. Pres./Professional Mgr.: E.J. "Rusty" Budde; Gen. Mgr.: David W. Cronan.

Silverhill Music, (BMI) PO Box 39439, 2380 Glendale Blvd., Ste. B, Los Angeles, CA, 90039, (213) 863-8073. Fax: (213) 669-1470. Pres.: David Haerle.

Silverline Music, Inc., (See Warner/Chappell Music, Inc.).

Silvertooth Records, (BMI) (See Diversified Sound Innovators).

Sinna Music Co., (ASCAP) (See NRP Music Group).

Simon Co./Sico, (BMI) JCK Center #6108, Westminster, MD, 21157, (301) 775-0368. Fax: (301) 775-2403. Pres.: Sheenah Fair.

Simply Said Songs, (BMI) (See Diversion Music).

Single Kick Music, (ASCAP) PO Box 747, La Canada, CA, 91012, (818) 902-0345. Pres.: Cho Paquet; Gen. Mgr.: Scott Kennington; Professional/Creative Mgr.: Echo Star Helstrom.

Single Phase Music, (BMI) PO Box 67, Covina, CA, 91723, 978 Amelia, San Dimas, CA, 91773, (714) 592-3098. Pres.: Steve Mortensen.

Shelby Singleton Music, Inc., (BMI) 3106 Belmont Blvd., Nashville, TN, 37212, (615) 385-1960. Fax: (615) 385-1964. Pres.: Shelby S. Singleton, Jr.; Vice Pres.: John A. Singleton.

Sinned Music, (ASCAP) 913 Wootton Rd., Bryn Mawr, PA, 19010, (215) 446-7100. Fax: (215) 446-7721. Pres.: Denny Somach.

Sir Winston Music, (BMI) (See Nashville Int'l Music Group).

Sirius I Music, (BMI) 63 Dixie Highway, Rossford, OH, 43460, (414) 666-2019. Fax: (419) 666-3141. Pres.: John M. Pocisk.

Sister John Music, Inc., (BMI) PO Box 5807, Englewood, NJ, 07631, (201) 568-3996. Fax: (201) 569-9580. Pres.: Philip S. Kurnit; Gen. Mgr.: Terry Cashman.

Sister Teresa Music, (ASCAP) (See Twelve To One Music, c/o Publishers' Licensing Corp.).

Sivatt Music, (BMI) PO Box 7172, Greenville, SC, 29610, (803) 295-3177. Pres.: Jesse B. Evatte; Gen. Mgr.: Derek Evatte.

Six Shooter Music, (ASCAP) (See Dave Burgess Ents.).

Sixteen Stars Music, (BMI) (See HoriPro Entertainment Group).

Sixth Floor Music, (BMI) (See Third Story Music Inc.).

Skidmore Music Co., Inc., (ASCAP) (See Shapiro, Bernstein & Co., Inc.).

Skinny Zach Music, (ASCAP) 19301 Ventura Blvd., Ste. 205, Tarzana, CA, 91356, (818) 708-1300. Fax: (818) 705-6332. Pres.: Zachary Glickman.

Skip Jack Music, (BMI) (See Mimic Music).

Skokie, (BMI) (See Catalogue Music).

Skunk DeVille Music, (BMI) General Delivery, Bexar, AR, 72515, (615) 458-2402.

Skyview Music Corp., (ASCAP) (See Neil Music, Inc.).

Skywalker Records, 8400 NE Second Ave., Miami, FL, 33138, (305) 573-0599. Fax: (305) 573-2437.

Slack, (BMI) (See Caprice Int'l Records/Canadian American Records).

Slack Publishing Co., (BMI) (See DiMaggio Publishing Co.).

Slamdek/Scramdown, (BMI) (See Nov. 17th Music).

Slash Music, (ASCAP/BMI) PO Box 48888, Los Angeles, CA, 90048, 7381 Beverly Blvd., Los Angeles, CA, 90036, (213)

937-4660. Fax: (213) 933-7277. Pres.: Bob Biggs; Gen. Mgr./Professional/Creative Mgr.: Mark Trilling.

Slocum Hollow Songs, (BMI) 180 Wallace Rd., #K-20, Nashville, TN, 37211, (615) 781-6118. Fax: (615) 781-6118. Pres.: Butch Baldassari.

Sloopus Music, (BMI) (See Wimot Music).

Jay Smar Traditional & Original, PO Box 68, Landingville, PA, 17942, (717) 366-0703. Pres.: Jay Smar.

Smith-Ruffin Publishing Co., (See Joe Joness Copyright Mgmt.).

Roy Smith Music Co., (BMI) (See Henry Jerome Music, Inc.).

Smooth Flight Music Co., (BMI) (See Joe Keene Music Co.).

Smorgaschord Music Co., (ASCAP) (See Hal Bernard Ents., Inc.).

Snakeman Music, Inc., (ASCAP) (See Maypop Music Group).

SoJourney Music, (BMI) (See Salt Works, Inc.).

Soft Sidewalk, (ASCAP) (See Nathan Bryden Music Co.).

Softcharay Music, (BMI) (See Le Bill Music Inc.).

Soldier Music, (BMI) (See Rent-A-Song).

Soley Administration Music, (BMI) (See Music Umbrella).

Solid Smash Music Pub., (ASCAP) (See Critique Music Pub. Co. Inc.).

Solid Smoke Songs, (ASCAP) PO Box 22372, San Francisco, CA, 94122, (415) 750-1225. Gen. Mgr.: Marty Arbutich.

Sombrero Moon Music, (BMI) PO Box 121561, Nashville, TN, 37212, (406) 442-9441. Pres.: Al Cantrell; Gen. Mgr.: Emily Cantrell.

Somebody's Music, (SESAC) (See Welk Music Group).

Sometimes You Win Music, (ASCAP) (See All Nations Music Publishing).

Somkey Music Co., (BMI) (See Jobete Music Co., Inc.).

Son Of A Pitch, (ASCAP) (See Pitch Pipe Music).

Sonata Records Co., 4304 Del Monte Ave., San Diego, CA, 92107, (619) 222-3346. Pres./Professional/Creative Mgr.: Paul DiLella; Gen. Mgr.: Joseph DiLella.

Song America Publishing, (BMI) 8727 E. Girard Ave., Denver, CO, 80231, (303) 695-8628. Pres.: Randi Perkins; Professional/Creative Mgr.: Mike Crowley.

Song Farm Music, (BMI) PO Box 24561, Nashville, TN, 37202, 1019 17th Ave. S., Nashville, TN, 37212, (615) 321-4875. Pres.: Tom Pallardy.

Song Pantry, (ASCAP) PO Box 120838, Nashville, TN, 37212.

Song of Sixpence, (SESAC) (See Music Craftshop, Inc.).

Song Source, Inc., (ASCAP) PO Box 120603, Nashville, TN, 37212, (615) 298-1694. Pres.: Byron Hill.

Song of the World, Inc., PO Box 40992, Nashville, TN, 37204, (615) 298-9960. Gen. Mgr.: Grahame Smith.

SongAmerica Pub., (BMI) (See AmeriSong, Inc.).

Songs of Calvary, (BMI) 142 Eighth Ave. N., Nashville, TN, 37203, (615) 244-8800. Pres.: Nelson Parkerson.

Songs & Creations, (ASCAP) PO Box 7, San Anselmo, CA, 94979, 64 Nokomis, San Anselmo, CA, 94960, (800) 227-2188.

Fax: (415) 258-4755. Pres.: Yohann Anderson; Gen. Mgr.: Anne Mallory.

Songs For Today, (BMI) 8 Mark Ln., New York, NY, 10956, (914) 634-8282. Fax: (914) 634-5888. Pres.: Jeffrey Kruger; Gen. Mgr.: Authur Braun; Professional Mgr.: Roland Rogers. Branch(es): 4002-A Auburn Ln., Nashville, TN, 37215.

Songs of Grand Coalition, (BMI) (See Malaco Music Group).

Songs On Hold, (SESAC) (See Rick Hall Music, Inc.).

Songs Of PolyGram Int'l, (BMI) 810 Seventh Ave., New York, NY, 10019, (212) 333-8300.

Songs of the Southland, (BMI) (See Scott Tutt Music).

Songsellers Co., Div. of Aloft Music Ents., Inc., (ASCAP) 1697 Broadway, Ste. 903, New York, NY, 10019, (212) 247-2904. Pres.: Ruby Fisher.

Songwriter's Network Music Publishing, (ASCAP) PO Box 190446, Dallas, TX, 75219, (214) 824-2739. Pres.: Phil Ayliffe.

Sonic Atmospheres Publishing, (BMI) (See Shades Music Co.).

Sono Inter, (BMI) (See Mateo San Martin Agency, Inc.).

Sonoeditora C.A., (SACVEN) (See Telearte Florida, Inc./Music Publishing Co.).

Sonotone Publishing Co., (BMI) (See Telearte Florida, Inc./Music Publishing Co.).

Sony Music Publishing, (See Chu Teh Music).

Sony Tunes, Inc., PO Box 4450, New York, NY, 10101.

Sorcerer Music, (ASCAP) 231 Sulton St., Ste. 2C, North Andover, MA, 01845, (508) 686-9811. Pres.: Ralph A. Barbagallo, Jr.; Gen. Mgr.: Sandra L.M. Scala.

Sorghum Music, (ASCAP) (See Gelfand, Rennett & Feldman).

Sotex Music, (BMI) PO Box 27, Converse, TX, 78109, (512) 653-3989. Partner: Frank Willson; Del Richerson.

Souci Music, (ASCAP) 15456 Cabrito Rd., Van Nuys, CA, 91406, (213) 873-7370. Fax: (818) 787-3981. Pres.: T. Skeeter; Gen. Mgr.: M. Richardson; Professional/Creative Mgr.: Shivaun O'Brien.

Soul Street Music Publishing, Inc., (ASCAP) 265 Main St., East Rutherford, NJ, 07073, (201) 933-2297. Fax: (212) 655-3581. Pres.: Glenn LaRusso; Professional/Creative Mgr.: Batcho Manguel.

SoulStreet Music, Inc., (ASCAP) 265 Main St., East Rutherford, NJ, 07073, (201) 933-2297. Fax: (212) 529-3511. Pres.: Glenn Larusso.

Sound of America, (BMI) (See Shirley's Music).

Sound of the City Music Publishing, (BMI) 102 D St., Clinton, SC, 29325. Pres.: Julian L. Dillard; Professional/Creative Mgr.: David L. Dillard.

Sound Column Companies, (ASCAP/BMI) 342 W. 200, S., Ste. 160, Salt Lake City, UT, 84101, (801) 355-5327. Pres.: Ron Simpson; Professional Mgr.: Mark Siddoway.

Sound Development, (BMI) PO Box 5052, Evanston, IL, 60204, (708) 328-0400. Fax: (708) 328-1700. Pres.: Graham Carlton; Gen. Mgr.: Mason Taylor; Professional Mgr.: Ken Rasek.

Are you making decisions about professional recording equipment and studios?

...Then you need Billboard's
1992 International Recording Equipment
and Studio Directory!

Worldwide listings include: •Studio Equipment •Blank Tape Charts & Manufacturers
•Studio Equipment Manufacturers •Studio Services •Recording Studio
•Plus an all new 1991 Brand Usage Study!

To order send \$37 plus \$3 S&H, (\$8 for International orders) to:
Billboard Directories

Dept. BDJM1519, P.O. Box 2016, Lakewood, NJ 08701

Please add appropriate sales tax in NY, NJ, CA, TN, MA, IL & DC.

For fastest service call toll-free: 1-800-223-7524 (outside NY), 212-536-5174

Or 1-800-344-7119 (outside NJ), in NJ 908-363-4156



- Sound Feelings Publishing**, 24266 Walnut St., Ste. 283, Newhall, CA, 91321, (805) 254-4938. Pres.: Howard Richman; Gen. Mgr.: Jackie Adair.
- Sounds of Hope**, (See Epoch Universal).
- Sounds of Praise & Celebration**, (ASCAP) (See Carl Fischer, Inc.).
- Sounds-Vision Music**, PO Box 3691, La Mesa, CA, 92044, (619) 447-1146. Fax: (619) 441-9606. Pres./Gen. Mgr.: Rod Hollman.
- Sourwood Music**, (BMI) PO Box 270, 102 Wheeler Path, Guilford, CT, 06437, (203) 457-0881. Pres.: Phil Rosenthal; Gen. Mgr.: Beth Sommers.
- Southern Arts Music**, (BMI) PO Box 121656, 1808 West End Ave., Ste. 825, Nashville, TN, 37212, (615) 242-2461. Fax: (615) 329-8111. Pres.: Jack J. Key; Professional Mgr.: E. Jimmy Key.
- Southern Crescent Publishing**, (BMI) (See Sugar Mama Music).
- Southern Grand Alliance**, (ASCAP) (See Malaco Music Group).
- Southern Melody Publishing Co.**, (BMI) PO Box 4040, Duke Sta., Durham, NC, 27706, (919) 489-4349. Fax: (919) 489-6080. Pres.: Barry Poss.
- Southern Most Publishing Co.**, (BMI) PO Box 3105, 1918 Devonshire Pl., Independence, MO, 64055, (816) 257-5032. Pres./Gen. Mgr.: Dann E. Haworth.
- Southern Music Co.**, PO Box 329, San Antonio, TX, 78292, 1100 Broadway, San Antonio, TX, 78215, (800) 284-5443. Fax: (512) 223-4537. Pres./Gen. Mgr.: Arthur B. Gurwitz.
- Southern Music Publishing Co., Inc.**, (See Peer-Southern Organization).
- Southern Music Publishing, Inc.**, (ASCAP) (See Peer-Talbot Music Group).
- Southern Writers Group, USA**, (ASCAP) PO Box 40764, 2804 Azalea Pl., Nashville, TN, 37206, (615) 383-8682. Fax: (615) 383-8696. Pres.: Buzz Cason; Gen. Mgr.: Carol Lindsey; Professional Mgr.: Doug Devlin.
- Southfield Music**, (ASCAP) (See Bridgeport Music, Inc., Globe Art, Inc.).
- Southwest Music**, (ASCAP) (See Titan Records).
- Southwing Publishing**, (ASCAP) (See Crown Music Group, Inc.).
- Spanda Music**, 155 B. Quincy Ct., Bloomingdale, IL, 60108, (312) 529-7127. Pres.: Carolyn P. Ford; Gen. Mgr.: Karen DiRenzo.
- The Sparrow Corp.**, PO Box 5010, 101 Winners Cir., Brentwood, TN, 37024, (615) 371-6800. Fax: (615) 371-6997. Pres.: Billy Ray Hearn; Mgr.: Lori Kelly. Branch(es): 54 Music Sq. E., Ste. 306, Nashville, TN, 37203, (615) 327-3800. Contacts: E. Madeira, R. Dennis.
- Sparrow Song**, (BMI) (See The Sparrow Corp.; Cherry Lane Music Publishing Co., Inc.).
- Sparta Florida Music Group**, (PRS) (See Music Sales Corp.).
- Special Kay Music**, (See Ronatole Music Publishing Co. Inc.).
- Speedster Music**, (BMI) PO Box 96, 6623 N. 51st Ave., Glendale, AZ, 85301, (602) 435-0314. Pres.: Frank E. Koehl.
- Spencer Press**, (ASCAP) (See Manna Music, Inc.).
- G. W. Spencer Music**, (ASCAP) 3221 Perryville Rd., Baldwinsville, NY, 13027, (315) 638-4286. Fax: (315) 635-4757. Pres.: Greg Spencer.
- Larry Spier, Inc.**, (ASCAP) 928 Broadway, New York, NY, 10010, (212) 460-8677. Fax: (212) 614-0166. Pres.: Larry Spier; Gen. Mgr.: Dorothy Spier.
- Spina Music**, (ASCAP) 2232 Vista Del Mar Pl., Los Angeles, CA, 90068, (213) 467-6018. Fax: (818) 988-1847. Pres.: Harold Spina; Projects Dir.: Lynne Moyer.
- Spiral Record Corp.**, (ASCAP) 50 W. 34th St., Ste. 3B-10, New York, NY, 10001, (212) 563-1893. Fax: (201) 833-4874. Gen. Mgr./Professional/Creative Mgr.: Harry Finfer.
- Spirit To Spirit Music**, (ASCAP) (See Shop Dat Music).
- Splatter**, (BMI) (See Locked Up Music, Inc.).
- Spring Rain Publications**, (See Conarch Prodn.).
- Spy Glass Music, Inc.**, (ASCAP) (See Orbob Music Inc. c/o Lipservice).
- Stable Music Co.**, (BMI) 6503 Wolfcreek Pass, Austin, TX, 78749, (512) 288-3370. Owner: Rex T. Sherry.
- Dave Stahl Music**, (BMI) PO Box 117, New Berlinville, PA, 19545, (215) 367-0335. Pres.: Dave Stahl.
- Stainer & Bell, Ltd.** (United Kingdom), (See E.C. Schirmer Music Co., Inc.).
- Stainless Music Corp.**, (BMI) 488 Madison Ave., Ste. 1710, New York, NY, 10022, (212) 223-0044. Fax: (212) 223-4531. Pres.: John E. Nathan.
- Stang Music Pub. Int'l**, (BMI) 753 Capitol Ave., Hartford, CT, 06106, (203) 951-8175. Pres.: Jack Stang; Gen. Mgr.: Bobbie Ginsberg.
- Thomas C. Stangland Co.**, (ASCAP) PO Box 19263, Portland, OR, 97280, 7804 SW 45th, #47, Portland, OR, 97219, (503) 244-0634. Pres.: Thomas Stangland.
- Star Rite**, (BMI) (See Glad Music Co.).
- Starbound Publishing**, (BMI) 207 Winding Rd., Friendswood, TX, 77546, (713) 482-2346. Gen. Mgr.: Buz Hart.
- Stargazer Music & Publishing**, (ASCAP) PO Box 34189, 100 De Montfort Ave., San Francisco, CA, 94134, (415) 239-6610. Pres.: Jack Shiner; Gen. Mgr.: Rudy Nelson; Professional/Creative Mgr.: Freddie Wolford.
- Startime Music**, (BMI) PO Box 643, 48-780 Eisenhower Dr., La Quinta, CA, 92253, (619) 564-4823. Pres./Professional/Creative Mgr.: Fred Rice; Gen. Mgr.: Robert Rice.
- Starwest Music**, (BMI) 6808 Willow Grove, Longview, WA, 98632, (206) 577-6558. Professional Mgr.: Mike Poe.
- State Of The Art Music**, (ASCAP) (See Qwest Music Publishing).
- Statiras Music Co.**, (ASCAP) 1304 Fletcher Rd., Titton, GA, 31794, (912) 382-6257. Fax: (912) 382-6761. Pres.: Gus P. Statiras; Gen. Mgr.: Genelle P. Statiras; Professional/Creative Mgr.: Perry G. Statiras.
- Stay Straight Music**, (BMI) (See Airdrome Music & Stonewood Lane Music).
- Stepping Stone Music**, (BMI) (See Mimic Music).
- Sterling Music Corp.**, (ASCAP) (See Fred Ahlert Music Corp.).
- Stevie B.**, (BMI) PO Box 917, Bala Cynwyd, PA, 19004.
- Stinger Music**, (BMI) (See Firedrum Music Publishers).
- Otis Stokes Publishing**, (ASCAP) PO Box 691068, Los Angeles, CA, 90069, (213) 274-1900. Pres.: Otis Stokes.
- Mike Stoller Music**, (ASCAP) (See Leiber-Stoller).
- Stone Agate Music**, (BMI) (See Jobete Music Co., Inc.).
- Stone Diamond Music Corp.**, (BMI) (See Jobete Music Co., Inc.).
- Stonebess Music Co.**, (BMI) 163 Orizaba Ave., San Francisco, CA, 94132, (415) 334-2247. Pres./Gen. Mgr.: WC. Stone.
- Stonebridge Music**, (ASCAP) (See The Bicycle Music Co.).
- Stonewood Lane Music**, (BMI) (See Int'l Music Services; Airdrome Music & Stonewood Lane Music).
- Stoney Point Music Co.**, (BMI) 1818 Lennox Ave., Charlotte, NC, 28203, (704) 375-0654. Pres.: William R. Bradford, III.
- Storn, Harris & Jones**, (ASCAP) (See Tobasco Music c/o Publishers' Licensing Corp.).
- Storyville Publishing Co.**, (BMI) (See John Berthelot & Assoc.).
- Strange Music**, (SESAC) (See AVI Music Publishing Group, Inc.).
- StrangeLand Music**, (BMI) 11846 Balboa Blvd., Ste. 135, Granada Hills, CA, 91344, (818) 377-4752, (818) 362-3550. Fax: (818) 361-2389.
- Stranten's Songs**, (BMI) (See Hickory Valley Music).
- Strawberry Lane Music**, (BMI) (See Tree Publishing Co., Inc.).
- Strawboss Music**, (BMI) 101 Hurts Rd., Hendersonville, TN, 37075, (615) 824-5900. Fax: (615) 824-8800. Pres.: Jim Pierce.
- Streets Of Gold Music**, (ASCAP) (See AMCORP Group).
- Streke Music**, (BMI) (See Periscope Music Co.).
- Strictly Administration Music**, (ASCAP) (See Music Umbrella).
- Stromberg Music**, (BMI) (See Bergstrom Music Ltd. c/o Publishers' Licensing Corp.).
- Stryper Music**, (See La Rana/El Porto Music).
- Marty Stuart Music**, (ASCAP) (See Fruit Music).
- Studio P/R**, (ASCAP/BMI) (See CPP/Belwin, Inc.).
- Stylecraft Music Co.**, (BMI) PO Box 802, 217 Hwy. 51 S., Madison, MS, 39130, (601) 856-7468. Pres.: Jason S. Wooten; Gen. Mgr.: Jason S. Wooten; Professional Mgr.: Style Wooten.
- Su-Ma Publishing Co.**, (BMI) PO Box 1125, Shreveport, LA, 71163, 1700 Centenary Blvd., Shreveport, LA, 71101, (318) 227-2228. Fax: (318) 227-0304. Pres.: Stanley J. Lewis.
- Subeck**, (BMI) (See The Music Group).
- Sublime Music**, (BMI) (See Songs For Today).
- Subliminal Music**, (ASCAP) (See Avatar Publishing Group).
- Suelor Music**, (BMI) 955 Venture Ct., Sacramento, CA, 95825, (916) 929-9181. Fax: (916) 929-4751. Pres./Gen. Mgr.: Bill Rase.
- Sueno Publishing Co.**, (BMI) 480 Lytton St., Troutman, NC, 28166, (704) 528-4843. Pres./Gen. Mgr.: Don E. Moose.
- Sugar Mama Music**, (BMI) 4545 Connecticut Ave., Ste. 805, Washington, DC, 20008, (202) 362-2286. Pres.: Jonathan Strong.
- Sugarfoot Prodn.**, (ASCAP) PO Box 1065, Joshua Tree, CA, 92252, (619) 366-9539. Pres.: Dewey Dobson; Gen. Mgr.: Sheila Dobson.
- Suite Seven Music**, (BMI) (See Room Seven Music).
- Preston Sullivan Music**, (ASCAP) 1217 16th Ave. S., Nashville, TN, 37212, (615) 327-8129. Fax: (615) 321-0928. Pres./Gen. Mgr.: Preston Sullivan.
- Sultan Music**, (BMI) (See Marullo Music Publishers).
- Summer Dawn Music**, (ASCAP) PO Box 120583, 103 Elmora, Madison, Nashville, TN, 37212, (615) 860-4282. Pres.: Bob Farrell; Gen. Mgr.: Carole Dove.
- Summy-Birchard Music**, (ASCAP) (See Warner/Chappell Music, Inc.).
- Sun Belt Music**, (ASCAP) (See Music Craftshop, Inc.).
- Sunbonnet Publishing Co.**, (BMI) 3316 Cocoa Dr., Nashville, TN, 37218, (615) 254-8712. Fax: (615) 254-8712. Pres.: Earl Lett; Professional/Creative Mgr.: Lamar Lett.
- Sundown Music**, (BMI) (See Earth Dance Music).
- Sunflower Music, Inc.**, (ASCAP) (See The Goodman Group Music Publishers).
- Sunny Home Music**, (BMI) (See Country Music Group).
- Sunnyslope Music, Inc.**, (ASCAP) (See Hal Bernard Ents., Inc.).
- Sunshine Music Co.**, (BMI) (See Gordon Music Co.).
- Supe & Rud Music**, (BMI) (See Get Rich Music/Stay Rich Music).
- Super Pegasus Music Publishing Corp.**, (BMI) (See Mateo San Martin Agency, Inc.).
- Super Seven Music**, (BMI) (See Doug Moody Music).
- SuperHype Publishing, Inc.**, (BMI) (See Warner/Chappell Music, Inc. (ASCAP) Cotillion Music, Inc.).
- Supernatural Publishing Co.**, (BMI) 504 W. 24th St., Ste. 19, Austin, TX, 78705, (512) 448-1820. Pres.: C.R. Hancock.
- Suresin Songs**, (BMI) PO Box 150708, Nashville, TN, 37215, (615) 292-8281. Fax: (615) 321-0928. Pres.: Preston Sullivan.
- Surf City Music**, (ASCAP) (See Pop Record Research).
- Surrey Music Co.**, (ASCAP) 102 Newcastle Dr., Franklin, TN, 37064, (615) 794-7956. Owner: Frank H. Stanton.
- Jimmy Swaggart Ministries**, PO Box 2550, Baton Rouge, LA, 70821, (504) 768-8300.
- Swamp Music**, (ASCAP) (See Crazy Cajun Music).
- Sweet-Art Music**, (BMI) (See Earwig Music Co., Inc.).
- Sweet Anointing Music**, (BMI) (See Jimmy Swaggart Ministries).
- Sweet Baby Music**, (BMI) (See Blackwood Music, Inc.).
- Sweet Glenn Music**, (BMI) PO Box 1067, Santa Monica, CA, 90406, (310) 452-0116. Pres.: Glenn Friedman; Gen. Mgr.: Mike Hunt; Professional/Creative Mgr.: Major Minor.
- Sweet Inspirations Music**, (ASCAP) (See California Country Music).
- Sweet Karol Music**, (BMI) (See Music Umbrella, Sweet Glenn Music).
- Sweet Sixteen Music, Inc.**, (ASCAP) (See The Bicycle Music Co.).
- Sweet Swamp Music**, (BMI) Red Kill Rd., Fleischmanns, NY, 12430, (914) 254-4565. Pres.: Berry Drake; Gen. Mgr.: Patricia Padla.
- Sweet Tater Tunes, Inc.**, (ASCAP) (See Mel Tillis Ents.).
- Sweet Tooth Music Publishing Co.**, (BMI) 2716 Springlake Ct., Irving, TX, 75060, (214) 790-5172. Pres./Gen. Mgr.: Kenny Wayne.
- Swiftwater Music**, (ASCAP) (See The Bicycle Music Co.).
- Swimming Bird Music**, (ASCAP) (See Flying Fish Music).
- Swing & Tempo Music, Inc.**, (BMI) 575 Laramie Ln., Mahwah, NJ, 07430, (201) 934-5665. Fax: (201) 934-1679. Pres.: Lionel Hampton; Gen. Mgr.: Bill Titone.
- Swordfire Music**, (ASCAP) (See Hittage Music).
- Syndicore Music, Div. of ESP-Disk'**, (BMI) PO Box 4104, Kingston, NY, 12401, (914) 657-7120. Gen. Mgr.: Flavia Stollman.

T

- TADM**, (ASCAP) 62 Congress St., Portsmouth, NH, 03801, (603) 431-5492. Pres./Gen. Mgr.: Thomas A. Daly.
- T-Boy Music Publishing, Inc.**, (ASCAP/BMI) (See Lipservice; Tommy Boy Music Inc.).
- TCB Music**, (BMI) (See Rob-Lee Music).
- TEK Publishing**, PO Box 1485, Lake Charles, LA, 70602, 313 Church St., Lake Charles, LA, 70601, (318) 439-4295.
- T-Girl Music Publishing Inc.**, (BMI) (See Tommy Boy Music Inc.).
- T.I.C. Music Publishing Co.**, (BMI) (See Telarc Music Publishing Co.).
- TIM-The International Music Co.**, (See Latin American Music Co., Inc.).
- TMA-The Michael Agency**, 29 S. Erie St., Toledo, OH, 43602, (419) 243-5300. Fax: (419) 255-2231. Pres.: Michael Drew Shaw.
- T-Men Publishing**, (SESAC) (See Tommy Boy Music Inc.).
- TRF Music, Inc.**, (See Alpha Music, Inc.).
- TRO (The Richmond Organization)**, 11 W. 19th St., Ste. 711, New York, NY, 10011, (212) 627-4646. Fax: (212) 633-1233. Pres.: Howard S. Richmond; Gen. Mgr.: Larry Richmond; Printed Music Mgr.: Judy Bell. Branch(es): Plaza 535 Kings Rd., Ste. 207, London, SW, 1005Z, United Kingdom, 01144718233773. Fax: 01144713513615. Managing Dir.: Frank Richmond.
- TSP Music, Inc.**, (ASCAP) (See Filmtrex Copyright Holdings, Inc.).
- T-Ski Publishing**, (BMI) (See ADRA Music).
- Tabou Combo**, (BMI) (See Mateo San Martin Agency, Inc.).
- Tadream Music**, (ASCAP) (See 23rd Street Publishing/Listening Room Music, Inc.).
- Taggie Music Co.**, (See Gopam Ents., Inc.).
- Taj Mahal Music**, (ASCAP) (See Jobete Music Co., Inc.).
- Tajah Music**, (BMI) (See Raybird Music).
- Takya Music**, (ASCAP) (See Raybird Music).
- Talbot Music Publishing, Inc.**, (BMI) (See Peer-Talbot Music Group).
- Tall Boy Music**, (See GUTU Corp.).
- Tall Dogs Music**, (BMI) (See The Music Group).
- Kirk Talley Music**, (BMI) (See Homeland Recording & Publishing).
- Tallyrand Music, Inc.**, (ASCAP) (See The Bicycle Music Co.).
- Taimadge Prodn.**, (ASCAP) (See Catalogue Music).
- Tancott Music**, (ASCAP) (See Northcott Music).
- Tandem Tunes, Inc.**, 1300 Divison St., Ste. 204, Nashville, TN, 37203, (615) 254-0572. Pres.: Beverly Beard.
- Tannen Music, Inc.**, (BMI) (See Ridge Music Corp.).
- Tapadero Music**, (BMI) (See Merit Music Corporation).
- Tarpell Music**, (ASCAP) 1080 N. Delaware Ave., Philadelphia, PA, 19125, (215) 425-8682. Fax: (215) 425-4376. Vice Pres./Creat. Mgr.: Michael Forte.
- Tashara Music**, (ASCAP) (See California Flight/Just Write Music Co.).
- Tasmanian Tiger**, (ASCAP) (See Int'l Music Services).
- Taylor Boy Music**, (BMI) 2980 W. 28th St., Ste. 343, Brooklyn, NY, 11224, (718) 946-0840. Fax: (718) 266-3972. Pres.: Robert Taylor.
- Taylor & Watts Music Co.**, (BMI) (See Country Music Group).
- Mick Taylor Music**, (BMI) 156 Fifth Avenue, Suite 434, New York, NY, 10010, (212) 691-5630. Fax: (212) 645-5038. Pres.: Mick Taylor; Gen. Mgr.: Bruce E. Colfin.
- Tayson Music Co.**, (ASCAP) (See Country Music Group).
- Techno Folk Music**, (BMI) (See Dave Burgess Ents.).
- Technoc Prodn.**, PO Box 8451, Emeryville, CA, 94662, (415) 653-5811. Contact: Jason Blaine.
- Tedesco Tunes**, (ASCAP) (See Dale Tedesco Music Co.).
- Dale Tedesco Music Co.**, (BMI) 16020 Lahey St., Granada Hills, CA, 91344, (818) 360-7329. Fax: (818) 886-1338. Pres./Pro-Creative Dir.: Dale Tedesco; Gen. Mgr.: Betty Lou Tedesco.

- Teeger Music Catalog**, (ASCAP) (See Henry Jerome Music, Inc.).
- Telarc Music Publishing Co.**, (ASCAP) 23307 Commerce Park Rd., Cleveland, OH, 44122, (216) 464-2313. Fax: (216) 464-4108. Chrmn.: Jack L. Renner; Pres.: Robert E. Woods.
- Telear Florida, Inc./Music Publishing Co.**, (ASCAP) 4380 NW 128th St., Miami, FL, 33054, (305) 688-7475. Fax: (305) 685-5697. Pres.: Peter Botome; Gen. Mgr.: Jorge A. Jure; Professional/Creative Mgr.: Diane Navarro.
- Telspin Music**, (ASCAP) PO Box 55, McLean, VA, 22101, Pres.: Richard Mason.
- Templeton Publishing**, (ASCAP) (See Shawnee Press, Inc.).
- Ten of Diamonds Music**, (BMI) 880 Front St., Ste. 661, Lahaina, Maui, HI, 96761, (808) 661-5151. Pres.: Jason Schwartz; Gen. Mgr.: Bonnie Fredericks; Professional/Creative Mgr.: Greta Warren.
- Ten-East Music Co.**, (BMI) PO Box 618, Lennox Hill Sta., New York, NY, 10021, (212) 689-0859. Pres.: B. Stone.
- Ten Squared Music**, (BMI) PO Box 865, North Hollywood, CA, 91603, (818) 506-3143. Contact: Michael Wenslow.
- Tenalina Music**, (ASCAP) 1609 Congress Rd., Eastover, SC, 29044, (803) 776-8397. Pres.: Howard A. Knight, Jr.
- Tennessee Valley Music**, (SESAC) (See Woodrich Publishing Co.).
- Anna Teresa Music Ltd.**, (ASCAP) 205 West End Ave., Ste. 4-M, New York, NY, 10023, (212) 724-3172. Pres.: Helene Blue.
- Termidor Musik**, (GEMA) (See Airdrome Music & Stonewood Lane Music).
- Terrace Entertainment Corp.**, PO Box 347, Prince St. Sta., New York, NY, 10012, (212) 741-0007. Fax: (212) 243-2603. Pres.: Robert John Jones; Gen. Mgr.: Margaret Jones.
- Terraform Music**, (ASCAP) (See Van Warmer Music).
- Terrapin Music**, (BMI) (See Folklore Music).
- Terri Music Co.**, (BMI) (See Lowery Music Co., Inc.).
- Teshmusic**, (BMI) (See 23rd Street Publishing/Listening Room Music, Inc.).
- Tetra/Continuo Music Group**, (See Plymouth Music Co., Inc.).
- Teis Brothers**, (BMI) (See Peter Teuis Music).
- Peter Teuis Music**, (BMI) PO Box 1102, Burbank, CA, 91507, (213) 874-7656. Pres.: Peter Teuis; Professional Mgr.: Scott Teuis.
- Tex-Tunes**, (ASCAP) (See Dark Heart Music).
- Texas Opry Publishing**, (BMI) 32243 Old Hempstead Rd., Magnolia, TX, 77355, (713) 356-6779. Pres.: Cookie Douglas; Gen. Mgr.: Mike Kelly; Professional/Creative Mgr.: Steve Douglas.
- Texascity Music**, (BMI) (See MCA Music Publishing).
- Thea Music**, (BMI) (See Ferry Boat Music).
- Theobald's Music, Inc.**, (ASCAP) (See PolyGram Music Publishing).
- Third Story Music Inc.**, (BMI) 740 N. La Brea Ave., 2nd Flr., Los Angeles, CA, 90038, (213) 938-5000. Fax: (213) 936-6354. Pres.: Martin Cohen.
- Third Story Records, Inc.**, (ASCAP) 5120 Walnut St., Philadelphia, PA, 19139, (215) 747-1201, (215) 747-1200. Pres.: John Wicks; Gen. Mgr.: Scott Herzog; Sales Dir.: Rod Burton.
- Third Stream Music**, (ASCAP) (See MJQ Music, Inc.).
- Gordon V. Thompson (Canada)**, (ASCAP) (See Oxford University Press, Inc.).
- Three Cheers Music**, (ASCAP) (See Darcy Music).
- 3 Minute Movie Music**, (BMI) PO Box 120316, Nashville, TN, 37212, (615) 356-4684. Pres.: John Lomax III.
- 3 Seas Music, Div. of Continental Communications Corp.**, (ASCAP) 450 Livingston St., Norwood, NJ, 07648, (201) 767-5551. Fax: (201) 767-8977.
- 337 Music**, (ASCAP) 6430 Sunset Blvd., Ste. 900, Hollywood, CA, 90028, (213) 467-0151. Fax: (213) 856-8796. Pres.: Bryan Turner; Gen. Mgr.: Stephen Drath.
- Thrusk Music**, (ASCAP) (See Wesco Music Group).
- Thumb Run Music Co.**, (ASCAP) (See Wynwood Music Co., Inc.).
- Thursday Music Corp.**, (BMI) (See Fred Ahlert Music Corp.).
- Tiffany Music**, (ASCAP) (See Peter Teuis Music).
- Tillis Tunes, Inc.**, (BMI) (See Mel Tillis Ents.).
- Mel Tillis Ents.**, 809 18th Ave. S., Nashville, TN, 37203, (615) 327-0750. Pres.: Mel Tillis; Professional Mgr.: Ben E. Payne, Jr.
- Timbertree Publishing**, (BMI) Rt. 8, 425 Orebank Rd., Kingsport, TN, 37664, (615) 323-3152. Pres./Gen. Mgr.: J.W. Hutchins.
- Timberwolf Music, Inc.**, (BMI) 2520 Cedar Elm, Plano, TX, 75075, (214) 867-6656. Fax: (214) 867-6657. Pres.: Michael M. Murphey; Gen. Mgr.: P.L. Murphey.
- Timbre Creek Music**, (ASCAP) 3705 N. Sterling, Peoria, IL, 61615, (309) 686-7664. Fax: (309) 686-7664. Pres.: Ronald C. Volz.
- Timestar Music**, (ASCAP) (See Newwriters Music).
- Tingle Music**, (ASCAP) (See Goosebump Music).
- Titan Records**, 1389 Primavera Dr. E., Palm Springs, CA, 92262, (619) 323-9880. Pres.: George R. Brown.
- Tobasco Music c/o Publishers' Licensing Corp.**, (BMI) PO Box 5807, Englewood, NJ, 07631, (201) 568-3996. Fax: (201) 569-9580. Pres.: Chico Hamilton.
- Toby Music**, (ASCAP) (See Warner/Chappell Music, Inc.).
- Tocep Music Co.**, (BMI) (See Avatar Publishing Group).
- Toe Knee Hangs Music**, (ASCAP) (See H.E.G. Music).
- Tolltone Publishing Co.**, (BMI) (See Condominium Publishing Group).
- Tomake Music Co., Inc.**, (ASCAP) (See Drake Music Group).
- Tommy Boy Music Inc.**, 1747 First Ave., New York, NY, 10128, (212) 722-2211. Fax: (212) 289-3708. Vice Pres. Sales/Mktg.: Steve Knutson.
- Tomorrows World Publishing**, (ASCAP) 203 Chapel Ave., Nashville, TN, 37206, (615) 226-4240. Pres.: V.A. Smith; Gen. Mgr.: N.T. Hill.
- Tompall and Music**, (BMI) PO Box 120821, Nashville, TN, 37212, (615) 385-1584. Owner/Professional/Creative Mgr.: Tomas P. Glaser.
- Tompaul Music Co.**, (BMI) 628 S. South St., Mount Airy, NC, 27030, (919) 786-2865. Pres./Gen. Mgr.: Paul E. Johnson.
- Tomsongs**, (ASCAP) (See Cherry Lane Music Publishing Co., Inc.).
- Tone Antone, Inc.**, (ASCAP) (See Akasha Records & Mgmt., Inc.).
- Tooter Scooter Music**, (BMI) (See Janell Music).
- Top Pin Publishing**, (See Elevation Publishing).
- Tori Taff Music**, (ASCAP) (See Skinny Zach Music).
- Torona Music**, (BMI) PO Box 88022, Indianapolis, IN, 46208, (317) 252-9286. Pres.: Inga D. McDaniel; Gen. Mgr.: W. Jackson; Professional Mgr.: C. Draper.
- Tortoise Music**, (ASCAP) (See Folklore Music).
- Total Spectrum**, (BMI) (See Graham Carlton Music Co.).
- Touch of Gold Music, Inc.**, (BMI) (See Rent-A-Song).
- Touchable Music**, (BMI) (See Funky but Music, Inc., dba Morningstar).
- Touchtone Pictures Music & Songs**, (ASCAP) (See The Walt Disney Co.).
- Tourmaine Music, Inc.**, (BMI) 900 Old Hickory Blvd., Brentwood, TN, 37027, (615) 373-5530. Fax: (615) 831-0991. Pres.: Justin Peters; Gen. Mgr.: Benjamin Peters.
- Toyiabe Music Co.**, (BMI) (See Sabteca Music Co.).
- Tradition Music Co.**, (BMI) Box 9195, Berkeley, CA, 94709, 10341 San Pablo Ave., El Cerrito, CA, 94530, (510) 525-7471. Fax: (510) 525-1204. Pres.: Chris Strachwitz.
- Treasure Chest Publications**, (See Ashley Publications, Inc.).
- Tree Music Int'l.**, (See W. Packhouse Music Publishing, Inc.).
- Tree Publishing Co., Inc.**, (BMI) 8 Music Sq. W., Nashville, TN, 37203, (615) 726-0890. Fax: (615) 242-3441. Pres.: Buddy Killen; Exec. Vice Pres.: Donna Hilley; Professional Mgrs.: D. Wilson, W. Campbell.
- Tremor Music**, (ASCAP) (See Joel S. Turtle).
- Tri-Chappell**, (SESAC) (See Warner/Chappell Music, Inc.).
- Tri-She Kieta Publishing Inc.**, (BMI) 122 W. Monroe St., Ste. 825, Chicago, IL, 60603, (312) 280-0808. Fax: (312) 280-9191. Pres.: Anthony B. Stephens; Gen./Professional/Creative Mgr.: John Bellamy.
- Triage Music, Inc.**, (BMI) (See Song Source, Inc.).
- Tranon Publications**, (BMI) PO Box 904, Royal Oak, MI, 48068, (313) 545-2146. Pres.: Devora Brown; Gen. Mgr.: Sheldon Brown; Professional Mgr.: Cindy Mandy.
- Trio Music Co., Inc.**, (BMI) (See Leiber-Stoller).
- Triple O Songs**, (BMI) (See J.D. Music/Frankly Music).
- Triple Scale Music**, (BMI) (See Jero Limited Music).
- Triple Star Music, Inc.**, (BMI) (See Filmtrax Copyright Holdings, Inc.).
- Triumvirate Music, Inc.**, (BMI) (See New Clarion Music Group).
- Troyer Music Group**, (BMI) 33200 Bainbridge Rd., Ste. 32, Cleveland, OH, 44139, (216) 893-2596. Fax: (216) 674-2461. Pres.: Robert Troyer; Professional Mgr.: Lisa Dauwalder; Foreign Products: Lee-Anne Martin.
- True Sound**, (See Fantasy, Inc.).
- True Friends/Betty Brown Music Publishing**, (BMI) (See FXL Sound Studios).
- Trusty Publications**, (BMI) 8771 Rose Creek Rd., Nebo, KY, 42441, (502) 249-3194. Pres.: Elsie Childers.
- Tsom Music**, (BMI) (See De Walden Music Int'l, Inc.).
- Tsukimaro, V.I.**, (ASCAP) PO Box 2896, 311 Mahogany Run, St. Thomas, VI, 00803, (809) 775-5377. Pres./Gen. & Professional Mgr: Joyce LaMotta.
- Ernest Tubb Music c/o King S. King**, (BMI) 200 Fourth Ave. N., 1200 Noel Pl., Nashville, TN, 37219, (615) 259-3456. Fax: 9615) 254-7907.
- The Tune Room, Inc.**, (ASCAP) 19 E. 80th St., New York, NY, 10021, (212) 734-1564. Fax: (212) 734-4965. Pres.: Jerry Ragovoy.
- Tunewords Music Co.**, (BMI) (See Rent-A-Song).
- Tunnel House Press**, (ASCAP) PO Box 162, Pomfret Center, CT, 06259, (203) 928-2334. Pres.: Robert F. Stanley.
- Turnout Brothers Music**, (ASCAP) (See Hittage Music).
- Joel S. Turtle**, 1630 Union St., San Francisco, CA, 94123, (415) 928-4500. Pres.: Joel S. Turtle.
- Tuskegee Music Press**, (SESAC) (See Neil A. Kjos Music Co.).
- Tutch Music**, (BMI) PO Box 163, West Redding, CT, 06896, (203) 266-7411. Pres.: Paul Hotchkiss.
- Scott Tutt Music**, (BMI) PO Box 121213, Nashville, TN, 37212, (615) 331-7400. Pres.: Scott Tutt; Gen. Mgr.: Sunny Richards.
- Twelve To One Music, c/o Publishers' Licensing Corp.**, (BMI) PO Box 5807, Englewood, NJ, 07631, (201) 568-3996. Pres.: Douglas Knight-Smith.
- 23rd Street Publishing/Listening Room Music, Inc.**, (ASCAP/BMI) 9014 Melrose Ave., Los Angeles, CA, 90069, (213) 859-9200. Fax: (213) 859-7408. Pres.: Ron Goldstein; Vice Pres./Gen. Mgr.: Lorraine Rebidas; Coord.: Christian Slater.
- Twilight City Music Publishers**, (BMI) (See Songsellers Co., Div. of Aloft Music Ents., Inc.).
- Two Grand Publishing Co.**, (ASCAP) 12224 Avila Dr., Kansas City, MO, 64145, (816) 942-8859. Pres./Professional/Creative Mgr.: Scott Smith.
- Two Music**, (BMI) (See Misam Music).
- Twinsong Music**, (BMI) PO Box 1014, Lebanon, TN, 37088, (615) 444-3865. Pres.: Chester E. Johnson; Gen. Mgr./Professional Mgr.: Kit Johnson.
- Conway Twitty Music**, (BMI) PO Box 1273, Nashville, TN, 37202, (615) 327-3162.
- Twittbird Music Co.**, (ASCAP) (See Tree Publishing Co., Inc.).
- Two Bees**, (SESAC) (See The Fred Morris Music Group).
- Two Fifty Nine Music**, (BMI) (See Brat Music).
- Two John's Music**, (BMI) 1058 E. Saint Catherine, Louisville, KY, 40204, (502) 637-2877. Fax: (502) 637-6199. Pres./Gen. Mgr.: John V. Heath; Professional/Creative Mgr.: Mae Heath.
- Two Knight Music**, (BMI) (See Malaco Music Group).
- Two Talk Common Music**, (BMI) (See Darksilver Music Ltd.).
- Twofold Music**, (BMI) PO Box 388, Goodlettsville, TN, 37072, (615) 851-6242. Pres.: C.R. Poston; Gen. Mgr./Professional Mgr.: Roland Pope.
- Tymena Music**, (BMI) (See Ty Lemley Music).
- Tyscott Publishing**, (ASCAP) 3532 N. Keystone Ave., 3404 N. Ralston Ave., Indianapolis, IN, 46218, (317) 926-6271. Fax: (317) 924-4689. Pres.: Leonard Scott; Gen. Mgr.: Bryant S. Scott.
- Tzonilli Music**, (BMI) 2200 Risa Dr., Glendale, CA, 91208, (818) 548-0850. Fax: (818) 240-5660. Pres.: Jose Silva; Gen. Mgr.: Zulma A. Jimenez.
- U**
- U/A Music, Inc.**, (ASCAP) (See MGM-Pathe Communications Co.).
- U-Do-2 Music**, (ASCAP) (See Zeiderman, Oberman & Assoc., Inc.).
- US Music**, (BMI) 535 Fifth Ave., New York, NY, 10017, (212) 682-8400. Pres.: Victor Benedetto; Gen. Mgr.: Wallace Collins; Professional/Creative Mgr.: Alex Benedetto.
- U.S. Songs, Inc.**, (ASCAP) (See Leiber-Stoller).
- Udder Publishing Co.**, PO Box 21118, Castro Valley, CA, 94545, (415) 538-6195. Fax: (415) 889-8533. Pres.: Thomas Wiggins; Gen./Professional/Creative Mgr.: Paul Jaulus.
- Ultima Thule Music**, (BMI) PO Box 245604, Sacramento, CA, 95820, (916) 448-5859. Pres.: Amerritt V. Covington; Professional Mgr.: Diana L. Curry.
- Unami Music**, (ASCAP) 505 N. Fifth St., Aspen, CO, 81611. Contact: Jimmy Ibbotson.
- Uncle Beave Music**, (ASCAP) 308 Timberdale Ct., Nashville, TN, 37211, (615) 834-7409.
- Un-Der 16 Songs**, (SESAC) Ste. 3, 1226 17th Ave. S., Nashville, TN, 37212, (615) 327-1632. Fax: (615) 726-3299. Pres./Professional Mgr.: Maurice Godwin; Gen. Mgr.: Hal Godwin.
- Unichappell Music, Inc.**, (BMI) (See Warner/Chappell Music, Inc.).
- Unicity Music**, (ASCAP) (See MCA Music Publishing).
- Unicorn Music Co.**, (ASCAP) (See Larry Spier, Inc.).
- Unified Concepts**, (BMI) 491 Hollyberry Ct., San Jose, CA, 95129, (408) 996-7560. Pres.: Don Gaynor.
- Unimusic, Inc./Musica Unica Pub.**, 3191 Coral Way, Ste. 110, Miami, FL, 33145, (305) 442-7273. Fax: (305) 445-7434. Pres.: Wilhelm Ricken; Professional/Creative Mgr.: Maria Flores.
- Union Musical Ediciones**, (SGAE) (See G. Schirmer, Inc.).
- United Int'l Copyright Reps.**, (ASCAP) (See Syndicore Music, div. of ESP-Disk).
- United Int'l Copyright Representatives (UNICORE)**, Div. of ESP-DISK, LTD., (ASCAP) PO Box 3968, Kingston, NY, 12401, Mgr.: Flavia Stollman.
- United Lion Music, Inc.**, (BMI) (See MGM-Pathe Communications Co.).
- United Sound Arts, T/A Kimbo Educational**, PO Box 477, 10 N. Third Ave., Long Branch, NJ, 07740, (800) 631-2187. Fax: (908) 870-3340. Pres.: Gertrude Kimble; Gen. Mgr.: James Kimble; Professional/Creative Mgr.: Amy Laufer, James Kimble.
- Universal Strrs Music, Inc.**, (See Headliner Stars Music).
- Unlimited Inspiration Records**, PO Box 614, Santa Cruz, CA, 95061, (408) 458-3022. Pres.: Larry Leeder; Gen. Mgr.: Sue Herzstein.
- Upam Music Co.**, (See Gopam Ents., Inc.).
- UpBeat Music/Publishing**, (ASCAP) 360 S. Euclid Ave., Ste. 316, Pasadena, CA, 91101, (818) 777-3978. Pres.: Brett W. Perkins.
- Urbana Arts Ltd.**, (ASCAP) 222 W. 14th St., New York, NY, 10011, (212) 727-1360. Fax: (212) 368-5979. Pres.: Jared Hoffman; Gen. Mgr.: David Brubaker.
- Ursula Music**, (BMI) (See Comet-Tale).
- Uvula Music Pub.**, (BMI) (See Kuper-Lam Music).
- V**
- VAAM Music Group**, (BMI) PO Box 29688, Hollywood, CA, 90029, (213) 664-7765. Pres.: Pete Martin.
- VAAP (Russian Agency of Composers)**, (VAAP) (See G. Schirmer, Inc.).
- VADO Music**, (ASCAP) 2557 E. First St., Brooklyn, NY, 11223, (718) 339-8047. Pres.: Tom Bosco; Gen. Mgr.: Ron Alexander.
- VAR Music Publishing Co.**, (BMI) (See The Music Office).
- VIM Music Corp.**, (BMI) (See Doug Moody Music).
- Valance Ents.**, (BMI) (See Power Metal Music, Inc.).
- Valand Publishing Group**, 1270 Avenue of Americas, New York, NY, 10020, (212) 489-9696. Pres.: Arthur Valando.
- Valco Music Publishers**, (BMI) 1327 Cobb St., Kalamazoo, MI, 49007, (616) 342-5328. Pres.: Victor Taylor; Gen. Mgr.: Vincent Taylor.
- Rocky Valdez Music**, 4640 W. 118th St., Hawthorne, CA, 90250, (213) 676-8882. Pres.: Rocky Valdez.

- Thomas J. Valentino, Inc.**, (ASCAP) 151 W. 46th St., New York, NY, 10036, (212) 869-5210. Fax: (212) 869-6259. Pres.: Thomas Valentino.
- Valynn Music, (BMI)** (See Heavy Jamin's Music).
- Van Gogh's Ear Music, (BMI)** (See Ryan's Songs).
- Van Warmer Music, (ASCAP)** PO Box 3112, Brentwood, TN, 37024, 1304 Robert E. Lee, Brentwood, TN, 37027, (615) 371-8912. Pres.: Randy Van Warmer, Gen. Mgr./Professional Mgr.: Susan Blosser.
- Vandor Motion Pictures, Phonorecords & Music Publishing Corp.**, 1826 Poplar Ln. SW, Albuquerque, NM, 87105, (505) 243-2881, (505) 247-4843. Pres.: Lois T. Cunningham; Gen. Mgr.: Paula Carman; Professional/Creative Mgr.: Tauni Roe.
- Vanessa Music Corp., (ASCAP)** (See Clyde Otis Music Group).
- Vanilla Dragonfly, (See Nov. 17th Music).**
- Vanjo Music, (BMI)** (See AMCORP Group).
- Varry White Music, 6607 Sunset Blvd.,** Los Angeles, CA, 90028, (213) 465-2700. Fax: (213) 465-8926. Pres.: Matt Dike, Michael Ross; Gen. Mgr.: Rick Ross.
- Vebeque Music, (ASCAP)** (See MMO Music Group).
- Velvet Apple, (BMI)** (See Screen Gems-EMI Music, Inc.).
- Verba-Lex, (See Tandem Tunes, Inc.).**
- Verde Vista Music Publishers, 2383 Union St., #4,** San Francisco, CA, 94123, (415) 567-6935. Pres.: S. White.
- Very Safe Music, (BMI)** 888 Seventh Ave., 37th Floor, New York, NY, 10106, (212) 541-9666. Fax: (212) 841-8144. Pres.: Sandy Pearlman; Gen. Mgr.: Steve Schenck; Professional Mgr.: Marc Fleisher.
- Vetter Music Publishing Co., (BMI)** PO Box 14685, Baton Rouge, LA, 70898, 5220 Essen Ln., Baton Rouge, LA, 70809, (504) 766-3233. Fax: (504) 766-4112. Pres.: Cyril E. Vetter; Gen. Mgr.: Courtney Westbrook; Professional/Creative Mgr.: Johnny R. Palazzotto.
- Victory Media Group, (ASCAP)** PO Box 858, Sonoma, CA, 95476, (707) 762-4858. Pres./Gen. Mgr.: G.W. Daniel; Professional Mgr.: Rick Ellis.
- Video-Verse Music, (BMI)** PO Box 24066, Nashville, TN, 37202, 108 Joyce Ln., Ashland City, TN, 37015, (615) 792-4468. Owner/Professional/Creative Mgr.: Thomas A. Boyles, Sr.
- Village Music Co., (BMI)** (See Hometown Music Co.).
- Vin-Joy Music, Inc., (ASCAP)** 872 Morris Park Ave., Bronx, NY, 10462, (212) 792-2198. Pres.: Vincent J. Gagliano; Gen. Mgr.: Joyce Heath; Professional/Creative Mgr.: Mike Semos.
- Viper Music, (BMI)** 3022 N. Allen, Chicago, IL, 60618, (312) 772-0043. Fax: (312) 772-2115. Gen. Mgr.: Jerry Del Giudice.
- Virgin Boy Publishing, (ASCAP)** PO Box 542792, Dallas, TX, 75354, (214) 257-1510. Pres.: James G. Yarbrough; Gen. Mgr.: Becky Buchanan.
- Virgin Music, Inc., (ASCAP)** 827 N. Hilldale Ave., W. Hollywood, CA, 90069, (213) 858-8727. Fax: (213) 858-1320. Vice Pres./Admin.: Silvia J. Blach.
- Branch(es):** 30 W. 21st St., 3rd Floor, New York, NY, 10010, (212) 206-9104. Vice Pres., East Coast: David Steel.
- Virginia Arts, (BMI)** PO Box 400, Keswick, VA, 22947, 512 Stewart St., Charlottesville, VA, 22901, (804) 971-1411. Pres.: R. Paul Brier.
- Virginia Music, 217 Main St., Fort Lee, NJ, 07024,** (201) 947-3900. Pres.: Al Thomas; Gen. Mgr.: Tom Argiro; Professional/Creative Mgr.: John Smack.
- Virtu Music, (ASCAP)** 8809-11 Rising Sun Ave., Philadelphia, PA, 19115, (215) 763-2825. Pres.: Frank Virtu; Gen. Mgr.: Mary Bozzi.
- Vizator Music Co., (BMI)** (See Diversified Sound Innovators).
- Vlad Music, (BMI)** (See Raybird Music).
- Jerry Vogel Music Co., Inc., (ASCAP)** 501 Fifth Ave., Ste. 1809, New York, NY, 10017, (212) 986-4399. Pres.: Milton M. Rosenblom.
- Vogue Music, (BMI)** (See Welk Music Group).
- Vokes Music Pub., Co., (BMI)** PO Box 12, New Kensington, PA, 15068, (412) 335-2775. Pres./Gen. Mgr.: Howard Vokes.
- Volkwein, (See CPP/Belwin, Inc.).**
- Harry Von Tilzer Music Publishing Co., (ASCAP)** (See Welk Music Group).
- Von Zerneck/Greenwald Music, (ASCAP)** (See Fricon Music Co.).
- Vossword Songs, (BMI)** 300 Esplanade Dr., Ste. 760, Oxnard, CA, 93030, (805) 988-1661. Fax: (805) 988-1658. Pres.: Ernie Campagna.
- Voyager Publications, 424—35th Ave.,** Seattle, WA, 98122, (206) 323-1112. Fax: (206) 329-2416. Pres.: Vivian T. Williams.
- W**
- W.B.M. Music Corp., (SESAC)** (See Warner/Chappell Music, Inc.).
- WG Publishing, (See Welch Grape Publishing).**
- WPN Music, (ASCAP)** (See Print Music Co., Inc.).
- W. Packhouse Music Publishing, Inc., (BMI)** 11 Music Cir. S., Nashville, TN, 37203, (615) 242-0230. Pres.: Willi Pack; Gen. Mgr.: Judy Free.
- Wahdude Music c/o Publishers' Licensing Corp., (ASCAP)** PO Box 5807, Englewood, NJ, 07631, (201) 568-3996. Fax: (201) 569-9580. Pres.: Fareed Haque.
- Wajji Music Group, (SESAC/BMI)** 423 Florida Ave. NE, Washington, DC, 20002, (202) 546-9121, (800) 545-9121. Fax: (202) 544-8447. Pres.: Will R. Walker.
- Walden Music, Inc., (ASCAP)** (See Cotillion Music, Inc., Warner/Chappell Music, Inc.).
- Walk On Water Music, Rt. 2, Box 566-H,** New Braunfels, TX, 78130, (512) 629-8008. Fax: (512) 625-2024. Pres./Gen. Mgr.: Kenneth D. Brazle.
- Will Walker Publishing, (BMI)** (See Wajji Music Group).
- Walking Creek Music, (BMI)** PO Box 3589, Saxonville, MA, 01701, (508) 820—4440. Fax: (508) 820-7769. Pres.: L.E. Joiner.
- Walrus Music Publishing, PO Box 11267,** Glendale, CA, 91226, (818) 242-2093. Fax: (818) 242-7704. Pres.: Danny Behrer; Gen. Mgr.: Robert Coomber; Professional/Creative Mgr.: Colleen Larsen.
- Tim Walsh Music, Inc., 156 Fifth Avenue,** Su te 434, New York, NY, 10010, (212) 691-5630. Fax: (212) 645-5038. Pres.: Tim Walsh; Gen. Mgr.: Bruce Coffin, Esq.
- Walters Music, (ASCAP)** (See Jay Jay Publishing Co.).
- Walton Music Corp., (See Plymouth Music Co., Inc.).**
- Waneta Music, (See You Heard It—Hear!)**
- Wanted Music, (BMI)** (See Wesco Music Group).
- Warner Bros., Inc., (ASCAP)** 9000 Sunset Blvd., Los Angeles, CA, 90069, (213) 273-3323.
- Branch(es):** 44 Music Sq. West, Nashville, TN, 37203, (615) 254-8777.
- Warner Chappell, Inc., (See Chu Teh Music).**
- Warner/Chappell, (BMI)** (See Ten-East Music Co.).
- Warner/Chappell Music, Inc., (ASCAP/BMI)** 9000 Sunset Blvd., Los Angeles, CA, 90069, (213) 273-3323. Fax: (213) 271-4843. Chrmn./CEO: Leslie E. Bider.
- Branch(es):** 810 Seventh Ave., New York, NY, 10019, (212) 399-6910, Sr. Vice Pres.: Frank Military; 21 Music Square East, Nashville, TN, 37203, (615) 254-8777. Vice Pres./Exec. Gen. Mgr.: Tim Wipperman.
- Warner/Refuge Music, Inc., (ASCAP)** (See Warner Bros., Inc.).
- Warner-Tamerlane Publishing Corp., (BMI)** (See Warner/Chappell Music, Inc.).
- Warrock Corp., (ASCAP)** (See Cherio Corp.).
- Warus Publishing, (BMI)** 1410 E. 72nd St., Chicago, IL, 60619, (312) 752-2755. Pres. Mgr./Gen. Mgr.: U.S. Warren.
- Washin'waz Music, (BMI)** (See Songsellers Co. (div. of Aloft Music Ents., Inc.)).
- Watt Works, Inc., (BMI)** Grog Kill Rd., Willow, NY, 12495, (914) 688-5373. Fax: (914) 688-2088. Pres./Gen. Mgr.: Michael Mantler.
- Wavemaker Music, Inc., (ASCAP/BMI)** (See Lipservices).
- Art Wayne Music, (See Pelton Publishing).**
- We Three Music, Inc., (BMI)** (See H/B Webman & Co.).
- We-U's & Co., (BMI)** PO Box 412, Bronx, NY, 10462, (212) 613-9049. Pres.: Vernon Wilson; Gen. Mgr.: Rick Robinson.
- Weaver of Words Music, (BMI)** PO Box 803, 200 Peery St., Tazewell, VA, 24651, (703) 988-6267. Pres.: H.R. Cook.
- H/B Webman & Co., (ASCAP)** 1650 Broadway, Ste. 701, New York, NY, 10019, (212) 586-0240. Fax: (212) 315-0286. Co-Owner/Gen. Mgr.: Belle Webman; Co-Owner/Professional Mgr.: Hal Webman.
- Bob Webster Music, (BMI)** PO Box 120477, Nashville, TN, 37212, (615) 383-0330.
- Wedge Music, Inc., (BMI)** (See Skinny Zach Music).
- Wee B Music, Inc., (ASCAP)** (See World Wide Music, Inc.).
- Josef Weinberger, Ltd. (London), (ASCAP)** (See Boosey & Hawkes, Inc.).
- Weintraub Music Library, (ASCAP)** (See Music Sales Corp.).
- Welchy Grape Publishing, 991 Oak St.,** West Barnstable, MA, 02668, (617) 362-4908. Pres.: Mike Welch.
- Welcome Home Press, (BMI)** (See Homeland Recording & Publishing).
- Welm Music Group, 1299 Ocean Ave.,** Ste. 800, Santa Monica, CA, 90401, (310) 451-5727. Fax: (310) 393-8671. Pres.: Larry Welk; Exec. Vice Pres.: Dean Kay.
- Branch(es):** 6255 Sunset Blvd., Suite 615, Hollywood, CA, 90028, Div. Mgr.: Rick Neigher; 54 Music Sq., East, Nashville, TN, 37203, Div. Mgr.: Bob Kirsch.
- Well Received Music, (ASCAP)** (See Joel S. Turtle).
- Wells Drive Music, (BMI)** (See Budd Music Corp.).
- Welz Music, (ASCAP)** (See Caprice Int'l Records/Canadian American Records, Comet-Tale).
- Wenba Publishing, (BMI)** 81 Chandler, Detroit, MI, 48202, (313) 875-0289. Fax: (313) 543-3948. Pres.: Wendell Harrison; Gen. Mgr.: Pamela Wise; Professional/Creative Mgr.: Pamela Wise.
- WestTones Music c/o Westwood Entertainment Group, (ASCAP)** 1115 Inman Ave., Ste. 330, Edison, NJ, 08820, (908) 548-6700. Fax: (908) 548-6748. Pres.: Victor Kaplij; Gen. Mgr.: Brian Clayton.
- Wesco Music Group, (BMI/ASCAP)** PO Box 24281, Nashville, TN, 37202, 1726 General George Patton Dr., #C, Brentwood, TN, 37027, (615) 661-5808. Fax: (615) 661-5905. Pres.: Jerry West; Gen. Mgr.: Mike Young; Professional/Creative Mgr.: Gary Campbell.
- West Side, (See Latin American Music Co., Inc.).**
- Western Americana, (BMI)** (See Startime Music, Yo-Yo Music).
- Western Int'l Music Publishing, (ASCAP)** 3707 65th Ave., Greeley, CO, 80634, (303) 330-6901. Fax: (303) 330-7738. Pres./Gen. Mgr.: William Schmidt; Professional/Creative Mgr.: Sharon Davis.
- Western Sierra Music, (BMI)** (See Northern Sierra Music (div. of Exit Records)).
- Weyman Music, (ASCAP)** 117 N. Las Palmas Ave., Los Angeles, CA, 90004, (213) 938-5482. Fax: (213) 933-1903. Pres.: Albert L. Marx.
- Whimsong Publishers, (ASCAP)** (See Rustron Music Publishers/Rustron Music Prodn.).
- Whitchurch Music Corp., (ASCAP)** (See Most Urgent! Music).
- White Cat Music, (ASCAP)** 10603 N. Hayden Rd., Ste. 114, Scottsdale, AZ, 85260, (802) 951-3115. Gen. Mgr.: Frank Fara; Professional/Creative Mgr.: Patty Parker.
- White Line Music, (BMI)** (See Coal Miners Music).
- White Oak Songs, (ASCAP)** 156 Fifth Ave., Ste. 916, New York, NY, 10010, (212) 633-0050.
- White Pillar Press, PO Box 175,** Eagle Creek, OR, 97022, (503) 252-6033. Pres./Gen. Mgr.: Michael Berkley.
- Alan White Music Co., (ASCAP)** 2505 Chamblee-Tucker Pl., #326, Chamblee, GA, 30341, (404) 452-0494. Pres.: Alan White; Gen. Mgr.: Michelle Johnson.
- Whitewing Music, (BMI)** 413 N. Parkerson Ave., Crowley, LA, 70526, (318) 788-0773. Fax: (318) 788-0776. Pres.: J.D. Miller.
- Whiting Music, (ASCAP)** PO Box 110002, 228 Nunley Dr., Nashville, TN, 37211, (615) 331-8945. Pres.: James Whiting; Professional/Creative Mgr.: Ernest H. Longworth, III.
- Whitsett Bros. Music, (BMI)** (See Most Urgent! Music).
- Whitsett Churchill Music Corp., (BMI)** (See Most Urgent! Music).
- Whole Armor Publishing Co., (BMI)** (See Songs For Today).
- Whole Wheat Music, (BMI)** (See AVI Music Publishing Group, Inc.).
- Whooping Crane Music, (BMI)** 38 NE 167th St., Miami, FL, 33162, (305) 948-6466. Fax: (305) 945-1055. Pres.: Bo Crane.
- Wilcom Publishing, (ASCAP)** PO Box 4456, West Hills, CA, 91308, (818) 348-0940. Pres.: William Clark.
- Wild Pony Music, (BMI)** 1721 S. Harbor Blvd., Anaheim, CA, 92802, (213) 560-4223. Fax: (714) 772-7869. Pres.: Albert Hagar; Gen. Mgr.: D. T. Richards.
- Wild Prairie Publishing, (BMI)** PO Box 9278, Mission, KS, 66201, 5616 Dearborn, Mission, KS, 66202, (913) 831-3225. Fax: (913) 831-0199. Pres.: Chris Stout; Professional/Creative Mgr.: Rob Arnold.
- Wild Thing Music, (BMI)** (See You Should Meet My Mother).
- Wild Twin Tunes, (BMI)** 172 E. 82nd St., #1A, New York, NY, 10028, (212) 570-9631. Pres.: Carter Cathcart; Gen. Mgr.: Nel Moore.
- Shane Wilder Music, (BMI)** PO Box 3503, Hollywood, CA, 90078, (818) 508-1433. Pres.: Shane Wilder; Gen. Mgr.: Aaron Wilder; Professional/Creative Mgr.: Ron Foster.
- Wiljex Publishing Co., (ASCAP)** (See Marco Music Group, Inc.).
- Willensden Music, Inc., (BMI)** (See Get Rich Music/Stay Rich Music, ADRA Music, Zomba Ents., Inc.).
- Dootsie Williams Publishing, (BMI)** 121 S. Hope St., Ste. 334, Los Angeles, CA, 90012, (213) 628-7768. Pres.: Dootsie Williams.
- Mary Williams Music Clearance Corp., 6223 Selma Ave.,** Ste. 211, Hollywood, CA, 90028, (213) 462-5755. Fax: (213) 462-3433. Pres.: Mary Williams; Gen. Mgr.: James G. Prentice; Professional Mgr.: Diane Prentice.
- Willin' David Music Group, 1203 16th Ave. S.,** Nashville, TN, 37212, (615) 320-7323. Fax: (615) 329-1304. Gen. Mgr.: Jeff Carlton; Partners: W. Jennings, D. P. Briggs.
- Willis Music Co., 7380 Industrial Rd.,** Florence, KY, 41042, (606) 283-2050. Pres.: Edward R. Cranley.
- Meredith Willson Music, (ASCAP)** (See MPL Communications, Inc.).
- Wilson Boy Music, (SESAC)** (See Wajji Music Group).
- Wimot Music, (BMI)** PO Box 917, Bala Cynwyd, PA, 19004, (215) 828-7030. Pres.: Steve Bernstein.
- Wind Haven, (BMI)** (See Farr-Away Music).
- Wind In The Trees Music, (BMI)** PO Box 158304, Nashville, TN, 37215, (615) 670-6129. Fax: (615) 670-6703. Gen. Mgr.: Jean Cramer.
- Window Music Pub., Co., Inc., (BMI)** (See Drake Music Group).
- Windsore, Inc., (BMI)** PO Box 1078, Vineland, NJ, 08360, (609) 696-0943. Pres.: Dennis Link; Gen. Mgr.: Frank Bea.
- Windwalker Music, (BMI)** (See Int'l Forecast Music).
- Winnebago, (ASCAP)** (See Cactus Music/Gidget Publishing).
- Wireless Globe, (See Nathan Bryden Music Co.).**
- Wishbone, (See NEM Entertainment Corp.).**
- With Any Luck, (BMI)** 50 Music Sq. W., Ste. 503, Nashville, TN, 37202, (615) 329-0185. Contact: Carol Sampletro.
- Wonderland Communications, Inc., 310 E. Chicago St.,** Elgin, IL, 60120, (708) 695-0711. Fax: (708) 695-0719. CEO: Gavin Morkel.
- Wonderland Music Co., Inc., (BMI)** (See The Walt Disney Co.).
- Wooden Bear Music, (ASCAP)** (See Big Heart Music, Inc.).
- Wooden Wonder Music, (SESAC)** (See Millhouse Music).
- Woodgrain Publishing, (ASCAP)** (See Fretboard Publishing).
- Wood'n Music, Inc., (BMI)** 3 Lakeview Dr., North White Plains, NY, 10603, (914) 682-0842, (914) 682-0843. Pres.: Elliot Rothpearl; Gen. Mgr./Professional Mgr.: John Stech.
- Woodrich Publishing Co., (BMI)** PO Box 38, Lexington, AL, 35648, (205) 247-3983. Pres./Gen. Mgr.: Woody Richardson.
- Lori Lee Woods Music, (BMI)** 825 Fifth St., Menasha, WI, 54952, (414) 725-4467. Pres.: Lori Lee Woods; Gen. Mgr.: Rebekah A. Pierce; Professional/Creative Mgr.: Jean M. Wilson.
- Word Music, (ASCAP)** 5221 N. O'Connor Blvd., Ste. 1000, Irving, TX, 75039, (214) 556-1900. Fax: (214) 401-2344. Pres.: Roland Lundy; Professional/Creative Mgr.: Debbie Atkins.
- Word Class Music, (SESAC)** (See Don King Music Group, Inc.).
- World Famous Music, (ASCAP)** 1830 Spruce Ave., Highland Park, IL, 60035, (708) 831-1028. Pres.: Chip Altholz.
- World Music, Inc., (ASCAP)** PO Box 1319, Fair Lawn, NJ, 07410, (212) 688-6230. Pres./Professional Mgr.: Marie Garbarine.
- World War III Music, (BMI)** (See Warner/Chappell Music, Inc.).
- World Wide Music, Inc., Rt. 2, Box 466B,** Central City, KY, 42203, (502) 754-5050. Fax: (502) 754-4466. Pres.: Bobby D. Reed; Gen. Mgr.: Paul C. Hayes; Professional Mgr.: Michael Kossler.
- Worldtrax Music, Inc., (ASCAP)** (See Filmtrax Copyright Holdings, Inc.).

George T. Worth Music Co., (ASCAP) (See Jerry Vogel Music Co., Inc.).
Wren Music Co., (BMI) (See MPL Communications, Inc.).
Wrensong Publishing Corp., (ASCAP/BMI) 1229 17th Ave. S., Nashville, TN, 37212, (615) 321-4487. Fax: (615) 327-7917. Pres.: Marie Guyer; Gen. Mgr.: Sabrina Parker.
Write Now Music, (See Own Write Music).
Write Road Music Co., (BMI) 1030 16th Ave. S., Nashville, TN, 37212, (615) 242-1375.
Writers Int'l Publishing Corp., 177 E. Second St., Huntington Station, NY, 11746, (516) 547-0600. Fax: (516) 547-0252. Pres.: Geraldo Laufer.
George Wyle Music, (ASCAP) (See Mary Williams Music Clearance Corp.).
Wynwood Music Co., Inc., (BMI) PO Box 101, Broad Run, VA, 22014, Rt. 5, Box 85, Warrenton, WA, 22186, (703) 349-8183. Pres./Gen. Mgr.: Peter V. Kuykendall.
Wyoming Brand Music, (BMI) 3015 Leeville Rd., Mount Juliet, TN, 37122, (615) 444-8431. Pres.: Chris LeDoux; Gen. Mgr.: Alfred H. LeDoux.

X

XLNT Music, Inc., (ASCAP) 38-62 240th St., Little Neck, NY, 11363, (718) 279-4139. Pres.: James Cohn.
Xpress'n Series Music, (BMI) PO Box 3691, La Mesa, CA, 91944, (800) 447-1132. Fax: (600) 447-1132. Pres.: Rod Hollman.

Y

Yak One Music, (BMI) (See Lichelle Music Co.).
Yamaha Music Foundation, (See Pablo Music).
YellowBrick Road Music, (ASCAP) (See Qwest Music Publishing).
Yesyes Records, (ASCAP) PO Box 32031, Richmond, VA, 23294, 12909 Copperas Ln., Richmond, VA, 23233, (804) 796-9983. Pres.: David L. Esteck; Gen. Mgr.: Elizabeth B. Cherry.
Ynot Senyahit Songs, (BMI) (See H.E.G. Music).
Yo Pee's Music, (BMI) (See Shekere Music).
Yo-Yo Music, (BMI) PO Box 643, 48-780 Eisenhower Dr., La Quinta, CA, 92253, (619) 564-4823. Pres.: Fred Rice; Gen. Mgr.: Robert Rice.
Yolite Publishing, 5250 Santa Monica Blvd., Ste. 311, Hollywood, CA, 90029, (213) 913-9100. Pres.: Jim Anderson; Gen. Mgr.: Lilie Paul; Professional Mgr.: Jackie Baptiste.
York Publishing, PO Box 540, Parksville, NY, 12768, (914) 292-5738. Fax: (914) 292-0270. Pres./Professional/Creative Mgr.: Dr York.
Rusty York Music, (BMI) PO Box 31078, Cincinnati, OH, 45231, (513) 522-9336. Fax: (513) 522-9915. Pres.: Rusty York; Gen. Mgr.: Linda York; Professional Mgr.: Linda York.
Yorke Editions (United Kingdom), (See E.C. Schirmer Music Co., Inc.).
You Heard It—Heart!, 1445 Sunset Ridge Rd., Glenview, IL, 60025, (312) 729-2047. Pres.: Eric Lindberg; Gen. Mgr.: Sven Lindberg; Professional Mgr.: Frank Littlewolf.
You & I Music, (ASCAP) 1800 Grand Ave., Nashville, TN, 37212.
You Should Meet My Mother, (ASCAP) 5159 Wheelis Dr., #110, Memphis, TN, 38117, (901) 683-1933. Pres.: Celia McRee.
Young Graham Music, (BMI) 19 Music Sq. W., Nashville, TN, 37203, (615) 255-5740. Pres.: John Young; Professional/Creative Mgr.: Valerie Graham.
Young Lord Music, (SESAC) (See Wajji Music Group).
Your Best Songs Publishing, (ASCAP) PO Box 2893, Ventura, CA, 93002, 158 S. Fir St., Ventura, CA, 93001, (805) 641-3105. Fax: (805) 653-0106. Pres.: John Markovich; Gen./Professional/Creative Mgr.: Craig Markovich.
Yuma Music Corp., (ASCAP) (See Shapiro, Bernstein & Co., Inc.).
Johnny Yuma Music, (BMI) (See Fitzgerald Hartley Co.).

Z

Zapricorn Prods., Inc., PO Box 446, North Hollywood, CA, 91603, (818) 761-5284, (818) 766-6146. Pres.: Joseph Modeliste.
Zawinul Music, (See Gopam Ents., Inc.).
Zebracorn Music, (BMI) (See Avatar Publishing Group).
Zedek Music, (BMI) (See Airdrome Music & Stonewood Lane Music).
Zeiderman, Oberman & Assoc., Inc., (ASCAP) 500 S. Sepulveda Blvd., Ste. 500, Los Angeles, CA, 90049, (213) 476-5333.
Zeitgeist Int'l Music Publishing Co., (BMI) (See Vando Motion Pictures, Phonorecords & Music Publishing Corp.).
Zentao II Publishing Group, Ltd., (ASCAP) 609 Brook Rd., Richmond, VA, 23220, (804) 788-8892. Pres.: Max Monroe.
Zerkall Music, Inc., (ASCAP) 155 W. 72nd St., Ste. 704, New York, NY, 10023, (212) 769-9362. Fax: (212) 496-0254. Pres./Gen. Mgr.: Paul Schutman.
Ziffren Brittenham & Branca, (BMI) 2121 Ave. of the Stars, Ste. 300, Los Angeles, CA, 90067, (213) 552-3388.
Zip Kid Publishing, (BMI) PO Box 8161, New York, NY, 10116, (908) 229-9422. Fax: (212) 643-8469. Pres.: Jacques Battel; Gen. Mgr.: Branson Belchie.

Zitzler Music, (BMI) PO Box 3034, Austin, TX, 78764, (512) 443-7444. Pres.: Bruce Sheehan.
Zomba Ents., Inc., (ASCAP) 137-139 W. 25th St., New York, NY, 10001, (212) 620-8751. Fax: (212) 989-6603. Pres.: Clive Calder; Sr. Vice Pres./Gen. Mgr.: David Renzer; Sr. Vice Pres./Music Pub.: Rachelle Greenblatt.
Zoo Crew, (ASCAP) 1516 16th Ave. S., Nashville, TN, 37212.
Zoomik Music, (BMI) (See De Walden Music Int'l, Inc.).
Zoonon Tunes, (See Randy Klein Music).
Zut Music, (BMI) (See Dawg Music).

SHEET MUSIC & FOLIO SUPPLIERS

Amida Music, Inc., 1845 N. Farwell Ave., Milwaukee, WI, 53202, (414) 272-6700. Contact: John Mory.
Ark Records, PO Box 230073, Tigard, OR, 97223.
BMG Music Publishing, One Music Cir. N., Ste. 380, Nashville, TN, 37203, (615) 780-5420. Admin. Asst.: Sharon Perifull.
The Benson Co., 365 Great Cir. Dr., Nashville, TN, 37228, (615) 259-9111. Pres.: Robert H. MacKenzie.
CPPI/Belwin, Inc., 15800 NW 48th Ave., Miami, FL, 33014, (305) 620-1500. Pres.: Sandy Feldstein; Pop Product Mgr.: Tom Reed.
Camera Publications, 535 Fifth Ave., 35th Floor Penthouse, New York, NY, 10017, (212) 682-8400. Publishing Dir.: Victor Benedetto.
Cherry Lane Music Co., Inc., PO Box 430, 10 Midland Ave., Port Chester, NY, 10573, (914) 935-5200. CEO: Peter Primont; Pres. Music Print Div.: Michael Lafferts.
Ciano Pub., PO Box 263, Brigantine, NJ, 08203, (609) 266-2623. Pres.: Ron Luciano; A & R: Jerry Denton.
Columbia Pictures Publications, 15800 NW 48th Ave., Miami, FL, 33014, (800) 327-7643. Contact: Sandy Feldstein.
Creative Concepts Publishing Corp., PO Box 848, 406 Bryant Cir., Ste. L, Ojai, CA, 93024, (805) 646-4811, (800) 222-9745. Fax: (805) 646-2621. Pres.: John L. Haag; Gen. Mgr.: Matt Haag.
Criterion Music Corp., 1025 17th Ave. S., Nashville, TN, 37212.
Cude & Pickens Distributing, 519 N. Halifax Ave., Daytona Beach, FL, 32118, (904) 252-0381. Fax: (904) 252-0381. Pres./Sales Mgr.: Bobby Lee Cude.
Duane Music, Inc., 382 Clarence Ave., Sunnyvale, CA, 94086, (408) 739-6133. Pres.: G.E. Thompson.
Charles Dumont & Sons, Inc., 1085 Dumont Dr., Voorhees, NJ, 08034, (609) 346-9100. Pres.: Charles J. Dumont; Gen. Mgr.: Michael S. Dumont.
Equa Music, 1800 Moway Ave., Fremont, CA, 94538, (415) 794-6637. Pres.: Dr. Warren M. Johnson; Gen. Mgr.: Sandra Johnson.
Carl Fischer Music Dist., 54 Cooper Sq., New York, NY, 10003, (212) 777-0900. Pres.: Walter Connor; Vice Pres.: Thomas Mormile.
Doris Fisher Music Corp., 1 Time Sq. Plaza, New York, NY, 10036, (212) 221-3434.
Sam Fox Music Sales Corp., 170 NE 33rd St., Fort Lauderdale, FL, 33334.
GlobeArt Book Service, Div. of GlobeArt, Inc., 1755 York Ave., Ste. 21F, New York, NY, 10128, (212) 860-3023. Pres.: Jane Peterer; Vice Pres.: A.C. Thompson.
Hansen House, 141 Kearney St., San Francisco, CA, 94108, (415) 986-2385. Pres.: Charles Hansen.
Heavy Jamin Music/Dr. Canada Music (ASCAP), PO Box 1622, Hendersonville, TN, 37077, (615) 822-1044. Mgr.: S.D. Neal.
Holy Grail Pub., 12609 Dessau Rd., Ste. A222, Austin, TX, 78753, (512) 251-0375. Vice Pres. A & R: Gary A. Coll; Gen. Mgr.: Brad L. Silverlight.
Bryon Hoyt Sheet Music, 2525 16th St., San Francisco, CA, 94103, Pres.: Arthur B. Gurwitz; Vice Pres./Mgr.: Donald M. Schmeer, Jr.
Ivory Palaces Music, 3141 Spottswood Ave., Memphis, TN, 38111, (901) 323-3509. Pres.: Jack Abell; Office Mgr.: Keith Soltys.
JTL Publications, 14505 Fox Knoll Dr., Colonial Heights, VA, 23834, (804) 530-5023. Pres.: James T. Lester.
Jay-Jay Record Tape & Video Co., PO Box 41-4155, Miami Beach, FL, 33138, (305) 758-0000. Pres.: Walter E. Jagiello.
Henry Jerome Music, Inc., 5 Van Etten Blvd., New Rochelle, NY, 10804, (914) 632-1270. Pres.: Miriam Jerome; Gen. Mgr.: Henry Jerome.
Jewish Family Music, 8116 Aedan Ct., San Diego, CA, 92120, (619) 582-5696.
Kimishi Publishing, Div. of Arway Records & Ents., Inc., PO Box 584, Marion, AR, 72364. Pres.: Mikki Hooper; Exec. Vice Pres.: Cleo Cashe.
Lantana Music, 9430 Live Oak Pl., #308, Fort Lauderdale, FL, 33324, (305) 472-7757. Pres.: Jack P. Bluestein.
Hai Leonard Publishing Corp., 7777 W. Bluemound Rd., Milwaukee, WI, 53213. Pres.: Keith Mardak; Vice Pres. Mktg.: Jack Schechinger.
Mick Lloyd Prods., Inc., 1018 17th Ave. S., Ste. 11, Nashville, TN, 37212, (615) 329-9093. Pres./Gen. Mgr.: Mick Lloyd; Professional Mgr.: Jackie Kerddall.
Loena Music Publishing Co., 239 W. 18th St., New York, NY, 10011, (212) 989-7200. Pres.: Ervin Litkei; Dir.: Donald Tannen.
M C A Music Publishing, 1114 17th Ave. S., Ste. 205, Nashville, TN, 37212, (615) 327-4622. Vice Pres. Creative Ser.: Noel Fox.

Makedw Publishing Co. Ltd., 10556 Arnwood Rd., Lake Terrace, CA, 91342, (818) 890-0730.
Mark Music Service, 255 Oser Ave., Hauppauge, NY, 11788, (516) 273-7500. Fax: (516) 273-7605. Vice Pres. Sales/Gen. Mgr.: Richard Klimbowski; Mktg. Dir.: Deborah DelGuidice.
Massmedia/Synphony, 7105 Reynolds St., Pittsburgh, PA, 15208, (412) 247-1301. Pres.: Jon Gorr.
Mester Music/Jimerlean Music (BMI), PO Box 90639, 902 42nd Ave. N., Nashville, TN, 37209, (615) 321-3319. Pres./Dir.: James Hendrix.
Music Sales Corp., 225 Park Ave. S., 18th Floor, New York, NY, 10003, (212) 254-2100. Pres.: Barrie Edwards; Professional Mgr.: Philip Black.
Najarian Music Co., Inc., 269 Lexington St., Waltham, MA, 02154, (617) 899-2200. Fax: (617) 899-0838. Pres.: Robert Najarian.
Nara Music, Inc., 1845 N. Farwell Ave., Milwaukee, WI, 53202, (414) 272-6700. Contact: John Mory.
Nashville Int'l Music Group, PO Box 121076, 116 17th Ave. S., Nashville, TN, 37212, (615) 244-5357. (615) 254-3464. Pres.: Reggie M. Chruhwell.
Pathway Music, 1080 Montgomery Ave., Cleveland, TN, 37311, (615) 478-7629. Adv. & Promo. Coord.: Grady Murphy; Music Mktg. Mgr.: Terrell Brinson.
Peer-Talbot Music Group, 2 Music Cir. S., Nashville, TN, 37203, (615) 244-6200. Gen. Mgr.: Jana Talbot.
Peermusic, 810 Seventh Ave., New York, NY, 10019, (212) 265-3910. Fax: (212) 489-2465. Pres.: Ralph Peer II.
Plymouth Music Co., Inc., 170 NE 33rd St., Fort Lauderdale, FL, 33334, (305) 563-1844.
Morse M. Freeman, Inc., 731 S. Spring St., Los Angeles, CA, 90055, (213) 623-7211. Pres.: Harold L. Freeman.
Prophecy Publishing, Inc., c/o Bug Music, 6777 Hollywood, 9th Floor, Hollywood, CA, 90028.
Pubco, The Daniel Bldg., 20 N. Third St., 20th Floor, Philadelphia, PA, 19106, (215) 629-0030.
E.C. Schirmer Music Co., Inc., 138 Ipswich St., Boston, MA, 02215, (617) 236-1935. Contact: Robert A. Schuneman.
Seven Arts Press, Inc. dba Suite Seven Music, PO Box 649, Hollywood, CA, 90078, (213) 469-1095. Pres./Professional Mgr.: Walter E. Hurst.
Son Key, Inc., PO Box 31203, Aurora, CO, 80041.
Southern Music Co., PO Box 329, 1100 Broadway, San Antonio, TX, 78292, (800) 284-5443. Pres./Gen. Mgr.: Arthur Gurwitz.
Summy-Birchard Music, 9000 Sunset Blvd., Penthouse, Los Angeles, CA, 90069, (213) 273-3323. Pres.: Jay Morgenstern; Sr. Vice Pres./Gen. Mgr.: Sy Feldman.
T.P. Prods., Inc., PO Box 24561, Nashville, TN, 37202, 1019 17th Ave. S., Nashville, TN, 37212, Owner: Tom Pallardy.
Dale Tedesco Music Co. (BMI)/Tedesco Tunes (ASCAP), 16020 Lahey St., Granada Hills, CA, 91344, (818) 885-0775. Pres.: Dale T. Tedesco.
V.I.P. Music Distributors, Inc., 214 W. Jefferson St., Syracuse, NY, 13202, (315) 472-6779. (800) 272-7820. Pres.: George Chacona; Sales Mgr.: Bob Makitlen.
Tommy Valando Publishing Group, 1270 Avenue of the Americas, Ste. 2110, New York City, NY, 10020, (212) 489-9696. Pres.: Tommy Valando; Gen. Mgr.: Arthur Valando.
Jerry Vogel Music Co., Inc., 100 E. 42nd St., Ste. 1020, New York, NY, 10017, (212) 697-2710. Pres.: Edmund C. Grainger, Jr.
Warner Bros. Pub., Inc., 9000 Sunset Blvd., Penthouse, Los Angeles, CA, 90069, (213) 273-3323. Pres.: Jay Morgenstern; Sr. Vice Pres./Gen. Mgr.: Sy Feldman.
 Branch(es): 1290 Avenue of the Americas, New York, NY, 10019, (212) 399-6910. Pres.: Jay Morgenstern; 265 Secaucus Rd., Secaucus, NJ, 07096, (201) 348-0700. Pres.: Jay Morgenstern; Vice Pres./Gen. Mgr.: Sy Feldman.
Western Int'l Music, Inc., 3707 65th Ave., Greeley, CO, 80634, (303) 330-6901. Pres.: William Schmidt.
White Lilac Press, PO Box 2556, Providence, RI, 02906, (401) 273-6678. Pres.: Susan K. Lundgren.

**Tell Them You
 Saw It In
 Billboard's
 1992
 International
 Buyer's
 Guide.**

In this section...

- Wholesaler & Distributors Index
- Wholesaler & Distributors
- Music & Video Accessory Manufacturers
- Audio Accessory Manufacturers
- Manufacturers: Retail Merchandising Products

MAKE MORE MONEY

Encore!

- Lowest prices - guaranteed
- Superior service - you get whatever you need and you get it now
- Extraordinary selection of independent label CDs and accessories
- Fill regularly in excess of 95% - no other distributor comes close
- Backorders regularly tracked
- Same day shipping
- Overnight and Saturday delivery available (often at no extra cost)
- Special sale pricing every day of the year
- Free promotional product with every order
- Knowledgeable, experienced sales staff
- Advertising department providing promotional support & co-op funds
- Worldwide export experts - Se habla Espanol

**Get faster delivery, more inventory turns
and lower costs. Buy from Encore and make
more money - Isn't that why you're in business?**

Encore Distributors Inc.
USA toll free

1-800-334-3394

2219 Market St., Denver, CO 80205
303-292-9333 FAX # 303-292-6969

The best prices The best service The best compact discs Period.

ACOUSTIC DISC AIRUS AJK MUSIC ALCAZAR ALLIGATOR AMERICAN
GRAMAPHONE ANTONE'S ARHOOIE ARIWA SOUNDS ATOMIC THEORY
BAINBRIDGE BIG RECORDS BIOGRAPH BLACK LION BLACK SUN BLACK
TOP BLIND PIG BLUE ORCHID BLUE PLATE MUSIC BLUE WAVE
BLUEMOON BRAINCHILD BULLSEYE BLUES CANDID CANYON CAPRI
CAPRICCIO/DELTA CELESTIAL HARMONIES CHASE CHESKY CLEAN CUTS
COLCANNON COLLEGIUM COMMODORE JAZZ CONCORD JAZZ
CONTEMPORARY COYOTE OLDMAN CRUSH CRUZ DARGASON DARING
DCC DEBUT DELMARK DMP DORIAN DRG EAST SIDE DIGITAL EN
POINTE ENJA FANTASY FLYING FISH FOLKWAYS FORTUNA GALAXY
GARLAND GECKO GLOBAL PACIFIC GNP GO JAZZ GOLD CASTLE GOLDEN
GATE GOOD TIME JAZZ GOURD GRAMAVISION GRATEFUL DEAD GREEN
LINNET GRP GRP HANNIBAL HDH HEADFIRST HEARTBEAT HEARTS OF
SPACE HIGH STREET HIGHER OCTAVE HIGHTONE HINDSIGHT ICHIBAN
IMPULSE ITI JASS JAZZLINE JUSTIN TIME K-TEL KALEIDOSCOPE
KUCKUCK L & R LANDMARK LASERLIGHT LIVING MUSIC MANGO
MARZIPAN MESA MESSIDOR MIGHTY TIGER MILESTONE MIRAMAR
MOBILE FIDELITY MONSTER MUSIC MOOSE MUSIC WEST MUSICMASTERS
NARADA NEBULA NESAK NEW ALBION NEW ALLIANCE
NICHOLS-WRIGHT NIGHTINGALE NORTH STAR NOUVEAU NOVA NOVUS
OH BOY OLIVIA OMEGA OPTIMISM ORIGINAL BLUES CLASSICS ORIGINAL
JAZZ CLASSICS ORIGINAL SOUND OWL PABLO PAIR PHILO PILZ
POSITIVE MUSIC PRESTIGE PRIVATE MUSIC PROPRIUS RAINWOOD RAS
RAY LYNCH PROD. REAL MUSIC REBEL RED HOUSE RED PAJAMAS
REDWOOD REFERENCE REITER RELIX RESTLESS RHINO RHYTHM SAFARI
RISING SON RISING SUN RIVERSIDE ROIR ROUNDER RYKO SAN
FRANCISCO SOUND SEA BREEZE SHANACHIE SHEFFIELD LAB SHELTER
SHINING STAR SILVER WAVE SLINGSHOT SONA GAIA SONIC
ATMOSPHERES SONIC EDGE SONY MUSIC SOUND DESIGNS OF ARIZONA
SPECIAL MUSIC SPECIALTY SPINDLETOP SPIRIT FEEL SST STANYAN
STASH STAX STORY OF BLUES SUGAR HILL SUMERTONE TALKING TACO
TALL TREE TAYLOR PARK TBA TELARC TEMPLE THIRD EAR THRIVAL TIME
IS TIP TOE TOMATO TOMATO TRILOKA VANGUARD VANGUARD CLASSICS
VARESE SARABANDE VARRICK VINTAGE JAZZ VISUAL MUSIC VOLT WALT
DISNEY RECORDS WINDHAM HILL WRESTLER YAZOO

ACCESSORIES

AUDIOSOURCE CASE LOGIC DENON TAPE EPPCO INTRACLEAN LIFT
DISPLAY MONSTER CABLE RECOTON SONY TAPES & ACCESS. TREE
DIMENSIONS UNIVENTURE WOOD TECHNOLOGY

Distribution & Consumer Product Manufacturers

WHOLESALEERS & DISTRIBUTORS INDEX

When locating a Wholesaler's name in the alphabetical listings, you will notice the appropriate state abbreviation to the right. By referencing that state in the 'Wholesalers & Distributors' section, you will have complete information on the Wholesaler.

A

AAA Pricerite Entertainment Corp.	NY
A-A-A Record Hunter Dist. Co.	NY
AAA Video Distributors	PA
ABA Record Distributors, Inc.	NJ
A-1 Record Sales	NY
A.S.K. Dist. Corp.	NY
AV Comm Ltd.	NY
A.V.I.	TN
Abbey Road Distributors	CA
Acme Merch., Inc.	CA
Acoustic Sounds	KS
Action Dist. Co.	MD
Action Music Sales, Inc.	OH
Advance Recording Prods.	CA
African Record Centre Dist.	NY
Alamo Record Dist., Inc.	TX
All Service One Stop, Inc.	NJ
Allegro Imports	OR
Alpha Music Corp.	CA
Alps, Inc.	NC
American Digital	NJ
American Music, Inc.	NJ
American Music Wholesalers, Inc.	FL
American Pie	CA
American Record Sales, Inc.	NJ
American Video/Disc, Inc.	NY
Angott Record & Tape Sales, Inc.	MI
Ansonia Records, Inc.	NJ
Antilla Record Distributors Inc.	NY
Apon Record & Video Co., Inc.	NY
Ark Group	CA
Arovax Record	NY
Arrow Distributing Co.	OH
Artec Dist., Inc.	MA, NY, PA, VT
Aspen Records	MI
Associated Dist., Inc.	AZ
Assn. of Research & Enlightenment	VA
The Audio Buff Co., Inc.	OH
Audio One	CT
Audio/Video Rack Services	OH
Austin Record Dist.	TX
Automated Video Business Corp.	IN
Azra Int'l.	CA

B

BC. Ent's. of Memphis Inc.	TN
BMG Dist.	CA, GA, IL, MD, MA, MI, MN, NY, OH, TX, WA
Backroads Distributors	CA
Baker & Taylor Video	AZ, CA, CO, FL, GA, IL, MA, NJ, NC, OR, PA
Balboa Records Co.	CA
Baly Records & Tape Dist.	CA
Barnes Record Dist.	PA
Barstow Pro	TX
Bassin-Distributors, Inc.	FL
Bayside Record Distributing Co.	CA
Bennett Marine Video	CA
Bennett Records Dist.	MS
Benson Co.	TN
Best Video, Inc.	OK, TX, UT
Bib Distributing Co., Inc.	NC
Big Apple Entertainment	NY
Big State Dist. Inc.	TX
Black Fire Dist.	DC
Boeing Bros. Inc.	FL

Bonnevillle Media Communications	UT
Bridge Records, Inc.	NY
Roger Brouso Phonograph Records	CT
Brown Bros., Inc.	MN
Buffalo One Stop	NY

C

CAP Exports/CW. Paas, Inc.	IL
CD City	FL
CD One Stop	CT
CEMA Distribution	CA, GA, IL, NJ, NC, OH, TX
CML, Inc.	MO
California Record Distributors	CA, WA, CA
Caltex Records	CA
Campus Records	NY, OH
Canterbury Records, Inc.	CA
Canyon Records & Indian Arts	AZ
Caroline Records	CA, NY
Casa de los Tapes, Inc.	PR
Cassettes Unlimited	CA
Cavages, Inc.	NY
Celluloid Records	NY
Center For The Queen of Peace	CA
Central Electronics	KY
Central Record & Tape Dist., Inc.	CT
Central South Music Sales, Inc.	TN
Chambers Records & Video Corp.	NY
Chidvilas Dist.	CO
Chin-Randy's Records	NY
Christys Record Sales	CO
City Hall Records	CA, OR, WA
City One Stop	CA
Cleveland One Stop Record, Inc.	OH
Collectables Record Corp.	PA
Comtron Corp.	AZ, CA, CO, FL, GA, IL, IA, MD, MI, NY, OH, OR, TX, UT, WA
Corbitt Co.	TN
Countrywide Tape & Record Dist., Inc.	NY
Crockett & Assocs. Sound Recording Sales	TX
Cude & Pickens Distributing Co.	FL
Curtiss Universal Record Masters	TN
Custom Rack Service	TN

D

Dairyland Prodn's, Inc.	WI
Daro Exports, Ltd.	NY
Dart Distributing Inc.	MN
Dayton Record Service, Inc.	OH
Dean's One Stop, Ltd.	VA
Destiny Records, Inc.	GU
DeVorss & Co.	CA
Dick's Record Co., Inc.	MA
The Disc-Connection	MO
Disc-O-Rama Music World Dist.	NY
Discount Records	AR
Discount Video Tapes, Inc.	CA
Distribuidora Nacional de Discos	NY, PR
Distribution Video & Audio—DV+A	FL
Dixie Exports, Inc.	TN
DixiRaks Records & Tapes	TN
Dolphin Music Distributors, Inc.	FL
Don Records Corp.	NY
Double Arrow Record Co., Inc.	NY
Dutch East India Trading	NY
Dutchland Distributing	PA

E

E-MC Rhythm Ltd., Inc.	NJ
E & R One Stop	TX
E.R.S. Distributors, Inc.	NY
E.T.D., Inc.	AZ, CA, LA, MO, NC, TX
East Coast Music Dist.	NY
East Side Digital	MN
Eastern Pacific Sounds, Inc.	CA
Educational Media Co.	NY
Educational Record Center, Inc.	GA
Educational Record & Tape Dist. of America	NY
Educational Video, Inc.	MI
Egner Ent's., Inc.	OR
The Electric Fetus, Inc.	MN
Electronix Corp.	OH
Elegance & Zesty Records Distributors	NY
Elkins Record Shop	WV
Emperor Entertainment	CA
Empire Records & Tapes	FL
Encinitas Imports	CA
Encore Dist. Corp.	CO, NY
Encore Int'l Corp.	MD

David Eskin, Inc.	NY
Espre Records & Cassettes	CA
Essex Entertainment	NJ
Euroline Communications	WI
European Video Distributors	CA
Eurpac Warehouse Sales	CA, VA
ExSell Mktg., div. of Weiss Ent's. Inc.	NC

F

FTC	CA
Facets Video	IL
Fiebre Latina	CA
First Video Exchange	CA
Fletcher's One Stop, Inc.	IL
Florida-Rock, Inc.	FL
Floyd's Wholesale Dist. Inc.	LA
Folk Arts Rare Records	CA
Frankie's Music Distributors	LA
Freckle Records	WA
Funkytown Music, Inc.	CA

G

Galaxy Records & Tapes	PA
Galgano Records	IL
Game Arts	NY
Garmisa Sales	CA
Gemini Distributing, Inc.	GA
General Record Service, Inc.	WA
Gentry II Corp.	OH
Michael Ginsburg Distribution	TN
Glo, Inc.	CA
Global Pacific Records, Inc.	CA
Global Video Dist., Inc.	FL
God's World	MI
The Gold Vault	MI
Goldband Record Dist. Corp.	LA
Golden Circle, Inc.	CT
Golden Oldies, Inc.	CA
Goldenrod Distribution Inc.	MI
Gonzales Music	LA
Gotham Dist.	PA
Great Atlantic & Pacific Music Co.	MO
Great Bay Dist., Inc.	MD, NJ

H

H.L. Dist., Inc.	FL
Handleman Co. Inc.	AR, CA, CO, FL, GA, IL, MD, MI, MO, NY, OH, TX, WA
Harbor Record Export Corp.	NY
Harmony House Records	MI
High Altitude Dist., Inc.	MT
Hits Unlimited	IL
Hoffman Tapes	KS
Home & Industrial Video	NJ
Hope Int'l Prodn's Ltd.	NY
Horizon Dist. & Promo.	MA
Horseshoe Distributors	TN
House Distributors	KS, MO
House of Guitars, Inc.	NY
House of Menorah	NY

I

IDC	CA
Image Entertainment	CA
Imaginary Entertainment Corp.	AL
Impact Music	AZ
Imperial Tape Co.	CA
Important Record Distributors	CA, GA, IL, NY, TX, WA
"Indie" Dist.	A
Infinity Video	OK
Ingram Entertainment Inc.	CA, FL, GA, IN, KS, MD, MN, NJ, OR, TN, TX
Ingram Merchandising Services	TN
Inter-Sports Book & Video Dist.	CO
Intera-Belmoor	NY
Interama	NY
Intercontinental Record & Cassette, Inc.	NY
International Records	CA
Interstate Group	MD

J-K

JFL Distributors, Inc.	FL
J.S.J. Tape Distributors	IL
Jamie/Guyden Dist. Corp.	PA
Jesus Music Dist.	PA

Just C.D.'s Dist., Inc. FL
 Justin Entertainment/Kiddieworks/Records GA
 KSG Distributing UT
 Keeling Reggae Video Dist. NY
 Kief's Records & Stereo Supply, Inc. KS
 King's Record Shop KY
 Kingston Int'l NY
 Koch Int'l Corp. NY
 Kona-Kai Dist. Co. HI

L

LIND Institute CA
 LSR/Dutch East India NY
 LaVal Record Dist. MI
 La Voz Hispana, Inc. IL
 Lady Slipper NC
 Landmark Distributors, Inc. CA, GA, IL, NY
 LeFon, Inc. CA
 Len's One Stop MI
 Levy Home Entertainment IL
 Levy Home Entertainment Music Div. MI
 Liaison Records, Inc. MD
 Lieberman Ent. GA, HI, IL, IN, MN, MO, NV,
 NJ, TX
 Lifedance Dist. OR
 Lindberg Records IL
 Linden Distributors NM
 Linden Int'l Children's Recording CA
 Little Major Records Distributors, Inc. NY
 The Little Warehouse OH

M

MCA Dist. Corp. CA, GA, IL, MA, MN, NY, PA,
 TN, TX
 MCM Distributors NY
 MDC NJ
 M.S. Distributing Co. IL, WI
 MTM Coin UT
 Maine Record Sales ME
 Major Video Concepts, Inc. AK, AL, CA, FL, IL,
 IN, MI, NC, OH, TN, UT, VA, WA, WY
 Malverne Distributors, Inc. MA, NY
 The Market Place IL
 Maxi Cassette Prods., Inc. CA
 Gail K. Mayer Distributor MI
 Media Concepts, Inc. FL
 Met Richmond Record Sales FL
 Microphone Music, Inc. HI
 Mid-America Record Service MO
 Midnight Int'l Records, Inc. NY
 Mill City Music MN
 Mr. Video CA
 Mobile Record Service Co. PA
 More Records, Inc. CA
 Motor City Music Distributing, Inc. MI
 Mountain Coin Machine Dist. AZ, CO, IA, NV, NM
 Movie Tape Exchange Inc. NJ
 Multinational Dist., Inc. IL
 Music City Record Dist., Inc. TN
 Music Craft Dist. of Hawaii, Ltd. HI
 Music Design, Inc. WI
 Music Distributors Inc. TX
 Music Ent. of Missouri MO
 Music Man, Inc. WV
 Music Merchandisers, Inc. IN
 Music Mood Ent. IN
 Music Suppliers, Inc. MA
 Music Town Record Distributors TN
 Music Video Distributors PA
 Music Wholesalers, Inc. IN

N

Nat'l Trends, Inc. MI
 Nationwide Sound Distributors TN
 Navarre Corp. CA, IL, MN, NY, WA
 Nert of New England MA
 New Day Christian Dist. Inc. TN
 New Leaf GA
 New Music Distribution Service NY
 Nightingale-Conant Corp. IL
 North Country Dist. NY
 North Star Music Co. TX
 Northeast One Stop, Inc. NY
 Norwalk Record Distributors CA
 Nova Distributing Corp. GA

O

Off Beat Records Inc MA
 Ohio Record Rack OH
 Old Fogey Dist. MI
 Olympia Distributing Corp. NY
 Omega Distribution NC
 One-Stop Record House, Inc. GA
 One Way Records, Inc. NY
 Only New Age Music, Inc. CA
 Operations International Inc. TX
 Optimism, Inc. CA
 Otoao Records Co. Int'l Ltd. NY
 Oxyoron, Inc. CA

P

Pacific Coast One-Stop CA
 Paradigm Distribution CA
 Paramount Records, Inc. NY
 Paulstarr Distributing IL, MN
 Pearl Music NY
 Performance Distributors NJ
 Peter's Record One-Stop MA
 Pete's Records TX
 Michael Phillips Ents., Inc. NC
 Photoco, Inc. OH
 Pioneer LDCA, Inc. CA
 Pocket Songs/MMO Music Group NY
 Polish Record Center of America IL
 PolyGram Group Distr. NY
 Poplar Tunes Record Shop, Inc. TN
 Pravda IL
 Precision Sound CA, TX, WA
 Prime Cut's Disc Distributors of
 New England MA
 Prime One Stop Dist. NJ
 Princeton Record Exchange NJ
 Priority Video Services/Hollywood Movie Co. WA
 Pro One Stop AZ
 Procanyn's Polka Palace NY
 Public Media Home Video IL
 Pyramid New Age Music Distributors CA

Q-R

Qualiton Imports Ltd. NY
 RAS Records (Real Authentic Sound) DC
 RCA/BMG Dist. TN
 R.D.I. MS
 RM Distributing, div. Aztec Corp. IL
 RMM Records & Videos Corp. NY
 R. S. Distributing IL
 RTI NE
 RTV Sales Corp. FL
 Rack Service Hawaii HI
 Rank Retail Services PA
 Rankin Records FL
 Rashid Sales Co. Inc. NY
 Real Music CA
 "Recommended" Seldom Seen Records CA
 Record Depot VA
 Record Theatre + Ambat Records OH
 Record-Wide Distributors, Inc. MO
 Records Ltd. CA
 Reggae Sunsplash Music Video Collection NY
 Rego Irish Records & Tapes, Inc. NY
 Release Records NY
 Rentrak Corp. OR
 Reyes Records, Inc. FL
 Rhody Records & Tape RI
 Richman Bros. Records, Inc.-One Stop MD,
 NJ
 Richman Bros. Records, Inc. NJ
 Ed Richter Mktg. WA
 Riggs Distributing KY
 Rock Bottom GA, FI
 Rockin' Relix Inc. NY
 George Romansic/Independent Distribution WA
 Henry Rosenberg & Assoc. NJ
 A. I. Rosenthal Assoc., Inc. PA
 Rough Trade CA, NY
 Rounder Distribution MA, NY, WA
 Royal Dist. MA
 Ruby Sales Co., Inc. IL
 Ruda Distributors NY

S

S & J Record One Stop NY
 Saint Expedite Dist. Co. LA
 Sallese Entertainment CA
 Satellite Sound, Inc. PA
 Saturn Records CA
 Schwartz Bros., Inc. GA, MD, NJ, OH
 Scorpio Music, Inc. NJ
 Scott Distributing Corp. NY, VA, CA
 Scott's One-Stop Records, Inc. IN
 Sea-Port Record One Stop, Inc. OR
 Seebro Prods. Co. IL
 Select-O-Hits Inc. TN
 Selectrak Family Video IL
 Shively Records, Inc. KY
 Sierra Amusement Corp. CA
 Sight & Sound Distributing Co. OR
 Sight & Sound Distributors AR, KS, LA, MN, MO
 Silo Music VT
 Silver Eagle Communications CA
 Jimmie Skinner Music Center OH
 Smash Record Distributors AZ
 Smith Record Sales, Inc. PA
 Sonocraft Corp. NY
 Sound Investment IL
 Sound N Vision Ent. Inc. NJ
 Sound of New Orleans LA
 Sound Service Inc. NC
 Sound Solutions, formerly RecTrack (USA) NJ
 Sound Splash, Inc. FL
 Sound Warehouse IL

Sounds Good Music Co. CA
 Sounds & Video Inc. WI
 Sounds-Vision Music CA
 South Texas Wholesale Records & Tapes, Inc. TX
 Southeastern Tape Dist. GA
 Southwest Wholesale Records & Tapes TX
 Spanish Music Club OH
 Specialty Dist. Co. FL
 Spring Arbor Dist. MI
 Square Deal Record Co. CA
 Stackhouse Delta Record Dist. MS
 Star City Records NY
 Star Video Entertainment, L.P. NJ, NY, PA, MA
 Stark Records & Tape Co. NC
 State Wide Distributing MI
 Subterranean Records CA
 Sun State Music Dist., Inc. CA
 Super Marketing Dist., Inc. PA
 Surplus Records NJ

T

TMC Prods. TX
 Tant Ent., Inc. MI
 Tapeworm Distributors CA
 Target Music Dist., Inc. FL
 Telemark Dance Records VA
 3-D TV Corp. CA
 Titan United Corp., div. Colony Group Inc. NJ
 Top 40 Video Leasing OH
 Total Music Distributors MI
 Transcontinent Record Sales &
 Record Theatre NY
 Transpac Trading Co. CA
 Trip/Tower Records/MTS Inc. CA
 Ernest Tubb Record Dist., Inc. TN
 Twin City Import Records, Inc. MN
 Twinbrook Music, Inc. NY

U

U.S. Laser Video Distributors NJ
 US Record Dist. NJ
 Unique Music Corp. NY
 United States Distributing, Inc. IA
 Universal Home Video PA
 Universal One Stop PA
 Universal Record Distributing Corp. PA
 Unlimited Resources Int'l NY

V

VAAM Music Nat'l Record Dist. CA
 VCR Lock Corp. FL
 VPD—Video Products Distributors, Inc. CA, WA
 V.P. Record Dist. NY
 V.R.C. UT
 VSI Dist., Inc. IL
 Valley Record Distributors CA
 Val's Halla IL
 Venus Records & Music Dist., Inc. NY
 Video Action CA
 Video Assoc. NY
 Tamber Video dba Video Broker Int'l NY
 Video Cassette Sales, Inc. NJ
 Video City Distributing CA
 Video Delivery Systems, Inc. CO
 Video Gold GA
 Video Marketing Int'l Inc. AZ
 Video Treasures NJ
 Video Trend, Inc. AK, CA, FL, IL, MI, UT, WA
 Video Vendor IL
 Videotakes NJ
 Viking Entertainment, Inc. AZ, CA
 Vintage Distributing, Inc. MD
 Vintage Vinyl IL
 Vinyl Vendors MI
 Vista Sounds Int'l, Inc. NJ

W-Z

Warner/Elektra/Atlantic Corp. CA, MA
 Waterfall Record Dist. NY
 Watts Music Inc. NY
 Wax Works-Video Works TN, KY
 Wayside Music MD
 West Side Sound Distributors, Inc. NJ
 Western Distributors CA
 Western Merchandisers, Inc. CO, UT, TX
 Western Record Sales Inc. CA
 W.E./Whitman Ent. CA
 Wiimi Sales Corp. NY
 Win Records & Video, Inc. NY
 Wishing Well Video Distributing CA
 Wolfram Video, Inc. WI
 Wolverine Galley WY
 Wood Knapp Video CA
 Curtis Wood Records & Tape Distributors TN
 World Class Music Dist. NY
 World Trading Center Inc. NY
 Worldtone Music Inc. NY
 ZBS Industries, Inc. OH
 Zango CA
 Zim Records NY

i n r h y t h m w i t h t h e w o r l d



SOUTHWEST WHOLESALE

r e c o r d s & t a p e s

**Your full line, full service one-stop
with the service and reliability that you expect.**

Over 50,000 titles	Dedicated Salespeople	Next day delivery	Weekly mailer
12% returns	Same day shipping	Weekly specials	Posters and promos

Full classical lines on SONY, CEMA, BMG, UNI, PGD, TELARC, & LASERLIGHT

A leader in Spanish Music (Tejano, Salsa, Merengue)

A complete inventory of all available LPs and 12" singles

Competitive rates on air shipments throughout the U.S.

ACCESSORIES

Maxell, Sony, Allsop, Napa Valley, Memorex, Discwasher
Case Logic, Denon, TDK, Stanton, Clik Case...and more



NEW LOCATION

**4240 Lockefield
Houston, Texas 77092**

**CALL TOLL FREE
and get on our
mailing list
TODAY!**

**Toll Free: 800/749-0212
Phone: 713/681-0629
Fax: 713/681-3037**

WHOLESALEERS & DISTRIBUTORS

ALABAMA

Imaginary Entertainment Corp., 332 N. Dean Rd., Auburn, 36830, (205) 821-7156, Proprietor: Lloyd E. Townsend Jr. (Distributor)

Labels Distributed: Audio: Above Ground, AP-GU-GA, BWL, Bogden, Dolce & Nuit, Eat, Farblossom, Home, Imaginary, Home, Lost Arts, Open Sky, Outatune, RH, Reptile, 77, TSMB, Utility Grade, Longview.

Major Video Concepts, 2620 Commerce Sq. Dr., Birmingham, 35210, (205) 956-9661, (800) 289-0918, Fax: (205) 956-1978, Branch Mgr.: Regena Lacey; Opns. Mgr.: Jerry Smith; Adv. Coord.: Susan Maxey, (Video (Cassette & Disc)) (Distributor) Labels Distributed: Video: See Indiana Listings For Product Distribution.

ALASKA

Major Video Concepts Inc., 907 E. Dowling Rd., #11, Anchorage, 99502, (907) 563-4060, (800) 478-4060. Labels Distributed: Video: See Indiana Listings For Product Distribution.

Video Trend, 907 E. Dowling Rd., #11, Anchorage, 99502, (907) 563-4060, (800) 478-4060, Opns. Mgr.: Julie Nash.

ARIZONA

Associated Dist., Inc., 3803 N. 36th Ave., Phoenix, 85019, (602) 278-5584, Fax: (602) 269-6356, Pres.: Leonard M. Singer; Buyer (Pre-Recorded Music): Angela Singer, Bob Fenty; Buyers (Music): Rita Powell, Pam Dunn; Sales Mgr.: Gus Figueroa. (Compact Disc, Pre-Recorded Audio Tape, Records (LP's, 12-Inch, Singles)) (Distributor, One-Stop) Labels Distributed: Audio: Alligator, American Gramophone, Amherst, Cardiac, Cheeta, Concord Jazz, Crescendo, Effect, 4-Sight, 4th & Broadway, Great Northern Arts, Hightone, Hot, Ichiban, Invasion, Joey Boy, Lethal Beat, Malaco, Mango, Mic Mac, Music West, Nastymix, Next Plateau, Pandisc, PAR, Priority, Profile, Pump, Rap-A-Lot, Quality, Rounder, Sin-Drome, Sugar Hill, Vision, Warlock.

Baker & Taylor Video, 3108 W. Thomas Rd., #1202, Phoenix, 85017, (602) 269-1407, (800) 848-9456, Fax: (602) 269-7383, Sales Mgr.: Luann Shaw. (Distributor, One-Stop) Labels Distributed: Audio: See Illinois Listing For Product Lines; Video: See Illinois Listings For Product Lines.

Canyon Records & Indian Arts

4143 N. 16th St., Phoenix, 85016, (602) 266-4823, Owner/Buyer: Bob Nuss. (Compact Disc, Pre-Recorded Audio Tape, Video (Cassette & Disc)) (Distributor) Labels Distributed: Audio: Celestial Harmonies, Silver Wave, Canyon Records, Indian House, Indian Sounds, Feather Stone, Soar, Tribal Music Int'l, Library of Congress, Sunshine Records; Many Independents including John Rainer, Kevin Locke, Peace Co., Floyd Westerman and others (cassettes, CDs, LPs and videos distributed are American Indian); Video: PBS Home Video, Tellens, American Indian Dance Theatre. Pay-Per Transaction. Labels Imported: Sunshine Records, Saskatchewan Indian Culture Center (Canada).

Commtron Corp., 2611 S. Roosevelt, #102, Tempe, 85282, (602) 966-6691, Fax: (602) 894-0329, Branch Mgr.: Steve Brown. (Distributor)

Labels Distributed: Audio: See Iowa Listing For Product Line; Video: See Iowa Listing For Product Line.

E.T.D., Inc., 2732 W. McDowell, Phoenix, 85009, (602) 233-3741, (800) 231-3218, Fax: (802) 233-2141, Branch Mgr.: Mario Henriquez. (Pre-Recorded Audio Tape, Video (Cassette & Disc)) (Distributor)

Labels Distributed: Audio: Promotional Lines; Video: All Major Studios & Most Independents. Pay-Per Transaction.

Futuristic South, PO Box 122, Bellwood, 36313, (205) 588-2546.

Impact Music, 910 S. Hohokam Dr., #101, Tempe, 85281, (602) 894-8550, Fax: (602) 894-6640, Pres./Buyer (Accys.): Brad Singer; Mgr./Buyer (Music): Rory Musil; Buyer (Video, Accys.): Mike Meyers. (Compact Disc, Pre-Recorded Audio Tape, Video (Cassette & Disc), Cutouts, Overstock, Accessories) (One-Stop)

Mountain Coin Machine Dist., 2439 W. McDonell, Phoenix, 85009, (602) 269-7596, Fax: (602) 278-3224, Mgr.: Dan Waters. (One-Stop)

Labels Distributed: Audio: See Colo. listing for product line. **Pro One Stop**, 1810 W. Fourth St., Tempe, 85281, (602) 894-9849, Chief Exec.: Jim Johnson; Buyer (Pre-Recorded Music): Paul Johnson; Buyer (Accessories): Carter Frey;

Mgr./Buyer (Video): Marty McDevitt; Buyer (Other): Sandy Gentry. (Compact Disc, Pre-Recorded Audio Tape, Video (Cassette & Disc), Records (LP's, 12-Inch, Singles), Cutouts, Overstock, Accessories) (Distributor, One-Stop, Rackjobber) Products/Accessories: CD, Tape & Record Products: Discwasher, Memorex; Blank Tape: TDK, Memorex; Other: Juke Box Title Strips, Specialty CD's.

Smash Record Distributors, 3402 W. Wilshire Dr., Ste. 24, Phoenix, 85009, (602) 278-9285, Owner/Buyer: Charlotte Harrington. (Compact Disc, Records (Singles)) (One-Stop) Labels Distributed: Audio: 45s and CDs only, sells all major labels to jukebox operators and deejays.

Products/Accessories: Storage & Carrying Cases: Boxes for 45s, LPs and CDs.

Video Marketing Int'l Inc., PO Box 51087, Phoenix, 85076, (602) 838-0923, Fax: (602) 838-8055, Buyer (Videos): James O'Donnell. (Video (Cassette & Disc)) (Distributor, One-Stop) **Viking Entertainment Inc.**, 3402 W. Flower St., Phoenix, 85017, Mgr.: John De Leon. (Rackjobber)

Cutouts/Overstocks: Cutout Cassettes, LPs, CDs, Videos.

ARKANSAS

Discount Records, 3400 S. University, Little Rock, 72204, (501) 565-0304, Fax: (501) 565-2294, Pres.: Jack Garner; Buyer (Pre-Recorded Music): L. Nolley, S. Harrison; Buyer (Needles, Blank Tape): Steve Harrison; Buyer (Gifts, Sunglasses): Lance Nolley. (Compact Disc, Pre-Recorded Audio Tape, Records (LP's, 12-Inch), Accessories) (Rackjobber)

Labels Distributed: Audio: CBS, Warner-Elektra-Atlantic, MCA, RCA, Capitol, Rhino, Epic, Geffen, I.R.S., SBK, etc. Products/Accessories: CD, Tape & Record Products: Alltop, Discwasher, Fidelitone; Storage & Carrying Cases: Case Logic; Blank Tape: Maxell, TDK; Batteries: Duracell; Diamond Needles: Pfanstiel, Fidelitone.

Handleman Co.-Little Rock, 11601 Otter Creek S. Blvd., Mabelvale, 72103, (501) 455-0308, Branch Mgr.: Ron Jones; Opns. Mgr.: Wade Permenter; Sales Mgr.: David King. (Compact Disc, Pre-Recorded Audio Tape, Video (Cassette & Disc)) (Rackjobber)

Labels Distributed: Audio: See Michigan Listings For Product Distribution; Video: See Michigan Listings For Product Distribution.

Sight & Sound Distributors, 2201 Brookwood Dr., Little Rock, 72202, (501) 664-1630, (800) 366-6603, Fax: (501) 664-4996, Branch Mgr.: Wayne Jung. (Distributor, Rackjobber) Labels Distributed: Audio/Video: See St. Louis, Mo., home office listing for product line.

CALIFORNIA

Abbeey Road Distributors

PO Box 15706, 2228 S. Ritchey St., Santa Ana, 92705, (714) 546-7177, Fax: (714) 546-0337, Pres.: Bruce Ogilvie; Mktg.: Al Kalin; Sales: Beverly Klingsick; Buyer Latin: Angel Vasquez; Buyer Singles: George Hunter; Buyer (Video): Vanssa Schatz; Indie Labels: Craig Doucette; Buyer (Accessories): Steve Boudreau; Major Label-Catalog: Anne Werner; Major Label-hits: John Kundrat.

Los Angeles Branch: 2430 E. 11th St., Los Angeles, 90021, (213) 629-5901, Fax: (213) 629-5985, Sales Mgr.: Sam Ginsburg. (Compact Disc, Pre-Recorded Audio Tape, Video (Cassette & Disc), Records (LP's, 12-Inch), Accessories) (One-Stop)

Products/Accessories: CD, Tape & Record Products: Alltop, Recoton, Discwasher, Phantone, Memorex, Maxell; Storage & Carrying Cases: Case Logic, Tree Dimensions, Napa Valley, Laserline; Blank Tape: Maxell, TDK, Sony, Denon; Head Phones: Memorex, Maxell, Recoton; Batteries: Duracell; Diamond Needles: Pfanstiel.

Acme Merch., Inc., PO Box 2451, Irwindale, 91706, (800) 888-3808, (818) 969-4886, Contacts: Terry So, Alan Kok. (Accessories) (Distributor, Importer)

Advance Recording Prods., 7190 Clairemont Mesa Blvd., San Diego, 92111, (619) 277-2540, (800) 854-1061, Fax: (619) 277-7610, Mgr.: Jim Norr. (Pre-Recorded Audio Tape) (Distributor)

Alpha Music Corp., 3729 S. Robertson Blvd., Culver City, 90232, (213) 838-8800, Fax: (213) 838-8926, Buyers: Chuck Rosenbloom, Mike Colestock. (Compact Disc, Pre-Recorded Audio Tape, Video (Cassette & Disc), Records (LP's), Cutouts, Overstock) (Distributor, Exporter) **American Pie**, PO Box 66455, Marina Del Rey, 90066, 13381 Beach Ave., Marina Del Rey, 90292, (310) 421-4005, Fax: (310) 423-3389, Principal: Wayne Volat; Mgr.: Paul Duray; Buyer (Pre-Recorded Music): Alex Moek. (Compact Disc, Pre-Recorded Audio Tape, Records (Singles)) (Rackjobber)

Ark Group, PO Box 410685, San Francisco, 94141, 425 Alabama St., San Francisco, 94110, (415) 863-7200, Pres.: Allan R. Kessler. (Distributor) Labels Distributed: Video: AEON, Awakening Heart, Norman Beerfar Prod., CTW, Camera One, Celestial Harmonies, Classical Vid. Concerts, Emaura, TDF, Halpern, Sound Rx, Healing Arts, Finley-Holiday, Immediate Future,

BEST PRICES!

WEEKLY SPECIALS!

AUDIO 1 ONE
Your Best Distributor of C.D.'s and Cassettes

**"If AUDIO ONE is not your 1st stop every order...
you are simply missing the AUDIO ONE ADVANTAGE."**

Call: **1-800-8-AUDIO-1**

Call: **1-203-381-0202**

FAX: **1-203-381-0255**

NEXT DAY DELIVERY AVAILABLE.. Call Today
400 Long Beach Blvd., Stratford, CT 06497

■ Your 1st Stop!

■ Your BEST Stop!

■ Your AUDIO 1 Stop!

Largest Distributor of Authentic American Indian Recordings

R. Carlos Nakai • Robert Tree Cody • John Rainer
Kevin Locke and others. Over 600 titles.

— Native American Flute Music —
for complete list write:

Canyon Records

4143 N. 16th St.
Phoenix, AZ 85016 • (602) 266-4823
Dealer Inquiries Invited



3rd Time Lucky?



Hardly.

We've Worked Hard To Become The Only
3-Time Recipient Of NARM's
One Stop Of The Year Award

And We Continue To Offer Our Customers
The Best In Service, Price And Fill.

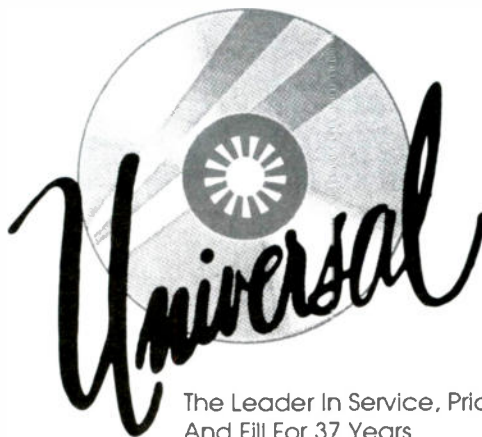

Universal One Stop

2055 Richmond Street Philadelphia PA 19125
(215) 426 3333 1 800 523 0834 FAX (215) 426 2667

IVN, Landvision, Malibu, Marine Mammal, Media Magic, Miramar, Moodtapes, Native Science Network, New Era Media, Pacific Arts, Pyramid, Peter Roberts Prods., Vid. Naturals, Warner, Western, Wilderness, Lumivision.

Azra Int'l, PO Box 459, 4343 E. 58th St., Maywood, 90270, (213) 560-4223, Fax: (213) 560-1240, Chief Exec.: D.T. Richards; Buyer (Music/Video): Al Martinez. (Distributor)
Labels Distributed: Audio: Iron Works, Metal Storm, Concor Classix, Masque, N.S.F.D.

BMG Dist., 5 Thomas Mellon Cir., #154, San Francisco, 94134, (415) 330-0200, Fax: (415) 330-0233, Sales Mgr.: Charlie Rice. Branch(es): 6363 Sunset Blvd., Ste. 605, Hollywood, 90028, (213) 468-4067, Fax: (213) 468-4073, Branch Mgr.: B. Graham; Sales Mgr.: M. Garrett. (Compact Disc, Pre-Recorded Audio Tape, Video (Cassette & Disc), Records) (Distributor)
Labels Distributed: Audio/Video: See New York Listing For Product Line.

Backroads Distributors, 417 Tamal Plaza, Corte Madera, 94925, (415) 924-4848, (800) 825-4848, Fax: (415) 924-0648, Owner: Lloyd Barde; Mgr.: Darlene Johnson; Buyer: Mark Jeffrey. (Distributor)

Labels Distributed: Audio: More than 350, including American Gramophone, Celestial Harmonies, Private Music, Music West, Silver Wave, Global Pacific, Higher Octave, Hearts Of Space, Sonic Atmospheres, Fortuna, Ca-

nyon, Sound Rx, Erdenklant, Ryko, Gold Castle, Real Music, New Albion, Music Of The World, Consensus, Beyond Music, Windham Hill, Emerald Green, Miramar, Lisem, Serenity, Invincible, Sugo, Talking Taco, Hay House; Video: Miramar and Others.

Baker & Taylor Video, 8501 Telfair Ave., Sun Valley, 91352, (818) 768-2900, (800) 621-5290, Fax: (818) 768-4858, Sales Mgr.: Don Farr. (Video (Cassette & Disc)) (Distributor, One-Stop)
Labels Distributed: Audio/Video: See Illinois Listings For Product Line.

Balboa Records Co.

10900 Washington Blvd., Culver City, 90230, (213) 204-3792, Fax: (213) 204-0886, Pres.: Valentin Velasco; Mgr.: Fernando Sanchez. (Compact Disc, Pre-Recorded Audio Tape, Records (LP's, Singles)) (Distributor, Importer)
Labels Imported/Distributed: Audio: Balboa, Codiscos, DLV, Musart (Mexico).

Baly Records & Tape Dist., PO Box 20832, Los Angeles, 90006, 1492 W. Washington Blvd., Los Angeles, 90007, (213) 731-7020, (800) 345-2259, Fax: (213) 781-8136, Owner: Isaac Baly; Buyer (Pre-Recorded Music): Alfonso Magana; Mgr/Buyer (Video, Other): Nissim Baly. (Compact Disc, Pre-

Recorded Audio Tape, Records (LP's, 12-Inch), Accessories) (Distributor, One-Stop, Rackjobber, Importer, Exporter)
Labels Distributed: Audio: Capitol EMI Latin, Fonovisa, Freddie, Globo, Karen, Kubaney, Musart, Ramex, Sonotone, Sony (CBS), TH Rodven, WEA Latina, Lung, Ariola, Orfeon, BMG (RCA) Joey, Mediterraneo, Cosmos, Peerles, Gil, Mar, Eastside Story, Balboa, Fuentes, Melody, Rio Bravo, Cintas Acuario, YM.

Products/Accessories: CD, Tape & Record Products: Pfanstiehl; Storage & Carrying Cases: Case Logic, BMD Audio Racks; Blank Tape: Memorex, Sony; Batteries: Duracell; Diamond Needles: Pranstiehl.

Bayside Record Distributing Co.

174 Paul Dr., San Rafael, 94903, (415) 472-2806, Fax: (415) 472-2567, Pres.: Robin Wise; Buyer: Jonathan Schiele; Promo.: Lindsey Marks. (Compact Disc, Pre-Recorded Audio Tape, Records) (Distributor, Importer)

Labels Distributed: Audio: Alamadina, Alcazar, Alligator, Alacazam, ARC, Arhollie, Black Top, Blind Pig, Blue Rock-It, Blue Wave, Bullseye, Capitol Steps, Copper Creek, County, Criminal, Delmark, Eternal, Flying Fish, Fogerty's Cove, Global Village, Heartbeat, India Navigation, Interplay, Iris, Kaleidoscope, Kent (Tape Only), Maison Del Sol, Monitor, Muse, NRG, Original, Orleans, Pax, Philo, RZ, Rebel Redhouse, Redwood, Roir, Rounder, Smithsonian/Folkways, Step One, Sugar Hill, Swallow, Temple, Time Is, Turquoise, Winner.

Labels Imported: Black & Blue (France); Blues Document, Document & Wolf (Austria); Charlie (England); Jazz Point (Germany); JVC (Japan); Stony Plain (Canada).

Bennett Marine Video, 730 Washington Blvd. E., Marina Del Rey, 90292, (213) 821-3329, Fax: (213) 306-3162, Chief Exec.: Michael Bennett; Mgr.: Roderic Kavanagh; Buyer (Videos): Jan Sherlock. (Video (Cassette & Disc)) (Distributor)
Labels Distributed: Video: Annapolis, Better Boating, Better Fishing, Disney, ESPN, Home Vision, MGM, Pacific Arts, Scuba World, WEA, Warren Miller.

Labels Imported: Labels From Australia, Japan, New Zealand, United Kingdom.

CEMA Distribution, 21700 Oxnard St., Ste. 700, Woodland Hills, 91367, (818) 587-4000, Pres.: Russ Bach; Vice Pres. Sales: Joe McFadden; VP Mktg. & Strategic Png.: Rand Bleimester. Branch(es): 111 N. First St., Burbank, 91502, (818) 563-6300, Fax: (818) 563-2410, Branch Mgr.: Vyto Lazauskas; 1115 Atlantic Ave., Ste. 102, Alameda, 94501, (415) 865-8441, (800) 234-7625, Fax: (415) 865-8469, Branch Mgr.: Terry Sauter; Distrib. Center, 3116 West Ave. 32, Los Angeles, 90065, (213) 257-8224, (800) 421-0132, Fax: (213) 255-3392, Contact: Roy Houghton. (Compact Disc, Pre-Recorded Audio Tape, Records) (Distributor)

Labels Distributed: Audio: Owned: Capitol, EMI Records USA, SBK, Angel, Blue Note, Capitol Nashville, Capitol/EMI Latin; Joint Venture: Chrysalis, I.R.S.; Third Party: Barking Pumpkin, Bellmark, Rhino, Gold Castle, Curb, American Record Distribution.

California Record Distributors

255 Parkside Dr., San Fernando, 91340, (818) 361-7979, Fax: (818) 365-7328, Pres.: George Hocutt; Sr. Vice Pres./Gen. Mgr.: Don Davis; Vice Pres./Opns. Mgr./Buyer: Rick Hocutt; Vice Pres. Mktg.: Ted Higashioka.

Branch(es): Tenth & Parker, 5th Floor, Berkeley, 94710, (415) 548-3203, Fax: (415) 548-4106, Branch Mgr.: Michael Wright; 6011 S. Roxbury, Seattle, WA, 98118, (206) 723-0900, Fax: (206) 723-9040, Sales Mgr.: George Bigley. (Records) (Distributor)

Labels Distributed: Audio: Alligator, Amherst, Cardiac, Concord Jazz, Cheetah, Fantasy Group, Flying Fish, GNP, Greatful Dead, Hightone, Ichiban, Island Trading Co., Malaco Group, Muse, Next Plateau, Oh Boy/Red Pajamas, Pair, Pan Disc, Pow Wow, Quality, RAS, R.O.M., Rounder, Shiloh, Sugar Hill, Tommy Boy, Warlock, Welk Group, Nasty Mix, Rap-A-Lot, Specialty.

Caltex Records, 9045-A Elton Ave., Canoga Park, 91304, (818) 700-8657, Fax: (818) 700-0285, Pres.: Mehrdad Pakravan; Mgr./Buyer: Shokoufeh Arosmand. (Compact Disc, Pre-Recorded Audio Tape, Video (Cassette & Disc), Records) (Distributor, Exporter)

Labels Distributed: Audio: Caltex, Of Oz Music Co., AVAZ Music Co.

Labels Imported: Iran (Persian Music).

Canterbury Records, Inc., 805 E. Colorado Blvd., Pasadena, 91101, (213) 681-4922, Fax: (213) 681-4924, Pres.: Charles Gordon; Buyer (Videos): Jeff Oronzo; Buyer (Accessories): Jeff Oronzo; Music Buyers: Jessie Bruno, J. Freedman; Contact: Cynthia Littleton. (Compact Disc, Pre-Recorded Audio Tape, Video (Cassette & Disc), Records (LP's, 12-Inch, Singles), Accessories) (One-Stop, Rackjobber, Exporter)
Products/Accessories: CD, Tape & Record Products: Discwasher, Memorex; Storage & Carrying Cases: Case Logic, Savoy; Blank Tape: TDK, Maxell, Memorex, Scotch; Head Phones: Memorex, Azden; Diamond Needles: Shure, Pfanstiehl.

Caroline Records California, Inc., 9838 Glenoaks Blvd., Sun Valley, 91352, (818) 504-0965, Fax: (818) 504-2745, Managing Dir.: Rick Williams. (Compact Disc, Pre-Recorded Audio Tape, Video (Cassette & Disc), Records (LP's, 12-Inch,

Abbey Road Distributors

We Are THE LEADING U.S. ONE-STOP WHOLESALE OF COMPACT DISCS, CASSETTE TAPES, PHONOGRAPH RECORDS, MUSIC VIDEOS, MUSIC AND MOVIE LASER DISCS AND AUDIO & VIDEO ACCESSORIES.

We Offer A full range of services to the music retailer. WE STOCK ALL ITEMS MANUFACTURED IN THE U.S. OUR SERVICES ARE STATE-OF-THE-ART.

Inquiries Welcome

WE LOOK FORWARD TO THE OPPORTUNITY TO PROVIDE YOUR STORE WITH THE FINEST SERVICE POSSIBLE. DOMESTIC: EXT. 423; EXPORT: EXT. 218.

Abbey Road Dist.

2228 S. Ritchey, Santa Ana, Ca. 92705
2430 E. 11th St., Los Angeles, Ca. 90058
TEL: 714-546-7177 Toll free anywhere
in U.S.: 1-800-827-7177. Faxes: 714-546-0337 (S.A.); 213-629-5985 (L.A.)



**BALBOA
RECORDS, CO.**

10900 WASHINGTON BOULEVARD, CULVER CITY, CA 90230
(213) 204-3792 (213) 204-3793 (213) 204-3794

Exclusive
Distributor of . . .



**Musart Records For
United States & Puerto Rico**

Singles)) (Distributor)
 Labels Distributed: Audio: E'G, Editions E'G, Caroline, Blue Plate, Venture, Frontline, Ill, Metal Blade, Megaforce, Plane 9, Sub Pop, Suicidal.

Cassettes Unlimited, 10995 Wrightwood Ln., Studio City, 91604, (213) 650-6510, Fax: (213) 654-4539, Pres./Mgr./Buyer: Herbert S. Dale; Buyer (Pre-Recorded Music): Bruce Dale. (Compact Disc, Pre-Recorded Audio Tape, Cutouts, Overstock) (Rackjobber)

Center For The Queen of Peace, PO Box 90035, Pasadena, 91109, 505 S. Flower St., Level C, Arco Plaza, Los Angeles, 90071, (818) 578-1858, (213) 629-4860, Pres./Director/Buyer: Rafael Brom. (Compact Disc, Pre-Recorded Audio Tape, Video (Cassette & Disc), Records) (Distributor, Rackjobber, Exporter)
 Labels Distributed: Audio/Video: Cosmotone.
 Pay-Per Transaction.

City Hall Records, 25 Tiburon St., San Rafael, 94901, (415) 457-9080, Fax: (415) 457-0780, Pres./Buyer (Pre-Recorded Music): Robin Cohn; Office Mgr.: Joan Andersen; Buyer (12" Records): Walter Zelnick.
 Branch(es): 11060 Mississippi Ave., Los Angeles, 90025, (213) 473-0477, Fax: (213) 444-9695, Branch Mgr.: Rick Frystak; 2055 Edinburg, Cardiff-By-The-Sea, 92007, (619) 943-1649, Fax: (619) 943-1649, Branch Mgr.: Forrest Haller. (Compact Disc, Pre-Recorded Audio Tape, Records) (Distributor, Importer, Exporter)
 Labels Distributed: Audio: Ace, Green Linnet, King, Modern Blues, Trumpet, Lyricord, Jass, Jewel, Nighthawk, Origin Jazz Library, Testament, Storyville, Vintage Jazz Classics, Syndrome, 4-Sight, Priority, Rhythm Safari, T-Cap, ASAP, F.B.I., In-A-Minute, Triad, Hip Rock, Tandem, Speed, Hot, Westbound, Instinct, Strictly Rhythm, Cutting, Strictly Business, Megatone, Newtown; Video: Rosetta, Vintage Jazz Classics.
 Labels Imported: Sackville (Canada); Dr. Horse, Earth Angel, Jukebox Lii, Phontastic, Route 66 (Sweden); Ace, Big Beat, Cascade, Demon, Edsel, Flyright, Fountain, Flyright, Globestyle, Jasmin, Jonzo, Krazy Kat, RBD, Red Lightnin'; Sequel, Trojan, VJM, Zu Zazz (U.K.); Diving Duck, Double Trouble, Moonshine, Sundown (Holland); Bear Family, Crosscut (Germany).

City One Stop, PO Box 58900, 2551 S. Alameda St., Los Angeles, 90058, (213) 234-3336, (800) 829-2489, Fax: (213) 234-4036, Mgr.: Sam Ginsburg; Buyer (Pre-Recorded Music): Shelly Tucker; Buyer (Videos): Patti Baca; Buyer (Accessories): Patti Baca; Gen. Mgr.: Richard Diamond. (Compact Disc, Pre-Recorded Audio Tape, Video (Cassette & Disc), Records (12-Inch), Computer Games) (One-Stop)

Commtron Corp., 2900 S. Fairview, Bldg. 21, Santa Ana, 92704, (714) 751-9011, Fax: (714) 540-0978, District Mgr.: John Badostain; Facility Mgr.: Chuck Davis; District Sales Mgr.:

Ron Lehman.
 Branch(es): 2365 Industrial Pkwy. W., Hayward, 94545, (415) 785-3730, Fax: (415) 785-5407, Branch Mgr.: Mike Evans; Sales Mgr.: Jamie Guzzaldo; 7900 Sepulveda Blvd., Van Nuys, 91405, (818) 988-9020, Fax: (818) 785-0454, Branch Mgr.: Ron Lehman; 5576 Inland Empire Blvd., #A, Ontario, 91761, (714) 948-7998, Fax: (714) 948-9778, Branch Mgr.: Andy Tenzler. (Video (Cassette & Disc)) (Distributor)
 Labels Distributed: Audio/Video: See Iowa Listing For Product Distribution.

DeVors & Co., PO Box 550, Marina del Rey, 90294, (213) 870-7478, (Distributor)

Discount Video Tapes, Inc., PO Box 7122, 833 "A" N. Hollywood Way, Burbank, 91510, (818) 843-3366, Fax: (818) 843-3821, Pres./Buyer: Woody Wise; Mgr.: Barb Fillmore. (Video (Cassette & Disc)) (Distributor)
 Labels Distributed: Video: Old Classics on Video (Wholesale and Retail).

E.T.D., Inc., 9260 Trade Pl., San Diego, 92126, (619) 530-2220, (800) 654-0658, Fax: (619) 530-2276, Branch Mgr.: John Eplett. (Pre-Recorded Audio Tape, Video (Cassette & Disc)) (Distributor)
 Labels Distributed: Audio: Promotional Lines; Video: All Major Studios & Most Independents.
 Pay-Per Transaction.

Eastern Pacific Sounds, Inc., 6325 De Soto Ave., Ste. F, Woodland Hills, 91367, (818) 884-2234, Fax: (818) 884-1268, Pres.: M. Yorozu; Vice Pres.: David Fonn; Mgr.: Shin Tankai; Buyer (Pre-Recorded Music): Tak Uchida. (Compact Disc, Pre-Recorded Audio Tape, Video (Cassette & Disc), Records (LP's, 12-Inch, Singles)) (Distributor, Importer, Exporter)
 Labels Distributed: Audio: Klavier, O.M. Record, Audiofon.

Emperor Entertainment, 271 Bolinas Rd., Fairfax, 94930, 321-C E. Valerio St., Santa Barbara, 93101, (415) 456-7807, Pres.: Mark Bredt; Buyer (Videos): Roger A. Ellman, N.S.C. (Video (Cassette & Disc)) (Distributor, License/Video)
 Pay-Per Transaction.
 Labels Imported: England, Europe, Japan.

Encinitas Imports, 955 Second St., Encinitas, 92024, (619) 436-9589, (Distributor, Importer)

Espree Records & Cassettes, 10747 Wilshire Blvd., Ste. 807, Los Angeles, 90024, (310) 824-3333, Fax: (310) 470-2111, (Distributor)
 Labels Distributed: Audio: Espree Books & Cassettes, Kessler Management Publications.

European Video Distributors, 2321 W. Olive Ave., Ste. C, Burbank, 91506, (818) 848-5902, Fax: (818) 848-1965, Pres./Buyer (Video): Bela Bunyik; Mgr./Buyer (Video): Bonnie Anderle. (Video (Cassette & Disc)) (Distributor)
 Labels Imported/Distributed: Video: Studios from Hungary, Poland, Czechoslovakia and Argentina.



174 Paul Drive
 San Rafael, CA 94903

DISTRIBUTOR/IMPORTER

In the San Francisco area:
 Main Office: (415) 472-2806
 FAX: (415) 472-2567

Sales: Vernon McNemar
 Chris Vincent
 Buyer: Jonathan Schiele
 Promotion: Lindsey Marks
 Phone Sales: Jeff Penney

In the Northwest:
 Allen Jones (503) 643-6518
 George Romansic (206) 282-4820

In Southern California:
 Rick Frystak (213) 473-0477
 Fred Norsworthy (714) 751-5918

In Texas:
 Michael Crockett (512) 451-2936

*blues, jazz, folk, oldies, rock,
 women's, cajun/zydeco,
 international, soundtracks*

CRDI

distribution is our business

• RECORDS • CASSETTES • COMPACT DISCS •

One of America's Largest
 Independent Distributors

SALES • PROMOTION • MERCHANDISING

Serving The West

CALIFORNIA RECORD DISTRIBUTORS

SAN FRANCISCO:
 10th & Parker/5th floor
 Berkeley, CA 94710
 (415) 548-3203
 fax (415) 548-9354

LOS ANGELES:
 255 Parkside Dr.
 San Fernando, CA 91340
 (818) 361-7979
 fax (818) 365-7328

SEATTLE:
 6011 S. Roxbury
 Seattle, WA 98118
 (206) 723-0900
 fax (206) 723-9040

Eurpac Warehouse Sales, Stes. M-N, 9566 Distribution Ave., San Diego, 92121, (619) 566-7662, Fax: (619) 566-0750, Pres.: Milt Kyle; Mgr./Buyer (Access.): Frank DeFalco; Buyer (Pre-Recorded Music): Paul Lawrence; Buyer (Videos): Peter Demeo; Buyers (Other): T. McNeil, Rosanne Cellini. (Compact Disc, Pre-Recorded Audio Tape, Video (Cassette & Disc), Accessories) (Rackjobber)
Products/Accessories: CD Players: Casio, Hitachi; Audio & Video Playback Equipment: Casio, Hitachi; CD, Tape & Record Products: Recoton; Storage & Carrying Cases: Case Logic, Recoton; Video Cassette Recorder: Hitachi; Blank Tape: Recoton; Head Phones: Recoton.
F.T.C., 8306 Wilshire Blvd., Ste. 544, Beverly Hills, 90211, (213) 965-9585, Fax: (213) 933-3118, Pres.: Jacques Hubert; Mgr.: Lewis Werner (Distributor, Importer, Exporter)
 Labels Distributed: Audio: Bloomdido, 52 Rue Est, Magnetic, Masters of Jazz, Volcanic, Vent du Sud (France); Fini Jazz/Liuto, Ird, Jazz Music Yesterday, Moon (Italy); Alfa, El Bandoneon, Fandango, Freshsound, Palladium, Trova, Tumbao (Spain); Capri, Emerald/Silvetto, K2B2, Nine Winds (U.S.).

Fiebre Latina

7626 Miramar Rd., Ste. 3600, San Diego, 92126, (619)

NAVARRE
CORPORATION

**DISTRIBUTION
FOR THE
FUTURE**

- Independent Label Music Product
- Distribution, Sales and Marketing Covering the Midwest, East & West Coast
- LOS ANGELES
8300 Tampa Avenue, Suite J
Northridge, CA 91324
(818) 718-6688
- SAN FRANCISCO
315 1/2 Baker St.
Petaluma, CA 94952
Adam Reiss (Territorial Sales Manager)
(707) 762-3488
- SEATTLE
4107 23rd Avenue S.W.
Seattle, WA 98106
Cindy Chinn (Sales Representative)
(206) 933-0462

WEST COAST • MIDWEST • EAST COAST

695-8863, Fax: (619) 695-3768, Pres./Buyer (Accessories): David Massry; Mgr./Buyer (Music, Video): Alex Hoy; Buyer (Other): Raul Arce. (Compact Disc, Pre-Recorded Audio Tape) (Distributor)
 Labels Distributed: Audio: Sony/CBS, BMG, WEA, Polygram, AMS Records, Capitol, Edgar, Elomar, Fonovisa, Gil Records, Joey Int'l, Karen Records, Mar, Balboa (Musart), TH Rodven, Ramex, Rico Records, RL Records, Sonido, Sonotone, Kubaney, Musical Prodn., Freddie Records, Luna Records.
 Labels Imported: Import/export to/from Mexico and USA.
Products/Accessories: Storage & Carrying Cases: Case Logic; Blank Tape: Sony, SKC; Head Phones: Sony, Memorex, Sentry, SKC; Batteries: Duracell.

First Video Exchange, 17503 S. Figueroa, Gardena, 90248, (213) 516-6422, (800) 247-2351, Pres.: Jeff Leyton; Mgr: Carol Vogel. (Video (Cassette & Disc), Computer Games) (Distributor)
 Labels Distributed: Video: New and used video movies and Nintendo games.

Folk Arts Rare Records, 3611 Adams Ave., San Diego, 92116, (619) 282-7833, Owner: Louis F. Curtiss; Buyer (Pre-Recorded Music): Frank H.P. Jaxon; Buyer (Videos): Lamar Wright. (Distributor, Importer, Sound Library)
 Labels Distributed: Audio: Gennett, QRS, Timely Tunes, Grey Gull, Black Swan, Meteor, Homestead, New Comfort, Electro Disc, Black Patti, Paramount, Lonesome Ace, Melotone and others.

Funkytown Music, Inc., 246 N. Western Ave., Los Angeles, 90004, (213) 464-1323, Fax: (213) 464-4728, Pres.: Kwang Ann; Mgr: Chris Luu; Buyer (Pre-Recorded Music): Steve Ann. (Compact Disc, Pre-Recorded Audio Tape, Records (LP's, 12-Inch, Singles)) (Importer, Exporter)
 Labels Imported: BMG, CBS, PolyGram, Capitol (EMI), Carere, Bellaphone, Intercord, Max, Blank Negro, ZYX, Power Rec, Central Station, Disco Magic; from/to Korea, Canada, Mexico, Holland, Belgium, England.

Garmisa Sales, 23811 Fairgreens E., Laguna Niguel, 92677, (714) 495-3999, Fax: (714) 495-3997, Owner: Robert M. Garmisa; Buyer (Accessories): Robert M. Garmisa. (Distributor, Mfr's Rep)
Products/Accessories: CD, Tape & Record Products: Pro-Wipes; Storage & Carrying Cases: Case Logic; Other: Gift-wraper/Flash-Wrap, CD Jewel Boxes, Norelco Boxes.
Glo, Inc., 2406 Fifth Ave., San Diego, 92101, (619) 233-9165, (Distributor)

Global Pacific Records, Inc., 270 Perkins St., Sonoma, 95476, (707) 996-2748, Fax: (707) 996-2658, Pres.: Howard Sapper; Sr. Vice Pres.: Howard Morris; Buyer: Bette Timm. (Distributor)
 Labels Distributed: Audio: Global Pacific, Heru, Sugo, Jaime Music, Talking Taco, Music For Little People, Acorn Music, Steven Bergman and others.

Golden Oldies, Inc., 7370 Forest Ave., 8317 Painter Ave., Whittier, 90602, (213) 945-5840, Fax: (213) 945-4317, Pres.: R. Ruiz; Mgr: Brenton Wood. (Compact Disc, Pre-Recorded Audio Tape, Records (LP's), Cutouts, Overstock) (Distributor, Importer, Exporter)
 Labels Distributed: Audio: Golden Oldies, Original Sound, Rhino.
 Cutouts/Overstocks: Some 60's & 70's Titles.
 Labels Exported: Warner Bros., CBS, Fania, Motown, Double Shot.

Gourd Music, 124 Mason St., Santa Cruz, 95060, (408) 425-4939.

Handleman Co. Los Angeles, 760 S. Epperson, City of Industry, 91748, (818) 912-8182, Branch Mgr.: Gary Van Valkenburg; Opns. Mgr.: Ed Da Silveira; Sales Mgr.: Carter Holt. (Compact Disc, Pre-Recorded Audio Tape, Video (Cassette & Disc)) (Rackjobber)
 Labels Distributed: Audio/Video: See Michigan Listings For Product Distribution.

IDC, 3115 Ocean Front Walk, #107-B, Marina Del Rey, 90292, (213) 306-5105, Fax: (213) 822-9246, Pres.: Rick Laudati. (Compact Disc, Pre-Recorded Audio Tape, Records (LP's))

(Distributor, Importer)

Labels Distributed: Audio: Acoustic Disc, Attack, Blue Beat, BMG/Brazil, Continental, BMJ/Illluki, Kicking Mule, Music of the World, NRG, Olive Branch, Siglas, Sunbeam, Testament, Texas Rose, Trojan, WEA/Brazil.
 Labels Imported: Attack, Trojan (U.K.); Blue Beat (France); BMC, Continental, EMI, PolyGram, RGE, Sigla, Sony, WEA (Brazil).

Image Entertainment, 6311 Romaine St., Hollywood, 90038, (213) 468-8867, (800) 421-4585, Fax: (213) 468-9236, Pres.: Martin W. Greenwald; Sr. Vice Pres. Sales: Lee Kasper; Vice Pres. Sales: Steve Garwood. (Distributor)
 Labels Distributed: Video: All Major Studios & Most Independents on Laserdisc.

Imperial Tape Co., 1928 14th St., Santa Monica, 90404, (213) 393-7131, (800) 736-8273, Fax: (213) 395-8255, (Distributor)
Important Record Dist., 20525 Manhattan Pl., Torrance, 90501, (213) 212-0801, Fax: (213) 212-6562.
 Branch(es): 3501 California St., San Francisco, 94118, (415) 221-3480, Fax: (415) 221-3513. (Pre-Recorded Audio Tape, Records) (Distributor)
 Labels Distributed: Audio: See New York Listings For Product Distribution.

Ingram Entertainment Inc., 3100 Zinfandel Dr., Ste. 200, Sacramento, 95670, (916) 631-1568, Branch Mgr.: Dennis Brajkovich.
 Branch(es): 11235 Knott Ave., Ste. C, Cypress, 90630, (714) 373-8855, Sales Mgr.: Fred LePore. (Distributor)
 Labels Distributed: Video: See Tennessee Listings For Product Distribution.

**International Records, PO Box 11117-1117, San Bernardino, 92423, 26200 Redlands Blvd., #75, San Bernardino, 92373, (714) 796-6110, Owner/Mgr./Buyer: John Brechler. (Compact Disc, Records (LP's)) (Distributor)
 Labels Distributed: Audio: Interplay, Courtney, Sea Jam, Geobo.**

LIND Institute, PO Box 14487, 584B Castro St., San Francisco, 94114, (415) 864-3396, Fax: (415) 864-1742, Pres.: Charles Schmid; Buyer (Pre-Recorded Music): Greg Lute; Vice Pres.: Ole Anderson; Sales Mgr.: John Olson. (Distributor)

Landmark Distributors, Inc., 3555 Lomica Dr., Unit D, Torrance, 90505, (213) 325-2680, Fax: (213) 325-6737, Mgr./Buyer: Jeanne Iannotta. (Distributor)
 Labels Distributed: Audio: Beachwood, Cosmic Force, Earth Beat/Music For Little People, Five Star, Giana, Golden Music, Hammer & Nails, Profile, Big Beat, Tuff City, DRG, Bay Cities, Alcazar, DB, Dynamix, Maggie's Music, Major, Metropolitan, Night Train, Polarix, Pravda, Rising Son, Rio's Raoyal, Terra Nova, Tri Records, DJ Int'l, Waterclog, Vision, Continuum Corp., Collectables, Dr. Dream, Amazin', D.I.W., Performance, Heart Music.

LeFon, Inc., 9532 Quakertown Ave., Chatsworth, 91311, (818) 886-2650, Fax: (818) 886-8079, Pres.: Doug Lexa. (Compact Disc, Video (Cassette & Disc), Records, Computer Games) (Importer, Exporter, Int'l Mktg. Svc. for Indies)

Linden Int'l Children's Recording, 170 State St., Los Altos, 94022, (415) 949-3390, Owner/Mgr./Buyer: Dennis Ronberg. (Distributor)
 Labels Distributed: Audio: A & M, Children's Group, Discovery Music, Lightyear, Windham Hill/Rabbit Ears, MCA, Kids Records, BMG, Creative Teaching Press, Rounder, Folkways, Hug Bug, Pacific Cascade, Turn Page Press, PolyGram; Video: A & M.

MCA Dist. Corp., 70 Universal Plaza, Universal City, 91608, (818) 777-4500, Exec. Vice Pres.: John Burns; Dir. Sales/Inventory: Cary Mansfield.

Branch(es): 100 N. First St., 4th Floor, Burbank, 91502, (818) 845-0365, Fax: (818) 845-2564, Regional Branch Mgr.: John Allison; Regional Sales Mgr.: Rod Linnum; Regional Video Dir.: Barbara Berger. (Distributor)
 Labels Distributed: Audio: MCA, GRP, Motown, Narada, Geffen, Varese Sarabande, Chess, Mechanic, Impulse, Art & Electronics, Melodiya; Video: MCA/Universal Home Music Video, Rhino Music Home Video.

Major Video Concepts Inc., 351-B Foster City Blvd., Foster City, 94004, (415) 345-8666, (800) 966-3324, Branch Mgr.: Joanne Hibbeln; Sales Mgr.: Gary House; Warehouse Mgr.: Mike Malmstrom.
 Branch(es): 10461 Old Placerville Rd., Ste. 130, Sacramento, 95827, (916) 363-0982, (800) 966-9978, Opns. & Warehouse Mgr.: Cinde Cobb; Sales Mgr.: Mariann Puliz; Credit Mgr.: Bert Bryant; 9263 Owensmouth, Chatsworth, 91311, (818) 709-7089; 97 W. Montague Expwy., Milpitas, 95035, (408) 942-0125.
 Labels Distributed: Video: See Indiana Listings For Product Distribution.

Maxi Cassette Prodn., Inc., 1442 E. Arrow Hwy., Unit P, Irwindale, 91706, (800) 344-6294, Fax: (818) 357-1666, Chief Exec.: Michael T. Aris. (Pre-Recorded Audio Tape, Video (Cassette & Disc)) (Importer)
Products/Accessories: Blank Tape: Magnetic Tape & Cassettes.

Mr. Video, 5550 Fulton Ave., Van Nuys, 91401, (818) 789-7238, (800) 432-4336, Fax: (818) 785-1238, CEO: Mike Young; Mgr: Vince Caetta. (Video (Cassette & Disc), Computer Games) (Importer)
 Labels Imported: Labels from Korea & Taiwan.

More Records, Inc., PO Box 1167, Simi Valley, 93062, 2935 Texas Ave., Simi Valley, 93063, (805) 526-1227, Pres.: Ed Guy. (Distributor)
 Labels Distributed: Audio: MCA, CMH, Texas Rose, Rural

FIEBRIE
LATINA

- Great Selection of Major Brands:
- CBS, RCA, Capitol Latino, Wea, Fonovisa, Fania, Sonotone and many more



LATIN MUSIC DISTRIBUTOR

7626 MIRAMAR ROAD • SUITE 3600 • SAN DIEGO • CALIFORNIA 92126



• Best Prices Guaranteed

• Personalized Service



• All Merchandise Bar-Coded

• We Accept All Major Credit Cards

PHONE : (619) 695-8863

FAX : (619) 695-3768

TOLL FREE : 1-800-74-LATIN

Rhythm, Old Homestead; Video: Cabin Fever.
Cutouts/Overstocks: Cut-Outs.
Pay-Per Transaction.
Products/Accessories: Other: Music Books.

Navarre Corp.

15400 Sherman Way, Van Nuys, 91410, (818) 778-3266, Fax: (818) 778-3268, West Coast Mgr.: Bob Lampkin. (Distributor)
Labels Distributed: Audio: Airns, AJK, Atlanta Int'l, AVM, Chi-Sound, CMH, Crush, DCG, Fresh, Golden Music, Headfirst, Homestead, Hearts Of Space, Invasion, Micmac, Nouveau, Nova, Optimism, Original Sound, Pathfinder, Positive Music, Rockville, Serenity, Shelter, Silverwave, Sleeping Bag, Soundings Of The Planet, Spindletop, SST, TBA, USA, Valley Vue, Visual Musik, Voss, Wax Trax.

Norwalk Record Distributors, 1193 Knollwood Cir., Anaheim, 92801, (714) 995-8111, (800) 874-6444, Fax: (714) 995-6294, Owner: David Shropshall; Gen. Mgr./Buyer: David Shropshall, Jr. (Compact Disc, Pre-Recorded Audio Tape) (One-Stop)

Only New Age Music, Inc., 648 N. Fuller Ave., Los Angeles, 90036, (213) 935-7774, Fax: (212) 935-0290, Pres./CEO: Suzanne Bell-Doucet; Buyer (Music/Video): Eric Reyes. (Compact Disc, Pre-Recorded Audio Tape, Video (Cassette & Disc)) (Distributor, Importer, Exporter)
Labels Distributed: Audio: Beyond, Seusihue Heatt, Doerr Music, Asho Music, Whispering Trees, Isis Music, Pyramid Music, Fire Husker, Wild Card Records, Ethereal Music, Red Dot Music, Rhythmythology, ATT; Video: Starflight, Only New Age Music-Video.

Optimism, Inc., 6355 Topanga Canyon Blvd., #309, Woodland Hills, 91367, (213) 850-3350, Contact: David Drozen; Contact: Sheryl R. Kay.

Oxymoron, Inc., 9532 Quakertown Ave., Chatsworth, 91311, (818) 886-2650, Fax: (818) 886-6079, Vice Pres.: Doug Lexa; Gen. Mgr.: Dave Love. (Distributor)
Labels Distributed: Audio: Breakthru, Core, Heads Up, Musidisc, Sierra, Soundquest Recordings.

Pacific Coast One-Stop

9158 Eton Ave., Chatsworth, 91311, (818) 709-3640, Fax: (818) 709-7722, (818) 709-4575, Pres./CEO: Steven Kall; Vice Pres./Managing Dir.: Lory Shaw; Opns. Mgr.: Dave Hoeltje; Buyer CEMA-WEA-Sony: Rich Lockwood; Buyer PGD-UNI-BMG: Mark Ballard; Buyer Indies: Pat Speer; Buyer (Videos): Laura Drilllock. (Compact Disc, Pre-Recorded Audio Tape, Video (Cassette & Disc), Records (LP's, 12-Inch, Singles),

Accessories) (One-Stop)
Products/Accessories: CD Players; Pioneer, Audio & Video Playback Equipment: Pioneer, CD, Tape & Record Products: Allsop, Discwasher, Maxell; Storage & Carrying Cases: Case Logic, Napa Valley, Tree Dimensions; Blank Tape: Maxell, TDK; Head Phones: Maxell; Batteries: Duracell; Other: Gopher Prods., Norelco Boxes, Jewel Boxes, Alpha Prods., 3M Security Prods.

Paradigm Distribution, PO Box 16982, San Diego, 92176, 3343 Adams Ave., San Diego, 92116, (619) 563-1981, Fax: (619) 563-1832, Owner: Karen Merry. (Distributor)
Labels Distributed: Audio: A & M Childrens, Canyon, Celestial Harmonies, Global Pacific, Higher Octave, Kaleidoscope, Music for Little People, Music of the World, Narada, Redwood, Sequoia.

Pioneer LDCA, Inc., 2265 E. 220th St., Long Beach, 90810, (213) 835-9177, Fax: (213) 816-0420, Pres.: Tetsuro Kudo; Sales Mgr.: Rich Buehler; Program Buyer: Satoshi Matsumoto. (Distributor)

Precision Sound, 3500 W. Olive Ave., #1160, Burbank, 91505, (818) 955-7037, Fax: (818) 955-7038, Branch Mgr.: Bob Carlton.
Branch(es): 903 Meadowhawk Dr., Vacaville, 95687, (707) 448-8005, Fax: Same, Branch Mgr.: Rob McDonald. (Distributor)
Labels Distributed: Audio/Video: See Washington State Listings for Product Line.

Pyramid New Age Music Distributors, 1577 Barry Ave., Los Angeles, 90025, (213) 207-2944, Fax: (213) 207-3996, Owner: Michael Anderson. (Compact Disc, Pre-Recorded Audio Tape) (Distributor, One-Stop)

Labels Distributed: Audio: Acorn Music, Canyon, Celestial Harmonies, Consensus, Dargason, Elfin, Global Pacific, Hearts of Space, Higher Octave, Interdimensional Music, Invincible, Light Unlimited, Lind Inst., Morgan, Narada, Nature Recordings, Raven, Real Music, Rykodisc, Sequoia, Serenity, Shining Star, Solitudes, Source, Spirit Music, Spring Hill, Sundown, Syntonic, Talking Taco, Willow Tree.

Real Music, 85 Libertyship Way, #207, Sausalito, 94965, (415) 331-8273, Fax: (415) 331-8278, Pres.: Terence Yallop; Vice Pres. Sales & Mktg.: Gary Chappell; Sales/Opns. Mgr./Buyer: Rick Jeffery. (Distributor)

Labels Distributed: Audio: American Gramophone, Canyon, Celestial Harmonies, Dargason, Global Pacific, Hearts of Space, Higher Octave, Miramar, Music West, Narada, Nature Recordings, Pure & Simple, Private Music, Real Music, Scarlet, Sequoia, Silver Wave, Sonic Atmospheres, Sounds of the Planet, Nichols Wright, Willow Tree, W.E.A. "Recommended" Seldom Seen Records, PO Box 91, Half

COPIOUS CLASSICS.



Welcome to the most complete selection of classical product in the United States! No other one-stop stocks more classical product than Valley Record Distributors.

Valley stocks every title of the six major labels and over 50 independent labels.

Valley also offers classical new release information and knowledgeable support personnel.

That's incredible. That's Valley Record Distributors.

Call us today for your FREE 400 page catalog!

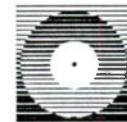

VALLEY RECORD DISTRIBUTORS
P.O. Box 2057, Woodland, CA 95695
FAX TOLL FREE: 800-999-1794
CALL TOLL FREE: 800-845-8444

**BE INDEPENDENT.
STAY INDEPENDENT.**

in-de-pen-dent *adj.* 1. free from the influence, guidance, or control of others: showing a desire for freedom and absence of constraint. 2. not dependent on or affiliated with a larger or controlling group or system. 3. not looking to others for one's opinions or for the guidance of one's conduct.

PRECISION SOUND... AN INDEPENDENT RECORD DISTRIBUTOR.

MAIN OFFICE:
14926 35th AVENUE WEST
LYNNWOOD, WA 98037
206-787-1030
FAX 206-787-1039

BRANCH OFFICES:
LOS ANGELES, CA
SAN FRANCISCO, CA
DALLAS, TX



Moon Bay, 94019, (415) 726-7251, (800) 962-6054, Fax: (415) 726-7080, Contact: Shawn Tracy. (Compact Disc, Pre-Recorded Audio Tape) (Distributor, Importer)
 Labels Imported: Vinyl Magic, Fonit Cetra, AYAA, Frigico, Merlin, SPM, Bellaphon, Karma, Sonet, Nacksving, Cleopatra, Tecval, Normal, Xthuluh, Supraphon, VRL, Faunus, Omega Studio, Turicaphon, WMMs, Amiga, Highfly, Schneeball, Brain, Targo, Casino, Iron Curtain, Round, Rockport, Bacillus, Cammoran, Frog, Re'R, Recommended, Tapioca.

Records Ltd., 1314 S. Hobart St., Los Angeles, 90006, (213) 737-2611, (Records) (Distributor)

Rough Trade, 326 Sixth St., San Francisco, 94103, (415) 621-0410, Fax: (415) 864-6942, CEO: Robin Hurley; Mgr.: Shari Wilkens; Buyer (Pre-Recorded Music): Uli Elser; Buyer: Michael Black. (Compact Disc, Pre-Recorded Audio Tape, Records) (Distributor, Importer, Exporter)
 Labels Distributed: Audio: (US) Pitch-A-Tent, Genius, Twin Tone, Coyote, Amphetamine Reptile, Heyday, Alchemy, First Warning, Netzwerk, Roir, Communion, Wax Trax, Homestead, SST, Restless, TAANG, Touch & Go, Shimmy Disc, Okra, Mordam, Alternative Tentacles, Texas Hotel, Subterranean, Ralph, Cargo, Walk Thru Fyre, Reckless, Frontier, Ooze, Buy Our Records; Video: Target, Atavistic, ReSearch, Motorbooty.
 Labels Imported: Rough Trade, Beggar's Banquet, Southern Studios, Revolver, 4 AD (U.K.); Au Go Go, Waterfront, Aberant, Red Eye/Black Eye (Australia); Flying Nun (New Zealand).

Sallèse Entertainment, 968 Emerald St., #253, San Diego, 92109, (619) 270-1157, Pres./Buyer: Bob Sallèse. (Video (Cassette & Disc)) (Distributor)
 Labels Distributed: Video: Video Exclusives, Evil Angel, Cinderella, Moonlight, Vivid, Parliament, Venus 99, Cabalero, VCA, Filmco, Factory Home, Intropics, Kiss, In Hand, Tango, Elfie, Executive, Coast To Coast, Limousine, Black Widow, VCX, Black Star, Homegrown, Studio One, Voyeur, Raunchorama, Diamond XX, Eve, 3 Hearts, Amateur Hour, Hollywood.

Saturn Records, PO Box 20590, 2658 W. Pico Blvd., Los Angeles, 90006, (213) 384-9526, Chief Exec.: Gale Phelps; Mgr.: Ken Richmond; Buyer (Pre-Recorded Music): Miles Sklenar. (Compact Disc, Pre-Recorded Audio Tape, Records (LP's, 12-Inch, Singles)) (One-Stop)

Scott Distributing Corp., 2605-C Hoover Ave., National City, 92050, (619) 477-8300, Branch Mgr.: Bill Anglin. (Compact Disc, Pre-Recorded Audio Tape, Video (Cassette & Disc)) (Distributor, Rackjobber, Military Sales)
 Labels Distributed: Audio/Video: All Major Brands.

Sierra Amusement Corp., 11500 Sunrise Gold Cir., #H, Rancho Cordova, 95742, (916) 638-3601, (800) 826-9982, Fax: (915) 638-3905, Pres./CEO: Bernie Rawitch; Mgr./Buyer: John Lago. (Distributor)

Labels Distributed: Video: Academy, Fries, Magnum, Sony, Silver Eagle Communications, 6930 Valjean Ave., Ste. 202, Van Nuys, 91406, (818) 786-2222, Fax: (818) 786-5550, Pres.: Lawrence Weisberg; Mgr.: Dorine Standifer; Buyer (Video/Accessories): Larry Knight. (Video (Cassette & Disc)) (Distributor, Producer)
 Labels Distributed: Video: Music Instrument Instructional Videos: Backstage Pass, Maestro, Power Rock, Homespun, Hot Licks, VDO, 1st Light Video Publishing, Kultur, and others.
 Pay-Per Transaction.

Sounds Good Music Co., PO Box 6022/500, Cypress, 90630, (213) 973-8800, Fax: (213) 679-3395, Dir.: Bonnie Levitin; Buyer: Mark O'Brien. (Compact Disc, Pre-Recorded Audio Tape, Records) (Distributor, Importer, Exporter)
 Labels Distributed: Audio: Alternative Tentacles, Big Time, BYO, CD Presents, Capitol, Chameleon, Frontier, Homestrade, ROIR, SST, Twin/Tone, Waxtrax!

Sounds-Vision Music, PO Box 3691, La Mesa, 91944, (800) 447-1132, Fax: Same, Pres./Buyer: Rod Hollman. (Distributor)
 Labels Distributed: Audio: Sounds-Vision, Lyricord Discs, Sirocco, ARO, Hepcat, Hannibal; Video: Sounds-Vision Videos.
 Products/Accessories: Other: Musical Instruments & Accessories.

Square Deal Record Co., 303 Higuera St., 150 Pismo St., San Luis Obispo, 93401, (805) 543-3636, Fax: (805) 543-3938, Chief Exec.: Richard W. Ferris. (Distributor)
 Cutouts/Overstocks: Cut-out LPs, cassettes, video games. Products/Accessories: Other: Store operating supplies, CD Jewelboxes, Cassette Boxes, LP Sleeves & Jackets.

Subterranean Records, PO Box 2530, Berkeley, 94702, (415) 821-5880, Fax: (415) 647-0678, Owner: Steven Tupper. (Distributor)
 Labels Distributed: Audio: Subterranean, Alternative Tentacles, Anomie, Banned, Boner, CFY, Cuneiform, Dionysus, Flipside, Fun, Freedom In A Vacuum, Generations Unlimited, Lookout, Stolen Art, Staal, Sympathy, SSS, Toxic Shock, Vacant Lot, Touch, Victo, Vinyl Communications, RRR, Rift, Panx, Really Fast, Ralph, Shimmy Disc, Seeland, Slap A Ham, R-Radical, Silent, Soleilmoon, Thermidor and others; Video: Target, Ace, Atavistic, Survival Research Labs, Ram, Ralph, Re/Search, Shimmy.

Sun State Music Dist., Inc., 2654 W. Pico Blvd., Los Angeles, 90006, (213) 383-4137, Gen. Mgr./Buyer: George Morte; Mgr./Buyer (Music): Theodore Ray. (Compact Disc, Pre-Recorded Audio Tape, Records (LP's, 12-Inch, Singles), Cutouts, Overstock, Accessories) (One-Stop)
 Products/Accessories: CD, Tape & Record Products: Pfanstiehl; Storage & Carrying Cases: Misc.; Blank Tape: All Major brands; Head Phones: Pfanstiehl; Diamond Needles: Pfanstiehl.

Tapeworm Distributors, 12420 Montague St., Unit B, Arleta,

91331, (818) 896-8899, (Distributor, Importer)
 Labels Distributed: Video: Labels with special interest foreign films, children's educational product and general educational product; manufacturer's rep to majors.

3-D TV Corp, PO Box 13059, 895 Greenberry Ln. (94903), San Rafael, 94913, (415) 479-3516, Fax: (415) 479-3316, Pres: Michael Starks; Mgr.: W. Schwyhart. (Video (Cassette & Disc), Accessories) (Distributor, Exporter)
 Labels Distributed: Video: 3-D TV Corp., 3-D video only. Products/Accessories: Audio & Video Playback Equipment: 3-D video viewing hardware; Video Cassette Recorder: 3-D camcorders.

Transpac Trading Co., PO Box 1147, Studio City, 91604, (213) 467-4614, Fax: (213) 856-0648, Contact: A. Fransson. (Compact Disc, Pre-Recorded Audio Tape, Video (Cassette & Disc), Computer Games) (Distributor, Exporter)

Trip/Tower Records/MTS Inc., 2500 Del Monte St., West Sacramento, 95691, (916) 373-2548, Fax: (916) 373-2511, Opns. Mgr.: Gary Gonsowski; Buyer (Pre-Recorded Music): Paul Ashley. (Compact Disc, Pre-Recorded Audio Tape) (Distributor, Importer)
 Labels Distributed: Audio: Alternative Tentacles, Boner, Collectables, Cruz, Cuneiform, Homestead, Knitting Factory, Ladd-Frith, Lagarto, Matador, Mordam, New Alliance, Ralph, Revolver, Rockville, ROIR, Rooney, Shimmy-Disc, Skyklad, SST, Staaltape, Subterranean, Touch & Go, Vanguard, Wax Trax, Widowspeak, Emigre, Silent, Dischord, Better Youth Organization.
 Labels Imported: Beggar's Banquet, Cherry Red, Crass, Globe Style, On-W Sound, Recommended, Touch, United Dairies, Virgin, Womad, 4 AD (U.K.); Crammed, KK, Made to Measure, Play It Again Sam (Belgium); Flying Nun (New Zealand); Hat Hut (Swiss); I.T.M., Une (Germany); Midi (Japan); New Rose, Orange Blue (France).

VAAM Music Nat'l Record Dist., 3740 Evans St., #101-B, Los Angeles, 90027, (213) 664-7765, Pres.: Pete Martin. (Distributor)
 Labels Distributed: Audio: Blue Gem, Hi-Lite, Pendragon.

VPD—Video Products Distributors, Inc., PO Box 15222, Sacramento, 95813, 6051 S. Watt Ave., Sacramento, 95829, (916) 386-2220, (800) 366-2111, Fax: (916) 366-9870, Pres./CEO: Timothy S. Shannahan; Buyer (Videos): Bob Kronenberg; (Accessories): Caron Shubin; Buyer (Video Games): John Lago; Buyer (Used Tapes): Jim Parks.
 Branch(es): 2350 Artesia Blvd., Long Beach, 90805, (206) 821-5522, Fax: (206) 820-6008; 4560 Alvarado Canyon, #1-B, San Diego, 92120, (619) 283-2271, Fax: (619) 283-1089; 4551 Brickell Privado, Ontario, 91761, (714) 988-0065, Fax: (714) 983-4728; 1290 Tully Rd., Ste. 701, San Jose, 95122, (408) 298-4397, Fax: (408) 298-8166. (Distributor)
 Labels Distributed: Video: All Major & Secondary Lines. Products/Accessories: CD, Tape & Record Products: Allsoop, Bib, Plantone; Storage & Carrying Cases: Alpha, Amaray,



TOLL FREE 800-736-3640

DOMESTIC FAX 818-709-7722

INTERNATIONAL FAX 818-709-4575

There are 5 or 6 major One-Stops in the United States that can completely service all of your retailing needs. Pacific Coast is one of them. We're not going to make outrageous claims about being the biggest or the largest with the mostest. That's playing a numbers and ego game and we think that you're smart enough to see through that. We also know that we're smart enough to never lose sight of the goals and level of service that have enabled us to grow to what we are today in just 7 short years.

- ◆ **OVER 500 LABELS IN STOCK.**
- ◆ **OVER 80,000 TITLES IN STOCK (WE STILL STOCK ALBUMS!).**
- ◆ **OVER 6,000 LASER DISC MOVIE TITLES IN STOCK.**
- ◆ **A TOTALLY INTEGRATED COMPUTER INVENTORY/PURCHASING SYSTEM THAT ENABLES US TO MAINTAIN A 93% FILL RATIO.**
- ◆ **GUARANTEED SAME DAY SHIPPING.**
- ◆ **A RESPONSIVE AND CONCERNED COMMITMENT TO PROVIDE A LEVEL OF SERVICE SECOND TO NONE.**
- ◆ **THE LOWEST OVER-ALL PRICES POSSIBLE. THERE ARE NO GAMES PLAYED WITH SELECTED, COME-ON TITLES OR CATAGORIES. EVERY ITEM THAT WE SELL IS AT ROCK BOTTOM PRICING INCLUDING NEW RELEASES.**
- ◆ **INTERNATIONAL SHIPPING SPECIALIST.**

9158 ETON AVENUE CHATSWORTH, CA. 91311 818-709-3640

Pride; Blank Tape: TDK, etc.

Valley Record Distributors

PO Box 2057, Woodland, 95695, (916) 661-6600, (800) 845-8444, Fax: (800) 999-1794, (Compact Disc, Pre-Recorded Audio Tape, Video (Cassette & Disc), Records (LP's, 12-Inch), Accessories) (One-Stop)
 Products/Accessories: CD, Tape & Record Products: Allsop, Discwasher; Storage & Carrying Cases: Case Logic, Lift, Napa Valley Box, Savoy, Tree Dimension; Blank Tape: Maxell, Sony, TDK, Denon; Diamond Needles: Prantone; Other: Alpha Security.

Video Action, 708 W. First St., Los Angeles, 90012, (213) 687-8262, Owner: Gregg S. Yokoyama. (Distributor)
 Labels Distributed: Video: Sony, Video Action.

Video City Distributing, 4266 Broadway, Oakland, 94611, (415) 654-6852, (415) 428-0202, Fax: (415) 654-7802, Mktg. Dir./Buyer: Bob Brown. (Distributor)
 Labels Distributed: Video: World Aviation, Chop-em Up, Art House, Combat, New Age, Video City Prodn. Video Magazines.
 Pay-Per Transaction.

Video Trend, Inc., 10461 Old Placerville Rd., Ste. 130, Sacramento, 95827, (916) 363-0982, (800) 966-9978, Fax: (916) 363-1259, Branch Mgr.: Gary Wagner; Sales Mgr.: Mariann Puliz; Buyer: Julie Shamus.
 Branches: 351 B. Foster City Blvd., Foster City, 94404, (415) 345-8666, (800) 966-3324, Fax: (415) 345-8990, Mgr.: Joenne Hibbeln; Sales Mgr.: Gary House; Buyer: Kim Jackson. (Distributor)
 Labels Distributed: Video: See Illinois listings for distribution.

Viking Entertainment, Inc., 4520 Valerio St., Burbank, 91505, (818) 843-2105, Fax: (818) 840-8456, Pres.: Jim McGraw; Vice Pres./Mgr.: Rick Gabaldon; Buyer: Charlie Simms. (Compact Disc, Pre-Recorded Audio Tape, Video (Cassette & Disc), Records (LP's), Cutouts, Overstock, Accessories) (Rackjobber)
 Cutouts/Overstocks: Cutout Cassettes, LPs, CDs, Videos.

Warner/EletraAtlantic Corp., 111 N. Hollywood Way, Burbank, 91505, (818) 843-6311, Sr. Vice Pres./Dir. Nat'l Sales: Fran Aliberte; Nat'l Sales Coord.: Tony Camardo; Dir. Opns./Inventory: Vinnie Campisi. (Pre-Recorded Audio Tape, Video (Cassette & Disc) Records) (Distributor)
 Labels Distributed: Audio: Bearsville, Cotillion, ECM, Gefen, Island, Qwest, Reprise, Sire, Swan Song, Warner Bros., Warner/Curb, Electra/Asylum/Nonesuch, Atlantic/Atco.

Western Distributors, 11841 Industrial Ct., Auburn, 95603, (916) 888-0780, Owner: John Gardner. (Compact Disc, Pre-Recorded Audio Tape) (Rackjobber)

Western Record Sales Inc., 5021 Seaport Ave., Richmond, 94804, (510) 235-8840, Fax: (510) 237-2480, Pres./Mgr./Buyer: Vern Cupples; Buyer (Pre-Recorded Music): Larry Ohran; Buyer (Accessories): Charlie Able. (Distributor)
 Labels Distributed: Audio: Disney, Pro Arte, Quintessence, Telarc, Nimbus, Living Language, Pro Jazz, Special Music, Compose, Black Union, Candio, Freedom, Tritoka, Blue Flame, Mobile Fidelity.
 Products/Accessories: CD, Tape & Record Products: Discwasher, Allsop, Recoton, TDK, Maxell, Memorex; Storage & Carrying Cases: Case Logic, Napa Valley, Savoy, Cal Oak, LDE, Laser Line; Blank Tape: BASF, Scotch, Sony; Head Phones: Sony, Koss, Recoton; Batteries: Duracell; Diamond Needles: Zalfira.

W.E./Whitman Ents., PO Box 452, 9901 Roscoe Blvd., Sun Valley, 91352, (818) 768-5242, CEO/Vice Pres. Mktg.: Gary Whitman; CEO/Vice Pres. Opns.: Kiki Whitman; Dir. Sales/Purchasing: Matt Sachs. (Compact Disc, Pre-Recorded Audio Tape, Video (Cassette & Disc), Records (LP's), Cutouts, Overstock) (Distributor, Rackjobber, Exporter)
 Labels Distributed: Audio: W.E., Jazmyn, Zion, Up; Video: W.E. Video, VVTV (Music-Video Show).
 Pay-Per Transaction.

Wishing Well Video Distributing, PO Box 7040, Santa Rosa, 95401, (707) 525-9355, Fax: (707) 542-3845, Pres./Buyer: Debra Giusti. (Video (Cassette & Disc)) (Distributor)
 Labels Distributed: Video: Over 2,000 video titles specializing in self-improvement, health, family, business, metaphysics.

Wood Knapp Video, 5900 Wilshire Blvd., Los Angeles, 90036, (213) 965-3500, (Pre-Recorded Audio Tape, Video (Cassette & Disc)) (Distributor)

Zango, PO Box 6308, Albany, 94706, (800) 688-0187, Fax: (510) 528-9342, Owner: Claudia Rosenthal; Mgr./Buyer: Beth Swilling. (Distributor)
 Labels Distributed: Audio: Olivia, Redwood, Narada, Canyon, Talking Taco, Music of the World, Kaleidoscope, Celestial Harmonies, Ladyslipper, Shanache/Koch, Ryko, Willow Tree, Lind Institute, Rounder, Music for Little People, Hearts of Space, Discovery Music, Higher Octave, Emerald Green, Flying Fish, JTG, Invincible, Fresh Fruit.
 Pay-Per Transaction.

Labels Distributed: Audio/Video: See Illinois Listings For Product Lines.

Chidvilas Dist., PO Box 1750, 2840 Wilderness Pl., Ste. D (80301), Boulder, 80308, (303) 449-7811, Fax: (303) 449-7099, Pres.: Parmita Pushman; Mgr.: Toshen Golias; Buyer: Peter Hill. (Distributor, Importer)

Labels Distributed: Audio: White Swan, Fonix, Rykodisc, Serenity, Shining Star, Silver Wave, Atlantis Angelis, Canyon, Celestial Harmonies, Coyote Oldman, Deuter, Earbeat, Ethernas Music, Global Pacific, Gourd Music, Green Linnet, Hearts Of Space, Helios, Higher Octave, Invincible, Linde Inst., Magic Music, Miramar, Music For Little People, Music Of The World, Music West, Nature Recordings, Private Music, Rounder and others; Video: Fonix, Miramar, Private Music, American Gramophone, Celestial Harmonies, Tropical Visions.
 Labels Imported: Fonix (Denmark); Tao Music, Nightingale (Germany).

Christus Record Sales, PO Box 367, Westminster, 80030, (303) 650-9170, Mgr.: Christina Marquet. (One-Stop, Juke Box-Vending)

Commtron Corp., 1101 E. 53rd Ave., #A, Denver, 80239, (303) 371-8372, Fax: (303) 373-4583, Branch Mgr.: Rene LaBelle; Sales Mgr.: Skip Swanson. (Video (Cassette & Disc)) (Distributor)
 Labels Distributed: Audio/Video: See Iowa Listing For Product Line.

E.T.D., Inc., 6776 E. 47th Ave. Dr., Denver, 80216, (303) 393-1400, (800) 824-9258, Fax: (303) 321-1097, Branch Mgr.: Craig Warmintor. (Pre-Recorded Audio Tape, Video (Cassette & Disc)) (Distributor)
 Labels Distributed: Audio: Promotional Lines; Video: All Major Studios & Most Independents.
 Pay-Per Transaction.

Encore Distributors, Inc.

2219 Market St., Denver, 80205, (303) 292-9333, (800) 334-3394, Fax: (303) 292-6969, Pres./Buyer (Accessories): Toby Knobel; Sales Mgr.: Tony Aguiro; Buyer (Pre-Recorded Music): Mark Noone; Adv. Dir.: Julie Hart. (Compact Disc) (Distributor, Exporter)

Labels Distributed: Audio: Acoustic Disc, Airus, AJK Music, Alcazar, Alligator, American Gramophone, Antone's, Arhoolie, Ariwa Sounds, Atomic Theory, Bainbridge, Big Records, Biograph, Black Lion, Black Sun, Black Top, Blind Pig, Blue Plate Music, Blue Wave, Bluemoon, Brainchild, Bullseye Blues, Candid, Canyon, Capri, Capriccio/Delta, Celestial Harmonies, Chase Music, Chesky, Clean Cuts, Collegium, Commodore Jazz Classics, Concord Jazz, Contemporary, Coyote Oldman, Crush, Cruz, Dargason, DCC, Debut, Delmark, DMP, Dorian, DRG, East Side Digital, En Pointe, Enja, Fantasy, Flying Fish, Folkways, Fortuna, Galaxy, Garland, Gecko, Global Pacific, JNP, Go Jazz, Gold Castle, Golden Gate, Good Time Jazz, Gourd Music, Gramavision, Grateful Dead, Green Linnet, GRR, Hannibal, HDH, Headfirst, Heartbeat, Hearts of Space, High Street, Higher Octave, Hightone, Hindsight, Ichiban, Impulse, ITI, JVC, Jass, Justin Time, K-tel, Kaleidoscope, Kuckuck, L & R, Landmark, Laserlight, Living Music, Mango, Marzipan, Mesa, Messidor, Mighty Tiger, Milestone, Miramar, Mobile Fidelity, Monster Music, Moose, Music West, Musicmasters, Narada, Nebula, Nesak, New Albion, New Alliance, Nichols-Wright, Nightingale, North Star, Nouveau, Nova, Novus, OBC, Oh Boy, OJC, Olivia, Omega, Optimism, Original Sound, Orleans, Owl, Pablo, Pair, Philo, Pilz, Prestige, Private Music, Proprius, Ranwood, RAS, Ray Lynch Prodn., Rebel, Red House, Red Pajamas, Redstone, Redwood, Reference, Relix, Restless, Rhino, Rhythm Safari, Rising Son, Rising Sun, Riverside, ROIR, Rounder, Ryko, SDG, San Francisco Sound, Sea Breeze, Shanachie, Sheffield Lab, Shelter, Shining Star, Silver Wave, Sora Gaia, Sonic Atmospheres, Sonic Edge, Sony Music, Special Music, Specialty, Spindletop, Spirit Feel, SST, Styanan, Stash, Stax, Story of Blues, Sugar Hill, Sumerstone, Talking Taco, Tall Tree, Taylor Park, TBA, Telarc, Temple, Third Ear, E. Thomas, Thrival, Time Is, Tip Toe, Tomato, Triloka,

Vanguard, Vanguard Classics, Varese Sarabande, Varrick, Vintage Jazz, Volt, Walt Disney Records, Whaleco, Windham Hill, Wrestler, Yazoo.

Products/Accessories: CD, Tape & Record Products: AudioSource, IntraClean; Storage & Carrying Cases: Tree Dimensions, Case Logic, Wood Technology, Eppco, Lift Display; Blank Tape: Sony, Denon; Head Phones: Sony; Other: Monster Cable, Recoton, Blister Packs, Jewel Boxes, Flip Files.

Handleman Co., 1795 E. 66th Ave., Bldg. A, Denver, 80229, (303) 288-0770, Branch Mgr.: Al Wosk; Sales Mgr.: Brian Duffy. (Compact Disc, Pre-Recorded Audio Tape, Video (Cassette & Disc)) (Rackjobber)
 Labels Distributed: Audio/Video: See Michigan Listings For Product Distribution.

Inter-Sports Book & Video Dist., 790 W. Tennessee Ave., Denver, 80223, (303) 778-8383, Fax: (303) 744-9383, Pres.: Roger Willbanks; Mgr.: Phil Marnell; Buyer: John Jones. (Distributor)
 Labels Distributed: Video: "How-to" indoor, outdoor, individual or team sports videos.

Mountain Coin Machine Dist., 345 W. 62nd Ave., Denver, 80216, (303) 427-2133, Fax: (303) 429-2104, Owner: Elden Kingston; Regional Mgr.: Jack Brown; Buyer: Jackie Lassman. (Compact Disc, Records (Singles, Accessories) (One-Stop)
 Labels Distributed: Audio: WEA, CEMA, BMG, PolyGram, Gotham, CBS, MCA, Commtron, Repete.
 Products/Accessories: Storage & Carrying Cases: Case Logic; Blank Tape: Scotch; Diamond Needles: Shure Cartridges.

Video Delivery Systems, Inc., 2045 S. Valentia, Ste. 5, Denver, 80231, (303) 333-5377, Pres.: Will Gardenswartz; Vice Pres./Mgr.: Bill Sandberg. (Mfr.)
 Products/Accessories: Other: Lock-box Video Delivery Systems.

Western Merchandisers, Inc., 4105 Holly St., Denver, 80216, (303) 320-4660, Branch Mgr.: Bob Krug. (Compact Disc, Pre-Recorded Audio Tape, Video (Cassette & Disc), Cutouts, Computer Games, Accessories) (One-Stop, Rackjobber)

CONNECTICUT

Audio One

400 Long Beach Rd., Stratford, 06497, (203) 361-0202, Fax: (203) 361-0255, Contact: Bill Lynch. (Compact Disc, Pre-Recorded Audio Tape, Video (Cassette & Disc), Accessories) (One-Stop)
 Products/Accessories: CD, Tape & Record Products: Memorex; Storage & Carrying Cases: Coast, Case Logic, Tree Dimensions, Audio Craft, & others; Blank Tape: That's, Memorex, Fuji, & others; Head Phones: Koss.

Roger Brouso Phonograph Records, 24 Scott St., Hamden, 06514, (203) 288-3838, (Compact Disc, Pre-Recorded Audio Tape, Records (LP's, 12-Inch)) (One-Stop)

CD One Stop

13 Francis J. Clarke Circle, Bethel, 06801, (203) 798-6590, (800) 388-8889, Fax: (203) 798-8852, Pres.: Alan Meltzer; Vice Pres./Mgr.: Ron Nicks; Vice Pres. Sales/Mktg.: Jay Fink; Dir. of Purchasing: Dave Carroll. (Compact Disc, Pre-Recorded Audio Tape, Video (Cassette & Disc), Accessories) (One-Stop)
 Products/Accessories: CD, Tape & Record Products: TDK, Memorex, Discwasher; Storage & Carrying Cases: Tree Dimensions, Case Logic; Blank Tape: Maxell, TDK, Denon, Sony, Memorex.

Central Record & Tape Dist., Inc., 145 S. Satellite Rd., South

COLORADO

Baker & Taylor Video, 1401 W. Bayaud Ave., Denver, 80223, (303) 698-0484, (800) 332-3813, Fax: (303) 698-1621, Sales Mgr.: Heather O'Connell. (Distributor, One-Stop)

Have You Gotten Any Lately?
 If you haven't received a copy of our 164 page catalog with over 5,000 items listed, you don't know what your missing!!! Records, Cass., CD's, 45's, Imports, Blank Tape, Books, Storage Boxes, Divider Cards, Sleeves, Jackets, etc.
Dealers Only 800-523-2036

BUDGET AUDIO

OVER 1000 SELECTIONS!

- ROCK N' ROLL
- POP
- COUNTRY
- R&B
- BIG BAND
- CLASSICAL
- GOSPEL
- SEASONAL

CALL, FAX OR WRITE FOR CATALOG

GOLDEN CIRCLE

1095 SOUTH AVE BRIDGEPORT, CT 06604
1-800-992-TAPE • 203-579-0435

Windsor, 06074, (203) 528-2171, Fax: (203) 528-6013, Pres./Mgr.: Robert L. Hoyt; Buyers (Pre-Recorded Music): Bob Hoyt, Gary Gilmore; Buyer (Videos): Rob Des Rocher; Buyer (Accessories): Rob Des Rocher; Buyer (45s): Sandi Melo; Buyer (Cassette Singles): Sandi Melo. (Compact Disc, Pre-Recorded Audio Tape, Video (Cassette & Disc), Records, Cutouts) (One-Stop, Rackjobber)
Folk Craft, High & Wheeler, Winstead, 06098, (203) 379-9857.
Golden Circle, Inc., 1095 South Ave., Bridgeport, 06604, (203) 579-1962, Pres./Buyer: Gene Tomatore. (Pre-Recorded Audio Tape, Cutouts, Overstock) (Distributor)
Labels Distributed: Audio: RCA (BMG), CEMA, Sony.
Cutouts/Overstocks: WEA, MCA.

DISTRICT OF COLUMBIA

Black Fire Dist., PO Box 31567, 4409 Douglas St. NE (20019), Washington, 20030, (202) 397-3572, Pres./Buyer: Jimmy Gray; Mgr.: Chip Donelson. (Distributor)
Labels Distributed: Audio: Black Fire, Sphinx, Glass Wing, Awareness Art Records, Tribe, Bet Car, Name Brand, African Music Gallery, Sybarite, Cosmic Fire.
Pay-Per Transaction.

RAS Records (Real Authentic Sound), PO Box 42517, Washington, 20015, 8878 Monard Dr., Silver Spring, MD, 20910, (301) 588-9641, Fax: (301) 588-7108, Pres.: Gary Himelfarb; Mgr./Buyer: Steve Cornwell. (Compact Disc, Pre-Recorded Audio Tape, Video (Cassette & Disc), Records (LP's)) (One-Stop)
Labels Distributed: Audio: RAS, Ariwa, Mango, Heartbeat, Shanachie, Sonic Sounds, Dynamic Sounds, Tuff Gong, Pow Wow, Profile, Live & Learn, R.O.I.R., CSA, VP, Jet Star, Sunsplash, Genes, Super Power, Rohit.

FLORIDA

American Music Wholesalers, Inc., 1320 Stirling Rd., Ste. 10B, Dania, 33004, (305) 921-2706, Fax: (305) 921-2711, Pres./Buyer (Music): Al Bitensky; Mgr.: Reney Joseph. (Compact Disc, Pre-Recorded Audio Tape, Video (Cassette & Disc), Cutouts, Overstock) (Distributor, One-Stop, Rackjobber)
Baker & Taylor Video, 15825 NW 15th Ave., Miami, 33169, (305) 624-3404, (800) 432-0118, Fax: (305) 620-5479, Sales Mgr.: Barry Erra; 7307 President's Dr., Orlando, 32809, (407) 859-0814, (800) 432-0118, Fax: (407) 855-6204, Sales Mgr.: Bob MacCauley. (Distributor, One-Stop)
Labels Distributed: Audio/Video: See Illinois Listings For Product Lines.

Bassin-Distributors

15959 NW 15th Ave., Miami, 33169, (305) 621-0070, (800) 329-7664, Fax: (305) 621-0465, Pres.: Jerry Bassin; Exec. Vice Pres.: Alan Shapiro; Vice Pres. Opns.: Alan Tuchman; Vice Pres. Sales/Mktg.: Bunky Wilson; Vice Pres Export: Gustavo Bello; Domestic Sales Mgr.: Mike Donohue; Accessory Sales Mgr.: Joe Stanzione. (Compact Disc, Laser Disc, Pre-Recorded Audio Tape, Music Video, Cs-Singles, 12" Maxi-Singles, LP's) (Distributor, One-Stop, Exporter)
Labels Distributed: Audio: Aishire, Amherst, Cheetah, Chesky, Concord Jazz, Delta/Laserlight, Disney, DCC, Effect, 4th & B'way, Hannible, Hot Prodn's, Ichiban, Joey Boy, Light, Malaco, Mango, Mic Mac, Nasty Mix, Next Plateau, Pandisc, Priority, Quality, Ras, Rykodisc, Shanachie, Sheffield Lab, SST, Telarc, Tyscot, Unidisc, Vanguard, Warlock, Wax Trax and more.
Products/Accessories: CD, Tape & Record Products: Allsop, Alpha, Amaray, Case Logic, Denon, Discwasher, EDS, Fuji, Gemini, Goldstar, Kinyo, Laserline, Maxell, Napa Valley, Pyle, Recoton, Scena, Savoy, Scotch, Solidex, Sony, Sony Headphones/Accessories, Stanton, TDK, Tree Dimension.
Also distributing Prof./Industrial Tapes.

Boening Bros. Inc., 668 N. Collier Blvd., Ste. 105, Marco Island, 33937, (813) 642-8938, Pres.: William Boening. (Compact Disc, Pre-Recorded Audio Tape, Cutouts, Overstock) (Distributor, Rackjobber)

Cutouts/Overstocks: Overstock, Cutouts, Budget Cassettes.
Products/Accessories: Other: Counter and Floor Cassette Displays.

CD City, PO Box 290452, Tampa, 33687, (813) 989-8273, Owner: Jimmy Holland. (Compact Disc, Cutouts) (Distributor, Importer, Exporter)
Products/Accessories: Other: Giant Posters, Rock Tees.
Commtron Corp., 3540 NW 56th St., Fort Lauderdale, 33309, (305) 733-7440, Fax: (305) 735-7752, Branch Mgr.: John McClure; Asst. Mgr.: Jean Mendelsohn; Sales Mgr.: Kit Kit-chens. (Video (Cassette & Disc)) (Distributor)
Labels Distributed: Audio/Video: See Iowa Listing For Product Line.

Cude & Pickens Distributing Co., 519 N. Halifax Ave., Daytona Beach, 32118, (904) 252-0381, Fax: (904) 252-0381, CEO/Buyer: Bobby Lee Cude. (Compact Disc, Pre-Recorded Audio Tape, Records (Singles, Accessories)) (Distributor)
Labels Distributed: Audio: Hard Hat, Maricao, National Band & Choral Directors Hall of Fame Records & Tapes.
Pay-Per Transaction.
Labels Exported: Hard Hat.

Distribution Video & Audio—DV+A, 700 Magnolia Dr., Clearwater, 34615, (813) 447-4147, Fax: (813) 441-3069, Pres.: Gene Bross; Mgr.: Ben Kugler; Buyers (Videos): Kate Ryan, Colleen Godfrey. (Distributor)
Labels Distributed: Video: 28,000 Titles.

Dolphin Music Distributors, Inc., 2071 Emerson St., Unit 16, Jacksonville, 32207, (904) 396-8003, Fax: (904) 396-8062, Pres.: Jeff Cohen; Mgr.: Michel Cohen; Buyer (Pre-Recorded Music): Vernon Morris. (Compact Disc, Pre-Recorded Audio Tape, Records (12-Inch, Singles), Accessories) (One-Stop)
Products/Accessories: CD, Tape & Record Products: TDK, Pfanstiehl, Memorex; Storage & Carrying Cases: Case Logic; Blank Tape: TDK.

Empire Records & Tapes, 760 W. Sample Rd., Pompano Beach, 33064, (305) 943-9865, Fax: (305) 943-9865, Pres.: Josh Noland; Vice Pres.: Jeff Noland. (Distributor)
Labels Distributed: Audio: Empire, Big Blue Dolphin.

Florida-Rock, Inc., 7315 NW 79th Terrace, Miami, 33166, (305) 887-4359, Pres.: W. Patrick Ernst; Mgr.: Bernard Binnick. (Records) (Distributor, Exporter)
Labels Distributed: Audio: Expansion, Florida-Rock, King Bee.
Cutouts/Overstocks: LPs/12-Inch Overstocks, Cutouts, Out of Prints.



for your audio & video budget

More **SERVICE**... with five branches to serve you, we deliver on our promises quickly and accurately.

More **SAVINGS**... our competitive pricing is even better when you consider the numerous special deals we offer in both audio and video.

More **SELECTION**... independent and major labels, audio and video, plus a full line of accessories.

Distributor of Distinction Since 1946

SCHWARTZ BROTHERS, INC.

4901 Forbes Boulevard ■ Lanham, Maryland 20706

(301) 459-8000 or 800-638-0243

AUDIO, ask for ext. 293 or 234

VIDEO, ask for ext. 400 or 260

FAX (301) 731-0323

We'll help you do more than just pinch

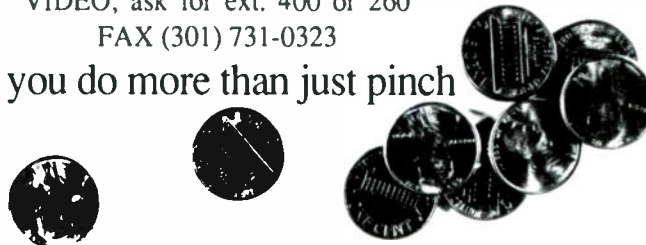

WHOLESALE
ONESTOP



DISTRIBUTOR
EXPORTER

LARGEST DISTRIBUTOR OF PRE-RECORDED MUSIC PRODUCTS IN THE WORLD!

COMPACT DISCS

LASER DISCS

CASSETTES

ACCESSORIES

PROFESSIONAL TAPE

VIDEOS

CASSETTE SINGLES

12" MAXI-SINGLES

POSTERS

T-SHIRTS

MUSIC, MUSIC, MUSIC

LATIN

GOSPEL

CLASSICAL

METAL

& MUCH, MUCH MORE

★ **Most Complete Compact Disc Inventory!
OVER 1,000,000 CD'S IN STOCK!**

All Major and Independent Labels.

★ **LARGEST SELECTION OF INDEPENDENT LABELS!**

Aishire, Amherst, Cheetah, Chesky, Concord Jazz, Delta/Laserlight, DCC, Effect, 4th & B'Way, Hannibal, Hot Productions, Ichiban, Joey Boy, Light, Malaco, Mango, Mic Mac, Nasty Mix, Next Plateau, Pandisc, Priority, Quality, RAS, Rykodisc, Shanachie, Sheffield Lab, SST, Telarc, Tyscot, Unidisc, Vanguard, Warlock, Wax Trax and many more!

★ **ACCESSORIES - Full Line Distributor Of:**

Allsop, Alpha, Amaray, Case Logic, Denon, Discwasher, EDS, Fuji, Gemini, Goldstar, Kinyo, Laserline, Maxell, Napa Valley, Pyle, Recoton, Scena, Savoy, Scotch, Solidex, Sony, Sony Headphones/Accessories, Stanton, TDK, Tree Dimensions.

ALSO DISTRIBUTING PROFESSIONAL/INDUSTRIAL PRODUCTS

3M, Sony, Ampex, Fuji, Maxell, TDK

★ **POSTERS AND T-SHIRTS**

Bassin Distributors carries the most complete line of posters - Music, Sports, Comic Book Characters, Swimsuits and a whole lot more, along with a wide variety of T-shirts from Guns'N'Roses To Whitesnake.

★ **WE SPECIALIZE IN NEW STORE OPENINGS!**

**HUGE INVENTORY, DEEP CATALOG, WEEKLY SALES
DYNAMITE PRICES, PERSONALIZED SERVICE**

15959 N.W. 15th AVENUE, MIAMI, FLORIDA 33169 ★ (305) 621-0070 ★ FAX: (305) 621-0465

U.S.A. TOLL FREE: 1-800-329-7664

Global Video Dist., Inc., 8181 NW 91st Terrace, Medley, 33166, (305) 887-1986, Fax: (305) 887-2590, Pres./Buyer: Angel Tomareo; Mgr.: Vicente Fernandez. (Video (Cassette & Disc), Computer Games, Accessories) (Distributor)
Labels Distributed: Video: Warner, HBO, MGM/UA, F.H.E., Live, Academy, Carolco, MCA/Universal, Rhino, Vidmark, Paramount, Republic, PM, SNS, RCA, Columbia, Full Moon, CBS/Fox, Disney, Nelson, Turner, Touchstone, Orion, Coliseum, Hollywood, A.I.P.

Products/Accessories: CD, Tape & Record Products: Kinyo; Blank Tape: JVC, SKC.

H.L. Dist., Inc., 1301 SW 70th Ave., Miami, 33144, (305) 262-7711, Fax: (305) 261-6143, CEO: Hinsul Lazo; Mgr.: Dave Benjamin; Buyer (Pre-Recorded Music): Manice Ryan. (Compact Disc, Pre-Recorded Audio Tape, Video (Cassette & Disc), Records) (Distributor, One-Stop)

Handleman Co., 4531 Oak Fair Blvd., Tampa, 33610, (813) 621-6087, Branch Mgr.: Robert Scappaticci; Opns. Mgr.: Charles Taylor; Sales Mgr.: Marc Stephens. (Compact Disc, Pre-Recorded Audio Tape, Video (Cassette & Disc)) (Rackjobber)

Labels Distributed: Audio/Video: See Michigan Listings For Product Distribution.

Ingram Entertainment Inc., 1935 NW 18th St., Pompano Beach, 33069, (305) 960-0006, Branch Mgr.: Hilton Torres.

(Distributor)

Labels Distributed: Video: See Tennessee Listings For Product Distribution.

JFL Distributors, Inc., 2602 NW Fifth Ave., Miami, 33127, (305) 573-7800, Fax: (305) 573-1006, Pres.: Jerry Suarez; Mgr.: Guy Long; Buyers (Pre-Recorded Music): Bibi Martinez, Joe Alonzo. (Compact Disc, Pre-Recorded Audio Tape, Records (LP's, 12-Inch)) (Distributor, Exporter)

Labels Distributed: Audio: WaxTrax, Marz, Next Plateau, Warlock, High Power, Mic Mac, Hot Prodn's., Effect, Joey Boy, TSR, Megatone, Pandisc, Kinetic, ROIR, 4-Sight, On-top, Oaklawn, Metropolitan, RAS, Instinct, Cutting, Bassment, Tommy Boy, Megatone, JR, JDC, Quark, Sandcastle, Sam, Ligosa, Luke, Sneak Tip, Tripodi, Upstairs, TOT, RTR.

Just C.D.'s Dist., Inc., 6854 NW 75th St., Bay #2, Miami, 33166, (305) 885-8346, Fax: (305) 887-2989, CEO: Adria E. Correoso; Mgr.: Ricky Correoso; Buyer (Pre-Recorded Music): George Navarro; Buyer: Alex Roman. (Compact Disc) (Distributor, Exporter)

Labels Distributed: Audio: All Major Labels in English, plus All Latin Labels.

Landmark Distributors, Inc., 9103 Vineyard Lake Dr., Plantation, 33324, (305) 424-3137.

Major Video Concepts, 6103 Johns Rd., Tampa, 33634, (813) 884-4050, (800) 274-0682, Branch & Sales Mgr.: Colin Wood-Bradley; Opns. Mgr.: Dee Wilson; Warehouse Mgr.: Brent Benson. (Video (Cassette & Disc)) (Distributor)
Labels Distributed: Video: See Indiana Listings For Product Distribution.

McCartney Menagerie, 224 E. Commercial Blvd., #303, Ft. Lauderdale, 33308.

Media Concepts, Inc., 559 49th St. S., Saint Petersburg, 33707, (813) 321-2122, Fax: (813) 321-2272, Pres.: Charles R. Skidmore; Mgr.: R. Edward Schmidt; Buyer: Richard Smith. (Distributor)

Labels Distributed: Video: Media Studio Group.

Met Richmond Record Sales, 11645 Privado Way, Boynton Beach, 33437, (407) 364-5883.

RTV Sales Corp., 4375 SW 60th Ave., Fort Lauderdale, 33314, (305) 581-9050, Contacts: Ingrid Sacke, Bob Schachner.

Rankin Records, 164 NE 167 St., Miami, 33162, (305) 940-2510, Fax: (305) 940-2510, Owner: Vern Rankin; Mgr.: George Wilton. (Compact Disc, Pre-Recorded Audio Tape, Video (Cassette & Disc), Records) (One-Stop)

Reyes Records, Inc.

140 NW 22nd Ave., Miami, 33125, (305) 541-6686, Fax: (305) 642-2785, Pres.: Enrique Reyes; Exec. Vice Pres.: Lilia Reyes. (Compact Disc, Pre-Recorded Audio Tape, Music Video, Cassette-Singles, Records (LP's, 12-Inch))

Labels Distributed: Audio: Alfa, AM, Ansonia, Antilla, Ariola, Arista, BMG, Borinquen, Cache, Capitol, Cayman, Chrysalis, Codisco, Combo, Curb, Discuba, EMI, Faisan, Fania, Farun, Fonovisa, Fuentes, Gas, Gardenia, Gema, Great Apple, Guajiro, Headsup, Higher Octave, Hispania, Hiit Makers, HN, Hollywood, Inca, Island, Jap, Jive, JN, Karen, Kubaney, Leon, Lo Mejor, Mango, Maype, Mediterraneo, Melody, Microfon, MITV, ML, Montilla, Mowtown, MR, MR, Musart, Orfeon, Palm, Panart, Polygram, Popular, Prime, Priority, Private Music, Prodisco, Revival, Rhino, RMM, Salsoso, SAR, Sonotone, Sony, Super Power, Team, Teca, TH-Rodven, Tico, TM, TR, TTH, Vaya, Velvet, VP, WEA, West Side & more.

Rock Bottom Inc., 6900 SW 21st Ct., #10-11, Davie, 33322, (305) 474-1114, Fax: (305) 474-4079, Chief Execs.: Frank Rochman, Jeff Scheible; Mgr./Buyer: Lou Gallowich. (Distributor)

Labels Distributed: Audio: Airus, Amer. Gramophone, Bainbridge, Brainchild, Celestial Harmonies, Chase Music Group, CMH, Delmark, Flat Town Music, Flying Fish, Hearts of Space, Higher Octave, Increase/Quicksilver, Invasion Group, Leisure Ent., Living Music, Mardi Gras, Mobile Fidelity, Modern Blues, Music West, Nesak Int'l, Nova, Optimism, Pair, Par Ent., Positive Music, Priority, Sheffield Lab, Sonic Atmospheres, Spindletop, Sugar Hill, Telarc, Voss Music; Video: Nesak, Quicksilver.
Products/Accessories: CD, Tape & Record Products: Posso, Swire Magnetics.

Shifting Sands Stereo Dist., 1555 NW 79th Ave., Miami, 33126, 474-1114, Fax: (305) 474-4079, Chief Execs.: Frank Rochman, Jeff Scheible; Mgr./Buyer: Lou Gallowich. (Distributor)

Sonotone Music Corp.—Export Div., 4380 NW 128th St., Opa Locke, 33054, (305) 477-5999, Fax: (305) 477-8996.

Sound Splash, Inc., 3964 Northlake Blvd., Palm Beach Gardens, 33403, (407) 627-7625, Contact: Matthew Reynolds. (Compact Disc) (Importer)

Specialty Dist. Co., PO Box 41-4155, Miami Beach, 33141, 35 NE 62nd St., Miami, 33138, (305) 758-0000, Pres./Buyer (Accessories): Walter Jagiello; Mgr.: Jeanette Jagiello; Buyer (Pre-Recorded Music): J. Kozak; Buyer (Videos): W. Jay. (Distributor)

Labels Distributed: Audio: Jay Jay, Drum-Boy, Polka Tone, Bonfire, A Great Variety, Bon-Haitian, Eagle; Video: Jay Jay, Czech, KVC.

Products/Accessories: Storage & Carrying Cases: Gayo.

Target Music Dist., Inc., 7925 NW 66th St., Miami, 33166, (305) 591-2188, Fax: (305) 591-7210, Pres.: Gary Kulla. (Compact Disc, Pre-Recorded Audio Tape, Cutouts, Overstock) (Distributor)

Labels Distributed: Audio: Budget Tapes and CDs.

VCR Lock Corp., 2031 Grant St., Hollywood, 33020, (305) 926-8035, (800) 637-3176, Pres.: Wayne Dennis. (Accessories) (Distributor)

MET RICHMOND RECORD SALES, INC. AND

DAVID LAST MUSIC

are glad to announce that
LICENSING OF MUSIC
and VIDEO MASTERS
are now being done at our
NEW OFFICES

11645 Privado Way
Boynton Beach, Fla. 33437-1925 U.S.A.
Tel. 407-364-5883 • Fax 407-369-5555



REYES RECORDS INC.

DISTRIBUTORS

140 N.W. 22 Avenue / Miami, Florida 33125
Tel (305) 541-6686 / Fax (305) 642-2785

 Largest Inventory in Latin Music

 All Major labels in American Music

 Compact Disc

 Cassettes

 Records

 Videos

30
YEARS
EXPERIENCE

SAME DAY SERVICES & FREE LOCAL DELIVERY

NOVA

DISTRIBUTING CORP.®

"FULL LINE" ONE-STOP

Catalog Is Our Specialty

Now In Our 11th Year

PRODUCT

CASSETTES & COMPACT DISCS,
CASSETTE SINGLES, 12 DISCOS
CD5's, MAXI CASSETTES, LP's,
MUSIC VIDEOS, PLUS A FULL LINE
OF MUSIC ACCESSORIES.
HOT PRODUCT PLUS DEEP CATALOG

SERVICE

SAME DAY SHIPPING
OVERNIGHT DELIVERY &
SATURDAY DELIVERY AVAILABLE AT
NO EXTRA CHARGE.
THREE PURCHASE PROGRAMS
LIBERAL RETURNS POLICY
IMMEDIATE CREDIT ON ALL RETURNS

SPECIAL CONSIDERATIONS

NO RISK PURCHASE PLAN FOR NEW STORE OPENINGS
DISCOUNTS FOR FAX ORDERS
DISCOUNT RESTOCKING PROGRAMS
HOT SPECIALS ALWAYS ON SALE
SPECIAL NEW RELEASE PROGRAM

WE ARE PROUD TO STOCK THE FOLLOWING ACCESORIES:

maxell ALPHA MEMOREX ALLSOP 3 SONY
Tree Dimensions  CASE LOGIC MONEY HOUSE Pfantone
GONESH  TDK LASERLINE Al
discwasher® SAIJOY SELECT TAJR

CALL 1-800-476-NOVA

NOVA
Distributing Corp.®

4515 South Old Peachtree Rd.
Norcross, Ga. 30071
FAX (404)662-0775

Products/Accessories: Other: Cassette-Style Locking Device For VCRs.

Video Trend, Inc., 6103 Johns Rd., Tampa, 33614, (813) 884-4050, (800) 966-4820, Fax: (813) 888-5936, Vice Pres./Gen. Mgr.: John Gallagher; Sales Mgr.: Tim Wiley; Buyer: Bob Moore. (Distributor)
Labels Distributed: Video: See Illinois listings for product distribution.

GEORGIA

BMG Dist., 3395 NE Expressway, Atlanta, 30341, (404) 452-2300, Fax: (404) 452-2322, Branch Mgr.: T. Love; Sales Mgr.: T. Teague. (Compact Disc, Pre-Recorded Audio Tape, Video (Cassette & Disc), Records) (Distributor)
Labels Distributed: Audio/Video: See New York Listing For Product Line.

Baker & Taylor Video, 5801-B Goshen Springs Rd., Norcross, 30071, (404) 447-6700, (800) 288-4336, Fax: (404) 242-0170, Sales Mgr.: Chris Buff. (Distributor, One-Stop)
Labels Distributed: Audio/Video: See Illinois Listings For Product Lines.

CEMA Dist.-Atlanta, 3500 Parkway Ln., Ste. 100, Norcross, 30092, (404) 447-0940, (800) 476-2327, Fax: (404) 449-4742, Branch Mgr.: Jerry Brackenridge. (Distributor)
Labels Distributed: Audio: Owned: Capitol, EMI Records USA, SBK, Angel, Blue Note, Capitol Nashville, Capitol/EMI Latin; Joint Venture: Chrysalis, I.R.S.; Third Party: Barking Pumpkin, Bellmark, Rhino, Gold Castle, Curb, American Record Distribution.

Commtron Corp., 4703 Fulton Industrial Blvd., Atlanta, 30336, (404) 691-6280, Fax: (404) 696-3944, Branch Mgr.: John Roberts; Opns. Mgr.: Bob DeSimone. (Video (Cassette & Disc)) (Distributor)
Labels Distributed: Audio/Video: See Iowa Listing For Product Line.

Educational Record Center, Inc., 1575 Northside Dr. NW, Atlanta, 30318, (404) 352-8282, (Compact Disc, Pre-Recorded Audio Tape, Records) (Distributor)

Gemini Distributing, Inc., 6115-C Northbelt Dr., Norcross, 30071, (404) 441-1868, Fax: (404) 441-9012, Pres.: H. Michael Walker; Mgr.: Kathy H. Walker; Buyer (Pre-Recorded Music): Rick Hess. (Compact Disc, Pre-Recorded Audio Tape, Records) (Distributor)
Labels Distributed: Audio: Beverly, Glen, CMH, Celestial Harmonies, Chameleon, Collegium, Continental Communication, DCC, Flying Fish, GNP Crescendo, Green Linnet, Muse, New World, Nova, Oxymoron, Peter Pan, RAS, ROM, Rounder, Rykodisc, Savoy, Shanachie, Sheffield Lab, Sonic Atmosphere, TBA, Tomato, Vanguard.

Handeman Co.-Atlanta, 1133 Culppepper Dr., Conyers, 30207, (404) 929-0575, Branch Mgr.: Gene Brown; Opns. Mgr.: Jim Lemmons; Sales Mgr.: Sam Freeman. (Compact Disc, Pre-Recorded Audio Tape, Video (Cassette & Disc)) (Rackjobber)
Labels Distributed: Audio/Video: See Michigan Listings For Product Distribution.

Important Record Dist., 380 Oakdale Rd., NE, Atlanta, 30307, (404) 525-7170, Fax: (404) 523-5462, Branch Mgr./SE Dir. Sales: Doug Wiley; Sales Contacts: Wesley Eisenberg; Contact: David Trent, Mary Sease. (Distributor)
Labels Distributed: Audio: Relativity/Effect/Combat, Guitar Recordings, ROIR, Nettwerk, Torrid, Revelation, Metal Blade, Roadracer/RC/Emergo, Earache, Triple X, Shrapnel, Restless, Grand Slam, DB, Mammoth, Dog One, Black Vinyl, SST, Texas Hotel, Alternative Tentacles, Dischord, BYO, Premiere, Alias, Dr. Dream, Mordam, Shimmydisc, Touch & Go, Rock Hard, Red Light, Wild Rags, World of Hurt, Rough Trade/Twintone and others.

Ingram Entertainment Inc., 5835 Peachtree Corners E., Ste. C, Norcross, 30092, (404) 447-4863, Acting Mgr.: Jim Chapman. (Distributor)
Labels Distributed: Video: See Tennessee Listings For Product Distribution.

Intersound Int'l, PO box 1724, Roswell, 30077, (404) 664-9262.
Justin Entertainment, 2960 Amwiler Rd., Atlanta, 30360, (404) 448-7772, (800) 631-3513, Fax: (404) 446-0068, Pres.: Tim Monnig; Mgr.: Bill Norman; Buyer (Accessories): Brenda Sritan; Buyer (Videos & Music): Jim Ogletree; Advertising: Kolette Kleber Annand. (Compact Disc, Pre-Recorded Audio Tape, Video (Cassette & Disc), Records (12-Inch), Accessories) (One-Stop)

Justin Kiddleworks, 2960 Amwiler Rd., Atlanta, 30360, (404) 448-7772, Fax: (404) 446-0068, Pres.: Tim Monnig; Mgr./Buyer (Music): Kolette Kleber Annand. (Distributor)
Labels Distributed: Audio: Barbie The Look, Teddy Ruxpin, A Child's World of Dreams, A Child's Gift of Lullabies, Rog's Christmas, Rog Sings, Valentine Prods. "Funucational" Tape Series, Rincon Recordings.

Justin Records, 2960 Amwiler Rd., Atlanta, 30360, (404) 448-7772, (800) 631-3513, Fax: (404) 446-0068, Pres.: Tim Monnig; Mgr./Buyer: Rodney White. (Distributor)
Labels Distributed: Audio: Atlanta Int'l, Brrtton Line, DB, Dynamix, Emotive, Hot Prods., Ichiban, Irma, JDC, Nasty Mix, Oak Lawn, Project X, Cheatah, Cutting, Jewel/Paula, Megatone, Quark, DJ Int'l, I.D., Instinct, JCI, Joey Boy, Mic Mac, New town, Strictly Rhythm, Yo, Random House, S.O.H., TSR, Wax Trax, SAM, Sparrow, Tandem, TVT, ZYX.

Keep On Tracking, PO Box 189, Lil Burn, 30226.

Landmark Distributors, Inc., 2775 E. Bankers Industrial Dr., Atlanta, 30360, (404) 446-8500, (800) 356-5720, Fax: (404)

446-8321, Opns. Mgr.: Jeff Martin; Buyer: Julian Buckner. (Distributor)
Labels Distributed: Audio: Mango, 4th & Broadway, Profile, Big Beat, Tuff City, Cardiac, Fantasy, DRG, Alligator, Miramar, Bay Cities, Malaco, Original Jazz Classics, Disneyland/Vista Records/Tapes, Vision, Pandisc Music Corp., Continuum Corp., Collectables, Effect, Concord, Stax, Delicious Vinyl/Mango, Heads Up Int'l., Dr. Dream, Savoy, Amazin', Heart Music, Relaxation, D.I.W., Hey Day, Earth Beat/Music for Little People, Golden.

Lieberman Ents. Atlanta Area, 2781 Peterson Pl., Norcross, 30071, (404) 448-3011, (800) 282-8925, Branch Mgr.: Dennis Nicholls. (Compact Disc, Pre-Recorded Audio Tape, Video (Cassette & Disc), Records) (Rackjobber)

MCA Dist. Corp., 5275 Triangle Pkwy, Ste. 100, Norcross, 30092, (404) 447-6405, Fax: (404) 263-8132, Regional Branch Mgr.: Carl Michelakos; Regional Sales Mgr.: Barry Yarbrough; Regional Mktg. Specialist: Steve Rubin. (Distributor)
Labels Distributed: Audio/Video: See California Listing For Product Line.

New Leaf, 5425 Tulane Dr., SW, Atlanta, 30336, (404) 691-6996, (Distributor)

Nova Distributing Corp.

PO Box 2507, Norcross, 30091, 4515 S. Old Peachtree Rd., Norcross, 30071, (404) 447-1591, (800) 476-6682, Fax: (404) 662-0775, Pres.: Steven "Bud" Libman; Buyers (Pre-Recorded Music): Bud Libman, John Underwood, Bob Patten, Travis McDaniel; Buyers (Video): Bud Libman, John Underwood; Buyer (Accessories): Bob Patten. (Compact Disc, Pre-Recorded Audio Tape, Video (Cassette & Disc), Records (LP's, 12-Inch), Accessories) (One-Stop)
Labels Distributed: Audio: Arvis, Ichiban, Effect, 4 Sight, Hot, Joey Boy, OnTop, Nasty Mix, Tommy Boy, TVT, Warlock, Sister Ruby, AIR (Atlanta Int.), Benson, DB, K-Tel, Spectra, Sparrow, RTD.

Products/Accessories: CD, Tape & Record Products: Allsop, Discwasher, Memorex, Plantone; Storage & Carrying Cases: Alpha, Case Logic, CD Mate, Laser Line, Savoy, Tree Dimensions, Napa Valley; Blank Tape: Fuji, Maxell, Memorex, Sony, TDK; Head Phones: Memorex; Diamond Needles: Pfanstiehl; Other: Incense, Fragrance Spray; Gopher, Gonesh, Money House.

One-Stop Record House, Inc., 881 Memorial Dr., Atlanta, 30316, (404) 223-0144, Vice Pres./Gen. Mgr.: Hugh West; Buyer (Pre-Recorded Music): Debra Holden; Buyer (Accessories): Justice Wade. (Compact Disc, Pre-Recorded Audio Tape, Records (LP's, 12-Inch, Singles), Accessories) (One-Stop)
Products/Accessories: CD, Tape & Record Products: Allsop, Discwasher, Storage & Carrying Cases: Case Logic; Blank Tape: Maxell, TDK, Sony; Head Phones: Sony; Diamond Needles: Pfanstiehl.

Rock Bottom, 3893 Glen Meadow Dr., Norcross, 30092, (404) 448-8439, Fax: (404) 246-0820, Owner: Jeff Scheible; Buyer (Pre-Recorded Music): Lou Gallowich. (Distributor)
Labels Distributed: Audio: Florida Listing for Product Distribution.

Schwartz Bros., Inc., 3065 McCall Dr., Ste. 4, Atlanta, 30340, (404) 986-0764, Fax: (404) 986-9169, Branch Mgr.: Jim Maddix; Buyer (Pre-Recorded Music): Fred Held; Opns. Mgr.: Mike Kelsey. (Distributor)
Labels Distributed: Audio: A.I.R., Arvis, Beracah, Bryant, Cheatah, Dynamix, 4-Sight, Faith, Grateful Dead, Heatwave, Ichiban, JCI, Joey Boy, JR, Lethal Beat, Little Major, Nasty Mix, Next Plateau, On Top, One Way, Pow Wow, Par, Priority, Quality, Rohit, Sam, Syndrome, Soundings of the Planet, Southern Tracks, Sugar Hill, Sweet Rain, Startrack, Vanguard, Warlock, Yo; Video: (No Video At This Branch).

Products/Accessories: CD, Tape & Record Products: Recoton, Maxwell, TDK; Storage & Carrying Cases: Case Logic, Napa Valley; Video Cassette Recorder: Samsung; Blank Tape: Maxell, TDK, SKC; Batteries: Maxell; Other: Jewel Boxes.

Southeastern Tape Dist., 3850 Peachtree Ind. Blvd., Duluth, 30136, (404) 476-5600, Fax: (404) 497-8327, Pres.: Steve Kuranoff; Mgr.: Richard Adams; Buyer (Pre-Recorded Music): Richard Adams; Buyer (Videos): Roy Thombly; Buyer: Kevin Barnett. (Pre-Recorded Audio Tape) (Rackjobber)

Video Gold, 1395 Marietta Pkwy, Bldg. 400, Ste. 104, Marietta, 30067, (404) 578-9615, Fax: (404) 499-2479, Pres./Buyer: Don Bexten. (Distributor)

HAWAII

Kona-Kai Dist. Co., 2290 Alahao Pl., Honolulu, 96819, (808) 847-4608, Fax: (808) 847-4609, CEO: Donald P. McDiarmid, III. (Distributor)
Labels Distributed: Audio: Hula, Hawaii Calls, Surfside; Video: Souvenirs of Hawaii.

Lieberman Ents., 2665 Mokumoa St., Bldg. E, Honolulu, 96819, (808) 833-2455, (800) 328-2960, Mgr.: Cary Hayashikawa; Buyer: Susan Tanabe. (Compact Disc, Pre-Recorded Audio Tape, Video (Cassette & Disc), Records) (Rackjobber)

Microphone Music, Inc., 2077 S. Beretania St., Honolulu, 96826, (808) 946-1488, Fax: (808) 942-0173, Pres./Buyer

(Videos, Accessories): Ken Kaizawa; Mgr./Buyer (Music): Aaron Kaizawa. (Compact Disc, Pre-Recorded Audio Tape, Video (Cassette & Disc)) (Distributor, One-Stop, Importer, Exporter)

Labels Distributed: Audio: Ranwood, Criterion, Total, Kahale, Kanikapila, Panini.
Labels Imported: Victor, Columbia, King, Tokuma, Crown, Polystar, Teichiko (Japan); Ode, Viking, Hibiscus (New Zealand).

Music Craft Dist. of Hawaii, Ltd., PO Box 2839, Honolulu, 96803, 296 Mokauea St., Honolulu, 96819, (808) 841-6219, Fax: (808) 842-0362, Pres./Mgr./Buyer: Walter Kurokawa. (Distributor)

Labels Distributed: Audio: Alshire, Alligator, Amherst, Bainbridge, Capitol EMI/Latin, Columbia Special Projects, Concord Jazz, Everest Group, 4th & Broadway/Mango/Delicious Vinyl, Gusto Group, Hot, Ichiban, Micmac, Monitor, Nastymix, Next Plateau, On Top/Joey Boy, Optimism, Original Sound, Pandisc, Pair, Peter Pan, Profile, Quality, RAS, R.O.I.R., Rounder, Sony Discos, TBA, Voss, V.P., Welk/Vanguard.

Rack Service Hawaii, 2073 S. Beretania St., Honolulu, 96826, (808) 946-7737, Fax: (808) 942-0173, CEO/Buyer (Accessories): Ken Kaizawa; Mgr./Buyer (Music): Aaron Kaizawa. (Compact Disc, Pre-Recorded Audio Tape, Records (LP's)) (Rackjobber)

ILLINOIS

BMG Dist., 15450 Summit Ave., #180, Villa Park, 60181, (312) 571-8300, Fax: (312) 571-8304, Branch Mgr.: N. Wolk; Sales Mgr.: Rick Wilcoxon. (Compact Disc, Pre-Recorded Audio Tape, Video (Cassette & Disc), Records) (Distributor)
Labels Distributed: Audio/Video: See New York Listing For Product Line.

Baker & Taylor Video

8140 Lehigh Ave., Morton Grove, 60053, (708) 965-8060, Fax: (708) 470-7860, Pres.: James Warburton; Sr. Vice Pres. Sales & Mktg.: James Ulmsar; Sr. Vice Pres. Purchasing: Stan Meyers. Buyer (Pre-Recorded Music, Videos, Accessories): Al Strutz. (Compact Disc, Pre-Recorded Audio Tape, Video (Cassette & Disc), Accessories) (Distributor, One-Stop)
Branch(es): 7000 N. Austin Ave., Niles, 60648, (708) 647-0800, (800) 323-0626, Fax: (708) 647-7396, Sales Mgr.: Maury Spier (See AZ, CA, CO, FL, GA, MA, NJ, NC, OR, PA for additional offices.)

Labels Distributed: Audio/Video: All major & secondary manufacturers.

Products/Accessories: CD, Tape & Record Products: Allsop, Geneva, Discwasher, Storage & Carrying Cases: Alpha, Amaray, Case Logic, MidAmerica, 2Bag, Tree Dimensions; Blank Tape: Maxell, TDK, Sony, Scotch, Samsung, Fuji; Head Phones: Audio Technica; Batteries: Duracell; Other: M + M/Mars, Newman's Own Popcorn, Impel Trading Cards, Topps Trading Cards, Imaginings 3, Golden Book, Naki Industries, Orville Redenbacher, Kinyo Rewinders, Doc-Tech, Clear Tech, Browser, Bib America, Applause, Recoton, Ballentine Books.

CAP Exports/C.W. Pass, Inc., 1039 W. Lake St., Chicago, 60607, (312) 733-1717, Fax: (312) 733-5819, Pres./Buyer (Pre-Recorded Music): Walter Paas. (Compact Disc, Pre-Recorded Audio Tape, Records (LP's, 12-Inch)) (Exporter)
CEMA Dist.-Chicago, 3105 N. Wilke Rd., Ste. A, Arlington Heights, 60004, (312) 577-5444, Fax: (312) 577-6953, Branch Mgr.: David Witzig. (Distributor)

Branch(es) Dist. Center, PO Box 579, 500 Capitol Way (62650), Jacksonville, 62651, (217) 243-8661, (800) 637-7454, Fax: (800) 288-2362, Contact: Teresa Wienger.

Labels Distributed: Audio: Owned: Capitol, EMI Records USA, SBK, Angel, Blue Note, Capitol Nashville, Capitol/EMI Latin; Joint Venture: Chrysalis, I.R.S.; Third Party: Barking Pumpkin, Bellmark, Rhino, Gold Castle, Curb, American Record Distribution.

Commtron Corp., 1842 Brumell Dr., Elk Grove Village, 60007, (312) 956-0222, (800) 621-1333, Fax: (312) 956-0431, Branch Mgr.: Dan Hanrahan; Mgr.: Bob Ott, Opns.; Asst. Mgr.: Stan Maiorana; Video Sales Mgr.: Bill Shanko. (Distributor)
Labels Distributed: Audio/Video: See Iowa Listing For Product Line.

Facets Video, 1517 W. Fullerton Ave., Chicago, 60614, (312) 281-9075. (Video (Cassette & Disc))

Fletcher's One Stop, Inc., 450 E. 75th St., Chicago, 60619, (312) 874-4484, (Compact Disc, Pre-Recorded Audio Tape, Video (Cassette & Disc), Records (LP's, 12-Inch, Singles), Cutouts, Overstock, Accessories)

Products/Accessories: Blank Tape: Memorex, TDK, Sony, Maxwell; Head Phones: Plantone; Batteries: Eveready; Diamond Needles: Pfanstiehl, Rivertone.

Galgano Records, 4001 N. Ravenswood, Chicago, 60613, (312) 327-4160, Fax: (312) 327-4362, Pres.: John Galgano; Mgr./Buyer: John Galgano, Jr. (Compact Disc, Pre-Recorded Audio Tape, Video (Cassette & Disc), Records (12-Inch, Singles), Overstock, Accessories) (One-Stop)
Products/Accessories: CD Players: Pioneer, Sharp, Hitachi, Samsung, Aiwa; Audio & Video Playback Equipment: Pioneer, Sharp, Hitachi, Samsung, Aiwa; CD, Tape & Record Products: Discwasher, Maxell, TDK, Bib; Storage & Carrying Cases: Case Logic; Video Cassette Recorder: Hitachi,

Samsung; Blank Tape: Maxell, TDK; Head Phones: Pioneer, Aiwa.

Handman Co.-Chicago, 423 Grace St., Addison, 60101, (312) 543-3700, Branch Mgr.: Mark Brechler; Opns. Mgr.: Keith Rayner; Sales Mgr.: Phil Szafranski. (Compact Disc, Pre-Recorded Audio Tape, Video (Cassette & Disc)) (Rackjobber)

Labels Distributed: Audio/Video: See Michigan Listings For Product Distribution.

Hits Unlimited, 4001 N. Ravenswood, Chicago, 60613, (312) 296-4487, Fax: (312) 296-4490, CEO: Les Reid; Buyer (Pre-Recorded Music): Les Reid. (Distributor)

Labels Distributed: Audio: Ace, Adelphi, Alternative Tentacles, Angel Eyes, Avaron, Baja, Big Foot, Black Label, Certain, Crosscountry, Cutting, D.B., Damabi, Delmark, Dunk Yer Funk, Earwig, Elijah, Genes, Gospel Train, I.S.P., Increase, J.D.C., Jewel, Le Jam, Oak Lawn, Paula, Pearl, Quark, Quicksilver, Ronn, Rooster Blues, Sattelite Sounds, Slammin, Spectra, Sunsplash, T.S.R., Tipitinas, Westbound, Wildcat, Z.Y.X. and others.

Important Record Dist., 880 Lee St., Ste. 206A, Des Plaines, 60016, (708) 298-5533, Fax: (708) 298-8708, Dir. Midwest Sales: Lee Musumeci. (Distributor)

Labels Distributed: Audio: See New York Listings For Product Line.

J.S.J. Tape Distributors, 6620 W. Belmont Ave., Chicago, 60634, (312) 286-4444. (Distributor)

La Voz Hispana, Inc., 2647 N. Kedzie, Chicago, 60647, (312) 252-5003, Pres.: Nelson Cruz. (Compact Disc, Pre-Recorded Audio Tape, Video (Cassette & Disc), Records) (Distributor)

Landmark Distributors, Inc., 880 Lee St., Ste. 206, Des Plaines, 60016, (708) 827-4487, Fax: (708) 827-2932, Mgr.: Jordan Berliant. (Distributor)

Labels Distributed: Audio: Tommy Boy, Big Beat, Tuff City, Profile, Miramar, Bay Cities, Continuum Corp., Collectables, Heads Up Int'l, Dr. Dream, Mic Mac, Beachwood, Celestial, One Way, Black Sun, Heart Music, D.I.W., Pravda, Alcazar, Arhoolie, Black Vinyl, Chase, CMP, Cutting, DRG, Flying Fish, Kaleidoscope, Olivia, Red House, Rising Sun, Stash, Sugarhill, Terra Nova, Waterdog, Earth Beat.

Levy Home Entertainment, 4201 Raymond Dr., Hillside, 60162, (708) 547-4504, Fax: (708) 547-4503, Pres./CEO: Carol Kloster; Mgr.: Ed Luikaart; Buyer (Videos): Kathleen Canfield. (Compact Disc, Pre-Recorded Audio Tape, Video (Cassette & Disc)) (Rackjobber)

Labels Distributed: Audio: PolyGram, CEMA Dist., Capitol, Sony, WEA, BMG, UNI and all independents; Video: Fox, Paramount, Warner, MGM, HBO, LIVE, RCA/Columbia, Disney, MCA, Starmaker, AVID, Video Treasures, Goodtimes, Simitar, Best Films, Hanna-Barbera, JCI, J2, Golden Western, Orion.

Products/Accessories: CD, Tape & Record Products: Gemini; Storage & Carrying Cases: Lebo, Case Logic; Blank Tape: TDK, Sony, Maxell, Denon.

Lieberman Ent's., Inc., Chicago, 1000 Touhy Ave., Elk Grove Village, 60007, (312) 593-2120, (800) 323-0363, Branch Mgr.: Steve Bartell. (Compact Disc, Pre-Recorded Audio Tape, Video (Cassette & Disc), Records) (Rackjobber)

Lindberg Records, 1445 Sunset Ridge Rd., Glenview, 60025, (312) 729-2047, Pres.: Sven Linberg; Mktg. Dir.: Bjorg Larsen; Int'l A&R: F. Littlewol; Pub. Rel. Dir.: Elizabeth Francis. (Pre-Recorded Audio Tape, Records) (Importer, Exporter)

MCA Dist. Corp., 1360 N. Wood Dale Rd., Ste. A, Wood Dale, 60191, (312) 860-3733, Fax: (312) 860-0353, Regional Branch Mgr.: Ben Sheats; Regional Mktg. Specialist: Mick Stevanovich; Regional Video Dir.: Dan Gant. (Distributor) Labels Distributed: Audio/Video: See California Listing For Product Line.

M.S. Distributing Co.

1050 Arthur Ave., Elk Grove Village, 60007, (708) 364-2888, (800) 688-3383, Fax: (708) 364-2593, Pres.: Anthony Dalesandro; Exec. Vice Pres.: John Salstone; Vice Pres. Opns./Buyer (Videos/Accessories): Rich Kujak. Sales Mgr. Audio: Rick Chrzan; Buyer (Pre-Recorded Music): Wayne Grossman. (Distributor)

Labels Distributed: Audio: Alligator, Antilles/Mango, Antones, Biind Pig, Cardiac, CMF, Concord Jazz, Delicious Vinyl, Disney, Delmark, Fantasy Family, 4th & Broadway, Grateful Dead, Hightone, Ichiban, Joey Boy, JCI, Macola, Malaco, Muse, Nastymix, Next Plateau, Pandisc, Pow Wow, Rap-A-Lot, RAS, Rohit, Rounder Family, Savoy, Vision, Warlock, Welk Group, Waxtrax.; Video: Academy, AIP, BMG, CMV, CBS/Fox, Coliseum, Disney, FHE, Fox Hills, FRIES, Hanna-Barbera, HBO, HiTops, LIVE, Lyons Group, MCA, Magnum, Maltack, Media, MGM, Nelson, NFL Films, Orion, Pacific Arts, Paramount, PolyGram, Prism, RCA, Republic, Rhino, CEMA, Sony, Vidmark, Warner, Best Films. Pay-Per Transaction.

Products/Accessories: CD, Tape & Record Products: Alpha, Recoton; Storage & Carrying Cases: Alpha, Recoton; Blank Tape: Fuji, Scotch, Maxell, TDK; Batteries: Kodak; Other: Video Head Cleaners: Scotch, Geneva, Bibb.

Major Video Concepts Inc., 5490 Milton Pkwy., Rosemont, 60016, (708) 678-3700, (800) 966-3409, Branch Mgr.: Ronda Widner; Sales Mgr.: Gary Andry; Warehouse Mgr.: David Stone.

Labels Distributed: Video: See Indiana Listings For Product Distribution.

The Market Place, PO Box 4126, Rockford, 61111, (815)

877-1514, CEO: Max Anderson. (Distributor)

Labels Distributed: Video: Inspirational programs produced by Ken Anderson Films.

Multinational Dist., Inc., 2490 S. Blue Island, Chicago, 60608, (312) 376-6111, Fax: (312) 376-8085, Vice Pres.: Magdiel Remon; Mgr./Music Buyer: Juan Rodriguez; Music Buyer: Guadalupe de la Rosa. (Distributor)

Labels Distributed: Audio: Sony Discos, Fonovisla, Freddie, Musart, RCA, Sonotone, Luna, Mar Int., WEA, EMU/Capitol, Gil, Garmex, Joey, Disa, DMV, Th Rodven, Remo, Fuentes, Ramex, Peerless, Eco, Combo, Musical Productions, Karen.

Products/Accessories: Blank Tape.

Navarre Corp., 2030 W. 111th St., Ste. 204, Chicago, 60642, (312) 239-3365, Regional Sales Mgr.: Darryl Cotton. (Distributor)

Labels Distributed: Audio: Airns, American Gramophone, Amherst, CMH, DCC Int'l, Fresh/Sleeping Bag, Hearts Of Space, Higher Octave, Hot, Invasion, Light, Living Music, Micmac, Music West, Nova, Optimism, Pathfinder, Quality, Restless, Shelter, Shining Star, Silverwave, Sonic Atmosphere, Sparrow, Spindletop, SST, Sugo, TBA, USA, Valley Vue, Visual Musik, Voss, Windstar, World One, Yo.

Nightingale-Conant Corp., 7300 N. Lehigh Ave., Chicago, 60648, (708) 647-0300, Fax: (708) 647-7145, Pres.: Vic Conant; Vice Pres. Mktg.: Mark Boyle. (Distributor)

Labels Distributed: Audio: Spoken word and other motivational tapes.

Paulstar Distributing, 1452 Carol Court, #3B, Palatine, 60067, (708) 590-0607, Regional Sales Mgr.: Jolene Nixon. (Distributor)

Labels Distributed: Audio: See Minnesota Listing For Product Line.

Polish Record Center of America, 3069 Milwaukee Ave., Chicago, 60618, (312) 539-9898, Owner: Jan Wojewodka. (Video (Cassette & Disc) Records) (Distributor, Importer) Labels Distributed: Audio: Muza, Pronit, Veriton (Poland); Melodia (U.S.).

Pravda, 3728 N. Clark, Chicago, 60614, (312) 549-3776, (Distributor)

Public Media Home Video, 5547 N. Ravenswood, Chicago, 60640, (312) 878-2600, Pres.: Wes Monty; Nat'l Sales Mgr.: Jeff McGuire. (Distributor)

Labels Distributed: Video: Home Vision, Public Media Video.

RM Distributing, div. Aztec Corp.

705 S. Washington St., Naperville, 60540, (708) 305-0770, Fax: (708) 305-0782, Pres./Buyer: M. Allan Shaw; Mgr./Buyer: Lisa Holmes. (Distributor)

Labels Distributed: Audio: American Licensing, Ball Bearing, Borderline, BG, Brandywine, Cactus, Clef, Cooper, Cross Country, Dark Angel, Depot, Dooley, Eastwind, Fannigan's, Folk Era, Homecoming, Hoot Mon, Kennebunk River, MTA, SGB, Tranquilla, West Knoll; Video: Folk Era, West Knoll, MTA, Kennebunk River, Golden Arrow. Pay-Per Transaction.

R. S. Distributing, 621 E. Green, Champaign, 61820, (217) 384-7227, Pres.: Phil Strang. (Distributor)

Labels Distributed: Audio: Independent local labels including Office, Pogo, Landmark Brothers and music of several Champaign-Urbana bands.

Ruby Sales Co., Inc., 4038 W. Armitage Ave., Chicago, 60639, (312) 276-5484, (312) 276-5485, Fax: (312) 276-4094, Pres./Buyer (Pre-Recorded Music): Jay S. Lawrence; Dir./Buyer (Pre-Recorded Music): Reuben W. Lawrence. (Records, Cutouts, Overstock) (Rackjobber, Exporter, Close Out).

Seebro Prods. Co., 2416 S. Michigan Ave., Chicago, 60616, (312) 842-8221, Pres./Buyer: R. Siegal. (Distributor)

Labels Distributed: Audio: Jay Jay, Peter Pan, Golden; Video: Jay Jay.

Products/Accessories: Storage & Carrying Cases: Amfile; Blank Tape: 3M; Batteries: Panasonic; Diamond Needles: Planstiehl; Other: Seebro Wire Storage Racks and TV Tables.

Selectrak Family Video, 4160 Madison St., Hillside, 60162, (708) 547-6100, Fax: (708) 547-6229, Vice Pres. & Gen. Mgr.: H. P. Davidson; Buyer (Videos): Eric Haley. (Video (Cassette & Disc)) (One-Stop)

Singer One Stop, 2130 W. Chicago Ave., Chicago, 60622, (312) 772-3450.

Sound Investment, 518 W. Lockport Rd., Plainfield, 60544, (815) 436-5363, (Distributor)

Sound Warehouse, 7317 S. Lemont Rd., Downers Grove, 60516, (312) 967-3410, (Distributor)

VSI Dist., Inc., 333 Commercial Ave., Northbrook, 60062, (312) 498-4130, Fax: (312) 498-4487, Pres.: Steven R. Weitzman. (Video (Cassette & Disc), Computer Games) (Distributor) Labels Distributed: Video: Used Tapes.

Val's Halla, 723 South Blvd., Oak Park, 60620, (312) 328-2899, (Distributor)

Video Trend Inc., 1011 E. Touhy, Ste. 500, Des Plaines, 60018, (312) 635-7100, Fax: (312) 635-8633, Vice Pres./Gen. Mgr.: Robert Tollini; Nat'l Purchasing Mgr.: Lee Goldstein.

Branch(es): 5490 Milton Pkwy., Rosemont, 60018, (708) 678-3700, (800) 966-3409, Fax: (708) 678-5924, Vice Pres./Gen. Mgr.: Rhonda Rose; Sales Mgrs.: Steve Bulzoni, Denise Hall; Buyer: Tena Watts. (Distributor) Labels Distributed: Video: Fox Video, Buena Vista, MCA/Universal, MGM-UA, HBO, Paramount, Orion,

RCA/Columbia, Warner, LIVE, Academy, Republic, Vidmark, AIP, Coliseum, Fries, Hanna Barbara, Imperial, Vestron, Pacific Arts, Prism, Shapiro, Glickenhau, Southgate, Starmaker, SVS, Turner, Worldvision and IMAGE Laserdiscs. Video Vendor, 622 Milwaukee Ave., Prospect Heights, 60070, (312) 537-8900, Fax: (312) 537-8954, Vice Pres. Sales: Barry Manning. (Distributor, Manufacturer)

Products/Accessories: Other: Video Vending Devices. Vintage Vinyl, 925 Davis St., Evanston, 60201, (312) 328-2899. (Distributor)

INDIANA

Automated Video Business Corp., 3512 Rockville Rd., Ste. 139C, Indianapolis, 46222, (317) 244-4287, CEO: Jacqueline J. Fisher; Mgr./Buyer (Video): John E. Fisher; Buyer (Video): Shane E. Fisher. (Distributor)

Labels Distributed: Video: All major studios and most independents; video vending machines.

Ingram Entertainment Inc., 7319 Innovation Blvd., For: Wayne, 46818, (219) 489-6046, Branch Mgr.: Greg Petry. (Distributor)

Labels Distributed: Video: See Tennessee Listings For Product Distribution.

RM DISTRIBUTING

HARD TO FIND MUSIC OF
THE 50'S, 60'S AND 70'S
PLUS CONTEMPORARY FOLK

LABELS DISTRIBUTED:

DCC Compact Classics

American Licensing

Borderline • BIG • Cleff

Brandywine • Cactus

Cooper • Cross Country

Dark Angel • Depot

Folk Era • Fannigan's

Eastwind • Dooley

Homecoming • Hoot Mon

SGB • Tranquilla

Kennebunk River • MTA

West Knoll • SFL

Vanguard (Folk Only)

Complete Recordings of:

Kingston Trio • Weavers

John Stewart • Limelitters

and others

Call 1-800-232-7328 Ext. 92
or FAX 1-708-305-0782

For Free Catalog

705 S. WASHINGTON ST.
NAPERVILLE, IL 60540

RUBY SALES COMPANY, INC.

HUGE SELECTION CUTOUTS

SOUL • JAZZ • C&W • GOSPEL

ROCK • SOUND TRACKS • ETHNIC

CLASSICAL • M.O.R. • KIDD E

CLOSE OUT PRICES

45's • LP's • CASSETTES • CD's

WE EXPORT

RUBY SALES

4038 W. ARMITAGE, CHICAGO, IL 60639
(312) 276-5484 FAX (312) 276-4094

Lieberman Ent's., 5953 W. 80th St., Indianapolis, 46278, (317) 872-6853, (800) 328-2960, Branch Mgr.: Tom Schmid. (Compact Disc, Pre-Recorded Audio Tape, Video (Cassette & Disc), Records) (Rackjobber)

Major Video Concepts, Inc., PO Box 68000, 7998 Georgetown Rd., Ste. 1000, Indianapolis, 46268, (317) 875-8000, (800) 365-0150, Fax: (317) 872-7067, Pres.: Walt Wiseman; Mgr.: Sr. Vice Pres. Opns./Doug Meadows; Exec. Vice Pres. Sales/Mktg.: Eric Smith; Vice Pres. Merchandising: Mike Davis. (Video (Cassette & Disc), Computer Games) (Distributor)
Labels Distributed: Video: Academy, Best, CBS/Fox, Celebrity, Coliseum, Disney, Family Home, Fox Hills, Fries, HBO, Hi-Tops, Imperial, Key Video, KVC, Lightning, LIVE, Magnum, Maljack Prods., MCA Dist., Media, MGM, Nelson, NFL Films, Nostalgia, Orion, Paramount, Playhouse, Prism, RCA/Columbia, Republic, Sony, Southgate, Touchstone, Vestron, Vid America, Video Communications, Warner Home, Worldvision and others.
Products/Accessories: Video games from 54 manufacturers.

Music Merchandisers, Inc., 902 Evans Ave., Valparaiso, 46383, (219) 464-1883, Chief Exec.: Mick Quick; Mgr.: Robert Michael; Buyer (Pre-Recorded Music): Sally Quick; Buyer (Music): Michael Quick. (Compact Disc, Pre-Recorded Audio Tape, Cutouts, Accessories) (Rackjobber)

Music Mood Ent's., PO Box 96, 229 W. Third St., Rushville, 46173, (317) 932-2821, Owner/Buyer: Terry Horn. (Records (Singles) (One-Stop)
Labels Distributed: Audio: 45 RPM Singles Only.

Music Wholesalers, Inc., 2904 E. Cascade Dr., Valparaiso, 46383, (219) 465-1567, (800) 328-2737, Fax: (219) 465-7635, Pres.: Mark Duggleby; Buyer (Pre-Recorded Music): David Bagnall; Mgr/Buyer: Keith Lawrence. (Compact Disc, Pre-Recorded Audio Tape, Cutouts, Accessories) (Rackjobber)
Products/Accessories: CD, Tape & Record Products: Memorex; Blank Tape: Memorex; Head Phones: Sentry and Memorex.

Scott's One-Stop Records, Inc.

2507 Roosevelt Ave., Indianapolis, 46218, (317) 639-5491, (800) 428-4165, Fax: (317) 639-5573, Opns.: Tom Rafferty; Sales: Jerry Jacobson; Buyers (Pre-Recorded Music): Tracy Downing, Cheryl Gregory, Elaine Klemesrud; Sec./Treas.: Don Gobrecht. (Compact Disc, Pre-Recorded Audio Tape, Video (Cassette & Disc), Records (LP's, 12-Inch, Singles), Accessories) (One-Stop)
Products/Accessories: CD, Tape & Record Products: Allsup, Discwasher, Storage & Carrying Cases: Savoy; Blank Tape: Maxell, TDK.

IOWA

Commtron Corp., 7900 Hickman Rd., Des Moines, 50265, (515) 226-3000, Fax: (515) 226-3594, CFO: Steve Lacy; Sr. Vice Pres. Video Sales/Mktg.: Vern Fross; Buyers (Video): Scott Voss, John Reding, Dan Norem. (Video (Cassette & Disc), Computer Games, Accessories)
Branch(es): 2450 Bell Ave., Des Moines, 50321, (515) 244-8233, Fax: (515) 282-1601, Branch Mgr.: Floyd Schrodt; Sales Mgr.: Curt Myall; Opns. Mgr.: Jim Finnegan. (Distributor)
Labels Distributed: Video: Academy, AIP, BMG Dist., CBS Records, Celebrity, Coliseum, Columbia TriStar, Walt Disney, FoxVideo Inc., Hanna-Barbera, Hemdale Film Corp., Imperial, LIVE, UNI Dist., Orion, Paramount, PolyGram, Prism Entertainment Corp., Random House, Sony Video

**Tell Them
You Saw It In
Billboard's
1992
International
Buyer's
Guide.**

Software Co., Shapiro Glickenhause Entertainment, South Gate Entertainment, Strand VCI Entertainment, Turner Home Entertainment, Vidmark, Warner Home Video.
Products/Accessories: CD Players: Magnavox, Panasonic, Craig; Audio & Video Playback Equipment: Panasonic, Magnavox, Quasar, Craig, Seiko, Lasonic, Randex, Starlite; CD, Tape & Record Products: Discwasher, Recoton, Bib, JASCO, Allsup, Scotch, Tape Mender; Storage & Carrying Cases: Alpha, Amaray, Movie Walker, Solidex, Tamarac, Travel Master; Video Cassette Recorder: Panasonic, Magnavox, Quasar, Samsung, Shintom, Movie Walker; Blank Tape: Maxell, TDK, Sony, Scotch, Fuji, JVC, Panasonic, Avanti; Head Phones: Sony, Labtec; Batteries: Power Plus; Other: Solidex, Quantum & JASCO video rewinders, cables, remotes.

"Indie" Dist., PO Box 2147, Sioux City, 51104, Dir/Buyer: Morrie Miller. (Compact Disc, Records (LP's, Singles)) (Distributor)

Labels Distributed: Audio: Claiming Race, Tractor, Little Chicago, Trick Bag, Blue-Eyed-Blues, Plus independent labels in the following areas: blues, 60's Rock Re-issues, 60's Soul Re-issues, Folk, Jazz, Spoken Word, Rock 'N' Roll, Etc.

Mountain Coin Machine Dist., 751 E. Broadway, Des Moines, 50313, (515) 282-6211, Fax: (515) 282-5554, Mgr.: Dan Kincade. (One-Stop)

Labels Distributed: Audio: See Colorado listing for product line.

United States Distributing, Inc., PO Box 97, Hwy. 44 E., Guthrie Center, 50115, (515) 747-8387, Fax: (515) 747-2534, Pres.: Larry C. Larsen. (Pre-Recorded Audio Tape, Cutouts, Overstock) (Rackjobber)

KANSAS

Acoustic Sounds, PO Box 2043, 146 S. Santa Fe, Salina, 67401, (913) 825-8609, Fax: (913) 825-0156, Owner: Chad Kassem; Mgr.: William Gallasser. (Compact Disc, Records (LP's, 12-Inch)) (Distributor, One-Stop, Exporter)

Labels Distributed: Audio: Analogue Prods., Albany, American Gramophone, ATR Mastercut, Audioquest, Bainbridge, British Pressings, Chesky, Concord Jazz, Delos, DMP, Dorian CD, East Wind CD, Elite CD, Gemini, Harmonia Mundi, Hungaraton, Klavier, M&K, Mobile Fidelity, Odin, Opus 3, Reference Recordings, Rounder, Sheffield Lab, Telarc, Three Blind Mice, Waterlily, Wilson.
Products/Accessories: CD, Tape & Record Products: Last, Nitty Gritty, Torumat, Audio Quest.

Hoffman Tapes, 15009 W. 101st Terrace, Lenexa, 66215, (913) 888-4885, Fax: (913) 888-1550, Pres.: Arnie Hoffman. (Compact Disc, Pre-Recorded Audio Tape, Cutouts, Overstock) (Rackjobber)

The House Dist., Inc., 2000 E. Prairie Cir., Olathe, 66062, (913) 829-6691, (800) 821-3324, Fax: (913) 780-0611, Pres.: Hal Brody; Mgr. (Pre-Recorded Music): Rick Henderson. (Distributor)

Labels Distributed: Audio: Alligator, Antones, Arhoolie, Black & Blue, Black Top, CMH, Concord Jazz, Contemporary, Fantasy, Flying Fish, Galaxy, GNP, Good Time Jazz, Grateful Dead, Hightone, Jungle, Kaleidoscope, Milestone, Oh Boy, Peter Pan, Philo, Prestige, Red Pajamas, Rounder, Thykodic, Specialty, Stax, Sugar Hill, Volt.

Ingram Entertainment Inc., 3060 S. 24th St., Kansas City, 66106, (913) 362-0391, Branch Mgr.: Glenn Andriano. (Distributor)

Labels Distributed: Video: See Tennessee Listings For Product Distribution.

Kief's Records & Stereo Supply, Inc., PO Box 2, Lawrence, 66044, 2429 Iowa St., Lawrence, 66046, (913) 842-0191, Fax: (913) 842-0501, Pres.: John J. Kiefer; Mgr/Buyer: Steven J. Wilson. (Compact Disc, Pre-Recorded Audio Tape) (One-Stop)

Products/Accessories: CD Players: Denon, Yamaha, Onkyo, Sony E.S., Nakamichi, NAD, Adcom.

Sight & Sound Distributors, 1144 Booth St., Kansas City, 66103, (913) 371-8152, (800) 366-6602, Fax: (913) 371-0428, Branch Mgr.: Dan Morrice. (Distributor, Rackjobber)
Labels Distributed: Audio/Video: See Missouri Listings For Product Distribution.

KENTUCKY

Central Electronics, 108 Ronaldson, Campbellsville, 42718, (502) 465-5631, Fax: (502) 465-5631, Owner/Buyer: Randall B. Herron. (Compact Disc, Pre-Recorded Audio Tape, Video (Cassette & Disc), Records, Cutouts, Overstock, Computer Games) (Distributor, One-Stop, Rackjobber, Importer, Exporter)

Labels Distributed: Audio: Various Religious, CW & Rock Labels Plus Various Cutouts & Overstocks.

Products/Accessories: CD Players: Toshiba, Pioneer, Video Cassette Recorder: Symphonic, Toshiba.

King's Record Shop, 240 W. Jefferson St., Louisville, 40202, (502) 584-5535, Chief Exec./Mgr.: Gene King; Buyer (Pre-Recorded Music): Wanda Shaw; Buyer (Videos): Robby King. (Compact Disc, Pre-Recorded Audio Tape, Video (Cassette & Disc), Records (LP's, 12-Inch, Singles)) (One-Stop, Retail)

Riggs Distributing, PO Box 58481, Louisville, 40268, (502) 937-5821, Mgr.: Robert Riggs. (Pre-Recorded Audio Tape,

Cutouts, Overstock) (Distributor)

Shively Records, Inc., 4450 Shively Center, Louisville, 40216, (502) 447-4951, Pres.: Theresa Burton. (Compact Disc, Pre-Recorded Audio Tape, Video (Cassette & Disc), Records) (One-Stop)

Wax Works/Video Works, 325 E. Third St., Owensboro, 42301, (502) 926-0008, Fax: (502) 685-0563, Pres.: Terry Woodward; Buyers (Pre-Recorded Music): Jim Roe, Marilyn Ramsay, Kathy Roberts, Debbie Cox; Buyer (Videos): Noel Clayton; Buyer (Accessories): Kirk Brandenberger. (Distributor)

Labels Distributed: Audio: Amer. Gramophone, Bainbridge, Benson, BMG, CMH, Disney, Flying Fish, GNP, Important, JCI, PolyGram, Ranwood, Rebel, Rounder, Sony, Sparrow, Spectra, Sugarhill, Telarc, TVT, Uni, WEA; Video: A.I.P., Academy, CBS/Fox, Celebrity, Coliseum, Disney, Fries, HBO, Hemdale, Imperial, Key, LIVE, MCA, Media, MGM, MTI, Nelson, Orion, Pacific Arts, Paramount, PBS, PolyGram Music Video, Prism, RCA/Columbia, Republic, Rhino, Simitar, Sony, Turner, Vestron, Vidmark, Warner Bros., Warner Music Video, Wood Knapp, WorldVision.
Pay-Per Transaction.

Products/Accessories: CD, Tape & Record Products: Allsup, Pfanstiel, Recoton; Storage & Carrying Cases: Savoy, Lazerline, Le-Bo, Casemakers; Blank Tape: TDK, Maxell, Scotch, Memorex, Fuji, Denon; Head Phones: Koss; Other: All major lines of video games and laser disks.

LOUISIANA

E.T.D. New Orleans, 1008 Harimaw Ct. W., Metairie, 70001, (504) 836-2855, (800) 423-7035, Fax: (504) 835-2917, Branch Mgr.: Steve LeBourgeois. (Pre-Recorded Audio Tape, Video (Cassette & Disc)) (Distributor)

Labels Distributed: Audio: Promotional Lines; Video: All Major Studios & Most Independents.

Floyd's Wholesale Dist. Inc., PO Drawer 10, 434 E. Main St., Ville Platte, 70586, (318) 363-2184, (318) 363-2139, Fax: (318) 363-5622, Pres.: Floyd Sotheau; Mgr.: Terry Guillion; Buyer (Pre-Recorded Music): Cynthia Fontenot. (Compact Disc, Records (12-Inch, Singles)) (Distributor, One-Stop)

Labels Distributed: Audio: Swallow, Maison de Soul, Jin, Arhoolie, Paula/Ronn, Lanor, Rounder, Ichiban, La Louisiane, Blues Unlimited, Kajun, Goldband, Montel and All Major Labels; Video: Learn to Cajun Dance Videos, Cajun & Zydeco Music Videos.

Frankie's Music Distributors, 1533 Corporate Dr., Shreveport, 71107, (318) 424-9441, Contact: Frankie Spano. (Distributor)

Goldband Record Dist. Corp., PO Box 1485, Lake Charles, 70602, (318) 439-8839, Pres.: Eddie Shuler; Buyer: Jeff Le June. (Pre-Recorded Audio Tape, Records) (Distributor, Importer, Exporter)

Gonzales Music, PO Box 428, Gonzales, 70707, Southland Dr., Gonzales, 70737, (504) 647-2133, Pres./Mgr/Buyer: Roy Shaw. (Compact Disc, Pre-Recorded Audio Tape, Records (LP's, 12-Inch, Singles)) (One-Stop)

Rounder Records Dist., 4444 Venus St., New Orleans, 70122, (504) 283-3211.

Saint Expedite Dist. Co., PO Box 13977, New Orleans, 70185, (504) 482-4211, Gen. Mgr./Buyer: John Berthelot. (Distributor)

Labels Distributed: Audio: Alligator, Black Top, Blind Pig, Bullseye, Clean Cuts, Dixieland Jubilee, Flying Fish, GNP Crescendo, Great Southern, Jin, Kom-A-Day, Maison de Soul, Mardi Gras, Rounder, Smokey Mary, Spindletop, RZ, Swallow, ZBC.

Sight & Sound Distributors, 5600 Jefferson Hwy., #284, New Orleans, 70123, (504) 734-1091, (800) 366-6630, Fax: (504) 734-7006, Branch Mgr.: Gladin Scott. (Distributor, Rackjobber)

Labels Distributed: Audio/Video: Missouri Listing For Product Distribution.

Sound of New Orleans, 5584 Canal Blvd., New Orleans, 70124, (504) 484-7222, Owner: Gary J. Edwards. (Compact Disc, Pre-Recorded Audio Tape) (Exporter)
Labels Imported: Exports: Sound Of New Orleans (US).

MAINE

Maine Record Sales, PO Box 1054, Bangor, 04401, (207) 285-7002, Owner/Mgr./Buyer: David Turbin. (Compact Disc, Records, Cutouts, Overstock) (Distributor, One-Stop, Rackjobber)

Labels Distributed: Audio: CBS, MCA, WEA, Capitol, RCA. Cutouts/Overstocks: Cutouts, Overstock.

MARYLAND

Action Dist. Co., 600 Reisterstown Rd., #403, Pikesville, 21208, (301) 653-8266, (301) 655-4031, CEO: Lois Anoff; Buyer (Pre-Recorded Music): Sam Anoff. (Compact Disc, Pre-Recorded Audio Tape, Records) (Distributor)

Labels Distributed: Audio: Axbar, Belaire, Curtom, C.J.M., Collectable, CMC, BMG, Damon, Easy Street, Flat Town, Hot Trax, Ichiban, Immix, Jay Jay, Konkrete, K-Tel, M&R, Merit, Miracle, Megatone, N.S.D., Par-T, Pantera, Merlin, Dearborn, Master Track, Stargem, Reptile, Step One, Star Trac, Southern Tracks, Reizer, Jewel/Paula/Ronn, Zakia, You Guys, Wild Dogs, Ripete, X-Rated.

BMG Dist., 6411 Ivy Ln., Ste. 120, Greenbelt, 20770, (301) 441-1900, Fax: (301) 441-3672, Branch Mgr.: T. O'Flynn; Sales Mgr.: S. Taylor. (Compact Disc, Pre-Recorded Audio Tape, Video (Cassette & Disc), Records) (Distributor)
Labels Distributed: Audio/Video: See New York Listings For Product Distribution.

Commtron Corp., 1349 Charwood Rd., Hanover, 21076, (301) 850-9191, Fax: (301) 850-9229, Branch Mgr.: John Lair.
Labels Distributed: Video: See Iowa Listings For Product Distribution.

Encore Int'l Corp., 9050 Red Branch Rd., Columbia, 21045, (301) 992-1990, Fax: (301) 992-0341, Pres.: Raymond L. Creighton; Buyer (Music, Accessories): Steve Bowen; Buyer (Videos): Sotti Lawson. (Compact Disc, Pre-Recorded Audio Tape, Video (Cassette & Disc), Records) (Rackjobber).

Great Bay Dist., Inc., 1400 Aliceanna St., Baltimore, 21231, (301) 675-7855, Fax: (301) 675-1102, Pres.: Joyce Lynn; Vice Pres./Gen. Mgr.: Merle Lucado. (Distributor)
Labels Distributed: Audio: 3-C, Amherst, Black Label, Bright Image, Cardiac, Coast To Coast, Drive By, Delicious Vinyl, Effect, 4th & Broadway, Great Jones, Hot Prodn's., Jewel, King James, Laurie, Lethal Beat, Malaco, Mango, Marz, Muscle Shoals, Nine, Onyx, Paula, Pow Wow, Priority, Quality, Satellite, Savoy, Select-O-Hits, Sound of Gospel, SOH, Sparrow, TBA, Valley Vue, Warlock, Westbound.

Handleman Co.-Baltimore, 521 McCormick Dr., Glen Burnie, 21061, (301) 553-9402, Branch Mgr.: John Schlamp; Opns. Mgr.: Dennis Johnson; Sales Mgr.: John Stroop. (Compact Disc, Pre-Recorded Audio Tape, Video (Cassette & Disc)) (Rackjobber)
Labels Distributed: Audio/Video: See Michigan Listings For Product Distribution.

Ingram Entertainment Inc., 8316 Sherwick Ct., Jessup, 20794, (301) 497-6170, Branch Mgr.: Mary Negri. (Distributor)
Labels Distributed: Video: See Tennessee Listings For Product Distribution.

Interstate Group, 100 Western Maryland Pkwy., Hagerstown, 21740, (301) 733-1378, Mgr.: Frank Griffin. (Records) (Rackjobber).

Liaison Records, Inc., 9445-K Washington Blvd. (Rear), Laurel, 20723, (301) 880-6111, Fax: (301) 776-4566, Co-Owners: Becky Marcus; Contact: Tom Goldfogle. (Distributor)
Labels Distributed: Audio: Bassment, Big Break, Club House, Cutting, D.J. Int'l, Deco, Digital Dungeon, Flourth Floor, Future Sound, Goff, Grove Street, Happy Wax, Hi Bias, House Jam, House N. Effect, Loop 'D Loop, Lumar, Martru, Maxi, Metropolitan, Micmac, Movin', Nugroove, Raw Venture, Rey-D, Rhythm Beat, Sound By Charlie, Sounds of the Capitol, Street, Strictly Rhythm, Tempest, Underground, Underworld, USA, ZYX.

Richman Bros. Records, Inc.-One Stop, 2 Serpentine Ct., Silver Spring, 20904, (301) 384-8833, Fax: (301) 384-9672,

Pres.: Allen Richman; Head Neuman: Ted Neuman; LP & Pre-recorded Video: Tim Comerford. (Pre-Recorded Audio Tape, Accessories) (Distributor, One-Stop).

Schwartz Bros., Inc.

4901 Forbes Blvd., Lanham, 20706, (301) 459-8000, (800) 638-0243, Fax: (301) 459-6418, Pres.: James Schwartz; Gen. Mgr. Audio Div.: Charles "Pip" Smith; Major Labels: Phil McConnell; Independent Labels: Ira Kessler; Buyers (Videos): Jim Hintze, Mike Sander; Buyer (Accessories): Jim Hintze. (Distributor)
Branch(es): (See GA, NJ, OH).

Labels Distributed: Audio: American Gramophone, Aegis, Atlanta Int'l, Beracah, Cheelah, CMC, Concord Jazz, DCC Compact Classics, DRG, Fantasy, 4PM, Grateful Dead, Ichiban, JCI, Little Major, Next Plateau, Nuage, On Top, Pair, Music West, Nasty Mix, Pandisc, Par, Rap-A-Lot, Rykodisc, Sheffield Lab, Rohit, Vision, Walt Disney, Sugar Hill; Video: Disney, Paramount, Fox, MGM, Columbia/Tri-Star, Media, HBO, WCI, MCA, LIVE, Orion, Nelson.

Products/Accessories: CD, Tape & Record Products: Recoton, Maxell, TDK; Storage & Carrying Cases: Case Logic, Napa Valley; Video Cassette Recorder: Samsung; Blank Tape: Maxell, TDK, SKC; Batteries: Maxell; Other: Blank Jewel Boxes.

3-C Sales Corp., 526 Fuselage Ave., Baltimore, 21221, (800) 344-8249.

Vintage Distributing, Inc.

8211-R Cloverleaf Dr., Millersville, 21108, (301) 553-9300, Fax: (301) 553-6902, Pres.: Murray Graber. (Distributor)
Labels Distributed: Audio: Accord, Applause, Arctic, Baby Boomers, Black Tulip, Blue City, Camden, Castle, Clearlight, Clifton, Crystal Ball, Deluxe, Dionn, Doowop, Groove Mchnt, Hollywood, Increase, Jamie/Guyden, Jazz Life, King, Legrand, Live Gold, Night Life, Original Sound, Post, Quicksilver, Relic, Richmond, Solid Rock, Special, Spotlight, Starday, Streetlife, Wizard and many more.
Products/Accessories: CD, Tape & Record Products: Paper & plastic sleeves, Corrugated storage boxes; Storage & Carrying Cases: Service Mfg., Lebo; Blank Tape: TDK, Memorex, Laser; Other: Mailers, sacks, wire baskets, divider cards, cassettes & CD security systems, record reasearch books, price guides, and budget cassettes.

Wayside Music, PO Box 6517, Wheaton, 20916, (Compact Disc, Records (LP's)) (Distributor)
Labels Distributed: Audio: Cuneiform Records, CMP, HC Prod., Lovely Music, Knitting Factory, Laser's Edge, New Albion, Reckless, Pogus, Rift.

Have You Gotten Any Lately?

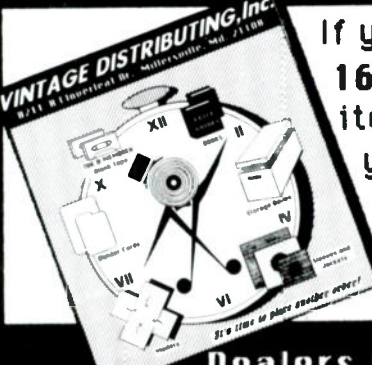

If you haven't received a copy of our 164 page catalog with over 5,000 items listed, you don't know what your missing!!! Records, Cass., CD's, 45's, Imports, Blank Tape, Books, Storage Boxes, Divider Cards, Sleeves, Jackets, etc.

Dealers Only 800-523-2036

SERVING MUSIC RETAILERS FOR 15 YEARS

SCOTT'S

one stop

2507 Roosevelt Avenue
Indianapolis, Indiana 46218-3693

1 800 428-4165
FAX 1 317 639-5573

WEEKLY FLYER

SAME DAY SHIPPING

ONLINE INVENTORY SYSTEM

EXTENSIVE CLASSICAL SELECTION

AUTOMATIC RETURN AUTHORIZATIONS

SPECIAL PRICES
NEW RELEASES
&
WEEKLY SPECIALS

TRY US ON
YOUR "OUTS"

Labels Imported: Ambiances Magnetiques (Canada), Auf Dem Nil (Italy), Bauta (Sweden), Dossier/Ear-Rational (Germany), Mantra (France), Multi-mood (Sweden), Rec Rec (Switzerland), ReR (UK), FMP (Germany), Victor (Canada).

MASSACHUSETTS

Artec Dist., Inc.-Boston Area, 65 Shawmut Rd., Bay 7, Canton, 02021, (617) 821-2700, (800) 451-5160, Branch Mgr.: Marcel Cayia. (Compact Disc, Pre-Recorded Audio Tape, Video (Cassette & Disc)) (Distributor, Rackjobber)
Labels Distributed: Audio: See Vermont Listing for product lines.

BMG Dist., 100 River Ridge Dr., #105, Norwood, 02062, (617) 255-0200, Fax: (617) 255-0209, Branch Mgr.: Mike Tawa; Sales Mgr.: W. Southards. (Compact Disc, Pre-Recorded Audio Tape, Video (Cassette & Disc), Records) (Distributor)
Labels Distributed: Audio/Video: See New York Listing For Product Line.

Baker & Taylor Video, 960 Turnpike St., Canton, 02021, (617) 821-2730, (800) 245-1172, Fax: (617) 821-1983, Sales Mgr.: Rick Ripley. (Distributor, One-Stop)
Labels Distributed: Audio/Video: See Illinois Listings For Product Lines.

Dick's Record Co., Inc., PO Box 208, 890 Providence Hwy., Dedham, 02026, (617) 326-8790, Fax: (617) 461-1472, Pres./Buyer: Richard Peach; Mgr./Buyer: Jim Mahan. (Compact Disc, Pre-Recorded Audio Tape, Records (12-Inch, Singles)) (One-Stop).

Horizon Dist. & Promo., 19 Lexington Ave., Hyde Park, 02136, (617) 361-5058, Owner/Buyer: Terry Grant; Mgr.: Merle Bicknell. (Distributor)

Labels Distributed: Audio: Olivia, Redwood, Ladyslipper, Iceberg, Flying Fish, Windham Hill, Shanachie, Kaleidoscope, Rising Sun (Arlo Guthrie), Hearts of Space, Halpern Sound, Rosetta, Global Pacific, Invincible, Sona Gita, Narada, Sounding of the Planet, Coyote, Spinning, Cypress, Gold Castle, Red House, Rabbit Ears, Shoreline, Elephant, Gentle Wind, Kids, RS, Discovery, Pacific Cascade, Second Wave, Music of the World.

MCA Dist. Corp., 400 W. Cummings Pike, Ste. 6900, Woburn, 01801, (617) 933-9290, Fax: (617) 932-0453, Regional Branch Mgr.: Rich Grobecker; Regional Mktg. Specialist: Kevin Twitchell. (Distributor)
Labels Distributed: Audio/Video: See California Listing For Product Line.

Malvern Dist. Inc., New England, 329 Washington St., Woburn, 01801, (617) 933-7346, Fax: (617) 933-7459, Sales Mgr.: Stan Goodman.

Labels Distributed: Audio: See New York Listings For Product Line.

Music Suppliers, Inc., PO Box 116, Needham Heights, 02194, (617) 444-9310, Pres.: Gordon Dinerstein; Buyer (Pre-Recorded Music): Vahan Aghajanian; Mgr./Buyer: Carol Dinerstein. (Compact Disc, Pre-Recorded Audio Tape) (One-Stop, Rackjobber)

Nert of New England, PO Box 268, Lawrence, 01842, 641 Haverhill St., Lawrence, 01841, (508) 686-4293, Pres./Buyer: Jerry P. Marcus. (Compact Disc, Pre-Recorded Audio Tape, Video (Cassette & Disc), Records (LP's, 12-Inch, Singles), Cutouts, Overstock, Computer Games, Accessories) (One-Stop, Exporter)

Products/Accessories: CD, Tape & Record Products: Discwasher; Storage & Carrying Cases: Savoy-Posso, Case Logic; Blank Tape: Maxell, Sony, TDK, BASF; Batteries: Eveready, Duracell; Diamond Needles: Pfanstiehl.

Off Beat Records Inc.

165 Front St., Tower #B, Chicopee, 01013, (413) 594-7552, (800) 395-2328, Fax: (413) 592-6055, Pres./Buyer (Video): Barry Grant Clark; Mgr./Buyer (Accessories): Gayle Crochiere; Buyers (Pre-Recorded Music): Barry G. Clark, Steve Maynard, Minnie Reardon. (Compact Disc, Pre-Recorded Audio Tape, Video (Cassette & Disc), Records (LP's, 12-Inch), Cutouts, Overstock, Accessories) (Distributor, Rackjobber, Importer, Exporter)
Labels Distributed: Audio: Vanguard, Tomato, Dcc Grateful Dead Records, Castle Communications, See for Miles, TVT, Knight Rider, OneWay, CBS Collectors Series, Sony Special Products, MCA Special Product, Chess Rec., Dejavu, Masters, Performance, Off-Beat; Video: Video Deletions, Overstock, Music Video Only.

Cutouts/Overstocks: All major label Product specializing in Independent, Laternative Domestic + Import labels. Labels Imported: England: Ace, Charly, Cardine, Mute, Virgin, EMI, Sonet; France: New Rose; Germany: Enys All Major + Independent Label Items.

Products/Accessories: CD, Tape & Record Products: Cassettes Norellco Boxes, CD Jewel Boxes; Blank Tape: Sony.

Peter's Record One-Stop, PO Box 212, Norwood, 02062, (617) 769-8340, Pres.: Peter McDermott; LP, Tape, CD Buyer: Donald Moscatelli. (Compact Disc, Pre-Recorded Audio Tape, Records) (One-Stop).

Prime Cut's Disc Distributors of New England, 262 Hollis St., Framingham, 01701, (508) 875-5745, Fax: (508) 875-5973, Pres./Buyer: Thomas J. Salem; Mgr.: Lori Salem. (Compact Disc, Records (LP's, Singles)) (Distributor, One-Stop)
Labels Distributed: Audio: RCA, Motown, Eric, American Pie, Ripete, Capitol, Laurie, MCA, Arista, CBS, Rhino, PolyGram, A & M, Rock'n Mania, WEA, Classic. Pay-Per Transaction.

Rounder Records Dist., One Camp St., Cambridge, 02140, (617) 354-0700, Fax: (617) 491-1970, Sales/Gen. Mgr.: Duncan Browne; Warehouse Mgr.: Peter Wetherbee; Contact: Steve Burton(Majors). (Compact Disc, Pre-Recorded Audio Tape, Video (Cassette & Disc), Records) (Distributor)
Labels Distributed: Audio: Alligator, Ace, Arhoolie, Delmark, Demon, DRG, Flying Fish, Green Linnet, Carthage/Hannibal, Heartbeat, Messidor, Mobile Fidelity, Murray Hill, RAS, Rounder, Philo, Shanachie, Speciality, Sugar Hill, Rykodisc, Swallow, Trojan, Twin Tone, Vanguard, Vee Jay, Womad; Video: Arhoolie, Barzton, Brazos, Caravan of Dreams, Central Sun, Fairport Assoc., Flower Films, Giorno Video, Rhapsody Films, Swallow, United Group Harmony Assoc., Video Artists Int'l, View Video.

Royal Dist., 262 Hollis St., Framingham, 01701, (617) 328-1822, (508) 872-1822, Owner/Buyer: Aaron Gross. (Compact Disc, Pre-Recorded Audio Tape, Records, Overstock) (One-Stop).

Star Video Entertainment L.P., 25 South St., Hopkinton, 01748, (508) 435-9701, (800) 446-1248, Vice Pres.: Wayne Mogel; Sales Mgr.: Mike McInnis. (Distributor)
Labels Distributed: Audio: Books On Tape; Video: See New Jersey listing for product line.

Warner/Elektra/Atlantic Corp., 8 Winchester Pl., Winchester, 01890, (617) 721-1991, New England Field Sls Mgr: Dann Cotter; Buyer: Don Cotter. (Records) (Distributor)
Labels Distributed: Audio: Warner, Elektra, Atlantic Labels.

MICHIGAN

Action Music Sales, Inc., 14611 E. Nine Mile Rd., East Detroit, 48021, (313) 779-1380.

Angott Record & Tape Sales, Inc., 2616 Puritan Ave., Detroit, 48238, (313) 341-7053, Fax: (313) 341-1511, Vice Pres.: Ken Walker; Buyer (Pre-Recorded Music): Steve Roberts, Frank Davis; Buyer (Videos): Mark Goulet; Buyer (Other): Reggie Herrell. (Compact Disc, Pre-Recorded Audio Tape, Video (Cassette & Disc), Records (LP's, 12-Inch, Singles), Accessories) (One-Stop).

Aspen Records, 18720 Wyoming, Detroit, 48221, (Records) (Distributor).

BMG Dist., 200 Kirts Blvd., Ste. 600, Troy, 48084, (313) 362-2985, Fax: (313) 362-2686, Branch Mgr.: Bob Bean. (Compact Disc, Pre-Recorded Audio Tape, Video (Cassette & Disc), Records) (Distributor)

Labels Distributed: Audio/Video: See New York Listing For Product Line.

Commtron Corp., 35245 Schoolcraft, Livonia, 48150, (313) 422-9955, Fax: (313) 422-1171, Branch Mgr.: Bill Zolman; Asst. Mgr.: Lou Roods. (Distributor)
Labels Distributed: Audio/Video: See Iowa Listing For Product Line.

Educational Video, Inc., 27601 Schoolcraft, Livonia, 48150, (313) 427-5980, Pres./Sales Mgr.: Pamela Bonk. (Distributor).

God's World, 13533 W. 7 Mile Rd., Detroit, 48235, (313) 862-8220, Chief Exec.: Larry Robinson; Mgr.: Melissa Walker; Buyer (Pre-Recorded Music): M. Walker; Buyer (Videos): M. Walker; Buyer (Accessories): M. Walker. (Compact Disc, Pre-Recorded Audio Tape, Video (Cassette & Disc), Records (LP's), Cutouts, Overstock, Accessories) (Distributor, One-Stop).

The Gold Vault, 3113 Haskell St., Kalamazoo, 49007, (616) 349-9413, (800) 234-2158, Fax: (616) 343-1016, CEP/Buyer (Music): Daniel V. Druckenbrodt; Buyer (Music): Cheryl Druckenbrodt. (Records (Singles) (Distributor, One-Stop, Importer, Exporter)

Labels Distributed: Audio: Eric, Collectable, Ripete, Underground, Old Gold, Original Sound, Specialty, LeGrand, Stax, Rock N Mania, Fantasy, CBS, American Pie. Labels Imported: Old Gold (U.K.); Underground (Canada).

Goldenrod Distribution Inc., 1712 E. Michigan Ave., Lansing, 48912, (517) 484-1712, Fax: (517) 484-1771, Pres.: Ms. Terry Grant; Mgr.: Susan Frazier; Buyer (Pre-Recorded Music): Cathy Andrews. (Distributor)

Labels Distributed: Audio: Redwood, Flying Fish, Alcazar, Alligator, Audio & Video Prodn, BMG, Canyon, CEMA, Celestial Harmonies, Chakra, Dargason, Discovery, Green Linnet, Kaleidoscope, Koch, Lady Slipper, Music For Little People, Olivia, Red House, Raven, Rosetta, Rounder, Serenity, Soundings of the Planet, Talking Taco, Uni, Hearts of Space, Music of the World, Pure & Simple and others.

Handleman Co. Inc., PO Box 7045, Troy, 48007, 500 Kirts Blvd., Troy, 48084, (313) 362-4400, Fax: (313) 362-3615, Chrmn: David Handleman; Buyer (Pre-Recorded Music): S. Vice Pres.: Mario DeFilippo; Pres.: Stephen Strom; Asst. Vice Pres. Video Prods.: Dave Stevens. (Compact Disc, Pre-Recorded Audio Tape, Video (Cassette & Disc)) (Rackjobber).

Handleman Co., 1291 Rickett Rd., Brighton, 48116, (313) 227-2231, Branch Mgr.: Jeff Skipton; Opls. Mgr.: Rhonda Schneider; Sales Mgr.: Mark Griffins. (Compact Disc, Pre-Recorded Audio Tape, Video (Cassette & Disc)) (Rackjobber)

Labels Distributed: Audio/Video: See Michigan Listings For Product Distribution.

Harmony House Records, 1755 E. Maple, Troy, 48083, (313) 524-2800, Pres.: Carl Thom; Gen. Mgr.: Jerry Adams. (Pre-Recorded Audio Tape, Records) (Distributor, One-Stop).

LaVal Record Dist., 1327 Cobb St., Kalamazoo, 49007, (616) 342-5328, CEO: Val LaVal; Mgr.: Vincent Taylor; Buyer (Pre-Recorded Music): Val Taylor. (Records (LP's, 12-Inch, Singles)) (Distributor)

Labels Distributed: Audio: Soul Set, Bay Tone, LaVal, Vic, Dooto, Lock, T&L, Harold, Partee, Funky, Funky Finger, Tico. Len's One Stop, 13040 W. 7 Mile Rd., Detroit, 48235, (313) 342-5990, Owner: Mr. Walker. (Records) (One-Stop).

Levy Moe Entertainment Music Div., 4245 44th St. SE, Grand Rapids, 49512, (616) 698-2340, Fax: (616) 698-2345, Vice Pres./Gen. Mgr.: Robert Hawley; Buyer (Pre-Recorded Music): Lou Busey; Buyer (Videos): Carol Kohn; Buyer (Accessories): Bob DeCoq; Buyer (Budget): Bill Heathcock. (Compact Disc, Pre-Recorded Audio Tape, Video (Cassette & Disc), Records, Cutouts, Computer Games, Accessories) (Rackjobber)

Products/Accessories: CD, Tape & Record Products: Gemini; Blank Tape: Denon, TDK, Maxell, Sony.

Major Video Concepts Inc., 12900 Richfield Ct., Livonia, 48150, (313) 591-0200, (800) 966-2802, Branch Mgr.: Dave Long; Sales Mgr.: Pat Charette; Credit Mgr.: Lillian Shriner. Labels Distributed: Video: See Indiana Listings For Product Distribution.

Gail K. Mayer Distributor, 4987 Lake Bluff Rd., West Bloomfield, 48323, (313) 683-0288, Pres.: Gail K. Mayer. (Distributor)
Labels Distributed: Audio: A&M Children's, Arhoolie, Astromusic, Audio Outlines, BMG, The Children's Group, Coden-White, Combs Music, Dargason, Gemini, Hearts of Space, High Windy, Invincible, Kids U.S.A., Lancaster Prod., Maggie's Music, Mardi Gras, Mish Mash Music, Music for Little People, Narada, Nichols-Wright, PAX, PGD, RC-BCP, Red House, Rounder, Round River, Shadow Play, Shining Star, Songsisters, Sugo, Turquoise, Uni, Raffi.

Motor City Music Distributing, Inc.

2628 Puritan Ave., Detroit, 48238, (313) 342-5550, (Distributor)

Labels Distributed: Audio: Best Recordings, Big Beat, Blues Factory, Inc., Blue Suit, D N A-Int'l, Hot Mix Five, Hot Prodn's, Inc., Ichiban, Jaguar, JCI, Joey Boy, Joyzee, K-Tel's Frontline Products, Luke, Nasty Mix, Newtown, On Top, Pandisc, Priority, Rap-A-Lot, R.L.P., Inc., RTR, Sam, Scorpio, Select-O-Hits, 75 Girls, Wild Pitch, Yo!

Nat'l Trends, Inc., 120 E. Columbia Ave., Pontiac, 48055, (313) 338-1210, (800) 322-8000, Contact: Jim George. (Records) (Distributor).

**It's Our Service
That Makes The Difference!**



**VINYL
VENDORS
Music Merchandisers**

**We sell it ALL!
AC/DC to Zappa... Bach to Zamfir
Compact Discs to Cassette Singles!**

**90% fill on 90% of your orders!
Box-lot prices!**

**Same day shipping!
Weekly new release mailer!**

**Professional Advice • Personal Service
Competitive Pricing!**

**Guaranteed initial orders for
all new customers!**

**SERVING OUR CUSTOMERS
SINCE 1975**

**3005 BUSINESS ONE DRIVE
KALAMAZOO, MI 49001
(616) 383-6200
FAX (616) 383-6216
1-800-446-0006**

Old Fogey Dist., PO Box 14210, Lansing, 48906, 1100 N. Washington, Lansing, 48901, (517) 372-7888, Fax: (517) 372-5155, Owner: Stan Werbin; Mgr./Buyer: Robin Pilger; Buyer: Carrie Rowe. (Distributor)

Labels Distributed: Audio: Rounder, Shanachie, Flying Fish, WEA, Alligator, Green Linnet, Rebel, Smithsonian/Folkways, Blacktop, Blind Pit, Taylor Park, CMH, Acorn, Alcazar, Biograph, County, Dargason, Delmark, Fogarty's Cove, Folk Legacy, Fossil, Front Hill, Guard, Kaleidoscope, Kicking Mule, Marimac, Metamora, Git Boy, Old Homestead, Arhoolie, Philo, Roheen, Sugar Hill, Swallow, Yazoo.

Spring Arbor Dist., PO Box 985, Belleville, 48111, (313) 481-0900, Fax: (313) 483-9560, Pres.: Glenn Bailey; Mgr.: Allen Knight; Buyer (Pre-Recorded Music): Margene Frownfelder; Buyer (Videos): Donna Alatti; Buyer (Print): Bill Washburn. (Distributor)

Labels Distributed: Audio: Several—mostly Christian; Video: Several—Mostly Christian.

Pay-Per Transaction.

State Wide Distributing, PO Box 157, 223 W. Main, Pottersville, 48876, (517) 645-8044, Fax: (517) 645-2389, Owner/Buyer (Access.): Norman Martens; Mgr./Buyer (Music, Video): Mark Martens; Advertising: Marie Martens. (Compact Disc, Pre-Recorded Audio Tape, Video (Cassette & Disc), Accessories) (Distributor, One-Stop, Rackjobber)

Labels Distributed: Audio: Ted Nugent Bowhunters World Records.

Products/Accessories: Storage & Carrying Cases: Case Logic; Blank Tape: Maxell, TDK, Sony, Dennon, Memorex.

Tant Ent's., Inc., PO Box 236, 4319 Fruitvale Rd., Montague, 49437, (616) 894-9063, Fax: (616) 894-4164, Pres./Mgr./Buyer: Billie W. Thomas. (Distributor)

Labels Distributed: Audio: Flying Fish, Alligator, Adelphi, Blind Pig, Blues R&B, CSP, Delmark, Demand Performance, Giants of Jazz, Good Time Jazz, Harlequin, Hightone, Hind-sight, Homespun, IAJRC, Kingsnake, MCA, Merrymakers, Modern Blues, Old Homestead, Pearl, Red Beans, Red House, RCA, Rounder, Shanachie, Sounds Great, Starline, Stash, Stomp Off, Sugar Hill, Tom, Totem, Vanguard, Yazoo.

Total Music Distributors, 2400 E. 30 Rd., Cadillac, 49601, (616) 775-5399, Mgr.: Roy Newland. (Compact Disc, Pre-Recorded Audio Tape, Accessories) (Distributor, Rackjobber)

Labels Distributed: Audio: You Guys (Youper Tapes).

Products/Accessories: Blank Tape: TDK.

Video Trend, Inc., 12900 Richfield Ct., Livonia, 48150, (313) 591-0200, (800) 966-2802, Fax: (313) 591-7662, Vice Pres./Gen. Mgr.: Dave Long; Sales Mgrs.: Jeff Zorn, Pat Charette; Buyer: Joan Guirlanda. (Distributor)

Labels Distributed: Video: See Illinois listing for distribution.

Vinyl Vendors

3005 Business One Dr., Kalamazoo, 49001, (616) 383-6200, Fax: (616) 383-6216, Pres.: Jeff Boyd; Buyers (Pre-Recorded Music): Don Stickroe, Howard Lutomski, Cathy Calme; Buyer (Videos/Accessories): J.W. Farris. (Compact Disc, Pre-Recorded Audio Tape, Video (Cassette & Disc), Accessories) (Distributor, One-Stop, Rackjobber)

Products/Accessories: CD, Tape & Record Products: Allsop, Discwasher, Pfan Tone, Memorex; Storage & Carrying Cases: Case Logic, Nappa Valley, Alpha, Lift, Open Stock, Clik Case, Tree Dimensions; Blank Tape: Denon, Maxell, Memorex, Sony, TDK; Head Phones: Sentry.

MINNESOTA

BMG Dist., 4570 W. 77th St., Ste. 101, Edina, 55435, (612) 896-1300, Fax: (612) 896-1304, Dir.: Tom White. (Compact Disc, Pre-Recorded Audio Tape, Video (Cassette & Disc), Records) (Distributor)

Labels Distributed: Audio/Video: See New York Listing For Product Line.

Brown Bros., Inc., 3346 N. Washington Ave., Minneapolis, 55412, (612) 522-6648, Pres.: Raymond W. Brown; Mgr./Buyer (Music): Richard E. Brown. (Records (Singles) (One-Stop).

Dart Distributing Inc., 1815 W. River Rd., N., Minneapolis, 55411, (612) 529-9571, Fax: (612) 529-1017, Pres./Budget & Promo.: Merrill Kirsch; Buyer (Pre-Recorded Music): Joel Corryell; Buyer (Videos): Tom Kellogg; Mgr./Buyer (Accessories): Tony Kirsch. (Compact Disc, Pre-Recorded Audio Tape, Video (Cassette & Disc), Records (Singles, Cutouts, Overstock, Accessories) (Rackjobber)

Products/Accessories: CD, Tape & Record Products: Pfan-tone, Memorex, Maxell; Storage & Carrying Cases: Dyna-sound, Case Logic, Imperial, Norse; Blank Tape: Maxell, Scotch, Memorex, Sony, TDK, Laser; Head Phones: Lebtex, Memorex; Batteries: Millenium rechargeables; Diamond Needles: Pfan-tone.

East Side Digital

530 N. Third St., Minneapolis, 55401, (612) 375-9188, (800) 468-4177, Fax: (612) 375-0272, Sales Mgr.: Brad Wroldstad, Contact: Brian Paulson. (Distributor)

Labels Distributed: Audio: Rykodisc, Grateful Dead, ESD, Green Linnet, Hannibal, Acoustic Disc, Crackpot, TEC Tones/Ralph.



OFFERING THE FINEST SELECTION OF CUTOUTS, OVERSTOCK, DELETIONS, IMPORTS, INDY AND ALTERNATIVE PRODUCTS ANYWHERE... LP, CASSETTE, CD's, Serving Wholesalers and Retailers Worldwide. Full Export/Domestic Service

CONTACT: 165 Front St • Tower #B • Chicopee, Mass. 01013
OFF-BEAT RECORDS 413-594-7552 / 1-800-395-BEAT / Fax 413-592-6055



MOTOR CITY MUSIC DISTRIBUTING, INC.

Michigan's Only Full Service Independent Warehouse
 Distributor Serving Michigan & Northern Ohio

2628 Puritan Ave., Detroit, Michigan 48238 • (313) 342-5550 • FAX# 313-342-8621



THE ELECTRIC fetus

ONE • STOP

2010 4th Avenue South
 Minneapolis, Minnesota 55404

(612) 870-1747
 TOLL FREE ORDERS:
1-800-328-5034

FULL LINE ONE-STOP
 MAJOR AND INDEPENDENT LABELS
 COMPACT DISCS • CASSETTES •
 CASSETTE SINGLES • VIDEO • ACCESSORIES •

SELECTION • SERVICE
 ★ PRE-ORDER PRICING
 ★ 3, 5, 10 COUNT AND BOX LOT PRICING
 ★ OPENING ORDER SERVICE
 SHIPPING PAID ON QUALIFYING ORDERS

OUR KNOWLEDGEABLE SALES STAFF SETS US APART

NAVARRE
CORPORATION

DISTRIBUTION FOR THE FUTURE

- Independent Label Music Product
- Distribution, Sales and Marketing Covering the Midwest, East & West Coast
- MINNEAPOLIS
6750 West Broadway
Brooklyn Park, MN 55428
Mike Gaffney (Vice President-Music)
Carole Glaser (Regional Sales Manager)
Jim Mossey (Buyer)
(612) 535-8333
- CHICAGO
504 Bensley
Calumet City, IL 60409
Darryl Colton (Regional Sales Manager)
(708) 891-1314

WEST COAST • MIDWEST • EAST COAST

The Electric Fetus, Inc.

2010 Fourth Ave. S., Minneapolis, 55404, (612) 870-1747, Fax: (612) 870-4664, Pres.: Keith Covart; Mgr.: Todd Haugesag; Buyer (Pre-Recorded Music): Bill Wade. (Compact Disc, Pre-Recorded Audio Tape, Video (Cassette & Disc), Records (LP's, 12-Inch), Accessories) (One-Stop)
Products/Accessories: CD, Tape & Record Products: Allstop, Discwasher, Memorex, Jewel Boxes; Blank Tape: Denon, Maxell, That's Audio.

Ingram Entertainment Inc., 2100 W. 96th St., Minneapolis, 55431, (612) 888-1719, Branch Mgr.: David Solomon. (Distributor)

Labels Distributed: Video: See Tennessee Listings For Product Distribution.

Lieberman Ents., 9549 Penn Ave. S., Minneapolis, 55431, (612) 887-5300, (800) 352-2802, Fax: (612) 887-9445, Pres./CEO: Gil Wachsman; Buyer (Pre-Recorded Music): Dusty Bowling; Buyer (Videos): Pat McDonough; Buyer (Accessories): Dave Rech; Vice Pres. New Bus.: Wim Stocks. (Compact Disc, Pre-Recorded Audio Tape, Video (Cassette & Disc), Records, Computer Games) (Rackjobber).

M C A Dist. Corp., 4530 W. 77th St., Ste. 220, Edina, 55435, (612) 835-6020, Fax: (612) 835-0795, Dir. Nat'l Accts.: Bill Pierce. (Distributor)

Labels Distributed: Audio/Video: See California Listing For Product Line.

M.S. Distributing Co., 4575 80th St., Circle #239, Bloomington, 55437, (612) 893-9915.

Mill City Music, 3019 27th Ave. S., Minneapolis, 55406, (612) 722-6649, Chief Exec.: John Kolstad; Mgr.: Barry Eiert; Buyer (Pre-Recorded Music): Dave Borsos. (Distributor)

Labels Distributed: Audio: American Gramophone, Narada, Time Line Prodn's., Revere, Solitudes, Combs Music, Sequoia, Peter Roberts Prodn's., Pure & Simple, Living Music, Lind Institute, Music West, NOME Co., Canyon, Madacy, St. Olaf Choir, Dale Wartland.

Navarre Corp.

6750 W. Broadway, Brooklyn Park, 55428, (612) 535-8333, Fax: (612) 533-2156, Contact: Mike Gaffney. (Distributor)
Labels Distributed: Audio: Airns, American Gramophone, Amherst, CMH, DCC Int'l, Fresh/Sleeping Bag, Hearts Of Space, Higher Octave, Hot, Invasion, Light, Living Music, Micmac, Music West, Nova, Optimism, Pathfinder, Quality, Restless, Shelter, Shining Star, Silverwave, Sonic Atmosphere, Sparrow, Spindletop, SST, Sugo, TBA, USA, Valley Vue, Visual Musik, Voss, Windstar, World One, Yo.

Paulstarr Distributing

3170 Ranchview Ln., Plymouth, 55447, (612) 559-8276, Fax: (612) 559-8353, Pres.: Joseph A. Cerami; Vice Pres./Gen. Mgr.: Scott Haidle; Vice Pres. Sales: "JC" Cerami; Buyer (Pre-Recorded Music): Larry Johnson; (Distributor)
Branch(es): 1452 Carol Ct., #3 B, Palatine, IL, 60067, (708) 590-0607, Regional Sales Mgr.: Jolene Nixon.
Labels Distributed: Audio: Artifax, Blue Plate, Country Music Foundation, Emerald Green, Happy Hour, Intrepid, Laurie, Nebula, Oh Boy, Orleans, Playback, Priority, Rap-A-Lot, Red Pajamas, Rhythm Safari, Scorpio, Tandem, Triad, World One.

Sight & Sound Distributors, 5186 W. 76th St., Minneapolis, 55435, (612) 835-5566, (800) 386-6641, Fax: (612) 835-0616, Branch Mgr.: Pat Donahue. (Distributor, Rackjobber)

Labels Distributed: Audio/Video: See St. Louis, Mo., home office listing for product line.

Twin City Import Records, Inc.

1263 Donohue Ave., Saint Paul, 55104, (612) 645-0227, Fax: (612) 645-1592, Pres.: John B. Carnahan; Mgr.: David E. Nelson; Buyer (Imports): Richard Elioff; Buyers (Domestic): Peter Bystol, Chad Nelson. (Compact Disc, Pre-Recorded Audio Tape, Video (Cassette & Disc), Records (LP's, 12-Inch, Singles)) (Distributor, Importer, Exporter)
Labels Distributed: Audio: Alias, Amrep, Byo, Ci/Z, Comm 3, Communion, Cruz, Dischord, Dr. Dream, Epitaph, Homestead, Moon, Mordam, N.R. Archives, Nemesis, Peaceville, Poshboy, Rave, Reckless, Restless, ROIR, Shimmy Disc, SST, Subterranean, Texas Hotel, Touch & Go, Toxic Shock, TVT, Twin Tone, Wax Trax, Staattape, Boner, DB Records, Crass, Matador.

MISSISSIPPI

Bennett Records Dist., 3109 Medgar Evers Blvd., Jackson, 39213, (601) 981-4328, Pres.: James Bennett. (Records) (Distributor, One-Stop)

R.D.I., 624 Robert E. Lee Dr., Tupelo, 38801, (601) 842-6401, Fax: (601) 842-3531, Pres./Buyer (Music): James L. Long; Mgr.: Gary M. Certain. (Pre-Recorded Audio Tape) (Rackjobber).

Stackhouse Delta Record Dist., 232 Sunflower Ave., Clarksdale, 38614, (601) 627-2209, Owner: Jim O'Neal; Mgr./Buyer: Julie Buchanan. (Distributor)
Labels Distributed: Audio: Ace, AL, Antone's, Arhoolie, Big Boy, Black Lable, Blue City, Blues Journey, Blue Suit, B.L.U.E.S. R&B, Cleo, Delmark, Double Trouble, Earwig, Flying Fish, High Water, Home Cooking, Intermedia, Jewel, Kent, LaJam, LeRoi du Blues, Modern Blues, OJL, Paula, Relic, Rooster Blues, Rustron, Swingmaster, Testament, Trumpet, Yazoo; Video: Juke Joint Saturday Night.

MISSOURI

CML, Inc., 660 Harding, Saint Louis, 63043, (314) 291-0608, Fax: (314) 291-0898, Pres./Buyer: D. Michael Stewart. (Compact Disc, Pre-Recorded Audio Tape, Video (Cassette & Disc), Accessories) (One-Stop)

Products/Accessories: CD, Tape & Record Products: Pfanstiehl, Discwasher; Storage & Carrying Cases: Case Logic; Blank Tape: TDK, Maxell, Sony, Denon; Head Phones: Pfanstiehl, Memorex; Batteries: Eveready.

Catholic Supply, 5851 Chippewa, St. Louis, 63109.
The Disc-Connection, PO Box 430097, 2743 Sutton Ave., Saint Louis, 63143, (314) 644-5174, Fax: (314) 644-5174, Owner/Mgr./Buyer (Music): Phil Steinberg; Buyer (Videos): Kieth Maceranka; Buyer (Accessories): Sherre Birenbaum; Buyer (Singles & 12"): Michael Erdere. (Compact Disc, Pre-Recorded Audio Tape, Records (LP's, 12-Inch, Singles)) (One-Stop).

E.T.D., Inc.-St. Louis, 1954 Innerbelt Bus. Center Dr., Overland, 63114, (314) 427-8080, (800) 321-4335, Fax: (314) 427-8302, Branch Mgr.: Chuck Spiedel. (Pre-Recorded Audio Tape, Video (Cassette & Disc)) (Distributor)

Labels Distributed: Audio: Promotional Lines; Video: All Major Studios & Most Independents.
Pay-Per Transaction.

Great Atlantic & Pacific Music Co., 3310 Samuel Shepard Dr., Saint Louis, 63103, (314) 531-4644, Fax: (314) 531-4646, Pres./Owner/CEO: Norman F. Hausfater; Sales Mgr. & Buyer: Lester Neal; Office Mgr.: Bill Price. (Compact Disc, Pre-Recorded Audio Tape, Video (Cassette & Disc), Records (LP's), Cutouts, Overstock) (Distributor)

Labels Distributed: Audio: Cutouts & Overstocks.
Handelman Co., 1800 Levee Rd., North Kansas City, 64116, (816) 421-0135, Branch Mgr.: Jim Scott; Sales Mgr.: Phil

Paulstarr

DISTRIBUTING

*Music distribution
for the independents.*

Minneapolis
Corporate Offices
3170 Ranchview Lane
Plymouth
Minnesota
55447
Tel 612 559 8276
Fax 612 559 8353

Serving the midwest

SALES

MARKETING

MERCHANDISING

PROMOTION



The listings contained in this publication are based solely upon information supplied to Billboard as of press time. All information is checked for accuracy as of that time. However, Billboard is not responsible for changes in management or any other related business associations that may supersede the listings contained herein.

Nunez. (Compact Disc, Pre-Recorded Audio Tape, Video (Cassette & Disc)) (Rackjobber)

Labels Distributed: Audio/Video: See Michigan Listings For Product Distribution.

House Distributors, 4128 Broadway, Kansas City, 64111, (816) 561-2744.

Lieberman Ent., Inc., 6131 Deramus Rd., Kansas City, 64120, (816) 231-2470, (800) 821-5064, Branch Mgr.: John Michael. (Compact Disc, Pre-Recorded Audio Tape, Video (Cassette & Disc), Records) (Rackjobber).

Mid-America Record Service, 7621 Troost, Kansas City, 64131, (816) 523-4080, (800) 759-6277, Fax: (816) 822-9478, CEO: Jan H. Fichman; Mgr.: Pat Kirk, Monica Girarard; Buyer: Phil Bourne. (Compact Disc, Pre-Recorded Audio Tape, Records, Cutouts) (One-Stop).

Music Ent. of Missouri, 24 Montauk Dr., St. Louis, 63146, (314) 991-8430, Fax: (314) 427-2229, Owner: Ken Schnitzmeier. (Distributor)

Labels Distributed: Audio: Bainbridge, Choice, Quartet, Discovery, Musicraft, Trend, AM/PM, GNP Crescendo, Creative World, Ktel, Arrival, Dominion, Era, Legend, Glendale, Giants of Jazz, Muse, Sea Breeze, Uptown, Benson Lables; Video: Benson Lables.

Record-Wide Distributors, Inc., 1755 Chase Dr., Fenton, 63026, (314) 343-7100, (800) 325-9690, Mgr.: Randell Lytle. (Pre-Recorded Audio Tape, Records, Cutouts, Overstock) (Distributor, Rackjobber).

Royal Mktg., 1421 W. 40 Hwy., Blue Springs, 64015, (816) 229-5084.

Sight & Sound Distributors, 2055 Walton Rd., Saint Louis, 63114, (314) 426-2388, (800) 366-6601, Fax: (314) 426-1307, Pres.: J. D. Mandelker; Buyer (Pre-Recorded Music): Tim Coggeshall; Buyer (Videos): Paul Stark; Buyer (Accessories): Paul Stark; Mktg. Coord.: Carol Craven; St. Louis Branch Mgr.: Dave Dawson. (Compact Disc, Pre-Recorded Audio Tape, Video (Cassette & Disc)) (Distributor, Rackjobber)

Labels Distributed: Audio: CEMA Dist. labels, CBS, MCA, PolyGram, M.S. Dist. labels, Peter Pan & Assoc., BMG Dist. labels, WEA Dist. labels; Video: AIP, Academy, Babe Winkelman, Buena Vista, CBS/Fox, CBS Music, Celebrity, Crocus, EMI, Fries, Goodtimes, Hanna Barbera, HBO, Imperial, IVE, J2, Lyons Group, Magnum, Maier Group, MCA/Universal, MGM/UA, MPI, Nelson/Orion, Paramount, Prism, RCA/Columbia, Republic Pictures, SGE Home Video, Sony, Southgate, Studio Ent., Turner Home Ent., Vestron Video, Vid America, Vidmark Ent., WEA, Wood Knapp.

Products/Accessories: Other: Wide assortment of NES video game titles.

WE DO WHAT'S EXPECTED FROM A ONE-STOP

ERTI

• Next Day Air & Saturday delivery available

• Flexible terms with qualified credit

• Broad selection and excellent fills

• Special promotions

• Pre-paid freight

• Weekly specials

13533 "I" CIRCLE • OMAHA, NE 68137 • 1-800-383-3257 • FAX 402-330-2272

East Side Digital

From the historic Warehouse District of Minneapolis directly to you ... the finest in contemporary sounds from these fabulous labels:

**ACOUSTIC DISC
CRACKPOT
ESD
GRATEFUL DEAD
GREEN LINNET
HANNIBAL
RYKODISC
TEC TONES/
RALPH**

530 North Third Street • Minneapolis MN 55401
612.375.9188 • facsimile 612.375.0272
3022 North Allen • Chicago IL 60618
312.772.0043 • facsimile 312.772.2115

call for a free catalog:
1.800.468.4177

**DISTRIBUTES THE FOLLOWING LABELS:**

ACCORD CLASSICS
 ACCORD JAZZ ANTHOLOGY
 ADES
 AUDIO EDITIONS BOOKS ON CASSETTE
 BEANSTALK CHILDREN'S RECORDINGS
 BERLITZ LANGUAGE COURSES
 BMG ITALY
 CABARET RECORDS
 CAM SOUNDTRACKS
 CAPRICE CLASSICS
 CAPRICE JAZZ
 DELPHINE RECORDS
 DISCHI RICORDI RECORDS
 HK RECORDS (BMG HONG KONG)
 KUBANEY RECORDS
 LMC
 MUSIDISC FRANCE
 NEW WORLD RECORDS
 POLYGRAM - FRANCE
 SILVA SCREEN SOUNDTRACKS
 SEA BREEZE JAZZ
 SIMON & SCHUSTER AUDIO
 SONY INTERNATIONAL (FRANCE)
 TH RECORDS & TAPES
 TOWN CRIER RECORDS

For More Information Call:

1-800-932-0625

TEL: 708-934-0870 • FAX: 708-934-6992

MONTANA

High Altitude Dist., Inc., 1120 E. Front St., Butte, 59701, (800) 735-7088, Fax: (406) 782-0747, Pres.: Craig Foley; Buyer (Pre-Recorded Music): Joe Barger. (Compact Disc, Pre-Recorded Audio Tape, Cutouts, Overstock, Accessories) (Rackjobber) Labels Distributed: Audio: Capitol, CBS, MCA, PolyGram, RCA, WEA, American Gramophone, Important, JCI, Disney, Book Of The Road, Metacom.
 Products/Accessories: CD Players: Pioneer; Audio & Video Playback Equipment: Pioneer; CD, Tape & Record Products: Memorex, Trackmate; Storage & Carrying Cases: Imperial, Case Logic; Blank Tape: Memorex, Denon.

NEBRASKA**RTI**

13533 "I" Cir., Omaha, NE, 68137, (402) 330-3013, (800) 383-3257, Fax: (402) 330-2772, Pres.: Bruce Hoberman; Vice Pres. Sales: Tom Weidner; Vice Pres. Merchandising: Bill Mulvey; Dir. of Music Merchandising: Mike Pichik; Merchandise Mgrs.: Billy Shearer, Diane Moore, Randy Hauser; Sales Mgr.: Music: Bill Ryan; Admin. Asst.: Alicia Simonsen. (Compact Disc, Pre-Recorded Audio Tape, Video (Cassette & Disc), Records (LP's, 12-Inch, Singles), Computer Games, Accessories) (One-Stop)
 Products/Accessories: CD Players: Magnavox, Sharp, Panasonic, Aiwa; Audio & Video Playback Equipment: Aiwa, Sharp, Magnavox, Panasonic, TEAC, Cerwin Vega; CD, Tape & Record Products: Allsop, Discwasher, Laser; Storage & Carrying Cases: Case Logic, Posso, Napa Valley, Tree Dimensions; Video Cassette Recorder: Panasonic, Magnavox, Samsung, Goldstar, Shintom; Blank Tape: Maxell, TDK, Sony, Fuji, Scotch, JVC, SKC, Laser; Head Phones: Koss, Recoton; Batteries: Millennium, Panasonic; Other: Componen Guard—Extended Warranty.

NEVADA

Lieberman Ents., 1095 Spice Islands Dr., #101, Sparks, 89431, (702) 331-5301, (800) 328-2960, Branch Mgr.: Buddy Parker. (Compact Disc, Pre-Recorded Audio Tape, Video (Cassette & Disc), Records) (Rackjobber).

Mountain Coin Machine Dist., 5675 S. Valley View, Las Vegas, 89118, (702) 798-0900, Fax: (702) 798-8431, Mgr.: Bill Britton. Labels Distributed: Audio: See Colo. listing for product line.

NEW HAMPSHIRE

Herrington Co., 3 Lymmes Dr., Londonderry, 03053.

NEW JERSEY

ABA Record Distributors, Inc., 175 Main St., Lodi, 07644, (201) 471-6543, Fax: (201) 471-7065, Chief Exec.: Ilias Panagakos; Mgr.: Michael O'Meara; Buyer (Pre-Recorded Music): Michael O'Meara. (Compact Disc, Pre-Recorded Audio Tape, Records (LP's, 12-Inch), Cutouts, Overstock) (One-Stop).

All Service One Stop, Inc.

950 Greeley Ave., Union, 07083, (908) 686-3500, Fax: (908) 686-7735, Pres./Buyer: Frank Di Marsico; Mgr.: John McGregor; Treas.: Edward Fredrick. (Compact Disc, Pre-Recorded Audio Tape, Video (Cassette & Disc), Records (LP's, 12-Inch, Singles), Accessories) (Distributor, One-Stop) Products/Accessories: Record, Tape & Video Program Accessories: Wide line of accessories including Lebo products.

American Digital, 573 Ridge Rd., North Arlington, 07031, (201) 945-3110, Fax: (201) 997-6621, Pres.: Irv Lukin; Mgr.: Tony Nardini. (Distributor)

Labels Distributed: Audio: DCC, Pair, Grateful Dead, Summertone, Performance, Acoustic Disc, San Francisco Sound, American Digi.

Cutouts/Overstocks: Relix, That's, Imports.

Products/Accessories: CD, Tape & Record Products: Wipe N Play; Blank Tape: Denon, Maxell, That's; Other: Allsop, Jewel Cases, Blister Packs.

American Music, Inc., 487 Hillside Ave., Hillside, 07205, (908) 687-4744, (800) 634-1625, Sales Mgr./Buyer: Drew Sadler. (Records) (One-Stop)

Labels Distributed: Audio: Dist. & export of independent 12-inch dance and rap product & hard-to get New York street labels.

American Record Sales, Inc.

PO Box 287, 1120 Crown Point Rd., Westville, 08093, (609) 848-1900, Fax: (609) 848-0808, Pres.: William R. Buster, Jr.; Vice Pres.: Antony W. Colombet; Contact: Jim Sunderlin. (Records) (One-Stop, Exporter)

Labels Distributed: Audio: Eric, American Pie, Rock'n Mania, Ripete, Laurie, Specialty, All 45-RPM Vinyl Oldies.

Ansonia Records, Inc., 750 Paterson Ave., East Rutherford, 07073, (201) 470-0301, Fax: (201) 470-8274, Pres.: Mercedes Glass. (Compact Disc, Records (LP's, 12-Inch)) (Distributor, Exporter)

Labels Distributed: Audio: Sony, BMG, Capitol, WEA, Ansonia, PolyGram.

Baker & Taylor Video, 22-J Worlds Fair Dr., Somerset, 08873, (201) 271-8100, (800) 245-1172, Fax: (201) 271-8131, Sales Mgr.: Don Goldberg. (Distributor, One-Stop)

Labels Distributed: Audio/Video: See Illinois Listings For Product Lines.

CEMA Dist.—New York Area, 3 University Park, Ste. 604, Hackensack, 07601, (201) 342-4900, (800) 524-0487, Fax: (201) 342-2319, Branch Mgr.: Gene Rumsey. (Distributor)

Labels Distributed: Audio: Owned: Capitol, EMI Records USA, SBK, Angel, Blue Note, Capitol Nashville, Capitol/EMI Latin; Joint Venture: Chrysalis, I.R.S.; Third Party: Barking Pumpkin, Bellmark, Rhino, Gold Castle, Curb, American Record Distribution.

E:MC Rhythm Ltd., Inc., PO Box 10167, Newark, 07101, 263 Central Ave., Ste. 6, East Orange, 07018, (201) 676-1375, Fax: (201) 673-2326, Pres./Buyer: Eric R. McPherson, Jr. (Compact Disc, Pre-Recorded Audio Tape, Records (LP's, 12-Inch, Singles), Cutouts, Overstock, Accessories) (Distributor, Rackjobber, Exporter).

Essex Entertainment, 560 Sylvan Ave., Englewood Cliffs, 07632, (201) 894-8700, Fax: (201) 894-8630, Managing Partners: Sam Goff, Richard Greener; Nat'l Sales Dirs.: T. Wolff, M. Cave, M. Basart; Dir. A & R/Mktg.: Doug Friedman. (Distributor)

Labels Distributed: Audio: Buddha, Maestro, Stradivari, Moss Music, Special Music, Pair, Arista Special Prods., CBS Special Prods., Capitol Special Prods., MCA Special Prods., PolyGram Special Prods., RCA Special Prods., Warner Bros Special Prods., Camden, Commodore.

Great Bay Dist.—New York Area, 40 Baldwin Rd., Parsippany, 07054, (201) 316-5866, Fax: (201) 316-0211, Vice Pres.: Andrew R. Miele Jr. (Distributor)

Labels Distributed: Audio: See Maryland listings.

Home & Industrial Video, 100 28th St., Fairlawn, 07410, (201) 777-4700, Fax: (201) 778-1257, Chief Exec.: Jonathan Cofino; Mgr.: Stu Sable; Buyer: Tom Croghan. (Distributor)

Labels Distributed: Video: Academy, CBS/FOX, Celebrity, Disney, FHE, Fox Hills, Hitops, Imperial, Ive, MCA, MPI, Magnum, Warner Nelson, New Star, Orion, Random House, Sony, Transworld, United.

ALL SERVICE**ONE STOP INC.**

950 Greeley Ave., Union, N.J. 07083
 (908) 686-3500, FAX# (908) 686-7735

WHOLESALE COMPACT DISC & TAPE DISTRIBUTORS**AUDIO & VIDEO**

ALL LABELS & ACCESSORIES
 EXPERTS IN JUKEBOX PROGRAMMING
 SPECIALISTS IN STORE OPENINGS
 BAZAARS, FAIRS, ETC.

PERFORMANCE**Retail Supplies • Indie Labels • Budget Music**

CD Blister Sealers, Blisters & Jewel Boxes • Shrinkwrapping Systems • Cassette Shells • Paper & Plastic Sleeves & Bags • Security Packaging • Blank Tape & Accessories • Divider Cards • Carrying Cases • Wood Storage • Patches, Photos and Backstage Passes • Comic Books • Complete Catalog

On Indie Labels • Budget CD's, LP's, Tapes & 45's

Call or write for your catalog today — Wholesale Only

2 Oak Street, New Brunswick, NJ 08903-0156

Tel: (908) 545-3004 Fax: (908) 545-6054

Ingram Entertainment Inc., 25 Branca Rd., East Rutherford, 07073, (201) 933-9797, Branch Mgr.: Jim Law. (Distributor) Labels Distributed: Video: See Tennessee Listings For Product Distribution.

J.J., 204 Grove St., Clifton, 07013, (201) 777-9100, (One-Stop) Lieberman Ents., 4 E. Stow Rd., Marlton, 08053, (609) 596-4000, (800) 582-7697, Fax: (609) 983-6169, Buyer (Pre-Recorded Music): Linda Metz; Buyer (Videos): Todd Hansen; Buyer (Accessories): Darrell Creckmur; Distribution Mgr.: Darrell Creckmur; Sales Dir.: Barry Hafft. (Compact Disc, Pre-Recorded Audio Tape, Video (Cassette & Disc), Records) (Rackjobber).

MDC, PO Box 953, Piscataway, 08855, (201) 560-9213, Fax: (201) 563-1731, Chief Exec.: B.J. Balbier; Mgr.: Peter J. McGrath. (Records (LP's, 12-inch, Singles), Cutouts, Overstock) (Distributor).

Movie Tape Exchange Inc., 328 S. White Horse Pike, Berlin, 08009, (609) 767-7339, Fax: (609) 767-3083, Vice Pres/Buyer: Tony DiBiacco; Mgr./Buyer (Music/Video): Warren Kahlenberg; Buyer: Cindi Seagrave. (Distributor).

One World Records

85 Fulton St., Unit 3, Boonton, 07005, (201) 263-2464, Fax: (201) 263-2364, Pres.: Christopher Spinosa. (Compact Disc, Pre-Recorded Audio Tape) (Distributor, Importer) Labels Distributed: Audio: Accord Classics, Accord Jazz Anthology, Ades, Audio Editions Books on Cassette, Bard Records (The Folger Consort), Beanstalk Childrens Recordings, Berlitz Language Courses, BMG Italy, Cabaret Records, Cam Soundtracks, Caprice Classics, Caprice Jazz, Delphine Records, Dischi Ricordi Records, Divucca Records, HK Records (BMG Hong Kong), Kubaney Records, LMC, Musidica France, New World Records, Polygram-France, Sea Breeze-Jazz, Simon & Schuster Audio, Sony Int'l (France), TH Records & Tapes, Town Crier Records.

Performance Distributors

PO Box 0156, 2 Oak St., New Brunswick, 08903, (908) 545-3004, Fax: (908) 545-6054, Owners: Stephen Kaplan, Arthur Marko; Mgr.: Jessica DiGiora, Independent Labels: Sal Dirico, Novelties: Keith Hydro. (Distributor) Labels Distributed: Audio: Ace, Adelph, Bak-Ta-Bak Pic-disks, Bomp, Castle, CD Presents Collectors, Db, Delmark, DRG, Flying Fish, Blind Pig, Giorno Poetry Systems, GNP, GH Tone, Homestead, Mardi Gras, Moxie, Mystic, Night Hawk, Paula, Performance, Posh Boy, Roir, Shimmy Disc, Skyclad, Stash, Sugar Hill, Sundazed, TVT, Twintone, Wax Trax.

Cutouts/Overstocks: Comics, Photos, Backstage Passes. Products/Accessories: CD, Tape & Record Products: Maxell; Storage & Carrying Cases: Coast; Blank Tape: Maxell, Denon; Head Phones: Maxell; Retail Operating Supplies; CD Blister, Jewel Boxes, Paper & Plastic Sleeves, LP Jackets, Cassette Shells, Shrinkwrap Film & Equipment, CD Blister Sealer.

Prime One Stop Dist., 131 N. Michigan Ave., Kenilworth, 07033, (908) 245-5252, Fax: (908) 245-6126, Pres.: Ralph Schechtman; Mgr./Buyer (Music): Neal Schechtman; Buyer (Video, Accys.): David Casey. (Compact Disc, Pre-Recorded Audio Tape, Records (Singles) (Distributor, One-Stop) Products/Accessories: CD, Tape & Record Products: Aim; Storage & Carrying Cases: Labo, Savoy; Blank Tape: TDK, Maxell; Head Phones: Stanton.

Princeton Record Exchange, 20 S. Tulane St., Princeton, 08542, (609) 921-0881, Pres.: Barry Weisfeld; Mgr.: Brian Dornbach; Buyer (Pre-Recorded Music): Don Rettman. (Retail).

Richman Bros. Records, Inc.

6935 Airport Hwy. Ln., Pennsauken, 08109, (609) 665-8085, (800) 233-3679, Fax: (609) 665-6358, Pres.: Jerry Richman; Head Buyer: Valerie Kargher; Singles (CD, Tape, Vinyl): Woody Dyer. (Compact Disc, Pre-Recorded Audio Tape, Video (Cassette & Disc), Records (LP's, 12-Inch, Singles), Cutouts, Accessories) (Distributor, One-Stop) Labels Distributed: Audio: Alcazar, Amazing, Ariwa, Alligator, Arhoolie, Antone, Blind Pig, Blacktop, Bainbridge, City Beats, Creative Funk, County, Comedy Int'l, CMH, Cole Harbour, DB, Delmark, Folk Legacy, Flying Fish, Freckle, Fogerty's Cove, Gateway, Green Linnet, High Power, Hightone, Heartbeat, Irish Int'l, Jass, June Appal, Kaleidoscope, Laurie, Ligosa, Music For Little People, Modern Blues, Mr. Rodgers, Nighthawk, Old Gold, Outergreen, Pax, Philo, Powerhouse, Rego, Rebel, Rass, Redhouse, Rainbow Morning, Rounder, ROIR, Spirit Feel, Sunsplash, Stash, Selecto Hits (SOH), Shanachie, Sugar Hill, Turquoise, USA, Varrick, Warlock and Yazoo. Products/Accessories: CD, Tape & Record Products: Discwasher, Memorex; Storage & Carrying Cases: Case Logic, Savoy, Tree Dimension, Service, Nappa Valley; Blank Tape: Maxell, TDK, Memorex, Denon, Fuji; Head Phones: Sentry, Calibron, Memorex; Batteries: Duracell; Diamond Needles: Pfanstiehl.

Henry Rosenberg & Assoc., PO Box 1451, Englewood Cliffs, 07632, (201) 569-6560, Fax: (201) 567-1565, CEO: Henry Rosenberg; Mgr.: Carol Green. (Distributor)

Labels Distributed: Audio: Special Music, Deja Vu, Satellite Industries; Video: Video Treasure, Best Films, 5th World (Spanish), United American, Silver Screen, Vid America, PPI.

Cutouts/Overstocks: MCA, RCA, Warner Bros, Atlantic, PolyGram.

Schwartz Bros., Inc., 1165 Markkress Rd., Cherry Hill, 08003, (609) 424-2211, (215) 923-1271, Fax: (609) 424-7897, Vice Pres./Branch Mgr.: Richie Salvador; Record Sales Mgr.: John Russo. (Compact Disc, Video (Cassette & Disc), Records (LP's 12-inch), Accessories) (Distributor) Labels Distributed: Audio: American Gramophone, Aegis, Atlanta Int'l, Beracah, Cheetah, CMC, Concord Jazz, DCC, 4 P.M., Grateful Dead, Ichiban, JCI, Little Major, Next Plateau, Nuage, On Top, Pair, Nasty Mix, Pandisc, Par, Project 3, Quality, Rap-A-Lot, Rykodisc, Sam, Sheffield Lab, Sin Drome, Vision, Walt Disney; Video: See Maryland listing for video & accessories distributed.

Products/Accessories: CD Players: Samsung, Teac; Audio & Video Playback Equipment: Samsung, Teac; CD, Tape & Record Products: Allsop, Geneva, Recoton; Storage & Carrying Cases: Case Logic, Savoy, Creative Point; Video Cassette Recorder: Samsung; Blank Tape: Maxell, TDK, Sony, Fuji, SKC; Head Phones: Sentry; Batteries: Kodak, Maxell; Other: Blank Jewel Boxes.

Branch(es): Serving New York/New England Areas, East 80, Rte. 4, Ste. 110, Paramus, 07652, (201) 909-0200, Fax: (201) 909-0363, Branch Mgr.: Ira Derfler. (Distributor)

Labels Distributed: Audio: Aegis, American Gramophone, Cheetah, Classic Artists, DCC Compact Classics, Dynamix II, East 11305, Exel, Grateful Dead, Great Northern Arts, Ichiban, Increase, Mardi Gras, One Way, Original Sound, Peter Roberts/Earth Sounds, Record Guys, Serenity/Great Northern Arts, Sheffield Lab, Soundings Of The Planet, Sumertone, Sugarhill, Sweet Rain, Triad, Vision, Warlock, Warwick, Yo; Video: See Maryland Listing For Video & Accessories Product Line.

Scorpio Music, Inc.

PO Box A, 2500 E. State St., Trenton, 08619, (609) 890-6000, Fax: (609) 890-0247, Pres.: John T. Gervasoni; Mgr./Buyer (Pre-Recorded Music): Steven S. Parelman. (Compact Disc, Pre-Recorded Audio Tape, Records, Cutouts, Overstock) (Distributor, One-Stop, Rackjobber, Importer, Exporter) Labels Distributed: Audio: Scorpio. Cutouts/Overstocks: CD's, Cassettes, LP's.

Sound N Vision Ents. Inc., 197 Kansas St., Hackensack, 07601, (201) 489-8644, Fax: (201) 489-0563, Pres.: Michael Rehani; Mgr.: Tima Rehani. (Video (Cassette & Disc), Ac-

Supplying the world with deletions for 22 years

A & M	Danya	Island	Omni	Scotti
Adelphi	Dark Horse	Jet	Optimism	Sefel
Ambient	Delicious Vinyl	Jive	Paisley Park	Shrapnel
Antilles	Delite	Kent	Palo Alto	Sire
Apple	Dunhill	King Snake	Pasha	Slash
Arista	Elektra	Kirschner	Passport	Sleeping Bag
Atco	EMI	Laserlight	Pausa	Smash
Atlanta	Enigma	Liberty	Philly World	Solar
Atlantic	Esparanza	Live & Learn	Philo	Soul Note
Bearsville	Excello	London	Polydot	Soundtown
Beserkley	First Priority	Manhattan	Portrait	Spindletop
Birthingright	Flying Fish	Mausoleum	Profile	Sugarhill
Blue Note	Gordy	MCA	Owest	Sutra
Blue Thumb	Gramavision	Megaforce	RAS	Tabu
Capitol	Greenworld	Megatone	RCA	Tamla
Capricorn	Grudge	Mercury	Relativity	TBA
Caroline	Grunt	Metal Blade	Relix	Tommy Boy
Carthage	Hannibal	MGM	Reprise	Total Experience
CBS	Heartbeat	Milestone	Rhino	Varrick
Celluloid	HME	Monument	Rohit	Vee Jay
Cold Chillin'	Hollywood	Nastymix	Rolling Stones	Vertigo
Columbia	Ichiban	Nonesuch	Rough Trade	Verve
Combat	Impulse		Rounder	Virgin
CTI	IRS		RSO	W-B



CD's as low as .75¢
LP's as low as .15¢
Cassettes starting at .30¢

All available, deletions, overstocks, cut-outs, and surplus.

7 million units in stock

scorpio music, inc.

Guaranteed Lowest Prices

2500 E State Street
Trenton, NJ 08619 USA
Phone: 609-890-6000
Telex: 843366
Fax: 609-890-0247

cessories) (Distributor, Importer, Exporter)
Labels Distributed: Audio: Pancakes; Video: V-O, T-120 and special length bulk video tapes (T-10 to T-105).
Labels Imported: Hong Kong, Korea.
Products/Accessories: Blank Tape: T-120 (Brand: 'Sound N Vision').

Sound Solutions, formerly RecTrack (USA)

PO Box 6150, 39 Veronica Ave., Somerset, 08875, (908) 846-0055, Fax: (908) 846-7769, Pres.: Robert Marin. (Distributor)
Labels Distributed: Audio: Point, Zillion, See For Miles, Magnum, Castle Communications, Trojan, Demon, Arabesque.

Star Video Entertainment, L.P., 550 Grand St., Jersey City, 07302, (201) 333-4600, (800) 354-5432, Fax: (201) 333-1609, Pres.: Bernard Herman; Mgr.: Daniel Miron; Buyer (Videos): Marty Yanega, Apollo Duncan; Vice Pres.: Arthur Bach. (Distributor)
Labels Distributed: Audio: Books On Tape; Video: Academy, Celebrity, Coliseum, Disney, Family, FRIES, Goodties, Imperial, J2, Key, Magnum, MCA, Media, MGM, Nelson, Republic, Orion, Orville Red, Paramount, Pacific Arts, Playhouse, Prism, Random, RKO, Hal Roach, RCA, Shapiro

Glickenhau, SVS, CBS, HBO, Vestron, Vid America, Video Treasure, Vidmark, Warner.
Surplus Records, 560 Sylvan Ave., Englewood Cliffs, 07632, Fax: (201) 894-0429, Vice Pres.: Michael Maslin. (Cutouts) (Distributor)
Cutouts/Overstocks: Largest Dist. Cut Outs & Overstock.
Titan United Corp., div. Colony Group Inc., 69 Van Reipen Ave., Jersey City, 07306, (201) 659-6006, Fax: (201) 659-0527, CEO: M. Roerber. (Distributor)
Labels Distributed: Audio: Represents Mfrs. To The Military Only.

U.S. Laser Video Distributors, 561 Bloomfield Ave., Verona, 07044, (201) 239-7978, Fax: (201) 239-1474, Pres.: David Goodman. (Distributor, One-Stop)
Labels Distributed: Video: A & M, CBS/Fox, Criterem, Disney, Lumivision, MCA, MGM/UA, New Visions, PolyGram, Republic, WEA.

US Record Dist., 132 W. Main St., Rahway, 07065, (908) 862-7208, Pres./Buyer: Robert Meehan; Mgr./Buyer: Steve Capra. (Compact Disc, Pre-Recorded Audio Tape, Records, Cutouts, Overstock) (Rackjobber, Exporter)
Cutouts/Overstocks: Cutouts, all labels.
Pay-Per Transaction.

Video Cassette Sales, Inc., 1767 Morris Ave., 1st Floor, Union, 07083, (213) 822-0882, Mgr.: Jonathan Kiser. (Distributor)
Video Treasures, 1767 Morris Ave., Union, 07083, (201) 964-5604, Fax: (201) 964-6946, Vice Pres.: George Port.

(Distributor)
Videotakes, PO Box 648, 187 Parker Ave., Manasquan, 08736, (908) 528-5000, Fax: (908) 528-5009, Pres.: Joe Kennedy; Dir. Opns.: Victoria Kennedy. (Distributor, Fulfillment Agent)
Labels Distributed: Video: PBS Home Video, Paramount, Vestron, MCA, Rhino, Warner, Pacific Arts, Kultur, IVE, Rand McNally, Video Visits, Holiday Film Corp., Best Film, View Video.

Vista Sounds Int'l, Inc.

215 Englewood Ave., Englewood, 07631, (201) 568-0040, Fax: (201) 568-2599, Pres.: Jeffrey Collins; Buyer: Mark Richards. (Compact Disc, Pre-Recorded Audio Tape, Records (LP's, 12-Inch), Cutouts, Overstock) (Distributor, Exporter)
Labels Distributed: Audio: Brooklyn Groove Prods., In'D, Echo USA, Dancefloor, Hangman, Proton, Strictly Rhythm, Nu-Groove, 4th Floor, Plus 8, Underground Resistance, Big Shot/Blast, Easy Street, E-Legal, Strobe, Right Area, Shockwave, Out Cut, Bottom Line, West Side, Sugar Hill, Rave, F.B.B., High Frequency, First Choice, Ace Beat, Atmosphere, Seige, Clubhouse, City Limits, Rey D, 247, E motive, Cupid, Euromixx, etc.
Labels Imported: United Kingdom, Germany, Belgium, Italy and Japan.

West Side Sound Distributors, Inc., PO Box 715, Tyler Park Sta., 1108 Grand Ave., North Bergen, 07047, (201) 866-5188, Fax: (201) 866-6219, Pres.: Arturo J. Saiz; Mgr.: Hector J. Varona; Buyer (Pre-Recorded Music): Manuel A. Montero. (Compact Disc, Pre-Recorded Audio Tape, Records (LP's)) (Distributor)
Labels Distributed: Audio: Seeco, Tropical, Bronjo, West Side, Raiz, A & S, Palacio.

VISTA SOUNDS INTERNATIONAL, INC.

DISTRIBUTORS OF DANCE MUSIC
ON 12" VINYL AND COMPACT DISC
FROM COAST TO COAST
WITH AN EXPORT DIVISION
THAT COVERS THE WORLD!

MOST INDEPENDENT LABELS AVAILABLE
PLUS MANY *EXCLUSIVE LINES:

- *American Dance
- *Big Shot/Blast
- *Classified
- *Dancefloor
- *Echo U.S.A. etc.

PLUS:
DANCE CLASSICS
BREAKS AND BEATS
D.J. MEGA-MIXES

VISTA SOUNDS INTERNATIONAL
215 Englewood Avenue
Englewood, N.J. 07631

Call, Write or FAX us
for our latest lists!

Tel: 201-568-0040
FAX: 201-568-2599



NEW MEXICO

Linden Distributors, 7400 Osuna Rd., NE, Albuquerque, 87109, (505) 884-8103, Owner: L. Blaschke; Buyer (Pre-Recorded Music): L.L. Blaskey; Buyer (Videos): L.L. Blaskey; Buyer (Accessories): L.L. Blaskey. (Compact Disc, Pre-Recorded Audio Tape, Video (Cassette & Disc), Records, Cutouts, Computer Games) (Rackjobber).
Mountain Coin Machine Dist., 2910 E. 4th St. NW, Albuquerque, 87107, (507) 345-7706, Fax: (507) 345-0865, Mgr.: Art Greiner. (One-Stop)
Labels Distributed: Audio: See Colo. listing for product line.

NEW YORK

AAA Pricerite Entertainment Corp.

PO Box 408, 61 Bennington Ave., Freeport, 11520, (516) 867-3770, Fax: (516) 867-3774, Pres.: Lawrence Sonin; Buyer (Pre-Recorded Music): Ricardo Leon; Buyer (Video & Cutouts): Lawrence Sonin. (Compact Disc, Pre-Recorded Audio Tape, Video (Cassette & Disc), Records (LP's), Cutouts, Overstock) (Distributor, One-Stop, Exporter)
Labels Distributed: Audio: Group labels from BMG, CBS, CEMA, PGD, Uni, Sony, WEA plus Adelphi, Alligator, Amazing, American Melody, Ansonia, Antones, Arhoolie, Audiophile, Bainbridge, Bantam, Biograph, Blind Pig, Blue Wave, Caedmon, Cassette Book Co., Chesky, Circle, Collectibles, Concord Jazz, Conversaphone, Cortina, Collectors Record Club, Creative World, Crystal, Delmark, Earwig and all labels listed in Spectrum & Opus.
Cutouts/Overstocks: All available labels.

A-A-A Record Hunter Dist. Co., 893 Broadway, 507 Fifth Ave. (10017), New York, 10003, (212) 986-6077, (212) 533-4303, Fax: (212) 533-1849, Pres.: Jay Sonin; Mgr.: Ira Hirsch; Buyer (Pre-Recorded Music): Sonin, Hirsch, F. Grimm; Buyer (Videos): J. Sonin, Foster Grimm; Buyer (Accessories): Sonin, Hirsch, Grimm; 12" & Dance Music Buyer: Sigmund Symzo. (Compact Disc, Pre-Recorded Audio Tape, Video (Cassette & Disc), Records) (Distributor, One-Stop, Exporter)
Labels Distributed: Audio: All major & independent labels (domestic and imported); Video: All major and independent labels.
Cutouts/Overstocks: Blank audio & video cassettes, accessories.

A-1 Record Sales, 528 W. 47th St., New York, 10036, (212) 246-1234, Mgr.: Otto Wilkerson. (Records) (One-Stop)
A.S.K. Dist. Corp., 244 E. Main St., Patchogue, 11772, (516) 654-1313, Fax: (516) 654-3995, CEO/Buyer: Alan Kusa; Buyer (Singles): Cathy Hunt. (Compact Disc, Pre-Recorded Audio Tape, Video (Cassette & Disc), Records (12-Inch)) (One-Stop)
Labels Distributed: Audio: Video Line is Music Only.
AV Comm Ltd., 21 Hanse Ave., Freeport, 11520, (516) 223-2570, Fax: (516) 223-2597, Chief Exec.: Sheldon E. Leibowitz; Buyer (Accessories): Alan Gangel. (Accessories) (Distributor)
Products/Accessories: Storage & Carrying Cases: Case Logic, Leslie Dame; Blank Tape: Denon, Maxell, TDK; Head Phones: LabTec, Sony; Batteries: Maxell; Diamond Needles: Pfanstiel & all major cartridges; Other: AV Comm Cables, wire & connectors.

Action Music Sales, Inc., 1800 Main St., Buffalo, 14209, (716) 883-2572.

African Record Centre Dist., 1194 Nostrand Ave., Brooklyn, 11225, (718) 493-4500, Fax: (718) 467-0099, (Compact Disc, Pre-Recorded Audio Tape, Video (Cassette & Disc), Records (LP's, 12-Inch), Cutouts, Overstock) (Distributor, One-Stop, Importer, Exporter).

Albany Music Distributors Inc., PO Box 5016, Albany, 12205, (518) 453-2203.

American Music Errands Inc., PO Box 5457, New York, 10185, (212) 330-0952.

American Video/Disc, Inc., 315 W. 57th St., Ste. 6A, New York, 10019, (212) 247-3188, (212) 246-4980, Fax: (212) 307-0359, CEO: David King; Pres.: Hope J. King; Int'l Vice Pres.: Warren Ashley, (Distributor, Exporter) Cutouts/Overstocks: LPs, 12-Inch discs, Cassettes, CDs, Videos, etc.

Antilla Record Distributors Inc., 661 Tenth Ave., New York, 10036, (212) 582-4546, Fax: (212) 977-7581, CEO/Mgr.: Xavier Hernandez; Buyer (Pre-Recorded Music): Jose Hernandez; Buyer (Videos): Jose Hernandez, (Compact Disc, Pre-Recorded Audio Tape, Video (Cassette & Disc), Records) (Distributor, One-Stop). Labels Distributed: Audio: Gema, CBS, Capitol, RCA, Rumba, Antilla, TH, Musart, Sonotone, Maype, WEA, Karen, RMM, Peerless, Algar, Orda, Borinquen, PDC, Aro, Ramex, PolyGram, Funny, Bravo, Luna, Marvela, Montilla, Suave, Salsoso, Marta, Manopla; Video: CBS.

Pay-Per Transaction.

Apon Record & Video Co., Inc., PO Box 3082, Steinway Sta., Long Island City, 11103, (718) 721-5599, CEO: Daria I. Poncic; Mgr.: Andrew M. Poncic, Jr.; Buyer (Pre-Recorded Music): Andrew M. Poncic, Jr. (Distributor, Importer, Exporter)

Labels Distributed: Audio: Apon, Amadeo, Discapon, Supraphon, Panton, Opus; Video: Apon, Love, Supraphon.

Arovox Record, 243 W. 18th Ave., New York, 10011, (212) 989-7200, Fax: (212) 633-8022, Pres.: Ervin Lilkei; Exec. Buyer: Larry Lipp; Buyer: Adelida Gomez, (Compact Disc, Pre-Recorded Audio Tape, Video (Cassette & Disc), Records, Computer Games) (Rackjobber, Exporter).

Artex Dist., Inc.—New York Area, 275 Edison Ave., West Babylon, 11704, (516) 420-0003, (800) 451-5160, Fax: (516) 420-0526, Branch Mgr.: Dominic Vilella, (Compact Disc, Pre-Recorded Audio Tape, Video (Cassette & Disc)) (Distributor, Rackjobber)

Labels Distributed: Audio: See Vermont listing for product lines.

BMG Dist., 1133 Avenue of the Americas, New York, 10036, (212) 930-4515, Fax: (212) 930-4398, Div. Pres.: Pete Jones; Sr. Vice Pres. Sales: Rick Cohen; Sr. Vice Pres. Mktg.: David Steffen, (Compact Disc, Pre-Recorded Audio Tape, Video

DUTCH EAST INDIA TRADING

Distributor/Exporter

The Direct Source For:

*Strange Fruit
(The Peel Sessions)
Homestead
Rockville
Dutch East Wax
Widowspeak*

Specializing In Import & US
Independent Labels

Call Or Write For A Free Catalog:
PO Box 800, Rockville Centre, NY 11571
Phone: (516) 764-6200 Fax: (516) 764-6315

★ **DEAL WITH THE PROFESSIONALS!** ★

PRICERITE IS • NOT A DEPARTMENT • NOT A DIVISION

**PRICERITE
DELIVERS!**

ORDERS SHIPPED 95% COMPLETE PROVIDED ITEMS ARE IN PRINT! ALL AVAILABLE LABELS!
BACK CATALOG AND SPECIAL ORDER CUSTOMERS GIVEN VERY SPECIAL ATTENTION.
Compact Discs • Cassettes • LP's • 12" Dance • Cassingles • Oldies • New Releases • And much, much more!
ALL TYPES OF MUSIC—YES, CLASSICAL ALSO!

✓ CORRECT DOCUMENTS

✓ COMPETITIVE PRICES

✓ PROMPT SHIPMENT

✓ SE HABLE ESPANOL

31 YEARS EXPERIENCE!

PRICERITE ENTERTAINMENT CORP.

61 Bennington Avenue • P.O. Box 408 • Freeport, NY 11520-0408
LAWRENCE SONIN, President • RICARDO LEON, Vice President
Phone (516) 867-3770 • Fax (516) 867-3774



**Music Is Our
Business!**

“Your Best Music Value” Is Now Your Sound Solutions



Formally RecTrack (USA)



**Service Is Our
Specialty!**

*For The Best Prices On CD's & Cassettes By
Demon Records - Arabesque, Ltd. - Trojan Records*

*Exclusive U.S. Distribution Of
Magnum Music Group - Castle Communications - See For Miles Records, Ltd.
Point Productions & Zillion Records*

TEL: (908) 846-0055

Somerset, N.J. 08875-6150

FAX: (908) 846-7769

NAVARRE
CORPORATION

**DISTRIBUTION
FOR THE
FUTURE**

- Independent Label Music Product
- Distribution, Sales and Marketing Covering the Midwest, East & West Coast
- NEW YORK
PO Box 128
Woodstock, NY 12498
Alan Marker (East Coast Manager)
(914) 657-6140

WEST COAST • MIDWEST • EAST COAST

**NORTHEAST
ONE STOP INC.**



**RECORD & TAPE ONE STOP
CD'S OUR SPECIALTY**

27 Warehouse Row • Albany, NY 12205
PH. 518-438-6153 • FAX 518-438-6995



specializing in **ROCK** for collector oriented stores. largest selection of U.S. & overseas **INDEPENDENT** labels. **50s & 60s ROCK, R&B, BLUES** reissues: **VINYL & CD's. IMPORTS** from France, UK, Australia, Sweden, Holland & more!! very competitive prices!
if the majors don't carry it, WE DO!
**IMPORT - EXPORT
MIDNIGHT RECORDS**
Box 390, Old Chelsea Sta., New York, NY 10011
(212) 675-2768 / FAX 212-7417230

We distribute
over 700
Jazz & Blues Labels
**NorthCountry
Distributors**
Cadence Building
Redwood, NY 13679
**315-287-2852
FAX: 315-287-2860**

**Fiesta The International Label
On Compact Disc And Cassette**
Servicing the Ethnic Market for the past 35 years
with Music from around the World
GERMAN SCOTTISH IRISH ITALIAN RUSSIAN MID-EASTERN
HUNGARIAN ISRAELI GREEK FRENCH HAWAIIAN POLKA
LATIN-DANCE STEELBAND and CALYPSO
Fiesta Record Company Inc.
251 Broadway • Lynbrook, New York 11563
Phone (516) 599-5522 Fax (516) 599-8766

(Cassette & Disc), Records (Distributor)
Branch(es): 1133 Sixth Ave., New York, 10036, (212) 930-4614,
Fax: (212) 930-4538, Branch Mgr.: C. Swedlow; Sales Mgr.:
B. Anderson.

Labels Distributed: Audio: RCA, A & M, Arista, BMG
Classics, BMG Int'l, Private Music, Grudge, Ariola, Beggars
Banquet, Bluebird, Bonsai, Cypress, Delos, Denon, Deut-
sche Harmonia Mundi, Eurodisc, Globo (Latin), Hacienda
(Latin), Jive/RCA, Melodia, Nempor, Nimbus, Noise/RCA,
Novus, RCA Victor, RCA Victor Gold Seal, RCA Victor Red
Seal, RCA/Curb, Shoreline, Silvertone.; Video: BMG Video,
6 West Home, A & M Video, RCA/Columbia Home Video,
BMG/Jive.

Big Apple Entertainment, 59-41 Maurice Ave., Maspeth, 11378,
(718) 417-5462, Fax: (718) 497-1791, Pres.: Rachelle Friedman;
Mgr.: Bill Lehman; Buyer (Pre-Recorded Music): B.J. Lober-
man; Buyer (Videos): Kim Corrigan. (Distributor)
Products/Accessories: Audio & Video Playback Equipment:
Shure, TDK, Maxell, WEA, Panasonic, ATT, Sony, TEAC,
Aiwa, Samsung, Scotch, Toshiba, Koss.

Bridge Records, Inc., GPO Box 1864, New York, 10116, (516)
487-1662, Fax: (516) 773-3397, Mgr.: Becky Starbin. (Com-
pact Disc) (Distributor, Exporter).

Buffalo One Stop, 1800 Main, Buffalo, 14208, (716) 883-2555,
Pres.: Leonard Silver; Mgr./Buyer: Larry Ver Hagen; Buyer:
Jim Primerano. (Compact Disc, Pre-Recorded Audio Tape,
Records) (One-Stop).

Campus Records

874 Albany-Shaker Rd., Latham, 12110, (518) 783-6698, (518)
783-6715, Fax: (518) 783-6753, Owner/Buyer: Bob Ellen-
bogen; Mgr./Buyer: Frank Harris. (Compact Disc, Records
(LP's, 12-Inch), Cutouts, Overstock, Accessories)
(Distributor, Importer, Exporter)
Cutouts/Overstocks: All major & Independent labels.

Caroline Records, Inc., 114 W. 26th St., New York, 10001, (212)
989-2929, Fax: (212) 989-9791, Pres.: Keith Wood; Mgr.: Dun-
can Huchison; Buyer (Pre-Recorded Music): P. Burgess,
Ashley Warren; Buyer (Videos): Paul Burgess. (Compact
Disc, Pre-Recorded Audio Tape, Video (Cassette & Disc),
Records (LP's, 12-Inch, Singles) (Distributor)
Labels Distributed: Audio: E'G, Editions E'G, Caroline, Blue
Plate, Venture, Frontline, Ill, Metal Blade, Megaforce, Plane
9, Sub Pop, Suicidal.

Cavages, Inc., 2600 Walden Ave., Buffalo, 14225, (716)
684-2600, Fax: (716) 685-2481, Pres.: Carl C. Cavage; Buyer
(Pre-Recorded Music): John D. Grandoni; Buyer (Videos):
John D. Grandoni; Buyer (Accessories): Thomas Kreppen-
neck. (Compact Disc, Pre-Recorded Audio Tape, Video
(Cassette & Disc), Records (LP's, 12-Inch), Cutouts, Ac-
cessories) (One-Stop)
Products/Accessories: CD, Tape & Record Products:
Recoton, Planstiehl; Storage & Carrying Cases: Napa
Valley, Service Mfg., Savoy; Blank Tape: Sony, TDK, Max-
ell, Memorex; Batteries: Eveready, Duracell; Diamond
Needles: Planstiehl.

Celluloid Records, 330 Hudson St., 4th Floor, New York,
10013, (212) 741-8310, Fax: (212) 741-8786, CEO: Jean
Karakos; Mgr.: Alexander Escoller; Buyer (Pre-Recorded
Music): Mark Painter. (Compact Disc, Pre-Recorded Audio
Tape, Records) (Distributor, Importer, Exporter)
Labels Distributed: Audio: French Celluloid, Charly, RAS,
Roir, US Celluloid.

Labels Imported: Labels from U.K., France, Africa.
Chambers Records & Video Corp., 2 Gramatan Ave., Mount
Vernon, 10550, (914) 699-1666, Fax: (914) 699-0724, Pres.:
Steven Rozenfeld; Buyer (Pre-Recorded Music): Gary Thal;
Buyer (Videos): Gary Thal; Mgr./Buyer: Gary Thal.
(Distributor, Mail order for libraries).

Labels Distributed: Audio: PolyGram, BMG, WEA, Sony,
UNI/MCA, CEMA, Harmonia Mundi, Koch Int'l, Quellton,
Allegro Imports, Albany, Independent labels; Video:
PolyGram, BMG, WEA, Sony, UNI/MCA, CEMA, Harmonia
Mundi, Koch Int'l, Quellton, Allegro Imports, Albany, In-
dependent labels.

Chin-Randy's Records, 1342 St. John's Pl., Brooklyn, 11213,
(718) 778-9470, Fax: (718) 778-8312, Owner: Victor Chin; Mgr.:
Monica Chin. (Records) (Distributor, One-Stop)
Labels Distributed: Audio: Chappy, Dynamic, Giant, Impact,
Randy.

Commtron Corp., 400 Airport Exec. Park, Spring Valley, 10977,
(914) 425-3191, Fax: (914) 425-7521, District Mgr.: Jeff Rouse;
Sales Mgr.: Steve Feldman. (Distributor)
Labels Distributed: Audio/Video: See Iowa Listing For Pro-
duct Line.

Coronet Delphine, Inc., Madison Ave., New York, 10022.
Countrywide Tape & Record Dist., Inc., PO Box 14247, 270
Oser Ave., Hauppauge, 11788, (516) 231-7171, Fax: (516)
231-8550, Pres./Buyer: Stanley Sirote; Sales Mgr.: Alan
McLachlan. (Distributor)
Cutouts/Overstocks: Cutouts and overstock from all
manufacturers.

Daro Exports, Ltd., 1468 Coney Island Ave., Brooklyn, 11230,
(718) 252-4355, Fax: (203) 261-1981, Pres.: Albert J. Okas.
(Compact Disc, Pre-Recorded Audio Tape, Video (Cassette
& Disc), Records (LP's, 12-Inch, Singles), Cutouts,
Overstock) (Exporter).

Disc-O-Rama Music World Dist., 186 W. Fourth St., New York,
10014, (212) 206-8417, Fax: (212) 741-0809, Pres./Buyer: Felix
Lo; Mgr./Buyer (Accessories): Simon Sassin. (Distributor)

Psychedelia • Heavy Metal • Punk • Jazz • Blues

Dance • Pop • Folk • Oldies •



Campus Records

Wholesale Distributor of
Deletions/Overstocks

874 Albany Shaker Road
Latham, N.Y. 12110
(518) 783-6698
(518) 783-6753 FAX

IMPORT

EXPORT

Thrash • Noise • New Age •

R&B • Electronic • 60's • Reggae • C&W • Industrial

*For a Unique Blend of Independent and
Major Label Closeouts and Overstocks*

**Ranked America's #1 One Stop
by Billboard Magazine***



- Over 500 Major & Independent Labels-55,000 Titles
- New Releases & TOP 100 Always At A Discount
- Same day Service
- Largest In-Stock Inventory In The U.S.
- Deep Catalog Specialists

Call Today And See Why We're #1

**CDs • CASSETTES • ACCESSORIES • CD5s
CASSETTE SINGLES • LASERDISC VIDEO**

New York 212-517-3737 Connecticut 203-798-6590
Los Angeles 213-388-9834 FAX 203-798-8852

*Annual Survey Of All Music Accounts, March 30, 1991

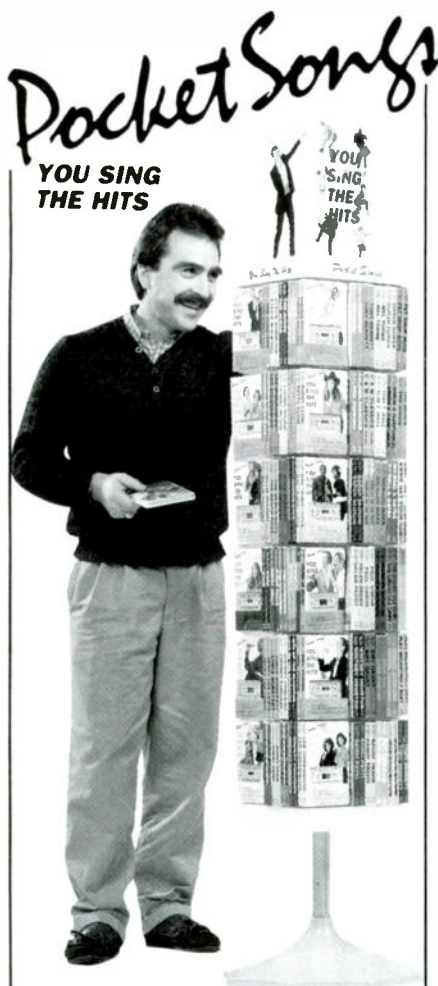

The largest Sing-along/Karaoke collection of tracks in the world. Pocket Songs have taken the retail music trade by storm. Singers world-wide are embracing this new way to sing. They now sing with the same quality backgrounds as provided to their favorite singers.

Over 5,000 songs are available in this exciting format. All have "removable vocals." That's right... just turn off the right speaker and the voice disappears, plus stereo tracks and printed lyrics. All Pocket Songs are 100% exchangeable. That means no unsold stock will remain in your store. If after six months, you feel the success of Pocket Songs is overstated, we'll accept your stock back and make a full refund, no questions asked!

Write for your Pocket Song sample. Learn what all the excitement is about.

For information or to order, call:

**1-800-Now Sing (669-7464), or
Fax: 1-914-591-5103.**

Carousel as pictured, available *Free* with initial order for 240 units.

Pocket Songs
YOU SING THE HITS

50 S. Buckhout Street
Irvington, New York 10533
(914) 591-5100

Labels Distributed: Audio: CBS/Sony, Warner Bros., PolyGram, RCA, Arista, Geffen, Atlantic, Epic, Chrysalis, Capitol, EMI, London, Phillips, Elektra, Motown, SBK, A&M, Rhino, Reprise, Mercury; Video: Vestron, RCA/Columbia, MCA, Buena Vista, Disney, CBS/Fox, Carolco, Paramount, Turner Video, MGM/UA, Warner Bros., Media, Republic, Embassy, Orion, HBO Video, Touchstone.

Pay-Per Transaction.
Products/Accessories: CD Players: Sony, Technics, Aiwa, Denon; Audio & Video Playback Equipment: Magnavox, Fisher, RCA, Toshiba, Sony, Hitachi; CD, Tape & Record Products: Discwasher, Royal Sound, Lebo; Storage & Carrying Cases: Case Logic, Nara Valley; Video Cassette Recorder: Sony, Magnavox, Fisher, Toshiba, Hitachi; Blank Tape: Maxell, TDK, Sony, Denon; Head Phones: Sony, Sennheiser, Aiwa; Batteries: Duracell; Diamond Needles: Pfanstiel.

Distribuidora Nacional de Discos, 442 E. 148th St., Bronx, 10455, (212) 993-5551, Fax: (212) 993-5553, Chief Exec.: L.R. Bernard; Mgr.: Dolores Vera. (Distributor).

Don Records Corp., 27 Grand Ave., Farmingdale, 11735, (516) 752-1770, Fax: (516) 752-1809, Pres./Buyer: Don Liberatore; Mgr./Buyer (Music): Diane Bennekemper. (Compact Disc, Records (Singles) (One-Stop).

Double Arrow Record Co., Inc.

43-50 11th St., Long Island City, 11101, (718) 786-5893, Fax: (718) 706-0014, Pres.: James C. Banthos; Mgr.: Jean E. Banthos. (Compact Disc, Pre-Recorded Audio Tape, Records (LP's)) (Importer)
Labels Imported: BBC, EMI (UK), Memoir, Music For Pleasure, President, Pickwick, and other UK Labels.

Dutch East India Trading

PO Box 800, 81 N. Forest Ave., Rockville Centre, 11571, (516) 764-6200, Fax: (516) 764-6315, Pres./Label Mgr.: Dutch East India: Barry Tenenbaum; Sales & Prodn. Mgr.: Terry Fillice; Buyer (Imports): Camille Sciarra; Buyer (Domestic): Jeff Gibson; Label Mgr.: Homestead Records: Ken Katkin; Label Mgr.: Rockville Records: Debbie Southwood-Smith. (Compact Disc, Records (LP's, 12-Inch)) (Distributor, Importer, Exporter)

Labels Distributed: Audio: Homestead, Rockville, Fire U.S., Widowspeak, Dutch East India Wax, SOL, 50,000,000,000,000,000,000,000 Watts, Nostradamus, Strange Fruit, Ace of Hearts, Restless, SST, Wax Trax, Mordam, Roir, Touch & Go, Taang, Shimmy Disc and many others.

Labels Imported: Red Eye, Black Eye (Australia); Flying Nun (New Zealand); Line (Germany); Beggars Banquet, 4AD, Sarah, Midnight, Wax, One Little Indian, Concrete.

E.R.S. Distributors, Inc., 20 Midland Ave., Hicksville, 11801, (516) 939-0060, (800) 645-6542, Fax: (516) 939-0765, Pres.: David Honigman; Exec. Vice Pres./Buyer: Stephen Honigman. (Accessories) (Distributor, Rackjobber)
Products/Accessories: CD Players: Toshiba, Magnavox, Hitachi, Lloyds; Audio & Video Playback Equipment: Toshiba, Magnavox, Hitachi, Lloyds; CD, Tape & Record Products: Recoton, Geneva, S. Tech, Gemini; Storage & Carrying Cases: Recoton, Solidex, Gemini; Video Cassette Recorder: Toshiba, Magnavox, Hitachi; Blank Tape: Sony (audio & video); Head Phones: Sony, Koss, Recoton, S. Tech; Batteries: Sony; Other: Fax machines, word processors, telephones.

East Coast Music Dist., 311 Willowbrook Rd., Staten Island, 10314, (718) 698-2280, Fax: (718) 761-6411, Mgr.: Joe Leung. (Compact Disc, Pre-Recorded Audio Tape, Records (LP's, 12-Inch), Cutouts, Overstock) (Distributor, One-Stop, Importer, Exporter)

Labels Distributed: Audio: All major group labels + American Gramophone, Athena Prods., Athena Records, Audiophile, Bainbridge, Cardas, Chesky, Clarity, CMP, Col-

legium, Concord Jazz, Creative Music Prods., Crystal, Fantasy/Prestige group, GRP, India Navigation, Jazzology, Joplin & Sweeney, Louisville, New World, North Star, Oriental, Pathfinder, Ravi Shankar, Reference, Sheffield Lab, Telarc, Varese Sarabande, Wilson.

Cutouts/Overstocks: Cut-outs & overstocks. Pay-Per Transaction.

Educational Media Co., 2878 Bayview Ave., Wantagh, 11793, (516) 781-7826, Owner/Mgr./Buyer: Al Rubin. (Records) (Distributor)

Labels Distributed: Audio: MZA, Disneyland, Folkways, Rounder, CMS, A & M, Artista, Youngheart, RS, Moose School, Ultrasound, American Melody, Round River, Caedmon, Flying Fish, Tom Paxton Records, CBS, Family Communications, Peter Pan, Wonderland, Barry Polisar Records, MZA.

Pay-Per Transaction.

Educational Record & Tape Dist. of America, PO Box 408, 61 Bennington Ave., Freeport, 11520, (516) 867-3770, Fax: (516) 867-3774, Pres.: Lawrence Sonin; Mgr./Dir. Sales: Jonathan Messeloff. (Compact Disc, Pre-Recorded Audio Tape, Video (Cassette & Disc), Records (LP's), Cutouts, Overstock) (Distributor, One-Stop, Exporter)

Labels Distributed: Audio: Suppliers to Schools, Libraries, Military, Government Agencies & Retail Stores for A&M, Action Tapes, Allegro, American Melody, American School Publishers, Astor, Audio-Forum, Bantam, B/B Records, Berlitz, Billy B, Brentwood, Caedmon, Children's Group, Cimino, Clearvue, Conversaphone, Dimension Five, Discovery, Disney, Dove Books On Tape, Dutton, Earth Mother Lullabies, Earwig, Elephant and others; Video: Walt Disney, Golden Book, Hanna-Barbera, Hap Palmer, Kidsongs, MGM/UA, My Baby Can Read, Random House, Sony, Starline, Twin Towers, View, Warner Home Video and other children's product.

Elegance & Zesty Records Distributors, 8027 Thurston Dr., Cicero, 13039, (315) 699-5613, (315) 699-7918, Pres./Mgr.: Sylvester Wallace Sr.; Buyer: Alicia Elaine Demps. (Compact Disc, Pre-Recorded Audio Tape, Video (Cassette & Disc), Records (LP's, 12-Inch, Singles), Accessories) (Distributor, Importer, Exporter) Labels Distributed: Audio: Elegance, Zesty, Nuff Said.

Encore Dist. Corp., 38-19 24th St., Long Island City, 11101, (718) 706-6300, Fax: (718) 361-6906, CEO: Nick Campanella; Buyer (Pre-Recorded Music): Murray Viscoso, CEO. (Distributor) Labels Distributed: Audio: Collectibles, Cheatah, Jass, Cur-tom, Ichiban, JCI Groups, Joey Boy, Laurie, M&R, Original Sound, On Top, Luke, Effect, Pandisc, Pathfinder, Metropolitan, Startrak, Esquire, SoundScreen, Pow Wow, Living Language, Unidisc, Voss, Coast To Coast, Epic, Chi, Sound, Jump Street, Kid Fest, Three Cherries, Unidisc (Import), Vinylmania, Voss, Suntown; Video: JCI, Kid Pics, Simitar, Childrens Video of America.

David Eskin, Inc., 400 Riverside Dr., New York, 10025, (212) 749-4757, Fax: (212) 316-3795, Chief Exec.: Rajna Eskin; Mgr.: David Eskin. (Compact Disc, Pre-Recorded Audio Tape, Video (Cassette & Disc), Records, Cutouts) (Distributor, Exporter)

Labels Distributed: Audio: Major Domestic & Independent Labels; Video: Domestic Labels.

Game Arts, 243 W. 18th St., New York, 10011, (212) 989-7200, Fax: (212) 645-5065, Mgr.: Jeff MacDonald; Buyer (Pre-Recorded Music): Jeff MacDonald. (Compact Disc, Pre-Recorded Audio Tape, Records (LP's, 12-Inch, Singles)) (One-Stop, Exporter)

Handieman Co./Albany, 3 Cornell Rd., Airport Park, Latham, 12110, (418) 783-5436, Branch Mgr.: Tom Novotny; Opns. Mgr.: Dan DiToro; Sales Mgr.: Jerry Wesol. (Compact Disc, Pre-Recorded Audio Tape, Video (Cassette & Disc)) (Rackjobber)

Labels Distributed: Audio/Video: See Michigan Listings For Product Distribution.

Harbor Record Export Corp., 10 Chestnut St., Liberty, 12754, (914) 292-3334, Fax: (914) 292-1550, Pres.: Michael H. Knack; Vice Pres.: Linda Reeves. (Compact Disc, Pre-Recorded Audio Tape, Video (Cassette & Disc), Records (LP's), Cutouts, Overstock, Accessories) (Exporter)

Labels Imported: Exports most USA labels and numerous independents.

Hope Int'l Prods. Ltd., 315 W. 57th St., Ste. 6-A, New York, 10019, (212) 247-3188, (212) 246-4980, Fax: (212) 307-0359, CEO: David King; Pres.: Hope J. King; Int'l Vice Pres.: Warren Ashley. (Distributor, Exporter)
Cutouts/Overstocks: LPs, 12-inch discs, Cassettes, CDs, Video, etc.

House of Guitars, Inc., 645 Titus Ave., Rochester, 14617, (716) 544-3500, Fax: (716) 544-8860, Pres./Accy. Buyer: Armand Scharbroeck; Mgr.: Greg Crack; Buyer (Pre-Recorded Music): Kim Simmons; Buyer (Videos): Lou Remeto; Buyer: Bruce Schaubroeck; Contact: Blaine Schaubroeck. (Compact Disc, Pre-Recorded Audio Tape, Cutouts) (Distributor, Importer, Exporter)

Labels Distributed: Audio: Mirror, House of Guitars, Darling, WEA, PolyGram, A & M, RCA, Arista, New Rose, CBS, Alligator, Maze, Caroline, Relativity, Catman, Telarc, Phillips. **House of Menorah**, 36 Eldridge, New York, 10002, (212) 925-7573, Fax: (212) 966-8524, Gen. Mgr./Buyer: Jonathan Tischler. (Compact Disc, Pre-Recorded Audio Tape, Video (Cassette & Disc), Records) (Distributor, One-Stop, Rackjobber, Importer, Exporter)

Labels Distributed: Audio: CBS, Hed Arzi, Galton, Hatakit, MA, Menorah and others.

IHR Inc., 146-05 130th Ave., Ozone Park, 11436.

★ ★ ★ ★ ★ ★ ★ ★ ★ ★ CHEAPEST PRICES

Wholesalers of
Cut-outs • Overstocks • Deletions

**CD's
LP's
Cassettes
T-Shirts
Music Books**

Export Specialist

WORLD TRADING CENTER, INC.

208 East 88 Street, Suite 3A
New York, NY 10128

Tel - 212-289-7997 • FAX - 212-860-5582

Important Record Distributors, 187-07 Henderson Ave., Hollis, 11423, (718) 740-5700, Fax: (718) 740-5660, Pres: Barry Kobrin; Buyer (Pre-Recorded Music): (Imports) John Lata; Nat'l Sales Dir.: Dean Tabaac; Export Sales (East Coast): S. Korff, (West) C. Staub. (Distributor)
 Labels Distributed: Audio: Relativity, Grand Slam, Wild Rags, Metal Magic, Mammoth, Century Media, Mechanic/World of Hurt, Nettwerk, Earache, Maze, Roadrunner, Midnight Music, Relix, Leviathan, Nuclear Blast, Chameleon/Dali, Star Dog, Shrapnel, Legato, DB, Dragon Street, Alias, Eplaph, Shimmy Disc, Wax Trax, Restless, Cargo, Southern Studios, Sky, Roir, Mordam, Touch & Go, Revelation, Redlight, Revolver.

Intera-Belmoor, 1365 39th St., Brooklyn, 11218, (718) 633-2800, (800) 221-5802, Fax: (718) 633-4375, Vice Pres: Dan Martin; Vice Pres. Components: Jerry Denker (Distributor)

Interama, 301 W. 53rd St., Ste. 19-E, New York, 10019, (212) 977-4830, Pres.: Nicole Jouve. (Distributor, Importer)
 Labels Distributed: Video: Foreign language titles.

Intercontinental Record & Cassette, Inc., 270 Oser Ave., Hauppauge, 11788, (516) 231-7171, Fax: (516) 231-8550, Pres.: Stanley Sirote; Sales Mgr.: Alan McLachlan. (Distributor, Importer)

Keeling Reggae Video Dist., 190 W. 135th St., New York, 10030, (212) 283-5825, Fax: (212) 281-0967, Gen. Mgr./Buyer: Keeling Beckford. (Video (Cassette & Disc)) (Distributor, One-Stop, Exporter)
 Labels Distributed: Video: Keeling's Reggae Music Videos, Keeling's Jamaican Movies.

Kingston Int'l, 9 Cygnet Dr., Smithtown, 11787, (516) 724-7644, Pres./Buyer (Music): Bob Szilagyi; Buyer (Other): Maribeth Sirotte. (Compact Disc, Pre-Recorded Audio Tape, Records (LP's, 12-inch), Cutouts, Overstock) (Exporter)
 Labels Distributed: Audio: Domestic sales of cutouts, overstocks, etc., all labels.

Koch Int'l Corp., 177 Contiague Rock Rd., Westbury, 11201, (516) 938-8080, Fax: (516) 938-8055, Pres.: Michael Koch; Buyer (Pre-Recorded Music): Fred Hoefler; Dir. Mktg. & Sales: Michael Rosenberg. (Distributor)
 Labels Distributed: Audio: Kotch Int'l, Koch Int'l Classics, Koch Schwann, Shanachie, Yazoo, Chandos, Melodiya, Mainstream, Smithsonian, Silva America, Prime Time, Supraphone, Orfeo, Bridge, CPO, Essay, Factory, MD&G, Nuova Era, Multisonic, Music & Arts, Ondine, Our Musical Past, Pearl, Preiser, Bluebell, Jazzpoint, Forlane, Spirit Feel and others.; Video: Shanachie, Yazoo.

LSR/Dutch East India, 81 N. Forest, Rockville Center, 11570, (Distributor).

Landmark Distributors, Inc., 12-20 36th Ave., Long Island City, 11106, (718) 937-6363, Fax: (718) 937-3923, Pres.: Burt Goldstein; Buyer (Pre-Recorded Music): (NY) April Steven-

CASSETTE SINGLE SPECIALIST

SAME DAY SERVICE
ORDER BY 3 PM

We Specialize in 12"/Maxi-Cass./Cass.Sing./Cd-5

- SPECIAL PRICES & OFFERS ON NEW RELEASE/CURRENT CD'S/CASSETTES LOW, LOW PRICES
- MAJOR & INDEPENDENT LABELS IN STOCK
- INCREDIBLE WEEKLY SPECIALS - ALL CD, LP, 12", CASSETTES
- WE SPECIALIZE IN NEW STORE OPENINGS - CD, LP, 12", CASSETTE INVENTORY
- OUR SALES STAFF CATER TO YOUR STORE NEEDS WITH PERSONAL COURTEOUS SERVICE

CALL OR FAX TODAY FOR FREE CATALOG & WEEKLY INFO

516-294-5900
800-992-9011
OUTSIDE N.Y. STATE

UNIQUE MUSIC CORP.

110 DENTON AVE., NEW HYDE PK., NY 11040
PH 800-992-9011 PH (NY STATE) 516-294-5900
FAX 516-741-3584

MALVERNE DISTRIBUTORS, INC.

Where Independent Distribution Is At Its Best!

Our 46th Year of Service to the Record Industry

DISTRIBUTING:

- | | | | |
|-----------------------|----------------|----------------|-------------------|
| AMHERST | GALAXY | MUSCLE SHOAL | RIVERSIDE |
| ATLANTA INTERNATIONAL | GOOD TIME JAZZ | MUSE | SAVOY GOSPEL |
| BAINBRIDGE | HOT | NASTY MIX | SIN-DROME |
| BENSON | JAZZ ALLIANCE | NEXT PLATEAU | SOH |
| BERACAH | JOEY BOY | OBC | SOUND OF GOSPEL |
| BOSSMAN | K-TEL | OJC | SPARROW |
| CONCORD JAZZ | KING JAMES | OMEGA CLASSICS | SPECIALITY |
| CONTEMPORARY JAZZ | KRAZIE NOISE | ON TOP | STARSONG |
| CREATIVE WORLD | LANDMARK | ONNA ROLL | STAX |
| CROSSOVER | LIGHT | OOPS | TRIBUTE |
| CRUISIN NELSON | M&R | PABLO | TYSCOT |
| DJ INTERNATIONAL | MALACO | PANDISC | UPSTAIRS |
| DISNEY | MARTRU | PAR | VANGUARD CLASSICS |
| EARLY BIRD | MEGATONE | POW WOW | VEE JAY |
| ENEMY | METROPOLITAN | PRESTIGE | VOLT |
| FANTASY | MICMAC | PROJECT X | WAYLO |
| GNP CRESCENDO | MILESTONE | PROXIMA | |

MALVERNE DISTRIBUTORS, INC.

35-35 35TH STREET, LONG ISLAND CITY, NY 11106 • (718) 392-5700 • FAX: (718) 786-9390
 NEW ENGLAND OFFICE: 329 WASHINGTON STREET, WOBURN, MA 01801 • (617) 933-7346

son; Dir. of Finance & Opns.: Doug Ball; Vice Pres. Sales: Harvey Rosen. (Distributor)
 Labels Distributed: Audio: Mango, Fourth & Broadway, Profile, Big Beat, Tuff City, Cardiac, VP, DRG, Miramar, Bay Cities, Continuum, Collectables, Effect, Heads Up Int'l, Dr. Dream, Amazin', Earth Beat/Music For Little People, Performance, Earthworks, Relaxation, Hey Day, Delicious Vinyl, Quark, Fortuna, Maggie's, Giana, Cosmic Force, Core, Beachwood, Minimal, Celestial, Heart Music, D.I.W., Great Jones.

Little Major Records Distributors, Inc., 244 W. 54th St., Ste. 609, New York, 11710, (212) 757-7222, Fax: (212) 757-7567, Pres.: Mel Fuhrman; Mgr.: Richard Fuhrman; Buyer (Pre-Recorded Music): Michael Closter; Buyer (Videos): Ron Eyre; Buyer: Jack Maher. (Distributor)
 Labels Distributed: Audio: Aegis, Cheetah, Esquire, Little Major, Mixed Emotions, Se-Ya, Soundscreen/Little Major, Sovereign.

M C A Dist. Corp., 1755 Broadway, 8th Floor, New York, 10019, (212) 841-8000, Fax: (212) 474-4193, Regional Branch Mgr.:

FILL ALL YOUR MUSIC NEEDS WITH ONE CALL

WE DISTRIBUTE ALL LABELS

FEATURING:

- MUSIC VIDEOS
- COMPACT DISCS
- CASSETTES
- SAME DAY SHIPPING
- DISCOUNT PRICES ON TOP 100
- LOW, LOW PRE-ORDER PRICES
- SPECIALIZING IN NEW STORE OPENINGS

WILMI SALES CORP.

TEL: 516/333-0275
FAX: 516/333-0232
800/722-0580 outside NY
556 Westbury Avenue
Carle Place, NY 11514

Call or FAX today for free
monthly mailer and weekly

Import/Export

*Specializing in the hard to find
jazz and blues labels.*

(516) 681-7102
 Fax: (516) 822-7952



18 Ivy Drive
 P.O. Box 158
 Jericho, NY 11753

ZIM RECORDS

Rich Cervino; Regional Mktg. Specialist: Gary Brody. (Distributor)

Labels Distributed: Audio/Video: See California Listing For Product Line.

M C M Distributors, 3672 Nostrand Ave., Brooklyn, 11229, (718) 332-0343, Fax: (718) 332-0447, Pres.: Meyer Minyan; Mgr./Buyer (Music): David Lubin. (Compact Disc, Pre-Recorded Audio Tape, Video (Cassette & Disc), Records (LP's, 12-Inch, Singles), Accessories) (One-Stop).

Malverne Distributors, Inc.

35-35 35th St., Long Island City, 11106, (718) 392-5700, Fax: (718) 786-9390, Pres.: Jerry Winston; Vice Pres.: Todd Van Gorp; Sales Mgr.: Ira Leslie; Buyer (Pre-Recorded Music): Tony Mascia. (Distributor)

Branch(es): 329 Washington St., Woburn, MA, 01801, (617) 933-7346, Fax: (617) 933-7459, Sales Mgr.: Stan Goodman. Labels Distributed: Audio: Amherst, Atlanta Int'l, Bainbridge, Benson Group, Bossman, Concord Jazz, D.J. Int'l, Disney, Early Bird, Enemy, Fantasy Group, GNP Crescendo, Hot, Joey, K-Tel, Krazie Noise, M & R, Malaco, Megatone, Metropolitan, MicMac, Muse, Nasty Mix, Next Plateau, On Top, Onna Roll, Pandisc Group, PAIR, PAR, Pow Wow, Proxima, Savoy Gospel, Sin-Drome, SOH, Sparrow.

Midnight Int'l Records, Inc.

PO Box 390, Old Chelsea Sta., 255 W. 23rd St., New York, 10011, (212) 675-2768, Fax: (212) 741-7230, Pres.: J. D. Martignon; Mgr.: Claire Baksa; Buyers: Jeff Smith, Ron Bally. (Compact Disc, Records) (Distributor, Importer, Exporter) Labels Distributed: Audio: Alternative Tentacles, Amoeba, Bomp + Vox, Boner, Crypt, DB Records, Dionysus, Dischord, GNP Crescendo, Link, Mammoth, Midnight, Mirror, Mordam, Poplama, Pravda, Reckless, Roir, Shimmy Disc, Sundazed, Skyclad, Star, Stash, Subterranean, Taang, Texas Hotel, Texas Archives, Touch & Go and others. Restless, SST (Export Only).

Labels Imported: Rhino, Eva, New Rose, Revenge (France); Bam Caruso, Demon, Edsel, Flyright, Jungle, Crazy Kat, See For Miles (United Kingdom); Citadel, Mushroom, Red Eye, Raven, Waterfront (Australia); Amigo, Sunjay, Star, Mr. R & B (Sweden); Resonance, Rock House, White Label (The Netherlands); Bear Family, Dee Jay, Repertoire, Line (Germany).

Navarre Corp.

3 Wolven Ln., Woodstock, 12498, (914) 679-4859, Fax: (914) 679-4859, East Coast Mgr.: Alan Marker. (Distributor) Labels Distributed: Audio: Airns, Brainchild, CMH, Enpointe, Higher Octave, ITI, L & R, Mu, Music House, Nova, Optimism, Positive Music, Palo Alto, Sheldstone, Shining Star, Silverwave, Spindletop, Tall Tree, TBA, USA, Valley Vue, Visual Musik, White Light, White Swan.

New Music Distribution Service, 500 Broadway, New York, 10012, (212) 925-2121, Fax: (212) 925-1689, Exec. Dir.: John Baskind; Mgr.: Spencer Richards; Buyer (Pre-Recorded Music): Steven Swartz. (Records) (Distributor)

Labels Distributed: Audio: About Time, Appollo, Apparition, Zoar, Watt, Dossier, Shimmydisk, Cuneiform, Jazz, Lovely Music, Neutral, New Artists, Recommended, Race Age, Tellus, Mu, Leo, Opus One, Sessoms, Vital Organ, Victo, Crevice, St. Joan, Giorno Poetry Systems, Aliso, CNLF, Crush, Fun Music, Maldoror, Touch; Video: Birth Records Videos featuring Gunther Hampel & Musicians. Pay-Per Transaction.

North Country Dist., Cadence Bldg., Redwood, 13679, (315) 287-2852, Fax: (315) 287-2860, Chief Exec.: Robert D. Rusch; Mgr.: Almost Slim; Buyer: Larry Raye. (Compact Disc, Video (Cassette & Disc), Records (LP's), Cutouts, Overstock, Accessories) (Distributor, One-Stop, Importer, Exporter)

Labels Distributed: Audio: About Time, American Clave, Artistry, Audiophile, Bainbridge, Blue Rock 'it, Broadway, Cadence Jazz, Caravan, Creative Works, Delmark, Emerald, Enemy, GNP Crescendo, IAJRC, India Navigation, Interplay, Jazz, Jazzmark, K2B2, Leo, Muscraft, New Albion, New Artists, Nine Winds, Northeastern, Ottavo, Reservoir, Seabreeze, Silkheart, Swingtime, Theresa, Unity, Uptown, VSOP, Xanadu, Yadeon; Video: Jazz Classics, Stash, Wenna.

Pay-Per Transaction. Labels Imported: Justin Time, Sackville, Victo (Canada); Steeplechase, Storyville (Denmark); Chabada, Nato, Orange Blue (France); Creative World, Dossier, Ear Rational, FMP, In & Out, Nabel, Sound Aspects (Germany); Cecma, Philology, Splas(h) (Italy); BVHaast, Criss Cross, Limetree, Nimbus, Timeless (The Netherlands); Gemini, Hot Club, Taurus (Norway); Dragon, Hat Art, Phontastic (Sweden); Blackion, Cadillac, Candid, Carlyne, Incus, Matchless, Mole (United Kingdom).

Products/Accessories: CD, Tape & Record Products: Last. **Northeast One Stop, Inc.**, 27 Warehouse Row, Albany, 12205, (518) 438-6153, Fax: (518) 438-6995, Pres.: Louis J. DeSignore; Buyer (Accessories): Wesley Miller; Mgr./Music Buyer: Michael Fitzgerald; Buyer: Robert Langford. (Compact Disc, Pre-Recorded Audio Tape, Video (Cassette & Disc), Records (LP's, 12-Inch), Accessories) (One-Stop)

Products/Accessories: CD, Tape & Record Products: Discwasher, Pro, Ultraline, Discube; Storage & Carrying Cases: Laserline, Case Logic, Napa Valley, Tree Dimension, Savoy, Scotch; Blank Tape: Fuji, Maxell, Sony, TDK, That's, Denon; Head Phones: Jasco; Batteries: Maxell.

Olympia Distributing Corp., 239 W. 18th St., New York, 10011, (212) 989-7200, Fax: (212) 633-8022, Pres.: Ervin Litkei; Vice Pres.: Ron Selmer; Buyer: Donald Tannen. (Compact Disc, Pre-Recorded Audio Tape, Records) (Distributor, One-Stop, Exporter)

Labels Distributed: Audio: RCA(BMG), CBS, CAP, MCA, Polygram, WEA, Malverne and all others. Labels Imported: All Labels.

One Way Records, Inc.

1 Prospect Ave., Albany, 12206, (518) 489-3288, Fax: (518) 489-3528, Pres.: David Schlang; Vice Pres. Sales & Mktg.: Harris Kozak; Buyer: Terry Wachsmuth. (Compact Disc, Pre-Recorded Audio Tape, Records, Cutouts, Overstock) (Distributor, Rackjobber, Exporter)

Labels Distributed: Audio: Deja Vu, One Way Records licensed product.

Cutouts/Overstocks: Deletions, budget, promotional, special products.

Otoao Records Co. Int'l Ltd., PO Box 1844-Cathedral Sta., New York, 10025, (Compact Disc, Pre-Recorded Audio Tape, Records (LP's)) (Distributor, Importer).

Paramount Records, Inc., 81 Shear Plaza, Plainview, 11803, (516) 249-1990, Fax: (516) 249-6526, Pres./Mgr.: Andrew Shenkan; Buyer (Pre-Recorded Music): Bill Forbes. (Compact Disc, Records) (Distributor, One-Stop, Rackjobber, Importer, Exporter)

Pearl Music, 40 20th St., Brooklyn, 11232, (718) 965-6628, Fax: (718) 788-2697, Pres./Buyer: Freddie Taylor. (Compact Disc, Pre-Recorded Audio Tape, Records (LP's, 12-Inch)) (One-Stop).

Pocket Songs/MMO Music Group

50 S. Buckhott St., Irvington, 10533, (914) 591-5100, Fax: (914) 591-5103, Pres.: Irv Kratka; Vice Pres.: Dave Kratka. (Compact Disc, Pre-Recorded Audio Tape) (Manufacturer) Labels Distributed: Audio: Music Minus One, Pocket Songs.

PolyGram Group Distr., 825 Eighth Ave., New York, 10019, (212) 333-8000, Fax: (212) 333-8249, Pres.: Gary Rockhold; Exec. Vice Pres./Mktg.: Robert Jamieson; Purchasing Dir.: John Bolowsky. (Compact Disc, Pre-Recorded Audio Tape, Video (Cassette & Disc)) (Distributor)

Labels Distributed: Audio: Abcco, Atlanta Artists, Barclay, Black Saint Casablanca, Compleat, De-Lite, Dera, ECM, Emarcy, Fontana, Gold Castle, Gramavision, Japo, JMT, London, Mercury, Minor Music, MPS, Oasis, Owl, Philips, Polydor, Red Records, Riva, Smash, Soul Note, Squawk, Tin Pan Apple, Threshold, 21, Vertigo, Verve.

Procanyn's Polka Palace, 4022 61st St., Woodside, 11377, (718) 458-7958, Pres.: Walt Procanyn. (Compact Disc, Video (Cassette & Disc), Records, Cutouts, Overstock) (Distributor, One-Stop)

Labels Distributed: Audio: Eastwind Int'l Artists.

Qualiton Imports Ltd., 24-02 40th Ave., Long Island City, 11101, (718) 937-8515, Fax: (718) 729-3239, Pres.: Otto Quittner; Buyer (Pre-Recorded Music): George Volckening; Nat'l Sales Mgr.: George Volckening; Vice Pres./Buyer: Judith Quittner. (Compact Disc, Records, Cutouts) (Distributor, Importer)

Labels Imported: BIS, Calliope, CRD, Hungaroton, Etcetera, Novalis, Pearl, Opal, Claves, Club 99, Bongiovanni, Melodram, Saydisc, Hunt, EBS, Nuova Era, White Label, Simax, Mennet, Bridge (Swiss), Cybelia, Adda, Globe, Relief, Zeta, Xanadu, Danica, Amon Ra and others.

RMM Records & Videos Corp., 568 Broadway, Ste. 806, New York, 10012, (212) 925-2828, Fax: (212) 925-6154, CEO: Ralph Mercado; Mgr.: Carlos Mario Gutierrez. (Compact Disc, Video (Cassette & Disc), Records (LP's, 12-Inch)) (Distributor, Exporter)

Labels Imported: Exports RMM products to Spain, Colombia, Mexico, Ecuador, Venezuela, Peru.

Rashid Sales Co. Inc., 191 Atlantic Ave., Brooklyn, 11201, (718) 852-3295, Fax: (718) 643-9522, Buyer (Pre-Recorded Music): Stanley Rashid; Mgr./Buyer (Video): Raymond Rashid. (Compact Disc, Pre-Recorded Audio Tape) (Distributor, Importer, Mail Order)

Labels Distributed: Audio: Sono Cairo, Sout el Hob, Sout el Fen, Cairophone, Stam, Americana, Voix Du Orient, Relax, Alam Co., Baidophone, Orient Records.

Record Imports, 161 Hudson St., New York, 10013, (212) 925-0065, (One-Stop)

Reggae Sunsplash Music Video Collection, c/o 361 Broadway, Ste. 510, New York, 10013, (212) 925-2445, (800) 344-9762, Fax: (212) 941-0001, Managing Dir.: Patrick H. Williams. (Video (Cassette & Disc)) (Distributor)

Labels Distributed: Video: All "Reggae Sunsplash" Music Videos, i.e., "Splashin' The Palace," "Dance Hall '87," "Dance Hall '88," "Dance Hall '89," "The Best of Reggae Sunsplash Vol. 1," "Dance Hall Special," "Vintage Night '90," "Dance Hall Night '90," "Singers Night '90," "Variety Night '90," and upcoming releases.

Rego Irish Records & Tapes, Inc., 64 New Hyde Park Rd., Garden City, 11530, (516) 328-7800, (800) 854-3746, Pres.: Paddy Noonan; Vice Pres.: Margaret Noonan; Gen. Mgr.: Vincent Mitchell. (Compact Disc, Pre-Recorded Audio Tape, Video (Cassette & Disc), Records) (Distributor, Importer) Labels Distributed: Audio: Distributor of Irish, Scottish, Folk & Religious labels from Ireland, United Kingdom & United States.

Labels Imported: DARA, Dolphin, Harmac, HARP, K-Tel, Lunar, RTE, Triskel, Rego Irish Video.

Release Records, 4346 Katanah Ave., Bronx, 10470, (212) 324-0995, (800) 922-8863, CEO/Buyer (Music): Daniel J. Ryan. (Compact Disc, Pre-Recorded Audio Tape) (Distributor, Importer)

Labels Distributed: Audio: Green Linnet, Invincible.

Labels Imported: Tara, Gaellin, Mother, Son, Dolphin, Harmac.

Rockin' Relix Inc., PO Box 92, Brooklyn, 11229, (718) 258-0009, Fax: (718) 692-4345, CEO/Accys. Buyer: Leslie D. Kippel. (Distributor)

Products/Accessories: Other: Rock & Roll Accessory Prods. such as shirts, jackets and other rock novelty products.

Rough Trade, 611 Broadway, Ste. 311, New York, 10012, (212) 777-0100, Fax: (212) 505-9314, CEO: Robin Hurley; Nat'l Sales Mgr.: Jack Sheehy; Buyer: Uli Elser. (Compact Disc, Pre-Recorded Audio Tape, Video (Cassette & Disc), Records (LP's, 12-Inch, Singles)) (Distributor, Exporter)

Labels Distributed: Audio: Twin-Tone, Genius, Absolute-A-Go-Go, Giorno Poetry Systems, Pitch A Tent, Okra, Bad Taste, C'est La Morte, Cow, Axis, One Little Indian, Young God, No 6, Vild, Mad Rover, SST, Touch & Go, Wax Trax, Alternative Tentacles, Daemon, Hey Day, Amphetamine Reptile, New Red Archive, Reckless, Matador, Bomp, Shimmy Disc, Mammoth, Research, Cruz, Boner, K, Epitaph, Texas Hotel.

Labels Imported: EXPORTS: Genius, Absolute-A-Go-Go, Giorno Poetry, Pitch A Tent, Okra, Bad Taste, C'est La Morte, Axis, Hang-Man, Young God, No 6, Vild, Mad Rover, Texas Hotel, Wax Trax, Daemon, Hey Day, New Red Archives, Amphetamine Reptile, Epitaph, Touch & Go, Matador.

Rounder Records Dist., 42-15 Crescent St., Ste. 805, Long Island City, 11101, (718) 937-9585, Fax: (718) 937-9587, Mgr.: David Nives. (Distributor)

Labels Distributed: Audio: Ryko, Alligator, King, Sugar Hill, Ace, Charly, Flying Fish, Arhoolie, DRG, Black Top, RAS, Collectables, Hannibal, Sony Special Products, Hightone, Vanguard, CMP, Stash, Radiola, Green Linnet.

Ruda Distributors, 915 Broadway, Buffalo, 14212, Owner: Don Ruda. (Distributor)

Labels Distributed: Audio: All Polka labels.

S & J Record One Stop, 933 Morris Park Ave., Bronx, 10462, 212 792-6031, Fax: (212) 829-4224, CEOs: Sal LaRocca, Jim Schefflin; Buyer (Pre-Recorded Music): Luis Flores; Buyer (Albums, Video): Jim Schefflin; Buyer (Singles): Ron Labus. (Compact Disc, Pre-Recorded Audio Tape, Video (Cassette & Disc), Records (LP's, 12-Inch, Singles)) (One-Stop)

Scott Distributing Corp., 4217 Austin Blvd., Island Park, 11558, (516) 432-1234, Fax: (516) 432-7908, Pres.: Kenneth Kruglick; Buyer (Pre-Recorded Music): James Mule; Buyer (Videos): James Mule; Sr. Vice Pres.: Robert Kruglick; Exec. Vice Pres./Mgr.: Harvey Lefkowitz. (Compact Disc, Pre-Recorded Audio Tape, Video (Cassette & Disc)) (Distributor, Rackjobber, Military Sales)

Labels Distributed: Audio/Video: All major brands.

Sonocraft Corp., 575 Eighth Ave., New York, 10018, (800) 274-7666, Sales Mgr.: Ed Sternbach. (Accessories) (Distributor)

Products/Accessories: CD Players: Sony, Technics, Onkyo, Pioneer; Storage & Carrying Cases: Nappa Valley, Dal Rax, Rayline; Video Cassette Recorder: Sony, Panasonic, Mitsubishi, Sharp, Toshiba; Blank Tape: TDK, Sony, Maxell, JVC, BASF; Head Phones: Sony, AKG, Sennheiser; Batteries: Duracell, Eveready, Panasonic, Maxell; Diamond Needles: Stanton, Shure, Astatic.

Star City Records, PO Box 331, Fort Ann, 12827, (518) 798-5975.

Star Video Entertainment, L.P., 2500 Walden Ave., Cheektowaga, 14225, (716) 683-8300, (800) 234-3880, Mgr.: Noah Kronenberg. (Distributor)

Labels Distributed: Audio: Books On Tape; Video: See New Jersey listing for product line.

Transcontinent Record Sales & Record Theatre, 1800 Main St., Buffalo, 14208, (716) 883-9520, Fax: (716) 884-1432, Owner/Mgr.: Leonard Silver; Buyer (Pre-Recorded Music): Jim Primerano; Buyer (Videos): Steve Silver; Music & Accys. Buyer: David Colson. (Compact Disc, Pre-Recorded Audio Tape, Video (Cassette & Disc), Records (LP's, 12-Inch, Singles), Cutouts, Overstock, Accessories) (Distributor, One-Stop, Rackjobber, Importer, Exporter, Mfr.: Amherst Records)

Labels Distributed: Audio: More than 356 Independent Labels.

Twinbrook Music, Inc.

227 W. 29th St., New York, 10001, (212) 947-0440, Fax: (212) 947-4567, Pres.: Jay Baney; Buyer (Pre-Recorded Music): Dave Ashley; Vice Pres./Mgr.: Dan Moretti. (Compact Disc, Records (LP's)) (Distributor, Exporter)

Labels Distributed: Audio: Airus, Brainchild, Capri, Chase Music Group, CMH, Enpointe CDs, Higher Octave, L & R,

VENUS RECORDS & MUSIC DISTRIBUTION INC.

SHIPPING RECORDS AROUND THE WORLD



596 Broadway
Suite 1216
NY, NY 10012
(212) 941-6530
(800) 445-3346
FAX: (212) 941-6536

We grew out of a small collector's shop, so we know the needs of the small specialty retailer. We give great service to even the smallest accounts. Our salespeople take care of your order from beginning to end, to assure top notch fill and delivery, with less mistakes, and less bent corners. And we have in stock those records that the other distributors have never even heard of, but your customers have been asking for.

ROCKABILLY • BLUES • PSYCHEDELIC • PUNK
• GARAGE • MERSEYBEAT • BRITISH INVASION
• HARDCORE • BOOKS • FANZINES
• ALTERNATIVE/NEW WAVE

WRITE, PHONE, OR FAX NOW FOR OUR
CURRENT WHOLESALE CATALOG.

win
records and video, inc.

**DISTRIBUTORS OF ALL MAJOR,
INDEPENDENT, RAP AND
DANCE MUSIC LABELS**

CALL:
718-335-2112 or
800-221-1220

FAX:
718-335-2184 or
800-851-2525
(IN NY STATE ONLY)

SERVING YOU FOR OVER 30 YEARS



WE OFFER YOU:

- ▶ The Most Extensive Selection of Cd's, Cassettes, 45's, 12 inch Singles, Oldies, Laser Discs and Video
- ▶ Same Day Service
- ▶ The Lowest Prices
- ▶ State of the Art Communications and Trafficking Facilities
- ▶ A Knowledgeable and Attentive Sales Staff

**CALL OR WRITE FOR OUR FREE CATALOG:
WIN RECORDS 76-05 51ST. AVE. ELMHURST, N.Y. 11373**

TWINBROOK MUSIC

DISTRIBUTORS & EXPORTERS OF THESE LABELS

- ★ AIRUS RECORDS ★
- ★ BRAINCHILD RECORDS ★
- ★ CAPRI RECORDS ★
- ★ CHASE MUSIC GROUP ★
- ★ SONIC ATMOSPHERES ★
- ★ NOVA RECORDS ★
- ★ OPTIMISM, INCORPORATED ★
- ★ SPINDLETOP RECORDS ★
- ★ TBA/PALO ALTO RECORDS ★
- ★ JVC RECORDS ★
- ★ MOSAIC RECORDS ★
- ★ STASH RECORDS ★
- ★ TOWN CRIER RECORDINGS ★
- ★ UPTOWN RECORDS ★
- ★ DUNHILL COMPACT CLASSICS ★
- ★ MUSIC WEST RECORDS ★
- ★ QUICKSILVER RECORDS ★
- ★ K-TEL RECORDS ★
- ★ USA MUSIC GROUP ★
- ★ HIGHER OCTAVE MUSIC ★
- ★ NEBULA RECORDS ★
- ★ RIVER MUSIC ★
- ★ SHINING STAR MUSIC ★
- ★ SILVER WAVE RECORDS ★
- ★ WHITE SWAN RECORDS ★
- ★ BRIDGE RECORDS ★

**SERVICE &
PROMOTION**
FROM THE HEART OF
MANHATTAN

TWINBROOK MUSIC, INC.

227 West 29th St. New York, NY 10001
Tel. (212) 947-0440 Fax (212) 947-4567

Mu, Nebula, Nightengale, Nova, Optimism, Positive Music, Shining Star, Shieldstone, Silver Wave, Spindletop, TBA, Uptown, USA Music Group, White Swan.
Labels Imported: Exports: Airus, Brainchild, Capri, Chase Music Group, Enpointe CDs, Nova, Optimism, Spindletop, TBA, Quartet, Jass, Stash, Town Crier Recordings, Uptown, Dunhill, Quicksilver, K-Tel, USA Music Group, Higher Octave, Nebula, River Music, Shining Star, Silver Wave, White Swan, Bridge, Musicmasters.

Unique Music Corp.

110 Denton Ave., New Hyde Park, 11040, (516) 294-5900, (800) 992-9011, Fax: (516) 747-1365, Pres.: Robert J. Miller; Mgrs.: Steve Flaster, Walter Michalski, Irv Chaffardet; Buyer (Pre-Recorded Music): Steve Flaster. (Compact Disc, Pre-Recorded Audio Tape, Video (Cassette & Disc), Records (LP's, 12-Inch)) (One-Stop)

Unlimited Resources Int'l, 200 Wilson St., #E-5A, Port Jefferson Station, 11776, (516) 473-5539, (800) 942-5515, Fax: (516) 473-5541, Pres.: Steven Moore; Sales Mgr.: Ramone Baker. (Distributor).

V.P. Record Dist., 170-21 Jamaica Ave., Queens, 11432, (718) 291-7058, (800) 441-4041, Fax: (718) 658-3573, Vice Pres.: Pat Chin; Mgr./Buyer: Christopher Chin; Buyer: Carl Miller. (Compact Disc, Pre-Recorded Audio Tape, Video (Cassette & Disc), Records) (Distributor, One-Stop, Importer, Exporter) Labels Distributed: Audio: Steeley & Clevie, Music Works, Dynamic Sounds, TSOJ, Nicole, Digital B, W.K.S, Sonic Sounds, Redman Int., Jet Star, Jammy's, Dennis Star, Tuff Gong, RAS, Shanachie & All Other Major Reggae Labels; Video: Sunsplash, Sting & All Other Reggae Video Labels.

Venus Records & Music Dist., Inc.

596 Broadway, Room 1216, New York, 10012, (212) 941-6530, Fax: (212) 941-6536, Pres.: Bill Shor. (Compact Disc, Video (Cassette & Disc), Records (LP's, 12-Inch, Singles)) (Distributor, Importer, Exporter)

Labels Distributed: Audio: Ace, Au Go Go, Bam-Caruso, Big Beat, Bomp, De Milo, Crypt, Dee Jay Jamboree, Demon, Dionysus, Edsel, Etiquette, Fly Right, Forced Exposure, Fred, Krazy Kat, Line, Live Gold, Mirror Revelation, See For Miles, Stash, Sundazed, Taang, Texas Archives, Touch & Go, Twintone, Wax Trax, Skyclad, Norton.

Labels Imported: United Kingdom, Holland, Germany, France, Italy, Australia, Canada.

Video Assoc., 777 Old Country Rd., Plainview, 11803, (516) 822-8222, Owner: Herb Goldfarb; Buyer (Videos): Sam Stolton. (Distributor)

Labels Distributed: Video: Nintendo Products.

Tamber Video dba Video Broker Int'l, 95 Seaview Blvd., Port Washington, 11050, (516) 625-9400, (800) 666-8433, Fax: (516) 625-9406, Pres.: Shep Alster; Mgr.: Stuart Cohen; Buyer (Videos): Peggy Shulaski; Nintendo & Video Games Buyer: Pat Darcy. (Video (Cassette & Disc), Cutouts, Overstock) (Distributor)

Labels Distributed: Video: Carries overstock and previewed movies and all lines of video games.

Waterfall Record Dist., PO Box 109, Canaan, 12029, (518) 392-3400, Mgr./Buyer: Arnold S. Caplin. (Records) (Distributor, Importer)

Labels Distributed: Audio: Aircheck, Biograph, Center, Columbia Special Projects, Dawn, Fanfare, Hindsight, Historical, Jazz Archives, Kaydee, Mamlsh, Melodeon, Relic, Rooster Blues, Radio Archives, Soundcraft, Sunbeam, Totem, Tulip, Western/Rambler, Xanadu.

Labels Imported: Affinity, Charley.

Watts Music Inc., 52 Rail Rd. Ave., Valley Stream, 11580, (516) 596-1888, Fax: (516) 596-0961, Contact: David Mena. (Compact Disc, Records (LP's, 12-Inch)) (Importer) Labels Imported: From Germany, England, Belgium, Holland, Sweden and Italy (Mostly Dance Labels).

Wilmi Sales Corp.

556 Westbury Ave., Carle Place, 11514, (516) 333-0275, (800) 722-0580, Fax: (516) 333-0232, Pres.: Ed Smith; Vice Pres.: Michael Smith. (Compact Disc, Pre-Recorded Audio Tape, Video (Cassette & Disc), Records (LP's, 12-Inch, Singles), Accessories) (One-Stop)

Labels Distributed: Audio: All Major Labels, Most Independent Labels, Tommy Boy, WEA, Sony, PolyGram, BMG, UNI, Relativity.

Pay-Per Transaction.

Products/Accessories: CD, Tape & Record Products: Pre Wipes; Storage & Carrying Cases: CD Flip Files; Blank Tape: Maxell.

Win Records & Video, Inc.

76-05 51st Ave., Eimhurst, 11373, (718) 335-2112, Fax: (718) 335-2184, Pres.: Sam Weiss; Vice Pres./Head Buyer: George Weiss; Buyer (Pre-Recorded Music): Bob Huber; Buyer (Videos): Bernie Dorfman; Buyer (12-Inch): Andy Davis; Buyer (Singles, CD's, Oldies): Michael Smokler. (Compact Disc, Pre-Recorded Audio Tape, Video (Cassette & Disc), Records (LP's, 12-Inch, Singles), Cutouts, Overstock, Computer Games, Accessories) (Distributor, One-Stop, Rack-jobber, Importer, Exporter)

Labels Distributed: Audio: MCA, Geffen, WEA, Capitol, EMI, SBK, Motown, PolyGram, A & M, Island, Sony, Jive, RCA, Arista, Sam, Grp and all others; Video: Pioneer, Image, Polydor, Warner Home Video, CBS/Fox.

Labels Imported: All.

Products/Accessories: CD Players: General Electric; Audio & Video Playback Equipment: General Electric; CD, Tape & Record Products: Allsop, Bib, Discwasher, Geneva; Storage & Carrying Cases: Amaray, Flip File; Video Cassette Recorder: General Electric; Blank Tape: SKC, TDK, Maxell, Denon; Head Phones: Stanton; Other: CD Jewel Boxes, CD Blister Packs, Cass Norelco Boxes, Video Storage Cases.

World Class Music Dist., 311 Willowbrook Rd., Staten Island, 10314, (718) 698-2280, Fax: (718) 761-6411, Mgr.: Robert Marino. (Compact Disc, Pre-Recorded Audio Tape, Records (LP's, 12-Inch), Cutouts, Overstock) (Distributor, One-Stop, Importer, Exporter)

Labels Distributed: Audio: All major groups + American Gramophone, Athena Prods., Athena Records, Audiophile, Bainbridge, Cardas, Chesky, Clarity, CMP, Collegium, Concord Jazz, Creative Music Prods., Crystal, Fantasy/Prestige group, GRP India Navigation, Jazzology, Joplin & Sweeny, Louisville, New World, North Star, Oriental Pathfinder, Ravi Shankar, Reference, Sheffield Lab, Southland, Telarc, Varese Sarabande, Wilson.

World Trading Center Inc., 208 E. 88th St., Ste. 3-A, New York, 10128, (212) 289-7997, Fax: (212) 860-5582, Contact: Arthur Danziger. (Compact Disc, Pre-Recorded Audio Tape, Records (LP's), Cutouts, Overstock) (Exporter) Cutouts/Overstocks: CDs, LPs, Audio Cassettes, All Musical Categories.

Products/Accessories: Other: Music Books, T-Shirts.

Worldtone Music Inc., 230 Seventh Ave., New York, 10011, (212) 691-1934, Pres./Buyer: Kenneth Spear. (Compact Disc, Pre-Recorded Audio Tape) (Distributor, Importer)

Labels Imported: Balkanton, Gega (Bulgaria).

Zim Records, PO Box 158, 18 Ivy Dr., Jericho, 11753, (516) 681-7102, Fax: (516) 822-7952, Owner: Arthur Zimmerman. (Compact Disc, Records (LP's)) (Distributor, Importer, Exporter)

Labels Distributed: Audio: Aerospace, Aircheck, American Music, Arbors, Arcadia, Artistry, Audiophile, Bandstand, Bravura, Broadway, Chiaroscuro, Echo Jazz, Ellington, Everybodys, GHB, Giants of Jazz, Golden Era, Homespun, Honeysuckle Rose, IAJRC, Interplay, Jazz Mark, Jazzology, Joyce, Merymakers, Progressive, Pumpkin, Shoestring, Sounds Great, Spokane, Sunbeam, Texas Rose, Totem,

Have You Gotten Any Lately?



If you haven't received a copy of our 164 page catalog with over 5,000 items listed, you don't know what your missing!!! Records, Cass., CD's, 45's, Imports, Blank Tape, Books, Storage Boxes, Divider Cards, Sleeves, Jackets, etc.

Dealers Only 800-523-2036

VSOP, Yadeon.

Labels Imported: Ambassador, Classic Jazz Masters, Everybody's, Jazz Document, Kenneth, Phontastic, Sison, Swedish Radio, Tax (Sweden); Collectors Item, Fountain, Jonzo, Retrieval, Status, VJM, Whoopee (UK); Gemini, Herman, Hot Club, Taurus (Norway); Grannophone, Panachord (Holland); Jazz Connoisseur, Unique Jazz (Italy); Storyville (Denmark); Teagarden (Canada).

NORTH CAROLINA

Alps, Inc., PO Box 31723, Raleigh, 27612, 946 W. US 64 Business, Wendell, 27591, (919) 365-3141, (800) 334-8363, Chief Exec.: Roy Rysdon; Mgr.: Judy Rysdon; Buyer (Videos): Joy G. Renfrow, (Manufacturer).

Baker & Taylor Video, 3400 C. Woodpark Blvd., Charlotte, 28206, (704) 596-5986, (800) 245-1172, Fax: (704) 596-9372, Sales Mgr.: Kelly Walden. (Distributor, One-Stop)
Labels Distributed: Audio/Video: See Illinois Listings For Product Lines.

Bib Distributing Co., Inc., 101 Yorkmont Rd., Charlotte, 28217, (704) 527-0440, Pres.: Bill Norman. (Compact Disc, Pre-Recorded Audio Tape, Records) (Distributor, One-Stop, Rackjobber)

Labels Distributed: Audio: Atlanta Int'l, Antilles/Mango, Amherst, Audiofidelity, Edge, Evejimm, 4-Sight, Future, Fresh, Gamble & Huff, Ichiban, King, Joey Boy, Malaco, Magic City, Pandisc, ShurFine Gospel, Sutra, Select, Savoy, Luke SkyWalker, Sleeping Bag, Southern Tracks, SunTown, Tommy Boy, Warlock, Waylo.

CEMA Distrib. Center, 4229 Beechwood Dr., Greensboro, 27410, (919) 854-2272, (800) 448-7322, Contact: Andrea Coleman.

Collector's Choice, 412 Jackson St., Kannapolis, 28083, (704) 933-0807.

E.T.D., Inc., 502 Radar Rd., Greensboro, 27410, (919) 854-5269, (800) 321-5999, Fax: (919) 854-5269, Branch Mgr.: Rick Peters. (Pre-Recorded Audio Tape, Video (Cassette & Disc)) (Distributor)

Labels Distributed: Audio: Promotional Lines; Video: All Major Studios & Most Independents.
Pay-Per Transaction.

ExSell Mktg., div. of Weiss Ents. Inc., PO Box 4069, Cary, 27519, 500-B Old Apex Rd., Cary, 27511, (800) 334-2484, Fax: (919) 467-3314, Pres.: William C. Weiss; Mgr./Buyer: Anne C. Daniel. (Distributor)

Products/Accessories: CD, Tape & Record Products: Allsop, Amaray, AudioSource, Discwasher, ProWipe, Recoton, Scotch, TDK; Storage & Carrying Cases: Case Logic, CD/Mate, Laserline, Napa Valley, Posso/Savoy, Tree Dimensions, Univenture; Blank Tape: Denon, Fuji, JVC, Maxell, Sony, TDK, 3-M; Head Phones: Philips, Sony; Batteries: Duracell; Diamond Needles: Shure, Stanton.

Lady Slipper, PO Box 3124, Durham, 27705, (919) 683-1570, Chief Exec.: Liz Snow; Mgr.: Laurie Fuchs; Buyer: Sue Brown. (Pre-Recorded Audio Tape, Records) (Distributor)
Labels Distributed: Audio: Ars Pro Femina, Cattail, Cityscape, Coyote, Evenkeel, Freedom's Music, Halcyon, Ladyslipper, Many Records, Mother of Pearl, Navada, Rana, Sea Wave, Sweater, Vrana, Whyscvack, Wild Patience, Womens Wax Works, West Virginia Woman Ova, T+R, Sumitra.

Major Video Concepts, 2940 Interstate St., Charlotte, 28208, (704) 399-1340, (800) 444-1340, Fax: (704) 398-0323, Opns. Mgr.: Larry Friend; Branch Mgr.: Scott Broadway; Customer Serv./Order Desk: Denise Burke. (Video (Cassette & Disc)) (Distributor)

Labels Distributed: Video: See Indiana Listings For Product Distribution.

Omega Distribution, PO Box 100, 470 New Hendersonville Hwy., Pisgah Forest, 28768, (704) 884-2320, Fax: (704) 884-4013, Chief Exec./Buyer: Linda B. Zuch; Mgr.: Diane Gardin; Buyer (Pre-Recorded Music): Kim Rollins. (Distributor)
Labels Distributed: Audio: World, Benson, Sparrow, Classic Recordings, Pinnacle, Spectra, Homeland, Starsong, Reunion, Renaissance, Jim, AIA, Pfeifer Evagn, Assoc., Berach, Bevlah, Lillenas, Betterway; Video: Benson, First Day, Sparrow, Word, Xenon.

Michael Phillips Ents., Inc., 500-A Old Apex Rd., Cary, 27511, (919) 460-8686, Fax: (919) 460-8848, Pres.: Michael Phillips; Gen. Mgr.: Kenny Hall; Sales Mgr.: Allison Varon. (Distributor, One-Stop, Rackjobber).

Sound Service Inc., PO Box 560784, Charlotte, 28256, (704) 597-8372, Fax: (704) 598-6385, Pres.: E. B. "Skip" Byrd; Mgr.: Ronald E. Cowles; Buyer: Ronnie Cowles. (Rackjobber)
Labels Distributed: Audio/Video: All major studios and most independents.

Stark Records & Tape Co., 628 S. South St., Mount Airy, 27030, (919) 786-2865, Owner/Pres./Music Buyer: Paul E. Johnson; Mgr./Buyer: Gertrude B. Johnson. (Pre-Recorded Audio Tape, Video (Cassette & Disc) Records (LP's, 12-Inch, Singles))
Labels Distributed: Audio: Ichiban, Broadcast, E.K.O., Spinn, Modern.

Products/Accessories: CD, Tape & Record Products: Stark Tape Heads Cleaner; Video Cassette Recorder: Stark Video Head Cleaner; Blank Tape: Pilot & Stark Video, Cassettes & 8 Track Blank tapes; Other: Stark Stereo Cassette, Audio Test Tape.

Wax Museum One Stop, 1505 Elizabeth Ave., Charlotte, 28204, (704) 379-0700.

OHIO

Action Music Sales, Inc., 6541 Eastland Rd., Cleveland, 44142, (216) 243-0300, Fax: (216) 243-4063, Vice Pres.: Dennis Baker; Buyer (Pre-Recorded Music): Clay Pasternack.
Branch(es): 5449 Lester Rd., Ste. 4, Cincinnati, 45213, (513) 631-7120. (Distributor)

Labels Distributed: Audio: Alligator, Amherst, Benson, Cardiac, Celestial Harmonies, Concord Jazz, Disneyland, Effect, 4th & Broadway, Flying Fish, Fantasy, Grateful Dead, Hightone, Hot, Light, Malaco, Mango, MicMac, Miramar, Mobile Fidelity, Muse, Optimism, Pandisc, Pow Wow, Profile, RAS, ROIR, Rounder, Savoy, Sparrow, SST, Starsong, Tommy Boy, VP, Wax Trax.

Arrow Distributing Co., 30400 Bruce Industrial Pkwy., Solon, 44139, (216) 349-3000, Fax: (216) 248-3460, Pres.: Don Weiss; Sr. Vice Pres. Merch.: Ken Corum; Buyer (Pre-Recorded Music): Tony Benner; Buyer (Videos): Gene Jaskiewicz; Buyer (Accessories): John Petrovic; (Compact Disc, Pre-Recorded Audio Tape, Video (Cassette & Disc), Accessories) (Rackjobber)

Products/Accessories: CD, Tape & Record Products: Memorex; Storage & Carrying Cases: World Trade Mktg., CaseLogic, Dynasound; Blank Tape: TDK, Maxell, Sony,

Scotch, Memorex, Certron; Head Phones: Sony, Memorex, Transcriber; Batteries: Maxell.

The Audio Buff Co., Inc., PO Box 2628, 9 Kenny Rd., Athens, 45701, (614) 593-3014, Fax: (614) 592-6693, Pres./Buyer: Martin Rubin; Mgr.: Mary Boyer. (Compact Disc, Pre-Recorded Audio Tape, Video (Cassette & Disc), Records (LP's, 12-Inch, Singles), Accessories) (One-Stop, Library Service)

AudioVideo Rack Services, PO Box 2255, 317 Tiffin Ave., Sandusky, 44870, (419) 625-0028, Fax: (419) 625-2911, CEO: Joseph F. Yost III; Buyer: Bill Lestock. (Pre-Recorded Audio Tape, Video (Cassette & Disc), Cutouts, Accessories) (Rackjobber)

BMG Dist., 5000 Rockside Rd., Independence, 44131, (216) 447-1400, Fax: (216) 447-1404, Sales Mgr.: R. Zadd. (Compact Disc, Pre-Recorded Audio Tape, Video (Cassette & Disc), Records) (Distributor)

Labels Distributed: Audio/Video: See New York Listing For Product Line.

CEMA Dist.—Cleveland, 17851 Jefferson Park Dr., #102, Middleburg Heights, 44130, (216) 826-1118, (800) 321-0790, Fax: (216) 826-1363, Branch Mgr.: Keith Spittler. (Distributor)

Labels Distributed: Audio: Owned: Capitol, EMI Records USA, SBK, Angel, Blue Note, Capitol Nashville, Capitol/EMI Latin; Joint Venture: Chrysalis, I.R.S.; Third Party: Barking Pumpkin, Bellmark, Rhino, Gold Castle, Curb, American Record Distribution.

CAMPUS RECORDS INC.

College
Market
Specialist

Wholesale Distributors

- COMPLETE STOCK OF CD's, LP's, & CASSETTES
- ALL MAJOR LABELS/EXTENSIVE INDIE LIST
- LOW PRICE LEADER/ORDERS SHIPPED SAME DAY
- SPECIALISTS IN NEW STORE OPENINGS
- COMPUTERIZED/IMMEDIATE RETURN CREDIT

Our Regular Everyday Low Prices Include

All major label frontline CD's — \$9.75
All major label superstar CD's — \$10.79
WEA Supersaver CD's (Hot titles) — \$7.83
WEA Supersaver CD's (minor titles) — \$8.24
CBS nice price CD's — \$6.39
\$9.98 List LP/Cass — \$6.25

Be Thrilled With Our

WEEKLY DEALS! Call Today to get on our mailing list!

CAMPUS RECORDS INC.

4147 Weaver Court South
Hilliard, Ohio 43026
614-771-9222 • FAX 614-771-9228
1-800-552-3472

EVERYTHING A ONE STOP SHOULD
BE & MORE

CLEVELAND **1** STOP INC.
1-800-321-3660 3622 PROSPECT
CLEVE. OH. 44115

Fax: 216-881-4396

CALL US FOR DETAILS ON EVERYDAY **LOW** PRICES!

Campus Records, Inc.

4147 Weaver Ct. S., Hilliard, 43026, (614) 771-9222, (800) 552-3472, Fax: (614) 771-9226, Contact: James Dawson. (Compact Disc, Pre-Recorded Audio Tape, Video (Cassette & Disc), Records (LP's, 12-inch), Accessories) (Distributor) Labels Distributed: Audio: All major and indie labels. Products/Accessories: CD, Tape & Record Products: Alpha; Blank Tape: TDK, Maxell, Sony, Case Logic, Jewel Boxes.

Cleveland One Stop Record, Inc.

3622 Prospect Ave., Cleveland, 44115, (216) 881-4393, Fax: (216) 881-4396, Sec./Treas./Buyer: Charles Young; Mgr./Buyer: Brad Bell. (Compact Disc, Pre-Recorded Audio Tape, Video (Cassette & Disc), Records (LP's, 12-inch, Singles), Accessories) (One-Stop) Products/Accessories: CD, Tape & Record Products: Pfanstiehl, Discwasher; Storage & Carrying Cases: Posso Savoy, Case Logic; Blank Tape: Memtek, TDK, Maxell; Head Phones: Memorex; Diamond Needles: Pfanstiehl.

Commtron Corp., 5265 Naiman Pkwy., Solon, 44139, (216) 248-1660, Fax: (216) 248-4393, Branch Mgr.: Tom Ryans; Asst. Mgr.: Darby Savage; Sales Mgr.: Joe Simpson. (Video (Cassette & Disc)) (Distributor) Labels Distributed: Audio/Video: See Iowa Listing For Product Line.

Dayton Record Service, Inc., PO Box 339, 10451 Old Gallia Pike, Wheelersburg, 45694, (614) 574-2583, Fax: (614) 574-2113, Vice Pres./Buyer: Joe Taylor; Mgr.: Jim Colly; Buyer (Pre-Recorded Music): Ray Lewis. (Compact Disc, Pre-Recorded Audio Tape, Video (Cassette & Disc), Cutouts, Overstock, Accessories) (Rackjobber) Products/Accessories: CD, Tape & Record Products: Sentry; Storage & Carrying Cases: Imperial; Blank Tape: Sony, Memorex, Scotch, Laser; Head Phones: Memorex, Sentry; Batteries: Ray-O-Vac.

Electronix Corp., 313 W. Main St., Fairborn, 45324, (513) 878-1828, Pres.: David Kushner. (Video (Cassette & Disc)) (Distributor) Labels Distributed: Video: Instructional Tapes Teaching VCR Repair For Video Store Owners. Products/Accessories: Other: VCR Repair Parts for Video Store Owners.

Gentry II Corp., 2150 Hamilton Ave., Cleveland, 44114, (216) 348-1600, Fax: (216) 348-1604, Pres./Mgr.: Ron Schafer; Buyer: Nick Tranchito. (Records (LP's, 12-inch), Cutouts, Overstock) (Rackjobber)

Handleman Co., 4288 Armstrong Blvd., Batavia, 45103, (513) 732-1900, Branch Mgr.: Dave Jones; Opns. Mgr.: Steve Evans; Sales Mgr.: Marty Young. Branches: 12111 DeBartolo Dr., North Jackson, 44451, (216) 538-3348, Branch Mgr.: John York; Opns. Mgr.: Rick Carlisle; Sales Mgr.: Debbie Wisen. (Compact Disc, Pre-Recorded Audio Tape, Video (Cassette & Disc)) (Rackjobber) Labels Distributed: Audio/Video: See Michigan Listings For Product Distribution.

The Little Warehouse

5505 Valley Belt Rd., Independence, 44131, (216) 398-0022, Fax: (216) 398-9980, Pres.: Jim Lesnick; Sales/Mktg. Dir.: Joe Kauffman. (Accessories) (Distributor) Products/Accessories: Blank Tape: Audio: Ampex, Agfa, 3M, DIC Digital; Video: Ampex, Agfa, 3M, TDK, Maxell.

Major Video Concepts, 1827 O'Brien Rd., Columbus, 43228, (614) 876-0137, (800) 876-0678, Fax: (614) 876-3027, Sales Mgr.: Jim Hayden; Sr. Inside Sales Reps.: T. Stanton, Cindy Bailey; Territory Sales Mgr.: Jim Pryor. (Distributor) Labels Distributed: Video: See Indiana Listing for Product Distribution.

Products/Accessories: Storage & Carrying Cases: Alpha, Amaray; Blank Tape: Fuji, TDK, Scotch; Other: Reclon Accessories.

Oho Record Rack, PO Box 523, 72 S. Main St., Miamisburg, 45343, (513) 866-3629, CEO/Mgr./Buyer: Chris Kondoff. (Compact Disc, Pre-Recorded Audio Tape, Records (LP's, 12-inch, Singles), Cutouts, Overstock) (Rackjobber, Exporter)

Photoco, Inc., 4347 Cranwood Pkwy., Cleveland, 44128, (800) 955-5505, Fax: (800) 321-1329, Pres.: David Teicher; Vice Pres.: Walter Laysler; Mktg. Mgr.: Keith Teicher. (Distributor) Labels Distributed: Video: Acme-Lite, Aztec Accessories, Dust-Away Plus, Goldberg Reels, Pelican Cases, Samsonite Camcases, Stitz Tripods, Tiffen Filters. Products/Accessories: Batteries: Maxell, Aztec, Duracell, Eveready, Panasonic.

Record Theatre + Ambat Records, 4590 Montgomery Rd., Cincinnati, 45212, (513) 531-8877, Mgr./Buyer (Music, Videos): Sarah Fitzpatrick; Buyer (Accessories): Theresa Bernert; Buyer (Singles): Todd Benjamin; Buyer (Indies): Kelly Carlier. (Compact Disc, Pre-Recorded Audio Tape, Video (Cassette & Disc), Records (LP's, 12-inch, Singles), Cutouts, Accessories) (One-Stop) Products/Accessories: Audio & Video Playback Equipment: Donnette Karaoke Machines; CD, Tape & Record Products: Maxell, Discwasher, Memorex; Storage & Carrying Cases: Lebo, Case Logic, Leslie Dame and others; Blank Tape: Maxell, Denon, TDK, Memorex, That's; Head Phones: Memorex; Other: Large selection of closeout LPs, CDs and Cassettes.

Schwartz Bros., Inc., 1231 E. 26th St., Cleveland, 44114, (216) 696-2701, Fax: (216) 696-2066, Branch Mgr.: Harvey Korman; Sales Mgr.: John Horn. (Distributor) Labels Distributed: Audio: American Gramophone, Aegis, Atlanta Int., Cheeta, CMC, DCC, Direct Co., 4 P.M., Grateful Dead, Ichiban, Little Major, Next Plateau, Nuage, Pair, Nasty Mix, Par, Project 3, Quality, Rap-A-Lot, Rykodisc, Sam, Sheffield Lab, Rohit, Vision, Walt Disney; Video: See Maryland Listing for product line. Pay-Per Transaction.

Jimmie Skinner Music Center, 5825 Vine St., Cincinnati, 45216, (513) 242-8000, Chief Exec.: Lou Ukehson. (Pre-Recorded Audio Tape, Records (LP's)) (Distributor, Exporter) Labels Distributed: Audio: County, Country Corner, Octev, Old Homestead, Papa Lou, Rebel, Star Time, Sugar, Vetco. Pay-Per Transaction.

Spanish Music Club, 520-D Enterprise Ave., Westerville, 43081, (614) 841-1555, Pres.: Carlos Ramirez; Mgr.: Sharon Manley. (Compact Disc, Pre-Recorded Audio Tape, Cutouts, Overstock, Accessories) (Distributor, Importer, Exporter) Labels Imported: Major and Independent Labels from Mexico, Spain, Central America and South America.

Top 40 Video Leasing, 4126 Mayfield Rd., South Euclid, 44121, (216) 381-1000, (800) 678-7640, Fax: (216) 381-6283, ZBS Industries, Inc., 701 Beta Dr., Mayfield Village, 44143, (216) 461-6275, (800) 321-8774, Fax: (216) 461-0230, Owners: Earl Stein, Larry Beyer, Jay Schultz. (Distributor) Labels Distributed: Video: CBS/Fox, Paramount, Walt Disney, MGM, Orion/Nelson, Warner Bros, Media, New World and others.

OKLAHOMA

Best Video, Inc., 50 NW 44th St., Oklahoma City, 73118, (405) 557-0066, Fax: (405) 524-6851, Pres.: John D. Bronstad; Buyer: Drake Colley. (Distributor) Labels Distributed: Video: All major studios and most independents.

Infinity Video, PO Box 55388, Tulsa, 74155, (918) 585-5033, (800) 678-2127, Fax: (918) 584-5536, Gen. Mgr.: Keith Provan; Mgr.: Dave Bordon. (Distributor) Labels Distributed: Video: Willie George Ministries, Fire By Nite Prods., Impact Prods., C.P. Annie Prods., Infinity Prods.

OREGON

Allegro Imports, 3434 SE Milwaukie Blvd., Portland, 97202, (503) 232-4213, Fax: (503) 232-9504, Pres.: Joseph Miscalet. (Distributor)

Labels Imported/Distributed: Audio: Delos, DMP, Dorian, Newport Classic, Conifer, Collins, IMP, Pickwick (UK), Arion, AS Disc, JVC, Playa Sound, Verona, Bellaphon, Classics for Pleasure, Continuum, CBC Records, Meridian, PRIORITY, Montaigne, Intercord, Fono, Eterna, Pierre Verany, Sound Products, Ricercar, Saga, Ode, Mastersound, Kontrapunkt, Classic Masters, Bandleader, Lyrita, Olympia and P. NAGRANA.

Baker & Taylor Video, 5769 NE Columbia Blvd., Portland, 97218, (503) 249-8397, (800) 452-1082, Fax: (503) 282-5904, Sales Mgr.: Bob Warren. (Distributor, One-Stop) Labels Distributed: Audio/Video: See Illinois Listings For Product Lines.

City Hall Records, 12090 SW Bowmont St., Portland, 97225, (503) 643-6518, Fax: (503) 644-5545, Branch Mgr.: Allen Jones. (Compact Disc, Pre-Recorded Audio Tape, Video (Cassette & Disc), Records) (Distributor, Importer, Exporter) Labels Distributed: Audio/Video: See California Listing For Product Line.

Commtron Corp., 7911 NE 33rd Dr., Ste. 270, Portland, 97211, (503) 281-2673, Fax: (503) 284-6046, Branch Mgr.: Skip Merkel; Sales Mgr.: Mike McQuery. (Video (Cassette & Disc)) (Distributor) Labels Distributed: Audio/Video: See Iowa Listing For Product Line.

Egner Entis, Inc., 13520 NW Cornell Rd., Portland, 97229, (503) 693-1492, Fax: (503) 693-1282, Pres.: Corey Egner. (Video (Cassette & Disc)) (Rackjobber)

Ingram Entertainment Inc., 6635 NE 59th Pl., Portland, 97218, (503) 284-3313, Branch Mgr.: Gene Zimmerman. (Distributor) Labels Distributed: Video: See Tennessee Listings For Product Distribution.

Lifedance Dist., 3479 NW Yeon Ave., Portland, 97210, (503) 228-9430, Fax: (503) 228-5039, Pres.: Morris McClellan; Buyer (Pre-Recorded Music): Dan Gassaway; Gen. Mgr.: Eleanor Ross. (Distributor)

Labels Distributed: Audio: Acorn Music, Brentwood, Channel Prods., Dargason Music, Earthtunes, Global Pacific, Gourd Music, Hearts of Space, Highland, Joplin & Sweeney, Laser Light, Lind Inst., Love Records & Tapes, Maggie's Music, Magic Wing, MagicMusic, MMMusic, MSP, Narada, Newell Oler, Nichols-Wright, North Star, Phileo, Radhika Miller Music, Real Music, Revere, Silver Wave, Sonic Atmospheres, Soulo Prods. and others.

Phone Booth Records, 2733 SW 18th Pl., Gresham, 97080. Rentrak Corp., PO Box 18888, Portland, 97218, (503) 284-7581, (800) 228-7581, Pres./CEO: Ron Berger; Dir., Prod. Development: Martin G. Graham. (Video (Cassette & Disc)) (Distributor)

Pay-Per Transaction. Sea-Port Record One Stop, Inc., 7911 NE 33rd Dr., #120, Portland, 97211, (503) 287-0868, Fax: (503) 287-0263, Pres.: Tom Choate; Sales Mgr.: Vicki Wooten; Buyers (Music, Videos): Vicki Oliveira, Arni May; Buyer (Accessories): Erik Engelke; Warehouse Mgr.: Kirk McShane; Buyers (Music, Video): Wilton Merrit. (Compact Disc, Pre-Recorded Audio Tape, Video (Cassette & Disc), Records (12-inch), Cutouts, Accessories) (One-Stop) Products/Accessories: CD, Tape & Record Products: Discwasher, Allsop, Memorex; Storage & Carrying Cases: Savoy, Lotz, Case Logic; Blank Tape: Maxell, TDK, Denon. Sight & Sound Dist. Co., 9750 SW Hillman Ct., Wilsonville, 97070, (503) 682-2770, Fax: (503) 682-3077, Owner: William A. Hall Sr. (Rackjobber)

PENNSYLVANIA

AAA Video Distributors, 500 Mill Rd., Bensalem, 19020, (800) 220-2200, Fax: (215) 638-0770, CEO: Jim McManus; Mgr.: John Torriello; Buyer (Video/Accessories): Denise Duffner; Buyer (Video/Accessories): Kim Gallagher. (Distributor) Products/Accessories: CD, Tape & Record Products: Kinyo Cleaners, Nintendo Game Kleen; Storage & Carrying Cases: Alpha & Amaray; Other: Kinyo Video Rewinders, Solodex Video Rewinders, Neo Geo Systems & Tapes.

Artec Dist., Inc., 1509 Pkwy. View Dr., Pittsburgh, 15205, (412) 788-1399, (800) 451-5160, Branch Mgr.: Scott Morse. (Compact Disc, Pre-Recorded Audio Tape, Video (Cassette & Disc)) (Distributor, Rackjobber) Labels Distributed: Audio: See Vermont listing for product lines.

Baker & Taylor Video, 100 Bus. Center Dr., Pittsburgh, 15205, (412) 787-8890, (800) 245-1172, Fax: (412) 787-0368, Sales Mgr.: Patty Lewis. (Distributor, One-Stop) Labels Distributed: Audio/Video: See Illinois Listings For Product Lines.

Barnes Record Dist., RD #2, Box 103, Lehighton, 18235, (717) 645-2321, Owner/Mgr./Buyer: Bill Barnes. (Compact Disc, Pre-Recorded Audio Tape, Video (Cassette & Disc), Records (Singles, Cutouts, Overstock, Accessories) (Distributor, Rackjobber)

Caprice Dist., PO Box 808, Lititz, 17543, (717) 627-4860. Collectables Record Corp., 2324 Haverford Rd., Ardmore, 19003, (215) 649-7650, Fax: (215) 649-0315, Chief Exec.: Jerry & Nina Greene. (Distributor)



THE LITTLE WAREHOUSE, INC.





MAKE TLW YOUR TAPE DISTRIBUTOR!

HERE ARE A FEW REASONS WHY...

BUY AMPEX 456 @

2" - \$114.08 / reel In Carton Qty. of 2

1" - \$ 55.32 / reel In Carton Qty. of 5

1/4" - \$ 9.90 / hub In Carton Qty. of 10

* FULL SERVICE AUDIO & VIDEO DUPLICATION *

CALL FOR YOUR FREE CATALOG



CUSTOM LOADED VHS

THE LITTLE WAREHOUSE, INC.

5505 Valley Belt Rd. - Suite F / Independence, OH 44131

(216) 398-0022 1-800-445-8273 Fax (216) 398-9980



GOTHAM

DISTRIBUTING CORPORATION

Home of

Collectables[®]

We Specialize in Oldies...

45 R.P.M. ■ Cassette & CD Singles
Cassettes ■ Albums ■ Box Sets

EXCLUSIVE DISTRIBUTOR OF 7" OLDIES SINGLES

**FOR... SONY ■ MOTOWN ■ POLYGRAM ■ A&M
ISLAND ■ COLUMBIA ■ EPIC**

**BUDDAH ■ COLLECTABLES ■ FANTASY ■ LAURIE ■ ROULETTE
SPECIALITY ■ STAX ■ SUN ■ RHINO ■ BEARVILLE**

GOTHAM DISTRIBUTING CORP. 2324 HAVERFORD AVE. ARDMORE, PA 19003

215-649-7650 • 1-800-4-GOTHAM outside PA

Write or call for a Free catalog

Labels Distributed: Audio: Seven-inch 45s from Sony, Motown, PolyGram, A&M, Island.

Dutchland Distributing, 499 N. Maple St., Ephrata, 17522, (717) 733-7842, Owners/Buyers: Robert & Janice Miller. (Compact Disc, Pre-Recorded Audio Tape, Video (Cassette & Disc)) (Distributor, Rackjobber)

Labels Distributed: Audio/Video: Word, Sparrow, Zondervan, Spectra, Multnomah, Brentwood, Star Song, Price-Stern-Sloan.

Galaxy Records & Tapes, 2400 Josephine St., Pittsburgh, 15203, (412) 481-8600, Fax: (412) 481-8693, Pres./Mgr.: Eugene Jakiela; Buyer (Music, Videos): Kevin C. Jakiela; Buyer (Accessories): Wayne Jakiela; Buyer: Singles: Norm Kirsch. (Compact Disc, Pre-Recorded Audio Tape, Video (Cassette & Disc), Records (LP's, 12-Inch, Singles), Overstock, Accessories) (One-Stop)

Products/Accessories: CD, Tape & Record Products: Pfantone; Storage & Carrying Cases: Case Logic; Blank Tape: TDK; Head Phones: Pfantone, Stanton; Diamond Needles: Pfantstiehl.

Gotham Dist.

2324 Haverford Rd., Ardmore, 19003, (215) 649-7650, Pres.: Jerry Greene; Vice Pres.: Melissa Greene; Mgrs.: Marcus Martin, Doug Sessoms; Buyer (Pre-Recorded Music): Vicky Leotta; (Records (Singles)) (Distributor, One-Stop, Rackjobber)

Labels Distributed: Audio: All Major Labels, Fantasy, Stax, Savoy, Specialty. (Exclusive oldie 45's for: Sony, Motown, PolyGram, Island, AtM, Fantasy, Stax, Specialty, Collectibles, Rhino, Sun, Bearsville).

Jamie/Guyden Dist. Corp., 2055 Richmond St., Philadelphia, 19125, (215) 426-4384, Pres.: Harold B. Lipsius; Mgr.: Paul Fien. (Distributor, Importer)

Labels Distributed: Audio: Arctic, Dionn, First Amendment, Guyden, Jamie, MSL, Montel, Phil-L.A. of Soul, Sundi, Tear-Drop, Top & Bottom.

Jesus Music Dist., 165 Little Creek Rd., Harmony, 16037, (412) 452-5556, Chief Exec.: Louis P. Hancherick. (Distributor) Labels Distributed: Audio: Joy Song, LoveRock, Private Label Products.

M C A Dist. Corp., 505 Wheatfield Ln., Newtown, 18940, (215) 579-1121, Fax: (215) 579-1185, Regional Sales Mgr.: Ron De Marino Sr. (Distributor)

Labels Distributed: Audio: See California Listing For Product Line. MCA Records, GRP, Motown, Narada, Geffen, Varese, Sara Bande, Chess, Mechanic, Impulse; Video: See California Listing For Product Line; MCA/Universal Home

Music Video, Rhino Music Home Video.

Mobile Record Service Co., 2716 Penn Ave., Pittsburgh, 15222, (412) 391-8182, Fax: (412) 391-8117, Chrmn.: Jim Oseroff; Pres./Buyer: Harvey Campbell; Buyers (Pre-Recorded Music): Ray Valerino, Davie McNally. (Compact Disc, Pre-Recorded Audio Tape, Records (Singles)) (Distributor, One-Stop)

Labels Distributed: Audio: Brow Rapper, Cleveland Beat, Damon, Fiat Baroque, HDM, Hype-Jam.

Music Video Distributors, PO Box 1128, Norristown, 19404, 500 E. Washington St., Norristown, 19401, (800) 888-0486, Fax: (215) 272-6074, Pres./Buyer: Thomas Seaman; Sales Mgr.: Ed Seaman. (Distributor)

Labels Distributed: Video: All music videos on all labels, some imports as well.

Rank Retail Services, 1000 Industrial Blvd., Aliquippa, 15001, (412) 857-0700, Mktg. Dir.: Pat McDonough. (Video (Cassette & Disc)) (Rackjobber)

A. I. Rosenthal Assoc., Inc., 302 Welsh Rd., Horsham, 19044, (800) 523-2472, Fax: (215) 784-0555, Pres.: Al Rosenthal; Exec. Vice Pres./Mgr.: Jeffrey S. Lane; Buyer (Accessories): Jim Eldridge. (Distributor)

Products/Accessories: CD, Tape & Record Products: Allsop, Discwasher, Geneva, Maxell, Recoton, Gemini; Storage & Carrying Cases: Case Logic, Savoy, Napa Valley, Amaray; Blank Tape: Maxell, TDK, Scotch, Sony, Fuji, JVC, Memorex, BASF; Head Phones: Sony, Memorex, Maxell; Batteries: Duracell, Eveready, Millenium.

Satellite Sound, Inc., PO Box 164, 1000 E. Ashland Ave., Folcroft, 19032, (215) 237-1149, Fax: (215) 237-8809. (Distributor, Wholesaler & Distributor)

Smith Record Sales, Inc., 1904 W. Cecil B. Moore Ave., Philadelphia, 19121, Owner: Ulysses C. Smith; Mgr.: Stanley Smith. (Distributor, One-Stop)

Labels Distributed: Audio: August, Behina's, Billesse, CH Special, Daystar, Dynamic, Pearl, Pulpit, Rasheeba, Redeemed, Sendus, Sweet Rain, Tryscot.

Star Video Entertainment, L.P., 1311 Ford Rd., Bensalem, 19020, (215) 638-1350, (800) 248-6333, Fax: (215) 638-9450, Vice Pres.: Phil Balsam; Sales Mgr.: Charlene Manieri. (Video (Cassette & Disc)) (Distributor) Labels Distributed: Audio: Books On Tape; Video: See New Jersey Listing for product line.

Super Marketing Dist., Inc., 65 Richard Rd., Ivyland, 18974, (215) 674-5410, CEO/Buyer: Sylvan Gross; Book Buyer: Paul Gross. (Compact Disc, Pre-Recorded Audio Tape, Video (Cassette & Disc), Records (LP's), Cutouts, Overstock) (Distributor, Rackjobber)

Universal Home Video, 2055 Richmond St., Philadelphia, 19125, (215) 426-3333, Fax: (215) 426-2667, Pres.: Harold B.

Lipsius; Mgr.: Len Rakliff. (Video (Cassette & Disc)) (Distributor, One-Stop)

Labels Distributed: Video: All labels.

Universal One Stop, 2055 Richmond St., Philadelphia, 19125, (215) 426-3333, Fax: (215) 426-2667, Pres.: Harold B. Lipsius; Mgr.: Bob Perloff; Buyer (Pre-Recorded Music): Kathy Walsh; Buyer (Music/Accessories): Frank Falkow. (Compact Disc, Pre-Recorded Audio Tape, Video (Cassette & Disc), Records (12-Inch, Singles), Accessories) (One-Stop) Products/Accessories: CD, Tape & Record Products: Allsop, Discwasher, Recoton; Storage & Carrying Cases: Case Logic, Clik! Case, Laserline, Napa Valley, Posso Savoy, Tree Dimension; Blank Tape: Denon, Fuji, Maxell, Recoton, Sony; Head Phones: Recoton, Sony, TDK; Diamond Needles: Recoton; Other: All Recoton accessories.

Universal Record Distributing Corp.

2055 Richmond St., Philadelphia, 19125, (215) 426-3333, Fax: (215) 426-2667, Pres.: Harold B. Lipsius; Mgr.: Len Rakliff; Buyer (Pre-Recorded Music): Kathy Walsh. (Distributor) Labels Distributed: Audio: Amherst, Astro, Collectable, Cutting, Disney, Effect, E.J. 4th Broad, Golden, Hot Prod., JCI, K-Tel, Kamo, LRC, Maggie, Magic, Mainstream, Mango, Metro, Muse, Opul, Pan Disc, Paula, Pow Wow, Rave, Sema, Shanachie, Sugarhill, Tandem, Tall Tree, TBA, Tommy Boy, TSR, UWC.

RHODE ISLAND

Rhody Records & Tape, Rear 509 N. Main, Providence, 02904, (401) 724-8200, Pres.: Zubin Zeidman; Mgr./Buyer: Jack Conroy. (Compact Disc, Pre-Recorded Audio Tape, Video (Cassette & Disc), Records) (One-Stop)

SOUTH CAROLINA

Major Video Concepts Warehouse, 2940 Interstate Rd., Charlotte, 28208, Fax: (803) 796-4573, (Video (Cassette & Disc)) (Distributor)

Labels Distributed: Video: See Indiana Listing For Product Line.

TENNESSEE

A.V.I., PO Box 145, Pleasant View, 37146, 1150 Moss Bennett Rd., Ashland City, 37015, (615) 746-8608, Fax: (615) 746-2758, Pres.: Bernice Fields. (Compact Disc, Records (LP's)) (Distributor)

Labels Distributed: Audio: C.B.F., Charburn.

B.C. Ent's of Memphis Inc., 726 E. McLemore Ave., Memphis, 38106, (901) 947-2553, CEO/Pres.: Bob Karriem; Mgr./Buyer (Pre-Recorded Music): Brandon Catron; Buyer (Videos): Robert L. Catron Jr.; Buyer (Accessories): Nat Engleberg; Buyer (Accessories): Claudette M. Colbert; Buyer (Other): Brenda Catron. (Distributor, Rackjobber)

Labels Distributed: Audio: Echo, Katron, Brian Manor, Tip-Top, Adam's Rib, CD Music Ctr., Big Boy, Rooster Blues, Get Buck, One the Strength, Nature Of Beast, Synthesis Century.

Products/Accessories: Storage & Carrying Cases: Lebo; Blank Tape: TDK, Sony, Maxell; Batteries: Eveready; Diamond Needles: DuoTone, Pfantstiehl.

Benson Co., 365 Great Cir. Rd., Nashville, 37228, (615) 742-6800, Fax: (615) 742-6911, CEO/Gen. Mgr.: Jerry Park; Regional Sales Mgrs.: Jim McKenna, Mike Gay. (Compact Disc, Pre-Recorded Audio Tape, Video (Cassette & Disc), Records) (Distributor)

Labels Distributed: Audio: Benson, Power Disc, Riversong, Frontline, ForeFront, Enigma; Video: Benson.

Central South Music Sales, Inc., 3730 Vulcan Dr., Nashville, 37211, (615) 833-5960, Fax: (615) 331-2501, Buyer (Pre-Recorded Music): John Bennett; Buyer (Video, Accessories): Joyce Mass. (Compact Disc, Pre-Recorded Audio Tape, Video (Cassette & Disc)) (One-Stop)

Products/Accessories: CD Players: Magnavox; Audio & Video Playback Equipment: Magnavox, Emerson; CD, Tape & Record Products: Maxell, Discwasher, Allsop, TDK, Calibron; Storage & Carrying Cases: Case Logic, Napa Valley; Blank Tape: TDK, Maxell, Memorex, Fuji; Head Phones: Sony, Labtec, Memorex, Maxell; Batteries: Duracell; Diamond Needles: Pfantstiehl.

Corbitt Co., 125 Tomarand Dr., Antioch, 37013, (615) 726-3105, Contact: Sharon Corbitt.

Curtis Universal Record Masters, PO Box 1622, Hendersonville, 37077, (615) 822-1044, Pres.: Wade T. Curtis; Sales Mgr.: Dick Derwald; Gen. Mgr.: S.D. Neal; Labels Distributed: Audio: Company licenses, leases, buys and sells master tapes.

Custom Rack Service, 7605 Hoff Lane, Knoxville, 37938, (615) 689-5273, Fax: (615) 689-5273, Chief Exec./Mgr./Buyer: Tommy V. Ayres. (Compact Disc, Pre-Recorded Audio Tape) (Distributor, Rackjobber)

Dixie Exports, Inc., 1420 Donelson Pike, Nashville, 37217, (615) 399-2844, Fax: (615) 399-2952, Opns./Trade Mgr.: Ray Vallone; Gen. Mgr.: Tommy Drake; Air Cargo Coord.: Jessica Nielsen. (Compact Disc, Pre-Recorded Audio Tape, Video



THE LARGEST SELECTION OF VINYL 45'S IN THE WORLD!

Oldies are our only business - we're the 45 RPM oldies specialists. Our catalog contains over 2,800 of the best selling oldies. Our Special Order Department has over 30,000 titles. If you can't find it, chances are we have it!

THE BEST FILLS!

Our fills average over 95%! Our frequent, up-to-date catalogs contain all the latest releases plus many titles no longer available from any other wholesaler.

ERIC RECORDS!

ERIC Records is our own high-quality oldies label with over 250 pairings. Many titles are in true stereo and available exclusively on ERIC.

NEW! - ERIC CD4's!

Oldies on CD Singles!

Each CD contains 4 solid ORIGINAL HITS by the ORIGINAL ARTIST. Each CD has been meticulously mastered to provide the best quality sound possible. These hits have NEVER SOUNDED BETTER! These \$ 5.98* mini-albums will appeal to your price conscious customers.

*Suggested List Price.

AMERICAN RECORD SALES, INC.

1120 Crown Point Road • P.O. Box 287 • Westville, NJ 08093
Phone: (609) 848-1900 • FAX: (609) 848-0808

WRITE OR PHONE FOR CATALOGS & ORDERING INFORMATION

(Cassette & Disc), Records (LP's), Cutouts) (Distributor, Exporter)

Labels Distributed: Audio: Alligator, Antone's, Black Top, Black Vinyl, Caroline, Relativity, Profile, Pair, CMH, Ryko, Country Music Foundation, Rebel, Mobile Fidelity, Varrick, Blind Pig, Austin, Adelphi.

DixieRaks Records & Tapes, PO Box 22325, Nashville, 37202, 1012 18th Ave. S., Nashville, 37212, (615) 327-7980, Fax: (615) 321-0464, Pres.: Noel Gibson; Mgr.: Brenda L. Madden; Buyer (Pre-Recorded Music): Linda Mae Wilson. (Compact Disc, Pre-Recorded Audio Tape, Records (LP's, Singles)) (Exporter)

Michael Ginsburg Distribution, 1430 Tittsworth Rd., Seymour, 37865, (615) 984-3803, Fax: (615) 977-5852, CEO: Michael Ginsburg. (Compact Disc, Pre-Recorded Audio Tape, Video (Cassette & Disc)) (Distributor, One-Stop, Rackjobber) Labels Distributed: Audio: Acorn, Artifax, Black Top, Blind Pig, Bullseye Blues, Combs Music, Dargason, Flying Fish, Gourd, Green Linnet, Heartbeat Reggae, Higher Octave, June Appal, Maggie's Music, Music West, Music of the World, Nichols-Wright, Nightingale, Nighthawk, Pearl Mae, Philo, Revere, River Music, Rounder, JFL, Shanachie, Shining Star, Smithsonian/Folkways, Soar, Sugar Hill, Temple, Thistlegate, Tourquois, Wood N' Strings; Video: Shanachie.

Horseshoe Distributors, 2937 Harlin Dr., Nashville, 37211, (615) 331-1125, Exec. Officer: Webb Foley; Mgr.: Ruth Brown. (Compact Disc, Records (Singles)) (Distributor, One-Stop) Labels Distributed: Audio: Fox, Goldcrest, M, Yoopers.

Ingram Entertainment Inc., 1123 Heil-Quaker Blvd., LaVergne, 37086, (615) 793-5000, (800) 759-5000, Fax: (615) 793-3875, Pres./CEO: John Taylor; Sr. Vice Pres.: Ray Capp; Buyer (Videos)/Buyer (Accessories): B. Bishop; Buyer (Laser Discs): H. Neuhoff. (Distributor)

Labels Distributed: Video: CBS/Fox, Live, WEA/HBO, MCA, Media, MGM, Orion/Nelson, Paramount, RCA/Columbia, Vestron/Lightning, Walt Disney/Touchstone, S.V.S., Academy, Celebrity, Coliseum, J2, MPI, Republic, Vidmark, BMG, PolyGram, Fries, JCI, Maer, Pacific Arts, Turner Home Ent., Better Homes & Garden, Random House, Star-maker, Southgate, 360 Corp. Wood Knapp, Worldvision and others.

Products/Accessories: CD, Tape & Record Products: Alpha, Recordon, Jasco, Amaray; Storage & Carrying Cases: Alpha, Amaray, Blackburn; Blank Tape: JVC, SKC, BASF, Scotch; Head Phones: Jasco, Recordon; Other: Video Game Accessories From Alpha.

M C A Dist. Corp., 1514 South St., Nashville, 37212, (615) 244-8944, Fax: (615) 244-4428, (Distributor) Labels Distributed: Audio/Video: See California Listing For Product Line.

M C A Dist. Corp., 3130 Tchulahoma Rd., Memphis, 38118, (901) 366-5000, Fax: (901) 795-7130, Opm. Mgr.: Chuck Reynolds; Contact: Jerry Eggert. (Distributor) Labels Distributed: Audio/Video: See California Listing For Product Line.

Major Video Concepts, 5215 Linbar Dr., Ste. 210, Nashville, 37210, (615) 781-6090, (800) 888-0682, Fax: (615) 781-0558, Branch Mgr.: Don Smith; Sales Mgr.: Ron Smithson; Adv. Coord.: Mike Parris. (Video (Cassette & Disc)) (Distributor) Labels Distributed: Video: See Indiana Listings For Product Distribution.

Music City Record Dist., Inc.

25 Lincoln St., Nashville, 37210, (615) 255-7315, (800) 251-3232, Fax: (615) 255-7329, Pres.: Bruce Carlock; Vice Pres.: Mike Wise; Vice Pres. Purchasing: Hayes Carlock; Gen. Mgr./Buyer: Ted Adams; Export Mgr.: Richard Le Besnerais. (Compact Disc, Pre-Recorded Audio Tape, Records, Cutouts) (Distributor, One-Stop, Exporter) Labels Distributed: Audio: All Major & Most Independents. Record, Tape & Video Program Accessories: Extensive Line of Accessories.

Music Town Record Distributors, 830 Glastonbury Rd., Ste. 614, Nashville, 37217, (615) 361-7902, Pres.: Cliff Ayers Ostermeyer; Mgr.: Hannah Onassis; Buyer (Pre-Recorded Music): Christopher Ostermeyer; Buyer (Videos): Bob Mitchell. (Distributor)

Labels Distributed: Audio: American Sound, Emerald, Country World, Black Gold, Blue Chip, Big Mama, Bullseye, Canyon, Cardinal, Celebrity, Colt, Dart, DeLite, Film City, Gordy, Keen, Kenco, Lincoln, MRC, Major, Mecca, Rimrock, Silver Seal, Sims, Starday, Tamla, Variety, Way Out, Westport, Wingate, Worth. Pay-Per Transaction.

Nationwide Sound Distributors, PO Box 23262, Nashville, 37202, 1012 18th Ave. S., Nashville, 37212, (615) 327-7988, Fax: (615) 321-0464, Pres.: Joe Gibson. (Distributor) Labels Distributed: Audio: NSD, Soundwaves, Bench and others.

New Day Christian Dist. Inc., 126 Shivel Dr., Hendersonville, 37075, (615) 822-3633, (800) 251-3633, Fax: (615) 822-5829, CEO: Dorothy Leonard; Mgr.: Vince Wehby Jr.; Buyer: Lisa Vance. (Distributor) Labels Distributed: Audio: Zondervan, Word, Sparrow, Spectra (all major & most independent labels); Exclusive distributor for Day Wind products; Video: All Major Studios and most independents.

Poplar Tunes Record Shop, Inc., PO Box 3026, Memphis, 38173, 308 Poplar Ave., Memphis, 38103, (901) 525-6348, Fax: (901) 525-3440, Pres.: John Novarese; Buyer (Pre-Recorded

Music): Cathy Reginelli; Buyer (Accessories): Frank Berretta; Vice Pres./Mgr.: John T. Novarese, Jr.; Buyer (Music/Video): Jim Burge. (Compact Disc, Pre-Recorded Audio Tape, Video (Cassette & Disc), Records (LP's, 12-Inch, Singles), Cutouts, Accessories) (One-Stop) Products/Accessories: CD, Tape & Record Products: Discwasher, Maxell, Memorex, All Sop, TDK; Storage & Carrying Cases: Savoy, LEBQ; Blank Tape: TDK, Maxell, Memorex; Head Phones: Memorex; Batteries: Eveready, Memorex; Diamond Needles: Pfanstiel; Other: Incense, Pfantone products.

RCA/BMG Dist., 30 Music Sq. W., Nashville, 37203, (615) 664-1200, Fax: (615) 664-1202, Sales Rep: Greg Sano. (Compact Disc, Pre-Recorded Audio Tape, Video (Cassette & Disc), Records) (Distributor)

Labels Distributed: Audio/Video: See New York BMG Listing For Product Line.

Select-O-Hits Inc., 1981 Fletcher Creek Dr., Memphis, 38133, (901) 388-1190, Fax: (901) 388-3002, CEO: Sam W. (Skip) Phillips; Mgr.: Johnny Phillips; Buyer (Pre-Recorded Music): Jee Ann McCain; Buyer (Videos): Tiffany Rubio; One-Stop Buyer: Kathy Gordon. (Distributor)

Labels Distributed: Audio: Alligator, Air, Amherst, Antone's, Amazing, Blind Pig, The Rounder Group, Cheetah, CMH, Collectables, Fantasy, Malaco, TBA, DCC, Ichiban, Hot, Pandisc, Effect, Priority, Quality, K-Tel, Next Plateau, Four-sight, Hightone, Tommy Boy, Quark, Sog, Sugar Hill, Nasty Mix, Optimism, OSR, Spindeltop, Warlock, Island Group, Wax Trax, SST.

Ernest Tubb Record Dist., Inc., PO Box 500, Nashville, 37202, 1024 17th Ave. S., Nashville, 37212, (615) 329-2356, Fax: (615) 329-0151, CEO/Mgr.: Jacqueline Rather; Buyers (Pre-Recorded Music, Videos): Jacqueline Rather, Pam Hier. (Compact Disc, Pre-Recorded Audio Tape, Video (Cassette & Disc), Records (LP's, Singles), Cutouts) (Distributor, Importer, Exporter)

Labels Distributed: Audio: All Major Labels Independent: Step One, Stony Plain, County, Rebel, Sugar Hill, Dark Angel 800, Play Back, many others; Video: All Major. Pay-Per Transaction.

Labels Imported: Bare Family (Germany); RCA Int'l (UK); Montana Records (Switzerland); Longhorn (UK); Jupiter (Germany); Harry's (Japan); T.O.C.P. (Japan).

Wax Works-Video Works, 4477 Winchester Rd., Bldg.C, Ste. 1, Memphis, 38118, (901) 366-4088, (800) 888-4088, Vice Pres.: Bill Burton; Mgr.: Sue Gatewood; Buyer: Noel Clayton. (Distributor)

Labels Distributed: Audio: CBS, Celebrity, Disney-RCA Columbia, Fox, Forum, HBO, MCA, MCM, Media, New Star, New World, Orion, Paramount, Prism, Transworld, Vestron, Vidmark, Virgin, Warner Academy.

Curtis Wood Records & Tape Distributors, 4416 Eatons Creek Rd., Nashville, 37218, (615) 876-1729, Fax: (615) 244-4314, Owner/Mgr./Buyer: D.M. Haddock. (Compact Disc, Pre-Recorded Audio Tape, Video (Cassette & Disc), Records (LP's, 12-Inch, Singles), Cutouts, Overstock) (Distributor, Rackjobber, Exporter)

Labels Distributed: Audio: Eagle Int'l, Step One, CMH, Playback, Bradley Bros., Goldband, Hal-Kat, American Cowboy.

TEXAS

Alamo Record Dist., Inc., PO Box 5276, San Antonio, 78201, (512) 344-1515, Contact: Carmen Limon. (Pre-Recorded Audio Tape, Records) (Rackjobber).

Austin Record Dist., PO Box 312, 4701 Chiappero Tr. (78731), Austin, 78767, (512) 451-9770, Owner: Susan Jarrett. (Distributor)

Labels Distributed: Audio: Amazing, Antones, Broken Spoke, Fable, Felicity, Guacamole, Pleasure, Rainlight, Philo/Rounder, Arhoolie, Step One, Austin, Texas Soul.

BMG Dist., 12160 Abrams Rd., Ste. 310, Dallas, 75243, (214) 480-5100, Fax: (214) 699-0213, Branch Mgr.: J. Silhan; Sales Mgr.: B. Navarrete. (Compact Disc, Pre-Recorded Audio Tape, Video (Cassette & Disc), Records) (Distributor)

Labels Distributed: Audio/Video: See New York Listing For Product Line.

Barstow Pro, 701 S. Main St., Ste. 114, Corsicana, 75110, (214) 874-3995, (Compact Disc, Pre-Recorded Audio Tape, Records) (Distributor).

Best Video, Inc., 10580 Newkirk, Ste. 100, Dallas, 75220, (214) 889-9641, Fax: (214) 556-1686, Contact: Jim Pollan; Branch Mgr.: Mike Howard.

Branch(es) 11849 Starcrest Dr., San Antonio, 78247, (512) 496-3832, Fax: (512) 496-5736, Branch Mgr.: Mike Rodriguez; 5200 Mitchelldale, Houston, 77092, (713) 681-9465, Fax: (713) 681-2856, Branch Mgr.: Mike Howard. (Video (Cassette & Disc)) (Distributor)

Labels Distributed: Video: All Major Studios & Most Independent.

Big State Dist. Corp., 4830 Lakawana St., Ste. 121, Dallas, 75247, (214) 631-1100, Fax: (214) 630-2866, Pres.: Billy Emerson; Vice Pres. Business Affairs: Mike Emerson; Vice Pres. Opm./Vice Pres. Sales: J. Emerson/L. Howell. (Compact Disc, Pre-Recorded Audio Tape, Video (Cassette & Disc), Records (LP's, 12-Inch, Singles), Accessories) (Distributor) Branch(es): 8410 Gold Creek, Houston, 77080, (713) 690-9592, Fax: (713) 690-1645, Sales Rep: Ben Morton. (Compact Disc, Pre-Recorded Audio Tape, Video (Cassette & Disc), Records) (Distributor, One-Stop); 4700 Rowena, Austin, 78751, (512) 451-2936.

Labels Distributed: Audio: Alligator, American Gramophone, Bainbridge, Buena Vista, Cardiac, Cheetah, Fantasy, Hightone, JCI, Macoia, Malaco, Mango, Milestone, Nasty Mix, Next Plateau, Oaklawn, OJC, OBC, Optimism, Pandisc, Prestige, Priority, Quality, Ranwood, Rounder, Silver Wave, Step One, Sugarhill, Sugar Hill, TBA, Tommy Boy, Vision, Voss, 4th & Broadway, Oh Boy; Video: AIP, Academy, Buena Vista, Cabin Fever, Celebrity, Fries, HBO, Hemdale, Imperial, JCI, J2, Kartes, MGM, Pacific Arts, Playboy, PolyGram, Republic, SGE, SVS, Southgate, Video-Treasures, Vidmark, Warner Bros., Wood Knapp.

Products/Accessories: CD Players: Hitachi; Audio & Video Playback Equipment: Hitachi; CD, Tape & Record Products: Recordon, Disc Washer; Storage & Carrying Cases: Case Logic, Nappa Valley; Video Cassette Recorder: Hitachi; Blank Tape: TDK, Maxell, Memorex; Batteries: Eveready.

CEMA Dist.—Dallas, 1231 Greenway Dr., Ste. 300, Irving, 75038, (214) 714-4550, Branch Mgr.: Tom Tilton. (Distributor) Labels Distributed: Audio: Owned: Capitol, EMI Records USA, SBK, Angel, Blue Note, Capitol Nashville, Capitol/EMI Latin; Joint Venture: Chrysalis, I.R.S.; Third Party: Barking Pumpkin, Bellmark, Rhino, Gold Castle, Curb, American Record Distribution.

Commtron Corp., 15002 Sommermeyer, Houston, 77041, (713) 937-3600, Fax: (713) 466-4316, Branch Mgr.: Mary Brock;

ERNEST TUBB RECORD DIST.

IMPORT/EXPORT

Independents - Major Label
Back Catalog

Country Bluegrass
Folk Gospel

45's + Albums - Cassettes
Compact Discs - Videos - Books

Tele: (615) 329-2356
FAX: (615) 329-0151



DOMESTIC • EXPORT

- COMPUTERIZED INVENTORY
- ALL MAJOR LABELS
- EXTENSIVE INDEPENDENT LABEL SELECTION
- COMPLETE LINE OF ACCESSORIES

MUSIC CITY RECORDS DIST., INC.

25 LINCOLN STREET, NASHVILLE, TN 37210
615-255-7315 FAX 615-255-7329 1-800-477-1010

Asst. Mgr.: Jim Westmeier; Opns. Mgr.: Mike Morrison. (Video (Cassette & Disc), Computer Games) (Distributor) Branch(es): 1430 Bradley Ln., #102, Carrollton, 75007, (214) 245-6088, Fax: (214) 323-3890, Branch Mgr.: Al Corscadden. Labels Distributed: Video: Academy, Cabin Fever, Celebrity, Disney, CBS/Fox, Fox-Lorber, Fries, Good Times, HBO, Hanna-Barbera, Glendale, Imperial, IVE, J-2, Lyons, Maier, Magnac, MCA, MGM, Media, Monarch, MPI, Nelson, Orion, Pacific Arts, Paramount, PolyGram, Random House, RCA/Columbia, Republic, Rhino, Shapiro-Glickenhause, Sony, Southgate, Strand, Turner, United, Vestron, Vidmark, Vid-America, Warner, Wood Knapp, Xenon. Products/Accessories: CD Players: Crown, Panasonic, Magnavox; Audio & Video Playback Equipment: Magnavox, Shintom, Emerson, Tradewest, Acclaim, Bandai America, Moviewalker, Samsung, Panasonic, Action; CD, Tape & Record Products: BiB, Jasco; Storage & Carrying Cases: Amaray, Alpha, Solidex; Video Cassette Recorder: Panasonic, Samsung, Shintom, Magnavox, Toshiba, Moviewalker, Quasar; Blank Tape: Sony, Maxell, TDK, Fuji, JVC; Head Phones: Sony.

Crockett & Assocs. Sound Recording Sales, 4700 Rowena, Austin, 78751, (512) 451-2936, Fax: (512) 451-5021, Sales Mgr.: Michael Crockett. (Distributors' Rep.) Labels Distributed: Audio: Rep for Big State (TX), Rounder (KS), Koch Int'l, Westbury, Musicrama (NY).

E & R One Stop, 119 E. Rhoady, San Antonio, 78216, (512) 342-6935, Fax: (512) 377-0039, Pres./Mgr.: Doris Hengst; Sec.: La Vonnia Moses; Buyer (Music, Video): Brian Alston. (Compact Disc, Pre-Recorded Audio Tape, Video (Cassette & Disc), Records (12-Inch, Singles)) (One-Stop).

E.T.D. Inc. HQ, 7171 Grand Blvd., Houston, 77054, (713) 748-2520, Fax: (713) 748-5103, Pres.: Ron Eisenberg; Buyer (Pre-Recorded Music): David Bennett; Buyer (Videos): Mike Russell; Buyer (Accessories): David Bennett; Buyer: Gary Barnes; Vice Pres. Video Div.: Hector Gonzalez. (Pre-Recorded Audio Tape, Video (Cassette & Disc)) (Distributor) Labels Distributed: Audio: Promotional Lines; Video: All Major Studios & Most Independents. Pay-Per Transaction.

Branch(es): 7171 Grand Blvd., Houston, 77054, (713) 748-2520, Branch Mgr.: Ken Kayes; 3409 Brinkman, Houston, 77018, (713) 861-9251, Fax: (713) 861-0149, Branch Mgr.: Wes Dally.

Handelman Co.-Dallas, 1515 Halsey Way, Carrollton, 75007, (214) 242-7915, Branch Mgr.: Roger Green; Sales Mgr.: Kenneth Reynolds. (Compact Disc, Pre-Recorded Audio Tape, Video (Cassette & Disc)) (Rackjobber) Labels Distributed: Audio/Video: See Michigan Listings For Product Distribution.

Important Record Dist., 11819 Forest Gate, Dallas, 75243, (214) 644-8608, Fax: (214) 644-8477, (Pre-Recorded Audio Tape, Records) (Distributor) Labels Distributed: Audio: See New York Listings For Products Distributed.

Ingram Entertainment Inc., 2259 Merritt Dr., Garland, 75041, (214) 840-6621, Branch Mgr.: Harvey Hoffner. (Distributor) Labels Distributed: Video: See Tennessee Listings For Product Distribution.

Lieberman Ents., Inc., 9801 Chartwell Dr., Dallas, 75243, (214) 349-2520, (800) 527-1552, Branch Mgr.: Jim Sinclair. (Compact Disc, Pre-Recorded Audio Tape, Video (Cassette & Disc), Records) (Rackjobber).

MCA Dist. Corp., 1501 LBJ Fwy., Ste. 550, Dallas, 75234, (214) 484-3001, Field Sales Mgr.: Jim Weatheron. (Distributor) Labels Distributed: Audio: See California Listing For Product Line; Video: See California Listing For Product Line.

Music Distributors Inc., 6504 Midway, Ste. 200, Haltom City, 76117, (817) 831-2982, Fax: (817) 831-3608, Pres.: Don F. Gillespie; Mgr.: Bebe Pulliam; Music Buyers: Scott Taylor; Contact: Melissa Queery. (Distributor) Labels Distributed: Audio: Albany, CMH, Cutting, Creative Funk, DB, DCC, Dr Dream, Effect, 4-Sight, GNP, Hot, Heatwave, Ichiban, KK, K-tel, Megatone, MicMac, Newtown, Nichols-Wright, Pair, Peter Roberts Prod., Pilz, Power Artist, RAS, ROIR, Soar, SOH, Spindletop, SST, Tandem, ValleyVue, Warlock, WaxTrax.

North Star Music Co., PO Box 1808, Southlake, 76092, (817) 481-1361, Fax: (817) 481-1361, Pres.: Will Johnson; Mgr.: Mike Moore; Buyer: Mark Jaeger. (Compact Disc, Video (Cassette & Disc), Records, Computer Games) (Importer, Exporter) Labels Imported: Product from USSR, France Belgium.

Operations International Inc., PO Box 670234, Dallas, 75367, 2927 Ladybird Ln., Dallas, 75220, (214) 350-7782, Fax: (214) 350-7783, Pres./Sales & Mktg. Dir.: Richard Chalk; Vice Pres.: J. N. Chalk. (Importer, Exporter) Products/Accessories: Blank Tape: Imports & Exports Audio and Video Tape.

Pete's Records, 2208 N. Zarzamora St., San Antonio, 78201, (512) 732-3300, Owner/Mgr./Buyer (Music): Pete Villela. (Records (Singles) (One-Stop).

Precision Sound, 400 S. Collins, #124, Arlington, 76010, (817) 265-7435, Fax: (817) 275-2022, Branch Mgr.: Brien Culver. (Distributor) Labels Distributed: Audio/Video: See Washington state listing for product line.

Rangel Dist. Co., 5357 W. Commerce, San Antonio, 78237. South Texas Wholesale Records & Tapes, Inc., 117 W. Almos Dr., San Antonio, 78212, (512) 829-7340, Fax: (512) 732-2655, CEO: R.W. Powers; Mgr.: H.C. Lozano; Buyer (Pre-Recorded Music): R.W. Powers, Allen Casey; Buyer (Videos): R.W. Powers; Buyer (Accessories): T.H. Knout. (Compact Disc,

Pre-Recorded Audio Tape, Video (Cassette & Disc), Records) (One-Stop, Rackjobber, Exporter) Labels Distributed: Video: Mexican, Japanese, European labels.

Southwest Wholesale Records & Tapes

4240 Lockfield, Houston, 77092, (713) 464-6507, (800) 749-0212, Fax: (713) 464-3769, Pres.: Richard Powers; Mgrs.: Robert Guillerman, Norman Nassis, Jim Pappas; Buyer (Pre-Recorded Music): Robert Guillerman, Norman Nassis, Rene Foster, Joe Kulesa, Tod Walker; Buyer (Spanish): Bob Olivo; Buyer (Videos): Norman Nassis; Buyer (Accessories): Norman Nassis. (Compact Disc, Pre-Recorded Audio Tape, Video (Cassette & Disc), Records (LP's, 12-Inch, Accessories) (One-Stop, Exporter) Branch(es): 117 W. Olmos, San Antonio, 78212.

Products/Accessories: CD, Tape & Record Products: Memorex, Discwasher, Allsop, Pfanstiehl; Storage & Carrying Cases: Case, Logic, Liftbox; Blank Tape: TDK, Maxell, Memorex, Denon, Sony; Head Phones: Memorex; Batteries: Maxell; Diamond Needles: Pfanstiehl, Stanton.

TMC Prods., 5230 San Pedro Ave., San Antonio, 78212, (512) 829-1909, Owner/Buyer: Joe Scates; Mgr.: Mark Scates. (Records (LP's, Singles)) (Distributor, Exporter) Labels Distributed: Audio: Axbar, Trophy, Jalo, Charro, Prince, Gringo, Cobra, Dobie, Joey, Nu-Country, Moonstone. Pay-Per Transaction.

Western Merchandisers, Inc.

421 E. 34th St., Amarillo, 79103, (806) 376-6251, Pres.: John Marmaduke; Buyer (Pre-Recorded Music): Jerry Wilkie; Buyer (Videos): Jane Love; Buyer (Accessories): Dick Snyder; Buyer (Reorders): John Rose; Buyer (Children's, Cut-outs): Rosemary Owen; Buyer (Spanish): Victor Fuentes.

Branch(es): 2301 Chovanetz Ct., Irving, 75038, (214) 550-0323, Vice Pres. Dallas Branch: Ted Hood; 520 W. 38th St., Houston, 77018, (713) 691-0025, Vice Pres. Wholesale Opns: John Sobieski; 4105 Holly St., Denver, CO, 80216, (303) 320-4860, Branch Mgr.: Bob Krug; PO Box 27116, 1971 S. 4990 W., Salt Lake City, UT, 84127, (801) 972-3800, Branch Mgr.: Dave Crabtree.

(Compact Disc, Pre-Recorded Audio Tape, Video (Cassette & Disc), Cutouts, Computer Games/Computer Software, Accessories) (One-Stop, Rackjobber).

UTAH

Best Video, Inc., 351 Lawndale Dr., Salt Lake City, 84115, (801) 487-8888, Fax: (801) 466-2915, Branch Mgr.: Ron McMillan. (Video (Cassette & Disc)) (Distributor) Labels Distributed: Video: All Major Studios & Most Independents.

Bonneville Media Communications, 130 Social Hall Ave., Salt Lake City, 84111, (801) 237-2382, Commn Corp., Freeport Center, Bldg. H-12 N., Clearfield, 84016, (801) 775-0555, Fax: (801) 773-8172, Asst. Mgr.: Bryan Mangels. (Distributor) Labels Distributed: Video: See Iowa Listing For Product Distribution.

KSG Distributing, 875 E. Hwy. 193, Layton, 84040, (800) 771-4053, Fax: (801) 771-0890, Chief Exec.: Kevin S. Garn; Buyer (Accessories): Jeni Taylor; One-Stop Mgr./Buyer: Rick Vander Does; Rack Mgr./Buyer: Greg Sanders. (Compact Disc, Pre-Recorded Audio Tape, Video (Cassette & Disc), Cutouts, Computer Games, Accessories) (One-Stop, Rackjobber) Labels Distributed: Audio: Cema, Sony, UNI, PGD, BMG, WEA, American Gramophone, Disney and many independent labels; Video: All Major Labels.

Products/Accessories: CD, Tape & Record Products: Allison; Storage & Carrying Cases: Case Logic; Blank Tape: Maxell, TDK, Memorex.

MTM Coin, 3753 S. State St., Salt Lake City, 84115, (801) 262-5493, Fax: (801) 268-4840, CEO: Eldon Kingston; Mgr.: Meryn Symes; Buyer: Jerry Demkers. (Compact Disc, Pre-Recorded Audio Tape, Video (Cassette & Disc), Records, Cutouts, Computer Games, Accessories) (Distributor, One-Stop) Labels Distributed: Audio: WEA, Sony, CEMA, UNI, SOR, PG.D., BMG, Gotham, Eric, IMG; See Colorado listings for product line.

Products/Accessories: CD Players: R.T.I., Wurlitzer, NSM; Audio & Video Playback Equipment: Worlitzer, NSM, Rockola; CD, Tape & Record Products: Le-Bo; Storage & Carrying Cases: Case Logic.

Major Video Concepts Inc., 1268 S. 500 W., Salt Lake City, 84101, (801) 973-0900, (800) 966-5799, Branch Mgr.: Noel Cahoon; Credit Mgr.: Brad Smith; Warehouse Mgr.: Cory Moffett. (Distributor) Labels Distributed: Video: See Indiana Listings For Product Distribution.

V.R.C., 1127 W. 2320 S., Ste. A, Salt Lake City, 84130, (801) 972-2200, (800) 733-1031, Fax: (801) 972-8362, (Distributor, Financier) Labels Distributed: Video: All major studios plus most in-

dependents; financial services.

Video Trend, Inc., 1268 S. 500 West, Salt Lake City, 84101, (801) 873-0900, (800) 966-5799, Fax: (801) 973-0971, Mgr.: Noel Cahoon; Sales Mgr.: John Bosworth; Buyer: Jean Ciak. (Distributor) Labels Distributed: Video: See Illinois listings for distribution.

Western Merchandisers, PO Box 27116, 1971 S. 4990 West, Salt Lake City, 84127, (801) 972-3800, Branch Mgr.: Dave Crabtree. (Compact Disc, Pre-Recorded Audio Tape, Video (Cassette & Disc), Cutouts, Computer Games, Accessories) (One-Stop, Rackjobber)

VERMONT

Artec Dist., Inc. HQ, 1 Pine Haven Shore Rd., Shelburne, 05482, (802) 985-9411, Fax: (802) 985-3403, Pres./CEO: Martin F. Gold; Buyer (Pre-Recorded Music): Doug Collette; Buyer (Videos): Diana Thut; Buyer (Accessories): Brian Danus; Vice Pres. Inventory: William Boyle. (Compact Disc, Pre-Recorded Audio Tape, Video (Cassette & Disc), Cutouts, Accessories) (Distributor, Rackjobber) Labels Distributed: Audio: All major labels and their music video subsidiaries, selected independent labels and audio accessory lines; Video: Academy, Celebrity, Coliseum, Fox Video, Hanna Barbera, Disney, Paramount, Orion, Columbia/Tristar, Warner Home Video, Live, Vestron, MCA, Media, Nelson, MGM, HBO, Random House, Touchstone, Hollywood Pictures & 60 smaller lines.

Artec Dist., Inc., 17 Avenue D, Williston, 05495, (802) 864-3910, (800) 451-5160, Branch Mgr.: Craig Decatur. (Distributor, Rackjobber).

Silo Music, PO Box 429, S. Main St., Waterbury, 05676, (802) 244-5178, Fax: (802) 244-6128, Owner: Joan Pelton; Buyer (Pre-Recorded Music): Meredith Trudeau; Sales Mgr.: Will Forest. (Distributor) Labels Distributed: Audio: Rounder, Narada, Fantasy, Original Jazz Classics, American Gramophone, Higher Octave, Ryko, Shanachie, Music Of The World and most major independents; Video: Most videos for children.

VIRGINIA

Assn. of Research & Enlightenment, PO Box 595, Virginia Beach, 23451, (804) 428-3588, (Distributor)

Dean's One Stop, Ltd., 2403 Chamberlayne Ave., Richmond, 23222, (804) 321-7515, Fax: (804) 329-6123, Pres.: Dean Hogue; Vice Pres./Buyer: Bobby Marshall; Buyer (CD's): Tommy Marshall. (Compact Disc, Pre-Recorded Audio Tape, Records) (One-Stop).

Eurpac Warehouse Sales, 1421 Diamond Springs Rd., Virginia Beach, 23455, (804) 460-1060, Fax: (804) 460-9110, Gen. Mgr.: Jim Burgin; Sales Mgr.: Sande Lewis. (Compact Disc, Pre-Recorded Audio Tape, Video (Cassette & Disc), Accessories) (Rackjobber) Products/Accessories: CD Players: Casio, Hitachi; Audio & Video Playback Equipment: Casio, Hitachi; CD, Tape & Record Products: Recoton; Storage & Carrying Cases: Case Logic, Recolon; Video Cassette Recorder: Hitachi; Blank Tape: Recoton; Head Phones: Recoton.

Major Video Concepts, 1550 E. Parham Rd., Richmond, 23228, (804) 262-0394, (800) 876-0682, Fax: (804) 264-4709, Opns. Mgr.: Woody Landers; Sales Mgr.: Keith Wood; Adv. Coord.: Mary Lynn Halloran. (Video (Cassette & Disc)) (Distributor) Labels Distributed: Video: See Indiana Listings For Product Distribution.

Record Depot, PO Box 3057, 3646-3 Ariel Way Dr., Roanoke, 24015, (703) 343-5355, Fax: (703) 343-3240, Owner: David Freeman; Mgr./Buyer: Chet Rhodes. (Distributor) Labels Distributed: Audio: Rebel, County, Sugar Hill, Rounder, Flying Fish, Shanachie, Copper Creek; Video: Central Sun. Pay-Per Transaction.

Scott Distributing Corp., 3418 Azalea Garden Rd., Norfolk, 23513, (804) 855-0188, Sr. Vice Pres./Buyer: Robert Kruglick. (Compact Disc, Pre-Recorded Audio Tape, Video (Cassette & Disc)) (Distributor, Rackjobber, Military Sales) Labels Distributed: Audio/Video: All Major Brands.

Telemark Dance Records, 46950 Community Plaza, #221, Sterling, 22170, (703) 450-7760, Pres.: Richard S. Mason; Office Mgr.: J. Vooght. (Compact Disc, Pre-Recorded Audio Tape, Video (Cassette & Disc), Records) (Importer, Exporter) Products/Accessories: CD Players: Phillips.

WASHINGTON

BMG Dist., 925 Industry Dr., Seattle, 98188, (206) 575-1410, Fax: (206) 575-1413, Branch Mgr.: C. Brown. (Compact Disc, Pre-Recorded Audio Tape, Video (Cassette & Disc), Records) (Distributor) Labels Distributed: Audio/Video: See New York Listing For Product Line.

California Record Dist., Inc., 6011 S. Roxbury, Seattle, 98118, (206) 723-0900, Fax: (206) 723-9040, Sales Mgr.: George Bigley. (Records) (Distributor) Labels Distributed: Audio: See California listings for distribution.

City Hall Records, 3038 21st Ave. W., Seattle, 98199, (206) 282-4820, Fax: (206) 284-4118, Branch Mgr.: George Romanic. (Compact Disc, Pre-Recorded Audio Tape, Records) (Distributor, Importer, Exporter)
Labels Distributed/Imported: Audio/Video: See California Listing For Product Line.

Commtron Corp., 6411 S. 216th, Bldg. F, Kent, 98032, (206) 395-3515, Fax: (206) 395-0650, Sales Mgr.: Sue Culbertson. (Video (Cassette & Disc)) (Distributor)
Labels Distributed: Audio/Video: See Iowa Listing For Product Line.

Freckle Records, PO Box 4005, 80 S. Washington, Seattle, 98104, (206) 682-3200, Owner/Mgr./Buyer: Jack Burg. (Distributor)

Labels Distributed: Audio: Chesire, Darkstream, Freckle, Nebula Circle, Poplila, Rainbow Planet, Red Rum, Santrofi.

General Record Service, Inc., PO Box 80926, Seattle, 98108, 6565 Seventh Ave. S., Seattle, 98109, (206) 767-7444, (800) 426-1621, Fax: (206) 762-4517, Gen. Mgr./Buyer (Singles): Russ Porteus; Buyer (Pre-Recorded Music (Singles)): Scott Geiver; Buyer (Accessories): Terry Kearns; Buyers (Music Video): Russ Porteus, Tom Smith; Buyer (Indies): Jim Johnson. (Compact Disc, Pre-Recorded Audio Tape, Video (Cassette & Disc), Accessories) (One-Stop, Rackjobber) Products/Accessories: CD, Tape & Record Products: Case Logic, Napa Valley; Storage & Carrying Cases: Case Logic, Napa Valley; Blank Tape: Sony, Maxell, Denon, Memorex.

Handleman Co.-Seattle, 20024 85th Ave. S., Bldg. C, Kent, 98031, (206) 872-8077, Branch Mgr.: Ken Yastic; Sales Mgr.: Ken Nelson. (Compact Disc, Pre-Recorded Audio Tape, Video (Cassette & Disc)) (Rackjobber)
Labels Distributed: Audio/Video: See Michigan Listings For Product Distribution.

Important Record Dist., 3407 Hunter Blvd. S., Seattle, 98144, (206) 722-8060, Fax: (206) 722-0462, (Distributor)
Labels Distributed: Audio: See New York Listings For Products Distributed.

Major Video Concepts Inc., 13221 SE 26th St., Bellevue, 98005, (206) 562-6900, (800) 966-1665, Branch/Sales Mgr.: Scott Farrand; Opns. Mgr.: Steve Thorsen; Warehouse Mgr.: John Sunderland. (Distributor)
Labels Distributed: Video: See Indiana Listings For Product Distribution.

Major Video Concepts Inc., 5013 Pacific Hwy. E., Ste. 13, Fife, 98424, (206) 922-2520, (Distributor)
Labels Distributed: Video: See Indiana Listings For Product Distribution.

Navarre Corp., 4107 23rd Ave. SW, Seattle, 98106, (206) 933-0462, (Distributor)
Labels Distributed: Audio: Airns, AJK, Atlanta Int'l, AVM, Chi-Sound, CMH, Crush, DCG, Fresh, Golden Music, Headfirst, Homestead, Hearts Of Space, Invasion, Micmac, Nouveau, Nova, Optimism, Original Sound, Pathfinder, Positive Music, Rockville, Serenity, Shelter, Silverwave, Sleeping Bag, Soundings Of The Planet, Spindletop, SST, TBA, USA, Valley Vue, Visual Musik, Voss, Wax Trax.

Precision Sound

14926 35th Ave. W., Ste. A, Lynnwood, 98037, (206) 787-1030, Fax: (206) 787-1039, CEO/Pres.: Frank Klammer; Vice Pres. Sales & Mktg.: Russ Martin; Adv. Mgr.: Janet Miller Johnson; Sales Coord.: Doug Ashland; Buyer CD/Tapes: Bill Larsen; Buyer (Pre-Recorded Music): Bill Larsen. (Distributor)

Branch(es): 3500 W. Olive Ave., Ste. #1160, Burbank, CA, 91505, (818) 955-7037, Fax: (818) 955-7038, Branch Mgr.: Bob Carlton; 903 Meadowhawk Dr., Vacaville, CA, 95687, (707) 448-8005, Fax: (707) 448-8005, Branch Mgr.: Rob McDonald; 14926 35th Ave. W., #A, Lynnwood, WA, 98037, (206) 787-1030, Fax: (206) 787-1039, Branch Mgr.: Thure Gray; 400 S. Collins, #124, Arlington, TX, 76010, (817) 265-7435, Fax: (817) 275-2022, Branch Mgr.: Brien Culver.

Labels Distributed: Audio: American Gramophone, Antones, Bainbridge, Benson, Biograph, Blind Pig, Celestial Harmonies, Chase, Chesky, CMP, Country Music Foundation, Dargason, Eastside Digital, Earth Sounds, Flying Fish, Frontline, Grateful Dead, Hannibal, Heads Up, Higher Octave, LRC Jazz Classics, Madacy, Miramar, Music Of The World, New Albion, New World, North Star, Omega/Vanguard Classics, OxyMoron, Real Music, Reference, Rykodisc, Sheffield Lab, Sonic Atmospheres, Sparrow, Starson and others; Video: American Gramophone, Benson, Earth Sounds (Peter Roberts Prodn.), Miramar, Reference, Sparrow.

Priority Video Services/Hollywood Movie Co., 22833 Bothell Way SE, Bothell, 98021, (206) 483-7091, (800) 220-7100, Fax: (206) 486-4955, Mgr.: John Baisden. (Distributor)

Ed Richter Mktg., 5025 California Ave. SW, #106, Seattle, 98136, (206) 937-2782, Fax: (206) 932-1051, Owner: Ed Richter.

George Romansic/Independent Distribution, 3038 21st Ave. W., Seattle, 98199, (206) 282-4820, Fax: (206) 284-4118, Sales Mgr.: George Romansic. (Independent Sales)
Labels Distributed: Audio: Represents City Hall Records, Bayside Record Dist., Qualiton Imports, Sterns U.S., Lyric Distribution, Zango, Festival (Canada), Flying Book Service.

Roundup Dist., Inc., 5822 S. 196th St., Kent, 98032, (206) 395-1202, Fax: (206) 395-4436, Chief Exec.: Chuck Blacksmith; Buyer (Pre-Recorded Music): Don Jensen; Buyer (Videos): Lenard Cordero; Vice Pres./Gen. Mgr.: Peter

Young. (Compact Disc, Pre-Recorded Audio Tape, Video (Cassette & Disc), Records, Cutouts, Overstock) (Rackjobber)

Video Products Distributors, 12318 134th Court NE, Redmond, 98052, (206) 821-5522, Fax: (206) 820-6008, (Distributor)

Labels Distributed: Video: All Major & Secondary Lines. Video Trend, Inc., 13221 SE 26th St., Ste. A, Bellevue, 98005, (206) 562-6900, (800) 966-1665, Fax: (206) 562-6970, Mgr.: Scott Farrand; Sales Mgr.: Kathy Post; Buyer: Christine Perula. (Distributor)

Labels Distributed: Video: See Illinois listings for distribution.

WEST VIRGINIA

Elkins Record Shop, 1127 Central Ave., Charleston 25302, (304) 343-7833, Owner/Buyer: Douglas T. Elkins. (Compact Disc, Records) (Distributor, One-Stop, Jukebox Operators)

Music Man, Inc., PO Box 5375, 2519 Fourth Ave., Huntington, 25703, (304) 522-7551, (304) 522-9011, Fax: (304) 523-9241, Pres./Mgr.: W. Dale Rowe Jr.; Buyers: Dale Rowe, Roger Russell. (Compact Disc, Pre-Recorded Audio Tape, Video (Cassette & Disc), Records (LP's, 12-Inch, Singles), Accessories) (One-Stop)

Products/Accessories: CD, Tape & Record Products: Memorex, Pfantone, Also; Storage & Carrying Cases: Case Logic, Memorex, Savoy, BMI; Blank Tape: Memorex, Fuji, TDK, Panasonic, Maxell; Head Phones: Memorex, Pfantone; Batteries: Memorex, Maxell; Diamond Needles: Pfantone; Other: Pfantone & Memorex Patch Cords & Cables.

WISCONSIN

Dairyland Prodn., Inc., 2309 N. 36th St., #11, Milwaukee, WI, 53210, (414) 445-4872, (Distributor).

Euroline Communications, PO Box 362, Sheboygan, WI, 53082, (414) 458-8880, Owner/Buyer: Dieter E. Helm. (Compact Disc, Pre-Recorded Audio Tape, Records, Cutouts) (Importer)

Labels Imported: Selected Labels From Austria, Germany & Switzerland Featuring Contemporary & Traditional Instrumentals.

M.S. Distributing Co., 11803 W. Fairview Ave., West Allis, WI, 53226, (414) 778-5353, (800) 258-4330, Fax: (414) 778-5357, Sales Mgr.: Robb Heilman. (Distributor)
Labels Distributed: Audio/Video: See Elk Grove Village, IL listing for product distribution.

Major Video Concepts Inc., 13105 Blue Mound Rd., 1st Floor W., Brookfield, WI, 53005, (414) 821-5130.

Labels Distributed: Video: See Indiana Listings For Product Distribution.

Music Design, Inc., 207 E. Buffalo St., Milwaukee, WI, 53202, (414) 272-1199, Fax: (414) 272-7459, Vice Pres./Buyer (Video): Wesley Van Linda; Buyer (Pre-Recorded Music): Liz Doan. (Distributor).

Northword Press Inc., PO Box 1360, 7520 Hwy. S., Minocqua, WI, 54548.

Sounds & Video Inc., 230 W. Wells St., Milwaukee, WI, 53203, (414) 276-7966, (800) 558-9066, Fax: (414) 276-3433, Pres./Owner/Buyer (Video): Noel A. Gimbel; Buyer (Pre-Recorded Music): Kathryn Stamm; Buyer (Videos): Lee Gimbel; Buyer (Accessories): R. Friesseke; Buyer (Music, Video): Donald E. Smith. (Compact Disc, Pre-Recorded Audio Tape, Video (Cassette & Disc), Records (12-Inch, Singles), Accessories) (One-Stop).

Wolfram Video, Inc., 1700 S. 60th St., West Allis, WI, 53214, (800) 433-1652, Fax: (414) 546-4654, Pres./Buyer: Wolf Zimmermann; Chart Mgr.: Mark Langhoff. (Distributor)
Labels Distributed: Video: All Major Labels Plus Over 500 Independents.

Products/Accessories: Audio & Video Playback Equipment; Video Messenger Character Generators.

WYOMING

Wolverine Galley, 449 Seventh Ave. S., Greybull, 82426, (307) 765-2603, (Compact Disc, Pre-Recorded Audio Tape, Records) (Distributor)

U.S. TERRITORY

GUAM

Destiny Records, Inc., PO Box 26014, G.M.F., Dededo, 96912, (671) 632-7147, Fax: (671) 637-3789, Vice Pres./Gen. Mgr.: J. Michael Teano. (Compact Disc, Pre-Recorded Audio Tape, Video (Cassette & Disc), Records (LP's, 12-Inch, Singles), Cutouts, Accessories) (One-Stop)

Products/Accessories: CD, Tape & Record Products: Allsop, Case Logic, Disc Washer, Recoton; Storage & Carrying Cases: CD Mate, Case Logic, MGM; Blank Tape: TDK, Sony, That's, Maxell, Ampex, Denon; Head Phones: AKG, Koss; Diamond Needles: Stanton; Other: Remixed CDs & Records.

A T T E N T I O N

ONE STOP SHOPPERS

GO with the One Stop that can give you more!

- The only One Stop with four full-service warehouses
- Automated inventory replenishing system
- Special incentives for new store openings
- Huge selection of compact discs, cassettes & music videos, plus accessories . . . all at the best prices
- Add-on sales with cutouts, T-shirts, buttons, posters, personal stereos, candy and more!

— OVER 25 YEARS IN SERVICE —



western Merchandisers One-Stop

DALLAS
(800) 727-9605
FAX (214) 550-9230

DENVER
(800) 235-6060
FAX (303) 321-6908

HOUSTON
(800) 695-0025
FAX (713) 691-4752

SALT LAKE CITY
(800) 950-7588
FAX (801) 972-6252

PUERTO RICO

Casa de los Tapas, Inc., PO Box 360160, San Juan, 00936, 178 O'Neil St., Hato Rey, 00918, (809) 765-1243, Fax: (809) 754-0644, Pres.: Jorge Jover; Gen. Mgr.: Fernando Ramos; Buyer (Videos): Manuel Portela; Buyer (Accessories): Frank Martinez; Head Buyer: Eduardo Berrios; Buyers (Other): Ernesto Duran, P. Roman. (Distributor)
Labels Distributed: Audio: PolyGram, Sony Music, Optimism, Alshire, BMG, Fania, Th Roven, WEA, Mesgidor, Brainchild, Chesky, Nova, Karen, Uni, Concord, Capitol, Chase Music Group, TBA, Combo, TTH, MP, Telarc, WEA Latino.
Products/Accessories: CD Players: Sony, Denon, Proton; Audio & Video Playback Equipment: Sony, Denon, JVC; CD, Tape & Record Products: Discwasher, Allstop, Geneva; Storage & Carrying Cases: Case Logic, Savoy; Video Cassette Recorder: Sony; Blank Tape: Maxell, TDK, Denon; Head Phones: Koss; Batteries: Maxell; Other: Speakers: Boston Acoustics, DCM, Mordaunt-Short, Bose, Acoustic Research.
Distribuidora Nacional de Discos, Inc., Calle Cerra 606, Pda. 15, Santurce, 00907, (809) 721-4964, Fax: (809) 721-4965, Vice Pres.: Aida Nery Gonzalez; Buyer (Videos): Armando Gonzalez. (Compact Disc, Pre-Recorded Audio Tape, Video (Cassette & Disc), Records (12-Inch), Accessories) (Distributor, One-Stop, Exporter)
Labels Imported: All labels from U.S.A.
Products/Accessories: CD, Tape & Record Products: Savoy, Lebo, Laser Line, Spartan, Rolydisc, Coast; Storage & Carrying Cases: Savoy, Lebo Laser Line, Spartan, Case Logic; Blank Tape: TDK, Sony, Memorex, Maxell, BASF; Head Phones: Memorex, Pickering, Sony.

MUSIC & VIDEO ACCESSORY MANUFACTURERS

ARS Recording & Tape Duplication, 11626 S. Pulaski, Alsip, IL, 60658, (708) 371-8424, Fax: (708) 371-9403, Pres.: Gary A. Cobb; Sales Mgr.: Allen L. Keilman.
CD—Care Products.
Record—Care Products.
Tape—Audio/Video: Head Cleaners.
Alpha Recording, Inc., PO Box 740, Elizabethtown, KY, 42701, (502) 765-7899, Fax: (502) 765-3734, Pres.: Jim Cottrill; Sales Mgr.: Don Cottrill; Mktg. Dir.: Lori Hawk; Studio Mgr.: Mark Goodman.
Record—Carrying & Storage Cases, Care Products.
Amaray Int'l Corp., 52 Green Pond Rd., Rockaway, NJ, 08766, (800) 426-2729, Fax: (201) 627-5730, Pres.: Ed Joyce Jr.
Record—Care Products (Cleaning Products).
Tape—Audio: Head Cleaners; Video: Head Cleaners, Carrying & Storage Cases.
American Recorder Technologies, Inc., PO Box 3592, 4395 Valley Fair St., Simi Valley, CA, 93063, (805) 527-9580, Fax: (805) 527-1433, Pres.: Alan Adelstein; Sales Mgr./Mktg. Dir.: Neil Frumkin.
CD—Care Products.
Tape—Audio/Video: Head Cleaners, Carrying & Storage Cases, Care Products.
Anvil Cases—subsidiary of Zero Corp., PO Box 1202, City of Industry, CA, 91745, 15650 Salt Lake Ave., La Puente, CA, 91749, (818) 968-4100, Fax: (818) 968-1703, Pres.: Jay Manwaring; Sales Mgr.: Whit Adams; Mktg. Dir.: Gabe Nakash.
CD—Carrying & Storage Cases.
Record—Carrying & Storage Cases.
Tape—Carrying & Storage Cases.
Audico, Inc., 7206 W. Grand, Elmwood Park, IL, 60635, (708) 456-0003, Fax: (708) 456-0418, Pres.: Barbara Deletzke.
Tape—Video: Carrying & Storage Cases.
Audio-Technica U.S., Inc., 1221 Commerce Dr., Stow, OH, 44224, (216) 686-2600, Pres.: Jon R. Kelly; Sales Mgr.: Dorie Johnson.
CD—Care Products.
Record—Care Products (AT6015 Reward Maintenance System), Replacement Styli.
AudioSource, Inc., 1327 N. Carolan Ave., Burlingame, CA, 94010, (415) 348-8114, Fax: (415) 348-8083, Vice Pres.: Lawrence Lurie.
CD—Platforms, Lens Cleaners.
B & L Sales, Inc., 10812 1/2 Magnolia Blvd., North Hollywood, CA, 91601, (818) 985-1792, Fax: (818) 508-1871, Pres.: Bill Pugliese; Mktg. Dir.: Lols Pugliese.
Tape—Audio: Head Cleaners, Care Products, Blank/TKD, Maxell, Marantz; Video: Head Cleaners, Care Products, Blank/TKD, Maxell.

BMI Beaux Merzon, Inc.

49-16 Maspeth Ave., Maspeth, NY, 11378, (718) 381-1303, Fax: (718) 381-4262, Pres.: Richard Merzon; Vice Pres., Nat'l Sales Mgr.: Larry Jacobson; Vice Pres., Gen. Mgr.: James Dowling.
CD—Carrying & Storage Cases, Home Storage Cabinets.
Record—Care Products (Brush Cleaner Solution, Record Brush).

Tape—Audio: Head Cleaners, Carrying & Storage Cases, Care Products; Video: Carrying & Storage Cases.

Bib America, 10497 Centennial Rd., Littleton, CO, 80127, (303) 972-0410, Fax: (303) 972-4519, Mktg. Dir.: Tony Marcon.
CD—Carrying & Storage Cases, Care Products.
Record—Care Products (A-634 record & Stylus care system).
Tape—Audio/Video: Head Cleaners, Carrying & Storage Cases, Care Products.
Blackbourn, Inc., 7550 Corporate Way, Eden Prairie, MN, 55344, (800) 842-7550, Fax: (612) 949-2553, Pres.: Todd Nicholson; Sales Mgr.: Jerry Forness; Mktg. Dir.: Mike Langert.
CD—Carrying & Storage Cases.
Record—Carrying & Storage Cases.
Tape—Audio/Video: Carrying & Storage Cases.
BonaFide Mgmt. Systems, Inc., 6018 Variel Ave., Woodland Hills, CA, 91367, (818) 999-9888, Fax: (818) 999-9895, Pres.: Larry Lai; Sales Mgr.: Betsy Herrick; Dir. Admin.: Caroline Vandeer.
Tape—Audio/Video: Computer Systems/Retailer.
W.H. Brady Co., PO Box 571, Milwaukee, WI, 53201, (800) 662-5688, Fax: (414) 377-6789, Sales Mgr.: John A. Cullen.
Tape—Audio/Video: Care Products, Tape Cleaning Fabric.
Bretford Mfg., 9715 Soreng Ave., Schiller Park, IL, 60176, (708) 678-2545, Fax: (708) 678-0852, Pres.: Edward Petrick; Sales Mgr.: Robert Redding; Mktg. Dir.: Trudy Brunot; Adv. Mgr.: Catherine J. Lundstrom.
Audio/Video: Carts, Stands, Furniture.
Burlington Audio/Video Tapes, Inc., 106 Mott St., Oceanside, NY, 11572, (516) 678-4414, (800) 331-3191, Fax: (516) 678-8959, Pres.: Ruth Schwartz; Sales Mgr.: Jan Schwartz; Mktg. Dir.: Rudy Schwartz.
Tape—Audio/Video: Head Cleaners, Care Products.
CDisplay, PO Box 801323, Santa Clarita, CA, 91380, (805) 294-9010, Fax: (805) 294-1254, Pres./Sales Mgr.: Don Krattiger; Mktg. Dir.: Pat Krattiger.
CD—Carrying & Storage Cases.
Cal Oak Products, 1000 Cal Oak Rd., Oroville, CA, 95965, (916) 534-1426, Fax: (916) 534-0306, Pres.: Guy Hall; Mktg. Dir.: Bruce Hall.
CD—Carrying & Storage Cases.
Record—Carrying & Storage Cases.
Tape—Carrying & Storage Cases.
Capital Mfg. of Tennessee, 412 W. Main St., Woodbury, TN, 37190, (615) 563-8501, Fax: (615) 563-8503, Contact: Ed Daugherty.
CD—Carrying & Storage Cases.
Tape—Carrying & Storage Cases.
Case Logic, Inc., 6303 Dry Creek Pkwy., Longmont, CO, 80503, (800) 447-4848, Pres.: James Temple; Dir. Int'l Opns.: J. Peter K. Storz; Int'l Admin.: Sally Strom.
CD—Carrying & Storage Cases.
Tape—Audio/Video: Carrying & Storage Cases.

Coast Mfg. Co.

200 Corporate Blvd. S., Yonkers, NY, 10701, (914) 376-1500, Pres.: William Moor; Exec. Vice Pres.: Richard Goldberg; Mktg. Dir.: Richard Flashenberg.
CD—Carrying & Storage Cases.
Tape—Audio: Carrying & Storage Cases, Car Tote Carry Case.

Core Systems, Inc., 48 W. 25th St., New York, NY, 10010, (212) 242-4497, Fax: (212) 366-6548, Pres.: Dimitri Karas; Vice Pres. Prodn.: J. Aricci.
Tape—Audio: Carrying & Storage Cases.
Creative Point, Inc., 4045 Clipper Ct., Bayside Bus. Park, Fremont, CA, 94538, (510) 659-8222, (800) 323-8222, Fax: (510) 659-8260, Pres.: Jerry M. Long; Sales Mgr.: Edward Dougherty; Vice Pres. Engineering: Peter Palmer.
CD—Carrying & Storage Cases, Home Storage.
Tape—Audio: Cassette home storage.
Leslie Dame Ents., Ltd., 111-20 73rd Ave., Forest Hills, NY, 11375, (718) 261-4919, Fax: (718) 793-8804, Pres.: Leslie Dame; Sales Mgr.: Jeff S. Magoltza; Mktg. Dir.: Steve Dame.
CD—Carrying & Storage Cases, Care Products, Home Storage Rack.
Record—Carrying & Storage Cases.
Tape—Audio/Video: Head Cleaners, Carrying & Storage Cases, Care Products.
Discwasher, Inc., 4310 Transworld Rd., Schiller Park, IL, 60176, (708) 678-9600, Fax: (708) 678-9610, Pres.: Kenneth C. Thomson; Sales Mgr.: Steven Sienicki; Mktg. Dir.: Daniel Peters.
CD—Carrying & Storage Cases, Care Products.
Record—Care Products, Turntable Mats.
Electronix Corp., 313 W. Main St., Fairborn, OH, 45324, (513) 878-1828, Pres.: David Kushner.
VCR Repair Parts/Instruction Tapes.
FP Video Services, Inc., 4415 Saguro Trail, Indianapolis, IN, 46268, (317) 299-9191, Fax: (317) 297-2998, Pres.: Charles J. Selden; Vice Pres./Treasurer: Steve Whetzel; Sales Mgr.: Lee Ann Richardson.
Tape—Video: Carrying & Storage Cases.
Fidelipac Corp., PO Box 808, Moorestown, NJ, 08057, (609) 235-3904, Fax: (609) 235-7779, Pres.: Roger Thanhauser; Sales Mgr.: John Tiedeck; Mktg. Dir.: Scott Martin.
Tape—Audio: Care Products.
Filam Nat'l Plastics, Inc., 13984 S. Orange Ave., Paramount, CA, 90723, (213) 630-2500, Fax: (213) 408-0712, Pres.: Vic

Flores; Mktg. Dir.: Brad Harse.
CD—Carrying & Storage Cases.
Tape—Audio: Carrying & Storage Cases.
Filam Nat'l Plastics Inc., 1200 N. St., Ste. 504, Lincoln, NE, 68508, (402) 435-5005, Fax: (402) 435-4722, Mktg. Dir.: Brad Harse.
Record—Carrying & Storage Cases.
Daniel E. Gelles Associates, Inc., PO Box 348, Mohonk Rd., High Falls, NY, 12440, (914) 687-7681, Fax: (914) 687-4324, Pres.: Daniel Gelles; Sales Mgr.: Robert S. Gelles; Mktg. Dir.: Joel Gelles.
CD—Carrying & Storage Cases, Jewel Box Indexer.
Geneva Group of Companies, Inc., 9909 S. Shore Dr., Plymouth, MN, 55441, (612) 546-5620, Fax: (612) 546-0933, Pres.: Edward E. Griffin; Sales Mgr.: Bruce A. Bowen; Mktg. Dir.: Laurel M. Anderson.
CD—Carrying & Storage Cases, Care Products.
Tape—Audio/Video: Head Cleaners, Care Products.
Ian Communications Group, Inc., 10 Upton Dr., Wilmington, MA, 01887, (508) 658-3700, Fax: (508) 694-9957, Pres.: Richard B. Berberian; Sales Mgr.: Todd Thibaud; Mktg. Dir.: James Rago.
Record—Turntable Mats, Replacement Styli, CD Storage Cases & Care.
Tape—Audio/Video: Head Cleaners, Carrying & Storage Cases.
Innovative Marketing Concepts, 701 Beta Dr., Mayfield Village, OH, 44143, (216) 461-6275, (800) 321-8774, Fax: (216) 461-0230, Pres.: Lawrence Beyer; Sales & Gen. Mgr.: Gail Perry.
CD—Carrying & Storage Cases.
Tape—Audio: Carrying & Storage Cases; Video: Head Cleaners, Carrying & Storage Cases, Care Products.
Int'l Cutterhead Repair SVC, Inc., 571 Boulevard, Hasbrouck Heights, NJ, 07604, (201) 288-0106, Pres.: Sharon Mizrahi; Sales Mgr.: Moty Mizrahi; Mktg. Dir.: Blanche Rand.
Record—Replacement Styli, conversion components.
Island Cases, 1121-1 Lincoln Ave., Holbrook, NY, 11741, (516) 563-0633, Fax: (516) 563-1390, Pres./Mktg. Dir.: Frank Maiella; Sales Mgr./Mktg. Dir.: Bruce PaPa.
CD—Carrying & Storage Cases.
Record—Carrying & Storage Cases.
Tape—Carrying & Storage Cases.
Jasco Products Co., Inc., PO Box 466, Oklahoma City, OK, 73101, (405) 752-0710, (800) 654-8483, Pres.: Steve Trice; Sales Mgr.: Brent Hall; Mktg. Dir.: Kent Shiplet.
CD—Care Products (Cleaning/Maintenance).
Record—Care Products (Cleaning/Maintenance), Inserts, Adaptors.
Tape—Audio/Video: Head Cleaners.
Joyce Molding Corp., 52 Green Pond Rd., Rockaway, NJ, 07866, (201) 586-2900, Fax: (201) 627-5730, Pres.: Ed Joyce; Sales Mgr.: Phil Koljeski.
CD—Carrying & Storage Cases, Care Products.
Record—CD Storage Cases.
Tape—Audio/Video: Carrying & Storage Cases.
Justin Entertainment, 2960 Amwiler Rd., Atlanta, GA, 30360, (404) 448-7772, Fax: (404) 446-0068, Pres.: Tim Monning; Sales Mgr.: Joe Bryant; Mktg. Dir.: Kolette Kleber Annand; Vice Pres. Purchasing: Jim Ogletree.
CD—Carrying & Storage Cases, Care Products.
Record—Carrying & Storage Cases.
Tape—Audio/Video: Head Cleaners, Carrying & Storage Cases, Care Products.
Kingdom Co., PO Box 506, Mansfield, PA, 16933, (717) 662-7515, Fax: (717) 662-3875, Pres.: Johnny Berguson; Sales Mgr.: Howard Darr; Mktg. Dir.: Gabe Phelps.
Tape—Audio/Video: Head Cleaners, Carrying & Storage Cases.
Lebo Peerless Corp., 33 West St., Bloomfield, NJ, 07003, (201) 429-8600, Fax: (201) 429-0686, Pres.: Patrick Mastronardo; Sales Mgr./Mktg. Dir.: Stuart Glenwick.
CD—Carrying & Storage Cases.
Tape—Audio/Video: Carrying & Storage Cases.
Lift Display, Inc., 115 River Rd., Edgewater, NJ, 07020, (201) 945-8700, Fax: (201) 945-9548, Pres.: Otto Schubert; Vice Pres./Mktg. Dir.: Colette Kreins.
CD—Carrying & Storage Cases.
Tape—Audio/Video: Carrying & Storage Cases.
Magnetic Reference Lab., 229 Polaris Ave., Ste. 4, Mountain View, CA, 94043, (415) 965-8187, Fax: (415) 965-8548, Pres.: J. McKnight.
Tape—Audio: Calibration/alignment tapes for open reel.
Matrix Assoc., Inc., 1425 Monje Grande Pl., Pacific Palisades, CA, 90272, (213) 459-6913, Fax: (213) 459-6416, Pres.: Ed Koeppel; Sales Mgr.: Karen Koeppel; Mktg. Dir.: Charlie Shuman.
CD—Carrying & Storage Cases, Care Products, Laser lens cleaner discs.
Tape—Audio/Video: Head Cleaners, Carrying & Storage Cases, Care Products.
Movie Memories & Poster Shop, 502 Waverly St., Palo Alto, CA, 94301, (415) 328-6265, Owner: David Kneubuhl.
Tape—Video: For sale & purchase.
Multi-Video, Inc., PO Box 35444, 1432 E. Independence Blvd., Charlotte, NC, 28235, (704) 536-6928, (800) 289-0111, Fax: (704) 334-1058, Pres.: Will Espin; Mktg. Dir.: Tommie Espin.
Tape—Audio: Care Products, Audio tape fixer; Video: Care Products, Workstation.
NRD, Inc., 2937 Alt Blvd. N., Grand Island, NY, 14072, (800) 525-8076, Fax: (716) 773-7744, Pres.: Larry Keating; Sales Mgr./Mktg. Dir.: Kelly J. Mang.

The accessorized state of the visual and audio arts.



Photo and video baggage from the Oasis™, Red Accent™, Brigade™, Mohawk™ and RedLine™ collections. GoldCoast™, Mohawk™ and Red Accent™ photo and video tripods. Coast Audio cases and totes. Darkroom supplies and pegboard photo accessories. All from COAST. *The one name in multi-media accessories that stands for quality, innovation, style... and reliability. No matter which of the visual and audio arts you practice.*

COAST. The Multi-Media Accessory Company.

The World's Largest Manufacturer of Photo, Video, Audio, Specialty Luggage and Accessories

COAST MANUFACTURING COMPANY • 200 CORPORATE BOULEVARD SOUTH • YONKERS, NY 10701
(914) 376-1500 • (800) 333-6282



Nat'l Audio Co., Inc., PO Box 3657 G.S., 1841 E. Bergman, Springfield, MO, 65808, (417) 863-1925, Fax: (417) 863-7825, Pres.: Steve Stepp; Sales Mgr.: Sandi Slonecker.
Tape—Audio: Head Cleaners, Care Products.

Neo Arte, 1534 California St., Elk Grove Village, IL, 60007, (708) 939-9800, Pres./Mktg. Dir.: Steve Bator; Sales Mgr.: Steve Butirro.
CD—Carrying & Storage Cases.

Oakridge Music Recording Service, 2001 Elton Rd., Fort Worth, TX, 76117, (817) 838-8001, Owner/Pres.: Homer Lee Sewell.
Tape—Audio: Head Cleaners.

Operations Int'l, Inc., PO Box 670234, Dallas, TX, 75367, 2927 Ladybird Ln., Dallas, TX, 75220, (214) 350-7782, Fax: (214) 350-7783, Pres.: Richard Chalk; Vice Pres.: J.N. Chalk.
CD—Carrying & Storage Cases.
Record—Carrying & Storage Cases.
Tape—Audio/Video: Carrying & Storage Cases.

Parentlock, 405 Graham Rd., Cuyahoga Falls, OH, 44221, (216) 929-4650, (800) 837-2040, Contact: Joe Kilbel; Device For VCR Control By Rating.

Performance Dist., PO Box 0156, 2 Oak St., New Brunswick, NJ, 08903, (908) 545-3004, Fax: (908) 545-6054, Owners: Stephen Kaplan, Arthur Marko; Mgr.: Jessica DiGiora.
CD—Blisters.

Philmore-Carter Craft, PO Box 6386, 2240 15th St., Rockford, IL, 61104, (815) 229-7773, Fax: (815) 229-7785, Pres.: Wayne Timpe; Sales Mgr.: Kittakaun Mejudhon.
CD—Carrying & Storage Cases, Care Products.
Record—Care Products (Record Cleaners).
Tape—Audio: Head Cleaners, Carrying & Storage Cases, Care Products, Connector,cable,earphones; Video: Head Cleaners, Carrying & Storage Cases, Care Products, Connector,cable,splitters.

Plastic Reel Corp. of America, Brislin Ave., Lyndhurst, NJ, 07071, (201) 933-5100, Fax: (201) 933-9468, Pres.: Ben Zuk; Sales Mgr./Mktg. Dir.: Pat Baccarella.
Tape—Video: Carrying & Storage Cases.

RGA Electronic Gear(MGM Brand), 6 W. 33rd St., New York, NY, 10001, (212) 594-1480, Fax: (212) 736-2307, Pres.: Charles Cornwell; Sales Mgr.: Joel Kochman; Mktg. Dir.: Ted Vail.
CD—Carrying & Storage Cases.
Tape—Audio: Carrying & Storage Cases, Camcorder & car stereo case.

R.P. Products, Inc., 1618 Waxwing Ct., Schaumburg, IL, 60173, (708) 397-4575, Fax: (708) 397-4576, Pres.: Roy Pink; Sales Mgr.: Dick Hirtz; Mktg. Dir.: Sent Fien.
CD—Carrying & Storage Cases.
Record—Carrying & Storage Cases.
Tape—Audio/Video: Carrying & Storage Cases.

RTI, Record Technology, Inc., 486 Dawson Dr., Camarillo, CA, 93012, (805) 484-2747, Fax: (805) 987-0508, Pres.: William Bauer; Sales Mgr.: Don MacInnis.
Tape—Audio: Tape degausseus; Video: Head Cleaners, Carrying & Storage Cases, Care Products, Tape cleaner/inspector.

Record-Rama Sound Archives, 4981 McKnight Rd., Pittsborough, PA, 15237, (412) 367-7330, Fax: (412) 367-7388, Pres.: Paul C. Mawhinney.
CD—Carrying & Storage Cases, Care Products.
Record—Carrying & Storage Cases, Care Products.

Recoton Corp., 46-23 Crane St., Long Island City, NY, 10011, (718) 392-6442, Fax: (718) 784-1080, Pres.: Robert L. Borchardt; Sales Mgr.: George Calvi.
Record—Care Products (Adapters), Replacement Styli, Cartridges/CD Storage Cases.
Tape—Audio: Head Cleaners; Video: Head Cleaners.

Research Technology Int'l, 4700 Chase Ave., Lincolnwood, IL, 60646, (708) 677-3000, Fax: (708) 677-1311, Pres.: Ray L. Short; Sales Mgr.: Bill Wolavka; Sales Mgr.: Tom Boyle; Mktg. Dir.: Tom Tisch.
CD—Carrying & Storage Cases.
Tape—Video: Head Cleaners, Carrying & Storage Cases, Care Products, Test equipment.

Savoy Division, Posso Corp., PO Box 8287, Haverhill, MA, 01835, (508) 374-0351, Fax: (508) 373-4184, Pres.: Patrick Posso; Gen. Mgr.: John A. McLean.
CD—Carrying & Storage Cases.
Record—Carrying & Storage Cases, CD Storage Cases.
Tape—Carrying & Storage Cases.

Seebro Products Co., 2416 S. Michigan Ave., Chicago, IL, 60616, (312) 842-8221, (312) 252-2266, Pres.: R. Siegal.
Record—Carrying & Storage Cases, Care Products (Cleaning cloths), Turntable Mats, Replacement Styli, Seebro wire record racks.

Shape, Inc.

PO Box 366, Biddeford Industrial Park, Biddeford, ME, 04005, (207) 282-6155, (800) 462-4165, Fax: (207) 283-9130, Chief Operating Officer: Michael Thomas; V.P. Audio Sales: Lloyd Pomber; Cust. Service Rep.: Patli Ellsworth.
CD—Storage Racks.

The Singing Machine Co., Inc., 6350 E. Rogers Cir., Boca Raton, FL, 33487, (407) 994-3100, Fax: (407) 997-8701, Pres.: Eugene B. Settler; Sales Mgr.: Richard Borden.
CD—Carrying & Storage Cases.
Record—Carrying & Storage Cases.
Tape—Audio: Carrying & Storage Cases, Care Products.

Sonrise Int'l, 110 E. 43rd St., Boise, ID, 83714, (208) 327-0772, (800) 231-8663, Fax: (208) 327-0669, Mktg. Dir.: Anne Picard.
CD—Carrying & Storage Cases.
Record—Carrying & Storage Cases, CD Storage Cases.
Tape—Carrying & Storage Cases.

Spin-Clean Record Washer System, PO Box 15395, Pittsborough, PA, 15237, (412) 367-7330, Fax: (412) 367-7388, Pres.: Paul C. Mawhinney.
CD—Care Products, Discmist-CD cleaner.
Record—Care Products (Spin-Clean Record Washer System).

Stanton Magnetics, Inc., 101 Sunnyside Blvd., Plainview, NY, 11803, (516) 349-0235, Fax: (516) 349-0230, Pres.: Walter O. Stanton; Mgr. Adv. & Promo.: Jean Kapen; Vice Pres. Int'l Sales: Frank Conlon.
Record—Turntable Mats, Replacement Styli.

Swire Magnetics (Professional Products Div.), 6701 I Northpark Blvd., Charlotte, NC, 28216, (704) 597-7145, Fax: (704) 597-7152, Vice Pres. Sales/Mktg.: Michael Tremblay.
Tape—Video: Carrying & Storage Cases.

Tapemaker, 48 Urban Ave., Westbury, NY, 11590, (516) 333-2700, Fax: (516) 333-0643, Pres.: Art Brandwein; Sales Mgr.: Mordey Brandwein; Mktg. Dir.: Matt Polakoff.
Tape—Audio/Video: Head Cleaners.

Tapeponents Co., PO Box 236, 60 Midvale Rd., Mountain Lakes, NJ, 07046, (201) 263-1442, (201) 263-1443, Fax: (201) 263-8640, Pres.: J. Clifford Anglum; Sales Mgr.: Robert Pitcher; Office Mgr.: Colleen Koch.
CD—Carrying & Storage Cases.
Tape—Audio: Carrying & Storage Cases; Video: Carrying & Storage Cases, Slip sleeves.

Tree Dimensions Mfg. Corp., PO Box 609, George Wilson Rd., Boone, NC, 28607, (704) 262-0220, Fax: (704) 262-0844, Pres.: Don Blair.
CD—Carrying & Storage Cases.
Record—Carrying & Storage Cases.
Tape—Audio/Video: Carrying & Storage Cases.

Charles W. Trent & Co., Inc., PO Box 4203, State Rd. 777 at 58 E., Martinsville, VA, 24115, (703) 638-3526, Fax: (703) 638-6317, Pres.: Kyle S. Trent; Sales Mgr.: Luanne Shuler; Mktg. Dir.: Charlie Trent.
CD—Carrying & Storage Cases.
Tape—Carrying & Storage Cases.

United Ad Label Co., Inc., 650 Columbia St., Brea, CA, 92621, (714) 990-2700, (800) 992-5755, Fax: (800) 423-8488, Pres.: Patrick Burns; Sales Mgr.: Denis Walp; Mktg. Dir.: Gary Harmon.
Tape—Audio/Video: Presentation/status label.

United Audio Video Group, Inc., 6855 Vineland Ave., North Hollywood, CA, 91605, (818) 980-6700, Fax: (818) 508-8273, Pres.: Miriam Newman; Vice Pres. Prodn.: Steve Newman; Sales Mgr.: Larry Schwartz; Mktg. Dir.: Laurie Newman.
CD—Carrying & Storage Cases, Care Products.
Tape—Audio/Video: Head Cleaners, Carrying & Storage Cases, Care Products.

Univertex, Inc., 6145-A Scherers Pl., Dublin, OH, 43017, (614) 761-2669, Fax: (614) 793-0202, Pres.: Ross O. Youngs; Sales Mgr.: Rich Williams; Corp. Communications Mgr.: Sandi Stein.
CD—Carrying & Storage Cases, Packaging.

VCR Lock Corp., 2031 Grant St., Hollywood, FL, 33020, (305) 926-8035, (800) 637-3176, Pres.: Wayne Dennis.
Cassette-Like Lock Device For VCRs.

Vinylweld, Div. of PEN-TAB Industries Inc., 2011 W. Hastings St., Chicago, IL, 60608, (312) 243-0606, Fax: (312) 942-0693, Vice Pres. Sales/Mktg. Dir.: Doug Engebretson.
Tape—Audio/Video: Carrying & Storage Cases.

Visual Impact Products, 9755 Independence Ave., Chatsworth, CA, 91311, (818) 407-0204, Fax: (818) 407-0850, Pres.: Kenneth R. Chane.
Tape—Video: Head Cleaners, Carrying & Storage Cases, Care Products.

Wide Range Electronics Corp., 174 Chesterfield Industrial Blvd., Chesterfield, MO, 63005, (314) 532-5887, (800) 728-4017, Fax: (314) 532-5492, Pres.: Don E. Toone; Sales Mgr.: T. Toone; Mktg. Dir.: O. Rauhut; Mgr.: G. Stecker.
Tape—Audio: Head Cleaners; Video: Head Cleaners, Carrying & Storage Cases.

Woodruff Corp., 1235 N.F. St., Richmond, IN, 47374, (317) 935-2990, Fax: (317) 935-1083, Gen. Mgr.: Mark Preston; Contact: Ann Thall.
CD—CD Divider Cards.
Record—LP & 45 Divider Cards.
Tape—Audio: Cassette Divider Cards.

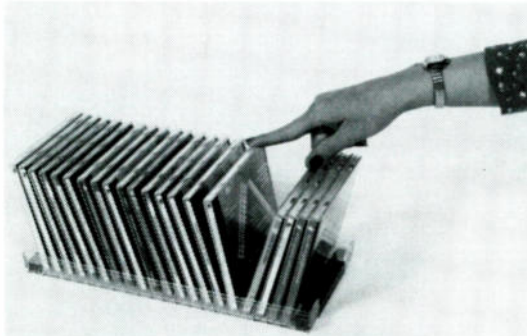

SHAPE[®]

CD FLIP FILE[™]

- compact disc storage rack
- protects, organizes and stores up to 20 CDs for quick and easy access
- **DISTRIBUTORS WANTED for this product**

Call 1-800-462-4165
or
Fax 207/283-9138

AUDIO ACCESSORY MANUFACTURERS

ARS Recording & Tape Duplication, 11626 S. Pulaski, Alsip, IL, 60658, (708) 371-8424, Fax: (708) 371-9403, Pres.: Gary A. Cobb; Sales Mgr.: Allen L. Kellman.
Video: Bulk Erasers, Demagnetizers, Leader Tape, Splicing Tape & Equipment.

American Recorder Technologies, Inc., PO Box 3592, 4395 Valley Fair St., Simi Valley, CA, 93063, (805) 527-9580, Fax: (805) 527-1433, Pres.: Alan Adelstein; Sales Mgr./Mktg. Dir.: Neil Frumkin.
Audio/Video: Demagnetizers.

R.B. Annis Co., Inc., 1101 N. Delaware St., Indianapolis, IN, 46202, (317) 637-9282, Fax: (317) 637-9282, Pres.: R.B. Annis.

Audio/Video: Bulk Erasers, Demagnetizers.
Audico, Inc., 7206 W. Grand, Elmwood Park, IL, 60635, (708) 456-0003, Fax: (708) 456-0418, Pres.: Barbara Deletzke.
 Video: Leader Tape, Splicing Tape & Equipment.
Audio Images, 70 Oak Grove St., San Francisco, CA, 94107, (415) 957-9131, Fax: (415) 957-1531, Pres.: Ron Timmons; Mktg. Dir: James Chen.
 Audio: Bulk Erasers, Demagnetizers, Leader Tape, Splicing Tape & Equipment.
Audiolab Electronics, Inc., 5831 Rosebud Ln., Bldg. C, Sacramento, CA, 95841, (800) 624-1903, Fax: (916) 348-1512, Pres.: Robert E. Stefan; Sales Mgr.: Ronald A. Stefan.
 Audio/Video: Bulk Erasers, Demagnetizers.
Audiopak, Inc., PO Box 3100, 1680 Tysons Dr., Winchester, VA, 22601, (703) 667-8125, Fax: (703) 667-6379, Pres.: Nick Krassowski; Sales Mgr.: G. Stafford.
 Video: Leader Tape.
Benjamin Int'l, Inc., 16 Newtown Plaza, Plainview, NY, 11803, (516) 753-0700, Fax: (516) 753-0839, Pres.: Joseph N. Benjamin; Vice Pres.: Charles T. Tanner.
 Audio/Video: Bulk Erasers, Demagnetizers, Splicing Tape & Equipment.
Bib America, 10497 Centennial Rd., Littleton, CO, 80127, (303) 972-0410, Fax: (303) 972-4519, Mktg. Dir: Tony Marcon.
 Audio: Demagnetizers, Splicing Tape & Equipment.
 Video: Bulk Erasers, Demagnetizers, Splicing Tape & Equipment, Audio/Video maintenance products.

W.H. Brady Co.

PO Box 571, 727 W. Glendale Ave., Milwaukee, WI, 53201, (800) 662-5688, (414) 332-8100, Fax: (414) 332-0861, Sales Mgr.: John A. Cullen.
 Audio/Video: Splicing Tape, Sensing Tapes.

Burlington Audio/Video Tapes, Inc., 106 Mott St., Oceanside, NY, 11572, (516) 678-4414, (800) 331-3191, Fax: (516) 678-8959, Pres.: Ruth Schwartz; Sales Mgr.: Jan Schwartz; Mktg. Dir: Rudy Schwartz.
 Audio/Video: Bulk Erasers, Demagnetizers, Leader Tape, Splicing Tape & Equipment.

Edifall, Div. of Xedit Corp., 218-31 97th Ave., Queens Village, NY, 11429, (718) 464-9400, Pres.: Claude M. Karczmer.
 Video: Splicing Tape & Equipment.
Fidellpac Corp., PO Box 808, Moorestown, NJ, 08057, (609) 235-3900, Fax: (609) 235-7779, Pres.: Roger Thanhauser; Sales Mgr.: John Tiedeck; Mktg. Dir: Scott Martin.
 Audio: Bulk Erasers.

Geneva Group of Companies, Inc., 9909 S. Shore Dr., Plymouth, MN, 55441, (612) 546-5620, Fax: (612) 546-0933, Pres.: Edward E. Griffin; Sales Mgr.: Bruce A. Bowen; Mktg. Dir: Laurel M. Anderson.
 Audio/Video: Bulk Erasers, Demagnetizers, Splicing Tape & Equipment.

Ian Communications Group, Inc., 10 Upton Dr., Wilmington, MA, 01887, (508) 658-3700, Fax: (508) 694-9957, Pres.: Richard B. Berberian; Sales Mgr.: Todd Thibaud; Mktg. Dir: James Rago.
 Audio: Leader Tape, Splicing Tape & Equipment.
 Video: Bulk Erasers, Demagnetizers.

Jasco Products Co., Inc., PO Box 466, Oklahoma City, OK, 73101, (405) 752-0710, (800) 654-8483, Pres.: Steve Trice; Sales Mgr.: Brent Hall; Mktg. Dir: Kent Shiptel.
 Audio: Demagnetizers.

King Instrument Corp., PO Box 1070, 80 Turnpike Rd., Westboro, MA, 01581, (508) 366-9141, Fax: (617) 870-5932, Pres.: William Cline; Vice Pres.: Paul Itoh, Sr.; Sales Engineer: Wayne Peterson.
 Video: Splicing Tape & Equipment.

Kingdom Co., PO Box 506, Mansfield, PA, 16933, (717) 662-7515, Fax: (717) 662-3875, Pres.: Johnny Berguson; Sales Mgr.: Howard Darr; Mktg. Dir: Gabe Phelps.
 Video: Bulk Erasers, Demagnetizers.

Multi-Video, Inc., PO Box 35444, 1432 E. Independence Blvd., Charlotte, NC, 28235, (704) 536-6928, (800) 289-0111, Fax: (704) 334-1058, Pres.: Will Espin; Mktg. Dir: Tommie Espin.
 Audio/Video: Splicing Tape & Equipment.

Nat'l Audio Co., Inc., PO Box 3657 G.S., 1841 E. Bergman, Springfield, MO, 65808, (417) 863-1925, Fax: (417) 863-7825, Pres.: Steve Stepp; Sales Mgr.: Sandi Slonecker.
 Audio: Bulk Erasers, Leader Tape, Splicing Tape & Equipment.
 Video: Leader Tape, Splicing Tape & Equipment.

Oakridge Music Recording Service, 2001 Elton Rd., Fort Worth, TX, 76117, (817) 838-8001, Owner/Pres.: Homer Lee Sewell.
 Audio: Bulk Erasers, Demagnetizers, Leader Tape, Splicing Tape & Equipment.

Philmore-Carter Craft, PO Box 6386, 2240 15th St., Rockford, IL, 61104, (815) 229-7773, Fax: (815) 229-7785, Pres.: Wayne Timpe; Sales Mgr.: Kitekaun Mejudhon.
 Audio: Demagnetizers, Splicing Tape & Equipment.
 Video: Splicing Tape & Equipment.

The listings contained in this publication are based solely upon information supplied to Billboard as of presstime. All information is checked for accuracy as of that time. However, Billboard is not responsible for changes in management or any other related business associations that may supersede the listings contained herein.

Pres-Tige Label Corp., 175-N Commerce Dr., Hauppauge, NY, 11788, (516) 273-0020, Fax: (516) 273-0092, Pres.: Ernie J. Menkes.

Audio: Splicing Tape & Equipment.
 Video: Splicing Tape & Equipment, Audio & Video labels.
RTI, Record Technology, Inc., 486 Dawson Dr., Camarillo, CA, 93012, (805) 484-2747, Fax: (805) 987-0508, Pres.: William Bauer; Sales Mgr.: Don MacInnis.
 Audio: Bulk Erasers.

Video: Bulk Erasers, Demagnetizers, Splicing Tape & Equipment.

Recoton Corp., 46-23 Crane St., Long Island City, NY, 10011, (718) 392-6442, Fax: (718) 784-1080, Pres.: Robert L. Borchart; Sales Mgr.: George Calvi.

Audio: Leader Tape.
 Video: Bulk Erasers, Demagnetizers, Splicing Tape & Equipment.

Research Technology Int'l, 4700 Chase Ave., Lincolnwood, IL, 60646, (708) 677-3000, Fax: (708) 677-1311, Pres.: Ray L. Short; Sales Mgrs.: Bill Wolavka, Tom Boyle; Mktg. Dir: Tom Tisch.

Audio: Bulk Erasers, Demagnetizers.
 Video: Bulk Erasers, Demagnetizers, Splicing Tape & Equipment.

Shintron Co., Inc., 45 Winthrop St., Concord, MA, 01742, (508) 371-7500, Fax: (508) 371-7554, Pres.: Sam Asano.
 Audio: Distribution Amplifiers.

Tapemaker, 48 Urban Ave., Westbury, NY, 11590, (516) 333-2700, Fax: (516) 333-0643, Pres.: Art Brandwein; Sales Mgr.: Mordey Brandwein; Mktg. Dir: Matt Polakoff.

Audio/Video: Leader Tape, Splicing Tape & Equipment.
Technical Service Specialists, Inc., PO Box 540, 90 Rt. 9 N., Astor Sq. #31, Rhinebeck, NY, 12572, (914) 876-3999, Fax: (914) 876-8632, Pres.: Chris Wasserbach; Sales Mgr.: Paul Gentner; Mktg. Dir: Dave Vercalletto; Construction Consultant: Steve Vercalletto.

Audio/Video: Custom designed equipment.
United Audio Video Group, Inc., 6855 Vineland Ave., North Hollywood, CA, 91605, (818) 980-6700, Fax: (818) 508-8273, Pres.: Miriam Newman; Vice Pres. Prodn.: Steve Newman; Sales Mgr.: Larry Schwartz; Mktg. Dir: Laurie Newman.

Audio: Bulk Erasers, Demagnetizers, Leader Tape, Splicing Tape & Equipment.
 Video: Splicing Tape & Equipment.

Wide Range Electronics Corp., 174 Chesterfield Industrial Blvd., Chesterfield, MO, 63005, (314) 532-5887, (800) 728-4017, Fax: (314) 532-5492, Pres.: Don E. Toone; Sales Mgr.: T. Toone; Mktg. Dir: O. Rauhut; Mgr.: G. Stecker.

Audio/Video: Bulk Erasers, Demagnetizers.

MANUFACTURERS: RETAIL MERCHANDISING PRODUCTS

ARS Recording & Tape Duplication, 11626 S. Pulaski, Alsip, IL, 60658, (708) 371-8424, Fax: (708) 371-9403, Pres.: Gary A. Gobb; Sales Mgr.: Allen L. Keilman.

Product(s): Posters, T-shirts.

AdTees Corp., 14 Stanley Ave., Thomasville, NC, 27360, (919) 472-3456, Vice Pres.: Ted Bacon; Vice Pres. Mktg.: Tim Tucker.

Product(s): T-shirts.
Angel Recording & Prodn., 9547 Tamarin Ct., Mentor, OH, 44060, (216) 639-1974, Pres.: Mark Luthardt; Sales Mgr.: Ben Rzepka.

Product(s): Jackets, T-shirts.
Atwater Press Litho Corp., 207 W. 25th St., New York, N.Y., 10001, (212) 675-2710, Fax: (212) 255-0933, Pres.: Peter Dreyfuss, Lester Dreyfuss.

Product(s): Posters.
B&F Plastic Graphics, Inc., 540 N. Eighth St., Richmond, IN, 47374, (800) 562-8365, Fax: (317) 962-7170, Pres.: Paul Bertsch IV.

Product(s): Vinyl banners.
B & H Co., 247 E. 157th St., Gardena, CA, 90248, (213) 719-7004, Fax: (213) 719-9894, Pres.: Robert Binder; Vice Pres.: Hadi Salem.

Product(s): T-shirts, All clothing.
C & R Guitars, 2140 S. Harvard, Tulsa, OK, 74114, (918) 747-1407, Fax: (918) 744-5477, Pres.: Bill Rich; Sales Mgr.: Anna Hickman; Mktg. Dir: Sara Rousso.

Product(s): Belt Buckles, Buttons/Badges, Hats/Caps, Jackets, Key Chains, Patches, Sunglasses, T-shirts, Custom design/mfr.

Community Professional Sound Systems, 333 E. Fifth St., Chester, PA, 19013, (215) 876-3400, Fax: (215) 874-0190, Pres.: Bruce Howze; Sales Mgr.: John Wiggins; Mktg. Dir.: Grace Paoli; Product Specialist: Greg Helm.

Product(s): Jackets, Key Chains, T-shirts.
Cude & Pickens Dist., 519 N. Halifax Ave., Daytona Beach, FL, 32118, (904) 252-0381, Fax: (904) 252-0381, Pres.: Bobby L. Cude.

Product(s): Belt Buckles, Buttons/Badges, Hats/Caps, Jackets, Key Chains, Patches, Posters, T-shirts, Artist/Per-



Melody Mates™

Greeting Cards for CD's & Cassettes

Now ... a new dimension in
PROFIT!
PROMOTION!
CONSUMER SATISFACTION!

"Let Your Customers Say it with Music!"

Profit on the sale of additional tapes and discs as well as on every card. Contemporary sayings for every occasion or mood on a background of **★** **★** colors. Individually shrinkwrapped to prevent damage. Unique gift certificates in jewel boxes and cassette cases. Your customers purchase their choice of compact disc, cassette, or gift certificate – each fits in its own size **Melody Mates**™ greeting card. Sturdy envelope for mailing. Custom counter and floor racks. Cards sell easily at 100% markup. Satisfaction guaranteed. Write, phone or fax for a sample and more ordering information.

Music Distributors:
We will design custom orders for your specific needs.
Fantastic for mailing promotional material!

© 1991, **Melody Mates, Inc.**, P.O. Box 1953, Dayton, OH 45401
Phone 513/ 253-5433 Fax 513/ 253-5838

Made in the U.S.A.

formers collector's cards.

Discount Video Tapes, Inc., PO Box 7122, Burbank, CA, 91510, (818) 843-3366, Fax: (818) 843-3821, Pres./Sales Mgr.: Woody Wise.
Product(s): Pre-recorded video.

Albert Elovitz Inc./American Int'l Mfg., 3812 Penn Ave., Pittsburgh, PA, 15201, (800) 233-2800, (412) 683-2900, Fax: 412-683-8375, Pres.: Albert Elovitz; Sales Mgr.: John Fullerton.
Product(s): Belt Buckles, Buttons/Badges, Hats/Caps, Jackets, Key Chains, Patches, Posters, Sunglasses, T-shirts, Music gifts.

Ephemera Buttons, PO Box 490, Phoenix, OR, 97535, (800) 537-7226, Pres.: Jeff Errick; Sales Mgr.: Ed Polish.
Product(s): Buttons/Badges.

Flash Int'l Ents., PO Box 580058, 16201 Buccaneer, Ste. 213, Houston, TX, 77062, (713) 488-1978, Pres./Mktg. Dir.: R.L. (Flash) Boudreaux.
Product(s): T-shirts.

GP Prods., 362 Third Ave., Ste. 1B, New York, NY, 10016, (212) 686-5267, Pres.: Gill R. Pessoa; Sales Mgr.: Y.L. Walton; Mktg. Dir.: Daryl A. Pessoa.
Product(s): Belt Buckles, Buttons/Badges, Hats/Caps, Jackets, Key Chains, Patches, Posters, T-shirts, P.O.P. displays, decals.

Gopher Products, 2201 Lockheed Way, Carson City, NV, 89701, (800) 648-0958, Fax: (702) 882-0958, Pres.: Warren Perkins; Gen. Mgr.: Gary Smith.
Product(s): Point of purchase signage.

Great Southern Co., 501 College St., Macon, GA, 31201, (912) 471-8050, (800) 221-2771, Fax: (912) 471-8070, Pres.: Ira Sokoloff; Vice Pres., Tour: Steve Miles; Vice Pres., Wholesale: Adam Sokoloff.
Product(s): Buttons/Badges, Hats/Caps, Jackets, Key Chains, Patches, Posters, T-shirts.

Holoubek, Inc., W238 N1800 Rockwood Dr., Waukesha, WI, 53188, (414) 547-0500, Fax: (414) 547-5847, Pres.: Verne Holoubek.
Product(s): T-shirts.

Identity, Inc., 1446 Broadway, Rm. 1610, New York, NY, 10036, (212) 719-1026, Fax: (212) 869-8101, Pres.: Lori Horowitz; Sales Mgr.: Jill Wierek; Mktg. Dir.: Miki Hagan.
Product(s): Buttons/Badges, Hats/Caps, Jackets, Patches, T-shirts.

ILL-Eagle Ents., 487 Bloomfield Ave., Caldwell, NJ, 07006, (201) 403-7888, Fax: (201) 403-7887, Pres.: Darryl Sage; Sales Mgr.: Sharon Kaye.
Product(s): Hats/Caps, Jackets, Patches.

Instant Button Machine Mfg./Instant Video Pictures, PO Box 6560, 15 Hamden Park Dr., Hamden, CT, 06517, (203) 877-9460, Fax: (203) 281-0294, Mktg. Dir.: Linda K. A. Cafalotte; Pres. & Sales Mgr.: Jack J. Alpert.
Product(s): Buttons/Badges, Button machines/supplies.

Knit Impressions, 362 Third Ave., Ste. 1B, New York, NY, 10016, (212) 686-5267, Pres.: Yvette L. Walton; Sales Mgr.: Gill R. Pessoa; Mktg. Dir.: Daryl A. Pessoa.
Product(s): Jackets, Posters, T-shirts, Hand knit music sweaters.

Laser Prints, Inc., PO Box 151, 241 Stuyvesant Ave., Lynhurst, NJ, 07071, (201) 438-6777, Fax: (201) 438-0903, Pres.: J. Principato.
Product(s): Posters.

Melody Mates, Inc.

PO Box 1953, 63 Gunckel Ave., Dayton, OH, 45410, (513) 253-5433, Fax: (513) 253-5838, Pres.: Jane Ellenberger; Sales Mgr.: Rocky Willis; Art Dir.: Susan Atkins.
Product(s): CD's & Tapes, Greeting cards with sturdy mailing "box/envelopes."

Metacom, Inc., 5353 Nathan Ln., Plymouth, MN, 55442, (612) 553-2000, Pres.: Phillip Levin.
Product(s): Posters.

Movie Memories & Poster Shop, 502 Waverly St., Palo Alto, CA, 94301, (415) 328-6265, Owner: David Kneubuhl.
Product(s): Buttons/Badges, Key Chains, Patches, Posters.

Musicol, Inc., 780 Oakland Park Ave., Columbus, OH, 43224, (614) 267-3133, Pres.: John W. Hull; Sales Mgr.: Warren Hull; Mktg. Dir.: Charlene Hull.
Product(s): Hats/Caps, Jackets, T-shirts.

Nalpac Ltd., 8700 Capital, Oak Park, MI, 48237, (313) 541-1140, Fax: (313) 544-9126, Pres.: Ralph Caplan; Sales Mgr.: Ken Sahn.
Product(s): Hats/Caps, Key Chains, Patches, Sunglasses, T-shirts, Tapestries, Incense, Jewelry.

Nat'l Trends, Inc., 2990 Lapeer Rd., Auburn Hills, MI, 48326, (313) 373-3322, Fax: (313) 373-3981, Pres.: James P. George; Sales Mgr.: Rick Barnes.
Product(s): Posters, T-shirts.

New Music Seminar, 632 Broadway, 9th Floor, New York, NY, 10012, (212) 473-4343, Fax: (212) 353-3162, Exec. Dir.: Mark Josephson; Exec. Dir.: Tom Silverman.
Product(s): Hats/Caps, Jackets, T-shirts.

OSP Publishing, Inc., 1001 Monterey Pass Rd., Monterey Park, CA, 91754, (213) 263-7361, Fax: (213) 263-9419, Pres.: Joseph Angard; Sales Mgr.: Wes Knitter; Mktg. Dir.: Matt Barisic.
Product(s): Buttons/Badges, Posters.

Oakridge Music Recording Service, 2001 Elton Rd., Fort Worth, TX, 76117, (817) 838-8001, Owner/Pres.: Homer Lee Sewell.
Product(s): Key Chains.

Plastic Works, Inc., 1038 Ashby Ave., Berkeley, CA, 94710, (510) 841-1001, Fax: (510) 841-6116, Pres.: Jeff Weinstein; Sales Mgr./Mktg. Dir.: Gary Schatan.
Product(s): Poster holders.

Plymouth Mills, Inc., 1407 Broadway, Ste. 504, New York, NY, 10018, (212) 302-4200, Fax: (212) 302-4208, Pres.: Joann Elenson; Sales Mgr.: Allen Bernstein.
Product(s): Hats/Caps, T-shirts.

Poster Service, Inc., 255 Northland Blvd., Cincinnati, OH, 45246, Fax: (513) 672-3280, Pres.: Daniel P. Regenold; Sales Mgr.-East Coast: Dana Gore; Sales Mgr./Mktg. Dir.: Lisa Bowen.
Product(s): Posters.

Power Thru Print, 7 Thorne St., Jersey City, NJ, 07307, (800) 874-4624, Fax: (201) 792-0193, Owner/Mktg. Dir.: Marie Mikolajczak; Owner/Sales Mgr.: John Rocco.
Product(s): Belt Buckles, Buttons/Badges, Hats/Caps, Jackets, Key Chains, Patches, Posters, Sunglasses, T-shirts, Press kits, Bumperstickers.

RHM Industries, Ltd., PO Box 378, 180 Orville Dr., Bohemia, NY, 11716, (516) 567-7222, Fax: (516) 567-7253, Pres.: Gerard Hughes.
Product(s): Posters.

Real Life, Inc., 22159 Rimbhurst, Unit 33, El Toro, CA, 92630, (714) 458-9131, CEO: Elizabeth Lacey.
Product(s): Misc Laser Engraved Items.

Regal, A Poly-Pak Industries Co., 125 Spagnoli Rd., Melville, NY, 11747, (516) 293-6767, Fax: (516) 454-6366, Pres.: Peter Levy; Sales Mgr.: Ken Trotter; Mktg. Dir.: Juliette H. McKenna.
Product(s): Giftwrap, Printed plastic bags.

Ross Ellis, Ltd., 1133 Broadway, Ste. 825, New York, NY, 10010, (212) 645-6110, (800) 223-6105, Fax: (212) 645-9376, Pres.: B. Ellis; Sales Mgr.: Nina Palmer Sheldon; Mktg. Dir.: Peter Kerr.
Product(s): Posters.

Ross-Ellis, Ltd., 1133 Broadway, Ste. 825, New York, NY, 10010, (212) 645-6110, Fax: (212) 645-9376, Pres.: B. Ellis; Sales Mgr.: Nina Palmer Sheldon; Mktg. Dir.: Peter Kerr.
Product(s): Posters.

Rothchild Group, 7900 Barnwell Ave., Eimhurst, NY, 11373, (718) 899-6000, Fax: (718) 397-1921, Pres.: Alan J. Rothchild; Mgr./Customer Service: Anne Owsianik.
Product(s): Posters.

Jasper Samuel Advertising & Printing, 406 W. 31st St., New York, NY, 10001, (212) 239-9544, Fax: (212) 594-0931, Pres.: Jasper Samuel; Sales Mgr.: Claude Chamlee; Mktg. Dir.: Courtland White.
Product(s): Buttons/Badges, Hats/Caps, Key Chains, Patches, Posters, T-shirts.

Scorpio Posters, Inc., 63 19th St., Brooklyn, NY, 11232, (718) 499-2001, (800) 221-6328, Fax: (718) 788-0512, Pres.: Frank Scorpio; Sales Mgr.: Liz Peace; Mktg. Dir.: Eileen Paris.
Product(s): Posters.

Star Title, PO Box 680, 1015 Park Ave., Lakewood, NJ, 08701, (908) 370-4044, Fax: (908) 364-4666, Pres.: Philip M. Falgares, Jr.
Product(s): Title strips for jukeboxes.

Starmakers Publishing Corp., 47-51 33rd St., Long Island, NY, 11011, (718) 767-8377, Fax: (718) 482-7708, Pres.: Eileen Miller; Sales Mgr.: George Fisher.
Product(s): Posters.

T-Shirt Distribution & Merchandising, Inc., 525 E. 71st St., New York, NY, 10021, (800) 626-3154, (800) 833-7565, (212) 772-0283, Fax: (212) 772-0297, Pres.: David Stern.
Product(s): Hats/Caps, Jackets, T-shirts, All Apparel. Custom screenprinting, embroideries, gifts & promotional item development for the music business.

United Ad Label Co., Inc., 650 Columbia St., Brea, CA, 92621, (714) 990-2700, (800) 992-5755, Fax: (800) 423-8488, Pres.: Patrick Burns; Sales Mgr.: Denis Walp; Mktg. Dir.: Gary Harmon.
Product(s): Buttons/Badges.

Vermont Specialty Products, Inc., 216 Battery St., Burlington, VT, 05401, (802) 804-7010.
Product(s): Buttons/Badges, Hats/Caps, T-shirts, Bumper stickers, Glassware.

Warjo Promos, Inc., 236 W. 27th St., New York, NY, 10001, (212) 627-2800, Fax: (212) 627-3136, Pres.: Warren Baker.
Product(s): Belt Buckles, Buttons/Badges, Hats/Caps, Jackets, Key Chains, Patches, Posters, Sunglasses, T-shirts, Imprinted items.

West & Co., Inc., PO Box 24281, Nashville, TN, 37202, 1726-C General George Patton Dr., Brentwood, TN, 37027, (615) 661-5808, Fax: (615) 661-5905, Pres.: Jerry West; Sales Mgr.: Mike Young; Mktg. Dir.: Gary Campbell.
Product(s): Buttons/Badges, Hats/Caps, Jackets, Key Chains, Patches, Posters, T-shirts.

Winterland Prods., 100 Harrison St., San Francisco, CA, 94105, (415) 597-9700, Fax: (415) 597-9744, Pres.: Dell Furano; Dir. Artist Merchandising: Steve Gerstman.
Product(s): Hats/Caps, T-shirts.

XJD Corp., 2023 W. Carroll Ave., Chicago, IL, 60612, (312) 226-1299, Fax: (312) 226-2637, Pres.: Tim J. Boeglin; Sales Mgr.: Jeff N. Given.
Product(s): Key Chains, CD clocks, Imprinted promo. items.

Zmachers Posters, Inc., 8181 NW 91 Terrace, B-6, Medley, FL, 33166, (305) 888-2238, Fax: (305) 888-1924, Pres.: Doris C. Hardison; Sales Mgr. & Mktg. Dir.: Cathy Zamora.
Product(s): Belt Buckles, Buttons/Badges, Hats/Caps, Key Chains, Patches, Posters, T-shirts.

"THE GOOD SWAG DUDE"

T-SHIRT DISTRIBUTION & MERCHANDISING CO.

GREAT IDEAS!
GREAT SERVICE!
GREAT PRICES!



From tour jackets and t-shirts to special gifts and promotional items. . . Give us a call!

1-800-833-7565 (U.S. & Canada)
1-800-626-3154 (Fax)
212-772-0283
212-772-0297 (Fax)

FREE CATALOGS

525 E. 71ST STREET, NEW YORK, NY 10021

Billboard 1991
RECORD
RETAILING
DIRECTORY
PRERECORDED
MUSIC VIDEO DEALERS
AND CHAIN
HEADQUARTERS

OVERWHELMING SUCCESS!

Reaching record retailers has never been easier!

Over 7,000 listings include:

- Independent retailers, owners and addresses
- Phone & fax numbers
- Chain headquarter locations
- Management staff
- Buyers
- Store Planners

...and more!

Now you can reach record retailers directly & this compact 6x9 directory fits right in your briefcase!

\$85
(includes s&h)

For fastest service / in NJ call / Or send check or money order to: Billboard
call 800-344-7119 / 908-363-4156 / Directories, PO Box 2016, Lakewood NJ 08701.

(Add appropriate sales tax in NY, NJ, CA, TN, MA, IL and DC.) Please add an additional \$5 per directory for foreign orders

BDDR5130

In this section...

- Store Fixture Manufacturers
- Security & Surveillance Systems Manufacturers
- Computer Systems & Services
- Associations & Professional Organizations
- Entertainment Attorneys
- Int'l Business Agents of Music/Video
- Performing & Mechanical Rights Organizations
- Music Libraries
- Public Relations
- Record Promotion
- Schools & Instruction

Industry Services & Suppliers

STORE FIXTURE MANUFACTURERS

- AdCo Products**, PO Box 17, Calimesa, CA, 92320, 13346 Rimview Ct., Yucaipa, CA, 92399, (714) 795-3663, Pres./Mktg. Dir.: Jack E. Adams; Sales Mgr.: Eloise M. Adams.
Display Racks—(CD, Tape, Video).
- Alpha Ent's., Inc.**, 330 S. Wood St., East Canton, OH, 44730, (216) 488-0361, Pres.: Jim Sankey.
Divider Cards—(CD, Record, Tape, Video).
- Alpha Recording, Inc.**, PO Box 740, Elizabethtown, KY, 42701, (502) 765-7899, Fax: (502) 765-3734, Pres.: Jim Cottrell; Sales Mgr.: Don Cottrell; Mktg. Dir.: Lori Hawk; Studio Mgr.: Mark Goodman.
Browser Boxes—(Tape); Display Racks—(CD, Tape); Divider Cards—(Tape).
- Alps, Inc.**, PO Box 31723, Raleigh, NC, 27622, 946 W. 64 Bus, Wendell, NC, 27519, (919) 365-3141, Fax: (919) 365-5119, Pres.: Roy Rysdon; Sales Mgr.: Joy Renfrow; Mktg. Dir.: Judy Rysdon.
Display Racks—(CD, Tape, Video); (Cabinets).
- Art-Phyl Creations**, 16250 NW 48th Ave., Miami, FL, 33014, (305) 624-2333, (800) 327-8318, Fax: (305) 621-4093, Pres.: Art Hochman.
Display Racks—(CD, Record, Tape, Video).
- B&F Plastic Graphics, Inc.**, 540 N. Eighth St., Richmond, IN, 47374, (800) 562-8365, Fax: (317) 962-7170, Pres.: Paul Bertsch IV.
Display Racks—(CD, Record, Tape, Video); Divider Cards—(CD, Record, Tape, Video).
- Bass Industries, Inc.**, 380 NE 67th St., Miami, FL, 33138, (305) 751-2716, Fax: (305) 756-6165, Pres.: Robert M. Baron; Sales Mgr.: Eric Finnegan; Mktg. Dir.: Irma Baron.
Display Racks—(CD, Record, Tape, Video).
- Bib America**, 10497 Centennial Rd., Littleton, CO, 80127, (303) 972-0410, Fax: (303) 972-4519, Mktg. Dir.: Tony Marcon.
Display Racks—(CD).
- Browser Display Systems**, 401 W. Superior, Chicago, IL, 60610, (800) 822-4410, (312) 822-0822, Fax: (312) 642-7880, Pres.: Howard Rosen; Sales Mgr.: Greg B. Hall.
Browser Boxes—(CD, Tape, Video); Display Racks—(CD, Tape, Video); Divider Cards—(CD, Tape, Video).

Burlington Audio/Video Tapes, Inc., 106 Mott St., Oceanside, NY, 11572, (516) 678-4414, (800) 331-3191, Fax: (516) 678-8959, Pres.: Ruth Schwartz; Sales Mgr.: Jan Schwartz; Mktg. Dir.: Rudy Schwartz.
Browser Boxes—(CD, Tape, Video).

CDisplay, PO Box 801323, Santa Clarita, CA, 91380, (805) 294-9010, Fax: (805) 294-1254, Pres./Sales Mgr.: Don Krattiger; Mktg. Dir.: Pat Krattiger.
Display Racks—(CD).

Can-Am Merchandising Systems, 900 Hertel Ave., Buffalo, NY, 14216, (800) 387-9790, Fax: (416) 475-1154, Pres.: Jerry Pila; Sales Mgr.: Gregg Ernst; Mktg. Dir.: Cathy Edney; Controller: Margaret Doherty.
Display Racks—(CD, Tape, Video).

Computer Dataware, Inc., 7580 E. Gray Rd., Ste. 102, Scottsdale, AZ, 85260, (602) 998-3163, Fax: (602) 951-3038, Pres.: Richard McDaniel; Sales Mgr.: Larry D. Brehm.
Display Racks—(Tape).

Creative Store Equipment, Inc., PO Box 933, Terrell, TX, 75160, (214) 563-5869, Pres./Sales Mgr.: Jerry White.
Display Racks—(Record, Tape).

Crown Store Equipment Co., PO Box 400, 8200 W. Central, Toledo, OH, 43617, (419) 841-2271, Fax: (419) 843-3980, Pres.: Timothy Gerou.
Browser Boxes—(CD, Record, Tape, Video); Display Racks—(CD, Record, Tape, Video); Divider Cards—(CD, Record, Tape, Video).

Daniel E. Gelles Associates, Inc.
PO Box 348, Mohonk Rd., High Falls, NY, 12440, (914) 687-7681, Fax: (914) 687-4324, Pres.: Daniel Gelles; Pres./North Atlantic Powder Coaters (Div. of Gelles Assoc.): Robert Yurasits; Sales Mgr.: Robert S. Gelles; Mktg. Dir.: Joel Gelles.
Browser Boxes—(CD, Record, Tape, Video); Display Racks—(CD, Record, Tape, Video); Other: Wall Accessories for Slatwall, Pegboard, etc., Store Design, Floor Layout.

Goldstar Electronics, Inc., 1000 Sylvan Ave., Englewood Cliffs, NJ, 07832, (201) 816-2000, Pres.: S. Chung; Sales Mgr.: Joe Stevens.
Display Racks—(CD).

Gopher Products Corporation

2201 Lockheed Way, Carson City, NV, 89706, (800) 648-0958, (702) 882-9333, Fax: (702) 882-0959, Pres.: Warren Perkins; Gen. Mgr.: Gary Smith.
Divider Cards—(CD, Record, Tape, Video).

Hannecke Display Systems, Inc., 300G Rt. 17 S., Mahwah, NJ, 07430, (201) 529-5995, Fax: (201) 529-9343, Pres.: Bruce C. Dreher; Mktg. Dir.: Grace Perusini.
Display Racks—(CD, Tape, Video).

J.D. Store Equipment

1904 E. Seventh St., Los Angeles, CA, 90021, (213) 623-4316, (800) 433-3543, Fax: (213) 624-9022, Pres.: John Maioriello; Sales Mgr.: Wayne Hibner; Mktg. Dir.: Donald Ross.
Browser Boxes—(CD, Record, Tape, Video); Display Racks—(CD, Record, Tape, Video); Divider Cards—(CD, Record, Tape, Video).

Jewelite, Signs, Letters & Displays, Inc., 106 Reade St., New York, NY, 10013, (212) 966-0433, Fax: (212) 966-4952, CEO: William Bank; Pres.: Joseph Bank; Sales Mgr.: Bob Bank; Mktg. Dir.: Dana Bank.
Browser Boxes—(CD, Tape, Video); Display Racks—(CD, Tape, Video); Divider Cards—(CD, Tape, Video).

Kingdom Co., PO Box 506, Mansfield, PA, 16933, (717) 662-7515, Fax: (717) 662-3875, Pres.: Johnny Berguson; Sales Mgr.: Howard Darr; Mktg. Dir.: Gabe Phelps.
Display Racks—(CD, Tape).

Klearfold, Inc., 364 Valley Rd., Warrington, PA, 18976, (215) 343-9300, Fax: (215) 343-0491, Pres.: Melvin Herrin; Vice Pres. Sales: David Tolley.
Browser Boxes—(CD, Tape); Display Racks—(CD, Tape); Divider Cards—(CD, Tape).

Liberty Mfg., Inc., PO Box 8431, 2467 Mariposa Rd., Stockton, CA, 95208, (209) 948-1176, (209) 952-6352, Fax: (209) 948-1197, Pres.: Gary Frush; Sales Mgr.: David Van Testlaar.
Browser Boxes—(CD, Record, Tape, Video); Display Racks—(CD, Record, Tape, Video).

Lift Display, Inc., 115 River Rd., Edgewater, NJ, 07020, (201) 945-8700, Fax: (201) 945-9548, Pres.: Otto Schubert; Vice

DIVIDER CARDS

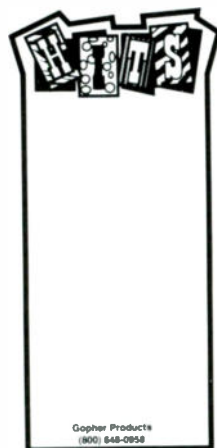

• Custom

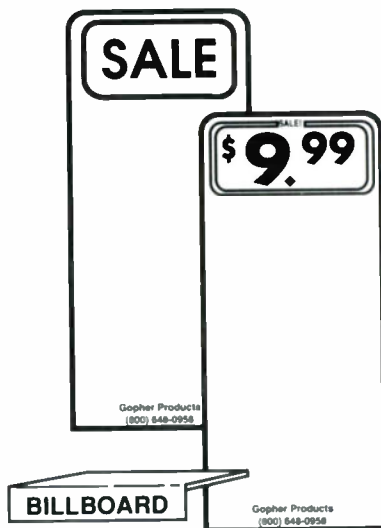

• Promotional Dividers

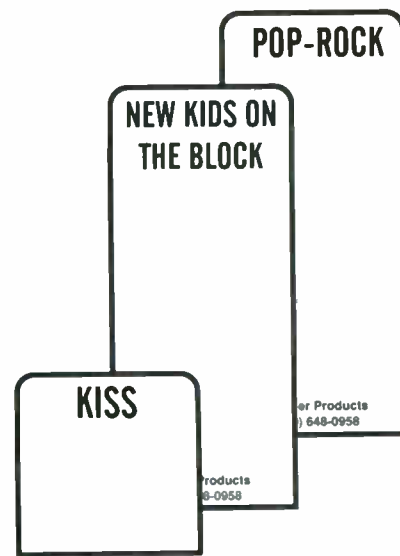

• Artists & Categories

- Over 1500 Artists & 180 Different Categories In Stock & Ready For Delivery.
- Wire Racks and Accessories

For a FREE Artist List
& Catalog CALL
(800) 648-0958
FAX (702) 882-0959



Gopher Products
2201 Lockheed Way
Carson City, Nv 89706

Pres./Mktg. Dir.: Colette Kreins.
Display Racks—(CD, Tape, Video); Divider Cards—(CD, Tape, Video).

Margold, Inc.

1058 Broadway, Albany, NY, 12204, (518) 463-2236, Fax: (518) 463-2361, Pres.: Marvin B. Kahn; Sales Mgr.: Jana B. Kahn. Custom Divider Cards, Stock & Custom Labels for Divider Cards (CD, Record, Tape, Video)

Metacom, Inc., 5353 Nathan Ln., Plymouth, MN, 55442, (612) 553-2000, Pres.: Phillip Levin.
Display Racks—(Tape).

Millrock, Inc., PO Box 974, Sanford Industrial Estates, Community Dr., Sanford, ME, 04073, (207) 324-0041, Fax: (207) 324-0134, Pres.: Martin Liebmann; Sales Mgr.: Spencer Liebmann; Mktg. Dir.: David Stackhouse; Treasurer: Richard Liebmann.

Display Racks—(CD, Record, Tape, Video).

Movie Memories & Poster Shop, 502 Waverly St., Palo Alto, CA, 94301, (415) 328-6265, Owner: David Kneubuhl.
Browser Boxes—(Video); Display Racks—(Video).

Performance Dist., PO Box 0156, 2 Oak St., New Brunswick, NJ, 08903, (908) 545-3004, Fax: (908) 545-6054, Owner: Stephen Kaplan; Owner: Arthur Marko; Mgr.: Jessica DiGiora.
Divider Cards—(CD, Record, Tape).

Plastic Works, Inc., 1036 Ashby Ave., Berkeley, CA, 94710, (510) 841-1001, Fax: (510) 841-6116, Pres.: Jeff Weinstein; Sales Mgr./Mktg. Dir.: Gary Schatan.

Display Racks—(CD, Record, Tape, Video).

R.P. Products, Inc., 1618 Waxwing Ct., Schaumburg, IL, 60173, (708) 397-4575, Fax: (708) 397-4576, Pres.: Roy Pink; Sales Mgr.: Dick Hirtz; Mktg. Dir.: Sent Fien.

Display Racks—(CD, Record, Tape, Video).

Recoton Corp., 46-23 Crane St., Long Island City, NY, 10011, (718) 392-6442, Fax: (718) 784-1080, Pres.: Robert L. Borchart; Sales Mgr.: George Calvi.
Divider Cards—(CD, Tape).

Royson, Inc., PO Box 90519, Long Beach, CA, 90809, 1500 Seabright Ave., Long Beach, CA, 90813, (800) 443-6110, Fax: (213) 435-7468, Pres.: Phillip Henderson; Sales Mgr.: Roy Morrison; Mktg. Dir.: Richard Henderson.
Display Racks—(CD); (Slatwall).

Seebro Products Co., 2416 S. Michigan Ave., Chicago, IL, 60616, (312) 842-8221, (312) 252-2266, Pres.: R. Siegal.
Display Racks—(Record).

Shannon Data & Display, 46 Westland Blvd. SW, Atlanta, GA, 30311, (404) 691-0042, (800) 247-8389, Fax: (404) 691-6361, Vice Pres. Sales & Mktg.: Ken Anderson.
Browser Boxes—(CD, Record, Tape, Video); Display Racks—(CD, Record, Tape, Video).

Statwall Systems by Wind Mill, 200 Balsam Rd., Sheboygan Falls, WI, 53085, Pres.: Jay Hogfeldt; COO: Fred Hollander; Sales Mgr.: Russell Otten; Mktg. Dir.: Mark Hunt.
Display Racks—(CD, Record, Tape, Video); (Slatwall panel); (Slatwall panels); (Statwall panels); (Slatwall panels).

Star Title, PO Box 680, 1015 Park Ave., Lakewood, NJ, 08701, (908) 370-4044, Fax: (908) 364-4666, Pres.: Philip M. Falgares, Jr.

Divider Cards—(CD, Record, Tape).

Sterling Title Strip, PO Box 5894, 2100 E. Ohio St., Pittsburgh, PA, 15209, (412) 322-4555, Fax: (412) 322-5073, Sales Mgr.: Edward Fedorchak.
Divider Cards—(CD, Tape).

Technical Service Specialists, Inc., PO Box 540, 90 Rt. 9 N., Astor Sq. #31, Rhinebeck, NY, 12572, (914) 876-3999, Fax: (914) 876-8632, Pres.: Chris Wasserbach; Sales Mgr.: Paul Genthner; Mktg. Dir.: Dave Vercelletto; Construction Consultant: Steve Vercelletto.
Display Racks—(Tape, Video).

Video Marquee, PO Box 1620, 5400 China Hill Rd., Diamond Springs, CA, 95619, (916) 622-7508, Fax: (916) 622-7799, Pres.: Alan Steward; Mktg. Dir.: Rich Lile.
Display Racks—(CD, Record, Tape, Video).

Visual Impact Products, 9755 Independence Ave., Chatsworth, CA, 91311, (818) 407-0204, Fax: (818) 407-0850, Pres.: Kenneth R. Chane.
Browser Boxes—(Video); Display Racks—(Video); Divider Cards—(Video).

Walls & Forms, Inc., 2619 Nova Dr., Dallas, TX, 75229, (214) 243-3038, Fax: (214) 247-2987, Pres.: Brad Boa; Mktg. Dir.: Dan L. South.
Display Racks—(CD, Record, Tape, Video).

Woodcraft Industries, Inc., PO Box 79580, 809 Burlington Rd., Fort Worth, TX, 76179, (800) 383-8961, Fax: (817) 847-6929, Pres.: Lynn McCauley; Sales Mgr./Mktg. Dir.: Neel E. Bobbitt.
Display Racks—(CD, Record, Tape, Video).

Woodruff Corp.

1235 N "F" St., Richmond, IN, 47374, (317) 935-2990, Fax: (317) 935-1083, Gen. Mgr.: Mark Preston.
Browser Boxes—(CD, Record, Tape, Video); Display Racks—(CD, Record, Tape, Video); Divider Cards—(CD, Record, Tape, Video).

SECURITY & SURVEILLANCE SYSTEMS MANUFACTURERS

Alpha Ent., Inc.

330 S. Wood St., East Canton, OH, 44730, (216) 488-0361, Pres.: Jim Sankey.

Reusable Security Packaging: CD, Audio Cassettes, Video Cassettes, Cassette Singles

W.H. Brady Co., PO Box 571, Milwaukee, WI, 53201, (800) 662-5688, Fax: (414) 377-6789, Sales Mgr.: John A. Cullen. Systems: Anti-piracy & tamper proof labels.

C & D Special Products, 309 Sequoia Dr., Hopkinsville, KY, 42240, (502) 885-8088, (800) 922-6287, Pres.: Bill MacTavish. Reusable Security Packaging.

Checkpoint Systems, Inc., 550 Grove Rd., Thorofare, NJ, 08086, (609) 848-1800, Fax: (609) 848-0937, Pres.: A.E. Wolf; Mktg. Dir.: Bill Riley.
Electronic: Walk-Through Security Systems.

Creative Store Equipment, Inc., PO Box 933, Terrell, TX, 75160, (214) 563-5869, Pres./Sales Mgr.: Jerry White.
Electronic Systems.

Empak, PO Box 376, Shakopee, MN, 55379, (612) 445-4110, Contact: Rob Van Dembroeck.
Reusable Security Packaging: CF-120 CD Longboxes.

G & Z Systems, Inc., 50 Broadway, Hawthorn, NY, 10532, (914) 741-0011, Fax: (914) 741-0482, Pres.: Richard A. Zuckerman; Vice Pres.-Sales & Mktg.: Louis M. Parks.
Video: P.O.S. system.

J.D. Store Equipment, 1920 E. Seventh St., Los Angeles, CA, 90021, (213) 623-4316, (800) 433-3543, Fax: (213) 624-9022, Pres.: John Maioriello; Sales Mgr.: Wayne Hibner; Mktg. Dir.: Donald Ross.
Reusable Security Packaging: Article surveillance systems. Systems: Turnstile & Railing Systems.

Lift Discplay, Inc., 115 River Rd., Edgewater, NJ, 07020, (201) 945-8700, Fax: (201) 945-9548, Pres.: Otto Schubert; Vice Pres./Mktg. Dir.: Colette Kreins.
Electronic Systems.
Systems: Behind counter storage cabinets.

Sensormatic Electronics, Corp., 500 NW 12th Ave., Deerfield Beach, FL, 33442, (305) 427-9700, (800) 241-6678, Fax: (305) 428-9253.
Reusable Security Packaging.

Shannon Data & Display, 46 Westland Blvd. SW, Atlanta, GA, 30311, (404) 691-0042, (800) 247-8389, Fax: (404) 691-6361, Vice Pres. Sales & Mktg.: Ken Anderson.
Reusable Security Packaging: Check Point.
Electronic: Check Point.
Systems: Point of sale computer systems.

Technical Service Specialists, Inc., PO Box 540, 90 Rt. 9 N., Astor Sq. #31, Rhinebeck, NY, 12572, (914) 876-3999, Fax: (914) 876-8632, Pres.: Chris Wasserbach; Sales Mgr.: Paul Genthner; Mktg. Dir.: Dave Vercelletto; Construction Consultant: Steve Vercelletto.
Reusable Security Packaging: KNOGO.
Electronic: Complete package.
Video: Time lapse, motion activated.

3M Co. Safety & Security Systems Div., 3M Center Bldg. 225-4N-14, Saint Paul, MN, 55144, (612) 736-6929, Mgr. Prog. Dev. Retail: Robert Dreger.
Electronic Systems.

COMPUTER SYSTEMS & SERVICES

Audiofile, Valley Record Distributors, Inc.

PO Box 2057, 1280 Santa Anita, Woodland, CA, 95695, (916) 661-6600, (800) 845-8444, Fax: (916) 661-5472, Mgr.: Samantha Rubendall.

BSI Braniff Systems, Inc., 43 Ironwood St., Staten Island, NY, 10308, (718) 494-2731, Pres.: Tom Braniff; Treas.: Sandra Boland.

Blackbourn, Inc., 7550 Corporate Way, Eden Prairie, MN, 55344, (800) 842-7550, Fax: (612) 949-2553, Pres.: Todd Nicholson; Sales Mgr.: Jerry Forness; Mktg. Dir.: Mike Langert.

Bonafide Mgmt. Systems, Inc., 6018 Variel Ave., Woodland Hills, CA, 91367, (818) 999-9888, Fax: (818) 999-9895, Pres.: Larry Lai; Sales Mgr.: Betsy Herrick; Dir. Admin.: Caroline Vandever.

Capital Business Systems, 2033 First St., Napa, CA, 94558, (707) 252-9122, Fax: (707) 252-6368, Pres.: George Burch.

LABELS for DIVIDER CARDS

IN STOCK



MOVE MORE MERCHANDISE

- FOR COMPACT DISC, LP & TAPE
- HUNDREDS OF ARTISTS & CATEGORIES
- COVER OLD TITLES / REUSE CARDS

Custom Printed Divider Cards
also our specialty

FOR **FREE** SAMPLES
CALL OR WRITE JUDY

MARGOLD
"The Other Divider Card Company"
1058 Broadway • Albany, NY 12204
518-463-2236

SUPERIOR QUALITY DIVIDER CARDS

FOR CASSETTES, CD'S, LP'S, 45'S AND SPECIFIC NEEDS

1-800-222-5116

WOODRUFF CORP. • 1235 NORTH F STREET • RICHMOND, IN 47374

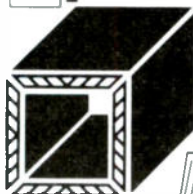

VALLEY RECORD
DISTRIBUTORS, INC.

Presents:

audiofile

The Music Retailer's Database

✓ **Comprehensive**

Complete information on over
70,000 titles

✓ **Accurate**

Information maintained daily

✓ **Timely**

Updates available every week

For more information about
Valley's complete **audiofile**

Call Toll Free:
800-845-8444



audiofile

P.O. Box 2057
Woodland, CA 95695
916-661-6600
FAX: 916-661-5472

Sales Mgr.: Gary Daniel.
Captain Blue Music, PO Box 1044, c/o TJS Technologies 413
E. Diamond Ave., Hazleton, PA, 18201, (717) 455-2502, Pres.:
Taylor Sappe; Sales Mgr.: Jean Zeppi; Mktg. Dir.: Roger
Taylor.

Cleveland Data Services, Inc.The Sound Solution, 8879
Brecksville Rd., #2, Brecksville, OH, 44141, (216) 838-4342,
Fax: (216) 838-4138, Pres.: John Kramer; CFO: Gary Eby;
Mktg. Dir.: Robin Werner.

Computer Dataware, Inc., 7580 E. Gray Rd., Ste. 102, Scotts-
dale, AZ, 85260, (602) 998-3163, Fax: (602) 951-3038, Pres.:
Richard McDaniel; Sales Mgr.: Larry D. Brehm.

Devra Ents. (Devra Hall), 361 W. California Ave., Ste. 8, Glen-
dale, CA, 91203, (818) 240-0425, Fax: (818) 240-6495, Pres.:
Devra Hall.

Forefront Technology Corp., 3508 Market St., Ste. 215,
Philadelphia, PA, 19104, (215) 386-1500, Pres.: David M. Direc-
tor; Sales Mgr./Mktg. Dir.: Betty Ann Director.

G & Z Systems, Inc., 50 Broadway, Hawthorn, NY, 10532, (914)
741-0011, Fax: (914) 741-0482, Pres.: Richard A. Zuckerman;
Vice Pres./Sales & Mktg.: Louis M. Parks.

GlobeArt Copyright Service, 1755 York Ave., Ste. 21F, New
York, NY, 10128, (212) 860-3023, Fax: (212) 831-0906, Pres.:
Jane Peterer.

Husky Computers, Inc., 13921 Icot Blvd., Clearwater, FL,
34620, (813) 530-4141, Pres.: Bill E. Newell; Mktg. Dir.: Karen
E. Burns; Vice Pres. Sales & Mktg.: Steve Bostwick; Con-
tact: Steve Bostwick.

Jasco Products Co., Inc., PO Box 466, Oklahoma City, OK,
73101, (405) 752-0710, (800) 654-8483, Pres.: Steve Trice;
Sales Mgr.: Brent Hall; Mktg. Dir.: Kent Shiple.

Leonardo Software, 10378 Holman Ave., Los Angeles, CA,
90024, (213) 277-5161, Fax: (213) 277-9086, Partner: Louis
Benioff.

Memcon Corp., 2410 S. 156th Cir., Omaha, NE, 68130, (402)
333-3100, Fax: (402) 333-2029, Pres.: Gerald Korth.

MicroSpec, Inc., PO Box 868085, Plano, TX, 75086, 1809
Avenue K, Plano, TX, 75074, (214) 881-0030, Fax: (214)
881-1809, Pres.: Richard Williamson.

Microsystem Technologies Corp., 2000 S. York Rd., Oak
Brook, IL, 60521, (708) 954-2800, Sales Mgr.: Steve Shriver.
Music Industry Resources, PO Box 190, San Anselmo, CA,
94960, (415) 457-0215, Pres.: Angie Blume.

Music Software, Inc., 151 Mineola Ave., Roslyn Heigh's, NY,
11577, (516) 625-6660, Contact: Vijay Verma.
Musicpro: File, PO Box 190, San Anselmo, CA, 94960, (415)
457-0215, Pres.: Augie Blume.

Musicware, 5611 Creedmoor Rd., Ste. 245, Raleigh, NC, 27612,
(919) 833-5533, Fax: (919) 833-5528, Vice Pres.: Helena
Swiderski; Vice Pres.: Christopher Aves.

Neonics, Inc., 24 The Valley Rd., Concord, MA, 01742, (508)
369-7117, (800) 832-6366, Pres.: John B. Hey; Sales Mgr.: Gigi
Estabrook.

OCI-Retail Computer Systems, 325 W. Third Ave., #106,
Escondido, CA, 92025, (619) 746-9142, Pres.: Del Stewart;
Sales Mgr.: Michael Alberson; Contact: Bill Kelsey.

PIC-Systems, Inc., 9420 Reseda Blvd., #407, Northridge, CA,
91324, (818) 360-0072, Fax: (818) 349-2556, Pres.: Greg Speer.

Record Trak

101 N. Plains Rd., Wallingford, CT, 06492, (203) 265-3440,
Pres.: Charles Beilman; Sales & Mktg. Dir.: Robert Trexler.

Royalty Participation Mgmt. (RPM)

4423 Tujunga Ave., Studio City, CA, 91602, (818) 769-0852,
Fax: (818) 766-1113, Pres.: Ian Marsh.

Savoy Division, Posso Corp., PO Box 8287, Haverhill, MA,
01835, (508) 374-0351, Fax: (508) 373-4184, Pres.: Patrick
Posso; Gen. Mgr.: John A. McLean.

Shannon Data & Display, 46 Westland Blvd. SW, Atlanta, GA,
30311, (404) 691-0042, (800) 247-8389, Fax: (404) 691-6361,
Vice Pres. Sales & Mktg.: Ken Anderson.

Solutions Engineering Corp., 10576-B Metropolitan Ave., Ken-
nington, MD, 20895, (301) 946-4003, Fax: (301) 946-1266, Pres.:
Richard Latty; Sales Mgr.: Mikel J. Frazee; Mktg. Dir.: Davis
Blum.

Summit Data Systems, PO Box 214, 1945 Old Hwy 66,
Edgewood, NM, 87015, (505) 281-1948, Fax: (505) 281-4005,
Pres.: John Bocock.

TM Century, Inc., 14444 Beltwood Pkwy., Dallas, TX, 75244,
(800) 937-2100, Fax: (800) 749-2121, Chairman: Dave Scott;
Vice Pres./Mktg. Dir.: Stuart McRae; Vice Pres./Sales Dir.:
Richie Allen.

Tempus Technologies, Inc., 108 N. Main St., Auburn, IN,
46706, (219) 281-2746, Exec. Vice Pres.: Paddy Pad-
manabhan; Sales Mgr. & Mktg. Dir.: Larry Cooney.

Thoughtful Software, 1735 King Dr., New Orleans, LA, 70122,
(504) 288-2063, Fax: (504) 288-2767, Pres.: Musa Eubanks;
Sales Dir.: Segun Eubanks.

Trade Service Corp., 10996 Torreyana Rd., San Diego, CA,
92121, (619) 457-5920, Fax: (619) 5469002, Pres.: James A.
Simpson; Sales Mgr.: Charles Pyce; Mktg. Dir.: Robin
Lansman; Mktg. Dir.: Dan Henehan.

Univenture, Inc., 6145-A Scherers Pt., Dublin, OH, 43017, (614)
761-2669, Fax: (614) 793-0202, Pres.: Ross O. Youngs; Sales

QUIT BITCHING ABOUT ROYALTIES!

RPM SYSTEM 2000 offers state-of-the-art software applications for Music Publishers and Record Companies. Complete, simple and easy to use systems designed to manage all accounting, contract information, pricing, reserves, advances, licensing, copyrights, royalty disbursements and auditing make **SYSTEM 2000** your best investment for the future.

ROYALTY PARTICIPATION MANAGEMENT

4423 TUJUNGA AVENUE STUDIO CITY, CA 91602 (818) 769-0852 • (818) 766-1113 fax

Mgr.: Rich Williams; Corp. Communications Mgr.: Sandi Stein.
VMS, Inc., 828 Lane Allen Rd., Ste. F5, Lexington, KY, 40504, (606) 276-1200, Pres.: Michael Stephens.
Video Data Equipment, 1377 Third St., Rensselaer, NY, 12144, (518) 434-2193, Fax: (518) 434-3457, Pres.: Thomas A. Dempsey; Sales Mgr.: Mike Downey; Video Software Mgr.: Joe Bolognino.
Winchester Data Products, Inc., 16 E. Rowan St., #310, Raleigh, NC, 27609, (919) 872-0995, Pres.: Sheryl M. Griffin.
Young Systems Ltd., PO Box 88569, 6753 B Jones Mill Court, Norcross, GA, 30092, (404) 449-0338, Fax: (404) 840-9723, Pres.: Andrea Young; Mktg. Dir.: Dennis Young.

ASSOCIATIONS & PROFESSIONAL ORGANIZATIONS

A.C.E.M.L.A., 442-44 E. 148th St., Bronx, NY, 10455.
AFTRA (American Federation of Television & Radio Artists), 260 Madison Ave., New York, NY, 10016, (212) 532-0800, Nat'l Exec. Dir.: Bruce A. York.
Academy of Country Music, PO Box 508, Hollywood, CA, 90078, 6255 Sunset Blvd., #923, Hollywood, CA, 90028, (213) 462-2351, Fax: (213) 462-3253, Pres.: Fred Reiser; Exec. Sec.: Fran Boyd.
Affiliated Independent Record Companies (AIRCO), PO Box 241648, Los Angeles, CA, 90024, (213) 208-2104, Fax: (213) 208-2104, Pres.: M. Wilkins; Sales Mgr.: P. Wilkins; Mktg. Dir.: T. Wilkins.
American Academy & Institute of Arts & Letters, 633 W. 155th St., New York, NY, 10032, (212) 368-5900, Pres.: Hugo Weisgall; Exec. Dir.: Virginia Dajani; Auditorium Mgr.: Ardiith Holmgren.
American Cinema Editors, 1041 N. Formosa Ave., West Hollywood, CA, 90046, (213) 850-2900, Pres.: George Grenville.
American Federation of Musicians, 230 Jones St., San Francisco, CA, 94102, (415) 775-8118, Pres.: Nick J. Barden.
American Film Institute (AFI), 2021 N. Western Ave., Los Angeles, CA, 90027, (213) 856-7600, Dir.: Jean Firstenberg.
American Guild of Music, 5354 Washington St., Downers Grove, IL, 60515, (708) 968-0173, Pres.: Joyce Lucido; Sales Mgr.: Richard Chizmadia; Registered Agent: Elmer Herrick.
American Guild of Musical Artists, 1727 Broadway, New York, NY, 10019, (212) 265-3687, Pres.: Nedda Casel; Nat'l Exec.: Gene Boucher.
American Guild of Organists, 475 Riverside Dr., Ste. 1260, New York, NY, 10115, (212) 870-2310, Exec. Dir.: Daniel N. Colburn, II.
American Mechanical Rights Agency, 333 S. Tamiami Trail, Venice, FL, 34285, (813) 488-9695, Fax: (813) 485-2982, Pres.: Patricia Bente; Sales Mgr.: Barbara Preston.
American Musicians Union, Inc., 8 Tobin Ct., Dumont, NJ, 07628, (201) 384-5378, Pres.: Ben Intorre.
American Symphony Orchestra League, 777 14th St. NW, Washington, DC, 20005, (202) 628-0099, Fax: (202) 783-7228, Chief Exec. Officer: Catherine French; Advertising Mgr.: Maritza Fleming.
American Video Assoc. (AVA), 2885 N. Nevada, #140, Chandler, AZ, 85225, (602) 892-8553, Fax: (602) 926-8358, CEO/ Pres.: John Power.
Amusement & Music Operators Assn., 401 N. Michigan Ave., Chicago, IL, 60611, (312) 245-1021, Fax: (312) 321-6869, Exec. Vice Pres.: John Schumacher.
Assn. for Recorded Sound Collections, Inc., PO Box 10162, Silver Spring, MD, 20914, (301) 593-6552, Exec. Dir.: Phillip Rochlin.
Audio Engineering Society, Inc., 60 E. 42nd St., New York, NY, 10165, (212) 661-8528, Fax: (212) 661-0477, Exec. Dir.: Donald J. Plunkett.
Beldock, Levine & Hoffman, 99 Park Ave., New York, NY, 10016, (212) 490-0400, Fax: (212) 557-0565, Sr. Partner: Elliot L. Hoffman; Partner: Peter Matorin, Esq.; Mktg. Dir.: Jeffrey Greenberg, Esq.
Boyd Sound Studio, PO Box 682, Wylie, TX, 75098, (214) 442-1620, Owner/Pres.: Anthony D. Boyd; Sales Mgr./Mktg. Dir.: Joseph Hargrave.
California Country Music Assn., PO Box 6116, Fullerton, CA, 92634, 2220 E. Chapman Ave., Villa # 25, Fullerton, CA, 92631, (714) 992-2262, Pres./Exec. Dir.: Gary Murray.
Chamber Music America, 545 Eighth Ave., New York, NY, 10018, (212) 244-2772, Fax: (212) 244-2776, Pres.: Paul Katz; Exec. Dir.: Dean K. Stein.
Chorus America, 2111 Sansom St., Philadelphia, PA, 19103, (215) 563-2430, Fax: (215) 563-2431, Pres.: Robert Page; Exec. Dir.: Kenneth Garner; Editor/Pub. Rel. Dir.: Wilson Jeffreys; Admin. Dir.: Melvin Jones.
Community Light & Sound, Inc., 333 E. Fifth St., Chester, PA, 19013, (215) 876-3400, Fax: (215) 874-0190, Pres.: Bruce Howze; Sales Mgr.: John T. Wiggins; Product Specialist: Greg Helm.
Country Music Assn., Inc. (CMA), One Music Cir. S., Nashville, TN, 37203, (615) 244-2840, Fax: (615) 726-0314, Exec. Dir.: Ed Benson.
Country Music Foundation of Colorado, PO Box 19435, Denver, CO, 80219, (303) 936-7762, Pres.: Gladys Hart.
Country Radio Broadcasters, Inc., 50 Music Sq. W., #604,

Nashville, TN, 37203, (615) 327-4487, (615) 329-4488, Pres.: Charlie Douglas; Exec. Dir.: Frank Mull.
Detroit Producers Assn., 6689 Orchard Lake Rd., Ste. 177, West Bloomfield, MI, 48322, (313) 737-4240, Fax: (313) 737-8024, Pres.: Shannon Hamed; Exec. Admin.: Joanne Goldberg.
Electronic Industries Assn. (EIA)/Consumer Electronics Group, 2001 Pennsylvania Ave. NW, Washington, DC, 20006, (202) 457-8700, Fax: (202) 457-4901, Pres.: Peter McClosky; Vice Pres.: Gary Shapiro; Sales Mgr.: Richard Scarfo; Mktg. Dir.: Phyllis Rosenthal.
F.I.D.O.F. (Int'l Federation of Festival Organizations), 4230 Stansbury Ave., Ste. 105, Sherman Oaks, CA, 91423, (818) 789-7596, Fax: (818) 784-9141, Pres.: Jim Halsey; Sec. Gen.: Prof. Armando Moreno.
Gospel Music Assn., PO Box 23201, Nashville, TN, 37202, 7 Music Cir. N., Nashville, TN, 37203, (615) 242-0303, Fax: (615) 254-9755, Pres.: John Styll; Exec. Dir.: Bruce Koblish; Vice Pres. Spec. Proj.: Donald W. Butler, Sr.
Independent Music Assn., 317 Skyline Lake Dr., Ringwood, NJ, 07456, (201) 831-1317, Pres.: Don Kulak; Sales Mgr.: Mark Wilkins; Mktg. Dir.: Christopher Kulak.
Int'l Assn. of Auditorium Managers, 4425 W. Airport Frwy. #590, Irving, TX, 75062, (214) 255-8020, Fax: (214) 255-9582, Pres.: Dick Walsh; Communications Mgr.: R.V. Baugus.
Int'l Assn. of Jazz Educators, PO Box 724, 601 Leavenworth, Manhattan, KS, 66502, (913) 776-8744, Fax: (913) 776-6190, Pres.: Bunky Green; Exec. Dir.: William F. McFarlin.
Int'l Assn. of Magnetic & Optical Media Mfr. & Related Industries, 505 Eighth Ave., Floor 12-A, New York, NY, 10018, (212) 643-0620, Fax: (212) 643-0624, Exec. Vice Pres.: Henry Brief.
Int'l Band and Choral Directors Hall of Fame, 519 N. Halifax Ave., Daytona Beach, FL, 32118, (904) 252-0381, Fax: (904) 252-0381, Dir.: Dr. Watie Riley Pickens.
Int'l Bluegrass Music Assn., 326 St. Elizabeth St., 319 E. Second St., Owensboro, KY, 42301, (502) 684-9025, Fax: (502) 926-4404, Exec. Dir.: Dan Hays.
Int'l Communications Industries Assn., 3150 Spring St., Fairfax, VA, 22031, (703) 273-7200, Fax: (703) 278-8082, Exec. Vice Pres.: Kenton Pattie; Gen. Mgr.: Terrence Bolis; Exposition Mgr.: Jennifer Allen; Show Opns. Assoc.: Jason McGraw.
Int'l Documentary Assoc., 1551 S. Robertson Blvd., Ste. 201, Los Angeles, CA, 90035, (213) 284-8422, Fax: (213) 785-9334, Pres.: Jon Wilkman; Admin. Coord.: Stephen Roth.
Int'l Entertainment Buyers Assn., 63 Music Sq. E., Nashville, TN, 37203, (615) 321-5130, Chrmn.: Harry Pebbles; Exec. Dir.: Dean Unkeler; Sec.: Judy A. Ade.
Int'l Fan Club Organization, PO Box 3, Nashville, TN, 37204, Pres.: Kay Johnson, Loretta Johnson; Pres./Sales Mgr.: Loudilla Johnson.
Int'l Tape Assn. (ITA), 505 Eighth Ave., New York, NY, 10018, (212) 643-0620, Fax: (212) 643-0624, Exec. Vice Pres.: Henry Brief; Exec. Dir.: Charles Van Horn.
Keyboard Teachers Assn., Int'l, Inc., 361 Pin Oak Ln., Westbury, NY, 11590, (516) 333-3236, Pres.: Albert DeVito.
Media Assoc., Inc., PO Box 5747, 7400 Fullerton Rd., Springfield, VA, 22150, (800) 628-3556, Fax: (703) 866-6100, Pres.: Don Evans; Mktg. Dir./Sales Mgr.: David J. Craver; Operations Mgr.: Don Miller.
Motion Picture Assn. of America (MPAA), 1133 Avenue of Americas, New York, NY, 10036, (212) 840-6161.
Music & Entertainment Industry Educators Assn. (MEIEA), Music Dept., State University College, Oneonta, NY, 13820, (607) 431-3425, Fax: (607) 431-2701, Pres.: Janet Nephke.
Music Teachers Nat'l Assn., 617 Vine St., Ste. 1432, Cincinnati, OH, 45202, (513) 421-1420, Fax: (513) 421-2503.
Nashville Assn. of Musicians, PO Box 120399, 11 Music Cir. N., Nashville, TN, 37212, (615) 244-9514, Pres.: Jay Collins.
Nashville Assn. of Talent Directors, PO Box 40707, Nashville, TN, 37204, (615) 385-5700, Fax: (615) 385-9992, Pres.: Sonny Simmons; Exec. Sec.: Teresa Simmons Klein.
Nashville Entertainment Assoc., PO Box 121948, 1815 Division St., Nashville, TN, 37212, (615) 327-4308, Fax: (615) 327-8405, Pres.: Kirke Martin; Exec. Dir.: Sherry Bond.
Nashville Songwriters Assn. Int'l, 1025 16th Ave. S., Ste. 200, Nashville, TN, 37212, (615) 321-5004, Fax: (615) 321-5027, Pres.: Merel Kilgore; Exec. Dir.: Pat Huber.
Nat'l Academy of Songwriters, 6381 Hollywood Blvd., Ste. 780, Hollywood, CA, 90028, (213) 463-7178, Fax: (213) 463-2146, Exec. Dir.: Dan Kirkpatrick; Managing Dir.: Steve Schalchlin.
Nat'l Academy of Recording Arts & Sciences, Inc. (NARAS), 9023 N. Glenoaks Blvd., Ste. 140, Burbank, CA, 91502, (818) 843-8233, Fax: (213) 849-2529, Pres.: Michael Greene; Office Mgr.: Joan Rodrigues.
Nat'l Academy of Recording Arts & Sciences (NARAS), 157 W. 57th St., Ste. 902, New York, NY, 10019, (212) 245-5440, Fax: (212) 489-0394, Pres.: Stu Ginsburg; Exec. Dir.: Laurie Goldstein.
The Nat'l Assn. of Composers/USA, PO Box 49652, Barrington Sta., Los Angeles, CA, 90049, (213) 541-8213, Pres.: Marshall Bialosky.
Nat'l Assn. of Broadcasters, 1711 N. St. NW, Washington, DC, 20036, (202) 429-5300, Pres.: Edward O. Fritts.
Nat'l Assn. of Music Merchants, 5140 Avenida Encinas, Carlsbad, CA, 92008, (619) 438-8001, Fax: (619) 438-7327, Exec. Vice Pres.: Larry R. Linkin.
Nat'l Assn. of Recording Merchandisers (NARM), Three Eves Dr., Ste. 307, Marlton, NJ, 08053, (609) 596-2221, Fax: (609) 596-3268, Exec. Vice Pres.: Pam Horovitz.

Nat'l Assn. of Retail Dealers of America (NARDA), 10 E. 22nd St., Ste. #310, Lombard, IL, 60148, (708) 953-8950, Contact: Jules Steinberg.
Nat'l Assn. of Theater Owners (NATO), 4605 Lankershim Blvd., Ste. 340, North Hollywood, CA, 91602, (818) 506-1778, Fax: (818) 506-0269, Pres.: William F. Kartozian; Exec. Dir.: Mary Ann Grasso.
Nat'l Assn. of Video Distributors, 1255 23rd St. NW, Washington, DC, 20037, Exec. Dir.: Mark T. Engle.
Nat'l Assn. of Independent Record Distributors & Manufacturers (NAIRD), PO Box 568, Maple Shade, NJ, 08052, (609) 547-3331, Fax: (609) 547-4762, Exec. Dir.: Holly Cass.
Nat'l Captioning Institute, Inc., 1443 Beechwood, Hollywood, CA, 90028, (213) 469-7000.
Nat'l Conference of Personal Mgrs., 210 E. 51st St., 2nd Floor, New York, NY, 10011, (212) 421-2670, Fax: (212) 838-5105, Pres.: Gerard W. Purcell; Eastern Div. Dir.: Joseph Rapp.
Nat'l Federation of Music Clubs, 1336 N. Delaware St., Indianapolis, IN, 46202, (317) 638-4003, Pres.: Virginia F. Allison; Exec. Sec.: Patricia M. Midgley.
Nat'l High School Choral Directors Hall of Fame, 519 N. Halifax Ave., Daytona, FL, 32118, (904) 252-0381, Fax: (904) 252-0381, Dir.: Dr. Watie Riley Pickens.
Nat'l Music Publishers' Assn./The Harry Fox Agency, Inc., 205 E. 42nd St., 18th Floor, New York, NY, 10017, (212) 370-5330, Fax: (212) 953-2471, Pres.: Edward P. Murphy; Pub. Rel. Mgr.: Margaret A. O'Keefe.
Nat'l School Orchestra Assn., 345 Maxwell Dr., Pittsburgh, PA, 15236, (412) 862-6696, Exec. Sec.: Norman Mellin.
New Music Seminar, 632 Broadway, 9th Floor, New York, NY, 10012, (212) 473-4343, Fax: (212) 353-3162, Exec. Dirs.: Mark Josephson, Tom Silverman.
New Orleans Jazz Club of California, PO Box 1225, Kerrville, TX, 78029, (512) 896-2285, Pres.: Bill Bacin.
OPERA America, 777 14th St. NW, Ste. 520, Washington, DC, 20005, (202) 347-9262, Fax: (202) 393-0735, CEO: Marc A. Scorca; Pres.: Ardis Krainik; Info. Service Dir.: Nancy Roberts-Lea; Communications Dir.: Martha Perry.
Pentangle Council On The Arts, PO Box 172, 39 Central St., Woodstock, VT, 05091, (802) 457-3981, Pres.: Ralph Lancaster; Dir.: David McWilliams.
Phi Mu Alpha Sinfonia Fraternity of America, 10600 Old State Rd., Evansville, IN, 47711, (812) 867-2433, Pres.: Dr. T. Jervis Underwood; Opns. Dir.: Jacky R. Howlett.
Premier Film & Recording Corp., 3033 Locust St., Saint Louis, MO, 63042, (314) 531-3555, Fax: (314) 726-8798, Pres.: Wilson Dalzell; Sales Mgr.: Donna Blue; Mktg. Dir.: Bob Heuermann.
Radio Central, 548 S. Spring St., #815, Los Angeles, CA, 90013, (213) 623-7589, Pres.: David B. Sigler; Sales Mgr.: CT. Hampson.
Radio-Television News Directors Assn., 1717 "K" St. NW #615, Washington, DC, 20006, (202) 659-6510, Pres.: David Bartlett.
Recording Industry Assn. of America, 1020 19th St. NW, Ste. 200, Washington, DC, 20036, (202) 775-0101, Fax: (202) 775-7253, Pres.: Jason S. Berman; Exec. Vice Pres.: Hilary B. Rosen; Sr. Vice Pres.: David E. Leibowitz; Vice Pres./Pub. Rel.: Tim Sites.
Screen Actors Guild, 7065 Hollywood Blvd., Hollywood, CA, 90028, (213) 465-4600, Fax: (213) 856-6603, Pres.: Barry Gordon; Pub. Rel. Dir.: Mark Locher.
SAC, Society Audio/Video Consultants, PO Box 10957, Beverly Hills, CA, 90213, (213) 550-8889, Fax: (213) 550-8889, Pres.: Jerry Joseph.
Society of Professional Audio Recording Services (SPARS), 4300 Tenth Ave. N., Lake Worth, FL, 33461, (407) 641-6648, Fax: (407) 642-8263, Pres.: Richard Trump; Exec. Dir.: Shirley P. Kaye.
Songwriters Guild of America, 276 Fifth Ave., New York, NY, 10001, (212) 686-6820, Fax: (212) 481-3680, Pres.: George David Weiss; Nat'l Projects Dir.: George Wurzbach.
South Carolina Country Music Assn., 1609 Congress Rd., Eastover, SC, 29044, (803) 776-8397, Pres.: Howard A. Knight Jr.
Southern California Broadcasters Assn., 1800 N. Highland Ave., Los Angeles, CA, 90028, (213) 466-4481, Fax: (213) 469-2510, Pres.: Gordon F. Mason; Mktg. Dir.: Carol Senor.
Southern Songwriters Guild, PO Box 6817, Shreveport, LA, 71136, 1038 College St., Shreveport, LA, 71104, (318) 425-4515, Pres./Pub. Rel.: Tommy G. Cassel.
Special Interest Video Assn. (SIVA), PO Box 4327, Denver, CO, 80204, (303) 850-0688, Exec. Dir.: Bill Bradburn.
Texas Songwriters Assn., PO Box 1285, Chandler, TX, 75758, (214) 849-2287, Pres.: Gigi Selman; Exec. Dir.: Shirley Hutchins.
Trebas Institute of Recording Arts, 6464 Sunset Blvd., The Penthouse, Hollywood, CA, 90028, (213) 467-6800, Fax: (213) 467-0946, Pres.: David P. Leonard; Sales Mgr.: Natasha Kabrinsky; Mktg. Dir.: Wyn Tunnickliff.
Tri-Son, Inc./Tri-Son Promos./Tri-Son News, PO Box 3, Nashville, TN, 37204, Pres.: Loudilla Johnson.
United States Institute for Theatre Technology, Inc., 10 W. 19th St., Ste. 5A, New York, NY, 10011, (212) 924-9088, Fax: (212) 924-9343, Pres.: Donald Shulman; Gen. Mgr.: David Diamond.
Utah Songwriters Assn., PO Box 71325, Salt Lake City, UT, 84107, (801) 292-1609, Pres.: Carolyn Boone-Smith; Sales Mgr.: Jerri Lou.
Video Software Dealers Assn. (VSDA), 303 Harper Dr., Moorestown, NJ, 08057, (609) 231-7800, Exec. Vice Pres.: Don Rosenberg; Exec. Vice Pres. Asst.: Ina Luber.

ENTERTAINMENT ATTORNEYS

Adesso, Merovitch & Lane, 153 Stevens Ave., Mount Vernon, NY, 10550, (914) 699-6052, (914) 699-6215, Fax: (914) 699-1769, Entertainment Attorney: Peter Lane.

Trip Aldredge, PO Box 120713, 1018 17th Ave. S., Ste. 3, Nashville, TN, 37212, (615) 327-9377, Fax: (615) 327-9379.

Armstrong Hendler & Hirsch, 1888 Century Park E., Ste. 1888, Los Angeles, CA, 90067, (213) 553-0305.

Arrow, Edelstein & Laird, P. C., 32 E. 57th St., 15th Floor, New York, NY, 10022, (212) 371-7111, Fax: (212) 644-5830, Contact: Paul Truss.

Arrow, Edelstein & Laird, P. C., 9220 Sunset Blvd., Los Angeles, CA, 90069, (213) 274-6184, Fax: (213) 271-2664, Pres.: Allen H. Arrow, Esq.

Beldock, Levine & Hoffman, 99 Park Ave., New York, NY, 10016, (212) 490-0400, Fax: (212) 557-0565, Sr. Partner: Elliott L. Hoffman; Partner: Peter Matorin, Esq.; Mktg. Dir.: Jeffrey Greenberg, Esq.

Benson & Siman, 1207 17th Ave. S., 3rd Floor, Nashville, TN, 37212, (615) 329-3323, Fax: (615) 321-3236.

Berger, Kahn, Shafon, Moss, Figler, Simon & Gladstone, PO Box C, 4000, 4215 Glencoe Ave., 2nd Floor, Marina Del Rey, CA, 90292, (213) 821-9000, Fax: (213) 578-6178, Contact: Leon Gladstone, Esq.; Contact: Frederick T. Jelin, Esq.

Berger, Steingut, Tarnoff & Stern, 600 Madison Ave., New York, NY, 10022, (212) 980-1400, Fax: (212) 980-1175, Partner: Kenneth B. Anderson.

Law Offices of Steven Lee Berger, 50 Braintree Hill Pk., Ste. 100, Braintree, MA, 02184, (617) 848-7622, Fax: (617) 380-8737, Pres.: Steven L. Berger.

Bernkopf, Goodman, & Baseman, 125 Summer St., Ste. 1300, Boston, MA, 02110, (617) 345-0770, Fax: (617) 737-8227, Contact: Steven G. Simon, Esq.

Law Offices of Michael Biber, 1416 N. Kings Rd., Los Angeles, CA, 90069, (213) 656-0161, Fax: (213) 654-7599, Owner: Michael Biber.

A. Lee Blackman, Esq., 100 Wilshire Blvd., 20th Floor, Santa Monica, CA, 90401, (310) 393-5345, Fax: (310) 395-8782, Pres.: A. Lee Blackman.

Blakeley, Sokoloff, Taylor & Zafman, 12400 Wilshire Blvd., 7th Floor, Los Angeles, CA, 90025, (213) 550-8282.

Blane, Gilburne, Williams & Johnston, 1900 Avenue of the Stars, Ste. 1200, Los Angeles, CA, 90067, (213) 552-2500, Fax: (213) 552-1191.

Boelter & Perry, 330 Washington St., Ste. 400, Marina del Rey, CA, 90292, (213) 822-5037, Fax: (213) 823-4325, Managing Partner: Al Boelter.

Law Offices of Joel L. Brooks, 1501 Broadway, Ste. 501, New York, NY, 10036, (212) 730-8015.

Steven Ames Brown, 69 Grand View Ave., San Francisco, CA, 94114, (415) 647-7700, Fax: (415) 285-3048, Pres.: Steven Ames Brown.

Douglas V. Browne, Attorney at Law, 1775 Broadway, Ste. 801, New York, NY, 10019, (212) 664-1131, Fax: (212) 582-9713, Esq.: Douglas V. Browne.

Gerald Burkett, 211 Union St., Ste. 518, Nashville, TN, 37201, (615) 244-4708, Pres.: Gerald Burkett.

Carlsmith, Ball, Wichman, Murray, Case, Mukai & Ichiki, 301 E. Ocean Blvd., Long Beach, CA, 90802, (213) 435-5631, Fax: (213) 437-3760, Rep.: Albert W. Gieseman, Jr.

Graham Carlton Co., 1320 Sherman, Evanston, IL, 80201, (708) 328-0400, Fax: (708) 328-1700, Pres.: Graham Carlton.

Law Offices of Donna Cobe & Assoc., 10351 Santa Monica Blvd., Ste. 410, Los Angeles, CA, 90025, (213) 785-9695, Fax: (213) 556-3821, Owner/Attorney: Donna Cobe.

Randal Neal Cohen, 16530 Ventura Blvd., Ste. 204, Encino, CA, 91436, (818) 990-3410, Fax: (818) 981-3526, Attorney At Law: Randal Neal Cohen.

Wallace E. J. Collins, III, 250 E. 39th St., Ste. 9K, New York, NY, 10016, (212) 661-3656, Contact: Wallace E. J. Collins, III.

Cooper, Epstein & Hurewitz, 345 N. Maple Dr., Ste. 200, Beverly Hills, CA, 90211, (213) 278-1111, Fax: (213) 271-0307.

Cowan & Gold, 477 Madison Ave., New York, NY, 10022, (212) 758-7474, Fax: (212) 758-7596, Partner: Jerrold Gold.

Deitch, Egan, Hamilton & Hand, P.C., PO Box 1398, 100 Congress, Ste. 1050, Austin, TX, 78767, (512) 474-1554, Fax: (512) 474-1579, Attorney: Ken Hamilton.

Richard P. Dieguez, Attorney at Law, 192 Garden St., Ste. 2, Roslyn Heights, NY, 11577, (516) 621-6424, (516) 621-6424, Contact: Richard P. Dieguez.

Parker Dinkins, Esq., 9 S. Park Pl., New Orleans, LA, 70124, (800) 328-7962, (504) 486-8171, Fax: (504) 488-9875.

Dodson, Parker & Behm, 306 Gay St., Ste. 400, Nashville, TN, 37201, (615) 254-2291, Fax: (615) 726-2241, Attorney: Tea Hickman.

John W. Edmunds, A Professional Law Corp., 12400 Wilshire Blvd., Ste. 1300, Los Angeles, CA, 90025, (213) 207-6025, Fax: (213) 207-4246, Pres.: John W. Edmunds; Office Mgr.: Staci S. Frank.

Fine, Perzik, Friedman & Singman, 1334 Park View Ave., Ste. 100, Manhattan Beach, CA, 90266, (213) 879-3300, Fax: (213) 479-8980.

The listings contained in this publication are based solely upon information supplied to Billboard as of press time. All information is checked for accuracy as of that time. However, Billboard is not responsible for changes in management or any other related business associations that may supersede the listings contained herein.

Richard I. Fine & Assoc., 10100 Santa Monica Blvd., Ste. 1000, Los Angeles, CA, 90067, (213) 277-5833, Fax: (213) 277-1543, Pres.: Richard I. Fine; Legal Asst.: Dolores E. Sullivan.

Fischbach, Medow & Perlstien, 1925 Century Park E., Ste. 1260, Los Angeles, CA, 90067, (213) 556-1956, Fax: (213) 203-8334, Principals: Bernard Fischbach; Principals: Evan Medow; Principals: Michael Perlstien.

Law Offices of Peter Franck, 90 New Montgomery St., Ste. 1500, San Francisco, CA, 94105, (415) 777-0313, Fax: (415) 777-9380, Pres./Sales Mgr.: Peter Franck; Legal Asst.: Connie Messer.

Fredrikson & Byron, 1100 Int'l Centre, 900 Second Ave. S., Minneapolis, MN, 55402, (612) 347-7000, Fax: (612) 347-7077, Pres.: Warren Mack; Mktg. Dir.: Gretchen Semler; Attorney: John Stout.

Randy Frisch, Esq., 1155 Trafalgar St., Teaneck, NJ, 07666, (201) 836-1194, Fax: (201) 692-0468.

Giles & Giles, 722 Frances Bldg., Sioux City, IA, 51101, (712) 252-4458, Attorney: William J. Giles, IV.

Glenn A. Goldstein, Attorney at Law, One Commerce Sq., 2005 Market St., 21st Floor, Philadelphia, PA, 19103, (215) 241-5061, Fax: (215) 241-1857, President: Glenn A. Goldstein.

Gordon, Martin & Jones, P.A., 49 Music Sq. W., Ste. 600, Nashville, TN, 37203, (615) 321-5400, Fax: (615) 321-5469, Pres.: S. Ralph Gordon.

Robert E. Gordon, 5725 Paradise Dr., Ste. 840, Corte Madera, CA, 94925, (415) 924-1112, Fax: (415) 924-7013, Contact: Robert E. Gordon.

Scott Gordon, 59 Hazelet Ave., Hazelet, NJ, 07730, (201) 888-0720, Fax: (908) 888-0820, Contact: Scott Gordon.

Gort, Hassett, Cohen & Beltschman, 3355 Lenox Rd., Ste. 600, Atlanta, GA, 30326, (404) 239-0600, Fax: (404) 266-1494, Attorney: Lee Beltschman.

Green & Green

1010 B St., Ste. 400, San Rafael, CA, 94901, (415) 457-8300, Fax: (415) 457-8757, Attorney: Beverly Robin Green.

Greenberg, Glusker, Fields, Claman & Machtlinger, 1900 Avenue of the Stars, Ste. 2000, Los Angeles, CA, 90067, (213) 553-3610, Fax: (213) 201-7482.

Law Offices of Robert S. Greenstein, 2049 Century Park E., #1100, Los Angeles, CA, 90067, (213) 203-9979, Sr. Partner: Robert S. Greenstein.

Law Office of Richard Greenstone, 10920 Wilshire Blvd., Ste. 1000, Los Angeles, CA, 90024, (213) 208-1100, Fax: (213) 208-7375, Partner/Owner: Richard J. Greenstone.

Grubman Indursky & Schindler, P. C., 575 Madison Ave., New York, NY, 10022, (212) 888-6600, Fax: (212) 758-1318.

Hall, Dickler, Lawler, Kent & Friedman, 2029 Century Park E., Ste. 3590, Los Angeles, CA, 90067, (310) 203-8410, Fax: (310) 203-8559, Partner: Fredric W. Ansis.

Hansen, Jacobson & Teller, 335 N. Maple Dr., Ste. 270, Beverly Hills, CA, 90210, (213) 271-8777, Fax: (213) 276-8310, Contact: Fred Goldring; Contact: Kenneth B. Hertz.

Hatcher, Coxium, Hewitt, Grimes & Manning, 4929 Wilshire Blvd., Ste. 1020, Los Angeles, CA, 90010, (213) 934-8014, Fax: (213) 937-8883, Resident Partner: Howard Manning, Jr.; Office Mgr.: Sheila Frazier.

Law Offices of Edward R. Hearn, 84 W. Santa Clara St., Ste. 660, San Jose, CA, 95113, (408) 998-3400, Fax: (408) 297-1104, Attorney: Edward R. Hearn.

Law Offices of David A. Helfant, 1901 Avenue of the Stars, 16th Floor, Los Angeles, CA, 90067, (213) 286-2141, Fax: (213) 556-5695, Attorney/Sole Proprietor: David A. Helfant.

Jerard C. Heller, Esq., 315 SE Seventh St., 1st Floor, Fort Lauderdale, FL, 33301, (305) 764-7600, Fax: (305) 763-4840.

Hertz, Schram, & Saratsky, P.C., 1760 S. Telegraph, Ste. 300, Bloomfield Hills, MI, 48302, (313) 335-5000, Fax: (313) 335-3346, Attorney: Howard Hertz.

Holland & Knight, 1200 Brickell Ave., Miami, FL, 33131, (305) 374-8500, Fax: (305) 374-1164, Attorney: Henri Spiegel; Attorney: Peter Baker.

Law Offices of Walter E. Hurst, PO Box 649, 6253 Hollywood Blvd., Ste. 1100, Los Angeles, CA, 90078, (213) 469-7209, Fax: (213) 469-7901, Pres.: Walter E. Hurst.

Hutzler & Charne, 329 Prospect St., Ridgewood, NJ, 07450, (201) 447-4327, Partner: James I. Charne.

Paul W. Insinna, Esq., 42 Underhill Ave., Ste. 2A, White Plains, NY, 10604, (914) 993-9702, Contact: Paul Insinna.

Jacobi & Jacobi, PA, 1313 NE 125th St., North Miami, FL, 33161, (305) 893-4135, Fax: (305) 893-4173, Partner: Allen Jacobi.

Jacobson & Colfin, P.C., 156 Fifth Ave., Ste. 434, New York, NY, 10010, (212) 691-5630, Fax: (212) 845-5036, Partner: Bruce E. Colfin, Esq.; Partner: Jeffrey E. Jacobson.

Johnson, Bromberg & Leeds, 2600 Lincoln Plaza, 500 N. Akard, Dallas, TX, 75201, (214) 740-2600, Fax: (214) 740-2601, Attorney: Mark S. Solomon.

Garrett M. Johnson, Attorney at Law, 443 W. 151st St., #3D, New York, NY, 10031, (212) 234-0026.

Law Office of Neville L. Johnson, 6255 Sunset Blvd., Ste. 915, Los Angeles, CA, 90028, (213) 962-1930, Fax: (213) 462-2407, Contact: Neville Johnson.

Law Offices Of Joe & Wong, 631 S. Olive St., Los Angeles, CA, 90014, (213) 629-9200.

Kassler & Feuer, 85 Devonshire St., Boston, MA, 02108, (617) 227-4800, Fax: (617) 227-0246, Contact: Michael Melford, Esq.

Katz, Cherry & Cohen, 3423 Piedmont Rd., Ste. 200, Atlanta, GA, 30305, (404) 237-7700, Fax: (404) 237-5260, Pres.: Joel A. Katz; Partner: Joel A. Cherry.

Edward Kelman, Attorney at Law, 747 Third Ave., New York, NY, 10017, 212 371-9490, Fax: (212) 421-4493, Contact: Edward Kelman.

Law Offices, John R. Kettle III, Esq., 248 Midland Ave., Montclair, NJ, 07042, (201) 748-0072, Fax: (201) 509-0684.

Clayton P. Knowles, Jr., Esq., 605 Third Ave., Ste. 1501, New York, NY, 10158, (212) 972-1100, Fax: (212) 963-5271.

Stephen L. Kopitko, 1775 Broadway, Ste. 601, New York, NY, 10019, (212) 245-6720, Fax: (212) 582-9713, Contact: Stephen L. Kopitko.

Law Offices of Leonard Korobkin, P.C., 315 S. Beverly Dr. Ste. 500, Beverly Hills, CA, 90212, (310) 277-8200, Fax: (213) 277-1910, Pres.: Leonard Korobkin, Esq.; Office Mgr.: Frieda Korobkin.

Law Offices of Rob Kragulac, Esq., 2970 Honolulu Ave., La Crescenta, CA, 91214, (213) 245-9005, Fax: (818) 248-7773.

M. William Krasilovsky, 51 E. 42nd St., Ste. 1601, New York, NY, 10017, (212) 682-8552, Fax: (212) 983-3228, Pres.: M. William Krasilovsky; Office Mgr.: Marti Cueva.

Eric Kronfeld, 38 E. 68th St., New York, NY, 10021, (212) 794-8600, Fax: (212) 794-9028.

Philip S. Kurnit, Esq., PO Box 5807, Englewood, NJ, 07631, (201) 568-3996, Fax: (201) 569-9580, Pres.: Philip S. Kurnit.

Leonard, Tillery & Davison, 1530 Chestnut St., 7th Floor, Philadelphia, PA, 19102, (215) 567-1530, Fax: (215) 564-4611, Sr. Partner: M. Kelly Tillery, Esq.

James M. Leonard, 11845 W. Olympic Blvd., Ste. 645, Los Angeles, CA, 90066, (213) 312-8680, Fax: (213) 312-8024.

Lawrence Lighter, 555 Madison Ave., New York, NY, 10022, (212) 371-8730, Fax: (212) 753-3630.

Lapton Law Offices, 12427 Ventura Blvd., Studio City, CA, 91604, (818) 506-6228, Fax: (818) 506-6290, Owner: Harley Lipton.

Livingston, Stone & McGowan, 595 Market St., Ste. 2820, San Francisco, CA, 94106, (415) 546-9962, Pres.: David L. Stone.

Loeb & Loeb, 1000 Wilshire Blvd., 17th Floor, Los Angeles, CA, 90017, (213) 552-7700.

Lopez & Gonzalez, 9665 Wilshire Blvd., Ste. 850, Beverly Hills, CA, 90212, (310) 858-7766, Fax: (213) 858-8906, Partners: Peter Lopez; Partner: Mario Gonzales.

Steven Lowy, 8444 Wilshire Blvd. 8th Floor, Beverly Hills, CA, 90211, (213) 653-8444, Fax: (213) 655-1814, Owner: Steven R. Lowy, Esq.

Maguire, Voorhis & Wells, P.A., PO Box 633, 2 S. Orange Plaza, Orlando, FL, 32802, (407) 843-4421, Fax: (407) 423-0345, Contact: Gregory B. Galloway.

Richard Manson & Assoc., 1314 Fifth Ave. N., Ste. 300, Nashville, TN, 37208, (615) 254-1600.

Mayer, Glassman & Gaines, 11726 San Vicente Blvd., Ste. 400, Los Angeles, CA, 90049, (213) 207-0007, Fax: (213) 207-3578, Sr. Partner: Frederic N. Gaines, Esq.

Mayer, Katz, Baker & Leibowitz, P.C., 75 Rockefeller Plaza, New York, NY, 10019, (212) 484-6450, Fax: (212) 484-6099, Partner: Marvin Katz.

McBride, Baker & Coles, 500 W. Madison, 40th Floor, Chicago, IL, 60661, (312) 715-5700, Fax: (312) 993-9350, Attorney-Partner: Thomas R. Leavens.

A. Victor Mendelson, Esq., 226 W. 47th St., New York, NY, 10036, (212) 768-3995, Fax: (212) 768-1044.

Menes Law Corp., 1901 Avenue of the Stars, 16th Floor, Los Angeles, CA, 90067, (213) 277-4895, Fax: (213) 556-5695, Managing Partner: Paul I. Menes.

Linda S. Mensch, P.C., 4318 Dearborn, Ste. 1302, Chicago, IL, 60605, (312) 922-2910, Fax: (312) 922-1865.

Alvin S. Milder, P.C., 10880 Wilshire Blvd., #1900, Los Angeles, CA, 90024, (213) 475-9777, Fax: (213) 475-5557, Pres.: Alvin S. Milder.

Milgrim Thomajan & Lee P.C., 53 Wall St., New York, NY, 10005, (212) 858-5300, Fax: (212) 858-5301, Contact: Charles B. Ortner.

Minter & Gray, 111 Broadway, New York, NY, 10006, (212) 587-0300, Fax: (212) 732-1522, Partner: Kendall A. Minter.

Mitchell, Silberberg & Knupp, 11377 W. Olympic Blvd., Los Angeles, CA, 90064, (213) 312-2000, Fax: (213) 312-3200.

Charles F. Morgan, Esq., The World Trade Center, Ste. 400, Baltimore, MD, 21202, (301) 752-7220, Fax: (301) 837-3282, Contact: Charles F. Morgan.

Peter Muller, Esq., 21 E. 66th St., New York, NY, 10021, (212) 472-8884, Fax: (212) 861-7581, Contact: Peter Muller.

Myman, Abell, Fineman & Greenspan, 11777 San Vicente Blvd., Ste. 2880, Los Angeles, CA, 90049, (213) 820-7717, Fax: (213) 207-2680, Partner: Eric Greenspan.

Nelson, Sheehan, Del, Tondo & Guggenheim, 12424 Wilshire Blvd., Ste. 1120, Los Angeles, CA, 90025, (213) 207-3694, Fax: (213) 207-0855.

Oshan, Grundman, Frome & Rosenzweig, 505 Park Ave., New York, NY, 10022, (212) 753-7200, Fax: (212) 755-1467, Attorney: Barry H. Platnick.

Law Offices of Averill Pasarow, 6420 Wilshire Blvd., Ste. 1400, Los Angeles, CA, 90048, (213) 653-2321, Fax: (213) 653-4164.

Tobias Pleniek, P.C., 635 Madison Ave., Ste. 400, New York, NY, 10022, (212) 935-5810, Fax: (212) 754-9590, Pres.: Toby Pleniek.

Premier Film & Recording Corp., 3033 Locust St., Saint Louis, MO, 63042, (314) 531-3555, Fax: (314) 726-8798, Pres.: Wilson Dalzell; Sales Mgr.: Donna Blue; Mktg. Dir.: Bob Heuermann.

Todd Alan Price, Attorney at Law, 80 Madison Ave., Ste. 1114, New York, NY, 10010, (212) 725-5883, Fax: (212) 725-5861, Attorney: Todd Alan Price.

Probstin & Welner, Attorneys at Law, 1925 Century Park E., Ste. 1260, Los Angeles, CA, 90067, (213) 556-1956, Fax: (213)

203-8334, Contact: Gerald B. Weiner; Contact: Jon Michael Probststein.

Probststein & Weiner, 488 Madison Ave., Ste. 1100, New York, NY, 10022, (212) 972-3250, Fax: (212) 772-2590, Partner: Jon Michael Probststein.

Public Information Network (P.I.N.), 3217 Dona Emilia Dr., Studio City, CA, 91604, (213) 650-1685, (213) 650-7985, Fax: (213) 650-4605, Pres.: Lilly Lipton; Sales Mgr.: Bobbie Cooker; Mktg. Dir: Denise Marcotte.

Record Co. of the South (RCS), 5220 Essen Ln., Baton Rouge, LA, 70809, (504) 769-2996, Fax: (504) 766-4112, Pres.: Cyril E. Vetter; Sales Mgr.: Johnny Palazzotto.

Reid & Priest, 40 W. 57th St., New York, NY, 10019, (212) 603-2000, Fax: (212) 603-2298.

Rogers & Harris, 9200 Sunset Blvd., #404, Los Angeles, CA, 90069, (213) 278-3142, Fax: (213) 271-3649, Partner: Michael Harris.

Rohde & Victoroff, 1880 Century Park East, Ste. 411, Los Angeles, CA, 90067, (213) 277-1482, Fax: (213) 277-1485, Pres.: Stephen F. Rohde.

Sanford R. Ross, Attorney at Law, 920 Park Ave., New York, NY, 10028, (212) 772-6637, Fax: (212) 772-6607.

Rubin & Bailin, 405 Park Ave., 15th Floor, New York, NY, 10022, (212) 935-0900, Fax: (212) 826-9307.

Calvin C. Saunders, Attorney at Law, 67 Wall St., #2411, New York, NY, 10005, (212) 323-8014, Fax: (212) 943-2300.

Schiff & Assoc., 18300 Von Karma Ave., Ste. 800, Irvine, CA, 92715, (714) 757-1094, Attorney: Laurie Schiff.

Daniel Schiffman, Law Office, 380 Lexington Ave., Ste. 4099, New York, NY, 10168, (212) 682-2373, Fax: (213) 682-8974, Pres.: Daniel Schiffman.

Alfred W. Schlesinger, Attorney at Law, 6255 Sunset Blvd., Ste. 1214, Los Angeles, CA, 90028, (213) 871-8181, Fax: (213) 464-7339.

Schnader, Harrison, Segal & Lewis, 1600 Market St., Ste 3600, Philadelphia, PA, 19103, (215) 751-2000, Fax: (215) 751-2205, Chrmn.: Carl A. Solano, Esq.; Mktg. Dir.: Mary Beth Pratt.

Ralph L. Seltzer, 1751 Draper Valley Rd., Selma, OR, 97538, (503) 597-2161, Pres.: Ralph L. Seltzer.

Serling Rooks & Ungar, 10 Columbus Cir., Ste. 2210, New York, NY, 10019, (212) 245-5733, Fax: (212) 586-5175, Partner: Joseph Lloyd Serling, Esq.

Law Offices of Thorpe Shuttleworth, 222 E. 44th St. 4th Floor, New York, NY, 10017, (212) 867-4030.

Stuart Silfen, P.C., 488 Madison Ave., New York, NY, 11510, (212) 826-5548, Fax: (212) 688-1292.

Silverman & Shulman P.C., 136 E. 57th St., New York, NY, 10022, (212) 758-2020, Fax: (212) 308-7243.

Barry Skidelsky & Assoc., 757 Third Ave., 26th Floor, New York, NY, 10017, (212) 832-4800, Fax: (212) 644-0544, Pres.: Barry Skidelsky.

Alan N. Skiena, Esq., 1775 Broadway, Ste. 601, New York, NY, 10019, (212) 664-1131, Fax: (212) 582-9713, Contact: Alan N. Skiena.

Sklar, Coben, Levinson & Dornstein, 2029 Century Park E., Ste. 1400, Los Angeles, CA, 90067, (213) 277-2582, Fax: (213) 286-0824, Partner: Mark L. Levinson.

Smith & Smith, 12121 Wilshire Blvd., Ste. 1103, Los Angeles, CA, 90025, (213) 476-6486.

Bernadette M. Smith, Attorney at Law, PO Box 93153, Atlanta, GA, 30377, (404) 875-0133, Fax: (404) 636-7738, Contact: Bernadette M. Smith.

Snow Becker Krauss, P.C., 605 Third Ave., 25th Floor, New York, NY, 10158, (212) 687-3860, Fax: (212) 949-7052, Partner: Marc Johnson; Contact: Michael Sukin.

Law Office of Marshall M. Snyder, 19 Music Sq. W., Nashville, TN, 37203, (615) 742-0833, Contact: Marshall M. Snyder.

Norman E. Solomon, Attorney at Law, PO Box 120356, 1503 17th Ave. S., Nashville, TN, 37212, (615) 385-3434, Fax: (615) 385-3489.

Stan Soochee, 111 Eighth Ave., 9th Floor, New York, NY, 10011, (212) 463-5522, Contact: Stan Soochee.

The Spiders, Inc., 3811 Quanton Rd., Bloomfield Hills, MI, 48302, (313) 540-7035, Contact: Asheet Bhan.

Alan L. Spielman, Ltd., 2037 Pine St., Philadelphia, PA, 19103, (215) 732-0471, Fax: (215) 732-6462, Pres.: Alan L. Spielman, Esq.

Al Steehely, Jr., P.C., 511 Stuart, Ste. 102, Houston, TX, 77006, (713) 528-6946, Fax: (713) 528-4817.

Steele & Utz, 2300 'M' St. NW, Ste. 800, Washington, DC, 20037, (202) 785-2130, Fax: (202) 293-3083, Sr. Partner: William N. Utz.

Stein & Kahan, 429 Santa Monica Blvd., 5th Floor, Santa Monica, CA, 90401, (213) 458-6900, Fax: (213) 394-4759.

Norman Stollman, 3720 Canterbury Way, Boca Raton, FL, 33434, (407) 482-7700, Fax: (408) 482-7784, Contact: Norman Stollman.

Joel R. Strote Professional Corp., 2029 Century Park E., Ste. 1700, Los Angeles, CA, 90067, (213) 858-8816, Fax: (213) 275-8416, Pres.: Joel R. Strote.

Law Offices of Neil Sussman, 10727 Interlake Ave. N., Seattle, WA, 98133, (206) 363-8070, Attorney At Law: Neil Sussman.

Mike Tolleson & Assoc., Inc., 2106 E. Martin Luther King, Jr. Blvd., Austin, TX, 78748, (512) 480-8822, Fax: (512) 479-6212, Pres.: Mike Tolleson.

Dr. Mac Truong, 377 Broadway, 2nd Floor, New York, NY, 10013, (212) 824-8970, (212) 824-8970.

Jack Uram, 630 Third Ave., New York, NY, 10017.

Walter, Conston, Alexander & Green, P.C., 90 Park Ave., 15th Floor, New York, NY, 10016, (212) 210-9400, Fax: (212) 210-9444.

White, Fleischer, Fino & Wade, 195 Broadway, New York, NY, 10007, (212) 227-6292, Fax: (212) 227-7812, Sr. Partner: Allan P. White.

Law Offices of Jack R. Willis, PO Box 93-3003, Los Angeles, CA, 90093, 7060 Hollywood Blvd., Hollywood, CA, 90028, (213) 465-6634, Pres.: Jack R. Willis.

Wolf, Greenfield & Sacks, 600 Atlantic Ave., Boston, MA, 02210, (617) 720-3500, Fax: (617) 720-2441, Partner: Mark A. Fischer.

Marvin Louis Wolf, 2049 Century Park E., #1800, Los Angeles, CA, 90067, (213) 553-5675.

Wyatt, Tarrant, Combs, Gilbert & Milom, 29 Music Sq. E., Nashville, TN, 37203, (615) 255-6161, Fax: (615) 254-4490, Office Coord.: Glenda Smith.

Lawrence S. Yudess, Esq., 2 Dicks Ln., Roslyn, NY, 11576, (516) 484-5291, Fax: (516) 484-6375, Contact: Lawrence Yudess.

Ziffren, Brittenham & Branca, 2111 Avenue of the Stars, 32nd Floor, Los Angeles, CA, 90067, (310) 552-3388, Fax: (310) 553-7068, Partner: John G. Branca.

Zimmerman, Rosenfeld & Gersh, 9107 Wilshire Blvd., Ste. 300, Beverly Hills, CA, 90210, (213) 278-7560, Fax: (213) 273-5602, Contact: Jeffrey Gersh.

Zissu, Stein & Moser, 270 Madison Ave., New York, NY, 10016, (212) 683-5320, Fax: (212) 686-2182.

Zumwalt, Almon & Hayes, 1014 16th Ave. S., Nashville, TN, 37212, (615) 256-7200, Fax: (615) 256-7106, Sr. Partner: Jim Zumwalt.

INTERNATIONAL BUSINESS AGENTS OF MUSIC/VIDEO

Steven Ames Brown, 69 Grand View Ave., San Francisco, CA, 94114, (415) 647-7700, Fax: (415) 285-3048, Pres.: Steven Ames Brown.

Graham Carlton Co., 1320 Sherman, Evanston, IL, 60201, (708) 328-0400, Fax: (708) 328-1700, Pres.: Graham Carlton.

DMR, 636 Broadway, Ste. 804, New York, NY, 10012, (212) 677-6770, Fax: (212) 979-6506, Pres.: Tom Silverman; Pres.: Vince Pellegrino; Editor: Karen Harris.

Endless Music, 7 Dogwood Ln., Ho-Ho-Kus, NJ, 07423, (201) 670-4507, Fax: (201) 447-4785, Pres.: Rusty Garner; Mktg. Dir.: Bob Bellas.

Front Page News Entertainment, 353 Sacramento St., Sixth Floor, San Francisco, CA, 94111, (415) 420-8452, Pres.: Demetra Mavis.

GlobeArt Copyright Service, 1755 York Ave., Ste. 21F, New York, NY, 10128, (212) 860-3023, Fax: (212) 831-0906, Pres.: Jane Peterer.

Ken Do Promos., 157 Ann St., Valley Stream, NY, 11580, (516) 825-2765, Fax: (516) 561-5269, Pres.: Ken Shankman.

Met Richmond Records Sales, Inc. & David Last Music, 11645 Privada Way, Boynton Beach, FL, 33437, (407) 364-5883, (407) 369-5555, Fax: (407) 626-3555, Pres.: David Last; Mktg. Dir.: B. Cohen.

Gary Musick Productions, Inc., 912 Twin Elms Ct., Nashville, TN, 37210, (615) 259-2400, Fax: (615) 259-2457, Pres.: Gary Musick; Sales Mgr.: Cynthia King; Sr. Producer: Eric Wyse.

Nashville Assn. of Talent Directors, PO Box 40707, Nashville, TN, 37204, (615) 385-5700, Fax: (615) 385-9992, Pres.: Sonny Simmons; Exec. Sec.: Teresa Simmons Klein.

Overseas Music Services, Inc., 488 Madison Ave., Ste. 1710, New York, NY, 10022, (212) 223-0044, Fax: (212) 223-4531, Pres.: John E. Nathan.

The Overseas Connection, 2225 Colorado Ave., Santa Monica, CA, 90404, (213) 315-3550, Fax: (213) 453-5529, Pres.: Peter Pasternak.

Real Deal Prodn., PO Box 2147, Sioux City, IA, 51104, Dir.: Morrie Miller.

Ross-Gaffney Video, 21 W. 46th St., New York, NY, 10036, (212) 997-1464, Fax: (212) 827-0426, Pres.: C.Y. Chang.

Ralph L. Seltzer, 1751 Draper Valley Rd., Selma, OR, 97538, (503) 597-2161, Pres.: Ralph L. Seltzer.

Starrights Co., 99 Park Ave., Ste. 1600, New York, NY, 10016, Pres.: Elliot T. Hoffman.

Steele & Utz, 2300 'M' St. NW, Ste. 800, Washington, DC, 20037, (202) 785-2130, Fax: (202) 293-3083, Sr. Partner: William N. Utz.

Norman Stollman, 3720 Canterbury Way, Boca Raton, FL, 33434, (407) 482-7700, Fax: (408) 482-7784, Contact: Norman Stollman.

Video Media Prodn., 2727 W. Southern Ave., Tempe, AZ, 85282, (602) 966-6545, Fax: (602) 438-2238, Pres.: J. M. Rinckenberger; Mktg. Dir.: Jim Pangborn.

Westworld Records/Carriage Music B.M.I. Co., 3966 Standish Ave., Cincinnati, OH, 45213, (513) 793-8191, (513) 559-1210, Owner/Pres.: Roosevelt Lee; Sales Mgr.: Ronald Lee.

Curtis Wood Record & Tape Dist., 4416 Eatons Creek Rd., Nashville, TN, 37218, (615) 876-1729, Fax: (615) 244-4314, Pres.: D.M. Haddock; Sales Mgr.: Durwood Haddock; Mktg. Dir.: D.B. Bolling.

PERFORMING & MECHANICAL RIGHTS ORGANIZATIONS

A.C.E.M.L.A., 442-44 E. 148th St., Bronx, NY, 10455.

AMRA (American Mechanical Rights Agency, Inc.), 1324 Roosevelt Dr., Venice, FL, 34293, (813) 493-8707, Fax: (813) 497-3028, Pres.: Patricia Bentle.

ASCAP (American Society of Composers, Authors & Publishers), 1 Lincoln Plaza, New York, NY, 10023, (212) 595-3050, Communication Coord.: Jeff Sapan; Membership Rep.: Marcy Drexler.

BMI (Broadcast Music, Inc.), 320 W. 57th St., New York, NY, 10019, (212) 586-2000, Fax: (212) 582-5972, Pres.: Frances W. Preston.

BMI (Broadcast Music, Inc.), 10 Music Sq. E., Nashville, TN, 37203, (615) 259-3625, Fax: (615) 256-7502, Pres.: Frances W. Preston.

Ralph Berliner Audio/Music Prodn., 35 W. 90th St., New York, NY, 10024, (212) 873-6390, Pres.: Ralph Berliner.

California Country Music Assn., PO Box 6116, Fullerton, CA, 92634, 2220 E. Chapman Ave., Villa #25, Fullerton, CA, 92631, (714) 992-2262, Pres./Exec. Dir.: Gary Murray.

Copyright Management, Inc., 1102 17th Ave. S., Ste. 400, Nashville, TN, 37212, (615) 327-1517, Fax: (615) 321-0652, Pres.: Terry H. Smith; Sr. Vice Pres.: Tim R. Smith; Adm. Asst.: Kymbirli M. Weaver.

Harry Fox Agency, Inc., 205 E. 42nd St., New York, NY, 10017, (212) 370-5330, Fax: (212) 953-2471, Pres.: Ed Murphy.

Joe Jones Mechanical & Performance Copyright Protection Worldwide Inc., 10556 Arnowood Rd., Lake View Terrace, CA, 91342, (818) 890-0730, Fax: (818) 899-4457, Pres.: CEO: Joe Jones; Vice Pres./Gen. Licensing: Marion Jones.

Joe Jones Sr. & Marion Jones Publishing Clearance House (JMPCH), 10556 Arnowood Rd., Lake View Terrace, CA, 91342, (818) 890-0730, (818) 890-0977, Fax: (818) 899-4457, Pres.: Joe Jones Sr.; Gen. Mgr.: Marion Jones; Contact: Dwayne Jones.

Master Sound Studios, Inc., 1227 Spring St., NW, Atlanta, GA, 30309, (404) 873-6425, Fax: (404) 875-1440, Pres.: Babs Richardson; Traffic Mgr.: Jennifer Simpson.

Premier Film & Recording Corp., 3033 Locust St., Saint Louis, MO, 63042, (314) 531-3555, Fax: (314) 726-8798, Pres.: Wilson Dalzell; Sales Mgr.: Donna Blue; Mktg. Dir.: Bob Heuermann.

Publishers' Licensing Corp., PO Box 5807, Englewood, NJ, 07631, (201) 568-3996, Fax: (201) 569-9580, Pres.: Philip S. Kurnit.

SESAC, Inc., 158 W. 56th St., New York, NY, 10019, (212) 586-3450, Fax: (212) 397-4682, Chrmn.: A.H. Prager; Pres./CEO: Vincent Candler; Sr. Vice Pres.: Charles Scully.

JEFFREY E. JACOBSON

BRUCE E. COLFIN

JACOBSON & COLFIN, P.C.
ATTORNEYS

5010 WISCONSIN AVE., N.W.
SUITE 118
WASHINGTON, D.C. 20016
202/895-2607

156 FIFTH AVENUE
NEW YORK, N.Y. 10010
212/691-5630
FAX: 212/645-5038

MUSIC LIBRARIES

Aircraft Prodn. Libraries, 77 N. Washington St., Boston, MA, 02114, (800) 343-2514, Fax: (617) 367-1521, Pres.: Mark Cuddy.
Alrwave Recording Co., 1830 NE 153rd St., North Miami Beach, FL, 33162, (305) 463-8995, (305) 949-9283, Fax: (305) 949-6835, Pres.: Rob Walker.
Alias Music Co., PO Box 26427, Tempe, AZ, 85282, (602) 839-2492, Pres.: Robert Henschler.
Alishre Int'l, Inc., PO Box 7107, 1015 Isabel St., Burbank, CA, 91510, (213) 849-4671, Fax: (818) 569-3718, Pres.: Al Sherman; Sales Mgr.: Richard Sherman; Custom Dept.: Mark Beckwith.
Apon Record Co., Inc., PO Box 3082, Steinway Sta., Long Island, NY, 11103, (212) 721-5599, Fax: (718) 721-5599, Pres.: Darian I. Poncic; Sales Mgr.: Andrew M. Poncic, Jr.; Mktg. Dir.: Don Zemann.
Pat Appleson Studios, Inc., 757 SE 17th St. Causeway, Ste. 358, Fort Lauderdale, FL, 33316, (305) 587-7900, Pres.: Patrick G. Appleson; Sales Mgr.: Alan Muller; Mktg. Dir.: Brenda Myer.
ARChive of Contemporary Music, 110 Chambers St., New York, NY, 10007, (212) 964-2296, Fax: (212) 619-3503, Dir.: Robert George.
Associated Prodn. Music, 6255 Sunset Blvd., Ste. 820, Hollywood, CA, 91364, (213) 461-3211, Fax: (213) 461-9102, Sales Mgr.: Jerry Burnham; Gen. Mgr.: Bill Brooks; Western Region/Sales: Cassandra Gorieb.
Associated Prodn. Music, 14875 NE 20th Ave., Ste. 7, North Miami, FL, 33181, (305) 948-9190, Fax: (305) 947-9207, Pres.: Bill Brooks; Sales Mgr.: Leslie Mogell; Mktg. Dir.: Leslie Mogell.
Berklee College of Music, 1140 Boylston St., Boston, MA, 02215, (617) 266-1400, Fax: (617) 336-2632, Pres.: Lee Elliot Berk; Mktg. Dir.: David J. Semanco; Adm. Dir.: Steven Lipman.
Ralph Berlin Audio/Music Prodn., 35 W. 90th St., New York, NY, 10024, (212) 873-6390, Pres.: Ralph Berliner.

Capitol Prodn. Music/THE PROFESSIONAL, Div. of Capitol Records

6922 Hollywood Blvd., Ste. 718, Hollywood, CA, 90028, (213) 461-2701, (800) 421-4163 (US only), Fax: (213) 461-1543, Managing Dir.: Ole Georg; Mktg. Mgr.: David W. Carroll; Promo. Mgr.: John D. Amato.

Captain Blue Music, PO Box 1044, c/o TJS Technologies, 413 E. Diamond Ave., Hazelton, PA, 18201, (717) 455-2502, Pres.: Taylor Sappe; Sales Mgr.: Jean Zeppi; Mktg. Dir.: Roger Taylor.
The Chadwick Co., 1841 Outpost Dr., Los Angeles, CA, 90068, (213) 851-1500, Pres.: Robert W. Chadwick; Mktg. Dir.: Mrs. James W. Chadwick.
Columbia Audio/Video, Second & Laurel, Highland Park, IL, 60035, (800) 256-2184, Fax: (800) 356-2188, Pres.: Norman Rozak; Sales Mgr.: Bruce Berg.
Cook Sound & Picture Works, 4801 Woodway, #355W, Houston, TX, 77056, (713) 960-8222, Pres.: Dwight Cook; Mgr.: Bill Wade.
Country Music Foundation, Inc., 4 Music Sq. E., Nashville, TN, 37203, (615) 256-1839, Fax: (615) 255-2245, Mktg. Dir.: Lisa Eubank; Dir.: William Ivey; Deputy Dir.: Charlie Seemann.
Creative Support Services, 1950 Riverside Dr., Los Angeles, CA, 90039, (213) 666-7968, Mktg./Sales Dir.: Michael M. Fuller.
D.S.M. Producers, Inc., 161 W. 54th St., New York, NY, 10019, (212) 245-0006, Fax: (212) 265-5726, Pres.: Suzan Bader; Vice Pres./Nat'l Sales Dir.: Doris Kaufman; Mktg. Dir.: Keith Lamar Newton; Dir.: A. & R. Elba T. Toast.
Famous Music Publishing Co., 15 Columbus Cir., New York, NY, 10023, (212) 373-7433, Fax: (212) 373-7031, Pres.: Sidney Herman.
First Com/Music House/Chappell, 13747 Montfort, Ste. 220, Dallas, TX, 75240, (214) 934-2222, (800) 858-8880, Fax: (214) 392-3454, Pres.: Cecelia Garr; Vice Pres.: Bob Jenkins; Sales Mgr.: Carol Rowden.
Happi Assocs., PO Box 110892, Nashville, TN, 37222, (615) 331-8570, (800) 264-0018, Fax: (615) 331-8571, Pres.: Skeeter Dodd.
Intersound, Inc., PO Box 1724, 11810 Willis Rd., Roswell, GA, 30077, (404) 664-9262, Fax: (404) 664-7316, Pres.: Don Johnson; Sales Mgr.: Bryan Hadley; Office Mgr.: Sharon Kurnett.
Joe Jones Mechanical & Performance Copyright Protection Worldwide Inc., 10556 Amwood Rd., Lake View Terrace, CA, 91342, (818) 890-0730, Fax: (818) 899-4457, Pres./CEO: Joe Jones; Vice Pres./Gen. Licensing: Marion Jones.
Leonardo Software, 10378 Holman Ave., Los Angeles, CA, 90024, (213) 277-5161, Fax: (213) 277-9086, Partner: Louis Benioff.
Liebert Recording Studios, Inc., 16 W. 46th St., New York, NY, 10036, (212) 840-1350, Fax: (212) 764-0440, Pres.: Bob Liebert; Sales Mgr.: Carmen Miller; Mktg. Dir.: Carmen Liebert.
Master Sound Studios, Inc., 1227 Spring St. NW, Atlanta, GA, 30309, (404) 873-6425, Fax: (404) 875-1440, Pres.: Babs Richardson; Traffic Mgr.: Jennifer Simpson.
Music Director Programming Service, PO Box 51978, Indian Orchard, MA, 01151, (413) 783-4626, Fax: (413) 783-3168, Pres.:

Budd Clain; Sales Mgr.: Herb Jackson; Mktg. Dir.: Bill Schoenborn.
Music Factory Ents Inc., Ste. 300, Ford & Washington Streets, Norristown, PA, 19401, (215) 277-9550, Pres.: Jeffrey Calhoun; Sales Mgr.: Jamie Bones; Mktg. Dir.: Dan Charles; Studio Mgr.: Linda Horvath.
Music In Media, 34 Starlight Ln., Levittown, NY, 11756, (516) 731-8735, Pres.: Howard Marshall; Vice Pres./Sales Mgr.: Sandee Samuels.
NFL Films, Inc., 330 Fellowship Rd., Mount Laurel, NJ, 08054, (609) 778-1800, Fax: (609) 722-6779, Pres.: Steve Sabor; Vice Pres., Facility Sales: Hal Lipman; Music Library Dir.: Denise Hurst.
Omnimusic, 52 Main St., Port Washington, NY, 11050, (800) 828-6664, Pres.: Doug Wood; Sales Mgr.: Patti Wood; Mktg. Dir./Gen. Mgr.: Sam White.
Pop Record Research, 17 Piping Rock Dr., Ossining, NY, 10562, (914) 762-8499, Pres.: Gary Theroux; Sales Mgr.: Joan Holpuch; Mktg. Dir.: Mark N. Rick.
Premier Film & Recording Corp., 3033 Locust St., Saint Louis, MO, 63042, (314) 531-3555, Fax: (314) 726-8798, Pres.: Wilson Dalzell; Sales Mgr.: Donna Blue; Mktg. Dir.: Bob Heuermann.
Promusic, Inc., 6555 NW Ninth Ave., Ste. 303, Fort Lauderdale, FL, 33309, (305) 776-2070, Fax: (305) 776-2074, Pres./Mktg. Dir.: Alain Leroux; Sales Mgr.: David Walters; Mgr.: Cheryl Mathauer.
Real Deal Productions, PO Box 2147, Sioux City, IA, 51104, Dir.: Morrie Miller.
Record-Rama Sound Archives, 4981 McKnight Rd., Pittsburgh, PA, 15237, (412) 367-7300, Fax: (412) 367-7388, Pres.: Paul C. Mawhinney.
Record Research, Inc., PO Box 200, W160 N8293 Old Orchard Ct., Menomonee Falls, WI, 53051, (414) 251-5408, Fax: (414) 251-9452, Pres.: Joel Whitburn; Sales Mgr.: Bill Hathaway.
Rights Chasers, 35 W. 90th St., New York, NY, 10024, (212) 873-6390, Fax: (212) 362-8022, Gen. Mgr.: Ralph Berliner.
Ron Rose Prodn., Inc., 3409 W. Lemon St., Tampa, FL, 33609, (813) 873-7700, Fax: (813) 875-6633, Pres.: Ronald N.S. Rocz; Sales Mgr.: Mike Stram.
ServiSound, Inc., 35 W. 45th St., New York, NY, 10036, (212) 921-0555, Fax: (212) 869-4296, Pres.: Michael J. Shapiro; Vice Pres.: Chris Nelson; Mktg. Dir.: Diane Ehrlichman.
The Singing Machine Co., Inc., 6350 E. Rogers Cir., Boca Raton, FL, 33487, (407) 994-3100, Fax: (407) 997-8701, Pres.: Eugene B. Settler; Sales Mgr.: Richard Borden.
South Street Music, 96 South St., Boston, MA, 02111, (617) 338-0085, Pres.: Carol E. Harper.
Southern Library of Recorded Music, 6777 Hollywood Blvd., Ste. 209, Hollywood, CA, 90028, (213) 469-9910, Fax: (213) 656-3298, Pres.: Ralph Peer, II; Sales Mgr./Mktg. Dir.: Roy Kohn.
Studio C Music Library, PO Box 767 Murray Hill Sta., New York, NY, 10156, (212) 986-2219, Pres.: Phil Cables.
TM Century, Inc., 14444 Beltwood Pkwy., Dallas, TX, 75244, (800) 937-2100, Fax: (800) 749-2121, Chairman: Dave Scott; Vice Pres./Mktg. Dir.: Stuart McRae; Vice Pres./Sales Dir.: Richie Allen.
TRF Prodn. Music Libraries, 1619 Broadway, 11th Floor, New York, NY, 10019, (800) 899-3667, Fax: (212) 956-3039, Pres.: Michael Nurko; Sales Mgr.: Michael Anderson; Mktg. Dir.: Norman Dozier; Contact: Julie Van Duser.
Trade Service Corp., 10996 Torreyana Rd., San Diego, CA, 92121, (619) 457-5920, Fax: (619) 5469002, Pres.: James A. Simpson; Sales Mgr.: Charles Pyce; Mktg. Dir.: Robin Lansman, Dan Henehan.
27th Dimension, Inc., PO Box 1149, 2312 SE 29th St., Okeechobee, FL, 34973, (800) 634-0091, (813) 763-4107, Fax: (813) 763-0410, Pres.: John St. John; Sales Mgr.: Fran Bell; Mktg. Dir.: Rex Bell; Office Mgr.: Wyn Johnson.
Valentino Music & Sound Effects Libraries, 151 W. 46th St., New York, NY, 10036, (212) 869-5210, Fax: (212) 869-6259, Pres.: Thomas Valentino.
Visual Music, Zeckendorf Towers, 111 E. 14th St., #355, New York, NY, 10003, (212) 505-9281, Pres.: Jay Henry; Mktg. Dir.: Brigita R. Petruitis.

PUBLIC RELATIONS

Bob Abrams & Assoc., 2030 Prosser Ave., Los Angeles, CA, 90025, (213) 475-7739, Fax: (213) 475-0369, Pres.: Bob Abrams; Sales Mgr.: Mary Abrams; Mktg. Dir.: Josh Abrams.
Sol Abrams Assoc., Inc., 331 Webster Dr., New Milford, NJ, 07646, (201) 262-4111, Pres.: Sol Abrams.
Ad Vertising Unlimited, PO Box 8135, Chicago, IL, 60680, (312) 224-5612, Pres.: Frank Howard, Jr.; Vice Pres.: R.C. Hillsman.
A.D. Adams Adv., Inc., 800 Meadowland Pkwy., Ste. 139 A, Secaucus, NJ, 07094, (201) 864-9066, Fax: (201) 864-8702, Pres.: A.D. Adams; Vice Pres.: Connie Adams.
Amy Alter Assoc., 799 Broadway, New York, NY, 10003, (212) 674-9505, Fax: (212) 353-9730, Pres.: Amy Alter Ross.
American Renaissance Music, Int'l, PO Box 1272, White Plains, NY, 10602, (914) 684-6139, Pres.: A.R. Moss.
Amorosano Assoc. Public Relations, 7715 Sunset Blvd., Ste. 210, Los Angeles, CA, 90046, (213) 850-8140, Fax: (213) 851-6658, Pres.: Ken Amorosano.
Aristo Music Assocs., Inc., PO Box 22765, Nashville, TN, 37202, 1620 16th Ave. S., Nashville, TN, 37212, (615) 269-7071, Fax: (615) 269-0131, Pres.: Jeff Walker.
Associated Essentials, PO Box 8135, Chicago, IL, 60680, (312) 224-5612, Pres.: Frank Howard, Jr.; Vice Pres.: R.C. Hillsman.

Atondra, PO Box 8135, Chicago, IL, 60680, (312) 224-5612, Pres.: Frank Howard, Jr.; Vice Pres.: R.C. Hillsman.
Sue Auclair, Publicity, 111 Perkins St., Ste. 179, Boston, MA, 02130, (617) 522-1394, Fax: (617) 522-4652, Pres.: Sue Auclair.
B S Promos., PO Box 130, New York, NY, 10024, (212) 787-8111, Pres.: Billy Smith.
Jeff Ballard Public Relations, 4814 Lemona Ave., Sherman Oaks, CA, 91403, (818) 501-0889, Fax: (818) 501-4727, Owner/Pres.: Jeff Ballard.
Frank Barth, Inc., 33 W. Main, Emsford, NY, 10523, (914) 345-8730, Fax: (914) 345-8740, Pres.: Katrine Barth; Mng. Partner: Bruce Maier.
Bender, Goldman & Helper, Inc., 11500 W. Olympic Blvd., #655, Los Angeles, CA, 90064, (213) 473-4147, Fax: (213) 478-4727, Pres.: Lee A. Helper.
Aleon Bennett, 13455 Ventura Blvd., Ste. 212, Sherman Oaks, CA, 91423, (818) 990-8070, Pres.: Aleon Bennett.
Susan Blond, Inc., 250 W. 57th St., Ste. 622, New York, NY, 10107, (212) 333-7728, Fax: (212) 262-1373, Pres.: Susan Blond.
Henri Bollinger Public Relations, 9200 Sunset Blvd., Ste. 330, Los Angeles, CA, 90069, (213) 274-8483, Fax: (213) 274-8479, Pres.: Henri Bollinger.
Brandy Co., 755 N. La Cienega Blvd., Los Angeles, CA, 90069, (213) 657-8320, Fax: (213) 657-4765, Pres.: Howard Brandy; Mktg. Dir.: Julie Holmes.
Bullwerks Graphic Design & Advertising Service, 134 E. Walnut St., Lancaster, PA, 17602, (717) 293-9554, Fax: (717) 293-9576, Pres.: Karen Mastropietro; Sales Mgr.: Peter Mastropietro.
F.S. Cameron, Inc., 45 E. 66th St., New York, NY, 10021, (212) 988-4619, Fax: (212) 861-9079, Pres.: Fred Stuart.
Carlton & Co. Public Relations, 648 Broadway, Ste. 700A, New York, NY, 10012, (212) 529-3101, Fax: (212) 308-4975, Pres.: Gaye Carlton; Mktg. Dir.: Jill Grev.
Maggie Cavender Ents., 803 18th Ave. S., Nashville, TN, 37203, (615) 321-5003, Owner: Maggie Cavender.
The Chadwick Co., 1841 Outpost Dr., Los Angeles, CA, 90068, (213) 851-1500, Pres.: Robert W. Chadwick; Mktg. Dir.: Mrs. James W. Chadwick.
Leo Cheslak Promos., Inc., 600 W. Lafayette Blvd., Detroit, MI, 48226, (313) 596-0372, Fax: (313) 964-0183, Pres.: Leo Cheslak.
Counterpart Creative Studios, Inc., 3744 Applegate Ave., Cincinnati, OH, 45211, (513) 661-8810.
Dassinger Creative Services, 44 Vernon Terrace, Bloomfield, NJ, 07003, (201) 748-7025, Fax: (201) 748-3114, Pres.: George W. Dassinger; Mktg. Dir.: Isabel Dassinger.
Davidson & Choy Publicity, 8105 W. Third St., Ste. 2, Los Angeles, CA, 90048, (213) 655-8926, Fax: (212) 655-9861, Partners: Judi Davidson, Tim Choy.
The Edward De Miles Co., 4475 Allisonville Rd., Eighth Floor, Indianapolis, IN, 46205, (800) 874-5799, Fax: (317) 549-9007, Pres.: Edward De Miles; Sales Mgr.: Dwayne Woolridge; Mktg. Dir.: Greg Payne.
Devra Ents., 361 W. California Ave., Ste. 8, Glendale, CA, 91203, (818) 240-0425, Fax: (818) 240-6495, Pres.: Devra Hall.
Dr. Jazz Operations, 24270 Eastwood, Oak Park, MI, 48237, (313) 542-7888, Fax: (313) 548-1764, Mktg. Dir.: Nicole Baiz.
Egg Ink, 156 Fifth Ave., Ste. 434, New York, NY, 10010, (212) 691-5630, Pres.: Abigail Storm; Sales Mgr.: Daniel Eggink.
Emerald Records, 830 Gastonbury Rd., #614, Nashville, TN, 37217, (615) 361-7902, Pres.: Cliff Ayers Ostermyer; Sales Mgr.: Yvonne Mathews; Mktg. Dir.: Buddy Preston.
Espre Books & Cassettes, 10747 Wilshire Blvd., #807, Los Angeles, CA, 90024, Contact: Joseph Kessler.
The FHL Co., 19722 Trull Brook Dr., Tarzana, CA, 91356, (818) 343-2626, Fax: (818) 343-1007, Pres.: Frank H. Lieberman.
F.I.D.O.F. (Int'l) Federation of Festival Organizations, 4230 Stansbury Ave., Ste. 105, Sherman Oaks, CA, 91423, (818) 789-7596, Fax: (818) 784-9141, Pres.: Jim Halsey; Sec. Gen.: Prof. Armando Moreno.
Lu Fields Promos., Inc., PO Box 4200, Hollywood, CA, 90078, (213) 467-3825, Pres.: Lu Fields.
Fischer & Lucas, Inc., 1618 16th Ave. S., Nashville, TN, 37203, (615) 292-3611, Pres.: Bobby Fischer.
Flash Int'l Ents., PO Box 580058, 16201 Buccaneer, Ste. 213, Houston, TX, 77062, (713) 488-1978, Pres./Mktg. Dir.: R.L. (Flash) Boudreaux.
The Franklyn Agency, 1010 Hammond St., #312, Sunset Strip, West Hollywood, CA, 90069, (213) 272-6080, Pres.: Audrey Pozen Franklyn; Mktg. Dir.: Sharon Fae; Mktg. Dir.: Allison Cargle.
Randy Frisch, Esq., 1155 Trafalgar St., Teaneck, NJ, 07666, (201) 836-1194, Fax: (201) 692-0468.
Front Page News Entertainment, 353 Sacramento St., Sixth Floor, San Francisco, CA, 94111, (415) 420-8452, Pres.: Demetra Mavis.
GP Prodn., 362 Third Ave., Ste. 1B, New York, NY, 10016, (212) 686-5267, Pres.: Gill R. Pessoa; Sales Mgr.: Y.L. Walton; Mktg. Dir.: Daryl A. Pessoa.
Gangwisch & Assoc., Inc., 207 Westport Rd., Kansas City, MO, 64111, (816) 931-8000, Fax: (816) 931-0289, Pres.: Kathy Gangwisch.
The Garrett Co., 6922 Hollywood Blvd., #407, Los Angeles, CA, 90028, (213) 462-4122, Fax: (213) 463-3792, Owner/Pres.: Don Garrett; Sales Mgr.: Liza Cranis; Mktg. Dir.: David Kadison.
Jo-Ann Geffen & Assoc., 4570 Encino Ave., Encino, CA, 91316, (818) 905-5511, Fax: (818) 905-9154, Pres.: Jo-Ann Geffen.
Richard Gersh Assoc., Inc., PO Box 930, 301 W. 53rd St., New York, NY, 10019, (212) 757-1101, Fax: (212) 245-6746, Pres.:

- Richard Gersh; Mktg. Dir. Arlene Gersh; Acct. Exec.: Lauri Lazarus.
- Glodow & Coats Publicity Services**, 4034 20th St., San Francisco, CA, 94114, (415) 864-2333, Fax: (415) 864-2238, President: John Glodow; Contacts: Michael Coats, Jeffrey Neal.
- Golden Loder Assoc.**, 209 Ross Pl., Westfield, NJ, 07090, (201) 233-2040, Fax: (908) 233-8192, Pres.: Pamela Golden Loder.
- Ren Grevatt Assoc., Ltd.**, 330 W. 58th St., Ste. 5F, New York, NY, 10019, (212) 582-0252, Fax: (212) 582-6922, Pres.: Ren Grevatt.
- The Group Public Relations**, 723 1/2 N. La Cienega Blvd., Los Angeles, CA, 90069, (213) 657-2211, Fax: (213) 657-7750, Pres.: Bob Gibson.
- Gurley & Co.**, 1101 17th Ave. S., Nashville, TN, 37212, (615) 329-0022, Fax: (615) 329-9329, Owner: Cathy Gurley.
- HWH Public Relations**, 1414 Avenue of the Americas, New York, NY, 10019, (212) 355-5049, Fax: (212) 593-0065, Chairman, CEO: Eliot Hess; Pres.: Lois Whitman.
- Hillside Records**, 948 Studer Ave., Columbus, OH, 43206, Pres.: Larry McKenzie.
- Horseshoe Dist. & Service Co.**, 2937 Harlin Dr., Nashville, TN, 37211, (615) 331-1125, Pres.: Jim Dolan; Sales Mgr.: Ruth Brown; Mktg. Dir.: John Dohnal; Contact: Webb Foley.
- Bernie Ilson, Inc.**, 65 W. 55th St., New York, NY, 10019, (212) 245-7950, Fax: (212) 977-3093, Pres.: Bernie Ilson.
- imPressive, Ltd.**, PO Box 2147, Sioux City, IA, 51104, (712) 276-2295, Publicity & Promo. Dir.: Morrie Miller.
- In-Press**, 928 Broadway, Ste. 405, New York, NY, 10010, (212) 228-8300, Fax: (212) 228-8495, Pres.: Ellen Bello; Mgr.: Marisa Scanzillo; Mktg. Dir.: Suzanne Haber.
- Inserv Corp.**, 1650 Howard St., Lincoln Park, MI, 48146, (313) 381-1530, Fax: (313) 381-5290, Pres.: Lowell Johnson; Mktg. Dir.: William Lane.
- Inter/Soul Promos.**, 2287 Lothrop Blvd., Detroit, MI, 48206, (313) 894-0710, Pres.: Ernest Kelley; Sales Mgr.: Irving R. Kelley; Mktg. Dir.: Jerome Cunningham.
- Int'l Events Group**, 213 W. Institute Pl., Ste. 303, Chicago, IL, 60610, (312) 944-1727, Fax: (312) 944-1897, Pres.: Lasa Ukman; Mktg. Dir.: Jon Ukman.
- JCPR**, 11377 Dullet Ave., Northridge, CA, 91326, (818) 360-4548, Fax: (818) 349-0403, Pres.: Jeri Carr; Mktg. Dir.: Devra Brenner.
- Jensen Communications**, 120 S. Victory Blvd., Ste. 201, Burbank, CA, 91502, (818) 841-3343, Fax: (818) 955-9900, Pres.: Michael R. Jensen.
- Little Richie Johnson Agency**, PO Box 3, 318 Horizon Vista Blvd., Belen, NM, 87002, (505) 864-7441, Fax: (505) 864-7442, Pres.: Little Richie Johnson; Sales Mgr.: Theresa Smrt.
- Joe Jones Mechanical & Performance Copyright Protection Worldwide Inc.**, 10556 Arwood Rd., Lake View Terrace, CA, 91342, (818) 890-0730, Fax: (818) 899-4457, Pres., CEO: Joe Jones; Vice Pres./Gen. Licensing: Marion Jones.
- KA Prods.**, PO Box 3500, 17 Sachem St., Pawtucket, RI, 02861, (401) 728-1689, Fax: (508) 399-6380, Pres.: Karen Pady.
- Kaplan/Lorber Public Relations, Inc.**, 407 Lincoln Rd., Miami Beach, FL, 33139, (305) 534-2300, Fax: (305) 531-8551, Pres.: Deeny Kaplan; Sales Mgr.: Beth Levin; Mktg. Dir.: Ken Lorber.
- Kayos Prods., Inc.**, 16 W. 19th St., Fifth Floor, New York, NY, 10011, (212) 645-9178, Fax: (212) 727-8282, Pres.: Carol Kaye.
- Ed Keeley Promos.**, 701 Bridgewood Cir., Ste. 432, Fort Worth, TX, 76112, (817) 429-9999, Fax: (817) 654-9998, Pres.: Edward L. Keeley; Mktg. Dir.: Fred M. Stewart III.
- Ken Do Promos.**, 157 Ann St., Valley Stream, NY, 11580, (516) 825-2765, Fax: (516) 561-5269, Pres.: Ken Shankman.
- Known Artist Records & Promos.**, 1219 Kerlin Ave., Brewton, AL, 36426, (205) 867-2228, Pres.: Roy Edwards; Sales Mgr.: Gus Grice; Mktg. Dir.: Shannon Edwards.
- Dana Kornbluth Public Relations**, 4000 Presidential Blvd., Ste. 324, Philadelphia, PA, 19131, (215) 877-7422.
- J. Lahm Consultants Inc.**, 2630 Coronado Dr., Fullerton, CA, 92635, (714) 738-8422, Fax: (714) 738-8860, Pres.: James Lahm.
- Bambe Levine Public Relations, Inc.**, 708 Third Ave., New York, NY, 10017, (212) 370-7878, Fax: (212) 599-5857, Pres.: Bambe Levine.
- Levinson Assoc.**, 1440 Veteran Ave., Ste. 650, Los Angeles, CA, 90024, (213) 460-4545, Fax: (213) 663-2820, Pres.: Robert S. Levinson.
- Lewis Co., Ltd.**, PO Box 7447, Westlake Village, CA, 91359, (818) 707-7393, Fax: (818) 707-7394, Pres.: Bud Lewis; Mktg. Dir.: Monika Winslow.
- Frank Liberman & Assoc.**, PO Box 69130, Los Angeles, CA, 90069, 1501 Lindcrest Dr., Beverly Hills, CA, 90210, (213) 278-1993, Fax: (213) 278-1999, Contact: Frank Liberman.
- "Little Chicago"**, PO Box 2147, Sioux City, IA, 51104, Producer/Dir., Pub. & Promo: "Daddy Blues".
- Loconto Prods./Sunrise Studio**, PO Box 16540, 10244 NW 47th St., Plantation, FL, 33318, (305) 741-7766.
- Mahoney Communications, Inc.**, 237 Park Ave., Ste. 2112, New York, NY, 10017, (212) 551-3616, Fax: (212) 697-0499, Pres.: Jim Mahoney; Dir. East Coast: Marilee Mahoney.
- Mahoney/Wasserman & Assoc., Inc.**, 345 N. Maple Dr., Ste. 185, Beverly Hills, CA, 90210, (213) 550-3922, Fax: (213) 550-7875, Pres.: Jim Mahoney; Contacts: Paul Wasserman, Sean Mahoney.
- Mike Mamakos & Assoc.**, 14200 Ventura Blvd., #106, Sherman Oaks, CA, 91423, (818) 788-0164, Fax: (818) 788-4749, Owner/Pres.: Mike Mamakos; Sales Mgr.: Helen Mann; Mktg. Dir.: B.T. Williams.
- Paul Marsh & Assoc.**, PO Box 2119, Toluca Lake, CA, 91610, (818) 761-3750, Fax: (818) 761-3750, Pres.: Paul Marsh.
- Michelle Marx, Inc.**, 8756 Holloway Dr., Los Angeles, CA, 90069, (213) 652-4700, Fax: (213) 652-5762, Pres.: Michelle Marx.
- Maryland Musician Magazine, Inc.**, 7510 Hartford Rd., Second Floor, Baltimore, MD, 21234, (301) 444-3776, (301) 444-3777, Fax: (301) 444-1807, Pres.: Susan E. Mudd; Sales Mgr.: Ken Massey; Mktg. Dir.: J. Doug Gill.
- Mazza Marketing Group**, 2730 Wilshire Blvd., Ste. 404, Santa Monica, CA, 90403, (213) 829-4401, Fax: (213) 828-3340, Pres.: Bob Mazza.
- Media Group**, 925 De La Vina, Third Floor, Santa Barbara, CA, 93101, (805) 564-6905, Fax: (805) 966-9175, Mktg. Dir.: Kimberly Mitchell.
- Lena Michals Entertainment**, 1802 Laurel Canyon Blvd., Los Angeles, CA, 90046, (213) 874-4002, Fax: (213) 654-1703, Pres.: Lena Michals; Exec. Asst.: Gisli Johannsson.
- Middleberg & Rosso, Inc.**, 130 E. 59th St., 13th Floor, New York, NY, 10022, (212) 371-1777, Fax: (212) 371-5327, Pres.: Wayne Rosso; Chairman: Don Middleberg; Account Supervisor: Mary Fiance.
- Joe Middleton**, 2212 Clays Mill Rd., Lexington, KY, 40503, (606) 278-4194, Pres.: Joe Middleton.
- Ann J. Morton Promos., & Public Relations**, PO Box 40364, Nashville, TN, 37204, (615) 297-8076, (615) 292-1539, Fax: (615) 292-0752, Pres.: Ann J. Morton; Pub. Rel. Dir.: Bill White.
- Neal Public Relations, Inc.**, 2182 N. Argyle, Hollywood, CA, 90068, (213) 856-9008, Fax: (213) 467-7528, Pres.: Roger Neal; Mktg. Dir.: Gabrielle Criming.
- Edwin Neuger & Assoc.**, 1221 Nicollet Mall, Ste. 320, Minneapolis, MN, 55403, (612) 333-6621, Fax: (612) 344-1809, Pres.: Edwin Neuger; Sales Mgr.: David Neuger; Vice Pres.: David Neuger.
- Nic Of Tyme Prods. Inc.**, PO Box 1994, 3333 Hedge Maple Cr., South Bend, IN, 46634, (219) 271-7291, Pres.: Tony Nicoletto; Sales Mgr./Mktg. Dir.: Jennifer Woods.
- Slick Norris Artists & Promos.**, PO Box 653, Highlands, TX, 77562, (713) 424-4235, Pres.: Slick Norris.
- Platinum Music Network**, 80 Broad St., Ste. 13M, Red Bank, NJ, 07701, (908) 842-6842, Pres.: Steve Zuckerman; Sales Mgr.: David Stefaniz.
- Porter/Novelli Public Relations**, 11755 Wilshire Blvd., Ste. 1600, Los Angeles, CA, 90025, (213) 444-7000, Vice Pres.: Tom Brocato.
- Potomac Public Relations, Inc.**, 529 S. Fairfax St., Alexandria, VA, 22314, (703) 684-8900, Pres.: Allan Schlosser.
- Prairie Sun Recording Studio**, PO Box 7084, Cotati, CA, 94931, 1039 Madrone Ave., Cotati, CA, 94928, (707) 795-7011, Pres./Mktg. Dir.: Mark "Mooka" Rennick; Opns. Mgr.: Jeffrey Sloan.
- Premier Film & Recording Corp.**, 3033 Locust St., Saint Louis, MO, 63042, (314) 531-3555, Fax: (314) 726-8798, Pres.: Wilson Dalzeli; Sales Mgr.: Donna Blue; Mktg. Dir.: Bob Heuermann.
- Prof/Creatives**, 25 W. Burda Pl., New City, NY, 10956, Pres.: David Rapp.
- Programming Aids For Progressive Radio**, PO Box 1805, Church St., New York, NY, 10008, Pres.: Jay Rosen.
- Public I Publicity Services Inc.**, 928 Broadway, Ste. 1102, New York, NY, 10010, (212) 505-8778, Fax: (212) 979-2768, Pres.: Ida S. Langsam; Acct. Exec.: Susan Burke.
- Public Information Network (P.I.N.)**, 3217 Dona Emilia Dr., Studio City, CA, 91604, (213) 650-1685, (213) 650-7985, Fax: (213) 650-4605, Pres.: Lilly Lipton; Sales Mgr.: Bobbie Cooker; Mktg. Dir.: Denise Marcotte.
- RPS Communications**, 3 Bittersweet Ct., Centerport, NY, 11721, (516) 754-3300, Fax: (516) 754-8168, Pres.: Randolph P. Savicky; Vice Pres.: Dr. Barbara Panos-Savicky.
- Radio Central**, 548 S. Spring St., #815, Los Angeles, CA, 90013, (213) 623-7589, Pres.: David B. Sigler; Sales Mgr.: C.T. Hampson.
- The Raleigh Group, Ltd.**, 806 S. Citrus Ave., Los Angeles, CA, 90036, (213) 937-4183, Pres.: Raleigh Pinsky.
- Redwing Mktg., Inc.**, 24495 Park Granada, Calabasas, CA, 91302, (818) 713-1918, Fax: (818) 346-0136, Pres.: Jack Hakim.
- Reliance Audio Visual Corp.**, 623 W. 51st St., New York, NY, 10019, (212) 586-5000, Fax: (212) 586-6047, Pres.: Gil Meyer; Contact: Norma Matthews.
- Charlie Roberts Adv. & Promo., Inc.**, Vat 69, Farmingdale, NJ, 07727, (201) 938-4351, Pres.: Charlie Roberts.
- Martin Roberts & Assoc., Inc.**, 270 N. Cannon Dr., Ste. 103, Beverly Hills, CA, 90210, (213) 273-0361, Fax: (818) 990-6802, Pres.: Martin Roberts; Sales Mgr.: G. Wells; Mktg. Dir.: Jon Roberts.
- Ray Roberts Promos.**, PO Box 110802, Nashville, TN, 37222, (615) 833-2052, Pres.: Ray Roberts.
- Victoria Rose Mktg./Pub. Rel.**, 171 E. 77th St., New York, NY, 10021, (212) 794-1899, Fax: (212) 879-5441, Pres.: Victoria Rose.
- Jasper Samuel Advertising & Printing**, 406 W. 31st St., New York, NY, 10001, (212) 239-9544, Fax: (212) 594-0931, Pres.: Jasper Samuel; Sales Mgr.: Claude Chamlee; Mktg. Dir.: Courtland White.
- K. Sandy Agency**, 2347 Coldwater Canyon Dr., Beverly Hills, CA, 90210, (213) 278-3343, Fax: (213) 785-1999, Pres.: Sandra Karvelas; Sales Mgr.: Diane Peitek; Mktg. Dir.: Robert Cannon.
- Scyne Records**, PO Box 1843, 93 Garfield Ave., Lynn, MA, 01903, (617) 581-1931, Contact: J.D. Brennan.
- Segal Assoc., Inc.**, 9200 Sunset Blvd., Ste. 415, Los Angeles, CA, 90069, (213) 288-0481, Fax: (213) 288-0679, Pres.: Rebecca Segal; Sr. Account Exec.: Kris Sotley.
- Dave Segel Promos.**, 1304 Cranwood Sq. S., Columbus, OH, 43229, (614) 885-2789, Fax: (614) 846-7036, President/Contact: Dave Segel.
- Shefrin Co.**, 800 S. Robertson Blvd., Los Angeles, CA, 90035, (213) 655-5960, Fax: (213) 657-0441, Pres.: Paul Shefrin.
- Shuman Associates, Inc.**, 120 W. 58th St., New York, NY, 10019, (212) 315-1300, Fax: (212) 757-3005, Pres.: Constance Shuman.
- Silco Prods.**, PO Box 4096, Leon Sta., Tallahassee, FL, 32315, (904) 385-1302, Owner: Lou Miller.
- Harriette Smith Publicity/Promotion**, 1244 S. LaJolla Ave., Los Angeles, CA, 90035, (213) 931-0855.
- Sollers/Roskin/Friedman, Inc.**, 45 W. 34th St., New York, NY, 10001, (212) 947-0515, Fax: (212) 947-0767, Partner: Sheldon Roskin.
- Saul Star Promos. Unlimited**, 6940 Carriage Hills Dr., Canton, MI, 48187, (313) 981-6625, Pres.: Lou Miller.
- Strategies & Solutions, Inc.**, 331 Webster Dr., New Milford, NJ, 07646, (201) 262-4111, Pres.: Zeldia Abrams; Mng. Dir.: Sol Abrams.
- Tri-Son, Inc./Tri-Son Promos./Tri-Son News**, PO Box 3, Nashville, TN, 37204, Pres.: Louella Johnson.
- Douglas Tuchman Talent & Entertainment Mktg.**, 417 E. 89th St., Ste. 1-B, New York, NY, 10128, (212) 427-3221, Fax: (212) 439-9109, Pres.: Douglas Tuchman.
- W3 Public Relations**, 8380 Melrose Ave., #105, Los Angeles, CA, 90069, (213) 852-1043, Fax: (213) 852-7127, Contact: Sharon Weisz.
- Harriet Wasser**, 250 W. 57th St., Ste. 1527, New York, NY, 10019, (212) 582-1960.
- Morton Dennis Wax & Assoc., Inc.**, 1560 Broadway, New York, NY, 10036.
- Westworld Records/Carriage Music B.M.I. Co.**, 3966 Standish Ave., Cincinnati, OH, 45213, (513) 793-8191, (513) 559-1210, Owner/Pres.: Roosevelt Lee; Sales Mgr.: Ronald Lee.
- Whats Happening**, PO Box 2147, Sioux City, IA, 51104, (712) 276-2295, Publicity Dir.: Morrie Miller.
- Norman Winter & Assoc.**, 6255 Sunset Blvd., #1023, Los Angeles, CA, 90028, (213) 469-3434, Fax: (213) 469-6422, Pres.: Norman Winter.

RECORD PROMOTION

- Sol Abrams Assoc., Inc.**, 331 Webster Dr., New Milford, NJ, 07646, (201) 262-4111, Pres.: Sol Abrams.
- Ad Vertising Unlimited**, PO Box 8135, Chicago, IL, 60680, (312) 224-5612, Pres.: Frank Howard, Jr.; Vice Pres.: R.C. Hillsman.
- Allen-Martin Prods., Inc.**, 9701 Taylorsville Rd., Louisville, KY, 40299, (502) 267-9658, Fax: (502) 267-9070, Pres.: Bill Porter; Sales Mgr./Mktg. Dir.: Bill Riles.
- Amperand Converters**, 11888 Westen Ave., Stanton, CA, 90680, (714) 893-4343, Fax: (714) 891-1231, Pres.: Lowell Matthews; Sales Mgr.: Paulette Carnes; Exec. Vice Pres./Mktg. Dir.: John Fontana.
- Atondra**, PO Box 8135, Chicago, IL, 60680, (312) 224-5612, Pres.: Frank Howard, Jr.; Vice Pres.: R.C. Hillsman.
- Sue Auclair, Publicity**, 111 Perkins St., Ste. 179, Boston, MA, 02130, (617) 522-1394, Fax: (617) 522-4652, Pres.: Sue Auclair.
- Audio Cassette Duplicator Co.**, 12426 1/2 Ventura Blvd., Studio City, CA, 91604, (818) 762-2232, Fax: (818) 508-8077, Owners: Steve Katz, Steve Mitchell.
- Audio Communications, Inc.**, 3170 Polaris Ave., Ste. 23, Las Vegas, NV, 89102, (702) 251-7732, Fax: (702) 251-5660, Mktg. Dir.: Karen McGire; Sales Mgr.: Charlie DeNatale.
- B&F Plastic Graphics, Inc.**, 540 N. Eighth St., Richmond, IN, 47374, (800) 562-8365, Fax: (317) 962-7170, Pres.: Paul Bertsch IV.
- B S Promos.**, PO Box 130, New York, NY, 10024, (212) 787-8111, Pres.: Billy Smith.
- Howard Bedno & Assoc.**, 549 W. Fullerton, Chicago, IL, 60614, (312) 883-0100, Pres.: Howard Bedno.
- Aleon Bennett**, 13455 Ventura Blvd., Ste. 212, Sherman Oaks, CA, 91423, (818) 990-8070, Pres.: Aleon Bennett.
- Fred Benson Promo.**, PO Box 14856, 3425 E. Ocean, Long Beach, CA, 90803, (310) 433-5735, Fax: (310) 433-5254, Pres.: Uncle Fred Benson.

RECORD PROMOTION

**EXPERIENCE!
EXCELLENCE! 25 YRS.!**
Working All Leading National Charts.

"One Of The Foremost
Names in Music Promotion"

RCI Records Inc.

PO. Box 110802 - IBG
Nashville, TN 37222-0802
(615) 833-2052

- Bernstein Artist Management Co.**, 2170 S. Parker Rd., Ste. 115, Denver, CO, 80231, (213) 273-8799, (800) 783-4487, Fax: (303) 755-2617, Pres.: Richard J. Bernstein; Admin. Asst.: Beth Payne.
- F.S. Cameron, Inc.**, 45 E. 66th St., New York, NY, 10021, (212) 988-4619, Fax: (212) 861-9079, Pres.: Fred Stuart.
- The Chadwick Co.**, 1841 Outpost Dr., Los Angeles, CA, 90068, (213) 851-1500, Pres.: Robert W. Chadwick; Mktg. Dir.: Mrs. James W. Chadwick.
- Loren Chaldez Promo.**, 530 W. 23rd St., #412, New York, NY, 10011, (212) 627-0981, Fax: (212) 929-6643, Pres.: Loren Chaldez.
- Leo Cheslak Promos., Inc.**, 600 W. Lafayette Blvd., Detroit, MI, 48226, (313) 596-0372, Fax: (313) 964-0183, Pres.: Leo Cheslak.
- Comstock Records, Ltd.**, 10603 N. Hayden, Ste. 114, Scottsdale, AZ, 85260, (602) 951-3115, Fax: (602) 951-3074, Pres.: Frank Fara.
- Counterpart Creative Studios, Inc.**, 3744 Applegate Ave., Cincinnati, OH, 45211, (513) 661-8810.
- Cross-Cross Industries**, 4708 Park Granada Blvd., #191, Calabasas, CA, 91302, (818) 222-4362, Pres.: Doc Remer.
- Bryan Cronin Promo./Mktg.**, 212 E. 47th St., New York, NY, 10017, (212) 751-1200, Pres.: Bryan Cronin.
- The Edward De Miles Co.**, 4475 Allisonville Rd., Eighth Floor, Indianapolis, IN, 46205, (800) 874-5799, Fax: (317) 549-9007, Pres.: Edward De Miles; Sales Mgr.: Dwayne Woolridge; Mktg. Dir.: Greg Payne.
- Marvin Deane**, 4241-H Colfax Ave., Studio City, CA, 91604.
- Digital House Ltd.**, 101 W. 57th St., New York, NY, 10019, (212) 333-5950, Fax: (212) 262-5631, Pres.: Jerome Bunke; Vice Pres. Tech. Services: Harry Hirsch; Vice Pres. Mktg.: Don Burkheimer.
- Dr. Jazz Operations**, 24270 Eastwood, Oak Park, MI, 48237, (313) 542-7888, Fax: (313) 548-1764, Mktg. Dir.: Nicole Baiz.
- Door Knob Records**, 3950 N. Mt. Juliet Rd., Mount Juliet, TN, 37122, (615) 754-0417, Owner/Pres.: Gene Kennedy.
- Emerald Records**, 830 Glastonbury Rd., #614, Nashville, TN, 37217, (615) 361-7902, Pres.: Cliff Ayers Ostermeyer; Sales Mgr.: Yvonne Mathews; Mktg. Dir.: Buddy Preston.
- Euro Tec Promos.**, 231 Glencrest Cr., Ventura, CA, 93003, (805) 658-2488, Fax: (805) 658-8241, Pres.: Bruce Caplin.
- F.I.D.O.F. (Int'l Federation of Festival Organizations)**, 4230 Stansbury Ave., Ste. 105, Sherman Oaks, CA, 91423, (818) 789-7596, Fax: (818) 784-9141, Pres.: Jim Halsey; Sec. Gen.: Prof. Armando Moreno.
- Fame & Fortune Ents.**, PO Box 121679, 1024 16th Ave. S., Ste. 101, Nashville, TN, 37212, (615) 244-4898, Pres.: Jim Cartwright; Partner: Scott Turner.
- Lu Fields Promos., Inc.**, PO Box 4200, Hollywood, CA, 90078, (213) 467-3825, Pres.: Lu Fields.
- Fischer & Lucus, Inc.**, 1618 16th Ave. S., Nashville, TN, 37203, (615) 292-3611, Pres.: Bobby Fischer.
- Flash Int'l Ents.**, PO Box 580058, 16201 Buccaneer, Ste. 213, Houston, TX, 77062, (713) 488-1978, Pres./Mktg. Dir.: R.L. (Flash) Boudreaux.
- The Franklyn Agency**, 1010 Hammond St., #312, Sunset Strip, West Hollywood, CA, 90069, (213) 272-6080, Pres.: Audrey Pozen Franklyn; Mktg. Dir.: Sharona Fae; Mktg. Dir.: Allison Cargle.
- Front Page News Entertainment**, 353 Sacramento St., Sixth Floor, San Francisco, CA, 94111, (415) 420-8452, Pres.: Demetra Mavis.
- GP Prods.**, #362 Third Ave., Ste. 1B, New York, NY, 10016, (212) 686-5267, Pres.: Gill R. Pessoa; Sales Mgr.: Y.L. Walton; Mktg. Dir.: Daryl A. Pessoa.
- GTE Service Corp.**, 1 Stamford Forum, Stamford, CT, 06901, (203) 965-2000, Pres.: Henry Droz; Sales Mgr.: Dennis O'Malley.
- The Garrett Co.**, 6922 Hollywood Blvd., #407, Los Angeles, CA, 90028, (213) 462-4122, Fax: (213) 463-3792, Owner/Pres.: Don Garrett; Sales Mgr.: Liza Cranis; Mktg. Dir.: David Kadison.
- Juggy Gayles, Inc.**, 67-45 E. 190th Ln., Fresh Meadows, NY, 11365, (212) 454-6593, Pres.: Juggy Gayles.
- Martin Genser Promos.**, 1005 Plaza Dr., Woodbridge, NJ, 07095, (908) 855-1698, Pres.: Martin S. Genser.
- Globe Art Copyright Service**, 1755 York Ave., Ste. 21F, New York, NY, 10128, (212) 860-3023, Fax: (212) 831-0906, Pres.: Jane Pelterer.
- Alex Greene & Assoc.**, 27380 Grafton Ave., Roseville, MI, 48066, (313) 779-0207, Fax: (313) 779-2565, Pres.: Alex Greene; Sales Mgr.: Annie Marjo.
- Horseshoe Dist. & Service Co.**, 2937 Harlin Dr., Nashville, TN, 37211, (615) 331-1125, Pres.: Jim Dolan; Sales Mgr.: Ruth Brown; Mktg. Dir.: John Dohnal; Contact: Webb Foley.
- Hotline Promos., Inc.**
(800) 622-PLAY, Fax: (800) TEL-FAXX, Pres.: Kristin Pearson; Vice Pres.: Jeff Wallace; Office Mgr.: Stephanie Bigonski; National Radio & Retail Promotions specializing in (Contemporary & Mainstream), N.A.C., New Age, World Music
- Pres.: Ron Huntsman.
- Ed Hurvitz Music Promos.**, 129 Bishop St., Brockton, MA, 02402, (508) 588-6348, Pres.: Edward M. Hurvitz; Sales Mgr.: Linda Berman.
- Impressive, Ltd.**, PO Box 2147, Sioux City, IA, 51104, (712) 276-2295, Publicity & Promo. Dir.: Morrie Miller.
- "Indie" Distributing**, PO Box 2147, Sioux City, IA, 51104, Publicity Dir.: Morrie Miller.
- Inter/Soul Promos.**, 2287 Lothrop Blvd., Detroit, MI, 48206, (313) 894-0710, Pres.: Ernest Kelley; Sales Mgr.: Irving R. Kelley; Mktg. Dir.: Jerome Cunningham.
- JTM Workshop**, PO Box 686, Knox, PA, 16232, (212) 797-5883, Pres.: Frank T. Battista.
- Jewel Records**, 1594 Kinney Ave., Cincinnati, OH, 45231, (513) 522-9336, Fax: (513) 522-9915, Pres.: Rusty York; Sales Mgr.: Rick Hopkins.
- Little Richie Johnson Agency**, PO Box 3, 318 Horizon Vista Blvd., Belen, NM, 87002, (505) 864-7441, Fax: (505) 864-7442, Pres.: Little Richie Johnson; Sales Mgr.: Theresa Smrt.
- Joe Jones Mechanical & Performance Copyright Protection Worldwide Inc.**, 10556 Arnwood Rd., Lake View Terrace, CA, 91342, (818) 890-0730, Fax: (818) 899-4457, Pres.: CEO: Joe Jones; Vice Pres./Gen. Licensing: Marion Jones.
- KA Prods.**, PO Box 3500, 17 Sachem St., Pawtucket, RI, 02861, (401) 728-1669, Fax: (508) 399-6380, Pres.: Karen Pady.
- Ed Keeley Promos.**, 701 Bridgewood Cir., Ste. 432, Fort Worth, TX, 76112, (817) 429-9999, Fax: (817) 654-9998, Pres.: Edward L. Keeley; Mktg. Dir.: Fred M. Stewart III.
- Ken Do Promos.**, 157 Ann St., Valley Stream, NY, 11580, (516) 825-2765, Fax: (516) 561-5269, Pres.: Ken Shankman.
- Gene Kennedy Ents., Inc.**, 3950 N. Mt. Juliet Rd., Mount Juliet, TN, 37122, (615) 754-0417, Owner/Pres.: Gene Kennedy.
- Known Artist Records & Promos.**, 1219 Kerlin Ave., Brewton, AL, 36426, (205) 867-2228, Pres.: Roy Edwards; Sales Mgr.: Gus Grice; Mktg. Dir.: Shannon Edwards.
- "Little Chicago"**, PO Box 2147, Sioux City, IA, 51104, Producer/Dir.-Pub & Promo: "Daddy Blues"
- Loconto Prods./Sunrise Studio**, PO Box 16540, 10244 NW 47th St., Plantation, FL, 33318, (305) 741-7766.
- Main Street Mktg. & Promo., Inc.**, 4517 Minnetonka Blvd., Ste. 104, Minneapolis, MN, 55416, (612) 927-4487, Fax: (612) 927-6427, Pres.: Tom Kay; Sales Mgr.: Lisa Nordmark; Mktg. Dir.: Jane Dyson.
- Main Tripp Records, Inc.**, 2804 Beechtree Dr., Sanford, NC, 27330, (919) 774-8926, Pres.: Bill Tripp; Mktg. Dir.: Wayne Ferrin.
- Marketing Plus**, 13062 Marcy Ranch Rd., Santa Ana, CA, 92705, (714) 669-9089, Pres.: Elaine Duran.
- Jim McCoy Prods., R. 2, Box 114**, Berkeley Springs, WV, 25411, (304) 258-2175, Pres.: Jim McCoy; Mktg. Dir.: Bertha McCoy.
- Dick Michaels Prods.**, 1131 Audelia Rd., Dallas, TX, 75243, (214) 348-4151, Contact: Dick Michaels.
- Joe Middleton**, 2212 Clays Mill Rd., Lexington, KY, 40503, (606) 278-4194, Pres.: Joe Middleton.
- Ann J. Morton Promos., & Public Relations**, PO Box 40364, Nashville, TN, 37204, (615) 297-8076, (615) 292-1539, Fax: (615) 292-0752, Pres.: Ann J. Morton; Pub. Rel. Dir.: Bill White.
- Music Factory Ents. Inc.**, Ste. 300, Ford & Washington Streets, Norristown, PA, 19401, (215) 277-9550, Pres.: Jeffrey Calhoun; Sales Mgr.: Jamie Bones; Mktg. Dir.: Dan Charles; Studio Mgr.: Linda Hoverson.
- Music Town Dist. & Promotions**, 830 Glastonbury Rd., #614, Nashville, TN, 37217, (615) 361-7902, Pres.: Cliff Ayers Ostermeyer; Sales Mgr.: Yvonne Mathews.
- Nationwide Sound Distributors, Inc.**, PO Box 23262, 1012 18th Ave. S., Nashville, TN, 37212, (615) 327-7988, Fax: (615) 321-0464, Pres.: Joe Gibson; Sales Mgr.: David N. Gibson.
- Nic Of Tyme Prods. Inc.**, PO Box 1994, 3333 Hedge Maple Cr., South Bend, IN, 46634, (219) 271-7291, Pres.: Tony Nicoletto; Sales Mgr./Mktg. Dir.: Jennifer Woods.
- Slick Norris Artists & Promos.**, PO Box 653, Highlands, TX, 77562, (713) 424-2335, Pres.: Slick Norris.
- Paradiso, Inc.**, PO Box 797, 21 Trails End Rd., Wilton, CT, 06897, (203) 762-5188, Fax: (203) 834-2810, Pres.: Ludwig Von Kleydorff; Office Mgr.: Iris A. Thomas.
- Park Avenue Prods.**, 90 Thacher Brook Cir., Ste. 10, Attleboro, MA, 02703, (617) 222-4837, Pres.: Richard D. Perez.
- Wade Pepper Promos.**, 1195 Mt. Paran Rd., NW, Atlanta, GA, 30327, (404) 233-5167, Fax: (404) 325-1075, Pres.: Wade G. Pepper.
- Brett W. Perkins Ents.**, 360 S. Euclid Ave., Ste. 136, Pasadena, CA, 91101, (818) 577-3978, Pres.: Brett W. Perkins.
- Pioneer Recording Studio, Inc.**, 4238 Ramsgate, Bloomfield Hills, MI, 48302, (313) 855-1466, Fax: (313) 855-1231, Pres.: Gary A. Rubin; Vice Pres./Sale Mgr.: Tom Connors.
- Platinum Music Network**, 80 Broad St., Ste. 13M, Red Bank, NJ, 07701, (908) 842-8842, Pres.: Steve Zuckerman; Sales Mgr.: David Stefaniz.
- Prairie Sun Recording Studio**, PO Box 7084, Cotati, CA, 94931, 1039 Madrone Ave., Cotati, CA, 94928, (707) 795-7011, Pres./Mktg. Dir.: Mark "Mooka" Rennick; Opns. Mgr.: Jeffrey Sloan.
- Premier Film & Recording Corp.**, 3033 Locust St., Saint Louis, MO, 63042, (314) 531-3555, Fax: (314) 726-8798, Pres.: Wilson Datzel; Sales Mgr.: Donna Blue; Mktg. Dir.: Bob Heuermann.
- Jack Pride Promo.**, 5156 Ashley Dr., Nashville, TN, 37211, (615) 331-3008, Fax: (615) 331-3009, Owner: Jack Pride.
- Pro/Creatives**, 25 W. Burda Pl., New City, NY, 10956, Pres.: David Rapp.
- Pro-Motion**, PO Box 38133, 7027 Twin Hills Ave., Dallas, TX, 75238, (214) 340-3353, Pres.: Bobby Dennis.
- Programming Aids For Progressive Radio**, PO Box 1805, Church St. Sta., New York, NY, 10008, Pres.: Jay Rosen.
- The Promotion Dept.**, PO Box 93666, Los Angeles, CA, 90093, (213) 468-1010, Fax: (213) 468-1011, Pres.: Kenny Ryback.
- Public Information Network (P.I.N.)**, 3217 Dona Emilia Dr., Studio City, CA, 91604, (213) 650-1685, (213) 650-7985, Fax: (213) 650-4605, Pres.: Lilly Lipton; Sales Mgr.: Bobbie Cooker; Mktg. Dir.: Denise Marcotte.
-
-
- RCI Records, Inc.**
PO Box 110802, Nashville, TN, 37222, (615) 833-2052, Pres.: Ray Roberts.
-
-
- Record Co. of the South (RCS)**, 5220 Essen Ln., Baton Rouge, LA, 70809, (504) 769-2996, Fax: (504) 766-4112, Pres.: Cyril E. Vetter; Sales Mgr.: Johnny Palazzotto.
- Record Room**, 308 E. Evesham Rd., Glendora, NJ, 08029, (609) 939-0034.
- Tony Richland Promo.**, 417 Spencer St., Glendale, CA, 91202, (818) 548-1332, Fax: (818) 548-7423, Pres.: Tony Richland; Sales Mgr.: Annie Richland; Mktg. Dir.: Mary Lou Richland.
- Ray Roberts Promos.**, PO Box 110802, Nashville, TN, 37222, (615) 833-2052, Pres.: Ray Roberts.
- Ray Roberts Promos.**, 405 Tarrytown Rd., Ste. 335, White Plains, NY, 10607, (914) 997-7004, Pres.: Ray Roberts.
- Rockbill, Inc.**, 228 E. 45th St., New York, NY, 10017, Pres.: Jay I. Coleman; Exec. Dir.: Joshua C. Simons.
- Round The Globe Music, Ltd.**, 145 W. 28th St., 10th Floor, New York, NY, 10003, (212) 947-5575, Fax: (212) 947-5575, Pres.: Neil Levine; Mktg. Dir.: Christine Book.
- Ruppenthal Ent.**, PO Box 235, Berkeley Springs, WV, 25411, (304) 258-2627, Pres./Sales Mgr.: Virgil H. Ruppenthal; Mktg. Dir.: Betty J. Ruppenthal.
- SRO Marketing**, 373 N. La Cienega Blvd., Los Angeles, CA, 90048, (213) 652-9002, Fax: (213) 659-6317, Pres.: Scott Martin; Sales Mgr.: Christopher Johnsen; Mktg. Dir.: Joe Pizzella; Opns. Mgr.: Lily Li.
- School of Modern Recording**, 753 Capitol Ave., Hartford, CT, 06106, (203) 951-8175, Pres./Dir.: Jack Stang.
- Scyne Records**, PO Box 1843, 93 Garfield Ave., Lynn, MA, 01903, (617) 581-1931, Contact: J.D. Brennan.
- Dave Segel Promos.**, 1304 Cranwood Sq. S., Columbus, OH, 43229, (614) 885-2789, Fax: (614) 846-7036, President/Contact: Dave Segel.
- Silco Prods.**, PO Box 4096, Leon Sta., Tallahassee, FL, 32315, (904) 385-1302, Owner: Lou Miller.
- The Spacek Co.**, PO Box 741506, Dallas, TX, 75374, (214) 340-7600, Fax: (214) 644-0555, Pres.: Ed Spacek.
- Saul Star Promos. Unlimited**, 6940 Carriage Hills Dr., Canton, MI, 48187, (313) 981-6625, Pres.: Saul Star.
- Greg Steffen Nat'l Music Mktg. Services**, PO Box 8446, Berkeley, CA, 94707, (510) 527-1861, Fax: (510) 527-9262, Pres./Mktg. Dir.: Greg Steffen.
- Skip Stevens Promos.**, 803 18th Ave. S., Nashville, TN, 37203, (615) 329-4499, Owner: Skip Stevens.
- Strata-East Records**, PO Box 36 GCS, New York, NY, 10163, Pres.: Charles Tolliver.
- Strategies & Solutions, Inc.**, 331 Webster Dr., New Milford, NJ, 07846, (201) 262-4111, Pres.: Zelda Abrams; Mng. Dir.: Sol Abrams.
- Peter Svendsen, Inc.**, PO Box 297, Cleburne, TX, 76033, 822 N. Main St., Cleburne, TX, 76031, (817) 641-7875, Fax: (817) 641-7876, Owner/Pres.: Peter Svendsen.
- Telegrams Inc.**, 150 Nassau St., Ste. 830, New York, NY, 10038, (212) 227-5966, Fax: (212) 571-0834, Pres.: Christopher A. Russo; Sales Mgr.: Glenn R. Evans; Mktg. Dir.: Adrienne Scott.
- Nick Terry Record Promo.**, 3008 Belden Dr., Los Angeles, CA, 90068, (213) 469-2719, Fax: (213) 464-2272.
- Rik Tinory Prods.**, PO Box 311, Cohasset, MA, 02025.
- Trac Record Co.**, 170 N. Maple, Fresno, CA, 93702, (209) 255-1717, Pres.: Stan Anderson.
- Trade Service Corp.**, 10996 Torreyana Rd., San Diego, CA, 92121, (619) 457-5920, Fax: (619) 5469002, Pres.: James A. Simpson; Sales Mgr.: Charles Pyce; Mktg. Dir.: Robin Lensman; Mktg. Dir.: Dan Henehan.
- VAAM Music Record Promos.**, PO Box 29688, Hollywood, CA, 90029, (213) 664-7765, Pres.: Peter Martin.
- Johnny Vee Promos.**, 1058 E. Saint Catherine, Louisville, KY, 40204, (502) 637-2877, Fax: (502) 637-6199, Pres./Artist Pro: John V. Heath; Sales Mgr./Mktg. Dir.: Mae Heath.
- Warner Elektra Atlantic Corp. (WEA)**, 8 Winchester Pl., Winchester, MA, 01890, (617) 721-1991, Fax: (617) 721-0062, Sales Mgr.: Dennis M. O'Malley; Field Sales Mgr.: Dann Cotter; Mktg. Dir.: Barbi Hodges.
- Bill Wence Promos.**, PO Box 110829, Nashville, TN, 37222, 2473 Rocky Fork Rd., Nolensville, TN, 37135, (615) 776-2060, Fax: (615) 776-2181, Owner/Pres.: Bill Wence.
- Westworld Records/Carriage Music B.M.I. Co.**, 3966 Standish Ave., Cincinnati, OH, 45213, (513) 793-8191, (513) 559-1210, Owner/Pres.: Roosevelt Lee; Sales Mgr.: Ronald Lee.
- Sylvia White**, 2383 Union St., #4, San Francisco, CA, 94123.
- Curtis Wood Record & Tape Dist.**, 4416 Eatons Crk. Rd., Nashville, TN, 37218, (615) 876-1729, Fax: (615) 244-4314, Pres.: D.M. Haddock; Sales Mgr.: Durwood Haddock; Mktg. Dir.: D.B. Bolling.
- XJD Corp.**, 2023 W. Carroll Ave., Chicago, IL, 60612, (312) 226-1299, Fax: (312) 226-2637, Pres.: Tim J. Boeglin; Sales Mgr.: Jeff N. Given.

SCHOOLS & INSTRUCTION

- Austin Community College**, PO Box 140707, Austin, TX, 78714, (512) 832-4806, (512) 932-4780, Dept. Head/Music Mgmt.: David Jones.
(Music)
- Belmont University (Music Business Dept.)**, 1900 Belmont Blvd., Nashville, TN, 37221, (615) 386-4504, Fax: (615) 385-6455, Pres.: Dr. William E. Troutt; Music Bus. Dir.: Robert E. Mulloy.
- Berklee College of Music**, 1140 Boylston St., Boston, MA, 02215, (617) 266-1400, Fax: (617) 336-2632, Pres.: Lee Elliot Berk; Mktg. Dir.: David J. Semanco; Dir. of Admissions: Steven Lipman.
(Engineering, Music)
- Bregman Electronic Music Studio**, Dartmouth College, Hanover, NH, 03755, (603) 646-3960, Dir.: Jon Appleton.
(Music)
- California State University, Dominguez Hills**, 1000 E. Victoria St., Carson, CA, 90747, (213) 516-3543, Music Dept. Chrmn.: Dr. Rod Butler.
- Cayuga Community College**, 197 Franklin St., Auburn, NY, 13021, (315) 255-1743, Fax: (315) 255-2050, Broadcasting Dept. Coord.: Steven Keeler.
- Center For The Media Arts**, 226 W. 26th St., New York, NY, 10001, (212) 299-5900, Fax: (212) 463-0746, Vice Pres.: Michael Martin; Admissions Dir.: Joyce Shelfo; Adv. Mgr.: Christine Nicholas.
- College for Recording Arts**, 665 Harrison St., San Francisco, CA, 94107, (415) 781-6306, Fax: (415) 781-0115, Pres.: Leo De Gar Kulka; Registrar: Patricia Kulka.
- College of St. Rose**, 432 Western Ave., Albany, NY, 12203, (518) 454-5718, Fax: (518) 438-3293, Program Dir.: Mary Ann Nelson.
(Engineering, Music)
- Columbia Audio/Video**, Second & Laurel, Highland Park, IL, 60035, (800) 256-2184, Fax: (800) 356-2188, Pres.: Norman Rozak; Sales Mgr.: Bruce Berg.
- Conservatory of Recording Arts & Sciences**, 1110 E. Missouri, Ste. 400, Phoenix, AZ, 85014, (602) 493-9898, Fax: (602) 277-6552, Pres.: Jacqueline Vican; Financial Aid Officer: Sue Jenkins.
- Eastern Artist Recording Studio**, 36 Meadow St., East Orange, NJ, 07026, (201) 673-5680, Pres.: Bill Galentz; Sales Mgr.: Mike Theodore.
- Eastman School of Music**, 27 Gibbs St., Rochester, NY, 14604.
(Music)
- Elizabeth City State University**, ECSU Dept. of Music, Box 809, Elizabeth City, NC, 27909, (919) 335-3377, Dir.: Dr. Scott Fredrickson; Dir.: Barry R. Hill.
(Engineering, Music)
- Elmhurst College Music Business Prog.**, 190 Prospect, Elmhurst, IL, 60126, (708) 617-3515, Program Dir.: Tim Hays; Admissions Dir.: Doug Beach.
- F.I.R.S.T./Studio Design & Construction**, PO Box 1121, Franklin, TN, 37065, (615) 794-3360, Fax: (615) 794-3660, Pres./Dir.: Danny M. Hillely.
(Engineering)
- Five Towns College**, 2165 Seaford Ave., Seaford, NY, 11783, (516) 783-8800, Fax: (516) 783-0568, Assoc. Dean: Martin Cohen; Admissions Officer: Jennifer Roemer.
- Full Sail Center for the Recording Arts**, 3300 University Blvd., Winter Park, FL, 32792, (407) 679-0100, Fax: (407) 671-1112, Pres.: Steve Phelps; Sr. Vice Pres.: Garry Jones.
- Fullerton College-Music Dept.**, 321 E. Chapman Ave., Fullerton, CA, 92634, (714) 992-7296, Instructor: Alex Cima.
- Hutchinson Technical College**, 2 Century Ave., Hutchinson, MN, 55350, (612) 587-3636, (800) 222-4424, Fax: (612) 587-9019, Pres.: Dick Lennes; Dept. Chrmn.: David Igl.
(Engineering)
- Institute of Audio Research**, 64 University Pl., New York, NY, 10003, (212) 677-7580, Fax: (212) 677-6549, Pres.: Albert B. Grundy; Dir.: Miriam Friedman; Admissions Dir.: Mark Kahn.
(Engineering)
- Institute of Audio-Video Engineering**, 1831 Hyperion Ave., Hollywood, CA, 90027, (213) 666-2380, Fax: (213) 660-1007, Pres.: Chaba Mehes; Mktg. Dir.: Dominic A. LaCasse.
- JTM Workshop**, PO Box 686, Knox, PA, 16232, (212) 797-5883, Pres.: Frank T. Battista.
(Engineering)
- Los Angeles City College**, 855 N. Vermont Ave., Los Angeles, CA, 90029, (213) 669-5545, Fax: (213) 666-4294, Pres.: Edwin Young; R-TV-F Chrmn.: Robert Stahley.
(TV/Film College)
- Loyola University**, Recording Studio, New Orleans, LA, 70118, (504) 865-3037, Dir.: Sanford Hinderlie.
(Music)
- McLennan Community College Commercial Music Program**, 1400 College Dr., Waco, TX, 76708, (817) 750-3578, Pres.: Dennis Michaels; Dir., Commercial Music Prog.: David Hibbard.
(Music)
- Memphis State University-Commercial Music Prog.**, CFA 232, Memphis, TN, 38152, (901) 678-2559, Fax: (901) 678-5118, Div. Coord.: Larry Lipman.
- Middle Tennessee State University**, R.I.M. Dept., PO Box 21, 1500 Greenland Dr., Murfreesboro, TN, 37132, (615) 898-2578, Fax: (615) 898-5682, Pres.: Dr. James Walker; Dean: Dr. Edward Kimbrell; Dept. Chrmn.: Dr. Richard D. Barnett.
(Music)
- Midland College-Commercial Music Studies/Audio Technology**, 3600 N. Garfield, Midland, TX, 79705, Dir.: Robert Hunt.
- The Music Business Institute**, 3376 Peachtree Rd., NE, Atlanta, GA, 30326, (404) 266-2662, Owner: Art Institute of Atlanta; Music Business Dept. Dir.: Louis L. Lewow.
(Audio, Video & Entertainment)
- Music Business Technology Program**, 777 Education Bldg., Dept. of Music Prof., New York, NY, 10003, (212) 998-5432.
- Music & Entertainment Industry Educators Assn. (MEIEA)**, Music Dept.-State University College, Oneonta, NY, 13820, (607) 431-3425, Fax: (607) 431-2701, Pres.: Janet Nephle.
- Music Factory Ents Inc.**, Ste. 300, Ford & Washington Streets, Norristown, PA, 19401, (215) 277-9550, Pres.: Jeffrey Calhoon; Sales Mgr.: Jamie Bones; Mktg. Dir.: Dan Charles; Studio Mgr.: Linda Hoverson.
- Music Mgmt. Assoc. div. of The Sound Column Co.**, PO Box 70784, Salt Lake City, UT, 84170, 3596 S. Acoma St., Salt Lake City, UT, 84120, (801) 355-5327, Fax: (801) 363-9700, Pres.: Ron Simpson.
- Musicians Institute**, 1655 McCadden Pl., Hollywood, CA, 90028, (213) 462-1384, Fax: (213) 462-6978, Pres.: Pat Hicks; Sales Mgr.: Dean Brown; Mktg. Dir.: Tina Fodrey.
(Music)
- Nat'l Assn. of Schools of Music**, 11250 Roger Bacon Dr., Ste. 21, Reston, VA, 22090, (703) 437-0700, Exec. Dir.: Samuel Hope.
- Ohio University, School of Telecommunications**, 9 S. College St., Athens, OH, 45701, (614) 593-4860, Instructor: Jeff Redefier.
- Platinum Music Network**, 80 Broad St., Ste. 13M, Red Bank, NJ, 07701, (908) 842-6842, Pres.: Steve Zuckerman; Sales Mgr.: David Stefaniz.
- Prairie Sun Recording Studio**, PO Box 7084, Cotati, CA, 94931, 1039 Madrone Ave., Cotati, CA, 94928, (707) 795-7011, Pres./Mktg. Dir.: Mark "Mooka" Rennick; Opns. Mgr.: Jeffrey Sloan.
(Engineering)
- Radio Central**, 548 S. Spring St., #815, Los Angeles, CA, 90013, (213) 623-7589, Pres.: David B. Sigler; Sales Mgr.: C.T. Hampson.
(Tape Dupl. & RCDR Studio)
- The Recording Workshop**, 455 Massieville Rd., Chillicothe, OH, 45601, (614) 663-2544, Fax: (614) 663-2427, Pres.: Jim Rosebrook; Sales Mgr.: Nancy Coltrill; Mktg. Dir.: Paul Pollard.
- A Richman Piano/Synth Training**, 15840 Ventura Blvd. #844-A, Encino, CA, 91436, (818) 344-3306, Pres.: Howard Richman.
(Music)
- Rosewood Audio Recording Institute**, PO Box 222, Knoxville, TN, 37901, (615) 573-5555, Fax: (615) 694-4004, Pres.: John Lods; Contact: Mike Mallowee.
(Engineering)
- SUNY at Oswego, Communication Studies**, 2 Lanigan Hall, Oswego, NY, 13216, (315) 341-2357, Fax: (315) 341-3195, Pres.: Dr. Stephen Weber; Broadcasting Coord.: Fritz Messere.
- School of Modern Recording**, 753 Capitol Ave., Hartford, CT, 06106, (203) 951-8175, Pres./Dir.: Jack Stang.
- The Singing Machine Co., Inc.**, 6350 E. Rogers Cir., Boca Raton, FL, 33487, (407) 994-3100, Fax: (407) 997-8701, Pres.: Eugene B. Settler; Sales Mgr.: Richard Borden.
(Music)
- Songwriters' Network**, PO Box 190446, Dallas, TX, 75219, (214) 842-2739, Pres.: Phil Ayliffe.
(Music, Home Study Correspondence)
- Southern Ohio College**, 1055 Laidlaw Ave., Cincinnati, OH, 45237, (513) 242-3791, Dept. Chrmn.: Mark R. Turner; Pres.: Ron Rountree; Sales Mgr.: Eunice Punghorst.
(Engineering, Audio/Video Prod.)
- Sunset Prodn.**, 117 W. Eighth, Hays, KS, 67601, (913) 625-9634, Fax: (913) 625-5757, Pres.: Mark Meckel.
(Engineering)
- Trade Service Corp.**, 10996 Torreyana Rd., San Diego, CA, 92121, (619) 457-5920, Fax: (619) 5469002, Pres.: James A. Simpson; Sales Mgr.: Charles Pyce; Mktg. Dir.: Robin Lensman; Mktg. Dir.: Dan Henehan.
- Trebas Institute of Recording Arts**, 6464 Sunset Blvd., The Penthouse, Hollywood, CA, 90028, (213) 467-6800, Fax: (213) 467-0946, Pres.: David P. Leonard; Sales Mgr.: Natasha Kabrinsky; Mktg. Dir.: Wyn Tunncliffe.
(Engineering, Music)
- UCLA Extension**, 10995 La Conte Ave., Los Angeles, CA, 90024, (800) 388-8252, (213) 825-9064, Fax: (213) 206-7382.
(Continuing education)
- Unity Gain Recording Inst.**, 2976-F Cleveland Ave., Fort Myers, FL, 33901, (813) 332-4246, Pres.: Anthony Iannucci.
- University of Massachusetts/Lowell Sound Recording Technology**, College of Music, One University Ave., Lowell, MA, 01854, (508) 934-3850, Dir.: William Moylan.
(Engineering, Recording)
- University of Miami School of Music**, PO Box 248165, 1314 Miller Dr., Coral Gables, FL, 33124, (305) 284-2245, Fax: (305) 284-6475, Dean: Dr. William Hipp; Admissions Dir.: Kenneth J. Moses.
(Music)
- University of New Haven-Music & Sound Recording Program**, 300 Orange Ave., West Haven, CT, 06516, (203) 932-7101, Chrmn.: Michael G. Kaloyanides.
- University of Northern Colorado**, Frasier 108, School of Music, Greeley, CO, 80639, (303) 351-2678, Fax: (303) 351-1923, Mktg. Dir.: Susan Nelson; Admin. Asst.: Mark Aderson.
- University of Southern California**, School of Music, Mus 409, Los Angeles, CA, 90089, (213) 740-6935, Fax: (213) 747-4176, Dir., Recording Arts: Richard J. McIlvery; Sec.: Lawrie Vandebrooke.
- Webster University-Dept. of Media Communications**, 470 E. Lockwood, Webster Groves, MO, 63119, (314) 968-6924, Chrmn.: Dr. Art Silverblatt; Asst. Professor: Barry Hulker.
- Western Sound Studios/Western Michigan University**, School of Music, Kalamazoo, MI, 49008, (616) 387-4720, Pres.: John Campos; Sales Mgr.: John Campos.
(Engineering)
- Wind River Broadcast Ctr.**, 329 E. Third, Loveland, CO, 80537, (303) 669-3442, Pres.: James R. McDonald; Sales Mgr.: N.J. McMillen.
(Studio Design Consultants)

Get answers to today's critical manufacturing questions on package design  duplicators  replicators  barcoding  shrinkwrapping  equipment and blank tape  & jewel box  suppliers

Get Billboard's 1991 TAPE/DISC DIRECTORY
(Formerly the International Manufacturing & Packaging Directory)

For fastest service call (800) 344-7119, in NJ (908) 363-4156
Or (800) 223-7524, in NY (212) 536-5174
Or send check/money order for \$35 (includes S&H) w/ this ad to
Billboard Directories, PO Box 2016, Lakewood NJ 08701.
Add appropriate sales tax in NY, NJ, CA, TN, MA, IL & DC
Plus \$5 per directory for foreign orders.



BD1B7171

In this section...

- Blank & Bulk Tape Manufacturers
- Blank Tape Loaders
- Consumer Tape Product Charts
- Pro Tape Product Charts
- Cartridges, Cassettes, Reels & Other Parts
- Jewel Box Manufacturers
- Raw Materials
- Envelopes & Mailers
- Jackets & Sleeves
- Labels
- Polybags & Shrinkwrap

Materials & Supplies

BLANK & BULK TAPE MANUFACTURERS

Ampex Recording Media Corp., 401 Broadway, M/S 22-02, Redwood City, CA, 94063, (415) 367-2011, Fax: (415) 367-4132, Pres.: Thomas J. Wheeler; Vice Pres. Sales: Richard A. Antonio; Mktg./Audio: Steve Smith; Mktg. Mgr./Video: Michael Wilke.

Ampex Recording Media Corp., 37 Music Sq. E., Nashville, TN, 37203, (615) 242-0022, (800) 241-3258, Fax: (615) 244-5207, Sr. Sales Engineer: Tom Clark.

Amtron, Inc., 2867 S. Vail., Commerce, CA, 90040, (213) 721-1717, Fax: (213) 721-1902, Pres.: Stanley Wong; Mktg. Dir.: David Yiu; Sales Mgr./Pro.: Yed Yen.

Audio Accessories Co., 25 Connecticut Ave., Enfield, CT, 06082, (708) 879-5998, Tape Sales Mgr.: John S. Maloney.

Audiopak, Inc., PO Box 3100, 1680 Tysons Dr., Winchester, VA, 22601, (703) 667-8125, Fax: (703) 667-6379, Pres.: Nick Krassowski.

Audiopak, Inc., 897 Oakpark Blvd., Ste 278, Pismo Beach, CA, 93449, (805) 481-8278, Fax: (805) 481-8729, Sales Mgr.: Gordon Stafford.

Aurex-Auriga, 1122 E. Lincoln Ave., Orange, CA, 92665, (714) 637-6800, Fax: (714) 637-3062, Dir. U.S. Opns.: Jerry Bronaugh; Sales Mgr.: Dennis Schleich.

Avanti Products, 8885 NW 23 St., Miami, FL, 33172, (305) 592-7830, Fax: (305) 591-3629, Pres.: Al Cortina; Sales Mgr.: Ed Maty.

BASF Corp Information Systems

35 Crosby Dr., Bedford, MA, 01730, (617) 271-4000, Exec. Vice Pres.: Hans Schmidt; Vice Pres. Mktg/Sales: Daniel Malcorp; Mktg. Comm. Mgr.: Teri Sosa; Dir. Sales: Terence D. O'Kelly; Consumer AV Sales Dir.: Andrew DaPuzzo; Professional Prod. Mgr.: Jo Anne Alliber; Retail Prod. Mgr.: Claude Guerlain.

Canon USA, Inc., Video Div., One Canon Plaza, Lake Success, NY, 11042, (516) 488-6700, Fax: (516) 354-5117, Pres.: H. Takemoto; Mktg. & Promos.: E. Yoshinari; Regional Sales Mgr.: K. Miura.

Certron Corp., 4929 Wilshire Blvd., Ste. 265, Los Angeles, CA, 90010, (213) 954-0477, (800) 854-3943, Fax: (213) 954-1732, Chrmn./CEO/Pres.: Marshall Kass.

CintasVAC, div. of Cintas Technologies, Inc., 1207 5th St., Imperial Beach, CA, 92032, (904) 445-5545, Fax: (904) 446-0964, Pres.: Ron Schneider; Dir. Sales/Marketing: Robert Piselli.

Columbia Magnetics/Sony Music Entertainment Inc., PO Box 1528, 5152 Columbia Dr., Carrollton, GA, 30117, (800) 654-4277, (404) 836-2000, Fax: (404) 836-2276, Vice Pres. Mktg.: Tony Formichelli; Opns. Dir.: Cher Anderson; Sales Rep.: Phil Deets.

DIC Digital

222 Bridge Plaza S., Fort Lee, NJ, 07024, (800) 328-1342, (201) 224-9344, Fax: (201) 224-9363, Pres.: Joseph Martinez; Nat'l Mktg. Mgr.: Kevin Kennedy; Audio/Video Tape Sales Mgrs.: Russ Brown, Jack Valdespino.

Denon America, Inc., Tape Div.

14849 E. Northam St., La Mirada, CA, 90638, (714) 994-0400, Fax: (714) 994-2222, Pres.: Robert Heiblm; Audio/Video Tape Sales Mgr.: Joe D'Angelo.

Douglas-Hanson Co., Magnetic Media Div., PO Box 207, 1565 Davis St., Hammond, WI, 54015, (800) 537-5327, Fax: (715) 796-2400, Pres.: Chris Hanson; Sales Mgr.: Jeff Hanson.

EMC Group, 655 Skyway Rd., Ste. 225, San Carlos, CA, 94070, (415) 591-9500, Fax: (415) 591-9641, Contacts: T.L. "Fred" Evans, Dawn Dangidang.

Eastman Kodak Co., Consumer Imaging Div., 343 State St. Eighth Floor, Bldg. 10, Rochester, NY, 14650, (716) 724-4638, Fax: (609) 853-2231, Contact: Tony Berardi.

Fidelipac Corp., PO Box 808, 97 Foster Rd., Moorestown, NJ, 08057, (609) 235-3900, Fax: (609) 235-7779, Pres./Mktg. Dir.: Roger Thanhauser; Sales Mgr.: Scott Martin.

Fuji Photo Film U.S.A., Inc., Pro/Consumer Div., 555 Taxter Rd., Elmsford, NY, 10523, (914) 789-8100, Fax: (914) 789-8490, Pres.: Stan Bauer; Sales Mgr.: Robert Kuczik; Product Mgr./Audio: William N. Drysdale; Pro Videotape Prod. Mgr.: Tom Daly.

Gemini Industries, Inc., 3040 Holcomb Bridge Rd., #A2, Norcross, GA, 30071, (201) 471-9050, (800) 526-7452, Fax: (201) 471-5174, Pres.: Sandor Garfinkle; Mktg. Dir.: Frank Natofl.

Goldstar Electronics Int'l, Inc., 1000 Sylvan Ave., Englewood Cliffs, NJ, 07632, (201) 816-2149, (216) 846-2000, Fax: (201) 816-0742, Pres.: Peter Suh; Bulk Tape Sales Mgr.: Charles

Han; Dir. Sales & Mktg.: Mitchell Ravitz; Goldstar Tape Sales Mgr.: Lauren Fratello.

JVC Co. of America, Consumer Products Div., 41 Slater Dr., Elmwood Park, NJ, 07407, (201) 794-3900, Fax: (201) 523-3601, Pres.: Hiroshi Sano; Vice Pres. Tape Merchandising: Terry Kikuchi; Nat'l Sales Admin. Magnetic Tape Div.: Susan M. Tirgrath.

JVC Magnetics America Co.-Westcoast, 5665 Corp. Ave., Cypress, CA, 90630, (714) 527-7500, Fax: (714) 952-2405, Nat'l Sales Mgr. Pro Tape: Fred MacKenzie.

JVC Magnetics America Co., 1 JVC Rd., Tuscaloosa, AL, 35405, (205) 556-7111, Pro Sales Coord.: Jennifer Hamel.

Kolon Scena, Inc., 180 Passaic Ave., Fairfield, NJ, 07006, (201) 575-2550, Fax: (201) 575-1332, Pres.: Kwang Mo Lee; Dir.: M. Y. Yu; Tape Sales Mgr.: C. Y. Lee.

Konica U.S.A., Inc., 440 Sylvan Ave., Englewood Cliffs, NJ, 07632, (201) 568-3100, Fax: (201) 569-2167, Pres.: M. Kimura; Vice Pres. Sales: Dick Carter; Mktg. Dir./Adv. Mgr.: Paul Gordon; Mktg. Service Mgr.: Dennis Puccio.

Lion Recording Services, Inc., 7532 Fullerton Ct., Springfield,

VA, 22153, (703) 569-3200, Fax: (703) 455-5600, Pres.: Harold Lion; Sales Mgr.: Karen Blackhall; Mktg. Dir.: Richard Lion.

Magnetic Media Corp., 150 Broad Hollow Rd., Melville, NY, 11747, (516) 424-7580, Fax: (516) 424-7621, Pres.: Aaron Wasserstrom; Sales Mgr.: John Cristiano.

Master Hi-Tech Video (USA), PO Box 5141, 876 Tanager, Inciine Village, NV, 89450, (702) 831-8800, (800) 678-8330, Fax: (702) 831-7888, Vice Pres. Sales/Mktg.: Jan Backman.

Maxell Corp. of America, 22-08 Rt. 208 South, Fair Lawn, NJ, 07410, (201) 794-5900, Fax: (201) 796-8790, Pres.: Mr. Matsumoto; Gen. Mgr. Pro/Ind. Div.: James J. Ringwood; Product Mgr.: Pat Byrne; Nat'l Sales Mgr./Consumer: Peter Brinkman.

MemTek Products (Memorex), PO Box 901021, 1600 Two Tandy Center, Fort Worth, TX, 76101, (817) 878-6700, Fax: (817) 878-6745, Gen. Mgr.: Linda Lambert; Audio/Video Sales Mgr.: Dwight Brandt; Mktg. Mgr.: Dave Williams; Mktg. Asst.: Shelagh Merrill.

Nakamichi America Corp., 19701 S. Vermont Ave., Torrance, CA, 90502, (213) 538-8150, Fax: (213) 324-7614, Sales Mgr.:

Sound Structure.

You can see it. You can hear it.
Brady Quality.

Audio and video duplicators demand absolute consistency and reliability from their suppliers. Brady's meticulous process controls assure uncompromised performance. Our international sales offices have been restructured to ensure prompt service and delivery worldwide.

Brady B-850 Audio Splicing Tape is an industry standard and the cornerstone of our expanding line of high performance tape products. We are pleased to

announce three new additions:

B-805 Tape Cleaning Fabric. Custom formulated non-woven fabric designed to remove debris from magnetic tape effectively and economically. 1/2" and 1" widths for both audio and video applications.

B-849 Video Splicing Tape features a new acrylic adhesive that provides optimal splice strength while minimizing adhesive buildup on loading equipment.

B-860 Sensing Tape is designed for splicing master tape to clear leader on high-speed video duplication equipment requiring optical sensing.

Brady sales and technical experts are ready to customize products to fit your specialized requirements.

Please call the W.H. Brady Co. office nearest you.

USA

W.H. Brady Co.
phone: 800-662-5688 or 414-961-6073
fax: 414-332-0861

UK

W.H. Brady Co.
phone: 0793-619242
fax: 0793-619243

HONG KONG

W.H. Brady Co.
phone: 852-302-1376
fax: 852-736-5688

BELGIUM

W.H. Brady nv
phone: 32-52-450311
fax: 32-52-450262

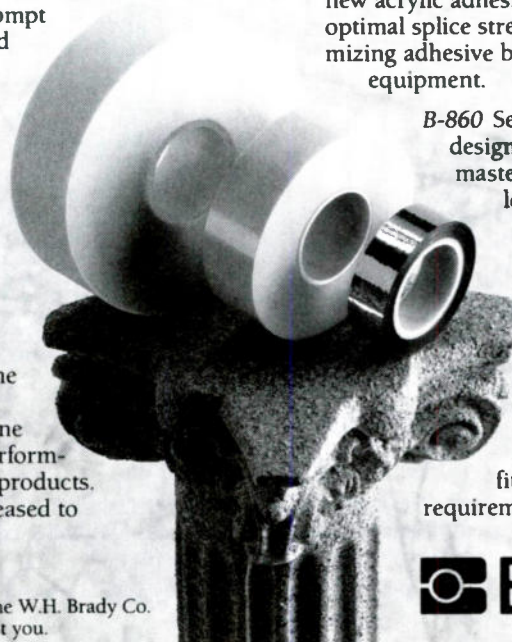

BRADY®

Len Provost; Technical Services Coord.: Hyam R. Sosnow. Nat'l Media Marketing, 419 Main St., Ste. E, Huntington Beach, CA, 92648, (714) 968-4004, Fax: (714) 536-8019, Pres.: Curt Byk.

Nippon Industries, Inc., Video Tape, 12 W. 23rd St., New York, NY, 10010, (212) 929-7700, Contact: Jack Gluck.

Nippon Industries, Inc.—Audio Tape, 210 Hanse Ave., Freeport, NY, 11520, (516) 623-7400, Contacts: George Gluck, Ivan Gluck.

Omni Magnetics Corp., 9500 NW 77th Ave., #B-3, Hialeah, FL, 33016, (305) 826-2191, Fax: (305) 826-4317, Pres.: J. Anthony Lanuza.

Panasonic Co., Special A/V Products, One Panasonic Way, #1B-7, Secaucus, NJ, 07094, (201) 392-6385, Fax: (201) 392-6365, Mktg. Mgr., A/V Products: Brian Hoffman; Audio Sales Mgr.: Bill DiMarzo; Video Sales Mgr.: George Dzan.

Pfanzstiel Chemical Corp., 3300 Washington St., Waukegan, IL, 60085, (708) 623-1360, Fax: (708) 623-9107, Pres.: Merle R. Nelson; Audio/Video Tape Sales Mgr.: Gordon Oakes.

Polaroid Corp., Consumer Video Prods., 549 Technology Sq., Second Floor, Cambridge, MA, 02139, (617) 577-4045, (617) 577-2000, Fax: (617) 577-4941, Pres.: I.M. Booth; Video Tape Sales Mgr.: John Gitelman.

RAKS Corp. of America, Inc., 201 Rt. 17, Ste. 300, Rutherford, NJ, 07070, (201) 438-0119, Fax: (201) 438-3185, Pres.: Sinan Turkomer.

Recoton Corp., 46-23 Crane St., Long Island City, NY, 11101, (718) 392-6442, Fax: (718) 784-1080, Chrmn.: Herbert Borchardt; Pres.: Bob Borchardt; Exec. Vice Pres.: Peter Wish; Dir. Mktg./Communication: Peter Ildau.

SKC America, Inc., 850 Clark Dr., Mount Olive, NJ, 07828, (201) 347-7000, Fax: (201) 347-7522, Pres.: E. H. Kim; Video Tape Sales Mgr.: Ed Havens.

Sentry Industries, 252C Lake Ave., Yonkers, NY, 10701, (914) 968-0180, Pres.: Barry Rosen; Vice Pres.: Daniel Rosen.

Sony Magnetic Products Group of America
1 Sony Dr., Park Ridge, NJ, 07656, (201) 930-7072, Fax: (201) 930-6806, Pres.: Shin Takagi; Professional Product Mgr.: Les Burger; Consumer Product Mgr.: Howard Podolnick; Consumer Product Mgr.: Steve Tenny; Professional Mktg. Dir.: Ken Wiedeman.

Sunkyong Magnetic/America, Inc.

4041 Via Oro Ave., Long Beach, CA, 90810, (213) 830-6000, Fax: (213) 830-0646, Exec. Vice Pres.: US Opns: S.W. Park; Vice Pres., U.S. Opns.: Tom Anderson; Vice Pres. Sales & Mktg.: Mike Ingalls.

Swire Magnetics, 6701 "I" Northpark Blvd., Charlotte, NC, 28216, (704) 597-7145, (800) 777-7947, Vice Pres. Sales: Michael Tremblay.

TDK Electronics, Pro. Prods. Div., 1411 W. 190th St., Ste. 270, Gardena, CA, 90248, (310) 538-5259, Fax: (310) 538-3368, Pres.: Takashi Tsujii; Vice Pres. Industrial Sales: Keizo Ito; Mktg. Dir.: Yoshio Tomazawa; Sales Mgr.: Doug Booth.

TDK Electronics Corp., Consumer Services
12 Harbor Park Dr., Port Washington, NY, 11050, (516) 625-0100, (800) 835-8273, Fax: (516) 625-0171, Pres.: Takashi Tsujii; Sales Mgr.: Chuck Roth; Vice Pres. Sales: Koyo Yokoi; Prod. Mgr.: Steve Diamond.

Tandy Magnetic Media, 1600 Memorex Dr., Santa Clara, CA, 95050, (408) 988-3100, Fax: (408) 982-5102, Pres.: Jack Counts; Audio/Video Sales Mgr.: Terry Semon.

Taylor Video Corp., 1208 W. Isabel St., Burbank, CA, 91506, (818) 954-0919, Fax: (818) 954-0770, Pres.: Rich Hall; Mktg. Dir.: Chris Sauer.

Thomson Consumer Electronics (RCA/GE), 2000 Clements Bridge, Deptford, NJ, 08096, (609) 853-2266, (609) 853-2223, Fax: (609) 853-2231, RCA & GE Nat'l Mktg. Mgr.: David Helterbran; RCA & GE Nat'l Sales Mgr.: James Heji.

3M Co. Professional Audio/Video, 3M Center, Bldg. 223-5N-01, Saint Paul, MN, 55144, (612) 733-1110, Fax: (612) 737-5583, Vice Pres.: Dr. Ennio Fatuzzo; Professional Sales Mgr.: Joseph L. Leon; Mktg. Dir.: Donald E. Rushin; Communications Dept.: Linda Nebur.

3M Co. Alaska Branch, 11151 Calaska Cir., Anchorage, AK, 99515, (907) 522-5200, Fax: (907) 522-1645, Contact: Jackie Wise.

3M Consumer Video & Audio Prods. Div., 3M Center, 223-5N-01, Saint Paul, MN, 55144, (800) 343-8077, (612) 738-9320, Div. Vice Pres.: Fred Harris; Nat'l Sales Mgr.: Jack Manely; Video Pancake Sales: Frank Russomano.

3M Hawaii & Guam, PO Box 30048, 4443 Malaai St., Honolulu, HI, 96818, (808) 422-2721, Fax: (808) 422-9557, Contact: Ernest Miki.

Unimagnetics USA, 1513 Sixth St., Ste. 204, Santa Monica, CA, 90401, (310) 393-1572, (800) 366-1176, Fax: (310) 451-0143, Sales Mgr.: Alex Tann; Customer Service: Terry Follonier.

Universal Security Instruments, Inc., 10324 S. Dolfield Rd., Owings Mills, MD, 21117, (301) 363-3000, Fax: (301) 363-2218, Pres.: Michael Kovens; Sr. Vice Pres., Sales & Mktg.: Robert Barnes; Video Tape Sales Mgr.: Burton Cohen.

BLANK TAPE LOADERS

Adams Magnetic Products, Inc., PO Box 597, 405 Plaza Rd. N., Fairlawn, NJ, 07410, (201) 652-6112, Fax: (201) 797-7369, Pres.: Bernie Adams.

American Magnetics, 5431-R Jonestown Rd., Harrisburg, PA, 17112, (717) 652-8000, Fax: (717) 652-9050, Pres.: A. L. Newhart, Jr.; Mktg. Dir.: Alan Newhart; Sales Mgr.: Glen Newhart.

Amtron, Inc., 2867 S. Vail, Commerce, CA, 90040, (213) 721-7177, Fax: (213) 721-1902, Pres.: Stanley Wong; Mktg. Dir.: David Yiu; Sales Mgr./Pro.: Yed Yen.

Andol Audio Products, Inc., 4122 14th Ave., Brooklyn, NY, 11219, (800) 221-6578, (718) 435-7322, Fax: (718) 853-2589, Pres.: Anthony Maniere; Sales Mgr.: Domenick Salvatore.

ARCAL Corp., 2732 Bay Rd., Redwood City, CA, 94063, (415) 369-7348, Fax: (415) 369-7446, Pres.: Sal Viola; Sales Mgr.: Steve Viola.

Audio Accessories Co., 25 Connecticut Ave., Enfield, CT, 06082, (708) 879-5998, Tape Sales Mgr.: John S. Maloney.

Burlington Audio/Video Tapes Inc., 106 Mott St., Oceanside, NY, 11572, (516) 678-4414, (800) 331-3191, Fax: (516) 678-8959, Pres.: Ruth Schwartz; Sales: Jan Schwartz; Sales: Tom Marchetti; Technical Assistance: John Clemente.

Crest Cassette Corp., 415 N. Figueroa St., Wilmington, CA, 90744, (213) 835-9677, Fax: (213) 835-7892, Pres.: William DeMucci.

Dixie Entertainment Prods., Inc., 215 Long Beach Blvd., Long Beach, CA, 90802, (310) 491-1082, Pres.: Raymond L. Jacobs; Exec. Vice Pres.: Gil Benzeevi.

Goldstar Electronics Int'l, Inc., 1000 Sylvan Ave., Englewood Cliffs, NJ, 07632, (201) 816-2149, (216) 846-2000, Fax: (201) 816-0742, Pres.: Peter Suh; Bulk Tape Sales Mgr.: Charles Han; Dir. Sales & Mktg.: Mitchell Ravitz; Goldstar Tape Sales Mgr.: Lauren Fratello.

Imperial Tape Co., Inc., 1928 14th St., Santa Monica, CA, 90404, (310) 396-2008, (800) 736-8273, Fax: (310) 396-8894, Pro. Sales Mgr.: Ileana San Martin; Contact: Howard E. Ganz.

Industrial Audio/Film Services, 6228 Oakton, Morton Grove, IL, 60053, (312) 965-8400, Fax: (312) 965-8426, Pres.: Lauren Leifer; Sales Mgr.: Jerry Bly.

Int'l Historic Films, 3533 So. Archer Ave., Chicago, IL, 60609, (312) 927-2900, (312) 436-2427, Mktg. Dir.: Frank Weinberg.

JVC Magnetics America Co.-Westcoast, 5665 Corp. Ave., Cypress, CA, 90630, (714) 527-7500, Fax: (714) 952-2405, Nat'l Sales Mgr. Pro Tape: Fred MacKenzie.

KABA Audio Prods., 24 Commercial Blvd., Novato, CA, 94949, (415) 883-5041, Fax: (415) 382-1417, Pres.: Kenneth A. Bacon; Sales Mgr.: Toni Lynn.

Lion Recording Services, Inc., 7532 Fullerton Ct., Springfield, VA, 22153, (703) 569-3200, Fax: (703) 455-5600, Pres.: Harold Lion; Sales Mgr.: Karen Blackhall; Mktg. Dir.: Richard Lion.

Loran Cassettes & Audio Products, 10-48 Clark St., Warren, PA, 16365, (800) 633-0455, (814) 723-8600, Fax: (814) 723-9490, Pres.: Robert T. Loranger; Audio Tape Sales Mgr.: Randy Britton.

Luna Tapes Ltd., 126 Dayton St., Yellow Springs, OH, 45387, (513) 767-7354, Fax: (513) 767-2282, Pres.: Chris Hertzler; Sales Mgr.: Joe Lee.

Magnetic Products, 27712 Avenue Mentry, Valencia, CA, 91355, (805) 295-8448, Fax: (805) 295-8278, Nat'l Sales Mgr.: Roy G. Lunel.

Magnetic Technologies Inc., 816 18th Ave. S., Nashville, TN, 37203, (615) 254-7001, Fax: (615) 254-4685, Owners: Mack & Maurine Evans.

Maiden America Corp., PO Box 24979, San Jose, CA, 95154, (408) 978-8857.

Maxi Cassette Prodn., Inc., 1442 E. Arrow Hwy., Unit P, Irwindale, CA, 91706, (800) 344-6294, (818) 358-1644, Fax: (818) 357-1666, Pres.: Michael Aris.

Maxima Magnetics, Inc., 300 Bonair Ave., Hatboro, PA, 19040, (215) 443-0700, Pres.: William R. Goss; Sales Mgr.: Carol M. Moore.

National Tape Corp., 1110 48th Ave. N., Nashville, TN, 37209, (615) 383-7881, Fax: (615) 383-1768, Pres.: Jerry Hutchinson; Vice Pres.: Thomas Beld.

National Tape Duplicators, Div. of Ken-Del Prods., Inc., 1500 First State Blvd., First State Prodn. Ctr., Wilmington, DE, 19804, (302) 999-1110, Fax: (302) 999-1656.

The New Alakh Corp., 89 Leuning St., Hackensack, NJ, 07060, (201) 343-2300, Fax: (201) 343-7989, Pres.: Narsing N. Narson.

Premiere AVD Corp., 18080 NE 88th St., Redmond, WA, 98052, (206) 882-1400, Fax: (206) 867-0718, Pres.: George M. Ricci.

Rome Recording Co., 1414 E. Broad St., Columbus, OH, 43205, (614) 253-4418, Pres./Sales Mgr.: Jack Casey.

Sawyer-Bashkin, Inc., 1208 W. Isabel St., Burbank, CA, 91506, (818) 843-1781, (800) 423-7779, Fax: (818) 954-0770, Pres.: Cliff Sawyer; Mktg. Dir.: Leslie Leb; Sales Mgr.: Walter Olson.

Sony Magnetic Products Group of America, 1 Sony Dr., Park Ridge, NJ, 07656, (201) 930-7072, Fax: (201) 930-6806, Pres.: Shin Takagi; Professional Product Mgr.: Les Burger; Consumer Product Mgrs.: Howard Podolnick, Steve Tenny; Professional Mktg. Dir.: Ken Wiedeman.

Soundd Investment, Inc., 3586 Pierce Dr., Chamblee, GA, 30341, (404) 458-1679, Fax: (404) 458-0276, Pres.: Douglas Wilmer; Mktg. Dir.: Audrey Wilmer; Sales Mgr.: Lou Simmons.

Superior Tapes Inc., 5760 Ayala St., Irwindale, CA, 91706, (818) 334-9486, Fax: (818) 334-7365, Pres.: James Cu-Unjieng; Sales Mgr.: Vicki Pineda.

Swire Magnetics Co., 301 E. Alondra Blvd., Gardena, CA, 90248, (213) 515-0494, (800) 421-2448, Fax: (213) 515-0371, Pres.: Jayme DeBarros; Sales Mgr.: Charles Trausch; Mktg. Dir.: M. Tremblay.

Tandy Magnetic Media, 1600 Memorex Dr., Santa Clara, CA, 95050, (408) 988-3100, Fax: (408) 982-5102, Pres.: Jack Counts; Audio/Video Sales Mgr.: Terry Semon.

Unimagnetics USA, 1513 Sixth St., Ste. 204, Santa Monica, CA, 90401, (310) 393-1572, (800) 366-1176, Fax: (310) 451-0143, Sales Mgr.: Alex Tann; Customer Service: Terry Follonier.

Are you making decisions about professional recording equipment and studios?

...Then you need Billboard's 1992 International Recording Equipment and Studio Directory!

Worldwide listings include: •Studio Equipment •Blank Tape Product Charts & Manufacturers
•Studio Equipment Manufacturers •Studio Services •Recording Studio
•Plus an all new 1991 Brand Usage Study!

To order send \$37 plus \$3 S&H, (\$8 for International orders) to:

Billboard Directories

Dept. BDJM1519, P.O. Box 2016, Lakewood, NJ 08701

Please add appropriate sales tax in NY, NJ, CA, TN, MA, IL & DC.

For fastest service call toll-free: 1-800-223-7524 (outside NY), 212-536-5174

Or 1-800-344-7119 (outside NJ), in NJ 908-363-4156

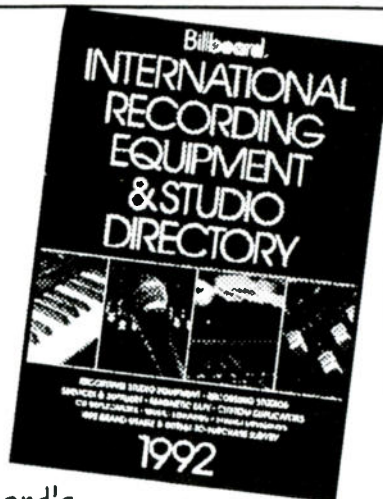

U.S. Blank Tape Product Charts—CONSUMER PRODUCTS ONLY

These products are sold at retail consumer chains.

AUDIO CASSETTE

SERIES/LINE PRODUCT	PLAYING TIME (MIN.)	COATING	SUGG. LIST PRICE
BASF Corp. Information Systems			
Ferro Extra I	C-60,90,100	FD	(NS)
Chrome Extra II	C-60,90,100	CrO2	(NS)
Chrome Maxima II	C-60,90	CrO2	(NS)
Chrome Super	C-90,100	(NS)	(NS)
Denon America, Inc., Tape Div.			
DX1	C-60,90	Type I	\$1.49-\$1.99
HD6	C-74,90,100	Type II	\$2.69,\$2.99,\$3.19
HD7	C-60,74,90,100	Type II	\$3.29,\$3.59,\$3.79
HD8	C-60,74,90,100	Type II	\$3.29,\$3.69,\$3.99,\$4.29
HDM	C-74,90,100	Metal	\$4.29,\$4.79,\$4.99
S-Port High	C-100	Type II	\$2.59
S-Port Metal	C-100	Metal	\$3.69
MGX	C-100	Metal	\$8.99
Fuji Photo Film U.S.A., Inc., Consumer Div.			
OR-I	C-60,90	Ferrix	\$1.49;\$1.99
OR-II	C-60,90,100	Beridox-DC	\$2.49;\$2.99;\$3.49
FR-IIIx	C-60,90,100	Beridox-DC	\$3.49;\$3.99;\$4.49
FR-IIIx Pro	C-60,90,100	Beridox-DC	\$4.49;\$4.99;\$5.49
FR-M	C-60,90,100	Metallix	\$5.49;\$5.99;\$6.49
Goldstar Electronics Int'l, Inc.			
HP	C-60,C-90	FD	\$.99,\$1.49
MTX	C-60,C-90	MT	\$3.49,\$4.49
CRX	C-60,C-90	Cobalt GFO	\$2.79,\$3.49
JVC Co. of America, Consumer Products Div.			
GI60/GI90	T-60,90	Type I	\$1.30;\$1.55
AFII60/AFII90	T-60,90	Type II	\$2.20;\$2.50
XFIV90	T-90	Type IV	\$3.90
Loran Cassettes & Audio Products			
ESQ	C-90	HB	\$4.99
Maxell Corp. of America			
UR Series	C-46,60,90,120	Type I, Crystal MP	\$1.49;\$1.49;\$1.79;\$2.79
UDI Series	C-60,90	Type I, NPMP	\$2.49;\$2.99
UDII Series	C-46,60,90,120	Type II, Clear-EMP	\$2.49;\$2.49;\$2.99;\$3.69
XLII Series	C-46,60,90,100	Type II, Pure EMP	\$3.29;\$3.29;\$3.79;\$4.39
XLII-S Series	C-60,90	Type I, SEMP	\$3.59;\$4.39
XLII-S Series	C-60,90,100	Type II, SEMP	\$3.59;\$4.39;\$4.99
MX Series	C-60,90,110	Type IV,SPMP	\$2.99;\$3.99;\$4.49
MX-S Series	C-60,90,100	Type IV,SPMP	\$4.39;\$5.29;\$5.99
MV 90	C-90	Type IV, SPMP	\$14.99
MemTek Products (Memorex Brand)			
CDX	C-90,110	Type IV	\$2.74;\$2.99
MRX	C-60,90	Type I	\$1.69;1.99
dB5	C-46,60,90,110,120	Type I	\$1.09;\$1.29;\$1.59;\$1.89;\$1.99
Cire I	C-50,100	Type I	\$1.09;\$1.39
Cire II	C-50,90,110	Type II	\$1.39;\$1.89;\$1.99
CIRE IV	C-90,110	Type IV	\$2.74;\$2.99
HBS	C-60,90,110	Type II	\$1.74;\$2.24;\$2.49
Nakamichi America Corp.			
ZX	C-90	MTY	\$10.00
SXII	C-90	SFCO	\$8.90
SX	C-90	FCO	\$6.50
EXII	C-90	FCR	\$6.00

AUDIO CASSETTE

SERIES/LINE PRODUCT	PLAYING TIME (MIN.)	COATING	SUGG. LIST PRICE
The New Alakh Corp.			
HE-60/90	C-60	(NS)	\$.69;\$.99
Panasonic Co., Special A/V Products			
Micro	T-60	FD	\$2.97
Micro	T-90	ME	\$6.95
Pfanstiehl Chemical Corp.			
HE-45,60,90	T-45,60,90	Oxide	\$1.59;\$1.79;\$1.99
C-60/3 (3-Packs)	T-60	Oxide	\$1.99
Sony Magnetic Products Group of America			
CDIT	T-54,74,94,100	CF/MT	\$2.29-\$4.49
ES	T-60,74,90,100	FCO	\$2.59-\$4.49
UX Turbo	T-60,90,100	CF	\$3.29-\$4.49
Metal SR	T-60,90,100	MT	\$2.99-\$3.99
Metal Master	T-90	MT	\$10.99
Sunkyoung Magnetic/America, Inc., Consumer Prods. (SKC Brand)			
GX Normal Bias	C-60,90,100	FO	\$1.39;\$1.59;\$1.99
QX High Bias	C-90	CF	\$2.79
CD High Bias	C-90,100	CrO2	\$3.39;\$3.99
ZX Metal Bias	C-90	Metal (Iron)	\$5.59
Swire Magnetics Co.			
Laser XL Plus NB	C-60,90	FO	\$.99,\$1.29
Laser XL Plus HB	C-76,100	FO	\$1.59;\$1.95
TDK Electronics Corp., Consumer Services			
MA-XG Type IV	C-60,90	Finavinx	\$16.99;\$18.99
MA-X Type IV	C-60,90,100	Ultra FX	\$4.39;\$5.29;\$5.99
MA Type IV	C-60,90,110	Ultra FX	\$2.99;\$3.99;\$4.49
SA-X Type II	C-50,60,90,100	SAV	\$3.29;\$3.99;\$4.49;\$4.99
SA (Type II)	C-50,60,80,90,100	SAV	\$3.29;\$3.29;\$3.69;\$3.79;\$4.39
SO (Type II)	C-50,60,90,100	AV	\$2.49;\$2.49;\$2.99;\$3.69
DS-X (Type I)	AR-60,90,100	NPF	\$2.49;\$2.99;\$3.69
D (Type I)	C-30,50,60,90,120	Ferric magnetic	\$1.49;\$1.69;\$1.69;\$1.99;\$2.99
Tandy Magnetic Media			
TVG	C-60,90	Type I	(NS)
TMG	C-60,90	Type I	(NS)
TCR	C-46,60,76,90,100,110	Type II	(NS)
3M Consumer Video & Audio Prods. Div. (Scotch Brand)			
CX	C-90	(NS)	\$1.99
BX	C-90	(NS)	\$2.99
XSII	C-90	(NS)	\$4.19
Universal Security Instruments, Inc.			
A-1102 (2-Packs)	C-100	FO	\$1.99
A-1063 (3-Packs)	C-60	FO	\$1.99

CONSUMER PRODUCT CHART KEY

AV—aviary	GF—gamma ferric	PM—pure metal
BC—back coated	GFO—gamma ferric oxide magnetic particles	Px—granulide
CAMP—ceramic armor metal particles	HB—high bias	SAN—super aviary
CEMP—clear epitaxial magnetic particles	LF—linear ferric	SOC—submicro cobalt gamma
CF—cobalt ferric	ME—metal evaporated	SEMP—super energy fine epitaxial magnetic particles
CrO2—chromium dioxide	MT—metal particle	SFCO—super ferricobalt
EMP—epitaxial magnetic particles	MTY—metalloy	SFX—super ferricobalt
FCO—ferricobalt	NOTM—nano dynamic tactoid metal	SPMP—super stabilized pure metal particles
FCR—ferrocobalt	NPMP—non porous epitaxial magnetic particles	TYPE I—standard bias
FE—ferrous oxide	NPF—non porous ferric	TYPE II—high bias
FO—ferrous oxide	(NS)—not supplied	TYPE IV—metal bias
FSC—flush surface cobalt	O—oxide	UFO—ultra ferric oxide
FX—helvetic		

U.S. Blank Tape Product Charts-CONSUMER PRODUCTS ONLY

AUDIO OPEN REEL

SERIES/LINE PRODUCT	TAPE WIDTH	LENGTH (FT.)	COATING	SUGG. LIST PRICE
Maxell Corp. of America				
XLI 35-90B/35-180B	1/4"	1800';3600'	EMP	\$13.99;\$38.99
UD 35-90/35-180	1/4"	1800';3600'	GFOMP	\$9.99;\$31.29
Tandy Magnetic Media				
TR 750	1/4"	1200';1800';3600'	Type I	(NS)
TR 18	1/4"	1200';1800';3600'	Type I	(NS)

DAT

SERIES/LINE PRODUCT	PLAYING TIME (MIN.)	COATING	SUGG. LIST PRICE
BASF Corp. Information Systems			
BASF DAT	R-60,90,120	MT	(NS)
DIC Digital Supply Corp.			
XR	R-30,46,60,90,120	MT	\$7.00;\$7.50;\$8.00;\$8.50;\$10.00
Denon America, Inc., Tape Div.			
R-DAT	R-60,90,120	(NS)	\$10.99;\$11.99;\$12.99
R-DM	R-20	(NS)	\$9.99
Fuji Photo Film U.S.A., Inc., Consumer Div.			
DAT	R-60,90,120	Metallix	\$10.95;\$11.95;\$12.95
JVC Co. of America, Consumer Products Div.			
R-XD	R-60,90,100,120	(NS)	\$10.00;\$12.00;\$12.80;\$14.00
Loran Cassettes & Audio Products			
Pro DAT	R-30;90;120;140	(NS)	(NS)
Maxell Corp. of America			
DAT DM Series	R-46,60,90,120	CAMP	\$8.99;\$10.99;\$12.99;\$14.99
Nakamichi America Corp.			
DAT	R-46,60,90,120	MTY	\$14.50;\$16.50;\$19.50;\$22.50
Panasonic Co., Special A/V Products			
RTR	R-46,60,90,120	Ultrafine MT	\$8.99;\$10.99;\$12.99;\$14.99
Sony Magnetic Products Group of America			
DT Series	R-60,90,120	MT	\$12.49-\$18.00
TDK Electronics Corp., Consumer Services			
DA	R-60,90,120	SFX PM	\$10.99;\$12.99;\$14.99

VIDEO CASSETTE

SERIES/LINE PRODUCT	PLAYING TIME (MIN.)	FORMAT	COATING	SUGG. LIST PRICE
BASF Corp. Information Systems				
EO	T-120,130,160	VHS	FC	(NS)
SHG	T-120,160,180	VHS	CrO2	(NS)
S-VHS	ST-120	S-VHS	CrO2	(NS)
8mm	P6-60,120	8mm	(NS)	(NS)
Kids HG	T-120	VHS	(NS)	(NS)
VHS-C	TC-20,30	VHS-C	(NS)	(NS)
DIC Digital Supply Corp.				
MPX	P6-15,30,60,90,120	8mm	MT	\$3.99;\$4.19;\$4.49; \$4.99;\$5.99
Denon America, Inc., Tape Div.				
UHG	P6-120,150	8mm	(NS)	\$12.99;\$14.99

VIDEO CASSETTE

SERIES/LINE PRODUCT	PLAYING TIME (MIN.)	FORMAT	COATING	SUGG. LIST PRICE
Douglas-Hanson Co., Magnetic Media Div.				
Chromax HS	T-120	VHS	CrO2 (Dupont Grade)	\$1.59-\$2.79
Chromax HQ	T-120	VHS	CrO2	\$1.59-\$2.79
Professional	T-120	VHS	CrO2 (Dupont Grade)	\$1.59-\$2.79
Fuji Photo Film U.S.A., Inc., Consumer Div.				
HQ	T-60,120,160	VHS	Beridox-DC	\$3.99; \$4.99; \$6.99
A/V Pro	T-60,120,160	VHS	Beridox-DC	\$4.99; \$5.99; \$7.99
A/V Master	T-120	VHS	Beridox-DC	\$8.99
S-VHS Pro	ST-30,60,120,160	S-VHS	Beridox S-DC	\$7.99-\$12.99
Goldstar Electronics Int'l, Inc.				
STD	T-30,60,90,120	VHS	CDGFO Alpha	\$3.29,\$3.99,\$4.99,\$5.99
SHG	T-120	VHS	High BET CDGFO	\$6.99
SHF	T-120	VHS	Ultra BET CDGFO	\$7.99
MP	120	P-8mm	MT	\$8.99
JVC Co. of America, Consumer Products Div.				
XR	T-30,60,120,160	VHS	(NS)	\$5.00;\$5.50;\$6.00;\$8.00
EHG	T-120,160	VHS	(NS)	\$7.00;\$9.50
PROHF	T-120	VHS	(NS)	\$8.00
STXG	ST-30,60,120	S-VHS	(NS)	\$13.00;\$13.50;\$14.00
STC-XG	STC-20,30	S-VHS-C	(NS)	\$13.00;\$15.00
TC-XR	TC-20	VHS-C	(NS)	\$6.00
TC-HG	TC-20,30	VHS-C	(NS)	\$6.50;\$8.00
TC-EHGX3	TC-20 (3-Packs)	VHS-C	(NS)	\$18.00
TCPRDHF	TC-20	VHS-C	(NS)	\$8.50
Konica U.S.A., Inc.				
Super SR	T-120	VHS	(NS)	\$4.79
Super Hi Grade	T-120	VHS	(NS)	\$7.49
Super VHS	T-120	VHS	(NS)	\$8.49
8mm	P-60,90,120	8mm	(NS)	\$5.99-\$7.99
VHS-C	T-20,30	VHS-C	(NS)	\$5.99-\$7.49
Super VHS-C	T-20	VHS-C	(NS)	\$7.99
Maxell Corp. of America				
EX T-60/120/160	T-60,120,160	VHS	(NS)	\$5.99;\$6.99;\$7.99
HGX Gold T-60/120/160	T-60,120,160	VHS	(NS)	\$8.39;\$9.29;\$13.99
XL HiFi	T-120	VHS	(NS)	\$12.59
Rx Pro T-120	T-120	VHS	(NS)	\$18.99
VX-T	T-120	VHS	Black Magnetite	\$4.99
HGX Black	T-120	VHS	Black Magnetite	\$5.99
XR-S Black	ST-120/160/180	S-VHS	Black Magnetite	\$10.99;\$13.99;\$19.99
EX TC-20	TC-20	VHS-C	(NS)	\$7.99
HGX Gold TC-20/30	TC-20,30	VHS-C	(NS)	\$9.99;\$12.99
Rx Pro TC-20	TC-20	VHS-C	(NS)	\$12.99
XR-S TC-20/30	TC-20,30	VHS-C	(NS)	\$16.98;\$22.99
EX-M 8mm Series	P6-30,60,90,120	8mm	(NS)	\$8.99;\$10.99; \$12.99;\$15.99
HGX-M 8mm Series	P6-30,60,90,120	8mm	(NS)	\$10.99;\$12.99; \$14.99;\$18.99
XR-M Hi8 Series	P6-15,30,60,90,120	Hi8	(NS)	\$10.99;\$11.99;\$13.99; \$15.99;\$21.99
XDP Hi8 ME	P6-30,60,120	Hi8	ME	\$26.99;\$31.99;\$41.99
MemTek Products (Memorex Brand)				
HS	T-120	VHS	(NS)	\$3.99
HG	T-120	VHS	(NS)	\$4.99
VHS-C	TC-20	VHS-C	(NS)	\$4.99
VHS-C	TC-30	VHS-C	(NS)	\$5.99

U.S. Blank Tape Product Charts-CONSUMER PRODUCTS ONLY

VIDEO CASSETTE

SERIES/LINE PRODUCT	PLAYING TIME (MIN.)	FORMAT	COATING	SUGG. LIST PRICE
MemTek Products (Memorex Brand)				
8mm	P6-120	8mm	(NS)	\$8.99
The New Alakh Corp.				
T-120	T-120	VHS	(NS)	\$2.99
E-180	T-120	Pal/Secam	(NS)	\$2.99
Panasonic Co., Special A/V Products				
T120SP	T-120	VHS	F0	\$2.99
T120SG	T-120	VHS	F0	\$3.99
TC30SG	T-30-90	VHS-C	F0	\$5.49
Pfannstiehl Chemical Corp.				
TV	T-120	VHS	(NS)	\$4.99
Polaroid Corp., Consumer Video Prods.				
VHS-SG	T-120,160	VHS	(NS)	\$3.99;\$4.99
VHS-HG	T-120	VHS	(NS)	\$4.99
Beta	L-750	Beta	Standard	\$3.99
VHS-C	TC-20/30	VHS-C	High Grade	\$5.99;\$7.99
8mm	MP6-30/60/90/120	8mm	MT	\$5.99;\$6.99;\$7.99;\$8.99
Sony Magnetic Products Group of America				
V	T-120,160	VHS	0	\$6.99-\$7.99
V High Grade	T-120,160	VHS	0	\$7.99-\$8.99
MP	P6-15-150	8mm	MT	\$5.49-\$11.99
HMP	P6-30,60,120	Hi Band 8mm	MT	\$10.99-\$17.99
Swire Magnetics Co.				
Laser HQ	T-120	VHS	(NS)	\$2.99
Laser HG	T-120	VHS	(NS)	\$3.99
TDK Electronics Corp., Consumer Services				
XP S-VHS	ST-120,160	S-VHS	Ultrafine SAV	\$18.99;\$26.99
HD-X Pro VHS	T-120	VHS	Ultrafine SAV	\$13.00
HiFi	T-120	VHS	SAV	\$10.50
E-HG	T-120,160	VHS	EHG SAV	\$8.50;\$11.50
HS	T-30,60,120,160	VHS	SAV	\$6.00;\$6.75;\$7.00;\$9.50
XPVHS-C	STC-20,30	S-VHS-C	Ultrafine SAV	\$12.00;\$15.00

VIDEO CASSETTE

SERIES/LINE PRODUCT	PLAYING TIME (MIN.)	FORMAT	COATING	SUGG. LIST PRICE
TDK Electronics Corp., Consumer Services				
HD-X Pro	TC-20	VHS-C	SAV	\$8.50
TC E-HG	TC-20,30	VHS-C	SAV	\$7.00;\$8.00
E-HG 8mm	P6-30,60,90,120	8mm	Ultrafine SAV	\$6.20;\$7.50; \$8.80;\$10.50
HS 8mm	P6-30,60,90,120	8mm	SAV	\$5.75;\$7.00;\$8.00;\$9.50
ME Hi-8	P6-90,120	Hi-8	ME Metallax	\$20.00;\$26.00
MP Hi-8	P6-30,60,90,120	Hi-8	SFX	\$10.70;\$13.00; \$15.20;\$17.50
Tandy Magnetic Media				
High Standard	T-120,E-180	VHS	(NS)	(NS)
Pro Cam	T-30,120	VHS	(NS)	(NS)
High Grade	T-120,E-180	VHS	(NS)	(NS)
Thomson Consumer Electronics (RCA/GE)				
GET120	T-120	VHS	(NS)	\$6.95
GET120SHG	T-120	VHS High Grade	(NS)	\$8.95
GETC20	T-20	VHS-C	(NS)	\$9.95
T120	T-120	VHS	(NS)	\$6.95
TC2#	T-20	VHS-C	(NS)	\$9.95
ST120	T-120	SVHS	(NS)	\$19.95
STC20	T-20	SVHS-C	(NS)	\$14.95
T120SHG	T-120	VHS High Grade	(NS)	\$8.95
3M Consumer Video & Audio Prods. Div.				
EG	T-120	VHS	(NS)	\$5.99
EG*	T-120,160	VHS	(NS)	\$6.99;\$7.99
EXG	T-120	VHS	(NS)	\$7.99
EXG HiFi	T-120	VHS	(NS)	\$8.99
Pro Cam	T-120	VHS	(NS)	\$10.99
S-VHS	ST-120	S-VHS	(NS)	\$14.99
S-VHS-C	STC-20	S-VHS-C	(NS)	\$14.99
Universal Security Instruments, Inc.				
V-2*00 SHG	T-120	VHS	UFO	\$4.99

Don't Forget!

Send for the latest edition of the free Consumer Information Catalog. □ The Catalog lists over 200 selected federal publications of consumer interest on subjects like health, nutrition, federal benefits, money management. □ The Catalog is free and so are many of the booklets. □ Just send your name and address, no strings attached. Write today:

Consumer
Information
Catalog



**Consumer Information Center
Department DF
Pueblo, Colorado 81009**

A public service of this publication and the Consumer Information Center of the U.S. General Services Administration.

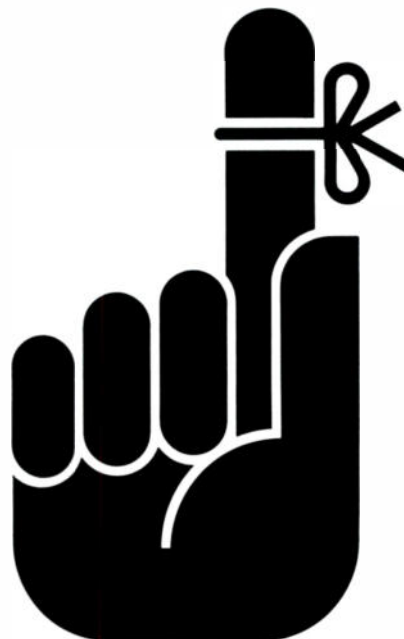

U.S. Blank Tape Product Charts—PRO-INDUSTRIAL PRODUCTS ONLY

These products are used for superior audio performance in studios and/or duplication of prerecorded products and commercials. The video products listed are for broadcast reproduction and for high speed duplication and other professional video applications.

AUDIO CASSETTE

SERIES/LINE PRODUCT	PLAYING TIME (MIN.)	COATING
Ampex Recording Media Corp.		
472 Studio Audio	C-5 to C-90	GFO
672 Professional Audio	C-30 to C-90	GFO
Amtron, Inc.		
Amtron	C-5 to C-90	(NS)
BASF Corp. Information Systems		
Ferro Extra I	C-60,90	FO
Ferro Super I	C-60,90	MFO
Chrome Extra II	C-60,90	CrO2
Chrome Maxima II	C-60,90	CrO2
Certron Corp.		
Low Noise	C-60,90	LN/FeO
High Density	C-30,45,60,90,120	LN/FeO
CTX	C-90	CrO2
Denon America, Inc., Tape Div.		
DX1	C-60,90	(NS)
H06	C-60,75,90,100	(NS)
H07	C-60,75,90,100	(NS)
H08	C-60,75,90,100	(NS)
H0M	C-60,75,90,100	(NS)
Fuji Photo Film U.S.A. Inc., Pro Div.		
DR-I	C-60,90	FX
DR-II	C-60,90,100	BRX
FR-Ilx	C-60,90,100	BRX
FR-Ilx Pro	C-60,90,100	BRX
FR-Metal	C-60,90,100	MTX
Goldstar Electronics Int'l, Inc.		
HO	C-45 to C-90	(NS)
HP	C-45 to C-90	(NS)
HR	C-45 to C-90	(NS)
HZ	C-45 to C-90	(NS)
Chrome	C-45 to C-90	CrO2
Metal	C-45 to C-90	PM
Lion Recording Services, Inc.		
LRS Normal	C-30,62,92,122	T-I
LRS Chrome	C-10 to C-92	CrO2
Loran Cassettes & Audio Products		
ES2 (ESQ)	C-90	HB
Studio Blank	C-5 to C-90	HB
Maxell Corp. of America		
Communicator Series	C-30,45,60,90,120	FGH
Duplicator Series	C-30,45,60,90,120	FGH
MemTek Products (Memorex)		
CDX	C-90,110	Metal T-IV
HBS	C-46,60,76,90,100,110	T-II
HBX	C-60,90	T-II
MRX	C-60,90	T-I
dBS	C-40,60,90,110,120	T-I
Cire I	C-50,100	T-I
Cire II	C-50,90,110	T-II

AUDIO CASSETTE

SERIES/LINE PRODUCT	PLAYING TIME (MIN.)	COATING
Nakamichi America Corp.		
SX	C-90	HC
SXII	C-90	FCO
EXII-C90	C-90	FCR
ZX	C-90	MTY
Omni Magnetics Corp.		
Premium Ferric (PE)	C-60,90	HE
Ultra Dynamic (UD)	C-46,60,90,120	HD
RAKS Corp. of America, Inc.		
ED-SX	C-60,90	T-I
CD-SX	C-60,90	T-I
SO-SX	C-60,90	T-II SCr
Sony Magnetic Products Group of America		
HF	C-60,90	T-I
UX	C-60,90,100	GFO (T-II)
UX-S	C-60,90	GFO (T-II)
UX-ES	C-60,90	GFO (T-III)
UX-Pro	C-60,90	GFO (T-III)
Metal Master	C-90	Metal (T-IV)
Metal SR	C-60,90,100	Metal (T-IV)
Sunkyong Magnetic/America, Inc., Pro Prods.		
GX	C-60,90,100	FO
QX	C-90	CF
CD	C-76,90,100	CrO2
ZX	C-90	Metal
Swire Magnetics Co.		
Laser Plus	C-60,90,100	FeO
TDK Electronics, Pro. Prods. Div.		
Duplication Master (ZM)	C-30,46,60,90,120	PGF
Medical Master (ME)	C-60,90,120	PGF
Instant Start Acoustic Master (AL)	C-30,60,90	PGF
Acoustic Master (AM)	C-30,46,60,90,120	PGF
Sound Master (SM)	C-10,20,30,60	SA/FC
Tandy Magnetic Media		
TVG	C-60,90	T-I
TMG	C-60,90	T-I
TCR	C-46,60,76,90,100,110	T-II

PRODUCT CHART KEY

BC—coated	F—ferric	HC—high coercivity	PGF—pure-grained ferric
BL—back lubricated	FC—ferric cobalt	HE—high energy	PMP—pure metal particle
C—chrome	FCC—fine crystal cobalt	ML—multi layer	PX—Prestxide
CAMP—ceramic armour MP	FCo—ferricobalt	MMP—microhinity MP	SAM—super alloy metal
CF—cobalt ferric	FCr—ferric crystal	MP—metal particle	SAV—Super Avilyn
CM—cobalt modified	FE—ferrite oxide	MPSA—metal particle super alloy	SDG—submicro cobalt gamma
CMO—cobalt modified oxide	FeO—iron oxide	MTX—Metallox	SCR—super chrome
CoG—cobalt gamma	FO—ferric oxide	MTY—metalloy	SFX—Super Finavinx
CrO2—chromium dioxide	FSC—flush-surface cobalt	NDTM—nano dynamic tactoid metal	SL—single layer
DC—double coated	FX—ferrix	(NS)—not supplied	T1—standard bias
DL—dual layer	GFO—gamma ferric oxide	O—Oxide	TII—high bias
EO—epitaxial oxide	HB—high bias	PC—pure chrome	TIV—metal bias



TECHNOLOGY
HAS CREATED MACHINES
TO DUPLICATE THE ENTIRE SOUND SPECTRUM

SUNKYONG
HAS CREATED MAGNETIC TAPE
TO DUPLICATE THE ENTIRE SOUND SPECTRUM

Sunkyong has created the ultimate in magnetic duplicating tape to meet the needs of today's technology.

From the clarity of classical orchestration to the cutting edge of hard rock,
you want the quality and consistency of Sunkyong.

Insist on Sunkyong UCR Chrome Tape for music duplication of unsurpassed excellence.

Depend on MCX Cobalt for high quality duplication from digital masters.

Rely on Sunkyong SKX Ferric, the premium grade tape for music duplication.

Specify Sunkyong SH Duplicating Tape for the last word in spoken word.

SUNKYONG
Professional Products

Sunkyong Magnetic/America Inc., 4041 Via Oro Ave. Long Beach, CA 90810 1-800-331-5729 Outside CA 1-800-237-8372
Technical support and inquiries may be directed to Sunkyong's Technical Center located in Long Beach, CA.

U.S. Blank Tape Product Charts—PRO-INDUSTRIAL PRODUCTS ONLY

AUDIO CASSETTE

SERIES/LINE PRODUCT	PLAYING TIME (MIN.)	COATING
That's Audio Cassettes/That's America		
Suono	C-46,60,74,90	NDTM
CD-IV	C-74,90,100	T-IV, NDTM
CD-MH	C-74,90,100	SAM-II
CD II	C-74,90,100	SCG
CD-I	C-74,90,100	FSC
AS-IV	C-60,90,100	PX-IV
AS-II	C-60,90,100	PX-II
3M Co. Professional Audio/Video		
SX Studio Master	C-30,60,90	FD
AVX Pro Cassettes	C-20,30,46,60,90,120	FD
IRC Instant Record	C-30,60,90	FD
Unimagnetics USA		
SDX-C	C-5 to C-90	F
PRO-C	C-5 to C-90	F
CHR-C	C-5 to C-90	PC

AUDIO OPEN REEL

SERIES/LINE PRODUCT	TAPE WIDTH	LENGTH (FT.)	COATING
Ampex Recording Media Corp.			
406/407 Mastering Tape	1/4", 1/2", 1", 2"	600';1200';2500';5000'	GFO
456 Grand Master	1/4", 1/2", 1", 2"	600';1200';2500';3750';5000'	GFO
467 Digital	1/4", 1/2", 1"	4600';7200';9700'	GFO
478 Low Print	1/4", 1/2"	600';1200';2500';5000'	GFO
641/642	1/4"	900';1800';3600'	
651	1/4"	1200';2400'	
661	1/4"	3600'	
Audiopak, Inc.			
17 Series/Studio	1/4"	1800';3600'	F/BC
BASF Corp. Information Systems			
PEM 369 Studio Mastering Tape	1/4"	3600'	FeO
PEM 468 Studio Mastering Tape	1/4", 1/2", 1", 2"	1250';2500';5000'	FeO
PEM 469 Studio Mastering Tape	1/4", 1/2", 1", 2"	1250';2500';5000'	FeO
PEM 526 Bin Mastering Tape	1/4", 1/2", 1"	2400'	FeO
Maxell Corp. of America			
UD Reel (7" & 10")	1/4"	1800';3600'	EO
XL Reel (7" & 10")	1/4"	1800';3600'	EO
Sony Magnetic Products Group of America			
D-1/4 730	1/4"	2,390'	GFO
D-1/2 1460, D-1/4 1460	1/2", 1/4"	4,790'	GFO
D-1/4 2190	1/4"	7,180'	GFO
D-1/2 2920	1/2"	9,580'	GFO
Tandy Magnetic Media			
TR 750	1/4"	1200';1800';3600'	Type I
TR 18	1/4"	1200';1800';3600'	Type I
3M Co. Professional Audio/Video			
226/227 Mastering Tape	2";1";1/2";1/4"	1200';1800';2500';3600';5000'	FO
250 Mastering Tape	2";1";1/2";1/4"	1200';2500';5000'	FO
806/807 HQ/LP Mastering Tape	2";1";1/2";1/4"	600';900';1200';1800';2500';3600';5000'	FO
808/809 LPLN Mastering Tape	1/4"	600';900';1200';1800';2500';3600'	FO
996 Mastering Tape	2";1";1/2";1/4"	1200';2500';3750';5000'	FO

AUDIO OPEN REEL

SERIES/LINE PRODUCT	TAPE WIDTH	LENGTH (FT.)	COATING
3M Co. Professional Audio/Video			
186 General Purpose Tape	1/4"	2500';5000'	FD
8026/8207/8614 Logging Tape	1";1/2";1/4"	3600';4800';7200';10800'	FD

DAT

SERIES/LINE PRODUCT	PLAYING TIME (MIN.)	COATING
Ampex Recording Media Corp.		
467 DAT	R-30 to R-80	MP
467 DATpak	R-30 to R-120	MP
BASF Corp. Information Systems		
BASF DAT	R-60,90,120	MP
DIC Digital		
XR (Reg. & Bulk)	R-15,30,46,60,90,120	MP
MO Series	R-15,30,48,62,92,122	MMP
Denon America, Inc., Tape Div.		
R-DAT	R-90,120	(NS)
Fuji Photo Film U.S.A., Inc., Pro Div.		
OAT	R-60,90,120	SF MTX
Goldstar Electronics Int'l, Inc.		
R-DAT	R-30,46,60,90,120	PM
Loran Cassettes & Audio Products		
Pro DAT	R-30 to R-140	T-IV
Maxell Corp. of America		
R-DAT	R-46,60,90,120	CAMP
Nakamichi America Corp.		
DAT	R-46,60,90,120	MTY
Panasonic Co., Special A/V Products		
RT	R-46,60,90,120	(NS)
RAKS Corp. of America, Inc.		
DAT	R-60,90,120	ML/BC
Sony Magnetic Products Group of America		
DT Series	R-60,90,120	Metal
TDK Electronics, Pro. Prods. Div.		
Digital Audio (DA)	R-60,90,120	SFX PMP
3M Co. Professional Audio/Video		
Pro DAT	R-46,60,90,120	MP
DIGITAL U-MATIC AUDIO		
SERIES/LINE PRODUCT	PLAYING TIME (MIN.)	COATING
Ampex Recording Media Corp.		
467 Digital Audio	DA-30,60,75,80	MP
Maxell Corp. of America		
KCA-DA	KCA-30,60	EO
KU-DA	KU-75	EO

NEW MQ™ SERIES. MASTER QUALITY DIC//DAT™ FOR THE ULTIMATE QUALITY MASTER.



DIC//DAT introduces its new MQ Series DAT tape. Master Quality media crafted with second-generation technical improvements based on extensive R&D and feedback from audio pros in the field. The one DIC//DAT perfected for professional use.

- ▶ **NEW MQ "Formulation Finish"** reduces friction and provides more efficient tape-to-head contact for superb performance even in the face of high search and rewind speeds.
- ▶ **NEW MQ proprietary DIC MicroFinity metal particle technology** creates a consistently high quality magnetic medium for uncompromising professional DAT recording.
- ▶ **NEW MQ exclusive DIC//DAT tape lengths** include an extra two minutes for tone recording, test signals and pre-roll identification—as well as the industry's only 15–30 minute DAT cassettes for small programs, demos and test tapes.
- ▶ **NEW MQ dust-busting cassette design** virtually eliminates recording errors and tape jamming due to environmental contamination.
- ▶ **NEW MQ unique window calibrations** for easier reading and more accurate time judgment.
- ▶ **NEW MQ extra-strong DIC//DAT cassette shell** made in the U.S., with new window ribs for increased stability, 100% anti-static plastic, and the industry's only fiber-filled slider for structural integrity, stands up to the most rigorous studio use.

DIC//DAT™

MQ™ SERIES

TAKING MUSIC TO THE *Nth* DEGREE.
222 Bridge Plaza South, Fort Lee, NJ 07024 • 1/800-DAT-I-DIC (in NJ, 201/224-9344)

© DIC DIGITAL SUPPLY CORPORATION, 1991 

U.S. Blank Tape Product Charts-PRO-INDUSTRIAL PRODUCTS ONLY

DIGITAL U-MATIC AUDIO

SERIES/LINE PRODUCT	PLAYING TIME (MIN.)	COATING
Sony Magnetic Products Group of America		
DAU	DAU-30,60,75	GFO
3M Co. Professional Audio/Video		
AUD	30,60,75	F0

AUDIO TAPE (Bulk Raw)

SERIES/LINE PRODUCT	LENGTH (FT.)	TAPE WIDTH	COATING
Ampex Recording Media Corp.			
617/618	8300'13500'	3.81mm	Fe
619/620	8200'11500'	3.81mm	CrO2
600 Series	600'3600'	1/4"	Fe
Audiopak, Inc.			
F/BC Loop	4,200'	3.81mm	F/BC
17 Series	1800',3600'	1/4"	F/BC
Aurex-Auriga			
703 (C-60)	12500',17300'	3.81mm	F
704 (C-90)	15000',17300'	3.81mm	F
BASF Corp. Information Systems			
LNS 619/919i	60:8200';10000';123000'; 90:11500';15000'	3.81mm	FeO
LHD 649/949	60:8200';10000';12300'; 90:11500';15000';17300'	3.81mm	FeO
CR-D 668/968	60:8200';10000';12300'; 90:11500';17300';12300'	3.81mm	CrO2/FC
CR-Super	8200',10800'	3.81mm	CrO2
CintasVAC, div. of Cintas Technologies, Inc.			
CMX-60	10000',12500'	3.81mm	F
CMX-90	12,500'	3.81mm	F
CRX-60	10000',12500'	3.81mm	C
CRX-90	12,500'	3.81mm	C
Columbia Magnetics/Sony Music Entertainment Inc.			
Ultra IV	60:12500'; 90:11500';15000'	3.81mm	GFO
DIC Digital			
DAT Pancake	7,874'	3.81mm	MMP
Fidelipac Corp.			
DYN-400X Standard	1800',3600'	1/4"	BL
DYN-375 Extended Play	4,200'	1/4"	BL
DYN-1000X Cobalt	1800',3600'	1/4"	BL
Goldstar Electronics Int'l, Inc.			
HP	60:8200'; 90:11500'	3.81mm	(NS)
HD	60:8200'; 90:11500'	3.81mm	(NS)
HR	60:8200'; 90:11500'	3.81mm	(NS)
HZ	60:8200'; 90:11500'	3.81mm	(NS)
Chrome	60:8200'; 90:11500'	3.81mm	CrO2
Metal	60:8200'; 90:11500'	3.81mm	PM
Magnetic Media Corp.			
XM-1	60:9000'; 90:11500'	3.81mm	FE
XM-2	60:9000'; 90:11500'; 120:8800'	3.81mm	FE
XM-3	60:9000'; 90:11500'	3.81mm	FE
Cobalt	60:8200'; 90:9600'	3.81mm	FCo/HB
Omni Magnetics Corp.			
Obuki	60:8200'; 90:10500'	3.81mm	F

AUDIO TAPE (Bulk Raw)

SERIES/LINE PRODUCT	LENGTH (FT.)	TAPE WIDTH	COATING
Sunkyong Magnetic/America, Inc., Pro Prods.			
SH	60:8200';10500';12500'; 90:11500';15000'	3.81mm	Fe
SKX	60:8200';10500';12500'; 90:11500';15000'	3.81mm	Fe
UCR	60:10500';12500'; 90:11500';15000'	3.81mm	CrO2
Swire Magnetics Co.			
Duplicator	60:10500; 90:12500	3.81mm	FE
TDK Electronics, Pro. Prods. Div.			
APA	60:7381'; 90:11072'	3.81mm	SL FCo SAV
APX	60:7381'; 90:11072'	3.81mm	DL FCo SAV
APM	60:7381'; 90:11072'	3.81mm	MA-X MP
Tandy Magnetic Media			
TVG Audio	60:10500';12500'; 90:10500';12500';13200'	3.81mm	Type I
TMG (C-60 & C-90)	60:10500';12500'; 90:10500';12500';13200'	3.81mm	Type I
TCR (C-60 & C-90)	60:10500';12500'; 90:10500';12500';13200'	3.81mm	Type II
LUB (B-Track)	6000'9600'	1/4"	Type I
That's Audio Cassettes/That's America			
MRX B/C Base	7380/8856	3.81mm	MP
EMX B/C Base	7380/8856	3.81mm	MPSA
SVX B/C Base	7380/8856	3.81mm	SCG
TX B/C Base	7380/8856	3.81mm	FCC
3M Co. Professional Audio/Video			
186 (Hubs)	2500',5000'	1/4"	FO
Unimagnetics USA			
SDX-P	8200',1200'	3.81mm	F
PRO-P	8200';10500';12200'	3.81mm	F
CHR-P	8200';10500';12200'	3.81mm	PC

VIDEO CASSETTE

SERIES/LINE PRODUCT	PLAYING TIME (MIN.)	FORMAT	COATING
Ampex Recording Media Corp.			
189	T-30 to T-127	VHS	CDGFO
199	T-30 to T-120	VHS	CDGFO
289	ST-30 to ST-180	S-VHS	CDGFO
188	L-60 to L-120	Beta	CDGFO
198	BC-5 to LC-90	Betacam	CDGFO
298	BC-5 to LC-90	Betacam SP	MP
187	5 to 60 min.	U-matic	CDGFO
197 (BCA & BCS)	5 to 60 min.	Mini U-matic	CDGFO
297 (SPA & SPS)	10 to 60 min.	U-matic SP	CDGFO
219 (Medium)	8 to 35 min.	D-1	CDGFO
219 (Large)	8 to 77.7 min.	D-1	CDGFO
319 (Small)	7.3 to 33.1 min.	D-2	MP
319 (Medium)	7.3 to 98.3 min.	D-2	MP
319 (Large)	128.3 to 210.4 min.	D-2	MP
Amtron, Inc.			
Amtron	T-5 to T-120	VHS	(NS)

We work for you...



...with quality

Listen. The silence is golden. The bass, rich. The highs, they simply soar. From the original BASF studio recording to the final duplicated cassette.

That's because BASF listens. From delivering high quality product innovations like our renowned PEM 468/469 mastering tape, to meeting your needs with the largest line of quality audio and video duplication tapes.

Quality worth hearing. Quality worth seeing.
Quality that *works* for you.

Headquarters: 800-225-3326 • Customer Service: 800-225-4350
Customer Service Fax: 800-446-BASF



We work for you

BASF

U.S. Blank Tape Product Charts-PRO-INDUSTRIAL PRODUCTS ONLY

VIDEO CASSETTE

SERIES/LINE PRODUCT	PLAYING TIME (MIN.)	FORMAT	COATING
BASF Corp. Information Systems			
EQ	T-120,130,160	VHS	FC
SHG	T-120,130,160,180	VHS	CrO2
SHG-S	ST-120	VHS-S	CrO2
EQ	L-750	Beta	F
Canon USA, Inc., Video Div.			
Hi-8 E6	P6-20,60,120	8mm	HME
8mm P6	P6-15,30,60,90,120	8mm	MT
Certron Corp.			
Certron HQ	T-120	VHS	FE
Certron HG	T-120	VHS	FE
DIC Digital			
MPX (Reg. & Bulk)	P6-15,30,60,90,120	8mm	Microfidelity MT
Douglas-Hanson Co., Magnetic Media Div.			
Chromax HS	T-120	VHS	CrO2
Chromax HQ	T-120	VHS	CrO2
Chromax Hi-Fi	T-120,160	VHS	CrO2
Chromax Bulk-B	T-5 to T-140	VHS	CrO2
Professional A Grade	T-5 to T-160	VHS	CrO2
Fuji Photo Film U.S.A., Inc., Pro Div.			
H471S	ST-30,60,90	S-VHS	BRX
H321E	BC-5 to BC-90	Betacam	BRX
M321SP	BC-5 to BC-90	Betacam SP	MTX
H521E PRO/BR/SP	10,20,30,60 min	U-matic	BRX
M401 M-II	10 to 90 min.	M-II	MTX
D2001 D-2 Digital	6 to 94 min.	D-2	MTX
Goldstar Electronics Int'l, Inc.			
HG	T-30 to T-120	VHS	CoG
ST	T-30 to T-120	VHS	CoG
HiFi	T-30 to T-120	VHS	CoG
Standard	ST-120	S-VHS	CoG
SG	TC-20,30	VHS-C	CoG
SHG	TC-20,30	VHS-C	CoG
MP	P6-30,60,90,120	8mm	MP
Konica U.S.A., Inc.			
SSR	T-120	VHS	CF
SHG	T-120	VHS	CF
S-VHS	ST-120	S-VHS	(NS)
VHS-C	TC-20,30	VHS-C	CF
MP6	P6-60,90,120	8mm	HE/MP
Master Hi-Tech Video (USA)			
Pro-Master	T-30,60,90,120	VHS	CMO 650
Pro-Master	TC-20,30	VHS-C	CMO 650
Pro-Master	P6-30,60	8mm	MP 1500
Gold Master	T-30,60,90,120	VHS	(NS)
Gold Master	TC-20,30	VHS-C	(NS)
Gold Master	P6-30,60	8mm	(NS)
Maxell Corp. of America			
PI Plus	T-30,60,90,120	VHS	EQ
PI Plus	L-250,500,750	Beta	EQ
HGX-Plus	T-160,120	VHS	EO
VHS BD	T-30,60,120	VHS	EO/BC
MemTek Products (Memorex)			
HS	T-120	VHS	Standard

VIDEO CASSETTE

SERIES/LINE PRODUCT	PLAYING TIME (MIN.)	FORMAT	COATING
MemTek Products (Memorex)			
HG	T-120	VHS	High Energy
Panasonic Co., Special A/V Products			
NV-ST	ST-60,120	S-VHS	(NS)
NV-STC20/30P	STC-20,30	S-VHS-C	(NS)
RAKS Corp. of America, Inc.			
VHS HG Bulk	T-10 to T-120	VHS	(NS)
HG Multi Layer	T-120	VHS	(NS)
SHG Multi Layer	T-120	VHS	(NS)
AG Super Advanced Grade	T-120	VHS	(NS)
SAQ Super Advanced Quality	T-120	VHS	(NS)
Sony Magnetic Products Group of America			
BCT-G	5 to 30 min.	Betacam	0
BCT-GL	5 to 90 min.	Betacam	0
BCT-GNP	5 to 20 min.	Betacam	0
BCT-M	5 to 30 min.	Betacam	Metal
BCT-ML	5 to 90 min.	Betacam	Metal
BCT-MNP	5 to 30 min.	Betacam	MP
LS (Bulk)	L-125 to L-750	Beta	0
TS-S	T-15 to T-60	VHS	0
T-PM/PR/BA	T-30 to T-120	VHS	0
TS	T-15 to T-127	VHS	0
KCA-BRS	5 to 60 min.	U-matic	0
KCS-BRS	10, 20 min.	U-matic	0
KSP	5 to 60 min.	U-matic	Metal
KSP-S	10, 20 min.	U-matic	Metal
KCA-XBR	10 to 60 min.	U-matic	0
KCS-XBR	10, 20 min.	U-matic	0
DCS-M	6 to 32 min.	D-2	Metal
DCM-M	6 to 94 min.	D-2	Metal
DCL-M	105 to 208 min.	D-2	Metal
DCS-MNP	3 to 6 min.	D-2	Metal
D1M, D1L	12 to 94 min.	D-1	0
HMPX	P6-30,60,120	8mm	Metal
PHB	P6-30 to P6-135	8mm	Metal
SKC America, Inc.			
HQ	T-120	VHS	(NS)
SHQ	T-120	VHS	(NS)
SHF	T-120	VHS	(NS)
SPro	T-120	VHS	(NS)
Beta	L-500,750	Beta	(NS)
MP-6	P6-30,60,90,120	8mm	(NS)
Swire Magnetics Co.			
Laser 8mm	P6-60,90,100	8mm	ME
High Grade (HG)	T-120	VHS	FeO
High Quality (HQ)	T-60,120	VHS	FeO
TDK Electronics, Pro. Prods. Div.			
Broadcast Master (BC)	BC-5,10,20	Betacam	SAV
Colour Master (CM)	ST-30,60,120	S-VHS	SAV
Visual Master (VM)	T-30,60,120	VHS	SAV
Tandy Magnetic Media			
Pro Cam	T-30,120	VHS	Pro Grade
High Grade	T-120, E-180	VHS	High Grade
High Standard	T-120, E-180	VHS	Std. Grade



THERE'S AN EMMY IN EVERY TAPE.

To Sony,™ an Emmy is more than a trophy. It's an affirmation. Winning the Emmy for "Developments in Metal Tape Technology" is further proof of our metal tape's astounding picture and sound clarity. Recognition of Sony Professional Tape's contribution in raising the standards of the entire broadcasting industry. And that's why Sony is the leader that video leaders follow.

SONY.
PROFESSIONAL TAPE

U.S. Blank Tape Product Charts-PRO-INDUSTRIAL PRODUCTS ONLY

VIDEO CASSETTE

SERIES/LINE PRODUCT	PLAYING TIME (MIN.)	FORMAT	COATING
Taylor Video Corp.			
Image HiFi	T120	VHS	EO
Silvercrest	T120	VHS	FO
Silvercrest	L-500,750	Beta	FO
Image HiFi	L-500,750	Beta	EO
3M Co. Professional Audio/Video			
Pro Broadcast	T-30,60,90,120,160	VHS	FO
Dub Pak	T15 to T120	VHS	FO
Master Broadcast (ST)	30,60,120	S-VHS	FO
Master Broadcast (PB)	5,10,20,30,60,90 min.	Betacam SP	MP
Broadcast (PB)	5,10,20,30,60,90 min.	Betacam	FO
Betacam (Bulk)	5,10,20,30 min.	Betacam	FC
Betacam Metal (Bulk)	5,10,20,30	Betacam	MT
MBR Master Broadcast	10,20,30,50,60min.	U-matic	FO
SP Broadcast (SP)	10,20,30,60 min.	U-matic	FO
MBR Mini U-Matic	5 & 20 min.	Mini U-matic	FO
8mm	P6-120	8mm	MP
D-1/4:2:2	10,30,75,90min.	D-1	FO
D-2	5 to 200 min.	D-2	MP
Master Broadcast (MM)	10,20,30,60,90 min.	MII	MP

VIDEO OPEN REEL

SERIES/LINE PRODUCT	TAPE WIDTH	LENGTH (FT.)	COATING
Ampex Recording Media Corp.			
175 Quad	2"	1200'7200'	GFO
196 Type B/C format	1"	160'9200'	CDGFD
Fuji Photo Film U.S.A., Inc., Pro Div.			
H621E	1"	1640-9100'	BRX
Maxell Corp. of America			
CV-80	1"	1640',3084',4626'	EO/BC
Sony Magnetic Products Group of America			
V16-18B/34B (8" reel)	1"	869',1640'	0
V16-66B (9" reel)	1"	3182'	0
V16-96B (10-1/2" reel)	1"	4626'	0
V16-126A (11 3/4" reel)	1"	6069'	0
V16-156A (12 1/2" reel)	1"	7513'	0
V16-188A (14" reel)	1"	9039'	0
V16-18/34SP (8" reel)	1"	869',1640'	0
V16-66SP	1"	3182'	0
V16-96/105SP	1"	4626',5052'	0
V16-126SP (11 3/4" reel)	1"	6069'	0
V16-156SP (12 1/2" reel)	1"	7513'	0
V16-188SP (14" reel)	1"	9039'	0
V1-K-18/34B (8" reel)	1"	869',1640'	0
V1-K-66B (9" reel)	1"	3084'	0
V1-K-96/105B (10 1/2" reel)	1"	4626',5052'	0
V1-K-126A (11 3/4" reel)	1"	6069'	0
V1-K-188A (14" reel)	1"	9039'	0
V1-K-18/34SP (8" reel)	1"	869',1640'	0
V1-66SP	1"	3084'	0
V1-K-96/105SP (10 1/2" reel)	1"	4626',5052'	0
V1-K-126SP (11 3/4" reel)	1"	6069'	0

VIDEO OPEN REEL

SERIES/LINE PRODUCT	TAPE WIDTH	LENGTH (FT.)	COATING
Sony Magnetic Products Group of America			
V1-K-156SP (12 1/2" reel)	1"	7513'	0
V1-K-188SP (14" reel)	1"	9039'	0
HD-1-33/48/63SP (9"11 3/4" reel)	1"	970',1410',1850'	0
V-1/2M-2M	1/2"	492'	MT
V-1/2M-3M	1/2"	885'	MT
V-1/2M-4M	1/2"	1279'	MT
3M Co. Professional Audio/Video			
480XT Master Broadcast	1"	1630' to 9100'	FO
479 Broadcast	1"	1630' to 9100'	FO

VIDEO TAPE (Bulk Raw)

SERIES/LINE PRODUCT	LENGTH (FT.)	TAPE WIDTH	COATING
BASF Corp. Information Systems			
PEV 192 SDX	16,370'	1/2"	CrO2
PEV 162 SDX	19,540'	1/2"	CrO2
PEV 192 HGX	16,370'	1/2"	CrO2
CV 19HG TMD	16,400'	1/2"	CrO2
DIC Digital			
8mm Pancake	10,433'	8mm	MMP
Fuji Photo Film U.S.A. Inc., Pro Div.			
UH 300 VHS Pancake	13,845'	1/2"	BRX
VHS UH400 Pancake	13,845'	1/2"	DC BRX
Goldstar Electronics Int'l Inc.			
UF0-1640	16,400'	1/2"	Cobalt Gamma
JVC Magnetics America Co.			
VM-231B-20	16,400'	1/2"	ER Grade
Maxell Corp. of America			
Pancake	16,400'	1/2"	EO
Nat'l Media Marketing			
Konica SA-50	16,400'	1/2"	CF
SKC America Inc.			
PC-LP (Thin Base)	16,400'	1/2"	(NS)
PC-TMD	16,400'	1/2"	PC
PC-TG/BC	16,400'	1/2"	GFD/BC
PC-TG	16,400'	1/2"	GFD
Sony Magnetic Products Group of America			
KRTA-5010 PA	16,433'	1/2"	Fe2O3
V-1/2M-4M	1,279'	1/2"	MP
V-1/2M-3M	885'	1/2"	MP
V-1/2M-2M	492'	1/2"	MP
TDK Electronics, Pro. Prods. Div.			
Standard Base VPRS4998ET	16,344'	1/2"	SAV
Thin Base VPRT6246ET	20,427'	1/2"	SAV
TMD Master MM-400-TA	1,312'	1/2"	SAV
TMD Copy VPC-S4998-UT	16,334'	1/2"	SAV
Tandy Magnetic Media			
Duplicator	16,400'	1/2"	Std. Grade
3M Consumer Video & Audio Prods. Div.			
8619 Pancake	16,450'	1/2"	FO

CARTRIDGES, CASSETTES, REELS & OTHER PARTS

ACME Merchandising, Inc.

17521 Railroad St., Unit G, Industry, CA, 91748, (818) 854-1733, (800) 888-3808, Fax: (818) 854-1732, Sales Mgr.: Alan Kok; Mktg. Dir.: Terry So.
Audio: C-0, preloaded cassette, display boxes.
Video: V-0, preloaded cassette, display boxes.
Other: Blank Audio/Video Cassette & Accessories-Distributor, Importer

ASR Recording Services of California, 8960 Eton Ave., Canoga Park, CA, 91304, (818) 341-1124, Fax: (818) 341-9131, Pres. (Mfg.): Allen Weintraub; Vice Pres./Sales: Lester P. Edwards.

Audio: Shells, Boxes.

Allison Industries Ltd., 2910 Expwy. Dr. S., Islandia, NY, 11722, (516) 348-7900, Fax: (516) 348-7021, Pres.: R. Marc Ligator.

Audio: C-0s, Norelco Boxes.

Video: V-0s, Custom tape loading.

Amaray Int'l Corp., 52 Green Pond Rd., Rockaway, NJ, 08766, (800) 426-2729, Fax: (201) 627-5730, Pres.: Ed Joyce Jr.

Video: Boxes.

Amaray Int'l Corp., 1603 SE 19th St., Ste. 202, Edmond, OK, 73013, (405) 340-8924, Vice Pres. Sales: Tom Lawrence.

Video: Boxes.

Amtron, Inc., 2867 S. Vail, Commerce, CA, 90040, (213) 721-1717, Fax: (213) 721-1902, Pres.: Stanley Wong; Sales Mgr.: Monisa Chan; Mktg. Dir.: David Wong.

Audio: C-0, C10, C90.

Video: V-0, T-5, T-120.

Andol Audio Products, Inc.

4212-14th Ave., Brooklyn, NY, 11219, (718) 435-7322, (800) 221-6578, Fax: (718) 853-2589, Pres.: Anthony A. Manlere; Sales Mgr.: Domenick Salvatore; Mktg. Dir.: Michael Salvatore.

Audio: C-0's, BASF Pancakes, Splicing Tape, DAT's, Norelco & Poly Boxes, Custom Cassettes.

Video: Custom Video Blanks, Storage Boxes, Sleeves, Labels.

ANDOL

AUDIO PRODUCTS INC.

RECORDING INDUSTRY SUPPLIES

4212 — 14th AVENUE
BROOKLYN, NY 11219

• 1-800-221-6578 • (718) 435-7322 • FAX # (718) 853-2589

YOUR ONE STOP FOR DUPLICATING AND LOADING SUPPLIES

- BASF AND MAGNETIC MEDIA BULK AUDIO CASSETTE TAPE (PANCAKES)
- AMPEX AND BASF DAT CASSETTES
- NORELCO & SOFT POLY BOXES COLORS AVAILABLE
- VINYL CASSETTE ALBUMS
- C-O CASSETTES
- SPLICING TAPE & CUTTER BLADES
- AMPEX MASTERING TAPE
- CASSETTE LABELS
- CUSTOMIZED BLANK AUDIO & VIDEO CASSETTES
- VIDEO ACCESSORIES
- EMPTY REELS & BOXES
- CD JEWEL BOXES



COMPETITIVELY PRICED AND STOCKED FOR IMMEDIATE SHIPMENT

Call today for our FREE catalog

and price list.

CALL TOLL FREE 1-800-221-6578
IN NY CALL (718) 435-7322 • FAX # (718) 853-2589



MAGNETIC MEDIA



poly-matrix



AMPEX

YOUR BEST CALL FOR AUDIO AND VIDEO

- C-O CASSETTES • NORELCO BOXES FOR CASSETTES
- JEWEL BOXES FOR CD'S • CD AND CASSETTE STORAGE SYSTEMS
- 1/4" TAPE REELS and BOXES
- VIDEO BOXES and V-O's

- Soft Poly Boxes
- Ampex Style Boxes
- C-O Cassettes (sonic and screw type)
- Hubs and Cores for Video and Cassette Tapes
- 7-1/2" Master Reels
- Cassette Splicing Tape

El Mar Plastics, Inc.

840 East Walnut Street, Carson, CA 90746

(800) 255-5210 Outside CA

(213) 327-3180, FAX (213) 327-0491



NEW PRODUCT: MULTI-CASSETTE ALBUM BOX

LEADER LOCK

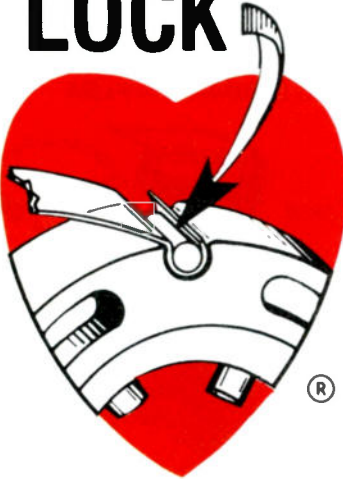

THE HEART OF YOUR CASSETTE

BETTER THAN EVER

That little piece of staking rod is the big difference in the quality of your cassette.

Our Leader Lock is better because of our unique Solid Extrusion process which delivers a rod diameter tolerance of not more than $\pm .0006''$ (.0127mm).

—Sizes from .049" (1.2446mm) to .068" (1.7272mm).

—Extruded in increments of .001" (.0254mm).

—Tolerance not more than $\pm .0006''$ (.020 mm).

—Popular sizes — .052" (1.320mm) and .062", (1.575mm) stocked for immediate shipment.

Designed and engineered for the cassette industry, our staking rod virtually eliminates cassette failure due to leader tape pull-out.

We also make special extrusions for particular requirements.

DUNN

Industries, Inc.

7 Perimeter Rd., Unit 11
Manchester, NH 03103
TEL: (603) 666-4800
FAX: (603) 666-4884

J.C. Anglum Co., Inc., PO Box 236, 60 Midvale Rd., Mountain Lakes, NJ, 07046, (201) 263-1442, Fax: (201) 263-8640, Pres.: J. Clifford Anglum; Sales Mgr.: Robert Pitcher; Office Mgr.: Colleen Koch.

Audio: Norelco style cassette boxes.
Video: VHS, Beta, Slip Sleeves.

Anwell (Cosmo Mktg. F.E.), 1152 N. Mountain Ave., #110, Upland, CA, 91786, (800) 800-4769, (714) 920-1065, Contact: Bosco Pereira.

Audio: C-0, Norelcos, Jewel Boxes.
Video: V-0.

Apex Engineering, Inc., 17 Downing Three, Pittsfield, MA, 01201, (413) 442-1414, Fax: (413) 443-7595, Vice Pres./Mktg. Dir.: Donna L. Rochelo; Pres./Sales Mgr.: Donald R. Rochelo.

Arcal Corp., 2732 Bay Rd., Redwood City, CA, 94063, (415) 369-7348, Fax: (415) 369-7446, Pres.: Sal Viola; Mgr.: Steve Viola.

Audio: C-0s, cassette boxes, plastic reels.

At The Top Duplicators, 3330 Earhart, Carrollton, TX, 75006, (214) 980-7671, (214) 233-9191, Fax: (214) 991-1853, Prodn. Mgr.: Bert Newmaner.

Audio: BASF Audo tape.

Video: Sony video tape.

Audiopak, Inc., PO Box 3100, 1680 Tysons Dr., Winchester, VA, 22601, (703) 667-8125, Fax: (703) 667-6379, Pres.: Nick Krassowski; Sales Mgr.: G. Stafford.

Audio: Cartridges & Open Reel.

Aurex/Auriga Plásticos, 1122 E. Lincoln Ave., Ste. 204, Orange, CA, 92665, (714) 637-6800, Fax: (714) 637-3062, Dir. US Opns.: Jerry Bronaugh; Sales Mgr.: Dennis Schleich.

Audio: C-0s, V-0s.

Beres Industries, Inc.

1785 Swarthmore Ave., Lakewood, NJ, 08701, (908) 367-5700, Fax: (908) 363-5085, Pres.: Charles Beres, Jr.; Gen. Mgr.: Paul Rolando.

Audio: C-0, Norelco Style Boxes.

W.H. Brady Co., PO Box 571, Milwaukee, WI, 53201, (800) 662-5688, Fax: (414) 377-6789, Sales Mgr.: John A. Cullen.

Audio/Video: Splicing & Sensing Tapes/Cleaning Fabric.

Burlington Audio/Video Tapes, Inc., 106 Mott St., Oceanside, NY, 11572, (516) 678-4414, (800) 331-3191, Fax: (516) 678-8959, Pres.: Ruth Schwartz; Sales Mgr.: Jan Schwartz; Mktg. Dir.: Rudy Schwartz.

Audio/Video: All sizes.

COSMO, PO Box 8744, 2639 S. King St., #205, Honolulu, HI, 96826, (800) 800-4769, Fax: (808) 949-5998, Pres.: Thomas D. Pereira.

Audio: C-0s, Norelcos, Double Norelcos, Polyboxes.

Video: V-0s.

DER Duplicating Services Inc., 212 NW Fourth Ave., Hallandale, FL, 33009, (305) 458-7505, Fax: (305) 458-8554, Pres.: Mike Rubin; Sales Mgr.: Allan Baird.

Video: V-0s.

Davkore Co., 1300-A Spacepark Way, Mountain View, CA, 94043, (415) 969-3030, Fax: (415) 969-0140, Pres.: CW. Webber; Sales Mgrs./Mktg. Dirs.: Tom Sherry, Jeanne Horan.

Audio: Cassettes.

Dixon Industries Corp. (A Bundy Co.), 386 Metacomb Ave., Bristol, RI, 02809, (401) 253-2000, Pres.: Charles F. Boyle; Mktg. Dir.: E. Rulon-Miller.

The Domain Group, 289 Main Pl., Carol Stream, IL, 60188, (708) 668-5300, Fax: (708) 668-0158, Pres.: Edward A. Elliott; Vice Pres./Sales Mgr.: James Draper.

Audio: Cassette, Open Reel-Blank and Duplicated.

Donnak Industries, 845 Broad Ave., Ridgefield, NJ, 07657, (201) 945-8820, Fax: (201) 945-4545, Pres.: Marvin Donalds.

Audio: Spring pad, leader tape, liners, hubs.

Dunn Industries, Inc.

7 Perimeter Rd., Unit 11, Manchester, NH, 03103, (603) 666-4800, Fax: (603) 666-4884, Pres.: Duane Dunn; Dir.: Chet Dunn.

Audio: Cassette Staking Rod, Pins, Windows.

EMC/Group, 853 Industrial Rd., #G, San Carlos, CA, 94070, (415) 591-9500, Fax: (415) 591-9641, Pres.: Terri L. Evans; Contact: Dawn Dangidang.

Audio: C-0s.

Video: V-0s.

El Mar Plastics, Inc.

840 E. Walnut St., Carson, CA, 90746, (213) 327-3180, (800) 255-5210, Fax: (213) 327-0491, Pres.: Allen Schor; Sales Mgr.: Maxine Hesse.

Audio: C-0, Norelcos, Soft Polys, CD Jewel Boxes, Reels & Boxes.

Video: V-0, Video Boxes.

Electronic Media Int'l, PO Box 2664, Kennebunkport, ME, 04046, 35 Western Ave., Kennebunk, ME, 04043, (207) 967-2894, Fax: (207) 967-4509, Pres.: Paul J. Gelardi; Mktg. Dir.: Susan B. Porter; Business Mgr.: Susan Turner.

Video: Recycled video cassettes.

Fabricators Int'l, Inc., 845 Broad Ave., Ridgefield, NJ, 07657, (201) 945-2000, Fax: (201) 945-4545, Pres.: Marvin Donalds.

Audio: Leadertape, Cassette liners.

Fastrax, Inc., 4033 Aurora Ave. N., Seattle, WA, 98103, (206) 632-8300, Pres.: Miriam Hamilton; Sales Mgr.: Candace Williams.

Audio: 5 screw shell, tape, reels.

Fidelipac Corp., PO Box 808, Moorestown, NJ, 08057, (609) 235-3900, Fax: (609) 235-7779, Pres.: Roger Thanhauser; Sales Mgr.: John Tiedeck; Mktg. Dir.: Scott Martin.

Audio: Broadcast Tape Cartridges.

Filam Nat'l Plastics, Inc.

13984 S. Orange Ave., Paramount, CA, 90723, (213) 630-2500, Fax: (213) 408-0712, Pres.: Vic Flores; Mktg. Dir.: Brad Harse.

Audio: C-0, Norelco Boxes, Poly Box.

Filam Nat'l Plastics Inc., 1200 N. St., Ste. 504, Lincoln, NE, 68508, (402) 435-5005, Fax: (402) 435-4722, Mktg. Dir.: Brad Harse.

Audio: C-0, Norelco Boxes, CD Jewel Boxes.

Video: V-0, Video Box.

GMG Exim (USA), Inc., 500 S. Sepulveda Blvd., Ste. 403, Los Angeles, CA, 90049, (213) 471-4111, Fax: (213) 471-2267, Pres.: E. Gondobintoro; Sales Mgr.: James Dien; Mktg. Dir.: Harry Choi.

Audio: C-0, Snap-Packs Mfr.

Video: V-0 Mfr.

Gage, Div. of Shape, Inc., PO Box 717, 301 US Rt. 1, Scarborough, ME, 04074, (207) 883-6316, (800) 462-4165, Fax: (207) 883-1068, Chief Operating Officer: Michael Thomas; Sales Mgr.: Walter Gordon; Mktg. Coord.: Tracy L. Hartman; Customer Service Rep.: Patti Ellsworth.

Audio: Norelco/DAT/DAT D-O loading, boxes, pkg.

Video: E-Sleeves.

Hyosung B & H Co., Ltd., 2400 E. Devon Ave., #200, Des Plaines, IL, 60018, (708) 297-7533, Fax: (708) 297-7535, Pres.: CY. Yoo; Gen. Mgr.: WS. Chol.

Video: Cassette Mfr.

Imperial Tape Co., Inc., 1928 14th St., Santa Monica, CA, 90404, (213) 393-2008, (800) 736-8273, Fax: (213) 396-8694, Pres.: Howard Ganz; Sales Mgr.: Ileana San Martin.

Audio: Hubs, C-0.

Video: Hubs, V-0.

Int'l Cutterhead Repair SVC, Inc., 571 Boulevard, Hasbrouck Heights, NJ, 07604, (201) 288-0106, Pres.: Sharon Mizrachi; Sales Mgr.: Moty Mizrachi; Mktg. Dir.: Blanche Rand.

Audio: Disk-masstering cutterhead; Haeco Sc-1.

Klearfold, Inc., 364 Valley Rd., Warrington, PA, 18976, (215) 343-9300, Fax: (215) 343-0491, Pres.: Melvin Herrin; Vice Pres. Sales: David Tolley.

Kyric Corp., 2111 E. 20th St., Tucson, AZ, 85719, (800) 528-4840, Pres./Sales Mgr.: K. Mokhtarian.

Audio: C-0, Boxes, Bulk Tape.

Laserfile, 690 Greenwich St., New York, NY, 10014, (212) 627-2977, Fax: (212) 807-1158, Mktg. Dir.: Gary Forman; Ex-

OUR PRECISION MAKES YOUR DECISION EASY.

At Olamon Industries, we are dedicated to producing superior audio cassette shells for meticulous users.

We've been doing it since 1985.

No brag, just fact.

Call us to discuss your requirements. Give our C-0s a try. Find out why so many cassette loaders have switched to Olamon Industries.

We love to show off.



OLAMON INDUSTRIES
Penobscot Indian Nation
Phone (207) 827-8051

25 River Road
Old Town, ME 04468
Fax (207) 827-8495

MADE WITH PRIDE IN THE USA

ec. Dir.: Arthur Herr; Vice Pres.: Jeff Tall.
Audio: Laserfile CD cases, Plastic, Paperboard.

Lenco Co.

Lenco Plaza, Waverly, NE, 68462, (402) 786-2000, Fax: (402) 786-5050, Contact: Daryl Chapelle.
Audio: Audio Video Components, C-0 Cassettes all Configurations.
Video: Video Display Boxes.

M & H Communications, 45 Hidden Ridge Dr., Syosset, NY, 11791, (516) 496-8920, Fax: (516) 496-4763, Pres.: Heidi Vincent.
Video: V-0.

Magnetic Marketing Corp., 18338 Lavaugh Dr., Northville, MI, 48167, (313) 349-5451, Pres.: Fred G. Fehlauer.
Video: Cassettes, tape.

Magnetic Media Corp., 150 Broad Hollow Rd., Melville, NY, 11747, (516) 424-7580, Fax: (516) 424-7621, Pres.: Aaron Wasserstrom; Vice Pres.: John Cristiano.
Audio: 5-screw/Sonic C-0 cass, Audio Cass. Tape.
Video: VHS V-0 cassette.

Magnetic Products, 27712 Avenue Mentry, Valencia, CA, 91355, (805) 295-8448, Fax: (805) 295-8278, Managing Dir.: R. Goldman.
Video: V-0s, L-0s, 8mm shells.

Marsal Prods., Inc., PO Box 37070, 1735 Castroville Rd., San Antonio, TX, 78237, (512) 433-9351, Fax: (512) 433-7973, Pres.: Antonio J. Menendez; Vice Pres./Sales Mgr.: Felix Elizondo

Marubeni America Corp., 200 Park Ave., New York, NY, 10166, (212) 599-3976, Fax: (212) 599-3742, Mktg. Dir.: M. Kely.
Audio: Jewel boxes.

Matrix Assoc., Inc., 1425 Monje Grande Pl., Pacific Palisades, CA, 90272, (213) 459-6913, Fax: (213) 459-6416, Pres.: Ed Koepppe; Sales Mgr.: Karen Koepppe; Mktg. Dir.: Charlie Shuman.
Video: V-0, loaded cassettes.

Michelex Industrial Group

PO Box 69, Industrial Park, Massena, NY, 13662, (315) 769-6616, Pres.: Tom Gramuglia.
Audio: Sonic & 5-Screw C-0s.
Video: V-0s, Bulk Loaded Cassettes.

Minnesota Rubber Co., 3630 Wooddale Ave. S., Minneapolis, MN, 55416, (612) 927-1400, Pres.: John Rentschler; Sales Mgr.: Del Carter.
Audio: 8 tr. pinch & drive rollers.

C-0 Cassettes & Norelco-Style Boxes

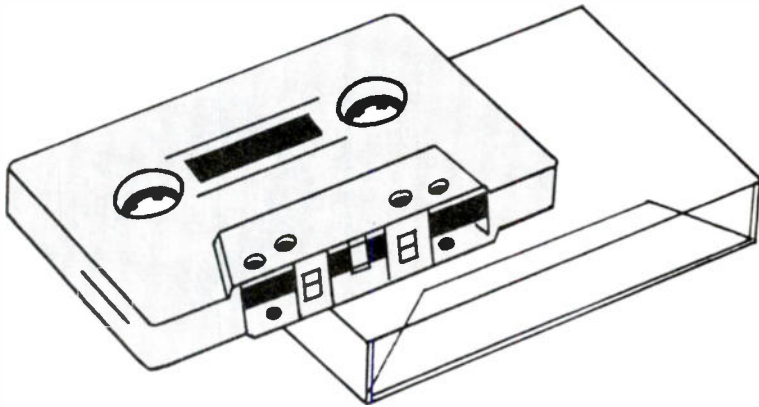

Made and Assembled in the U.S. by

BERES

Call Charles Beres Jr., President

(908) 367-5700 or Fax (908) 363-5085

Beres Industries Inc.

1785 Swarthmore Ave., Lakewood, NJ 08701

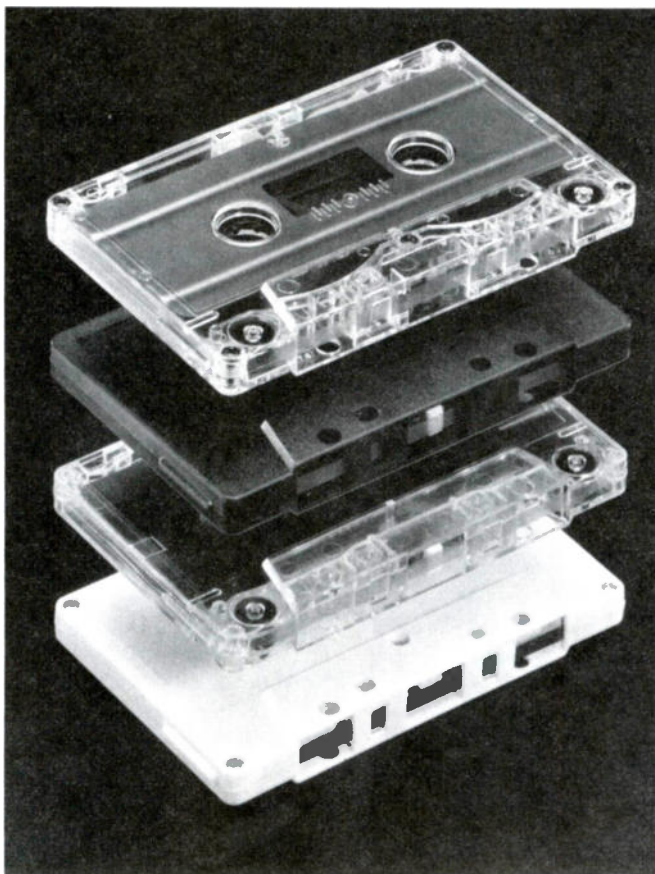

Lenco Audio Cassette Products

The competition just doesn't stack up.

For years we've been known as the leader in providing CØ cassettes and boxes to America's recording and blank load industries. We offer sonic and 5-screw CØ cassettes in clear and opaque. The internal design of these cassettes provides excellent azimuth and tracking. The external cosmetics make these cassettes look as good as they work. Lenco also offers soft poly, Ampex-style and Norelco display boxes. And, like all Lenco products, these are available from distribution warehouses in Los Angeles, Dallas, Nebraska, Atlanta and New York.

Lenco guarantees the finest competitively priced audio cassette products available. Delivered when and where you need them. Call or write for prices and samples and see for yourself why we're the leader.

LENCO

Lenco Plaza / Waverly, NE 68462 • (402) 786-2000 / FAX (402) 786-5050

Poly-matrix

Manufacturers & Exporters of Norelco Type Cassette Boxes, Compact Disc, Jewel Cases Soft Poly Boxes.

Poly-Matrix
40 Downing
Industrial Pk.
Pittsfield,
MA 01201
413-499-3550
FAX #
413-442-8610

OP Overland Products Co.



**No. 201
Cassette Spring Pad**

Metal stamping since 1961
Special Designs on request

OP Overland Products Co.

Box 567 • Fremont, NE 68025
402/721-7270 • Fax 402/721-2678

Monster Cable Products, Inc., 274 Wattis Way, South San Francisco, CA, 94080, (415) 871-6000, Fax: (415) 871-6555, Pres.: Noel Lee; Sales Mgr.: Howard Harman; Mktg. Dir. Nicolette Stultz.

Audio: Cables, Fiber Optic Cables.
Video: Cables.

Nat'l Audio Co., Inc., PO Box 3657 G.S., 1841 E. Bergman, Springfield, MO, 65808, (417) 863-1925, Fax: (417) 863-7825, Pres.: Steve Stepp; Sales Mgr.: Sandi Slonecker.

Audio: Mfg. of professional quality audio cassette.

New Age Video, PO Box 68, 3480 So. Clinton Ave., South Plainfield, NJ, 07080, (201) 756-7500, Fax: (201) 757-1991, Pres.: Steven Nasar; Sales Mgr.: Jack Nasar; Vice Pres.: Joey Nasar.

Video: VHS V-0s.

Ocean Development America, Inc.

2500 Wilshire Blvd., Ste. 809, Los Angeles, CA, 90057, (213) 380-9099, Fax: (213) 380-8970, Dir. Pres.: Mr. Guo Junwei; Vice Pres. Mr. Cai Kal Yuan.

Olamon Inds.

25 River Rd., Old Town, ME, 04468, (207) 827-8051, Fax: (207) 827-8495, Pres.: Al Marquis.

Audio: 5 Screw, Sonic C-0s, Cassingles & Norelco Boxes.

Overland Products Co.

PO Box 567, 1687 Airport Rd., Fremont, NE, 68025, (402) 721-7270, Fax: (402) 721-2678, Pres./Sales Mgr.: Howard Pearson; Sales Mgr.: James Pearson.

Audio: Cassette spring pressure pads.

Poly-Matrix, Inc.

40 Downing Industrial Park, Pittsfield, MA, 01201, (413) 499-3550, Fax: (413) 442-8610, Contact: Steve Rufo.

Audio: C-0.
Video: V-0.

Polyline Corp.

1233 Rand Rd., Des Plaines, IL, 60016, (708) 390-6464, Fax: (708) 827-6851, Pres.: Ed Kaiser; Sales Mgr.: Paula Schaub.

Quality Right Down The Line

Film quality products will help your production line run smoothly with better throughput and fewer rejections. Call us for • C-0 Cassettes and Boxes • CD Boxes • VHS/Beta Boxes • Hub Locks and Accessories.



Audio & Video Packaging from



Film National Plastics, Inc.

13984 South Orange Avenue, Paramount, CA 90723
(213) 630-2500 FAX: (213) 408-0712 TLX: 75106 FNPIUD

1200 N. Street, Suite 504, Lincoln, NE 68508
(402) 435-5005 FAX: (402) 435-4722

Audio: Reels & boxes 1/4, 1/2, 1" & 2".
Video: Reels & boxes 1" & 2".

Ponica Industrial Co., Ltd., 425 N. Smith Ave., Corona, CA, 91720, (714) 371-5781, Fax: (714) 371-2869, Pres.: Joseph Chien.
Audio: C-0, Norelco Box & audio pancake.
Video: V-0, library cases.
Premiere AVD Corp., 4025 Pleasantdale Rd., Atlanta, GA, 30340, (404) 448-1280.
Video: VHS/PVC case; 8mm video case.
Premiere AVD Corp., 1099 Brown St., Wauconda, IL, 60084, (708) 526-1800, (800) 922-8080.
Video: VHS/PVC case; 8mm video case.
Bud Pressner Music & Recording Service, 6860 Broadway, Merrillville, IN, 46410, (219) 769-0011, Pres.: Bud Pressner.
Audio: Cassettes, Reels.
Reynard CVC, Inc., 690 Greenwich St., New York, NY, 10014, (212) 627-2977, Fax: (212) 807-1158, Mktg. Dir. Gary Forman; Exec. Dir.: Arthur Herr; Vice Pres.: Jeff Tall.
Audio: Laserfile CD cases, Plastic, Paperboard.

Shape, Inc.-Audio Products Div.

PO Box 366, Biddeford Industrial Park, Biddeford, ME, 04005, (207) 282-6155, (800) 462-4165, Fax: (207) 283-9130, Chief Operating Officer: Michael Thomas; Vice Pres., Audio Sales: Lloyd Pomber; Mktg. Coord.: Tracy Hartman; Customer Service Rep.: Patti Ellsworth.
Audio: C-0 Audio Cassettes.

Shape, Inc.-Video Products Div.

PO Box 920, Meadows Ln., Kennebunk, ME, 04043, (207) 985-4970, (800) 462-4165, Fax: (207) 985-3224, Chief Operating Officer: Michael Thomas; Vice Pres. Video Sales: Lindsay Gable; Customer Service Rep.: Susan Mason.
Video: Full line of VHS V-0 video cassettes.

Sony Music Entertainment, Inc., 5152 Columbia Dr., Carrollton, GA, 30117, (404) 836-2000, Fax: (404) 836-2173, Opns. Dir.: Cher Anderson; Vice Pres./Sales-Mktg.: Scott Bartlett.
Audio: C-0s (Gray, Clear).
SOUND INVESTMENT Co., Inc., 3586 Pierce Dr., Chamblee, GA, 30341, (404) 458-1679, (800) 649-8273, Fax: (404) 458-0276, Pres.: Douglas Wilmer; Sales Mgr.: W. Louis Simmons, Jr.; Mktg. Dir.: Lori Albert.
Audio: Reels, boxes, C-0s, pancake tapes.

HI-TECHNOLOGY & QUALITY SOURCE

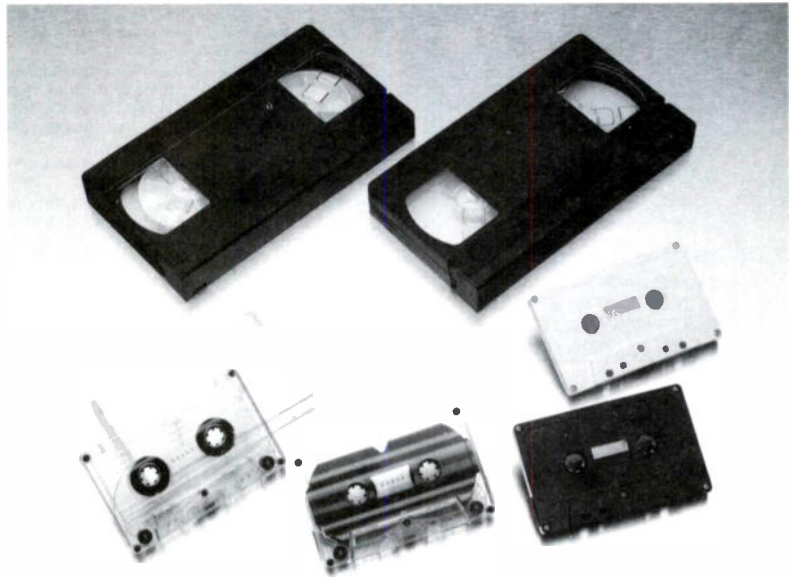

WE ARE THE MANUFACTURER OF:

- C-ZERO'S, BLANK AUDIO CASSETTE TAPES C-0 TO C-122, IN CLEAR WHITE/BLACK OR COLOR HOUSING.
- V-ZERO'S, BLANK VIDEO CASSETTE TAPES V-0 TO V-160/E-0 TO E-240, IN BLACK OR COLOR HOUSING.
- AUDIO NORESCO BOXES, VIDEO VHS, BETA LIBRARY CASES & CD JEWEL BOXES.

QUALI-SOURCE LIMITED

15/F, UNIT 8, HEWLETT CENTRAL, 52-54 HOI YUEN ROAD, KWUN TONG, KOWLOON, HONG KONG
TEL: (852) 797 2881 FAX: (852) 790 8703 TELE: 46033 QSTHKTW
U.S.A. TOLL FREE: 800-888 3808

Return this coupon for your free sample package of Michelex audio components

For over a decade, Michelex Industrial Group has been designing, manufacturing and providing quality audio components to the professional recording & duplicating industry worldwide. We are proud of the high quality of our products, and would like to show you why — simply mail or fax the coupon at right, and we'll send you samplings of our products, including Sonic and S-screw C-0s, CD Jewel boxes, cassette boxes, and soft poly boxes.

If your business demands special products, we can probably provide. Jot down your specific requirements (like "opaque or clear C-0s," "chrome notch or normal bias," or "double cassette boxes") in the space provided and we'll let you know how we can accommodate your request. We'll do our best to provide exactly what you need — on time and competitively priced.

Save time by simply attaching your business card to this coupon and mailing to address below. For fastest service, phone toll-free in U.S.A. 1-800-MXAUDIO (1-800-692-8346) or fax 315/764-0182

Company Name: _____
Mailing Address: _____
State/Province: _____
Country: _____
Zip/Postal Code: _____
Phone Number: _____
Special Requirements (if any): _____

Would you like to receive future Michelex mailings?
 Yes No

Return to:
MICHELEX INDUSTRIAL GROUP, P.O. Box 69,
Massena, New York, U.S.A. 13662

(If you'd rather not cut this publication, just send us a photocopy of this coupon to get your free audio buyers' package)

Your free sample package of Michelex professional audio components will be rushed directly to you from our closest plant (Los Angeles, Chicago or New York) the same day we receive your request. For fastest service, phone toll-free in the United States 1-800-MXAUDIO (1-800-692-8346) or fax your request to 315/764-0182

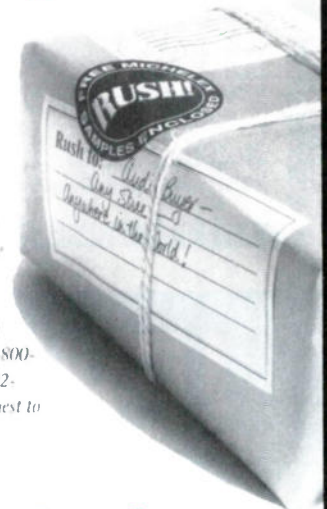

Michelex INDUSTRIAL GROUP

Head Office: Andrews Street, P.O. Box 69, Massena, New York, U.S.A. 13662 • Local Telephone 315/769-6616 • Toll-Free in U.S.A. 1-800-MX AUDIO (1-800-692-8346) • Fax 315/764-0182 • Telex 857487 MICHELEX GRA

C-ZEROS • DOUBLE NORELCOS
POLY BOXES • V-ZEROS • JEWEL BOXES
State of the Art Perfection
COSMO



1-800-800-4769 (GROW)
USA & CANADA INT'L SALES
 (714) 920-1065 Fax (714) 920-1099
EUROPEAN (UK) SALES
 (081) 560-6082 Fax (081) 560-9939

Sprague Magnetics, Inc., 15720 Stagg St., Van Nuys, CA, 91406, (818) 994-6602, Fax: (818) 994-2153, Pres.: Dorothy Sprague; Vice Pres., Mktg/Sales: Lee F. Schellin.
 Audio: Magnetic Heads & Parts.
 Stanton Magnetics, Inc., 101 Sunnyside Blvd., Plainview, NY, 11803, (516) 349-0235, Fax: (516) 349-0230, Pres.: Walter O. Stanton; Mgr. Adv. & Promo.: Jean Kapen; Vice Pres. Int'l Sales: Frank Conlon.
 Audio: Magnetic Cartridges & styl, headphones.
 Success Specialty Sales Corp., PO Box 77, Rockville Centre, NY, 11570, 47 Wellington Pl., Amityville, NY, 11701, (516) 798-2311, Fax: (516) 789-4011, Pres.: Stanley Gilman; Sales Mgr.: Ray Eriksen.
 Audio: Splicing/Sensing Tapes, tape wipes.
 Video: Splicing tapes, tape wipes.
 Sunkyoung Magnetic/America, Inc., 4041 Via Oro Ave, Long Beach, CA, 90810, (213) 830-6000, Fax: (213) 830-0646, Sales Mgr./Mktg. Dir.: Tom Anderson.
 Audio: C-0.
 Video: V-0.
 Suttman Prodn., PO Box 72, Dayton, OH, 45409, (513) 278-4601, Pres.: Eric J. Suttman.
 Swire Magnetics (Professional Products Div.), 6701 I Northpark Blvd., Charlotte, NC, 28216, (704) 597-7145, Fax: (704)

597-7152, Vice Pres. Sales/Mktg.: Michael Tremblay.
 Audio/Video: Shells, loaded blanks, pancake.
 Swire Magnetics, 301 E. Alondra Blvd., Gardena, CA, 90248, (213) 515-0494, (800) 421-2448, Fax: (213) 515-0371, Pres.: Jayme D'Barros; Sales Mgr.: Mike Tremblay.
 Audio/Video: C-0 audio cassette shells.
 Tapemaker, 48 Urban Ave., Westbury, NY, 11590, (516) 333-2700, Fax: (516) 333-0643, Pres.: Art Brandwein; Sales Mgr.: Mor-dy Brandwein; Mktg. Dir.: Matt Polakoff.
 Audio/Video: Splicing tape, wipes, leader tape, tabs.
 Tapeponents Co., PO Box 236, 60 Midvale Rd., Mountain Lakes, NJ, 07046, (201) 263-1442, (201) 263-1443, Fax: (201) 263-8640, Pres.: J. Clifford Anglum; Sales Mgr.: Robert Pitcher; Office Mgr.: Collen Koch.
 Audio: Poly, Norelco, & Jewel boxes, hubs.
 Thalco Audio, Inc., 2 Dickens Ave., Dix Hills, NY, 11746, (516) 667-1616, Fax: (516) 496-4763, Pres.: Michael Thaler; Mktg. Dir.: Glenn Thaler.
 Audio: C-0s.
 Video: V-0s.
 Ultraspec A.V.P., Ltd., 6820 Eight St., Buena Park, CA, 90620, (714) 739-2311, (714) 739-2333, Fax: (714) 739-8606, Pres.: Kingston Wong; Sales Mgr.: Leticia Magdelano; Mktg. Dir.: Don W. Wong.
 Audio: C-0, Jewel & Norelco boxes.
 Video: V-0, B-0.
 Unimagnetics USA, 1513 Sixth St., Ste. 204, Santa Monica, CA, 90401, (213) 393-1572, Fax: (213) 451-0143, Export Mgr.: Alex Tan; Customer Service: Thierry Follonier.
 Audio: C-0s, Norelco boxes.
 United Audio Video Group, Inc., 6855 Vineland Ave., North Hollywood, CA, 91605, (818) 980-6700, Fax: (818) 508-8273, Pres.: Miriam Newman; Vice Pres. Prodn.: Steve Newman; Sales Mgr.: Larry Schwartz; Mktg. Dir.: Laurie Newman.
 Audio: Cassettes, Dat, Open Reel, Mastery Tape.
 Video: Cassettes, XHS, Beta, 8mm, 3/4 sp, Betacam.
 Unlimited Resources Int'l, 200 Wilson St., #E-5-A, Port Jefferson Station, NY, 11776, Fax: (516) 473-5541, Pres.: Steven Moore; Sales Mgr.: Ramone Baker.
 Audio: Norelco & poly boxes.
 West & Co., Inc., PO Box 24281, Nashville, TN, 37202, 1726-C General George Patton Dr., Brentwood, TN, 37027, (615) 661-5808, Fax: (615) 661-5905, Pres.: Jerry West; Sales Mgr.: Mike Young; Mktg. Dir.: Gary Campbell.

PLASTIC REELS

For Audio Tape

- Competitive Pricing
- Shipped from Stock
- For 1/4" & 1/2" Tape, 5" thru 10-1/2" Reels

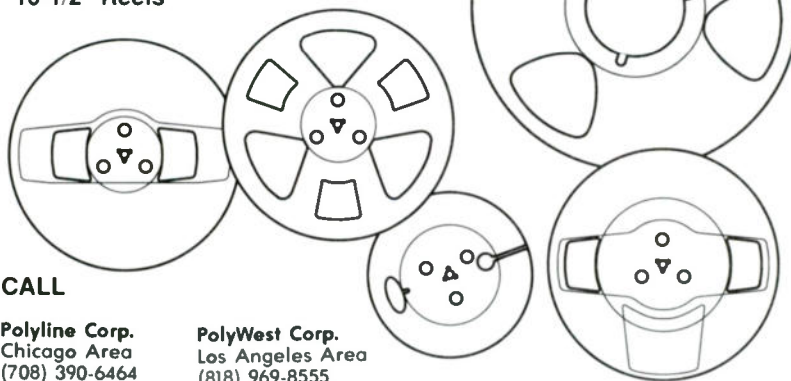

CALL

Polyline Corp.
 Chicago Area
 (708) 390-6464

PolyWest Corp.
 Los Angeles Area
 (818) 969-8555

Polyline Corp.
 1233 Rand Road Des Plaines IL 60016

JEWEL BOXES

INTERNATIONAL PACKAGING CORPORATION

5601 Industrial Rd., Ft. Wayne, IN 46825
 (219) 484-9000 • FAX: 219-482-8941

Contact: Gene Hull

JEWEL BOX MANUFACTURERS

Allison Industries Ltd., 2910 Expwy. Dr. S., Islandia, NY, 11722, (516) 348-7900, Fax: (516) 348-7021, Pres.: R. Marc Ligator.
 Alpha Ents., Inc., 330 S. Wood St., East Canton, OH, 44730, (216) 488-0361, Pres.: Jim Sankey.
 Ameritrade Optical Disc, 520-D Enterprise Dr., Westerville, OH, 43081, (614) 841-1555, Pres.: Carlos Ramirez; Gen. Mgr.: Rogelio Ramirez.
 J.C. Anglum Co., Inc., PO Box 236, 60 Midvale Rd., Mountain Lakes, NJ, 07046, (201) 263-1442, Fax: (201) 263-8640, Pres.: J. Clifford Anglum; Sales Mgr.: Robert Pitcher; Office Mgr.: Collen Koch.
 Apex Engineering, Inc., 17 Downing Three, Pittsfield, MA, 01201, (413) 442-1414, Fax: (413) 443-7595, Vice Pres./Mktg. Dir.: Donna L. Rochelo; Pres./Sales Mgr.: Donald R. Rochelo.
 Bib America, 10497 Centennial Rd., Littleton, CO, 80127, (303) 972-0410, Fax: (303) 972-4519, Mktg. Dir.: Tony Marcon.
 Blackburn, Inc., 7550 Corporate Way, Eden Prairie, MN, 55344, (800) 842-7550, Fax: (612) 949-2553, Pres.: Todd Nicholson; Sales Mgr.: Jerry Forness; Mktg. Dir.: Mike Langert.
 COSMO, PO Box 8744, Honolulu, HI, 96830, 2639 S. King St., Ste. 205, Honolulu, HI, 96826, (808) 949-2811, (800) 800-4769, Fax: (808) 949-5998, Pres.: Thomas Pereira.
 Leslie Dame Ents., Ltd., 111-20 73rd Ave., Forest Hills, NY, 11375, (718) 261-4919, Fax: (718) 793-8804, Pres.: Leslie Dame; Sales Mgr.: Jeff S. Magoitza; Mktg. Dir.: Steve Dame.
 Design Plastics, Inc., 3550 N. Keystone Dr., Omaha, NE, 68134, (402) 572-7177, Fax: (402) 572-0500, Pres.: John Nipper; Vice Pres. Mktg./Sales: Sylvio J. Reboloso.
 Discwasher, Inc., 4310 Transworld Rd., Schiller Park, IL, 60176, (708) 678-9600, Fax: (708) 678-9610, Pres.: Kenneth C. Thomson; Sales Mgr.: Steven Sienicki; Mktg. Dir.: Daniel Peters.
 El Mar Plastics, Inc., 840 E. Walnut St., Carson, CA, 90746, (213) 327-3180, (800) 255-5210, Fax: (213) 327-0491, Pres.: Allen Schor; Sales Mgr.: Maxine Hesse.
 Electronic Media Int'l, PO Box 2664, Kennebunkport, ME, 04046, 35 Western Ave., Kennebunk, ME, 04043, (207) 967-2894, Fax: (207) 967-4509, Pres.: Paul J. Gelardi; Mktg. Dir.: Susan B. Porter; Business Mgr.: Susan Turner.
 Filam Nat'l Plastics, Inc., 13984 S. Orange Ave., Paramount, CA, 90723, (213) 630-2500, Fax: (213) 408-0712, Pres.: Vic Flores; Mktg. Dir.: Brad Harse.
 Filam Nat'l Plastics Inc., 1200 N. St., Ste. 504, Lincoln, NE, 68508, (402) 435-5005, Fax: (402) 435-4722, Mktg. Dir.: Brad Harse.
 Gage (A Div. of Shape, Inc.), PO Box 717, 301 US Rt. 1, Scarborough, ME, 04074, (207) 883-6316, (800) 462-4165, Fax: (207) 883-1068, COO: Michael Thomas; Sales Mgr.: Walter Gordon; Mktg. Coord.: Tracy L. Hartman; Customer Service Rep.: Patti Ellsworth.

Int'l Packaging Corp.

5601 Industrial Rd., Fort Wayne, IN, 46825, (219) 484-9000, Fax: (219) 482-8941, Pres.: Philip M. Clemens; Vice Pres./Mktg.: F.E. (Gene) Hull.

Jasco Products Co., Inc., PO Box 466, Oklahoma City, OK, 73101, (405) 752-0710, (600) 654-8483, Pres.: Steve Trice; Sales Mgr.: Brent Hall; Mktg. Dir.: Kent Shiple.

Joyce Molding Corp., 52 Green Pond Rd., Rockaway, NJ, 07866, (201) 586-2900, Fax: (201) 627-5730, Pres.: Ed Joyce; Sales Mgr.: Phil Koljeski.

Lebo Peerless Corp., 33 West St., Bloomfield, NJ, 07003, (201) 429-8600, Fax: (201) 429-0686, Pres.: Patrick Mastronardo; Sales Mgr./Mktg. Dir.: Stuart Glenwick.

Matrix Assoc., Inc., 1425 Monje Grande Pl., Pacific Palisades, CA, 90272, (213) 459-6913, Fax: (213) 459-6416, Pres.: Ed Koeppe; Sales Mgr.: Karen Koeppe; Mktg. Dir.: Charlie Shuman.

Michelex Industrial Group, PO Box 69, Industrial Park, Massena, NY, 13662, (315) 769-6616, Pres.: Tom Gramuglia.
PRC of America, 8140 Webb, North Hollywood, CA, 91605, (818) 504-0400, Fax: (818) 504-0946, Pres.: V. J. Carbello; Sales Mgr.: P. Baccarella.

Performance Dist., PO Box 0156, 2 Oak St., New Brunswick, NJ, 08903, (908) 545-3004, Fax: (908) 545-6054, Owners: Stephen Kaplan, Arthur Marko; Mgr.: Jessica DiGiora.

Poly-Matrix, Inc., 40 Downing Industrial Park, Pittsfield, MA, 01201, (413) 499-3550, Fax: (413) 442-8610, Contact: Steve Rufo.

Shape South, Inc. (A Subsidiary of Shape Inc.), PO Box 186, 100 Rice Ave., Dadeville, AL, 36853, Plant Mgr.: William Stevens; Sales Mgr.: Betsy Gibson.

Skarborg Invest USA, Inc., 4502 107th Cir. NE, Clearwater, FL, 34622, (813) 572-4461, Fax: (813) 572-4643, Pres.: Ken Swanick.

Sony Music Entertainment, Inc., 5152 Columbia Dr., Carrollton, GA, 30117, (404) 836-2000, Fax: (404) 836-2173, Opns. Dir.: Cher Anderson; Vice Pres./Sales-Mktg.: Scott Bartlett.
Suttman Prods., PO Box 72, Dayton, OH, 45409, (513) 278-4601, Pres.: Eric J. Suttman.

Tapeponents Co., PO Box 236, 60 Midvale Rd., Mountain Lakes, NJ, 07046, (201) 263-1442, (201) 263-1443, Fax: (201) 263-8640, Pres.: J. Clifford Anglum; Sales Mgr.: Robert Pitcher; Office Mgr.: Colleen Koch.

Univenture, Inc., 6145-A Scherers Pl., Dublin, OH, 43017, (614) 761-2669, Fax: (614) 793-0202, Pres.: Ross O. Youngs; Sales Mgr.: Rich Williams; Corp. Communications Mgr.: Sandi Stein.

Virtue Recording & Video & Disc Mastering, 8809-11 Rising Sun Ave., Philadelphia, PA, 19115, (215) 763-2825, Pres.: Frank Virtue; Sales Mgr.: Mary Bozzi; Mktg. Dir.: Linda Vitacolina.

West & Co., Inc., PO Box 24281, Nashville, TN, 37202, 1726-C General George Patton Dr., Brentwood, TN, 37027, (615) 661-5808, Fax: (615) 661-5905, Pres.: Jerry West; Sales Mgr.: Mike Young; Mktg. Dir.: Gary Campbell.

RAW MATERIALS

J.C. Anglum Co., Inc., PO Box 236, 60 Midvale Rd., Mountain Lakes, NJ, 07046, (201) 263-1442, Fax: (201) 263-8640, Pres.: J. Clifford Anglum; Sales Mgr.: Robert Pitcher; Office Mgr.: Colleen Koch.

Product(s): Styrene, Record PVC compounds.
C M Magnetics Corp., 13731 Bora Dr., Santa Fe Springs, CA, 90670, (213) 921-5886, Fax: (213) 921-0035, Pres.: Carlos Maciel; Sales Mgr.: M. Nahbani; Mktg. Dir.: Terry Wherlock.

Celene Plastics & Specialty Co., 26 Main St., Chatham, NJ, 07928, (201) 635-2600.

Product(s): CELANAR polyester film.
Ceralox Corp., 7800 S. Kolb Rd., Tucson, AZ, 85706, (602) 294-5201, Fax: (602) 294-5208, Pres.: Jan Schieffler; Sales/Mktg. Mgr.: M. R. Chamberlin.

Product(s): High purity, particle size aluminum oxides.
Chevron Chemical Co., Aromatics & Derivs. Div.-Styretic Polymers, PO Box 3766, Houston, TX, 77253, (713) 754-4197, Fax: (713) 754-2016, Sales Mgr.: H. Wade Little; Bus. Mgr.-Styretic Polymers: George Avdey.

Product(s): Styretic polymers for shells and jewel boxes.
Dow Chemical USA, 2020 Dow Center, Midland, MI, 48640, (800) 441-4369, Listing Editor: Shirley Clark.

Product(s): Resins, coatings.
Dow Plastics-Consumer Electronics, 2040 Willard H. Dow Center, Midland, MI, 48640, (800) 441-4369.

Product(s): Polystyrene, Polycarbonate, ABS plastics.
E.I. DuPont de Nemours & Co. Inc., Electronics Dept./BMP 13-1150, Wilmington, DE, 19898, (302) 992-6690, Fax: (302) 992-6994, Sales Mgr.: J.S. Morris; Mktg. Dir.: M.J. Koch.

Product(s): Chromium dioxide, "Mylar" polyester film.
GE Plastics, 1 Plastics Ave., Pittsfield, MA, 01201, (413) 448-7110, Mgr., Press Relations: Diana L. Wall.

Product(s): LEXAN polycarbonate resin.
G.S.P. Metals & Chemicals Corp., 2535 E. 28th St., Los Angeles, CA, 90058, (213) 582-0685, Fax: (213) 582-4527, Pres.: Shepard Drazin; Sales Mgr.: David Baker.

Product(s): Electro chemicals, metals, equipment.
BF Goodrich Corp. SP&C Div., 991 Brecksville Rd., Cleveland, OH, 44141, (216) 447-5000, Fax: (216) 447-5750, Pres.: Kent Lee; Sales Mgr.: T. Gregory Naples; Mktg. Dir.:

Karl Schreiber; Nat'l Sales Mgr.: T. Gregory Naples.

Product(s): Estane, Polyurethane.
Hochst Celanese Corp., PO Box 1400, Hood Rd., Greer, SC, 29652, (803) 879-5000, Fax: (803) 879-5006, Import/Export Mgr.: Howard R. Hrbek.

Product(s): Hostalan base film.
Keycor-Century Corp., 26000 Springbrook Ave., Saugus, CA, 91350, (805) 259-2360, Fax: (805) 259-7937, Pres.: Howard Hill; Mktg. Dir.: Paul Merrigan.

Product(s): Phonograph record compounds.
Marubeni America Corp., 200 Park Ave., New York, NY, 10166, (212) 599-3976, Fax: (212) 599-3742, Mktg. Dir.: M. Kely.

Product(s): Polycarbonate.
Mobay Corporation, Mobay Rd., Pittsburgh, PA, 15205, (412) 777-2000, Fax: (412) 777-2447, Pres.: J.C. Wulff; Public Relations Coord.: Barb Bosley.

Product(s): Polycarbonate.
Morton Int'l, 137 Folly Mill Rd., Seabrook, NH, 03874, (603) 474-2100, Fax: (603) 474-5721, Business Mgr.: Fred Quinn; Sales/Mktg. Mgr.: Robert L. Markley.

Product(s): Binder polymers.
Ocean Development America, Inc., 2500 Wilshire Blvd., Ste. 809, Los Angeles, CA, 90057, (213) 380-9099, Fax: (213) 380-8970, Dir. Pres.: Mr. Guo Junwei; Vice Pres.: Mr. Cai Kai Yuan.

Olin Corp., 120 Long Ridge Rd., Stamford, CT, 06904, (203) 356-2162, Fax: (203) 356-2678, Bus. Mgr.: David E. Losch.

Product(s): Magnetic particles.
SKC America, Polyester Film Div., 850 Clark Dr., Mount Olive, NJ, 07828, (201) 347-7000, Fax: (201) 347-7522, Div. Mgr.: J.K. Lee; Mktg./Sales Mgr.: Don Focht.

Product(s): Polyester base film, various treatments & grades.
Tapeponents Co., PO Box 236, 60 Midvale Rd., Mountain Lakes, NJ, 07046, (201) 263-1442, (201) 263-1443, Fax: (201) 263-8640, Pres.: J. Clifford Anglum; Sales Mgr.: Robert Pitcher; Office Mgr.: Colleen Koch.

Product(s): Polystyrene, Record PVC compounds, UV coating.
Teijin America, Inc., 10 Rockefeller Plaza, Ste. 1001, New York, NY, 10020, (212) 307-1130.

Product(s): Polyester film for audio/video tape mfg.
Toda Kogyo Corp., 700 S. Flower St., Ste. 1900, Los Angeles, CA, 90017, (213) 688-0665, Fax: (213) 613-1352, Mgr.: Akira Tanaka.

Product(s): Magnetic iron Oxides, barium ferrites.
Toray Industries (America) Inc., 600 Third Ave., New York, NY, 10016, (212) 697-8150, Fax: (212) 972-4279, Exec. Vice Pres.: Ryoichi Ikegami.

Product(s): Polyester base film, ABS resin.
Tosoh SMD, Inc., 3515 Grove City Rd., Grove City, OH, 43123, (614) 875-7912, Fax: (614) 871-9542, Pres.: Raymond L. Kidner;

Sales Mgr.: R.L. Murphy; Mktg. Dir.: Bruce R. Nelson; Product Mgr.: Michael D. Murphy.

Product(s): Forte sputtering targets-CD metallization.
Ville Platte Record Mfg. Co., PO Drawer 10, 120 E. Cypress St., Ville Platte, LA, 70586, (318) 363-2104, Fax: (318) 363-5622, Pres./Sales Mgr.: James Floyd Soileau; Sales Mgr.: Peggy Fontenot.

Product(s): Vinyl.

ENVELOPES & MAILERS

A + R Record & Tape Mfg. Co., 902 N. Industrial Blvd., Dallas, TX, 75207, (214) 741-2027, Fax: (214) 638-6801, Pres.: Richard Sobel; Sales Mgr.: Stan Getz II; Mktg. Dir.: Maxine Sobel. (Audio—Tape, LP)

ASR Recording Services of California, 8960 Eton Ave., Canoga Park, CA, 91304, (818) 341-1124, Fax: (818) 341-9131, Pres. (Mfg.): Allen Weintraub; Vice Pres./Sales: Lester P. Edwards. (Audio—CD, Tape)(Video—Tape)

A to Z Audio Services, Inc., PO Box 26087, 21929 Lorain Rd., Fairview Park, OH, 44126, (216) 333-0040, Fax: (216) 333-0104, Pres.: Duane Abarca; Vice Pres.: Greg Zarnoski; Sales Mgr.: Jean Rust. (Audio—CD, Tape)

The Absolute Press, Inc., 47-69 32nd Pl., Long Island City, NY, 11101, (718) 729-5293, Fax: (718) 784-2527, Pres.: Gill R. Pessoa. (Audio—CD, Tape, LP)(Video—Tape, Disc)

Alpha Records, Inc., PO Box 15011, Fort Lauderdale, FL, 33318, 1400 NW 65th Ave., Fort Lauderdale, FL, 33313, (305) 587-6011, Pres.: Richard Smith; Sales Mgr.: Barbara Smith. (Audio—LP)

American Helix Technology Corp., 1857 Colonial Village Ln., Lancaster, PA, 17601, (717) 392-7840, Fax: (717) 392-7897, Pres.: David Dering; Vice Pres.: Jim Boyer; Dir. of Sales/Mktg.: Marc Feingold. (Audio—CD)

Anvid Recording Co., PO Box 8130, Bartlett, IL, 60103, 69 S. LaSalle St., Aurora, IL, 60505, (708) 837-9840, Fax: (708) 897-6998, Pres.: David Schuler. (Audio—Tape)(Video—Tape)

At The Top Duplicators, 3330 Earhart, Carrollton, TX, 75006, (214) 980-7671, (214) 233-9191, Fax: (214) 991-1853, Prodn. Mgr.: Bert Newman. (Audio—Tape)(Video—Tape)

Blackbourn, Inc., 7550 Corporate Way, Eden Prairie, MN, 55344, (800) 842-7550, Fax: (612) 949-2553, Pres.: Todd Nicholson; Sales Mgr.: Jerry Forness; Mktg. Dir.: Mike Langert. (Audio—CD, Tape)(Video—Tape, Disc)

Bowers Envelope Co., Inc., 5331 N. Tacoma Ave., Indianapolis, IN, 46220, (317) 253-4321, Fax: (317) 254-2239, Pres.: James E. Bowers; Vice Pres.: Thomas Bowers. (Audio—CD, Tape, LP)(Video—Tape, Disc)

Bruce Packaging Co., 8010 N. Lowell Ave., Skokie, IL, 60076, (708) 674-0541, Pres.: Leonard Halperin. (Audio—CD, Tape, LP)

OCEAN DEVELOPMENT AMERICA, INC.

We are the American division of Shantou Ocean Enterprise Group Corporation which now is one of the largest corporations in China with 3 industries of high polymer, audio/video program, and magnetic recording material. You can count on us to provide the quality products and services as follows:

- Program audio cassettes and professional duplication
- Program video tapes and professional duplication • Compact discs • C-Zeros
- Audio pancakes, C-60, C-90, and variable length under C-90
- V-Zeros • Video tapes and pancakes • Floppy discs 2D and 2HD
- Polyester film for the manufacture of audio tape and video tape, capacitor film, electro insulating film and packaging film • Polyester soft drink bottles
- Polyester chip for the manufacture of polyester film and polyester soft drink bottles
- Polystyrene resin GPPS and HIPS

We guarantee the competitive price. We deliver when and where you need.

13453 BROOKS DRIVE UNIT A

BALDWIN PARK, CA 91706

TEL. (818) 856-2183 • FAX. (818) 856-2182



- Burlington Audio/Video Tapes, Inc.**, 106 Mott St., Oceanside, NY, 11572, (516) 678-4414, (800) 331-3191, Fax: (516) 678-8959, Pres.: Ruth Schwartz; Sales Mgr.: Jan Schwartz; Mktg. Dir.: Rudy Schwartz. (Audio—CD, Tape)(Video—Tape)
- Cinema Sound Ltd.**, 311 W. 75th St., New York, NY, 10023, (212) 799-4800, Pres.: Joan S. Franklin; Chief Eng./Studio Mgr.: John Rockwell. (Audio—Tape)
- Crown Magnetics, Inc.**, 1223 Bittner Blvd., Lebanon, PA, 17042, (717) 274-2812, (800) 736-9001, Fax: (717) 274-3615, Pres.: Chuck Musser; Mktg. Dir.: Bob Turner; Sales: Judy Musser. (Audio—CD, Tape)
- Davkore Co.**, 1300-A Spacepark Way, Mountain View, CA, 94043, (415) 969-3030, Fax: (415) 969-0140, Pres.: CW. Webber; Sales Mgr./Mktg. Dir.: Tom Sherry, Jeanne Horan. (Audio—Tape)(Video—Tape)
- Disc Makers**, 1328 N. Fourth St., Philadelphia, PA, 19122, (800) 468-9353, (215) 232-4140, Fax: (215) 236-7763, Pres.: Morris Ballen; Sales/Mktg. Dir.: Tony Van Veen. (Audio—CD, Tape, LP)(Video—Tape)
- Disc Makers**, Senda De La Posada N-6, Quintas Del Rio, Bayamon, PR, 00961, (809) 740-0010, Fax: (809) 785-5554, Sales Mgr.: David Rodriguez. (Audio—CD, Tape, LP)(Video—Tape)
- Disc Makers**, 1650 Broadway, Ste. 1010, New York, NY, 10019, (212) 265-7505, Fax: (212) 262-0798, Sales Mgr.: Howard Roseff. (Audio—CD, Tape, LP)(Video—Tape)
- EMC Prodn.**, 300 York Ave., Saint Paul, MN, 55101, (612) 771-1555, Fax: (612) 771-5629, Pres.: Paul Winter; Mktg. Dir.: Paula Jeske; Vice Pres.: Dick Stevens. (Video—Tape)
- Fastrax, Inc.**, 4033 Aurora Ave. N., Seattle, WA, 98103, (206) 632-8300, Pres.: Miriam Hamilton; Sales Mgr.: Candace Williams. (Audio—Tape, LP)
- Filam Nat'l Plastics, Inc.**, 13984 S. Orange Ave., Paramount, CA, 90723, (213) 630-2500, Fax: (213) 408-0712, Pres.: Vic Flores; Mktg. Dir.: Brad Harse. (Audio—CD, Tape)
- Flash Int'l Ent's.**, PO Box 580058, 16201 Buccaneer, Ste. 213, Houston, TX, 77062, (713) 488-1978, Pres./Mktg. Dir.: R.L. (Flash) Boudreaux. (Audio—LP)
- G Cee Graphics, Inc.**, 18653 Ventura Blvd., Ste. 223, Tarzana, CA, 91356, (818) 347-1136, Fax: (818) 889-4773, Pres.: Gregory Higgins. (Audio—CD, Tape, LP)(Video—Tape, Disc)
- GP Prodn.**, 362 Third Ave., Ste. 1B, New York, NY, 10016, (212) 686-5267, Pres.: Gill R. Pessoa; Sales Mgr.: Y.L. Walton; Mktg. Dir.: Daryl A. Pessoa. (Audio—CD, Tape, LP)(Video—Tape, Disc)
- Georgia Record Pressing**, 262 Rio Cir., Decatur, GA, 30030, (404) 373-2673, Fax: (404) 373-0950, Pres.: Hugh West; Sales Mgr.: James C. Ayers. (Audio—Tape, LP)
- HCV, Inc.**, 12229 Montague, Arleta, CA, 91331, (818) 896-4321, Pres.: Ed De Roo; Mktg. Dir.: Chuck Arnone. (Video—Tape)
- Houston Records, Ltd.**, 3300 Jensen Dr., Houston, TX, 77026, (713) 223-5971, Pres.: Chris Puccio; Sales Mgr.: Steve Puccio. (Audio—LP)
- Intervideo Duplication Services**, 3533 S. Archer Ave., Chicago, IL, 60609, (312) 927-9091, Fax: (312) 927-9211, Pres./Sales Mgr.: Peter Bernotas. (Video—Tape)
- Ivy Hill Corp.**, PO Box 3189, Terre Haute, IN, 47803, (812) 466-9851, Vice Pres.: Donald Ford. (Audio—LP)
- Kewall Real Time Tape Duplicators**, 77 Bay Shore Rd., Bay Shore, NY, 11706, (516) 586-2486, Fax: (516) 586-2486, Pres.: Keith A. Gutschwager; Sales Mgr.: Larry Andrews; Contact: Dorothy E. Gutschwager. (Audio—Tape)(Video—Tape)
- Keycor-Century Corp.**, 26000 Springbrook Ave., Saugus, CA, 91350, (805) 259-2360, Fax: (805) 259-7937, Pres.: Howard Hill; Mktg. Dir.: Paul Merrigan. (Audio—LP)
- Kingdom Co.**, PO Box 506, Mansfield, PA, 16933, (717) 662-7515, Fax: (717) 662-3875, Pres.: Johnny Berguson; Sales Mgr.: Howard Darr; Mktg. Dir.: Gabe Phelps. (Audio—Tape)(Video—Tape)
- Laser Prints, Inc.**, PO Box 151, 241 Stuyvesant Ave., Lyndhurst, NJ, 07071, (201) 438-6777, Fax: (201) 438-0903, Pres.: J. Principato. (Audio—CD, LP)
- Lion Recording Services**, 7532 Fullerton Ct., Springfield, VA, 22153, (703) 569-3200, Fax: (703) 455-5600, Pres.: Harold Lion; Mktg. Dir.: Karen Blackhall; Vice Pres./Sales Mgr.: Richard Lion. (Audio—Tape)
- The Little Warehouse, Inc.**, 5505 Valley Belt Rd., Ste. F, Independence, OH, 44131, (216) 398-0022, Fax: (216) 398-9980, Pres.: Jim Lesnick; Sales Mgr./Mktg. Dir.: Joe Kauffman. (Video—Tape)
- Lundy Recording & Cassette Dup.**, PO Box 408, Heidrick, KY, 40949, (606) 546-6650, Pres.: David Lundy; Sales Mgr.: Viola Lundy; Mktg. Dirs.: Duran & Davie Lundy. (Audio—Tape)
- Magnetic Products**, 27712 Avenue Mentry, Valencia, CA, 91355, (805) 295-8448, Fax: (805) 295-8278, Managing Dir.: R. Goldman. (Video—Tape)
- Majestic Duplicating Service**, 1208 W. Isabel St., Burbank, CA, 91506, (818) 843-1806, Fax: (818) 954-0770, Pres.: Leslie Sawyer; Sales Mgr.: John Northrop; Mktg. Dir.: Chris Saver. (Video—Tape)
- Mark Custom Recording Service**, 10815 Bodine Rd., Clarence, NY, 14031, (716) 759-2600, Pres./Owner: Mark J. Morette. (Audio—CD, Tape, LP)
- Matchbook Albums (Sub. of Beach West Designs)**, 711 John St., Secaucus, NJ, 07094, (215) 478-1585, Pres.: Walt Henkel. (Audio—CD)
- Melody Prodn.**, 7712 23rd Ave., NW, Seattle, WA, 98117, (206) 783-8694, Fax: (206) 781-1765, Pres.: James A. Bostad, Sr.; Sales Mgr.: Melody Bostad; Mktg. Dir.: Sally Bostad; Engineers: Jason & Jeremy Bostad. (Audio—Tape)
- Musical, Inc.**, 780 Oakland Park Ave., Columbus, OH, 43224, (614) 267-3133, Pres.: John W. Hull; Sales Mgr.: Warren Hull; Mktg. Dir.: Charlene Hull. (Audio—Tape, LP)
- Musifex Video**, 2701-C Wilson Blvd., Arlington, VA, 22201, (703) 525-6476, Fax: (703) 525-0949, Pres.: Frank Maniglia, Jr.; Gen. Mgr.: Guinevere Meyer; Sales Mgr./Mktg. Dir.: Jeanne Chisholm. (Audio—CD, Tape, LP)(Video—Tape, Disc)
- PRC of America**, 8140 Webb, North Hollywood, CA, 91605, (818) 504-0400, Fax: (818) 504-0946, Pres.: V. J. Carbellio; Sales Mgr.: P. Baccarella. (Audio—Tape)(Video—Tape)
- Charlie Passantino, Inc.**, 311 W. 43rd St., New York, NY, 10036, (212) 586-1469, Pres.: Michelle Barrett; Sales Mgr./Mktg. Dir.: Ed Regan. (Audio—CD, Tape, LP)
- Photo-Graphics, Inc.**, PO Box 730, Ardsley, NY, 10502, (800) 444-1931, (914) 674-1212, Fax: (914) 764-1212, Pres.: Jeff Hapoienu; Sales Mgr.: J. Reed; Mktg. Dir.: Sandy Hapoienu. (Audio—CD, Tape)
- Polyline Corp.**, 1233 Rand Rd., Des Plaines, IL, 60016, (708) 390-6464, Fax: (708) 827-6851, Pres.: Ed Kaiser; Sales Mgr.: Paula Schaub. (Audio—CD, Tape)(Video—Tape)
- Premier Film & Recording Corp.**, 3033 Locust St., Saint Louis, MO, 63042, (314) 531-3555, Fax: (314) 726-8798, Pres.: Wilson Dalzell; Sales Mgr.: Donna Blue; Mktg. Dir.: Bob Heuermann. (Audio—LP)
- Premiere AVD Corp.**, 18080 NE 68th St., Redmond, WA, 98052, (206) 882-1400, Fax: (206) 867-0718, Pres.: George M. Ricci; Sales Mgr.: Gary M. Ricci. (Video—Tape)
- Bud Pressner Music & Recording Service**, 6860 Broadway, Merrillville, IN, 46410, (219) 769-0011, Pres.: Bud Pressner. (Audio—Tape, LP)
- Producers Tape Service**, 395 E. Elmwood Ave., Troy, MI, 48083, (313) 585-8273, Fax: (313) 585-1270, Pres.: William Gutherie; Sales Mgr.: James Champion; Mktg. Dir.: Catherine Chytry. (Audio—Tape)(Video—Tape)
- Progressive Label Co.**, 200 F Executive Dr., Edgewood, NY, 11717, (516) 242-0201, Fax: (516) 242-7310, Pres.: Bernard Stein; Sales Mgr.: Tony Cutrone; Prodn. Mgr.: Mike Cutrone. (Audio—CD, Tape, LP)(Video—Tape, Disc)
- OCA, Inc.**, 2832 Spring Grove Ave., Cincinnati, OH, 45225, (513) 681-8400, Fax: (513) 681-3777, Pres.: Jim Bosken; Sales Mgr.: Amber Hines; Mktg. Dir.: Rusty Sweeney. (Audio—CD, Tape, LP)
- R.P. Products, Inc.**, 1618 Waxwing Ct., Schaumburg, IL, 60173, (708) 397-4575, Fax: (708) 397-4576, Pres.: Roy Pink; Sales Mgr.: Dick Hirtz; Mktg. Dir.: Sent Flein. (Audio—CD, Tape, LP)(Video—Tape, Disc)
- RTI, Record Technology, Inc.**, 486 Dawson Dr., Camarillo, CA, 93012, (805) 484-2747, Fax: (805) 987-0508, Pres.: William Bauer; Sales Mgr.: Don MacInnis. (Audio—CD, Tape, LP)
- Rainbo Records & Cassettes**, 1738 Berkeley St., Santa Monica, CA, 90404, (213) 829-0355, (213) 829-3476, Fax: (213) 828-8765, Pres.: Jack G. Brown; Gen. Mgr./Sales Mgr.: Steven E. Sheldon. (Audio—CD, Tape, LP)
- Rank Video Services America**, 555 Huehl Rd., Northbrook, IL, 60062, (708) 291-4275, Fax: (708) 291-4282, Pres.: Philip A. Clement; Mktg. Project Mgr.: Marilyn L. Quist. (Video—Tape)
- Bill Rase Prodn.**, Inc., 955 Venture Ct., Sacramento, CA, 95825, (916) 929-9181, Fax: (916) 929-4751, Pres./Sales Mgr.: Bill Rase; Mktg. Dir.: Esther Manchoff; Sec.: Shirely Rase. (Audio—Tape, LP)
- Record-Rama Sound Archives**, 4981 McKnight Rd., Pittsburgh, PA, 15237, (412) 367-7330, Fax: (412) 367-7388, Pres.: Paul C. Mahwinney. (Audio—CD)
- Regal, A Poly-Pak Industries Co.**, 125 Spagnoli Rd., Melville, NY, 11747, (516) 293-6767, Fax: (516) 454-6366, Pres.: Peter Levy; Sales Mgr.: Ken Trotter; Mktg. Dir.: Juliette H. McKenna. (Audio—CD, Tape, LP)(Video—Tape, Disc)
- Reliance Plastics & Packaging**, 217 Brook Ave., Passaic, NJ, 07055, (201) 473-7200, Fax: (201) 473-1023, Pres.: Marshall L. Weingarden; Vice Pres.: Sales: Hale Smith; Vice Pres., Gen. Mgr.: Harry Polans; Adv. Mgr.: Barbara Weingarden. (Audio—CD, Tape, LP)
- Romaba Record Pressing Corp. of America**, 33-34th St., Brooklyn, NY, 11232, (718) 499-3060, Fax: (718) 499-3061, Pres.: Theodore E. Kolsky; Vice Pres.: Dara Kolsky; Sales Mgr.: Vicki M. Guerra; Mktg. Dir.: Jennifer Kolsky. (Audio—LP)
- SOUND INVESTMENT Co., Inc.**, 3586 Pierce Dr., Chamblee, GA, 30341, (404) 458-1679, (800) 649-8273, Fax: (404) 458-0276, Pres.: Douglas Wilmer; Sales Mgr.: W. Louis Simmons, Jr.; Mktg. Dir.: Lori Albert. (Audio—Tape, LP)(Video—Tape)
- Suttman Prodn.**, PO Box 72, Dayton, OH, 45409, (513) 278-4601, Pres.: Eric J. Suttman. (Audio—CD, Tape)(Video—Tape)
- United Audio Video Group, Inc.**, 6855 Vineland Ave., North Hollywood, CA, 91605, (818) 980-6700, Fax: (818) 508-8273, Pres.: Miriam Newman; Vice Pres. Prodn.: Steve Newman; Sales Mgr.: Larry Schwartz; Mktg. Dir.: Laurie Newman. (Audio—Tape)(Video—Tape)
- Unlimited Resources Int'l**, 200 Wilson St., #E-5-A, Port Jefferson Station, NY, 11776, Fax: (516) 473-5541, Pres.: Steven Moore; Sales Mgr.: Ramone Baker. (Audio—CD, Tape)(Video—Tape)
- Video Media Prodn.**, 2727 W. Southern Ave., Tempe, AZ, 85282, (602) 966-6545, Fax: (602) 438-2238, Pres.: Jim Rinkenberger; Mktg. Dir.: Jim Pangborn. (Video—Tape)
- Video West**, Broadcast Hse., #5 Triad Cir., 55 N. 300 West, Salt Lake City, UT, 84110, (801) 575-7400, Fax: (801) 575-7449, Sales Mgr.: Jim Yorgason; Mktg. Dir.: Don Paver; Vice Pres./Gen. Mgr.: Allan W. Henderson; Distribution Serv. Mgr.: Mel Miller. (Video—Tape)
- Ville Platte Record Mfg. Co.**, PO Drawer 10, 120 E. Cypress St., Ville Platte, LA, 70586, (318) 363-2104, Fax: (318) 363-5622, Pres./Sales Mgr.: James Floyd Soileau; Sales Mgr.: Peggy Fontenot. (Audio—LP)
- VinylWed (Div. of PEN-TAB Industries) Inc.**, 2011 W. Hastings St., Chicago, IL, 60608, (312) 243-0606, Fax: (312) 942-0693, Vice Pres. Sales/Mktg. Dir.: Doug Engebretson. (Audio—CD, Tape)(Video—Tape, Disc)
- Virtue Recording & Video & Disc Mastering**, 8809-11 Rising Sun Ave., Philadelphia, PA, 19115, (215) 763-2825, Pres.: Frank Virtue; Sales Mgr.: Mary Bozzi; Mktg. Dir.: Linda Vitacolonna. (Audio—CD, Tape, LP)
- WMG, Inc. (World Media Group)**, 8472 Brookville Rd., Indianapolis, IN, 46239, (317) 353-1113, Fax: (317) 353-0750, Pres.: J.A. Mellentine; Sales Mgr.: Curt Albright. (Audio—CD, Tape, LP)
- West & Co., Inc.**, PO Box 24281, Nashville, TN, 37202, 1726-C General George Patton Dr., Brentwood, TN, 37027, (615) 661-5808, Fax: (615) 661-5905, Pres.: Jerry West; Sales Mgr.: Mike Young; Mktg. Dir.: Gary Campbell. (Audio—CD, Tape, LP)
- Edward R. White Co.**, 190 Morgan Ave., Brooklyn, NY, 11237, (718) 366-3400, Pres.: Brian E. Sadowsky; Sales Mgr.: Morris Sadowsky. (Audio—LP)
- World Class Tapes**, PO Box 7611, Ann Arbor, MI, 48107, 670 Airport Blvd., Ann Arbor, MI, 48108, (313) 769-7575, Fax: (313) 662-0997, Pres.: R.G. Martens; Vice Pres.: J.W. Spencer; Sales Mgr.: Sue Gillis. (Audio—Tape)

JACKETS & SLEEVES

- AGI, Inc.**, 6363 W. Sunset Blvd., Ste. 910, Los Angeles, CA, 90028, (213) 462-0821, Fax: (213) 463-4367, Sales Mgr.: Rich Oppenheimer. (Jackets/Sleeves-Audio: CD, LP)
- AGI, Inc.**, 1950 N. Rugby St., Melrose Park, IL, 60160, (708) 344-9100, Fax: (708) 344-9113, Pres.: Richard Block; Vice Pres./Creative Dir.: Jim Ladwig; Sales Mgr.: Jim Oppenheimer; Mktg. Dir.: Gary Mankoff. (Jackets/Sleeves-Audio: CD, Tape, LP)(Jackets/Sleeves-Video: Tape, Disc)
- A + R Record & Tape Mfg. Co.**, 902 N. Industrial Blvd., Dallas, TX, 75207, (214) 741-2027, Fax: (214) 638-6801, Pres.: Richard Sobel; Sales Mgr.: Stan Getz II; Mktg. Dir.: Maxine Sobel. (Jackets/Sleeves-Audio: Tape, LP)
- ASR Recording Services of California**, 8960 Eton Ave., Canoga Park, CA, 91304, (818) 341-1124, Fax: (818) 341-9131, Pres. (Mfg.): Allen Weintraub; Vice Pres./Sales: Lester P. Edwards. (Jackets/Sleeves-Audio: Tape)(Jackets/Sleeves-Video: Tape)
- A to Z Audio Services, Inc.**, PO Box 26087, 21929 Lorain Rd., Fairview Park, OH, 44126, (216) 333-0040, Fax: (216) 333-0104, Pres.: Duane Abarca; Vice Pres.: Greg Zarnoski; Sales Mgr.: Jean Rust. (Jackets/Sleeves-Audio: Tape)
- The Absolute Press, Inc.**, 47-69 32nd Pl., Long Island City, NY, 11101, (718) 729-5293, Fax: (718) 784-2527, Pres.: Gill R. Pessoa. (Jackets/Sleeves-Audio: CD, Tape, LP)(Jackets/Sleeves-Video: Tape, Disc)
- American Helix**, 1857 Colonial Village Ln., Lancaster, PA, 17601, (908) 367-8700, Contacts: Jim Boyer, Marc Feingold. (Jackets/Sleeves-Audio: CD)

American Multimedia, Inc.

- 2609 Tucker St. Ext., Burlington, NC, 27215, (919) 229-5554, (800) 849-TAPE, (800) 849-DAAD, Fax: (919) 228-1409, Pres.: David J. Forsyth; Sales Mgr./Mktg. Dir.: Timothy V. Mallard; Customer Service Dir.: Jeanne Conklin. (Jackets/Sleeves-Audio: Tape)(Jackets/Sleeves-Video: Tape)

- At The Top Duplicators**, 3330 Earhart, Carrollton, TX, 75006, (214) 980-7671, (214) 233-9191, Fax: (214) 991-1853, Prodn. Mgr.: Bert Newmaner. (Jackets/Sleeves-Audio: Tape)(Jackets/Sleeves-Video: Tape)
- Blackburn, Inc.**, 7550 Corporate Way, Eden Prairie, MN, 55344, (800) 842-7550, Fax: (612) 949-2553, Pres.: Todd Nicholson; Sales Mgr.: Jerry Forness; Mktg. Dir.: Mike Langert. (Jackets/Sleeves-Audio: CD, Tape)(Jackets/Sleeves-Video: Tape, Disc)
- Bowers Envelope Co., Inc.**, 5331 N. Tacoma Ave., Indianapolis, IN, 46220, (317) 253-4321, Fax: (317) 254-2239, Pres.: James E. Bowers; Vice Pres.: Thomas Bowers. (Jackets/Sleeves-Audio: CD, LP)(Jackets/Sleeves-Video: Disc)
- Burlington Audio/Video Tapes, Inc.**, 106 Mott St., Oceanside, NY, 11572, (516) 678-4414, (800) 331-3191, Fax: (516) 678-8959, Pres.: Ruth Schwartz; Sales Mgr.: Jan Schwartz; Mktg. Dir.: Rudy Schwartz. (Jackets/Sleeves-Video: Tape)
- Colorscan Services, Inc.**, 241 Stuyvesant Ave., Lyndhurst, NJ, 07071, (201) 438-6729, Fax: (201) 438-0903, Pres.: J. Principato. (Jackets/Sleeves-Audio: CD, LP)
- Compact Disc, Inc.**, 1908 Rainbow Dr., Silver Spring, MD, 20905, (301) 384-0012, Pres.: Robert Rager; Mktg. Dir.: Doug Turner. (Jackets/Sleeves-Audio: CD)
- Crown Magnetics, Inc.**, 1223 Bittner Blvd., Lebanon, PA, 17042, (717) 274-2812, (800) 736-9001, Fax: (717) 274-3615, Pres.: Chuck Musser; Mktg. Dir.: Bob Turner; Sales: Judy Musser. (Jackets/Sleeves-Audio: CD, Tape)
- The Cutting Edge Disc Mastering**, Box 217, Ferndale, NY, 12734, (914) 292-5965, Fax: (914) 292-2313, Pres.: Paul Gerry; Sales Mgr./Mktg. Dir.: Patricia Gerry. (Jackets/Sleeves-Audio: LP)
- Davkore Co.**, 1300-A Spacepark Way, Mountain View, CA, 94043, (415) 969-3030, Fax: (415) 969-0140, Pres.: CW. Webber

(Continued on page 179)

Satisfying Customers, Worldwide. Netstal Uniline.



Satisfied customers the world over produce compact discs with Netstal's turn-key manufacturing system. In satisfying them, we've dealt with every technical, logistic, and application challenge imaginable. This experience—combined with the system's ease of installation and operation, and our global service capability—makes Uniline the most reliable CD production system available today.

Uniline features:

- One year/6,000 hours warranty
- Only in-line CD production system to use vertical sputtering
- Specially designed silkscreen printing for higher quality graphics
- Integrated AID optical scanner

- Rapid stamper change and minimum lost time in screen set-up
- Advanced central controls for production and quality supervision

For more information on the Netstal Uniline please contact

First Light Technology, Inc.
88 Industrial Park Drive, P.O. Box 70
Saco, ME 04072 USA
Telephone: (207) 282-4698
Fax: (207) 282-9884

For North and South America:

Netstal Machinery, Inc.
20 Authority Drive
Fitchburg, MA 01420 USA
Telephone: (508) 345-9400
Fax: (508) 345-6153



In this section...

- Tape Custom Duplicators
- Compact Disc Manufacturers & Videodisc Manufacturers
- Plating & Pressing Plants
- Mastering Facilities
- Packaging & Labeling Services
- CD Replicating Systems Equipment Manufacturers
- Tape Duplicating & Processing Equipment Manufacturers
- Tape Equipment Manufacturers
- Tape Packaging & Labeling Equipment Manufacturers

Manufacturing Plants, Services & Equipment

TAPE CUSTOM DUPLICATORS

ALABAMA

TapeSouth, Inc., 1801 First Ave. S., Ste. 333, Birmingham, AL, 35233, (205) 250-8015, Fax: (205) 250-8013, Pres.: Kerri Bennett; Sales Mgr.: Jeino Bennati.
Audio: Cassette, Real-time.
Audio Packaging Services: Inserting, Collating, Labeling.

ARIZONA

AAZTEC Recording & Tape Duplicating, Inc., 1110 E Missouri, Ste. 400, Phoenix, AZ, 85014, (602) 279-0808, Fax: (602) 277-6552, Pres.: Ron Briskman; Sales Mgr.: Marc Bennett.

Audio: Cassette, Open Reel, Real-time.
Video: ½ VHS Cassette.
Audio Packaging Services: Inserting, Collating, Labeling, Mailing.

Video Packaging Services: Inserting, Labeling, Mailing.
Other Services: Warehouse, Direct Response—800 services, Credit Card Clearance Services.

Christian Cassette, 2650 W. Glenrosa, Ste. 5, Phoenix, AZ, 85017, (602) 246-4976, Pres.: Mark F. Wintermute; Sales Mgr.: Jill Campbell.

Audio: Cassette, Real-time.
Video: ½ VHS Cassette.
Audio Packaging Services: Inserting, Collating, Labeling, Mailing.
Other Services: Freight.

Terry Lessig Sound, PO Box 9162, Phoenix, AZ, 85068, 1626 N. Seventh St., Phoenix, AZ, 85006, (602) 255-0155, Pres.: Terry W. Lessig.

Audio: Cassette, Open Reel.
Master Duplicating Corp., 2002 N. 25th Dr., Phoenix, AZ, 85009, (800) 228-8919, Fax: (602) 484-7325, Pres./Mktg. Dir.: Janita Cooper; Office Mgr.: Chris Eaton.

Audio: Cassette, Open Reel, Real-time.
Video: ½ VHS Cassette.
Audio/Video Packaging Services: Inserting, Collating, Labeling, Mailing.

Other Services: Warehouse.
Moon Valley Cassette, 10802 N. 23rd Ave., Phoenix, AZ, 85029, (602) 870-3987, Fax: (602) 944-7378, Pres.: Jo Ellen Serey; Vice Pres./Sales Mgr.: Mark R. Bruno.

Audio: Cassette, Open Reel.
Audio Packaging Services: Inserting, Collating, Labeling.
Vaughn Duplication Services, 3802 E. University Dr., Ste. #2, Phoenix, AZ, 85034, (602) 437-5344, Fax: (602) 437-3718, Vice Pres./Gen. Mgr.: Donald Drapeau; Sales Mgrs.: Bob Mercer, Susan Ulrich; Mktg. Dir.: Michelle Sahlin; Regional Mgr.: Jim Lawson.

Video: ¾ U-Matic, ½ VHS Cassette, ¼ CVC Cassette, 8mm, S-VHS. High Speed Capability—TMD: SP, EP.
Video Packaging Services: Inserting, Collating, Labeling, Mailing, Macrovision Antipiracy coding.
Other Services: Warehouse, Freight, Direct Response—800 services, Int'l standards conversions.

Video Media Prods., 2727 W. Southern Ave., Tempe, AZ, 85282, (602) 966-6545, Fax: (602) 438-2238, Pres.: Jim Rinkenberger; Mktg. Dir.: Jim Pangborn.

Audio: Cassette.
Video: ¾ U-Matic, ½ VHS Cassette, 8mm, S-VHS, Beta.
Other Services: Warehouse, Freight, Direct Response—800 services.

WinterSun, Inc., 10802 N. 23rd Ave., Phoenix, AZ, 85029, (602) 870-3987, Fax: (602) 944-7378, Pres.: Jo Ellen Serey; Exec. Vice Pres./Sales Mgr./Mktg. Dir.: Mark R. Bruno.

Audio: Cassette, Open Reel.
Audio Packaging Services: Inserting, Collating, Labeling.

ARKANSAS

Magnafax Int'l, Inc.

Rt. 1, Box 764, Rogers, AR, 72756, (501) 925-1818, Fax: (501) 925-1841, Pres.: Dennis Tallakson.
Audio: Cassette, Open Reel.

Richardson Tape, HC 71, Box 231, Mountain View, AR, 72560, (501) 269-3908, Fax: (501) 269-3908, Pres.: Aubrey

Richardson.
Audio: Cassette, Real-time.
Audio Packaging Services: Inserting, Labeling.

CALIFORNIA

AAPEX Tape Duplication, 28 Paul Dr., Ste. #E, San Rafael, CA, 94903, (415) 492-1300, Fax: (707) 585-1330, Pres.: Warren Dennis; Sales Mgr./Mktg. Dir.: Devon Hulett.

Audio: Cassette, DAT, Real-time, Direct from digital.
Audio Packaging Services: Inserting, Labeling, Mailing, Shrinkwrap.

ACME Merchandising, Inc., 17521 Railroad St., Unit G, City of Industry, CA, 91748, (818) 854-1733, Fax: (818) 854-1732, Sales Mgr.: Alan Kok; Mktg. Dir.: Terry So.

Audio: Cassette, Real-time.
Video: ½ VHS Cassette.
Other Services: Warehouse, Freight.

AME, 1133 Hollywood Way, Burbank, CA, 91505, (818) 841-7440, Fax: (818) 841-7949, Pres.: Larry Kingen; Mktg. Dir.: Bob Creamer.

Video: ¾ U-Matic, ½ VHS Cassette, S-VHS.
Video Packaging Services: Inserting, Labeling.
Other Services: Freight, Direct Response—800 services, Credit Card Clearance Services.

AME Video Cassette Duplication Div., 5510 Cleon Ave., North Hollywood, CA, 91601, (818) 509-7717, Fax: (818) 509-5990, Vice Pres. Sales/Mktg.: Chip Viering; Gen. Mgr.: Yolanda Nash.

Video: ¾ U-Matic, ½ VHS Cassette, 8mm, S-VHS, 1", D-2, Betacam SP, Beta II, Real-time SP only.
Other Services: Warehouse, Freight.

ASR Recording Services of California, 8960 Eton Ave., Canoga Park, CA, 91304, (818) 341-1124, Fax: (818) 341-9131, Pres. (Mfg.): Allen Weintraub; Vice Pres./Sales: Lester P. Edwards.

Audio: Cassette, DAT, High Speed—120,000 daily.
Audio Packaging Services: Inserting, Collating, Labeling, Mailing.

Other Services: Warehouse, Freight, Direct Response—800 services.
Abbey Tape Duplicators, Inc., 9525 Vassar Ave., Chatsworth, CA, 91311, (818) 882-5210, (800) 346-3827, Fax: (818) 407-5900, Pres.: Norman C. Cooke; Sales Rep.: Bill Snow.

Audio: Cassette, Open Reel, Real-time.
Video: ¾ U-Matic, ½ VHS Cassette.
Audio Packaging Services: Inserting, Collating, Labeling.
Video Packaging Services: Inserting, Collating, Labeling, Mailing.

Other Services: Warehouse.
Robert Adels Creative Services, PO Box 69954, West Hollywood, CA, 90069, (213) 276-9731, Fax: (213) 276-6447, Pres.: Robert Adels.

Video: Design Services.
Advance Recording Products, 7190 Clairemont Mesa Blvd., San Diego, CA, 92111, (619) 277-2540, (800) 854-1061, Fax: (619) 277-7610, Pres.: Rosie Anand; Gen. Mgr.: Jim Norr.

Audio: Cassette.
Alshire Int'l, Inc., PO Box 7107, 1015 Isabel St., Burbank, CA, 91510, (213) 849-4671, (818) 843-6792, Fax: (818) 569-3718, Pres.: Al Sherman; Sales Mgr.: Richard Sherman; Custom Dept.: Mark Beckwith.

Audio: Cassette.
Audio Packaging Services: Inserting, Collating, Labeling, Mailing.
Other Services: Warehouse, Freight.

American Sound & Video Corp. (West), 27790 Ave. Hopkins, Valencia, CA, 91355, (805) 257-0700, Fax: (805) 257-0715, Gen. Mgr.: Gerold Pool.

Video: Audio, VHS & Beta.
Associated Prodn. Music, 6255 Sunset Blvd., Ste. 820, Hollywood, CA, 91364, (213) 461-3211, Fax: (213) 461-9102, Sales Mgr.: Jerry Burnham; Gen. Mgr.: Bill Brooks; Western Region/Sales: Cassandra Gorieb.

Audio Cassette Duplicator Co., 12426 ½ Ventura Blvd., Studio City, CA, 91604, (818) 762-2232, Fax: (818) 508-8077, Owners: Steve Katz, Steve Mitchell.

Audio: Cassette, Open Reel, DAT, Real-time.
Audio Packaging Services: Inserting, Labeling.
Audio Recorders, 3843 Richmond, San Diego, CA, 92103, (619) 296-6355, Pres.: J. Mullen.

Audio: Cassette, Open Reel.
Video: ½ VHS Cassette.
Audiodyne, PO Box 825, San Jose, CA, 95106, (408) 287-3520, Pres.: L.R. Chiaramonte.

Audio: Cassette, Open Reel.
Backstage Pass Prods., Inc., 6930 Valjean Ave., Ste. 202, Van Nuys, CA, 91406, (818) 786-2222, Fax: (818) 786-5550, Pres.: Lawrence Weisberg; Sales Mgr.: Barry Knight.

Video: ½ VHS Cassette, PAL, SECAM, NTSC.
Banco Records, 221 Lawrence St., Fullerton, CA, 92632, (714) 738-6197, Gen. Mgr.: George Baker.

Audio: Cassette, small lot for radio programming & library services.
Video: ½ VHS Cassette, S-VHS.
Other Services: Audio & video restoration services.

Batish Recording Ent's., 1310 Mission St., Santa Cruz, CA, 95060, (408) 423-1699, Pres.: S.D. Batish; Sales Mgr.: Ravi Batish; Mktg. Dir.: Ashwin Batish.
Audio: Cassette, Real-time.
Video: ½ VHS Cassette.

Audio Packaging Services: Inserting, Labeling.
Bauer Communications, Inc., 6887 Farmdale Ave., Bldg. 12, North Hollywood, CA, 91605, (800) 627-7277, Fax: (818) 894-0715, Pres.: Jim Bauer.

Audio: Cassette, Real-time.
Audio Packaging Services: Inserting, Labeling.
Cassette Express, 1815 E. Wilshire St., Ste. 904, Santa Ana, CA, 92705, (714) 667-0714, Fax: (714) 667-3921, Pres.: Lee Kovacs; Sales Mgr.: David Morton.

Audio: Cassette, Open Reel, DAT, Real-time.
Audio Packaging Services: Inserting, Collating, Labeling, Mailing.
Cassette Prods. Unlimited, Inc., 5796 Martin Rd., Irwindale, CA, 91706, (818) 969-6881, Fax: (818) 969-8403, Pres.: Jeffrey E. Baker; Sales Mgr.: Richard A. Guthy; Exec. Vice Pres./Mktg. Dir.: Mark R. Ashland.

Audio: Cassette.
Video: ¾ U-Matic, ½ VHS Cassette.
Video Packaging Services: Inserting, Collating, Labeling, Mailing.
Other Services: Warehouse, Freight.

Celebrity Duplicating Services, Inc., 21540 Blythe St., Canoga Park, CA, 91304, (818) 716-7755, Fax: (818) 716-8271, Pres.: Robert S. Miller.

Command Prods., 107 Industrial Center Bldg., Harbor Dr., Sausalito, CA, 94965, (415) 332-3161, Pres.: Warren Weagant; Sales Mgr.: John Edwards.

Audio: Cassette, Open Reel, DAT, Real-time.
Video: ½ VHS Cassette.
Audio Packaging Services: Inserting, Collating, Labeling, Mailing.

R.E. Copsy Recording, PO Box 367, Camarillo, CA, 93011, (805) 484-2415, Pres.: R.E. Copsy.
Audio: Cassette.

Crest Cassette Corp., 415 N. Figueroa St., Wilmington, CA, 90744, (213) 835-9677, Fax: (213) 835-7892, Pres.: Michael DeMucci; Vice Pres., Sales/Mktg.: Kathy Boag.

Video: ¾ U-Matic, ½ VHS Cassette.
Video Packaging Services: Inserting, Collating, Labeling, Mailing.
Other Services: Warehouse, Freight, Direct Response—800 services.

Custom Duplication, Inc., 3404 Century Blvd., Inglewood, CA, 90303, (213) 670-5575, Fax: (213) 412-2731, Pres.: Bob Hively; Vice Pres. Sales: Rick Hively.

Audio: Cassette, DAT.
Video: ¾ U-Matic, ½ VHS Cassette, 8mm.
Audio/Video Packaging Services: Inserting, Collating, Labeling, Mailing, Fulfillment, Warehouse.

Other Services: Warehouse, MIS (Inventory), Freight.
Datatape Incorporated, 360 Sierra Madre Villa, Pasadena, CA, 91109, (818) 796-9381, Fax: (818) 353-5329, Pres.: Gordon Smith; Mktg. Dir.: Jerry Norton; Regional Sales Mgr.: E. David Franssens.

Video: S-VHS.
Davkore Co., 1300-A Spacepark Way, Mountain View, CA, 94043, (415) 969-3030, Fax: (415) 969-0140, Pres.: C.W. Webber; Sales Mgrs./Mktg. Dir.: Tom Sherry, Jeanne Horan.

Audio: Cassette, Open Reel, DAT, Real-time.
Video: ¾ U-Matic, ½ VHS Cassette, 8mm, S-VHS.
Audio/Video Packaging Services: Inserting, Collating, Labeling, Mailing.

Diner + Allied, 620 Third St., San Francisco, CA, 94107, (415) 777-1700, Fax: (415) 957-1842, Pres.: William H. Smith; Div. Mgr.: Chuck Berg.

Video: ¾ U-Matic, ½ VHS Cassette. High Speed Capability—SP, EP, Sprinter—SP, EP.
Video Packaging Services: Inserting, Collating, Labeling, Mailing.
Other Services: Warehouse, Freight.

Dubs Inc., 1220 N. Highland Ave., Hollywood, CA, 90038, (213) 461-3726, Vice Pres. Mktg.: Dick Millaiss.

Video: ¾ U-Matic, ½ VHS Cassette, 8mm, S-VHS, 2", 1", D1, D2, Betacam SP, M-II.
The Duplicator, 405 14th St., Ste. 612, Oakland, CA, 94612, (415) 832-5178, Pres.: Glenn Davidson.

Audio: Cassette, Open Reel, Real-time.
Audio Packaging Services: Inserting, Collating, Labeling, Mailing.

Duane M. Everts & Assoc./Esoteric Video Services, PO Box 453, 6155 Hazelbrook Ave., Lakewood, CA, 90712, (213) 422-4252, Pres.: Duane M. Everts; Sales/Mktg. Dir.: Thomas J. McCormick.

Video: ¾ U-Matic, ½ VHS Cassette, ¼ CVC Cassette, S-VHS. High Speed Capability—SP, LP, EP.

Video Packaging Services: Inserting, Collating, Labeling, Mailing.

Other Services: Consulting, installations.

Fast Forward, 1025 Sansome St., San Francisco, CA, 94111, (415) 989-6245, Fax: (415) 989-0349, Pres./Mktg. Dir.: Paul Grippaldi; Sales Mgr.: Jay Hack.

Audio: Cassette, Open Reel, Real-time.

Video: ¾ U-Matic, ½ VHS Cassette, 8mm, S-VHS, D-2, 1", Betacam SP, Hi-8mm, ¾" SP.

Audio Packaging Services: Inserting, Collating, Labeling, Mailing.

52nd Street Studios, 1741 N. Ivar Ave., Los Angeles, CA, 90065, (213) 463-5252, Fax: (213) 465-2079, Pres.: Neil B. Posner; Sales Mgr.: Stuart A. Yahm; Account Executive: Michael Abraham.

Audio: Cassette, Open Reel, DAT, Real-time.

Video: ½ VHS Cassette.

Audio/Video Packaging Services: Inserting, Collating, Labeling, Mailing.

GMG Exim (USA), Inc., 500 S. Sepulveda Blvd., Ste. 403, Los Angeles, CA, 90049, (213) 471-4111, Fax: (213) 471-2267, Pres.: E. Gondobintoro; Sales Mgr.: James Dien; Mktg. Dir.: Harry Choi.

Audio: Cassette.

Audio Packaging Services: Inserting, Labeling.

Good Vibrations Recording & Prodn. Co., PO Box 764, 4050 Troon Way, Bonita, CA, 92002, (619) 267-0307, Partner: Don Marshall.

Audio: Cassette, DAT, Real-time, High speed & double time.

Audio Packaging Services: Inserting, Labeling.

HCV, Inc., 12229 Montague, Arleta, CA, 91331, (818) 896-4321, Pres.: Ed De Roo; Mktg. Dir.: Chuck Arnone.

Video: ¾ U-Matic, ½ VHS Cassette, S-VHS.

Other Services: Warehouse, Freight.

Highland Labs, 840 Battery St., San Francisco, CA, 94111, (415) 981-5010, Pres.: B. Brose; Sales Mgr.: A. McKie.

Audio: Cassette.

Video: ¾ U-Matic, ½ VHS Cassette, 2", D-2, Betacam SP.

Imperial Tape Co., Inc., 1928 14th St., Santa Monica, CA, 90404, (213) 393-2008, (800) 736-8273, Fax: (213) 396-8894, Pres.: Howard Ganz; Sales Mgr.: Illeana S. Martin.

Audio: Cassette, Open Reel, DAT, Real-time.

Video: ½ VHS Cassette.

Audio/Video Packaging Services: Inserting, Labeling, Mailing.

Other Services: Warehouse, Freight, Direct Response—800 services.

Intersound, Inc., 8746 Sunset Blvd., Los Angeles, CA, 90069, (213) 652-3741, Fax: (213) 854-7290, Pres.: Ahmed Agrama; Exec. Vice Pres.: Kent Harrison Hayes; Exec. Dir. Mktg.: Garry Morris; Prodn. Mgr.: Gerard Shadrick.

Video: ¾ U-Matic, ½ VHS Cassette, Video 8 w/ PCM audio, Hi-band Video 8.

Audio: Cassette, Open Reel, DAT, Real-time.

Audio Packaging Services: Inserting, Collating, Labeling, On-cassette imprinting, standard & deluxe.

Macola Record Group, Inc., 8831 Sunset Blvd., Ste. #202, West Hollywood, CA, 90069, (213) 659-6036, Fax: (213) 659-6039, Pres.: Donald MacMillan; Sales Mgr.: James Takeda; Mktg. Dir.: Lee Denton.

Audio: Cassette.

Audio Packaging Services: Inserting, Collating, Labeling, Mailing.

Magnetic Products, 27712 Avenue Mentry, Valencia, CA, 91355, (805) 295-8448, Fax: (805) 295-8278, Managing Dir.: R. Goldman.

Video: ¾ U-Matic, ½ VHS Cassette, 8mm, Betamax.

Audio Packaging Services: Inserting, Collating, Mailing.

Video Packaging Services: Inserting, Collating, Labeling, Mailing.

Other Services: Warehouse, Freight.

Majestic Duplicating Service, 1208 W. Isabel St., Burbank, CA, 91506, (818) 843-1806, Fax: (818) 954-0770, Pres.: Leslie Sawyer; Sales Mgr.: John Northrop; Mktg. Dir.: Chris Saver.

Video: ¾ U-Matic, ½ VHS Cassette, 8mm, S-VHS. High Speed Capability—SP, EP, Sprinter—SP, EP.

Audio Packaging Services: Inserting, Collating, Labeling, Mailing, Printing.

Other Services: Warehouse, Freight, Direct Response—800 services.

Mann Endless Cassette Industries, PO Box 1347, 3700 Sacramento St., San Francisco, CA, 94101, (415) 221-2000, Fax: (415) 387-2425, Sales Mgr.: John Gumba; Pres./Mktg. Dir.: Donald Mann.

Audio: Cassette, Real-time, Endless cassettes.

Master Track Prodn., Inc., 1524 W. Winton Ave., Hayward, CA, 94545, (415) 782-0877, Fax: (415) 782-6280, Contact: Sandi Larson.

Audio: Cassette, Open Reel.

Maxi Cassette Prodn., Inc., 1442 E. Arrow Hwy, Unit P, Irwindale, CA, 91706, (818) 358-1644, (800) 344-6294, Fax: (818) 357-1666, Pres./Mktg. Dir.: Michael T. Aris; Sales Mgr.: Ken Guilford.

Audio: Cassette, Open Reel, DAT, Real-time.

Audio Packaging Services: Inserting, Collating, Labeling, Mailing.

Other Services: Direct Response—800 services, Credit Card Clearance Services.

Mirror Image, 7315C Sunset Blvd., Hollywood, CA, 90046, (213) 876-1666, Pres.: Dean Acheson.

Audio: Cassette, Real-time.

Video: ½ VHS Cassette.

Mr. Speed Cassette Duplication, 12426 ½ Ventura Blvd., Studio City, CA, 91604, (818) 767-7333, Fax: (818) 508-8077, Owners: Steve Katz, Steve Mitchell.

Audio: Cassette, Open Reel, DAT, Hi-speed Duplication.

Audio Packaging Services: Inserting, Collating, Labeling.

Mobile Fidelity Sound Lab, 1260 Holm Rd., Petaluma, CA, 94954, (707) 778-0134, Fax: (707) 778-6532, Pres.: Herbert A. Belkin; Sales Mgr.: James G. Benz; Mktg. Dir.: Phyllis Schwartz; Vice Pres. Product Development: Michael Grantnam.

Audio: Cassette, DAT, Beta, VHS.

Montclair Tape Supply, 13755 Bayliss Rd., Los Angeles, CA, 90049, Pres.: Wallace Todd.

Audio: Cassette, Open Reel, DAT, Real-time.

Video: ¾ U-Matic, ½ VHS Cassette, ¼ CVC Cassette, S-VHS.

Morris Media & TV, 2730 Monterey St., Ste. 105, Torrance, CA, 90503, (213) 533-4800, Fax: (213) 533-1993, Pres.: Dawn Morris; Sales Mgr.: Roger Casas; Mktg. Dir.: Bruce Barton; Chairman: George Morris.

Video: ¾ U-Matic, ½ VHS Cassette.

Video Packaging Services: Inserting, Collating, Labeling, Mailing.

Other Services: Warehouse, Direct Response—800 services, Credit Card Clearance Services.

Music Annex Duplication, 42650 Christy St., Fremont, CA, 94538, (415) 226-0800, Fax: (415) 226-0455, Pres.: David H. Porter; Plant Mgr.: Brian Herndon; Mktg. Dir.: Keith Hatschek; Sales: C. Furness, S. Urquhart.

Audio: Cassette, Open Reel, Real-time.

Audio Packaging Services: Inserting, Collating, Labeling, CD brokering & CD packaging.

Other Services: Warehouse, Freight.

North Hollywood Tape Duplicating, 5014 Lankershim Blvd., North Hollywood, CA, 91601, (818) 985-9737, Fax: (818) 508-6443, Pres.: Charlene Schulz.

Audio: Cassette, Open Reel, Real-time.

Phantasma Sound, 7909 Fremont Ave., Ben Lomond, CA, 95005, (408) 336-2494, Pres.: Errol G. Specter.

Audio: Cassette, Real-time.

Prairie Sun Recording Studio, PO Box 7084, Cotati, CA, 94931, 1039 Madrone Ave., Cotati, CA, 94928, (707) 795-7011, Pres./Mktg. Dir.: Mark "Mooka" Rennick; Opns. Mgr.: Jeffrey Sloan.

Audio: Cassette, DAT, Real-time.

Pro Video, 801 N. La Brea Ave., Hollywood, CA, 90038, (213) 934-8840, Fax: (213) 934-8837, Pres.: Joel Webb.

Video: ¾ U-Matic, 1" Type C.

Quadim Corp., 31542 Rustic Oak Dr., Westlake Village, CA, 91361, (818) 706-8843, Fax: (818) 706-8426, Pres.: Guy Costa.

Audio: Cassette, Open Reel, DAT, Real-time.

Audio Packaging Services: Inserting, Collating, Labeling, Mailing.

RTI, Record Technology, Inc., 486 Dawson Dr., Camarillo, CA, 93012, (805) 484-2747, Fax: (805) 987-0508, Pres.: William Bauer; Sales Mgr.: Don MacInnis.

Audio: Cassette, DAT.

Audio Packaging Services: Inserting, Collating, Labeling, Mailing.

Other Services: Warehouse, Freight.

Radio Central, 548 S. Spring St., #815, Los Angeles, CA, 90013, (213) 623-7589, Pres.: David B. Sigler; Sales Mgr.: C.T. Hampson.

Audio: Cassette, Open Reel.

Rainbo Records & Cassettes
1738 Berkeley St., Santa Monica, CA, 90404, (213) 829-0355, Fax: (213) 828-8765, Pres.: Jack G. Brown; Gen. Mgr.: Steve Sheldon.

Audio: Cassette.

Rank Video Services America, 970 W. 190th St., Torrance, CA, 90502, (213) 515-6499, Fax: (213) 515-6049, Pres.: Phil Clement; Nat'l Sales Mgr.: Hal Blakeslee.

Video: ½ VHS Cassette, 8mm High Speed Capability—TMD: SP, EP, Sprinter—SP, EP.

Video Packaging Services: Inserting, Collating, Labeling, Mailing.

Other Services: Warehouse, Freight, Direct Response—800 services, Credit Card Clearance Services.

Bill Rase Prodn., Inc., 955 Venture Ct., Sacramento, CA, 95825, (916) 929-9181, Fax: (916) 929-4751, Pres./Sales Mgr.: Bill Rase; Mktg. Dir.: Esther Manchoff; Sec./Treas.: Shirely Rase.

Audio: Cassette, Open Reel, DAT, Real-time.

Video: ¾ U-Matic, ½ VHS Cassette, 8mm.

Audio Packaging Services: Inserting, Collating, Labeling.

Other Services: Freight.

Rose Studios, 1098 Rose Ave., El Centro, CA, 92243, (619) 352-5774, Pres.: Danny Berg.

Audio: Cassette, Real-time.

Video: ½ VHS Cassette.

Superior Tapes, Inc., 5620 Ayala Ave., Irwindale, CA, 91706, (818) 334-9486, (800) 458-7538, Fax: (818) 334-7365, Pres.: James Cu-Ungleng; Sales Mgr.: Vicki Tiongco.

Audio: Cassette.

Other Services: Warehouse.

Tape Specialty, Inc., 13411 Saticoy St., North Hollywood, CA, 91605, (818) 786-6111, Fax: (818) 904-0267, Pres.: Steven Feldman; Sales Mgr.: Nancy Catipano.

Audio: Cassette, DAT.

Audio Packaging Services: Inserting, Collating, Labeling, Mailing.

Other Services: Warehouse, Freight, Drop Shipment.

Tapette Corp., 15702 Producer Ln., Huntington Beach, CA, 92649, (714) 638-7960, Fax: (714) 891-0638, Pres.: James Neiger II; Sales Mgr.: Stewart Schlosberg; Mktg. Dir.: Mary Neiger.

Audio: Cassette.

Video: ¾ U-Matic, ½ VHS Cassette.

Audio/Video Packaging Services: Inserting, Collating, Labeling, Mailing.

Other Services: Warehouse.

Technicolor Videocassette
2000 Anchor Ct., Newbury Park, CA, 91320, (805) 499-5861, Fax: (805) 499-9086, Pres.: Emmet Murphy; Sales Mgrs. Paul Chabot (313-591-5826), Tonya Bates (215-941-9993), Jennifer Schneider (317-577-4772); Mktg. Dir.: Jim Pagniaro (212-888-8988).

Video: ½ VHS Cassette, 8mm, S-VHS. High Speed Capability—SP, EP, Sprinter—SP, EP.

Video Packaging Services: Inserting, Collating, Labeling, Mailing, Complete fulfillment services.

Other Services: Warehouse, MIS (Inventory), Freight.

Uni-Sette, Inc., 1852 Fulton Ave., Sacramento, CA, 95825, (916) 485-9534, Fax: (916) 485-9535, Pres.: Rudolph DeGroot.

Audio: Cassette, DAT.

Video: ½ VHS Cassette.

Unimagnetics USA, 1513 Sixth St., Ste. 204, Santa Monica, CA, 90401, (213) 393-1572, Fax: (213) 451-0143, Export Mgr.: Alex Tan; Customer Service: Thierry Follonier.

Audio: Cassette, Open Reel, DAT.

Other Services: Warehouse, Freight, Direct Response—800 services.

United Audio Video Group, Inc., 6855 Vineland Ave., North Hollywood, CA, 91605, (818) 980-6700, Fax: (818) 508-8273, Pres.: Miriam Newman; Vice Pres. Prodn.: Steve Newman; Sales Mgr.: Larry Schwartz; Mktg. Dir.: Laurie Newman.

Audio: Cassette, Open Reel, DAT, Real-time.

Video: ¾ U-Matic, ½ VHS Cassette, ¼ CVC Cassette, 8mm, S-VHS, Hi-8, Betacam, 1", D-2.

Audio Packaging Services: Inserting, Labeling, Mailing.

Video Packaging Services: Inserting, Collating, Labeling, Mailing.

Other Services: Warehouse, Freight.

Universal Tape Corp., Inc., 860 E. Walnut St., Carson, CA, 90746, (213) 327-3203, Fax: (213) 273-5646, Pres.: Edward O. Praeger.

Audio: Cassette, Open Reel, Wollensak.

VCA Telecronic in Beverly Hills Video Group, 1749 14th St., Santa Monica, CA, 90404, (213) 452-1511.

Audio: Cassette, Open Reel.

Video: ¾ U-Matic, ½ VHS Cassette, Interformat Post Productions.

Vaughn Duplication Services, 1201 N. Latabee, Ste. 103, Los Angeles, CA, 90069, (213) 652-1253, Vice Pres.: Donald Drapeau; Sales: Brendan Cahill; Mktg. Dir.: Michelle Sahlin.

Video: ¾ U-Matic, ½ VHS Cassette, ¼ CVC Cassette.

1095 South Ave. Bridgeport, CT. 06604

Tapecom

INC.

NEW ENGLAND'S LARGEST CASSETTE DUPLICATOR

AUDIO CASSETTE DUPLICATION • WAREHOUSING
RECORDING FACILITIES • SPECIAL PACKAGING
TYPESETTING & DESIGN • COMPETITIVE PRICING
QUALITY ORIENTATED • FAST TURN AROUND
ADVANCED TECHNOLOGY

CALL OR WRITE TODAY
PHONE: 203-579-7888
FAX: 203-579-0435



8mm, S-VHS. High Speed Capability—TMD: SP, EP. Video Packaging Services: Inserting, Collating, Labeling, Mailing, Macrovision Antipiracy coding. Other Services: Warehouse, Freight, Direct Response—800 services, Int'l Standards Conversions.

Virco Recording Co., Inc., 700 S. Date Ave., Alhambra, CA, 91803, (213) 283-1888, Fax: (818) 281-5901, Pres.: Virginia C. Watts.

Audio: Cassette, Open Reel.

Audio Packaging Services: Inserting.

WEA Mfg., Inc., 3601 W. Olive Ave., Ste. 420, Burbank, CA, 91505, (818) 953-2941, Sr. Vice Pres. Mktg.: David L. Brown.

Audio: Cassette.

Audio Packaging Services: Inserting, Collating, Labeling. **West Coast Video Duplicating, Inc.**, 385 Valley Dr., Brisbane, CA, 94005, (415) 468-7330, Fax: (415) 468-1386, Pres.: John Roth; Sales Mgr. (East Coast): Bob Diamond; Sr. Vice Pres. Sales: Paula Tait; Los Angeles Sales Rep.: Howard Kropf. Video: ¾ U-Matic, ½ VHS Cassette.

Word of Faith Tape & Sound, PO Box 1147, Azusa, CA, 91702, (818) 969-4544, Fax: (818) 969-9589, Pres.: Ron Gibson; Sales Mgr.: Mike Finerock; Mktg. Dir: Walt Werblatsch.

Audio: Cassette, Open Reel, Real-time.

Audio Packaging Services: Inserting, Collating, Labeling, Mailing.

COLORADO

Chidvllas, PO Box 17550, Boulder, CO, 80308, (303) 449-7811, Fax: (303) 449-7099, Pres.: Parmita Pushman; Sales Mgr.: Vimian VanDien; Mktg. Dir: Peter Hill.

Audio: Cassette.

Video: ½ VHS Cassette.

Jackson Sound Productions, LTD., 3897 S. Jason St., Englewood, CO, 80110, (303) 761-7940, Fax: (303) 789-0557, Pres.: Joseph Jackson; Sales Mgr.: Linda Loughman.

Audio: Cassette.

Audio Packaging Services: Inserting, Collating, Labeling, Mailing.

Tapes Again, 1135 Pearl St., #7, Boulder, CO, 80302, (303) 447-8787, Pres.: Mitch Rose; Sales Mgr.: Lennie Noltes.

Audio: Cassette, Real-time.

CONNECTICUT

Tapecom, Inc., 1095 South Ave., Bridgeport, CT, 06604, (203) 579-7666, Contact: Ed L. Harm.

Audio: Cassette.

Traxx Recording Products & Duplication, 24 Crestway KC, New Fairfield, CT, 06812, (203) 746-3561, Pres.: Jim Beck.

Audio: Cassette, Open Reel, Real-time.

DELAWARE

Nat'l Tape Duplicators, 1500 First State Blvd., Prodn. Center, Wilmington, DE, 19804, (302) 999-1110, Fax: (302) 999-1656, Pres.: H. Edwin Kennedy; Sales Mgr.: Shirley Kay; Mktg. Dir.: S. Lotz; Prodn. Mgr.: William Burgess, III.

Audio: Cassette, Open Reel, DAT, Real-time.

Video: ¾ U-Matic, ½ VHS Cassette, 8mm, S-VHS, S-8mm.

Audio Packaging Services: Inserting, Collating, Labeling, Mailing, Shrinkwrap, Storage vault.

Video Packaging Services: Inserting, Collating, Labeling, Mailing, Storage vault.

Other Services: Warehouse, Freight.

DISTRICT OF COLUMBIA

Multitape, 1630 Euclid St. NW, Ste. 131, Washington, DC, 20009, (202) 332-1522, Fax: (202) 462-1163, Pres./Mktg. Dir.: Bruce Moyer; Sales Mgr.: Julie Spicer.

Audio: Cassette, Open Reel, DAT, Real-time.

Video: ¾ U-Matic, ½ VHS Cassette, 8mm.

Audio Packaging Services: Inserting, Collating, Labeling, Mailing.

FLORIDA

All American Records/A Div. of All American Record Mfg. Inc., 4380 NW 128th St., Opa Locka, FL, 33054, (305) 688-7475, Fax: (305) 685-5697, Pres.: Peter Botome; Sales Mgr.: Marilynn Moreno; Mktg. Dir.: Bertilda Torres; Exec. Dir.: Jorge A. Jure.

Audio: Cassette.

Video: ¾ U-Matic, ½ VHS Cassette.

Audio Packaging Services: Inserting.

Other Services: Warehouse, Freight, Direct Response—800 services.

Allied Film & Video, 4364 35th St., Orlando, FL, 32811, (407) 649-0008, Fax: (407) 649-9005, Pres.: Bill Smith; Sales/Mktg. Mgr.: Richard Skillman.

Video: ¾ U-Matic, ½ VHS Cassette, ¼ CVC Cassette, 8mm, S-VHS, D2, Hi8, PAL/SECAM. High Speed Capability—SP, LP, EP. Sprinter—SP, LP, EP.

Video Packaging Services: Inserting, Collating, Labeling, Mailing.



— SINCE 1939 —

RAINBO RECORDS & CASSETTES

1738 BERKELEY STREET
SANTA MONICA, CA 90404
(310) 829-3476 • (310) 829-0355
FAX: (310) 828-8765

In over 50 years . . .
We've gone from:
78 RPM Shellac to
33 1/3-45 RPM Vinyl
Mono to Stereo
Analog to Digital
Pops to Hisses
Grooves to Bytes
From Disc to Dat
So What Else Is New!

RAPPERz hoo Rapped w/RAINBO n Racked Stax of FAT WAX

YOUR HIP + OUR HOP = A CHART START TO THE TOP

CST	CD	12"	ARTIST	LABEL
±	*		M.C. POOH	IN-A-MINUTE RECORDS
		+	SIR *MIX*A*LOT	NASTY MIX
	*	X	ICE CUBE	PRIORITY
		+	N.W.A.	RUTHLESS
†	*		GETO BOYS	RAP A LOT
	†	*	MAAD CIRCLE	PRIORITY
		‡	BOOGIE DOWN PRODUCTIONS	B-BOY RECORDS
X	+		PROFER DOS	BIG CHILL
*		†	DEF JEF	DELICIOUS VINYL
*	X		H.W.A.	QUALITY/DRIVE-BY
+	X	†	M.C. HAMMER	BUSTIN RECORDS
+	*	*	tone loc	DELICIOUS VINYL
	*		BRAND NEW HEAVIES	DELICIOUS VINYL
	X		M.C. SWAY & DJ KING TECH	ALL CITY/GIANT
+	*		DE LA SOUL	TOMMY BOY
		+	RODNEY O. & JOE COOLEY	NASTY MIX
*	X	†	ERIC B & RAKIM	UNI/MCA
*		■	STETSASONIC	TOMMY BOY
†	+		COMPTON'S MOST WANTED	KRU-CUT/ TECHNO HOP
X		■	MC TWIST	LETHAL BEAT
+	▶	1	U.R. NEXT	UR-OWN*

***Your Talent • Our Know How • A Mix That Slix!!!**

D.J. PROMO

100 - 12" VINYL
\$599.00
METAL PARTS • LACQUER MASTER
TWO COLOR LABELS • WHITE JACKETS W/HOLE
WHITE INNER SLEEVE



TEST PRESSINGS • SHRINK WRAP

CD PACKAGE

1000 - \$2299
INCLUDES: ORIGINATION
4-COLOR COVER* WITH
BLACK/WHITE BACK & INLAY CARD
2-COLOR LABEL IMPRINT
JEWEL BOX & SHRINK WRAP
500 CD'S MINIMUM ORDER



CASSETTE SINGLE

500 - \$499.95
REORDER - \$349
1000 - \$799.95
REORDER - \$659

INCLUDES:
• RUNNING MASTER
• TEST CASSETTE
• APEX PRINTING ON CASSETTE SHELL
• 1-COLOR WRAP-AROUND CARD*
• COMPOSITE NEGS • SHRINK WRAP



500 Cassettes • \$585

Complete (including)
• Composite Negatives from your Camera Ready Artwork
• Cassette Running Master • Test Cassette In Five Days • Apex Printing on Cassette • 1000 One-Color Inserts (500 for re-order)
• Norelco Box - Cello Wrapped • 10-12 Working Days

REORDER ANYTIME \$385 22 min. per side max.

1000 12" FULL-COLOR PACKAGE†	\$1,799
MASTERING/PROCESSING/8 TESTS/2-COLOR LABELS/4-COLOR JACKETS*/SHRINK WRAP COMPLETE IN 15 DAYS / REORDER - 12 WORKING DAYS - \$1329	
1000 12" ONE-COLOR PACKAGE†	\$1,599
[AS ABOVE WITH 1-COLOR JACKET*] / REORDER - 10 WORKING DAYS - \$1119	
1000 7" 45's	\$699
MASTERING/PROCESSING/8 TESTS/2-COLOR LABELS/WHITE SLEEVE COMPLETE - 10 DAYS REORDER - \$359	
500 7" 45's	\$549
[SAME AS ABOVE] REORDER - \$229	
1000 FULL-COLOR CASSETTES†	\$899
MASTERING/TEST/2,000 4-COLOR INSERTS* (1000 EXTRA FOR REORDER) APEX PRINTING ON SHELL/NORELCO BOX/SHRINK WRAP/22 MIN. PER SIDE (MAX.) COMPLETE: 15 DAYS REORDER - \$750	
†Does not include composite negatives *From your camera-ready artwork	

THE OLDEST AND LARGEST INDEPENDENT CD, AUDIOTAPE & VINYL DUPLICATING FACILITY

Other Services: Warehouse, Freight, Direct Response—800 services, Credit Card Clearance Services.

Alpha Records, Inc., PO Box 15011, Fort Lauderdale, FL, 33318, 1400 NW 65th Ave., Fort Lauderdale, FL, 33313, (305) 587-6011, Pres.: Richard Smith; Sales Mgr.: Barbara Smith. Audio: Cassette.

Audio Packaging Services: Inserting, Labeling, Mailing.

Pat Appleson Studios, Inc., 757 SE 17th St. Causeway, Ste. 358, Fort Lauderdale, FL, 33316, (305) 587-7900, Pres.: Patrick G. Appleson; Sales Mgr.: Alan Muller; Mktg. Dir.: Brenda Myer. Audio: Cassette, Open Reel, DAT, Real-time. Audio Packaging Services: Inserting, Collating, Labeling, Mailing.

Other Services: Warehouse, Freight.

Audio Recording & Duplicating, 323 Santa Villa Dr., Milton, FL, 32571, (904) 994-4799, Pres.: Ty Bracken; Sales Mgr.: Glenda Bracken. Audio: Cassette.

DER Duplicating Services Inc., 212 NW Fourth Ave., Hallandale, FL, 33009, (305) 458-7505, Fax: (305) 458-8554, Pres.: Mike Rubin; Sales Mgr.: Allan Baird. Video: ¾ U-Matic, ½ VHS Cassette. High Speed Capability—TMD: SP, LP, EP, Sprinter—SP, LP, EP. Video Packaging Services: Inserting, Collating, Labeling, Mailing, Displays.

Other Services: Warehouse, Freight.

Digital 1, 658 Douglas Ave., Altamonte Springs, FL, 32714, (407) 682-7790, Pres.: Jon Phelps; Sales/Mktg. Dir.: Batt Donovan. Audio: Cassette, DAT, Real-time. Audio Packaging Services: Inserting, Labeling.

Other Services: Warehouse.

Eva-Tone, Inc., 4801 Ulmerton Rd., Clearwater, FL, 34622, (813) 382-8663, Fax: (813) 572-6214, Pres.: Richard E. Evans; Printing Sales Mgr.: Dick Evans; Audio: Norman H. Welch, Jr. Audio: Cassette. Video: ½ VHS Cassette. Audio Packaging Services: Inserting, Collating, Labeling, Mailing.

Magnetix Corp., 770 W. Bay St., Winter Garden, FL, 34787, (407) 656-4494, Fax: (407) 656-4825, Pres.: John Lory. Audio: Cassette, Open Reel, DAT. Audio Packaging Services: Inserting, Collating, Labeling, Mailing.

Other Services: Warehouse, Freight.

Miami Tape, Inc., 8180 NW 103th St., Hialeah Gardens, FL, 33016, (305) 558-9211, Fax: (305) 825-9873, Pres.: Carlos O. Garcia; Sales Mgr.: Mirella Tunon. Audio: Cassette. Audio Packaging Services: Inserting, Collating, Labeling.

Mirror Image Sound & Recording, Inc., 619 S. Main St., Gainesville, FL, 32601, (904) 376-8742, Prodn. Mgr.: Ray Valla. Audio: Cassette, Real-time. Audio Packaging Services: Inserting, Collating, Labeling, Mailing.

Progressive Music, 2116 Southview Ave., Tampa, FL, 33606, (813) 251-8093, Fax: (813) 251-6050, Pres.: Ken Veenstra; Sales Mgr.: Billy Garrow. Audio: Cassette, Open Reel, Real-time. Audio Packaging Services: Inserting, Labeling.

Other Services: Warehouse, Freight.

Trackmaster, Inc., 2692 E. Atlantic Blvd., Pompano Beach, FL, 33062, Pres.: Roy Parsons; Sec./Treas.: Lupe Parsons. Audio: Cassette. Other Services: Warehouse, Freight.

Vaughn Duplication Services, 5414 Beaumont Center Dr., Ste. 202, Tampa, FL, 33634, (813) 889-0182, Fax: (813) 889-0182, Vice Pres.: Donald Drapeau; Sales Mgr.: Kenneth Cheek; Mktg. Dir.: Michelle Sahlin; Sales Rep.: Ric Everett; Sales Rep.: Rick Mabeus. Video: ¾ U-Matic, ½ VHS Cassette, ¼ CVC Cassette, 8mm, S-VHS. High Speed Capability—TMD: SP, EP. Video Packaging Services: Inserting, Collating, Labeling, Mailing, Macrovision Antipiracy coding. Other Services: Warehouse, Freight, Direct Response—800 services, Package consulting, Int'l standards conversion.

GEORGIA

American Sound & Video Corp. (South), 2225 Faulkner Rd. NE, Atlanta, GA, 30324, (404) 633-4577, Fax: (404) 728-9744, Gen. Mgr.: Peter Thomason. Audio: Mono & Stereo. Video: ¾ U-Matic, ½ VHS Cassette, Hi-Fi Stereo, Full Packaging.

Doppler Studios, 1922 Piedmont Cir., Atlanta, GA, 30324, (404) 873-6941, Fax: (404) 872-2160, Pres.: Wilber W. Caldwell; Studio Mgr.: Bill Quinn. Audio: Cassette, Open Reel, Real-time.

Hottrax Records, 1957 Kilburn Dr., Atlanta, GA, 30324, (404) 662-6661, Pres.: Aleck Janouli; Sales Mgr.: Hamilton Underwood; Mktg. Dir.: Teri Blackman. Audio: Cassette, Open Reel.

Master Sound Studios, Inc., 1227 Spring St. NW, Atlanta, GA, 30309, (404) 873-6425, Fax: (404) 875-1440, Pres.: Babs Richardson; Traffic Mgr.: Jennifer Simpson. Audio: Cassette, Open Reel, DAT, Real-time.

Premiere AVD Corp., 4025 Pleasantdale Rd., Atlanta, GA, 30340, (404) 448-1280.

Video: ½ VHS Cassette, Video Hi-speed duplication; video loading.

Project 70 Audio Services, Inc., 777 Lambert Dr. NE, Atlanta, GA, 30324, (404) 875-7000, Fax: (404) 875-7007, Pres.: Jerry L. Connell. Audio: Cassette, Open Reel. Audio Packaging Services: Inserting, Collating, Labeling, Mailing.

Sony Music Entertainment, Inc., 5152 Columbia Dr., Carrollton, GA, 30117, (404) 836-2000, Fax: (404) 836-2173, Opns. Dir.: Cher Anderson; Vice Pres. Sales/Mktg.: Scott Bartlett. Audio: Cassette. Video: ½ VHS Cassette. High Speed Capability—SP, Sprinter—SP. Audio/Video Packaging Services: Inserting, Collating, Labeling.

Other Services: Warehouse.

Sound Video Corp., 3125-A Gateway Dr., Norcross, GA, 30071, (404) 448-5020, Fax: (404) 448-0112, Pres.: Bill Evans; Sales Mgr.: Billy McDaniel. Video: ¾ U-Matic, ½ VHS Cassette, S-VHS, 1", BETA SP. Other Services: Warehouse, Freight, Direct Response—800 services.

SOUND INVESTMENT Co., Inc., 3586 Pierce Dr., Chamblee, GA, 30341, (404) 458-1679, (800) 649-8273, Fax: (404) 458-0276, Pres.: Douglas Wilmer; Sales Mgr.: W. Louis Simmons, Jr.; Mktg. Dir.: Lori Albert. Audio: Cassette, Real-time. Video: ¾ U-Matic, ½ VHS Cassette.

Video Copy Services, Inc., 1699 Tullie Cir., Ste. #117, Atlanta, GA, 30329, (404) 321-6933, (800) 553-3616, Fax: (404) 321-4876, Pres.: Tim Harris. Video: ¾ U-Matic, ½ VHS Cassette, 8mm, S-VHS, D2, Int'l Standards Conversions. Video Packaging Services: Inserting, Labeling, Mailing. Other Services: Warehouse, Freight.

ILLINOIS

ARS Recording & Tape Duplication, 11626 S. Pulaski, Alsip, IL, 60658, (708) 371-8424, Fax: (708) 371-9403, Pres.: Gary A. Cobb; Sales Mgr.: Allen L. Keilman. Audio: Cassette, Open Reel, DAT, Real-time. Audio Packaging Services: Inserting, Collating, Labeling.

Acme Recording, 1708 W. Belmont, Chicago, IL, 60657, (312) 477-7333, Pres.: Jim Rasfeld; Sales Mgr.: Mike Beck. Audio: Cassette, Open Reel, DAT, Real-time. Audio Packaging Services: Inserting, Labeling.

Allied Film & Video, Chicago Div., 1322 W. Belmont Ave., Chicago, IL, 60657, (312) 348-0373, Fax: (312) 348-5669, Div. Mgr.: Grant Ireland. Audio: Cassette. Video: ¾ U-Matic, ½ VHS Cassette, 8mm, S-VHS. Audio Packaging Services: Inserting, Collating, Labeling, Mailing.

Other Services: Warehouse, Freight.

Anvid Recording Co., PO Box 8130, Bartlett, IL, 60103, 69 S. LaSalle St., Aurora, IL, 60505, (708) 837-9840, Fax: (708) 897-8998, Pres.: David Schuler. Audio: Cassette, Real-time. Video: ½ VHS Cassette. Audio/Video Packaging Services: Inserting, Collating, Labeling, Mailing.

Other Services: Warehouse, Freight.

Audio Images Plus, 6228 W. Oakton St., Morton Grove, IL, 60053, (800) 752-6754, (708) 965-8401, Fax: (708) 965-8426, Pres.: Lauren Laifer; Mktg. Dir.: Anne Carney; U.P. Technical OP: Janice Nakashima. Audio: Cassette. Audio Packaging Services: Inserting, Collating, Labeling, Mailing.

Other Services: Warehouse, Freight, Direct Response—800 services, on location recording, printing services.

Cassette Services, Inc., 557 W. Golf Rd., Arlington Heights, IL, 60005, (708) 806-1100, Fax: (708) 806-1142, Pres.: Michael Connor; Sales/Mktg. Dir.: Joe Givliani. Audio: Cassette. Audio Packaging Services: Inserting, Labeling, Mailing.

Dwight Cavendish Co., 6444 N. Ridgeway Ave., Chicago, IL, 60645, (708) 673-0937, Fax: (708) 673-1389, Sales Mgr.: Carter Ruehrdanz; Agent: Marshall A. Ruehrdanz. Video: Video duplicating systems & modules.

Center Video Industrial Co., Inc., 5615 W. Howard St., Niles, IL, 60648, (708) 647-8700, Fax: (708) 647-8707, Pres.: Edward Sussman; Vice Pres.: Stephen B. Rudolph; Sales Mgr.: Rick Haverstock; Mktg. Dir.: Helen Peters. Video: ¾ U-Matic, ½ VHS Cassette. Audio Packaging Services: Inserting, Labeling.

The Domain Group, 289 Main Pl., Carol Stream, IL, 60188, (708) 668-5300, Fax: (708) 668-0158, Pres.: Edward A. Elliott; Vice Pres./Sales Mgr.: James Draper. Audio: Cassette, Open Reel. Audio Packaging Services: Inserting, Collating, Labeling, Mailing, On-Cassette Printing, Shrinkwrap. Other Services: Warehouse, Direct Response—800 services.

Duplicates, 11 E. Hubbard St., Chicago, IL, 60611, (312) 822-0305, Fax: (312) 464-0762, Pres.: Michael A. Freeman. Audio: Cassette, Open Reel, DAT, Real-time. Audio Packaging Services: Inserting, Collating, Labeling, Mailing.

International Audio, Inc., 2934 Malmo Rd., Arlington Heights, IL, 60005, (708) 956-6030, Fax: (708) 956-6190, Pres.: Richard Mally; Sales Mgr.: Paul Mally. Audio: Cassette, Diskette Duplication.

Intervideo Duplication Services, 3533 S. Archer Ave., Chicago, IL, 60609, (312) 927-9091, Fax: (312) 927-9211, Pres./Sales Mgr.: Peter Bernotas. Audio: Cassette, Real-time. Video: ¾ U-Matic, ½ VHS Cassette, ¼ CVC Cassette, 8mm, S-VHS. High Speed Capability—SP, LP, EP. Video Packaging Services: Inserting, Collating, Labeling, Mailing.

Jor-Dan, Inc., 1100 Wheaton Oaks Ct., Wheaton, IL, 60187, (708) 653-1919, Fax: (708) 665-4966, Vice-Pres.: Dan Zimbelman. Audio: Cassette, Open Reel. Video: ¾ U-Matic, ½ VHS Cassette. Video Packaging Services: Inserting, Collating, Labeling, Mailing.

Major Media, Inc., 3326 Commercial Ave., Northbrook, IL, 60062, (708) 498-4610, Pres.: Jay Steinberg. Audio: Cassette, Open Reel, Real-time. Video: ¾ U-Matic, ½ VHS Cassette, 8mm, S-VHS. Audio/Video Packaging Services: Inserting, Collating, Labeling, Mailing.

Other Services: Warehouse, Freight.

Pentagon Industries, Inc., 5115 N. Sheridan Rd., Chicago, IL, 60640, (312) 271-8300, Fax: (312) 271-0027, Pres.: Lateef Khan; Gen. Mgr./Sales Mgr.: John Vinci. Audio: Cassette.

Premiere AVD Corp., 1099 Brown St., Wauconda, IL, 60084, (708) 526-1800, (800) 922-8080. Video: ½ VHS Cassette, Video Hi-speed duplication; video loading.

Quality Cassette Services, 403 S. Woodlawn St., Wheaton, IL, 60187, (708) 668-2787, Pres.: Mary M. Newitt. Audio: Cassette, Open Reel, Real-time. Audio Packaging Services: Inserting, Labeling.

Rank Video Services America, 555 Huehl Rd., Northbrook, IL, 60062, (708) 291-4275, Fax: (708) 291-4282, Pres.: Philip A. Clement; Mktg. Project Mgr.: Marilyn L. Quist. Video: ½ VHS Cassette, 8mm, S-VHS. High Speed Capability—TMD: SP, LP, EP, Sprinter—SP, LP, EP. Video Packaging Services: Inserting, Collating, Labeling, Mailing.

Other Services: Warehouse, Freight, Direct Response—800 services, Credit Card Clearance Services.

Renaissance Video Corp., 130 S. Jefferson, Chicago, IL, 60661, (312) 930-5000, Fax: (312) 930-9030, Pres.: Eric Thurman; Sales Mgr.: Patrick Sweeney; Operations Mgr.: Gene Cosentino. Video: ¾ U-Matic, ½ VHS Cassette, S-VHS, 1". Video Packaging Services: Inserting, Collating, Labeling, Mailing.

Other Services: Direct Response—800 services.

INDIANA

ARP Media Ents., 1600 Rich Rd., Richmond, IN, 47374, (317) 962-9511, Fax: (317) 962-1564, Pres.: David Ambault; Sales/Mktg. Dir.: Albert R. Santoro. Audio: Cassette, DAT. Video: ¾ U-Matic, ½ VHS Cassette, 8mm, S-VHS. Audio Packaging Services: Inserting, Collating, Labeling, Mailing, Bag & Blister Pack, Folding Boxes. Video Packaging Services: Inserting, Collating, Labeling, Mailing.

Other Services: Warehouse.

Digital Audio Disc Corp., PO Box 3710, Terre Haute, IN, 47803, 1800 N. Fruitridge Ave., Terre Haute, IN, 47804, (812) 462-8100, Fax: (812) 466-9125, Chrmn./CEO: James Frische; Vice Pres./Mktg. Dir.: Scott Bartlett. Audio: DAT. Audio Packaging Services: Inserting, Collating, Labeling, Mailing.

Other Services: Warehouse, Freight.

electro sound, Inc., 1805 West, Rt. 44, Shelbyville, IN, 46176, (317) 392-1656, Sr. Vice Pres. Sales: Hugh Landy; Gen. Mgr.: Curt Albright. Audio: Cassette, Open Reel, DAT, Vinyl, CD. Video: ½ VHS Cassette.

FP Video Services, Inc., 4415 Saguaro Trail, Indianapolis, IN, 46268, (317) 299-9191, Fax: (317) 297-2998, Pres.: Charles J. Selden; Vice Pres./Treas.: Steve Whetzel; Sales Mgr.: Lee Ann Richardson. Video: ¾ U-Matic, ½ VHS Cassette, ¼ CVC Cassette, 8mm, S-VHS. Video Packaging Services: Inserting, Collating, Labeling, Mailing, Order capture through 800-numbers.

Other Services: Warehouse, Freight, Direct Response—800 services, Credit Card Clearance Services, Market feasibility studies.

KVC Home Video, PO Box 68881, 7225 Woodland Dr., Indianapolis, IN, 46268, (317) 297-1000, (800) 582-2000, Fax: (317) 297-5892, Sales Mgr.: Jeff Jacobs; Mktg. Dir.: Bruce Stickle. Audio: Cassette.

Precision Audio, Inc., 18582 US 20, Bristol, IN, 46526, (219) 295-7493, Pres.: Sanford Swantzendruber; Sales Mgr.: Philip Miller. Audio: Cassette, Open Reel.

LYREC DUPLICATION SYSTEMS - THE COMPLETE SOLUTION FROM MASTER TO CASSETTE!

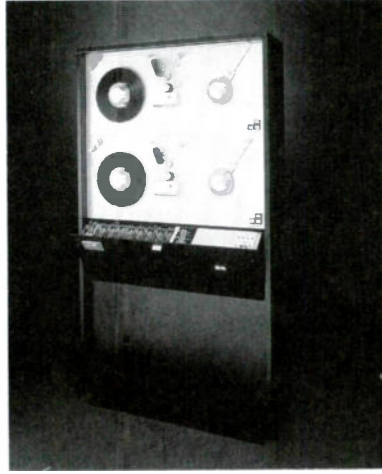
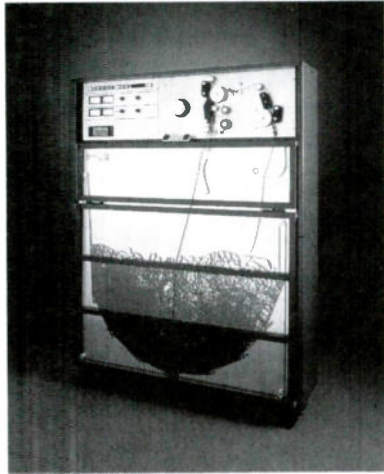

WE HAVE GOT IT ALL !

WE SUPPORT WHAT
WE SELL !

COMPARE IF YOU
DARE,

GIVE US A CALL.

HIGH YIELD -

HIGH QUALITY -

DUPLICATION

AND LOADING

SYSTEMS

1/4" STEREO

RECORDERS -

1/2" 4-TRACK

MASTER MAKERS -

TEST EQUIPMENT

AND QC MACHINES

SALES AND TECHNICAL CENTRES.

LYREC MANUFACTURING A/S, DENMARK
MEDIA TECHNOLOGIES, LTD, N. AMERICA
AUDIO CONSULTORES, MEXICO
LYREC (U.K.) LTD
LYREC ROBOTECNICA S.R L., ITALY
SEOUL SOUND TECHNOLOGY GROUP, KOREA
GLOBE MAGNETIC SCIENCES, SINGAPORE
JOLLY SOUND LIMITED, HONG KONG

	TEL	FAX
	+45 445 32522	+45 445 35335
	+516 467 1200	+516 467 1258
	+52 83445270	+52 83445270
	+44 844278866	+44 844278810
	+39 39746815	+39 39743422
	+82 25844313	+82 25885655
	+65 4497700	+65 4453339
	+852 362 0202-5	+852 7642475



Lyrec Manufacturing A/S, Box 123 (Mileparken 22)
DK-2740 Skovlunde, Denmark, Tel +45 44 53 25 22
Fax +45 44 53 53 35, Tlx 37568 lyrec dk

Bud Pressner Music & Recording Service, 6860 Broadway, Merrillville, IN, 46410, (219) 769-0011, Pres.: Bud Pressner. Audio: Cassette, Open Reel. Audio Packaging Services: Inserting, Collating, Labeling, Mailing. Other Services: Warehouse.

Sound Ideas of Ft. Wayne, 6803 Salge Dr., Fort Wayne, IN, 46835, (219) 485-3658, Pres.: Jack Flanigan. Audio: Cassette, Real-time.

WMG, Inc. (World Media Group), 8472 Brookville Rd., Indianapolis, IN, 46239, (317) 353-1113, Fax: (317) 353-0750, Pres.: J.A. Mellentine; Sales Mgr.: Curt Albright. Audio: Cassette. Video: ½ VHS Cassette. Audio/Video Packaging Services: Inserting, Collating, Labeling, Mailing. Other Services: Warehouse, Freight.

IOWA

RMS Recording & Electronics, PO Box 1075, 1141 Stanley Dr., Gilbert, IA, 50105, (515) 232-7464, Pres.: Randall M. Slocum. Audio: Cassette, Open Reel, Real-time. Video: ½ VHS Cassette. Audio Packaging Services: Inserting, Labeling, Mailing.

Triad Studios, 1910 Ingersoll Ave., Des Moines, IA, 50309, (515) 243-2125, Fax: (515) 243-2055, Pres.: Richard Trump; Duplication Mgr.: Greg Tracy. Audio: Cassette, Open Reel.

Vaughn Duplication Services, 2906 Brady St., Davenport, IA, 52803, (319) 322-1525, Fax: (319) 322-5920, Pres.: Ken Nicholls; Sales Mgr.: Peter Leverenz. Video: ¾ U-Matic, ½ VHS Cassette.

KANSAS

High Fidelity Recording, Inc., 1059 Porter, Wichita, KS, 67203, (316) 262-6456, Pres./Sales Mgr.: James Strattan; Mktg. Dir. Nancy Strattan. Audio: Cassette, Open Reel. Video: ¾ U-Matic, ½ VHS Cassette.

R.S.R.T., 4020 Stateline, Kansas City, KS, 66103, (913) 262-5335, Fax: (913) 262-5364, Pres./Sales Mgr.: Royal Scanlon; Prodn. Mgr.: Dan Shanks. Audio: Cassette, Open Reel, Real-time. Video: ¾ U-Matic, ½ VHS Cassette. Audio Packaging Services: Inserting, Collating, Labeling, Mailing, On Cassette Imprinting, Shrinkwrap.

Sunset Prodn., 117 W. Eighth, Hays, KS, 67601, (913) 625-9634, Fax: (913) 625-5757, Pres.: Mark Meckel. Audio: Cassette, Open Reel, DAT, Real-time. Audio Packaging Services: Inserting, Collating, Labeling, Mailing.

KENTUCKY

Alpha Recording, Inc., PO Box 740, Elizabethtown, KY, 42701, (502) 765-7899, Fax: (502) 765-3734, Pres.: Jim Cottrell; Sales Mgr.: Don Cottrell; Mktg. Dir. Lori Hawk; Studio Mgr.: Mark Goodman. Audio: Cassette, Real-time. Video: ¾ U-Matic, ½ VHS Cassette. Audio/Video Packaging Services.

Lundy Recording & Cassette Dup., PO Box 408, Heidrick, KY, 40949, (606) 546-6650, Pres.: David Lundy; Sales Mgr.: Viola Lundy; Mktg. Dirs.: Duran Lundy, Davie Lundy. Audio: Cassette, Open Reel, Real-time. Audio Packaging Services: Inserting, Collating, Labeling, Mailing. Other Services: Warehouse.

SSDigital, PO Box 43551, 809 Echo Bridge, Louisville, KY, 40253, (502) 473-0068, Pres.: Jesus Rosebud; Sales Mgr.: Nohpar King; Mktg. Dir. Vernon T. McEnos; Project Coord.: K. Scott Riltcher. Audio: Cassette, DAT, Real-time, 8-Track. Audio Packaging Services: Inserting, Labeling.

Trusty Tuneshop Recording Studio, 8771 Rose Creek Rd., Nebo, KY, 42441, (502) 249-3194, Pres.: Elsie Childers. Audio: Cassette, Open Reel, Real-time.

MAINE

Klarity Kasette, Inc., Main St., One Post Office Sq., Waterville, ME, 04901, (800) 458-6405, Fax: (207) 873-3924, Pres.: Paul McCormick; Sales Mgr.: Michael Pepin. Audio: Cassette, Real-time. Audio Packaging Services: Inserting, Collating, Labeling.

Mustard Seed Ministries, 79 Lewiston St., Mechanic Falls, ME, 04256, (207) 345-9073, Pres.: Stephen Kilbreth. Audio: Cassette.

MARYLAND

Allied Film & Video, Maryland Div., 5840 Kirby Rd., Clinton, MD, 20735, (301) 297-7600, Fax: (301) 297-4250, Opns. Mgr.: Deborah Farrell.

Audio: Cassette, Real-time. Video: ¾ U-Matic, ½ VHS Cassette, Beta I, Beta II, Macrovision protection. Audio Packaging Services: Inserting, Collating, Labeling, Mailing, Shrinkwrapping.

Live Sound Prodn., 1934K Lincoln Dr., Annapolis, MD, 21401, (301) 269-8008, Pres.: Leslie Louis Lentz. Audio: Cassette, Real-time. Audio Packaging Services: Labeling.

Richardson Audio Video, 1938 Baltimore Annapolis Blvd., Annapolis, MD, 21401, (401) 757-3733, Pres./Sales Mgr.: Charles A. Richardson. Audio: Cassette, Open Reel, Real-time. Video: ½ VHS Cassette, S-VHS.

Satellite Broadcasting, 93 Monocacy Blvd., Bldg. A1-10, Frederick, MD, 21701, (301) 662-0371, Fax: (301) 662-4014, Pres.: Frederic S. Berney. Audio: Cassette, Open Reel, DAT, Real-time. Video: ¾ U-Matic, ½ VHS Cassette, 8mm, S-VHS. Audio/Video Packaging Services: Inserting, Collating, Labeling, Mailing.

MASSACHUSETTS

Continental Recordings, Inc., 230 Adams St., Newton, MA, 02158, (617) 630-0007, Pres.: L. Daniel Flynn; Engineer: Dick Durante. Audio: Cassette, Open Reel, High-Speed. Audio Packaging Services: Inserting, Collating, Labeling, Mailing.

Diamond Tape Prodn., 22 Bridge St., Watertown, MA, 02172, (617) 266-3131, Pres.: Raymond Fournier; Sales Mgr.: Stella Manning. Audio: Cassette, Open Reel.

Distrans, PO Box 7, Arlington Heights, MA, 02175, (617) 646-4139, Owners: J. Pfister, T. Pope. Audio: Cassette.

Ian Communications Group, Inc., 10 Upton Dr., Wilmington, MA, 01887, (508) 658-3700, Fax: (508) 694-9957, Pres.: Richard B. Berberian; Sales Mgr.: Todd Thibaud; Mktg. Dir. James Rago. Audio: Cassette, Open Reel, DAT. Video: ¾ U-Matic, ½ VHS Cassette, 8mm, S-VHS, 1"; BETA SP, NTSC, PAL, SECAM Conversion & Duplication. Audio/Video Packaging Services: Inserting, Collating, Labeling, Mailing. Other Services: Warehouse, Freight, Direct Response—800 services, Credit Card Clearance Services.

Poly-Matrix, Inc., 40 Downing Industrial Park, Pittsfield, MA, 01201, (413) 499-3550, Fax: (413) 442-8610, Contact: Steve Rufo. Audio Packaging Services.

Professional Sound Film & Video, Inc., 136 Arlington St., Boston, MA, 02116, (617) 423-0007, Pres.: Vincent R. Parla; Sales Mgr.: John P. Parla; Vice Pres.: Vincent E. Parla, Jr. Audio: Cassette, Open Reel, DAT. Audio Packaging Services: Inserting, Collating, Labeling, Mailing. Other Services: Warehouse, Military Audio Work, Audio Forensic.

Soundworks, 10 Wheeler Ct., Watertown, MA, 02172, (617) 924-0065, Owners: Brian Capouch, Ken Selcer. Audio: Cassette, Open Reel, DAT, Real-time.

Tape Complex, Inc., 4 Haviland St., Boston, MA, 02115, (617) 437-9449, Fax: (617) 437-9227, Pres.: Peter Cecere; Sales Mgr.: Dianne Cecere. Audio: Cassette, Open Reel, Real-time.

MICHIGAN

A & F Music Services, 2834 Otsego, Waterford, MI, 48328, (313) 682-9025, (313) 669-3100, Owner: Frank C. Merwin. Audio: Cassette. Other Services: Warehouse, Freight, Direct Response—800 services.

ARC Electronic Services Inc., 2557 Knapp NE, Grand Rapids, MI, 49505, (616) 364-0022, Pres.: Ron Harkal. Audio: Cassette, Open Reel.

Allied Film & Video, Detroit Div., 7375 Woodward Ave., Detroit, MI, 48202, (313) 871-2222, Fax: (313) 871-5907, Div. Mgr.: Jimmy Naito. Audio: Cassette. Video: ¾ U-Matic, ½ VHS Cassette, S-VHS. Audio Packaging Services: Inserting, Collating, Labeling, Mailing. Other Services: Warehouse.

American Sound & Video Corp. (HQ), 3100 E. Ten Mile Rd., Warren, MI, 48091, (313) 755-0654, Fax: (313) 755-6705, Pres.: Frank S. Day. Audio: Cassette, Real-time. Video: ¾ U-Matic, ½ VHS Cassette, ¼ CVC Cassette, 8mm, S-VHS. Audio/Video Packaging Services: Inserting, Collating, Labeling, Mailing. Other Services: Direct Response—800 services.

American Sound & Video Corp. (Midwest), 7300 Miller Dr., Warren, MI, 48092, (313) 268-5558, Fax: (313) 268-1708, Vice Pres. Opns./Plant Gen.Mgr.: Paul Hayes. Audio: Mono & Stereo.

Video: ¾ U-Matic, ½ VHS Cassette, Hi-Fi Stereo, Full Packaging.

Audio Graphics Services, 1516 Ferris Ave., Royal Oak, MI, 48067, (313) 544-1793, Pres.: E.J. Wolfrum; Sales/Mktg. Dir.: Walter Wolfrum. Audio: Cassette.

Pioneer Recording Studio, Inc., 4238 Ramsgate, Bloomfield Hills, MI, 48302, (313) 855-1466, Fax: (313) 855-1231, Pres.: Gary A. Rubin; Vice Pres./Sale Mgr.: Tom Connors. Audio: Cassette, Open Reel. Video: ½ VHS Cassette, 8mm. Audio/Video Packaging Services: Inserting, Collating, Labeling, Mailing.

Playtown Sound Prodn., PO Box 241, 625 Connable Ave., Petoskey, MI, 49770, (616) 347-0063, Pres.: Robert Bollinger. Audio: Cassette, Open Reel, DAT, Real-time. Audio Packaging Services: Inserting, Labeling.

Premiere Video, Inc., 35687 Industrial Rd., Livonia, MI, 48150, (313) 464-4650, Fax: (313) 464-8939, Pres.: Larry Bennett; Dir. Sales/Mktg.: David Travis. Video: ¾ U-Matic, ½ VHS Cassette, 8mm, S-VHS. Video Packaging Services: Inserting, Collating, Labeling, Mailing. Other Services: Warehouse, Direct Response—800 services.

Producers Color Service, Inc. (Video Cassette Div.), 1000 N. Crooks Rd., Clawson, MI, 48017, (313) 288-9000, Fax: (313) 288-6510, Pres.: Ronald Balousek; Sales Mgr.: Leon Chick; Gen. Mgr.: P. Eric Petersen. Video: ¾ U-Matic, ½ VHS Cassette, Macrovision. High Speed Capability—TMD: SP, EP. Video Packaging Services: Inserting, Collating, Labeling, Mailing. Other Services: Warehouse, Freight.

Producers Tape Service, 395 E. Elmwood Ave., Troy, MI, 48083, (313) 585-8273, Fax: (313) 585-1270, Pres.: William Guthrie; Sales Mgr.: James Champion; Mktg. Dir.: Catherine Chytry. Audio: Cassette. Video: ¾ U-Matic, ½ VHS Cassette, 8mm, S-VHS. Audio/Video Packaging Services: Inserting, Collating, Labeling, Mailing.

Solid Sound, Inc., PO Box 7611, 670 Airport Blvd., Ann Arbor, MI, 48105, (313) 662-0669, Fax: (313) 662-0997, Pres.: Robert G. Martens; Sales Mgr.: Susan A. Gillis. Audio: Cassette. Audio Packaging Services: Inserting, Labeling, Mailing, On-shell Printing.

Tape-Tronics, Inc., 750 E. Mandoline, Madison Heights, MI, 48071, (313) 588-8281. Audio: Cassette.

Technicolor Videocassette

39000 Seven Mile Rd., Livonia, MI, 48152, (313) 591-1555, Fax: (313) 591-6020, Pres.: Emmet Murphy; Sales Mgrs.: Paul Chabot (313-591-5826), Tonya Bates (215-941-9993), Jennifer Schneider (317-577-4772); Mktg. Dir.: Jim Pagliaro (212-888-9888). Video: ½ VHS Cassette, 8mm, S-VHS. High Speed Capability—SP, EP, Sprinter. Video Packaging Services: Inserting, Collating, Labeling, Mailing, Complete fulfillment services. Other Services: Warehouse, MIS (Inventory), Freight.

The Transfer Zone, 13251 Northend, Oak Park, MI, 48237, (313) 548-7580, Fax: (313) 548-0924, Pres.: Robert Nusholtz; Mktg. Dir.: Roxane Nusholtz. Video: ¾ U-Matic, ½ VHS Cassette, 8mm, S-VHS, ¾ SP Int'l video standards.

World Class Tapes, PO Box 7611, Ann Arbor, MI, 48107, 670 Airport Blvd., Ann Arbor, MI, 48108, (313) 769-7575, Fax: (313) 662-0997, Pres.: R.G. Martens; Vice Pres.: J.W. Spencer; Sales Mgr.: Sue Gillis. Audio: Cassette. Audio Packaging Services: Inserting, Labeling.

MINNESOTA

EMC Prodn., 300 York Ave., Saint Paul, MN, 55101, (612) 771-1555, Fax: (612) 771-5629, Pres.: Paul Winter; Mktg. Dir. Paula Jeske; Vice Pres.: Dick Stevens. Audio: Cassette. Video: ¾ U-Matic, ½ VHS Cassette, S-VHS. Audio/Video Packaging Services: Inserting, Collating, Labeling, Mailing. Other Services: Warehouse, Freight, Direct Response—800 services, Credit Card Clearance Services.

Metacom, Inc., 5353 Nathan Ln., Plymouth, MN, 55442, (612) 553-2000, Pres.: Phillip Levin. Audio: Cassette.

Precision Tapes Inc., 2301 E. Hennepin Ave., Minneapolis, MN, 55413, (612) 379-7554, Fax: (612) 623-8244, Pres.: Dan Piepho. Audio: Cassette, Open Reel, DAT, Real-time. Video: ¾ U-Matic, ½ VHS Cassette, 8mm, S-VHS, 1", 2", D2, Betacam SP, Hi-fi VHS. Audio Packaging Services: Inserting, Collating, Labeling, Mailing.

Vaughn Duplication Services, 7951 Computer Ave. S., Minneapolis, MN, 55435, (612) 832-3100, Fax: (612) 832-3179, Vice Pres.: Donald Drapeau; Sales Mgr.: Douglas Olzenak; Mktg.

Dir. Michele Sahlin; Cust. Service Supervisor: Jackie Robb.
Video: ¾ U-Matic, ½ VHS Cassette, 8mm, S-VHS.
Other Services: Freight, Direct Response—800 services.
Video Packaging Services: Inserting, Collating, Labeling, Mailing, Macrovision anti piracy coding.
Other Services: Warehouse, Freight, Direct Response—800 services, Package Consulting, Int'l conversions.
Westmark Prodn., 8345 Duluth St., Golden Valley, MN, 55427, (612) 544-3050, Fax: (612) 544-2443, Pres./Mktg. Dir.: DuWayne Kloos; Sales Mgr.: Joann Kloos.
Audio: Cassette, Real-time.
Video: ½ VHS Cassette.
Audio/Video Packaging Services: Inserting, Collating, Labeling, Mailing.

MISSOURI

AUDITEC, 156 W. Argonne Dr., Saint Louis, MO, 63122, (314) 965-9005, Fax: (314) 965-9024, Pres.: William F. Carver.
Audio: Cassette, Open Reel, DAT, Real-time.
Audio Packaging Services: Mailing.
Aard-Vark, Inc., 335 S. Jefferson, Springfield, MO, 65806, (800) 822-1226, Fax: (417) 869-1133, Pres.: H.W. Jacobsen.
Audio: Cassette.
Audio Packaging Services: Inserting.
Acme Distributors, PO Box 8123, Kansas City, MO, 64112, (816) 444-8123, Fax: (816) 331-9158, Pres.: F.W. Black.
Audio: Cassette.
Video: ½ VHS Cassette.
Audio/Video Packaging Services: Inserting, Collating, Labeling, Mailing.
Other Services: Warehouse, Freight.
Audio Duplication & Services, Inc., PO Box 31546, 1927 Boaz, Saint Louis, MO, 63131, (314) 965-8895, Fax: (314) 965-8895, Pres.: Richard Schaumberger, Jr.
Audio: Cassette.
Audio Packaging Services: Inserting, Collating, Labeling.
Audio-Video Graphics, PO Box 1883, 13801 E. 35th St., Independence, MO, 64055, (800) 322-2832, Fax: (816) 254-0045, Pres.: Gerald W. Riegler; Sales/Mktg. Dir.: Jeff Propst.
Audio: Cassette, Open Reel, DAT, Real-time, Hi-Fi Stereo on Video Cassette.
Video: ¾ U-Matic, ¾ U-Matic SP, ½ VHS Cassette, 8mm, VHS, S-VHS, Hi-Fi Stereo.
Audio Packaging Services: Inserting, Collating, Labeling, Mailing, On Cassette Label Printing.
Other Services: Warehouse, Freight, Direct Response—800 services, Credit Card Clearance Services, Fulfillment, Drop Shipment.
Audiophile Realtime Cassette Duplication, 13801 E. 35th St., Independence, MO, 64055, (800) 322-2832, Fax: (816) 254-0045, Pres.: G.W. Riegler; Sales/Mktg. Dir.: Tom Stack.
Audio: Cassette, Open Reel, DAT, Real-time.
Video: ¾ U-Matic, ½ VHS Cassette, 8mm, S-VHS.
Audio Packaging Services: Inserting, Collating, Labeling, Mailing.
Other Services: Warehouse, Freight, Direct Response—800 services.
Nat'l Audio Co., Inc., PO Box 3657 G.S., 1841 E. Bergman, Springfield, MO, 65808, (417) 863-1925, Fax: (417) 863-7825, Pres.: Steve Stepp; Sales Mgr.: Sandi Stonecker.
Audio: Cassette, Open Reel.
Audio Packaging Services: Labeling.
Premier Film & Recording Corp., 3033 Locust St., Saint Louis, MO, 63042, (314) 531-3555, Fax: (314) 726-8798, Pres.: Wilson Dalzell; Sales Mgr.: Donna Blue; Mktg. Dir.: Bob Heuermann.
Audio: Cassette, Open Reel, DAT, Real-time.
Video: ¾ U-Matic, ½ VHS Cassette.
Video Packaging Services: Inserting, Collating, Labeling, Mailing.
Other Services: Warehouse, Freight.
Sound Recorders, Inc., 3947 State Line Rd., Kansas City, MO, 64111, (816) 931-8642, Fax: (816) 561-3671, Pres.: Ron Dabbs; Mktg. Dir.: Stacey Mings.
Audio: Cassette, Open Reel.
Vaughn Duplication, 13241 Tandem Dr., Creve Cocur, MO, 63146, (314) 576-6804, Fax: (314) 576-3070, Vice Pres.: Donald Drapeau; Mktg. Dir.: Michelle Sahlin; Sales Rep.: Pete Leverenz.
Video: ¾ U-Matic, ½ VHS Cassette, ¼ CVC Cassette, 8mm, S-VHS. High Speed Capability—TMD: SP, EP.
Video Packaging Services: Inserting, Collating, Labeling, Mailing, Macrovision Anti piracy coding.
Other Services: Warehouse, Freight, Direct Response—800 services, Package consulting, Int'l standards conversion.

MONTANA

Jester Sound & Video, 423 Kuhlman Dr., Billings, MT, 59105, (406) 248-5896, Pres.: Bob Hale.
Audio: Cassette, Real-time.
Video: ¾ U-Matic, ½ VHS Cassette, S-VHS.
Video Packaging Services: Inserting, Collating, Labeling, Mailing.
NCMG, Inc., PO Box 2244, 721 Second St. S., Great Falls, MT, 59403, (406) 761-7877, Fax: (406) 761-2029, Pres.: Margaret Kochman; Mktg. Dir.: Marty Wilcox.
Audio: Cassette, Open Reel.

Video: ¾ U-Matic, ½ VHS Cassette, 8mm, S-VHS.
Other Services: Freight, Direct Response—800 services.

NEBRASKA

Memcon Corp., 2410 S. 156th Cir., Omaha, NE, 68130, (402) 333-3100, Fax: (402) 333-2029, Pres.: Gerald Korth.
Video: ½ VHS Cassette.
Video Packaging Services.

NEW HAMPSHIRE

Captain Fiddle Music, 4 Elm Ct., Newmarket, NH, 03857, (603) 659-2658, Pres.: Ryan Thomson; Owner: Ryan Thomson.
Audio: Cassette, Real-time.
Audio Packaging Services: Inserting, Collating, Labeling, Mailing.

NEW JERSEY

AMP Recording & Duplicating Service, 307 W. Main St., Maple Shade, NJ, 08052, (609) 667-1667, Pres.: Gerald Tyson.
Audio: Cassette, DAT, Real-time.
Audio Packaging Services: Labeling, Mailing.
American Sound & Video Corp. (East), 3 Fairfield Crescent, West Caldwell, NJ, 07006, (201) 575-8484, Fax: (201) 575-6957, Gen. Mgr.: Michael Pugliese.
Audio: Stereo & Mono.
Video: ¾ U-Matic, ½ VHS Cassette, Hi-Fi Stereo, Disk: 5 1/4", 3 1/2", S/S, D/S.
J.C. Anglum Co., Inc., PO Box 236, 60 Midvale Rd., Mountain Lakes, NJ, 07046, (201) 263-1442, Fax: (201) 263-8640, Pres.: J. Clifford Anglum; Sales Mgr.: Robert Pitcher; Office Mgr.: Collen Koch.

Video Packaging Services: Inserting, Collating, Labeling.
Other Services: Warehouse, Freight.

Audio Plus Video Int'l, 240 Pegasus Ave., Northvale, NJ, 07647, (201) 767-3800, Fax: (201) 784-2146, Vice Pres./Gen. Mgr.: Andre Macaluso; Sales Mgr./Mktg. Dir.: Beth Simon.
Video: ¾ U-Matic, ½ VHS Cassette, 8mm, S-VHS, 1", D1, D2, MII, Betamax, Betacam, Betacam SP, 2".
Cassette Dub, Inc., 245 Livingston St., Northvale, NJ, 07647, (201) 767-7077, Fax: (201) 767-3472, Vice Pres./Gen. Mgr.: Leonard P. Weg; Sales/Mktg. Dir.: Paul Raineri.
Video: ¾ U-Matic, ½ VHS Cassette, 8mm, S-VHS, Beta I/II, Betacam, Betacam SP, M2, D2.
Cassette Prodn., Inc., 109 Prospect Pl., Hillsdale, NJ, 07642, (201) 666-3300, Contact: Shelby Horowitz.
Audio: Cassette.
Future Network, Inc., 18-01 Pollitt Dr., Fair Lawn, NJ, 07410, (201) 791-7079, Fax: (201) 791-6378, Product Mgr.: Jerry Horowitz.
Video: ¾ U-Matic, ½ VHS Cassette, S-VHS, 1". High Speed Capability—TMD: SP, LP, EP.
Video Packaging Services: Inserting, Collating, Labeling, Mailing.
Other Services: Warehouse, Freight, Direct Response—800 services, Credit Card Clearance Services.
Goldstar Electronics, Inc., 1000 Sylvan Ave., Englewood Cliffs, NJ, 07632, (201) 816-2000, Pres.: S. Chung; Sales Mgr.: Joe Stevens.
Audio: Cassette.
Video: ½ VHS Cassette.
New Age Video, PO Box 68, 3480 S. Clinton Ave., South Plainfield, NJ, 07080, (201) 756-7500, Fax: (201) 757-1991, Pres.: Steven Nasar; Sales Mgr.: Jack Nasar; Vice Pres.: Joey Nasar.
Video: ½ VHS Cassette. High Speed Capability—TMD: SP, LP, EP, Real-time.
Other Services: Warehouse.
PAV, 32 Chambers Bridge Rd., Lakewood, NJ, 08701, (908)

V I D E O D U P L I C A T I O N

MILLIONS

In Any Format

Video Duplication Of World Class Quality

- NTSC • PAL • SECAM • Future Duplicators is the Largest and Most Experienced JVC-Licensed High Speed Duplicator on the East Coast.
- No Job Too Large or Too Small in Real Time or TMD High Speed

FAST RELIABLE VOLUME SERVICE HIGHEST QUALITY FULFILLMENT SERVICES

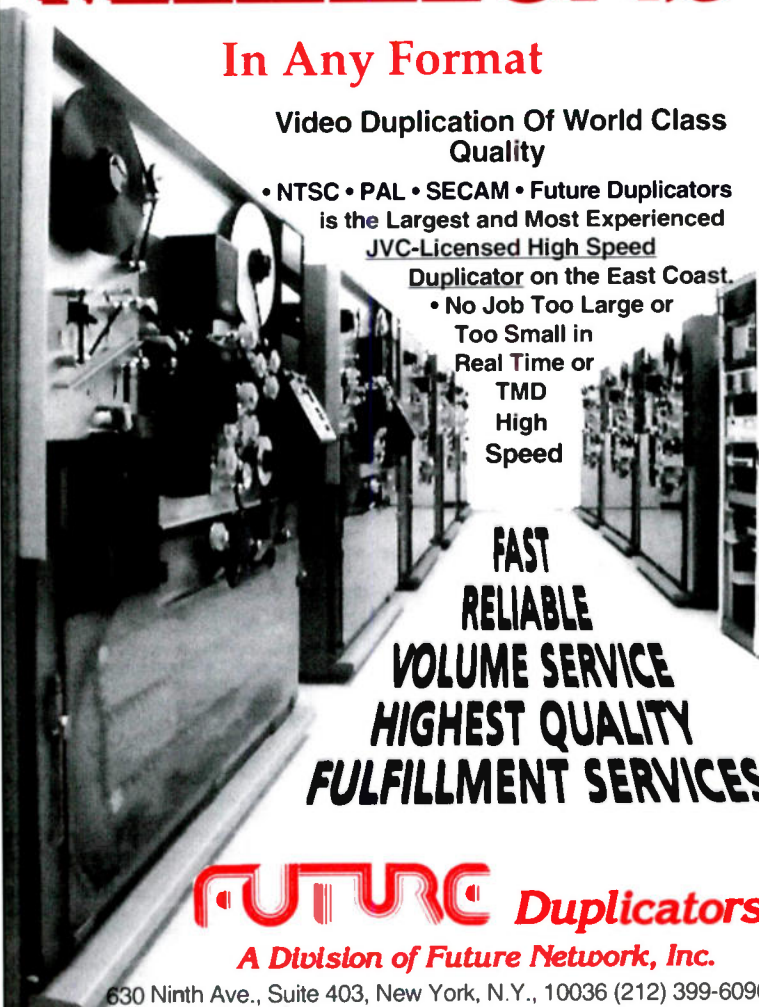

FUTURE Duplicators

A Division of Future Network, Inc.

630 Ninth Ave., Suite 403, New York, N.Y., 10036 (212) 399-6090

363-4141, Fax: (908) 363-4406, Pres.: Robert Kriss; Sales Mgr.: Edward Joseph; Mktg. Dir.: William Marchini.
Video: ¾ U-Matic, ½ VHS Cassette. High Speed Capability—SP, LP, EP, Sprinter—SP, LP, EP.
Other Services: Warehouse, Freight.
PSI Industries, 135 Ludlow Ave., Northvale, NJ, 07647, (201) 768-8007, Fax: (201) 768-8314, Pres.: Stephanie L. Volpe; Sales Mgr.: Mary Ann Spitalotta.
Audio: Cassette, DAT, Real-time. Predominantly high-speed duplication.
Video: ¾ U-Matic, ½ VHS Cassette, S-VHS, SP, LP, EP. High Speed Capability—SP, EP.
Audio/Video Packaging Services: Inserting, Collating, Labeling, Mailing.
Other Services: Warehouse, Freight.

RPL, Inc.

1100 State St., Camden, NJ, 08105, (609) 963-3000, Fax: (609) 963-3854, Pres.: Ron Ollano; Sales Mgr.: Lisa Ollano; New York Branch: 2 Penn Plaza, 15th Floor, New York, NY, 10001, (212) 868-3115.
Audio: Cassette, Open Reel, Broadcast Cartridge.
Video: ¾ U-Matic, ½ VHS Cassette.
Floppy Disc: 3-1/2 in., 5-1/4 in., High-Density.
Packaging Services: Inserting, Collating, Labeling, Mailing.
Other Services: Printing Labels & J-Cards, Imprint on Cassettes, Warehouse, Recording Studio, Digital Editing.

Sound Arts Co., Inc., 5 Cindy Ln., Ocean, NJ, 07712, (908) 493-8666, Fax: (908) 493-0667, Pres.: Charles J. Gspann; Sales Mgr.: Ethel Davidson; Vice Pres.: Frank Gspann.
Audio: Cassette.
Audio Packaging Services: Inserting, Collating, Labeling, Mailing.

Sun Plastics Co., Inc./Dynamic LP Stereo Record Pressing Co., Inc., 534 Passaic Ave., East Newark, NJ, 07029, (201) 482-6749, (212) 349-0977, Fax: (201) 483-0031, Pres./Mktg. Dir.: Jerry Salerno; Sales Mgr.: Vicky Salerno.
Audio: Open Reel, DAT.
Audio Packaging Services: Inserting, Collating, Labeling, Mailing.

Trutone Inc., 310 Hudson St., Hackensack, NJ, 07601, (201) 489-9180, Fax: (201) 489-1771, Pres.: Carl Rowatti; Sales/Mktg. Mgr.: Adrienne Rowatti; Office Mgr.: Ann Marie Cassar.
Audio: Cassette, Open Reel, DAT, Real-time, Double-time duplication & high speed-64:1 & 80:1 H.
Audio Packaging Services: Inserting, Collating, Labeling, Mailing, Custom pressing of records, CD's.
Other Services: Warehouse, Freight.

VCA Teletronics, Inc., 500 Willow Tree Rd., Leonia, NJ, 07605, (201) 947-6450, Fax: (201) 947-0448, Sales Mgr./Mktg. Dir.: Ernest Heisser.
Video: ¾ U-Matic, ½ VHS Cassette, 8mm, S-VHS, D2, Beta, Betacam, 1".
Video Packaging Services: Inserting, Collating, Labeling, Mailing, Custom Package, Video Fulfillment.
Other Services: Warehouse, Credit Card Clearance Services, Telelink.

VideoLab Cassette, Inc.

506 Jersey Ave., New Brunswick, NJ, 08901, (908) 418-1020, Fax: (908) 418-1230, Pres.: Vincent Hallisey; Vice Pres./Gen. Mgr.: Mr. Jan F. Sotnikoff.
Video: ¾ U-Matic, ½ VHS Cassette, 8mm, S-VHS, D-2, Betacam, Int'l Standards Conversions. High Speed Capability—SP, EP, Sprinter.
Video Packaging Services: Inserting, Collating, Labeling, Mailing.
Other Services: Warehouse, MIS (Inventory), Freight, Direct Response—800 services, Credit Card Clearance Services.

Wired 4 Sound, PO Box 683, 799 Grove St., Clifton, NJ, 07012, (201) 773-2565, Fax: (201) 773-3077, Pres.: Andre Grandnetti.
Audio: Cassette.
Video: ½ VHS Cassette.
Audio Packaging Services: Labeling, Mailing.

NEW MEXICO

Rainbow Cassette Studio, PO Box 472, Colonias Rd., Taos, NM, 87571, (505) 776-2268, Pres.: Tony Isaacs; Mgr.: Judy Lujan.
Audio: Cassette.
Audio Packaging Services: Inserting, Collating, Labeling.
Other Services: Warehouse.

NEW YORK

Audio Image, 95 Little Tree Ln., Hilton, NY, 14468, (716) 392-9500, Fax: (716) 392-2386, Pres.: Lawrence Ellis.
Audio: Cassette.
Audio Packaging Services: Inserting, Collating, Labeling, Mailing.
Audio Post, Inc., 27 E. 21st St., New York, NY, 10010, (212) 475-3522, Fax: (212) 674-0788, Pres.: Edward Steinberg; Sales Mgr.: Nick Tatura.

Video: ¾ U-Matic, ½ VHS Cassette, S-VHS, D-2.
Video Packaging Services: Inserting, Labeling, Mailing.
Other Services: Warehouse, Freight.
Ralph Berliner Audio/Music Prodn., 35 W. 90th St., New York, NY, 10024, (212) 873-6390, Pres.: Ralph Berliner.
Audio: Cassette, Open Reel.
Burlington Audio/Video Tapes, Inc., 106 Mott St., Oceanside, NY, 11572, (516) 678-4414, (800) 331-3191, Fax: (516) 678-8959, Pres.: Ruth Schwartz; Sales Mgr.: Jan Schwartz; Mktg. Dir.: Rudy Schwartz.
Audio: Cassette, Open Reel, DAT, Real-time.
Video: ¾ U-Matic, ½ VHS Cassette, ¼ CVC Cassette, 8mm, S-VHS.
C & C Duplicators, Inc., 2231 Fifth Ave., Ronkonkoma, NY, 11779, (516) 467-4100, Contact: Frank Carroll.

Dick Charles Mastering, 130 W. 42nd St., #1106, New York, NY, 10036, (212) 819-0920, Fax: (212) 768-7822, Pres.: Dick Charles.

Audio: Cassette, DAT.
Audio Packaging Services: Labeling.
Cine Magnetics Video & Film Laboratories, 650 Halstead Ave., Mamaroneck, NY, 10543, (914) 698-3434, (800) 431-1102, Fax: (914) 698-0680, Pres.: Joseph J. Barber, Jr.; Vice Pres.: Robert Orzack; Gen. Mgr.: Vincent Spangnolo, Jr.
Video: ¾ U-Matic, ½ VHS Cassette, 8mm, S-VHS, High Band 8, Beta III. High Speed Capability—SP, EP, Sprinter—SP, EP.
Video Packaging Services: Inserting, Collating, Labeling, Mailing, Computerized Dist. Services.
Other Services: Warehouse, Freight, Direct Response—800 services, Credit Card Clearance Services.

Cinema Sound Ltd., 311 W. 75th St., New York, NY, 10023, (212) 799-4800, Pres.: Joan S. Franklin; Chief Eng./Studio Mgr.: John Rockwell.
Audio: Cassette, Open Reel.
Audio Packaging Services: Inserting, Collating, Labeling, Mailing.

Columbia Record Prodn., 51 W. 52nd St., New York, NY, 10019, (212) 445-8203, Fax: (212) 445-8119, Sales Mgr.: Robert Fernandez; Vice Pres.: Anthony Formicelli.
Audio: Cassette.

Core Systems, Inc., 48 W. 25th St., New York, NY, 10010, (212) 242-4497, Fax: (212) 366-6548, Pres.: Dimitri Karas; Vice Pres. Prodn.: J. Aricci.
Audio: Cassette, Open Reel, Real-time.
Video: ½ VHS Cassette, S-VHS.
Audio/Video Packaging Services: Inserting, Collating, Labeling, Mailing.
Other Services: Warehouse, Freight.

Crystal City Tape Duplicators, Inc., 48 Stewart Ave., Huntington, NY, 11743, (516) 421-0222, Fax: (516) 423-2226, Pres.: Frank Russo.
Audio: Cassette.
Video: ¾ U-Matic, ½ VHS Cassette.
Audio Packaging Services: Inserting, Collating, Labeling, Mailing, Scandia Wrap.

The Cutting Edge Disc Mastering, Box 217, Ferndale, NY, 12734, (914) 292-5965, Fax: (914) 292-2313, Pres.: Paul Gerry; Sales Mgr./Mktg. Dir.: Patricia Gerry.
Audio: Cassette, Real-time.

D.S.M. Producers, Inc., 161 W. 54th St., New York, NY, 10019, (212) 245-0006, Fax: (212) 265-5726, Pres.: Suzan Bader; Vice Pres./Nat'l Sales Dir.: Doris Kaufman; Mktg. Dir.: Keith Lamar Newton; Dir. A&R: Elba T. Toast.
Audio: Cassette, DAT.

Demo-Vox Sound/DVX Int'l Video Prodn., 1038 Bay Ridge Ave., Brooklyn, NY, 11219, (718) 680-7234, Pres.: Frank J. Grassi; Vice Pres./Sales Mgr.: Laura B. Grassi.
Audio: Cassette, Open Reel, Real-time.
Video: ¾ U-Matic, ½ VHS Cassette, S-VHS.
Audio Packaging Services: Inserting, Collating, Labeling, Mailing.
Video Packaging Services: Inserting, Labeling, Mailing.
Other Services: Warehouse, Freight.

Devlin Videoservice, 1501 Broadway, #408, New York, NY, 10036, (212) 391-1313, Fax: (212) 391-2744, Sales Mgr.: John Krams; Managing Dir.: Jim Lindner.
Video: ¾ U-Matic, ½ VHS Cassette.

Digital House Ltd., 101 W. 57th St., New York, NY, 10019, (212) 333-5950, Fax: (212) 262-5631, Pres.: Jerome Bunke; Vice Pres. Tech. Services: Harry Hirsch; Vice Pres. Mktg.: Don Burkheimer.
Audio: Cassette, DAT, Real-time.
Other Services: Freight.

Disc Makers, 1650 Broadway, Ste. 1010, New York, NY, 10019, (212) 265-7505, Fax: (212) 262-0798, Sales Mgr.: Howard Roseff.
Audio: Cassette, Real-time, Design, Separations, Printing, Packaging.
Video: ½ VHS Cassette, Design, Separations, Printing, Packaging.
Audio Packaging Services: Inserting, Collating, Labeling, Slipcase Design, Color Sep/Printing.

Other Services: Freight, Complete Retail Ready Packaging.
Du Art Video, 245 W. 55th St., New York, NY, 10019, (212) 757-3681, Pres.: Robert M. Smith; Sales Mgr.: Frank Buccini; Gen. Mgr.: Tim Spitzer.
Video: ¾ U-Matic, ½ VHS Cassette, Film-to-tape transfers.
The Dupe Coop, 229 W. 26th St., #1 C, New York, NY, 10001, (212) 989-9341, Sales Mgr.: Tom Sleeve.
Audio: Cassette.

Duplication Specialists, 4584 Austin Blvd., Island Park, NY, 11558, Pres.: David J. Schwartz; Sales Mgr.: James E. Void.
Audio: Cassette, Open Reel, DAT, Real-time.
Video: ¾ U-Matic, ½ VHS Cassette, 8mm.
Audio/Video Packaging Services: Inserting, Collating, Labeling, Mailing, Design, Pre-press, Print services.
Other Services: Warehouse, Direct Response—800 services, Credit Card Clearance Services.

Eastern Standard Prodn., Inc., 26 Baxter St., Buffalo, NY, 14207, (800) 527-9225, (716) 876-1454, Fax: (716) 877-6395, Pres.: Mark S. Mekker; Vice Pres. Sales/Mktg.: Deborah Mekker; Customer Service: Teresa M. Fay.
Audio: Cassette, Open Reel, DAT, Real-time.
Video: ½ VHS Cassette. High Speed Capability—TMD: SP, EP.

Audio/Video Packaging Services: Inserting, Collating, Labeling, Mailing.
Other Services: Warehouse, Freight.

ElectroSound Group, Inc., 1290 Motor Pkwy., Hauppauge, NY, 11788, (516) 234-2010, Fax: (516) 234-2384, Pres.: Richard Protain; Sr. Vice Pres. Sales: Hugh Landy.
Audio: Cassette.

Video: ¾ U-Matic, ½ VHS Cassette.
Audio/Video Packaging Services: Inserting, Collating, Labeling, Mailing.
Other Services: Warehouse, Freight.

ElectroSound Group, Inc., 888 Seventh Ave., New York, NY, 10106, (212) 757-3097, (212) 757-3149, Fax: (212) 581-6102, Pres.: Richard Protain; Vice Pres. Sales: Hugh Landy.
Audio: Cassette.

Video: ¾ U-Matic, ½ VHS Cassette.
Europadiak, Ltd., 75 Varick St., New York, NY, 10013, (212) 226-4401, Fax: (212) 966-0456, Pres.: James P. Shelton; Sales Mgr.: Jeremy Guttenberg.
Audio: Cassette.
Video Packaging Services: Inserting, Collating, Labeling.

Future Network, Inc.

630 Ninth Ave., Ste. 403, New York, NY, 10036, (212) 399-6090, Fax: (212) 399-6092, Pres.: Ken Washino; Vice Pres. Sales: Tim Forster; Mktg. Mgr.: C. Mitchell Dixon (201-791-7079).
Video: ¾ U-Matic, ½ VHS Cassette, S-VHS, 8mm, D-2, M-2, 1", NTSC, PAL, SECAM; Standards Conversions.
High Speed Capability—TMD: SP, LP, EP.
Video Packaging Services: Inserting, Collating, Labeling, Mailing.
Other Services: Warehouse, Freight, Fulfillment, Direct Response—800 services, Credit Card Clearance Services.

GoodTimes Home Video, 401 Fifth Ave., 6th Floor, New York, NY, 10016, (212) 889-0044, Fax: (212) 213-9319, COO: Bill Follett; Pres.: Joe Cayre.
Video: ½ VHS Cassette. High Speed Capability—SP, LP.
Video Packaging Services: Inserting, Collating, Labeling, Mailing.
Other Services: Warehouse, Freight.

Grenadier, 10 Parkwood Ave., Rochester, NY, 14620, (716) 442-6209, (716) 275-2942, Pres.: T. Greene; Sales/Mktg. Dir.: P. Greene.
Audio: Cassette, Real-time cassette.
Audio Packaging Services: Inserting, Collating, Labeling, Mailing.

HMG Ltd.

15 Gilpin Ave., Hauppauge, NY, 11788, (516) 234-0200, Fax: (516) 234-0022, Pres.: Donald L. Olesen; Vice Pres. Sales/Mktg.: Brian Willson.
Audio: Cassette, DAT.
Video: ½ VHS Cassette.
High Speed Capability: SP Mode.
Audio/Video Packaging Services: Inserting, Collating, Labeling, Mailing.
Other Services: Warehouse, MIS (Inventory), Freight.

The Hit Factory-DMS, Inc., 237 W. 54th St., 130 W. 42nd St., 10th Floor, New York, NY, 10019, (212) 768-4141, Fax: (212) 768-9818, Pres.: Edward Germano; Mgr.: Patti Firrincilli.
Audio: Cassette, Open Reel, DAT, Real-time, CD Reference Discs.

In Sync Laboratories, Inc., 2211 Broadway, New York, NY, 10024, (212) 873-6769, Pres.: E. Alan Silver.
Audio: Real-time.
Video: Remote Digital Recording.

Intercontinental TeleVideo, Inc., 29 W. 38th St., New York, NY, 10018, (212) 719-0202, Fax: (212) 391-2993, Pres.: Gerald Citron; Vice Pres.: Nigel Toovey; Sales Mgr.: Robin Reeves Zorthian.

Video: ¾ U-Matic, ½ VHS Cassette, PAL/SECAM/NTSC in D2, Betacam, BVU, 1".
Video Packaging Services: Inserting, Labeling, Mailing, Film to tape transfers for video.
Other Services: Digital standards conversions.

Int'l Recording Co., 49 Desmond Ave., Bronxville, NY, 10708, (914) 337-5726, Pres.: Claire M. Rie.
Audio: Cassette.
Video: ¾ U-Matic, ½ VHS Cassette.

Kewall Real Time Tape Duplicators, 77 Bay Shore Rd., Bay Shore, NY, 11706, (516) 586-2486, Fax: (516) 586-2486, Pres.: Keith A. Gutschwager; Sales Mgr.: Larry Andrews; Contact: Dorothy E. Gutschwager.

Audio: Cassette, Open Reel, DAT, Any length cassettes.
Audio Packaging Services: Inserting, Collating, Labeling, Mailing.
Other Services: Direct Response—800 services, Credit Card Clearance Services.

M & H Communications, 45 Hidden Ridge Dr., Syosset, NY, 11791, (516) 496-8920, Fax: (516) 496-4763, Pres.: Heidi Vincent.
Video: ¾ U-Matic, ½ VHS Cassette, ¼ CVC Cassette.

Mark Custom Recording Service, 10815 Bodine Rd., Clarence, NY, 14031, (716) 759-2600, Pres./Owner: Mark J. Morette.
Audio: Cassette, DAT, Real-time.
Audio Packaging Services: Inserting, Collating, Labeling, Mailing.
Other Services: Warehouse, Freight.

The Music Connection, Inc., Flatiron Bldg., 175 Fifth Ave., Ste. 511, New York, NY, 10010, (212) 529-0557, Fax: (212) 529-1281, Pres.: R. Ralton; Sales Mgr.: Ira Cohen; Vice Pres.: Fred Levy.
Audio: Cassette.
Video: ½ VHS Cassette.

Music Doctors Ltd., Inc., 130 W. 42nd St., Ste. 551, New York, NY, 10036, (212) 382-1234, Fax: (212) 382-1241, Sales Mgr.: David Moldauer.
Audio: Cassette, DAT.

Nat'l Video Center, 460 W. 42nd St., New York, NY, 10036, (212) 279-2000, Fax: (212) 947-6439, Pres.: Harold Lustig; Sales Dir.: Steve Ostrow.
Audio: Cassette, Open Reel.
Video: ¾ U-Matic, ½ VHS Cassette.

Progressive Tape Corp., 40-H Corbin Ave., Bay Shore, NY, 11706, (516) 242-4646, Fax: (516) 243-3849, Pres.: Paul Glantzman.
Audio: Cassette.

Quik Cassette Corp., 250 W. 57th St., Ste. 2101, New York, NY, 10107, (212) 977-4411, Sales Mgr.: Ron Klipstein.
Audio: Cassette, Open Reel, DAT, Real-time.
Audio Packaging Services: Inserting, Collating, Labeling, Mailing.

Rank Video Services America, 505 Fifth Ave., Ste. 600, New York, NY, 10017, (212) 697-7355, Fax: (212) 986-5934.
Video: ¾ U-Matic, ½ VHS Cassette, 1" Quad.

Reliance Audio Visual Corp., 623 W. 51st St., New York, NY, 10019, (212) 586-5000, Fax: (212) 586-6047, Pres.: Gil Meyer; Contact: Norma Matthews.
Audio: Cassette, Open Reel.
Video: ¾ U-Matic, ½ VHS Cassette, ¼ CVC Cassette, 8mm, S-VHS.

Ross-Gaifney Video, 21 W. 46th St., New York, NY, 10036, (212) 997-1464, Fax: (212) 827-0426, Pres.: C.Y. Chang.
Video: ¾ U-Matic, ½ VHS Cassette, 8mm, S-VHS, 1", Betacam SP.

ServiSound, Inc., 35 W. 45th St., New York, NY, 10036, (212) 921-0555, Fax: (212) 869-4296, Pres.: Michael J. Shapiro; Mktg. Dir.: Diane Ehrlichman; Vice Pres.: Chris Nelson.
Audio: Cassette, Open Reel.

Sorcerer Sound, 19 Mercer St., New York, NY, 10013, (212) 925-1365, Sales Mgr.: Greg Guarino.
Audio: Cassette, Open Reel, DAT, Real-time.

Studio Magnetics Co., Inc., 12 Long Island Ave., Holtsville, NY, 11742, (516) 289-3400, (800) 874-2202, Fax: (516) 289-1604, Pres.: George Clahane; Sales Mgr.: Craig Balaban; Mktg. Dir.: Doug Young.
Audio: Cassette.
Audio Packaging Services: Inserting, Collating, Labeling, Mailing.
Other Services: Warehouse, Freight.

Superdupe, 295 Madison Ave., New York, NY, 10017, (212) 683-6854, Fax: (212) 779-1676, Pres.: Keith Gordon; Gen. Mgr.: Jon Adelman.
Audio: Cassette, Open Reel.
Video: ¾ U-Matic, ½ VHS Cassette.

TV-R, Inc./Mastercolor Transfer, Inc., 333 W. 52nd St., 15th & 16th Floors, New York, NY, 10019, (212) 541-4030, Fax: (212) 307-7061, Pres.: James C. Mahoney; Sales Mgr./Mktg. Dir.: Joseph Grasso; Colorist: Alex Lobel.
Video: ¾ U-Matic, ½ VHS Cassette.

Thalco Audio, Inc., 2 Dickens Ave., Dix Hills, NY, 11746, (516) 667-1616, Fax: (516) 496-4763, Pres.: Michael Thaler; Mktg. Dir.: Glenn Thaler.
Audio: Cassette.
Video: ½ VHS Cassette. High Speed Capability—SP, LP, EP, Sprinter—SP, LP, EP.
Audio/Video Packaging Services: Inserting, Collating, Labeling, Mailing.
Other Services: Warehouse.

United Recording Labs, 681 Fifth Ave., New York, NY, 10022, (212) 751-4660, Contact: Anita Adams.

Variety Recording Studio, 130 W. 42nd St., Ste. 551, New York, NY, 10036, (212) 221-6625, Fax: (212) 382-1241, Pres.: Herman Vargas.
Audio: Cassette, Open Reel, DAT, Real-time.

Vaughn Duplication Services, 10 E. 39th St., New York, NY, 10016, (212) 447-1038, Fax: (212) 684-3650, Vice Pres.: Donald Drapeau; Mktg. Dir.: Michelle Sahlin; Sales: Lloyd Dorfman.
Video: ¾ U-Matic, ½ VHS Cassette, ¼ CVC Cassette, 8mm, S-VHS. High Speed Capability—TMD: SP, EP.
Video Packaging Services: Inserting, Collating, Labeling, Mailing, Macrovision Antipiracy coding.
Other Services: Warehouse, Freight, Direct Response—800 services, Int'l standards conversion.

Video Dimensions, 530 W. 23rd St., New York, NY, 10011, (212) 929-6135, Pres.: Allan Greenfield; Sales Mgr.: Weldon

Emmett.
Video: ¾ U-Matic, ½ VHS Cassette.

Video Dub, Inc., 423 W. 55th St., New York, NY, 10019, (212) 757-3300, Fax: (212) 489-6186, Vice Pres./Gen. Mgr.: Leonard Schwartz; Vice Pres. Opns.: Steve Gabrielli.

WEA Mfg., Inc., 75 Rockefeller Plaza, New York, NY, 10019, (212) 399-8831, Vice Pres. Sales Services: David A. Grant.
Audio: Cassette.
Audio Packaging Services: Inserting, Collating, Labeling.

Winthrop Prods., Inc., 156 W. 94th St., New York, NY, 10025, (212) 662-8685, Fax: (212) 749-8387, Owner: Susan Winthrop.
Audio: Cassette, Open Reel, Real-time.
Audio Packaging Services: Labeling.

NORTH CAROLINA

American Multimedia, Inc., 2609 Tucker St. Ext., Burlington, NC, 27215, (919) 229-5554, (800) 849-8273, Fax: (919) 228-1409, Pres.: Dave J. Forsyth; Sales Mgr./Mktg. Dir.: Tim V. Mallard; Customer Service Dir.: Jeanne Conklin.
Audio: Cassette, Open Reel, DAT, Real-time.
Video: ¾ U-Matic, ½ VHS Cassette, S-VHS. High Speed Capability—SP, EP.
Audio/Video Packaging Services: Inserting, Collating, Labeling, Mailing, RF Seal, Heat Seal.
Other Services: Warehouse, Freight, Direct Response—800 services.

ICCA, Inc., 429 Briarwood Dr., Charlotte, NC, 28209, (704) 523-7219, Fax: (704) 529-5277, Pres.: Harrel Canning; Sales Mgr.: John Firestone.
Audio: Cassette.
Audio Packaging Services: Inserting, Collating, Labeling.
Other Services: Warehouse, Freight.

Lamon Records Int'l, 7017 E. W.T. Harris Blvd., Charlotte, NC, 28215, (704) 535-7263, Fax: (704) 537-0133, Pres.: Carlton Moody; CEO: D. Moody Jr.; Mktg. Dir.: Mike Evans; Sales Rep.: David Moody.
Audio: Cassette, Real-time.
Audio Packaging Services: Mailing.
Other Services: Warehouse.

Main Tripp Records, Inc., 2804 Beechtree Dr., Sanford, NC, 27330, (919) 774-8926, Pres.: Bill Tripp; Mktg. Dir.: Wayne Ferrin.
Audio: Cassette, Real-time.
Audio Packaging Services: Inserting, Labeling, Mailing.
Other Services: Warehouse.

Sonopress, Inc., 108 Monticello Rd., Weaverville, NC, 28787, (704) 658-2000, Fax: (704) 658-2008, CEO: Johannes Mohn; Vice Pres. Sales/Mktg.: Dieter Baier; Client Services Supr.: Don Fiscus.

Audio: Cassette, DAAD.

United American Video, PO Box 7647, 2730 Rozzells Ferry Rd., Charlotte, NC, 28208, (704) 394-8796, Fax: (704) 394-5154, Pres.: Vernon B. Brannon, II; Exec. Vice Pres. Sales: Don Matthews; Exec. Vice Pres. Mktg.: Jerry Pettus, Jr.
Video: ½ VHS Cassette. High Speed Capability—TMD: SP, EP.

OHIO

A to Z Audio Services, Inc., PO Box 26087, 21929 Lorain Rd., Fairview Park, OH, 44126, (216) 333-0040, Fax: (216) 333-0104, Pres.: Duane Abarca; Vice Pres.: Greg Zarnoski; Sales Mgr.: Jean Rust.
Audio: Cassette, Real-time.
Audio Packaging Services: Inserting, Labeling, Imprinting.

Audiocraft Recording Co., 915 W. Eighth St., Cincinnati, OH, 45203, (513) 241-4304, Fax: (513) 241-3477, Pres.: Earl T. Herzog, Jr.; Sales Mgr.: Dave Rinaldi.
Audio: Cassette, Open Reel, Real-time.
Video: ¾ U-Matic, ½ VHS Cassette, 8mm.
Audio/Video Packaging Services: Inserting, Collating, Labeling, Mailing.
Other Services: Warehouse.

Cassette Duplicating Service, C.D.S., 444 Dimmick Ave., Cincinnati, OH, 45246, (513) 851-1956, Pres.: Carl Burkhardt.
Audio: Open Reel.

Cavaller Prods., Inc., 3412 Erie Ave., Cincinnati, OH, 45208, (513) 871-8818, Pres.: Edward H. Foss.
Audio: Cassette.
Audio Packaging Services: Inserting, Collating, Labeling.

Discovery Systems, 7001 Discovery Blvd., Dublin, OH, 43017, (614) 761-2000, Fax: (614) 761-4258, Pres.: Jeffrey Wilkins; Mktg. Dir.: Mary Vaughn; Vice Pres. Sales: Michael Ward.
Audio: Multi-color printing & fulfillment.
Video: ½ VHS Cassette.

Jewel Records, 1594 Kinney Ave., Cincinnati, OH, 45231, (513) 522-9336, Fax: (513) 522-9915, Pres.: Rusty York; Sales Mgr.: Rick Hopkins.
Audio: Cassette, Open Reel, Real-time.

The Little Warehouse, Inc., 5505 Valley Belt Rd., Ste. F, Independence, OH, 44131, (216) 398-0022, Fax: (216) 398-9980, Pres.: Jim Lesnick; Sales Mgr./Mktg. Dir.: Joe Kauffman.
Audio: Cassette, Open Reel, DAT.
Video: ¾ U-Matic, ½ VHS Cassette, S-VHS.
Audio Packaging Services: Inserting, Collating, Labeling, Mailing.

Magnetic Studios, Inc., 1201 Olentangy River Rd., Columbus, OH, 43212, (614) 291-9641, Fax: (614) 297-1616, Pres.: John

If You've Heard One You've Heard Them All.

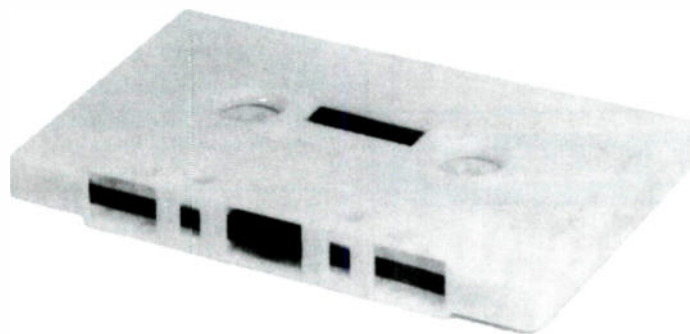

GUARANTEED CONSISTENT QUALITY.



CASSETTE CD & RECORD MANUFACTURING & PACKAGING
2832 SPRING GROVE AVENUE • CINCINNATI, OH 45225 (513) 681-8800

R. Fippin; Sales Mgr.: Francie Dannemiller.
 Audio: Cassette, Open Reel.
Majestic Audio, 1568 Marabar Dr., Reynoldsburg, OH, 43068,
 (614) 861-6076, Pres.: Jack Gurio.
 Audio: Cassette.
Musicol, Inc., 780 Oakland Park Ave., Columbus, OH, 43224,
 (614) 267-3133, Pres.: John W. Hull; Sales Mgr.: Warren Hull;
 Mktg. Dir.: Charlene Hull.
 Audio: Cassette, Open Reel, Real-time.
 Video: ½ VHS Cassette, 8mm.
 Audio Packaging Services: Inserting, Collating, Labeling,
 Mailing.
 Other Services: Freight.

QCA, Inc.

2832 Spring Grove Ave., Cincinnati, OH, 45225, (513)
 681-8400, Fax: (513) 681-3777, Pres.: Jim Bosken; Sales Mgr.:
 Amber Hines; Mktg. Dir.: Rusty Sweeney.
 Audio: Cassette.
 Audio Packaging Services: Inserting, Collating, Labeling,
 Mailing.
 Other Services: Warehouse, MIS (Inventory), Freight.

Sonic Sculptures, 636 Northland Blvd., Cincinnati, OH, 45240.

500 CUSTOM CASSETTES with FULL COLOR INSERTS \$799.⁰⁰

Includes

- ✓ Custom Full Color Card Inserts
- ✓ Mastering and Proof Cassettes
- ✓ Premium Music Grade Tape
- ✓ Dolby Encoding and Dolby HX-Pro
- ✓ Cassette Printing
- ✓ Norelco Box and Shrink Wrap

1000 Music Grade Normal Bias.....\$1089
 500 Chrome and Clear Shell.....\$ 849
 1000 Chrome and Clear Shell.....\$1189

(add .01/minute over 45 minutes)

Also Available - CD packages and
 Full 24 Track All Digital Studio

Forge Recording Studios Inc.



800/331-0405
 Lincoln & Morgan Sts.
 Phoenixville, PA 19460
 215/935-1422
 215/935-1940 fax

(513) 851-0055, Pres.: Lan A. Ackley; Sales Mgr.: James
 Winger.
 Audio: Cassette.
 Audio Packaging Services: Inserting, Collating, Labeling,
 Mailing.
SoundSpace, Inc., 126 Dayton St., Yellow Springs, OH, 45387,
 (513) 767-7353, Pres.: Chris Hertzler.
 Audio: Cassette, Open Reel, Real-time.
 Audio Packaging Services: Inserting, Collating, Labeling,
 Mailing.
Suttman Prodn., PO Box 72, Dayton, OH, 45409, (513)
 278-4601, Pres.: Eric J. Suttman.
 Audio: Cassette, Open Reel, DAT, Real-time.
 Video: ¾ U-Matic, ½ VHS Cassette, S-VHS.
 Audio Packaging Services: Inserting, Collating, Labeling,
 Mailing.
Video Duplication Services, Inc., 2682 S. Dixie Ave., Dayton,
 OH, 45459, (513) 294-5883, Fax: (513) 294-7087, Sales Mgr.:
 Patricia Hiatt.
 Video: ¾ U-Matic, ½ VHS Cassette.
Video Duplication Services, Inc., 4908 Van Epps Rd.,
 Cleveland, OH, 44131, (216) 741-3827, Fax: (216) 741-3828,
 Sales Mgr.: Paul Sedivy.
 Video: ¾ U-Matic, ½ VHS Cassette.
Video Duplication Services, Inc., PO Box 18337, Columbus,
 OH, 43218, 384 N. Sixth St., Columbus, OH, 43215, (800)
 289-4301, Fax: (614) 221-0559, Gen. Mgr.: Michael Kearney.
 Video: ¾ U-Matic, ½ VHS Cassette, 8mm, S-VHS, D2, 1",
 3/4" SP, Hi-8, Standards Conversion. High Speed
 Capability—TMD: SP, EP.
 Video Packaging Services: Inserting, Collating, Labeling,
 Mailing, Shrinkwrap.
 Other Services: Warehouse, Freight, Direct Response—800
 services, Credit Card Clearance Services.

OKLAHOMA

Benson Sound, Inc., 3900 E. I-240, Oklahoma City, OK, 73135,
 (405) 670-4461, Pres.: Larry R. Benson; Sales Mgr.: Linda
 Groves.
 Audio: Cassette, Real-time.
EL Jay Ents., Inc., 3202 E. 21st St., Tulsa, OK, 74114, (918)
 627-2054, (800) 886-8273, Fax: (918) 744-1223, Pres.: Leon
 Whitman; Sales Mgr.: Raymond Foyester.
 Audio: Cassette, Open Reel.
 Video: ¾ U-Matic, ½ VHS Cassette, 8mm, S-VHS.
 Audio Packaging Services.
 Other Services: Warehouse, Direct Response—800
 services.

OREGON

Musicon Recording & Duplicating, 27501 SW 95th Ave., Ste.
 930, Wilsonville, OR, 97070, (503) 682-8668, Fax: (503)
 682-3043, Pres.: William E. Berry; Sales Mgr.: Stephen J.
 Ziegler.
 Audio: Cassette, Open Reel, DAT, Real-time.
 Audio Packaging Services: Inserting, Collating, Labeling,
 Mailing, Shrinkwrap.
 Other Services: Warehouse, Freight, Program Production.
Phylco Audio/Video Duplicating Service, 11693 Old Stage Rd.,
 Gold Hill, OR, 97525, (800) 348-6194, Gen. Mgr.: Robert
 Deates; Sales Mgr.: Gail Husa; Prodn. Mgr.: Ken Husa.
 Audio: Cassette.
 Video: ½ VHS Cassette.
 Audio/Video Packaging Services: Inserting, Collating,
 Labeling, Mailing.
 Other Services: Warehouse.
Super Duper-Audio Duplicators, 3235 SE 39th Ave., Portland,
 OR, 97202, (503) 239-6070, Fax: (503) 239-0296, Pres.: Rick
 McMillen; Sales Mgr.: Todd Chatelas; Mktg. Dir.: Kevin
 Laurila.
 Audio: Open Reel, DAT, Real-time.
 Audio Packaging Services: Inserting, Collating, Labeling,
 Mailing, J-Cards, On-Cassette Printing.
 Other Services: Freight.

PENNSYLVANIA

Aircraft Studios & Tape Duplication, Dormont Sq., Pittsburgh,
 PA, 15216, (412) 343-5222, Pres.: Bernard Lee; Sales Mgr.:
 Perry Pinto.
 Audio: Cassette, Real-time.
 Audio Packaging Services: Inserting, Labeling.
American Helix Technology Corp., 1857 Colonial Village Ln.,
 Lancaster, PA, 17601, (717) 392-7840, Fax: (717) 392-7897,
 Pres.: David Dering; Vice Pres.: Jim Boyer; Dir. Sales/Mktg.:
 Marc Feingold.
 Audio: Cassette, Real-time.
 Video Packaging Services: Inserting, Collating, Labeling,
 Mailing.
 Other Services: Warehouse, Pre-mastering Custom
 Packing.
Audio Visual Communications, Inc., 435 Crooked Ln., King
 of Prussia, PA, 19406, (215) 272-8500, Fax: (215) 272-8604,
 Pres.: John Butterworth; Sales Mgr.: Frank Matys.
 Audio: Cassette, Open Reel, Real-time.
 Video: ¾ U-Matic, ½ VHS Cassette.

Audio Packaging Services: Inserting, Collating, Labeling,
 Mailing.
Crown Magnetics, Inc., 1223 Bittner Blvd., Lebanon, PA,
 17042, (717) 274-2812, (800) 736-9001, Fax: (717) 274-3615,
 Pres.: Chuck Musser; Mktg. Dir.: Bob Turner; Sales: Judy
 Musser.
 Audio: Cassette.
 Audio Packaging Services: Inserting, Collating, Labeling,
 Mailing.
 Other Services: Warehouse, Freight.

Disc Makers

1328 N. Fourth St., Philadelphia, PA, 19122, (800) 468-9353,
 (215) 232-4140, Fax: (215) 236-7763, Pres.: Morris Ballen;
 Sales/Mktg. Dir.: Tony Van Veen.
 Audio: Cassette, Real-time
 Video: ½ VHS Cassette.
 Audio/Video Packaging Services: Inserting, Collating,
 Labeling.
 Other Services: Complete Graphic Design, Color Separations,
 Printing, Freight.

Forge Recording Studios, Inc.

PO Box 861, Valley Forge, PA, 19481, Location: 3rd Floor,
 Byrne Bldg., Lincoln & Morgan Sts., Phoenixville, PA, 19460,
 (215) 935-1422, (800) 331-0405, Fax: (215) 935-1940, Pres./Mktg.
 Dir.: Warren R. Wilson.
 Audio: Cassette, Open Reel, DAT.
 Audio Packaging Services: Inserting, Collating, Labeling,
 Mailing.
 Other Services: Warehouse, MIS (Inventory).

Heid Productions, 701 Washington Rd., Pittsburgh, PA, 15228,
 (412) 561-3399, Fax: (412) 561-1755, Pres.: George Heid; Sales
 Mgr.: Jay Dudt; Contact: Carol Heid.
 Audio: Cassette, Open Reel.
 Audio Packaging Services: Inserting, Collating, Labeling,
 Mailing, Shrinkwrap, Printing, Artwork.
Kingdom Co., PO Box 506, Mansfield, PA, 16933, (717)
 662-7515, Fax: (717) 662-3875, Pres.: Johnny Berguson; Sales
 Mgr.: Howard Darr; Mktg. Dir.: Gabe Phelps.
 Audio: Cassette, Open Reel, Real-time.
 Video: ¾ U-Matic, ½ VHS Cassette, S-VHS.
 Audio Packaging Services: Inserting, Collating, Labeling,
 Mailing, Fulfillment House.
 Video Packaging Services: Inserting, Collating, Labeling,
 Mailing.
 Other Services: Warehouse, Freight, Direct Response—800
 services, Credit Card Clearance Services.

Loran Audio, 10-48 Clark St., Warren, PA, 16365, (800)
 633-0455, Fax: (814) 723-9490, Pres.: Robert L. Loranger;
 Sales/Mktg. Dir.: Earl J. Keeney, Jr.; Sales Coord.: Randy
 L. Britton.
 Audio: Cassette, DAT, Real-time.
 Audio Packaging Services: Inserting, Collating, Labeling,
 Mailing.
 Other Services: Direct Response—800 services, Credit
 Card Clearance Services.

Masterwork Recording, Inc., 1020 N. Delaware Ave.,
 Philadelphia, PA, 19125, (215) 423-1022, Fax: (215) 423-6020,
 Pres.: Peter Humphreys; Sales Mgr.: Albert Oon.
 Audio: Real-time.

Music Factory Ents. Inc., Ste. 300, Ford & Washington Sts.,
 Norristown, PA, 19401, (215) 277-9550, Pres.: Jeffrey
 Calhoun; Sales Mgr.: Jamie Bones; Mktg. Dir.: Dan Charles;
 Studio Mgr.: Linda Hoverson.
 Audio: Cassette, Open Reel, DAT, Real-time.
 Other Services: Direct Response—800 services, Credit
 Card Clearance Services.

E.J. Stewart, Inc., 525 Mildred Ave., Primos, PA, 19018, (215)
 626-6500, Fax: (215) 626-2638, Sales Mgr.: Eric Bentley; Gen.
 Mgr.: David Bowers.

Video: ¾ U-Matic, ½ VHS Cassette, 1", Betacam SP.
Virtue Recording & Video & Disc Mastering, 8809-11 Rising
 Sun Ave., Philadelphia, PA, 19115, (215) 763-2825, Pres.:
 Frank Virtue; Sales Mgr.: Mary Bozzi; Mktg. Dir.: Linda
 Vitacolonia.
 Audio: Cassette.
 Video: ¾ U-Matic, ½ VHS Cassette.

WEA Mfg., Inc., 210 N. Valley Ave., Olyphant, PA, 18447, (717)
 383-2471, Fax: (717) 383-2165, Pres.: Richard C. Marquardt;
 Sr. Vice Pres. Mktg.: David L. Brown; Vice Pres. Sales Svcs.:
 David A. Grant.
 Audio: Cassette.
 Audio Packaging Services: Inserting, Collating, Labeling.
 Other Services: Warehouse, Freight.

WRS Motion Picture & Video Laboratory, 1000 Napor Blvd.,
 Pittsburgh, PA, 15205, (800) 345-6977, Fax: (412) 922-1020,
 Pres.: F. Jack Napor; Sales/Mktg. Dir.: Ed Janow; Cust. Ser-
 vice Mgr.: David Simpson.
 Audio: Cassette, Open Reel, DAT, Real-time.
 Video: ¾ U-Matic, ½ VHS Cassette, 8mm, S-VHS, DII P!TSC
 & PAL. High Speed Capability—SP, EP, Sprinter—SP, EP.
 Audio/Video Packaging Services: Inserting, Collating,
 Labeling, Mailing.
 Other Services: Warehouse, Freight, Direct Response—800
 services, Credit Card Clearance Services.

DISC MAKERS

User Friendly
 CD, Cassette, &
 LP Manufacturing



FREE design and typesetting
 Call for our free, full color catalog:
1-800-468-9353

1328 N. 4th Street, Philadelphia, PA 19122
 215-232-4140, FAX: 215-236-7763

PUERTO RICO

Disc Makers, Senda De La Posada N-6, Quintas Del Rio, Bayamon, PR, 00961, (809) 740-0010, Fax: (809) 785-5554, Sales Mgr.: David Rodriguez.
Audio: Cassette, Real-time, Design, Separations, Printing, Packaging.
Video: ½ VHS Cassette.
Audio/Video Packaging Services: Inserting, Collating, Labeling.
Other Services: Freight.

SOUTH CAROLINA

Mainstay Media, PO Box 27109, 1200 Woodruff Rd., C-18, Greenville, SC, 29616, (803) 288-0000, (800) 868-8273, Fax: (803) 234-6519, Pres.: Jere Davis; Opns. Vice Pres.: Mark Young; Sales Mgr.: Jesse Evatte.
Audio: Cassette, Open Reel.
Video: ¾ U-Matic, ½ VHS Cassette. High Speed Capability—SP, LP, EP.
Audio/Video Packaging Services: Inserting, Collating, Labeling, Mailing.
Other Services: Warehouse, Freight, Direct Response—800 services, Credit Card Clearance Services, Computer Software Duplication.

TENNESSEE

Allied Film & Video, 370 J.D. Yarnell Ind. Pkwy., Clinton, TN, 37716, (615) 457-7772, Fax: (615) 457-7799, Div. Mgr.: Wayne Whitehurst.
Audio: Cassette, Real-time.
Video: ½ VHS Cassette, 8mm, S-VHS. High Speed Capability—SP, EP, Sprinter—SP, EP.
Audio/Video Packaging Services: Inserting, Collating, Labeling, Mailing.
Other Services: Warehouse, Freight, Direct Response—800 services, Credit Card Clearance Services.

Cassette Express, 114 17th Ave. S., Nashville, TN, 37203, (615) 244-5667, Fax: (615) 242-2472, Pres.: Albert Jolson; Sales Mgr.: James Rose; Mgr./Mktg. Dir.: Tim Malone.
Audio: Cassette, Real-time, Double Time.

Custom Tape Duplicators, Inc., 341 Hill Ave., Nashville, TN, 37210, (615) 256-1728, Fax: (615) 256-6713, Pres.: Cliff Tant; Sales Mgr.: Tom James.
Audio: Cassette.
Video: ½ VHS Cassette.

Disc Mastering, Inc., 30 Music Sq. W., Nashville, TN, 37203, (615) 254-8825, Fax: (615) 254-8826, Pres.: Randall F. Kling; Sales Mgr.: Karen Bush.
Audio: Cassette, Real-time.

The Lacquer Place, 116 17th Ave. S., Nashville, TN, 37203, (615) 244-5355, Pres.: Ted Fuller; Studio Mgr./Engineer: Roy Snowden.
Audio: Cassette, Real-time.

Magnetic Technology, 816-18th Ave. S., Nashville, TN, 37203, (615) 254-7001, Fax: (615) 254-4685, Owner/Pres.: Mack Evans.
Audio: Real-time, Blank Cassette Loading.

Nashville Record Prods., Inc., 469 Chestnut St., Nashville, TN, 37203, (615) 259-4200, Fax: (615) 244-3734, Pres.: George A. Ingram; Sales Mgr.: Alma Cato; Studio Mgr.: John Eberle.
Audio: Cassette, Real-time.
Audio/Video Packaging Services: Inserting, Collating, Labeling, Custom loading of blank cassettes.

Nat'l Tape Corp., 1110 48th Ave. N., Nashville, TN, 37221, (615) 383-7881, Fax: (615) 383-1768, Pres.: Jerry Hutchinson; Vice Pres.: Thomas Beld.
Audio: Cassette.
Other Services: Warehouse, Freight.

L. Nix & Co., Inc., 2000 Madison Ave., Memphis, TN, 38104, (901) 725-0855, Fax: (901) 725-7011, Pres.: Larry Nix.
Audio: Cassette.

Herb O'Mell Prods., Inc., PO Box 11022, Memphis, TN, 38111, 200 Linden Ave., Memphis, TN, 38126, (901) 682-6811, Fax: (901) 525-2796, Pres.: Herbert S. O'Mell; Sales Mgr.: Randi Vangergrift; Mktg. Dir.: Laura O'Mell.
Audio: Cassette.

Opryland Prods. Duplicating Services, 916 Twin Elm Ct., Nashville, TN, 37210, (615) 242-2483, (800) 554-2348, Fax: (615) 254-9364, Mgr.: Buddy Wilkins.
Video: ¾ U-Matic, ½ VHS Cassette, 3/4" SP, Beta SP.

S & S Custom Tapes, Inc., Rt. 4, Box 328-A, Church Hill, TN, 37842, (615) 357-8273, Pres.: S.M. Shipley; Sales Mgr.: Rose Yonts.
Audio: Cassette.

Skyline Prods./Big Oak Duplication, 108 Midtown Ct., Ste. 206, Hendersonville, TN, 37075, (615) 822-0088, Pres.: Timothy W. Chesney; Sales Mgr.: Melanie Chesney.
Audio: Cassette.
Video: ¾ U-Matic, ½ VHS Cassette.
Audio/Video Packaging Services: Inserting, Labeling, Mailing.
Other Services: Warehouse, Freight.

Sound Impressions

PO Box 101244, Nashville, TN, 37224, 748 Fesslers Ln., Nashville, TN, 37210, (615) 244-3535, Fax: (615) 255-3882,

Pres./Sales Mgr.: James Lenahan; Prodn. Coord.: Charlotte A. Mitchell.
Audio: Cassette.
Audio Packaging Services: Inserting, Labeling.
Other Services: Freight.

West & Co., Inc., PO Box 24281, Nashville, TN, 37202, 1726-C General George Patton Dr., Brentwood, TN, 37027, (615) 661-5808, Fax: (615) 661-5905, Pres.: Jerry West; Sales Mgr.: Mike Young; Mktg. Dir.: Gary Campbell.
Audio: Cassette.
Audio Packaging Services: Inserting, Collating, Labeling, Mailing.

TEXAS

A + R Record & Tape Mfg. Co., 902 N. Industrial Blvd., Dallas, TX, 75207, (214) 741-2027, Fax: (214) 638-6801, Pres.: Richard Sobel; Sales Mgr.: Stan Getz II; Mktg. Dir.: Maxine Sobel.
Audio: Cassette, Open Reel, DAT, Real-time.
Video: ½ VHS Cassette.
Audio/Video Packaging Services: Inserting, Collating, Labeling, Mailing.
Other Services: Warehouse, Freight, Direct Response—800 services, Credit Card Clearance Services.

Allied + WBS, Dallas Div., Bldg. #111, 6305 N. O'Connor Rd., Dallas, TX, 75039, (214) 869-0100, Fax: (214) 869-2117, Div. Mgr.: Dave Erickson.
Video: ¾ U-Matic, ½ VHS Cassette, 8mm, S-VHS.
Video Packaging Services: Inserting, Collating, Labeling, Mailing, Fulfillment.
Other Services: Freight.

At The Top Duplicators, 3330 Earhart, Carrollton, TX, 75006, (214) 980-7671, (214) 233-9191, Fax: (214) 991-1853, Prodn. Mgr.: Bert Newman.
Audio: Cassette.
Video: ¾ U-Matic, ½ VHS Cassette, 1", Beta.
Audio/Video Packaging Services: Inserting, Collating, Labeling.
Other Services: Warehouse, Freight.

Creative Sound Prods., Inc., PO Box 720941, 8383 Commerce Park Dr., #604, Houston, TX, 77272, (713) 777-9975, Fax: (713) 774-3419, Pres.: Edward B. Smith; Sales Mgr.: Michele Crosby.
Audio: Cassette.
Video: ½ VHS Cassette.
Audio/Video Packaging Services: Inserting, Collating, Labeling.
Other Services: Freight.

Crystal Clear Sound, 4902 Don Dr., Dallas, TX, 75247, (214) 630-2957, Pres./Mktg. Dir.: Sam Paulos; Sales/Duplication Mgr.: Sia Ahmadzadeh.
Audio: Cassette, DAT, Real-time, KABA System, BASF Chrome.
Audio/Video Packaging Services: Inserting, Collating, Labeling.

Destiny Media, Ind. dba DMI Record Mfg., 1422 W. Poplar St., San Antonio, TX, 78207, (512) 732-6176, Fax: (512) 732-6199, Pres.: Jerold B. Johnson; Sales Mgr.: Joey Rodriguez.
Audio: Cassette.

Flash Int'l Entls., PO Box 580058, 16201 Buccaneer, Ste. 213, Houston, TX, 77062, (713) 488-1978, Pres./Mktg. Dir.: R.L. (Flash) Boudreaux.
Audio: Cassette.
Video: ½ VHS Cassette.

GODTEL Prods. (A Div. of GODTEL Ministries), 330 E. Main St., Nacogdoches, TX, 75961, (409) 560-4282, Pres.: June Gentry; Vice Pres./Studio Mgr.: Richard C. Smith.
Audio: Cassette, Real-time.
Audio/Video Packaging Services: Inserting, Collating, Labeling, Shrink-wrapping.

Bob Green Prods., Inc., 7950 Westglenn, Houston, TX, 77063, (713) 977-1334, Fax: (713) 977-1305, Pres.: Bob Green; Vice Pres.: Jim Spurlock, Don Fisher; Office Mgr.: Emily Getz.
Audio: Cassette, Open Reel.

Houston Records, Ltd., 3300 Jensen Dr., Houston, TX, 77026, (713) 223-5971, Pres.: Chris Puccio; Sales Mgr.: Steve Puccio.
Audio: Cassette.
Audio/Video Packaging Services: Inserting, Labeling.

Int'l Cassette Corp., PO Box 1928, Greenville, TX, 75401, (214) 454-9164, Fax: (214) 454-4172, Pres./Sales Mgr.: Ollie Moyer.
Audio: Cassette, Open Reel.
Video: ¾ U-Matic, ½ VHS Cassette.

Jordan Sound Prods., Inc., PO Box 130845, Tyler, TX, 75713, (214) 839-6623, Owner/Pres.: Gary Jordan; Sales Mgr.: Terri Jordan.
Audio: Cassette, Open Reel, Real-time.
Video: ½ VHS Cassette.
Audio/Video Packaging Services: Inserting, Collating, Labeling, Mailing.

Marsal Prods., Inc., PO Box 37070, 1735 Castroville Rd., San Antonio, TX, 78237, (512) 433-9351, Fax: (512) 433-7973, Pres.: Antonio J. Menendez; Vice Pres./Sales Mgr.: Felix Elizondo.
Audio: Cassette.
Audio/Video Packaging Services: Inserting, Labeling.
Other Services: Warehouse, Freight.

Master Prods. Recording & Video, 307 S. Missouri St., Weslaco, TX, 78596, (512) 968-5777, Pres.: Jose A. Leal.
Audio: Open Reel, DAT.
Video: ½ VHS Cassette, ¼ CVC Cassette.

The Musik Factory, 1812 Procter St., Port Arthur, TX, 77640, (409) 982-7121, Owner: Floyd Badeaux.
Audio: Cassette.

Sound Recorders, Inc., 4031 Guadalupe, Austin, TX, 78751, (512) 454-8324, (800) 880-0270, Fax: (512) 454-5594, Pres.: Miles Muller; Sales Mgr.: Basil Thomas; Mktg. Dir.: Matt Wiedemann.
Audio: Cassette, Open Reel, DAT, Real-time.
Audio/Video Packaging Services: Labeling, Mailing.
Other Services: Warehouse.

Sword & Shield Record Co., PO Box 211, Arlington, TX, 76010, (817) 572-1414, Pres.: Calvin Willis.
Audio: Cassette.

Tapemasters, Inc., PO Box 550158, Dallas, TX, 75355, 10486 Brockwood Rd., Dallas, TX, 75238, (214) 349-0081, Fax: (214) 349-3819, Pres.: John Rheingans; Sales Mgr.: W.O. Murray.
Audio: Cassette, Open Reel.
Audio/Video Packaging Services: Inserting, Collating, Labeling.

UTAH

Cassette Prods., Inc., 4910 W. Amelia Earhart Dr., Salt Lake City, UT, 84116, (801) 531-7555, (800) 622-6036, Fax: (801) 531-0740, Pres.: Mark Hanks; Sales Mgr./Mktg. Dir.: Marv Curtis.
Audio: Cassette.
Video: ½ VHS Cassette. High Speed Capability—TMD: SP, EP.
Audio/Video Packaging Services: Inserting, Collating, Labeling, Mailing.
Other Services: Warehouse, Freight, Direct Response—800 services, Credit Card Clearance Services.

Covenant Communications, PO Box 416, 920 E. State Rd., American Fork, UT, 84003, (801) 756-9966, Fax: (801) 756-1049, Vice Pres.: Paul Lee.
Audio: Cassette.
Audio/Video Packaging Services: Inserting, Collating, Labeling.

Sound Concepts, PO Box 299, 175 W. 300 S., Provo, UT, 84603, (801) 375-7333, Fax: (801) 377-4723, Pres.: McKinley M. Oswald.
Audio: Cassette, Open Reel, DAT.
Audio/Video Packaging Services: Inserting, Collating, Labeling, Mailing.

Video West, Broadcast Hse., #5 Triad Ctr., 55 N. 300 West, Salt Lake City, UT, 84110, (801) 575-7400, Fax: (801) 575-7449, Sales Mgr.: Jim Yorgason; Mktg. Dir.: Don Paver; Vice Pres./Gen. Mgr.: Allan W. Henderson; Distribution Serv. Mgr.: Mel Miller.
Video: ¾ U-Matic, ½ VHS Cassette, 1", 2", Post Production Editing/Video tape loading.
Video/Video Packaging Services: Inserting, Collating, Labeling, Mailing, Shrinkwrap.



A Division of SIA, Inc.

748 Fesslers Lane
Nashville, TN 37210

Call for information:
1-800-458-7756

IN TENNESSEE CALL 615 244 3535 ■ FAX 615 255 3882

P R E M I U M

CASSETTE & CD MANUFACTURING

Custom Packaging
In-House Graphics Department

A Full Service Manufacturing Facility
Serving the Audio Industry for over 22 years

Other Services: Warehouse, Freight, Direct Response—800 services, Credit Card Clearance Services, Distribution.

VERMONT

Analogue Industries

217 S. Union St., Burlington, VT, 05401, (800) 777-1927, Fax: (802) 863-1234, Pres.: George Frehner; Sales Mgr.: Rick Dexter.
Audio: Cassette, Open Reel, DAT, Real-time, 16x voice duplication.
Audio Packaging Services: Inserting, Collating, Labeling, Mailing, Shrink Wrap, Graphic Design.
Other Services: Freight, Direct Response—800 services.

Resolution, Inc., 19 Gregory Dr., South Burlington, VT, 05403, (802) 862-8881, Fax: (802) 865-2308, Pres.: William Schubart; Sales/Mktg. Dir.: Linda A. Citro.
Video: ¾ U-Matic, ½ VHS Cassette, S-VHS. High Speed Capability—TMD: SP, EP.
Video Packaging Services: Inserting, Collating, Labeling, Mailing, Custom Printing.
Other Services: Warehouse, Freight, Direct Response—800 services, Credit Card Clearance Services.

White Crow Audio, 19 Marble Ave., Burlington, VT, 05401, (802) 658-6475, Owner: Todd Lockwood; Gen. Mgr.: Douglas Jaffe.
Audio: Real-time.
Audio Packaging Services: Inserting, Labeling, On-Shell/Insert Printing, Shrinkwrap.

VIRGINIA

Gerald Lewis Recording, PO Box 3671, Arlington, VA, 22204, (703) 521-1871, Pres.: Gerald M. Lewis.
Audio: Cassette, Open Reel, DAT, Real-time.
Linden, Inc., 229 N. Henry St., Alexandria, VA, 22314, (703) 549-4424, Pres./Sales Mgr.: Katherine Monteith.
Audio: Cassette, Open Reel.
Video: ¾ U-Matic, ½ VHS Cassette, 8mm, S-VHS.

Lion Recording Services, 7532 Fullerton Ct., Springfield, VA, 22153, (703) 569-3200, Fax: (703) 455-5600, Pres.: Harold Lion; Mktg. Dir.: Karen Blackhall; Vice Pres./Sales Mgr.: Richard Lion.
Audio: Cassette, Open Reel, DAT, Micro-Cassette.
Audio Packaging Services: Inserting, Labeling, Mailing, Custom Packaging.
Other Services: Warehouse, Freight, Credit Card Clearance Services.

Masterworks Studios, 4024 Williamsburg Ct., Fairfax, VA, 22032, (703) 385-1780, Pres./Sales Mgr.: Michael Zook.
Audio: Cassette, Open Reel, DAT, Real-time, Mid-speed Stereo, High-speed Mono.
Audio Packaging Services: Inserting, Collating, Labeling, Mailing.

Media Assoc., Inc., PO Box 5747, 7400 Fullerton Rd., Springfield, VA, 22150, (800) 628-3556, Fax: (703) 866-6100, Pres.: Don Evans; Mktg. Dir./Sales Mgr.: David J. Craver; Operations Mgr.: Don Miller.
Video: ¾ U-Matic, ½ VHS Cassette, 8mm. High Speed Capability—SP, EP, Sprinter—SP, EP.
Video Packaging Services: Inserting, Collating, Labeling, Mailing.
Other Services: Warehouse, Freight.

Musifex Video, 2701-C Wilson Blvd., Arlington, VA, 22201, (703) 525-6476, Fax: (703) 525-0949, Pres.: Frank Maniglia, Jr.; Gen. Mgr.: Guinevere Meyer; Sales Mgr./Mktg. Dir.: Jeanne Chisholm.
Audio: Cassette, Open Reel, DAT, Real-time.
Video: ¾ U-Matic, ½ VHS Cassette.

WASHINGTON

American Production Services, 2247 15th Ave. W., Seattle, WA, 98119, (206) 282-1776, Fax: (206) 282-3535, Pres.: Conrad Denke; Sales Mgr.: Eric Denke; Mktg. Dir.: Michelle Ford.
Audio: Cassette, Open Reel, DAT.

Video: ¾ U-Matic, ½ VHS Cassette, ¼ CVC Cassette, S-VHS, D-2, 1".
Audio Packaging Services: Inserting, Collating, Labeling.
Video Packaging Services: Inserting, Collating, Labeling, Mailing.
Other Services: Warehouse, Freight.

Audio Recording, Inc., 4718 38th Ave., Seattle, WA, 98105, (206) 525-7372, (206) 623-2030, Pres.: Kearney W. Barton.
Audio: Cassette.
Audio Packaging Services: Inserting, Labeling.

Cassette Technologies, 5722 Swan Crk. Dr. E., Tacoma, WA, 98404, (206) 474-9835, Sales Mgr.: Dean K. Hart.
Audio: Cassette.

Fastrax, Inc., 4033 Aurora Ave. N., Seattle, WA, 98103, (206) 632-8300, Pres.: Miriam Hamilton; Sales Mgr.: Candace Williams.
Audio: Cassette, Open Reel, DAT, Real-time.
Audio Packaging Services: Inserting, Labeling, Mailing, Printed Labels & J Cards.
Other Services: Warehouse.

Martin Audio Group, 1200 Westlake Ave. N., #414, Seattle, WA, 98109, (206) 784-0139, Fax: (206) 782-9044, Pres.: Scott Olsen; Sales Mgr.: Ivar Sandmark; Engineer: Bob Boeck.
Audio: Cassette, Real-time.
Audio Packaging Services: Inserting, Collating, Labeling, Mailing.
Other Services: Warehouse, Freight.

Melody Prods., 7712 23rd Ave. NW, Seattle, WA, 98117, (206) 783-8694, Fax: (206) 781-1765, Pres.: James A. Bostad, Sr.; Sales Mgr.: Melody Bostad; Mktg. Dir.: Sally Bostad; Engineers: Jason Bostad, Jeremy Bostad.
Audio: Cassette, Open Reel, DAT, Real-time, On MR-2B Nak.
Video: ¾ U-Matic, ½ VHS Cassette, 8mm.
Audio Packaging Services: Inserting, Labeling, Mailing, Shrinkwrap.
Other Services: Warehouse, Freight.

Premiere AVD Corp., 18080 NE 68th St., Redmond, WA, 98052, (206) 882-1400, Fax: (206) 867-0718, Pres.: George M. Ricci; Sales Mgr.: Gary M. Ricci.
Video: ½ VHS Cassette. High Speed Capability—SP, LP, EP, Sprinter—SP, LP, EP.
Video Packaging Services: Inserting, Collating, Labeling, Mailing.
Other Services: Warehouse, Freight.

The Recording Chamber, Inc., 18912 SE 133rd Pl., Renton, WA, 98056, (206) 235-8273, Pres.: Dennis L. Palmer.
Audio: Cassette.

Ruther Remote Recording, 108 N. Roosevelt St., Walla Walla, WA, 99362, (509) 522-0438, Pres.: Bud Ruther.
Audio: Cassette, Real-time.

The Sound Preservers Co., 911 E. Fourth Ave., Olympia, WA, 98506, (206) 352-9097, Pres.: Allen P. Giles.
Audio: Cassette, DAT, Real-time.
Audio Packaging Services: Inserting, Collating, Labeling, Mailing.
Other Services: Warehouse, Direct Response—800 services.

WEST VIRGINIA

Jim McCoy Prods., Rt. 2, Box 114, Berkeley Springs, WV, 25411, (304) 258-2175, Pres.: Jim McCoy; Mktg. Dir.: Bertha McCoy.
Audio: Cassette.
Audio Packaging Services: Inserting, Labeling, Mailing.

WISCONSIN

Centercom, Inc., 5737 W. Hemlock St., Milwaukee, WI, 53223, (414) 353-2001, Fax: (414) 353-7227, Pres.: Bob Harmon; Vice Pres.: Jeff Johnson; Sales/Mktg. Dir.: David Davis.
Audio: Cassette.

Video: ¾ U-Matic, ½ VHS Cassette, 8mm, S-VHS. High Speed Capability—TMD: SP, EP, Pal & Secam.
Audio/Video Packaging Services: Inserting, Collating, Labeling, Mailing.
Other Services: Warehouse, Freight, Direct Response—800 services, Credit Card Clearance Services.

Concept Prods., Inc., PO Box 44345, 7878 Big Sky Dr., Madison, WI, 53744, (608) 833-8273, (800) 728-2731, Pres.: Rod F. Bareilmann; Vice Pres./Prodn. Service Dir.: C. Dan Geocar.
Audio: Cassette, Open Reel, Real-time.

Video: ¾ U-Matic, ½ VHS Cassette.
Audio/Video Packaging Services: Inserting, Labeling, Mailing.

Full Compass Systems, Ltd., 5618 Odana Rd., Madison, WI, 53719, (608) 271-1100, Fax: (608) 273-6336, Pres.: Jonathan Lipp.
Audio: Cassette.

General Electronics, Inc., 5300 N. Port Washington Rd., Glendale, WI, 53217, (414) 964-7660, Pres.: John Shutter; Sales Mgr.: J. Stoecker; Contact: Dave Wallace.
Audio: Cassette, Open Reel.

Video: ¾ U-Matic, ½ VHS Cassette.
RSVP, Inc., 7701 N. Teutonia, Milwaukee, WI, 53209, (414) 354-6400, Fax: (414) 354-7303, Pres.: Larry Hansen; Sales Mgr.: Jim Schaefer; Mktg. Dir.: Linda Hanson.
Audio: Cassette, Open Reel, Real-time.

Video: ½ VHS Cassette.
Audio/Video Packaging Services: Inserting, Collating, Labeling, Mailing.

Other Services: Freight, Direct Response—800 services.
Vaughn Duplication Services, 700 W. Michigan Ave., Ste. 270, Milwaukee, WI, 53233, (414) 276-6511, Fax: (414) 276-0555, Vice Pres.: Donald Drapeau; Sales Mgr.: Tom Brunhart; Mktg. Dir.: Michelle Sahlin.

Video: ¾ U-Matic, ½ VHS Cassette, ¼ CVC Cassette, 8mm, S-VHS. High Speed Capability—TMD: SP, EP.
Video Packaging Services: Inserting, Collating, Labeling, Mailing, Macrovision Antipiracy coding.
Other Services: Warehouse, Freight, Direct Response—800 services, Package Consulting, Int'l Standards Conversion.

COMPACT DISC MANUFACTURERS & VIDEO DISC MANUFACTURERS

ALABAMA

JVC Disc America Co., 2 JVC Rd., Tuscaloosa, AL, 35405, (205) 556-7111, Fax: (205) 556-3003, Pres.: Masanori Iwasaki; Vice Pres.: Joe Y. Ikeda; Nat'l Sales Dir.: Paul West.
Type: CD.

CALIFORNIA

Alshire Int'l, Inc., PO Box 7107, 1015 Isabel St., Burbank, CA, 91510, (213) 849-4671, Fax: (818) 569-3718, Pres.: Al Sherman; Sales Mgr.: Richard Sherman; Custom Dept.: Mark Beckwith.
Type: CD, CDV.

Alshire Int'l, Inc., 1015 Isabel St., Burbank, CA, 91506, (213) 849-4671, (818) 843-6792, Fax: (818) 569-3718, Pres.: Al Sherman; Sales Mgr.: Richard Sherman; Custom Dept.: Mark Beckwith.
Type: CD.

C.D.M. (Clarified Digital Mastering), PO Box 76848, Los Angeles, CA, 90076, 4007 W. Sixth St., Los Angeles, CA, 90020, (213) 383-2155, Fax: (213) 383-2158, Pres.: Hank Wang; Mktg. Dir.: Paul Dell'Quadri.
Type: CD, Videodisk, CDV.

Disc Manufacturing, Inc.

3500 W. Olive St., Ste. 1020, Burbank, CA, 91505, (818) 953-7790, Fax: (818) 953-7791, Pres./CEO: Myron Shain; Vice Pres. Sales: Sue Simone; Regional Sales Mgr., NY: John Mangini (212) 599-5300.
Type: CD, Videodisk, CDV.

Disctronics

3800 Barham Blvd., Ste. 102, Los Angeles, CA, 90068, (213) 851-7300, Fax: (213) 851-7579, Exec. Vice Pres./CD Mktg.: Cal Roberts; Sales Mgr.: Mort Weiner.
Type: CD.

ANALOGUE

I n d u s t r i e s

Cassette Duplication Services

**Real-time & High-speed
Large and small runs**

**CD and Vinyl pressing
Packaging design & printing**

Faxline: 1-802-863-1234

217 S. Union St. Burlington VT 05401

FREE CATALOG

1-800-777-1927



AUDIOPHILE QUALITY CASSETTES
DUPLICATED ON THE KABA SYSTEM

REFLECTION OF PERFECTION

DISC MFG, INC

DISC MANUFACTURING, INC.
A QUIXOTE COMPANY

SALES INFORMATION: SUE SIMONE BURBANK, CA 818/953-7790 FAX 818/953-7791
JOHN MANGINI NEW YORK, NY 212/599-5300 FAX 212/599-3227

F.D.S. Labs, Inc., PO Box 76848, Los Angeles, CA, 90076, 4007 W. Sixth St., Los Angeles, CA, 90020, (213) 383-2155, Fax: (213) 383-2158, Pres.: Hank Waring, Mktg. Dir.: Paul Delliquadr.

Type: CD, Videodisk, CDV.

52nd Street Studios, 1741 N. Ivar Ave., Los Angeles, CA, 90065, (213) 463-5252, Fax: (213) 465-2079, Pres.: Neil B. Posner, Sales Mgr.: Stuart A. Yahm, Account Exec.: Michael Abraham.

Type: CD.

JVC Disc America Co., 9229 W. Sunset Blvd., Ste. 810, Los Angeles, CA, 90069, (213) 274-2221, Fax: (213) 274-4392, Exec. Vice Pres.; Sales: Joe Y. Ikeda. Sales Mgr.: Kevin Elliott; Mktg. Dir.: Paul West.

Type: CD.

Nimbus Records CD Mfg. West Coast Sales, 4524 Tobias Ave., Sherman Oaks, CA, 91403, (818) 783-4250, (800) 729-0932, Fax: (818) 783-7475, West Coast Dir. Sales: Sandy Richman.

Type: CD.

Optical Media Int'l, 485 Alberto Way, Ste. 115, Los Gatos, CA, 95032, (408) 395-4332, Fax: (408) 395-6544, Pres.: Allen Adkins; Sales Mgr.: Myra Arnstein; Mktg. Dir.: Syl Peser.

Type: CD

PDO (Philips and Du Pont Optical Company), 3815 W. Olive Ave., Ste. 202, Burbank, CA, 91505, (818) 848-2442, Fax: (818) 848-3090, Vice Pres. Sales: Spence Berland.

Type: CD, Videodisk, CDV.

Pliz Compact Disc, Inc., 22321 Gilberto, Ste. #100, Rancho Santa Margarita, CA, 92688, (714) 858-3663, Fax: (714) 858-3397, Gen. Mgr.: Martin Mair.

Type: CD.

Pioneer LDCA, Inc., 2265 E. 220th St., Long Beach, CA, 90810, (213) 746-6337, Fax: (213) 816-0402, Pres.: Tetsuro Kudo; Sales Mgr.: Rick Buehler; Mktg. Dir.: David Wallace.

Type: CDV.

RTI, Record Technology, Inc., 486 Dawson Dr., Camarillo, CA, 93012, (805) 484-2747, Fax: (805) 987-0508, Pres.: William Bauer; Sales Mgr.: Don MacInnis.

Type: CD.

Rainbo Records & Cassettes, 1738 Berkeley St., Santa Monica, CA, 90404, (213) 829-0355, Fax: (213) 828-8765, Pres.: Jack G. Brown; Gen. Mgr.: Steve Sheldon.

Type: CD.

WEA Mfg., Inc., 3601 W. Olive Ave., Ste. 420, Burbank, CA, 91505, (818) 953-2941, Sr. Vice Pres. Mktg.: David L. Brown.

Type: CD.

CONNECTICUT

Americ Disc Inc., 7D Horse Hill Rd., Danielson, CT, 06239, (203) 774-1666, Fax: (203) 774-4414, Pres.: Pierre-A. Deschenes; Exec. Vice Pres.: Claude Fragman; Sales Mgr.: Peter Baldes.

Type: CD.

FLORIDA

Miami Tape, Inc., 8180 NW 103 St., Hialeah Gardens, FL, 33016, (305) 558-9211, Fax: (305) 825-9873, Pres.: Carlos O. Garcia; Sales Mgr.: Mirella Tunon.

Type: CD.

GEORGIA

Denon Digital Industries Inc., 1380 Monticello Rd., Madison, GA, 30650, (404) 342-3425, Fax: (404) 342-0637, Pres.: Suguru Okuma; Sales Mgr.: Abe Chayet; Managing Dir.: Dick Melner; Customer Service: Joe Crowell.

Type: CD, Videodisk, CDV.

ILLINOIS

Duplicates, 11 E. Hubbard St., Chicago, IL, 60611, (312) 822-0305, Fax: (312) 464-0762, Pres.: Michael A. Freeman.

Type: CD.

INDIANA

ARP Media Ents., 1600 Rich Rd., Richmond, IN, 47374, (317) 962-9511, Fax: (317) 962-1564, Pres.: David Ambault; Sales/Mktg. Dir.: Albert R. Santoro.

Type: CD.

Digital Audio Disc Corp.

PO Box 3710, 1800 N. Fultridge Ave., Terre Haute, IN, 47804, (812) 462-8100, Fax: (812) 466-9125, Chrmn./CEO: James Frische; Vice Pres. Sales/Mktg. Dir.: Scott Bartlett.

Type: CD, Videodisk, CDV.

U.S.' Most Complete Facility!

EUROPADISK LTD.

Audiophile Quality...

- Compact Disc Production
- CASSETTE Duplication
- VINYL Record Pressing
- GRAPHICS Design & Printing
- MASTERING STUDIOS - CD, LP, Cassette

CONVENIENT PACKAGE PRICING plus state-of-the-art Neve Digital Mastering for CD; Studer and Lyrec HX-Pro Cassette Duplication; DMM Direct Metal Mastering for Vinyl and complete in-house Art Department. Call or write for our informative brochure!

EUROPADISK LTD. 75 Varick Street, New York, NY 10013
 (212) 226-4401 FAX (212) 966-0456





Reading
worth
writing
for.



Consumer Information Center
Department RW
Pueblo, Colorado 81009

U.S. General Services Administration.

If you're looking for some good reading, you've just found it. The free Consumer Information Catalog.

The Catalog lists about 200 federal publications, many of them free. They can help you eat right, manage your money, stay healthy, plan your child's education, learn about federal benefits and more.

So sharpen your pencil. Write for the free Consumer Information Catalog. And get reading worth writing for.

American Helix

Compact Disc Replicators

BETTER THAN EVER

and still growing.

Compact Disc Replication

Premastering

Mastering

Visual Design

5 Color Disc Printing

PictureDisc™ Printing

Custom Packaging

Fulfillment Services

Product Development

Music Licensing

Music Premiums

Professional AudioTape Products

Cassette Duplication

The User-Friendly Compact Disc People

800 525 6575



AmericanHelix™

Member of

NAIRD

LOUISIANA

Ville Platte Record Mfg. Co., PO Drawer 10, 120 E. Cypress St., Ville Platte, LA, 70586, (318) 363-2104, Fax: (318) 363-5622, Pres./Sales Mgr.: James Floyd Soileau; Sales Mgr.: Peggy Fontenot.

MAINE**U.S. Optical Disc, Inc.**

One Eagle Dr., Sanford, ME, 04073, (207) 324-1124, Dir. Mktg.:

Michael Rosenbaum.
Type: CD.

MASSACHUSETTS

Northeastern Digital Recording, Inc., 2 Hidden Meadow Ln., Southborough, MA, 01772, (508) 481-9322, Fax: (508) 624-6437, Pres.: Dr. Toby Mountain; Sales Mgr.: Anne Shepard; Mastering Engineer: Jonathan Wyner.
Type: CD.

MICHIGAN

Audio Graphics Services, 1516 Ferris Ave., Royal Oak, MI, 48067, (313) 544-1793, Pres.: E. J. Wolfrum; Sales/Mktg. Dir.: Walter Wolfrum.
Type: CD.

Technidisc, Inc., 2250 Meijer Dr., Troy, MI, 48064, (800) 321-9610, Fax: (313) 435-8540, Pres.: Ron Balousek; Sales Mgr.: Leon Chick.
Type: CD, Videodisk.

MINNESOTA

Metacom, Inc., 5353 Nathan Ln., Plymouth, MN, 55442, (612) 553-2000, Pres.: Phillip Levin.
Type: CD.

3M Optical Recording Department, 3M Center Bldg., 223-5N-01, Saint Paul, MN, 55144, (612) 733-2142, Fax: (612) 733-0158, Sales Mgr.: Vivian Ebersman; Mgr. Pre-recorded Bus.: David H. Wenck; Mktg. Mgrs.: Jon Hove, Mark Arps.
Type: CD, Videodisk, CDV.

**CD REPLICATION
&
PACKAGING**

**THE HIGHEST QUALITY
AT THE LOWEST COST**

**THE
MUSIC
CONNECTION
(212) 529-0557
FAX (212) 529-1281**

FLATIRON BUILDING
175 FIFTH AVE. STE 511
NEW YORK, N.Y. 10010

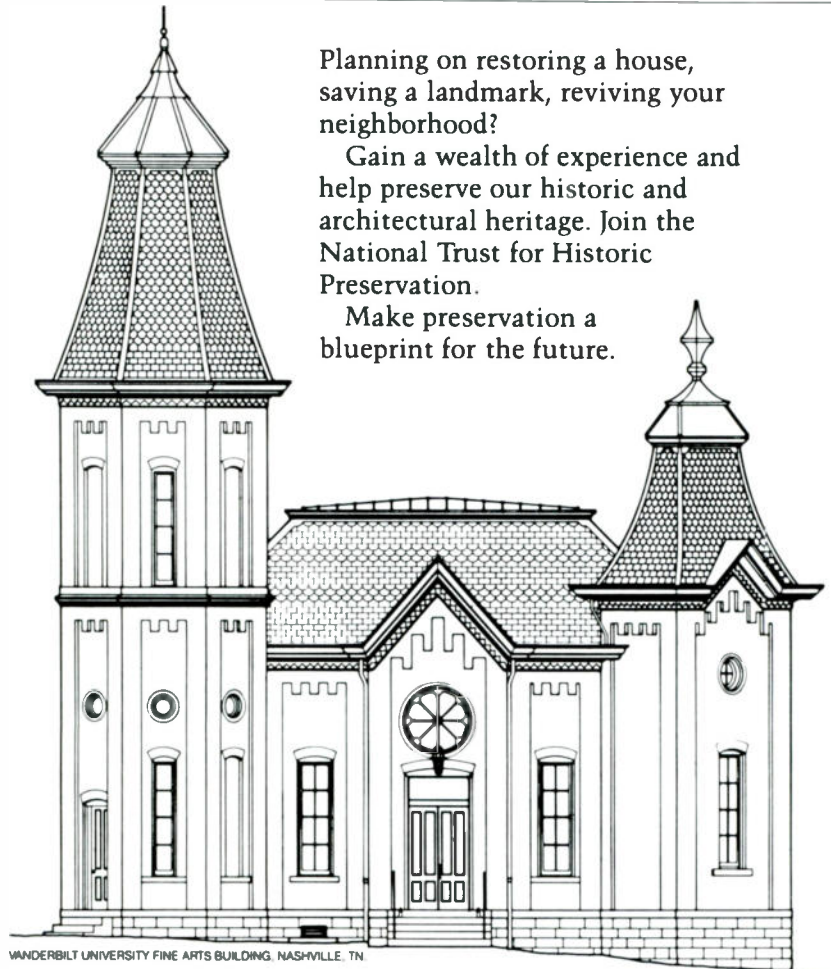

WANDERBILT UNIVERSITY FINE ARTS BUILDING, NASHVILLE, TN

Planning on restoring a house, saving a landmark, reviving your neighborhood?

Gain a wealth of experience and help preserve our historic and architectural heritage. Join the National Trust for Historic Preservation.

Make preservation a blueprint for the future.

Write:



**National Trust for Historic Preservation
Department PA
1785 Massachusetts Ave., N.W.
Washington, D.C. 20036**

MISSOURI

Aard-Vark, Inc., 335 S. Jefferson, Springfield, MO, 65806, (800) 822-1226, Fax: (417) 869-1133, Pres.: H. W. Jacobsen.
Audio Duplication & Services, Inc., PO Box 31546, 1927 Boaz, Saint Louis, MO, 63131, (314) 965-8895, Fax: (314) 965-8895, Pres.: Richard Schaumberger, Jr.
Type: CD.

NEW JERSEY

Nimbus Records CD Mfg. East Coast Sales, 66 Spenser Dr., Short Hills, NJ, 07078, (201) 379-2890, (800) 451-8725, Fax: (804) 985-4892, East Coast Dir. Sales: Ric Sherman; Sales Coord.: Susan High.
Type: CD.

NEW YORK

DP Plus Digital Services, PO Box 694, Lynbrook, NY, 11563, (516) 872-2325, Pres.: Joel Kerr; Vice Pres.: Kathy Kerr.
Type: CD.

Digital House Ltd., 101 W. 57th St., New York, NY, 10019, (212) 333-5950, Fax: (212) 262-5631, Pres.: Jerome Bunke; Vice Pres. Tech. Services: Harry Hirsch; Vice Pres. Mktg.: Don Burkheimer.
Type: CD.

Disc Makers, 1650 Broadway, Ste. 1010, New York, NY, 10019, (212) 265-7505, Fax: (212) 262-0798, Sales Mgr.: Howard Roseff.
Type: CD.

Disk Manufacturing, Inc., 441 Lexington Ave., Ste. 803, New York, NY, 10017, (212) 599-5300, Fax: (212) 599-3227, Sales Contact: John Mangini.
Type: CD, CDV.

Eastern Standard Prodn., Inc., 26 Baxter St., Buffalo, NY, 14207, (800) 527-9225, (716) 876-1454, Fax: (716) 877-6395, Pres.: Mark S. Mekker; Vice Pres. Sales/Mktg.: Deborah Mekker; Customer Service: Teresa M. Fay.
Type: CD, Videodisk.

Electro Sound Group, Inc., 1290 Motor Pkwy., Hauppauge, NY, 11788, (516) 234-2010, Fax: (516) 234-2384, Pres.: Richard Projain; Sr. Vice Pres. Sales: Hugh Landy.
Type: CD.

ElectroSound Group, Inc., 888 Seventh Ave., New York, NY, 10106, (212) 757-3097, (212) 757-3149, Fax: (212) 581-6102, Pres.: Dick Projain; Vice Pres. Sales: Hugh Landy.
Type: CD.

ElectroSound Group, Inc., 1290 Motor Pkwy., Hauppauge, NY, 11788, (516) 234-2010, Fax: (516) 234-2384, Pres.: Richard Projain; Vice Pres./Dir. Mktg.: Hugh T. Landy.
Type: CD.

Frankford/Wayne Mastering Labs, Inc., 1697 Broadway, Ste. #1404, New York, NY, 10019, (212) 582-5473, Fax: (212) 245-2309, Pres.: Thomas S. Steele; Sales Mgr.: Jimmy Lee; Mktg. Dir.: Carol Steele.
Type: CD.

Grenadier, 10 Parkwood Ave., Rochester, NY, 14620, (716) 442-6209, (716) 275-2942, Pres.: T. Greene; Sales/Mktg. Dir.: P. Greene.
Type: CD.

JVC Disc America Co., 1500 Broadway, Ste. 810, New York, NY, 10036, (212) 768-8413, Fax: (212) 768-8416, Exec. Vice Pres.: Joe Ikeda; Sr. Vice Pres. Mktg./Sales: Jack Kiernan.
Type: CD.

Koch Int'l Corp., 2700 Shames Dr., Westbury, NY, 11590, (516) 333-4800, Fax: (516) 333-4818, Pres.: Michael Koepfle; A & R: Michael Fine; Promo.: Rachelle Schlosser.
Type: CD, Videodisk.

The Music Connection, Inc., 175 Fifth Ave., New York, NY, 10010, (212) 529-0557, Pres.: R. Ralton; Vice Pres.: Fred Levy; Sales Mgr.: Ira Cohen.
Type: CD.

PDO (Philips and Du Pont Optical Company), 1251 Avenue of the Americas, New York, NY, 10020, (212) 512-9350, Fax: (212) 512-9358, Sr. Vice Pres.: Bob Wray; Sales Dir.: Bob Bloom.
Type: CD.

Spotlight of New York, 119 Ramona Ct., New Rochelle, NY, 10804, (914) 576-2624, Pres.: Harry Klane.
Type: CD.

WEA Mfg., Inc., 75 Rockefeller Plaza, New York, NY, 10019, (212) 399-8831, Vice Pres. Sales Services: David A. Grant.
Type: CD.

OHIO

Ameritrade Optical Disc, 520-D Enterprise Dr., Westerville, OH, 43081, (614) 841-1555, Pres.: Carlos Ramirez; Gen. Mgr.: Rogelio Ramirez.
Type: CD.

Discovery Systems, 7001 Discovery Blvd., Dublin, OH, 43017, (614) 761-2000, Fax: (614) 761-4258, Pres.: Jeffrey Wilkins; Mktg. Dir.: Mary Vaughn; Vice Pres. Sales: Michael Ward.
Type: CD.

OCA, Inc., 2832 Spring Grove Ave., Cincinnati, OH, 45225, (513) 661-8400, Fax: (513) 681-3777, Pres.: Jim Bosken; Sales Mgr.: Amber Hines; Mktg. Dir.: Rusty Sweeney.
Type: CD.

RELEASE DATE STARING YOU IN THE FACE?



R e l a x . . .

We take the pressure out of pressing CDs.

U.S. Optical Disc Inc.

Tel.: (207) 324-1124





Meet The Faces Behind Most Medical Advances.

There are a lot of doctors and researchers out there who deserve credit for society's medical achievements. But the fact is, they'll have to share the credit. Because before any medical project can break new ground, it has to get *off* the ground. And that takes money. We urge you to contribute to the hospital of your choice. Your help could mean a solution to many of today's most pressing medical concerns. The first of which is, quite frankly, funding.

Give To Your Local Hospital. Give To Life. 

National Association for Hospital Development

Sonic Sculptures, 636 Northland Blvd., Cincinnati, OH, 45240, (513) 851-0055, Pres.: Lan A. Ackley; Sales Mgr.: James Winget.

Type: CD.

Suttman Prods., PO Box 72, Dayton, OH, 45409, (513) 278-4601, Pres.: Eric J. Suttman.

Type: CD.

OREGON

Super Duper-Audio Duplicators, 3235 SE 39th Ave., Portland, OR, 97202, (503) 239-6070, Fax: (503) 239-0296, Pres.: Rick McMillen; Sales Mgr.: Todd Chatalas; Mktg. Dir.: Kevin Laurila.

Type: CD.

PENNSYLVANIA

American Helix, 1857 Colonial Village Ln., Lancaster, PA, 17601, (908) 367-8700, Contacts: Jim Boyer, Marc Feingold.

Type: CD.

Disc Makers, 1328 N. Fourth St., Philadelphia, PA, 19122, (800) 468-9353, (215) 232-4140, Fax: (215) 236-7763, Pres.: Morris Ballen; Sales/Mktg. Dir.: Tony Van Veen.

Type: CD.

Forge Recording Studios, Inc., PO Box 861, Byrne Bldg-Lincoln & Morgan Sts, Valley Forge, PA, 19481, (215) 935-1422, (800) 331-0405, Fax: (215) 935-1940, Pres.: Warren R. Wilson.

Type: CD.

Technetronics Assoc., 201 Carter Dr., Ste. 300, West Chester, PA, 19381, (215) 430-6800, Fax: (215) 430-6804, Pres.: Gene Bennett; Sales Mgr.: Rick Rohall.

Type: CD, CDV.

Virtue Recording & Video & Disc Mastering, 8809-11 Rising Sun Ave., Philadelphia, PA, 19115, (215) 763-2825, Pres.: Frank Virtue; Sales Mgr.: Mary Bozzi; Mktg. Dir.: Linda Vitacolonina.

Type: CD, Videodisk.

WEA Mtg., PO Box 321, Olyphant, PA, 18447, (717) 383-2471, Fax: (717) 383-2165, Contact: Dave Grant.

Type: CD.

PUERTO RICO

Disc Makers, Senda De La Posada N-6, Quintas Del Rio, Bayamon, PR, 00961, (809) 740-0010, Fax: (809) 785-5554, Sales Mgr.: David Rodriguez.

Type: CD.

TENNESSEE

Americ Disc Inc., 377 Riverside Dr., Ste. 302, Franklin, TN, 37064, (615) 791-0297, Fax: (615) 791-0298, Pres.: Pierre-A. Deschenes; Exec. Vice Pres.: Claude Fragman; Sales Dir.: Peter Miller.

Type: CD.

Custom Tape Duplicators, Inc., 341 Hill Ave., Nashville, TN, 37210, (615) 256-1728, Fax: (615) 256-6713, Pres.: Cliff Tant; Sales Mgr.: Tom James.

Type: CD.

West & Co., Inc., PO Box 24281, Nashville, TN, 37202, 1726-C General George Patton Dr., Brentwood, TN, 37027, (615) 661-5808, Fax: (615) 661-5905, Pres.: Jerry West; Sales Mgr.: Mike Young; Mktg. Dir.: Gary Campbell.

Type: CD.

TEXAS

Flash Int'l Ents., PO Box 580058, 16201 Buccaneer, Ste. 213, Houston, TX, 77062, (713) 488-1978, Pres./Mktg. Dir.: R.L. (Flash) Boudreaux.

Type: Videodisk.

Sound Recorders, Inc., 4031 Guadalupe, Austin, TX, 78751, (512) 454-8324, (800) 880-0270, Fax: (512) 454-5594, Pres.: Miles Muller; Sales Mgr.: Basil Thomas; Mktg. Dir.: Matt Wiedemann.

Type: CD.

VIRGINIA

Nimbus Records, Inc.

PO Box 7427, Charlottesville, VA, 22906, Sr 629, Guildford Farm, Ruckersville, VA, 22968, (804) 985-1100, Fax: (804) 985-4692, Exec. Vice Pres.: Gary Helfrecht; East Coast Sales Mgr.: Ric Sherman; West Coast Sales Mgr.: Sandy Richman; Mgr. of Manufacturing: Rob Lynch; Mgr. Customer Service: Kathy Vidunas.

Type: CD, CD ROM.

WORLDWIDE INDEPENDENCE...

With round-the-clock CD manufacturing facilities in the U.S. and Europe, one master tape and a phone call gets you quick turnaround with no problems

Best of all, Nimbus quality is good as gold!



Servicing the Independent Label in a Global Marketplace

Member of
NAIRD

Virginia Manufacturing Facility:	Phone 800-782-0778	Fax 804-985-4692
West Coast Sales (CA):	Phone 800-729-0932	Fax 818-783-7475
East Coast Sales (NJ):	Phone 800-451-8725	Fax 201-379-4883
U.K. Manufacturing (Monmouth):	Phone (0600) 890 682	Fax (0600) 890 779



The Queen's Award for
Technological Achievement

PLATING & PRESSING PLANTS

CALIFORNIA

Alshire Int'l, Inc., 1015 Isabel St., Burbank, CA, 91506, (310) 849-4671, (818) 843-6792, Fax: (818) 569-3718, Pres.: Al Sherman; Sales Mgr.: Richard Sherman; Custom Dept.: Mark Beckwith. (LP's)

C.D.M. (Clarified Digital Mastering), PO Box 76848, Los Angeles, CA, 90076, 4007 W. Sixth St., Los Angeles, CA, 90020, (213) 383-2155, Fax: (213) 383-2158, Pres.: Hank Waring; Mktg. Dir.: Paul Delliquadri. (Videodisk)

Diectronics, 3800 Barham Blvd., Ste. 102, Los Angeles, CA, 90068, (213) 851-7300, Fax: (213) 851-7579, Exec. Vice Pres./CD Mktg.: Cal Roberts; Sales Mgr.: Mort Weiner.

Erika Records, Inc.

PO Box 4916, 13909 Artesia Blvd., Cerritos, 90703, (310) 926-8992, Fax: (310) 926-9987, Pres.: Elizabeth Dunster; Mktg. Dir.: Sandy Gallardo. (LP's, Color Records, Shpes, Picture Records).

F.D.S. Labs, Inc., PO Box 76848, Los Angeles, CA, 90076, 4007 W. Sixth St., Los Angeles, CA, 90020, (213) 383-2155, Fax: (213) 383-2158, Pres.: Hank Waring; Mktg. Dir.: Paul Delliquadri. (Videodisk)

G.S.P. Metals & Chemicals Corp., 2535 E. 28th St., Los Angeles, CA, 90058, (213) 582-0685, Fax: (213) 582-4527, Pres.: Shepard Drazin; Sales Mgr.: David Baker.

K M Records, Inc., 2980 N. Ontario St., Burbank, CA, 91504, (818) 841-3400, Fax: (818) 845-6478, Vice Pres./Sales Dir.: William J. Riley. (LP's)

Kidac Mastering Studios, 6550 Sunset Blvd., Hollywood, CA, 90028, (213) 466-1323, Fax: (213) 466-7237, Pres.: Bill Lightner; Office Mgr.: Julie Gach.

Keyser-Century Corp., 26000 Springbrook Ave., Saugus, CA, 91350, (805) 259-2360, Fax: (805) 259-7937, Pres.: Howard Hill; Mktg. Dir.: Paul Merrigan.

James G. Lee Record Processing, 145 W. 154th St., Gardena, CA, 90248, (213) 321-2187, Pres.: Donald Wheehelon; Sales Mgr.: Edward Tobin Jr.

Macola Record Group, Inc., 8831 Sunset Blvd., Ste. #202, West Hollywood, CA, 90069, (213) 659-6036, Fax: (213) 659-6039, Pres.: Donald MacMillan; Sales Mgr.: James Takeda; Mktg. Dir.: Lee Denton. (LP's)

Optical Media Int'l, 485 Alberto Way, Ste. 115, Los Gatos, CA, 95032, (408) 395-4332, Fax: (408) 395-6544, Pres.: Allen Adkins; Sales Mgr.: Myra Arnstein; Mktg. Dir.: Syl Peser.

PDO (Phillips and Du Pont Optical Company), 3815 W. Olive Ave., Ste. 202, Burbank, CA, 91505, (818) 848-2442, Fax: (818) 848-3090, Vice Pres. Sales: Spence Berland. (Videodisk)(Type: LV)

Pioneer LDCA, Inc., 2265 E. 220th St., Long Beach, CA, 90810, (213) 746-6337, Fax: (213) 816-0402, Pres.: Tetsuro Kudo; Sales Mgr.: Rick Buehler; Mktg. Dir.: David Wallace. (Videodisk)(Type: LV)

RTI Record Technology, Inc., 486 Dawson Dr., Camarillo, CA, 93012, (805) 484-2747, Fax: (805) 987-0508, Pres.: William Bauer; Sales Mgr.: Don MacInnis. (LP's)

Rainbo Records & Cassettes, 1738 Berkeley St., Santa Monica, CA, 90404, (213) 829-0355, Fax: (213) 828-8765, Pres.: Jack G. Brown; Gen. Mgr.: Steve Sheldon. (LP's)

Bill Smith Custom Records, Inc., 127 Penn St., El Segundo, CA, 90245, (213) 322-6386, Fax: (213) 322-1813, Pres.: Bill Smith; Sales Mgr.: Kevin Smith; Mktg. Dir.: Beth Smith. (LP's)

Virco Recording Co., Inc., 700 S. Dale Ave., Alhambra, CA, 91803, (213) 283-1888, Fax: (818) 281-5901, Pres.: Virginia C. Watts.

WEA Mfg., Inc., 3601 W. Olive Ave., Ste. 420, Burbank, CA, 91505, (818) 953-2941, Sr. Vice Pres. Mktg.: David L. Brown. (LP's)

FLORIDA

Allied Film & Video, 4364 35th St., Orlando, FL, 32811, (407) 649-0008, Fax: (407) 849-9005, Pres.: Bill Smith; Sales/Mktg. Mgr.: Richard Skillman. (Videodisk)(Type: CED, LV)

Alpha Records, Inc., PO Box 15011, Fort Lauderdale, FL, 33318, 1400 NW 65th Ave., Fort Lauderdale, FL, 33313, (305) 587-8011, Pres.: Richard Smith; Sales Mgr.: Barbara Smith. (LP's)

Eva-Tone, Inc., 4801 Ulmerton Rd., Clearwater, FL, 34622, (813) 382-8663, Fax: (813) 572-6214, Pres.: Richard E. Evans; Printing Sales Mgr.: Dick Evans; Audio: Norman H. Welch Jr. Miami Tape, Inc., 8180 NW 103 St., Hialeah Gardens, FL, 33016, (305) 558-9211, Fax: (305) 825-9873, Pres.: Carlos O. Garcia; Sales Mgr.: Mirella Tunon. (LP's)

GEORGIA

Georgia Record Pressing, 262 Rio Cir., Decatur, GA, 30030, (404) 373-2673, Fax: (404) 373-0950, Pres.: Hugh West; Sales Mgr.: James C. Ayers. (LP's)

Hottrax Records, 1957 Kilburn Dr., Atlanta, GA, 30324, (404) 662-6661, Pres.: Aleck Janouli; Sales Mgr.: Hamilton Underwood; Mktg. Dir.: Teri Blackman. (LP's)

ILLINOIS

Duplicates, 11 E. Hubbard St., Chicago, IL, 60611, (312) 822-0305, Fax: (312) 464-0762, Pres.: Michael A. Freeman. (LP's)

INDIANA

Digital Audio Disc Corp., PO Box 3710, Terre Haute, IN, 47803, 1800 N. Fruitridge Ave., Terre Haute, IN, 47804, (812) 462-8100, Fax: (812) 466-9125, Chrmn./CEO: James Frische; Vice Pres./Mktg. Dir.: Scott Bartlett. (Videodisk)

electro sound, inc., 1805 W. Rt. 44, Shelbyville, IN, 46176, (317) 392-1656, Sr. Vice Pres. Sales: Hugh Landy; Gen. Mgr.: Curt Albright.

LOUISIANA

Ville Platte Record Mfg. Co., PO Drawer 10, 120 E. Cypress St., Ville Platte, LA, 70586, (318) 363-2104, Fax: (318) 363-5622, Pres./Sales Mgr.: James Floyd Soileau; Sales Mgr.: Peggy Fontenot. (LP's)

MAINE

U.S. Optical Disc, Inc., One Eagle Dr., Sanford, ME, 04073, (207) 324-1124, Dir. Mktg.: Michael Rosenbaum.

MICHIGAN

Audio Graphics Services, 1516 Ferris Ave., Royal Oak, MI, 48067, (313) 544-1793, Pres.: E. J. Wolfrum; Sales/Mktg. Dir.: Walter Wolfrum.

MINNESOTA

3M Optical Recording Department, 3M Center Bldg.,

223-5N-01, Saint Paul, MN, 55144, (612) 733-2142, Fax: (612) 733-0158, Sales Mgr.: Vivian Ebersman; Mgr. Pre-recorded Bus.: David H. Wenck; Mktg. Mgrs.: Jon Hove & Mark Arps. (Videodisk)(Type: LV)

MISSOURI

Audio Duplication & Services, Inc., PO Box 31546, 1927 Boaz, Saint Louis, MO, 63131, (314) 965-8895, Fax: (314) 965-8895, Pres.: Richard Schaumberger Jr. (LP's)

Premier Film & Recording Corp., 3033 Locust St., Saint Louis, MO, 63042, (314) 531-3555, Fax: (314) 726-8798, Pres.: Wilson Dalzell; Sales Mgr.: Donna Blue; Mktg. Dir.: Bob Heuermann. (LP's)

NEW JERSEY

D & G Mastering, PO Box 175, Englishtown, NJ, 07726, (908) 446-2411, Pres.: Don Van Gorden. (LP's)

Hub-Servall Record Mfg. Corp., Cranbury Rd., Cranbury, NJ, 08512, (609) 655-2166, Fax: (609) 655-8749, Sales Mgr.: Barry Rugg; Customer Service Mgr.: Jo Corbett. (LP's)

Nimbus Records CD Mfg. East Coast Sales, 66 Spenser Dr., Short Hills, NJ, 07078, (201) 379-2890, (800) 451-8725, Fax: (804) 985-4692, East Coast Dir. Sales: Ric Sherman; Sales Coord.: Susan High.

Sun Plastics Co., Inc./Dynamic LP Stereo Record Pressing Co., Inc.

534 Passaic Ave., East Newark, NJ, 07029, (201) 462-6749, (212) 349-0977, Pres.: Jerry Salerno; Sales Mgr.: Vicky Salerno; Mktg. Dir.: Jerry R. Salerno. (LP's)

Superior Record Pressing Corp. West, 901 E. Clements Bridge Rd., Runnemede, NJ, 08078, (609) 784-0626, Pres.: J. H. Dunn.

Tracy-Val Corp., 201 Linden Ave., Somerdale, NJ, 08083, (609) 627-3000, Pres.: James Miller; Sales Mgr.: Joan Miller. (LP's)

NEW YORK

Athena Prodn., 311 Willowbrook Rd., Staten Island, NY, 10314, (718) 698-2280, Fax: (718) 761-6411, Sales Mgr.: Robert Marino. (LP's)

Audio Matrix, Inc., 400 Madison Ave., New York, NY, 10017, (212) 308-6888, Fax: (212) 308-5817, Pres./Mktg. Dir.: Milton B. Gelfand; Sales Mgr.: Perry Jambor; Technician: Gus Grafeo. (Videodisk)

Dick Charles Mastering, 130 W. 42nd St., #1106, New York, NY, 10036, (212) 819-0920, Fax: (212) 768-7822, Pres.: Dick Charles.

Columbia Record Prodn., 51 W. 52nd St., New York, NY, 10019, (212) 445-8203, Fax: (212) 445-8119, Sales Mgr.: Robert Fernandez; Vice Pres.: Anthony Formichelli. (LP's)

The Cutting Edge Disc Mastering, Box 217, Ferndale, NY, 12734, (914) 292-5965, Fax: (914) 292-2313, Pres.: Paul Gerry; Sales Mgr./Mktg. Dir.: Patricia Gerry. (LP's)

Disc Makers, 1650 Broadway, Ste. 1010, New York, NY, 10019, (212) 265-7505, Fax: (212) 262-0798, Sales Mgr.: Howard Roseff. (LP's)

Disk Manufacturing, Inc., 441 Lexington Ave., Ste. 803, New York, NY, 10017, (212) 599-5300, Fax: (212) 599-3227, Sales Contact: John Mangini.

Eastern Standard Prodn., Inc., 26 Baxter St., Buffalo, NY, 14207, (800) 527-9225, (716) 876-1454, Fax: (716) 877-6395, Pres.: Mark S. Mekker; Vice Pres. Sales/Mktg.: Deborah Mekker; Customer Service: Teresa M. Fay. (LP's)

ElectroSound Group, Inc., 888 Seventh Ave., New York, NY, 10106, (212) 757-3097, (212) 757-3149, Fax: (212) 581-6102, Pres.: Dick Protain; Vice Pres. Sales: Hugh Landy. (LP's)

ElectroSound Group, Inc., 1290 Motor Pkwy., Hauppauge, NY, 11788, (516) 234-2010, Fax: (516) 234-2384, Pres.: Richard Projain; Vice Pres./Dir. Mktg.: Hugh T. Landy. (LP's)

Europadisk, Ltd., 75 Varick St., New York, NY, 10013, (212) 226-4401, Fax: (212) 966-0456, Pres.: James P. Shelton; Sales Mgr.: Jeremy Guttenberg.

Frankford/Wayne Mastering Labs, Inc., 1697 Broadway, Ste. #1404, New York, NY, 10019, (212) 582-5473, Fax: (212) 245-2309, Pres.: Thomas S. Steele; Sales Mgr.: Jimmy Lee; Mktg. Dir.: Carol Steele.

Int'l Recording Co., 49 Desmond Ave., Bronxville, NY, 10708, (914) 337-5726, Pres.: Claire M. Rie. (LP's)

Mastercraft Record Plating, Inc., 609 W. 51st St., New York, NY, 10019, (212) 410-3214.

The Music Connection, Inc., 175 Fifth Ave., New York, NY, 10010, (212) 529-0557, Pres.: R. Ralton; Sales Mgr.: Ira Cohen; Vice Pres.: Fred Levy. (LP's)

Music Doctors Ltd., Inc., 130 W. 42nd St., Ste. 551, New York, NY, 10036, (212) 382-1234, Fax: (212) 382-1241, Sales Mgr.: David Moldauer. (LP's)

Romaba Record Pressing Corp. of America, 33-34th St., Brooklyn, NY, 11232, (718) 499-3060, Fax: (718) 499-3061, Pres.: Theodore E. Kolsky; Vice Pres.: Dara Kolsky; Sales Mgr.: Vicki M. Guerra; Mktg. Dir.: Jennifer Kolsky. (LP's)

Sunshine Sound, Inc., 1650 Broadway, New York, NY, 10019, (212) 582-6227, Pres.: Frank J. Trimarco. (LP's)

Variety Recording Studio, 130 W. 42nd St., Ste. 551, New York, NY, 10036, (212) 221-6625, Fax: (212) 382-1241, Pres.: Herman Vargas. (LP's)



Sun Plastics Company, Inc.
Dynamic L.P. Record Pressing Co., Inc.

900 Passaic Avenue East Newark, N.J. 07029
Phones: N.J. 201-482-6749 • N.Y. 212-349-0977

46 YEARS OF SERVICE TO THE RECORD INDUSTRY

Complete Cassette Duplication Service Now Available
Jerry Salerno, President Vicky Salerno, Secretary

WEA Mfg., Inc., 75 Rockefeller Plaza, New York, NY, 10019,
(212) 399-8831, Vice Pres. Sales Services: David A. Grant.
(LP's)

NORTH CAROLINA

Sonopress, Inc., 108 Monticello Rd., Weaverville, NC, 28787,
(704) 658-2000, Fax: (704) 658-2008, CEO: Johannes Mohn;
Vice Pres. Sales/Mktg.: Dieter Baier, Client Services Super-
visor: Don Fiscus.

OHIO

Discovery Systems, 7001 Discovery Blvd., Dublin, OH, 43017,
(614) 761-2000, Fax: (614) 761-4258, Pres.: Jeffrey Wilkins;
Mktg. Dir: Mary Vaughn; Vice Pres. Sales: Michael Ward.
Jewel Records, 1594 Kinney Ave., Cincinnati, OH, 45231, (513)
522-9336, Fax: (513) 522-9915, Pres.: Rusty York; Sales Mgr.:
Rick Hopkins. (LP's)
Musicol, Inc., 780 Oakland Park Ave., Columbus, OH, 43224,
(614) 267-3133, Pres.: John W. Hull; Sales Mgr.: Warren Hull;
Mktg. Dir.: Charlene Hull. (LP's)
QCA, Inc., 2832 Spring Grove Ave., Cincinnati, OH, 45225,
(513) 681-8400, Fax: (513) 681-3777, Pres.: Jim Bosken; Sales
Mgr.: Amber Hines; Mktg. Dir: Rusty Sweeney. (LP's)
Sonic Sculptures, 636 Northland Blvd., Cincinnati, OH,
45240, (513) 851-0055, Pres.: Lan A. Ackley; Sales Mgr.:
James Winget. (LP's)

PENNSYLVANIA

Disc Makers, 1328 N. Fourth St., Philadelphia, PA, 19122, (800)
468-9353, (215) 232-4140, Fax: (215) 236-7763, Pres.: Morris
Ballen; Sales/Mktg. Dir.: Tony Van Veen. (LP's)
Technetronics Assoc., 201 Carter Dr., Ste. 300, West Chester,
PA, 19381, (215) 430-6800, Fax: (215) 430-6804, Pres.: Gene
Bennett; Sales Mgr.: Rick Rohall.
Virtue Recording & Video & Disc Mastering, 8809-11 Rising
Sun Ave., Philadelphia, PA, 19115, (215) 763-2825, Pres.:
Frank Virtue; Sales Mgr.: Mary Bozzi; Mktg. Dir: Linda
Vitacolonia. (LP's, Videodisk)

WEA Mfg.

PO Box 321, Olyphant, PA, 18447, (717) 383-2471, Fax: (717)
383-2165, Contact: Dave Grant. (LP's)

PUERTO RICO

Disc Makers, Senda De La Posada N-6, Quintas Del Rio,
Bayamon, PR, 00961, (809) 740-0010, Fax: (809) 785-5554,
Sales Mgr.: David Rodriguez. (LP's)

TENNESSEE

Custom Tape Duplicators, Inc., 341 Hill Ave., Nashville, TN,
37210, (615) 256-1728, Fax: (615) 256-6713, Pres.: Cliff Tant;
Sales Mgr.: Tom James.
Dixie Record Pressing, Inc., 631 Hamilton Ave., Nashville, TN,
37203, (615) 256-0922, Fax: (615) 242-8956, Pres.: James B.
Gann. (LP's)

TEXAS

A + R Record & Tape Mfg. Co., 902 N. Industrial Blvd., Dallas,
TX, 75207, (214) 741-2027, Fax: (214) 638-6801, Pres.: Richard
Sobel; Sales Mgr.: Stan Getz II; Mktg. Dir.: Maxine Sobel.
(LP's)
Destiny Media, Ind. dba DMI Record Mfg., 1422 W. Poplar
St., San Antonio, TX, 78207, (512) 732-6176, Fax: (512)
732-6199, Pres.: Jerold B. Johnson; Sales Mgr.: Joey
Rodriguez. (LP's)
Merlin Galvanic Co., 2686 Myrtle Springs, Dallas, TX, 75220,
(214) 358-0306, Pres.: Eddie Gorecki. (LP's)
Houston Records, Ltd., 3300 Jensen Dr. Houston, TX, 77026,
(713) 223-5971, Pres.: Chris Puccio; Sales Mgr.: Steve Puc-
cio. (LP's)

WEST VIRGINIA

Jim McCoy Prods., Rt. 2, Box 114, Berkeley Springs, WV,
25411, (304) 258-2175, Pres.: Jim McCoy; Mktg. Dir.: Bertha
McCoy. (LP's)

WYOMING

Rocky Mountain Recording, 8305 Christensen Rd.,
Cheyenne, WY, 82009, (307) 638-8733, Pres.: Ray Alexander;
Sales Mgr.: Georgia Alexander. (LP's)

MASTERING FACILITIES

ARIZONA

Vaughn Duplication Services, 3802 E. University Dr., Ste. #2,
Phoenix, AZ, 85034, (602) 437-5344, Fax: (602) 437-3718, Vice
Pres./Gen. Mgr.: Donald Drapeau; Sales Mgr.: Bob
Mercer/Susan Ulrich; Mktg. Dir: Michelle Sahlin; Regional
Mgr.: Jim Lawson. (Video)
Video Media Prodn.s., 2727 W. Southern Ave., Tempe, AZ,
85282, (602) 966-6545, Fax: (602) 438-2238, Pres.: Jim
Rinkenberger; Mktg. Dir.: Jim Pangborn. (Video)

CALIFORNIA

ASR Recording Services of California, 8960 Eton Ave.,
Canoga Park, CA, 91304, (818) 341-1124, Fax: (818) 341-9131,
Pres. (Mfg.): Allen Weintraub; Vice Pres./Sales: Lester P. Ed-
wards. (Audio)
Aishire Int'l, Inc., 1015 Isabel St., Burbank, CA, 91506, (213)
849-4671, (818) 843-6792, Fax: (818) 569-3718, Pres.: Al Sher-
man; Sales Mgr.: Richard Sherman; Custom Dept.: Mark
Beckwith. (Audio)
Audio Cassette Duplicator Co., 12426-1/2 Ventura Blvd.,
Studio City, CA, 91604, (818) 762-2232, Fax: (818) 508-8077,
Owners: Steve Katz, Steve Mitchell. (Audio)
Bauer Communications, Inc., 6887 Farmdale Ave., Bldg. 12,
North Hollywood, CA, 91605, (800) 627-7277, Fax: (818)
894-0715, Pres.: Jim Bauer. (Audio)
C.D.M. (Clarified Digital Mastering), PO Box 76848, Los
Angeles, CA, 90076, 4007 W. Sixth St., Los Angeles, CA,
90020, (213) 383-2155, Fax: (213) 383-2158, Pres.: Hank War-
ing; Mktg. Dir.: Paul DelliQuadri. (Audio)
CMS Digital, Inc., 182 S. Raymond Ave., Pasadena, CA, 91105,
(818) 405-8002, Fax: (818) 796-4319, Pres.: John Codenhead;
Sales Mgr.: Gene Shiveley. (Audio)
Cassette Prodn.s. Unlimited, Inc., 5796 Martin Rd., Irwindale,
CA, 91706, (818) 969-6881, Fax: (818) 969-8403, Pres.: Jeffrey
E. Baker; Exec. Vice Pres./Mktg. Dir.: Mark R. Ashland; Sales
Mgr.: Richard A. Guthy. (Audio & Video)
Davkore Co., 1300-A Spacepark Way, Mountain View, CA,
94043, (415) 969-3030, Fax: (415) 969-0140, Pres.: C.W. Web-
ber; Sales Mgrs./Mktg. Dirs.: Tom Sherry, Jeanne Horan.
(Audio)
Different Fur Digital, 3470 19th St., San Francisco, CA, 94110,
(415) 864-1967, Pres.: Howard Johnston; Vice Pres./Gen.
Mgr.: Susan Skaggs. (Audio)



WEA MANUFACTURING
210 North Valley Avenue
Olyphant, PA 18447
Telephone: (717) 383-2471

Allied Records Corporation
Los Angeles, CA 90040
Specialty Records Corporation
Olyphant, PA 18447

EXPERIENCE & INNOVATION

Compact Disc, Cassette, Record & Laser Disc Replication

As manufacturers for the Warner Music Group as well as a host of other labels, WEA Manufacturing has established an unparalleled tradition of excellence. This standard-setting quality we've brought to some of the world's finest music and entertainment software is now within your reach. Our industry-leading compact disc, cassette, record and laser disc replication services can be put to work for you. Call us today and find out how we can help your product sound and look its best.

WEA Manufacturing is proud to feature

digalog™

the ultimate state-of-the-art cassette tape duplication process

© 1991 WEA Manufacturing, Inc. A Time Warner Company.

DigiPrep, 1425 N. Cole Pl., Hollywood, CA, 90028, (213) 461-1709, Fax: (213) 461-8890, Partner: Warren Salyer. (Audio)
 Diner + Allied, 620 Third St., San Francisco, CA, 94107, (415) 777-1700, Fax: (415) 957-1842, Pres.: William H. Smith; Div. Mgr.: Chuck Berg. (Video)

District, 3800 Barham Blvd., Ste. 102, Los Angeles, CA, 90068, (213) 851-7300, Fax: (213) 851-7579, Exec. Vice Pres./CD Mktg.: Cal Roberts; Sales Mgr.: Mort Weiner. (Audio)

Dubs Inc., 1220 N. Highland Ave., Hollywood, CA, 90038, (213) 461-3726, Vice Pres. Mktg.: Dick Millalass. (Video)

F.D.S. Labs, Inc., PO Box 76848, Los Angeles, CA, 90076, 4007 W. Sixth St., Los Angeles, CA, 90020, (213) 383-2155, Fax: (213) 383-2158, Pres.: Hank Waring; Mktg. Dir.: Paul Delliquadri. (Audio)

Fast Forward, 1025 Sansome St., San Francisco, CA, 94111, (415) 989-6245, Fax: (415) 989-0349, Pres./Mktg. Dir.: Paul Grippaldi; Sales Mgr.: Jay Hack. (Video)

52nd Street Studios, 1741 N. Ivar Ave., Los Angeles, CA, 90065, (213) 463-5252, Fax: (213) 465-2079, Pres.: Neil B. Posner; Sales Mgr.: Stuart A. Yahm; Account Executive: Michael Abraham. (Audio)

Gregory Fulginiti Co., 1541 N. Wilcox, Hollywood, CA, 90028, (213) 466-6444, Pres.: Gregory Fulginiti. (Audio)

Future Disc Systems, Inc., 3475 Cahuenga Blvd. W., Hollywood, CA, 90068, (213) 876-8733, Fax: (213) 876-8143, Pres.: Gary Rice; Sales Mgr.: Susan West. (Audio)

Good Vibrations Recording & Prodn. Co., PO Box 764, 4050 Troon Way, Bonita, CA, 92002, (619) 267-0307, Partner: Don Marshall. (Audio)

K M Records, Inc., 2980 N. Ontario St., Burbank, CA, 91504, (818) 841-3400, Fax: (818) 845-6478, Vice Pres./Sales Dir.: William J. Riley. (Audio)

Kdisc Mastering Studios, 6550 Sunset Blvd., Hollywood, CA, 90028, (213) 466-1323, Fax: (213) 466-7237, Pres.: Bill Lightner; Office Mgr.: Julie Gach. (Audio)

The Mastering Lab, 6033 Hollywood Blvd., Hollywood, CA, 90028, (213) 466-8589, Fax: (213) 465-7570, Studio Mgr.: Shannon Ahern. (Audio)

Maxi Cassette Prodn., Inc., 1442 E. Arrow Hwy., Unit P, Irwindale, CA, 91706, (818) 358-1844, (800) 344-6294, Fax: (818) 357-1666, Pres./Mktg. Dir.: Michael T. Aris; Sales Mgr.: Ken Guilford. (Audio)

Mobile Fidelity Sound Lab, 1260 Holm Rd., Petaluma, CA, 94954, (707) 778-0134, Fax: (707) 778-6532, Pres.: Herbert A. Belkin; Sales Mgr.: James G. Benz; Mktg. Dir.: Phyllis Schwartz; VP Product Development: Michael Grantnam. (Audio)

Morris Media & TV, 2730 Monterey St., Ste. 105, Torrance, CA, 90503, (213) 533-4800, Fax: (213) 533-1993, Chrmn.: George Morris; Pres.: Dawn Morris; Sales Mgr.: Roger Casas; Mktg. Dir.: Bruce Barton. (Video)

Optical Media Int'l, 485 Alberto Way, Ste. 115, Los Gatos, CA, 95032, (408) 395-4332, Fax: (408) 395-6544, Pres.: Allen Adkins; Sales Mgr.: Myra Arstein; Mktg. Dir.: Syl Peser.

Pioneer LDCA, Inc., 2265 E. 220th St., Long Beach, CA, 90810, (213) 746-6337, Fax: (213) 816-0402, Pres.: Tetsuro Kudo; Sales Mgr.: Rick Buehler; Mktg. Dir.: David Wallace.

Prairie Sun Recording Studio, PO Box 7084, Cotati, CA, 94931, 1039 Madrone Ave., Cotati, CA, 94928, (707) 795-7011, Pres./Mktg. Dir.: Mark "Mooka" Rennick; Opns. Mgr.: Jeffrey Sloan. (Audio)

Pro Video, 801 N. La Brea Ave., Hollywood, CA, 90038, (213) 934-8840, Fax: (213) 934-8837, Pres.: Joel Webb.

Quadrim Corp., 31542 Rustic Oak Dr., Westlake Village, CA, 91361, (818) 706-8843, Fax: (818) 706-8426, Pres.: Guy Costa. (Audio)

RTI, Record Technology, Inc., 486 Dawson Dr., Camarillo, CA, 93012, (805) 484-2747, Fax: (805) 987-0508, Pres.: William Bauer; Sales Mgr.: Don MacInnis. (Audio)

Rainbo Records & Cassettes, 1738 Berkeley St., Santa Monica, CA, 90404, (213) 829-0355, Fax: (213) 828-8785, Pres.: Jack G. Brown; Gen. Mgr.: Steve Sheldon. (Audio)

Bill Rase Prodn., Inc., 955 Venture Ct., Sacramento, CA, 95825, (916) 929-9181, Fax: (916) 929-4751, Pres./Sales Mgr.: Bill Rase; Mktg. Dir.: Esther Manchoff; Sec./Tres.: Shirley Rase. (Audio & Video)

Rose Studios, 1098 Rose Ave., El Centro, CA, 92243, (619) 352-5774, Pres.: Danny Berg. (Audio)

Soundworks West, Ltd., 7317 Romaine St., West Hollywood, CA, 90046, (213) 850-1510, Fax: (213) 874-1420, Pres.: Alan Ramer; Studio Mgr.: Beth Reinstein. (Audio)

Tapete Corp., 15702 Producer Ln., Huntington Beach, CA, 92649, (714) 638-7960, Fax: (714) 891-0638, Pres.: James Neiger II; Sales Mgr.: Stewart Schlosberg; Mktg. Dir.: Mary Neiger. (Audio & Video)

United Audio Video Group, Inc., 6855 Vineland Ave., North Hollywood, CA, 91605, (818) 980-6700, Fax: (818) 508-8273, Pres.: Miriam Newman; Vice Pres. Prodn.: Steve Newman; Sales Mgr.: Larry Schwartz; Mktg. Dir.: Laurie Newman. (Audio & Video)

Howard Valentine Sound Services, 6263 Leland Way, Hollywood, CA, 90028, (213) 464-8888, Owner: Howard Valentine. (Audio)

Vaughn Duplication Services, 1201 N. Latrobe, Ste. 103, Los Angeles, CA, 90069, (213) 652-1253, Vice Pres.: Donald Drapeau; Sales: Brendan Cahill; Mktg. Dir.: Michelle Sahlin. (Video)

Virco Recording Co., Inc., 700 S. Date Ave., Alhambra, CA, 91803, (213) 283-1888, Fax: (818) 281-5901, Pres.: Virginia C. Watts. (Audio)

WEA Mtg., Inc., 3601 W. Olive Ave., Ste. 420, Burbank, CA,

91505, (818) 953-2941, Sr. Vice Pres. Mktg.: David L. Brown. (Audio)

DELAWARE

Nat'l Tape Duplicators, 1500 First State Blvd., Prodn. Center, Wilmington, DE, 19804, (302) 999-1110, Fax: (302) 999-1656, Pres.: H. Edwin Kennedy; Sales Mgr.: Shirley Kay; Mktg. Dir.: S. Lotz; Prodn. Mgr.: William Burgess III. (Audio & Video)

DISTRICT OF COLUMBIA

Multitape, 1630 Euclid St., NW, Ste. 131, Washington, DC, 20009, (202) 332-1522, Fax: (202) 462-1163, Pres./Mktg. Dir.: Bruce Moyer; Sales Mgr.: Julie Spicer. (Audio)

FLORIDA

Allied Film & Video, 4364 35th St., Orlando, FL, 32811, (407) 649-0008, Fax: (407) 649-9005, Pres.: Bill Smith; Sales/Mktg. Mgr.: Richard Skillman. (Video)

DER Duplicating Services Inc., 212 NW Fourth Ave., Hallandale, FL, 33009, (305) 458-7505, Fax: (305) 458-8554, Pres.: Mike Rubin; Sales Mgr.: Allan Baird. (Video)

Digital 1, 658 Douglas Ave., Altamonte Springs, FL, 32714, (407) 682-7790, Pres.: Jon Phelps; Sales/Mktg. Dir.: Batt Donovan. (Audio)

Eva-Tone, Inc., 4801 Ulmerton Rd., Clearwater, FL, 34622, (813) 382-8663, Fax: (813) 572-6214, Pres.: Richard E. Evans; Printing Sales Mgr.: Dick Evans; Audio Sales Mgr.: Norman H. Welch, Jr. (Audio)

Fullersound, Inc., 1755 NE 149th St., Miami, FL, 33181, (305) 945-6697, Pres.: Michael Fuller.

Kinura Records, PO Box 660236, Miami Springs, FL, 33166, (305) 887-5329, Pres.: C. R. Hertzburg. (Audio)

Magnetix Corp., 770 W. Bay St., Winter Garden, FL, 34787, (407) 656-4494, Fax: (407) 656-4825, Pres.: John Lory. (Audio)

Miami Tape, Inc., 8180 NW 103 St., Hialeah Gardens, FL, 33016, (305) 558-9211, Fax: (305) 825-9873, Pres.: Carlos O. Garcia; Sales Mgr.: Mirella Tunon. (Audio)

Mirror Image Sound & Recording, Inc., 619 S. Main St., Gainesville, FL, 32601, (904) 378-8742, Prodn. Mgr.: Ray Valla. (Audio)

Vaughn Duplication Services, 5414 Beaumont Center Dr., Ste. 202, Tampa, FL, 33634, (813) 889-0182, Fax: (813) 889-0182, Vice Pres.: Donald Drapeau; Sales Mgr.: Kenneth Cheek; Mktg. Dir.: Michelle Sahlin; Sales Rep.: Ric Everett; Sales Rep.: Rick Mabeus. (Video)

GEORGIA

Holtrax Records, 1957 Kilburn Dr., Atlanta, GA, 30324, (404) 662-6661, Pres.: Aleck Janoulis; Sales Mgr.: Hamilton Underwood; Mktg. Dir.: Teri Blackman.

Project 70 Audio Services, Inc., 777 Lambert Dr., NE, Atlanta, GA, 30324, (404) 875-7000, Fax: (404) 875-7007, Pres.: Jerry L. Connell. (Audio)

Video Copy Services, Inc., 1699 Tullie Cir., Ste. #117, Atlanta, GA, 30329, (404) 321-6933, (800) 553-3616, Fax: (404) 321-4876, Pres.: Tim Harris. (Video)

ILLINOIS

Acme Recording, 1708 W. Belmont, Chicago, IL, 60657, (312) 477-7333, Pres.: Jim Rasfeld; Sales Mgr.: Mike Beck. (Audio)
 Allied Film & Video, Chicago Div., 1322 W. Belmont Ave., Chicago, IL, 60657, (312) 348-0373, Fax: (312) 348-5669, Div. Mgr.: Grant Ireland. (Video)

Anvid Recording Co., PO Box 8130, Bartlett, IL, 60103, 69 S. LaSalle St., Aurora, IL, 60505, (708) 837-9840, Fax: (708) 897-6998, Pres.: David Schuler. (Audio)

Duplicates, 11 E. Hubbard St., Chicago, IL, 60611, (312) 822-0305, Fax: (312) 464-0762, Pres.: Michael A. Freeman. (Audio)

Intervideo Duplication Services, 3533 S. Archer Ave., Chicago, IL, 60609, (312) 927-9091, Fax: (312) 927-9211, Pres./Sales Mgr.: Peter Bernotas. (Video)

Jor-Dan, Inc., 1100 Wheaton Oaks Ct., Wheaton, IL, 60187, (708) 653-1919, Fax: (708) 665-4966, Vice-Pres.: Dan Zimbelman. (Audio)

Major Media, Inc., 3326 Commercial Ave., Northbrook, IL, 60062, (708) 498-4610, Pres.: Jay Steinberg. (Audio & Video)

Renaissance Video Corp., 130 S. Jefferson, Chicago, IL, 60661, (312) 930-5000, Fax: (312) 930-9030, Pres.: Eric Thurman; Sales Mgr.: Patrick Sweeney; Operations Mgr.: Gene Cosentino. (Video)

Session Masters, Inc., 25 W. 360 Geneva Rd., Unit 4, Wheaton, IL, 60188, (708) 653-1516, Fax: (708) 653-1517, Pres.: Christine Zack; Engineer: Mark Richardson. (Audio)

INDIANA

ARP Media Ents., 1600 Rich Rd., Richmond, IN, 47374, (317) 962-9511, Fax: (317) 962-1564, Pres.: David Ambault; Sales/Mktg. Dir.: Albert R. Santoro. (Audio)

Digital Audio Disc Corp., PO Box 3710, Terre Haute, IN, 47803, 1800 N. Fruitridge Ave., Terre Haute, IN, 47804, (812) 462-8100, Fax: (812) 466-9125, Chrmn./CEO: James Frische; Vice Pres./Mktg. Dir.: Scott Bartlett. (Audio & Video)

Bud Pressner Music & Recording Service, 6860 Broadway, Merrillville, IN, 46410, (219) 769-0011, Pres.: Bud Pressner. (Audio)

WMG, Inc. (World Media Group), 8472 Brookville Rd., Indianapolis, IN, 46239, (317) 353-1113, Fax: (317) 353-0750, Pres.: J.A. Meilentine; Sales Mgr.: Curt Albright. (Audio)

KANSAS

R.S.R.T., 4020 Stalene, Kansas City, KS, 66103, (913) 262-5335, Fax: (913) 262-5364, Pres./Sales Mgr.: Royal Scanlon; Prodn. Mgr.: Dan Shanks. (Audio)

KENTUCKY

Alpha Recording, Inc., PO Box 740, Elizabethtown, KY, 42701, (502) 765-7899, Fax: (502) 765-3734, Pres.: Jim Cottrell; Sales Mgr.: Don Cottrell; Mktg. Dir.: Lori Hawk; Studio Mgr.: Mark Goodman. (Audio & Video)

MAINE

U.S. Optical Disc, Inc., One Eagle Dr., Sanford, ME, 04073, (207) 324-1124, Dir. Mktg.: Michael Rosenbaum. (Audio)

MARYLAND

Allied Film & Video, Maryland Div., 5840 Kirby Rd., Clinton, MD, 20735, (301) 297-7600, Fax: (301) 297-4250, Opns. Mgr.: Deborah Farrell. (Video)

Live Sound Prodn., 1934K Lincoln Dr., Annapolis, MD, 21401, (301) 269-8008, Pres.: Leslie Louis Lentz. (Audio)

Richardson Audio Video, 1938 Baltimore Annapolis Blvd., Annapolis, MD, 21401, (401) 757-3733, Pres./Sales Mgr.: Charles A. Richardson. (Audio)

MASSACHUSETTS

Ian Communications Group, Inc., 10 Upton Dr., Wilmington, MA, 01887, (508) 658-3700, Fax: (508) 694-9957, Sales: Richard B. Berberian; Sales Mgr.: Todd Thibaud; Mktg. Dir.: James Rago. (Audio)

Northeastern Digital Recording, Inc., 2 Hidden Meadow Ln., Southborough, MA, 01772, (508) 481-9322, Fax: (508) 624-6437, Pres.: Dr. Toby Mountain; Sales Mgr.: Anne Shepard; Mastering Engineer: Jonathan Wyner. (Audio)

MICHIGAN

A & F Music Services, 2834 Otsego, Waterford, MI, 48328, (313) 682-9025, (313) 669-3100, Owner: Frank C. Merwin. (Audio)

ARC Electronic Services Inc., 2557 Knapp, NE, Grand Rapids, MI, 49505, (616) 364-0022, Pres.: Ron Harkai. (Audio)

Allied Film & Video, 7375 Woodward Ave., Detroit, MI, 48202, (313) 871-2222, Fax: (313) 871-5907, Pres.: William H. Smith; 7375 Woodward Ave., Detroit, MI, 48202, (313) 871-2222, Fax: (313) 871-5907, Div. Mgr.: Jimmy Naito. (Video)

American Sound & Video Corp. (HQ), 3100 E. Ten Mile Rd., Warren, MI, 48091, (313) 755-0654, Fax: (313) 755-6705, Pres.: Frank S. Day. (Audio & Video)

Audio Graphics Services, 1516 Ferris Ave., Royal Oak, MI, 48067, (313) 544-1793, Pres.: E. J. Wolftrum; Sales/Mktg. Dir.: Walter Wolftrum. (Audio)

Playtown Sound Prodn., PO Box 241, 625 Connable Ave., Petoskey, MI, 49770, (616) 347-0063, Pres.: Robert Bollinger. (Audio)

Premiere Video, Inc., 35687 Industrial Rd., Livonia, MI, 48150, (313) 464-4650, Fax: (313) 464-8939, Pres.: Larry Bennett; Dir. Sales & Mktg.: David Travis. (Video)

Technidisc, Inc., 2250 Meijer Dr., Troy, MI, 48064, (800) 321-9610, Fax: (313) 435-8540, Pres.: Ron Balousek; Sales Mgr.: Leon Chick. (Audio)

MINNESOTA

EMC Prodn., 300 York Ave., Saint Paul, MN, 55101, (612) 771-1555, Fax: (612) 771-5629, Pres.: Paul Winter; Mktg. Dir.: Paula Jeske; Vice Pres.: Dick Stevens. (Audio & Video)

3M Optical Recording Department, 3M Center Bldg., 223-5N-01, Saint Paul, MN, 55144, (612) 733-2142, Fax: (612) 733-0158, Sales Mgr.: Vivian Ebersman; Mgr. Pre-recorded Bus.: David H. Wenck; Mktg. Mgrs.: Jon Hove, Mark Arps. (Audio & Video)

MISSOURI

Aard-Vark, Inc., 335 S. Jefferson, Springfield, MO, 65806, (800) 822-1226, Fax: (417) 869-1133, Pres.: H. W. Jacobsen. (Audio)

Audio Duplication & Services, Inc., PO Box 31546, 1927 Boaz, Saint Louis, MO, 63131, (314) 965-8895, Fax: (314) 965-8895, Pres.: Richard Schaumberger, Jr. (Audio)

Audio-VideoGraphics, PO Box 1883, 13801 E. 35th St., Independence, MO, 64055, (800) 322-2832, Fax: (816) 254-0045, Pres.: Gerald W. Riegle; Sales/Mktg. Dir.: Jeff Propst. (Audio & Video)

Audiophile Realtime Cassette Duplication, 13801 E. 35 St., Independence, MO, 64055, (800) 322-2832, Fax: (816) 254-0045, Pres.: G.W. Riegle; Sales/Mktg. Dir.: Tom Stack. (Audio & Video)

Nat'l Audio Co., Inc., PO Box 3657 G.S., 1841 E. Bergman, Springfield, MO, 65808, (417) 863-1925, Fax: (417) 863-7825, Pres.: Steve Stepp; Sales Mgr.: Sandi Slonecker. (Audio)

Premier Film & Recording Corp., 3033 Locust St., Saint Louis, MO, 63042, (314) 531-3555, Fax: (314) 726-8798, Pres.: Wilson Dalzell; Sales Mgr.: Donna Blue; Mktg. Dir.: Bob Heuermann. (Audio)

Sound Recorders, Inc., 3947 State Line Rd., Kansas City, MO, 64111, (816) 931-8642, Fax: (816) 561-3671, Pres.: Ron Dabbs; Mktg. Dir.: Stacey Mings. (Audio)

Vaughn Duplication, 13241 Tandem Dr., Creve Cocur, MO, 63146, (314) 576-6804, Fax: (314) 576-3070, Vice Pres.: Donald Drapeau; Mktg. Dir.: Michelle Sahlin; Sales Rep.: Pete Leverenz. (Video)

NEW JERSEY

AMP Recording & Duplicating Service, 307 W. Main St., Maple Shade, NJ, 08052, (609) 667-1667, Pres.: Gerald Tyson. (Audio)

D & G Mastering, PO Box 175, Englishtown, NJ, 07726, (908) 446-2411, Pres.: Don Van Gorden. (Audio)

Int'l Cutterhead Repair Service Inc., 571 Boulevard, Hasbrouck Heights, NJ, 07604, (201) 288-0106, Pres.: Sharon Mizrachi; Sales Mgr.: Motty Mizrachi; Mktg. Dir.: Blanche Rand. (Audio)

New Age Video, PO Box 68, 3480 So. Clinton Ave., South Plainfield, NJ, 07080, (201) 756-7500, Fax: (201) 757-1991, Pres.: Steven Nasar; Sales Mgr.: Jack Nasar; Vice Pres.: Joey Nasar. (Video)

Trutone Inc.

310 Hudson St., Hackensack, NJ, 07601, (201) 489-9180, Fax: (201) 489-1771, Pres.: Carl Rowatti; Sales/Mktg. Mgr.: Adrienne Rowatti; Office Mgr.: Ann Marie Cassar. (Audio)

NEW MEXICO

Rainbow Cassette Studio, PO Box 472, Colonias Rd., Taos, NM, 87571, (505) 776-2268, Pres.: Tony Isaacs; Mgr.: Judy Lujan. (Audio)

NEW YORK

Athena Prodn., 311 Willowbrook Rd., Staten Island, NY, 10314, (718) 698-2280, Fax: (718) 761-6411, Sales Mgr.: Robert Marino. (Audio)

Audio Post, Inc., 27 E. 21st St., New York, NY, 10010, (212) 475-3522, Fax: (212) 674-0788, Pres.: Edward Steinberg; Sales Mgr.: Nick Tatura. (Audio & Video)

Dick Charles Mastering, 130 W. 42nd St., #1106, New York, NY, 10036, (212) 819-0920, Fax: (212) 768-7822, Pres.: Dick Charles. (Audio)

Classic Sound, Inc., 129 W. 67th St., New York, NY, 10023, (212) 496-7100, Pres.: Tim Martyn; Chief Engineer: Robert Rapley. (Audio)

Columbia Record Prodn., 51 W. 52nd St., New York, NY, 10019, (212) 445-8203, Fax: (212) 445-8119, Sales Mgr.: Robert Fernandez; Vice Pres.: Anthony Formicelli.

The Cutting Edge Disc Mastering, Box 217, Ferndale, NY, 12734, (914) 292-5965, Fax: (914) 292-2313, Pres.: Paul Gerry; Sales Mgr./Mktg. Dir.: Patricia Gerry. (Audio)

DP Plus Digital Services, PO Box 694, Lynbrook, NY, 11563, (516) 872-2325, Pres.: Joel Kerr; Vice Pres.: Kathy Kerr. (Audio)

D.S.M. Producers, Inc., 161 W. 54th St., New York, NY, 10019, (212) 245-0006, Fax: (212) 265-5726, Pres.: Suzan Bader; Vice Pres./Nat'l Sales Dir.: Doris Kaufman; Mktg. Dir.: Keith Lamar Newton; Dir. A&R: Elba T. Toast. (Audio)

Demo-Vox Sound/DVX Int'l Video Prodn., 1038 Bay Ridge Ave., Brooklyn, NY, 11219, (718) 680-7234, Pres.: Frank J. Grassi; Vice Pres./Sales Mgr.: Laura B. Grassi. (Audio & Video)

Barry Diamant Audio, 2728 Henry Hudson Pkwy., Riverdale, NY, 10463, (212) 543-2079, Pres./Mktg. Dir.: Barry Diamant; Sales Mgr.: Mary Antonelli; Engineer: Campbell Bonaire. (Audio)

Digital House Ltd., 101 W. 57th St., New York, NY, 10019, (212) 333-5950, Fax: (212) 262-5631, Pres.: Jerome Bunke; Vice Pres. Tech. Services: Harry Hirsch; Vice Pres. Mktg.: Don Burkheimer. (Audio)

Disc Makers, 1650 Broadway, Ste. 1010, New York, NY, 10019, (212) 265-7505, Fax: (212) 262-0798, Sales Mgr.: Howard Roseff. (Audio)

Duplication Specialists, 4584 Austin Blvd., Island Park, NY,

11558, Pres.: David J. Schwartz; Sales Mgr.: James E. Void. (Audio & Video)

Eastern Standard Prodn., Inc., 26 Baxter St., Buffalo, NY, 14207, (800) 527-9225, (716) 876-1454, Fax: (716) 877-6395, Pres.: Mark S. Mekker; Vice Pres. Sales/Mktg.: Deborah Mekker; Customer Service: Teressa M. Fay. (Audio)

Electro Sound Group, Inc., 1290 Motor Pkwy., Hauppauge, NY, 11788, (516) 234-2010, Fax: (516) 234-2384, Pres.: Richard Projain; Sr. Vice Pres. Sales: Hugh Landy. (Audio & Video)

Europadisk, Ltd., 75 Varick St., New York, NY, 10013, (212) 226-4401, Fax: (212) 966-0456, Pres.: James P. Shelton; Sales Mgr.: Jeremy Guttenberg.

Executive Recording, Ltd., 300 W. 55th St., Ste. 4-P, New York, NY, 10019, (212) 247-7434, Pres.: Lucille Sayet. (Audio)

Frankford/Wayne Mastering Labs, Inc., 1697 Broadway, Ste. #1404, New York, NY, 10019, (212) 582-5473, Fax: (212) 245-2309, Pres.: Thomas S. Steele; Sales Mgr.: Jimmy Lee; Mktg. Dir.: Carol Steele. (Audio & Video)

Future Duplicators, Inc., 630 Ninth Ave., Ste. 403, New York, NY, 10036, (212) 399-6090, Fax: (212) 399-6092, Pres.: Ken Washino; Vice Pres.: Timothy P. Forster; Vice Pres. Mktg.: C. Mitchell Dixon. (Video)

Grenadier, 10 Parkwood Ave., Rochester, NY, 14620, (716) 442-6209, (716) 275-2942, Pres.: T. Greene; Sales/Mktg. Dir.: P. Greene. (Audio)

In Sync Laboratories, Inc., 2211 Broadway, New York, NY, 10024, (212) 873-6769, Pres.: E. Alan Silver. (Audio)

Int'l Recording Co., 49 Desmond Ave., Bronxville, NY, 10708, (914) 337-5726, Pres.: Claire M. Rie. (Audio)

Kewall Real Time Tape Duplicators, 77 Bay Shore Rd., Bay Shore, NY, 11706, (516) 586-2486, Fax: (516) 586-2486, Pres.: Keith A. Gutschwager; Sales Mgr.: Larry Andrews; Contact: Dorothy E. Gutschwager. (Audio)

Mark Custom Recording Service, 10815 Bodine Rd., Clarence, NY, 14031, (716) 759-2600, Pres./Owner: Mark J. Morette. (Audio)

Master Cutting Room, Inc., 250 W. 49th St., 3rd Floor, New York, NY, 10019, (212) 765-8496, Fax: (212) 765-8630, Pres.: Joseph Brescio. (Audio)

Masterdisk Corp., 545 W. 45th St., New York, NY, 10036, (212) 541-5022, Fax: (212) 265-5645, Pres.: Douglas Levine; Gen. Mgr.: Linda Duffany. (Audio)

Music Doctors Ltd., Inc., 130 W. 42nd St., Ste. 551, New York, NY, 10036, (212) 382-1234, Fax: (212) 382-1241, Sales Mgr.: David Moldauer. (Audio)

Romaba Record Pressing Corp. of America, 33-34th St., Brooklyn, NY, 11232, (718) 499-3060, Fax: (718) 499-3061, Pres.: Theodore E. Kolsky; Vice Pres.: Dara Kolsky; Sales Mgr.: Vicki M. Guerra; Mktg. Dir.: Jennifer Kolsky. (Audio)

Ross-Gaffney Video, 21 W. 46th St., New York, 10036, (212) 997-1464, Fax: (212) 827-0426, Pres.: C.Y. Chang. (Video)

Sterling Sound, Inc., 1790 Broadway, 9th Floor, New York, NY, 10019, Pres.: Lee Hulko; COO: David E. Anderson. (Audio)

Sunshine Sound, Inc., 1650 Broadway, New York, NY, 10019, (212) 582-6227, Pres.: Frank J. Trimarco. (Audio)

TV-R, Inc./Mastercolor Transfer, Inc., 333 W. 52nd St., 15th & 16th Floors, New York, NY, 10019, (212) 541-4030, Fax: (212) 307-7061, Pres.: James C. Mahoney; Sales Mgr.: Joseph Grasso; Mktg. Dir.: Joseph Grasso; Colorist: Alex Lobel. (Video)

Thalco Audio, Inc., 2 Dickens Ave., Dix Hills, NY, 11746, (516) 667-1616, Fax: (516) 496-4763, Pres.: Michael Thaler; Mktg. Dir.: Glenn Thaler. (Audio & Video)

Variety Recording Studio, 130 W. 42nd St., Ste. 551, New York, NY, 10036, (212) 221-6625, Fax: (212) 382-1241, Pres.: Hernan Vargas. (Audio)

Vaughn Duplication Services, 10 E. 39th St., New York, NY, 10016, (212) 447-1038, Fax: (212) 684-3650, Vice Pres.: Donald Drapeau; Mktg. Dir.: Michelle Sahlin; Sales: Lloyd Dorfman. (Video)

WEA Mfg., Inc., 75 Rockefeller Plaza, New York, NY, 10019, (212) 399-8831, Vice Pres. Sales Services: David A. Grant. (Audio)

NORTH CAROLINA

American Multimedia, Inc., 2609 Tucker St. Ext., Burlington, NC, 27215, (919) 229-5554, (800) 849-8273, Fax: (919) 228-1409, Pres.: Dave J. Forsyth; Sales Mgr./Mktg. Dir.: Tim V. Mallard; Customer Service Dir.: Jeanne Conklin. (Audio & Video)

OHIO

Audiocraft Recording Co., 915 W. Eighth St., Cincinnati, OH, 45203, (513) 241-4304, Fax: (513) 241-3477, Pres.: Earl T. Herzog, Jr.; Sales Mgr.: Dave Rinaldi. (Audio)

Jewel Records, 1594 Kinney Ave., Cincinnati, OH, 45231, (513) 522-9336, Fax: (513) 522-9915, Pres.: Rusty York; Sales Mgr.: Rick Hopkins. (Audio)

Musicol, Inc., 780 Oakland Park Ave., Columbus, OH, 43224, (614) 267-3133, Pres.: John W. Hull; Sales Mgr.: Warren Hull; Mktg. Dir.: Charlene Hull. (Audio)

QCA, Inc., 2832 Spring Grove Ave., Cincinnati, OH, 45225, (513) 681-8400, Fax: (513) 681-3777, Pres.: Jim Bosken; Sales Mgr.: Amber Hines; Mktg. Dir.: Rusty Sweeney. (Audio)

Sonic Sculptures, 636 Northland Blvd., Cincinnati, OH, 45240, (513) 851-0055, Pres.: Lan A. Ackley; Sales Mgr.: James Winget. (Audio)

SoundSpace, Inc., 126 Dayton St., Yellow Springs, OH, 45387, (513) 767-7353, Pres.: Chris Hertzler. (Audio)

Suttman Prodn., PO Box 72, Dayton, OH, 45409, (513) 278-4601, Pres.: Eric J. Suttman. (Audio)

OKLAHOMA

EL Jay Ents., Inc., 3202 E. 21st St., Tulsa, OK, 74114, (918) 627-2054, (800) 886-8273, Fax: (918) 744-1223, Pres.: Leon Whitman; Sales Mgr.: Raymond Foyester. (Audio)

OREGON

Musicon Recording & Duplicating, 27501 SW 95th Ave., Ste. 930, Wilsonville, OR, 97070, (503) 682-8668, Fax: (503) 682-3043, Pres.: William E. Berry; Sales Mgr.: Stephen J. Ziegler. (Audio)

Super Duper-Audio Duplicators, 3235 SE 39th Ave., Portland, OR, 97202, (503) 239-6070, Fax: (503) 239-0296, Pres.: Rick McMillen; Sales Mgr.: Todd Chatalas; Mktg. Dir.: Kevin Laurila. (Audio)

PENNSYLVANIA

American Helix, 1857 Colonial Village Ln., Lancaster, PA, 17601, (908) 367-8700, Contacts: Jim Boyer, Marc Feingold. (Audio)

Audio Visual Communications, Inc., 435 Crooked Ln., King of Prussia, PA, 19406, (215) 272-8500, Fax: (215) 272-8604, Pres.: John Butterworth; Sales Mgr.: Frank Matys. (Audio)

Crown Magnetics, Inc., 1223 Bittner Blvd., Lebanon, PA, 17042, (717) 274-2812, (800) 736-9001, Fax: (717) 274-3615, Pres.: Chuck Musser; Mktg. Dir.: Bob Turner; Sales: Judy Musser. (Audio)

Disc Makers, 1328 N. Fourth St., Philadelphia, PA, 19122, (800) 468-9353, (215) 232-4140, Fax: (215) 236-7763, Pres.: Morris Ballen; Sales/Mktg. Dir.: Tony Van Veen. (Audio)

Forge Recording Studios, Inc., PO Box 861, Byrne Bldg-Lincoln & Morgan Sts, Valley Forge, PA, 19481, (215) 935-1422, (800) 331-0405, Fax: (215) 935-1940, Pres.: Warren R. Wilson. (Audio)

Heid Prodn., 701 Washington Rd., Pittsburgh, PA, 15228, (412) 561-3399, Fax: (412) 561-1755, Pres.: George Heid; Sales

**If You Don't Sound Good,
We Don't Look Good.**

State of the art mastering, replication, and duplication services for the discriminating producer.



TRUTONE INC.

310 Hudson St. Hackensack, NJ 07601

Phone: 201-489-9180 Fax: 201-489-1771

NOW THAT YOU'VE MADE THE MUSIC
..... MAKE THE CONNECTION

CD REPLICATION CASSETTE & VIDEO DUPLICATION RECORD PRESSING

THE MUSIC CONNECTION

THE HIGHEST QUALITY
AT THE LOWEST COST

FOR ALL YOUR NEEDS

(212) 529-0557
FAX (212) 529-1281

FLATIRON BUILDING
175 FIFTH AVE. STE. 511
NEW YORK, N.Y. 10010

Audio & Video Packaging

Custom & Stock Packaging for:

- Video Cassettes
- Audio Cassettes
- CDs, CD-ROMs
- Videodiscs
- Slides
- Floppy Disks
- Custom Imprinting
- Many Styles
- 100 piece minimum order

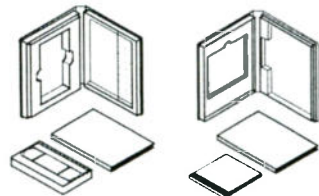
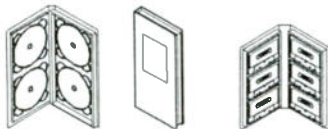

Experienced sales representatives can help with your packaging needs. Call today for a quote and free color catalog.

RELIANCE®

Plastics & Packaging Division
217 Brook Ave., Passaic, NJ 07055
Fax (201) 473-1023 Phone (201) 473-7200

Mgr.: Jay Dudt; Contact: Carol Heid. (Audio)
Kingdom Co., PO Box 506, Mansfield, PA, 16933, (717) 662-7515, Fax: (717) 662-3875, Pres.: Johnny Berguson; Sales Mgr.: Howard Darr; Mktg. Dir.: Gabe Phelps. (Audio & Video)
Loran Audio, 10-48 Clark St., Warren, PA, 16365, (800) 633-0455, Fax: (814) 723-9490, Pres.: Robert L. Loranger; Sales/Mktg. Dir.: Earl J. Keeney, Jr.; Sales Coord.: Randy L. Britton. (Audio)
Masterwork Recording, Inc., 1020 N. Delaware Ave., Philadelphia, PA, 19125, (215) 423-1022, Fax: (215) 423-6020, Pres.: Peter Humphreys; Sales Mgr.: Albert Oon. (Audio)
Music Factory Ents Inc., Ste. 300, Ford & Washington Streets, Norristown, PA, 19401, (215) 277-9550, Pres.: Jeffrey Calhoun; Sales Mgr.: Jamie Bones; Mktg. Dir.: Dan Charles; Studio Mgr.: Linda Hoverson. (Audio)
E.J. Stewart, Inc., 525 Mildred Ave., Primos, PA, 19018, (215) 626-6500, Fax: (215) 626-2638, Sales Mgr.: Eric Bentley; Gen. Mgr.: David Bowers. (Video)
Virtue Recording & Video & Disc Mastering, 8809-11 Rising Sun Ave., Philadelphia, PA, 19115, (215) 763-2825, Pres.: Frank Virtue; Sales Mgr.: Mary Bozzi; Mktg. Dir.: Linda Vitacolonia. (Audio & Video)
WEA Mfg., PO Box 321, Olyphant, PA, 18447, (717) 383-2471, Fax: (717) 383-2165, Contact: Dave Grant. (Audio)
WRS Motion Picture & Video Laboratory, 1000 Napor Blvd., Pittsburgh, PA, 15205, (800) 345-6977, Fax: (412) 922-1020, Pres.: F. Jack Napor; Sales/Mktg. Dir.: Ed Janow; Customer Service Mgr.: David Simpson. (Audio & Video)

PUERTO RICO

Disc Makers, Senda De La Posada N-6, Quintas Del Rio, Bayamon, PR, 00961, (809) 740-0010, Fax: (809) 785-5554, Sales Mgr.: David Rodriguez. (Audio)

SOUTH CAROLINA

Mainstay Media, PO Box 27109, 1200 Woodruff Rd., C-18, Greenville, SC, 29616, (803) 288-0000, (800) 868-8273, Fax: (803) 234-6519, Pres.: Jere Davis; Opns. Vice Pres.: Mark Young; Sales Mgr.: Jesse Evatte. (Audio)

TENNESSEE

Allied Film & Video, 370 J.D. Yarnell Ind. Pkwy., Clinton, TN, 37716, (615) 457-7772, Fax: (615) 457-7799, Div. Mgr.: Wayne Whitehurst. (Video)
Disc Mastering, Inc., 30 Music Sq. W., Nashville, TN, 37203, (615) 254-8825, Fax: (615) 254-8826, Pres.: Randall F. Kling; Sales Mgr.: Karen Bush. (Audio)
Georgetown Masters, Inc., 33 Music Sq. W., Ste. 108, Nashville, TN, 37203, (615) 254-3233, Fax: (615) 254-3237, Pres./Mktg. Dir.: Denny Purcell; Office Mgr.: Trudy Tenison. (Audio)
The Lacquer Place, 116 17th Ave. S., Nashville, TN, 37203, (615) 244-5355, Pres.: Ted Fuller; Studio Mgr./Engineer: Roy Snowden. (Audio)
Nashville Record Prodn., Inc., 469 Chestnut St., Nashville, TN, 37203, (615) 259-4200, Fax: (615) 244-3734, Pres.: George A. Ingram; Sales Mgr.: Alma Cato; Studio Mgr.: John Eberle. (Audio)
L. Nix & Co., Inc., 2000 Madison Ave., Memphis, TN, 38104, (901) 725-0855, Fax: (901) 725-7011, Pres.: Larry Nix.
Skyline Prodn./Big Oak Duplication, 108 Midtown Ct., Ste. 206, Hendersonville, TN, 37075, (615) 822-0088, Pres.: Timothy W. Chesney; Sales Mgr.: Melanie Chesney. (Audio)
Sound Impressions, PO Box 101244, Nashville, TN, 37224, 748 Fesslers Ln., Nashville, TN, 37210, (615) 244-3535, Fax: (615) 255-3882, Pres./Sales Mgr.: James Lenahan; Prodn. Coord.: Charlotte A. Mitchell; Mktg. Dir.: Ed Buckles. (Audio)

TEXAS

A + R Record & Tape Mfg. Co., 902 N. Industrial Blvd., Dallas, TX, 75207, (214) 741-2027, Fax: (214) 638-6801, Pres.: Richard Sobel; Sales Mgr.: Stan Getz II; Mktg. Dir.: Maxine Sobel. (Audio)
Creative Sound Prodn., Inc., PO Box 720941, 8383 Commerce Park Dr., #604, Houston, TX, 77272, (713) 777-9975, Fax: (713) 774-3419, Pres.: Edward B. Smith; Sales Mgr.: Michele Crosby. (Audio)
Bob Green Prodn., Inc., 7950 Westglen, Houston, TX, 77063, (713) 977-1334, Fax: (713) 977-1305, Pres.: Bob Green; Vice Pres.: Jim Spurlock/Don Fisher; Office Mgr.: Emily Getz. (Audio)
Houston Records, Ltd., 3300 Jensen Dr., Houston, TX, 77026, (713) 223-5971, Pres.: Chris Puccio; Sales Mgr.: Steve Puccio. (Audio)
The Musik Faktory, 1812 Procter St., Port Arthur, TX, 77640, (409) 982-7121, Owner: Floyd Badeaux. (Audio)
Sound Recorders, Inc., 4031 Guadalupe, Austin, TX, 78751, (512) 454-8324, (800) 880-0270, Fax: (512) 454-5594, Pres.: Miles Muller; Sales Mgr.: Basil Thomas; Mktg. Dir.: Matt Wiedemann. (Audio)

UTAH

Sound Concepts, PO Box 299, 175 W. 300 S., Provo, UT, 84603, (801) 375-7333, Fax: (801) 377-4723, Pres.: McKinley M. Oswald. (Audio)
Video West, Broadcast House, #5 Triad Center, 55 N. 300 W., Salt Lake City, UT, 84110, (801) 575-7400, Fax: (801) 575-7449, Sales Mgr.: Jim Yorgason; Mktg. Dir.: Don Paver; Vice Pres./Gen. Mgr.: Allan W. Henderson; Distribution Service Mgr.: Mel Miller. (Video)

VERMONT

Resolution, Inc., 19 Gregory Dr., South Burlington, VT, 05403, (802) 862-8881, Fax: (802) 865-2308, Pres.: William Schubart; Sales/Mktg. Dir.: Linda A. Citro. (Audio & Video)

VIRGINIA

Lion Recording Services, 7532 Fullerton Ct., Springfield, VA, 22153, (703) 569-3200, Fax: (703) 455-5600, Pres.: Harold Lion; Mktg. Dir.: Karen Blackhall; Vice Pres./Sales Mgr.: Richard Lion. (Audio)
Masterworks Studios, 4024 Williamsburg Ct., Fairfax, VA, 22032, (703) 385-1780, Pres.: Michael Zook; Sales Mgr.: Michael Zook. (Audio)
Musifex Video, 2701-C Wilson Blvd., Arlington, VA, 22201, (703) 525-6476, Fax: (703) 525-0949, Pres.: Frank Maniglia, Jr.; Gen. Mgr.: Guinevere Meyer; Sales Mgr./Mktg. Dir.: Jeanne Chisholm. (Audio & Video)

WASHINGTON

Martin Audio Group, 1200 Westlake Ave. N., #414, Seattle, WA, 98109, (206) 784-0139, Fax: (206) 782-9044, Pres.: Scott Olsen; Sales Mgr.: Ivar Sandmark; Engineer: Bob Boeck. (Audio)
Melody Prodn., 7712 23rd Ave., NW, Seattle, WA, 98117, (206) 783-8694, Fax: (206) 781-1765, Pres.: James A. Bostad Sr.; Sales Mgr.: Melody Bostad; Mktg. Dir.: Sally Bostad; Engineers: Jason & Jeremy Bostad. (Audio)
Premiere AVD Corp., 18080 NE 68th St., Redmond, WA, 98052, (206) 882-1400, Fax: (206) 867-0718, Pres.: George M. Ricci; Sales Mgr.: Gary M. Ricci. (Video)
Ruther Remote Recording, 108 N. Roosevelt St., Walla Walla, WA, 99362, (509) 522-0438, Pres.: Bud Ruther. (Audio)

WEST VIRGINIA

Jim McCoy Prods., Rt. 2, Box 114, Berkeley Springs, WV, 25411, (304) 258-2175, Pres.: Jim McCoy; Mktg. Dir.: Bertha McCoy. (Audio)

WISCONSIN

Centercom, Inc., 5737 W. Hemlock St., Milwaukee, WI, 53223, (414) 353-2001, Fax: (414) 353-7227, Pres.: Bob Harmon; Vice Pres.: Jeff Johnson; Sales & Mktg. Dir.: David Davis. (Video)
Concept Prodn., Inc., PO Box 44345, 7878 Big Sky Dr., Madison, WI, 53744, (608) 833-8273, (800) 728-2731, Pres.: Rod F. Barelmann; Vice Pres./Prodn. Service Dir.: C. Dan Geocaris. (Audio)
Full Compass Systems, Ltd., 5618 Odana Rd., Madison, WI, 53719, (608) 271-1100, Fax: (608) 273-6336, Pres.: Jonathan Lipp. (Audio)
RSVP, Inc., 7701 N. Teutonia, Milwaukee, WI, 53209, (414) 354-6400, Fax: (414) 354-7303, Pres.: Larry Hansen; Sales Mgr.: Jim Schaefer; Mktg. Dir.: Linda Hanson. (Audio & Video)
Vaughn Duplication Services, 700 W. Michigan Ave., Ste. 270, Milwaukee, WI, 53233, (414) 276-6511, Fax: (414) 276-0555, Vice Pres.: Donald Drapeau; Sales Mgr.: Tom Brunhart; Mktg. Dir.: Michelle Sahlin. (Video)

WYOMING

Rocky Mountain Recording, 8305 Christensen Rd., Cheyenne, WY, 82009, (307) 638-8733, Pres.: Ray Alexander; Sales Mgr.: Georgia Alexander. (Audio)

PACKAGING & LABELING SERVICES

AGI, Inc., 6363 W. Sunset Blvd., Ste. 910, Los Angeles, CA, 90028, (213) 462-0821, Fax: (213) 463-4367, Sales Mgr.: Rich Oppenheimer.
AGI, Inc., 1950 N. Rugsy St., Melrose Park, IL, 60160, (708) 344-9100, Fax: (708) 344-9113, Pres.: Richard Block; Sales Mgr.: Jim Oppenheimer; Mktg. Dir.: Gary Mankoff; Vice Pres., Creative Dir.: Jim Ladwig. (Inserting, Collating, Labeling, Mailing, Shrinkwrapping).

AJM Inc., 1600 Wyatt Dr., Ste. 12, Santa Clara, CA, 95054, (408) 980-8631, Fax: (408) 980-0281, Sales Mgr.: Mike Frug.
The Absolute Press, Inc., 47-69 32nd Pl., Long Island City, NY, 11101, (718) 729-5293, Fax: (718) 784-2527, Pres.: Gill R. Pessoa. (Inserting, Collating, Labeling, Mailing).
Album Design, PO Box 4, 33 Lancaster St., Cherry Valley, NY, 13320, (607) 264-3785, Fax: (607) 264-3476, Dir.: Carol Goss; Gen. Mgr.: Jim Kosinski. (Inserting, Mailing, CD, LP & Cassette Design & Printing).

Apex Machine Co.

3000 NE 12th St., Fort Lauderdale, FL, 33334, (305) 565-APEX, Fax: (305) 563-2844, Contact: Bob Covingsby. (Inserting, Labeling).

Artistic License, 904 Silver Spur Rd., Ste. 630, Colling Hills Estates, CA, 90274, (213) 944-6871, Fax: (213) 544-6874, Pres.: Eric Schor; Art Dir.: Pamela Schor. (Design of audio & video pkg.).

Blackbourn, Inc., 7550 Corporate Way, Eden Prairie, MN, 55344, (800) 842-7550, Fax: (612) 949-2553, Pres.: Todd Nicholson; Sales Mgr.: Jerry Forness; Mktg. Dir.: Mike Langert. (Inserting, Collating, Labeling, Mailing, Fulfillment Services).

Disc Graphics, Inc., 10 Gilpin Ave., Hauppauge, NY, 11788, (516) 234-1400, Fax: (516) 234-1460, Pres.: Donald Sinkin; Vice Pres. Finance: John Rebecchi; Admin. Asst.: Angie David.
Disctronics, 3800 Barham Blvd., Ste. 102, Los Angeles, CA, 90068, (213) 851-7300, Fax: (213) 851-7579, Exec. Vice Pres./CD Mktg.: Cal Roberts; Sales Mgr.: Mort Weiner. (Inserting, Collating, Labeling, Mailing).

Electronic Media Int'l, PO Box 2664, Kennebunkport, ME, 04046, 35 Western Ave., Kennebunk, ME, 04043, (207) 967-2894, Fax: (207) 967-4509, Pres.: Paul J. Gelardi; Mktg. Dir.: Susan B. Porter; Business Mgr.: Susan Turner. (Inserting, Labeling, Mailing).

Fenton Label Co., 3850 Coral St., Philadelphia, PA, 19124, (215) 288-2910, Fax: (215) 533-5390, Pres.: J. K. Tompkins; Sales Mgr.: P. McKean. (Labeling).

G Cee Graphics, Inc., 18653 Ventura Blvd., Ste. 223, Tarzana, CA, 91356, (818) 347-1136, Fax: (818) 889-4773, Pres.: Gregory Higgins. (Inserting, Collating, Labeling, Mailing, Specialty).
GP Prodn., 362 Third Ave., Ste. 1B, New York, NY, 10016, (212) 686-5267, Pres.: Gill R. Pessoa; Sales Mgr.: Y.L. Walton; Mktg. Dir.: Daryl A. Pessoa. (Inserting, Collating, Labeling, Mailing, Booklets, Special Packaging).

Hannecke Display Systems, Inc., 300G Rt. 17 S., Mahwah, NJ, 07430, (201) 529-5995, Fax: (201) 529-9343, Pres.: Bruce C. Dreher; Mktg. Dir.: Grace Perusini.

Imperial Paper Box Corp., 252 Newport St., Brooklyn, NY, 11212, (718) 346-6100, Fax: (718) 922-1125, Pres.: Louis Sukoff; Sales Mgr.: Ira Sukoff; Mktg. Dir.: Steven Sukoff. (Inserting, Collating, Labeling, Mailing).

Independent Classical Recording, 170 W. 73rd St., #3C, New York, NY, 10023, (212) 799-0690, Pres.: Dongsok Shin. (Inserting, Collating, Labeling, Mailing).

Inserv Corp., 1650 Howard St., Lincoln Park, MI, 48146, (313) 381-1530, Fax: (313) 381-5290, Pres.: Lowell Johnson; Mktg. Dir.: William Lane. (Inserting, Collating, Labeling, Mailing).

Ivy Hill Corp., 170 Varick St., 12th Floor, New York, NY, 10013, (212) 741-1404, Pres.: Ellis Kern; Exec. Vice Pres.: Arthur Kern; Vice Pres. Mktg.: Herbert Friedman.

Just Design, 160 Fifth Ave., Ste. 905, New York, NY, 10010, (212) 620-4672, Fax: (212) 727-1322, Owners/Creative Dir.: Spencer Drate & Judith Salavetz. (Package Design).

Laser Prints, Inc., PO Box 151, 241 Stuyvesant Ave., Lyndhurst, NJ, 07071, (201) 438-6777, Fax: (201) 438-0903, Pres.: J. Principato. (Printing).

Polyform, Inc.

311 S. Sixth St., Mount Vernon, NY, 10550, (914) 668-4700, Fax: (914) 668-4820, Pres.: Ron Brazzo

Liebert Recording Studios, Inc., 16 W. 46th St., New York, NY, 10036, (212) 840-1350, Fax: (212) 764-0440, Pres.: Bob Liebert; Sales Mgr.: Carmen Miller; Mktg. Dir.: Carmen Liebert. (Inserting, Collating, Labeling, Mailing).

Location Recording Service, Inc./Print Div., 2609 W. Burbank Blvd., Burbank, CA, 91505, (818) 846-8300, Fax: (818) 845-8357, Pres.: Allen Fraiberg; Prodn. Gen. Mgr.: Jay Ceballos. (Inserting, Collating, Labeling, Mailing).

Marvell Pharnacal & Packaging Co., 490 Rt. 46 E., Fairfield, NJ, 07004, (201) 882-9339, Fax: (201) 575-6637, Pres.: R. Teich; Sales Mgr.: B. Berman; Mktg. Dir.: Scott Trich. (Inserting, Collating, Labeling, Mailing, Shrink, Blister, Gluing, Assembly).

Matchbook Albums (Sub. of Beach West Designs), 711 John St., Secaucus, NJ, 07094, (215) 478-1585, Pres.: Walt Henkel. (Package Design).

Modern Album Of Tennessee, 1130 Davidson St., Nashville, TN, 37206, (615) 227-0200, Fax: (615) 228-5307, Pres.: Richard Meagher; Sales Mgr.: Charles Reinhardt. (4-Color Printing/ Ultraviolet Coat).

PDO (Phillips and Du Pont Optical Company), 1251 Avenue of the Americas, New York, NY, 10020, (212) 512-9350, Fax: (212) 512-9358, Sr. Vice Pres.: Bob Wray; Sales Dir.: Bob Bloom. (Inserting, Collating, Labeling, Mailing).

Pressure Sensitive Tape & Label Corp., 135 Schmitt Blvd., Farmingdale, NY, 11735, (516) 293-7305, Fax: (516) 293-7384.



SCANDIA
THE PACKAGING LEADER

Let Scandia help you with your packaging needs:

- **AUDIO: Norelco Box Loading and Overwrapping**
- **VIDEO: Cartoning and Overwrapping**
- **CD: Jewel Case Overwrapping**

Available for 1990

R-DAT and 8mm
Box Loading & Overwrapping Systems

180 Brighton Rd., Clifton, New Jersey 07012
(201) 473-6100 • Telex #133513 • Fax #(201)473-7226

Where do the smart companies go for the best electroforming equipment?

POLYFORM

INC.

of course

In addition to the best electroforming equipment in the industry, Polyform can supply:

- *For Video and Audio Discs: Hydraulic Stamper Punch for ID & OD
- * Tape conversion, analog to digital, noise reduction, etc.
- * Glass mastering to CD spec. and special applications
- * Fathers, Mothers, Stampers (from up to 420mm Masters)
- * Stamper Analysis Equipment
- * CD QC Testing Equipment
- * Low-cost Mastering System
- * Stamper Backfinishing Equipment
- * Stamper Trimming Equipment
- * Beta Ray Thickness Measuring Equipment
- * PC Computer Interface and Monitoring Systems

Polyform, Inc., 311 South Sixth Avenue Mount Vernon, NY 10550
Telephone: (914) 668-4700 FAX: (914) 668-4820

OPEN HERE

Tear Tape got you down?

SPEED UP!

Try our new pressure sensitive Tear Tape



Edelstein Diversified
1-800 461-8273

Pres.: Daniel Cooper; Sales Mgr.: Bruce Cooper. (Inserting, Collating, Labeling, Mailing).

Queens Group California, Inc., 6290 Sunset Blvd., Ste. 703, Hollywood, CA, 90028, (213) 464-7700, Pres.: Len Verebay; Exec. Vice Pres.: Richard Roth; Sr. Vice Pres.: Jack Sims.
Queens Group, Inc., 52-35 Barnett Ave., Long Island City, NY, 11104, (718) 457-7700, Fax: (718) 457-9285, Pres.: Len Verebay; Vice Pres./Nat'l Sales Mgr.: Keith Kiedinger; Exec. Vice Pres.: Richard Roth; Sr. Vice Pres.: Jack Sims. (Inserting, Collating, Printing & Finishing of Cartons).

Reliance Plastics & Packaging

217 Brook Ave., Passaic, NJ, 07055, (201) 473-7200, Fax: (201) 473-1023, Pres.: Marshall L. Weingarden; Mgr. Sales: Hale Smith; Vice Pres., Gen. Mgr.: Harry Polans; Adv. Mgr.: Barbara Weingarden. (Inserting, Collating, Labeling, Mailing, Albums, Mailers, Stock & Custom Imprinted Audio/Video Tape CD, Videodisc).

Romaba Record Pressing Corp. of America, 33-34th St., Brooklyn, NY, 11232, (718) 499-3060, Fax: (718) 499-3061, Pres.: Theodore E. Kolsky; Vice Pres.: Dara Kolsky; Sales Mgr.: Vicki M. Guerra; Mktg. Dir.: Jennifer Kolsky. (Inserting, Collating, Labeling, Mailing).

Ross-Ellis Ltd.

8300 Tampa Ave., Northridge, CA, 91325, (818) 993-4767, (800) 447-2149, Fax: (818) 993-4760, Contacts: Nina Sheldon, Peter Kerr. (Jackets, Sleeves, CD Boxes & Booklets, Cassette Inserts).

Rothchild Group, 7900 Barnwell Ave., Elmhurst, NY, 11373, (718) 899-6000, Fax: (718) 397-1921, Pres.: Alan J. Rothchild; Mgr./Customer Service: Anne Owsianik. (Inserting, Collating, Labeling, Mailing).

SRO Marketing, 373 N. La Cienega Blvd., Los Angeles, CA, 90048, (213) 652-9002, Fax: (213) 659-6317, Pres.: Scott Martin; Sales Mgr.: Christopher Johnsen; Mktg. Dir.: Joe Pizzella; Opns. Mgr.: Lily Li. (Mailing).

Shorewood Packaging of Georgia, 1707 Shorewood Dr., LaGrange, GA, 30240, (404) 884-3036, Gen. Mgr.: Charles Wardlaw.

Sterling Sound, Inc., 1790 Broadway, 9th Floor, New York, NY, 10019, Pres.: Lee Hulko; COO: David E. Anderson. (Labeling).

Tapeponents Co., PO Box 236, 60 Midvale Rd., Mountain Lakes, NJ, 07046, (201) 263-1442, (201) 263-1443, Fax: (201) 263-8640, Pres.: J. Clifford Anglum; Sales Mgr.: Robert Pitzer; Office Mgr.: Collen Koch. (Inserting, Collating, Label-

ing, Mailing, Shrinkwrap).

Tri-Plex Packaging Corp., 267 Fifth Ave., 10th Floor, Ste. 1010, New York, NY, 10016, (212) 481-6070, Fax: (212) 481-1550, Pres.: Ken Golden; Sales Mgr.: Andy Napolitano; Mktg. Dir.: Jerry DeLuise. (Inserting, Heat Sealing).

U.S. Optical Disc, Inc., One Eagle Dr., Sanford, ME, 04073, (207) 324-1124, Dir. Mktg.: Michael Rosenbaum. (Inserting).
Vinylweb (Div. of PEN-TAB Industries) Inc., 2011 W. Hastings St., Chicago, IL, 60608, (312) 243-0606, Fax: (312) 942-0693, Vice Pres. Sales/Mktg. Dir.: Doug Engebretson. (Inserting, Collating, Labeling, Mailing, Mfg. Audio & Video Cassette Pkgs).

CD REPLICATING SYSTEMS EQUIPMENT MANUFACTURERS

Alshire Int'l, Inc., 1015 Isabel St., Burbank, CA, 91506, (213) 849-4671, (818) 843-6792, Fax: (818) 569-3718, Pres.: Al Sherman; Sales Mgr.: Richard Sherman; Custom Dept.: Mark Beckwith.

American Helix Technology Corp.

1857 Colonial Village Ln., Lancaster, PA, 17601, (201) 662-7883, Pres.: David Dering; Vice Pres.: Jim Boyer; Dir. of Sales/Mktg.: Marc Feingold.
 Product(s): Custom CD Mfg. Module.

R.B. Annis Co., Inc., 1101 N. Delaware St., Indianapolis, IN, 46202, (317) 637-9282, Fax: (317) 637-9282, Pres.: R.B. Annis.
 Product(s): Erasing Equipment/Head Demagnetizer.

Audio Matrix, Inc., 400 Madison Ave., New York, NY, 10017, (212) 308-6888, Fax: (212) 308-5817, Pres./Mktg. Dir.: Milton B. Gelfand; Sales Mgr.: Perry Jambor; Technician: Gus Graffeo.
 Product(s): Audiotape Stamper Equipment.

Automatic Inspection Devices, Inc.

PO Box 6295, 1700 N. Westwood Ave., Toledo, OH, 43614, (419) 536-1963, Fax: (419) 536-2793, Pres.: Charles Drake; Sales Mgr./Mktg. Dir.: Arthur D. Harmala.
 Product(s): CD Disc Inspection Systems.

Balzars, 8 Sagamore Park Rd., Hudson, NH, 03051, (603) 889-8888, Fax: (603) 889-8573, Pres.: George McGee; Prod. Mgr.: Ralph Schmidgall.
 Product(s): CD & Laser disc metalizing & mastering.

EAM, 4 Washington Ave., Scarborough, ME, 04074, (508) 372-2889, Fax: (508) 372-3386, Sales Mgr.: Andrew Powell.
 Product(s): CD packaging machine.

electro sound, inc., 1805 W. Rt. 44, Shelbyville, IN, 46176, (317) 392-1656, Sr. Vice Pres. Sales: Hugh Landy; Gen. Mgr.: Curt Albright.
 Product(s): Total system.

Europadisk, Ltd.

75 Varick St., New York, 10013, (212) 226-4401, Fax: (212) 966-0456, Pres.: James P. Shelton; Sales Mgr.: Jeremy Guttenberg.
 Brochure Available

First Light Technology, Inc.

PO Box 70, 88 Industrial Park Dr., Saco, ME, 04072, (207) 282-4698, Fax: (207) 282-9884, Pres.: Art LeBlanc.
 Product(s): UNILINE, Integrated Compact Disc Prod. System.

Gotham Audio Corp., 1790 Broadway, 8th Floor, New York, NY, 10019, (212) 765-3410, Fax: (212) 265-8459, Pres.: Russell Hamm; Sales Mgr.: Jerry Graham; Sales Engineer: Harry Klane.

Product(s): CDR-90 O.R. Disc Sys./SPOT-90 CD Prod. Sys.
Int'l Cutterhead Repair SVC, Inc., 571 Boulevard, Hasbrouck Heights, NJ, 07604, (201) 288-0106, Pres.: Sharon Mizrahi; Sales Mgr.: Moty Mizrahi; Mktg. Dir.: Blanche Rand.

Product(s): Haeco sc-1 & haeco sc-2 disk mastering c.
JVC Prof. Products Co., 41 Slater Dr., Elmwood Park, NJ, 07407, (201) 794-3900, Fax: (201) 523-3601, Pres.: Shinzo Nakao.

Product(s): Digital Audio Mastering System.
KPC Moldmakers, PO Box 88, Industrial Park Dr., Saco, ME, 04072, (207) 282-0700, Fax: (207) 282-0799, Pres.: David A. Philippe; Sales Rep.: Mark G. Jandro.

Product(s): Injection Molds for CD Jewel Boxes.
Kingdom Co., PO Box 506, Mansfield, PA, 16933, (717) 662-7515, Fax: (717) 662-3875, Pres.: Johnny Berguson; Sales Mgr.: Howard Darr; Mktg. Dir.: Gabe Phelps.

Product(s): JVC.
Koch Int'l Corp., 2700 Shames Dr., Westbury, NY, 11590, (516) 333-4800, Fax: (516) 333-4818, Pres.: Michael Koepfle; A & R: Michael Fine; Promo: Rachelle Schlosser.
 Product(s): CD & DAT quality control systems.

ROSS-ELLIS

Using environmentally friendly materials in all our products.

Quality Packaging for the Music Industry

1133 Broadway, Suite 825
 New York, N.Y. 10010
 Telex: 00971638
 Phone: (212) 645-6110
 Toll free: (800) 223-6105
 Fax: (212) 645-9376

8300 Tampa Avenue,
 Northridge, CA. 91325
 Phone: (818) 993-4767
 Toll free: (800) 447-2149
 Fax: (818) 993-4760

A Vision of CD Quality Control

A.I.D.'s Optical Disc Inspection Systems

An affordable high speed defect detection system that monitors the production process can prevent bad product from ever being shipped. Prevention and process information provide a more effective mode of operation, that can and will dramatically increase quality and productivity.

Optical Disc Inspection of:

• CD-Audio • CD-ROM • CD-V, LD 200 and 300 • CD-I • CD-WORM • MO • MD

Options available include:

• Bar Code Reader • High Speed Batch Inspection
 • Catalog ID Verification • CD Counter



Automatic Inspection Devices, Inc.

Subsidiary of MEDAR, Inc.

P.O. Box 6295 • Toledo, Ohio 43614 USA • Phone +1 (419) 536-1983 • Fax +1 (419) 536-2793

Leybold Technologies, Inc., 120 Post Rd., Enfield, CT, 06082, (203) 741-2267, Fax: (203) 741-0267, Vice Pres. Special Coating: Dale Butrymowicz; Sales Engineer: Dale Butrymowicz.
Product(s): Metallizers for mastering & replication.

The Music Connection, Inc., Flatiron Bldg., 175 Fifth Ave., Ste. 511, New York, NY, 10010, (212) 529-0557, Fax: (212) 529-1281, Pres.: R. Ralton; Vice Pres.: Fred Levy; Sales Mgr.: Ira Cohen.

Netstal Machinery

20 Authority Dr., Fitchburg, MA, 01420, (508) 345-9400

Nobler Technologies, Inc.

111A Island St., Stoughton, 02072, (617) 344-0999, Fax: (617) 341-2427, Gen. Mgr.: Vladimir Schwartz; Sales Mgr.: Klaus M. Bierwagen.
Product(s): NT-1000 & NT 1500 Compact Disc Sputter Coaters, UV-Spincoater, Camera Inspection Systems, Stand Alone Automation Systems, MSI-1000 Single Line Prodn. Systems, MSI-2000 Double Line Prodn. System, Laser Disc Metallizers, Engineering Services.

Optical Disc Corp., 12150 Mora Dr., Santa Fe Springs, CA, 90670, (213) 946-3050, Fax: (213) 946-6030, Pres.: Richard Wilkinson; Vice Pres./Domestic Mktg./Sales: John F.N. Browne; Vice Pres. Int'l Mktg./Sales: Donald R. Hayes.
Product(s): ODC Model 530 Master recording station.

Optical Disc Mastering, 8000 Corporate Center Dr., Ste. 210, Charlotte, NC, 28226, (704) 542-5303, Fax: (704) 542-5309, U.S. Gen. Mgr.: David M. Pushic.

Product(s): Mastering/Electroforming/Replication.
Optical Media Int'l, 485 Alberto Way, Ste. 115, Los Gatos, CA, 95032, (408) 395-4332, Fax: (408) 395-6544, Pres.: Allen Adkins; Sales Mgr.: Myra Arnstein; Mktg. Dir.: Syl Peser.
Product(s): CD Audio/CD Rem premastering systems.

Polyform, Inc., 311 S. Sixth Ave., Mount Vernon, NY, 10550, (914) 668-4700, Fax: (914) 668-4820, Pres.: Ron Blazo.
Product(s): Electroforming equip. for CD's & CD-ROM.

Ranstele Audio, Inc., 1697 Broadway, New York, NY, 10019, (212) 265-5563, Fax: (212) 245-2306, Pres.: Tom Steele; Sales Mgr.: Carol J. Steele.

Studer, 1425 Elm Hill Pk., Nashville, TN, 37210, (615) 254-5651, Fax: (615) 256-7619, Pres./Mktg. Dir.: Tore Nordahl; Dir., Prof. Products: Dave Bowman; Sales Mgr.: Joe Bean; Mgr., Pub. Rel.: Sandra Hale.
Product(s): D-740 CD Recorder.

U.S. Optical Disc, Inc., One Eagle Dr., Sanford, ME, 04073, (207) 324-1124, Fax: (207) 490-1707, Pres.: Christopher Clark; Sales/Mktg. Dir.: Robert G. Pettit.

Vacuum Solutions, Inc., 110 Industrial Park Rd., Hingham, MA, 02043, (617) 749-3229, Fax: (617) 749-9515, Pres.: Sherwood L. Pratt; Sales Mgr.: Debra A. Lombardo.
Product(s): CDC-6000/CDC-1200/CD Metallizers.

Wexit Engineering, 1109 N. Cedar St., Glendale, CA, 91207, (818) 242-0006, Fax: (818) 242-0006, Pres.: Paul Wechsler.
Product(s): Stamper backfinishing/workholders/tools.

TAPE DUPLICATING & PROCESSING EQUIPMENT MANUFACTURERS

ADA, 7303-D Edgewater Dr., Oakland, CA, 94621, (415) 632-1323, Fax: (415) 632-9358, Pres.: D. Tarnowski; Sales Mgr.: L. Marcus; Contact: L. Carrelli-Gonden.
Product(s): Amplification & signal processing.

AEG Corp., 2201-K Fifth Ave., Ronkonkoma, NY, 11779, (516) 467-1200, Fax: (516) 467-1258, Sales Mgr.: Rainer K. Zopf.
Product(s): Automatic Audio Cassette Loaders & Lyrec.

Accurate Sound Corp.

3475-A Edison Way, Menlo Park, CA, 94025, (415) 365-2843, Fax: (415) 365-3057, Pres.: Ronald M. Newdell; Sales Mgr.: Don O'Bella.
Product(s): New & reconditioned high speed cassette loop bin & 1/4" reel to reel duplicating system. High speed audio duplicating electronics replacement package for 64:1 speeds.

Alshire Int'l, Inc., 1015 Isabel St., Burbank, CA, 91506, (213) 849-4671, (818) 843-6792, Fax: (818) 569-3718, Pres.: Al Sherman; Sales Mgr.: Richard Sherman; Custom Dept.: Mark Beckwith.
Product(s): Gauss 2400, King 790.

American Recorder Technologies, Inc., PO box 3592, 4395 Valley Fair St., Simi Valley, CA, 93063, (805) 527-9580, Fax: (805) 527-1433, Pres.: Alan Adelstein; Sales Mgr./Mktg. Dir.: Neil Frumkin.

Product(s): Professional Audio/Video Head Cleaner.
R.B. Annis Co., Inc., 1101 N. Delaware St., Indianapolis, IN, 46202, (317) 637-9282, Fax: (317) 637-9282, Pres.: R.B. Annis.
Product(s): Head Demagnetizer/Magnetometers.

Audio Craft, 2701 E. Sunrise Blvd., Fort Lauderdale, FL, 33304, Product(s): Real Time/Hi-Speed Dup./Full Remast.Fac.
Audiomatic Corp., 400 Madison Ave., Ste. 1211, New York, NY, 10017, (212) 308-6888, Fax: (212) 308-5817, Pres./Mktg. Dir.: Milton Gelfand; Sales Mgr.: Perry Jambor.
Product(s): Electro Sound, Concept Design, Gauss Dup.
Dwight Cavendish Co., 6444 N. Ridgeway Ave., Chicago, IL, 60645, (708) 673-0937, Fax: (708) 673-1389, Sales Mgr.: Carter Ruehrdanz; Agent: Marshall A. Ruehrdanz.
Product(s): DA's, routing switchers & machine control.

Concept Design Electronics & Mfg., Inc., 1105-A Pomeroy St., Graham, NC, 27253, (919) 229-6500, Fax: (919) 229-0063, Pres.: Robert I. Farrow; Tech. Writer/Advertising: Kathleen R. Farrow.
Product(s): DAAD, Master Making/Master Transfer Sys.

Dupltronics, Inc., 160 Abbott Dr., Wheeling, IL, 60090, (708) 459-6610, Fax: (708) 459-6615, Pres.: Jeffrey T. Binder; Mktg. Dir.: Rainer Zopf.
Product(s): Digital bins & mastering equipment.

EAM, 4 Washington Ave., Scarborough, ME, 04074, (508) 372-2889, Fax: (508) 372-3386, Sales Mgr.: Andrew Powell.
Product(s): C-0 manual assembly equipment.

Eagle Mfg., 1353 Boston Post Rd., Ste. 11, Madison, CT, 06443, (203) 245-1444, .
Product(s): High-Speed Bin-Loop Duplicating Machines.

EL Jay Ent's., Inc., 3202 E. 21st St., Tulsa, OK, 74114, (918) 627-2054, (800) 886-8273, Fax: (918) 744-1223, Pres.: Leon Whitman; Sales Mgr.: Raymond Foyester.
Product(s): Ampex Bim 200 & staves.

electro sound, inc., a Mark IV Co.

9130 Glenoaks Blvd., Sun Valley, CA, 91352, (818) 504-3820, Fax: (818) 504-3828, Pres.: Jim Williams; Customer Service Mgr.: Joe O'Connor
Product(s): High speed audio duplication systems.

Electrosound, Inc., PO Box 60639, 160 San Gabriel Dr., Sunnyvale, CA, 94088, (408) 245-6600, Fax: (408) 733-0632, Pres.: James R. Williams; Vice Pres. Sales & Mktg.: Mark Nevejan.

Future Network, Inc., 630 Ninth Ave., Ste. 403, New York, NY, 10036, (212) 399-6090, Fax: (212) 399-6092, Pres.: Ken Washino; Sales Mgr.: Tim Forster; Mktg. Dir.: Mitch Dixon; Dir., Video Prodn.: Jerry Horowitz.
Product(s): Group controllers, source routers.

Gauss, a Mark IV Co.

9130 Glenoaks Ave., Sun Valley, CA, 91352, (213) 875-1900, Fax: (818) 767-4479, Pres.: Jim Williams; Customer Service

How to increase your duplicating capacity by 2 to 4 times & save up to \$90,000 too!

It's simple. Just trade your aging duplication technology for a high-speed enhanced Accurate™ Master/Slave Duplicating System. Our Master/Slave units have been redesigned and then remanufactured from older brand name systems.

Increase to 32:1 and 64:1.

All the mechanical and electronic components are either rebuilt or replaced to give you reliable precision duplication at, 32:1 and 64:1. These systems are completely rebuilt piece by piece.

Here's a sample of what you get:

- 32:1 and 64:1 operation
- 1/2 inch loop bin
- Microprocessor system control
- Tentrols for constant tape tension
- Adj. az. using 'T-Bar' head mount

Or, for less than \$6,000 we will provide you with a 5MHz bias amplifier and four record reproduce amplifiers to upgrade your current system to 32:1 and 64:1.

Remanufacturing! Big savings!

Discover how Accurate's high quality, rebuilt duplicators give you the same top-performance of a new system at a fraction of the cost. Save as much as \$90,000 over the cost of a new master and 5 slaves.

Call us today for more information:

1 415 365 2843

ACCURATE™

Precision Recording for Professionals.



©1991, Accurate Sound Corporation • 3475A Edison Way • Menlo Park, CA 94025
Accurate and "Precision Recording for Professionals" are trademarks of Accurate Sound Corporation.

Mgr.: Joe O'Connor.
Product(s): High Speed Audio Tape Duplicating Equip.

Icon Electronics, 753 Enterprise St., Cape Girardeau, MO, 63701, (314) 334-4433, Pres.: /Mktg. Dir.: Bob Henson; Vice Pres. Engineering: Rich Fay; Vice Pres. Opns.: James Timberlake.

Product(s): Sync gens., syst. timing, encode, decode.

Infonics, Inc., PO Box 1111, 2302 E. Michigan Blvd., Michigan City, IN, 46360, (219) 879-3381, Fax: (219) 879-3383, Pres./Mktg. Dir.: Carol Lant; Sales Mgr.: David M. Smith.
Product(s): Audio cassette duplication equipment.

KABA Research & Development

24 Commercial Blvd., Novato, CA, 94949, (800) 231-TAPE, (415) 883-5041, Fax: (415) 883-5222, Pres.: Kenneth A. Bacon; Technical Sales Reps.: Anne Baker, Robin Yeager, Tom Anderson.

Product(s): KABA 4-track, Real-time & 2x audiophile audio cassette duplication system.

Kingdom Co., PO Box 506, Mansfield, PA, 16933, (717) 662-7515, Fax: (717) 662-3875, Pres.: Johnny Berguson; Sales Mgr.: Howard Darr; Mktg. Dir.: Gabe Phelps.
Product(s): Telex, Nakamichi.

Lamon Records Int'l, 7017 E. W.T. Harris Blvd., Charlotte, NC, 28215, (704) 535-7263, Fax: (704) 537-0133, CEO: D. Moody Jr.; Pres.: Carlton Moody; Mktg. Dir.: Mike Evans; Sales Rep.: David Moody.

Lyrec/Media Technologies Ltd., 2210-K Fifth Ave., Ronkonkoma, NY, 11779, Contact: Rainer K. Zopf.
Product(s): Lyrec Audio Cassette Duplicating System with speed ratio 80:1 & 100:1, Quality Control Deck; Automatic Cassette Loader Line.

Magnafax Int'l, Inc., Rt. 1, Box 764, Rogers, AR, 72756, (501) 925-1818, Fax: (501) 925-1841, Pres.: Dennis T. Tallakson.
Product(s): Tape duplicators & Degaussers.

Magnetic Marketing Corp., 18338 Lavaugh Dr., Northville, MI, 48167, (313) 349-5451, Pres.: Fred G. Fehlauer.
Product(s): Tapematic cassette loaders.

Marshall Electronics, Inc., PO Box 2027, 5649 Mesmer Ave., Culver City, CA, 90230, (213) 390-6608, Fax: (213) 391-8926, Pres.: Henry Shultz; Sales Mgr.: Roger Jackson; Mktg. Dir.: Leonard Marshall; Opns. Mgr.: Hugh Neep.
Product(s): Wire, cable & connectors for installing.

Master Recording Supply, 4000 W. Magnolia Ave., Ste. J, Burbank, CA, 91505, (818) 841-7500, Fax: (818) 841-8134, Pres.: Bud La Grandeur; Sales: Blair La Grandeur; Sales: Jacque Fleischman; Sales: Jacques Fleischman.

Product(s): SYSTEK Audio & Video tape loaders.

Media Technologies, Ltd.

2201-K Fifth Ave., Ronkonkoma, NY, 11779, (516) 467-1200, Fax: (516) 467-1258, Pres.: Rainer K. Zopf.
Product(s): Lyrec Audio Cassette Duplicating System with speed ratio 80:1 & 100:1, Quality Control Deck; Automatic Cassette Loader Line.

Memcon Corp., 2410 S. 156th Cir., Omaha, NE, 68130, (402) 333-3100, Fax: (402) 333-2029, Pres.: Gerald Korth.
Product(s): Video & computer tape.

Musicon Recording & Duplicating, 27501 SW 95th Ave., Ste. 930, Wilsonville, OR, 97070, (503) 682-8668, Fax: (503) 682-3043, Pres.: William E. Berry; Sales Mgr.: Stephen J. Ziegler.
Product(s): Versadyne, Magnafax, King(6), Roldex.

Mycomp Technologies Corp., 1959 Plaza Real, Oceanside, CA, 92056, (619) 630-0567, Fax: (619) 630-0693, Pres.: Steve Price; Mktg. Dir.: Frank Hofmeister.
Product(s): Amplifier/QC Station-Video Duplication.

Nat'l Audio Co., Inc., PO Box 3657 G.S., 1841 E. Bergman, Springfield, MO, 65808, (417) 863-1925, Fax: (417) 863-7825, Pres.: Steve Stepp; Sales Mgr.: Sandi Stonecker.
Product(s): Ampex 3200 open reel, Telex 6120 cassett.

Oakridge Music Recording Service, 2001 Elton Rd., Fort Worth, TX, 76117, (817) 838-8001, Owner/Pres.: Homer Lee Sewell.

Otari Corp., 378 Vintage Park Dr., Foster City, CA, 94404, (415) 341-5900, Fax: (415) 341-7200, Pres.: Jack Soma; Vice Pres. Sales/Mktg.: John Carey; Sales Mgr.: James Goodman.
Product(s): Audio & video tape duplicators.

Panasonic (div. of Matsushita Electric Corp. of America), One Panasonic Way, Secaucus, NJ, 07094, (201) 348-7118, (201) 348-7826, Fax: (201) 392-4312, Mktg. Mgr.: Rick Nuffer; Nat'l Sales/Mktg. Mgr.: George Curry.
Product(s): VHS Duplicators, Cassette Changers.

Polyform, Inc., 311 S. Sixth Ave., Mount Vernon, NY, 10550, (914) 668-4700, Fax: (914) 668-4820, Pres.: Ron Blazo.
Product(s): Tape conversion, analog to digital equip.

Prairie Sun Recording Studio, PO Box 7084, Cotati, CA, 94931, 1039 Madrone Ave., Cotati, CA, 94928, (707) 795-7011, Pres./Mktg. Dir.: Mark "Mooka" Rennick; Opns. Mgr.: Jeffrey Sloan.
Product(s): Kaba 4trk Duplication, Sony Dat's.

Premier Film & Recording Corp., 3033 Locust St., Saint Louis, MO, 63042, (314) 531-3555, Fax: (314) 726-8798, Pres.: Wilson Dalzell; Sales Mgr.: Donna Blue; Mktg. Dir.: Bob Heuermann.
Product(s): Telex.

Progressive Music, 2116 Southview Ave., Tampa, FL, 33606, (813) 251-8093, Fax: (813) 251-6050, Pres.: Ken Veenstra; Sales Mgr.: Billy Garrow.

Product(s): 44 Real Time Denon, 11 Sony HiSpeed.
Radio Central, 548 S. Spring St., #815, Los Angeles, CA, 90013, (213) 623-7589, Pres.: David B. Sigler; Sales Mgr.: CT. Hampson.

Product(s): Magnafax, Magnagord.
Recortec, Inc., 1290 Lawrence Station Rd., Sunnyvale, CA, 94089, (408) 734-1290, Fax: (408) 734-2140, Pres.: Lester H. Lee; Sales Mgr.: Ronald Troxell; Vice Pres. & Mktg. Dir.: El Don Corl.
Product(s): Open reel high speed audio cassette dupl.

Research Technology Int'l, 4700 Chase Ave., Lincolnwood, IL, 60646, (708) 677-3000, Fax: (708) 677-1311, Pres.: Ray L. Short; Sales Mgr.: Bill Wolavka; Sales Mgr.: Tom Boyle; Mktg. Dir.: Tom Tisch.

Product(s): Video tape evaluation, cleaning equip.
Shintron Co., Inc., 45 Winthrop St., Concord, MA, 01742, (508) 371-7500, Fax: (508) 371-7554, Pres.: Sam Asano.
Product(s): Distribution Amplifiers.

Sontec Electronics, Audio Dr., Goldbond, VA, 24094, (703) 626-7256, Gen. Mgr./Sales Mgr.: Burgess MacNeal.
Product(s): EQ's, Compressors, Hi-Frequency Limiters.

Sony Educational Systems, 10833 Valley View St., Cypress, CA, 90630, (800) 326-7669, Fax: (714) 229-4351, Pres.: Tony Park; Mktg. Dir.: Douglas R. Williams.
Product(s): Cassette, hi-speed tape duplicators.

Sony Information Systems Co., Sony Dr., Park Ridge, NJ, 07656, (201) 930-6292, Fax: (201) 573-8608, Major Accts. Sales Mgr.: Tom Hofbauer; Nat'l Sales Mgr.: Willard Harlow.

Sprague Magnetics, Inc., 15720 Stagg St., Van Nuys, CA, 91406, (818) 994-6602, Fax: (818) 994-2153, Pres.: Dorothy Sprague; Vice Pres., Mktg/Sales: Lee F. Schelin.
Product(s): Mfg. magnetic heads for duplicating mach.

Studer, 1425 Elm Hill Pk., Nashville, TN, 37210, (615) 254-5651, Fax: (615) 256-7619, Pres./Mktg. Dir.: Tore Nordahl; Dir., Prof. Products: Dave Bowman; Sales Mgr.: Joe Bean; Mgr., Pub. Rel.: Sandra Hale.
Product(s): A-820 MR Bin Loop Master Recorder.

Studer-Revov America, Inc., 16102 Hart St., Van Nuys, CA, 91406, (818) 780-4234, Fax: (818) 780-4797, Sales Mgr.: Tom Jenny.
Product(s): Duplicating-Master-Recorder, CD-QC-Player.

Sunset Prodn., 117 W. Eighth, Hays, KS, 67601, (913) 625-9634, Fax: (913) 625-5757, Pres.: Mark Meckel.
Product(s): Sony-KABA.

Tape Automation America, PO Box 340, Old Alewife Rd., West Kennebunk, ME, 04094, (207) 985-2892, Fax: (207) 985-4917, Pres.: Fred Wieglieb.
Product(s): Duplicators, Xenon video cassette loaders.

The EAM CD Packaging Machine

PRODUCTION PROVEN!

at 40+ parts per minute

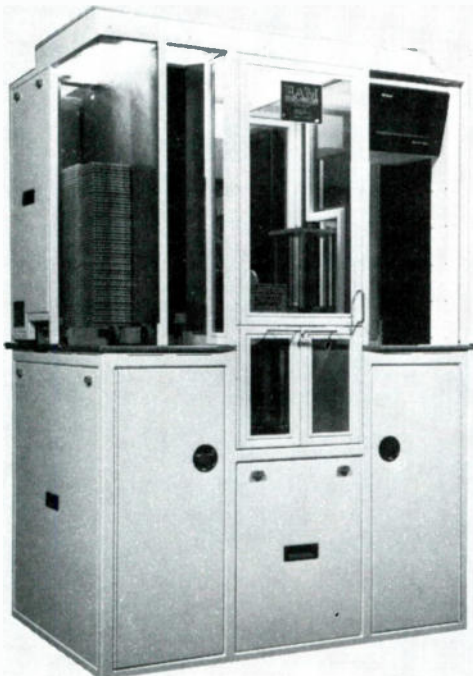

Tape Duplicators:

The EAM CD Packaging Machine is the most efficient way to become a full service supplier! Its compact size, low energy consumption, short run compatibility and low initial investment make the EAM Machine the right choice for the supplier purchasing bulk discs or specializing in short runs.

Multi-Pack Producers:

EAM announces a packaging machine able to run both standard jewel boxes and multi-pack jewel boxes (with two, three or four discs) – The EAM Multi-Pack CD Packaging Machine

For more information on the EAM CD packaging machine please contact:

In the U.S.:
deVille Integrated
Andrew Powell
Phone: 508.372.2889
Fax: 508.372.3386

In Europe:
Kalteren International
The Netherlands
Phone: (31) 85 45 25 41
Fax: (31) 85 45 14 02

Tape Duplication Technology, Inc., 1830 Wayne Trace, Fort Wayne, IN, 46803, (219) 424-1007, Fax: (219) 422-1023, Pres.: Leon Giannakoff; Mng. Dir.: Jerry Torres.
Product(s): High-Speed Bin-loop duplication systems.

Tape Specialty, Inc., 13411 Saticoy St., North Hollywood, CA, 91605, (818) 786-6111, Fax: (818) 904-0267, Pres.: Steven Feldman; Sales Mgr.: Nancy Citanova.
Product(s): Tentrol Holders, Precision Roller guides.

Telex Communications, Inc., 9600 Aldrich Ave. S., Minneapolis, MN, 55420, (612) 884-4051, Fax: (612) 884-0043, Pres.: Jeff Wetherall; Sales Mgr.: Rick Peterson; Mktg. Dir.: Ted Nemzek.
Product(s): high speed in-cassette duplicators.

Thalco Audio, Inc., 2 Dickens Ave., Dix Hills, NY, 11746, (516) 667-1616, Fax: (516) 496-4763, Pres.: Michael Thaler; Mktg. Dir.: Glenn Thaler.
Product(s): Replac. Heads Electro Sound Audio Dup.

Universal Tape Corp., Inc., 860 E. Walnut St., Carson, CA, 90746, (213) 327-3203, Fax: (213) 273-5646, Pres.: Edward O. Praeger.
Product(s): Wollensak high speed cassette duplicator.

Versadine Int'l Inc., 504-D Vandell Way, Campbell, CA, 95008, (408) 379-0900, (800) 367-6909, Fax: (408) 379-0902, Pres.: Robert W. Kratt.
Product(s): High Speed Bin-Loop Duplication Systems.

Weircliffe USA, 2752 Walnut Ave., Tustin, CA, 92680, (714) 838-8833, Fax: (714) 838-9619, Pres.: Roger L. Bailey; Sales Mgr.: Gene Tollini; Mktg. Dir.: Earl Jamgochian; Product Specialist: Jim Owen.
Product(s): Degaussers.

Audio/Video: Blank Audio Cassettes & Accessories.

The Hit Factory-DMS, Inc., 237 W. 54th St., 130 W. 42nd St., 10th Floor, New York, NY, 10019, (212) 768-4141, Fax: (212) 768-9818, Pres.: Edward Germano; Mgr.: Patti Firrincii.
Audio: Ampex.

Industrial Electroforming Systems Corp., 309 11th Ave. S., Nashville, TN, 37203, (615) 383-4406, Fax: (615) 385-1688, Pres.: William Westermann.

Instant Replay, 2601 S. Bayshore Dr., Ste. 1050, Miami, FL, 33133, (305) 854-8777, Fax: (305) 858-9053, Pres.: Charles Azar; Sales Mgr.: Deborah Azar.
Video: Multi-systems/standards converting VCRs.

Int'l Cutterhead Repair SVC, Inc., 571 Boulevard, Hasbrouck Heights, NJ, 07604, (201) 288-0106, Pres.: Sharon Mizrachi; Sales Mgr.: Moty Mizrachi; Mktg. Dir.: Blanche Rand.

JRF Magnetic Sciences, Inc., PO Box 121, 249 Kennedy Rd., Greendell, NJ, 07839, (201) 579-5773, Fax: (201) 579-6021, Pres./Sales Mgr.: John R. French; Lab Mgr.: Dennis Charney.
Audio: T-Bar Azimuth Adjust. Mount For Slave Assemblies.

JVC Prof. Products Co., 41 Slater Dr., Elmwood Park, NJ, 07407, (201) 794-3900, Fax: (201) 523-3601, Pres.: Shinzo Nakao.

Joyce Molding Corp., 52 Green Pond Rd., Rockaway, NJ, 07866, (201) 586-2900, Fax: (201) 627-5730, Pres.: Ed Joyce; Sales Mgr.: Phil Koljeski.
Audio: Poly Norelco & Jewel Boxes, Single & Double.
Video: Storage Cases, Beta, VHS, U-Matic, All Formats.

KPC Moldmakers, PO Box 88, Industrial Park Dr., Saco, ME, 04072, (207) 282-0700, Fax: (207) 282-0799, Pres.: David A.

Philippe; Sales Rep.: Mark G. Jandro.
Audio: Injection Molds For C-0s, Components, Jewel Boxes.
Video: Injection Molds For V-0s And All Components.

King Instrument Corp., PO Box 1070, 80 Turnpike Rd., Westboro, MA, 01581, (508) 366-9141, Fax: (617) 870-5932, Pres.: William Cline; Vice Pres.: Paul Itoh, Sr.; Sales Engineer: Wayne Peterson.
Audio/Video: Cassette Loading Equipment.

Magnifax Int'l, Inc., Rt. 1, Box 764, Rogers, AR, 72756, (501) 925-1818, Fax: (501) 925-1841, Pres.: Dennis Tallakson.

Magnetic Products, 27712 Avenue Mentry, Valencia, CA, 91355, (805) 295-8448, Fax: (805) 295-8278, Managing Dir.: R. Goldman.
Video: Blank Video Tape, All Formats.

Mastercraft Record Plating, Inc., 609 W. 51st St., New York, NY, 10019, (212) 410-3214.

Nat'l Audio Co., Inc., PO Box 3657 G.S., 1841 E. Bergman, Springfield, MO, 65808, (417) 863-1925, Fax: (417) 863-7825, Pres.: Steve Stepp; Sales Mgr.: Sandi Slonecker.
Audio: CD-9000 Loaders, King 790 + Mk-2000 Loader.

Netzsch, Inc., 119 Pickering Way, Exton, PA, 19341, (215) 363-8010, Fax: (215) 363-0971, Sales/Mktg. Mgr.: Roland Swett; Sales/Mktg. Asst. Mgr.: George Murphy.
Audio/Video: Magnetic Coating Precision Bead Mills And Mixers.

Optical Media Int'l, 485 Alberto Way, Ste. 115, Los Gatos, CA, 95032, (408) 395-4332, Fax: (408) 395-6544, Pres.: Allen Adkins; Sales Mgr.: Myra Arnstein; Mktg. Dir.: Syl Peser.

TAPE EQUIPMENT MANUFACTURERS

AEG Corp., 2201-K Fifth Ave., Lakeland, NY, 11779, (516) 467-1200, Fax: (516) 467-1258, Sales Mgr.: Rainer K. Zopyf.

All American Records/A Div. of All American Record Mfg. Inc., 4380 NW 128th St., Opa Locka, FL, 33054, (305) 688-7475, Fax: (305) 685-5697, Pres.: Peter Botome; Sales Mgr.: Marilyn Moreno; Mktg. Dir.: Bertilda Torres; Exec. Dir.: Jorge A. Jure.
Video: Ampex.

American Multimedia, Inc., 2609 Tucker St. Ext., Burlington, NC, 27215, (919) 229-5554, (800) 849-8273, Fax: (919) 228-1409, Pres.: Dave J. Forsyth; Sales Mgr./Mktg. Dir.: Tim V. Mallard; Customer Service Dir.: Jeanne Conklin.
Audio: DAAD & Other Manufacturing Upgrades.

R.B. Annis Co., Inc., 1101 N. Delaware St., Indianapolis, IN, 46202, (317) 637-9282, Fax: (317) 637-9282, Pres.: R.B. Annis.

Apex Machine Co., 3000 NE 12th Terrace, Fort Lauderdale, FL, 33334, (305) 566-2739, Fax: (305) 563-2844, Contact: Bob Covingsby.
Audio/Video: Direct On-Cassette Printing Machinery.

Audico, Inc., 7206 W. Grand, Elmwood Park, IL, 60635, (708) 456-0003, Fax: (708) 456-0418, Pres.: Barbara Deleitzke.
Audio: Timer/Rewinder/Exerciser/Avoid Program Length Prob.

C M Magnetics Corp., 13731 Bora Dr., Santa Fe Springs, CA, 90670, (213) 921-5886, Fax: (213) 921-0035, Pres.: Carlos Maciel; Sales Mgr.: M. Nahbani; Mktg. Dir.: Terry Wherlock.
Audio: Coater, Calenders, Slitters For Audio & Video.

Concept Design Electronics & Mfg., Inc., 1105-A Pomeroy St., Graham, NC, 27253, (919) 229-6500, Fax: (919) 229-0063, Pres.: Robert I. Farrow; Tech. Writer/Advertising: Kathleen R. Farrow.
Audio: CD9000 Cass. Loader, MSI, Multistacker, Fast Feed.

DDW, Inc., 309 11th Ave. S., Nashville, TN, 37203, (615) 383-4406, Fax: (615) 385-1688, Pres.: William Westermann.

Diamond Tape Prodn., 22 Bridge St., Watertown, MA, 02172, (617) 266-3131, Pres.: Raymond Fournier; Sales Mgr.: Stella Manning.

Egan Machinery, PO Box 671, S. Adamsville Rd., Somerville, NJ, 08876, (908) 722-6000, Fax: (908) 722-6444, Pres.: Robert A. Pierfelice; Product Mgr.: Glenn W. Whitmore; Bus. Analyst: Bob Cicciari.

Egan Machinery, PO Box 987, 229 Van Buren St., Oconto Falls, WI, 54154, (414) 846-2892, Fax: (414) 846-3976, Vice Pres. Sales/Mktg.: Bill Bryant.

Electro Sound, Inc., a Mark IV Co., 9130 Glenoaks Blvd., Sun Valley, CA, 91352, (818) 504-3820, Fax: (818) 504-3828, Pres.: Jim Williams; Cust. Serv. Mgr.: Joe O'Connor.
Audio: High speed audio cassette loader.
Video: Pancake QC machine.

Electrosound, Inc., PO Box 60639, 160 San Gabriel Dr., Sunnyvale, CA, 94088, (408) 245-6600, Fax: (408) 733-0632, Pres.: James R. Williams; Vice Pres. Sales & Mktg.: Mark Nevejans.
Audio: Hi-Speed Audio Cassette Tape Duplication Equipment.

Fidelipac Corp., PO Box 808, Moorestown, NJ, 08057, (609) 235-3900, Fax: (609) 235-7779, Pres.: Roger Thanhauser; Sales Mgr.: John Tiedeck; Mktg. Dir.: Scott Martin.
Audio: 1/4" Audio Tape.

Goldstar Electronics, Inc., 1000 Sylvan Ave., Englewood Cliffs, NJ, 07632, (201) 816-2000, Pres.: S. Chung; Sales Mgr.: Joe Stevens.
Audio: C60 C90 C100 All Positions.

Greencorp USA, Inc., 1015 W. Newport Center Dr., Ste. 105, Deerfield Beach, FL, 33442, (305) 429-9225, Fax: (305) 429-9214, Pres.: Dorothy Goldstein; Sales Mgr.: Monique Charon.

Project Studio or Production House

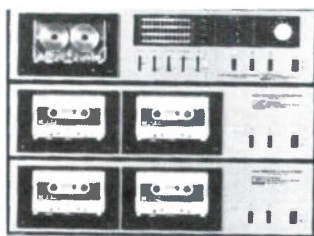

Whether you want to make 50 cassettes a day or 50,000 a month, KABA makes the best real time audio duplication systems around. Thanks to our modular design, you can stack the decks to meet your needs affordably.

- Real time or double time for superior sound and efficiency
- Most flexible system available; accepts audio from any master source, 2-track or 4-track to cut duplication time in half
- Incredible 10,000 + hour transport life improves cost effectiveness
- Specialists in Turnkey Systems: loaders, cassette imprinters, labelers, packaging equipment, accessories

WE'VE MASTERED AUDIO DUPLICATION.

Try for 15 days — risk free. Phone, FAX or write to



KABA
Research & Development

24 Commercial Blvd., Novato, CA 94949 (415) 883-5041
1-800-231-TAPE FAX (415) 883-5222

Polyform, Inc., 311 S. Sixth Ave., Mount Vernon, NY, 10550, (914) 668-4700, Fax: (914) 668-4820, Pres.: Ron Brazzo.

Progressive Music, 2116 Southview Ave., Tampa, FL, 33606, (813) 251-8093, Fax: (813) 251-6050, Pres.: Ken Veenstra; Sales Mgr.: Billy Garrow.
Audio: Electro Sound loaders.

Ransteale Audio, Inc., 1697 Broadway, New York, NY, 10019, (212) 265-5563, Fax: (212) 245-2306, Pres.: Tom Steele; Sales Mgr.: Carol J. Steele.
Audio: Digital Audio Transfer Consoles.

Research Technology Int'l, 4700 Chase Ave., Lincolnwood, IL, 60646, (708) 677-3000, Fax: (708) 677-1311, Pres.: Ray L. Short; Sales Mgr.: Bill Wolavka; Sales Mgr.: Tom Boyle; Mktg. Dir.: Tom Tisch.
Video: Test Equipment: Dropout Counters.

Sprague Magnetics, Inc., 15720 Stagg St., Van Nuys, CA, 91406, (818) 994-6602, Fax: (818) 994-2153, Pres.: Dorothy Sprague; Vice Pres., Mktg/Sales: Lee F. Scheilin.
Audio: Mfg. For Magnetic Tape Heads For Recording & Film.

Studer-Revax America, Inc., 16102 Hart St., Van Nuys, CA, 91406, (818) 780-4234, Fax: (818) 780-4797, Sales Mgr.: Tom Jenny.

Tape Automation America, PO Box 340, Old Alewife Rd., West Kennebunk, ME, 04094, (207) 985-2892, Fax: (207) 985-4917, Pres.: Fred Wieglieb.

Tillis Assoc., PO Box 2245, Danville, CA, 94526, (415) 736-1117, Pres.: Frances Tillis; Sales Mgr.: Robert Tillis.

Worldwide Converting Machinery Co., 240 W. Crescent Ave., Allendale, NJ, 07401, (201) 327-5690, Fax: (201) 327-5970, Vice Pres.: Dan Grynberg.
Audio: "Coating Lines" For Production Of Magnetic Tape.

TAPE PACKAGING & LABELING EQUIPMENT MANUFACTURERS

AJM Inc., 1600 Wyatt Dr., Ste. 12, Santa Clara, CA, 95054, (408) 980-8631, Fax: (408) 980-0281, Sales Mgr.: Mike Frug.
Product(s): Shrink Packaging Equipment.

APS Packaging, PO Box 712, 1275 Bloomfield Ave., Fairfield, NJ, 07004, (201) 575-1040, Fax: (201) 575-6540, Pres.: Henry Verbeke; Sales Mgr.: Eric Verbeke.
Product(s): Shrink Systems.

ATW Mfg. Co., Inc., PO Box 7755, 4065 W. 11th Ave., Bldg. 5, Eugene, OR, 97401, (503) 484-2111, Fax: (503) 484-1493, Pres.: Tom Drew; Sales Mgr.: Jeff Spencer; Mktg. Dir.: Janie Wilson.
Product(s): Shrink Wrapping Equipment & Supplies.

Acme Business Forms, 7931 NE Halsey, Ste. 101, Portland, OR, 97213, (503) 255-5595, Fax: (503) 256-0561, Vice Pres.: Roger Booth.
Product(s): Bar Coded Labels.

Alshire Int'l, Inc., 1015 Isabel St., Burbank, CA, 91506, (213) 849-4671, (818) 843-6792, Fax: (818) 569-3718, Pres.: Al Sherman; Sales Mgr.: Richard Sherman; Custom Dept.: Mark Beckwith.
Product(s): Iselman, Apex.

Apex Machine Co., 3000 NE 12th Terrace, Fort Lauderdale, FL, 33334, (305) 566-2739, (305) 566-1572, Fax: (305) 563-2844, Pres.: A. Robert Coningsby; Sales/Mktg. Dir.: Alfred R. Coningsby, III.
Product(s): Audio Cassette & Insert Packaging.

At The Top Duplicators, 3330 Earhart, Carrollton, TX, 75006, (214) 980-7671, (214) 233-9191, Fax: (214) 991-1853, Prodn. Mgr.: Bert Newmeyer.
Product(s): ITI Labler.

Audio Craft, 2701 E. Sunrise Blvd., Fort Lauderdale, FL, 33304.
Product(s): Full Service Packaging.

Audiomatic Corp., 400 Madison Ave., Ste. 1211, New York, NY, 10017, (212) 308-6886, Fax: (212) 308-5817, Pres./Mktg. Dir.: Milton Gelfand; Sales Mgr.: Perry Jambor.
Product(s): Apex On-Cassette Printers.

Bennett Data Forms, 2033 Lamolme Ave., Fort Lee, NJ, 07024, (201) 944-3320, Vice Pres.: Bob Antoville.
Product(s): Bar Code Labels, Printers, Shrink Equip.

Blackbourn, Inc., 7550 Corporate Way, Eden Prairie, MN, 55344, (800) 842-7550, Fax: (612) 949-2553, Pres.: Todd Nicholson; Sales Mgr.: Jerry Forness; Mktg. Dir.: Mike Langert.
Product(s): Audio Cassette Vinyl Boxes, Video Tapes.

Carter-Craft Inc., 2240 15th St., Rockford, IL, 61004, (815) 229-7773, Pres.: Wayne Timpe.
Product(s): Bar Coding, Shrink Wrapping Equipment.

Continental Plastic Card Co., PO Box 8408, 3651 NW 120th Ave., Coral Springs, FL, 33065, (305) 753-8505, Sales Mgr.: Chuck Siegel.
Product(s): Bar Code Labels, In-House Systems.

Creative Data Services, 13748 Shoreline Ct. E., Earth City, MO, 63048, (314) 291-0699, Dir. Sales: Alan Parker.
Product(s): Cards, Pre-Print Labels.

Creative Packaging, PO Box 6069, 1469 Patton Dr., Boulder, CO, 80306, (800) 345-1469, Contact: Mike Colpitt.

Data Composition Inc., 1099 Essex Ave., Richmond, CA, 94801, (415) 232-6200, (800) 227-2121, Fax: (415) 235-2176, Vice Pres. Mktg/Sales: B.J. Armstrong.
Product(s): Pre-Print Labels.

deVillie Integrated, 55 Ward Hill Ave., Haverhill, MA, 01835, (508) 372-2889, Fax: (508) 372-3386, Pres.: Andrew Powell.
Product(s): CD Jewel Box Packaging Machines & Custom Automations.

Diamond Tape Prodn., 22 Bridge St., Watertown, MA, 02172, (617) 266-3131, Pres.: Raymond Fournier; Sales Mgr.: Stella Manning.
Product(s): ITI Labler.

Duplication Specialists, 4584 Austin Blvd., Island Park, NY, 11558, Pres.: David J. Schwartz; Sales Mgr.: James E. Void.
Product(s): Specialized PC Compatible Software.

EAM

4 Washington Ave., Scarborough, ME, 04074, (508) 372-2889, (508) 372-3386, Mktg. Rep.: Andrew Powell.
Product(s): CD Jewel Box Packaging Machines & Custom Automations.

Eagle Mfg., 1353 Boston Post Rd., Ste. 11, Madison, CT, 06443, (203) 245-1444.
Product(s): Audio & Video.

EL Jay Entls., Inc., 3202 E. 21st St., Tulsa, OK, 74114, (918) 627-2054, (800) 886-8273, Fax: (918) 744-1223, Pres.: Leon Whitman; Sales Mgr.: Raymond Foyester.
Product(s): Cassette Imprinter.

Fenton Label Co., 3650 Coral St., Philadelphia, PA, 19124, (215) 288-2910, Fax: (215) 533-5390, Pres.: J. K. Tompkins; Sales Mgr.: P. McKean.
Product(s): Full Range of Label Applicators.

G Cee Graphics, Inc., 18653 Ventura Blvd., Ste. 223, Tarzana, CA, 91356, (818) 347-1136, Fax: (818) 889-4773, Pres.: Gregory Higgins.
Product(s): Higgie Box-Famos w/Syndicators.

Graphic Technology Inc., 301 Gardner Dr., Industrial Airport, KS, 66031, (800) 767-9920, (913) 829-8000, Fax: (913) 829-1462, Pres.: Terry Van Der Tuuk; Sales/Mktg.: Rue Chagoll; Mktg. Mgr.: Karen Wilcox.
Product(s): Bar Coded Labels, Coded Membership Cards.

Hannecke Display Systems, Inc., 300G Rt. 17 S., Mahwah, NJ, 07430, (201) 529-5995, Fax: (201) 529-9343, Pres.: Bruce C. Dreher; Mktg. Dir.: Grace Perusini.
Product(s): Manufacturer of Display Systems for A/V.

Identronics, 425 Lively Blvd., Elk Grove Village, IL, 60007, (708) 437-2654, Sales Mgr.: Greg Powell.
Product(s): Bar Coded Labels.

JLP Graphics, Inc., 42A Columbia Rd., Somerville, NJ, 08876, (908) 722-7077, Fax: (908) 722-0877, Pres.: Jack Palmer; Sales Mgr.: Victor M. Nichols.
Product(s): Video & Tape.

Kingdom Co., PO Box 506, Mansfield, PA, 16933, (717) 662-7515, Fax: (717) 662-3675, Pres.: Johnny Berguson; Sales Mgr.: Howard Darr; Mktg. Dir.: Gabe Phelps.
Product(s): AB Dick.

Labeling Systems Inc., 97 McKee Dr., Mahwah, NJ, 07430, (901) 529-5311, Fax: (201) 529-8023, Pres.: T.N. Zaccaro; Sales Mgr.: Steve Pullman.
Product(s): Label Equip. for Cassettes, Audio & Video.

M. Latte Mfg., Inc., 3669 Seventh Ave., Los Angeles, CA, 90018, (213) 737-0440, Fax: (213) 737-4867, Pres.: Mel Latte; Sales Mgr.: Neal Taiki.
Product(s): Mfg. Shrinkwrap Equipment.

Magnetic Marketing Corp., 18338 Lavaugh Dr., Northville, MI, 48167, (313) 349-5451, Pres.: Fred G. Fehlaier.
Product(s): Apex Cassette Imprinters.

Markem Corp., Customark Div., 2340 Bering Dr., San Jose, CA, 95131, (408) 435-8901, Sales Dir.: Chris Speck.
Product(s): Bar Code Labels & Printing Equipment.

Markem Corp., Customark Div., 150 Congress St., Keene, NH, 03431, (603) 352-1130, Product Mgr.: Rick Bangham.
Product(s): Bar Code Labels & Printing Equipment.

Market Line Int'l (MLI), 15 Emerald St., Hackensack, NJ, 07601, (201) 646-0225.
Product(s): Bar Coded Labels.

Master Recording Supply, 4000 W. Magnolia Ave., Ste. J, Burbank, CA, 91505, (818) 841-7500, Fax: (818) 841-8134, Pres.: Bud La Grandeur; Sales: Blair La Grandeur, Jacques Fleischman.
Product(s): Apex, Scandia.

Memcon Corp., 2410 S. 156th Cir., Omaha, NE, 68130, (402) 333-3100, Fax: (402) 333-2029, Pres.: Gerald Korth.

Nat'l Audio Co., Inc., PO Box 3657 G.S., 1841 E. Bergman, Springfield, MO, 65808, (417) 863-1925, Fax: (417) 863-7825, Pres.: Steve Stepp; Sales Mgr.: Sandi Stonecker.
Product(s): ITI-LIB.

OAL Associates, Inc., PO Box J, 1175-0 Industrial Ave., Escondido, CA, 92033, (619) 743-7143, Fax: (619) 743-2460, Pres.: Mark Lohkemper.
Product(s): Shrinkwrap Tunnel/Conveyor Ovens.

Paktec Automation, Inc., 28130 Ave. Crocker, Unit 308, Valencia, CA, 91355, (805) 257-7616, Fax: (805) 257-9474, Pres.: Darrell Zielke.
Product(s): O-Card/Norelco Box/Soft Poly Box Inserts.

Performance Dist., PO Box 0156, 2 Oak St., New Brunswick, NJ, 08903, (908) 545-3004, Fax: (908) 545-6054, Owner: Stephen Kaplan; Owner: Arthur Marko; Mgr.: Jessica DiGiora.
Product(s): CD Sealer, Seals Single Blister Pak.

Personal Touch Systems, 655 E. 4500 S., Ste. 100, Salt Lake City, UT, 84107, (801) 266-4484, Sales Mgr.: Mike Wilde.
Product(s): Bar Coded Labels.

Premier Film & Recording Corp., 3033 Locust St., Saint Louis, MO, 63042, (314) 531-3555, Fax: (314) 726-8798, Pres.: Wilson Dalzell; Sales Mgr.: Donna Blue; Mktg. Dir.: Bob Heuermann.
Product(s): Commodore, Okidata.

Pres-Tige Label Corp., 175-N Commerce Dr., Hauppauge, NY, 11788, (516) 273-0020, Fax: (516) 273-0092, Pres.: Ernie J. Menkes.
Product(s): Pressure Sensitive Label Applicators.

Romaba Record Pressing Corp. of America, 33-34th St., Brooklyn, NY, 11232, (718) 499-3060, Fax: (718) 499-3061, Pres.: Theodore E. Kolsky; Vice Pres.: Dara Kolsky; Sales

apex

since 1903

- the inventor and manufacturer of the first production on-video cassette printer
- the inventor and manufacturer of the first production on-audio cassette printer.
- the largest and finest manufacturer of on-audio and on-video cassette printers in the world.

why settle for less ? ?

apex machine company
3000 n.e. 12th terrace • ft. lauderdale, fl 33334
phone: 305-565-apex • fax: 305-563-2844 • telex: 271601 apex ur

international representative audiomatic corporation
400 madison avenue • new york, ny 10017 usa
ph. 212-308-6888 • fax: 212-308-5817 • telex: 12-6419

domestic representatives west coast master recording supply, inc.
4000 w magnolia blvd., ste. j • burbank, ca 91505
ph. 818-841-7500 • fax. 818-841-8134

mid-west encore marketing company
p.o. box 386 • kenilworth, il 60043
ph 708-256-6223 • fax: 708-256-8362

Mgr: Vicki M. Guerra; Mktg. Dir: Jennifer Kolsky.
Product(s): Weldotron.

Scandia Packaging Machinery Co.

PO Box 575, Allwood Sta., 180 Brighton Rd., Clifton, NJ, 07012, (201) 473-6100, Fax: (201) 473-7226, Pres.: W. B. Bronander, Jr.; Vice Pres. Sales Mgr: Bill Bronander.
Product(s): Audio, Video, R-Dat, 8mm Case Loading.

Seal-O-Matic Co., 900 Passaic Ave., East Newark, NJ, 07029, (201) 481-6500, (800) 631-2072, Pres.: Samuel Ortner; Sales Mgr: Lee Chesin; Mktg. Dir: Tom Eaton.
Product(s): Dispensers, Label Guns, Heat Sealers.

Traxx Recording Products & Duplication, 24 Crestway KC, New Fairfield, CT, 06812, (203) 746-3561, Pres.: Jim Beck.
Product(s): Tuck & Shrink-Wrap.

Vanguard ID Systems Div., 116 S. Ship Rd., Exton, PA, 19341, (213) 524-7433, Vice Pres.: Rick Warther.
Product(s): Bar Code Labels.

Jackets & Sleeves...

(Continued from page 146)

ber; Sales Mgrs./Mktg. Dirs.: Tom Sherry, Jeanne Horan. (Jackets/Sleeves-Audio: Tape)(Jackets/Sleeves-Audio: Tape)
Design Plastics, Inc., 3550 N. Keystone Dr., Omaha, NE, 68134, (402) 572-7177, Fax: (402) 572-0500, Pres.: John Napper; Vice Pres. Mktg./Sales: Sylvio J. Rebolloso. (Jackets/Sleeves-Audio: CD)

Digital House Ltd., 101 W. 57th St., New York, NY, 10019, (212) 333-5950, Fax: (212) 262-5631, Pres.: Jerome Bunke; Vice Pres. Tech. Services: Harry Hirsch; Vice Pres. Mktg.: Don Burkimer. (Jackets/Sleeves-Audio: CD, Tape)

Disc Graphics, Inc., 10 Gilpin Ave., Hauppauge, NY, 11788, (516) 234-1400, Fax: (516) 234-1460, Pres.: Donald Sinkin; Vice Pres. Finance: John Rebecchi; Admin. Asst.: Angie David. (Jackets/Sleeves-Audio: CD, Tape, LP)(Jackets/Sleeves-Audio: Tape, Disc)

Disc Makers, 1328 N. Fourth St., Philadelphia, PA, 19122, (800) 468-9353, (215) 232-4140, Fax: (215) 236-7763, Pres.: Morris Ballen; Sales/Mktg. Dir: Tony Van Veen. (Jackets/Sleeves-Audio: CD, Tape, LP)(Jackets/Sleeves-Audio: Tape)

Disc Makers, Senda De La Posada N-6, Quintas Del Rio, Bayamon, PR, 00961, (809) 740-0010, Fax: (809) 785-5554, Sales Mgr: David Rodriguez. (Jackets/Sleeves-Audio: CD, Tape, LP)(Jackets/Sleeves-Audio: Tape)

Disc Makers, 1650 Broadway, Ste. 1010, New York, NY, 10019, (212) 265-7505, Fax: (212) 262-0798, Sales Mgr: Howard Roseff. (Jackets/Sleeves-Audio: CD, Tape, LP)(Jackets/Sleeves-Audio: Tape)

Duplicates, 11 E. Hubbard St., Chicago, IL, 60611, (312) 822-0305, Fax: (312) 464-0762, Pres.: Michael A. Freeman. (Jackets/Sleeves-Audio: CD, Tape, LP)

EMC Prods., 300 York Ave., Saint Paul, MN, 55101, (612) 771-1555, Fax: (612) 771-5629, Pres.: Paul Winter; Vice Pres.: Dick Stevens; Mktg. Dir: Paula Jeske. (Jackets/Sleeves-Audio: Tape)

Edison Printing Co., 986 Main St., Sanford, ME, 04073, (207) 324-5410, Fax: (207) 324-1798, Pres.: Robert Rosenfield; Sales Mgr.: Pamela Ewers. (Jackets/Sleeves-Audio: CD, Tape)

Film Nat'l Plastics, Inc., 13984 S. Orange Ave., Paramount, CA, 90723, (213) 630-2500, Fax: (213) 408-0712, Pres.: Vic Flores; Mktg. Dir: Brad Harse. (Jackets/Sleeves-Audio: CD, Tape)

G Cee Graphics, Inc., 18653 Ventura Blvd., Ste. 223, Tarzana, CA, 91356, (818) 347-1136, Fax: (818) 889-4773, Pres.: Gregory Higgins. (Jackets/Sleeves-Audio: CD, Tape, LP)(Jackets/Sleeves-Audio: Tape, Disc)

GP Prods., 362 Third Ave., Ste. 1B, New York, NY, 10016, (212) 686-5267, Pres.: Gill R. Pessoa; Sales Mgr: Y.L. Walton; Mktg. Dir.: Daryl A. Pessoa. (Jackets/Sleeves-Audio: CD, Tape, LP)(Jackets/Sleeves-Audio: Tape, Disc)

Gage, Div. of Shape, Inc., PO Box 717, 301 US Rt. 1, Scarborough, ME, 04074, (207) 883-6316, (800) 462-4165, Fax: (207) 883-1068, COO: Michael Thomas; Sales Mgr: Walter Gordon; Mktg. Coord.: Tracy L. Hartman; Customer Service Rep.: Patti Ellsworth. (Jackets/Sleeves-Audio: Tape)

Gopher Products, 2201 Lockheed Way, Carson City, NV, 89701, (800) 648-0958, Fax: (702) 882-0958, Pres.: Warren Perkins; Gen. Mgr.: Gary Smith. (Jackets/Sleeves-Audio: LP)
Grenadier, 10 Parkwood Ave., Rochester, NY, 14620, (716) 442-6209, (716) 275-2942, Pres.: T. Greene; Sales/Mktg. Dir.: P. Greene. (Jackets/Sleeves-Audio: CD, Tape)

Houston Records, Ltd., 3300 Jensen Dr., Houston, TX, 77026, (713) 223-5971, Pres.: Chris Puccio; Sales Mgr.: Steve Puccio. (Jackets/Sleeves-Audio: CD, Tape, LP)

Ian Communications Group, Inc., 10 Upton Dr., Wilmington, MA, 01887, (508) 658-3700, Fax: (508) 694-9957, Pres.: Richard B. Berberian; Sales Mgr: Todd Thibaud; Mktg. Dir: James Rago. (Jackets/Sleeves-Audio: Tape)(Jackets/Sleeves-Audio: Tape)

Imperial Paper Box Corp., 252 Newport St., Brooklyn, NY, 11212, (718) 346-6100, Fax: (718) 922-1125, Pres.: Louis Sukoff; Sales Mgr: Ira Sukoff; Mktg. Dir: Steven Sukoff. (Jackets/Sleeves-Audio: CD, Tape, LP)

Ivy Hill Corp., PO Box 3189, Terre Haute, IN, 47803, (812) 466-9851, Vice Pres.: Donald Ford. (Jackets/Sleeves-Audio: LP)

Ivy Hill Corp., 170 Varick St., 12th Floor, New York, NY, 10013, (212) 741-4404, Pres.: Ellis Kern; Exec. Vice Pres.: Arthur Kern; Vice Pres. Mktg.: Herbert Friedman. (Jackets/Sleeves-Audio: CD, Tape, LP)(Jackets/Sleeves-Audio: Tape, Disc)
JP5 Design Co., 7702 Daytona Dr., Parma, OH, 44134, (216) 845-2459, Pres./Sales Mgr: John Petrick. (Jackets/Sleeves-Audio: CD, LP)

Joyce Molding Corp., 52 Green Pond Rd., Rockaway, NJ, 07866, (201) 586-2900, Fax: (201) 627-5730, Pres.: Ed Joyce; Sales Mgr: Phil Koljeski. (Jackets/Sleeves-Audio: Tape)
KABA Audio Prods., 24 Commercial Blvd., Novato, CA, 94949, (415) 883-5041, (800) 231-8273, Fax: (415) 883-5222, Pres.: Kenneth A. Bacon; Sales Mgr: Toni Lynn; Customer Service Reps.: Ted Stratton, Nate Hazing. (Jackets/Sleeves-Audio: Tape)

Keycor-Century Corp., 26000 Springbrook Ave., Saugus, CA, 91350, (805) 259-2360, Fax: (805) 259-7937, Pres.: Howard Hill; Mktg. Dir.: Paul Merrigan. (Jackets/Sleeves-Audio: LP)

Klearfold, Inc., 364 Valley Rd., Warrington, PA, 18976, (215) 343-9300, Fax: (215) 343-0491, Pres.: Melvin Herrin; Vice Pres. Sales: David Tolley. (Jackets/Sleeves-Audio: CD)

Lamon Records Int'l, 7017 E. WT. Harris Blvd., Charlotte, NC, 28215, (704) 535-7263, Fax: (704) 537-0133, CEO: D. Moody Jr.; Pres.: Carlton Moody; Mktg. Dir.: Mike Evans; Sales Rep.: David Moody. (Jackets/Sleeves-Audio: CD, Tape, LP)
Laser Prints, Inc., PO Box 151, 241 Stuyvesant Ave., Lyndhurst, NJ, 07071, (201) 438-6777, Fax: (201) 438-0903, Pres.: J. Principato. (Jackets/Sleeves-Audio: CD, LP)

Lee-Myles Assoc., Inc., 10 Cutter Mill Rd., #401, Great Neck, NY, 11021, (516) 466-7814, Fax: (516) 487-5324, Pres.: Howard Roseff; Sales Mgr: Ray Kissel. (Jackets/Sleeves-Audio: CD, LP)

Lion Recording Services, 7532 Fullerton Ct., Springfield, VA, 22153, (703) 569-3200, Fax: (703) 455-5600, Pres.: Harold Lion; Vice Pres./Sales Mgr: Richard Lyon; Mktg. Dir: Karen Blackhall. (Jackets/Sleeves-Audio: Tape)

Location Recording Service, Inc./Print Div., 2609 W. Burbank Blvd., Burbank, CA, 91505, (818) 846-8300, Fax: (818) 845-8357, Pres.: Allen Fraiberg; Prodn. Gen. Mgr.: Jay Ceballos. (Jackets/Sleeves-Audio: CD, Tape, LP)

Lundy Recording & Cassette Dup., PO Box 408, Heidrick, KY, 40949, (606) 546-6650, Pres.: David Lundy; Sales Mgr: Viola Lundy; Mktg. Dirs.: Duran & Davie Lundy. (Jackets/Sleeves-Audio: Tape)

Macola Record Group, Inc., 8831 Sunset Blvd., Ste. #202, West Hollywood, CA, 90069, (213) 659-6036, Fax: (213) 659-6039, Pres.: Donald MacMillan; Sales Mgr: James Takeda; Mktg. Dir.: Lee Denton. (Jackets/Sleeves-Audio: CD, Tape, LP)

Majestic Duplicating Service, 1208 W. Isabel St., Burbank, CA, 91506, (818) 843-1806, Fax: (818) 954-0770, Pres.: Leslie Sawyer; Sales Mgr: John Northrop; Mktg. Dir: Chris Saver. (Jackets/Sleeves-Audio: Tape)

Mark Custom Recording Service, 10815 Bodine Rd., Clarence, NY, 14031, (716) 759-2600, Pres./Owner: Mark J. Morette. (Jackets/Sleeves-Audio: CD, Tape, LP)

Matchbook Albums (Sub. of Beach West Designs), 711 John St., Secaucus, NJ, 07094, (215) 478-1585, Pres.: Walt Henkel. (Jackets/Sleeves-Audio: CD)

Miami Tape, Inc., 8180 NW 103 St., Hialeah Gardens, FL, 33016, (305) 558-9211, Fax: (305) 825-9873, Pres.: Carlos O. Garcia; Sales Mgr: Mirella Tunon. (Jackets/Sleeves-Audio: CD, Tape, LP)

Modern Album Of Tennessee, 1130 Davidson St., Nashville, TN, 37206, (615) 227-0200, Fax: (615) 228-5307, Pres.: Richard Meagher; Sales Mgr: Charles Reinhardt. (Jackets/Sleeves-Audio: CD, Tape, LP)(Jackets/Sleeves-Audio: Tape, Disc)

Modern of California

3116 Vanowen St., Burbank, CA, 91505, (818) 841-8683, (213) 849-5763, Fax: (818) 841-3157, Pres.: William S. Pine; Exec. Vice Pres: Joshua Pine; Sales Mgr., Jack Bratel; Mktg. Dir.: Jonathan Pine. (Jackets/Sleeves-Audio: CD, Tape, LP) (Jackets/Sleeves-Audio: Tape, Disc)

The Music Connection, Inc., 175 Fifth Ave., New York, NY, 10010, (212) 529-0557, Pres.: R. Ralton; Vice Pres.: Fred Levy; Sales Mgr: Ira Cohen. (Jackets/Sleeves-Audio: CD, LP)

Musical, Inc., 780 Oakland Park Ave., Columbus, OH, 43224, (614) 267-3133, Pres.: John W. Hull; Sales Mgr.: Warren Hull; Mktg. Dir.: Charlene Hull. (Jackets/Sleeves-Audio: Tape, LP)
Musiflex Video, 2701-C Wilson Blvd., Arlington, VA, 22201, (703) 525-6476, Fax: (703) 525-0949, Pres.: Frank Maniglia, Jr.; Gen. Mgr.: Guinevere Meyer; Sales Mgr/Mktg. Dir: Jeanne Chisholm. (Jackets/Sleeves-Audio: Tape)

New Age Video, PO Box 68, 3480 So. Clinton Ave., South Plainfield, NJ, 07080, (201) 756-7500, Fax: (201) 757-1991, Pres.: Steven Nasar; Vice Pres.: Joey Nasar; Sales Mgr.: Jack Nasar. (Jackets/Sleeves-Audio: Tape)

PRC of America, 8140 Webb, North Hollywood, CA, 91605, (818) 504-4040, Fax: (818) 504-0946, Pres.: V.J. Carbello; Sales Mgr.: P. Baccarella. (Jackets/Sleeves-Audio: Tape)

Photo-Graphics, Inc., PO Box 730, Ardley, NY, 10502, (800) 444-1931, (914) 674-1212, Fax: (914) 764-1212, Pres.: Jeff Hapoienu; Sales Mgr: Jerf Reed; Mktg. Dir.: Sandy Hapoienu. (Jackets/Sleeves-Audio: CD, Tape)(Jackets/Sleeves-Audio: Tape)

Pilgrim Press Corp., 36-01 43rd Ave., Long Island City, NY, 11101, (718) 937-9515. (Jackets/Sleeves-Audio: LP)

Premiere AVD Corp., 18080 NE 68th St., Redmond, WA, 98052, (206) 882-1400, Fax: (206) 867-0718, Pres.: George M. Ricci;

Sales Mgr: Gary M. Ricci. (Jackets/Sleeves-Audio: Tape)
Pressure Sensitive Tape & Label Corp., 135 Schmitt Blvd., Farmingdale, NY, 11735, (516) 293-7305, Fax: (516) 293-7384, Pres.: Daniel Cooper; Sales Mgr.: Bruce Cooper. (Jackets/Sleeves-Audio: Tape)

Producers Tape Service, 395 E. Elmwood Ave., Troy, MI, 48083, (313) 585-8273, Fax: (313) 585-1270, Pres.: William Guthrie; Sales Mgr.: James Champion; Mktg. Dir.: Catherine Chytry. (Jackets/Sleeves-Audio: Tape)(Jackets/Sleeves-Audio: Tape)
QCA, Inc., 2832 Spring Grove Ave., Cincinnati, OH, 45225, (513) 681-8400, Fax: (513) 681-3777, Pres.: Jim Bosken; Sales Mgr: Amber Hines; Mktg. Dir: Rusty Sweeney. (Jackets/Sleeves-Audio: CD, Tape, LP)

Queens Group Indiana, Inc., 620 S. Belmont Ave., Indianapolis, IN, 46221, (317) 635-7777, Pres.: Len Verebay; Exec. Vice Pres.: Richard Roth, Manny Ungar; Sr. Vice Pres.: Jack Sims. (Jackets/Sleeves-Audio: CD, Tape, LP)(Jackets/Sleeves-Audio: Tape, Disc)

Queens Group Kentucky, Inc., 4501 Allmond Ave., Louisville, KY, 40209, (502) 368-7777, Pres.: Len Verebay; Exec. Vice Pres.: Richard Roth; Sr. Vice Pres.: Jack Sims. (Jackets/Sleeves-Audio: CD, Tape, LP)(Jackets/Sleeves-Audio: Tape, Disc)

Queens Group North Carolina, Inc., 1101 Hwy. 27 S., Stanley, NC, 28164, (704) 263-9200, Pres.: Len Verebay; Exec. Vice Pres.: Richard Roth; Sr. Vice Pres.: Jack Sims. (Jackets/Sleeves-Audio: CD, Tape, LP)(Jackets/Sleeves-Audio: Tape, Disc)

Queens Group California, Inc., 6290 Sunset Blvd., Ste. 703, Hollywood, CA, 90028, (213) 464-7700, Pres.: Len Verebay; Exec. Vice Pres.: Richard Roth; Sr. Vice Pres.: Jack Sims. (Jackets/Sleeves-Audio: CD, Tape, LP)(Jackets/Sleeves-Audio: Tape, Disc)

Queens Group, Inc., 52-35 Barnet Ave., Long Island City, NY, 11104, (718) 457-7700, Fax: (718) 457-9285, Pres.: Len Verebay; Exec. Vice Pres.: Richard Roth; Sr. Vice Pres.: Jack Sims; Vice Pres./Nat'l Sales Mgr: Keith Kiedinger. (Jackets/Sleeves-Audio: CD, Tape, LP)(Jackets/Sleeves-Audio: Tape, Disc)

RHM Industries, Ltd., PO Box 378, 180 Orville Dr., Bohemia, NY, 11716, (516) 567-7222, Fax: (516) 567-7253, Pres.: Gerard Hughes. (Jackets/Sleeves-Audio: CD, Tape, LP)(Jackets/Sleeves-Audio: Tape, Disc)

RTI, Record Technology, Inc., 486 Dawson Dr., Camarillo, CA, 93012, (805) 484-2747, Fax: (805) 987-0508, Pres.: William Bauer; Sales Mgr.: Don MacInnis. (Jackets/Sleeves-Audio: LP)

Rainbo Records & Cassettes, 1738 Berkeley St., Santa Monica, CA, 90404, (213) 829-0355, Fax: (213) 828-8765, Pres.: Jack G. Brown; Gen. Mgr.: Steve Sheldon. (Jackets/Sleeves-Audio: CD, Tape, LP)

Rank Video Services America, 555 Huehl Rd., Northbrook, IL, 60062, (708) 291-4275, Fax: (708) 291-4282, Pres.: Philip A. Clement; Mktg. Project Mgr.: Marilyn L. Quist. (Jackets/Sleeves-Audio: Tape)

Record-Rama Sound Archives, 4981 McKnight Rd., Pittsburgh, PA, 15237, (412) 367-7330, Fax: (412) 367-7388, Pres.: Paul C. Mawhinney. (Jackets/Sleeves-Audio: CD)

Rexham Packaging, PO Box 240007, 1700 Industrial Dr., Charlotte, NC, 28224, (704) 889-2621, Fax: (704) 889-4680, Mktg. Comm. Admn.: Julie Lampe. (Jackets/Sleeves-Audio: CD, Tape)(Jackets/Sleeves-Audio: Tape, Disc)

Rocky Mountain Recording, 8305 Christensen Rd., Cheyenne, WY, 82009, (307) 638-8733, Pres.: Ray Alexander; Sales Mgr: Georgia Alexander. (Jackets/Sleeves-Audio: LP)

Romaba Record Pressing Corp. of America, 33-34th St., Brooklyn, NY, 11232, (718) 499-3060, Fax: (718) 499-3061, Pres.: Theodore E. Kolsky; Vice Pres.: Dara Kolsky; Sales Mgr: Vicki M. Guerra; Mktg. Dir: Jennifer Kolsky. (Jackets/Sleeves-Audio: LP)

Ross-Elis, Ltd., 1133 Broadway, Ste. 825, New York, NY, 10010, (212) 645-6110, Fax: (212) 645-9376, Pres.: B. Ellis; Sales Mgr: Nina Palmer Sheldon; Mktg. Dir: Peter Kerr. (Jackets/Sleeves-Audio: CD, Tape, LP)(Jackets/Sleeves-Audio: Tape, Disc)

Rothchild Group, 7900 Barnwell Ave., Elmhurst, NY, 11373, (718) 899-6000, Fax: (718) 397-1921, Pres.: Alan J. Rothchild; Mgr./Customer Service: Anne Owsianik. (Jackets/Sleeves-Audio: CD, Tape, LP)(Jackets/Sleeves-Audio: Tape, Disc)

Jasper Samuel Advertising & Printing, 406 W. 31st St., New York, NY, 10001, (212) 239-9544, Fax: (212) 594-0931, Pres.: Jasper Samuel; Sales Mgr: Claude Chamlee; Mktg. Dir: Courtland White. (Jackets/Sleeves-Audio: CD, Tape, LP) (Jackets/Sleeves-Audio: Tape, Disc)

Shorewood Packaging of Georgia, 1707 Shorewood Dr., LaGrange, GA, 30240, (404) 884-3036, Gen. Mgr.: Charles Wardlaw. (Jackets/Sleeves-Audio: LP)

Shorewood Packaging of California, 7080 Hollywood Blvd., Ste. 914, Hollywood, CA, 90028, (213) 463-3000, Fax: (213) 465-4300, Pres.: Paul Shore; Sales Mgr: Jim Palmer. (Jackets/Sleeves-Audio: CD, Tape, LP)(Jackets/Sleeves-Audio: Tape, Disc)

Shorewood Packaging Corp., 10 E. 53rd St., New York, NY, 10022, (212) 371-1500, Fax: (212) 752-5610, Pres.: Paul Shore; Sales Mgr: Ken Rosenblum; Mktg. Dir.: Floyd Gilnert. (Jackets/Sleeves-Audio: CD, Tape, LP)(Jackets/Sleeves-Audio: Tape, Disc)

SoundSpace, Inc., 126 Dayton St., Yellow Springs, OH, 45387, (513) 767-7353, Pres.: Chris Hertzler. (Jackets/Sleeves-Audio: CD, Tape)

Spin-Clean Record Washer System, PO Box 15395, Pittsburgh, PA, 15237, (412) 367-7330, Fax: (412) 367-7388, Pres.: Paul C. Mawhinney. (Jackets/Sleeves-Audio: CD)

Sun Plastics Co., Inc./Dynamic LP Stereo Record Pressing Co., Inc., 534 Passaic Ave., East Newark, NJ, 07029, (201) 482-6749, (212) 349-0977, Fax: (201) 483-0031, Pres.: Jerry Salerno; Sales Mgr.: Vicky Salerno; Mktg. Dir.: Jerry R. Salerno. (Jackets/Sleeves-Audio: LP)

Sunrise Packaging, Inc., 9937 Goodhue St., NE, Minneapolis, MN, 55434, (612) 785-2505, (800) 634-8160, Fax: (612) 785-2210, Pres.: Rod Herdina; Sales Mgr.: Merf Schaub; Mktg. Dir.: Ed O'Phelan. (Jackets/Sleeves-Audio: CD, Tape) (Jackets/Sleeves-Video: Tape, Disc)

Suttman Prodn., PO Box 72, Dayton, OH, 45409, (513) 278-4601, Pres.: Eric J. Suttman. (Jackets/Sleeves-Audio: CD, Tape)(Jackets/Sleeves-Video: Tape)

Tri-Plex Packaging Corp., 267 Fifth Ave., 10th Floor, Ste. 1010, New York, NY, 10016, (212) 481-6070, Fax: (212) 481-1550, Pres.: Ken Golden; Sales Mgr.: Andy Napolitano; Mktg. Dir.: Jerry DeLuise. (Jackets/Sleeves-Audio: CD, Tape)(Jackets/Sleeves-Video: Tape)

United Audio Video Group, Inc., 6855 Vineland Ave., North Hollywood, CA, 91605, (818) 980-6700, Fax: (818) 508-8273, Pres.: Miriam Newman; Vice Pres. Prodn.: Steve Newman; Sales Mgr.: Larry Schwartz; Mktg. Dir.: Laurie Newman. (Jackets/Sleeves-Audio: Tape)(Jackets/Sleeves-Video: Tape)

Univenture, Inc., 6145-A Scherers Pl., Dublin, OH, 43017, (614) 761-2869, Fax: (614) 793-0202, Pres.: Ross O. Youngs; Sales Mgr.: Rich Williams; Corp. Communications Mgr.: Sandi Stein. (Jackets/Sleeves-Audio: CD)

Video Media Prodn., 2727 W. Southern Ave., Tempe, AZ, 85282, (602) 966-6545, Fax: (602) 438-2238, Pres.: Jim Rinckenberger; Mktg. Dir.: Jim Pangborn. (Jackets/Sleeves-Video: Tape)

Ville Platte Record Mfg. Co., PO Drawer 10, 120 E. Cypress St., Ville Platte, LA, 70586, (318) 363-2104, Fax: (318) 363-5622, Pres./Sales Mgr.: James Floyd Soileau; Sales Mgr.: Peggy Fontenot. (Jackets/Sleeves-Audio: LP)

Vinylworld, Div. of PEN-TAB Industries Inc., 2011 W. Hastings St., Chicago, IL, 60608, (312) 243-0606, Fax: (312) 942-0693, Vice Pres. Sales/Mktg. Dir.: Doug Engebretson. (Jackets/Sleeves-Audio: CD, Tape)(Jackets/Sleeves-Video: Tape, Disc)

Virtue Recording & Video & Disc Mastering, 8809-11 Rising Sun Ave., Philadelphia, PA, 19115, (215) 763-2825, Pres.: Frank Virtue; Sales Mgr.: Mary Bozzi; Mktg. Dir.: Linda Vitacolonia. (Jackets/Sleeves-Audio: CD, Tape, LP)

WMG, Inc. (World Media Group), 8472 Brookville Rd., Indianapolis, IN, 46239, (317) 353-1113, Fax: (317) 353-0750, Pres.: J.A. Mellentine; Sales Mgr.: Curt Albright. (Jackets/Sleeves-Audio: CD, Tape, LP)

West & Co., Inc., PO Box 24281, Nashville, TN, 37202, 1726-C General George Patton Dr., Brentwood, TN, 37027, (615) 661-5808, Fax: (615) 661-5905, Pres.: Jerry West; Sales Mgr.: Mike Young; Mktg. Dir.: Gary Campbell. (Jackets/Sleeves-Audio: CD, Tape)

Wide Range Electronics Corp., 174 Chesterfield Industrial Blvd., Chesterfield, MO, 63005, (314) 532-5887, (800) 728-4017, Fax: (314) 532-5492, Pres.: Don E. Toone; Sales Mgr.: T. Toone; Mktg. Dir.: O. Rauhut; Mgr.: G. Stecker. (Jackets/Sleeves-Video: Tape)

Wynalda Litho, Inc., 8331 Graphic Industrial Dr., Rockford, MI, 49341, (616) 866-1561, Fax: (616) 866-4316, Pres.: Robert M. Wynalda, Sr.; Exec. Vice Pres. Sales Mgr.: Robert M. Wynalda, Jr. (Jackets/Sleeves-Video: Tape)

LABELS

AGI, Inc., 1950 N. Ruby St., Melrose Park, IL, 60160, (708) 344-9100, Pres.: Richard Block; Vice Pres. Sales/Mktg. Dir.: Jim Oppenheimer. (Audio—CD, Tape, LP)

A + R Record & Tape Mfg. Co., 902 N. Industrial Blvd., Dallas, TX, 75207, (214) 741-2027, Fax: (214) 638-6801, Pres.: Richard Sobel; Sales Mgr.: Stan Getz II; Mktg. Dir.: Maxine Sobel. (Audio—Tape, LP)

ASR Recording Services of California, 8960 Eton Ave., Canoga Park, CA, 91304, (818) 341-1124, Fax: (818) 341-9131, Pres. (Mfg.): Allen Weintraub; Vice Pres./Sales: Lester P. Edwards. (Audio—Tape)(Video—Tape)

A to Z Audio Services, Inc., PO Box 26087, 21929 Lorain Rd., Fairview Park, OH, 44126, (216) 333-0040, Fax: (216) 333-0104, Pres.: Duane Abarca; Vice Pres.: Greg Zarnoski; Sales Mgr.: Jean Rust. (Audio—Tape)

The Absolute Press, Inc., 47-69 32nd Pl., Long Island City, NY, 11101, (718) 729-5293, Fax: (718) 784-2527, Pres.: Gill R. Pessoa. (Audio—CD, Tape, LP)(Video—Tape, Disc)

Ace Label Systems, Inc., 140 Jackson Ave. N., Hopkins, MN, 55343, (612) 933-3105, Fax: (612) 933-3465, Pres.: Art Bakshian; Sales Mgr.: Linda Rundell. (Audio—CD, Tape, LP) (Video—Tape, Disc)

American Helix, 1857 Colonial Village Ln., Lancaster, PA, 17601, (908) 367-8700, Contact: Jim Boyer; Contact: Marc Feingold. (Audio—CD)

American Multimedia, Inc., 2609 Tucker St. Ext., Burlington, NC, 27215, (919) 229-5554, (800) 849-8273, Fax: (919) 228-1409, Pres.: Dave J. Forsyth; Sales Mgr./Mktg. Dir.: Tim V. Mallard; Customer Service Dir.: Jeanne Conklin. (Audio—Tape) (Video—Tape)

Arcal Corp., 2732 Bay Rd., Redwood City, CA, 94063, (415) 369-7348, Fax: (415) 369-7446, Pres.: Sal Viola; Mgr.: Steve Viola. (Audio—Tape)

Athens Prodn., 311 Willowbrook Rd., Staten Island, NY, 10314, (718) 698-2280, Fax: (718) 761-6411, Sales Mgr.: Robert Marino. (Audio—LP)

Audico, Inc., 7206 W. Grand, Elmwood Park, IL, 60635, (708) 456-0003, Fax: (708) 456-0418, Pres.: Barbara Deletzke. (Audio—Tape)(Video—Tape)

Audiophile Realtime Cassette Duplication, 13801 E. 35 St., Independence, MO, 64055, (800) 322-2832, Fax: (816) 254-0045, Pres.: G.W. Riegler; Sales/Mktg. Dir.: Tom Stack. (Audio—Tape)(Video—Tape)

Burlington Audio/Video Tapes, Inc., 106 Mott St., Oceanside, NY, 11572, (516) 678-4414, (800) 331-3191, Fax: (516) 678-8959, Pres.: Ruth Schwartz; Sales Mgr.: Jan Schwartz; Mktg. Dir.: Rudy Schwartz. (Video—Tape)

Command Prodn., 107 Industrial Center Bldg., Harbor Dr., Sausalito, CA, 94965, (415) 332-3161, Pres.: Warren Weagant; Sales Mgr.: John Edwards. (Audio—Tape)

Creative Sound Prodn., Inc., PO Box 720941, 8383 Commerce Park Dr., #604, Houston, TX, 77272, (713) 777-9975, Fax: (713) 774-3419, Pres.: Edward B. Smith; Sales Mgr.: Michele Crosby. (Audio—Tape)

Crown Magnetics, Inc., 1223 Blittner Blvd., Lebanon, PA, 17042, (717) 274-2812, (800) 736-9001, Fax: (717) 274-3815, Pres.: Chuck Musser; Mktg. Dir.: Bob Turner; Sales: Judy Musser. (Audio—CD, Tape)

The Cutting Edge Disc Mastering, Box 217, Ferndale, NY, 12734, (914) 292-5965, Fax: (914) 292-2313, Pres.: Paul Gerry; Sales Mgr./Mktg. Dir.: Patricia Gerry. (Audio—LP)

Davkore Co., 1300-A Spacepark Way, Mountain View, CA, 94043, (415) 969-3030, Fax: (415) 969-0140, Pres.: C.W. Webber; Sales Mgr./Mktg. Dir.: Tom Sherry/Jeanne Horan. (Audio—Tape)(Video—Tape)

Disc Makers, 1328 N. Fourth St., Philadelphia, PA, 19122, (800) 468-9353, (215) 232-4140, Fax: (215) 236-7763, Pres.: Morris Ballen; Sales/Mktg. Dir.: Tony Van Veen; 1650 Broadway, Ste. 1010, New York, NY, 10019, (212) 265-7505, Fax: (212) 262-0798, Sales Mgr.: Howard Roseff; Mgr. De La Posada, N-6, Quintas Del Rio, Bayamon, PR, 00961, (809) 740-0010, Fax: (809) 785-5554, Sales Mgr.: David Rodriguez. (Audio—LP)

Duplicates, 11 E. Hubbard St., Chicago, IL, 60611, (312) 822-0305, Fax: (312) 464-0762, Pres.: Michael A. Freeman. (Audio—Tape, LP)

Duplication Specialists, 4584 Austin Blvd., Island Park, NY, 11558, Pres.: David J. Schwartz; Sales Mgr.: James E. Void. (Audio—Tape)(Video—Tape)

EMC Prodn., 300 York Ave., Saint Paul, MN, 55101, (612) 771-1555, Fax: (612) 771-5629, Pres.: Paul Winter; Mktg. Dir.: Paula Jeske; Vice Pres.: Dick Stevens. (Video—Tape)

Edison Printing Co., 986 Main St., Sanford, ME, 04073, (207) 324-5410, Fax: (207) 324-1798, Pres.: Robert Rosenfield; Sales Mgr.: Pamela Ewers. (Audio—CD, Tape)

Fastrax, Inc., 4033 Aurora Ave. N., Seattle, WA, 98103, (206) 632-8300, Pres.: Miriam Hamilton; Sales Mgr.: Candace Williams. (Audio—Tape)

Fenton Label Co., 3850 Coral St., Philadelphia, PA, 19124, (215) 288-2910, Fax: (215) 533-5390, Pres.: J. K. Tompkins; Sales Mgr.: P. McKean. (Audio—CD, Tape, LP)(Video—Tape, Disc)

Forge Recording Studios, Inc., PO Box 861, Byrne Bldg., Lincoln & Morgan Sts., Valley Forge, PA, 19481, (215) 935-1422, (800) 331-0405, Fax: (215) 935-1940, Pres.: Warren R. Wilson. (Audio—Tape)

G Cee Graphics, Inc., 18653 Ventura Blvd., Ste. 223, Tarzana, CA, 91356, (818) 347-1136, Fax: (818) 889-4773, Pres.: Gregory Higgins. (Audio—CD, Tape, LP)(Video—Tape, Disc)

GP Prodn., 362 Third Ave., Ste. 1B, New York, NY, 10016, (212) 686-5267, Pres.: Gill R. Pessoa; Sales Mgr.: Y.L. Walton; Mktg. Dir.: Daryl A. Pessoa. (Audio—CD, Tape, LP)(Video—Tape, Disc)

Graphic Technology Inc., 301 Gardner Dr., Industrial Airport, KS, 66031, (800) 767-9920, (913) 829-8000, Fax: (913) 829-1462, Pres.: Terry Van Der Tuuk; Sales/Mktg.: Rue Chagall; Mktg. Mgr.: Karen Wilcox. (Audio—CD, Tape, LP)(Video—Tape, Disc)

Grenadier, 10 Parkwood Ave., Rochester, NY, 14620, (716) 442-6209, (716) 275-2942, Pres.: T. Greene; Sales/Mktg. Dir.: P. Greene. (Audio—CD, Tape)

HCV, Inc., 12229 Montague, Arleta, CA, 91331, (818) 896-4321, Pres.: Ed De Roo; Mktg. Dir.: Chuck Arnone. (Video—Tape)

Houston Records, Ltd., 3300 Jensen Dr., Houston, TX, 77026, (713) 223-5971, Pres.: Chris Puccio; Sales Mgr.: Steve Puccio. (Audio—CD, Tape, LP)

Ian Communications Group, Inc., 10 Upton Dr., Wilmington, MA, 01887, (508) 658-3700, Fax: (508) 694-9957, Pres.: Richard B. Berberian; Sales Mgr.: Todd Thibaud; Mktg. Dir.: James Rago. (Audio—Tape)(Video—Tape)

Imperial Tape Co., Inc., 1928 14th St., Santa Monica, CA, 90404, (213) 393-2008, (800) 736-8273, Fax: (213) 396-8894, Pres.: Howard Ganz; Sales Mgr.: Ileana San Martin. (Audio—Tape)

Ivy Hill Corp., 170 Varick St., 12th Floor, New York, NY, 10013, (212) 741-1404, Pres.: Ellis Kern; Exec. Vice Pres.: Arthur Kern; Vice Pres. Mktg.: Herbert Friedman. (Audio—CD, Tape)

KABA Audio Prodn., 24 Commercial Blvd., Novato, CA, 94949, (415) 883-5041, (800) 231-8273, Fax: (415) 883-5222, Pres.: Kenneth A. Bacon; Sales Mgr.: Toni Lynn; Customer Service Reps.: Ted Stratton, Nate Hazing. (Audio—Tape)

K M Records, Inc., 2980 N. Ontario St., Burbank, CA, 91504, (818) 841-3400, Fax: (818) 845-6478, Vice Pres./Sales Dir.: William J. Riley. (Audio—LP)

Kewall Real Time Tape Duplicators, 77 Bay Shore Rd., Bay Shore, NY, 11706, (516) 586-2486, Fax: (516) 586-2486, Pres.: Keith A. Gutschwager; Sales Mgr.: Larry Andrews; Contact: Dorothy E. Gutschwager. (Audio—Tape)

Keycor-Century Corp., 26000 Springbrook Ave., Saugus, CA, 91350, (805) 259-2360, Fax: (805) 259-7937, Pres.: Howard Hill; Mktg. Dir.: Paul Merrigan. (Audio—LP)

Kimberly Clark/Brown-Bridge Corp., 518 E. Water St., Troy, OH, 45373, (800) 543-9452, Fax: (513) 339-4045, Pres.: J. E. Carter; Sales Mgr.: D. B. Cox; Gen. Mgr. Sales & Mktg.: J. E. Miller. (Audio—CD, LP)

Laser Prints, Inc., PO Box 151, 241 Stuyvesant Ave., Lyndhurst, NJ, 07071, (201) 438-6777, Fax: (201) 438-0903, Pres.: J. Principato. (Audio—CD, LP)

Lee-Myles Assoc., Inc., 10 Cutter Mill Rd., #401, Great Neck, NY, 11021, (516) 466-7814, Fax: (516) 487-5324, Pres.: Howard Roseff; Sales Mgr.: Ray Kissel. (Audio—CD, LP)

Lion Recording Services, 7532 Fullerton Ct., Springfield, VA, 22153, (703) 569-3200, Fax: (703) 455-5600, Pres.: Harold Lion; Mktg. Dir.: Karen Blackhall; Vice Pres./Sales Mgr.: Richard Lion. (Audio—Tape)

Location Recording Service, Inc./Print Div., 2609 W. Burbank Blvd., Burbank, CA, 91505, (818) 846-8300, Fax: (818) 845-8357, Pres.: Allen Fraiberg; Prodn. Gen. Mgr.: Jay Ceballos. (Audio—Tape, LP)

Lundy Recording & Cassette Dup., PO Box 408, Heidrick, KY, 40949, (606) 546-6650, Pres.: David Lundy; Sales Mgr.: Viola Lundy; Mktg. Dirs.: Duran & Davie Lundy. (Audio—Tape)

Magnetic Products, 27712 Avenue Mentry, Valencia, CA, 91355, (805) 295-8448, Fax: (805) 295-8278, Managing Dir.: R. Goldman. (Audio—Tape)

Majestic Duplicating Service, 1208 W. Isabel St., Burbank, CA, 91506, (818) 843-1806, Fax: (818) 954-0770, Pres.: Leslie Sawyer; Sales Mgr.: John Northrop; Mktg. Dir.: Chris Saver. (Video—Tape)

Mark Custom Recording Service, 10815 Bodine Rd., Clarence, NY, 14031, (716) 759-2600, Pres./Owner: Mark J. Morette. (Audio—CD, Tape, LP)

Miami Tape, Inc., 8180 NW 103 St., Hialeah Gardens, FL, 33016, (305) 558-9211, Fax: (305) 825-9873, Pres.: Carlos O. Garcia; Sales Mgr.: Mirella Tunon. (Audio—CD, Tape, LP)

Musical, Inc., 780 Oakland Park Ave., Columbus, OH, 43224, (614) 267-3133, Pres.: John W. Hull; Sales Mgr.: Warren Hull; Mktg. Dir.: Charlene Hull. (Audio—Tape, LP)

Musifex Video, 2701-C Wilson Blvd., Arlington, VA, 22201, (703) 525-6476, Fax: (703) 525-0949, Pres.: Frank Maniglia Jr.; Gen. Mgr.: Guinevere Meyer; Sales Mgr./Mktg. Dir.: Jeanne Chisholm. (Audio—Tape)(Video—Tape)

New Age Video, PO Box 68, 3480 So. Clinton Ave., South Plainfield, NJ, 07080, (201) 756-7500, Fax: (201) 757-1991, Pres.: Steven Nasar; Sales Mgr.: Jack Nasar; Vice Pres.: Joey Nasar. (Video—Tape)

Charlie Passantino, Inc., 311 W. 43rd St., New York, NY, 10036, (212) 586-1469, Pres.: Michelle Barrett; Sales Mgr./Mktg. Dir.: Ed Regan. (Audio—CD, Tape, LP)

Photo-Graphics, Inc., PO Box 730, Ardsley, NY, 10502, (908) 444-1931, (914) 674-1212, Fax: (914) 764-1212, Pres.: Jeff Hapoienu; Sales Mgr.: Jerf Reed; Mktg. Dir.: Sandy Hapoienu. (Audio—CD, Tape)

Pressure Sensitive Tape & Label Corp., 135 Schmitt Blvd., Farmingdale, NY, 11735, (516) 293-7305, Fax: (516) 293-7384, Pres.: Daniel Cooper; Sales Mgr.: Bruce Cooper. (Audio—CD, Tape)(Video—Tape, Disc)

Producers Color Service, Inc. (Video Cassette Div.), 1000 N. Crooks Rd., Clawson, MI, 48017, (313) 288-9000, Fax: (313) 288-6510, Pres.: Ronald Balousek; Gen. Mgr.: P. Eric Petersen; Sales Mgr.: Leon Chick. (Video—Tape, Disc)

Producers Tape Service, 395 E. Elmwood Ave., Troy, MI, 48083, (313) 585-8273, Fax: (313) 585-1270, Pres.: William Gutherie; Sales Mgr.: James Champion; Mktg. Dir.: Catherine Chytry. (Audio—Tape)(Video—Tape)

Progressive Label Co., 200 F Executive Dr., Edgewood, NY, 11717, (516) 242-0201, Fax: (516) 242-7310, Pres.: Bernard Stein; Sales Mgr.: Tony Cutrone; Prodn. Mgr.: Mike Cutrone. (Audio—CD, Tape, LP)(Video—Tape, Disc)

QCA, Inc., 2832 Spring Grove Ave., Cincinnati, OH, 45225, (513) 681-8400, Fax: (513) 681-3777, Pres.: Jim Bosken; Sales Mgr.: Amber Hines; Mktg. Dir.: Rusty Sweeney. (Audio—CD, Tape, LP)

RHM Industries, Ltd., PO Box 378, 180 Orville Dr., Bohemia, NY, 11716, (516) 567-7222, Fax: (516) 567-7253, Pres.: Gerard Hughes. (Audio—CD, Tape, LP)(Video—Tape, Disc)

RTI, Record Technology, Inc., 486 Dawson Dr., Camarillo, CA, 93012, (805) 484-2747, Fax: (805) 987-0508, Pres.: William Bauer; Sales Mgr.: Don MacInnis. (Audio—CD, Tape, LP)

Rainbo Records & Cassettes, 1738 Berkeley St., Santa Monica, CA, 90404, (213) 829-0355, Fax: (213) 828-8765, Pres.: Jack G. Brown; Gen. Mgr.: Steve Sheldon. (Audio—CD, Tape, LP)

Rank Video Services America, 555 Huehl Rd., Northbrook, IL, 60062, (708) 291-4275, Fax: (708) 291-4282, Pres.: Philip A. Clement; Mktg. Project Mgr.: Marilyn L. Quist. (Video—Tape)

Rocky Mountain Recording, 8305 Christensen Rd., Cheyenne, WY, 82009, (307) 638-8733, Pres.: Ray Alexander; Sales Mgr.: Georgia Alexander. (Audio—LP)

Romaba Record Pressing Corp. of America, 33-34th St., Brooklyn, NY, 11232, (718) 499-3060, Fax: (718) 499-3061, Pres.: Theodore E. Kolsky; Vice Pres.: Dara Kolsky; Sales Mgr.: Vicki M. Guerra; Mktg. Dir.: Jennifer Kolsky. (Audio—LP)

Rothchild Group, 7900 Barnwell Ave., Elmhurst, NY, 11373, (718) 899-6000, Fax: (718) 397-1921, Pres.: Alan J. Rothchild; Mgr./Customer Service: Anne Owsianik. (Audio—CD, Tape, LP)(Video—Tape, Disc)

(Continued on page 311)

In this section...

EUROPEAN LISTINGS

This portion of the International Buyers Guide is prepared by Music & Media. All correspondence pertaining to any of the following countries should be directed to Music & Media, PO Box 9027, 1006AA, Rijnburgstraat 11, 1059 AT Amsterdam, The Netherlands, Tel.: 31-20-669-1961, Fax 31-20-669-1941. All correspondence pertaining to any of the following countries should be directed to Music & Media. The countries are Austria, Belgium, Bulgaria, Czechoslovakia, Denmark, Finland, France, Germany, Greece, Iceland, Ireland, Italy, Luxembourg, The Netherlands, Norway, Poland, Portugal, Romania, Spain, Sweden, Switzerland, United Kingdom, U.S.S.R., and Yugoslavia.

INTERNATIONAL

This section is organized alphabetically by geographic area, country and company name. Listings of approximately 40 countries are included.

MUSIC & VIDEO COMPANIES

- **Record Labels**
These listings also include distributors, one-stops, rackjobbers, importers and exporters of audio/video products.
- **Home Video Companies (Theatrical, Music & Special Interest)**
- **Music Publishers**
Affiliates and administered companies are cross referenced back to their primary company listings.
- **Sheet Music & Folio Suppliers**

DISTRIBUTION & CONSUMER PRODUCT MANUFACTURERS

- **Music & Video Accessory Manufacturers**
- **Audio Accessory Manufacturers**
- **Manufacturers: Retail Merchandising Products**

INDUSTRY SERVICES & SUPPLIERS

- **Store Fixture Manufacturers**
- **Security & Surveillance Systems Manufacturers**
- **Computer Systems & Services**
- **Associations & Professional Organizations**
- **Entertainment Attorneys**
- **Performing & Mechanical Rights Organizations**
- **Music Libraries**
- **Public Relations**
- **Record Promotion**
- **Schools & Instruction**

MANUFACTURING PLANTS, SERVICES & EQUIPMENT

- **Tape Custom Duplicators**
Companies providing duplicating services for tape audio/video products.
- **Compact Disc Manufacturers & Videodisc Manufacturers**
- **Plating & Pressing Plants**
- **Mastering Facilities**
- **Packaging & Labeling Services**
- **CD Replicating Systems Equipment Manufacturers**
- **Tape Duplicating & Processing Equipment Manufacturers**
- **Tape Equipment Manufacturers**
- **Tape Packaging & Labeling Equipment Manufacturers**

MATERIALS & SUPPLIES

- **Blank & Bulk Tape Manufacturers**
- **Blank Tape Loaders**
- **Consumer Tape Product Charts**
- **Pro Tape Product Charts**
- **Cartridges, Cassettes, Reels & Other Parts**
- **Jewel Box Manufacturers**
- **Raw Materials**
- **Envelopes & Mailers**
- **Jackets & Sleeves**
- **Labels**
- **Polybags & Shrinkwrap**



PASSION AS A GUIDING PRINCIPLE

It requires a special approach to materialize an ideal. In a word, it takes passion. Look at the artist and know that hard work alone is not enough. It takes rapture - being fully absorbed in one's art. This alone will result in a thing called 'state of the art'. This is ODME's (Optical Disc Manufacturing Equipment) guiding principle. Always on the look-out for innovation. Always fighting for uncompromising quality. The result: a range of mastering, electroforming, replication and packaging equipment, based

on a revolutionary concept, featuring as main benefits: saving on labour, reject rate, investment and production time.

The ODME concept uniquely integrates all production stages for the manufacture of optical storage media. This concept is characterized by built-in cleanrooms, robotization, central control units, automation, integrated inspection stages and a turn-key approach including all required equipment, consumables, service and training.

OD ME

Optical Disc Manufacturing Equipment, P.O. Box 167, 5500 AD Veldhoven
The Netherlands, Phone: +31 40 543815, Telefax: +31 40 541985.

European Listings

AUSTRIA

RECORD COMPANIES

AGS RECORDS, Hebststrasse 3, 1160 Vienna, 01.924 583, MD: Alfred Schittler

ALPHA MUSIC, Brauhirschengasse 52/4, 1150 Vienna, 01.832 374, MD: Robert Opratko

AMADEO KLASSIK, Edelsinnstrasse 4, 1120 Vienna, PO Box 85 (Zip: 1122), 01.831 524, Fax: 01.831 300, MD: Nicole Bachmann

AMPEL RECORDS, Neidlinger Strasse 18, 3121 Karlstetten, 02741.7370, Fax: 02741.7423, MD: Gertraud Neuninger, Mktg: Friedrich Neuninger, Labels (owned): Ampel Records; Main product: Country, Dance, Folk

ANIMATION RECORDS, Pebalstrasse 31, 8700 Leoben, 03842.46929, Fax: 03842.42024, MD: Klaus Katzianka

APE RECORDS, Schwanthaler Strasse 43, 5026 Salzburg, 0662.274 951, Fax: 0662.274 9513, Main product: EHR, Country, Folk, R&B

AUSTROKLING, Seb Stoellnerstrasse 12, 5020 Salzburg, 0662.847 0015, MD: Gottfried Schinko

BALL-MUSIC, Lortzinggasse 1/2/21, 1140 Vienna, 01.924 8532

BANANANAS RECORDS, Pebalstrasse 31, 8700 Leoben, 03842.46929, Fax: 03842.42024, Contact: Klaus Katzianka

BELLAPHON RECORDS, Grundsteingasse 5-7, 1160 Vienna, 01.436 122, Fax: 01.439 240, MD: Gerhard David

BMG TRIOLA AUSTRIA, Erlachgasse 134-140, 1100 Vienna, PO Box 188 (Zip: 1151), 01.60154, Fax: 01.602 3620, Tlx: 131862, MD: Stephan von Friedberg, Mktg Mgr: Erich Krapfenbacher, Label Mgr: Monika Krapfenbacher, A&R Mgr: Peter Rosinak, Promo Mgrs: Margit Munkas, Heide Spacke

CACTUS RECORDS, Breitenseer Strasse 82a/4, 1140 Vienna, 01.924 7073, MD: Hans Hartel

CONFUSION RECORDS SHOP, Griedplatz 35, 8020 Graz, 0663.838 769, MD: Michael Huettler, Promo: Franz Christian Schwarz, Label Mgr: Christian Hempel, Labels (owned): Confusion; Main product: Dance, Album Rock

DOMINO BLUE ONE, Johannesgasse 9-13/1/17, 1010 Vienna, 01.513 3759, Fax: 01.858 662, Contacts: Thomas Achleitner, Suzanne Kreuzberger

DOMINO MUSIKPRODUKTION, Untermarkt 15, 5270 Mauerkirchen, 07724.215 811-3, Fax: 07724.215 822, GM: Guenter Menschik, A&R Mgr: Rosemarie Menschik

DUM DUM RECORDS, Opernring 1, 1010 Vienna, 01.566 515, Fax: 01.566 515, MD: Wolfgang Strobl, Mktg/Sales: Thomas Neffe, Int'l Mgr: Marcus Wagner

EARL RECORDS, Giesshueblerstrasse 69, 2371 Hinterbrühl, 02236.86656, Fax: 02236.22051, Sales Mgr: Renate Herzog

ECHO RECORDS (AUSTRIA), Schillerstrasse 31, 8010 Graz, 0316.334 380, Fax: 0316.334 383, MD: Roland Schober, Fin Dir: Gertraude Schober, Mktg Mgr: Herfried Schober, Label Mgr: Eric Karner, Sales Mgr: Carmen Dampf, Promo Mgr: Silvia Farber

ECHO RECORDS (AUSTRIA), Gruenenertorgasse 8/2/9, 1090 Vienna, 01.319 9791, Fax: 01.310 9128, Promotion office of Echo Records in Graz (Aus)

EIGENART RECORDS, Muehlgassee 1/20, 2353 Guntramsdorf, 02236.53006, Fax: 02236.530 0690, MD: Franz Grohs

EMI AUSTRIA, Webgasse 43, 1060 Vienna, PO Box 83 (Zip: 1060), 01.599 890, Fax: 01.569 336, Tlx: 113386, MD: Hans Reinisch, F&A Dir: Guenter Jegodtka, Sales Mgr: Gerhard Schopf, GMS: Christine Feldhuetter (Promo), Karin Fitzka (Mktg), Silvia Mouchka (Promo), A&R (Local): Rudolf Spreitzer, Labels (owned): Angel, Blue Note, Capitol, Crystal, EMI, EMI Austria, Electrola, EMI Manhattan, Fame, His Master's Voice, Imperial, Music for Pleasure, Odeon, Pathe Marconi, SBK, United Artists, Impact American, World Pacific, Roulette Jazz, Built It, EMI Classics, Coltempo; (Lic): Apple, Classic for Pleasure, Chrysalis, IRS, MPL, Musicians, Negram, Papagayo, Rockport, Toshiba, Voix de l'Orient, Zonophone; Distribution: Diuo

EMP TONTRAEGER HANDELSGESELLSCHAFT, Weinitzenstrasse 1, 8045 Graz, 0316.693 500, Fax: 0316.692 923, MD: Egon Hinz, Contact: Martin Wagner, Labels (owned): EMP

DIE EXTRAPLATTE, Waehringerstrasse 46 II 12/13, 1091 Vienna, PO Box 2 (Zip: 1094), 01.310 1084/340 0444, Fax: 01.310 0324, MD: Harald Quendler, Mktg/Sales: Julian Schoenfeld

FRIZZEY RECORDS, Art of Belladonna Tonstudio, 6522 Prutz 13, 05472.6349, Fax: 05472.6779, Contact: Friedrich Greif

GAMMA MUSIKPRODUKTIONS, Volkermarkter Ring 1, 9020 Klagenfurt, 0463.5320, Fax: 0463.532 010, MD: Eddy Korsch

GIG RECORDS, Fuehrichgasse 8, 1010 Vienna, 01.512 2491, Fax: 01.513 7646, Tlx: 133906, MD: Markus Spiegel, A&R (Int'l): Peter Rauhofer

GRANIT RECORDS, PO Box 6, 2111 Harmannsdorf, 02264.6341, Contact: Paul Fiedls

HEY-U RECORDS, Speisinger Strasse 121-127, 1238 Vienna,

01.885 5250, Fax: 01.885 609, MD/Int'l Sales: Herwig Ursin, F&A: Ladislaus Helbig, Promo Mgr: Susi Benedikt, Distribution: Polygram

INPART, Breitenleer Strasse 101, 1226 Vienna, 01.227 378, Fax: 01.228 735, MD: Gabriele Schweiger

KOCH INTERNATIONAL (AUSTRIA), Elbigenalp 91, 6652 Tirol, 05634.64440, Fax: 05634.644 470, Tlx: 55581 koch, President: Franz Koch, Admin Mgr: Anton Selb, A&R Mgr: Franz Wolf, Label Mgr: Joe Morscher, Int'l Licensing: Rudy Schedler, Mktg/Sales: Helmut Fischer, Legal Dept: Georg Hittmaier

LEMON RECORDS, Zollergasse 13, 1070 Vienna, 01.930 147, Fax: 01.933 234, Contact: Ernie & Gitti Seuberth

LESBORNE, Pachmannngasse 36-38, 1140 Vienna, 01.941 298, Fax: 01.943 364, MD: Hermann Macek

LION BABY RECORDS, Wintergasse 61/18, 3001 Purkersdorf, 02231.5436, Contact: Peter Lossack

LIVE RECORDS, Bahnhofstrasse 66, 4910 Ried im Innkreis, 07752.6777, Contact: Rudolf Marsch

MEDIA SOUNDTRACKS INTERNATIONAL, Rotmoosweg 31, 8045 Graz, 0316.692 963, Fax: 0316.918 904, MD: Richard Sutcliffe

MUSIC POOL AUSTRIA, Korneuburger Strasse 86, 2103 Langenzersdorf, 02244.4580, Fax: 02244.4582, MD: Gottfried Indra, Mktg: Robert Indra

MUSIC PRODUCTION RIHA, Palmgasse 10, 1150 Vienna, 01.838 569, Fax: 01.834 474, Dir: Fritz Riha, Promo: Jeannie Siegl, Labels owned: RI, RiHA, Happy Records, Sound of Austria

MUSICA SCHALLPLATTEN VERTRIEB, Webgasse 43, 1060 Vienna, PO Box 451 (Zip: 1060), 01.5975 6460, Fax: 01.5975 64636, MD: Franz J Wallner, Label Mgr (Classical): Katharina Boese, A&R: Michael Hufnagel

PEARL RECORDS, Johannesgasse 15/1/20a, 1010 Vienna, 01.513 9370, Fax: 01.513 9371, Contact: Heinz Schmid

PERFECT SOUND RECORDS, St Veiterstrasse 144, 8046 Graz, 0316.691 305, Fax: 0316.691 305, MD: Harald Werth, A&R: Robert Kozak, Mktg: Nano Conway, Main product: Dance, Album Rock, New Age

PG RECORDS, Oberschoefring 37, 4502 St. Marien, 07227.8589, Fax: 0732.246 030, Contact: Peter Guschelbauer, Labels (Owned): PG Records; (Dist): MPA, Thema, Groen Klang, Nueva, Stunt Records, Olufsen Records, Sundance; Main product: Dance, AC, Album Rock, Jazz, New Age

POLYGRAM AUSTRIA, Edelsinnstrasse 4, 1120 Vienna, PO Box 85 (Zip: 1122), 01.831 524, Fax: 01.831 300, Tlx: 114577, MD: Chris Wenckan, F&A Mgr: Heinz Erdmann, Mktg/Distr: Gottfried Urschler, Sales: Johann Prueckler, A&R: Wulf Mueller (Int'l), Juergen Mueller (Local), Labels (pop): Acid Jazz, Abfahrt, A & M, Archiv, Argo, Atom, Attic, Barclay, Berlitz, Big Life, Black Heart, Bludgeon Riffla, Brain, Cactus, Casablanca, Circle, Club, Cog-Sinister, Condor, Cooking Vinyl, CTI, Debut, Def American, De Lite, Delphine, Deram, Desire, Disco Magic, DJM, Dreyfus, Dum Dum, Dunhill, Eastwind, ECM, ECM New Series, Emarcy, Enja, Factory, FFRF, Fiction, First Heard, Fontana, Fontana Special, Garland, General Music, Global Village, Go! Disc, Horizon, Hungaraton, Hypertension, Imp, Increase, In & Out, Jambco, Japo, Jass, JMT, Jungle, Karussell, Lax, Limestone, Line, Lipstick, Literarische Archiv, Logo, L'Orseau-Lyre, London, Magenta, Mercury, Metronome, M & G, Milan, Minor, Mint, Mobile Suit Corporation, Mole, Mood, Moss, MPS, MSI, Musicmasters, Musician, Nature, Neo Neo, New World, Open Minds, Phiffit, Pleasure People, Polar, Polydor, Polyphon, Polystar, Really Useful Company, Reflektor, 13 Records, Rhythm Attack, Riva, Rocket, Roo Art, Roots, Scotti Bros, Sherman, Slash, Squawk, Stash, Stormy Turtle, Swing, Talk'n' Loud, Threshold, Tip-toe, Ton Art, TP, Tutu, Universe, Uptone Records, Urban, Vanguard, Vendetta, Vertigo, Verve, Verve-Forecast, Victory, Watt, Watt-Extra, Wing, Wol; Labels (Classical): Amadeo, Amadeo Classic/Sound/Literatur, Deutsche Grammophon, Decca, Philips

RAGE MUSIC, Josefstrasse 25, 3100 St. Poelten, 02742.68512, Fax: 02742.675 7830, A&E Exec: Steve Rhodes, Admin: Manfred Henzl, Main product: Dance

RST RECORDS, Schoenbrunnerstrasse 14, 1050 Vienna, PO Box 7 (Zip: 1052), 01.587 1687, Fax: 01.5871 6874, MD: Rudolf Staeger

SBF RECORDS, Molln 129, 4591 Molln, 07584.28430, Fax: 07584.284 315, MD: Manfred Prentner, Promo: August Viertbauer, Production/Distributor: SBF Records

SHAMROCK RECORDS, Altwaidhofen 37, 3830 Waidhofen an der Thaya, 02842.3986, Fax: 02842.2826, MD: Uwe Kraner, Mgr: Werner Weiss

SING SANG RECORDS, Lothringerstrasse 20, 1030 Vienna, 01.724 3230, Fax: 01.724 3218, MD: Richard Oesterreicher

SONY MUSIC ENTERTAINMENT (AUSTRIA), Erlachgasse 134-140, 1101 Vienna, 01.601 570, Fax: 01.602 3615, Tlx: 132123 cbsr, MD: Martin Pammer, Mktg Dir/Classic Mgr: Rudolf Nikles, A&R/Prod Mgr: Andy Zhradnik, Promo Mgr: Gerald Hajos, Special Mktg: Willi Schlager, Labels owned: Austro Star, Artone, Blue Star, Caribou, Cleveland Int'l, Columbia, Def Jam, Doubias, Dore, Embassy, Emurgo, Epic, FM, Full Moon/Epic, GTO, Harmony, Invictus, Inner Vision,

Jet, Johnston, Kirshner, LPS, Masterworks, Maestro, Memory, Monuments, OBR, Odyssey, Philadelphia/Int'l, Portrait, Pangaea, Pasha, Private 1, Precision, Roadracer, Robbie, Solar, Sony Classical, Squatt, Sky, Starfilite, Tabu, T-Neck, Touchstone, Unlimited Gold, VCH, WTG

SOUNDBORN RECORDS, Schoenbornngasse 9, 1080 Vienna, 01.430 834, Fax: 01.408 1614, Producer: Gerhard Wessely, Mktg Mgr: Hannes Chladt

SOUNDDESIGN RECORDS, Muehlgassee 1/20, 2353 Guntramsdorf, 02236.53006, Fax: 02236.530 0690, MD: Franz Grohs

THEMA MUSIK, Lacknergasse 6-8/3, 1170 Vienna, 01.454 746, Fax: 01.459 503, MD: Georg Strzyzowski, Mktg Mgr: Ulrike Strzyzowski

TIME PRODUCTIONS MUSIC DISTRIBUTION, Keplerstrasse 95, 8020 Graz, PO Box 34 (Zip: 8027), 0316.918 974, Fax: 0316.918 904, MD: Kurt Seidnitzer, Sec: Ingrid Gleichweit, Bookkeeping: Gudrun Kummer, Label Mgrs: Michael Broser, Hannes Seidnitzer

TONORA RECORDS, Seb Stoellnerstrasse 12, 5020 Salzburg, 0662.847 0015, MD: Kurt Kleindienst, Promo: Ingrid Schell

TYROLIS, Meilstrasse 36, 6170 Zirl, Tirol, 05238.2403, Fax: 05238.362 151, Tlx: 533947, MD: Helmut & Elsa Rasinger

UPTONE RECORDS, Hillebrandngasse 6, 3400 Klosterneuburg, 02243.85100, Fax: 02243.88908, Contact: Gary Lux

VM RECORDS (AUSTRIA), PO Box 47, 6430 Otztal, 05266.8126, Fax: 05266.818 320, Owner: Hubert Pirschner

WARNER MUSIC AUSTRIA, PO Box 285, 1101 Vienna, 01.601 590, Fax: 01.602 3623, MD: Manfred Lappe, Sales Dir: Harald Neuteufl, Mktg Dir: Manfred Wodara, Contr: Wolfgang Laimer, Labels: ABC, Antic, Asylum, Atco, Atlantic, Automatic, Backstreet, Berserkley, Big Tree, Billy Jack, Bizarre, Blanco Y Negro, Blue Inc, Bravo, Buddah, Bunny CGD, Chimney Ville, Clean, Clintone, Constellation, Coral, Cotillion/Countryside, Cube, Dark Horse, Discreet, Dunhill, Edel/Edelton, Elektra (Musician), Embryo, Emerald City, Es Paranza, Eternal, Exultia, Finnadar, Food Label, Full Moon, Geffen, Gemigo, GMP, Idiot, Kinney, Korova, Kwanza, Lightning, Little David, Loma, Magnet, Marisma, MCA (Linyl Vinyl), Metropolis, Midi, Migration, Mirage, Niktom, Nonesuch, Opal, Pacific, Paradise, Pentagram, Prophesy, PWL Quest, Raccon, Radar, Raft, Real, Repertoire, Reprise (Brother), RFC, Riva, SGC, Sho, Sire, State, Stone Flower, Sutra, Swan Song, Target, Teldec, The Hits Album, Tommyboy, Valentino, valiant, Viva, Warner Bros, Wea Int'l, Westbound, Whitfield, Win or Lose, WMOT, Yuki, ZTT Records

WIR WORLD INTERNATIONAL RECORDS, Alois Kellnerstrasse 18, 2324 Rannersdorf, 01.707 3710, Fax: 01.707 8422, GM: Peter Jordan, Main product: Adult Contemporary, Country, Reggae, Classical, Dance, Gold/Oldies, Black (R&B), New Age, Pop

WM PRODUCTIONS, Neulercherfelderstrasse 3-7, 1160 Vienna, 01.4035 9910, Fax: 01.4035 99113, MDs: Thomas Albrecht, Hans Granzer, Peter Jerka, Labels (Owned): WM Production, Euro Pool; Distribution: Musica, W Weiss

WOODOO RECORDS, Hollandstrasse 14/12a, 1020 Vienna, 01.214 3385, Fax: 01.408 1614, Contact: Despina C Chlad

WRM WOJK RECORDS MUSIC, Adolf Loosgasse 12/12/20, 1210 Vienna, 01.256 7775, Contact: Andreas Wojik

YEDERMANN PRODUCTIONS VIENNA, Riemergasse 14/29, 1010 Vienna, 01.512 2175, Fax: 01.512 8302, President: Christine Jones, Chmn: Peter Schrammel, VP: Littigo Keller

ZIPP RECORDINGS, Neubachgasse 19, 2325 Himberg, 02235.89567/888 093, Fax: 02235.895 675, MD: Hannes Thomas Beyer, Studio Mgr: Hannes Bayer Labels (owned): Zipp Records

MUSIC PUBLISHERS

4A MUSIK, see Weinberger Music Group

ALLROUND MUSIC, Giesshueblerstrasse 49, 2371 Hinterbrühl, 02236.86656, Fax: 02236 22051, Contact: Renate Herzog

ANDOLFO MUSIC, Hellbrunnerstrasse 9/15, 5020 Salzburg, 0662.849 400

AQUARIUS PUBLISHING, Alois Kellnerstrasse 18, 2324 Rannersdorf, 01.707 3710, Fax: 01.707 8422, GM: Peter Jordan, Main product: Adult Contemporary, Country, Reggae, Classical, Dance, Gold/Oldies, Black (R&B), New Age, Pop

ARENS MUSIC, see Weinberger Music Group

ARION-MUSIKVERLAG, see Music Production Riha

AUTARC, see Warner Chappell Musikverlag Gesellschaft

AXXIS, see Warner Chappell Musikverlag Gesellschaft

B-MUSIK, see Warner Chappell Musikverlag Gesellschaft

BELLAPHON RECORDS, Grundsteingasse 5-7, 1160 Vienna, 01.436 122, Fax: 01.439 240, MD: Gerhard David

BELVEDERE, Herbststrasse 3, 1160 Vienna, 01.924 583, MD: Alfred Schittler

DACAPO, see Weinberger Music Group

DIE, Waehringerstrasse 46 II 12/13, 1091 Vienna, PO Box 2 (Zip: 1094), 01.310 1084/340 0444, Fax: 01.310 0324, MD: Harald Quendler

DONAU LAND KREMAJYR & SCHERIAU, Niederhofstrasse 37, 1120 Vienna, 01.811 020, Fax: 01.811 024, Tlx: 131405.

DUM DUM RECORDS, Opernring 1, 1010 Vienna, 01.566 515, Fax: 01.566 515, MD: Wolfgang Strobl.

EC, see Warner Chappell Musikverlag Gesellschaft.

ECHO RECORDS (AUSTRIA), Schillerstrasse 31, 8010 Graz, 0316.334 380, Fax: 0316.334 383, MD: Roland Schober.

EDITION LESBORNE, Pachmannngasse 36-38, 1140 Vienna, 01.941 298, Fax: 01.943 364, MD: Hermann Macek.

EDITION MUSICA MUSIKVERLAG, Webgasse 43, 1060 Vienna, PO Box 451 (Zip: 1060), 01.5975 6460, Fax: 01.5975 64636, Tlx: 133274, MD: Franz J Wallner.

EDITION PIN UP, see Hey-U Music Produktions.

EDITION TONORA, Seb Stoelnerstrasse 12, 5020 Salzburg, 0662.847 0015, MD: Kurt Kleinleinst.

EDITIONS ANYA, Pebaistrasse 31, 8700 Leoben, 03842.46929, Fax: 03842.42024, MD: Klaus Batzianka.

EDITIONS BERTON, see Koch Music Publishing (Austria).

EMI STARSONGS, Webgasse 43, 1060 Vienna, 01.599 89-0, Fax: 01.569 336, Tlx: 113386 emia, E-Mail: Reinisch-Vie, MD: Hans Reinisch.

EURO MUSIC, see Weinberger Music Group.

EUROPOOL, Neulercherfelderstrasse 3-7, 1160 Vienna, 01.4035 9910, Fax: 01.4035 99113, MDs: Hans Granzer, Peter Jirka.

EXTRA, see Step Two Music.

FONIT CETRA, see Warner Chappell Musikverlag Gesellschaft.

FRIZZEY RECORDS, Art of Belladonna Tonstudio, 8522 Prutz 13, 05472.6349, Fax: 05472.6779, Contact: Friedrich Greif.

FROGSOUND, Salzburger Vorstadt 8, 5280 Braunau am Inn, 07722.3408, Fax: 07722.215 822, MD: Guenter Menschik.

GENERAL, see Step Two Music.

GLOCKENVERLAG, see Weinberger Music Group.

GOTTFRIED INDRAS MUSIK- UND BÜHNENVERLAG, Kornhuber Strasse 86, 2103 Langenzerdorf, 02244.4580, Fax: 02244.4582, MD: Gottfried Indra.

HANNA BARBERA, see Warner Chappell Musikverlag Gesellschaft.

HEY-U EDITION, see Hey-U Music Produktions.

HEY-U MUSIC PRODUKTIONS, Speisinger Strasse 121-127, 1238 Vienna, 01.885 5250, Fax: 01.885 609, President: Herwig Ursin, VP: Ladislaus Helbig, MD: Susi Benedikt. (Owned): Hey-U Edition, Public Appeals; (Admin): Edition Pin Up; Main product: Album Rock, Jazz, Gold/Oldies, Classical.

HIT FABRIK, Muehlgasse 1/20, 2353 Guntramsdorf, 02236.53006, Fax: 02236.530 0690, MD: Franz Groihs.

ITALOTON MUSIKVERLAG, Volkermarkter Ring 1, 9020 Klagenfurt, 0463.5320, Fax: 0463.532 010, MD: Eddy Korsche.

JOHANN HARTEL MUSIK, Breitenseer Strasse 82a/4, 1140 Vienna, 01.924 7073, MD: Hans Hartel.

JUPITER, see Step Two Music.

KINETON, see Koch Music Publishing (Austria).

KOCH MUSIC PUBLISHING (AUSTRIA), Elbigenalp 91, 6652 Tirol, 05634.64440, Fax: 05634.644 470, Tlx: 55581 koch, President: Franz Koch, MD: Rudy Schedler. (Owned): Koch Music Publishing; (Admin): Editions Berton, Kineton, MGK, Ringstrasse, Select.

LEVEL 42, see Warner Chappell Musikverlag Gesellschaft.

LIBERO, see Warner Chappell Musikverlag Gesellschaft.

LUDWIG KRENN, see Weinberger Music Group.

M-P-Z/MUSIC PUBLISHING ZERGA, Erdbergstrasse 27, 1030 Vienna, 01.712 3564, Fax: 01.715 1444, MD: Manuela Zerga.

MAMBO, see Step Two Music.

MCA GROUP, see Step Two Music.

MELTEMI MUSIC, Hirschtstetterstrasse 26/13, 1220 Vienna, 01.232 272, Fax: 01.232 226, Contact: Horst Bichler.

MERIDIAN, see Step Two Music.

MGK, see Koch Music Publishing (Austria).

MORRIS CHAPPELL, see Warner Chappell Musikverlag Gesellschaft.

MORRISON LEAHY, see Warner Chappell Musikverlag Gesellschaft.

MUSIC PRODUCTION RIHA, Palmgasse 10, 1150 Vienna, 01.838 569, Fax: 01.834 474, MD: Fritz Riha. (Sub-pub): Arion-Musikverlag.

MUSIK UNSERER ZEIT, see Warner Chappell Musikverlag Gesellschaft.

NEUE WELT, see Warner Chappell Musikverlag Gesellschaft.

NEUNINGER URSULA, Neubaugasse 2, 3121 Karlstetten, 02741.360, Fax: 02741.7423, MD: Gerhard Neuninger, Prof Mgr: Friedrich Neuninger. (Owned): Ursula Neuninger; Main product: Dance, Folk.

PAPAGENO, see Weinberger Music Group.

PEERMUSIC, see Southern Music GmbH Wien.

POLYGRAM/ANTENNA MUSIKVERLAG, Edelsinnstrasse 4, 1122 Vienna, PO Box 85 (Zip: 1122), 01.831 524, Fax: 01.831 300, Tlx: 114577, MD: Chris Wenckan, Contact: Adolf Hoffmann.

PUBLIC APPEALS, see Hey-U Music Produktions.

RINGSTRASSE, see Koch Music Publishing (Austria).

SBF PUBLISHING, Molin 129, 4591 Molin, 07584.28430, Fax: 07584.284 315, MD: Manfred Prentner, Promo: August Viertbauer.

SELECT, see Koch Music Publishing (Austria).

SHAMROCK RECORDS, Altwaidhofen 37, 3830 Waidhofen an der Thaya, 02842.3986, Fax: 02842.2826, MD: Uwe Kraner, Mgr: Werner Weiss.

SIEGEL & HOCHMUTH, Grinzingerstrasse 76a, 1190 Vienna, 01.371 505, Fax: 01.375 453, MD: Edith Hochmuth, Joachim Neubauer.

SOLISTEN, see Weinberger Music Group.

SOUNDESIGN MUSIKVERLAG, Oberschoerfling 37, 4502 St. Marien, 07227.8589, Fax: 0732.246 030, Contact: Peter Guschelbauer. (Owned): Sounddesign; Main product: Dance, AC, Album Rock, Jazz, New Age.

SOUNDESIGN, see Sounddesign Musikverlag.

SOUTHERN MUSIC GMBH WIEN

Grinzingerstrasse 76A, A-1190 Vienna, (43-222) 37-15-05, Fax: (43-222) 37-54-53, Tlx: 135049, MD: Edith Hochmuth, Joachim Neubauer.

STEP TWO MUSIC, Neulercherfelderstrasse 3-7, 1160 Vienna, 01.4035 9910, Fax: 01.4035 99113, MDs: Ralph Siegel, Joachim Neubauer, Thomas Albrecht. (Sub-pub): Extra, General, Jupiter, Mambo, Meridian, MCA Group.

TAMPA PUBLISHING, Weinitzenstrasse 1, 8045 Graz, 0316.693 500, Fax: 0316.692 923, MD: Egon Hinz, Contact: Martin Wagner.

THEMA MUSIK, Lacknergasse 6-8/3, 1170 Vienna, 01.454 746, Fax: 01.459 503, MD: Georg Strzyzowski, Mktg Mgr: Ulrike Strzyzowski.

U2, see Warner Chappell Musikverlag Gesellschaft.

UNION MUSIK, Harter Strasse 73, 8053 Graz, 0316.293 251, Fax: 0316.293 2519, MD: Helmut Leitner.

URSULA NEUNINGER, see Neuninger Ursula.

VM RECORDS (AUSTRIA), PO Box 47, 6430 Otztal, 05266.8126, Fax: 05266.818 320, Owner: Hubert Pirchner.

WARNER CHAPPELL MUSIKVERLAG GESELLSCHAFT, Diefenbachgasse 35, 1150 Vienna, 01.894 1920, Fax: 01.894 1615, MD: Peter Gruber, Prof Mgr: Franz Handl, Copyright: Brigitte Nowak. (Owned): Autarc, Axxis, B-Musik, Libero, Musik Unserer Zeit, Neue Welt; (Admin): EC, Fonit Cetra, Hanna Barbera, Level 42, Morris Chappell, Morrison Leahy, U2.

WEINBERGER MUSIC GROUP, Neulercherfelderstrasse 3-7, 1160 Vienna, 01.4035 9910, Fax: 01.4035 99113, MDs: Johann Michel, Hans Granzer, Peter Jirka, Thomas Albrecht, Richard Toeman. (Admin): Arends Music, Dacapo, Euro Music, 4A Music, Glockenverlag, Ludwig Krenn, Papageno, Solisten, Wien Melodie, Wiener Arion, Wiener Musikproduktion.

WIEN MELODIE, see Weinberger Music Group.

WIENER ARION, see Weinberger Music Group.

WIENER MUSIKPRODUKTION, see Weinberger Music Group.

VIDEO PROGRAM SUPPLIERS & BUYERS

APE RECORDS, Schwanthaler Strasse 43, 5026 Salzburg, 0662.274 951, Fax: 0662.274 9513.

AUSTRO VIDEO, Ortstrasse 18, 2331 Vösendorf, 01.692 586, Contact: M. Zrounig, Distributor.

AVV AUSTRIA, Altmannsdorfer Strasse 144, 1232 Vienna, 01.804 6158, Fax: 01.804 1098. Production and distribution.

DOMINO BLUE ONE, Johannesgasse 9-13/117, 1010 Vienna, 01.513 3759, Fax: 01.585 662, Contact: Thomas Achleitner, Suzanne Kreuzberger.

DOMINO MUSIKPRODUKTION, Untermarkt 15, 5270 Mauerkirchen, 07724.215 811-3, Fax: 07724.215 822, GM: Guenter Menschik, A&R Mgr: Rosemarie Menschik.

DORO PRODUCTIONS, Winckelmanstrasse 8, 1150 Vienna, 01.832 635, Fax: 01.832 143, Dir/Producer: Rudi Dolezal, Hannes Rossacher. Video production company of music & promo videos.

DUM DUM RECORDS, Opernring 1, 1010 Vienna, 01.566 515, Fax: 01.566 515, MD: Wolfgang Strobl, Mktg/Sales: Thomas Neffe, Int'l Mgr: Marcus Wagner.

ECOVISION, Gumpendorferstrasse 65, 1060 Vienna, 01.587 3220, Fax: 01.587 3225.

EUROPOOL, Neulercherfelderstrasse 3-7, 1160 Vienna, 01.4035 9910, Fax: 01.4035 99113, MDs: Hans Granzer, Peter Jirka.

FILM FACTORY, Prinz-Eugen-Strasse 14/23, 1040 Vienna, 01.505 4222, Fax: 01.509 9438.

KNOLL VIDEO, Rienasslgasse 1, 1040 Vienna, 01.572 711.

LIVE RECORDS, Bahnhofstrasse 66, 4910 Ried im Innkreis, 07752.6777, Contact: Rudolf Marsch.

MAGNA VIDEO, Probst Peitlstrasse 54, 2103 Langenzerdorf, 02244.2653, Fax: 02244.265 319, President: Bernhard Bettstein, Sales Mgr: Erwin Boehm, Distributor.

PETER KASPERAK FILMPRODUKTION, Capistrangasse 3/20, 1060 Vienna, 01.575 8252, Fax: 01.587 5119, Dir: Michael Kreihsl.

POLYGRAM VIDEO, Edelsinnstrasse 4, 1120 Vienna, PO Box 85 (Zip: 1122), 01.831 524, Fax: 01.831 300, Tlx: 114577, MD: Karl Bednarik.

PRE TV, Ankerstrasse 4, 8054 Graz, 0316.282 551. 2nd address: Favoritenstrasse 20, 1040 Vienna, 01.505 2384.

RAINBOW VIDEO, Sudranstrasse/Wagner Schoenkirchgasse, 1232 Vienna, 01.677 629, Fax: 01.677 632.

SYNCHRO VIDEO, Haydngasse 5, 1060 Vienna, 01.597 4162, Contact: Alexander Wieser. Post production.

VIDEO VERTRIEB, Webgasse 43, 1060 Vienna, 01.597 9795, Fax: 01.5975 64633/6, President: Franz J Wallner, Sales: Wolfgang Kalntrath. Distributor.

WARNER HOME VIDEO (AUSTRIA), Zieglergasse 10, 1070 Vienna, PO Box 85 (Zip: 1072), 01.964 674/963 672/3, Fax: 01.939 462, Contact: Mr. Holzermayer. Distributor.

WM PRODUCTIONS, Neulercherfelderstrasse 3-7, 1160 Vienna, 01.4035 9910, Fax: 01.4035 99113, MD: Thomas Albrecht, Hans Granzer, Peter Jirka.

RECORD DISTRIBUTORS

EMP TONTRAEGER HANDELSGESELLSCHAFT, Weinitzenstrasse 1, 8045 Graz, 0316.693 500, Fax: 0316.692 923, MD: Egon Hinz, Contact: Martin Wagner. Labels (Dist): Castle Communications, EFA, Repertoire, TIS, Rams Horn, CTE, Boulevard.

EMP TONTRAEGER HANDELSGESELLSCHAFT, Weinitzenstrasse 1, 8045 Graz, 0316.693 500, Fax: 0316.692 923, MD: Egon Hinz. Labels (Dist): Castle Communications, EFA, Repertoire, TIS, Rams Horn, CTE, Boulevard.

FRIZZEY RECORDS, Art of Belladonna Tonstudio, 6522 Prutz 13, 05472.6349, Fax: 05472.6779, Contact: Friedrich Greif.

IXTHULUH, Wiener Bundesstrasse 38, 4061 Pasching, 07229.61808, Fax: 07229.62360, MD: Werner Ponesch.

JUKE-BOX VERTRIEB, Adalbert Stifter Strasse 73, 1200 Vienna, 01.334 6410, Fax: 01.3346 4141, MD: Josef Muff Sopper. Labels (dist): Breakin' Records, JMS, Tonau Records.

KNOEBEL RECORDS, Thalberg 4, 8241 Dechantskirchen, 03357.2414, Fax: 03357.6090.

KOCH INTERNATIONAL (AUSTRIA), Elbigenalp 91, 6652 Tirol, 05634.64440, Fax: 05634.644 470, Tlx: 55581 koch, President: Franz Koch, Admin Mgr: Anton Selb, A&R Mgr: Franz Wolf, Label Mgr: Joe Morscher, Int'l Licensing: Rudy Schedler, Mktg/Sales: Helmut Fischer, Legal Dept: Georg Hittmair. Labels (dist): Anies, Aperto, ASV, Aulos, Aurophon, Austria, Autoprophe, Bella Musica, Black and Blue, Cadenza, Chant du Monte, Chandos, Classics for You, CPO, Divox, DRG, Edition Koch, Emston, Europa Musica, Fantastik, Five Star, Forlane, Fresh Sound, Germany, Heimatmelodie, Hyperion, Koch Digital Class, Koch Digital Disc, Koch Int'l Classics, Koch Int'l Legacy, Koch Micro Sound, Koch Records Classics, Koch Records Int'l, Koch Records Special, Koch Records, Koch Select, Miki, Motette, Multisconic, Musique en Wallonia, Northeastern, Ondine, Organum, Pan, Paragon, Pantan, Phanton, Profil Records, Roko, Royal Classics, Schwann, Schwann Mundi, Schwann Sacra, Swiss, Supraphon, Syncoop, Tring.

MUSIC SERVICE CENTRE, Erlachgasse 134-140, 1100 Vienna, 01.60153, Fax: 01.602 3621, MD: Harald Gold. Distribution for: BMG Ariola, Sony Music, Warner Music.

MUSICA SCHALLPLATTEN VERTRIEB, Webgasse 43, 1060 Vienna, PO Box 451 (Zip: 1060), 01.5975 6460, Fax: 01.5975 64636, MD: Franz J Wallner, Label Mgr (Classical): Katharina Boese, A&R: Michael Hufnagel. Labels (Dist): Alligator, Amati, AMC, Arion, ARS Vivendi, Artriphon, Austrophon, Austrotone, Bayer, Bell, Biber, Blue Vision, Butterfly, Buy, Calig, Chesky, Christophorus, Cirrus, Clan, Columbus, Criss-Cross, Dabringhaus & Grimm, Denon, DMP, Duke Street, EBS, Edition 23, Elisar, Elite Special, Eurex, Euro Pool, Fresh, Gaia, Ghetto, GMG-Production, Gramavis, GRP, INAK, Irrepressible, JVC, Kaz, Klavins, Kontrapunkt, Landmark, Livin Legend, L&M, Lunar, Macho, MDG, MFSL, Morena, Muse, Musica Austria, Muve, Nato, Nimbus, OK, Orfeo, Pink Dust, Plastic Head, RAI, Respond, Savoy Jazz, Signum, Sigla, Sion, Sonia, Steeple Chase, Survival, TBA, Telarc, Tomato, Vagabond, Vogue, Wayto, Zensor, Zeppelin.

RECORDTRADE, Palmgasse 10, 1150 Vienna, 01.838 569, Fax: 01.834 474, MD: Fritz Riha.

TIME PRODUCTIONS MUSIC DISTRIBUTION, Keplerstrasse 95, 8020 Graz, PO Box 34 (Zip: 8027), 0316.918 974, Fax: 0316.918 904, MD: Kurt Seindlitzer, Sec: Ingrid Gleichweit, Bookkeeping: Gudrun Kummer, Label Mgr: Michael Broser, Hannes Seindlitzer. Labels (Dist): Old Gold, Magnum, Streethat, Pickwick, BGO, Ambra, See For Miles, Prism Leisure, Semaphore, Start, SST, Neue Dimensionen, TST Network, AMV, Acoustic, Laika, Smash, Jazz Point, Ronin, Bananas, Red Lighting, Seagull, DMC, Tring; Main product: Dance, Album Rock, Jazz, Gold/Oldies, Country, Black (R&B), Reggae, new Age, Classical.

RETAIL ACCESSORY SUPPLIERS

LIFT VERKAUFSGERAETE, Franzensgasse 25, 1050 Vienna, 01.587 3838, Fax: 01.587 4509, Tlx: 136684.

PATACO (AUSTRIA), Auustrasse 37, 6250 Kundl, 05338.8587, Fax: 05338.8588, Contact: Christian Trapl. Retail supplies/shopping: fully automatic listening facilities, sales promotion facilities, theftproof security systems for audio/video media, audio/video switching facilities.

ASSOCIATIONS & PROFESSIONAL ORGANIZATIONS

AKM, Baumannstrasse 8-10, 1031 Vienna, 01.713 1555, Fax: 01.713 55559, Tlx: 613222581, President: Gerhard Wimberger, GM: Ernst Huemer. Association of authors, composers and publishers.

AMP AUSTRIAN MUSIC PRODUCERS, PO Box 2, 1094 Vienna, 02244.4580, President: Guenter Menschik.

ART INSTITUT VIENNA, Rechte Wienzeile 19, 1043 Vienna, PO Box 101 (Zip: 1043), 01.568 578/911 2616, Fax: 01.587 0971/911 2176, President: Gregor Jasch, Heavy Metal Consultant: Gregor Streng, Promo: Eva Nova. Centre of Austrian rock information.

AUSTRO-MECHANA, Baumannstrasse 8-10, 1031 Vienna, 01.757 679/535 6036, Fax: 01.712 7136, President: Johann Juranek, Dir: Helmut Steinmetz. Mechanical rights society.

BUNDESGREMIUM DES RADIO & ELECTROHANDELS, Wiener Hauptstrasse 63, 1045 Vienna, 01.50105/501 3353, Fax: 01.501 292, Tlx: 11187 buka, Contact: Alfred Prenner. Association of radio, TV and appliance stores.

FACHVERBAND AUDIOVISIONS & FILMINDUSTRIE, Wiedner Hauptstrasse 63, 1045 Vienna, PO Box 327 (Zip: 1045), 01.5010 53010, Fax: 01.5020 6270, MD: Elmar Peterlunger. Austrian audiovisual and film industry professional association.

IFPI AUSTRIA, Habsburgergasse 6-8/18, 1010 Vienna, 01.535 6035, Fax: 01.535 5191, President: Stephan von Friedberg, MD: Harald Buechel, Treasurer: Manfred Lappe, Fin Dir: Gerhard Gorgosilich, Anti-Piracy Officer: Andreas Weinek.

IMZ INTERNATIONAL MUSIC CENTRE, Lothringerstrasse 20, 1030 Vienna, 01.713 0777, Fax: 01.7130 77717, Tlx: 75311745 imz, President: Dennis Marks, Exec Dir: Eric Marinitsch.

LSG, Biennengasse 5-8, 1060 Vienna, 01.5871 7290, Fax: 01.5872 1490, Dir-Gen: Paul Fuerst. Broadcasting/performing rights organization for artists.

LSG, Habsburgergasse 6-8/18, 1010 Vienna, 01.535 6035, Fax: 01.535 5191, Dir-Gen: Harald Buechel. Broadcasting/performance rights society of producers.

MUSIKVERLAGE UNION, Baumannstrasse 8-10, 1030 Vienna, 01.7131 5550, Fax: 01.7131 55559, Tlx: 613222581, President: Johann Juranek.

OESTERREICHISCHE TONMEISTERVEREINIGUNG, Hanselmayergasse 15, 1130 Vienna, 01.825 9702, Chmn: Geza Laszloffy. Association of Austrian sound recordists.

VBT (BILD & TON), Habsburgergasse 6-8, 1010 Vienna, 01.535 6035, Fax: 01.535 5191, President: Harald Buechel, VP: Holger Mueller, Bd Members: Manfred Lappe, Stephan von Friedberg. Broadcasting/performance rights of music videos.

PUBLIC RELATIONS & RECORD PROMOTION

AMV ENTERTAINMENT, Margaretenstrasse 79/Top 1, 1050 Vienna, 01.544 350, Fax: 01.555 186, MD: Alexander Vyborny.

ART PR, Rechte Wienzeile 19, 1040 Vienna, 01.568 578, Fax: 01.587 0971, MD: Gregor Jasch, Media Relations: Gregor Streng, Photo Dept: Eva Nova.

HIT FABRIK, Muehlhage 1/20, 2353 Guntramsdorf, 02236.53006, Fax: 02236.530 0690, MD: Franz Groihs.

POINT PROMOTIONS, Erlachplatz 2-4, 1100 Vienna, 01.604 4100, Fax: 01.604 4105, PR/Mktg Mgr: Wolfgang Poetsch, Asst: Christa Poetsch.

SCHEIBMAIER, Argentinierstrasse 71, 1040 Vienna, 01.505 3526, Fax: 01.505 0286, MD: Karl Scheibmaier.

WOODOO RECORDS, Hollandstrasse 14/12a, 1020 Vienna, 01.214 3385, Fax: 01.408 1614, Contact: Despina C Chlad.

COMPACT DISC MASTERING & REPLICATING PLANTS

DADC AUSTRIA, Niederalm 282, 5081 Anif, 06246.2260, Fax: 06246.2090, Tlx: 633216. CD/Video disc pre-mastering.

HEY-U STUDIOS/POWER SOUND FACTORY, Hennesdorferstrasse 92, 2481 Achau, 01.885 5250, Fax: 01.885 609, Producer: Herwig Ursin, Peter Koller. CD pre-mastering & disc-cutting/mastering.

MAGIC SOUND, Schoenaustrasse 53a, 8010 Graz, 0316.832 425, Studio Mgr/Eng: Andi Beit, Eng: Manfred Kepplinger. CD pre-mastering.

VIENNOLA, Heidestrasse 11, 2433 Margarethen am Moos, 02230.2654, Fax: 02230.265 485, Tlx: 133357, MD: Josef Dellinger. Disc-cutting & CD pre-mastering.

AUSTRO-TAPE, Hauptstrasse 40, 7503 Grosspetersdorf, 03362.7866, Fax: 03362.7267, Contact: Christian Amtmann. CD manufacture.

DADC AUSTRIA, Niederalm 282, 5081 Anif, 06246.2260, Fax: 06246.2090, Tlx: 633216, MD: Otto Zich, Mktg Mgr: Peter Zwickler. CD, CD-ROM, CD Video laserdisc manufacturers.

KOCH DIGITALDISC, Elbigenalp 91, 6652 Tirol, 05634.64440, Fax: 05634.644 470, Tlx: 55581 koch, President: Franz Koch, Mktg Mgr: Ralph Gropp. CD manufacturing and vinyl pressing; Annual cap: 12m.

VIENNOLA, Heidestrasse 11, 2433 Margarethen am Moos, 02230.2654, Fax: 02230.265 485, Tlx: 133357, MD: Josef Dellinger. CD manufacturing and vinyl pressing.

PLATING, MASTERING & PRESSING PLANTS

AARDVARKS' SAULA SOUND STUDIO, Nachtigallenstrasse 18, 5023 Salzburg, 0662.663 012, MD: Michael Wagner.

AUSTRO-TAPE, Hauptstrasse 40, 7503 Grosspetersdorf, 03362.7866, Fax: 03362.7267, Contact: Christian Amtmann. Vinyl pressing.

HEY-U STUDIOS/POWER SOUND FACTORY, Hennesdorferstrasse 92, 2481 Achau, 01.885 5250, Fax: 01.885 609, Producer: Herwig Ursin, Peter Koller. CD pre-mastering & disc-cutting/mastering.

KOCH DIGITALDISC, Elbigenalp 91, 6652 Tirol, 05634.64440,

Fax: 05634.844 470, Tlx: 55581 koch, President: Franz Koch, Mktg Mgr: Ralph Gropp. CD manufacturing and vinyl pressing; Annual cap: 12m.

KOCH STUDIOS, Elbigenalp 91, 6652 Tirol, 05634.64440, Fax: 05634.644 470, Tlx: 55581 koch, President: Franz Koch, Studio Mgr: Josef Schoenleitner.

SBF RECORDS, Molln 129, 4591 Molln, 07584.28430, Fax: 07584.284 315, MD: Manfred Prentner, Eng: Johannes Peter Mair. Disc-cutting/mastering.

VIENNA WORKSHOP STUDIO, Hoeritzergasse 4/2, 1140 Vienna, 01.949 1295/924 7073, Contact: Hans Hartel.

VIENNOLA, Heidestrasse 11, 2433 Margarethen am Moos, 02230.2654, Fax: 02230.265 485, Tlx: 133357, MD: Josef Dellinger. Disc-cutting & CD pre-mastering, CD manufacturing and vinyl pressing.

TAPE CUSTOM DUPLICATORS

AUSTRO-TAPE, Hauptstrasse 40, 7503 Grosspetersdorf, 03362.7866, Fax: 03362.7267, Contact: Christian Amtmann.

BERTON RECORDS TONSTUDIO, Muehlhage Strasse 36, 6972 Fussach, 05578.2627, Fax: 05578.3452, MD: Helmut Rasinger.

GERHARD HEINZ TONSTUDIO, Penzingerstrasse 72, 1140 Vienna, 01.8946 2390, Fax: 01.8946 2390, Contact: Gerhard Heinz.

HEY-U STUDIOS/POWER SOUND FACTORY, Hennesdorferstrasse 92, 2481 Achau, 01.885 5250, Fax: 01.885 609, Producers: Herwig Ursin, Peter Koller.

KOCH DIGITALDISC, Elbigenalp 91, 6652 Tirol, 05634.64440, Fax: 05634.644 470, Tlx: 55581 koch, President: Franz Koch, Mktg Mgr: Ralph Gropp. Audio cassette duplication; Annual cap: 5m.

MCP MAGNETICS, Industriestrasse 5, 6430 Oetzal, 05266.542606, Fax: 05266.8310, MD: Hans Jochler.

SBF RECORDS, Molln 129, 4591 Molln, 07584.28430, Fax: 07584.284 315, MD: Manfred Prentner, Eng: Johannes Peter Mair. Audio cassette duplication.

TONSTUDIO KOHLBAUER, Reichraming 45, 4462 Reichraming, 07255.8454, MD: Manfred Kohlbauer.

TYROLIS STUDIOS, Meilstrasse 36, 6170 Zirl, Tirol, 05238.2403, Fax: 05238.362 151, Tlx: 533947, MD: Elsa Rasinger.

VIENNA POWER STATION, PO Box 11, 1106 Vienna, 01.604 8881, MDs: Sascha Goebel (Mktg), Michael Zastoupil (Eng). Audio cassette duplication; Nakamichi tape deck.

VIENNOLA, Heidestrasse 11, 2433 Margarethen am Moos, 02230.2654, Fax: 02230.265 485, Tlx: 133357, MD: Josef Dellinger.

CASSETTES REELS & PARTS, JEWEL BOX MANUFACTURERS

LUGER, Linzer Strasse 17, 3002 Purkersdorf, 02231.3539, Fax: 02231.353 952, Tlx: 111459.

MAGNA TON/BILDRAEGER, Probst-Peittl Strasse 54, 2103 Vienna, 01.392 542.

PRINTING, PACKAGING & LABELS

PANINI AUSTRIA, Muenchner Strasse 21, 6330 Kufstein, PO Box 80 (Zip: 6330), 05372.71122/23, Fax: 05372.71124.

VIENNOLA, Heidestrasse 11, 2433 Margarethen am Moos, 02230.2654, Fax: 02230.265 485, Tlx: 133357, MD: Josef Dellinger.

BLANK & BULK RAW TAPE

3M AUSTRIA, PO Box 100, 2380 Perchtoldsdorf-Vienna, 01.86660, Fax: 01.866 6242, Sales Dir: Peter Zehetner.

AGFA-GEVAERT, Mariahilferstrasse 198, 1153 Vienna, 01.85020, Fax: 01.850 2200, Tlx: 112715 agfge, Contact: Albert Svoboda.

MEMOREX, Gunoldstrasse 14, IPZ, 1199 Vienna, 01.368 850, Fax: 01.3688 5044, Sales Dir: Wilhelm Stark.

SONY OPERATIONS (AUSTRIA), Laxenburger Strasse 214, 1232 Vienna, 01.6105 0114, Fax: 01.610 509, Sales Dir: Mr. Mueller.

CD, RECORD & TAPE MANUFACTURING SYSTEMS

LUGER, Linzer Strasse 17, 3002 Purkersdorf, 02231.3539, Fax: 02231.353 952, Tlx: 111459.

BALTICS

RECORD COMPANIES

KULDNOKK RECORDS, Luise 13-14, 200001 Tallinn, Estonia, 0014.666 020, Fax: 0014.452 349, Tlx: 173205 thkt.

ZONA RECORDS, Seskinen 79, 2010 Vilnius, Lithuania, 00122.428 019/228 998, Fax: 00122.229 991, Tlx: 261215 zona, MD: Giedrius Klimkevicius.

ASSOCIATIONS & PROFESSIONAL ORGANIZATIONS

ASSOC. OF LITHUANIAN CONCERT PROMOTERS, Zemaitijos Street 8/11-222, 2001 Vilnius, Lithuania, 00122.622 913, Fax: 00122.623 120, Tlx: 261168 muza.

VAAP, Toompuiestee 7, 200101 Tallinn, Estonia, 0014.453 788/442 596.

PUBLIC RELATIONS & RECORD PROMOTION

NATA PROMOTION BUREAU, Suderves 7-45, 232000 Vilnius, Lithuania, 00122.459 178, Tlx: 411700 ptb.

PLATING, MASTERING & PRESSING PLANTS

RITONIS, Kalnsiema 40, 226046 Riga, Latvia, 0132.611 783, Fax: 0132.624 942, Tlx: 161197 ridze, Dir-Gen: Y Kambala, MD: A Medvedjev, Mktg Mgr: M Boudlevskis.

TAPE CUSTOM DUPLICATORS

AUVI (TALLINN RECORDING & PRODUCTION), Lohu Street 12, 200026 Tallinn, Estonia, 00142.537 108, Tlx: 173205 thkt, MD: Mart Mikalaj.

RITONIS, Kalnsiema 40, 226046 Riga, Latvia, 0132.611 783, Fax: 0132.624 942, Tlx: 161197 ridze, Dir-Gen: Y Kambala, MD: A Medvedjev, Mktg Mgr: M Boudlevskis. Audio cassette duplication; Annual capacity: 1 mil.

BELGIUM

RECORD COMPANIES

ACCENT, Eikstraat 31, 1673 Beert, 02.356 1878, Fax: 02.360 2718, Pres/MD: Andreas Giatt.

ACOUSTICS, Meilaan 157, 1200 Brussels, 02.763 1550, Fax: 02.772 2989, MD: Catherine v/d Genachte, GM: Kris de Bruyne, Prod Mgr: Marianne v/d Maat, Traffic Mgr: Sandra Cattoor.

AMC ARTISTS & MUSIC COMPANY, Avenue de Tervuren 412, 1150 Brussels, 02.771 0678, Fax: 02.771 6801, MD: Jean-Marie Sohie.

ANTLER-SUBWAY RECORDS, Jozef Thielemansstraat 38, 3200 Aarschot, 016.567 666, Fax: 016.567 670, MD: Roland Beelen, Maurice Engelen, Label Mgr: Eric Dries, Prod Mgr: Tejo de Roeck, A&R Mgr: Patrick Claessen. Labels owned: Antler, Antler Subway, Subway, Subway Dance, Kaos, Complete Kaos, Integrety, VW Records, Red Vendetta, Papa W, Pop Gun, House Records, World Domination, Speed, Dance Opera, Beat Box, Paradise Music.

ARCADE INDISC, Wandstraat 209, 1020 Brussels, 02.268 0010, Fax: 02.266 0987, President: Herman Heinsbroek, GM: Richard Dedapper, Label Mgr: Jan van den Bergh.

ARS PRODUCTIONS, Landboustraat 16, 2020 Antwerp, 03.216 1750/1, Fax: 03.216 3597, Tlx: 71784, MD: Patrick Busschots, Ludo Vercaemmen. Distribution: CNR.

ATOM, Sint Jacobsmarkt 75, 1st floor, 2000 Antwerp, 03.232 0409/3838, Fax: 03.226 2030, Joint MD: Jan Van Den Bergh. Labels (owned): Sub System, Systeme Imaginieve, Sven Van Hees, Liza Ne Eliaz; Main product: Dance.

BALTIC, Rederijkersstraat 82, 2610 Antwerp-Wilrijk, 03.828 4084, Fax: 03.829 1068, President: Maria Wuylts, MD: Ben Gyselincx, Mktg/Sales/PR: Daniel Gillet, Mgr (Export): Henk Coops. Labels (owned): Baltic, Euram, West Music; Main product: Dance, Jazz, New Age, Classical, Film (OST).

BIZET PRODUCTIONS & PUBLICATIONS, Ingendaellaan 30, 1652 Aelseberg, 02.380 7493, Fax: 02.380 9117, Dir (Jazz): Veronique Bizet. Labels (owned): Jazz Club; Main product: Jazz.

BMG ARIOLA BELGIUM, Francois Riga Square 30/8, B-1030 Brussels, (32) 02.216 9780, (32) 02.215 1992, Fax: (32) 02.242 3608, MD: Derk Jan Jolink, GM: Cesar Boesten, Fin Contr: Wim Peynenburg, Mktg Mgr: Stefaan Cockmartin, Mgr New Enterprises: Amaury de Jamblin, Sales Mgr: Marc van den Abeele, Asst. & Copyright Admin: Lieve Lambaets. Labels (owned): RCA, Arista, Ariola, Ariola Express; (Lic): Island, Geffen, MCA, Motown, Baby; (Dist): Jive.

BOOM RECORDS, Bergensesteenweg 19, 1500 Halle, 02.360 2851, Fax: 02.360 2851, MD: J P Haezendonck. Labels (owned): Boom Records, Elephant Candy.

BOUDISQUE, De Jambline de Meux Plein 39, 1040 Brussels, 02.732 3386, Fax: 02.734 0234, MD: Lieven Van den Broeck, Promo Mgr: Erik Didden, Sales: Arthur Praet, Francis Belle, Contact: Chris Dierick.

BUSY-MUSIC, Rue Saint-Denis 276, 1190 Brussels, 02.347 0304, Fax: 02.343 0707, Tlx: 24167, Contact: Alex Busanel.

CARDINAL RECORDS, Wouter Haeccklaan 15C, 2100 Deurne, 03.321 5581, MD: Rocco Granata.

CARREFOURS, Rue Melsens 13, 1000 Brussels, 02.502 1267, Fax: 02.502 1267, MD: Nico Zangardi, Int'l Mgr: Jean-Luc Wierzbinski. Labels (owned): Carrefours; Main product: Dance, Album Rock, Int'l Pop, Easy Listening.

CARRERA RECORDS INTERNATIONAL, Rue de la Marliere 97, 7700 Mouscron, 056.331 539, Fax: 056.344 236, MD: Philippe De Keukeleire, Int'l Mgr: Pierre Vandemaële, Asst: Cathy De Keukeleire. Labels (owned): Alpina, Alfetta.

CARRERE BELGIQUE, Chaussée de Jette 591, 1090 Brussels, 02.428 8954, Fax: 02.425 0489, MDs: Roger Meylemans, Francine van Vandersmissen, Label Mgr: Pieter van Dovern.

CIM, Kardelaan 20, 2180 Ekeren, 03.542 6685, Fax: 03.542 4622, MD: Luc Cruysweegs. Labels (owned): CIM (Bel/Hol); (Lic): BCM, BMG Ariola, Phonogram (Fra), Sarema, Slim Prod. (Fra), Level (Spa).

CIRKEL PRODUCTIONS, Willem van Nassaustraat 24, 9000 Ghent, 091.227 584, Fax: 091.227 584, MD: Steef Verwee.

CLIP RECORDS, Rozemarijnstraat 12, 9300 Aalst, 053.673 737, Fax: 053.673 334, GM: Mark Adam.

CMP RECORDS AND VIDEOS, Rue Fays 89, 4400 Ivroz-Ramet, 041.752 754, Fax: 041.750 216, Prod Mgr: Silvio Carozzo.

CNR BELGIUM, 't Hofveld 6a, 1702 Groot-Bijgaarden, 02.466 9733/9800, Fax: 02.466 8033/8054, MD: Rik Blomme, GM: Bert Burm, A&R/Promo Mgr: Jeroen Mulders, Promo: Marleen Bassez, Caroline Lemaire, Label Mgr (Classical): Marc Cotemans, Sales Mgr: Luc Berghmans, Mktg/Sales: Luc v/d Schelden. Labels (owned): CNR, Bite, Jaws, Sound Products; (Lic): HKM, ARS, Select, Delphine, Busy; Distribution: CDB.

CONGAS PRODUCTIONS, Rue les Quartiers 7, 5330 Sart Bernard, 081.402 266, Fax: 081.401 774, President: Christian de Coster, MDs: Muriel Dacq, Alec Mansion.

CRAMMED DISCS, Rue General Patton 43, 1050 Brussels, 02.640 7914, Fax: 02.648 8369, MD: Marc Dhollander, GM: Hanna Gorjaczowska, Promo Mgr: Dirk van de Auwera, Int'l Mgr: Marcus Graham, Acct Dir: Philippe Marchal. Labels owned: Crammed, SSR, Made to Measure, Furax, Cramworld; Main product: Dance, Album Rock, New Age.

DE HAECK, St. Antoniuslei 39, 2930 Brasschaat, 03.664 3761, Fax: 03.664 3761, MD/Owner: Martin de Haeck. Labels (owned): Limbo Records, Limbophone, Flandria; Main product: Jazz, Country, Dance, Pop.

DEXON, Avenue Mascaux 800, Pavillon C4, 6001 Marcinelle-Charleroi, PO Box 1661 (Zip: 6000), 071.438 970, Fax: 071.471 581, Dir: Pierre Delfosse, PR: Philippe Antoine. Labels (owned): Dexon; Main product: Dance, Album Rock.

DISCO SMASH INTERNATIONAL, 249 Rue de Lille, 8600 Menen, 056.515 303, Fax: 056.511 613, Tlx: 86141 dismas.

LES DISQUES DU CREPUSCULE, 15 Galerie du Roi, 1000 Brussels, 02.511 8424, Fax: 02.511 8654, Dir: Michel Duval, Prod Mgr: Joelle Dagny, Promo Mgr: Daniel Haesen. Labels (owned): Dancyclopaedia, Interior Music, Lome Arme; (Lic): Laylah, Little Circle; Main product: Adult Contemporary, Album Rock.

DISQUES DUCHESNE—BELGIAN WORLD RECORDS, Rue des Guillaumeins 41, 4000 Liege, 041.520 701, Fax: 041.520 701, Dir: Jean Duchesne.

DISTRIDISC INTERNATIONAL, Provinciestraat 318, 2018 Antwerp, 03.230 9778, Fax: 03.230 5378, MD: Getty Burgelman. Label (owned): Tilt. (Distr): all major and independent imports.

DOE RECORDS, Apostelstraat 9, 2000 Antwerp, 03.232 3298, Fax: 03.231 6383, Dirs: Hugo Helsen, Marc Dingemans. Labels (owned): D.O.E., Junior Records; Distribution: Durelco, Sony.

DORIAN RECORDING EUROPE, 34 Rue van Eyck, 1050 Bruxelles, 02.647 6375, Fax: 02.647 6129, Contact: Jean van Win.

DURECO BELGIUM, Luttebruglaan 19-21, 1190 Brussels, 02.343 9860/2106, Fax: 02.343 6825, Tlx: 63068, MD: Xavier Pelgrims de Bigard, GM: J. Deschulteneer, Promo: Elvina Rens.

ELVER RECORDS INTERNATIONAL, Rue de la Marliere 99, 7700 Mouscron, 056.331 539, Fax: 056.344 236, MD: Philippe De Keukeleire, Int'l Mgr: Pierre Vandemaële, Asst: Cathy De Keukeleire. Labels (owned): Elver.

EMI BELGIUM, 128 rue Colonel Bourg, 1140 Brussels, 02.732 5858, Fax: 02.732 1926, MD (EMI Benelux): Kick Klimbe, MD: Guy Brutez, A&R/Mktg: Dirk de Clippelle, Promo Mgr: Bart Coops, Promo: Sylvie Hendrick (T&P RTB-RTL), Marjolaine de Groote (Radio), Prod Mgr: Erwin Goegebeur.

EUFODA/DAVIDSFONDS, Blijde Inkomststraat 79-81, 3000 Louvain, 016.221 801, Fax: 016.222 532, Dir: Jos Rens, Production: Hilde Vanmechelen. Labels (owned): Eufoda; Main product: Classical, Children's, Folk.

EUROVOX MUSIC GROUP, 43 Rozenlaan, 2970 's Gravenwezel, 03.353 6234, Fax: 03.353 7372, President: Lou van Rymenant, Chmn: Jean Leroi. Labels (owned): Eurovox, Cannon, Arcade.

EVA BELGIUM, Francois Riga Square 30, 1st Floor, 1030 Brussels, 02.215 4530, Fax: 02.215 3329, GM: Amaury de Jamblinne, Comm Asst: An de Keyser. Compilation albums: EMI, Virgin, BMG.

FLORIAN MUSIC, Rue Pichelin 46, 5140 Tongrinne, 071.887 620, Dir: Norbert Blancke.

FONTI MUSICALI, Rue Jean d'Ardenne 33, 1050 Brussels, 02.511 6772, Fax: 02.511 6772, Dir: Claude Flagel.

GLAVERBEL, Chaussée de la Hulpe, 1170 Brussels, 064.540 288, Fax: 064.540 926, Mktg Mgr: Daniel Skala.

HET GERUCHT, Rue F. Bernier/F. Bernierstraat 38, 1060 Brussels, 02.538 3797/3521, Fax: 02.538 3768, MD: Herman van Laar.

HI TENSION RECORDS, J B Tassinsstraat 52, 2070 Zwijndrecht, 03.252 8882, Fax: 03.253 0420, MD: Raymond Muylle, MD/Producer: Fanny de Wulf. Labels (owned): Decadance, NBC; Main product: Dance.

INDISC BELGIUM, Rue de Wand 209-213, 1020 Brussels, 02.268 0010, Fax: 02.268 0987, Tlx: 24416, GM: Richard Dapper, Label Mgrs: Jan van den Berg, Katrien Klauwing, Promo Mgr: Jan van den Neste.

JEAN KLUGER, Avenue Moliere 86, 1180 Brussels, 02.345 4129/4203, Fax: 02.347 0954, President: Jean Kluger, MD: Myriam Dekoster. Labels (owned): Topkapi.

JEP RECORDS, Turnhoutsebaan 152, 2470 Retie, 014.378 789, Fax: 014.372 266, MD: Jules Keersmaekers. Labels (owned): JEP, WIPP; Main product: EHR, Dance.

JUMP RECORDS & MUSIC, Lange munt 71, 9420 Erpe-Mere, 053.627 377, President: Eddy van Mouffaert. Labels (owned): Jump, Flower; (Lic): Yeah Songs.

KAFKA PRODUCTIONS, Leon Gilliotlaan 87, 2630 Aartselaar, 03.877 0786, MD: Jan Verheyen.

KK RECORDS (BELGIUM), Krijgsbaan 240, 2070 Zwijndrecht-Antwerp, 03.253 1480, Fax: 03.253 1496, GM: Jozef Verbruggen.

LACE MUSIC, Spoorwegstraat 38, 8000 Brugge, 050.383 224, President: Yvan Guillini, MD: Carolina Guillini. Main product: new age, pop, dance.

LAMBRECHTS, Kwadenplasstraat 19, 2220 Heist-op-den-Berg, 015.241 625, Fax: 015.249 967, MD: Rene Lambrechts.

LAVIAL, Rue Tenbroek 25a, 1640 Rhode Saints Genese, 02.380 3737, Fax: 02.380 4964, Tlx: 26045, Dir: Raoul Jakou.

MASTERMIXERS UNITY, Rue des Buissons 9, 4000 Liege, 041.262 768, Fax: 041.240 052, Presidents: Luc Rigaux (Int'l Mgr), Patrick Samoy (Mktg & Promo). Labels (owned): International Dance Music IDM Records, Xymo Records; Main product: Dance, Black (R&B), Remix/Megamixes.

MENTAL RADIO, Jozef Thielemansstraat 38, 3200 Aarschot, 016.567 666, Fax: 016.567 670, Contact: Nicky van Lierop.

NEW MUSIC HEBRA RECORDS, Rue St. Christophe 30, 1000 Brussels, 02.512 7361, Fax: 02.512 9375, Mgr: Jean Darlier.

NIROLA BENELUX, Chemin du Lanternier 15, 1380 Plancenoit, 02.633 1074, Fax: 02.633 4327, GM: Robert Nirola.

ONE & ONE, Avenue Legrand 80, 1050 Brussels, 02.649 6390, Fax: 02.649 1557, President: Gordon A Edwards, MD: Pierre-Paul Puljiz.

PARSIFAL, Gulden Vlieslaan 67, 8000 Brugge, 050.339 516, Fax: 050.333 386, President: Gilda Behaeghel, MD: Nico A Mertens, Promo: Charles Dumolin, Accts Mgr: Lieve Demarest. Labels (owned): Parsifal, Discus, Blue Sting, Moonshine, Sundown; (Lic): Rooster, Stony Plain, Powerhouse; (Distr): Double Trouble, Dividing Duck, Blue Shadow, Blind Pig, Flying Fish, Rooster, Rounder, Powerhouse, Black Top, Varrick, JSP, Topic, Special Delivery, Flyright, Crazy Kat, Red Lightnin', Crosscut, Stony Plain, A.O.; Main product: blues, R&B, soul, folk, world music.

PAVANE RECORDS, 17 Rue Ravenstein, 1000 Brussels, 02.513 0965, Fax: 02.514 2194, MD: Antoine de Wouters d'Oplinter, Exports: Bertrand de Wouters d'Oplinter.

PLAY IT AGAIN SAM, 90 Rue de Veeweyde, 1070 Brussels, 02.520 6670, Fax: 02.527 0471, MDs: Kenny Gates, Michel Lambert, Artist Dev: Jean-Marc Dehoul, Mktg/Label Mgr: Joe Robeyns, Mgr (Export): Philippe Sion, Promo Mgr: Jan Hubla, Fin Dir: Philippe Saussons. Labels (owned): Play It Again Sam, RRE, Who's That Beat?, LD, G-Rox-P; (Lic): 4AD, Beggars Banquet, One Little Indian, Boucherie Productions, Crepuscule, Some Bizarre, Netwerk Europe; Main product: Dance, Album Rock, Alternative/Progressive.

POLYGRAM BELGIUM, Avenue de Rodebeek/De Rodebeeklaan 30, 1040 Brussels, 02.733 9690, Fax: 02.733 5177, Tlx: 24516, MD: Charles Licoppe, Prod Mgr: Francois Vaes, Prod Mgrs: Anne Hajdu (Phonogram Int'l), Mia Baudot (Classic), Liz Hadju (Classic), Jean-Luc Leroy (French Rep), Special Projects: Christophe Turckin, Promo: Dominique Poucke (A&M), Alexandra Liebaert (Phonogram), Marc De Keyser (Phonogram), Deirdre Keustermans (Polydor), Contr: Hugo Segers.

PRESTATION MUSIC/MULTI SOUND, Gachard Street 24, 1050 Brussels, 02.649 2847, Fax: 02.648 7931, MD: Pierre Pletinckx. Labels owned: Selection, B. Sharp.

PRIVATE LIFE RECORDS, 40 avenue de Woluwe St Lambert, 1200 Brussels, 02.732 2858, Fax: 02.732 2858, MD: Olivier Verhaeghe, Label Mgr: Nathalie Flohr, Composers: Vito Lucente, Mike Delannay. Labels (owned): Private Life Records; Main product: Dance.

PROMAX RECORDS, Avenue Jean Dubrucq/Jean Dubrucq-qaan 86, 1210 Brussels, 02.425 5454, Fax: 02.425 5454, Label Mgr: Alain Mathieu, Promo: Colette Derammaux, Promo (FM/Clubs): Jean Luc Goossens, Sales Rep: Henk Piccini, Mktg: Christiane Libersens, Contact: Catherine Kuevler, Asst to Direction: Patty Burns. Labels (owned): Promax, Savana, Abigwan; (Distr): Vogue, Archip'l, Espera, Tempo.

PYRAMID INT'L MUSIC, Lepelhoekstraat 26, 9100 Sint Niklaas, 03.778 1854, Fax: 03.778 1559, President: Marc de Coen. Distribution: Carrere.

RAINBOW RECORDS, Herentalsesteenweg 20a, 2220 Heist op Den Berg, 015.244 950, Fax: 015.241 470, Tlx: 64440, GM: Constant Verbeek.

REACTION RECORDS, Avenue des Sept-Bonniers 55, 1180 Brussels, 02.344 2659, Fax: 02.344 4017, MD: Mr. Bertrand, Label Mgr: Mr. Kuzmek, GM: Ms. van Daele.

RICERCAR, Burnaumont 73, 6890 Anloy, 061.656 144, Fax: 061.656 246, Art Dir: Jerome Lejeune.

ROUGH TRADE RECORDS (BELGIUM), Pelikaansstraat 14, 1000 Brussels, 02.217 6288, Fax: 02.217 9452, MD: Chris Pro-ve, Promo Mgr: Marleen Eynde.

RUMBLE RECORDS, PO Box 108, 2610 Antwerp, 03.226 5694, Fax: 041.378 225, Contact: Jos Kloek.

SMASH PRODUCTIONS INT'L/NOW DISCS, 68 Dronckaertstraat, 8930 Rekkem, 056.422 180/300, Fax: 056.422 520, MD: Michel Nachtergaele.

SONY MUSIC ENTERTAINMENT (BELGIUM), Place Stephanie 20, 1050 Brussels, 02.513 8445, Fax: 02.513 5139, Tlx: 22642, MD: Bert Cloeckaert, A&R/Mktg: Bernadette Feller, Special Mktg: Linda Coopman, Promo Mgrs: Monique de Neef (French), Tine Verschaë (Jazz/Flemish), Label Mgr (Classical): Patrick Suttels. Labels (owned): Columbia, Epic, Squatt; (Lic): Blue & Master, Now Disc, ARS, Curb, Record King; Main product: EHR, Dance, AC, Album Rock, Jazz, Gold/Oldies, Country, Black (R&B), Classical.

SWEETWOOD PRODUCTIONS, Schupstraat 15, 2018 Antwerp, 03.225 1012, Fax: 03.225 0772, President: Jacqui Suessholz. Production and distribution; Main product: Traditional Jewish Music.

TACTICS, Boulevard Saint Michel 14, 1150 Brussels, 02.732 4500, Fax: 02.732 4610, Contact: Fritz Sundermann.

TEAM FOR ACTION, Rue de la Roue 17, 1000 Brussels, 02.502 0432, Fax: 02.512 0895, MD: Claude Martin, Mktg Mgr: Laurent Ingels, Prod Mgr: Christian Martin, Copyright Mgr: Renaud Janson. (Owned): Wooden Trucks, Asoha, Klaus Klang, Perry Rose, Citizen Jane, Les Malheurs de Sophie, Pierre Rapsat; Main product: Adult Contemporary, Album Rock.

TEMPO (TOP ENTERTAINMENT EDITIONS), Noendries 81c, 9000 Gent, 091.202 121, Fax: 091.218 100, GM: Luc Standaert, Asst Mgr: Tine Lecompte, Promo Mgr: Chris de Brakeleer. Labels owned: Tempo, Healthfood, Magt' lets Meer Zij; Main product: EHR, Dance.

TIGER-LYNCH, Rue des Ailes 116, 1030 Brussels, 02.344 2659, Label Mgr: Georgers Hanouna.

TILT & PARTNERS, Rue du Vieux Marche aux Grains 11/2, 1000 Brussels, 02.514 0612, Fax: 02.513 9257, MD: Herve Verhoosel, Asst: K Demol. Main product: Dance, French; Distribution: Divuca (Spa), Distrisound (Bel), Atoll/Sony (Fra).

TLR RECORDS, Chaussée de Tongres 309, 4540 Amay, 085.312 235, Fax: 085.312 000, Contact: Jean Stasse.

TMD RECORDS, Timmermanstraat 6, 8400 Coostende, 059.509 722, Fax: 059.509 722, President: Hugo Helsen. Labels (owned): Junior Records, TMD Records; (Distr): Doe Records; Main product: Jazz, Country, Reggae, Classical, Dance, Album Rock, Gold/Oldies.

TONICAN, Kasteel Brakelse Steenweg 243, 1502 Lambeek, 02.360 1255, Fax: 02.360 1939, Tlx: 20575, President: Jan Neef.

TRADINOR, 24 Rue Rene Delrue, 7522 Blandain, 069.351 666, Fax: 069.351 667, Dir: Veronique van Copenol.

USA IMPORT & RECORDS, Sint Jacobsmarkt 75, Ground Floor, 2000 Antwerp, 03.232 0409/3838, Fax: 03.226 2030, MD: Jose Pascal, A&R: Elfride Verhelst. Labels (owned): Confetti's, Liaisons D, ATM+OZ+FEAR, Mappa Mundi, Nueva Dimension, Deck 8-9, Tech-Noise; Main product: Dance.

VIRGIN RECORDS BELGIUM, Avenue Gen Wahis/Gen Wahislaan 41, 1030 Brussels, 02.735 0093, Fax: 02.735 3371, Tlx: 26789, MD: Dirk de Vries, Prod/Mktg Mgr: Firmin Michiels, Promo: Philippe Lec (T&P France Labels), Ariella Maggini (Radio).

WARNER MUSIC BELGIUM, Lambermontlaan 79, 1030 Brussels, 02.242 5757, Fax: 02.242 5761, Tlx: 61218, MD: Ted Sikkink, Mktg/Prod Mgr: Francois De Kock, Promo Mgr: Agnes Meyer, Sales Mgr: Patrick Waedens, Press Officer: Michel Will.

THE WATER COMPANY, Zwaardstraat 4, 2000 Antwerp, 03.226 5810, Fax: 03.226 5750, GM: Robert de Groot.

WINNER RECORDS, 15 Rue Felis, 1040 Bruxelles, 02.649 8274, Fax: 02.648 6589, Label Mgr: Michel Kestermont, Prod Mgr: Serge Kestermont.

YES, Avenue Notre Dame 91, 1140 Evere, 02.242 8410, Fax: 02.216 3146, Producer: Christian Lecocq.

MUSIC PUBLISHERS

AA MUSIC, see Templar Music.

ABIGWAN, see Promax Records.

ADASONG PRODUCTIONS, Boulevard de la Cense 84, 1410 Waterloo, 02.354 2034, Fax: 02.354 8488, President: Andre d'Anjou, Label Mgr: Nicole Schoeffert. (Owned): Alain Tomasi, Caron, David Hanson, Golden Gate Quartet, Philippe de Canck; (Admin): TJ Turner, Magoria, Petula Clark, Mac Gyver Music; Main product: Adult Contemporary, Dance, New Age, National.

ALAIN TOMASI, see Adasong Productions.

ALFETTA, see Carrera Records International.

ALPINA, see Carrera Records International.

AMAY MUSIC, see De Haeck.

AMC, see Templar Music.

ANNICK DAAL, see Scorpion Music.

ANTLER—BE'S SONGS, Jozef Thielemansstraat 38, 3200 Aarschot, 016.567 666, Fax: 016.567 670, MDs: Maurice Engelen, Roland Beelen.

ARDEE, see Reader's Digest.

ARS PRODUCTIONS, Landbouwstraat 16, 2020 Antwerp, 03.216 1750/1, Fax: 03.216 3597, Tlx: 71784, MD: Patrick Busschots, Bus Affairs: Stefan Calle.

ASOHA, see Team For Action.

ATM+OZ+FEAR, see USA Import & Records.

ATMOSPHERE, see Prestation Music/multi Sound.

- ATOM**, Sint Jacobsmarkt 75, 1st floor, 2000 Antwerp, 03.232 0409/3838, Fax: 03.226 2030, Joint MD: Van Van Den Bergh. (Owned): Sub System, Systeme Imaginique, Sven Van Hees, Liza N Eliaz; Main product: Dance.
- AXEL LANE**, see Scorpion Music.
- B L REININGER**, see Het Gerucht.
- BA BA BLAXI**, see Het Gerucht.
- BALTIC**, Rederijersstraat 82, 2610 Antwerp-Wilrijk, 03.828 4084, Fax: 03.829 1068, President: Maria Wuylts, MD: Ben Gyselincx. (Owned): Baltic, West Music, Euram.
- BANG KOK PADDOCK**, see Team For Action.
- BARZO**, see Carrera Records International.
- BB DOC**, see Team For Action.
- BERTRAND**, see Reaction Records.
- BETTY BOOP**, see Team For Action.
- BIZET PRODUCTIONS & PUBLICATIONS**, Ingendaellaan 30, 1652 Aisemberg, 02.380 7493, Fax: 02.380 9117, Dir (Jazz): Veronique Bizet. Main product: Jazz.
- BLACK GIPSY INT. MUSIC**, see Pyramid Int'l Music.
- BLOND X**, see Reaction Records.
- BMC PUBLISHING**, Landbouwstraat 16, 2020 Antwerp, 03.216 1750, Fax: 03.216 3597, Tlx: 71784, MD's: Patrick Busschots, Ludo Vercammen.
- BMG ARIOLA BELGIUM**, Francois Riga Square 30/8, 1030 Brussels, 02.216 9780, Fax: 02.242 3608, MD: Cesar Boosten, Fin Contr: Wim Peynenburg, Mktg Mgr: Stefaan Cockmartin, Mgr New Enterprises: Amaury de Jamblinn, Sales Mgr: Marc van den Abeele.
- BOUDISQUE**, De Jamblinne de Meux Plein 39, 1040 Brussels, 02.732 3386, Fax: 02.734 0234, MD: Lieven Van den Broeck.
- BOUNEKHLA FARID EDITIONS**, Rue de Bosnie 49, 1060 Brussels, 02.538 5030, Fax: 02.539 0708, Art Dir: Michel Bellens.
- BOURG MUSIC**, see Radio Tele Music.
- BRUITS ESSENTIELS**, see Het Gerucht.
- BUY MY RECORD**, see Het Gerucht & Templar Music.
- CANNA DOMINO**, see Het Gerucht.
- CAPITOL MEDIA MUSIC**, see Prestation Music/multi Sound.
- CARACOL MUSIC EDITIONS**, Boulevard Jamar 39-41, Box 10, 1070 Brussels, 02.524 2508, Fax: 02.522 0226, GM: Timothy Hagelstein, Admin: Manuel da Cruz, Press: Teresinha Moiteiro, Dir (Pop): Sidonio Pereira. (Owned): Cezame Argile, Koka Media, Ligne Bleue, Floyd, Jabel, MC Music (Bel); (Admin): HC Publishing, Caramba Discossete; Main product: Jazz, Country, New Age, Classical, Chansons.
- CARAMBA DISCOSSETE**, see Caracol Music Editions.
- CARNABY**, Dorp 30, 9991 Maldegem, 050.712 951, Fax: 050.712 554, MD: Mr. van Landschoot.
- CARON**, see Adasong Productions.
- CARREFOURS**, Rue Melsens 13, 1000 Brussels, 02.502 1267, Fax: 02.502 1267, MD: Nico Zangardi, Int'l Mgr: Jean-Luc Wierzbinski.
- CARRERA RECORDS INTERNATIONAL**, Rue de la Marliere 97, 7700 Mouscron, 056.331 539, Fax: 056.344 236, MD: Philippe De Keukeleire, Int'l Mgr: Pierre Vandemaële, Asst: Cathy De Keukeleire. (Owned): Alpina, Alfetta, Titanik; (Admin): Barzo.
- CELTIC**, see Elver Records International.
- CENER MUSIC PUBLISHING**, see Cnr Belgium.
- CEZAME ARGILE**, see Caracol Music Editions.
- CHAMAY**, see De Haeck.
- CHRIS CLARK**, see Scorpion Music.
- CIM**, Kardelaan 20, 2180 Ekeren, 03.542 6685, Fax: 03.542 4622, MD: Luc Cruysweegs. (Owned): CIM; (Sub-pub): Sliem (FRA).
- CIRKEL PRODUCTIONS**, Willem van Nassaustraat 24, 9000 Ghent, 091.227 584, Fax: 091.227 584, MD: Steef Verwee.
- CITIZEN JANE**, see Team For Action.
- CNR BELGIUM**, 't Hofveld 6a, 1702 Groot-Bijgaarden, 02.466 9733/9800, Fax: 02.466 8033/8054, MD: Rik Blomme. (Owned): Cener Music Publishing.
- CODA**, see Elver Records International.
- COLOURSOUND**, see Prestation Music/multi Sound.
- CONFETTI'S**, see Usa Import & Records.
- CONGAS PRODUCTIONS**, Rue les Quartiers 7, 5330 Sart Bernard, 081.402 266, Fax: 081.401 774, President: Christian de Coster, MDs: Muriel Dacq, Alec Mansion.
- COPPELIA**, see Prestation Music/multi Sound.
- CREA SOUND**, see Prestation Music/multi Sound.
- DANCING I**, see Radio Tele Music.
- DANCING II**, see Radio Tele Music.
- DANNY BRENDON**, see Scorpion Music.
- DANNY GREEN**, see Scorpion Music.
- DANNY JOE**, see Scorpion Music.
- DAVID HANSON**, see Adasong Productions.
- DAVID JANSSEN**, see Reaction Records.
- DAVIDSAN**, Colombialaan 7 b.5, 1050 Brussels, 02.736 4336, Fax: 02.673 8349, MD: Arthur Blanckaert.
- DE HAECK**, St. Antoniuslei 39, 2930 Brasschaat, 03.664 3761, Fax: 03.664 3761, MD/Owner: Martin de Haeck. (Owned): Amay Music, Chamay; Main product: Jazz, Country, Dance, Pop.
- DECK 8-9**, see Usa Import & Records.
- DEVINE**, see Het Gerucht.
- DEXON**, Avenue Mascoux 800, Pavillon C4, 6001 Marcinelle-Charleroi, PO Box 1661 (Zip: 6000), 071.438 970, Fax: 071.471 581, Dir: Pierre Delfosse, PR: Philippe Antoine.
- DOUBLE DYNAMIC BAND**, see Scorpion Music.
- DSE**, Rue Willems 16 b.0505, 1040 Brussels, 02.230 9754, Fax: 02.230 9754, Contact: Bernard Kostman.
- EDDY GOVERT**, see Scorpion Music.
- ELVER RECORDS INTERNATIONAL**, Rue de la Marliere 99, 7700 Mouscron, 056.331 539, Fax: 056.344 236, MD: Philippe De Keukeleire, Int'l Mgr: Pierre Vandemaële, Asst: Cathy De Keukeleire. (Owned): Moderny, Coda, Celtic.
- EMI MUSIC PUBLISHING BELGIUM**, Eugene Plaskyalaan 140b, 1040 Brussels, 02.735 2902, Fax: 02.735 9214, MD (EMI Benelux): Arjen Witte, Prof Mgr: Guido Janssens.
- ESPERA**, Rue de la Madeleine 13, 1000 Brussels, 02.511 6728, Fax: 02.614 4101, MD: Jean Martin.
- EURAM**, see Baltic.
- EUROVOX MUSIC GROUP**, 43 Rozenlaan, 2970 's Gravenwezel, 03.353 6234, Fax: 03.353 7372, President: Lou van Rymenant, Chmn: Jean Leroi. Catalogues (owned): Eurovox, Intervox, Glorious Music.
- EVELIEN**, see Scorpion Music.
- FIL FILIPS**, see Scorpion Music.
- FILMTRAX MOGULL INC.**, see Radio Tele Music.
- FLOYD**, see Caracol Music Editions.
- FRANSIS**, see Scorpion Music.
- GARCONS BOUCHERS**, see Team For Action.
- GEMINI**, see Prestation Music/multi Sound.
- GLORIOUS MUSIC**, see Eurovox Music Group.
- GOLDEN GATE QUARTET**, see Adasong Productions.
- GRACE KAIROS**, see Het Gerucht.
- HANS KUSTERS MUSIC**, Broekstraat 10, 1730 Kobbegem, 02.452 7203, Fax: 02.452 3425, Tlx: 62228, MD: Hans Kusters.
- HAPPY DRIVERS**, see Team For Action.
- HC PUBLISHING**, see Caracol Music Editions.
- HET GERUCHT**, Rue F. Bernier/F. Bernierstraat 38, 1060 Brussels, 02.538 3797/3521, Fax: 02.538 3768, MD: Herman van Laar. (Owned): Het Gerucht, Bruits Essentiels, Canna Domino, B L Reininger, Walter Hus, Jazz Passengers, Devine, Station; (Admin/sub-pub): Ba Ba Blaxi, Grace Kairos, Johannes Kerkerrel, Play That Beat, Telex, Buy My Record.
- HI TENSION MUSIC**, J B Tassynstraat 52, 2070 Zwijndrecht, 03.252 8882, Fax: 03.253 0420, Tlx: 33713, MD: Raymond Muyfle.
- HIBOU**, see Promax Records.
- IDP**, see Templar Music.
- INTERSONG**, Place de J. de Meux/J. de Meuxplein 39, 1040 Brussels, 02.733 9789, Fax: 02.734 0234, MD: Charles Kuiper.
- INTERVOX**, see Eurovox Music Group.
- INTOP MUSIC INTERNATIONAL**, Watermolenstraat 1, 9000 Ghent, 091.237 307, Fax: 091.233 078, MD: Laurent Vanmeerhaeghe.
- JABEL**, see Caracol Music Editions.
- JAZZ PASSENGERS**, see Het Gerucht.
- JEP RECORDS**, Turnhoutsebaan 152, 2470 Retie, 014.378 789, Fax: 014.372 266, MD: Jules Keersmaekers.
- JOHANNES KERKERREL**, see Het Gerucht.
- JOHN PALMER**, see Scorpion Music.
- JOKERS MUSIC**, Steenwinkelstraat 470, 2627 Schelle, 03.887 5832, Mgr: Jozef Idauwers. Main product: EHR, Adult Contemporary, Dance, Album Rock, Black (R&B), New Age.
- JUMP AND SHOUT**, see Templar Music.
- JUMP RECORDS & MUSIC**, Lange munt 71, 9420 Erpe-Mere, 053.627 377, President: Eddy van Mouffaert. Owned: Jump Music; Sub-pub: Scorpion Music.
- KARAKTER**, see Scorpion Music.
- KLAUS KLANGE**, see Team For Action.
- KOKA MEDIA**, see Caracol Music Editions.
- KRISISMUSIC**, Meilaan 157, 1200 Brussels, 02.763 1550, Fax: 02.772 2989, President: Kris de Bruyne, MD: Catherine v/d Genachte.
- LACE MUSIC**, Spoorwegstraat 36, 8000 Brugge, 050.383 224, President: Yvan Gullini.
- LE GRAND JYLOT**, see Scorpion Music.
- LELOUSONG**, Rue de France 69c, 6921 Wellin, 084.389 343, MD: Mady Lassaux.
- LES EDITIONS CONFIDENTIELLES**, Rue de Cureghem 67, 1000 Brussels, 02.514 1300, Fax: 02.511 8039, MD: Michel Lambot.
- LES EDITIONS DE LA BASCULE**, Rue General Patton 43, 1050 Brussels, 02.640 7914, Fax: 02.648 8369, MD: Marc Dhollander, GM: Hanna Gorjaczowska. Owned: Editions de la Bascule; Main product: Dance, Album Rock, New Age.
- LES MALHEURS DE SOPHIE**, see Team For Action.
- LIAISONS D**, see Usa Import & Records.
- LIGNE BLEUE**, see Caracol Music Editions.
- LIZA N ELIAZ**, see Atom.
- MAC GYVER MUSIC**, see Adasong Productions.
- MAGORIA**, see Adasong Productions.
- MAPPA MUNDI**, see Usa Import & Records.
- MARKA**, see Team For Action.
- MC MUSIC**, see Caracol Music Editions.
- MODERNY**, see Elver Records International.
- MONIQUE MONSARA**, see Scorpion Music.
- MUSI-ART**, see Promax Records.
- NICOLE & HUGO**, see Scorpion Music.
- NIGHT MUSIC**, Chaussee de Jette 218, 1080 Brussels, 02.425 9157, Contact: Giovanna Adamo.
- NUEVA DIMENSION**, see Usa Import & Records.
- ONADISC**, Oude Dorpsweg 21a, 8902 Varsenare, 050.382 835, Fax: 050.382 835, MD: Christoff Wybouw.
- ONE & ONE**, Avenue Legrand 80, 1050 Brussels, 02.649 6390, Fax: 02.649 1557, President: Gordon A Edwards, MD: Pierre-Paul Puljiz.
- PARSIFAL**, Gulden Vlieslaan 67, 8000 Brugge, 050.339 516, Fax: 050.333 386, President: Gilda Behaeghel, MD: Nico A Mertens, Promo: Charles Dumolin, Accts Mgr: Lieve Demarest.
- PASSE PARTOUT III**, see Radio Tele Music.
- PAT MORE MUSIC**, Gentssteenweg 1380, 1080 Brussels, 02.465 8993, MD: Patrick Mortier.
- PEERMUSIC (BELGIUM)**, Square Marie-Louise 42, 1040 Brussels, 02.230 7720, Fax: 02.230 3603.
- PERRY ROSE**, see Team For Action.
- PETULA CLARK**, see Adasong Productions.
- PHILIPPE DE CANCK**, see Adasong Productions.
- PHILIPPE SWAN**, see Team For Action.
- PIERRE RAPSAT**, see Team For Action.
- PIGALLE**, see Team For Action.
- PLAY THAT BEAT!**, Rute de la Ruche 8, 1030 Brussels, 02.241 4584, Fax: 02.343 9533, MD: Theo Linder.
- PLEASANTVILLE MUSIC**, see Reader's Digest.
- POLYGRAM BELGIUM**, Avenue de Rodebeek/De Rodebeeklaan 30, 1040 Brussels, 02.733 9724, Fax: 02.733 5177, Royalties Mgr: Fred Buhrs, Sec: Vera Keller.
- PRESTATION MUSIC/MULTI SOUND**, Gachard Street 24, 1050 Brussels, 02.649 2847, Fax: 02.648 7931, MD: Pierre Pletinckx. (Sub-pub): Coloursound, Sonoton (Ger, Atmosphere (UK), Capitol Media Music (USA), Gemini (Ita), Coppelia (Fra), Crea Sound (Can) etc.
- PROMAX RECORDS**, Avenue Jean Dubrucq/Jean Dubrucq-qlaan 86, 1210 Brussels, 02.425 5454, Fax: 02.425 5454, Label Mgr: Alain Mathieu, Asst to Direction: Patty Burns. (Owned): Promax, Savana, Abigwan; (Sub-pub): Musi-Art (Can), Hibou (Fra).
- PROMEDIT**, Rue du Vinave 14, 4450 Liers, 041.783 156, Fax: 041.783 463, MD: Jos Vanesse.
- PYRAMID INT'L MUSIC**, Lepelhoekstraat 26, 9100 Sint Niklaas, 03.778 1854, Fax: 03.778 1559, President: Marc de Coen. (Owned): Black Gypsy Int. Music.
- RADIO TELE MUSIC**, Chaussee de Waterloo 868-870, Bte 7, 1180 Brussels, 02.375 6560, Fax: 02.375 6259, Dir: Ray van Cant, Sec: Nadia Cornet. (Owned): RTM, Dancing I, Dancing II, Passe Partout III; (Sub-pub, Admin): Filmtrax Mogull Inc, Rainbow, Bourg Music, DSE (Kostman); Main product: Dance, MOR, Pop-Rock.
- RAINBOW**, see Radio Tele Music.
- REACTION RECORDS**, Avenue des Sept-Bonniers 55, 1180 Brussels, 02.344 2659, Fax: 02.344 4017, MD: Mr. Bertrand, Label Mgr: Mr. Kuzmek, GM: Ms. van Daele. (Owned): Bertrand, David Janssen, Setoe Choeur, Blond X; Main product: Dance, Album Rock, Soundtrack.
- READER'S DIGEST**, Quai du Hainaut 29, 1080 Brussels, 02.423 2591, Fax: 02.426 8908, Tlx: 21876, Int'l Rptoir/Admin: Henri Heymans. (Owned): Ardee, Pleasantville music.
- REGINA MUSIC**, Rue Marie de Hongrie 3, 1080 Brussels, 02.468 2166, Contact: Edgard Plumart.
- ROADRUNNERS**, see Team For Action.
- ROB HEAVY**, see Scorpion Music.
- ROCKY**, see Scorpion Music.
- ROLAND KLUGER MUSIC**, Rue Fernand Neuray 8, 1360 Brussels, 02.344 4840, Fax: 02.347 5164, President: Roland Kluger, Int'l Mgr: Ida Halila.
- RONALD & DONALD**, see Scorpion Music.
- ROSEMARY'S BABIES**, see Team For Action.
- ROTONDO MUSIC PUBLISHING**, Timmermanstraat 6, 8400 Oostende, 059.509 722, Fax: 059.509 722, President: Hugo Helsen. Main product: Country, Dance, Album Rock, Gold/Oldies, Black (R&B), New Age.
- RTM**, see Radio Tele Music.
- RUDY SILVESTER**, see Scorpion Music.
- SAMANTHA**, see Scorpion Music.
- SAVANA**, see Promax Records.
- SCHOTT FRERES**, Rue Saint-Jean 30, 1000 Brussels, 02.512 3980, Fax: 02.514 2845, Dir: Jean-Jacques & Roger Junne.
- SCORPION MUSIC**, Pijnderslaan 84, 9200 Dendermonde, 052.218 987, Fax: 052.225 260, MD: Hendrik Deschuyteneer, Producer: Eddy van Mouffaert, PR: Danny de Brandt. (Owned): Le Grand Jylot, Ronald & Donald, Nicole & Hugo, Chris Clark, John Palmer, Fil Filips, Eddy Govert, Danny Brendo, Rob Heavy, Samantha, Straight Forward, Double Dynamic Band, Monique Monsara, Rocky, Fransis, Danny Joe, Karakter, Danny Green, Rudy Silvester, Evelien, Soolo, Annick Daal, Axel Lane, and others; Also distributor; Main product: EHR, Dance, Light entertainment/amusement.
- SETOE CHOEUR**, see Reaction Records.
- SLIM**, see Cim.
- SMASH MUSIC/NOWDI MUSIC**, 68 Dronckaertstraat, 8930 Rekkem, 056.422 180/300, Fax: 056.422 520.
- SONOTON**, see Prestation Music/Multi Sound.
- SONY MUSIC ENTERTAINMENT (BELGIUM)**, Place Stephanie 20, 1050 Brussels, 02.513 8445, Fax: 02.513 5'39, Tlx: 22642, MD: Bert Cloeckaert.
- SOOLO**, see Scorpion Music.
- STATTON**, see Het Gerucht.
- STELLA**, see Team For Action.
- STEP EIGHT MUSIC**, Broekstraat 10, 1730 Kobbegem, 02.452 7203, Fax: 02.452 3425, Tlx: 62228, Dirs: Hans Kusters, Joachim Neubauer.
- STRAIGHT FORWARD**, see Scorpion Music.
- SUB SYSTEM**, see Atom.
- SVEN VAN HEES**, see Atom.
- SYSTEME IMAGINIQUE**, see Atom.
- TAMARA KING-SONYBEL MUSIC**, Leopoldlei 26, 2220 Heist op den Berg, 015.241 419, Fax: 015.247 820, Dir: Luc Derdin.
- TEAM FOR ACTION**, Rue de la Ruche 17, 1000 Brussels, 02.502 0432, Fax: 02.512 0895, MD: Claude Martin, Mktg Mgr: Laurent Ingels, Prod Mgr: Christian Martin, Copyright Mgr: Renaud Janson. (Owned): Philippe Swan, Stella.

Wooden Trucks, Asoha, Klaus Klange, Perry Rose, Citizen Jane, Les Malheurs de Sophie, Marka, Pierre Rapsat, Garcans Bouchers, Roadrunners, Happy Drivers, Tetines Noires, Bang Kok Paddock, BB Doc, Pigalle, Rosemary's Babies, Betty Boop; Main product: Adult Contemporary, Album Rock.

TECH-NOISE, see Usa Import & Records.

TELEX, see Het Gerucht.

TEMLAR MUSIC, Avenue de Tervueren 412, 1150 Brussels, 02.771 0678, Fax: 02.771 6801, MD: Pierre Mossiat, Prof Mgr: Emile J. Garin. (Owned: IDP, AMC, Jump and Shout, Templar Music; (Admin): Night Music, AA Music, Buy My Record.

TETINES NOIRES, see Team For Action.

THE TALENT FACTORY, Oudergemein 308, 1040 Brussels, 02.646 6193, Fax: 02.646 6739, Publ: Linda van Waesberge.

TIGER-LYNCH, Rue des Ailes 116, 1030 Brussels, 02.344 2659, Mgr: Georgers Hanoua.

TILT & PARTNERS, Rue du Vieux Marche aux Grains 11/2, 1000 Brussels, 02.514 0612, Fax: 02.513 9257, MD: Herve Verhoeseel, Asst: Catherine de Strel. Main product: Dance, French.

TITANIK, see Carrera Records International.

TJ TURNER, see Adasong Productions.

USA IMPORT & RECORDS, Sint Jacobsmarkt 75, Ground Floor, 2000 Antwerp, 03.232 0409/3838, Fax: 03.226 2030, MD: Jose Pascual, A&R: Elfride Verhelst. (Owned): Confetti's, Liaisons D, ATM + OZ + FEAR, Mappa Mundi, Nueva Dimension, Deck 8-9, Tech-Noise; Main product: Dance. **VIRGIN MUSIC BELGIUM**, Avenue General Wahis 41, 1030 Brussels, 02.735 0093, Fax: 02.735 3371, Tlx: 26789, Mgr: Elly Maassen.

WALLONIE-BRUXELLES MUSIQUE, 61 rue Marche aux Herbes, 4 etage, 1000 Brussels, 02.514 5136, Fax: 02.514 4136, Co-Ord: Patrick Printz.

WALTER HUS, see Het Gerucht.

WARNER CHAPPELL BELGIUM, Place de J. de Meux / J. de Meuxplein 39, 1040 Brussels, 02.733 9789, Fax: 02.734 0234, MD: Charles Kuiper, Copyright: Myriam Verpeet, Asst: Anita Vogelaers.

WEST MUSIC, see Baltic.

WOODEN TRUCKS, see Team For Action.

WORLD MUSIC, Fernand Neuraystraat 8, 1060 Brussels, 02.344 4840, Fax: 02.347 5164, Tlx: 26350, President: Felix Faecq.

XYLO PRODUCTIONS, 79 Rue General Leman, 1040 Brussels, 02.648 9488, Fax: 02.770 4102, Dir: Pierre Ansoult.

VIDEO PROGRAM SUPPLIERS & BUYERS

ARGOS, General Jacqueslaan 137, 1050 Brussels, 02.640 2227, Fax: 02.640 2227, Prod/Sales Mgrs: F. Depraetere, Koen van Daele. Distributor of music videos.

CNR BELGIUM, 't Hofveld 6a, 1702 Groot-Bijgaarden, 02.466 9733/9800, Fax: 02.466 8033/8054, MD: Rik Blomme, Sales Dirs: Francis Heselma (Sell Thru'), Mark Wouters (Rental Benévista—HVP), Hans Jacobs (Rental CNR—Lumina).

DISTRIDISC INTERNATIONAL, Provinciestraat 318, 2018 Antwerp, 03.230 9778, Fax: 03.230 5378, President: Patrick Asselberghs, MD: Getty Burgelman, Video Dir: Karl Ceuppens.

SONY MUSIC ENTERTAINMENT (BELGIUM), Place Stephanie 20, 1050 Brussels, 02.513 8445, Fax: 02.513 5139, Tlx: 22642, MD: Bert Cloeckaert. Distribute: CMV, Palace Video.

WARNER HOME VIDEO (BELGIUM), Boulevard Brand Whitlock 42, 1200 Brussels, 02.735 4242, Fax: 02.732 2712, MD (Benelux): Ruud Lamers, Sales/Mktg Dir: Benoit de Benoit, Sales Mgr: Serge Couvreur.

RECORD DISTRIBUTORS

BALTIC, Rederijersstraat 82, 2610 Antwerp-Wilrijk, 03.828 4084, Fax: 03.829 1068, President: Maria Wuyts, MD: Ben Gyselincx, Mktg/Sales/PR: Daniel Gillet, Mgr (Export): Henk Coops. Labels (distr): Amon, RA, Balkanton, Bandleader, Black Saint, Black Hawk, Calig, CWB Arabe, Concord, Cosmos, CRD, Criss Cross, Crystal, Danacord, Danica, Divox, Duchesne, Ellisar, Elite, Forlane, Four Leaf Clover, Fred Rabold, Frequenz, Gallo, GHA, Gimmel, Marco Polo, IRD, Kontrapunk, Lyrixn, Meridian, Music & Arts, Music Master, Nimbus, Optimisim, Opus, Pan Swiss, Pantan, Pro Arte, Paula, Phono Suecia, Caprice, Phontastic, Point, Promotheus, Red, Rem, Rondo, Saydisc, Scottdisc, September, Silva Screen, Soulnote, Splash, Steeple Chase, Submarine, Supraphon, Sydney Thompson, Tax, Ter, Tudor, Valentine, Van Hooft, Verany.

BMG ARIOLA BELGIUM, Francois Riga Square 30/8, 1030 Brussels, 02.216 9780, Fax: 02.242 3608, MD: Derk Jan Jolink, Fin Contr: Wim Peynenburg, Mktg Mgr: Stefaan Cockmartin, Mgr New Enterprises: Amaury de Jamblinn, Sales Mgr: Marc van den Abeele. Labels (distr): Jive.

CD-IDEE, Emile Jacquemannaan 95, 1000 Brussels, 02.211 0811, Fax: 02.218 0532, MD: Philippe Belpaire. Direct marketing of CD's.

CNR BELGIUM, 't Hofveld 6a, 1702 Groot-Bijgaarden, 02.466 9733/9800, Fax: 02.466 8033/8054, MD: Rik Blomme, Order Service: Tania Reyes. Labels (distr): PWL, Dino, Big Wave, BCM, BR Music, Centropa, Colour, Multidisk, Friends, In-

jection, Red Bullet, Demon, Charly, China Records, Munich, Star, Paradiso, Telstar.

DISTRIDISC INTERNATIONAL, Provinciestraat 318, 2018 Antwerp, 03.230 9778, Fax: 03.230 5378, President: Patrick Asselberghs, MD: Getty Burgelman.

DISTRISOUND, 34 Rue Henri Deleers, 1070 Brussels, 02.523 4135, Fax: 02.520 4702, MD: Maurice Mertens, Promo: Marleen Bassez, Robert Navez.

DOREMI, Rue des Vierges 14-20, 1000 Brussels, 02.511 0007, Fax: 02.514 2278, MD: Gedeon Zaharakis.

FNAC—SODAL, Hermesstraat 4c, 1930 Nossegem, 02.725 3080, Fax: 02.725 3131, GM: Louis Tilmant, Prod Mgr: Ivo Petre, Lionel Michaut. Wholesale; Formats: all formats carried; Main product: all categories carried.

MUSIC MACHINE, Beekstraat 46, 9031 Drogenen, 091.265 590, Fax: 091.265 748, Dir: Rainier Schnocks.

MUSIC MAN IMPORT, Steendam 72, 9000 Gent, 091.250 230, Fax: 091.331 049, GM: Hessel Tietier.

PLAY IT AGAIN SAM, 90 Rue de Veeweyde, 1070 Brussels, 02.520 6670, Fax: 02.527 0471, MDs: Kenny Gates, Michel Lambot, Artist Dev: Jean-Marc Dehou, Mktg/Label Mgr: Joe Robeyns, Mgr (Export): Philippe Sion, Promo Mgr: Jan Hublay, Fin Dir: Philippe Saussus. Labels (distr): Antler Subway, Earache, Apt, New Rose; Main product: Dance, Album Rock, Alternative/Progressive.

PROVA RECORD, Avenue du Pont de Luttre 19-21, 1190 Brussels, 02.343 9860, Fax: 02.343 6825, Tlx: 61269, MD: Nicole de Smet.

READER'S DIGEST, Quai du Hainaut 29, 1080 Brussels, 02.423 2591, Fax: 02.426 8908, Tlx: 21876, Int'l Rptoir/Admin: Henri Heymans. Direct mail.

RECORD MAIL, Avenue de Scheut 19, 1070 Brussels, 02.522 4790, Fax: 02.521 2181, Admin Dir: Joel Renaux.

SCHOTT FRERES, Rue Saint-Jean 30, 1000 Brussels, 02.512 3980, Fax: 02.514 2845, Dir: Jean-Jacques & Roger Junne. Distribute classical CD's.

SONY MUSIC ENTERTAINMENT (BELGIUM), Place Stephanie 20, 1050 Brussels, 02.513 8445, Fax: 02.513 5139, Tlx: 22642, MD: Bert Cloeckaert, A&R/Mktg: Bernadette Feller, Special Mktg: Linda Coopman. Labels (distr): Roadrunner, Boudisque; Main product: EHR, Dance, AC, Album Rock, Jazz, Gold/Oldies, Country, Black (R&B), Classical.

USA IMPORT & RECORDS, Sint Jacobsmarkt 75, Ground Floor, 2000 Antwerp, 03.232 0409/3838, Fax: 03.226 2030, MD: Jose Pascual, A&R: Elfride Verhelst.

RETAIL ACCESSORY SUPPLIERS

BLINKI BUIZEN, Industriezone De Bruwaan 5d, 9700 Oudenaarde, 05531.5644/0955, Fax: 05531.9595. Agent of Frejo display systems.

ASSOCIATIONS & PROFESSIONAL ORGANIZATIONS

B.A.R.S., 77 Rue Moorslede, 1020 Brussels, 02.425 0183, Chmn: Erwin Vervaecke, Sec: Dan Lacksman. Belgian association of recording studios.

BELGIAN MUSIC FEDERATION, Stationsteenweg 238 b, 2560 Nijlen, 03.489 3134/238 4570, MD: Francis Thijs.

BELGIAN MUSIC PUBLISHERS ASSOCIATION, Fernand Neuraystraat 8, 1060 Brussels, 02.344 4840, Fax: 02.347 5164, Tlx: 26350, President: Roland Kluger, PR: Lucy Rozenbaum.

EAAA, Avenue du Barbeau 28, 1160 Brussels, 02.672 4336, Fax: 02.672 0014, Dir: Ronald Beatson. European Association of Advertising Agencies; Consultants to European Community.

EBU/EURO RADIO, 32 Avenue Albert Lancaster, 1180 Brussels, 02.375 5990, Fax: 02.375 5081, Tlx: 21230, Sec-Gen: Jean-Bernard Muench, Dep: H Perez. Eurovision operations of European Broadcasting Union.

EUREKA AUDIOVISUEL, Avenue des Arts 44, 1040 Brussels, 02.511 0640, Fax: 02.512 9166.

GRIB, 46 Avenue des Pincons, 1850 Kraainem, 02.640 6645, President: Pierre Houtmans, Sec-Gen: Daniel Soudant. French language independent radio association.

IFPI BELGIUM, Place Keym 43/23, 1170 Brussels, 02.672 8016, Fax: 02.672 6242, MD: Vincent van Mele. Organization offering protection and promotion of the record industry; Members: Antler, ARS Records, Baltic, BMG Ariola Belgium, Boudisque, Carrere Belgique, CNR Belgium, EMI Music, Indisc, Hans Kusters Music, MMC Carnaby, New Music Hebra Records, PolyGram, Play It Again Sam, Pro-max Records, Private Life Records, Rough Trade, Schott Freres, Sony Music Entertainment Belgium, Virgin Belgium, Warner Music Belgium.

IFPI EUROPE, 10 Rue de la Science, 1040 Brussels, 02.230 8510, Fax: 02.230 8488, GM: Michel Kains.

SABAM, 75-77 Rue d'Arion, 1040 Brussels, 02.230 2660, Fax: 02.231 1800, Tlx: 65854, Chmn: Victor Legley, MD: Jean Darlier, Gaston Nuyts. Performing rights society.

VEVORA, Hof ter Lo 7, PO Box 47, 2140 Antwerp, 03.235 2400, Fax: 03.271 1263, President: Frank Laysen, Sec: Freddy Standaert. Flemish language independent radio association.

WALLONIE-BRUXELLES MUSIQUE, 61 rue Marche aux Herbes, 4 etage, 1000 Brussels, 02.514 5136, Fax: 02.514 4136, Co-Ord: Patrick Printz.

PUBLIC RELATIONS & RECORD PROMOTION

ARS PRODUCTIONS, Landboustraat 16, 2020 Antwerp, 03.216 17501, Fax: 03.216 5977, Tlx: 71784, MDs: Patrick Busschots, Ludo Vercaemmen.

BELGIAN ARTISTIC PROMOTION OF SABAM, Aarlenstraat 75-77, 1040 Brussels, 02.230 2660, Fax: 02.231 1800, Chmn: Jean Darlier, Gaston Nuyts.

F.L.D., 18 Place Van Meenen, 1060 Brussels, 02.539 2676, Fax: 02.7151 8401, President: Fabienne Lebrun, Lionel Dewez.

FPC, Boulevard Saint Michel 14 b1, 1150 Brussels, 02.732 4500, Fax: 02.732 4610, Contact: Jan Florizoone.

IMC, Rue Saint-Denis 155, 1190 Brussels, 02.347 4707, Fax: 02.343 4247, President: Olivier Loeb.

LUCY ROZENBAUM PR, Fernand Neuraystraat 8, 1060 Brussels, 02.344 2112, Fax: 02.347 5164, MD: Lucy Rozenbaum.

P.R.C. BELGIUM, Hoogkouter 47, 1653 Dworp (Beersel), 02.380 0179/1327, Fax: 02.380 9891, MD: Jean Linthout, Photographer: Virginie Vermeersch, PR: Fernand Linthout, Co-Ord (Radio/Press): Christian Alan, Sec: Claudine Sohie.

PRE-TEXT, Appelstraat 23, 2140 Borgerhout, 03.235 4943, Fax: 03.235 2734.

TAILOR MADE PRODUCTIONS, Desguinlei 220, 2018 Antwerpen, 03.236 5969, Fax: 03.236 9989, Contact: Annick Suy.

VARIETY, Boechoutlaan 55, 18533 Grimbergen, 02.460 0844, Fax: 02.460 8181, Contact: Marc Klein.

WALLONIE-BRUXELLES IMAGES, Rue Marche aux Herbes 61, 1000 Brussels, 02.514 5136, Fax: 02.514 4136, Contact: Patrick Printz, Daniel Sofiaux.

COMPACT DISC MASTERING & REPLICATING PLANTS

ACE STUDIOS, Leon Gilliotlaan 87, 2630 Aartselaar, 03.887 0590, Fax: 03.877 0828, Dir: Rud Torfs, Studio Mgr: Frank van Bogaert, Engineer: Herwig Duchateau. CD pre-mastering and editing on Soundtools (Digidesign) 350 Mbyte.

DIGIPRO INTERNATIONAL, Rue des Deux Eglises 46, 1040 Brussels, 02.217 4589, Fax: 02.218 2076, MDs: Jacques Krischer, Patrick de Lannoy, Studio Mgr: Michael Lunt. CD pre-mastering; 6 studios: Otari, MCI (A), Lexicon Opus, AD Soundstation2 (D); Console: Neve DTC-1, Lexicon Opus; Monitoring: Genelec, BW-808; Other: sound restoration, video post-production, CD-I pre-mastering, CD-Worm.

DRUCO, Beertsestraat 273, 1500 Halle, 02.360 0190, Fax: 02.360 0335. Disc cutting, CD pre-mastering.

DURECO BELGIUM, Luttrebruglaan 19-21, 1190 Brussels, 02.343 9860/2106, Fax: 02.343 6825, Tlx: 63068. Disc cutting, CD pre-mastering.

FOON MASTERING CENTER, Baron Carolylaan 55-57, 2500 Lier, 03.480 4661, Fax: 03.489 3334, MD/Eng: Paul van der Jonckheyl, Eng: Bill van der Jonckheyl. CD pre-mastering & disc-cutting/mastering; 2 studios.

INTER SERVICE PRESS, Appelweg 88-94, 1880 Nieuwrode, 016.568 363/569 882, Fax: 016.569 477, MD: Paul Smits. Capacity: 5m per year, minimum order: 1,000, re-order: 500, special packing on request. Also supplies electroplating equipment for CD/vinyl discs.

SONARE, Sint Cordulaplein 11, 2900 Schoten, 03.658 4577, Fax: 03.658 7317, Contact: Jos de Backer. CD pre-mastering.

PLATING, MASTERING & PRESSING PLANTS

DISCO-PRESS, Houwlikerstraat 1, 3540 Herk-de-Stad, 013.553 111, Fax: 013.551 493, MD: Andre Willems. Annual capacity 4m.

DRUCO, Beertsestraat 273, 1500 Halle, 02.360 0190, Fax: 02.360 0335, MD: Magda Debeck, Contact: Tony Jansens.

DURECO BELGIUM, Luttrebruglaan 19-21, 1190 Brussels, 02.343 9860/2106, Fax: 02.343 6825, Tlx: 63068. Disc cutting, CD pre-mastering.

FOON MASTERING CENTER, Baron Carolylaan 55-57, 2500 Lier, 03.480 4661, Fax: 03.489 3334, MD/Eng: Paul van der Jonckheyl, Eng: Bill van der Jonckheyl. CD pre-mastering & disc-cutting/mastering; 2 studios.

HARRY'S & MUELLER, Bergstraat 100, 2220 Heist-op-den-Berg, 015.244 950, Tlx: 63379, MD: Stan Verbeeck.

IGLOO STUDIO, Rue de la Mutualite 41/4, 1180 Brussels, 02.343 7756, Fax: 02.347 1897, Dir & Engineer: Daniel Leon, Eng: Patrick Hubant.

INTER SERVICE PRESS, Appelweg 88-94, 1880 Nieuwrode, 016.568 363/569 882, Fax: 016.569 477, MD: Paul Smits.

TAPE CUSTOM DUPLICATORS

DISCO-PRESS, Houwlikerstraat 1, 3540 Herk-de-Stad, 013.553 111, Fax: 013.551 493, MD: Andre Willems.

DIPLITAPE BELGIUM, Aalstersesteenweg 99, 9400 Ninove, 054.325 949, Fax: 054.322 281, Tlx: 13786, MDs: Erna van Eerenbruch, Jean Marc Montagne, Chief Eng: Kor Scheers. **EMI BELGIUM**, 128 rue Colonel Bourg, 1140 Brussels, 02.732 5858, Fax: 02.732 1926.

FREE SOUND STUDIO, Rue Frans Hals 64, 1070 Brussels, 02.520 8688.
HVH BARROW MAGNETICS, Diepstraat 15, 3511 Kuringen Hasselt, 011.254 833.
INFORMEA INTERNATIONAL, 39 Avenue Wellington, 1410 Waterloo, 02.354 1936, Fax: 02.253 0429.
SONARE, Sint Cordulaplein 11, 2900 Schoten, 03.658 4577, Fax: 03.658 7357, Contact: Jos de Backer.

CASSETTES REELS & PARTS, JEWEL BOX MANUFACTURERS

BLOMHOF, Boulevard Industriel 25, 1070 Brussels, 02.522 1813, Fax: 02.520 0305, Tlx: 63086, MD: C L Janssen, Sales Mgr: P Gemenick.
DE GREEF, Chaussee d'Alsemberg 367, 1180 Brussels, 02.345 3918, Tlx: 24616, MD: F Morris.
INFORMEA INTERNATIONAL, 39 Avenue Wellington, 1410 Waterloo, 02.354 1936, Fax: 02.253 0429.
MONOPOLE, Kwadenplasstraat 19, 2220 Heist-op-den-Berg, 015.241 625, Fax: 015.249 967, Contact: Marcel van den Broeck.
W. H. BRADY CO., Industriepark C3, 9240 Zele, 052.450 311, Fax: 052.450 262.

PRINTING, PACKAGING & LABELS

DRUCO, Beertsestraat 273, 1500 Halle, 02.360 0190, Fax: 02.360 0335, MD: Magda Debeck, Contact: Tony Janssens.
GILLIS, 1 Rue Plantin, 1070 Brussels, 02.522 3969/5458, Fax: 02.520 0378, MD: Dirk Gillis.
HVH BARROW MAGNETICS, Diepstraat 15, 3511 Kuringen Hasselt, 011.254 833.
IMAGE BUILDING, Belgielei 27, 2018 Antwerp, 03.239 3815, Fax: 03.218 8634, MD: Patrick Gijpen, Chris Mattheus, Manufacturer.
MONOPOLE, Kwadenplasstraat 19, 2220 Heist-op-den-Berg, 015.241 625, Fax: 015.249 967, Contact: Marcel van den Broeck.

BLANK & BULK RAW TAPE

3M BELGIUM, Nieuwe Nijverheidslaan 7, 1831 Diegem, 02.722 5111, Fax: 02.720 0225, Dir: Stig Eriksson, Sales Mgr: Dominique Orts.
3M EUROPE, 106 Boulevard de la Woluwe, 1200 Brussels, 02.761 2211, Fax: 02.762 7978, President: Douglas Henson, Sec: Els Klierx.
AGFA-GEVAERT, Septstraat 27, 2640 Mortsel, 03.444 2111/450 9711, Fax: 03.444 7094, Dir: Etienne Wolf.
BASF BELGIUM, Avenue Hamoir 14, 1180 Brussels, 02.373 2441, Fax: 02.375 2450, Tlx: 22016-61506, Int'l Sales Dir: Thierry Noesen, Sales Mgr: Simon-Pierre Gilliot, Manufacturer/Distributor of professional & consumer blank audio cassette tape, blank video cassette tape, DAT; Brand: BASF; Other products: tape, computer accessories (diskettes, MTC, data cartridges, computer tape).
BLOMHOF, Boulevard Industriel 25, 1070 Brussels, 02.522 1813, Fax: 02.520 0305, Tlx: 63086, MD: C L Janssen, Sales Mgr: P Gemenick, Distribute Maxell.
FUJI, Fotografietlaan 22, 2610 Wilrijk, 03.830 0367, Fax: 03.830 4810.
DE GREEF, Chaussee d'Alsemberg 367, 1180 Brussels, 02.345 3918, Tlx: 24616, MD: F Morris.
MEMOREX INTERNATIONAL, Aarschotsebean 321, 2950 Berlaar, 03.482 3838, Fax: 03.482 3839.
SONY OPERATIONS (BELGIUM), Luchtschipstraat 55, 1130 Brussels, 02.721 4950, Fax: 02.721 3843.
TROUBADOUR/MAGNEX, Diamantlaan 91/93, 1040 Brussels, 02.736 7831, Fax: 02.734 9637, Tlx: 25987, MD: Rene Balanger.

CD, RECORD & TAPE MANUFACTURING SYSTEMS

EML AUDIO DISTRIBUTION, Maastrichtstraat 323, 3747 Mopertingen-Bilzen, 011.415 278/491 660, Fax: 011.491 662, Tlx: 39338, MD: Luc Hermans, Distribute: Lyrec (Den).
INTER SERVICE PRESS, Appeliweg 88-94, 1880 Nieuwrode, 016.568 363/569 882, Fax: 016.569 477, MD: Paul Smits.
NETSTAL BELGIUM, Hermesstraat 8b, 1930 Zaventem, 02.725 3530, Fax: 02.725 3939, MD: P Hotz.
STAAR, Chaussee de Roodebeek 137-143, 1200 Bruxelles, 02.772 0520, Fax: 02.771 2789.

TAPE PACKAGING & LABELING EQUIPMENT

BEAURAIN, Woluwelaan 150, 1920 Diegem, 0272.14802, Fax: 0272.53644, MD: M Beaurain, Agents for Marden Edwards & Co (packaging/labelling manufacture).
NETSTAL BELGIUM, Hermesstraat 8b, 1930 Zaventem, 02.725 3530, Fax: 02.725 3939, MD: P Hotz.

BULGARIA

RECORD COMPANIES

BALKANTON TRADING, Haidushka Poliana Street 6, 1612 Sofia, 02.541 392/525 451, Fax: 02.542 744, Tlx: 22916 balkton, President: Victor Martin Radev. Labels (lic): EMI, GEGA, Rakovski Street 122b, 1000 Sofia, 02.878 950, Fax: 02.871 267, Tlx: 22267 hemkik, MD: Julijana Marinova, Prod Mgr: Michael Bojerlanov, Sales Mgr: Rosstiza Kandilarova. Labels (owned): Gega; Main product: Classical.
MEGA SOFIA, Svetoslav Terter Street 17, 1124 Sofia, 02.687 125/686 048, Fax: 02.686 172, Tlx: 24263, MD: Peter Tchernev.

MUSIC PUBLISHERS

BALKANTON, Haidushka Poliana Street 6, 1612 Sofia, 02.541 392/525 451, Fax: 02.542 744, Tlx: 22916 balkton, President: Simeon Ignatov.
MEGA SOFIA, Svetoslav Terter Street 17, 1124 Sofia, 02.687 125/686 048, Fax: 02.686 172, Tlx: 24263, MD: Peter Tchernev.

VIDEO PROGRAM SUPPLIERS & BUYERS

BULGARIAN VIDEO, bul Samokov 60, 1113 Sofia, 02.63941, Fax: 02.659 249, Contact: Marcho Markov.

ASSOCIATIONS & PROFESSIONAL ORGANIZATIONS

COMMITTEE FOR TELEVISION & RADIO, ul San Stefano 29, 1504 Sofia, 02.43481/790, Fax: 02.441 796, Tlx: 22581, President: Ognyan Saparev.
JUSAUTOR, bul Ernst Taelmann 17, 1463 Sofia, 02.547 021/51501, Fax: 02.873 740, Tlx: 23042 jusar, Dir-Gen: Jana Markova. Performing rights society.
TELERIMPEX, ul San Stefano 29, 1504 Sofia, 02.661 111/665 269, Fax: 02.662 388, Tlx: 22305, Dir: Todor Markov.
UNION OF BULGARIAN COMPOSERS, Ivan Vazov Str 2, 1000 Sofia, 02.881 560, Fax: 02.874 378, President: Parashkev Hadjiev, Sec: Victor Chuchkov.

COMPACT DISC MASTERING & REPLICATING PLANTS

BALKANTON TRADING, Haidushka Poliana Street 6, 1612 Sofia, 02.541 392/525 451, Fax: 02.542 744, Tlx: 22916 balkton, President: Victor Martin Radev. CD manufacture, vinyl pressing and tape duplication.
BULGARIAN RADIO STUDIO, bul Dragan Zankov 4, 1421 Sofia, 02.885 862, Fax: 02.662 215, Tlx: 22557, Sound Engineer: Bogoan Bazov. Mastering/disc-cutting.

BLANK & BULK RAW TAPE

KOM, Sektion BASF, ul. 20 April 16, 359 Sofia, 02.527 451/541 243/547 2, Fax: 02.543 200, Tlx: 22340 basf. BASF representative.

CZECHOSLOVAKIA

RECORD COMPANIES

AB PLUS, Plynarenska 1503, 274 00 Slany, 02.762 218.
AG KULT, Na Bucance 11/1318, 140 00 Prague 4, 02.424 393, Fax: 02.424 393, President: Tom Lockenbauer, Film/Video Mgr: David Ondricek, Music Mgr: Jiri Patek, Mktg Mgr: Vaclav Zan. Labels (owned): Akce Punk, Prouza, Zikkurat, Temelin, Priessnitz, Klec, Skampovo Kvarteto; Main product: Album Rock, Classical.
ALEXIM, Charkovska 20, 101 00 Prague 10, 02.744 393/495, Fax: 02.744 393, MD: Alexander Cihar.
APOLLO RECORDS, Petra Fastra 5, Ricany u Prahy, MD: Petr Spaleny.
ARTA RECORDS-ARTIA, Vaclavske nam. 33, 11000 Prague 1, 02.265 835, Fax: 02.265 834, President: Otakar Svoboda, MD: Vitezslav Janda. Labels (owned): Artia; Main product: Jazz.
BEST IA RECORDS, Gorazdova 13, 120 00 Prague 2, 02.291 787/203.93137, President: Jiri Tkadlec, MD: Petr Janda, Mgrs: Petr Ackermann, Ondrej Soukup. Labels (owned): Missa Solemnis, Yo Yo Band, Nasycen; Main product: Classical, Album Rock.
BMG PRAGUE, Jungmannova 14, 110 00 Prague 1, 02.627 8372, Fax: 02.731 823, Contact: Petr Belohlavek. 2nd address: Vodickova 17, 110 00 Prague 1.
BONTON, Severozapadni IV 39, 140 00 Prague 4, 02.766 204/382, Fax: 02.765 750, CEO: Martin Kratochvil, MD: Zdenek Kozak, Pres (Int'l): Mick Hawk, Distr Mgr: Ladislav Hrabec, Promo Mgr: Jan Kruta, CFO: Zbynek Knobloch.

Labels (Owned): Bonton; (Lic): Virgin, BMG Ariola; (Distr): Sony Music; Main product: EHR, AC, Jazz, New Age, Classical.
BRIAMI RECORDS, Malostranske nabr. 1, Prague 1, 02.530 489, MD: Ms. Kaslova.
CHERRY, Kourimska 24, 130 00 Prague 3, 02.269 149/740 407, MD: Vladimir Mertlik.
DISCORD RECORDS, Haskova 1, 638 00 Brno, 05.529 608, Fax: 05.751 581, MD: Radek Kypson, Promo/Mktg: Lenka Kypsonova. Main product: Hardcore, Rap; Formats: mainly CD.
DYNAVAC, Tr. Zdenka Nejedleho 7, 46042 Liberec, 048.24781.
EDIT, Krymska 12, 110 00 Prague 10, 02.746 170, MD: Ales Sigmund.
EUROPRODUCTION, Podolska 50, 140 00 Prague 4, 02.430 096, Fax: 02.434 122, MD: Hubert Pata.
GENNEX, Hluhocepska 6, 150 00 Prague 5, 02.258 023
GLOBUS INTERNATIONAL, Jaromirova 61, 128 00 Prague 2, 02.439 593/436 536, Fax: 02.532 733, MD: Karel Havelka.
HECK, Orlova 757, 735 14, 04269.233 420/04296.22320, MD: Petr Stenbera.
HIFI CLUB, Jasekka 11, 160 41 Prague 6, 02.342 663.
KK COMPANY, Mlynska 67, 97400 Banska Bystrica, 088.33318, Mgr: Karol Konarik.
LUNARION, V Olsinach 792/7, 100 00 Prague 10, 02.525 7161, MD: Vaclav Tebor.
MONITOR RECORDS, Na Kampe 12, 118 00 Prague 1, 02.533 9392/539 678, Fax: 02.539 678, President: Josef Prib, GM: Vladimir Kocandrie, Sales Mgr: Ladislav Kolman, Promo Mgr: Marcela Vavrichova. Labels (owned): Vrba; Main product: Dance, Album Rock, Heavy Metal, Hardcore, Punk, Brassmusic, (Distr): Mute CS, Multisonic, Europroduction, Antler, Opus in Bohemia; Main product: Dance, Album Rock, Heavy Metal, Hardcore, Punk, Brassmusic.
MULTISONIC, PO Box 322, 106 00 Prague 10, 02.740 675, Fax: 02.749 295, GM: Katerina Novotna.
MUTE CZECHOSLOVAKIA, Jana Masaryka 41, 120 00 Prague 2, 02.206 658, Fax: 02.206 658, Mgr: George Votka.
OPUS RECORDS & PUBLISHING, Mlynske Nivy 73, 872 15 Bratislava, 07.222 680/235 783, Fax: 07.69091, Tlx: 92219 opus c, Contact: Zlatica Mocikova. Labels (Lic): BMG/Ariola, Baby Records, EMI, PolyGram, Virgin. Licensees: DJ Music (UK), Vogue (Fr), Baltic (Bel), Koch Import Service (USA).
ORION, Stichova 592, 149 00 Prague 4, 02.791 4418/792 8502, Fax: 02.792 8605, MD: Frantisek Janecek.
PANTON, Radlicka 99, 150 00 Prague 5, 02.532 797/534 137, Fax: 02.548 627, MD: Zdenek Veselka. Labels (owned): Panton. (Lic): Pilz.
PARMA PRODUCTIONS, Aubrechtova 1/3106, 106 00 Prague 10, 02.758 147, MD: Jindrich Parma.
PELAMI, Pod Kihovkou 2, 150 00 Prague 5, 02.522 293.
POPORN, Na Cikance 2, 150 00 Prague 5, 02.524 500, MD: Mr. Rychtarik.
PRAGOSPECTRUM, Vocolova 3, 120 00 Prague 2, 02.235 9343/0424, MD: Mr. Ulrich.
PREMIERA, Radlicka 103, 150 00 Prague 5, 02.530 426, MD: Jitka Markvatova.
PUNC, Ve Smeckach 13, 110 00 Prague 1, 02.236 4811, MD: Mr. Rezny.
ROCK POP JAZZ AGENCY, Jakubovo nam 12, 814 99 Bratislava, 07.59701, Fax: 07.331 466, Tlx: 92536, Mgr: Martin Sarvas. Main product: EHR, Dance, AC, Album Rock, Jazz.
ROGI STUDIO, Machova 8, 120 00 Prague 2, 02.257 584.
ROMART, Samalova 96, 615 00 Brno, 05.633 694/638 646.
SLOVART FOREIGN TRADE CORPORATION, Nam. Slobody 6, 817 64 Bratislava, 07.498 841, Fax: 07.496 256/494 054, Tlx: 93394 slov, Gen Dir: Michal Loerincz, Heads: Valentin Zbynovsky (Audio Dept), Daniela Bezakova (Gramo Dept). Labels (owned & distr): Slovart; Main product: Classical, Dance, New Age.
SONY MUSI ENTERTAINMENT (CZECHOSLOVAKIA), Na Valech 6, 160 00 Prague 6, 02.342 149, MD: Susanne Smetana.
SUPRAPHON, Palackeho 1, 112 99 Prague 1, 02.268 141, Fax: 02.262 562, Tlx: 121218 sunp, President: Zdenek Cejka, MD: Lubos Cmuchar, A&R Mgr: Vaclav Matatko, Sales Mgr: Marta Peroutkova, Lic Mgr: Klara Jiraskova, Lic & Copyright: Libuse Schlossbergerov. Labels (licensed): A&M, BMG, Columbia, EMI, PolyGram, WEA, Virgin, Melodia, Panton. Licensees: Supra (Ger), SPS Leisure (UK), Vogue (Fr), Baltic (Bel), Nowo (Ita). Also video production and distribution. Video directors: Klaus Lindemann, Franz Kabelka, Adam Rezek, Jan Bonaventura.
TOMMU RECORDS, 742 31 Stary Jicin, 0656.21560, MD: Alena Kellarova.
ZERAS, V Holesovicach 9a, 180 00 Prague 8, 02.375 277/373 711.

MUSIC PUBLISHERS

BC PUBLISHING, Slezska 93, 130 00 Prague 3, 02.277 279/031.3191, Fax: 02.731 823, MD: Jaroslav Cada, GM: Petr Belohl vek.
EDIT, Krymska 12, 110 00 Prague 10, 02.746 170, MD: Ales Sigmund.
EDITIO SUPRAPHON, Vodickova 29, 110 00 Prague 1, 02.236 9863, Fax: 02.236 9863, MD: V P Cernik.
MULTISONIC, PO Box 322, 106 00 Prague 10, 02.740 675, Fax: 02.749 295, GM: Katerina Novotna.
OPUS RECORDS & PUBLISHING, Mlynske Nivy 73, 872 15 Bratislava, 07.222 680/235 783, Fax: 07.69091, Tlx: 92219

opus, Contact: Zlatica Mocikova.
ORION, Stichova 592, 149 00 Prague 4, 02.791 4418/792 8502, Fax: 02.792 8605, MD: Frantisek Janecsek.
PANTON, Radlicka 99, 150 00 Prague 5, 02.532 797/534 137, Fax: 02.548 627, MD: Zdenek Veselka.
UHER PUBLISHING, Kollarova 404, Uherske Hradiste, 0632 78346, MD: Evzen Uher.

VIDEO PROGRAM SUPPLIERS & BUYERS

AG KULT, Na Bucance 11/1318, 140 00 Prague 4, 02.424 393, Fax: 02.424 393, Video Prod Dir: David Ondricek. Distribution and production company of music & promo videos.
BOHEMIA VIDEO ART, Na Jezerce, 140 00 Prague 4, 02.437 047, MD: Jiri Hubac.
BONTON, Severozapadni IV 39, 140 00 Prague 4, 02.766 204/382, Fax: 02.765 750, CEO: Martin Kratochvil.
INTERUNISOUND, Jankovcova 18, 170 00 Prague 7, 02.805 763, Dirs: Petr Tolar, Dusan Sulc, Milan Scuka.
SUPRAPHON, Palackeho 1, 112 99 Prague 1, 02.268 141, Fax: 02.262 562, Tlx: 121218 sunp, President: Zdenek Cejka.
USTREDNI PUJCOVNA FILMU, Narodni Trida 28, 111 21 Prague 1, 02.227 041/4.

RETAIL ACCESSORY SUPPLIERS

LIFT SYSTEMS, Kirovova 270, 83106 Bratislava-Raca, 07.288 836/282 600, Fax: 07.288 011, Contact: Ervin Pauliak, Eva Blahova.

ASSOCIATIONS & PROFESSIONAL ORGANIZATIONS

CZECH MUSICAL FUND, Besedni 3, 110 00 Prague 1, 02.530 546/549, MD: J. Sevcik.
DILIA, Vysehradska 28, 128 24 Prague 2, PO Box 34 (Zip: 128 24), 02.236 651/194 222/296 6, Fax: 02.297 695, Tlx: 121367 dili, MD: Libor Ladek, Heads: Zdenek Candra (Musical Dept), Olga Loulova (Media Dept), Milena Fiserova (Legal Dept), Vaclav Suchy (Literary Dept), Helena Kafkova (Theatrical Dept). Theatrical & literary agency; Activities: copyright protection, author representation, consultancy, publish dramatical works, music material.
DMC CZECHO-SLOVAKIA (DISCO MIX CLUB), Klincova 12, 812 62 Bratislava, 07.212 392, Fax: 07.287 777, Contact: Dusak Marusak.
GUILD OF CZECH COMPOSERS & CONCERT ARTIS, Valdstejnske nam. 1, 110 00 Prague 1, 02.531 584, President: Jan Seidel, GM: Vaclav Kucera.
IFPI CZECHOSLOVAKIA, Gorkeho Nam. 23, 11282 Prague 1, 02.2114 2373, Fax: 02.262 562.
MUSIC INFO CENTRE—SLOVAK MUSIC FUND, Fucikova 29, 811 02 Bratislava, 07.331 380, Fax: 07.333 569, Tlx: 92575, Dir (Music Fund): Milos Kocian, Head of Info Centre: Viera Polakovcova. Publicity & information concerning Slovak composers, musicologists & performers. MIC provides a music library service, as well as issuing its own magazine—Slovak Music Organizes listening sessions and concerts of contemporary music eg: Evenings of New Music Festival.
MUSIC INFORMATION CENTRE, Besedni 3, 118 00 Prague 1, 02.530 546/539 720, Fax: 02.539 720, Exec Mgr: Nina Vseteckova.
OCHRANNY SVAZ AUTORSKY (OSA), Cs. Armady 20, 165 56 Prague 6, 02.312 1241-8, Fax: 02.312 3073, President: Karel Richard Svoboda, MD: Josef Stanina. Czech mechanical & performing rights society.
RAPID, ul. 28 Rijna 13, 110 00 Prague 1, 02.267 941/262 139, Advertising agency.
SLOVAK COMPOSERS/CONCERT ARTISTS ASSOCIATION, Sladkovicova 11, 337 94 Bratislava, 07.33794, President: Eugen Suchon.
SOZA, Kollarovo nam. 20, 813 27 Bratislava, 07.55796/59188, President: Julius Kincek, GM: Pavol Harsanyi. Slovak mechanical and performing rights society.

PUBLIC RELATIONS & RECORD PROMOTION

CTK/MADE IN..., PO Box 18, 140 04 Prague 4, 02.422 155, Tlx: 122501, President: Otakar Dusek.
MONITOR RECORDS, Na Kampe 12, 118 00 Prague 1, 02.533 9392/539 678, Fax: 02.539 678, President: Josef Prib, GM: Vladimir Kocandrie, Sales Mgr: Ladislav Kollman, Promo Mgr: Marcela Vavrichova.
MUSIC INFORMATION CENTRE, Besedni 3, 118 00 Prague 1, 02.530 546/539 720, Fax: 02.539 720, Exec Mgr: Nina Vseteckova.
RAPID, ul. 28 Rijna 13, 110 00 Prague 1, 02.267 941/262 139.

COMPACT DISC MASTERING & REPLICATING PLANTS

GRAMOFONOVE ZAVODY, 267 12 Lodenice u Berouna, 0311.962 388/963 111, Fax 0311 962 143, Tlx: 132431, MD:

Zdenec Pelc. CD manufacturing, vinyl pressing and tape duplication.
OPUS STUDIOS, Dunajska 18, 815 04 Bratislava, 07.53337, MD: Ivan Stanislav, Contact: Rudolph Homer. Disc cutting & CD pre-mastering.
SUPRAPHON, Palackeho 1, 112 99 Prague 1, 02.268 141, Fax: 02.262 562, Tlx: 121218 sunp, President: Zdenek Cejka, Contact: Stanislav Sykora. Disc cutting.

BLANK & BULK RAW TAPE

BASF CZECHOSLOVAKIA, Na Safrance 27, 110 00 Prague 10, 02.740 648/582, Tlx: 123536 basf. Blank tape supply.
EQUIPEX, PO Box 44, Rybna 1, 111 21 Prague 1, 02.231 6761, Fax: 02.231 6805, Contact: Petr Svoboda. Agent for Fuji tapes and equipment.
SLOVART FOREIGN TRADE CORPORATION, Nam. Slobody 6, 817 64 Bratislava, 07.498 841, Fax: 07.496 256/494 054, Tlx: 93394 slov, Gen Dir: Michal Loerincz, Head (Audio Dept): Valentin Zbynovsky.

DENMARK

RECORD COMPANIES

AMBIA MUSIC, Koebmagergade 26, 1150 Copenhagen, 3311 1015, Fax: 3314 7512, Tlx: 16205, President: Henning Schaedler. Labels (owned): Music Mecca; Main product: Jazz.
BMG ARIOLA (DENMARK), Vestergade 14-16, 1456 Copenhagen K, 3393 8822, Fax: 3393 5055, Tlx: 27393, MD: Dietmar Glodde, Bengt Svan, Promo Mgr: Lone Nielsen, Label Mgrs: Claus Junget Madsen, Susanne Kier (3rd Parties), Inge Mulvad Eje (Classical), CFO: Jorgen Larsen, Asst to MD: Helle Molbech, Promo Asst: Merete Bjornved, Sec: Benita Schmidt. Labels (owned): RCA, Ariola, Ariola, The Record Station, Genlyd, DDD, Bluebird, Novus; (Lic): Jive, Zomba, Silvertone, Island, Private Music, Motown, Mango, Antilles; (Dist): MCA, Geffen, GRP, Zoo, Imago, Dedicated, Anxious, Survival.
BUMS RECORDS, PO Box 110, 8543 Hornslet, 8699 6099, Fax: 8699 6988, MD: Kim Meinert Pedersen. Main product: Album Rock.
DACAPO, Gronnegade 41b, 1107 Copenhagen, 3393 2930, Fax: 3393 2932, Dir: Mogen Wenzel Andreassen. Labels (owned): Dacapo; Main product: Classical. Soon to co-work with Marco Polo Records (Hong Kong).
DANACORD RECORDS, Gernersgade 35, 1319 Copenhagen, 3315 1716, Fax: 3312 1514, GM: Jesper Buhl. Label (owned): Danacord; (Lic) Eastern European labels; Main product: Classical.
ELAP MUSIC, Bransagervej 4-6, 9490 Pandrup, 9824 6066, Fax: 9824 6045, MD: Verner Bach Pedersen, Mktg Mgr: Benny Bach, Promo Mgr: Christian Gunbak Kjeldsen.
EMI RECORDS DENMARK, Hoefdingsvej 18, 2500 Valby, 3630 6711, Fax: 3630 6998, Tlx: 16631, MD: Hans Peter Hansen, Sales Mgr: Joergens Sparre, Mktg Mgr: Mogens V Hansen, A&R Mgrs: Thomas Hoehne (Int'l), Jan Thomsen (Local), Prod Mgrs: Steen Soerensen, Svend-Age Juncker, Promo Mgr: Anne Marie Buch, Promo Asst: Suzanne Top. Labels: Angel, Apple, Blue Note, Capitol, Chrysalis, Classics for Pleasure, Electrola, EMI, EMI-USA/Disc/Int'l, Toshiba, Enigma, Harvest, His Master's Voice, IRS, Mega Records, MPL, Music For Pleasure, Odeon, Orpheus, Oz, Parlophone, Pathe, SBK, Seraphim, Starline, Sunset.
GARDEN RECORDS, Gi Kongevej 47b, 1610 Copenhagen, 3124 2436, Fax: 3124 3553, President: Peter Yngen, MD/A&R/Mktg/Promo: Nene la Beet. Labels (owned): Garden Records; (Dist): Mislur, Wire; Main product: Rock, Pop.
GENLYD GRAMMOFON, Haraldsgade 23, 8260 Viby J, 8614 9700, Fax: 8614 9707, MD: Jesper Bay, Press/PR Mgr: Annetta Elmo. Labels (Owned): Genlyd, Respons; Distribution: GDC; Division of BMG Ariola.
HARLEKIN MUSIK, Bulowsovej 5c, 1870 Frederiksberg-Copenhagen, 3131 3800, Fax: 3131 3660, MDs: Paul Bach, Caille Sand, Promo Mgr: Sanne Arvidsen. Labels owned: Harlekin, Piccolo, Casino, Ambulance; Main product: EHR, Adult Contemporary, Dance.
ICEBERG MUSIC, Roennale 78, 8600 Silkeborg, 8682 7377, Fax: 8682 7733, President: Manfred Zahringer, Promo/Label Mgr: Mette Wiene. Labels (owned): Iceberg; Main product: Pop, Rock; Distribution: PolyGram.
INTERMUSIC, Klintevej 21a, 8240 Risskov, PO Box 25 (Zip: 8240), 8617 7577, Fax: 8617 7014, President: Hans Jorn Henriksen, A&R: Allan Grauenkaer. Labels (Owned): Intermusic, Right Tone; Main product: AC, Album Rock, Jazz.
MEDIA MANAGEMENT, Klingsøvej 11, PO Box 1718, 2720 Vanlose, 3174 8200, Fax: 3174 8288, President: Kurt Andreassen, Promo Mgr: Malene Tofte. Labels (owned): Davs; Main product: Pop, Rock.
MEDLEY RECORDS, Skelmosevej 10, 2500 Valby, Copenhagen, 3117 1411, Fax: 3117 1766, MD: Michael Ritto, Poul Bruun, Mktg/Int'l A&R: Mik Christensen, A&R (Local): Nik Foss, Jesper Mardahl, Promo Mgr: Lisbeth Juul. Labels (owned): Medley, Soulpower; (Lic): MFN, OTT Records, Zap-a Records, MNW, Radium, Beggars Banquet, Pias, Blast First, Factory, 4AD, Antler, Situation Two, Delphine.

MEGA RECORDS (DENMARK), Frederiksborggade 31, 1360 Copenhagen K, 3311 7711, Fax: 3313 4010, Owner: Kjeld Wennick, Mktg/Promo: Lene Olsen, Fin: Kim Poulsen, A&R: Martin Dodd, Prod Contr: Ejvin Schytte, Promo: Jonas Sandberg, Unni Arnesen, Bus Affairs: Claes Cornelius, Prod Contr: Jan Wennick, Sec: Birgitte Moesgaard. Labels (owned): Carrere, Music Factory, KLF Communications, Tommy Boy, Marc On Wax, Cube, Coma; Main product: Dance, Album Rock, Black (R&B).

MIX SOUND PRODUCTIONS, Tyrolsgade 9, 2300 Copenhagen, 3154 5506, MD: Mikkel Boltzauw.
NETTO MUSIC, Bredgade 50, 9490 Pandrup, 9824 6133, Fax: 9824 6070, Tlx: 69843, MD: Mogens Villadsen.
OH MUSIK, Jersie Strandvej 5, 2680 Solrod Strand, 5314 6644, Fax: 5314 6667, President: Ole Høglund, MD: Marianne Høglund. Labels (owned): Danica, Point, Rondo, Poco, Amber, Logr, Stellavox, Eminent, Ferry, Fiola; (Dist): Paula, Menvel, FMS, Big Ben, Novalis, Tempel, Ondine, Artemis, Nostalgia, Hyperion, Simax; Main product: classical, jazz.

OLAFSSONGS, Anker Heegardsgade 2, 1572 Copenhagen, 3311 0020, Fax: 3311 1120, MD: Finn Olafsson, Creative Mgr: Frank Marstokk. Labels (owned): Olafssongs; (Lic & distr): Nexo, Baltic, HB 130; Main product: Adult Contemporary, Album Rock.

OLE ERLING LYDPRODUKTION, Riskaer 16, 2765 Smorum, 4466 0505, Fax: 4265 0403, MD: Ole Erling. Labels (owned): Pool Records, PM Musik.

OLUFSENS RECORDS, Skt Knudsvej 8, 1903 Fredriksberg C, 3186 8126, Fax: 3186 1708, President: Finn Olafsson.
PATRICIA RECORDS, Magevej 34, PO Box 195, 8700 Horsens, 7560 1733, Fax: 7560 2633/44, MD: Britta P Kraul. Labels (owned): World Classic, All Star; (Lic): Patricia Classic, Royal Collection; Main product: Jazz, Classical, Gold/Oldies.

PINEAPPLE, Fronesgade 74, 6700 Esbjerg, 7513 4077, Fax: 7513 4764, Mgr: Soren T. Højberg.

PLADECOMPAGNIET, Kobmagergade 31, 1150 Copenhagen, 3332 1415, Fax: 3332 0707, MD: Jan Degner.

POLYGRAM RECORDS (DENMARK), Emdrupvej 115a, 2400 Copenhagen NV, 3969 2522, Fax: 3969 4616, Tlx: 19202, MD: Stefan Fryland, Label Mgrs: Dennis Ploug (Phonogram), Keld Stefansen (Polydor), Ole Jochimsen (Classical), Jens Ove Friis (Local), Promo Mgrs: Rene B Sten, Lene Thomsen, Contr: Jorgen Klarskov Jorgensen.

POUL HANSEN BALLERUP, Energivej 42b, 2750 Ballerup, 4265 2341, Fax: 4265 6522, Purchasing Manager: Poul E Skindballe, MD: Poul Hansen. Labels (owned): Flap Music; Main product: Adult Contemporary.

RECA MUSIC PRODUCTIONS, Nykobingvej 18, 4571 Grevinge, 5345 9389, President: Finn Reiner, MD: Ole Petersen. Labels owned: Recca, Favorit; Distr: GDC; Main product: Jazz, Country, Classical, Dance, Album Rock, Folk.

REPLAY RECORDS (DENMARK), Frederikssundsvej 60c, 2400 Copenhagen NV, 3834 3435, Fax: 3834 3433, MD: Henrik Bodtcher.

SONET GRAMMOFON (DENMARK), Kabbelejvej 20, 2700 Bronshøj, 3889 0042, Fax: 3889 0811, MD: Cai Leitner, A&R Mgr (Int'l): David Rowley. Labels (owned): Sonet, Storyville, Ton Son Ton; (Lic): Alligator, Amigo, Attic, BCM, Black Mark Production, China, City, Crazy Life, Curb, Dino, ECM, Enemy, Expression, Fantasy, Fotodisk, Ghetto, Grand Prix, GWR, Hollywood, In+Out, Ja/Nein Musikverlag, Mushroom, Mute, Noise, One Little Indian, Pike Records, PWL, Razor, Ricochet, Rough Trade, Round Tower, Soul Note, SPV, Supreme, SweMix, Telegram, Tyfon, Vanguard.

SONY MUSIC ENTERTAINMENT (DENMARK), Kobmagergade 47, PO Box 57, 1002 Copenhagen K, 3311 8711, Fax: 3313 7778, Tlx: 85527520, MD: Steen Sorgenfrei, Prod Mgrs: Philippe Lاراينو (Columbia), Gwen Wisti (Local), A&R Mgrs: Kim Hyttel (Local), Neils Hoirup (Classical), Mktg Dir: Philip Sager.

SOULPOWER PRODUCTIONS, Skelmosevej 10, 2500 Valby, Copenhagen, 3117 1703, Fax: 3117 1766, MD: Carsten Schack, Joint MD: Mich Hansen, Label Mgr: Jeppe Bisgaard, Promo Mgr: Niclas Anker. Labels (owned): Soulpower; Main product: Dance.

STEEPLECHASE RECORDS, PO Box 35, 2930 Klampenborg, 3164 4244, Fax: 3164 5044, MD: Niis Winther, Label Mgr: Mihoko Winther, Asst Mgr: Erik Udsen. Labels owned: Steeplechase, Kontrapunkt; Main product: classical, jazz.
SUNDANCE/STUNT MUSIC, Gi Kongevej 47b, 1610 Copenhagen, 3122 6080, Fax: 3124 3553, Tlx: 27555, President: Dietmar Schmidt, MD: Peter Littauer.

VIRGIN RECORDS DENMARK, Ny Vestergade 7B, 1471 Copenhagen K, 3313 2666, Fax: 3332 2449, Tlx: 16924, MD: Henriette Blix, Mktg Mgr: Peter Sorensen, Promo Mgr: Las Thomsen, Sales Mgr: Jes Panduro, Personal Asst to MD: Lilian Bager.

WARNER CHAPPELL MUSIC DENMARK, Anker Heegardsgade 2, 1572 Copenhagen V, 3313 3315, Fax: 3313 3330, MD: Finn Olafsson. Label: Royton Music.

WARNER MUSIC DENMARK, Antoinettevej 2, 2500 Valby, 3116 6888, Fax: 3117 0077, Tlx: 27073, MD: Finn Work, Sales/Mktg Mgr: Bent Mouritzen, Label Supervisor: Lars Bennike, Promo Mgr: Glennie Pettersson, Asst: Linda Borchard.

ZING ZING MUSIC PRODUCTION & MGMT, Kirkegaardsgade 3, 9000 Aalborg, 9810 3511, Fax: 9816 6462, President: Birgitte Rode, PR/Promo Dir: John Bagger, Press/Promo: Karin Holm. Label (owned): Zing Zing.

MUSIC PUBLISHERS

BEKA, see EMI Music Publishing.
DACAPO MUSIKFORLAG, see Warner Chappell Music Denmark.
DANISH BRASS, see Oh Musik.
DANISH JAZZ CENTER, THE, Borupvej 66b, 4683 Ronede, 5371 1327/381, Fax: 5371 1749, Dir-Gen: Arvid Meyer, Chmn: Bent Haastруп, Archivist: Lief Bierborg. Sound archives and jazz library (25,000 records & files).
DAVS MUSIK, Klingseyvej 11, PO Box 1718, 2720 Vanlose, 3174 8200, Fax: 3174 8288, President: Kurt Andreassen. (Owned): Davs Musik; Owned by Media Management, same address.
DAVS MUSIK, see Media Management.
EDITION EGTVED, PO Box 20, 6040 Egtved, 7555 1411, Fax: 7555 2316, MD: Ole Ugilt. Main product: Choral Music.
EDITION WILHELM HANSEN, Bornholmsgade 1, 1266 Copenhagen, 3311 7888, Fax: 3314 8178, MD: Tine Birger Christensen.
ELAP MUSIC, Bransagervej 4-6, 9490 Pandrup, 9824 6066, Fax: 9824 6045, MD: Verner Bach Pedersen.
EMI MUSIC PUBLISHING (DENMARK), Gladsaxevej 135, 2860 Soborg, 3156 1444, Fax: 3156 2156, Dir: John Rasmussen. (Owned): Imudico, Beka.
EMI, see Kleinerts Musik Forlag.
ENGSTROM & SODRING, Palaegade 6, 1261 Copenhagen, 3314 3228, Fax: 3314 3227, President: Helge Schlenkert.
FONIX MUSIC, Sonder Alee 28-30, 8000 Arhus, 8619 5811, Fax: 8619 5101, MD: Ole Kjaer. Main product: New Age.
GARDENIA MUSIC, Gl. Kongevej 47 B, 1610 Copenhagen, 3124 2436, Fax: 3124 3535, President: Anders Moren, Prof Mgr: Jan Winters, Copyright Mgr: Nene la Beet.
HANS SIKORSKI, see Kleinerts Musik Forlag.
HARLEKIN MUSIC, Bulowvej 5c, 1870 Frederiksberg-Copenhagen, 3131 3800, Fax: 3131 3660, MD: Paul Bach, Calle Sand. Main product: EHR, Adult Contemporary, Dance.
HEBANINI, see Warner Chappell Music Denmark.
HECK MUSIC, see Warner Chappell Music Denmark.
IMUDICO, see EMI Music Publishing.
INTERSONG, see Warner Chappell Music Denmark.
INTERSOUND, see Kleinerts Musik Forlag.
JK SOUND MUSIKFORLAG, see Warner Chappell Music Denmark.
KB LAURESEN MUSIKFORLAG, see Warner Chappell Music Denmark.
KLEINERTS MUSIK FORLAG, Gladsaxevej 135, 2860 Soborg, 3156 1444, Fax: 3156 2156, MD: John Rasmussen. (Owned): Morks, Tempo, Presto; (Admin): EMI, Multitone; (Sub-pub): Hans Sikorski, Sonoton, Intersound, Proviva.
LOGR, see Oh Musik.
MEDIA MANAGEMENT, Klingseyvej 11, PO Box 1718, 2720 Vanlose, 3174 8200, Fax: 3174 8288, President: Kurt Andreassen. (Owned): Davs Musik, Westend Music.
MORKS, see Kleinerts Musik Forlag.
MULTITONE, Sondermarksvej 16, 2500 Valby, 3146 7755, Fax: 3117 3453, MD: Bent Faprius Bjerre.
MULTITONE, see Kleinerts Musik Forlag.
NODESERVICE, Paarupvej 44, 3230 Graested, 4229 2259, Fax: 4229 2259, Print Mgr: Torsten Olafsson, Sales Mgr: Anne Vensman. Printing & distribution of music books/scores on behalf of Warner Chappell Music Denmark; Owned by Warner Chappell Music Denmark.
OH MUSIK, Jersie Strandvej 5, 2680 Solrod Strand, 5314 6644, Fax: 5314 6667, President: Ole Hoeglund, MD: Marianne Hoeglund. (Owned): Logr, Danish Brass, Oh-Music.
OLAFSSONGS, Anker Heegaardsgade 2, 1572 Copenhagen, 3311 0020, Fax: 3311 1120, MD: Finn Olafsson, Creative Mgr: Frank Marstokk. (Owned): Olafssongs; Main product: Adult Contemporary, Album Rock.
OLAFSSONGS, see Warner Chappell Music Denmark.
POLYGRAM PUBLISHING, see Warner Chappell Music Denmark.
PRESTO, see Kleinerts Musik Forlag.
PROVIVA, see Kleinerts Musik Forlag.
ROYTON MUSIC, see Warner Chappell Music Denmark.
SB MUSIC, see Warner Chappell Music Denmark.
SONOTON, see Kleinerts Musik Forlag.
STEEPLECHASE MUSIC, PO Box 35, 2930 Klampenborg, 3164 4244, Fax: 3164 5044, MD: Nils Winther. Main product: jazz, classical.
SUNDANCE/STUNT MUSIC, Gl. Kongevej 47B, 1610 Copenhagen, 3122 6080, Fax: 3124 3553, Tlx: 27555, President: Dietmar Schmidt, MD: Peter Littauer.
TEMPO, see Kleinerts Musik Forlag.
WARNER CHAPPELL MUSIC DENMARK, Anker Heegaards Gade 2, 1572 Copenhagen V, 3313 3315, Fax: 3313 3330, MD: Finn Olafsson. (Owned): Intersong, Dacapo Musikforlag, Royton Music; (Admin): Hebanini, Olafssongs, SB Music, PolyGram Publishing, JK Sound Musikforlag, KB Laursen Musikforlag, Heck Music; Printing & distribution by: Nodesevice, Paarupvej 44, 3230 Graested, 4229 2259.
WENNICK MUSIC, Frederiksberggade 31, 1360 Copenhagen K, 3311 7711, Fax: 3313 4010, Owner: Kjeld Wennick, A&R (Int'l): Martin Dodd, Promo/Mktg: Lene Olsen, Prod Mgr: Ejvin Schytte, Bus Mgr: Claes Cornelius, Fin: Kim Poulsen. (Owned): Megason; Main product: Dance, Album Rock, Adult Contemporary, Jazz, Black (R&B).
WESTEND MUSIC, see Media Management.
WINCKLER MUSIKFORLAG, Engrojel 18, 2670 Greve Strand,

4290 7547, GM: Inge Winckler. (Owned) Winckler; Main product: Pop.

ZING ZING MUSICPRODUCTION & MGMT, Kirkegaardsgade 3, 9000 Aalborg, 9810 3511, Fax: 9816 6462, President: Birgitte Rode, PR/Promo Dir: John Bagger.

VIDEO PROGRAM SUPPLIERS & BUYERS

ACTION MUSIC, Roskildevej 33, 2000 Copenhagen F, 3116 8611, Fax: 3116 8698, President: Brian Christensen, Sales: Morten Manfelt. Distributor.
BENT HELVANG MEDIA, Ibsvej 7, 2680 Solrod Strand, 4215 1718, Fax: 4215 2630, Tlx: 43140, President: Bent Helvang, Mgr: Bjarne Rasmussen.
METRONOME VIDEO, Sondermarksvej 16, 2500 Copenhagen, 3146 7755, Fax: 3117 3453, Tlx: 19497, MD: Henrick Fabrizius-Pjerre.
POLYGRAM RECORDS (DENMARK), Emdrupvej 115a, 2400 Copenhagen NV, 3969 2522, Fax: 3969 4616, Tlx: 19202, MD: Stefan Fryland, Prod Mgr: Tom Elmskov.
SONET GRAMMOFON (DENMARK), Kabellejev 20, 2700 Bronshoj, 3889 0042, Fax: 3889 0811, MD: Cai Leitner, A&R Mgr (Int'l): David Rowley.
STV/VIDIA, Ansgarsgade 7, 5000 Odense C, 6612 5570, Fax: 6613 9370, MD: Rene Sczrybak, Photographer/Video Ed: Lars Fuchs, Sound Engineer: Anders Wiuff, Studio Mgr/Eng: Peter Aagaard, Sales Dir: Jens Mikkelsen, Fin Dir: Janne Petersen. Video production—STV.
VIDEO ONE APS, Kronprinsessegade 54a, 1306 Copenhagen, 3333 8333, Fax: 3333 7030, Chief Eng: Roberto Johansson, Eng: Flemming N Madsen, Video Dir: Lars Christiansen.
WENNICK MUSIC, Frederiksberggade 31, 1360 Copenhagen K, 3311 7711, Fax: 3313 4010, Owner: Kjeld Wennick, Prod Dir: Ejvin Schytte. Distributor & production company of music & promo videos; Recent productions: Bakerman, Highway of Love/Laid Back (BMG Ariola).

RECORD DISTRIBUTORS

ACTION MUSIC, Roskildevej 33, 2000 Copenhagen F, 3116 8611, Fax: 3116 8698, President: Brian Christensen, Sales: Morten Manfelt.
AMBIA MUSIC, Koebmagergade 26, 1150 Copenhagen, 3311 1015, Fax: 3314 7512, Tlx: 16205, President: Henning Schaedler. Importers of mainly Finnish labels.
CASABLANCA DISTRIBUTION, Gl Kongevej 39, 1610 Copenhagen V, 3124 8514, Fax: 3124 0495, Dir: Flemming Larsen. Main product: underground music.
DANISH MUSIC IMPORT, Nyrnberggade 29, 2300 Copenhagen S, 3157 7374, Fax: 3195 7593, President: Frank Obel, Mktg: Bjarne Jorgensen, Jette Wohler. Labels (Distr): ASV, Steeplechase, Caprice, BBC, Dragon, Bellaphon, ITM, West Wind, Calig, FSM, CRD, Proprius, Narada, Windham Hill, Verabra, Intuition, American Clave, Main product: AC, Jazz, New Age, Classical.
ETTOL AUDIO, Grenaaevj 670, 8541 Skoedstrup/Aarhus, 8699 2000, Fax: 8699 2038, MD: Soeren V Krog Labels (Distr): Sheffield Lab, Mobile Fidelity, Chesky, Reference, Bainbridge, Quartet, Wilson Audio, Delos, Opus 3, Proprius Musik, Gecko, Water Lily, Cardas, Audio, Stereoplay, Zounds.
GDC DISTRIBUTION, Horkaer 18, Box 739, 2730 Herlev, 4284 7777, Fax: 4284 7677, MD: Elmer Thorsen
INTERMUSIC, Klintevej 21a, 8240 Risskov, PO Box 25 (Zip: 8240), 8617 7577, Fax: 8617 7014, President: Hans Jorn Henriksen, A&R: Allan Grauenkaer, Labels (Distr): Black Lion, Disques Cellier, MA Music, Grappa, EFA Medien, Vielklang, Music Maniac; Main product: AC, Album Rock, Jazz.
MANHATTAN IMPORT, Sylvestervej 18, 2610 Rodovre, 3672 0211, Fax: 3672 0217, Owner: Poul Dehnhardt.
MIS. LABEL, Bygholmen 14, PO Box 533, 9000 Aalborg, 9811 3344, Fax: 9812 2783, MD: John Butzau Olsen. Labels (distr): Ace, Enja, Rhino, Demon, Charly, Beat Goes On, Ryko/Hanibal, Intercord, Line, Magnum, New Rose, See For Miles, Red Lightnin, Connoisseur, Hypertension, First Night, Aurophon, Greentrax, Repertoire, Communique, MGI, Bedrock, CMP, Receiver, Temple, Great Expectations, Scottisc.
NETTO MUSIC, Jonstrupvej 5, Hune, 9492 Blokhus, PO Box 268 (Zip: 9492), 9824 8333, Fax: 9824 8585, MD: Mogens Villadsen.
OLGA MUSIK, Boelstvej 4, 8680 Ry, 8689 2428, Fax: 8689 0033, MD: Birger Hansen. Main product: classical, ethnic
PATRICIA RECORDS, Magevej 34, PO Box 195, 8700 Horsens, 7560 1733, Fax: 7560 2633/44, MD: Britta P Kraul. Labels (distr): World Music, World Star Collection, Triangle, EP Collection, Duchesse, BRS, Carnaby, Back Trax, Duchesse Classique, Maybellene, Ce-De Int'l, Jazz World; Main product: Jazz, Classical, Gold/Oldies.
STREET DANCE RECORDS, Vestergade 17, 1456 Copenhagen, 3315 9070, Fax: 3393 9070, MD: Peter Larsen, Claus Hoeglund. Distributed: all majors and many independent dance labels.

RETAIL ACCESSORY SUPPLIERS

MATRIX, Bylyngen 4, 3230 Blistrup, Graested, 4211 7677, Fax:

4211 7602, MD: Niels & Ginny Norgaard. Agent of lift display systems.

RUDOLF SCHMIDT, Lyskaer 7, 2730 Herlev, 294.5511, Fax: 294 2126. Agent of Frejo display systems.

VARIA PLAST, Vesterkaersvej 16, 9670 Logstor, 868.1111, Fax: 868.1246. Agent of Frejo display systems

ASSOCIATIONS & PROFESSIONAL ORGANIZATIONS

DANISH JAZZ ASSOCIATION, Kjelds Langes Gade 4a, 1367 Copenhagen K, 3393 9811, Fax: 3393 4413, President: Erling Kroner, Sec: Lars Thorborg.
THE DANISH JAZZ CENTER, Borupvej 66b, 4683 Ronede, 5371 1327/381, Fax: 5371 1749, Dir-Gen: Arvid Meyer, Chmn: Bent Haastруп, Archivist: Lief Bierborg. Non-profit trade organization providing promotional support of Danish Jazz. Activities include information, consultation, international liaison, organization of festivals and jazz projects (JAZZ-PAR jazz prize).
DANISH MUSIC COUNCIL, Vesterbrogade 24, 1620 Copenhagen, 3124 6166, Fax: 3124 2242, Chmn: Lars Grunth, Gen Sec: Erik Skovgaard-Petersen. Organization funded by the Ministry of Culture; Principal function is to distribute monetary aid to the Danish music industry to applicants.
DANISH MUSIC INFORMATION CENTRE, Vimmelskaflet 48, 1161 Copenhagen, 3311 2066, Fax: 3332 2016, Dir: Bendt Viinholt Nielsen. MIC is a non-profit, self-governing institution subsidized by the Ministry of Cultural Affairs. Provides documentation, registration and information on activities concerning Danish music and music culture in Denmark and abroad. Affiliated with the IAMIC (International Association of Music Information).
DANISH MUSIC PUBLISHERS ASSOCIATION, PO Box 20, 6040 Egtved, 7555 1411, Fax: 7555 2316, Chmn: John Rasmussen, Sec: Hans-Ulrik Barfoed. Members: Davs Musik, Edition Egtved, Edition Wilhelm Hansen, EMI Music Publishing (Denmark), Engstrom & Sodring, Inhouse Music Publishing, Kleinerts Musik Forlag, Multitone, Oktav Musik, Olafssongs, SteepleChase Music, Warner/Chappell/Royton Music, Winckler Musikforlag.
DANISH PRO AUDIO GROUP, Danmarksvej 30LI, 8660 Skanderborg, 8652 1880, Fax: 8652 1922, Contact: Dorit Larsen.
DANSK MUSIKER FORBUND, Vendersgade 25, 1363 Copenhagen K, 3313 4661, Fax: 3314 5175, Contact: Gert Kring.
DANSK VIDEOGRAMDISTRIBUTORER, Oslo Plads 14, 2100 Copenhagen O, 3142 2166, Dir: Johan Schlueter
DJBA, Kierkegade 19, 1308 Copenhagen K, 3112 0109. Jazz, rock & folk music composers society.
IFPI DENMARK, Bredgade 6, 2160 Copenhagen K, 3314 3333, Fax: 3314 7124, Chmn: Stefan Fryland, Sec: Johan Schlueter
KODA, Maltegardevej 24, 2820 Gentofte, 3168 3800, Fax: 3168 3813, GM: Niels Bak, Asst Gen Mgr: Jorgen Blomquist. Performing right society.
KOMM, Klampenborgvej 50, 2950 Klampenborg, 3164 5055, Fax: 3164 5077. Association of commercial radio- and TV stations
NORDISK COPYRIGHT BUREAU, Frederiksgade 17, 1265 Copenhagen K, PO Box 2094 (Zip: 1013), 3312 8700, Fax: 3312 4262, Tlx: 19371 ncbt, GM: Kurt Reiler, Asst Mgr: Thorkil Emborg, Operations Division: Ida Holbek, Doc & Distr: Annelise Tengbom. Mechanical right society for Nordic countries
ROSA-DANISH ROCK COUNCIL, Sondervej 56, 5700 Svendborg, 6220 6162, Fax: 6220 7172, Consultant: Michael Hoejris.
SAMSPIL, Sjaellandsgade 51, 8000 Aarhus C, 8612 1230, Fax: 8676 0566, Chmn/MD: Gunnar Madsen. Association of independent concert venues

COMPACT DISC MASTERING & REPLICATING PLANTS

DANDISC PRODUCTION, Skiftevej 2, 4990 Sakskobing, 5389 4400, Fax: 5389 4499, President: Christian Karmark Andersen, VP (Sales/Mktg): Lars Alm, Sales Mgrs: Hans Jorn Henriksen (Eur), Anne-Marie Mik (Scandinavia). Second sales office: Klintervej 21a, 8240 Risskov, 8617 7584, Fax: 8617 7536, Annual cap: 10 m; Min order: 1,000
HOLM CASSETTE, Gadelandet 20, 2700 Broenshoej, 3889 1333, Fax: 3889 0912, MD: Joergen Holm. CD pre-mastering; Sony equipment
SWEET SILENCE STUDIOS, Strandlodsvej 85, 2300 Copenhagen, 3159 1200, Fax: 3284 0510, MD: Freddy Hansson, Chief Eng/Prod: Flemming Rasmussen. CD pre-mastering.
TOCANO MUSIC, Himmelev Bygade 49, 4000 Roskilde, 4236 4400, Fax: 4236 4959, Tlx: 43206, President: Alex Frederiksen, MD: Jesper Boysen. CD mastering
WERNER STUDIOS, Frederikssundsvej 60c, 2400 Copenhagen NV, 3834 3435, Fax: 3834 3433, MD: Henrik Boedtcher, Studio Mgr: Mogens Balle. CD-premastering & video post production

TAPE CUSTOM DUPLICATORS

ARP STUDIET, Skovvejen 11-13, 8000 Aarhus C, 8612 9465,

Fax: 8612 9002, MD/Owner: Lasse Nielsen.
DANSK LYD & LYS, Noerrevoldgade 4, 5000 Odense, 8611 3806, Fax: 6591 8703, President: Willy Olsson, MDs: Kent Salomonsen, Joergen Brosboel.
HOLM CASSETTE, Gadelandet 20, 2700 Broenshoej, 3889 1333, Fax: 3889 0912, MD: Joergen Holm. Cassette duplication; Annual capacity: 3.5 m.
OLE ERLING LYDPRODUKTION, Riskaer 16, 2765 Smorum, 4466 0505, Fax: 4265 0403, MD: Ole Erling. Tape duplication.
PER MEISTRUP PRODUCTIONS, Evashoej, PO Box 300, 2690 Karlslunde, 5314 6677, Fax: 5314 5144, MD: Per Meistrup.
PRO-LYD, Str. Tranders Bygade 24, 9220 Aalborg, 9831 4488, President: Leif Bach, Dir: Benny Kristensen. Annual capacity: 10,000.
TOCANO CASSETTE, Himmelev Bygade 49, 4000 Roskilde, 4236 4400, Fax: 4236 4959, Tlx: 43206, President: Alex Frederiksen, MD: Jesper Boysen. Annual cap: 9 mil.

CASSETTES REELS & PARTS, JEWEL BOX MANUFACTURERS

H SAXE HANSEN, Walgerholm 17, 3500 Vaerloose, Tlx: 35127.
MTH INTERNATIONAL, Pile Alle 55, 2000 Frederiksberg, 3123 1966, Fax: 3123 1457. Distribute: Jewel boxes, cassettes, video cassettes, cassette boxes, micro floppy disks.
RECA MUSIC PRODUCTIONS, Nykobingvej 18, 4571 Grevinge, 5345 9389, MD: Finn Reiner.
STEEN HAUERBACH, Kaervej 23, 2970 Horsholm, 4576 8010, Fax: 4576 8060, MD: Steen Hauerbach, Admin: Niels Hamerich, Sales Mgr: Johnny Biehlert.

PRINTING, PACKAGING & LABELS

JOHNSON & JOHNSON, Aldersrogade 8, 2100 Copenhagen, 3129 8688, Fax: 3129 5005, MD: Henning Nielsen.
MW TRADING (DENMARK), Dursvej 33, 7870 Glyngore, 9773 1275, Tlx: 66604, MD: Julius Morensen.
NOTEX OFFSET, Rosenkaeret 43, 2860 Soborg, 3167 3300, Fax: 3156 5560, MD: Niels Lindell. Printers.

BLANK & BULK RAW TAPE

3M DENMARK, Fabriksparken 15, 2600 Glostrup, 4348 0100, Fax: 4296 8596, MD: Valori Seitz, PR Dir: Henning Christiansen. Blank tape manufacturer.
BASF DANMARK, Ved PO Box 1734, 2300 Copenhagen, 3157 0011, Fax: 3157 2202, MD: Hans Norfang.
FHC ELECTRONICS, Borgergade 14, 1300 K Copenhagen, 3314 6993, MD: H Lippert.
MOJN MEDIA & MARKETING, Sonderport 31, PO Box 44, 6200 Aabenraa, 7462 6349, Fax: 7462 5776, MD: Steen Sodergreen. Supplier of blank tapes, all major brands.
MTH INTERNATIONAL, Pile Alle 55, 2000 Frederiksberg, 3123 1966, Fax: 3123 1457. Distribute: cassettes, video cassettes, micro floppy disks.
OLE ERLING LYDPRODUKTION, Riskaer 16, 2765 Smorum, 4466 0505, Fax: 4265 0403, MD: Ole Erling. Annual capacity: 500,000.
STEEN HAUERBACH, Kaervej 23, 2970 Horsholm, 4576 8010, Fax: 4576 8060, MD: Steen Hauerbach, Admin: Niels Hamerich, Sales Mgr: Johnny Biehlert. Audio & video cassettes & open reels, DAT; Brands: Ampex, Fuji.

CD, RECORD & TAPE MANUFACTURING SYSTEMS

H SAXE HANSEN, Walgerholm 17, 3500 Vaerloose, Tlx: 35127.
LYREC MANUFACTURING, Mileparken 22, 2740 Skovlunde, PO Box 123 (Zip: 2740), 4453 2522, Fax: 4453 5335, Tlx: 37568 lyrec, MD: Orjan Svedberg, Sales Mgrs: Flemming Skovgaard Jensen, Johan von Schoultz (Tech Spec).

TAPE PACKAGING & LABELLING EQUIPMENT

KAI ERICHSEN, Gersonsvej 13, 2900 Hellerup, 3940 0066, Fax: 3940 1285, Dir: Andersen Juel. Agents for Marden Edwards & Co (packaging/labelling manufacture).

FINLAND

RECORD COMPANIES

AMIGO MUSIK (FINLAND), Tuotekatu 10, 15700 Lahti, 918.875 013, Fax: 918.875 014, MD: Martti Heikkinen.
ANDANIA, Puistokaari 8, 00200 Helsinki, 90.676 445, MD: Christian Schwindt.
AUDIOVOX RECORDS, Hoylaamotie 8, 00380 Helsinki, PO Box 109 (Zip: 00381), 90.506 1311, Fax: 90.506 1370, Tlx: 122087 vox, President: Markku Weyner, MD: Klaus Weyner, Mktg Dir: Asko Jarvi. Label (owned): AXR. (Distributed): AMT, MTV.
BANG TRAX, Kapteeninkatu 10/D, 00140 Helsinki, 90.624 515,

Fax: 90.612 1109, Tlx: 126234 taumu, MD: Lasse Norres.
BASE-BEAT STUDIOS, Viljatie 4/C, 00700 Helsinki, 90.354 255, Fax: 90.354 285.
BLUEBIRD MUSIC, Henrikintie 5/C, 00370 Helsinki, PO Box 12 (Zip: 00370), 90.506 1877, Fax: 90.506 1488, Tlx: 124934 blueb, MD: Osmo Ruuskanen, Mktg Mgr: Seppo Manttila.
BMG ARIOLA FINLAND, PO Box 9, 02711 Espoo, 90.509 3100, Fax: 90.509 3260, Tlx: 122705, MD: Maija Kuusi, Label Mgr: Olli Nummi, Promo Mgr: Kari Hynninen, Tarja Lempiainen. Labels (owned): RCA, Arista, Ariola, Record Station; (lic): Geffen, MCA, Island, Motown, Jive.
CAJ MUSIC, Haukantie 13, 10640 Dragsvik, 911.62647, Fax: 911.62688, MD: Chrissi Johansson.
CASTLE MUSIC & VIDEO, Orapihajatie 35, 00320 Helsinki, 90.578 877, Fax: 90.575 215, MD: Esko Koliseva.
EMI FINLAND, Arinatie 6/E, 00370 Helsinki, 90.558 421, Fax: 90.565 3162, Tlx: 122482 emi, MD: Hobo Puhakka, Int'l Rep Mgr/Classical: Jari Helenius, Promo Mgr: Hannu Sormunen, A&R (Local): Pertti "Neumann" Nieminen, Sales Mgr: Matti Raatikainen. Labels (owned): all EMI affiliates; (Lic): IRS, Chrysalis; (Dist): Impact, SBK, Herodes, Sibony.
ENSIO MUSIC/FIFTY-FIFTY RECORDS, Ylipistonkatu 24/C, 20100 Turku, 921.327 958, Fax: 921.501 005, MD: Rauno Lepisto.
FAZER MUSIC/FAZER FINNLEVY, Lansituulentie 1/A, 02100 Espoo, PO Box 169 (Zip: 02101), 90.435 011, Fax: 90.455 2352, Tlx: 122782 flev, Mktg Mgr: Jaakko Karilainen, A&R Mgr: Timo Lindstrom, Prod Mgrs: Peppe Schwarzenberg (Local), Pia Louhivuori, Pekka Salla, Jari Tiessalo, Head of Comm: Lasse Norres. Labels (owned): Blue Master, Blue Master Special, Delta, Digit, Finlandia, Finnlevy, Hi-Hat, Kompass, M & T Tuotanto, Rondo Safari, Sauna, Scandia, Shokki, Tiit, Top Voice; (Lic): A & M, Barclay, FM-Revolver, PolyGram Group, TOCO Int'l.
FINLANDIA RECORDS, Lansituulentie 1/A, 02100 Espoo, PO Box 169 (Zip: 02101), 90.435 011, Fax: 90.455 2352, Tlx: 122782 flev, Mgr: Jari Tiessalo, Export/Publicity: Brita Toivonen.
FINNGOSPEL, Fredrikinkatu 34, 00100 Helsinki, 90.693 1311, Fax: 90.694 1710, Chmn: Stig Frisk, MD: Jan-Erik Linqvist, Mktg/Sales/PR: Bjarne Bergsten, Mktg/Sales: Tintti Heino. Labels (owned): Finngospel, Just, KP Sound, Svensk Musik i Finland; (Dist): Gospel & Classical International labels.
FLAMINGO MUSIC, Vapaalantie 2/B, 01650 Vantaa, 90.853 2177, Fax: 90.853 2023, MD: Vexi Salmi, Music Dir: Kassu Halonen. Labels owned: Flamingo, Gold Disk.
GOOFIN' RECORDS, PO Box 63, 01601 Vantaa, 90.532 499, Fax: 90.532 499, Contact: Pete Hakonen. Labels (owned): Goofin'; Main product: Country, Rockability.
IKAROS MUSIIKKI, Liesipolku 7/A, 00630 Helsinki, 9742 577, **LEO RECORDS (FINLAND)**, Kylasaarekatu 8, 00550 Helsinki, 90.701 1801, Contact: Edward Wesata. Jazz label.
MAINOS TV, Ilmalantori 2, 00240 Helsinki, 90.150 0240, Contact: Ari Oinonen.
MAU MAU MUSIC, PO Box 365, 60101 Seinajoki, 964.233 560, Fax: 964.233 560, Contact: Pertti Hakala. Label: Mau Mau.
MEGA RECORDS/RIOPOP, Kapteeninkatu 10/D/10, 00140 Helsinki, 90.624 515, Fax: 90.612 1109, Tlx: 126234 taumu, MD: Lasse Norres.
MEGAMANIA, Hameentie 6/A/1, 00530 Helsinki, 90.701 5152, Fax: 90.701 3802, MD: Atte Blom, A&R/Promo: Anne Koskinen, Producer: Pekka Aarnio. Labels owned: Megamania, Pyramid, AMT; Distribution: Sony Music.
MTR MUSIIKKI, Kaskenkatu 2/B, 20700 Turku, 921.330 323, Contact: Teppo Ruuhonen.
MUSICMAKERS, Pursimiehenkatu 29/E, 00150 Helsinki, 90.625 885, Fax: 90.170 874, Contact: Kim Kuusi.
MUSIIKKI-LAIHO, Veikkointie 4, 03100 Nummela, PO Box 32 (Zip: 03101), 90.222 3744, Fax: 90.222 1845, MD: Veikko Laiho, Prod Mgr: Kari Hillo. Labels (Owned): Finnart, ML, Adagio, Fantasia; Main product: Dance, Gold/Oldies, Classical.
OLARIN MUSIIKKI, Eilispiskuja 7/B/9, 02210 Espoo, 90.882 334, President: Timo Narvainen, Press/PR: Sirku Narvainen. Distribution: PEC Musiikkittuku.
ONDINE RECORDS, Lutherinkatu 12/A, 00100 Helsinki, 90.493 913, Fax: 90.493 956, MD: Reijo Kiilunen. Main product: Classical.
ONE INCH ROCK, Meritullinkatu 26/A/45, 00170 Helsinki, 90.354 255, Fax: 90.354 285, Contact: Ralf Orn.
POLARVOX, Arinatie 2/A, 00370 Helsinki, 90.565 3100, Fax: 90.554 282, Tlx: 123186 juvox, MD: Leena Juuranto, A&R: Chrissi Johansson, Mktg/Int'l: Olavi Makimattila. Special Projects: Juhana Juuranto. Labels owned: Polarvox, Kiss, Cityboy, Amulet, Nukkumatti, Sateenkaari, Yahoo!
ROCKFUN, Pohjoispuisto 3, 28100 Pori, 939.415 422. Label: West Coast.
ROXY, Tuureporinkatu 2, 33100 Turku, 921.500 436, Fax: 921.513 680, MD: Kalevi Ramo.
SBC RECORDS, Ojatoyrantie 2, 45150 Kouvola, 951.252 938.
SONET SUOMI, Kuusiniemi 2, 02711 Espoo, PO Box 9 (Zip: 02711), 90.509 3100, Fax: 90.509 3260, Tlx: 122705 disco, MD: Gugl Kokkijuschkin, A&R Mgrs: Timo Narvainen (Int'l), Riku Mattila (Local), Sales Mgr: Risto Kaijainen, Promo: Anne Lappi. Labels (owned): Sonet, Spirit; (Lic): Alliigator, Attic, City, Crammed, Creation, Expression, Curb, Cypress, Fotodisk, Ghetto, In+Out, Mushroom, Mute, Noise, One Little Indian, PWL, Razor, Ricochet, Rough Trade, SPV, SwebMix, Telegram, Tyfon, Hollywood, Black Mark, Vanguard.
SONY MUSIC ENTERTAINMENT (FINLAND), Ahventie 4/B, 02170 Espoo, PO Box 12 (Zip: 02171), 90.452 3700, Fax: 90.452 3707, MD: Antti Holma, Contr: Matti Sihvola, Artist/Spec Mktg Mgr: Hans Rautio, A&R Mgr (Local): Timo Laukkanen, Prod Mgrs: Aku Valta (Epic), Timo Poirjari (Col-

umbia). Labels (owned): Columbia, Epic, Def Jam, OBR, RAL, No Face, Fever, JMJ, PRO Divisions, True Blue Records, Portrait, Sony Classical, Masterworks, Cupol.
TATSIA MUSIIKKI, Vanha Hameenkatu 52, 02680 Espoo, 90.545 598.
TWINTONE, PO Box 301, 00121 Helsinki, Fax: 9449 861. Label: Stupido Twins.
UNITOR/POKO RECORDS, Kytalankatu 6, 33101 Tampere, PO Box 483 (Zip: 33101), 931.120 500, Fax: 931.133 732, Tlx: 22460 untor, MD: Kari Helenius, Int'l Director: Pertti Palkoaho, Mktg/Sales Dir: Jukka Hynninen, F&A Mgr: Marita Helenius. Labels (owned): Poko (Int'l), Shokk, Jokamies; (Lic): Music For Nations, Roadrunner, Enigma, MNW, Amaltea, Factory, 4AD, Beggars Banquet, Play It Again Sam, Loop/Link, Major, Replay. Distribution: PEC Music.
VIRGIN RECORDS FINLAND, Kuusiniemi 2, 02711 Espoo, PO Box 9 (Zip: 02711), 90.509 3100, Fax: 90.509 3260, Tlx: 122705 disco, Label Mgr: Timo Narvainen, Promo: Anne Lappi.
WARNER MUSIC FINLAND, Melkonkatu 28/E, 00210 Helsinki, 90.682 1366, Fax: 90.675 531, MD: Marita Kaasalainen, Mktg Mgr: Ari Lohenoja. Labels: Asylum, Atco, Atlantic, Atlantic Jazz, Cold Chillin', Dark Horse, East-West America, Elektra Asylum/Entertainment/Nonesuch, Giant, Megaforce, Opal, Paisley Park, Qwest, Reprise, Sire, Teldec, Tommy Boy, Warner Bros, Warner Reprise Video.

MUSIC PUBLISHERS

AIR-MUSIC, PO Box 285, 33101 Tampere, 931.112 157.
ANNORA, Mannerheimintie 27/A/46, 00250 Helsinki, 90.408 498, Fax: 90.448 009, MD: Antero Paivalainen.
AUDIOVOX, Hoylaamotie 8, 00380 Helsinki, PO Box 190 (Zip: 00381), 90.506 1311, Fax: 90.506 1370, Tlx: 122087 vox, President: Markku Weyner, MD: Klaus Weyner.
BAHAMA MUSIC, Hoylaamotie 8, 00380 Helsinki, PO Box 190 (Zip: 00380), 90.506 1311, Fax: 90.506 1370.
BARK BOAT MUSIC, Kuusiniemi 2, 02710 Espoo, PO Box 9 (Zip: 02710), 90.509 3100, Fax: 90.509 3260, Tlx: 122705 disco, MD: Gugl Kokkijuschkin, Prof Mgr: Christine Kokkijuschkin.
BLUEBIRD MUSIC, Henrikintie 5/C, 00370 Helsinki, PO Box 12 (Zip: 00370), 90.506 1877, Fax: 90.506 1488, Tlx: 124934 blueb, MD: Osmo Ruuskanen.
BLUESWAY, Hameenpuisto 27a/14, 33100 Tampere, 931.220 021.
CAJ MUSIC, Haukantie 13, 10640 Dragsvik, 911.62647, Fax: 911.62688, MD: Chrissi Johansson.
CLEVER, Aleksis Kiven Katu 32/B, 33200 Tampere, 931.114 423, Contact: Jyri Paavola.
DISCOPHON/EDITION CODA, Kuusiniemi 2, 02711 Espoo, 90.509 3100, Fax: 90.509 3260.
EMI FINLAND, Arinatie 6/E, 00370 Helsinki, 90.558 421, Fax: 90.565 3162, Tlx: 122482 emi, MD: Hobo Puhakka.
ENSIO MUSIC/FIFTY-FIFTY RECORDS, Ylipistonkatu 24/C, 20100 Turku, 921.327 958, Fax: 921.501 005, MD: Rauno Lepisto.
ERIK LINDSTROM KUSTANNUS, Vanrikki Stoolinkatu 12b, 00100 Helsinki, 90.444 148.
EUROS, Pohjoisranta 20-22/B, 00170 Helsinki, 90.622 1400, Fax: 90.622 1442, Tlx: 121368, MD: Jari Vaananen.
FAZER MUSIC/FAZER SONGS, Lansituulentie 1, 02100 Espoo, PO Box 169 (Zip: 02101), 90.435 011, Fax: 90.455 2162, Tlx: 122782 flev, Publ Mgr: Raimo Henriksson, Prof Mgr: Turku Mali. (Owned): Fazer, Finnmusic, JKC, Johanna, Kompass Records, Levysavel, Levytuottajat, Love/Fazer, M & T Tuotanta, Scandia, Soitin ja Nuotti, Westerlund, X-Savel. Main product: Popular music.
FAZER MUSIC/PUBLISHING DIVISION, Lansituulentie 1/A, 02100 Espoo, PO Box 169 (Zip: 02101), 90.435 011, Fax: 90.455 2162, Tlx: 122782 flev, Dir: Matti Kemilainen. Main product: Classical, Contemporary Music.
FINLANDS SVENSKA SANG/OCH MUSIKFORBUND, Handelsplanaden 23a, 65100 Vasa, 961.121 211, Fax: 961.125 270.
FINNMUSIC, Osuuskunnantie 50/A, 00660 Helsinki, 90.748 559, Contact: Rauno Lehtinen.
FLAMINGO MUSIC, Vapaalantie 2/B, 01650 Vantaa, 90.853 2177, Fax: 90.853 2023, MD: Vexi Salmi, Prof Mgr: Kristian Jernstrom.
HELASVUO, Albertinkatu 19/B, 00120 Helsinki, 90.640 730/608 108.
IMUDICO, Arinatie 6/E, 00370 Helsinki, PO Box 28 (Zip: 00371), 90.558 421, Fax: 90.565 3162, Tlx: 122482 emi.
JASEMUSIIKKI, Lukiokatu 36, 13130 Hameenlinna, 917.23146.
JEE JEE MUSIC, Kytalankatu 6, 33100 Tampere, PO Box 483 (Zip: 33100), 931.120 500, Fax: 931.133 732, MD: Pertti Palkoaho.
JKC, see Fazer Music/fazer Songs.
JOHANNA, see Fazer Music/fazer Songs.
KOMPASS RECORDS, see Fazer Music/fazer Songs.
LEVYSAVEL, see Fazer Music/fazer Songs.
LEVYTUOTTAJAT, see Fazer Music/fazer Songs.
LOVE KUSTANNUS, Hameentie 6/A/1, 00530 Helsinki, 90.737 028, Fax: 90.701 3802, MD: Sini Perho.
LOVE/FAZER, see Fazer Music/fazer Songs.
M & T TUOTANTA, see Fazer Music/fazer Songs.
MARTENS RECORDS, Miilukontie 15, 02740 Espoo, 90.862 622.
MODUS MUSIIKKI, PO Box 40, 33271 Tampere, 931.445 233.
MUSICMAKERS, Pursimiehenkatu 29/E, 00150 Helsinki, 90.625 885, Fax: 90.170 874, Contact: Kim Kuusi.
OLARIN MUSIIKKI, Eilispiskuja 7/B/9, 02210 Espoo, 90.882

334, President: Timo Narvainen, Press/PR: Sirkku Narvainen. (Owned: Olarin Musiikki.
POLARVOX MUSIC PUBLISHING, Arinatie 2/A, 00370 Helsinki, PO Box 9 (Zip: 00370), 90.556 3100, Fax: 90.554 282, Tlx: 123186 Juvox, MD: Leena Juuranto, Copyright Mgrs: Juha Juuranto, Chrissie Johansson.
RAUTAJEN SOITTAJAT HYVINKAA, Paavolankatu 17, 05900 Hyvinkää 90, 914.88980.
REETU RECORDS, Koydenpuojankatu 8j/211, 00180 Helsinki, 90.422 455, Fax: 90.422 711.
ROCKADILLO RECORDS, Keskustori 7/A, 33100 Tampere, 931.131 260, Fax: 931.131 297, Tlx: 22004, MD: Tapio Kerjus.
SAUNA MUSIC, PO Box 36, 00661 Helsinki, 90.748 559, Contact: Rauno Lehtinen.
SCANDIA, see Fazer Music/fazer Songs.
SIMO SAUSO, Ojaniemi KP 3, 66500 Vahakyo, 961.784 165.
SOFT MUSIC, Aurakatu 1c, 20100 Turku, 921.319 679.
SOITIN JA NUOTTI, see Fazer Music/fazer Songs.
SONY MUSIC ENTERTAINMENT (FINLAND), Ahventie 4/B, 02170 Espoo, PO Box 12 (Zip: 02171), 90.452 3700, Fax: 90.452 3707, MD: Antti Holma.
SULASOL, Fredrikinkatu 61, 00100 Helsinki, 90.694 8655, Fax: 90.694 0232.
SUOMALAISEN MUSIIKIN JULKISTAMISSEURA, Vihertie 56c, 01620 Vantaa, 90.878 5686.
SUOMEN KIRKOMUSIIKKILIITTO, Tollinpolku 1c, 00410 Helsinki, 90.566 5660.
SUOMEN SAVELTAJAT, Runeberginkatu 15/A/11, 00100 Helsinki, 90.445 589.
SUOMEN TYOVAEN MUSIIKKILIITTO, Hameenpuisto 33/B/25, 33200 Tampere, 931.114 416, MD: Jesko Rasilainen.
TAURUS MUSIC, Kapteeninkatu 10/D/10, 00140 Helsinki, 90.624 441, Fax: 90.612 1109, Tlx: 126234, MD: Antero Paivalainen.
X-SAVEL, see Fazer Music/fazer Songs.
YHTYNEET KUVALEHDET, Melkonkatu 10/C, 00210 Helsinki, 90.68261, Fax: 90.682 6206, Tlx: 122730 lehe sh, EIC: Jyrki Hamalainen.

VIDEO PROGRAM SUPPLIERS & BUYERS

ALFA PANORAMA FILM & VIDEO, Kilpolantie 10, 00940 Helsinki, 90.687 465, MD: Freddy Kamras.
CASTLE MUSIC & VIDEO, Orapihlajantie 35, 00320 Helsinki, 90.578 877, Fax: 90.575 215, MD: Esko Koliseva.
ESSELTE VIDEO, Italahdenkatu 22b/A, 00210 Helsinki, PO Box 94 (Zip: 00211), 90.670 700, Fax: 90.671 400, MD: Robert Gripenberg. Music video distributor.
EUROPA VISION, Koivuvaaranranta 2, 01640 Vantaa, 90.85281, MD: Elma Pehkonen Rajamaki.
INFORFILM, Et. Makasiininkatu 4, 00130 Helsinki, 90.174 511, MD: Ilkka Pulkkinen.
NORDIC FILM GROUP, Pohj Rautatienkatu 15/B/10, 00100 Helsinki, 90.499 099, Fax: 90.495 643, VP: Timo Lahtinen.
SONET SUOMI, Kuusiniemi 2, 02711 Espoo, PO Box 9 (Zip: 02711), 90.509 3100, Fax: 90.509 3260, Tlx: 122705 disco, MD: Gugli Kokljuschkin.

RECORD DISTRIBUTORS

AMIGO MUSIK (FINLAND), Tuotekatu 10, 15700 Lahti, 918.875 013, Fax: 918.875 014, MD: Martti Heikkinen.
BLUEBIRD MUSIC, Henrikintie 5/C, 00370 Helsinki, PO Box 12 (Zip: 00370), 90.506 1877, Fax: 90.506 1486, Tlx: 124934 blueb, MD: Osmo Ruuskanen, Mktg Mgr: Seppo Mantintalo. Labels distr: Bluebird, Birdie, LeBaron, Hittikorva.
DISCOMASTER, Aurakatu 10/B, 20100 Turku, 921.515 553, Tlx: 62494, Contact: Gosta Sjöman.
DISCOPHON/EDITION CODA, Kuusiniemi 2, 02711 Espoo, 90.509 3100, Fax: 90.509 3260, Contact: Vasilij Kokljuschkin.
EKA CORPORATION, Kaenkuja 3-5, 00500 Helsinki, PO Box 1060 (Zip: 00501), 90.733 2530, Fax: 90.733 2331, Contact: Timo Rakkola.
EUROS, Pohjoisranta 20-22/B, 00170 Helsinki, 90.622 1400, Fax: 90.622 1442, Tlx: 121368, MD: Jari Vaananen.
FAZER LEVYPISTE, Lansituulentie 1/B, 02100 Espoo, PO Box 171 (Zip: 02101), 90.435 011, Fax: 90.455 2840, MD: Juhani Tammivuori, Mktg Mgr: Kari Heikkinen, Prod Mgrs: Tony Vapalahti, Tuomo Tikkanen.
FAZER MUSIC/FAZER FINNLEVY, Lansituulentie 1/A, 02100 Espoo, PO Box 169 (Zip: 02101), 90.435 011, Fax: 90.455 2352, Tlx: 122782 flev, Mktg Mgr: Jaakko Karilainen, Prod Mgrs: Peppe Schwarzenberg (Local), Pia Louhivuori, Pekka Salla, Jari Tiessalo, Head of Comm: Lasse Norres. Labels (distr): Andania. Bluebird, Euros, Flamingo, Levytuottajat, Warner Music.
FUGA OY, Unioninkatu 28, 00100 Helsinki, 90.631 181, MD: Markku Nuotio.
HARRY AALTONEN/MINIMUSIC, Haapakyla, 03100 Nummela, 913.222 2661, MD: Harry Aaltonen.
KTEL INTERNATIONAL, Hameentie 157, 00560 Helsinki 53, 90.757 1522, Fax: 90.790 653, Tlx: 123438, MD: Jorma Kosonen. Also distributes local products like Megamania and Polarvox.
KARAS-SANA, PO Box 48, 08101 Lohja, 912.87755. Gospel music.
MUSIIKKI-LAIHO, Veikkointie 4, 03100 Nummela, PO Box 32 (Zip: 03101), 90.222 3744, Fax: 90.222 1845, MD: Veikko Laiho, Prod Mgr: Kari Hillö. Labels (distr): Pickwick, PWKS,

Hollywood, Starinc, BR, Fun, The Collection, Symphony, ONN; Main product: Dance, Gold/Oldies, Classical.
PEC DISTRIBUTION, PO Box 46, 00370 Helsinki, 90.556 383, Fax: 90.556 018, MD: R. Kokomekki. Labels (distr): EMI, Columbia, Sonet.
POWER RECORDS (FINLAND), Launeenkatu 82, 15610 Lahti, 918.527 711, Fax: 918.527 712, Tlx: 16004, MDs: Markku Hintanen, Markus Ollikainen.
PYRAMID MUSIC, Hameentie 6/A, 00530 Helsinki, 90.701 5152, Fax: 90.701 3802, MDs: Sisko Ramsay, Pekka Aarnio.
RISTIN VOITTO, PO Box 75, 01301 Vantaa, 90.826 377, Fax: 90.826 124, MD: Rauno Liukkonen.
ROCK MEDIA EXPORT, Kytälankatu 6, 33100 Tampere, PO Box 483 (Zip: 33101), 931.120 500, Fax: 931.133 732, Tlx: 22460, MD: Pertti Palkoaho.
ROCKADILLO RECORDS, Keskustori 7/A, 33100 Tampere, 931.131 260, Fax: 931.131 297, Tlx: 22004, MD: Tapio Kerjus.
SONY MUSIC ENTERTAINMENT (FINLAND), Ahventie 4/B, 02170 Espoo, PO Box 12 (Zip: 02171), 90.452 3700, Fax: 90.452 3707, MD: Antti Holma, Contr: Matti Sihvola. Labels (distr): Megamania, Pyramid, One Inch Rock, Bulltone.
VALITUT PALAT READERS DIGEST, Sentnerikuja 5, 00440 Helsinki, PO Box 42 (Zip: 00421), 90.503 441/563 2011, Fax: 90.503 4499, Prod Mgr: Petteri Lahikainen.

RETAIL ACCESSORY SUPPLIERS

FAZER MUSIC/FAZER FINNLEVY, Lansituulentie 1/A, 02100 Espoo, PO Box 169 (Zip: 02101), 90.435 011, Fax: 90.455 2352, Tlx: 122782 flev, Mktg Mgr: Jaakko Karilainen.

ASSOCIATIONS & PROFESSIONAL ORGANIZATIONS

DISC JOCKEY ASSOCIATION, Ruolank 16/5, 15150 Lahti, 90.662 218, Exec: Tapani Ripatti.
FDCT, PO Box 570, 33101 Tampere, 931.462 522. Organization for disco professionals.
FINNISH CABLE TELEVISION ASSOCIATION, Asemamiehenkatu 2/C, 00520 Helsinki, 90.144 718, Fax: 90.148 2323, Dir: Mikko Huuskonen, Info Officer: Riitta Luhtala.
FINNISH FOREIGN TRADE ASSOCIATION, Arkadiankatu 4-6/B, 00101 Helsinki, 90.69591, Fax: 90.694 0028, Tlx: 121696.
FINNISH MUSIC INFORMATION CENTRE, Runeberginkatu 15/A/6, 00100 Helsinki 10, 90.409 134, Fax: 90.409 634, Contact: Jarmo Sermila, Aero Lupari. Also distributing unpublished Finnish music.
FINNISH MUSIC PUBLISHERS ASSOCIATION, Runeberginkatu 15/A/12, 00100 Helsinki 10, 90.444 877, Fax: 90.440 377, President: Raimo Henriksson, VP: Osmo Ruuskanen.
FINNISH MUSICAL ARTISTS, Runeberginkatu 15/A, 00100 Helsinki, 90.445 589.
FINNISH MUSICIANS UNION, Uudenmaankatu 36/D/21, 00120 Helsinki, 90.640 758, Fax: 90.611 282, President: Raimo Vikstrom. Trade Union.
GRAMEX, Hietaniemenkatu 2, 00100 Helsinki, 90.494 280, Fax: 90.441 224, Contact: E Termaat. Artists and producers copyright society.
IFPI FINLAND, Runeberginkatu 15/A/12, 00100 Helsinki, 90.440 877, Fax: 90.440 377, President: Arto Alaspaa, Info Officer: Paivi Ryokas. Trade organization for the Finnish record producers and video distributors; member association for the Finnish collecting society for performing artists and record producers GRAMEX.
RADIO RETAIL ASSOCIATION, Vuorimiehenkatu 21, 00140 Helsinki, 90.174 233, Fax: 90.624 474, Contact: Erkki Raitala.
ROCK MUSICIANS ASSOCIATION, Uudenmaankatu 36/F/34, 00120 Helsinki, 90.641 290, Fax: 90.611 282, Chmn: Nissila Pekka.
SUOMEN PAIKALLISRADIOLIITTO, Italahdenkatu 22/B-C, 00210 Helsinki, 90.682 1322, Fax: 90.682 1124, MD: Kai Salmi. Association of Finnish Radio Broadcasters; trade organisation for the independent and commercial radio in Finland.
SUOMEN SANOMALEHTIMIESTEN LIITTO/RTV, Hietalahdenkatu 2, 00180 Helsinki, 90.647 326, Fax: 90.640 361. Rights organization for journalists in press, radio and television.
TEOSTO, Lauttasaarentie 1, 00200 Helsinki, 90.692 2511, Fax: 90.677 134, Tlx: 123785 teos, MD: Pekka Kallio. Finnish composers' international.

PUBLIC RELATIONS & RECORD PROMOTION

ROCKMEDIA LTD, PO Box 210, 67101 Kokkola, 949.282 050, Fax: 968.314 981, Producer: Sakri Viklund.

PLATING, MASTERING & PRESSING PLANTS

FINNVOX STUDIOS, Arinatie 8, 00370 Helsinki, 90.554 521, Fax: 90.550 971, Tlx: 123166, MD: Erkki Ertesuo, Pressing/Dupl Mgr: Yrjo Salonen. Vinyl pressing.
MTV AUDIO-VIDEO, Ilmatoriti 2, 00240 Helsinki, 90.150 025, Fax: 90.150 0690, Dirs: Kalevi Mattila, A P Kivenen.

TAPE CUSTOM DUPLICATORS

AAC-OPISTO, PO Box 355, 00101 Helsinki, 90.177 355.
AARAMAA, Kassetituotantola, 62200 Kauhava, 964.354 493.
BENERATE, Viljatie 4/C, 00700 Helsinki, 90.354 399.
BETESDA-APU, Porthaninkatu 10/D/82, 00530 Helsinki, 90.701 2436.
BSM STUDIO, Ilkontie 27, 36220 Suorama, 931.640 700.
FINNVOX STUDIOS, Arinatie 8, 00370 Helsinki, 90.554 521, Fax: 90.550 971, Tlx: 123166, MD: Erkki Ertesuo, Pressing/Dupl Mgr: Yrjo Salonen.
FOOTPRINT, PO Box 98, 00241 Helsinki, 90.754 1599.
HARRY SOUND, Helenenkatu 30/A/6, 05800 Hyvinkää, 914.12950.
KARAS-SANA VIVAMO, PO Box 48, 008101 Lohja, 912.87755.
KASETTILINJA, Hoylaamontie 5, 00380 Helsinki, 90.554 422, Fax: 90.555 672.
KASSETTIMONISTUS, Waino Aaltosentie 11, 00570 Helsinki, 90.684 8112.
KASSETTIMONIKKO AVOINYHTIO, Pohjolankatu 35/A/1, 00610 Helsinki, 90.799 402.
KUSTANNUSOSAKEYHTIO OTAVO, Uudenmaankatu 10, 00210 Helsinki, 90.647 022.
MARKETTA OPAS TMI, Toolonkatu 44-48/A, 00250 Helsinki, 90.406 631.
MTV AUDIO-VIDEO, Ilmatoriti 2, 00240 Helsinki, 90.150 025, Fax: 90.150 0690, Dirs: Kalevi Mattila, A P Kivenen.
SUPERKASSETTI, Vanha Hameenkyläntie 52, 02680 Espoo, 90.544 733.
UNIMUSIC, PO Box 40, 20501 Turku, 9021.740 460.

CASSETTES REELS & PARTS, JEWEL BOX MANUFACTURERS

P PAASO, Malmi Raitti 17, 00700 Helsinki 70, 90.359 312, Fax: 90.345 1744.

PRINTING, PACKAGING & LABELS

ALMIGHTY, Ojakatu 1, 33100 Tampere, 931.227 942, Fax: 931.227 942, Design: Liisa Repo.
KIRJAPAINO KURONEN ERKKI, Arentitie 9, 00410 Helsinki 90, 90.563 3655, Fax: 90.531 284, MD: Osmo Aromaa.
UUDENMAAN AMMATTIPAINO, Honkasuonti 9, 00390 Helsinki, 90.546 927, Fax: 90.546 071.

BLANK & BULK RAW TAPE

AUDIOVOX, Hoylaamontie 8, 00380 Helsinki, PO Box 190 (Zip: 00381), 90.506 1311, Fax: 90.506 1370, Tlx: 122087 vox, President: Markku Weyner, MD: Klaus Weyner, Mktg Dir: Asko Jarvi.
BASF, Maistraatinportti 4, 00241 Helsinki, 90.15981, Fax: 90.159 8250.
FUJI FINLAND, Martinkyläntie 41, 01720 Vantaa, 90.85631.
HELECTRON, Vitikka 4, 02630 Espoo, 90.50291, Fax: 90.5022 9350. Supply Sony.
INTO, Lammittajankatu 4, 00810 Helsinki, PO Box 95 (Zip: 00811), 90.755 7711, Fax: 90.755 3581, Tlx: 121836 into. Authorized Studer representative.
MS-AUDIOTRON, Laitilantie 10, 00420 Helsinki, PO Box 28 (Zip: 00421), 90.566 4644, Fax: 90.566 6582, Tlx: 125778, President: Matti Sarapalio, Mktg Dir: Kari Jaksola, Mgr: Jarmo Roivas.
NORES, Mankkaantie 32, 00101 Helsinki 78, PO Box 889 (Zip: 00101), 90.520 311. Distributor.
SAHKO-POMO, Fiemiginkatu 13, 00500 Helsinki, 90.701 4757/710 361.
STUDIOTEK, Kuusiniemi 2, 02720 Espoo, PO Box 5 (Zip: 02721), 90.592 055, Fax: 90.592 090, MD: Peter Stralman, Mktg Dir: Heimo Hippo. Cassettes, open reel & DAT; Distribute: BASF, Dic DAT.
SUOMEN 3M, PO Box 26, 02630 Espoo 63, 90.52521.

CD, RECORD & TAPE MANUFACTURING SYSTEMS

P PAASO, Malmi Raitti 17, 00700 Helsinki 70, 90.359 312, Fax: 90.345 1744.

FRANCE

RECORD COMPANIES

8EME AVENUE, 304 rue Saint-Honore, 75001 Paris, 1.4297 5252, Fax: 1.4297 4227, A&R Mgr: Thierry Kerhornou, Dir: Herve de la Rochefoucault, Promo: Karen Zeglin. Main product: Dance, Album Rock, Country.
AB PRODUCTIONS, 144 avenue du President Wilson, 93210 La Plaine-Saint-Denis, 1.4809 2001, Fax: 1.4809 8371, Tlx: 234120, President: Claude Berda, Artistic Dir: Jean Luc Azoulay, Mktg Dir: Patrick Lambert.
ACAPELLA, 8 boulevard de Nancy, 67000 Strasbourg, 8822

- 2000/8823 0202, Fax: 8822 3594, MD: Freddy Brua. Label (owned): Bella Music.
- ADDA**, 8 rue Jules Verne, 93400 Saint-Ouen, 1.4012 6030, Fax: 1.4012 4287, Tlx: 234022, Contact: Anne DuHomme, Comm Mgr: Christine Menvielle.
- ADELISE PRODUCTION**, 69 rue Gorge-de-Loup, 69009 Lyons, 7847 1843, Fax: 7847 2917, Dir: Serge Adélise. Main product: Adult Contemporary, Jazz, Country, Reggae, Classical, Album Rock, Black (R&B), New Age.
- ADES**, 54 rue Saint-Lazare, 75009 Paris, 1.4874 8530, Fax: 1.4285 1580, Tlx: 280422, President: Lucien ADES.
- ADN MUSIC**, 51 rue de Paradis, 75010 Paris, 1.4022 0252, Fax: 1.4246 9628, Tlx: 280975, MD: Cyril Dohar, Contact: Jean-Hugues Feugeas.
- ALCINTER**, 76-78 avenue des Champs Elysees, 75008 Paris, 1.4359 4122, Contact: Levon Sayan.
- ALIZE PRODUCTION**, 21 rue du Passeleu, 93100 Montreuil, 1.4857 4063, Contact: Patrick Debort.
- ANAIIS RECORDS**, 8 Passage Duhesme, 75018 Paris, 1.4223 0766, President: Edouard Delmer, Sales Mgr: Marc Anderson, Artist Mgr: Danielle Brion. Labels: Anais Records.
- APA ARTISTES ET PRODUCTEURS ASSOCIES** back: N), 39 rue Jean Goujon, 75008 Paris, 1.4225 4652/4256 3939, Fax: 1.4074 0193, Tlx: 643948, MD: Christian de Ronseray, Mktg Mgr: Frank Lipsik.
- ARCADE INDISC FRANCE**, 88 avenue du General Leclerc, 92100 Boulogne-Billancourt, 1.4603 0899, Fax: 1.4712 0654, President: Herman Heinsbroek, GM: Jean Luc Lavignette, Label Mgr: Jean Mareska, PR Dir: Nicolette van Galen. Labels (owned): Indisc; Distribution: Sony, EMI, Vogue.
- ARENA**, 9 rue Saint-Florentin, 75008 Paris, 1.4296 0200, Fax: 1.4020 0529, Tlx: 290724, President: Alain Puglia, Int'l Mgr: Philippe Brat.
- ARION**, 36 avenue Hoche, 75008 Paris, 1.4563 7670, Fax: 1.4563 7954, President: David Matalon, Dir: Manuela Ostrolenk Matalon. Labels (owned): Arion; Main product: Classical, Traditional.
- L'ARNO PRODUCTION**, PO Box 177, 57804 Fleyming-Merlebach cedex, 8704 7073, Fax: 8787 1234, President: Arnold Dine, A&R: Gilles Naudin, Mktg Mgr: Fedronic Saaro. Labels (owned): Mikael Dean; Main product: Dance, Album Rock, Black (R&B), New Age.
- ARPEGE**, 14 rue de la Justice, 60204 Compiègne cedex, 4423 2765, Fax: 4486 8279, MD: Mr. Le Calve.
- ART TRAFFIC**, 68 rue de la Méditerranée, 34000 Montpellier, 6722 0500, Fax: 6722 0840, Contact: Etienne Imer, 2nd address: 166 Boulevard Magenta, 6e face, 75010 Paris, 1.4569 0292, Fax: 1.4596 0285.
- ART' PUBLIC IMAGE**, 21 rue de Montmorency, 95350 Saint Brice, 1.3990 0303, Fax: 1.3990 7919, MD: Jean-Michel Ghemiet, Art Dir: Jean-Pierre Petit. Labels: Toots Thlemians, Denis Badault, Elene Dee, Marc Perrone, Paris-Musette, Le Bucher des Silences, Georges Robert/Tom Harrellster, Anne Sylvestre; Main product: Jazz.
- ARTEM**, 14 rue Tivoli, 31068 Toulouse cedex, 6133 5079, Fax: 6226 2636, Dir: Alain Jouffray.
- ASP**, 3 place d'Iena, 75016 Paris, 1.4070 9401, Fax: 1.4070 9402, MD: Ms. Hernandez.
- ATOLL MUSIC**, 18-20 rue du Borrego, 75020 Paris, 1.4366 6922, Fax: 1.4366 5221, Tlx: 215795, President: Charles Igbui, Asst: Martine Moscovitz. Labels (owned): Atoll, Jonathan, Ring, Ouragan, Ascot; Distribution: CS, Carrere, Musidisc, Polygram.
- ATOPRA RECORDS**, 60 rue Madame, 75006 Paris, 1.4222 5587, Contact: Denis Desrouvres.
- AUVIDIS**, 12 avenue Maurice Thorez, 94200 Ivry-sur-Seine, 1.4672 3939, Fax: 1.4658 8507, President: Louis Bricard, Production: Thierry Delecoix, Press/Promo: Philippe Pinon, Mktg/Sales: Bruno Quetin, Accts: Pierrette de Freitas. Labels (owned): Astree, Valois, Unidisc, Tempo, Ethnic, Sonore Hachette, Unesco, Audiolive.
- AVALANCHE**, Chemin Charre, 13600 Ceyreste, 4283 2040/9176 1300, Fax: 9176 2220, MDS: Alain Castagnola, Dominic Campillo, Promo Mgr: Anne Carpena. Labels (owned): IAM, Soul Swing 'N Radical, Dee Rock, Mascotte Possee; Main product: Rap.
- AVREP**, 44 rue de Miromesnil, 75008 Paris, 1.4265 8780, Fax: 1.4742 9099, Tlx: 643037, MD: Pierre Alain Simon, Exports: Dalida Mariani.
- AZIMUTH**, 38 rue Marcel Dessault, 92100 Boulogne-Billancourt, 1.4761 9090, Fax: 1.4761 0352, Dir: Genevieve Girard.
- B*TOV MUSIC**, 24 rue Pasteur, 92800 Puteaux, 1.4901 9636, Fax: 1.4901 9521, Producer: Francky Samama.
- BADLAND RECORDS**, 7 rue du Mont Valerien, 92210 Saint-Cloud, 1.4771 6562, Fax: 1.4800 0767, Tlx: 200907, Label Mgr: Serge Leroy. Labels (owned): Badland Records; Main product: EHR, Adult Contemporary, Jazz, Classical, Dance, Album Rock, New Age, New Artists.
- BAILLEMONT PRODUCTIONS**, 26 rue des Beaux Sites, 95390 Saint-Prix, 1.3959 3026, Fax: 1.3959 8673, Prod Mgr: Lionel Baillemont, Fin Dir: Myriam Leroux, Sales Mgr: Yves Legros. Labels (distr): Musica, Oreade, Fonix Musik, Nightingale, Omega; Main product: Album Rock, New Age, French Artists.
- BANG MUSIC**, 41 boulevard Beaumarchais, 75003 Paris, 1.4277 8803, Fax: 1.4363 5138, Tlx: 840115, President: Gerard Bangalter.
- BARCLAY**, 5 rue des Reculettes, 75013 Paris, 1.4408 8000, Fax: 1.3535 8030, PDG: Philippe Constantin, MD: Pascal Negre, A&R Dir: Eric Clermontel, Mktg Dir: Paul Bassy, Prod Mgr: Olivier Caillart (Int'l), Promo Mgr: Gregoire Bedot, Contr: Edouard De Vesinne.
- BAXTER MUSIC**, 80 avenue de la Grande Arme, 75017 Paris, 1.4055 0844, Fax: 1.4572 6430, Tlx: 640551, Dir: Dominique Rousseau.
- BCM RECORDS (FRANCE)**, 94 rue St Lazare, 75009 Paris, 1.4016 8122, Fax: 1.4280 6930, MD: Gerard Langella, Promo (FM/Clubs): Remi Catnot, Co-Ord: Catherine Susser.
- BELIDOR PRODUCTION**, 14 bis avenue Hoche, 75008 Paris, 1.4359 7181, Contact: Francois Frey.
- BELLA MUSICA (FRANCE)**, 8 boulevard de Nancy, 67000 Strasbourg, 8823 0202/8832 2229, Fax: 8822 3594, Dirs: Freddy Brua, J Rinschler, Contact: Michael Thoma.
- BIPER**, 12 rue de Lorraine, 92300 Levallois-Perret, 1.4730 0030, Fax: 1.4730 1815, Tlx: 649945, Dir: Martin Garat, Promo: Nicole Schluss.
- BIRD**, 34 rue du General Delestraint, 75016 Paris, 1.4071 0180, Fax: 1.4071 0405, PDG: Thierry Roze, A&R Dir: Bertrand Loquegniot, Mktg Dir: Olivier Guidet, Promo Dir: Jean-Claude Pietrola. Distribution: BMG.
- BLOOMDIDO PRODUCTIONS**, 5 rue Humblot, 75015 Paris, 1.4577 2114, Fax: 1.4577 0669, MD: Nathalie Lallemond. Main product: Jazz.
- BLUE-LINE**, 82 rue du Faubourg Saint Martin, 75010 Paris, 1.4803 3399, Fax: 1.4803 2450, MD: Michel Vautrot, Label Mgr: Alexandre Madelin. Labels (Owned): Trio Machado, J M Dicit, Lohrer, Le Lann, Moutin; (Lic): Gouirand; Main product: AC, Jazz.
- BMG FRANCE**, 9 avenue Matignon, 75008 Paris, 1.4299 1900, Fax: 1.4563 6947, Tlx: 650703, President: Bernard Carbonez, MDS: Marc Guez (Fin/Admin), Antoine Chouchani (RCA), Philippe Desindes (Ariola), Operations Dir: Claude Amrane, Fin Dir: Philippe Dufraisie, Sales Mgr: M Y Cabaret, Label Mgrs: Gerard Woog (MCA/Geffen), Jean Paciulli (Classical), Eric Vandepoortier (RCA). Labels (owned): Anxious, Ariola, Arista, Bluebird, BMG Classics, Dedicated, Deutsche Harmonia Mundi, DDD, Ear Candy, Eurodisc, Geffen, Gold Seal, GRP, Hansa, Imago, Jive, Georges Mary, MCA, Motown, Neige Music, Novus, Private Music, Real Seal, RCA, Silverstone, Tabata Music, Victrola, Zoo; (Dist): Avrep, Constant Boudagne Productions, Milan, Charles Talar/Zone Music.
- BOFURE PRODUCTIONS**, 17 rue de Montreuil, 75011 Paris, 1.4379 8855, Fax: 1.4372 4991, MD: Eric Dagu-Debris, Mktg/A&R: Yves le Carpentier, Promo: Marsu (A&R), Catherine Lemaire, Emmanuelle Tirmarche, Int'l Mktg: Tamsin Briggs. Labels (owned): Houlaia, Houlaia Int'l, Zelig, Independence; (Lic): Vinyl Solution; Main product: Adult Contemporary, Dance, Album Rock.
- BOUCHERIE PRODUCTIONS**, 32 rue des Cascades, 75020 Paris, 1.4797 9517, Fax: 1.4797 2578, Contact: Francois Hadji-Lazaro, A&R: Thierry Svahn, Promo: Steffi Gotkovski, Mktg: Natalie Luc. Labels: Boucherie; Distribution: Island, PolyGram; Main product: Album Rock.
- BUDA RECORDS**, 188 boulevard Voltaire, 75011 Paris, 1.4024 0103, Fax: 1.4024 0427, Tlx: 215595, GM: Giles Fruchaux, Sales & Mktg Dir: Philippe Gaviglio.
- CAPTAIN CLICK PRODUCTION**, 47 Villa des Tulipes, 75018 Paris, 1.4226 1615, Fax: 1.4627 7999, Mgr: Malvina Masselot.
- CARAMBA PRODUCTIONS**, 9 place de Seoul, 75014 Paris, 1.4321 5818, Fax: 1.4279 8892, Contact: Luc Gaurichon, Laurence Niro.
- CARAVAGE**, 130 rue Marius Aufan, 92300 Levallois-Perret, 1.4759 9451, Fax: 1.4759 0965, Tlx: 270105, MD: Jean-Paul Smets. Labels owned: Caravage, Axis, Epifrance; Distribution: Carrere.
- CARRERE MUSIC**, 27 rue de Surenne, 75008 Paris, 1.4268 1300, Fax: 1.4266 5811, Tlx: 841581, President: Claude Carrere, Dir-Gen: Yvan Yaieb, Promo Dirs: Annie Markhan, Cecile Geneuvre, Fin Dir: Christophe Waignier, Comm Dir: Robert Juarez, Int'l Development: Jean Noel Ogouz, Special Mktg: Bernard Ducrocq. Labels (owned): Carrere; (Lic): Fantasy, Stax, Pablo, Prestige, Milestone, Riverside, Contemporary, Cube, Immediate, Vanguard, Legacy, Buddah, Kama Sutra, Warner Music.
- CAT MUSIC (FRANCE)**, 30 rue Sainte Felicite, 75015 Paris, 1.4620 0327, Fax: 1.4620 3025, PR: Catherine Angeloz, Asst: Gisele Andrieux.
- CDR PRODUCTIONS**, 86 rue Haxo, 75020 Paris, 1.4363 9519, Fax: 4363 4641, MD: Jacky Reggan. Main product: Classical.
- CEDRE PRODUCTION**, 20 passage de la Bonne Graine, 75011 Paris, 1.4700 4053, Fax: 1.4700 1000, Producer: Jacqueline Attellian.
- CELLULOID PRODUCTION**, 50 rue Stendhal, 75020 Paris, 1.4349 5864, Fax: 1.4358 6226, Tlx: 212698, MD: Gilbert Castro.
- CELP MUSIQUE**, 95 rue Edmond Rostand, 13008 Marseille, 9137 4336, President: Andre Jaume, Producer: Robert Bonaccorsi. Label: Celp Musique; Main product: Jazz; Distribution: Harmonia Mundi France.
- CENT POUR CENT**, 10 boulevard des Batignolles, 75017 Paris, 1.4387 0413, Fax: 1.4387 0386, MD: Marc Britan, Mktg Dir: Jean-Marc Malairan.
- CHA CHA MUSIC**, 21 bis rue Joffrin, 94100 Saint-Maur-des-Fosses, 1.4883 6109/3916, Fax: 1.4397 2816, Contact: Pascal Wuthrich.
- CHRYSALIS RECORDS (FRANCE)**, 43 rue Camille Moulins, 92130 Issy les Moulineaux, 1.4629 2053, Fax: 1.4629 2151, MD: Christophe Magny, Promo Dir: Isabelle Colders, AM Radio: Marino Leblais, FM Radio: Brigitte Philibert. Distribution: EMI.
- CKL PRODUCTIONS**, 145 rue Saint-Dominique, 75007 Paris, 1.4753 7508, Contact: Charles Bey.
- CLUB DU DISQUE ARABE**, 125 boulevard de Menilmontant, 75011 Paris, 1.4357 6869, Fax: 1.4355 3761, President: Ms. Hachlef, MD/A&R: Mr. Le Canu, Mktg/Promo: Ms. Favier, Mr. Belhamissi. Labels (owned): AAA, Algeriavox, Algeriaphone; (Lic): Baidaphone, Calrophone, Voix de l'Orient, Soutelphan; Main product: Arabic.
- CMC RECORDS**, 25 Passage Panoramas, PO Box 325, 75064 Paris cedex 02, 1.4026 4322, Fax: 1.4233 1631, Tlx: 215907, Contact: Claude Saffy, Mgr: Dupays Tchocck.
- COLUMBIA (SONY MUSIC FRANCE)**, 1-3 rue du Chateau, 92552 Neuilly sur Seine cedex, 1.4738 0808, Fax: 1.4738 8463, MD: Patrick Decam, Mktg Dir: Virginie Auclair, Prod Mgrs: Agnes Haegel, Valerie Michelin, Olivier Chatelin, Sophie Zannettacci, Marc Grafeuille, Promo Dir: Michel de Folligne, Int'l Promo: Catherine Cuny, A&R Dir: Dominique Lefebvre.
- COM'NICOLE COURTOIS HIGELIN**, 13 rue de Rivoli, 75004 Paris, 1.4272 2961, Fax: 1.4272 5199, MD: Nicole Courtois, Asst: Nathalie Jeanne.
- COMOTION MUSIQUE**, 10-12 rue de la Vacquerie, Espace Kiron, 75011 Paris, 1.4373 5025, Fax: 1.4373 5510, Tlx: 210377, Dir: Jean-Patrick Teysseier, Bus Affairs: Frank Pinon, Import/Export: Juliette Husson. Distribution: Wotre Music. Main product: Rock, Dance, Variety.
- COOP BREIZH**, Kerangwenn, 29540 Spezet, 9893 8314, Fax: 9893 8913, Mgr: Yann Goasdoev, Promo/Mktg Dir: Marie-Claude Trebert, Representative: Yves Fortlorou.
- COPPELIA**, 21 rue de Pondichery, 75015 Paris, 1.4567 3066, Fax: 1.4306 3026, Mgr: Jean-Philippe Olivi.
- CORELIA**, 2 hameau du Four Blanc, PO Box 3, 91780 Chalo-Saint-Mars, 1.8495 4193, Fax: 1.8495 4851, Dir: Jean-Paul Eggermont. Label (owned): Corelia; Main product: Wind instrument.
- CORNELIA PRODUCTIONS**, 7 rue Damiens, 92100 Boulogne-Billancourt, 1.4621 1717, Fax: 1.4621 7454, Tlx: 250649, MD: Guy Boyer.
- CRISTAL INN PRODUCTION**, 1 rue Edgar Poe, 75019 Paris, 1.4241 9427, Contact: Christophe Ruggia.
- CROSS OVER DISQUES**, 59 rue des Trois Freres, 75018 Paris, 1.4254 4490, Fax: 1.4254 0509, Art Dir: Flavien Pierson.
- CYBELIA**, Le Chateau d'Epreville, 76400 Epreville, 3529 0467, Fax: 3527 8933, Contact: Gerard Verdier.
- CYBORG/7TH RECORDS**, 101 avenue Jean Jaures, 93806 Epinay-sur-Seine, 1.4826 1027, Fax: 1.4827 2688, President: Francis Linon, MD: George Besnier.
- DAM DIFFUSION ARTISTIQUE ET MUSICALE** back: Q), 95 rue de France, 77300 Fontainebleau, PO Box 13 (Zip: 77300), 1.6422 0720, Fax: 1.6072 3600, Tlx: 692723 dam, President: Didier Briaud, Mktg Mgr: A Turban.
- DANCETERIA**, 222 rue Solferino, 59000 Lille, 2078 2878, Fax: 2078 2623, President: Laurent Blaha, MDS: Bertrand Blaha, Pierre Cauvelier. Labels (owned): Danceteria, Tuesday Records.
- DANTE**, 208 rue Marcadet, 75018 Paris, 1.4252 7677, Fax: 1.4043 9610, Dir: Bruno Saint Germain.
- DELPHINE PRODUCTIONS**, 150 boulevard Haussman, 75008 Paris, 1.4562 0102, Fax: 1.4289 1922, Tlx: 642908, President: Olivier Toussaint, Int'l Mgr: Anne-Marie Joassim.
- DIAMA MUSIC**, 4 avenue Voinon, 93700 Drancy, 1.4830 5819, Fax: 1.4831 2460, President: Andre Hackiere, Label Mgr: Freddy Brua. Labels (owned): A H, Diama; (Lic): Titan, BIB Productions, Le Bistrot du Mussee, Albatros, L'Heur Maxime; Distribution: Carrere, Musidisc.
- DIAMANT RECORDS INTERNATIONAL**, 17 avenue du President Wilson, 75116 Paris, 1.4723 7919, Fax: 1.4723 0027, Pres/Dir-Gen: Mr. Belolo, Dir-Gen: Sonia Belolo, Mktg Dir: Stephanie Parker, Promo Dir: Sabrina Williams, Int'l Mgr: Alan Belolo. Labels: Top Records, On the Top, Beat Tracks; Main product: Dance Music; Distribution: Sony Music, Vogue, Diamant Records Int'l.
- DIDIER GUINOCHE PRODUCTIONS**, 4 allée des Thuyas, 78860 Saint-Nom-La-Bretèche, 3462 0843, Contact: Didier Guinochet.
- DIMANCHE**, 3 rue Lamonnay, 21000 Dijon, 8065 1881, Fax: 8065 8124, Contact: A Carbonare, F Royer.
- DIRECTIONS**, 6 rue Laurençin, 69002 Lyons, 7240 9236, Fax: 7240 9264, MD: Francois Andre.
- DISC'AZ**, 3-5 rue Albert de Vatimesnil, 92305 Levallois cedex, 1.4758 1290, Fax: 1.4758 6748, MD: Alain Olivier.
- DISCANDSE PRODUCTIONS**, 12 rue de la Saunerie, 34000 Montpellier, 6792 6850, Fax: 6792 6136, Sales Mgr: Jean-Claude Calazel.
- DISQUES ADES**, 54 rue Saint-Lazare, 95009 Paris, 1.4874 8530, Fax: 1.4285 1580, MD: Francois Grandchamps.
- DISQUES CORIOLAN**, Chemin des Hourtets, 11000 Carcassonne, 6825 3863, Mgr: Jean-Louis Bergnes.
- DISQUES DEESSE**, 11 rue Lepic, 75018 Paris, 1.4255 0900, Fax: 1.4252 6001, Tlx: 270105, President: Pierre Celler, Artistic Dirs: Michel Celler, Alain Butet.
- DISQUES DREYFUS**, 26 avenue Kleber, 75116 Paris, 1.4500 7707, Fax: 1.4500 2618, Tlx: 611130, President: Francis Dreyfus. Labels (owned): Dreyfus, Motors; (Lic): DJ International (USA); Distribution: PolyGram.
- DISQUES LORIANE**, 40 rue du Ranelagh, 75016 Paris, 1.4050 1310, Fax: 1.4050 0830, President: Lise Lemaire, Dir: J J Chardeau.
- DISQUES MERLIN**, 49 avenue de Brocclande, 35400 Saint-Malo, 9956 3251, Dir: Marc Vincent. Labels (owned): Disques Merlin; Main product: Adult Contemporary, French.
- DISQUES VERNOU**, PO Box 22, 37130 Langeais, 4796 8059, Fax: 4796 6497, President: Andrée Colson.
- DIXIEFROG**, 218 rue du Faubourg Saint-Denis, 75010 Paris, 1.4208 7704, Fax: 1.4607 1440, MD: Philippe Langlois, Mgr: Alain Rivey.

- DJAVAN**, 77 rue Blomet, 75015 Paris, 1.4531 4144, Fax: 1.4531 1738, MD/Producer: Michel Boucarut. Label (owned): Djavan.
- DOLPHIN MUSIC**, Rte de l'Escarene, Residence Pin Calvin, 06390 La Pointe de Contes, 9391 1225, Fax: 9391 1556, MD: Salah Ksontini, Prod/Eng: Richard Gow. Labels (owned): Dolphin Music, Cote d'Azur. Main product: Adult Contemporary, Jazz, Reggae, Classical, Dance, Album Rock, Black (R&B), New Age.
- DROLE DE ZEBRE**, PO Box 2195, 13207 Marseille cedex 01, 9190 7949, Fax: 9156 6885, President: Christian Fettouche, Art Dir: Stephane Abbadie, Promo: Agnes Durdyn, Mktg: Michel Cabrera. Main product: Dance, New Age, Rap.
- EDITIONS DE PLEIN VENT**, 5 rue Jean-Jaures, 07600 Vals-Les-Bains, PO Box 75 (Zip: 07600), 7594 6355, Fax: 7537 6366, Tlx: 345790 dpv, President: Jean Gibaud, Dir: Marie Helene Gibaud. Labels (owned): De Plein Vent; (Dist): Balkanton, Gens de Lorraine, SE City, Hibou, Collegium, RGIP, Divertimento, Scot Discs, Vista Records, Discandse; Main product: Classical, New Age, Children.
- EDITIONS DU SOLEIL ET DE L'ACIER**, 38 rue des Soeurs Macarons, 54000 Nancy, PO Box 236 (Zip: 54004), 8332 2571, Fax: 8356 9089, Tlx: 961742 code 141, President: Gerard Nguyen, Assoc: Christine Mathieu. Labels owned: Labyrinthes; Distribution: Danceteria.
- EDITIONS ZAGORA**, 9 rue de Versailles, 92430 Marnes-la-Coquette, 1.4741 6198, Fax: 1.4741 7805, President: Daniel Vargarde.
- EDWARDS RECORDS**, 58 rue du Docteur Calmette, 59320 Sequedin, 2007 5701.
- ELLEBORE**, 12 rue Claude Tillier, 75012 Paris, 1.4367 5757, Fax: 1.4367 5151, Tlx: 213907, Contact: Jean-Paul Barriolade.
- EM PRODUCTIONS**, 39 rue Jean Goujon, 75008 Paris, 1.4225 4652, Fax: 1.4074 0193, Contact: Claude Moine.
- EMI FRANCE**, 41-43 rue Camille de Moulines, 92130 Issy Les Moulineaux, 1.4629 2020, Fax: 1.4629 2121, MD: Gilbert Ohayon, Mktg Dir (POP): Michel Liberman, Int'l Mktg Mgr: Herve Defranoux, Prod Mgrs: Herve Deplas (Capitol/Enigma), Fabienne Lefort (EMI UK), Christian Giraud (Blue Note/IRS-Dance), Olivier Lebeau (EMI USA/SBK), Exploitation Mgr: Sophie Cayre. Labels: Capital, EMI USA, EMI SBK, TRS, Impact; (Lic): Food, Parlophone, Chrysalis, EMI Sweden, EMI France, Big Ben Music, Electrola, PMI, EMI Italy, EMI Belgium.
- EMMA PRODUCTIONS**, 5 rue Andrieux, 75008 Paris, 1.4387 7474, Fax: 1.4387 0237, Contact: Max Amphoux.
- EPIC (SONY MUSIC FRANCE)**, 168 avenue Charles de Gaulle, 92522 Neuilly-sur-Seine cedex, 1.4738 0808, Fax: 1.4745 0113, Label Dir: Laurence le Ny, Prod Mgrs: Pierre Mallon, Pierre-Louis Bertalotier, A&R: Christophe Lameignere.
- EPM MUSIC**, 188 boulevard Voltaire, 75011 Paris, 1.4024 0103, Fax: 1.4024 0427, Tlx: 215595, Dir: Francois Dacla.
- ERATO-COSTALLAT**, 50 rue des Tournelles, 75003 Paris, 1.4827 7000, Fax: 1.4804 9543, Tlx: 214196, President: Daniel Toscan Du Plantier, MD: Frederic Sichter.
- ERSKA PRODUCTIONS**, 71 rue de Maubeuge, 75010 Paris, 1.4282 9912, Fax: 1.4281 9730, Dir: Jean Rene Pouilly. Labels (owned): Erska; Main product: various.
- EUROPEAN MUSIC PRODUCTION**, Chemin de Rode, 81310 Lisle-sur-Tarn, 6340 4506/6358 4067, Fax: 6340 4692, President: Philippe Tetard, Treasurer: Frederic Tari, Sec: Philippe Teissier du Crus, Alain Vacque. Labels (owned): Gibraltar, Two Bass Hit, Belleville, Row MC Clure/Aldo Romano, John Abercrombie, Dennis Gouzil; Main product: Jazz.
- FAIRAND SQUARE**, 68 rue du Faubourg Montmartre, 75009 Paris, 1.4285 0128, Fax: 1.4016 1487, Tlx: 660146, President: Fabrice Absil, Chmn: Jean Luc Marre. Labels (lic): Play It Again Sam, Antler.
- FAMILY ORGANISATION**, 54 rue d'Hauteville, 75010 Paris, 1.4246 8133, Fax: 1.4359 7670, Tlx: 642138, President: Claude Danu.
- FASSBEE INTERNATONAL**, 7 rue Damiens, 92100 Boulogne-Billancourt, 1.4608 2223/4621 1717, Fax: 1.4621 7454, MD: Guy Boyer.
- FB CONSEIL**, 3 rue Affre, 75018 Paris, 1.4252 0003, MD: Francois Branchon.
- FILMTRAX (FRANCE)**, 71 rue de Provence, 75009 Paris, 1.4874 1112, Fax: 1.4874 3776, Tlx: 280994, President: Francis O'Neill, GM: Claude Duvivier.
- FLARENASCH**, 9 rue Saint-Florentin, 75008 Paris, 1.4296 0200, Fax: 1.4020 0529, Tlx: 290724, President: Alain Puglia, A&R/Mktg Mgr: Daniel Goldschmidt.
- FLAT & SHARP**, 3 rue du Moulin, PO Box 9, 78117 Chateaufort, 1.3956 1285, Fax: 1.3956 5103, GM: Francois-Emmanuel Porche.
- FNAC MUSIC**, 101 rue du Cherche Midi, 75006 Paris, 1.4222 6011, Fax: 1.4222 6016, President: Georges Huber, GM: Laurent Treille, PR: Pierre Marie Dufour, Legal Affairs: Virginie Borgeaud, Development Dir: Myckael Wynen, Promo Co-Ord: Christine Chabeneix. Distribution: Wotme Music.
- FORLANE**, 15 rue de l'Ancienne Mairie, 92100 Boulogne-Billancourt, 1.4825 1217, Fax: 1.4603 2547, Tlx: 205013, Pres/Dir-Gen: Ivan Pastor.
- FREE LANCE RECORDS**, 13 rue de Bellevend, 75009 Paris, 1.4874 3402, Fax: 1.4280 5140, MD: Jean-Paul Rodrigue. Labels (owned): Free Lance; Main product: Jazz.
- FRENCH RIVIERA PRODUCTION ORGANISATION** (back: N), 10 rue Lycklama, 06400 Cannes, 9339 2244, Fax: 9298 6890, President: Patrick Chobert, Chmn: Roger Foy, MD: Olivier Bouteille. Labels owned: French Riviera.
- GAM INT'L-SEPHORA, LA MUSIQUE DE LA VIE**, 6 place Jean-Paul Sartre, PO Box 30, 51170 Fismes, 2648 8348, Fax: 2648 8730, MD: Marc Brunet, Sales: Veronique Brunet, PR/Promo: Annick Iwulski, Exec Sec: Francoise Brunet. Labels (owned): Mayim; Main product: Adult Contemporary, Album Rock, Black (R&B).
- GARAGE**, 14 bis rue Juillet, 75020 Paris, 1.4636 7615, Fax: 1.4636 9127, Contact: Bernard Natier.
- GATKISS PRODUCTIONS**, Le Cluzeau, 24560 Monmarves, 5358 7559, Fax: 5358 7529, MD: Mr. Gaudillat.
- GB PRODUCTIONS**, Les Noues, 78120 La Boissiere, 1.3485 0667, Fax: 1.3485 0482, GM: Georges Bessonnet, Prod Dir: Bernard Le Noan.
- GLOBO RECORDS (FRANCE)**, 47 rue de Liege, 75008 Paris, 1.4387 6580/6579, Fax: 1.4294 2883, Tlx: 280348, Mgr: Joel Bruno Leibovitz.
- GORGONO PRODUCTIONS**, 1 place aux Bleuets, 59800 Lille, 2031 3231, Fax: 2051 9323, Producer: Eric Gleizer, Mgr: Catherine Leguen, Sec of MD: Sylvie Drapier. Labels (owned): Gorgone; Main product: EHR, Jazz, Album Rock.
- GRIFFE-MASQ**, 48 rue de la Rochefoucault, 75009 Paris, 1.4874 9409, Fax: 1.4878 1680, Mgr: Herve Bergeret. Label owned: Griffie.
- GROOVE INTERNATIONAL RECORDS**, 90 bis rue Alexandre Georges, PO Box 225, 62004 Arras cedex, 2107 4514, Fax: 2107 4514, Label Mgr: Eric Wagner.
- GROUPE DECLIC/BLUE SILVER DISTRIBUTION**, 45 rue de Belleville, 75019 Paris, 1.4203 1111, Fax: 1.4206 8690, President: Bruno Barre, Eric Basset, Sales Mgr: Michel Levy; A&R Mgr (Int'l): Philippe Gallard. Labels (owned): Blue Silver, Declic; Main product: Reggae, Album Rock, World Music.
- GUILDE INTERNATIONALE DU DISQUE**, 22 rue Cocherel, 27001 Evreux, 3229 2949, Fax: 3239 6593, MD: Mr. Guillard.
- HACIENDA RECORDS**, Chemin du Danguin, PO Box 84, 69170 Tarare, 7463 0240, Fax: 7405 0345, Tlx: 305783, MD: Jean Gamet.
- HAPPY MUSIQUE SERVICE**, 38 rue Voltaire, 92800 Puteaux, 1.4728 0015, Fax: 1.4099 9051, Tlx: 250303, MD: Pierre Forgas, PR: Delphine Gosset. Labels owned: Beverly, Perfect, On The Beat.
- HARMONIA MONDI (FRANCE)**, 108 rue Vieille du Temple, 75008 Paris, 1.4277 2447, Fax: 1.4277 3129, MD: Mr. Coutaz. Admin centre for Harmonia Mundi France.
- HARMONIA MONDI (FRANCE/ARLES)**, Petite Route de St. Gilles, Mal de Vert, 13200 Arles, 9049 9049, Fax: 9049 9614, MD: Mr. Coutaz. Labels (owned): Harmonia Mundi, Saison Russe, Quintana.
- HEXAGONE**, 5 rue Lincoln, 75008 Paris, 1.4359 0622, Fax: 1.4563 7573, Tlx: 642068, MD: Nicole Boyer.
- HM PRODUCTION**, 5 Allee Rembrandt, 95500 Gonesse, 1.3985 3195, Fax: 1.3985 3272, GM: Herve Maillet.
- HOLISTIC PRODUCTION**, 37 rue Voltaire, 92800 Puteaux, 1.4204 6114, Fax: 1.4204 6115.
- HOOD MUSIC**, 72 rue Jean-Pierre Timbaud, 75011 Paris, 1.4338 0162, Fax: 1.4355 4647, Mgr: Etienne Dooch, Dir: Marie-Line Descroix, Promo: Pascal Kocher. Labels (owned): SHS Records; Main product: Dance, Album Rock, Black (R&B), Reggae, New Age.
- HOPi-MESA**, 36 rue des Cevennes, 75015 Paris, 1.4557 2636, Fax: 1.4557 8003, Tlx: 206544, MD: Jacques Marbehant. Distribution: Vogue.
- HORIZON MUSIC**, 6 residence le Genevois, 74160 Saint-Julien, 5035 0430.
- HUBERT PRODUCTION**, 32 avenue Pierre I de Serbie, 75008 Paris, 1.4720 3605, Fax: 1.4723 8262, MD: Philippe & Herve Hubert.
- HUGUES DESALLE**, 5 rue d'Artois, 75008 Paris, 1.4359 4138.
- ILLUSTRASON**, 16 boulevard Vital Bouhot, 92200 Neuilly-sur-Seine, 4637 5019, Fax: 4640 0434, Tlx: 612561, Dir: Regis Delaye.
- INEDIT**, 101 boulevard Raspail, 75006 Paris, 1.4544 7230, Fax: 1.4544 7660, Tlx: 204941 Alifran, Dir: Cherif Khaznadar, Artistic Dir: Francoise Gruend, Prod Asst: Pierre Bois.
- INTERLOISIRS DISC**, 57 rue Exudier, 92100 Boulogne-Billancourt, 1.4603 4068, Fax: 1.4825 2941, Mgr: Yves H Faget.
- ISLAND RECORDS (FRANCE)**, 29 rue da Louvre, 75002 Paris, 1.4221 0060, Fax: 1.4221 1771, President: Jean Pierre Weiller, Sales Dir: Isgidore Brobst, Contr: Garbis Migurian. Labels: Island, 4th & Broadway, Anittles, Mango, Mother, Taxi, Island Visual Arts, Sense, Discos Fuentes, Axiom, Best Sounds, Media Records, Delicious Vinyl, Boucherie Productions; Distribution: Polygram.
- JENI PRODUCTION**, 29 rue Vasco de Gama, 75015 Paris, 1.4060 0075, GM: Jacqueline Lelouvier.
- JOGGING TO THE BAR**, 34 avenue des Champs Elysees, 75008 Paris, 1.4277 0219/4255 6856, MD: Evelyne Tognazzoni.
- JUSTINE**, 5-7 rue Paul Bert, 93581 Saint-Ouen cedex, 1.4011 6099, Fax: 1.4011 6057, Tlx: 234479.
- KAKI RECORDS**, 38 rue de Bassano, 75008 Paris, 1.4723 5518, Fax: 1.4070 0130, MD: Philippe Brat. Labels (owned): Kaki Music; Main product: EHR, Adult Contemporary, Dance.
- KANGOUROU**, 2275 avenue Roger Salengro, 92370 Chaville, 1.4709 3314, Fax: 1.4750 6619, Mgrs: Jean-Louis Witas, Jean Marnay. Labels (owned): Magazine.
- KARAMEL**, 19 rue de l'Echiquier, 75010 Paris, 1.4770 0148, Fax: 1.4022 0211, GM: Edward Arahamian.
- KELTIA MUSIQUE**, 1 place au Beur, 29000 Quimper, 9895 4582, Fax: 9895 7319, Tlx: 941348, GM: Alain Le Meur. Labels (Owned): Keltia Musique; Main product: New Age, Folk, Celtic.
- KID RECORDS**, 11 rue Jean de Beauvais, 75005 Paris, 1.4329 7506, Fax: 1.4325 3214, MD: Jean Louis Riset.
- KONDO RA**, Bateaux Jupiter, Chemin de Helage, 77310 Saint-Sargeau, 1.6080 2432/6409 9187, Fax: 1.6065 9021, Dir: Herve Lacroix.
- LA CALIFUSA/SKY RANCH RECORDS**, 2 rue des Capuc ns, 92190 Meudon, 1.4626 1194, Fax: 1.4626 1363, President: Philippe Bras, Asst: Tim Catina. Labels (Owned): La Califusa, Sky Ranch, Heading West. (Lic) Legato Records. Distribution: Wotme Music. Euro Reprs: Teldec (Ger), Play It Again Sam (Bel), Amigo (Nor/Fin), Border (Swe), Mislable (Den), IRD (Ita), Munich (Hol), COD (Swi), FM (Gre).
- LA FRANCAISE DES PLASTIQUES**, Route de Vitre, PO Box 4, 35680 Louvigne-de-Bais, 9949 0070, Fax: 9949 0781, Tlx: 950309, Dir: Roland Thivault.
- LABALME**, 1-3 passage Riviere, 75011 Paris, 1.4806 6167, Fax: 1.4021 9072, Dir: Jacques Labalme, Asst: Nadine Conoir. Labels (Owned): Bronx Records, Must Records, JLB; Main product: Dance, Album Rock, Chansons, Ethnic.
- LABEL BLEU/VILLE D'AMIENS**, PO Box 0631, MCA, 80000 Amiens, 2297 7979, Fax: 2292 5217, Dir: Michel Orin, Producer: Martine Patrice.
- LAZER PRODUCTION**, 15 montée de la Butte, 69001 Lycns, 7839 0532, Fax: 7200 8154, MD: Michel Nicod, Artistic Mgr: Jean-Pierre Jussey, Mgr (Classical): Nils Dalsbaek. Labels (owned): Lazer Production; Main product: Dance, Album Rock, Jazz, Classical.
- LES TRETAEUX INTERNATIONAL**, 20 allée Saint-Exupéry, 92390 Villeneuve-La-Garenne, 1.4798 1284, MD: Roger Ducousset, Mgr: Jean Bergouonoux.
- LEVITAN**, PO Box 50317, 95940 Roissy Charles de Gaulle cedex, 1.4863 7633, Fax: 1.4863 7652, Tlx: 231117, President: Christian Levitan, Dir: Emmanuel Dawidowicz.
- LICHERE**, LA, 9 rue des Apennins, 75017 Paris, 1.4228 8701, Fax: 1.4229 9409, Pres/Dir-Gen: Patrick Tandin.
- LINGUAPHONE**, 12 rue Lincoln, Centre Nobelia, 75008 Paris, 1.4359 3074.
- LINK COMPANY**, 50 rue des Francs Bourgeois, 75003 Paris, 1.4029 9111, Fax: 1.4029 9030, Tlx: 212755, Chmn: Christiane Terbeche, MD: Dany Terbeche. Labels (owned): Jump, Link. Distribution: Vogue (Jump), Just'in (Link).
- LOFT RECORDS**, 16 rue Strasbourg, 03200 Vichy, 7032 3536, Fax: 7032 5004, Tlx: 283155, MD: Christian Di Natale.
- LA LOUPE**, 18 rue Papillon, 75009 Paris, 1.4723 5580, Fax: 1.4720 1586, Tlx: 649530, Contact: Francois Ravart.
- MACARRON PRODUCTIONS & EDITIONS**, 111 Grand Rue, PO Box 37, 01290 Pont de Veyle, 8531 7573, Fax: 8531 7593, Artistic Dir: Pierre Bonnat, PR: Nathalie Pons, Sound Engineer: Philippe Biguet-Mermet. Main product: EHR, Dance, Album Rock.
- MADE TO MEASURE**, 39 quai de Grenelle, 75015 Paris, 1.4577 0818, Fax: 1.4058 1366, Label Mgr (France): Evelyne Hebey. Label owned by Crammed Discs, 42 rue du General Patton, 1050 Brussels, Belgium, tel: (+32)2.640 7914, fax: (+32)2.648 8369; Main product: Adult Contemporary, Jazz, New Age.
- MAIA PRODUCTIONS**, 29 rue Coquilliere, 75001 Paris, 1.4233 0355/0978, MD: Guy Burguin.
- MANTARIAN PRODUCTION**, 44 rue d'Inkermann, 69006 Lyons, 7274 9117, Fax: 7852 6276, Producer: Andre Mantarian. Labels (owned): Mantarian, Lidanto; Main product: Dance.
- MARA**, Las Coumes, 32300 Ponsan-Soubiran, 6267 0744, Fax: 6267 0909, Dir: Jean-Claude Mara.
- MAZERES DISQUES**, 5 rue Leboutoux, 75017 Paris, 1.4380 7070, Fax: 1.4622 6588, Pres/Dir-Gen: Serge Mazeress, Mktg/Promo: Sylvie Castric.
- MC PRODUCTION**, 27 rue Tailbout, 75009 Paris, 1.4523 3045, Fax: 1.4523 5810, Dir-Gen: Marie-Christine Merlin, Art Dir: Charles Spahn.
- MELODIE**, 50 rue Stendhal, 75020 Paris, 1.4349 5900, Fax: 1.4358 6226, MD: Gilbert Castro.
- MICROCODIL**, 186 boulevard Pereire, 75017 Paris, 1.4574 0999, Fax: 1.4574 1451, President: Marie-France Gabarre.
- MIKONOS MUSIC**, L'Hubac des 4 Tours, 06750 Thorenc, 9369 0083, Fax: 9360 0150, MD: Gerard Michel.
- MILK SHAKE**, 41 boulevard de Stalingrad, 94400 Vitry-sur-Seine, 1.4682 6598, Fax: 1.4680 9798, MD: Pierre Benazeth. Labels owned: Milk Shake, I Love Records; Distribution: EPM/ADES, Musidisc, New Rose.
- MN PRODUCTIONS**, 34 avenue des Champs Elysees, 75008 Paris, 1.4562 4212, Fax: 1.4225 6997, MD: Marc Nouchy.
- MOTS ET MUSIQUES**, 156 chemin du Marais du Soucis, 93270 Sevran, 1.4384 7004, Admin: Patrick Kipper. Distribution: Scalen' disc.
- MUSIC ACTION RECORDS**, 102 avenue des Champs Elysees, 75008 Paris, PO Box 276 (Zip: 75265 Cedex 06), 1.4624 6795, Tlx: 203045, GM: Jean Clouet, Promo: Gratiene de Rochecouste.
- MUSICA 2001**, 21 rue Germain Pilon, 75018 Paris, 1.4223 7096, Fax: 1.4223 7564, Art Dir: Yves Josse.
- MUSICAL FORCE**, 6 rue Guynemer, 93200 Saint-Denis, 1.4829 3639, Fax: 1.4023 0146, Tlx: 649061, Dir: Jean-Stephane Berger.
- MUSIDISC (FRANCE)**, 3-5 rue Albert de Vatimesnil, PO Box 190, 92305 Levallois-Perret cedex, 1.4758 1290, Fax: 1.4758 6748, Chmn: Francois Grandchamp Des Raux, GM: Alain Olivier, Fin Mgr: Jean Grandchamp Des Raux, Int'l Mgr: Jonathan Miles. Labels (distr): Fully Radical, Tom Tom Club, MFN, Mushroom, Jungle, Luke Skywalker, Cherry Red, Castle Communications, Ryko, Relativity, FM Revolver, Rough Trade, etc.

MUSIQUE DES ANGES, 4 square Carpeaux, 75018 Paris, 1.4226 0995, Dirs: Michel Jonasz, Roland Katz, Anne Foret.

MUSIQUE ET COMMUNICATION, 50 rue Stendhal, 75020 Paris, 1.4349 5864.

MUTE RECORDS (FRANCE), 61 rue de Belleville, 75019 Paris, 1.4245 1414, Fax: 1.4245 9111, Tlx: 210434, Dirs: Jacques Attali, Bruno Rossignol.

NETWORK MUSIC GROUP/AIRPLAY RECORDS QJ, 39 rue de la Rochefoucauld, 92100 Boulogne, 1.4603 6688, Fax: 1.4603 4277, Int'l Dir: A&R: Remy Philibert St Jacques, Mktg Dir: Jean Michel Doue, Promo Mgr: Pierrick Cheruel, Mktg Mgr: Gino Castagnette. Labels owned: Airplay Records; Main product: Dance.

NEW ROSE, 7 rue Pierre Sarrazin, 75006 Paris, 1.4354 2890, Fax: 1.4633 2612, Tlx: 205420, Dirs: Patrick Mathe, Patrick Blain.

NEW TRADY INTERNATIONAL, 10 avenue Isaac Newton, ZI du Coudray, 93150 Le Blanc Mesnil, 1.4791 2240, Fax: 1.4591 2197, Tlx: 231064, MDs: David & Edith Muflarz, Mktg Mgr: Andre LeRay. Labels (owned): Paixad, Always The Best, Pickwick, Conte Moi un Conte; (Lic) Innovative Communications.

NOCTURNE, 66 rue Ernest Savat, 93100 Montreuil, 1.4724 2411, Fax: 4725 0099, Tlx: 620994, President: Bruno Theol, Producers: Jose Monplet, Noel Herve.

NOUVELLES PRODUCTIONS EUROPEENES (NPE) back: N, 27 rue de la Vistule, 75013 Paris, 1.4582 9209, Fax: 1.4424 3755, President: Jean-Claude Delayer.

NUMBER ONE DJ/CARDELLI, 22 rue P Chenavard, 69001 Lyons, 7839 5252, Fax: 7830 0304, Tlx: 380157, Dir: Patrice Cardelli.

OCORA, 116 avenue du President Kennedy, Room 6345, 75016 Paris, 1.4230 2616, Fax: 1.4230 1437, Dir: Pierre Tourelle.

OMD, 1 bis rue Jean Menans, 75019 Paris, 1.4240 9988, Fax: 1.4240 1718, Mgr: Philippe Vincent, Comm Dir: Daniel Lelong.

ORANGE BLUE PRODUCTIONS, 8 rue Corot, 75016 Paris, 1.4050 7581, Fax: 1.4050 7582, Prod Dir: Victor Mitz.

ORLANDO PRODUCTIONS, 10 rue Damremont, 75018 Paris, 1.4606 8835, Fax: 1.4264 2847, MD: Orlando, Asst: Antoine Angelelli.

PAM SALVADOR, 6 place Vendome, 75001 Paris, 1.4260 8705.

PHASE PRODUCTION, 84 avenue de Versailles, 75016 Paris, 1.4808 4412, Fax: 1.4520 2192, MD: Florence de Fremand. Distribution: Vogue.

PHONOGRAM (FRANCE), 89 boulevard Auguste Blanqui, 75013 Paris, 1.4078 7000, Fax: 1.4581 0118, Tlx: 270673, MD: Michel de Souza. Joint MD: Philippe Vidalenc, Bus Affairs: Christophe Soulard, Contr: Valerie Isbled, Int'l Mktg: Sarah Silver, Int'l Dir: Armand de Forceville, A&R Mgr: Mick Lanaro.

PIANOLA MUSIC/SNEAK PREVIEW, 9 rue Jean Mermoz, 75008 Paris, 1.4256 0985, Fax: 1.4225 5558, Legal Dept: Alain Ravel, Promo/Mktg: Alain Umberto Zaino. Labels (owned): Clever; Main product: Dance.

PIERRE VERANY RECORDS, PO Box 206, 13607 Aix-En-Provence cedex, 4223 1229, Fax: 4296 3029, MD: Pierre Verany. Labels (owned): Pierre Verany Records.

PLG RECORDS, 24 rue Pasteur, 92800 Puteaux, 1.4901 9520, Fax: 1.4901 9521, President: Jean Lahcene.

POLYDOR (FRANCE), 2 rue Cavallotti, 75018 Paris cedex 18, 1.4522 0539, Fax: 1.4522 0168/0341, MD: Nagi Baz, Mktg Mgr: Jean-Luc Bres, A&R (Local): Didier Varrod, Prod Mgrs: Isabelle Roche, Catherine Hardouin (Local), Hugue de Salvadoré (Dance), Jerome Chung. Labels (owned): Polydor, Archiv Produktion, Deutsche Grammophon, Verve; (Lic): A&M, Baby Records.

POLYGRAM CLASSIQUE, 89 boulevard Auguste Blanqui, 75013 Paris, 1.4078 7070, Fax: 1.4588 5032, Tlx: 270673, MD: Kevin Kleinmann, Contr: Valerie Isbled.

POLYGRAM DISQUES (FRANCE), 89 boulevard Auguste Blanqui, 75013 Paris, 1.4078 7000, Fax: 1.4581 0118, Chmn/CEO: Paul-Rene Albertini, Contr: Christian Nicault.

POLYGRAM FRANCE, 2 square Petrarque, 75016 Paris, 1.4727 5959, Fax: 1.4727 1214, Tlx: 642589, MD: Gilles Paire, Sec-Gen: Michel Parent, Bus Affairs: Jose Covo, F&A: Alain Rebillard, Comm Dir: Clement Boulais, Int'l Dir: Nanou Lambin.

POLYGRAM JAZZ (FRANCE), 2 rue Cavallotti, 75018 Paris, 1.4522 0539, Fax: 1.4294 0005, Tlx: 650522, Dir-Gen: Philippe Allard. Labels: Verve, Emarcy, Mercury, ECM, GMT, Amadeo, Watt; Main product: Jazz.

POWDER, 8 rue Lavoisier, PO Box 60, 91430 Igny Principal, 6985 3497, Fax: 6985 3471, Tlx: 603945, President: Jean-Louis Bourguet.

PRODUCTIONS ALLELUIA, 10 rue Saint-Florentin, 75001 Paris, 1.4260 8505, Fax: 1.4927 9569, Contact: Gerard Meys.

PRODUCTIONS BLEU CITRON, 20 avenue de la Porte de la Villette, 75019 Paris, 1.4036 0100, Fax: 1.4036 6059, Dir: Gilles Jumaire.

PRODUCTION EDITION MARTINEZ, 59 boulevard Exelmans, 75016 Paris, 1.4651 0629, Fax: 1.4651 0235, Tlx: 649232, President: Claude Martinez, Int'l Promo: Laurence Vager, Comm Mktg Dir: Patrick Verdier.

PSI PROMO SONOR INTERNATIONAL RECORDS back: N, 30 rue de Saussure, 75017 Paris, 1.4227 3669, Fax: 1.4380 5645, Mgr: Jo Pucheu.

PVM PRODUCTIONS, 3 rue Trenca, 06500 Menton, 9335 4530, President: Patrick Varitto, Dir: Salah Ksontini, Mktg: Patricia Petitjean, Promo: Philippe Delry. Labels (owned): Dolphin, Orcele; Main product: EHR, Dance, AC, Album Rock.

QUINZE TRENTA MUSIC, 18 rue Thibourvier, 75015 Paris,

1.4530 2288, Fax: 1.4531 0491, MD: Daniel Perreau. Label: Quinze Trenta Radio.

RADIO PROGRAMMES-MAJESTIC, 24 rue Nungesser et Coi, 75016 Paris, 1.4605 3649, Fax: 1.4605 4717, Dir: Jacques Canetti.

RDC RECORDS, 43 rue de la Roquette, 75011 Paris, 1.4805 4191/4370, Fax: 1.4805 4482, Assoc Dir: Frank Hagege.

REM, 4 rue Saint-Marie-des-Terreaux, 69001 Lyons, 7830 0571, Fax: 7827 3849, Dir: Jacques Guillaubez.

REMARK, 89 rue de la Boetie, 75008 Paris, 1.4076 0854, Fax: 1.4076 0855, President: Marc Lombroso, Int'l Exploitation: Sophie Bramley, Mktg: Carole Lambillon. Distributed: Play It Again Sam.

REVOLUM, Rue des Nobles, PO Box 4, 09190 Saint-Lizier, 6166 2660, Fax: 6166 3237, Dir: Michel Berthoumieux. Production/Distribution; Main product: Country, Classical.

RHESUS BLUES PRODUCTIONS, PO Box 70, 81400 Carmaux, 7456 1198/6336 9051, Fax: 7461 1215/6336 8292, Dir: Jean Luc Suarez, Admin Dir: Jacques Garcia. Record label; Main product: Blues.

RIVIERA BOOGIE, 3 rue d'Antrechaux, 83000 Toulon, 9409 1481, Fax: 9442 0121, Mktg/Promo Mgr: Frederic P Ballestra. Labels (owned): Riviera Boogie Records, Cherry Hogs Records; Main product: Jazz, Country, Album Rock, New Age.

SABAN, 3-5 boulevard de Courbevoie, 92200 Neuilly-sur-Seine, 1.4745 2030, Fax: 1.4745 4475, MD: Jacqueline Tordjman.

SCAM, 28 rue Louis Nouveau, 06400 Cannes, 9292 2584, Fax: 9292 1671, MD: Bernard Neveu. Labels (owned): BNL Productions.

SCORPIO MUSIC, 5 rue Clement Marot, 75008 Paris, 1.4720 4395, Fax: 1.4952 0378, GM: Daniel Belolo, Producer: Henri Belolo, Mgr: Ginette Miramoh, Int'l: Martine Levy. France's premier Dance label; Labels (owned): Touch of Gold, Hot Tracks, Who's Who in Jazz; Distribution: PolyGram, Carere Records; Main product: Dance.

SCORPION PRODUCTION, Hameau du Plan N1, Villa N 7, 83500 Vidauban, 9473 5404, Fax: 9473 5406, Contact: Joel Salemi.

SEPAM-MILAN, 165 boulevard de Valmy, 92706 Colombes cedex, 1.4786 3619, Fax: 1.4786 3631, MD: Emmanuel Chambeorod, Contr: Vinh Soupaseum. Labels (lic): Milan Sur; Distribution: BMG.

SERGEANT MAJOR COMPAGNIE, 32 boulevard de Strasbourg, 75010 Paris, 1.4824 1386, Fax: 1.4241 2807, MD: Jacques Dejean. Main product: Adult Contemporary, Dance, New Age.

SERP, 6 rue de Beauna, 75007 Paris, 1.4261 0973, Fax: 1.4261 1625, MD: Mr. Pollobere.

SHOW 2000, 23 rue Jean Giraudoux, 75016 Paris, 1.4723 8421/8210, MD: Marise Lerot.

SILENCE DE LA RUE, LE, 8 rue de la Fontaine du But, 75018 Paris, 1.4255 6134, Fax: 1.4254 5583, Mgrs: Christophe Ouali, Marie Jose Couderc. Labels (owned): Le Silence de la Rue; Main product: Album Rock.

SONODISC, 85 rue Fondary, 75015 Paris, 1.4577 3034, Fax: 1.4579 1472, Tlx: 204018, President: Marcel Perse, MD: Michel David. Labels (owned): Africa7, African, Esperance, Kouma, Sonafic, Sonodisc; Main product: African, Ethnic.

SONY MUSIC ENTERTAINMENT (FRANCE) QJ, 1-3 rue du Chateau, 92522 Neuilly-sur-Seine cedex, 1.4738 0808, Fax: 1.4738 0768, Tlx: 620646, President: Henri de Bodinat, MD: Jean-Claude Gastineau, Dep MD: Jacques Campet, Dir Legal Affairs: Marina Ristich de Gr, Bus Affairs Dir: Nicolas Galibert, Dir (Columbia): Patrick Decam, Label Mgrs: Laurence Le Ny (Epic), Didier Tuailion (Squatt), Special Mktg: Mier Malinsky. Labels (owned): Columbia, Epic, Squatt; (Dist): ALB, Columbia, Chris Music, Clever, Comotion, Deesse, Epic, Griffe, Illegal Records, IRMA, JPK, Martinez Lederman Productions, NBS, On the Beat, Parissimo, Pasha, Philadelphia Int'l, Records, Portrait, Productions Editions Martinez, Royalty, SFC, Squatt, Sterne, Tabu, Tyna Music, Versailles.

SQUATT, 168 avenue Charles de Gaulle, 92200 Neuilly, 1.4738 0960, Fax: 1.4738 0927, MD/A&R: Didier Tuailion, Prod Mgr: Valerie Esquavez, Press: Emmanuelle Renom, Promo (Radio): Richard Brunois. Label of Sony Music; Main product: Album Rock.

STUDIO SM, 3 rue Nicolas Chuquet, 75017 Paris, 1.4267 0137, Fax: 1.4766 3968, Tlx: 649884 sm disc, Dir: Martine Andersen.

SUNSET FRANCE, 66 rue de l'Est, 92100 Boulogne-Billancourt, 1.4603 7681, Fax: 1.4825 9770, Tlx: 283155, Dir: Alain Normand. Distribution: Auidis.

SYSMO, 136 rue Champignonnet, 75018 Paris, 1.4255 6462, Fax: 1.4289 3362, MD: Dominique Samarcq.

TABATA MUSIC, 307 route Nationale, 78810 Feucherolles, 1.3054 4646, Fax: 1.3054 5612, Tlx: 695067, MD: Michel Ferodoff. Distribution: BMG.

TAKTIC MUSIC, 145 boulevard Magenta, 75010 Paris, 1.4522 4530, Fax: 1.4387 9092, President: Mr. Ouaki, MD: Mr. Reusser, A&R: Ms. Valletti. Labels (owned): Takdisc; Distribution: WMD/FNAC; Main product: Adult Contemporary, Album Rock.

TELARC, 40 rue Montmorency, 75003 Paris, 1.4029 9669, Fax: 1.4029 9411, Mgr: Gerard Schoumann. Classical Music.

TELMONDIS, 15 rue Mesnil, 75116 Paris, 1.4727 0384, Fax: 1.4727 8365, Tlx: 649078, Pres/Dir-Gen: Josette Affergan.

TEMPOREL, 2 rue du Marquis de More, 92380 Garches, 1.4741 4741, Fax: 1.4795 0303, Dir: Guy Beart.

TIMPANI, 10 rue Saint-Marc, 75002 Paris, 1.4039 9379, Fax: 1.4039 9078, Tlx: 211420, Dir-Gen: Stephane Topakian.

TITAN RECORDS (FRANCE), 8 boulevard de Nancy, 67000 Strasbourg, 8823 0202/8832 2229, Fax: 8822 3594, Dir: Walter Krieger.

TOP RECORDS INTERNATIONAL, 17 avenue du President Wilson, 75116 Paris, 1.4723 7919/4720 4057, Fax: 1.4723 0027, Pres/Dir-Gen: Mr. Belolo, Dir-Gen: Sonia Belolo, Producer: Stephane Belolo, Int'l Mgr: Alan Belolo, Promo/Mktg Dir: Sabrina Williams, Promo/A&R: Stephane Parker, Accts: Collette Simon. Labels: TP Records, Top Records; Distribution: Sony, Vogue, Diamant Records International.

TOPOMUSIC, 105 rue de Normandie, 92400 Coubouvoia, 1.4333 6515, Fax: 1.4333 5857, Tlx: 699635, Chmn: Pascal Jaubert, President: Pierre Jaubert, MD: Laurent Jaubert, Mktg: Alex Jaubert, Promo: Stephanie Jaubert. Distribution: Carrere.

TORPEDO PRODUCTIONS, 4 rue le Marois, 75016 Paris, 1.4651 1010, Fax: 1.4651 6880, Tlx: 613670, Dirs: Francois Berthelot, Thibaut Chatel.

TREMA, 62 rue Pierre Charron, 75008 Paris, 1.4256 0882, Fax: 1.4225 2528, President: Jacques Revaux, MDs: Alain Renaud, Regis Talar, GM: Catherine Regnier, Mktg: Laurence Zabolcki, Consultant: Claude Philippe Brunet.

TWO PAR DEUX, 24 rue Saint-Antoine, 75004 Paris, 1.4278 4003, Fax: 1.4278 8901, MD: Jean-Pierre Lenoir.

TYNA MUSIC, 37 rue des Mathurins, 75008 Paris, 1.3976 7574, Fax: 1.3976 0224, Mgr: Dominique Mouyeaux.

ULYSSE MUSIQUE, 28 rue Keller, 75011 Paris, 1.4355 2525, Fax: 1.4355 1838, Tlx: 215254, Dir: Raphael Gimenez.

UNE DEUX PLUS, 4 rue de Seze, 75009 Paris, 1.4742 2707, Fax: 1.4924 0102, Producer: Verenne Ferrari.

VIRGIN RECORDS FRANCE, 11 place des Vosges, 75004 Paris, 1.4029 0000, Fax: 1.4029 0757, President: Fabrice Nataf, F&A Dir: Michele Huiban, F&A Mgr: Luc Marot, Legal Mgr: Valerie Queenne, Mktg/Int'l Mgr: Alain Artaud-Macari, Sales Mgr: Pierre Madon, Production Mgr: Thomas Walter, Int'l Development: Mireille Roulet, Promo Mgr: Marc Marechal, Int'l Label Mgrs: Marie Sauvet, Laurent Chapeau, Gerard Beullac, Label Mgr Classical: Patrick Mouyren. Labels (lic): Beggars Banquet, 4AD, Music Memoria, Mute, Rough Trade, Single Ko, Creation, Alias Records, One Little Indian, 50 Seal Street Records, Bad Girl, Mute/France, Factory.

VOGUE RECORDS, 82 rue Robert Grandcoing, 93430 Villetaneuse, 1.4821 2500, Fax: 1.4821 2113, Tlx: 649650, President: Jean-Louis Detry, GM: Remy Roux, Development Dir: Jean Claude Gangneux, Int'l Mgr: Bob Salazar, Promo Mgr: Catherine Angelloz, Int'l Director: Edouard Brinon, A&R Dir (Int'l): Claude Ismael, Jazz Music: Giles Gallot. Labels (lic): Polar, Roulette, Savoy, Muse, SJ, Sleeping Bag, Solar, Sugar Hill, BCM, Blue Bird, Camundo Product, Cherry Red, Cotarie, Management, Crescendo, Expanded, Fire Records, Grabaciones, IIC, Little Big Apple.

VOICES (LYONS), 27 rue Gasparin, PO Box 2571, 69002 Lyons cedex, 7240 9212, Fax: 7240 2637, Tlx: 389000, Chmn: Farzam Ghaemmaghami, MD: Sylvie Riccardi, A&R Mgr: Chantal Laurent. Labels (owned): Directions, Elsa, Andre, Lucky Frency; (Lic): Destroyika, Hold Up, Fric-Frac, Collection Rencontre; Distribution: Vogue, Musidisc, Polygram, New Rose, Directions.

WALT DISNEY PRODUCTIONS, 44 avenue des Champs Elysees, 75008 Paris, 1.4420 5500/4359 0220, Fax: 1.4563 8111, Tlx: 640062, MD: Pierre Sissman, Mgr (Eur): Mathieu Lauriot Prevost.

WARNER CLASSICS, 14 avenue Albert Einstein, ZI du Coudray, 93155 Blanc Mesnil, 1.4814 5000, Fax: 1.4814 5050, Mgr: Didier Durand-Bancel, Promo/Publ Mgr: Herve Boissiere.

WARNER MUSIC FRANCE, 100 avenue du President Kennedy, 75116 Paris, 1.4430 4000, Fax: 1.4430 4045, Tlx: 649577, President: Luigi Theo Calabrese, Fin Contr: Patrick Ferry.

WEA MUSIC FRANCE, 100 avenue du President Kennedy, 75116 Paris, 1.4430 4000, Fax: 1.4430 4050, GM: Philippe Laco, Asst To Pres: Jacques Metges, Bus Affairs: Paul Boublil, Fin Contr: Marcou Riblier, Sales Mgr: Philippe Lefort, Int'l Mgr: Stephan Barret, Int'l Label Mgrs: Virginie Poustis, Ashley Pierce, A&R Mgr: Daniel Betan, Mktg Mgr: Jacques Weiss, Prod Mgr (Nat'l): Anne-Catherine Bley. Division of Warner Music France.

WELCOME, 19-21 rue Jean Goujon, 75008 Paris, 1.4075 0909, Fax: 1.4256 4907, Tlx: 651374, President: Olivier Widmaier Picasso.

YUNI PRODUCTIONS, 8 rue Saint-Marc, 75002 Paris, 1.4236 3810, Fax: 1.4236 3822, Producer: Jacques Van dem Borgh.

ZAP ZAP RECORDS, PO Box 36, 78160 Marly-Le-Roi, 1.3958 5835, Fax: 1.3916 6599, President: Philippe Loison. Distribution: Danceteria.

MUSIC PUBLISHERS

A CAPPELLA, see Diama Music.

AB PRODUCTIONS, 144 avenue du President Wilson, 93210 La Plaine-Saint-Denis, 1.4809 2001, Fax: 1.4809 8371, Tlx: 234120, President: Claude Berda, Artistic Dir: Jean Luc Azoulay.

ABILENE, 50 avenue du President Wilson, 93210 La Plaine-Saint-Denis, 1.4937 7752, Fax: 1.4937 7741, MD: M Mathieu.

ADN MUSIC, 51 rue de Paradis, 75010 Paris, 1.4022 0252, Fax: 1.4246 9628, Tlx: 280975, MD: Cyril Dohar.

AGF, see Rondor Music.

AL JARREAU, see Disques Dreyfus.

ALAIN BOUILLI EDITIONS, 20 rue de la Tremoille, 75008 Paris, 1.4720 7678, Fax: 1.4070 0565, MD: Daniel Boubill.

ALBATROS, see Diama Music.

- ALIZES, 33 rue du General Delestraint, 75016 Paris, 1.4071 0180, Fax: 1.4071 0405, PDG: Thierry Roze.
- ALL NATIONS, see Allo Music.
- ALLISON MUSIC, 140 rue Legendre, 75017 Paris, 1.4627 5862, Dir: Patrick Huard.
- ALLO MUSIC, 3-5 rue Albert de Vatimesnil, 92300 Levallois-Perret cedex, 1.4757 4918, Fax: 1.4758 6748, Tlx: 630946, MD: Alain De Ricou, Copyright Mgr: Danyla Ho-Kong-Ciat. (Owned): Allo Music, Leross Music; (Sub-pub): ATV Group, Lorimar, Private I Group, All Nations, Bowling Green/Mandina and Rocksmith; (Admin): Prophit, Fantasia, Sydney Productions, Atina, Mediartis.
- AMARAGGI, 134 rue d'Avron, 75004 Paris, 1.4348 4816, Songwriter: Tony Amaraggi, Contact: Maria Amaraggi.
- AMAZONES MUSIC, see FR Music.
- AMBRE, see French Fried Music.
- ANDRE RECORDS, see Voices.
- ANGEL, see Editions Virgin Musique.
- ANGLO PIC, 64 rue de Sevres, 92100 Boulogne-Billancourt, 1.4525 5200, Fax: 1.4525 8736, Contact: Pierre Henry.
- ANTLER, see Fregate Music.
- ANXIOUS, see BMG Music Publishing France.
- APA ARTISTES ET PRODUCTEURS ASSOCIES, 39 rue Jean Goujon, 75008 Paris, 1.4225 4652/4256 3939, Fax: 1.4074 0193, Tlx: 643948, MD: Christian de Ronseray.
- ARABELLA CATALOG, see BMG Music Publishing France.
- ARENA, 9 rue Saint-Florentin, 75008 Paris, 1.4296 0200, Fax: 1.4020 0529, Tlx: 290724, President: Alain Puglia, Int'l Mgr: Philippe Brat.
- ARGILE-CEZAME, 2 rue Flechier, 75009 Paris, 1.4878 4523, Fax: 1.4874 0144, Tlx: 660146, MD: Jean-Michel Gallois-Montbrun.
- ARISTA/CAREERS, see BMG Music Publishing France.
- ARPEGE, 14 rue de la Justice, 80204 Compegne cedex, 4423 2765, Fax: 4486 8279, MD: Mr. Le Calve.
- ART MUSIC FRANCE, 62 rue Pierre Charon, 75008 Paris, 1.4256 0882/4359 4861, Fax: 1.4225 2528, Tlx: 630170, MD: Regis Talar, A&R/Mktg Mgr: Claude Bitton, Dir: Alain Revaud.
- ARTHUR BUSTER STAHR, see Rondor Music.
- ASCOT MUSIC, see Atoll Music.
- AT LAT/MARZIQUE, see BMG Music Publishing France.
- ATALANTE, 10 rue Danremont, 75018 Paris, 1.4606 8835, Fax: 1.4264 2847, MD: Orlando.
- ATINA, see Allo Music.
- ATOLL MUSIC, 18-20 rue du Borrego, 75020 Paris, 1.4366 6922, Fax: 1.4366 5221, Tlx: 215795, President: Charles Ibgui, Asst: Martine Moscovitz. (Owned): Atoll, Ascot Music, J.J.M. (Hol). (Admin): Dessca Music, Roy Be Music.
- ATV GROUP, see Allo Music.
- AVALANCHE, Chemin Charre, 13600 Ceyreste, 4283 2040/9176 1300, Fax: 9176 2220, MDs: Alain Castagnola, Dominic Campillo, Promo Mgr: Anne Carpena.
- AVREP, 44 rue de Miromesnil, 75008 Paris, 1.4265 8780, Fax: 1.4742 9099, Tlx: 643037, MD: Pierre Alain Simon.
- BA BA BLAXI, see BMG Music Publishing France.
- BACCHANALES, 88 rue Lamarck, 75018 Paris, 1.4257 4761, Dir: Alain Pommier.
- BAILLEMENT PRODUCTIONS, 26 rue des Beaux Sites, 95390 Saint-Prix, 1.3959 3026, Fax: 1.3959 8673, MD: Lionel Baillement.
- BANG MUSIC, 41 boulevard Beaumarchais, 75003 Paris, 1.4277 8803, Fax: 1.4363 5138, Tlx: 640115, President: Gerard Bangalter.
- BASICALLY GASP, see BMG Music Publishing France.
- BELWIN MILLS, see Editions Henry Lemoine.
- BERLIN, see Editions Du Soleil Et De L'Acier.
- BIB PRODUCTIONS, see Diana Music.
- BIG BROTHERS COMPANY, 12 rue Xaintraillies, 75013 Paris, 1.4586 3410, Fax: 1.4586 4438, MD: Chloe Charbonnier.
- BIG LIFE, see BMG Music Publishing France.
- BIKAYE, see Yaba Music.
- BLACK BULL, see BMG Music Publishing France.
- BLEU BLANC ROUGE, 9 rue de Versailles, 92430 Marne-la-Coquette, 1.4741 6198, Fax: 1.4741 7805, Tlx: 203249, Chmn: Jean Kluger, President: Huguette Kluger.
- BLOCK & GILBERT, see BMG Music Publishing France.
- BLUE SILVER, see FR Music.
- BLUE-LINE, 82 rue du Faubourg Saint Martin, 75010 Paris, 1.4803 3399, Fax: 1.4803 2450, MD: Michel Vautrot, Prof Mgr: Alexandre Madelin. (Owned): Machado, Gouirand, Moutin; Main product: AC, Jazz.
- BMG MUSIC PUBLISHING FRANCE, 9 avenue Matignon, 75008 Paris, 1.4299 1900, Fax: 1.4299 1709, Tlx: 650703, GM: Stephane Berlow, Prof Mgr: Jean-Luc Roume, Copyright/Royalty Mgr: Roselyn Heskes, Copyright Asst: Lili Baker, Lic & Copyright: Monique Scherrer, Company Sec: Catherine Barry. (Owned): all BMG Music affiliates, Rideau, Rouge, RCA, Arabella Catalog; (Sub-pub): Gibb Brothers, Plangent Visions, Malaco/Muscle Shoals, Two Knight, Big Life, Block & Gilbert, Druse/Stratum, Rockaholic, Anxious, MPI, Harmony Gold, Harrison, Jodaway, Arista/Careers, Chinnichap, Inter World, Hudmar, California Phase, Liedela, Little Steven, Mike Curb, Osnat, Empire, RSP, Point, Kilaueta, At Lat/Marziqque, Basically Gasp, prob Nobilem, E'G, Ba Ba Blaxi, See The Light, Smooth Dog, Black Bull, Ganga, New Music Group, Pop'N'Roll, iSBA, La Bascute, Pop Music, Lowery, Fuzal, Handle, i Before E, Prelude/Unidisc, Swag, Nash Notes, Chuzzlewit Ditties; (Admin): Editions Laurent Voulzy, Editions Alain Souchon, Editions Bertrand Lepage, Editions Musicales Vendome, Flarenasch Music.
- BOITE A CHANSONS, Au Pied de la Montagne, 01220 Divonne les Bains, 5020 0851, Fax: 5020 0907, MD: Mr. Liotta. Main product: Choral.
- BONEY M, see Fregate Music.
- BOOMER MUSIC, see Melisse Music.
- BOURNE, see Editions Paul Beuschler.
- BOVENTOON, see FR Music.
- BOWLING GREEN/MANDINA AND ROCKSMITH, see Allo Music.
- BRAINTREE, see Rondor Music.
- BROCKMAN, see Rondor Music.
- CABLE, see Voices.
- CALEB, see Rondor Music.
- CALIFORNIA PHASE, see BMG Music Publishing France.
- CAMPBELL CONNELLY FRANCE, 5 rue Lincoln, 75008 Paris, 1.4359 0622, Fax: 1.4563 7573, Tlx: 642068, MD: Rene Boyer.
- CANALI 5 MUSIC, see Sugar Music.
- CARAVAGE, 130 rue Marius Aujan, 92300 Levallois-Perret, 1.4759 9451, Fax: 1.4759 0965, Tlx: 270105, MD: Jean-Paul Smets.
- CARAVELLE NOUVELLE EDITIONS, 35 boulevard Malessherbes, 75008 Paris, 1.4265 0893, Fax: 1.4265 1134, Tlx: 281753, Dir: Thomas Arena, Copyright/Royalty Mgr: Anna Maria Platt.
- CARRERE EDITIONS, 50 avenue du President Wilson, 93210 La Plaine-Saint-Denis, 1.4937 7752, Fax: 1.4937 7741, MD: Claude Carrere, Dir: D Cabrignac, GM: Yvan Taieb, Mgr: Angele Salvat.
- CENT POUR CENT, 10 boulevard des Batignolles, 75017 Paris, 1.4387 0413, Fax: 1.4387 0386, MD: Marc Britan.
- CHAMPION MUSIC, see Scorpion Music.
- CHAMUSIC, see French Fried Music.
- CHAPULIN, see Sugar Music.
- CHARISCOURT, see Rondor Music.
- CHESTER, see Editions Henry Lemoine.
- CHICAGO, see Rondor Music.
- CHIFFRE NEUF, 14 rue Andre del Sarte, 75018 Paris, 1.4252 1173, Fax: 1.4255 5058, Dir: Helene Bignon.
- CHINNICHAP, see BMG Music Publishing France.
- CHUZZLEWIT DITTIES, see BMG Music Publishing France.
- CMC RECORDS, 25 Passage Panoramas, PO Box 325, 75064 Paris cedex 02, 1.4026 4322, Fax: 1.4233 1631, Tlx: 215907, Contact: Claude Safty.
- COLETTE MUSIC, 24 rue de Longchamp, 75116 Paris, 1.4661 2444, Tlx: 613725, MD: Colette Plait.
- COLLECTION, see Voices.
- COLOVE MUSIC, 8 rue de l'Est, 92100 Boulogne-Billancourt, 1.4605 4321, Fax: 1.4604 3740, Contact: Ms. Moughil.
- COM'NICOLE COURTOIS HIGELIN, 13 rue de Rivoli, 75004 Paris, 1.4272 2961, Fax: 1.4272 5199, MD: Nicole Courtois, Asst: Nathalie Jeanne.
- COMPANY OF THE TWO P(I)ETERS, see French Fried Music.
- COPPELIA, 21 rue de Pondichery, 75015 Paris, 1.4567 3066, Fax: 1.4306 3026, Mgr: Jean-Philippe Oliu.
- COPYRIGHT MANAGEMENT, see French Fried Music.
- CRECELLES (JULIEN CLERC), 18 rue Papillon, 75009 Paris, 1.4723 3101, Fax: 1.4723 3472, MD: Julien Clerc.
- CREPUSCULE, see Editions Virgin Musique.
- CRITERION, see French Fried Music.
- CV SOUND MUSIC, 4 rue Moliere, 91380 Chilly-Mazarin, 1.6909 0199, Fax: 1.6909 5497, MD: Annie Vallois.
- CYBERNETIC ART, 76 boulevard Deltour, 31500 Toulouse, 6180 6257, Fax: 6154 7608, Dirs: Pascal Zenou, Frederique Bezanere.
- DANCETERIA, 222 rue Solferino, 59000 Lille, 2078 2878, Fax: 2078 2623, President: Laurent Blaha, MDs: Bertrand Blaha, Pierre Cauvelier.
- DATA ALFA, see Fregate Music.
- DAVA MUSIQUE, 48 rue de la Rochefoucauld, 75009 Paris, 1.4874 9409, Fax: 1.4878 1680, Contact: Herve Bergerat.
- DCL, see Editions Henry Lemoine.
- DESPERADO MUSIC, 22 rue Vignon, 75009 Paris, 1.4742 3189, Fax: 1.4288 4266, MD: Joel Devouges.
- DESSCA MUSIC, see Atoll Music.
- DIAMA MUSIC, 4 avenue Voiron, 93700 Drancy, 1.4830 5819, Fax: 1.4831 2460, President: Andre Hackiere, Prof Mgr: Daniel Delannoy, Affiliates: A Cappella, Bib Productions, L'Heur Maxime, Albatros.
- DIAMANT RECORDS INTERNATIONAL, 17 avenue du President Wilson, 75116 Paris, 1.4723 7919, Fax: 1.4723 0027, Pres/Dir-Gen: Mr. Belolo, Dir-Gen: Sonia Belolo, Mktg Dir: Stephane Parker, Promo Dir: Sabrina Williams, Int'l Mgr: Alan Belolo, Producer: Stephane Belolo.
- DIAPASON-HARMONIE, 9/13 rue du Colonel Pierre Avia, 75754 Paris cedex 15, 1.4662 2526, Fax: 1.4662 2533, Contact: Martine Fontanel.
- DIFFICULT, see Editions Virgin Musique.
- DIGITAL MUSIC, 1 rue Hippolyte Deslandes, 78150 Le Chesnay, 1.3955 0438, Fax: 1.3955 0438, Dir: Guy Battarel.
- DISQUES ADES, 54 rue Saint-Lazare, 95009 Paris, 1.4874 8530, Fax: 1.4285 1580, MD: Francois Grandchamps.
- DISQUES DEESSE, 11 rue Lepic, 75018 Paris, 1.4255 0900, Fax: 1.4252 6001, Tlx: 270105, President: Pierre Celie, Artistic Dirs: Michel Celie, Alain Butet.
- DISQUES DREYFUS, 26 avenue Kleber, 75116 Paris, 1.4500 7707, Fax: 1.4500 2618, Tlx: 611130, President: Francis Dreyfus, Publ Mgr: Daniele Feuillat, Copyright Mgr: Jocelyne Gilles. (Owned): Francis Dreyfus, Editions Labrador; (Sub-pub): Elvis Presley, Al Jarreau, Thriller Miller, Hiatus, Maybrow, Enja, Don Williams, Lupus, Four Knights, Emily, Paul Vance Music.
- DISQUES LORIANE, 40 rue du Ranelagh, 75016 Paris, 1.4050 1310, Fax: 1.4050 0830, President: Lise Lemaire, Dir: J J Chardeau.
- DISQUES MEYS, 10 rue Saint-Florentin, 75001 Paris, 1.4260 8505, Fax: 1.4927 9569, MD: Gerard Meys.
- DJAVAN, 77 rue Blomet, 75015 Paris, 1.4531 4144, Fax: 1.4531 1738, MD/Producer: Michel Boucarut.
- DON WILLIAMS, see Disques Dreyfus.
- DOORS, see Rondor Music.
- DRUSE/STRATUM, see BMG Music Publishing France.
- DUO, see Radio Days.
- DYAD, see Rondor Music.
- E'G, see BMG Music Publishing France.
- E3M EDITIONS MUSICALES, 3-5 rue de Solferino, 92100 Boulogne-Billancourt, 1.4609 0311, Fax: 1.4608 1327, MD: Jehol van Bay.
- EDEN ROC, see MCA/Caravelle Music France.
- EDITION DURAND, 215 rue du Faubourg Saint-Honore, 75008 Paris, 1.4289 1713, Fax: 1.4563 6291, Tlx: 649693, President: Jean-Manuel de Scarano.
- EDITION WESTBROOK, see Melisse Music.
- EDITIONS 23, 15 avenue Hoche, 75008 Paris, 1.4225 0089, Fax: 1.4225 6490, Tlx: 641478, Contact: Remy Le Moal.
- EDITIONS ADELE, 39 rue Jean Goujon, 75008 Paris, 1.6408 1030, Fax: 1.6408 0748, MD: Simone Perret.
- EDITIONS ALAIN SOUCHON, see BMG Music Publishing France.
- EDITIONS ANDORRA, see Editions Universelles.
- EDITIONS ATLAS, 89 rue de la Boetie, 75008 Paris, 1.4563 0414, Fax: 1.4561 1995, Tlx: 642481, Pres/Dir-Gen: Patrick Lemarchand, Public Relations: Pascale Dymowski.
- EDITIONS BERTRAND LEPAGE, see BMG Music Publishing France.
- EDITIONS BRETON, 3 rue Rossini, 75009 Paris, 1.4824 5364, Fax: 1.4523 1736, MD: Mme Breton. Main product: French Chansons.
- EDITIONS CARAVELLE, see MCA/Caravelle Music France.
- EDITIONS CHOUDESIN, 38 rue Jean-Mermoz, 75008 Paris, 1.4266 6297, Fax: 1.4266 6279, Dir: Andre Chevrier.
- EDITIONS CONFIDENTIELLES, see Fairand Square.
- EDITIONS DAVID PLATZ MUSIC, 37/C3 avenue Franklin Roosevelt, 75008 Paris, 1.4359 6301, Fax: 1.5463 8102, Tlx: 280316, Contact: Brigitte Bertholier-Spahn.
- EDITIONS DE PLEIN VENT, 5 rue Jean-Jaures, 07600 Vals-Les-Bains, PO Box 75 (Zip: 07600), 7594 6355, Fax: 7537 6366, Tlx: 345790 dpx, President: Jean Gibaud, Dir: Marie Helene Gibaud.
- EDITIONS DU MOULIN JOLY, 68 boulevard de Port Royal, 75005 Paris, 1.4238 0343, Fax: 1.4573 2594, Contact: Gerard Berliner.
- EDITIONS DU SOLEIL ET DE L'ACIER, 38 rue des Soeurs Macarons, 54000 Nancy, PO Box 236 (Zip: 54004), 8332 2571, Fax: 8356 9089, Tlx: 961742 code 141, President: Gerard Nguyen, Assoc: Christine Mathieu. Affiliates: Faux Pas, Berlin.
- EDITIONS E WARNER, 94 rue de la Fontaine, 75016 Paris, 1.4525 5131, Fax: 1.4527 3907, Contact: H Warner.
- EDITIONS GILLES PELLEGRINI, Brivoire de la Dame, 38360 Sassenage, 7626 7928, Fax: 7627 0534, MD: Gilles Pellegrini.
- EDITIONS HENRY LEMOINE, 24 rue Pigalle, 75009 Paris, 1.4674 0925, Fax: 1.4526 7442, Pres/Dir-Gen: Pierre Lemoine. (Owned): Editions Henry Lemoine, HL Music; (Admin): Guitar Solo, Gendai Publications, Music Sales, IMP, Hal Leonard, Chester, Wilhelm Hansen, REH, Sher Publications, DCL, Video Hot Licks, Belwin Mills.
- EDITIONS LABRADOR, see Disques Dreyfus.
- EDITIONS LAURENT VOULZY, see BMG Music Publishing France.
- EDITIONS MADURA, 2 avenue Foch, 94300 Vincennes, 1.4374 0421, Fax: 1.4374 4624, President: Eric Vincent.
- EDITIONS MUSICALES AMPLITUDE, 18 rue du Chataignier Brule, 95230 Soisy-sous-Montmorency, 1.3417 3755, Fax: 1.3417 5607, Tlx: 607573, Mgr: Jean Claudel.
- EDITIONS MUSICALES CLAUDE PASCAL, 4 rue Denis Poisson, 75017 Paris, 1.4574 4372, Fax: 1.4260 8626, Tlx: 641477, Contact: Claude Pascal.
- EDITIONS MUSICALES HACHETTE ET ASSOCIES, see Hachette Editions Musicales.
- EDITIONS MUSICALES SFORZANDO, 42 rue Laugier, 75017 Paris, 1.4267 0469, Fax: 1.4766 5329, Tlx: 260717, MD: Roger Tokarz.
- EDITIONS MUSICALES VENDOME, see BMG Music Publishing France.
- EDITIONS PAUL BEUSCHLER, 27 boulevard Beaumarchais, 75004 Paris, 1.4271 2211, Fax: 1.4272 3700, Tlx: 670877, Pres/MD: Philippe Seiller, Dir: Philippe Wuibout. (Owned): Paul Beuschler, Arpege; (Admin): Bourne.
- EDITIONS PEER-SOUTHERN, see SEMI (Societe D'Editions Musicales Internationales).
- EDITIONS PENGUIN CAFE, see Melisse Music.
- EDITIONS PLURIEL, la Planchotiere, PO Box 21, 61350 Passais la Conception, 3338 7723, Fax: 3338 8166, Dir: Jean Foucher.
- EDITIONS SALABERT, 22 rue Chauchat, 75009 Paris, 1.4624 5560, Fax: 1.4247 1756, Tlx: 649722, President: Nelly Boufathal.
- EDITIONS SEMI, see SEMI (Societe D'Editions Musicales Internationales).
- EDITIONS SITELLE, Chateaubois, 38350 La Mure-d'Isere, 7681 2395, Fax: 7630 9695, Ed/Mgr: Jean Roche.
- EDITIONS UNIVERSELLES, 52 rue du Faubourg Saint-Martin, 75010 Paris, 1.4202 2115, Dir: Yves Baquet. (Owned): Editions Andorra, Pierre Baets Editions.
- EDITIONS VIRGIN MUSIQUE, 15 place des Vosges, 75004 Paris, 1.4274 5806, Fax: 1.4274 5986, Tlx: 214455, President:

Emmanuel de Buretel, VP: Michel Duval, Asst: Lyhoa Chung, Royalties Mgr: Luigi Nocera, Prof Mgr: Marc Thonon, Asst: Alexandre Poye, Copyright: Elisabeth Cornaton, Asst: Valerie Lastenet, Accts: Ariane Thezenas, Mgr (Virgin Sound): Philippe Cohen-Sola, Asst: Laurence Derbois. (Admin): Angel, Difficult, Rockslam, Tboy-Tgirl, Rythm King, Soss, Swanyard, Soul Makossa, Riff, Satori, Patchanka, Indochine, Kelly Music, Go Discs, Crepuscule. **EDITIONS ZAGORA**, 9 rue de Versailles, 92430 Marnes-la-Coquette, 1.4741 6198, Fax: 1.4741 7805, President: Daniel Vangarde, Mgr: Christian Francois.

EDWARDS RECORDS, 58 rue du Docteur Calmette, 59320 Sequedin, 2007 5701.

ELEUTHERA, 143 boulevard Murat, 75016 Paris, 1.4050 0423, Fax: 1.4050 0424, Contact: B de Choisy.

ELSA, see Voices.

ELVIS PRESLEY, see Disques Dreyfus.

EMI MUSIC PUBLISHING, 22 rue Jasmyn, 75016 Paris, 1.4525 5200, Fax: 1.4525 8736, Tlx: 650753, MD: Olivier Huret.

EMILY, see Disques Dreyfus.

EMPIRE, see BMG Music Publishing France.

ENJA, see Disques Dreyfus.

EPIC PRODUCTION, 168 avenue Charles de Gaulle, 92522 Neuilly-sur-Seine cedex, 1.4738 0808, Fax: 1.4745 0113, Dir: Nicolas Galibert.

EPM MUSIC, 188 boulevard Voltaire, 75011 Paris, 1.4024 0103, Fax: 1.4024 0427, Tlx: 215595, Dir: Francois Dacla.

ESPERANCE, 85 rue Fondary, 75015 Paris, 1.4577 3034, Fax: 1.4579 1472, Tlx: 204018, MD: Marcel Perse, Mktg Mgr: Michel David.

ESPOIR, see Link Company.

ETHIQUE MUSIC, 84 avenue de Versailles, 75016 Paris, 1.4808 4412, Fax: 1.4520 2192, MD: Florence de Fremand.

FACTO COMMUNICATION, 2 bis rue Eugene Carriere, 75018 Paris, 1.4223 4343, Fax: 1.4264 5437, Dir: Marc Schloha, Promo: Katherine Saurat. Main product: Dance, AC, Album Rock, New Age.

FAIRAND SQUARE, 68 rue du Faubourg Montmartre, 75009 Paris, 1.4285 0128, Fax: 1.4016 1487, Tlx: 660146, President: Fabrice Absil, Chmn: Jean Luc Marre. (Owned): Fair & Square. (Admin/sub-pub): Editions Confidentielles, Nettoword Publishing.

FAMILY ORGANISATION, 54 rue d'Hauteville, 75010 Paris, 1.4246 8133, Fax: 1.4359 7670, Tlx: 642138, President: Claude Danu.

FANTASIA, see Allo Music.

FAUX PAS, see Editions Du Soler Et De L'Acier.

FEFEE MUSIC, 21 rue Lauriston, 75116 Paris, 1.4553 7968, Fax: 1.4527 0318, MD: Hugues Kirichian.

FELA, see Yaba Music.

FILMTRAX (FRANCE), 71 rue de Provence, 75009 Paris, 1.4874 1112, Fax: 1.4874 3776, Tlx: 280994, President: Francis O'Neill, GM: Claude Duviour.

FLARENASCHE MUSIC, see BMG Music Publishing France.

FNAC MUSIC PUBLISHING, 101 rue du Cherche Midi, 75006 Paris, 1.4544 8844, Fax: 1.4222 6016, President: Georges Huber, GM: Laurent Treille, Publ Mgr: Alain Laurensen, Lic Mgr: Sara Jane Richardson.

FORTIN EUROMUSIC, 4 cite Chaptal, 75009 Paris, 1.4526 3590, Fax: 1.4526 9826, Tlx: 650365, Contact: M Multrier.

FOUR KNIGHTS, see Disques Dreyfus.

FR MUSIC, 23 rue de Villiers, 92200 Neuilly-sur-Seine, 1.4757 4570, Fax: 1.4748 0161, GM: Daniele Feret. (Admin): Blue Silver, Tele Images, Boventoon, Totem Songs, Amazones Music.

FRANCINETTE EDITIONS, 47 rue Belliard, 75018 Paris, 1.4637 4036, Fax: 1.4745 3987, Prod Co-Ord: Francine Robineau.

FRANCIS DREYFUS, see Disques Dreyfus.

FRANCIS KERTEKIAN PRODUCTIONS, 18 rue de Reuilly, 75012 Paris, 1.4370 5527, Fax: 1.4370 3981, MD: Francis Kertekian, Asst: Gracieuse Coste.

FRED ALBERT, see Tilby Music.

FREGATE MUSIC, 31 chemin Bas Trou Martin, 78380 Paris, 1.4225 6060/3918 1616, Fax: 1.3082 7040, President: Charles Orioux. Affiliates: Sandra, Freiheit, Boney M, Modern Talking, Jack White, Antler, Subway, Data Alfa, Ziegel. Main product: Adult Contemporary, Jazz, Dance, Album Rock.

FREIHEIT, see Fregate Music.

FRENCH FRIED MUSIC, 38 rue de Bassano, 75008 Paris, 1.4723 5518, Fax: 1.4070 0130, Tlx: 630144, President: Eileen Chamussy, VP: Bo Goldsen, Admin Dir: Mireille Celerier. (Owned): French Fried, Chamusic, Kaki, Ambre, Les Editions du Quartier, Seven 7; Affiliates: Criterion, Copyright Management, The Espy Group, Terrace Music, Leosong (Apra), Global, The Company of the Two Pijetters.

FRENCH RIVIERA PRODUCTION ORGANISATION, 10 rue Locklaima, 06400 Cannes, 9339 2244, Fax: 9298 6890, President: Patrick Chobert, Chmn: Roger Foy, MD: Olivier Bouteille. (Owned): Francinette.

FRESSIAS, see MCA/Caravelle Music France.

FUZALU, see BMG Music Publishing France.

G.M., 8 rue Lincoln, 75008 Paris, 1.4563 9037, Fax: 1.4563 7624, MD: Georges Mary.

GANGA, see BMG Music Publishing France.

GARAGE SONGS, see MCA/Caravelle Music France.

GAUMONT MUSIQUE, 24 rue Jacques Dulud, 92200 Neuilly-sur-Seine, 1.4738 2000, Fax: 1.4738 2017, Tlx: 610162, MD: Nicolas Seydoux.

GENDAI PUBLICATIONS, see Editions Henry Lemoine.

GEORGES CHATELAIN, 85 boulevard Pasteur, 75015 Paris, 1.4321 4140.

GIBB BROTHERS, see BMG Music Publishing France.

GIPIY, see Sepam-milan.

GLOBAL, see French Fried Music.

GLOBO RECORDS (FRANCE), 47 rue de Liege, 75008 Paris, 1.4387 6580/6579, Fax: 1.4294 2883, Tlx: 280348, MD: Joel Bruno Leibovitz.

GO DISCS, see Editions Virgin Music.

GOLD SOVEREIGN, see Tilby Music.

GOLDOR, see Hachette Editions Musicales.

GOUIRAND, see Blue-Line.

GREEN FOREVER, see Sugar Music.

GROUPE NACASH, see Tilby Music.

GUILDE INTERNATIONALE DU DISQUE, 22 rue Cocherel, 27001 Evreux, 3229 2949, Fax: 3239 6593, MD: Mr. Guillard.

GUITAR SOLO, see Editions Henry Lemoine.

GYPSY BOY, see Rondor Music.

HACHETTE EDITIONS MUSICALES, 26 bis rue Francois I, 75008 Paris, 1.4723 1405, Fax: 1.4723.8813, Tlx: 630809, MD: Jacques Wolfsohn. (Owned): Editions Musicales Hachette et Associes, TDP No. 1, Tremplin, Goldor.

HAL LEONARD, see Editions Henry Lemoine.

HANDLE, see BMG Music Publishing France.

HARMONIA MUNDI (FRANCE), 108 rue Vieille du Temple, 75008 Paris, 1.4277 2447, Fax: 1.4277 3129, MD: Mr. Coutaz. Admin centre for Harmonia Mundi France.

HARMONIA MUNDI (FRANCE/ARLES), Petite Route de St. Gilles, Mal de Vert, 13200 Arles, 9049 9049, Fax: 9049 9614, MD: Mr. Coutaz.

HARMONY GOLD, see BMG Music Publishing France.

HARRISON, see BMG Music Publishing France.

HELLO THERE, see Tilby Music.

HEXAGONE, 5 rue Lincoln, 75008 Paris, 1.4359 0622, Fax: 1.4563 7573, Tlx: 642068, MD: Nicole Boyer.

HIATUS, see Disques Dreyfus.

HL MUSIC, see Editions Henry Lemoine.

HOOD MUSIC, 72 rue Jean-Pierre Timbaud, 75011 Paris, 1.4338 0162, Fax: 1.4355 4647, Mgr: Etienne Dooh, Dir: Marie-Line Descroix, Promo: Pascal Kocher.

HOPPI-MESA, 36 rue des Cevennes, 75015 Paris, 1.4557 2636, Fax: 1.4557 8003, Tlx: 206544, MD: Jacques Marbehan.

HORTENSIA, 46 rue de Douai, 75009 Paris, 1.4874 5264, MD: Robert Mezbourian.

HUDMAR, see BMG Music Publishing France.

HYPHEN, 130 rue Marius Aude, 92300 Levallois-Perret, 1.4759 9451, Fax: 1.4759 0965, MD: Jean-Paul Smets, Mktg Mgr: Eve Belus, Spec Prod Mgr: Sophie Smets. (Owned): Hyphen; Main product: Jazz, Gold/Oldies, New Age, Classical, World Music, Folk.

I BEFORE E, see BMG Music Publishing France.

IBACH MUSIC, 40 rue de l'Est, 92100 Boulogne-Billancourt, 1.4603 2361, Fax: 1.4712 0434, MD: Meme Ibach.

IBEROAMERICA, see Sepam-milan.

ID MUSIC, 34 rue Kleber, PO Box 54, 92400 Courbevoie, 1.4788 2592, Fax: 1.4768 7428, Tlx: 613711, President: Philippe C Aegon, Dir: Thierry Chevrier de Choudens. Main product: Jazz, Reggae, Classical, Album Rock, New Age.

IDA, see Sepam-milan.

ILLUSTRATION, 16 boulevard Vital Bouhot, 92200 Neuilly-sur-Seine, 4637 5019, Fax: 4640 0434, Tlx: 612561.

IMP, see Editions Henry Lemoine.

INDOCHINE, see Editions Virgin Music.

INDUSTRIAL MUSIC, see Metisse Music.

INTER WORLD, see BMG Music Publishing France.

ISBA, see BMG Music Publishing France.

ISLAND MUSIC (FRANCE), 10 rue du Colisee, 75008 Paris, 1.4562 0600, Fax: 1.4563 7182, MD: Frederic Pascal, Dir: Robin Leproux. Distributed by Polygram France.

J GARZON, 13 rue de l'Echiquier, 75010 Paris, 1.4770 3915, Fax: 1.4246 5076, MD: Luis Garzon.

J.J.M., see Atoll Music.

JACK WHITE, see Fregate Music.

JASPERILLA, see Rondor Music.

JAYBEL, 56 rue d'Auteuil, 75016 Paris, 1.4224 7674, Fax: 1.4520 8397, MDs: Jay Alanski, Marc Lebel.

JOBERT, see Sedim.

JODAWAY, see BMG Music Publishing France.

JOGGING TO THE BAR, 34 avenue des Champs Elysees, 75008 Paris, 1.4277 0219/4255 6856, MD: Evelyne Tognazzoni.

JOKER, 20 rue du General Guilhem, 75011 Paris, 1.4338 7978, Fax: 1.4021 7491, MD: Cedric Naimi, GM: Olivier Roger.

JULIE DE CARNEILHAN, see Radio Days.

KAKI RECORDS, 38 rue de Bassano, 75008 Paris, 1.4723 5518, Fax: 1.4070 0130, MD: Philippe Brat. Main product: EHR, Adult Contemporary, Dance.

KANGOURROO, 2275 avenue Roger Salengro, 92370 Chaville, 1.4709 3314, Fax: 1.4750 6619, Mgr: Jean-Louis Witas, Mgr: Jean Marnay. (Owned): Vitas.

KELLY MUSIC, see Editions Virgin Music.

KILAUEA, see BMG Music Publishing France.

KLUGER MUSIQUE, 137 boulevard Malesherbes, 75017 Paris, 1.4267 9989, Fax: 1.4266 1049, Pres/Dir-Gen: Roland Kluger.

KNOLLWOOD, see Tilby Music.

L'ALT MUSIQUE, 7 place Chazette, 69001 Lyons, 7839 6581, Fax: 7200 0314, Dir: Jean-Pierre Lafoy.

L'HEUR MAXIME, see Diana Music.

LA BASCULE, see BMG Music Publishing France.

LA SECONDE, see Radio Days.

LA SOULE, see Radio Days.

LABALME, 1-3 passage Thiere, 75011 Paris, 1.4806 6167, Fax: 1.4021 9072, Dir: Jacques Labalme, Asst: Nadine Conoir.

LABEL BLEU/VILLE D'AMIENS, PO Box 0631, MCA, 80000 Amiens, 2297 7979, Fax: 2292 5217, Dir: Michel Orier.

LE BLE EN HERBE, see Radio Days.

LE SOUFFLE D'OR, PO Box 3, 05300 Barret le Bas, 9265 2499, Fax: 9265 0879, Dir: Yves Michel. Publisher/Distributor; Main product: New Age.

LEOSONG, see French Fried Music.

LEROS MUSIC, see Allo Music.

LES EDITIONS DE PARIS, 5 rue Lincoln, 75008 Paris, 1.4359 0622, Fax: 1.4563 7573, Tlx: 642068, MD: Fernande Fay.

LES EDITIONS DU KARDAN, 27 rue du Maire-Haag, 67800 Strasbourg-Bischheim, 8883 4134, Fax: 8822 3594, Ed: Karin Nickerl, Sales Dir: Daniel Franck.

LES EDITIONS DU QUARTIER, see French Fried Music.

LES EDITIONS PRODUCTIONS GEORGES MARY, 5 rue d'Artois, 75008 Paris, 1.4225 9816, Fax: 1.4256 2835, Tlx: 642504, MD: Georges Mary.

LET & CO MUSIC, 10 rue Montmartre, 75001 Paris, 1.4221 3757, Fax: 1.4221 3756, MD: Colette de Wouters, Prod Asst: Karim Gassama. Main product: Jazz, Black (R&B), World Music.

LIDO MELODIES, 12 rue de Penthièvre, 75008 Paris, 1.4525 9520, MD: Christian Bonneau.

LIEBSTONE MUSIC, see Metisse Music.

LIEDELA, see BMG Music Publishing France.

LINGUAPHONE, 12 rue Lincoln, Centre Nobelia, 75008 Paris, 1.4359 3074.

LINK COMPANY, 50 rue des Francs Bourgeois, 75003 Paris, 1.4029 9111, Fax: 1.4029 9030, Tlx: 212755, Chmn: Christiane Terbeche, MD: Dany Terbeche. (Owned): Espoir.

LITTLE STEVEN, see BMG Music Publishing France.

LORIMAR, see Allo Music.

LOUIS GASTE, 5 rue du Bois de Boulogne, 75116 Paris, 1.4500 5353, Fax: 1.4501 2223, Tlx: 642197, MD: Louis Baste.

LOUVRE MUSIQUE PRODUCTIONS, 20 quai du Louvre, 75010 Paris, 1.4236 9232, Fax: 1.4824 9232, MD: Georges Petillaud. Main product: Jazz, Soundtracks.

LOWERY, see BMG Music Publishing France.

LUPUS, see Disques Dreyfus.

MACHADO, see Blue-Line.

MAGE MUSIC, 44 rue de Miromesnil, 75008 Paris, 1.4265 8780, Fax: 1.4742 9099, Tlx: 643037, MDs: Armenie & Martine Marouani.

MAJESTIC, 24 rue Nungesser et Coli, 75016 Paris, 1.4605 2870, Contact: Jacques Canetti.

MALACO/MUSCLE SHOALS, see BMG Music Publishing France.

MARILU MUSIC, 6 rue Raspail, 92300 Levallois-Perret, 1.4739 7052, Fax: 1.4270 6744, Contact: Eric Dieulesaint.

MAX ESCHIG, 48 rue de Rome, 75008 Paris, 1.4522 6664, Fax: 1.4522 8650, Contact: Mr. Mobilion.

MAXI MUSIC, 99 rue de Couronnes, 75020 Paris, 1.4797 2703, MD: Bernard Martin.

MAYFLOWER, see Disques Dreyfus.

MAZERES DISQUES, 5 rue Leboutoux, 75017 Paris, 1.4380 7070, Fax: 1.4622 6588, Pres/Dir-Gen: Serge Mazeret.

MC PRODUCTION, 27 rue Taitbout, 75009 Paris, 1.4523 3045, Fax: 1.4523 5810, Dir-Gen: Marie-Christine Merlin.

MCA/CARAVELLE MUSIC FRANCE

35 Boulevard Malesherbes, 75008 Paris, 1.4265 0893, Fax: 1.4265 1134, MD: Thomas Arena, Copyright Dir: Tanja Neumann. (Owned): Editions Caravelle, Paris Tour Eiffel, Eden Roc, Fressias. (Admin): Island Music France, Garage Songs.

MEDIARTIS, see Allo Music.

MELANIE MELODIES, 58 boulevard Edgar Quinet, 75014 Paris, 1.4322 0398, MD: Alain Mallet.

MELODY NELSON, 40 rue Francois I, 75008 Paris, 1.4723 5580, Fax: 1.4720 1586, MD: Cristian Dulcy.

MERCENAIRES GRAPHIQUES, 57 quai des Moulins, 34200 Sete, 6748 9800, Fax: 6748 9288, Comm Mgr: Bernard Munoz.

MERIDIAN, see Peermusic (France).

METISSE MUSIC, 88 rue de Lourmel, 75015 Paris, 1.4059 0473, Fax: 1.4575 0480, President: Petra Gehrmann. (Co-owned): Edition Westbrook, Owl Records; (Admin): Skaynes Music, Liebstone Music, Moorea Music, Wintrup Musik, Opal Music, Private Music, Boomer Music, Editions Penguin Cafe, Termidor, Industrial Music; Main product: Adult Contemporary, Jazz, Dance.

METROPOLITAINES, 11 rue de Provence, 75009 Paris, 1.4246 6033, Contact: Pierre Ribert.

MICROCODIL, 186 boulevard Periere, 75017 Paris, 1.4574 0999, Fax: 1.4574 1451, MD: Marie-France Gabarre.

MIKE CURB, see BMG Music Publishing France.

MILAN, see Sepam-milan.

MILK SHAKE, 41 boulevard de Stalingrad, 94400 Vitry-sur-Seine, 1.4682 6598, Fax: 1.4680 9798, MD: Pierre Benazeth, Dir: Frederic Esteban.

MK, Ecrammeville, 14710 Trevieres, 3122 5553, MD: Monique Kruehel.

MN PRODUCTIONS, 34 avenue des Champs Elysees, 75008 Paris, 1.4562 4212, Fax: 1.4225 6997, MD: Marc Nouchy.

MODERN TALKING, see Fregate Music.

MONICA, 5 rue Lincoln, 75008 Paris, 1.4359 0622, Fax: 1.4563 7573, Tlx: 642068, Contact: Rene Boyer.

MONKEY BUSINESS, 39 rue Volta, 75003 Paris, 1.4804 9039, Fax: 1.4277 9000, GM: Graham Henderson.

MONTEL DOMINIQUE, Logiciel Bertioz, 30350 Lédignan, 6683 4653, Fax: 6683 4709, Dir: Dominique Montel.

MONTARNASSE 2000, 22 rue Jasmyn, 75016 Paris, 1.4525 5200, Fax: 1.4525 8736, Contact: Claude Duviour.

MOOREA MUSIC, see Metisse Music
MORY KANTE, see Yaba Music.
MOUTIN, see Blue-Line.
MPI, see BMG Music Publishing France.
MR BONES, see Tilby Music.
MUSIC ACTION RECORDS, 102 avenue des Champs Elysees, 75008 Paris, PO Box 276 (Zip: 75265 Cedex 06), 1.4624 6795, Tlx: 203045, GM: Jean Clouet
MUSIC SALES, see Editions Henry Lemoine.
MUSIC SERVICES, 12 rue Jonquoy, 75014 Paris, 1.4044 7000, Fax: 1 4044 9223, GM: Marie-Christine Szokolczai.
MUSICAL FORCE, 6 rue Guynemer, 93200 Saint-Denis, 1.4829 3639, Fax: 1 4023 0146, Tlx: 649061, Dir: Jean-Stephane Berger.
MUSICOM (FRANCE), 25 rue d'Hauteville, 75010 Paris, 1.4770 1573, Fax: 1.4247 1405, Tlx 282352, President: Joseph Behar.
MUSIQUE CINEMA TELEVISION, 12 rue Augereau, 75007 Paris, 1.4551 4608, Fax: 1.4753 7264, MD: Rene Taquet.
MUSIQUE DES ANGES, 4 square Carpeaux, 75018 Paris, 1.4226 0995, Dirs: Michel Jonasz, Roland Katz, Anne Foret.
MUSIQUES DES ANGES, 26 quai de Champignol, 94210 La Varenne-Sainte-Hilaire, 1.4028 4051, Fax: 1.4026 2224, Art Dir: Roland Katz
MUTE RECORDS (FRANCE), 61 rue de Belleville, 75019 Paris, 1.4245 1414, Fax: 1 4245 9111, Tlx: 210434, Dir: Jacques Attali, Bruno Rossignol
NASH NOTES, see BMG Music Publishing France
NETTOVERBOARD PUBLISHING, see Fairand Square.
NEW MUSIC GROUP, see BMG Music Publishing France
NEW ROSE, 7 rue Pierre Sarrazin, 75006 Paris, 1.4354 2890, Fax: 1.4633 2612, Tlx: 205420, Dir: Patrick Mathe, Patrick Blain
OCEAN BLUE, see Sugar Music
OPAL MUSIC, see Metisse Music
OPUS 111, 12 rue Copreaux, 75015 Paris, 1.4566 4045, Fax: 1.4306 6901, Label Mgr: Yolanta Skura.
OSCAR MUSIC, 20 rue Duperré, 75009 Paris, 1.4874 8454, Fax: 1.4016 4338, MD: Daniel Savides.
OSNAT, see BMG Music Publishing France
OWL RECORDS, see Metisse Music
PARIS TOUR EIFFEL, see MCA/Caravelle Music France.
PATCHANKA, see Editions Virgin Musique
PAUL BEUSCHER, see Editions Paul Beuscher
PAUL VANCE MUSIC, see Disques Dreyfus
Peermusic, see SEMI (Societe D'Editions Musicales Internationales)
PEMA MUSIC, 5 rue Denis-Poisson, 75017 Paris, 1.4574 4372/4285 5300, MD: Patrick Aumigny
PIANO BLANC, 44 rue de Miromesnil, 75008 Paris, 1.4265 8780, Fax: 1.4265 2850, Contact: Martine Marouani, MD: Collette Sanson
PIANOLA MUSIC/SNEAK PREVIEW, 9 rue Jean Mermoz, 75008 Paris, 1.4256 0985, Fax: 1.4225 5558, President: Philippe Renaux, Mgr: Marie Helene Gontan
PIERRE BAETZ EDITIONS, see Editions Universelles
PIERRE BENSUSAN MUSIQUE, 182 rue Cardinet, 75017 Paris, 1.4229 3195, Fax: 1.4228 9148, President: Pierre Bensusan
PIERRE VERANY RECORDS, PO Box 206, 13607 Aix-En-Provence cedex, 4223 1229, Fax: 4296 3029, MD: Pierre Verany, Catalogue (owned) Vogue Nouvelles Editions. (Owned) Vogue Nouvelles Editions
PLANGENT VISIONS, see BMG Music Publishing France.
POINT, see BMG Music Publishing France
POLYGRAM FRANCE, 10 rue du Colisée, 75008 Paris, 1.4562 0600, Fax: 1.4563 7182, MD: Robin Leproux (Owned), Island Music
POP MUSIC, see BMG Music Publishing France
POP'N'ROLL, see BMG Music Publishing France
POPOLICO MUSIC, 5 rue Denis Poisson, 75017 Paris, 1.4285 5200, Contact: V. Andre.
PRELUDE/JUNIDISC, see BMG Music Publishing France
PRESENCE, 33 rue du Faubourg Saint-Martin, 75010 Paris, 1.4040 0471, MD: Francis Baxler
PRIVATE I GROUP, see Allo Music
PRIVATE MUSIC, see Metisse Music
PROB NOBLEM, see BMG Music Publishing France
PRODUCTION EDITION MARTINEZ, 59 boulevard Exelmans, 75016 Paris, 1.4651 0629, Fax: 1.4651 0235, Tlx: 649232, President: Claude Martinez, Comm Mktg Dir: Patrick Verdier
PRODUCTIONS ALLELUIA, 10 rue Saint-Florentin, 75001 Paris, 1.4260 8505, Fax: 1.4927 9569, Contact: Gerard Meys
PRODUCTIONS CLAUDE CARRERE, 27 rue de Surenne, 75008 Paris, 1.4268 1300, Fax: 1.4266 5811, President: Claude Carrere.
PROPHIL, see Allo Music
QUENOTTE, 86 rue Haxo, 75020 Paris, 1.4363 9519, Fax: 1.4363 4641, MD: Jacky Reggan
QUINZE TRENTE MUSIC, 18 rue Thiboumery, 75015 Paris, 1.4530 2288, Fax: 1.4531 0491, MD: Daniel Perreau
RADIO DAYS, 100 rue de Sevres, 92100 Boulogne, 4603 0177, Fax: 4825 8617, Chmn/MD: Marie-Christine de Montbrial, Dir: Michel Fricchet (Owned): La Soule, La Seconde, Duo, Le Ble en Herbe, Julie de Carneilhan; Main product: Film Music
RADIO MUSIC FRANCE, 22 rue Bayard, 75008 Paris, 1.4720 4364, Fax: 1.4720 1438, Tlx: 610518, MD: Ray van Cant, Copyright Mgr: Marie-Christine Willaume
RADIO PROGRAMMES-MAJESTIC, 24 rue Nungesser et Coli, 75016 Paris, 1.4605 3649, Fax: 1.4605 4717, Dir: Jacques Canetti

RAMSES, 11 rue Jean de Beauvais, 75005 Paris, 1.4329 7506, Fax: 1.4325 3214, MD: Jean Louis Rizet.
RAYBIRD, see Rondor Music.
RCA, see BMG Music Publishing France
RDC RECORDS, 43 rue de la Roquette, 75011 Paris, 1.4805 4191/4370, Fax: 1.4805 4482, Contact: Frank Hagege.
REH, see Editions Henry Lemoine.
RENCONTRE, see Voices
RIDEAU ROUGE, 9 avenue de Matignon, c/o BMG, 75008 Paris, 1.4299 1900, Fax: 1.4299 1709, Contact: B Brunet.
RIFF, see Editions Virgin Musique.
ROADMOVIES, see Sepam-milan.
ROBERT BIALEK CONSEILS, 19 rue Monsigny, 75002 Paris, 1.4742 7585, Fax: 1.4007 0022, MD: Robert Bialek.
ROBIN SONG, see Peermusic (France).
ROCKAHOLIC, see BMG Music Publishing France.
ROCKSLAM, see Editions Virgin Musique.
ROLAND KLUGER MUSIC, 15 rue d'Astorg, 75008 Paris, 1.4266 6364, Fax: 1.4266 1049, MD: Roland Kluger.
RONDOR MUSIC, 32 rue Etienne Marcel, 75002 Paris, 1.4026 1814, Fax: 1.4236 0731, MD: Halit Uman, Copyright: Nigel Burlinson, Asst: L. Ligaudan. Affiliates: AGF, Braintree, Chariscourt, Straitjacket, Brockman, Chicago, Willin' David, Dyad, Jasperilla, Take Out, Raybird, Gypsy Boy, Caleb, Arthur Buster Stahr, Stuck On, Silver Cab, Tangerine, Doors.
ROUGE, see BMG Music Publishing France.
ROY BE MUSIC, see Atoll Music.
RSP, see BMG Music Publishing France.
RYTHM KING, see Editions Virgin Musique.
SADIM, 151 avenue Jean-Jaures, 75019 Paris, 1.4200 2900, Fax: 1.4803 1980, MD: Patrick Marcland (Owned): Transatlantiques.
SAINTE FRANCAISE DE MUSICOLOGIE, see Sedim.
SALABERT, see Sedim.
SANDRA, see Fregate Music.
SATORI, see Editions Virgin Musique.
SBK SONGS FRANCE, 22 rue Jasmin, 75016 Paris, 1.4525 5200, Fax: 1.4525 8735, Tlx: 650753, Contact: Pierre Henry.
SCORPIO MUSIC, 5 rue Clement Marot, 75008 Paris, 1.4720 4395, Fax: 1.4952 0378, GM: Daniel Belolo, Writer: Henri Belolo. (Owned): Champion Music; Main product: Dance.
SEDIM, 151 avenue Jean-Jaures, 75019 Paris, 1.4200 2900, Fax: 1.4803 1980, Tlx: 283155 etra, President: Patrick Marcland. (Rep): Salabert, Jobert, Transatlantiques, Sainte Francaise de Musicologie.
SEE THE LIGHT, see BMG Music Publishing France.

SEMI (SOCIETE D'EDITIONS MUSICALES INTERNATIONALES)

5 rue Lincoln, 75008 Paris, 1.4359 0622, Fax: 1.4563 7573, MD: Rene Boyer, Creative Dir./Art Dir: Claude Henri. (Sub-publ): Campbell Connelly, Hexagone, Monica, Meridian, Robin Song, SEMI-Meridian, Tro-Essex, SEMI-Patricia.

SEMI-MERIDIAN, see SEMI (Societe D'Editions Musicales Internationales)
SEMI-PATRICIA, see SEMI (Societe D'Editions Musicales Internationales)
SEPM-MILAN, 165 boulevard de Valmy, 92706 Colombes cedex, 1.4786 3619, Fax: 1.4786 3631, MD: Emmanuel Chamboredon. (Owned): Milan, (Sub-Pub): Roadmovies, Gipsy; (Admin): Iberoamerica, IDA; Main product: jazz, Argentinian contemporary music
SERENITY MUSIC, 61 rue de Belleville, 75019 Paris, 1.4245 1414/4878 2650, Fax: 1.4245 9111, Mgrs: Jacques Attali, Dominique Daffos, Alain Pons.
SERGEANT MAJOR COMPAGNIE, 32 boulevard de Strasbourg, 75010 Paris, 1.4824 1386, Fax: 1.4241 2807, MD: Jacques Dejean, Main product: Adult Contemporary, Dance, New Age
SERP, 6 rue de Beaune, 75007 Paris, 1.4261 0973, Fax: 1.4261 1625, MD: Mr. Pollober.
SEVEN 7, see French Fried Music.
SHER PUBLICATIONS, see Editions Henry Lemoine.
SIDONIE, 31 rue Francois I, 75008 Paris, 1.4723 3101, Fax: 1.4720 1586, Tlx: 649530, Contact: Mr. Fougere.
SILEX, 41 bis Quai de la Loire, 75019 Paris, PO Box 68 (Zip: Riom 63202), 1.4245 2121, Fax: 1.4239 5704, Contact: Philippe Krumm.
SILVER CAB, see Rondor Music
SIPUCI BLUE, see Sugar Music.
SKAYNES MUSIC, see Metisse Music.
SMOOTH DOG, see BMG Music Publishing France.
SONIMAGE, 4 rue de Beynes Cressay, 78640 Neauphle-le-Chateau, 1.3489 0307, Fax: 1.3489 8490, MD: Robert Viger.
SONODISC, 85 rue Fondary, 75015 Paris, 1.4577 3034, Fax: 1.4579 1472, Tlx: 204018, President: Marcel Perse, MD: Michel David, Main product: African, Ethnic, World Music.
SONY MUSIC PUBLISHING, 1-3 rue du Chateau, 92522 Neuilly-sur-Seine, 1.4738 0722/0808, Fax: 1.4638 0997/4745 6463, Dirs: Michel Boulanger, Nicolas Galibert.
SOSS, see Editions Virgin Musique
SOUL MAKOSSA, see Editions Virgin Musique.
SPAN, 59 avenue Victor Hugo, 75116 Paris, 1.3054 4646, Fax: 1.3054 5612, Tlx: 695067, MD: Herve Louchet.
STERLING, see Tilby Music.
STRADAVARIA, 33 rue des Petits Champs, 75001 Paris, 1.4286 8602, Fax: 1.4286 8550, MD: Paul Banes
STRAITJACKET, see Rondor Music
STUCK ON, see Rondor Music
STUDIO SM, 3 rue Nicolas Chuquet, 75017 Paris, 1.4267 0137,

Fax: 1.4766 3968, Tlx: 649884 sm disc, Dir: Martine Andersen.
SUBWAY, see Fregate Music.
SUGAR MUSIC (FRANCE), 90 avenue des Champs Elysees, 75008 Paris, 1.4562 3549, Fax: 1.4225 6062, GM: Marcel Marouani. (Sub-pub): Sugar Music, Canali 5 Music, Chapulin, Sipuci Blue/Ocean Blue/Green Forever.
SUNSET FRANCE, 66 rue de l'Est, 92100 Boulogne-Billancourt, 1.4603 7681, Fax: 1.4825 9770, Tlx: 283155, Dir: Alain Normand.
SWAG, see BMG Music Publishing France.
SWANYARD, see Editions Virgin Musique.
SYDNEY PRODUCTIONS, see Allo Music.
SYSMO, 136 rue Champignonnet, 75018 Paris, 1.4255 6462, Fax: 1.4289 3362, MD: Dominique Samarq.
TABATA MUSIC, 307 route Nationale, 78810 Feucherolles, 1.3054 4646, Fax: 1.3054 5612, Tlx: 695067, MD: Michel Fedoroff, Contact: Ms. Chalmandrier.
TAKE OUT, see Rondor Music.
TANGERINE, see Rondor Music.
TBOYTGIRL, see Editions Virgin Musique.
TDP NO. 1, see Hachette Editions Musicales.
TECHNISONOR, 10 rue Magellan, 75008 Paris, 1.4720 9660, Fax: 1.4070 9432, Tlx: 610035, Contact: J Gauthier.
TELE IMAGES, see FR Music.
TERMIDOR, see Metisse Music.
TERRACE MUSIC, see French Fried Music.
THE ESPY GROUP, see French Fried Music.
THE YOUNG GODS, 283 rue du Faubourg Saint-Antoine, 75011 Paris, 1.4348 5151, Fax: 1.4348 5753, Mgr: Patrick Jammes.
THRILLER MILLER, see Disques Dreyfus.
THURSDAY, see Tilby Music.
TILBY MUSIC, 121 rue de Longchamps, 92200 Neuilly-sur-Seine, 1.4747 6909, Tlx: 250303, Owners: Rolande Bismuth, Jean Jacques Tilche. (Sub-pub): Fred Alther, Hello There, Sterling, Mr Bones, Gold Sovereign, Knollwood, Thursday; (Admin): Groupe Nacash.
TOP RECORDS INTERNATIONAL, 17 avenue du President Wilson, 75116 Paris, 1.4723 7919/4720 4057, Fax: 1.4723 0027, Pres/Dir-Gen: Mr. Belolo, Dir-Gen: Sonia Belolo, Int'l Mgr: Alan Belolo.
TOPOMUSIC, 105 rue de Normandie, 92400 Coubevoie, 1.4333 6515, Fax: 1.4333 5857, Tlx: 699635, Chmn: Pascal Jaubert, President: Pierre Jaubert, MD: Laurent Jaubert, Mktg: Alex Jaubert, Promo: Stephanie Jaubert.
TOTEM SONGS, see FR Music.
TRANSATLANTIQUES, see Sedim.
TREMPLIN, see Hachette Editions Musicales.
TRIANGLE INTERNATIONAL, 3-5 rue de Solferino, 92100 Boulogne-Billancourt, 1.4608 0303, Fax: 1.4608 2330, Tlx: 633026.
TRISTAR MUSIC, 59 boulevard de la Saussage, 92200 Neuilly-sur-Seine, 1.4637 4841, Fax: 1.4747 1051, Tlx: 613564, Mgr: Valentin Coupeau.
TRO-ESSEX, see Peermusic (France).
TWO KNIGHT, see BMG Music Publishing France.
TWO PAR DEUX, 24 rue Saint-Antoine, 75004 Paris, 1.4278 4003, Fax: 1.4278 8901, MD: Jean-Pierre Lenoir.
ULYSSE MUSIQUE, 28 rue Keller, 75011 Paris, 1.4355 2525, Fax: 1.4355 1838, Tlx: 215254, MD: Raphael Gimenez.
UPCP, Maison des Ruralies, PO Box 1, 79230 Vouille, 4975 6771, Fax: 4975 8207, MD: Jean-Pierre Tissiane. Music publisher; Also Animation.
VAL PRODUCTIONS, 59 boulevard de la Saussage, 92200 Neuilly-sur-Seine, 1.4637 4841, Fax: 1.4747 1051, Tlx: 613564, Mgr: Valentin Coupeau.
VERSCHUREN, 28 avenue du Gal Leclerc, 60500 Chantilly, 1.4607 8905, Contact: A Verschuren.
VIDEO HOT LICKS, see Editions Henry Lemoine.
VITAS, see Kangourou.
VOGUE NOUVELLES EDITIONS, see Pierre Verany Records.
VOGUE RECORDS, 82 rue Robert Grandcoing, 93430 Villetaneuse, 1.4821 2500, Fax: 1.4821 2113, Tlx: 649650, President: Jean-Louis Detry, GM: Remy Roux.
VOICES (LYONS), 27 rue Gasparin, PO Box 2571, 69002 Lyons cedex, 7240 9212, Fax: 7240 2637, Tlx: 389000, Chmn: Farzam Ghaemmaghami, MD: Sylvie Riccardi. (Owned): Andre Records, Cabbie, Elsa, Collection, Rencontre.
WALT DISNEY PRODUCTIONS, 44 avenue des Champs Elysees, 75008 Paris, 1.4420 5500/4359 0220, Fax: 1.4563 8111, Tlx: 640062, MD: Pierre Sissman, Mgr: Monique Moulin.
WARNER CHAPPELL FRANCE, 12 rue de Penthièvre, 75008 Paris, 1.4266 4042, Fax: 1.4266 2917, President: Jean Davoust.
WILHELM HANSEN, see Editions Henry Lemoine.
WILLIN' DAVID, see Rondor Music.
WINTRUP MUSIK, see Metisse Music.
YABA MUSIC, 18 rue de Reuilly, 75012 Paris, 1.4348 4277, Fax: 1.4348 5722, President: Francis Kertekian, MD: Anne Marie Blanc, A&R: Guesnola Thepault, Copyright Mgr: Jean Pierre Lautier. (Owned): Fela, Mory Kante; (Admin): Alizes Music, Zazou, Bikaye.
ZAZOU, see Yaba Music.
ZEAX PRODUCTIONS, 25 rue Henri Monnier, 75009 Paris, 1.4285 1333, Fax: 1.4280 2935, MD: Leon Desclozeaux.
ZIEGEL, see Fregate Music. VIDEO PROGRAM SUPPLIERS & BUYERS
CARRERE VIDEO, 27 rue de Surenne, 75008 Paris, 1.4268 1300, Fax: 1.4268 0172, Tlx: 283591, President: Claude Carrere, MD: Rene Guittion.
CIC VIDEO, 1 bis rue du Petit Clamart, 78142 Velizy

CISAC SECRETARIAT GENERAL, 11 rue Keppler, 75116 Paris, 1.4720 5937/2252, Fax: 1.4723 0266, Tlx: 649940, President: Ariel Ramirez, VP: Milo Dor, Sec-Gen: Jean Alexis Ziegler. International confederation of composers.

CNRL, PO Box 2311, 13232 Marseille cedex 2, 9191 5547, President: Jacques Soncin.

CONSEIL SUPERIEUR DE L'AUDIOVISUEL (CSA), 39-43 quai André Citroën, Tours Mirabeau, 75015 Paris, 1.4058 3800, Fax: 1.4599 0006, President: Jacques Boutet, Consultant: Roland Faure.

CSDEM, 62 rue Blanche, 75009 Paris, 1.4874 0929, Fax: 1.4281 1987, President: Rene Boyer, VPs: Pierre Henry, Jean Davoust, Sec-Gen: Nelly Querol. Music publishers association.

CSPJ, 31-33 rue du Louvre, 75002 Paris, 1.4508 8671, Fax: 1.4508 1558, MD: Mr. Guncua. Journalists association.

FCM, 141 rue La Fayette, 75010 Paris, 1.4878 5060, Fax: 1.4596 0697, Dirs: Jean-Francois Michel, Bruno Rony. Organization to support French music.

FEDERATION NATIONALE DE LA PRESSE, 6 bis rue Gabriel Laumain, 75010 Paris, 1.4824 9830, Fax: 1.4246 1403, President: M Publ.

FEPS, 17 rue Brey, 75017 Paris, 1.4267 1305, Fax: 1.4380 9929, President: Roland Bertin. European federation of events organisers.

FERL, Les Quatre Reines, PO Box 42, 04300 Forcalquier, 9276 1058, Contact: F Bourchardeau.

FESTIVAL INTERNATIONAL DE TELEVISION, 2a Boulevard de Moulins 2a, Ctr Presse, 98000 Monaco, 9330 4227, Fax: 9315 0154, MD: Jacqueline Berti. Organizers of the Int'l Television Festival in Monaco; 1992: 29 January-14 February.

FIAD, 43 boulevard des Malherbes, 75008 Paris, 1.4266 0532, Fax: 1.4266 9692, President: Luc Hemelaer, GM: Gilbert Gregoire. International federation of film distributors associations.

FIF, 71 rue du Faubourg Saint Honore, 75008 Paris, 1.4266 9220, Fax: 1.4266 6885, Tlx: 650705, Dir: Pierre Viot. Organizer of the Cannes International Film Festival.

FNAMU, 41 bis quai de la Loire, 75019 Paris, 1.4300 1718, MD: Catherine Lesage. National music association.

FNRL, 17 boulevard de la Seine, 92000 Nanterre, 1.4721 0541, Fax: 1.4721 0571, Dir: Claude Palmer. Radio association.

FOND DE SOUTIEN DES VARIETES, 20 bis rue Daru, 75008 Paris, 1.4380 0142, Fax: 1.4622 4975, Dirs: Philippe Dampenon, Jean Michel Boris. Concert promoters association.

GRF (GROUPE DES RADIODIFFUSEURS FRANCAISES), 99 avenue Aristide de Briand, PO Box 514, 92542 Montrouge cedex, 1.4655 8155, Fax: 1.4655 8174, President: Xavier Gouyou-Beauchamps.

GRIF (GROUPEMENT DES RADIO INDEPENDENTS EN FRANCE), Avenue d'Evian, c/o Radio Tholion, 74200 Thonon-les-bains, 5026 6970, Fax: 5071 5444, President: Bernard Vivien, Sec-Gen: Francois Gresset, Trustees: Marc Zenou, Jean-Michel Sauvage. Association of independent local radio broadcasters.

IMAGINA, 4 avenue d'Europe, 94366 Bry sur Marne Cedex, 1.4983 2684, Fax: 1.4983 3185, Organizer: Yves Louchet. Audiovisual & computer-graphics trade fair and exhibition in Monte-Carlo; 1992: January 29-January 31.

INA, 4 avenue de l'Europe, 94366 Bry-Sur-Marne cedex, 1.4983 2000, Fax: 1.4875 8081, Tlx: 670296, Dirs: Jacques Katan, Henri Dasse. National audiovisual association.

MIDEM/MIPCOM ORGANISATION, 179 avenue Victor Hugo, 75116 Paris, 1.4505 1403, Fax: 1.4755 9122, Tlx: 630547, CEO: Xavier Roy, Prog Mgr: Olivia Thomas, Int'l Sales Dir: Christophe Blum, Sales Mgr (Int'l): Anne Marie Parent. Organizers of the annual MIDEM festival for music publishers, record producers, recording studios, equipment manufacturers, radio stations and video music production companies. MIDEM 1992 will take place 19-23 January in the Palais des Festivals in Cannes, France.

SACD, 11 bis rue Ballu, 75442 Paris cedex 09, 1.4280 6065, Fax: 1.4526 7428, Tlx: 643355 drama, President: Claude Santelli, Vice-Chmn: Mr. Youri, Dir: Hubert Astier, Contact: Nina Companeze, Jean-Michel Damase.

SACEM, 225 avenue Charles de Gaulle, 92521 Neuilly-sur-Seine cedex, 1.4715 4715, Fax: 1.4745 1294, Tlx: 630312, President: Gerard Calvi, Dir-Gen: Jean Loup Tourneur, Dirs: Thigry Desurmont, Elie-Pierre Rochiccioli, Mgr (Media Rel): Eric Dufaire. Rights society of authors, composers, and publishers in the music industry.

SCPP, 159 avenue Charles de Gaulle, 92200 Neuilly-sur-Seine, 1.4640 1000, Fax: 1.4640 1317, Tlx: 613752, Dirs: Monique Laurent, Rene Guitton. Rights society of record companies.

SDRM, 225 avenue Charles de Gaulle, 92521 Neuilly-sur-Seine cedex, 1.4747 5650, Fax: 1.4745 1294, Tlx: 630312 musica, Dir-Gen: Jacques Molnet, Dir: Jacques Demarny. Mechanical rights society.

SIRTI, 6 rue Alain Chartier, 75015 Paris, 1.4524 0321, President: Eric Hauville.

SNAAL, 17 rue Brey, 75017 Paris, 1.4267 1305, Fax: 1.4380 9929, President: Roland Bertin. Artistic agents national association.

SNAC, 80 rue Taitbout, 75009 Paris, 1.4874 9630, Dirs: Jean Drejac, Antoine Duhamel. National association of authors and composers.

SNEP, 48 boulevard des Batignolles, 75017 Paris, 1.4387 2266, Fax: 1.4387 1079, Tlx: 281890 snephon, President: Patrick Zelink, GM: Bertrand Delcros, VPs: Patrice Fichet, Gilles

Paire, Gilbert Ohayon, Bernard Carbonez, Henri de Bodinat, Rene Guitton, Jean Grandchamp Des Raux, Treasurer: Nicolas Trite, Treas Asst: Jacques Campet, PR: Marie-Christine Fontenil. SNEP (Syndicat National de l'Édition Phonographique) is a national organization for record producers, music publishers, music video producers. Member of CNPF & Federation Nationale de la Musique. Makes up the nation representation of the IFPI, and other international music organizations.

SNRP (SYNDICAT NATIONAL DES RADIO PRIVEES), 18 allée des Biches, 78680 Epone, 1.3095 8787, Fax: 1.3090 2156, President: Claude Bayard, VPs: Franck Toubiana, Marc Zenou, Trustee: Jean-Michel Sauvage. National syndicate of private radio stations.

SPEDIAM, 8 rue de Bremonter, 75017 Paris, 1.4227 4309, Fax: 1.4054 8619, Dir: Maurice Husson. Rights society of musical and dance artists.

SPFF, 1 rue Garnier, 92200 Neuilly-sur-Seine, 1.4641 0585, Fax: 1.4641 0583, President: Charles Talar, Dir-Gen: Francois Wellebrouck, Rights society of authors and composers in the theatre industry. Rights society for independent record producers, including copyright on records and music-videos.

SPRE, 36 avenue Matignon, 75008 Paris, 1.4289 0787/4561 4609, Fax: 1.4561 1614, Dirs: Monique Laurent, Francois Wellebrouck, Francois Nowak, Francois Parrot. Copyright & royalties protection.

SYNDICAT DES ARTISTES MUSIENS, 14-16 rue des Lilas, 75019 Paris, 1.4240 5588, Fax: 1.4240 9020, Dir: Pierre Allemand. Musicians union.

SYNDICAT DES DISQUAIRES DE FRANCE, 10-12 rue Rodier, 75009 Paris, 1.4029 9111, Fax: 1.6945 1181, President: James Moreau.

PUBLIC RELATIONS & RECORD PROMOTION

AGONE ORGANISATION, 33 rue de l'Arcade, 75008 Paris, 1.4742 1400, Fax: 1.4542 8048, Contact: Jean-Patrick Teysaire.

ALAIN PONS PROMOTION, 23-25 rue Jean Jacques Rousseau, 75001 Paris, 1.4026 5901, Fax: 1.4026 6107, Dir: Alain Pons.

AMAPROMO, 39 rue Volta, 75003 Paris, 1.4277 5500, Fax: 1.4277 9000, MD: Albert Amar. Promotion company of artists, radio & TV.

ART MAC, 54 rue d'Hauteville, 75010 Paris, 1.4246 7455, Fax: 1.4246 1778, Dir-Gen: Jean-Pierre Carriau, MD: Fabrice Laurent. Television and radio promotion and public relations.

B'TOV MUSIC, 24 rue Pasteur, 92800 Puteaux, 1.4901 9636, Fax: 1.4901 9521, Dir: Francky Samama.

BELIER CONSEIL, 40 quai de Dion Bouton, 92800 Puteaux, 1.4693 3333, Fax: 1.4693 3334, Dirs: Christiane Quenard, Jacques Henocq.

BODO-LATRAVERSE, 7 rue Debelleyme, 75003 Paris, 1.4276 0696, Fax: 1.4272 4292, MDs: Michele Latraverse, Jocelyne Bodo. Concerts & theatre PR.

BRIGITTE BERTHELOT, 8 rue du Bel Air, 92190 Meudon, 1.4626 3206, Fax: 1.4651 0331/6880, Asst: Veronique Delroisse.

CENTRALE DES ARTS DE LA SCENE, 24-28 rue Henri Poincare, 75020 Paris, 1.4030 1111, Fax: 1.4030 0063, Dir-Gen: Thierry Nossin, GM: Pascale Randon, Comm Mgr: Marie Liamedo, Artistic Mgr: Veronique Toux.

CJR COMMUNICATION, 62 avenue de Wagram, 75017 Paris, 1.4763 3188, Fax: 1.4766 8068, Pres/Dir-Gen: Claude Roulleau.

COM'NICOLE COURTOIS HIGELIN, 13 rue de Rivoli, 75004 Paris, 1.4272 2961, Fax: 1.4272 5199, MD: Nicole Courtois, Asst: Nathalie Jeanne. Clients: Arthur H, Festival de Jazz d'Amiens, Jacques Higelin, Doudou N'Diaye Rose, Casino de Paris.

COULEURS SUR PARIS, 188 boulevard Voltaire, 75011 Paris, 1.4024 2062, Fax: 1.4024 0427, Contact: Martine Houadec, Marie Pechal.

DECLIC COMMUNICATIONS, 45 rue de Belleville, 75020 Paris, 1.4203 1111, Fax: 1.4206 8690, Art Dir: Philippe Gaillard.

DIAL, PO Box 200, 92185 Antony cedex, 1.4096 0744, Fax: 1.4096 9420, Tlx: 632549, Chmn/CEO: Dennis Boyer, Contr: Robert Chabance. Direct marketing company.

DIAMANT RECORDS INTERNATIONAL, 17 avenue du President Wilson, 75116 Paris, 1.4723 7919, Fax: 1.4723 0027, Pres/Dir-Gen: Mr. Belolo, Dir-Gen: Sonia Belolo, Producer: Stephane Belolo, Int'l Mgr: Alan Belolo, Mktg Dir: Stephane Parker, Promo Dir: Sabrina Williams.

DISC O'FIL PROMOTION, 83 rue du Chateau, 92513 Boulogne-Billancourt cedex, 1.4604 9494, Fax: 1.4909 0622, MD: Mr. Baumann.

DLB, 24 rue Saint-Antoine, 75004 Paris, 1.4278 4003, Fax: 1.4278 8901, MD: Dominique Bordes, Artistic Dir: Jean-Pierre Lenoir, Promo: Claude Bernath.

DM CONSEIL, 36 rue des Cevennes, 75015 Paris, 1.4557 2636, Fax: 1.4557 8003, Contact: Daniel Margules, Martine Moreau.

DOMINIQUE SEGAL, 19 rue Marboeuf, 75008 Paris, 1.4720 3434, Fax: 1.4720 9508, MD: Dominique Segal.

EURL SERENA WOOLF, 17 rue de la Republique, 78100 Saint-Germain-en-Laye, 1.3973 4051, Fax: 1.3973 4062, MD: Serena Woolf. Marketing, promotion & PR in the classical music field.

FAIRPLAY PROMOTION, 68 rue du Faubourg Montmartre, 75009 Paris, 1.4285 0128, Fax: 1.4016 1467, Tlx: 660146, President: Fabrice Absil, Chmn: Jean Luc Marre. French branch of DMC (Disco Mix Club) and promotion of overseas labels.

FRANCE INTERNATIONAL PROMOTION, 52 rue Michael Ange, 75016 Paris, 1.4651 2259, Fax: 1.4651 6327, Contact: Katia-Jean Paul Laleu.

FREDERIC HENRY COMMUNICATION, 84 rue Lamarck, 75018 Paris, 1.4223 4246, Fax: 1.4223 0606, President: Frederic Henry, Dir: D'jo Dufeil. Recent clients: Cartoon Creations, Faziolo Piano, World Culture Association, Made In France (rock-festival), Salut! (magazine), etc.

FRENCH RIVIERA PRODUCTION ORGANISATION, 10 rue Lycklama, 06400 Cannes, 9339 2244, Fax: 9298 6890, President: Patrick Chobert, Chmn: Roger Foy, MD: Olivier Bouteille.

GILL PAQUET ORGANISATION, 20 rue Clement Marot, 75008 Paris, 1.4720 1717, Fax: 1.4952 0351, President: Gill Paquet, MDs: Catherine Batner, Anne Marie Aleman.

GREGOIRE COLARD, 8 rue Bourcier, 75885 Paris cedex 18, 1.4038 3847.

HOPi-MESA, 36 rue des Cevennes, 75015 Paris, 1.4557 2636, Fax: 1.4557 8003, Tlx: 206544, MD: Jacques Marbehan.

JACKY GAILLARD, 39 bis rue Andre Tessier, 94120 Fontenay-sous-Bois, 1.4394 9025, Fax: 1.4394 9016, Dir: Eric Andre.

LAFONT DOMINIQUE, 68 rue Henri Regault, 92210 Saint-Cloud, 1.4602 3404.

MARS INTERNATIONAL, 6 boulevard de Strasbourg, 75010 Paris, 1.4202 3917, Fax: 1.4206 6806, Tlx: 213577, President: Jean-Francois Miller, Sales Mgr (Int'l): Sylvie Canal. Int'l market for performing arts, music business & communications.

PROFUSION, 19 boulevard des Nations Unies, 92190 Meudon, 1.4623 1111, Fax: 1.4623 1415, Tlx: 632359, President: Bernard Ladurantie, MD: Michel Le Guyader de Srees.

PROMO ONE, Avenue du Capitain Galaner, 4450, 93585 Saint-Ouen cedex, 1.4948 6245/6020, Fax: 1.4948 6246, MD: Philippe Delon.

RIF COMMUNICATION, 102 avenue des Champs Elysées, 75008 Paris, 1.4545 9466/4539 5217, Fax: 1.4539 0673, Contact: Jimmy Gallier.

ROBERT TOUTAN RELATIONS PUBLIQUES, 4 rue Rembrandt, 75008 Paris, 1.4256 0001, Fax: 1.4256 2950, MD: Robert Toutan.

RVB, 3 rue Valadon, 75007 Paris, 1.4551 0334, Fax: 1.4359 7283, Contact: Serge Taviltzki, Jean Pierre Agnelet, Christine Pavlas.

SALAMMBO, 71 rue Pajol, 75018 Paris, 1.4205 6452, Fax: 1.4205 6433, MD: Isabelle Lemann.

SCP, 22 bis rue Bayard, 75008 Paris, 1.4070 4070, Fax: 1.4070 4411, Dir: Stephans Duhamel, PR: Sophie Siepca. PR/promo division of RTL.

SEE LANCE, 5 avenue du Parc, 95033 Cergy-Pontoise, 1.3425 3372, Fax: 1.3425 3220.

SEGUI PROMOTION, 188 boulevard Voltaire, 75011 Paris, 1.4024 0284, Fax: 1.4024 0427, Contact: Francoise Segui.

SUITE 1024, 21 de la Fontaine au Roi, 75011 Paris, 1.4338 1024, Fax: 1.4338 4262, Contact: Patrick Robin.

TETES D'AFFICHE, 3-5 rue de Solferino, 92100 Boulogne-Billancourt, 1.4640 0210, MDs: Stan Witold, Michele Sebbag.

TOP TEN, 22 avenue Friedland, 75008 Paris, 1.4359 8569, Fax: 1.4289 0357, MD: Charles Orioux.

VIVIANE PRIOU AGENCY, 60 rue Saint-Sabin, 75011 Paris, 1.4021 8125, Fax: 1.4806 3509, MD: Viviane Priou. Recent clients include: Sony Music (Jazz & Video Depts), Warner Chappell, Verabra.

VIVIANE SICNASI PROMOTION, 28 avenue Marceau, 75008 Paris, 1.4723 6336, Fax: 1.4723 8385, Mgr: Viviane Sicnasi.

VOICES (LYONS), 27 rue Gasparin, PO Box 2571, 69002 Lyons cedex, 7240 9212, Fax: 7240 2637, Tlx: 389000, Chmn: Farzam Ghaemmaghami, Promo Mgr: Sylvie Riccardi.

YANOU COLLART, 3 rue Francois I, 75008 Paris, 1.4225 2416/4868, Fax: 1.4225 5618, MD: Yanou Collart.

YIN & YANG, 165 boulevard de la Vilette, 75010 Paris, 1.4910 0430, MD: Stephan Barret.

COMPACT DISC MASTERING & REPLICATING PLANTS

AUDIO PLUS, 20 avenue d'Ivry, 75013 Paris, 1.4585 1599, Fax: 1.4586 6386, Tlx: 201197, President: Serge Doubine.

CDV (COMPAGNIE DE DEPOTS SOUS VIDE), 3 avenue ces Ormeaux, 78180 Montigny-Le Bretonneux, 1.3057 5730, Fax: 1.3057 9122, Tlx: 669689, Contact: Pierre Antoine Berthold.

CNAI, 256 rue Marcadet, 75018 Paris, 1.4229 2461, Fax: 1.4229 3598, Dirs: Herve Molla Vignerot, J-C Thuel Chassaing. CD Manufacturing; Annual cap: 500,000; Min order: 1,000.

DISQUES LIBET, 26 rue Carnot, 76700 Harfleur, 3545 8160, Contact: Guy Libet.

LOR-DISC, Zone d'Activite, 88470 Saint-Michel-Sur-Meurthe, 2958 4070, Fax: 2958 3656, Tlx: 960798 Iordisc, Chmn: Roger Comeau, Prod Mgr: Patrick Guillemint, Int'l Relations: Laurent Rippe, Contact: Nathalie Guillemont. CD, CD-V, CDi, CD ROM, LD; Annual capacity: 10 m.; Minimum order: 1,000; Sales office: 4 place de la Concorde, 75008 Paris, 1.4266 3843, Fax: 1.4266 3845.

MPO DISQUES, Lorgerie Averton, 53700 Villaines-La-Juhel, 4308 3600, Fax: 4303 7933, Tlx: 721432, Presidents: Pierre & Monique de Poix, Comm Dir: Bruno d'Orcheval. Paris of-

Office: 195 avenue Charles de Gaulle, 92200 Neuilly-sur-Seine, 1.4722 2000, Fax: 1.4722 6077.
PDO (FRANCE) SA, 43 avenue Marceau, 75116 Paris, 1.4070 1123, Fax: 1.4070 1126, Tlx: 640905, MD: Edmond Lang, Comm Dirs: Genia Brauman, Regis Poubelle.
PIERRE CORBY PUBLICCONTACT, 8 rue de Babylone, 75007 Paris, 1.4222 3232, Fax: 1.4549 2365, Mgr: Michelle Mortier.
SOCIETE NOUVELLE AREACEM (SNA), PO Box 1, 61190 Tourouvre, 3325 0613, Fax: 3325 7606, Tlx: 171015, President: Philippe Pierrard, MDs: Michel Denieul, Olivier Nosny, CD, CDV, CD-ROM & CD-I. Sales office: 76 rue Duhesme, 75018 Paris, 1.4257 9497, Fax: 1.4262 2544. Daily cap: 7" 100k; LP 30k, CD 200k; Booklets & Sleeves 200k.
VOICES (LYONS), 27 rue Gasparin, PO Box 2571, 69002 Lyons cedex, 7240 9212, Fax: 7240 2637, Tlx: 389000, Chmn: Farzam Ghaemmaghami. Agent for Digital Press Hellas (Greece).

PLATING, MASTERING & PRESSING PLANTS

CABANA MUSIC, 95 rue Roger Francois, 94700 Maisons Alfort, 4376 7837, MD: Gilles Cabana.
CDV (COMPAGNIE DE DEPOTS SOUS VIDE), 3 avenue des Ormeaux, 78180 Montigny-Le-Bretonneux, 1.3057 5730, Fax: 1.3057 9122, Tlx: 689689, Contact: Pierre Antoine Berthold.
DIGIPRESS, 18 rue Bailey, 14050 Caen, 3147 2500, Fax: 3147 2501, President: Jean Ledieu, VP: Marc Delfassieux, Mktg Dir: John Mathews, Prod Mgr: Franck Murray.
DIGIPRO FRANCE, 110 rue de la Boetie, 75008 Paris, 1.4256 0186, Fax: 1.4289 4308, MD: Jacques Krischer. Digital/analogue mastering.
DIGITAL SERVICES, 11 rue Andre-Antoine, 75018 Paris, 1.4254 3350, Fax: 1.4223 1253, Contact: Pierre Bouriot. Digital mastering.
DISCO FRANCE, PO Box 32, 28260 Saussay, 3741 9277, Fax: 3741 4596, MD: Jean Berge.
DISQUES LIBET, 26 rue Carnot, 76700 Harfleur, 3545 8160, Contact: Guy Libet.
DYAM MUSIC, 8 rue Gustave Dore, 75017 Paris, 1.4227 0313, Fax: 1.4622 7621, MD: Yves Delaunay.
GAM INTERNATIONAL/CHIC STUDIO, Avenue d'Haussez, 38500 Voiron, PO Box 85 (Zip: 38500), 7605 6385, Fax: 7665 6649, MD: Raphael Fernandez, Planning: Cathy Tasca.
LOR-DISC, Zone d'Activite, 88470 Saint-Michel-Sur-Meurthe, 2958 4070, Fax: 2958 3656, Tlx: 960798 Iordisc, Chmn: Roger Commeau, Prod Mgr: Patrick Guilleminot, Int'l Relations: Laurent Rippel, Contact: Nathalie Guilleminot.
MIX-IT, 33-35 rue Saint-Sebastien, 75011 Paris, 1.4700 4495, Fax: 1.4355 6239, MD: Charles Hurbier, Chief Eng: Jean Labbe, Eng: Philippe Sevin.
MPO DISQUES, Lingerie Averton, 53700 Villaines-La-Juhel, 4308 3600, Fax: 4303 7933, Tlx: 721432, President: Pierre & Monique de Poix, Comm Dir: Bruno d'Orcheval. Paris office: 195 avenue Charles de Gaulle, 92200 Neuilly-sur-Seine, 1.4722 2000, Fax: 1.4722 6077.
OMEGA, 3 rue Deserte, 67000 Strasbourg, 8832 4776, Fax: 8875 5961, MD: Francis Adam.
PARELIES, 101 rue de Javel, 75015 Paris, 1.4575 0744, Fax: 1.4058 1633, MD: Francois Terrazoni. Mastering.
PIERRE CORBY PUBLICCONTACT, 8 rue de Babylone, 75007 Paris, 1.4222 3232, Fax: 1.4549 2365, Mgr: Michelle Mortier.
QUARANTE QUATRE.UN (44.1), 97 boulevard Magenta, 75010 Paris, 1.4246 0186, Fax: 1.4246 2048, Contact: Paul Henri Wagner.
SATVA, 44 rue Pierre Joseph Proudhon, 78800 Houilles, 3968 6095, Fax: 3968 2890, Dir: Claude Hamelin.
SOCAL, 8 rue Lavoisier, 91430 Igny, 6985 3497, Fax: 6985 3471, Tlx: 693945, MD: Jean-Louis Bourget.
SOCIETE NOUVELLE AREACEM (SNA), PO Box 1, 61190 Tourouvre, 3325 0613, Fax: 3325 7606, Tlx: 171015, President: Philippe Pierrard, MD: Michel Denieul.
STEREOPHONC, 94/98 rue Haxo, 75020 Paris, 1.4362 6332, Fax: 1.4031 1266, MD: Thierry Delongas.
STUDIO MALFROY, PO Box 124, 40103 Dax cedex, 5874 3171, Fax: 5874 1647, MD: Jean Malfroy. Video tape duplication.
T.R.M., 8 rue des Acacias, 75017 Paris, 1.4766 9103, Fax: 1.4380 5193, MD: Thierry Rateau.
TELETRONIC BERTELSMANN, 44-46 rue de la Bienfaisance, 75008 Paris, 1.4563 6707, Fax: 1.4359 6673, Tlx: 642141, MD: Hertha Bornholdt.
VOICES (LYONS), 27 rue Gasparin, PO Box 2571, 69002 Lyons cedex, 7240 9212, Fax: 7240 2637, Tlx: 389000, Chmn: Farzam Ghaemmaghami, MD: Sylvie Riccardi.

TAPE CUSTOM DUPLICATORS

AGENCE TAM-TAM, 5 place Fernand Rey, 69001 Lyons, 7830 4920, Fax: 7829 6608, MD: Jean-Pierre Kilian, Sales Dir:

The listings contained in this publication are based solely upon information supplied to Billboard as of presstime. All information is checked for accuracy as of that time. However, Billboard is not responsible for changes in management or any other related business associations that may supersede the listings contained herein.

Gabrielle Poncelin de Raucou, Studio Dir: Fred Boudenon. Cassette duplication, annual cap: 20,000; Min order: 30.
AUDIO PLUS, 20 avenue d'Ivry, 75013 Paris, 1.4585 1599, Fax: 1.4586 6386, Tlx: 201197, President: Serge Doubine.
CABANA MUSIC, 95 rue Roger Francois, 94700 Maisons Alfort, 4376 7837, MD: Gilles Cabana.
CDV (COMPAGNIE DE DEPOTS SOUS VIDE), 3 avenue des Ormeaux, 78180 Montigny-Le-Bretonneux, 1.3057 5730, Fax: 1.3057 9122, Tlx: 689689, Contact: Pierre Antoine Berthold.
CNAI, 256 rue Marcadet, 75018 Paris, 1.4229 2461, Fax: 1.4229 3598, Dirs: Herve Molla Vigneron, J-C Thuel Chassaingne. Audio cassette duplication; Annual cap: 3 m.; Min order: 500.
COLOR CITY SON, 77-79 rue Pierre Brosolette, 93160 Noisy-Le-Grand, 1.4592 9010, Fax: 1.4305 2966, Tlx: 232762, MD: Didier Jacques.
DISCO FRANCE, PO Box 32, 28260 Saussay, 3741 9277, Fax: 3741 4596, MD: Jean Berge.
DUPLICOLOR, 36 rue Thiers, 94130 Nogent-Sur-Marne, 1.4877 3070, Fax: 1.4877 0106, MD: Geraro Laguette.
DUPLITAPE, 30/32 rue Salvador Allende, 95876 Bezons, 3076 2059, Fax: 3076 2989, Dirs: Victor Aleksander, Roger Boussugue, Son Nguyen.
EMI FRANCE, 2 rue Emile Pathe, 78400 Chatou, 1.3071 9200, Fax: 1.3071 3606, MD: Mr. Lervere.
FRANCE CASSETTE, 20 rue Gay Lussac, 94430 Chennevières sur Marnes, 1.4594 2162, Fax: 1.4594 7462, Tlx: 262098, MD: Michel Charmont.
GAM INTERNATIONAL/CHIC STUDIO, Avenue d'Haussez, 38500 Voiron, PO Box 85 (Zip: 38500), 7605 6385, Fax: 7665 6649, MD: Raphael Fernandez, Planning: Cathy Tasca.
GAM INTERNATIONAL/SONIDO, Avenue d'Haussez, 38500 Voiron, PO Box 85 (Zip: 38500), 7605 6385, Fax: 7685 6649, Mgr: Marc Brunet, Planning: Cathy Tasca. Audio cassette duplication, annual cap: 150,000; Min order: 300; Agent broker for Versadyne (duplication equipment), AGFA (blank tape).
KB CASSETTE, 307 route Nationale, 78810 Feucherolles, 3054 4015, Fax: 3054 5023, Tlx: 698910, MD: Patrick Roy.
LOR-DISC, Zone d'Activite, 88470 Saint-Michel-Sur-Meurthe, 2958 4070, Fax: 2958 3656, Tlx: 960798 Iordisc, Chmn: Roger Commeau, Prod Mgr: Patrick Guilleminot, Int'l Relations: Laurent Rippel, Contact: Nathalie Guilleminot.
LYNX DUPLICATION, 116 avenue Aristide Briande, 93150 Blanc-Mesnil, 1.4865 7994, Fax: 1.4867 9470, MD: Gilles Cabana.
MPO DISQUES, Lingerie Averton, 53700 Villaines-La-Juhel, 4308 3600, Fax: 4303 7933, Tlx: 721432, Presidents: Pierre & Monique de Poix, Comm Dir: Bruno d'Orcheval. Paris office: 195 avenue Charles de Gaulle, 92200 Neuilly-sur-Seine, 1.4722 2000, Fax: 1.4722 6077.
PICO 7, 25 rue du Mont Thabor, 75001 Paris, 1.4927 9292, Fax: 1.4927 0617, MD: Jean-Luc Delorme.
PIERRE CORBY PUBLICCONTACT, 8 rue de Babylone, 75007 Paris, 1.4222 3232, Fax: 1.4549 2365, MD: Pierre Corby, Mgr: Michelle Mortier.
SATVA, 44 rue Pierre Joseph Proudhon, 78800 Houilles, 3968 6095, Fax: 3968 2890, MD: Claude Hamelin.
SOCAL, 8 rue Lavoisier, 91430 Igny, 6985 3497, Fax: 6985 3471, Tlx: 693945, MD: Jean-Louis Bourget. Audio & video tape duplication.
SOCIETE NOUVELLE AREACEM (SNA), PO Box 1, 61190 Tourouvre, 3325 0613, Fax: 3325 7606, Tlx: 171015, President: Philippe Pierrard, MD: Michel Denieul.
STEREOPHONC, 94/98 rue Haxo, 75020 Paris, 1.4362 6332, Fax: 1.4031 1266, MD: Thierry Delongas.
STUDIO MALFROY, PO Box 124, 40103 Dax cedex, 5874 3171, Fax: 5874 1647, MD: Jean Malfroy. Video tape duplication.
T.R.M., 8 rue des Acacias, 75017 Paris, 1.4766 9103, Fax: 1.4380 5193, MD: Thierry Rateau.
TELETRONIC BERTELSMANN, 44-46 rue de la Bienfaisance, 75008 Paris, 1.4563 6707, Fax: 1.4359 6673, Tlx: 642141, MD: Hertha Bornholdt.
VOICES (LYONS), 27 rue Gasparin, PO Box 2571, 69002 Lyons cedex, 7240 9212, Fax: 7240 2637, Tlx: 389000, Chmn: Farzam Ghaemmaghami, MD: Sylvie Riccardi.

CASSETTES REELS & PARTS, JEWEL BOX MANUFACTURERS

LFP, PO Box 4 Louvigne de Bais, 35680 Bais, 9949 0070, Fax: 9949 0781, Tlx: 950309, Dirs: Alain Roland, Alain Pigeon.
NETSTAL FRANCE, Allée du Clos des Charmes, 77400 Collegien, 1.6017 7410, Fax: 1.9017 8728, Tlx: 691977.

PRINTING, PACKAGING & LABELS

ADOLARC, 10 rue Vauvenargues, 75018 Paris, 1.4254 0400, Fax: 1.4262 7410, President: J-M Delaye, Fin Contr: Claude Daboudet, Dir: Jacques Auble.
ALPA FILM, 18 rue Pasteur, 94800 Villejuif, 1.4677 8085, Fax: 1.4678 1838, Tlx: 263481, MDs: Albert Pascual, Daniele Bourdekas.
CABANA MUSIC, 95 rue Roger Francois, 94700 Maisons Alfort, 4376 7837, MD: Gilles Cabana.
CENTRALE DES ARTS DE LA SCENE, 24-28 rue Henri Poincare, 75020 Paris, 1.4030 1111, Fax: 1.4030 0063, Dir-Gen: Thierry Nossin, GM: Pascale Randon, Comm Mgr: Marie Llamado, Artistic Mgr: Veronique Toux.
COLOR CITY SON, 77-79 rue Pierre Brosolette, 93160 Noisy-

Le-Grand, 1.4592 9010, Fax: 1.4305 2966, Tlx: 232762, MD: Didier Jacques.
DS AUDIO, Ferme de la Liegue, 27490 Ecardenville-Sur-Eure, 3253 5211, Fax: 3252 0837, MD: Didier Simon.
DUPLICOLOR, 36 rue Thiers, 94130 Nogent-Sur-Marne, 1.4877 3070, Fax: 1.4877 0106, MD: Gerard Laguette.
DUPLITAPE, 30/32 rue Salvador Allende, 95876 Bezons, 3076 2059, Fax: 3076 2989, Dirs: Victor Aleksander, Roger Boussugue, Son Nguyen.
EMI FRANCE, 2 rue Emile Pathe, 78400 Chatou, 1.3071 9200, Fax: 1.3071 3606, MD: Mr. Lervere.
FRANCE CASSETTE, 20 rue Gay Lussac, 94430 Chennevières sur Marnes, 1.4594 2162, Fax: 1.4594 7462, Tlx: 262098, MD: Michel Charmont.
GD IMPRIMERIE, 78 rue Jouffroy, 75017 Paris, 1.4764 9191, Fax: 1.4764 9185, MD: Gerard Dahan.
GLORY, 7 rue Louis Armand, 92602 Asnières, 1.4790 6231, Fax: 1.4790 6231, MDs: Frederic Bussiere, Jacques Lesueur.
IMPRIMERIE GROUDENEZ & JOLY, 19 rue des Saints-Peres, 75006 Paris, 1.4260 3737, Fax: 1.4015 9572, Dirs: Mr. Groudenez, Pierre Leroux.
JAT ARTS GRAPHIQUES, 41 rue Paul Bert, 92100 Boulogne-Billancourt, 1.4825 8484, Fax: 1.4603 7531, Dirs: Alain Texier, Claude Watelle, Monique Legris.
KB CASSETTE, 307 route Nationale, 78810 Feucherolles, 3054 4015, Fax: 3054 5023, Tlx: 698910, MD: Patrick Roy.
MPO DISQUES, Lingerie Averton, 53700 Villaines-La-Juhel, 4308 3600, Fax: 4303 7933, Tlx: 721432, Presidents: Pierre & Monique de Poix.
PDO (FRANCE) SA, 43 avenue Marceau, 75116 Paris, 1.4070 1123, Fax: 1.4070 1126, Tlx: 640905, MD: Edmond Lang, Com Dir: Genia Brauman, Regis Poubelle.
PICO 7, 25 rue du Mont Thabor, 75001 Paris, 1.4927 9292, Fax: 1.4927 0617, MD: Jean-Luc Delorme.
PIERRE CORBY PUBLICCONTACT, 8 rue de Babylone, 75007 Paris, 1.4222 3232, Fax: 1.4549 2365, Mgr: Michelle Mortier. Printing & packaging services.
STEREOPHONC, 94/98 rue Haxo, 75020 Paris, 1.4362 6332, Fax: 1.4031 1266, MD: Thierry Delongas.
T.R.M., 8 rue des Acacias, 75017 Paris, 1.4766 9103, Fax: 1.4380 5193, MD: Thierry Rateau.
TELETRONIC BERTELSMANN, 44-46 rue de la Bienfaisance, 75008 Paris, 1.4563 6707, Fax: 1.4359 6673, Tlx: 642141, MD: Hertha Bornholdt.

BLANK & BULK RAW TAPE

AMPEX, 2 rue Curnonsky, Tour Courcelor L, 75017 Paris, 1.4270 5500, Fax: 1.4756 1695, Tlx: 620903, GM: Michel Candelier.
AUDIO PLUS, 20 avenue d'Ivry, 75013 Paris, 1.4585 1599, Fax: 1.4586 6386, Tlx: 201179, MD: Serge Doubine.
BASF FRANCE, 126 rue Jules Guesde, 92303 Levallois-Perret, 1.4730 5714/5500, Fax: 1.4730 2173, MD: Patrick Lecel, Prof Mgr: Francois Gravellier.
JOHNSON TVI, 21 Les Jouxoux, 64700 Hendaye, 5920 0580, Fax: 5920 1836. Distribute Strand Magnetics.
MAXELL (FRANCE), 14 rue du Petit Albi, 95801 Cergy-Pontoise, 1.3424 8811, Fax: 1.3073 5677, MD: Mr. Goto.
MEMOREX FRANCE, 3-5 rue Maurice Ravel, 92300 Levallois-Perret, 1.4739 3204.
OMEGA, 3 rue Deserte, 67000 Strasbourg, 8832 4776, Fax: 8875 5961, MD: Francis Adam. Distributor: Agfa.
REVOX FRANCE, 14 bis rue Marbeuf, 75008 Paris, 1.4723 5588, Fax: 1.4720 3879, Tlx: 280989, President: Marco Vifian, Contact: Nicolas Giddings.
SONY OPERATIONS (FRANCE), 15 rue Floreal, 75017 Paris, 1.4945 4000/4017, Fax: 1.4010 9250, Tlx: 234032, Contact: Charles Paquet.
SUNKYONG FRANCE, 4 rue Diderot, 92150 Suresnes, 1.4204 0504, Fax: 1.4204 1209, Tlx: 612234, MD: J S Suh, Mktg Dir: Y K Løe. Manufacturer/distributor of professional & consumer blank audio and blank video tape cassette (open reel); Brand: SKC; Other: Floppy disks, V-0, C-0.
T.R.M., 8 rue des Acacias, 75017 Paris, 1.4766 9103, Fax: 1.4380 5193, MD: Thierry Rateau.
THAT'S, 6 rue Saint-Vincent, 78100 Saint-Germain-en-Laye, 1.3061 0461, Fax: 1.3061 4105, Tlx: 697550, Contact: Michel Metayer.

CD, RECORD & TAPE MANUFACTURING SYSTEMS

NETSTAL FRANCE, Allée du Clos des Charmes, 77400 Collegien, 1.6017 7410, Fax: 1.9017 8728, Tlx: 691977.
SONY OPERATIONS (FRANCE), 15 rue Floreal, 75017 Paris, 1.4945 4000/4017, Fax: 1.4010 9250, Tlx: 234032, Contact: Charles Paquet.
SOUND STUDIO TECHNIQUES, 18 rue de Douai, 75009 Paris, 1.4281 5047, Fax: 1.4285 8247, Tlx: 42282143, MD: Serge Uzan.

TAPE PACKAGING & LABELLING EQUIPMENT

SERMATEC, 50290 Brehal, Coudeville, 3351 5858, Fax: 3351 5184, Tlx: 170610 sermtec, Dir: J Deschamps, Sales Mgr: J C Boucher. Agent for Marden Edwards & Co (packaging/labelling equipment manufacturers).

GERMANY

RECORD COMPANIES

99 RECORDS IMPORT, Karl-Hofer Strasse 35, 1000 Berlin 37, 030.801.3099, Fax: 030.801.2212, MD: Peter Schimmelpfennig, Dir: Egon Werther, Mgr (Import): Uwe Van Straten.

ABACO RECORDS, Ostlandstrasse 14, 5000 Cologne 40, 02234.79035, Fax: 02234.48960, GM: Elmar Kast, A&R: Gerry Bolton. Labels owned: Abaco, Lipstick; Distribution: Constar.

ACT MUSIC & VISION, Gustav Freytag Strasse 10, 2000 Hamburg 76, 040.227.8090, Fax: 040.220.6078, President: Siegfried Loch, Partners: Annette Humpe, Jim Rakete.

AGM, Kisslingweg 44, 7130 Muhlacker, 07041.4766, Fax: 07041.83960, MD: Arno Graul.

ALPANA, Am Schoenblick 9, 8069 Reichertshausen, 08441.4294, Fax: 08441.4280, President: Etienne Cap, MD/A&R: Alain Cap, Distr: Paula Cap. Labels (Owned): Red Rose, Alpina, Belgavox, SAE; Main product: EHR, Dance, Jazz, Ballroom..

ALPHABEAT, PO Box 1201, 6980 Wertheim am Main, 09342.84155, President: Stephan Dehn, A&R: Marga Zimmermann, Creative Services: Heiko Koefel, Wolfgang Weinmann.

AMERICAN CLAVE, PO Box 270126, 5000 Cologne 1, 0221.512.031, Fax: 0221.529.563, President: Vera Brandes, MD: Michael Jacoby.

ANOTHER RECORD COMPANY, Rahstedterstrasse 65, 2000 Hamburg 73, 040.673.3537, Fax: 040.673.4400, Tlx: 2165513, MDs: Hubert Branzko, Mike Thulke.

APM RECORDS, Diepenbeek Allee 4, 5000 Cologne 40, 02234.79672/4611, MD: Udo Kamjunkte, Promo: Lil Trube.

ARCADE DEUTSCHLAND, Konigsallee 60f, 4000 Duesseldorf 1, 0211.890.3226, Fax: 0211.890.3999, GM: Sylvain Jonkerogwo, Main product: Adult Contemporary, Jazz, Country, Reggae, Dance, Album Rock, Gold/Oldies, Black (R&B).

ARTEG PRODUCTIONS, Eppendorferweg 7, 2000 Hamburg 20, PO Box 203312 (Zip: 2000), 040.430.0339, Fax: 040.439.6587, MD: Arno H van Vught, Promo: Michael Frommhold, Licensing: Gertraud Witte.

AS ARTIST SERVICE, Eppendorfer Baum 13, 2000 Hamburg 20, 040.487.080/482.828, Fax: 040.463.061, MDs: Elke Heilkamp, Annett Imholz, Representative: Andreas Reth.

AUTOGRAM RECORDS, Burgstrasse 9, 4405 Nottuin, 02502.6151, Fax: 02502.1825, MD: Willy Schwenken. Labels owned: Autogram, Autophon, Monogram, Autochthon, Autodrom.

BCM RECORDS (GERMANY), Winterhuder Weg 76, 2000 Hamburg 76, 040.227.4390, Fax: 040.2274.3915, Pres/MD: Brian Carter, A&R Asst: Conny Voss, Sales/Distrib: Fritz Wiebelhaus, Legal & Bus Affairs: Emma Herkes.

BEAR FAMILY RECORDS, PO Box 1154, 2864 Vollersode, 04794.1399, Fax: 04794.1574, Dirs: Hermann Knuelle, Richard Weize. Labels (owned): Bear Family, Tanzbear, (Lic): Bear Tracks (Intercord); (Distr): Buffalo Bop, White Label, Rollercoaster, Sun Jay, Rock Star, Detour, Relic.

BELLAPHON RECORDS, Mainzer Landstrasse 87/9, 6000 Frankfurt am Main, 069.27120, Fax: 069.271.2117, Tlx: 4160046, President: Branko Zivanovic, PR Mgr: Renate Strack-Hahnlein. Labels (owned): Bacillus, Bellaphon, Bellaphon Int'l, Bellaphon Klassik, City, Heimatland, Independent, L&R, Pick up, Rare Bird; (Lic): Audio Fidelity, Concord Jazz, Emergency, Greensleeves Masters, Metal Enterprises, Optimism, Passport Jazz, Prelude, SSS International, Streetwise, Sun, Sunnyview, Theresa, Timeless, Warlock; Main product: Adult Contemporary, Jazz, Dance, Album Rock.

BIBER RECORDS, Heusteigstrasse 69, 7000 Stuttgart, 0711.600.711, Fax: 0711.649.2369, Tlx: 723942, MDs: Detlef Engelhard, Friedemann Wittecka.

BIG NOISE RECORDS, Hospelstrasse 66, 5000 Cologne 30, 0221.542.830, Fax: 0221.542.620, Distribution: Semaphore.

BLACKBIRD MUSIC, Rheingaustrasse 2, 1000 Berlin 41, 030.822.4996, Fax: 030.821.9760, President: Andreas Hommelsheim, MD: Sara Hommelsheim. Labels (owned): AH Records, Blackbird Records, Ash Records; (Lic): DA Music (USA); Artists (Nat): Thomas Schiedel, Ronald Folegatti, Norbert Saric's BOBS, Iwan Janzil, Vielharmonie, Torsten Zwingenberger, Victor von Halen; (Int'l): Khalil Chahine, Jean Michel Kajdan; Distribution: Ariola Import Service, DA Music, Haeb (Swi), Magnum (UK), TL Music (Fin), LTE (S Africa), DAM (Fra), Haedong (Korea), IMS (Benelux), Discomania (Spa), DMI (Den), DA Music (USA); Main product: Adult Contemporary, Jazz, Classical, Dance, World Music.

BLUE FLAME RECORDS, Heinrich Kuderli Strasse 57, 7050 Waiblingen, 07151.54494, Fax: 07151.54425, MDs: Fridemann Leinert, Ilona Ortner. Labels (owned): Red Flame, Black Flame; (Lic): Ambience; Distribution: DA-Music.

BMG ARIOLA GERMANY (HAMBURG), Osterstrasse 116, 2000 Hamburg 20, PO Box 201343 (Zip: 2000), 040.490.690, Fax: 040.491.2060, Tlx: 214193, MD: Michael Anders, A&R Dir: Franz von Auersperg, A&R Mgr (Local): Alex Alexander, Ad Mgr: Anke Bahsi, Mktg Dir: Eckhart Gundel, Int'l Label Mgr: Klaus Gundacker, Promo Dir: Lothar Dungs, Motown Head: Dieter Thoele. Labels (owned): Bluebird, Camden, Eurodisc (Classic rep), Novus, Numero Uno, RCA, RCA Extra, RCA Int'l, RCA Jazz Tribune, RCA Special, Skylark; (Lic):

Anxious, De Construction, Deutsche Harmonia Mundi, Flying Dutchman, Gordy, Morocco, Motown, MSA, Prodigal, Rare Earth, Reproduction, Rocking Horse, Soul, Tamla, Tamla-Motown, Tent, Dedicated, Perfecto, Imago, BMG Zoo Entertainment, MCA, Geffen, RCA Victor Red Seal, RCA Victor Silver Seal, RCS Victor Gold Seal; Distribution: Bertelsmann Distribution..

BMG ARIOLA GERMANY (MUNICH), Steinhauser Strasse 1-3, 8000 Munich 80, 089.41360, Fax: 089.477.608, Tlx: 523487, MD: Thomas Stein, Dep MD: Andreas Schuermann, F&A Dir: Christoph Schmidt, Dir Int'l A&R: Gerd Ludwigs, Int'l Exploitation: Susan Armstrong, Mktg Mgr: Albert Czapski, Promo Head: Biggi Hamer. Labels (owned): Arabella, Ariola-Express, Ariola-Line, Ariola-Ufa, Arista, Eurodisc, Hansa. (Licensed): Baby, Bonaire, Wannier, EMI, Coconut, DDD, FM Revolver, Global, Go feet, Isartoni, Island, Jack White, Mariboro, Melodia, Red Bus, 2 Tone, Virgin, Jive.

BMG MUSIC INTERNATIONAL CENTRAL EUROPE, Steinhauser Strasse 1-3, 8000 Munich 80, 089.413.6474, Fax: 089.475.394, Tlx: 523.487, Sr Vice President: Arnold Bahlmann.

BMKK MUSIC PRODUCTION, Hoehnkoppel 14, 2000 Hamburg 71, 040.641.3728, Fax: 040.641.7580, President: Detlef Kuntke, MD: Stefan Muenzel, A&R: Guenter Brackmann, PR: Rainald Kuntke. Labels (owned): Glamour.

BOOGIETUNES MUSIKPRODUKTION, Seelingstrasse 33, 1000 Berlin 19, 030.321.6047, Fax: 030.325.6997, Tlx: 186671 pool, MD: Timothy Green, Promo: Marion Reinhardt. Labels (owned): Boogie Records, Hafen Klang, Geil Records, TGR; Main product: Dance, AC, Album Rock, Gold/Oldies.

BREEZE MUSIC, Hauptstrasse 33, PO Box 3149, 5024 Pülheim 3, 02238.2004, Fax: 02238.2734, President: Dieter Dierkes, MD: Fred Hoock, Promo: Karen Tobias, A&R Mgr: Gaby Hoffmann. Main product: Album Rock..

CARLTON MUSIVERTREIBER, Frankenforster Strasse 40, PO Box 100435, 5060 Bergisch-Gladbach, 02204.20030, Fax: 02204.200.333, President: Gunter Ilgner, A&R: Lutz Ilgner (Nat'l), Horst Senker (Int'l), Promo: Hanni Specht (Radio/TV). Labels (owned & distr): Papagayo, MPW, Comedy.

CHLUDWIG MUSIK, Luxemburgerstrasse 42, 5000 Cologne 1, 0221.234.165, Fax: 0221.239.364, President: Walter & Karl Heinz Puetz, Thomas Stein, Label Mgr: Bogusia Gornik, Promo Mgr: Rafael Fuchsgruber. Distribution: BMG Ariola/Munich.

CHRYSALIS RECORDS (GERMANY), Tal 48, 8000 Munich 2, 089.221.465, Fax: 089.223.997, MD: Jochen Kraus, A&R/Mktg Dir: Monika Bendig, Sales/Mktg/Prod Mgmt Dir: Hubert Haas, Promo Dir: Susanne Hort, Press: Stefan Vogel. Labels (owned): Chrysalis, Cooltempo, Dover; Main product: EHR, Adult Contemporary, Dance, Album Rock.

CHZ RECORDS, Juelicherstrasse 24, Brachelshof, 5013 Oberebmit, 02274.1075, Fax: 02274.81314, MD: Christoph Haumann.

COCONUT RECORDS, Nachtigallenweg 34, 5202 Hennef 1, 02242.3082, Fax: 02242.83210, Tlx: 889775, MD: Karin Hartmann, Tony Hendrik.

COLOSSEUM SCHALLPLATTEN, Bayernstrasse 100, 8500 Nuremberg 44, PO Box 404252 (Zip: 8500), 0911.474.0170, Fax: 0911.474.0160, MD: Armin Luther, PR Mgr: Francoise Lemporte, Prod Mgr: Susanne Coerper, Mgr (Export): Margot Koge. Labels (owned): Colosseum, Celine, CST, Fokton, IMS, Spatz; (Lic): Varese-Sarabande..

COMMA RECORDS & TAPES, PO Box 2148, 6078 Neulsenburg, 06102.52696, Fax: 06102.52696, Tlx: 4158600, E-Mail: 6102.52696 BTX, President: Roland Bauer, MDs: Klaus Mohn, Theo Weinberger. Labels owned: Big Sound, Comma International, Comma Classic, Max-Banana Tunes, Tropicana Line, Home-Cooking Music.

COMMUNITY 3 INTERNATIONAL, Andernacherstrasse 23, 8500 Nuremberg 10, 0911.952.770, Fax: 0911.952.7750, MD: Thomas Hartmann, A&R: Albert Garzon.

COSMUS, Johannesstrasse 8, 6780 Pirmasens, 06331.76096-8, Fax: 06331.31379, A&R Mgr: Manfred Bock.

COUNTDOWN MUSIC, Harksheider Weg 74, 2085 Quickborn, PO Box 1145 (Zip: 2085), 04106.5041, Fax: 04106.67046, President: Rainer Eitzrodt, MD: Helena Eitzrodt, Mgr (Export): Irmgard Peuschel. Labels owned: Countdown, Playback.

CRAZY LIFE MUSIC, Langes Hof 48, 4630 Bochum 6, 02327.320.768, Fax: 02327.320.921, President: Axel Thubeauville. Labels owned: US Metal, Shark, MMT Records; Distribution: Rough Trade.

CTE (COMMON TARGET ENTERTAINMENT), Jesinger Strasse 33, 7312 Kirchheim/Teck, 07021.42057, Fax: 07021.56920, MDs: Wolfgang Breuer, Norbert Siara. Labels (owned): CTE; (Lic): American Gramophone, Off Road, Expression, Fink & Star, Living Music, Windstar, Heads Up, Oxyoron, Acto & Facto, Big Z, Coyote, Devilsh; (Distr): GRP, Landmark, Gramavision, Celluloid; Main product: Adult Contemporary, Jazz.

CUPPAMORE RECORDS, Christstrasse 38, 1000 Berlin 19, 030.322.7847, Fax: 030.883.6168, President: Horst Koch. Distribution: BMG Ariola, Aris.

DA MUSIC/DEUTSCHE AUSTROPHON, Kruppstrasse 7, 2840 Diepholz, PO Box 1160 (Zip: 2840), 05441.2081, Fax: 05441.7833/8824, President: Rolf Neumann, MD: Rainer Koppermann, Local Sales Mgr: Gerhard Huesken, A&R Mgr: Uwe Kasten, Int'l Mgr: Andreas Hoellige. Labels (Owned): Artiphon, Elite Special, DA Records, DA Music, Picture Records, Orchestra, Mandolino, Racket Records, Car-sound, ESP Collection, Piccolo, Sonia, Sonia Classic, Digital Classic, Brook, Black Lion, Freedom, Blaxx Maxx; (Lic): Candid; (Distr): Heimatexpress, Pinorckle, Vagabond,

Extra, Shy, IC, Elisar, Blue Flame, USS, Londonstreet, AH, Prudence, Wundertuete, Musikantonerz, "Toi, Toi, Toi", Selected Sound, Beautiful Music, NEM, Palm, Story of Blues, BCM.

DANSE MACABRE, Luitpoldplatz 18, 8580 Bayreuth, 0921.12201, Fax: 0921.12230.

DELTA MUSIC, Zur Muhle 2, 5020 Frechen 4, 02234.60060, Fax: 02234.600.640, MD: K Juergen Moll.

DEUTSCHE GRAMMOPHON GESELLSCHAFT, Alte Rabenstrasse 2, 2000 Hamburg 13, PO Box 132286 (Zip: 2000), 040.441.810, Fax: 040.4418.1188, Tlx: 21243420, Pres/Label Dir (Archiv Produktion): Andreas Holschneider, Exec VP/HD Creative Ser: Pali Meller Marcovicz, VPs: Aman Pedersen (A&R Dir), Chris Schmoekel (Legal & Bus Dir), Hanno Rinke (Int'l Mktg Dir). Labels (owned): Deutsche Grammophon, Archiv Produktion; Main product: Classical.

DEUTSCHE SCHALLPLATTEN, Reichstager 4-5, O-1108 Berlin, (+37) 2.220.900, Fax: (+37) 2.220.9218, Dir-Gen: Paul Arnhold, Dir: Alexander Schindler.

DINO MUSIC, Bleichstrasse 5, 6242 Kronberg, 06173.709.90, Fax: 06173.5132, Tlx: 418350, President: Frank Pietzsch, MD: Helmut Schnauer, A&R Mgr: Mike Ungfehr, Sales Mgr: Joachim Wawrzeczek, F&A: Dieter Koch. Labels owned: DINO, Magnif, Crownhill, Neue Zeit.

EAST WEST RECORDS, Heussweg 25, PO Box 201251, 2000 Hamburg 20, 040.490.620, Fax: 040.4906.2267, MD: Juergen Otterstein, Promo: Elfi Kuester (Pop), Detlef Lauschke (Radio), Bus Affairs Dir: G Horst, Mktg Mgr (Classical): Luc Knoedler, A&R Dir (Local): Klaus Ebert. Labels (owned): Convoy, Oh-Ha, Teldec, Tis, Frontrow, Up Front; (Lic): Acto Records, Atilla Records, Atlantic, Buddha Records, Carrere, Commodore, East West, Erato, PWL, Sugar Hill; Main product: Jazz, Classical, Dance, Album Rock, Black (R&B), Adult Contemporary.

EBS RECORDINGS, Handelsstrasse 60, 4234 Alpen, 02802.4407, Fax: 02802.7230, MD: Gerd Buschhever. Labels owned: EBS, Mondosonic..

ECM, PO Box 600331, 8000 Munich 60, 089.851.048, Fax: 089.854.5652, MD: Manfred Eicher.

EDEL, Wichmannstrasse 4, Haus 8, 2000 Hamburg 52, PO Box 520151 (Zip: 2000), 040.890.850, Fax: 040.896.521, MD: Michael Hantjes.

EDITION TSHETON, Herzogstrasse 103, 8000 Munich 40, 089.300.9061, Fax: 089.300.9061, President: Melvin Wayne Edmondson, A&R/Mktg: Christian Fischer.

EFA-MEDIEN, Billwerder Neuer Deich 334a, 2000 Hamburg 26, 040.782.254-5, Fax: 040.782.783, A&R Mgr: Ulrich Vormehr.

EFA-MEDIEN, Mousonstrasse 12, 6000 Frankfurt am Main, 069.444.198/495.0991, Fax: 069.495.092, President: Ulrich Vormehr, MD: Horst Lewald. Labels (owned): Frog, Fog, What's So Funny About, Yellow, Houses in Motion, Cashbeat; Main product: Alternative, Punk, Hardcore, Avantgarde, Jazz..

EISENBERG MUSIKVERLAG, St. Apern Strasse 10-12, 5000 Cologne 1, 0221.219.409, Fax: 0221.239.257, President: Alfred Rhiem, A&R/Producer: Carlos Peron. Labels owned: Eisenberg.

ELECTROLA, Maarweg 149, 5000 Cologne 30, PO Box 300329 (Zip: 5000), 0221.49020, Fax: 0221.497.2335, Tlx: 8881290, Acting Div MD: Helmut Fest, Mktg: Roman Rybnikar, A&R: Stefan Trapp, Promo: Horst Mittmann, Int'l Mktg & Exploitation: Gabi Zangerl, Sales: Georg Salzmann. Labels (distr): Chrysalis; Main product: German & continental European repertoire..

EMI CLASSICS, Maarweg 149, 5000 Cologne 30, PO Box 300329 (Zip: 5000), 0221.49020, Fax: 0221.497.2335, Tlx: 8881290, Div MD: Bernhard Krajewski, A&R: Gerd Berg, Prod Mgmt: Helmut Schmitz, Mktg: Klaus Werner, Promo: Dorit Adenauer, Dieter Fuoss, Sales: Martin Pohl.

EMI ELECTROLA, Maarweg 149, 5000 Cologne 30, PO Box 300329 (Zip: 5000), 0221.49020, Fax: 0221.497.2335, Tlx: 8881290, Reg MD (EMI Music Ger/Sw/Aus) & Acting MD (Electrola): Helmut Fest, MDs: Friedrich E. Wottawa (EMI Operations Cologne), Erwin Bach (EMI), Bernhard Krajewski (EMI Classics), Chmn of Supervisory Board: Wilfried Jung, F&A: Armin Thur (Ger/Sw/Aus), Jochen Frese (Ger), Legal & Bus Affairs (Ger/Sw/Aus): Donald Valbert.

EMI GERMANY, Maarweg 149, 5000 Cologne 30, PO Box 300329 (Zip: 5000), 0221.49020, Fax: 0221.497.2335, Tlx: 8881290, Div MD: Erwin Bach, Prod Mgmt: Michael Golla, Sales Mktg: Marcel Ewald, Special Mktg: Jochen Pack, Promo: Winfried Ebert, Bernd Piepenbring, Sales: Friedhelm Kaulen. Labels (distr): Capitol, EMI USA, SBK; Main product: USA & UK repertoire..

EMI MUSIC CENTRAL EUROPE, Maarweg 149, 5000 Cologne 30, PO Box 300329 (Zip: 5000), 0221.49020, Fax: 0221.497.2335, Tlx: 8881290, Reg MD: Helmut Fest.

ENJA RECORDS, Frundsbergstrasse 36, 8000 Munich 19, 089.161.777/165.685, Fax: 089.167.8810, President: Matthias Winkelmann, Promo/Sales Dir: Gerd Filtgen, GM: Heike Krause, Art Dir: Elisabeth Winkelmann. Labels (owned): Enja, Tiptoe, Blues Beacon.

ENJA RECORDS, Volkartstrasse 19, 8000 Munich 8, 089.165.172, Fax: 089.166.839, President: Horst Weber, Mgr: Werner Aldinger. Labels (Owned): Enja, Tutu; Int'l licencences: Mesa (USA), Crown (Jap); Int'l distributors: Harmonia Mundi (Fra/Ger), IMS (Aus), Dureco (Hol).

ERDE RECORDS, Muelheimer Strasse 34, PO Box 200244, 5060 Bergisch Gladbach 2, 02202.59942, Fax: 02202.22074, MD: Manuel Roman. Production; Labels owned: ERDE; Distr: ARIS-Ariola; Distribution: ARIS-Ariola; Main product: World Music.

- ERDENKLING MUSIKVERLAG**, Halstenbeker Weg 17, 2000 Hamburg 54, 040.576 035, Fax: 040.574 304, Tlx: 212108, MD: Ulrich Reutzel, Asst: Hedda Schweder. Labels owned: Erdenklang, Crossculture.
- ESPERANZA MUSIKVERLAG & MUSIKPRODUKTION**, Heimhuder Strasse 73, 2000 Hamburg 13, 040.445 276, Fax: 040.449 467, Pres/MD: Werner Triepke. Labels (owned): Esperanza; Main product: Adult Contemporary, Country, Classical, Dance, Gold/Oldies.
- EWM ETHNIC WORLD MUSIC**, Hopfenstrasse 2, 2000 Hamburg 36, 040.319 4773/3792, Fax: 040.319 2116, MD: Manlio Celotti, Dir (Int'l): Patrick Lee Thorp. Labels (owned): EWM, EDM; (Lic): Mountain, Sea, CSR, Kijima, GSE, Unity; Main product: Dance, Jazz, World Music.
- EXTRA RECORDS & TAPES, KLAUS BOEHNKE**, Lessingstrasse 3, 2359 Henstedt-Ulzburg, PO Box 1322 (Zip: 2359), 04193.1781, Fax: 04193.77647, Tlx: 2180277, MD: Klaus Boehnke. Main product: Dance, Album Rock, Jazz, Gold/Oldies, Country, Classical.
- EYE O RECORDS**, Eppsteiner Strasse 43, 6000 Frankfurt am Main 1, 069.721 561, Fax: 069.724 0294, MD: Heinz Roth, A&R: Matthias Hoffmann, Sven Vaeth, Company Sec: Sabine Benkmann. Labels (owned): Zyon, Sunchild feat. Joanne Shenandoah, Odysee of Noises, Hardfloor, Mignon feat. Esra; Main product: Dance.
- FALCON**, Ulz Burgerstrasse 111, 2000 Norderstedt, 040.525 4578, Fax: 040.525 6263, MD: Renate Otte.
- FAT RAT MUSIC**, Am Haselweg 17, 8011 Pasdorf, Munich, 089.903 9043, Fax: 089.903 0258, MD: Magda La Bomte-Cooke, A&R: Ruth McCartney. Main product: Adult Contemporary, Dance, Album Rock, Black (R&B).
- FUN FACTORY!**, Hermannstadtweg 9, 4400 Muenster, 0251.78321, Fax: 0251.780 1874, MD: Axel Seitz, Sales/Mktg: Heinz Bovenschulte, Promo/PR: Chris Kreuzer, Int'l: Corinne Gagnier. Labels owned: Funfactory!, Popfactory!, Dancefactory!, Soundfactory!; Distribution: Rough Trade.
- GAMA MUSIKVERLAG**, Dettinger Strasse 95, 7312 Kirchheim unter Teck, 07021.52817, Fax: 07021.83321, Tlx: 7267319, MDs: Guenter Marek, Peter Garattoni.
- GARBITOWSKI**, Metzger Strasse 30, 5000 Cologne 1, 0221.323 611, Fax: 0221.329 244, MD: Juergen Garbitowski. Labels owned: Gato, Karo, Risk.
- GLOBAL RECORDS (GERMANY)**, Niederlingerstrasse 21, 8000 Munich 19, 089.151 063, Fax: 089.151 060, President: Peter Kirsten, A&R Dir: Abi Lin, Label Mgr: Holger Decken. Labels (owned): Global, Global-Musicom/Satellite, Deep Groove; (Lic): Luke; Distribution: BMG Ariola.
- HAMMER MUSIK**, Christophstrasse 38, 7000 Stuttgart 1, 0711.648 7620/27, Fax: 0711.648 7629, Tlx: 723094 hamu, MD: Ingo Kleinhammer. Labels owned: Avenue, Boulevard Records; Distribution: Teldec.
- HANSA MUSIC**, Wittelsbacherstrasse 18, 1000 Berlin 31, 030.884 140, Fax: 030.882 5065, Tlx: 184714 intro, President: Hans Blume, MDs: Andre Selleneit (Promo), Bruno Wendel (Bus Affairs), Mktg: Christian Wolff. Labels (owned): Hansa, MCI; Main product: Adult Contemporary, Dance, Black (R&B).
- HANSSLER-VERLAG**, Bismarckstrasse 4, PO Box 1220, 7303 Neuhausen-Stuttgart, 07158.1770, Fax: 07158.177 199, Sales Mgr: Guenter Hanssler.
- HEARTBEAT RECORDS**, Erlaserkirchstrasse 16, 5000 Cologne 91, 0221.866 081, Fax: 0221.862 308, Mgr: Paul Grau.
- HEILMAIER TONTRAGER**, Uhlstrandstrasse 107, 2102 Hamburg 93, 040.225 748, Fax: 040.225 179, Chmn: Andreas Heilmeyer.
- HELLHALER INTERNATIONAL**, Teckstrasse 64, 7000 Stuttgart 1, 0711.268 7613, Fax: 0711.268 7676, Tlx: 723046, MD: Bernd Hellthaler.
- IDE—MARLBORO MUSIC**, Fallstrasse 42, 8000 Munich 70, 089.723 2043, Fax: 089.723 9486, Tlx: 523957, Presidents: Sieglinde Pehl, Lothar Jehle, Prod Mgr: Martin Brem. Labels (owned): Marlboro Music; Distribution: Virgin.
- IN & OUT RECORDS**, Im Meierbuehl 37, 7800 Freiburg 33, 07664.59380, Fax: 07664.59357, MD: Frank Kleinschmidt, VP (Mktg): Juergen Schwab.
- IN-AKUSTIK**, Untermatten 14, 7801 Ballrechten-Dottingen, 07634.728, Fax: 07634.6532, Tlx: 772965, President: Guenter Sumser, MDs: Bernhard Roessle, Alex Manninger. Labels (Owned): Inak; (Lic): Biber, Blue Vision, Sion; Main product: AC, Album Rock, Jazz, New Age, Classical.
- INTERCORD TONGESSELLSCHAFT**, Aixheimer Strasse 26, 7000 Stuttgart 75, 0711.47630, Fax: 0711.476 3324, Tlx: 722814, MD: Herbert R Kollisch, Head of A&R: Peter Cadera, F&A Dir: Werner Beck, Sales Mgr: Wolfgang Wingerath. Labels (owned): Intercord, Mute, Sonet, Hollywood Rec, Creation, Blow UP, Capo Rec, Tommy Boy, Ghetto, Musedisc, Zappa, Skylight, Concerto Collection, Saphir, Art of Classics.
- INTERMEDIA MUSIK SERVICE**, Albrechtstrasse 10, 1000 Berlin 41, 030.791 1041-43, Fax: 030.791 7916, Exec Dir: Thomas Jost, A&R/Promo: Birgit Bauer, Co-Ord: Mirko Krueger. Labels (owned): Funky Records, Deutsche Vita, Harmonie, Hatch; Main product: EHR, Adult Contemporary, Country, Dance, Album Rock, Gold/Oldies.
- INTERSOUND**, Schleibinger Strasse 10, 8000 Munich 80, 089.488 151, Fax: 089.480 1701, President: Gerhard Narholz, MD: Rotheide Narholz, Prod Mgr: Alfred Dilz, Tech Dir: Gerhart Frel. Labels (owned): Intersound, Pro Viva.
- INTUITION RECORDS**, PO Box 270126, 5000 Cologne 1, 0221.512 031, Fax: 0221.529 563, Tlx: 8886685 vbr, President: Vera Brandes, MD: Michael Jacoby.
- ITALOHEAT MUSIC PRODUCTIONS**, Kaarsterstrasse 51/3, 4044 Neuss-Kaarst 2, 02101.68078, Fax: 02101.603 750, Tlx: 8518068 heat, MD: John A Taylor, Sales Dir: Gary Cooper, Mgr: Susanne Bergander, Promo: Manuela Konigshofen.
- ITM RECORDS**, Gueterstrasse 20, 5600 Wuppertal 1, 0202.426 255, Fax: 0202.426 902, President: Uli Blobel.
- JOYBRINGER**, Scheiderer Strasse 26, 6602 Dudweiler, 06897.73472, Fax: 06897.73446, President: Dragan Nikitovic.
- JUMBO**, Schnackenburgallee 54, 2000 Hamburg 54, 040.545 555, Fax: 040.545 666, President: Gabriele Swiderski. Labels (owned): Jumbo, Goya, Hallol.
- JUNIOR MUSIKPRODUKTION**, Sendlinger Strasse 64, 8000 Munich 2, 089.260 941 617, Fax: 089.260 7131, Tlx: 5214521, President: Frank Pleyer, MD: Siegi Pleyer.
- JUPITER RECORDS**, Hoehelstrasse 2, 8000 Munich 80, 089.984 926, Fax: 089.980 250, Tlx: 522946, A&R Dir: Martin Unger, President: Ralph Siegel, MD: Joachim Neubauer, GM: Werner Schueler, Int'l Director: Helgard von Schenckendorf.
- K & K RECORDS**, Cretzschmarstrasse 13, 6000 Frankfurt am Main, 069.707 2827, Fax: 069.709 483, MD: Thomas M Kann, A&R: Claudia Cruen.
- KARUSSELL MUSIK & VIDEO**, Oberstrasse 14b, 2000 Hamburg 13, 040.423 0070, Fax: 040.423 0050, Tlx: 2183925, MD: Gerd Brendemeuhl, Mktg Dir: Astrid Rix, Sales Mgr: Thomas Altemeyer, Snr Prod Mgr: Michael Schneider. New address from January 1, 1992: Holzdam 57-61, 2000 Hamburg 1.
- KBC RECORDS INTERNATIONAL**, Friedrich Ebert Damm 202, 2000 Hamburg, 040.669 0613, Fax: 040.661 822, President: Cay Hume, Chmn: Abdul Aziz, MDs: Harald Hecht (A&R/Dist), Sonja Dorger (Promo). Labels (lic): Golden Star.
- KLAVINS MUSIC**, Bergstrasse 27a, 5210 Troisdorf, Bergheim, 0228.454 243, Fax: 0228.454 330, President: David Klavins, Assoc: Idli Jensen, Studio: Jungstrasse 26, 5300 Bonn 3, 0228.461 515, Fax: 0228.476 213.
- KMS REINER KAFITZ MEDIENSERVICE**, Graf Berge von Trips Ring 68, 5014 Kerpen-Horrem, 02273.2781, Fax: 02273.2710, MD: Reiner Kafitz, Customer Services: Erika Kafitz.
- KOCH INTERNATIONAL (GERMANY)**, Hermann Schmidt Strasse 10, 8000 Munich 2, 089.746 135-10, Fax: 089.725 4759, Tlx: 5213408 koch, President: Franz Koch, A&R Mgrs: Franz Selb, Alfred Duebbl, Label Mgr: Norbert Gubo.
- KRIWEIT RECORDS**, Schomburgstrasse 120, 2000 Hamburg 50, 040.381 406, Fax: 040.389 5818.
- LOGIC RECORDS**, Strahlenbergerstrasse 125a, 6050 Offenbach, 069.880 633, Fax: 069.816 072, MD: Matthias Martinsohn.
- LOW SPIRIT**, Monnsenstrasse 59, 1000 Berlin 12, 030.324 3128, Fax: 030.324 3664, Contact: Maximilian Lenz.
- LRO MUSIC**, PO Box 380222, 1000 Berlin 38, 030.813 4182, Fax: 030.814 1632, MD: Frank Osterland. Main product: Dance, Album Rock, Ethnic.
- M A MUSIC INTERNATIONAL**, Weg Beim Jaeger 151, 2000 Hamburg 61, 040.553 1061, Fax: 040.553 3084, President: Marion Kaempfer, Chmn: Allan Botschinsky, Int'l Co-Ord: John Baer, MD: Manfred Peter. Distribution: IMS (PolyGram).
- MAINHATTAN MUSIC**, Oberthausenstrasse 70, 6052 Mulheim am Main 3, 06108.73051, Fax: 06108.77446, President: Werner Schwarzer, Chmn: Uwe Block, MD: Christina Tassiss, Asst To Pres: Isabel Tassis.
- MAJOR RECORDS**, Bahnhofstrasse 35, 5810 Witten, 02302.24006-7, Fax: 02302.23400, GM: Carlos Reuter, A&R/Mktg: Arno Hartfiel, Prod Mgr: Susanne Urban, Label Mgr: Ralf Hubert. Labels (owned): Aaarng Records, Atom H, C & C; Main product: Album Rock.
- MANNO ULLRICH MUSIC**, Salzmannstrasse 102, 8000 Munich 83, 089.601 5493, Fax: 089.601 6563, GM: Manno Ullrich.
- MARIE RECORDS**, Rahlstedterstrasse 65, 2000 Hamburg 73, 040.673 3557, Fax: 040.673 4400, MDs: Mike Thulke, Hubert Branzko. Labels (owned): Marie Records; (Lic): Banane, SBF, Pink 7 Records; Distribution: Aris, Alles Records, Charly.
- MCA RECORDS (GERMANY)**, Osterstrasse 116, 2000 Hamburg 20, 040.4906 9237/8, Fax: 040.496 164, MD: Heinz Canibol, Mktg Mgr: Joerg Eiben.
- MEDIAPHON**, Zettachring 12a, 7000 Stuttgart 80 (Fasanenhof), 0711.723 031, Fax: 0711.728 9559, MD: Udo Unger, Sales Mgr (Int'l): Elke Ruemmelein, GM: (Classical): Wilfried Ammel.
- MEISTERSINGER MUSIK**, Breitenlohestrasse 48, 8550 Forchheim, 09191.80808, Fax: 09191.66797, Dir: Rudolf Hohenberger. Labels (owned): Nightingale Records; Main product: New Age.
- MENDE & DEROUGE MUSIC PRODUCTIONS**, Gerauer Strasse 58a, 6082 Moerfelden-Walldorf, 06105.22067-8, Fax: 06105.26403, MDs: Guenter Mende, Candy Derouge. Main product: EHR, Dance, Album Rock, Black (R&B).
- MESSIDOR MUSIK**, Kleine Bockenheimer Strasse 10/2, 6000 Frankfurt am Main 1, PO Box 170442 (Zip: 6000), 069.295 113, Fax: 069.288 667, GM: Goetz A Woerner.
- METRONOME MUSIK**, Glockengiesserwall 3, 2000 Hamburg 1, PO Box 104909 (Zip: 2000), 040.308 704, Fax: 040.308 7307, Tlx: 2174735, MD: Albert Stendebroek, Mktg Mgr: Freddie de Wal, Head of M-Street Rec: Gibson Kemp, Head of A&R: Oliver Helwig, Exploitation Mgr: Ulla Hoppe. Labels (Owned): Metronome, Brain, Nature, M-Street; (Lic): Westside, London, Fiction, Desire, Dischi Ricordi, Barclay, Big Life, frr, Gol! Discs.
- METROPOLITAN**, Widenmayerstrasse 5, 8000 Munich 22, 089.224 024, Fax: 089.228 3863, Tlx: 523429, President: Michael Fuehr.
- MINOR MUSIC-RHYTHM ATTACK PRODUCTIONS**, Methweg 14, 5000 Cologne 30, 0221.173 087, Fax: 0221.173 647, Presi-
- dent: Stephan Meyner. Labels (owned): Minor Music, RAP; Main product: Jazz, Black (R&B).
- MINT RECORDS**, Habsburger Platz 1, 8000 Munich 40, 089.331 808, Fax: 089.397 179, MD: Helmuth Schmidt.
- MODERN MUSIC**, Kurfuerstenstrasse 23, 1000 Berlin 30, 030.261 9085, Fax: 030.262 4448, Tlx: 185738 modm, MD: Karl-Ulrich Walterbach, Int'l: Birgit Nielsen, A&R: Ulla Meurer, Jor Mulder. Labels (owned): Noise International, Madcat, Aggressive Rockproduktionen, Black Top, Machinery, Fluxus.
- MUSIC PLUS (GERMANY)**, Nordenstrasse 30, 6000 Frankfurt am Main 1, 069.597 0168, Fax: 069.553 201, President: Andreas Kirnberger, Peter Hauke, Rudolf Weber, A&R Mgr: Ralph Schalk, Asst: Uschi Block, Camilla Meyer. Labels (owned): The Label; Main product: Adult Contemporary, Album Rock.
- MUSICONTACT**, Heuauerweg 21, 6900 Heidelberg, 06221.71011/12, Fax: 06221.783 422, Dir: Hanno Pfisterer, Sales Mgr: Thomas Hinz, Mgr (Export): Thomas Christen.
- MUVI MUSIK & VIDEO**, Otto Suhr Allee 59, 1000 Berlin 10, 030.341 2046, Fax: 030.341 8627, Tlx: 186093, MDs: Frank Haemmerle, Roland Jung.
- MYRDIN MUSIC**, Schlehdorferweg 22, 5000 Cologne 40, 0221.483 499, Fax: 0221.487 611, President: Andreas Schlaebitz.
- NANA RECORDS**, Dragoner Strasse 21, 3000 Hanover 1, 0511.392 950, Fax: 0511.392 553, MD: Elke Fleing, Konrad Haas, Uli Schmid. Labels (owned): Nana; (Lic): IMC.
- NORMAL RECORDS**, Bonner Talweg 276, 5300 Bonn 1, 0228.213 041/2, Fax: 0228.211 656, Dir: Edward Ruhlmann, A&R: Stephan Werner. Labels (owned): Normal; (Lic): Flying Nun, Citadel, Rattlesnake, Red Eye & Black Eye; Distribution: Rough Trade.
- ORFEO INTERNATIONAL**, Augustenstrasse 79, 8000 Munich 2, 089.522 031, Fax: 089.529 190, Tlx: 5218324, MD: Christiane Delank.
- P 1 RECORDS**, Eibenstrasse 18, 3012 Langenhagen 8, 0511.784 202, Fax: 0511.814 988, Tlx: 5118447, President: Raymond Bacharach, MD: Christian Leibl, Andy Weiner, Promo Mgr: Susanne Weiner. Labels owned: P 1 Records, Big Maxx, Blue Flamingo; Distribution: SPV; Main product: dance, rock.
- PARADISE MUSIC**, Schwibbogengasse 27a, PO Box 112140, 8900 Augsburg 1, 0821.33336, Fax: 0821.33309, MD: Hubert G Feil, Mktg Mgr: Doris Mosburger. Labels (owned): Marisma, PMG, Extraphon, Europaradise, Manitu; Main product: EHR, Dance, New Age, Classical.
- PHONOGRAM (GERMANY)**, Brauereistrasse 14, 5000 Cologne 40, PO Box 400428 (Zip: 5000), 02234.4050, Fax: 02234.405 299, Tlx: 8881277 phk, MD: Louis Spillmann, Contr: Maria Topp, Sr Mktg/Prom Mgrs: Tony Joannou (Int'l), Prod Mgr: Cliff Roles (Phonogram Int'l), Int'l Exploitation: Astrid Seilly. Labels (owned): Mercury, Vertigo, Philips, Casablanca, Fontana; (Dist): Rocket, DEF America; Main product: EHR, Adult Contemporary, Album Rock.
- PILZ MUSIC**, Wendenstrasse 309, 2000 Hamburg 26, 040.251 6090, Fax: 040.2516 0911.
- PLAENE RECORDS**, Balkenstrasse 17/9, 4600 Dortmund 1, PO Box 104151 (Zip: 4600), 0231.577 9036, Fax: 0231.577 9030, Tlx: 822292 plaen, President: Juliane Stuermann, Mktg/Sales: Udo Brosko, A&R: Ulrich Hetscher. Labels (owned): Plaene records, Westpark Music, Edition V; Distribution: BMG Ariola.
- PLAY IT AGAIN SAM SCHALLPLATTEN**, Spaldingstrasse 74, 2000 Hamburg 1, 040.231 014, Fax: 040.231 317, MDs: Mark Chung, Frank Luedtke, Promo Mgrs: Ines Weidemann, Jilietta Kuehle.
- PLAYBONES MUSIC**, Eppendorferweg 7, 2000 Hamburg 20, PO Box 203312 (Zip: 2000), 040.430 0339, Fax: 040.439 6587, MD: Arno H van Vught, Promo: Michael Frommhold, Licensing: Gertraud Witte. Labels (owned): Playbones Records, Playbones Music, Rondo Records; (Lic): Valentine, Bandleader, Range Records.
- POLYDOR (GERMANY)**, Glockengiesserwall 3, 2000 Hamburg 1, 040.308 702, Fax: 040.308 7604, MD: Goetz Kiso, Legal & Bus Affairs: Stefan Beutler, Int'l Prod: Thomas Starkjohann, Int'l Licensing: Polly Schlottermann, Press Int'l: Birgit Schmueser. Labels (owned): Polydor, Verve, A&M, Talking Loud, MPS, EnArCy, Amadeo; (Lic): ECM, JMT, Low Spirit, Mint, Tabu, Perspective, Morgan Creek, Off The Track.
- POLYGRAM CLASSICS (GERMANY)**, Glockengiesserwall 3, 2000 Hamburg 1, PO Box 104909 (Zip: 2000), 040.308 701, Fax: 040.308 7282, Tlx: 215024, MD: Oliver Schulten, Contr: Klaus Henschel, Label Mgrs: Sabine Max (Deutsche Gram), Juergen Backhaus (Philips Classics), Manfred Wichmann (Decca). Labels (owned): Deutsche Grammophon, Philips Classics, Decca, Archiv-Produktion, L'Oiseau Lyre, Argo; (Lic): Mercury; (Dist): Amadeo.
- POLYGRAM GERMANY**, Glockengiesserwall 3, 2000 Hamburg 1, PO Box 104909 (Zip: 2000), 040.308 701, Fax: 040.308 7655, Tlx: 2163923, President/CEO: Wolf-D Gramatke, Exec VP: Wim Punte, MDs: Goetz Kiso (Polydor), Louis Spillmann (Phonogram), Albert Stendebroek (Metronome Music), Oliver Schulten (PolyGram Klassik), Joost van Os (PolyGram Songs), Werner Klose (PolyMedia). Companies owned: PolyGram Vertrieb, Polydor, Phonogram, Metronome Musik, PolyGram Klassik, PolyStar, Karussell Musik und Video, PolyGram Songs, International Music Service, PolyGram Video, PolyMedia Marketing Group, Polyphon.
- POLYMEDIA MARKETING GROUP**, Oberstrasse 14b, 2000

- Hamburg 13, 040.423 0070, Fax: 040.4230 0750, Tlx: 2163925, MD: Werner Klose, Contr: Wouter de Groot, Bus Affairs: Peter Jens Kaundinya, MD: Gerd Brendemuehl (Karussell), GMs: Chris Georgi (Polystar), Bernd Wiesner (PolyGram Video), Juergen Wockert (Polystar), Harry Kunnecke (Spec Mktg), Uwe Bald (Int'l Music Svc). New address from January 1, 1992: Holzdammer 57-61, 2000 Hamburg 1.
- POLYPHON**, Glockengießerwall 3, 2000 Hamburg 1, 040.308 7461, Fax: 040.308 7516, Tlx: 2163924, GM: Juergen Wockert. New address from January 1, 1992: Holzdammer 57-61, 2000 Hamburg 1.
- POLYSTAR**, Glockengießerwall 3, 2000 Hamburg 1, PO Box 104909 (Zip: 2000), 040.308 7456, Fax: 040.308 7545, Tlx: 2163922, GM: Chris Georgi, Prod Mgr: Gaby Balder, Distr Mgr: Manfred Schuettler. New address from January 1, 1992: Holzdammer 57-61, 2000 Hamburg 1.
- POOL MUSIKPRODUKTION**, Seelingstrasse 33, 1000 Berlin 19, 030.321 5045, Fax: 030.325 6997, Tlx: 186671, MD: Peter Schimmelpfennig.
- POWERPLAY MUSIC (PPM)**, Bahnhofstrasse, 8223 Trostberg, 08621.5363, Fax: 08621.62827.
- PRO: MUSIK COLOGNE**, Schadowstrasse 53, 5000 Cologne 30, 0221.552 026/8, Fax: 0221.557 561, MD: Teddy Hoersch, A&R Mgr: Olaf Nessensohn.
- PRO: MUSIK MUNICH**, Seufertstrasse 25, 8036 Breitbrunn am Ammersee, 08152.5243, Fax: 08152.5840, MD: Teddy Hoersch.
- PUBLIC PROPAGANDA WEGENER & WEGENER**, Bramfelder Chaussee 238c, 2000 Hamburg 17, 040.642 5041, Fax: 040.642 9475, Pres/MD: Jens-Markus Wegener, Pres/Promo: Kay-Oliver Wegener. Labels (owned): Pinpoint, USS, Skizzo, Independence, Rotation; (Lic): SweMix, Radium 226.05, Cooking Vinyl, Concrete; Main product: Album Rock, Dance, Indie.
- RED LINE RECORDS**, Lagerstrasse 67, 8039 Puchheim-Munich, 089.800 2880, Fax: 089.800 2879, Tlx: 521 8426, MD: Theo Harl.
- REPertoire RECORDS KUMBERGER & NEELSEN**, Gaensemarkt 24, 2000 Hamburg 36, 040.346 878/340 732, Fax: 040.354 411, MD/Owner: Killy Kumberger, Mktg/Sales/Owner: Thomas Neelsen, Lic Asst/PR: Sylvia Newman. Labels (owned): Repertoire Records; Main product: Jazz, Album Rock, Gold/Oldies, back-catalogues, re-releases, compilations, licensing.
- ROBA MUSIC**, Feldbrunnenstrasse 50, 2000 Hamburg 13, 040.445 086, Fax: 040.443 272, Tlx: 2173377, MD: Rolf Baierle.
- ROCKOKO PRODUCTION**, Nordendstrasse 30, 6000 Frankfurt am Main 1, 069.597 0168, Fax: 069.553 201, MDs: Peter Hauke, Andreas Kirnberger, Rudolf Weber, A&R Mgr: Ralph Schalk.
- ROUGH TRADE RECORDS (GERMANY)**, Eicklerstrasse 25, 4690 Herne 1, 02325.6970, Fax: 02323.697 222-3, MDs: Kurt Thielen, Heino Drecker, Promo Mgr: Dietrich Eggert, Mktg Mgr: Carsten Stricker, Sales Mgr: Reiner Machauer, Distr Mgr: Martin Widera. Labels (owned): Factory, Fire, Foundation, 4AD, One Little Indian, Outhar Rhythm, Republic, Rough Trade, Some Bizarre, WARR, World Service, Our Choice, Network.
- SATTVA ART**, Herzog Wilhelm Strasse 7, 8000 Munich 2, 089.260 3814, Fax: 089.260 4083, President: Sonja Wiesbeck, Chmn: Oliver Serano-Alve, MD: Anton Vogl, Representatives: Bernd Krompass, Peter T C Gerasch.
- SCHIPPER MUSIK**, Fritz Reuter Strasse 52, 2940 Wilhelmshaven 1, 04421.60882, MD: Hans-Juergen Schipper.
- SEMAPHORE**, Andernacherstrasse 23, 8500 Nuremberg 10, 0911.952 770, Fax: 0911.952 775/0, Tlx: 626939 sema, MD: Markus Roeder, Sales Mgr: Steffen Richartz, A&R Mgrs: Thomas Hartmann, Uli Eisler, Promo: Jutta Baechner, Admin: Elke Regensburger. Labels (owned): Resonance, Flametrader, Prophecy, Schemer, Semaphore; (Lic): Buy Our Records, Wild Rags, Shimmy Disc, Record Collect, Community 3; Main product: Album Rock, Alternative.
- SEYCHELLES MUSIC**, PO Box 130144, 5000 Cologne 1, 0221.720 179, Fax: 0221.739 3476, Tlx: 8882798, President: Walther Kahl, MD: Sabine Kahl, Licensing: Kamilla Parpart, Admin: Gabriele Parpart.
- SHERMAN RECORDS**, Kollaustasse 6, 2000 Hamburg, 040.553 3322/1446, Fax: 040.553 6741, President: Sherman F Heing, MD: Mary A Johnson, A&R: Anja Baumgarten. Labels (owned): Sherman Records, Black Label; (Lic): Striped Horse, Panarecord, Beverly Hills Records; Distribution: Polygram, Metronome.
- SONY CLASSICAL**, Nonnenstieg 1, 2000 Hamburg 13, 040.414 1080, Fax: 040.456 816.
- SONY MUSIC ENTERTAINMENT (BERLIN)**, Fasanenstrasse 46, 1000 Berlin 15, 030.882 3038, Fax: 030.882 3268, Promo Mgrs: Bettina Exner, Gaby Schubert (East Ger). Promotion office.
- SONY MUSIC ENTERTAINMENT (COLOGNE)**, An der Burgmauer 60, 5000 Cologne 1, 0221.137 900, Fax: 0221.131 541, Promo: Claudia Andries (Radio/TV), Barbara Sieg (Press). Promotion office.
- SONY MUSIC ENTERTAINMENT (GERMANY)**, Bleichstrasse 64, 6000 Frankfurt am Main, 069.13051, Fax: 069.130 5440, Tlx: 414368, MD: Jochen Leuschner, Dep MD & Spec Mktg Dir: Uwe-Stefan Fend, Dirs: Harald Herndorff (Ops, Personnel & Admin), Roland Pelka (Fin & Contr), Hubert Wandjo (Artist Mktg), Snr Mgr (Bus Affairs): Eberhard Kromer. Labels (owned): Columbia, Epic, Dance Pool, Merzklang.
- SONY MUSIC ENTERTAINMENT (HAMBURG)**, Tesdorpfstrasse 12, 2000 Hamburg 13, 040.453 630, Fax: 040.454 764, Promo: Monica Wendt (Radio), Annette Meyns (T&P). Promotion office.
- SONY MUSIC ENTERTAINMENT (MUNICH)**, Bavariaring 18, 8000 Munich 2, 089.530 089, Fax: 089.537 475, Promo: Helmut Ochs (Radio), Sonia Skarpil (T&P). Promotion office.
- SPV**, Brueseler Strasse 14, 3000 Hanover 72, 0511.8709-0, Fax: 0511.870 9181-2, President: Manfred P Schuetz, A&R/Int'l Lic: Jutta Kestner, Asst Label Mgr: Bauke de Grot, Prod Mgrs: Jay Lansford (Indie/Rock), Thomas Beer (Dance/Pop). Labels (owned): Steamhammer, Animalized, Rebel, 1st, SPV, 101 Records, Armageddon, Blue Turtle; (Lic): Beggars Banquet, New Renaissance, Situation Two; Distribution: SPV.
- SPV PROMOTION SUEID**, im Eichwald 12, Unit 20, 6900 Heidelberg-Boxberg, 06221.384 405, Fax: 06221.382 105, Promo: Thomas Ziegler. Promotion office for southern Germany.
- STORZ MUSIK**, Hauptstrasse 114, 3360 Osterode, 05522.73044, Fax: 05522.75481, MD: Erich Storz.
- STREETHEAT MUSIC PRODUKTION**, Kaarsterstrasse 53, 4044 Neuss-Kaarst 2, 02101.68078, Fax: 02101.603 750, Tlx: 8518068 heat, President: John A Taylor, A&R Dir: Gary Cooper, Fin Dir: Jurgen Goebbels, Head Of Sales: Gerd Behet, Int'l Co-Ord: Jurgen Kehles, Copyright: Susanne Bergander. Labels (Owned): Italoheat, Street Heat, Filmflam, Techno-Mix, SOS; (Lic): Macola, Hit'n'Run, Oceana, Futura International, Dream Team, Tandem, Mixx It, Metromix, Perfect Beat, Ultimix, Megamix.
- SUBWAY RECORDS**, Paul Zenetti Strasse 4, 8880 Dillingen, PO Box 1222 (Zip: 8880), 09071.6554, Fax: 09071.1432, MD/A&R: Michael Schuster, A&R/Promo/Sales: Katrin Disselhorst, Promo: Martin Hintermayer. Labels (owned): Subway, Subway-Single-Club, South-West-Studio; Main product: Underground.
- SUGAR MUSIK**, Gruental 34, 8000 Munich 81, 089.986 691, Fax: 089.981 175, MD: Elio Gariboldi.
- SUNDANCE MUSIC**, Beckstrasse 15, 2820 Bremen 70, 0421.656 544/5, Fax: 0421.656 599, Presidents: Dietmar Schmidt, Christiane Siedenburger, MD: Volker Siedenburger, PR/Promo: Petra Heidkamp. Labels owned: Sundance, Stunt, Rockfarm, Divolo; Distribution: DMD, Constar, JN-Akustik, GDC.
- TANTRIC**, PO Box 270126, 5000 Cologne 1, 0221.512 031, Fax: 0221.529 563, President: Vera Brandes, MD: Michael Jacoby.
- TELDEC CLASSICS INTERNATIONAL**, Schubertstrasse 5-9, 2000 Hamburg 76, 040.229 320, Fax: 040.2293 2230, Tlx: 214881, GM: Hans Hirsch, A&R Dir: Wolfgang Mohr, Mktg Dir: Franz-Christian Wulff, Contr: Rudolf Ratjen.
- TELDEC IMPORT SERVICE (TIS)**, Borsteler Chaussee 85-99, Haus 12, 2000 Hamburg 61, 040.514 4090, Fax: 040.5144 0930, Tlx: 2174537, MD: Rolf Baehnk, Label Mgrs: Juergen Tiessen (Pop), Michael Saloman (Pop), Kai-Yves Linden (Classical). Labels (owned): TIS; (Lic): Chess, MCA, Melos Music, Spoon, Cellier, Boulevard, Day Eight, MMP, WEA, CGD, Musicdisc, Accord, VeraBra, ADDA, Unicorn.
- TIMM MUSIC**, Weberstrasse 3, 4800 Bielefeld 1, 0521.64937/66808, Fax: 0521.172 723, GM: Peter Timpe.
- TITAN RECORDS (GERMANY)**, Sudweg 12, 5206 Neunkirchen-Seelscheid 1, 02247.1011, Fax: 02247.2261, Tlx: 8869528, MDs: Toni Bunte, Heinz Bartmann.
- TMS MUSIC**, PO Box 2022, 7012 Fellbach, 0711.588 303/583 433, Fax: 0711.579 594, MD: Nico Gerdes, Sec: Doris Ditz. Main product: Adult Contemporary, Country, Reggae, Dance, Album Rock, Gold/Oldies, Black (R&B), New Age.
- TOTENKOPF SCHALLPLATTEN**, Lierenfelder Strasse 45, 4000 Duesseldorf, 0211.733 5372, Fax: 0211.733 3773, Tlx: 8588249, MD: Jochen Huelder.
- TRANSPARENT RECORDS**, Glashuettenstrasse 79, 2000 Hamburg 6, 040.430 1041, Fax: 040.438 867, Tlx: 2165987, Mgr: Angelica Oplersch.
- UBM RECORDS**, Aachener Strasse 1112a, 5000 Cologne 40, 02234.74081, Fax: 02234.79730, President: Uwe Buschkoetter, GM: Lothar Braun.
- V-RAM DISCS EUROPE**, Struetsweg 1, 8751 Bessenbach, 06095.1437.
- VERABRA MUSIC GROUP**, PO Box 270126, 5000 Cologne 1, 0221.512 031, Fax: 0221.529 563, Tlx: 8886685, President: Vera Brandes, MD: Michael Jacoby, Mktg Mgr: Elke Hiel, Promo (Radio): Christoph Bornefeld-Ettm. Labels owned: VeraBra Records, Intuition, American Clave, Tantric, Go Jazz, 101 South.
- VIRGIN SCHALLPLATTEN**, Herzogstrasse 64, 8000 Munich 40, 089.381 809/0, Fax: 089.381 809-18, Tlx: 897949, MD: Udo Lange, Sales Dir: Tarara Rainer, A&R Mgrs: Patrick Orth, Michael Wolf, Label Mgrs: Anja Beisse, Ernie Lange, Karin Schemik, Janine Folger. Labels (owned): Luna, Piccobello; (Lic & distr): Nicht Records, Virgin Classics, Luna, Circa, Gold Castle, EG, Earthworks, Virgin America, Editions EG, Pointblank, Ten Records, Piccobello, Siren, Charisma, Venture, MP, Clubtone, Cardiac, Caroline, Realworld, Movie Music, Linn Records, Marlboro Music, D.
- WARNER MUSIC GERMANY (HAMBURG)**, Arndtstrasse 16, 2000 Hamburg 76, 040.228 052-0, Fax: 040.2280 5297, Tlx: 214881, Pres: Warner Music/Central Europe: Manfred Zunkeller, MD (WEA): Gerd Gebhardt, Dir Finance & Adm: Helmar Escher, Sales Dir: Ernst-Wilhelm Teske.
- WATERMAN MUSIC**, Johannisstrasse 30, 4500 Osnabrueck, PO Box 3180 (Zip: 4500), 0541.26257, Fax: 0541.26319, MD/Producer: Udo Michels, A&R/Promo: Verena Michels. Label (owned): Waterman Records; Main product: Dance, Black (R&B), Pop.
- WE BITE RECORDS**, Goenninger Strasse 3, 7417 Pfullingen, 07121.7893/4, Fax: 07121.79507, MDs: Thomas Issler, Margit Wellenreuther, Promo: Patrick Riess. Label (owned): We Bite; (Lic): Chainsaw Murder Records (Swi); Distribution: SPV.
- WESTSIDE**, Brelumstrasse 7, 6100 Darmstadt, 06150.82091, Fax: 06150.87083, Contact: Achim Volker.
- WIDDER MUSIK**, Von Anckelnstrasse 12, 2050 Hamburg 80, 040.724 2437, Fax: 040.721 4587, Owner: Gunter Baumgart.
- WINKEL**, Am Moosfeld 37, 8000 Munich 82, 089.420 030, Fax: 089.420 0342, Tlx: 522636, MD: W G Winkel, Mktg Mgr: Swetlana Winkel.
- ZYX RECORDS**, Benzstrasse, Industriegebiet, 6295 Merenberg, 06471.5050, Fax: 06471.50599, Tlx: 48216-4, President: Bernhard Mikulski, MD: Reinhard Piel, Label Mgr (Jazz): Steve Hamelink, Mgr (Import): Andy Kappel. Labels (Owned): Memory, Freshline, ZYX Metal, Classic Records, Galaxis, Abfahrt, Technodrome, Elbtaler Schallplatten; (Lic): Fantasy, Prestige, Milestone, Riverside, Pablo, Storyville, GNP, Hotsound, Groove Street, Lanesound.

MUSIC PUBLISHERS

- TIL TUNES**, see Warner/Chappell Germany.
- 1980 MUSIC**, see Marie-Marie Music.
- 4 FRUCHT MUSIKVERLAG**, Cretzschmarstrasse 13, 6000 Frankfurt am Main, 069.707 2827, Fax: 069.709 483, MD: Thomas M Kann.
- 99 RECORDS IMPORT**, Karl-Hofer Strasse 35, 1000 Berlin 37, 030.801 3099, Fax: 030.801 2212, MD: Peter Schimmelpfennig.
- A LA CARTE MUSIC**, Nachtigallenweg 34, 5202 Hennef 1, 02242.3082, Fax: 02242.83210, Tlx: 889775, MDs: Karin Hartmann, Tony Hendrik.
- A THOUSAND MILES LONG**, see Sony Music Publishing.
- AARON SPELLING**, see Warner/Chappell Germany.
- ABC/DUNHILL**, see MCA Music.
- ABSTRACTIVE**, see Warner/Chappell Germany.
- ABZ**, see Warner/Chappell Germany.
- ACARA**, see Warner/Chappell Germany.
- ACUFF-ROSE**, see Warner/Chappell Germany.
- ADDINGTON STATE**, see Valentine Musikverlag.
- ADHOC PUBLISHING**, see Rudolf Slezak Musik.
- ADLER MUSIC/JERRY ROSS**, see Warner/Chappell Germany.
- ADRA**, see Wintrup Musikverlage.
- ADVANCED**, see Warner/Chappell Germany.
- AFFIRMATIVE**, see Warner/Chappell Germany.
- AFG**, see MCA Music.
- AFI**, see Warner/Chappell Germany.
- AFTER HOURS**, see Marie-Marie Music.
- AFTER THE RAIN**, see Warner/Chappell Germany.
- AGALOCO MUSIKVERLAG**, Bismarckstrasse 14, 5000 Cologne 50, 0221.395 802, Fax: 0221.393 697, MDs: Wolfgang Schroeder, Wolfgang Gerhard.
- AIR BEAR**, see Warner/Chappell Germany.
- AIR FORCE**, see Selected Sound (emi Music Publishing).
- AKTIVE MUSIK**, Balkenstrasse 17/9, 4600 Dortmund 1, PO Box 100128 (Zip: 4600), 0231.577 9038, Fax: 0231.577 9030, President: Ulrich Hetscher, Copyright/A&R: Helga Reichel.
- ALBA**, see Peer Musikverlag.
- ALBION**, see Wintrup Musikverlage.
- ALL NATIONS**, see Melodie Der Welt.
- ALMOND LEGG**, see Warner/Chappell Germany.
- ALPHABEAT**, PO Box 1201, 6980 Wertheim am Main, 09342.84155, President: Stephan Dehn.
- ALSTER MUSIK VERLAG**, Bramfelder Chaussee 238c, 2000 Hamburg 71, 040.642 5041, Fax: 040.642 9475, MD/A&R: Jens-Markus Wegener, A&R Dir: Jorg-Ingmar Hiller. Main product: EHR, Dance, Album Rock, Black (R&B).
- ALTO VOYAGE**, see Sony Music Publishing.
- AMADEUS**, see Warner/Chappell Germany.
- AMERICA TODAY MUSIC**, see R D Clevere Musikverlag.
- AMERICAN BROADCASTING**, see MCA Music.
- AMERICANINO**, see Warner/Chappell Germany.
- AMEUROPE**, see Rudolf Slezak Musik.
- ANANAS**, see Warner/Chappell Germany.
- AND WHAT NOT**, see Sony Music Publishing.
- ANDROS**, see Warner/Chappell Germany.
- ANGEL NOTES**, see Warner/Chappell Germany.
- ANGRY FISH MUSIC**, see Freibank Musikverlag.
- ANLON MUSIC**, see MCA Music.
- ANOTHER NOTE**, see Sundance Music.
- ANTENNA**, see Polygram Songs Musikverlag.
- APOLLEON**, see Warner/Chappell Germany.
- AQUA BLUE**, see Warner/Chappell Germany.
- ARABELLA**, see BMG Ufa Musikverlage.
- ARBOS**, see Global Musikverlage.
- ARETA**, see Peer Musikverlag.
- ARGO**, see Warner/Chappell Germany.
- ARGOT**, see Valentine Musikverlag.
- ARLON ENTERPRIS**, see Warner/Chappell Germany.
- ARROW**, see Warner/Chappell Germany.
- ARTAG**, see Paradise Music.
- ARTEG**, see Mento Music Group.
- ARTFORCE**, see Siegel Music Companies.
- ARTHUR'S MOTHER**, see Valentine Musikverlag.
- ARTO**, see Warner/Chappell Germany.
- AS ARTIST SERVICE**, Eppendorfer Baum 13, 2000 Hamburg 20, 040.487 080/482 828, Fax: 040.463 061, MDs: Elke Heitkamp, Annett Imholz, A&R Mgr: Andreas Reih. Library; Main product: Adult Contemporary, Jazz, Country, Classical, Dance, Album Rock, Black (R&B), New Age.

- AS ARTIST SERVICE, Eppendorfer Baum 13, 2000 Hamburg 20, 040.487 080/482 828, Fax: 040.463 061, MDs: Eike Heitkamp, Annett Imholz, A&R Mgr: Andreas Reth. Publisher; Main product: Adult Contemporary, Jazz, Country, Classical, Dance, Album Rock, Black (R&B), New Age.
- ASCHENPUTTEL, see Warner/Chappell Germany.
- ASHDALE, see Warner/Chappell Germany.
- ATMOSPHERE, see Selected Sound (emi Music Publishing).
- ATV MUSIC GROUP, see MCA Music.
- AUDIGRAM, see Warner/Chappell Germany.
- AUNTIE GRAVITY, see Warner/Chappell Germany.
- AUSTRALIAN MUSHROOM, see Sony Music Publishing.
- AUTARC, see Warner/Chappell Germany.
- AUTEURSUNIE MUSIC, see Mento Music Group.
- AUTOGRAM RECORDS, Burgstrasse 9, 4405 Nottuin, 02502.6151, Fax: 02502.1825, MD: Willy Schwenken. (Owned): Autonom.
- AUTONOM, see Autogram Records.
- AUTUMN, see Warner/Chappell Germany.
- AVANTI, see Global Musikverlage.
- AVID ONE, see MCA Music.
- AVOCADO, see Warner/Chappell Germany.
- AXXIS MUSIKVERLAG, Arabellastrasse 5/140, 8000 Munich 81, 089.910 2089, Fax: 089.916 934, MD: George Naschke. (Owned): AXXIS; (Admin/sub-pub): C'est Music, Constantin Music, Giorgio Moroder Publishing, Quackenbush Music, Revelation Music, Say Yes Music, Stan Bush Music, Swindle Music, Texas Twang Music.
- AYERS ROY UBIQUITY, see Warner/Chappell Germany.
- B SCHOTT'S SOEHNE, Weihergarten 5, 6500 Mainz, PO Box 3640 (Zip: 6500), 06131.2460, Fax: 06131.248 211, Tlx: 4187821, Contact: Bernd Muller.
- B.A.T, see Stretheat Music Produktion.
- B.O.P, see Valentine Musikverlag.
- BAD BOYS, see Siegel Music Companies.
- BAD COMPANY, see MCA Music.
- BADOS, see Progressive Musikverlag.
- BALMAIN, see Warner/Chappell Germany.
- BANANANAS, see Warner/Chappell Germany.
- BANGS AND CRASHES, see Sony Music Publishing.
- BANTHA, see Warner/Chappell Germany.
- BARBADOS, see Warner/Chappell Germany.
- BARCLAY MORRIS, see Warner/Chappell Germany.
- ARIATON, see BMG Ufa Musikverlage.
- BARRACUDA, see Warner/Chappell Germany.
- BARTON, see Warner/Chappell Germany.
- BASH, see Progressive Musikverlag.
- BASQUE, see Warner/Chappell Germany.
- BE-BOP, see Sony Music Publishing.
- BE, see Warner/Chappell Germany.
- BEACHHOUSE, see Warner/Chappell Germany.
- BEAM DOWN, see Warner/Chappell Germany.
- BEAT BITS, see Siegel Music Companies.
- BEAU-DI-O, see Warner/Chappell Germany.
- BECKBEAT, see Warner/Chappell Germany.
- BECO, see Schacht Musik.
- BEL CANTO, see BMG Ufa Musikverlage.
- BELLAPHON RECORDS, Mainzer Landstrasse 87/9, 6000 Frankfurt am Main, 069.27120, Fax: 069.271 2117, Tlx: 4160046, President: Branko Zivanovic, PR Mgr: Renate Strack-Hahnlein.
- BELLKAT, see Warner/Chappell Germany.
- BELLVER MUSIC, Mainzer Landstrasse 87/9, 6000 Frankfurt am Main, 069.27120, Fax: 069.271 2117, Tlx: 4160046, President: Branko Zivanovic. (Owned): Bellver Music; (Admin/sub-pub): Bellver, Vienna, Emergency Music, Not Fragile, Shelby Singleton, WENAH.
- BEMA, see MCA Music.
- BEN SCOTTI, see Warner/Chappell Germany.
- BENCHMARK, see Warner/Chappell Germany.
- BENYET MUSIC, see Siegel Music Companies.
- BERBUER, see Melodie Der Welt.
- BERLIN, see Warner/Chappell Germany.
- BERNHARD MIKULSKI MUSIKVERLAG, Grosse Friedberger Strasse 23-27, 6000 Frankfurt am Main 1, 069.299 8670, Fax: 069.299 8670, MD: Bernhard Mikulski. Main product: Adult Contemporary, Jazz, Dance, Black (R&B).
- BERTUS, see Warner/Chappell Germany.
- BETTIS, see Warner/Chappell Germany.
- BETTY EARLAND, see Warner/Chappell Germany.
- BIG APPLE, see Warner/Chappell Germany.
- BIG BANG, see Warner/Chappell Germany.
- BIG KITTY, see Warner/Chappell Germany.
- BIG LIFE, see Hammer Musik.
- BIG PIG, see Warner/Chappell Germany.
- BIG SEVEN, see Warner/Chappell Germany.
- BIG SIX, see Warner/Chappell Germany.
- BIG SKY, see Warner/Chappell Germany.
- BIG SOUND, see R D Clevere Musikverlag.
- BIRDIE, see Siegel Music Companies.
- BLACK DRAGON, see Warner/Chappell Germany.
- BLACK ICE PUBLISHING, see MCA Music.
- BLACK MOUNTAIN ROAD, see Warner/Chappell Germany.
- BLACK SHEEP, see Warner/Chappell Germany.
- BLACKBIRD MUSIC, Rheingaustrasse 2, 1000 Berlin 41, 030.822 4996, Fax: 030.821 9760, President: Andreas Hommelsheim, MD: Sara Hommelsheim. Main product: Jazz, Classical.
- BLACKKEYE, see Warner/Chappell Germany.
- BLACKHILL, see Warner/Chappell Germany.
- BLACKOUT, see Siegel Music Companies.
- BLEU DISQUE, see Warner/Chappell Germany.
- BLIND HORSE, see Freibank Musikverlag.
- BLM MUSIK, Hubertusstrasse 11, 5340 Bad Honnef 6, PO Box 6160 (Zip: 5340), 02224.80726, Fax: 02224.80253, MD: Wolfgang P Lentz.
- BLOWING ROCK, see Warner/Chappell Germany.
- BLUE BOX, Netzegastrasse 1, 8000 Munich 70, 089.7148 582, Fax: 089.718 687, MD: Karin Wirthmann.
- BLUE FLAME, see Warner/Chappell Germany.
- BLUE GUM, see Warner/Chappell Germany.
- BLUE HORIZON, see Paradise Music.
- BLUE PEARL, see Warner/Chappell Germany.
- BLUE SEAS, see Melodie Der Welt.
- BLUE TEAM, see Warner/Chappell Germany.
- BLUEWATER, see Progressive Musikverlag.
- BM, see Global Musikverlage.
- BMG UFA MUSIKVERLAG, Neumarkter Strasse 18, D-8000 Munich 80, PO Box 802009 (Zip: 8000), (49) 089.431 9800, Fax: (49) 089.4319 8070, Tlx: 523265 ufa, MD/VP: Hartwig Masuch, Dep MD: Hans Scharfen, Int'l Repertoire Mgr/Dir. Creative Affairs: Willi Schlosser, Copyright Mgr: Helga Moltkau. (Owned): Arabella, Bariaton, Bel Canto, Brull, Cap Sounds, Chinnichap, Crescendo, Cyclus, Discoton, Dreiklang Dreimask, Figaro, Folklore, Interworld, Modern Records, Neuton, Ufaton, Wiener Boheme; (Admin): Bug, Chlodwig, ERP, Gama, Kilaua, Kollo, Rex; New address (Feb 1992): Steinhäuserstrasse 1-3, 8000 Munich 80.
- BMKK MUSIC PUBLISHING, Amsinckstrasse 45, 2000 Hamburg 1, 040.232 771/490 5360, Fax: 040.491 1172, MD: Stefan Muenzel.
- BOHANNON, see Warner/Chappell Germany.
- BONA RELATIONS, see Warner/Chappell Germany.
- BOOGIESONGS, see Warner/Chappell Germany.
- BOOGIETUNES, see Warner/Chappell Germany.
- BORDER, see Warner/Chappell Germany.
- BOURNE, see Melodie Der Welt.
- BRAMPTON, see Melodie Der Welt.
- BRAUSE BEAT, see Warner/Chappell Germany.
- BREEZE MUSIC, Hauptstrasse 33, PO Box 3149, 5024 Pullheim 3, 02238.2004, Fax: 02238.2734, President: Dieter Dierks, MD: Fred Hoock, Promo: Karen Tobias, A&R: Gaby Hoffmann. Main product: Album Rock.
- BREGMAN VOCCO, see Warner/Chappell Germany.
- BRIAN MORRISON, see Warner/Chappell Germany.
- BROCKMAN, see Warner/Chappell Germany.
- BROGUE, see Warner/Chappell Germany.
- BRUCO, see Warner/Chappell Germany.
- BRULL, see BMG Ufa Musikverlage.
- BSM-BAVARIASONOR MUSIKVERLAG, Bavariafilm Platz 7, 8022 Geiselgasteig, 089.649 2238, Fax: 089.649 2507, Tlx: 523254, President: Guenter Rohrbach, Chmn: Guenter Brakelmann, MD: Harald Junge.
- BUCKHORN, see Valentine Musikverlag.
- BUFFALO, see Warner/Chappell Germany.
- BUG, see BMG Ufa Musikverlage.
- BUGLE, see Warner/Chappell Germany.
- BULLET PROOF, see Warner/Chappell Germany.
- BURLINGTON, see Warner/Chappell Germany.
- BURNT ASH, see Valentine Musikverlag.
- BUSHKA, see Warner/Chappell Germany.
- BUXTON HILL, see Warner/Chappell Germany.
- BYTE 'N' BIT, see Wintrup Musikverlage.
- C & D, see Warner/Chappell Germany.
- C'EST MUSIC, see Axxis Musikverlag.
- CABBAGE FLAKE, see Sony Music Publishing.
- CADERO, see Marie-Marie Music.
- CADILLAC PINK, see MCA Music.
- CALD THIS, see Warner/Chappell Germany.
- CALREN, see Wintrup Musikverlage.
- CANCON, see Valentine Musikverlag.
- CANDIDA, see Warner/Chappell Germany.
- CANE GARDEN, see Warner/Chappell Germany.
- CANVEE, see Warner/Chappell Germany.
- CANZONETTA, see Schacht Musik.
- CAP SOUNDS, see BMG Ufa Musikverlage.
- CAP-SOUNDS MUSIC PUBLISHING, Sudetenweg 6, 6239 Krieffel, 06192.45861, Fax: 06192.45861, MD: Manfred Holz. Main product: EHR, Dance.
- CAPELLA, see Gerig Music.
- CAPLIN SONGS, see Warner/Chappell Germany.
- CAPRICCIO, see Warner/Chappell Germany.
- CARBELLA, see Siegel Music Companies.
- CARLIN, see Warner/Chappell Germany.
- CARLTON, see Gerig Music.
- CARMEL, see Warner/Chappell Germany.
- CAROL BAYER SAGER, see Melodie Der Welt.
- CAROLCO, see Melodie Der Welt.
- CARREN, see Schacht Musik.
- CART BEFORE HORSE, see Sony Music Publishing.
- CASA DAVID, see Melodie Der Welt.
- CASA DE ORO, see Warner/Chappell Germany.
- CASABLANCA, see Warner/Chappell Germany.
- CASAPARK, see Peer Musikverlag.
- CASARICA, see Warner/Chappell Germany.
- CASINO MUSIK, Boekmannstrasse 5, 2000 Hamburg 1, 040.241 617-9, Fax: 040.249 448, President: Klaus Schulz.
- CASS COUNTY, see Warner/Chappell Germany.
- CASTLE HILL, see Warner/Chappell Germany.
- CAT PEOPLE, see MCA Music.
- CAT TALK, see Siegel Music Companies.
- CATSTYLE, see Warner/Chappell Germany.
- CAVALIER, see Gerig Music.
- CAVENDISH, see Sonoton Music Library.
- CC SONGS, see Warner/Chappell Germany.
- CCC-TON, see Schacht Musik.
- CHAMBRE 810, see Freibank Musikverlag.
- CHAMPION, see MCA Music.
- CHANDFAME, see Warner/Chappell Germany.
- CHANNEL 5, see Siegel Music Companies.
- CHAPPELL, see Warner/Chappell Germany.
- CHARLOTTE, see Warner/Chappell Germany.
- CHART PROMOTIONS, see Warner/Chappell Germany.
- CHARTE, see Warner/Chappell Germany.
- CHEWY, see Warner/Chappell Germany.
- CHEYENNE, see Warner/Chappell Germany.
- CHEZ RAVEL, see Sony Music Publishing.
- CHI-SOUND, see Warner/Chappell Germany.
- CHIC, see Warner/Chappell Germany.
- CHICO, Schnackenburgallee 215, 2000 Hamburg 54, 040.544 227, Fax: 040.545 666, MD: Ulrich Maske.
- CHINNICHAP, see BMG Ufa Musikverlage.
- CHIPPESTAR, see Warner/Chappell Germany.
- CHLODWIG MUSIK, Luxemburgerstrasse 42, 5000 Cologne 1, 0221.234 165, Fax: 0221.239 364, President: Walter & Karl Heinz Puetz, Thomas Stein, Promo Mgr: Rafael Fuchsgruber, Label Mgr: Bogusia Gornik.
- CHLODWIG, see BMG Ufa Musikverlage.
- CHLOE SONGS, see Warner/Chappell Germany.
- CHONG, see Warner/Chappell Germany.
- CHRIS GILBEY, see MCA Music.
- CHRISISMUSI, see Global Musikverlage.
- CHRISII, see Siegel Music Companies.
- CHRISTIAN ANDERS, see Paradise Music.
- CHRISWALD, see MCA Music.
- CHRYSAL COPY, see Warner/Chappell Germany.
- CHU-FIN, see Seychelles Music.
- CINEVOX, see Gerig Music.
- CLARKEE, see Warner/Chappell Germany.
- CLASSEAST, see Warner/Chappell Germany.
- CLOCKWORK, see Wintrup Musikverlage.
- COACHMAN, see Gerig Music.
- COLORIT, see Gerig Music.
- COMMANDER, see Warner/Chappell Germany.
- COMPLETE, see Wintrup Musikverlage.
- CONCORDE, see Warner/Chappell Germany.
- CONROY, see Sonoton Music Library.
- CONSTANTIN MUSIC VERLAGS, Goethestrasse 68, 8000 Munich 2, 089.530 9135/6, Fax: 089.537 678, Tlx: 523019, President: Edwin Leicht, Alfred Meier.
- COOL CAT MUSIC, Heinrich Hertz Strasse 106, 2000 Hamburg 76, 040.227 0903, Tlx: 2174960, MDs: Klaus Gerlach, Nina Martin.
- COOL-SPRINGS, see Warner/Chappell Germany.
- COOLKING, see Warner/Chappell Germany.
- COPELIA, see Marie-Marie Music.
- COPYRIGHT MANAGEMENT, see Global Musikverlage.
- CORBETTA, see Warner/Chappell Germany.
- CORE MUSIC, see Schacht Musik.
- CORNER STONE, see Valentine Musikverlag.
- CORNET, see Gerig Music.
- COSIMA, see Warner/Chappell Germany.
- COSMUS, Johannesstrasse 8, 6780 Pirmasens, 06331.76096-8, Fax: 06331.31379, President: Josef Minderjahn.
- COTILLION, see Warner/Chappell Germany.
- COUNTDOWN MUSIC, Harksheider Weg 74, 2085 Quickborn, PO Box 1145 (Zip: 2085), 04106.5041, Fax: 04106.67046, President: Rainer Eitzrodt. (Owned): Countdown Music, Quimus Musikverlag; Main product: Adult Contemporary, Country, Classical, Dance.
- CRAZY LIFE MUSIC, Holsterhauserstrasse 96, 4300 Essen 1, 0201.707 498, Fax: 0201.702 694, President: Axel Thubeauville. (Owned): Shark, US Metal, MMT; Main product: Hard Rock.
- CREA SOUND, see Sonoton Music Library.
- CREATIVE, see Warner/Chappell Germany.
- CREATIVE BLOC, see Warner/Chappell Germany.
- CRESCENDO, see BMG Ufa Musikverlage.
- CRMV, see Warner/Chappell Germany.
- CROSSCULTURE, see Erdenklang Musikverlag.
- CROSSTOWN, see Warner/Chappell Germany.
- CRYPT, see Freibank Musikverlag.
- CTM, see Win Music.
- CULTURE CLUB, see Freibank Musikverlag.
- CUPPAMORE MUSIC, Christstrasse 38, 1000 Berlin 19, 030.322 7847, Fax: 030.883 6168, President: Horst Koch.
- CURACAO, see MCA Music.
- CYCLUS, see BMG Ufa Musikverlage.
- DACSA, see Selected Sound (emi Music Publishing).
- DAEDALUS, see Warner/Chappell Germany.
- DAILY SOUND, see Global Musikverlage.
- DAKAR, see Warner/Chappell Germany.
- DALIAH, see Warner/Chappell Germany.
- DALY CITY, see Warner/Chappell Germany.
- DAMONT, see Warner/Chappell Germany.
- DANGEROUS, see Warner/Chappell Germany.
- DANY MUSIC MUSIKVERLAG, Drususgasse 7-11, 5 Cologne 1, 0221.234 833, Fax: 0221.207 9897, Tlx: 8881233, MDs: Ray van Cant, Gunter Ilgner.
- DANY, see Gerig Music.
- DARK WINGS MUSIKVERLAG, Kurfuerstenstrasse 23, 1000 Berlin 30, PO Box 110226 (Zip: 1000), 030.261 9085, Fax: 030.262 4448, Tlx: 185738 modm, President: Karl-Ulrich Walterbach, MD: Annegret Quintus-Winther.
- DAROMELLA, see Siegel Music Companies.
- DARREL BROWN, see Warner/Chappell Germany.
- DATA ALFA, see Siegel Music Companies.
- DAVID ROSE, see Warner/Chappell Germany.

- DAVID, see Warner/Chappell Germany.
 DAVIMAR, see Warner/Chappell Germany.
 DAVRAY, see Warner/Chappell Germany.
 DAWG + ZUT, see Warner/Chappell Germany.
 DE BLACK FOOSS, see Gerig Music.
 DECREED, see MCA Music.
 DEERTRACK, see Warner/Chappell Germany.
 DEFROSTER, see Global Musikverlage.
 DELAY, see Global Musikverlage.
 DELICATE ISSUES, see Marie-Marie Music.
 DENISE BARRY, see Warner/Chappell Germany.
 DENJAC, see Warner/Chappell Germany.
 DERRY, see Valentine Musikverlag.
 DIABOLO, see Warner/Chappell Germany.
 DIAMOND MINE, see Warner/Chappell Germany.
 DICK JAMES, see Polygram Songs Musikverlag.
 DIE KRUPPST, see Human Noise.
 DIESELHOME, see Siegel Music Companies.
 DINO MUSIC, Bleichstrasse 5, 6242 Kronberg, 06173.709 90, Fax: 06173.5132, Tlx: 418350, President: Frank Pletzsch, MD: Helmut Schnauffer, Copyright Mgr: Juergen Besemer. (Owned): Edition NIDO: (Sub-pub): Sottovoce.
 DIRT HEAD, see Warner/Chappell Germany.
 DISCORDIA, see Warner/Chappell Germany.
 DISCOTON, see BMG Ufa Musikverlage.
 DIVING FOR PEARLS, see Sony Music Publishing.
 DIVOLO, see Sundance Music.
 DOGMO, see Valentine Musikverlag.
 DOLPHIN, see Valentine Musikverlag.
 DON SCHLITZ, see MCA Music.
 DONAR MUZIEK, see Warner/Chappell Germany.
 DONNA LEE, see Valentine Musikverlag.
 DONNA WEISS, see Warner/Chappell Germany.
 DOBBIE BROTHERS, see Warner/Chappell Germany.
 DORAFLO, see Warner/Chappell Germany.
 DORFF, see Warner/Chappell Germany.
 DORMANT, see Warner/Chappell Germany.
 DOTS + LINES, see Warner/Chappell Germany.
 DOUBLE DUCK, see Warner/Chappell Germany.
 DOUGH BOY, see Warner/Chappell Germany.
 DOUGLAS SAHM, see Warner/Chappell Germany.
 DOVAN, see Warner/Chappell Germany.
 DREAMHOUSE, see Warner/Chappell Germany.
 DREIKLANG DREIMASK, see BMG Ufa Musikverlage.
 DREYFUSS, see Warner/Chappell Germany.
 DRUSENINJA, see Warner/Chappell Germany.
 DU MONDE MELODIE, see Sundance Music.
 DUANE, see Warner/Chappell Germany.
 DUCHESS, see MCA Music.
 DUCK BALLADS, see Warner/Chappell Germany.
 DWARF, see Warner/Chappell Germany.
 DYNAMIC, see Warner/Chappell Germany.
 DYNATONE, see Warner/Chappell Germany.
 EARTH, see Warner/Chappell Germany.
 EASY ACTION, see Warner/Chappell Germany.
 EASY MONEY, see Warner/Chappell Germany.
 EATON, see Gerig Music.
 EB MARKS, see Warner/Chappell Germany.
 EBELER, see Gerig Music.
 EC, see Warner/Chappell Germany.
 EDEL, Wichmannstrasse 4, Haus 8, 2000 Hamburg 52, PO Box 520151 (Zip: 2000), 040.890 850, Fax: 040.896 521, MD: Michael Haentjes.
 EDGE OF FLUKE, see Warner/Chappell Germany.
 EDIE BRICKNELL SONGS, see Warner/Chappell Germany.
 EDISTO SOUND INT'L, see Sony Music Publishing.
 EDITION AUTARC, Heussweg 25, 2000 Hamburg 20, PO Box 201251 (Zip: 2000), 040.491 4145, Fax: 040.4906 2267, Tlx: 213545, MD: Thomas Stein.
 EDITION BLEI, see Freibank Musikverlag.
 EDITION DAGOBERT, see MCA Music.
 EDITION EDIT, see Siebenpunkt Verlags.
 EDITION FENN, see Marie-Marie Music.
 EDITION INTRO GEBR MEISEL, Wittelsbacherstrasse 18, 1000 Berlin 31, 030.884 140, Fax: 030.881 6243/883 5201, Tlx: 184174, MD: George Glueck, Prod Mgrs: Karin Robinson, Marion Hofmann. Main product: Adult Contemporary, Dance, Pop.
 EDITION KILLYTON, see Rudolf Slezak Musik.
 EDITION KING'S SINGERS MUSIC, see Rudolf Slezak Musik.
 EDITION MAXWOOD, see Rudolf Slezak Musik.
 EDITION MIRIAM FRANCES, see Rudolf Slezak Musik.
 EDITION NIDO, see Dino Music.
 EDITION ORNUMUSIC, see Rudolf Slezak Musik.
 EDITION REPEX, see Repex Music.
 EDITION SET-A-LITE, PO Box 380222, 1000 Berlin 38, 030.813 4182, Fax: 030.814 1632, MD: Riff La Roche. Main product: Dance, Album Rock, Ethnic.
 EDITION SIEG-TON, Geistingergplatz 1A, 5202 Hennef-Sieg 1, 02242.81516, Fax: 02242.83472, MD: Georg Russmann Jr, A&R Dir: Thomas Haustmann.
 EDITION SPV MUSIC, Hoehchstrasse 2, 8000 Munich 80, 089.984 926, Fax: 089.980 250/981 779, MDs: Joachim Neubauer, Manfred P Schuetz, Ralph Siegel.
 EDITION TSHETON, Herzogstrasse 103, 8000 Munich 40, 089.300 9061, Fax: 089.300 9061, President: Melvin Wayne Edmondson.
 EDITION WACHTEL, see Seychelles Music.
 EDITION WECKER, see Global Musikverlage.
 EDITION, see Rudolf Slezak Musik.
 EDWIN ELLIS, see Warner/Chappell Germany.
 EGE MUSIC, Zum Schussenersprung 26, 7953 Bad Schussenried, 07583.2768, Fax: 07583.4141, Owner: Brigitte Ege, A&R Mgr: Dieter Ege.
 EGO, see Warner/Chappell Germany.
 EGREM, see Termidor Musikverlag.
 EIGHT TWELVE, see Warner/Chappell Germany.
 EIMC, see Wintrup Musikverlage.
 EISBRECHER, see Warner/Chappell Germany.
 EISENBERG MUSIKVERLAG, St. Apem Strasse 10-12, 5000 Cologne 1, 0221.219 409, Fax: 0221.239 257, MD: Alfred Rhiem, Prof Mgr: Carlos Peron.
 ELDORADO, see Warner/Chappell Germany.
 ELEKSYLUM, see Warner/Chappell Germany.
 ELEKTRIC SUN, see Warner/Chappell Germany.
 ELGIN, see Schacht Musik.
 ELLENSONG, see Warner/Chappell Germany.
 ELLYMAX, see Progressive Musikverlag.
 EMERGENCY MUSIC, see Bellver Music.
 EMI MUSIC PUBLISHING (GERMANY), Alsterchaussee 25, 2000 Hamburg 13, PO Box 2663 (Zip: 2000), 040.414 0150, Fax: 040.4140 1515, Tlx: 212530 emi mp, MD: Peter Ende, Creative Dir: Andreas Kiel.
 ENCINO, see Warner/Chappell Germany.
 ENCORE, see Warner/Chappell Germany.
 ENEMY, see Warner/Chappell Germany.
 ENERGIE, see Siegel Music Companies.
 ENJA EUROPEAN NEW JAZZ MUSIC, Frundsbergstrasse 36, 8000 Munich 19, 089.161 777, Fax: 089.167 8810, President: Matthias Winckelmann, Horst Weber, GM: Katharin Reiser.
 ENJA RECORDS, Volkartstrasse 19, 8000 Munich 8, 089.165 172, Fax: 089.166 839, President: Horst Weber, Contact: Patricia Flesh. Main product: Jazz.
 EPIC/PORTRAIT SOLAR, see Warner/Chappell Germany.
 EPM, see Gerig Music.
 ERDENKLANG MUSIKVERLAG, Halstenbeker Weg 17, D-2000 Hamburg 54, (040) 576035, Fax: (040) 574304, Pres.: Ulrich Ruetzel, GM: Hedda Schweder, Prof./Creative Mgr.: Thomas Kunadt.
 ERICHOUSE, see Warner/Chappell Germany.
 ERP, see BMG Ufa Musikverlage.
 ESPERANZA MUSIKVERLAG & MUSIKPRODUKTION, Heimhuder Strasse 73, 2000 Hamburg 13, 040.445 276, Fax: 040.449 467, Pres/MD: Werner Triepke. (Owned): Esperanza, Casarica, TRIMAN, Morningsong; (Admin): Newkeys Music, Southern Arts; Main product: Adult Contemporary, Country, Classical, Dance, Gold/Oldies.
 ESPRESSO, see Gerig Music.
 ESSEX, see Gerig Music.
 ETHNIC WORLD MUSIC, see Freibank Musikverlag.
 EUPHONIUS, see Warner/Chappell Germany.
 EUROPATON, Reichsstrasse 4, 1000 Berlin 19, 030.302 2084, MDs: Gerda Nordenholz, Maria Theresia Schaeffer.
 EUROPEAN, see Warner/Chappell Germany.
 EVERSONGS, Egerlandstrasse 1, 8043 Unterfoehring, PO Box 1122 (Zip: 8043), 089.950 4416, Fax: 089.950 3057, Tlx: 1789797 ever, President: Joerg Evers, Promo/PR: Roswitha Wolfram. Main product: Adult Contemporary, Classical, Dance, Album Rock, New Age.
 EVITA, see MCA Music.
 EXOSCELETAL, see Warner/Chappell Germany.
 EXTRA, see Siegel Music Companies.
 FAITH HOPE & CHARITY, see Warner/Chappell Germany.
 FAMA, see Siegel Music Companies.
 FAMILY DOGG, see Hammer Musik.
 FANFARE, see Global Musikverlage.
 FANIA, see Termidor Musikverlag.
 FAR EAST & ORIENT, see R D Clevere Musikverlag.
 FAR FETCHED, see Warner/Chappell Germany.
 FAT RAT, see Siegel Music Companies.
 FEATHERSPACE, see Warner/Chappell Germany.
 FECKLESS, see Warner/Chappell Germany.
 FEESONGS, see MCA Music.
 FEIN, see Warner/Chappell Germany.
 FICTION SONGS, see Warner/Chappell Germany.
 FIDDLEBACK, see Warner/Chappell Germany.
 FIGARO, see BMG Ufa Musikverlage.
 FILMKUNST MUSIKVERLAG, Kardinal Faulhaber Strasse 15, 8000 Munich 2, 089.236 9080, Fax: 089.2369 0860, Tlx: 524786, MD: Thomas Haffa, A&R Mgr: Gaby Werth.
 FILMTRAX, see Siebenpunkt Verlags.
 FINGERS, see Warner/Chappell Germany.
 FIRE ESCAPE, see Warner/Chappell Germany.
 FIRELAND, see Siegel Music Companies.
 FIRST ARTISTS, see Warner/Chappell Germany.
 FIRSTCOM, see Ubm Records.
 FIX & FANCY, see Siegel Music Companies.
 FIXX, see Warner/Chappell Germany.
 FLEX-TON, see Wintrup Musikverlage.
 FLIMFLAM, see Streethet Music Produktion.
 FLYING DUTCHMAN, see Warner/Chappell Germany.
 FOCUS, see Sonoton Music Library.
 FOFU, see Warner/Chappell Germany.
 FOLKLORE, see BMG Ufa Musikverlage.
 FON, see MCA Music.
 FONIT CETRA, see Warner/Chappell Germany.
 FONTAINE, see MCA Music.
 FORMUST, see Warner/Chappell Germany.
 FORT KNOX, see Warner/Chappell Germany.
 FOSTER & RICE, see Valentine Musikverlag.
 FOSTER FREES, see Warner/Chappell Germany.
 FOUR JAYS, see Warner/Chappell Germany.
 FOX FILM, see Warner/Chappell Germany.
 FRANK ZAPPA, see Melodie Der Welt.
 FRANKL, see Siegel Music Companies.
 FRED KERSTEN STUDIO, Gruninger Weg 22, 6301 Pohlheim 2, 06404.4900, Fax: 06404.4800, MD: Fred Kersten.
 FRED RAPHAEL, see Warner/Chappell Germany.
 FREEDOM SONGS, see Warner/Chappell Germany.
 FREIBANK MUSIKVERLAG, Spaldingstrasse 74, 2000 Hamburg 1, 040.231 011, Fax: 040.231 317, MD: Mark Chung, Prof Mgr/A&R: Klaus Maeck. (Admin/Sub-pub): Angry Fish Music, Blind Horse, Chambre 810, Crypt, Culture Club, Ethnic World Music, Gold, Sandbank, Yvresse, Edition Blei; Main product: Dance, Album Rock.
 FREIHEIT, see Siegel Music Companies.
 FRENCH FRIED MUSIC, see Global Musikverlage.
 FROST, see Warner/Chappell Germany.
 FRY KING, see Warner/Chappell Germany.
 FS, see Warner/Chappell Germany.
 FTS, see Warner/Chappell Germany.
 FULL KEEL, see Warner/Chappell Germany.
 FUN FACTORY!, Hermannstadiweg 9, 4400 Muenster, 0251.78321, Fax: 0251.780 1874, MD: Axel Seitz, A&R: Alex Sander.
 FUNKTIONELLE MUSIK, Fraunhoferstrasse 2, 8033 Planegg 2 (Martinsried), 089.857 2011, Fax: 089.857 7729, MD: Michael Hartmann. Distributor of professional background music.
 GAINWEST, see Warner/Chappell Germany.
 GALLOP, see Warner/Chappell Germany.
 GAMA MUSIKVERLAG, Dettlinger Strasse 95, 7312 Kirchhe m unter Teck, 07021.52817, Fax: 07021.83321, Tlx: 7267319, MDs: Peter Garattoni, Guenter Marek.
 GARBITOWSKI, Metzger Strasse 30, 5000 Cologne 1, 0221.323 611, Fax: 0221.329 244, MD: Juergen Garbitowski.
 GARLAND JEFFRIES, see Warner/Chappell Germany.
 GARRISONS, see Siebenpunkt Verlags.
 GATEWAY HOUSE, see Warner/Chappell Germany.
 GE GE, see Warner/Chappell Germany.
 GEAR BOX, see Warner/Chappell Germany.
 GEFENN, see Warner/Chappell Germany.
 GEMUS, see Gerig Music.
 GENERAL, see Siegel Music Companies.
 GEORG LOFFLER MUSIKVERLAG, Schleissheimerstrasse 189, 8000 Munich 40, 089.300 4141, Fax: 089.307 1569, Publ: Georg F. Loffler.
 GERDES, see Gerig Music.
 GERHARD TREDE, see Selected Sound (emi Music Publishing).
 GERIG MUSIC, Frankenforster Strasse 40, PO Box 100435, 5060 Bergisch Gladbach 1, 02204.20030, Fax: 02204.200 333, President: Gunter Ilgner, A&R: Lutz Ilgner (Nat'l), Horst Senker (Int'l). (Owned & Admin): Gerig, Capella, Carlton, Cavalier, Cinevox, Coachman, Colorit, Cornet, Dany, De Black Fooss, Eaton, Ebeler, EPM, Espresso, Essex, Gemus, Gerdes, Goldberg, Homburg, Masterphone, Mondial, Orania, Ostermann, Papagayo, Presto, Rhine, Rialto, Riccardo, Schmitz, Schnorrenberg, Sidemton, Spoon, Titan-a, Turnstar, Viktoria.
 GERSHWIN, see Warner/Chappell Germany.
 GET INTO MAGIC, see Warner/Chappell Germany.
 GIKO, see Warner/Chappell Germany.
 GINO VANNELLI, see Warner/Chappell Germany.
 GIORGIO MORODER PUBLISHING, see Axxis Musikverlag.
 GLASS SEA, see Warner/Chappell Germany.
 GLEN SONGS, see Warner/Chappell Germany.
 GLENMORE SONGS, see Sony Music Publishing.
 GLISSANDO, see Warner/Chappell Germany.
 GLITTERBEST, see Warner/Chappell Germany.
 GLOBAL MUSIKVERLAGE, Nederlingerstrasse 21, 8000 Munich 19, 089.151 063, Fax: 089.151 060, President: Peter Kirsten, Publ Mgr: Joerg Fischer. (Owned): Arbos, Avanti, BM, Chrismusi, Copyright Management, Dailysound, Defroster, Delay, Fanfare, French Fried Music (Ger) GMG Productions, Laker, MAM, Manito, Melaphon, Pinwand, Prom, SWL, Edition Wecker, Jumbolino, Transworld, Munich Entertainment; (Admin): over 250 catalogues.
 GLOBULE, see Marie-Marie Music.
 GMG PRODUCTIONS, see Global Musikverlage.
 GODFATHERS, see Sony Music Publishing.
 GOLD, see Freibank Musikverlag.
 GOLDBERG, see Gerig Music.
 GOLDEN KEY, see Siebenpunkt Verlags.
 GOLDEN SPREAD, see Warner/Chappell Germany.
 GOLORA, see Valentine Musikverlag.
 GONE GATOR, see MCA Music.
 GOOD FLAVOUR, see Warner/Chappell Germany.
 GOOD FRIENDS, see Warner/Chappell Germany.
 GOOD HIGH, see Warner/Chappell Germany.
 GORNO, see Marie-Marie Music.
 GRAHAM, see Warner/Chappell Germany.
 GRAND H MUSIC, Haller Strasse 40, 2000 Hamburg 13, 040.441 8020/890 3898, Fax: 040.453 327/895 697, President: Hille Hillekamp. (Admin): Professional Music Consultants (London), Q Music (London); Main product: Dance.
 GRANDMASTER FLASH, see Warner/Chappell Germany.
 GRANT STREET, see MCA Music.
 GRASSHOPPER, see Warner/Chappell Germany.
 GRAVY TRAIN, see Siegel Music Companies.
 GREEN PARK MUSIC, see Wintrup Musikverlage.
 GREENHEART, see Warner/Chappell Germany.
 GREENSTONE, see Warner/Chappell Germany.
 GRIFFIN, see Warner/Chappell Germany.
 GULP, see Siegel Music Companies.
 GUNS 'N' ROSES, see Warner/Chappell Germany.
 HACKADY, see Warner/Chappell Germany.
 HAFENKLANG, see Wintrup Musikverlage.

HALSEY BROTHERS, see Warner/Chappell Germany.
HAMMER MUSIK, Christophstrasse 38, 7000 Stuttgart 1, 0711.648 7620/27, Fax: 0711.648 7629, Tlx: 723094 hamu, MD: Ingo Kleinhammer. (Owned): Hammer Musik, Industrial Music, Westside; (Sub-pub): Sound of Future, Vertex, Musicolor, Supreme, Big Life, Family Dogg, etc.
HAMMOND, see Warner/Chappell Germany.
HANNA BARBERA, see Warner/Chappell Germany.
HANSA MUSIC, Wittelsbacherstrasse 18, 1000 Berlin 31, 030.884 140, Fax: 030.882 5065, Tlx: 184174 intro, President: Hans Blume, Bus Affairs: Bruno Wendel, Promo: Andre Sellenelt.
HANSEATIC, see Warner/Chappell Germany.
HAPPLY, see Warner/Chappell Germany.
HARDERBERG, see Schacht Musik.
HARLEKIJN, see Warner/Chappell Germany.
HARMONIE, see Warner/Chappell Germany.
HARMS, see Warner/Chappell Germany.
HATZ, see Warner/Chappell Germany.
HAVONA, see Warner/Chappell Germany.
HEARTS DELIGHT, see Warner/Chappell Germany.
HEAVY PETAL, see Warner/Chappell Germany.
HEDGECOCK, see Warner/Chappell Germany.
HEEN, see Warner/Chappell Germany.
HENSLEY, see Warner/Chappell Germany.
HERALD SQUARE, see Warner/Chappell Germany.
HERBE, see Warner/Chappell Germany.
HET GERUCHT, see MCA Music.
HIGH LONESOME, see Warner/Chappell Germany.
HILL & RANGE, see Warner/Chappell Germany.
HILL SONGS, see Warner/Chappell Germany.
HILLSTREET, see Sony Music Publishing.
HIMMIGANE, see Warner/Chappell Germany.
HIT N' RUN, see Streethat Music Produktion.
HITCHINGS, see Warner/Chappell Germany.
HITS 'N' MO' HITS, see Warner/Chappell Germany.
HITTAGE, see Wintrup Musikverlage.
HOFFMANNS WVE, see Siegel Music Companies.
HOMBURG, see Gerig Music.
HOPLA, see Progressive Musikverlag.
HOT MELT, see MCA Music.
HOT NIGHT, see R D Clevere Musikverlag.
HOT, see Marie-Marie Music.
HOUSE OF BRYANT, see Valentine Musikverlag.
HOUSE OF FUN, see Warner/Chappell Germany.
HOUSE OF GOLD, see Warner/Chappell Germany.
HUB, see MCA Music.
HUCKEPACK, see Siegel Music Companies.
HUCKSTERS OF COOL, see Sony Music Publishing.
HUDSON BAY, see Warner/Chappell Germany.
HUE & CRY, see Warner/Chappell Germany.
HUMAN NOISE, Kopernikusstrasse 26, 4000 Duesseldorf 1, 0211.315 943, Fax: 0211.319 0182, MD: Juergen Engler, Mgr: Christina Schneidenburger. (Owned): Male, Die Krumpst, The Birdy Num Nums; Main product: Dance, Album Rock.
HUNDEKUCHEN, see Sony Music Publishing.
HUSTLERS, see Warner/Chappell Germany.
HUT-SUT, see Valentine Musikverlag.
I SQUARED, see Warner/Chappell Germany.
I-DUR, see Progressive Musikverlag.
ICE GOLD, see Warner/Chappell Germany.
ICE NINE, see Warner/Chappell Germany.
ICM, see Warner/Chappell Germany.
IDE, Fallstrasse 42, 8000 Munich 70, 089.723 2043, Fax: 089.723 9486, Prof Mgr: Matthias Kuerten.
IDIOD SONGS, see Warner/Chappell Germany.
IDLE SPECULATION, see Warner/Chappell Germany.
IMMORTAL, see Paradise Music.
IMPS, see Warner/Chappell Germany.
IN A BUNCH, see Warner/Chappell Germany.
INAR, see Warner/Chappell Germany.
INDEX, see Warner/Chappell Germany.
INDIA GREEN, see Warner/Chappell Germany.
INDUSTRIAL MUSIC, see Hammer Musik.
INEVITABLE, see Warner/Chappell Germany.
INFINITE, see Warner/Chappell Germany.
INTER, see Melodie Der Welt.
INTERNATIONAL MUSIC BUSINESS SERVICES, Schlossstrasse 67, 1000 Berlin 41, 030.834 2691, Fax: 030.834 3606, Contact: Rolf Nicklaus.
INTERNATIONAL WORLDLINE, see Siegel Music Companies.
INTERPOL, see Warner/Chappell Germany.
INTERVAL, see Siegel Music Companies.
INTERWORLD, see Warner/Chappell Germany.
INVISIBLE MENDEZ, see Warner/Chappell Germany.
IQ, see Warner/Chappell Germany.
IRVING, see Warner/Chappell Germany.
ISAAK, see Warner/Chappell Germany.
ISLAND MUSIC, see Polygram Songs Musikverlag.
ITALIA OK MUSIC, see Siebenpunkt Verlags.
ITALO HEAT, Kaarsterstrasse 51/3, 4044 Neuss-Kaarst 2, 02101.68078, Fax: 02101.603 750, Tlx: 8518068 heat, MD: John A Taylor, Sales Dir: Gary Cooper, Mgr: Susanne Bergander, Promo: Manuela Konigshofen.
ITM, see Warner/Chappell Germany.
JA/NEIN MUSIKVERLAG, Hallerstrasse 72, 2000 Hamburg 13, 040.410 2161, Fax: 040.448 850/443 597, Tlx: 2173368 ka-ja, GM: Mary Dostal, Admin Mgr: Heino Mueller. Main product: AC, Album Rock, Jazz.
JACK DEJOHNETTE, see MCA Music.
JAKMAX, see Warner/Chappell Germany.
JALYNNE, see Warner/Chappell Germany.

JAMM, see Warner/Chappell Germany.
JANE ANN MC, see MCA Music.
JARY, see Melodie Der Welt.
JAYREM, see Marie-Marie Music.
JAZZ HORN, see Warner/Chappell Germany.
JBMM, see Warner/Chappell Germany.
JECILLA, see MCA Music.
JEDDRAH, see Warner/Chappell Germany.
JEFF COHEN, see Sony Music Publishing.
JERO, see Siegel Music Companies.
JERRY & BILL, see Valentine Musikverlag.
JERRY FOSTER, see Valentine Musikverlag.
JESS, see Warner/Chappell Germany.
JESSI VANESSI, see Siegel Music Companies.
JETSTAR, see Warner/Chappell Germany.
JJJ, see Warner/Chappell Germany.
JONALION, see Warner/Chappell Germany.
JONDON, see MCA Music.
JONES, see Warner/Chappell Germany.
JOSLEY, see Warner/Chappell Germany.
JOURNEY PARTNERSHIP, see Warner/Chappell Germany.
JOYBRINGER, Scheidter Strasse 26, 6602 Dudweiler, 06897.73472, Fax: 06897.73446, President: Dragan Nikitovic.
JSH, see Warner/Chappell Germany.
JTR MUSIC, Osdorfer Landstrasse 9, 2000 Hamburg 52, 040.823 397, Fax: 040.824 728, MDs: Petra Thomsen-Roeder, Peter Jaederberg, A&R/Promo: Susanna Mahnken. Main product: Adult Contemporary, Dance, Ethnic, Blues.
JUDITH RANDALL/ATZO, see Warner/Chappell Germany.
JUDY CHEEKS, see Warner/Chappell Germany.
JULIANA, see Warner/Chappell Germany.
JUMAR, see Wintrup Musikverlage.
JUMBOLINO, see Global Musikverlage.
JUMP TUNES, see Warner/Chappell Germany.
JUNGLE AELIE AELI, see Warner/Chappell Germany.
JUNIOR MUSIKPRODUKTION, Sendlinger Strasse 64, 8000 Munich 2, 089.260 941 617, Fax: 089.260 7131, Tlx: 5214521, MD: Siegi Pleyer, President: Frank Pleyer.
JUNIPIGGY, see Warner/Chappell Germany.
JUPITER, see Siegel Music Companies.
JYMI, see Warner/Chappell Germany.
K-DAVE-S, see Warner/Chappell Germany.
KALAHARI, see Warner/Chappell Germany.
KASKAT, see Warner/Chappell Germany.
KASPAREK, see Siegel Music Companies.
KATE BUSH, see Warner/Chappell Germany.
KATJA, see Warner/Chappell Germany.
KBC MUSIC, Friedrich Ebert Damm 202, 2000 Hamburg, 040.669 061, Fax: 040.661 822, President: Cay Hume, Chmn: Abdul Aziz, MDs: Harald Hecht, Sonja Dorger.
KEEFER, see Warner/Chappell Germany.
KELLY & LLOYD, see Mento Music Group.
KENNEY, see Warner/Chappell Germany.
KENYA, see Warner/Chappell Germany.
KG RGS MUSIK, see Rudolf Slezak Musik.
KHUFU, see Warner/Chappell Germany.
KICK MUSIKVERLAG, Burgunderstrasse 8, 5000 Cologne 1, 0221.317 076, Fax: 0221.325 742, MD: Goetz & Alexander Elbertzhagen, Copyright Expl: Elke Langer, Tina Holker.
KICK-START, see Warner/Chappell Germany.
KIDADA, see Warner/Chappell Germany.
KIKI, see Siegel Music Companies.
KILAUEA, see BMG Ufa Musikverlage.
KINAALDA, see Warner/Chappell Germany.
KIRBYPACE, see Warner/Chappell Germany.
KISSING THE PINK, see Warner/Chappell Germany.
KMZ MUSIKVERLAG, Roehler Tal 4, 5000 Cologne 60, 0221.765 223, Fax: 0221.764 634, MD: Kurt Zerwas.
KOCH MUSIC PUBLISHING (GERMANY), Hermann Schmidt Strasse 10, 8000 Munich 2, 089.746 135-10, Fax: 089.725 4759, Tlx: 5213408 koch, President: Franz Koch, MD: Rudy Schedler.
KOHLER MUSIC, Weidestrasse 118, 2000 Hamburg 76, 040.271 180, Fax: 040.671 198, MD: Manfred H Kohler.
KOLLO, see BMG Ufa Musikverlage.
KORTCHMAR, see Warner/Chappell Germany.
KOSTER, see Warner/Chappell Germany.
KPM, see Selected Sound (emi Music Publishing).
KROKUS, see Warner/Chappell Germany.
KUBANEY, see Termidor Musikverlag.
KUHL, see Melodie Der Welt.
KUUMBA, see Warner/Chappell Germany.
LA SKYY, see Sony Music Publishing.
LAGO, see Warner/Chappell Germany.
LAKIVA, see Warner/Chappell Germany.
LALY, see Sony Music Publishing.
LAMPLIGHT, see Mento Music Group.
LAPAPALA, see Mento Music Group.
LAREDO, see Warner/Chappell Germany.
LARGO, see Ubm Records.
LATCHMERE, see Valentine Musikverlag.
LAUNHARDT, see Siegel Music Companies.
LET CORD MUSIC, see Mento Music Group.
LEVEL 42, see Warner/Chappell Germany.
LIBRAPHON MUSIC, Liebknechtstrasse 14, 6072 Dreieich, 06103.63804, Fax: 06103.63876, MD: Candy Derouge.
LIDO, see Warner/Chappell Germany.
LIKELY STORY, see Warner/Chappell Germany.
LILITON, see Warner/Chappell Germany.
LIMES, see Siegel Music Companies.
LINE MUSIC, see Schacht Musik.
LINGO, see Warner/Chappell Germany.
LITHA/THALIAN, see Melodie Der Welt.

LITTLE DIVA, see Warner/Chappell Germany.
LITTLE FUGITIVE, see Warner/Chappell Germany.
LITTLE HARPS, see Sony Music Publishing.
LITTLE LIFE, see Progressive Musikverlag.
LITTLE MOLE, see Warner/Chappell Germany.
LITTLE REATA, see Warner/Chappell Germany.
LIVINGSTON, see Warner/Chappell Germany.
LIZZY'S BLUES, see R D Clevere Musikverlag.
LOLLIPOP, see Siegel Music Companies.
LOMBARDONI, see Warner/Chappell Germany.
LONG ACRE, see Warner/Chappell Germany.
LONGITUDE, see Warner/Chappell Germany.
LONGNECK, see Warner/Chappell Germany.
LORIMAR, see Warner/Chappell Germany.
LOST TOY PEOPLE, see Warner/Chappell Germany.
LOTUSDRIVE, see Warner/Chappell Germany.
LOVE SONGS, see Warner/Chappell Germany.
LOVE THING, see Sony Music Publishing.
LUCKYU, see Warner/Chappell Germany.
LUKER, see Global Musikverlage.
M & M, see Warner/Chappell Germany.
M'OCEAN, see Warner/Chappell Germany.
MACLEN, see Warner/Chappell Germany.
MACS, see Schacht Musik.
MAD, see Sony Music Publishing.
MAGAZINE MUSIC, Fontenay 11, 2000 Hamburg 36, PO Box 302040 (Zip: 2000), 040.4118 2104/5, Fax: 040.4118 3888, Tlx: 2162918, Presidents: John Jahr, Ray van Cant, Chmn: Wilfried Achterfeld, MD: Manfred Heydweiller, Prof Mgr: Angela Scheaffer.
MAGIC SONG, see Warner/Chappell Germany.
MAGIDSON, see Warner/Chappell Germany.
MAGISTER, see MCA Music.
MAGNET, see Warner/Chappell Germany.
MAGNETIC, see Warner/Chappell Germany.
MAINHATTAN MUSIC, Oberthausenstrasse 70, 6052 Mulheim am Main 3, 06108.73051, Fax: 06108.77446, President: Werner Schwarzer, Chmn: Uwe Block, MD: Christina Tassis.
MALDOROR MUSIKVERLAG, Kurfuertenstrasse 23, 1000 Berlin 30, PO Box 110226 (Zip: 1000), 030.261 9085, Fax: 030.262 4448, Tlx: 185738 modm, President: Karl-Ulrich Walterbach, MD: Annegret Quintus-Winther.
MALE, see Human Noise.
MAM, see Global Musikverlage.
MAMBO MUSIK, Herzogstrasse 39, 8000 Munich 40, 089.339 192, Fax: 089.339 141, Tlx: 5218542, MD: Juergen Thurnau.
MAMPF, see Siegel Music Companies.
MANDALA, see Warner/Chappell Germany.
MANGOWORK, see Warner/Chappell Germany.
MANITO, see Global Musikverlage.
MANITU, see Paradise Music.
MANNY ROSE, see Warner/Chappell Germany.
MANX, see Warner/Chappell Germany.
MANY PRODUCTION MUSIC, see Siebenpunkt Verlags.
MARATHON MUSIC, Schwanthaler Strasse 141, 8000 Munich 2, 089.508 226, Presidents: Henning Wolf (Mktg), Anja Kusch (Promo).
MARATHON, see Valentine Musikverlag.
MARBOT, see Peer Musikverlag.
MARIE-MARIE MUSIC, Rahstedter Strasse 65, 2000 Hamburg 73, 040.673 3537, Fax: 040.673 4400, Prof Mgr: Hubert Branzko, Copyright Mgr: Verena Hammer. (Owned): Edition Fenn, R'n'D, On-Line, Cadero, Wohlklang; (Admin/sub-pub): After Hours, Delicate Issues, Globule, Gorno, Hot, Jayrem, Marie-Marie Music (Hoi), Vitamine, Pink 7, SBF, Coppelia, 1980 Music.
MARISMA, see Paradise Music.
MARR SONGS, see Warner/Chappell Germany.
MASTERPHONE, see Gerig Music.
MATCHBOURNE, see Warner/Chappell Germany.
MATKOSKY, see Warner/Chappell Germany.
MATRAGUN, see Warner/Chappell Germany.
MAUE, see Warner/Chappell Germany.
MAURICE WHITE, see Sony Music Publishing.
MAX BANANA, see R D Clevere Musikverlag.
MAYDAY/MEDIARTS, see MCA Music.
MAZE MUSIC, see Progressive Musikverlag.

MCA MUSIC (GERMANY)

Osterstrasse 124, 2000 Hamburg 20, (4940) 490.30.21, Fax: 040.490 3463, MD: Adrian Facklan-Wolf, Prof Mgr/A&R: Janine Becker (Int'l), Armand Hacaturyan (Nat'l), Copyright: Marianne Schwartau. (Owned): Magister, Curacao, Taktell, Star Musik; (Admin/sub-pub): ABC/Dunhill, American Broadcasting, Bad Company, Cadillac Pink, Cat People, Champion, Chris Gilbey, Decreed, Don Schlitz, Duchesse, Evita, Feesongs, Fon, Fontaine, Gone Gator, Jane Ann Mc, Hot Melt, Hub, Jondon, Mayday/Mediarts, Michael Browning, Mingles, Nolana, Ready For The World, Skoek, Smackin' Starship, Texas City, Tol, Two-Beat, Unicity, Valley, Het Gerucht, Edition Dagobert, Geffen, ATV Music Group, Thriller Millier, BEMA, Grant Street, TET Publishing, Ruthless Attack, AFG, Black Ice Publishing, Jecilla, Jack DeJohnette, What Music, Avid One, Chriswald, Two Jays Publishing, Anlon Music.

MCKEE, see Warner/Chappell Germany.
MCT, see Selected Sound (emi Music Publishing).
MEADOWLANE, see Warner/Chappell Germany.
MEDIAPHON, Zettachring 12a, 7000 Stuttgart 80 (Fasanenhof), 0711.723 031, Fax: 0711.728 9559, MD: Gerhard R Fink.

MEGADUDE, see Warner/Chappell Germany.
MEISEL MUSIK, Wittelsbacherstrasse 18, 1000 Berlin 31, 030.884 140, Fax: 030.882 5065, Tlx: 183008, MD: Thomas Meisel.
MEISTERSINGER MUSIK, Breitenlohestrasse 48, 8550 Forchheim, 09191.80808, Fax: 09191.66797, Dir: Rudolf Hohenberger. Main product: New Age.
MELAN, see Warner/Chappell Germany.
MELAPHON, see Global Musikverlage.
MELODIE DER WELT, Grosse Friedberger Strasse 23-27, 6000 Frankfurt am Main 1, 069.299 8670, Fax: 069.2998 6710, President: Johann Michel, VPs: Wolfgang Mewes, Paul Lenz (Int'l), Copyright: Hans Mai. (Owned): Berbuer, Jary, Kuhl, Rheinischer, Supra, West Ton, Woitschach; (Admin): All Nations, Blue Seas, Bourne, Brampton, Carol Bayer Sager, Carolco, Casa David, Frank Zappa, Inter, Litha/Thalian, MPL, Mike Chapman, Mikulski, RAK, Rock/Plantent Visions, Shapiro Bernstein, Third Story, TREE Group. Main product: Adult Contemporary, Jazz, Country, Reggae, Dance, Album Rock, Gold/Oldies, Black (R&B).
MELODISC, see Mento Music Group.
MELODYSCALE, see Warner/Chappell Germany.
MEMORY, see Zyx Records.
MENTO MUSIC GROUP, Eppendorferweg 7, 2000 Hamburg 20, PO Box 203312 (Zip: 2000), 040.430 0339, Fax: 040.439 6587, MD: Arno H van Vught, Promo: Michael Frommhold, Copyright: Gertraud Witte. (Owned): Arteg, Summerlea, Winterlea, Lapapala, Auteursunie Music; (Admin/sub-pub): Melodisc, Lamplight, Mick Lloyd Productions, Kelly & Lloyd, Service Winner, Second Serve, Let Cord Music.
MERANO, see Siebenpunkt Verlags.
MERIDIAN, see Siegel Music Companies.
METEOR, see Siegel Music Companies.
METORION, see Schacht Musik.
METRO, see Warner/Chappell Germany.
METROMANIA, see Warner/Chappell Germany.
METROPOLIS, see Warner/Chappell Germany.
MI-JAMBE, see Warner/Chappell Germany.
MICHAEL BROWNING, see MCA Music.
MICK LLOYD PRODUCTIONS, see Mento Music Group.
MICK RALPHS, see Warner/Chappell Germany.
MIDDLE EIGHT, see Valentine Musikverlag.
MIDNIGHT, see Valentine Musikverlag.
MIGHTY BOYS MUSIC, see Wintrup Musikverlage.
MIGHTY NICE, see Progressive Musikverlag.
MIGHTY THREE, see Warner/Chappell Germany.
MIJAC, see Warner/Chappell Germany.
MIKALANNA, see Warner/Chappell Germany.
MIKE CHAPMAN, see Melodie Der Welt.
MIKULSKI, see Melodie Der Welt.
MILENE, see Warner/Chappell Germany.
MINGLES, see MCA Music.
MIRAN, see Warner/Chappell Germany.
MISSISSIPPI MUD, see Warner/Chappell Germany.
MMT, see Crazy Life Music.
MOBETTA, see Warner/Chappell Germany.
MOBI, see Warner/Chappell Germany.
MODERN MEDIA, see Warner/Chappell Germany.
MODERN RECORDS, see BMG Ufa Musikverlage.
MOFFETT-DICKINSON, see Valentine Musikverlag.
MOFO, see Warner/Chappell Germany.
MOM, see Warner/Chappell Germany.
MONDIAL, see Gerig Music.
MONEY FOR MUSIC, see Schacht Musik.
MONOTON, see Progressive Musikverlag.
MONTANA, Koeniginstrasse 121, 8000 Munich 40, 089.343 036, Fax: 089.347 260, Tlx: 5215200, MDs: Mariette Temme, Hans R Beierlein.
MONTY SEWARD, see Warner/Chappell Germany.
MOONQUAKE MUSIC, Eppsteinerstrasse 43, 6000 Frankfurt am Main 1, 069.727 230, Fax: 069.724 0294, MD: Heinz Roth, Sec: Sabine Benkmann. (Owned): Cheyenne; Main product: EHR, Adult Contemporary, Dance.
MOOREA MUSIC, Hochallee 35, 2000 Hamburg 13, 040.440 541, Fax: 040.410 2503, MD: Ulrike Schoen.
MOPAGE, see Warner/Chappell Germany.
MOREL, see Peer Musikverlag.
MORNINGSONG, see Esperanza Musikverlag & Musikproduktion.
MORRIS-CHAPPELL, see Warner/Chappell Germany.
MOT, see Siegel Music Companies.
MOTEL, see Sony Music Publishing.
MOTHER MARTHA, see Valentine Musikverlag.
MOTLEY CRUE, see Warner/Chappell Germany.
MPL, see Melodie Der Welt.
MPM MUSIKVERLAG, Scheinerstrasse 13, 8000 Munich 80, 089.987 488, Fax: 089.981 929, President: Anja Hauptmann.
MSA PUBLISHING, Schaefferstrasse 5, 8000 Munich 2, 089.222 901, Fax: 089.296 989, Tlx: 523122 tripm, Dir: Mario Mendrzycki.
MUENCHENER HUMOR, see Siegel Music Companies.
MULTI MEDIA, see Peer Musikverlag.
MULTI-CULLER, see Sony Music Publishing.
MUNICH ENTERTAINMENT, see Global Musikverlage.
MUSENKUSS, see Siegel Music Companies.
MUSIC HOUSE, see Sonoton Music Library.
MUSIC TO PICTURE, see Valentine Musikverlag.
MUSICOLOR, see Hammer Musik.
MUSIK UNSERER ZEIT, see Warner/Chappell Germany.
NAKED SNAKE, see Warner/Chappell Germany.
NAZARETH, see Schacht Musik.
NEARYSONGS, see Warner/Chappell Germany.

NEBRASKA, see Warner/Chappell Germany.
NEEB, see Warner/Chappell Germany.
NEEWOLLAH, see Warner/Chappell Germany.
NEHEMIA, see Warner/Chappell Germany.
NEIGHBOURHOOD, see Warner/Chappell Germany.
NEMO, see Warner/Chappell Germany.
NESSIE, see Warner/Chappell Germany.
NETTOVERBOARD, see Wintrup Musikverlage.
NEUE WELT, see Warner/Chappell Germany.
NEUEREICH, see Warner/Chappell Germany.
NEUOLEUM, see Warner/Chappell Germany.
NEUTON, see BMG Ufa Musikverlage.
NEUTRAL GRAY, see Warner/Chappell Germany.
NEW A, see Siegel Music Companies.
NEW BOHEMIANS, see Warner/Chappell Germany.
NEW CADENZA, see Warner/Chappell Germany.
NEW EAST, see Warner/Chappell Germany.
NEW MALDEN, see Valentine Musikverlag.
NEW WORLD PICTURES, see Warner/Chappell Germany.
NEW WORLD, see Warner/Chappell Germany.
NEWKEYS MUSIC, see Esperanza Musikverlag & Musikproduktion.
NIGHT RIVER, see Warner/Chappell Germany.
NIKKI LYNN, see Sony Music Publishing.
NITESTALK, see Warner/Chappell Germany.
NO INTEGRITY, see Sony Music Publishing.
NO SURRENDER, see Warner/Chappell Germany.
NOA-NOA, see Warner/Chappell Germany.
NOB, see Warner/Chappell Germany.
NODLEW, see Warner/Chappell Germany.
NOLANA, see MCA Music.
NOM, see Warner/Chappell Germany.
NORMAL, see Warner/Chappell Germany.
NORTH COUNTRY, see Valentine Musikverlag.
NOSEBAG, see Warner/Chappell Germany.
NOT FRAGILE, see Bellver Music.
NOVEL BOND, see Valentine Musikverlag.
NUITSTYA, see Sony Music Publishing.
NUMBER NINE, see Warner/Chappell Germany.
NURK TWINS, see Warner/Chappell Germany.
NWP, see Warner/Chappell Germany.
O'KEEFE, see Warner/Chappell Germany.
OG RHYME, see Sony Music Publishing.
OIL SLICK, see Warner/Chappell Germany.
OKTAVE, see Schacht Musik.
OLD WAY, see Warner/Chappell Germany.
OLDE GROG, see Warner/Chappell Germany.
OMNIPRESENT HALO, see Warner/Chappell Germany.
ON-LINE, see Marie-Marie Music.
OPPERKNOCKITY, see Progressive Musikverlag.
OPRY ROSE, see Warner/Chappell Germany.
ORANIA, see Gerig Music.
ORLEANS MUSIC PRODUCTION, Defreggerstrasse 16, 8013 Haar, 089.462 030, Fax: 089.468 834, President: Marcel Schmitt.
OSTERMANN, see Gerig Music.
OTCASEK, see Warner/Chappell Germany.
OUT OF POCKET, see Warner/Chappell Germany.
OVERDUE, see Warner/Chappell Germany.
P2, see Sony Music Publishing.
PAGE THREE, see Warner/Chappell Germany.
PALACE PRODUCTIONS, see Warner/Chappell Germany.
PALACE, see Peer Musikverlag, Warner/Chappell Germany.
PALADIN, see Warner/Chappell Germany.
PALANCAR, see Warner/Chappell Germany.
PALOMINO, see Warner/Chappell Germany.
PANAORAMA SONG, see Warner/Chappell Germany.
PAPAGAYO, see Gerig Music.
PARADISE MUSIC, Schwibbogenstrasse 27a, PO Box 112140, 8900 Augsburg 1, 0821.33336, Fax: 0821.33309, MD: Hubert G Feil, Prof Mgr: Doris Mosberger. (Owned): Paradise, Imortal, PMG Robintown, Sternstunde, Manitu, PMG, Marisma, Shannandoa; (Admin): Artag, Christian Anders, Blue Horizon, Shriil; Main product: EHR, Dance, New Age, Classical.
PARADOX, see Warner/Chappell Germany.
PARRY MUSIC, see Sonoton Music Library.
PART-I-DUR, see Progressive Musikverlag.
PAUL SIEGEL, see Siegel Music Companies.
PAYADU, see Termidor Musikverlag.
PAZUZU PEABO, see Warner/Chappell Germany.
PEACEFUL, see Warner/Chappell Germany.
PEEK-A-BOO, see Warner/Chappell Germany.

PEER MUSIKVERLAG GMBH (GEMA)

Muehlenkamp 43, 2000 Hamburg 60, PO Box 602129 (Zip: 2000), 040.271 3371, Fax: 040.270 6259, MD: Michael Karnstedt, A&R Mgr: Hans Cuny, Prof. Mgr: Martin Koehler. (Affil): Alba, Areta, Casapark, Marbot, Team, Robin, Multi Media, Morel, Palace, Zoopah.

PEER-SOUTHERN PRODNS. GMBH, see Peer Musikverlag GmbH (GEMA)
PEERMUSIC, see Peer Musikverlag GmbH (GEMA)
PEFC, see Warner/Chappell Germany.
PEGLARI, see Valentine Musikverlag.
PENDULUM, see Warner/Chappell Germany.
PENTABLE, see Warner/Chappell Germany.
PEPAMAR, see Warner/Chappell Germany.
PEPE, see Siegel Music Companies.
PEPPER, see Warner/Chappell Germany.

PERFECT SONGS, see Warner/Chappell Germany.
PERGEE, see Valentine Musikverlag.
PERICO, see Warner/Chappell Germany.
PETER PIPER, see Valentine Musikverlag.
PFLUG & COMPANY, see Warner/Chappell Germany.
PHILLIPSONGS, see Warner/Chappell Germany.
PHILLSTER, see Sony Music Publishing.
PHILLY-CREED, see Warner/Chappell Germany.
PICKET, see Warner/Chappell Germany.
PICKLE, see Valentine Musikverlag.
PICKWICK, see Warner/Chappell Germany.
PIF, see Siegel Music Companies.
PILATUS, see Warner/Chappell Germany.
PILZ MUSIC, Wendenstrasse 309, 2000 Hamburg 26, 040.251 6090, Fax: 040.2516 0911.
PINCUSGIL, see Siegel Music Companies.
PINGO, see Warner/Chappell Germany.
PINK 7, see Marie-Marie Music.
PINK BAT, see Warner/Chappell Germany.
PINK, see Warner/Chappell Germany.
PINWAND, see Global Musikverlage.
PIPPIN THE FRIENDLY RANGER, see Warner/Chappell Germany.
PIROL, see Siegel Music Companies.
PITCH CONTROL, see Warner/Chappell Germany.
PLAINS, see Valentine Musikverlag.
PLAN-9, see Warner/Chappell Germany.
PLANET SUSHI, see Warner/Chappell Germany.
PLANETARY, see Warner/Chappell Germany.
PLATINUM EAR, see Warner/Chappell Germany.
PLC, see Siebenpunkt Verlags.
PMG ROBIN TOWN, see Paradise Music.
PMG, see Paradise Music.
POLYGRAM SONGS MUSIKVERLAG, Glockengiesserswall 3, 2000 Hamburg 1, PO Box 104909 (Zip: 2000), 040.308 7315, Fax: 040.308 7368, Tlx: 2174735, MD: Joost van Os, GM: Uwe Krop, Contr: Thomas Lucht. (Owned): Ed. Antenna, Dick James, The Welk Music Group, Island Music, Sweden Music.
POMERANTS, see Warner/Chappell Germany.
PONTI, see Warner/Chappell Germany.
POOL MUSIKPRODUKTION, Seelingstrasse 33, 1000 Berlin 19, 030.321 5045, Fax: 030.325 6997, Tlx: 186671, MD: Peter Schimmelpfennig, Mgr: Gudrun Eckner.
POOPY'S, see Warner/Chappell Germany.
POOR, see Sony Music Publishing.
POPPA WILLIE, see Warner/Chappell Germany.
PORK TARTARE, see Sony Music Publishing.
PORTER CARROLL JR, see Sony Music Publishing.
POSITUNES, see Sony Music Publishing.
POSTPROFIT, see Warner/Chappell Germany.
POWDER KEG, see Valentine Musikverlag.
PRELUDE, see Valentine Musikverlag.
PRESSED HAM HITS, see Warner/Chappell Germany.
PRESTO, see Gerig Music.
PRIMA MUSIK, Bundesallee 141, 1000 Berlin 41, 030.851 4097, Fax: 030.851 8580, MD: Frank Pehligrimm.
PRIME, see Warner/Chappell Germany.
PRINCE STREET, see Warner/Chappell Germany.
PRIX FORMULAT I, see Warner/Chappell Germany.
PRIZE, see Seychelles Music.
PRO MEDIA, see Warner/Chappell Germany.
PRO NOVA, see Sonoton Music Library.
PRO: SONGS, Schadowstrasse 53, 5000 Cologne 30, 0221.552 0268, Fax: 0221.557 561, MD: Teddy Hoersch.
PROFESSIONAL, see Warner/Chappell Germany.
PROGRESSIVE MUSIKVERLAG, Bramfelder Chaussee 238c, 2000 Hamburg 71, 040.642 5046, Fax: 040.642 5999, MD: Rudy Holzhauer, Copyright Mgr: Annette Schaefer, Prof Mgrs: Franz Plasa, Peter Hoffmann. (Owned): Hopia, I-Dur, Part-I-Dur, Monoton, Van Dyke Songs; (Admin): Maza Music, Opperknockity, Elymax, Little Life, Bados, Bluewater, Mighty Nice, Bash, Wood Monkey Music; Main product: Dance, Rock, Pop.
PROM, see Global Musikverlage.
PROMCO, see Warner/Chappell Germany.
PRONTO, see Warner/Chappell Germany.
PROTOONS, see Warner/Chappell Germany.
PUD, see Warner/Chappell Germany.
PULLMANN, see Warner/Chappell Germany.
Q MUSIC, see Grand H Music.
QUACKENBUSH MUSIC, see Axxis Musikverlag.
QUIMUS MUSIKVERLAG, see Countdown Music.
QUINCE, see Warner/Chappell Germany.
R D CLEVERE MUSIKVERLAG, PO Box 2145, 6078 Neu-Isenburg, 06102.52696, Fax: 06102.52696, Tlx: 4185600, E-Mail: 6102.52696 BTX, President: Klaus Oestreich, MDs: Tony Hermonez (Int'l/A&R), Wanja Kremer (Licensing). (Owned): Hot Night, Big Sound, Lizzy's Blues, Max Banana, R.D. Clevere-Cocabana, Far East & Orient, America Today Music.
RIN'D, see Marie-Marie Music.
RADIO TELE MUSIC, Wittelsbacherstrasse 18, 1000 Berlin 31, 030.884 140, Fax: 030.882 5065, Tlx: 184174, MD: Ray van Cant, Thomas Meisel.
RAINBOW, see Valentine Musikverlag.
RAK, see Melodie Der Welt.
RALPH MARIA SIEGEL, see Siegel Music Companies.
RAM'S HORN, see Warner/Chappell Germany.
RAMSEL, see Warner/Chappell Germany.
RANCHO BOGARDO, see Warner/Chappell Germany.
RANDY MICHELLE, see Warner/Chappell Germany.
RAPP BEAT, see Sundance Music.

- RASHIDA, see Warner/Chappell Germany.
 RATED, see Seychelles Music.
 RATTERTON, see Warner/Chappell Germany.
 RAWLOU, see Warner/Chappell Germany.
 READY FOR THE WORLD, see MCA Music.
 RECOMBINANT, see Warner/Chappell Germany.
 RED BULLET, see Warner/Chappell Germany.
 RED CLOUD, see Warner/Chappell Germany.
 RED LINE RECORDS, Lagerstrasse 67, 8039 Puchheim-Munich, 089.800 2880, Fax: 089.800 2879, Tlx: 521 8426, MD: Theo Hartl.
 RED RIVER, see Warner/Chappell Germany.
 REDONDO, see Sony Music Publishing.
 REETHAUS, see Warner/Chappell Germany.
 REFUGE, see Warner/Chappell Germany.
 REGANESQUE, see Warner/Chappell Germany.
 REHTAKUL VEETS, see Warner/Chappell Germany.
 RELLA, see Sony Music Publishing.
 REMICK, see Warner/Chappell Germany.
 RENT-A-SONG, see Warner/Chappell Germany.
 REPEX MUSIC, Seeuferstrasse 25, 8036 Breitbrunn am Ammersee, 08152.5774, Fax: 08152.5840, President: Birgit S Kraus. (Owned): Edition Repex.
 REPEX, see Warner/Chappell Germany.
 REVELATION MUSIC, see Axxis Musikverlag.
 REVELATION, see Warner/Chappell Germany.
 REWIND, see Warner/Chappell Germany.
 REX, see BMG Ufa Musikverlage.
 RHEINISCHER, see Melodie Der Welt.
 RHINE, see Gerig Music.
 RIALTO, see Gerig Music.
 RICCARDO, see Gerig Music.
 RICHARD KAUN, see Siegel Music Companies.
 RICK KEEFER/PUNALUU, see Warner/Chappell Germany.
 RICKIM, see Warner/Chappell Germany.
 RINGER, see Sony Music Publishing.
 RITZY, see Warner/Chappell Germany.
 RIVA, see Warner/Chappell Germany.
 ROB-ROY WEST, see Warner/Chappell Germany.
 ROBA MUSIC, Feldbrunnenstrasse 50, 2000 Hamburg 13, 040.445 086, Fax: 040.443 272, Tlx: 2173377, MD: Rolf Baierle.
 ROBERT MELLIN, see Siegel Music Companies.
 ROBERT RUEHLE, see Siegel Music Companies.
 ROBIN HILL, see Warner/Chappell Germany.
 ROBIN, see Peer Musikverlag.
 ROCK DOG, see Warner/Chappell Germany.
 ROCK/PLANGENT VISIONS, see Melodie Der Welt.
 ROCKERFELLA, see Warner/Chappell Germany.
 ROCKOKO MUSIC MUSIKVERLAG, Nordendstrasse 30, 6000 Frankfurt am Main 1, 069.597 0168, Fax: 069.553 201, MDs: Peter Hauke, Rudolf Weber, Andreas Kimberger.
 ROCKSHIRE, see Warner/Chappell Germany.
 ROCKSLAM, see Warner/Chappell Germany.
 ROCKVIEW, see Sony Music Publishing.
 RODRA BERNA, see Warner/Chappell Germany.
 ROLF BUDE MUSIKVERLAG, Hohenzollerndamm 54A, 1000 Berlin 33, 030.823 4015, Fax: 030.823 7076, Tlx: 184770, MD: Rolf & Andreas Budde.
 RONDO, see Warner/Chappell Germany.
 RONDOR MUSIKVERLAG, Schlueterstrasse 75, 2000 Hamburg 13, 040.447 360, Fax: 040.457 098, MD: Tommy Richter.
 ROOF, see Warner/Chappell Germany.
 ROWLAND, see Warner/Chappell Germany.
 RSO, see Warner/Chappell Germany.
 RUBEN BLADES ENTS, see Termidor Musikverlag.
 RUD-MOR, see Warner/Chappell Germany.
 RUDOLF SLEZAK MUSIK, Theresienstieg 3, 2000 Hamburg 76, 040.229 2051, Fax: 040.229 2053, Tlx: 213425, MD: Rudolf Georg Slezak, Prof Mgr: Gabriele Richt. Affil: Schmolzi & Schlezak Musik, KG RGS Musik, Edition Maxwood, Whale Songs, Adhoc Publishing, Edition OrnuMusic, Edition Killyton, Edition Killyton, Edition Ameurope, Edition King's Singers Music, Edition Miriam Frances.
 RUESSEL MUSIK, Papenhuder Strasse 61, 2000 Hamburg 76, PO Box 762132 (Zip: 2000), 040.220 1262/5, Fax: 040.227 9895, Contact: Otto Waalkes, Hans Otto Mertens.
 RUMANIAN PICKLE WORKS, see Warner/Chappell Germany.
 RUSH, see Schacht Musik.
 RUSTY DWARF TUNES, see Sony Music Publishing.
 RUTHLESS ATTACK, see MCA Music.
 RUTLAND ROAD, see Warner/Chappell Germany.
 RWU SOUND, see Warner/Chappell Germany.
 SAFESPACE, see Warner/Chappell Germany.
 SAIFAM, see Zyx Records.
 SALOON SONGS, see Warner/Chappell Germany.
 SAMOS, see Warner/Chappell Germany.
 SANDBANK, see Freibank Musikverlag.
 SANDY SONGS, see Warner/Chappell Germany.
 SANPAN, see Warner/Chappell Germany.
 SANTA FE, see Warner/Chappell Germany.
 SATELLITE MUSIC, see Tgm.
 SATSONG, see Warner/Chappell Germany.
 SAXSONGS, see Warner/Chappell Germany.
 SAY YES MUSIC, see Axxis Musikverlag.
 SBF, see Marie-Marie Music.
 SCHACHT MUSIK, Herbert Weichmann Strasse 45, 2000 Hamburg 76, 040.225 143/45, Fax: 040.220 8459, Tlx: 213723 smvr, GM: Benjamin Schacht, Promo: Alexandra Neumann, Mgr: Gerd Kromholz. (Owned): Oktave, Meteoron, CCC-Ton, Beco, Tonika, Canzoneita, Carren, White-Noise, Harderberg, Line Music; (Admin): Nazareth (Macs, Elgin, Money for Music), Rush (Core Music).
 SCHERZO, see Warner/Chappell Germany.
 SCHMITZ, see Gerig Music.
 SCHMOLZI & SCHLEZAK MUSIK, see Rudolf Slezak Musik.
 SCHNORRENBERG, see Gerig Music.
 SCREAMING BLUE MESSIAH, see Warner/Chappell Germany.
 SEASHELL, see Warner/Chappell Germany.
 SECOND HAND, see Siegel Music Companies.
 SECOND RAIL MUSIK, Seeuferstrasse 25, 8036 Breitbrunn am Ammersee, 08152.5243, Fax: 08152.5840, President: Jochen Kraus.
 SECOND SERVE, see Mento Music Group.
 SEE THIS HOUSE, see Warner/Chappell Germany.
 SELECTED SOUND (EMI MUSIC PUBLISHING), Alsterchasse 25, 2000 Hamburg 13, PO Box 2663 (Zip: 2000), 040.414 0150, Fax: 040.4140 1515, Tlx: 212530 emi mp, MD: Peter Ende, Head of Music Libraries: Hans Mueller. (Owned): Selected Sound; (Admin): KPM, Themes Int'l, Carlin, Atmosphere, Telemusic, MCT, Dacsa, Air Force, Gerhard Trede.
 SEPHEA/JUSTIN GRANT, see Warner/Chappell Germany.
 SERGEANT, see Warner/Chappell Germany.
 SERIOUS BASS, see Sundance Music.
 SERVICE WINNER, see Mento Music Group.
 SEYCHELLES MUSIC, PO Box 130144, 5000 Cologne 1, 0221.720 179, Fax: 0221.739 3476, Tlx: 8882798, President: Walther Kahl, MD: Sabine Kahl, Licensing: Kamilla Parpart. (Owned): Seychelles; (Sub-pub): Chu-Fin, Priza, Rated, Shelby Singleton, Edition Wachtel.
 SHAKIN' BAKER, see Warner/Chappell Germany.
 SHANNANDOO, see Paradise Music.
 SHAPIRO BERNSTEIN, see Melodie Der Welt.
 SHARK, see Crazy Life Music.
 SHARLEENE, see Wintrup Musikverlage.
 SHELBY SINGLETON, see Belver Music, Seychelles Music.
 SHERWOOD, see Sundance Music.
 SHNOK MUSIC, Kollastrasse 6, 2000 Hamburg, 040.553 3322, Fax: 040.553 6741, President: Sherman F Heinig, MD: Mary A Johnson.
 SHOOT FOR THE MOON, see Warner/Chappell Germany.
 SHREWSHAM, see Warner/Chappell Germany.
 SHRILL, see Paradise Music.
 SIDEMTON, see Gerig Music.
 SIEBENPUNKT VERLAGS, Habsburger Platz 1, 8000 Munich 40, 089.331 808, Fax: 089.397 179, MD: Helmut Schmidt. (Sub-pub): Zig Zag, Songs for Today, Filmtrax, PLC, Garisongs; (Admin): Golden Key, Many Production Music, Touch Down Music, Italia OK Music, Merano, Edition Edit.
 SIEGEL MUSIC COMPANIES, Hoehelstrasse 2, 8000 Munich 80, 089.984 926, Fax: 089.980 250/981 779, President: Ralph Siegel, MD: Joachim Neubauer. (Affil): Bad Boys, Beat Bits, Benyet Music, Gravy Train, Cat Talk, Channel 5, Chrissi, Limes, Daromella, Data Alfa, Dieselhome, Robert Ruehle, Energie, Fama, Fireland, Extra, General, Gulp, Fie & Fanc, Frankl, Freiheit, Hoffmanns Wwe, Hucklepack, Intervall, JeRo, Jupiter, Kasperek, Kiki, Lollipop, Mambo, Mampf, Meridian, Meteor, New A, Paul Siegel, PIF, Piro, Ralph Maria Siegel, Richard Kaun, Robert Mellin, Sieste, Singing Bird, SPV, Suedpropa, Symphonic, Symphony House, Launhardt, Teoton, Totenkopf, Whitehouse, Blackout, Second Hand, Artforce, Fat Rat, Mot, Muenchener Humor, Musenkuss, Dieselhome, Uberschall, Carabella, Vine, International Worldline, Pepe, Pincusgil, Jessi Vanessi, Birdie.
 SIEGTON, see Warner/Chappell Germany.
 SIESTE, see Siegel Music Companies.
 SIGEM, see Warner/Chappell Germany.
 SIKORSKI INTERNATIONALE MUSIKVERLAG, Johnsallee 23, 2000 Hamburg 13, PO Box 132001 (Zip: 2000), 040.414 1000, Fax: 040.414 0041, Tlx: 211027, Presidents: Hans & Dagmar Sikorski, Prof Mgr: K H Adrio, Copyright: L Diezel, PR/Promo: A Buderath.
 SILENT BEAUTY, see Erdenklang Musikverlag.
 SILHOUETTE, see Warner/Chappell Germany.
 SILVER ROSE, see Warner/Chappell Germany.
 SILVER SUN, see Warner/Chappell Germany.
 SILVERBIRD, see Warner/Chappell Germany.
 SIMILE, see Warner/Chappell Germany.
 SINGING BIRD, see Siegel Music Companies.
 SISTER FATE, see Warner/Chappell Germany.
 SISTER TERESA, see Sony Music Publishing.
 SITIZENZ, see Warner/Chappell Germany.
 SITTING PRETTY, see Warner/Chappell Germany.
 SKOEK, see MCA Music.
 SKY HARBOR/SEAGRAPE, see Warner/Chappell Germany.
 SKY HEART, see Warner/Chappell Germany.
 SKY WRITING, see Warner/Chappell Germany.
 SLICK SKILLET, see Warner/Chappell Germany.
 SLOW DANCING, see Warner/Chappell Germany.
 SLOW LOVE, see Warner/Chappell Germany.
 SLUGGOSONGS, see Warner/Chappell Germany.
 SMACKIN' STARSHIP, see MCA Music.
 SMOKESTONE, see Warner/Chappell Germany.
 SNAKESAGE, see Sony Music Publishing.
 SNEAK ATTACK, see Warner/Chappell Germany.
 SNICKERBUSH, see Sony Music Publishing.
 SNOW, see Warner/Chappell Germany.
 SONG, see Warner/Chappell Germany.
 SONGBIRDS OF PARADISE, see Warner/Chappell Germany.
 SONGS FOR TODAY, see Siebenpunkt Verlags.
 SONGS O'STEEL, see Warner/Chappell Germany.
 SONGS OF LOGIC, see Warner/Chappell Germany.
 SONIMAGE, see Sonoton Music Library.
 SONOTON MUSIC LIBRARY, Schliebinger Strasse 10, 8000 Munich 80, 089.488 282, Fax: 089.480 701, President: Gerhard Narholz, MD: Rotheide Narholz, Prof Mgr: Alfred Dilz, Bus Dev: Peter Schmidt. (Owned): Sonoton, Pro Nova; (Affil): Music House, Sonimage, Focus, Parry Music, Crea Sound, Valentino, Conroy, Cavendish.
 SONUB, see Warner/Chappell Germany.
 SONY MUSIC PUBLISHING (GERMANY), Bleichstrasse 64, 6000 Frankfurt am Main, 069.13051, Fax: 069.130 5440, Tlx: 414368, MD: Jochen Leuschner, Publ Dir: Mike Weller, Admin Mgr: Robert Stegmueller. (Owned): Be-Bop, Glenmore Songs, Hillstreet, Hundekuchen; (Admin): Alto Voyage, And What Not, A Thousand Miles Long, Australian Mushroom, Bangs and Crashes, Cabbage Flake, Cart Before Horse, Chez Ravel, Diving For Pearls, Edisto Sound Int'l, Godfathers, Hucksters of Cool, Jeff Cohen, Laly, LA Sky, Little Harps, Love Thing, MAD, Maurice White, Motel, PZ-Culler, Nikki Lynn, No Integrity, Nulitsty, OG Rhyme, P2, Phillster, Poor, Pork Tartare, Porter Carroll Jr, Positunes, Redondo, Relia, Ringer, Rockview, Rusty Dwarf Tunes, Sister Teresa, Snakesage, Snickerbush, Sony Music Publishing Worldwide, Sony Songs/Tunes, Throbs, Toronado, Twelve To One, Twilson Songs, Verdigris Valley, Vision Of Love Songs, Watersound, Wild Crusade, Wild Wild West.
 SONY MUSIC PUBLISHING WORLDWIDE, see Sony Music Publishing.
 SONY SONGSTUNES, see Sony Music Publishing.
 SOOKLOOZY, see Warner/Chappell Germany.
 SOUND DIAGRAMS, see Warner/Chappell Germany.
 SOUND OF FUTURE, see Hammer Musik.
 SOUTHCOTE, see Warner/Chappell Germany.
 SOUTHERN ARTS, see Esperanza Musikverlag & Musikproduktion.
 SPECIAL RIDER, see Warner/Chappell Germany.
 SPHERIC, see Warner/Chappell Germany.
 SPIDERMAN, see Warner/Chappell Germany.
 SPOON, see Gerig Music.
 SPORTSMAN, see Warner/Chappell Germany.
 SPROCKET, see Warner/Chappell Germany.
 SPZ, see Warner/Chappell Germany.
 SQUARE, see Warner/Chappell Germany.
 ST. FRANCIS, see Valentine Musikverlag.
 STAN BUSH MUSIC, see Axxis Musikverlag.
 STAR MUSIK, see MCA Music.
 STEADY STATE, see Warner/Chappell Germany.
 STEEL-CHEST, see Warner/Chappell Germany.
 STEFAN SULKES, see Warner/Chappell Germany.
 STEINBRUCH, see Warner/Chappell Germany.
 STEPMOTHER, see Warner/Chappell Germany.
 STERNSTUNDE, see Paradise Music.
 STEVEN BISHOP, see Warner/Chappell Germany.
 STIFF, see Warner/Chappell Germany.
 STONE FLOWER, see Warner/Chappell Germany.
 STORY SONGS, see Warner/Chappell Germany.
 STORZ MUSIK, Hauptstrasse 114, 3360 Oesterode, 05522.73044, Fax: 05522.75481, MD: Erich Storz.
 STRAWSONGS, see Warner/Chappell Germany.
 STRAY NOTES, see Warner/Chappell Germany.
 STREETHEAT MUSIC PRODUKTION, Kaarsterstrasse 53, 4044 Neuss-Kaarst 2, 02101.68078, Fax: 02101.603 750, Tlx: 8518068 heat, President: John A Taylor, Fin Dir: Jurgen Goebels, Copyright: Susanne Bergander. (Owned): Italoheat; (Admin): Hit'n'Run, B.A.T, Filmflam.
 STREETLIGHTS, see Warner/Chappell Germany.
 STRIPED HOUSE, see Warner/Chappell Germany.
 STUDIO HAMBURG, see Warner/Chappell Germany.
 STYLE, see Warner/Chappell Germany.
 SUBIDDU, see Warner/Chappell Germany.
 SUCCUBUS, see Warner/Chappell Germany.
 SUEDPROPA, see Siegel Music Companies.
 SUMMERLEA, see Mento Music Group.
 SUNDANCE MUSIC, Beckstrasse 15, 2820 Bremen 70, 0421.656 544/5, Fax: 0421.656 599, Presidents: Dietmar Schmidt, Christiane Siedenburg, MD: Volker Siedenburg. (Owned): Divolo, Sundance; (Sub-Pub): Another Note, Serious Bass, Rapp Beat, Unclaimed, Sherwood, Du Monde Melodie.
 SUPERHYPE, see Warner/Chappell Germany.
 SUPERTONIC, see Warner/Chappell Germany.
 SUPRA, see Melodie Der Welt.
 SUPREME, see Hammer Musik.
 SURPRISE, see Warner/Chappell Germany.
 SWALLOW TURN, see Warner/Chappell Germany.
 SWEDEN MUSIC, see Polygram Songs Musikverlag.
 SWEET HARMONY, see Warner/Chappell Germany.
 SWEET KAROL/SWEET GLENN, see Warner/Chappell Germany.
 SWELL SOUNDS, see Warner/Chappell Germany.
 SWIGGEROUX, see Warner/Chappell Germany.
 SWINDLE MUSIC, see Axxis Musikverlag.
 SWL, see Global Musikverlage.
 SYMBOL, see Warner/Chappell Germany.
 SYMPHONIC, see Siegel Music Companies.
 SYMPHONY HOUSE, see Siegel Music Companies.
 T-B.OY, see Warner/Chappell Germany.
 T-GIRL, see Warner/Chappell Germany.
 TAKTELL, see MCA Music.
 TAMALE, see Warner/Chappell Germany.
 TAMBURINE, see Warner/Chappell Germany.
 TANIT MUSIKVERLAG, Ullmenstrasse 1, 6000 Frankfurt am Main 1, 069.724 1270, Fax: 069.172 838, MD: Matthias Raue,

- Asst: Margareta Schoenerstedt.
- TARGA ITALIA**, see Warner/Chappell Germany.
- TARNEY**, see Warner/Chappell Germany.
- TEAM**, see Peer Musikverlag.
- TELEMUSIC**, see Selected Sound (emi Music Publishing).
- TELSTAR MUSIC VERLAGS**, Goethestrasse 68, 8000 Munich 2, 089.530 9135/6, Fax: 089.537 678, Tlx: 523019, MD: Stephan Meier.
- TEN EAST/FIVE WEST**, see Warner/Chappell Germany.
- TEOTON**, see Siegel Music Companies.
- TERMIDOR MUSIKVERLAG**, Heusteigstrasse 69, 7000 Stuttgart, 0711.600 711, Fax: 0711.649 2369, Tlx: 723942, GMS: Detlef Engelhard, Goetz A Woerner. (Affil): Fania, Vaya, EGREM, Payador, Ruben Blades Ents, Unimusic, Kubaney.
- TERRA FIRMA**, see Warner/Chappell Germany.
- TESS**, see Warner/Chappell Germany.
- TET PUBLISHING**, see MCA Music.
- TEXAS CITY**, see MCA Music.
- TEXAS TWANG MUSIC**, see Axis Musikverlag.
- TGM**, Reichstagufer 4-5, O-1080 Berlin, (+37) 2.229 9141, Fax: (+49) 30.325 6997, Tlx: 186671 pool (W Berlin), MD: Timothy Green, Dir: Frank Nietsch, Promo: Marion Reinhardt. (Owned): TGM; (Admin): Satellite Music; Main product: Dance, AC, Album Rock, Gold/Oldies, Country.
- THAMES TALENT**, see Warner/Chappell Germany.
- THE BIRDY NUM NUMS**, see Human Noise.
- THE WELK MUSIC GROUP**, see Polygram Songs Musikverlag.
- THEMES INT'L**, see Selected Sound (emi Music Publishing).
- THIRD STORY**, see Melodie Der Welt.
- THORNWALL**, see Warner/Chappell Germany.
- THREE SHIPS**, see Warner/Chappell Germany.
- THRILLER MILLER**, see MCA Music.
- THROBS**, see Sony Music Publishing.
- TIMES SQUARE**, see Warner/Chappell Germany.
- TIMM MUSIC**, Webeierstrasse 3, 4800 Bielefeld 1, 0521.64937/66808, Fax: 0521.172 723, GM: Peter Timpe.
- TINTA**, see Warner/Chappell Germany.
- TITANIA**, see Gerig Music.
- TIZZ**, see Warner/Chappell Germany.
- TM**, see Warner/Chappell Germany.
- TOBEY**, see Warner/Chappell Germany.
- TODDMARK**, see Warner/Chappell Germany.
- TOL**, see MCA Music.
- TOMSCOT**, see Warner/Chappell Germany.
- TONIKA**, see Schacht Musik.
- TONOPAH/TIDEWATER**, see Warner/Chappell Germany.
- TOP TONE MUSIKVERLAG**, Koelenberg 65, 2300 Kiel 14, 0431.711 912, Fax: 0731.711 895, MD: Joachim Niesche.
- TOPOGRAPHIC**, see Warner/Chappell Germany.
- TORONADO**, see Sony Music Publishing.
- TORSO**, see Warner/Chappell Germany.
- TOTENKOPF**, see Siegel Music Companies.
- TOUCH & GO**, see Warner/Chappell Germany.
- TOUCH DOWN MUSIC**, see Siebenpunkt Verlags.
- TOUCHSTONE PICTURES**, see Warner/Chappell Germany.
- TOUGHKNOT**, see Warner/Chappell Germany.
- TRANSPARENT MUSIC**, Glashuettenstrasse 79, 2000 Hamburg 6, 040.430 1041, Fax: 040.438 867, Tlx: 2165987, MD: Angelica Oplersch.
- TRANSWORLD**, see Global Musikverlage.
- TREE GROUP**, see Melodie Der Welt.
- TREMANDER**, see Warner/Chappell Germany.
- TRIMAN**, see Esperanza Musikverlag & Musikproduktion.
- TRIO**, see Warner/Chappell Germany.
- TRUE**, see Warner/Chappell Germany.
- TURNSTAR**, see Gerig Music.
- TUSKEN**, see Warner/Chappell Germany.
- TWELVE TO ONE**, see Sony Music Publishing.
- TWENTIETH CENTURY**, see Warner/Chappell Germany.
- TWENTYONE**, see Warner/Chappell Germany.
- TWILSON SONGS**, see Sony Music Publishing.
- TWO JEYS PUBLISHING**, see MCA Music.
- TWO-BEAT**, see MCA Music.
- TYREACH**, see Warner/Chappell Germany.
- U 2**, see Warner/Chappell Germany.
- UBERSCHALL**, see Siegel Music Companies.
- UBIQUITTY**, see Warner/Chappell Germany.
- UBM RECORDS**, Aachener Strasse 1112a, 5000 Cologne 40, 02234.74081, Fax: 02234.79730, President: Uwe Buschkoetter, GM: Lothar Braun. (Owned): UBM, Largo; (Sub-Pub): Firstcom.
- UFATON**, see BMG Ufa Musikverlage.
- ULTRA SONGS**, see Warner/Chappell Germany.
- UNCLAIMED**, see Sundance Music.
- UNCLE BEAVE**, see Warner/Chappell Germany.
- UNICITY**, see MCA Music.
- UNIMUSICA**, see Termidor Musikverlag.
- UNOBSKY**, see Warner/Chappell Germany.
- UROCK**, see Warner/Chappell Germany.
- US METAL**, see Crazy Life Music.
- VALENTINE MUSIKVERLAG**, Eppendorferweg 7, 2000 Hamburg 20, PO Box 203312 (Zip: 2000), 040.430 0339, Fax: 040.439 6587, MD: Arno H van Vught, Promo: Michael Frommhold, Copyright: Gertraud Witte. (Owned): Argot, Arthur's Mother, Burnt Ash, Cancon, Midnight, Rainbow, Golora, Middle Eight, Corner Stone, B.O.P, Valentine, Latchmere, Marathon, Dolphin, Pickle; (Admin/sub-pub): Derry, St. Francis, Prelude, House of Bryant, Buckhorn, Jerry & Bill, Jerry Foster, Addington State, Dogmo, Valgroup, Hut-Sut, Moffett-Dickinson, Mother Martha, Peglari, New Malden, Donna Lee, Foster & Rice, Novel Bond, Pergee, Music To Picture, North Country, Peter Piper, Plains, Powder Keg.
- VALENTINO**, see Sonoton Music Library.
- VALGROUP**, see Valentine Musikverlag.
- VALLEY OF VIDAL**, see Warner/Chappell Germany.
- VALLEY**, see MCA Music.
- VAN DYKE SONGS**, see Progressive Musikverlag.
- VAN HALEN**, see Warner/Chappell Germany.
- VAVOOM**, see Warner/Chappell Germany.
- VAYA**, see Termidor Musikverlag.
- VERA CRUZ**, see Warner/Chappell Germany.
- VERABRA MUSIC**, Luetticher Strasse 15, PO Box 270126, 5000 Cologne 1, 0221.512 031, Fax: 0221.529 563, Tlx: 8886685 vbr, President: Vera Brandes, MD: Michael Jacoby.
- VERDIGRIS VALLEY**, see Sony Music Publishing.
- VERTEX**, see Hammer Musik.
- VICTORIA**, see Warner/Chappell Germany.
- VIENNA**, see Bellver Music.
- VIKTORIA**, see Gerig Music.
- VINE**, see Siegel Music Companies.
- VIRGIN MUSIC GERMANY**, Herzogstrasse 64, 8000 Munich 40, 089.337 955, Fax: 089.3818 0918, MD: Udo Lange, GM: Gaby Urban.
- VISION OF LOVE SONGS**, see Sony Music Publishing.
- VITAMINE**, see Marie-Marie Music.
- VOICE VERSA**, see Warner/Chappell Germany.
- VOLLTON MUSIKVERLAG**, Heusteigstrasse 69, 7000 Stuttgart, 0711.600 711, Fax: 0711.649 2369, Tlx: 723942, GM: Detlef Engelhard, Friedemann Witecka.
- WALDEN**, see Warner/Chappell Germany.
- WALT DISNEY**, see Warner/Chappell Germany.
- WARCOPS**, see Warner/Chappell Germany.
- WARNER HOUSE OF MUSIC**, see Warner/Chappell Germany.
- WARNER-TAMERLANE**, see Warner/Chappell Germany.
- WARNER/CHAPPELL GERMANY**, Haller Strasse 40, 2000 Hamburg 13, 040.441 8020, Fax: 040.453 327, Creative GM: Norbert Masch, Legal & Bus Affairs & Admin GM: Gabriele Schultze-Spahr, Promo Mgr: Rolf Harz.
- WARNER/CHAPPELL GERMANY**, Ismaninger Strasse 21, 8000 Munich 80, 089.470 8031, Fax: 089.470 8030, MD: Ed Heine, F&A: Juergen Grunwald, Copyright Mgr: Norbert Hauptfleisch, Int'l Creative Affairs Dir: Frank Dietrich. (Owned): Amadeus, Americanino, Andros, Apollon, Aschenputtel, Autarc, Avocado, Barbados, Beckbeat, Big Bang, Boogiesongs, Boogietunes, Brause Beat, Candida, Capriccio, Carmel, Chyenne, Cosima, CRMV, Dallah, Diabolo, Double Duck, Ego, Eisbrecher, Eisenberg, Eldorado, Ellensong, Enemy, Fein, Foto, Get Into Magic, Giko, Grand H, Griffin, Hanseatic, Happly, Harmonie, ICM, IDE, Interpol, ITM, Koster, Lago, Lilion, Lingo, Lombardoni, Mandala, Maue, (Mauve) Style, Melan, Metromania, Momi, Modern Media, MOM, Musik Unserer Zeit, Nemo, Nessie, Neue Welt, Neureich, Opre Rose, Panoram Song, Peek-A-Boo, Pflug & Company, Pingo, Pink, Pro Media, Pro: Songs, Ratterton, Reethaus, Repex, Rondo, Roof, RWU Sound, Samos, Second Rail, Siegton, Songs of Logic, Spiderman, SPZ, Square, Steinbruch, Studio Hamburg, Surprise, Tamburine, Tess, Tinta, TM, Touch & Go, Transparent, Ultra Songs, Voice Versa, Wellenreiter, Wolfbite, Zardoz; (Admin): Aaron Spelling, Absotively, ABZ, Acara, Acuff-Rose, Adler Music/Jerry Ross, Advanced, Affirmative, Afi, After The Rain, Air Bear, Almond Legg, Ananas, Angel Notes, Aqua Blue, Argo, Arlon Enterpris, Arrow, Art, Ashdale, Audigran, Auntie Gravity, Autumn, Ayers Roy Ubiquity, Balmain, Bananas, Bantha, Barclay Morris, Baracuda, Barton, Basque, Be, Beachhouse, Beam Down, Beau-Di-O, Bellkat, Benchmark, Ben Scotti, Berlin, Bertus, Bettis, Betty Earland, Big Apple, Big Bang, Big Kitty, Big Pig, Big Seven, Big Six, Big Sky, Black Dragon, Blackeye, Blackhill, Black Mountain Road, Black Sheep, Bleu Disque, Blowing Rock, Blue Flame, Blue Gum, Blue Pearl, Blue Team, Bohannon, Bona Relations, Border, Bregman Vocco, Brian Morrison, Brockman, Brogue, Bruco, Buffalo, Bugle, Bullet Proof, Burlington, Bushka, Buxton Hill (Cole Porter), Call This, Cane Garden, Canvee, Caplin Songs, Carlin, Casablanca, Casarica, Casa de Oro, Cass County, Castle Hill, Catstyle, CC Songs, C & D, Chandlane, Chappell, Charlotte, Charte, Chart Promotions, Chewy, Chic, Chippenstar, Chi-Sound, Chioe Songs, Chong, Chrystal Copy, Clarke, Classeast, Commander, Concorde, Cookling, Cool-Springs, Corbetta, Cotillion, Creative, Creative Bloc, Crosstown, Daedalus, Dakar, Daly City, Damont, Dangerous, Darrel Brown, David, David Rose, Davimar, Davray, Dawg + Zut, Deertrack, Denise Barry, Denjac, Diamond Mine, Dirt Head, Discordia, Donar Muziek, Donna Weiss, Doobie Brothers, Dorafio, Dorff, Dormant, Dots + Lines, Dough Boy, Douglas Sahn, Dovan, Dreamhouse, Dreyfuss, Druse/Ninja, Duane, Duck Ballads, Dwarf, Dynamic, Dynatone, Earth, Easy Action, Easy Money, EB Marks, EC, Edge of Fluke, Edie Bricknell Songs, Edwin Ellis, Eight Twelve, Eleksylum, Elektrik Sun, Encino, Encore, Epic/Portrait Solar, Erichouse, Euphonius, European, Exoskeletal, Faith Hope & Charity, Far Fetched, Featherspace, Feckless, Fiction Songs, Fiddleback, Fingers, Fire Escape, First Artists, Fixx, Flying Dutchman, Fonit Cetra, Formust, Fort Knox, Foster Frees, Four Jays, Fox Film, Fred Raphael, Freedom Songs, Frost, Fry King, FS, FTS, Full Keel, Gainwest, Gallop, Garland Jeffries, Gateway House, Gear Box, Geffen, Ge Ge, Gershwin, Gino Vannelli, Glass Sea, Glen Songs, Glissando, Glitterbest, Golden Spread, Good Flavour, Good Friends, Good High, Graham (Brothers), Grandmaster Flash, Grasshopper, Greenheart, Greenstone, Guns 'n' Roses, Hackady, Halsey Brothers, Hammond, Hanna Barbera, Harlekijn, Harms, Hatz, Havona, Hearts Delight, Heavy Petal, Hedgecock, Heen, Hensley, Herald Square, Herbe, High Lonesome, Hill & Range, Hill Songs, Himmicane, Hitchings, Hits 'n' Mo' Hits, House of Fun, House Of Gold, Hudson Bay, Hue & Cry, Hustlers, Ice Gold, Ice Nine, Idiot Songs, Idle Speculation, IMPS, In A Bunch, Inar, Index, India Green, Inevitable, Infinite, Interworld, Invisible Mendez, IQ, Irving, Isaak, I Squared, Jakmax, Jalynne, Jamm, Jazz Horn, JBM, Jed-drah, Jess, Jetstar, JJJ, Jonaion, Jones, Josley, Journey Partnership, JSH, Judith Randall/Atzo, Judy Cheeks, Juliana, Jump Tunes, Jungle Aelie Aeli, Junipiggy, Jyri, Kalahari, Kaskat, Kate Bush, Katja, K-Dave-S, Keefe, Kenney, Kenya, Khufu, Kick-Start, Kidada, Kinaalda, Kirbypace, Kissing The Pink, Korchmar, Krokus, Kuumba, Lakiva, Laredo, Level 42, Lido, Likely Story, Little Diva, Little Fugitive, Little Mole, Little Reata, Livingston, Long Acre, Longitude, Longneck, Lorimar, Lost Toy People, Lotusdrive, Love Songs, Luckyu, Maclen, Magic Song, Magidsor, Magnet, Magnetic, Mangowork, Manny Rose, Manx, Marr Songs, Matchbourne, Matkosky, Matragun, McKee, Meadowlane, Megadude, Melodyscale, Metro, Metropolis, Mick Ralphs, Mighty Three, MiJacs, Mi-Jame, Mikalanna, Milene, Miran, Mississippi Mud, M & M, Mobbetta, M'Occan, Motley Crue, Mofu, Monty Seward, Mopage, Morris-Chappell, Naked Snake, Nearysongs, Nebraska, Neeb, Neevollah, Nehemia, Neighbourhood, Neouleum, Neutral Gray, New Bohemians, New Cadenza, New East, New World, New World Pictures, Night River, Nitealstak, No-Noa, NOB, Nodlew, Nom, Normal, Nosebag, No Surrender, Number Nine, Nurk Twins, NWP, Oil Slick, O'Keefe, Olde Grog, Old Way, Omnipresent Halo, Otcasek, Out Of Pocket, Overdue, Page Three, Palace, Palace Productions, Paladin, Palancar, Palomino, Paradox, Pazuza Peabo, Peaceful, PEFC, Pendulum, Pentable, Pepamar, Pepper, Perfect Songs, Perico, Phillipsongs, Philly-Creed, Picket, Pickwick, Pilatus, Pink Bat, Pippin The Friendly Ranger, Pitch Control, Plan-9, Planetary, Planet Sushi, Platinum Ear, Pomerants, Ponti, Poopy's, Poppa Willie, Postprofit, Pressed Ham Hits, Prime, Prince Street, Prix Formulat 1, Professional, Promo, Pronto, Protoons, Pud, Pullmann, Quince, Ramsel, Ram's Horn, Rancho Bogardo, Randy Michelle, Rashida, Rawlou, Recombinant, Red Bullet, Red Cloud, Red River, Refuge, Reganesque, Rehtakul Veets, Remick, Rent-A-Song, Revelation, Rewind, Rickim, Rick Keefer/Punaluu, Ritzy, Riva, Robin Hill, Rob-Roy West, Rock Dog, Rockerfella, Rockshire, Rockslam, Rodra Berna, Rowland, RSO, Rud-Mor, Rumanian Pickle Works, Rutland Road, Safespace, Saloon Songs, Sandy Songs, Sanpan, Santa Fe, Satsong, Saxsongs, Scherzo, Screaming Blue Messiah, Seashell, See This House, Sephra/Justin Grant, Sergeant, Shakin' Baker, Shoot For The Moon, Shrewsham, Sigem, Silhouette, Silverbird, Silver Rose, Silver Sun, Simile, Sister Fate, Sitzenz, Sitting Pretty, Sky Harbor/Seagrape, Sky Heart, Sky Writing, Slick Skillet, Slow Dancing, Slow Love, Sluggosongs, Smokestone, 'WHITE-NOISE', see Schacht Musik.
- WHITEHOUSE**, see Siegel Music Companies.
- WHITESNAKE**, see Warner/Chappell Germany.
- WIENER BOHEME**, see BMG Ufa Musikverlage.
- WILD CRUSADE**, see Sony Music Publishing.
- WILD GATOR**, see Warner/Chappell Germany.
- WILD WILD WEST**, see Sony Music Publishing.
- WILLEDEN**, see Warner/Chappell Germany.
- WIN MUSIC**, Ilchingerstrasse 14, 8011 Kirchseeon, 08091.4759, Fax: 08091.4770, MD: Hardy Schuetze. (Owned): Win, Cyclus; (Admin): CTM; Main product: Dance, AC.
- WINDCHIME**, see Warner/Chappell Germany.
- WINDSWEEP PACIFIC**, see Warner/Chappell Germany.
- WINE 'N' DINE**, see Warner/Chappell Germany.
- WINTERLEA**, see Mento Music Group.
- WINTRUP MUSICVERLAGE**, Schubertplatz 15, 4930 Daimold, 05231.27011, Fax: 05231.27390, MD: Walter Holzbaur, A&R/Promo Mgr: Petra Buttler, Copyright Mgr: Rita Koehler, Special Projects: Maria Abele-Holzbaur, Sec: Michaela Blume. (Owned): Flex-Ton, Clockwork, Jumar, Hafenklang, Sharleene, EIMC, Calren; (Admin): Maldoror, Byte 'n' Bit; (Sub-pub): ADRA, Albion, Complete, Nettoverboard, Hitage, Green Park Music, Wintrup Songs, Mighty Boys Music; Main product: Dance, Album Rock, New Age, Hard Rock.
- WINTRUP SONGS**, see Wintrup Musikverlage.
- WIRRRUP**, see Warner/Chappell Germany.
- WITMARK**, see Warner/Chappell Germany.
- WOHLKLANG**, see Marie-Marie Music.
- WOITSCHACH**, see Melodie Der Welt.
- WOLFBITE**, see Warner/Chappell Germany.
- WONDERLAND**, see Warner/Chappell Germany.
- WOOD MONKEY MUSIC**, see Progressive Musikverlag.
- WORLDS END**, see Warner/Chappell Germany.
- WOW & FLUTTE**, see Warner/Chappell Germany.
- WRITERS HOUSE**, see Warner/Chappell Germany.
- YA-D-SIR**, see Warner/Chappell Germany.
- YAH MO**, see Warner/Chappell Germany.
- YAYA**, see Warner/Chappell Germany.
- YELLOWBRICK ROAD**, see Warner/Chappell Germany.
- YELLOW DOG**, see Warner/Chappell Germany.
- YESSUP**, see Warner/Chappell Germany.
- YOUNG MUSIK**, Umlandstrasse 173/4, 1000 Berlin 15, 030.882 7383, Fax: 030.882 5903, Tlx: 182989, President: Jack White Mgr: Karl-Heinz Klemppow.
- YUMA**, see Warner/Chappell Germany.
- YVRESSE**, see Freibank Musikverlag.

ZARDOZ, see Warner/Chappell Germany.
 ZELAKON, see Warner/Chappell Germany.
 ZEON, see Warner/Chappell Germany.
 ZIG ZAG, see Siebenpunkt Verlags.
 ZILLION, see Warner/Chappell Germany.
 ZIPCODE, see Warner/Chappell Germany.
 ZOMBA, see Warner/Chappell Germany.
 ZOO, see Warner/Chappell Germany.
 ZOOPEAH, see Peer Musikverlag.
 ZYX RECORDS, Benzstrasse, Industriegebiet, 6295
 Merenberg, 04671.5050, Fax: 06471.50599, Tlx: 4821614,
 President: Bernhard Mikulski. (Owned): ZYX Metal/Classic;
 (Admin): Memory, SAIFAM.

VIDEO PROGRAM SUPPLIERS & BUYERS

CAMELOT MUSIC TRADING, Gutenberggring 55B, 2000
 Norderstedt, 040.523 3081, Fax: 040.523 3971, Tlx: 214184
 wifo, President: Wilfried Todt, Mktg Local: Susanne Todt,
 Accts Mgr: Barbara Rauscher.
KARUSSELL MUSIK & VIDEO, Oberstrasse 14b, 2000 Ham-
 burg 13, 040.423 0070, Fax: 040.423 0050, Tlx: 2163925, MD:
 Gerd Brendemuehl, Mktg Dir: Astrid Rix, Sales Mgr:
 Thomas Altemeier, Snr Prod Mgr: Michael Schneider. New
 address from January 1, 1992: Holzdam 57-61, 2000 Ham-
 burg 1; Main product: Children's, Feature Films.
PICKWICK GERMANY, Oststrasse 13, 4000 Duesseldorf 1,
 0211.360 432, Fax: 0211.361 3975, MD: Tony Harris. Main pro-
 duct: EHR, Classical, Children's videos.
POLYGRAM VERTRIEB, Glockengiesserwall 3, 2000 Ham-
 burg 1, PO Box 104909 (Zip: 2000), 040.308 701, Fax: 040.308
 7655, Tlx: 2163923, MD: Fritz Lehmann.
POLYGRAM VIDEO, Glockengiesserwall 3, 2000 Hamburg 1,
 PO Box 104909 (Zip: 2000), 040.308 701, Fax: 040.308 7346,
 Tlx: 215024, GM: Bernd Wiesner.
POLYMEDIA MARKETING GROUP, Oberstrasse 14b, 2000
 Hamburg 13, 040.423 0070, Fax: 040.423 0750, Tlx: 2163925,
 MD: Werner Klose, GM (PolyGram Video): Bernd Wiesner.
SATVA ART, Herzog Wilhelm Strasse 7, 8000 Munich 2,
 089.260 3814, Fax: 089.260 4083, President: Sonja
 Wiesbeck, Chmn: Oliver Serano-Alve, MD: Anton Vogl.
SPV, Bruesseler Strasse 14, 3000 Hanover 72, 0511.8709-0,
 Fax: 0511.870 9181-2, President: Manfred P Schuetz,
 A&R/Promo: Jutta Kestner, Distr Mgr: Uwe Cimala, Sales
 Dir: Kurt Erping, Legal Affairs: Anja Riekenberg, Export
 Mgr: Martin Ruder. Distributor of music videos.
STUDIO K7, Kaiserdamm 7, 1000 Berlin 19, 030.321 1007, Fax:
 030.325 5495, Tlx: 183060, MD: Horst Weidenmueller. Music
 video distributor, specializing in independent video labels.
WARNER HOME VIDEO (GERMANY), Hans Henny Jahn Weg
 35, 2000 Hamburg 76, 040.227 1250, Fax: 040.2271 2519.

RECORD DISTRIBUTORS

99 RECORDS IMPORT, Karl-Hofer Strasse 35, 1000 Berlin 37,
 030.801 3099, Fax: 030.801 2212, MD: Peter
 Schimmelpfennig.
 AMV, Strahlenbergerstrasse 125A, 6050 Offenbach, 069.880
 402/50, Fax: 069.888 844, Mgr: Alexander Azary.
ARIS-ARIOLA IMPORT SERVICE, Verler Strasse 430, 4830
 Guetersloh, 05241.40246, Fax: 05241.47748, GM: Michael
 Poerschke.
ASTI RECORDS, Eichendorferstrasse 33, 4040 Neuss,
 02101.45363, Fax: 02101.409 204, Tlx: 8517957 asti, MD:
 Roger Stitson. Labels distr: all German labels, direct im-
 port; Main product: pop, rock, heavy metal.
AUTOGRAM RECORDS, Burgstrasse 9, 4405 Nottuin,
 02502.6151, Fax: 02502.1825, MD: Willy Schwenken.
AUTONOM RECORDS, Burgstrasse 9, 4405 Nottuin,
 02502.6151, Fax: 02502.1825, MD: Willy Schwenken. Main
 product: folk, blues, roots, ethnic, rare music.
BELLA MUSICA (GERMANY), Rheinstrasse 26, 7580 Buehl,
 07223.27009, Fax: 07223.30109, Contact: J Rinschler.
BERTELSMANN DISTRIBUTION, An der Autobahn, 4830
 Guetersloh, 05241.805 108, Fax: 05241.46626, MD: Friedrich
 Quest, Sales Mgr: Horst Ramsch.
BIG FUN RECORDS, Zum Schussenenring 26, 7953 Bad
 Schussenenfeld, 07583.2768, Fax: 07583.4141, MD: Dieter Ege.
BMG ARIOLA GERMANY (MUNICH), Steinhäuser Strasse
 1-3, 8000 Munich 80, 089.41360, Fax: 089.477 608, Tlx:
 523487, MD: Albert Czapski. Labels distributed: Ariola,
 Arista, Island, DDD, Logic, Chlodwig.
CAMELOT MUSIC TRADING, Gutenberggring 55B, 2000
 Norderstedt, 040.523 3081, Fax: 040.523 3971, Tlx: 214184
 wifo, President: Wilfried Todt, Accts Mgr: Barbara
 Rauscher, Mktg (Local): Susanne Todt. Labels distr: Colum-
 bia, WEA, Polygram, EMI, Intercord, Koch, Bellaphon,
 Pickwick, Naxos, Dacapo; Main product: pop, classical.
COLOSSEUM SCHALLPLATTEN, Bayernstrasse 100, 8500
 Nuremberg 44, PO Box 440252 (Zip: 8500), 0911.474 0170,
 Fax: 0911.474 0160, MD: Armin Luther, PR Mgr: Françoise
 Lempote, Prod Mgr: Susanne Coerper, Mgr (Export):
 Margot Koge. Labels distr: Andante, AVM, Chalfont, Citadel,
 First Night, Intermesso, Starlog, That's Entertainment,
 Varese-International/Sarabande, Vinilo, EMU-Records.
COSMUS, Johannesstrasse 8, 6780 Pirmasens,
 06331.76096-8, Fax: 06331.31379, A&R Mgr: Siegfried Ipach.
DA MUSIK/DEUTSCHE AUSTROPHON, Kruppstrasse 7, 2840
 Diepholz, PO Box 1160 (Zip: 2840), 05441.2081, Fax:

05441.7833/8824, President: Rolf Neumann, MD: Rainer
 Koppermann, Int'l Mgr: Andreas Hoellige. Labels (Distr):
 Heimatexpress, Pinorrock, Vagabond, Extra, Shy, IC, Elisar,
 Blue Flame, USS, Londonestreet, AH, Prudence, Wunder-
 tuete, Musikantonzherz, "Toi, Toi, Toi", Selected Sound,
 Beautiful Music, NEM, Palm, Story of Blues, BCM.
DELL & STOFFEL, PO Box 120450, 6800 Mannheim 1,
 0621.22888, Fax: 0621.105 801, MD: Hans Demmel.
DEMMELE TONTRAEGER, Carl Zeiss Ring 13, 8045 Ismaning,
 PO Box 1365 (Zip: 8045), 089.960 9420, Fax: 089.9609 4210,
 MD: Hans Demmel.
DISCO BUDGET, An der Guempesbruecke 26, 4044 Kaarst,
 02101.60040, Fax: 02101.61423/60040, MDs: Alfred Zinke,
 Manfred Schmitz, Manfred Scheerer (Import), Rainer
 Lessmann (Export), Gerd Drenker (Import), Video Sales
 Mgr: Sabine Fiori, Contact: Mr. von Kothen. Labels distr:
 BCM; Main product: dance music.
DISCO SCHALLPLATTEN, Alpenroder Strasse 14, 6230
 Frankfurt am Main 80, 069.346 031, Fax: 069.342 304, MDs:
 Horst Wiedfeldt, Martin Hoetzel, Promo/Mktg/Sales Dir:
 Michael Jung. Distributor; Main product: EHR, Classical,
 Dance, Album Rock, Gold/Oldies, Black (R&B).
DISCOVERY TONTRAEGERVERTRIEB, Daimlerstrasse 8,
 4044 Kaarst 2, PO Box 1163 (Zip: 4044), 02101.60030, Fax:
 02101.67532, MDs: Manfred Schmitz, Hans Rabe, Mgr (Ex-
 port): Rainer Lessmann, Buyer: Klaus Brauner, Sales Rep:
 Renate Freter.
EDEL, Wichmannstrasse 4, Haus 8, 2000 Hamburg 52, PO
 Box 520151 (Zip: 2000), 040.890 850, Fax: 040.896 521, MD:
 Michael Haentjes.
EFA BERLIN, Forster Strasse 4-5, 1000 Berlin 36, 030.618
 5050/9, Fax: 030.619 9382, MD: Werner Schroedl.
EFA-MEDIEN, Mousonstrasse 12, 6000 Frankfurt am Main,
 069.444 198/495 0991, Fax: 069.495 092, President: Ulrich
 Vormehr, MD: Horst Lewald. Labels (distr): Homestead, AB
 Strag, Messidor, Zensor, Jaro, What Goes On, Pinpoint, Tri-
 kont, Dossier, Glitterhouse, Worldmusic, World-Record,
 Bitzcore, Touch & Go, 45, Torso, Low Spirit, Weser, Sup Up,
 Dischord, Enemy, Happy Valley, Worker's Play It, Wemix,
 Vielklang, Vinyl Solution, Mr. Trodo, Constrictor, Radium
 Midnight, Collision, Alternative Tentacles, Nate Starkman
 & Son, Sup Pop, Amphetamine Reptile, Doggy Bag; Main
 product: Alternative, Punk, Hardcore, Avantgarde, Jazz.
EFA-MEDIEN, Billwerder Neuer Deich 334a, 2000 Hamburg 2,
 040.782 254-5, Fax: 040.782 783, Mgr (Export): Tom
 Meyer, Exports: Gabi Tullmann. Central Stock.
EMI ELECTROLA OPERATIONS, Von Huenefeldt Strasse 2,
 5000 Cologne 30, 0221.5964-9, Fax: 0221.596 4780, MD (EMI
 Operations Cologne): Friedrich E Wolltaw, Dir of Distr Ctr
 Butzweiler Hof: Heinz Migge, Central Classical Store Eur:
 Helmut Siebenmorgen, F&A (Ops): Josef Gauls.
EWV ETHNIC WORLD MUSIC, Hopfenstrasse 2, 2000 Ham-
 burg 36, 040.319 4773/3792, Fax: 040.319 2116, MD: Manlio
 Celotti, Dir (Int'l): Patrick Lee Thorp. Labels (Distr): DRG,
 Celtic, Black Crow, Alba, Gæl Linn, Guitar Workshop, Lap-
 wing, Leaper, Making Waves, Mulligan, Personal, SpinDrift,
 Wippet, Trailer, Dambuster; Main product: Dance, Jazz,
 World Music.
EXTRA RECORDS & TAPES, KLAUS BOEHNKE, Less-
 ningstrasse 3, 2359 Henstedt-Ulzburg, PO Box 1322 (Zip:
 2359), 04193.1781, Fax: 04193.77647, Tlx: 2180277, MD: Klaus
 Boehnke.
FENN MUSIC SERVICE, Holtenkinker Strasse 62, 2050 Ham-
 burg 80, 040.724 3620, Fax: 040.722 6774, MD: Walter Fenn.
FRONTLINE, Lilienstrasse 16, 3000 Hanover 1, 0511.700 0519,
 Fax: 0511.700 0949, Contact: Frank Ahorner, Stefan Heyer,
 Torsten Lange.
GLAPA, Behringstrasse 3, 8752 Mainaschaff, 06021.7201, Fax:
 06021.75699. Main product: blues.
HMV VERTRIEBS, Havighorster Weg 8, 2050 Hamburg 80,
 040.739 6090, Fax: 040.739 7852, MD: Erhard Mayer.
IN-AKUSTIK, Unterarten 14, 7801 Ballebrunn-Dottingen,
 07634.728, Fax: 07634.6532, Tlx: 772965, President: Guent-
 her Sumser, MDs: Bernhard Roessle, Alex Manninger.
 Labels (distr): Chesky, DMP, Erdenklang, K-Tel, Mesa, MFSL,
 Sound Product, Telarc, Tomato; Main product: AC, Album
 Rock, Jazz, New Age, Classical.
INTERCORD RECORD SERVICE, Schoenbergstrasse 47, 7302
 Ostfildern 4—Kemnat, 0711.476 3376, Fax: 0711.476 3351,
 Mgr: Joerg Hacker, Promo Mgr: Martin Schuhmacher.
 Labels: Music for Nations, Zappa, Roadrunner, Narada, Pro-
 file, Ichiban, Mighty Boy, Musidisc, Essential, Mushroom,
 Rising Sun, Cherry Red, Metal Blade, KAZ Records, Silenz,
 Alligator, Active, Red Light, Roundtower, New Albion, Nato,
 Head First, Antone's, Bear Tracks, Hollywood Rec, Kaola,
 Link. Plus all Sony-imports exclusively.
INTERNATIONAL MUSIC SERVICE, Bayernstrasse 20, 3012
 Langenhagen 7, 0511.730 682, Fax: 0511.782 736, GM: Uwe
 Bald. Labels distr: Deutsche Grammophon, Polydor,
 Phonogram, Philips Classics, Mercury, Verve, A&M, Line
 Records, M.A. Music, Arhoolie, Steeple Chase, Cooking
 Vinyl, Playa Sound, Melodram, Auvidis, Bongiovanni, New
 World Records; Distributor for special product and
 Polygram's Import Division.
KOCH INTERNATIONAL (GERMANY), Hermann Schmidt
 Strasse 10, 8000 Munich 2, 089.746 135-10, Fax: 089.725
 4759, Tlx: 5213408 koch, President: Franz Koch, A&R Mgrs:
 Franz Selb, Alfred Duebell, Label Mgr: Norbert Gubo.
 Labels (distr): Aperto, Atlantis, Aurophon, Austria,
 Autographic, Bella Musica, Black and Blue, Chandos,
 Classics For You, Europa Musica, Fantastik, Forlane, Ger-
 mania, Hyperion, Koch Int'l Classics, Koch Int'l Legacy,
 Koch Records, Koch Records Int'l, Koch Records Int'l

Fivestar, Koch Records Spezial, Micki, Multisonic, Musi-
 que en Wallonie, Northeastern, Panton, Phanton, Roko,
 Royal Classics, Schwann AMS-Studio, Schwann Musica
 Mundi, Schwann Musica Sacra, Supraphon, Syncoop, Tring.
LOGIC MEDIA DISTRIBUTION, Strahlenbergerstrasse 125A,
 6050 Offenbach, 069.880 633, Fax: 069.816 072, MD: Mat-
 thias Martinsohn.
MADRA MUSIC, Lenenweg 14, 4154 Toenisvorst 1, 02151.790
 037, Fax: 02151.700 740, MD: Drathen Vlekpleiter.
MIKULSKI DISTRIBUTION, Limburgerstrasse 18, 6251 Elbtal
 Dorchheim, 06436.6020, Fax: 06436.4102/6262, Tlx: 4821614,
 President: Bernhard Mikulski, MD: Reinhard Piel, Mgrs:
 Andy Kappel (Import), Lance Warren (Export). Labels (distr):
 Memory, Freshline, ZYX Metal/Classic/Records, Galaxis,
 Abfahrt, Technodrome, Fantasy, Prestige, Milestone, River-
 side, Pablo, Storyville, GNR, Hotsound, Groove Street, Lane-
 sound, Dance Street, Boy, PBI; Main product: dance, jazz.
NEUWIENER SCHALLPLATTEN, Im Schuetzengrund 54,
 5450 Neuwied 21, 02622.2036-8, Fax: 02622.5130, MD:
 Joerg Moerer.
OUT NOW, Neersener Strasse 32-33, 4044 Kaarst 1, 02101.668
 07778, Fax: 02101.603 681, Mgr: Uwe Broich.
OUTLINE IMPORT, Luette Marsch 1, 2000 Hamburg 65,
 040.608 3502, Fax: 040.608 0500, Dir: Thomas Grote.
 Wholesaler.
PILZ MEDIA GROUP, Ingrid Pilz Strasse 1, 8051 Kranzberg,
 Munich, 08166.300, Fax: 08166.30296/7.
POLYGRAM DIRECT EXPORT, Alte Rabenstrasse 2, 2000
 Hamburg 13, PO Box 132266 (Zip: 2000), 040.4418 1104-5,
 Fax: 040.4418 1203, Tlx: 212393, GM: Lothar Steyer.
POLYGRAM RECORD SERVICE, Klusriede 26, 3012
 Langenhagen 1, PO Box 1409 (Zip: 3000), 0511.730 600, Fax:
 0511.731 802, Tlx: 924077, MD: Cor van Dijk, Contr: Michael
 Kosemund.
POLYGRAM VERTRIEB, Glockengiesserwall 3, 2000 Ham-
 burg 1, PO Box 104909 (Zip: 2000), 040.308 701, Fax: 040.308
 7655, Tlx: 2163923, MD: Fritz Lehmann, Contr: Edmund
 Strebe, Sales Mgrs: Juergen Thiede (Pop), Horst Dengler
 (Classic). Labels (distr): Brain, Coda, Metronome, Nature,
 Reflector, Amadeo, Attic, Barclay, Big Life, Dischi Ricordi,
 DJM, Fiction, FRRR, Go Disc, London, Casablanca, Fon-
 tana, Mercury, Philips, Vertigo, Star Club, Rocket,
 Brunswick, Capricorn, Polydor, A&M, China, Jupiter, Polar,
 RSO, Polystar, Polyphon, Archiv Production, Deutsche
 Grammophon, Ades, ACM.
POOL MUSICPRODUKTION, Seelingstrasse 33, 1000 Berlin
 19, 030.321 5045, Fax: 030.325 6997, Tlx: 186671, MD: Peter
 Schimmelpfennig, Mgr: Mike Pyczak.
PROTON VERTRIEBS, Holtenkinker Strasse 62, 2050 Ham-
 burg 80, 040.724 2947/3822, Fax: 040.724 7452, President:
 Ulla Siegfried, Int'l Mktg: Victor R Cordani, Sales/Mktg:
 Peter Kiefer. Labels (owned): CMC, Alhambra. (Distr): FMS,
 BBC, Nostalgia, Danica, Jax Pax, Temple, High Grade,
 Bridge, Figaro, Look back, Cellier, Condor, JMS, Vivavox,
 Globo, Ocean Wide, Dragon, Cream, Ades, Buda, EPM,
 Green Linnet, Flying Fish, Blind Pig, Topic, Greenrux, Zeta,
 IDA, Freelance (Fra), Ode, Cerberus, MCS (Swi), Special
 Delivery, Springthyme, COD, TAX, Phontastic, Label La
 Lichera, Aroc, Bleu Caribes, Chansophone, CY, Doctor Jazz,
 DV More, Face Music, Four Leaf, Hep, Jazz Anthology, Jazz
 Classics, JMC, Label X, Open, PAN, Plant Life, Point, Pream-
 ble, Southern Cross, Triumph.
RAINBOW DIRECT MAIL VERSAND, Am Moosfeld 33, 8000
 Munich 82, 089.4200 8310, Fax: 089.4200 8312, MD: Kristian
 Nicol Wobbs. Labels (Lic): Rainbow Music Video; (Distr):
 Life Live CD; Main product: Album Rock, Jazz, Country,
 Black (R&B), Reggae.
ROUGH TRADE RECORDS (GERMANY), Eicklerstrasse 25,
 4690 Herne 1, 02325.6970, Fax: 02323.697 222-3, MDs: Kurt
 Thielens, Heino Drecker, Promo Mgr: Dietrich Eggert, Mktg
 Mgr: Carsten Stricker, Sales Mgr: Reiner Machauer, Distr
 Mgr: Martin Wiedera. Labels (distr): Creation, CRUZ, Day Glo,
 Earache, Eksakt, Fuego, Fun Factory, Heartbeat, INK,
 Manic Ears, Mega Disc, MMT, MNS/Black Star Revenge,
 Music Maniac, New Alliance, New Wind, No Dance, Nor-
 mal, Peaceville, Red Flame, Revolver, SST, Tupelo, U.S.
 Metal, Wire.
SATVA ART, Herzog Wilhelm Strasse 7, 8000 Munich 2,
 089.260 3814, Fax: 089.260 4083, President: Sonja
 Wiesbeck, MD: Anton Vogl. Labels distr: Satva Art Music,
 Vieugels, Vier Turme.
SCHALLPLATTEN TRUHE, Industriestrasse 16, 4420
 Coesfeld-Lette, 02546.7033/5, Fax: 02546.7276, MD: Mr.
 Ricka.
SEMAPHORE, Andernacherstrasse 23, 8500 Nuremberg 10,
 0911.952 770, Fax: 0911.952 7750/40, Tlx: 626939 sema, MD:
 Markus Roeder, Sales Mgr: Stefan Richartz, A&R Mgrs:
 Thomas Hartmann, Ulj Elser, Promo: Jutta Baechner, Ad-
 min: Elke Regensburger. Labels (Distr): Heyday, Flying Nun,
 Alias, Hypnobate, Contempo, Vox Pop, KK, Energy, Posh
 Boy, Mystic, Epitaph, Roir, Concrete, Shakin' Street; Main
 product: Album Rock, Alternative.
SPV, Bruesseler Strasse 14, 3000 Hanover 72, 0511.8709-0,
 Fax: 0511.870 9181-2, President: Manfred P Schuetz, MD:
 Uwe Cimala, Sales & Mktg Dir: Kurt Erping, Busche
 Juergen, Foreign Distribution: Martin Ruder. Labels (distr):
 Antler, Black Out, Crepuscule, Fan Club, Fundamental,
 Lively Art, Merciful Release, Network, New Rose, Noise,
 Play It Again Sam, Wax Tracks, We Bite; Main product: hard-
 core, heavy metal, wave, pop, punk, dance.
STORZ, Steyerherg 2, 3360 Osterode, 05522.73044, Fax:
 05522.73080, MD: Erich Storz.

SUBWAY RECORDS, Paul Zenetti Strasse 4, 8880 Dillingen, PO Box 1222 (Zip: 8880), 09071.6554, Fax: 09071.1432, MD/AR: Michael Schuster, A&R/Promo/Sales: Katrin Disselhorst, Promo: Martin Hintermayer. Labels (Distr): Huckleberry Home, Rotz; Main product: Underground.

SUMMAPHON, Koelnerstrasse 12, 7000 Stuttgart-Hallshag 50, 0711.541 292, Fax: 0711.564 418/556 076, MD: Mr. Dutta.

TELDEC IMPORT SERVICE (TIS), Borsteler Chaussee 85-99, Haus 12, 2000 Hamburg 61, 040.514 4090, Fax: 040.5144 0930, Tlx: 2174537, MD: Rolf Baehnk. Labels (distr): ACE, Kent, Globestyle, American Clave, Arion, ASV, BGO, Celtic Music, Repertoire, Crosscut, Demon, Edsel, Zippo, Hi, Bam Caruso, Frances Concert, Jasmine, Giants of Jazz, Kuckuck, ERP, Hunt, Magnum, Thunderbolt, Sundown, Unicorn, Musidisc, Festival, AZ, Red Lightnin', Rockhouse, Accord, Rounder, Heartbeat, Varrick, See for Miles, Cocleau, Stern's, Hyperion, Helios, Largo, Triple Earth, World Circuit, Stetson, Sugar Hill, P. Verany, Verabra Records, Vogue, Soma, Sigla, Bear Family, ASV, RPO, Laudis, Foyer, M & A.

UKK TRADING ENTERPRISES, In der Maienkammer 18, 5000 Cologne 60, 0221.712 1977, Fax: 0221.712 3909, MD: Arto Kazandjian.

UPTOWN MUSIKDIENST, Alpenroder Strasse 14, 6230 Frankfurt am Main 80, 069.346 879, Fax: 069.348 055, MDs: Markus Schweitzer, Horst Wiedefeldt, Promo/Mktg/Sales Mgr: Michael Jung. Labels (Distr): Buzz, Indico.

URT, Klement Gottwald Strasse 15, O-5085 Erfurt, (+37) 61.35282, Fax: (+37) 61.31215.

WISHBONE RECORDS, Weiherstrasse 21, 4630 Bochum 1, 0234.37031, Fax: 0234.300 109, Tlx: 825735, MD: Ferdinand Koether.

WZTONTRAEGER, im Strasser Feld 1, 5120 Herzogenrath, 02406.2071/75, Fax: 02406.5992, Tlx: 832251, MDs: Richard Vanwersch, Werner Zanders, Import/Export Dir: Tony Harris.

RETAIL ACCESSORY SUPPLIERS

DISCO BUDGET, An der Guempesbrücke 26, 4044 Kaarst, 02101.60040, Fax: 02101.61423/60040, MD: Manfred Schmitz, Alfred Zinke.

FORTY FOUR, Geschwister-Scholl-Strasse 47a, 4050 Moenchgladbach 1, 02161.85053/4, Fax: 02161.896 324, MD: P Schmitz.

HADOS MOEBELFABRIK DOLL, Industriegebiet an der Autobahn, 7520 Bruchsal, 07251.7230, Fax: 07251.72315, Contact: Mr. Laufink.

LIFT GERMANY, Oberrecht 71-73, 2082 Neuenheid, 04122.47001, Fax: 04122.1074, Contact: Mr. Hausser. Agent of Lift display & storage systems.

LIFT VERKAUFSGERAETE DRESDEN, Fabrikstrasse 7, O-8290 Kamenz im Sachsen, (+37) 525.6038, Fax: (+37) 525.6038, Contact: Evelin Berte. Agent of Lift display & storage systems.

MUSIKSERVICE NORD, Schwertfegerstrasse 9, 2400 Luebeck 1, 0451.8905 211, Fax: 0451.8905 213, Contact: Mr. Ulbrecht. Agent for Frejo display systems.

PATACO (GERMANY), Austrasse 37, 6250 Kundl, (+43) 5338.8587, Fax: (+43) 5338.8588, Contact: Christian Trapl. Retail suppliers/shopfitting: fully automatic listening facilities, sales promotion facilities, theftproof security systems for audio/video media, audio/video switching facilities.

WERTHMULLER SYSTEM-EINRICHTUNG, Philipp Riis Strasse 2, 6411 Kuenzelt 3, 0661.32074, Fax: 0661.32075, Contact: Mr. Werthmuller.

ASSOCIATIONS & PROFESSIONAL ORGANIZATIONS

ANSTALT FUER KABELKOMMUNIKATION BERLIN, Europa-Center 14 OG, 1000 Berlin 30, 030.261 1521, Fax: 030.262 1048, Tlx: 308582 akbln.

BERLIN INDEPENDENCE DAYS, Koethenerstrasse 38, 1000 Berlin 49, 030.261 8343, Fax: 030.261 8806, MD: Wolfgang Doebeling, Int'l Co-Ord: Tracey Bigelow, Admin Mgr: Penny Herman, Sales Mgr: Mirko Whitfield. Independent labels convention/association (conferences, tradeshows, showcases).

BLM, Fritz Erlerstrasse 30, 8000 Munich 83, 089.638 0880, Fax: 089.637 4336, Tlx: 897342, Contact: Heinz Heim, Monika Fendt.

BPW, Grelckstrasse 36, 2000 Hamburg 54, 040.580 258, Fax: 040.582 842, Chmn: Manfred Zunkeller, MDs: Norbert Thurow, Peter Zombik. German national record industry association.

BREMISCHES LANDESMEDIENANSTALT, Am Wall 140, 2800 Bremen 1, 0241.14282.

BUERO DES RUNDFUNKBEAUFTRAGTEN, Nalepastrasse 10-50, O-160 Berlin, (+37) 2.636 4220-1/(+49) 30.261 8612, Contact: Rudolf Muehlfeinzel.

BUNDESVERBAND DEUTSCHER ZEITUNGSVERLEGER, Riemenschneiderstrasse 10, 5300 Bonn 2, 0228.810 040, Tlx: 885461. National newspaper publishers association.

BUNDESVERBAND VIDEO, Goelittstrasse 31, 2000 Hamburg 1, 040.241 298, Fax: 040.246 763, MD: Joachim A. Birr. German national video retail association.

DEUTSCHE DISC-JOCKEY ORGANISATION, Kaiser Friedrich Allee 1-3, 5100 Aachen, 0241.76076, Fax: 0241.76078, Contact: Klaus Quirini.

DEUTSCHE LANDESGRUPPE DER IFPI, Grelckstrasse 36, 2000 Hamburg 54, 040.580 258, Fax: 040.582 842, Chmn: Friedrich E. Wottawa, President: Norbert Thurow, MD: Peter Zombik. German branch of the International Federation of Phonogram and Videogram Producers.

DEUTSCHE MUSIKVERLEGER VERBAND, Friedrich Wilhelm Strasse 31, 5300 Bonn, 0228.238 565, Fax: 0228.235 916, President: Maja Maria Reis, VP: Hans Sikoraki, MD: Hans-Henning Wittgen. German national music publishers association.

EUROPEAN CINEMA SOCIETY, Muenchener Strasse 6, 1000 Berlin 30, 030.261 1888/9, Fax: 030.243 545, Sec-Gen: Aina Bellis.

FACHVERBAND AUDIO & VIDEOTECHNIK IM ZVEI, Stresemannallee 19, 6000 Frankfurt am Main 70, 069.630 2219, Fax: 069.630 2317, MD: Manfred Dannemeyer. Division within ZVEI which represents professional audio & video equipment manufacturers.

GEMA, Rosenheimer Strasse 11, 8000 Munich 80, PO Box 800767 (Zip: 8000), 089.480 0300, Fax: 089.480 3969, Tlx: 522306, President: Reinhold Kreile, PR: Gabriel M. Steinschulte. Author's rights society.

GVL, Heimhuder Strasse 5, 2000 Hamburg 13, 040.410 6031, MDs: Rolf Duennwald, Norbert Thurow. Royalty and performing rights organization.

HAMBURGISCHE ANSTALT FUER NEUE MEDIEN, Schauenburger Strasse 47-49, 2000 Hamburg 1, 040.369 0050, Fax: 040.366 909.

IFA, Neuer Deich 334A, 2000 Hamburg 26, 040.782 255, Fax: 040.782 783, Tlx: 2166013 ifa, MD: A Boehm. Federation of European distributors.

INTERGU, Rosenheimer Strasse 11, 8000 Munich 80, 089.480 0300, Fax: 089.480 3969, President: Erich Schulze, Sec-Gen: Vera Movsessian, Ed: Marcel Schultze. International copyright society.

INTERNATIONAL FILM FESTIVAL COLOGNE, Am Naizbuechel 628. 5000 Cologne 1, 0221.202 390, Fax: 0221.202 3920, Contact: Mr. Maekelburg.

INTERNATIONALE FUNKAUSSTELLUNG BERLIN, Meesedamm 22, 1000 Berlin 19, 030.3038 2024 02020, Fax: 030.3038 2325, Tlx: 182908.

LANDESANSTALT FUER DAS RUNDFUNKWESEN, Hindenburgufer 85, 2300 Kiel 1, 0431.81066, Fax: 0431.81068.

LANDESANSTALT FUER RUNDFUNKWESEN, Karlsruherstrasse 4, 6800 Saarbruecken 1, 0681.39428, Fax: 0681.39420.

LANDESZENTRALE FUER NEUE MEDIEN, Thomas-Dehler-Strasse 25, 8000 Munich 83, 089.638 080.

LANDESZENTRALE FUER PRIVATFUNK, Rheinuferstrasse 8, 6700 Ludwigshafen 21, PO Box 210863 (Zip: 6700), 0621.521 031-4, Fax: 0621.517 682, Tlx: 6215976 lprlu.

LFK BADEN-WUERTEMBERG, Moerickstrasse 21, 7000 Stuttgart 1, PO Box 102927 (Zip: 7000), 0711.649 580, Fax: 0711.649 5815, Tlx: 7111174 lfk.

LFR NORDRHEIN-WESTFALEN, Willi Becker Allee 10, 4000 Duesseeldorf 1, PO Box 5305 (Zip: 4000), 0211.770 070, Fax: 0211.727 170, Tlx: 2114258 lfrnw.

LPR HESSEN, Leipziger Strasse 35-37, 3500 Kassel, PO Box 310202 (Zip: 3500), 0561.572 071/2, Fax: 0561.571 673.

MEDIA CONTROL (GERMANY), PO Box 625, 7570 Baden-Baden, 07221.366 202, Fax: 07221.366 298, Tlx: 781331.

NIEDERSACHSISCHER LR, Arndtstrasse 19, 3000 Hanover 1, 0511.327 508, Fax: 0511.15944, Chmn: Guenther Volker, Dep Chmn: Volker Mueller, Juergen Weinstbach, Mgr: Friedrich-Wilhelm Raasch, Prog/Promo Dir: Annegret Hupe-Hilbrich. Controls the programmes of private television and broadcasting stations.

POPKOMM, Rotscheider Strasse 6, 5600 Wuppertal 11, PO Box 201414 (Zip: 5600), 0202.563 2304/785 023, Fax: 0202.789 161, Dir: Dieter Gorny.

ROCKBUERO NRW/POPKOMM/INPOP, Rotscheider Strasse 6, PO Box 201414, 5600 Wuppertal 11, 0202.563 2304/785 023, Fax: 0202.789 161, Dir: Dieter Gorny, Admin Dir: Ulrich Grossmaas, Promo Mgr: Ralf Plaschka, Research: Reiner Niketta. Financed by the "Secretariat fur gemeinsame Kulturarbeit in Nordrhein Westfalen", NRW provides financial and cultural support to art, music, literature & theatre; represents artists; deals with organizational problems; provides technical representation of rock events; liaisons with organizations and government departments; and organizes German music fair PopKomm, Eurorock & Ruhrrock festivals; INPOP is the research and documentation centre.

RUNDFUNKAUSSCHUSS, c/o Senatskanzlei Rathaus, 2800 Bremen 1, 0421.361 2143.

VERBAND DEUTSCHER KONZERTAGENTUREN, Nicolaistraße 55, O-7010 Leipzig, (+37) 41.281 650, Fax: (+37) 41.281 656, Tlx: 0512235, Chmn: Mr. Chalupzky.

VERBAND DEUTSCHER TONMEISTER, Honiggasse 16, 5010 Bergheim-Glessen, 02238.43098, Fax: 02238.43294, President: Guenter Griewisch, 2nd office: Masurenallee 8-14, 1000 Berlin.

VERBAND DEUTSCHER ZEITSCHRIFTEN VERLEGER, Winterstrasse 50, 5300 Bonn 2, 0228.382 030, Fax: 0228.382 0340, Tlx: 8869391. National magazine publishers association.

VPLT, Vahrenwalder Strasse 205-207, 3000 Hanover 1, 0511.551 880, Fax: 0511.554 040, MD: Florian van Hofen. Association for professional sound & lighting industry; New telephone & fax numbers from January 1, 1992.

VPRT, Wachsbleiche 7, 5300 Bonn 1, 0228.695 703, Fax: 0228.695 672, MD: Guenther Winfried Läss. German national private broadcasters association.

PUBLIC RELATIONS & RECORD PROMOTION

ART PROMOTION URBAN, Solalindenstrasse 26C, 8000 Munich 82, 089.439 3940/439 3960, Fax: 089.439 3950, Contact: Eddy Urban.

ARTS & PROMOTION, Luxemburgerstrasse 42, 5000 Cologne 1, 0221.236 054, Fax: 0221.239 364, MD: Manfred Schweiker.

AS ARTIST SERVICE, Eppendorfer Baum 13, 2000 Hamburg 20, 040.487 080/482 828, Fax: 040.463 061, MD: Eike Heitkamp, Annett Imholz, A&R Mgr: Andreas Reth. Promotion company.

BACKSTAGE PROMOTION, Merksstrasse 4a, 8120 Weilheim, 0881.3455, Fax: 0881.2394, MD: Bela Kasper.

BLUE NOISE, Schnackenburgallee 215, 2000 Hamburg 54, 040.545 555, Fax: 040.545 666, MDs: Ben Ahrens, Bernd Schurtz.

BMKK MUSIC PRODUCTION, Hoehnkoppel 14, 2000 Hamburg 71, 040.641 3728, Fax: 040.641 7580, President: Detlef Kuntke, PR: Rainald Kuntke.

CASTOR PROMOTIONS, Dragonerstrasse 21, 3000 Hanover, 0511.392 950/1, Fax: 0511.392 553, MD: Eike Fleing. Artists: African Tam Tam, BareFoot Girels, Berlinger, Blue Valentine, B-Sharp, Gay City Rollers, Havana, The Youngbucks, Le Chat Noir, Madam I'm Adam, Mini Pigs, Moulin Rouge, Shaman's Blue, Sophie's Treasure, Frank Suchland & Band, Storemage, The Heartbreakers, The Pride, Tierra, Time Out Blues Band.

CHARTBUSTER PROMOTIONS, Glashuettenstrasse 79, 2000 Hamburg 36, 040.430 1041, Fax: 040.438 867, President: Pepe Nuesch, Sales: Annette Opliesch, Press: Bernhard Hein. Radio, TV, press, sales promotion.

CONTI PUBLIC RELATIONS, Paul Gerhard Allee 52, 8000 Munich 60, 089.820 000, Fax: 089.832 557, Tlx: 5213119 cpr, Contact: Christina Harrison.

DHC DR HARTEL CONSULTING, Pailhausen 6, 8050 Freising, 08165.8877, Fax: 08165.8848, MD: Kurt Hartel.

GEMA MEDIA & PR, Adenauerallee 134, 5300 Bonn 1, 0228.219 370, Fax: 0228.229 381, Tlx: 8861114, PR Mgr: Gabriel M. Steinschulte.

HEINRICH BAUER PROGRAMMZEITSCHRIFTEN, Burchardstrasse 11, 2000 Hamburg 1, PO Box 100444 (Zip: 2000), 040.3019 4001, Fax: 040.327 264, Chief Ed: Bernd-Peter Zolker, Asst Chief Ed: Andreas Burchard, Wolf-Peter Enke. Publishing house.

JANUS MUSIC, Greifensteinweg 19, 8500 Nuremberg 10, PO Box 140132 (Zip: 8500), 0911.528 227, Fax: 0911.523 680, President: Oliver Thons, Asst Mgr: Petra Thons, Mgr (Swi): Oliver Macchi. Recent clients: Semaphora, 99 Records, Communique Records, SPV, Drakkar Promotions, TAOB, Fiamertrader, Wild Rags.

JTR MUSIC, Osdorfer Landstrasse 9, 2000 Hamburg 52, 040.823 397, Fax: 040.824 728, MD: Petra Thoms-Roeder, Peter Jaederberg, A&R/Promo: Susanna Mahnen. Promotion agency; Main product: Adult Contemporary, Dance, Ethnic, Blues.

KELLERER & PARTNER, Karlstrasse 41, 7900 Ulm, PO Box 1111 (Zip: 7900), 07131.152 022/32, Fax: 07131.152 077, MD: Rainer Herbrecht. Publishing house.

KC WALTHER KAHL COMMUNICATIONS, Neusserstrasse 1, 5000 Cologne 1, PO Box 130144 (Zip: 5000), 0221.720 177, Fax: 0221.739 3476, MD/Owner: Walther Kahl, VP: Sabine Kahl, Press Mgr: Bettina Tollkamp-Bretz, Admin Mgr: Kamilla Parpart, Dir Radiokit Prods: Georg Zeiss.

KMS REINER KAFITZ MEDIENSERVICE, Graf Berghue von Trips Ring 68, 5014 Karpen-Horrem, 02273.2781, Fax: 02273.2710, MD: Reiner Kafitz, Customer Services: Erika Kafitz.

KONZERTBUERO RAINER LINDNER, Am Hohen Berg 2, 6316 Gemuenden 4, 06634.8513, Fax: 06634.8513, MD: Rainer Lindner. Artists: Bettina Wegner, Stephan Krawczyk.

MODERN MEDIA, Ernst-Mehlich-Strasse 6, 4600 Dortmund 1, 0231.527 501/201.721 686, Fax: 0231.575 673, Contact: Karoline Gennaio, Willi Wrede.

MUSIK INFORMATION, Ekbertstrasse 14, 3300 Braunschweig, 0531.81074/6, Fax: 0531.82112, Tlx: 952604, Contact: Killy Metz.

NTT PROMOTION, Theaterstrasse 96, 5100 Aachen, 0241.23192, Fax: 0241.32751.

PHOENIX INTERMEDIA, Frauenstrasse 5, 8000 Munich, 089.228 9131, Fax: 089.228 3988, Tlx: 5213100, MD: Lech Kunkel, Dir: Elizabeth Leopold. Publishing house; Head of office co-ordinating Popcorn magazine for Poland and Czechoslovakia; Features come from Popcorn Germany with separate national music news; Main topics: Music, Film & Entertainment.

PRO: MUSIK COLOGNE, Schadowstrasse 53, 5000 Cologne 30, 0221.552 026/8, Fax: 0221.557 561, MD: Teddy Hoersch.

PUBLIC PROPAGANDA WEGENER & WEGENER, Bramfelder Chaussee 238c, 2000 Hamburg 71, 040.642 5041, Fax: 040.642 9475, MD/Owner: Jens-Markus Wegener. Promo: Kay-Oliver Wegener (Head), Thomas Weber (Press), Jan Weber (Radio), Office Mgr: Pierre Ode, Head of DJ Propaganda: Christian Tjaben. Recent clients: BMG Ariola, WEA, East West, Polydor, Logic, New Rose, Intercord/Creation.

ROBA PROMOTION, Feldbrunnen Strasse 50, 2000 Hamburg 13, 040.445 086, Fax: 040.443 272, Tlx: 217377, MD: Rolf Baierle.

SHOWBIZ, Neusserstrasse 1, 5000 Cologne 1, PO Box 130144 (Zip: 5000), 0221.720 177, Fax: 0221.739 3476, Tlx: 8882798

kahl, Chmn: Walther Kahl, MD: Sabine Kahl, Asst: Kamilla Parpart, Artist Promo: Gabriele Parpart, Press Mgr: Bettina Tollkamp-Bretz. Artists PR service.

SUNDANCE MUSIC, Beckstrasse 15, 2820 Bremen 70, 0421.656 5445, Fax: 0421.656 599, President: Dietmar Schmidt, Christiane Siedenbaur.

SZV VERLAG, Schellingstrasse 39, 8000 Munich 40, 089.237 260, Fax: 089.2372 6125, MDs: Stratos Tsobanoglou, U Ploeger. Publishing house; Publish: Video Magazin, Stereo, Fonoforum, Fachblatt Musik Magazin, Live in Concert, HiFi & Video Markt.

TALK TALK PROMOTION, St. Apert Strasse 10-12, 5000 Cologne 1, 0221.219 409, Fax: 0221.239 257, MD: Alfred Riehm.

TORSTEN LIPKE NEWS & INFORMATION, Trapphofstrasse 108, 4600 Dortmund 41, 0231.452 993, Fax: 0231.445 521, MD: Torsten Lipke.

VERABRA PROMOTION, Luetticher Strasse 15, PO Box 270126, 5000 Cologne 1, 0221.512 031, Fax: 0221.529 563, Tlx: 8886685 vbr, President: Vera Brandes, MD: Michael Jacoby, Dir (Int'l): Ulrike Dams. PR/promo, record plugging for: veraBra, Intuition and American Clave.

WOERNLE BECHTOLD KOPF & PARTNER, Schwetzingen Strasse 20, 6800 Mannheim 1, 0621.409 702, Fax: 0621.441 463, MD: Peter Woernle, Mktg: Andreas Kopf, Sales: Rainer Bechtold. 2nd office: Huebnerstrasse 2a, 8000 Munich 19; Mobile 0161.162 2486.

COMPACT DISC MASTERING & REPLICATING PLANTS

BAUER STUDIOS, Markgroeninger Strasse 46, 7140 Ludwigsburg, 07141.31097, Fax: 07141.38197, MDs: Eva Bauer-Oppelland & Reiner Oppelland, Sales/Bookings Dir: Rita Falkenberg. CD pre-mastering.

CD-PRESSWERK, BERNHARD MIKULSKI, Benzstrasse, Industriegebiet, 6295 Merenberg, 06471.51146, Fax: 06471.51147, President: Bernhard Mikulski, MD: Josef Jung.

CDT COMPACT DISC TONTRAEGER, Gustav Meyer Allee 25, 1000 Berlin 65, 030.463 5095, Fax: 030.469 4602, Tlx: 185825 cdp, MDs: Guenter A Kiefer, Claus H Winkler. Annual capacity: 9m.; Minimum order: 1,000.

HAM AUDIO MASTERING, Wrangelstrasse 29, 2000 Hamburg 20, 040.422 2240, Fax: 040.422 7414. CD pre-mastering.

INTERPRESS TONTRAEGER, Steinhofstrasse 26, 6380 Bad Homburg 6, 06172.40170, Fax: 06172.401 749, Tlx: 415859, MD: Branko Zivanovic, Sales Dir: Edmund Herbert, Planning: Wolfgang Holhorst.

KMS REINER KAFITZ MEDIENSERVICE, Graf Berghe von Trips Ring 68, 5014 Kerpen-Horrem, 02273.2781, Fax: 02273.2710, MD: Reiner Kafitz, Customer Services: Erika Kafitz.

MAGNA TONTRAEGER PRODUKTIONS, Sonnenallee 255, 1000 Berlin 44, 030.689 971, Fax: 030.6899 7269, Tlx: 183845, MD: Karl Moessnang, Mktg Dir: Karlheinz Steike.

P+O COMPACT DISC, Auf dem Esch 51, 2840 Diepholz, 05441.4014, Fax: 05441.4010, President: Rolf Neumann, Admin Mgr: Ingeborg Grossman, Order Service: Edgar Emker. Annual cap: 10m.

PAULER ACOUSTICS, St. Blasien, Herrhaus, 3410 Northeim, 05551.61313, Fax: 05551.8020, Dirs: Guenter Pauler (Disc-Cut), Hans-Joerg Maucksch (CD-Pre). CD pre-mastering with Sonic-Solutions-NoNoise System, Sony-Start-Lab, CD-Maker.

PILZ COMPACT DISC, Ingrid Pilz Strasse 1, 8051 Kranzberg-Munich, 08166.300, Fax: 08166.30296. CD-Audio, CDV, CD-Rom, 40m capacity, minimum order 1,000.

POLYGRAM RECORD SERVICE, Klusriede 26, 3012 Langenhagen 1, 0511.730 6289, Fax: 0511.730 6295, MD: Leon Vogels, Sales Dir: Hinrich Behnke.

PROSOUND TONTRAEGERHERSTELLUNG, Hasenberg 20-22, 3000 Hanover, 0511.756 789, MD: Michael Westerwinter.

SONOPRESS (PRESSING), Carl Bertelsmann Strasse 161, 4830 Guetersloh, 05241.803 445, Fax: 05241.75863, Tlx: 933406 sonop, MD: Frank D Bargsten, Mktg Mgr: Guido Korff. CD manufacturing.

SONOPRESS (STUDIOS), Carl Bertelsmann Strasse 161, 4830 Guetersloh, 05241.805 241, Fax: 05241.75863, Tlx: 933822 sono, MD: Frank D Bargsten, Studio Mgr: Hans-Dieter Queren. CD mastering.

TELDEC PRESS TONTRAEGER, Niedemstrasse 3-7, 2353 Nortorf, 04392.380, Fax: 04392.38218, President: Friedrich Carl Coch, Chief Eng: Detlev Ermacora. Laserdisc and musicassettes.

THEMEDIA, Carl Bertelsmann Strasse 161, 4830 Guetersloh, 05241.802 872, Fax: 05241.75863, Tlx: 933822 sono, MD: Franz Netta, Mktg Mgr: Ulrich Staub. Laserdiscs.

TONTRAEGER, Heppenheimer Strasse 35, 6090 Ruesselsheim, PO Box 1417 (Zip: 6090), 06142.34884, Fax: 06142.34883. CD manufacturing; Annual cap: 100,000; Min order: 500; Agent broker for: P+O, Orchestrola, Pallas.

WARNER MUSIC MANUFACTURING EUROPE, Max Planck Strasse 1-9, 5110 Alsdorf, 02404.58335, Fax: 02404.58202, Tlx: 8329616, President: Friedrich Carl Coch.

WESTRA ELECTRONIC, Hofstetterstrasse 20, 8901 Welden-Augsburg, 08293.6111, Tlx: 539717, MDs: Anton Kammermeier, Anneliese Kammermeier. CD pre-mastering.

WIZARD RECORDS, Reichshofstrasse 9, 5840 Schwerte 3, 02304.6996, Fax: 02304.63337, MD: Dario Corte. Shaped discs, coloured vinyl, sleeves, labels; Annual capacity: 3m.

PLATING, MASTERING & PRESSING PLANTS

BAUER STUDIOS, Markgroeninger Strasse 46, 7140 Ludwigsburg, 07141.31097, Fax: 07141.38197, MDs: Eva Bauer-Oppelland & Reiner Oppelland, Sales/Bookings Dir: Rita Falkenberg. Disc-cutting/mastering.

ELA-TOENTECHNIK, Seiligenstaedterstrasse 118, 6050 Offenbach, 069.896 118, Fax: 069.897 001, MD: D Mehtieff.

EMI ELECTROLA OPERATIONS, Maarweg 149, 5000 Cologne 30, PO Box 300329 (Zip: 5000), 0221.49020, Fax: 0221.497 2246, Tlx: 8881290, MD (EMI Operations Cologne): Friedrich E Woltawa, Mftg: Hans Herzog.

H LAMPING & COMPANY, Aschen 86, 2840 Diepholz, 05441.3011, Fax: 05441.3999, MD: Susanne Lamping. Annual capacity: 1.8m.

HAM AUDIO MASTERING, Wrangelstrasse 29, 2000 Hamburg 20, 040.422 2240, Fax: 040.422 7414. Disc cutting, CD pre-mastering.

INTERPRESS TONTRAEGER, Steinhofstrasse 26, 6380 Bad Homburg 6, 06172.40170, Fax: 06172.401 749, Tlx: 415859, MD: Branko Zivanovic, Sales Dir: Edmund Herbert, Planning: Wolfgang Holhorst.

KMS REINER KAFITZ MEDIENSERVICE, Graf Berghe von Trips Ring 68, 5014 Kerpen-Horrem, 02273.2781, Fax: 02273.2710, MD: Reiner Kafitz, Customer Services: Erika Kafitz.

MAARWEG STUDIOS/EMI ELECTROLA OPERATIONS, Maarweg 149, 5000 Cologne 30, PO Box 300329 (Zip: 5000), 0221.491 3200/490 2412, Fax: 0221.496 106, Tlx: 8881290, MD (EMI Operations Cologne): Friedrich E Woltawa, Rec Studios: Ernst Rothe.

MAGNA TONTRAEGER PRODUKTIONS, Sonnenallee 255, 1000 Berlin 44, 030.689 971, Fax: 030.6899 7269, Tlx: 183845, MD: Karl Moessnang, Mktg Dir: Karlheinz Steike.

PALLAS, Auf dem Esch 8, 2840 Diepholz, 05441.4014, Fax: 05441.6437, President: Rolf Neumann, Admin Mgr: Ingeborg Grossmann, Order Service: Carola Wutsching, Baerbel Meins.

PAULER ACOUSTICS, St. Blasien, Herrhaus, 3410 Northeim, 05551.61313, Fax: 05551.8020, Dirs: Guenter Pauler (Disc-Cut), Hans-Joerg Maucksch (CD-Pre). Disc-cutting/mastering.

PROSOUND TONTRAEGERHERSTELLUNG, Hasenberg 20-22, 3000 Hanover, 0511.756 789, MD: Michael Westerwinter.

RM-SCHALLPLATTENPRESSWERK, Benzstrasse, Industriegebiet, 6295 Merenberg, 06471.51146, Fax: 06471.51147, President: Bernhard Mikulski, MD: Josef Mueller.

SONOPRESS (PRESSING/STUDIOS), Carl Bertelsmann Strasse 161, 4830 Guetersloh, 05241.803 445/805 241, Fax: 05241.75863, Tlx: 933406 sonop, MD: Frank D Bargsten, Mktg Mgr: Guido Korff.

SOUND FABRIK, Hofmann Strasse 7, 8000 Munich 70, 089.785 1312, Fax: 089.784 636, MD: Peter Luebke.

TELDEC PRESS TONTRAEGER, Niedemstrasse 3-7, 2353 Nortorf, 04392.380, Fax: 04392.38218, President: Friedrich Carl Coch, Chief Eng: Detlev Ermacora.

TONTRAEGER, Heppenheimer Strasse 35, 6090 Ruesselsheim, PO Box 1417 (Zip: 6090), 06142.34884, Fax: 06142.34883. Vinyl pressing; Annual cap: 250,000; Min order: 300; Agent broker for: P+O, Orchestrola, Pallas.

WARNER MUSIC MANUFACTURING EUROPE, Max Planck Strasse 1-9, 5110 Alsdorf, 02404.58335, Fax: 02404.58202, Tlx: 8329616, President: Friedrich Carl Coch.

WESTRA ELECTRONIC, Hofstetterstrasse 20, 8901 Welden-Augsburg, 08293.6111, Tlx: 539717, MDs: Anton Kammermeier, Anneliese Kammermeier. Disc-cutting & mastering/CD pre-mastering.

WIZARD RECORDS, Reichshofstrasse 9, 5840 Schwerte 3, 02304.6996, Fax: 02304.63337, MD: Dario Corte. Shaped discs, coloured vinyl, sleeves, labels; Annual capacity: 3m.

TAPE CUSTOM DUPLICATORS

ARMINIA MUSIKPRODUKTION, Hauptstrasse 114, 3360 Osterode, 0552.73041. Cassette duplication.

AV STUDIO JACOB, Freigrafenweg 20, 4600 Dortmund 15, 0231.371 198, Fax: 0231.373 020, MD: Anne-Dore Jacob.

BAUER STUDIOS, Markgroeninger Strasse 46, 7140 Ludwigsburg, 07141.31097, Fax: 07141.38197, MD: Eva Bauer-Oppelland, MD: Reiner Oppelland, Sales/Bookings Dir: Rita Falkenberg. Audio cassette duplication on Lyrec D4400 Loop 3in Master & Twin Slave.

BMG ARIOLA-MILLER, Justus von Liebig Ring 2-4, 2085 Quickborn, PO Box 1280 (Zip: 2085), 04106.6140, Fax: 04106.68650, Tlx: 212386, GM: Rolf Lerschmacker. Cassette duplication.

DEKABO VIDEO, Goeddertgarten 34-36, 5309 Meckenheim bei Bonn, 02225.3637/3670, Fax: 02225.15426. Video tape duplication.

ELA-TOENTECHNIK, Seiligenstaedterstrasse 118, 6050 Offenbach, 069.896 118, Fax: 069.897 001, MD: D Mehtieff.

FRED KERSTEN, Gruninger Weg, 6301 Pohlheim 2, 06404.4900, MD: Fred Kersten. Cassette duplication.

FRED KERSTEN STUDIO, Gruninger Weg 22, 6301 Pohlheim 2, 06404.4900, Fax: 06404.4800, MD: Fred Kersten.

GEYER-SYNCHRON, Harzer Strasse 39/46, 1000 Berlin 44, 030.680 1311, Fax: 030.680 1202, MD: Reinhard Lorenz. Audio cassette duplication.

INTERPRESS TONTRAEGER, Steinhofstrasse 26, 6380 Bad Homburg 6, 06172.40170, Fax: 06172.401 749, Tlx: 415859, Planning: Wolfgang Holhorst. Vinyl & cassette.

INTERPRESS TONTRAEGER, Steinhofstrasse 26, 6380 Bad Homburg 6, 06172.40170, Fax: 06172.401 749, Tlx: 415859, MD: Branko Zivanovic, Sales Dir: Edmund Herbert, Planning: Wolfgang Holhorst.

ITON INGO KLINGBEIL, Ludwigsstrasse 11, 8033 Krailingen, 089.857 4499, Fax: 089.857 1333, MD: Ingo Klingbeil.

KMS REINER KAFITZ MEDIENSERVICE, Graf Berghe von Trips Ring 68, 5014 Kerpen-Horrem, 02273.2781, Fax: 02273.2710, MD: Reiner Kafitz, Customer Services: Erika Kafitz. Video tape duplication.

KS-CASSETTEN, Suerenhelderstrasse 110, 4837 Verl, PO Box 1202 (Zip: 4837), 05246.1611, Fax: 05246.3586, MD: Ralf Roehrer. Audio cassette duplication; Annual cap: 500,000; Min order: 40; Repres, entative for Infonics Duplicators.

LUBRA-CASSETTEN, Rottmayrplatz 1, 8229 Laufen, 08682.620, Fax: 08682.7589. Video tape duplication.

MAGNA TONTRAEGER PRODUKTIONS, Sonnenallee 255, 1000 Berlin 44, 030.689 971, Fax: 030.6899 7269, Tlx: 183845, MD: Karl Moessnang, Mktg Dir: Karlheinz Steike.

MPB MUSIKPRODUKTIONS SERVICE, Seewiesenstrasse 49, 7150 Backnang-Steinbach, 07191.84478, MD: Birgit Beck.

ORCHESTROLA, Auf dem Esch 8, 2840 Diepholz, 05441.4014, Fax: 05441.6437, President: Rolf Neumann, Admin Mgr: Ingeborg Grossmann, Order Service: Martina Kreiss.

PARZIVAL, Lerchenstrasse 10, 8000 Munich 50, 089.351 0031, Fax: 089.351 0033, MD: Josef Reinholz. Cassette & floppy disc duplication, jewel boxes & cases, labels, inlays etc.

POLYBAND, Am Moosfeld 37, 8000 Munich 82, 089.420 030, Fax: 089.420 0342, MD: W G Winkel, MD: Svetlana Winkel. Cassette duplication.

PROFIMAZ, Josef Baumann Strasse 18, 4630 Bochum 1, 0234.85686, Fax: 0234.85680. Video tape duplication.

PROSOUND TONTRAEGERHERSTELLUNG, Hasenberg 20-22, 3000 Hanover, 0511.756 789, MD: Michael Westerwinter. Video tape duplication.

SONOPRESS (PRESSING), Carl Bertelsmann Strasse 161, 4830 Guetersloh, 05241.803 445, Fax: 05241.75863, Tlx: 933406 sonop, MD: Frank D Bargsten, Mktg Mgr: Guido Korff. Audio cassette duplication.

SOUND STUDIO N, Unter Kirschen 8, 5000 Cologne 1, 0221.534 061, Fax: 0221.536 754, MD: Georgi Nedeltsokev. Cassette duplication.

SPLIFF STUDIO, Huttenstrasse 41-44, 1000 Berlin 21, 030.345 2505, Fax: 030.344 6671, Dir: Reinhold Heil, Dir: Herwig Mitreger, Dir: Manfred Praeker, Dir: Bernhard Potschka, Eng: Hardy Dix. Audio cassette duplication.

TELDEC PRESS TONTRAEGER, Niedemstrasse 3-7, 2353 Nortorf, 04392.380, Fax: 04392.38218, President: Friedrich Carl Coch, Chief Eng: Detlev Ermacora.

TON-ATELIER WOLFGANG SCHMITZ, Am Wehrhahn 63, 4000 Duesseldorf, 0211.352 178. Cassette duplication.

TONOMATIC TONTRAEGER, Schwabelstrasse 2, 8011 Munich-Hoehenkirchen, 08102.3909, Fax: 08102.6655, MD: Mr. Winkler.

TONSTUDIO CORNET, Aachener Strasse 1112a, 5000 Cologne 40, 02234.75801, Owner/Mgr: Ferdj Klein.

TONTRAEGER, Heppenheimer Strasse 35, 6090 Ruesselsheim, PO Box 1417 (Zip: 6090), 06142.34884, Fax: 06142.34883. Audio cassette duplication; Annual cap: 300,000; Min order: 300; Agent broker for: P+O, Orchestrola, Pallas.

VISOTON, Ellesdorfer Strasse 9, 5300 Bonn-Bad Godesberg, 0228.348 626, Fax: 0228.349 650.

WAGNER, Konrad Adenauer Strasse 42, 6507 Ingelheim, 06132.40412, Fax: 06132.4043, MD: Monika Wagner. Video tape duplication.

WARNER MUSIC MANUFACTURING EUROPE, Max Planck Strasse 1-9, 5110 Alsdorf, 02404.58335, Fax: 02404.58202, Tlx: 8329616, President: Friedrich Carl Coch.

WIZARD RECORDS, Reichshofstrasse 9, 5840 Schwerte 3, 02304.6996, Fax: 02304.63337, MD: Dario Corte. Shaped discs, coloured vinyl, sleeves, labels; Annual capacity: 3m.

CASSETTES REELS & PARTS, JEWEL BOX MANUFACTURERS

ADETEC, Papenstrasse 41, 2000 Hamburg 76, 040.250 1055, Fax: 040.256 531, MD: Jan H Bruett. Audio & video splicing tape, parts & accessories, DAT.

CASSETTEN COPY SERVICE, Kluckstrasse 35, 1000 Berlin 30, 030.261 5788, MD: Alf Adamietz.

CD-TECH LUCKOW, Buergemeister Schade Strasse 2, 2314 Schoenkirchen, 04348.1046, Fax: 04195.391.

ELIMEX HANDELS, Waechtersbachstrasse 89, 6000 Frankfurt am Main 60, 069.420 8293, Fax: 069.420 8233, Tlx: 4175906 csb, Dir: E Lee. Supplier/distributor of CD jewel boxes, C-0, Norelco Box, V-0, Library Case.

ESTEMAC ELECTRONIC, Alter Teichweg 67, 2000 Hamburg 70, 040.610 609/617 271, Fax: 040.610 660, Tlx: 215719 estie, MD: Heinz Schlusner, Mktg Mgr: Dagmar Castro. Audio & video library cases and boxes distribution.

EUROTAPE, Buckowerhaeue 62, 1000 Berlin 48, 030.724 041, Fax: 030.724 046, Tlx: 183369, Mktg/Sales: Burckhardt Kusch, Andreas Freikowski, Kirsten Feldges, Susann Thiede. Audio/video post-production & duplication, sub-contracting of labels, inlays, jewel & library boxes.

HEINO ILSEMAN VERPACKUNGSMASCHINEN, Zum Panrepel 24, 2800 Bremen 44, 0421.486 060, Fax: 0421.486

0648, Tlx: 244055, MD: H Ilseman, Contact: H Cordes.
LUBRA-CASSETTEN, Rottmayrplatz 1, 8229 Laufen, 08682.620, Fax: 08682.7589.
NETSAL VERTRIEBS, Dreifelderstrasse 42, PO Box 720369, 7000 Stuttgart 70, 0711.454 017, Fax: 0711.457 715, Tlx: 723347 nvgs, Sales Dir: Gerhard Lutz, Post Sales Mgr: Guntner Kaiser. Distributors of injection moulding machines.
NEUFANG & NEUFANG, Strassweg 15, 2000 Hamburg 52, 040.897 774, Fax: 040.897 775, MD: Hans Neufang, GM: Ulrich Neufang, Mgrs: Frank Radde, Stefan Hinz. Jewel boxes/accessories; acrylic boxes for CD/VIC/MC.
SCHNEIDER, Carl Schneider Strasse 1, 6105 Ober-Ramstadt/Rohrbach, 06154.7300, Fax: 06154.73191, MD: Mr. Diehl. C-O audio cassettes.
SOVOTEC, Hanauer Strasse 3, 6148 Heppenheim, 06252.73021, Fax: 06252.77802, Owner: Christian Geiger. Main product: C-0, 3.5" Floppy Disks.

PRINTING, PACKAGING & LABELS

ALPHA DRUCK, Joseph von Fraunhofer Strasse 6, 5110 Alsdorf, 02404.55020, Fax: 02404.550 240, Tlx: 8329263, Sales Mgr: Ton Geeraedts.
EUROPAE, Buckowerhaeuser 62, 1000 Berlin 48, 030.724 041, Fax: 030.724 046, Tlx: 183369, Mktg/Sales: Burckhardt Kusch, Andreas Freikowski, Kirsten Feldges, Susann Thiede. Audio/video post-production & duplication, sub-contracting of labels, inlays, jewel & library boxes.
HEINO ILSEMAN VERPACKUNGSMASCHINEN, Zum Panrepel 24, 2800 Bremen 44, 0421.486 060, Fax: 0421.486 0648, Tlx: 244055, MD: H Ilseman, Contact: H Cordes.
MAGNA CONTRAERER PRODUKTIONS, Sonnenallee 255, 1000 Berlin 44, 030.689 971, Fax: 030.689 972, Tlx: 183845, MD: Karl Moessnang, Mktg Dir: Karlheinz Steike.
PALLAS, Auf dem Esch 8, 2840 Diepholz, 05441.4014, Fax: 05441.6437, President: Rolf Neumann, Admin Mgr: Ingeborg Grossmann, Order Service: Carola Wutschig, Baerbel Meins.
PANINI VERLAGS, Gutenbergstrasse 3, 8044 Unterschleissheim, PO Box 1465 (Zip: 8044), 089.310 6063, Fax: 089.310 4717, Tlx: 5212462 pani.
PROSOUND CONTRAERERHERSTELLUNG, Hasenberg 20-22, 3000 Hanover, 0511.756 789, MD: Michael Westerwinter.
SONOPRESS (PRESSING), Carl Bertelsmann Strasse 161, 4830 Guetersloh, 05241.803 445, Fax: 05241.75863, Tlx: 933406 sonop, MD: Frank D Bargsten, Mktg Mgr: Guido Korff.
WARNER MUSIC MANUFACTURING EUROPE, Max Planck Strasse 1-9, 5110 Alsdorf, 02404.58335, Fax: 02404.58202, Tlx: 8329616, President: Friedrich Carl Coch.
WIZARD RECORDS, Reichshofstrasse 9, 5840 Schwerte 3, 02304.6996, Fax: 02304.63337, MD: Dario Corte. Shaped discs, coloured vinyl, sleeves, labels; Annual capacity: 3m.

BLANK & BULK RAW TAPE

3M DEUTSCHLAND, Carl Schurz Strasse 1, 4040 Neuss, 02101.140, Fax: 02101.2951.
AKAI DEUTSCHLAND, Kurt Schumacher Ring 15, 6073 Engelsbach, 06103.4070, Fax: 06103.407312/422, Sales Dir: Mr. Sugiyama.
AMPEX EUROPA, Otto Volger Strasse 7c, 6231 Sulzbach, 06196.76500, Fax: 06196.74511, Tlx: 4072669, Sales Mgr: Rudolf Fischer. 2nd address: Ampex Europa, Stefan George Ring 20, 8000 Munich 81, 089.932 039, Fax: 089.930 3157, Sales: Christian Kolb.
BASF AKTIENGESELLSCHAFT, Gottlieb Daimler Strasse 10, 6800 Mannheim 1, 0621.140 081, Fax: 0621.604 4395, Tlx: 46499, Contact: Berndt Geisler.
DATALINE INDUSTRIEPRODUKTE, Mannheimer Strasse 15, 6000 Frankfurt am Main, 069.9055 6591, Fax: 069.231 566, MD: Thomas Blank, Sales/Mktg: Ingrid Kuerten. European co-ord for THAT'S tapes.
ELIMEX HANDELS, Waechtersbachstrasse 89, 6000 Frankfurt am Main 60, 069.420 8293, Fax: 069.420 8233, Tlx: 4175906 csb, MD: E Lae. Supplier/distributor of professional & consumer blank audio and blank video tape cassettes (open reel).
ESTEMAC ELECTRONIC, Alter Teichweg 67, 2000 Hamburg 70, 040.610 609/617 271, Fax: 040.610 660, Tlx: 215719 este, MD: Heinz Schleusner, Mktg Mgr: Dagmar Castro. C-0/V-0 cassette distribution.
FUJI PHOTO FILM (EUROPE), Heesenstrasse 31, 4000 Duesseldorf 11, 0211.5089, Fax: 0211.508 9344.
ISS RECORDS, Reyheruetterstrasse 45-47, 4050 Moenchengladbach 1, 02161.49050, Fax: 02161.490 562, MD: Henri Gerrits, Sales Mgr: Gerard Mossink.
JVC MAGNETICS EUROPE, Korschenbroicher Strasse 599, 4050 Moenchengladbach 1, 02161.49010, Video tapes.
KODAK AKTIENGESELLSCHAFT, PO Box 600345, 7000 Stuttgart 60, 0711.4060, Fax: 0711.406 5385.
MAXELL EUROPE, Am Seestern 24, 4000 Duesseldorf 11, 0211.59510, Fax: 0211.593867, MD: Mr. Kurokawa, Tech Mgr: David Hobbs.
MEMTECH PRODUCTS (MEMOREX), Rahlau 4-6, 2000 Hamburg 70, 040.668 1256, Fax: 040.665 346.
PHILIPS, Alexanderstrasse 1, 2000 Hamburg 1, 040.2811, Fax: 040.281 2854, Tlx: 2170130.

SONY OPERATIONS (GERMANY), Hugo Eckener Strasse 20, 5000 Cologne 30, 0221.59661, Fax: 0211.596 6349, MD: J Brauner.
SOVOTEC, Hanauer Strasse 3, 6148 Heppenheim, 06252.73021, Fax: 06252.77802, Owner: Christian Geiger.
SUNKYONG DEUTSCHLAND, Lyoner Strasse 36, Arabella Centre, 6000 Frankfurt am Main, 069.669 001, Fax: 069.666 1099.
TDK ELECTRONICS EUROPE, Christianstrasse 25, 4030 Ratingen, 02102.4870, Fax: 02102.471 531.
VIDEOR TECHNICAL, Maybachstrasse 5, 6074 Roedermarkt/Frankfurt, 06074.91010, Fax: 06074.99804.

CD, RECORD & TAPE MANUFACTURING SYSTEMS

AEG AKTIENGESELLSCHAFT, Bucklstrasse 1-5, 7750 Constance, 07531.862 370, Fax: 07531.852 370, Tape Loaders.
AUVICON AUDIO & VIDEO CONSULT, Talweg 28, 2104 Hamburg 92, 040.796 6701, Fax: 040.796 7223, Sales Dir: Mr. Murra.
BAYER, Bayerwerk, Dept KU-A-Makrolon, 5090 Leverkusen, 0214.306 1179, Fax: 0214.303 072, Tlx: 85103210 byd, Contact: Reiner Vesper. Polycarbonate for CDs.
CONVAC, PO Box 60, 7135 Wiernsheim 2, 07041.8060, Fax: 07041.3036, Tlx: 7263783 (BTX), MD: Ilona Kunze Conewitz.
ERWIN SICK OPTIK-ELEKTRONIK, Machtlfinger Strasse 21, 8000 Munich 70, 089.78700. Laser scanning measurement systems.
ESTEMAC ELECTRONIC, Alter Teichweg 67, 2000 Hamburg 70, 040.610 609/617 271, Fax: 040.610 660, Tlx: 215719 este, MD: Heinz Schleusner, Mktg Mgr: Dagmar Castro. Distribution of audio magnetic tape in pancakes, C-0/V-0 cassettes.
GEORG NEUMANN, Charlottenstrasse 3, 1000 Berlin 61, 030.259 930, Fax: 030.259 93108, Tlx: 184595, MDs: Werner Roder, Lutz Hoffmann, Mktg Dir: Dirk Rowehl. DMM cutting equipment.
HARMONIA MUNDI ACOUSTICA, In den Sigristmatten 6, 7800 Freiburg, 0761.491 506, Fax: 0761.491 842, President: Benjamin Bernfeld.
HEYNA, Waldgraben 9, 2105 Seevetal 2, 040.768 2132, Fax: 040.768 4364, Contact: Mr. Heyna.
KLAUS H ZIMMERMANN, Media Division, PO Box 1637, 2150 Buxtehude, PO Box 1637 (Zip: 2150), 04161.87643, Fax: 04161.86993, MD: Klaus H Zimmermann. Agent for Versadyne, Lyndes.
KRAUSS-MAFFEI KUNSTSTOFFTECHNIK, Kraus Maffei Strasse 2, 8000 Munich 50, 089.88990, Fax: 089.8899 3219, President: Rolf Lidl, MDs: Manfred Petersen, Wolfgang Koenig, Stefan Schulz, Sales Mgrs: Axel Hahne (Export), Klaus Scheikowski, Mktg Mgr: Elmar Bischof. CD/cassette manufacturing equipment.
LEYBOLD, Wilhelm-Rohn-Strasse 25, PO Box 1555, 6450 Hanau, 06181.340, Fax: 06181.341 690, Tlx: 4152060 lh, Sales Dir: D Schulz, Prod Mgr: R Seiler. Manufacture of vacuum coating systems for CD production lines.
NETSAL VERTRIEBS, Dreifelderstrasse 42, PO Box 720369, 7000 Stuttgart 70, 0711.454 017, Fax: 0711.457 715, Tlx: 723347 nvgs, Sales Dir: Gerhard Lutz, Post Sales Mgr: Guntner Kaiser.
OTARI DEUTSCHLAND, Rudolf Diesel Strasse 12, 4005 Meerbusch 2, 02159.50861/3, Fax: 02159.1778, Tlx: 8531638, GM: S Koizumi.
PILKINGTON MICRONICS, Otto Seeling Strasse 7, 5810 Witten, PO Box 1309 (Zip: 5810), 02302.582 241, Fax: 02302.582 353.
PLUS AUDIO, An den Drei Hasen 26, 6370 Oberursel, 06171.4026, Fax: 06171.4401, MD: Chris Wiedenbeck. Distribute: Lyrec.
RODEL, Lichtensteinstrasse 4, 8000 Munich 70, 089.714 0219, Fax: 089.714 1259, VP: Gregory Shepard, Admin Mgr/Eur Sales: Catherine Walker. Manufacturer of chemicals & polishing products for CD manufacturer, R-35 aluminium oxide polishing slurry.
SONY OPERATIONS (GERMANY), Hugo Eckener Strasse 20, 5000 Cologne 30, 0221.59661, Fax: 0211.596 6349, MD: J Brauner.
WOELKE MAGNETBANDTECHNIK, Woelkestrasse 2-3, 8069 Schweitenkirchen, 08444.710, Fax: 08444.7118, Tlx: 55573 woema, GMs: Werner Wendrich, Constantin Varelas, Sales Mgr: Wolfgang Jaksch. Main product: Master & Slave replacement heads for tape duplication, magnetic heads for audio (record, playback, erase).

TAPE PACKAGING & LABELLING EQUIPMENT

AUVICON AUDIO & VIDEO CONSULT, Talweg 28, 2104 Hamburg 92, 040.796 6701, Fax: 040.796 7223, Sales Dir: Mr. Murra.
HEINO ILSEMAN VERPACKUNGSMASCHINEN, Zum Panrepel 24, 2800 Bremen 44, 0421.486 060, Fax: 0421.486 0648, Tlx: 244055, MD: H Ilseman, Contact: H Cordes.
W KOPP VERPACKUNGSMASCHINEN, Steltener Strasse 111-117, 7300 Esslingen, 0711.372 071, Fax: 0711.372 075, Tlx: 7256456 kopp, Dir: Ludwig P Goller, Sales Dir: Walter Weber, Purchasing Manager: Otto Priessnitz. Manufacturer/distributor of overwrapping and bundling machines, film welding machines; Agent for Marden Edwards & Co.

GREECE

RECORD COMPANIES

AMMON RECORDS, PO Box 10779, 541 10 Thessaloniki, 031.821 113, Fax: 031.840 122, Tlx: 412373, MD: Vassiliis Turonis.
BMG ARIOLA GREECE, 230 Mesogion, 1 Perikleous, 155 61 Holargos, 01.652 8401-5, Fax: 01.653 6880, Tlx: 224345 bmg, MD: Miltos Karadsas, Prod Mgr Int'l: Aris Kakariaris, Promo Mgr Int'l: Alexandros Richardos, A&R Mgr Local: Vangelis Yannopoulos, Mktg Mgr: George Stouyantzikis, Sales Mgr: Elias Eliopoulos, F&A Mgr: Nick Papanikolaou.
FM RECORDS, Knossou Street 7, 111 46 Galatsi, Athens, 01.222 2301/3/291 2127, Fax: 01.222 1603, President: Nicos Courtis, Int'l Mktg Mgr: Dina Courtis, Bus Cons: Tasos Kademnidis, Import Mgr: Cathrine Kotsikona, Sales Mgr: Dimitris Kappos, Promo/Publ Mgr: Gina Foundoulaki, Fin Contr: Christina Viami. Labels (owned): Graffiti, Taboo, Heavy Metal Records; Main product: Jazz, Reggae, Dance, Album Rock, Gold/Oldies, Black (R&B).
INTERSONIC S.A., 136 71 Acharnai, 1 Naxos Str., Attiki, 01.246 1438, 01.2461 592, Fax: 01.2461 446, Tlx: 214312 inte gr, MD: Kostas Vlassopoulos.
LYRA RECORDS, Kriessotou Street 11, 106 71 Athens, 01.361 5529/6716/6798, Fax: 01.364 5168, MD: Panos Maravelias.
MEDITERRANEAN TRADING CO., Aristotelous Street 8, 176 71 Athens, 01.923 4177/032, Fax: 01.325 4355, Tlx: 225545, Contact: Vassilis Adam.
MINOS EMI, Messogion Avenue 245-247, 154 51 Neo Psychiko, Athens, 01.671 1811, Fax: 01.647 8968, Tlx: 218647 mino, Chmn: Makis Matsas, MD: Costas Bourmas, Mktg Mgr: Manos Xydous. Financial and accounts: Heraklito Street 127, 111 42 Athens, PO Box 3287 (Zip: 102 10), 01.252 7102/7502/3702, Fax: 01.251 7913, Tlx: 214192.
MUSIC BOX INTERNATIONAL, Alimou Avenue 76, 164 72 Argyroupoli, Athens, 01.995 3613/635/657, Fax: 01.993 3525, President: Andre Kataphas, Int'l Mgr: Akis Ladikos, Sales Mgr: Vassilis Doucas, A&R Local: Mihalis Nikoloudis, Asst A&R: Kate Avari, PR: Efi Kanelloupolou. Labels (owned): MBI; (Lic): Toco, Crepuscule, Trema, GNP, JSP, Munich, FNAC, Melodie, Rounder; Main product: Jazz, Reggae, Classical, Dance, Album Rock, Black (R&B).
ORATA, 53 Agias Lavras, 157 73 Zografou, Athens, 01.681 3168/823 6840, Fax: 01.724 9508, Tlx: 218344 lbs, Owner/Mgr: Christodoulos Halaris, Mktg/Fin Dir: Aram Krikorian, PR Mgr: Eleni Halaris, A&R Mgr: Ranayotis Mathos. Labels (owned): Orata, Neati; Main product: Classical.
PENGUIN RECORDS, Lambrou Katsoni Street 58, 114 71 Ampelokipi, Athens, 01.644 7058, Fax: 01.364 6875, Tlx: 224152 peng, MD: Poppy Stavroskis, President: Akis Stavroskis.
POLYGRAM GREECE, Messogion Avenue 296, 155 10 Chologos, Athens, 01.652 4213, Fax: 01.652 5797, Tlx: 216124, MD: Victor Antippas, F&A Mgr: Yannis Katsiadas, Int'l Mgr: Nicos Mouratides, Production: Anna Archodaki, Promo: Kostas Rekiouniotis (Radio), Elaine Delapopoulos (Press/TV), A&R Mgrs Local: Nicos Karayannis, Giorgos Makrakis.
SAKKARIS RECORDS, Ebrar Street 7, 155 25 Neo Psihiko, Athens, 01.647 5986/671 1690, Fax: 01.647 7536, Tlx: 224131, MD: Kostas Sakkaris, Promo Mgr: George Georgiou.
SEAGULL RECORDS, Ch. Trikoupi Street 18, 106 78 Athens, 01.363 8386/361 2375, Fax: 01.360 7711, Tlx: 222505, MD: Panayotis Kokkalis, Promo Mgr: Chris Lentzas.
SIRIUS CO, 76 Alimou Street, 16472 Argyroupolis, 01.995 3613/35, Fax: 01.993 3525, MD: Manos Hadjiadakis, A&R Mgr: Vicky Galatou, Music Mgr: Nicos Kipourgos, PR Mgr: Nicos Gravaris, Royalties Mgr: Nicos Polykretis.
SONY MUSIC ENTERTAINMENT (GREECE), Messogion Avenue 311, 152 31 Halandri, Athens, PO Box 62037 (Zip: 152 31), 01.647 6491, Fax: 01.672 2150, Tlx: 216220 cbsr, MD: Dimitris Yarmenitis, Sr Dir Creative Ops: George Polychroniou, F&A Dir: Petros Zaritas, Sales Dir: Spiros Sofronis, Int'l A&R/Promo Mgr: Thanos Karagioris, Promo & Press Officer: Harry Bakas. Labels owned: Columbia, Epic, Portrait and associated labels, Akti.
VIRGIN RECORDS GREECE, Messogion Avenue 557, 153 44 Stratos, Athens, 01.655 0924/0902, Fax: 01.656 7401, Tlx: 223511, MD: Yannis Petridis, A&R (Int'l): Yannis Doxas, Admin: Penelope Kondyli. Labels (owned): Virgin, Siren, Circa, 10, Charisma, EG, Real World, Earthworks; (Lic): Mute, 4AD, Rough Trade, Beggars Banquet, Sonet, Rhino, Tommy Boy, Factory, Silva Screen, Varese, Colosseum; Distribution: EMI-Matsas.
WARNER MUSIC GREECE, Messogion Avenue 319, 152 31 Halandri, Athens, 01.647 5881-5, Fax: 01.672 5401, Tlx: 210716, MD: Ion Stamboulis, A&R/Prod/Promo Mgr Int'l: Christos Ha, A&R Mgr Local: Stelios Fotiadis, Sales Mgr: Stefanos Kotatis.

MUSIC PUBLISHERS

BMG MUSIC PUBLISHING LTD., 230 Mesogion & 1, Perikleous, GR 155 61, Holargos, Athens, (30) 01.652 8401/5, Fax: (30) 01.653 6880, Tlx: 224345 bmg gr, GM: Costas Zougiris.
EMI MUSIC PUBLISHING (GREECE), Heraklito Street 127, 111 42 Athens, PO Box 3287 (Zip: 102 10), 01.251 3007/252

9003, Fax: 01.252 9240, Contact: Maria Karidi.
FM RECORDS, Knossou Street 7, 111 46 Galatsi, Athens, 01.222 2301-3/291 2127, Fax: 01.222 1603, President: Nicos Courtis, Int'l Mktg Mgr: Dina Courtis. Main product: Jazz, Reggae, Album Rock, Gold/Oldies, New Age.

GRECEPHON EDITIONS MUSICALES, Eleftheriou Venizelou Avenue 52, 176 76 Kallithea, Athens, 01.958 0243, Tlx: 221082, President: Marika Gesar.

INTERSONG HELLAS, Messogion Avenue 319, 152 31 Halandri, Athens, 01.647 5881, Fax: 01.672 5401, Tlx: 210716, MD: Ion Stamboulis, Publ Mgr: Mary Bravo.

LYRA—GENERAL PUBLISHING COMPANY, Kriezotou Street 11, 106 71 Athens, 01.361 5529/6716/6798, Tlx: 219920, President: Panos Maravelias.

MINOS EMI, Messogion Avenue 245-247, 154 51 Neo Psychico, Athens, 01.671 1811, Fax: 01.647 8968, Tlx: 218647 mino, Chmn: Makis Matsas, MD: Costas Bourmas.

PENGUIN RECORDS, Lambrou Katsoni Street 58, 114 71 Ampelokipi, Athens, 01.644 7058, Fax: 01.364 6875, Tlx: 224152 peng, MD: Poppy Stavroskis, President: Akis Stavroskis.

SAKKARIS RECORDS, Ebrar Street 7, 155 25 Neo Psihiko, Athens, 01.647 5986/671 1690, Fax: 01.647 7536, Tlx: 224131, MD: Kostas Sakkaris, Promo Mgr: George Georgiou.

SONY MUSIC PUBLISHING (GREECE), Messogion Avenue 311, 152 31 Halandri, Athens, PO Box 62037 (Zip: 152 31), 01.647 6491, Fax: 01.672 2150, Tlx: 216220 cbsr, MD: Dimitris Yarmenitis, Publ Mgr: Youla Rosou.

VIRGIN MUSIC GREECE, Messogion Avenue 557, 153 44 Stravos, Athens, 01.655 0902/24, Fax: 01.656 7401, Tlx: 223511 virg, MD: Yannis Petridis.

VIDEO PROGRAM SUPPLIERS & BUYERS

AUDIO-VISUAL ENTERPRISES, Sohou 7, Neo Psychico, Athens, 01.647 5901.

GEORGE KARRAYANIS, Skalidi 16/8, 11525 Athens, 01.671 7297, Fax: 01.647 5057.

HOME VIDEO HELLAS, Messogion Avenue 275, 152 31 Halandri, Athens, 01.671 2089, Fax: 01.647 0073, MD: Manos Drezias.

MTC, Aristotelous 8, 176 71 Kallithea, Athens, 01.325 4356, Fax: 01.325 4355, Dir: John Adam.

SONY MUSIC ENTERTAINMENT (GREECE), Messogion Avenue 311, 152 31 Halandri, Athens, PO Box 62037 (Zip: 152 31), 01.647 6491, Fax: 01.672 2150, Tlx: 216220 cbsr.

VIDEO SONIC, Evrydamantos Street 1, 117 45 Athens, 01.921 9412, Fax: 01.902 5950, Tlx: 223858 spzr, MD: John Sarras.

RECORD DISTRIBUTORS

A & N RECORDS, Ag Sofias 71, 546 33 Salonika, 031.283 849, Fax: 031.227 039, President: Nikos Vozikis, MD: Anna Nikolaidou.

ART NOUVEAU, Solomou 23, 106 82 Athens, 01.364 3556, Fax: 01.363 9234, Tlx: 222700, President: Nick Kontogouris, MD: Stathis Papoulas. Wholesaler; Formats: CD, Vinyl Albums, Vinyl Singles, Cassettes; Main product: Album Rock, Dance, Gold/Oldies, Black (R&B), Adult Contemporary.

BLOW UP, Aristotelous Street 8, Thessaloniki, 031.233 255/276 394, Fax: 031.237 101.

DISCOBOLE RECORDS, Ippokratous Street 33, 106 80 Athens, 01.361 6307, Fax: 01.362 6935, President: George Canellis, Andreas Riggas, MD: Nikolas Manos, Mgr Import: George Malamas. Label (distr): ZYX (Ger); Main product: Adult Contemporary, Dance, Album Rock, Gold/Oldies, Black (R&B).

FM RECORDS, Knossou Street 7, 111 46 Galatsi, Athens, 01.222 2301-3/291 2127, Fax: 01.222 1603, President: Nicos Courtis, Int'l Mktg Mgr: Dina Courtis, Bus Cons: Tasos Kademnidis, Import Mgr: Cathrine Kotsikoua, Sales Mgr: Dimitris Kappos, Promo/Publ Mgr: Gina Foundoulaki, Fin Contr: Christina Viami. Labels (distr): Roadrunner Records, Steamhammer, Castle Communications, Demon Records, Ace Records, Arcade International, Music Products, Tring International, Elap Music, Revolver Distribution, Black Dragon, Discomag, SPV, Wotre Music, New Rose, Creation Records, Profile Records, Crazy Life, FM Revolver Records, Weton Wesgram, Special Music Products; Main product: Jazz, Reggae, Dance, Album Rock, Gold/Oldies, Black (R&B).

GREEK RECORD CLUB, Akadimias 57, 106 79 Athens, 01.363 1819, Fax: 01.363 8877, MD: Elsie Saratsis. Distribute all major independent classical record labels: Astree, Amati, Bayer, Calig, Cascavalle, Christophorus, Claves, CPO, EBS, Gimell, Haenssler, Hyperion, Kock International, MDG, Nimbus, Ondine, Pavilion, Unicorn-Kanchana, Valois, Chanel Classics, Orfeo, Wergo, Edelweiss, Biddulph, APR, Opera Rara; Main product: Classical. Also classical music videos and laserdiscs.

MUSIC BOX INTERNATIONAL, Alimou Avenue 76, 164 72 Argyroupoli, Athens, 01.995 3613/635/657, Fax: 01.993 3525, President: Andre Kataphas, Int'l Mgr: Akis Ladikos, Sales Mgr: Vassilis Doucas, A&R (Local): Mihails Nikoloudis, Asst A&R: Kate Avari, PR: Efi Kaniellopoulou. Labels (distr): Toco, BCM, Pickwick, Sonadisc, Topic, World Circuit, Ras, Bellaphon, Aurophone, Tomato; Main product: Jazz, Reggae, Classical, Dance, Album Rock, Black (R&B).

NEW WAVE INTERNATIONAL, Larissis Street 4, 115 23

Athens, 01.691 4837/49, Fax: 01.692 9833, MD: Phil Hadjipanayotou, Mktg/Sales Mgr: Nicolas Voukoutis, Sales Exec: Theodore Lingas, Accts Contr: Evi Alyssandrato. Labels (distr): Phonomatic, IMC, Masters, Patricia, That's Entertainment, See For Miles, Indisc, Rounder, Beat Goes On, BBC, Recommended, Vogue, Sonodisc; Main product: all categories.

ROCK CITY, Socratous Street 79-81, 104 32 Athens, 01.522 4370, Fax: 01.522 7089, President: Anna Nasopoulou, VP: Aristidis Zouroudis, Import Mgr: Angelo Baltas, Chief Accountant: Isidoros Birlis. Main product: Heavy Metal, Hard Rock.

RETAIL ACCESSORY SUPPLIERS

LIFT HELLAS, Kanigos & Stournar Street 33, 4th floor, 106 83 Athens, 01.362 2086, Fax: 01.360 6030.

VELICO HELLAS, Alexioupoleos 47/9, 164 52 Argyroupolis Athene, 01.993 0093/006. Agent of Frejo display systems.

ASSOCIATIONS & PROFESSIONAL ORGANIZATIONS

AEPI, Delighianni Street 14, 106 83 Athens, 01.821 3917, President: Mimis Traiforos. Copyright society.

IFPI GREECE, 83 Ag. Praskevis Street, 152 34 Halandri, 01.684 0757/6198, Fax: 01.684 0757, President: Costas Bourmas, Sec: Miltos Karadsas.

INTERNATIONAL MUSIC COUNCIL, Mitropoleos Street 38, 105 63 Athens, 01.322 3302, President: Demetre Michaelides.

PUBLIC RELATIONS & RECORD PROMOTION

LAKIS KLEOPAS PRODUCTIONS, Salaminos Street 10, Thessaloniki, 031.516 493/494.

MONDIAL PROMOTIONS, Ermou Street 6, 105 63 Athens, 01.325 4086, Fax: 01.323 2033, Tlx: 225306, MDs: Dinis Deris, George Courmouzis, Mgr: Costas Varcados.

PRESS BUREAU, Po Box 1032, Thessaloniki, 031.276784, Tlx: 412 373.

COMPACT DISC MASTERING & REPLICATING PLANTS

DIGITAL PRESS HELLAS, Messogion Avenue 275, 152 31 Athens, 01.672 6104/674 4042, Fax: 01.672 6258, Tlx: 226272 dph, MD: E Krezias, Comm Mgr: Costas N Baladis, Prod Mgr: Yannis Moschous, Studio Mgr: Yannis Ioannidis. CD Manufacturing; Annual capacity: 2m; Min order: 1,000.

PLATING, MASTERING & PRESSING PLANTS

FABELSOUND, Irakliou Street 72, Heraklion, Athens, 01.281 6956.

GPI (GREEK PHONOGRAPHIC INDUSTRIES), Odos Demokratias 248, 135 62 Agii Anargyri, Athens, 01.263 3129.

TAPE CUSTOM DUPLICATORS

DIGITAL PRESS HELLAS, Messogion Avenue 275, 152 31 Athens, 01.672 6104/674 4042, Fax: 01.672 6258, Tlx: 226272 dph, MD: E Krezias, Comm Mgr: Costas N Baladis, Prod Mgr: Yannis Moschous, Studio Mgr: Yannis Ioannidis. Audio cassette duplication; Annual capacity: 1m; Min order: 500.

ERACORD, Halandriou 19 & Souliou Street, 153 43 Athens, 01.638 1294, Fax: 01.657 0091, Tlx: 222831, MD: Nikos Paunopoulos.

FABELSOUND, Irakliou Street 72, Heraklion, Athens, 01.281 6956.

GPI (GREEK PHONOGRAPHIC INDUSTRIES), Odos Demokratias 248, 135 62 Agii Anargyri, Athens, 01.263 3129.

TOP CLUB RECORDING STUDIO, Salaminos 21, 153 43 Agia Paraskevi, Athens, 01.655 0907, Fax: 01.639 2350, President: Joseph Avramoglou, Sales Mgr: Panayotis Papadopoulos, Prod Mgr: Billy Mayakos. Audio cassette duplication.

CASSETTES REELS & PARTS, JEWEL BOX MANUFACTURERS

DR DEMETRIOS A DELIS, Pal Benizelou 5, 105 56 Athens, 01.329 7222, Fax: 01.323 0550, Tlx: 215336.

INTERSONIC (GREECE), Naxou Street 1, 136 71 Acharnes, Attiki, 01.246 5004/1592, Fax: 01.246 1446, Tlx: 214312 inte, MD: Kostas Vlassopoulos. Manufacturer and distributor of blank loaded audio cassettes, C-0 audio cassettes, cassette boxes, audio/video plastic cases, jewel boxes and other plastic storage products.

BLANK & BULK RAW TAPE

3M GREECE, Kifissias Avenue 20, 151 25 Maroussi, Athens, 01.684 2902, Fax: 01.684 3281, Tlx: 215216.

BASF (c/o DELIS), Paleologou Benizelou 5, 105 56 Athens, 01.329 722, Fax: 01.323 0550, Tlx: 215336 deli, Contact: D A Delis.

BASF (C/O PAPAS), PO Box 8355, 100 10 Athens, 01.575 2944, Fax: 01.575 4540, Tlx: 24217.

INTERSONIC (GREECE), Naxou Street 1, 136 71 Acharnes, Attiki, 01.246 5004/1592, Fax: 01.246 1446, Tlx: 214312 inte, MD: Kostas Vlassopoulos. Manufacturers of audio cassettes.

CD, RECORD & TAPE MANUFACTURING SYSTEMS

DR DEMETRIOS A DELIS, Pal Benizelou 5, 105 56 Athens, 01.329 7222, Fax: 01.323 0550, Tlx: 215336.

KEM ELECTRONICS, Katechaki Street 32, 115 25 Athens, 01.647 5659, Fax: 01.363 9234, Tlx: 222700, MD: Thimios Koliokotsis.

HUNGARY

RECORD COMPANIES

CRAFT RECORDS, Vihar utca 36, 1035 Budapest, 01.188 4845, Fax: 01.188 9161, MD: Miklos Bornemissza, Music Dir: Attila Kornyei.

HUNGARON, Vorosmarty ter 1, 1051 Budapest, PO Box 31 (Zip: 1364), 01.117 6222, Fax: 01.118 4571, Tlx: 226504, Dir-Gen: Istvan Ella, Int'l Director: Gyula Karsay, Fin Dir: Yvonne Kovacs, Import/Export Dir: Zsuzsanna Kanizsai, Classical Music: Mate Hollos, Music Dir: Laszlo Benko. Labels (owned/distributed): Hungaroton, Qualiton, Profil, Start, Favorit, Pepita, Bravo, Gong, Krem. (Licensed): BMG, Columbia, EMI, PolyGram, Virgin, WEA.

MMC RECORDS, Havas utca 5, 1056 Budapest, 01.118 1031, Fax: 01.118 2514, MD: Ferenc Kaszas.

PROTON, Rozsa F utca 4-6, 1077 Budapest, 01.121 0932, Fax: 01.122 2412, MD: Erno Enyedi. Proton is the biggest private record company in Hungary, and has the biggest distribution network in the country.

QUINT RECORDS, Nephadsereg utca 12, 1055 Budapest, 01.131 2528, Fax: 01.131 0558, MD: Jenő Bors, Music Mgr: Imre Wilpert.

RAKOCZI RECORDS, Pannonia utca 25, 1136 Budapest, 01.149 5669, MD: Miklos Deak, Prod Mgr: Katai Nagy.

RING RECORDS, Ora utca 8, 1125 Budapest, 01.155 6666, Fax: 01.155 6666, MD: Tibor Csabai.††† **MUSIC PUBLISHERS**

CRAFT RECORDS, Vihar utca 36, 1035 Budapest, 01.188 4845, Fax: 01.188 9161, MD: Miklos Bornemissza, Music Dir: Attila Kornyei.

EDITIO MUSICA BUDAPEST, Vorosmarty ter 1, 1051 Budapest, 01.118 4190/4228, Fax: 01.138 2732, Tlx: 225500, MD: Istvan Homolya, Int'l Promo Mgr: Gabor Knisch.

HUNGARON, Vorosmarty ter 1, 1051 Budapest, PO Box 31 (Zip: 1364), 01.117 6222, Fax: 01.118 4571, Tlx: 226504, Dir-Gen: Istvan Ella, Fin Dir: Yvonne Kovacs, Import/Export Dir: Zsuzsanna Kanizsai, Lic Mgr: Ferenc Kaszas, Classical Music: Mate Hollos, Music Dir: Laszlo Benko.

JLX, Eotvos utca 42, 1067 Budapest, 01.111 3857, Fax: 01.175 0696, President: Jozsef Laux.

LAUDE, PO Box 506, 1374 Budapest, 01.185 5433, MD: György Czippán.

MAGNEOTON, Florian ter 4-5, 1033 Budapest, 01.168 9317, Fax: 01.168 9317, MD: Peter Rado.

MULTIMEDIA, Belgrad rakpart 21, 1056 Budapest, 01.117 9488, Fax: 01.117 9228, Tlx: 226948, MD: Laszlo Hegedus.

MUSIC SOURCE, Rottenbiller utca 62, Budapest, 01.133 9996, Fax: 01.133 9995. Management: PG Consulting, Vezer utca 53/d-VII/26, 1144 Budapest, 01.184 8679, Fax: 01.142 3358.

RING MUSIC PUBLISHING, Ora utca 8, 1125 Budapest, 01.155 6666, Fax: 01.155 6666, MD: Tibor Csabai.

TALENTUM, Rottenbiller utca 16-22, 1074 Budapest, 01.122 4841, Fax: 01.122 4841, MD: Laszlo Harsanyi, Prof Mgr: Zoltan Veréb.

WEAST PRODUCTIONS/CMC AGENCY, Afonya utca 2b/II/3, 1025 Budapest, 01.135 0527, Fax: 01.135 0527, MD: György Szasz.

VIDEO PROGRAM SUPPLIERS & BUYERS

INTERCOM, Karolina ut 65, 1113 Budapest, PO Box 97 (Zip: 1507), 01.186 9766, Fax: 01.166 6377, Tlx: 226761, MDs: Istvan Gardos, George Mihaly, Mgr: Andras Kalman.

INTERVIDEO, Matyas Kiraly ut 11/b, 1021 Budapest, 01.156 4084/175 9322, Fax: 01.175 9570, President: Michael Kovacs, MD: Ferenc Bartha. Film and video manufacturing and distribution.

MOKEP, Bathory utca 10, 1054 Budapest, 01.111 3478/2097/6650, Fax: 01.153 1850, Tlx: 225487/225768, Contact: Jozsef Gombar, Bela Csoma.

MOKEP VIDEO PUBLISHING, Mezo Imre ut 25, 1081 Budapest, 01.113 4257, Tlx: 225487, Dir: Zoltan Kiss.
NIVO RECORDS, Oththon utca 10, 1118 Budapest, 01.182 0376, Fax: 01.166 2564, MD: Istvan Horvath, Mktg Mgr: Lajos Koszegi.

RECORD DISTRIBUTORS

ALLAMI KONYVTERJESZTO VALLALAT, Nador utca 22, 1051 Budapest, 01.111 4600, Fax: 01.117 2020, MD: Istvan Fuzer, Co-Ord: Gaborne Horvath, Dir Rec Ops/Publ: Judit Gazdag Ujlakine.
KAPOCS, Szekely Mihaly utca 13, 1061 Budapest, 01.122 8288, Fax: 01.122 8288, MD: Ferenc Konya. Wholesale.
MUSIC SOURCE, Rottenbilller utca 62, Budapest, 01.133 9996, Fax: 01.133 9995. Wholesale & retail; Management: PG Consulting, Vezer utca 53/d-VII/26, 1144 Budapest, 01.184 8679, Fax: 01.142 3358.
MUVELT NEP, Andrassy ut 21, 1061 Budapest, 01.122 4421/142 9760, Fax: 01.142 5717, Tlx: 224914, MD: Istvan Jeney.
QUITTNER IMPORT, Fo ter 1, 1033 Budapest, 01.180 4020, Fax: 01.180 3340, MD: Otto Quittner.
TEKA KONYVERTEKESITO VALLALAT, Vacsi ut 19, 1134 Budapest, 01.111 1462, Fax: 01.131 1566, Tlx: 226772, MD: Jozsef Ronga, Asst: Jozsefne Toth.

RETAIL ACCESSORY SUPPLIERS

LIFT HUNGARY, Felso korut 14, 9730 Koszeg, 094.21559, Fax: 094.421 559, Contact: Andrea & Jozsef Aradi. Agent of Lift display systems.

ASSOCIATIONS & PROFESSIONAL ORGANIZATIONS

ARTISJUS MUSICAL AGENCY, Vorosmarty ter 1, 1051 Budapest, 01.118 4629, Fax: 01.118 5597, Tlx: 226527 arjus, Mgr: Istvan Szilagyi. Mechanical and performing right society.
BUDAPEST FESTIVAL OFFICE (INTERPART), Vorosmarty ter 1, 1051 Budapest, 01.117 9910, Fax: 01.118 4767, Tlx: 224121, Contact: Tamas Klenjanszky.
INSTITUTE OF MUSICOLOGY, Tancsics utca 7, 1014 Budapest, 01.175 9011, MD: Janos Marothy.
KULTURA HUNGARIAN FOREIGN TRADE COMPANY, Fo utca 32, 1011 Budapest, PO Box 149 (Zip: 1389), 01.201 4411, Fax: 01.201 3207, Tlx: 224441 kult, Dir-Gen: Jozsef Meszaros, Sales Mgr: Geza Halmi. Foreign trading: export-import of books, newspapers, teaching aid material, art, audio-video productions.
KULTURINNOV, Szentharomsag ter 6, Budapest, 01.155 0122, Fax: 01.175 1886, Tlx: 226490, MD: Peter Polonyi.
MUSICIANS TRADE UNION, Gorkoj fasor 38, 1068 Budapest, 01.142 8927, Fax: 01.122 5412, President: Sanor Solyom Nagy.

PUBLIC RELATIONS & RECORD PROMOTION

ARTISJUS MUSICAL AGENCY, Vorosmarty ter 1, 1051 Budapest, 01.118 4629, Fax: 01.118 5597, Tlx: 226527 arjus, Div Head: Istvan Szilagyi.
PG CONSULTING, MARKETING & MANAGEMENT, Vezer utca 53/d-VII/26, 1144 Budapest, 01.184 8679, Fax: 01.142 3358. Management for Music Source (records, publishers), international development for Petofi Csarnok (concert promotion).

COMPACT DISC MASTERING & REPLICATING PLANTS

GLORIA KOMPAKLEMEX—GYARTO, PO Box 175, 8001 Szekesfehervar, 0222 9132, Fax: 0222 9133, Tlx: 29313, MD: Batath Istvan.
HUNGAROTON STUDIO, VII Rottenbilller utca 47, 1071 Budapest, PO Box 31 (Zip: 1071), 01.142 8546/122 8839, Fax: 01.118 4571, Tlx: 226504, MD: Laszlo Csintalan.

PLATING, MASTERING & PRESSING PLANTS

HUNGAROTON STUDIO, VII Rottenbilller utca 47, 1071 Budapest, PO Box 31 (Zip: 1071), 01.142 8546/122 8839, Fax: 01.118 4571, Tlx: 226504, MD: Laszlo Csintalan.
NIVO RECORDS, Oththon utca 10, 1118 Budapest, 01.182 0376, Fax: 01.166 2564, MD: Istvan Horvath, Mktg Mgr: Lajos Koszegi. Vinyl and tape.
POLIMER, Saletrom utca 4, 1085 Budapest, PO Box 254 (Zip: 1444), 01.133 4955, Fax: 01.1114 5304, Tlx: 224813 pomer, MD: Laszlo Kiss, Mktg Mgr: Gyula Szabo, Consultant Dir: Antal Puskas, Eng: Ervin Kaas. Audio cassette duplication. Annual cap: 1 mil.
WOLFEX, Sport utca 2, 2040 Budapest, 01.185 2238, MD: Tamas Kenyeres.

BLANK & BULK RAW TAPE

MAGNEW MANUFACTURING & TRADING COMPANY, Gyomroi utca 60-62, 1103 Budapest, 01.147 0371/157 4888, Fax: 01.147 0371, MD: George Nagy, Tech Dir: Steven Gyengo, Mktg Dir: Joseph Ferenczi. Manufacturer of professional & consumer blank video tape cassette and open reel; Brand: Genesis type V-0.
POLIMER, Saletrom utca 4, 1085 Budapest, PO Box 254 (Zip: 1444), 01.133 4955, Fax: 01.1114 5304, Tlx: 224813 pomer, MD: Laszlo Kiss, Mktg Mgr: Gyula Szabo, Consultant Dir: Antal Puskas, Eng: Ervin Kaas. Tape manufacture.

ICELAND

RECORD COMPANIES

FILADELFIA FORLAG, Hatun 2, PO Box 5135, 125 Reykjavik, 01.25155, Fax: 01.620 735, Tlx: 3000 simtex forlag, GM: Gudni Einarsson, Sales Mgr: Gudny Einarsdottir. Labels (owned): Filadelfia, Horpustrengir; (Dist): Word Group; Main product: Gospel.
GEIMSTEINN, Skolaveg 12, 230 Keflavik, 02.12717, Pres/MD: Runar Juliusson, A&R/Producer: Thor Baldursson, Mktg/Sec: Maria Baldursdottir. Main product: Dance, AC, Album Rock, Jazz, New Age.
GRAMM RECORDS, Klapparstig 25-27, 101 Reykjavik, 01.16222, Fax: 01.129 323, MD: Asmundur Jonsson. Distribution.
ITM, Freyjugata 1, 121 Reykjavik, PO Box 978 (Zip: 121), 01.12322, Fax: 01.625 622, Tlx: 3000 icemic, Chmn: Thorkell Sigurbjornsson, MD: Bergljot Jonsdottir.
PS MUSIK, Nybylavegur 4, 200 Kopavogur, PO Box 320 (Zip: 202), 01.46725, Fax: 01.46790, Tlx: 2388 steric, MD: Petur Kristjansson. Main product: EHR, Jazz, Album Rock, New Age.
STEINAR, Nybylavegur 4, 200 Kopavogur, PO Box 320 (Zip: 202), 01.46799, Fax: 01.46790, Tlx: 2388 steric, President: Steinar Berg Isleifsson, A&R (Nat'l): Jonatan Gardarsson, Int'l Mktg A&R: Kjartan Gudbergsson, Import/Sales Mgr: Bergur Isleifsson. Labels (lic): Sony Music; (Dist): Warner Music; Main product: EHR, Jazz, Album Rock, New Age.

MUSIC PUBLISHERS

FILADELFIA FORLAG, Hatun 2, PO Box 5135, 125 Reykjavik, 01.25155, Fax: 01.620 735, Tlx: 3000 simtex forlag, GM: Gudni Einarsson. Main product: Gospel, Hymns.
GEIMSTEINN, Skolaveg 12, 230 Keflavik, 02.12717, Pres/MD: Runar Juliusson, A&R: Thor Baldursson.
GRAMM RECORDS, Klapparstig 25-27, 101 Reykjavik, 01.16222, Fax: 01.129 323, MD: Asmundur Jonsson.
ICELAND MUSIC INFORMATION CENTRE, Freyjugata 1, 101 Reykjavik, PO Box 978 (Zip: 121), 01.12322, Fax: 01.625 622, Tlx: 3000 icemic, MDs: Thorkell Sigurbjornsson, Bergljot Jonsdottir.
SKIFAN, Skeifan 17, 108 Reykjavik, PO Box 8120 (Zip: 128), 01.600 900, Fax: 01.687 670, Chmn: Jon Olafsson, MD: Kristinn Sigtryggsson. Main product: Adult Contemporary, Jazz, Classical, Dance, Album Rock, Gold/Oldies.

VIDEO PROGRAM SUPPLIERS & BUYERS

SAGA FILM, Vatnagordum 4, 104 Reykjavik, 01.685 085, Fax: 01.814 802, Sales Dir: Gonchor Hannesson.
SKIFAN, Skeifan 17, 108 Reykjavik, PO Box 8120 (Zip: 128), 01.600 900, Fax: 01.687 670, Chmn: Jon Olafsson, MD: Kristinn Sigtryggsson, Import Mgr: Oskar Thorisson. Production and distribution of music & promo videos; Clients: Sidan Skein Sol, Bjorgvin Halldorsson, Laddi, Geiri Saem, Studmenn, Strax.

RETAIL ACCESSORY SUPPLIERS

SKIFAN, Skeifan 17, 108 Reykjavik, PO Box 8120 (Zip: 128), 01.600 900, Fax: 01.687 670, Chmn: Jon Olafsson, MD: Kristinn Sigtryggsson. Agent of Lift display systems.

ASSOCIATIONS & PROFESSIONAL ORGANIZATIONS

ICELANDIC COMPOSERS SOCIETY, Laufasvegur 40, Reykjavik, 01.24972.
ICELAND MUSIC INFORMATION CENTRE, Freyjugata 1, 101 Reykjavik, PO Box 978 (Zip: 121), 01.12322, Fax: 01.625 622, Tlx: 3000 icemic, MDs: Thorkell Sigurbjornsson, Bergljot Jonsdottir. Library of Icelandic music, information services, publisher—scores and recordings, promotional activities.
IPFI ICELAND, Kringlan 4, PO Box 3360, 123 Reykjavik, 01.678 013, Fax: 01.678 014, Sec: Gunnar Gudmundsson.
STEF, Laufasvegur 40, Reykjavik, 01.24972. Performing rights society.

TAPE CUSTOM DUPLICATORS

HOT ICE STUDIO, Troenuhraun 6, 220 Hafnarfirdi, 01.651 877, Fax: 01.814 986, President: Jonas Jonsson, Chmn: Jon Jonasson, MD: Ingvar Georgsson. Audio cassette duplication.

IRELAND

RECORD COMPANIES

A & C RECORDS, Ballindrait, Gordon House, Lifford, County Donegal, 074.41088, Fax: 0504.885 802, MD: Charlie Friel.
A & M RECORDS (IRELAND), 130 Slaney Road, Dublin Ind Estate, Glasnevin, Dublin 11, 01.309 077, Fax: 01.307 130, Tlx: 30434, Mgr: Lynne Fitzgerald.
BLACKBIRD RECORDS, 67-68 Lower Baggot Street, The Mews, Dublin 2, 01.766 752, Fax: 01.766 786, MD: Maurice Cassidy.
BMG IRELAND, Naas Road, Carriglea Industrial Estate, Dublin 12, 01.553 001, Fax: 01.553 990, Tlx: 25724, GM: Freddie Middleton, A&R/Sales Mgr: Joe Stuart, Admin Asst: Kathryn Mason. Labels (owned): RCA, Arista, BIG; (Lic): Motown, Jive, Silverstone; Main product: Adult Contemporary, Jazz, Country, Classical, Dance, Album Rock.
CLADDAGH RECORDS, Dame Street, Dame House, Dublin 2, 01.778 943, Fax: 01.793 664, MD: Garech Browne, Company Sec: Jane Bolton, A&R: Tom Sherlock, Sales: Sardy Harsch.
CMR RECORDS, 5-6 Lombard Street East, Dublin 2, 01.779 762, Fax: 01.710 421, Tlx: 32618, MD: Brian Molloy.
COMET RECORDS, 5 Cope Street, Dublin 2, 01.718 592, Fax: 01.718 592, MD: Brian O'Kelly, Sales Mgrs: Gerry O'Boyle, Jim O'Mahony. Labels (owned): Comet; Main product: Indie.
CRASHED RECORDS, 130 Slaney Road, Dublin Ind Estate, Glasnevin, Dublin 11, 01.729 714, Fax: 01.729 970, Tlx: 33562 emid.
DANCELINE, 267 Crodaun Forest Park, Celbridge, County Kildare, 01.627 1900, MD: Pete the Roz, Head Of A&R: Eddie Joyce. Labels (owned): Danceline, Cascade; Main product: EHR.
DARA/DOLPHIN RECORDS, 56 Moore Street, Dublin 1, 01.729 993, Fax: 01.720 405, MD: Joe O'Reilly.
DINO ENTERTAINMENT (IRELAND), 20 Upper Sheriff Street, The Stockyard, Dublin 1, 01.363 823, Fax: 01.741 954, MD: Jack McNeice.
EMI RECORDS (IRELAND), 130 Slaney Road, Dublin Ind Estate, Glasnevin, Dublin 11, 01.309 077, Fax: 01.729 970, Tlx: 33562 emid, MD: William Kavanagh, Mktg Mgr: Rory Cowan, Promo: Yvette Folan. Distributed: Polygram, Dico.
Gael-Linn, 26 Merrion Square, Dublin 2, 01.767 283, Fax: 01.612 438, Tlx: 90314, MD: Riobard Mac Gorain.
HARMAC MUSIC, 67 Amiens Way, Dublin 1, 01.366 599, Fax: 01.366 997, MD: Brendan Harvey, Sales Mgr: John O'Neill.
K-TEL IRELAND, 30-32 Sir John Rogersons Quay, Dublin 2, 01.714 011, Fax: 01.770 426, MD: Shay Hennessy, Sales/Promo: Sharon Mc Cabe. Distribution: Record Services.
LUNAR RECORDS, 5-6 Lombard Street East Dublin 2, 01.779 762, Fax: 01.710 421, Tlx: 32618, MD: Brian Molloy.
MCA RECORDS (IRELAND), 30-32 Sir John Rogersons Quay, Dublin 2, 01.714 317/001/226, Fax: 01.714 554, GM: Dave Pennyfather.
MOTHER MUSIC, 30-32 Sir John Rogersons Quay, Dublin 2, 01.777 330, Fax: 01.777 276, Mgr: Dave Pennyfather, Prod Mgr: Ann Acheson, Promo: Jane O'Keefe, A&R Mgr: Richard O'Donovan.
NEWBERRY RECORDS, Derryneel, Ballinalee, County Longford, 0432.3165, Fax: 0432.3376, MD: Mattie Fox.
NUGGET RECORDS, 5-6 Lombard Street East, Dublin 2, 01.779 762, Fax: 01.710 421, Tlx: 32618, MD: Brian Molloy. Labels owned: Lunar, Nugget, Monitor, Unicorn, J&B.
OCEAN RECORDS (IRELAND), Lower Fitzwilliam Street, Clifton House, Dublin 2, 01.613 788, Fax: 01.615 200, Tlx: 90989, MD: Aidan Cavey. Distribution: Chart Distributors.
OGHAM RECORDS, 67-68 Lower Baggot Street, The Mews, Dublin 2, 01.766 752, Fax: 01.766 786, MD: Maurice Cassidy.
OWL RECORDS, 2 Auburn Avenue, Dun Laoghaire, County Dublin, 01.285 1562, Fax: 01.285 1500, MD: Reg Keating, Label Mgr: John Connolly. Labels owned: Owl, Emerald Isle, Debut, Interlingo, Storytape; Distribution: Chart Records.
PHAETON RECORDS, Dame Street, Dame House, Dublin 2, 01.778 943, Fax: 01.793 664, Chmn: Mathew Gallagher, Mgr: Jane Bolton.
POGUE MAHONE RECORDS, 8 Crow Street, Dublin 2, 01.777 930/349, Mgr: Terry O'Neill.
POLYGRAM IRELAND, 130 Slaney Road, Dublin Ind Estate, Glasnevin, Dublin 11, 01.309 077/729 651, Fax: 01.307 130, Tlx: 30434, Chmn: Maurice Oberstein, MD: Paul Keogh, Promo Mgr: Karen Fitzpatrick, Contr: Michael Herity. Distribution: EMI Records.
RINGSEND ROAD RECORDS, 20 Ringsend Road, Dublin 4, 01.685 567, Fax: 01.685 352, MDs: Clive Hudson, Andrew Boland, Mktg Mgr: Tom McCarthy, Artist Dev: Kay Sheehy. Labels lic: Jangle (Swi); Distribution: EMI.
RITZ RECORDS, 5-6 Lombard Street East, Dublin 2, 01.779 046/244, Fax: 01.779 386, MD: Michael Clerkin, Mgr: Michael O'Riordan. Distribution: Chart Records.

ROUND TOWER MUSIC, 43 Offington Lawn, Sutton, Dublin 13, 01.390 665, Fax: 01.390 855, MD: Clive Hudson, Promo/Label Mgr: Claire Hudson. Labels (owned): Round Tower Music, Thunder Road; (Lic, Ireland only): Sonet, Alligator; (Dist, Ireland only): Utility; Main product: Adult Contemporary, Album Rock.

RSE RECORD COMPANY, 11-13 Station Road Raheny, Dublin 5, 01.988 555, Fax: 01.988 351, MD/Promo/A&R: Raymond Smyth, Mktg/Distr Dir: Breide Smyth. Labels (owned): RSE; Main product: Dance, AC, Country, Classical, Folk, Irish.

SCOFF RECORDS, 14-15 Sir John Rogerson's Quay, Dublin 2, 01.713 033, Fax: 01.719 493, MD: Deke O'Brien, Press Officer: Liz Rafferty. Labels owned: Vixen.

SOLID RECORDS, Earlsfort Centre, Alexandra House, Dublin 2, 01.762 462/762 022, Fax: 01.763 549, MD: Oliver Walsh, Label Mgr: Suriya Moodliar. Labels (lic): Mute Records, Rhythm King, One Little King, Produce Records, Supreme Records, Rough Trade, Fire, Factory, Beechwood Music, Big Wave, Trax Music; (Owned): Solid; Distribution by Warner Music Ireland.

SON RECORDS, 30-32 Sir John Rogersons Quay, Dublin 2, 01.711 141, Fax: 01.714 554.

SONY MUSIC ENTERTAINMENT (IRELAND), Naas Road, Carriglea Ind Estate, Unit 2, Dublin 12, 01.553 001, Fax: 01.553 990, Tlx: 93901 cbar, MD: John Sheenan. Labels (lic): Chrysalis; (Dist) BMG.

SULAN RECORDS, The Mills, Ballyvourney, County Cork, 026.45123, Fax: 026.45432, MD: Tadhg Kelleher, Mktg: Patricia Kelleher. Labels owned: Sulan, Grapevine, TKS Records; Distribution: Record Services.

TARA RECORDS, 8 Anne's Lane, Dublin 2, 01.776 921/771 650, Fax: 01.679 1314, Tlx: 32618 gddg, MD: John Cook.

TELSTAR, 130 Slaney Road, Dublin Ind Estate, Glasnevin, Dublin 11, 01.303 700, Fax: 01.303 736, Tlx: 33667, GM: Brian O'Brien.

TREASURE ISLAND DISCS, Harbour Road, Bartra Lodge, Dalkey, County Dublin, 01.280 1235, Fax: 01.280 0743.

VIRGIN RECORDS IRELAND, 9 Whitefriars, Dublin 2, 01.757 700/758 007, Fax: 01.757 860, GM: Rory Golden, Press/PR: Josephine Nestor.

WARNER MUSIC IRELAND, Alexandra Hs, Earlsfort C, Earlsfort Ter, Dublin 2, 01.762 022, Fax: 01.762 602, MD: Peter Price, Fin Contr: John Taggart, Sales/Mktg: Peter Kenny. Labels (distr): Telstar Records, Solid Records; Main product: all categories carried.

MUSIC PUBLISHERS

A & C RECORDS, Ballindrait, Gordon House, Lifford, County Donegal, 074.41088, Fax: 0504.885 802, MD: Charlie Friel.

AIGLE MUSIC, 6 Daniell Drive, Artane, Dublin 5, 01.312 580, MDs: Nicky & Roma Ryan.

AMOUR MUSIC, Slane Studios, Beauparc, County Meath, 041.24357/24358, Contact: John Dee.

AQUARIAN MUSIC, Ballinclea Road, Ballinclea Lodge, Killiney, County Dublin, 01.285 0851, Fax: 01.285 0851, MD: Pat Dempsey.

ASDEE, see Bardis Music.

BARDIS MUSIC, Glenageary Office Park, Dun Laoghaire, County Dublin, 01.285 8711, Fax: 01.285 8928, President: Peter Bardon. (Sub-pub): Chappell Recorded Music, Bruton, Music House, Primrose Library, Filmtrax, Asdee, Rondon Music.

BEANN EADAIR MUSIC, 20 Ringsend Road, Dublin 4, 01.685 567, Fax: 01.685 352, MDs: Clive Hudson, Andrew Boland, Mgr: Pat Dempsey.

BRIAR MUSIC, 5-6 Lombard Street East, Dublin 2, 01.779 762, Fax: 01.710 421, Tlx: 32618, MD: Brian Molloy.

BRUTON, see Bardis Music.

CARASEL MUSIC, 8 St. Mel's Avenue, Walkinstown, Dublin 12, 01.509 429, Contact: Val Kearney.

CASTLE MUSIC, 5-6 Lombard Street East, Dublin 2, 01.779 762, Fax: 01.710 421, Tlx: 32618, MD: Brian Molloy.

CHAPPELL RECORDED MUSIC, see Bardis Music.

CLANNAD MUSIC, 14-15 Sir John Rogerson's Quay, Dublin 2, 01.714 344, Fax: 01.714 151, MD: David Kavanagh.

DANCELIN, 267 Crodaun Forest Park, Celbridge, County Kildare, 01.627 1900, MD: Pete the Roz, Head Of A&R: Eddie Joyce. Main product: EHR.

DARK FOX MUSIC, 14-15 Sir John Rogerson's Quay, Dublin 2, 01.713 033, Fax: 01.719 493, MD: Deke O'Brien, Press Officer: Liz Rafferty.

EMMA MUSIC, 5-6 Lombard Street East, Dublin 2, 01.779 046/244, Fax: 01.779 386, MD: Michael O'Riordan. Owned:

Watermill Music.

EVOLVING MUSIC, see Trax On Wax Music.

FILMTRAX, see Bardis Music.

FRONTIER MUSIC, 5-6 Lombard Street East, Dublin 2, 01.779 046/244, Fax: 01.779 386, MD: Michael O'Riordan.

HOLMES & MORIARTY PRODUCTIONS, Mincloon, Rahoon, County Galway, 01.22855, Fax: 01.22514, Dir/Producer: Anthony Sellers, Producer: Cecily Velleher. Main product: TV/Film Soundtracks.

Keady Music, 67-68 Lower Baggot Street, The Mews, Dublin 2, 01.766 751, Fax: 01.766 786, MD: Maurice Cassidy.

KT MUSIC, 2 Auburn Avenue, Dun Laoghaire, County Dublin, 01.285 1562, Fax: 01.286 1500, MD: Reg Keating.

MILD MUSIC, 8 Anne's Lane, Dublin 2, 01.776 921/771 650, Fax: 01.679 1314, Tlx: 32618 gddg, MD: John Cook.

MOTHER MUSIC, 30-32 Sir John Rogersons Quay, Dublin 2, 01.777 330, Fax: 01.777 276, Dir: Barbara Galavan.

MUSIC HOUSE, see Bardis Music.

MYSTERY TUNES, 130 Slaney Road, Dublin Ind Estate, Glasnevin, Dublin 11, 01.303 700, Fax: 01.303 736, Tlx: 33667, Contact: Tina McCarthy.

OGHAM MUSIC, 67-68 Lower Baggot Street, The Mews, Dublin 2, 01.766 751, Fax: 01.766 786, MD: Maurice Cassidy.

PRIMROSE LIBRARY, see Bardis Music.

RAINBOW MUSIC, 30-32 Sir John Rogersons Quay, Dublin 2, 01.714 317/001/226, Fax: 01.714 554, MD: Brian Wynne.

RITZ RECORDS, 5-6 Lombard Street East, Dublin 2, 01.779 046/244, Fax: 01.779 386, MD: Michael Clerkin, Mgr: Michael O'Riordan. (Owned): Rosetta, Emma Music.

RONDON MUSIC, see Bardis Music.

ROSETTA, see Ritz Records.

ROSETTE MUSIC, 5-6 Lombard Street East, Dublin 2, 01.779 046/244, Fax: 01.779 386, MD: Michael O'Riordan.

ROUND TOWER MUSIC, 43 Offington Lawn, Sutton, Dublin 13, 01.390 665, Fax: 01.390 855, MD: Clive Hudson, Promo/Label Mgr: Claire Hudson. Main product: Adult Contemporary, Album Rock.

RSE PUBLISHING, 11-13 Station Road, Raheny, Dublin 5, 01.988 555, Fax: 01.988 351, MD: Raymond Smyth. (Owned): RSE; Main product: Country, Irish.

SKIN MUSIC, PO Box 747, Kilcock, County Kildare, 01.287 590, MDs: Derek & Brian Warfield, Tommy Byrne, Noel Nagle.

SQUIRREL MUSIC, 5-6 Lombard Street East, Dublin 2, 01.779 762, Fax: 01.710 421, Tlx: 32618, MD: Brian Molloy.

SULAN MUSIC, The Mills, Ballyvourney, County Cork, 026.45123/01.714 317/011, Fax: 01.714 554, MD: Brian Wynne, Fin Dir: Terry Wynne, Sales/Mktg Mgr: Lindsey Holmes, Distr: Robbie Delaney. Labels (distr): MCA/Geffen, Island, K-Tel, Castle Communications, Mother, EMI, Tring, MCI/Object, Prism, all Irish labels.

RSE DISTRIBUTION, 11-13 Station Road, Raheny, Dublin 5, 01.988 555, Fax: 01.988 351, MD/Promo/A&R: Raymond Smyth, Mktg/Distr Dir: Breide Smyth. Labels (distr): RSE, Merlgan; Main product: Dance, AC, Country, Classical, Folk, Irish.

ASSOCIATIONS & PROFESSIONAL ORGANIZATIONS

THE ARTS COUNCIL, 70 Merrion Square, Dublin 2, 01.611 840, Fax: 01.761 302, Pop Music Officer: Keith Donald. Educational Initiatives in rock music, advice & information concerning rock music.

ASSOCIATION OF INDEPENDENT RECORD RETAILERS, c/o 5 Cope Street, Dublin 2, 01.718 592, Fax: 01.718 592, President: Brian O'Kelly. Represents rights of music retailers with respect to government, record companies, etc. 42 member retailers.

IASC, 15 Herbert Street, Dublin 2, 01.592 519, President: Donal Lunny, Chmn: John D'Ardis, Exec Sec: Peter Sherry Association of songwriters and composers.

IFPI IRELAND, 26 Merrion Square, Dublin 2, 01.767 283, Fax: 01.767 030, Tlx: 90314, Chmn: Paul Keogh, Sec: Riobard MacGorain.

INTERNATIONAL SONGWRITERS ASSOCIATION, Rabeen, Limerick Town, County Limerick, 061.28837, MD: Richard Glynn.

IRISH FEDERATION OF MUSICIANS, 63 Lower Gardiner Street, Dublin 1, 01.744 645, Fax: 01.744 645, President: Richard Glynn.

IRISH VIDEOGRAM ASSOCIATION, Russell Court, St. Stephen's Green, Dublin 2, 01.782 622, Fax: 01.784 572,

Chmn: Jimmy Hayden, Contact: Muriel Graham.

IRTC INDEPENDENT RADIO & TV COMMISSION, Clanwilliam Court, Marine House, Dublin 2, 01.760 966, Fax: 01.760 948, Chief Exec: Michael O'Keefe.

MECHANICAL COPYRIGHT PROTECTION SOCIETY, 15 Herbert Street, Dublin 2, 01.766 996, Fax: 01.611 316, MD: Victor Finn.

PERFORMING RIGHTS SOCIETY (PRS), 15 Herbert Street, Dublin 2, 01.614 844, Fax: 01.613 789, Chief Exec: Hugh Duffy.

PHONOGRAPHIC PERFORMANCE (IRELAND), Temple Road, Temple Hall, Blackrock, County Dublin, 01.288 2464/567, Fax: 01.283 3504, GM: Oliver F. Sheridan.

POPULAR MUSIC INDUSTRY ASSOCIATION, 70 Merrion Square, Dublin 2, 01.611 840, Sec: Keith Donald.

RIMPA, 2 Kilmorony Close, The Donahies, Dublin 13, 01.729 714, President: Michael O'Riordan, Sec: Shay Hennessy. Music publishers association.

PUBLIC RELATIONS & RECORD PROMOTION

CHRIS ROACHE PUBLICITY, 16 Upper Pembroke Street, Dublin 2, 01.612 364/612 228, Fax: 01.619 854, MD: Chris Roche.

DONAL K O'BOYLE, Bunbeg, Letterkenny, County Donegal, 01.353 075, MD: Donal K O'Boyle.

FREEBIRD RECORDS, 1-2 Eden Quay, Dublin 1, 01.731 250, Fax: 01.731 250, Partners: Des Kiely, Brian Foley.

HEADLINE NEWS, 8 Crow Street Dublin 2, 01.777 930/349, Contact: Terry O'Neill.

LIP SERVICE, 130 Slaney Road, Dublin Ind Estate, Glasnevin, Dublin 11, 01.304 815, Fax: 01.303 736, MD: Oliver Walsh, Contact: Justin Green.

MICHAEL HUTCHINSON ASSOCIATES, 5 Clyde Lane, Ballsbridge, Dublin 4, 01.682 036/43, Fax: 01.682 286, Contact: Michael Hutchinson.

THE NETWORK AGENCY, 23-25 Moss Street, Dublin 2, 01.770 643, Fax: 01.770 131, Dirs: Sandy Fitzgerald, Maeve O'Sullivan. PR & marketing for arts and community groups. Clients: The Arts Council (Dublin), Dublin Street Carnival, City Arts Centre (Dublin).

PAT EGAN PROMOTIONS, 24 Merchants Quay, Merchants Court, Dublin 8, 01.798 080/797 700, Fax: 01.797 495, Contact: Pat Egan.

QUALITY ARTISTS MANAGEMENT, 16 Parnell Square, Dublin 1, 01.743 906, Fax: 01.786 487, MD: Oliver Barry.

WORDS & MUSIC, 13 Trinity Street, Dublin 2, 01.795 077/091, Fax: 01.679 5097, MD: Jackie Hayden.

PLATING, MASTERING & PRESSING PLANTS

LANSDOWNE SOUND STUDIOS, 8 Upper Grand Canal Street, Dublin 4, 01.606 852, Fax: 01.609 409, Dir/Studio Mgr: Tom O'Donoghue. Mastering.

TREND STUDIOS, 9 South Prince's Street Dublin 2, 01.713 544, Fax: 01.710 042, MD: John D'Ardis. CD pre-mastering.

WINDMILL LANE STUDIOS, 4 Windmill Lane, Dublin 2, 01.713 444, Fax: 01.718 413, Dir: Brian Masterson, Studio Mgr: Fiona Whelan.

TAPE CUSTOM DUPLICATORS

ANR COMMUNICATIONS, Stillorgan Industrial Park, Unit T4, Blackrock, County Dublin, 01.952 221, Fax: 01.952 193, Contact: Jorgan Andreason. Video tape duplication.

APEX ELECTRICAL, 56 Moore Street, Dublin 1, 01.729 998/364, MD: Joe O'Reilly.

RINGSEND ROAD STUDIOS, 20 Ringsend Road, Dublin 4, 01.685 567, Fax: 01.685 352, MD: Andrew Boland, Studio Mgr: Colm Sexton.

SULAN STUDIOS, The Mills, Ballyvourney, County Cork, 026.45123, Fax: 026.45123, MD: Tadhg Kelleher, Bookings: Rosarie Dineen.

TREND STUDIOS, 9 South Prince's Street, Dublin 2, 01.713 544, Fax: 01.710 042, MD: John D'Ardis. Audio cassette duplication; Annual cap: 3 m.; Min order: 100.

BLANK & BULK RAW TAPE

3M IRELAND, Adelphi Centre, Adelphi House, Dun Laoghaire, County Dublin, 01.280 3555, Fax: 01.280 3509, Sales Dir: Tony Senior.

AGFA-GEVAERT, Naas Road, John F Kennedy Drive, Dublin 12, PO Box 368A (Zip: 12), 01.506 733, Fax: 01.519 613, Sales Dir: M Glynn.

BASF IRELAND, Frascati Road, Enterprise House, Blackrock, County Dublin, 01.283 2888, Fax: 01.283 2671, Sales Dir: Joseph Keegan.

FUJI IRELAND, 78 Lanagan Road, Glasnevin, Dublin 11, 01.309 511, Fax: 01.309 351, Sales Dir: Leo O'Connor.

PEATS WHOLESALE, 2 Chapel Lane, Parnell Street, Dublin 1, 01.722 577, Fax: 01.722 642, Contact: Bernard Creery. Distribute TDK.

SONY (IRELAND), 82 Broomhill Road, Tallaght, Dublin 24, 01.519 311/008, Fax: 01.510 045, Sales Dir: John Jordan.

**Tell Them You Saw
It In Billboard's
1992 International
Buyer's Guide.**

ITALY

RECORD COMPANIES

AAA PROLOGO, Via Rossini 8, 20090 Cesano Boscone (MI), 02.450 1984, Fax: 02.4860 0310, President: Aldo Pagani, Promo: Angela Tarenzi, Artistic Dir: Piero Cotto. Labels (owned): Paganmusic, On the Rocks, Ivoire, AAA Prologo, Eleven, Elevegreen.

ACV, Via Tommaso da Celano 5, 00179 Rome (RM), 06.780 6441/66, Fax: 06.780 6719, President: Tony Verde, Int'l Mgr: Ciro Verde, Promo: Daniela Fusco.

ALA BIANCA GROUP

Via Mazzoni 34-36, 41100 Modena (MD), 059.223 897/719, Fax: 059.219 218, Tlx: 512087, President: Tony Verona, MD: Maurizio Bettelli, Area Mgr (Benelux): Henry Lessing, Label Mgr: Guido Felicani, Int'l Dept: Alessandra Garagnani, Int'l Mgr: David J Smith, Admin: Emilia Pancaldi, Copyright: Carla Giovanardi. Labels (owned/distributed by): River Nile Records/CGD-WEA, Bravo Records/CGD-WEA, Flea Records/Non-stop Distribution, Mighty Quinn Records/Flying Distribution, In-Lite Records/Flying Distribution; Main product: Adult Contemporary, Jazz, New Age, Dance, House, Album Rock.

ALA RECORD, Via Provinciale, 89025 Rosarno (RC), 0966.773 682, Fax: 0966.773 682, MD: Antonio La Ruffa.

ALPHARECORD, Via G. Rossa 2, 20040 Burago Mogora (MI), 039.660 659, Fax: 039.681 287, Dir: Mario Tiesi.

ALTA MAREA, Galleria del Corso 4, 20122 Milan (MI), 02.702 357, GM: Bruno Tavernese. Distribution: Dischi Ricordi.

AMICI, Via Città di Castello 19, 00191 Rome (RM), 06.306 0533/4, Fax: 06.333 0584, Contact: Edoardo Vianello.

AMTAL RECORDS/AMTAL BLADE, Via della Colonna 27, 50121 Florence (FI), 055.248 0940, Mgr: Simone Fringuelli, Promo: Fabrizio Biasiolo.

ANALOGY, Via Tremonti 84, 98100 Messina (ME), 090.49421, MD: Angelo Pepe.

ANDROS MUSIC, Via San Angelo dei Ricchi 57-59, 70031 Andria (BA), 0883.23986, Fax: 0883.557 353, MD: Mimmo Cristiani.

ARCADE ITALY, Via Amedei 9, c/o Sony Music Italy, 20123 Milan, 02.8536, Fax: 02.860 175, PR Dir: Nicolette van Galen. Main product: Adult Contemporary, Jazz, Country, Reggae, Dance, Album Rock, Gold/Oldies, Black (R&B).

ARIANOVA, Viale Salandra 10/c, 70124 Bari (BA), 080.364 281, MD: Mario Benardi.

ARISTON GROUP, Via G. Frua 6a, 20146 Milan, 02.4800 5039, Fax: 02.498 9537, President: Alfredo Rossi, MD: Sandro Delor, Head Of Int'l: Bob Lumbroso, Label Mgr: Andrea Rossi, Admin: F. Marulli. Labels (owned): Ariston, Jingle, Background Music, Jazz Italy, Music Pop. Vinyl Pressing at: Via Gorki 21, 20098 S. Guil Milanese (MI), 02.984 6974, Fax: 02.984 1410.

ARMONIA, Piazza G. Monaco 2, 52100 Arezzo (AR), 0575.354 087/0337.675 159, MD: Giuseppe Tinti.

ARRESTO CARDIACO, Via Leopardi 10, 09010 Portoscuso (CA), 0781.508 496, MD: Albert Cadeddu, Producer: Marco Maiani. Labels (owned): Arresto Cardiac, Arresto del Rio, Al Fatah; Main product: rock, punk, industrial; also, wholesale and mail order.

ART RECORDS, Via Lazzaro Palazzi 2/A, 20124 Milan (MI), 02.203 842/271 5684, MDs: Carlo Stretti, Ernesto Tabarelli.

ASA RECORDS INT'L, Via E. Fermi 1/7, 20090 Opera (MI), 02.5760 6635, Fax: 02.5760 6646.

ASIA RECORDS, Via Cao Pra 54, 37060 Verona (VR), Fax: 045.984 359, Owners/Artistic Mgrs: Giuliano Crivellente, Mauro Farina, GM/Owner: Florian Fadinger, Admin Dir: Christina Zoccatelli. Labels (owned): Asia, Meal Power, Factory; (Lic): Beaver.

ATLANTIDE MUSIC NETWORK, Via Crocefisso 4, 24100 Bergamo (BG), 035.223 335, Fax: 035.247 019.

ATLAS RECORDS, Corso Buenos Aires 10, 20124 Milan (MI), 02.2940 5972/209 953/4, Fax: 02.225 562, Tlx: 333414, President: Alessandro Coppola.

AUTOSTOP MUSIC, Via Bricco 1/3, 17040 Cadibona (SV), 019.89160, MD: Giuseppe Genta. Labels: Autostop, Fragola, Gomitolo, Turbodiesel.

BEST INTERNATIONAL, Via Monte Rosa 74, 20149 Milan (MI), 02.4800 7289, Fax: 02.481 9071, MDs: Roberto Duca, Adelfo M. Forni.

BABY RECORDS (ITALY), Via Timavo 34, 20124 Milan (MI), 02.607 1474/266, Fax: 02.689 8701, President: Freddy Naggiar, MD: Monica Dahl. Distribution: Polygram.

BALLA CON NOI/SOLEDA, Via Tansini 29, 29100 Piacenza (PC), 0253.455 629/754 784.

BANANA RECORD, Piazza Duccio 7, 00192 Rome (RM), 06.361 2801, Fax: 06.361 0610, President: Giancarlo Meo.

BANG BANG RECORDS (ITALY), Via Carlo Torre 24, 20143 Milan (MI), 02.8940 9895, Fax: 02.837 6374, MDs: Federico Nuggiar, Giorgio Oddoini. Labels (owned): Bang Bang, Bis Bas, Disco Doc, Star Track.

BARLEY ARTS PRODUCTIONS, Via Bellotti 7, 20129 Milan (MI), 02.7600 9400, Fax: 02.7600 9071, MD: Claudio Trotta.

BASE RECORDS, Via Collamarini 26, 40138 Bologna (BO), 051.534 697, Fax: 051.538 017, Tlx: 511483, President: Giuseppe Nannucci. Labels (owned): Agenda, Base

Records, Motor Show; (Lic): Black Lion, Factory, Gorecord, Gull Records, Neat Records, Uniteledis, Candid, Freedom, Magic Music, Giucar Records.

BEAT RECORDS COMPANY, Via Filippo Nicolai 16, 00136 Rome (RM), 06.349 8458, Fax: 06.349 8094, GM: Franco De Gemini, Int'l Mgr: Luciana Morello De Gemini.

BEBA RECORDS, Via Lago di Patria 7, Palazzo Siviglia, 80014 Lago Patria Giugliano (NA), 081.509 2515/935, MD: Domenico Barrella, Mgr: Antonio Benadduce. Labels: Basky, Beba, Bra.

BEBAS RECORD, Via Magellano 5, 20094 Corsico (MI), 02.440 5551, MD: Bruno Barbone.

BELMUSIC, Via Termopili 20, 20127 Milan (MI), 02.282 8905/9473, Fax: 02.282 8905, Pres/Sound Eng: Severino Pecchenini, MD: Domizia Gandolfi, Sound Engineer: Rosolino Croce. Labels (owned): Belmusic, Piggy, Gemini; Main product: Folk, Children.

BEST SUNSET, Via False 33, 36050 Montaviale (VI), 0444.552 600, Fax: 0444.552 688, President: Paola Gatto, Art Dir: Alfredo Tisocco, Sales Mgr: Alberto Brendolin. Labels (owned & distr): Artis; (Lic & distr): Cramps; Main product: Adult Contemporary, New Age, Ethnic.

BHF PRODUCTIONS, Via Campagnola 90, 35137 Padova, 045.862 0927, Fax: 045.862 0937, Owner: Paul Bisnach.

BMG ARIOLA ITALY (MILAN), Galleria del Corso 2, 20122 Milan (MI), 02.7600 4737, Fax: 02.7601 5026, Tlx: 310689 bmgmi, Promo Dir: Michele Mondella, Promo Mgr: Antonella Camera.

BMG ARIOLA ITALY (ROME), Via di Sant' Alessandro 7, 00131 Rome (RM), 06.419 951, Fax: 06.4199 5474, Tlx: 610428 bmgmi, MD: Franco Reali, Mktg Dir: Giorgio Ferris, A&R Dir: Popi Fabrizio, Manufacturing Dir: Benito Bolle, Bus Affairs Dir: Ettore Zeppegno, Fin Dir: Franco Pallotta, Ad & Promo Dir: Michele Mondella. Labels (owned): RCA, Ariola, Arista, Bluebird; (Lic): Motown, Zomba (Jive, Silvertone), Island, Private Music, EDIG, IT, Cantare in Italiano, Ribot, Time Music, Pressing, DDD, Zerolandia, MCA, Geffen; (Distr): GRP, Windham Hill.

BMS RECORDS, Via Panzano 219, 41013 Castelfranco Emilia (MO), 059.927 210, Fax: 059.920 256, Tlx: 512087, MD: Dino Melotti.

BORGATTI, Via Calzavecchio 38, 40033 Casalecchio di Reno (BO), 051.571 899, MD: Paolo Borgatti, Promo/PR: G. Franco Borgatti. Labels: Borgatti, Disco Jeans, Pretty Cats.

BUBBLE RECORDS, Via Romeo Romei 15, 00136 Rome (RM), 06.311 280/870.

BULLDOG, Via Manara 5, 20122 Milan (MI), 02.846 3000, Tlx: 350512, Mgr: Massimo Buffa.

BUMSHIVA MUSIC, Via G. Rossa 12, 20089 Rozzano (MI), 02.824 3705, Fax: 02.824 3705, MD: Luigi Fedele. Main product: Dance, Album Rock, New Age.

CLS RECORDS, Via Volturino 80, Condominio dei Fiori, 20047 Brugherio (MI), 039.879 085, MD: Detto Mariano.

CAM, Via Virgilio 8, 00193 Rome (RM), 06.687 4332/227/290, Fax: 06.687 4046, Tlx: 621195 camrom, Owner: Giuseppe Campi, MD: Francesca Campi.

CANARIA, Via Santa Lucia 20, 80132 Naples (NA), 081.415 643/411 228, MD: A. Guzzo.

CAPITAN, PO Box 359, 42100 Reggio Emilia, 0522.25314.

CARNEVAL, Corso Palermo 75, 10154 Turin (TO), 011.858 037, MD: Piera Nocera, Promo Dir: Marisa Nocera.

CAROSELLO CEMED, Galleria del Corso 4, 20122 Milan (MI), 02.793 008/7602 3008, Fax: 02.7601 4504, Tlx: 332683, President: Giuseppe Gramitto Ricci, MD: Alfredo Gramitto Ricci, Int'l: Isa Sordelli, Elena Galimberti, Press/Promo: Alda Faidutti, Tony Martucci. Distribution: Dischi Ricordi.

CASA MUSICALE ECO, Via Giovanni Battista Lulli 5, 20131 Milan, 02.2951 8096, Fax: 02.2951 8096, Art Dir: Eugenio Consonni, Prod Dir: Giampaolo Geravini. Main product: Classical.

CAVALIERI & COMPANY, Via Isonzo 206, 70125 Bari (BA), 080.224 610/226 880, Fax: 080.224 947, MD: Lino Cavalieri.

CDF, Via Montebello 21, 10124 Turin (TO), 011.836 409, MD: Tony Carrino, Ed Dir: Bruno Trucco. Labels: CDF, Okay Records.

CEDI, Via Caboto 35, 10129 Turin (TO), 011.503 366-8, Fax: 011.501 516, GM: Gabriele Calegro Dell'Utri.

CENTOTRE EDIZIONI MUSICALI, Via Minghetti 41/4, 40038

Vergato (BO), 051.911 163, Fax: 051.911 991, MD: Luigi Barion. **CGD MILAN**, Via Ugo Foscolo 1, 20121 Milan (MI), 02.721 281, Fax: 02.7212 8300, Tlx: 315086 cgdmil, President: Marco Antonio Bignotti, MD: Stefano Senardi, Mktg Dir: Andrea Rosi, A&R Dir: Tino Silvestri, Comm Dir: Giancarlo Spadacenta, Rome Office Dir: Tullia Brunetto, Promo Mgr: Luciano Linzi, Int'l Mgr: Alda Dury. Labels: Atco, Atlantic, Esperanza, First Priority, Immediate, Megaforce, Ruthless Record, Swan Song, Yes, Interscope, Third Stone, Titanium, CGD Pooh, CGD Vanilla, CGD Warner Chappel, Ala Bianca, Clan, Emergency, Five, Frizitaliana, La Mela Vip, Materiali Sonori, Target.

CGD ROME, Viale Mazzini 114b, 00197 Rome (RM), 06.310 881/380 403, Fax: 06.370 0046, Promo Dir: Tullia Brunetto.

CHEYENNE RECORDS, Via Croce del Piperno 42, 80124 Naples (NA), 081.728 4222/766 1535, Fax: 081.766 3080, Artistic Advisor: Gino Magurno.

CINEVOX RECORD, Via Romeo Romei 15, 00136 Rome (RM), 06.325 1570/80, Fax: 06.372 2190, Tlx: 616241 cinbox, President: Carlo Bixio, GM: Franco Bixio, A&R Mgr: Gianni Dell'Orso, Int'l A&R: Miriam Westercappel. Labels: Bubble Record, Gale International, Pump!

CIPO CIPO RECORDS, Corso Cavour 372, 19100 La Spezia, PO Box 27 (Zip: 19100), 0187.717 959/73, Fax: 0187.529 048, Producer: Giorgio Mangora, Export Mgr: Patrizia Orlandi, Accountant: Enrico Mangora. Labels (owned): Seagull, Lobster, Manic Depr, Vultura, Beech Marten, Papillon; Format: CD, 'Live'.

CITY RECORD, Galleria del Corso 4, 20122 Milan (MI), 02.794 266, Fax: 02.794 266, MD: Alessandro Friggiere, A&R Dir: Ugo Arman, Music Consultant: Vittorio Inzaina, PR: Annamaria Bonomi. Labels: City, Metropol; Distribution: Continental.

CLAC RECORDS, Via Salvatore di Giacomo 73, 00142 Rome (RM), 06.541 1225, Fax: 06.540 1615, Tlx: 610366 panass, Chmn: Giulio Albamonte, MDs: Piero Calabrese, Massimo Calabrese, Marco Lecci. Labels (lic): Arena Flarenasch, Carere, Pathe Marconi EMI (Fra), Don Disco (Spa), Gama (Ger), Supraphon (Cze), Polarvox (Fin), PolyGram, Durium; (Distr): Phrases.

CLOU DISQUE, Via Bolzano 28, 20127 Milan (MI), 02.289 5421/284 1905, Fax: 02.289 5822, MD: Pino Scarpettini, Promo: Paola Rosmini.

CONTEMPO INTERNATIONAL, Corso de' Tintori 8-16, 50122 Florence (FI), PO Box 1369 (Zip: 50122), 055.234 5555, Fax: 055.234 5888, Chmn: Giampiero Barottti, Import Mgr: Nicola Vannini, Export Mgrs: Aldo Mey, Dar Luciano, A&R/Label Mgr: Sebastian Koch, Promo Mgr: Gianpiero Giachery. Labels (owned): Contempo, Rosemary's, BBAT, Lacerba, Dischi Impero, Minus Habens, musica Maxima Magnetica; (Lic): 4AD, Wild, Nostradamus, Anterior; Main product: Indie, Underground, Trash.

CONTINI E M & RODGERS, Via G. Frua 7, 20146 Milan, 02.463 705, Fax: 02.4800 1178, MDs: Alberto Contini, Giancarlo Pasquini. Labels (owned): A Beat C, C&R, Volume; Main product: Dance.

COSTA EST, Via Fabio Massimo 95, Palazzo Borgognoni, 00192 Rome (RM), 06.314 341/321 0605, Fax: 06.311 777, GM: Willy David.

CRAMPS RECORDS, Via Caposite 2, 20137 Milan (MI), 02.5518 1630/07, Fax: 02.545 1692. Distribution: Best Sunset.

CREAMUS, Piazza Velasca 6, 20122 Milan (MI), 02.861 922, Fax: 02.874 892, Tlx: 326542, President: Michelangelo La Bionda, Mktg Mgr: Luca Todarello, A&R: Carmelo La Bionda.

CREPUSCULE, Via Trenno 32, 20151 Milan (MI), 02.308 6491, MD: Sergio Veschi. Labels: Next Step, Red Record.

CRESUS ENTERPRISES, Viale Bruno Buozzi 51, 00197 Rome, 06.376 1690/844 1844, Fax: 06.808 8025/841 9701, MD: Paul Mazzolini.

CRONOS, Via M. Colonna 16, 22100 Como (CO), 031.523 233, MD: Paolo Beretta.

CRUISIN' RECORDS, Via Bellini 65, 41100 Modena (MD), 059.225 940/902, Fax: 059.220 609, Tlx: 226390, President: Cinzia Macchioni, MD: Ennio Tricomi, A&R Mgr: Rossella Solmi.

CYCLOPE RECORDS, Via Duca degli Abruzzi 36, 95127 Catania, 095.386 075, Fax: 095.386 075, MD: Francesco

ALABIANCA

GROUP

PUBLISHING & RECORD COMPANY

WE ARE PROUD
TO BE
INDEPENDENT



Ala Bianca group s.r.l. Publishing and Record Company 41100 Modena Italy via Mazzoni 34/36 Phone 059/22897 Fax 059/219218

Virlinzi, Asst MD: Steve Perrin, Assts: Chiara Jemma, George Doukakis. Main product: Album Rock.
D'HERIN RECORDS, Via Silva 2, 10078 Venari (TO), 011.497 338, Fax: 011.495 560, MD: Rene D'Herin. Labels: D'Herin, Fantasy Metal, Hot Ice; 2nd office: Piazza Borromini 76, 10132 Turin, 11.885 858, Fax: 11.885 858.
DANIELE-KANSAS, Galleria Subalpina 30, 10123 Turin (TO), 011.542 735/232 546, MD: Seren Gay.
DDD (DROGUERIA DI DRUGOLO), Via Vittoria Colonna 23, 20149 Milan (MI), 02.481 9209, Fax: 02.469 0139, Tlx: 353366, MD: Roberto Galanti, Int'l Mgr: Donatella De Gaetano, Int'l Dept: Licia Galanti. Labels (owned): DDD, Vitamin.
DELTA MUSIC, Corso Buenos Aires 10, 20124 Milan (MI), 02.2940 5972, Fax: 02.225 562, Tlx: 333414 escim, MD: Alessandro Coppola, Artistic Advisor: Massimo Parretti, Promo Dir: Daniela Festari, Promo Mgr (Radio): Claudio Meroni.
DIG IT INTERNATIONAL, Via Orombelli 7/11, 20131 Milan (MI), 02.235 102/366 609, MD: Max Bugatti.

DISCHI RICORDI

Via Berchet 2, 20121 Milan (MI), 02.8881, Fax: 02.888 1270, Tlx: 310177 ricor, President: Guido Rignano, GM: Fabio Boldi, Int'l Mgr: Franco Dedevisi, Label Mgr: Patrizia Meazza. Labels (owned/lic): Attic, A.V.M., Beggar's Banquet, Chapter 22, Cherry Red/EL, Cooking Vinyl, Creation, Cypress, Gama, Ghetto, Island, Logo/Transatlantic, Malaco, Mute, Off The Track, One Little Indian, Ranwood, Razor, Rhino, Rhythm King, Ricordi, Ricordi Int'l, Rough Trade, Savoy Jazz, Sonet; (Dist): Ariston, Bollicine, Bubble, Casorello, Carrere Italy, Cinevox, CLS, D'Angelo Production, Divox, Durium, Fonit Cetra, Frequenz, Gala, GN, Green Line, Heinz, Italian Ipersazio, Kono, Lupus, Merak, Movimento Musica, Muvicom, N.A.R., New Tone, Nuova Marca, OM (Riverside, Prestige, Pablo, Fantasy), Panareco, Sintesi 3000, Spinnaker, Together, Yep, 21 Edizioni Musicali.

DISCHIMIA, Via Desenzano 6, 20146 Milan, 02.843 9950, Producer: Flavio Ferri, Promo (Radio/Media): Roberta Benedetti, Concert Promo/Artist Mgr: Paolo Storti.
DISCO 3, Via Lessona 2, 20157 Milan, 02.3900 0568. Distribution: SAAR.
DISCO MAGIC, Via Mecenate 78a, 20138 Milan (MI), 02.506 3842-4, Fax: 02.506 4675/89, Tlx: 326350 magic, President: Severino Lombardoni, MD (Int'l): Anna Lombardoni, F&A: Giacomo Maiolini, Import/Export: Alessandro di Francesco, Mario Fraisi, A&R/Sales Mgr: Fabrizio Giruzzi, Label Mgr: Alberto Contini. Labels (owned): Discmagic, High Energy, Lombardoni, Metalmaster, Out; (Dist): Finzy, Groove Groove Melody, Macho, Radiorama, Time; Distribution: self, EM.
DISCO TEAM, Via della Costituzione 8, 52037 Sansepolcro (AR), 0575.735 985, Fax: 0575.735 985, MD: Luigi Medori, A&R Dir: Patrizia Canosci.
DISCOKIO/ORG. GIORGIO VINCIS, Corso Italia 4/6, 17100 Savona, 019.821 770/145, Fax: 019.821 378, MD: Giorgio Vincis, A&R Dir: Donatella Genoni, Mktg Dir: Cinzia Gabossi, Promo Dir: Cinzia Frontari.
DISCOLACCIO RECORDS, Via Emilia 20, 35047 Solesino (PD), 0429.708 511, Fax: 0429.708 511, Art Dir: Gianluigi Cavaliere, Public Relations: Roberto Toso.
DRUMS EDIZIONI MUSICALI, Via Camerana 28, 10128 Turin (TO), 011.553 095/517 258, MD: Mario Mattio, Admin: Chiara Torcasso.
DUCALE, Via per Cadrezzate 6, 21020 Brebbia (VA), 0332.770 189/784, Fax: 0332.771 047, Tlx: 380231 ducale, MD: Davide Matalon. Labels: Arion, Bainbridge, Drive, Ducale, Fidelio, Pausa, Sound, Vivace.
DUCK RECORDS (ITALY), Via Leonardo da Vinci 24, 20094 Corsico (MI), 02.4860 0800, Fax: 02.4860 0761, MD: Bruno Barbone, Comm Dir: Gianni Domaschio, Int'l Mgr: Luigi Fedele, Promo Mgr: Emanuele Pirrello. Labels: Duck Gold, Bebas, Butterfly, Dixie Live, Dub, Duck, Green, Intensity.
DYNAMIC, Via Mura di Chiappe 39, 16136 Genoa (GE), 010.214 584, Fax: 010.214 584, Pres/GM: Pietro Moselli Casaretto, Artistic Dir: Edward Neill, Graphics Dir: Luisa Dagnino. Labels (owned): Dynamic; Main product: Classic; Distribution: Florence International.
EASY RECORDS ITALIANA, Via Nomentana 1111, 00137 Rome (RM), 06.827 5266/8305, Fax: 06.808 4608, MD: Claudio Mattone.
EDELWEISS RECORDS, Cannaregio 6125, 30131 Venice (VE), 041.520 7526, Fax: 041.520 8905, President: Daniel Levy, Dep Dir-Gen: Luciano Porru, PR/Promo: Roberto de Langes.
EDI-PAN, Viale Mazzini 6, 00195 Rome (RM), 06.385 574/322 5952, Fax: 06.322 3471.
EDIZIONI CAPITAN, Via Antonio Peretti 11, 42100 Reggio Emilia (RE), 0522.25314, MD: Carlo Cavazza, Comm Dir: Dimma Borghi. Labels: Capitan, Diamond, Excelsior, Jaguar, Minerva.
EDIZIONI PAOLINE, Via Portuense 746, 00148 Rome (RM), 06.685 0051, MD: Eligio Ermeti. Labels: EP, Hit; warehouse address: Via IV Novembre 19, 00041 Albano Laziale (RM), 6.932 2228/9.
EMI ITALIANA (MILAN), Piazza San'Agustino 6, 20123 Milan (MI), 02.8940 1061, Fax: 02.8940 5895, A&R/Pror: no Mgr: Roberto Gasparini.
EMI ITALIANA (ROME), Via Muggia 21, 00195 Rome (RM), 06.325 1246-9, Fax: 06.325 1248, MD: Michele Di Lernia.
EMI ITALIANA, Via Bergamo 315, 21042 Caronno Pertusella

(VA), 02.96511, Fax: 02.965 6002, Tlx: 312679 emital, MD: Roberto Citterio, Mktg Co-Ord: Beppe Ciaraldi, Int'l Repertoire Mgr: Nico Spinosa.
ENERGY PRODUCTION, Viale Mazzini 140, 00195 Rome (RM), 06.384 886/385 859, Fax: 06.370 0542, MDs: Dario Raimondi, Alvaro Ugolini (Int'l/A&R), Sec: Barbara Ugolini, Lawyer: Kendall Minter. Labels (owned): X-Energy, Fun Records; Main product: Dance.
ERMITAGE, Piazza Trento Trieste 1, 40136 Bologna (BO), 051.341 754, MD: G Salvini. Distribution: Dischi Ricordi.
ERREBIESSE, Via Matteotti 5, 22050 Paderno d'Adda (CO), 039.513 844. Labels: Albatros, Ars Nova, RBS, Vedette.
ESAGONO RECORD, Via Lodovico il Moro 119, 20143 Milan (MI), 02.470 886, Fax: 02.4830 0971, MD: Marco Inghirami, A&R: Michele Violante, Int'l: Marisa Casazza.
ESTATE RECORD, Via Rovereto 8, 20127 Milan (MI), 02.287 1290, MD: Cosimo Bomba.
EUTERPE, Via Bolzano 12/3, 16166 Genoa (GE), 010.332 239, Fax: 010.332 239, MD: Giustino Meneghini. Labels: Fashion, Microfon, Sparrow, Voice.
EXPANDED MUSIC, Via Belvedere 10, 40121 Bologna (BO), 051.222 228, Fax: 051.263 509, President: Giovanni Natale. Labels (owned): DFC, Expanded, Italian Records, Third Label.
FESTA, Via D. Fontana 64 bis, 80129 Naples (NA), 081.741 0561, Fax: 081.552 0878, MD: F. Coppelo.
FIUMARA, Via dell'Adda 41, 20041 Agrate Brianza (MI), 039.650 983/9. Labels: Match, Mister, Pagine Immortali.
FIVE RECORDS, Corso Europa 48, 20093 Cologno Monzese (MI), 02.2514 7536-40, Fax: 02.2514 7499, Tlx: 326582/316197, President: Adriano Bioicchi, Chmn: Luigi Lacchini, Prof Mgr: Vladimiro Albera, Int'l Mgr: Gianfranco Finamore, Press/PR: Luciano Giacotto, A&R: Augusto Martelli. Labels (owned): Five, Publifive, Pop Corn, (Lic): Equinox, Legacy, Ichigan (UK), Sherman (Ger); Distribution: CGD.
FLIPPERMUSIC, Piazza Prati Sirozzi 31, 00195 Rome (RM), 06.315 615/383 146, Fax: 06.318 426, Tlx: 620266, Pres/MD: Romano Di Bari, Sales: Gialluca Quarto.
FLORENCE INTERNATIONAL, Via Camillo di Cavour 60, 50129 Florence (FI), 055.216 645, Fax: 055.284 058, MD: Roberto Bartoli, Asst: Marina Manetti. Labels (owned): Cherubini, Europa; Main product: Classical.
FMA EDIZIONI MUSICALE E DISCOGRAFICHE, Via Enrico Toti 4, 20123 Milano, 02.435 093/463 920/4801 2493, Fax: 02.4819 4098, MD: Davide Allione. Labels (owned): Bull & Butcher Recordings, FMA; Main product: Dance.
FONOLA FONOTECNICA, Via Ariberto 21, 20123 Milan (MI), 02.8940 4626/835 4626, MD: Marco Braga. Labels: Astra, Fonola, Melody, Revival, Souvenir.
FONOPRINT, Via De' Colteili 5/2 ab, 40124 Bologna (BO), 051.228 022/266 714, Fax: 051.234 634, Tlx: 511299 api bo, President: Luciano Nicolini, MD: Paola Cevenini, Tech Dir: Sandro Sandrolini.
FONTANA, Corso Venezia 7, 20121 Milan (MI), 02.760 027/782 407, MD: Tito Fontana, Contact: Ferdinando Arno. Labels: Dire Jazz/Arte/Music.
FRANCESCO BONGIOVANNI DISCHI, Via Rizzoli 28a, 40125 Bologna, 051.225 722, Fax: 051.226 128, President: Giancarlo Bongiovanni, Mktg Dir: Andrea Bongiovanni. Main product: Classical, Soundtracks.
FRANTON RECORDS, Via San Girolamo 7, 30174 Mestre (VE), 041.959 055, Fax: 041.959 991, Tlx: 223545, President: Tony Tasinato, MD: Francesco Sanavio.
FREMUS, Via Adda 29, 20041 Agrate Brianza (MI), 039.650 962, Fax: 039.654 434, MDs: Maria Rita Reitano, Gege Reitano.
FULL BEAT PRODUCTION, Via Bazzoni 1, 00195 Rome (RM), 06.312 006, Fax: 06.325 0677, President: Faber Cucchetti, MD: Ennio Baldelli. Label (owned): Mix Juice; Distribution: New Music.
FULL TIME PRODUCTION, Via Friuli 51/1, 20135 Milan (MI), 02.5518 7344/344, Fax: 02.5518 7484, President: Franco Donato, Prod/Sales Mgr: Enzo Barbieri, Art Dir: Paola Grasselli, Int'l Dept: Ghada Choulak, Acct Mgr: Ermanno Scalerandi. Labels (owned): London Street, Dance Classics, Spice 7, Mr Disc, Good Vibes, Yenon, Jooks, Full Time Records; (Lic): Unidisc, Mantra, Megatone Records, Prelude; Main product: Dance.
GDM, Via Ponte Nuovo 24, 20128 Milan (MI), 02.259 2695, MD: Maurizio Truglia. Labels: Alemar, Amazzonia, America, Hit Record, Tasmania, Top Sound.
G7 RECORDING STUDIO, Via Mercanti 16, 10122 Turin, 011.540 328/547 748, Fax: 011.510 560, President: Gualtiero Gatto, Dir: Marcello Quarantone.
GALA RECORDS MUSIC, Via Leonino da Zara 6, 35020 Albignasego (PD), 049.862 5456/5510, Fax: 049.862 5501, President: Umberto Marcato, Mktg Dir: Dino Marcato, Int'l Mgr: Paolo Checchetto, A&R Dir: Enrico Santacatterina, Admin Dir: Catia Agostini. Labels (owned): Gala Records, Tema Records; Main product: Adult Contemporary, Jazz, Album Rock, Gold/Oldies.
GALLETTI-BOSTON, Corso Mazzini 38, 48018 Faenza (RA), 0546.22235, MDs: Alessandra Galletti, Anna Galletti, A&R Dir: Walter Pergoli. Labels: Boston, Edig; Distribution: BMG Ariola.
GIPIESSE, Via G B Bertini 5, 20154 Milan (MI), 02.349 4145/797, Fax: 02.349 0548, Tlx: 315413 gipies, MD: Gian Piero Simontacchi, Admin: Maria Cantadore Simontacchi, Marina Lucioni.
GLOBO RECORDS (ITALY), Via Ildebrando Vivanti 34, 00144 Rome (RM), 06.598 4835, Fax: 06.598 4486, Tlx: 614296 andisn, MD: Cesare Benvenuti, Label Co-Ord: Andrea Cocchi, Promo Dir: Leonardo Alessandrini.

GREEN LINE RECORDS, Via Piemonte 22, Frazione Sesto Uitto, 20098 San Giuliano Milanese (MI), 02.9828 0828, Fax: 02.9828 0850, MD: Graham Johnson, A&R Mgr: Maurizio Re.
HEINZ MUSIC, Corso Genova 24, 20123 Milan (MI), 02.832 1231/1206, Fax: 02.835 8540, President: Roberto Dane.
HIGH TIDE, Via San Girolamo 7, 30174 Venice, 041.959 055, Fax: 041.959 991, President: Tony Tasinato, GM: Francesco Alaimo. Labels (owned): High Tide, DJ Tech; Main product: Adult Contemporary, Jazz, Dance, New Age.
I SOLUZIONISTI, Largo dell'Olgiate 15-Isola 59-3/2, 00123 Rome (RM), 06.378 9764/374 5748, Fax: 06.378 9995, MD: Oderso Rubini, Dir: Stefano Bonagura, Promo: Marie Jose' Furcy. Labels (owned): Stile Libero, Caesar Records; Distribution: Virgin; Main product: New Age.
INTERBEAT EDIZIONI, Via Alessandro Stradella 174, 00124 Rome (RM), 06.609 5353, Fax: 06.609 7200, MD: Stefano Piergiorgio, GM: Luigi Piergiorgio, Mktg Mgr: Claudio Poggi, Promo Dir: Tonino Corvino. Labels (owned): Interbeat; (Lic): Blitz, Ellecci, Gold, Magnum, Moonlight, Movie, Picci, Zound; Distribution: Warner Italiana.
INTER SOUND & SOFT, Loretostrasse 47-49, 39040 Salurn (BZ), 0471.884 646, Fax: 0471.884 646, MD/Sound Eng/Programmer: Constantin Coreth.
IREC, Via San G.B. De La Salle 4, 20132 Milan (MI), 02.259 2326, MD: Giovanni Bonandrini. Labels: Appaloosa, Black Saint, Soul Note; Distribution: I.R.D.
IRMA RECORDS/DISCOIN, Via de' Carracci 6, 40129 Bologna (BO), 051.353 666, Fax: 051.356 326, GM: Massimo Benini, Int'l Co-Ord: Daniela Milesi, Music Dir: Umbi Damiani, Claudio Rispoli, Label Mgr: Cesare Collina. Labels (owned): Irmacasadiprimordine, Calypso Records, Eviva Records, Calpirinha; (Lic): Onizom Music, Antima Records, Atmo Music, Trance Records, Final Groove; Main product: Dance.
IT DISCHI ITALIA EDIZIONI, Via Guido Banti 46, 00191 Rome (RM), 06.327 3468/4043/4802, Fax: 06.333 8197, President: Vincenzo Micocci, MD/Promo: Stefano Micocci, MD/Bus Affairs: Francesco Micocci, Promo: Fulvia Martuscelli, Patriccia Guenzar, Roberta Retacchi, Fiore Durand. Labels (owned): IT, Unasorsconluxit; Distribution: BMG Ariola, Virgin.
JUMP EDIZIONI, Via F. Boccioni 1, 20136 Milan (MI), 02.546 3255, Fax: 02.5830 5166, MD: Dante Panzuti, Foreign Relations: Andrea Panzuti. Labels (owned): Jump, Rio, Power, Music Scene, Present, (Lic): Intersound, Prestation, Focus.

KALEIDOSCOPIC MUSIC

Viale Manzoni 52, PO Box 57, 00052 Cerveteri (Rome) (RM), 06.994 1925, 06.994 3022-3-4, Fax: 06.994 1915, 06.9943040, President: Ricky Zucchi, Import Mgr: Angelo Brini, Import/Export Mgr: Francesco Severati, Label Mgr: Robbie Zucchi, Mgr (Nat): Lillo Brini. Labels (owned): Kaleidoscopic Music, Underground, Insect Records, Gorgon; (Dist): Aulica, Anthology, Aulica Never Ends, Men At Work, Stonehenge, Red Phantom, Skeleton.
KARELL RECORDING STUDIOS, Via degli Ulivi 19, 00040 Lavinio (RM), 06.982 2518/969 5879, Fax: 06.968 2058, MD: Giancarlo Silva, VP: Erika Grassi, Promo: Manlio Goldner.
KEEP ON MUSIC, Via Pomezia 7, 20127 Milan (MI), 02.2611 2230, Fax: 02.2611 2240, MD: Ruggero Penazzo, Int'l Relations: Elisabetta Galletta. Distribution: DDD/BMG Ariola.
KING, Via Cilea 136, 80127 Naples (NA), 081.640 678, MD: Maria Rosaria Matone. Labels: Capri, Folk, Indios, King Universal, Paperino, Star, Vesuvio Records.
KING STEVE RECORDS, Via Donna Olympia 5, 00152 Rome (RM), 06.537 0666, Fax: 06.785 7858, MD: Pino Fiadini, Int'l: Stefano Zito. Labels (owned): King Steve; (Dist): A.R.D.M., Brooklyn, CGP Music, Crammed Discs, Crashed, Giro, King, K.S. Record, Heavy Load Metal, Help, Himalaya, Mask, Mauvaise Copie, Mill Metal, Scalp, Shiva, Steve Record, Studio B, Trade, Unni, VCM Studio.
KONO, Viale Lunigiana 40, 20125 Milan (MI), 02.667 251, Fax: 02.6671 3323, Tlx: 328579, President: Enrico Rovelli, Press: Monica Passonni. Distribution: Dischi Ricordi.
L'ORSA MAGGIORE, Via Gaspara Stampa 8, 20123 Milan (MI), PO Box 1533 (Zip: 20100), 02.805 6939, Chmn: Liborio Pusateri, MD: Loredana Cavagnini. Labels (owned): Frame, Braba, Jazz OP, Jazzway, Lady Dana; Main product: Jazz.
LA BARONI, Via Depretis 37, 27058 Voghera (PV), 0383.48064/6048, Fax: 0383.62373, MD: Romano Menini.
LA BOTTEGA DISCANTA, Via Neroni 5, 20123 Milan, 02.862 966, Fax: 02.7200 0642, MD: Luigi Graziosi.
LA ROCCA RECORDS, Via Brioschi 50/5, 20141 Milan (MI), 02.849 3357, Fax: 02.849 3357, MD: Meio Fideilo. Labels: La Rocca, Laser Show.
LABELLE MUSIC, Via Sidoli 17, 42020 Salvarano, Quattro Castella (RE), 0522.886 058, Fax: 0522.886 058, President: Larry Pignagnoli.
LARIANA EDIZIONI MUSICALI, Galleria del Corso 4, 20122 Milan (MI), 02.793 592/796 227, President: Paulino Pennacchioli, A&R Dir: Giancarlo Alati, Music Consultant: Gerardo Tarallo, Promo: Patrizia Zoccolo.
LASAPA, Via Zamenhof 21, 20136 Milan (MI), 02.839 7916/837 3551, Fax: 02.837 5852, MD: Silvana Areggasc Savorelli, Purchasing Manager: Pier Quinto Carriaggi.
LCS CLAN RECORDS, Via G. Modena 3, 20129 Milan (MI), 02.2040 9469/271 9469, Fax: 02.204 3155, Tlx: 314082 otrimi, MD: Luciano Andrisani.
LEONE RAMPANTE, Via alla Val 8, 38050 Povo (TN), 0461.810 170, Fax: 0461.810 170, MD: Ianes Francesco.

LES FOLIES RECORDS, Via Zara 20, 20052 Monza (MI), 039.741 6477/740 054, Fax: 039.200 1432, Tlx: 310850, GM: Sergio Pisano.

LOGO MUSIC, Piazza Verbanò 16, 00199 Rome (RM), 06.844 0231/687 0963, Fax: 06.687 2926, President: Lanfranco Gambini, Admin: Marina Gambini, Legal Adviser: Giorgio Gaetano, PR: Adelmo de Sanctis.

LIVE MUSIC, Via A Righi 3, 15100 Alessandria (AL), 0131.235 854, Fax: 0131.41287, Tlx: 221128, GM: Claudio Accatino, Promo: Federico Rimonti. Labels (owned): Live Music; Main product: Dance, Latin.

LUCAS RECORDS, Via Calabria 3, 87046 Montalto Uffugo (CS), 0984.931 156, Fax: 0984.931 156, MD: G Aspremonte.

LUNATIC RECORDS, Via G Reina 6, 00123 Rome (RM), 06.376 1690, Fax: 06.376 6286, MD: Paul Mazzolini, MD/Mktg Dir: Gustavo Romagna Manosa, A&R Co-Ord: Roberto Russo, Fin Exec: Paolo Bottai, Promo (Nat): Pasquale Mammalo. Labels (owned): Lunatic Records, Gaffe Records, Cresus Records; Distribution: BMG Ariola Italy; Main product: EHR, Adult Contemporary, Dance, Album Rock.

LUPUS, Via Prospero Santacroce 131/c, 00167 Rome (RM), 06.623 0739/622 8731, MD: Massimo Di Cicco, A&R Dir: Anna Di Cicco. Labels: Anaconda, Lupus, Move, Nuova Idea, Wolf International; Distribution: Dischi.

M C M RECORDS, Villa Colloredo, 62019 Recanati (MC), 071.982 022, Fax: 071.982 586, President: Enrico Ragni, MDs: Silvana Stroligo, Tina Paoltroni.

MAGIC SERVICE, Via Actobello 8a, 30172 Mestre (VE), 041.970 455, Fax: 041.974 245, President: Lucio Da Ru.

MANY EDIZIONI MUSICALI, Viale Bianca Maria 8, 20129 Milan (MI), 02.540 1389/548 3862, Fax: 02.548 3974, President: Stefano Scalera, Head PR/Promo: Lucia Pozzoni, Int'l Asst: Mary Mennelli. Labels (owned): Many Records, Palmares, Diva; Main product: Dance, House.

MARCO ZANI PRODUCTIONS, Via Osella 6 bis, 13011 Borgosesia (VC), 0163.25273, MD: Marco Zani. Labels: Free Dance, Marco Zani; Main product: EHR, Adult Contemporary, Country, Reggae, Dance, Album Rock, Black (R&B), New Age.

MARTON CORPORATION, Via Massena 2, 20145 Milan (MI), 02.349 0511/0630, Fax: 02.659 7051, MD: Claudio Cecchetto.

MATERIALI SONORI, Via Trieste 35, 52027 San Giovanni Valdarno (AR), 055.943 888, Fax: 055.912 0370, Tlx: 573436 report, President: Giampiero Bigazzi, MDs: Lucia Baldini, Francesca Pieraccini, Int'l Mgr: Annette Jarvie. Labels (owned): Materiali Sonori, Urgent Label, Fuzz Dance, Greetings; (Lic): Crammed Discs, Blast First, Les Disques du Crepuscule, Cicada, Rec Rec, Sordide Sentimental; Distribution: CGD.

MEDIA THE SOUND OF THE FUTURE, Via Martiri della Libertà 277-279/a, 25030 Roncadelle (BS), 030.258 2353, Fax: 030.258 2161, President: Gianfranco Bortolotti, MD: Diego Leoni, Int'l Mgr: Rita Di Luca, Promo Mgr: Franco Ghidini, Media & Promotion: Nicola Pollastri, Int'l Dept: Monica Pedrinelli. Labels (owned): Media (Black/White/Japan), Underground, Inside, GFB Records, Baia Degli Angeli.

MELODRAM, Via Cosimo del Fante 9, 20122 Milan, 02.5831 0083, Fax: 02.5831 0303, GM: Ina Felderer.

MEMORY RECORDS, Piazza della Repubblica 1, 43056 San Polo di Torrita, 0521.819 427, Fax: 0521.819 125, MD: Alessandro Zanni.

MILLEVILLE RECORDS, Via B Migliarina 8, 41010 Fossoli (MO), PO Box Millevil (Zip: 41010), 0337.562 262, Fax: 059.660 393, GM: Rino Filippin, A&R: Luca Filippin, Admin: Tiziana Colliva.

MINSTREL EDIZIONI MUSICALI INTERNAZIONAL, Via Bonaventura Cerretti 32, 00167 Rome (RM), 06.621 6946/622 6724, MD: Maria Augusta Bruni, A&R Dir: Fabio Fabor. Labels (owned): BAM, Flam, Fonovideo, Hard, Kronal, Music Scene, Phonocolor, Ring, Style, World; (Lic): Best Seller, Caravage, Selection, Telemusic.

MOVIMENTO MUSICA, Via Volturmo 80, Edinord/Portico 1, 20047 Brugherio (MI), 039.884 415, Fax: 039.884 111, MD: Salvatore Caruselli, Admin Dir: Paola Magagnini, Ed Dir: Giovanni Caruselli, Prod Mgr: Roberto Rossetti. Labels: Movimento Musica; Distribution: Dischi Ricordi, CGD.

MUSICA SOLARE, Via della Nazioni 51, 47042 Cesenatico (FO), 0547.86041, Fax: 0547.85744, Dirs: Raoul Casadei, Carolina Casadei. Distribution: Ricordi.

MUVICOM, Via Abbondio Sangiorgio 12, 20145 Milan (MI), 02.9065 8176, MD: Alessandro Colombini, Labels: Conveyor, Muvicom, Spaghetti.

NAR (NUOVA AUTORI RIUNITI), Via Lessona 2, 20157 Milan (MI), 02.357 5225, Fax: 02.357 5335, MD: Mario Limongelli, A&R/Promo Mgr: Sabino Mogavero. Labels: N.A.R. Disco 3, Free; Distribution: Dischi Ricordi.

NEW ENIGMA, Via Cagliero 4, 20125 Milan (MI), 02.607 1306, Fax: 02.607 2227, MDs: Ezio Scime, Amleto Silvestri. Distribution: CGD.

NEW MUSIC, Via Mecenate 84, 20138 Milan (MI), 02.5540 0314/327/356, Fax: 02.5540 0360, President: Pippo Landro, Label Mgr: Luciano Cantone, Export Mgr: Simon Holton, Sales/Mktg: Salvo Trovato, Asst to MD: Bettina Plannmoeller. Labels (owned): New Music, Meet, Special, PLM; (Dist): Interactive Test; Main product: Dance, Album Rock, Black (R&B).

NEW RECORDS, Via Giardini 466, 41100 Modena (MD), 059.340 512, MD: Maretti Osvaldo.

NEXTOWN RECORDS, Via Rovello 3, 20121 Milan (MI), 02.874 898, Fax: 02.7200 3676, President: Gianni Vitale, Mgr: Eugenio Tovini.

NUEVA, Piazza della Repubblica 30, 20124 Milan (MI), 02.2900

2014, Fax: 02.2900 4062, Contact: Giovanni Cereda. Distribution: BMG Ariola.

NUOVA ERA RECORDS, Via Vincenzo Monti 38, 22060 Carugo (CO), 031.763 838, Fax: 031.763 833, Mktg Mgr: Angelo Curtolo, Prod Mgr: Alessandro Nava, A&R Dir: Danilo Prefumo. Labels (owned): Nuova Era, Memories; Main product: Classical.

NUOVA FONIT CETRA, Via Giuseppe Meda 45, 20141 Milan (MI), 02.843 2551-3, Fax: 02.843 6482, Tlx: 314653, President: Sisto Dalla Palma, VP: Federico Radice, MD: Lucio Salvini, Dir-Gen: Germano Gogna, GM: Antonietta Ferrante Campi, Exec Asst: Elio Sabella, Mktg Dir: Dino Piretti, A&R Dir: Sergio Poggi, Prod Mgr: Elio Cipri (Pop), Giancarlo Chiaramello (Classic), Press Officer: Eraldo Di Vita. Labels: Bulldog, Fonit Cetra, Italia, Pellicano, Nuova Records, Riva Alto; Distribution: Dischi Ricordi.

OM DISCS, Via Marchesi De Taddei 3, 20146 Milan (MI), 02.439 2964, Fax: 02.469 6309, MD: Augusto Brivio. Labels: Battle, Bluesville, Charles Mingus, Contemporary, Debut, Enterprise, Fantasy, Galaxy, Gennett, Good Time Jazz, Gospel Truth, Jazzland, jazz Workshop, Judson, Milestone, Moodsville, New Jaxx, Off Beat, Orpheum, Pablo, Prestige, Riverside, Status, Stax, Swingville, Tru-Sound, Truth, Volt, Washington.

PAN POT PRODUCTION, Via della Corte 15, 42023 Cavriago (RE), 0522.942 624, Fax: 0522.942 634, Int'l Mgr: Davide Culzoni. Labels (owned): Pan Pot Records; Main product: Dance.

PANARECORD DISCHI PALLADIUM, Viale Mazzini 132, 00195 Rome, 06.310 058/372 2379, Fax: 06.310 005, President: Carlo Nasi.

PARC RECORDS, LE, Via Coghetti 182g, 24100 Bergamo (BG), 035.256 602, Fax: 035.256 602, President: Richard Milella, Chmn: Manlio Cangelini, Asst to Chmn: Lorella Ghilardi. Labels (owned): Le Parc Records.

PARKING, Via Crescenzo 43, 00193 Rome (RM), 06.659 409, MD: Giancarlo Lucariello. Labels: Paradiso.

PENTAFLOWERS, Via Filippo Nicolai 16, 00136 Rome (RM), 06.349 8458, Fax: 06.349 8094. Jazz music.

PHONOGRAM (ITALY), Via Carlo Tenca 2, 20124 Milan (MI), 02.67961, Fax: 02.679 6201, Tlx: 334140, MD: Bruno Tibaldi, Mktg Mgr: Roberto Biglia.

PHONOGRAPHIC CENTER COMPANY, Via IV Novembre 13, 20078 San Colombano al Lambro (MI), 0371.89005, Owner: Giuseppina Bagatta, A&R Dir: Giuseppe De Vecchi, Promo Mgr: Ivonne Saltarelli. Labels: Fiammetta's, Leonsoico, Phonorama, Sabrina, Starmaker, Stereomaster.

PHONOTYPE RECORDS, Via E. De Marinis 4, 80134 Naples (NA), 081.205 873/552 7195/716, Fax: 081.552 2649, MD: Vincenzo Esposito.

PILZ, Via I Maggio 42, 37012 Bussolengo (VR), 045.670 0240, Fax: 045.670 0241.

PINCIANA MUSIC, Via Carlo Mirabello 25, Scala B int. 2,

00195 Rome (RM), 06.319 375/575 8776, MD: Fulvio Corradini. Labels: Aureus, Dany, Funky, Pinciana, Speedy Records.

PIZZICATO EDIZIONI MUSICALI, Via Monte Ortigara 10, 33100 Udine (UD), 0432.45288, Fax: 0432.45288, President: Anna Maria Fasano, Art Dir: Bruno Rossi. Main product: Ethnic.

PLF, Via Aldo Moro 64f, 15057 Tortona (AL), 0131.811 638.

POLYDOR (ITALY), Viale Tunisia 50, 20124 Milan (MI), 02.67961, Fax: 02.679 6451, MD: Adrian A Berwick, Head Of Promo: Stefano Zappaterra, Comm Dir: Piergiorgio Coletti, Prod Mgrs: Giovanni Arcovito (Int'l), Claudia Cevenini (Nat), Paolo Kranchini (Cat/Jazz), Promo Mgrs (Milan): Anne Maria Penne (Milan), Umberto Borini (Rome).

POLYGRAM CLASSICS (ITALY), Via Carlo Tenca 2, 20124 Milan (MI), 02.67961, Fax: 02.679 201, Tlx: 334140, GM: Bruno Fedetto.

POLYGRAM ITALIA (ROME), Circonvallazione Clodia 29, 00195 Rome (RM), 06.325 1024, Fax: 06.325 1212, Tlx: 620017, Dir: Danilo Ciotti.

POLYGRAM ITALIA, Via Carlo Tenca 2, 20124 Milan (MI), 02.67961, Fax: 02.679 6201, Tlx: 344140, President: Gianfranco Rebulia, F&A Dir: Jos de Raaij, Comm Dir: Piergiorgio Coletti, Bus Affairs: Oscar Dal Pozzo, PR/Promo Dir: Danilo Ciotti.

POLYXENA EDIZIONI MUSICALI, Via Asiago 6, 00195 Rome (RM), 06.361 3379, MD: Carloquinto Talamona, A&R Dir: Stefano Calzecchi Onesti. Distribution: BMG Ariola.

PRAVO MUSIC, Via Enrico Toti 4, 20123 Milan (MI), 02.435 093/463 920/4801 2493, Fax: 02.4819 4098, MD: Mario Allione.

PSYCHO, Via Frascati 7, 20149 Milan (MI), 02.481 5395, Fax: 02.469 4535, Contact: Claudio Dentes. Distribution: CBS.

PUBLIC IMAGE PRODUCTIONS, Via Bernardino Vero 39c, 20141 Milan (MI), 02.846 6660, Fax: 02.8951 3162, Tlx: 316393 nostop attn: Beat Club, MD: Marco Marsili, Press Officer: Clay Montana, Producers: Lorrie Pozzi, Sugar Richfield, Sales: Terry Doria. Labels (owned): Vulkan Records, Mandalino Records, Public Image Productions; Main product: Dance, AC, Black (R&B), Reggae, New Age, House, Rap, Techno/Eurobeat.

QUALITY RECORDS, Galleria A 108, Block 2a, 40050 Centergross, Funo d'Argelato (BO), 051.864 308, Fax: 051.863 970, President: Raffaele Ottavio.

RDS, Via Giambellino 7, 20146 Milan, 02.654 706/422 2588, GM/Sound Eng: Pasquale Soggiu, Art Dir: Teresa Pestarini.

REC GROUP, Via Valparaiso 13, 40127 Bologna (BO), 051.268 264/221 254, Fax: 051.223 287, MD: William Baravelli, A&R: Corrado Bacchelli.

RECORDINGS, Via Marsala 4, 50137 Florence (FI), 055.679 378, MDs: Maurizio Nannucci, Maurizio Della Nave. Labels (owned): Recordings; (Lic): Zona Productions; (Dist): all small labels.

RICORDI

always with music

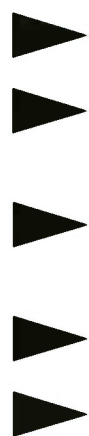

RECORDING COMPANY

RECORDS AND VIDEOS DISTRIBUTION

CLASSICAL AND POP MUSIC PUBLISHING

40 MUSIC STORES

GRAPHIC ARTS

Headquarters
20121 MILAN - Via Berchet, 2

REPLAY-BRICOLAGE, Via Ceresara 88, 36012 Asiago (VI), 0424.463 089, Fax: 0424.463 089, MD: Pelosi Ilter.

ROSSODISERA RECORDS, Via Asiago 2, 00195 Rome (RM), 06.361 2458, Fax: 06.321 6954, MD: Renato Venturiero. Labels (owned): Studio Records, Studio B Records, Escargot Records; Main product: Album Rock, New Age.

SAAR RECORDS & TAPES, Viale di Porta Vercellina 14/10, 20123 Milan, 02.469 6251-4/4801 3033, Fax: 02.481 3058/4819 3944, Tlx: 321277 saar, MD: Walter Franz Gurtler, Comm Dir: Luigi Meloni, A&R Co-Ord: Vanni Moretto, Promo Cons: Dinah Ventura, Adviser: Boris von Scheidt. Labels (owned): Everest/Europa, Harmony, Joker, Saar, Signal Up, Stella, (Lic): Blow Up, Music Power, Disco 3; Main product: all categories carried.

SAMPALLO, Via Portuense 746, 00148 Rome (RM), 06.685 0051, Fax: 06.685 5966.

SANGY PRODUCTIONS, Via S.S. Apostoli 51, 36100 Vicenza (VI), 0444.324 426, Fax: 0444.321 776, President: Maurizio Sangineto.

SANREMO HIT, Via Bellini 1, 17100 Savona, 019.823 750/811 649, Fax: 019.823 750, MD: Giggi Mosello, A&R Dir: Mauro Biglietto, Prod Mgr: Patrizia Sala. Labels: Sanremo Hit, Discofilm, A.A.A.

SANTA MONICA, Viale Mazzini 4, 00195 Rome (RM), 06.321 8079/7380, Fax: 06.321 7891, Exec Dir: Pino Toma, Int'l Exploitation: Marta Onorato.

SC PRODUCTIONS, Via Ravenna 1/4A, 16127 Genova (GE), 010.261 490, Fax: 010.223 621, MD: Salvatore Cusato, Producers: Giorgio Canepa, Elvio Pieri, Sec: Giovanna Cusato. Labels (owned): Esseci Dance, SCO; Distribution: Discomag; Main product: Dance.

SENTEMO RECORDS, Via Calstorta Vecchia 21, 31040 Cessalto, Treviso, 0421.327 755/955, Fax: 0421.327 850, President: Paolo Boarato, Exec Dir: Diego Sandrin, Prod Exec: Maurizio Soranzo, Bus Affairs: Julie Moss, Admin: Claudia Minotto, Art Dir: Piermarco Cianni. Labels (owned): Sentemo, United Project; Main product: Jazz.

SIGLA (ITALY), Via Ildebrando Vivanti 34, 00144 Rome (RM), 06.598 4835, Fax: 06.598 4886, Tlx: 614296 sigla, MD: Cesare Benvenuti, Label Co-Ord: Ambra Cocchi, Promo Dir: Leonardo Alessandrini.

SINTESI 3000, Via Giuseppe Bonito 32, 80129 Naples (NA), 081.374 646/417 452. Labels: Sintesi 3000, Blue Angel, La Canzonetta; Distribution: Dischi Ricordi.

SONY MUSIC ENTERTAINMENT (ITALY), Via Amedei 9, 20123 Milan (MI), 02.8536, Fax: 02.860 175, Tlx: 332806, Pres/MD: Franco Cabrini, Sales Dir: Gianni Barbieri, A&R Dir: Fabrizio Intra, Publ Dir: Mike Vicino, Fin Dir: David Kinsley, Artist Mktg Dir: Massimo Bonelli, Label Mgrs: Leo De Rosa (Columbia), Andrea Papalia (Epic), Special Mktg Dir: Gabriele Paoli, Sony Classical Dir: Fausto Barzaghi, Bus Affairs Dir: Claudio Buja, Operations & Personnel Dir: Antonio di Dio, Rome Office Dir: Susan Duncan Smith. Labels (owned): Columbia, Epic, Sony Classical, WTG, Portrait, Sony Music Special Products, Def Jam, OBR, Dance Pool.

SONY MUSIC ENTERTAINMENT (ROME), Via G Nicotera 24, 00195 Rome (RM), 06.321 7710, Fax: 06.321 7692, Tlx: 625697, Dir: Susan Duncan Smith.

SOPI, Via Rubra 236, 00188 Rome (RM), 06.300 4521/456, Fax: 06.691 3171, MD: Elisabetta Ponti. Labels: Nuova Sound Records; Distribution: BMG Ariola.

SOUND AND MUSIC, Via Mazzarossa 125, 55100 Lucca (LU), 0583.581 327, Fax: 0583.588 502, Tlx: 590576, Dir: Lorenzo Santi.

SPLASH, Via G Jannelli 51, 80128 Naples (NA), 081.546 7733/6222, Fax: 081.545 5355, Tlx: 722185, MD: Giuseppe Faiella.

SPRAY RECORDS, Via Saline 8/c, 65013 Marina di Citta San Angelo (PE), 085.959 350, MDs: Maurizio Lattanzio, Belfino De Leonardis.

STOP RECORDS, Via Pineta Sacchetti 484, 00168 Rome (RM), 06.301 0150, President: Piero Perdoni. Labels (owned): Stop Records, Petrus.

STRING RECORDS, Corso Garibaldi 113, 47100 Forli (FO), 0543.30697, MD: Mauro Nerl.

STUDIOTTANTA-FORTUNA RECORDS, Via Cernaia 3, 14031 Calliano (AT), 0141.928 174/45, Fax: 0141.599 656, President: Massimo Visentin, Sec: Monica Preziosi. Labels (owned): SFR, Fortuna, Born to Sing; Main product: Dance, AC, Jazz, Italian House.

SUNSET STUDIO, Via Vincenzo Padula 2, 80123 Naples (NA), 081.769 4883, Fax: 081.769 4883, President: Max Carola, MD: Gabriella Rinaldi.

SUPPORTI FONOGRAGICI, Corso di Porta Ticinese 100, 20123 Milan (MI), 02.8940 0420, MDs: Peter Pestalozza, Carlo Villa, Ugo Battaini.

SYNERGY RECORDS, Via Chivasso 38/1, 10020 Colombaro Po (TO), 011.919 1239, Fax: 011.919 1239, Pres/Chief Eng: Beppe Crovella, Eng: Giuseppe Soldano, Prod/Eng: Riccardo Mazza.

TACTUS, Via S. Allende 26, 40065 Pianoro (BO), 051.775 799, Fax: 051.774 336, MD: Serafino Rossi.

TARGA ITALIANA, Viale Pasubio 6/8, 20154 Milan (MI), 02.650 356/2900 0356, Fax: 02.659 9320, Mgr: Mario Rapallo.

TEATROMUSICA, Via Giambertoni 15, 92100 Agrigento (AG), 0922.25287, MD: Giovanni Moscato.

TIME, Via Sabotino 5, 25100 Brescia, 030.370 1050, Fax: 030.370 1066, President: Giacomo Maiolini. Labels (owned): Time Records, Italian Style, Line Music; Main product: Dance.

TOP CAT PRODUCTIONS, Via Comonte 34, 24068 Seriate, Bergamo, 035.297 918, Fax: 035.301 894, MD: Anna Lombardi.

doni. Labels (owned): Top Cat Production; Main product: Dance.

TOP RECORDS (ITALY), Galleria del Corso 4, 20122 Milan (MI), 02.791 141, Fax: 02.791 141, Tlx: 311250, President: Guido Palma, Chmn: Abbate Giulia, MD: Paola Palma. Labels (owned): Dingo, Sap, Kiwi, Smoking; Distribution: CGD.

TORNADO ED. MUSICALI & DISCOGRAFICHE, Via Enrico Toti 4, 20123 Milan, 02.435 093/463 920/4801 2493, Fax: 02.4819 4098, MD: Mario Allione.

TOSCO RECORDS, Via G d'Annunzio 51a, 50135 Florence, 055.654 0039, Owner/Mgr: Alfonso Corsini.

ULTIMA USCITA, Via E. Aubert 3, 11100 Aosta, 0165.236 883, Fax: 0185.236 883, GM: Paolo G Passanante, Art Dir: Giorgio Galli, Int'l Relations: Carlo Enrietti.

UNIFUNK, Corso di Porta Romana 87/a, 20122 Milan (MI), 02.546 3756, Purchasing Manager: Antonio Rinaldi. Labels: Activ, R.A.R., Uni Funk.

VIAREGGIO, Via Verdi 88, 55049 Viareggio (LU), 0584.46437/8/9, MD: Gianni Santini. Labels: Lido, Molo, Pineta, Spiaggia.

VIDEOSTAR, Via 4 Novembre 8/3, 17100 Savona (SV), 019.825 932, Fax: 019.852 420.

VINYL MAGIC, Via Tibaldi 29, 20136 Milan, 02.837 7270.

VIP ORGANISATION, Via Simone del Pozzo 9, 27029 Vigevano (PV), 0381.83222, Fax: 0381.83222, President: De Rosa Luca Sharp, Mktg/Promo: Patrizia Politi.

VIRGIN DISCHI (MILAN), Via Porpora 26, 20131 Milan (MI), 02.2951 8305, Fax: 02.2951 7891/5961, MD/Gen Mgr: Luigi Mantovani, Mktg Mgr: Angelo Vaggi, Int'l Mgr: Gilberto Barantani, Press: Rossella Leonardi, A&R (Local): Marco Boraso, Eleonora Tarantino, Sales Mgr: Marco Meraviglia, Publicity: Bruno Marro. Labels: BEF, Bluebird Records, Cardiac, Caroline, Charisma, Cheyenne Records, Circa Record, DEP Int'l, DIN Disc, Earthworks, EG Edizioni, EG Records, Foundry, Front Line, Gold Castle, Hedd, Linn Records, MDM, Metal Beat, Paradox, Point Blank, Real World, Red Eye, Siren Records, Some Bizzare, Stile Libero, Telegraph, Ten Records, Venture, Virgin, Virgin Classics, Virgin Int'l, W Mot Records, Zarjazz.

VIRGIN DISCHI (ROME), Via Guido Banti 46, 00191 Rome (RM), 06.333 8196/8233, Fax: 06.333 8197, MD: Stefano Micocci.

VISA RECORDS, Via Lentasio 7, 20122 Milan, 02.5830 3121/3287, Fax: 02.5830 5720.

WARNER MUSIC ITALY, Via Milano 16, 20090 Redecese di Segrate (MI), 02.21681, Fax: 02.216 8299, Tlx: 320668/341183, President: Marco Antonio Bignotti, VP/Fin Dir: Gerolamo Caccia Dominioni, MIS Dir: Salvatore Monteleone, Bus Affairs: Mauro Pedrini.

WEA ITALIANA (MILAN), Via Milano 16, 20090 Redecese di Segrate (MI), 02.21681, Fax: 02.216 8299, Tlx: 320668/341183, President: Marco Antonio Bignotti, MD: Massimo Giuliano, A&R Dir (Local): Fabrizio Giannini, Sales Mgr: Dino Panaro, Head Of Int'l: Elena Zannoni, Mktg Services Mgr: Paolo De' Torna, Label Mgrs: Bruno Pasini (Warner/WEA UK), Luca Fantacone (Elektra/WEA/EastWest), Promo: Michele Barrie (Local), Sander Mallasz (Int'l), Press (Int'l): Umberto Candiolo. Labels: Asylum, Blanco Y Negro, Charter, Cold Chillin', Cotillon, Dark Horse, Duck Record, East West, Elektra, Erato, Eternal, Full Moon, Giant, Howard Jones, Korova, Magnet, Modern Record, Musician, Nonesech, Opal, Paisley Park, Qwest Records, Reprise, Sire Records, Teldec, Warner, WEA, WEA International, Wilbury.

WEA ITALIANA (ROME), Via Muggia 8, 00195 Rome (RM), 06.359 9526/388 317, Fax: 06.319 527, Tlx: 622171, Promo Dir: Alberto Cusella.

WESTUDIO RECORD, Via Mattei 141, 21040 Cislago (VA), 02.9638 0575, Fax: 02.9638 2511, President: Enzo Malepasso, Art Dir: Andrea Costa, Sound Engineers: Marco Balbo, Sandro Raspagliesi, Admin: Claudia Rosara. Distribution: Dischi Ricordi.

WHITE STUDIO, Via Generale Giardino 4, 36078 Valdagno (VI), 0445.408 982, President: Aldo Menti.

ZARD INIZIATIVE, Viale Mazzini 6, 00195 Rome (RM), 06.314 444, Fax: 06.360 6555, Tlx: 621356 muzeta, President: David Zard, MD: Roberto Mineo, Production: Dory Zard, PR/Promo Head: Patrizia Tomasich. Labels (owned): Muzarda, Zard Records.

ZEUS RECORD, Piazzetta Matilde Serao 15, 80132 Naples, 081.406 791/415 997, Fax: 081.406 791, MDs: Ciro Barucci, Antonio Barucci. Labels: AB Record, Boom, Eros, Interlancio, Moulin Rouge, Sidi, Suez, Zeus Record.

Giovanardi, Admin: Emilia Pancaldi. (Owned): Ala Bianca; (Admin): Bella Ciao Dischi del Sole; Main product: Adult Contemporary, Jazz, Dance, Album Rock, New Age, Folk.

ALABAMA, see Best International.

ALFRED MUSIC, see Nuova Carisch.

ALIGNMARK, see BMG Music.

ALL FRIENDS MUSIC ITALY, see Sugarmusic.

ALL NATIONS, see Franton Music.

AMBASSADOR, see Edizione Caramba.

ANASAZI, see Iksos Music.

ARABA FENICE, Via de Gombruti 12, 40123 Bologna (BO), 051.268 264, Fax: 051.275 826, Mgr: Walter Mamelli.

ARIE TE, see Curci Edizioni.

ARISTON GROUP, Via G Frua 6a, 20146 Milan, 02.4800 5039, Fax: 02.498 9537, President: Alfredo Rossi, MD: Sandro Delor, Int'l: Bob Lumbroso, Label Mgr: Andrea Rossi. (Owned): Ariston, Equipe, Eur, Fun House & Co, La Bussola, La Fucina, Santa Cecilia, Valentine Music Italia, Carre d'As.

ARISTON, see Nuova Carisch.

ARLEQUIN, see BMG Music.

AROMANDO, see Sugarmusic.

ASPIRINE, Via Fracati 9, 20149 Milan (MI), 02.435 424, Fax: 02.4800 9058/469 4535, Contact: Claudio Dentes.

ASSIEME EDIZIONI, Via Roma 54/4, 18038 San Remo (IM), 0184.883 442, Fax: 0184.883 443, Tlx: 271456 disnoi, MD: Mariano Schiavolini.

ASSIST, see Nuova Carisch.

ASSO, see Curci Edizioni.

AUTOSTOP MUSIC, Via Bracco 1/3, 17040 Cadibona (SV), 019.89160, MD: Giuseppe Gentà.

BABY RECORDS (ITALY), Via Timavo 34, 20124 Milan (MI), 02.607 1474/266, Fax: 02.689 8701, President: Freddy Naggiar, MD: Monica Dahl. (Owned): Chapulin.

BAERENREITER, see Nuova Carisch.

BALLA CON NOI/SOLEDA, Via Tansini 29, 29100 Piacenza (PC), 0253.455 629/754 784.

BANG BANG MUSIC, Via Carlo Torre 24, 20143 Milan (MI), 02.8940 9895, Fax: 02.837 6374, MD: Giorgio Odochini.

BASKY, Via Lago di Patria 7, Palazzo Siviglia, 80014 Lago Patria Giugliano (NA), 081.509 2515/935, MD: Domenico Barrella.

BEAT RECORDS COMPANY, Via Filippo Nicolai 16, 00136 Rome (RM), 06.349 8458, Fax: 06.349 8094, GM: Franco De Gemini, Int'l Mgr: Luciana Morello De Gemini.

BEBAS RECORD, Via Magellano 5, 20094 Corsico (MI), 02.440 5551, MD: Bruno Barbone.

BELLA CIAO DISCHI DEL SOLE, see Ala Bianca Group.

BEST INTERNATIONAL, Via Monte Rosa 74, 20149 Milan (MI), 02.4800 7289, Fax: 02.481 9071, MDs: Adelfo M Forni, Roberto Duca. (Sub-pub): Two Pijeters, May Pop, Alabama, Hammer, Edimusa, George Tobin, Happy Valley Music.

BIDERI EDIZIONI, Via San Pietro a Majella 17, 80138 Naples (NA), 081.450 744, Fax: 081.451 942, MDs: Jole Bideri, Luciano Villeville Bideri. (Owned): Bideri, Gennarelli, Santa Lucia, Santoianni, Scia; Promotions office: Via Teulada 52, 00195 Rome, 6.380 700.

BIG LIFE, see Franton Music.

BLACK ROCK, see Edizione Caramba.

BLUE JEAN, see Edizioni Southern Music.

BLUE TEAM MUSIC, see Nuova Carisch.

BMG ARIOLA, see BMG Music.

BMG MUSIC (ITALY), Via di Sant' Alessandro 7, 00131 Rome, 06.4199 5210/20, Fax: 06.4199 5462/263, MD: Mario Cantini, Int'l Mgr: Angelo Franchi, Prod Mgr: Olimpio Petrossi, Soundtrack/Print/Classical Mgr: Guido Podesta. (Owned): BMG Ariola, Acqua Azzurra, Mimo, Universale; (Admin): Gibb Brothers, Prob Nobilem, Cherry Lane, Toto, Bob-A-Lew, Intro Musikverlag, Far Musikverlag, Memory Lane, Delbine Editions, Ibanema, French Fried Music, Little Feat, Swag Songs, Miracle Creek, Zachary Creek, See The Light, T Boy-T Girl, California Phase, Alignmark, Neil Diamond, Volta, NEM Entertainment, Jimmy Webb, Arlequin, GEM; Main product: Dance, AC.

BOB-A-LEW, see BMG Music.

BORGATTI, Via Calzavacchio 38, 40033 Casalecchio di Reno (BO), 051.571 899, MD: Paolino Borgatti.

BUFFALO BILL, see Sugarmusic.

BULL & BUTCHER RECORDINGS, see FMA.

BUMSHIVA MUSIC, Via G Rossa 12, 20089 Rozzano (MI), 02.824 3705, Fax: 02.824 3705, MD: Luigi Fedele. (Admin): Edi Musica (Colombia), Tillandis Music (USA), D'Nico Int'l (USA); Main product: Dance, Album Rock, New Age, Tropical Music.

CA ROSSI EDITORE, see Nuova Carisch.

CALIFORNIA PHASE, see BMG Music.

CAM, Via Virgilio 8, 00193 Rome (RM), 06.687 4332/227/290, Fax: 06.687 4046, Tlx: 621195 camrom, Owner: Giuseppe Campi, MD: Francesca Campi.

CAMPING, see Sugarmusic.

CANALE 5 MUSIC, Viale Europa 48, 20093 Cologno Monzese (MI), 02.2514 7662/7540, Fax: 02.2514 7499, Tlx: 326582/316197, President: Adriano Galliani, Chmn: Luigi Lacchini, Prof Mgr: Vladimir Albera, Int'l: Gianfranco Finamore. (Owned): Canale 5; (Admin): Legacy, Ichigan (UK), Kbaney (USA).

CANZONI MODERNE CA-MO, see Sugarmusic.

CAPITAN, PO Box 359, 42100 Reggio Emilia, 0522.25314.

CAPPUCCINO MUSIC, Via Abruzzi 2, San Felicino, 20068 Peschiera Borromeo (MI), 02.753 2723, Fax: 02.753 2723, President: Marco Marati, MD: M Antonietta Borrometi.

CAPRICCIO, see Centotre Edizioni Musicali.

CARISCH, see Nuova Carisch.

MUSIC PUBLISHERS

103 EDIZIONI MUSICALI, Via Binda 33, Milan, 051.911 163, Fax: 051.911 991, President: Luigi Barion.

AAA PROLOGO, Via Rossini 8, 20090 Cesano Boscone (MI), 02.450 1984, Fax: 02.4860 0310, President: Aldo Paganini. (Owned): Elevenmusic, Paganmusic, AAA Prologo.

ABRAMO ALLIONE, Via Enrico Toti 4, 20123 Milano, 02.435 093/463 920/4801 2493, Fax: 02.4819 4098, MD: Italo Allione.

ACCORDO, see Curci Edizioni.

ACQUA AZZURRA, see BMG Music.

ACV, Via Tommaso da Celano 15, 00179 Rome (RM), 06.780 6441/66, Fax: 06.780 6719, President: Tony Verde, Int'l Mgr: Ciro Verde, Promo: Daniela Fusco.

AIRPLANE, see Centotre Edizioni Musicali.

ALA BIANCA GROUP, Via Mazzoni 34-36, 41100 Modena (MD), 059.223 897/719, Fax: 059.219 218, Tlx: 512087, President: Tony Verona, MD: Maurizio Bettelli, Copyright: Carla

CARNEVAL, Corso Palermo 75, 10154 Turin (TO), 011.858 037, MD: Piera Nocera.

CAROSSELLO, see Curci Edizioni.

CARRE D'AS, see Ariston Group.

CASA MUSICALE ECO, Via Giovanni Battista Lulli 5, 20131 Milan, 02.2951 8096, Fax: 02.2951 8096, Art Dir: Eugenio Consonni, Prod Dir: Giampaolo Geravini. Main product: Classical.

CDF, Via Montebello 21, 10124 Turin (TO), 011.836 409, MD: Tony Carrino.

CEDI, Via San Francesco da Paola 20, 10123 Turin (TO), 011.543 176, GM: Gabriele Dell'Utri. 2nd address: Via Caboto 35, 10129 Turin (TO), 11.503 355/7/8.

CENTROTRE EDIZIONI MUSICALI, Via Minghetti 41/4, 40038 Vergato (BO), 051.911 163, Fax: 051.911 991, MD: Luigi Barion. Labels: Airplane, Capriccio, Speedy, 103; Distribution: Errebiesse.

CERVINO, see Curci Edizioni.

CHANTALAIN, Via Augusto Riboty 22, 00195 Rome (RM), 06.352 384, Fax: 06.317 824, Tlx: 621600 pprmmz attn: chantalain, MD: Rolando D'Angeli, Artistic Dir: Luciano Giandiorgi, PR: Cinzia Colantolito.

CHAPULIN, see Nuova Carisch.

CHARLY, see Franton Music.

CHERRY LANE, see BMG Music.

CIELO-VIDEO EDIZIONI MUSICALI, Via F. Bocconi 1, 20136 Milan (MI), 02.546 3255, Fax: 02.5830 5166, President: Virgilio Panzuti, Foreign Relations: Dante Panzuti. (Admin): Sonoton (Ger), Tele-Music (Fra); Also music library.

CIP CANTANTI, Via Pomezia 7, 20127 Milan (MI), 02.2611 2230, Fax: 02.2611 2240, MD: Ruggero Penazzo.

CLAC RECORDS, Via Salvatore di Giacomo 73, 00142 Rome (RM), 06.541 1225, Fax: 06.540 1615, Tlx: 610366 panass, MDs: Piero Calabrese, Massimo Calabrese, Marco Lecci, Chmn: Giulio Albamonte.

CLAN, see Sugarmusic.

CORA, see Edizioni Southern Music.

COSTA EST, see Nuova Carisch.

CPP, see Nuova Carisch.

CREAMUS, Piazza Velasca 6, 20122 Milan (MI), 02.861 922, Fax: 02.874 892, Tlx: 326542, President: Michelangelo La Bionda.

CRUISIN' RECORDS, Via Bellini 65, 41100 Modena (MD), 059.225 940/902, Fax: 059.220 609, Tlx: 226390, President: Cinzia Macchioni, MD: Ennio Tricomi.

CURCI EDIZIONI, Galleria del Corso 4, 20122 Milan (MI), 02.794 746, Fax: 02.7601 4504, Tlx: 332683 curci, GM: Giuseppe Gramitto Ricci, Publ Mgr: Gabriele G Abbate. (Owned): Accordo, Ariete, Asso, Carosello, Cervino, Curci, D'Anzi, Eaton, Festival, Franchi C, Italcanto, Italian Yank, Izzo, MPL Communications Italy, Music Union, Number Two, Orchestralmusic, PDU Italiana, RTV, Senso Unico, Star; Main product: Adult Contemporary, Jazz, Country, Classical.

D'ANZI, see Curci Edizioni.

D'NICO INT'L, see Bumshiva Music.

D&W, see Expanded Music.

DANIELE-KANSAS, Galleria Subalpina 30, 10123 Turin (TO), 011.542 735/232 546, MD: Seren Gay. (Owned): Kansas, Daniele.

DDD (DROGUERIA DI DRUGOLO), Via Vittoria Colonna 23, 20149 Milan (MI), 02.481 9209, Fax: 02.469 0139, Tlx: 353366, MD: Roberto Galanti, Publ: Romeo Frumento.

DELBINE EDITIONS, see BMG Music.

DELTA MUSIC, Corso Buenos Aires 10, 20124 Milan (MI), 02.2940 5972, Fax: 02.225 562, Tlx: 333414 escim, MD: Alessandro Coppola.

DEMOMUSIC INT'L, see Nuova Carisch.

DEXTER GORDON, see Franton Music.

DFC, see Expanded Music.

DI LAZZARO, see Sugarmusic.

DIG IT INTERNATIONAL, Via Orombelli 7/11, 20131 Milan (MI), 02.235 102/366 609, MD: Max Bugatti.

DINGO MUSIC, Galleria del Corso 4, 20122 Milan (MI), 02.791 141, Fax: 02.791 141, Tlx: 311250, President: Guido Palma, Chmn: Giulia Abbate, MD: Paola Palma.

DISCHI RICORDI, Via Berchet 2, 20121 Milan (MI), 02.8881, Fax: 02.888 1270, Tlx: 310177 ricor, President: Guido Rignano, GM: Fabio Boldi. (Owned): Edir, Editori Associati, Fado, Fama, Fono Film, Iller, Jubal, Life, Metron, Mondia Music, Pegaso, Radio Record, R.R.R., Ritmie Canzoni, Senza Pensieri, Settebello, Soedi Musica.

DISCOCKIO/ORG. GIORGIO VINCIS, Corso Italia 4/6, 17100 Savona, 019.821 770/145, Fax: 019.821 378, MD: Giorgio Vincis.

DISCORSI, see Nuova Carisch.

DIVA, see Many Edizioni Musicali.

DON WILLIAMS, see Franton Music.

DOPPIO PUNTO, see Edi Nufa.

DRUMS EDIZIONI MUSICALI, Via Camerana 28, 10128 Turin (TO), 011.553 095/517 258, MD: Mario Mattio, Admin: Chiara Torcaso.

DUCALE, Via per Cadrezzate 6, 21020 Brebbia (VA), 0332.770 189/784, Fax: 0332.771 047, Tlx: 380231 ducale, MD: Davide Matalon.

DUCK RECORDS (ITALY), Via Leonardo da Vinci 24, 20094 Corsico (MI), 02.4860 0800, Fax: 02.4860 0761, MD: Bruno Barbone.

DUNVAGEN, see Franton Music.

EASY RECORDS ITALIANA, Via Nomentana 1111, 00137 Rome (RM), 06.827 5266/8305, Fax: 06.808 4608, MD: Claudio Mattoni.

EATON, see Curci Edizioni.

EDI MUSICA, see Bumshiva Music.

EDI NUFA, Galleria del Corso 4, 20122 Milan (MI), 02.794 256, Fax: 02.794 256, MD: Alessandro Friggieri. (Owned): EDI Nufa, Doppio Punto.

EDI-PAN, Viale Mazzini 6, 00195 Rome (RM), 06.385 574/322 5952, Fax: 06.322 3471.

EDIMUSA, see Best International.

EDIR, see Dischi Ricordi.

EDITION SOUTHERN MUSIC, see Nuova Carisch.

EDITORI ASSOCIATI, see Dischi Ricordi.

EDIZIONE CARAMBA, Via Del Caravaggio 13, 20144 Milan (MI), 02.469 0823, Fax: 02.4819 6113, President: Maurizio Cor-echa. (Owned): Black Rock, Ambassador. (Represented): Parry Music.

EDIZIONI PAOLINE, Via Portuense 746, 00148 Rome (RM), 06.685 0051, MD: Eligio Ermeti.

EDIZIONI SOUTHERN MUSIC SRL

Piazza del Liberty 2, 20121 Milan (MI), (39) 02.796 473/180/181, Fax: (39) 02.7600 2530, Tlx: 314098, MD: Franco Dal Dello, Creative Mgr: Alfredo Rapetti. (Owned): Blue Jean, Cora, Fon, Giovane, Mayor, Microphon, Orange, RiFi, Spark.

EDIZIONI SUVINI ZERBONI SPA, Via Quintiliano 40, 20138 Milan (MI), 02.50841, Fax: 02.508 4261, Tlx: 321063 suvini, MD: Ettore Carrera.

ELEVENMUSIC, see AAA Prologo.

EMI MUSIC PUBLISHING ITALY, Via C. Ravizza 43-45, 20149 Milan (MI), 02.4801 0216, Fax: 02.4801 0046, Tlx: 335360, MD: Antonio Marrapodi, A&R Dir: Paolo Corsi.

EMI SONGS, see Nuova Carisch.

ENERGY PRODUCTION, Viale Mazzini 140, 00195 Rome (RM), 06.384 886/385 859, Fax: 06.370 0542, MDs: Dario Raimondi, Alvaro Ugolini (Int'l/A&R), Sec: Barbara Ugolini, Lawyer: Kendall Minter.

ENJA, see Franton Music.

EQUIPE, see Ariston Group.

ERREBIESSE, see Centotre Edizioni Musicali.

ESAGONO RECORD, Via Lodovico il Moro 119, 20143 Milan (MI), 02.470 886, Fax: 02.4830 0971, MD: Marco Inghirami, Mgr: Mauro Graziano, Int'l: Marisa Caiazza.

ESCARGO RECORDS, see Rossodisera Edizioni Musicali.

ESSEX ITALIANA, see Sugarmusic.

EUR, see Ariston Group.

EUTERPE, Via Bolzano 12/3, 16166 Genoa (GE), 010.332 239, Fax: 010.332 239, MD: Giustino Meneghini.

EXPANDED MUSIC, Via Belvedere 10, 40121 Bologna (BO), 051.222 228, Fax: 051.263 509, President: Giovanni Natale. (Owned): Expanded Music, DFC, D&W, Los Quaranta, First Cut; Main product: Dance.

FADO, Via Berchet 2, 20121 Milan (MI), 02.8881, Fax: 02.888 1270, Tlx: 310177, President: Guido Rignano.

FAMA, see Dischi Ricordi.

FAR MUSIKVERLAG, see BMG Music.

FESTA, Via D. Fontana 64 bis, 80129 Naples (NA), 081.741 0561, Fax: 081.552 0878, MD: F Coppeto.

FESTIVAL, see Curci Edizioni.

FIRST CUT, see Expanded Music.

FIRST ORGANIZATION, Via Andrea Baffie 13, 00195 Rome (RM), 06.358 1758/1235, Tlx: 620238, MD: Massimo Lazzari, Promo (Radio): Varis Casini, PR: Eleonora Di Maggio.

FLIPPER MUSIC, Piazza Prati Strozzi 31, 00195 Rome (RM), 06.315 615/383 146, Fax: 06.318 426, Tlx: 620266, Pres/MD: Romano Di Bari.

FMA EDIZIONI MUSICALE E DISCOGRAFICHE, Via Enrico Toti 4, 20123 Milano, 02.435 093/463 920/4801 2493, Fax: 02.4819 4098, MD: Davide Allione. (Owned): Bull & Butcher Recordings, FMA; Main product: Dance.

FOCUS, see Jump Edizioni.

FON, see Edizioni Southern Music.

FONO FILM, see Dischi Ricordi.

FONOLA FONOTECNICA, Via Ariberto 21, 20123 Milan (MI), 02.8940 4626/835 4626, MD: Marco Braga.

FRANCHI C, see Curci Edizioni.

FRANTON MUSIC, Via San Girolamo 7, 30174 Mestre (VE), 041.959 055, Fax: 041.959 991, Tlx: 223545, President: Tony Tassinato, MD: Francesco Sanavio. (Sub-pub): All Nations, Riva, Momentum, Lupus, Pat Metheny, Wayne Shorter, Josef Zawinul, Dunvagen, Tom Collins, Enja, Mayflower, Don Williams, Steeplechase, Big Life, Charly, G.W. Jr. Music, Mike Chapman, Mighty Three, Ornette Coleman, Dexter Gordon.

FRENCH FRIED MUSIC, see BMG Music.

FUN HOUSE & CO, see Ariston Group.

G.W. JR. MUSIC, see Franton Music.

GALA ED, see Gruppo Ed. Bixio.

GALA RECORDS MUSIC, Via Leonino da Zara 6, 35020 Albignasego (PD), 049.862 5456/5510, Fax: 049.862 5501, President: Umberto Marcato, Mktg Dir: Dino Marcato, Int'l Mgr: Paolo Checchetto, A&R Dir: Enrico Santacaterina, Admin Dir: Catia Agostini. (Owned): Gala Records Music; Main product: Adult Contemporary, Jazz, Album Rock, Gold/Oldies.

GALLETTI-BOSTON, Corso Mazzini 38, 48018 Faenza (RA), 0546.22235, MDs: Alessandro Galletti, Anna Galletti.

GATTO CI COVA, Via Mercanti 16, 10122 Turin, 011.547 748/540 328, Fax: 011.510 560, President: Gualtiero Gatto, Dir: Donato Mastrofrancesco, Alberto Mastrofrancesco.

GEM, see BMG Music.

GENNARELLI, see Bideri Edizioni.

GEORGE TOBIN, see Best International.

GETAR EDIZIONI MUSICALI, Via San Maurizio 13, 20123 Milan (MI), 02.7200 0417, Fax: 02.879 791, Mgr: Angelo Carrara.

GIBB BROTHERS, see BMG Music.

GIENNE, see Nuova Carisch.

GIGOLONE EDIZIONI MUSICALI, Via Anfossi 6, 20135 Milan, 02.551 1650/545 5570, Fax: 02.5518 5194, MD: Sergio cosentino.

GIOVANE, see Edizioni Southern Music.

GIPIESSE, Via G B Bertini 5, 20154 Milan (MI), 02.349 4145/797, Fax: 02.349 0548, Tlx: 315413 gipies, MD: Gian Piero Simontacchi, Admin: Maria Cantadore Simontacchi, Marina Lucioni.

GIPSY, Via Mazzini 41, 00195 Rome (RM), 06.316 532/385 709, MD: Piero Colasanti.

GRANADINE ED, see Gruppo Ed. Bixio.

GRANDE FIRME DELLA CANZONE, see Gruppo Ed. Bixio.

GRUPPO ED. BIXIO, Via Romeo Romei 15, 00136 Rome (RM), 06.372 2279/325 1570/80, Fax: 06.372 2190, Tlx: 616241 cimbix, President: Carlo Bixio, GM: Franco Bixio, A&R Mgr: Gianni Dell'Orso, Miriam Westercappel (Int'l). (Owned): Grande firme della Canzone, Bixio, Ed. Nido, Gala Ed, Stero Oceanía, Granadine Ed.

GRUPPO ED. SUGAR, see Nuova Carisch.

HAL LEONARD, see Nuova Carisch.

HAMMER, see Best International.

HAPPY VALLEY MUSIC, see Best International.

HARMONY MUSIC, Via del Padule 23f, 50018 Scandicci (FI), 055.754 273, Fax: 055.752 955, Contact: Andrea Ugolini.

IBANEMA, see BMG Music.

ICHIGAN, see Canale 5 Music.

IKSOS MUSIC, Via E. Cirino 18, 00136 Rome (RM), 06.343 445, Copyright Mgr: Maria Mauceri. (Sub-pub): Anasazi, Yxox.

IL PONTE, see Nuova Carisch.

IL VOLATORE, see Nuova Carisch.

ILLER, see Dischi Ricordi.

IMP, see Nuova Carisch.

INTERBEAT EDIZIONI, Via A. Stradella 174, 00124 Rome (RM), 06.609 5353, Fax: 06.609 7200, MD: Stefano Piervogiani.

INTERSOUND & SOFT, Loretostrasse 47-49, 39040 Salurn (BZ), 0471.884 646, Fax: 0471.884 646, MD/Sound Eng/Programmer: Constantin Coreth.

INTRO MUSIKVERLAG, see BMG Music.

IT DISCHI ITALIA EDIZIONI, Via Guido Banti 46, 00191 Rome (RM), 06.327 3468/4043/4802, Fax: 06.333 8197, MDs: Stefano Micocci, Vincenzo Micocci, Francesco Micocci.

ITALCANTO, see Curci Edizioni.

ITALIAN YANK, see Curci Edizioni.

IZZO, see Curci Edizioni.

JIMMY ZEBIN, see BMG Music.

JOSEF WAWINUL, see Franton Music.

JUBAL, see Dischi Ricordi.

JUMP EDIZIONI, Via F. Bocconi 1, 20136 Milan (MI), 02.546 3255, Fax: 02.5830 5166, MD: Dante Panzuti, Foreign Relations: Andrea Panzuti. (Owned): Music Scene, Jump, Rio; (Sub-pub): Intersound (Ger), Prestation (Bel), Focus (UK).

KANSAS, see Daniele-Kansas.

KARELL RECORDING STUDIOS, Via degli Ulivi 19, 00040 Lavinio (RM), 06.982 2518/969 5879, Fax: 06.968 2058, VP: Erika Grassi, MD: Giancarlo Silva, Promo: Manlio Goldner.

KRAMER, see Nuova Carisch.

KUBANEY, see Canale 5 Music.

LA BARONI, Via Depretis 37, 27058 Voghera (PV), 0383.48084/6048, Fax: 0383.62373, MD: Romano Menini.

LA BUSSOLA, see Ariston Group.

LA CHIOCCIOLA, see Nuova Carisch.

LA DROGUERIA DI DRUGOLO, see Nuova Carisch.

LA FUCINA, see Ariston Group.

LA ROCCA RECORDS, Via Brioschi 50/5, 20141 Milan (MI), 02.849 3357, Fax: 02.849 3357, MD: Melo Fidello.

LA ROSA DELL'INVERNO, see Nuova Fonit Cetra.

LABELLE MUSIC, Via Sidoli 17, 42020 Salvarano, Quattro Castella (RE), 0522.886 058, Fax: 0522.886 058, President: Larry Pignagnoli.

LANPI, Via Mecenate 84, 20138 Milan, 02.506 5200/4990, Fax: 02.5540 0360, President: Pippo Landro, Asst To Pres: Lidia Noseda. Main product: Dance, Album Rock, Black (R&B).

LARIANA EDIZIONI MUSICALI, Galleria del Corso 4, 20122 Milan (MI), 02.793 592/796 227, President: Paolino Pennacchioli.

LASAPA, Via Zamenhof 21, 20136 Milan (MI), 02.839 7916/837 3551, Fax: 02.837 5852, MD: Silvana Areggasc Savorelli.

LCS CLAN RECORDS, Via G Modena 3, 20129 Milan (MI), 02.2040 9469/271 9469, Fax: 02.204 3155, Tlx: 314082 otrimi, MD: Luciano Andrisani.

LEGACY, see Canale 5 Music.

LEONE RAMPANTE, Via alla Val 8, 38050 Povo (TN), 0461.810 170, Fax: 0461.810 170, MD: Ianes Francesco.

LGO MUSIC, Piazza Verbano 16, 00199 Rome (RM), 06.844 0231/687 0963, Fax: 06.687 2926, President: Lanfranco Gambini, Admin: Marina Gambini. (Owned): LGO Music.

LIFE, see Dischi Ricordi.

LITTLE FEAT, see BMG Music.

LOMBARDONI, Via Mecenate 78/a, 20138 Milan (MI), 02.506 3842/3/4, Fax: 02.506 4689, Tlx: 326350 magic, MD: Severino Lombardoni.

LOS QUARANTA, see Expanded Music.

LUPOMANNARO, Via Lorenzina 22, 22040 Malgrate (CO), 0341.580 950/39.650 962, Fax: 039.654 434, President: Mariella Reitano, Art Dir: Riccardo Bolognesi, Public Relations: Barbara Bolognesi. Main product: Pop, New Age.

LUPUS, see Franton Music.

MANAROLA EDIZIONI MUSICALI, Corso Genova 24, 20123 Milan, 02.832 1231/206, Fax: 02.835 8540, President: Roberto Dane.

MANY EDIZIONI MUSICALI, Viale Bianca Maria 8, 20129 Milan (MI), 02.540 1389/548 3862, Fax: 02.548 3974, President: Stefano Scalera, Asst To Pres: Mary Mennelli. (Owned): Many Records, Palmara, Diva; Main product: Dance, House.

MANY RECORD ITALY, see Media-the Sound Of The Future.

MASCHERONI, see Sugarmusic.

MAY POP, see Best International.

MAYFLOWER, see Franton Music.

MAYOR, see Edizioni Southern Music.

MCA MUSIC ITALY S.R.L.

Via degli Omenoni 2, 20121 Milan, (392) 86.14.71, Fax: 0(392) 86.90.28.9, MD: Corrado Bonfanti.

MEDIA THE SOUND OF THE FUTURE, Via Martiri della Libertà 277-279/a, 25030 Roncadelle (BS), 030.258 2353, Fax: 030.258 2161, President: Gianfranco Bortolotti, MD: Diego Leoni. (Owned): Mhara Record, Many Record Italy.

MELODI, see Sugarmusic.

MEMORY LANE, see BMG Music.

MEMORY RECORDS, Piazza della Repubblica 1, 43056 San Polo di Torriola, 0521.819 427, Fax: 0521.819 125, MD: Alessandro Zanni.

METRON, see Dischi Ricordi.

MHARA RECORD, see Media-the Sound Of The Future.

MICROPHONE, see Edizioni Southern Music.

MIGHTY THREE, see Franton Music.

MIKE CHAPMAN, see Franton Music.

MILLEVILLE MUSIC, Via B. Migliarina 8, 41010 Fossoli (MO), PO Box Millevil (Zip: 41010), 0337.562 262, Fax: 059.660 393, GM: Rino Filippin, Promo: Edda Bertesi. Main product: Album Rock, New Age.

MIMO, see BMG Music.

MINSTREL EDIZIONI MUSICALI INTERNAZIONALE, Via Bonaventura Cerretti 32, 00167 Rome (RM), 06.621 6946/622 6724, MD: Maria Augusta Bruni.

MIRACLE CREEK, see BMG Music.

MOMENTUM, see Franton Music.

MONDIA MUSIC, see Dischi Ricordi.

MOVIMENTO MUSICA, Via Voltorno 80, Edinord/Portico 1, 20047 Brugherio (MI), 039.884 415, Fax: 039.884 111, MD: Salvatore Caruselli, Admin Dir: Paola Magagnoli, Ed Dir: Giovanni Caruselli, Prod Mgr: Roberto Rossetti.

MPL COMMUNICATIONS ITALY, see Curci Edizioni.

MUSIC SCENE, see Jump Edizioni.

MUSIC UNION, see Curci Edizioni.

MUSIZA, see Zard Iniziative.

MUVICOM, Via Abbondio Sangiorgio 12, 20145 Milan (MI), 02.9065 8176, MD: Alessandro Colombini.

NAR (NUOVA AUTORI RIUNITI), Via Lessona 2, 20157 Milan (MI), 02.357 5225, Fax: 02.357 5335, MD: Mario Limongelli.

NEIL DIAMOND, see BMG Music.

NEM ENTERTAINMENT, see BMG Music.

NUMBER TWO, see Curci Edizioni.

NUOVA CARISCH, Via Quintiliano 40, 20136 Milan (MI), 02.5801 1120, Fax: 02.5801 1101/17, President: Pietro Meraviglia Mantegazza, MD: Franco Paradiso, Fin Contr: Mario Turri, Sales Mgr: Pietro Camera, Prod Mgr: Roberto Razzini. (Owned): Carisch; (Lic): Ariston, Assist, BMG Ariola, Canale 5 Music, Chapulin, Discorsi, Edition Southern Music, EMI Music Publishing Italy, Gruppo Ed. Sugar, La Drogueria di Drugolo, Peer, Polygram Italia, Sony Music Publishing, Virgin, Warner Chappell Music Italy, Warner Brothers Music Italy, Aspire Music, Blue Team Music, CA Rossi Editore, Costa Est, Demomusic Int'l, EMI Songs, Franton Music, Gienne, Il Ponte, Il Volatore, Kramer, La Chiocciola, Pagan Music, Parking, Pul, Serraglio, Settenote, Sipse Ed. Musicali, Vittoria Ed. Musicali; (Dist): IMP, Warner Brothers Publishing, CPP, Hal Leonard, Cherry Lane, Baerenreiter, Alfred Music; Main product: Jazz, Country, Reggae, Classical, AC.

NUOVA FONIT CETRA, Via Giuseppe Meda 45, 20141 Milan (MI), 02.843 2551-3, Fax: 02.843 6482, Tlx: 314653, MD: Lucio Salvini, GM: Germano Gogna. (Owned): La Rosa dell'Inverno, Nuova Fonit Cetra, Sera Latina.

ORANGE, see Edizioni Southern Music.

ORCHESTRALMUSIC, see Curci Edizioni.

ORNETTE COLEMAN, see Franton Music.

PAGAN MUSIC, see Nuova Carisch.

PAGANMUSIC, see AAA Prologo.

PALMARES, see Many Edizioni Musicali.

PANAMUSIC, Corso Venezia 40, 20121 Milan (MI), 02.7600 8541, Fax: 02.783 548, Tlx: 340014 panar, MD: Sergio De Gennaro.

PARC MUSIC, LE, Via Coghetti 182g, 24100 Bergamo (BG), 035.256 602, Fax: 035.256 602, President: Richard Milella, Chrm: Manlio Cangelini, Asst. to Chrm: Loretta Ghilardi.

PARKING, Via Crescenzo 43, 00193 Rome (RM), 06.659 409, MD: Giancarlo Lucariello, see Nuova Carisch.

PARRY MUSIC, see Edizione Caramba.

PAT METHENEY, see Franton Music.

PDU ITALIANA, see Curci Edizioni.

PEERMUSIC, see Edizioni Southern Music.

PEGASO, see Dischi Ricordi.

PINCIANA MUSIC, Via Carlo Mirabello 25, Scala B int. 2, 00195 Rome (RM), 06.319 375/575 8776, MD: Fulvio Corradini.

PIZZICATO EDIZIONI MUSICALI, Via Monte Ortigara 10, 33100 Udine (UD), 0432.45288, Fax: 0432.45288, President: Anna Maria Fasano, Art Dir: Bruno Rossi. (Owned): Catalogo Generale 91, Music Sheets/Stationary No 2; Main product: Classical.

PLATZ MUSIC, Via F.lli Cervi M12, Residenza dei Sassi, 20090 Segrate (MI), 02.2641 0884, Fax: 02.2641 0884, Tlx: 43311250, Contact: Sandro Pieralli.

POLYGRAM ITALIA, Via Carlo Tenca 2, 20124 Milan (MI), 02.67961, Fax: 02.679 6201, Tlx: 344140, President: Gianfranco Rebulla.

POLYXENA EDIZIONI MUSICALI, Via Asiago 6, 00195 Rome (RM), 06.361 3379, MD: Carloquinto Talamona.

PONZO, Via Piffetti 42, 10143 Turin (TO), 011.771 4672/013, MD: Maria Ponso.

PRAVO MUSIC, Via Enrico Toti 4, 20123 Milan (MI), 02.435 093/463 920/4801 2493, Fax: 02.4819 4098, MD: Mario Allione.

PRESTATION, see Jump Edizioni.

PROB NOBLEM, see BMG Music.

PULL, see Nuova Carisch.

R.R.R., see Dischi Ricordi.

RADIO RECORD, see Dischi Ricordi.

RADIORAMA, see Saifam Music.

RECORDINGS, Via Marsala 4, 50137 Florence (FI), 055.679 378, MDs: Maurizio Nannucci, Maurizio Della Nave.

REPORTER, Via Tagliamento 29, 60124 Ancona (AN), 071.33054, Fax: 071.32844, MD: Stefano Galcazzi.

RIFI, see Edizioni Southern Music.

RIO, see Jump Edizioni.

RITMIE CANZONI, see Dischi Ricordi.

RIVA, see Franton Music.

ROSSODISERA EDIZIONI MUSICALI, Via Asiago 2, 00195 Rome (RM), 06.361 2458, Fax: 06.321 6950, MD: Renato Venturiero. (Owned): Studio Records, Studio B Records, Escargot Records; Main product: Album Rock, New Age.

RTV, see Curci Edizioni.

SAAR EDIZIONI MUSICALI, Viale di Porta Vercellina 14, 20123 Milan (MI), 02.469 6251-4, Fax: 02.481 3058/4819 3944, Tlx: 321277 saar, MD: Walter Franz Gurtler, Comm Dir: Luigi Meloni, Purchasing Manager: Ausilia Cremonesi. Main product: EHR, Adult Contemporary, Jazz, Reggae, Classical, Dance, Album Rock, Gold/Oldies, Black (R&B), New Age.

SAIFAM MUSIC, Via Tamburino Sardo 10, 37137 Verona (VR), 045.862 0927/984 026, Fax: 045.862 0937/984 359, GM: Mauro Farina, President: Giuliano Crivellente, Int'l Dept Mgr: Florian Fadinger. (Owned): SAIFAM; (Admin/sub-pub): Radiorama.

SANGY PRODUCTIONS, Via S.S. Apostoli 51, 36100 Vicenza (VI), 0444.324 426, Fax: 0444.321 776, President: Maurizio Sanginetto.

SANTA CECILIA, see Ariston Group.

SANTA LUCIA, see Bideri Edizioni.

SANTOIANI, see Bideri Edizioni.

SCIA, see Bideri Edizioni.

SEE THE LIGHT, see BMG Music.

SENTO UNICO, see Curci Edizioni.

SENTEMO EDIZIONI MUSICALI, Via Calstora Vecchia 21a, 31040 Cessalto (TR), 0421.327 755, Fax: 0421.327 850, President: Diego Sandrin, VP: Paolo Boarato, Exec: Julie Moss, Prod Exec: Maurizio Soranzo. (Owned): Sentemo, United Project; Main product: Jazz.

SENZA PENSIERI, see Dischi Ricordi.

SERA LATINA, see Nuova Fonit Cetra.

SERRAGLIO, see Nuova Carisch.

SETTEBELLO, see Dischi Ricordi.

SETTENOTE, Via Vittoria Colonna 23, 20149 Milan (MI), 02.481 9209/14, Fax: 02.469 0139, Tlx: 353366, Presidents: Roberto Galanti, Romeo Frumentio.

SIGMA RADIO INTERNATIONAL, Via Santorre Di Santarosa 15, 10131 Turin, 011.839 5454-5, Via Enrico Toti 4, 20123 Milan, 02.435 093/463 920/4801 2493, Fax: 02.4819 4098, MD: Mario Allione.

TOSCO RECORDS, Via G d'Annunzio 51a, 50135 Florence, 055.654 0039, Owner/Mgr: Alfonso Corsini.

TOTO, see BMG Music.

TWO P(I)ETERS, see Best International.

UNITED PROJECT, see Sentemo Edizioni Musicali.

UNIVERSALE, see BMG Music.

VALENTE MUSIC ITALIA, see Ariston Group.

VIANELLO EDIZIONI MUSICALI, Via Citta di Castello 19, 00191 Rome (RM), 06.306 0533/4, MD: Edoardo Vianello.

VIA REGGIO, Via Verdi 88, 55049 Viareggio (LU), 0584.46437/8/9, MD: Gianni Santini.

VIGESSE, Corso Vittorio Emanuele 287, 00186 Rome (RM), 06.687 9286, Fax: 06.689 6359, MD: Antonietta Ugo Salvo.

VIRGIN DISCHI EDIZIONI MUSICALI, Via Porpora 26, 20131 Milan (MI), 02.2951 8305, Fax: 02.2951 7891/5961, MD: Luigi Mantovani, GM: Mariangela Roveda.

VITTORIA ED. MUSICALI, see Nuova Carisch.

VOLTA, see BMG Music.

WARNER BROTHERS MUSIC ITALY, see Nuova Carisch.

WARNER BROTHERS PUBLISHING, see Nuova Carisch.

WARNER CHAPPELL MUSIC ITALIANA, Corso Buenos Aires 79, 20124 Milan (MI), 02.6671 0333, Fax: 02.6698 0757/2354, Tlx: 316682 sinfmi, MD: Adriano Solaro, Int'l Director: Marco Volonte, Snr Creative Mgr: Luigi Bartolotta, Prof Mgrs: Michele di Salvia, Mirella Giorgini.

WAYNE SHORTER, see Franton Music.

WESTUDIO RECORD, Via Mattei 141, 21040 Cislago (VA), 02.9638 0575, Fax: 02.9638 2511, President: Enzo Malepasso, Art Dir: Andrea Costa. (Owned): Tappo Music.

WORLDMUSIC, see Sugarmusic.

XYXOS, see Iksos Music.

ZACHARY CREEK, see BMG Music.

ZARD INIZIATIVE, Viale Mazzini 6, 00195 Rome (RM), 06.314 444, Fax: 06.360 6555, Tlx: 621356 muzeta, President: David Zard, MD: Roberto Mineo, PR/Promo Head: Patrizia Tomaschi. (Owned): Musiza.

ZIG ZAG MUSIC, Via Friuli 51/1, 20135 Milan (MI), 02.5518 7344/7494, Fax: 02.5518 7484, President: Claudio Donato, Publ: Bruno Kassar.

VIDEO PROGRAM SUPPLIERS & BUYERS

AVELCA VIDEO RECORDS, Via Lumiere 6, 20093 Cologno Monzese (MI), 02.2730 0572, Fax: 02.2539 1380, Contact: Luciano Poretti.

AVO FILM, Via C. Ravizza 20, 20149 Milan (MI), 02.4801 2707/17/27, Fax: 02.4801 2737, Contact: Maria Gloria Bulath. Labels (dist): Natural Video, 3B Magnum.

AZZURRA HOME VIDEO, Via Francesco Denza 19a, 00197 Rome (RM), 06.807 8896/2542, Contact: Marco Scaffardi.

BMG ARIOLA ITALY (ROME), Via di Sant' Alessandro 7, 00131 Rome (RM), 06.419 951, Fax: 06.4199 5474, Tlx: 610428 bmgm, MD: Franco Reali.

CD VIDEOSUONO, Via Quintiliano 40, 20138 Milan (MI), 02.50841, Fax: 02.508 4400/4261, Tlx: 321063 suvini, VP: Roberto Guerrazzi, Prod Mgr: Loredana Garlaschi, Sales Dir: Franco Cornetti.

CIC VIDEO, Via Cechov 48, 20156 Milan (MI), 02.3809 3212-3, Fax: 02.3809 3262, MD: Sergio Simonelli, Mktg Dir: Roberto Beretta, Prod Dir: Gianni Fabris, Sales Dir: Alfonso Savi, F&A Dir: Massimo Pozzoli. Video distributor of Universal and Paramount movies.

CINEHOLLYWOOD, Via Reguzzoni 15, 20125 Milan (MI), 02.643 9042/647 3612, Fax: 02.643 0471, Tlx: 331641, President: Roberto Cepparo.

COSMO VIDEO, Via Donatello 37, 20131 Milan, 02.236 6680, MD: Emilio Zerbi.

CREAZIONI HOME VIDEO, Via Agnello 18, 20121 Milan, 02.805 6903/9394, Fax: 02.8901 0833.

DB VIDEO, Via Poma 7, 20129 Milan, 02.738 2773, Fax: 02.736 2500, MD: Angela Ciuffo.

DELTA VIDEO, Corso Buenos Aires 10, 20124 Milan (MI), 02.209 953/4, Fax: 02.225 562, MD: Alessandro Coppola.

DISCHI RICORDI, Via Berchet 2, 20121 Milan (MI), 02.8881, Fax: 02.888 1270, Tlx: 310177 ricor, President: Guido Rignano, MD: Fabio Boldi, Prod Dir: Riri Contiero, Sales Dir: Rolando Bacherini. Video distributor of music videos, fiction and documentaries.

DOMOVIDEO, Via della Madonna 38, 55012 Capannori Santa Margherita (LU), 0583.980 980, Fax: 0583.980 962, Contact: Mariano Volani.

DUPLAS AVELCA, Via Clerici 11, 21040 Gerenzano (VA), 02.968 2517, Fax: 02.968 9524, Contact: Sergio Moretti.

DUPLI VIDEO SOUND, Via Oslavia 17, 20134 Milan (MI), 02.214 1543/215 2354, Fax: 02.214 1312, Tlx: 350148 dvs, MD: Franco Venturato.

EDIZIONI EDEN, Via Melzi d'Eril 29, 20154 Milan (MI), 02.3310 4705/701/691, Fax: 02.3310 4721, President: Gianni Eusebio, Comm Dir: Massimo Moscatti, Roberto Bennati.

ELEVEN, Via Morosini 40, 20135 Milan, 02.546 9909, Fax: 02.5518 0414.

EMI ITALIANA, Via Bergamo 315, 21042 Caronno Pertusella (VA), 02.965114, Fax: 02.965 6002, Tlx: 312679 emital, MD: Roberto Citterio.

FINVER VIDEO PRODUCTIONS, Via Mazzoni 34-36, 41100 Modena (MO), 059.223 8977/19/244 244, Fax: 059.219 218, President: Tony Verona, MD: Jean-Luc Dorn. Distributor of music videos; Affiliated to Ala Bianca Group—Publishing & Music productions.

FOX VIDEO ITALIA, Corso Europa 12, 20122 Milan (MI), 02.7601 3009, Fax: 02.7601 3032, Tlx: 332809 ibc mi, MD: Elvio Gasperini.

GENERAL VIDEO RECORDING, Via Panziera 28, 50047 Prato (FI), 0574.631 013, Fax: 0574.635 170, Tlx: 572517, Contact: Marco Durandini.

GRUPPO EDITORIALE LOGICA 2000, Via F. Sforza 14, 20122 Milan (MI), 02.331 4829, Contact: Antonio Lucarella.

KONO, Viale Lunginaga 40, 20125 Milan (MI), 02.667 251, Fax: 02.6671 3323, Tlx: 328579, President: Enrico Rovelli.

LVR, Via Polistena 10, 00173 Rome (RM), 06.722 2241, Fax: 06.722 2511, Contact: Domenico Bavasso.

MARGY, Via Ori 2, 20122 Milan (MI), 02.551 7545, Fax: 02.545 9918, MD: Giuliana Gallo.

MONDADORI VIDEO, Via Mondadori, 20090 Segrate (MI), 02.75421, Fax: 02.7542 3230, MD: Pietro Varvello.

NEW PENTAX FILM, Via Domenico Cimarosa 18, 00158 Rome (RM), 06.854 3382/3284, Fax: 06.855 8105, Contact: Gianluca Corti, Daniela Coscarella.

NUOVA FONIT CETRA, Via Giuseppe Meda 45, 20141 Milan (MI), 02.843 2551-3, Fax: 02.843 6482, Tlx: 314653, MD: Lucio Salvini, GM: Germano Gogna, Dir: Emanuela Bompiani. Labels: Fonit Cetra Video, Videorai.

PANARECORD, Corso Venezia 40, 20121 Milan (MI), 02.7600 8541, Fax: 02.783 548, Tlx: 340014 panar, President: Sergio De Gennaro, Mktg Dir: Fabrizio La Rosa, Repertoire Mgr: Violetta Nasi, Comm Mgr: Alberto Maravalle. Labels: MGM/UA, Panarecord.

PANTHEON, Via Val di Sangro 13, 00141 Rome, 06.812 3874/886 2936, Fax: 06.886 3260, Dir: Marco Casanova, Dub

FIRST ORGANISATION, Via Andrea Bafille 13, 00195 Rome (RM), 06.358 1758/1235, Tlx: 620238, MD: Massimo Lazzari, PR: Eleonora Di Maggio.

FRIZ ITALIANA, Via Principi d'Acaja 28, 10138 Turin (TO), 011.747 114, Fax: 011.404 0250, Tlx: 210310 ppto attn: friz.

INTER-NOS, Viale Angelico 78, 00195 Rome (RM), 06.372 8648/0337.741 269, Fax: 06.372 4002, MD: Alex Di Martino, Promo: Susy Di Martino.

INTER PRESS SERVICE, Via Panisperna 207, 00184 Rome, 06.485 692, Fax: 06.481 7877.

IT DISCHI ITALIA EDIZIONI, Via Guido Banti 46, 00191 Rome (RM), 06.327 3468/4043/4802, Fax: 06.333 8197, MDs: Vincenzo Micocci, Francesco Micocci, Stefano Micocci.

KARMA PROMOTION, Via Abetone 18, 20137 Milan (MI), 02.545 5096, Tlx: 340619 nordal, Sec: Rossana Ghidini.

LUCIANO TALLARINI, Via Giannone 2, 20154 Milan (MI), 02.316 427, Fax: 02.331 1921, Contact: Luciano Tallarini.

MARTI NELLO, Via Fiamma 15, 20129 Milan (MI), 02.744 630/738 0033, Fax: 02.738 6110, MD: Nello Marti.

MORENO SONATORI MANAGEMENT, Via delle Pinzochere 1, 50121 Florence, 055.241 652/245 991/245 222, Fax: 055.245 883, Tlx: 575813 firmals, MD: Moreno Sonatori.

POOL GROUP, Via Deruta 20, 20132 Milan, 02.261 0805, Fax: 02.261 0593.

PROMARCO ADVERTISING, Via Zenale 15, 20123 Milan (MI), 02.498 8137, Fax: 02.481 4311, Tlx: 350117 promar, President: Gian Marco Bragadin, GM: Carlo Biagi.

PROMO CLUB, Via Coghetti 182/g, 24100 Bergamo (BG), 035.256 602, Fax: 035.252 445, MD: Richard Milella. Private radio, TV, press promotions; Music consultant for: RBS, Vedette, DiscoMagic, Scasso Matto, New Music, WIP.

WARNING PROMOTIONS, Via Bellotti 7, 20123 Milan (MI), 02.7611 0700, Fax: 02.761 0871, Tlx: 328628, MD: Claudio Trotta.

COMPACT DISC MASTERING & REPLICATING PLANTS

CAPRI DIGITAL STUDIOS, Via Tuoro 11, 80073 Capri (NA), 081.837 5157/60, Fax: 081.837 5141, MD: Carloquinto Talamona, Chief Eng: Gaetano Ria, Keyboard Prog: Max Carola, Tech Mgr: Jon Mansey, Maintenance Eng: Roberto Russo. CD pre-mastering.

LUNATIC STUDIOS, Via G Reina 6, 00123 Rome (RM), 06.376 1690, Fax: 06.376 6286, MD/Studio Mgr/Prod: Paul Mazzolini, Bookings: Maria Conte, Chief Eng: Emanuele Donnini, Asst Eng: Tony Marino, Hardware: Stefano Oddenino. CD pre-mastering.

NUOVA DECIBEL, Via Cremona 18, 20020 Lainate (MI), 02.937 3383/3384/3089, Fax: 02.937 2671, Presidents: Aldo Zuffada, Gerardo Festa, Sales Mgr: Renzo Benini.

OPTI.M.E.S., Via Visconti di Modrone 1, 20122 Milan (MI), 02.784 153, Fax: 02.7600 4061, MD: Valeriano Toschi, Mktg/Sales Mgr: Paolo Macchi, Sales Mgr: Pasquale Isso, Mktg Spec: Marco Vecchi. CD pre-mastering & duplication; 2nd sales office: Via Panama 52, Rome, 06.855 2966, Fax: 06.854 6197; Plant: 0862.3311, Fax: 0862.317 905.

OPTICAL, Via Privata Emilia 1, 20010 Pogliano Milanese (MI), 02.9325 6537, Fax: 02.9325 8055, Tlx: 324833 ciamer, Contact: G Ciamer. Annual capacity: 2 mil.

PHONOCOMP, Via Rossini 4, 20067 Tribiano (MI), 02.9063 1711/3088, Fax: 02.9063 0564, Tlx: 310239 phonoc. CD pre-mastering & duplication.

PHONOPRESS, SS Paullese Km 10, 20090 Settala (MI), 02.9589 9160, Fax: 02.9589 9160, MD: Michele Gagliardi.

POZZOLI, Via G di Vittorio 11, 20065 Inzago (MI), 02.954 7351-3, Fax: 02.954 7438, President: Aldo Pozzoli, GM: Cesare Brunelli.

SONOPRESS, Galleria del Corso 2 (c/o BMG Italia), 20122 Milan (MI), 02.7600 4737, Fax: 02.7601 5026, Tlx: 310689 bmgmi, Comm Dir: Paolo Montagna. Agent for Sonopress (Ger).

VAI VIDEO APPLICAZIONI INDUSTRIALE, Via della Meccanica, 04100 Latina (LT), 06.928 2718, Fax: 06.928 2723, Dir: Antonio Perla.

PLATING, MASTERING & PRESSING PLANTS

ACTION STUDIO, Corso Galileo Ferraris 141, Turin (TO), 011.995 4988, Fax: 011.995 4963. Disc cutting.

ARISTON, Via Massimo Gorki 21, 20098 San Gulliano Milanese (MI), 02.984 6974, Fax: 02.984 1410, President: Alfredo Rossi, MD: Adriana Zuccaro.

BABY STUDIOS, Via Timavo 34, 20124 Milan (MI), 02.607 1474/266, Fax: 02.689 8701, President: Freddy Naggiar, MD: Monica Dahl. Disc cutting.

DUCALE, Via per Cadrezzate 6, 21020 Brebbia (VA), 0332.770 189/784, Fax: 0332.771 047, Tlx: 380231 ducale, MD: Davide Matalon.

EMI ITALIANA, Via Bergamo 315, 21042 Caronno Pertusella (VA), 02.96511, Fax: 02.965 1403, Tlx: 312679 emital, M&D Dir: Ludovico Drilo Iojlo. Disc cutting & vinyl pressing.

EUROPRESS, Via Quintiliano 40, 20138 Milan (MI), 02.5801 1071, Fax: 02.5801 1059, Tlx: 321063 suvini, MD: Cesare Brunelli.

FONOLA FONOTECNICA, Via Ariberto 21, 20123 Milan (MI), 02.8940 4626/835 4626, MD: Marco Braga.

LOGIC STUDIOS, Via Quintiliano 40, 20138 Milan (MI), 02.5801 1160, Fax: 02.5540 0317, MD: Michelangelo La Bionda,

Studio Mgr: Francesca Cominelli. Disc cutting.

NUOVA DECIBEL, Via Cremona 18, 20020 Lainate (MI), 02.937 3383/3384/3089, Fax: 02.937 2671, Presidents: Aldo Zuffada, Gerardo Festa, Sales Mgr: Renzo Benini.

NUOVA FONIT CETRA, Via Giuseppe Meda 45, 20141 Milan (MI), 02.843 2551-3, Fax: 02.843 6482, Tlx: 314653. Disc cutting.

PHONO-PLAST, Via A Grandi 50, 20068 Peschiera Borromeo (MI), 02.547 1321/2740, Tlx: 326498 phono, Contact: Benito Sgamboto, Leonardo Ardigo.

PHONOCOMP, Via Rossini 4, 20067 Tribiano (MI), 02.9063 1711/3088, Fax: 02.9063 0564, Tlx: 310239 phonoc, President: Giovanni Tedoldi, MD: Giovanni Bonandrini. Disc cutting & vinyl pressing.

PHONOPRESS, SS Paullese Km 10, 20090 Settala (MI), 02.9589 9160, Fax: 02.9589 9160, MD: Michele Gagliardi.

PHONOTYPE RECORDS, Via E De Marinis 4, 80134 Naples (NA), 081.205 873/552 7195/716, Fax: 081.552 2649, MD: Vincenzo Esposito.

SAAR, Via Gramsci 4, 20016 Pero (MI), 02.3810 0163/5, Fax: 02.353 6696, Contact: Giuseppe Zaina. Disc cutting & vinyl pressing.

SONOPRESS, Galleria del Corso 2 (c/o BMG Italia), 20122 Milan (MI), 02.7600 4737, Fax: 02.7601 5026, Tlx: 310689 bmgmi, Comm Dir: Paolo Montagna. Agent for: Sonopress (Ger).

TAPE CUSTOM DUPLICATORS

ACTION STUDIO, Corso Galileo Ferraris 141, Turin (TO), 011.995 4988, Fax: 011.995 4963.

ANALOGY, Via Tremonti 84, 98100 Messina (ME), 090.49421, MD: Angelo Pepe.

AUDIO VIDEO PRODUCTION, Via Gandhi 2, 25030 Erbusco (BS), 03.724 0588, Fax: 03.724 1641, Tlx: 305264 avp, President: Edoardo Cattaneo.

BELMUSIC, Via Termopili 20, 20127 Milan (MI), 02.282 8905/9473, Fax: 02.282 8905, Pres/Sound Eng: Severino Pecchenini, MD: Domizia Gandolfi, Sound Engineer: Rosolino Croce.

CIAC STUDIO 88, Viale Angelico 90, 00195 Rome (RM), 06.391 818/316 202, Fax: 06.381 918, GM: Adriano Zonin, Dir: Donatella Bagliov, Consultant: Ernesto Marra.

DOMOVIDE, Via della Madonna 38, 55012 Capannori Santa Margherita (LU), 0583.980 980, Fax: 0583.980 962, Contact: Mariano Volani.

DUCALE, Via per Cadrezzate 6, 21020 Brebbia (VA), 0332.770 189/784, Fax: 0332.771 047, Tlx: 380231 ducale, MD: Davide Matalon.

DUPLI VIDEO SOUND, Via Oslavia 17, 20134 Milan (MI), 02.214 1543/215 2354, Fax: 02.214 1312, Tlx: 350148 dvs, MD: Franco Venturato.

DUPLIMATIC, Via Toscanini 23-25, 20093 Cologno Monzese (MI), 02.2539 0270/0468, Fax: 02.253 6496, MD: Guido Mezzadra.

DUREMA, Via Imperia 28, 20142 Milan (MI), 02.843 0740, Fax: 02.843 7344, MD: Claudio Occhiena.

ECOFINA, Via Vincenzo Monti 44, 20123 Milan (MI), 02.481 6121/5, Fax: 02.498 0463, MD: Mourad Sabet.

EMI ITALIANA, Via Bergamo 315, 21042 Caronno Pertusella (VA), 02.96511, Fax: 02.965 6002, Tlx: 312679 emital, MD: Ludovico Dello Iojlo.

FONOLA FONOTECNICA, Via Ariberto 21, 20123 Milan (MI), 02.8940 4626/835 4626, MD: Marco Braga.

MAGNETOPLAST, Via Magenta, 20010 Boffalora Ticino (MI), 02.975 4307, President: Giuseppe Zanardo, Dir: Silvio Bertasi. Administrative office: Via Leida 8, 37100 Verona (VR), 045.504 491.

MAYDAY STUDIO, Via Pomezia 7, 20127 Milan (MI), 02.287 1569, Fax: 02.2611 2240, Studio Mgr: Ruggero Penazzo.

NATALI, Via Empoli 11, 50142 Florence, 055.732 1231, Fax: 055.732 3432, President: Wilvivo Natali, Chief Eng: Mario Panari, Sales Dir: Susanna Santini.

NUOVA DECIBEL, Via Cremona 18, 20020 Lainate (MI), 02.937 3383/3384/3089, Fax: 02.937 2671, Presidents: Aldo Zuffada, Gerardo Festa, Sales Mgr: Renzo Benini.

PHONO-PLAST, Via A Grandi 50, 20068 Peschiera Borromeo (MI), 02.547 1321/2740, Tlx: 326498 phono, Contact: Benito Sgamboto, Leonardo Ardigo.

PHONOCOMP, Via Rossini 4, 20067 Tribiano (MI), 02.9063 1711/3088, Fax: 02.9063 0564, Tlx: 310239 phonoc, President: Giovanni Tedoldi, MD: Giovanni Bonandrini.

PHONOPRESS, SS Paullese Km 10, 20090 Settala (MI), 02.9589 9160, Fax: 02.9589 9160, MD: Michele Gagliardi.

PHONOTYPE RECORDS, Via E De Marinis 4, 80134 Naples (NA), 081.205 873/552 7195/716, Fax: 081.552 2649, MD: Vincenzo Esposito.

POZZOLI, Via G di Vittorio 11, 20065 Inzago (MI), 02.954 7351-3, Fax: 02.954 7438, President: Aldo Pozzoli, GM: Cesare Brunelli.

SAAR, Via Gramsci 4, 20016 Pero (MI), 02.3810 0163/5, Fax: 02.353 6696, Contact: Giuseppe Zaina.

WESTUDIO RECORD, Via Mattei 141, 21040 Cislago (VA), 02.9638 0575, Fax: 02.9638 2511, President: Enzo Malepasso, Sound Engineers: Marco Balbo, Sandro Raspagliesi.

ZEUS RECORD, Piazzetta Matilda Serao 15, 80132 Naples, 081.406 791/415 997, Fax: 081.406 791, MDs: Ciro & Antonio Barrucci, Sales Dir/Studio Mgr/Eng: Esposito Barrucci, Eng: Massimo Perna.

CASSETTES REELS & PARTS, JEWEL BOX MANUFACTURERS

A.T.B. SpA

Via Palmiro Togliatti 30, 20030 Senago (MI), 02.998 9976-8, Fax: 02.998 6718, Tlx: 334457 atibix, MD: Abramo Bordignon. C-0 & V-0 cassette components.

AUDIOGRAMM, Via Fratelli Kennedy N 2/4, 25050 Passirano, 03.657 360, Tlx: 300850, President: Edoardo Cattaneo.

BIG (BREVETTI INTERNAZIONALI GRAFICI), Via Manzoni 9, 22012 Cernobbio (CO), 031.513 480, Fax: 031.512 401.

DUCALE, Via per Cadrezzate 6, 21020 Brebbia (VA), 0332.770 189/784, Fax: 0332.771 047, Tlx: 380231 ducale, MD: Davide Matalon.

EUROPA COMPACT CASSETTE (ECC), Via Martiri della Libertà 53, 25035 Ospiateletto (BS), 030.640 134, Fax: 030.642 815, MD: Rinaldo Bianchi. C-0 cassettes & boxes.

FILP, Via Plinio 63, 20129 Milan (MI), 02.940 8827/0451, Fax: 02.043 092, Tlx: 316383 filp, President: Eugenio Marccasoli, MD: Marco Gariboldi, Sales Mgr: Nedo Zaghini, Purchasing Manager: Massimo Avanti. C-0 components, leader tape, lining sheets, spring pads, screws, metal strips, stacking rodwire.

FLI MARCHESI, Via Maneli, 20060 Cassina de Pecchi (MI), 02.952 9278, Fax: 02.952 9346, Contact: Mr. Balconi.

GI-ESSE, Via LB Alberti 8, 20149 Milan, 02.331 1448, Fax: 02.3310 3745.

INTERNATIONAL COMPACT CASSETTE, Via Larga, Porzano di Leno, 25024 Brescia (BS), 030.906 484/906 7196, Fax: 030.906 123, President: Antonio Pier Cavagnoni, MDs: Marina Guerra, Simona Zanotti. C-0 cassettes & library cases.

MUNTER ELETRONICA, Via Dei Partigiani 116, 20092 Cinisello Balsamo (MI), 02.2622 1143, Fax: 02.240 8379, Contact: Massimo Munter.

NUOVA SIAT, Via Dell'Orto 19, 21047 Saronno (VA), 02.960 7450, Fax: 02.9670 1589, Tlx: 335884 nsiat, Contact: Mr. Benetton. C-0 & V-0 cassettes & components.

OPAC DI F OPESSI, Via Bianca de Savoia 7, 20122 Milan, 02.5518 5530/5490, Fax: 02.5830 0766, Tlx: 315219 opac, Dir: Franco Oppesio. Agent for Marden Edwards & Company.

PLASTICOM, Viale Aldo Moro 32 bis, 24054 Calcio (BG), 0363.968 233-4, Fax: 0363.968 161, Tlx: 320042 weco, MD: Mario Comendulli, Tech Mgr: Terenzio Comendulli, Quality Contr/Sales: Carlo Rondelli. Jewel boxes for CDs, MCs & video cassettes.

POLIMEK, Via Pace 64, 20017 Rho (MI), 02.930 1742, Tlx: 330501, President: Rosario Mandina.

PRINTING, PACKAGING & LABELS

DUPLI VIDEO SOUND, Via Oslavia 17, 20134 Milan (MI), 02.214 1543/215 2354, Fax: 02.214 1312, Tlx: 350148 dvs, MD: Franco Venturato. Packaging/mailling services.

DUPLIMATIC, Via Toscanini 23-25, 20093 Cologno Monzese (MI), 02.2539 0270/0468, Fax: 02.253 6496, MD: Guido Mezzadra. Packaging/mailling services.

DUREMA, Via Imperia 28, 20142 Milan (MI), 02.843 0740, Fax: 02.843 7344, MD: Claudio Occhiena. Packaging/mailling services & sleeve/label printer.

ECOFINA, Via Vincenzo Monti 44, 20123 Milan (MI), 02.481 6121/5, Fax: 02.498 0463, MD: Mourad Sabet. Sleeve/label printer & packaging/mailling services.

FLYTEK, Via Palombarese 150, 00013 Santa di Mentana (RM), 06.905 0411, Fax: 06.905 0253. Packaging/mailling services.

GRAFICHE DOTTI, Via Cinque Giornate 38, 22012 Cernobbio (CO), 031.512 400, Fax: 031.512 401. Sleeve/label printer.

MAGNETOPLAST, Via Magenta, 20010 Boffalora Ticino (MI), 02.975 4307, President: Giuseppe Zanardo, Dir: Silvio Bertasi. Packaging/mailling services.

NUOVA DECIBEL, Via Cremona 18, 20020 Lainate (MI), 02.937 3383/3384/3089, Fax: 02.937 2671, Presidents: Aldo Zuffada, Gerardo Festa, Sales Mgr: Renzo Benini. Sleeve/label printer.

PHONOCOMP, Via Rossini 4, 20067 Tribiano (MI), 02.9063 1711/3088, Fax: 02.9063 0564, Tlx: 310239 phonoc, President: Giovanni Tedoldi, MD: Giovanni Bonandrini. Packaging/mailling services.

BLANK & BULK RAW TAPE

3M ITALIA, PO Box 10411, 20110 Milan (MI), 02.755 2030, Fax: 02.7545 3076.

ADORNI & SEGANTINI, Via Bissolati 29, 20125 Milan (MI), 02.606 402, Fax: 02.608 1291. Distribute: Ampex.

AEDO, Via Milano 9a, 09100 Cagliari (CA), 070.300 360. Distribute: Ampex.

AMPEX ITALIANA, Riccardo Gigante 4, 00143 Rome (RM), PO Box 10720 (Zip: 00100), 06.500 971, Fax: 06.5009 7224/34, MD: Claudio Prezzi, Dir: Quinto Frosini (Magnetic Tape), Romolo Quinto (Video Sys), Fin Mgr: Giuliana Onofri. Audio & video cassettes.

AUDIOVIDEO SYSTEM, Viale Olimpia 12, 42100 Reggio Emilia (RE), 0522.566 850/55/80, Fax: 0522.556 865. Distribute: Ampex.

BASF ITALIA, Via Vincenzo da Seregno 44, 20161 Milan (MI), 02.64081, Fax: 02.645 3145.

RESEARCH, TECHNOLOGY & AUTOMATION

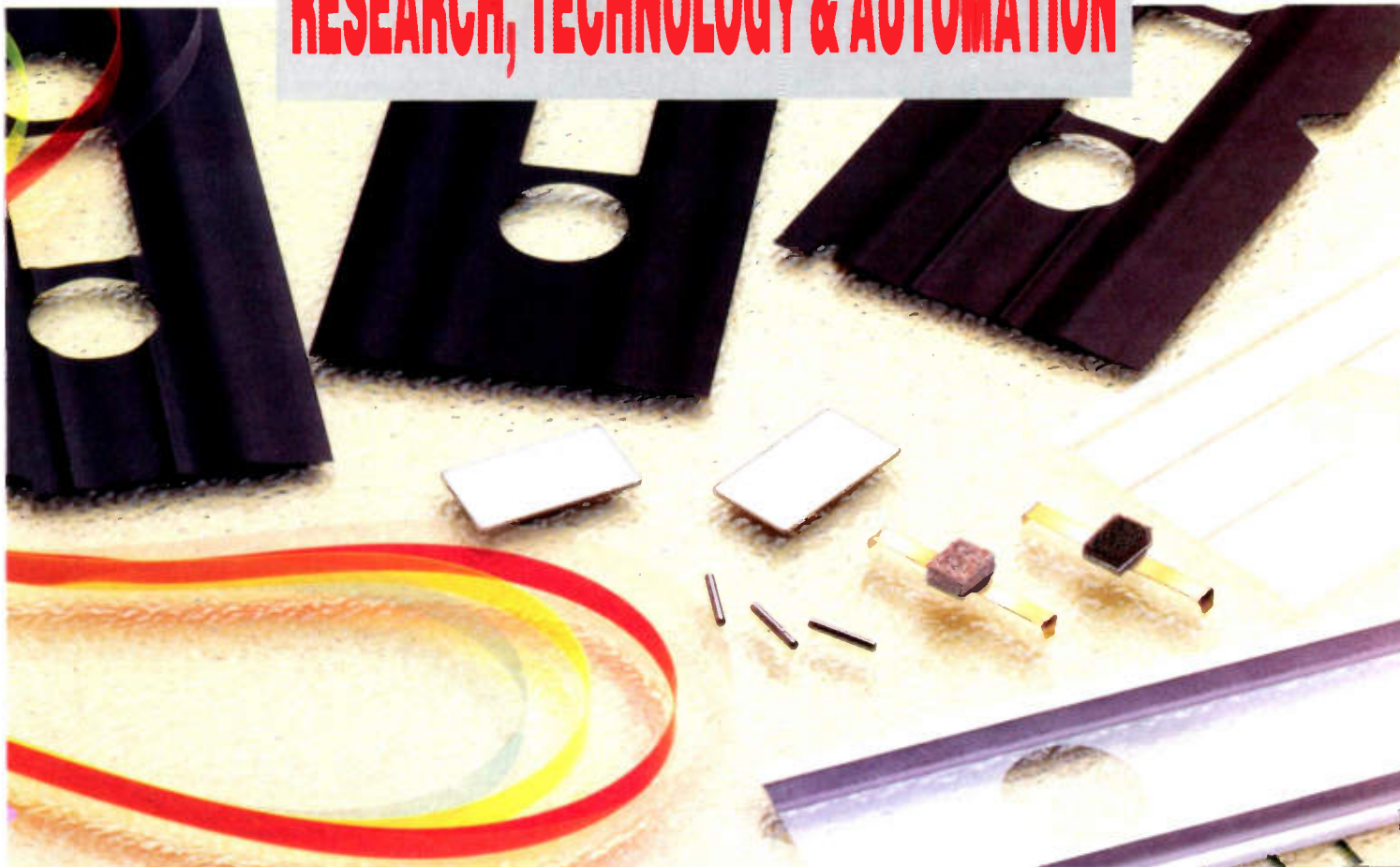

Research, Technology, Automation
is the philosophy of ATB's production.

In audiocassette components,
the strict application of
this Standard, has allowed ATB
to obtain qualified products
ideally suited to fulfill
Automatic Assembling Technology.

Synthetic velvet flock

Synthetic felt

**SPRING PAD
SWINGING
ON BOSSES**

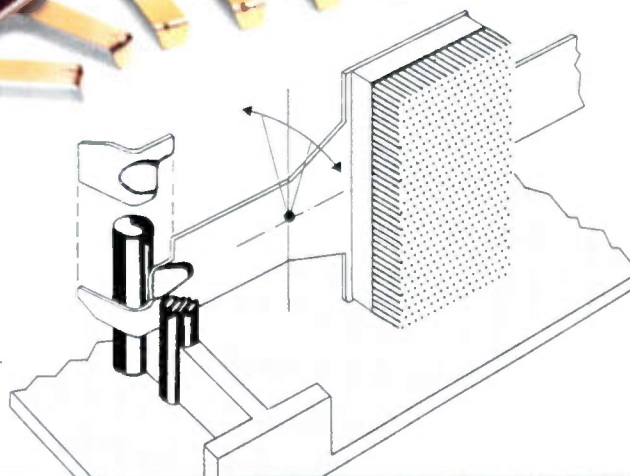

Audio & Video Cassette Components

A.T.B. SpA
20030 Senago - Milano (Italy)
Via Palmiro Togliatti, 30
Telefono 02-9989976/7/8
TLX 334457 ATIBIX I
T.FAX 02-9986718

European agent:
CTI Ltd.
Bergstrasse 43 - CH 8805 RICHTERSWIL
Tel. + 41-(0)1-7861811
Fax + 41-(0)1-7861819

DATATEX, Corso Trapani 104, 10141 Turin (TO), 011.377 846, Fax: 011.335 8972. Distribute: Ampex.

EUROPA SERVICE, Via Rio 14a, 86020 Trivento (CB), 0874.871 381, Fax: 0874.871 617. Distribute: Ampex.

GIOVANNI ANTONNACCI, Via Padre M Kolbe 6, 70125 Bari (BA), 080.580 201, Fax: 080.580 201. Distribute: Ampex.

HELP, Via delle Resede 8a, 00171 Rome (RM), 06.241 0333, Fax: 06.241 0307. Distribute: Ampex.

PASQUALE SANTORO, Via Milano 84, 80142 Naples (NA), 081.266 765, Fax: 081.266 765. Distribute: Ampex.

PELLEGRINI, SS Adriatica 184, 60017 Marzocca di Senigallia (AN), 071.69036/698 000, Fax: 071.69449. Distribute: Ampex.

PROFESSIONAL SHOW, Viale Nazionale 171, 36050 Belvedere di Tezze (VI), 0424.560 661, Fax: 0424.560 706. Distribute: Ampex, Maxell.

SICILDUPLI, Viale Lorenzo Botolano 45, 95122 Catania (CT), 095.515 549, Fax: 095.516 923.

SONY OPERATIONS, Via Fratelli Gracchi 30, 20092 Cinisello Balsamo (MI), 02.612 1551, Tlx: 331569.

STUDIO SOUND LIGHTS, Via E Toti 75, 90128 Palermo (PA), 091.487 748, Fax: 091.599 055. Distribute: Ampex.

SUNKYONG ITALIA, Strada 7A, Palazzo TI, 20089 Rozzano (MI), 02.824 5235, Fax: 02.824 5106.

TECNOMARKET, Viale Aspromonte 5/2 D, 16128 Genoa (GE), 010.580 448, Fax: 010.580 448. Blank tape distributor.

VIDEOSERVICE, Via Fiume 10, 50123 Florence (FI), 055.284 745, Fax: 055.289 174. Distribute: Ampex.

CD, RECORD & TAPE MANUFACTURING SYSTEMS

CONSTRUZIONI STAMPI TERMOPLASTICI (CST), Viale Aldo Moro 20, 24045 Calcio (BG), 0363.968 233/4, Fax: 0363.968 161. Vinyl & tape equipment.

GENERAL TAPE EQUIPMENT (GTE), Via Ragusa 8, 20125 Milan (MI), 02.689 8065, Tlx: 333046, GM: Ottaviano Clerici Bagozzi. Vinyl & tape equipment.

GIMA, Via Del Lombardi 3a, 40069 Zola Predosa (BO), 051.755 209, Fax: 051.752 378, Tlx: 521088 gima. CD packaging equipment.

LA C DI CLAMER, Via Rosmini 14, 20010 Pogliano Milanese (MI), 02.9325 6537, Fax: 02.9325 5758, Tlx: 324833. CD equipment.

MDA, Via San Giuseppe 137, 20147 Saronno (MI), 02.962 0914, Tlx: 380426, GM: Pinuccia Grassi. Vinyl & tape equipment.

ROBOTECNICALYREC, Via Cagni 5, 20052 Monza (MI), 039.744 122, Fax: 039.743 422, Tlx: 322888, MD: Rizza Attilio, Asst Dir: Marco Parravicini. Distribute: Lyrec; Product: automatic tape winding equipment.

STM, Via Lombardia 26, 20060 Vignate (MI), 02.956 0364, Fax: 02.956 0114, Contact: Mr. Sanna. Vinyl & tape equipment & packaging/labeling equipment.

TAPE TECHNOLOGY LAB (TTL), Via Pirandello 4/a, 20144 Milan (MI), 02.469 5213, Tlx: 325236 rzzttl, President: A Rizza. Vinyl & tape equipment.

TAPEMATIC, Via Vimerate 32, 20060 Ornago (MI), 039.601 0145, Fax: 039.601 0558, Tlx: 340233 tapeml, Contact: Mr. Perego. Packaging/labeling equipment & vinyl & tape equipment.

TAPE PACKAGING & LABELING EQUIPMENT

MUSICBOX/VIDEOSON, Via Castegnato 8 bis, 25050 Rodengo Saiano (BS), 030.610 931, Fax: 030.611 395, Tlx: 303056 vidson, Contact: Franco Rossetti. Packaging/labeling equipment.

STM, Via Lombardia 26, 20060 Vignate (MI), 02.956 0364, Fax: 02.956 0114, Contact: Mr. Sanna. Vinyl & tape equipment & packaging/labeling equipment.

TAPEMATIC, Via Vimerate 32, 20060 Ornago (MI), 039.601 0145, Fax: 039.601 0558, Tlx: 340233 tapeml, Contact: Mr. Perego. Packaging/labeling equipment & vinyl & tape equipment.

LUXEMBOURG

RECORD COMPANIES

INTERCOMMUNICATION, 275 route d'Arion, 8001 Strassen, 0310 471, Fax: 0310 615, GM: Roby Raus, Mgr: Alex Felten.

MUSIC PUBLISHERS

RADIO MUSIC INTERNATIONAL, Villa Louvigny, 2825 Luxembourg-ville, 0472 317, Fax: 0471 171, Tlx: 3796, MD: Ray van Cant, Copyright: Arlette Goebel.

WALTZING-PARKE PRODUCTIONS, PO Box 59, 2010 Luxembourg-ville, 0445 779, Fax: 0456 377, Dir: Gast Waltzing, Publ Mgr: Margaret Parke.

ASSOCIATIONS & PROFESSIONAL ORGANIZATIONS

SACEM, 46 rue Goethe, 1637 Luxembourg-ville, 0475 559, Fax:

0480 276, Contact: Pierre Neuen. Society of authors, composers & music editors.

THE NETHERLANDS

RECORD COMPANIES

7 HORSES, Oude Enghweg 7, 1217 JA Hilversum, 035.284 458, Fax: 035.284 450.

AKM RECORDS, Eendekool 28, 5151 RL Drunen, 04163.74991, Fax: 04163.74075, Dir: Ad Kramer, Denise Christian, Harry Thomas.

AMG RECORDS, Piersonware 13, 8014 PX Zwolle, 038.657 006, Fax: 038.652 537, Dir: Michel Baudel.

ANTLER-SUBWAY NEDERLAND, Lambertus Hortensiuslaan 36, 1412 GW Naarden, 02159.51176, Fax: 02159.44609, MDs: Ad de Feyter, Sjon Martens. Distribution: Rough Trade.

ARCADE BENELUX & INTERNATIONAL, Groningenhaven 18, 3433 PE Nieuwegein, PO Box 1308 (Zip: 3430 BH), 03402.65400, Fax: 03402.60975, President: Herman Heinsbroek, VP: Bert de Liefde, A&R Dir: Nan Schuring, Mktg Mgr: Sylvain Jonkergouw, Dir Rec Ops/Publ: Andre de Raaff, Sales Mgr: Marijke Ruiters, Creative Mgr: Svenno Koemans, Media & Creative Ser Mgr: Cor Hemerijck, Prod Mgr: Niel van Hoff. Main product: Jazz, Country, Reggae, Classical, Dance, Album Rock, Gold/Oldies, Black (R&B).

ARTY PROMOTIONS HOLLAND, Zuidhoek 191b, 3082 PG Rotterdam, PO Box 59118 (Zip: 3008 PC), 010.428 2951, Fax: 010.429 5367, GM: Jan Beunk, Asst Dir: L Browne, Int'l Sales Mgrs: H Akkerman, J van Voordt. Labels distr: Arty Lux, APH Records.

ASSOCIATED ARTISTS MUSIC INT'L & MEDIA, Maarschalklaan 47, 3417 SE Montfoort, 03484.2860, Fax: 03484.2860, President: Joop Gerrits, MD: Jochem van Renesse, Sec: Iris Gabeler, President (Media): Gianfranco Bortolotti, Prod/Label Mgr (Media): Peter Boertje. Labels (owned): Armada, AAMI; (Lic): Horus, Media, Inside, Underground, GFB, Bala Degli Angeli, Whole Records, Many, True People, Palmares; Main product: EHR, Reggae, Dance, Black (R&B).

AUDIO VISUAL PRODUCTIONS, Nagtglaslaan 18, 1412 EH Naarden, 02159.42760, Fax: 02159.41768.

B & B RECORDS, Huizerweg 13, 1261 AS Blaricum, 02153.87574, Fax: 02153.12523, Tlx: 73107 ledis, MDs: Rob & Ferdi Bolland, Bus Mgr: Michael Lambrechtsen, A&R/Prod Mgr: Eric Van Den Brink, Exec Asst/Proj Mgr: Marion Mulder. Labels (owned): B&B Records; Main product: EHR, Dance.

BARRICADE RECORDS
Molenbaan 30, 2908 LM Capelle aan de IJssel, 010.442 4022, Fax: 010.442 4080.

BLUE SHADOW RECORDS, PO Box 43003, 1009 ZA Amsterdam, 020.665 0670, Fax: 020.665 0670, President: H J W Kramer, MD: H F A Schalken. Main product: Black (R&B), Blues.

BMG ARIOLA BENELUX, Laapersveld 63, 1213 VB Hilversum, PO Box 752 (Zip: 1200 AT), 035.256 256, Fax: 035.233 872, MD: Dorus Sturm, Fin Contr: Frank Moors, Bus Affairs Mgr: Coen van Wermeskerken, Gen Sales Mgr: Ben ten Katen, Ad/PR Mgr: Tibor Benkhard, Spec Prod Mgr: Gertrude Janssen, Mktg Mgrs: Gerard Kostermans (Ariola), Maarten Steinkamp (RCA), Prod Mgr: Willem Wijgers (BMG Classics), BMG Video, DDD, Ear/Candy, EVA, Hansa, Melodia/Eurodisc, Novus, RCA, RCA Victor; (Lic): Deutsche Harmonia Mundi, Geffen, GRC, Imago Island, MCA, Motown, Private Music; (Distr): Jive, Silverstone, Zomba.

BOJU RECORDS & PUBLISHING, Willem Bayerstraat 5, 6042 BJ Roermond, 04750.16629, A&R: June Rollocks, PR: Beau van Gils.

BOUDISQUE RECORDS, De Ruyterkade 41-43, 1012 AA Amsterdam, 020.626 0311, Fax: 020.627 6310, MD: Ruud Jacobs, GM: Laurens Q Meijer, A&R: Eleanore Hamaker (Int'l Label Mgr), Fred Berkhout (Dance Dept), Eric van Eerdenburg (RTV Promo), H/R Promo: Jack Brouwer. Labels (owned): ESP, Fokkerij Grammofoonplaten, Go Bang!, Palace Records, Torso Dance, Torso Kino, Torso Records; (Lic): Active Records, Best Records, Food for Thought, Fun After All, Homestead, Metal Blade, Music For Nations, Off The Track, Rough Justice, Under One Flag; (Distr): Crambo, Crammed Discs, Cramworld, Erde Records, Furax Records, KK Records, Kickin' Records, Madagascar, Made to Measure, Rainland, SSR, ZazaBoem; Main product: EHR, Dance, Album Rock, Black (R&B).

BR MUSIC, Tolhuislaan 12, 3862 WL Nijkerk, 03494.54410, Fax: 03494 60431, Tlx: 12523, MD: Bert van Breda.

CAT MUSIC (HOLLAND), Herenweg 9, 2465 AA Rijnsaterwoude, 01721.9853/9468, Fax: 01721.7642, MDs: Geertjan Hensing, Aart Mol.

CHRYSALIS RECORDS (HOLLAND), Oefloof 24, 1251 EB Laren, 02153.17573/5, Fax: 02153.17565, MD: Hans van der Wal, Promo= Lisette Kruijs (Press/TV), Hans Christenhus (Radio). Labels (owned): Chrysalis, Cooltempo, Ensign, Dover; Distribution: EMI.

CITY RECORD, Wagnertlaan 30, 9402 SH Assen, PO Box 735 (Zip: 9400 AS), 05920.43904, Fax: 05920.43904, MDs: Herman Bettén (A&R), Menno Ockeloen (Label Mgr).

CNC MUSIC PRODUCTIONS, Schutsestraat 27, 4841 EC Prinsenbeek, PO Box 42 (Zip: 4841 EC), 076.413 034, Fax: 076.412 050, Tlx: 54143, President: Clemens Duynstee, Int'l:

Mark de Raaff. Distribution: CNR; Main product: ballroom dance, special projects.

CNR RECORDS, Franciscusweg 249, 1216 SG Hilversum, PO Box 654 (Zip: 1200 AR), 035.255 611, Fax: 035.236 122, President: CL. Baas, MD: Will Nagel, Promo: Ruud van Dulkenraad (A&R), Rudo de Raaff (Radio), Michel Weber (Radio), Mellen Boenk (TV), Product Mgrs: Ronald van der Meyden (Int'l), Rob Peters (Nat'l), Int'l Label Mgr: Hans de Boer. Labels (owned): CNR, Bite, Injection, Hotline, Jaws, HKM; (Lic): Transatlantic, Quintessence, Empire (SBCD), 21 Records, Jupiter, Delphine, Skywalker, Charly, Supreme, Cube, Naxos, ARS, Telstar, Pianola.

COLLECTOR RECORDS, PO Box 1200, 3260 AE Oud-Beijerland, 01860.18529, Fax: 01860.20180.

COLUMBUS RECORDS, Bilderdijkpark 4a, 1052 RZ Amsterdam, 020.187 018, Fax: 020.180 565, Contact: Paul van Dijk.

COMMUNITY 3 INTERNATIONAL, Zijlweg 16a, 1742 NE Schagen, PO Box 213 (Zip: 1740 AE), 02240.15045, Fax: 02240.16001/12776, Tlx: 57529 semap, Mgr: Rory Faber, A&R: Albert Garzon, Promo: Yolanda Grauta. US correspondence address: 438 Bedford Avenue, Brooklyn, NY 11211, +1.718.599 2205. Labels (owned): Community 3; (Distr): Frog Records; Main product: Pop, Punk, Cross-Over.

COROUROY PRODUCTIONS, Zevenend 23, 1251 RK Laren NH, 02153.83800, Fax: 02153.83664.

COSMO RECORDS, Achter Herengracht 23, 1380 AG Weesp, PO Box 288 (Zip: 1380 AG), 02940.30686, Fax: 02940.31296, Presidents: M Lee A Fong, W Samson, MD: E Laffeur, Asst: E Vermaire. Labels (owned): Cosmo, Laffeur, Sound Productions; (Lic): Jackson, Kubaney, Sonotone, TH Rodven, Rohit, Guajiro Records; Main product: salsa, soul, reggae.

CREATORS INTERNATIONAL, Toscaninstraat 50, 2551 LX The Hague, 070.345 2034, Fax: 070.362 1217, MD: Ernesto Rozendal, A&R/Prod: Robert Brouwers, Promo: Marcoello Betto, Composer: Jan van der Toorn, Mktg: Curie den Berg. Main music product: Dance, Swing-House.

DE LEEUW AUDIO VISUAL COMMERCIALS, Ruilstraat 7-15, 3023 XJ Rotterdam, 010.478 0698/477 8982, Fax: 010.478 0688, Owner: P Sanker Sing.

DELUXE PRODUCTIONS, Corantijnstraat 1, 1058 DA Amsterdam, PO Box 9010 (Zip: 1006 AA), 020.618 3109, Fax: 023.889 2751, President: Hans W van Pol.

DINO MUSIC, PO Box 2225, 1200 CE Hilversum, 035.213 657, Fax: 035.240 432, President: Tony Berk, GM: Jan van Akooy, Prod Mgr: Frits van Swoll. Label (owned): Pump; Distribution: CNR.

DISKY COMMUNICATIONS, Protonweg 36, 1627 LD Hoorn, PO Box 249 (Zip: 1620 AE), 02290.12608, Fax: 02290.17214, Tlx: 37979, MD: Paul Smith, Mktg/Sales Dir: Co Hermans, Prod Mgr: Bert Eggen. Labels (owned): Disky, Push, Symphony, K-West; (Lic): Savannah, Creole, Intercord, Trema, Buddah, Immediate, Sun (Budget), Telstar (Hol), Elisar; Distribution: Castle Communications, Vogue.

LE DISQUE HOLLAND, Huiszweg 13, 1261 AS Blaricum, 02153.87574, Fax: 02153.12523, Tlx: 73107 ledis, MDs: Rob & Ferdi Bolland, Bus Mgr: Michael Lambrechtsen, A&R/Prod Mgr: Eric Van Den Brink, Exec Asst/Proj Mgr: Marion Mulder. Main product: EHR, Adult Contemporary, Dance, Album Rock.

DIVING DUCK RECORDS, PO Box 43003, 1009 ZA Amsterdam, 020.665 0670, Fax: 020.665 0670, President: H J W Kramer, MD: H F A Schalken. Main product: Black (R&B) & Blues.

DJAX RECORDS, Oude Stadsgracht 120, 5611 DJ Eindhoven, PO Box 2408 (Zip: 5600 CK), 040.450 434, Fax: 040.445 057, President: Saskia Slegers. (Owned): Djax Records, Djax-Up Records; (Distr): Squadron Supreme; Main product: Dance.

DONEMUS FOUNDATION, Paulus Potterstraat 14, 1071 CZ Amsterdam, 020.676 4436, Fax: 020.673 3588, MD: Ber Deuss. Labels (owned): Composer's Voice; Main product: Classical.

DURECO, Pampuslaan 45, 1382 JM Weesp, PO Box 12 (Zip: 1380 AA), 02940.15321, Fax: 02940.18725, MD: Xavier Pelgrims de Bigard, GM: Hans Vatter, Sales Mgr: Peter Beutler, A&R Mgr: Rob Ebbens, Prod Mgrs: Hans Gouweloos (Spec Mktg), Marie-Josée Batenburg (Classic), Jan Zwart (Reli), Jan Quintus (Reli), Huib Bergman (Import/Jazz), Diny Mourik (New Age), Promo: Viviane Metselaar, Mgr (Dureco Mftg): Cees Stam, Fin Contr: Koen Janmaat.

DUTCH GRAMOPHONE COMPANY, Prins Bernhardlaan 3, 1921 BB Akersloot, 02513.12541, Fax: 02513.15300, MD: Paul Jonkers, Sales Mgr: Rinus Groeneveld. Labels owned: Astoria, Xenophone; Main product: classical.

EDDY OUWENS PRODUCTIONS, De Bazelstraat 36, 1222 RJ Hilversum, 035.831 354, Fax: 035.835 636, Dir: Eddy Ouwens (Producer), Producer: Cees Stolk, Sec: Judith Schalkwijk. Labels (owned): PPF, Coliseum; Main product: Classical, Dance, Gold/OI, dies, Black (R&B), MOR.

EMI BOVEMA, Bronsteeweg 49, 2101 AB Heemstede, PO Box 139 (Zip: 2100 AC), 023.231 514, Fax: 023.286 951, Tlx: 41257, MD: Kick Klimbie, Sales Dir: Gerard Wollenberg, Head Prod/Mktg: Danny Friedrichs, Sr Product Mgrs: Willem van Starrenburg, Connie Kemp, Prod Mgrs: Marc Bremer (Eur), Anne Baugnee (French Rep), Bert 't Hoen (Nat'l), Jan Steenhuizen (Classic), Special Projects Mgr: Hans van Exter, Promo: Pim van der Kolk (Mgr), Dirk van Eljk (Radio), Reinhold van Gerrisheim (Co-ord), Charna Verheugen (Press), Traffic Mgr: Sandra Cats. Labels (owned): Angel CD, Capitol, Columbia, Classics for Pleasure, Credo, EMI, His Master's Voice, Imperial, Music for Pleasure, Parlophone, Capitol, EMI Manhattan, IRS, SBK, Enigma, Studio,

Reference, Reflexe, Sunset, Modern Records, Blue Wave Records. Distribution: EMI Services Benelux. IRS coordination office: 023.231.500.

EMI MUSIC CONTINENTAL EUROPE, Overboslaan 6, 2100 AM Heemstede, PO Box 139 (Zip: 2100 AC), 023.231.514, Fax: 023.286.951, E-Mail: emi-europe, Sr Dir A&R/Mktg: Roel Kruize, Mktg Co-Ord: R Wollenberg. Continental European office.

EUROPEAN RECORD DISTRIBUTORS/INC, Konstruktieweg 4, 6074 NJ Roermond, PO Box 567 (Zip: 6040 PN), 04750.24499, Fax: 04750.25999, MDs: Peter Boertje (Mktg/Sales), Jan Frei (Int'l A&R), Sales/Promo: Dick Zuydwijk, Producer: Peter Vriendts, Sales: Jose Durieux. Labels (owned): IMC Records, Made Up Music; (Lic): Masters, M-Music, ZYX, Radical, Abyss, Westside, Storyville, Streetheat, Film Flam, Boy, Dance Street, CBMC, SOS, Power Records.

EVA, Laapersveld 63, 1213 VB Hilversum, PO Box 752 (Zip: 1200 AT), 035.256.329, Fax: 035.233.872, Tlx: 73232/73138, GM. Jan Wiesebron, Office Mgr: Carla van Teeseling, Label Mgr: Maarten van Droffelaar, Asst: Hester Hagemeijer. TV Merchandiser; Main product: various.

FRIENDS RECORDS, PO Box 283, 2040 AG Zandvoort, 035.214.214, Fax: 035.219.494, MD: Karel Hendrikse. Labels (owned): Friends Records, Injection; (Lic & Distr): Mollywood, MKP; Main product: EHR, Reggae, Dance, Black (R&B).

FUTUREMUSIC, Allersmastraat 7a, 9716 AT Groningen, 0050.731.671.

GMI RECORDS, PO Box 210, 6880 AE Velp, 085.646.815, Fax: 085.646.608, Dir: Hans Groeneveld. Gospel music.

GREENHEART PRODUCTIONS, Dotterweide 12, 2742 GD Waddinxveen, PO Box 170 (Zip: 2740 AD), 01828.17653/31292, MD: Ruud A J Kriebaum. Labels (owned): Roxon; (Distr): Direct Promotions; Main product: Dance, Album Rock.

HERMANEX, Protonweg 36, 1627 LD Hoorn, PO Box 249 (Zip: 1620 AE), 02290.12808, Fax: 02290.17214, Tlx: 37979 herma, MD: Kees & Jaac Hermans.

HOLLANDSCHE NIEUWE, Agatha Dekenstraat 37, 1053 AM Amsterdam, 020.639.0903/618.0136, Fax: 020.639.0932.

HOTSOUND/HIP HOP RECORDS, Pleinweg 242 A/D, 3083 EZ Rotterdam, 010.484.1936, Fax: 010.484.1503, Tlx: 43639, Dir: Erik van Vliet, Prod Mgr: S Camps.

IANSA PRODUCTS, Frederik Hendrikstraat 105, 1052 HM Amsterdam, 020.686.0565, President: Hilde Houwing, Mktg/Promo Mgr: Ingrid van Gerstel. Main product: Brazilian Music/Dance, African.

INDISC BENELUX, Groningenhaven 18, 3433 PE Nieuwegein, PO Box 1308 (Zip: 3430 BH), 03402.62240, Fax: 03402.61418, Dir: Andre de Raaff, A&R/Promo Mgr: Willem van Schijndel, Label Mgr: Joke Asman. Labels (owned): Buzz, Indisc, Vanguard; (Lic): Profile, Bounce, Tommy Boy, Blastfirst, KLF, Mute, Alligator, Solar, Savage, Collins; Main product: Adult Contemporary, Reggae, Classical, Dance, Black (R&B), Soundtracks, Rap.

INTERLAD, PO Box 3100, 5102 RC Venlo, 077.870.040, Fax: 077.872.979, MD: Tony Hueber. Labels owned: Ars Vivendi, Lunar, Musicando, Domino.

IRS, Overboslaan 6, 2100 AC Heemstede, PO Box 139 (Zip: 2100 AC), 023.231.514, Fax: 023.294.455, Int'l Mgrs: Henry Padovani, Fiona Klonarides.

IVORY TOWER RECORDS, Tusveld 89, 7627 NW Bornerbroek, 05408.718, Fax: 05408.316, MD: Fred Rootveld, Studio Mgr: Bobby Rootveld, Sales Dir: Angie Rootveld, Eng: Sarah Rootveld.

JOE BOURNE PRODUCTIONS, Schaeppmanplein 22, 2314 EH Leiden, 071.897.745, Fax: 071.897.943, President: Joe Bourne, A&R/Mktg: Flory Bourne. Labels owned: Tawana; Main product: Christmas, soft soul.

JOHNNY HOES/TELSTAR STUDIOS, Uilenweg 38, 6006 SK Weert, PO Box 70 (Zip: 6000 AB), 04950.35640, Fax: 04950.35684, Owner: Johnny Hoes, Dir: Jacques Hoes, Chief Eng/Prod: Fred Limpens, A&R: Maalke Vlaanderen. Labels (owned): Telstar, Sky.

KEYTONE PRODUCTIONS, PO Box 337, 3720 AH Bilthoven, 030.292.404, Fax: 030.250.394, MD: Chris Hinze, GM: Marga de Soeten, PR: E Buchheim. Labels owned: Keytone, Pop Eye, Royal Conservatory Series, Keytone African Line; Distribution: Dureco.

KIX-4-U RECORDS, Nieuwveensweg 23, 2421 LA Nieuwkoop, 01725.71432/2896, Fax: 01725.73202, Dir: Bert Rockhuizen, GM: Frances Rockhuizen. Labels (owned): Rockhouse, Kix-4-U; (Distr): MPR, Welcome.

KOCH BENELUX, Weegbreestraat 22, 3765 XV Soest, PO Box 3180 (Zip: 3760 DD), 02155.12051, Fax: 02155.11713, Dir: Bob Spits. Main product: AC, Jazz, Country, Reggae, Classical, German Folk.

LANA LANE RECORDS, Faas Eliastaan 13, 3742 AR Baarn, 02154.24955, Fax: 02154.25042, MDs: Gerry van der Zwaard, Peter Laanen. Main product: Pop.

LOWER EAST SIDE RECORDS, Govert Flinckstraat 285 I, 1073 CA Amsterdam, 020.671.1292, Fax: 020.671.1292.

MAGNUM, Mozartlaan 25, 1217 CM Hilversum, 035.261.603/4, Fax: 035.235.124, GM: Jan Groenewoud. TV merchandiser; Magnum is a joint venture of Phonogram, Polydor, Sony Music, and Warner Music.

MARLSTONE RECORDINGS, Lindenlaan 72, 6223 BD Bunde/Maastricht, 043.641.027/622.298, Fax: 043.641.027, MD: B Knubben-Kraft, Conny Peters.

MASTERS RECORDS, Konstruktieweg 4, 6074 NJ Roermond, 04750.27316, Fax: 04750.20525, MD: Emiel Kamzol.

MILLION RECORDS/LESLIE RIEL PRODUCTIONS, Van

Alkemadelaan 1056, 2597 BJ The Hague, PO Box 96965 (Zip: 2509 JJ), 070.354.5242, Fax: 01751.18032, President: Leslie L Riel. Distribution: CNR, Corduroy; Main product: EHR, Dance, Black (R&B).

MUNICH RECORDS, Edeseweg 33, 6721 JN Bennekom, PO Box 81 (Zip: 6720 AB), 08389.16777/19377, Fax: 08389.16588, Tlx: 30553 murec, President: Jop Zomer, MD/A&R: Ben Matlijssen, Sales/Mktg: Bert Pijpers, F&A Mgr: Jose Heltzel, PR/Promo: Eric Timmerman, Sales: Jan Lighthart, Boudewijn van Wijk, Theo van der Horst. Labels (owned): Munich Records, Stof; (Lic): Oldie Blues, Rounder, Greensleeves, Bullseye Blues, FNAC Music, Sky Ranch, Zensor, Special Delivery, Amalthea, Heart Beat; Main product: Adult Contemporary, Jazz, Country, Reggae, Album Rock, Gold/Oldies, Black (R&B), World Music.

MUSHROOM RECORDS INTERNATIONAL, Strawinskyalaan 3127, 1077 ZX Amsterdam, 020.549.8200, Fax: 020.549.8250, Tlx: 18525 pwwant, Dir: Simon Young, Bus Affairs: Janine Kerr.

MUSIC & WORDS (HOLLAND), Hondsrug 605, 3524 BZ Utrecht, 030.885.011, Fax: 030.897.990, A&R Dir/Import: Hans Peters, Promo/Sales Dir: Liesbeth Puts. Labels (owned): MW Records; Main product: Black (R&B), Roots, Traditional.

NARADA PRODUCTIONS, Jacobus Pennweg 2, 1217 JH Hilversum, PO Box 2301 (Zip: 1200 CH), 035.238.462, Fax: 035.42090, Dir (Eur Mktg): Jaap Hoitingh. Labels (owned): Narada, Narada Lotus/Mystique, Equinox, Sona Gaia; Main product: AC, New Age.

NORTH STAR RECORDS, Koningsweg 30, 9731 AT Groningen, PO Box 3108 (Zip: 9701 DC), 050.418.003, Fax: 050.423.853, President: Joop Top, MD: Jan Schenk, Asst Board: Eddy Harms.

OREADE MUSIC, PO Box 101, 2110 AC Aerdenhout, 023.245.223, Fax: 023.244.201, GMs: Frank van der Velden, David Grabijn. Main product: New Age.

OTTAVO RECORDINGS, Nassau Dillenburgstraat 1, 2596 AB The Hague, 070.324.7557, Fax: 070.324.1583, GM: Edo Santman, Fin Mgr: M Zoutendijk. Label (owned): Ottavo; Main product: Classical.

PAN RECORDS, PO Box 155, 2300 AD Leiden, 071.219.479, Fax: 071.226.869, Tlx: 20010 pms, President: B Kleikamp, A&R: R Spoorman. Labels (owned): Pan, Para; (Lic): Claddagh; Main product: Ethnic, Folk.

PANAMA RECORDS, Allersmastraat 7a, 9716 AT Groningen, 050.731.671, Fax: 050.145.297.

PARTRIDGE, Berkenbosch Blokstraat 5, 2586 HD The Hague, 070.350.2763, Fax: 070.358.4718, Bus Affairs Dir: Huub Sprangers, Artist Mgr: Jan A M Wolf. Labels (owned): Partridge, Heron; Main product: Classical.

PEER-SOUTHERN PRODUCTIONS, Larensweg 159, 1221 CL Hilversum, 035.831.214, Fax: 035.830.520, MD: Jacques van Dijk, Asst: Cyrille Vermue.

PETER POWER PUBLISHING, Lindenlaan 72, 6223 BD Bunde/Maastricht, 043.641.027/622.298, Fax: 043.641.027, President: B Knubben-Kraft, C Peters. Labels (owned): Marlstone; Distribution: C.R.M.

PHILIPS CLASSICS PRODUCTIONS, Gerrit van der Veenlaan 4, 3743 DN Baarn, PO Box 23 (Zip: 3740 AA), 02154.19911, Fax: 02154.23312, President: Johannes H Kinzi, VPs: Tadaast Atarishi (Mktg), Giel Bessels (Bus Affairs), Costa Pilavachi (A&R), Martin Slagt (Organisation), Comm Dir: Pierre Collet, Dir Int'l Mktg: Paul Schwendener, Contr: Niek van den Hoven.

PHONOGRAM (HOLLAND), Catherina van Renneslaan 10, 1217 CX Hilversum, PO Box 432 (Zip: 1200 AK), 035.47541, Fax: 035.233.291, Tlx: 43302, MD: Jan Corduwener, GM: Anton Witkamp, Sales Mgr: Wim Dercksen, Promo Mgrs: Dries vd Schuyt (Int'l Mktg), Herman vd Zwan (Nat'l Mktg), Gerard van de Pot (Radio), Albert Hol (Radio), Aard Scholteijer (Radio), Janus Toethuis (Radio), Prod Mgrs: Arjan Boonacker (Int'l), Han Kruiser (Int'l), Marcel Slabbaert (Nat'l), Rick Hartman (Nat'l), Contr: Geurt van Woudenberg. Labels owned: Philips, Decca, Vertigo, Fontana, Mercury, NT Records.

PLING PLONG, PO Box 3221, 2601 DE Delft, 015.121.212, Fax: 015.121.211, MD: Ferry van Dorsten.

POLYDOR (HOLLAND), Mozartlaan 25, 1217 CM Hilversum, PO Box 2057 (Zip: 1200 CB), 035.261.500, Fax: 035.46126, Tlx: 73352 pol, MD: Albert van der Kroft, Prod/Promo/Mktg Mgr: Andre Otto, Sales/Mktg Mgr: Andre van der Loest, A&R Mgr: Paul Brinks, F&A Mgr: Adri Twigt, Promo: Silvia Snel (TV), Menno Jansen (Radio), Han Koerense (Radio), Marc Bierens (Press), Prod Mgrs: Henk Keuter, Jacqueline Jansen, Ruud Vinke, Richard van der Veen.

POLYGRAM NEDERLAND, Gerrit van der Veenlaan 4, 3743 DN Baarn, PO Box 23 (Zip: 3740 AA), 02154.19911, Fax: 02154.22065, Contr (Classical Music Div): Willem Back, Legal Counsel: Robert Stuyt, Contr: William Feeny.

POLYGRAM NEDERLAND, Mozartlaan 25, 1217 CM Hilversum, PO Box 2057 (Zip: 1200 CB), 035.261.500, Fax: 035.235.124, Tlx: 73352, President: Paul Hertog, CFO: Bert de Wit.

POLYGRAM SPECIAL PROJECTS (HOLLAND), Mozartlaan 25, 1217 CM Hilversum, PO Box 2057 (Zip: 1200 CB), 035.261.650, Fax: 035.235.124, Tlx: 73352, MD: Jan Zandhuis, Contr: Adri Twigt.

PROMM PRODUCTIONS, PO Box 233, 1270 AE Huizen, 035.219.264, Fax: 035.40248, Owner: Sjoerd Vanderbrug.

PROVOQUE MUSIC PRODUCTIONS, Molenaant 30, 2908 LM Capelle a/d IJssel, 010.442.4022, Fax: 010.442.4080, President/A&R: Jan van der Linden, Mktg/Promo Dir: Ron Euser. Labels (owned): Provoque, Barricade Records; Main product: Album Rock.

PWL RECORDS, PO Box 2225, 1200 CE Hilversum, 035.213.657, Fax: 035.240.432, President: Tony Berk, GM: Steven Schoenzeitler. Label (owned): Empire; Distribution: CNR.

RAMS HORN-GW PRODUCTIONS, PO Box 35, 2110 AA Aerdenhout, 023.292.154, Fax: 023.293.724, President: Guido Weyprecht, Simone Weyprecht. Labels (owned): Rams Horn, GWP, Stamina, Taurus Records, Blue Mood Records; (Lic): Macola Records (USA).

RED BULLET INTERNATIONAL, Alexanderlaan 2, 1213 XS Hilversum, PO Box 2231 (Zip: 1200 CE), 035.857.841, Fax: 035.834.112, Pres/MD: Willem van Koolen, Prod/Promo: Edu Hasselt, Sec of MD: Sylvia van der Horst, Accountant: Frank Geerdes. Labels (owned): Red Bullet, MIR, 4 Jocks Only; (Lic): Sugar Hill Records; Main product: Reggae, Dance, Album Rock, Gold/Oldies, New Age.

REPLAY RECORDS (HOLLAND), Herenweg 9, 2465 AA Rijnsaterwoude, 01721.7450, Fax: 01721.7642, MDs: Geertjan Hensing, Aart Mol. Labels (Owned): Replay, Kretona, Orca, Break.

RHYTHM RECORDS, Henpoint 6f, 1013 GA Amsterdam, 020.622.2867/681.3411, Fax: 020.681.3446. Labels (owned & distr): Rhythm Records; Main product: Dance, Black (R&B).

ROADRUNNER RECORDS, Baarsjesweg 273, 1058 AD Amsterdam, 020.616.9921, Fax: 020.616.0776, Tlx: 10972 road, VP: Cees Wessels, Mktg Mgr: Ed van Zijl.

ROB DE JONG PRODUCTIONS, PO Box 318, 6700 AH Wageningen, 08370.21730, Fax: 08370.21178, Contact: Rob de Jong.

ROCKHOUSE RECORDS, Nieuwveensweg 23, 2421 LA Nieuwkoop, 01725.71432/2896, Fax: 01725.73202, Dir: Bert Rockhuizen, GM: Frances Rockhuizen. Labels (owned): Rockhouse, Kix-4-U; (Distr): MPR, Welcome.

RUNNTERLANDS, Brusselsestraat 8, 6211 PE Maastricht, 043.255.396, Fax: 043.217.468, President: Guido Delvoux.

SEMAPHORE PRODUCTIONS & DISTRIBUTION, Zijperweg 16a, 1742 NE Schagen, 02240.15045, Fax: 02240.16001/12776, Tlx: 57529 semap, MD: Rory Faber, GM: Johan Visser, Label Mgr (Prophecy): Marcel Pauvort, Promo: Yolanda Graute. Labels (owned): Schemer, Community 3, Semaphore, Prophecy, Flametrader; (Lic): Wild Rags, C/J Records. Main product: Garage, Punk, Pop, Metal/Hardcore, World Music, 60's.

SILENZ RECORDS, Stadhouderskade 61 I, 1072 AC Amsterdam, PO Box 55559 (Zip: 1007 NB), 020.662.2735, Fax: 020.662.9580, Pres/MD: Marië Witbrink, GM: Wim Reijnen (Promo), Promo Mgrs: Marique de Vries (Press), Kees de Blois (Radio). Labels: Pat Meats, East Meets West, Miners of Muzo, Fish Hospital, Alejandro Guzman, Greg Kina Band, D-Extreme, MU Records, Carlyle Records, Labor Records; Main product: Album Rock.

SILVER DISC, Rijksstraatweg 370, 2242 AD Wassenaar, PO Box 450 (Zip: 2240 AL), 01751.18549/070.358.5916, Fax: 01751.76322, MD: Stan Snelleman, Fin Dir: Jan Hermans. Labels (owned): Silver Disc; Main product: Gold/Oldies.

SILVERPOINT PRODUCTIONS, Schapenkamp 8a, 1211 PA Hilversum, PO Box 300 (Zip: 1200 AH), 035.218.144, Fax: 035.216.387, MD: Arjen Witte.

SONY MUSIC ENTERTAINMENT (HOLLAND), Herenweg 115, 2105 MG Heemstede, PO Box 151 (Zip: 2100 AD), 023.233.233, Fax: 023.292.169, Tlx: 41051 cbs, MD Benelux: Richard Denekamp, Mktg Mgr/Int'l A&R: Gerard Rutte, Snr Product Mgr: Ruud Roeben, Prod Mgrs: Perry Stritzko, Jos Lauwers, Local A&R: Bert Smit, Sales Mktg: Henk Penseel, Prod Mgr: Henry Wapperon (Spec Mktg), Mgr Classical: Ronald Geurts, Promo Mgr: Ben Stuurman, Promo: Andre vd Heyden (Radio), Diana Muus (TV), Paul Jong (Press).

SOUND OF MUSIC, Kasteel Schaalstraat 60A, 6222 TP Maastricht, 043.637.636, Fax: 043.635.915, Owner: Grace Smislaert, Sales Mgr: Mario Aldini. Labels (owned): Sound of Music; (Distr): Star Music, Disco Magic, Pabno/Fantasy; Main product: Jazz, Dance, Gold/Oldies.

SOUND PRODUCTS HOLLAND, Lindelaan 101, 1231 CK Loosdrecht, PO Box 88 (Zip: 1230 AB), 02158.25924, Fax: 02158.21958, Tlx: 43260 solo, MD: Hans van Woerkens, Sales Mgr: Harry Jager, Prod Mgrs: Roy Teyssse (Pop), Wim Vogels (Classic). Labels (Owned): SPH Records, Fidelio Classics, Vivace, Saga, Sound, Midnight Classics; (Lic): Chandon, BBC, Arcobaleno, BCM, Ace; (Distr): Orfeo, Demon, Hyperion, IC Records, Pickwick, Tuxedo, Old Gold Records, Vogue, Nuova Era; Main product: Dance, AC, Jazz, Gold/Oldies, New Age, Classical.

SPACE RECORDS, Finnmark 4, 3831 JG Leusden, 033.941.888, Fax: 033.951.892.

STAR RECORDS/PETER'S MUSIC FACTORY, Zijlweg 328, 2015 CP Haarlem, 023.277.744, Fax: 023.271.214, MD: Peter Kloeth, A&R Mgr: Dennis Kloeth. TV merchandiser.

STARLIGHT RECORDS, Transvaalstraat 101A, 1092 HG Amsterdam, 020.693.4727, Fax: 020.662.9580, MD: Helmer Cruden.

SWEAT RECORDING PRODUCTION, Groenloseweg 34, 7216 AN Ruurlo, 05735.1022, Fax: 05735.1072, MD/A&R/Mktg/Promo: Lee Roberts. Labels (owned & distr): Sweat Records, Art-Con Records.

TIMELESS RECORDS, Roghorst 303, 6700 AE Wageningen, PO Box 201 (Zip: 6700 AE), 08370.13440, Fax: 08370.22616, President: Wim Wigt, VP: Ria Wigt, Label Mgr: Anne de Jong. Labels (owned): Timeless, Timeless Traditional, Timeless Classic; (Distr): Limetree; Main product: Jazz, Classical.

TINK! RECORDS (TOMORROW IS NOW, KID!), van Diemenstraat 410-412, Het Veem, 1013 CR Amsterdam,

020.624 5930, Fax: 020.626 0002, MD/A&R: Jose Salvador, A&R: Rik Zwaan, Bob Pieck, Prod/Prmo: John Debmth. Main product: Dance.

TOP HOLE RECORDS, 't Skeane Ein 10, 8404 GG Langezwaag, 05130.88622, Fax: 05130.88796, MD: Jos Haijer. Distribution: Virgin.

TORSO, De Ruyterkade 41-43, 1012 AA Amsterdam, 020.626 0311, Fax: 020.627 6310.

UNIVERSE PRODUCTIONS, Spanjaardslaan 33, 8971 AL Leeuwarden, 058.120 194/124 522, Fax: 058.120 194.

VAN RECORDS, Surinamestraat 17, 2585 GG The Hague, 070.360 0306, Fax: 070.356 3300, GM: William Haighton, A&R Mgr: Harry Hoving. Labels (owned): Van Records; (Dist): Red House; Main product: AC, Album Rock, Country, Black (R&B).

VANGUARD CLASSICS, Groningehaven 18, 3433 Pe Nieuwegein, PO Box 1308 (Zip: 3430 BH), 03402.65400, Fax: 03402.60975, GM: Gerard Hulsebosch, Prod Mgr: Pieter Winkel. Labels (owned): Vanguard Classics; (Dist): Telarc Int'l, Collins Classics; Main product: Classical.

VARAGRAM, PO Box 175, 1200 AD Hilversum, 035.711 911, Fax: 035.711 429.

VERA RECORDS, PO Box 3816, 4800 DV Breda, 076.418 325, Fax: 076.421 159.

VIA RECORDS, PO Box 2277, 1200 CG Hilversum, 035.211 255, Fax: 035.212 666, Prod Mgr: H Voortman.

VIRGIN RECORDS HOLLAND, Melkpad 29, 1217 KA Hilversum, 035.212 451, Fax: 035.219 357, Tlx: 73466, MD: Dirk de Vries, Label Mgr: Remmelt van Beyerbergen, Mktg/Prod Mgr: Dick Stolk, Promo: Henri Collignon (Radio), Erik Duit (TV), Desiree van Horsen (Press).

VYNALITE RECORDS, PO Box 10729, 1001 ES Amsterdam, 020.664 4022, Fax: 020.664 4022.

WARNER MUSIC NETHERLANDS, Noorderweg 68, 1221 AB Hilversum, PO Box 749 (Zip: 1200 AS), 035.882 211, Fax: 035.859 995, Tlx: 43510, MD: Ted Sikkink, Dep MD/Fin Dir: Kees de Wildt, Mktg Mgr: Rob Schouw, Sales Mgr: Richard Postma, Prod Mgr: Michiel ten Veen, Theodor Lap (Classic), Creative Mgr: Rob van Beek, Promo Mgr: Dick Pieren, Promo: Martin Jessurun (Radio), Simon Mol (Radio), Nicole van der Valk (TV), Heidi Lichtveld (Press), William Janssens (Press).

WETON-WESGRAM, Veerlaan 82/92, 3072 ZZ Rotterdam, PO Box 51067 (Zip: 3007 BG), 010.486 1166, Fax: 010.484 3880, Tlx: 28798, President: Marius A Eygelsheim, MD: Willem van Duin. Labels (owned): DGR, Golden Nightingale, ATM, 16 Catalogue, Pulsar, WSP; (Lic): Walt Disney, Sesamstraat; (Dist): Pickwick, Success, Digital Concertos; Main product: MOR instrumental.

WINDHAM HILL EUROPE, Oude Enghweg 24, 1217 JD Hilversum, 035.249 970, Fax: 035.249 319, GM: Frank van Houten. Labels (owned): Windham Hill, Windham Hill Jazz, High Street Records; Main product: Adult Contemporary, Jazz, New Age, New Folk.

ZAPF RECORDS, Faas Eliaslaan 13, 3742 AR Baarn, 02154.25041, Fax: 02154.25040, MDs: Alex van Oostrom, Gerry van der Zwaard. Main product: Dance.

ZOMBA EUROPE, Hoefloot 24, 1251 EB Laren, 02153.16314, Fax: 02153.16785, Dir: European Ops: Bert Meyer.

ZOMBA HOLLAND, Hoefloot 24, 1251 EB Laren, 02153.16314, Fax: 02153.16785, Dir: Bert Meyer, Mktg Mgr: Charles Hunfeld, Promo Mgr: Florent Luycx. Labels (owned): Jive Records, Silvertone, Zomba Records.

ZYX MUSIC, MIKULSKI, Konstruktieweg 4, 6074 NJ Roermond, 04750.24499, Fax: 04750.25999, President: Bernhard Mikulski, MD: Emiel Kamzol. Labels (Owned): Memory, Freshline, ZYX Metal, Classic Records, Galaxis, Abfahrt, Technodrome, Elbtaler Schallplatten; (Lic): Fantasy, Prestige, Milestone, Riverside, Pablo, Storyville, GNR, Hot-sound, Groove Street.

MUSIC PUBLISHERS

21 MUSIC, see Canada Music.

4 TUNE, Zonnelaan 13, 1217 ND Hilversum, 035.15042, Fax: 035.43393, Tlx: 43395, MD: Jean-Pierre Burdorf.

AAMI, see Associated Artists Music Int'l & media.

AIRWAVE MUSIC, see Cm Songs.

ALL BOYS, see TBM.

ALL NATIONS, see Canada Music.

ALMO MUSIC, see Rondor Music (holland).

ALSON MUSIC, Jan van Goienlaan 28, 1075 HS Amsterdam, 020.671 7926, Contact: Albert Dam.

AMPHONIC-SOUND STAGE, see Av Music Publishers.

AMPLITUDE, see Av Music Publishers.

ARCADE MUSIC PUBLISHING, Groningehaven 18, 3433 PE Nieuwegein, PO Box 1308 (Zip: 3430 BH), 03402.65400, Fax: 03402.65454, Tlx: 40420, MD: Andre de Raaff, Asst: Lieseth Vos.

ARS NOVA, see Universal Songs Holland.

ART-CON PRODUCTIONS, see Happy Jacks's Music Publisher.

ARTEMIS MUZIEK UITGEVERIJ, Flevolaan 41, 1411 KC Naarden, 02159.58598, Fax: 02159.47490, Tlx: 43191 hobo, MD: Charles Kuiper, F&A Mgr: C Smith. (Affil): Fiction Songs, Big Pig, Guns N'Roses, Francis Dreyfus, Carlin, Caledonia Productions, Greenheart, Axis, Windswept Pacific, Rickim Music; Parent company: Warner-Chapell Music.

ARTY PROMOTIONS HOLLAND, Zuidhoek 191b, 3082 PG Rotterdam, PO Box 59118 (Zip: 3008 PC), 010.428 2951, Fax:

010.429 5367, GM: Jan Beunk.

ASSOCIATED ARTISTS MUSIC INT'L & MEDIA, Maarschalklaan 47, 3417 SE Montfoort, 03484.2860, Fax: 03484.2860, MDs: Joop Gerrits, Jochem van Renesse, Sec: Iris Gabeler. (Owned): AAMI; (Admin): Many, Mhara, Ruben Blades Music, Horus, Avenue Road Music, Termidor Music, Egrem, Musicabana, Universal Musica, Pablo del Cerro, Editora Musica de Cuba; Main product: EHR, Jazz, Reggae, Dance, Black (R&B).

ATMOSPHERE, see Av Music Publishers.

ATRA MUSIC, see Munich Music.

ATTIC, see Universal Songs Holland.

AV MUSIC PUBLISHERS, Pieter de Hooghlaan 10 a, 1213 BT Hilversum, 035.235 650, Fax: 035.235 654, MD: Peter J van Epen. (Owned): AV Music; (Sub-pub): Amphonic-Sound Stage, Amplitude, Atmosphere, Boosey & Hawkes Cavendish, Bosworth, Caramba, Caravage, Castle, Coda, Colour-sound, Focus, French Trade, Happy Records, IMM, Iota, Jammy, JRB, Jump, Junior, JW Music Library, Koka Media, Koslnus, K-vox, Largo, Match, MCT, Mondiphone-Crea Sound, Mood-Spectrum, Music Scene, Omniscopic, Patchwork, Professional Broadcast, Parry, Red Bus, Ring, SBK April-Orchestra, Sonimage, Sound Music Album, Standard Music Library, Studio G, Studio Music, Supraphon, UBM Records, Valentino, Intermede.

AVALON, see Number One Music Holland.

AVENUE ROAD MUSIC, see Associated Artists Music Int'l & media.

AXIS, see Artemis Muziek Uitgeverij.

BARRICADE, see Provoque Music.

BEST MUSIC, Crispijnstraat 9, 5171 CH Kaatsheuvel, 04167.73270, MD: Peter van Best. (Owned): Best; (Admin): Otvair, Yiasoo/Arnold Jay; Main product: Dance, AC, Album Rock, Black (R&B), Reggae, New Age, EHR.

BIG PIG, see Artemis Muziek Uitgeverij.

BIG SCREEN, see TBM.

BLICKS, see Universal Songs Holland.

BLUE SKY RIDER, see Rondor Music (holland).

BMG MUSIC PUBLISHING, Lindenheuvel 3, 1217 JV Hilversum, PO Box 1299 (Zip: 1200 BG), 035.232 241, Fax: 035.234 648, MDs: Peter Schoonhoven, Pieter van Bodegraven. (Owned): BMG affiliates, Herman's Songs, Ryder, Carmels, Chicken Skin Music, Chartel/Motel Musac.

BMG TWO P(I)ETERS MUSIC, Lindenheuvel 3, 1217 JV Hilversum, PO Box 1299 (Zip: 1200 BG), 035.232 241, Fax: 035.234 648, Dirs: Peter Schoonhoven, Pieter van Bodegraven.

BOB MARLEY, see Rondor Music.

BOJU RECORDS & PUBLISHING, Willem Bayerstraat 5, 6042 BJ Roermond, 04750.16629, A&R: June Rollocks, PR: Beau van Gils.

BOLLAND MUSIC, Huizerweg 13, 1261 AS Blaricum, 02153.87574, Fax: 02153.12523, Tlx: 73107 ledis, MDs: Rob Bolland, Ferdi Bolland, Bus Mgr: Michael Lambrechtsen, A&R/Prod Mgr: Eric Van Den Brink, Exec Sec: Marion Mulder. Main product: EHR, Adult Contemporary, Dance, Album Rock.

BOOSEY & HAWKES CAVENDISH, see Av Music Publishers.

BOSWORTH, see Av Music Publishers.

BOY MEETS GIRL, see Rondor Music (holland).

BR MUSIC, Tothuislaan 12, 3862 WL Nijkerk, 03494.54410, Fax: 03494 60431, Tlx: 12523, Contact: Bert van Breda.

BROWN FOOT, see Munich Music.

BRUCE SPRINGSTEEN, see Canada Music.

BULLET SOUND LIBRARY, see Canada Music.

CA MUSIC, see Continental Sound Music.

CALEDONIA PRODUCTIONS, see Artemis Muziek Uitgeverij.

CARAMBA, see Av Music Publishers.

CARAVAGE, see Av Music Publishers.

CARLIN, see Artemis Muziek Uitgeverij.

CARMELS, see BMG Music Publishing.

CASTLE PRODUCTIONS, Willem Barentsstraat 45, 2315 TZ Leiden, 071.218 205, GM: Bart van Kasteel, Mgr: Robert van der Pluym. Music library; PO Box Address: PO Box 620, 2240 AN Wassenaar, Holland.

CASTLE, see Av Music Publishers.

CD-ROM & ASSOCIATES, see Mcn Muziek Catalogus Nederland.

CENER, see TBM.

CHARISCOURT, see Rondor Music (holland).

CHARTEL/MOTEL MUSAC, see BMG Music Publishing.

CHERRY LANE, see Universal Songs Holland.

CHICKEN SKIN MUSIC, see BMG Music Publishing.

CHICS DE BURGH, see Rondor Music (holland).

CM SONGS, Harenweg 9, 2465 AA Rijnsaterwoude, 01721.9853/9468, Fax: 01721.7642, MDs: Geertjan Hensing, Aart Mol. (Owned): Airwave Music, Orka Songs, Ten Men Music.

CNC MUSIC PRODUCTIONS, Schutsestraat 27, 4841 EC Prinsengeb, PO Box 42 (Zip: 4841 EC), 076.413 034, Fax: 076.412 050, Tlx: 54143, President: Clemens Duynstee, Int'l: Mark de Raaff. Main product: ballroom dance, special projects.

CODA, see Av Music Publishers.

COLIN VEARNCOMBE, see Rondor Music (holland).

COLOURSOUND, see Av Music Publishers.

CONTINENTAL SOUND MUSIC, Robert Kochplaats 342, 3068 DR Rotterdam, PO Box 81065 (Zip: 3009 GB), 010.456 8688, Fax: 010.455 9022, President: L. La Riviere, Chmn: P Grasmeyer, MDs: R Hulsman, J Daurloo. (Owned): Continental Music; (Affil): Ears & Eyes, Thank You, Scripture in Song, CA Music, Lifestyle Music.

COOLWINE, see TBM.

COPYRIGHT MANAGEMENT, see Universal Songs Holland.

CREOLE MUSIC, see Herman's Songs.

CRUSTY MUSIC, see Rondor Music (holland).

CT, see Rondor Music (holland).

CURCI BENELUX, see Canada Music.

DAWSON, see Mcn Muziek Catalogus Nederland.

DAYLOW, see Canada Music.

DC SONGS, see European Record Distributors/Imc.

DELICATE, see Rondor Music (holland).

DENNIS MUSIC, PO Box 585, 1200 AN Hilversum, 035.212 761, Fax: 035.219 862.

DONAR MUZIEK, see TBM.

DUTCH REBEL, see Canada Music.

DUTCHY PUBLISHING, Pampuslaan 45, 1382 JM Weesp, 02940.15321, Fax: 02940.18725, MD: Xavier Pelgrims de Bigard, GM: Rob Ebbers. (Admin/sub-pub): Vader Abraham, Kassner, Page One Music, Performance Music, Kubaney, SGO Music, ENJA, Edition Tutu; Main product: EHR, Jazz, Dance.

EARS & EYES, see Continental Sound Music.

EAST MEMPHIS, see Rondor Music (holland).

EDITION ACTUEEL, see Canada Music.

EDITION DELPHINE, see TBM.

EDITION TUTU, see Dutchy Publishing.

EDITORIA MUSICA DE CUBA, see Associated Artists Music Int'l & media.

EGREM, see Associated Artists Music Int'l & media.

ELVIS PRESLEY/GLADYS, see Universal Songs Holland.

EMI MUSIC PUBLISHING BENELUX, Schapenkamp 8a, 1211 PA Hilversum, PO Box 300 (Zip: 1200 AH), 035.218 144, Fax: 035.216 387, MD: Arjen Witte, Repertoire Exploitation: Joop van Huizen, A&R: Frank Klunhaar.

ENJA, see Dutchy Publishing.

ESSEX, see Universal Songs Holland.

EUROPEAN RECORD DISTRIBUTORS/IMC, Konstruktieweg 4, 6074 NJ Roermond, PO Box 567 (Zip: 6040 PN), 04750.24499, Fax: 04750.25999, MDs: Peter Boertje (Mktg/Sales), Jan Frei (Int'l/A&R). (Admin/sub-pub): DC Songs.

FATAL FLOWERS MUSIC, see Rock Rose.

FICTION SONGS, see Artemis Muziek Uitgeverij.

FIVE DAUGHTERS, see TBM.

FOCUS, see Av Music Publishers.

FONIOR, see Canada Music.

FOOD MUSIC, see Rondor Music (holland).

FRANCIS DREYFUS, see Artemis Muziek Uitgeverij.

FREAKY, see Canada Music.

FRENCH TRADE, see Av Music Publishers.

FRIENDS MUSIC, PO Box 283, 2040 AG Zandvoort, 035.214 214, Fax: 035.219 494, Mgr: Karel Hendrikse. Main product: EHR, Adult Contemporary, Reggae, Dance, Black (R&B).

FRISIA CANTAT, see Universal Songs Holland.

FRONTDYKE MUSIC, De Ruyterkade 41-43, 1012 AA Amsterdam, 020.626 0311, Fax: 020.627 6310, Tlx: 12569 bouda, Contact: Ruud Jacobs.

GALLO PUBLISHING, see Universal Songs Holland.

GANGA PUBLISHING, see Canada Music.

GOODSINGLE, see Rondor Music (holland).

GREENHEART PRODUCTIONS, Dotterweide 12, 2742 GD Waddinxveen, PO Box 170 (Zip: 2740 AD), 01828.17653/31292, MD: Ruud A J Krebaum.

GREENSLEEVES, see Munich Music.

GUNS N'ROSES, see Artemis Muziek Uitgeverij.

HAIKU,* see Av Music Publishers.

LE DISQUE MUSIC PUBLISHING, Huizerweg 13, 1261 AS Blaricum, 02153.87574, Fax: 02153.12523, Tlx: 73107 ledis, MDs: Rob Bolland, Ferdi Bolland, Bus Mgr: Michael Lambrechtsen, A&R/Prod Mgr: Eric Van Den Brink, Exec Asst/Proj Mgr: Marion Mulder. Main product: EHR, Adult Contemporary, Dance, Album Rock.

LIFESTYLE MUSIC, see Continental Sound Music.

LISPET, see Universal Songs Holland.

MAM, see Soss Music Publishing.

MAMBO, see TBM.

MANY, see Associated Artists Music Int'l & media.

MARYLEBONE, see Canada Music.

MATCH, see Av Music Publishers.

MAUREEN, see Canada Music.

MCA MUSIC (HOLLAND)

PO Box 81, 1250 AB Laren (n.h.), (31) 2153.13222, Fax: (31) 02153.17399, Vice Pres. MCA Music Int'l: John Brands, Prof. Mgr.: Kees van der Hoeven.

Mcn MUZIEK CATALOGUS NEDERLAND, PO Box 119, 1200 AC Hilversum, 035.772 450, Fax: 035.775 228, Dir: Lucas van Dijk. (Admin): Dawson (UK), Musica Real (Spa), Prokordeon (Ger), CD-ROM & Associates (Australia).

MCT, see Av Music Publishers.

MEMORY LANE, see Universal Songs Holland.

MHARA, see Associated Artists Music Int'l & media.

MICRON MUSIC, see Number One Music Holland.

MITCHELLS MUSIC MACHINE, see Moonshine Music.

MONDIOPHONE-CREA SOUND, see Av Music Publishers.

MOOD-SPECTRUM, see Av Music Publishers.

MOONSHINE MUSIC, Langeweid 7, 1831 BL Koedijk, 072.615 857, Fax: 020.682 9580, President: Evert Wilbrink, MDs: Vincent Fusco, Willie Mitchell. (Owned): Zillion Songs, Moonshine Music; (Sub-pub): Poppa Willie, Mitchell's Music Machine, Haiku, Zillion Songs, Moonshine, Tunaramo, Twins Across The Ocean.

MOTION MUSIC, Korenpad 1, 6534 AS Nijmegen, 080.554 959, Fax: 080.566 152.

010.442 1311, MD: Michiel de Ruiter, Export Mgr: Almer Apon, Buyer: Bram Apon, Import Buyer: Dirk van Huffel, PV/Distr: Jan van Ditmarsch, Sales Mgr (Hol): Wim van der Gaag. Labels (distr): Bear Family, Active, Cafe Records, Connoisseur, Edelweiss, Grand Gala, Line, Luminar, MFSL, MGI, Pendragon, Provogue, Rhino, Roots, Seagull, See For Miles, Sky, Taxim, Zappa Records, Fresh Sound, Barricade.

BOOGAARD TRADING LOPIK, Vierde Industrieweg 2, 3411 M Lopik, PO Box 164 (Zip: 3400 AD), 03485.9211, Fax: 03485.3281, Tlx: 40568 boog, Sales Dir: Herman A van den Wall Bake.

BOUDISQUE DISTRIBUTION, De Ruyterkade 41-43, 1012 AA Amsterdam, 020.626 0311, Fax: 020.627 6310, Tlx: 12589 bouda, Distr Mgr: Eleanor Hamaker, Distr: Koos Nuijens, Rob Boskamp. Label/Origin (distr): (UK) Syncophant, Too Pure, Touch & Go, Trance, Trance Syndicate, Twin/Tone, Underdog, Vinyl Solution, Viva Records, Waterfront, Wax Trax, Wetspots, Wiiiija Records, Words of War, World, Ignition, Jennif Hartman, Kickin' Records, Looney Tunes, Madhouse Records, Mind Matter, Noiseville, Nomad Community, On-U Sound, Pigboy, Poontang, Pusmort, Quarter Stick, R Radical, Raging, Rat Cage, Red Decibel, Roundabout, Spigot, State Injust, Adult Swim, Agitprop, Alchemy, Belfagor, Belly Up, Better Youth, Big Cat UK, Big Kiss, Blanc, Bluurg, Bluurg Ex, Cargo, Caroline US, Cat & Mouse, Century, Concrete Productions, Corpus Christi, Crass, Cut Deep, Damage Records, Decoy, Dischord, Earth Zone, Himalayan; (Ger) Twang, Vielklang, Weird System, Weserlabel, X-Mist, Yellow, Your Choice, Zick Zack, Zoth Ommog, Independence, Interfish, King Size, Lemon Groove, Lepzone, Metal Machine Music, Musical Tragedies, New Zone, Normal, Parade Amoureuse, Planet Core, Pork Pie, QDK, Rattlesnake, Red Eye Records, Repulsion, Sub Up, Suck Me Plasmal, Aberrant Records, Artlos, Ata Tak, Big Sex, Black Cat, Black Eye Records, Citadel, City Slang, Constrictor, Destiny, Exil, Extreme, Flying Nun Europe, Fun-fundvierzig, Gymnastic, Houses in Motion, Human Wreochords; (Bel) KK Records, Madagascar, Zazaboem; (Swi) Vision, Rec Rec, Seeland, Because of You; (Hol) Lower Eastside; (USA) TEC Tones, Ralph, Rockville, Homestead.

CIESLUK IMPORT & EXPORT, Vaenmos 77, 8265 HS Kampen, 05202.22973, Fax: 05202.19093, Pres/MD: Zbigniew Ciesluk, MD: Annemarie Ciesluk.

CNR RECORDS, Franciscusweg 249, 1216 SG Hilversum, PO Box 654 (Zip: 1200 AR), 035.255 611, Fax: 035.236 122, Pres/dent: C L Baas, MD: Will Nagel, Promo/A&R: Ruud van Duikenraad, Product Mgrs: Ronald van der Meyden (Int'l), Rob Peters (Nat'l), Int'l Label Mgr: Hans de Boer. Labels (distr): Quintessence, Corduroy, VNC, AKM, BR, Replay, Friends, Dino, Cat Music, Big Wave, P.W.L., Munich, Mirasound, Red Bull.

DANCE TRACKS, Nieuwe Nieuwstraat 69, 1012 NG Amsterdam, 020.639 0853, Fax: 020.639 1367, Contact: Anton Seters.

DATRA RECORDS AND TAPES, Utrechtaven 6, 3433 PN Nieuwegein, 03402.67500, Fax: 03402.63454, MD: Raymond Dix, Log Mgr: Frank van Vliet, Sales Mgr: Ben Evers.

DISK HOUSE, Lage Kamp 14, 7317 AT Apeldoorn, 055.214 392, Fax: 055.226 039, MD: Walther Bakker, Sales Mgr: Lex Jacobs.

DOUBLE DUTCH, PO Box 2078, 3140 BB Maassluis, 01899.23228, Fax: 01899.26170, Contact: Hans van Vuuren. Specialist in collectors items.

DUTCH GRAMOPHONE COMPANY, Prins Bernhardlaan 3, 1921 BB Akersloot, 02513.12541, Fax: 02513.15300, MD: Paul Jonkers, Sales Mgr: Rinus Groeneveld.

EMI COMPACT DISC HOLLAND, Industrielaan 24, 5406 XC Uden, 04132.85555, Fax: 04132.66695, MD: Hans van Luit, Contact: Anton Lommerse.

EUROPEAN RECORD DISTRIBUTORS/SMC, Konstruktieweg 4, 6074 NJ Roermond, PO Box 567 (Zip: 6040 PN), 04750.24499, Fax: 04750.25999, MDs: Peter Boertje (Mktg/Sales), Jan Frei (Int'l/A&R). Labels (distr): ICM Records, Made Up Music, Masters, M-Music, ZYX, Radical, Abyss, Westside, Storyville, Streetheat, Film Flam, Boy Records, Dancetreet, CBMC, SOS, Power Records; Main product: dance, MOR, classical.

GRAMMOPLAN, Koningsweg 30, 9731 AT Groningen, PO Box 3108 (Zip: 9701 DC), 050.418 003, Fax: 050.423 953, President: Joop Ton. Wholesaler.

HAASST, Prinseneiland 99, 1013 LN Amsterdam, 020.623 9799, Fax: 020.624 3534.

HOME ENTERTAINMENT SERVICES, Klokhoeke 1, 3833 GW Leusden, PO Box 270 (Zip: 3830 AG), 033.948 300, Fax: 033.948 709, President: Fred van der Flier, Mgr: Mario Krussse. Wholesaler; Formats: CD albums & singles, Cassette albums & singles, Vinyl albums & singles, Music videos.

IMPORT MUSIC SERVICE, Mozartlaan 25, 1217 CM Hilversum, PO Box 2057 (Zip: 1200 CB), 035.261 675, Fax: 035.235 508, MD: Kees van Weijen, Repertoire Mgr: Rob Grève, Contr: Adri Twigt. Labels (distr): (Ger)—Third, AH Records, Bellaphon, Christophorus, Erdenklang, ITM Records, ITM-Pacific, Innowo, Jazz City, Jazz Door, Jazz Men, Jazz Up, Justice Records, Kriwet Records, Lipstick, MA Music, Messidor, Minor Music, Nabel, Rhythm Attack, Tropical Music, Westwind; (USA)—Artful Balance, Big World, Bridge Records, Chase Music Group, Delfon, Dominion, Elan, Higher Octave, Just in Time, Music Masters, Nova Records, Optimism, Par Records, Radiola, Sandy Hook, Spindletop, Stash, Strata East, TBA/Paoli Alto, USA Records, Windham Hill; (Fra)—Atoll Music, MSI; (Hol)—Doris Baaten, Marjol Flore, Granny's Records, Heren Op Zicht, Interfolk,

Koninklijke Marine, Koninklijke Militaire K.

INDISC BENELUX, Groningenhaven 18, 3433 PE Nieuwegein, PO Box 1308 (Zip: 3430 BH), 03402.62240, Fax: 03402.61418, MD: Andre de Raaff, A&R/Promo Mgr: Willem van Schijndel, Label Mgr: Joke Asman. Labels (distr): Sepam, Milan, Profile, Varese Sarabande, Tam Tam, Telarc, DMP; Main product: Adult Contemporary, Reggae, Classical, Dance, Black (R&B), Soundtracks, Rap.

LW PROJECT CONSULTANCY, Lisdoddekreek 10, 2353 JR Leiderdorp, 071.416 515, Fax: 071.415 783, President: Leo Wijnald, MD: Lia Janssen. Import CD/MC/LP.

MASTERS HOLDING, Lage Kamp 14, 7317 AT Apeldoorn, 055.226 025, Fax: 055.226 039, MD: Walther Bakker.

MUNICH RECORDS, Edeseweg 33, 6721 JN Bennekom, PO Box 81 (Zip: 6720 AB), 08389.16777/19377, Fax: 08389.16588, Tlx: 30553 murec, President: Job Zomer, MD: Ben Mattijssen, Sales Mgr: Bert Pijpers. Labels (distr): Rounder, Greensleeves, Sugar Hill, Hannibal, Rykodisc, Concord Jazz, Bellaphon, Ras Records, Shanachie, Bullseye Blues, Trojan, FNAC Music, Sky Ranch, Yazoo, Arhoolie, L&R, Sterns, Beat Goes On, World Circuit, Zensor, Special Delivery, Black Top, Amalthea, Heart Beat; Main product: Adult Contemporary, Jazz, Country, Reggae, Album Rock, Gold/Oldies, Black (R&B), World Music.

MUSIC & WORDS (HOLLAND), Hondsrug 605, 3524 BZ Utrecht, 030.885 011, Fax: 030.897 990, A&R Dir/Import: Hans Peters, Promo/Sales Dir: Liesbeth Puts. Labels (distr): Green Linnet, Delmark, Blind Pig, Flying Fish, Interstate, Type, Hypertension, Original Music, Piranha, Tara, Swallow, Maison de Soul, Trikont, Pan, Celtic Music, Amigo, Escalibur, Brambus, and many others; Main product: Black (R&B), Roots, Traditional.

MUSIC PRODUCTS, Positronweg 10, 3542 AZ Utrecht, PO Box 1480, 3600 BL Maarssen, 030.413 666, Fax: 030.412 491, GM: Ria Daep, Log Mgr: Willy Daep. Labels (distr): Star Inc, BR, Fun, Skyline, Butterfly, Paradise, Hollywood, BS, Golden Stars, Jazz Time, Golden Classics, Verona, Romance of Jazz, Music on my Mind; Main product: Gold/Oldies.

NANDI IMPORT, Het Kleine Loo 414U, 2592 CK The Hague, 070.382 1379, Fax: 070.385 3581, MD: Marijke de Jong, Sales: Theodor Lap. Main product: classical, folk.

NIPPER CV, 1st Passeerdersdwarstraat 88, 1016 XD Amsterdam, 020.620 5130, Fax: 020.638 1058, Contact: Hans Stok. Labels (distr): Aura (Hol), Jeton, Tacet (Ger), Bergen, For X, Gemini, Helio, Herman, Hot Club, Kierkig Kulturversted, Meantime, Nopa, Odin, Taurus, Veps, Villa (Nor), Opus 3 (Swe), 20/Something, Bainbridge, Colossus, Musician Series, Quartet, Reference Recordings, Sheffield Salon Series, Sheffield Lab, Sound Effects Library, Time Jazz Series, Water Lily Acoustics, Wilson Audiophile (USA).

ORCAM TRADING, Vening Meinesstraat 1, 6717 AJ Ede, 08380.36506, Fax: 08380.36255, MD: Rob Korporaal.

PHONOMATIC HOLLAND, PO Box 164, 3400 AD IJsselstein, 03485.9211, Fax: 03485.9290, Tlx: 40568, MD: Harry Venema.

PLAY IT AGAIN SAM, Vaartweg 129, 1217 SN Hilversum, PO Box 2115 (Zip: 1200 CC), 035.235 480, Fax: 035.284 208, MD: Wally van Middendorp, Promo: Corne Bos, Sales Reps: Frank Bloemen, Jan Scholing, Sales/Promo: Ad de Feyter, Tele Sales: Leo Chaik. Labels (distr): Play It Again Sam, Nettwerk, 4AD, Crepuscule, Antler Subway, Kaos, House, New Rose, SPV, Imaginary, APT, Who's That Beat, Sub Rosa, Earache, Beechwood, Beggars Banquet, Groove Hissing, One Little Indian, Steamhammer, Solid, Boucherie Productions, Avatlantic, Dance Opera, Beat Box, Little Circle, Fanclub, Document, G-Rox-P, LD Records, MNW, Radium 225.6, RRE, Tomato; Main product: Dance, Album Rock.

POLYGRAM RECORD SERVICE, Torenlaan 17, 3742 CR Baarn, PO Box 23 (Zip: 3740 AA), 02154.19911, Fax: 02154.23504, MD: Rien van Regteren, Contr: Johan Borren.

RECORD SERVICE BENELUX, Franse Akker 9, 4824 AL Breda, PO Box: Postbus 2042 (Zip: 4800 CA), 076.480 911, Fax: 076.480 310, Tlx: 54926, MD: Nico van Biemen, EDP Mgr: Henk Schell, R&O Mgr: Riet Biemans, Log Mgr: Frans van Gelden, Fin Contr: Roel Kruit. Labels (distr): all labels of WMI, BMG-Ariola, PolyGram, Virgin.

RHYTHM IMPORT, Singel 10, 1013 GA Amsterdam, 020.622 2867, Fax: 020.622 8844, Tlx: 14509, Contact: Peter Duykersloot.

RIGU SOUND WHOLESALE, Rodenrijweg 28C, 2651 BV Berkel en Rodenrijs, 01891.8277, Fax: 01891.8664, MD: Rick Guurink, Mgr: Pim van den Akker.

ROUGH TRADE DISTRIBUTION (HOLLAND), Voldersgracht 11a, 2611 ET Delft, 015.158 935, Fax: 015.130 091, Contact: Willy Frissen.

SEMAPHORE PRODUCTIONS & DISTRIBUTION, Zijperweg 16a, 1742 NE Schagen, 02240.15045, Fax: 02240.16001/12776, Tlx: 57529 semap, MD: Rory Faber, GM: Johan Visser, Promo: Yolanda Graute. Labels (distr): Gaga Goodies, Epitaph, Etrjus, Torso, Feel Good All Over, Resonance, Buy Our Records. Main product: Garage, Punk, Pop, Metal/Hardcore, World Music, 60's.

SILVERLINE RECORDS, Nieuw Maanderbuurtweg 32, 6717 AS Ede, PO Box 8209 (Zip: 6710 AE), 08380.24373, Fax: 08380.25821, MD: C Heikamp.

TOCO INTERNATIONAL, PO Box 654, 1200 AR Hilversum, 035.255 765, Fax: 035.40753, Tlx: 43408 toco, MD: Ton van den Bremer.

VEL WAYS SALES SYSTEM, Haver-Akker 3, PO Box 161, 3941 LD Doorn, 03430.16980, Fax: 03430.16980, MD: Peter van der Velden. Wholesaler.

RETAIL ACCESSORY SUPPLIERS

BOB SCHMIDT TRADING, Nieuwe Havenweg 77a, 1216 BP Hilversum, 035.233 631, Fax: 035.284 668.

CDN NEDERLAND, Utrechtseweg 8, 1213 TS Hilversum, PO Box 1922 (Zip: 1200 BX), 035.238 835, Fax: 035.239 307, MD: Chris van Houten. Computer software for retailers.

FORTY FOUR, PO Box 2244, 6802 CE Arnhem, 085.629 096, Fax: 085.634 932, President: J Barenbrug, Sales Mgr: G Duuren. Manufacture CD/MC/Record storage systems and cases; also printed with logos or character designs.

FREJO GROEP, Dorresteinweg 73, 3762 KH Soest, 02155.15216, Fax: 02155.21550, MD: A. Buchwaldt, Prod Mgr: A Wildeman. Manufacturer of LP, MC, CD, video shopfitting and displays.

IPW INTERPARTS, James Wattstraat 1, 8013 Zwolle, 038.650 346, Fax: 038.655 251, Dir: J Winkel, S Sollie, R Stevens. Shop design & equipment.

LIFT BENELUX APeldoorn, Lage Kamp 14, 7317 AT Apeldoorn, 055.226 025, Fax: 055.226 039, MD: Walther Bakker, Sales Mgr: Lex Jacobs. Distribute in-store retail equipment.

MAGNA-ZONAL BENELUX, PO Box 3100, 5102 RC Venlo, 077.870 040, Fax: 077.872 979, MD: Tony Hueber, Office Mgr: Simon Christiaans. CD storage, boxes, trays and other racking systems.

MASTERS HOLDING, Lage Kamp 14, 7317 AT Apeldoorn, 055.226 025, Fax: 055.226 039, MD: Walther Bakker.

PRUKO, De Leliestraat 40/2, 3364 AJ Sliedrecht, 01840.19244, Fax: 01840.20181, MDs: A de Kok, H G Prummel.

RNA SYSTEMS, Spoorakkerweg 2b, 5071 NC Udenhout, PO Box 8 (Zip: 5070 AA), 04241.4440, Fax: 04241.4827, MD: A C J van de Sanden. Manufacture CD storage systems.

SOUNDY INTERIEURMAKERS, Nieuwe Haven 99, 3116 AB Schiedam, PO Box 510 (Zip: 3100 AM), 010.426 9315, Fax: 010.426 7173, Dir: JP Brouwer, Sales: A M Overmeer.

VAN DEN DOEL ACCESSORIES, Lijsterweg 16, 1221 JK Hilversum, 035.855 048, Fax: 035.856 032, MD: P van den Doel. Racking systems and boxes; Care products for CD, MC, and LP.

VAN DER WAARD, Aalsterweg 118L, 5615 CJ Eindhoven, 040.120 299, Fax: 040.123 119.

VEL WAYS SALES SYSTEM, Haver-Akker 3, PO Box 161, 3941 LD Doorn, 03430.16980, Fax: 03430.16980, MD: Peter van der Velden. Audio systems & display racks.

WALVIS PLASTICS, Vliegdenweg 9, 1406 MX Bussum, PO Box 221 (Zip: 1400 AE), 02159.32925, Fax: 02159.37057, Tlx: 41605, Dir: R D W Epen.

ASSOCIATIONS & PROFESSIONAL ORGANIZATIONS

BUMA STEMRA, Professor E M Meyerslaan 3, 1183 AV Amstelveen, PO Box 725 (Zip: 1180 AS), 020.540 7911, Fax: 020.540 7496, Tlx: 12399 autor, Dir: Ger Willemsen, Contact: Gerard van Laar. Buma performing, Stemra mechanical rights.

CINEMUSICA, Gondel 11/66, 8243 BH Lelystad, PO Box 406 (Zip: 8200 AK), 03200.46177, Chmn: J Wolthuis. Filmmusic information center.

COMMISARIAAT VOOR DE MEDIA, PO Box 1426, 1200 BK Hilversum, 035.721 721, Fax: 035.721 722, Chmn: Aard Geurtsen.

CONAMUS FOUNDATION, Vaartweg 32, 1217 SV Hilversum, PO Box 929 (Zip: 1200 AX), 035.218 748, Fax: 035.212 750, MD: John de Mol. Represents interests of composers, songwriters and music publishers; promotes all aspects of Dutch light music. A non-profit organization, affiliate of BUMA.

CPG, Edward Jennerstraat 328, 2035 EW Haarlem, 023.366 444, Fax: 023.353 407, Dir: Jan Gaasterland. Association for promotion of soundcarriers.

DMC HOLLAND (DISCO MIX CLUB), Faas Eliaslaan 13, 3742 AR Baarn, 02154.25187, Fax: 02154.25040, Presidents: Alex van Oostrom, Danielle Kok. DJ only organization, organizes European DJ & Music Convention, the Dutch DJ Championship, manages Dutch DJ Promotions Pool.

DUTCH BROADCAST CONGRESS, PO Box 576, 1200 AN Hilversum, 035.258 689, Fax: 035.214 559.

DUTCH ROCK MUSIC FOUNDATION, Wibautstraat 214, 1091 GS Amsterdam, 020.668 2255, Fax: 020.668 5041, E-Mail: MCI-Mail: 3545209, Dir: Jaap van Beusekom, Public Relations: Laurence van Haren, Legal & Bus Affairs Dir: Margriet Koedooder. Promotes Dutch rock music.

FILM FESTIVAL ROTTERDAM, PO Box 21696, 3001 AR Rotterdam, 010.411 8080, Contact: Sandra Den Hamer.

GENECO, E M Meyerslaan 3, 1183 AV Amstelveen, PO Box 725 (Zip: 1180 AS), 020.540 7416, Fax: 020.540 7496, Tlx: 12399 autor, President: Gillius van Bergijk, Sec: Alex Manassen, Treasurer: Tera de Marez Oyens, Sec: Linda Wilhelm. Composers association.

IFPMP, Eikbosserweg 181, 1213 RX Hilversum, 035.48104, Fax: 035.216 387, President: Ralph Peer II, Gen Sec: Cor Smit. International Federation of Popular Music Publishers.

INTERNATIONAL DOCUMENTARY FILM FESTIVAL, Kleine Gartmanplantsoen 10, 1017 RR Amsterdam, 020.627 3329, Fax: 020.638 5388, Contact: Irma Dulmers.

MEDIARAAD, Lange Voorhout 19, 2514 EB The Hague, 070.361 5935, Fax: 070.360 0901, Sec: JW Kalkman. Advisory board for government.

MEDIAVISIE, Europaplein, RAI Gebouw, 1078 GZ Amsterdam, 020.549.1212, Fax: 020.646.4469. Audiovisual communications trade fair.

NTB, Herengracht 272, 1016 BW Amsterdam, 020.620.3131. Musicians federations.

NVGD, De Noord 3, 1452 PS IJpendam, 02902.3135, Fax: 02902.3145, Mgr: Ron Remeëus. Record retailers association.

NVPI, Albertus Perkstraat 36, 1217 NT Hilversum, 035.40951, Fax: 035.41954, MDs: Rob Edwards, L Boudewijns, Dep MD: P Solleveld. Dutch national IFPI group.

OLON, Sint Annastraat 1, 6524 EA Nijmegen, PO Box 441 (Zip: 6500 AK), 080.601.222, Fax: 080.601.656, President: H Posthoorn, Dir: P de Wit, Contact: T Bastiaansen, I van Hof. Local radio and TV stations federation; Main activities: advocating, practical support of members (training, equipment).

PALM, Vaartweg 32, 1217 SV Hilversum, 035.214.911, Fax: 035.212.750, Chmn: Cees Schrama, Sec: Eric Boom. Professional authors of light music association.

R O O S, PO Box 444, 1200 JJ Hilversum, 035.210.875, Fax: 035.216.900, Chmn: Herman Stoekenbroek, Co-Ord: Ben Groenendijk, Asst: Heleen van Kasbergen. Organisation of regional broadcasters.

STICHTING ETHER RECLAME (STER), PO Box 344, 1200 AH Hilversum, 035.211.841, Fax: 035.218.940, Contact: P F Kenninck. TV/Radio advertising control organisation.

STICHTING NATIONALE PLATENBONN, De Noord 3, 1452 PS IJpendam, 02902.3135, Fax: 02902.3145.

STICHTING NATIONALE TOP 100, Vaartweg 32, 1217 CV Hilversum, PO Box 483 (Zip: 1200 AL), 035.235.500, Fax: 035.215.959, Charts Mgr: Stephanie de Nooy, Comm Mgr: Leo Salden. Compilation of different national Top 100 chart lists, as well as promotion of the organization.

STICHTING NEDERLANDSE TOP 40, PO Box 706, 1200 AS Hilversum, 035.231.647, Fax: 035.40354, MD: Sieb Kroeske, Asst Dir: Francis Bouman. Chart organization; Publishing: monthly Top-40 video magazine, weekly Top-40 music charts magazine (Holland).

UNIM, Eikbosserweg 181, 1213 RX Hilversum, 035.48104, Chmn: Guus Jansen jr., Sec: Cor Smit. Music publishers association.

VECAI, Noorderdijk 207, 3311 RN Dordrecht, 078.310.777, Fax: 078.313.396.

VECTA, Uiterdijksehof 28, 1394 JM Nederhorst den Berg, 02945.2306, Fax: 02945.3398, Sec: Jan Riemeyer. Entertainment agents & event organisers association.

VMM, Eikbosserweg 181, 1213 RX Hilversum, 035.48104, Chmn: P A van Zuylen. Retailers organisation.

PUBLIC RELATIONS & RECORD PROMOTION

A.Z.I.9 PRODUCTIONS, PO Box 143, 4100 AC Culemborg, 03450.21422, Fax: 03450.20840, Contact: H G Leerintveld.

ARTY PROMOTIONS HOLLAND, Zuidhoek 191b, 3082 PG Rotterdam, PO Box 59118 (Zip: 3008 PC), 010.428.2951, Fax: 010.429.5367, GM: Jan Beunk, Asst Dir: L Browne, Int'l Sales Mgrs: H Akkerman, J van Voordt.

BEST MUSIC, Crispijnstraat 9, 5171 CH Kaatsheuvel, 04167.73270, MD: Peter van Best.

BPI COMMUNICATIONS, Rijnsburgstraat 11, 1059 AT Amsterdam, 020.669.1961, Fax: 020.669.1941, Tlx: 12938, President: Theo Roos. Publishing house.

DARO, Kobelaan 376, 3067 MD Rotterdam, 010.420.9176, Fax: 010.455.5896, MD: J W Prohn.

DENTSU, Honthorststraat 9, 1071 DC Amsterdam, 020.570.5300, Fax: 020.675.2076, Contact: M A C Boots.

FLYING DUTCHMAN, Rijnsburgstraat 11, 1059 AT Amsterdam, PO Box 9027 (Zip: 1006 AA), 020.669.1981, Fax: 020.617.0856, Tlx: 12938, MD: Jan Abbinck, Promo Mgr: Rick van Schooten, Publicity Mgr: Karen Holt. Pan-European artist promotion, retail marketing; Recent clients: Extreme, Secret Mission, Rebel Pebbles.

GO 4 ITI, De Amsterdamse Poort 10, 1102 BE Amsterdam-Zuidoost, 020.696.0281, Fax: 020.696.0281, MD: Mark Reinhoudt.

GROTE PRIJS VAN NEDERLAND, Mauritsweg 42B, 3000 AT Rotterdam, PO Box 771 (Zip: 3000 AT), 010.414.2644, Fax: 010.411.8624, Chmn: Willem van Beusekom, MD: Robin Groenewald. Promotion of Dutch rock music.

INDY PROMOTIONS & PRODUCTIONS, Willem Buitewechstraat 147-149, 3024 XE Rotterdam, 010.476.2923, Fax: 010.476.3606, President: N J D Halliwell, Operating Mgr: A R M Siwalette.

LEX COESEL PROMOTION SERVICE, Oude Enghweg 24-26, 1217 JD Hilversum, PO Box 1590 (Zip: 1200 BN), 035.213.893, Fax: 035.219.840, Owner: Lex Coesel.

LOUIS BOLSUIS PRODUCTIONS, Nieuwlandstraat 28, 5038 SN Tilburg, 013.363.077, Fax: 013.357.755, MD: Louis Bolsius, Sales Mgrs: F ter Doest, S Iyriboz, B Verhagen, Ellen van Hooff. Business to business events and sales promotions.

LW PROJECT CONSULTANCY, Lisdoddekreek 10, 2353 JR Leiderdorp, 071.416.515, Fax: 071.415.763, President: Leo Wijnald, MD: Lia Janssen. Promotion, marketing, advertising, production, design.

MALIBU PROMOTIONS, Damrak 30, 1012 LJ Amsterdam, 020.382.271, Fax: 020.382.271, MD: Ad Latjes.

MULTI MEDIA INTERNATIONAL, Stroombaan 4, 1181 VX Amstelveen, PO Box 469 (Zip: 1181 VX), 020.547.3550, Fax: 020.643.8581, Contact: Iris Boersbroek. Publishing house.

MVSP, Franciscusweg 271, 1216 SG Hilversum, 035.255.800, Fax: 035.283.830, President: Monique van Schendelen, Asst: Pauline Verhoeven. Publicity, promotion, pr.

POWERPLAY AGENCY, Neuweg 50a, 1214 GV Hilversum, 035.40152, Fax: 035.40561, Int'l: Jan Kind.

ROCKSUPPORT SINCE 1991, PO Box 90207, 1006 BE Amsterdam, 020.620.8188, Fax: 020.620.8188, GM: Freddie Vialle. Also talent scouting, transport. Clients include Late Road Lunatics, Silent Blue, Lost Moment Records, DDI Records (UK), Europop, EMI Records.

TCS PUBLISHING PARTNERS, Weesperzijde 103/2, 1091 EM Amsterdam, 020.663.0740, Fax: 020.693.2706, MD: Barend Toet, Mktg/Sales Mgr: Kate Russell. Consultancy for production, development & management of publications; Editorial & photography agency.

VEL WAYS SALES SYSTEM, Haver-Akker 3, PO Box 161, 3941 LD Doorn, 03430.16980, Fax: 03430.16980, MD: Peter van der Velden. Marketing services.

VIP, Achterstraat 6, 4101 BB Culemborg, 03450.20666, Fax: 03450.20666, MD: Bert vd Watering. Pan-European promotion.

COMPACT DISC MASTERING & REPLICATING PLANTS

AUDIOSTUDIO JOOP WESSELIUS, Zuidelinde 40, 2371 BW Roelofarendsveen, 01713.17001, Fax: 01713.13170, MD: Joop Wessellius, Chief Eng: Kees Griepink, Eng: Mathilda Granetia. CD pre-mastering.

CHANNEL CLASSICS STUDIO, Jacob van Lennepkade 334e, 1053 NJ Amsterdam, 020.616.1775, Fax: 020.616.0528, MD: C Jared Sacks. CD pre-mastering, 2 editing suites/mobile, Sony DMS 1100 & DMS3000.

DIGIPRO NETHERLANDS, Nieuwstraat 44a, 3762 TR Soest, 02155.21745, Fax: 02155.16714, MDs: Jacques Krischer, Patrick de Lannoy. CD pre-mastering suite.

DURECO MANUFACTURING, Pampuslaan 45, 1382 JM Weesp, 02940.15321, Fax: 02940.18923, Mgr: Cees Stam.

DYNAMIC LASERDISC, 2e Loswal 1, 1216 BC Hilversum, 035.238.555, Fax: 035.235.113. Laserdisc manufacturing.

EMI COMPACT DISC HOLLAND, Industrielaan 24, 5406 XC Uden, 04132.85555, Fax: 04132.66695, MD: Hans van Luit, Contact: Sead Suhonjic.

EUROPE OPTICAL DISC, Dr Paul Janssenweg 140, 5026 RH Tilburg, 013.437.437, Fax: 013.685.488, Tlx: 52493 eod, MD: Leo Davenport, Comm Mgr: Jan de Boer. Laserdisc/CD-rom.

HOLLAND CUTTING/THE MASTERS, Jan Gooienlaan 90, 3764 XL Soest, 02155.16581, Fax: 02155.16581, MD: Maarten Boer. 3 studios for CD-premastering, hard disk editing, disc cutting, CD-wo.

PHILIPS INTERNATIONAL, Kastanjelaan 8, 5600 JB Eindhoven, 040.735.911, Fax: 040.737.932, Dir IMS: G Bastiaans. Laserdisc and CD-I.

SONOPRESSE INTERNATIONAL, Ochterveltstraat 43B, 3015 XL Rotterdam, PO Box 2677 (Zip: 3000 CR), 010.477.0060, Fax: 010.477.2430, MD: Leo Ritmeester.

SONY OPERATIONS (HOLLAND), Nijverheidsweg 26-42, 2031 CP Haarlem, 023.182.838, Fax: 023.321.853, Tlx: 41538/9, GM: Peter Bouwens, Contact: Alex Bisi.

WISSELOORD STUDIOS, Catharina van Renneslaan 12, 1217 CX Hilversum, 035.217.256, Fax: 035.44881, Tlx: 43339, CD pre-mastering.

PLATING, MASTERING & PRESSING PLANTS

BEVERLY BEAT STUDIOS, Kottenseweg 85, 7101 JS Winterswijk, PO Box 36 (Zip: 7100 AA), 05430.22022, Fax: 05430.21735, Studio Mgr: Marcel Kramer, Sales/Prod Dir: Herman van den Heiden.

DURECO MANUFACTURING, Pampuslaan 45, 1382 JM Weesp, 02940.15321, Fax: 02940.18923, Mgr: Cees Stam.

HOLLAND CUTTING/THE MASTERS, Jan Gooienlaan 90, 3764 XL Soest, 02155.16581, Fax: 02155.16581, MD: Maarten Boer. 3 studios for CD-premastering, hard disk editing, disc cutting, CD-wo.

POLYGRAM RECORD SERVICE, Torenlaan 17, 3742 CR Baarn, PO Box 23 (Zip: 3740 AA), 02154.19911, Fax: 02154.23504, MD: Rien van Regteren, Contr: Johan Borren.

SONOPRESSE INTERNATIONAL, Ochterveltstraat 43B, 3015 XL Rotterdam, PO Box 2677 (Zip: 3000 CR), 010.477.0060, Fax: 010.477.2430, MD: Leo Ritmeester. Vinyl pressing and Flexidiscs.

SONY OPERATIONS (HOLLAND), Nijverheidsweg 26-42, 2031 CP Haarlem, 023.182.838, Fax: 023.321.853, Tlx: 41538/9, GM: Peter Bouwens, Contact: Alex Bisi.

SPITSBERGEN RECORDING STUDIO, Spitsbergen 5, 9636 TD Zuidbroek, 05980.97688, Fax: 05980.99678, Contact: Jan-Willem Ludolph. Mastering.

TAPE CUSTOM DUPLICATORS

ALCAS HOLLAND, Rubberstraat 9, 1411 AL Naarden, PO Box: 5068 (Zip: 1140 AB), 02159.48591, Fax: 02159.48500, Tlx: 73369, MD: Hans Hatt.

BEVERLY BEAT STUDIOS, Kottenseweg 85, 7101 JS Winterswijk, PO Box 36 (Zip: 7100 AA), 05430.22022, Fax: 05430.21735, Studio Mgr: Marcel Kramer, Sales/Prod Dir: Herman van den Heiden.

DUPLICASE, Rozenlaan 57, 2771 DC Boskoop, 01727.17838, MD: Kees van Dorth. Audio cassette duplication; Annual cap: 500,000; Min order: 10.

DUPLITRON, Bosmankamp 71a, 4191 MT Geldermalsen, 03455.75619, Fax: 03455.74909. Video duplication.

EFO VIDEO DUPLICERING, Roentgenweg 4, 3752 LJ Bunschoten, 03499.82333, Fax: 03499.83254. Video duplication.

INTERCASSETTE, Papiermakerstraat 1, 1531 NA Wormer, 02982.1304, Fax: 02982.7390, MD: H I Renaud.

MCR PRODUCTIONS, 4e Industrieweg 2, 3411 Lopik, 03485.9281, Fax: 03495.9290, MD: Hans de Deugd.

POLYGRAM RECORD SERVICE, Torenlaan 17, 3742 CR Baarn, PO Box 23 (Zip: 3740 AA), 02154.19911, Fax: 02154.23504, MD: Rien van Regteren, Contr: Johan Borren.

RCS/THE CASSETTE MASTERS, Samuel Mullerplein 9a, 3032 SK Rotterdam, 010.477.7872. Cassette duplication.

SALISBURY SOUND, Zuidendijk 327, 3317 NR Dordrecht, 078.184.422, Fax: 078.176.717, Tlx: 28673 caset, MDs: Fred Tollenaar, Renee Palm. Annual capacity: 800,000.

SONOPRESSE INTERNATIONAL, Ochterveltstraat 43B, 3015 XL Rotterdam, PO Box 2677 (Zip: 3000 CR), 010.477.0060, Fax: 010.477.2430, MD: Leo Ritmeester. Audio cassette duplication.

SONY OPERATIONS (HOLLAND), Nijverheidsweg 26-42, 2031 CP Haarlem, 023.182.838, Fax: 023.321.853, Tlx: 41538/9, GM: Peter Bouwens, Contact: Alex Bisi.

STONESOUND STUDIO, Nucleon Weg 24, 4706 PZ Roosendaal, 01650.45886, Fax: 01650.45886, MD: Willem Steentjes, Mgr: Margreth Steentjes.

TAVS, Kervelstraat 34, 7322 PW Apeldoorn, 055.664.666, Fax: 055.668.597. Video duplication.

TECHNICOLOR VIDEOCASSETTE

Vossenbeemd 51, 5705 CL Helmond, PO Box 3055 (Zip: 5700 JD), (3149) 205-0545, Fax: (3149) 205-2505, Pres.: Emmet Murphy, Gen. Mgr: Ted Frodyma, Customer Service/Sales: F Mols, Prod Mgr: A Houpeylyne. Annual capacity: 7m. Video: 1/2 VHS Cassette. High Speed Capability: Sprinter. SP, EP. Video Packaging Services: Inserting, Collating, Labeling, Mailing. Other Services: Complete Fulfillment Services, Warehouse, MIS (Inventory), Freight.

VIDEO DUPLICATION HOLLAND, J. van Beierenstraat 123, 1211 HS Hilversum, 035.231.239, Fax: 035.284.794. Video duplication.

VIDEO EXPERIENCE, Verfmolen 101, 1622 LR Hoorn, 02290.42173, Fax: 02290.43871. Video duplication.

WISSELOORD STUDIOS, Catharina van Renneslaan 12, 1217 CX Hilversum, 035.217.256, Fax: 035.44881, Tlx: 43339, Mgr: Bert Baars.

CASSETTES REELS & PARTS, JEWEL BOX MANUFACTURERS

GEVEKE WERKTUIGBOUW, Kabelweg 21, 1000 AV Amsterdam, PO Box 820 (Zip: 1000 AV), 020.582.9111, Fax: 020.666.1604.

GPT AXXIO, Kanaaldijk ZW 7B, 5700 AE Helmond, PO Box 237 (Zip: 5700 AE), 04920.36822, Fax: 04920.33825, Tlx: 51025, MD: D J Boer, Mktg Mgr: J van Dijk, Operations Mgr: J L J de Graaf, Sales: G H J M van Dierendonck. Cartridges/jewel boxes and adaptors, all different formats.

INTERLAD, PO Box 3100, 5902 RC Venlo, 077.870.040, Fax: 077.872.979, MD: Tony Hueber, Office Mgr: Simon Christiaans. Audio: C-0 & boxex; CD jewel boxes, trays.

MAGNA-ZONAL BENELUX, PO Box 3100, 5102 RC Venlo, 077.870.040, Fax: 077.872.979, MD: Tony Hueber, Office Mgr: Simon Christiaans. CD boxes and trays, Audio C-0 and boxes.

MASTERS HOLDING, Lage Kamp 14, 7317 AT Apeldoorn, 055.226.025, Fax: 055.226.039, MD: Walther Bakker.

NIPPER CV, 1st Passeerdersdwarstraat 88, 1016 XD Amsterdam, 020.620.5100, Fax: 020.638.1058, Contact: Hans Stok. Finyl CD-sound improver, Nitty Gritty LP-cleaning.

RNA SYSTEMS, Spoorakkerweg 2b, 5071 NC Udenhout, PO Box 8 (Zip: 5070 AA), 04241.4440, Fax: 04241.4827, MD: A C J van de Sanden. Manufacturer of jewel boxes, video boxes, CD storage systems.

TRANSTEC, Brugwachter 19, 3034 KB Rotterdam, 010.414.7055, Fax: 010.411.3580, Dir: B Tellegen.

PRINTING, PACKAGING & LABELS

AKTUPRINT, PO Box 1392, 100 BJ Amsterdam, 020.622.7466.

ALMERE PRINTING, Draaibrugweg 19, 1300 AA Almere, 03240.20554.

ARNO VAN ORSOUW, Oosterburgervoorstraat 71, 1018 MP Amsterdam, 020.622.2898, Tlx: 13442.

DRUKKERIJ DEN HERTOEG, Warmoesstraat 4, 1521 CK Wormerveer, 075.288.350.

DRUKKERIJ HOEKMAN, Saasjkij 25, 8281 BM Genemuiden, 05208.55122, Fax: 05208.56474, MD: Dick Hoekman.

DRUKKERIJ VAN DE STEEG, Lentweg 8, 7532 RB Enschede, 053.613344, Fax: 053.615545, Tlx: 44401, Mktg Mgr: Harry Smit.

ODME, PO Box 167, 5500 AD Veldhoven, 040.543 815, Fax: 040.541 985, Tlx: 51652, Pres/MD: L Dielesen, Pres/MD: R Kok, Mktg Dir: R van der Berg, PR Mgr: Hans Walters.
SONY OPERATIONS (HOLLAND), Nijverheidsweg 26-42, 2031 CP Haarlem, 023.1822 838, Fax: 023.321 853, Tlx: 41538/9, GM: Peter Bouwens.
VAN DEN STEEG, PO Box 110, 7500 AC Enschede, 053.613 344, Fax: 053.615 545, MD: Harry Smit. Laserdisc & LP sleeves. Video, DAT, MC & CD slipcases and boxes.
ZEEFDRIUKKERIJ VAN BEERS, West Havendijk 14, 4703 NZ Roosendaal, PO Box 1123 (Zip: 4703 NZ).

BLANK & BULK RAW TAPE

3M NETHERLANDS, PO Box 193, 2300 AD Leiden, 071.450 450, Fax: 071.450 212.
AMPEX, Coloradodreef 36, 3565 BV Utrecht, PO Box 9026 (Zip: 3506 GA), 030.612 921, Fax: 030.618 367, Sales Mgr: Ewoud Stroeven.
AUDIO VISUAL PRODUCTS, Nieuwstadterweg 12, 6136 KN Sittard, PO Box 628 (Zip: 6130 AP), 046.581 716, Fax: 046.581 300, Dir: G A A Hueber. Blank tape supply; Brand: Greencorp.
BASF, PO Box 1019, 6801 MC Arnhem, 085.717 171, Fax: 085.717 246, Dir: H Mylanus, Sales Mgr: H G Koolhaas.
DUPLICASE, Rozenlaan 57, 2771 DC Boskoop, 01727.17838, MD: Kees van Dorth. Blank audio cassettes manufacturers.
FUJI/TRADE FILM BENELUX, Henri Polaklaan 42, 1018 CT Amsterdam, 020.625 0714, Fax: 020.620 8006, Contact: Peter Roelofs.
INTERLAD, PO Box 3100, 5902 RC Venlo, 077.870 040, Fax: 077.872 979, MD: Tony Hueber, Office Mgr: Simon Christiaans. Supplier/Distributor of professional & consumer blank audio tape cassette and open reel.
KODAK NETHERLANDS, Zeisterweg 1, 3984 NH Odijk, 03405.99911, Fax: 03405.99599.
MAGNA-ZONAL BENELUX, PO Box 3100, 5102 RC Venlo, 077.870 040, Fax: 077.872 979, MD: Tony Hueber, Office Mgr: Simon Christiaans. Supplier/distributor of professional & consumer blank audio tape cassette and open reel.
MAXELL (NETHERLANDS), Wamberg 37, 1083 CW Amsterdam, 020.646 0346, Fax: 020.642 6685, Contact: NOT AVAILABLE.
PD MAGNETICS, Moltenstraat 37, PO Box 82, 4902 NM Oosterhout, 01620.85910, Fax: 01620.34558, GM: R C Buis, Mktg Dir: Jack Blink. Manufacturer of professional & consumer blank audio and blank video tape cassettes (open reel); Brand: PDM.
PHILIPS INTERNATIONAL, Kastanjelaan 8, 5600 JB Eindhoven, 040.735 911, Fax: 040.737 932, Mktg Dir: N Brokking. Audio and DCC tapes.
RC&S THE CASSETTE MASTERS, Samuel Mullerplein 9a, 3032 SK Rotterdam, 010.477 7872. Blank audio cassettes.
SONY NEDERLAND, Jan van Gentstraat 119, 1171 GK Badhoevedorp, 020.658 1911, Fax: 020.659 3367, MD: Robert Geel.
SUNKYONG NETHERLANDS, Wilhelmplein 2/4, Berghaus-Plaza, 1062 HK Amsterdam, 020.617 0571, Fax: 020.615 0407, Tlx: 18049 sky.
TAPES ROTTERDAM, Nieuwe Binnenweg 316, 3021 GV Rotterdam, 010.425 4344, Fax: 010.425 4355, Sales Dirs: Erik van der Werff, Heyo Beentje. Audio & video cassettes & open reels; Distribute: Sony, Ampex, 3M, AGFA, BASF, Fujii, Maxell, TDK, Fidelipak, Duplicating Tape, Kenwood CD-R.

CD, RECORD & TAPE MANUFACTURING SYSTEMS

AUDIO VISUAL PRODUCTS, Nieuwstadterweg 12, 6136 KN Sittard, PO Box 628 (Zip: 6130 AP), 046.581 716, Fax: 046.581 300, Dir: G A A Hueber. Manufacturer & Distributor of Vinyl & Cassettes.
CHANNEL CLASSICS STUDIO, Jacob van Lennepkade 334e, 1053 NJ Amsterdam, 020.616 1775, Fax: 020.616 0528, MD: C Jared Sacks. CD manufacturing; Annual cap: 300,000; Min order: 500.
DOC&DISC, Venrayseweg 32, 5902 RA Venlo, PO Box 3033 (Zip: 5902 RA), 077.872 200, Fax: 077.873 255, Tlx: 58715, Exec Dir: Joseph Beaujean. Rotary printing installations.
GEVEKE WERKTUIGBOUW, Kabelweg 21, 1000 AV Amsterdam, PO Box 820 (Zip: 1000 AV), 020.582 9111, Fax: 020.686 1604.
GPT AXIIO, Kanaaldijk ZW 7B, 5700 AE Helmond, PO Box 237 (Zip: 5700 AE), 04920.36822, Fax: 04920.33825, Tlx: 51025, MD: D J Boer, Mktg Mgr: J van Dijk, Operations Mgr: J L J de Graaf, Sales: C P Jonge. Injection moulds, all formats.
MAYCOM AUTOMATION SYSTEMS, Dorpsstraat 29b, 6661 EG Elst, 08819.77525, Fax: 08819.77380, MD: T van de Pol, R&D Dir: P C L Zandbergen, Int'l Sales/Mktg Mgr: Miranda van de Pol, R&D: Ronald Vorstenbosch, B van den Brink, H Dekker. CD Manufacturing equipment.

OD+ME

Rekvelden 15, 5503 NZ Veldhoven, PO Box 167, 5500 AD Veldhoven, (31+) 40.543 815, Fax: (+31) 40.541 985, Tlx: 51652, Pres/MD: L Dielesen, R Kok, Mktg Dir: Hans Walters. Manufacturers of CD equipment: mastering equipment, laser disc equipment.

OPTICAL DISC CORPORATION, Koninginneweg 213, 1075 CS Amsterdam, 020.671 8741, Fax: 020.671 3256, VP (Int'l Mktg): Donald Hayes. CD mastering equipment.
OPTICAL DISC MASTERING (ODM), Lodewijkstraat 1, 5600 MD Eindhoven, PO Box 218 (Zip: 5600 MD), 040.724 0817/22 997, Fax: 040.723 737, Tlx: 35000 phtc, MD: N Lawley, Mktg/Sales Dir: R van den Berg, Mktg/Comm: Annie v/d Linden, Int'l Sales Mgr: Gary P.M. Bergman, Joost van Rijswijk, Jack Heeren. Design, manufacture, and distribution of stand alone and totally integrated solutions for the production of CD-Audio, CD-ROM, Preformat and Video discs.
ROX HANDELSONDERNEMING, PO Box 36, 5140 Waalwijk, 0160.32581, Fax: 04160.42186, MD: Chris van Delft. Raw materials.

TAPE PACKAGING & LABELING EQUIPMENT

KALTEREN INTERNATIONAL, Nieuwstraat 44-48, 6811 HX Arnhem, 085.452 541, Fax: 085.451 402, MD/Mktg Dir: N Jellesma, Sales Dir: F A Boonstoppel. CD/Jewel Box packaging machines.
LANDRE VERPAKKINGSTECHNIEK, PO Box 63, 4130 EB Vianen, 03473.61311, Fax: 03473.71485, Dir: W G de Ruiter. Agent for Marden Edwards & Co (packaging/labeling equipment manufacturers).

NORWAY

RECORD COMPANIES

ARNE BENDIKSEN RECORDS, Jørnstadveien 62, 1360 Nesbru, 02.784 778, Fax: 02.790 630, MD: Arne Bendiksen. Labels: AB Records, Triola, Flower, Flora, Country, Maestro.
BMG ARIOLA NORWAY, Bentsebrugate 13b, 0476 Oslo, PO Box 4383 Torshov (Zip: 0402), 02.225 220, Fax: 02.156 921, MD: Erling Johannessen, Mktg Mgr: Morten Jensen, F&A Mgr: Jeanette Bragnes, Prod Mgrs: Hilde Hatlebrette, Helge Barra (MCA/Geffen/RCA), Head PR/Promo: Irene Heiersjø, A&R (Local): Eivind Roellets. Labels (owned): RCA, Ariola, Arista, Record Station; (Lic): Jive/Silverstone, Island, Medley Records, Private Music, MCA, Geffen, GRP, Norsk Plateproduksjon, Frituna Production.
CNR NONSTOP, Sandakerveien 24c, PO Box 4240 Torshov, 0401 Oslo, 02.714 110, Fax: 02.714 125/185 (sales), MD: Ole Vidar Lien, Sales/Mktg Dir: Leif Hemmingsen, A&R (Int'l): Magne Sand. Labels (owned): CNR Records, Marlann, Nonstop Records; (Lic): Grand Records.
CONTINENTAL RECORDS, St. Halvardsgate 33, 0135 Oslo, PO Box 3707 (Zip: 0135), 02.190 250, Fax: 02.687 190, President: Barry Matheson, MD: Borre Brenne. Labels (owned): Continental, Central Records; Main product: Special products for non-traditional markets.
CREMA, Schutzgate 9, 0365 Oslo, PO Box 6 (Zip: 0319), 02.607 335, Fax: 02.569 812, MD: Arve Sigvaldsen.
EMI NORSK, Frysjaeveien 33e, PO Box 42 Korsvoll, 0808 Oslo, 02.231 488, Fax: 02.231 494, Tlx: 76294 emias, MD: Fredrik Mueller, Sales Mgr: Frode Skulstad, Hd of A&R/Promo: Tor Eriksen, Label Mgrs: Unni Arnesen, Frank Hauge, Helge Barr. Labels (owned): Angel, Appel, Arcade, Ardek, Blue Note, Capitol, Chrysalis, CFP, Columbia, Cooltempo, Dover, Double Up, Elektra, EMI, EMI America, Encose, Fame, Glen, Golden Age, Harvest, HMV, Hispavox, Hor Zu, Imperial, Liberty, Manhattan, MFP, Odeon One Up, Pangea, Parlophone, Pathe Marconi, Purple, Rak Reflexe, Regal Zonophone, Rondo, Roulette, Sovereign, Starline, Stateside, Sunset, Syncopate Trio, United Artists, Waverley, World Record Club, Zonophone; Ensign, IRS, SBK.
GRAMMOFON ELECTRA, St. Halvardsgate 33, 0192 Oslo, 02.190 250, Fax: 02.677 145, MD: Kristin Grindaker. Labels (owned): Musica; Main product: Children's Music.
GRAPPA RECORDS, Akersgate 7, 0158 Oslo, PO Box 5650 (Zip: 0209), 02.412 400, Fax: 02.415 552, MD: Helge Westbye. Main product: AC.
JORG-FR ELLERTSEN, PO Box 149 Refstad, 0513 Oslo, 02.228 070.
JUSTEIN SVENDSEN MANAGEMENT, Normannsgate 3, 9400 Harstad, PO Box 1123 (Zip: 9401), 082.65678, Fax: 082.61053, MD: Jostein Svendsen. Labels: JSH Records; Main product: EHR, AC, Country, Dance, Album Rock, Black (R&B).
NOTABENE RECORDS, Bogstadeveien 31b, 0366 Oslo, 02.691 169, Fax: 02.696 305, MD: Ole Sorli, GM: Vibeke Olason. Artists: Dollie de Luxe; Main product: rock, opera, musicals.
ORIGON NORSK PLATESKAP, PO Box 26, 2014 Blystadlia, 02.701 050, Fax: 02.701 050, Contact: E B Vike.
PLATESKAPET (THE RECORD COMPANY), Magnus Berfottsveien 24b, 7046 Trondheim, 07.513 330, Fax: 07.520 595, Contact: Gunnar Horvick, Kari Thorvik.
POLYGRAM NORWAY, Marcus Thranesgate 2, 0473 Oslo, 02.372 905, Fax: 02.356 757, Tlx: 78521, MD: Joern Johnsen, A&R/Mktg Mgr: Petter Singaas, Mgr (Classical): Mikkel Aas, F&A Mgr: Kari Rivedal. Distribution: MSO (Music Service Organisation).
PRO-MUSICA, Sandakerveien 76, PO Box 4379 Torshov, 0402 Oslo, 02.711 216, Fax: 02.711 056, MDs: Tore Simonsen, Arne Akselberg. Labels (owned): Simax, Pro Musica; Distribution: Musikkdistribusjon, Olympos; Main product: classical, contemporary.

SHARATIMA RECORDS, Seljehollet 12a, 1344 Haslum, 02.124 461, MD: Lars Hoel.
SLAGERFABRIKKEN, Maridalsveien 87b, 0405 Oslo 4, 02.352 830, Fax: 02.355 539, Tlx: 76512 sonet, MD: Terje Engen, A&R: Audun Tylden.
SONET GRAMMOFON (NORWAY), Maridalsveien 87b, 0405 Oslo 4, 02.352 830, Fax: 02.355 539, Tlx: 76512 sonet, MD/A&R: Terje Engen, Mktg: Harald Tomte, Int'l Label Mgr: Chris Kirkmyr, PR: Linde Gelberg. Labels (owned): Sonet, Slagerfabrikken, Plateselskapet; (Lic): Alligator, Antone's, Attic, BCM, China, City, Cohesion, Creation, Curb, Expression, Ghetto, Hollywood, In+Out, Legacy, Mute, One Little Indian, PWL, Ricochet, Rough Trade, Round Tower, Swemix, Telegram.
SONOR, Fjordgate 82, 7010 Trondheim, PO Box 332 (Zip: 7001), 07.966 355, Fax: 07.964 615, MD: Trygve Hernaes. Labels (owned): Herman Records, Sonor Records; Main product: Jazz, Classical, Folk.
SONY MUSIC ENTERTAINMENT (NORWAY), Ostre Akerveie 19, 0581 Oslo, PO Box 134 (Zip: 0509), 02.643 790, Fax: 02.644 133, Tlx: 19356 cbar, MD: Rune Hagberg, Mktg Dir: Jan Ostli, Prod Mgrs: Thomas Sem, Espen Omdahl, A&R: Per Ostmark (Mgr), Marius Lillalien (Asst), Press/Promo: Helene Rognoy, Solvi Johansen (Asst). Labels (owned): Abe's, Blue Sky, CBS, CBS Associated Records, CBS Jazz Masterpieces, Cleveland Int'l, Columbia, Columbia Jazz Masterpieces, Contemporary Masters, CTI, Cupol, Dance Pool, Def Jam, Digital Masters, Embassy, Epic, Essential Classics & Jazz, FM, Full Moon/Epic, Great Performances, I Love Country, I Love Jazz, Imagine, Jazztheque, Legacy, Maestro, Masterworks, Memory Pop Shop, Mixed Masters, Nation, Nice Price, No Face, OBR, Odyssey, Original Black Records, Portrait, Portrait Masters, RAL, Rhyme Syndicate, Scarlett, Sony Music Videos, Solid Gold, Solid Gold, Sony Classical, Squatt, True Blue, Vivarte, WTG Records; (Lic): ARS Productions, Caribou, Futive, In-Effect, Jet, Kirsch.
STRAWBERRY RECORDS, Etterstadgate 9, 0658 Oslo, 02.682 064, Fax: 02.672 446, President: Dag Warner. Labels (owned): Strawberry, Crazy Kat, Askeladden; (Dist): Castle Communications, Line, Magnum Music Group, Ryko Disc, Amazing, Blind Pig, Sugar Hill, Landslide, Rhino, Connoisseur Collection, Dixie Frog, Flame Records, Norlid, President, Start.
VIRGIN RECORDS NORWAY, Inkognitogate 33, 0256 Oslo, 02.562 970, Fax: 02.559 274, GM: Gyro Laira, Mktg Mgr: Bjorn Johansen, Promo: Marit Nielsen. Distribution: WEA Records.
WARNER MUSIC NORWAY, Maridalsveien 87b, 0461 Oslo, PO Box 4494 Torshov (Zip: 0403), 02.374 520, Fax: 02.370 761, Tlx: 79461, MD: Mats Nilsson, A&R (Local): Fred Engh, Promo Mgr: Ingvar Aarholt, Prod Mgr: Jonny Styve.

MUSIC PUBLISHERS

AAGE ALEKSANDERSEN, see Frost Music.
ARCO, see Frost Music.
ARNT HAUGENS, see Frost Music.
ARTIC, see Frost Music.
BENNY BORG, see Frost Music.
BENSON, see Frost Music.
BIG HAND, see Frost Music.
BUCCANEER MUSIC, see Frost Music.
CAVENDISH, see Frost Music.
CEZAME-ARGILE, see Frost Music.
CHEERY, see Frost Music.
CNR NONSTOP, Sandakerveien 24c, PO Box 4240 Torshov, 0401 Oslo, 02.714 110, Fax: 02.714 125/185 (sales), MD: Ole Vidar Lien. (Admin): Tony Berk Music.
COMPANION MUSIC (NORWAY), PO Box 38 Refstad, 0513 Oslo, 02.115 073, Fax: 02.418 990, MD: Philip Kruse.
CONTINENTAL RECORDS, St. Halvardsgate 33, 0135 Oslo, PO Box 3707 (Zip: 0135), 02.190 250, Fax: 02.687 190, President: Barry Matheson, MD: Borre Brenne. (Sub-pub): NewCut Music.
CREMA, Schutzgate 9, 0365 Oslo, PO Box 6 (Zip: 0319), 02.607 335, Fax: 02.569 812, MD: Arve Sigvaldsen.
EDITIO NORVEGICA, Tofftesgate 69, 0552 Oslo, 02.370 909, Fax: 02.356 938, Chmn: Jostein Simble.
EDITION AAP, Aaswangsveien 8, 1600 Fredrikstad, 09.312 304.
EIVIND GROVENS INSTITUTE, Ekebergveien 59, 1181 Oslo, 02.679 123, MD: Dagmar Grovens Myheren.
FROST MUSIC, Osterhausgate 9, 0183 Oslo, PO Box 38 (Zip: 0513), 02.115 073, Fax: 02.418 990, President: Philip Kruse, Chmn: Birger Brynjulfson, MD: Odd Stenstberg. (Owned): Companion, Gulmoen, Kaare Korneliussens, Snowflake, Snowball, Artic, KK Music; (Admin/sub-pub): Aage Aleksandersen, Arco, Arnt Haugens, Hitsongs, Mingles, Oscar Skau's, Noah, Terje Tysland, Noel Gay, Cherry, Cavendish, Sonoton, Ring, Cezame-Argile, Benson, Benny Borg, Big Hand, Buccaneer Music.
GULMOEN, see Frost Music.
HARALD LYCHE & COMPANY, PO Box 2171 Stromso, 3003 Drammen, 03.833 970, Fax: 03.838 087, Contact: Arne Haslerud.
HIGH ENERGY, Osterhausgate 10, 0183 Oslo, 02.360 600, Fax: 02.523 052, Contact: Anne Christine Henriksen.
HITSONGS, see Frost Music.
KAARE KORNELIUSSSENS, see Frost Music.
KK MUSIC, see Frost Music.
MINGLES, see Frost Music.

MUSE, Kristian Augustgate 11b, 0164 Oslo 1, 02.110 930, Fax: 02.111 597, MD: Gary Helder.

MUSIKKHUSET FORLAG, Dronningensgate 21, 0116 Oslo, PO Box 822 Sentrum (Zip: 0104), 02.425 090, Contact: Arne Damsgaard.

NEW-CUT MUSIC, see Continental Records.

NOAH, see Frost Music.

NOEL GAY, see Frost Music.

NORSK KOMPONISTERS FORLAG, Gjernesveien 24, 5700 Voss, 05.513 325, Contact: Johannes Hellene.

NORSK MUSIKKFORLAG, PO Box 1499 Vika, 0116 Oslo, 02.173 470, Fax: 02.424 435, Admin Mgr: Leif Dramstad.

NORWEGIAN MUSIC INFORMATION CENTRE, Toftegate 69, 0552 Oslo, 02.370 909, Fax: 02.356 938, MD: Jostein Simble, Contact: Hilde Holback Hanssen. Manuscript and reference library with orchestral rental materials, study and listening rooms available.

OSCAR SKAU'S, see Frost Music.

RING, see Frost Music.

SHARATIMA RECORDS, Seljehollet 12a, 1344 Haslum, 02.124 461, MD: Lars Hoel.

SKANDIA MUSIKKPRODUKSJON, Jornstadveien 62, 1360 Nesbru, 02.784 778, Fax: 02.790 630, MD: Arne Bendiksen.

SNOWBALL, see Frost Music.

SNOWFLAKE, see Frost Music.

SONOTON, see Frost Music.

STRAWBERRY RECORDS, Etterstadgate 9, 0658 Oslo, 02.682 064, Fax: 02.672 446, President: Dag Warner.

TERJE TYSLAND, see Frost Music.

TONY BERK MUSIC, see CNR Nonstop.

WARNER CHAPPEL MUSIC NORWAY, PO Box 18 Bryn, 0611 Oslo, 02.722 390, Fax: 02.721 685, MD: Odd Steenberg.

VIDEO PROGRAM SUPPLIERS & BUYERS

METRO FILM PRODUCTIONS, PO Box 2005 Grunerlukka, 0505 Oslo, 02.370 058, Fax: 02.718 423, Dir: Skule Eriksen. Video production of promo videos.

POLYGRAM VIDEO, Marcus Thranesgate 2, 0413 Oslo, 02.372 905, Fax: 02.356 757, Tlx: 78521, MD: Eilif Amundsen.

THULE FILM AND TV, Sagveien 17, 0458 Oslo, 02.717 121, Fax: 02.719 369, President: G Davidson, MD: Oyvind Asbjornsen, Prod Mgr: Gudni Einarsson, Post Prod Mgr: Th Hafsteinsson, Producer: Bjarne Nilssen. Main product: promo clips, long-form music videos, documentaries, TV shows; distribution/studio facilities.

VIP SCANDINAVIA, Verftsgate 2c, 5011 Bergen, 05.239 920, Fax: 05.231 492, Tlx: 42011, MD: Olaf Olsen, Dir: Knut Eide.

WINJE & COMPANY, Baldersgate 11, 0263 Oslo 2, 02.557 015/695 001, Fax: 02.697 955, Contact: Ragnhild "Renee" Winje.

RECORD DISTRIBUTORS

ALBEDO RECORD CLUB, Toftegate 69, 0552 Oslo, 02.370 810, Fax: 02.376 027, President: Geir Johnson, MD: Helge Skansen. Record club of association Ny Musikk; Labels (Dist): Norsk Musikkproduksjon, WER, PALP, CAP, ECN, Deutsche Grammophon, PH.

BIG BOX TRADING, Gladengveien 18, 0661 Oslo, 02.572 790, Fax: 02.571 810, MD: Rune Johannessen, Buyer: Rigmor Flataker. Wholesale & distribution.

CICADA MUSIC, PO Box 118, 1930 Aurskog, 06.301 5975, Fax: 06.862 288, MD: Jan Magnus Hemmingbye, Mktg Dir: Ivar Anstad.

CNR NONSTOP, Sandakerveien 24c, PO Box 4240 Torshov, 0401 Oslo, 02.714 110, Fax: 02.714 125/185 (sales), MD: Ole Vidar Lien, Sales/Mktg Dir: Leif Hemmingsen, A&R (Int'l): Magne Sand. Labels (distr): 4AD, Beggars Banquet, Magnum, Start, NMG, Denon, Rounder, Bullseue, Sugar Hill, Zappa Records, Music for Nations, Facotry, MNW, Tyfon/Black Mark, Noise, Amalthea, Reel, Sequel, Sesam, Grappa, Revolution, SPH, ToCo, Electra, Dino, Scranza.

FAMOUS RECORDS, PO Box 4301, 5028 Bergen, 05.247 100, Fax: 05.247 150, MD: Knut Horne.

KJELL BJORGE ENGROS, Stromsveien 314, 1081 Oslo, 02.301 840, Fax: 02.302 141, GM: Kjell Borge.

M & R IMPORT, Holbergsgate 32, 4601 Kristiansand, 042.26968/27625, Fax: 042.70987, Sales Dir: Clifford Maylem.

MUSE, Kristian Augustgate 11b, 0164 Oslo, 02.110 930, Fax: 02.111 597, MD: Gary Helder.

MUSIKK DISTRIBUTUSJON, Sandakerveien 76, 0402 Oslo, PO Box 4379 (Zip: 0402), 02.710 140, Fax: 02.710 960, Tlx: 79205 mudi, President: Arne-Peter Rognan, MD: Reidar Mikalsen, Sales Mgr: Odd Gjelsnes, Accts Mgr: Hakon Gjesvik, Export Mgrs: Angela Carruthers-Guldal (Classical), Carl Morten Iversen (Jazz). Main product: classical, jazz, folk.

NORWEGIAN MUSIC INFORMATION CENTRE, Toftegate 69, 0552 Oslo, 02.370 909, Fax: 02.356 938, MD: Jostein Simble, Sec: Lisbeth Risnes.

NORWEGIAN RECORD PRODUCTIONS, Krusegate 8, 0263 Oslo, 02.449 921, Fax: 02.446 640, President: Ivar Dyrraug. Distribution: MSO.

ROADHOUSE RECORDS DISTRIBUTION, Industriveien 7, 1300 Sandvika, PO Box (Zip: 1301), 02.518 303, Fax: 02.545 695, Owner: Jens Morten Frohoel. Main product: Blues, Country, American-Rock.

SONOR, Fjordgate 82, 7010 Trondheim. PO Box 332 (Zip:

7001), 07.966 355, Fax: 07.964 615, MD: Trygve Hernaes. Labels (distr): Denon, Bandleader, American Music, GHB, Jazzology, Audiophile; Main product: Jazz, Classical, Folk.

SOUND SOLUTIONS, Gladengveien 18, 0661 Oslo, 02.572 790, Fax: 02.571 810, MD: Rune Johannessen, Dir: Tore Heggglund, Ove Olsen, Jan Johansen.

RETAIL ACCESSORY SUPPLIERS

CNR NONSTOP, Sandakerveien 24c, PO Box 4240 Torshov, 0401 Oslo, 02.714 110, Fax: 02.714 125/185 (sales), MD: Ole Vidar Lien, Sales/Mktg Dir: Leif Hemmingsen. Ateka display systems, Allsop, Posso.

LIFT NORGE, Hjalmar Brantingsveien 8, 0581 Oslo, 02.648 370, Fax: 02.724 890.

M & R IMPORT, Holbergsgate 32, 4601 Kristiansand, 042.26968/27625, Fax: 042.70987, Sales Dir: Clifford Maylem. Agent of Frejo display systems.

ASSOCIATIONS & PROFESSIONAL ORGANIZATIONS

FONO, PO Box 5949 Heddehaugen, 0308 Oslo, 02.714 110/462 299, Fax: 02.600 789, Chmn: Jan Paulsen, Bd Members: Ivar Dyrraug, Helge Westbye, Tone Winje, Arne-Peter Rognan. Independent record producers association.

IFPI NORWAY, Sandakerveien 52, 0477 Oslo, 02.221 788, Fax: 02.221 768, Chmn: Rune Hagberg, MD: Saemund Fiskvik.

NORSK MUSIKKHANDLERFORBUND, PO Box 1499 Vika, 0116 Oslo 1, 02.173 470, Fax: 02.424 435.

NORWEGIAN MUSIC INFORMATION CENTRE, Toftegate 69, 0552 Oslo, 02.370 909, Fax: 02.356 938, MD: Jostein Simble, Contact: Hilde Holback Hanssen.

NORWEGIAN MUSIC PUBLISHERS, PO Box 822 Sentrum, 0104 Oslo, 02.425 090, Fax: 02.425 541, MD: Arne Damsgaard.

NORWEGIAN MUSICIANS UNION, Youngsgate 11, 0181 Oslo, 02.401 050, MD: Tore Nordvik.

NY MUSIKK, Toftegate 69, 0552 Oslo, 02.370 810, Fax: 02.376 027, President: Geir Johnson, MD: Helge Skansen. Norwegian section of the International Society for Contemporary Music.

RECORD WHOLESALERS ASSOCIATION, PO Box 4352, 0402 Oslo, 02.372 905, Fax: 02.356 757, Tlx: 78521.

PUBLIC RELATIONS & RECORD PROMOTION

JOSTEIN SVENDSEN MANAGEMENT, Normannsgate 3, 9400 Harstad, PO Box 1123 (Zip: 9401), 082.65678, Fax: 082.61053, MD: Jostein Svendsen. Labels: JSH Records; Main product: EHR, AC, Country, Dance, Album Rock, Black (R&B).

NORSK PRESSE SERVICE, Sorkedalsveien 10b, Majorstua, 0304 Oslo, 02.694 495, Tlx: 71890. Press agency.

COMPACT DISC MASTERING & REPLICATING PLANTS

CNR NONSTOP, Sandakerveien 24c, PO Box 4240 Torshov, 0401 Oslo, 02.714 110, Fax: 02.714 125/185 (sales), MD: Ole Vidar Lien, Contact: Elin Huse. CD manufacture & vinyl pressing.

DURECO NORGE, Svaddeveien 125, 3660 Rjukan, 036.94545, Fax: 036.94510, MD/Sales Dir: Eve Kliffen. CD manufacture; Annual cap: 10 mil; Min order: 1,000.

TAPE CUSTOM DUPLICATORS

CNR NONSTOP, Sandakerveien 24c, PO Box 4240 Torshov, 0401 Oslo, 02.714 110, Fax: 02.714 125/185 (sales), MD: Ole Vidar Lien, Contact: Elin Huse.

HIT COMPANY STUDIOS, Skippergatan 28, 0154 Oslo, 02.423 310, Fax: 02.424 479, Studio Mgr: Ingar Helgesen.

KASSETKOPI, Ostensjoveien 9, PO Box 6033 Etterstad, 0601 Oslo, 02.654 020, Fax: 02.643 806, MD: Margareta Anderson.

CASSETTES REELS & PARTS, JEWEL BOX MANUFACTURERS

H-STEIN, PO Box 25, 1342 Jar, 02.120 860, Fax: 02.539 614, Tlx: 71098.

SKANDINAVISK ELETRONIKK, Ostre Akerveien 99, Oslo, 02.150 090.

BLANK & BULK RAW TAPE

3M NORWAY, Hvamveien 6, 2013 Skjetten, 06.847 500, Fax: 06.841 788.

BASF, Laangbukta 40, PO Box 233, 1371 Asker, 02.904 600, Fax: 02.904 755.

CD, RECORD & TAPE MANUFACTURING SYSTEMS

ASEC, Stromsveien 56, 1473 Skaarer, 02.707 401. Distribute: Sony.

AUDIOTRON, PO Box 2068 Grunerlokka, 0505 Oslo, 02.352 096, Fax: 02.384 128. Distribute: Tascam.

H-STEIN, PO Box 25, 1342 Jar, 02.120 860, Fax: 02.539 614, Tlx: 71098.

PHILIPS NORSK, Sandstuveien 70, 0612 Oslo, 02.680 200.

SEEM AUDIO, PO Box 115, 1380 Heggdal, 02.797 730, Fax: 02.796 154, Tlx: 79207 25, MD: Finn Tuft, Mktg Mgr: Ketil Grotlum. Distribute: Lyrec (Den).

SIEMENS, PO Box 10 Veitvet, 0518 Oslo, 02.633 000, Fax: 02.646 446, Tlx: 78477, Contact: Mrs Unni Braathen.

SIVING BENUM, PO Box 145 Vinderen, 0319 Oslo, 02.145 460, Fax: 02.148 259. Distribute: Genelec, Otari, SSL.

POLAND

RECORD COMPANIES

ALCOM INTERNATIONAL, PO Box 12, 02-676 Warsaw, +48.3912 0394, Fax: +48.3912 0394, President: Lech Pozniak, Pres/Mktg & Promo: Andrzej Chmura, Sales Mgr: Artur Sent. Main product: Adult Contemporary, Album Rock, Gold/Oldies; Format: mainly CD's.

ARSTON RECORDS, ulica Nowogrodzka 49, 00-695 Warsaw, 2.628 7071 ext: 66/67, Fax: 2.230 311, Tlx: 816515, Owner: Boleslaw Ropiak, Dir: Marek Pioro, Contact: Eligiusz Ropiak. Labels (lic): BMG; Music product: R&R, Punk, Album Rock.

DIGITON, Aleje Stanow Zjednoczonych 53, 04-028 Warsaw, 22.106 492, Fax: 22.100 592, Chmn: Ryszard Marciniak, MD: Krzysztof Domaszynski. Main product: Pop, rock, electronic.

DNA, ulica Przybyszewskiego 80-82, 01-824 Warsaw, 22.345 162, Fax: 22.347 070 (+48.3912 0648), Dir: Jacek Morawski, A&R Mgr: Krzysztof Kozinski, Mktg Mgr: Piotr Dubiel. Main product: reggae, new age, punk rock & rap.

INTERSONUS, Aleja 3 Maja 215, 00-391 Warsaw, 2.625 5576, Fax: 2.625 5194, President: Ryszard Adamus, VP: Edmund Czubak.

JACEK MUSIC, ulica Bohaterow Warszawy 116/5, 70-367 Szczecin, 91.46562, Owner: Danuta Wojcik.

LECH, ulica Grobla II, 12-14 D/4, 80-835 Gdansk, 58.312 077, Owner: Grazyna Kaminska.

LION RECORDS, PO Box 5, 01-800 Warsaw 45, 22.330 152, Fax: 22.325 713/659 3040, Tlx: 813593, Int'l Dir/A&R: Piotr Gryglewicz, Int'l Asst: Agata Gryglewicz. Main co: x-b-IMJM MUSIC PL, ulica Elektoralna 4/6-49, 00-139 Warsaw, 22.247 334, Fax: 22.247 334, Owner: Andrzej Pawel Wojciechowski. Labels (owned): MJM; co: x-b-IMM POTOCKA PRODUCTIONS, Zwiciezcow 8 m 1, 00-941 Warsaw, 22.175 965, Fax: 22.175 965, President: Malgorzata Potocka, VP: Andrzej Gutowski, GM: Anna Iwaskiewicz, Mgr/Promo: Jerzy Tolak, Mktg: Wojciech Gaca.

MPG DISTRIBUTIONS, ulica Hoza 66-68, 00-682 Warsaw, 2.628 7129, Fax: 2.628 8535, Tlx: 825393 czm, Dir-Gen: Miroslaw Gorski, Art Dir: Antoni Roszczuk, Sales Mgr: Malgorzata Bulikowska. Main product: Jazz, New Age, Album Rock, Classical.

POLJAZZ RECORDS & TAPES, ulica Chmielna 20, 00-920 Warsaw, 22.276 581, Fax: 22.279 575, Tlx: 812275, MD: Stanislaw Sobola. Main product: Jazz, Classical and Folk.

POLMUSIC, ulica Polinezyjska 12/33, 02-777 Warsaw, 2.641 4715, Owner: Andrzej Bronarski. Main product: Classical.

POLSKIE NAGRANIA, ulica Golezowska 6, 01-249 Warsaw, 22.373 510, Fax: 22.373 735, Tlx: 817831, Dir-Gen: Aleksander Olszewski, MD: Janusz Teczkowski, Fin Dir: Aleksander Zasada, Mktg/Promo: Jacek Klimkiewicz, Chief Accountant: Szczepan Kultys. Labels (owned): Polskie Nagrania, Muza; Main product: Dance, AC, Album Rock, Jazz, Gold/Oldies, Country, Black (R&B), Reggae, New Age, Classical, Children's.

POLTON RECORDS & TAPES, ulica Lustrzana 20, 01-350 Warsaw, 22.360 190, Fax: 22.360 190, Tlx: 825904 polto, President: Jan Chojnacki.

SELENE, ulica Szafirowa 1, 05-500 Piaseczno, 22.570 024, MD: Stanislaw Dybowski. Main product: classical.

SONIC, ulica Srebrna 16, 00-810 Warsaw, 22.202 663, Fax: 22.202 663, MD: Marek Proniewicz. Record company and distributor.

VERITON RECORDS, ulica Bobrowiecka 1, 00-728 Warsaw, 22.401 011, Fax: 22.295 202 (Incovertitas), President: Wlodzimierz Marszalek, Dir: Bogustaw Debski, Mktg: Celina Kozlowska. Main product: Classical, Religious.

WIFON, ulica Woronicza 17, 00-950 Warsaw, 22.478 680-81, Tlx: 817023, MD: Dionizy Kilbach, A&R: Zofia Skubikowska, Sales/Mktg: Bozena Olszewska. Main product: Adult Contemporary, Classical, Album Rock.

ZIC-ZAC MUSIC COMPANY, ulica Nobla 9, 03-930 Warsaw, 22.176 445, Fax: 22.177 503, President: Marek Kosciukiewicz, Mgrs: Pawel Walczak, Leszek Gruszewski, Promo: Piotr Marjewski, Mktg: Piotr Kubiacyk. Main product: Jazz, Dance, Album Rock, New Age.

ZPR RECORDS, ulica Senatorska 13/15, 00-075 Warsaw, 22.260 617, Fax: 2.635 0334; (+48.3912 0316), Tlx: 812413 :pr, Dir: Zbigniew Benbenek.

MUSIC PUBLISHERS

AUTHORS' AGENCY, ulica Hipoteczna 2, 00-950 Warsaw, 22.278 396/275 876, Fax: 22.275 882, Tlx: 812470 zaiks, Dir: Ewa Michalska.

POLSKIE NAGRANIA, ulica Goleszowska 6, 01-249 Warsaw, 22.373 510, Fax: 22.373 735, Tlx: 817831, Dir-Gen: Aleksander Olszewski.

VIDEO PROGRAM SUPPLIERS & BUYERS

ITI, ulica Wernyhora 14, 02-787 Warsaw, 22.433 488/432 824, Fax: 22.434 532/430 585, Tlx: 816943, MD: Mariusz Walter, Tech Dir: Wladyslaw Bajsert, Media Service Dir: Zygmunt Napierala. Video production; Distribute: Warner Bros and CIC co: x-b-1MM POTOCKA PRODUCTIONS, Zwieczow 8 m 1, 00-941 Warsaw, 22.175 965, Fax: 22.175 965, President: Malgorzata Potocka, VP: Andrzej Gutowski, GM: Anna Iwaskiewicz, Mgr/Promo: Jerzy Tolak, Mktg: Wojciech Gaca. (Music) video production company and distributor.

MONTEVIDEO PRODUCTION, ulica Poznanska 116 f/55, 05-850 Ozarow-Mazowiecki, 22.587 051 ext: 236, Art Dir: Wlodzimierz Grzywacz. Video production.

ODEON, Aleje Wyzwolenia 18/5, 00-570 Warsaw, 2.628 1677, Fax: 2.628 1677, Tlx: 814439, Owner: Michael Madejewski, Dir: Tomasz Szadkowski. Video production.

POLSKIE NAGRANIA, ulica Goleszowska 6, 01-249 Warsaw, 22.373 510, Fax: 22.373 735, Tlx: 817831, Dir-Gen: Aleksander Olszewski. Distribution and duplication.

RECORD DISTRIBUTORS

AGENCJA IMPRESARYNA AIA, Aleje Ujazdowskie 22/18, 00-478 Warsaw, 2.628 6851/625 7448, Fax: 2.628 6851, Tlx: 816130 aia, Chmn: Krzysztof-Ponton Konarzewski, MD: Adam Galas.

ALCOM INTERNATIONAL, PO Box 12, 02-676 Warsaw, +48.3912 0394, Fax: +48.3912 0394, President: Lech Pozniak, Pres/Mktg & Promo: Andrzej Chmura, Sales Mgr: Artur Sent. Main product: Adult Contemporary, Album Rock, Gold/Oldies.

ARS (FOREIGN TRADE ENTERPRISES), ulica Krakowska Przedmieście 7, 00-068 Warsaw, 22.264 758/261 201, Fax: 22.177 145, Tlx: 813498 apw, Vice-Dir: Monika Bialecka. Labels (distr): Muza, Pronit, Tonpress, Veriton, Wifon.

DISCOPOL, ulica Stoleczna 19/21, Pawillon 30, 01-595 Warsaw, 22.335 351, Fax: 22.153 396, Owner: Edmund Berg. Import and distribution of CDs.

GAMBIT, ulica Czarnieckiego 9a, 61-535 Poznan, 61.334 772, Fax: 61.334 778, Tlx: 412968, GM: Zbigniew Strzalkowski, Foreign Trade: Rafal Przondo (UK), Mariusz Tomczak (Ger). Wholesaler; Formats: CD, Cassettes, Music Videos; Main product: Jazz, Country, Classical, Dance, Album Rock, Gold/Oldies.

HADEX, ulica 28 Czerwca 1956, 231-239, 60-965 Poznan, 61.321 385, Fax: 61.321 401, Tlx: 413353, Dir: Jan Czapracki, Vice-Dir: Lukasz Zalewski.

HELICON, ulica Freta 45-47, 00-227 Warsaw, 2.635 0077, Fax: 22.174 948.

METAL MIND PRODUCTIONS, ulica Szeligiewicza 8/22, 40-044 Katowice, PO Box 2536 (Zip: 40-227), 32.511 780, Fax: 32.511 780, Tlx: 315388 mmp, MD: Tomasz Dziubinski. Distributor co: x-b-1MJM MUSIC PL, ulica Elektoralna 4/6-49, 00-139 Warsaw, 22.247 334, Fax: 22.247 334, Owner: Andrzej Pawel Wojciechowski. Labels (distr): Sony Music, EMI, Virgin.

PARADOX, Aleje Wojciecha Korfanego 2, 40-004 Katowice, 32.586 072, Fax: 32.597 666, Tlx: 312749 txc, Dir-Gen: Wojciech Gorczyca, MD: Jerzy Pucka, Comm Mgr: Tadeusz Jakubowski, Mktg Mgr: Jerzy Paluch. Record distribution and mail order; Main product: Jazz, Country, Classical, Dance, Album Rock, Gold/Oldies, Black (R&B), Pop. Labels (lic): ECM, BMG, Schwartz Bros, CD One Stop, Elap Music, Pickwick, Lasgo Exports.

POLSKIE NAGRANIA, ulica Goleszowska 6, 01-249 Warsaw, 22.373 510, Fax: 22.373 735, Tlx: 817831, Dir-Gen: Aleksander Olszewski, MD: Janusz Teczkowski, Fin Dir: Aleksander Zasada, Mktg/Promo: Jacek Klimkiewicz, Chief Accountant: Szczepan Kultys. Record distribution and wholesale; Formats: CDs, Cassettes, Vinyl, Music video's.

QUAZAR DENIS, ulica Pradzynskiego 11-13, 01-222 Warsaw, 22.325 713/473 913, Fax: 22.325 713/473 913, Comm Dir: Stanislaw Dyminski, Dir: Mieczyslawa Izabella Marcjanska. Main product: EHR, Dance, AC, Album Rock.

SKLADNICA KSIEGARSKA, ulica Mazowiecka 9, 00-052 Warsaw, 22.244 431/264 394, Tlx: 813701. Wholesaler.

VERITON RECORDS, ulica Bobrowiecka 1, 00-728 Warsaw, 22.401 011, Fax: 22.295 202 (Incoveritas), President: Wlodzimierz Marszalek, Dir: Wlodzimierz Marszalek, Mktg: Celina Kozlowska.

RETAIL ACCESSORY SUPPLIERS

ASTAR LIFT, ulica Reja 3, 80-404 Gdansk, 58.431 723/432 431, Fax: 58.432 431, Tlx: 512722, Owner: Andrzej Rosinski, MD: Malgorzata Kurowska.

POLSKIE NAGRANIA, ulica Goleszowska 6, 01-249 Warsaw, 22.373 510, Fax: 22.373 735, Tlx: 817831, MD: Janusz Teczkowski, Sales Mgr: Barbara Roszkowska.

ASSOCIATIONS & PROFESSIONAL ORGANIZATIONS

ASSOCIATION OF POLISH MUSICIANS (SPAM), ulica Krucza 24/26, 00-526 Warsaw, 22.218 647/212 802, President: Tadeusz Strugalla, VPs: Jerzy Kusiak, Maxymilian Bylicki, Eugeniusz Sasiadek, Jozef Podsiadlo.

AUTHORS' AGENCY, ulica Hipoteczna 2, 00-950 Warsaw, 22.278 396/275 876, Fax: 22.275 882, Tlx: 812470 zaiks, Dir: Ewa Michalska. Obtains options for foreign translations of literature & music, negotiates contracts for foreign publication, promotes Polish music and literature, offers a theatrical library of Polish and foreign titles, organizes congresses and exhibition for Polish authors and artists, represents a wide section of authors, musicians, and artists.

THE FRYDERYK CHOPIN SOCIETY, ulica Okolnik 1, 00-368 Warsaw, 22.275 471/279 589, Fax: 22.279 599, Tlx: 816498 tific, Dir: Bogumil Pallasz. Established in 1934 the TiFC (Towarzystwo im F Chopina), collects and preserves Chopin's heritage and promotes all aspects of the composer. There is also a Chopin Museum, which holds the most comprehensive collection of Chopin publications in the world. The Society's activities include: organizes seminars & congresses, Polish Piano Competitions, International Chopin Piano competition, International Chopin Record competition, organizes courses, publish 2 catalogues concerning Chopin.

POLISH JAZZ SOCIETY, ulica Mazowiecka 11, 00-950 Warsaw, 22.277 904/272 109/276 731, Fax: 22.277 904, Tlx: 817654 zgpsj, Chmn: Henryk Majewski, GM: Jan-Plaszyn Wroblewski. Organize the Jazz Jamboree Festival (Oct).

POLISH MUSIC COUNCIL, ulica Fredry 8, 00-097 Warsaw, 2.635 2230, President: Jan Steszewski, VP: Jozef Patkowski. **RAPID**, ulica Ksawerow 23a, 02-656 Warsaw, 22.478 830/486 163, Fax: 22.486 162, Chmn: Krzysztof Teodor Teopliiz, Dir-Gen: Andrzej Filipowicz. Audio/video programme producers and distributors association.

STOMUR, ulica Lwowska 13, 00-660 Warsaw, 22.214 709/381, Fax: 22.214 709, Chmn: Maciej Czarnecki, Dir: Stanislaw Czerwinski. Association of entertainment musicians.

STOWARZYSZENIE DZIENNIKARZY POLSKICH, ulica Foksal 3-5, 00-366 Warsaw, 22.278 718, Fax: 22.278 717, Tlx: 813207, Chmn: Marian Podkowiński, Sec-Gen: Andrzej Ziemiński. Polish association of journalists.

STOWARZYSZENIE PRYWATNYCH OSRODKOW R&TV, ulica Powstancow Slaskich 95, 53-385 Wroclaw, 71.611 151/605 651, Fax: 71.611 151, Tlx: 0715633, Chmn: Ireneusz Orzechowski. Association of private radio & TV stations.

UNION OF POLISH COMPOSERS (ZKP), Rynek Starego Miasta 20, 00-272 Warsaw, 22.311 634/311 741, Fax: 22.310 807, Tlx: 816996 zkpz, President: Andrzej Chodkowski, MD: Alina Sawicka-Baird.

ZAIS, ulica Hipoteczna 2, 00-092 Warsaw, 22.277 950/276 061, Fax: 2.635 1349, Tlx: 812470 zaiks, Chmn: Edward Pallasz, MD: Witold Kolodziejcki. Performing and mechanical right society.

ZAKR, ulica Hipoteczna 2, 00-950 Warsaw, 2.635 1704, Fax: 2.635 1704, Chmn: Jan Majdrowski, Sec-Gen: Lucjan Radzikowski. Association of authors and composers.

PUBLIC RELATIONS & RECORD PROMOTION

ART B PRESS, ulica Wielka 19, 61-755 Poznan, 61.529 233, Fax: 61.529 463, Dir: Janusz Lesniewski.

INTERART, ulica Pugeta 6, 51-628 Wroclaw, 71.484 102, Fax: 71.481 451, Tlx: 715542 art, Chmn: Maciej Partyka.

MODERN SOUND, ulica Chwarzynska 154a, 81-602 Gdynia, 58.242 970/241 360, Fax: 58.217 611, Tlx: 54400 txcab, MD: Piotr Lyszkiwicz. Music promotion agency.

PAP (POLSKA AGENCJA PRASOWA), Aleje Jerozolimskie 7, 00-950 Warsaw, 22.280 001/218 518, Fax: 22.213 439, Tlx: 814201, Chmn: Ignacy Rutkiewicz. Press agency.

ROK CORPORATION, ulica Jasna 1, 00-013 Warsaw, 22.274 531/275 734, Fax: 22.274 531 (+48.3912 0672), Chmn: Jozef Wegrzyn.

TMM INFO SERVICE, ulica Spiezynska 5-8, 00-215 Warsaw, 2.635 872/9523, Fax: 2.635 7930 (+48.3912 1450), Tlx: 817657, Contact: Tadeusz Makowski.

YNTERSTER, ulica Baleya 9, 02-132 Warsaw, 2.659 1132, Fax: 2.659 1132, EIC: Zygmunt Konopka, MD: Jacek Marciniak.

PLATING, MASTERING & PRESSING PLANTS

ARSTON PZ, ulica Nowogrodzka 49, 00-695 Warsaw, 2.628 7071 ext: 56/67, Fax: 22.300 311, Tlx: 816515, Owner: Boleslaw Ropiak, Contact: Eligiusz Ropiak. Vinyl pressing, tape duplication.

CCS STUDIO, ulica Strawczynska 4, 01-473 Warsaw, 22.377 361, Fax: 22.300 021, Contact: Walter Chelstowski. Mastering and midi-suite.

POLSKIE NAGRANIA, ulica Goleszowska 6, 01-249 Warsaw,

22.373 510, Fax: 22.373 735, Tlx: 817831, Dir-Gen: Aleksander Olszewski, Foreign Trade Exec: Jacek Popko. Annual capacity: 3m. (vinyl/video), 6m. (cassette); minimum order: 1,000.

POLTON RECORDS & TAPES, ulica Lustrzana 20, 01-350 Warsaw, 22.360 190, Fax: 22.360 190, Tlx: 825904 polto, Dir: Kajalet Slonina. Vinyl and cassettes; Annual capacity 1.5m., minimum order 1,000.

STUDIO S-4/6 (POLISH RADIO REC. DEPT), ulica Woronicza 17, 00-950 Warsaw, 22.476 425/051, Fax: 22.437 408, Tlx: 825333 rtv, MD: Stanislaw Leszczynski, Vice-Dir: Jan Popis, Eng: Wojciech Makowski, Artist Mgr: Andrzej Haluch. CD pre-mastering & disc-cutting/mastering.

TAPE CUSTOM DUPLICATORS

DEO RECORDINGS, Skr Pocz. 15, 43-460 Wisla, 3865.3621, Fax: 3865.3621, Dir: Henryk Krol.

GAMBIT, ulica Czarnieckiego 9a, 61-535 Poznan, 61.334 772, Fax: 61.334 778, Tlx: 412968, GM: Zbigniew Strzalkowski, Foreign Trade: Rafal Przondo (UK), Mariusz Tomczak (Ger). Audio cassette duplication (GAUSS).

ITI, ulica Wernyhora 14, 02-787 Warsaw, 22.433 488/432 824, Fax: 22.434 532/430 585, Tlx: 816943, MD: Mariusz Walter, Dir: Jacek Standerski. Video duplication.

POLMARK, ulica J. Conrada 30, 01-922 Warsaw, 22.350 488/800, Fax: 22.350 800, Tlx: 816863 mark, Owner: Henryk A Banasiak, Gen Dir: Krystin Kulmatycki, Prod Dir: Tadeusz Krasnodebski, Sales Dir: Wanda Kuczynska, Bookkeeping: Elzbieta Sereda. Audio cassette duplication; Annual capacity: 1.5m.; Min order: 1,000.

WIFON, ulica Woronicza 17, 00-950 Warsaw, 22.478 680-81, Tlx: 817023, MD: Dionizy Kilbach, Mgr: Ryszard Jaroslowski, Sales/Mktg: Bozena Olszewska. Audio cassette duplication; Annual capacity: 500,000; Min order: 5,000.

BLANK & BULK RAW TAPE

CHEMITEKXWISKORD, ulica Transportowa 1, 70-715 Szczecin, 91.613 583, Tlx: 422243, Gen Dir: Stanislaw Krogulec, MD: Zdzislaw Czekala, Sales Dir: Eleonora Szczygiel, Asst to MD: Elzbieta Dopierala. Manufacturer of professional & consumer blank audio tape cassettes; Brand: Superton; Other: C-0 cases.

PORTUGAL**RECORD COMPANIES**

BMG ARIOLA PORTUGAL, Rua Gregorio Lopes Lote 1514/2, 1400 Lisbon, 01.301 7323-5, Fax: 01.301 7322, MD: Toze Brito, Mktg Mgr: Pedro Oliveira, Promo Mgr: Paulo Bismark.

CARLOS CORREIA, Rua Catana Ramos 7 c/v d/ta, 1300 Lisbon, 01.693 475/690 574, Fax: 01.387 5593, MD: Carlos Correia.

DISCOSSETE, Rua Doctor Faria de Vasconcelos 4a, 1900 Lisbon, 01.847 2822/2823/848 5724/8590, Fax: 01.809 867, President: Helena Cardinali, Press/Promo: Maria Jose Ribeiro.

MUSICATA, Rua da Venezuela 43a, 1500 Lisbon, 01.715 3902/3618, Fax: 01.715 3843, Tlx: 63362 musicat, President: Firojail Habib, MD: Carlos Sousa, Label/A&R Mgr: Carla Sousa, Press/Promo: Fatima Douwens. Labels (owned): Musicata; (Lic): Disco Magic, Energy, BMS Records, Ala Bianca (Ita), Divucsa, Max Music, Blanco y Negro (Spa), Transparent, Jupiter, ZYX, Ring Music (Ger), Dureco (Hol), Koch (Aus), ARS (Bel), Scorpio (Fra), PWL, Arishma, Blue August (UK).

POLYGRAM DISCOS (PORTUGAL), Rua Professor Reinaldo dos Santos 12d, 1500 Lisbon, 01.787 101/9, Fax: 01.780 212, Tlx: 14074 polyil, MD: Rodrigo Marin, Contr: Hipolito Santos, A&R: Carlos Maria Trindade (Nat'l), Joao Miguel Almeida (Int'l), Mktg/Sales: Jorge Silverio. Labels (owned): Philips, Decca, DGG, Polydor, A&M, Island; Distribution: BMG Ariola.

SONY MUSICA (PORTUGAL), Rua Julio Quintinha 11, 1500 Lisbon, 01.714 5521, Fax: 01.714 2976, Tlx: 65748 sony m, MD: Carlos Pinto, Mktg Dir: Jose Serrao.

VIDISCO COMERCIO & INDUSTRIA DE SOM, Avenida Bombeiros Voluntarios 304b/1, 1675 Pontinha, Lisbon, 01.479 3124, Fax: 01.479 6191, Tlx: 62201 vidisc, GMS: Jose Manuel & Joao Pedro Jadaui, Int'l Mgr: Artur Antunes, A&R (Nat'l): Antonio Lopes. Production/Distribution: Main product: Dance, Various.

WARNER MUSIC PORTUGAL, Largo Jean Monnet 1/1e, 1200 Lisbon, 01.356 3302, Fax: 01.525 479, Tlx: 64032 wea, MD: Daniel de Sousa, Sales: Nelson Gomes, Int'l: Pedro Gaspar, Promo/PR: Elsa Salido. Labels (owned): WB, Elektra, Atlantic, Teldec; (Lic): MCA, Geffen, Delehne; Distribution: EMI/Valentim de Carvalho.

MUSIC PUBLISHERS

CANCIONES DEL MUNDO, see Warner Chappell Portugal. **CARAMBA MUSIC**, Rua Rodrigo da Fonseca 95/1, 1200 Lisbon, 01.682 080/691 652/3, Fax: 01.691 513, Tlx: 13011,

President: Fernando de Albuquerque, Prof Mgr: Artur Soares.

CLIPPER'S EDICIONES MUSICALES, see Discossete.
DISCOSSETE, Rua Doctor Faria de Vasconcelos 4a, 1900 Lisbon, 01.847 2822/2823/848 5724/8590, Fax: 01.809 867, President: Helena Cardinali, MD: Artur Soares. (Admin): Peer Music, Clipper's Ediciones Musicales.

EDISOM, Rua M Ferreira de Andrade 6b, 1500 Lisbon, 01.740 3817, Fax: 01.780 661, Tlx: 14495, MD: Carlos Jorge.

EMI SONGS PORTUGAL, Praca Nuno Rodriguez dos Santos 7, 1600 Lisbon, 01.726 9011, Fax: 01.726 9985, Tlx: 62738, MD: Jan van Dijk.

EMI-VALENTIM DE CARVALHO, Rua Cruz dos Poais 111, 1200 Lisbon, 01.600 111, Fax: 01.678 400, Tlx: 16696, MD: David Ferreira, Publ Dir: Henrique Amoroso.

ESIL EMPRESA DE SOM E INFORMATICA, Rua Eugenio de Castro 2 r/c dto, 2725 Mem Martins, 01.920 0777/05, Fax: 01.922 1634, MD: Rui E Simoes. (Owned): ESIL; Main product: Dance.

MOVIEPLAY PORTUGUESA, Estrada de Benfica 382/B5, 1500 Lisbon, 01.787 977-78, Fax: 01.780 882.

PEER MUSIC, see Discossete.

SONY MUSICA (PORTUGAL), Rua Juliao Quintinha 11, 1500 Lisbon, 01.714 5521, Fax: 01.714 2976, Tlx: 65748 sony m, MD: Carlos Pinto, Mktg Dir: Jose Serrao.

VADECA, Rua 31 de Janeiro 210, 4000 Lisbon, 02.204 712/3, Fax: 02.316 850, Tlx: 23437, MD: Francisco Vasconcelos.

VIDISCO COMERCIO & INDUSTRIA DE SOM, Avenida Bombeiros Voluntarios 304b/1, 1675 Pontinha, Lisbon, 01.479 3124, Fax: 01.479 6191, Tlx: 62201 vidisc, GMS: Jose Manuel & Joao Pedro Jadauji, Int'l Mgr: Artur Antunes, A&R (Nat'l): Antonio Lopes. Music publisher; Main product: Dance, Various.

WARNER CHAPPELL PORTUGAL, Largo Jean Monnet 1/1e, 1200 Lisbon, 01.356 3302, Fax: 01.525 479, Tlx: 64032 wea, MD: Daniel de Sousa, Int'l: Paula Duarte. (Admin): Canciones del Mundo.

VIDEO PROGRAM SUPPLIERS & BUYERS

EDIVIDEO, Rua M Ferreira de Andrade 6b, 1500 Lisbon, 01.740 3817, Fax: 01.780 661, Tlx: 14495.

EURO AIM, Costa do Castelo 66-68, 1100 Lisbon, 01.876 439, Fax: 01.872 080, Contact: Paolo Trancoso.

FILMITALUS, Rua Alexandre Herculano 2, 1100 Lisbon, 01.547 988, Fax: 01.524 674, Tlx: 63570.

IMAVIDEO, Rua Margues da Fronteira 117, 1000 Lisbon, 01.693 629/729, Fax: 01.693 652, Tlx: 42657.

MUSICATA, Rua da Venezuela 43a, 1500 Lisbon, 01.715 3902/3618, Fax: 01.715 3843, Tlx: 63382 musicat, President: Firojiali Habiboo, MD: Carlos Sousa, Mgr: Carlos Lourenco.

WARNER MUSIC PORTUGAL, Largo Jean Monnet 1/1e, 1200 Lisbon, 01.356 3302, Fax: 01.525 479, Tlx: 64032 wea, MD: Daniel de Sousa, Sales: Nelson Gomes, Int'l: Pedro Gaspar, Promo/PR: Elsa Isidoro.

RECORD DISTRIBUTORS

ANDANTE DISCOS, Avenida Boavista 1471 Loja 8, 4100 Porto, 02.606 4585/3518, Fax: 02.606 3416, President: Jean Pierre Jongenelen, Exec VP (Sales): Humberto Braga, Promo Dir: Orlando Ferreira, A&R (Pop/Dance): A Castro.

EDISCO, Rua Doctor Alves da Veiga 175, 4000 Porto, 02.564 201/560 455, Fax: 02.580 349, President: Armando Joaquim Cerqueira, Comm Dir: Armando Manuel Pimenta Cerqueira, Admin Dir: Sonia Maria Pimenta Cerqueira, Import Mgr: Ana Paula Costa Oliveira, Export Mgr: Gisela Maria Garcia Goncalves.

EDISOM, Rua M Ferreira de Andrade 6b, 1500 Lisbon, 01.740 3817, Fax: 01.780 661, Tlx: 14495, MD: Carlos Jorge.

EMI-VALENTIM DE CARVALHO, Rua Cruz dos Poais 111, 1200 Lisbon, 01.600 111, Fax: 01.678 400, Tlx: 16696, MD: David Ferreira, Mktg Mgr: Rui Ferreira.

ESIL EMPRESA DE SOM E INFORMATICA, Rua Eugenio de Castro 2 r/c dto, 2725 Mem Martins, 01.920 0777/05, Fax: 01.922 1634, MD: Rui E Simoes.

MEGAMUSICA, Avenida D Vasco da Camara 7a, 2775 Carcavelos, PO Box 13 (Zip: 2777 Codex), 01.246 0255, Fax: 01.247 2481, Tlx: 12400 cab tx, MD: Jose Eduardo Santos, A&R: Cristina Ventura, Sec: Ana Silva. Labels (dist): Pro-Jazz, Pro Arte, Maxiplay, Quintessence, Green Linnett, New World, New Albion Records (USA), Accent Ricercar, GHA (Bel), Intercord (Ger), Knight, Greentrax, Iona, Springthyme (UK).

MUSICAT, Estrada de Luz 26b, 1600 Lisbon, 01.725 575/722 858, President: Arnaldo Trindale, Mgr: Fernando de Albuquerque.

OVACAO, Avenida 25 de Abril 205c, 1675 Lisbon, 01.996 946/995 992, Fax: 01.995 992, Tlx: 65298, Dirs: Carlos de Lacerda, Fernando Matias.

RISO E RITMO DISCOS, Estrada de Benfica 382/B5, 1500 Lisbon, 01.787 977-78, Fax: 01.780 882.

VADECA, Rua 31 de Janeiro 210, 4000 Lisbon, 02.204 712/3, Fax: 02.316 850, Tlx: 23437, MD: Francisco Vasconcelos.

RETAIL ACCESSORY SUPPLIERS

ANDANTE DISCOS, Avenida Boavista 1471 Loja 8, 4100 Por-

to, 02.606 4585/3518, Fax: 02.606 3416, President: Jean Pierre Jongenelen. Agent of Lift display/storage systems.

ASSOCIATIONS & PROFESSIONAL ORGANIZATIONS

AFP ASSOCIACAO FONOGRAFICA PORTUGUESA, Rua Augusto dos Santos 2/2, 1000 Lisbon, 01.352 8268, Fax: 01.527 325, Tlx: 16776 legis, President: Daniel de Sousa, VPs: Carlos Pinto, David Ferreira, Dir-Gen: Eduardo Simoes. IFPI national group for Portugal; Members: PolyGram Discos, Sony Music (Portugal), EMI-Valentim de Carvalho, Edisom-Edicao & Producao de Som, Selecoes do Reader's Digest (Portugal), Warner Music Portugal, BMG Ariola (Audiovisual), Edisco, Valentim de Carvalho, Circulo de Leitores.

FEVIP, Rua Augusto dos Santos 2/2, 1000 Lisbon, 01.352 8268, Fax: 01.527 325, Tlx: 16776. Video industry association.

ICP (INSTITUT DAS COMUNICACOES DE PORTUGAL), Avenida Jose Malhoa, Lote 1683, 1000 Lisbon, 01.726 9223, Fax: 01.726 3743, Tlx: 66345 icp, Chmn: Fernando Mendes, Bd Members: Robalo de Almeida, Simoes Carneiro. Media regulating body (licensing).

SPA, Avenida Duque de Loule 31, 1098 Lisbon, 01.578 370/20, Fax: 01.530 257, Contact: Franciscu Iebello. Authors & composers society.

PLATING, MASTERING & PRESSING PLANTS

OVACAO, Avenida 25 de Abril 205c, 1675 Lisbon, 01.996 946/995 992, Fax: 01.995 992, Tlx: 65298, Dirs: Carlos de Lacerda, Fernando Matias.

VALENTIM DE CARVALHO, Estrada de Paco D'Arcos 26, 2780 Oeiras, 01.443 3398, Fax: 01.443 2195, President: Rui Valentim de Carvalho, MD: Julio Antonio Valverde, Dir: Francisco Vasconcelos. Vinyl pressing; Annual cap: 4 mil; Min order: 500.

TAPE CUSTOM DUPLICATORS

CAPISOM, Rua Sebastiao e Silva, Loja E-6, Massama, 2745 Queluz, 043.76754/76672, Fax: 043.76216, Tlx: 13798.

EDISCO, Rua Doctor Alves da Veiga 175, 4000 Porto, 02.564 201/560 455, Fax: 02.580 349, President: Armando Joaquim Cerqueira, Comm Dir: Armando Manuel Pimenta Cerqueira.

OVACAO, Avenida 25 de Abril 205c, 1675 Lisbon, 01.996 946/995 992, Fax: 01.995 992, Tlx: 65298, Dirs: Carlos de Lacerda, Fernando Matias.

VALENTIM DE CARVALHO, Estrada de Paco D'Arcos 26, 2780 Oeiras, 01.443 3398, Fax: 01.443 2195, President: Rui Valentim de Carvalho, MD: Julio Antonio Valverde, Dir: Francisco Vasconcelos. Audio cassette duplication; Annual capacity: 2 mil; Min order: 500.

CASSETTES REELS & PARTS, JEWEL BOX MANUFACTURERS

CONSORCIO COMERCIAL DE MAQUINAS, Avenida Sacadura Cabral 25/a-e, Lisbon 1, 01.733 233, Tlx: 14726.

BLANK & BULK RAW TAPE

3M, Rua Conde de Redondo 98, 1199 Lisbon Codex, 01.561 131.

BASF PORTUGUESA, Rua do Salitre 56-7, 1200 Lisboa, 01.562 511, Fax: 01.537 674.

MINNESOTA (3M) DE PORTUGAL, Rua Conde de Redondo 98, 1199 Lisbon Codex, 01.561 131.

CD, RECORD & TAPE MANUFACTURING SYSTEMS

CONSORCIO COMERCIAL DE MAQUINAS, Avenida Sacadura Cabral 25/a-e, Lisbon 1, 01.733 233, Tlx: 14726. CD duplication equipment.

JACOTRI, Rua Maria 68 b/c, 1100 Lisbon, 01.836 112, Fax: 01.837 481, MD: Joao Costa. Vinyl & tape duplication equipment; Distribute: Lyrec.

ROMANIA

RECORD COMPANIES

ARTEXIM-ROMSTAR, Piata Presei Libere 1, 71341 Bucharest 1, 00.183 080, Tlx: 11191 cpoli, MD: Constantino Voiculescu.
ELECTRECORD, Timisoara Boulevard 94, 78702 Bucharest, 00.786 078, Fax: 00.786 078, Tlx: 10086 elcor, Dir-Gen: Grigore Petreanu, A&R Dir: Paul Enigarescu, Import/Export:

Adrian Stefanescu. Labels (owned): Electrecored; Main product: Dance, AC, Album Rock, Country, Classical.

MUSIC PUBLISHERS

EDITURA MUZICALA, Poiana Narciselor 6, 70718 Bucharest, 00.138 743, GM: Vlad Ulpiu.

RECORD DISTRIBUTORS

ARTEXIM-ROMSTAR, Piata Presei Libere 1, 71341 Bucharest 1, 00.183 080, Tlx: 11191 cpoli, Dir: Sorin Radulescu, Dep Dir: Radu Gheciu (Artist Mgmt), Gheorghe Birsan (Records). Import/exporter of records/books/printings

ASSOCIATIONS & PROFESSIONAL ORGANIZATIONS

ARTEXIM-ROMSTAR, Piata Presei Libere 1, 71341 Bucharest 1, 00.183 080, Tlx: 11191 cpoli, Dir: Sorin Radulescu, Dep Dir (Artist Mgmt): Radu Gheciu. Assumed artist management activities of the former ARIA.

MINISTERUL CULTURII, Piata Presei Libere 1, 71341 Bucharest 1, 00.170 904, Minister: Andrei Plesu, Music Mgr: Gheorghe Firca.

UNION OF ROMANIAN COMPOSERS & MUSICIANS, Ca ea Victoriei 141, Sector 1, 70179 Bucharest, 00.138 159, President: Pascal Bentoiu, VPs: Cornel Taranu, Adrian Iorgulescu.

PLATING, MASTERING & PRESSING PLANTS

ELECTRECORD, Timisoara Boulevard 94, 78702 Bucharest, 00.786 078, Fax: 00.786 078, Tlx: 10086 elcor, Dir-Gen: Grigore Petreanu, A&R Dir: Paul Enigarescu, Import/Export: Adrian Stefanescu. Disc-cutting/mastering and tape duplication.

TAPE CUSTOM DUPLICATORS

GRAPHITE-ROMANIA, B-dul Uverturii Nr. 120, 6 Bucharest 7000, 90.603 394, Pres.: Adrian Anghel, Sales Mgr.: Vasile Anghel, Mktg. Dir.: Cristian Dumitru.

Audio: Cassette.
Video: 1/2 VHS Cassette.
Audio/Video Packaging Services: Inserting, Labeling, Mailing.
Other Services: Mastering Facilities, Warehouse, Freight.

SPAIN

RECORD COMPANIES

ARCADE ESPAGNA, Paseo Castellana 93, c/o Sony Music, 28046 Madrid, 01.555 3845, Fax: 01.555 3642, GM: Michiel Wolff. Main product: Adult Contemporary, Jazz, Country, Reggae, Dance, Album Rock, Gold/Oldies, Black (R&B).

ASPA RECORDS, c/ Constantino Rodriguez 34, 28023 Pozuelo de Alarcon, Madrid, 01.351 0704/34/64, Fax: 01.351 0087, MD: Manuel Gomez, Prod Mgr: Juan Manuel Gomez, Mktg Dir: Jose Hernandez. Labels (owned): Discos Aspa, Molino; Main product: Jazz, New Age.

AUDIO & VIDEO, Abdon Terradas 3-5, 28015 Madrid, 01.449 2350, Fax: 01.243 9690, Tlx: 48183 stia, Contact: Fidel Perez.

AUDIOVISUALS DE SARRIA, Nena Casas 60-22, 08017 Baixos, Barcelona, 03.204 0016, Fax: 03.205 5343, GM: Joan Ribo Liger.

AZ MUSIC, Apartado 51, 08301 Mataro, Barcelona, PO Box 51 (Zip: 08301), 03.796 3311, Fax: 03.755 0630, MD: Braulio Paz. Labels (owned): AZ Records.

BERMAN INTERNACIONAL, PO Box 10.036, 08080 Barcelona, 03.429 4241, Fax: 03.352 3557, President: Luis Segarra, VP: Susana Batalla. Labels (owned): Berman Internacional; (Dist): Masterdisk; Main product: Jazz, Dance, Album Rock.

BLANCO Y NEGRO MUSIC, Amigo 20-22/1/C, 08021 Barcelona, 03.200 7077, Fax: 03.202 0878, Tlx: 98064, President: Manuel Buget Rafanell, MD: Luis Buget Mangione, Int'l Mgr: Felix Buget Mangione.

BMG ARIOLA SPAIN, Avenida de los Madroños 27, 28043 Madrid, 01.388 0002, Fax: 01.200 6647, Tlx: 44316 disc, Int'l VP Latin Region/President: Ramon Segura, VP/MD: Jose Maria Camara. Classical Mktg/RCA Mktg Asst: Alicia Arauzo, BMG Local A&R: Manuel Cubedo, Alvaro de Torres, Dir: RCA: Lydia Fernandez, Label Mgr (RCA Int'l): Luis F Garcia, BMG Finance and Admin Mgr: Miguel Angel Gonzalez. BMG Sales Mgr: Cesar Gonzalez, BMG Mus ca Latina A&R: Fernando Iniguez, BMG Business Affairs: Javier Martin, Mktg Mgr (MCA/Geffen): Carlos Ituino, Ariola Int'l Label Mgr: Jose Mateos, Dir (Ariola): Camilo Muedra, Int'l Exploitation: Sandra Rotondo, BMG Music Video: Alberto Aza. Labels: NCA, Geffen, Karen Records, Hansa,

IQ, Silverstone, Island, 4th Broadway, Gee Street, Mango, Antilles, Axiom, Delicious Vinyl, Sense, DDD, Jive, Motown, Private, Zomba, Imago, GRP, Zoo, Virus.

BOY RECORDS, c/ Industria 132, bajos, 08025 Barcelona, 03.347 5077, Fax: 03.348 0568, Tlx: 98894 gmv, MD: Ana Moran, Mktg: Julio Madronal.

CARILLON DISCOS, Boulevard Santa Maria da Sepulcro 12-4c, 07012 Palma De Mallorca, 071.717 239, Contact: Laureano Irzazabal.

SONY MUSIC ENTERTAINMENT SPAIN, Paseo de la Castellana 93-9, 28046 Madrid, 01.555 3845, Fax: 01.555 3642, Tlx: 22890 cbs, President: Claudio Conde, Mktg Dir: Ramon Crespo, A&R Dirs: Adriano Vogel (Int'l), Rafael Alvero (Local), A&R Mgr (Int'l): Bruno Galindo, Sales Dir: Javier Zoreda, Operations Dir: Albino Jimenez.

CIRCULO DE LECTORES, Valencia 344, 08009 Barcelona, 03.258 7600, Fax: 03.258 5928, Contact: Mr. Maymo.

DIAL, c/ Antonio Cabezon 83, 28034 Madrid, 01.358 2631, Fax: 01.358 2932, MD: Laurentino Ramos Diez, Artistic Dir: Alberto Cimarra, Promo: Alejandro Bonavente.

DISCMEDI, Argentina 3-5, 08024 Barcelona, 03.284 9516, Fax: 03.219 8510, Contact: Alex Estlva Hungria.

DIVUCSA, Paseo Carlos I, 128-130, 08013 Barcelona, 03.265 4974, Fax: 03.265 4655, Tlx: 98303 divuc, MDs: Gabriel Orfila, Julio Canas, A&R Mgr: Ramon Rodo, Int'l Mgr: Susana Nieto Wael. Labels (owned): Perfil, Perfil Classic, Baby Disco; (Lic): Kubaney, Peerless, Carosello, Discomoda, Sonolux and others.

DON DISCO PRODUCTIONS, Miguel Tort 1, 08750 Molins de Rei, Barcelona, 03.668 4100, Fax: 03.668 8751, Tlx: 57449, MD: Miguel Casas Casain.

DRO (DISCOS RADIACTIVOS ORGANIZADOS), Francisco Remiro 5-7, 28028 Madrid, 01.355 4000, Fax: 01.356 6069, Tlx: 48215 vibi, President: Miguel Angel Gomez, A&R Mgr: Jose Carlos Sanchez, Int'l Mgr: Ana Enriquez, Promo Mgr: Andres Ochaita, Comm Mgr: Jean Pierre Marine, Mktg Mgr: Alejandro Sacristan. Labels (owned): DRO, Tres Cipreses; (Lic): Enigma Group, Cooking Vinyl, Ghetto Recording, Off The Track, IC/Digit, Go! Discs; (Distr): Gasa, Twins, Nola Sa, RTVE, Grabaciones Interferencias, Barsa Producciones, Discos El Cohete; Barcelona office: Corcega 369-3, 08037 Barcelona, (9)3.257 1000.

DUY, Plaza Fernando de Lesseps 33 bajos 8-9, 08014 Barcelona, 03.217 4510, Fax: 03.217 6313, President: Rafael Duyos, Bus Mgr: Marta Marti, Chief Exec: Adolfo Martinez, MD: Alberto Verges, Chmn: Jorge Botines. Main product: Dance, AC, Album Rock, New Age.

ECB RECORDS, Passage Garrofers 4, 08026 Barcelona, 03.256 5765, Fax: 03.256 5765, GM: Augustin Ramirez Petra.

EDIGAL, Avenida Rodrigue de Viguri 9-1a, 15703 Santiago de Compostela, La Coruna, 081.588 822.

EKIPO S.A., Buenaventura Polles 25, 08014 Barcelona, (34) 3.296 4160, Fax: (34) 3.296 5371, Admin: Francisco Lopez Soler, GM: Arturo Mas Aguado, Mktg. Mgr: Francisco Heredero Camps. Labels (owned): Ekipto, Direxa, Fixit, Alondra, Subur, Unic, Trebol, Dimension, Taurus, Alcance, Arleouin.

EMI/HISPAVOX, Torrelaguna 64, 28043 Madrid, 01.415 2304, Fax: 01.519 0401, Tlx: 46859 voxsa, MD: Rafael Gil, Sales Dir: Francisco Ardanaz, Dir EMI/Odeon: Carlos Daniel Sanmartin, Int'l Mktg: Ana Villacorte, Int'l Repertoire: Carlos Lopez, Lidia Giovanni, Promo: Andres Fernandez, Ange Pecci, Dir Hispavox: Javier del Moral.

ENFASIS RECORDS, Eugenia de Montijo 59, Portal 5-4a, 28025 Madrid, 01.466 5958, Fax: 01.525 0001, GM: Juan Miguel Ramirez de Cartagena, A&R Mgr: Luis Soler. Labels (owned): Enfasis.

FONOMUSIC, c/ Garcia de Paredes 12, 28010 Madrid, 01.446 7748/7784, Fax: 01.593 0239, Tlx: 43077 Inmc, President: Alfonso Delgado, A&R/Artist Liaison: Margarita Celada, Int'l: Paqueta Munoz, Contact: Carlos Casale. Labels (owned): La General, Gong; (Lic): Antler-Subway, Egrem-Areito, Fanfare, Fuentes, Supraphon.

FONOTRON, Arrayan 40-42/b-c, 41003 Seville, 05.438 8357, Fax: 05.438 6550, GM: Juan Castaneda, Sales Dir: Diego Pizarro.

FP RECORDS, c/ La Coruna 9-11, 08026 Barcelona, 03.265 6757/817, Fax: 03.265 6877, President: Jose Maria Felip Espigo, Promo: Ramon Nicolau.

GINGER MUSIC, c/ Industria 132, bajos, 08025 Barcelona, 03.347 5077, Fax: 03.348 0568, Tlx: 98894 gmv, President: Jaime Buget Mangione, MDs: Angel Munoz, Carlos Daniel, Promo Mgr: Julio Madronal, Mgr (Import): Ramon Balsalobre.

GRABACIONES ACCIDENTALES, Moratin 52-4d, 28014 Madrid, 01.429 3835, Fax: 01.429 1161, Contact: Maribel Schumacher.

HORUS, EDICIONES MUSICALES, Llobet i Vall, Llosera 42-44, 08032 Barcelona, 03.348 1500, Fax: 03.347 4605, MD: Eugeni Serch Civis, A&R: Jose Rosero Herrero, Sales Mgr: Antonio Sanchez, Press/Mktg Serv Mgr: Angel Lacalle. Labels (owned): Horus; (Lic): Alshire (USA), Pegasus, Double Hache, E.C.B. Records.

IRIS RECORDS, Serrano 93-4e, 28006 Madrid, 01.564 5279, Fax: 01.564 5367, President: Jose Entrecanales, Chmn: Fernando Mitjavila, MD: Manuel de la Calva, Production: Viviana Avbin, Mktg: Adolfo Piniero. Labels (owned): Iris, Funny, Mandarin, Castaneda; Distribution: EMI-Hispavox.

JUSTINE, c/ Gomis 15 bajos, 08023 Barcelona, 03.211 2825, Fax: 03.211 0919.

KAREN RECORDS, Amnistia 12, II left, 28013 Madrid, 01.559 1474, Fax: 01.559 1901, Contact: Nacho Scola.

LEVEL RECORDS, Los Vascos 19, 28040 Madrid, 01.533 5365, Fax: 01.534 1236, President/A&R: Alejandro Vazquez Prager, MD/Promo: Julian Gallego. Labels (owned): Level; (Lic): Disco Mix Club, PLR (Bel).

MAX MUSIC, Bailen 71, 08009 Barcelona, 03.232 4413, Fax: 03.231 0207, Tlx: 93079, MDs: Miguel Dega, Ricardo Gomez.

MAYO FONOGRAFICA S.A., Buenaventura Polles 23, 08014 Barcelona, (34) 3.296 5975, Fax: (34) 3.296 5371, GM: Arturo Mas Aguado, Sales Mgr: J.M. Duran. Labels (owned): Mayo, Happy, Temple, More.

METROPOL RECORDS, Avenida Republica Argentina 62/1/5, 08940 Cornellana de Llobregat, Barcelona, 03.376 3666, Fax: 03.376 3504, GM: Ceferino Cuadrado.

MUSICA CLASSICA, Suero de Quinones 38, 28002 Madrid, 01.564 3210, Fax: 01.564 3235, Dir: Melchior Hidalgo. Labels: Philips Classics, Decca, Deutsche Grammophon.

MUSICA INAUDITA, c/ Cerdanya 311-313, local 7, 08025 Barcelona, 03.459 0780, Fax: 03.3207 7320, Dir: Toni Aya.

NATXO'S PRODUCCIONS, Arago 187, pral 1a, 08011 Barcelona, 03.253 9667, President: Natxo Herbera, Chmn: Ignacio Bargallo, MD: Josepa Armengol.

NUEVOS MEDIOS, Marques del Duero 8, 28001 Madrid, 01.435 5472, Fax: 01.575 2188, Dir: Mario Pacheco.

OIHUKA, c/ Amaya 2b-4a/b, 31002 Pamplona, 048.229 385/406, Fax: 048.248 658, Contact: Pachi Goni.

OPEN RECORDS, c/ Emerica Augusta 6, 08028 Barcelona, 03.330 0708, Fax: 03.411 1953, President: Jose Manuel Gonzalez. Labels (owned): Open Records, Sonotex.

OVERDRIVE, Maitena 2, 2 Izquierda, PO Box 129, 20500 Arasate, 043.770 283, Fax: 043.770 986, Exec Prod/A&R/Promo: Vicente Javier Mena, Exec Prod/Mktg/Account: Marisa Perez. Label: Overdrive; Main product: Thrash Metal.

PASARELA, Jesus del Gran Poder 7-2j, 41002 Seville, 054.375 898/372 262, Fax: 054.388 359, MDs: Luis Cueva, Maria de la Cueva.

PDI, Paseo de Gracia 74-3-1a, 08008 Barcelona, 03.215 6008, Fax: 03.215 3546, Tlx: 98050, MD: Manuel Ibanez.

PHONOGRAM SPAIN, Suero de Quinones 38, 28002 Madrid, 01.564 3210, Fax: 01.564 3235, Dir: Jose Luis Garcia Ramos. Labels: Casablanca, DJM, Deram, Fontana, Island, London, Mercury, Philips, Rocket, FFRR, Vertigo, Smash, B-Marcy, Go Disc.

POLYDOR SPAIN, Suero de Quinones 38, 28002 Madrid, 01.564 3210, Fax: 01.564 3235, Dir: Carlos Borrallo. A&M, Barclay, Fiction, Karusel, Metronome, Polydor, Verve, Windham Hill, Tip, Big Life.

POLYGRAM IBERICA, Suero de Quinones 38, 28002 Madrid, PO Box 2248 (Zip: 28002), 01.564 3310, Fax: 01.564 3235/3339/3295, Tlx: 22849 igrm, MD: Mariano de Zuniga, F&A Mgr: Jose Fernandez Alonso, Comm/Sales Mgr: Jose Pascual, Mktg Mgrs: Jose Luis Garcia Ramos (Phonogram), Carlos Borrallo (Polydor), Melchior Hidalgo (Classical), Promo: Juan Molina (Phonogram), Jose Luis Rodriguez (Polydor). Labels (owned): Casablanca, Fontana, DJM, Island, London, Mercury, Philips, Rocket, Vertigo, Smash, A&M, Barclay, Polydor, Windham Hill, Karusel, Metronome, Verve; (Distr): Go! Discs; Main product: EHR, Dance, AC, Album Rock, Jazz, Gold/Oldies, Country, New Age, Classical.

RAYA RECORDS, Bailen 71, 08009 Barcelona, 03.232 4413, Fax: 03.231 0207, Tlx: 93079, MD: Cesar Calero.

ROMILAR, Ferrra 33-4-5, 28008 Madrid, 01.542 0349.

SALSETA DISCOS, c/ Bailen 207-209, 08037 Barcelona, 03.207 6591, Fax: 03.459 4388, Dir: Salvador Escriba Rene.

SANNI RECORDS, Paseo de la Castellana 140/7d, 28046 Madrid, 01.564 7350, Fax: 01.564 7397, Pres/MD: Stig von Bahr, Mktg Mgr: Antonio Luna, Int'l Product Mgr: Yann Barbot. Labels (owned): Sanni Records; (Lic): Mute Records, PWL, Hollywood, 4AD; Main product: EHR, Adult Contemporary, Jazz, Classical, Dance, Album Rock.

SENADOR, Jesus de Gran Poder 70, 41002 Seville, 054.386 381, Fax: 054.438 9593, Contact: Benito Peinado.

SERDISCO, c/ Silva 6-4c, 28013 Madrid, 01.541 9424, Fax: 01.542 1410, Tlx: 22690 zalire, President: Esteban Garcia Morencos, Chmn: Luis Melero, A&R/Mktg Mgr: Jesus Pozo, Promo Mgr: Fernando Bravo, Sales Mgr: Pedro Siguro. Labels (owned): Zafiro, Abanico, CFE, Chapa; (Lic): Charly, Solar, Big Time, Avimus, Transatlantic, Logo, Melodia.

TWINS RECORDS, c/ Martinez Carrochano 3, 28007 Madrid, 01.501 1631/1959, Fax: 01.501 1686, Tlx: 41250, Dir: Paco Martin, Promo: Ricardo de la Morena.

URANTIA RECORDS, Rambla dels Estudis 126 4 1a, 08002 Barcelona, 03.301 9738, Fax: 03.302 6459, Chmn: Ramon Bertran, Promo: Robert Mills.

VICTORIA EDICIONES MUSICALES, Narvaez 14-1a, 28009 Madrid, 01.575 8784/8501, Fax: 01.577 4367, MD: Gerhard Haltermann. Labels (owned): Victoria, Vemsa, Diana; (Lic): Beggars Banquet, Neat, MNW, Cube, Metalworks, AVM, Rounder, Flying Fish.

VIRGIN ESPANA, Hortaleza 104-1, 28004 Madrid, 01.308 3056, Fax: 01.308 5876, Tlx: 48629 vrgn, MD: Carlos Juan Casado, GM: Leonor Villanueva, Int'l Product Mgr: Julian Huntly, Mktg Asst: Gillian Bow, Head Of Promo: Nuria Riba, Sales: Dolores Flores, Promo: Eva Borge (TV), Pilar Valverde (Radio), Pilar Cruz (Press), Nuria Ballesteros (Asst), Admin: Carlos Rodriguez.

VRANTIA RECORDS, Ramblas 126-4-1, 08002 Barcelona, 03.301 9738.

WARNER MUSIC SPAIN (BARCELONA), Aribau 282-284, 7th floor II, 08006 Barcelona, 03.201 7033, Fax: 03.202 0731, Promo: Ferran Loto (Radio/TV), Luuk Holten (Press/Radio).

WEA SPAIN, Lopez de Hoyos 42, 28006 Madrid, 01.411 5144,

Fax: 01.261 6165, Tlx: 47420, MD: Saul Tagarro, A&R Mgr: Iggo Zabala, Prod Mgr: Eva Dalda, Fin Contr: Juan Luis Calleja, Sales Mgr: Angel Lopez, Promo Mgr: Alfonso Gonzalez, Distr: Jose Manuel Chozas.

WELCOME RECORDS, Aribau 15 5 6a, 08011 Barcelona, 03.254 9503, Fax: 03.254 9502, Dir: Jose Alfonso Sanchez Hortas.

MUSIC PUBLISHERS

ABS EDICIONES, c/ Rector Ubach 19-1, 08021 Barcelona, 03.209 9606, Fax: 03.209 9606, President: Frank Andrada, Copyright Mgr: Frederique Brion. (Owned): ABS, Rumba Tres, Taboo; (Sub-pub): Hans Kusters-ABS, ADN, Chick Corea Music.

ACAPULCO, see Serdisco.

ACM EDICIONES/ARIAN MUSIC, Serrano 93-4e, 28006 Madrid, 01.564 5279, Fax: 01.564 5367, President: Manuel de la Calva, MD: Fernando Mitjavila. (Owned): Miriam, Steana, Autobahn; (Sub-pub): Armem Music, Hacia el Sur, Timbal, Unimusic.

ACUFFE ROSE-OPRYLAND, see Southern Music Espanola S.A.

ADN, see ABS Ediciones.

ALHAMBRA EDITORIAL, Claudio Cuello 76, 28001 Madrid, 01.431 6460, Contact: Pedro Porta.

ALL BOYS MUSIC, see Southern Music Espanola S.A.

ALONDRA MUSIC, Ramon Gomez de la Serna 66i/5c, 28035 Madrid, 01.373 4437, Fax: 01.316 8044, Tlx: 23261 colim, Contact: Isabel Turrientes. (Admin): Aspa, Matt Hing; (Sub-pub): Sonet Publishing, Dying Art, Rhythm King Music, San Juan Music Group, French Fried Music, Les Editions Confidentielles.

ARMEM MUSIC, see ACM Ediciones/Arian Music.

ARPA MUSIC, Alcalá 70, 28009 Madrid, 01.577 0751/52, Fax: 01.575 7645, Tlx: 44745 quir, President: Carlos P Cancio, GM: Manuel Lopez-Quiroga. (Admin): Prisma Music, Raps Music, Sila Music, Plasticos y Decibelios; Main product: Country, Reggae, Dance, Album Rock.

ASPA, see Alondra Music.

ATMOSPHERE MUSIC, see Sintonia.

AUTOBAHN, see ACM Ediciones/Arian Music.

BE BOP, c/ Rosellon 256/1/1a, 08037 Barcelona, 03.487 1312, Fax: 03.487 0032, MD: Carles Fontova, Int'l Contact: Marjorie Berry.

BERRY MUSIC, see Sintonia.

BMG ARIOLA SPAIN, Avenida de los Madrones 27, 28043 Madrid, 01.388 0002, Fax: 01.200 6647, Tlx: 44316 disc, GM: Carmen Lopez Figueroa, Fin Dir: Miguel Angel Gonzalez, Copyright Int'l: Jorge Montes.

BOCACCIO EDICIONES MUSICALES, Paseo de la Castellana 93-13, 28046 Madrid, 01.456 2400, Fax: 01.455 3065, Tlx: 49963, MD: Luis Calvo.

BRUTON, see Sintonia.

BUCKS MUSIC, see Southern Music Espanola S.A.

CALYPSO EDS. MUSICALES, see Seemsa.

CANCIONES DEL MUNDO, Magallanes 25, 28015 Madrid, 01.448 2350, Fax: 01.447 6620, Tlx: 45890, MD: Luis Regatero, Int'l Mgr: Dominic Gibson, Contact: Enrique Magaz.

CAPITOL MUSIC, see Sintonia.

CETISA, c/ Caspe 33-2-1a, 08010 Barcelona, 03.501 8892/8919, Fax: 03.301 6479, Tlx: 93181 dgui, Dir: Rudy Basso.

CHAPPELL MUSIC LIBRARY, see Sintonia.

CHICK COREA MUSIC, see ABS Ediciones.

CLIPPERS EDICIONES MUSICALES, c/ Valencia 335-Pral.2a, 08009 Barcelona, 03.207 3913, Fax: 03.257 6353, Tlx: 51539 clip, GM: Julio Guiu Arbeloa, Ssr Dir: F Vinuesa Gimenez.

CODA, see Seemsa.

COMPANY OF THE TWO P(I)ETERS, see Victoria Ediciones Musicales.

DEJAMUS, see PolyGram Iberica.

DIANA, see Victoria Ediciones Musicales.

DICK JAMES MUSIC, see PolyGram Iberica.

DISCORAMA, EDICIONES MUSICALES, Gran Via 62, 28013 Madrid, 01.248 0403, Contact: Alida Genta.

DON DISCO PRODUCTIONS, Miguel Tort 1, 08750 Molins de Rei, Barcelona, 03.668 4100, Fax: 03.668 8751, Tlx: 57449, MD: Miguel Casas Casain.

DUY, Plaza Fernando de Lesseps 33 bajos 8-9, 08014 Barcelona, 03.217 4510, Fax: 03.217 6313, President: Rafael Duyos, Bus Mgr: Marta Marti, Chief Exec: Adolfo Martinez, MD: Alberto Verges, Chmn: Jorge Botines.

DYING ART, see Alondra Music.

EDICIONES CUBICAS, Calle San Isidro Labrador 19, 28005 Madrid, 01.265 8400, Fax: 01.265 8409, MD: Manuel Dominguez.

EDICIONES HERSANT, see Southern Music Espanola S.A.

EDIMUSA, see Serdisco.

EDICIONES MUSICALES S.A. EMTESA EDITORIAL (EMSA), Buenaventura Polles 25, 08014 Barcelona, (34) 3.296 4160, Fax: (34) 3.296 5371, Pres.: Francisco Lopez Soler, GM: Arturo Mas Aguado.

EDITORIAL OPEN MUSIC, Mestra Blanc 9, 08750 Molins de Rei (Barcelona), (34) 3.668 9340, Fax: (34) 3.296 5371, Owner: Arturo Mas Aguado.

EDS. MUSICALES MADRID, see Seemsa.

EGO MUSICAL, Paseo de la Castellana 93, 28046 Madrid, 01.456 2400, Contacts: Luis Calvo, Margarita Tamames, Fernando Mitjavila.

ELVIS PRESLEY MUSIC, see Southern Music Espanola S.A.

EMEC, see Seemsa.

EMI MUSIC SPAIN, Paseo de la Castellana 93, 28046 Madrid, 01.556 2400, Fax: 01.555 3065, Tlx: 49963, MD: Luis Calvo.
FABRICA MAGNETICA, c/ Dr. Fourquet 31 bajos, 28012 Madrid, 01.468 6489/6040, Fax: 01.468 0540, Contact: Servando Caballar.

FIRSTCOM DIGITAL, see Sintonia.

FONTANA, see PolyGram Iberica.

FRENCH FRIED MUSIC, see Alondra Music.

GLADYS MUSIC, see Southern Music Espanola S.A.

GREVER, see Serdisco.

HACIA EL SUR, see ACM Ediciones/Arian Music.

HANS KUSTERS-ABS, see ABS Ediciones.

HISPAVOX, Torrelaguna 64, 28043 Madrid, 01.415 2304, Fax: 01.415 8259, Contact: Javier del Moral.

HNOS MARQUEZ, see Serdisco.

HORUS, EDICIONES MUSICALES, Llobet i Vall. Llosera 42-44, 08032 Barcelona, 03.348 1500, Fax: 03.347 4605, President: Eugeni Serch Cavis, Sales Mgr: Antonio Sanchez, Press/Mktg Serv Mgr: Angel Lacalle.

INTERSOUND, see Sintonia.

JESUS GARZON, see Seemsa.

KPM, see Sintonia.

LARRY SHAYNE, see Serdisco.

LES EDITIONS CONFIDENTIELLES, see Alondra Music.

MATT HUNGO, see Alondra Music.

MAX MUSIC, Bailen 71, 08009 Barcelona, 03.232 4413, Fax: 03.231 0207, Tlx: 93079, MDs: Miguel Dega, Ricardo Gomez.

MIRIAM, see ACM Ediciones/Arian Music.

MOMENTO MUSICAL, see Seemsa.

MUNDO DE RITMOS, see Seemsa.

MUSICA DEL SUR, see Southern Music Espanola S.A.
MUSICA SIN FIN, Calle San Isidro Labrador 19, 28005 Madrid, 01.265 8400, Fax: 01.265 8409, MD: Juan Alberto Arteche.

NASHLON, see PolyGram Iberica.

NUEVAS EDICIONES, Gran Via 32, 28013 Madrid, 01.522 1260, Fax: 01.347 0709, Tlx: 27638 ser, Prof Mgr: Victoriano Gamarra, Copyright Mgr: Jose E S Gomez.

PAMPA, see Seemsa.

PASARELA, Jesus del Gran Poder 7-2j, 41002 Seville, 054.375 898/372 262, Fax: 054.388 359, MDs: Luis Cueva, Maria de la Cueva.

PATCH, see Southern Music Espanola S.A.

Peermusic, see Southern Music Espanola S.A.

PENTA MUSIC, Garcia de Paredes 12, 28010 Madrid, 01.446 7748, Fax: 01.593 0239, Tlx: 43077 fnmc, MD: Juan Canal.

PLASTICOS Y DECIBELIOS, see Arpa Music.

PLATZ MUSIC ESPANOLA, Hortaleza 18-5, 28004 Madrid, 01.531 0661, Fax: 01.522 4301, Contact: Jose Carreras.

POLYGRAM IBERICA, Suero de Quinones 38, 28002 Madrid, PO Box 2248 (Zip: 28002), 01.564 3310, Fax: 01.564 3235/3339/3295, Tlx: 22849 fgram, MD: Mariano de Zuniga, Publ Mgr: Jesus Moll, Copyright Mgr: Juana Arranz (Int'l), Guillermo Nunez (Local). (Owned): PolyGram, Discorama, Fontana, Welk, PolyGram International, Dick James Music; (Admin): Dejamus, Nashlon.

PRISMA MUSIC, see Arpa Music.

RADIO POP MUSIC, Gran Via 62, 28013 Madrid, 01.541 9424, Fax: 01.542 1410, Tlx: 22690, Dirs: Ray van Cant, Esteban Morencos.

RAPS MUSIC, see Arpa Music.

RAYA RECORDS, Bailen 71, 08009 Barcelona, 03.232 4413, Fax: 03.231 0207, Tlx: 93079, MD: Cesar Calero.

RHYTHM KING MUSIC, see Alondra Music.

RITMO & MELODIA, see Seemsa.

ROBINSONG MUSIC, see Southern Music Espanola S.A.

RUMBA TRES, see ABS Ediciones.

SALAMANDRA, c/ Oltira 8, 28028 Madrid, 01.361 0456/0661, Contact: Jesus del Campo.

SAN JUAN MUSIC GROUP, see Alondra Music.

SEEMSA, Alcalá 70, 28009 Madrid, 01.577 0751, Fax: 01.575 7645, Tlx: 44745 quir, President: Carlos P Cancio, GM: Manuel Lopez-Quiroga, Int'l Mgr: Yolanda de Felipe. (Owned): Calypso Eds. Musicales, Ritmo & Melodia, Emec, Mundo de Ritmos, Teclado, Coda, Eds. Musicales Madrid, Momento Musical, Zzelesta, Jesus Garzon, Pampa; Main product: Adult Contemporary, Country, Classical, Dance, Album Rock, New Age, Pop, Ethnic.

SERDISCO, c/ Silva 6-4c, 28013 Madrid, 01.541 9424, Fax: 01.542 1410, Tlx: 22690 zafire, President: Esteban Garcia Morencos, Chmn: Luis Melero. (Admin/Sub-pub): Larry Shayne (USA), Grever, Edimusa, Acapulco, HNOS Marquez (Mex), Weak Spot (UK).

SILA MUSIC, see Arpa Music.

SINTONIA, Abdon Terradas 3-5, 28015 Madrid, 01.449 2350, Fax: 01.243 9690, Tlx: 48183 stia, President: Bartolome Espadale, Fin Dir: Fidel Perez. (Owned): Sintonia: (Sub-pub): KPM, Bruton, Chapell Music Library, Berry Music, Themes Int'l, Atmosphere Music (UK), Sonoton, Intersound, UBM Publishing (Ger), Capitol Music, Firstcom Digital (USA).

SONET PUBLISHING, see Alondra Music.

SONOBIG, Paseo Carlos I, 128-130, 08013 Barcelona, 03.265 4974, Fax: 03.265 4655, Tlx: 98303 divuc, GM: Joaquin Alfonso.

SONOTON, see Sintonia.

SONY MUSIC ENTERTAINMENT SPAIN, Paseo de la Castellana 93-10, 28046 Madrid, 01.555 3845, Fax: 01.555 3642, Tlx: 22890 cbs, President: Claudio Conde, Publ Mgr: Monica Scheffler.

SOUTHERN MUSIC ESPANOLA S.A.

Hortaleza #18, 28004 Madrid, (34-1) 531-0661/64, Fax: (34-1) 522-4301, MD: Jose Carreras, GM: Ignacio Ballesteros, Creative Mgr: Jimmy Bascunan. (Owned): Peermusic, Southern Music, Musica del Sur, Tro-Essex, Platz Music; (Admin): Ediciones Hersant, Acuff Rose-Opryland, Bucks Music, Patch, Robinsong Music, Elvis Presley Music, Gladys Music, All Boys Music.

STEANA, see ACM Ediciones/Arian Music.

TABOO, see ABS Ediciones.

TARANTULA EDICIONES DE MUSICA, Diagonal 474, 08006 Barcelona, 03.218 5850, Fax: 03.415 0095, GM: Salvador Perez Munoz.

TECLADO, see Seemsa.

TEDDY SOUND, Ronda General Mitre 207, 08023 Barcelona, 03.417 8790, Fax: 03.418 4366, Tlx: 99819 tedy, President: Joaquin Alfonso Navas, Int'l Mgr: Teresa Alfonso.

THEMES INT'L, see Sintonia.

TIMBAL, see ACM Ediciones/Arian Music.

TRO-ESSEX, see Southern Music Espanola S.A.

UBM PUBLISHING, see Sintonia.

UNIMUSIC, see ACM Ediciones/Arian Music.

VALENTINE, see Victoria Ediciones Musicales.

VICTORIA EDICIONES MUSICALES, Narvaez 14-1a, 28009 Madrid, 01.575 8784/8501, Fax: 01.577 4367, MD: Gerhard Haltermann. (Owned): Victoria, Diana; (Admin/Sub-Pub): Valentine, Company of the Two Pjeters.

VIRGIN ESPANA, Hortaleza 104-1, 28004 Madrid, 01.308 3056, Fax: 01.308 5876, Tlx: 48629 vrgn, MD: Carlos Juan Casado, Prof Mgr: Juan Marquez.

WARNER CHAPPELL SPAIN, Magallanes 25, 28015 Madrid, 01.448 2350, Fax: 01.447 6620, Tlx: 45890, MD: Luis Regatero, Int'l Mgr: Dominic Gibson, Contact: Enrique Magaz.

WEA SPAIN, Lopez de Hoyos 42, 28006 Madrid, 01.411 5144, Fax: 01.261 6165, Tlx: 47420, MD: Saul Tagarro.

WEAK SPOT, see Serdisco.

WELK, see PolyGram Iberica.

ZZELESTA, see Seemsa.

VIDEO PROGRAM SUPPLIERS & BUYERS

ARCADE VIDEO ESPANA, Paseo de la Castellana 240, 28046 Madrid, 01.733 9494/61.

AUDIO PROFESIONAL, Francisco Tarrega 11, 08027 Barcelona, 03.340 2504, Fax: 03.340 2766, Tlx: 51526, Chmn: Jaime Garos Barba, MD: Jorge Juan Fuste Tortosa.

BMG ARIOLA SPAIN, Avenida de los Madroños 27, 28043 Madrid, 01.386 0002, Fax: 01.200 6647, Tlx: 44316 disc, Contact: Alberto Aza.

DISTRIBUCIONES DISCLUB, Alava 140, 08018 Barcelona, 03.300 6000, Fax: 03.309 0363, President: Manuel Amat, Import/Export Mgr: Jose A. Chueca.

FOX VIDEO SPAIN, Paseo de la Castellana 141-21b, 28046 Madrid, 01.572 0379, Fax: 01.570 1296, Tlx: 48109 cfve, MD: Rafael Arenas, Fin Dir: Emilio Aparicio.

IBERCOM, Pradillo 46, 28002 Madrid, 01.415 8797/519 3103, Fax: 01.415 8797/519 3103, Tlx: 44122, Chmn: Francisco Lavilla, MD: Manuel Rogian, Head Of Production: Pedro Lozano.

IMAGEN 35/GRUPPA EUROPA 92, Paseo de la Habana 20, 28036 Madrid, 01.563 2774/563 2476, Fax: 01.563 2480, MDs: Fralle Olea, Garcia Delgado.

IMATCO, Conseil de Cent 280, pral, 08007 Barcelona, 03.318 8900, Fax: 03.315 0323, Tlx: 97416, President: Jover Ricart.

INTERNATIONAL FILM GRUP, Gran Via De Les Cortes 1176 bis/21/8a, 08020 Barcelona, 03.305 3650, Fax: 03.305 3259, President: Salvador Diago Subirana, Mgr: Jacqueline Castillo.

MEGAVISION, c/ Frederico Salmon 7-2, 2801 Madrid, 01.475 4304/7, Fax: 01.457 0508, Tlx: 43303.

POLYGRAM IBERICA, Suero de Quinones 36, 28002 Madrid, PO Box 2248 (Zip: 28002), 01.564 3310, Fax: 01.564 3235/3339/3295, Tlx: 22849 fgram, MD: Mariano de Zuniga, Sales: Jose Pascual, F&A Mgr: Jose Fernandez Alonso, Video Dir: Manuel Bejar.

WARNER HOME VIDEO (SPAIN), c/ Angel Munoz 14-16, Entreplanta, 28043 Madrid, 01.413 0543, Fax: 01.519 5759, Tlx: 45962, MD: Alex de Muns.

RECORD DISTRIBUTORS

ASPA RECORDS, c/ Constantino Rodriguez 34, 28023 Pozuelo de Alarcon, Madrid, 01.351 0704/34/64, Fax: 01.351 0087, MD: Manuel Gomez, Prod Mgr: Juan Manuel Gomez, Mktg Dir: Jose Hernandez. Labels (distr): Silver Wave, Miramar, Sonic Atmosphere, K-Tel, Blue Flame, Prudence, Racket Records, Hwyl, Multimood, Clear Productions; Main product: Jazz, New Age.

CAROLINE ESPANA, Avenida de Manoteras 22, Local 94, 28050 Madrid, 01.383 0505/0607, Fax: 01.383 8170, GM: Julian Sanz Escalona.

DISCOS PORTOBELLO, Rua Ciega 1, 15003 La Coruna, 081.213 562, Fax: 0213 009, President: Jaime Manso Rey, MDs: Javier Edreira Seijo, Dirk Bontenbal.

DISTRIBUCIONES DISCLUB, Alava 140, 08018 Barcelona, 03.300 6000, Fax: 03.309 0363, President: Manuel Amat, Import/Export Mgr: Jose A. Chueca.

DISTRIMUSIC, c/ Montes de Leon, Zna Ind de Torrejon, 28350 Poligono San Fernando, Madrid, 01.445 8409, Fax: 01.593 0239, Tlx: 43077, President: Cirilo Madrid, Int'l Mgr: Manuel Guardio. Labels (distr): Elkar, Foriomicus, Hispamusic, Intermitente, Justine, Matasellos, Oihuka, Poesia Negra, Antler-Subway-Kaos, BCM, Cha Cha; Pianola, Play It Again Sam, Sneak, Dance A Disc-Serious, Preview, ZYX.

ENFASIS RECORDS, Eugenia de Montijo 59, Portal 5-4a, 28025 Madrid, 01.466 9588, Fax: 01.525 0001, GM: Juan Miguel Ramirez de Cartagena, Int'l Asst: Carmen Rubio. Labels (distr): Concord Jazz, Concord Picante, Timeless, Global Pacific, Rhino Records, King Records, Passport Jazz, Jazzmen, Nova Records, Chase Music Group, Mesa Bluemoon, Sonic Atmospheres, Star Direct, Lipstick Records, Bleu Citron, Sweet Brasil, LR Records, Konnex, Sugar Hill Records, Teledisc, Optimism, Club Rio, Jazz City. Main music product: Jazz, Dance, Gold/Oldies, Country, New Age.

EUROGYC CD RECORDS, Doctor Ferran 22/b, 08034 Barcelona, 03.280 0198, Fax: 03.280 4934, GM/Partner: Agustin Bori Pons, Partner: Rafael Vinuales, Mktg Mgr/Partner: Ricardo Villamayor.

IECO—MARTANA, Botanica 95 Pol. Industrial Gran Via Sur, 08908 Hospitalet Llobregat, Barcelona, 03.263 2423, Fax: 03.263 2416, MD: Alfonso Serra, Sales Mgr: Joaquin Gomez. Wholesaler; Formats: CD, Vinyl Albums, Cassettes; Main product: Jazz, Country, Reggae, Classical, Album Rock, Gold/Oldies, Black (R&B), New Age.

INDUSTRIAS DEL FUNK, Saliente 1, 28007 Madrid, 01.504 2961/573 2104, Fax: 01.574 6776, Owner: M.A. Sanchez Andres, MD: Ricardo Manzaneres Iniesta, Int'l Promo: Frank Zemmouri, Mktg: Leo Lopez. Import/export, all labels distributed. Also mail-order.

LEVEL RECORDS, Los Vascos 19, 28040 Madrid, 01.533 5365, Fax: 01.534 1236, President: Alejandro Vazquez Prager. Labels (distr): Disco Mix Club, PLR (Bel), Unidisc (Can).

PABLO LOPEZ BALADA, Pelayo 14, 08001 Barcelona, 03.318 7776, Fax: 03.323 3429, Tlx: 99386, Dir: Pablo Lopez Balada.

RETAIL ACCESSORY SUPPLIERS

LIFT ESPANA, c/ Silva 4/2/A, 28013 Madrid, 01.542 9944/6615, Fax: 01.541 6566, Contacts: Miguel Angel, Matilde Sanchez. Agent of Lift display systems.

MARFELUM, Espronceda 164, 08018 Barcelona, 03.070 192/404, Fax: 03.077 801, MD: Carlos Elduque Benedi, Comm Mgr: Georgia Elduque Vesga.

ASSOCIATIONS & PROFESSIONAL ORGANIZATIONS

AIE, c/ Principe de Vergara 9, bajo derecha, 28001 Madrid, 01.578 2302, Fax: 01.431 2610, President: Luis Cobos, MD: Miguel Perez Solis. Collecting society for performing artists.

AEDEM, Avenida de los Madroños 27, 28043 Madrid, 01.200 8046/0, President: Luis Regatero, VP: Jose Carreras. Association of music publishers.

AEEMS, Concepcion Jeronima 10, 28012 Madrid, 01.577 0752, Fax: 01.575 7645, Tlx: 44745, President: Carlos Perez Cancio.

AERP, Villalar 1-4, Izquierda, 28002 Madrid, 01.435 7072, Fax: 01.435 6196, Sec-Gen: Alfonso Ruiz de Assin. Private radio broadcasters association.

AFVYE, c/ Pedro Muguruza 8, Entreplanta Izq, 28036 Madrid, 01.457 4154, Fax: 01.457 6674, Dir-Gen: Carlos Grande. Spanish national IFPI group.

ARTE, Montera 24-4g, 28013 Madrid, 01.232 6401/02. Concert technicians association.

SGAE, Fernando VI 4, 28004 Madrid, 01.319 2100, Fax: 01.410 6049, Tlx: 46469 sgae, President: JJ Alonso Millan, VP: Eduardo Bautista, Mgr: Enrique Loras. Writers, composers and publishers society.

PUBLIC RELATIONS & RECORD PROMOTION

AGENCIA EFE, Espronceda 32, 28003 Madrid, 01.441 5599, Fax: 01.441 0905. Press agency.

BARCELONA PROMOCION INSTAL. OLIMPIQUES, Passeig Olimpic s/n, Palau San Jordi, 08004 Barcelona, 03.426 2089, Fax: 03.423 1516, MD: Jordi Vallverdu. Management & promotion of sports and music facilities.

CLARIN PUBLICIDAD, Paseo de la Castellana 130, 28046 Madrid, 01.262 5530, MD: Joaquin de Aguilera Moyano.

EUROGYC CD RECORDS, Doctor Ferran 22/b, 08034 Barcelona, 03.280 0198, Fax: 03.280 4934, GM/Partner: Agustin Bori Pons, Partner: Rafael Vinuales, Mktg Mgr/Partner: Ricardo Villamayor.

LEVEL RECORDS, Los Vascos 19, 28040 Madrid, 01.533 5365, Fax: 01.534 1236, President: Alejandro Vazquez Prager.

R P S, Seminario de Nobles 4-2-129, 28015 Madrid, 091.541 7869, Fax: 091.542 7651, Dir: Carlos Alonso Cimiano, Label Mgr: Angel Prieto.

COMPACT DISC MASTERING & REPLICATING PLANTS

CD MASTER, Sanchez Pacheco 31, 28002 Madrid, 01.413 4066, Fax: 01.519 1496, President: Jesus N Gomez, GM: Regina Marfil. Disc-cutting/CD pre-mastering; 1 studio: 2-track (A), 2/4-track (D); Monitoring: JBL; Other: digital services.

IBERMEMORY, Avenida Fuentemar 35, Poligono Industrial, 28820 Costada, Madrid, 01.671 2200/4, Fax: 01.671 3909, Tlx: 42797, MD: Luis Carbo, Tech Mgr: Eusebio Rey.

SERVICIOS IBERICOS ENTERTAINMENT, Ctra Leganes a Alcorcon, Polig. Urtinsa, 28925 Alcorcon (Madrid), PO Box 35066 (Zip: 28925), 01.643 1080, Fax: 01.643 0709, GM: Francisco Cenalmor, Sales Dir: Pilar Sanchez, Prod Dir: Diego Villanueva, Purchasing Dir: Jose Maria Urbano. CD manufacturing; Annual cap: 5 mil.

TECNO CD SPAIN, Las Fabricas 2 bis, Poligono Ind.Urtinsa, 28925 Alcorcon, Madrid, 01.643 1238, Fax: 01.643 0238, Mktg/Sales Mgr: Gilles Bastit, Comm Dept: Mercedes Martinez. Annual capacity: 6 mil, Min order: 500.

PLATING, MASTERING & PRESSING PLANTS

CD MASTER, Sanchez Pacheco 31, 28002 Madrid, 01.413 4066, Fax: 01.519 1496, President: Jesus N Gomez, GM: Regina Marfil. Disc-cutting/CD pre-mastering; 1 studio: 2-track (A), 2/4-track (D); Monitoring: JBL; Other: digital services.

EUROGRAM, Ctra Leganes a Alcorcon, Polig. Urtinsa, 28925 Alcorcon (Madrid), PO Box 35066 (Zip: 28925), 01.643 1080, Fax: 01.643 0709, GM: Francisco Cenalmor, Fin Dir: Salvador Villalba, Sales Dir: Pilar Sanchez, Prod Dir: Diego Villanueva, Purchasing Dir: Jose Maria Urbano. Vinyl pressing; Annual cap: 15 mil.

IBEROFON, Avenida Fuentemar 35, Poligono Industrial, 28820 Costada, Madrid, 01.671 2200/4, Fax: 01.671 3909, Tlx: 42797.

SONOLAND, Avenida Fuentemar 35, Poligono Industrial, 28820 Costada, Madrid, 01.671 5205/4122, MD: Sociedad Anonima, Studio Mgrs: Raul Marcos, Manuel Diaz.

SONY MUSIC ENTERTAINMENT SPAIN, Paseo de la Castellana 93-9, 28046 Madrid, 01.555 3845, Fax: 01.555 3642, Tlx: 22890 cbs, President: Manolo Diaz, Operations Dir: Albino Jimenez.

TECNIFON (SPAIN), Doctor Fleming 5, 08210 Barbera del Valles, Barcelona, 03.718 4011/4951, Fax: 03.718 0206, President: Jose Miguel Burgos, Sales Mgr: Maria Garcia, Tech Mgr: Arturo Roldan.

TECNODISCO, Las Fabricas 2, Poligono Ind. Urtinsa, 28925 Alcorcon, Madrid, 01.643 4022/255, Fax: 01.643 4249, President: Jose Ortiz, Comm Dept: Rafael Cantos.

TAPE CUSTOM DUPLICATORS

BOCSA, Cuzco 19, 08030 Barcelona, 03.311 1811, Fax: 03.311 7206, MD: Francisco Batlle, Prod Dir: Jesus Bautista, Fin Contr: Francisco Rodriguez, Sales/Mktg Dir: Alfonso Galofre. Audio cassette & Video duplicators.

SONY MUSIC ENTERTAINMENT SPAIN, Paseo de la Castellana 93-9, 28046 Madrid, 01.555 3845, Fax: 01.555 3642, Tlx: 22890 cbs, President: Manolo Diaz, Operations Dir: Albino Jimenez.

DIGITALVISION, Ctra Leganes a Alcorcon, Polig. Urtinsa, 28925 Alcorcon (Madrid), PO Box 35066 (Zip: 28925), 01.643 1080, Fax: 01.643 0709, GM: Salvador Villalba, Sales Dir: Pilar Sanchez, Prod Dir: Diego Villanueva, Purchasing Dir: Jose Maria Urbano. Video cassette duplication; Annual cap: 4 mil.

DISCAN, Canalejas 61-1 Izq., 35003 Las Palmas de Gran Canaria, 028.367 558, Contact: Jose L Gomez de Luis.

EMI MUSIC GROUP, Torrelaguna 64, 28043 Madrid, 01.415 2304, Tlx: 22931 voxsa, MD: Rafael Gil.

ESTUDIOS GEMA, Segre 18, Poligono Industrial Cadesbank, 08291 Ripollet, Barcelona, 03.691 3011/692 5412, Fax: 03.691 9002, Tlx: 54942 orti, MD: Jose Ortiz, Mktg/Sales Mgr: Jose Miguel Burgos, Comm Dept: Eliseo Vila, Juan Moreno.

EUROGRAM, Ctra Leganes a Alcorcon, Polig. Urtinsa, 28925 Alcorcon (Madrid), PO Box 35066 (Zip: 28925), 01.643 1080, Fax: 01.643 0709, GM: Francisco Cenalmor, Fin Dir: Salvador Villalba, Sales Dir: Pilar Sanchez, Prod Dir: Diego Villanueva, Purchasing Dir: Jose Maria Urbano. Audio cassette duplication; Annual cap: 20 mil.

FONOTRON, Arrayan 40-42/b-c, 41003 Seville, 05.438 8357, Fax: 05.436 6550, GM: Juan Castaneda, Sales Dir: Diego Pizarro. Audio cassette duplication; Annual cap: 5 mil; Min order: 1,000.

IBEROFON, Avenida Fuentemar 35, Poligono Industrial, 28820 Costada, Madrid, 01.671 2200/4, Fax: 01.671 3909, Tlx: 42797, MD: Luis Carbo.

PDS VIDEOGRAMAS Y FONOGRAMAS, Dr Esquerdo 184, 28007 Madrid, 01.410 3130.

SONIDUPLEX, Lepanto 171, bajos, 08013 Barcelona, 03.232 9057, President: Ramon Cava, MD: Carlos Cava.

SONOSOR FONORUZ, Avenida Andalucía 52, 14550 Montilla, Cordoba, 057.651 277.

TECNODISCO, Las Fabricas 2, Poligono Ind. Urtinsa, 28925 Alcorcon, Madrid, 01.643 4022/255, Fax: 01.643 4249, President: Jose Ortiz, Comm Dept: Salvador Del Bas.

CASSETTES REELS & PARTS, JEWEL BOX MANUFACTURERS

ECHAZARRA, c/ Javier Ferrero 13, 28002 Madrid, PO Box 2064 (Zip: 28002), 01.416 1800, Fax: 01.416 9146.

ESTUDIOS GEMA, Segre 18, Poligono Industrial Cadesbank, 08291 Ripollet, Barcelona, 03.691 3011/692 5412, Fax: 03.691 9002, Tlx: 54942 orti, MD: Jose Ortiz, Mktg/Sales Mgr: Jose Miguel Burgos, Comm Dept: Eliseo Vila, Juan Moreno.

FORMAS PLASTICAS, Poligono Ind. Riera de Caldes, PO Box 8, 08184 Palau de Plegamans, Barcelona, 03.864 8658/82, Fax: 03.864 5554.

IBEROFON, Avenida Fuentemar 35, Poligono Industrial, 28820 Costada, Madrid, 01.671 2200/4, Fax: 01.671 3909, Tlx: 42797, MD: Luis Carbo.

ORTIPLAS, Segre 4-5, Poligono Industrial Cadesbank, 08291 Ripollet, Barcelona, 03.691 3011/692 5412, Fax: 03.691 9002, Tlx: 54942 orti, MD: Jose Ortiz, Mktg/Sales Mgr: Jose Miguel Burgos, Comm Dept: Eliseo Vila, Juan Moreno. Video cassette & jewel-box manufacture.

PRINTING, PACKAGING & LABELS

IBEROFON, Avenida Fuentemar 35, Poligono Industrial, 28820 Costada, Madrid, 01.671 2200/4, Fax: 01.671 3909, Tlx: 42797, MD: Luis Carbo.

SONY MUSIC ENTERTAINMENT SPAIN, Paseo de la Castellana 93-9, 28046 Madrid, 01.555 3845, Fax: 01.555 3642, Tlx: 22890 cbs, President: Manolo Diaz, Operations Dir: Albino Jimenez.

TECNIFON (SPAIN), Doctor Fleming 5, 08210 Barbera del Valles, Barcelona, 03.718 4011/4951, Fax: 03.718 0206.

BLANK & BULK RAW TAPE

3M ESPANA, Josefa Varcacel 31, 28027 Madrid, 01.742 0012, Fax: 01.742 4357.

AMPEX EUROPE, Princesa 47/5d, 28008 Madrid, 01.541 0919/2194, Fax: 01.542 5465, Tlx: 46661, Sales Mgr: Jose Batlaglio, Fin Mgr: Eduardo Escano. Manufacturer of professional blank audio & blank video tape cassette (open reel, DAT); Brand: Ampex.

BASF ESPANOLA, Paseo de Gracia 99, 08008 Barcelona, 03.215 1354, Fax: 03.487 1387.

IBEROFON, Avenida Fuentemar 35, Poligono Industrial, 28820 Costada, Madrid, 01.671 2200/4, Fax: 01.671 3909, Tlx: 42797, MD: Luis Carbo.

MAGNETRON, Cardenal Siliceo 22, 28002 Madrid, 01.519 2416, Fax: 01.519 6444, Tlx: 42451 magne, Mktg Mgr: Alfonso Bares. Distributor: Revox, Dynamax.

OPEN RECORDS, c/ Emerita Augusta 6, 08028 Barcelona, 03.330 0708, Fax: 03.411 1953, President: Jose Manuel Gonzalez.

SOCIMAG, Napoles 4-6, 08210 Barbera del Valles, Barcelona, 03.718 4011, Fax: 03.718 7699, Mktg/Sales Mgr: Ignacio Duran. Audio tape manufacture.

SONIDUPLEX, Lepanto 171, bajos, 08013 Barcelona, 03.232 9057, President: Ramon Cava, MD: Carlos Cava. Cassette manufacture & duplication.

STRAND MAGNETICS, Benedicto Mateo 50, 08034 Barcelona, 03.204 4495, Fax: 03.205 1560.

CD, RECORD & TAPE MANUFACTURING SYSTEMS

ECHAZARRA, c/ Javier Ferrero 13, 28002 Madrid, PO Box 2064 (Zip: 28002), 01.416 1800, Fax: 01.416 9146.

IBERICA DE COMUNICACIONES, Paseo de la Habana 169, 28036 Madrid, 01.250 7877, Fax: 01.458 1093, MD: Eugenio Fontan. Distribute: Lyrec (Den).

ORTIPLAS, Segre 4-5, Poligono Industrial Cadesbank, 08291 Ripollet, Barcelona, 03.691 3011/692 5412, Fax: 03.691 9002, Tlx: 54942 orti, MD: Jose Ortiz, Mktg/Sales Dir: Jose Miguel Burgos, Comm Dept: Eliseo Vila, Juan Moreno.

SWEDEN

RECORD COMPANIES

ALPHA RECORDS, Rasundavagen 45, 171 52 Solna, PO Box 3042 (Zip: 171 03), 08.730 0400, Fax: 08.730 1015, Tlx: 10551 sound, President: Benny Hedlund.

AMALTHEA GRAMMOFON, PO Box 286, 201 22 Malmö, 040.79889, Fax: 040.976 008, Tlx: 33918 amal, MD: Torgny Sjöo.

AMIGO MUSIK, Norrbackgatan 47, PO Box 6058, 102 31 Stockholm, 08.340 195, Fax: 08.340 698, MD: Per Anders Boquist, Int'l Mgr: Fredrik Boquist, Label Mgr: Joakim Ohlsson, Producer: Ulf Lindqvist. Labels (owned): Amigo; (Lic): Fantasy.

BIG BAG RECORDS, PO Box 31, 532 00 Skara, 0511.13035, Fax: 0511.18088, MDs: Anders Hjalmarsson, Torgny Soderberg.

BLITZ RECORDS, PO Box 347, 101 26 Stockholm 1, 08.282 890/4, Fax: 08.290 122, Tlx: 12481 blitz, MD: Wolfgang Jedlic-

zka. Labels (owned): Blitz; (Distr): Blitz, Indies (Ger, Spa, UK, USA, Bel, Hol); CD distributor.

BMG ARIOLA SWEDEN, Stårbacksgatan 1, PO Box 126, 172 21 Sundbyberg, 08.627 5300, Fax: 08.294 337, Tlx: 11794 bmg, MD: Hasse Breitholtz, Mktg Mgr: Bengt Berg, Hans Andersson (MCA/Geffen), A&R (Local): Marie Ledin. Labels (owned): Milli, Rival.

BORG MUSIC, PO Box 14014, 200 22 Malmö, 040.937 678, Fax: 040.937 496, President: Bjorn Gardsby, MD: Anders Theander, Prod Mgr: Bjorn Holmberg. Labels (owned): Borg Music, Cream.

BTECH, Sveavagen 9-11, PO Box 7799, 103 96 Stockholm, 08.210 710, Fax: 08.210 083, MD: Jan Ekholm, A&R: Ingrid Rudefors, Dir (UK): Morgan King, Promo: Pernillie Rudefors. Labels (owned): Btech, Hangar, Main product: Dance.

CAPRICE RECORDS, Schoenfeldts Grand 1, PO Box 1225, 111 82 Stockholm, 08.791 4600/92, Fax: 08.7109 992, Tlx: 13594, President: Bengt Hall, Chmn: Sten Wickborn, GM: Ruud de Sera, Label Mgrs: Lars Silen, Jan Kask, Prod Co-Ord: Miriam Lebrin, Contr: Roland Olsson. Labels (owned): Reportage, Expo Norr, Caprice Composer Series, Caprice Artist Series.

CARELESS MUSIC RECORDS, PO Box 5094, 131 05 Nacka 5, 08.735 6855/615 1605, Fax: 08.735 6875, Dir: Les Carlton, Mgr: Margareta Henriksson.

CHRYSALIS RECORDS (SWEDEN), Valhallavagen 134, PO Box 10220, 100 55 Stockholm, 08.666 0354, Fax: 08.663 9235, Tlx: 12335 airmsg, GM: Martin Ingestrom, Press/ Promo: Li Eriksson. Distribution: EMI.

DINO MUSIC, Klippgatan 24a, PO Box 1144, 171 23 Solna, 08.836 200, Fax: 08.833 658, Contact: Christer Wedin.

EMI SWEDEN, Tritonvagen 17, PO Box 1289, 171 25 Solna, 08.764 3800, Fax: 08.297 407, Tlx: 10046, Chmn: Alexis Rotelli, MD: Rolf Nygren, Mktg Dir: Lars Bremer, Sales Mgr: Fredrik Norlin, SR Prod Mgr (UK & ROW & USA): Sven Peterson, Prod Mgrs: Michael Manasse (USA), Arne Almqvist (Classic), Promo Head: Marie Dimberg, A&R Mgr (Local): Magnus Nygren. Labels (distr): Mega, Mariann, AIR, Hawk, SR, KM Records, Torgny Bjork.

EMPIRE RECORDS, Duvholmsgränd 56, PO Box 4049, 127 04 Suarholmen, 08.740 6401, Fax: 08.740 1855, President: Jimmy Andersson, Chmn: Patrik Yderberg. Distribution: Marianne Distribution.

EUROTON MUSIK, Kata Dalströms Gata 10, PO Box 6066, 126 06 Hagersten, 08.464 8008, Fax: 08.976 670, MDs: Eva Junegren, Rune Junegren.

EVA RECORDS, Kortagatan 7, 171 54 Solna, 08.986 420, Fax: 08.985 712, Contact: Lars Høglund.

FOUR LEAF CLOVER RECORDS, PO Box 1231, 172 26 Sundbyberg, 08.982 808, Fax: 08.982 855, President: Lars Samuelson, MD: Hakan Samuelson. Labels (owned): Four Leaf Clover, PLA, Star; (Distr): Stunt, Gala, Nabel.

FRITUNA PRODUKTION, Vartavagen 15, 115 28 Stockholm, 08.663 1345, Fax: 08.660 1754, Tlx: 123 28 frituna, President: Goran Waltner.

GLENN PRODUCTIONS, PO Box 67, 182 71 Stocksund, 08.856 800, Fax: 08.856 801, Tlx: 14885, MDs: Ann-Louise Glenmark, Bruno Glenmark.

GRAMMOFON BIS, Bragevagen 2, 182 64 Djursholm, 08.755 4100, Fax: 08.755 7676, Contact: Robert von Bahr.

GRAND MUSIC PRODUCTIONS, Dalvagen 20 a, 171 36 Solna, 08.275 758, Fax: 08.275 194, Producer: Svenolov Bagge.

HAWK RECORDS, Polhemsgatan 28, 112 30 Stockholm, 08.652 0260, Fax: 08.652 5256, MD: Bjorn Hakansson, Press/Promo: Mia Fridlund. Labels (owned): Hawk Records, Classic Hawk; Main product: AC, Album Rock.

HSM MUSIC (SWEDEN), PO Box 1122, 221 04 Lund, 046.149 775, Fax: 046.184 940, President: Berne Paulsson, MD: Ulf Lundwall. Labels (owned): HSM Records; Main product: Album Rock, Hard Rock.

ITCHY MUSIC, PO Box 357, 901 07 Umea, 090.180 165, Fax: 090.180 164, MD: Stig Waldemarsson.

KEN-TONE RECORDS & PUBLISHING, PO Box 344, 184 26 Akersberga, 0764.23456, Fax: 0764.23145, MD: Ken Neptune, Press: Christine Neptune. Main product: Dance.

LADYBIRD, Tegnergatan 29, 111 40 Stockholm, 08.240 299, Fax: 08.210 652, Mgrs: Bjorn Johansson, Maria Molin Lunggren.

LYNX RECORDS, Tallmatargatan 1c, 721 34 Vastaras, 021.129 500, Fax: 021.129 212, MD: Roger Bengtson, Mktg Mgr: Nalle Eldas.

MEGA RECORDS (SWEDEN), Rissneleden 134, 172 48 Sundbyberg, 08.733 3165/2415, Fax: 08.733 4930, MD: Tyko Blake. Labels (owned): Mega Records, Mega Rock, Coma Records; (Lic): Tommy By, Next Plateau, ARS, Equinox, Blanco Y Negro.

MILL RECORDS, Fyrgård 4, PO Box 1163, 171 23 Solna, 08.834 360, Fax: 08.839 903, Tlx: 12442, MD: Hans Larsson. Labels: Bandana, Box, Mill, Rival, Swe-Disc.

MISTLUR RECORDS, Ingmarsgatan 1a, 104 32 Stockholm, 08.612 8220, Fax: 08.612 3086, President: Peter Yngren, MD: Stefan Glaumann, A&R: Lizzie Jorgensen. Labels (owned): Garden, Wire, Telegram Records. Distribution: Musikdistribution.

MNW, Radhusgata 19, PO Box 271, 185 21 Vaxholm, 0764.33450, Fax: 0764.30060, MD: Jonas Sjöstrom, Int'l Mgr: John Cloud, Import/Export Mgr: Ann-Marie Beckman-Forsman, Prod Mgrs: Lars Tengroth, Curt-Ake Stefan (Eng), Accts: Chris Jangelov, Lena Skold. Labels (owned): MNW, Silence, Radium 226.05, Public Records; (Lic): Tommy Boy, Blast First; Main product: Album Rock, Dance, Reggae, Folk, New Age.

THE MUSIC ORGANIZATION, PO Box 16118, 200 25 Malmö, 040.187 050, Fax: 040.187 050, MD: Christer Gardsby.

NEW/LIONHEART RECORDS, PO Box 10062, 100 55 Stockholm, 08.662 0452, Fax: 08.661 7291, Presidents: Roffe Persson, Bobby Ljunggren, Admin Dir: Maria Ljunggren.

PHONO SUECIA, Sandhamnsgränd 79, PO Box 27327, 102 54 Stockholm, 08.783 8800, Fax: 08.662 6275, Tlx: 15591 stim, Label Mgr: Ann Marie Befrage. Labels (owned): Phono Suecia, Favorit, Friendship Through Music; Main product: Swedish contemporary, classical, jazz.

PITCH CONTROL, PO Box 295, 10125 Stockholm, 08.208 030, Fax: 08.140 568, MD: Michel Petre.

PLANET RECORDS & MUSIC, Torggatan 15, 171 54 Solna, 08.627 9797, Fax: 08.627 9796, Tlx: 14392 planrec, President: Mats Olsson, MD: Maj-Britt Olsson, A&R/Artist Liason (Int'l): Fredrik Olsson, Mktg/Sales: Mikael Andersson. Labels (owned): Planet, Bastun, Dance Disco, Pianola, Clever, Knight, Sequel, Masterpiece, Magnum; (Distri): Afinity, Atlantis, Bluelime Caliente, Charly, Chess, Decal, Goldband, Malaco, Max, Raya, DJ Connection, Official, Sun, Swingtime.

POLAR MUSIC, PO Box 26212, 100 41 Stockholm, 08.677 6700, Fax: 08.215 333, MD: Stig Anderson. Distribution: Sonet.

POLYGRAM SWEDEN, Marikhallsvägen 37, Box 20510, 161 02 Bromma, 08.764 7350, Fax: 08.764 5688, Tlx: 10466, MD: Lennart Backman, Mktg Mgr: Krister Nilsson, A&R Mgr: Peo Berghagen, Contr: Kennel Oxelgren.

PROPRIUS MUSIK, Vartavägen 35, PO Box 10251, 100 55 Stockholm, 08.660 9602, Fax: 08.660 9749, President: Jacob Boethius. Labels (owned): Propius, Lyricon, Alving Classical Records; Main product: Jazz, Classical.

PUBLIC ROAD RECORDS, Allmänna Vägen 26, 41460 Goteborg, 03112 2106, Fax: 03124 1808, MD: Stegan Engberg.

RADIUM 226.05, Sodra Allegatan 3, 413 05 Goteborg, 031.130 039, Fax: 031.139 039, President: Ulrich Hillebrand.

THE RECORD STATION, Starrbacksgatan 1, PO Box 26, 172 21 Sundbyberg, 08.733 5300, Fax: 08.294 337, Tlx: 11794 bmg, A&R: Marie Ledin, Press/Promo: Nutta Hultman.

REEL RECORDS, PO Box 19003, 10432 Stockholm, 08.612 8220, Fax: 08.612 3086, MD: Tomas Summo.

RICOCHET PRODUCTIONS, PO Box 39061, 100 54 Stockholm, 08.664 0460, Fax: 08.664 0479, MD: Peter Swartling, Press/Promo: Frank Ronningen, A&R: Lars Ryen. Labels (owned): Ricochet, Rhyme Records; (Lic): Control; Distribution: CNR/SGA; Main product: Dance, Black (R&B).

SCRANTA GRAMMOFON, PO Box 2037, 691 02 Karlskoga, 0586.56030, Fax: 0586.55400, Tlx: 73931, MD: Ebbe Nilsson.

SONET GRAMMOFON (SWEDEN), Tappavägen 24, PO Box 20105, 161 02 Bromma, 08.627 3800, Fax: 08.983 0770, Tlx: 10037 sonet, Chmn: Dag Haeggvist, Int'l Director: Lars-Olof Helen, A&R Mgrs: Patrik Sventelius (Int'l Promo), Ola Hakansson (Local), Promo (Local): Jonas Holst. Labels (owned): Sonet, Storyville, Gazell, Spotlight; (Lic): Alligator, Attic, Expression, Curb, Fotodisk, Ghetto, In+Out, Mushroom, Mute, One Little Indian, PWL, Rhythm King, Rough Trade, SweMix, Telegram, Antone's, China, Genlyd, Hollywood, Legacy, Round Tower; Main product: all categories carried—no New Age.

SONY MUSIC ENTERTAINMENT (SWEDEN), Mariehallsvägen 40, PO Box 20037, 161 02 Bromma, 08.980 250, Fax: 08.286 751, Mktg Dir: Per Sundin, Artist Mktg Dir: Hakan Krantz, Sales Dir: Niklas Back, A&R Dirs (Local): Thomas Haggblom, Billy Bolero, Int'l Product Mgrs: Hans Skoglund, Elisabet Lova, Promo Mgr: Eva Hulth, Promo Asst: Vickie Harris.

STERLING, Smalandsgatan 11, 11146 Stockholm, 08.212 096, Fax: 08.611 6011, Dir: Bo Hyttner.

SUPERFAX PRODUCTIONS, Skogsgäntan, 510 95 Dalstorp, PO Box 18 (Zip: 510 95), 0321.60547, MD: Richard Halifax.

SWEMIX RECORDS & PUBLISHING, Tjarnhovsgatan 10, 116 21 Stockholm, 08.643 4500, Fax: 08.644 4484, MD: Tom Talomaa, Label Mgr: Rene Hedemyr, Producer: Stone Bridge, Promo Mgr: Sten Hallstrom. Labels owned: SweMix, Basement Division, Back to Basics; Distribution: Sonet.

SYNCHRO SOUND MUSIC, Vasagatan 6, PO Box 1049, 172 21 Sundbyberg, 08.281 346/289 864/604 4083(pr), Fax: 08.984 140, VP: Douglas Lawton, Mgr: Hasse Olsson.

TAB, PO Box 196, 732 24 Arboga, 0589.10350, Fax: 0589.10350, MD/A&R: Harry Holm. Labels (owned): TAB; Main product: Dance, AC, Album Rock, Gold/Oldies, Country.

TELEGRAM RECORDS, Ingmarsgatan 1a, 104 32 Stockholm, 08.612 8220, Fax: 08.612 3086, MD/Owner: Peter Yngen, A&R/Owner: Klas Lundung, Production: Lizzie Jorgensen, Camilla Andersson. Labels (Owned): Ohm, Swing-a-ling; Main product: Dance, Jazz, Black (R&B), Reggae, New Age, Techno.

TRA LA LA PRODUCTIONS, Krukmakargatan 29, 118 51 Stockholm, 08.844 720, Fax: 08.669 7140, MD: Alexander Bard (Producer), A&R: Michael Goulos (Producer), Producer: Anders Wollbeck. Labels (owned): Sunrise, Ton Son Ton; Main product: Dance, Black (R&B).

VINYL MANIA, PO Box 20043, 161 02 Bromma, 08.988 840, Fax: 08.296 704, Tlx: 12828, MD: Fredrik Ramel, Import/Export: Michel Petre, Int'l Director: Per Lonstrom.

VIRGIN RECORDS SWEDEN, Tappavägen 24, PO Box 806, 161 24 Bromma, Stockholm, 08.627 3800, Fax: 08.985 712, MD: Anders Hjelmtorp, Deputy MD: Bertil Holmgren, Mktg Dir: Janne Lundquist, Sales Dir: Anders Wiklund, A&R: Per Lonstrom, Label Mgrs: Mikael Agnepl, Asa Tornevad, Promo: Ulf Waldecrantz. Distribution: Warner.

VIVA RECORDS, Sollentunavägen 141, PO Box 85, 191 22 Sollentuna, 08.926 860, Fax: 08.963 694, MD: Lars Pettersson, Mktg/A&R: Leif Cederfjord. Labels (owned): Cantio Records, Megaphone, Viva.

WARNER/METRONOME MUSIC SWEDEN, Osterogatan 4, PO Box 1228, 164 28 Kista, 08.752 2600, Fax: 08.752 9650, MD: Hans Englund, Fin Contr: Susan Olmert, Dep MD: Ingemar Ostberg, Mktg Dir: Kjell Andersson, Int'l Label Mgr: Mattias Wachtmeister, Promo Mgr: Bo Frolander, Promo/Label Mgr: Lotta Boderholm.

WIRE RECORDS, Ingmarsgatan 1a, 104 32 Stockholm, 08.612 8899, Fax: 08.612 3086, President: Per Kviman, Chmn: Peter Yngen, Sec: Mia Hansson. Distribution: Musikdistribution.

MUSIC PUBLISHERS

AIR MUSIC SCANDINAVIA, Valhallavägen 134, PO Box 10220, 100 55 Stockholm, 08.663 0720, Fax: 08.663 9235, Tlx: 12335 airmv, President: Lars Wiggman, MD: Martin Ingestrom. (Owned): Flamingo musik; (Sub-pub): Essex, David Platz, Bug, Eaton, Chrysalis, Hamstein, Albert Music.

ALBERT MUSIC, see Air Music Scandinavia.

ALL NATIONS MUSIC, see Sonet Music.

ALPHA RECORDS, Rasundavägen 45, 171 52 Solna, PO Box 3042 (Zip: 171 03), 08.730 0400, Fax: 08.730 1015, Tlx: 10551 sound, President: Benny Hedlund.

AMALTHEA GRAMMOFON, PO Box 286, 201 22 Malmö, 040.79889, Fax: 040.3976 008, Tlx: 33918 amal, MD: Torngy Sjöo.

AMIGO MUSIK, Norrbackgatan 47, PO Box 6058, 102 31 Stockholm, 08.340 195, Fax: 08.340 698, MD: Per Anders Boquist, Mgr: Jan Boquist.

ANGELICA, see Borg Music.

BAD DOG, see Misty Music.

BANDAMA, see Borg Music.

BMG MUSIC PUBLISHING, Starrbacksgatan 1, PO Box 1026, 172 21 Sundbyberg, 08.627 5300, Fax: 08.294 337, MD: Stefan Eklund.

BORG MUSIC, PO Box 14014, 200 24 Malmö, 040.937 678, Fax: 040.937 496, President: Bjorn Gardsby, MD: Anders Theander, Prod Mgr: Bjorn Holmberg. (Owned): Dark Continent, Mango Chutney, Bandama, These Blude Days, Sannie, Michael Surdi, Angelica, Karen Krogh.

BREEZE MUSIC, see New Music.

BRUCE SPRINGSTEEN, see Sonet Music.

BUG, see Air Music Scandinavia.

CAMP MUSIC, PO Box 231, 172 26 Sundbyberg, 08.982 808, Fax: 08.982 855, President: Lars Samuelson, MD: Hakan Samuelson. (Owned): Camp Music; (Sub-pub): Two John's Music, Just A Note Music, Heath Music.

CARELESS MUSIC RECORDS, PO Box 5094, 131 05 Nacka 5, 08.735 6855/615 1605, Fax: 08.735 6875, Dir: Les Carlton, Mgr: Margareta Henriksson.

CASADIDA, see Scandinavian Songs.

CASTLE MUSIC LIBRARY, see Cue Musikreklam.

CHRYSALIS, see Air Music Scandinavia.

CLOUD MACHINE, see Misty Music.

CMM CREATIVE MUSIC MAKERS, PO Box 31, 532 21 Skara, 0511.13035, Fax: 0511.18088, President: Torngy Soderberg, Producer: Lasse Holm, Label Mgr: Anders Hjalmarsson, Prof Mgr: Chris Severinsson.

COMPANION MUSIC (SWEDEN), Polhemsgatan 28, 112 30 Stockholm, 08.652 0260, Fax: 08.652 5256, MD: Kaj Lunden Welden.

CUE MUSIKREKLAM, PO Box 17047, 104 62 Stockholm, 08.105 810, Fax: 08.644 6272, President: Eva Golert, MD: Max Ljungquist. (Owned): Interpool Music Library, Rader Publishing; (Admin): Castle Music Library, Focul Music Library (UK), Network Music Library (UK), Network Sound Effects (USA).

CURCI, see Scandinavian Songs.

DARK CONTINENT, see Borg Music.

DAVID PLATZ, see Air Music Scandinavia.

EATON, see Air Music Scandinavia.

ECHO BAY SONORICS, see Misty Music.

EG, see Sonet Music.

EHRLING & LOFVENHOLM, see Nordiska Musikforlaget.

ELKAN & SCHILDKNECHT, EMIL CARELIUS, Eriksdalsgatan 20nb, 118 59 Stockholm, 08.641 0606, President: Anders Carelius. Main product: Gold/Oldies, Classical.

ELLYMAX, see Misty Music.

EMERALD FOREST ENTERTAINMENT, see Misty Music.

EMI MUSIC PUBLISHING SCANDINAVIA, Humblegatan 20, 172 39 Sundbyberg, PO Box 3516 (Zip: 172 03), 08.294 040, Fax: 08.986 028, Tlx: 19687 emi pub, MD: Stefan Egmar, Prof Mgr: Nina Schrijvershof, Synchronization Lic Mgr: Bjorn Skylling, Copyright/Royalty Mgr: Mats Svensson. (Owned): EMI Music Publishing Scandinavia, EMI Songs Scandinavia, EMI Catalogue Partnership Scandinavia; (Admin): Step Six Music.

EMPIRE RECORDS, Duvholmsgränd 56, PO Box 4049, 127 04 Svarholmen, 08.740 6401, Fax: 08.740 1855, President: Jimmy Andersson, Chmn: Patrik Yderberg.

ESSEX, see Air Music Scandinavia.

FLAMINGO MUSIK, see Air Music Scandinavia.

FLAMINGO MUSIKFORLAG, Valhallavägen 134, PO Box 10220, 100 55 Stockholm, 08.663 0720, Fax: 08.663 9235, Tlx: 12335 airmv.

FOLCUS MUSIC LIBRARY, see Cue Musikreklam.

FORLAGET FILADELFIA, Gammelgardsvägen 38-42, 105 36 Stockholm, 08.130 340, Fax: 08.657 9029, Tlx: 10888, Contact: Olle Widlirp.

FRITUNA PRODUKTION, Vartavägen 15, 115 28 Stockholm, 08.663 1345, Fax: 08.660 1754, Tlx: 123 28 frituna, President: Goran Waltner.

FUZZBOX, see Misty Music.

GARDENIA, see Misty Music.

GLEN SONGS, PO Box 67, 182 71 Stocksund, 08.856 800, Fax: 08.856 801, MDs: Ann-Louise Glenmark, Bruno Glenmark.

GOOD WILL MUSIC, Osterangsvägen 33, 181 47 Lidingsö, 08.792 3545, Fax: 08.792 3545, President: Hans Busch.

GULL SONGS, see Misty Music.

HAMSTEIN, see Air Music Scandinavia.

HAWK, see Scandinavian Songs.

HEATH MUSIC, see Camp Music.

HSM MUSIC (SWEDEN), PO Box 1122, 221 04 Lund, 046.149 775, Fax: 046.184 940, President: Bernt Paulsson, MD: Ulf Lundwall. (Owned): HSM Music; Main product: Album Rock, Hard Rock.

IGLOO, see Misty Music.

IMAGE, see Scandinavian Songs.

IMPATIENT, see Misty Music.

INTERPOOL MUSIC LIBRARY, see Cue Musikreklam.

ITCHY MUSIC, PO Box 357, 901 07 Umea, 090.180 165, Fax: 090.180 164, MD: Stig Waldemarsson.

JAY BEE MUSIC, PO Box 39061, 100 54 Stockholm, 08.783 0202, MD: Peter Swartling, Prof Mgr: Torbjorn Johansson. (Owned): Jay Bee Music; (Admin): Ricochet Music, Upfront Songs; Main product: Dance, Black (R&B).

JIMMY FUN MUSIC, Brickebergsvägen 21a, 702 21 Örebro, 019.360 015, Fax: 019.361 015, Contact: Jan Beime.

JUST A NOTE MUSIC, see Camp Music.

KAREN KROGH, see Borg Music.

KASHIF, see Sonet Music.

KEN-TONE RECORDS & PUBLISHING, PO Box 344, 184 26 Akersberga, 0764.23456, Fax: 0764.23145, MD: Ken Neptune, Press: Christine Neptune. Main product: Dance.

KRISMIK & ZOOMIK, see Misty Music.

MANGO CHUTNEY, see Borg Music.

MARK-CAIN, see Misty Music.

MEGA RECORDS (SWEDEN), Rissneleden 134, 172 48 Sundbyberg, 08.733 3165/2415, Fax: 08.733 4930, MD: Tyko Blake.

MEGATRON, see Misty Music.

MICHAEL SURDI, see Borg Music.

MISTY MUSIC, Ingemarsgatan 1a, 104 32 Stockholm, PO Box 19003 (Zip: 104 32), 08.612 8220, Fax: 08.612 3086, MD: Anders Moren. (Owned): Gardenia, Igloo, Telegram, Too Bossy, Impatient, Plinque Plonque, SweMix, Sone, Ricochet, Fuzzbox; (Admin): MNW, Echo Bay Sonorics, Silence, Red Herring, Cloud Machine, Ellymax, Emerald Forest Entertainment, MMA, Mark-Cain, Terrace Entertainment, Gull Songs, Megatron, Nettoverboard, Wixen, Bad Dog, Krismik & Zoomik.

MMA, see Misty Music.

MNW, Radhusgata 19, PO Box 271, 185 21 Vaxholm, 0764.33450, Fax: 0764.30060, GM: Jonas Sjostrom.

NETTOVERBOARD, see Misty Music.

NETWORK MUSIC LIBRARY, see Cue Musikreklam.

NETWORK SOUND EFFECTS, see Cue Musikreklam.

NEW MUSIC, PO Box 10662, 100 55 Stockholm, 08.662 0452, Fax: 08.661 7291, President: Roffe Persson. (Admin): Breeze Music.

NORDIC SONGS, see Nordiska Musikforlaget.

NORDISKA MUSIKFORLAGET, Nybrogatan 3, 114 34 Stockholm, 08.144 240, Fax: 08.112 167, Tlx: 11859 music, President: John Eric Westo, Project Mgr: Karl Vase. (Owned): Nordiska, Wilhelm Hansen Stockholm, Ehrling & Lofvenholm, Nordic songs.

PAUL SIMON, see Sonet Music.

PEER MUSIC A.B.

Barstigen 28, S-161, 46 Bromma, Stockholm, (46-8) 704-0140, Fax: (46-8) 704-8100, MD: Hasse Skoog, Creative Dir.: Lars Karlsson.

PLANET RECORDS & MUSIC, Torggatan 15, 171 54 Solna, 08.627 9797, Fax: 08.627 9796, Tlx: 14392 planrec, President: Mats Olsson, MD: Maj-Britt Olsson.

PLANGENT VISIONS, see Sonet Music.

PLATA PUBLISHING, Engelbrektsgratan 14b III, 11432 Stockholm, 08.789 8908, Fax: 08.791 8833, VP: Willard Ahdrizt.

PLINQUE PLONQUE, see Misty Music.

PROPHONE MUSIC, Selmedalsringen 15, 126 70 Stockholm, PO Box 210 (Zip: 126 02), 08.191 960, Fax: 08.197 528, President: Erlend Boethius. (Owned): Prophone; Main product: Jazz, Classical.

PROPRIUS MUSIK, Vartavägen 35, PO Box 10251, 100 55 Stockholm, 08.660 9602, Fax: 08.660 9749, President: Jacob Boethius.

RADER PUBLISHING, see Cue Musikreklam.

RED HERRING, see Misty Music.

RICHTERS FOERLAG, O. Foerstadsgatan 46, 205 75 Malmö, 040.380 600, Fax: 040.930 820, Tlx: 33180, MD: Lars G Gustafsson, Mktg Mgr: Joergen Hansen.

RICOCHET MUSIC, see Jay Bee Music.

RIVAL INTERNATIONAL, Fryrgård 4, 171 23 Solna, 08.834 360, Fax: 08.839 903, Tlx: 12442, MD: Owe Midner.

SANNIE, see Borg Music.

SCANDINAVIAN SONGS, Polhemsgatan 28, 112 30 Stockholm, 08.652 0260, Fax: 08.652 5256, MD: Kaj Lunden Welden. (Owned): Hawk; (Admin): Casadida, Young Musikverlag, Image, Curci, Slager, TBM Scandinavia, Sing A Song Publishing.

BLANK & BULK RAW TAPE

3M SWEDEN, Bollstanaesvagen 3, 191 89 Sollentuna, 08.922 100, Fax: 08.754 5537, Contact: Attn: Buyer.

AMPEX SCANDINAVIA, Rissneleden 8, 172 07 Sundbyberg, PO Box 7056 (Zip: 172 07), 08.282 910, Fax: 08.293 396, Tlx: 10867, MD: W Bjoerklund, Contact: Teddie at Buren.

BASF SWEDEN, Kungssportsavenyen 31-35, PO Box 53008, 400 14 Goteborg, 031.639 800, Fax: 031.187 681, Contact: Attn: Buyer.

BENSSON ENTERPRISES, Bragevagen 8, 114 24 Stockholm, 08.791 0098, Fax: 08.791 8905, Contact: Lawrence Bensson.

MAXELL SWEDEN, PO Box 200, 161 20 Bromma, 08.988 650, Fax: 08.292 890.

CD, RECORD & TAPE MANUFACTURING SYSTEMS

ARVA TRADING, Hostbruksvagen 15-17, 222 60 Lund, PO Box 1239 (Zip: 221 05), 046.320 370, Fax: 046.320 360, MD: Olof Arvidsson. Distribute: Lyrec (Den).

AUDIO DEVELOPMENT, Nora Neptunigatan 5, 211 20 Malmo, 040.128 140, Fax: 040.232 710, MD: Jan Rundqvist, Sales Mgr: Monika Oesterheim. CD computer-aided test equipment.

AVAC APPLIED VACUUM, PO Box 5047, 580 05 Linköping, 013.115 170, Fax: 013.104 190, MD: Ulf Blomquist. CD manufacturing equipment.

BENSSON ENTERPRISES, Bragevagen 8, 114 24 Stockholm, 08.791 0098, Fax: 08.791 8905, Contact: Lawrence Bensson.

MASKINTEKNIK JAN HUUSMAN, Radiovagen 5d, 135 48 Tyreso, 08.798 9830, Fax: 08.742 6933.

P.F. SAMSON AKTIEBOLAG, Sveavägen 1, 335 00 Gnosjö, 0370.9187/92210, Fax: 0370.92265, Dir: Freddie Samson.

STUDIO TEKNIK, Banvaktsvagen 24, 171 48 Solna, 08.734 0750, Fax: 08.824 476, President: Tore Hedlund. Sales and distribution.

TOOLEX ALPHA, PO Box 1176, 172 25 Sundbyberg, 08.289 030, Fax: 08.289 532, MD: Bjorn Lindberg, Contact: Gunnar Axe. Optical disc storage manufacturing systems.

VIDEOGRAM, PO Box 295, 580 01 Linköping, 013.136 460, Tlx: 50029, MD: Roger Fransson.

TAPE PACKAGING & LABELING EQUIPMENT

ZANDERS INTERNATIONAL, Kryptogatan 6, 431 33 Molndal, 03187 0520, Fax: 03187 7230, Tlx: 21631 zanders, Dir: Stefan Spang, Sales Mgr: Lennart Brick. Agent for Marden Edwards & Co (packaging/labelling equipment manufacturers).

SWITZERLAND**RECORD COMPANIES**

ACTIV RECORDS, Bettlistrasse 28, 8600 Duebendorf, 01.821 9595, Fax: 01.821 9651, Tlx: 825337, MD: Guido Eugster.

B & H SOUND MEDIA VERSAND, Kostastrasse 6, 6010 Kriens, 041.458 877, Fax: 041.458 881, Tlx: 865590 eur.

BAUR MUSIC PRODUCTION, Steinhaldenstrasse 8, 8954 Geroldswil, 01.748 1001, Fax: 01.748 0075, Chmn: Rene Baur, A&R Mgr: Beat Starkermann. Labels (owned): Baur Music Production (TV advertised), Drive (budget-line CD's).

BELLAPHON, Farbhofstrasse 21, 8048 Zurich, 01.431 7402, Fax: 01.432 1382, MD: Branko Zivanovic.

BLACK CAT, Eggstrasse 5a, 8124 Maur, 01.980 0925, Fax: 01.980 3083, Contact: Kurt Heilinger.

BMG ARIOLA SWITZERLAND, Letziggraben 89, 8047 Zurich, 01.491 5390, Fax: 01.491 3809, Tlx: 822462, MD: Marco Zanotta, A&R Mgr: Bruno Huber, Head of Mktg & Promo: Hans Perret, Head of Prod Mgmt: Urs Widmer, Prod Mgrs: Marco Duschetta, Gilbert Dupuis, Label Mgrs: Sonia Wiederkehr (Virgin), Daniel Batsiger (MCA/Geffen), Promo Mgr: Barbara Singer, F&A: Guido Vendramini.

BPM RECORDS, Roemerstrasse 4, 5400 Baden, 041.5621 2748, Fax: 041.5621 2748.

BRAMBUS RECORDS/GRAMMOPHONE HEEB, Alexanderstrasse 14, PO Box 216, 7001 Chur, 081.226 244, Fax: 081.227 427, Dir: Markus Heeb, Label Mgrs: Paul Rostetter, Alice Hendry (Asst), Sec: Pia Heeb. Labels (owned): Brambus Records.

CANARIS RECORDS, Zugeroseeweg 1, 8810 Horgen, 01.725 7946, Fax: 01.725 7965, MD: Helen Burkhalter, Admin: Walter Eberhardsen. Distribution: Phonag.

CHAMPAGNE MUSIC, Untermuehleweg 9, 6300 Zug, 042.321 043, Fax: 042.310 041, MDs: Daniel Joerin, Monika Joerin.

CLAVES RECORDS, Truelweg 14, 3600 Thun, 033.231 649, Fax: 033.228 003, MD: Marguerite Duetschler-Huber.

CLEO MUSIC, Buechlistrasse 27, 8854 Gaigenen, 055.644 570, Fax: 055.645 616, Art Dir: Gian Piero Reverberi.

COD RECORDS, Steinhaldenstrasse 21, 6330 Cham, 042.414 666, Fax: 042.418 008, President: Hans Raymondaz.

CSR RECORDS, Dienersstrasse 62, 8004 Zurich, 01.241 5870, Fax: 01.291 528, MD: Cyrill Schlaepfer.

DINO MUSIC, Ruessenstrasse 5b, 6340 Baar, 042.322 808, Fax: 042.322 870, MD: Andre Lehmann, Asst to MD: Max Buerki. Labels (owned): Dino; Main product: EHR, Adult Contemporary, Classical, Dance, Album Rock, Gold/Oldies, Black (R&B).

DIRCOM, Fausse-Brayes 19, 2000 Neuchatel, 038.258 893, Fax: 038.258 295. Main product: Dance.

DISCOTRAGE, Langstrasse 64, 8026 Zurich, PO Box 130 (Zip: 8026), 01.242 7322, Fax: 01.241 9425, President: Alec von Tavel, MD: Ursula Rohr, Sales Mgr: Daniel Campigotto. Labels (owned): Out of Tune; Main product: Dance, Album Rock, Country.

ELECTROMUSIC, Industriestrasse 121, 4147 Aesch, 061.782 100, Fax: 061.782 922, Tlx: 63754, Dir: Beat Fogelin, Sales Mgr: J Dreier, Prod Dir: Hans Peter Eggenberger, Contact: Kurt Mettler. Labels (owned): Tell, EMR, Alpina.

EMI RECORDS, Buckhauserstrasse 24, 8048 Zurich, 01.491 0010, Fax: 01.493 2255, Tlx: 822150, MD: Peter Mampell, Fin Dir: Urs Raebensamen, Mktg Dir: Teddy Meier, Snr Prod Mgr: Peter Kuendig, Snr Promo Mgr: Gaby Wyss, Mgr (Classical): Daniel Hungerbuehler, Promo Mgr (Classical): Theres Zuegg, Sales Mgr: Max Trostel.

EUROTOP MUSIC & PRODUCTIONS, Birmerweg 22, 3303 Jegenstorf, 031.961 996, Fax: 031.851 365, Tlx: 911680 prod, Artist Mgr: Frank Furrer.

EXIT RECORDS, Ringstrasse 14, PO Box 173, 8600 Duebendorf-Zurich, 01.821 3003, Fax: 01.820 3060, MD: Willy Vitka. Labels (owned): Cala Dor, Cantitalia, Catch 22, Exit, Vitka-Exit, Music Association, Alcala, Chamberi, Cuatro Caminos, Salida, Quatro, Way Out; (Lic): Chrystal Vision, Danger, 41, Fremus, Gilt Edge, Horus, NJM, Pingo, RGJ, Scrinta, Stop 'N', Sylvia, Wild Angle, AZ, Farias, La Rocca, Jingle Express, Mondrago, Scarabes, Second Hand.

FANTASY INTERNATIONAL, Aarberggasse 35, 3011 Bern, 031.229 294, Fax: 031.229 295, President: Tony D, VP: Paolo Pavan, MD: Max Witschi.

FINK & STAR PRODUCTION, Josefstrasse 106, 8031 Zurich, PO Box 108 (Zip: 8031), 01.271 8820, Fax: 01.271 3350, President: George Reinhart, MD: Urs Ullmann, A&R: Hildegard Schmidt, Admin: Peter Wagener, Production: Stefan Hose. Distribution: Phonag Records; Main product: AC, Album Rock, New Age.

FONO LUZERN, Zinggendorferstrasse 5, 6006 Lucerne, 041.511 254, Fax: 041.515 452, MD: Paul Cron. Main product: Jazz & spiritual music.

GOLD RECORDS, Alte Landstrasse 23, 8942 Oberrieden, 01.720 8200, Fax: 01.720 8700, Tlx: 59013, MDs: Madeleine Henriou, Bernard Henriou.

GRP RECORDS, Stampfenbachstrasse 69, 6035 Zurich, 01.363 6716, Fax: 01.363 3745, Eur Affairs Dir: Jon Diamond, Mktg Dir: Kurt Weil, Fin Contr: Rachel Deprez.

HAT HUT RECORDS, PO Box 461, 4106 Therwil, 061.736 655, Fax: 061.736 655, Contact: Werner Uehlinger. Main product: jazz, modern music.

HIPPO RECORDS, Forchwaldstrasse, PO Box 47, 6318 Walchwil, 042.771 380, Fax: 042.772 377, Contact: Frank Valdor.

IDG MUSIC, Marktgasse 12, 6340 Baar, 042.310 157, Fax: 042.310 744, MD/Producer: Jim Duncombe.

JECKLIN & COMPANY, Raemistrasse 42, 8024 Zurich, 01.261 7733, Fax: 01.252 4503, Tlx: 58507, Contact: Catherine Meystre.

JUNGLE RECORDS (SWITZERLAND), Chemin Taverney 7, 1218 Grand Saconnex, Geneva, 022.798 3770, Fax: 022.798 1523, President: Christian Joller, Dir Music Dept: Jose Dubey. Labels (owned): CPE; (Lic): Thrill.

KTEL INTERNATIONAL, Toedistrasse 68, PO Box 236, 8810 Horgen 1, 01.725 3683, Fax: 01.725 3633, Tlx: 826906, President: Martin Schiess, Mgmt Services: Walter Bestel, Sales Mgr: Kurt Lehmann, A&R: Reinhard Frey (Classical), Corinna Kiente (Pop/Dance), Export Mgr: John Lee, Promo: Susanne Behrendt. Labels (owned): Ara, Custom, Discophon, Jubila, Max, Maxli, Top-Disc, Top-Disc Gold, K-Tel, Blue Martin; Main product: all categories carried.

KOCH INTERNATIONAL, Wiedenstrasse 15, 9470 Buchs, PO Box 431 (Zip: 9470), 085.66061, Fax: 085.63284, Tlx: 855254, President: Franz Koch, GM: Elmar Fuerer. Labels (dist): Aperto, Aulos, Aurophon, Bella Musica, Buesi, Cottonfield, DRG, Europa Musica, Fortane, Int'l Chorakademie, Minos, Northeastern, Ondine, Organum, Selected Sound Carrier, Schwann, Schwanni, Studio Classico Berlin, Syncoop, Wuenschelburger Edition.

LAM LARGHETTO MUSIC, Boulevard James Fazy 10, Geneva, 022.732 8730, Fax: 022.732 3923, Dir: Pierre-Richard Muller.

MAULEY MUSIC, Rue Maunoir 16, 1207 Geneva, 022.736 4311, Fax: 022.736 0398, President: Thierry Mauley-Fervant. Labels (owned): M Records, Quartz Music; Distribution: Discoffice.

MBD PRODUCTION, Route de Lausanne 72, 1052 Le Mont-sur-Lausanne, 021.653 6042, Fax: 021.652 5908, Mgr: Valerie Perucchi.

MUSIC ASSOCIATION, Ringstrasse 14, PO Box 173, 8600 Duebendorf-Zurich, 01.821 3500, Fax: 01.820 3060, President: Willy Vitka. Labels (owned): BPM, MA; Distribution: Exit Records.

MUSIC CONSORT, Eugen Huber Strasse 61, 8048 Zurich, 01.432 7560, Fax: 01.432 6525.

O.B.H. MUSIKVERLAG, PO Box 2691, 6901 Lugano 1, 091.685 586, Fax: 091.685 586, President: Otto Hartmann. Labels (owned): Kick, Okay, Expo.

P B R RECORDS, Avenue du Tir Federal 80, 1024 Ecublens,

Lausanne, 021.691 2591/2, Fax: 021.691 2596, Contact: Bruno Pepe. Main product: South American folk music.

PANTHERA RECORDS, Johannes Gasse 6, 8005 Zurich, 01.271 9911, Fax: 01.271 1132, Owner: Rolf Graf.

PDU, Via Generoso 4, 6900 Lugano, 091.548 751, Fax: 091.545 780, Tlx: 844283, MD: Giacomo Mazzini, A&R/Prod Mgr: Massimiliano Pani, Asst to MD: Catherine Lackzo. Distribution: EMI.

PHONAG RECORDS, Wartstrasse 6, 8401 Winterthur, 052.213 6231, Fax: 052.212 5719, President: Peter Frei. Labels (owned): Helvetia, Phonag, Halleluja.

PICK RECORDS, Brunnwiesenstrasse 26, 8049 Zurich, 01.341 4440, Fax: 01.341 3325, Tlx: 822678, President: Anton Peterer, MD: Stephen F Peterer, Mktg Mgr: Oriana Gmuar, Sales Mgr: Jean Yves Konrad. Labels (owned): Pick Records, Pick International, Aktuell, Classic Pick, Hot Pick, Pickli, Swiss Made, International Pick; Distribution: Buch- und Musikhandel.

PINK SEVEN MUSIC, Zwingerstrasse 10, 4053 Basel, 061.352 800, Fax: 061.352 900, MD: Dieter Maerki.

PLAINISPHARE PRODUCTIONS & DISTRIBUTION, Route de Luins, 1267 Vich, 022.643 290, Fax: 022.643 584, President: Jef Duplain, MD: Rolf Knuesel, Promo: Khien Nguyen. Labels (owned): Plainisphere, Zone; (Dist): over 100 jazz labels; Main product: Jazz, Folk, Classical.

POLYGRAM SWITZERLAND, Rue du Roveray 14, 1211 Geneva, 022.736 9369, Fax: 022.786 5189, Tlx: 413278, GM: Brando Parlatano, Artist Liaison: Nadia Bugada. Branch office French-speaking Switzerland.

POLYGRAM SWITZERLAND, Bahnhofstrasse 6, 8952 Schlieren, Zurich, 01.732 4111, Fax: 01.732 4219, Tlx: 827715 ply, Chmn: Karl-Henry Borner, MD: Ossi Drechsler, Head Of Admin: Yves De Kinkel, Sales Mgr: Max Gfeller, Personnel/Logistic Mgr: Philipp Graf. Divisions: Polydor, Phonogram, Metronome, Barclay, A&M.

PRELUDIO PRODUCTIONS, Chemin de la Colice 11, PO Box 46, 1023 Crissier, 021.634 6644, Fax: 021.634 6647, MD: Philippe Stiner.

PRODUCTIONS CASCABELLE, Chemin de Bellefontaine 23, 1223 Cologny, Geneva, 022.735 7862, Fax: 022.735 7407, Art Dir: Erich Lauer.

PRODUCTIONS MUSICALES EVASION, Rue de l'Ale 25, 1003 Lausanne, 021.209 555, Fax: 021.311 0172, President: Francois Vautier, Dir: Pierre-Alain Chatton. Labels (owned): Evasion; Main product: Dance, AC, New Age, Chanson.

READERS DIGEST, Raefelstrasse 11, 8021 Zurich, 01.430 3833, Fax: 01.463 3523, Tlx: 813231, A&R Mgr: Lairo Burkhalter.

REC REC, PO Box 717, 8026 Zurich, 01.241 5055/71, Fax: 01.242 0344, Tlx: 814196, Contact: Daniel Waldner, Dominik Suss, Karin Koch.

SONY MUSIC ENTERTAINMENT, Oberneuhofstrasse 6, 6340 Baar, 042.333 363, Fax: 042.318 954, Tlx: 845868874, MD: Norman Block, Mktg Mgr: Annelies Hophan, Promo/Publ Mgr: Claude Bravi.

SOUND & MANAGEMENT, Forsterstrasse 66, 8044 Zurich, 01.262 2051/362 0558, Fax: 01.262 2051, MDs: Roger Furrer, Renate Maier. Labels (owned): Expression Records, Musicamundia Latin, Spass Records.

SOUND SERVICE WIGRA, Eigerweg 16, 3073 Gumligen, 031.520 710, Fax: 031.520 787, Contact: Rolf Widmer. Distributor.

TURICAPHON, PO Box, 8616 Riedikon/Uster, 01.941 1311, Fax: 01.941 2640, Dir-Gen: Hans Oestreich. Labels (owned): Elite Special, Artiphon, L&M, Bambi, AMC. (Lic): Airlift, Firebird.

TUXEDO MUSIC, Baumettes 15, 1020 Renens, 021.635 9091, Fax: 021.635 9096, Tlx: 450157 gefi, MD: Jean-Yves Leroy, Asst to MD: Laurence Gobet, Int'l Product Mgrs: Joelle Singy, Gaelle Giorgy. Labels (owned): Tuxedo; (Lic): Expression Records.

VANESSA PRODUCTIONS, Rue Neuve du Molard 8, 1204 Geneva, 022.215 278, Fax: 022.294 336, Tlx: 429800 dtg, MD: Stephane Hohl.

VDE-GALLO, PO Box 14, 1407 Donneloye, 024.331 546, Fax: 024.331 718, Tlx: 457219, Pres/Dir-Gen: Olivier Buttex, Asst Mgr: Catherine Noel. Labels (owned): Gallo, VDE, Paroles; Distribution: Disques Office.

VIRGO ARTIST MUSIC, PO Box 689, 1214 Vernier, Geneva, 022.413 986, Fax: 022.413 985, President: Erich Lauer. Labels (owned): Virgo Disc; Main product: classical, jazz, modern music.

VITEKA MUSIC, Ringstrasse 14, PO Box 173, 8600 Duebendorf-Zurich, 01.821 3003, Fax: 01.820 3060, MD: Willy Vitka. Labels (owned): Cantitalia, Vitka-Exit; Distribution: K-Tel International.

WARNER MUSIC SWITZERLAND, Avenue de Chillon 70, 1820 Montreux, 021.963 2763, Fax: 021.963 2760, Tlx: 453178, MD: Claude Nobbs. Labels: Asylum, Atco, Atlantic, Blanco Y Negro, CGD, Cold Chillin, Cottilion, Critique, Crusaders, Dark Horse, Duck, Edition 23, Elektra, Es Paranza, Finnadar, Franceval, Full Moon, Gaumont, General Music, Impulse, Korova, Lorimar, Master Series, Megaforce, Midl, Musician, Muvis, Nonesuch, Paisley Park, Philly World, Qwest, Reprise, Sire, Suddah, Swan Song, Tommy Boy, Valentino, Warner Bros, WEA Europe, WEA Int'l, Westminster, Zebra; Distribution: Musikvertrieb.

WOLF DOG INTERNATIONAL, Gjuchstrasse 15, 8953 Dietikon, 01.740 0000, Fax: 01.740 0558, Tlx: 828365, Dirs: Michel Eggenschwiller, Peter Boni.

ZAR, Dreiliindenstrasse 42, 9011 St. Gallen, 071.255 666, Fax: 071.254 098, Owner: Victor Waldburger, Mgrs: Sabine

Waldburger, Marc Liyanage. Labels (owned): ZAR, Bommerang; Main product: Dance, Album Rock, New Age, Heavy Metal, Techno House.

MUSIC PUBLISHERS

150 BPM, see Cod Records.
ALAG MUSIC, Josefstrasse 106, 8031 Zurich, PO Box 108 (Zip: 8031), 01.271 8820, Fax: 01.271 3350, MD: Urs Ullmann, Asst: Peter Wagner. Main product: AC, Album Rock, New Age.
ALEGRIA MUSICA, Steinerstrasse 4, 8914 Ottenbach, 01.761 2406, Fax: 01.761 4516, Tlx: 817585104.
ALEXAS MUSIC CONNECTION, see Leuberg Edition.
ALL BOYS MUSIC INTERNATIONAL, Ringstrasse 14, PO Box 173, 8600 Duebendorf-Zuerich, 01.821 3003, Fax: 01.820 3060, Chmn: Pete Waterman, MD: Willy Viteka. (Owned): All Boys Music.
ANACONDA, see Viteka Music.
ASCONA, see Wintasco Verlag.
AUTOBAHN, see Leuberg Edition.
BLACK CAT, Eggstrasse 5a, 8124 Maur, 01.980 0925, Fax: 01.980 3083, President: Kurt Heilingner.
BLOOMFIELD, see Edition Intermelodie.
BLUE PICASSO, see Zar.
BRIDGEPORT, see Edition Intermelodie.
BROTHER & BROTHER, see Check Point Music Publishing.
CALA DOR MUSIC, see Viteka Music.
CANARIS, see Wintasco Verlag.
CHECK POINT MUSIC PUBLISHING, Rainweg 6, 8967 Widen, 057.331 917, Fax: 01.725 3633, Owner: Martin Schiess, Publ Mgr: John Lee. (Owned): Jeff Turner, Steve Whitney Band, Fool House, Sydney, East; (Admin): Savannah Label, Brother & Brother; Main product: Adult Contemporary, Country, Album Rock, Gold/Oldies, Black (R&B).
CRYSTAL VISION, see Viteka Music.
CLAVES RECORDS, Truelweg 14, 3600 Thun, 033.231 649, Fax: 033.228 003, MD: Marguerite Duetschler-Huber.
CLEO MUSIC, Buechlistrasse 27, 8854 Galgenen, 055.644 570, Fax: 055.845 616, Art Dir: Gian Piero Reverberi.
COD RECORDS, Steinhäuserstrasse 21, 6330 Cham, 042.414 666, Fax: 042.418 008, President: Hans Raymondaz. (Owned): 150 BPM, Fun Key, Soundways, Decoder, Lux Noise.
COSIMA MUSIC, see Leuberg Edition.
CRAMMED DISCS, see Obsession Editions.
DANCETERIA, see Obsession Editions.
DECODER, see Cod Records.
DENISE RICH CATALOGUE, see IDG Music.
DICK JAMES, see Leuberg Edition.
DISCTRADE, Langstrasse 64, 8026 Zurich, PO Box 130 (Zip: 8026), 01.242 7322, Fax: 01.241 9425, President: Alec von Tavel, MD: Ursula Rohr, Sales Mgr: Daniel Campigotto. (Owned): Out of Tune.
DISQUES OFFICE, Route de la Glane 31, 1700 Fribourg, 037.246 261, Fax: 037.241 986/243 763, Tlx: 942335, President: Jean-Claude Vial, MDs: Marcel Jaquier, Damien Vial.
EAST, see Check Point Music Publishing.
EDITION ANABELLA, PO Box, 8616 Riedikon-Uster, 01.941 1311, Fax: 01.941 2640, MD: Hans Oestreichner.
EDITION CODA, Leubergstrasse 16, 8615 Wermatswil, Zurich, 01.941 1311, Fax: 01.941 2640, President: Cedric Dumont, MD: Hans Oestreichner-Thurner. (Admin): Intro-Meisel, Ring Musik, Euphon.
EDITION HELBLING, PO Box 2076, 8604 Volketswil, 01.945 4393, Fax: 01.945 6928, President: Peter Brunner, Dir: Rita Brunner.
EDITION INTERMELODIE, Brunnwiesenstrasse 26, PO Box 140, 8049 Zurich, 01.341 4440, Fax: 01.341 3325, Tlx: 822678, President: Stephen F Peterer, Chmn: Markus Peterer. (Owned): Bridgeport Switzerland, Edition Jane & Anton Peterer, Verlag Jane Peterer, Globe Art Publishing; (Admin): Bloomfield, Malbiz, Bridgeport, Rosuki, Southfield, Ted Groya Music, Globe Art Music; Main product: Jazz, Album Rock, Black (R&B).
EDITION MELODIE, Brunnwiesenstrasse 26, PO Box 260, 8049 Zurich, 01.341 4440, Fax: 01.341 3325, Tlx: 822678, President: Anton Peterer, MD: Stephen F Peterer. (Owned): EJR Verlag, Pan, Swisston, Uraniation; (Admin): Sotos.
EDITION TURICAPHON, PO Box, 8616 Riedikon-Uster, 01.941 1311, Fax: 01.941 2640, President: Hans Oestreichner.
EDITIONS ERIC WEBER, Avenue de Secheron 4, 1202 Geneva, 022.731 4909, Contact: Christopher Reed. Main product: film, children's music.
EDITIONS GUILYS, Via Lavizzari 2, 6600 Locarno, 09332 1323, Fax: 09332 1470, Dir: Jean Guioit.
EDITION JANE & ANTON PETERER, see Edition Intermelodie.
EDITION PLURAL, see O.B.H. Music Verlag.
EJR VERLAG, see Edition Melodie.
EUPHON, see Edition Coda.
FACE MUSIC, Dorfstrasse 29-1, 8800 Thalwil-Zurich, 01.720 2684, Fax: 01.720 2759.
FANFAN MUSIC, Rue de Hesse 8-10, 1211 Geneva 11, 022.215 185, Fax: 022.781 3119, Contact: Bertrand Liechti.
FANTASY INTERNATIONAL, Aarberggasse 35, 3011 Bern, 031.229 294, Fax: 031.229 295, President: Tony D, VP: Paolo Pavan, MD: Max Witschi.
FELIX, see Viteka Music.
FLORA, see Leuberg Edition.
FOCUS, see Leuberg Edition.
FOOL HOUSE, see Check Point Music Publishing.
FUN KEY, see Cod Records.

GIpsy KINGS, see Vanessa Productions.
GIVE GIVE, see Zar.
GLOBE ART MUSIC, see Edition Intermelodie.
GLOBUS-MUSIC-SWISS, Im Huel 15, 4147 Aesch, 061.701 4350, Contact: Erich Bachmann.
GOLDEN MELODY, see Wintasco Verlag.
HETON MUSIC, Welschdoerfl 15, 7000 Chur, PO Box 525 (Zip: 7000), 081.228 083, Fax: 081.223 458, Owner: Horst Heinz Henning, MD: Bernd Stuerzel.
HYPER MUSIC, Dombergweg 12, 4423 Hersberg, 061.921 3120, Contact: Stella Space, P J Wassermann.
IDG MUSIC, Marktgasse 12, 6340 Baar, 042.310 157, Fax: 042.310 744, Contact: Jim Duncombe, Jacqueline Duncombe-Wuethrich. (Owned): Denise Rich Catalogue.
IMG INTERNATIONAL MELODIES GENEVE, Rue de Hesse 8-10, 1211 Geneva, 022.215 185, Fax: 022.781 3119, Tlx: 428657, President: Bertrand Liechti.
IMPACT MUSIC, Sempacherstrasse 16, 8032 Zurich, 01.557 511, Fax: 01.555 134, Contact: Hanswalter Huggler, Sylvie Rossi.
INTERSOUND, see Leuberg Edition.
INTRO-MEISEL, see Edition Coda.
IRRMUSIC, Langgasse 14, 4534 Flumenthal, 065.771 804, Fax: 065.772 011, Gen Dir: Fredy Gruber. (Owned): Irrwisch; Main product: Album Rock.
IRRWISCH, see Irrmusic.
JECKLIN & COMPANY, Raemistrasse 42, 8024 Zurich, 01.261 7733, Fax: 01.252 4503, Tlx: 58507, Contact: Catherine Meyste.
JEFF TURNER, see Check Point Music Publishing.
JUNIOR MARKETING GROUP, Rue Sismondi 16, 1201 Geneva, 022.732 4161, Fax: 022.738 2606, MD: Nelly Goodyear.
JUST TWO, see Zar.
KBL MUSIC, Place D'Armes 12, 1277 Carouge, 022.439 465, Fax: 022.413 985, Contact: Christian Oestreichner, Erich Lauer.
KIMONO, see Wintasco Verlag.
KOCH MUSIC PUBLISHING, Wiedenstrasse 15, 9470 Buchs, PO Box 431 (Zip: 9470), 085.66061, Fax: 085.63284, Tlx: 855254, President: Franz Koch, MD: Rudy Schedler.
LAUSANNE MUSIQUE, PO Box 14, 1407 Donneloye, 024.331 546, Fax: 024.331 718, Tlx: 457219, Pres/Dir-Gen: Olivier Buttex.
LEUBERG EDITION, Leubergstrasse 16, 8615 Wermatswil, 01.941 1311, Fax: 01.941 2640, President: Hans Oestreichner-Thurner. (Owned): Alexas Music Connection, Music Service Ulster. (Admin): Polygram Songs, Dick James, Moorea Music, Simon-Giny, Cosima Music, Autobahn, Focus, Intersound, Sonoton, Sigma, Flora, Transworld, Magazine Music.
LOS PINOS DOR MUSIC, see Viteka Music.
LUX NOISE, see Cod Records.
MAGAZINE MUSIC, see Leuberg Edition.
MALBIZ, see Edition Intermelodie.
MAULEY MUSIC, Rue Maunoir 13, 1207 Geneva, 022.736 4311, Fax: 022.736 0398, President: Thierry Mauley-Fervant. (Owned): Mauley Music, Quartz Music.
MONDIA MUSIC, Rue de Hesse 8-10, 1211 Geneva 11, 022.215 185, Fax: 022.781 3119, Contact: Bertrand Liechti.
MOOREA MUSIC, see Leuberg Edition.
MORE FUN MUSIC, Forsterstrasse 66, 8044 Zurich, 01.262 2051/362 0558, Fax: 01.262 2051, MDs: Roger Furrer, Renate Maier.
MUSIC ASSOCIATION, Ringstrasse 14, PO Box 173, 8600 Duebendorf-Zuerich, 01.821 3500, Fax: 01.820 3060, President: Willy Viteka.
MUSIC CLUB VERLAG, Alte Landstrasse 23, 8942 Oberrieden, 01.720 8200, Fax: 01.720 8700, MDs: Madeleine & Bernard Henron.
MUSIC LABEL SOCIETY, Avenue des Alpes 43, 1820 Montreux, PO Box 124 (Zip: 1820), 021.963 1834/1966, Fax: 021.963 2096, President: Bernard Mutelet, MD: Jean-Marie Mutelet.
MUSIC SERVICE ULSTER, see Leuberg Edition.
MUSIKUS MUSIKVERLAG, PO Box, 8616 Riedikon-Uster, 01.941 1311, Fax: 01.941 2640, MD: Hans Oestreichner.
NADINE MUSIC, Fronhof 100, 8260 Stein am Rhein, PO Box 2 (Zip: 8260), 054.415 415, Fax: 054.415 420, Tlx: 822882 tkch, President: Freddy Angstmann.
NERCILIA EDITION, Las Morasses 8, 1920 Martigny, 026.27040, MD: Jean-Michel Bochaty.
NIGHT TOWER PUBLISHING, Gluchstrasse 15, 8953 Dietikon, 01.740 000, Fax: 01.740 0558, Tlx: 828365, Dir: Donald Haeflinger, A&R Mgr: Rene Zingg.
O.B.H. MUSIKVERLAG, PO Box 2691, 6901 Lugano 1, 091.685 586, Fax: 091.685 586, President: Otto Hartmann. (Owned): Edition Plural.
OBSESSION EDITIONS, PO Box 174, 1010 Lausanne 10, 021.286 585, Fax: 021.280 731, President: Antoine Muller, Chmn: Thierry Catherine, MD: Eric Jeantet. (Admin): Danceteria, Play It Again Sam, Crammed Discs.
OUT OF TUNE MUSIC, Langstrasse 64, 8026 Zurich, 01.242 7322, Fax: 01.241 9425, President: Alec von Tavel, Chmn: Ursula Rohr.
PAN, see Edition Melodie.
PBR RECORDS, Avenue du Tir Federal 80, 1024 Ecublens-Lausanne, 021.691 2591/2, Fax: 021.691 2596, Contact: Bruno Pepe.
POU, Via Generoso 4, 6900 Lugano, 091.548 751, Fax: 091.545 780, Tlx: 844283, MD: Giacomo Mazzini.
PEERMUSIC, see Southern Music A.G.
PLAY IT AGAIN SAM, see Obsession Editions.
POLYGRAM SONGS, see Leuberg Edition.

QUARTZ MUSIC, see Mauley Music.
REC REC, PO Box 717, 8026 Zurich, 01.241 5055/71, Fax: 01.242 0344, Tlx: 814196, Contact: Daniel Waldner, Dominik Suss, Karin Koch.
RING MUSIK, see Edition Coda.
ROSUKI, see Edition Intermelodie.
SAMORA MUSIC VERLAG, Rosenstrasse 2, 9444 Diepoldsau/SG, 071.754 121, Fax: 071.756 443, Contact: Veronica Sander.
SAVANNAH LABEL, see Check Point Music Publishing.
SEVENTH MUSIC, Via del Tiglio 11, 6906 Lugano Cassarate, 091.518 071, Contact: Ina Caidelari.
SIGMA, see Leuberg Edition.
SIMON-GINY, see Leuberg Edition.
SONOTON, see Leuberg Edition.
SOTOS, see Edition Melodie.
SOUND SERVICE/POK PRODS, PO Box 10, 3073 Gumliigen, 031.520 710/404, Fax: 031.520 787, Contact: George Georgiou, Rolf Widmer, Andre Fasser.
SOUNDWAYS, see Cod Records.

SOUTHERN MUSIC A.G.

Pfaeffikerstrasse 6, 8604 Volketswil, (41-1) 945-4393, Fax: (41-1) 945-6928, Tlx: 828854, MD: Rita Brunner.

SOUTHFIELD, see Edition Intermelodie.
STEVE WHITNEY BAND, see Check Point Music Publishing.
SUGAR MUSIC (SWITZERLAND), Rue de Hesse 8-10, 1211 Geneva 11, 022.215 185, Fax: 022.781 3119, Contact: Bertrand Liechti.
SWISS CONNECTION MUSIC, Carmenstrasse 12, 8030 Zurich, 01.251 9055-6, Fax: 01.252 3339, MD: Peter Zumsteg.
SWISSTON, see Edition Melodie.
SYDNEY, see Check Point Music Publishing.
TABOO, see Zar.
TED GROYA MUSIC, see Edition Intermelodie.
TRANSWORLD, see Leuberg Edition.
TUXEDO MUSIC, Baumettes 15, 1020 Renens, 021.635 9091, Fax: 021.635 9096, Tlx: 450157 gefi, MD: Jean-Yves Leroy, Asst to MD: Laurence Gobet.
URANIATION, see Edition Melodie.
VANESSA PRODUCTIONS, Rue Neuve du Molard 8, 1204 Geneva, 022.215 278, Fax: 022.294 336, Tlx: 429800 dtg, MD: Stephane Hohli. (Owned): Gipsy Kings.
VERLAG JANE PETERER, see Edition Intermelodie.
VINYL ART EDITIONS/ARTWAYS PRODUCTION, PO Box 30, 1800 Vevey, 021.921 6868, Fax: 021.922 6587, Exec Producer: Michel Schaefer, Dir: Heinz Dill, Prod Mgr: Yvelise Damoiseau.
VIP PRODUCTIONS, Beatengasse 11, 8001 Zurich, 01.221 3233, Fax: 01.221 3730, MD: Urs-Peter Keller. Main product: Adult Contemporary.
VITEKA MUSIC, Ringstrasse 14, PO Box 173, 8600 Duebendorf-Zurich, 01.821 3003, Fax: 01.820 3060, MD: Willy Viteka. (Owned): Cala Dor Music, Los Pinos Dor Music, Viteka Music (Spa, It, UK); (Admin): All Boys Music, Anacoda, Chrystal Vision, Felix, Nigel Jenkins, Pingo, RGJ, Stop 'N' Go, Sylvia, Wide Angle, Yard Style Music.
WESTINGER VERLAG, Eggstrasse 5a, 8124 Maur, 01.980 0925, Fax: 01.980 3083, Contact: Kurt Heilingner.
WINTASCO VERLAG, Zugeroseweg 1, 8810 Horgen, 01.725 7946, Fax: 01.725 7965, Contact: Helen Burkhalter. (Owned): Ascona, Canaris, Golden Melody, Kimono.
WOLF DOG INTERNATIONAL, Gjuichstrasse 15, 8953 Dietikon, 01.740 0000, Fax: 01.740 0558, Tlx: 828365, Dirs: Michel Eggerschwiller, Peter Boni.
YELLOWBIRD MUSIC, Rue de Hesse 8-10, 1211 Geneva, 022.215 185, Fax: 022.781 3119, Tlx: 428657, Dirs: Joachim Neubauer, Bertrand Liechti.
Z.MUSIK, Carmenstrasse 12, 8030 Zurich, 01.251 9055-6, Fax: 01.252 3339, MD: Peter Zumsteg.
ZAR, Dreilindenstrasse 42, 9011 St Gallen, 071.255 666, Fax: 071.254 098, Owner: Victor Waldburger, Mgr: Sabine Waldburger. (Owned): Taboo, Just Two, Blue Picasso, Give Give; Main product: Dance, Album Rock, New Age, Heavy Metal, Techno House.
ZOLLER MUSIC, Ringstrasse 16, 8600 Duebendorf, 01.821 8686, Fax: 01.821 8708, President: Bruno Zolller. Main product: Jazz, Gold/Oldies, Country, Classical.

VIDEO PROGRAM SUPPLIERS & BUYERS

DISQUES OFFICE, Route de la Glane 31, 1700 Fribourg, 037.246 261, Fax: 037.241 986/243 763, Tlx: 942335, President: Jean-Claude Vial, MDs: Marcel Jaquier, Damien Vial.
FRANCA PELSTER FILMS, Breiten 33, 3232 Ins, 032.833 033, Fax: 032.833 368, Tlx: 931495, GM: Franca Pelster, Mktg: Claus Zschokke.

RECORD DISTRIBUTORS

BE-BOP RECORDS, Eienstrasse 1010, PO Box 24, 5745 Safenwil, 062.972 121, Fax: 062.974 369, GM: Bruno Vogel. Labels distr: Unit (Swi), Enja, Tutu (Ger), OMD (Fra), Topic, Hannibal, Stern's, Triple Earth (UK), Minos (Gre), Rounder, Shanachie, Sugarhill (USA), DIW (Jap).

BMG ARIOLA SWITZERLAND, Letzigraben 89, 8047 Zurich, 01.491 5390, Fax: 01.491 3809, Tlx: 822462, MD: Marco Zanotta, A&R Mgr: Bruno Huber, Head of Mktg & Promo: Hans Perret, Head of Prod Mgmt: Urs Widmer, Prod Mgrs: Marco Duschetta, Gilbert Dupuis, Label Mgr: Sonia Wiederkehr (Virgin), Daniel Baisiger (MCA/Geffen), Promo Mgr: Barbara Singer, F&A: Guido Vendramini.

BRAMBUS RECORDS/GRAMMOPHONE HEEB, Alexanderstrasse 14, PO Box 216, 7001 Chur, 081.226 244, Fax: 081.227 427, Dir: Markus Heeb, Label Mgr: Paul Rostetter, Alice Hendry (Asst), Sec: Pia Heeb. Labels (distr): Alcazar Records, IC, AH Records, Fono, Greentrax, Springthyme, Temple, Blue Flame, Red Flame, Black Flame, Prudence, Mar, ROM, Vamp, Rotz & Wasser, Partridge, PAN, Strictly Country, Red House, Oreade, Foenix, Colins, Caprice, Bluebell, Klavier, Main product: Adult Contemporary, Jazz, Country, Classical, Album Rock, Black (R&B), New Age.

BUCH- UND MUSIKHANDEL, Brunnwiesenstrasse 26, PO Box 260, 8049 Zurich, 01.341 4440, Fax: 01.341 3325, Tlx: 822678, President: Anton Peterer, MD: Stephen F Peterer, Sales Mgrs: Hubert Horst, Reinggli Andreas. Labels (distr): Pick Records, Pick International, Aktuell, Hot Pick, Pickli, Swiss Made, International Pick, Inner City, Aebersold, City Sound, Studio PR; Main product: Sheet Music, Folios.

DINO MUSIC, Ruessenstrasse 5b, 6340 Baar, 042.322 808, Fax: 042.322 870, MD: Andre Lehmann. Labels (distr): Crown Hill, Quality Records, Hype, Magnif; Main product: EHR, Adult Contemporary, Classical, Dance, Album Rock, Gold/Oldies, Black (R&B).

DISCTRADE, Langstrasse 64, 8026 Zurich, PO Box 130 (Zip: 8026), 01.242 7322, Fax: 01.241 9425, President: Alec von Tavel, MD: Ursula Rohr, Sales Mgr: Daniel Campigotto. Labels (distr): Beserkley, Celluloid, Danceteria, Emergo, Grateful Dead, Factory, Line, Metal Blade, Music For Nations, New Rose, Play It Again Sam, Provogue, Relativity, Roadrunner, Rough Trade, Shrapnel, Zappa; Main product: Dance, Album Rock, Country.

DISQUES OFFICE, Route de la Glane 31, 1700 Fribourg, 037.246 261, Fax: 037.241 986/243 763, Tlx: 942335, President: Jean-Claude Vial, MDs: Marcel Jaquier, Damien Vial. Labels distr: AB Production, Accord, Ades, Apache, Arion, Atoll, Avrep, Agone, Carrere, Cellier, Celluloid, Canetti, Charles Talar, Clever, Deesse, Dreyfus, Duck, EFN, Erato, Encore, Five, Flarenash, Fonit Cetra, Globo, JMS, Just'in, Lederman, Masq, Mauley, Music Zone, Pianola, Scorpio, Sefra Music, Sneak Preview, Sonodisc, Studio SM, Talar, Trema, Verany, Vogue, Wotre, Zine Music.

HOUSE OF ELECTRONICS, Rotwandstrasse 52, 8004 Zurich, 01.241 0407, Fax: 01.241 0227, President: Mimmo Dutili, Exec Sec: Yolanda Huppi, Legal Adviser: Claude Langley, Talent Acquisition: Peter Volkart, PR Mgr: Robbie Winston-Nater. Labels (owned): Bison Records; (Distr): AVM, Blue Moon, Breakthru', Bridge, Magnum Force, Meteor, MMG, New Albion, Rykodisc, Som Da Gente, Sundown, Thunderbolt, Heads Up Records.

K-TEL INTERNATIONAL, Toedistrasse 68, PO Box 236, 8810 Horgen 1, 01.725 3683, Fax: 01.725 3633, Tlx: 826906, President: Martin Schiess, Mgmt Services: Walter Bestel, Sales Mgr: Kurt Lehmann, A&R (Classical): Reinhard Frey (Classical), Corinna Kienle (Pop/Dance), Export Mgr: John Lee, Promo: Susanne Behrendt. Labels (distr): American Jazz Classics, Amnra, Ascolto, Biber, Black Lion, Candid, Chesky, Corema, Cosmos, Colta Hoerbuheine, DA, Delos, Disky, Dominion, EBS, Etcetera, Exit, Facet, Freedom, Globe, Haenssler Classic, Hermes, Hot Blood, Imperial, In-Akustik, Jeton, Laudate Lingman Videos, MFSL, Musicolor, Nimbus, Redmoon, Savannah, Saydisc, Tomato; Main product: all categories carried.

MAGIC RECORDS INTERNATIONAL, Schulackerstrasse 27, 4142 Munchenstein, 061.460 687, Fax: 061.697 8251, GM: Markus Herrmann.

MUSIC CONSORT, Eugen Huber Strasse 61, 8048 Zurich, 01.432 7560, Fax: 01.432 6525, President: Yves Aellig. Main product: Classical.

MUSIKVERTIEB, Badenerstrasse 555, 8048 Zurich, 01.491 9754, Fax: 01.493 0953, Tlx: 822384, MD: Jack Dimenstein, GM (Records): Lucien Monnerat, Mktg Mgr: Christian Wepfer, Sales Mgr: Juerg Hofmann, Label Mgr: Christophe Roth (Wea), Dave Grob (Teldec), Warehouse Mgr: Gilbert Dupuis, Promo Mgr: Reto Lazzarotto, Claude Bravi (Wea), Michele Raue (Teldec), Mgr (Classical): Daniel Rimensberger. Labels (lic): Ace of Clubs/Diamonds, ACJ, AFP, Animal, Antilles, Argo, Ariola, Arista, Ascolta, Asylum, Atco, Athena, Atlantic (America), Avenue, Baby, Baccarola, Baur Music, Beggars Banquet, Big Mouth, Black Sun, Blanco Y Negro, Blue Bird, Blue Guitar, BMG, BMP, Bonaire, Bronze, Buddaa, Bunny, Caroline Melody, Carosello, Celestial Harmonies, CGD, Charisma, Chess, Chris, Chrysalis, Circa, Clan, Clemence, Coconut, Cold Chillin', Commodore, Cool Tempo, Cotillion, Creole, Critique, Crusaders, Cube, Curb, Decca, Dance Sound of Detroit, Dark Horse, DDD, Dean, Decca, Delicious Vinyl, Delphine (Int'l), Dep Int'l, Deram, Din Disc, Dischi Numero Uno, Dreamland, Duck, Dum Dum, East-West, Edition 23, EG.

POPLIGHT RECORDS, Muhlendorffstrasse 5, 3001 Bern, PO Box 7563 (Zip: 3001), 031.555 542, Fax: 031.564 944, GM: Therese Gillmann, Buyer: Alex Rudin.

PRODUCTIONS MUSICALES EVASION, Rue de l'Ale 25, 1003 Lausanne, 021.209 555, Fax: 021.311 0172, President: Francois Vautier, Dir: Pierre-Alain Chatton. Labels (distr): Mary Josee, Elebore, Paris Album, Baillement, Big Beat, VDE-Gallo, Victory; Main product: Dance, AC, New Age, Chanson.

TUXEDO MUSIC, Baumettes 15, 1020 Renens, 021.635 9091, Fax: 021.635 9096, Tlx: 450157 gefi, MD: Jean-Yves Leroy, Asst to MD: Laurence Gobet, Int'l Product Mgrs: Joelle Singy, Gaelle Giorgy. Labels distr: Autographe, Balkaton, BGO Records, CD-I, Counterpoint, Dante, Dom Disques, Ensayo, Fidelio, FM Revolver, Harmonic Records, Imfrac, Jazz Workshop, Magnum, Meridian Records, M Quartz, MSI, Old Gold, Prism Leisure, Repertoire, See For Miles, Sound Products, Supraphon, Trojan, Tuxedo, Zorba.

RETAIL ACCESSORY SUPPLIERS

PATAC (SWITZERLAND), St. Gallerstrasse 3, 8353 Eigg, 052.482 521, Fax: 052.481 210, Contact: Othmar Bruehwiler, Roger Mueller. Agent of Lift display systems, fully automatic listening facilities, sales promotion facilities, theftproof security system for audio/video media, audio/video switching facilities.

TUXEDO MUSIC, Baumettes 15, 1020 Renens, 021.635 9091, Fax: 021.635 9096, Tlx: 450157 gefi, MD: Jean-Yves Leroy.

ASSOCIATIONS & PROFESSIONAL ORGANIZATIONS

ASSOCIATION OF SWISS CONCERT AGENTS, Rue de la Fontaine 7, 1204 Geneva 3, PO Box 965 (Zip: 1211), 022.214 009, Fax: 022.214 436, President: Jack Yfar.

EUROPEAN ASSOCIATION OF MUSIC FESTIVALS, Rue de Lausanne 122, 1202 Geneva, 022.732 2803, Fax: 022.738 4012, President: Frans de Ruitter, Sec-Gen: Henry Siegwart. EAMF promotes 53 music festivals throughout western & eastern Europe.

EUROPEAN BROADCASTING UNION, Ancienne Route 17, 1218 Grand Saconnex-Geneva, PO Box 67 (Zip: 1218), 022.717 2111, Fax: 022.798 5897, Tlx: 415700 ebu, President: Albert Scharf, Sec-Gen: Jean-Bernard Muench, Dir Radio: T Alexanderson, Tech Dir: G Waters, Legal Adviser: W Rumphorst. Non-governmental international association promoting cooperation between its member broadcasting organizations & international broadcasting organizations, in the area of programming, legal, technical affairs; Activities include Eurovision & Euroradion news & programme exchanges; Total members: 97 in 66 countries (of which 39 are active members, 58 associated).

IFPI SWITZERLAND, Toblerstrasse 76a, 8044 Zurich, 01.252 5866, Fax: 01.252 6167, President: Juerg Rordorf.

INTERNATIONAL FEDERATION OF MUSICIANS, Hofackerstrasse 7, 8032 Zurich, 01.556 611, Fax: 01.556 502, President: John Morton, Sec: Yvonne Burckhardt.

INTERNATIONAL TELECOMMUNICATION UNION-IT, Place des Nations, 1211 Geneva 20, 022.730 5111, Fax: 022.733 7256, Sec-Gen: Pekka Tarjanne, Dep Sec-Gen: Jean Jpguep.

INTERNATIONAL TELEVISION SYMPOSIUM, PO Box 97, Montreux, 021.963 3220, Fax: 021.9633 7895.

MEDIA CONTROL, Post Passage 2, 4002 Basle, 061.271 8989, Fax: 061.271 8987, Tlx: 964341, MD: Uschi Heeb Hedinger.

SMV (SCHWEIZERISCHER MUSIKERVERBAND), Elisabethenstrasse 2, 4051 Basle, 061.272 8786, Fax: 061.272 1288, President: Pascal Grisoni. Swiss musicians association.

SUISA, Bellariastrasse 82, 8038 Zurich, 01.485 6520, Fax: 01.483 0666. Rights society.

SUISA, PO Box 409, 2001 Neuchatel, 038.252 536, Fax: 038.240 472, Dir: Claude Delley, Asst: Stefan Schwarz. Foundation to encourage the composition of Swiss music.

SVMM, PO Box, 8616 Riedikon-Uster, 01.941 1311, Fax: 01.941 2640, President: Willy Vitke. Swiss association of music publishers & producers.

SZM, Zeughausgasse 9, 6301 Zug, 042.219 016, Fax: 042.218 600, President: Erika Hug, Sec: Beat Thoma. Swiss music industry association.

VSSF, Zeughausgasse 9, 6301 Zug, 042.219 016, Fax: 042.218 600, President: Bernhard Pfister, Sec: Beat Thoma. Swiss record retailers association.

PUBLIC RELATIONS & RECORD PROMOTION

BBMP PRESS & PUBLIC RELATIONS, Carmenstrasse 25, 8030 Zurich, 01.251 8484, Fax: 01.252 7106, MD: Heier Laemmler. Recent clients: Marlboro, Good News Concert Agency, Freddy Burger Management Group (Artists: Udo Juergens, Pepe Lienhard), Nissan, Mama Concerts, Lippmann & Rau.

DANCOM, Vergers de la Gottaz 7, 1110 Morges, PO Box 277 (Zip: 1110), 021.802 2814, Fax: 021.802 3962, Tlx: 458445, President: Daniel Hofmann.

DPS DISCREET PRODUCTION SERVICE, St. Gallerstrasse 54, PO Box 829, 9500 Will, 073.237 848, Fax: 073.238 733, President: Martin Zimmermann.

IBINEWS, Langackerstrasse 35, 8057 Zurich, 01.362 0558, Fax: 01.262 2051, Journalist: Roger Furrer, Photographer: Sonia Salcedo.

INTERNATIONAL ROCK RESEARCH, Hohfuren 15, 8126 Zumikon, 01.918 1537/488 7674, Contact: Arthur Ash.

MONTREUX TOURIST OFFICE, Grand Rue, 1820 Montreux, PO Box 97 (Zip: 1820), 021.963 1212, Fax: 021.963 7895, Tlx: 453222, Exec Dir: Michel Ferla, Golden Rose Co-Ord: Massouma Zaia.

OBSESSION EDITIONS, PO Box 174, 1010 Lausanne 10, 021.286 585, Fax: 021.280 731, President: Antoine Muller, Chmn: Thierry Catherine, MD: Eric Jeantet.

PAGELLI WERBUNG, Ebnaterstrasse 79, 9630 Wattwil, 074.75666, Fax: 074.61065.

PIELKEN & PARTNERS, Chemin des Paumiers 6, 1196 Gland, 022.641 880, Fax: 022.642 864, Tlx: 419612, MD: Walter Pielken.

ROCKSHOW PRODUCTIONS, Rue de Bernex 261a, 1233 Bernex, Geneva, 022.757 5297, MD: Herve Eltschinger.

COMPACT DISC MASTERING & REPLICATING PLANTS

INTERTAPE, Spinnererstrasse 21, 8753 Mollis, 058.343 134, Fax: 058.344 259, President: Peter Baumgartner, MD: Louis Bishop.

MOBILES TONSTUDIO, Gubelstrasse 15, 8965 Berikon, 057.332 090, Fax: 057.332 090, MD/Owner: Peter Pfister. Disc-cutting/mastering & CD pre-mastering with DAE 3000; Umatic DSP, Lexicon Reverb, Digital limiter.

MULTI MEDIA MASTERS & MACHINERY, Avenue des Sports 42, 1400 Yverdon-les-Bains, 024.237 111, Fax: 024.237 112, President: Raymond Jaund.

POWERPLAY STUDIOS, Jaandlandstrasse 20, 8124 Maur, 01.980 1521, Fax: 01.980 3083, MD: Juerg Peterhans, Studio Mgr: Higi Heilingler, Eng: Etienne Bron. CD pre-mastering.

TECVAL MEMORIES, Baumettes 15, 1020 Renens, PO Box 746 (Zip: 1001 Lausanne), 021.635 9091, Fax: 021.635 9096, Tlx: 450157 gefi, MD: Jean-Yves Leroy, Asst MD: Laurence Gobet. CD, CD-ROM, CDV, CD-I, printing & packaging; Plant: PO Box 118, 1337 Valloire, tel: 21.843 3333, Fax: 21.843 3384.

PLATING, MASTERING & PRESSING PLANTS

KOCH INTERNATIONAL, Wiedenstrasse 15, 9470 Buchs, PO Box 431 (Zip: 9470), 085.66061, Fax: 085.63284, Tlx: 855254, GM: Elmar Fuerer.

MASTERS STUDIOS, Dreilindenstrasse 42, 9011 St. Gallen, 071.255 666, Fax: 071.254 098, Contact: Victor Waldburger, Chief Eng: Daniel Ruehle. Disc-cutting/mastering.

MEGA WAVE STUDIO, Place d'Armes 12, 1227 Carouge, 022.439 465, MD: Christian Oestricher.

MOBILES TONSTUDIO, Gubelstrasse 15, 8965 Berikon, 057.332 090, Fax: 057.332 090, MD/Owner: Peter Pfister. Disc-cutting/mastering & CD pre-mastering with DAE 3000; Umatic DSP, Lexicon Reverb, Digital limiter.

TURICAPHON, PO Box, 8616 Riedikon-Uster, 01.941 1311, Fax: 01.941 2640, Dir-Gen: Hans Oestreicher.

TAPE CUSTOM DUPLICATORS

BBH VIDEOCOPY, Schaffhauserstrasse 439, 8052 Zurich, 01.302 2311.

EUROTAP MUSIC & PRODUCTIONS, Kirchweg 13, 3324 Bern-Hindelbank, 034.512 000, Fax: 034.512 001.

ICM SWITZERLAND, Boehnirainstrasse 14, 8800 Thalwil, 01.723 6333, Fax: 01.723 6464.

INTERTAPE, Spinnererstrasse 21, 8753 Mollis, 058.343 134, Fax: 058.344 259, President: Peter Baumgartner, MD: Louis Bishop. CD production also arranged.

KOCH INTERNATIONAL, Wiedenstrasse 15, 9470 Buchs, PO Box 431 (Zip: 9470), 085.66061, Fax: 085.63284, Tlx: 855254, GM: Elmar Fuerer.

KPK KASSETTENPRODUKTION, Baltenschwilerstrasse 29, 8962 Dietikon, 01.741 4844, Fax: 01.741 3032, Tlx: 828358, MD: Daniel Kieser.

MCS, Schufelstrasse 8, 8863 Buttikon, 055.671 414, Fax: 055.672 050.

TURICAPHON, PO Box, 8616 Riedikon-Uster, 01.941 1311, Fax: 01.941 2640, Dir-Gen: Hans Oestreicher.

CASSETTES REELS & PARTS, JEWEL BOX MANUFACTURERS

ICM SWITZERLAND, Boehnirainstrasse 14, 8800 Thalwil, 01.723 6333, Fax: 01.723 6464. Jewel boxes/parts & accessories.

PANINT, Bohnerstrasse 1-3, 8157 Dielsdorf, 01.853 2176, President: Mr. Reil. Jewel boxes/parts & accessories.

POSSO, Baumettes 15, 1020 Renens, PO Box 746 (Zip: 1001 Lausanne), 021.635 6363, Fax: 021.635 9096, Tlx: 450157 gefi, MD: Patrick Posso, F&A Mgr: Rolf Anderes, Mktg Mgr: Roel Creveld, Sales Mgr: Carel Jansen. CD filing systems & tape boxes.

SONOGRAPHIC RECORDING, Muehleackerstrasse 19, 8952 Schlieren, Zurich, 01.730 2229, Mgr: W A Wettler, Sales Mgr: A Brand. Jewel boxes/parts & accessories & packaging/mailling services.

SPE PLASTIC & ELECTRONIC, Rue de l'Industrie 179, 1791 Courtaman/Fribourg, 037.341 144, Fax: 037.342 473, President: Gerard Koerberle, MD: Zita Koerberle. Professional recording tape supplies & accessories.

TURICAPHON, PO Box, 8616 Riedikon-Uster, 01.941 1311, Fax: 01.941 2640, Dir-Gen: Hans Oestreicher. Jewel boxes/parts & accessories & packaging/mailling services.

PRINTING, PACKAGING & LABELS

INTERTAPE, Spinnereistrasse 21, 8753 Mollis, 058.343 134, Fax: 058.344 259, President: Peter Baumgartner, MD: Louis Bishop. Packaging & mailing services.

SONOGRAPHIC RECORDING, Muehleackerstrasse 19, 8952 Schlieren, Zurich, 01.730 2229, Mgr: W A Wettler, Sales Mgr: A Brand.

SYMPHONY TONE PRODUCTION, 30 route de Lussy, 1162 St. Prex, 021.761 026, Tlx: 58975. Sleeves/label printer.

TURICAPHON, PO Box, 8616 Riedikon/Uster, 01.941 1311, Fax: 01.941 2640, Dir-Gen: Hans Oestreicher.

BLANK & BULK RAW TAPE

3M SWITZERLAND, Eggstrasse 93, 8803 Rueschlikon, 01.724 9090, Fax: 01.724 0242.

AMPEX WORLD OPERATIONS, Routes des Arsenaux 15, 1700 Fribourg, PO Box 1031 (Zip: 1701), 037.218 686, Fax: 037.218 673, Tlx: 942421, MD: Arnold Buhlmann, Mktg/Sales Dir: Jean-Daniel Renevey, Sales Reps: Ivan Ivanovic, Elmar Durret. Audio & video cassettes & open reels, DAT.

BASF (SCHWEIZ), Appital, PO Box, 8820 Waedenswil/Au, 01.783 9111, Fax: 01.783 9388.

SONY MUSIC ENTERTAINMENT, Kutistrasse 12, 8952 Schlieren-Zurich, 01.733 3111, Contact: Franz Egler.

TECVAL MEMORIES, Baumettes 15, 1020 Renens, PO Box 746 (Zip: 1001 Lausanne), 021.635 9091, Fax: 021.635 9096, Tlx: 450157 gefl, MD: Jean-Yves Leroy, Asst MD: Laurence Gobet.

CD, RECORD & TAPE MANUFACTURING SYSTEMS

APPARATE + WERKZEUGBAU, 5630 Muri, 057.443 215, Fax: 057.443 223. Vinyl & tape duplication equipment.

BALZERS, 9496 Balzers, Fuerstentum, Liechtenstein, 075.44111, Fax: 075.42764, Contact: Horst Lorenz. CD, vinyl & tape duplication equipment.

CTI, Bergstrasse 43, 8805 Richterswil, 01.786 1811, Fax: 01.786 1819. Vinyl & tape duplication equipment; Agent for ATB Italy.

GOTHAM, Althardstrasse 238, 8105 Regensdorf, PO Box 122 (Zip: 8105), 01.840 0144, Fax: 01.841 0726, MD: Franz R Ammann. Vinyl & tape duplication equipment; Distribute: Lyrec, Bruel & Kjaer.

INTERMERKUR, Dufourstrasse 43, 8034 Zurich, 01.250 8511, Fax: 01.251 7119, MD: Erich Haas. CD equipment.

INTERTECHNIKA, Rue Ami-Lullin 4, 1211 Geneva 3, PO Box 475 (Zip: 1211). Vinyl & tape duplication equipment.

NETSTAL MACHINERY, 8752 Naefels, 058.366 111, Fax: 058.344 241, VP (Optical Disc Sys): Ruedi Krebsler, Mktg/Sales Mgr (Optical Disc Sys): Kees de Jonge. CD equipment.

SPE PLASTIC & ELECTRONIC, Rue de l'Industrie 179, 1791 Courtaman/Fribourg, 037.341 144, Fax: 037.342 473, President: Gerard Koerberle, MD: Zita Koerberle. CD, vinyl & tape equipment, professional recording tape supplies & accessories.

TECAPRINT, Bohlstrasse 17, 8240 Thayngen, 053.392 333, Fax: 053.392 596. CD screen printing machines.

TAPE PACKAGING & LABELING EQUIPMENT

AMPACK, Seeblichstrasse 50, 9400 Rorschach, 07142 6262, Fax: 07142 3990, Dir: A Deschwanden. Packaging & labeling equipment; Agent for Marden Edwards & Company.

UNITED KINGDOM**RECORD COMPANIES**

10 RECORDS, 553-579 Harrow Road, Kensal House, London W10 4RH, 081.968 6688.

20-20 RECORDS, 143 Westmead Road, Sutton, Surrey SM1 4JP, 081.643 2429, Fax: 081.770 0108, MD: Steven Macintosh, Label Mgr: Joseph Charles.

3 Y'S RECORDS, 40 Elm Road, Kingston-upon-Thames, Surrey KT2 6HP, 081.546 4561, Owner: Mark Goodard. Labels (owned): 3 Y's Records; Main product: Alternative, Indie.

3-45 RECORDS, 15 Ceylon Street, Hull, North Humberside HU9 5RD, 0482.798 014.

3-D PRODUCTIONS, PO Box 993, London E12 6UT, 081.552 0432, Fax: 081.552 3323.

310 PRODUCTIONS, Reading Road, The Cottage, Lower Basildon, Reading, Berkshire RG8 9NL, 0491.671 789, Fax: 0491.671 443, Tlx: 8953097, MD: Del Taylor, Dirs: Jolanda Taylor, Adam Sleaf, GM: Enzo Taylor.

42ND STREET RECORDS, 115 Station Road, Baulk House, Amersham, Buckinghamshire HP7 0AH, 0494.725 676, Owner: Nigel Browning. Labels (owned): 42nd Street, SNT, Big Sounds.

4AD RECORDS, 15 Alma Road, London SW18 1AA, 081.870 9724, Fax: 081.874 6600, Tlx: 915733 begban, President: Ivo Watts-Russell, Int'l Mgr: Simon Harper, Press: Deborah Edgley, Mktg/Sales: Chris Staley, Video Co-ord/Artist Liaison: Jo Higson. Main product: Albion Rock.

4D LIGHT RECORDS, 22 Wakelin Road, London E15 3BH, 081.519 7549, MD: H Werth.

53RD & 3RD, 21a Alva Street, Edinburgh, Lothian EH2 4PS, 031.226 3129, Fax: 031.226 3133.

8 RECORDS, 46-50 Wood Street, Holme's Bld, Std 370, Liverpool, Merseyside L01 4AQ, 051.709 0889, Fax: 051.709 5545, MD: Pete Davies.

A & M RECORDS (UK), 136-144 New Kings Road, London SW6 4LZ, 071.736 3311, Fax: 071.731 4606, Tlx: 916342, MD: Howard Berman, Deputy MD: Tony Clark, Mktg Dir (Int'l): Bert de Ruiter, Int'l Mktg Dir (UK Acts): Lucie Avery, Promo Dir: Julian Spear, Int'l Mgr: Janice Hague. Labels (lic): Automatic, AMPM; Distribution: PolyGram.

A CROSSE THE WORLD, 11a Kensington Park Road, London W11 3BY, 071.221 8823, President: Jon Crosse.

A1 RECORDS, 281 Walworth Road, London SE17 3RP, 071.708 0003, Fax: 071.708 1152, President: Ray Levy, Label Mgr: Mike Howell. Labels (owned): A1, Fastglobe; (Lic): P.E.M. (Fra), Dureco, Media (Ita), Grundy (Australia).

ABACO RECORDS, 4 Imandra Close, Trentham, Stoke-On-Trent, Staffordshire, 0782.659 515, MD: John Fisher, A&R: Constance Fisher. Labels owned: Abaco, Lipstick Records (Ger).

ABBEY RECORDING COMPANY, Abbey Street, Eynsham, Oxford OX8 1HR, 0865.880 240, Fax: 0865.882 443, MD: H F Mudd. Main product: Choral, Organ Music.

ABBEY RECORDS, Magdalen Road, 4 Newtec Place, Oxford, Oxfordshire OX4 1RE, 0865.790 472, Fax: 0865.790 472, Tlx: 83147.

ABC RECORDS, 202 Fulham Road, c/o Muirhead Mgmt, London SW10 9PJ, 071.351 5167, Fax: 071.352 1514, Contact: Dennis Muirhead, Jane Austin. Record company; UK Rep: Muirhead Management, London, United Kingdom.

ABOUT TIME RECORDS, 68 Wharton Avenue, Sheffield, Yorkshire S31 0SA, 0742.879 882, Fax: 071.482 3444, A&R/Promo Mgr: Mike Ward, Fin/Design Dir: Jaffa. Label: About Time; Main product: Black (R&B), Dance; Distribution: Jet Star, Revolver, and all specialist Black Music outlets.

ABSOLUTE RECORDS, 46 Lyne Road, Kidlington, Oxfordshire OX5 1AD, 08675.78175, MD: S Richter.

ABSTRACT RECORDS, 10 Tiverton Road, London NW10 3NL, 081.969 4018, Fax: 081.960 0410, Contact: Edward Christie. Labels (Owned): Metal Core, Rhyne 'n' Reason; Main product: Dance, AC, Albion Rock.

ACE RECORDS, 48-50 Steele Road, London NW10 7AS, 081.453 1311, Fax: 081.961 8725, MDs: Ted Carroll, Roger Armstrong, Trevor Churchill, Mktg Mgr: Chris Popham, Sales Mgr: Phil Stoker. Labels (owned): Ace, BGP, Big Beat, Blue Horizon, Boplicity, Cascade, Globestyle, Impact, Kent, Southbound; (Lic): Contemporary, Fantasy, Milestone, Pablo, Prestige, Riverside, Stax, Westbound.

ACID JAZZ, 21 Denmark Street, London WC2H 8NE, 071.379 9807/081518, Fax: 071.379 9814, Label Mgr: Eddie Piller, A&R Mgr: Kieran Hurley, Prod Mgr (Live): Kevin Winder, Mktg Mgr: Dean Rutland, Promo Mgr: Anne Bigby, Accts Mgr: Emma Quigley. Labels owned: Re-elect The President, Acid Jazz, Countdown; Main product: Dance, Acid Jazz.

ACOUSTICS RECORDS, PO Box 350, Reading, Berkshire RG6 2DQ, 0734.268 615, MD: H Jones.

ACTION REPLAY RECORDS, 31-39 Camden Road, Twyman House, 2nd flr, London NW1 9LF, 071.267 6899, Fax: 071.267 6746.

ADDICTIVE MUSIC PUBLISHING, 4 Birchfields Road, Manchester, Greater Manchester M13 0XR, 061.225 5140, Fax: 061.628 8001, Tlx: 669755 office attn: imm, MD: John Turner, A&R/Prod: Juan Da Silva, Int'l Mktg: Simon Edwards, Label Mgrs: Bob Garton, Mick Jones, Ian McArthur. Labels owned: Mega (UK), M&M, Kinetic.

ADVENTURE RECORDS, 29 Gloucester Mews, London W2 3HT, 071.402 3045, Fax: 071.262 0677.

ADVENTURES UNDER GROUND, 23 New Mount Street, Manchester, Greater Manchester M4 4DE, 061.953 4004, Fax: 061.953 4001, Contact: David Lawrence.

AFRICAN RECORDS INTERNATIONAL, 44 Cowley Road, Oxford, Oxfordshire OX4 1HZ, 0865.728 447. Main product: African, Ethnic.

AGIT-PROP, 52 Call Lane, Box 4, Leeds, West Yorkshire LS1 6DT, 0532.790 739, Label Mgr: Oprah Nobacon. Main product: 90's Dance, Politically-edged.

AHEAD OF OUR TIME, 15 Little Portland Street, London WIN 5DE, 071.323 3888, Fax: 071.323 5392.

AIM (A&M/ISLAND MARKETING), 107a Hammersmith Bridge Road, London W6 9DA, 081.748 4700, Fax: 081.748 4740, MDs: Howard Berman, Marc Marot, Sales Dir: John Pearson.

AJK RECORDS, 620 Western Avenue, K-tel House, London W3 0TU, 081.992 8055, Fax: 081.993 3652, Tlx: 9341958 kteluk.

ALBANY RECORDS, PO Box 12, Carnforth, Cumbria LA5 9PD, 0524.735 873, Fax: 0524.736 448.

ALBINO RECORDS, 100-104 Upper Richmond Road, London SW15 2FP, 081.785 4511, Fax: 081.785 9816, Tlx: 262964.

ALL GIRLS MUSIC, 16 Battle Street, Reading, Berkshire RG1 7NU, 0734.590 657, Fax: 0734.391 099.

ALLIGATOR RECORDS, 78 Stanley Gardens, London W3 7SN, 081.746 1234, Fax: 081.740 9899.

ALTAIR RECORDS, 70 Boyne Road, London SE13 5AW,

081.852 4017, Fax: 081.761 9434, MD: Paul M Tams.

ALTERNATIVE TENTACLES RECORDS, 64 Mountgrove Road, London N5 2LT, 071.354 5455, Fax: 071.359 2232. Main product: Alternative, Hardcore.

AMBIENT RECORDS (ISLE OF MAN), 2 Bridge Street, Bajor House, Peel, Isle of Man, 0624.844 136, Fax: 0624.844 135, Chmn: Rick Wakeman, Creative Dir: Nira Wakeman, Mktg/A&R: Frank Fallows, A&R: Susie James.

AMBITION RECORDS, 8 Raymond Close, West End, Southampton, Hampshire SO3 3HF, 0703.476 985, MD: M L Pearson. Production/Distribution; Main product: Indie Guitar Pop.

AMPHONIC RECORDS (BELGIUM), 59 Fitzwilliam Street, Wath-upon-Dearne, Rotherham, South Yorke S63 7HG, 0709.872 875, Fax: 0709.872 875.

AMCO RECORDS, 2 Gawsorth Road, Macclesfield, Cheshire SK11 8UE, 0625.420 163, Fax: 0625.420 163.

AMERICAN ACTIVITIES, 29 St. Michaels Road, Leeds, West Yorkshire LS6 3BG, 0532.742 106, Fax: 0532.786 291.

AMP RECORDS, PO Box 387, London N22 6SF, 081.889 0616, Fax: 081.889 0616.

AMPHONIC MUSIC, Waterhouse Lane, The Kerchesters, Kingswood, Surrey KT20 6HT, 0737.832 837, Fax: 0737.833 812, Chmn: Sydney Dale, MD: Ian G Dale. Labels (owned): Go Ahead Music; (Lic): Koka Media; (Distr): Sound Stage; Main product: film, TV music.

ANAGRAM RECORDS, 25-29 Fulham High Street, Bishops Pk Hse, London SW6 3JH, 071.371 5844, Fax: 071.384 1854, Tlx: 943763 crocom.

ANGLO ATLANTIC ENTERTAINMENTS, 5 Albemarle Street, London W1X 3HF, 071.493 4292, Fax: 071.493 2692.

ANGLO RECORDS, 128b Rodbourne Road, The Studio, Swindon, Wiltshire SN2 2AX, 0793.491 285, Fax: 0793.491 298.

ANTILLES, Island Records, 22 St Peters Square, London, 071.741 1511, Fax: 071.741 5194, Tlx: 934541, Label Mgr: Trevor Wyatt.

ANXIOUS RECORDS, 2-4 The Broadway, Devonshire House, Crouch End, London N8 9SN, 081.340 8357, Fax: 081.341 5480, MD: Tony Quinn, GM: Alan Gee.

APOLLO SOUND, 32 Ellerdale Road, London NW3 6BB, 071.435 5255, MD: H Herschmann.

ARABESQUE RECORDS, 29-39 Stirling Road, Network House, London W3 8DJ, 081.993 5966, Fax: 081.992 0340, MD: Terry Winsor, Mktg Mgr: Arthur Richmond, Sales (UK): Ruth Smith, Label Mgr: John Brown, Distr Mgr: Raj Arora, Mgr (Export): Amanda Bells. Labels (owned): Baktabak, Kikbak Records; Distribution: Arabesque. Also distribute Music Calenders for: Danilo, Culture Shocks.

ARC MUSIC PRODUCTIONS INT'L, PO Box 111, East Grinstead, West Sussex RH19 2YF, 0342.328 567, Fax: 0342.315 958, MD: Horst Tubbesing. World & folkmusic.

ARC RECORDS, Askew Crescent Workshops, Unit 2b, London W12 9DP, 081.994 1956, Fax: 081.747 0778, Tlx: 934386.

ARCADE RECORDS (UK), 58 Queen Anne Street, London W1 M9LA, 071.935 2887, Fax: 071.224 6073, GM: Sylvia Curd, A&R Mgr: Gleave Parsons, Sales Mgr: Brian Kempster. Labels (owned): Arcade; Main product: Adult Contemporary, Dance, Albion Rock, Gold/Oldies; Distribution: Sony. Also TV -promoted albums for retail sale.

ARDENT, PO Box 4, Ferryhill, County Durham DL17 9BP, 0740.653 132, Fax: 0740.653 434.

ARISHMA RECORDS, 31-37 Leather Lane, London EC1N 7RJ, 071.405 3931/831 2113, Fax: 071.831 3779, MD: Deepack Manjit.

ARISTA RECORDS, 423 New Kings Road, Cavendish House, London SW6 4RN, 071.973 8040, Fax: 071.371 9324, Tlx: 920946, MD: John Preston, Mktg Dir: Tim Prior, A&R Mgr: Chris Cooke, Head Of Press: Sue Brown, Svs Affairs Mgr: Steve Fernie. Labels (owned): Arista, Logic; Distribution: BMG Operations. Arista is a division of BMG Records (UK).

ARIWA SOUNDS, 34 Whitehorse Lane, South Norwood, London SE25 6RE, 081.653 7744, Fax: 081.771 1911, MD: Neil Fraser.

ARKA SOUND, 23 Whitechapel Street, Manchester, Greater Manchester M20 0UB, 061.330 9855, Fax: 061.339 0412, MD: M A Ward. Labels (owned): ARKA Sound; (Lic): Antler Subway (Bel); Distribution: APT (UK); Main product: East/west Fusion, Dance, Country, Classical, New Age.

ARKBEAT/ARK RECORDS, 55 Lark Lane, Liverpool, Merseyside L17 8UW, 051.728 8400, Fax: 051.728 9828, MD: Pete Fulwell, Label Mgr: Jill Thompson. Main product: Dance, Avant Garde.

ARRIVAL RECORDS, 39 Leyton Road, Harpenden, Hertfordshire AL5 2JB, 0582.715 098, Fax: 0582.715 098, MD: David Blaylock, Dir: Judy Dixon. Labels owned: Arrival; Main product: EHR, Popular.

ARTISAN RECORDS, The Manor House, Great Linford, M Keynes, Buckinghamshire MK14 5AX, 0908.667 432, Fax: 0908.668 164.

ARTS RECORDINGS, 5 Wigmore Street, London W1H 9LA, 071.491 4117, Fax: 081.767 8525.

ASH RECORDS, Salmon Lane, Cropwell House, Kirkby, Ashfield, Nottinghamshire NG17 9HB, 0623.752 448, MD: S Stevens.

ASM MUSIC, 318a Kennington Road, London SE11 4LD, 071.735 1932, MD: Alan Stuart, A&R Mgr: Simon Maine, Label Mgr: Mark Carman.

ASV ACADEMY SOUND & VISION, 179-181 North End Road, London W14 9NL, 071.381 8747, Fax: 071.385 2653, MD: Hywell Davies, GM: Neil Heyland, Audio Cons: Martin Haskeil, A&R: Pawlina Bednarczyk, Sales/Distr: Richard Harrison, Mktg Mgr: Ray Crick. Labels (owned): ASV, Living Era, White Line, Transacord, Quicksilva, COE, Gau-

- deanus. ASV AMM (music master); (Dist): Novalis; Main product: Jazz, Classical, MOR.
- ATLANTIC RECORDS (UK)**, 35 Harwood Road, Broadway House, London SW6 4QP, 071.371 5633, Fax: 071.371 5518, Tlx: 911019, Mgr (Eur) Mary Hooton, Head Of A&R: Ian Wilson.
- AUDICORD**, PO Box 33, Hinkley, Leicester, Leicestershire LE10 0FQ, 0455.637 935, Snr Producer: T Grace. Labels (owned): Audicord; Main product: Organ, Documentary.
- AUDIO-VISUAL PRODUCTIONS**, School Hill Centre, Chepstow, Gwent NP6 5PH, 0291.25439, Fax: 0291.279 671.
- AURA RECORDS**, 1 Liverpool Road, London W5 5NZ, 081.579 4333, Fax: 081.579 4333, President: Aaron Sixx, Distribution: Cartel
- AVALANTIC RECORDS**, Thornton Grove Works, Thornton Grove, Leeds, West Yorkshire LS12 3JB, 0532.310 145, Fax: 0532.310 229, MD: A M Doyle, A&R: P Marson, P Berry, Mktg Mgr: D Horner, Promo Mgr: A Porter. Labels owned: Avalantic; Main product: Album Rock, New Age.
- AVENUE X RECORDS**, 65 Walford Road, London N16 8EF, 071.923 0383, Fax: 071.923 0383, MD: William Cameron, Labels (owned), Avenue X; Main product: Dance.
- AVM RECORDS**, 27 Windsor Road, Wraybury, Middlesex TW19 5DE, 0784.483 764, Fax: 0784.483 028, Dirs: Catherine Brown, Brian Adams, A&R: Pete Chalcraft.
- AWARENESS RECORDS**, 6 Vernon Avenue, Raynes Park, London SW20 8BW, 081.543 1537, Fax: 081.545 0272, Tlx: 22233 harlex, E-Mail: 78 harbottle-uk, MD: Andy Ware, GM: Chrissie Reilly, Asst: Bunny, Record Label; Distributed by Pinnacle through Revolver Sales (UK); Main product: Adult Contemporary, Country, Album Rock, New Acoustic.
- AWESOME RECORDS**, 59 Moore Park Road, London SW6 2HH, 071.731 0022, Fax: 071.731 1715, MD: Falcon N Stuart, Press: Alice Hiller, A&R: Jack Stafford, Mktg: Ze Stuart, Distribution: Rough Trade.
- AXL RECORDS**, 1 North Worpole Way, London SW14 8QB, 081.876 2533, Fax: 081.878 4229.
- AZURE RECORDS**, 32 Kenton Lane, Kenton, Harrow, Middlesex HA3 8TX, 081.907 5583, Proprietor: Steve Lane, Labels (owned), VJM (Vintage Jazz Music), (Dist): Iatrc, Arcadia, Tonzo; Main product: Jazz
- BACKS RECORDING COMPANY**, St. Mary's Works, St. Mary's Plain, Norwich, Norfolk NR3 3AF, 0603.624 290, Fax: 0603.619 999.
- BACKS RECORDS**, St. Mary's Plain, St. Mary's Works, Norwich, Norfolk NR3 3AF, 0603.626 221624 290, Fax: 0603.619 999, MD: Jonathan Appel, GM: Derek Chapman.
- BAD GIRL RECORDS**, 440 Thurlow Park Road, London SE21 8JA, 081.761 7107, Fax: 071.326 0028, Head: John Yates, A&R: Ken Topp, Michael Chinaski, Promo: Angus Batey.
- BALACLAVA RECORDS**, 20-24 Beaumont Road, London W4 5AP, 081.995 5432, Fax: 081.747 1931, Tlx: 265871.
- BALAENA RECORDS**, 27 Strathern Road, Struan Lodge, Broughtly Ferry, Dundee, Tayside DD5 1PP, 0382.75031, Snr Partner: Stewart Brown, Main product: Traditional, Scottish; Distribution: Gordian Duncan, Entertainment UK
- BAND OF JOY**, Ridgway, Sarabee House, Pyrford, Woking, Surrey GU22 8PW, 09323.49048, Fax: 09323.44500.
- BANDLEADER RECORDS**, 7 Garrick Street, London WC2E 9AR, 071.240 0658, Fax: 071.497 9242, MD: John Nice.
- BASELINE RECORDS**, PO Box 624, Ascot, Berkshire SL5 8UX, 0990.255 745, Fax: 0990.872 009.
- BASS RECORDS**, 183 High Street, Harlesden, London NW10 4TE, 081.961 7422, Fax: 081.965 3948, MD: Ron Boulding.
- BASS-IC RECORDS**, 35 The Headrow, Leeds, West Yorkshire LS1 6PU, 0532.436 743, Fax: 0532.340 421, MD: Steve Mulhaire.
- BAT MUSIC**, 68 Sunningdale, Round Green, Luton, Bedfordshire LU2 7TE, 0582.412 460, MD: Tim Raidl.
- BBC RECORDS & TAPES**, 80 Wood Lane, Woodlands, London W12 0TT, 081.743 5588, Fax: 081.743 0393, Tlx: 928937/935963, Overseas Mgr: Alison Ward, Mktg Mgr: Paul Holland.
- BCM RECORDS (UK)**, Seven Oaks Way, Orpington Estate Unit 2, St. Mary's Cray, Orpington, Kent BR5 3SR, 0689.890 749, Fax: 0689.890 757, Contact: Ruth Rothwell, Fitzgerald Muff, Main product: Dance
- BEDROCK RECORDS**, 64 Mountgrove Road, London N5 2LT, 071.354 5455, Fax: 071.359 2232, Main product: R&B
- BEECHWOOD RECORDS**, 62 Beechwood Road, South Croxson, Surrey CR2 0AA, 081.657 2813, Fax: 081.651 6080.
- BEGGARS BANQUET RECORDS**, 17-19 Alma Road, London SW18 1AA, 081.870 9912, Fax: 081.871 1766, Tlx: 915733, MD: Martin Mills, A&R: Roger Trust, Legal Dept: James Wylie, F&A: Nigel Bolt, Mktg: Graham Jeffs, Int'l: Sara Cohen, Promo: John Empson, Creative Services: Steve Webbon, Labels owned: Beggars Banquet, Situation 2, Citybeat, 4AD
- BENSON & HEDGES MUSIC COMPANY**, Eiford Park House, Yelverton, Devon PL20 6AH, 0822.853 000, Fax: 0822.853 173, MD: Martin Griffin, Snr Int'l Exec: Dorian Burrows.
- BESERKLEY AUDIO AND VISUAL**, Leatherhead Road, 29 Barwell Bus, Park, Chessington, Surrey KT9 2NY, 081.974 1021, Fax: 081.974 2674, MD: John Doukas, GM: Brian Leafe, Comm Mgr: Jon Beecher, Labels (owned): Beserkley, Red Hot; Main product: Adult Contemporary, Album Rock.
- BETTER YOUTH**, PO Box 59, London N22, 081.888 8949, Fax: 081.889 6166, Tlx: 268041 sthrn.
- BGO RECORDS (BEAT GOES ON)**, PO Box 22, Bury St. Edmunds, Suffolk IP28 6XQ, 0284.762 137, Fax: 0284.762 433/245, MD: Andy Gray, Label Mgr: Mike Gott, Sec: Hazel Armstrong, Labels (Lic): Sony Music UK, PolyGram Special Products, EMI Records; Main product: AC, Album Rock, Country, Black (R&B).
- BIG BEAR RECORDS**, PO Box 944, Birmingham, West Midlands B16 8UT, 021.454 7020, Fax: 021.454 9996, MD: Jim Simpson, Sales Mgr: Joe Norman, Press Officer: David Yates, Labels (owned): Big Bear, Grandstand; Main product: Jazz, Blues.
- BIG CAT UK RECORDS**, PO Box 1561, London NW6 4SW, 081.960 0028, Fax: 081.960 3702, MD: Linda Obadiah, Joint MD: Abbo, Label Mgr: Tav, Personal Asst: Jacqui.
- BIG LIFE RECORDS**, 15 Little Portland Street, London W1N 5DE, 071.323 3888, Fax: 071.323 5392, MDs: Jazz Summers, Dennis Collopy, A&R: Tim Parry.
- BIG MOOSE RECORDS**, 17 Russell Square, Brighton, East Sussex BN1 2EE, 0273.202 151, Fax: 0273.205 713.
- BIG ONE RECORDS**, 343 Goswell Road, London EC1V 7JT, 071.278 0842, Fax: 071.833 2687, Tlx: 27659 CALLIN, MD: Patrick J Meads, Personal Asst: Helen Street, Labels owned: First Ban Records; Distribution: Rough Trade.
- BIG R RECORDS INTERNATIONAL**, James Square, Biggar, Strathclyde ML12 6DA, 0899.20202, Fax: 0899.21020.
- BIG SHOT RECORDS**, 9 Carnaby Street, London W1V 1PG, 071.437 1958/9, Fax: 071.437 3852, GM: Jackie Khan, Label Mgr: Chris Childs.
- BIG WAVE RECORDS**, 75 Summerstown, London SW17 0BQ, 081.944 7117, Fax: 081.944 0097, Chmn: Bill Kimber, MD: Colin Ashby, F&A: Jimmy Coote.
- BIG WORLD RECORDS**, 1c Clarendon Cross, North Light House, London W11 4AP, 071.792 9931, Fax: 071.792 9612, MD: David Massey.
- BIRDLAND RECORDS**, 39 Clitterhouse Crescent, London NW2 1DB, 081.458 1020, Fax: 081.346 3160.
- BITE BACK!**, 51 Bath Road, Southsea, Hampshire PO4 0HX, 0705.752 782, Label Mgrs: Ian Binnington, Claire Davies, Labels (Owned): Bite Back!; Distribution: Backs/RTM (UK).
- BLACK CROW RECORDS**, Midgy Hall, Sharperton, Morpeth, Northumberland NE65 7AS, 0669.40252, Fax: 0669.40252, Partners: G Heslop, D Bulmer, N Sharpley, Labels (owned & distr): Black Crow Records; Main product: Folk.
- BLACK LION PRODUCTIONS**, 16 Castleinau, Barnes, London SW13 9RU, 081.741 3608, Fax: 081.563 0013, MD: Alan Bates, Int'l: Nieves Pascua, Labels (owned): Candid, American Jazz Classics, American Blues Classics, Broadway, Choice; European Licence: DA Music (Ger).
- BLACK MAGIC RECORDS**, 201 Holland Park Avenue, London W11 4UN, 071.603 4500, Fax: 071.603 1830, Tlx: 8950117 azitap, MD/A&R/Mktg/Promo: Mataya Clifford, Main product: Reggae, Dance, Black (R&B), Zimbabwean.
- BLACK MOUNTAIN RECORDS**, Dinefwr Park, Dinefwr House, Llandello, Dyfed SA19 6RT, 0558.823 864, Fax: 0558.823 862.
- BLACK SUN RECORDS**, 37 Tavistock Place, London WC1H 9SE, 081.667 0298, Fax: 071.383 4093, Tlx: 925788.
- BLANCO Y NEGRO**, 66 Golborne Road, London W10 5PS, 081.960 9888, Fax: 081.968 6715, MD/A&R: Geoff Travis, A&R: Jeannette Lee.
- BLENHEIM RECORDS**, 38 Carter Street, Fordham, Ely, Cambridgeshire CB7 5NG, 0638.720 659, MD: Gwydion Brooke.
- BLOSSOM RECORDS**, 62 Blencathra Street, Keswick, Cumbria CA12 4HX, 07687.74098, MD: Eric Williamson, Sales Mgr: Colin Dixon.
- BLUE AUGUST RECORDS**, 35 Mansted Gardens, Romford, Essex RM6 4ED, 081.590 2524, Fax: 081.599 2065, MD: John McDonald, Labels (owned): Blue August; Main product: Dance.
- BLUE DOT RECORDS**, 35 Mansted Gardens, Romford, Essex RM6 4ED, 081.590 2524, Fax: 081.599 2065, MD: Phil Harding, Dir: John McDonald, Labels (owned): Blue Dot; Main product: Dance, Album Rock.
- BLUE GUITAR RECORDS**, 12 Stratford Place, London W1N 9AF, 071.408 2355, Fax: 071.409 0858, Tlx: 21753.
- BLUE HAT RECORDS**, PO Box 1, Bradford-on-Avon, Wiltshire BA15 1YQ, 0225.782 550, Fax: 0225.783 108.
- BLUE MOVES RECORDS**, 46 Willow Street, London EC2A 4BH, 071.739 2400, Fax: 071.739 1925.
- BLUE TRAC**, School Road, Acton Bus Centre, Unit B, London NW10 6TD, 081.961 6049, Fax: 081.965 4248.
- BLUEBIRD RECORDS**, 376-378 Edgware Road, London W2 1EB, 071.723 9090, Fax: 071.723 5746, Tlx: 291379.
- BLUURG**, PO Box 59, London N22 4NS, 081.888 8949, Fax: 081.889 6166, Tlx: 268041 sthrn.
- BMG CLASSICS**, 69-79 Fulham High Street, Bedford House, London SW6 3JW, 071.973 0011, Fax: 071.371 9571, Tlx: 920896, Snr Dir: Gareth Harris, Mgr: Michael Deacon, Labels (owned): Deutsche Harmonia Mundi, Editio Classica, Eurodisc, RCA Victor, RCA Victor Gold Seal, RCA Victor Opera Series, RCA Victor Red Seal, RCA Victor Seon, RCA Victor Silver Seal, RCA Victor Van Cliburn Collection, RCA Victorla; Distribution: BMG Operations; Main product: Classical. BMG Classics is a division of BMG Records (UK).
- BMG ENTERPRISES**, 423 New Kings Road, Cavendish House, London SW6 4RN, 071.973 0011, Fax: 071.973 0345, Tlx: 920896, Snr Dir: Gareth Harris, Comm Mgr: Chris Haralambous, Lic Mgr: Veronica Jones, Cat Mktg Mgr: Paul Robinson, Prod Mgr: Jo Kennedy, Press/PR Mgr: Val Rooker, Video Mgr: Vicky Blood, Labels (owned): Ariola, Bluebird, Novus, Private Music; Distribution: BMG Operations. BMG Enterprises is a division of BMG Records (UK).
- BMG INDEPENDENT GROUP**, 69-79 Fulham High Street, Bedford House, London SW6 3JW, 071.973 0011, Fax: 071.371 9571, Tlx: 920896, Div Dir (Motown & Assoc Labels): Roger Semon, Mktg Mgr: Julian Wall, Labels (owned): Anxious, Dedicated, Funki Dreds, Motown, IQ, Sacred, Survival, Taj Records, Tamlam Motown; Distribution: BMG Operations. BMG Independent Group is a Bertelsmann Music Group Company.
- BMG INTERNATIONAL**, 69-79 Fulham High Street, Bedford House, London SW6 3JW, 071.731 4914, Fax: 071.731 3914, Tlx: 922876, VP (A&R/Mktg): Chris Stone, Mktg Dir (Int'l): Steve McCaughey, Mktg Mgr: Barbara Stanton, Promo Mgr: Jane Potter, Creative Services: Jacqueline Buxton, F&A Dir: Steve Pado, Labels owned: RCA, Ariola, Ariola.
- BMG RECORDS (UK)**, 69-79 Fulham High Street, Bedford House, London SW6 3JW, 071.973 0011, Fax: 071.371 9298, Tlx: 920896, Chmn/MD: John Preston, Snr Sales/Mktg Dir: Gareth Harris, Fin Dir: Ratnam Bala, Distr/Op Dir: John Henderson, MD (Music Publishing): Paul Curran, Int'l Dir: Chrissie Harwood, Personnel Director: Jim Chester, MIS Dir: Antin Pinilow. BMG Records (UK) is a Bertelsmann Music Group Company.
- BOLD REPRIVE RECORDS**, 110 High Street, Hythe, Kent, 0303.67876, Fax: 0303.261 013, Tlx: 934999 txlink.
- BOLTS RECORDS**, 6-9 Salisbury Prom, Arena Hse, Green Lee, London N8 0RX, 081.809 1460, Fax: 081.809 2237, Dir: Julie Batten, A&R: Nicky Price, Asst A&R: Paul Smith, Label: Bolts Records; Main product: Dance.
- BONNYMOVE RECORDS**, Manor Road, Manor Court, Loughton, Essex IG10 4RP, 081.809 1460, Fax: 081.802 8395.
- BOOT RECORDS & TOUR SERVICES**, PO Box 1745, London W9 3QL, 081.960 9587, Fax: 081.960 0578, MD: Steve Bootland, Labels (Owned): Boot; Main product: Album Rock, Reggae, New Age.
- BOSS RECORDS**, 74a High Street, Harlesden, London NW10 4SJ, 081.961 9839.
- BPL RECORDS**, PO Box 3595, London WC1N 3XX, 081.883 3252, Fax: 081.883 0945.
- BREAKIN' RECORDS**, 16 King Street, Luton, Bedfordshire, 0582.453 638, Fax: 0582.22000, President: Graham Dean, Chmn: James Rooney, MD: Kath Marshall, A&R: Steve Summer, David Schofield, Press/Promo: Linda Cannel.
- BREWHOUSE MUSIC**, 57 High Street, Breds Farm, Wicken, Ely, Cambridgeshire CB7 5XR, 0353.720 309, Fax: 0353.723 364, Music/Studio Dir: Eric Cowell, Art & Design Dir: Ray Cowell, Labels (owned): Brewhouse, Home Brew, Corner Shop; Main product: Classical, Traditional.
- BRIT-TONE RECORDS**, 129 Park Street, c/o Acuff Rose Music, London W1Y 3FA, 071.629 0392/81.449 6261, Fax: 071.499 9718, MD: Brian Carrole.
- BRIGHT RECORDS**, 2 Harwood Terrace, London SW6 2AB, 071.384 1599, Fax: 071.384 2236, MD: Martin Wyatt.
- BRIILLANT RECORDS**, Rotary Street, The Sunday School, London SE1 6LG, 071.384 1599, Fax: 071.384 2236.
- BRITANNIA MUSIC COMPANY**, 60-70 Roden Street, Ilford, Essex IG1 2AE, 081.553 3333, Fax: 081.553 4317, Tlx: 896C73, MD: John Nelligan, Mktg Dir: Gerald Good, F&A Contr: Roy Darling.
- BROADSIDE**, 68 Limes Road, Tettenhall, Wolverhampton, West Midlands WV6 8RB, 0902.753 047, MD: John Raven, Labels (owned): Bees Wing, Chesterscourt, Shooting Star; Main product: Folk, Traditional.
- BROKEN RECORDS**, 18 Yeoman Way, Hainault, Ilford, Essex IG6 2RN, 081.501 4116, Fax: 0984.23030.
- THE BROTHERS ORGANIZATION**, Oakmead Road, Falcon Mews, London SW12 9SJ, 081.675 5584, Fax: 081.675 6313, Joint MDs: Ian & Nick Titchener, Label Mgr: Zareena Husain, Labels (owned): The Brothers Organisation, Yo Bro; (Lic): Low Spirit; Main product: Dance.
- BROUHHAHA RECORDS**, 1-2 Hanover Street, London W1, 071.408 1611, Fax: 071.408 1006, Tlx: 27918 apalt.
- BUCKS MUSIC**, 1a Farm Place, London W8 7SX, 071.221 4275, Fax: 071.229 6893, MD: David Platz, A&R: Simon Platz, Admin Mgr: Margaret Fraser, Asst: Claire Pileri, Labels (owned): Fly, Weekend, Sepia Records; Distribution: BMG, Via Total Records; Main product: Dance, AC, Jazz.
- BUDEAUX'S**, 23a Carlisle Road, Bedford, Bedfordshire MK40 4HR, 0234.353 746, MD/Head of A&R: Richard Compton, Production: Tony Bone, Labels (owned): Budeaux's; Main product: Dance, Jazz, New Age.
- BULLSEYE RECORDS**, AIR House, Spennymoor, County Durham DL16 7SE, 0388.814 632, Fax: 0368.812 445, Tlx: 587513, MDs: Colin Pearson, John Wray.
- BURN ONE RECORDS**, 69 Highburgh Road, Hyndland, Glasgow, Strathclyde G72 9EW, 041.334 5499, Fax: 041.337 2344.
- BURNING SOUNDS RECORDINGS**, 31-39 Camden Road, Twymen House, 2nd flr, London NW1 9LF, 071.267 6899, Fax: 071.267 6746.
- BUTT RECORDS**, 29 Beethoven Street, London W10 4LG, 081.960 1871, Fax: 081.969 1694, MD: Brian Leafe, Labels (owned): Butt; Main product: Album Rock.
- C-SIDE RECORDS**, 8 Berwick Street, London W1V 3RG, 071.437 0630, Fax: 071.494 1229, Tlx: 86626 mynews.
- C5 RECORDS**, Littleton Road, Littleton House, Unit 10, Ashford, Middlesex TW15 1UU, 0784.247 176, Fax: 0784.241 168, Contact: Mark Rye.
- CABAL RECORDS**, 9-10 Regent Square, London WC1H 8HZ, 071.837 9648, Fax: 071.242 8495.
- CABALETTA RECORDING**, Fowimere House, Fowimere, Royston, Hertfordshire SG8 7SU, 0763.208 453, Fax: 0763.208 188, Dir: Hugh Richardson, Labels (owned): Caballetta, Tetraphon; Main product: Classical.
- CADILLAC MUSIC**, 180 Shaftesbury Avenue, London WC2H 8SJ, 071.836 3646, Fax: 071.497 9102.
- CALECHE RECORDS**, 175 Bankside Street, Leeds, West Yorkshire LS8 5AD, 0532.494 941, Fax: 0532.489 243, MD:

- Lesley Colman. Labels (owned): Caleche (Soul), CMC (Pop, MOR), Clique (Reggae).
- CALLIGRAPH PRODUCTIONS**, Wantz Road, 4 The Midas Business Centre, Dagenham, Essex RM10 8PS, 081.984 0322, Fax: 081.593 0198, Label Mgr: J K Walsh. Labels (owned): Calligraph; Main product: Jazz.
- CAMBRIDGE CLASSICAL RECORDS**, Alnsworth Place, Cambridge, Cambridgeshire CB1 2PQ, 0223.67878, Fax: 0223.314 069.
- CAPO RECORDS**, 45-53 Sinclair Road, Nomis Studios, London W14 0NS, 071.602 6341, Fax: 071.603 5941, Tlx: 8951475 strnge.
- CARA MUSIC**, 23 The Green, Southgate, London N14 6EN, 081.447 8882, Fax: 081.882 7679, MD: Michael McDonagh.
- CARGOLD PRODUCTIONS**, 39 Clitterhouse Crescent, London NW2 1DB, 081.458 1020, Fax: 081.346 3160.
- CARITAS RECORDS**, 28 Dalrymple Crescent, Edinburgh EH9 2NX, 031.667 3633, Fax: 031.662 4650, MD: James Douglas, Sales/Mktg: Katherine Douglas. Labels (owned): Caritas, Electa; Main product: AC, Album Rock, Jazz, New Age, Classical.
- CAROLINE INTERNATIONAL**, 56 Standard Road, London NW10 6ES, 081.961 2919, Fax: 081.961 1873, MD: Jonathan Gilbride.
- CARRERE RECORDS**, Sanctuary Street, 4-7 The Vineyard, London SE1 1QL, 071.403 0007, Fax: 071.403 3390, E-Mail: PWL-UK, MD: Freddy Cannon.
- CASSETTES FOR YOUNG PEOPLE**, 346 Lea Bridge Road, London E10 7LD, 081.556 1125, Fax: 081.539 8834.
- CASTLE COMMUNICATIONS**, 29 Barwell Business Park, Leatherhead Road, Chessington, Surrey KT9 2NY, 081.974 1021, Fax: 081.974 2674, Chmn: Terry Shand, Comm Dir: Jon Beecher, Operations Mgr: Chris Cole, Int'l Mgr: Tony Harris, F&A: Cliff Dane, Sales Dir: Ray Jenks, Lic Mgr: Nick Cotton. Labels: Collector Series, Castle Classics, Essential, Cirrus, Knight Records, Pye, Bronze, Immediate, Buddha, Kama Sutra, Sugarhill, All Platinum, NEMS.
- CATT RECORDS ENTERPRISES**, 45 Milton Avenue, London E6 1BG, 081.471 3209, Fax: 071.738 3265, MD/A&R: Anthony McNabb, Promo Dir: Bentley Applewhite, Dir: D Gale, Mktg: R Johnson, Sec: L A McNabb. Labels (owned): Catt; Main product: Dance.
- CAVELL MUSIC**, 26 Goodge Street, London W1P 1FG, 071.580 4740, Fax: 071.323 9295, Dirs: William Prendergast, Tony Berry. Labels (owned): Cavell Music; Main product: Adult Contemporary, Dance, Album Rock.
- CD RECORDS (UK)**, 131-133 Ballard's Lane, Euro House, Finchley, London N3 1LJ, 081.349 2224, Fax: 081.349 1840.
- CENTRAL MUSIC**, Broad Street, Central House, Birmingham, West Midlands B1 2JP, 021.643 9898, Fax: 021.616 1360, Contact: Duncan Smith.
- CHA CHA RECORDS**, 30 Culdesden Road, Kenley, Surrey CR2 5LR, 081.668 4833, MD: Oswin Faiquero.
- CHAMPION RECORDS**, 181 High Street, Harlesden, London NW10 4TE, 081.961 5202, Fax: 081.965 3948, President: Mel Medalie, GM: Raj Porter, A&R: Ron Boulding.
- CHANDOS RECORDS**, Commerce Way, Chandos House, Colchester, Essex CO2 8HQ, 0206.577 300, Fax: 0206.41104.
- CHANTEL RECORDS**, 3a Ashfield Parade, Southgate, London N14 5EH, 081.886 6238.
- CHAPTER 22 RECORDS**, 230 Broad Str, Broadwalk Bus Ctr, Unit 32, Birmingham B15 1AY, 021.643 3434, Fax: 021.643 6980, MD: Craig Jennings, A&R/Label Mgr: Rod Thomson, Asst A&R: Richard Bunce.
- CHARLY RECORDS**, 156-166 Ilderton Road, London SE15 1NT, 071.639 8603, Fax: 071.639 2532, Tlx: 8953184, E-Mail: 19022300, Chmn: Jean-Luc Young, MD: Tony Heneberry, Sales Dir: Alan Firth, Export Mgr: Brian Stevens, A&R: Joop Visser, Prod Contr: Allison Peat, Royalties Dir: Pat Evans. Labels (owned): Affinity, Atlantis, Bandy, BYG, Caliente, Charly, Charly Groove, Charly R&B, Decal, Directional, Instant, New Cross, New Cross Gospel, Now, Seven B, Topline; (Lic): Allegre, Bandit, Baron, Bethlehem, Blue Cat, Celloid, Chi-Sound, Cobra, Cotique, Demi Monde, Dial, Fania, Fire Fury, Folk Star, Goldband, Inca, Jewel, Lewis, Minaret, One-Way, Paula, Plantation, Red Bird, Red Robin, Ronn, Sansu, Silver Fox, Soul Power, SSS Int'l, Sun Tico, Tomato, Truth, USA, Vaya, Whirlin Disc, Whit.
- CHARM RECORDS**, 155 Old Street, Ashton-under-Lyne, Tameside, Lancashire OL6 7SQ, 061.343 1810, Fax: 061.343 1809.
- CHERRY RED RECORDS**, 25-29 Fulham High Street, Bishops Park Hse, London SW6 3JH, 071.371 5844, Fax: 071.731 8595, Tlx: 943763, MDs: Ian McNay, Martin Costello, GM: Danny Hagan.
- CHINA RECORDS**, 27 Queensdale Place, London W11 4SQ, 071.602 5031, Fax: 071.602 5039, MD: Derek Green, Dir: Bob Grace, GM: Adrian Sear, A&R: Paul Weighall, Mktg Mgr: Gordon Biggins, Promo Mgr: Rachel Speers.
- CHOOSE IT! PRODUCTION**, 3 Anson Road, Cricklewood, London NW2 3UX, 081.450 3655, MD: Gerard Brenis, Creative Mgr: Colin Goddard, Publicity: Nick Page. Labels (owned): Face To Face; Main product: EHR, Adult Contemporary, Jazz, Album Rock, New Age.
- CHRISTABEL RECORDS**, PO Box 232, Harrow, Middlesex HA1 2NN, 081.907 1905, Fax: 081.907 6762, Tlx: 8951182 gecoms.
- CHRYSALIS RECORDS (UK)**, 13 Bramley Road, The Chrysalis Building, London W10 6SP, 071.221 2213, Fax: 071.221 6455, Chmn: Chris Wright, President: Paul Conroy, MD (UK Ops): Roy Eldridge, Int'l Director: Mike Allen, Mktg/Prod Mgrs: Carrie Norrish, Karl Badger, Int'l Mktg Mgr: Phil Patterson, Int'l Press: Kay MacCauley, Int'l Production Co-Ord: Anna Macario, Head Of Int'l Promo: Liam McCoy, Promo Dir: Judd Lander, Promo: Katie Rennie (TV), Andi Taylor (Radio). Labels (owned): Chrysalis, Ensign, Cooletempo, Dover, Compulsion; Main product: EHR, Adult Contemporary, Dance, Album Rock.
- CIRCA**, 1-7 Vernon Yard (off Portobello Road), London W11 2DX, 071.221 7535, Fax: 071.221 0957, MDs: Ray Cooper, Ashley Newton, Head of Mktg: David Steele, Head of Promo: Matthew Austin, Head of Press: Shelley Clarke, Head of Dance Promo: Rob Manley, Fin Contr: Sandy Lawrence. Labels (owned): Circa, 10, Siren, Virgin America, Charisma, Cardiac, Virgin International, EG, Virgin Movie Music, Caroline, Wild Bunch; Main product: EHR, Dance, AC, Album, Black (R&B), Reggae.
- CIRCA RECORDS**, 15a Ives Street, London SW3 2ND, 071.584 0012, Fax: 071.439 2028, MDs: Ray Cooper, Ashley Newton, GM: John Whyton, A&R: Harvey Leonard, GM (Chrysalis Music): Paul Rump. Labels (owned): Circa, Wild Bunch.
- CIRCLE SOUND SERVICES**, 14 Waveney Circle, Circle House, Bicester, Oxfordshire OX6 8GP, 0869 240 051, Owner: John Willett. Labels (owned): Circle; Main product: Gospel.
- CITIZEN KANE**, 73 Beacon Way, Rickmansworth, Hertfordshire WD3 2PB, 0923.775 911, Fax: 0923.774 334.
- CITYBEAT RECORDS**, 17-19 Alma Road, London SW18 1AA, 081.870 7511, Fax: 081.871 1766, Tlx: 915733 begban, Label Mgr: Nick Halkes.
- CLASSIQUE RECORDS**, 620 Western Avenue, London W3 0TU, 081.992 8055, Fax: 081.993 3652, Tlx: 934195, Chmn: Ron Winter, MD: Hasan Akhtar, Sales Dir: Tony Smith, Prod Mgr: Rosette Bond.
- CLAY RECORDS**, 31-39 Camden Road, Twyman House, 2nd flr, London NW1 9LF, 071.267 6899, Fax: 071.267 6746, Tlx: 22787 thayer, MD: Mike Stone.
- CLOUD NINE RECORDS**, 261 Royal College Street, Silva House, London NW1 9LU, 071.284 0525, Fax: 071.482 2385, MD: David Wishart.
- COCTEAU RECORDS**, Littleton Road, Littleton House, Unit 10, Ashford, Middlesex TW15 1UU, 0784.247 176, Fax: 0784.241 168, Contact: Mark Rye.
- CODA RECORDS**, Rainville Road, Thames Wharf Studios, London W6 9NA, 071.386 9940, Fax: 071.386 9682, Contact: Nicholas Austin.
- COHESION RECORDS/COLD HARBOUR RECORDS**, PO Box 786, London SE13 6RN, 081.318 9529, Fax: 081.318 9529, A&R/Mktg (Int'l): Steve Fernie, Helen Milner.
- COLIN CAMPBELL RECORDS**, Easter Bauds Farm, Fochabers, Morayshire IV32 7LJ, 0343.820 450, MD: Colin Campbell.
- COLLEGIUM RECORDS**, PO Box 172, Whittlesford, Cambridge CB2 4QZ, 0223.832 474, Fax: 0223.836 723, Owner: John Rutter.
- COLLINS CLASSICS**, 77-85 Fulham Palace Road, London W6 8JB, 081.741 7070, Fax: 081.307 4753, GM: Alan Booth, Sales Mgr: Julian Haylock, Mktg/PR: Anna Gregory, Prod Mgr: Anne Finerty, Admin: Helen Hogh. Main product: Classical.
- COLOURTONE RECORD COMPANY**, Yewtone Farm, The Studio, Charing Heath, Kent TN27 0AU, 023371.3431, Fax: 023371.3592, Tlx: 965147.
- COLUMBIA RECORDS**, 17-19 Soho Square, London W1V 6HE, 071.734 8181, Fax: 071.287 9959, Tlx: 24203 csbrsc, Chmn: Paul Russell, MD: Tim Bowen, A&R Dir: Rob Stringer, Int'l Mktg & Artist Dev: Alan Phillips, Mktg Dir: Brian Yates. Labels (lic): Def Jam, Go Bang, Rush Associated Labels; Distribution: Sony Music Operations.
- COMMUNIQUE RECORDS**, 15 Great Western Road, London W9 3NW, 071.266 4100, Fax: 071.266 2628, President: Tom Doherty, Fin Dir: Martin Fielding, MD: Dave Oberle, Accts Dir: Kevin Alderton, A&R Dir (Tombstone/Vice): Mark Gray. Labels (owned): Tombstone, Curio, Vice; Main product: Album Rock, Heavy Metal.
- CONCRETE PRODUCTIONS**, PO Box 798, London W14 9NT, 071.385 8690, Fax: 071.385 3807, MD: Andrew Burton. Labels (owned): Concrete; Main product: Dance.
- CONIFER RECORDS**, Horton Road, West Drayton, Middlesex UB7 8JL, 0895.447 707, Fax: 0895.420 713, Chmn: E.C. Demetriou, MD: Alison Wenham, Fin Dir: John D Milton, Mktg Dir: Brian Hopkins, Label Mgr (Classical): John Kehoe, Int'l Mgr: Anne Cater, Promo Mgr: Pat Lennox. Labels: Lime, Talking Tape, Conifer, Tel, Bis, Hungaraton.
- CONNOISSEUR COLLECTION**, THE, 44 Seymour Place, London W1H 5WQ, 071.724 1502, Fax: 071.706 1754, Tlx: 26741, MD: Pete Summerfield.
- CONSCIENCE RECORDS**, 92 Brownhill Road, London SE6 2EW, 081.461 4454, Fax: 081.698 2808, MD: H J Percival, Promo/A&R: C Gibson, Admin Dir: F Dillnutt. Labels owned: Conscience Records; Main product: EHR, Adult Contemporary, Dance.
- COOKING VINYL**, PO Box 1741, London W9 3LA, 081.960 6000, Fax: 081.960 1120, MD: Martin Goldschmidt, A&R: Neil Armstrong, Mktg Mgr: Harriet Simms, Sales Mgr: Phil Buden. Main product: Adult Contemporary, Album Rock, World Roots.
- COOLETEMPO RECORDS**, 13 Bramley Road, The Chrysalis Building, London W10 6SP, 071.221 2213, Fax: 071.221 6455, Tlx: 21753.
- COOMBE MUSIC INTERNATIONAL**, 165-167 Willesden High Road, London NW10 2SG, 081.459 8899, Fax: 081.459 8727, Tlx: 919884 zomba, MD: David M. Stone, Mktg Mgr: Michael J. Bayler, Mktg Asst: Petra Miller. Main product: covers, soundalikes, classical.
- COPASETIC RECORDS**, 2 Ruston Mews, London W11 1RB, 071.229 4074, Fax: 071.221 7240.
- CORBAN RECORDS**, PO Box 2, Glasgow, Strathclyde G44 3LB, 041.637 5277, MD: Alastair MacDonald. Main product: MOR, Folk, Scottish Contemporary.
- CORDELIA**, 8 Denis Close, Leicestershire LE3 6DQ, 0533.858 025, MD: Blodwin P Teabag. Main product: Obscure, Indie.
- CORPUS CHRISTI**, PO Box 59, London N22, 081.888 8949, Fax: 081.889 6166, Tlx: 268041 sthrn.
- COUSINS COVE**, 58 Picton Road, Wavertree, Liverpool, Merseyside L15 4LH, 051.734 2268, MD: Norma Cousins, Dirs: Erwin & Jemima Cousins, Prod Mgr: Roy Cousins. Labels (owned): Tamokl-Wambesi, Dove; Main product: Reggae.
- COW RECORDS**, PO Box 410, Manchester, Greater Manchester M60 3WD, 061.953 4044, Fax: 061.953 4033, MD: Anthony Bogglano.
- CRAIGHALL SOUND PRODUCTIONS**, 2 Craighall Gardens, Edinburgh, Lothian EH6 4RJ, 031.552 3685, Tlx: 031.229 5466, MD: Bruce Laing. Main product: Scottish, Brass Bands, MOR.
- CRASS**, PO Box 279, London N22, 081.888 8949, Fax: 081.889 6166, Tlx: 268041 sthrn.
- CREATION RECORDS**, 8 Westgate Street, London E8 3RN, 081.986 7145, Fax: 081.986 7184, MD: Alan McGee.
- CREOLE MUSIC**, France Hill Drive, The Chilterns, Camberley, Surrey GU15 3QA, 0276.688 077, Fax: 0276.688 055, MD: Bruce D White, Dir: Sue White. Labels (Owned): Creole, Cactus, Big, Blast From The Past, Stag, Replay, Volume; (Lic): Dynamic, Revue, PVK; Main product: Dance, Album Rock, Black (R&B), Reggae.
- CRITERION RECORDS**, Churt Rd, Beacon Hill Park, W Wing House, Hindhead, Surrey GU26 6HU, 0428.605 771, Fax: 0428.605 896.
- CRUSH MUSIC**, 620 Western Avenue, K-tel House, London W3 0TU, 081.992 8055, Fax: 081.993 3652, Tlx: 934195 kteluk.
- CSA RECORDS**, 101 Chamberlayne Road, London NW10 3NP, 081.960 8466, Fax: 081.968 0804, Tlx: 8954958, MD: Clive Stanhope.
- CTR CHEQUE THIS RECORDS**, 63a Portland Road, London W11 4LJ, 071.229 7329, Fax: 071.381 3141.
- CULBURNIE RECORDS**, 2 Harestanes Gardens, Kirkintilloch G86 2BT, 041.776 0113, Partner: Iain Fraser, Alasdair Fraser, Sally Ashcraft. Labels (owned): Culburnie; Main product: Folk, Traditional.
- CURSOR RECORDS**, Nursery Road, Gievefield House, Walton-on-the-Hill, Surrey KT20 7TZ, 0737.812 271, Fax: 0737.813 160, Tlx: 8952445 chery.
- CUT DEEP RECORDS**, 3 Waterloo Road, Stockport, Cheshire SK1 3BD, 061.429 8480, Fax: 061.480 1989.
- CUZZO MUSIC PRODUCTIONS & RECORDS**, 13 Grimston Lane, Trimley St. Martin, Ipswich, Suffolk IP10 0RU, 0394.275 307, MD: Glen Ambrose. Labels (Owned): Cuzzo; Main product: Dance, Soundtrack.
- DA DOO RON RON RECORDS**, Granville Road, Granville Manor, Southport, Merseyside PR8 2HU, 0704.64323, Fax: 0704.63061.
- DADDY'S GIRL MUSIC**, 7 Sylvan Avenue Woodgreen, London N22 5HX, 081.881 9475, Dir: Johnny Mac, A&R/Mktg: Merval Mac. Labels (owned): Record Company, Daddy's Girls; Main product: Dance, Black (R&B).
- DANCE LAB**, 34 Hawksley Road, London N16 0TJ, 071.923 0020, Fax: 071.254 3534, MD: Alex Georgiuk.
- DANCETERIA (UK)**, PO Box 2200, Barnet, Hertfordshire EN5 4BT, 081.440 3005, Fax: 081.441 9935, Contact: M Mellows.
- DAYLIGHT RECORDS**, 150 High Street, The Old Bakehouse, Honiton, Devonshire EX14 8JX, 0404.42234, Fax: 0404.45346, Mgr: Paul Bateman. Labels (owned): Daylight; Main product: Dance, AC, Album Rock, Classical.
- DDT**, 21a Alva Street, Edinburgh, Lothian EH2 4PS, 031.226 3129, Fax: 031.226 3133.
- DE WOLFE MUSIC**, 80-88 Wardour Street, London W1V 3LF, 071.439 8481/6, Fax: 071.437 2744, Contact: Warren De Wolfe.
- DE-MIX PRODUCTIONS LTD**, 7 Croxley Road, London W9 3HH, 081.960 1115, Dir: Martin Lascelles.
- DEAD FLY RECORDS**, 98 Ravenhead Road, St. Helens, Merseyside WA10 3LR, 0744.612 125, MD: Paul Bunion .
- DEAD HEDGEHOG ENTERPRISES**, 815 St. Albans Road, Orient House, Watford, Hertfordshire WD2 6LE, 0923.53153, Fax: 0923.894 321.
- DECCA INTERNATIONAL**, 347-353 Chiswick High Road, London W4 4HS, 081.747 8787, Fax: 081.994 2834, Tlx: 23533 decca, President: Roland Kommerell, Exec VP: Raymond Minshull, Contr: Roy Hindocha, VP (Mktg): Richard Rolfebon.
- DECEMBER SONGS**, 42 Park View Road, London NW10 1AL, 081.450 5987, GM: T Lutterodt. Labels (owned): Waiting-in-Vain Records, Europa; Main product: Adult Contemporary, Dance, Black (R&B).
- DECONSTRUCTION RECORDS**, 132 Liverpool Road, London N1 1LA, 071.609 8978, Fax: 081.700 0230, Tlx: 266222 rollin, MDs: Pete Hadfield, Keith Blackhurst, A&R/Artist Liaison: Kevin Dawson.
- DEDICATED RECORDS**, 37 Uxbridge Street, London W8 7TQ, 071.221 6677, Fax: 071.221 2868, MD: Doug D'Arcy, GM: Karen Brown.
- DEE O'REILLY MANAGEMENT**, 112 Gunnersbury Avenue, London W5 4HB, 081.993 7441, Fax: 081.992 9993, MD/Artist Mgr: Dee O'Reilly, Agency Mgr: Hazel Hemmings, PR Dir: Elizabeth Kane. Main product: Adult Contemporary, Classical, New Age.
- DEEP END**, 130a Plough Road, London SW11 2AA, 071.738 0779, Fax: 071.924 1471, MDs: John Wright, Paul Callaghan,

- Tony Hickmott, Label Mgr: Daniel Ryan.
DEJAMUS PRODUCTIONS, 44 Baker Street, Accurist House, Unit 11, London W1M 1DH, 071.486 5838, Fax: 071.487 2634, MD: Stephen James.
- DEMI MONDE RECORDS**, Foel Studio, Llanfair, Caerinion, Powys SY21 ORZ, 0938.810 748/0952.883 962, Fax: 0952.728 176, MD: Dave Anderson, Sec: Julie Warelne. Labels (owned): Demi Monde; Distribution: RTM, APT, Backs, Magnum; Main product: Album Rock, New Age.
- DEMON RECORDS**, Transport Avenue, Canal House, Brentford, Middlesex TW8 9HF, 081.847 2481, Fax: 081.568 8223, Tlx: 894666, Fin Dir: Lew Difford, PR/Promo/A&R Mgr: Spike Hyde, Mktg/Sales Dir: Pete Macklin. Labels (owned): Demon, Diabolo, Demon Verbals, Edsel, Mau Mau, Zippo, Bam Caruso, Hi, Drop Out, HDH, Rounder Europa, Mondeca, Demon Transatlantic; Distribution: Pinnacle.
- DENON (NIPPON COLUMBIA)**, Chiltern Hill, Hayden House, Chalfont St. Peter, Buckinghamshire SL9 9UG, 0753.888 447, Fax: 0753.880 109, Tlx: 849469 haylab.
- DEP INTERNATIONAL**, 92 Fazely Street, Birmingham, West Midlands B85 5RD, 021.633 4742, Fax: 021.643 4904, Tlx: 339447, MD: P Davies, Mktg Dir: Dave Harper.
- DESIRE RECORDS**, 97 Charlotte Street, London W1P 1LB, 071.323 5555, Fax: 071.323 5323, MD: Chris Parry. Distribution: Pinnacle.
- DG RECORDS**, 5 Paddington Street, London W1M 3LA, 071.935 1588, Fax: 071.487 3016.
- DI MUSIC**, 13 Bank Square, Wilmslow, Cheshire SK9 1AN, 0625.527 844, Fax: 0625.536 101, Tlx: 635091 albion.
- DIAMOND RECORDS**, 162 Regent Street, Linen Hall, Ste 609, London W1R 7FB, 071.437 1777, Fax: 071.494 1648.
- DINO ENTERTAINMENT (UK)**, 10 Allied Way, Dino House, London W3 0RQ, 081.743 2019, Fax: 081.743 6165, President: Raymond Kives, MD: Mark Rosenfield, Mktg Mgr: N C Moran, Fin Contr: Gary Lim. Labels (owned): Dino, Pump; Distribution: Pinnacle.
- DIRECT FORCE PROMOTIONS**, 45 Tudor Road, Unit 4, London E9 7SN, 081.985 1512, Fax: 081.533 1549, Head Of Production: Philip Richards, A&R Dir: John Jap, Promo Dir: Carly Richards. Labels (owned): Soul Train, Direct Force, Hands & Heart, Mental House, John Dread Productions; Main product: House, Hip Hop, Ragga.
- DISCHORD**, PO Box 59, London N22 4NS, 081.888 8949, Fax: 081.889 6166, Tlx: 268041 sthrn.
- DISCS INTERNATIONAL RECORDS & TAPES**, 133-137 Kilburn Lane, London W10 4AN, 071.497 2444, Fax: 081.960 4944.
- DISQUES DU GRAND MICHEL**, 42 Park View Road, Neasden, London NW10 1AL, 081.450 5987, GM: T Lutterodt. Main product: Adult Contemporary, Dance, Black (R&B).
- DMC RECORDS**, PO Box 89, Slough, Buckinghamshire SL1 8NA, 06286.67276, Fax: 06286.67057, Tlx: 849855, Contact: Christine & Tony Prince.
- DOCUMENT RECORDS**, North Road, United House, London N1 2RR, 071.700 3890, Fax: 071.700 3876. Re-issue specialist.
- DOLPHIN RECORDS**, 6a Mandalay Road, London SW4 9ED, 081.673 2285, Fax: 081.673 9247.
- DOMINO RECORDS**, 27 The Tricorn Marketway, Portsmouth, Hampshire PO1 4AN, 0703.617 671, Fax: 0703.618 124, MD: Gary Jones. Labels (owned): Domino; Main product: Dance.
- DON'T PANIC PRODUCTIONS**, Oakmead Road, Falcon Mews, London SW12 9SJ, 081.675 5584, Fax: 081.675 6313, MDs: Ian & Nick Titchener, Mgr: Zareena Hussain. Producers represented: 3 to the Power, Colin Peter, Carl Ward.
- DONSIDER RECORDS**, Waterside, Pitcaple, Inverurie AB15 9HN, 0467.681 269, MD: Charles Esson. Main product: Scottish Country.
- DOR (EUROPE)**, PO Box 1797, London E1 4TX, 071.702 7842, Fax: 071.790 0764. Labels (owned): DOR; (Distr): TFI.
- DOVE RECORDS**, 36 Eastcastle Street, London W1N 7PE, 071.436 2990, Fax: 071.436 2519, Dirs: Arthur Martin, Simon Wallace. Labels (owned & distr): Dove; Main product: Black Gospel.
- DOVER RECORDS**, 13 Bramley Road, The Chrysalis Building, London W10 6SP, 071.221 2213, Fax: 071.221 6341, Tlx: 21753, MDs: John & Phil Cokell. Labels (Owned): Dover; Main product: AC, Album Rock, Gold/Oldies, Classical.
- DRAGG-ON RECORDS**, 35a Jubilee Road, Weston-super-Mare, Avon BS23 3AW, 0934.417 052, Fax: 0934.620 257.
- DRAGON RECORDS**, 5 Church Street, Aylesbury, Buckinghamshire HP20 2QP, 0296.415 333, Fax: 0296 397 092, Chmn: Joan Heydon, MD: Derek Harrison, Company Sec: Sue Harrison. Labels (owned): Dragon Records; Main product: Folk.
- DTP RADIO PRODUCTION STUDIOS**, 3 Giebe Road, Weston-super-Mare, Avon BS23 3AP, 0934.417 174, MD: Don Todd, Producer: Rikki Caine.
- DUCK RECORDS (UK)**, 77 Harley House, Regents Park, London NW1 5HF, 071.486 8056, Fax: 071.487 5663.
- DULCIMA RECORDS**, 39 Tadorne Road, Tadworth, Surrey KT20 5TF, 0737.812 922, MD: Johnny Douglas, Dirs: Gerald Camby, Jan Douglas, Company Sec: Norma Camby. Labels (owned): Dulcima; Main product: MOR, Easy Listening.
- DUNKLED RECORDS**, The Old Schoolhouse, Buttersone, Dunkeld, Tayside PH8 0AS, 03504.281, Fax: 03504.228, MDs: Dougie Maclean (Production), Jennifer Maclean (Admin), Promo: Melanie Caban. Labels (owned): Dunkled; Main product: AC, New Age, Folk.
- DYNAMITE DISCS**, 27 Old Gloucester Street, London WC1N 3XX, 071.404 5011, Fax: 071.831 9489.
- EARACHE RECORDS**, Theatre Sq, Westminster Bldg, Unit 19, Nottingham, Nottinghamshire NG1 6LG, 0602.506 400, Fax: 0602.508 585.
- EARTHWORKS**, 19 Finstock Road, London W10 6LT, 081.969 1387, Fax: 081.968 6533.
- EAST WEST RECORDS**, 46 Kensington Ct, ELEC Lighting Station, London W8 5DP, 071.938 2181, Fax: 071.937 6645, Tlx: 261425, MD: Max Hole, MD (Magnet): Sanji P Tandan, Mktg Dir: Elyse Taylor, Promo Dir: Alan McGee, Head Of Press: Lee Ellen Newman, Dir (Int'l): Anne-Marie Nicol, Mgr (Int'l): Alison Smith, Mktg Mgr: Richard Engler, A&R Dir: Malcolm Dunbar, Promo: Hassan Choudhury (TV), Siobhan Pestano (TV), Jo Reddington (Radio), Nick Jackson (Radio). Labels (owned): Magnet; (Lic): Dead Dead Good, Oval, Atlantic, Atco, East West America, Interscope; Main product: EHR, Dance, AC, Album Rock, Jazz, Gold/Oldies, Black (R&B).
- ECCENTRIC RECORDS**, 29a Connaught Street, London W2 2AY, 071.262 0836, Fax: 071.723 8977.
- ECHO RECORDS (UK)**, The Manor House, Hayling Island, Hampshire PO11 0QW, 071.828 3651, Fax: 071.828 3654, Tlx: 268312 westcom.
- ECLECTIC RECORDS**, 9 Alvanley Terrace, Whitehouse Loan, Edinburgh, Lothian EH9 1DU, 031.229 9299, Fax: 031.229 8380, MD: Gordon Stevenson. Main product: Scottish, Folk, Jazz, Rock.
- EG RECORDS**, 180 Kings Road, Blenheim House, London SW3 5XS, 071.352 1010, Fax: 071.352 0344, Chmn: Sam Alder, Mark Fenwick, Assoc Dir: Alec Byrn, Bus Affairs: Andrew Stanger, Comm Affairs Mgr: Karen Christie. Labels (owned): EG Records, Editions EG; Distribution: AVL (Virgin).
- ELECTRIC PLANET**, 1 Bowerleaze, Sea Mills, Bristol BS9 2HJ, 072.681 571, Fax: 072.238 011, Contact: Clive Stevens.
- ELEFANTZTRUNK RECORDS**, 3 Claremont Villas, Southampton Way, London SE5 7SS, 071.708 4604, Fax: 071.708 4604, MD: Stuart Witcher. Main product: R & B.
- ELEKTRA RECORDS**, 83 Baker Street, London W1M 1AJ, 071.486 1414, Fax: 071.486 6892, Tlx: 266170, Contact: Roxanna Ashton.
- ELYSIUM RECORDS**, The Old School, Paul, Penzance, Cornwall TR19 6UD, 0736.732 800, Fax: 0736.731 232, MD: Brian Smith, A&R: Brian Miller, Sales/Mktg: Eddie Webster, Promo: Geraldine Sylvester, Fin: John Vaughan. Labels (owned): Elysium; Main product: instrumental music.
- EMI MUSIC WORLDWIDE**, 30 Gloucester Place, London W1A 1ES, 071.486 6022, Fax: 071.465 0770, Tlx: 8953682, CEO: Jim Field, Chmn: Colin Southgate, Exec VP: Philip Rowley, MDs: Alexis Rotelli (Eur), David Stockley (Int'l), Peter Kneeb (Eur M&D Ops), GM (SMD): Mike Heatley, Dir Int'l Mktg: Hennie van Kuijeren, Int'l Mktg Mgrs: Didier Zerath (Capitol), Plero Giramonti (EMI), Neil Cox (EMI), Promo Head (Cont Eur): Mitch Clark, Legal & Bus Affairs Dir: Dick Vliet, Bus Affairs: Donald Valbert (GAS), Pierluigi Raimondi Cominesi (Southern Europe), Jocelyne Apperce (Fra). Labels: EMI USA, SBK, Impact American, IRS.
- EMI RECORDS (UK)**, 20 Manchester Square, London W1A 1ES, 071.486 4488, Fax: 071.465 0770, Tlx: 22643 emihq, MD: Rupert Perry, MDs: Martin Haxby (PMI), Clive Swan (EMI/EMI/USA), Andrew Pryor (Capitol/Parlophone), Legal/Bus Affairs Dir: Gareth Hopkins, A&R Dir: Nick Gaffield, Dir Int'l Mktg/Promo: John Briley, Strategic Mktg Dir: David Hughes, Dir Classic: Roger Lewis, Dirs Human Resources: Eddie White, Knox Millar, Sales Dir: Keith Staton, Fin Dir: Tony Bates. Labels (owned): EMI, Parlophone, EMI USA, Capitol, SBK, Blue Note; (Lic): IRS, Impact.
- ENERGY RECORDS**, PO Box 130, Hove, East Sussex BN3 6QU, 0273.550 088, Fax: 0273.540 969.
- ENSIGN RECORDS**, 3 Monmouth Place (off Monmouth Road), London W2 5SH, 071.727 0527, Fax: 071.727 6131, MD: Nigel Grainge, A&R Mgr: Chris Hill, GM: Doreen Loader. Ensign is part of the Chrysalis Group.
- EPIC RECORDS**, 17-19 Soho Square, London W1V 6HE, 071.734 8181, Fax: 071.287 8854, MD: Andy Stephens, A&R Dir: Gordon Charlton, Mktg Dir: Kit Buckler. Labels (lic): Rhythm King, ARS, Curb, Relativity, Combat, Solar; Distribution: Sony Music Operations.
- EQUINOX RECORDS**, 30 Strutton Ground, London SW1P 2HR, 071.233 1070, Fax: 071.233 2225.
- ESCAPE RECORDS**, Hartsbourne Avenue, 1 Hartswood Green, Bushey Heath, Hertfordshire WD2 1JL, 081.950 8925, Fax: 081.950 8926, MD: Barry Blue, A&R Dirs: Ian & Lyn West, Royalties Mgr: A Werth.
- ESR RECORDS**, 61 Burnthorpe Lane, Exeter, Devonshire EX2 6AZ, 0392.57880, Fax: 0392.54880, President: John Greenslade, MDs: June Greenslade, T Jennings. Labels (owned): ESR, J&J Music; Main product: AC, Gold/Oldies, Country.
- EUROPEAN ARTISTS & ENTERTAINMENT**, 620 Western Avenue, London W3 0TU, 081.992 8055, Fax: 081.993 3652, Tlx: 934195, Chmn: Ron Winter, MD: Hasan Akhtar, Sales Dir: Tony Smith, Prod Mgr: Rosette Bond.
- EVOLUTION RECORDS**, 15 Overbury Road, The Cottage, London N15 6RH, 081.802 3226, Fax: 081.802 3226, A&R: Rick Davey. Labels (Owned): Evolution; Main product: Dance, New Age.
- EXPRESSION RECORDS**, St. Ann's Hill Road, St. Ann's Court, Chertsey, Surrey KT16 97W, 0932.571 000, Fax: 0932.567 567, Dir: Phil Manzanera, GM: Joan Marindin.
- EXTRAVAGANZA RECORDS**, 9 Vicarage Gate, London W8 4AG, 071.229 7104, Fax: 071.792 1036.
- F-BEAT RECORDS**, Transport Avenue, Canal House, Brentford, Middlesex TW8 9HF, 081.847 2481, Fax: 081.568 8223, Tlx: 894666, MD: Jake Riviera, A&R: Spike Hyde. Distribution: Demon.
- FACE MUSICAL PRODUCTIONS**, 211 Wingrove Road, Newcastle-upon-Tyne, Tyne & Wear NE4 9DB, 091.273 4443, Contact: Dave Maughan.
- FACE RECORDS**, 29 Falcon Way, Sunbury-on-Thames, Middlesex TW16 6UN, 0932.785 709, MD: Els Calvert.
- FACTORY CLASSICAL**, 322 Uxbridge Road, London W3 9QP, 081.993 3899, Fax: 081.752 0023.
- FACTORY COMMUNICATIONS**, Charles Street, Manchester, Greater Manchester M1 7EB, 061.953 0251, Fax: 061.953 2051, Chmn: Tony Wilson, MDs: Alan Erasmus, Lieve Monnens, Eric Longley, Prod Mgr: Gary McCousland, Promo/PR: Alison Patchett, F&A: Christopher Smith.
- FANFARE RECORDS**, Deodar Road, 25 Blades Court, London SW15 2NU, 081.877 9488, Fax: 081.877 9523, MD: Iain Burton, Mktg/A&R: Simon Cowell.
- FASHION RECORDS**, 274 Lavender Hill, London SW11 1LJ, 071.223 3757, Fax: 071.350 2688.
- FAT FORWARD COMMUNICATION**, 21a Alva Street, Edinburgh, Lothian EH2 4PS, 031.226 3129, Fax: 031.226 3133, MDs: Brian Guthrie, Janice Evans, Int'l: Lindsay Hutton, Press/Promo: Graeme Roberts. Labels (lic): DDT, Fifty-Third and Third, New Alba Recordings, Mental Records, Blast Furnace, Nightshift, Velocity, Cathexis, Next Big Thing; (Distr): Cathexis, DDT, 53rd and 3rd, Mental, New Alba Recordings, Temple, Blast Furnace, Next Big Thing, Velocity, Paint It Red.
- FAT TERRY RECORDS & COMMUNICATIONS**, 1 Falkirk Walk, Manchester, Greater Manchester M23 8XZ, 061.437 4731, Fax: 061.483 1775, MD: Fat Terry, A&R: Kevin Moran. Labels (owned): Fat Terry Records; Main product: Adult Contemporary, Album Rock, Indie.
- FELLSIDE RECORDINGS**, 15 Banklands, Workington, Cumbria CA14 3EW, 0900.61556, MD: Paul Adams. Labels (owned): Fellside, Lake, PME; Main product: Jazz, Folk.
- FLECTION RECORDS**, 97 Charlotte Street, London W1P 1LB, 071.323 5555, Fax: 071.323 5323, Tlx: 265871 flection, E-Mail: DGS 1936.
- FINAL FRONTIER MUSIC**, 29 Roundwood Road, Hastings, Sussex TN37 7LD, 0424.753 792, MD: David Roberts. Labels (owned & distr): FF Cassettes; Main product: New Age.
- FIRE RECORDS**, 91 Highbury New Park, London N5 2E, 071.359 6142, Fax: 071.359 9661, MD: Clive Solomon, GM: Dave Bedford, Production: Tim Maxwell, Int'l: Juliet Howles, Label Mgrs: Lawrence Bell, Dave Barker. Labels (owned): Roughneck, Paperhouse.
- FIRST NIGHT RECORDS**, 44 Seymour Place, London W1H 5WQ, 071.723 8464, Fax: 071.723 3410, Tlx: 267412, MD: Jon Craig.
- FIRST TIME RECORDS**, 12 Trewartha Road, Sovereign House, Praa Sands, Penzance, Cornwall TR20 9ST, 0736.762 826, Fax: 0736.763 328, MD: Roderick G Jones, Bus Affairs: Carole A Jones, Production: Colin Eade. Main product: EHR, Dance.
- FITZI FILMS**, 18a Hinchley Drive, Robin House, Esher, Surrey KT10 0BZ, 081.398 9067, Fax: 081.398 9979, Contact: Stuart Fitzsimmons.
- FLAIR RECORDS**, Lion Chambers, Northgate, Cleckheaton, West Yorkshire BD19 3HZ, 0274.851 365, Fax: 0274.874 329.
- FLAT RECORDS**, 5 Doods Road, Reigate, Surrey RH2 0NT, 0737.241 893, Fax: 0737.223 694, Tlx: 934999 txlink, E-Mail: 219996162.
- Flickknife RECORDS**, 5-10 Eastman Road, The Metrostore, London W3 7YG, 081.993 6524, Fax: 081.749 7665.
- FLY RECORDS**, 1a Farm Place, London W8 7SX, 071.221 4275, Fax: 071.229 6893, MD: David Platz, A&R: Simon Platz, Admin Mgr: Margaret Fraser, Asst: Claire Pieroni. Main product: Dance, AC, Jazz.
- THE FLYING RECORD COMPANY**, 110 Clarendon Road, FM House, London W11 2HR, 071.221 7799, Fax: 071.221 5016, Tlx: 21684 flying, MD: Paul K Walden, Fin Contr: Yvonne Legon, Asst to MD: Lindsey Dennis. Labels (owned): F y-ing Records; Main product: Adult Contemporary, Gold/Oldies.
- FM RECORDS**, 152 Goldthorn Hill, Penn, Wolverhampton, West Midlands WV2 3JA, 0902.345 345, Fax: 0902.345 155, MD: Paul Birch, Int'l Mgr: Pete Cook, Sales Mgr: Bob James. Labels (owned): Revolver, FM, Black, FM-Dance, Heavy Metal, Heavy Metal America/Worldwide; Main product: AC, Album Rock, Black (R&B).
- FOLK HERITAGE RECORDINGS**, 14 North Parade, Llandudno, Gwynedd LL30 2LP, 0492.77719, Fax: 0492.76601.
- FOLK SOUND RECORDS**, 250 Earlsdon Avenue North, Coventry, West Midlands CV5 6GX, 0203.715 541, MD: Graham Bradshaw.
- FOLKTRACKS & SOUNDPOST PUBLICATIONS**, 16 Brunswick Square, Gloucester, Gloucestershire GL1 1UG, 0452.415 110, Contact: Peter Kennedy. Labels (owned): Folktracks.
- FOOD RECORDS**, 76 Brewer Street, 1st floor, London W1R 7PH, 071.734 2104, Fax: 071.439 7226, MD: Dave Balfe, A&R Dir: Andy Ross. Distribution: EMI.
- FORCE 10 RECORDS**, 187 Portobello Road, London W11 2ED, 071.727 0904, Pres/Chief Exec: D Manestar, MD: M Marri, Mktg: R Hertner, Promo: D Hertner, A&R: J Crosse. Labels (Owned): Friction, Mass, Parabellum; Main product: AC, Album Rock, Jazz.
- FOREST AUDIO**, Vine House, Cleobury, Kidderminster, Worcestershire DY14 8DQ, 0299.270 543, Fax: 0562.748 504.
- THE FOUNDATION LABEL**, 79b Moore Park Road, London SW6 2HH, 071.371 5946, Fax: 071.371 5947, Dirs: Jerry Smith, Stephen Street. Main product: Dance, Album Rock.
- FREE REED RECORDS**, Bridge Street, The Old Chapel,

- Belper, Derbyshire DE5 1AZ, 0773.827 910, Fax: 0773.825 662. Labels (owned): Free Reed; Main product: Folk.
- FREESTYLE RECORDS**, 177 High Street, London NW10 4TE, 081.961 3889, Fax: 081.961 4620, Tlx: 8954780, President: David Landau, MD: Alan Bellman, GM: Rakha J Desai, Sales: John Kaufman, A&R: Robin Scott. Labels (owned): Timeless, Detail; (Lic): Rio Records; Distribution: BMG (via Total).
- FRO**, 35-39 Oldham Street, Afflecks Arcade, Manchester, Greater Manchester M1 1RJ, 061.839 1141, Fax: 061.832 7720.
- FROG RECORDS**, 4 Ashcombe Gardens, Edgware, Middlesex HA8 8HS, 081.958 9947, MD: Bob Clifford.
- FROTTY MUSIC**, 162 Temple Avenue, Dagenham, Essex RM8 1NB, 081.668 3457, Fax: 081.668 6484.
- FUNDAMENTAL MUSIC**, 74 Eldon Street, York, North Yorkshire YO3 7NE, 0904.611 656, Fax: 0904.644 190.
- FURIOUS FISH**, 30a Jackson Road, London N7 6EJ, 071.607 9851, Fax: 071.729 2606.
- FURRY RECORDS**, 11 Witherfield Way, Bonamy Estate, London SE16 3AP, 071.231 7678, President: Clive Parker, MD: Tracey Anne Sparkes, Head Of A&R: Alan Wishart, A&R Mgr: Colin Cummin. Labels (Owned): Furry; Main product: AC.
- FUTURE DANCE MUSIC**, 56 Royal Lane, Yiewsley, West Drayton, Middlesex UB7 8DN, 0895.441 513, MD: Steven Paul Fisher, Art & Design Dir: Dale Xzavier, Fin Mgr: Marc Bouron, Media Mgr: Guy Byrne, Mktg Mgr: Verity Johnstone, Acct Mgr: Bob Arundell. Label (owned): Future Dance Music; Main product: Adult Contemporary.
- FUTURE EARTH RECORDS & TAPES**, 59 Fitzwilliam Street, Wath-upon-Dearne, South Yorkshire S63 7HG, 0709.872 875, Fax: 0709.872 875.
- G&M TAPES & RECORDS**, South Access Road, Forest Bus. Park, Unit 11, London E17 8BA, 081.509 3344, Fax: 081.521 7177.
- GABADON MUSICAL SERVICES**, 25 Fir Street, Sheffield, South Yorkshire S6 3TG, 0742.343 527, Partners: Chris McMahon, Warren Jacques. Labels (owned): Gabadon Records; Main product: New Age, Progressive Rock.
- GALA INTERNATIONAL**, PO Box 24, London SW15 3NL, 081.874 7000, Fax: 081.874 0075.
- GALAXY MUSIC**, The Pine House, 18 Woodlands Road, Bushey, Herts WD2 2LR, 0923.211 331, Fax: 0923.211 332, MD: Malcolm Sharp.
- GALAXY RECORDS**, Hutson Terrace, Purfleet, Essex RM16 1SB, 0708.861 684, Fax: 0708.860 672.
- GALLUS MUSIC**, 187 Wilton Street, Glasgow, Strathclyde G20 6DF, 041.946 2817, Proprietor: Ewan McVicar. Main product: Folk.
- GAMMER RECORDS**, 39 Ivygreen Road, Chorlton-cum-Hardy, Greater Manchester, 061.860 4133.
- GAMUT RECORDINGS**, Lancaster Way, Gamut House, Ely, Cambridgeshire CB6 5NP, 0353.662 366, Fax: 0353.662 346.
- GARDEN ISLE RECORDS**, 45 Brook Road, Shanklin, Isle of Wight PO37 7LD, 0983.866 601, MD: Martin Chambers.
- GEE BEE RECORDS**, 9 Kingsway, 6th floor, London WC2B 6XF, 0260.270 560, Fax: 0260.298 206, Tlx: 267097 Ionsol.
- GEE STREET**, 57 Gee Street, London EC1V 3RS, 071.251 2405, Fax: 071.250 3212.
- GENERAL PRODUCTION RECORDINGS**, 6 Cheshunts, Basildon, Essex SS13 3NJ, 0268.554 906, MD: Wayne Archibold. Main product: Dance; Distribution: Total Via BMG.
- THE GHETTO RECORD COMPANY**, 1 Star Street, London W2 1OD, 071.258 0093, Fax: 071.402 9238, Tlx: 266259 mfm, MDs: Dick Leahy, Paul Kinder, A&R/Artist Liaison: Stuart Lawn, Stephen Peet, Int'l: Lizer Loyer. Main product: Dance, Black (R&B), Reggae.
- GIMELL RECORDS**, Magdalen Road, Newtec Place, Unit 4, Oxford, Oxfordshire OX4 1RE, 0865.244 557, Fax: 0865.790 472, Tlx: 83147 vior q, Int'l Mgr: Peter Bromley.
- GIPSY RECORDS**, Adamsbridge Bus. Ctre Unit 5, South Way, Wembley, Middlesex HA9 0HU, 081.903 5059, Fax: 081.903 7853, Dir: Sarah-Anne Green. Main product: R&B, Adult Contemporary.
- GLOBAL RECORDS (UK)**, 171 Southgate Road, London N1 3LE, 071.359 2974, Fax: 071.704 9879, Tlx: 265137, Contact: Peter Knight Jnr.
- GNMC RECORDS**, PO Box 94, London SW1V 4PH, 071.834 8337, Fax: 071.834 8331.
- GO AHEAD MUSIC**, Waterhouse Lane, The Kerchesters, Kingswood, Surrey KT20 6HT, 0737.833 853, Fax: 0737.833 812, Contact: Ian Dale.
- GO! DISCS**, 72-80 Black Lion Lane, Black Lion House, Hammersmith, London W6, 081.748 7973, Fax: 081.741 5936, MD: Andy MacDonald, Dir: Juliet MacDonald, A&R Dir: Jona Cox, Mktg Mgr: Paul Dowling, Int'l Dir: Alan Cowderoy, Labels (owned): Go! Discs, Go! Discs Music, Go! Global, Go! Beat; Main product: Adult Contemporary, Dance, Album Rock.
- GOLDEN ERA RECORD COMPANY**, 1099a Finchley Road, London NW11 0QB, 081.455 6620, Dir: Herbert W Wilcox. Labels (owned): Golden Era, Delta, Southland, Nostalgia, Celebrity, Zodiac; Main product: Jazz, Gold/Oldies.
- GOLDEN SOUNDS**, 33 Sharnan Way, Gnosall, Staffordshire ST20 0LX, 0785.823 348, MD: Mr. Pattinson.
- GOOD VIBRATIONS RECORDS**, 121 Great Victoria Street, Belfast, County Antrim BT2 7AH, 0232.233 156, MD: Terri Hooley.
- GRADUATE RECORDS**, St Swithun's Institute, The Trinity, Worcester, Worcestershire WR1 2PN, 0905.20882, Fax: 0905.726 677, Tlx: 337300, MD: David Vurr. Labels (owned): Graduate Records, Ready Steady Go!; Main product: Adult Contemporary, Reggae, Dance, Album Rock, Gold/Oldies.
- GRAND RECORDS**, 107a High Street, Canvey Island, Essex SS8 7RF, 0268.694 888, Fax: 0268.695 009.
- GRAPEVINE RECORDS (UK)**, 47 Belsize Avenue, London NW3 4BN, 071.794 4255, Fax: 071.263 0240.
- GRAPHIC RECORDS**, 14 Blackstock Mews, London N4 2DR, 071.354 0306, Fax: 071.354 1399, Tlx: 925859 elwood.
- GRASMERE RECORDS**, 62 Port Street Mews, Knightsbridge, London SW1X 0EF, 071.584 9765, Fax: 071.823 7100, MD: Bob Barrett. Labels (owned): Grasmere; Main product: MOR.
- GREAT RECORDING COMPANY**, North Road, United House, London N1 2RR, 071.700 3914, Fax: 071.700 3876. Labels (owned): Nursery, Revolution 45; Main product: EHR, Dance, AC, Album Rock, Country, Black (R&B), New Age.
- GREAT WESTERN RECORDS**, London Road, Rock House, St Mary's, Chalford, Gloucestershire GL6 8PU, 0453.886 252, Fax: 0453.885 361, President: John Beecher.
- GREENHOUSE RECORDS**, 34-38 Provost Street, London N1 7QY, 071.253 7101, Fax: 071.251 1770.
- GREENSLEEVES RECORDS**, Brackenhurst Road, Goldhawk Estate Unit 7, London W6 0BA, 081.749 3277, Fax: 081.749 7360, MD: Chris Sedgwick, A&R/Promo: Chris Cracknell. Labels (owned): Greensleeves, UK Bubblerz; (Lic): RAS, Live & Learn; (Dist): Heartbeat, Shanachie. Distribution: BMG, Jet Star, Self.
- GREENTRAX RECORDS**, 3 Morven Street, Edinburgh, Lothian EH4 7LG, 031.339 4567, Fax: 031.339 8575, Owner: Ian David Green. Labels (owned): Greentrax; Main product: Scottish Traditional.
- GROOVE & MOVE RECORDS**, South Access Rd, Forest Bus. Park, Unit 11, London E17 8BA, 081.509 3344, Fax: 081.521 7177, Tlx: 263164.
- GTI MUSIC/KICKIN RECORDS**, 282 Westbourne Park Road, London W11 1EH, 071.221 8698, Fax: 071.792 3326, MD: Peter Harris, Int'l Affairs Mgr: Frank Otto, Promo: John Stanley. Labels (owned): GTI, Kickin, Pandemonium; Main product: Dance, Rave, Techno House, Industrial House.
- GUERILLA RECORDS & MUSIC**, 10 Sutherland Avenue, London W9 2HQ, 071.286 5487, Fax: 071.266 3283, Dir: Dick O'Dell. Labels (owned): React 2 Rhythm, DOP, Sound of Sha'Bass, Supereal; Main product: Dance.
- GUILD RECORDS**, Portsmouth Road, The Warehouse, Send, Woking, Surrey GU23 7DB, 0483.223 706, Fax: 0483.211 637, Contact: Nick Ware.
- GULL RECORDS**, 4-7 The Vineyard, off Sanctuary Street, London SE1 1QL, 071.403 0007, Fax: 071.403 3390, MD: David Howells.
- HALL OF FAME PRODUCTIONS**, 23 New Mount Street, Manchester, Great Manchester M4 4DE, 061.953 5353, Fax: 061.953 0170.
- HAMMER FILM MUSIC**, Goldcrest Elstree Studios, Borehamwood, Hertfordshire WD6 1JG, 081.953 1600, Fax: 081.905 1127.
- HAMMER RECORDS**, Chantry Park Road, Springvale Farm, Sprooughton, Suffolk IP8 3AS, 0473.86817, Fax: 0473.86810.
- HANDLE MUSIC**, 20 Wood Mews, London W1Y 3AH, 071.493 9637, Fax: 071.629 6360.
- HANGMAN RECORDS**, c/o 5 Kentish Town Road, London NW1 8NH, 071.482 1095, MD: B Childish.
- HAPPY FACE RECORDS**, 1 Post Office Lane, Old Smithy Studio, Kempsey, Worcestershire WR5 3NS, 0905.820 659, Fax: 0905.820 015, Tlx: 334142.
- HARBOUR TOWN RECORDS**, 25 Church Walk, Ulverston, Cumbria LA12 7EN, PO Box 25 (Zip: LA12 7UN), 0229.580 577, Fax: 0229.580 577/908.614 534, MD: Gordon Jones. Labels (owned): Harbourtown; Main product: Folk, Roots.
- HARBOUR SOUNDS**, PO Box 786, London SE13 6RN, 081.318 9529, Fax: 081.318 9529, A&R/Mktg (Int'l): Steve Fernie, Helen Milner.
- HARMONIA MUNDI (UK)**, 19-21 Nile Street, London N1 7LR, 071.253 0863, Fax: 071.253 3237, MD: David Blake, Distr Mgr: Barbara Cronin.
- HASMICK PROMOTIONS**, Kent House Lane, Gardner Estate, Unit 23, Beckenham, Kent BR3 1QZ, 081.659 7112, Fax: 081.659 7114.
- HAVOC HOUSE RECORD COMPANY**, Little Stort Farm, Cornwood, Ivybridge, Devonshire PL21 9PH, 0755.37243, Fax: 0755.37554.
- HEADSCOPE**, Scotsford Road, Broad Oak, Heathfield, East Sussex TN21 8TU, 0435.863 994, Fax: 0435.867 027, Partners: Ron & Frances Geesin. Labels (owned): Headscope, Ron Geesin; Main product: AC, New Age.
- HEART & SOUL AUDIO VISUAL**, 41 Blackhorse Road, London E17 7AS, 081.521 2040, Fax: 081.521 1499, Contact: Nicola Olliff. Labels owned: Soundscapes; Main music product: AC, Dance, Classical.
- HEAVEN RECORDS**, 110 Bridle Road, Burton Joyce, Nottingham NG14 5FP, 0602.313 184, MD: Matthew Johnson, A&R/Mktg: Mark Randall, Promo/Art Dir: Shelagh Clarkson. Labels (owned): Heaven, Two Pint Takehome, Sweet William, Windmill; Main product: Indie Pop.
- HEAVENLY**, 83 Clerkenwell Road, London EC1R 5AR, 071.430 9060, Fax: 071.430 0176.
- HEAVY METAL RECORDS**, 28 Talbot Road, London W2 5LJ, 071.243 0992, Fax: 071.792 2338, MD: Paul Birch, A&R Dir: David Roberts. Labels (owned): Heavy Metal Records/America/Worldwide; Distribution: BMG/Ariola.
- HECTIC HOUSE**, Sunderland Street, Macclesfield, Cheshire SK11 6HN, 0625.434 185, Fax: 0625.434 185, MD: T O'Neill, A&R: A O'Peesha, Sales: S Git, Promo: Tad Pole, Asst: Pott Shrigley. Main product: Comedy.
- HENGIS RECORDS**, 33 St. Georges Road, Palmers Green, London N13 4AT, 081.882 4797, MD: Dave Saffin.
- HENRY HADAWAY ORGANIZATION**, 3 Blackburn Road, Satriil House, London NW6 1RZ, 071.435 8063, Fax: 071.328 9037, Tlx: 8954958.
- HEP RECORDS**, 42 Carlton Terrace Lane, Edinburgh, Lothian EH7 5DA, 031.556 7083, Fax: 031.557 8713, Owner: Alastair Robertson. Labels (owned): Hep, Hep 1000/2000; Main product: Jazz.
- HI-HAT RECORDS**, Clifton Gardens, Connaught Hse, Unit 15g, London W9 1AL, 071.286 7571, Fax: 071.289 8172.
- HIT & RUN RECORDS**, 25 Ives Street, London SW3 2ND, 071.581 0261, Fax: 071.584 5774, Tlx: 8952998 hitrun, E-Mail: DGS 1007, Chmn: Tony Smith, Dir: Jon Crawley, Fin Contr: Robin Moore, Creative Mgr: David Massey, Prof Mgr: Julie Braconnier.
- HOLLYWOOD RECORDS**, 35-37 Parkgate Road Unit 2 Ranges Dock, London SW11 4GP, 071.228 4000, Fax: 071.924 1608, Contact: Hein van der Ree, Int'l Mktg: Suzanne Catty.
- HOT FOOD MUSIC**, 112 Talbot Road, London W11 1JR, 071.727 8555, Fax: 071.221 7240.
- HOT HOUSE RECORDS**, 291 Pentonville Road, London N1 9NP, 071.278 0703, Fax: 071.833 1029.
- HOUSE OF CHAOS**, 48 Princess Street, Manchester, Greater Manchester M1 6HR, 061.228 2457, Fax: 061.236 0261.
- THE HOUSE OF TEETH**, 125a Wilberforce Road, London N4 2SX, 071.226 8423, Fax: 0482.42677.
- HSL HAL SHAPER RECORDS**, 34 Great James Street, London WC1N 3HB, 071.823 8524, Fax: 071.581 5855.
- HTD RECORDS**, 70 Bridgen Road, Bexley, Kent DA5 1JG, 0322.524 424, Fax: 0322.288 036, Dir: Barry Riddington.
- HUDSON RECORDING COMPANY**, 80-88 Wardour Street, London W1V 3LF, 071.439 8481, Fax: 071.437 2744.
- THE HUMAN TOUCH**, The White House, Bures, Suffolk CO8 5DD, 0787.227 866, Fax: 0787.227 098.
- HWY RECORDS**, 2 The Square, Yapham, York, North Yorkshire YO4 2PJ, 0759.304 514, Fax: 0759.304 514, MD: Steve Parry, A&R: Julia Parry. Main product: Jazz, New Age.
- HYDE PARK MUSIC/HYDE PARK RECORD PROD.**, 110 Westbourne Terrace Mews, London W2 6QG, 071.402 8419, Fax: 071.723 6104, MD: Tony Hiller, Dir: Leigh Hiller.
- HYPERION RECORDS**, 33 Avery Hill Road, London SE9, PO Box 25 (Zip: SE9 1AX), 081.294 1166, Fax: 081.294 1161, MD: Ted Perry, Accts: Peter King, Sales Mgr: Mike Spring, Promo Mgr: Celia Ballantyne, Prod Mgr: Richard Howard. Labels (owned): Hyperion, Helios; Distribution: Gamut; Main product: Classical.
- HYSTERIA RECORDS**, 6-9 Salisbury Prom, Arena Hse, Green Lne, London N8 0RX, 081.809 1460, Fax: 081.809 2237, Dir: Julie Batten, A&R: Nicky Price, Asst A&R: Paul Smith. Label: Hysteria Records; Main product: Dance.
- I'LL CALL YOU RECORDS**, Lupus Street, 6 Robin Court, London SW1V 3ED, 071.834 8337, Fax: 071.834 8331, Dir: E R Bickersteth.
- I-ANKA**, PO Box 917, London W10 5FA, 081.968 6221, Fax: 081.749 7665.
- I&B RECORDS**, 2a Wrentham Avenue, London NW10 3HA, 081.960 9160/9, Fax: 081.968 7332, Dir: Martin J McDonald, William Delaney. Labels (owned): I&B Records; (Dist): Dolphin, Chyme, Ritz, Outlet, Play, Harmal, RTE, Tara, Prism, Lunar, Claddagh, K-Tel (Ire), CMR, Dara; Main product: Country, Irish.
- IAMBIC PRODUCTIONS**, The Production Hse, 147a St Michaels Hill, Bristol B52 8DB, 0272.731 729, Fax: 0272.238 343, MD: Chris Hunt.
- ICHIBAN RECORDS**, Fraser Road, Research House, Perivale, Middlesex UB5 45Y, 081.991 5990, Fax: 081.991 9504, Tlx: 918434 reshde, Dir: Gof Abbey.
- IMAGINARY MUSIC**, 10 Westover Gardens, Westbury, Wym B59 3LE, 0272.500 370, MD: G P Hall. Main product: New Age.
- IMAGINARY RECORDS**, 28 Hopwood Avenue, Hopwood, Heywood, Lancashire OL10 2AX, 0706.624 616/071.274 2025, Fax: 071.274 9709, Contact: Alan Duffy.
- IMAGINE RECORDS**, 32 Willesden Lane, London NW6 7ST, 071.625 0231, Fax: 071.372 5439, Dirs: Laurie Jay, Peter Todd, Mgr: Janie Bailey.
- IMAGO RECORDING COMPANY**, 28 Brook Street, London W1Y 1AG, 071.409 2900, Fax: 071.629 0010, GM/A&R Admin: Alison Rogers, A&R/Label Mgr: Lauren Bromley, A&R Mgr: Michael Murphy.
- IMMACULATE RECORDS**, Vale Road, Pacific House, London N4 1QB, 081.800 4465, Fax: 081.800 3242, Tlx: 261478.
- INASENSE RECORDS**, 20 Newcastle Avenue, Gedling, Nottingham, Nottinghamshire NG4 3ND, 0602.872 835, Fax: 0602.872 835.
- INNER HARMONIES**, 3 Craill View, Northleach, Gloucestershire GL54 3QH, 0451.60155, Fax: 0451.60011.
- INSTANT HIT COMMUNICATIONS**, 20 Dunbar Road, Pad-dock Hill, Frimley, Surrey GU16 5UZ, 0252.837 566, Fax: 0252.834 298, GM (A&R): Jon Monks, Company Sec: Gill Kempton. Labels (owned): Pork Product; (Dist): IHC; Main product: Indie.
- INTERMEZZO**, c/o Cornwall Road, Target House, Croydon, Surrey CR9 2TG, 081.686 3322, Fax: 081.681 5323, Tlx: 819868 target, MD: Jeremy Elliot.
- INTOUCH RECORDS**, PO Box 358, Ealing, London W5 1TY, 081.998 5976, Fax: 081.991 9634.
- INTOWN RECORDS**, 24a Southwark Street, London SE1 1TU, 071.403 9374, Fax: 071.378 7871.
- IONA RECORDS**, 155 Stockwell Street, Glasgow, Strathclyde G1 4LR, 041.552 0969, Fax: 041.552 0969, MD: George Jackson, Sales Mgr: Gavin Robertson. Distribution: CM, Gordon Duncan.

- IRS RECORDS**, 21a Noel Street, Bugle House, London W1V 3PD, 071.486 4488, Fax: 071.439 7649, Tlx: 299338, MD: Steve Tannett, GM: Brian Justice, Int'l Mgr: Henry Padovani, Fin Mgr: Steve Pennington, Royalties Mgr: Torquil Creevy, Sales Dir: Anne Kelly, Distribution: EMI (Eur), MCA (USA/Can).
- ISLAND INTERNATIONAL**, 22 St. Peters Square, London W6 9NW, 081.741 1511, Fax: 081.748 6114, Tlx: 934541, Chmn: Tom Hayes, MD: Phil Cooper, Int'l Press: Carey Nicholas. Labels: Island, Mango, 4th And Broadway, Antilles, Tuff Gang, Gee Street; Main product: Adult Contemporary, Jazz, Reggae, Dance.
- ISLAND RECORDS**, 22 St. Peters Square, London W6 9NW, 081.741 1511, Fax: 081.748 1998, Tlx: 934541, Chmn: Tom Hayes, MD: Marc Marot, A&R Dir: Nick Angel, Dirs: Julian Palmer (4th & Broadway), Giles Barwood (Fin), Phil Cooper (Int'l), Ian Moss (Legal/Bus Aff). Labels: Island, 4th & Broadway, Antilles, Mango, Mother, Taxi, Island Visual Arts, Sense, Discos Fuentes, Axiom, Best Sounds, Media Records, Delicious Vinyl; Distribution: PolyGram; Main product: Adult Contemporary, Reggae, Dance.
- J'ACE**, 31 Cunneery Meadow, Leyland, Preston, Lancashire PR5 2RN, 0772.457 081, MD: John Sutton.
- JAEGO/FUEGO UK**, 1 Murray Street, London NW1 2RE, 071.700 2411, Fax: 071.700 2411.
- JAM TODAY**, 363-365 Harrow Road, London W9 3NA, 081.969 8348, Fax: 081.968 4897, Tlx: 94713640 abs.
- JAMMY RECORDS**, 244 Annieland Road, Glasgow, Strathclyde G13 1XA, 041.954 1873, Fax: 041.954 6341.
- JASMINE RECORDS**, Kent House Lane, Gardner Estate, Unit 23, Beckenham, Kent BR3 1QZ, 081.659 7112, Fax: 081.659 7114.
- JAY CEE MUSIC**, Albany Rd, Prescott Trade Ctr, Units M1-2, Prescott, Merseyside L34 2SH, 051.493 1166, Fax: 051.430 7441.
- JAZZ CAFE**, 5-7 Parkway, London NW1 7PG, 071.284 4358, Fax: 071.487 2438, Dir: John Dabner.
- JBM RECORDS**, 29 Falcon Way, Sunbury-on-Thames, Middlesex TW16 6JN, 0932.785 709, MD: Els Calvert.
- JDS**, PO Box 1435, London NW2 3HT, 081.208 4444, Fax: 081.208 4455. Main product: Country, Album Rock.
- JELLY STREET RECORDS**, Warrington Road, Juniper Hill, Mere, Cheshire WA16 0TE, 0565.830 077, Fax: 0565.830 657, MD: Kevin P Kinsella, A&R/Prod: Kevin P D Kinsella, Mktg/Promo: Chris Dickie. Labels (owned): Jelly Street, RHIM, Rare Rhythm, Red Rock; Main product: Jazz, Dance, AC, Album Rock.
- JET STAR RECORDS**, 155 Acton Lane, London NW10 7NJ, 081.961 5818, Fax: 081.965 7008, MD: Carl Palmer. Labels (owned): Charm, Sure Delight, Jet Star.
- JETTISOUNDZ**, 28-30 The Square, St. Annes-on-Sea, Lancashire FY8 1RF, 0253.712 453, Fax: 0253.712 362.
- JEWISH MUSIC PRODUCTIONS**, PO Box 232, Harrow, Middlesex HA1 2NN, 081.907 1905, Fax: 081.907 6762, Tlx: 8951182 gecoms.
- JG RECORDINGS & ARPEGGIO MUSIC**, 85 Rogers Lane, Stoke Poges, Slough, Berkshire SL2 4LW, 0753.644 373, Chmn: John Gregory, MD: Beverley Campion. Main product: Jazz, Latin Jazz, Gold/Oldies.
- JIVE RECORDS**, 165-167 Willesden High Road, London NW10 2SG, 081.459 8899, Fax: 081.451 3900, Tlx: 919884 zomba, MD: Steve Jenkins, Sales/Mktg Dir: Andy Richmond, A&R Dir: Steven Howard, Promo: Duncan Warwick, Press: Vicky Bruce. Labels (owned): Jive, Silvertone, Zomba; Distribution: BMG.
- JM RECORDS**, Cadbury Camp Lane, Clapton-in-Gordano, Bristol, Avon BS20 9SB, 0275.854 675/856 770, Fax: 0275.810 186.
- JSE MUSIC**, 9 Eccleston Street, London SW1W 9LX, 071.730 9875, Fax: 071.730 2721, Tlx: 265871 monref, E-Mail: DGS 1750, MD: John Sherry, GM: Colin Davie. Labels (owned): Vital Vinyl, Stud Records.
- JSP RECORDS**, PO Box 2025, London NW4 1RJ, 081.203 1324, Fax: 081.203 1351.
- JUICE RECORDS**, 38a Ovington Square, London SW3 1LR, 071.589 5445, Fax: 0372.69346.
- JUNGLE RECORDS (UK)**, 62 Chalk Farm Road, Old Dairy Mews, London NW1 8AN, 071.267 0171, Fax: 071.267 0912, Tlx: 896559 gecoms, MDs: Alan Hauser, Graham Combi. Labels (owned): Jungle, Fall-Out, Obsession, Mint; (Lic): Ministry of Power; (Dist): Mortarhate, Filcknife, Normal; Main product: AC, Album Rock, Independent.
- K RECORDS**, PO Box 12, Wolverhampton, West Midlands WV3 0BQ, 0902.21815, Fax: 0902.21763.
- K-TEL ENTERTAINMENT (UK)**, 192 Windmill Lane, Greenford, Middlesex UB8 9DW, 081.566 6789, Fax: 081.575 2264, MD: Pat Broderick, Creative Mgr: Jane Webber, Mktg Mgr: Sharon Davis, Comm Mgr: Nigel Peacock. Labels (owned): K-Tel; Main product: Adult Contemporary, Gold/Oldies.
- KAK RECORDS**, 5 Holmes Road, London NW5, 071.267 0752, Fax: 071.482 6348, MD: Phil Rapier Smith, A&R: Jonah Sharp. Main product: Dance, AC, Jazz, New Age, House.
- KARON PRODUCTIONS**, 20 Radstone Court, Woking, Surrey GU22 7NB, 0483.755 153, Fax: 0483.728 303.
- KAZ RECORDS**, PO Box 560, London SW19 6HS, 081.780 2007, Fax: 081.780 2517, Chmn/MD: Graham Jenks, Company Sec: Linda Nevill. Labels owned & distr: KAZ; Distr: Pulse; Main product: Jazz, Country, Reggae, Classical, Black (R&B), New Age, World, Africa artists.
- KEENBOY RECORDINGS**, 35 Oakfield Avenue, Kelvinbridge, Glasgow, Strathclyde G12, 041.357 4980, MD: John R Keenan. Labels (owned): Contribution Records; Main product: Dance.
- KETTLE RECORDS**, The Post House, Kingskettle, Fife KY7 7PN, 0337.31211, Fax: 0337.31374, MD: Mr. Trezise, Admin: Bob Willox.
- KEYMAN RECORDS**, PO Box 12, Wolverhampton, West Midlands WV3 0BQ, 0902.21815, Fax: 0902.21763.
- KIJIMA RECORDS**, 147 Waller Road, London SE14 5LX, 071.358 0802, Fax: 071.635 9545, Tlx: 8951182.
- KILLERWATT RECORDS**, 119 The Broadway, Crown House, London NW2 3JG, 081.208 4448, Fax: 081.208 4343.
- KINGSWAY MUSIC**, 1 St. Anne's Road, Eastbourne, Sussex BN21 3UN, 0323.410 930, Fax: 0323.411 970.
- KITCHENWARE RECORDS**, St. Thomas Street, The Stables, Newcastle-Upon-Tyne, Tyne & Wear NE1 4LE, 091.232 4895, Fax: 091.232 0262, MD: Keith Armstrong, Mktg/Press Mgr: Phil Mitchell, Accts Mgr: Paul Ludford.
- KLUB RECORDS**, 9 Watt Road, Hillington Industrial Estate, Hillington, Glasgow, Strathclyde G52 4RY, 041.882 9060, Fax: 041.883 3686, Dirs: Isabel Gibson Waugh, Angus McDonald, Sales: Roy Carcary. Labels (owned): Igus, Lochshore, Monarch, OK, Elm; Main product: Scottish, Irish, MOR, EHR.
- KNIGHT RECORDS**, 174 Mill Lane, West Heath Studios, London NW6 1TB, 071.431 2966, Fax: 071.431 4368, MD: Chris Harding, GM: Judy Head.
- KNIGHTS TEMPLAR INTERNATIONAL**, 55 Albion Street, Otley, Yorkshire LS21 1BZ, 0943.467 395, Fax: 0977.683 288, President: Richard Rouska. Labels (owned): Rouska; Main product: Dance, Album Rock.
- KOCH INTERNATIONAL (UK)**, 23 Warple Way, London W3 0RX, 081.749 7177, Fax: 081.749 7124, MD: Klemens Kundratitz, A&R/Mktg: Keith Shadwick. Labels (owned): Koch, Koch Int'l Classics, Koch-Schwann; Main product: Classical, Jazz, Nostalgia, World Music.
- KOLD SWEAT PRODUCTIONS**, 127 Askev Road, The Basement, London W12 9AV, 081.746 2118, Fax: 081.740 5268, Dirs: Tony Hickmott, Susanne Hickmott.
- KONGO RECORDS**, 146 Manor Park Road, London NW10 4JP, 081.453 0638, Fax: 081.453 0428, MDs: Byron Eye-Fook, Root Jackson. Labels (owned): Kongo Dance; Main product: Dance, Jazz, Hip Hop.
- KOOL KAT RECORDS**, Stratford Place, Stratford House, Camp Hill, Birmingham, West Midlands B12 0HT, 021.766 7311, Fax: 021.773 9751.
- KRYPTON RECORDS**, 31 Fife Street, St James, Northampton, Northamptonshire NN5 5BH, 0604.752 800, Dirs: Robert & Tony Cotton, A&R Dir: Ray Cotton. Labels owned: Krypton Records; Main product: Rock & Roll, Rockabilly.
- L&R RECORDS**, Foxhollow, West End, Nailsea, Bristol, Avon BS19 2DB, 0275.853 170, Fax: 0275.853 170, Dirs: David Rees, Ken Lintern. Labels (owned): Big Dipper; Main product: Folk.
- LAMPLIGHT MUSIC**, 109 Eastbourne Mews, London W2 6LQ, 071.402 5169, Fax: 081.423 2768, MD: Derek Bowman, Chmn: David Essex.
- LAND RECORDS**, 330 Harrow Road, London W9 2HP, 071.286 9532, Fax: 071.289 3949, Tlx: 265871, E-Mail: DGS 1094.
- LAPWING RECORDS**, 2-4 High Street, Starbeck, Harrogate, North Yorkshire HG2 7AY, 0423.888 979, Fax: 0423.885 761, Dirs: Andy Wheat, Pete Storey.
- LAZY RECORDS**, 83 Clerkenwell Road, London EC1R 5AR, 071.831 8923, Fax: 071.404 4292.
- LDR RECORDINGS**, PO Box 93, Leatherhead, Surrey KT22 9PX, 0372.57227, Fax: 0372.59713.
- LEGEND MUSIC GROUP**, Edgware Road, Symal House, London NW9 0HU, 081.905 9191, Fax: 081.205 8619.
- LEO RECORDS**, Judd Street, 7 Clare Court, London WC1H 9QW, 071.833 4117, Fax: 071.833 4117. Main product: Jazz, Avant-Garde.
- LEOPARD RECORDS**, Stockwell Rd, 23 Thrayle House, London SW9 0XU, 071.274 9533/81.672 6158, Fax: 071.737 7881, President: Errol Jones, Dirs: Terri Schiavo, F Campbell. Labels (owned): Leopard Records, Jet Set Int'l Records; Main product: EHR, Adult Contemporary, Reggae, Dance, Album Rock, Black (R&B), New Age.
- LEVEL VIBES**, Marylebone Road, 81 Harley House, London NW1 5HT, 071.486 8794, Fax: 071.486 5722, MD: Erskine Thompson. Main product: Reggae, Dance, Black (R&B).
- LIBIDO RECORDS**, Sanctuary Street, 4-7 The Vineyard, London SE1 1QL, 071.403 0007, Fax: 071.378 0516.
- LIFETIME RECORDS**, 81 Southern Row, Unit 10, London W10 5AL, 081.964 0699, Fax: 081.964 0700, MDs: Richard Niles, Graeme Perkins.
- LINK RECORDS AND MUSIC**, PO Box 157, Sittingbourne, Kent ME10 3SD, 0795.422 990, Fax: 0795.420 811.
- LINN RECORDS**, Floors Road, Waterfoot, Eaglesham, Glasgow, Strathclyde G76 0EY, 041.644 5111, Fax: 041.644 4262, Tlx: 77301 linn, MD: Ivor Tiefenbrun, Rec/Label Mgr: Philip Hobbs, Admin: Amanda Thomson. Main product: Jazz, Classical.
- LISSON RECORDS**, Sanctuary Street, 4-7 The Vineyard, London SE1 1QL, 071.403 0007, Fax: 071.403 8202.
- LISTEN PRODUCTIONS**, 31 Rubigny Gardens, London SW15 1JR, 081.785 3099, Fax: 081.785 3926, Tlx: 26325 iis.
- LITTLE MISTY MUSIC**, PO Box 8, Perth, Tayside PH2 7EX, 0738.34564, President: Ian White, VP: Carol White, Sec: Dan Stewart. Artist: Ian White; Main product: Christian Contemporary.
- LITTLE PRINCE RECORDS**, 8 Escher Close, Ford Estate, Birkenhead, Merseyside L43 9XL, 051.606 0463, MD: N Galloway.
- LIVING BEAT RECORDS**, 22 Hanway Street, London W1P 9DD, 071.631 3846, Fax: 071.436 0715.
- LNV LATE NITE VINYL**, 1 Orchard Road, Reigate, Surrey RH2 0PA, 0737.244 666, MD: Mike Fames. Main product: Easy Listening, MOR.
- LOADING BAY RECORDS**, 586 Bristol Road, Selly Oak, Birmingham, West Midlands B29 6BQ, 021.472 2463, Fax: 021.414 1540, MD: Duncan Finlayson, A&R: Mike Coppock. Labels (owned): Loading Bay Records, Loading Bay Classics; (Dist): Rockies, Manic, Principal, Almighty. Main product: Dance.
- LOE RECORDS**, 159 Broadhurst Gardens, London NW6 3AU, 071.328 6100, Fax: 071.624 6384.
- LOGO RECORDS**, 52 Red Lion Street, London WC1R 4PF, 071.242 9397, Fax: 071.831 7827, Tlx: 24637.
- LONDISC RECORDS**, 371-373 Green Street, Upton Park, London E13 9AU, 081.552 2936, Fax: 081.472 1136, Owner: J A Peart, GM: Andrew Peart, A&R Mgr: Joseph Harris, Company Sec: Fay Thompson. Labels (owned & distr): Londisc Records, Crystal Records; Main product: Reggae, Dance, Black (R&B).
- LONDON RECORDS**, 72 Chancellors Road, Chancellors House, London W6 9RF, 081.741 1234, Fax: 081.741 1656/7677, Tlx: 263828, MD: Roger Ames, GM: Colin Bell, Mktg Mgr: Keith Bennett, Int'l Mgr: John Reid, A&R Dirs: Tracy Bennett, Paul McDonald, Head Of Press: Eugene Manzi, Promo: Billy MacLeod (Head), Rebecca Coates (Radio).
- LONG BEACH RECORDS**, 11 Tipton Road, Tidvale, Warley, West Midlands B69 3HY, 021.559 3488, Fax: 0384 410 320.
- LOOSE TUBES**, 224 Amelia Street, London SE17 3AS, 071.701 6070, Fax: 071.703 9288, MD: Colin Lazerini.
- LOST MOMENT RECORDS**, Ebbwson Road, Factory 1, Apsley, Hertfordshire W6 9XG, 0442.240 637, MD: S D Carter, Mgr: Richard Barnett.
- LUKE RECORDS**, 444 Brixton Road, Unit 401, London SW9 8EJ, 071.738 5660, Fax: 071.738 5039, MD: Chris Williams.
- LUMINA MUSIC**, 112 Ifield Road, London SW10 9AF, 071.373 2562, Fax: 0604.770 022.
- LYRITA RECORDED EDITION**, 99 Green Lane, Burnham, Slough, Buckinghamshire SL1 8EG, 0628.604 208, Owner: A R Iiter. Labels (owned): Lyrita; Main product: Classical.
- M & G**, 222 Kensal Rd, Canalot Studios, Unit 305, London W10 5BN, 081.968 1552, Fax: 081.968 1308, MD: Michael Levy, Label Mgr: Steve Cutner.
- MAESTRO CASSETTES**, Simmonds Bridge, Wisborough Green, West Sussex RH14 0BD, 0403.700 287, Dir: Mr. Lawson.
- MAFIA MUSIC**, Forest Road, Parklands Studio, Denmead, Waterlooville, Hampshire PO17 6TZ, 0705.258 985, Fax: 0705.241 448.
- MAGNUM MUSIC GROUP**, High Street, Magnum House, Lane End, High Wycombe, Buckinghamshire HP14 3JG, 0494.882 858, Fax: 0494.882 631, Tlx: 837685 magnum, MD: Nigel Molden.
- MAINSTREAM DIRECT**, PO Box 5452, London SW6 5ER, 071.371 5452, Fax: 071.371 9991.
- THE MAJOR RECORD COMPANY**, Askew Crescent Workshops, Unit 2b, London W12 9DP, 081.994 1956, Fax: 081.747 0778.
- MALACO RECORDS**, 38 Langham Street, London W1 5RH, 071.636 5822, Fax: 071.436 8503, Tlx: 9419076, Contact: Peter Feistead. Labels owned: Knight, Sequel, Masterpiece Music.
- MANIAC RECORDS**, 93 Eaton Place, London SW1X 8LZ, 071.235 4217, Fax: 071.631 0961, MDs: Nikki Barton, Carlo Boero.
- MANIC RECORDS**, 55 The Crescent, Southshore, Blackpool, Lancashire FY1 4HT, 0253.49219/24901, Fax: 0253.752 025, MDs: Philip Holmes, Ian Maclean.
- MARATHON RECORDS**, 17 Hanson Street, Flat 2, London W1P 7LN, 071.637 2256, Fax: 081.318 1439, Tlx: 8951182 gecoms.
- MARQUEE RECORDS**, 105 Charing Cross Road, London WC2H 0DT, 071.287 2874, Fax: 071.434 1651, MD: Frederick Bestall.
- MASTER RECORDS**, 33 Spring Hill, c/o Blue Beat, London E5, 081.806 1701, Fax: 081.806 8472.
- MAWSON AND WAREHAM (MUSIC)**, Midgy Hall, Sharperton, Morpeth, Northumberland NE65 7AS, 0669.40252/91.232 5317, Fax: 0669.40252/91.232 5317, MD: Brian Manson, Sec: R Stewart. Labels (owned & distr): MWM Records, Rubber Records; Main product: Gold/Oldies, Folk.
- MBR (MILITIA BEAT RECORD) PROMOTIONS**, 350 Waterloo Street, Waterloo Building, Newcastle-upon-Tyne, Tyne & Wear NE1 4DJ, 091.230 3746, Owner/Mgr: Martin Jones. Main product: Dance, Indie.
- MCA RECORDS (UK)**, 72-74 Brewer Street, London W1 3PH, 071.437 9797, Fax: 071.437 3121, Tlx: 23158, MD: Tony Powell, A&R Dir: Jeff Young, Promo Head: Phil Smith, Press: Pete Basset. Labels (owned): MCA, Geffen.
- MCA RECORDS INTERNATIONAL**, 5 Sherwood Street, London W1B 7RA, 071.287 2345, Fax: 071.434 2940, Snr VP: Stuart Watson, Dir Mktg: Chris Griffin, Fin Dir: Neil Gillespie, Promo Mgr (MCA/Geffen): Liz Morris, Admin Dir: Eamon Sherlock. Labels (owned): Geffen, GRP.
- MCM RECORDS**, 71 High Street, Belmont, Bolton, Lancashire BL7 8AJ, 020.481 352, MD: Steve Diggle. Labels (owned): MCM; Main product: Melodic Rock; Distribution: ABT.
- MEGA RECORDS (UK)**, 195 Two Trees Lane, Denton, Greater Manchester M34 1QL, 061.320 8021, Fax: 061.443 1379, Tlx: 669755, MD: Bob Garton, Bus Affairs: John Turner. Distribution: AMT.
- MEGABLAST RECORDINGS**, 23 New Mount Street, Man-

- chester M4 4DE, 061.953 4003, Fax: 061.953 4001, MD: Danny Bennett.
- MEMOIR RECORDS**, PO Box 66, Pinner, Middlesex HA5 2SA, 081.866 4865, Fax: 081.866 8170.
- MENU RECORDS & TAPES**, 23 Sandringham Court, London W9 1VA, 071.289 1190, Fax: 071.266 3166.
- MERCIFUL RELEASE**, 19 All Saints Road, London W11 1HE, 071.229 7661, Fax: 071.792 8300, MDs: Boyd Steenson, A Taylor. Distribution: APT International.
- MERIDIAN RECORDS**, PO Box 317, London SE9 4SF, 081.857 3213, Fax: 081.857 0731.
- METROMEDIA COMMUNICATIONS INTERNATIONAL**, 37 Tavistock Place, London WC1H 9SE, 081.667 0298, Fax: 071.383 4093, Tlx: 925788.
- MIDAS RECORDS**, 1 Barb Mews, Concorde House, London W6 7PA, 071.602 8822, Fax: 071.603 2352, Tlx: 94012318 star.
- MIDNIGHT MUSIC (RECORDS)**, PO Box 333, Bushey, Watford, Hertfordshire WD2 3UN, 081.950 9507, Fax: 081.950 3806, Tlx: 9419501 midmus.
- MIND MATTER**, PO Box 59, London N22 4NS, 081.888 8949, Fax: 081.889 6166, Tlx: 268041 sthrn.
- MISSION DISCS**, Littleton Road, Littleton House, Unit 10, Ashford, Middlesex TW15 1UU, 0784.247 176, Fax: 0784.241 168, Contact: Mark Rye.
- MIX FACTORY RECORDS**, Lloyds Bank Chambers, Weston-super-Mare, Avon BS23 1HQ, 0934.419 355, Fax: 0934.623 608.
- MIX RECORDS**, 27 Newton Street, London WC2B 5EL, 071.242 0415, Fax: 071.831 3620, MD: K Georgiou, A&R: V L Georgiou. Main product: AC, Country.
- THE MMATRIX**, 6 Farm Court, Farm Road, Frimley, Camberley, Surrey GU16 5TJ, 0276.684 209, MD: Mick Magic, Asst to MD: Sensemillia Peach. Labels (owned): MMATT, The Mmatrix; Main product: New Age, Electronic, Album Rock.
- MODERN RECORDS/EMERALD RECORDS**, 120a Coach Road, Templepatrick, County Antrim BT39 0HB, 08494.32619, Fax: 08494.32162, Chief Exec: George Doherty. Labels (owned): Modern, Emerald, Mint, GBS Great Bands; Distribution: Solomon & Peres (BMG); Main product: Country, Irish & Scottish.
- MOGGIE RECORDS**, 10 Hazlewood Lane, London N13 5HQ, 081.886 2801, Fax: 081.882 7380.
- MOHOCK RECORDS**, 12 Trewartha Road, Sovereign House, Praa Sands, Penzance, Cornwall TR20 9ST, 0736.762 826, Fax: 0736.763 328, MD/A&R/Mktg/TrO: Roderick G Jones, Bus Affairs: Carole A Jones, Production: Colin Eade. Main product: Country, Folk.
- MOLE JAZZ**, 291 Pentonville Road, London N1 9NP, 071.278 0703, Fax: 071.833 1029.
- MOLES RECORDS INTERNATIONAL**, 14 George Street, Bath, Avon BA1 2EN, 0225.3833 448, Fax: 0225.447 645.
- MONROE STUDIOS**, 164 High Street, Brakeshear House, Unit 3, Barnet, Hertfordshire EN5 5XP, 081.449 3394, Fax: 081.449 3384, Chmn: Alexander Hughes, Studio Mgr: Debbie Francis.
- MONT MUSIC**, 2 Heydons Close, St. Albans, Hertfordshire AL3 5SF, 0727.56806, Fax: 0727.46360.
- MORGAN BLUE TOWN**, 31-39 Camden Road, Twyman House, 2nd flr, London NW1 9LF, 071.267 6899, Fax: 071.267 6746.
- MOSA RECORDS**, 104a Oxford Gardens, London W10 6NG, 081.960 0311, MD: C Lewis. Main product: Hip-Hop, Indie.
- MOTORCY RECORDS**, 325 Uxbridge Road, London W3 9RA, 081.993 6775, Fax: 081.993 2454, Tlx: 918469 soprod, MD: Ian Levine.
- MOTOWN RECORDS (UK) C/O BMG (BIG)**, 69-79 Fulham High Street, Bedford House, London SW6 3JW, 071.973 0011, Fax: 071.371 9571, Tlx: 920896, Div Dir: Roger Seimon, Promo Exec (Radio/TV): Lorna Hastings, Head of Mktg: Mervyn Lyn, Press Asst: Judith Winteron, Label Mgr: Gordon Frewin, Mktg Co-Ord: Nikki Sayer. Labels (owned): Funki Dreds, Motown, Taj Records, Tania Motown; Distribution: BMG Operations.
- MR SAM (MUSIC)**, 31-39 Camden Road, Twyman House, 2nd flr, London NW1 9LF, 071.267 6899, Fax: 071.267 6746.
- MTR**, 6 Chardmore Road, London N16 6HX, 081.442 4248, Fax: 081.442 4247.
- MULL RECORDINGS**, Quinish, Dervaig, Isle of Mull, 0688.4223, Fax: 0688.4383.
- MURDER MUSIC**, 8 Finchfield Avenue, Woodford Green, Essex IG8 7JW, 081.505 2877, Fax: 071.255 1134.
- MURBERTONE PRODUCTIONS**, 23 New Mount Street, Manchester, Great Manchester M4 4DE, 061.953 4004, Fax: 061.953 4001.
- MUSIC FACTORY DANCE**, 222 Kensal Rd, Canalot Studios, Unit 4, London W10 5BN, 081.960 2739, Fax: 081.960 7937, MD: John Pickles, Mktg Mgr: Irving Soremekun.
- MUSIC FOR NATIONS**, 102 Belsize Lane, London NW3 5BB, 071.794 0283, Fax: 071.437 3531, Tlx: 296217, Chmn: Steve Mason, MD: Martin Hooker, GM: Ken Howard, Int'l: Andy Black, Press: Liz Wells.
- MUSIC FOR PLEASURE**, 1-3 Uxbridge Road, Hayes, Middlesex UB4 0SY, 081.561 8722, Fax: 081.569 2163, Tlx: 934614.
- MUSIC GALORE**, 29 Beethoven Street, London W10 4LG, 081.960 1871, Fax: 081.969 1694, MD: Brian Leafe. Labels (owned): Shanghai, Butt; Main product: Album Rock.
- MUSIC MAKER RECORDS**, Forehill, Alexander House, Ely, Cambridgeshire CB7 4AF, 0353.665 577, Fax: 0353.662 489.
- MUSIC MAN (UK)**, 9 Greyhound Road, London N17, 081.801 8146, Fax: 081.885 4604.
- MUSIC MASTERS**, Gurnells Road, The End House, Seer Green, Buckinghamshire HP9 2XJ, 0494.672 803, Fax: 0494.678 016, Chief Exec: Michael John, Bus Mgr: Nicholas John, Sales Mgr: Susan Murphy. Labels owned: Music Masters, Souvenir, Framework; Main product: Gold/Oldies, Classical, Military/Brass Band.
- MUSIC OF LIFE RECORDS**, 22 Hanway Street, London W1P 9DD, 071.631 3846, Fax: 071.438 0715, Chmn: Simon Harris, MD: Chris M France, Press/PR: Michelle Harry.
- MUSIC SALES**, 224 Shore Road, Carrickfergus, County Antrim, 084865 422860 710, MD: Eddie Graham. Distributor.
- MUSIC WAVES RECORDS**, PO Box 537, Thorton Heath, Surrey CR7 8AY, 081.771 7894, Owner: N Lewes.
- MUSIDISC (UK)**, 32 Queensdale Road, London W11 4SB, 071.602 1124, Fax: 071.602 0704, MD: Jeremy Thomas. Labels (owned): Musidisc (Rock); (Lic): Jazz Accord, Jazz Anthology, Accord (classical); Distribution: APT (rock), Target (jazz), Gamut (classical).
- MUSKETEER RECORDS**, 56 Castle Bank, Stafford, Staffordshire ST16 1DW, 0785.58746, Fax: 0785.55367.
- MUTE RECORDS (UK)**, 429 Harrow Road, London W10 4RE, 081.969 8866, Fax: 081.968 4777, Tlx: 268623 muteg, MD: Daniel Miller, Int'l Director: Kent Munch, Dirs: Duncan Cameron, Fred de Jong, Promo Head: Mick Patterson, Int'l Press & Promo: Janice Issitt.
- MVM RECORDS**, PO Box 131, Banstead, Surrey SM7 1PH, 0737.224 151, MD: Ms. Midgley.
- MYSTIC RECORDS**, 81 Brecon Road, Belgrave House, Abergavenny, Gwent NP7 7RD, 0873.77633, Fax: 0873.79265.
- NATION RECORDS**, 19 All Saints Road, 1st Floor, Notting Hill, London W11 1HE, 071.792 8167/221 7931, Fax: 071.792 2854, MD: Katherine Candville, Joint MD: Aki Nawaz, A&R: Inder Matharu, Promo Mgr: Chris Greenwood. Labels (owned): Nation Records; Main product: Reggae, Dance, World Dance Fusion.
- NEAT RECORDS**, 71 High Street East, Wallsend, Tyne & Wear NE28 7RJ, 091.262 4999, Fax: 091.263 7082, MD: David Wood.
- NECTAR RECORDS**, PO Box 24, London SW15 3NL, 081.874 7000, Fax: 081.874 0075. Labels (owned): Nectar, De-Luxe, Revue.
- NERVOUS RECORDS**, 7-11 Minerva Road, Unit 6, London NW10 6HJ, 081.963 0352, Fax: 081.963 1170, President: Roy Williams. Labels (Owned): Nervous, Madhouse, Fury; Main product: Rockabilly.
- NETWORK**, Stratford Place, Stratford House, Camp Hill, Birmingham, West Midlands B12 0HT, 021.766 7311, Fax: 021.773 9751.
- NEUFELD JACQUEMIN MUSIC**, 68a Delancey Street, London NW1 7RY, 071.485 3733, Fax: 071.284 1020, Dirs: Robert Neufeld, Andre Jacquemin. Music production for film & TV.
- NEUTRON RECORDS**, Canham Road, Canham Mews, Unit 6, London W3 7RS, 081.749 9596, Fax: 081.740 9767, MDs: Martin Fry, Mark White, Admin Co-Ord: Janene Weymouth.
- NEW LEAF RECORDS**, 9 Church Road, Conington, Peterborough, Cambridgeshire PE7 3QJ, 0487.830 778, MD/A&R: Andrew W Clifton. Labels (owned): New Leaf, Molesworth, Indie 500; Main product: Indie Pop.
- NEW MUSIC ENTERPRISES**, Reach Lane, 'Meredale' The Dell, Leighton Buzzard, Bedfordshire 0U7 0AL, 052523.7700, President: Paul Davis. Labels (owned): New Music; (Lic/Distr): Herald, Figtree; Main product: Country, Gospel.
- NEW MUSIC INTERNATIONAL**, 57 Old Church Street, London SW3 5BS, 071.376 4488, Fax: 071.376 8111, President: Aart Dalhuisen.
- NEW WORLD**, Paradise Farm, Westhall, Halesworth, Suffolk IP19 8RH, 050.279 279, Fax: 050.279 886, MD: Collin Wilcox, Dir: Carmen Salvat. Labels (owned): New World Cassettes; Main product: New Age.
- NEW YEAR RECORDS**, 22 The Garstons, Great Bookham, Leatherhead, Surrey KT23 3DS, 0372.54580, Fax: 0372.59388.
- NEWS MUSIC INTERNATIONAL**, 14 St. John's Wood Terrace, London NW8 6JJ, 071.483 1886, Fax: 071.483 2175.
- NICE NOISE RECORDS**, Grove End Road, Addison House, Unit 324, London NW8, 071.266 2549, Fax: 071.226 3453.
- NICO POLO RECORDS**, St. Peters Road, Braylands, Northney, Hampshire PO11 0RT, 0705.461 934, Fax: 0705.461 935, MD: Mark Ringwood, Mktg: Caroline Hargley, A&R: Sue Carey. Labels (Owned): Nico Polo, Just William; Main product: Folk, Children's Music.
- NIGHTFLITE COMMUNICATIONS**, PO Box 50, Walton-on-Thames, Surrey KT12 1EB, 0932.242 073, Fax: 0753.692 243, Tlx: 934618.
- NIGHTSHIFT RECORDS**, Newhouse Road, Falkirk Bus Park, Units 15-16, Grangemouth, Stirlingshire FK3 8LL, 0324.484 014, Fax: 0324.482 404, MD: Brian Guthrie.
- NIMBUS RECORDS (UK)**, Wyastone Lays, Monmouth, Gwent NP5 3SR, 0600.890 682, Fax: 0600.890 779, Tlx: 498378 nimbus, President: A Labinsky, Chmn: Peter Laister, MDs: Gerald Reynolds, Michael Reynolds, Music Dir: Adrian Farmer, Company Sec: Stuart Garman, Sales/Mktg Dir: Roger Bateson, Label Mgr: Martin Earle. Labels owned: Nimbus, Hermes.
- NITE OUT RECORDS**, PO Box 130, Walton-on-Thames, Surrey KT12 2RU, 0932.231 238, MD: Peter Gammons, Promo Mgr: Carl Ritchie. Labels (owned): Nite Out Records, Night Out Records, Impact Records; Main product: Adult Contemporary, Dance.
- NMC THE RUMPO**, 3-7 Hazlewood Road, Northampton, Northamptonshire NN1 1LG, 0604.26742, Fax: 0604.28229.
- NO BOYFRIEND MUSIC**, 13 Edith Grove, Flat 3, London SW10 0JZ, 071.351 4526, Partner: Nicola Jack.
- NO LOGO RECORDS**, 26 Dovedale Avenue, Prestwich, Man-
- chester M25 8BU, 061.795 8545, Owner: Avril Eventhal. Distribution: No Logo Records, Greyhounds; Main product: High Energy, Dance.
- NOIR RECORDS**, 70 Gloucester Place, London W1H 4AJ, 071.935 5988, Tlx: 9312130870 Ip, E-Mail: DGS 1881, MDs: Clifford Gee, Gary Davison.
- NOISE INTERNATIONAL**, 44 Greyhound Road, London W6 8NX, 071.381 8986, Fax: 071.385 2398, MD: Andrew Ward, Press/Promo: Chris Watts, A&R/Artist Liaison: Emma Gray. Labels (owned): Noise International, Madcat; Distribution: EMI, independents.
- NON FICTION RECORDS**, 97 Charlotte Street, London W1P 1LB, 071.323 5555, Fax: 071.323 5323, Tlx: 265871 fiction, E-Mail: DGS 1936.
- NORTHWOOD RECORDS**, PO Box 53, Ilford, Essex IG6 2AL, 081.551 5570, Fax: 081.550 7537, MD: R Frensham. Labels (owned): KY Records; Main product: Country, Gold/Oldies, Black (R&B), Rockabilly, Rock & Roll.
- NOSTALGIA RECORDS**, 35 Park Road, Prestwich, Greater Manchester M25 8ES, 061.721 4076, Fax: 061.795 3857.
- NTV MUSIC (UK)**, 159 Broadhurst Gardens, London NW6 3AU, 071.372 3966, Fax: 071.624 6384, Dep MD: Andy McQueen, Creative Dir: Cate Latto.
- NUNS MEADOWS PRODUCTIONS**, Church Rd, 2 Highgates, The Old Nunnery, Gosfield, Halstead, Essex CO9 1TL, 0787.474 794, MD: James Bisgood. Main product: Early 16th & 17th Music.
- NYJO RECORDS**, 11 Victor Road, Harrow, Middlesex HA2 6PT, 081.863 2717, Fax: 081.863 8685.
- OCEAN RECORDS (UK)**, 75-85 Summerstown, London SW17 0BQ, 081.944 7117, Fax: 081.944 0097.
- OFF THE WALL RECORDS**, Accommodation Road, Knowle View, Bleadon, Weston-super-Mare, Avon BS24 0AP, 0934.812 332, Fax: 0934.812 162.
- OGUN RECORDS**, 180 Shaftesbury Avenue, London WC2H 8JB, 071.836 3646, Fax: 071.497 9102, MD: Hazel Miller, Dirs: John M Jack, Keith & Elizabeth Beal. Labels (owned): Ogun; Main product: Jazz.
- OLD NICK MUSIC GROUP**, 436 Essex Road, Leroy Bus Ctr, Unit 2L, London N1 3QP, 071.354 8560, Fax: 071.354 8560, A&R Mgr: Nick Peterson, Mktg Mgr (Ger/Aus/Sw): Christine Peterson. Labels (owned): Old Nick; Main product: Dance, Album Rock, Jazz.
- OLD RECORDS**, 17 Moor Close, Darwen, Lancashire BB3 3LG, 0254.772 850, President: Joel David, A&R: Maureen Seaburg, Producer: Andrew J H. Labels (owned): Old Records, Miracle; Main product: Adult Contemporary, Jazz, Gold/Oldies.
- OLDFIELD MUSIC**, 46-47 Upper Berkeley Street, London W1H 7PN, 0494.764 042, Fax: 0494.763 587.
- ON THE BEACH RECORDINGS**, 107a High Street, Canvey Island, Essex SS8 7RF, 0268.698 777, Fax: 0268.695 009.
- ON-U SOUND RECORDS**, 25-29 Fulham High Street, Bishops Park, London SW6 3JH, 081.889 6166, Fax: 081.883 0331, MD: Adrian Sherwood.
- ONE ELEVEN RECORDS**, 111 Shackwell Lane, London E8 2EB, 071.254 6543, Fax: 081.365 0778, Tlx: 9312102397 oe.
- ONE LITTLE INDIAN RECORDS**, 250 York Road, Battersea, London SW11 3SJ, 071.924 1661, Fax: 071.924 4274, MD: Derek Birkett.
- OPERA RARA**, 25 Compton Terrace, London N1 2UN, 071.359 1777, Fax: 071.354 3942, Admin Dir: Don White, Artistic Dir: Patric Schmid. Labels (owned): Opera Rara; Main product: Opera.
- OPTIMISM RECORDS**, 6 Chardmore Road, London N16 6HX, 081.442 4248, Fax: 081.442 4247.
- ORANGE RECORDS**, 91-103 Lomond Grove, Unit 3M1, London SE5 7HN, 071.708 1305, Fax: 071.408 4847.
- ORBIT RECORDS**, 49 High Street, TAC House, Southend-on-Sea, Essex SS1 1HZ, 0702.338 792, Fax: 0702.330 293.
- OUTBURST RECORDS**, 71 High Street East, WallSEND, Tyne & Wear NE28 7RJ, 091.262 4999, Fax: 091.263 7082.
- OUTER SPACE RECORDS**, 37 Colville Terrace, London W11 1, 071.229 4236, Fax: 071.221 9397, A&R Dir: Francesca Nesi.
- OUTLET RECORDING**, 15-21 Gordon Street, Belfast, County Antrim BT1 2LG, 0232.322 826, Fax: 0232.332 671, MD: Martin McBurney, Sales: James Bough, Accts: Ann Collin. Labels (owned): Ara, Derry, Glen, Folk, Homespun, Horslips, Praise, Top Spin; (Distr): all majors, Prism, K-Tel, Pickwick, Word UK.
- OVAL RECORDS**, 326 Brixton Road, London SW9 7AA, 071.326 4907, Dirs: Charlie Gillett, Gordon Nelki.
- OZONE RECORDINGS**, PO Box 49, Sheffield, South Yorkshire S1 1SD, 0302.370 889, Fax: 0302.370 654.
- PACER RECORDS**, Mill Lane, Fyfield, Willaston, Wirral, Cheshire LG4 1RN, 051.327 5143, MD: G Marsden.
- PAISLEY PARK RECORDS**, 28 Alexander Street, London W2 5NU, 071.221 2110, Fax: 071.221 3070.
- PANDA RECORDS**, 28 Inkerman Street, Llanelli, Dyfed SA15 2PA, 0554.752 490, Fax: 0554.777 848.
- PARK RECORDS**, 20 Raleigh Street, North Hinksey, Oxford, Oxfordshire OX2 9AZ, 0865.248 493, Fax: 0865.864 192, MD: John Dagnell. Main product: AC, New Age, Folk.
- PARKGATE STUDIO**, Catsfield, Battie, E Sussex TN33 9DT, 04246.4810, Fax: 04246.4088, Dir: Daniel Priest. Labels (owned): Desperate Dan Records; Main product: Album Rock.
- PASSION RECORDS**, 81 Crabtree Lane, Skratsh Music House, London SW6 6LW, 071.381 8315, Fax: 071.385 6785, MDs: Les McCutcheon, Nigel Wright, Label Mgr: Anne Plaxton. Labels (owned): Skratsh, Passion, Debut, Jumpin' & Pumpin'.

PASTAFONT (MUSIC), Hambleton Hill, Richland House, Epsom, Surrey KT18 7BZ, 0372.722 202, Fax: 0372.742 327, Tlx: 24667 impemp.

PEACEVILLE RECORDS, PO Box 17, Dewsbury, West Yorkshire WF12 8AA, 0924.457 821, Fax: 0924.455 120, MD: Paul Halmshaw, Press Officer: Dave Pypas, Sec: Johnny Humpleby, Admin: Shaun 'Dinger' Crabtree. Labels (owned): Peaceville, Dreamtime Records, Deaf Records, Major Records.

PEBBLES PUBLISHING & RECORDING, 2 Bridge Street, The Old Forge, Hadleigh, Suffolk IP7 6BY, 0437.828 277, Fax: 0437.828 064, Tlx: 98289 winmed.

PEOPLE UNITE PUBLICATIONS, 13 King Street, Southall, Middlesex UB2 4DG, 081.574 1718, Fax: 081.574 8576, MD: Clarence Baker, Dir: Walford Tyson, Sec: Delbert McKay. Main product: Black (R&B), Reggae, New Age.

PEPPER RECORDS, 178 Muswell Hill Road, London N10 3NG, 081.444 1762, Fax: 081.883 5665, Tlx: 94070957 pep.

PERMANENT RECORDS, 32 Holmes Road, London NW5 3AB, 071.482 4535, Fax: 071.284 0493, Tlx: 265871.

PHAB RECORDS, Sheerwater Avenue, High Notes, Woodham, Weybridge, Surrey KT15 3DS, 09323.48174, Fax: 09323.40921.

PHFFFT RECORDS, Stratford Place, Stratford House, Camp Hill, Birmingham, West Midlands B12 0HT, 021.772 2221, Fax: 021.766 6929, MD: John Mostyn, A&R Dir: Jonathan Hughes. Main product: Album Rock.

PHOENIX TREE RECORDS, 57 Viscount Street, Rusholme, Manchester, Greater Manchester M14 5UJ, 061.224 2207, MD: David Robinson, Promo/Mktg Dir: Joseph Holdemess, A&R Mgr: Christian London. Labels (owned): Phoenix Tree; Main product: EHR, Alternative.

PHONOGRAM (UK), 72 Chancellors Road, Chancellors House, London W6 9QB, 081.741 1212, Fax: 081.741 4901, Tlx: 261583, E-Mail: DGS1541, Chmn: Maurice Oberstein, MD: David Cliphsham, Mktg Dir: Nick Rowe, Mktg Mgrs: John Chuter, Steve Matthews, Ian Grenfell (Int'l), Bus Affairs Dir: John Watson, Fin Contr: Clive Ellis, Promo Dir: Martin Nelson, Promo: Wendy K (Clubs), Karen Taylor (TV), Mark Howells (Radio), Paul Martin (Dance), Head Of A&R: David Bates, A&R Mgrs: Gilles Peterson, Alan Pell, Norman Jay, Russ Conway, Int'l Director: Bernadette Coyle, Prod Mgr: Julie Heathcote. Labels (owned): Mercury, Vertigo, Fontana, Philips, Club, Casablanca, Roarot, Def American; (Lic): Precious, Bludgeon Riffola; Distribution: PolyGram Record Operations; Main product: AC, Album Rock.

PICASSO UK, 52 Red Lion Street, London WC1R 4PF, 071.242 9397, Fax: 071.831 7827, Tlx: 24637.

PINNACLE RECORDS, Cray Avenue, Election House, St. Mary's Cray, Orpington, Kent BR5 3PN, 0689.870 622, Fax: 0689.878 269, Chmn: Steve Mason, Dir: Sean Sullivan, Operations Mgr: Alan King, Sales Mgr: Steve Dickson, A&R/Label Mgr: Dominic Jones. Labels (owned): Windsong Video, Music For Nations, Corona, Connoisseur Collection, First Night; Main product: all formats carried, including Film Soundtracks, Spoken Word.

PIP RECORDS, 29 North End Road, London NW11 7RJ, 081.455 4707, Dir: Judith Williams, GM: Ian Cameron. Main product: MOR.

PIZZA EXPRESS RECORDS, 29 Wardour Street, London W1V 3HB, 071.437 7215, Fax: 071.494 1653.

PLANKTON RECORDS, 236 Sebert Road, Forest Gate, London E7 0NP, 081.534 8500, Snr Partner: Simon Law, Producer/Distributor; Labels owned: Plankton, Sea Dream; Lic: Wildtracks (UK), Radio (UK), Gutta (Swe), Cantio (Swe), Embryo Arts (Bel); Main product: Christian-orientated rock.

PLANT LIFE RECORDS, Gleebe Road, Cirrus, Unit 5, Huntingdon, Cambridgeshire PE18 9DX, 0480.434 333, Fax: 0480.411 441, Tlx: 94014953 rasl.

PLASTIC HEAD RECORDS, Old London Road, Atlanta House, Wallingford, Oxfordshire OX9 6PL, 0491.25029, Fax: 0491.26320.

PLAY HARD RECORDS, 48 Princess Street, Manchester, Greater Manchester M1 6HR, 061.228 1256, Fax: 061.236 5249.

PLAY RECORDS, 266 King Street, London W6 0SP, 081.563 0585, Fax: 081.741 7644, MDs: Noel Carty, David Stacey. Main product: MOR.

PLAZA RECORDS, PO Box 726, London NW11 7XQ, 081.455 7965, Fax: 071.379 3101.

PMR MUSIC, Woburn Hill, Highview House, Weybridge, Surrey KT15 2QE, 0932.845 100, Fax: 0932.847 260.

POLO RECORDS, 23 Powis Gardens, London NW11 8HH, 081.455 2469, Fax: 081.965 3948.

POLYDOR UK, 1 Sussex Place, PO Box 1421, London W6 9XT, 081.846 8090, Fax: 081.741 4901, Tlx: 263828 polygm, MD: Jimmy Devlin, Snr Dir: Andrew Jenkins, Bus Affairs Dir: Judi O'Brian, A&R Dir: Graham Carpenter, Mktg Dir: John Waller, Head Of Press: Lee Leschasin, Contr: Nick Thomas, Dir Int'l Mktg: Annie Newell. Labels (owned): Fiction, Desire, Urban, Love, M&G, Wonderland, Big Life, Far Out Recording.

POLYGRAM CLASSICS (UK), 1 Sussex Place, London W6 9XS, PO Box 1420 (Zip: W6 9XS), 081.846 8515, Fax: 081.741 4901, Tlx: 916155/263828 polygm, Div Dir: Peter Russell, Dirs: Terri Robson (Decca), Isabel Collins (Philips), Mike Sage (Deutsche Grammophon), Mktg Mgr: Paul Moseley Head of Press & Promo: Margaret Skeet, Press & Promo Dir: Isabella Sabata, Creative Svcs Co-ords: Debbie Butler (Decca), Carol Ansell (Philips), Anneliese Cameron (Deutsche Grammophon), Fin Contr: Neville Acaster. Labels (own-

ed): Decca, Philips, Deutsche Grammophon; Main product: Classical.

POLYGRAM INTERNATIONAL, 30 Berkeley Square, London W1X 5HA, 071.493 8800, Fax: 071.499 2596, Tlx: 263872/261508, President/CEO: Alain Levy, Exec VPs: Jan Cook (CFO), Maurice Oberstein, Tim Harrold (Classics), Snr VPs: Michael Kuhn (Media), David Munns (Pop/Mktg), Bruce Mackenzie (Regg Ops), Chief Exec (Music Publ): David Hockman, Gen Counsel: Richard Constant, Head of Corp PR: Amanda Whitwell. Labels (owned): Mercury, Polydor, Fontana, A&M, Island, Vertigo, Verve, Barclay, Metronome, Deutsche Grammophon, Decca, Philips Classics; Main product: all categories carried.

POLYGRAM UK, 1 Sussex Place, PO Box 1420, London W6 9XS, 081.846 8515, Fax: 081.741 4995/4901, Chmn: Maurice Oberstein, Snr Dir Comm Affairs: Tony Pye, Dir Legal Affairs: Clive Fisher, Fin Dir: Nick Carrington. Labels (owned): Polydor, Phonogram, Decca, Deutsche Grammophon, Philips, Go! Discs, London, A&M, Island; (Dist): Virgin, HLL, Rio; These also include all the affiliated labels.

POLYPHONIC REPRODUCTIONS, 77-79 Dudden Hill Lane, London NW10 1BD, 081.459 6194, Fax: 081.451 6470, MD: S G Kitchen, Mktg/Promo: P Williams, Music Ed/Prod: P Sparke, Accts: J Long. Main product: Brass/Military Band.

POP & ARTS, 112 Station Road, Premier House, Edgware, Middlesex HA8 7AQ, 081.950 5656, Fax: 081.951 6648. TV compilations merchandising.

PORTOBELLO PRODUCTIONS, 56 Long Acre, Covent Garden, London WC2E 9JL, 071.379 5566, Fax: 071.379 5599, Tlx: 266388.

POSITIVE BEAT RECORDS, PO Box 1981, London W11, 081.968 8002, MD: Andrew Perly, A&R Mgr: Mr. Skori, Prod Mgr: Mr. Zebie. Labels (owned): Positive Beat; Main product: Dance, Hip Hop.

POSITIVE RESPONSE, PO Box 153, London SW10 0RL, 081.540 0455, Fax: 081.545 0231.

POST GLOW, 56 Lewisham Hill, London SE13 7EL, 081.318 9570, Fax: 081.318 1439, Tlx: 8951182.

POWI RECORDS, 165 Wolverhampton Road, Sedgley, Dudley, West Midlands DY3 1QR, 09073.2211, Fax: 09073.3356.

POWER OF VOICE COMMUNICATIONS, 35 Mansted Gardens, Romford, Essex RM6 4ED, 081.590 2524, Fax: 081.599 2065, MD: John McDonald, Dir: Phil Harding. Labels (owned): Alternative, Dance.

POWER RECORDS (UK), 29 Riversdale Road, Thames Ditton, Surrey KT7 0QN, 081.398 5236, Fax: 081.398 7901, MD: Barry Evans.

POWERSTATION RECORDS, James Nicholson Link, Marsden Park Unit, York, North Yorkshire YO3 8XG, 0904.642 451, Fax: 0904.641 214, Tlx: 57854, MD: Kevin Nixon.

PPK PRODUCTIONS, 31 Horsedje Street, St Marys House, Oldham, Greater Manchester OL1 3XE, 061.628 4262, Fax: 061.628 8001, Contact: Patrick Ricketts.

PRACTICAL RECORDS, 13 Salegate Lane, Temple Cowley, Oxfordshire OX4 2HQ, 0865.770 272, MD: Janet Sherbourne. Main product: Contemporary, Ethnic.

THE PRECIOUS ORGANISATION, 24 Gairbraid Avenue, Maryhill, Glasgow, Strathclyde, Scotland G20 8YE, 041.946 3366, Fax: 041.946 4326, MD: Elliot P Davis.

PREMIERE UK, 152 High Street North, London E6 2HT, 081.552 6102, Fax: 081.552 8744.

PRESIDENT RECORDS, Exmouth House, 11 Pine Street, London EC1R 0JH, 071.837 5020, Fax: 071.837 4795, Chmn: Edward Kassner, MD: David Kassner. Labels (owned): President, Bulldog, Crystal, Energy, Enterprise, Gemini, Jayboy, Joy, Max's Kansas City, Rhapsody, Seville, Spiral, TBG-President, Thunderbird; Distribution: H R Taylor, Arabesque, Enterprise, Prism Leisure.

PRESS RECORDS, 29 Beethoven Street, London W10 4LG, 081.960 1871, Fax: 081.969 1694, Label Mgr: Brian Leaf. Labels (lic): Press, Press Avant; Main product: Album Rock.

PRESSGANG RECORDS, 2 Walters Mead, Ashtead, Surrey KT21 2BP, 0372.275 827, MD: Aide Orange. Main product: Dance.

PRESTIGE RECORDS, 34 Great James Street, London WC1N 3HD, 071.405 3786, Fax: 071.405 5245, MD: Keith Thomas, A&R Dirs: Stella Groves, Ian Taylor King, Admin Dir: John Beattie, Promo: Daniella Madalo. Labels (owned): Balkanton, Sleeping Giant Records; (Lic): USA-Music Group; Main product: Adult Contemporary, Jazz, Country, Reggae, Classical, World, Dance, Album Rock, Gold/Oldies, Black (R&B), New Age.

PRISM LEISURE CORPORATION, Baird Road, Unit 1, Enfield, Middlesex EN1 1SQ, 081.804 8100, Fax: 081.805 8001, MD: Ivor Young, Sales Dir: Steve Brink, Sales Mgrs: Lawrence Kuttner, Simon Checketts. Labels (owned): Platinum Music, Dance Band Days; Main product: Country, MOR, Irish.

PRISM RECORDS, 41 Market Place, Lance House, Driffield, North Humberside YO25 7AN, 0377.47191, Fax: 0377.46031.

PROBE PLUS RECORDING & DISTRIBUTION, 8-12 Rainford Gardens, Liverpool, Merseyside, 051.236 6591, Fax: 051.227 1228.

PRODUCT RECORDS, 1026-1028 Harrow Road, London NW10 5NN, 081.960 2225, Fax: 081.960 2137, Dirs: Rob Collins, Geoff Muncney. Main product: Album Rock.

PROFILE RECORDS, Warple Way, 10 Tech West, London W3 0RQ, 081.749 8777, Fax: 081.749 3703, MD: Andrew Cleary.

PULSE-8 RECORDS, 31 Norfolk Place, London W2 1QH, 071.224 9405, Fax: 071.224 9425, MD: Frank Sansam. Main product: Dance.

PURE BASS RECORDS, PO Box 775, London EC1A 4LB, 071.490 7093, Fax: 071.490 7920, MD: Andrew E Beer, Ad-

min: Judith T Annakie. Label: Pure Bass; Main product: Dance, Black (R&B).

PURE GOLD RECORDS, 12 Trewartha Road, Sovereign House, Praa Sands, Penzance, Cornwall TR20 9ST, 0736.762 826, Fax: 0736.763 328, MD: Roderick G Jones, Bus Affairs: Carole A Jones, Production: Colin Eade. Main product: Gold/Oldies, Country.

PURE TRASH RECORDS, 18 Elmthorpe Road, Wovercote, Oxfordshire OX2 8PA, 0865.514 432, Fax: 0865.514 432.

PVA RECORDINGS, Paradise Circus, Alpha Tower, Birmingham, West Midlands B1 1TT, 021.643 4011, Fax: 021.633 3947, A&R: Stephen Pink. Label (owned): PVA; Main product: Adult Contemporary, Classical, Church Music.

PWL RECORDS (UK), Sanctuary Street, 4-7 The Vineyard, London SE1 1QL, 071.403 0007, Fax: 071.403 3390, President: David Howells, Chmn: Pete Waterman, Mktg/Sales: Tilly Rutherford. Labels (owned): PWL, PWL Continental; Distribution: Warner Music; Main product: EHR.

R RADICAL, PO Box 59, London N22 4NS, 081.888 8949, Fax: 081.889 6166, Tlx: 268041 sthrn.

RADIOACTIVE RECORDS, 321 Fulham Road, London SW10 9QL, 071.351 7421, Fax: 071.351 4769, MDs: Ian Flocks, Gary Kurlfirst. Labels (owned): The Fatima Mansions, Live, Birdland, Goodbye Mr Mackenzie.

RAGE RECORDS, PO Box 726, London SW10 0QW, 071.351 4895, Fax: 071.352 0771. Main product: Rock, Rockabilly.

RAINY DAY RECORDS, 12 Trewartha Road, Sovereign House, Praa Sands, Penzance, Cornwall TR20 9ST, 0736.762 826, Fax: 0736.763 328, MD/A&R/Mktg/Promo: Roderick G Jones, Bus Affairs: Carole A Jones, Production: Colin Eade. Main product: all categories.

RAK RECORDS, 42-48 Charlbert Street, London NW8 7BU, 071.586 2012, Fax: 071.722 5823, Tlx: 299501 rak.

RANDOM CENTURY CHILDREN'S BOOKS, 20 Vauxhall Bridge Road, Random House, London SW1V 2SA, 071.973 9750, Fax: 071.233 7398.

RANGE RECORDS, 7 Garrick Street, London WC2 9AR, 071.240 1628, Fax: 071.497 9242, MD: John Nice.

RAW FRUIT, Ridgway, Sarabee House, Pyrford, Woking, Surrey GU22 8PW, 09323.49048, Fax: 09323.44500.

RAW GROOVE RECORDS, 4 Birchfields Road, Network House, Manchester, Greater Manchester M13 0XR, 061.225 5140/628 4252, Fax: 061.443 1379, Tlx: 669755 office attn: network, MD: John Turner, A&R: Pamela Millbrook.

RAZOR RECORDS, 52 Red Lion Street, London WC1R 4PF, 071.242 9397, Fax: 071.831 7827, Tlx: 24637 wigmor, Chmn: J. Bloomfield, MD: R Greatrex, A&R: Keith Harper. Labels owned: Razor, Episode, Rock Machine, Metal Masters.

RCA RECORDS (UK), 69-79 Fulham High Street, Bedford House, London SW6 3JW, 071.973 0011, Fax: 071.371 9298, Tlx: 920896, MD: John Preston, Snr Sales/Mktg Dir: Gareth Harris, Head Of A&R: Korda Marshall, Mktg Head: Joe Cokell, Promo Dir: Nick Godwyn, Promo Mgr (Clubs): Andrew Wood, Head Of Press: Dave Harper, Bus Affairs Mgr: Eduard van Eyk. Labels (sub-publ/lic): Boom Town, De Construction, DDD, Grunt, Imago, Lazy Recordings, MSA, Perfecto, Prelude, RCA; Distribution: BMG Operations. RCA is a label of BMG Records (UK).

REACHIN' RECORDS, 5-10 Eastman Road, Metrostore Unit 302, London W3 7QS, 081.749 8619, Fax: 081.746 1209, Dirs: D A Pearce, M J Morston, Int'l Mgr: Thomas Foley. Dance label.

REACTOR, 1026-1028 Harrow Road, London NW10 5NN, PO Box 1966 (Zip: NW10 5NQ), 081.960 2225, Fax: 081.960 2137, MD: Geoff Muncney. Main product: Album Rock.

READY, STEADY, GO, St. Swithun's Institute, The Trinity, Worcester, Worcestershire WR1 2PN, 0905.20882, Fax: 0905.726 677, Tlx: 337300.

REAL WORLD RECORDS, Mill Lane, Millside, Box, Wiltshire SN14 9PN, 0225.744 122, Fax: 0225.743 481, Tlx: 94081031 woma, Contact: Amanda C. Jones.

REBOT INTERNATIONAL, 91 Mount Pleasant Road, Brixham, Devon TQ5 9RU, 08045.4420, Fax: 0803.882 948, MD: Peter Smith.

RECEIVER RECORDS, 31-39 Camden Road, Twyman House, 2nd flr, London NW1 9LF, 071.267 6899, Fax: 071.267 6746.

RECKLESS RECORDS, 79 Upper Street, London N1 0NU, 071.704 0249, Fax: 071.359 9509, A&R: Mark Burgess, Mgr: Duncan Kerr.

RECOMMENDED DISTRIBUTION, 387 Wandsworth Road, London SW8 2JL, 071.622 8834, Fax: 081.682 3414, Dist'r Mgr: Howard Jacques, Mail Order Mgr: Andrew Jacques, Label Mgr: Phil England. Labels (owned): These Records, Srrrd, Syncpulse; Main product: Avant-Garde, New Music.

RED BARON RECORD COMPANY, Old Bath Road, Colnbrook Ind. Est., Unit 18, Colnbrook, Berkshire SL3 0NJ, 0753.683 129, Fax: 0753.683 107, Dir: Keith Purcell. Labels (owned): Red Baron, Airport Records; Main product: Country, Pop.

RED BUS RECORDS, 48 Broadley Terrace, Red Bus House, London NW1 6UL, 071.258 0324, Fax: 071.724 2163, Tlx: 25873.

RED DOT RECORDS, 35 Harwood Road, Broadway House, London SW6 4QP, 071.371 5633, Fax: 071.371 5515.

RED HOT RECORDS, 29 Beethoven Street, London W10 4LG, 081.960 5874, Fax: 081.969 1694, President: John Douglas, MD: Brian Leaf. Main product: Adult Contemporary, Jazz, Album Rock.

RED LIGHTNIN' RECORDS, The Street, The White House, North Lopham, Diss, Norfolk IP22 2LU, 0379.88693, Fax: 0379.88559, Tlx: 97203 blues.

RED SKY RECORDS, PO Box 7, Stonehouse, Gloucestershire GL10 3PQ, 0453.826 200, MD/A&R: Johnny Coppin.

- Main product: AC, Folk.
- REDROCK RECORDS**, 58 Hillside Road, The Weald, Northwood, Middlesex HA6 1QB, 09274.25997, Fax: 0923.855 221.
- REFLEX RECORDS**, 21 Wells Road, Adelaide House, Unit 3, Malvern, Worcestershire, 0684.568 470, Fax: 0684.892 275, Tlx: 335626 sopersv.
- REL RECORDS**, 40 Sciennes, Edinburgh, Lothian EH9 1NH, 031.668 3366, Fax: 031.662 4463, MD: Neil Ross, Admin: Patricia Dunlop. Producer/Distributor; Main product: Scottish music, music videos.
- REPORT RECORDS**, Vale Road, Pacific House, London N4 1QB, 081.800 4465, Fax: 081.800 3242, Tlx: 261478.
- REPRO RECORDS**, 4 Lonsdale Road, London NW6 6RD, 071.625 4458, Fax: 071.629 7025, MDs: Bryan Harris, Mark & Anna Jolley, A&R: Theresa Wolfe (Club Promo), Matt Rowe.
- REPUBLIC RECORDS**, 7 Caledonian Rd, Old Forge Ctr, Unit A5, London N1 9DX, 071.837 2322, Fax: 071.833 1046, Tlx: 929555 rtracs.
- RER MEGACORP**, 19-23 St. Saviour's Road, London SW2 5HP, 081.671 7843, Fax: 081.671 7273.
- RESPECT RECORDS**, 3 Chester Lane, Green Lane, Northwood, Middlesex HA6 2XX, 0927.422 124, Fax: 0927.83628.
- RETRIEVAL RECORDINGS**, 1 Walnut Tree Cottage, Burnham, Buckinghamshire SL1 8DH, 0628.604 811, Dirs: John R T Davies, Charles Crump. Labels (owned): Retrieval.
- REVERB RECORDS**, 27a Pembroke Villas, Studio 7, London W11 3EP, 071.938 1917, Fax: 071.229 7511, Dir: Ian Wright. Labels (owned): Reverb, Stealth Sonic Recordings; Main product: Adult Contemporary, Dance, New Age.
- REVOLUTION IN OUR TIME (RIOT) RECORDS**, 7 Hutson Terrace, Purfleet, Essex RM16 1SB, 0708.861 684, Fax: 0708.860 672.
- REVOLVER RECORDS**, 152 Goldthorn Hill, Penn, Wolverhampton, West Midlands WV2 3JA, 0902.345 345, Fax: 0902.345 155, MD: Paul Birch, Int'l Mgr: Pete Cook, Sales Mgr: Bob James. Labels (owned): Revolver, FM, Black, FM-Dance, Heavy Metal, Heavy Metal America/Worldwide; Main product: AC, Album Rock, Black (R&B).
- RHAM! RECORDS**, PO Box 21, Wallasey, Merseyside L44 9HF, 051.639 5959, Fax: 051.639 0168.
- RHINO RECORDS**, France Hill Drive, The Chilterns, Camberley, Surrey GU15 3QA, 0276.686 077, Fax: 0276.686 055, MD: Bruce D White, Dir: Sue White. Labels (owned): Rhino; Main product: Album Rock, Jazz, Gold/Oldies, Country, Black (R&B).
- RHYME 'N' REASON RECORDS**, 10 Tiverton Road, London NW10 3HL, 081.969 4018, Fax: 081.960 0410, MD: Edward Christie. Main product: Dance.
- RHYTHM KING RECORDS**, 117-121 Salusbury Road, Queens Studios, London NW6 6RG, 071.372 3959, Fax: 071.372 4634, MD: Martin Heath, A&R: Callaghan O'Rourke, Mktg Mgr: Allison Wilson, Press Officer: Adele Nozadar, Promo Mgr: Sonya Dunsdon. Labels (owned): Rhythm King, Outer Rhythm, Transglobal; Main product: Dance.
- RIMSHOT RECORDS**, 213b Chevening Road, London NW6 6DT, 081.968 7364, Fax: 081.968 8588, Dir: Andy Case, A&R Mgr: Gerard Joyce, Admin: Nicky Shawcross. Main product: Album Rock, Indie.
- RIO RECORDS**, 177 High Street, London NW10 4TE, 081.961 3889, Fax: 081.961 4620, Tlx: 8954780.
- RIPPLE PRODUCTIONS**, 344 Kings Road, London SW3 5UR, 071.352 5628, Fax: 071.351 7700.
- RISIN' RECORDS**, 3 Blackburn Road, London NW6 1RZ, 071.435 8063, Fax: 071.328 9037.
- RITZ RECORDS**, 1 Grangeway, London NW6 2BW, 071.435 8063, Fax: 071.624 4471.
- RIVIERA RECORDS**, Church Lane, The Cottage, Hambrook, Bristol BS16 1ST, 0272.560 672, Fax: 0272.571 500, Contact: Shirley Britton.
- RMO RECORDS**, 8 Fernham Road, Thornton Heath, Surrey CR7 8JD, 081.653 9022, Fax: 081.768 0584, MD: Reg Mclean, Mktg: Allan Block, Fin Dir: Derrick Morris, A&R: Susan Craig. Labels (owned): Code, RMO Music/Film; Main product: EHR, Dance, Gold/Oldies, Black (R&B), Reggae, New Age, Classical.
- ROADRUNNER RECORDS**, 387 Harrow Road, 1st floor, London W9 3NA, 081.969 6099, Fax: 081.968 8388, MD: Mark Palmer, Promo: Andy Saunders (Indie), Sofie Williams (Metal), Nicki Greenhough (Radio), Label Mgr (Lafayette): Dave Howell.
- ROARECORDS**, Thatre Street, Flat 1A, London SW11 5NE, 071.228 9133, Fax: 071.228 9133.
- ROBIN RECORDS**, 1133 Hessele High Road, Priory House, Hull, Humberside HU4 6SB, 0482.565 444, Fax: 0482.53635.
- ROCKET RECORD COMPANY**, 32 Galena Road, London W6 0LT, 081.741 9933, Fax: 081.741 3938, Tlx: 265870, Chmn: John Reid, MD: Robert Key.
- ROGUE RECORDS**, PO Box 337, London N4 1TW, 081.340 9651, Fax: 081.348 5626, MD/A&R: Ian Anderson. Labels (owned): Rogue, FMS; Main product: Folk, Roots, World Music.
- ROLLERCOASTER RECORDS**, London Road, Rock House, St. Mary's, Chalford, Gloucestershire GL6 8PU, 0453.886 252, Fax: 0453.885 361, Dirs: J I Allison, John Beecher, GM: Yvonne Saunders. Labels (owned): Rollercoaster, Lawn, Swan, Spade, Thunder.
- RONIN RECORDS**, 80a Holland Park Avenue, London W11 3RE, 071.792 9650, Fax: 071.229 7860, Dir: Alex Turnbull.
- RONNIE SCOTT'S JAZZ HOUSE RECORDS**, 22 Little Portland Street, London W1N 5AF, 071.580 0007, Fax: 071.580 7771, MD: Derek Everett.
- ROOART EUROPE**, 74 Belsize Lane, London NW3 5BQ, 071.794 4904, Fax: 071.433 3710.
- ROOSTER RECORDS**, 33 Park Chase, Wembley, Middlesex HA9 8EQ, 081.902 5523, MD: Eddie Stevens, Sec: Margaret Mantering. Main product: Dance and Theme Tunes.
- ROPE & LEISURE RECORDS**, 18 Highfield, Sale, Cheshire M33 3DN, 061.976 2041, Dirs: Rob Dixon, John McArdle, Mark Needham, A&R Mgr: Viv Hallack. Labels (owned): Rope & Leisure, Thieves 40 Thieves Records; Main product: Album Rock.
- ROSIE RECORDS**, 14 Brickendon Green, Brickenden, Hertfordshire SG13 8PB, 0992.86404, MD: J Dye. Main product: Country, Reggae, Pop.
- ROSS RECORDS**, 29 Main Street, Turriff, Grampian AB53 7AB, 0888.68899, Fax: 0888.68890, MDs: Gibson Ross, Ann Ross. Labels (Owned): Ross Records.
- ROUGH TRADE RECORDINGS(UK)**, 66 Golborne Road, London W10 5PE, 081.960 9888, Fax: 081.968 6715, MD: Geoff Travis, Mktg Mgr: Andy Childs, Int'l Mgr: Tim Kelly, Fin Contr: Lloyd Mitchell. Distribution: RTM.
- ROUSKA**, Lymby Hill, The White House, Unit 113, Monk Fryston, West Yorkshire LS25 5EB, 0977.683 288, Fax: 0532.421 702.
- RTV RECORDS**, 100 Portland Road, Rushden, Northamptonshire NN10 0DP, 0933.319 205, Fax: 0933.224 786.
- RUBY RED RECORDS**, Cleveland Street, Wolverhampton, West Midlands WV1 3HH, 0902.771 186, Fax: 0902.28300, Tlx: 338490.
- RUMOUR RECORDS**, 15 Falcon Road, London SW11 2PJ, 071.223 7662, Fax: 071.228 6972, MD: David Brooker.
- RUPERT PARKER**, 17b Mabley Street, London E9 5RH, 081.985 3078, Fax: 081.704 9879, Comp: Rupert Parker.
- RYKODISC EUROPE**, 106b Westbourne Grove, London W2 5RU, PO Box 2401 (Zip: W2 5SF), 071.727 7480, Fax: 071.229 4190, MD: Joe Boyd, A&R Co-Ord: Amel Bendeddouche, Sales Mgr (Eur): Christopher May, Fin Mgr: Susan Warren, Promo Dir: Jody Yebga. Labels (owned): Hannibal, Rykodisc; Main product: Jazz, Country, Reggae, Classical, Album Rock, New Age, World, Folk, Roots.
- SAFARI RECORDS**, 44 Seymour Place, London W1H 5WQ, 071.723 8464, Fax: 071.724 3410, Tlx: 267412, MD: John Craig.
- SAIN (RECORDIAU)**, Canolfan Sain, Liandwrog, Caernarfon, Gwynedd, Wales LL54 5TG, 0286.831 111, Fax: 0286.831 497, MD: Dafydd Iwan, Sales Dir: O P Huws, PR: Elin Owen. Labels (owned): Sain, Cral, Cambrian, Tylan; Main product: Welsh language Rock, Pop, Folk, Choir Music.
- SARAH RECORDS**, PO Box 691, Bristol, Avon BS99 1FG, 0272.730 510, MDs: Claire Wadd, Matt Haynes. Main product: Indie.
- SATRIL RECORDS**, 3 Blackburn Road, London NW6 1RZ, 071.435 8063/5, Fax: 071.328 9037, Tlx: 895458, MD: Henry Hadaway, GM (Int'l Prod): Beverly King, Mktg/Label Mgr: Ray Santilli.
- SATURN RECORDS**, 3 Cromwell Road, Hayes, Middlesex UB3 2PP, 081.569 3435, Fax: 081.569 2432.
- SAVAGE RECORDS**, 31a Clerkenwell Green, London EC1R 0DU, 071.490 1210, Fax: 071.250 3186, President: David Mimran, MD: Ali Alkhami, Promo/Mktg Dir: Lawrence Bouvier, Label Mgr: Bernard Fanin, Admin/ACcts: Jane Glover, Royalties Mgr: Guy Morris. Labels (owned): Savage, Tam Tam, S&M; Distribution: Sony Music; Main product: Adult Contemporary, Dance, Album Rock.
- SAVOY RECORDS**, PO Box 271, Croydon, Surrey CR9 1ZH, 081.660 5046, MD: Wendy Smith.
- SAYDISC RECORDS**, The Chipping, Chipping Manor, Wotton-under-Edge, Gloucestershire GL12 7AD, 0453.845 036, Fax: 0453.521 056, Partner: Gef Lucena.
- SBK RECORDS**, 127 Charing Cross Road, London WC2H 0EA, 071.434 2131, Fax: 071.287 5256, Tlx: 269189, MD: Peter Reichardt, A&R Dir: Sally Perryman, A&R Mgr: Guy Moot, A&R Co-Ord: Fran Malyan. Owned by EMI Records.
- SCARLETT RECORDS**, 169-171 Willesden High Road, London NW10 2SE, 081.451 3727, Fax: 081.451 4600, Chmn: Robin Millar, MD: Phillip Rambow.
- SCOTDISC/BGS PRODUCTIONS**, Newtown Street, Kilsyth, Glasgow, Strathclyde, Scotland G85 0JX, 0236.821 081, Fax: 0236.825 683, Dirs: Bill Garden, Dougie Stevenson, Sales/Export: Yvonne Lang. Main product: Country, Scottish Easy Listening.
- SCOTTISH RECORDS**, Brig o'Turk, Post House, Callander, Perthshire FK17 8HT, 08776.238, MD: Mr. Gray.
- SCREEN VENTURES**, 49 Googde Street, London W1P 1FB, 071.580 7448, Fax: 071.631 1265, Tlx: 8951182 gteloms, MD: Christopher Mould.
- SEDITION RECORDSINGS**, 31-39 Camden Road, Twyman House, 2nd flr, London NW1 9LF, 071.267 6899, Fax: 071.267 6746.
- SEE FOR MILES RECORDS**, Littleton Road, Littleton House, Unit 10, Ashford, Middlesex TW15 1UU, 0784.247 176, Fax: 0784.241 168, MD: Colin Miles.
- SENTINEL RECORDS**, The Old School, Paul, Penzance, Cornwall TR19 6UD, 0736.731 246, Fax: 0736.731 232, MD: Brian Smith, Dir: Brian Miller, Sales/Mktg: Eddie Webster, Promo: Geraldine Sylvester, Fin: John Vaughan. Labels (owned): Sentinel; Main product: MOR, Religious.
- SERENGETI RECORDS**, 43a Old Woking Road, West Byfleet, Surrey KT14 6LG, 09323.51925, Fax: 09323.36431.
- SETANTA RECORDS**, 123 Shakespeare Road, London SE24, 071.703 0971, Fax: 071.252 6165.
- SHAKIN' STREET RECORDS**, Churchland House, Hove, Sussex BN3 2LW, 0273.417 673, Fax: 0273.205 713, MD: Alan Pilsworth, Mgr: Karen Pilsworth. Labels (owned): Shakin' Street, One Louder; Main product: Garage Punk.
- SHANGHAI RECORDS**, 29 Beethoven Street, London W10 4LG, 081.960 1871, Fax: 081.969 1694, MD: Brian Leaf. Labels (owned): Shanghai; Main product: Album Rock.
- SHEER BRAVADO! RECORDS**, 1 College Close, Lincoln, Lincolnshire LN1 3EA, 0522.568 179, MD: Vince Ford, A&R: Kingsley Gratrix, Mktg/Sales Dir: Paul Whitehouse. Labels (owned): Sheer Bravado!; Main product: Indie.
- SHOCK RECORDS**, PO Box 775, London EC1A 4LB, 071.490 7093, Fax: 071.490 7920, MD: Massimo Filippi, A&R: Andrew E Beer. Label: Shock Records; Main product: Album Rock.
- SHUT UP AND DANCE**, 53 Bellgrade Road, London N16 8DH, 071.254 2943, Fax: 071.923 4198, MD: Smiley. Main product: Dance.
- SIDELINE RECORDS**, Rushcroft Road, 1 Clarence House, London SW2 1JJ, 071.978 8611, Fax: 071.738 5039, Chmn: Broderick Crawford, MD: Chris J Rose, Head of A&R: John Rose, Artist Liaison: Karen Childs, Artist Dev: Brian O'Neill.
- SIERRA RECORDS**, 3 Berwick Street, London W1V 3RG, 071.287 6388, Fax: 071.494 2763, Tlx: 8951882 gecoms.
- SILENT RECORDS**, 132 West End Lane, London NW6 1SA, 071.625 8973, Mgr: Oliver Greene.
- SILVA SCREEN RECORDS**, 261 Royal College Street, Silva House, London NW1 9LU, 071.284 0525, Fax: 071.482 3385, Tlx: 8951182, MD: Reynold d' Silva, Sales Dir: James Fitzpatrick, Label Mgr: David Stokes.
- SILVER EDGE RECORDS**, 78c Ritherdon Road, London SW17 8QG, 081.767 6788, Fax: 081.767 6788, MD: Jo Harper, A&R Dir: Franklin Spence. Labels (owned): Silver Edge Records; (Distr): Love Light; Main product: Reggae.
- SILVERTONE RECORDS**, 165-167 Willesden High Road, London NW10 2SG, 081.459 8899, Fax: 081.459 3720, Tlx: 919884 zomba, MD: Andrew Lauder, Sales Dir: Andy Richmond.
- SILVERWAVE RECORDS**, Crickhowell, Powys NP8 1LB, 0873.810 142, Fax: 0873.811 557, MD: Kevin Holland-King, Company Sec: Joan Holland-King. Labels (owned): Silverwave, Welsh Gold; Main product: Country, Gold/Oldies.
- SIN RECORDINGS**, Coldharbour Ln, 6 Clifton Mansions, London SW9 8LL, 071.737 6243, MD: Colin Stewart.
- SINEWAVE STUDIO**, 51 Gas Street, Birmingham, West Midlands B1 2JX, 021.643 4016, Fax: 021.446 4528.
- SINISTER PRODUCTIONS**, 138 Park Lane, London W1Y 3AD, 071.493 8366, Fax: 071.408 1687, Tlx: 298550.
- SIREN RECORDS**, 326-328 Kensal Road, Kensal Dock, London W10 5BZ, 081.960 2224, Fax: 081.964 0687, MD: David Betteridge, A&R Dir: Simon Hicks. Distribution: Virgin.
- SKETCH! RECORDS**, 14 Cambridge Mansions, London SW11 4RX, 071.223 9793, MD: Mr. Robins. Main product: Dance, Rock.
- SKYSAW RECORDS**, PO Box 21, Wallasey, Merseyside L44 9HF, 051.639 5959, Fax: 051.639 0168.
- SLAM JAM RECORDS**, 35-37 Parkgate Rd, Ransoms Dk, Unit 32, London SW11 4NP, 071.228 4000, Fax: 071.924 1608, Tlx: 893991.
- SLAUGHTERBACK RECORDS**, 39 Dunlace Road, London E5 0NF, 081.985 1447, Fax: 081.985 7765.
- SLEEPING BAG RECORDS**, 58 Tournay Road, London SW6 7UF, 071.386 7860, Fax: 071.386 5681.
- SMALL LITTLE RECORD LABEL**, 112 Gunnersbury Avenue, London W5 4HB, 081.993 7441, Fax: 081.992 9993, MD: Dee O'Reilly, A&R Dir: Hazel Hemmings.
- SMITH MAYNARD INTERNATIONAL**, 72 Rushton Road (Studio), Desborough, Northamptonshire NN14 2QD, 0536.760 402, Producer/Comp: Graham Smith, Michael Maynard.
- SOHO RECORDS**, 187 Wardour Street, London W1V 3FA, 071.437 2394/723 2463, Fax: 071.434 0648, MD: Mark Teverson.
- SOLENT RECORDS**, PO Box 22, Newport, Isle of Wight PO30 1LZ, 0983.528 608, Fax: 0983.821 156, MD/Owner: John Waterman. Labels (owned): Solent; Main product: Adult Contemporary, Jazz, New Age.
- SOMAR RECORDS**, 79 The Larches, London N13 5QD, 081.886 7668, Fax: 081.886 7668, MD: Mark Winters.
- SOME BIZARRE**, 166 New Cavendish Street, London W1M 7FJ, 071.831 3140, Fax: 071.323 4321, MD: Stevo Pearce.
- SONET LONDON**, 78 Stanley Gardens, London W3 7SN, 081.746 1234, Fax: 081.740 9899, Tlx: 25793, MD: Rod Buckle, Label Mgrs: Dee Sparrow, Michael Puppelt, Promo: Alexander Sneddon. Labels (owned): Vasco da Gama, Ton Son Ton, Red Stripes, A22, Titanic, Neoplan, Stone, A-Side, Sonet-Jazz, Team Sonet; (LIC): Storyville, Alligator, Gazell, Amigo, Red Stripes, Red House, Antones, Grand Prix, Round Tower, Natural, Sonet.
- SONIC RECORDS**, 72 Watlans View, Newcastle-under-Lyme, Staffordshire ST5 8AH, 0782.713 111, Fax: 0782.713 112, MD: Mike Stone, Sec: Dave Hill.
- SONY MUSIC ENTERTAINMENT (UK)**, 17-19 Soho Square, London W1V 6HE, 071.734 8181, Fax: 071.734 4321/287 9959, Tlx: 24203 cbpsrc, Chmn: Paul Russell, MD: David Black (Sony Music ops), Dave Bowen (Columbia), Andy Stephens (Epic), Muff Winwood (Sony Soho Square), Sales Dir: John Aston, MIS Dir (UK & Eur): David Barrie, Bus Affairs Dir: Sylvia Coleman, Fin Serv Dir: Peter Corbett, Comm Dir: Laurie Crow, Press/PR Dir: Jonathan Morrish, Public Relations: Rhona Levene. Labels (owned): Columbia, Epic, Sony Soho Square, Sony Classical, Sony Masterworks; Distribution: Sony Music Operations.
- SONY MUSIC INTERNATIONAL (UK)**, 1 Red Place, London W1Y 3RE, 071.629 5555, Fax: 071.491 1392/355 1907, Tlx: 263973, Sr VP: Manolo Diaz, Artist Mktg Dir: Gary Williams, Special Mktg Dir: Chris Black, Snr VP: Patrick Hurley, Pro-

- mo Mgr: Mitch Vannoni. Labels (owned): Columbia, EPIC. **SONY SOHO SQUARE**, 17-19 Soho Square, London W1V 6HE, 071.734 8181, Fax: 071.434 0979, MD: Muff Winwood, A&R Dir: Lincoln Elias. Distribution: Sony Music Operations.
- SOPHISTICATED NOISE**, 2 Harewood Road, Ramacre Cottage Studios, South Croydon, Surrey CR2 7AL, 081.688 5240, Fax: 081.680 2543.
- SOUL SUPPLY RECORDS**, 4 Gaol Mews, Stafford, Staffordshire ST16 2RH, 0785.57097, Fax: 0785.55237, Tlx: 36540 hours.
- SOUTHTOWN 45 RECORDS**, 6-9 Salisbury Prom, Arena Hse, Green Ln, London N8 0RX, 081.809 1460, Fax: 081.802 2237, Dir: Julie Batten. Labels (owned): Soultown 45 Records; Main product: Dance.
- SOUND AND MUSIC CORPORATION, THE**, PO Box 993, London E12 6UT, 081.552 0432, Fax: 081.552 3323.
- SOUND SOLUTIONS (UK)**, Purley Way, Mill Lane Estate, Unit 1, Croydon, Surrey CR0 4AA, 081.686 3636/6555 (orders), Fax: 081.681 8005/1388 (orders), MD: Peter Collins, Sales Dir: Philip Worsfold, Fin Contr: Tom Varughese, Operations Mgr: Robert Worsfold, Field Sales Mgr: Laurence Miele, Van Sales Contr: Alistair Baumgartner, Distr Mgr: Robert Harris, Merch Contr: Nick Blewett, Admin: Barbara Byron. Labels (owned): Big Band Era, Big Country, Big Time, Black Tulip, Blue City, Commander, Groove Merchant, Heartbeat, Jazz Life, Laser, Mainline, MCR, Musique International, Noel, Onyx Classics, Point Productions, Streetlife, Sonata, Supreme, Virtuoso, Zillion. Division of The Phonomatic Group; formerly known as Mainline Records.
- SOVEREIGN RECORDS**, The Pyghtle, Pyghtle Cottage, Denham Village, Uxbridge, Middlesex UB9 5BD, 0895.832 063, MD: Ben Lisbet.
- SPECIAL DELIVERY**, 50 Stroud Green Road, London N4 3ES, 071.263 6403, Fax: 071.281 5671.
- SPELLBOUND RECORDS**, Churt Road, Beacon Hill Park, W Wing House, Hindhead, Surrey GU26 6HU, 0428.605 771, Fax: 0428.605 896.
- SPIDERCOM**, 68 Berwick Street, London W1V 3PE, 071.434 1373/734 2296, Fax: 071.287 4743, MD: Debbie Bourne, Heads: Nick Burgess Jones (Creative/Video Prod), Adam Gale (Merchandising), David Phillips (Mgmt Solid Pleasure), Dir Solid Pleasure: Dieter Meier. Labels (owned): Solid Pleasure; Main product: Dance.
- SPIV RECORDS**, 24 Devonshire Road, Liverpool, Merseyside L8 3TY, 051.728 9589, MD: Chris Bray. Labels (owned): Spiv; Main product: Reggae, Album Rock, Black (R&B).
- SPOTLITE RECORDS**, 103 London Road, Sawbridge, Hertfordshire CM21 9JJ, 0279.724 572, Fax: 0279 723 464, Owner: Tony Williams. Labels (owned): Spotlite; (Distr): Sackville; Main product: Jazz.
- SPRINGTIME!**, 3 Netherhall Gardens, The Basement, London NW3 5RN, 071.435 1166, Tlx: 265871.
- SPRINGTHYME RECORDS**, Balmalcolm House, Kingskettle, Fife KY7 7TJ, 0337.30773, President: Peter Shephard. Distribution: Gordon Duncan, Celtic Music, Graeme Tosh. Main product: Scottish traditional.
- SPRITZ RECORDS**, 30a Robert Street, Harrogate, North Yorkshire HG1 1HP, 0423.531 001, Fax: 0423.530 043.
- SQUARE BIZ RECORDS**, Beresford Road, Beresford Lodge, Unit 16, London N5 2HX, 071.354 0841, Fax: 071.490 7920.
- SQUARE ONE RECORDS**, Phoenix Street, Alexander House, Bury, Lancashire BL9 0HS, 061.797 2908, Fax: 061.762 9367.
- STANDARD RECORDS**, 33 Coatbank Street, Coatbridge ML5 3SP, 0236.31585, Fax: 0236.31585, MD: Max Hogg.
- STARGOAT RECORDS**, The White Cottage, Nethercote, banbury, Oxfordshire OX16 8ST, 0295.271 398, MD: Mr. Cox. Main product: New Bands, Pop.
- START RECORDS**, The Hyde Industrial Estate, Unit 1b, London NW9 6JU, 081.200 5335, Fax: 081.205 0109, Tlx: 264597 oldgol.
- STELLA FIVE RECORDS**, 13 Hill Crescent, Shrewsbury, Shropshire SY3 7RW, 0743.356 570, MD: Neville Street.
- STEPHAN RECORDS**, 402 Kingstanding Road, Great Barr, Birmingham, West Midlands B44 8LD, 021.382 3323, Fax: 021.377 8933.
- STETSON RECORDS**, Kent House Lane, Gardner Estate, Unit 23, Beckenham, Kent BR3 1OZ, 081.659 7112, Fax: 081.659 7114.
- STIFF RECORDS**, 42-46 St. Luke's Mews, London W11 1DG, 071.221 5101, Fax: 071.221 3374, Tlx: 299894.
- STILETTO BRASILIA**, 177 High Street, London NW10 4TE, 081.961 3889, Fax: 081.961 4620.
- STOLEN SOUND RECORDS**, 372 Meanwood Road, Leeds, West Yorkshire LS7 2JF, 0532.621 572, MD: Alaric Noville. Main product: Indie Rock.
- STOMP RECORDS**, 53 High Street, 20th Century House, Kings Langley, Hertfordshire WD4 9HU, 09277.60989, Fax: 09277.60166.
- STRANGE FRUIT RECORDS**, Ridgway, Sarabee House, Pyrford, Woking, Surrey GU22 8PW, 09323.49048, Fax: 09323.44500, MD: Clive Selwood, GM: Shurley Selwood. Distribution: Pinnacle.
- STREET BEAT RECORDS**, 115-117 London Road, Redhill, Surrey RH1 2JG, 0737.778 774, Fax: 0737.773 127.
- STRIKE BACK RECORDS**, 271 Royal College Street, Empire House, London NW1 9LU, 071.482 0115, Fax: 071.267 1169, MD: Maurice Bacon, Press/Promo: Patricia Dietz. Labels owned: Strike-Back, Blipvert; Distribution: Rough Trade.
- STRIKE RECORDS**, PO Box 396, London W11 2LZ, 071.727 4159, Fax: 071.636 7421.
- STUD RECORDS**, 9 Eccleston Street, London SW1W 9LX, 071.730 9875, Fax: 071.730 2721, Tlx: 265871 monref, E-Mail: DGS 1750.
- STUFF U RECORDS**, 110 Westbourne Grove, London W2 5RU, 071.727 8636, Fax: 071.229 4061, MD: Chris Gilbert, A&R/Creative Dev: Julie O'Neil. Main product: Alternative. Indie.
- STYLUS MUSIC**, 3 Burlington Lane, Hogarth Business Park, London W4 2T, 081.742 1662, Fax: 081.742 1469, Tlx: 416848, Chief Exec: Cho Jock Kim, GM: Malcolm McGlynn (Mktg), Prod Mgr: Sue Bergin, Sales: Brian Kempster, Distr: Phil Hayes.
- SUBMISSION RECORDS**, 389-394 Alfred Street N, The Square Cir, Nottingham, Nottinghamshire NG3 1AA, 0602.417 272, Fax: 0602.412 277, President: Tim Andrews, Chmn: John Crossley.
- SUBURBS OF HELL RECORDS**, 22 Villier Street, Uxbridge, Middlesex UB8 2PU, 0895.34846, Mgr: Douglas Benford. Labels (owned): Suburbs of Hell Records, Inertia Records; Main product: Adult Contemporary, Dance, Album Rock.
- SUE SEEK RED RUBY**, 134 Oldfield Grove, London SE16 2NE, 071.252 0598. Labels (Owned): Red Ruby.
- SUMMERHOUSE RECORDS, PO Box 13**, Stockton-on-Tees, Cleveland TS18 1RX, 0909.475 789, Contact: William Jones.
- SUMO RECORDS**, 31 New Street, Wigton, Cumbria CA7 9AL, 06973.43777, Fax: 06973.45011.
- SUN ZOOM SPARK**, Chambord St, Strickland House, Unit 13, London E2, 071.729 1355, Fax: 071.609 0246.
- SUNNYSIDE RECORDINGS**, 101 Sunnyside Road, Ilford, Essex IG1 1HY, 081.478 7774, Fax: 081.553 5216, Tlx: 23645 jrcltd.
- SUNSTONE RECORDS**, 15-16 Montagu Mews South, London W1H 1TE, 071.706 3745, Fax: 071.706 3748.
- SUPREME RECORDS**, 1a Waterloo Road, London N19 5JN, 071.281 6292, Fax: 071.281 7795, Tlx: 917618, MD: Nick East, Creative Dir: Kate Farmer, Bus Affairs Mgr: Steve Irons, Prod Mgr: Terry Woolner. Labels (lic): Escape, Vogue (Fra), CNR, (Hol), CBS (Spa), Dischi Ricordi (Ita); Distribution: Pinnacle; Main product: dance music.
- SURE DELIGHT RECORDS**, 155 Acton Lane, London NW10 7NJ, 081.961 5818, Fax: 081.965 7008, Tlx: 8952720.
- SURVIVAL RECORDS, PO Box 337**, London W5 4XD, 081.847 26257, Fax: 081.568 6154, Tlx: 896619, MD: Anne-Marie Heighway, A&R: David Rome. Labels (owned): Survival, Premonition; Distribution: The Cartel, BMG.
- SWAN RECORDS**, 80 Tolworth Road, Surbiton, Surrey KT6 7SZ, 081.397 2036, Fax: 081.394 2220.
- SWANYARD RECORDS**, 12-27 Swan Yard, London N1 1SD, 071.354 3737, Fax: 071.359 7544.
- SWOOP RECORDS**, Hill Bottom Road, Stewart House, High Wycombe, Buckinghamshire HP12 4HJ, 0630.81674, Fax: 0630.81612, MD: Ron Lee, Promo: Cathrine Lee, A&R: Xavier Lee. Labels (owned): Swoop, Pogo, Zarg, Grenouille, Check; Main product: Dance, Album Rock, Gold/Oldies, Classical, EHR, MOR.
- SYLVANTONE RECORDS**, 17 Allerton Grange Way, Leeds, West Yorkshire LS17 6LP, 0532.687 788, Owner: Tony Goodacre, Partner: Sylvia J Goodacre. Labels (owned): Sylvantone; Main product: Country.
- TABITHA RECORDS**, 1-2 Sandpiper Court, Exeter, Devonshire EX4 8NS, 0392.462 294, Fax: 0392.462 299, MDs: Graham & Denise Sclater.
- TANGENT RECORDS**, 50 Stroud Green Road, London N4 3EF, 071.263 6403, Fax: 071.281 5671, MD: Michael Steyn.
- TEATIME RECORDS**, 54 Treefield Road, Clevedon, Avon BS21 6JB, 0272.875 031, MD: Stewart Durban. Main product: Indie, Guitar.
- TEK RECORDS**, 6-9 Salisbury Promenade, Green lanes, Harrogate, London N8 0RX, 081.809 1460, Fax: 081.802 8395, Contact: Julie Batten.
- TELEDISC**, 22 Little Portland Street, London W1N 5AF, 071.580 0007, Fax: 071.580 7771, MD: David Pick, Sales Mgr: Roger Kent, F&A: Doug Wilson, A&R/Prod Mgr: Kathy Doherty. Direct response regard sales and TV merchandising; Labels (owned): Tellydisc, Impression Records.
- TELEPATHY**, 1026-1028 Harrow Road, London NW10 5NN, 081.960 2225, Fax: 081.960 2137, Dirs: Rob Collins, Geoff Muncy. Main product: Album Rock.
- TELSTAR RECORDS**, Barnes High Street, Prospect Studios, London SW13 9LE, 081.878 7888, Fax: 081.878 7886, Chmn: Sean O'Brien, Creative Dir: Neil Palmer, Fin Dir: Ian Dewar, Bus Affairs Dir: Graham Williams, Dirs: Tony Prior, Don Reedman, Sales Dir: Barry Watts, Prod Mgr: Anita Hobson, A&R Mgr: Rupert Lord, Office Mgr: Lyndsey Goldsmith, Premium Sales Execs: Tony Pearce, Tim Collins. Distribution: BMG.
- TEMBO RECORDS, PO Box 1655**, London W8 5HZ, 071.937 1040, Fax: 071.938 2670.
- TEMPLE RECORDS**, Shillinghill, Temple, Midlothian EH23 4SH, 087.530 328, Fax: 087.530 392, President: Robin Morton. Main Product: folk/traditional.
- TEN RECORDS**, 61-63 Portobello Road, London W11 3DD, 071.792 0941, Fax: 071.221 5414, Int'l Product Mgr: Jayne Jones.
- THAT'S ENTERTAINMENT RECORDS**, 107 Kentish Town Road, London NW1 8PD, 071.485 9593, Fax: 071.485 2282, Tlx: 896691, MD: John Yap, GM: Andy Barker. Labels distr: TER, TER Classics, TER VIP Series. Main product: musical theatre, opera, solo artists.
- THEOBALD DICKSON PRODUCTIONS**, Dean Street, 3 Richmond Buildings, London W1V 5AE, 071.439 6924, Fax: 071.734 2919, Tlx: 924725 rm td, Chmn: Bernard Theobald, MD: Barbara Dickson.
- THESE RECORDS**, 387 Wandsworth Road, London SW8 2JL, 071.622 8834, Fax: 081.682 3414, Label Mgrs: Howard Jacques, Phil England. Record label; owned by Recommended Distribution at same address; Main product: Avant-Garde, New Music.
- THIN LINE RECORDS**, 32 Zetland Road, Chorlton-cum-Hardy, Greater Manchester M21 2TH, 061.860 6470, Fax: 061.881 1184.
- THINK MUSIC**, 108 New Bond Street, London W1Y 9AA, 071.499 9192, Fax: 071.499 7517, Tlx: 262690.
- THIRD MIND RECORDS**, 387 Harrow Road, London W9 3NA, 081.969 6099, Fax: 081.968 8388, Dir: Gary Levermore. Main product: Album Rock.
- TIMBUKTU RECORDS**, 41-42 Berners Street, London W1P 3AA, 071.436 3371, Fax: 071.436 2837, Tlx: 21485 timbuk, Dirs: Peter Bond, Mike Edwards, Artist Liaison: Joanna Mudie. Main product: Adult Contemporary, Dance, Album Rock.
- TIME 1 RECORDS**, Holly Street Est, Lilac Court, Unit 30, London E8 3JJ, 071.241 4258, MD: Paul Love. Main product: Reggae, Dance; Distribution: VP Records, Sonic Sounds, Greensleeves, Jet Star-EMI.
- TIMELESS RECORDS (UK)**, 177 High Street, London NW10 4TE, 081.961 3889, Fax: 081.961 4620, Tlx: 8954780.
- TINSLEY ROBOR**, 27 Sirdar Road, The Dolphin, London W11 4EF, 071.221 2412, Fax: 071.221 8249. Sales office for: Tinsley Robor Sales, Icon Communications, R&B Litho, Sonic Plates, TR Display Print, Tinsley Robor Labels and James Upton.
- TITAN INTERNATIONAL PRODUCTIONS**, 185a Newmarket Road, Norwich, Norfolk NR4 6AP, 0603.51139, MD: Peter Newbrook. Labels (owned): Esquire, Starlight; Main product: Jazz.
- TKO RECORDS, PO Box 130**, Hove, East Sussex BN3 6QU, 0273.550 088, Fax: 0273.540 969, Chmn: J S Kruger, MD: Leslie Lewis. Labels (owned): Bulldog, Ember, Energy, Great Voices of The Century, Exploition; Main product: Jazz, Country, Classical, Gold/Oldies.
- TM RECORDS, PO Box 354**, Reading, Berkshire AG2 7JB, 0734.312 580, Fax: 0734.312 582, MDs: Laurence Aston, Jon Hiseman. Labels (owned): TM Records; (Lic): Black Sun, Celestial Harmonies, Fortuna, Kuckuck, Line, M.A. Music; Distribution: Conifer.
- TON SON TON**, 78 Stanley Gardens, London W3 7SN, 081.746 1234, Fax: 081.740 9899, Tlx: 25793.
- TONY SAVAGE RECORDS**, 21 Eaton Road, Margate, Kent CT9 1BX, 0843.220 765, MDA&R: Tony Savage, Mktg Dir: Mare Savage. Labels (owned): Savage Records; Main product: Dance, Gold/Oldies.
- TOPIC RECORDS**, 50 Stroud Green Road, London N4 3EF, 071.263 6403, Fax: 071.281 5671, MD: Tony Engle, Contact: John Martin.
- TORSO RECORDS**, 10 Myddleton Road, c/o Southern, London N22 4NS, 081.889 6555, Fax: 081.889 6166.
- THE TOTAL ORGANISATION, PO Box 284**, Glasgow, Strathclyde G12 9KW, 041.334 3191, MD: Robert H King, Asst MD: Morven Lister, Mktg: Brett Hirta, Promo: M T Rudnich, Promo/Liaison: S Hend. Labels (owned): Total, TFI, Nemesis; Main product: Dance, Techno, Soundtrack, Avant Garde.
- THE TOTAL RECORD COMPANY**, 84-96 The Chase, Pepys Court, Unit 7, London SW4 0NF, 071.978 2300, Fax: 071.498 6420, MD: Henry Semence, Dir: Duncan Finlayson, Sales Mgr: Tony Patoto. Main product: EHR, Adult Contemporary, Dance, Album Rock, Gold/Oldies, Black (R&B).
- TOUCH**, 13 Oswald Road, London SW17 7SS, 081.767 2368, Fax: 081.682 3414. Labels (owned): Touch, Spiral, Touch Tone.
- TOUCH AND GO, PO Box 59**, London N22 4NS, 081.888 8949, Fax: 081.889 6166, Tlx: 268041 sthrn.
- TOWER RECORDS**, 121-123 High Street, Epping, Essex CM6 4BD, 0378.76461, Fax: 0378.73326.
- TOWNBOUND RECORDS**, 57 Harvey Road, Hillingdon, Middlesex UB10 0HS, 0895.239 850, MD: David John Moore.
- TRAM PROMOTIONS/GABLE RECORDS**, 16 Pendle Court, Astley Bridge, Bolton, Lancashire BL1 6PY, 0204.596 643, A&R/Mktg: Len Goodwin. Labels (owned): Gable Record; Main product: Adult Contemporary.
- TRANSLANTIC RECORDS**, 68 Berwick Street, London W1, 071.434 9926, Fax: 071.494 0198.
- TRAX MUSIC**, 121-123 Camden High Street, 1st floor, London NW1 7JR, 071.482 6383, Fax: 071.267 9279, Tlx: 94016170 trax.
- TREATMENT RECORDS/BLACK ROCK PRODUCTIONS**, 10a Clifton Rise, London SE14 6TP, 081.692 8935, Fax: 081.692 9996, MD: Cyril Wayne, A&R Dir: Eddie Edwards, Mktg Dir: Paul Wane. Labels (owned): Treatment, Buzz; Main product: Reggae, Dance, Album Rock, Black.
- TREVOR VALLIS PRODUCTION COMPANY**, Stubblefield Farmhouse, Otterden, Kent ME13 0BZ, 0622.859 948, Fax: 0622.859 948, MD: Trevor Vallis.
- TRILOGY RECORDS**, 60 The Oval, Bath, Avon BA2 2HD, 0225.336 262, MD: Mr. Dunstone.
- TRING INTERNATIONAL**, 46 Western Road, Tring, Hertfordshire HP23 4DD, 044282.8515, Fax: 044282.8587, MD: Mark Levinson.
- TRIPLE EARTH RECORDS**, 1-8 Whitfield Place, London W1P 5RW, 071.380 0098, Fax: 071.388 2756, Tlx: 8953742, Partners: Iain Scott, Bunt Stafford Clark, Sec: Felicia Nkomo. Labels (owned): Triple Earth, Trio; Main product: World Music.
- TROIKA**, Bellever, Cross Park, Totnes, Devonshire TQ9 5EQ, 0803.862 393, Mgr: Basil Bunelk. Main product: East European Folk.
- TROJAN SALES**, 31-39 Camden Road, Twyman House, 2nd

- flr, London NW1 9LF, 071.267 6899, Fax: 071.267 6746, Dirs: Colin Newman, Frank Lea, Enzo Hamilton. Labels (owned): Trojan, Receiver, Attack, Clay, Sedition, Mooncrest, Action Replay, Cheapskate, Burning Sounds, Echo.
- TRUE**, 47 Lavell Street, London E1, 081.952 1056, Fax: 071.265 8052.
- TW RECORDS**, 7 Argyle Street, Bath, Avon BA2 4BA, 0225.331 521, Fax: 0225.481 555, MD: Jenni Nicholson.
- TWILIGHT MANOEUVRES**, PO Box 333, Bushey, Watford, Hertfordshire WD2 3UN, 081.950 9507, Fax: 081.950 3806, Tlx: 9419501 midmus.
- TWINK RECORDS**, 17 Gladstone Road, Colchester, Essex CO1 2EA, 0206.560 989, Fax: 0206.560 979, MD: John C Alder. Main product: Cosmic Rock.
- UBIK RECORDS**, 26 Sternhall Lane, Unit 4, Peckham, London SE15 4NT, 071.358 0058/9867, Fax: 071.358 1084, MDs: Mike Spencer, Greg Shaw.
- ULTIMATE RECORDS**, 271 Royal College Street, London NW1 9LU, 071.482 0115, Fax: 071.267 1169, Dirs: Andrew Winters, Maurice Bacon, Head Of Promo: Jo Bartlett, Head Of A&R: Chris King.
- ULTRA SONIC RECORDS**, North Villas, 8 Church Studios, London NW1 9AY, 071.482 4868, Fax: 071.485 1819, MDs: Martin Sexton, Stefan Lux, Sec: Sarah Taylor.
- UNAMERICAN ACTIVITES**, 29 St. Michaels Road, Leeds, West Yorkshire LS6 3BG, 0532.742 106, Fax: 0532.786 291.
- UNICORN RECORDS**, 14 Hillgate Place, London W8 7SJ, 071.727 3881, Fax: 071.243 1701, MD: Nigel Brandt.
- UPBEAT RECORDINGS**, Restmor Way, Sulton Business Centre, Wallington, Surrey SM6 7AH, 081.773 1223/647 5275, Fax: 081.669 6752, Partners: Liz Biddle, Maureen Phillips, Mktg Co-Ord: Jill Doggett. Main product: Jazz, MOR.
- UPFRONT RECORDS**, Wadsworth Rd, Sheraton Bus Ctr, Unit 30, Perivale, Middlesex UB6 7JB, 081.566 7117, Fax: 081.997 5862.
- UTILITY RECORDS**, 6 Bravington Road, Flat B, London W9 3AH, 081.960 4438, Fax: 081.969 8458, Tlx: 931213.
- V-KRIS RECORDS**, 2-4 Bank Road, Bredbury, Stockport, Cheshire SK6 1DR, 061.430 5052, Fax: 061.430 5052, Dir: Chris Statham. Main product: Adult Contemporary, Album Rock.
- V-RAM DISCS UK**, Spring Gardens, Mill Cottage, Oldford, Frome, Somerset BA11 2NZ, 0373.466 695, Admin (UK): Roger Bourne. Labels (owned): V-Ram Discs, Songstream Music; Main product: Adult Contemporary, Dance, Album Rock.
- VALENTINE MUSIC GROUP**, 7 Garrick Street, London WC2E 9AR, 071.240 1628/9, Fax: 071.497 9242, MD: John Nice. Labels (owned): Bandleader Military/Brass, Valentine, Range; Distribution: Conifer.
- VANESSA RECORDS AND TAPES**, 3 Glebe Road, Weston-super-Mare, Avon BS23 3AP, 0934.417 174, Dir: Don Todd. Main product: popular and classical organ music.
- VANISHING RECORDS**, 14 Victoria Road, Wellingborough, Northamptonshire NN8 1HN, 0933.663 644, Fax: 0933.224 786.
- VASCO DA GAMA**, 78 Stanley Gardens, London W3 7SN, 081.746 1234, Fax: 081.740 9899, Tlx: 25793.
- VCN RECORDS**, 35 Mansted Gardens, Romford, Essex RM6 4ED, 081.590 2524, Fax: 081.599 2065, MD: John McDonald, Dir: Phil Harding. Labels (owned): VCN; Main product: Hi-NRG.
- VFM (CASSETTE DISTRIBUTORS)**, Faraday Road, Unit 21, Aylesbury, Buckinghamshire HP19 3RY, 0296.437 307, Fax: 0296.392 019, Tlx: 838705 tape, MD: Roy Jackson-Moore, Fin Dir: Michael McLoughlin, Sales Dir: Geoff Pearman. Labels (Owned): VFM, VCA, STC, SFC, OTC; Main product: Country, Classical, Children's.
- VIBE RECORDS**, 31 Horsedje Street, St Marys House, Oldham, Greater Manchester OL1 3XE, 061.628 4252, Fax: 061.628 8001, Dirs: K J D'Faye, K Duffy, Label Mgr: John Turner, Int'l: Nikki Daly.
- VINYL SOLUTION**, 231 Portobello Road, London W11 1LT, 071.792 9791, Fax: 071.792 9871.
- VIRGIN CLASSICS**, 474 Harrow Road, London W9 3RU, 071.266 2060, Fax: 071.289 6229.
- VIRGIN RECORDS UK**, 553-579 Harrow Road, Kensal House, London W10 4RH, 081.968 6688, Fax: 081.964 0386, Tlx: 22542, President: Richard Branson, Chmn: Simon Draper, MDs: Jon Webster (Records), Ken Berry (Music Div), A&R Dir: Willie Richardson, Mktg Dir (Int'l): Juliette Joseph, Operations Dir: Rick Carter, Legal/Bus Affairs Dir: Shelagh Macleod, F&A Dir: Torrens Lyster, GM: Mark Williams, Int'l Licensee Mgr: Connie Sutherland, A&R: John Wooler, Int'l Promo Mgr: Jane Dolan, Promo Radio: Tony Barker, Head Of Sales: Mike Lawrence, Int'l Prod Mgrs: Debra Clancy (Virgin UK), Dino Ostacchini (Virgin UK), Tania Davies (Virgin US), Guy Hayden (Venture), Int'l Production Co-Ord: Ingrid Johansen. Labels (owned): Virgin, Siren, Virgin Classics, Circa, Ten, Venture Night Records; Distribution: PolyGram.
- VISION DISCS**, PO Box 92, Gloucester, Gloucestershire GL4 8HW, 0452.812 442, Fax: 0452.812 106.
- VIZA RECORDS**, 76 Adelaide Road, London W13, 081.840 0990, Fax: 081.566 3597.
- VOTP RECORDS**, 28-30 Horseferry Pl, Wood Wharf Studios, London SE10 9BT, 081.853 4766, Fax: 0959.75960, Creative Dir: Billy Jenkins, Admin: Anne Canny, A&R: Alice Mercedes, Harriet Lattice. Labels (owned): VOTP; (Lic): Allmusic, DCM, Plymouth Sounds, Thin Sliced, Wood Wharf; Main product: Adult Contemporary, Jazz, Acid Jazz, New Rage. Distribution: Cadillac, 071.836 3646, Fax: 071.497 9102; Recommended Distribution, 071.622 8834, Fax: 081.682 3414.
- WAR WORLD ARTIST RECORDS**, 2 Great Marlborough Street, Top floor, London W1V 1DE, 071.287 0531, Fax: 071.734 9828.
- WARNER CLASSICS INTERNATIONAL (LONDON)**, 83 Baker Street, London W1M 1AJ, 071.486 1414, Fax: 071.486 6892, Snr VP (Classical): Peter Andry, GM (Int'l Mktg): Michael Letchford.
- WARNER MUSIC EUROPE**, 83 Baker Street, London W1M 1AJ, 071.486 1414, Fax: 071.935 3669, Snr VP: Manfred Zunkeller, VPs: David Evans (Mktg/Sales Eur), Beatrice Silva-Tarouca (Bus Affairs), Mktg Mgrs: Rainer Focke (Elektra, Atlantic & Anc), Lars Toft (Warner Bros & Assoc Labels), Kevin Barter (Ancillary Mktg), Artist Promo Dir: Jaquelyne Ledent-Villain, Promo Mgr: Sue Wildish, Mktg Analyst: Graham Doyle.
- WARNER MUSIC INTERNATIONAL (LONDON)**, 83 Baker Street, London W1M 1AJ, 071.486 1414, Fax: 071.486 6892, Chmn/CEO: Ramon Lopez, Exec VP/CFO: Ken Cooper, Snr VPs: Keith Brue (Asian Pacific Reg), Peter Ikin (Int'l Mktg/Artist Dev), VP (Fin): Gordon Rossmeyer.
- WARNER MUSIC UK (LONDON)**, 28a Kensington Church Street, Warner Bld, London W8 4EP, 071.937 8844, Fax: 071.938 3901, Tlx: 927125, Chmn: Rob Dickens, F&A Dir: Roger Brighton, Bus & Comm Affairs Dir: Fran Nevrlka.
- WARP RECORDS**, 1 Brown Street, Studio 2, Sheffield, South Yorkshire S1 2BS, PO Box 474 (Zip: S1 3BW), 0742.750 033, Fax: 0742.757 589, MDs: S P Beckett, R O Mitchell, Head Of Promo: F Hilbert, Head Of A&R: A Robinson, Head Of Mktg: R Edwards, Head Of Int'l: G Evelyn. Main product: Dance.
- WARREN STUDIO RECORDS**, Woodside Avenue, The Warren, Grantown-on-Spey, Grampian PH26 3JR, 0479.2263.
- WARRIOR DANCE UK**, 389 Harrow Road, London W9 3QA, 081.960 7141, Fax: 081.969 5024.
- WARRIOR RECORDS**, PO Box 775, London EC1A 4LB, 071.490 5475, Fax: 071.490 7920, MD: Andrew E Bear, Admin: Judith T Annakie. Label: Warrior Records; Main product: Dance, Black (R&B).
- WATERFALL RECORDS**, 109 Fort Road, Newhaven, East Sussex BN9 9BY, 0273.515 803, Fax: 0273.517 990, MD: Neil Taylor. Labels (owned): Waterfall, Other, Nosrednas, Wounded Knee; Main product: Album Rock.
- WATERFRONT RECORDS**, 19 Mount Pleasant, Crewkerne, Somerset TA18 7AH, 0460.77444, Fax: 0460.74551.
- WATERLOO SUNSET RECORDS**, 21a Culdesden Road, Kenley, Surrey CR2 2LR, 081.668 0493, MD: Russel Brennan. Main product: Sixties-influenced.
- WAW! MR MODO RECORDS**, PO Box 483, Sheffield, South Yorkshire S1 2BY, 0742.725 804, Fax: 0742.729 562. Labels (owned): Waw! Mr Modo, Youth Sounds, Manna Records; Main product: Dance, Reggae.
- WAX RECORDS**, 28 Chalvedon Avenue, Pitsea, Basildon, Essex SS13 1AF, 0268.590 743, Fax: 0268.728 574.
- WAXTRAX**, PO Box 59, London N22 4NS, 081.888 8949, Fax: 081.889 6166, Tlx: 268041, E-Mail: sthr.
- WEA UK**, 28a Kensington Church Street, Warner Bld, London W8 4EP, 071.937 8844, Fax: 071.938 3910, Tlx: 261425, MD: Jeremy Marsh, Publ/Art Dev Dir: Moira Bellas, Head Of A&R: Michael Rosenblatt, GM (USA): Phil Knox-Roberts, Heads: Barbara Charrone (Press), Chris Mason (Promo), Tony McGuinness (Mktg).
- WEB RECORDS**, Leicester Road, One Ash, Loughborough, Leicestershire LE12 8UE, 0509.413 863, Fax: 0509.412 236, MD: William Dlsley.
- WERGO RECORDS**, 48 Great Marlborough Street, London W1V 2BN, 071.437 1246, Fax: 071.437 0263.
- WEST 4 TAPES & RECORDS**, 105 Stocks Lane, Bracklesham Bay, West Sussex PO20 8NU, 0243.671 238, MD: Kenneth G Roe, Sales Dir: Mary A Roe. Labels (owned): West 4, WIV; Main product: Spoken Word, Documentary.
- WESTMOOR MUSIC**, London Road, c/o Spartan Records, Wembley, Middlesex HA9 7HQ, 081.903 4753, Fax: 081.903 7853, Tlx: 923175.
- WHAT PRODUCTIONS**, BCM, PO Box 4263, London WC1N 3XX, 071.379 1019, Fax: 071.379 1013, Contact: Rachel Dignam.
- WHAT RECORDS**, 11 Dugdale Street, The Record Centre, Nuneaton, West Midlands CV11 5JQ, 0203.382 694, MD: Tim Ellis. Main product: Dance.
- WHICH WITCH**, Glendower Place, 2 Glendower Mansions, London SW7 3DS, 071.589 4796, Fax: 071.584 7359, President: Ole Sorli. Labels (owned): Notabene Records; Main product: Rock, Opera, Musical; Other: music & theatre productions.
- WIENERWORLD**, 90 Old Church Lane, Stanmore, Middlesex HA7 2RR, 081.954 8777, Fax: 081.954 2999, Tlx: 94014029 wrrwd, MD: Ian Wiener, Bus Affairs Dir: Anthony Broza. Production and Int'l distribution; Main product: Adult Contemporary, Dance, Album Rock, Hi-NRG.
- WILCOX-ZODIAC RECORD COMPANY**, 1099a Finchley Road, London NW11 0QB, 081.455 6620, Fax: 081.455 3128, MD: Herbert W Wilcox. Labels (owned): Zodiac, Delta, Golden Era, Al Bowly, Southland, London Jazz; Main product: Jazz, Gold/Oldies.
- WING AN A PRAYER RECORDS**, 187 Charlemont Road, London E6 4AG, 081.472 9252, Dirs: Stephen Alpert, Kevin Smith, Morris Ammar, Promo/Mktg Dir: Andrew Skortis. Main product: Dance, Jazz, Black (R&B), Reggae, Rap, Instrumental.
- WINSLOW RECORDS**, 122a Cambridge Road, Southend-on-Sea, Essex SS1 1ER, 0702.347 353, Fax: 0702.342 698.
- WISEPACK**, Latimer Road Industrial Est, Unit 12, London W10 6RG, 081.969 6933, Fax: 081.969 4438, MD: J Florey. Labels (owned): Legends in Music, Stardust, Apollo Classics.
- WOMAD RECORDS**, Mill Lane, Millside, Box, Wiltshire SN14 9PN, 0225.744 044, Fax: 0225.743 481, Tlx: 94081031 womad.
- THE WONDERFUL MUSIC COMPANY**, 14 Victoria Road, Wellingborough, Northamptonshire NN8 1HN, 0933.663 644, Fax: 0933.224 786.
- WORD (UK)**, 9 Holdom Avenue, Bletchley, Milton Keynes MK1 1QR, 0908.648 440, Fax: 0908.648 592, MD: Ian Hamilton, Comm Dir: David Withers, A&R Dir: David Bruce, Mktg: Jerry Johnson. Labels (owned): Spirit of Praise, Myrrh, Word, Dayspring; Main product: Gospel.
- WORKERS PLAYTIME**, 64 Mountgrove Road, London N5 2LT, 071.354 5455, Fax: 071.359 2232. Main product: World Music, Indie.
- WORKSHOP RECORDS (UK)**, Fraser Road, Research House, Greenford, Middlesex UB6 7AQ, 081.997 9384, Fax: 081.991 2653.
- WORLD**, 10 Myddleton Road, London N22 4NS, 081.888 8949, Fax: 081.889 6166, Tlx: 268041 sthr.
- THE WYE RECORD COMPANY**, 818 Bristol Road, Selly Oak, West Midlands B29 6NA, 021.414 1288, Fax: 021.472 5269.
- XCENTRIC NOISE RECORDS**, 17 West End Road, Cottingham, North Humberside HU16 5PL, 0482.843 411, MD: A R Thompson. Main product: Punk, Alternative.
- YORK AMBISONIC**, PO Box 66, Lancaster, Lancashire LA2 6HS, 0524.823 020, MD: Brendan Hearne, Company Sec: Gerda Kloos. Main product: Classical.
- YOUNG GOD RECORDS**, 1026-1028 Harrow Road, London NW10 5NN, 081.960 2225, Fax: 081.960 2137, Dir: Rob Collins, Michael Gira, Geoff Muncy. Labels (owned): Young God Records; Main product: Album Rock.
- ZED BEAT**, 165-167 Willesden High Road, London NW10 2SG, 081.459 8899, Fax: 081.451 3900, Tlx: 919884 zomba.
- ZENITH RECORDS**, 163 Gerrard Street, Birmingham, West Midlands B19 2AP, 021.554 7424, Fax: 021.515 1664, Chmn: Rufus Corbin, MD: Ron Thompson, Promo/Mktg Dir: Colin King, A&R: Matt Bolton. Main product: Reggae, Dance, Album Rock.
- ZING AUDIO**, PO Box 4, Ferryhill, County Durham DL17 9BP, 0740.653 132, Fax: 0740 653.434.
- ZIPPO MUSIC GROUP**, 37-39 Clapham Park Road, London SW4 7EE, 071.720 2341, Fax: 071.622 5796.
- ZOMBA RECORDS**, 165-167 Willesden High Road, London NW10 2SG, 081.459 8899, Fax: 081.451 3900, Tlx: 919884 zomba. MD: Steven Howard, A&R Dir: Charlie Eyre, Promo Head: Duncan Warwick, Int'l Promo: Kerian Fenning, Contact: Andy Richmond. Labels (owned): Jive, Silvertone Records; Distribution: BMG.
- ZONESPEC**, PO Box 770, London EC1R 5AQ, 071.833 2149, Fax: 071.833 8014, Copyright: Iris Cousins, Takuya Matsunoki, Admin: Sylvia Banks, Wakaba Sato. Labels (owned): Zonespec, Ian David; Main product: Adult Contemporary, Jazz, Country, Classical, Album Rock.
- ZOO EXPERIENCE RECORDS**, 653-655 Commercial Road, London E14 7LW, 071.790 0468, Fax: 071.790 0479.
- ZTT RECORDS**, 42-46 St. Luke's Mews, Blue Building, London W11 1DG, 071.221 5101, Fax: 071.221 3374, MD: Jill Sinclair, Label Mgr: Caroline Kautze, A&R: Simon Aldridge.
- ZYX RECORDS (UK)**, Heather Park Drive, Trinity House, Wembley, Middlesex HA0 1SX, 081.902 6398, Fax: 081.902 5896, President: Bernhard Mikulski, MD: Christine Vincent. Labels (owned): Memory, Freshline, ZYX Metal, Classic Records, Galaxis, Abfahrt, Technodrome, Elbtaler Schallplatten.

MUSIC PUBLISHERS

- 10 MUSIC, see Virgin Music.
- 400 BLOWS, see Warrior Records.
- ABACO MUSIC, 4 Imandra Close, Trencham, Stoke-On-Trent, Staffordshire, 0782.659 515, MD: John Fisher, A&R: Constanze Fisher.
- ABC CIRCLE, see Minder Music.
- ACUFF ROSE OPRYLAND MUSIC, 129 Park Street, London W1Y 3FA, 071.629 0392, Fax: 071.499 9718, GM: Tony Peters. Main product: Country.
- AD-CHOREL MUSIC, 40 Sciennes, Edinburgh, Lothian EH9 1NH, 031.668 3366, Fax: 031.662 4463, MD: Neil Ross.
- ADDITIVE MUSIC PUBLISHING, 4 Birchfields Road, Manchester, Greater Manchester M13 0XR, 061.225 5140, Fax: 061.628 8001, Tlx: 669755 office attn: inn, MD: John Turner, Company Sec: Pamela Millbrook. (Owned): Slow Bongo Floyd, Diskonexion; Main product: Dance.
- ADDINGTON STATE, see Valentine Music Group.
- ADRIAN GURVITZ MUSIC, see AG Publishing.
- AG PUBLISHING, 121-123 High Street, Epping, Essex CM16 4BD, 0378.76461, Fax: 0378.78580, MDs: Harvey & Linda Wolfinger, A&R Dir: Lara Wolfinger. (Owned): Adrian Gurvitz Music.
- AI MUSIC, 281 Walworth Road, London SE17 3RP, 071.708 0003, Fax: 071.708 1152, MD: Ray Levy.
- AIR MUSIC, see Chrysalis Music.
- AIR-EDEL ASSOCIATES, 18 Rodmarton Street, London W1H 3FW, 071.486 6466, Fax: 071.224 0344, MD: Maggie Rodford, Studio Mgr: Nicole Jacob.
- ALFRED LENGNICK & COMPANY, 7-8 Greenland Place, London NW1 0AP, 071.267 3697, Fax: 071.485 5133, Chmn: Tim Hollier.

- ALL BOYS MUSIC**, Sanctuary Street, 4-7 The Vineyard, London SE1 1QL, 071.403 0007, Fax: 071.403 8202, E-Mail: PWL-UK, President: Pete Waterman, Admin: Lucy Anderson.
- ALL MEDIA**, see Paul Rodriguez Music.
- ALL NATIONS**, see Sony Music Publishing.
- ALLIED MUSIC COMPANY**, 76 Tottenham Court Road, London W1P 9PA, 071.631 0583, Fax: 071.486 3207, MD: Andy Grover, GM: Suzy Walker, Prof Mgrs: Danny Brittain, Sean Quinn. Main product: AC, Album Rock, Jazz, Black (R&B), Reggae.
- ALLIED WEST ENTERTAINMENTS**, 7-8 Greenland Place, London NW1 0AP, 071.267 3697, Fax: 071.485 5133, Chmn: Tim Hollier.
- ALON MUSIC**, see Charly Publishing.
- ALPADON**, see Valentine Music Group.
- AMBER MUSIC**, 222 Kensal Rd, Canalot Studios, Unit 220, London W10 5BN, 081.969 9686, Fax: 081.968 8542, Contact: Lenny Zakatek.
- AMBIENT RECORDS (ISLE OF MAN)**, 2 Bridge Street, Bajor House, Peel, Isle of Man, 0624.844 136, Fax: 0624.844 135, Chmn: Rick Wakeman, Creative Dir: Nina Wakeman, Mktg/A&R: Frank Fallows, A&R: Susie James.
- AMCORP GROUP**, see Kassner Associated Publishers.
- AME OF NEW YORK**, see Kassner Associated Publishers.
- AMERICAN BROADCASTING**, see Minder Music.
- AMOKSHASONG**, PO Box 102, London E15 2HH, 081.555 5423, Fax: 081.519 6834, MD/Owner: Charles Cosh. Main product: Dance.
- AMPHONIC MUSIC**, Waterhouse Lane, The Kerchesters, Kingswood, Surrey KT20 6HT, 0737.832 837, Fax: 0737.833 812, Chmn: Sydney Dale, MD: Ian G. Dale, Prof Mgr: Jane Holloway, Copyright Mgr: Erica Dale, Admin: Cezame/Argile, Koka Media (Fra).
- ANDERSON**, see Rocksong Music Publishing.
- ANDI BAXTER**, see United Nations Music Publishing.
- ANXIOUS MUSIC**, 2-4 The Broadway, Devonshire House, Crouch End, London N8 9SN, 081.340 8357, Fax: 081.341 5480, MD: Phil Hope.
- ANY KIND OF MUSIC**, see Supreme Songs.
- APPLIED**, see Bucks Music.
- ARC MUSIC PRODUCTIONS INT'L**, PO Box 111, East Grinstead, West Sussex RH19 2YF, 0342.328 567, Fax: 0342.315 958, MD: Horst Tubbesing.
- ARCTIC KING MUSIC**, 360 Oxford Street, Avon House 4th floor, London W1N 9HA, 071.499 5244, Fax: 071.493 4286, Tlx: 22721, MD: Dennis Arnold.
- ARLON MUSIC**, Penn Street, Pavilion House, Amersham, Buckinghamshire HP7 0PX, 0494.712 555, Fax: 0494.712 510, Tlx: 83275, MDs: Deke & Jill Arlon.
- ARMY OF LOVERS MUSIC**, see Team Sonet Publishing.
- ART SCHOOL**, see Asterisk Music.
- ARTHUR'S MOTHER**, see Valentine Music Group.
- ASTERISK MUSIC**, London Road, Rock House, St. Mary's, Chalfont, Gloucestershire GL6 8PU, 0453.886 252, Fax: 0453.885 361, Dirs: Jon Beecher, Tony Atkins, GM: Yvonne Saunders. (Admin): Art School, Atham, Blue Cat, Brookside, Cee Cee, Chick-A-Boom, Chipglow, Dartson's, Flip Flop, Olrac, One Note, Rollercoaster, RT Sli, Snappersongs, Spadesongs, Stinkhorn, Tanspan, Verge, White Elephant, Mighty Iron Music.
- ATHAM**, see Asterisk Music.
- AURA MUSIC**, 1 Liverpool Road, London W5 5NZ, 081.579 4333, Fax: 081.579 4333, MD: Aaron Sixx.
- AV MUSIC**, see John Fiddy Music.
- AVI**, see Valentine Music Group.
- BACON EMPIRE PUBLISHING**, 271 Royal College Street, Empire House, London NW1 9LU, 071.482 0115, Fax: 071.267 1169, MD: Maurice Bacon.
- BANDLEADER**, see Valentine Music Group.
- BARK BOAT MUSIC**, see Sonet London.
- BATHUB MUSIC**, 7 Argyle Street, Bath, Avon BA2 4BA, 0225.331 521, Fax: 0225.481 555, MD: Jenni Nicholson.
- BEAMLINK MUSIC**, see Paul Rodriguez Music.
- BEAR SONGS**, PO Box 944, Birmingham, West Midlands B16 8UT, 021.454 7020, Fax: 021.454 4487, MD: Jim Simpson.
- BEAVER**, see H & B Webman & company.
- BEE BEE MUSIC**, PO Box 472, London SW7 4NL, 081.937 6614, Fax: 081.937 8680, Tlx: 21879, MD: Joe Lustig.
- BEECHMONT**, see H & B Webman & company.
- BEEZ & HEAVENLY**, see Paul Rodriguez Music.
- BEGGARS BANQUET RECORDS**, 17-19 Alma Road, London SW18 1AA, 081.870 9912, Fax: 081.871 1766, Tlx: 915733, MD: Martin Mills. (Owned): Beggars Banquet, Heathwave, Momentum.
- BEIJING**, see Music Galore.
- BELL PUBLISHING**, 60a Jacksons Lane, Highgate, London N6 5SY, 081.348 0783, Fax: 081.348 1076, Contact: Paul Hickey.
- BERKELEY**, see Bucks Music.
- BEST MUSIC**, 32 Willesden Lane, London NW6 7ST, 071.625 0231, Fax: 071.372 5439, Dirs: Laurie Jay, Peter Todd, GM: Dee Sparrow.
- BIG EARS MUSIC**, 147 Waller Road, London SE14 5LX, 071.385 0802, Fax: 071.635 9545, Tlx: 8951182, MD: Greg Cutler.
- BIG LIFE MUSIC LIBRARY**, 2 Tunstall Road, Suite B, London SW9 8DA, 071.738 7950, Fax: 071.738 3265, Contact: Caroline Robertson.
- BIG ONE PUBLISHING**, 343 Goswell Road, London EC1V 7JT, 071.278 0842, Fax: 071.833 2687, Tlx: 27659 CALLIN, MD: Patrick J. Meads, Personal Asst: Helen Street. (Owned): Music Like Dirt.
- BIXIO**, see Kassner Associated Publishers.
- BL&H**, see H & B Webman & company.
- BLACK SUN MUSIC**, see Temple Music.
- BLACK TOP**, see Demon Music.
- BLUE AEROPLANES**, see Dizzy Heights Music.
- BLUE AUGUST MUSIC**, 7 Kentish Town Road, London NW1 8NH, 071.485 1449, Fax: 071.267 7087, MD: John McDonald. Main product: Dance, AC, Album Rock.
- BLUE CAT**, see Asterisk Music.
- BLUE MER**, see Blueytones/Shanna Music.
- BLUEBEARD**, see PolyGram Music Publishing.
- BLUEPRINT MANAGEMENT**, 134 Lots Road, London SW10 0RJ, 071.351 4333, Fax: 071.352 4652, Tlx: 893851 wrenst, Pdedent: John Glover. (Owned): Street Tunes; (Admin): Dodey songs.
- BLUEYTONES/SHANNA MUSIC**, Hartsbourne Avenue, 1 Hartswood Green, Bushey Heath, Hertfordshire WD2 1JL, 081.950 8925, Fax: 081.950 8926, MD: Barry Blue. Affiliates: Blue Mer, Door To Door Music; Mobile 0836.771 542.
- BMG MUSIC PUBLISHING (UK)**, 69-79 Fulham High Street, Bedford House, London SW6 3JW, 071.973 0980, Fax: 071.973 0337, Tlx: 920896, MD: Paul Curran, Legal & Bus Affairs: Clive Rich, Fin Contr: Will Downs.
- BMG MUSIC PUBLISHING INTERNATIONAL**, 69-79 Fulham High Street, Bedford House, London SW6 3JW, 071.973 0980, Fax: 071.973 0337, Tlx: 920896, Sr VP: Diana Graham, Int'l Mgr: Nigel Rush, Admin Mgr: Adam Singfield, Int'l Repertoire Mgr: Janice Stokoe.
- BOBBING MUSIC**, Littleton Road, Littleton House, Unit 10, Ashford, Middlesex TW15 1UJ, 0784.247 176, Fax: 0784.241 168, Contact: Mark Rye.
- BOCU MUSIC**, Wyndham Place, 1 Wyndham Yard, London W1H 1AR, 071.402 7433, Fax: 071.602 2866, MD: John Spalding, GM: Carole Broughton.
- BONSKEID MUSIC**, 8 Queen's Gardens, Edinburgh, Lothian EH4 2DA, 031.332 3652, Fax: 031.315 2160, MD: Freeland Barbour. (Owned): Sileas, F Barbour, C Dewar, G Duncan, J Duncan, S Howie, J Douglas, J McCreadie; Main product: Scottish, Folk.
- BOO HEWERDINE**, see Dizzy Heights Music.
- BOOGA DOOGA MUSIC**, see Sonet London.
- BOP**, see Valentine Music Group.
- BR TV & FILMS**, see United Nations Music Publishing.
- BRAMPTON MUSIC**, 9 Carnaby Street, London W1V 1PG, 071.437 1958, Fax: 071.437 3852, MD: Tony Hall.
- BRAND NEW MUSIC**, 154 Burwood Road, Walton-On-Thames, Surrey KT12 4AS, 0932.221727, MD: Mike Vernon.
- BRIGHT MUSIC**, 2 Harwood Terrace, London SW6 2AB, 071.384 1599, Fax: 071.384 2236, MD: Martin Wyatt.
- BRIGHT SPARK SONGS**, 10 Pembridge Place, Flat A, London W2 4X8, 071.221 3980, Fax: 071.221 4091, MD: John McDonald.
- BROADWAY**, see Kassner Associated Publishers.
- BROOKSIDE**, see Asterisk Music.
- BROTHERS ORGANIZATION, THE**, Oakmead Road, Falcon Mews, London SW12 9SJ, 081.675 5584, Fax: 081.675 6313, Joint MDs: Ian & Nick Titchener, Label Mgr: Zareena Hussain.
- BROWN RICE**, see Demon Music.
- BRUCE WELCH MUSIC**, Marshall Street, 64 Stirling Court, London W1V 1LQ, 071.434 1839, Fax: 071.434 1839, MD: Bruce Welch.
- BRUCO**, see EG Music.
- BRUJO MUSIC**, see Sonet London.
- BUCKHORN**, see Valentine Music Group.
- BUCKS MUSIC**, 1a Farm Place, London W8 7SX, 071.221 4275, Fax: 071.229 6893, MD: David Platz, A&R: Simon Platz, Admin Mgr: Margaret Fraser, Asst: Claire Pieroni. (Owned): Bucks Music, Key, Newquay, Harmony, Standard; (Admin): Applied, Myra, TVS, Misty River, Hammer, Berkeley.
- BUGLE SONGS**, 21a Noel Street, Bugle House, London W1V 3PD, 071.439 2282, Fax: 071.439 7649, Tlx: 268152, MD: Miles Copeland, GM: Torquil Creavy.
- BULK MUSIC**, 9 Watt Road, Hillington Industrial Est, Hillington, Glasgow, Strathclyde G52 4RY, 041.882 9060, Fax: 041.883 3686, MDs: Angus McDonald, Isabel Gibson Waugh.
- BULLSEYE MUSIC**, AIR House, Spennymoor, County Durham DL16 7SE, 0388.814 632, Fax: 0388.812 445, Tlx: 587513, MDs: Colin Pearson, John Wray.
- BUTTER MUSIC**, see Demon Music.
- C DEWAR**, see Bonskeid Music.
- CACTUS MUSIC**, see Creole Music.
- CALEDONIA**, see PolyGram Music Publishing.
- CAMBRIAN**, see Sain.
- CAMPBELL CONNOLLY MUSIC**, see Music Sales.
- CANOPY/WHITE OAK**, see Eaton Music.
- CAPITOL PRODUCTION MUSIC**, see Sound Stage.
- CARA MUSIC**, 23 The Green, Southgate, London N14 6EN, 081.447 8882, Fax: 081.882 7679, MD: Michael McDonagh.
- CARES MUSIC INC**, see TKO Music.
- CARITAS**, see Eschenbach Editions.
- CARLIN MUSIC CORPORATION**, 3 Bridge Approach, Iron Bridge House, Chalk Farm, London NW1 8BD, 071.734 3251, Fax: 071.439 2391, President: Freddy Bienstock, VP: Miriam Bienstock, MD: David Japp, Legal/Bus Affairs Dir: Joe Whitston, Fin Dir: Julie Arnold, Sr Creative Mgr: Kip Trevor, Creative Mgr: Jane Nesbitt, Copyright Mgr: Penny Fillekes.
- CARLYLE**, see H & B Webman & company.
- CARNABY MUSIC**, see Negus-Fancey Company.
- CARTEL-LEWIS MUSIC**, see Southern Music Publishing Co. Ltd.
- CAVELL MUSIC**, 26 Gooedge Street, London W1P 1FG, 071.580 4740, Fax: 071.323 9295, Dirs: William Prendergast, Tony Berry. Main product: Main product: Album Contemporary, Dance, Album Rock.
- CECIL LENNOX**, see Kassner Associated Publishers.
- CEDARWOOD**, see PolyGram Music Publishing.
- CEE CEE**, see Asterisk Music.
- CELESTIAL HARMONIES**, see Temple Music.
- CELTIC MUSIC**, 2 High Street, Starbeck, Harrogate, North Yorkshire, 0423.888 979, Fax: 0423.885 761, Tlx: 57978, MD: Dave Bulmer.
- CENTRAL RECORDS**, Broad Street, Central House, Birmingham, West Midlands B1 2JP, 021.643 9898, Fax: 021.616 4860, Head Of Music: John Patrick.
- CEZAME/ARGILE**, see Amphonic Music.
- CHANTELLE MUSIC**, 3a Ashfield Parade, Southgate, London N14 5EH, 081.886 6236.
- CHAPPAQUID MUSIC**, see Hobo Railways.
- CHARLIE PARKER**, see Kassner Associated Publishers.
- CHARLY PUBLISHING**, 156-166 Ilderton Road, London SE15 1NT, 071.732 5647, Fax: 071.639 2532, Tlx: 8953184, Chmn: Jean-Luc Young, MDs: Joop Visser, Terry Huxtable. (Owned): Tune Kel, Jarb, Alon Music, INC, Seven B Music, Valliant Publishing.
- CHARLY**, see Margaret Brace Copyright Bureau.
- CHELSEA MUSIC**, 70 Gloucester Place, London W1H 4AJ, 071.224 0066, Fax: 071.224 0067, MD: Eddie Levy.
- CHESTER MUSIC**, 8-9 Frith Street, London W1V 5TZ, 071.434 0066, Fax: 071.439 2848, MD: James Rushton. Owned by Music Sales, same address.
- CHICK-A-BOOM**, see Asterisk Music.
- CHIPGLOW**, see Asterisk Music.
- CHRIS NORTON**, see United Nations Music Publishing.
- CHRISTABEL MUSIC**, see Robert Kingston Music.
- CHRISWOOD**, see International Music Network.
- CHRYSALIS MUSIC**, 13 Bramley Road, London W10 6SP, 071.221 2213, Fax: 071.221 6337/6455, Chmn: Chris Wright, President: Stuart Slater, Creative Dir: Jill Stein. (Owned): Air Music, Space Songs, MAM, Ian Anderson, Salamander & Son Music, Dizzy Heights, Jouissance, Precious, Tent, Hulex, Schenker Songs.
- CIRCA MUSIC**, see Virgin Music.
- CLEARWATER**, see Nectar Music.
- CLITA**, see Minder Music.
- CLOUDBERRY SONGS**, see Sonet London.
- CLOUSEAU MUSIC**, see Southern Music Publishing Co. Ltd.
- CMO PUBLISHING**, 35-37 Parkgate Rd, Ransomes Dock Unit 32, London SW11 4NP, 071.228 4000, Fax: 071.924 1608, Tlx: 893991 cmo, MD: Chris Morrison.
- CODE**, see RMO Music.
- COLETTE**, see Eaton Music.
- COMPLETE MUSIC**, 25-29 Fulham High Street, Bishops Pk Hse, London SW6 3JH, 071.731 8595, Fax: 071.731 8595, Tlx: 943763, MD: Martin Costello.
- COMPOSERS INC**, see Eaton Music.
- CONSTRUCTIVISM MUSIC**, 79b Moore Park Road, London SW6 2HH, 071.371 5946, Fax: 071.371 5947, Dirs: Jerry Smith, Stephen Street.
- COOMBIE MUSIC INTERNATIONAL**, 165-167 Willesden High Road, London NW10 2SG, 081.459 8899, Fax: 081.459 8727, Tlx: 919884 zomba, MD: David M Stone, Mktg Mgr: Michael J Bayler, Mktg Asst: Petra Miller.
- COPI**, see Margaret Brace Copyright Bureau.
- CORNER STONE**, see Valentine Music Group.
- COLOURSOUND**, see John Fiddy Music.
- CRAI**, see Sain.
- CRANE & FISHLOCK MUSIC**, Marylebone Road, Harley House 34, Regents Park, London NW1 5HT, 071.224 5962, Fax: 071.224 5946, MDs: Charlie Crane, John Fishlock.
- CREOLE MUSIC**, France Hill Drive, The Chilterns, Camberley, Surrey GU15 3QA, 0276.686 077, Fax: 0276.686 055, MD: Bruce D White, Dir: Sue White. (Owned): Creole, Cactus Music; (Admin): Revue, Piggy, Sheila Music; Main product: Dance, Album Rock, Black (R&B), Reggae.
- CROSS-TIE**, see Paul Rodriguez Music.
- CROSSBAR**, see Valentine Music Group.
- CRUSOE MUSIC**, 169-171 Willesden High Road, London NW10 2SE, 081.451 3727, Fax: 081.451 4600, Chmn: Robin Millar, Prof Mgr: Nigel Rush.
- CRYSTAL COPY**, see The Time Group Of Companies.
- CURIO SOUNDS**, 6-9 Upper St. Martins Lane, London WC2H 9DF, 071.379 6080, Fax: 071.240 9310, Tlx: 22698.
- CYPHER**, see International Music Network.
- D I MUSIC**, 13 Bank Square, Wilmslow, Cheshire SK9 1AN, 0625.522 014, Fax: 0625.536 101, MD: Irving T Wilson.
- DANCETERIA (UK)**, PO Box 2200, Barnet, Hertfordshire EN5 4BT, 081.440 3005, Fax: 081.441 9935, Contact: M Mellows.
- DARTSON'S**, see Asterisk Music.
- DE WOLFE MUSIC**, 80-88 Wardour Street, London W1V 3LF, 071.439 8481/6, Fax: 071.437 2744, Contact: Warren De Wolfe.
- DEEAY MUSIC**, 22 Westfield Drive, Forfar, Tayside DD8 1EQ, 0307.64324, Fax: 0307.64913, Owner: Douglas R Adamson (Owned): Deeay, Sidlaw; Main product: Scottish, Folk.
- DEEKERS**, see Eaton Music.
- DEEP END**, 130a Plough Road, London SW11 2AA, 071.738 0779, Fax: 071.924 1471, MD: John Wright, Dirs: Pau Callaghan, Tony Hickmott.
- DEJAMUS PRODUCTIONS**, 44 Baker Street, Accurist House, Unit 11, London W1M 1DH, 071.486 5838, Fax: 071.487 2634, MD: Stephen James.
- DEMI MONDE PUBLISHING**, Foel Studio, Llanfair, Caereinion, Powys SY21 0RZ, 0938.810 748/952.883 962, Fax: 0952.728 176, MD: Dave Anderson, Sec: Julie Wareine. Main product: Album Rock, Gold/Oldies, New Age.

- DEMON MUSIC**, Transport Avenue, Canal House, Brentford, Middlesex TW8 9HF, 081.847 2481, Fax: 081.568 8223, Tlx: 894666, Repertoire Dir: James Bedbrook, Fin Dir: Lew Dilorford. (Admin/sub-pub): Fair Deal, Brown Rice, Screamin' Jay Hawkins Music, Butter Music, Symbolic Gesture, Teal Music (Zam), Black Top.
- DERRY**, see Valentine Music Group.
- DESHUFFLIN**, see Sonet London.
- DICE MUSIC**, see Tabitha Music.
- DINSONG**, see Virgin Music.
- DIRECT INJECT**, 3 Edith Grove, Bridge House, Unit 2, London SW10 0JZ, 071.352 3623, Fax: 071.351 6702, Contact: Tom Blackwood.
- DISKONEXION**, see Addictive Music Publishing.
- DIZZY HEIGHTS MUSIC**, 3 Monmouth Place (off Monmouth Road), London W2 5SH, 071.727 0527, Fax: 071.727 6131, MD: Nigel Grainge, GM: Doreen Loader. (Admin): Waterboys, Sinead O'Connor, Boo Hewardine (Bible), Blue Aeroplanes, Laurie Freelove, Into Paradise.
- DJM**, see PolyGram Music Publishing.
- DODEY SONGS**, see Blueprint Management.
- DONAVAN MUSIC**, see Southern Music Publishing Co. Ltd.
- DOOR TO DOOR MUSIC**, see Bluetunes/Shanna Music.
- DUB PLATE**, see Greensteves Publishing.
- EATON MUSIC**, 8 West Eaton Place, London SW1X 8LS, 071.235 9046, Fax: 071.235 7193, Chmn: Terry Oates, MD: Mandy Oates, A&R Mgr: David Jaymes. (Admin): Sundergrade, Shogun, Sabre, Composers Inc, Final Score, Tembo, Witzend, Treblemain, Deekers, Whitman, Mango Sound, Two P(ile)ters, Supa Bota, Golden Syrup, Canopy/White Oak, Colette.
- EBONY MUSIC**, Hemingborough Hall, North Yorkshire YO8 7QE, 0757.638812, Tlx: 597695, MD: Darryl Johnston.
- EDWARD KASSNER MUSIC**, see Kassner Associated Publishers.
- EEL PIE PUBLISHING**, Ranelagh Drive, The Boathouse, Twickenham, Middlesex TW1 1QZ, 081.891 3903, Fax: 081.891 5932, MD: Pete Townsend.
- EG MUSIC**, 180 Kings Road, Blenheim House, London SW3 5XS, 071.352 1010, Fax: 071.352 0344, Chmn: Sam Alder, Mark Fenwick, Bus Affairs: Andrew Stanger, Comm Affairs Mgr: Karen Christie, A&R: Alex Paterson. (Owned): EG Music; (Admin/sub-pub): Bruco, George Glueck, Hitchings, Jomark (USA), Feaseheart, Steelchest, Forever, Steve Glen, Skysaw, Loose Tubes Music.
- ELBOMO**, see International Music Network.
- ELECTRIC PLANET**, 1 Bowerfeaze, Sea Mills, Bristol BS9 2HJ, 0272.681 571, Fax: 0272.236 011, Contact: Clive Stevens.
- EMBER ENTERPRISES**, see TKO Music.
- EMI MUSIC PUBLISHING**, 127 Charing Cross Road, London WC2H 0EA, 071.434 2131, Fax: 071.434 3531, Tlx: 269189, MD: Peter Reichardt, Fin Dir: Terry Foster-Key, Bus Affairs Dir: Deborah Harris, A&R Dir: Sally Perryman, Bus Dev Mgr: Kay O'Dwyer, Int'l Mgr: Frank Ferguson, Creative Mgr: Fran Malayan, Copyright Mgr: Cathy Paice, Cat Mgr: Bob Clifford, A&R Mgrs: Guy Moot, Allen Jacobs. Over 100 catalogues owned and/or administered—please contact the company itself.
- EMI MUSIC WORLDWIDE**, 30 Gloucester Place, London W1A 1ES, 071.486 6022, Fax: 071.465 0770, Tlx: 8953882, Snr VP (Strat Planning): Martin Reidy.
- EMILE MUSIC**, see Sonet London.
- EMPEROR**, see H & B Webman & company.
- EMPIRE MUSIC**, 27 Queensdale Place, London W11 4SQ, 071.602 5031, Fax: 071.602 5039, MD: Bob Grace.
- ESCHENBACH EDITIONS**, 28 Dalrymple Crescent, Edinburgh EH9 2NX, 031.667 3633, Fax: 031.662 4650, MD: James Douglas, Sales/Mktg: Katherine Douglas. (Owned): Eschenbach, Caritas; Main product: AC, Album Rock, Jazz, New Age, Classical.
- ESSENTIAL**, see PolyGram Music Publishing.
- EUCAUTIONAL MUSIC COMPANY**, see MRM.
- EUSTON MUSIC**, 44 Seymour Place, London W1H 5WQ, 071.723 8464, Contact: John Craig.
- EXCELLOREC**, see Valentine Music Group.
- EXPRESSION MUSIC**, St. Ann's Hill Road, St. Ann's Court, Chertsey, Surrey KT16 9NW, 0932.564 350, Fax: 0932.567 567, Dir: Phil Manzanera.
- EYEBALL MUSIC**, see Team Sonet Publishing.
- F BARBOUR**, see Bonskeid Music.
- FACE MUSIC PRODUCTIONS**, 211 Wingrove Road, Newcastle-upon-Tyne, Tyne & Wear NE4 9DB, 091.273 4443, Contact: Dave Maughan.
- FAIR DEAL**, see Demon Music.
- FANCY FREE MUSIC**, see Fay Gibbs Music Service.
- FANFARE MUSIC**, Deodar Road, 25 Blades Court, London SW15 2NU, 081.877 9488, Fax: 081.877 9523, MD: Iain Burton, Contact: Simon Cowell.
- FAY GIBBS MUSIC SERVICE**, Lansdowne Road, Lansdowne House, London W11 3LP, 071.727 7160, Fax: 071.792 9940, President: Fay Gibbs, MD: Paige Gibbs, Mktg/PR: Samantha Hughes. (Owned): Gibbville, Fancy Free Music; (Admin/Sub-pub): Primrose Music, Prestation, Multisound, Image Music Library, GBW, Wind Valley Music.
- FEASEHEART**, see EG Music.
- FINAL SCORE**, see Eaton Music.
- FIRED UP**, see Minder Music.
- FIRST TIME MUSIC PUBLISHING UK**, 12 Trewartha Road, Sovereign House, Praa Sands, Penzance, Cornwall TR20 9ST, 0736.762 826, Fax: 0736.763 328, Dir: Roderick G Jones, Company Sec: Carole A Jones, Prod Mgr: Colin Eade. Registered member of MCPS (Mechanical Copyright Protection Society) and PRS (Performing Rights Society); Main product: all music styles.
- FLAGG MUSIC**, see Sonet London.
- FLAT TOWN MUSIC**, see Team Sonet Publishing.
- FLIP FLOP**, see Asterisk Music.
- FM MUSIC PUBLISHING**, see Roksong Music Publishing.
- FOCUS**, see John Fiddy Music.
- FOLKTRACKS & SOUNDPOST PUBLICATIONS**, 16 Brunsworth Square, Gloucester, Gloucestershire GL1 1UG, 0452.415 110, Contact: Peter Kennedy.
- FOREVER**, see EG Music.
- FORTISSIMO**, see Negus-Fancey Company.
- FOURTH HOUSE MUSIC**, see TKO Music.
- FRANK TOVEY MUSIC**, see Sonet London.
- FROZEN INCA MUSIC**, see Sonet London.
- FUN-TASTIK MUSIC**, 43 Seaforth Gardens, Stoneleigh, Surrey KT19 0LR, 081.393 1970, Fax: 081.394 1805, Partner: Andy Grossart.
- FUTURE PUBLISHING**, 30 Monmouth Street, Bath, Avon BA1 2BW, 0225.442 244, Fax: 0225.446 019, Publ Dir: Kevin Cox. G DUNCAN, see Bonskeid Music.
- G HUTCHINS**, see United Nations Music Publishing.
- GALLERY MUSIC**, St. Ann's Hill Road, St. Ann's Court, Chertsey, Surrey KT16 91W, 0932.564 350, Fax: 0932.567 567, Dir: Phil Manzanera.
- GALLUS MUSIC**, 187 Wilton Street, Glasgow, Strathclyde G20 6DF, 041.946 2817, Proprietor: Ewan McVicar. Main product: Folk.
- GARRON MUSIC**, Newtown Street, Kilsyth, Glasgow, Scotland G65 0JX, 0236.821 081, MD: Bill Garden. Main product: Traditional Scottish.
- GBW**, see Fay Gibbs Music Service.
- GEORGE DEMOPOULOS**, 131 Nags Head Road, Enfield, Middlesex EN3 7AD, 081.804 5487, Fax: 081.804 5487, Composer: George Demopoulos. Main product: Dance, AC, Soul Ballads.
- GEORGE GLUECK**, see EG Music.
- GIBBSVILLE**, see Fay Gibbs Music Service.
- GIPSY MUSIC**, Adamsbridge Bus. Ctre Unit 5, South Way, Wembley, Middlesex HA9 0HU, 081.903 5059, Fax: 081.903 7853, Dir: Sarah-Anne Green.
- GLEN CAMPBELL PUBLISHING**, see TKO Music.
- GLISSANDO**, see Negus-Fancey Company.
- GLOBAL MUSIC GROUP**, 171 Southgate Road, London N1 3LE, 071.359 2974, Fax: 071.704 9879, Tlx: 265137, MD: Peter Kirsten, GM: Peter Knight Jr.
- GO AHEAD MUSIC**, Waterhouse Lane, The Kercheres, Kingswood, Surrey KT20 6HT, 0737.833 853, Fax: 0737.833 812, Contact: Ian Dale.
- GO MUSTER**, see Greensteves Publishing.
- GO! DISCS MUSIC**, 72-80 Black Lion Lane, Black Lion House, Hammersmith, London W6, 081.748 7973, Fax: 081.741 5936, MD: Andy MacDonald, GM: Bruce Craigie.
- GOLDEN SYRUP**, see Eaton Music.
- GORDEN MUSIC INC**, see TKO Music.
- GRABBING HANDS**, see Sonet London.
- GRADUATE MUSIC**, St Swithun's Institute, The Trinity, Worcester, Worcestershire WR1 2PN, 0905.20882, Fax: 0905.726 677, Tlx: 337300, MD: David Vurr. Main product: Adult Contemporary, Reggae, Dance, Album Rock.
- GREAT OUTLOOK MUSIC**, see Sonet London.
- GREEN PEPPER JUNCTION**, 14 Hamilton Park Avenue, Glasgow, Scotland G12, 041.339 6745, Fax: 041.334 3919, President: Asher Halle. Main product: all categories carried.
- GREENSLEEVES PUBLISHING**, Brackenhury Road, Goldhawk Estate Unit 7, London W6 0BA, 081.749 3277, Fax: 081.749 7360, MD: Chris Sedgwick. (Admin/sub-pub): Dub Plate, Tafari (UK), Live & Learn, Liftmoney, Go Muster, Shadows International (Eur).
- GROVE MUSIC**, see Tabitha Music.
- GUERILLA RECORDS & MUSIC**, 10 Sutherland Avenue, London W9 2HQ, 071.286 5487, Fax: 071.266 3283, Dir: Dick O'Dell. Main product: Dance.
- H & B WEBMAN & COMPANY**, 2 Raymond Buildings, Grays Inn, London WC1R 5BZ, 071.242 8404, Fax: 071.831 7413, Joint MDs: Hal & Belle Webman, Dir: Maxi Alexander. (Owned): Princess, Beaver, Carlyle, BL&H, Myriad, Montauk, Emperor, We Three, Beechmont; (Admin): Music Makers; Main product: AC, Jazz, Gold/Oldies.
- HAMMER**, see Bucks Music.
- HANDLE MUSIC**, 20 Wood Mews, London W1Y 3AH, 071.493 9637, Fax: 071.629 6360, MD: David Walker.
- HANNIBAL MUSIC**, 106b Westbourne Grove, London W2 5SF, PO Box 2401 (Zip: W2 5SF), 071.727 7480, Fax: 071.229 4190, Tlx: 9312131805 hn, E-Mail: hannibal-UK, MD: Joe Boyd.
- HAPPY FACE MUSIC**, 1 Post Office Lane, Old Smithy Street, Kempsey, Worcestershire WR5 3NS, 0905.820 659, Fax: 0905.820 015, Tlx: 334142, MD: Muff Murfin.
- HARDCORE MUSIC PUBLISHING**, 6 Chestnuts, Basildon, Essex SS13 3NJ, 0268.554 906, MD: Wayne Archibold.
- HARMONY**, see Bucks Music.
- HARRISONS**, 26 Cadogan Square, London SW1X 0JP, 071.581 1265, Fax: 071.584 7338, Tlx: 8951338, Contact: Lucy Rigo. (Admin/sub-pub): Material World Charitable Foundation.
- HATLEY MUSIC**, see Robert Kingston Music.
- HEAD MUSIC PUBLISHERS**, 1-2 Munro Terrace, London SW10 0DL, 071.351 3355, Fax: 071.351 5569, Tlx: 8954921, MD: John Curd.
- HEARTSONGS**, see MRM.
- HEATHWAVE**, see Beggars Banquet Records.
- HEAVY METAL MUSIC**, see Roksong Music Publishing.
- HEAVY TRAFFIC MUSIC**, see Sonet London.
- HET GERUCHT MUSIC**, see Sonet London.
- HIT & RUN MUSIC**, 25 Ives Street, London SW3 2ND, 071.581 0261, Fax: 071.584 5771/4, Tlx: 8952998, Chmn: Tony Smith, Dir: Jon Crawley, Copyright Mgr: Jatta Howell, Fin Contr: Robin Moore, Creative Mgr: David Massey, Prof Mgr: Julie Braconier.
- HITCHINGS**, see EG Music.
- HOBO RADIO AND MUSIC PRODUCTIONS**, see Hobo Railways.
- HOBO RAILWAYS**, 14-16 Brewer Street, London W1R 3FS, 071.734 1452, Fax: 071.437 9984, MD: James Little, Dir: Phillip Nicholl, Prof Mgr: Tim Wheelk, Copyright Mgr: Roger Barking. (Admin): Chappaquidic Music, R. Buzzardsongs, Kate Wilder Music, Hobo Radio and Music Productions.
- HOT TODDY MUSIC**, see Sonet London.
- HOUSE OF BRYANT**, see Valentine Music Group.
- HOUSE OF GEMINI**, see Minder Music.
- HOWLIN' MUSIC**, 70 Gloucester Place, London W1H 4AJ, 071.935 4965, Fax: 071.224 0067, MD: Howard Marks.
- HULEX**, see Chrysalis Music.
- HUMPH**, see Paul Rodriguez Music.
- HYDE PARK MUSIC/HYDE PARK RECORD PROD**, 110 Westbourne Terrace Mews, London W2 6QG, 071.402 8419, Fax: 071.723 6104, MD: Tony Hillier, Dir: Leigh Hillier.
- IAN ANDERSON**, see Chrysalis Music.
- IAN DAVID**, see Zonespec.
- IMAGE MUSIC LIBRARY**, see Fay Gibbs Music Service.
- IMAGO SONGS**, 28 Brook Street, London W1Y 1AG, 071.409 2900, Fax: 071.629 0010, VP/GM: Ann Munday. Main product: Album Rock, Adult Contemporary.
- INC**, see Charly Publishing.
- INTERNATIONAL MASTERS NETWORK**, 4 Birchfields Road, Network House, Manchester, Greater Manchester M13 0XR, 061.225 5140, Fax: 061.443 1379, Tlx: 669755 office attn: imm, MD: John Turner, Bus Affairs: Pamela Millbrook. Labels lic: M2M, Kinetic, Mega, Raw Groove Records; Distribution: A.M.T.; Main product: dance music.
- INTERNATIONAL MUSIC NETWORK**, 83 Palmerston Road, Buckhurst Hill, Essex IG9 5NS, 081.505 2588, Fax: 081.505 2588, Contact: Ellis Rich. (Admin): Chriswood, Tomija, Elbomo, Cypher, Penumbra Music; Main product: EHR, Dance, AC, Album Rock, Gold/Oldies, Country, Black (R&B).
- INTERNATIONAL MUSIC PUBLICATIONS**, Southend Road, Woodford Green, Essex IG8 8HN, 081.551 6131, Fax: 081.551 3919, GM: Ron Fry.
- INTERSOUND**, see John Fiddy Music.
- INTO PARADISE**, see Dizzy Heights Music.
- ISLAND MUSIC (UK)**, 334-336 King Street, Media House, London W6 0RA, 081.846 9141, Fax: 081.741 4036, Tlx: 934541, MD: Richard Manners, GM: Steve Lindsey.
- J & C RICHARD ENTERPRISE**, 17 Finlay Street, London SW6 6HE, 071.736 1977, Owner: John Richard.
- J DOUGLAS**, see Bonskeid Music.
- J DUNCAN**, see Bonskeid Music.
- J MCCREADIE**, see Bonskeid Music.
- JARB**, see Charly Publishing.
- JAY BOY**, see Kassner Associated Publishers.
- JEFF WAYNE MUSIC PUBLISHING**, Green Street, Lyndhurst, Shenley, Nr Borham Wood, Radlett, Herts WD7 9BD, 081.207 1002, MD: Jeff Wayne.
- JERRY WILLIAMS MUSIC**, see Sonet London.
- JESS MUSIC**, Hammersley Lane, Hammersley Lodge, Penn, Buckinghamshire HP10 8HE, 0494.816 987, Fax: 0494.815 524, President: Mike Collier, Chmn: Joyce Collier. (Admin): Nubian Music, Record Music.
- JIGSAW MUSIC**, 115 Old Lodge Lane, Purley, Surrey CR8 4DP, 081.668 3457, Fax: 081.668 6484, MD: Dave Williams, Pro Mgr Dir: Sue Williams. Main product: AC, Album Rock.
- JIMMY'S**, see Valentine Music Group.
- JOBETE MUSIC**, 35 Gresse Street, Tudor House, London W1P 1PN, 071.631 0380, Fax: 071.631 0983, Tlx: 8811658, Contact: Wendy Harlow.
- JOHN CARTER MUSIC**, 29 Fife Road, London SW14 7EJ, 081.876 9871, Fax: 081.392 2371, MD: John Carter, F&A: Gill Shakespeare. (Owned): John Carter Music; Main product: Adult Contemporary.
- JOHN FIDDY MUSIC**, Fruit Farm House, Foxton, Cambridgeshire CB2 6RT, 0763.208 610/142, Fax: 0763.208 241, MD: John Fiddy. (Owned): John Fiddy Music; (Admin): AV Music, Coutsouround, Focus, Intersound, KMP SFX, Novoton, Omni, Omni SFX, Orange Power, PBS, Pro Viva, Sonimage, Sonoton, Supraphon.
- JOHN T BENSON MUSIC**, see United Nations Music Publishing.
- JOHNS MUSIC**, see Sonet London.
- JOMARK**, see EG Music.
- JONICO MUSIC**, see United Nations Music Publishing.
- JOISSANCE**, see Chrysalis Music.
- JSE MUSIC**, 9 Eccleston Street, London SW1W 9LX, 071.730 9875, Fax: 071.730 2721, Tlx: 265871 monref, E-Mail: DGS 1750, MD: John Sherry.
- JUICE MUSIC**, 38a Ovington Square, London SW3 1LR, 071.589 5445, Fax: 0372.69346, MD: Roland Rennie.
- KASSNER ASSOCIATED PUBLISHERS**, Exmouth House, 11 Pine Street, London EC1R 0JH, 071.837 5020, Fax: 071.837 4795, Chmn: Edward Kassner, MD: David Kassner, Copyright/Prod Mgr: Victoria Haslam. (Owned): Edward Kassner Music, Cecil Lennox, Pan Musik, Performance, Page One, Mayhaw Music; (Sub-pub): Amcorp Group, AME of New York, Tideland, Bixio, Charlie Parker, Broadway, Jay Boy, Myers Music.

KATE WILDER MUSIC, see Hobo Railways.

KEEP CALM MUSIC, Oakmead Road, Falcon Mews, London SW12 9SJ, 081.675 5584, Fax: 081.675 6313, Joint MDs: Ian & Nick Titchener.

KEEPER OF THE GARDEN MUSIC, Rainville Road, Thames Wharf Studios, London W6 9HA, 071.386 9940, Fax: 071.386 9682, Contact: Vicky Kerr.

KENMAR MUSIC, see Margaret Brace Copyright Bureau.
KENNY DENTON MUSIC, see Sonet London.

KEY, see Bucks Music.

KINETIC, see International Masters Network.

KINMOR MUSIC, Shillinghill, Temple, Gorebridge, Midlothian EH23 4SH, 087.530 328, Fax: 087.530 392, President: Robin Morton.

KITCHEN MUSIC, St. Thomas Street, The Stables, Newcastle-Upon-Tyne, Tyne & Wear NE1 4LE, 091.232 4895, Fax: 091.232 0262, MD: Keith Armstrong.

KMP SFX, see John Fiddy Music.

KNIGHTS TEMPLAR INTERNATIONAL, 55 Albion Street, Otley, Yorkshire LS21 1BZ, 0943.467 395, Fax: 0977.683 288, President: Richard Rouska.

KOKA MEDIA, see Amphonic Music.

KONKWEST, see Margaret Brace Copyright Bureau.

KPM MUSIC, 127 Charing Cross Road, London WC2H 0EA, 071.434 2131, Fax: 071.287 5256, Contact: Tim Hardy.

LA BONNE MUSIQUE, see Sonet London.

LATIN AMERICAN MUSIC, see Southern Music Publishing Co. Ltd.

LAURIE FREELove, see Dizzy Heights Music.

LBS STUDIOS, 30-32 Fouberts Place, London W1V 1HF, 071.439 6337, Fax: 071.437 2237, MD: Andy Beven. (Owned): Noise Boys.

LEE MUSIC, Hill Bottom Road, Stewart House, High Wycombe, Buckinghamshire HP12 4HJ, 0630.81674, Fax: 0630.81612, MD: Ron Lee, Promo: Cathrine Lee, A&R: Xavier Lee.

LEMATT MUSIC, Hill Bottom Road, Stewart House, High Wycombe, Buckinghamshire HP12 4HJ, 0630.81674, Fax: 0630.81612, MD: Ron Lee, Promo: Cathrine Lee, A&R: Xavier Lee.

LEOSONG COPYRIGHT MANAGEMENT, 7-8 Greenland Place, London NW1 0AP, 071.267 3697, Fax: 071.485 5133, Chmn: Tim Hollier.

LEXICON MUSIC, see United Nations Music Publishing.
LIBER SOUTHERN, see Southern Music Publishing Co. Ltd.
LIFESONG MUSIC PRESS, see United Nations Music Publishing.

LIFESTYLE MUSIC, see Sovereign Music.

LIFTMONEY, see Greensleeves Publishing.

LINDA A MYERS, Little Shalford, Square Drv, Kingsley Gr, Haslemere, Surrey GU27 3LW, 0428.54329, Composer: Lynda A Myers.

LIONHEART MUSIC, 29 Maddox Street, London W1R 9PF, 071.499 0567, Fax: 071.629 1885, Tlx: 8953097, MD: Richard Gillinson.

LITTLE MISTY MUSIC, PO Box 8, Perth, Tayside PH2 7EX, 0736.34564, President: Ian White, VP: Carol White, Sec: Dan Stewart.

LITTLECHAP MUSIC, 8-9 Ivor Place, Oliver House, London NW1 6BY, 071.724 2471, Fax: 071.724 6245, Tlx: 261234, MDs: Jeff Wayne, Alison Wallace.

LIVE & LEARN, see Greensleeves Publishing.

LOOSE TUBES MUSIC, see EG Music.

LORENZ CORP, see United Nations Music Publishing.

LORNA KIRTLAND MUSIC, 23 Upper Wimpole Street, London W1M 7TA, 081.501 1163, MD: Lorna Kirtland.

LOUVIGNY MUSIC, 74 Newman Street, London W1P 3LA, 071.436 4666, Fax: 071.436 4017, Tlx: 263912 luxdn, Dir: Maurice Vass.

LUPUS MUSIC COMPANY, 1 Star Street, London W2 1QD, 071.258 0093, Fax: 071.402 9238, Tlx: 266589 lmm, MD: Bryan Morrison, Contact: Cora Barnes.

M2M, see International Masters Network.

MACAULAY, see PolyGram Music Publishing.

MADE TO MEASURE MUSIC, 25-26 Poland Street, London W1V 3DB, 071.734 9491, Fax: 071.437 0410, Producer: Andrew Sunnucks.

MAINSTREAM DIRECT, PO Box 5452, London SW6 5ER, 071.371 5452, Fax: 071.371 9991, MD: Humphrey Walwyn.

MAM, see Chrysalis Music.

MANGO SOUND, see Eaton Music.

MARGARET BRACE COPYRIGHT BUREAU, 7-8 Greenland Place, London NW1 0AP, 071.276 3697, Fax: 071.485 5133, MD: Margaret Brace. (Admin): Sparta Florida, Konkwest, Charly, Copi, Patterdale, PC Music, Kenmar Music.

MARYLEBONE MUSIC, 73 Summerstown, London SW17 0BQ, 081.944 6550, Fax: 081.944 6610, MD: Tony Calder.

MASTERSONG MUSIC, 47 Kelburn Close, South Millers Dale, Chandlers Ford, Hampshire SO5 2PW, 0703.267 449, MD: Paul Rutter.

MATCH MUSIC LIBRARY, 21 Foley Street, London W1P 7LH, 071.323 0515, Fax: 071.323 0952, Contact: Anne Martin.

MATERIAL WORLD CHARITABLE FOUNDATION, see Harrisonsgs.

MAXIMUS MUSIC, PO Box 144, Stockport, Cheshire SK4 4DU, 061.431 6298, Fax: 061.431 0786, Tlx: 666514 tordec, MD: Mike Maxfield, Copyright: Simon Maxfield, Promo: Merle Maxfield. Music library background music.

MAYFLOWER MUSIC, see Temple Music.

MAYHEW MUSIC, see Kassner Associated Publishers.

MCA MUSIC (UK)

77 Fulham Palace Road, Elnore House, London W6 8JA, 081.741 8686, Fax: 081.741 8646, MD: Nick Phillips, Creative Mgr: Paul Connolly, Mgr/Int'l Affairs: Barbara Zamoyska, Bus. Affairs Mgr: Mark Fiori.

MEADOWGREEN, see United Nations Music Publishing.

MEGA, see International Masters Network.

MELLOW FELLOWS MUSIC, see Sonet London.

MELODY LAUREN MUSIC, 90 Old Church Lane, Stanmore, Middlesex HA7 2RR, 081.954 8777, Fax: 081.954 2999, Tlx: 94014029 wrwd, MD: Ian Wiener, Dir: Anthony Broza.

MEMORY LANE MUSIC, 22 Denmark Street, London, WC2H 8NA, 071.240 5349, Fax: 071.379 5205, MD: Larry Spier, GM: Frank Coachworth.

MIDNIGHT CREEPER MUSIC, see Sonet London.

MIDNIGHT, see Valentine Music Group.

MIGHTY DEVILS, see Old Nick Music Group.

MIGHTY IRON MUSIC, see Asterisk Music.

MILESTONE MUSIC, PO Box 195, Weybridge, Surrey KT13 0BQ, 0932.843 872, Fax: 0932.846 400, MD: R. Lofting, GM: Tim Doyle.

MINDER MUSIC, 22 Bristol Gardens, London W9 2JQ, 071.289 7281, Fax: 071.289 2648, Tlx: 923421 wemsec, MD: John Fogarty, Dir: Beth Clough, Copyright Asst: Heidi Kahlich. (Owned): Tempco (BMI), Clita (BMI), House of Gemini (BMI), Sign of the Twins (ASCAP), Fired Up (ASCAP). Admin: American Broadcasting (ASCAP), ABC Circle (BMI). Main product: Dance, Gold/Oldies, Black (R&B), Film/TV Soundtracks.

MISTY RIVER, see Bucks Music.

MOMENTUM MUSIC, 17-19 Alma Road, London SW18 1AA, 081.871 2121, Fax: 081.871 1766, Tlx: 915733, Dir: Andy Heath.

MOMENTUM, see Beggars Banquet Records.

MONTAUK, see H & B Webman & company.

MORRISON LEAHY MUSIC, 1 Star Street, London W2 1QD, 071.258 0093, Fax: 071.402 9238, Dirs: Dick Leahy, Bryan Morrison, GM: Peter J Stretton.

MOSTYN MUSIC, Stratford Place, Stratford House, Camp Hill, Birmingham, West Midlands B12 0HT, 021.772 2221, Fax: 021.766 6929, MD: John Mostyn. 2nd office: Notting Hill Gate, 27a Pembridge Villas, Unit 2, London W11 3EP, 071.221 1722, Fax: 071. 221 7696.

MPI, see United Nations Music Publishing.

MRM, 49a Avenue Gardens, London W3 8HB, 081.993 4721, Fax: 081.993 4721, MDs: Mark Rowles, Deborah T Moore, Fin Dir: Arthur Rowles. (Owned): The Educational Music Company. (Admin): Heartsongs; Main product: Jazz, New Age, Classical, Folk.

MULTICORD, 1-6 Ravensworth View, Dunston, Gateshead, Tyne & Wear NE11 9DQ, 091.460 9209, Fax: 091.460 1494, Contact: Ken McKenzie.

MULTISOUND, see Fay Gibbs Music Service.

MUSIC BOX, see Paul Rodriguez Music.

THE MUSIC FACTOR, 42 Lucerne Road, London N5 1TZ, 071.359 2814, Fax: 071.704 8044, Tlx: 8951182 gecoms, Contact: Paul Rodriguez. Main product: Jazz, Reggae, Classical, Dance.

MUSIC FACTORY MUSIC, 222 Kensal Rd, Canalot Studios, Unit 4, London W10 5BN, 081.960 2739, Fax: 081.960 7937, MD: John Pickles, Mktg Mgr: Irving Soremekun.

MUSIC FOR FILMS, 34 Batchelor Street, London N1 0EG, 071.278 4288, Fax: 071.704 9335, Dir: Rob Gold.

MUSIC GALORE, 29 Beethoven Street, London W10 4LG, 081.960 1871, Fax: 081.969 1694, MD: Brian Leaf. (Owned): Beijing. Main product: Album Rock.

MUSIC HOUSE INTERNATIONAL, 5 Newburgh Street, London N1V 1LH, 071.434 9678, Fax: 071.434 1470, Contact: Robin Phillips.

MUSIC LIKE DIRT, see Big One Publishing.

MUSIC MAKERS, see H & B Webman & company.

MUSIC MASTER, 1 De Cham Avenue, Hastings, East Sussex TN37 6HE, 0424.715 181, Fax: 0424.422 805, GM: C Pusey, Sales Mgr: P Hitchin. (Owned): Music Master; Main product: EHR, Dance, AC, Album Rock, Jazz, Gold/Oldies, Country, Black (R&B), Reggae, New Age.

MUSIC OF LIFE RECORDS, 22 Hanway Street, London W1P 9DD, 071.631 3846, Fax: 071.436 0715, Chmn: Simon Harris, MD: Chris M. France.

MUSIC SALES, 8-9 Frith Street, London W1V 5TZ, 071.434 0066, Fax: 071.439 2848, Tlx: 21892, MD: Robert Wise. (Owned): Chester Music, Campbell Connolly Music, Shapiro Bernstein.

THE MUSIC TO PICTURE COMPANY, 12 Belsize Lane, Hampstead, London NW3 5AB, 071.794 6834, Fax: 071.794 6834, Tlx: 94081033 music, Contact: Michael Omer.

MUSICAL MOMENTS EUROPE, see Sonet London.
MUSICAL MOMENTS, see Sonet London.

MUSICQ, School Road, Windy Ridge, Windlesham, Surrey GU20 6PB, 0276.74181, MD: Ivan Chandler.

MUSSELWHITE MUSIC, see Team Sonet Publishing.

MUSTARD SEED MUSIC, see Sovereign Music.

MYERS MUSIC, see Kassner Associated Publishers.

MYRA, see Bucks Music.

MYRIAD, see H & B Webman & company.

NAT GOODMAN GROUP, see TKO Music.
NEAT MUSIC PUBLISHERS, 71 High Street East, WallSEND, Tyne & Wear NE28 7RJ, 091.262 4999, Fax: 091.263 7082, President: David Wood, MD: Judi Wood.

NECTAR MUSIC, PO Box 24, London SW15 3NL, 081.874 7000, Fax: 081.874 0075. (Admin): Clearwater.

NEGUS-FANCEY COMPANY, 15 Ossington Street, London W2 4LZ, 071.727 2063, Fax: 071.229 4188, Contact: Chris Andrews, Charles & Cathy Negus-Fancey. (Owned): Glissando, Fortissimo, Carnaby Music; (Sub-pub): Willy Russell, Tatham Music.

NEIL MUSIC, see Sonet London.

NEO-PHONIC MUSIC, Waterhouse Lane, The Kerchesters, Kingswood, Surrey KT20 6HT, 0737.832 837, Fax: 0737.833 812, Contact: Ian Dale.

NEW AGE MUSIC, 100 Chalk Farm Road, London NW1 8EH, 071.485 0131, Fax: 071.485 0494, President: Penny Bron.
NEW MEDIA MUSIC, see Sonet London.

NEWQUAY, see Bucks Music.

NOEL GAY ORGANISATION, THE, 19 Denmark Street, London WC2H 8NH, 071.836.3941, Fax: 071.379 7027, Tlx: 21760 rango, Chmn: George X Constantinidi, Chief Exec/MD: Charles Armitage. Noel Gay Music: publishes over 1,000 titles used for commercials and theatre productions.

NOISE BOYS, see LBS Studios.

NORMANDIE SOUND, PO Box 509, St Helier, Jersey Island JE4 8XZ, 0534.37066, Fax: 0534.46295, Managing Editor: Spencer Pryor.

NORSU BOOKS, PO Box 509, St. Helier, Jersey JE4 8XQ, 0534.37066, Managing Editor: Spencer Pryor. Asst Ed: Dee Michoux.

NOVOTON, see John Fiddy Music.

NTV MUSIC (UK), 159 Broadhurst Gardens, London NW6 3AU, 071.372 3966, Fax: 071.624 6384, Dep MD: Andy McQueen, Creative Dir: Cate Latta.

NUBIAN MUSIC, see Jess Music.

OLD NICK MUSIC GROUP, 436 Essex Road, Leroy Bus Ctr, Unit 2L, London N1 3QP, 071.354 8560, Fax: 071.354 8560, Publ: Nick Peterson. (Admin): The Mighty Devils; Main product: EHR, Dance, Album Rock, Jazz, Gold/Oldies. New Age.

OLD SCHOOL SONGS, see Team Sonet Publishing.

OLOFSONG MUSIC, 6 Heath Close, London W5 3EG, 081.991 0993, MD: Jan Olofsson.

OLRAC, see Asterisk Music.

OMNI SFX, see John Fiddy Music.

OMNI, see John Fiddy Music.

ON-U SOUND RECORDS, 25-29 Fulham High Street, Bishops Park, London SW6 3JH, 081.889 6166, Fax: 081.883 0331, MD: Adrian Sherwood.

ONE NOTE, see Asterisk Music.

ORANGE POWER, see John Fiddy Music.

ORIANA MUSIC, 38 Langham Street, London W1 5RH, 071.636 5822, Fax: 071.436 8503, Tlx: 9419076, MD: Peter Felstead.

OVAL MUSIC, 326 Brixton Road, London SW9 7AA, 071.326 4907, Tlx: 94012230, MD: Charlie Gillett, Exec: Gordon Nelki.

P.C. MUSIC, see Margaret Brace Copyright Bureau.

PAGE ONE, see Kassner Associated Publishers.

PAN MUSIK, see Kassner Associated Publishers.

PANAMA MUSIC LIBRARY, 12 Trewartha Road, Sovereign House, Praa Sands, Penzance, Cornwall TR20 9ST, 0736.762 826, Fax: 0736.763 328, MD: Roderick G Jones, Company Sec: Carole A Jones, Prod Mgr: Colin Eade. Music library; Registered member of MCPS (Mechanical Copyright Protection Society) and PRS (Performing Rights Society); Main product: all styles of production/library music.

PARAGON MUSIC, see United Nations Music Publishing.
PARRY, see Studio G Production Music Library.

PATCH MUSIC, see Southern Music Publishing Co. Ltd.
PATERNOSTER MUSIC, 16 Thorpewood Avenue, London SE26 4BX, 081.699 1245, Fax: 081.291 5584, Bus Affairs: Stan Wynne.

PATTERDALE MUSIC, 62 Pont Street Mews, London SW1X 0EF, 071.584 9765, Fax: 071.823 7100, MD: Bob Barratt, Legal Adviser: Irving Spellman, Copyright Mgr: Margaret Brace. (Owned): Patterdale; Main product: MOR.

PAUL LYNTON (CONSULTANT), 112 Station Road, Premier House, Edgware, Middlesex HA8 7AQ, 081.950 8732, Fax: 081.951 6648, MD: Paul Lynton. International repertoire media marketing.

PAUL ROBERTS MUSIC, see Sonet London.
PAUL RODRIGUEZ MUSIC, 42 Lucerne Road, London N5 1TZ, 071.359 2814, Fax: 071.704 8044, President: Paul Rodriguez; Research Cons: Jon Gillaspie. (Owned): Humph, Rybar, Music Box, All Media, Beamlink Music; Sub-pub: Cross-Tie, Beez & Heavenly, Stomp Off Music (USA); Main product: Dance, Jazz, Reggae, Classical, Black (R&B).

PBS, see John Fiddy Music.
PEER INTERNATIONAL, see Southern Music.

PEERMUSIC, see Southern Music.

PEER-SOUTHERN INT'L, see Peermusic (UK).

PENTANGLE, 78 Stanley Gardens, London W3 7SN, 081.745 1234, Fax: 081.740 9899.

PENUMBRA MUSIC, see International Music Network.
PEOPLE UNITE PUBLICATIONS, 13 King Street, Southall, Middlesex UB2 4DG, 081.574 1718, Fax: 081.574 8576, MD: Clarence Baker, Dir: Walford Tyson, Sec: Delbert McKay.

PERFECT SONGS, 42-46 St. Luke's Mews, Blue Building, London W11 1DG, 071.221 5101, Fax: 071.221 3374, MD: Jill Sinclair, GM: Liam Teeling.

PERFORMANCE, see Kassner Associated Publishers.

PHOENIX MUSIC, 63 Moor Lane, Maidenhead, Berkshire SL6 7JX, 0628.33943, Fax: 0628.25681, MD: Kate Banks.

PICTURE PARADE, 3 Percy Street, London W1P 9FA, 071.580 1157, Fax: 071.436 4808, Contact: Claire Rawcliffe.

PIGGY, see Creole Music.

PINDROP MUSIC, see Robert Kingston Music.

PINK FLOYD/ROCK MUSIC, 27 Noel Street, London W1V 3RD, 071.734 6892, Fax: 071.439 4613, Tlx: 28905, MD: Peter Barnes.

PLACE OF REFUGE, see United Nations Music Publishing.

PLANGENT VISIONS MUSIC, 27 Noel Street, London W1V 3RD, 071.734 6892, Fax: 071.439 4613, Dir: Peter Barnes.

PLAYBOY MUSIC, 101 Chamberlayne Road, London NW10 3NP, 081.960 8466, Fax: 081.969 8920, Tlx: 8954958, MD: Clive Stanhope.

PLUS MUSIC PUBLISHING, 36 Follingham Court, Drysdale Place, London N1 6LU, 071.729 4482, Fax: 071.729 5293, MD: Ronald Chisholm, Personal Asst: Marianne Hall, Contact: Desmond Chisholm.

PLUTO MUSIC, Hulgrave Hall, Tiverton, Tarpotley, Cheshire CW6 9UQ, 0829.732 427, Fax: 0829.733 802, MD: Keith Hopwood.

POINT MUSIC, Fitzhugh Grove, RVP Building, Studio 5, London SW18 3SX, 081.871 4155, Fax: 081.871 4158, MD: Rupert Merton, Copyright: Sam Mortimer.

POLAR UNION, 119-121 Freston Road, London W11 4BD, 071.243 0011, Fax: 071.221 2722, Tlx: 8954780, MD: Dai Davies, Artist Mgr: Biddy Nolan.

POLYGRAM INTERNATIONAL MUSIC PUBLISHING, 30 Berkeley Square, London W1X 5HA, 071.493 8800, Fax: 071.409 3285/499 2596, Tlx: 263872/261508, Chief Exec: David Hockman, Contr: Jeff King, Bus Affairs Dir: Christin Evans, Int'l Repertoire Mgr: Debbie Williams.

POLYGRAM MUSIC PUBLISHING, 1 Sussex Place, PO Box 1420, Hammersmith, London W6 9XT, 081.741 1515, Fax: 081.741 1626, Tlx: 263828 polygm, MD: Lucian Grainge, Comm Mgr: Kate Thompson, Legal & Bus Affairs: Sally Caplan, A&R Mgrs: Paul Adam, Colin Barlow, Prof Mgr: Nigel Elderton, Owned: DJM, Welk, Cedarwood, Macaulay, Admin: Bluebeard, Caledonia, Essential.

POLYGRAM/ISLAND MUSIC PUBLISHING (ADMIN), 334-336 King Street, Media House, London W6 ORA, 081.846 9376, Fax: 081.846 9566, Admin Mgr (Int'l): Theo Strickers.

PRECIOUS, see Chrysalis Music.

THE PRECIOUS MUSIC COMPANY, 24 Gairbraid Avenue, Maryhill, Glasgow, Strathclyde G20 8YE, 041.946 3366, Fax: 041.946 4326, MD: Elliot P Davis.

PRELUDE, see Valentine Music Group.

PRESET SONGS, 177 High Street, London NW10 4TE, 081.961 3669, Fax: 081.961 4620, Tlx: 8954780, MDs: Alan Beliman, John Kaufman.

PRESTATION, see Fay Gibbs Music Service.

PRIMROSE MUSIC, see Fay Gibbs Music Service.

PRINCESS, see H & B Webman & company.

PRO VIVA, see John Fiddy Music.

PROTOONS MUSIC, Warple Way, 10 Tech West, London W3 ORQ, 081.749 8777, Fax: 081.749 3703, MD: Andrew Cleary, Main product: Dance, Black (R&B), Reggae.

R. BUZZARDSONGS, see Hobo Railways.

RADIO MUSIC BRITAIN, 86 Fulham Palace Road, London W6 8JA, 071.493 5961, Fax: 071.499 9419, Tlx: 22219, MD: Ray van Cant, John Brands, Dir: Maurice Vass.

RAK MUSIC, 42-48 Charlbert Street, London NW8 7BU, 071.586 2012, Fax: 071.722 5823, MD: Mickie Most, Contact: Jenny Merriman.

RAW GROOVE, see International Masters Network.

RAY WILLIAMS & ASSOCIATES, 8-9 Ivor Place, Oliver House, London NW1 6BY, 071.724 3660, Fax: 071.724 6245, MD: Ray Williams.

REAL LIFE MUSIC, 122 Holland Park Avenue, London W11 4UA, 071.221 3077, Fax: 071.221 1606, Contact: Ann Munday.

REALLY USEFUL GROUP, Dean Street, 12/13 Richmond Buildings, London W1V 5AF, 071.439 7515, Fax: 071.439 8021, Tlx: 917605, Music Division Dir: Jonathan Simon.

RECORD MUSIC, see Jess Music.

RED BUS MUSIC, 48 Broadley Terrace, Red Bus House, London NW1 6UL, 071.258 0324, Fax: 071.724 2163, Tlx: 25873, MDs: Ellis Elias, Elliot Cohen.

REMIDI MUSIC, see Sonet London.

REPRO MUSIC, 4 Lonsdale Road, London NW6 6RD, 071.625 4458, Fax: 071.629 7025, MD: Bryan Harris, Mark & Anna Jolley.

RESTORATION MUSIC, see Sovereign Music.

REVOLVER MUSIC, see Rocksong Music Publishing.

REVUE, see Creole Music.

RHYTHM KING MUSIC, 117-121 Salusbury Road, Queens Studios, London NW6 6RG, 071.372 5474, Fax: 071.372 4215, MD: Theo Chalmers.

RICKIMUSIC, 1 Stevenage Road, Big M House, Knebworth, Hertfordshire SG3 6AN, 0438.814 433, Fax: 0438.815 252, President: Joyce Wilde, Chmn: Marty Wilde, MD: Ricky & Kim Wilde, GM: Nick Boyles.

RIPPLE MUSIC, 344 Kings Road, London SW3 5UR, 071.352 5628, Fax: 071.351 7700, Tlx: 296835, MD: Bill Wyman.

RIVER MUSIC, see Robert Kingston Music.

RIVERDAKS, see United Nations Music Publishing.

RMO MUSIC, 8 Fernham Road, Thomton Heath, Surrey CR7 8JD, 081.653 9022, Fax: 081.768 0584, MD: Reg Mclean, Mktg: Allan Block, Fin Dir: Derrick Morris, A&R: Susan Craig. (Owned): Voyage Songs, Code, RMO; Main product: EHR, Dance, Gold/Oldies, Black (R&B), Reggae, New Age, Classical.

ROBERT KINGSTON MUSIC, 43 Fairfield Road, Uxbridge, Middlesex UB8 1AZ, 0895.237 257, Fax: 0895.810 392, MD: Robert C Kingston, Company Sec: K M Kingston. (Owned): River Music, Pindrop Music, Hatley Music, Christabel Music; Main product: Adult Contemporary, Gold/Oldies, Film/TV music.

ROCKET MUSIC, 32 Galena Road, London W6 0LT, 081.741 9933, Fax: 081.741 3938, Tlx: 265870, Chmn: John Reid.

ROCKIN' MUSIC, 48-50 Steele Road, London NW10 7AS, 081.453 1311, Fax: 081.961 8725, Tlx: 893805 acerec, MDs: Trevor Churchill, Roger Armstrong, Ted Carroll.

ROCKSONG MUSIC PUBLISHING, 152 Goldthorn Hill, Penn, Wolverhampton, West Midlands WV2 3JA, 0902.345 345, Fax: 0902.345 155, Tlx: 335419, Chmn: Paul Birch, MD: David Roberts. (Owned): Revolver Music, Andersong, Heavy Metal Music, FM Music Publishing.

ROD THOMPSON MUSIC, 73 Bromfelde Road, London SW4 6PP, 071.720 0866, Fax: 071.720 0866, Contact: Rod Thompson.

ROLLERCOASTER, see Asterisk Music.

ROUND MUSIC, 10a Parsons Green, London SW6 4TW, 071.731 4161, Fax: 071.736 1880, Tlx: 8951674, MD: Stuart Hornall, Sr Dir: Tom Bradley, Int'l Mgr: Zara Morris, GM: Alan Jones.

ROSETTE, see Valentine Music Group.

ROUGH TRADE PUBLISHING, 81 Wallingford Road, Goring, Reading, Berkshire RG8 0HL, 0491.873 612, Fax: 0491.873 612, Dirs: Peter Walmsley, Kathy Gibson.

RT SLI, see Asterisk Music.

RTL MUSIC, Hill Bottom Road, Stewart House, High Wycombe, Buckinghamshire HP12 4HU, 0630.81674, Fax: 0630.81612, MD: Ron Lee, Promo: Cathrine Lee, A&R: Xavier Lee.

RYBAR, see Paul Rodriguez Music.

S HOWIE, see Bonselid Music.

SABRE, see Eaton Music.

SAFE HOUSE MUSIC, see Sonet London.

SAFTA JAFFERY PRODUCTIONS, 117 Hampstead Road, London NW1 3EF, 071.388 8635, Fax: 071.387 0233, MD: Safta Jaffrey.

SAIN (RECORDIAU), Canolfan Sain, Llandwrog, Caernarfon, Gwynedd, Wales LL54 5TG, 0286.831 111, Fax: 0286.831 497, MD: Dafydd Iwan, Sales Dir: O P Huws, PR: Elin Owen. (Owned): Sain, Crai, Cambriam, Tryfan; Main product: Welsh language Rock, Pop, Folk, Choir Music.

SALAMANDER & SON MUSIC, see Chrysalis Music.

SATRIL MUSIC, 3 Blackburn Road, London NW6 1RZ, 071.435 8063, Fax: 071.328 9037, Tlx: 8954958, MD: Henry Hadaway.

SAVOY BROWN MUSIC, see Sonet London.

SCHENKER SONGS, see Chrysalis Music.

SCOTSCORES, Muse Cottage, Allanton, Duns, Borders, 089081.8884, Partners: Muriel A Johnstone, Bill Zobel. Main product: Scottish Traditional, New Age.

SCREAMIN' JAY HAWKINS MUSIC, see Demon Music.

SECRET AFFAIR, see Supreme Songs.

SEE FOR MILES MUSIC, Littleton Road, Littleton House, Unit 10, Ashford, Middlesex TW15 1UU, 0784.247 176, Fax: 0784.241 168, MD: Colin Miles.

SEVEN B MUSIC, see Charly Publishing.

SGO MUSIC MANAGEMENT, see Southern Music Publishing Co. Ltd.

SHADOWS INTERNATIONAL, see Greenleaves Publishing.

SHAPIRO BERNSTEIN, see Music Sales.

SHEILA MUSIC, see Creole Music.

SHINING SHADOWS MUSIC, see Sonet London.

SHOGUN, see Eaton Music.

SIDLAW, see Deasy Music.

SIGN OF THE TWINS, see Minder Music.

SILEAS, see Bonselid Music.

SINEAD O'CONNOR, see Dizzy Heights Music.

SINGSPIRATION, see United Nations Music Publishing.

SKRATCH MUSIC PUBLISHING, 81 Crabtree Lane, Skratz Music House, London SW6 6LW, 071.381 8315, Fax: 071.385 6785, MDs: Les McCutcheon, Nigel Wright, Prof Mgr: Colin Smith.

SKYSAW, see EG Music.

SKYVIEW MUSIC, see Sonet London.

SLEEPING GIANT MUSIC, 34 Great James Street, London WC1N 3HB, 071.405 3786, Fax: 071.405 5245, MD: Keith Thomas, A&R Dir: Ian Taylor King, Admin Dir: John Beattie, Promo: Daniella Madaio.

SLOW BONGO FLOYD, see Addictive Music Publishing.

SMITH MAYNARD INTERNATIONAL, 72 Rushton Road (Studio), Desborough, Northamptonshire NN14 2QD, 0536.760 402, Producers/Composers: Graham Smith, Michael Maynard.

SNAPPERSONGS, see Asterisk Music.

SOHO PUBLISHING, 187 Wardour Street, London W1V 3FA, 071.437 2394/723 2463, Fax: 071.434 0648, MD: Mark Teverson. Main product: Dance, Black (R&B).

SON TON SON MUSIC, see Team Sonet Publishing.

SONET LONDON, 78 Stanley Gardens, London W3 7SN, 081.746 1234, Fax: 081.740 9899, Tlx: 25793, MD: Rod Buckle, Copyright Mgr: Alan J Whaley. (Owned): Grabbing Hands, Musical Moments, Musical Moments Europe, Frank Tovey Music, Hot Toddy Music, Johns Music, Neil Music, Skyview Music, La Bonne Musique, Deshufflin, New Media Music, TZ Music, Remidi Music, Great Outlook Music, Volume Music, Paul Roberts Music, Safe House Music, Heavy Traffic Music, Tortoise Music, Shining Shadows Music, Kenny Denton Music, Whitewing Music, Midnight Creeper Music, Booga Dooga Music, Jerry Williams Music, Swamp Dogg Music, Frozen Inca Music, Bark Boat Music, Het Gerucht Music, Mellow Fellows Music, Flagg Music, Emile Music, Stainless Music, Savoy Brown Music, Sonet Music AB, Cloudberry Songs, Brujo Music, Tannen Music.

SONET MUSIC AB, see Sonet London.

SONGS AVAILABLE, 2-4 Bank Road, Bredbury, Stockport,

Cheshire SK6 1DR, 061.430 5052, Fax: 061.430 5052, Songwriter: Chris Statham. Songwriting: Main product: Adult Contemporary, Album Rock.

SONGS FOR TODAY, see TKO Music.

SONGSTREAM MUSIC, Spring Gardens, Mill Cottage, Oldford, Frome, Somerset BA11 2NZ, 0373.466 695, MD: Roger Bourne. (Owned): Songstream Music, V-Ram Discs; Main product: Adult Contemporary, Dance, Album Rock.

SONIMAGE, see John Fiddy Music.

SONOTON, see John Fiddy Music.

SONY MUSIC PUBLISHING, 17-19 Soho Square, London W1V 6HE, 071.734 8181, Fax: 071.287 8135, Tlx: 24203, Snr VP: Jeremy Pearce, Prof Mgr: James Little, Copyright Mgr: Jenny Parkes, Talent Scout: John Rahim. Affiliates: Anxious Music, All Nations.

SOUND DIAGRAMS, 39 Great Windmill Street, London W1V 7PA, 071.287 4580, Tlx: 9312131125, E-Mail: DGS 1552, President: Bob Last, F&A: Elva Williamson.

SOUND STAGE, Waterhouse Lane, The Kerchesters, Kingswood, Surrey KT20 6HT, 0737.832 837, Fax: 0737.833 812, Contact: Ian Dale. (Owned): Amphonic Music, Sound Stage; Sub-pub: Koka Media (Fra), Capitol Production Music (USA).

SOUTHERN LIBRARY MUSIC, see Southern Music Publishing Co. Ltd.

SOUTHERN MUSIC PUBLISHING CO. LTD.

8 Denmark Street, London WC2H 8LT, (44) 71-836-4524, Fax: (44) 71-379-4701, Tlx: 23557, Cable: Southmusic, MD: Stuart Ongley, Prof. Mgr.: Dee Hellier, Creative Dept.: Rannoch Donald. Affiliates: Southern Music, Latin American Music, Liber Southern, Donavan Music, Cartel-Lewis Music, Southern Library Music, Patch Music, SGO Music Management, Clouseau Music, Peer International.

SOVEREIGN MUSIC, PO Box 356, Leighton Buzzard, Bedfordshire LU7 8WP, 0525.385 578, Fax: 0525.372 743, MD: Robert Lamont. (Admin/sub-pub): Lifestyle Music, Mustard Seed Music, Restoration Music.

SPACE SONGS, see Chrysalis Music.

SPADESONGS, see Asterisk Music.

SPARTA FLORIDA MUSIC GROUP, 34 Great James Street, London WC1N 3HD, 081.594 2428, Fax: 071.581 5855, Tlx: 8956057 sparta, President: Hal Shaper, Int'l Director: Stella Groves, Fin Dir: Keith Thomas, Copyright: Margaret Brace.

SPRINGTHYME MUSIC, Balmalcolm House, Kingskettle, Fife KY7 7TJ, 0337.30773, President: Peter Sheppard.

ST. FRANCIS, see Valentine Music Group.

STAINLESS MUSIC, see Sonet London.

STAMPS BAXTER MUSIC, see United Nations Music Publishing.

STANDARD, see Bucks Music.

STEELCHEST, see EG Music.

STEVE GLEN, see EG Music.

STINKHORN, see Asterisk Music.

STOMP OFF MUSIC, see Paul Rodriguez Music.

STRADA SONGS, 533 Kings Road, The Studio, Chelsea, London SW10 0TZ, 071.351 6977, Fax: 071.351 7749, MD: Evros Stakis, Contact: Alison Mackenzie.

STRAWBERRY MUSIC, see Team Sonet Publishing.

STREET TUNES, see Blueprint Management.

STUDIO G PRODUCTION MUSIC LIBRARY, Ridgeway House, Great Brington, Northampton NN7 4JA, 0604.770 511, Fax: 0604.770 022, Owner/Mgr: John Gale, Mktg Mgr: Barry Mockbridge, Admin: Lynn Turley. (Owned): Studio G; Admin: Parry, Abaco.

SUBMUSIC PUBLISHING, 389-394 Alfred Str Nrth, The Square Cntr, Nottingham NG3 1AA, 0602.417 272, Fax: 0602.412 277, President: Tim Andrews, Chmn: John Crossley.

SUISSE INTERNATIONAL, see TKO Music.

SUN-PACIFIC MUSIC (LONDON), Havelock Road, 13/17 Sussex Chambers, Hastings, East Sussex TN34 1HR, PO Box 5 (Zip: TN34 1HR), 0424.721 196, Fax: 0424.717 704, President: David P. Corkill, MD: Gilbert Gibson. Specialists in stage & film musical libretti & scores.

SUNDERGRADE, see Eaton Music.

SUPA BOTA, see Eaton Music.

SUPERNATURAL MUSIC, see Team Sonet Publishing.

SUPERTRACK MUSIC, see United Nations Music Publishing.

SUPRAPHON, see John Fiddy Music.

SUPREME SONGS, PO Box 78, Woodford Green, Essex IG9 5SY, 081.559 2251, Fax: 081.559 2251, Dir: Kate Farmer. (Admin): Secret Affair, Any Kind Of Music; Main product: EHR, Dance, AC, Album Rock, Gold/Oldies, Black (R&B), New Age.

SWAMP DOGG MUSIC, see Sonet London.

SYMBOLIC GESTURE, see Demon Music.

TABITHA MUSIC, 1-2 Sandpiper Court, Exeter, Devonshire EX4 8NS, 0392.462 294, Fax: 0392.462 299, Chmn: Graham Sclater, MD: Denise Sclater. (Owned): Tabitha Music, Dice Music; Sub-pub: Grove Music (Jam).

TAFARI, see Greenleaves Publishing.

TANNEN MUSIC, see Sonet London.

TANSPAN, see Asterisk Music.

TATHAM MUSIC, see Negus-Fancey Company.

TBP MUSIC, 55 Futham High Street, London SW6 3JJ, 071.736 5925, Fax: 071.731 6921, Tlx: 919946 solo, MD: John Giddings, Personal Asst to MD: Carole Murray.

TEAL MUSIC, see Demon Music.

TEAM SONET PUBLISHING, 78 Stanley Gardens, London W3 7SN, 081.746 1234, Fax: 081.740 9899, MD: Rod Buckle, GM: Alan J. Whaley. (Owned): Eyeball Music, Son Ton Son Music, Supernatural Music, Old School Songs, Strawberry Music, Musselwhite Music, Flat Town Music, Army of Lovers Music.

TEMBO, see Eaton Music.

TEMPCO, see Minder Music.

TEMPLE MUSIC, 48 The Ridgeway, Sutton, Surrey SM2 5JU, 081.642 3210, Fax: 081.642 8692, MD: Jon Hiseman, Copyright Mgr: Diana Cuthbert. (Admin): Mayflower Music, Celestial Harmonies, Black Sun Music.

TENT, see Chrysalis Music.

TIDELAND, see Kassner Associated Publishers.

TIMBUKTU MUSIC, 41-42 Berners Street, London W1P 3AA, 071.436 3371, Fax: 071.436 2837, Tlx: 21485 timbuk, Dir: Peter Bond, Mike Edwards, Artist Liaison: Joanna Mudie.

THE TIME GROUP OF COMPANIES, 52 Blucher St, IMEX House, Suite 119, Birmingham, West Midlands B1 1QT, 021.633 3303, Fax: 021.643 4630, MD: Keith Baker, GM: Rik Staines. (Admin): Crystal Copy, Tritex Songs.

TKO MUSIC, PO Box 130, Hove, East Sussex BN3 6QU, 0273.550 088, Fax: 0273.540 969, Chmn: J S Kruger, MD: R Rogers. Affiliates: Cares Music Inc, Ember Enterprises, Fourth House Music, Glen Campbell Publishing, Gordon Music Inc, Weiser Music Group, Nat Goodman Group, Suisse International, Varia Music Group, Veridian Music Group, Young World Music. (Owned): Songs For Today.

TOMIJA, see International Music Network.

TOPIC MUSIC, 50 Stroud Green Road, London N4 3EF, 071.263 6403, Fax: 071.281 5587, MD: Tony Engle.

TORTOISE MUSIC, see Sonet London.

TREBLEMAIN, see Eaton Music.

TRITEC SONGS, see The Time Group Of Companies.

TRYFAN, see Sain.

TUNE KEL, see Charly Publishing.

TVS, see Bucks Music.

TWO P(I)ETERS, see Eaton Music.

TZ MUSIC, see Sonet London.

ULTRA SONIC SONGS, North Villas, 8 Church Studios, London NW1 9AY, 071.482 4868, Fax: 071.485 1819, MD: Martin Sexton, Stefan Lux, Sec: Sarah Taylor.

UNICORN RECORDS, 14 Hillgate Place, London W8 7SJ, 071.727 3881, Fax: 071.243 1701, MD: Nigel Brandt.

UNITED NATIONS MUSIC PUBLISHING, 75 High Street, Needham Market, Suffolk IP6 8AN, 0449.721 825/71.580 2060, Fax: 0449.721 630, Dirs: H Spencer, P Hazel. (Owned): BR TV & Films, Universal Songs, Supertrack Music, MPI, Jonico Music, Wizzy Bus Music, Singspiration, Stamps Baxter Music, John T Benson Music, Paragon Music, Lifesong Music Press, Lorenz Corp, Meadowgreen, Riverdaks, Place of Refuge, Lexicon Music, Chris Norton, Andi Baxter, G Hutchins.

UNIVERSAL SONGS, see United Nations Music Publishing.

V-RAM DISCS, see Songstream Music.

VALENTINE MUSIC GROUP, 7 Garrick Street, London WC2E 9AR, 071.240 1628/9, Fax: 071.497 9242, MD: John Nice. (Owned): Bandleader, Corner Stone, Valentine Music Group. (Admin): Alpadon, Addington State, Arthur's Mother, BOP, Crossbar, Midnight, Music To Picture, Rosette, AVI, Buckhorn, Derry, Excellore, House of Bryant, Jimmy's, Prelude, St. Francis (USA).

UNITED NATIONS MUSIC PUBLISHING, 75 High Street, Needham Market, Suffolk IP6 8AN, 0449.721 825/71.580 2060, Fax: 0449.721 630, Dirs: H Spencer, P Hazel. (Owned): BR TV & Films, Universal Songs, Supertrack Music, MPI, Jonico Music, Wizzy Bus Music, Singspiration, Stamps Baxter Music, John T Benson Music, Paragon Music, Lifesong Music Press, Lorenz Corp, Meadowgreen, Riverdaks, Place of Refuge, Lexicon Music, Chris Norton, Andi Baxter, G Hutchins.

UNIVERSAL SONGS, see United Nations Music Publishing.

V-RAM DISCS, see Songstream Music.

VALENTINE MUSIC GROUP, 7 Garrick Street, London WC2E 9AR, 071.240 1628/9, Fax: 071.497 9242, MD: John Nice. (Owned): Bandleader, Corner Stone, Valentine Music Group. (Admin): Alpadon, Addington State, Arthur's Mother, BOP, Crossbar, Midnight, Music To Picture, Rosette, AVI, Buckhorn, Derry, Excellore, House of Bryant, Jimmy's, Prelude, St. Francis (USA).

VALLIANT PUBLISHING, see Charly Publishing.

VANESSA MUSIC, 3 Glebe Road, Weston-super-Mare, Avon BS23 3AP, 0934.417 174, Dir: Don Todd.

VARIA MUSIC GROUP, see TKO Music.

VERGE, see Asterisk Music.

VERIDIAN MUSIC GROUP, see TKO Music.

VIBE MUSIC, 31 Horsedog Street, St Marys House, Oldham, Greater Manchester OL1 3XE, 061.628 4252, Fax: 061.628 8001, Contact: John Turner.

VIRGIN MUSIC (PUBLISHERS), 328 Kensal Road, London W10 5XJ, 081.960 3030, Fax: 081.968 7775, MD: Steve Lewis, Head of Creative Dept: Mike McCormack, Prof Mgr: Blair McDonald, Copyright Mgr: Caroline Wallace, GM: Maria Forte, Fin Contr: Neil Fenton, Head of Legal & Bus Affairs: James Rubinstein, Royalties Mgr: Hilary Woolnough. (Owned): 10 Music, Dinsong, Circa Music.

VOLUME MUSIC, see Sonet London.

VOYAGE SONGS, see RMO Music.

WARNER CHAPPELL MUSIC (UK), 129 Park Street, London W1Y 3FA, 071.629 7600, Fax: 071.499 9718, MD/Snr VP (Int'l A&R): Robin Godfrey-Cass, Snr VP (Int'l Legal & Bus Affairs): John Brunning, VP Group Contr (Eur): John Hammond, Fin Dir: Barry Hitchens, Int'l Royalty Exec: Glad Dreamer, Legal

& Bus Affairs Dir: Andrew Gummer, Bus Affairs Mgr: Alison Cooper, Copyright Mgr: Kevin White, Royalties Mgr: Jana Yell, Prof Admin Mgr: Lesley Hatch, Special Projects: Stuart Newton, Head Of A&R: Sas Metcal, Snr Creative Mgr: Stewart Feeney, Auren Ritchie, Head Of Int'l: Patsy Winkelman, Strnd Rep Mgr: Caroline Underwood, A&R Mgr: John Brice.

WARRIOR MUSIC, PO Box 798, London W14 9NT, 071.490 5475, Fax: 071.250 1910, MD: Andrew E Beer, Head Of Admin: Judith T Annakie. (Owned): Warrior, 400 Blows; Main product: UK black dance music.

WATERBOYS, see Dizzy Heights Music.

WE THREE, see H & B Webman & company.

WEISER MUSIC GROUP, see TKO Music.

WELK, see PolyGram Music Publishing.

WELSH MEDIA MUSIC, Plas Dinefwr Television Centre, Llanelilo, Dyfed, 0558.823 811, Fax: 0558.823 867, Contact: Dafydd Pierce.

WESTBURY MUSIC, 2 Tunstall Road, Suite B, London SW9 8DA, 071.738 7950, Fax: 071.738 3265, Contact: Caroline Robertson.

WHITE ELEPHANT, see Asterisk Music.

WHITEWING MUSIC, see Sonet London.

WHITMAN, see Eaton Music.

WIENERWOLD, 90 Old Church Lane, Stanmore, Middlesex HA7 2RR, 081.954 8777, Fax: 081.954 2999, Tlx: 94014029 wrrd, MD: Ian Wiener, Bus Affairs Dir: Anthony Broza. Main product: Adult Contemporary, Dance, Albun Rock, Hi-NRG.

WILDLIFE MUSIC & PRODUCTION, Levington Road, Wildlife House, Ipswich, Suffolk IP3 0NJ, 0473.729 711, Fax: 0473.729 039, MD: Allan Alderson.

WILLY RUSSELL, see Negus-Fancey Company.

WIND VALLEY MUSIC, see Fay Gibbs Music Service.

WINSOR BECK PR, 29-39 Stirling Road, Network House, London W3 8DJ, 081.993 7506, Fax: 081.993 8276, Tlx: 291908.

WITZEND, see Eaton Music.

WIZZY BUS MUSIC, see United Nations Music Publishing.

YOUNG WORLD MUSIC, see TKO Music.

YOUR MUSIC, 39 Leyton Road, Harpenden, Hertfordshire AL5 2JB, 0582.715 098, Fax: 0582.715 098, MD: David Blaylock, Dir: Judy Dixon. Main product: EHR, Popular.

ZOMBA MUSIC, 165-167 Willesden High Road, London NW10 2SG, 081.459 8899, Fax: 081.451 3900, Tlx: 919884 zomba, MD: Jim Doyle, Prof Mgr: Andy Graham.

ZOMBA SCREEN MUSIC, 82 Bishops Bridge Road, The Colonnades, London W2 6BB, 071.229 4477, Fax: 071.243 0470, Contact: Jonathan Channon.

ZONESPEC, PO Box 770, London EC1R 5AQ, 071.833 2149, Fax: 071.833 8014, Copyright: Iris Cousins, Takuya Matsunoki, Admin: Sylvia Banks, Wakaba Sato. (Owned): Zonespec, Ian David; Main product: Adult Contemporary, Jazz, Country, Classical, Albun Rock.

ZYX MUSIC (UK), Heather Park Drive, Trinity House, Wembley, Middlesex HA0 1SX, 081.902 6398, Fax: 081.902 5896, President: Bernhard Mikulski, MD: Christine Vincent.

VIDEO PROGRAM SUPPLIERS & BUYERS

ARTS COUNCIL FILMS, 14 Great Peter Street, London SW1 3NQ, 071.973 6454, Fax: 071.973 6581, Sales Exec: Richard Gooderick, Sales Asst: Anne Sinclair, Sec: Alicia Matthews.

BIG PICTURE PRODUCTIONS, 36 Golden Square, London W1R 4AH, 071.734 8080, Fax: 071.494 6280, Tlx: 27937, Contact: Mark Young.

BMG OPERATIONS (DEPOT), Lyng Lane, West Bromwich, West Midlands B70 7ST, 021.500 5545, Fax: 021.553 6880, Tlx: 336072, Distr/Op Dir: John Henderson. Labels (distr): BMG Video, Castle Music Video, Castle Pictures, Castle Vision, Hendring Video, Mute, Scorpio Video, Soccer Vision, Telstar Video. A division of BMG Records (UK).

BRITANNICA FILMS, Station Approach, Carew House, Wallington, Surrey SM6 0DA, 081.669 4355, Fax: 081.773 0809, Contact: Tim Dare.

BRITISH HOME ENTERTAINMENT, 20 High Street, Walton-on-Thames, Surrey KT12 1DA, 0932.228 832, Fax: 0932.247 759, Contact: Clive Williamson.

CAROLINE INTERNATIONAL, 56 Standard Road, London NW10 6ES, 081.961 2919, Fax: 081.961 1873, MD: Jonathan Gilbride, GM: Nik Podgorski.

CBC ENTERPRISES, 43-51 Great Titchfield Street, London W1P 8DD, 071.580 0336, Fax: 071.323 5658, Tlx: 917738, Contact: Susan Jolley.

CENTRE ENTERTAINMENT, 118 Cleveland Street, London W1P 5DN, 071.387 4045, Fax: 071.388 0408, Contact: K Walwin.

CREATIVE COMMUNICATIONS ASSOCIATES, 15 Bramley Road, London W10 6SP, 071.221 2213, Fax: 071.221 6455, Tlx: 21753, Contact: Tony Orsten.

CSAKY, 32 Willow Road, London NW3 1TL, 071.794 1574, Fax: 071.431 4695, Contact: Mick Csaky.

DANDELION DISTRIBUTION, Station Road, 5 Churchill Court, North Harrow, Middlesex HA2 7SA, 081.863 1888, Fax: 081.863 0463, Tlx: 27972, Contact: Noel Cronin.

DIAMOND TIME, 16-26 Rosemont Road, London NW3 6NE, 071.433 3355, Fax: 071.794 8383, Tlx: 269867 videos, MDs: Bruce Higham, Martin Davls.

DIRECTORS INTERNATIONAL PRODUCTIONS, 45 Neal Street, London WC2H 9PJ, 071.240 7391, Fax: 071.831 1216, Contact: Carol Wilson.

ENTERTAINMENT FILM DISTRIBUTORS, 27 Soho Square,

London W1V 5FL, 071.439 1606, Fax: 071.734 2483, Tlx: 262428 entvif, Contact: Trevor Green.

ENTERTAINMENT IN VIDEO, 27 Soho Square, London W1V 5FL, 071.439 1979, Fax: 071.724 2483, Tlx: 262428 entvif, Contact: Nigel Green.

EQUESTRIAN VISION, Sausalands, Coolham, Horsham, West Sussex RH13 8QB, 0403.741 666, Fax: 0703.741 647, Contact: James Hawksfield.

FIRST INDEPENDENT FILMS, 69 New Oxford Street, London WC1A 1DG, 071.528 7767, Fax: 081.528 7770, Tlx: 22868, MD: Michael Myers, Deputy MD: Norman Dinesen. Video distributor of feature films and sell-through programming.

FLASHBACK COMMUNICATION, 25 Greenhead Street, Glasgow, Strathclyde, Scotland G40 1ES, 041.554 6868, Fax: 041.554 6869, MD: Chris Atkins, Producer: Ros Borland. Video distributor of promo videos.

FPA INTERNATIONAL DISTRIBUTORS, 31a Regent Park Road, London NW1 7TL, 071.267 9198, Fax: 071.267 8852, Contact: Derek Blades.

FREEWAY FILMS, 67 George Street, Edinburgh EH2 2JG, 031.225 3200, Fax: 031.225 3667, Contact: Susie Brown.

GLENBUCK FILMS, Glenbuck Road, Surbiton, Surrey KT6 6BT, 081.399 0022, Fax: 081.399 6651, Tlx: 9413833, Contact: S Savill.

GUILD HOME VIDEO, 2 Church Street, Crown House, Walton-on-Thames, Surrey KT12 2QS, 081.546 3377, Fax: 081.546 4888, Tlx: 269651, MD: Thomas Hedman, Mktg Dir: Nick Pendrell, Fin Dir: John Graham, Sales Dir: Peter Dowsett.

HAMILTON FILM & TELEVISION, The Old Vicarage, Cwmyoy, Abergavenny, Gwent NP7 8NT, 0873.890 486, Fax: 0873.890 527, Tlx: 929416 movies, Contact: Christopher Hamilton.

HEARST ENTERTAINMENT, 18 Hanover Street, London W1R 9HG, 071.408 1229, Fax: 071.499 0465, Tlx: 268570, Contact: Michael Doury.

IMPERIAL ENTERTAINMENT, East Lane, GEC Estate, Building 1, Wembley, Middlesex HA9 7FF, 081.904 0421, Fax: 081.908 6785.

INTERNATIONAL VIDEO NETWORK, 39 Holland Road, Kensal Green, London NW10 5AH, 081.968 4954, Fax: 081.969 7247, Office Mgr: Allison Hale, Mktg/Sales: Naomi Taylor. Travel.

ISLAND WORLD COMMUNICATIONS, 40 St Peters Road, London W6 9BD, 081.748 9000, Fax: 081.748 0841, Tlx: 934541, MD: Andy Frain, Sales/Mktg Mgr: Mike Preece. Video distributor & publisher of feature films, comedy, children's & education programming.

ITEL, 48 Leicester Square, London WC2H 7FB, 071.491 1441, Fax: 071.493 7677, Tlx: 25353, Contact: Fiona Eldridge.

J & M ENTERTAINMENT, 2 Dorset Square, London NW1 6PU, 071.723 6544, Fax: 071.724 7541, Tlx: 298538 filmin, Contact: Peter Rogers.

KING ROLLO FILMS, High Street, Dolphin Court, Honiton, Devonshire EX14 8LS, 0404.45218, Fax: 0404.45328, Tlx: 24637 wigmor, MD: Clive Juster, Sales Mgr (Int'l): Lucy Ellson. Video distributor of animated films for children.

LINK ENTERTAINMENT, 7 Baron's Gate, 33-35 Rothschild Road, London W4 5HT, 081.995 5080, Fax: 081.747 9452, MD: Claire Dery, Chmn/Fin Dir: David Hamilton, Sales Mgr (Int'l): Jo Kavanagh. Main product: children's animation series.

MCCANN INTERNATIONAL PROGRAMME MARKETING, 68 Gloucester Place, London W1H 3HL, 071.224 4748, Fax: 071.487 5071, Tlx: 597957, Contact: Andrew Luff.

MCEG—VIRGIN VISION, 1 Rockley Road, Atlantic House, London W14 0DL, 081.740 5500, Fax: 081.967 1360/1, Chmn/CEO: Bill Tennant, MD: Angus Margerison, GM: Johnny Fewings, Prod Dev Mgrs: John Paveley.

MIA, 18 Upper Brook Street, London W1Y 1PD, 071.355 2066, Fax: 071.493 8780, MD: Laurence Romson.

NBC EUROPE, 3 Shortlands, London W6 8BX, 081.846 8704, Fax: 081.846 8768, Contact: Paul le Drullennec.

NBD PICTURES, 310-312 Regent Street, Remo House, London W1R 5AJ, 071.499 9701, Fax: 071.493 9587, Contact: Maro Korkou.

NEW WORLD, Paradise Farm, Westhall, Halesworth, Suffolk IP19 8RH, 050.279 279, Fax: 050.279 886, MD: Collin Willcox, Dir: Carmen Salvat. Video distributor of self-help, ambient videos.

NVC ARTS, 74-80 Camden Street, The Forum, London NW1 0JL, 071.388 3833, Fax: 071.383 5332, Tlx: 893405 nvc, Chmn: Julian Wills, MD: John Kelleher, Publicity Mgr: Shelagh Hughes, Fin Contr: Philip Jones, Legal & Bus Affairs Dir: Michael Pigott.

PACIFIC TELEVISION ENTERPRISES, 100 Oxford Street, Century House, London W1N 9FB, 071.437 9314, Fax: 071.631 3049, Tlx: 261779 movies, Contact: Chris Cary.

PARKFIELD ENTERTAINMENT, 103 Bashley Road, London NW10 6SD, 081.965 5555/9292, Fax: 081.961 8040, Tlx: 927813, Gen Dir: Vaughan Bendall, Video Dir: Brian Yershon.

PICKWICK INTERNATIONAL, The Hyde Industrial Estate, Unit 1b, London NW9 6JU, 081.200 7000, Fax: 081.200 8995, Tlx: 922170, Chmn: Ivor Schlosberg, Sales/Mktg Dir: Garry le Count, Dir of Video Ops: Walter Woyda, Comm Dir: Dick Speller, Mgr (Export): Mike Diplock, Publ Mgr: Kate Charters.

POLYGRAM VIDEO INTERNATIONAL, 6 Castle Row, Horticultural Place, Chiswick, London W4 4JQ, 081.994 9199, Fax: 081.994 6840, Tlx: 298816 rmtel, MD: Will Evans, Mktg Dir: Hugh Reece-Parnell, Contr: Michael Walsh.

PRESET VIDEO INTERNATIONAL, 177 High Street, London NW10 4TE, 081.961 3889, Fax: 081.961 4620, Tlx: 8954780, MD: Alan Bellman, John Kaufman; Mktg Dir: Rakha Desai

RAY ATKINSON MULTI MEDIA MARKETING, PO Box 160, Beckenham, Kent BR3 2YH, 081.650 0039, Fax: 081.650 4453, Contact: Ray Atkinson.

RM ASSOCIATES, 46 Great Marlborough Street, London W1V 1DB, 071.439 2637, Fax: 071.439 2316, Tlx: 24549 rmaltdg, Contact: Ron Lloyd.

RPTA, Seymour Mews House, London W1H 6EB, 071.935 9000, Fax: 071.487 3975, Tlx: 22872, Contact: Simon Wilcock.

SAFIR FILMS, 22 Soho Square, London W1V 5FJ, 071.734 5085, Fax: 071.734 1329, Tlx: 25572, Contact: Lawrence Safir.

SCREEN VENTURES, 49 Googde Street, London W1P 1FB, 071.580 7448, Fax: 071.631 1265, Tlx: 8951182 geloms, Contact: Christopher Mould.

SOLOMON AND PERES DISTRIBUTION, 120 Coach Road, Templepatrick, Ballyclare, County Antrim BT39 0HB, 08494.32711/32693, Fax: 08494.32800, President: Mervyn Solomon, MD: Richard Solomon.

SONY MUSIC OPERATIONS (UK), Rabans Lane, Aylesbury, Buckinghamshire HP19 3BX, 0296.26151, Fax: 0296.81009, MD: David Black, MIS Dir (UK & Eur): David Barrie, Fin Serv Dir: Peter Corbett, Comm Dir: Laurie Crow, Fin Dir: Jan Gach, Mfgt Dir: Lionel Smithers, Distr Dir: Fred Whittle. Labels (distr): Ariel Films, Braveworld, Buona Vista, CIC, Entertainment in Video, First Independent Films, High Fliers, Island World Communications, Odyssey, RCA/Columbia Pictures Video, Sony Music Videos.

SPAN PICTURES, 35-36 Oxford Street, Oxford House, Southampton, Hampshire SO1 1DS, 0703.222 429, Fax: 0703.635 526, Contact: Phillip Goodhand-Tait.

SPORTS/LEISURE NETWORK, 5 Factory Lane, Croydon, Surrey CR9 3RA, 081.781 6444, Fax: 081.681 2340, MD: Frazer Ashford, Snr Producer: Julia Bartle.

SR PROGRAMS INTERNATIONAL, 98 Mount Street, London W1Y 5HF, 071.493 2400, Fax: 071.629 1696, Tlx: 929970, Contact: Susan Darer.

TALBOT TELEVISION, 7c-d Bayham Street, London NW1 0EY, 071.380 1189, Fax: 071.383 5369, Tlx: 298477, Contact: Peter Baker.

TELEVISION SPORT & LEISURE, 40 Sloane Street, London SW1X 9LP, 071.235 1813, Fax: 071.259 6510, Tlx: 919703, Contact: Carolyn Viccari.

TELSON INTERNATIONAL, 84 Buckingham Gate, London SW1E 6PD, 071.976 7188, Fax: 071.976 7113, Tlx: 919225, Contact: Bernard Macleod.

TKO COMMUNICATIONS, PO Box 130, Hove, East Sussex BN3 6OU, 0273.550 088, Fax: 0273.540 969, Chmn: J S Kruger, GM: Peter Hazelwood.

TRANSATLANTIC FILMS, 100 Blythe Road, Blythe Hall, London W14 0HE, 071.727 0132, Fax: 071.603 0668, Contact: Revel Guest.

UNITED MEDIA, 14-17 Wells Mews, 4th floor, London W1A 1ET, 071.580 5586, Fax: 071.323 0464, Tlx: 262384, Contact: John Wolstenholme.

VISION VENTURES INTERNATIONAL, 12 Neals Yard, London WC2H 9DP, 071.379 0733, Fax: 071.379 0117, Contact: Joseph McCann.

WARNER HOME VIDEO (UK), 135 Woodour Street, London W1V 4AP, 071.494 3441, Fax: 071.494 3297, Contact: Barry Humphreys.

WIENERWORLD, 90 Old Church Lane, Stanmore, Middlesex HA7 2RR, 081.954 8777, Fax: 081.954 2999, Tlx: 94014029 wrwd, MD: Ian Wiener, Bus Affairs Dir: Anthony Broza. Video distributor of music & promo videos.

WORKHOUSE, St. Peter Street, Granville House, Winchester, Hampshire SO23 9AF, 0962.63449, Fax: 0962.841 026, Tlx: 477987, Contact: Louise Herbert.

RECORD DISTRIBUTORS

ABOUT TIME RECORDS, 68 Wharton Avenue, Sheffield, Yorkshire S31 0SA, 0742.879 882, Fax: 071.482 3444, A&R/Promo Mgr: Mike Ward, Fin/Design Dir: Jaffa. Distribute US independent Black/Soul records, also promote independent US labels; Main product: Dance, Black (R&B).

ACD TRADING, 378-388 High Rd, Chapmans Estate, Unit 2, London NW10 2DY, 081.451 4494, Fax: 081.451 4495, GM: Richard Stern. Formats: CD, CD Singles, Vinyl Albums, Vinyl Singles, Cassettes, Cassette Singles, Music Videos; Main product: Adult Contemporary, Classical, Dance, Album Rock, Gold/Oldies, Black (R&B); Other: overstocks, deletions.

AMT DISTRIBUTION, 27 Windsor Road, Wraysbury, Staines, Middlesex TW19 5DE, 0784.482 551/681, Fax: 0784.482 203.

APT DISTRIBUTION, 74 Eldon Street, York, North Yorkshire YO3 7NE, 0904.611 656, Fax: 0904.644 190, GM: Peter Thompson, Sales/Mktg Mgr: Andy Stephenson, Label Mgr: Gerard Myers. Labels (distr): Play It Again Sam, Imaginary, Some Bizarre, Tomato, Kitchenware, Crpescule, Merciful Release, Probe Plus, Way Cool, Network, Who's That Beat, Unicorn, Cheree, Nation, Receiver; Main product: Dance, Adult Contemporary, Album Rock, Indie.

ARABESQUE RECORDS, 29-39 Stirling Road, Network House, London W3 8DJ, 081.993 5966, Fax: 081.992 0340, MD: Terry Winsor, Export Mgr: Fran Beckertes, Import Mgr: Brian Horne, Sales (UK): Arthur Richmon, Distr Mgr: Raj Arora, Mgr (Export): Amanda Bells. Labels (distr): Success, Masters, All Time, Telstar, Wesgram, Pickwick, Castle, President, Red Lightning, Emerald, Tring Int'l, Sovereign, Link Records; Also distribute Music Calendars for: Danilo, Culture Shocks.

AUDIO MERCHANDISERS/SOTOSOUND, Forest Road, Forest Works, Units 1-2, London E17 6JF, 081.523 2981, Fax: 081.523 3202, MD: Chris Webb, Sales Dir: Graham Lambdon. Rackjobbers & wholesalers.

AVANTI RECORDS, Spitfire Way, Airlinks Ind Est, Unit 11, Heston, Middlesex TW5 9NR, 081.848 9800, Fax: 081.756 1883, MD: Paul Weiss, GM: David Dunn.

BACKS RECORDS, St. Mary's Plain, St. Mary's Works, Norwich, Norfolk NR3 3AF, 0603.626 221/624 290, Fax: 0603.619 999, Label Mgr: Derek Chapman, Sales Mgr: Chris Evans, Int'l Mgr: Mary Creed. Labels (distr): Aldabra, Vox Bomp, Reckless, Backs, Arishma, Multitone, Ichiban, Lost Moments, Re-Elect The President, Power of Voice, Survival, Small Wonder, Wau MR Mood, and others.

BMG OPERATIONS (DEPOT), Lyng Lane, West Bromwich, West Midlands B70 7ST, 021.500 5545, Fax: 021.553 6880, Tlx: 336072, Distr/Op Dir: John Henderson. Labels (distr): Action Replay, A1, Anxious, Ariola, Arista, Arista Diamond Series, Beatrice, Big Wave, Bluebird, Bros. Org, Caroline, Castle Communications, Champion Records, Chess, Coconut, Complete Records, DDD, DGC, De Construction, Deutsche Harmonia Mundi, Different Class, Editio Classica, Dedicated, Diva, Equinox, Eurodisc, Fanfare, Flair, Freestyle, Funki Dreds, GRP, Geffen, Gordy, Greensleeves, Grunt, Happy Learning, Heart, IQ Records, IRS, Icy, Jive, Joba, Kaz, Knight, Lamplight, Lazy Recordings, Logic, Loud, Lumina, MCA, Masterpiece, Melt-down, Memoir, Motown, MSA, Music Factory, Music Factory Dance, Noise, Novus, Perfecto, Omen Recordings, Polo, Pop & Art, Prelude, Private Music, RCA, RCA Diamond Series, RCA Jazz Tribune, RCA Victor, RCA Victor Gold Seal, RCA Victor Opera Series, RCA Victor Papillon Collection, RCA Victor Red Seal, RCA Victor Seon, RCA Victor Silver Seal, RCA Victor Van Cliburn Collection, RCA Victrola, Rumble Records, Sacred, Sequel, Solar, Sonic, Stefan, Strada, Strange Fruit, Survival, Swanyard, Taj Records, Tania Motown, Telstar, Tug, Viceroy, Wam, Yobro; Management address: 69-79 Fulham High Street [see entry under BMG Records (UK)]. BMG Operations is a division of BMG Records (UK).

CAROLINE INTERNATIONAL, 56 Standard Road, London NW10 6ES, 081.961 2919, Fax: 081.961 1873, MD: Jonathan Gilbride, GM: Nik Podgorski. Main product: all UK labels, pop, dance, classical imports.

CHARLY RECORDS, 156-166 Illderton Road, London SE15 1NT, 071.639 8603, Fax: 071.639 2532, Tlx: 8953184, E-Mail: 19022300, Chmn: Jean-Luc Young, MD: Tony Heneberry, Sales Dir: Alan Firth. Labels (distr): Bedrock, Black Top, Bullseye Blues, Celluloid, Chess, Clean Cuts, El Bando-neon, Flyright, Fresh Sounds, Green Line, Hands & Heart, Heartbeat, Hindsight, Hot Dots, Jambalaya, Jazz Band, Kicks 4 You, Le Jazz, Magnetic, Malaco, Minor Music, Palladium, Perfect Words & Music, Philo, Rhythm Attack Productions, Rockhouse, Rounder, Sketch, Smithsonian Folkway, Snatch, Submarine, Varrick, Wave, Waylo, Woodworm.

CHEAPO CHEAPO RECORDS, 53 Rupert Street, London W1V 7HN, 071.437 8272, MD: Mr. Cording.

CM DISTRIBUTION, 2-4 High Street, Starbeck, Harrogate, North Yorkshire HG2 7HY, 0423.888 979, Fax: 0423.885 761, Contact: John Fuller, Andrew Wheatstone. Main product: folk, blues, jazz, world music, reggae, country.

THE COMPLETE RECORD COMPANY, 2 Heppburn Mews, 63a Webbs Road, London SW11 6SE, 071.924 3174, Fax: 071.924 3114, MD: Jeremy Elliott. Labels distributed: Hyperion, Cala, Vanguard Classics, Ace Jazz, Channel Classics, Interphon, Verona, Lyric, EBS, Olympia, Caprise, Tuxedo, Harmonic (Swi), Simax (Nor), Pavane (Bel), Club '99 (USA), Prestige, Tropical (Ger), JSP Records; (Sub-distr under Olympia label): Mezhkniga (USSR), Polski Nagrania (Pol); Main product: Jazz, Classical, Opera.

CONTACT (UK), Fraser Road, Research House, Greenford, Middlesex UB6 7AQ, 071.997 5662-3, Fax: 071.997 5664-5, MD: Michael Lo Bianco, GM: Geoff Kite, Prod Mgr: Howard Williams. Exporter; Main product: AC, Reggae, Dance, Album Rock, Black (R&B), New Age; Also: music videos & merchandising.

CRUSADER MARKETING, Ivyhouse Lane, Haywood Way Unit 5, Hastings, East Sussex TN35 4PL, 0424.435 511, Fax: 0424.424 035, MD: Ray Murrell, Pieter Riley, Fin Dir: Lisa Donney. Labels (owned): Crusader Jazz, Masterworks; (Distr): King, Gusto, Jasmine, Stetson, Ace, Castle, Star-day, VFM, AIM, Musidisc, Carrer, Homeland, deleted products.

CSA RECORDS/DISTRIBUTION, 101 Chamberlayne Road, London NW10 3NP, 081.960 8466, Fax: 081.969 8920, Tlx: 8954958, MD: Clive Stanhope.

DEITRA MARKETING, 83 Clerkenwell Road, London EC1R 5HP, 071.250 0176, Fax: 071.730 8021, President: Terry Hollingsworth, MD: Trevor Hollingsworth, Company Sec: Caroline Poulton. Main product: Jazz, Reggae, Dance, Album Rock, New Age.

DEMI MONDE RECORDS, Foel Studio, Llanfair, Caereinion, Powys SY21 0RZ, 0938.810 749/952.883 962, Fax: 0952.728 176, MD: Dave Anderson, Sec: Julie Wareine.

DISCOVERY RECORDS, Kings Corner, Old Church Mission Room, Pewsey, Wiltshire SN9 5BS, 0672.63931, Fax: 0672.63934, MD: Mike Cox, Sales Mgr: Bill Trythall. Labels (distr): CBS Europe, Vogue, Arion, EPM, Buda, Tumi, Ode, Music Memoria; Main product: Jazz, World Music, Rock (back-catalogue).

DY-NA-MIX, 38 Church Street, The Old Fire Station, Fenny

Stratford, Milton Keynes MK2 2NY, 0908.270 811, Fax: 0908.270 822. Labels (distr): Underground Resistance, Plus +; Main product: Dance.

EMI MUSIC SERVICES (UK), 1-3 Uxbridge Road, Hayes, Middlesex UB4 0SY, 081.561 8722, Fax: 081.569 2214, Tlx: 934614 emirec, MD: Jim Leftwich, Head Of Sales: Alan Williams. Labels (distr): HMV Records, Capitol Records, Parlophone Records, Synopate Records, Roulette Records, Manhattan Records, Lifetime Records, Starline Records, Liberty UK, Hour of Pleasure, Music for Pleasure, Classics for Pleasure, Eminence, Fame, Music for Pleasure Duo, Music for Pleasure Trio, Listen for Pleasure, Golden Age, Compacts for Pleasure, Laser MFP, Argo MFP, Premier MFP, EMI Records, EMI-Virgin Joint Venture, PMI, Jetstar, Chrysalis, Dover, Ensign, Cooltempo, Charity, SBK, EMI America, MGM Records, MMC Records, Engima, Liberty US, Power Records, HTD Records, MSP Projects.

ENTERTAINMENT UK, Blyth Road, Hayes, Middlesex UB3 1DN, 081.848 7511, Fax: 081.754 6603, MD: Jonathan Weeks, Comm Dir: Ken Lewis, Operations Dir: Richard Cowan, Head Of Sales: Nick Wenham, Head Of Music Buying: Eddy Cunningham, Video Buying Mgr: Richard Green, Mktg Contr: Les Willis. Wholesaler, rackjobber.

ESSEX RECORD DISTRIBUTION, 71 High Street, Billericay, Essex CM12 9AS, 0277.656 196, Chmn: W.B. Connell, Dir: A M Taylor. Labels (distr): Match Box, Hunter's Moon, Bedivere, Cromwell Audio, Redbridge.

EUROPEAN MUSIC SERVICES, Mark Road Industrial Estate, Unit 4, Hemel Hempstead, Hertfordshire HP2 7BN, 0442.232 907, Fax: 0442.232 813, MD: Barry Ereira, Comm Dir: Mike Denton, Sales Dir: Chris Denton. Main product: Album Contemporary, Jazz, Country, Reggae, Dance, Album Rock, Gold/Oldies, Black (R&B), New Age.

GORDON DUNCAN RECORD & TAPE DISTRIBUTION, 9 Market Place, Inverurie, Aberdeenshire AB5 9PU, 0467.21517, Contact: Gordon Duncan, Colin Morrison. Main product: over 60 Scottish labels.

GREAT WESTERN RECORDS, London Road, Rock House, St Mary's, Chalford, Gloucestershire GL6 8PU, 0453.886 252, Fax: 0453.885 361, President: John Beecher, MD: Sandi Beecher. Main product: 60's & 70's soul on original labels.

GREENTRAX RECORDS MAIL ORDER, 3 Morven Street, Edinburgh, Lothian EH4 7LG, 031.339 4567, Fax: 031.339 8575, Owner: Ian David Green. Formats: CDs, Cassettes, Vinyl, Music video's; Main product: Scottish Traditional, World Music.

GREYHOUND RECORDS, 130a Plough Road, London SW11 2AA, 071.924 1166, Fax: 071.924 1471, MD: John Wright, Dirs: Paul Callaghan, Tony Hickmott, Distr Mgr: Daniel Ryan, Buyers: Mike Maguire, Andy Marriott. Labels (distr): Shimmy Disc, Schemer, Buy Our Records, Skyywalker, Resonance, Deep End, Kold Sweat, Expansion, Surka Records, Ardal Discs, Eva, Mantra, Revenge, Trash Can; Main product: rock, dance music.

GRS DISTRIBUTION, Chestow Street 3, Canada House, Manchester M1 5EN, 061.236 5368/9, Fax: 061.236 7287, MD: Anne Geotz, GM: Dave Annis, Sales Mgr: Jane Evans.

INGRAM ENTERTAINMENT, 103 Bashley Road, Park Royal, London NW10 6SD, 081.965 5555, Fax: 081.961 8040, MD: Raymond Laren, GM: Vaughan Bendall.

JET STAR RECORDS, 155 Acton Lane, London NW10 7NJ, 081.961 5818, Fax: 081.965 7008, MD: Carl Palmer. Importer, exporter. Main product: Dance music, reggae, soca.

KINGDOM RECORDS, 119 The Broadway, Crown House, London NW2 3JG, 081.208 4448, Fax: 081.208 4343, MD: Terry King. Labels (distr): Kingdom, Kingdom Jazz, Cavalier, Killerwatt, Bandit, Twinkle, Shaka, Mixing Lab.

KOCH INTERNATIONAL (UK), 23 Warple Way, London W3 0RX, 081.749 7177, Fax: 081.749 7124, MD: Klemens Kunderlitz, A&R/Mktg: Keith Shadwick. Labels (distr): Calig, Bayer, Inak, Northeastern, Divox, Black & Blue, New World, Black Lion, Candid, Europa Musica, Freedom, Autographe, Aurophon, Supraphon, Gallo, GHA, Ondine, ASV, Duvidis, Factory, Mainstream, Shanachie, Yazoo, Multisonic, Gothic; Main product: Classical, Jazz, Nostalgie, World Music.

KONGO RECORDS, 146 Manor Park Road, London NW10 4JP, 081.453 0638, Fax: 081.453 0428, MDs: Byron Lye-Fook, Root Jackson.

LASGO EXPORTS, 378-388 High Rd, Chapmans Estate, Unit 2, London NW10 2DY, 081.459 8800, Fax: 081.451 5555, Tlx: 22111, MD: Peter Lassman, Dir: Nick Lassman, Mgr: Stuart Mudd, Sales Mgr: Charlie Paulinski, Head: Martin O'Donnell. Main product: Dance, Album Rock, Jazz, Gold/Oldies, Country, Black (R&B), Reggae, Classical.

LIGHTNING EXPORTS, Forest Road, Forest Works, Units 1-2, London E17 6JF, 081.503 2030, Fax: 081.527 9757, Sales Dirs: Graham Lambdon, Michael Gething. Exporter/importer worldwide.

LISMORE RECORDINGS, 27-29 Carnoustie Place, Scotland Place, Glasgow, Strathclyde G5 8PH, 041.420 1881, Fax: 041.420 1892, MDs: Ronnie Simpson, J Andrew Harvey, A&R: Bob McDowall, Accts: Kate Sena. Labels: all Scottish labels exported incl: Temple, Iona, Ridge, Scotdisc, Greentrax, Ross, Kettle, Dunkeld, Lapwing, Springthyme.

MICHELE INTERNATIONAL, Roebuck Road, The Acorn Centre, Unit E, Hainault, Essex IG6 3TU, 081.500 1819, Fax: 081.500 1745, Tlx: 893334 dial, MD: Terry Denoff.

MOVEMENT SOUL, 14 Comlan Street, London W10 6AR, 081.968 0228, Fax: 081.968 0697, MD: Martin West, Sales Dir: Kevin Birchall, Admin Mgr: Andrew McKay. Main product: dance music.

Please enter my **Billboard** subscription—**SAVE \$34** off the newsstand price

Name _____
 Title _____
 Company _____
 Address _____ Apt. No. _____
 City _____ State _____ Zip _____

\$ _____ Total Amount Enclosed Bill me
 Charge my credit card as follows:
 American Express Visa Master Card
 Card Expires _____
 Card Number _____
 Signature _____
 New Renewal CA residents: Please add applicable sales tax
 I do not wish to receive promotional material from other mailers.

In order to process your order we must receive your business classification. Please indicate your primary industry function in the correct box. Thank you.

- Billboard Classifications**
- | | |
|---|--|
| <input type="checkbox"/> 01. Retailers of records, CDs tapes, video/computer software, communications hardware | <input type="checkbox"/> 05. Studios, pressing plants, video and film industries |
| <input type="checkbox"/> 02. Distributors of records, tapes, CDs and software including rack jobbers, one stops | <input type="checkbox"/> 06. Artists, managers, agents, attorneys |
| <input type="checkbox"/> 03. Radio, discos, TV Cable personnel | <input type="checkbox"/> 07. Concert promoters, concert facilities |
| <input type="checkbox"/> 04. Manufacturers of records and software, including recording | <input type="checkbox"/> 08. Music fans |
| | <input type="checkbox"/> 09. Music publishers, unions, industry associations |
| | <input type="checkbox"/> 10. Mass merchandisers |
| | <input type="checkbox"/> 11. Other (Please be specific) _____ |

For Immediate Action
 Call Toll Free 1-800-247-2160
 In Iowa 1-800-362-2860

Please allow 6 weeks for delivery of first issue.

- Domestic**
- | | |
|--|-------|
| <input type="checkbox"/> 1 year (51 issues) | \$199 |
| <input type="checkbox"/> 6 months (26 issues) | 115 |
| <input type="checkbox"/> 2 years (102 issues) | 325 |
| <input type="checkbox"/> 1 year (First Class) | 310 |
| <input type="checkbox"/> Alaska (First Class Only) | 310 |
- Canada**
- | | |
|---|------------|
| <input type="checkbox"/> 1 year | \$205 U.S. |
| <input type="checkbox"/> 6 months | 125 U.S. |
| <input type="checkbox"/> 1 year First class | 325 U.S. |
- Overseas—1 year**
- | | |
|---|----------|
| <input type="checkbox"/> Australia & New Zealand (Air Jet) | \$340 |
| <input type="checkbox"/> Central America & Caribbean (Air Mail) | 325 |
| <input type="checkbox"/> Mexico (Air Mail) | 325 |
| <input type="checkbox"/> South America (Air Mail) | 390 |
| <input type="checkbox"/> Continental Europe (Air Mail)** | \$183 |
| <input type="checkbox"/> Asia, Africa & all others | 483 |
| <input type="checkbox"/> Japan (Air Mail) | Y102.000 |
- ** Send to Billboard
 Quadrant Subscription Service Ltd.
 Perrymount Road, Haywards Heath,
 West Sussex, England



Q1116

BILLBOARD'S ESSENTIAL REFERENCE GUIDES

International Buyer's Guide

1992 Edition. Worldwide listings include key people, address, phone number and marketing information of record and video companies, music publishers, distributors, manufacturers and suppliers. Also manufacturers and wholesalers of hardware, software and accessories for Compact Disc and Video.

International Talent & Touring Directory

1992 Edition. The source for U.S. and international talent, booking agencies, facilities, services and products. Used by everyone who buys and books talent—promotes and manages tours.

International Recording Equipment and Studio Directory

1992 Edition. All the information you need on professional recording equipment, recording studios and recording studio equipment.

Tape/Disc Directory

1991 Edition for the CD, Record and Audio/Video Industries. Professional services and supplies for record, audio and video manufacturers, audio and video tape manufacturers, video program suppliers and buyers, video music producers and production facilities.

Record Retailing Directory NEW

1991 Edition. The industry's first and only comprehensive directory of independent music stores and chain operations across the USA—contains over 7,000 listings.

Country Music Sourcebook

1991 Edition. Personal managers, booking agents, performing artists, radio stations, venues everyone involved in Country Music.

Return this coupon to: BILLBOARD Directories, P.O. Box 2016, Lakewood, NJ 08701

Please add \$3 per directory for S&H, for foreign orders please add \$8

Copies Price S&H Total (includes S&H)

- _____ International Buyer's Guide—\$75.00 (8230-8044-7)
 _____ International Talent & Touring Directory—\$67.00 (8230-8042-0)
 _____ International Recording Equipment and Studio Directory—\$37.00 (8230-8043-9)
 _____ Tape/Disc Directory—\$32.00 (8230-8040-4)
 _____ Country Music Sourcebook—\$33.00 (8230-8041-2)
 _____ Recording Retailing Directory—\$85.00 (8230-7595-8)

NAME _____

COMPANY NAME _____

ADDRESS _____

CITY _____

STATE _____

ZIP _____

TELEPHONE _____

Enclose check or money order or charge to your credit card:

American Express MasterCard VISA

Card # _____

Exp. Date _____

Signature _____

Add appropriate sales tax in NY, NJ, CA, TN, MA, IL and DC. Foreign and Canadian orders payable in U.S. Funds only.

Call Toll Free (orders only) 1-800-344-7119

In New Jersey, call (908) 363-4156

Please allow 6 weeks for delivery of first issue

BDBG1091

Billboard Directories are indispensable reference sources. They are, in fact, the main sources of vital information for the entire Music/Record/Tape and Video Industries.



LISTING CORRECTIONS OR ADDITIONS?

- I'd like to be listed in next year's directory. Please send me a questionnaire.
- We have moved, please note our new address.
- The information listed about my company needs revision.
- Please send me advertising information.

Name _____

Title _____

Company Name _____

Business Category _____

Address _____

City _____

State _____

Zip _____

Telephone Number () _____

Fax Number () _____

IBG92



NO POSTAGE
NECESSARY
IF MAILED
IN THE
UNITED STATES

BUSINESS REPLY MAIL
FIRST CLASS PERMIT NO. 642 MARION, OH

POSTAGE WILL BE PAID BY ADDRESSEE

Billboard

SUBSCRIPTION DEPT
PO BOX 2011
MARION OH 43306-2111



NO POSTAGE
NECESSARY
IF MAILED
IN THE
UNITED STATES

BUSINESS REPLY MAIL
FIRST CLASS MAIL PERMIT NO. 72 LAKEWOOD, NJ

POSTAGE WILL BE PAID BY ADDRESSEE

Billboard

Directories
PO Box 2016
Lakewood NJ 08701-9882



Place
stamp
here

Daniel Bale
BPI Communications, Inc.
Directories Central
P.O. Box 24970
Nashville, TN 37202

MUSIC GALORE, 29 Beethoven Street, London W10 4LG, 081.960 1871, Fax: 081.969 1694, MD: Brian Leaf. Labels (distr): Red Hot, Aftermath, Lick, AMP, Press, Press Avant; Main product: Album Rock.

NEW NOTE DISTRIBUTION, Seven Oaks Way, Unit 2 Orpington Estate, Orpington, Kent BR5 3SR, 0689.877 884, Fax: 0689.877 891, MDs: Graham Griffiths, Eddie Wilkinson. Labels marketed: ECM, GRP, Concord, JVC, Landmark, Nuova Era, New Sound Planet, Paddlewheel, Electric, Bird, Mole Jazz, Hot House, Loose Tubes, Jazz House, Messidor; Distribution: Pinnacle Records.

OBJECT ENTERPRISES, Caxton Way, Strand/VCI House, Watford, Hertfordshire WD1 8UF, 0923.55558, Fax: 0923.816 880, MDs: Mark Frey, Phil Robinson, Peter Stack, Fin Dir: Sue Stubbs, Mgr (Export): Steve Fruin, Sales Mgr (UK): Darren Ridgwell, Prod Contr: Karen Jones. Main product: mid price, budget CD's/cassettes.

OLD GOLD RECORDS, The Hyde Industrial Estate, Unit 1b, London NW9 6JU, 081.200 5335, Fax: 081.205 0109, Tlx: 264597 oldgold, MDs: Keith Yershon, Brian Gibbon, Sales Mgr (Export): Danny Keene, Sales Dev Mgr: Bob Lewis, Label Mgr: Michael Neudis.

OLDIES UNLIMITED, Dukes Way, St. Georges, Telford, Shropshire TF2 9NQ, 0952.616 911, Fax: 0952.620 361, MD: Anthony Lewis. Importer, exporter. Main product: overstocks, deleted product.

PANTHER MUSIC, 378-388 High Rd, Chapmans Estate, Unit 4, London NW10 2DY, 081.459 1234, Fax: 081.459 1119, MDs: Aniff Allybokus, Trevor Reidy, Sales Mgr: Neil Kellas. Main product: overstocks, deleted products, US imports, UK chart lines.

PICKWICK INTERNATIONAL, The Hyde Industrial Estate, Unit 1b, London NW9 6JU, 081.200 7000, Fax: 081.200 8995, Tlx: 922170, Chmn: Ivor Schiosberg, A&R Mgr: Monty Lewis, Sales/Mktg Dir: Garry Ie Count, Sales Mgr (Export): Mike Diplock.

PINNACLE RECORDS, Cray Avenue, Electron House, St. Mary's Cray, Orpington, Kent BR5 3PN, 0689.870 622, Fax: 0689.878 269, MD: Steve Mason, Dir: Sean Sullivan, Operations Mgr: Alan King, Sales Mgr: Steve Dickson, A&R/Label Mgr: Dominic Jones. Labels (distr): China, Creation, Dino, Factory, Non Fiction, One Little Indian, Demon, GWR, Legacy, Produce, Roadrunner, Desire, Network, Music of Life, BBC Enterprises, Ace, Hannibal, See For Miles, Abstract, and others; Main product: all formats carried, including Film Soundtracks, Spoken Word.

PLASTIC HEAD MUSIC DISTRIBUTION, Old London Road, Atlanta House, Benson, Oxfordshire OX10 6PL, 0491.25029/26233, Fax: 0491.26320, Dir: Steve Beatty, Label Mgr: Dave Ellesmere, Company Sec: Elaine Sutcliffe. Main product: Independent/Hard Core.

POLYGRAM OPERATIONS UK, Grove Road, Clyde Works, PO Box 36, Chadwell Heath, Romford RM6 4QR, 081.590 6088, Fax: 081.597 1011, Operations Dir: Eric Wordsworth, GM: John Meer, F&A: Marcus Wallis.

PRIORY RECORDS, Airfield Estate, Unit 25, Marston, Tring, Hertfordshire HP23 4QR, 0296.662 793, Fax: 0296.662 650, Partners: Neil Collier, P Crichon, Sales Admin: H Ferguson. Labels (distr): Motette, Fy, CPO, DaG, Cybelia, Ottavo, Prezioso, Christophoros, Pyramid, Regent, Mirabius, Stoltice, Festivo, Woodward, Miltra, Tudor, Fone; Main product: Classical.

PRISM LEISURE CORPORATION, Baird Road, Unit 1, Enfield, Middlesex EN1 1SQ, 081.804 8100, Fax: 081.805 8001, MD: Ivor Young, Sales Dir: Steve Brink, Sales Mgr: Lawrence Kuttner, Simon Checketts. Labels (distr): BR Music, Tring International; Main product: Country, MOR, Irish.

PROJECTION RECORD DISTRIBUTION, 19 Mount Pleasant, Crewkerne, Somerset TA18 7AH, 0460.74551/77444, Fax: 0460.73988, Contact: David & Ellie Hatfield. Labels (owned): Waterfront Records; Main product: Roots, Folk, Blues, World, Country.

RARE RECORDS, 13 Bank Square, Wilmslow, Cheshire SK9 1AN, 0625.522 014, Fax: 0625.536 101, Chmn: Irving T Wilson, MD: Alan Wilson, Dir: Lesley Thompson. Labels (distr): Campion, Baton, Ophelia, Opus, Euroson, JMP, Leman; Main product: classical, jazz, ethnic, MOR.

READER'S DIGEST ASSOCIATION, 25 Berkeley Square, Berkeley Square Hse, London W1X 6AB, 071.629 8144, Fax: 071.499 9751, Head Of Music: Tricia Killen.

RECOMMENDED DISTRIBUTION, 387 Wandsworth Road, London SW8 2JL, 071.622 8834, Fax: 081.682 3414, Distr Mgr: Howard Jacques, Mgr: Andrew Jacques, Label Mgr: Phil England. Labels (distr): Touch, Rec Rec, Sub Rosa, ReR, Recommended, Leo, Matchless, Victo, Ambiances Magnétique, Broadcast, Woolf, Ralph, No Man's Land, Made to Measure, Cuneiform, Staalplaat, Spoon; Main product: Avant-Garde, New Music.

REVOLVER DISTRIBUTION, 3 Dove Lane, St. Pauls, Bristol, Avon BS2 9HP, 0272.540 004, Fax: 0272.540 013, MD: M A Chadwick, Label Mgrs: Heather Simmonds, Debbie Cavanagh, Alan Hale, Sales Mgr: Penny Mitchell. Labels (distr): Cooking Vinyl, Earache, Peaceville, Lazy, Awareness, Tupelo, Three Stripe, Sarah, Subway, McQueen, Vinyl Drip, Acid Jazz, Ariwa, In Your Face, Product Inc, Strange Things, Heavenly, Pathological, Native, and many others.

RM ASSOCIATES, 46 Great Marlborough Street, London W1V 1DB, 071.439 2637, Fax: 071.439 2316, Tlx: 24549 rmaltdg, MD: Reiner Moritz.

ROLLERCOASTER RECORDS, London Road, Rock House, St. Mary's, Chalford, Gloucestershire GL6 8PU, 0453.886 252, Fax: 0453.885 361, Dir: John Beecher, J Allison, GM:

Yvonne Saunders. Main product: Rock'n'Roll, Country/Western.

ROSS RECORDS, 29 Main Street, Turriff, Grampian AB53 7AB, 0888.68899, Fax: 0888.68890, MDs: Gibson & Ann Ross. Labels (distr): Lismor, Klub, Ritz, Scotdisc, Play, Corries, House of Scotland, Harmac, Park Film, Bluebell, Edinburgh Tattoo, Aberdeen City Arts, Alba Creag, Ardo, Adam Rennie, Ardvenc, Currie Bros, Whirlie, Attic, AUK, Bracken Lads, Homespun, Culbriene, Stetson, Bjoro Haland, Bothy Lands, Sel, Dolphin, Ian Powerie, Dunkeld, Irish Heritage, Platinum, Emerald, Harper, Hawk (Dublin), Celtic, Pickwick, MFP, Runrig (Chrysalis), K-Tel (Ire), Music Box, Mary McCann, Grampian, Rainbow, Nabo, Telstar, Tring, Scotland The What, Springthyme, TC Records, Stebelin, Scotsoun, REL, Kettle, Eden, Donside, CJ, Rounder, Beechwood, Cairngorm Music, Linda Little, Mayker, Outlet, Pan, Connell, Greenxtr, Temple, Ridge, Green Linnel, Trimtop, Deay Music, BBC, Dino.

RTM, 339 Seven Sisters Road, London N15 6RD, 081.802 8696, Fax: 081.802 8142, MD: John Best. Sales, Marketing and Distribution company; over 50 labels distributed.

S GOLD & SONS (RECORDS), 69 Flempton Road, Gold House, London E10 7NL, 081.539 3600, Fax: 081.539 2176, MD: Barrie Gold, Export Mgr: Jonathan Gold, Sales Dir: Garry Elwood, Buyer: Stuart Persky. Exporter, wholesaler.

THE SALE PEOPLE, 213-218 Edward Place, London SE8 5HD, 081.692 0372, Fax: 081.694 9301, MD: Malcolm Mills.

SAVANNA SOUNDS, Quaker Coppice, Crewe, Cheshire CW1 1FA, 0270.589 321, Fax: 0270.587 438, MD: Michael Bates.

SKIRLING MUSIC/BIG-R RECORDS, 5 James Square, Biggar, Lanarkshire, Scotland ML12 6DL, 0899.20202, Fax: 0899.21020, MD: Drew Taylor.

SOLOMON AND PERES DISTRIBUTION, 120 Coach Road, Templepatrick, Ballyclare, County Antrim BT39 0HB, 08494.32711/32693, Fax: 08494.32800, Contact: Mervyn Solomon, Les R Paterson.

SONY MUSIC OPERATIONS (UK), Rabans Lane, Aylesbury, Buckinghamshire HP19 3BX, 0296.26151, Fax: 0296.81009, MD: David Black, MIS Dir (UK & Eur): David Barrie, Fin Serv Dir: Peter Corbett, Comm Dir: Laurie Crow, Fin Dir: Jan Gach, Manufacturing Dir: Lionel Smithers, Distr Dir: Fred Whittle. Labels (distr): Columbia, Def Jam, Go Bang, Rush Associated Labels, Epic, Rhythm King, ARS, Curb, Relativity, Combat, Solar, Soho Square, Sony Classical, Sony Masterworks, Arcade, Hollywood, Savage.

SOUND SOLUTIONS (UK), Purley Way, Mill Lane Estate, Unit 1, Croydon, Surrey CR0 4AA, 081.686 3636/6555 (orders), Fax: 081.681 8005/1388 (orders), MD: Peter Collins, Sales Dir: Philip Worsfold, Fin Contr: Tom Varughese, Operations Mgr: Robert Worsfold, Field Sales Mgr: Laurence Miele, Van Sales Contr: Alistair Baumgartner, Distr Mgr: Robert Harris, Merch Contr: Nick Blewett, Admin: Barbara Byron. Labels (distr): Happy Days, Rhino, major label non-UK imports; Also supply music & video overstocks and deletions to the retail music industry.

SOUTHERN STUDIOS, 10 Myddleton Road, London N22 4NS, 081.888 8949, Fax: 081.889 6166, Tlx: 268041 sthrm, MD: John Loder, Sales Dir: Allison Schnackenberg.

SP&S SALES/HERMANEX, 137a High Road, Loughton, Essex IG10 4LT, 081.508 3723, Fax: 081.508 0432, MD: Peter Harris, Sales Mgr: David Gadsby. Main product: deletions, overstocks.

SPARTAN RECORDS, London Road, Wembley, Middlesex HA9 7HQ, 081.903 4753/8223, Fax: 081.903 7853, MD: Thomas McDonnell, Contact: David G Thomas.

TARGET RECORDS, Cornwall Road, Target House, Croydon, Surrey CR9 2TG, 081.686 3322, Fax: 081.681 6523, MD: Laurie Adams.

TAYLOR'S, Hay Hall Road, 58 Rovey Business Park, Tulseley, Birmingham, West Midlands B11 2AQ, 021.765 4024, Fax: 021.765 4451, MD: Derek Wareham, Contact: Ian Summers.

TEESBEAT DISTRIBUTION, 10 South Road, Norton-on-Tees, Cleveland TS20 2ST, 0642.551 328, MD: John Hodgson. Labels (owned): Teesbeat, Smellytapes; (Distr): Smac Media; Main product: Reggae, Dance, Album Rock, Alternative/Indie.

TERRY BLOOD DISTRIBUTION/WYND UP, Rosevale Road, Parkhouse Est. Unit 18-20, Newcastle-Under-Lyme, Staffordshire ST5 7QT, 0782.566 566, Fax: 0782.565 400, Tlx: 367106, MD: Norman Smith, Sales/Mktg Dir: Dave McWilliams.

THAMES DISTRIBUTORS, Station Road, Thames House, Hampton, Middlesex TW12 2BT, 081.979 9033, Fax: 081.979 5055, Tlx: 296447 thames, Dir: Norman C Woolfson.

TRACK LEISURE DISTRIBUTION, 25 Castlereagh Street, Castle House, London W1H 5YR, 071.224 4473, Fax: 071.487 4759, MD: Paula Cushion.

VFM (CASSETTE DISTRIBUTORS), Faraday Road, Unit 21, Aylesbury, Buckinghamshire HP19 3RY, 0296.437 307, Fax: 0296.392 019, Tlx: 838705 tape, MD: Roy Jackson-Moore, Fin Dir: Michael McLoughlin, Sales Dir: Geoff Pearman.

WARNER MUSIC UK (WEMBLEY), Alpertown Lane, PO Box 59, Wembley, Middlesex HA0 1FJ, 081.998 8844, Fax: 081.998 3429, Tlx: 936460, Dir: Dennis Woods, Sales Dir: Geoff Beard, Comm Dir: Gwen Pearce.

WAVELENGTH, Wembley Comm Ctr, Building B, Unit 3, North Wembley, Middlesex HA9 7FH, 081.908 5229, Fax: 081.904 0221, Partner: James Ali.

WILCOX-ZODIAC RECORD COMPANY, 1099a Finchley Road, London NW11 0QB, 081.455 6620, Fax: 081.455 3128, MD: Herbert W Wilcox.

WINDSONG INTERNATIONAL, Cray Avenue, Electron House, St. Mary's Cray, Orpington, Kent BR5 3RJ, 0689.36969, Fax: 0689.836 969, MDs: Steve Bradley (Export),

Paul Hallett (Import), Sales Mgr: Carlton Sandercock. Importer/Exporter, Labels (distr): Connoisseur, Roir; Main product: CD's, LP's, video's, indies, overstocks, deletions, classical.

WORD (UK), 9 Holdom Avenue, Bletchley, Milton Keynes MK1 1QR, 0908.648 440, Fax: 0908.648 592, MD: Ian Hamilton, Comm Dir: David Withers, A&R Dir: David Bruce, Mktg: Jerry Johnson. Labels (distr): Benson, Brentwood, Sparrow, Star Songs, Maranathal, Hosanna/Integrity, Ocean, Warner Alliance, Broken, Frontline, Forefront, Viva, Arc, Royal; Main product: Gospel.

WORLD CIRCUIT, 18a Avenue Road, London N6 5DW, 081.347 9370, Fax: 081.347 9236, MD: Nick Gold.

RETAIL ACCESSORY SUPPLIERS

ATEKA TAPE RACKS, Station Road Industrial Estate, Unit 8, Hailsham, East Sussex BN27 2ER, 0323.845 880, Fax: 0323.843 366, Tlx: 87622 atypro, MD: G J Willamowski. Designer, maker, and distributor of display racks for CD's, music and video cassettes.

INTERNATIONAL DISPLAYS, 51 Ermine Street, Huntingdon, Cambridgeshire PE18 6EZ, 0480.414 204, Fax: 0480.414 205, Partners: Brian W Jones (Admin), David F Clark (Manu'), John C Findlay (Sales). Display racking systems.

LIFT (UK), Wendover Rd, Triangle Bus Park, Unit 13, Stoke Mandeville, Buckinghamshire HP22 5BL, 0296.615 151, Fax: 0296.612 885, MD: Robert Walker.

MIKE THORN DISPLAY AND DESIGN, Kings Avenue, Kings Place Unit 1, London N10 1PA, 081.442 0279, Fax: 081.442 0496, President: Mike Thorn, MD: Martin Brophy.

MUSICWARE EUROPE, Saxony House, Easthampnett, Chichester, Sussex PO18 0JY, 0243.775 419, Fax: 0243.776 327, MD: Christopher Aves, Mktg: Helena Swiderski. Computer systems.

OPTIONS INTERNATIONAL, North Street Workshops, Stoke-sub-Hamdon, Somerset TA14 QR, 0935.824 072, Fax: 0935.823 993, MD: D Collins. Designers of point of sale.

RARE RECORDS, 13 Bank Square, Wilmslow, Cheshire SK9 1AN, 0625.522 014, Fax: 0625.536 101, Chmn: Irving T Wilson, MD: Alan Wilson, Dir: Lesley Thompson.

SPONG RETAIL SYSTEMS, Field Road, Department 100, Mildenhall, Suffolk IP28 7AR, 0638.713 011, Fax: 0638.718 342, Sales Dir: P Whitmore.

UK DISPLAY, 100-102 Woodhouse Road, Leytonstone, London E11 3NA, 081.519 6232, Fax: 081.519 8564, Proprietor: Alan Wilson. Specializing in design & production of 3-dimensional point-of-sale material and nationwide display campaigns.

ASSOCIATIONS & PROFESSIONAL ORGANIZATIONS

THE ADVERTISING ASSOCIATION, 15 Wilton Road, Abford House, London SW1V 1NJ, 071.828 2771, Fax: 071.931 0376. Federation of 30 trade associations and professional bodies representing advertisers, agencies, the media and support services.

AGB AUDITS OF GREAT BRITAIN, Hangar Lane, Research Center, West Gate, London W5 1UA, 081.967 0007, Fax: 081.967 4060, Contact: Mark Booth.

AIRC, 46 Westbourne Grove, London W2 5SH, 071.727 2645, Fax: 071.229 0352, Tlx: 24543, Chmn: Richard Findlay, D: Brian West, Sec: Don Edserton, Mktg Exec: James Galpin. Association of independent radio contractors.

APRS, Silver Street, 2 Windsor Square, Reading, Berkshire RG1 2TH, 0734.756 218, Fax: 0734.756 216, Chmn: Rodger Bain. Chief Exec: Philip Vaughan. Association of Professional Recording Services (facilities/suppliers/consultants/etc.).

ASCAP (UK), 52 Haymarket, Suite 10-11, London SW1Y 4RP, 071.973 0069, Fax: 071.973 0068, Reg Dir: James Fisher. Performing rights organization.

ASP FREQUENCY MANAGEMENT, Edgcott House, Lawn Hill, Edgcott, Aylesbury, Bucks HP18 0QW, 0296.770 458, Fax: 0296.770 423, Chmn: Norman C Woolfson, Company Sec: Brian Copey. Organization licensed by the DTI to manage frequency allocations.

ASSN OF PROFESSIONAL VIDEO DISTRIBUTORS, PO Box 25, Godalming, Surrey GU7 1PL, 0468.423 429, Chmn: Hary Drake, Dir: Charles Potter. Organization ensuring that both purchaser and supplier receive quality video equipment.

BARB, Hammersmith Grove, Glenthorpe House, London W6 0ND, 081.741 9110, Fax: 081.741 1943, Chief Exec: Bob Hulks. Broadcasters audience research board; Parent company: BBC and ITV Association.

BARD, Blyth Road, Hayes, Middlesex UB3, 081.848 7511, Fax: 081.848 9769, Chmn: Brian McLaughlin, Vice-Chmn: Mike Sommers, Sec: Chris Ash, Sec-Gen: Bob Lewis. British Association of Record Dealers.

BASCA, 34 Hanway Street, London W1P 9DE, 071.436 2261/2, President: David Heneker, Chmn: Don Black, Gen Mgr: Eileen Stow. British Academy of Songwriters, Authors & Composers.

BECTU, 181-185 Wardour Street, London W1V 4BE, 071.439 7585, Fax: 071.434 3974, Gen Sec: Tony Hearn, Dep Gen Sec: Roy Lockett, Contact: David Cormack. Broadcasting entertainment and cinematograph technicians union.

BETA, 181-185 Wardour Street, London W1V 4BE, 071.439 7585, Gen Sec: D A Hearn. Trade union for non-performing grades in broadcasting, film, theater and related entertainment and cultural media.

BMI BROADCAST MUSIC INCORPORATED, Marylebone Road, 79 Harley House, London NW1 5HN, 071.935 8517, Fax: 071.487 5091, Dir: European Relations: Phil Graham, Snr Advisor: Bob Musel. US performing rights organization.

BOTB (BRITISH OVERSEAS TRADE BOARD), 52 Horseferry Road, London SW1P 2AG, 071.215 7877, Dir: Gerry Bradshaw.

BPI (BRITISH PHONOGRAPHIC INDUSTRY), 273-287 Regent Street, Roxburghe House, London W1R 7BP, 071.629 8642, Fax: 071.493 3667, Dir-Gen: John Deacon, Legal Affairs Dir: Sarah John, R&D Dir: Peter Scaping, Press/PR Dir: Jeremy Silver. Trade association for the British Record Industry.

BRITISH ASSOCIATION OF CONCERT AGENTS, 26 Wadham Road, London SW15 2LR, 081.874 5742, Fax: 081.877 0434, Contact: Thomas Ponsobly.

BRITISH COPYRIGHT COMMISSION, 29-33 Berners Street, London W1P 4AA, 071.580 5544, Fax: 071.631 4136, Tlx: 892678 prson, Contact: Lesley Bray.

BRITISH RADIO & ELECTRONIC EQUIPMENT ASS., Landseer House, 19 Charing Cross Road, London WC2H 0ES, 071.930 3206.

BRITISH TAPE INDUSTRY ASSOCIATION, 7-15 Landsdowne Road, Croydon, Surrey CR9 2PL, 081.688 4422, Fax: 081.881 2134, MD: A C Skipper.

BRITISH VIDEOGRAM ASSOCIATION, 22 Poland Street, London W1V 3DD, 071.437 5722, Fax: 071.437 0477, Dir: Norman Abbott.

BROADCASTERS' AUDIENCE RESEARCH BOARD, Hammersmith Grove, Glenthorne House, London W6 0ND, 081.630 5033, Fax: 081.741 1943, Chief Exec: Bob Hulks.

CABLE TELEVISION ASSOCIATION, Artillery Row, Artillery House, Floor 5, London SW11, 071.222 2900, Fax: 071.790 1471, Dir-Gen: Richard Wooliam.

CHART INFORMATION NETWORK (CIN), 245 Blackfriars Road, Ludgate House, 8th, London SE1 9UR, 071.334 7333, Fax: 071.928 2881, CEO: Adrian Wistreich. CIN commissions the UK charts for use by the BBC, world-wide radio, trade press and other media.

COMMUNITY RADIO ASSOCIATION, 119 Southbank House, London SE1 7DF, 071.582 8732/9792, Fax: 071.735 1555, Dir: Steve Buckley, Contact: Lorraine Carver.

COUNTRY MUSIC ASSOCIATION, 52 Haymarket, Suite 3, London SW1Y 4RP, 071.930 2445, Fax: 071.930 2446, Dir (Eur): Martin Satterthwaite, Asst: Laura Buckley.

ENTERTAINMENT AGENTS ASSOCIATION, Dolphin Square, Keyes House Unit 4, London SW1V 3NA, 071.834 0515, Fax: 071.821 0261, Sec Gen: Gordon Blackie.

GUILD OF INT'L SONGWRITERS & COMPOSERS, 12 Trewartha Road, Sovereign House, Praa Sands, Penzance, Cornwall TR20 9ST, 0736.762 826, Fax: 0736.763 328, Membership Secretary: Carole A Jones. Int'l organization offering advice to guild members: promotion of songs; recording, publishing & management contracts; legal advice; copyright; song assessment service; demonstration recording service. Members receive the quarterly magazine 'Songwriting and Composing'. Other facilities: world-wide music industry reference library, artists & company directory.

IFPI, 54 Regent Street, London W1R 5PJ, 071.434 3521, Fax: 071.439 9166, Tlx: 919044, President: John Morgan, Chmn: David Fine, Dir Int'l Ops & Legal Affairs: Nick Garnett, Dir-Gen: Ian Thomas, F&A Dir: Trevor Pearcey, Legal Advisers: Philippe Kearn, Ian Haffey, Anti-Piracy Officer: Funkazi Korye, Press Officer: Mark Kingdon. International Federation of the Phonographic Industry.

INCORPORATED SOCIETY OF MUSICIANS, 10 Stratford Place, London W1N 9AE, 071.629 4413, Fax: 071.408 1538, Chief Exec: Neil T Hoyle, Admin Dir: Dominic McGonigal. Professional association for musicians (performers, composers, teachers, students, etc). Offering legal and professional advice, insurance, seminars & conferences, monthly music journal.

THE INDEPENDENT RADIO AUTHORITY, 70 Brompton Road, London SW3 1EY, 071.584 2888/7011, Fax: 071.589 1529, Chmn: Lord Chalfont, Chief Exec: Peter Baldwin, Deputy Chief-Exec: Paul Brown, Press Officer: Tracey Mullins. Licensing & regulatory body.

INDEPENDENT TELEVISION ASSOCIATION (ITV), 56 Mortimer Street, Knighton House, London W1N 8AN, 071.636 6866, Fax: 071.580 7892, Chmn: Richard Dunn, MD: David Shaw. Association representing the 16 UK independent programme companies.

INDEPENDENT TELEVISION COMMISSION, 70 Brompton Road, London SW3 1EY, 071.584 7011, Fax: 071.589 5533, Tlx: 24345, Chmn: George Russell, Chief Exec: David Glenross, Dep CE: Peter Rogers.

IPPA, 50-51 Berwick Street, London W1V 4RA, 071.439 7034, Fax: 071.494 2700, Dep: Fred Hasson, Publications Mgr: Janet Watson. Independent Production Producers Association, representing 700 TV production companies throughout the UK in negotiations with broadcasters.

JAZZ CENTRAL, Navigation Street, 29-30 Guildhall Bldg, Birmingham, West Midlands B2 4BT, 021.632 4921, Fax: 021.643 4804, Admin: Sam O'Sullivan, Dir: Alan James, Membership Secretary: Dorothy Jones. Assistance organization for jazz activity in Midlands region (financial, marketing, etc). Membership scheme. Some direct promotion.

MECHANICAL-COPYRIGHT PROTECTION SOCIETY, 41 Streatam High Road, Elgar House, London SW16 1ER, 081.769 4400, Fax: 081.769 8792, Tlx: 946792, MD: Frans de Wit, Comm Ops: Graham Churchill, Lic Contr: Mark Isherwood, Corp PR: Julia Heddin. Mechanical Copyright Protection Society.

MIDEM ORGANISATION, 22 Percy Street, Metropolis House,

London W1P 9FF, 071.528 0086, Fax: 071.895 0949, Tlx: 920173, MD: Peter Rhodes, UK Administrator: Debbie Carney.

MIRIB, Fitzhugh Grove, RVP Building, London SW18 3SX, 081.874 6466, Fax: 081.877 3628, MDs: Daffy Rees, Barry Lazell. Media Research Information Bureau; compilation of music, video, film, theatre charts.

MUSIC PUBLISHERS ASSOCIATION, 103 Kingsway, 7th floor, London WC2B 6QX, 071.831 7591, Fax: 071.242 0612, Sec: Peter Dadsweil, Asst Sec: Janice Cable.

MUSICIANS UNION, 60-62 Clapham Road, London SW9 0JJ, 071.582 5566, Fax: 071.582 9805, Tlx: 8814691, Sec: Dennis Scard.

NATIONAL DISCOGRAPHY, 41 Streatam High Road, Elgar House, London SW16 1ER, 081.769 4400, Fax: 081.769 8792, Tlx: 946792, Database Contr: Godfrey Rust.

NATIONAL TRANSCOMMUNICATIONS, Crawley Court, Winchester, Hampshire SO21 2QA, 0962.823 434, Fax: 0962.822 378, MD: John Forrest. Organization maintaining broadcasting transmitters.

THE ONE SHOW, c/o APRS, 2 Windsor Square, Silver Street, Reading RG1 2TH, 0734.756 218, Fax: 0734.756 216. Pro audio industry show; Showcase of products and systems for recording, broadcasting, post-production and sound reinforcement.

PHONOGRAPHIC PERFORMANCE LTD (PPL), 14-22 Ganton Street, London W1V 1LB, 071.437 0311, Fax: 071.734 9797, Chmn: John Brooks, MD: John Lowe, PR: Jeremy Moynihan, Head of Gen Lic: David Newham, Mgr (Music Sys)/BPI Liaison: Rehan S Khan, Head Of Broadcasting: Peter Rogers.

PRS PERFORMING RIGHT SOCIETY, 29-33 Berners Street, London W1P 4AA, 071.580 5544, Fax: 071.631 4136, Tlx: 892678, President: Vivian Ellis, Chief Exec: Michael Freegard.

RADIO ACADEMY, PO Box 4S2, London W1A 4S2, 071.323 3837, Dir: Lin Glover, Admin: Ann James. Educational center for the radio broadcasting industry.

SCOTTISH RECORD INDUSTRY ASSOCIATION, New Street, Canongate Venture, Unit 5, Edinburgh EH8 8BH, 031.556 0728, Fax: 031.556 0731, Chmn: Robin Morton, Admin: Shirley-Ann Simpson.

SOCIAL SURVEYS (GALLUP POLL), 307 Finchley Road, London NW3 6EH, 071.794 0461, Fax: 071.431 0252, Tlx: 261712 gallup, MD: Gordon Heald, Charts Dir: Graham Dossett, Charts Mgr: John Pinder.

THE SOCIETY OF AUTHORS, 84 Drayton Gardens, London SW10, 071.373 6642, Fax: 071.373 5788, Contact: Oliver Fryer.

SOUND & COMMUNICATIONS INDUSTRIES FED, 4b High Street, Burnham, Slough, Berkshire SL1 7JH, 0628.667 633, Fax: 0628.665 882, Chief Exec: Ken Walker, Exec Admin: Brenda White, Membership Secretary: Angela Quartermaine. Trade Association in the public address and sound reinforcement industries, including the Institute of Sound & Communications Engineers, the Sound & Communications Suppliers Association. Individual membership available through the Institute.

TAC-WELSH INDEPENDENT PRODUCERS, Gronant, Caernarfon, Gwynedd, 0286.671 123, Fax: 0286.77449, Contact: Sion Pyrs.

TRADITIONAL MUSIC AND SONG ASSOCIATION, 10 Belmont Street, 4th floor, Aberdeen, Grampian AB1 1JE, 0224.632 978.

UMBRELLA ORGANIZATION, PO Box 297, London SE24 0NH, 081.960 1871, Fax: 081.969 1694, Members: Brian Leaf, Dave Loader, Peter Jenner, Ian Binnington, Janelle Garthwaite, Kenny Addison, Tony Engle. Independent record labels trade organization.

VIDEO PERFORMANCE (VPL), 14-22 Ganton Street, London W1V 1LB, 071.437 0311, Fax: 071.734 9797, Chmn: John Brooks, Consultant Dir: Roger Drage, Sr Licensing Mgr: Ross Penney, Admin Mgr: Jane Samuels.

VIDEO TRADE ASSOCIATION, 54d High Street, Northwood, Middlesex HA6 1BL, 09274.29122, Fax: 0923.835 980, Contact: D Mann.

VOICE OF THE LISTENER, 101 King's Drive, Gravesend, Kent DA12 5BQ, 0474.564 676, Fax: 0474.564 676, Chmn: Jocelyn Hay, Treasurer: Alan Laws. Radio listeners association working to ensure the maintenance of high standards in broadcasting.

PUBLIC RELATIONS & RECORD PROMOTION

3MV, 33-34 Warple Way, Unit 4E/F, London W3 0RX, 081.740 5959, Fax: 081.740 5943, MD: Mike Heneghan, Bus Affairs Dir: Max Kenny, Operations Dir: Phil Cliff, Sales Dir: Dave Trafford, Sales Admin: Jayne Creamer. Clients: Factory, Mute, Rhythm King, London, Creation, 4AD, Go-Disc, Fiction, Debut, KLF, Virgin, Revolver, PVVL, BMG.

A CROSSE THE WORLD, 11a Kensington Park Road, London W11 3BY, 071.221 8823, President: Jon Crosse.

ACE INTERNATIONAL ON TOUR, 39 Newton Way, Sandy, Bedfordshire SG19 1QX, 0767.682 845, Fax: 0767.691 453, Dir: Alastair Massie, Partner: Alastair Massie.

ACTIVE PROMOTION, 120 Malpas Road, 14 Myatt Court, London SE4 1BZ, 081.692 6330, Fax: 081.692 7573, Mgr: Matthew Lee, John Blackhurst. College radio promotion, general college club & press promotion, local/regional radio promotion, club promotion.

AFTER HOURS PR, 130 London Road, London SE1 6LG, 071.620 1383, Fax: 071.928 3662, MD: Peter Mash.

AGENT SERVICES, 6 The Broadway, Denham, Middlesex UB9 5HB, 0895.834 483, Fax: 0895.835 178, MD: C Lewin.

ALAN JAMES PR, 130 London Road, London SE1 6LF, 071.620 1383, Fax: 071.928 3662, MD: Alan James, Promo: Peter Mash, Cindy Levell, Press/Promo: Lavine Labelle. Recent clients include: Ensign/Crysalis, East West, Gefen/Stuff, Play It Again Sam, BMG/Dedicated, Waxtrax, Network, Imaginary, Sheerjy, Midsight.

ALPHA RECORDS OXFORD, Abbey Street, Eynsham, Oxford OX8 1HR, 0865.880 240, Fax: 0865.882 443, MD: H F Mudd.

APPEARING (SCOTT PIERING), 61-71 Collier Street, London N1 9BE, 071.833 2841, Fax: 071.837 4132, MD/Owner: Scott Piering, Promo (TV): Vicky Harris, Office Mgr: Jane Bartlett. London radio promotion, and all UK television promotion for the following clients: Blue Pearl (Big Life), Hoodlum Priest (PARC), The Lightning Seeds (Ghetto), the KLF (KLF), Magik Roundabout (Wau!Mr. Modo), the Mockturtles (Siren), The Orb (Big Life), Paris Angels (Virgin), Primal Scream (Creation), Ride (Creation), Slowdive (Creation), The Soup Dragons (Big Life), The Sundays (Rough Trade), Zee (Wau!Mr. Modo).

ASV ACADEMY SOUND & VISION, 179-181 North End Road, London W14 9NL, 071.381 8747, Fax: 071.385 2653, MD: Hywell Davies, GM: Neil Heyland, Audio Cons: Martin Haskell, A&R: Pawlina Bednarczyk, Sales/Distrib: Richard Harrison, Mktg Mgr: Ray Crick.

BARKERS SCOTLAND, 234 West George Street, Glasgow, Strathclyde G2 4QY, 041.248 5030, Fax: 041.204 0033, MD: Robert Bain.

BEER DAVIES, 50 Margaret Street, London W1N 7FD, 071.323 3003, Fax: 071.323 4768, MD: Gareth Davies.

BEST IN PRESS, 4 Camden Terrace, London NW1 9BP, 071.485 2239, Fax: 071.267 6774, MD: John Best. x.

BPI COMMUNICATIONS, c/o Billboard, 23 Ridgmount Str, 3rd, London WC1E 7AH, 071.323 6686, Fax: 071.323 2314, Pres Eur Operations: Theo Ross, Int'l EIC: Adam White, Mktg/Sales Dir: Patricia E Rod. Publishing house.

BRASSNECK PUBLICITY, Wapping Wall, Metropolitan Wharf, Whse D, London E1 9SS, 071.481 2172/45, Fax: 071.488 0154, MD: Mick Houghton.

BRIAN GIBSON PUBLICITY, 16 Fourth Avenue, Flat 2, Hove, East Sussex BN3 2PJ, 0273.732 121, MD: Brian Gibson.

CAROL HAYES & ASSOCIATES, 213-215 Kilburn Lane, Park Mews, Unit 2, London W10 4BQ, 081.969 3426, Fax: 081.964 0609, MD: Carol Hayes.

CLIFFORD ELSON (PUBLICITY), 1 Richmond Mews, Dean Street, London W1V 5AG, 071.437 4822, Fax: 071.287 6314, MD: Clifford Elson, Dir: Patricia Lake Smith, Howard Elson.

CLUB PREVIEW, 6-9 Salisbury Promenade, Arena House, Green Lanes, London N8 0RX, 081.809 1460, Fax: 081.802 8395, Dir: Julie Batten, Promo Mgr: Nicky Price. Recent clients include: VCN Records (Blue August), Bop Records, Hysteria, Arista.

REVOLVER DISTRIBUTION, 3 Dove Lane, St. Pauls, Bristol, Avon BS2 9HP, 0272.540 004, Fax: 0272.540 013, MD: A Chadwick, Label Mgrs: Heather Simmonds, Debbie Cavanagh, Alan Hale, Sales Mgr: Penny Mitchell. Labels (distr): Cooking Vinyl, Earache, Peaceville, Lazy, Awareness, Tupelo, Three Stripe, Sarah, Subway, McQueen, Vinyl Drip, Acid Jazz, Ariwa, In Your Face, Product Inc, Strange Things, Heavenly, Pathological, Native, and many others.

RM ASSOCIATES, 46 Great Marlborough Street, London W1V 1DB, 071.439 2637, Fax: 071.439 2316, Tlx: 24549 rmaltdg, MD: Reiner Moritz.

ROLLERCOASTER RECORDS, London Road, Rock House, St. Mary's, Chalfont, Gloucestershire GL6 8PU, 0453.886 252, Fax: 0453.885 361, Dir: John Beecher, J I Allison, GM: Yvonne Saunders. Main producer: Rock'n'Roll, Country/Western.

ROSS RECORDS, 29 Main Street, Turriff, Grampian AB53 7AB, 0888.68899, Fax: 0888.68890, MDs: Gibson & Ann Ross. Labels (distr): Lismor, Klub, Ritz, Scotdisc, Play, Corries, House of Scotland, Harmac, Park Film, Bluebell, Edinburgh Tattoo, Aberdeen City Arts, Alba Creag, Arko, Adam Rennie, Ardven, Currie Bros, Whirlie, Attic, AUK, Bracken Lads, Homespun, Culbriene, Stetson, Bjoro Haland, Bothy Lands, Seil, Dolphin, Ian Powerie, Dunkeld, Irish Heritage, Platinum, Emerald, Harper, Hawk (Dublin), Celtic, Pickwick, MFP, Runrig (Chrysalis), K-Tel (Ire), Music Box, Mary McCann, Grampian, Rainbow, Nabo, Telstar, Tring, Scotland The What, Springthyme, TC Records, Stebalin, Scotsoun, REL, Kettle, Eden, Donside, CJ, Rounder, Beechwood, Cairngorm Music, Linda Little, Mayker, Outlet, Pan, Connell, GreenTrax, Temple, Ridge, Green Linnet, Trimtop, Deay Music, BBC, Dino.

RTM, 339 Seven Sisters Road, London N15 6RD, 081.802 8696, Fax: 081.802 8142, MD: John Best. Sales, Marketing and Distribution company; over 50 labels distributed.

S GOLD & SONS (RECORDS), 69 Flempton Road, Gold House, London E10 7NL, 081.539 3600, Fax: 081.539 2176, MD: Barrie Gold, Export Mgr: Jonathan Gold, Sales Dir: Garry Elwood, Buyer: Stuart Persky. Exporter, wholesaler.

THE SALE PEOPLE, 213-218 Edward Place, London SE8 5HD, 081.692 0372, Fax: 081.694 9301, MD: Malcolm Mills.

SAVANNA SOUNDS, Quaker Coppice, Crewe, Cheshire CW1 1FA, 0270.589 321, Fax: 0270.587 436, MD: Michael Bates.

SKIRLING MUSIC/BIG-R RECORDS, 5 James Square, Biggar, Lanarkshire, Scotland ML12 6DL, 0899.20202, Fax: 0899.21020, MD: Drew Taylor.

SOLOMON AND PERES DISTRIBUTION, 120 Coach Road, Templepatrick, Ballyclare, County Antrim BT39 0HB, 08494.32711/32693, Fax: 08494.32800, Contact: Mervyn Solomon, Les R Paterson.

SONY MUSIC OPERATIONS (UK), Rabans Lane, Aylesbury, Buckinghamshire HP19 3BX, 0296.26151, Fax: 0296.81009, MD: David Black, MIS Dir (UK & Eur): David Barrie, Fin Serv Dir: Peter Corbett, Comm Dir: Laurie Crow, Fin Dir: Jan Gach, Manufacturing Dir: Lionel Smithers, Distr Dir: Fred Whittle. Labels (distr): Columbia, Def Jam, Go Bang, Rush Associated Labels, Epic, Rhythm King, ARS, Curb, Relativity, Combat, Solar, Soho Square, Sony Classical, Sony Masterworks, Arcade, Hollywood, Savage.

SOUND SOLUTIONS (UK), Purley Way, Mill Lane Estate, Unit 1, Croydon, Surrey CR0 4AA, 081.686 3636/6555 (orders), Fax: 081.681 8005/1388 (orders), MD: Peter Collins, Sales Dir: Philip Worsfold, Fin Contr: Tom Varughese, Operations Mgr: Robert Worsfold, Field Sales Mgr: Laurence Miele, Van Sales Contr: Alistair Baumgartner, Distr Mgr: Robert Harris, Merch Contr: Nick Blewett, Admin: Barbara Byron. Labels (distr): Happy Days, Rhino, major label non-UK imports; Also supply music & video overstocks and deletions to the retail music industry.

SOUTHERN STUDIOS, 10 Myddleton Road, London N22 4NS, 081.888 8949, Fax: 081.889 6166, Tlx: 268041 sthnm, MD: John Loder, Sales Dir: Allison Schnackenberg.

SP&S SALES/HERMANEX, 137a High Road, Loughton, Essex IG10 4LT, 081.508 3723, Fax: 081.508 0432, MD: Peter Harris, Sales Mgr: David Gadsby. Main product: deletions, overstocks.

FARRAN & TARYN PROMOTIONS, 222 Kensal Rd, Canalot Studios, Unit 104, London W10 5BN, 081.964 0648, Fax: 081.960 4844, MDs: Maggi Farran, Taryn Hill.

FEEDBACK PROMOTIONS, 28 Greenbank, Torrington, Devonshire EX38 7DP, 0805.22152, Promo Mgr: R Higgs. Recent clients include: Jive Turkey, Sweet Thangs.

FERRET & SPANNER PR, 76 Stanley Gardens, London W3 7BL, 081.746 1818, Fax: 081.746 1011, E-Mail: DGS 1791 plugging.uk, MD: Neil Ferris, Dir: Nigel Sweeney, Head Of Press: Vicky Harris, Head of PR: Duncan Thomas, Co-ord (Radio/TV): Erainne Mullian. Media promotion for UB-40, Neneh Cherry, Erasure, Depeche Mode, Simply Red, Elvis Costello, T'pau, Rolling Stones.

FFI FOR FURTHER INFORMATION, 35 Harwood Road, Broadway House, London SW6 4QP, 071.371 5633, Fax: 071.371 0520, Partners: Mike Mathieson, Julian Able. Clients: Reading Rock Festival.

FIRST CLASS RADIO & CLUB PROMOTIONS, PO Box 11, Bathgate, West Lothian EH48 1RX, 0506.54305, Fax: 0506.630 907, MD: Bill Grainger. Record promotion; Also publish a free publication—Club Scene—which reviews Dance Clubs and Records in Central Scotland.

FLEMING & SMALLMAN, 42 Colwith Road, The Courtyard, London W6 9EY, 081.846 8080, Fax: 081.846 8050, MD: Oliver Smallman, Contact: Richard Evans.

FRED FABER PROMOTIONS, 90 Leswin Road, London N16 7ND, 071.254 9158, GM: Fred Faber.

FREELANCE CORPORATION, 188 Archway Road, London N6 5BB, 081.341 0944, Fax: 081.348 5961, MD: Robert Douglas, Sales Dir: R Nelson, Creative Dir: R Purllinson.

FRONTIER PROMOTIONS, 115 Old Lodge Lane, Purley, Surrey CR8 4DP, 081.668 3457, Fax: 081.668 6484, Dir: Sue & Dave Williams. Main product: Rock, EHR, AC, Metal.

FULL FORCE PROMOTIONS, 90 Lots Road, Studio 45, London SW10 0QD, 071.376 5335, Fax: 071.376 8275.

GBA GEORGE BARTRAM ASSOCIATES, 5 Commercial Street, Stonewood House, Birmingham, West Midlands B1 1RS, 021.643 9346, Fax: 021.633 3469, MD: Robert Holme.

GEOFF ATHERTON PROMOTIONS, 19 Elmstead Close, Ewell Court, Surrey KT19 0EA, 081.393 5425, Fax: 081.393 6622, MD: Geoff Atherton, Company Sec: Lynn Atherton, Mktg Dir: Norman Michael, Dir (Radio): Jeff Austin.

GEOFF COLLINGS PROMOTIONS, Southfields Road, "Lodene", Woldingham, Surrey CR3 7BG, 088.365 2207, MD: Geoff Collins. Recent clients include: Columbia, Epic, Virgin, Chrysalis, Ritz Productions.

GROOVEMASTERS RECORD POOL, Falcon Mews, London SW12 9SJ, 081.675 5584, Fax: 081.675 6313, MD: Nick Titchener.

GUT REACTION, 36 Boston Place, London NW1 6ER, 071.706 2402, Fax: 071.706 0324, MD: Guy Holmes. Radio and TV promotion.

HALL OR NOTHING, 35 Harwood Road, Broadway House, London SW6 4QP, 071.371 5633, Fax: 071.371 0520, MD: Philip Hall.

HEIDI KIPLING ASSOCIATES, 1 Peel Terrace, Scarborough, North Yorkshire YO12 7HP, 0723.379 994, Fax: 0723.500 117.

HENRY SELLERS (PROMOTIONS), PO Box 262, London NW8 0NJ, 071.586 7963, Fax: 071.483 2469, MD: Henry Sellers. Clients: The Drifters, Bobby Vee, Brian Hyland, Chris Montez, Tommy Roe, Shangri-La's, The Mavelettes, Salute to Nat King Cole starring Freddy Cole, The Tymes, The Chi-Lites, Harold Melvin & the Blue Notes, Jimmy Ruffin, Dwayne Eddy, and many others; Also set up video deals.

HIGH PRIORITY, 23 New Mount Street, J.M.P. Unit 113, Manchester. Greater Manchester M4 4DE, 061.953 4010, Fax: 061.953 4001.

HOLISTIC ENTERPRISES, 7 Argyle Street, Bath, Avon BA2 4BA, 0225.331 521, Fax: 0225.481 555, MD: Jenni Nicholson. New-Age promotion; Clients: Denise Linn, Gift of Alien.

HOWARD HARDING ASSOCIATES, 10 Greycoat Place, Premier House, London SW1P 1SB, 071.222 7541, Fax: 071.222 7542.

HOWLIN' PROMOTION COMPANY, 70 Gloucester Place, London W1H 4AJ, 071.935 4965, Fax: 071.486 0942, MD: Howard Marks.

IMMEDIATE PUBLICITY, 330b Portobello Road, London W10 5RV, 081.960 0186, Fax: 081.960 1430, Dir: Chris Poole, Mariella Frostrup, Debbie Bennet.

THE IMPACT AGENCY, 5 Warren Mews, London W1P 5DJ, 071.387 1770, Fax: 071.387 2324, MDs: Linda Batt-Rawling, Hedley Finn. Recent clients include: Aero Drink, Carnation Coffee-mate, Libby's, Monkeypuzzle/First Class Stamps, Nescafe, Radio Lollipop, Rowntree, Sun-Pat, Whitbread.

IMPULSE CLUB PROMOTIONS, 10-16 Chaplin Road, London NW2 5PN, 081.459 8866, Fax: 081.459 5711, Tlx: 919884, Contact: Tony Rounce.

IMPULSE RADIO PROMOTIONS, 10-16 Chaplin Road, London NW2 5PN, 081.459 8866, Fax: 081.459 5711, Tlx: 919884, MD: Helen Hancock, Contact: Shaun King.

THE INDEPENDENT PROMOTION COMPANY, 181 Oxford Gardens, London W10 6NE, 081.968 8213, Fax: 081.968 8871.

INTERFACE PROMOTION MANAGEMENT, 59 St Elmo Road, London W12 9DZ, 081.740 4560, Fax: 081.740 0386, MD: Douglas Kean.

INTERNATIONAL RADIO PROMOTIONS, 112 Talbot Road, London W11 1JR, 071.727 3456, Fax: 071.221 7240, MD: Mike Plumley, Promo: Nigel Simpson (Radio), Richard Hare (Clubs).

INTERNATIONAL RESCUE, 100 Westbourne Grove, Leo's House, London W2 5RX, 071.221 6795/5360, Fax: 071.229 4939, Dir: Sue Johnstone, Nadja Severa. International publicity, marketing and licensing. Clients: Happy Mondays, Depeche Mode, Prefab Sprout, Radioactive Records, Ned's Atomic Dustbin, Des'Ree.

INTERNATIONAL THOMSON PUBLISHING, 249-259 Regent Street, 7 Swallow Place, London W1R 7AA, 071.491 9484, Fax: 071.493 4253, MD: Brian Cottee. Publishers of: Broadcast, Screen International, Communications, Communications International, TV World, International Broadcasting.

JAC PUBLICITY & MARKETING CONSULTANTS, 113 Wardour Street, Hammer House, London W1V 3TD, 071.734 6965, Fax: 071.439 1400, Tlx: 28553 jaccub, MD: Claire Forbes.

JENNIE HALSALL CONSULTANTS, 208a King Street, London W6 0RA, 081.741 0003, Fax: 081.846 9652, MD: Jennie Halsall, Exec: Sharon Wheeler.

JESTER PROMOTIONS, 24a Southwark Street, Basement, London SE1 1TU, 071.403 8119, Fax: 071.378 7871, MD/Promo: Jackie Forbes. Regional radio & TV, press and club promotion. Recent clients include: That Petrol Emotion, Rebel MC, Ocean Color Sence, Candyland, Double Trouble.

JOHN FOLEY PROMOTIONS, 21 Ridgewood Drive, Pensby, Merseyside L61 8RD, 051.648 2172, Fax: 051.648 5925, MD: John Foley, Fin Dir: Julie Foley, Promo Mgr: Sarah Bourne.

JUDY TOTTON PUBLICITY, 130 Elgin Avenue, London W9 2NS, 071.266 4865, Fax: 071.266 4933, MD: Judy Totton. Clients: Steve Miller, The Kinks, Mike Oldfield, Runrig, Castle Donnington Monsters of Rock Festival, Danceteria label, Energy Raves 1 & 2, CORE Trust Royal Charity Luncheon, Will Downing.

KANTOR CONCERT MANAGEMENT/PR, 30 Weymouth Street, London W1N 3FA, 071.580 0309, Fax: 071.436 3275, Tlx: 262244 kantor, MD: Denise Kantor, Dir: Dawn Marshall.

KEITH ALTHAM PUBLICITY, 55 Fulham High Street, London SW6 3JJ, 071.371 9522, Fax: 071.384 2364, MD: Keith Altham.

KENNIC MUSIC, 11 Kings Road, London SW3 4RP, 071.569 7711, Fax: 071.581 2727, Tlx: 268084.

KNIGHTS TEMPLAR INTERNATIONAL, 55 Albion Street, Otley, Yorkshire LS21 1BZ, 0943.467 395, Fax: 0977.683 288, President: Richard Rouska.

LAISTER DICKSON, 2 Newburgh Street, London W1V 1LH, 071.439 7222, Fax: 071.734 2933, Chief Exec: Wendy Laister, MD: Clare Singers, Dir: Bernard Doherty, Accts Mgrs: Julian Henry, Fiona Duff.

LAWTON ADVERTISING, Shamrock Quay, William Street, Southampton, Hampshire SO1 1QL, 0703.639 133, Fax: 0703.225 954, Chmn: Anthony Clarke, MD: Michael Lawton, Dir: Jeffrey Ware, Dir & Sec: Stephen Carey, Media Mgr: Carole Munden.

LEISURE FOR PLEASURE, 5 Burcot Avenue, Wolverhampton, West Midlands WV1 2SB, 0902.452 194, Fax: 0902.422 893.

LENA DAVIS ASSOCIATES, Whiston Road, Cotton's Farmhouse, Cogenhoe, Northamptonshire NN7 1NL, 0604.891 487, MD: Lena Davis.

LEOPARD RECORDS, Stockwell Road, 23 Thrayle House, London SW9 0XU, 071.274 9533/81.672 6158, Fax: 071.737 7881, President: Errol Jones, Dir: Terri Schiavo, F Campbell.

LIAISON & PROMOTION COMPANY, 70 Gloucester Place, London W1H 4AJ, 071.935 5988, Fax: 071.224 0067, MD: Clifford Gee, Gary Davison.

LIMELIGHT PR, 17 Cholmley Gardens, Alfred Road, London NW6 1AE, 071.794 8744, MD: Desmond McKeogh. Newspaper promotions; special projects only.

LIPSEY MEADE PR, 95 Mortimer Street, London W1N 7TA, 071.436 2721, Fax: 071.436 3505, MDs: Judy Lipsey, Roxey Meade.

LYNNE FRANKS PR, 6-10 Frederick Close, Stanhope Place, London W2 2HD, 071.724 6777, Fax: 071.724 8484, Contact: Eddi Siegel.

MAC MAC ARTS PR, 253 Liverpool Road, London N1 1LX, 071.700 6591, Fax: 071.700 1436, MD: Martha Oakes. PR company, specializing in art, world and dance music, fine arts, theatre.

MAD MANAGEMENT, 34-35 D'Arby Street, London W1V 3FE, 071.734 2712, Fax: 071.734 7404.

MAGGI FARRAN PRESS OFFICE, 222 Kensal Rd, 110 Canalot Studios, London W10 5BN, 081.960 6309/5030, Fax: 081.960 1044, MD: Maggi Farran, Press Mgr: Sheila Sedgwick. Press and promotion agency.

MARK BORKOWSKI PR, 50 Margaret Street, London W1N 7FD, 071.323 1108, Fax: 071.323 4788, MD: Mark Borkowski.

MATTHEW FREUD ASSOCIATES, 14-16 Great Putney Street, 3rd floor, London W1R 4AR, 071.734 2243, Fax: 071.494 3077, Chmn: Matthew Freud, MDs: Nick Wiszowaty, Alex Johnston.

MBR (MILITIA BEAT RECORD) PROMOTIONS, 350 Waterloo Street, Waterloo Building, Newcastle-upon-Tyne, Tyne & Wear NE1 4DJ, 091.230 3746, Owner/Mgr: Martin Jones.

MEE & CO, School Lane, Rutland House, Bunbury, Cheshire CW6 9NR, 0829.261 119, Fax: 0829.261 120, Contact: Mike Crompton. 2nd office in Maidenhead.

MICHAEL PEYTON ASSOCIATES, 318-326 Wandsworth Bridge Road, Studio 5, London SW6 2TZ, 071.731 1422, Fax: 071.371 0334, MD: Michael A Peyton, Promo Mgr: Alexander Alexandrou. Artist roster: A Man Called Adam, Ashley & Jackson, Colin Blunstone, Breathe, Bieu Pearl, Steve Booker, Coldcut, Cutting Crew, Distant Cousins, Debonair Zoom, De La Soul, Gang Of Four, Kevin Hopper, Horse, It's Immaterial, Junior Reid, Lies Damned Lies, Lightning Seeds, Oldland Montano, Robert Reilly, Greg Roberts, Sonny Southon, Skin Lagoon, Shack, The It, T'Pau, The Orb, The Amazing Colossal Man, The Soup Dragons, Bobby Valentino, Ultraviolet, Peter Wyllie, Yaz. Recent clients include: BBC Video, Big Life, Ghetto, Siren, Scarlett Recordings.

MIKE IRVING PROMOTIONS, 5 Stockens Green, Knebworth, Hertfordshire SG3 6DG, 0438.812 051, Fax: 0438.816 299, Dir: Mike Irving, Company Sec: Julie E Irving. Clients: Technotronic, Candy Flip, Massimo, Don Pablos Animals, Nomad, Offshore, Frances Nero. Radio promotion at BBC radio 1, Capital FM, Kiss FM, GLR, Radio Luxembourg & all national television.

MIRACLE WORKS, 33 Goodge Street, London W1P 1FD, 071.323 3324, Fax: 071.636 4563, Tlx: 9419076 miracl, Press: Khym Buchanan. Recent clients include: Phot Disk, Legacy, Metal XS, Great Northern Rock, Uriah Heep.

MORE NEWS, 132 Dalling Road, Dalling House, London W6 0EP, 081.741 7000, Fax: 081.563 0039, MD: Julius Just, Asst to MD: Fabienne Freijo.

MOVEMENT SOUL, 14 Comlan Street, London W10 6AR, 081.968 0228, Fax: 081.968 0697, MD: Martin West, Admin Mgr: Andrew McKay. Specialises in dance music.

MUSIC ENTERPRISES, 126-128 New Kings Road, Elysium Gate, London SW6 4LZ, 071.371 5005, Fax: 071.371 0180, MD: Gary Gordon, Dir: Nicki Denaro. Club & regional radio promo.

NAMARA COWAN, 45 Poland Street, London W1V 4DF, 071.434 3871, Fax: 071.439 6489, MD: Naim Atallah.

NETWORKING PR, 222 Kensal Rd, Canalot Studios, Unit 307, London W10 5BN, 081.960 1452, Fax: 081.960 1452, MD: Jenni Francis.

NORTHERN DISCO PROMOTION SERVICES, Granville Road, Granville Manor, Southport, Merseyside PR8 2HU, 0704.643233, Fax: 0704.63061, Contact: Ron Ellis. DJ's for in-store/outdoor promotions, etc.

OMER-LI COHEN PUBLIC RELATIONS, 67 Gloucester Avenue, London NW1 8LD, 071.586 9795, Fax: 071.586 9880, MD: Omer-Li Cohen. Clients: Mayfair Studios, Britannia Row Studios, British Record Producers Guild, Stirling Audio, EMI, Roar Management.

ORIGINAL CONCEPT, 1a Tavistock Street, Covent Garden, London WC2E 7PA, 071.240 0099, Fax: 071.240 2447, MD: Caroline Adair. PR and marketing company, mostly for conferences, exhibitions.

ORPHEUS PUBLICATIONS, 20 Mandela Street, Centro House, 4th, London NW1 0DU, 071.387 3848, Fax: 071.388 8532. Publisher of: DJ.

OUT PROMOTIONS, 83 Clerkenwell Road, London EC1R 5HP, 071.405 0695, Fax: 071.430 0469, MDs: Nicki Kefalas, Steve Morton.

PALMER EVANS ASSOCIATES, 76 Chestnut Grove, London SW12 8JJ, 081.675 7411, Fax: 081.675 7411.

PARK PROMOTIONS, 20 Raleigh Street, North Hinksey, Oxford, Oxfordshire OX2 9AZ, 0865.248 493, Fax: 0865.864 192, MD: John Dagnell.

PARROT PRODUCTIONS, Gilbert Street, 24 Cavendish Buildings, London W1Y 1FD, 071.629 2998, Fax: 071.355 3510, MD: Cindy Hacker, Dir: P Smith, Asst: Alex Whittall.

PETER THOMPSON ASSOCIATES, 134 Great Portland Street, London W1N 5PH, 071.436 5991, Fax: 071.436 0509, MD: Peter Thompson.

PEZ PROMOTIONS, 20 Blenheim Gardens, London NW2 4NS, 081.208 2113, Fax: 071.243 1359, MD: Perry Morgan.

PHIL JAY, 6 Roxy Avenue, Chadwell Heath, Romford, Essex RM6 4AN, 081.590 3125, MD: Phil Jay. Main product: Disco.

PLAYTIME PUBLICITY, 27 Church Street, 2nd floor, Manchester, Greater Manchester M1 6HR, 061.839 5338, Fax: 061.839 5258, MD: Paula Greenwood.

POOLE/EDWARDS PUBLICITY, 97 Charlotte Street, London W1P 1LB, 071.436 3633, Fax: 071.436 3632, Dir: Chris Poole, Alan Edwards, Assoc: Richard Dennis.

POP PROMOTIONS, 249-251 Kinsal Road, London W10 5DG, 081.968 8459, Fax: 081.969 4538.

POWER PROMOTIONS/EUROPOWER, 32 Holmes Road, Kentish Town, London NW5 3AB, 071.482 0728, Fax: 071.482 0881, MD: Paul Gotel. Specialises in dance music; recent clients include: Big One/First Bass (King Bee, Deskee, Kash Da Mastal), Big Wave (Whyte), Big World (Blood Brothers,

Pressure Drop), Columbia/Epic (Judie Tzuke, Malcolm McLaren, Guy Called Gerald, Paul Johnson), Creation (Hypnotone, Crazie Eddie), CT (Heavyshift), Dedicated (Synergy), Deja Vu (Messiah), Desire (Rebel MC), EMI (Them, Cabaret Voltaire), 4th & Broadway (David Grant), Freetown (Mark Rogers), Industrial (Bass Culture, Predator), Island (U2, Christians), Kold Sweat (SL Troopers), Luke Skywalker (Prof. Griff), Music of Life (Hardnoise, Duke Daddy Freddie), Mute (Renegade, Soundwave), Network/Kool Kat (Nexus 21, Rhythmic, Model 500, Kaos), Non Fiction (Die Warzau), One Little Indian (Shamen, Soul Family Sensation), Phonogram (Electric 101), Polydor (Great Northern Electric), Pulse 8 (Rozala), RCA (Alisha Warren), Reachin (Urban Hype, TDP, Boneshakers), Rhythm King (Beatmasters, Bomb The Bass), Rumour (Nomad), Virgin (Cash Crew), Warp (The Step, Tuff Little Unit, Tomas), Warriors Dance (Addis Posse, No Smoke, Bang The Party), Wau Mr.Modo (Insync, Mystic Knights, Jam on the Mutha, Paradise X), Zoom (Moodswings).

PRESS COUNSEL, 21 Denmark Street, 1st Floor, London WC2H 8NE, 071.379 9805/6, Fax: 071.379 9814, MD: Penny Caplowe, Press Officer: Charly Caplowe. Recent clients include: The Wonder Stuff, Thousand Yard Stare, Presence, First Offence, Acid Jazz (Label).

PRESS-GANG PUBLIC RELATIONS, 9b Delancey Passage (off Delancey St), London NW1 7NL, 071.383 5525, Fax: 071.383 0025, MD: Christine Kyriacou.

PRIMETIME TELESALES, 10-16 Chaplin Road, London NW2 5PN, 081.459 8866, Fax: 081.459 5711, Tlx: 919884, MD: Shaun King, GM: Gary Beggs.

PSA PUBLIC RELATIONS, 3 Grosvenor Gardens, London SW1W 0BD, 071.630 9082, Fax: 071.630 9998, Tlx: 8956658, MD: Phil Symes.

THE PUSH & PLUG COMPANY, 197 Crookes, Sheffield, South Yorkshire S10 1TE, 0742.670 351, Fax: 0742.686 902, Head PR/Promo: Richard Tandy, Client Services: Barbara Edwards. Radio, TV, club promotions.

RN'R PROMOTIONS, 222 Kensal Rd, Canalot Studios, Unit 104, London W10 5BN, 081.964 0648, Fax: 081.969 1044, MD: Ray Stock.

RADIO PROJECTS, 37 Golden Square, London W1R 3AA, 071.287 3734, Fax: 071.287 3735, MD: Rhian Garbett-Edwards. Radio promotion and sponsorship.

RD.L, 27 Brampton Close, Cheshunt, Hertfordshire EN7 6HZ, 0992.29970, Fax: 0992.33488, Co-Ord: S J Jaques.

REAL TIME, 69 Wells Street, London W1P 3RB, 071.232 0310, Fax: 071.636 5608, Dirs: Dave Whitehead, Richard Powell, Promo: Charlie Inskip, Dir (Ger): Simon Edwards. UK & European press/radio promotions; Recent clients include: SST, Ror, Blast First, Eve, Jungle, Big Cat, Frontier.

RICHARD LAYER PUBLICITY, Kensington High St, 3 Troy Court, London W8 7RA, 071.937 7322, Fax: 071.937 8670, MD: Richard Layer. Recent clients include: Video Arts, Pierce Brosnan, Alfredo Kraus, Luigi Albertoni-Bianchi.

RICHARD WOOTTON PUBLICITY, 120 Kingston Road, Manor House, London SW19, 081.542 8101, Fax: 081.540 0691, MD: Richard Wootton, Acct Exec: Claire Horton.

RILEY ASSOCIATES, 82 Berwick Street, London W1V 3PJ, 071.287 1417, Fax: 071.734 5411, MD: Tony Riley. Recent clients include: Shirley Bassey, PolyGram Records, Sharon Benson.

RJB COMMUNICATIONS, 11a Victoria Road, London N4 3SH, 071.263 7504, Fax: 071.272 3092, MD: Bob Ridges. PR and communications.

ROCK HARD PR, 17a Rastell Avenue, London SW2 4XP, 081.671 5321, Fax: 081.671 3162, MD: Caron Malcolm.

ROGERS & COWAN INTERNATIONAL, Gainsford Street, Coriander House, London SE1 2NE, 071.522 2200, Fax: 071.522 2201, MD: Tony Fitzpatrick, Music Dir: Alan Edwards.

ROLAND HYAMS PR, 17a Rastell Avenue, London SW2 4XP, 081.671 5321, Fax: 081.671 3126, MD: Roland Hyams.

ROWLEY MARKETING, 1 Christchurch Place, Hertford, Hertfordshire SG14 3BB, 0992.587 350/553 177, Fax: 0992.586 059, MD: Anne Rowley, Fin Dir: Wendy Hutson. Marketing agency: design, printing, point-of-sale, below-the-line, launch parties, album sleeve design, specialist product design and print.

RPM PROMOTIONS, 141 Raitton Road, London SE24 0LT, 071.733 3181, Fax: 071.733 3181.

RSA, 79-80 Margaret Street, Kenilworth House, London W1N 7HB, 071.631 0185, Fax: 071.631 3203, Chmn: Richard Robson, MD: Tim Smith.

RUSH RELEASE, Oakmead Road, Falcon Mews, London SW12 9SJ, 081.675 4916, Fax: 081.675 6313, Dir: Roy Pearce, Promo Clubs: Alina Bea, Dean Gannon.

SCOTTISH DJ RECORD POOL/TC PROMOTIONS, 4 Gaia Avenue, Dundee, Tayside DD2 4EJ, 0382.644 003, Fax: 0382.646 167, MD: Tony Cochrene. PR company, also organize promotional tours.

SCREENTIME, 51 Beechwood Avenue, Kew, Richmond, Surrey TW9 4DD, 081.876 6715, Fax: 071.637 2590, Tlx: 266075, MD: Dick Hawkes.

SENIOR KING, 14-15 Carlisle Street, London W1V 5RE, 071.734 5855, Fax: 071.437 1908, MD: Grahame Senior.

SHARON CHEVIN PR, 392b Harrow Road, London NW4 4TD, 071.266 2147, Fax: 071.286 0163, MD: Sharon Chevin, Press Officer: Michelle Kerr. Recent clients include: Billy Idol, Milton Keynes '91, Whitney Houston, Yes.

SHARON WHEELER PUBLIC RELATIONS, 51 Surbiton Court, Surbiton, Surrey KT6 4ED, 081.399 3529, Fax: 0372.740 424.

SHARP END PROMOTIONS, 2-3 Golden Square, Grafton House, London W1R 3AD, 071.439 8442, Fax: 071.439 1814, Dirs: Robert Lemon, Ron McCreight, Press Officer: Sue Foster, Promo (TV): Liz Watson.

SHOW BASE, 40-44 Cliphstone Street, Production Ctre, London W1P 7EA, 071.323 3220, Fax: 071.637 2590, MD: Lorne Magory. Computer data-base with UK actors & actresses; hoping to expand to a Pan-European information service.

SINGLE MINDED PROMOTION, 71 Talgarth Road, London W14 9DJ, 071.602 8566, Fax: 071.381 1520, MD: Tony Byrne. Radio & television promotions.

SOFT, 5 Newton Street, St. Margaret's Chambers, Manchester, Greater Manchester M1 1HL, 061.236 4138, Fax: 061.236 4042.

SOLID PROMOTIONS, Bennet Street, White Swan House, London W4 2AH, 081.995 6229, Fax: 081.994 0654, Partner: Ray Stock, Steve Payne. Specialize in Rock music; Mobile phone: 0860.473 603.

THE SOLUTION PROMOTION COMPANY, PO Box 200, Ashford, Kent TN24 0RN, 0233.646 646, Fax: 0233.647 647, MD: Bob James, Joint MD: Colin Line.

SONG AND MEDIA PROMOTIONS, 12 Trewartha Road, Sovereign House, Praa Sands, Penzance, Cornwall TR20 9ST, 0736.762 826, Fax: 0736.763 328, MD: Roderick G Jones, Mktg Dir: Carole A Jones, Production: Colin Eade.

SONIC BOOM PRODUCTIONS, PO Box 1306, London N16 5XY, 081.802 6770, Fax: 081.802 6141.

SOS MANAGEMENT, 42 Philbeach Gardens, London SW5 7EB, 071.370 4776, Fax: 071.370 4456, Dirs: Meredith Cork, Shannon O'Shea. Clients: Dick Scott Management, Lookout Management, MCA Music (USA), Wea Records (USA), James Ingram, Chagall Guevara, Hora Hey.

SOUND PUBLIC RELATIONS, Oxgate Lane, 1 Horseshoe Close, London NW2 7JJ, 081.208 1036, Fax: 081.208 3382, MD: Ginny Goudy, Execs: David Allison, Phil Ward.

SOUTHERN RAG, PO Box 337, London N4 1TW, 081.340 9651, Fax: 081.348 5626, MD: Ian Anderson. Publisher of: Folk Roots.

SPARK PLUGGING, 4 Birchfields Road, Network House, Manchester, Greater Manchester M13 0XR, 061.225 5140, Fax: 061.443 1379, Tlx: 669755 office attn: network, MD: John Turner, Prof Mgr: Pamela Millbrook.

SPIN PROMOTIONS, 363-365 Harrow Road, London W9 3NA, 081.960 2227, Fax: 081.968 4869, Dir: Lucho Zuidema, Mark Houghrough.

SPOTLIGHT PUBLICATIONS, 245 Blackfriars Rd, Ludgate Hse, 8th flr, London SE1 9UR, 071.620 3636, Fax: 071.401 8036. Member of the United Newspapers Group; owns Studio Sound & Broadcast Systems International trade magazines.

SPRING PROMOTIONS, 6a Mandalay Road, London SW4 9ED, 081.673 2285, Fax: 081.673 9247, Head of Mktg: Peter Gladstone. Specialists in promoting new talent on regional radio and press in UK, France and USSR.

ST PIERRE PUBLICITY, 24 Beauval Road, London SE22 8UQ, 081.693 6463, Fax: 081.299 0791, MD: Roger St Pierre.

STARDATA, 222 Kensal Rd, Canalot Studios, Unit 110, London W10 5BN, 081.960 6309, Fax: 081.960 4844.

STATION 11 STATION, 322 Kentish Town Road, London NW5 2TH, 071.482 5272, Fax: 071.482 3861, MD: Stephen Tandy, Press/Promo: Jo Milloy, Radio/TV: Julia Christy, Dispatch Contr: Lorraine Stewart.

STREETS AHEAD PROMOTIONS & MARKETING, 8 Granville Park, London SE13 7EA, 081.852 8836, Fax: 081.297 0450, MD/Mktg: Catherine Richardson, Mgr: Stephanie Reid, Asst: Stan Hopkins. Promotions to alternative dance clubs, rock clubs, college DJ's and college radio. Clients: Meat Beat Manifesto, Definition of Sound, The Chimes, Front 242, Neneh Cherry, The Woodentops, The Pixies, The Fall, The Soup Dragons, Inspiral Carpets, Sinead O'Connor, Skid Row, Jeff Healey, Bad Brains, No Sweat, and many other acts.

STUZZ-V-KRIS SONG PROMOTIONS, 2-4 Bank Road, Bredbury, Stockport, Cheshire SK6 1DR, 061.430 5052, Fax: 061.430 5052.

SUREFIRE COMMUNICATIONS, 18 Ennismore Avenue, London W4 1SF, 081.994 8694, Fax: 081.995 5051, Tlx: 94019471 sfire, E-Mail: ILJX: TVLINK, Dir: Janet Greco.

TONY BRAINSBY PUBLICITY, 16b Edith Grove, London SW10 0NL, 071.834 8341, Fax: 071.352 9451, Dir: Tony Brainsby. Recent clients include: Pink Floyd, ELO Part II, Penthouse Mag, David Essex, Ah-Ha, Arbitr Karaoke, Music Therapy Charity, Marquee Records.

TONY BYRNE (LONDON RADIO & TV PROMOTION), 31 Norfolk Place, London W2 1QH, 071.258 0035, Fax: 071.723 8092.

TONY DENTON PROMOTIONS, 60 South Grove, Alpha Bus. Ctre, Unit 46, Walthamstow, London E17 7NX, 081.503 7506, Fax: 081.520 6547, Promo Mgr: David Curley.

TONY MICHAELIDES PROMOTIONS, 48 Princess Street, Manchester, Greater Manchester M1 6HR, 061.228 1029, Fax: 061.228 6948, Dirs: Tony Michaelides, Tony Riley. Clients: Simply Red, Happy Mondays, Masslive, Hue & Cry, Neneh Cherry, Northside, New Order, Steve Winwood, Pixies, Julia Fordham, Throwing Muses, Sydney Youngblood, a.o.

TOTAL RECALL, 84-96 The Chase, Pepys Court, Unit 7, London SW4 0NF, 071.978 2300, Fax: 071.498 6420, MD: Henry Semence, Dir: Fran O'Donnell, Mgr: Susie Tomkins. Telesales.

TRACE PUBLICITY, 8 Darlaston Road, 1 Wolsey Court, London SW19 4LG, 081.879 1905, Dirs: Tracy Francis, Chazz

Kogan.
TRANSORBITAL PRODUCTIONS, 557 Street Lane, Leeds, West Yorkshire LS17 6JA, 0532.687 886, MD: Carl Kingston, Promo Contr: Michael Laing.

VIBE PROMOTIONS, 31 Horedge Street, St Marys House, Oldham, Greater Manchester OL1 3XE, 061.628 4252, Fax: 061.628 8001, Contact: John Turner, Nikki Daly.

W M & P, 2 Tunstal Road, Brixton, London SW9 8DA, 071.978 9488, Fax: 071.738 3265, Partner: Yvonne Thompson, Werbayne McIntyre. PR, marketing, advertising & design.

WAYWARD PUBLICITY, 444 Brixton Road, Unit 401, London SW9 8EJ, 071.978 8611, Fax: 071.738 5039, President: Chris J Rose, Promo: Karen Childs, Press: Brian O'Neill. PR Company; Recent clients: MNW Records, Radium 226.05 Records, Semaphore, Community 3, Z Records, Epitaph Records, Clawfist Records, Sunflower Records, Overground Records, reVision Films, Jettisoundz Video, Gallon Drunk, The Sunflowers, Daisy, Chainsaw, Whipped Cream, The Wannadies, Pankow, Black Rose, Perspex Whiteout, Bongwater.

WINSOR BECK PR, 29-39 Stirling Road, Network House, London W3 8DJ, 081.993 7506, Fax: 081.993 8276, Tlx: 291908, MDs: Cathy Beck, Geri Winsor, Acct Dirs: Lesley Neate (Theatre), Helen White (Video & Publ), Acct Mgr: Cassandra Gage, Acct Exec: Kate Lee. Clients: Warner Film Distributors, Warner Theatres, Warner Home Video, First Independent, Columbia Pictures, Ritz Video Film Hire, Guild Home Video, Capital Home Video, Braveworld, Legend, K-Tel Entertainment (UK).

COMPACT DISC MASTERING & REPLICATING PLANTS

A-Z MUSIC SERVICES, 97 Charlotte Street, London W1P 1LB, 071.323 5590, Fax: 071.323 9174, Contact: Paddy Prendergast, Helen Odysseos.

ABBEY ROAD STUDIOS, 3 Abbey Road, London NW8 9AY, 071.286 1161, Fax: 071.289 7527, Contact: Maggie O'Sullivan. Disc cutting, CD premastering.

AWL COMPACT DISC COMPANY, 356 Scraftoff Lane, Leicester, Leicestershire LE5 1PB, 0533.413 979, Fax: 0533.433 760, MD: Andrew Lipinski, Partner: Irena Lipinski.

CHOP 'EM OUT, 2-4 Trinity Mews, off Cambridge Gardens, London W10 6JA, 081.960 8128, Fax: 081.968 0341, Contact: Bernie Spratt, Natalie Reeve. CD premastering.

CLOCK HOUSE RECORDING STUDIO, The Clock House, Keele, Staffordshire ST5 5BG, 0782.621 111 ext 3858, Studio Mgr: Cliff Bradbury. CD pre-mastering.

COPYMASTERS, Bagleys Lane, 13 The Talina Centre, London SW6 2BW, 071.731 5758, Fax: 071.384 1750, MD: David Moore, Studio Mgrs: Margaret Johnson, Tony Wagner. Disc cutting, CD premastering.

CTS STUDIOS, Engineers Way, The Music Centre, Wembley, Middlesex HA9 0DR, 081.903 4611, Fax: 081.903 7160, Tlx: 923400. Disc cutting, CD premastering.

DAMONT AUDIO, Blythe Road, Hayes, Middlesex UB3 1BY, 081.573 5122, Fax: 081.561 0979, MD: Chris Clark, Sales Dir: Ian Mackay, Tech Dir: Colin Rye, Prod Dir: Chris Rose, Fin Dir: Ian Ramsden. Annual capacity: 2.2m; Min order: 500.

DISC TRONICS EUROPE, Hammersmith Grove, Glenthorpe House, London W6 0LG, 081.741 9192, Fax: 081.748 2106, Tlx: 263851, Sales Mgr: James Mitchell, Acct Mgr: Mary Moran, Plant Mgr: David Williamson. Annual cap: 25m; Min order: 1,000.

EMI COMPACT DISC (UK), Kelvin Road, Greenbridge Ind. Estate, Swindon, Wiltshire SN3 3LP, 0793.511 168, Fax: 0793.526 630, Tlx: 444445, Operations Dir: Richard Green, Prod Mgr: Tim Crouch.

FINESPLICE, 1 Summerhouse Lane, Harmondsworth, West Drayton, Middlesex UB7 0AW, 081.564 7839, Fax: 081.759 9629. CD premastering.

GOUGHSOUND, 29 Beethoven Street, London W10 4LG, 081.960 1871, Fax: 081.969 1694, MD: Brian Leaf. Min order: 1,000; Agent broker for: MYOB.

HIT FACTORY, 31-37 Whitfield Street, London W1P 5RE, 071.636 3434, Fax: 071.580 0543, Studio Dir: Ray Davidson, Mastering Fac Mgr: Annabel Florman. Disc cutting, CD pre-mastering.

HHB COMMUNICATIONS, 73-75 Scrubs Lane, London NW10 6QU, 081.960 2144, Fax: 081.960 1160, Tlx: 923393 laser. CD pre-mastering.

ICC STUDIOS, Silverdale Road, Eastbourne, East Sussex BN20 7AB, 0323.643 341/2, Fax: 0323.649 240, MD: Helmut Kaufmann, Studio Mgr: Mike Newson. CD pre-mastering.

INDIE PRESSING SERVICES, 26 Sternhall Lane, Unit 4, Peckham, London SE15 4NT, 071.358 0058/9867, Fax: 071.358 1084, MDs: Ivor Mason, Mike Spencer.

KG ENGINEERING, Edgelands Lane, Ipplepen Bus. Prk, Unit 6, Ipplepen, Devon, 0803.813 833, MD: Keith Goud. CD pre-mastering.

MAYFAIR STUDIOS, 11a Sharpleshall Street, London NW1 8YN, 071.586 7746, Fax: 071.586 9721, Bookings: Denise Love, Press/PR: Robin Smith. CD/video disc pre-mastering.

MAYKING RECORDS, 250 York Road, Battersea, London SW11 3SJ, 071.924 1661, Fax: 071.924 2147, MD: Brian Bonnar, Mktg Mgr: Clive Robins.

MUSIC MANUFACTURERS, 100 Clapham Road, Bedford, Bedfordshire MK41 7PL, 0234.213 535, Fax: 0234.216 146, Operations Dir: Nick Flower, Tech Dir: Roy Matthews, Sales Dir: Malcolm Pearce, Prod Mgr: Tim Taylor.

NIMBUS RECORDS (UK), Wyalstone Lays, Monmouth, Gwent

NP5 3SR, 0600.890 682, Fax: 0600.890 779, Tlx: 498378 nimbus, President: A Labinsky, Chmn: Peter Laister, MDs: Gerald Reynolds, Michael Reynolds, GM: John Denton. CD/CD-Rom & CDI mastering & manufacturing; Annual capacity 30m.

PDO, 11 The Green, Queen Anne House, Richmond, Surrey TW9 1PX, 081.948 7368, Fax: 081.940 7137, Tlx: 928940, Sales Mgr: Roger Twynham.

THE PRODUCERS, Vale Road, Pacific House, London N4 1QB, 081.809 4445, Fax: 081.802 8840, MD: Steve Athey.

SOUNDS GOOD, Station Road, Chiltern Centre, Unit 12, Theale, Berkshire RG7 4AA, 0734.302 600, Fax: 0734.303 181, Sales Dir: Katrina Larkin, Prod Dir: Henry Smithson, Admin Dir: Martin Hayward. Annual capacity: 500,000; Min order: 1,000.

SRT SOUND RECORDING TECHNOLOGY, Edison Road, St. Ives, Huntingdon, Cambridgeshire PE17 4LF, 0480.61880, Fax: 0480.496 100, MD: David Richardson.

SUTTON SOUND, 228 Bishopgate, London EC2M 4QD, 071.262 9066, Fax: 071.262 3235, Studio Mgr: Mark Sutton, Bookings/Admin: Henrietta Brougham. Disc-cutting/mastering, CD pre-mastering.

TAM STUDIO, 13a Hamilton Way, London N3 1AN, 081.346 0033, Fax: 081.346 0530, Contact: Tony & Myrtle Batchelor. CD pre-mastering.

TAPE ONE STUDIOS, 29-30 Windmill Street, London W1P 1HG, 071.580 0444, Fax: 071.580 5455, MD: Barry Ainsworth, Contact: Joyce Adams. CD pre-mastering & disc-cutting.

TOWNHOUSE STUDIOS, 150 Goldhawk Road, London W12 8HH, 081.743 9313, Fax: 081.740 1180, MD: Barbara Jeffries, Bookings: Gay Marshall. CD pre-mastering, disc-cutting & mastering; 5 studios, console: Neumann, Studer; Sonic Solutions system, Harmonia Mundi digital, Teldec DMM lathe.

UTOPIA STUDIOS, 7 Chalcot Road, London NW1 8LH, 071.586 3434, Fax: 071.586 3434, Tlx: 298701, MD: Phil Wainman, Mgr: George Saunders. Disc cutting, CD pre-mastering.

VIDEO TIME, 22-24 Greek Street, London W1V 5LG, 071.439 1211, Fax: 071.439 7336, MD: Candy Fry. Videodisc mastering.

PLATING, MASTERING & PRESSING PLANTS

ABBAY ROAD STUDIOS, 3 Abbey Road, London NW8 9AY, 071.286 1161, Fax: 071.289 7527, Contact: Maggie O'Sullivan. Disc cutting, CD pre-mastering.

ADRENALIN RECORDS, 252-253 Argyle Avenue, Trading Estate, Slough, Berkshire SL1 4HA, 0753.23200/31837, Fax: 0753.692 243, Contact: Adrian Owlett, Tony Wicking.

AUDIO SERVICES (VINYL DIVISION), 6 Orsman Road, London N1 5JQ, 071.739 9672, Fax: 071.739 4070, MD: Steve Mason, GM: Mel Gale. Annual capacity: 7.5m.

BLACK BARN RESIDENTIAL STUDIOS, The Green, Dunsborough Cottages, Unit 3, Ripley, Surrey GU23 6AL, 0483.222 600, Fax: 0483.222 855, Tlx: 859470, MD: Robin Black.

COPYMASTERS, Bagleys Lane, 13 The Talina Centre, London SW6 2BW, 071.731 5758, Fax: 071.384 1750, MD: David Moore, Studio Mgrs: Margaret Johnson, Toni Wagner. Disc cutting, CD pre-mastering.

CTS STUDIOS, Engineers Way, The Music Centre, Wembley, Middlesex HA9 0DR, 081.903 4611, Fax: 081.903 7160, Tlx: 923400. Disc cutting, CD pre-mastering.

DAMONT AUDIO, Blythe Road, Hayes, Middlesex UB3 1BY, 081.573 5122, Fax: 081.561 0979, MD: Chris Clark, Sales Dir: Ian Mackay, Tech Dir: Colin Rye, Prod Dir: Chris Rose, Fin Dir: Ian Ramsden. Annual capacity 18m; Min order: 1,000.

EMI MUSIC SERVICES (VINYL & CASSETTE), 1-3 Uxbridge Road, Hayes, Middlesex UB4 0SY, 081.561 8722, Fax: 081.569 2212, Tlx: 934614 emirec, MD: Jim Leftwich, Manufacturing Dir: Peter Hall. Vinyl & cassette; Annual capacity: 100m; Minimum order: 5,000.

FLEXI RECORDS, Maritime Industrial Estate, Unit 1, London SE7 7AY, 081.853 3000, Fax: 081.305 1191, Contact: Margaret Smith.

GEDMAL GALVANIC, Quenborough Estate, Melton Road, Leicester LE7 8FP, 0533.602 064, Fax: 0533.600 108, MD: William Komedara. Lacquer processing. Vinyl pressing.

GOUGHSOUND, 29 Beethoven Street, London W10 4LG, 081.960 1871, Fax: 081.969 1694, MD: Brian Leafe. Min order: 1,000; Agent broker for: MYOB.

THE HIT FACTORY, 31-37 Whitfield Street, London W1P 5RE, 071.636 3434, Fax: 071.580 0543, Studio Dir: Ray Davidson, Mastering Fac Mgr: Annabel Florman. Disc cutting, CD pre-mastering.

INDIE PRESSING SERVICES, 26 Sternhall Lane, Unit 4, Peckham, London SE15 4NT, 071.358 0058/9867, Fax: 071.358 1084, MDs: Ivor Mason, Mike Spencer.

LYNTONE AUDIO REPRODUCTION, 5-9 Wedmore Street, London N19 4RU, 071.263 1378, Fax: 071.263 0240, MD: Ian MacKay.

MAGNETIC IMAGE MASTERING, West Row, Grand Union Centre, Unit 6, London W10 5AX, 081.960 7337, Fax: 081.968 1378, MD: Robin Springall.

MAYKING RECORDS, 250 York Road, Battersea, London SW11 3SJ, 071.924 1661, Fax: 071.924 2147, MD: Brian Bonnar. Mktg Mgr: Clive Robins.

MONTMUSIC, 2 Heydons Close, St. Albans, Herts AL3 5SF, 0727.56806, Fax: 0727.46360, MD: Monty Presky, Sales:

Philip Presky. Also agent for Sonopress CD, Germany.

MULTICORD, 1-6 Ravensworth View, Dunston, Gateshead, Tyne & Wear NE11 9DQ, 091.460 9209, Fax: 091.460 1494, MD: Ken McKenzie.

MUSIC MANUFACTURERS, 100 Clapham Road, Bedford, Bedfordshire MK41 7PL, 0234.213 535, Fax: 0234.216 146, Operations Dir: Nick Flower, Tech Dir: Roy Matthews, Sales Dir: Malcolm Pearce, Prod Mgr: Tim Taylor.

NIGHTFLITE COMMUNICATIONS, PO Box 50, Walton-on-Thames, Surrey KT12 1EB, 0932.242 073, Fax: 0753.692 243, Tlx: 934618, MD: Sue Owlett, Dir: Adrian Owlett.

ORLAKE RECORDS, Rainham Road South, Sterling Works, Dagenham, Essex RM10 8HP, 081.592 0242, Fax: 081.595 8182, Contact: John Powell.

PORKY'S MASTERING SERVICES, 55-59 Shaftesbury Avenue, London W1V 7AA, 071.494 3131/5, Fax: 071.494 1669, MD: George Peckham. Disc cutting.

PR RECORDS, 9 Endeavor Way, Hamilton House, London SW19 8UH, 081.946 8686/5045, Fax: 081.944 1165, Contact: Bill Dedman, Ray Young, George Hatley.

THE PRODUCERS, Vale Road, Pacific House, London N4 1QB, 081.809 4445, Fax: 081.802 8840, MD: Steve Athey.

SRT SOUND RECORDING TECHNOLOGY, Edison Road, St. Ives, Huntingdon, Cambridgeshire PE17 4LF, 0480.61880, Fax: 0480.496 100, MD: David Richardson.

STATEMENT, Grant Road, Wellingborough, Northamptonshire NN8 1EE, 0933.277 442, Fax: 0933.276 217, MD: Andrew Lipinski.

SUTTON SOUND, 228 Bishopgate, London EC2M 4QD, 071.262 9066, Fax: 071.262 3235, Studio Mgr: Mark Sutton, Bookings/Admin: Henrietta Brougham. Disc-cutting/mastering, CD pre-mastering.

THE TAPE DUPLICATING COMPANY, 4-10 North Road, London N7 9HN, 071.609 0087, Fax: 071.607 7143, Sales Mgr: Jon Powell. Vinyl pressing, picture-disc & flexi-disc pressing; Annual capacity: 8m; Min order: 500.

TAPE ONE STUDIOS, 29-30 Windmill Street, London W1P 1HG, 071.580 0444, Fax: 071.580 5455, MD: Barry Ainsworth, Contact: Joyce Adams. CD pre-mastering & disc-cutting.

TOWNHOUSE STUDIOS, 150 Goldhawk Road, London W12 8HH, 081.743 9313, Fax: 081.740 1180, MD: Barbara Jeffries, Bookings: Gay Marshall. CD pre-mastering, disc-cutting & mastering; 5 studios, console: Neumann, Studer; Sonic Solutions system, Harmonia Mundi digital, Teldec DMM lathe.

TRANSCO MASTERING SERVICES, 9 Dean Street, London W1V 5RL, 071.287 3563, Fax: 071.494 3583, MD: P G J Rooke, Dir: J Rooke. Distribute: Transco Lacquer discs.

UTOPIA STUDIOS, 7 Chalcot Road, London NW1 8LH, 071.586 3434, Fax: 071.586 3434, Tlx: 298701, MD: Phil Wainman, Mgr: George Saunders. Disc cutting, CD pre-mastering.

TAPE CUSTOM DUPLICATORS

A-Z MUSIC SERVICES, 97 Charlotte Street, London W1P 1LB, 071.323 5590, Fax: 071.323 9174, Contact: Paddy Prendergast, Helen Odysseos.

ABLEX AUDIO VIDEO, 14 Halesfield, Harcourt, Telford, Shropshire TF7 4QR, 0952.680 131, Fax: 0952.583 501, MD: Peter Banks, Fin Dir: Ron Pitt. Annual capacity: 18m.

ACCURATE SOUND, Melton Road, Quenborough Estate, Quenborough, Leicestershire LE7 8FP, 0533.602 064, Fax: 0533.600 108, MD: William Komedara.

AIR TV FACILITIES, 13 Hawley Crescent, London NW1 8NP, 071.485 4121, Fax: 071.485 3667, Contact: Graham Hall. Video duplication.

AIRWAVE RECORDING STUDIOS, Northgate Place, Crawley, West Sussex RH10 2BB, 0293.523 441, Fax: 0293.553 461, MD: N D Abdool.

AOSIS AUDIO/VISUAL, 10a Belmont Street, London NW1 8HH, 071.485 4810, Fax: 071.267 5710, MD: Laurie Marsh, Studio Mgr: Mimi Kerns, Eng: Leigh Jemison, Asst Engs: Riik Jacobs, Reed Fisher. Cassette duplication; Facilities: Sony TCK 630ES cassette recorders, JBL 4401 monitoring, Yamaha P2050 power amp, Roland S-EQ 315 graphic, Studer/Revox C270, Technics SV-360 DAT recorder.

ARION COMMUNICATIONS, North Orbital Road, Global House, Denham, Middlesex UB9 5HL, 0895.834 484, Contact: Steve Davis. Video duplication.

ARMCO ALPHA RECORDING & MARKETING CO., Forest Industrial Park, Units 1-2, Hainault, Essex IG6 3HL, 081.500 1981, Fax: 081.501 1319, MD: Alan Boddie, Sec: Brenda Boddie. Audio cassette duplication; Annual capacity: 1.5m; Min order: 250.

ASHLEY VIDEO, 3 Ashley Industrial Estate, Leeds, West Yorkshire LS7 2HG, 0532.625 650, Fax: 0532.374 008, Sales Admin: Dee Alder. Video duplication.

ASPEN SPAFAX TELEVISION BRISTOL, Pritchard Street, 6 Portland Place, Bristol, Avon BS2 8RH, 0272.232 880, Fax: 0272.429 5454, Contact: Ian Simpson. Video duplication.

AUDIO & DATA DUPLICATION, 2 Station Yard, Hungerford, Berkshire RG17 0DY, 0488.681 144, Fax: 0488.681 091, Contact: Richard Denning.

AUDIO SERVICES (TAPE DIVISION), 159 Stafford Road, Windsover House, Croydon, Surrey CR0 4NN, 081.760 9710, Fax: 081.680 8494, MD: Steve Mason, Dir: Freddy Cannon, GM: Eddie Wilcox.

AWFULLY NICE VIDEO COMPANY, 29 Kingsend, Ruislip, Middlesex HA4 7DD, 0895.678 477, Fax: 0895.621 162, Contact: Graham Maunder. Video duplication.

AWL COMPACT DISC COMPANY, 356 Scraftoft Lane, Leicester, Leicestershire LE5 1PB, 0533.413 979, Fax: 0533.433 760, MD: Andrew Lipinski, Partner: Irena Lipinski.

BACKYARD STUDIO, Crickhowell Road, Willowbrook Units 4-5, St. Mellons, Cardiff CF3 0EF, 0222.777 739, Fax: 0222.798 901, MD: Phil Silver.

BIRNAM CASSETTE DUPLICATION, 9 Tottie Street, Alyth, Blairgowrie, Scotland PH11 8BP, 082.833 330, Owner: Martin L Hadden. Audio cassette duplication; Min order: 50.

BOLTON WELLS, Playing Field Road, West Works, Westbury, near Brackley, Northampton NN13 5JS, 0280.701 330, Fax: 0280.700 032, President: Bernard Lane, Sales Exec: T Lewin.

BRUNSWICK FILM & VIDEO, 26 Macroom Road, London W9 3HY, 081.960 0066, Fax: 081.960 4997, Contact: Dianne Falls. Video duplication.

BTS TELEVISION, 115 Portland Street, Manchester, Greater Manchester M1 6DW, 061.236 6911, Fax: 061.236 6914, Contact: D Taylor. Video duplication.

CABIN TAPE SERVICES, 55 Copewood Road, Watford, Hertfordshire WD2 5DY, 0923.247 129, MD: Chris Andrew Cassette duplication.

CAMERON VIDEO SYSTEMS, Burnfield Road, Giffnock, Glasgow, Strathclyde, Scotland G46 7TH, 041.633 0077, Fax: 041.633 1745, MD: Chris Cameron, Contact: Teri Carnegie, Sales Mgr (UK): John Johnstone, Prod/Fac Mgr: John Friday, Hire/Dupl Mgr: David Gardner. Video duplication, sales & service.

CAPITAL TELEVISION, 22 Newman Street, London W1P 4AJ, 071.636 3663, Fax: 071.436 3989, Contact: Patricia Finch Video duplication.

CASEY'S FILM & VIDEO, Mitre Way, Mitre Bridge Ind Park, Unit 9, London W10 6AU, 081.960 0123, Fax: 081.969 3714, Contact: John Casey. Video duplication.

CASSETTE DUPLICATORS, Tything Rd, Unit 4d, Arden Forest Ind Es, Alcester, Warwickshire B49 6ES, 0789.765 507, Fax: 0789.400 516, MD: John Wood, Mktg Dir: Mark Wood, Sales Dir: Ian Wood. Audio cassette duplication; Annual capacity: 4m; Min order: 500.

CAVENDISH CASSETTES, Chequers Close, The Chequers, Crowborough, East Sussex TN6 2SD, 081.491 4117/0892.655 298, Contact: Norman Austin.

CHANDOS RECORDS, Commerce Way, Chandos House, Colchester, Essex CO2 8HQ, 0206.577 300, Fax: 0206.41104, Contact: Ralph Couzens.

CHANNEL 5 AUDIO/VIDEO, 14 Centre Way, Claverings Ind Estate, Edmonton, London N9 0AH, 081.803 9036, Fax: 081.884 2440, MD: Denis Holland, Claire Seaman. Annual capacity 25,000; Minimum order: 25.

CINEPHOTO PRODUCTIONS, 17 The Crescent, Salford, Manchester, Greater Manchester M5 4PF, 061.736 6221, Fax: 061.736 9158, Contact: Richard Hagon. Video duplication.

CM PRODUCTIONS, 2 High Street, Starbeck, Harrogate North Yorkshire, 0423.888 979, Fax: 0423.885 761, Tlx: 57978, MD: Dave Bulmer.

COLECASTLE VIDEO DUPLICATIONS, Riverside Rd, Wimbledon Bus Ctr, Unit 51, London SW17 0BA, 081.946 7311, Fax: 081.944 1936, Contact: Harold Woolf. Video duplication.

COLOUR VIDEO SERVICES, Baker Street, 22/5 Portman Close, London W1, 071.486 2881, Fax: 081.997 8738, Tlx: 24672, Contact: Ron Rogers. Video duplication.

COMPONENT BROADCAST FACILITIES, 6 Springwell Court, Leeds, West Yorkshire LS12 1AL, 0532.425 460, Fax: 0532.449 094, MD: Mike Bryden, Snr Ed: Duncan Foster. Video duplication.

CONSTRUCTIVE VIDEO, Soho Square, 9-11 Bateman Buildings, London W1V 5TW, 071.734 1563, Fax: 071.734 0015, Contact: Rosemary Ricketts. Video duplication.

COPYMASTERS, Bagleys Lane, 13 The Talina Centre, London SW6 2BW, 071.731 5758, Fax: 071.384 1750, MD: David Moore, Studio Mgrs: Margaret Johnson, Toni Wagner. Cassette duplication.

CORPORATE VIDEO BROKERS, 201 Bilton Road, Perivale, Middlesex UB6 7HQ, 081.991 2610, Fax: 081.991 0180, Contact: Phil Stringer. Video duplication.

COTTAGE RECORDING, 2 Gawsworth Road, Macclesfield, Cheshire SK11 8UE, 0625.20163, Fax: 0625.20163, MDs: Deborah Boden, R Boden. Cassette duplication.

CROW FILM & TV SERVICES, 12 Wendell Road, London W12 9RT, 081.749 6071, Fax: 081.740 0795, Contact: Fiona Maxwell. Video duplication.

CUNNINGGS RECORDING ASSOCIATES, Brodrick Road, Brodrick Hall, London SW17 7DY, 081.767 3533, Fax: 081.767 8525, Owner: M J Cunnings. Audio cassette duplication. Annual capacity: 400,000; Min order: 1.

DAMONT AUDIO, Blythe Road, Hayes, Middlesex UB3 1BY, 081.573 5122, Fax: 081.561 0979, MD: Chris Clark, Sales Dir: Ian Mackay, Tech Dir: Colin Rye, Prod Dir: Chris Rose, Fin Dir: Ian Ramsden. Annual cassette duplication; Annual capacity: 10.8m; Min order: 1,000; Other: Audio Cassette Mastering, Vinyl Matrix Plating.

DOUBLEVISION, 7-11 Lexington Street, London W1R 3HQ, 071.434 4461, MD: Katrina Usher. Video duplication.

DRAGON TELEVISION FACILITIES, The Old Church, Boilington, Cheshire SK10 5PW, 0625.572 544, Fax: 0625.574 520, Contact: Vicky Geldart. Video duplication.

DUBBS, 25-26 Poland Street, London W1V 3DB, 071.625 0055, Fax: 071.287 8796, Contact: Richard Nardi. Video duplication.

THE DUPLICATION PLANT, 1 Portland Drive, Willen, Milton Keynes MK15 9JW, 0908.663 848, Fax: 0908.666 654, MD: Patrick Rogers, Fin Dir: David Valey, Dir: Nigel Regrim.

- Audio & Video cassette duplication; Annual capacity: 1,500,000 (audio), 350,000 (video); Min order: 1 (audio, video).
EDRIC AUDIO VISUAL, 34-36 Oak End Way, Gerrards Cross, Buckinghamshire SL9 8BR, 0753.884 646, Fax: 0753.887 163, Contact: Caroline Starr. Video duplication.
- ELMAG VIDEO SERVICES, Caxton Court, Unit B, Porters Wood, St. Albans, Hertfordshire AL3 6PB, 0727.36464, Fax: 0727.39080. Video duplication.**
- EMI MUSIC SERVICES (VINYL & CASSETTE), 1-3 Uxbridge Road, Hayes, Middlesex UB4 0SY, 081.561 8722, Fax: 081.569 2212, Tlx: 934614 emirc, MD: Jim Leftwich, Manufacturing Dir: Peter Hall. Annual capacity: 100m; Minimum order: 5,000.**
- ENG VIDEO, Elgar Road South, 3 Nimrod Way, Reading, Berkshire RG2 0EB, 0734.751 555, Fax: 0734.861 482, Contact: Ian Williams. Video duplication.**
- EYE TV, 10 Myddleton Road, London N22 4NS, 081.888 8949, Fax: 081.889 6166, Contact: Peter Fowler. Video duplication.**
- FAIRLINE VIDEO SERVICES, 30 Dean Street, London W1N 5AN, 071.434 1108, Fax: 071.734 1662, Contact: Tony Appleton. Video duplication.**
- FILMATIC LABORATORIES, 16 Colville Road, London W11 2BS, 071.221 6081, Fax: 071.229 2718, Contact: Michael Gibbs. Video duplication.**
- FLASHBACK COMMUNICATION, 25 Greenhead Street, Glasgow, Strathclyde, Scotland G4 1ES, 041.554 6868, Fax: 041.554 6869, MD: Chris Atkins, Producer: Ros Borland. Video duplication, house design & print.**
- FOEL STUDIO, Foel Studio, Llanfair, Caerinion, Powys SY2 0RZ, 0938.810 758/952.883 962, Fax: 0952.728 176, MD: Dave Anderson, Studio Mgr: Harry Love.**
- FRASER PEACOCK ASSOCIATES (CASSETTES), 204 Durnsford Road, London SW19 8DR, 081.946 4288, Fax: 081.879 1990, Chmn: G F Peacock, MD: P West, I F Peacock. Annual capacity 7m.**
- FRASER PEACOCK ASSOCIATES (VIDEO), 2 Endeavor Way, Durnsford Estate, Unit D, London SW19, 081.946 5388, Fax: 081.947 8992, Contact: Mike Carey.**
- GAV VIDEO FACILITIES, 34-36 Bickerton Road, London N19 5JS, 071.263 9561, Fax: 071.272 0146, Contact: Robert Brian-court. Video duplication.**
- GEDMAL GALVANIC, Queenborough Estate, Melton Road, Leicester LE7 8FP, 0533.602 064, Fax: 0533.600 108, MD: William Komedara. Lacquer processing. Vinyl pressing.**
- GOUGHSOUND, 29 Beethoven Street, London W10 4LG, 081.960 1871, Fax: 081.969 1694, MD: Brian Leafe. Audio cassette duplication; Min order: 500; Agent broker for: MYOB.**
- GRAMPIAN RECORDS, Industrial Estate, Unit 4A, Wick, Calthness-shire, 0955.5030, Fax: 0955.4418, Contact: John Hunter.**
- GUILD DUPLICATION, Maxwell Road, Unit 13-4, Peterborough, Northamptonshire PE2 0HU, 0733.231 811, Fax: 0723.236 443, Contact: Margaret Watt. Video duplication.**
- GWBB AUDIOVISION, 42 Lancaster Gate, London W2 3NA, 071.723 5190, Fax: 071.224 8317, MD: Siegfried Pracher, Contact: Michael Stout. Audio cassette duplication; Annual capacity: 2.5m; Min order: 1; Based on C30; Video duplication & conversion, 24 hr/7 day service; Annual capacity: 1.5m; Min order: 1, based on E10.**
- THE HIT FACTORY, 31-37 Whitfield Street, London W1P 5RE, 071.636 3434, Fax: 071.580 0543, Studio Dir: Ray Davidson, Mastering Fac Mgr: Annabel Florman. Cassette duplication [refer to studio listing for equipment list].**
- HOCKEN AUDIO VISUAL, 5 Waterhouse Lane, Kingswood, Tadsworth, Surrey KT20 6EB, 0737.370 371, Fax: 0737.370 372, Contact: Richard Haines. Video duplication; Member of APVD.**
- HOLIDAY BROTHERS AUDIO & VIDEO, 172 Finney Lane, Heald Green Cheadle, Cheshire SK8 3PU, 061.437 0538, Fax: 061.499 1540, MD: Stewart Holiday. Video duplication.**
- HOLLOWAY FILM & TELEVISION, 70 Wardour Street, London, 071.494 0777, Fax: 071.494 0309, Contact: David Holloway. Video duplication.**
- HOMESTEAD STUDIOS, 57a Main Street, Randalstown, County Antrim BT41 3BB, 08494.73592, Fax: 08494.73707, Contact: Hugh McMaster.**
- HTV PRODUCTION SERVICES, Culverhouse Cross, Cardiff, Glamorganshire CF5 6XJ, 0222.590 341, Fax: 0222.597 183, Tlx: 497703, MD: Mike Towers, Prod Mgr: Mark Allen. Video duplication.**
- HUMPHRIES VIDEO SERVICES, 17 Willow Lane, Willow Bus Ctr, Unit 2, Mitchum, Surrey CR4 4NX, 081.648 6111, Fax: 081.648 5261, MDs: R Dent, Stuart English, GM: David Brown. Video duplication.**
- HYDROGLYPHIX, 148 Devonshire Road, London W4 2AW, 081.742 1758, Fax: 081.742 1758, Contact: Rod Hawkins. Video duplication.**
- ICC STUDIOS, Silverdale Road, Eastbourne, East Sussex BN20 7AB, 0323.643 341/2, Fax: 0323.649 240, MD: Helmut Kaufmann, Mgr: Geoff Durrant, Prod Mgr: Calvin Game. Audio cassette duplication; Annual capacity: 1.5m; Min order: 100.**
- INTERVIDEO, 87 Boundary Road, St. John's Wood, London NW8 0RG, 071.624 1711, Fax: 071.624 2683, Contact: Trevor Nash. Video duplication.**
- ISIS DUPLICATING COMPANY, The Runnings, Shaftesbury Centre Unit 11, Cheltenham, Gloucestershire GL51 9NH, 0242.571 818, Fax: 0242.571 315, Dirs: Douglas Brochiche, Peter Rinne, Sales Mgr: Glyn Ellis-Evans. Audio cassette duplication; Annual capacity: 6m; Min order: 500.**
- ITD (INDEPENDENT TAPE DUPLICATORS), Faraday Road, Unit 21, Aylesbury, Buckinghamshire HP19 3RY, 0296.27211, Fax: 0296.392 019, MD: Roy Jackson-Moore, Fin Dir: Michael McLoughlin. Cassette & video duplication.**
- ITN HOUSE FACILITIES, 6 Mortimer Street, London W1, 071.580 8333, Fax: 071.637 1542, Tlx: 298935, Contact: Katherine Deeprose. Video duplication.**
- JAMES YORKE, Corpus Street, Yorke House, Cheltenham, Gloucestershire GL52 6XH, 0242.584 222, Fax: 0242.222 445, MD: James Scarlett, Fin Dir: L R J Price, Sales Mgr: Ken Leeks, Prod Mgr: R H Harmer. Cassette duplication; Annual capacity: 13m; Min order: 500; Agent broker for several CD manufacturers.**
- JETTISOUNDZ MUSIC VIDEO, 28-30 The Square, St. Annes-on-Sea, Lancashire FY8 1RF, 0253.712 453, Fax: 0253.712 362, Chmn: John Bentham, President: J H Ashworth, Dirs: P van Mann, K Bentham. Video duplication; Minimum order: 100; Annual capacity: 500,000.**
- JOHN HEMSON ASSOCIATES, Bedford Road, The Bakehouse, Milton Keynes, Buckinghamshire MK17 8DH, 0908.583 062, Fax: 0908.281 035, Contact: John Hemson. Video duplication.**
- KAY FILM & VIDEO, 22 Soho Square, London W1V 5FJ, 071.437 7811, MD: P MacCrimmon. Video duplication.**
- KEYNOTE CASSETTES, Wishanger Lane, Churt, Farnham, Surrey GU10 2QJ, 0251.254 253, Fax: 0251.252 642, MD: Tim Wheatley. Cassette duplication.**
- KG ENGINEERING, Edgelands Lane, Ipplepen Bus. Prk, Unit 6, Ipplepen, Devon, 0803.813 833, MD: Keith Gould.**
- LADYBIRD PICKWICK STUDIOS, The Hyde Industrial Estate, Unit 1b, London NW9 6JU, 081.205 2464, Fax: 081.200 0759, Contact: Peter Chipping. Video duplication.**
- LEEOLME AUDIO SERVICES, 340-344 Lea Bridge Road, Leyton, London E10 7LD, 081.556 1125, Fax: 081.539 8834, MD: Mike Kitson, Sales Dir: John Bassett. Cassette duplication.**
- LEGEND TELEVISION, Pinewood Road, Pinewood Studios, Iver Heath, Buckinghamshire SL0 0NH, 0753.656 027, Fax: 0753.656 028, Contact: Robin DeAth. Video duplication.**
- LIVELINK SYSTEMS INTERNATIONAL, 45 Manfield Gardens, St. Osyth, Essex, 0255.820 937, Fax: 0255.820 961, Contact: Andy Stulpa. Video duplication.**
- THE LONDON TAPE COMPANY, Charlotte Despard Ave, D & RCA Unit 18, Battersea, London SW11, 071.720 6976, Fax: 071.498 1460, MD: Colin Collino. Cassette duplication.**
- MAGNETIC IMAGE PRODUCTIONS, West Row, Grand Union Centre, Unit 6, London W10 5AX, 081.960 7337, Fax: 081.968 1378, MD: Mike Bailey. Cassette duplication.**
- MAGNETIC MEDIA, PO Box 35, Salisbury, Wiltshire SP1 2JT, 0722.790 372, Fax: 0722.339 104, Tlx: 477019 asr, MD: Campbell Gifford, Sales Dir: N Morris.**
- MALCOLM BRISTOW STUDIOS, Soho Square, 1-8 Bateman Buildings, London W1V 5TW, 071.439 7737, Fax: 071.287 8745, Contact: Douglas Glen. Video duplication.**
- MAYKING RECORDS, 250 York Road, Battersea, London SW11 3SJ, 071.924 1661, Fax: 071.924 2147, MD: Brian Bonnar, Mktg Mgr: Clive Robins.**
- MAYRON UK, 69 Whitton Avenue East, Greenford, Middlesex UB8 0QD, 081.903 6290/2725, Fax: 081.903 2052, Dirs: M E & T C Ho. Cassette duplication; Annual capacity: 24m.**
- MC2, High Street, Langford Farmhouse, Newton Poppleford, Sidmouth, Devonshire EX10 0DU, 0395.68249, Contact: Joyce McCarthy. Video duplication.**
- MEDIA CENTRE, South Hill Park, Bracknell, Berkshire, 0344.860 681, Fax: 0344.411 427, Contact: Bob Gibbs. Video duplication.**
- METROVIDEO, 57-59 Great Suffolk Street, London SE1 0BS, 071.928 2088, Fax: 071.261 0685, Tlx: 896559, Chmn: David Pacey, MD: Raul Jackman, Fin Dir: Ian Taylor, Tech Dir: Tim Rawlings, Mktg Dir: Geraldine Scher, Mktg Co-Ord: Justine Hall. Video duplication.**
- MOLINARE, 34 Fouberts Place, London W1V 2BH, 071.439 2244/734 6813, Contact: George Landin. Video duplication.**
- MONTMUSIC, 2 Heydons Close, St. Albans, Herts AL3 5SF, 0727.56806, Fax: 0727.46380, MD: Monty Presky, Sales: Philip Presky. Also agent for Sonopress CD, Germany.**
- MULTICORD, 1-6 Ravensworth View, Dunston, Gateshead, Tyne & Wear NE11 9DQ, 091.460 9209, Fax: 091.460 1494, MD: Ken McKenzie. Cassette & video duplication.**
- MUSIC MANUFACTURERS, 100 Clapham Road, Bedford, Bedfordshire MK41 7PL, 0234.213 535, Fax: 0234.216 146, Operations Dir: Nick Flower, Tech Dir: Roy Matthews, Sales Dir: Malcolm Pearce, Prod Mgr: Tim Taylor.**
- NATIONAL SOUND REPRODUCERS, 3 Parr Road, Stanmore, Middlesex HA7 1PZ, 081.951 0222, Fax: 081.951 1434, Tlx: 924896, Contact: Ron Walker, Studio Mgr: Peter Kiely.**
- OASIS TELEVISION, 76a Wardour Street, London W1V 3LF, 071.434 4133, Fax: 071.494 2843, MD: Andrew Coppin, Facilities Mgr: Helen Leicester, Snr Ed: Tony Cloarec. Video duplication and dubbing.**
- PEAK WHITE VIDEO, Latimer Road, Teddington, Middlesex TW11 8QA, 081.943 1922, Fax: 081.977 8357, MD: Richard Bonfield. Video duplication.**
- PHOENIX VIDEO, Maple Cross Industrial Estate, Unit 4, Maple Cross, Rickmansworth, Hertfordshire WD3 2AS, 0923.777 782, Fax: 0923.772 163, Contact: Paul Bridgen. Video duplication.**
- PLAZAHURST VIDEO SERVICES, 90-91 Queensbury Rd, Montague Wks, Unit 4, Wembley, Middlesex HA0 1QG, 081.998 8848, Fax: 081.998 6170, Contact: Shashi. Video duplication.**
- PMPP FACILITIES, 69 Dean Street, London W1V 5HB, 071.437 0979, Fax: 071.434 0386, GM: Rosanne Levy. Video duplication.**
- THE PRODUCERS, Vale Road, Pacific House, London N4 1QB, 081.809 4445, Fax: 081.802 8840, MD: Steve Athey. Audio & video duplication.**
- PROFESSIONAL MAGNETICS, 329 Hunslet Road, Cassette House, Leeds, West Yorkshire LS10 1NJ, 0532.706 066, Fax: 0532.718 106, MD: J Barrie Rhodes, Sales Dir: Hilary Rhodes. Audio & video duplication.**
- PROGRAMME TECHNICAL SERVICES, 19 Garamonde Drive, Wymshub, Milton Keynes, Buckinghamshire MK8 8DF, 0908.569 696, Fax: 0908.561 603, Contact: R Venis. Video duplication.**
- QUADRANT TV, 17 Westhill, Wandsworth, London SW18 1RB, 081.870 9933, Fax: 081.870 7172, Contact: Sam Key. Video duplication.**
- QUEST TELEVISION, Lyncastle Way, 5 Asher Court, Ajpleton, Warrington, Cheshire WA4 4ST, 0925.860 180, Fax: 0925.860 138, Contact: Mark Pooyer. Video duplication.**
- RADIO LUXEMBOURG (LONDON), 74 Newman Street, London W1P 3LA, 071.436 4666, Fax: 071.436 4017, Tlx: 263912 luxldn, MD: John N Cattlett.**
- RANDS VIDEO, 10 Hibel Road, Macclesfield, Cheshire SK10 2AB, 0625.26248, Fax: 0625.613 208, Contact: Ray Brierley. Video duplication.**
- RANK VIDEO SERVICES, Great West Road, Phoenix Park, Brentford, Middlesex TW8 9PL, 081.568 4311, Fax: 081.847 4032, MD: Hugh Cortance, Mktg/Sales Dir: Andrew Bourne. Video duplication.**
- REALITY POST PRODUCTION, 15 Kingly Court, London W1R 6LE, 071.287 3612, Fax: 071.734 1592, Contact: John McSherry. Video duplication.**
- REFLEX AUDIO SYSTEMS, Glebe Road, Unit 5, Cirrus, Huntingdon PE18 7DX, 0480.434 333, Fax: 0480.411 441, Contact: John Garrad. Cassette duplication.**
- RETEL VIDEO, East Lane, GEC Estate, Wembley, Middlesex HA9 7FF, 081.904 4333, Fax: 081.904 5933, Contact: Nathan Manickam. Video duplication.**
- RICHMOND SOUND, 509 Upper Richmond Rd West, Hillier Hse, London SW14 7EE, 081.948 4399, Contact: M. Bull. Video and Audio cassette duplication; Capacity: 100,000; Min order: 1.**
- RTS RAINHILL TAPE SPECIALISTS, Albany Rd, Prescott Trade Ctr, Units M1-2, Prescott, Merseyside L34 2SH, 051.430 9001, Fax: 051.430 7441, MD: John Fairclough, Sales/Mktg Dir: Dave Morris, Prod Contrs: Jan Hayes, Lewis Lin. Audio cassette duplication; Annual capacity: 2.5m; Min order: 1.**
- SATELLITE CONSULTANTS COMPANY, Commercial Wy, Abbey Rd Ind Park, Unit 20, London NW10 7XF, 081.965 5955, Fax: 081.961 8071, Tlx: 946326 satco. Contact: Beverley Everson. Video duplication.**
- SELECTA SOUND, 5 Margaret Road, Romford, Essex RM2 5SH, 0402.453424, Fax: 0402.455565, Dirs: John & Carol Smalles.**
- SIGNAL VISION, Park Gate Estate, Knutsford, Cheshire WA16 8DX, 0565.55678, Fax: 0565.4164, Contact: Mark Ambrose. Video duplication.**
- SIMON STABLE PRODUCTIONS, 20 West End, Launton, Oxford OX6 0DF, 0869.252 831, Fax: 0869.245 024, MD: Simon Stable, Mgr: Dat Tucker. Cassette duplication.**
- SOHO STUDIOS, 187 Wardour Street, London W1V 3FA, 071.437 2394/723 2463, Fax: 071.434 0648, MD: Mark Teverson.**
- SONOPTICS PRODUCTIONS, Rosier Farm, Billingshurst, West Sussex RH14 9DE, 0403.782 386, Fax: 0403.784 949, Contact: Nigel Fraser. Video duplication.**
- SONY MUSIC OPERATIONS (UK), Rabans Lane, Aylesbury, Buckinghamshire HP19 3BX, 0296.26151, Fax: 0296.81009, MD: David Black, MIS Dir (UK & Eur): David Barrie, Mktg Dir: Lionel Smithers. Audio & video duplication.**
- THE SOUND & PICTURE HOUSE, 2 Greenfield Crescent, Birmingham, West Midlands B15 3BE, 021.456 1429, Fax: 021.454 6427, Contact: Phil Brice. Video duplication.**
- SOUNDS GOOD, Station Road, Chiltern Centre, Unit 12, Theale, Berkshire RG7 4AA, 0734.302 600, Fax: 0734.303 181, Sales Dir: Katrina Larkin, Prod Dir: Henry Smithson, Admin Dir: Martin Hayward. Audio duplication; Annual capacity: 3m; Min order: 50; Video duplication; Annual capacity: 100,000; Min order: 10.**
- SOUNDS NATURAL, Upper End, Fullbrook, Oxfordshire OX8 4BX, 099382.2167, Contact: Ken Jackson.**
- SOUTH RIDING VIDEO & TELEVISION, Wilthorpe Road, BIC Innovation Way, Barnsley, South Yorkshire SY5 1JL, 0226.204 401, Fax: 0226.249 625, Tlx: 54687, Contact: Rachel Dawson. Video duplication.**
- SPECTEL COMMUNICATIONS, 95 High Street, 1st floor, Kingswood, Bristol, Avon BS15 4AD, 0272.676 863, Fax: 0272.606 102, Partners: Jane & Brian Batt. Video tape duplication, standards' conversions.**
- SPOOL DUPLICATION & DISTRIBUTION, 1st Avenue, Deeside Industrial Park, Deeside, Clwyd CH5 2NU, 0244.280 602, Fax: 0244.288 581, Tlx: 94011643 spoo, MD: Roy Varley, Sales Dir: Jeff Johnson, Prod Dir: Harold Waltho, Disk Dept Mgr: Wendy Grant. Audio cassette duplication & distribution services.**
- SRT SOUND RECORDING TECHNOLOGY, Edison Road, St. Ives, Huntingdon, Cambridgeshire PE17 4LF, 0480.61880, Fax: 0480.496 100, MD: David Richardson.**
- STABLE RECORDINGS, Lochend, Beith, Strathclyde KA15 2LN, 0505.85488, Fax: 0505.85488, Contact: Alastair Wilson. Video duplication.**
- STANDARD SOUND PRODUCTIONS, 1 Post Office Lane, Old Smyth Studio, Kempsey, Worcestershire WR5 3NS, 0905.820 659, Fax: 0905.820 015, Tlx: 334142, MD: Muff Murfin. Annual capacity: 75,000.**

STUDIO FILM & VIDEO SERVICES, 72-73 Dean Street, London W1V 6DE, 071.437 4161/0831, Fax: 071.734 3331, Contact: David Atkinson. Video duplication.

STUDIO REPUBLIC, 47 High Street, Pinner, Middlesex HA5 5PU, 081.868 5555, Fax: 081.868 5555, MD: John Bales. Cassette duplication; Min order: 100; Agent Brokers for: CD MFG.

SUMMIT MAGNETICS, 43a Old Woking Road, West Byfleet, Surrey KT14 6LG, 0932.351 925/340 940, Fax: 0932.336 431, MD: Mike Wells.

SUTTON SOUND, 228 Bishopgate, London EC2M 4QD, 071.262 9066, Fax: 071.262 3235, Studio Mgr: Mark Sutton, Bookings/Admin: Henrietta Brougham. Audio cassette duplication.

TAM STUDIO, 13a Hamilton Way, London N3 1AN, 081.346 0033, Fax: 081.346 0530, Contact: Tony & Myrtle Batchelor. Cassette duplication; Other: custom wound blanks, one-off CD's, digital editing.

THE TAPE DUPLICATING COMPANY, 4-10 North Road, London N7 9HN, 071.609 0087, Fax: 071.607 7143, Sales Mgr: Jon Powell. Audio cassette duplication; Annual capacity: 26m; Min order: 500; Video cassette duplication; Annual capacity: 21m; Min order: 500.

THE TAPE GALLERY, 28 Lexington Street, London W1R 3HR, 071.439 3325, Fax: 071.734 9417, Contact: Melanie Moser. Audio & video cassette duplication.

TAPELINE, York Street, York Works, Unit 2, Audenshaw, Manchester M34 5HD, 061.344 5436, Partners: Alan & Wendy Williams. Audio cassette duplication; Annual capacity: 2.5m; Min order: 500.

TEAM TELEVISION, Mount Stuart Square, Exchange Building, Cardiff, Glamorganshire CF1 6EA, 0222.484 230, Fax: 0222.494 210, Contact: Penny King. Video duplication.

TECHNICOLOR VIDEOCASSETTE

Beresford Ave, Northfield Est, Unit 18, Wembley, Middlesex HA0 1NW, 4481-900-1182, Fax: 4481-903-0294, Pres.: Emmet Murphy, Gen. Mgr.: Roy Fossett, Mktg. Dir.: Richard Gray. Video: 1/2 Video Cassette, S-VHS, 8mm. High Speed Capability: Sprinter: SP, EP modes. Video Packaging Services: Inserting, Collating, Labeling, Other Services: Complete Fulfillment Services, Warehouse, MIS (Inventory), Freight.

TOWNHOUSE STUDIOS, 150 Goldhawk Road, London W12 8HH, 081.743 9313, Fax: 081.740 1180, MD: Barbara Jeffries, Bookings: Gay Marshall.

TRANSMISSION (TX), Studios Rd, Shepperton Studios, Unit 2a, Shepperton, Middlesex TW17 0QD, 0932.562 611, Fax: 0932.566 913, Contact: Steve Lloyd. Video duplication.

TSI VIDEO, 10 Grape Street, London WC2H 8DY, 071.379 3435, Fax: 071.379 4589, Contact: Nick Doff. Video duplication.

TUDOR ENTERPRISES, Warne Road, 2 Quadeast, Weston-Super-Mare, Avon BS23 3UU, 0934.628 219, Fax: 0934.624 630, GM: Ronald Cardwell, Sales Mgr: Simon Cardwell, Quality Contr Mgr: Paul Cardwell, Prod Mgr: Luke Cardwell, Eng: Brian Monk. Audio cassette duplication; Annual capacity: 5m; Min order: 300.

TVP VIDEODUBBING, 2 Golden Square, London W1R 3AD, 071.439 7138, Fax: 071.434 1907, Joint MDs: Nick Panaman, Simon Kay, Facilities Dir: Michael Ashley. Full promo dubbing & distribution services, editing, telecine, cassette duplication, and standards conversion via ADAC; Formats: D2, 1" PCM, 1" C, Beta SP, BVU, U-matic, VHS, Hi 8, Video 8, Betamax.

TWELVE O'CLOCK PRODUCTIONS, PO Box 333, Bushey, Watford, Herts WD2 3UN, 081.950 9507, Fax: 081.950 3806, MD: Nick Ralph. Cassette duplication.

TWENTIETH CENTURY VIDEO, East Lane, Wembley Comm Ctr, Unit 2.5, Wembley, Middlesex HA9 7UU, 081.904 6271, Fax: 081.904 0172, MD: Clive Rumble, Mktg Mgr: Bob Allan. Video duplication.

TWTV, 20 Kingy Street, London W1R 5LD, 071.437 4706, Fax: 071.734 0703, Contact: Toby Wallis. Video duplication.

VECTOR TELEVISION, Battersea Rd, Heaton Mersey Ind Estate, Stockport, Cheshire SK4 3EA, 061.442 7887, Fax: 061.442 8963, Contact: Steve Brookes. Video duplication.

VIDEO INN PRODUCTION, Welford Road, 33 Cedrus Court, Northampton, Northamptonshire NN2 8EU, 0604.846 857, Fax: 0604.821 662, Contact: Roger Bentley. Video duplication.

VIDEOCOPY, Meanwood Rd, Buslingthorpe Green, Unit 3, Leeds, West Yorkshire LS7 2HG, 0532.625 625, Fax: 0532.374 008, MD: R D Morley, Sales Dir: R Linton. Video duplication.

VIDEOPRINT, 250 York Road, Battersea, London SW11 3SJ, 071.924 1333, Fax: 071.924 2148, Tlx: 935100 vidprg, MD: Brian Bonnar, GM: Simon Valley, Sales Dir: Jackie Winston. Video duplication.

VIEWPLAN, Temple Way, Temple Meads Estate, Unit 15, Bristol, Avon BS1 6HA, 0272.276 500, Fax: 0272.279 700, Contact: Steven Morris. Video duplication.

VISUAL MEDIA SERVICES, 36 Hartham Road, Isleworth, Middlesex TW7 5ES, 081.569 9958, Fax: 081.569 9961, Contact: Ian Leslie. Video duplication.

VMI VIDEO MANIA, 146-148 Granville Road, Ind Estate, Unit 1, London NW2 2LD, 081.209 1313, Fax: 081.458 5047, MD: Monica Basset. Video duplication.

WARREN RECORDINGS, 59 Hendale Avenue, London NW4 4LP, 081.203 0306, MD: Stanley Warren. Cassette duplication.

WEST COAST VIDEO, Caxton Court, Unit B, Porters Wood, St. Albans, Hertfordshire AL3 6PB, 0727.836 464, Fax: 0727.839 080, MD: Sandy Davidson, Sales/Mktg Mgr: Clive Alicott, Factory Mgr: Martin Devereaux, Accts Mgr: Paul Gooderham. Video duplication; Annual capacity: 5m.

WILDLIFE SOUND PRODUCTIONS, Levington Road, Wildlife House, Ipswich, Suffolk IP3 0NJ, 0473.729 711, Fax: 0473.729 039, MD: Allan Alderson, Mgr: Ian Thomas.

WISEMAN, 27-35 Lexington Street, London W1V 4J9, 071.439 8901, Fax: 071.437 2481, Contact: Brian Wiseman. Video duplication.

WTN WORLDWIDE TELEVISION NEWS, 31-36 Foley Street, London W1P 7LB, 071.323 3255, Fax: 071.580 1437, Tlx: 23915, Contact: Lorie Graham-Morgan. Video duplication.

YO YO FILM PRODUCTIONS, 79 Dean Street, London W1V 5HA, 071.287 6543, Fax: 071.287 6544, Contact: L C Postma. Video duplication.

CASSETTES REELS & PARTS, JEWEL BOX MANUFACTURERS

4M, Faraday Road, Aylesbury, Buckinghamshire HP19 3RY, 0296.27211, Tlx: 838 705.

ACCURATE SOUND, Melton Road, Queniborough Estate, Queniborough, Leicestershire LE7 8FP, 0533.602 064, Fax: 0533.600 108, MD: William Komedara.

ARKAL UK, 107 Eleanor Cross Road, Waltham Cross, Herts EN8 7NT, 0992.654 801-4, Fax: 0992.713 197, Mktg Dir: J Ebbins.

BESHARA PRESS, 7 Ambrose Street, Cheltenham, Gloucestershire GL50 3LQ, 0242.516 329, Fax: 0242.516 630, MD: Hugh Tollmache, Mktg Mgr: Mike Candler.

COMPACT CASSETTE COMPANY INT'L, Calvea Park, Mercury House, Aldermaston, Berkshire RG7 4OW, 0734.817 421, Fax: 0734.811 505, Sales Mgr: Martyn Currey.

DAMONT AUDIO, Blythe Road, Hayes, Middlesex UB3 1BY, 081.573 5122, Fax: 081.561 0979, MD: Chris Clark, Comm Dir: Ian Mackay.

ENPLAS UK, 70 Alston Drive, Bradwell Abbey, Milton Keynes, Buckinghamshire MK13 9HQ, 0908.221 818, Fax: 0908.221 919, Tlx: 827 705, MD: T Okada. Cassette components.

EURO TECHNOLOGY, Kingsway Building, Bridgend Ind. Estate, Bridgend, Glamorganshire CF31 3SN, 0656.59212, Fax: 0656.645 294, MD: Robert Richardson.

HAYDEN PRO-AUDIO, Chiltem Hill, Hayden House, Chalfont St. Peter, Buckinghamshire SL9 9UG, 0753.888 447, Fax: 0753.880 109, Tlx: 849469 haylab, MD: E Barrett.

MAGNETIC MEDIA, PO Box 35, Salisbury, Wiltshire SP1 2JT, 0722.790 372, Fax: 0722.339 104, Tlx: 477019 asr, MD: Campbell Gifford, Sales Dir: N Morris.

MAYRON UK, 69 Whitton Avenue East, Greenford, Middlesex UB8 0QD, 081.903 6290/2725, Fax: 081.903 2052, Dirs: M E & T C Ho. CD jewel boxes, distributor of audio cassette components: library cases, single, double, triple & butterfly cases, and magnetic tape (200m. distribution worldwide).

NETSAL SALES & SERVICES, Emerald Way, Stone Business Park, Stone, Staffordshire ST15 0SD, 0785.815 166-9, Fax: 0785.815 132, Tlx: 36219.

REFLEX AUDIO SYSTEMS, Glebe Road, Unit 5, Cirrus, Huntingdon PE18 7DX, 0480.434 333, Fax: 0480.411 441, Contact: John Garrad.

SELECTA SOUND, 5 Margaret Road, Romford, Essex RM2 5SH, 04024.53424, Fax: 04024.55565, Dirs: John & Carol Smalles. New Tel (Sep 1992): 0708.453 424.

SONY MUSIC MOULDINGS, Park Crescent, Waterton Ind. Estate, Bridgend, Mid Glamorgan CF31 3YN, 0656.661 411, Fax: 0656.659 211, Fin Contr: Andrew Moore, Prod/Purch Mgr: A Kot. C-0 audio cassettes, library cases & jewel boxes.

SOUND & VIDEO SERVICES (UK), Shentonfield Road, Sharston Ind. Estate, Manchester M22 4RW, 061.491 6660, Fax: 061.491 6669, MD: Mike Glasspole, Dir: John Cooper. Distributor of custom cassette loader and duplicator.

SUMMIT MAGNETICS, 43a Old Woking Road, West Byfleet, Surrey KT14 6LG, 0932.351 925/340 940, Fax: 0932.336 431, MD: Mike Wells.

TRIANGLE PRESS, North End Road, Smiths Forge Ind Estate, Yatton, Avon BS19 4AU, 0934.832 880, Fax: 0934.835 442, Chmn: Keith Pike, MD: Alan Pegg, Sales/Mktg Mgr: Nick Edwards, Audio Print: Mel Spuffard.

UNIMAGNETIC EUROPE, 509 Upper Richmond Rd W, Hillier House, London SW14 7EE, 081.878 8059, Fax: 081.878 0767, Dir: Tony Fernandez. Products: C-0 shells, V-0 shells, Norelco & CD jewel boxes.

W H BRADY COMPANY, 30-33 Milton Road, Swindon, Wiltshire SN1 5GA, 0793.619 242, Fax: 0793.619 243, Mgr (Eur): Terry Mockler. Audio & video splicing & cleaning tapes.

WEIRCLIFFE INTERNATIONAL, St. Andrews Road, Exwick, Exeter, Devonshire EX4 2AG, 0392.72132, Fax: 0392.413 511, MD: Jeff Bailey, Sales Dir: Andrew Smith. Manufacturers of bulk tape erasers/degaussers; Sales office: London, 081.759 3894, Fax: 081.759 3891.

WHITE KNIGHT PRODUCTS, 4 Hawthorn Road, Eastbourne, East Sussex BN23 6QA, 0323.410 111, Fax: 0323.410 017, MD: Mr. Brinkhurst. Audio packaging products, CD jewel boxes.

YEARNBADGE, 16 Cleveland Drive, Laleham, Middlesex TW18 2SW, 0784.457 403.

PRINTING, PACKAGING & LABELS

A-Z MUSIC SERVICES, 97 Charlotte Street, London W1P 1LB, 071.323 5590, Fax: 071.323 9174, Contact: Paddy Prendergast, Helen Odysseos.

ABLEX AUDIO VIDEO, 14 Halesfield, Harcourt, Telford, Shropshire TF7 4QR, 0952.680 131, Fax: 0952.583 501, MD: Peter Banks, Fin Dir: Ron Pitt.

ACCURATE SOUND, Melton Road, Queniborough Estate, Queniborough, Leicestershire LE7 8FP, 0533.602 064, Fax: 0533.600 108, MD: William Komedara.

ADVANCE AYLESBURY, Northern Road, Unit 2-3, Aylesbury, Buckinghamshire HP19 3QT, 0296.27178, Fax: 0296.26106, MD: Alan Savage.

THE ALTERNATIVE NATIONWIDE DISPLAY GROUP, 1-3 Princes Lane, Lonstow House Unit 9-10, London N10, 081.440 2569, Fax: 081.444 3235, Tlx: 25688, Contact: Pauline Carr, David Bentley. Birmingham 01.2440 2569; Manchester 061.288 3882.

AMALGAMATED KEMPNER GROUP, 498 Honeypot Lane, Stanmore, Middlesex HA7 1JZ, 081.952 5262, Fax: 081.952 8061, Tlx: 21400 kempnr, Joint MDs: Richard Jankel, I McCartney, Mktg Dir: E Rollinson.

AUDIOPRINT, Wolsey Court, Woburn Road Ind. Estate, Kempston, Bedfordshire MK42 7AY, 0234.857 566, Fax: 0234.841 700, Dir: Peter Hull. Label printers.

AWL COMPACT DISC COMPANY, 356 Scraftoft Lane, Leicester, Leicestershire LE5 1PB, 0533.413 979, Fax: 0533.433 760, MD: Andrew Lipinski, Partner: Irena Lipinsk. Label/Sleeve printers, also booklets & inlays, typesetting and film work.

BARNES MUSIC ENGRAVING LTD., Sheepwash Lane, Blackboys, East Sussex TN22 4HA, 0825.85751, Fax: 0825.85311, Contact: Mark Brod.

BESHARA PRESS, 7 Ambrose Street, Cheltenham, Gloucestershire GL50 3LQ, 0242.516 329, Fax: 0242.516 630, MD: Hugh Tollmache.

BIRNAM CASSETTE DUPLICATION, 9 Tottie Street, Alyth, Blairgowrie, Scotland PH11 8BP, 082.833 330, Owner: Martin L Hadden. Printed labels, inlay cards.

BOLTON WELLS, Playing Field Road, West Works, Westbury, near Brackley, Northampton NN13 5JS, 0280.701 330, Fax: 0280.700 032, President: Bernard Lane, Sales Exec: T Lewin.

BPCC HANNIBAL, Pinfold Road, Thurmaston, Leicester, Leicestershire LE4 8AP, 0533.695 413, Fax: 0533.601 072, Tlx: 34627, GM: R Blow, Sales Dir: B J Smith. Label printers, including holograms.

BURGHLEY PRINTING, 10 St. Mary's Hill, Stamford, Lincolnshire PE9 2DP, 0780.51736/66067, Fax: 0780.53415, Tlx: 329297, MD: Ken Cox.

CALIGRAVING, Brunel Way, Thetford, Norfolk IP24 1HP, 0842.752 116, Fax: 0842.755 512, Tlx: 81246 muspri, Dir: Michael Egan. Labels.

CHANNEL 5 AUDIO/VIDEO, 14 Centre Way, Claverings Ind. Estate, Edmonton, London N9 0AH, 081.803 9036, Fax: 081.884 2440, MD: Denis Holland.

CHORD PRINT AND DESIGN, 25 Cowleaze Road, Unit 13, Kingston-upon-Thames, Surrey KT2 6DZ, 081.549 4807, Fax: 081.549 4807, Partners: Glen & C Miller. CD & cassette inlays & record labels.

CMCS PRINT & COLOUR, Kennet Road, Unit 1, Dartford, Kent DA1 4QN, 0322.59393, Fax: 0322.53741, Tlx: 8953691, Dir: John Hersey-Walker, Contact: Colin Barden.

COLLECTOR SET PRINTERS, Forstal Road, St. Michaels Close, Unit F, Aylesford, Kent ME20 7BU, 0622.716 636, Fax: 0622.717 515, MD: Roy Edwards, GM: Bob Brumwell.

CONDOR LITHO, 24 Scotts Road, Bromley, Kent BR1 3QD, 081.464 2177, Fax: 081.313 0331, MD: Mike Andrews.

CORPORATE VIDEO BROKERS, 201 Bilton Road, Perivale, Middlesex UB8 7HQ, 081.991 2610, Fax: 081.991 0180, Contact: Phil Stringer.

CRESCENT PRINTING, 30 Church Lane, Mansfield, Nottinghamshire NG18 1AR, 0623.21192, Fax: 0623.650 011, Dir: A N Dixon.

DELGA PRESS, 8 Marlborough House, Dingwall House, Bromley, Kent BR2 9NH, 081.460 0112/3, Fax: 081.466 169-, Tlx: 895 1346, MD: Martyn Edwards, Sales Dir: Terry Edwards, Prod Mgr: Tommy Rogers.

DESIGN MACHINE, 13 Sedley Place, London W1R 1HH, 071.493 6366, MD: Eddie Foster, Dirs: A Watling-Darrell, Robin Nicol.

DIGITAL PICTURES, 32 Marshall Street, London W1V 1LL, 071.439 1727, Fax: 071.494 0159, Contact: Jay Williams.

DOWNSOFT, Epsom Road, Downsown House, Ashted, Surrey KT21 1LD, 0372.272 422, Fax: 0372.276 122, MD: Martin Dare. Labels.

FLEXISCREEN, Horizon Way, Maritime Ind. Estate Unit 2, Charlton, London SE7 7AY, 081.853 3000, Fax: 081.305 119-, Tlx: 8951182, Contact: G Dale.

GOTHIC PRINT FINISHERS, Airport Industrial Estate, Unit 3, Biggin Hill, Kent TN16 3BW, 0959.71316, Fax: 0959.76972, Tlx: 957369, MD: A H Harvey.

GOUGHSOUND, 29 Beethoven Street, London W10 4LG, 081.960 1871, Fax: 081.969 1694, MD: Brian Leaf. Sleeve and label printers; Video and audio mail order service.

GRAYSON & BECKFORD, 56 Peartree Street, Peartree House, London EC1 3VS, 071.250 0722, Fax: 071.250 3139, Contact: Jack Grayson.

HOWARDS PRINTERS, Mill Street, Slough, Berkshire SL2 5DT, 0753.32271, Fax: 0753.70831, Contact: Chris Baker.

JAMES UPTON, 98-138 Barford Street, Birmingham, West Midlands B5 6AP, 021.692 1171, Fax: 021.666 6529, MD: Nick

Toms, Sales/Mktg Dir: John Williams, GM/Prod Dir: Maurice Legge, Works Dir: Mark Whitehead. Sleeve, label printer. **JOHN HEYER PAPER**, Sheldon Way, Chronicle House, Larkfield, Kent ME20 6SE, 0622.75261, Tlx: 96425, Contact: Mark Gooseman, Sales Dir: Mike Parry.

JOY BARLING LOYLA ILLUSTRATIONS, May Street, 6 Tomay Cottages, Hawthorne Corner, Herne Bay, Kent CT6 6TH, 0227.786 604, Fax: 0227.364 421, MD: Joy Barling Loyla, Mgr: Theo Loyla. Full colour illustration and design of record & book covers.

KFA ASSOCIATES, Clarendon Road, 2 Guillemot Place, London N22 6XG, 081.881 2239, Fax: 081.888 2133, MD: M U Fitzgerald.

LEEHOLME AUDIO SERVICES, 340-344 Lea Bridge Road, Leyton, London E10 7LD, 081.556 1125, Fax: 081.539 8834, MD: Mike Kitson, Sales Dir: John Bassett.

LITHOSPHERE PRINTING, 82-90 Queensland Road, London N7 7AW, 071.700 6545, Fax: 071.700 1821, MD: Tom Reed, Contact: Jim Pennington.

LYNTOLE AUDIO REPRODUCTION, 5-9 Wedmore Street, London N19 4RU, 071.263 1378, Fax: 071.263 0240, MD: Ian MacKay. Shrink wrap, boxes and special packaging.

MAINARTERY, 213-215 Kilburn Lane, Park Mews, Unit 3, London W10 4BQ, 081.938 0919, Fax: 081.938 0801, MD: Jo Mirowski.

MATRIX PROMOTIONS 3.2, 53 Lucerne Close, Cocoon House, Cherry Hinton, Cambridgeshire CB1 4YR, 0223.412 740, Fax: 0480.494 043, Dirs: Tim & Henry Harding.

MAYKING RECORDS, 250 York Road, Battersea, London SW11 3SJ, 071.924 1881, Fax: 071.924 2147, MD: Brian Bonnar, Mktg Mgr: Clive Robins.

MEANTIME REPROGRAPHICS, 91/3 Paul Street, London EC2A 4NQ, 071.608 1238, Fax: 071.608 2482, MD: John Hersey-Walker, Contact: Andy Kerr.

METLOC PRINTERS, Church Road, Bates Industrial Estate, Harold Wood, Romford, Essex RM3 0HU, 04023.40081, Contact: Pauline Gray.

MODERN PUBLICITY SERVICES, Kennet Road, Unit 1, Dartford, Kent DA1 4QN, 0322.59393, Fax: 0322.53741, Tlx: 8953691, MD: John Hersey-Walker, Contact: Graham Percival.

MSC PACKAGING, Green Lane, Clapham, Bedfordshire MK41 6EJ, 0234.213 535, Fax: 0234.365 559, MD: Owen Tollman. Cartons.

MW EDWARDS PRINTING, Forstal Road, St. Michaels Close, Unit D, Aylesford, Kent ME20 7BU, 0622.719 1369, MD: Martyn Edwards, GM: Matthew Edwards, Estimator: David Comber.

NIGHTFLITE COMMUNICATIONS, PO Box 50, Walton-on-Thames, Surrey KT12 1EB, 0932.242 073, Fax: 0753.692 243, Tlx: 934618, Dir: Adrian Owlett.

PARSONS GRAPHICS, 364 Brentwood Road, Gidea Park, Romford, Essex RM2 5TD, 04024.73454, Fax: 04024.37805, MD: Mr. Parsons.

PETER GREY PRINTERS, Wellington, Bromley, Kent BR2 9NG, 081.464 0827, Fax: 081.464 759, Tlx: 8951346, GM: Colin Edwards, Sales Dir: Terry Edwards, Prod Mgr: Jim O'Brien.

POINTBLANC REPROGRAPHICS, 46 Willow Street, London EC2A 4BH, 071.729 3911, Fax: 071.739 1925, Dirs: Ray Hyde, David Pampel.

R & B LITHO REPRODUCTIONS, 67 Rosoman Street, Tinsley House, London E1R 0HY, 071.278 8054, Tlx: 267985, MD: Philip Edward Judd, Sales Dir: Brian Bigrave, Works Dir: Paul Bigrave, Comm Works Dir: Roger Bowes.

RECORD CARE, 74 Brockley Rise, London SE23 1LN, 081.690 1961, Contact: J Wilkes.

ROBERT STACE & COMPANY, Longfield Road, Chalkin Works, Royal Tunbridge Wells, Kent TN2 3ET, 0892.24225, Fax: 0892.547 334, Tlx: 95577, GM: David Mitchell, Contacts: Malcolm Ross, Ron Viveash.

ROWLEY MARKETING, 1 Christchurch Place, Hertford, Hertfordshire SG14 3BB, 0992.587 350/553 177, Fax: 0992.586 059, MD: Anne Rowley, Fin Dir: Wendy Hutson. Album sleeve designers, specialist product design & printing.

RYFORD, Brickyard Road, Aldridge, Walsall, West Midlands WS9 8SR, 0922.54747, Fax: 0922.59429, Tlx: 336779, MD: D W Pennell.

SENOLO PRINTING, 6 Sandiford Road, Kimpton Trading Estate, Sutton, Surrey SM3 9RD, 081.641 3890, Fax: 081.641 3486, Dirs: Jacqui Gunn, Chris Bennett, Anthony Long, Peter Smith, Prod Mgr: Jeanette Hoskins.

THE SHALFORD PRESS, 85b Bradford Street, Braintree, Essex CM7 6AU, 0376.21125, Fax: 0376.24535, Contact: Pauline Braithwaite.

SHELLWAY PRESS, 42-44 Telford Way, London W3 7XS, 081.749 8191, Fax: 081.749 8721, Tlx: 935265 shelwa, MD: Stuart Shelborn. Lithographic printers.

SHOREWOOD PACKAGING CO., 36 Berwick Street, London W1V 3RF, 071.434 0854, Fax: 071.434 0856, Sales Dir: John Curtis.

SIGH PACKING, 328 High Road, Sigh House, London N15 4BN, 081.855 5577, Fax: 081.801 5356, Tlx: 886280, Contact: George Hargreaves.

SONIC PLATES, 168-172 Old Street, Bentima House, London EC1V 9BP, 071.250 0244, MD: Phil Judd.

SPOOL DUPLICATION & DISTRIBUTION, 1st Avenue, Deeside Industrial Park, Deeside, Clwyd CH5 2NU, 0244.280 602, Fax: 0244.288 581, Tlx: 94011643 spoo, MD: Roy Varley, Sales Dir: Jeff Johnson, Prod Mgr: Harold Walther, Disk Dept Mgr: Wendy Grant.

STATUTINE, Grant Road, Wellingborough, Northamptonshire NN8 1EE, 0933.277 442, Fax: 0933.276 217, MD: Andrew Lipinski.

SWAN PACKAGING, Princewood Road, Earlstrees Ind. Est. Un 6, Corby, Northants NN17 2AP, 0536.204 272, Fax: 0536.201 327, MD: Bill Stallman, Joint MD: Peter Wells.

SWANNACK BROWN & CO., 13 Anlaby Road, Hull, North Humberside HU1 2PJ, 0482.24322, MD: Ron Firth, Dir: David Firth.

TECHNI-MEDIA GRAPHICS, 5 Kentish Town Road, London NW1 8NH, 071.482 1095, MD: N Garrard. Sleeve & label printers, also T-shirts and posters.

TINSLEY ROBOR LABELS, 31 Rea Street South, Birmingham, West Midlands B5 6LB, 021.622 6741, Fax: 021.622 1488, Tlx: 336731, MD: Steve Toms, Works Dir: Andrew Watts, Works Mgr: Ron Smith, Prod Mgr: George Leck, Sales Mgr: John Hyslop. CD & cassette inlays, self-adhesive labels, & slip cases.

TINSLEY ROBOR SALES, 27 Sirdar Road, The Dolphin, London W11 4EF, 071.221 2412, Fax: 071.221 8249, Dirs: Lee Newbon, John Butcher, Bob Barnes, George Duffy, Peter Grey.

TR DISPLAY PRINT, Petersfield Avenue, Albion Close, Slough, Berkshire SL2 5DU, 0753.78836, Fax: 0753.70831, Contact: Scott Donnithorne.

TRIANGLE PRESS, North End Road, Smiths Forge Ind Estate, Yatton, Avon BS19 4AU, 0934.832 880, Fax: 0934.835 442, Chmn: Keith Pike, MD: Alan Pegg, Sales/Mktg Mgr: Nick Edwards, Audio Print: Mel Spuffard.

VIDEOPRINT, 250 York Road, Battersea, London SW11 3SJ, 071.924 1333, Fax: 071.924 2148, Tlx: 935100 vidprg, MD: Brian Bonnar, GM: Simon Valley.

WILTON OF LONDON, 4/8 Highgate, Stanhope House, London N6 5UL, 081.341 7070, Fax: 081.341 1176, Tlx: 267363 skyman, Contact: Kristina Samuels.

ZINCPARK, Trout Street, Kaymar Industrial Park, Preston, Lancashire, W77.56221, Fax: 0772.56221, MD: A Talbot.

BLANK & BULK RAW TAPE

3M UNITED KINGDOM, 3M House, Box 1, Bracknell, Berkshire RG12 1JU, 0344.858 385, Fax: 0344.858 175, Tlx: 849 371 mmuka, Market Dev Mgr: Mark Nicholson, Sales/Mktg Mgr: Joe Clerkin. Manufacturer of professional blank audio and blank video tape cassette, Open Reel, Audio DAT; Brand: 3M.

AMPEX RECORDING MEDIA INTERNATIONAL, Acre Road, Reading, Berkshire RG2 0QR, 0734.875 200, Fax: 0734.869 889, MD: Pete Goldsmith, Mktg Dir: Keith Smith, Mktg Mgr: Dennis Atkins.

BACKYARD STUDIO, Crickhowell Road, Willowbrook Units 4-5, St. Mellons, Cardiff CF3 0EF, 0222.777 739, Fax: 0222.798 901, MD: Phil Silver.

BASF UK, 151 Wembley Park Drive, BASF House, Wembley, Middlesex HA9 6JG, 081.908 3188, Fax: 081.908 5866, MD: Brian Rigby. Audio and video cassette tape.

COSMO MARKETING, 164 Ealing Road, Brentford, Middlesex TW8 9PX, 081.560 6082, Fax: 081.560 9939, MD: Victor C Arundell, Mktg Dir: Thomas Pereira.

DOWNSOFT, Epsom Road, Downsway House, Ashted, Surrey KT21 1LD, 0372.272 422, Fax: 0372.276 122, MD: Martin Dare. Distribution of reel-to-reel cassettes & video cassettes; Also computer discs.

EURO TECHNOLOGY, Kingsway Building, Bridgend Ind. Estate, Bridgend, Glamorganshire CF31 3SN, 0656.59212, Fax: 0656.645 294, MD: Robert Richardson.

FUJI PHOTO FILM (UK)/MAGNETIC PROD DIV, 125 Finchley Road, London NW3 6JH, 071.586 1121, Fax: 071.722 4259, Tlx: 8812995, MD: S Takahashi, Sales Dir: Brian Smith. Manufacturer/Distributor of professional & consumer blank audio cassettes, blank video cassettes, DAT; Brand: Fuji.

GRAFF ELECTRONIC MACHINES, Woodhill Road, Collingham, Newark, Nottinghamshire NG23 7NR, 0636.893 036, Fax: 0636.893 317, Tlx: 377119, GM: Alan Leonard, Sales Mgr: Roger Platts.

GTS FABRICATIONS, Pembrey Industrial Estate, Burry Port, Dyfed SA16 0EJ, 05546.3451, Fax: 05546.4902, Tlx: 48496, MD/Mktg Dir: Ceri Davis. Audio/video/DAT cassettes.

HUTCHINGS MAGNETICS, South Road, The Old Bakery, Unit 2, Reigate, Surrey RH2 7LB, 0737.221 228, Fax: 0737.223 206, MD: Harry Hutchings. Agent for Pyral Magnetics.

JAMES YORKE, Trading Estate, Unit 16K, Hucclecote, Gloucestershire GL3 4AF, 0452.614 878, Fax: 0242.222 445, Tlx: 43269 rompac, MD: James Scarlett, Sales/Mktg Dir: Stephen Yull, Plant Mgr: Roger Harmer.

LEE ENGINEERING, Eversley Way, Sky Business Park, Unit 3, Thorpe, Surrey TW20 8RF, 0784.471 188, Fax: 0784.471 160, Tlx: 928475, Contact: Ms. Lafferty.

MAGNETIC MEDIA, PO Box 35, Salisbury, Wiltshire SP1 2JT, 0722.790 372, Fax: 0722.339 104, Tlx: 477019 asr, MD: Campbell Gifford, Sales Dir: N Morris.

MASSEY AV, 117-119 High Road, London W4 2EE, 081.994 1317, Fax: 081.742 1456, Sales Dir: A Macaskill, Mgr: R Sandford. Sony industrial video, duplicating, & VHS tapes.

MAXELL (UK), 3a High Street, Rickmansworth, Hertfordshire WD3 1HR, 0923.777 171, Fax: 0923.777 710, Tlx: 893667, Comm Dir: K Nakano, Sales Mgr (Pro Div): Mick Martin, Mktg/Sales Mgr (Audio/Video): Steve Boyd, Adv/Promo Co-ord: Neale Horstead.

MEMOREX UK, Hutch Lane, Summit Centre, Harmondsworth, Middlesex UB7 0LJ, 081.897 3939, Fax: 081.564 9122, Sales Mgr (UK): Barry Freshwater.

PROFESSIONAL MAGNETICS, 329 Hunslet Road, Cassette House, Leeds, West Yorkshire LS10 1NJ, 0532.706 066, Fax: 0532.718 106, MD: J Barrie Rhodes, Sales Dir: Hilary

Rhodes. Manufacturer/Distributor of professional & consumer blank audio and blank video tape cassettes & DAT; Brands: Sony, Fuji, BASF, all major brands.

SONY BROADCAST & COMMUNICATIONS (UK), Jays Close, Viablies Industrial Estate, Basingstoke, Hampshire RG22 4SB, 0256.55011, Fax: 0256.474 585/483 400, Tlx: 858424, Chmn: K H Barratt, MD: M Tsurumi, Sales/Mktg Dir: H Shephard. Head office: Import.

SONY OPERATIONS (UK), South Street, Staines, Middlesex TW18 4PF, 0784.467 000, Fax: 0784.463 721, Snr Sales Mgr: Alan Peacock. Distribution unit.

SOUND & VIDEO SERVICES (UK), Shentonfield Road, Sharston Ind. Estate, Manchester M22 4RW, 061.491 6660, Fax: 061.491 6669, MD: Mike Glasspole, Dir: John Cooper. Distributor of audio & video tape and cassettes.

STANLEY PRODUCTIONS, 147 Wardour Street, London W1V 3TB, 071.439 0311/437 5472, Fax: 071.437 2126, Tlx: 269836, MD: Stanley Arons, Sales Dir: Ronny Arlen.

STRAND MAGNETIC TAPES, Condon Close, Strand House, Unit 74, Wimborne, Dorsetshire BH21 6SZ, 0202.823 421, Fax: 0202.826 926/827 091, Sales/Mktg: Bernie Fairhurst.

SUMMIT MAGNETICS, 43a Old Woking Road, West Byfleet, Surrey KT14 6LG, 0932.351 925/340 940, Fax: 0932.336 431, MD: Mike Wells.

SUNKYONG EUROPE, Vine Lane, Cedar House, Hillington, Middlesex UB10 0BX, 0895.72200, Fax: 0895.813 282, Sales Dir: Steve Castle.

TAPEMATIC SERVICES, 13 Elm Road, Faringdon, Oxfordshire SN7 7EJ, 0367.240 262, Fax: 0367.242 839, MD: R Evans. Sonorex. C-0 cassettes and library cases.

TRANSCO MASTERING SERVICES, 9 Dean Street, London W1V 5RL, 071.287 3563, Fax: 071.494 3583, MD: P G J Rooke, Dir: J Rooke. Audio & video tape.

W H BRADY COMPANY, 30-33 Milton Road, Swindon, Wiltshire SN1 5GA, 0793.619 242, Fax: 0793.619 243, Mgr (Eur): Terry Mockler. Audio & video splicing & cleaning tapes.

WEST COAST VIDEO, Caxton Court, Unit B, Porters Wood, St. Albans, Hertfordshire AL3 6PB, 0727.836 464, Fax: 0727.839 080, MD: Sandy Davidson, Sales/Mktg Mgr: Clive Allcott, Factory Mgr: Martin Devereaux, Accy Mgr: Paul Gooderham.

ZONAL, Holmetherop Avenue, Redhill, Surrey RH1 2NX, 0737.767 171, Fax: 0737.767 610, MD: A Heise, Sales/Mktg Dir: S Malek Jahanian.

CD, RECORD & TAPE MANUFACTURING SYSTEMS

AEROSONIC, Pool Road, Giles Technology Park, Unit 9, Newtown, Powys SY16 3AJ, 0686.627 355, Fax: 0686.627 494, Sales Dir: J H Steynor. Test equipment for the video-tape market.

AVCOM SYSTEMS, Stanlake Mews, London W12 7HS, 081.749 2201, Fax: 081.740 8481, GM: Eric Bastin. Telex duplicators.

BRANCH & APPLEBY, Stonefield Way, Ruislip, Middlesex HA 4 0YL, 081.864 1577, Fax: 081.422 2949, Contact: John Grumbridge.

CETEC INTERNATIONAL, Beresford Ave, Northfield Est, Unit 15, Wembley, Middlesex HA0 1YB, 081.900 0355, Fax: 081.900 2793, MD: Mr. Harris, Sales Dir: Mr. Goodchild.

COPS, Barnmead Road, Kent Hse Station Approach, Beckenham, Kent BR3 1JD, 081.778 8556, Fax: 081.676 9716, MD: Elie Dahdi. Manufacturer of CD manufacturing, vinyl pressing and tape duplication equipment.

DBM, 159 Park Road, Kingston, Surrey KT2 6DQ, 081.547 1229, Fax: 081.549 2858, Tlx: 889294 dbm, MD: Richard Watts. Exclusive European agent for Gauss, Electro Sound, CST Manufacturing.

DWIGHT CAVENDISH DEVELOPMENTS, Alington Road, Vincent House, Eynesbury, Cambridgeshire PE19 4EA, 0480.215 753, Fax: 0480.74525. Duplication systems.

EASTERN PLASTICS MACHINERY, Coggeshall Industrial Park, Coggeshall, Essex CO6 1TW, 0376.562 288, Fax: 0376.561 385, MD: K W Siddall, Tech Dir: C W Siddall, Dir: I Siddall.

GRAFF ELECTRONIC MACHINES, Woodhill Road, Collingham, Newark, Nottinghamshire NG23 7NR, 0636.893 036, Fax: 0636.893 317, Tlx: 377119, GM: Alan Leonard, Sales Mgr: Roger Platts. Professional bulk audio cassette erasers.

JOHN BROWN PLASTICS MACHINERY, Bath Road, Stroud, Gloucestershire GL5 3TL, 0453.762 261, Fax: 0453.751 007, MD/Sales Dir: Michael Rechowicz. Manufacturers of equipment for the plastic grinding.

LEYBOLD UK, Waterside Way, Plough Lane, London SW17 7AB, 081.947 9744, Fax: 081.947 0210, MD: K G Schneider, Sales Dir: Peter McGrail. CD coatlers.

LYREC UK, Old London Road, Milton Common, Oxford, Oxfordshire OX9 2JR, 084427.8866, Fax: 084427.8810, Tlx: 838725, MD: Dag Fellner.

MAGNETIC AND MEMORY TECHNOLOGY, Westem Avenue, Bridge End Ind. Estate, Bridge End, Mid Glamorgan CF31 3RT, 0656.648 047, Fax: 0656.647 612, MD: Jim Dimmock.

MUSITECH CD, George Street, High Wycombe, Buckinghamshire HP13, 0494.464 488, Fax: 0494.462 743, Contact: John Matthews.

NETSAL SALES & SERVICES, Emerald Way, Stone Business Park, Stone, Staffordshire ST15 0SD, 0785.815 188-9, Fax: 0785.815 132, Tlx: 36219.

OTARI ELECTRIC (UK), Elder Way, Unit 13, Waterside Drive,

Langleigh, Slough, Berkshire SL3 6EP, 0753.580 777, Fax: 0753.542 600, Tlx: 849453 otari, Dir: S Koizumi.

P & J SIBERT & COMPANY, Ridgway, Ridgway House, Pyford, Woking, Surrey GU22 8PN, 0932.351 921, Fax: 0932.351 923, MD: Paul Sibert. CD & video test tables.

PILKINGTON MICRONICS, Fourth Avenue, Deeside Ind. Park, Deeside, Clwyd CH5 2NR, 0244.288 337, Fax: 0244.288 935/288 473. Glass optical discs for mastering for CD-A and CD-V.

RTI, Waterloo Road, Swan Warf, Unit 6, Uxbridge, Middlesex UB8 2RA, 0895.252 191, Fax: 0895.274 692, MD: Jonathan Banks, Sales Mgr: Mark McMullon. Film cleaning & quality control machines for video-tapes.

TAPE AUTOMATION, The Pinnacles, Haslemere Estate, Unit B, Harlow, Essex CM19 5SY, 0279.635 300, Fax: 0279.411 573, Tlx: 818442 tape, MD: John Gardner, Sales Mgr: Ray Worth.

TAPEMATIC SERVICES, 13 Elm Road, Faringdon, Oxfordshire SN7 7EJ, 0367.240 262, Fax: 0367.242 839, MD: R Evans.

TAPETEK, Hurricane Way, 13 Hurricane Close, Wickford, Essex SS11 8YR, 0268.561 999, Fax: 0268.561 709, Tlx: 858 623, MD: David Hill, GM: Jack Plumridge. Sales & service of Tapematic equipment and Saki magnetic tape heads.

TOM TAPE SERVICES, Oxford Street, Long Eaton, Nottinghamshire NG10 1JR, 0602.720 949, Fax: 0602.461 953, MD: Tony Lorkin.

VERITY SYSTEMS, 12 Manaway, Aldershot, Hampshire GU12 4RH, 0252.317 000, Fax: 0252.316 555, MD: David Tucker, Eng Dir: Brian Fleming, Sales/Mktg Dir: Andrew Page. Products: Magnetic tape conditioning equipment.

TAPE PACKAGING & LABELING EQUIPMENT

AMALGAMATED KEMPNER GROUP, 498 Honeygot Lane, Stanmore, Middlesex HA7 1JZ, 081.952 5262, Fax: 081.952 8061, Tlx: 21400 kempnr, Joint MDs: Richard Jankel, I McCartney, Mktg Dir: E Rollinson. Supplier.

DBM, 159 Park Road, Kingston, Surrey KT2 6DQ, 081.547 1229, Fax: 081.549 2858, Tlx: 889294 ddbm, MD: Richard Watts. Exclusive European agent for CST Manufacturing.

MARDEN EDWARDS & CO, 3 Cobham Road, Ferndown Ind. Estate, Wimborne, Dorsetshire BH21 7PD, 0202.861 200, Fax: 0202.861 400, Tlx: 41202 mecomb, Dirs: G M Edwards, B E Marden, J L Edwards, J A Bushby, J B Marden, Sales Mgr: J C Wrixon. Packaging/labelling equipment manufacture.

TAPEMATIC SERVICES, 13 Elm Road, Faringdon, Oxfordshire SN7 7EJ, 0367.240 262, Fax: 0367.242 839, MD: R Evans.

TAPETEK, Hurricane Way, 13 Hurricane Close, Wickford, Essex SS11 8YR, 0268.561 999, Fax: 0268.561 709, Tlx: 858623, MD: David Hill, GM: Jack Plumridge.

USS—SOVIET UNION

RECORD COMPANIES

BIZ ENTERPRISES, Bolshaya Serpukhovskaya Street 44, 113093 Moscow, PO Box 27 (Zip: M-93), 0095.237 3780/236 2288, Fax: 0095.237 8402, President: Eduard Ratnikov.

COMMUNITY 3 RUSSIA, Sadovo Triumfalnaya 14-12, 103006 Moscow, 0095.229 0831, Fax: 0095.938 2077, MD: Lev Ginsburg, A&R: Albert Garzon.

MELODIYA, Tverskoi Boulevard 24, 103009 Moscow, 0095.229 2530/9248, Fax: 0095.200 2249, Tlx: 411073 arfa, Dir-Gen: Valeri Sukhorado, Mktg Dir: Vladimir Markin, Prod Mgr: Nadiiezha Kurkiaskowa. Label (owned): VTPO Firma Melodiya (All Union Record Company); (Lic): BMG, EMI, Virgin.

MUSIC PUBLISHERS

BIZ ENTERPRISES, Bolshaya Serpukhovskaya Street 44, 113093 Moscow, PO Box 27 (Zip: M-93), 0095.237 3780/236 2288, Fax: 0095.237 8402, President/CEO: Boris Zosimov, VP: Vitaliy Khnykin, Rec Label Pres: Eduard Ratnikov, Mgr: Sergei Dubenko, NY Office: Brian Dublin, LA Office: Olga Chaiko.

BMG, see Mezhdunarodnaya Kniga.

EMI, see Mezhdunarodnaya Kniga.

MEZHDUNARODNAYA KNIGA, 39 Dimitrova Street, 113095 Moscow, 0095.238 4600, Fax: 0095.230 2117, Tlx: 411160 mkn, Dir-Gen: Stanislav Ostapishin, Dep Dir: Alexander Belostotsky. (Lic): Sony Music, PolyGram, BMG, EMI.

MULTIS ACTION, Stankevitch Street H.16/4, Flat 73, 103009 K-9, Moscow, 0095.229 5525, Fax: 0095.213 8758, MD: Michail Sigalov, Office Mgr: Evgeny Perejotov, Asst: Sergei Sergejev.

MUZYKA PUBLISHERS, ulica Neglinnaya 14, 103031 Moscow, 0095.923 0497, Fax: 0095.921 8353, Dir: Leonid Sidelnikov. State publishing house.

POLYGRAM, see Mezhdunarodnaya Kniga.

SONY MUSIC, see Mezhdunarodnaya Kniga.

SOVETSKY KOMPOZITOR, 14-12 Sadovo-Triumfalnaya Street, 103006 Moscow, 0095.209 2384, Dir: Boris Korotkov.

VAAP, Bolshaya Bronnaya 6a, 103670 Moscow, 0095.203 5355/4599, Fax: 0095.200 1263, Tlx: 411327 avtr, Chmn: Nikolaj Tchvetverikov, Dep Dir: Nikolai Popov, Music Division Dir: Sergei Semenov, Legal Dept: Boris Kokin.

VISTA CO-OP VENTURE, 32 Primorski pr., 197228 St Petersburg, 081282.239 2584, Tlx: 121449 Ifest, Chmn: Yevgeni Tchernilovsky.

VIDEO PROGRAM SUPPLIERS & BUYERS

MEZHDUNARODNAYA KNIGA, 39 Dimitrova Street, 113095 Moscow, 0095.238 4600, Fax: 0095.230 2117, Tlx: 411160 mkn, Dir-Gen: Stanislav Ostapishin, Dep Dir: Alexander Belostotsky. Production and distribution.

SINTEZ RECORDS, Bolshaia Spaskaia 33 R 10, 129010 Moscow, 0095.280 2876/4160, Fax: 0095.230 2446, President: Leonid Lebedev, Dir: Alexei Khariok, Mktg Mgr: Valery Sokolov, Mktg Exec (Eur): Dmitry Oussachov.

VIDEOFILM, Gnezdnikovskiy Per 7, 103877 Moscow, 0095.229 8881, Tlx: 411417 kino, Dir: Oleg Uralov. Operates chain of video rental stores.

RECORD DISTRIBUTORS

MEZHDUNARODNAYA KNIGA, 39 Dimitrova Street, 113095 Moscow, 0095.238 4600, Fax: 0095.230 2117, Tlx: 411160 mkn, Dir-Gen: Stanislav Ostapishin, Dep Dir: Alexander Belostotsky. Distributed: MK, Melodiya.

ASSOCIATIONS & PROFESSIONAL ORGANIZATIONS

INTERNATIONAL MUSIC COUNCIL, ul Nyezhdanovi 8, Moscow K-9, 0095.229 5444/4893, Fax: 0095.200 42 73, Contact: Boris Dimentman. National committee.

UNION OF COMPOSERS OF THE USSR, ul Nyezhdanovi 8, Moscow K-9, 0095.229 5444/4893, Chmn: Tikhon Khrjnnikov, Contact: Yevgeni Krivosjev.

VAAP, Bolshaya Bronnaya 6a, 103670 Moscow, 0095.203 5355/4599, Fax: 0095.200 1263, Tlx: 411327 avtr, Chmn: Nikolaj Tchvetverikov. USSR copyright agency.

PUBLIC RELATIONS & RECORD PROMOTION

MEZHDUNARODNAYA KNIGA, 39 Dimitrova Street, 113095 Moscow, 0095.238 4600, Fax: 0095.230 2117, Tlx: 411160 mkn, MD: Igor Preferansky, Dep Dirs: Vladimir Rybin, Evgeni Yurchenko.

MULTIS ACTION, Stankevitch Street H.16/4, Flat 73, 103009 K-9, Moscow, 0095.229 5525, Fax: 0095.213 8758, MD: Michail Sigalov, Publ Mgr: Dimtry Lovkovsky, Office Mgr: Evgeny Perejotov, Asst: Sergei Sergejev.

VAAP, Bolshaya Bronnaya 6a, 103670 Moscow, 0095.203 5355/4599, Fax: 0095.200 1263, Tlx: 411327 avtr, Chmn: Nikolaj Tchvetverikov.

COMPACT DISC MASTERING & REPLICATING PLANTS

GRAMZAPIS EXPERIMENTAL PLANT, Kronshadtsky Boulevard 7, 125212 Moscow, 0095.452 1246, Dir: A A Mazin. CD's, originals and stampers.

MELODIYA, Tverskoi Boulevard 24, 103009 Moscow, 0095.229 2530/9248, Fax: 0095.200 2249, Tlx: 411073 arfa, Dir-Gen: Valeri Sukhorado, Mktg Dir: Vladimir Markin, Prod Mgr: Nadiiezha Kurkiaskowa.

PLATING, MASTERING & PRESSING PLANTS

ALMA-ATA STUDIO, ALMA-ATA, pr. Kommunisticheskii 38, 480004 Alma, 0327.322 707, Dir: Mrs S Tairova. Mastering/tapes.

APRELEVSKY RECORD PLANT, 143360 Aprelevka, Moscow Region, 0095.436 5194, Dir: YU F Khlopov. Vinyl and cassettes.

ST PETERSBURG RECORD PLANT, ul. Tsvetochnaya 7, 196006 St Petersburg, 081282.298 3756, Dir: A P Chuchukin. Vinyl and cassettes.

ST PETERSBURG RECORDING STUDIO, pr. K Marksa 57, 194044 St Petersburg, 081282.542 5669, Dir: B Glybovsky. Mastering.

MELODIYA, Tverskoi Boulevard 24, 103009 Moscow, 0095.229 2530/9248, Fax: 0095.200 2249, Tlx: 411073 arfa, Dir-Gen: Valeri Sukhorado, Mktg Dir: Vladimir Markin, Prod Mgr: Nadiiezha Kurkiaskowa. Vinyl and cassettes.

SINTEZ RECORDS, Bolshaia Spaskaia 33, R 10, 129010 Moscow, 0095.280 2876/4160, Fax: 0095.230 2446, President: Leonid Lebedev, MD: Alexander Chechetkin. Vinyl and cassettes.

TASHKENT RECORD PLANT, ulica Gramplastinok 58, 700032 Tashkent, 0371.676 223, Dir: Y Rogachev. Vinyl and cassettes.

BLANK & BULK RAW TAPE

APRELEVSKY RECORD PLANT, 143360 Aprelevka, Moscow Region, 0095.436 5194, Dir: YU F Khlopov.

BAKU BLANK CASSETTES PLANT, ulica 15th Nagornaya, Kvartal 1055, 370122 Baku, 0892.314 916, Dir: M Aliev.

BASF, Pereulok Sadovskich 4, Wohnung 13, 103001 Moscow, 0095.209 6521, Fax: 0095.230 2106. Audio/video all formats.

YUGOSLAVIA

RECORD COMPANIES

CROATIA RECORDS, Niska Ulica bb, 41040 Zagreb, Croatia, 041.266 622/264 309, Fax: 041.264 309, Tlx: 21857 jugoton, Dir-Gen: Mirko Bosnjak, Dep Dir-Gen: Zlatko Ruzic, Repertoire Mgr: Sinisa Skarica, Int'l Label Mgr: Veljko Despot, Int'l Operations: Zvonimir Bencic, Prod Mgr: Veljko Lipovscak.

DISKOTON, Nahorevska 5, 71000 Sarajevo, Bosnia and Hercegovina, 071.218 855, Fax: 071.38799, Tlx: 21597 dtksa, Dir-Gen: Nenad Bilic, A&R Dir: Vujovic Slobodan. Labels (lic): Creole Records; Main product: Adult Contemporary, Jazz, Country, Classical, Dance, Album Rock, Gold/Oldies.

HELIDON TOVARNA GRAMOFONSKIH PLOSC, Cyelovska 142, 61000 Ljubljana, Slovenia, 061.551 379/559 047/557 842, Fax: 061.551 047, MD: Frank Filipic, Music Division Dir: Vilko Ovsinik.

IMC INFO-MEDIA CENTAR, Malekovic 18, 41221 Bedekovcina, Fax: 049.21741, GM: Ban Alojz. Distribution.

JUGODISK, Ljubicka 15, 11000 Belgrade, Serbia, 011.473 009/471 327, Fax: 011.471 327, Contact: Radomir Krkic. Main product: Folk music.

ROPOP RECORDS, Ilirska 4, 61000 Ljubljana, Slovenia, 061.319 662/317 114, Fax: 061.317 114, MD: Igor Vidmar.

RTB RECORDS, Makedonska Street 21, 11000 Belgrade, Serbia, PO Box 509 (Zip: 11000), 011.325 850, Fax: 011.327 528, Tlx: 12030 rtbpgp, GM: Stanko Terzic, Comm Mgr: Aleksandar Backovic, Int'l Label Mgr: Dragoljub Ilic, Import/Export Mgr: Niko Radonjic, Int'l PR: Miroslava Glisic. Label (lic): PolyGram.

SUZU RECORDS, Gruska 10, 41000 Zagreb, Croatia, 041.519 955, Fax: 041.518 556, Dir-Gen: Milan Skrnug, Int'l Mgr: Ranko Antonic, A&R Mgr: Blasko Novak, Press/Promo: Toni Svalina.

MUSIC PUBLISHERS

CR CROATIA MUSIC PUBLISHING, Niska Ulica bb, 41040 Zagreb, Croatia, 041.266 622, Fax: 041.264 309, Tlx: 21857, GM: Mirko Bosnjak, A&R: Sinisa Skarica.

FAVORITE MUSIC, Gruska 10, 41000 Zagreb, Croatia, 041.519 955, Fax: 041.518 556, Dir: Ranko Antonic.

HELIDON TOVARNA GRAMOFONSKIH PLOSC, Cyelovska 142, 61000 Ljubljana, Slovenia, 061.551 379/559 047/557 842, Fax: 061.551 047, MD: Frank Filipic.

JUGOSLOVENSKA KNIGA, Obilicev Venac 24, 11000 Belgrade, Serbia, 011.623 799.

MUSIC INFORMATION CENTRE (SOKOJ), Misarska 12-14, PO Box 213, 11000 Belgrade, Serbia, 011.338 761, Fax: 011.338 168, Tlx: 72655 sokoj, President: Dimitrije Buzarovski, Sec-Gen: Ivan Kovac, GM: Vesna Koric.

RTB MUSIC, Makedonska Street 21, 11000 Belgrade, Serbia, 011.327 528, Fax: 011.327 528, Tlx: 12030 rtbpgp, Dir-Gen: Stanko Terzic, Int'l PR: Miroslava Glisic.

VIDEO PROGRAM SUPPLIERS & BUYERS

AUDIO VIDEO STUDIO, Stularjeva 5, 61000 Ljubljana, Slovenia, 061.50774, Fax: 061.327 187, Tlx: 31660, MD: Joe Racman.

CROATIA RECORDS, Niska Ulica bb, 41040 Zagreb, Croatia, 041.266 622/264 309, Fax: 041.264 309, Tlx: 21857 jugoton, Dir-Gen: Mirko Bosnjak. Distribute RCA Columbia.

RETAIL ACCESSORY SUPPLIERS

DIGITALIA, Gregorciceva 9, 61000 Ljubljana, Slovenia, 061.223 501, Fax: 061.212 709, MD: Irina Dicko. Agent of Lift display/storage systems.

IDM, Tomislavov trj.18, 41000 Zagreb, Croatia, 041.433 733, Fax: 041.431 767/420 983, MD: Tomo Muchlen. Agent of Lift display/storage systems.

ASSOCIATIONS & PROFESSIONAL ORGANIZATIONS

COMPOSERS ASSOCIATION OF CROATIA, Berislaviceva 9, 41000 Zagreb, Croatia, 041.423 463, Fax: 041.422 850, MD: Eriko Krpan.

JAZZ & LIGHT MUSIC MUSICIANS ASSOCIATION, Zmaj Jovina 4, 11000 Belgrade, Serbia, 011.633 868/632 979, Fax: 011.344 376.

(Continued on page 311)

International

This section is organized alphabetically by geographic area, country and company name. Listings of approximately 40 countries are included.

AFRICA

EGYPT

RECORD LABELS

EMI-Sout El Hob, 37 Takafal St., Taawon Sta., Guiza, (20-2) 853700, (20-2)621409. Fax: (20-2) 621408. Gen. Mgr.: N. Noreldin.

El Dawila Audio Visual Co., 36 Trapis St., El Mantka El Sad-sa, Nasr City, Cairo, (202) 2689007, (202) 2689008. Fax: (202) 2621069. Chrmn.: Mohamed El Naggari; A & R Mgr.: Nasr Sadd; Int'l Mgr.: Susan Yousef.

Label(s): (Distributed) A & M, CBS Int'l, PolyGram Int'l, Hansa (Germany).

Sizzle Records, 7 Salem Salem St., Agouza, Giza, (20-2)348-3905. Fax: (20-2)344-4429. Pres.: Teneen Ali.

Sound of America, Inc., 44.B. Talaat Harb, Cairo, (2) 765-742, (2) 760-285. Gen. Mgr.: Essam Fahmy.

TAPE CUSTOM DUPLICATORS

EMI-Sout El Hob, 37 Takafal St., Taawon, Pyramids Rd., Guiza, 12111, (02) 853700. Fax: (02) 621408. Pres.: Nagati Noreldin; Sales Mgr.: Maher Elshaer.

KENYA

RECORD LABELS

A. I. Records (Kenya) Ltd., PO Box 41152, Church Hse., Moi Ave., Nairobi, (2) 331427. Fax: (2) 331697. Managing Dir.: Michael R. Andrews; Office Mgr.: Julie E. Gill.

Label(s): (Owned) Editions Mazembe, Editions Franc Afrique, Editions AIT, (Distributed) BMG Int'l, EMI, MCA, Int'l Reps.: Serengeti Records (England).

CBS Records (Kenya) Ltd., PO Box 60299, Nairobi, (254) 2/337184, (254) 2/337195. Managing Dir.: Gideon Njenga.

PolyGram Records Ltd., PO Box 43695, Nanyuki Rd., Nairobi, (254-2) 541210. Managing Dir.: Ronald Andrews; Financial Mgr.: Stephen Gatiba; Mktg. Mgr.: James Costabir; Rep. Mgr.: Justus Musyoka; Comm. Coord.: Stephen Wachira.

BLANK & BULK TAPE MANUFACTURERS

3M Kenya, Ltd., PO Box 48567, Dar-Es-Salaam Rd., Nairobi, Kenya, (254)2 542-880. Fax: (254)2 542-885. Contact: F. Hassan.

NIGERIA

RECORD LABELS

CBS (Nigeria) Ltd., PO Box 21426, 10 Allen Ave., Ikeja, Lagos, (234) 1/932670. Managing Dir.: Mrs. Keji Okunowo; Finance Mgr.: Oyeniyi Oyesiku.

EMI (Nigeria) Ltd., 10/12 Adenubi Close, P.M.B., Ekeja, Lagos, 21288, 901720. Managing Dir.: Bode Akinyemi.

Olude Music, V-688 Lantoro Rd., Ogun State. PolyGram Records Ltd., PO Box 2997, Lagos, 88 04 53. Fax: 234 1 681186. Mng. Dir.: Tom Steenberg; Mktg. Mgr.: E. E. A. Ndem; A & R Creative Mgr.: Wole Iyaniwura.

Label(s): (Owned) Polydor, Mercury, Philips.

BLANK & BULK TAPE MANUFACTURERS

Minnesota Nigeria Ltd., PO Box 10380, Isolo Expwy., Mushin, Lagos, Nigeria, (234)1 52417. Fax: (234)1 52491. Contact: James Adeshida.

SOUTH AFRICA

RECORD LABELS

A-Ra-Ba Afrik Talent Pro/Records Int'l, PO Box 01866 OSU, Accra, Ghana West.

Absolute Sound (Pty) Ltd., PO Box 656, Bedfordview, 2008, (011) 53-4228. Managing Dir.: H. M. Zaczek.

Bet-el Publishers, PO Box 23227, Innesdale, Pretoria, 0031, (12) 215-655. Fax: (012) 325-6517. Managing Dir.: Robbie Engelbrecht; Mktg. Dir.: Dicky Thomas; Financial Mgr.: Trudie Potgieter.

Label(s): (Distributed) Benson Co., Rainbow Sound, Brentwood, Sky-Lite Sing, Tempo Inc.

CCP Record Co. (Pty) Ltd., PO Box 11254, Johannesburg, 2000, (011) 613-2011. Fax: (011) 613-5650. Managing Dir.: Ken Haycock.

Label(s): (Owned) Black Cat, Black Music, Brenda, Bullet, Goli, Gull, Ili Trax, Intuhuko, Hot Stuff, Yashingoma, Jamloti, Kaya-Lami, Mabob City, Lake Victoria, Reggae, Ring, (Distributed) Salsoul (USA), Twohit, Soundrays, Miza, Minc, Namibia, Vulombo, Flame, Greensteves (UK), Family, Columbia, Daylite Beat, Brenda.

D.P.M.C., PO Box 91323 Auckland Park, Johannesburg, 2092, (011) 726-5475. Fax: (011) 726-5612. Managing Dir.: Dave Penhale; Dir.: Chris Kritzinger; Mktg. Exec.: Thembi Malabi; Vice Pres. A&R: Alec Khaoli.

Label(s): (Owned) Alec Kaholi Prodn., D.P.M.C.

Decibel Music, PO Box 80101, Ridgeview, Johannesburg, 1701, No. 1 11th St., Delarey, Johannesburg, 1700, (011) 673-3012, (011) 673-3013. Fax: (011) 673-7873. Managing Dir.: W.F. Pretorius; Pub. Rel.: L. Winchester.

Label(s): (Owned) Decibel Music Labels.

EMI Music South Africa (Pty) Ltd. (IFPI), PO Box 11254, Steeledale, Johannesburg, 2197, (11) 613 2011. Managing Dir.: Mike Edwards; Financial Dir.: Keith Coulthard; A & R Dir.: R. Quin.

Label(s): (Owned) Blue Note, Brigadiers, Capitol, HMV, Columbia, Harvest, Parlophone, Odeon, Stateside, Starline, Swinger, (Distributed) Powderworks, Liberty, Chiswick, Enigma, Carere, BBC.

E. Z. Music, C.C., PO Box 754, Crown Mines, Johannesburg, 2025, 51 8th Ave., Mayfair, Johannesburg, 2092, (011) 837-9344. Fax: (011) 839-3810. Partners: Emil Zoghby; Roland Rennie.

Eric Frisch Music (Ptd) Ltd., PO Box 626, Johannesburg, 2000, (27) 11/483-18. Fax: (27)11/728-197. Managing Dir.: Eric Frisch; Dir.: David Gresham; Allan Goldswain; Gen. Mgr.: P. Hannay.

Label(s): (Owned) Ntu, Mpumelelo, Buffalo Records, EFM, MOB, FG.

G.S.E. Claremont Records, PO Box 250, 55 Palmboom Rd., Newlands, 7725, (021) 686-6915. Fax: (021) 686-6043. Owner: Donald Graham; Admin./Acct.: Mary Graham.

Label(s): (Owned) G.S.E. Claremont, (Distributed) New World, Sound Prod. Holland, Etcetera.

Int'l Reps.: Avan-Guard (Australia); Sound Prod. (Holland); Target Recordings (United Kingdom); Ethnic World Music (Germany); Allegro Imports (United Kingdom).

Gallo—GRC (Pty) Ltd., PO Box 2445, Johannesburg, 2000, (27) 11/337-40. Chrmn.: John Sturgeon; Managing Dir.: Fred Withers; Sales Dir.: Doug Hill; Dir. of Mktg./A & R: Charles Kuhn.

Label(s): (Distributed) (Germany), Arcade, Baby (United Kingdom), Auckland Park, Bronze, Capasetic, Country Music, Chrysalis, Delphine (France), Hansa, Ronco (all United, Hispavox (Spain), States), Telefunken, The Sun.

Gallo Record Co., PO Box 2445, Gallo House, Hood Ave., Rosebank, Johannesburg, 2000, (011) 788-0519. Fax: (011) 788-7080. Managing Dir.: Doug Hill; Mktg. Dir., A & R: Duncan Gibbon; Financial Dir.: Guy Henderson.

Label(s): (Owned) Gallo, (Distributed) Naxos, Sony.

Gold Record Music, PO Box 5070, Brenthurst, TVL, 1542, 782 Prince George Ave., Brakpan, TVL, 1540, (011) 813-3418. Fax: (011) 813-1936. Pres.: Phyllis De Gouveia; Mgr.: Teresa Malone; Prof. Mgr./Vice Pres. A&R: Mynie Grove.

Label(s): (Distributed) Dennis Heany Promos., Vidisco, Music Box Prodn.,

Int'l Reps.: Music Box Prodn., Dennis Heaney Prods. (Ireland), Vidisco (Portugal).

Grace Music, PO Box 997, 130 Goldman St., Florida, 1710, (027) 11 674-2. Fax: (027)11/472-166. Pres.: Jenny Crickmore-Thompson; Black Music Mgr.: Johannes Ntombini.

Label(s): (Distributed) CA, Dorohn, Image VII Canada, GMI (Holland), Word, Word UK, KIR Switzerland, Maranatha!, Vineyard, Spark (Holland).

David Gresham Record Co. (Pty) Ltd.

PO Box 46020, Orange Grove, 2119, (2711) 4442630. Fax: (2711) 4441932. CEO/Managing Dir.: David Gresham; Joint Managing Dir.: Allan Goldswain; Financial Dir.: Nick Birky; Mktg./A&R Dir.: Sue Brews.

Branch(es): 12424 Wilshire Blvd., Sta. 1120, Los Angeles, CA, 90025, (214) 239-0323. Fax: (213) 207-0855. Pres.: David Gresham; 13534 Preston Rd., Ste. 100, Dallas, TX, 75240, (214) 239-0323. Pres.: David Gresham.

Label(s): (Owned) In The Groove, Gresham, Truth, (Distributed) Ghetto, Gull, K-Tel, Mute, PPI Video, Next Plateau, Passion, Rumour, Supreme, Sonet, Attic.

Hit City Records, PO Box 2116, Johannesburg, 2000, 6/F, Lousan House, 141 Pritchard St., Johannesburg, 2001, (011) 402-3209. Fax: (011) 402-7314. Managing Dir.: John Galanakis; Gen. Mgr.: Jill Galanakis; Studio Mgr.: Richard Felani Gumbi.

Label(s): (Owned) Leopard, White Dove, Hit City.

Hope Records, PO Box 31089, Braamfontein, 2017, Contact: Hendrick Labona.

Jo'burg Records & Music Publishing (Pty) Ltd., PO Box 93005, Yeoville, Johannesburg, 2163, (011) 728-4715. Managing Dir.: S. M. Cohen.

Label(s): (Owned) King, Soweto.

Kohinoor Stories, 70 A Krws St., Johannesburg, 2001, (011) 237104. Fax: (011) 8341363. Chief Exec.: Suleiman I. Vally; Mgr.: Nazim I. Vally; Buyer (Record/Tape): Yusuf I. Vally;

(Compact Disc, Pre-Recorded Audio Tape, Video (Cassette & Disc), Records, Cutsouts, Overstock) (Distributor) Labels Distributed: Audio: As-Shams, Kohinoor, Manola, Solutown, The Sun.

Products/Accessories: CD Players: K.I.C., Hitachi, Yamaha, Sony.

Laser Music Int'l (Pty) Ltd., PO Box 23179, Claremont, Capetown, 7735, 42-C Goldbourne Rd., Kenilworth, Capetown, 7700, (021) 782-3610. Fax: (021) 782-5197. Exec. Dir.: Peter Kramer; Financial Dir.: Isabelle Ronaldson; Admin. Dir.: Anne Kramer.

Label(s): (Distributed) Telarc, Tuxedo, Olympia, Pacific Music, T.E.R., Pavilion, ASV, Capriccio, Chandos, Delta Music, Discovery Sounds, Denon, Everest, Intersound, Moss Music, Laserlight.

Mac-Villa Music (Pty) Ltd., PO Box 65, Honeydew, 2040, (011) 795-3781. Fax: (011) 795-2603. Gen. Mgr.: Andre' Viljoen.

Label(s): (Owned) Challenger, UJU.

Mountain Records, PO Box 70, 9 Clifton Terrace, Observatory, 7935, (27)21 477358. Fax: (27) 21 471359. Managing Dir.: Patrick Lee Thorpe.

US Reps.: Intersound (GA).

Int'l Reps.: EWM (Germany); Big Ears Music (United Kingdom).

Music For Pleasure (Pty) Ltd., PO Box 83448, South Hills, 2136, (011) 613 6791. Managing Dir.: N. J. Blignaut; Mktg. Dir.: Peter Hochfelden; Sales Dir.: A. Blignaut.

Label(s): (Owned) Flame, Dynamite, Skyline, Mellow, Mood, (Distributed) Music For Pleasure, Music Way, Sounds Superb (all United Kin, Classics For Pleasure).



THE DAVID GRESHAM ENTERTAINMENT GROUP

P.O. Box 46020, Orange Grove, 2119, Republic of South Africa

incorporating

The David Gresham Record Company (Pty) Ltd

Little Monster Music

Stylus Recording Studios

Gresham Video

Phone (27 11) 444 2630 Fax (27 11) 444 1932

Music Team, PO Box 23535, Joubert Park, 2044, 887-7313.
Fax: 887-7357. Contact: Maurice Horwitz.

Phase 2 Records, PO Box 48321, Roosevelt Park, Johannesburg, 2129, (011) 4771226. Fax: (011) 678-4544. Managing Dir.: Terry Fairweather; A & R Dir.: Mark Hughes; Promo. Mgr.: Gary Arkondarkis.

Label(s): (Owned) Phase Two Music, (Distributed) First Night, Music For Nations.

Principal Records Co., PO Box 48934, Roosevelt Park, 2129, 642-7236. Fax: 642-1425.

Priority Records (Pty) Ltd., PO Box 1510, Johannesburg, 2000, 402-5700. Fax: 402-6576. Contact: Bill Brooks.

RPM Record Co., PO Box 2807, Johannesburg, 2000, 1 Hood Ave., 1/F President Pl., Rosebank, 2196, (011) 880-6400. Fax: (011) 442-5962. Managing Dir.: Irving Schlosberg; Mktg. Dir.: Ronnie Graver; Sales Dir.: John De Beer.
Label(s): (Distributed) MCA, Geffen.

Radium Records, PO Box 2888, Benoni, 1500, (018) 3-2274. Creative Writer: Jonathan Handley; Singer: David Davies.

Rainbow Records & Tapes, PO Box 93503, Yeoville, 2143, (011) 23-9293. Managing Dir.: Etienne Cronje.

Reamus Records, PO Box 96395, Brixton, Johannesburg, TVL, 2019, 4 Wordsworth Ave., Senderwood, Bedfordview, Johannesburg, TVL, 2019, (011) 453-1432. Fax: (011) 453-2572. Proprietor: Clive Risko; Exec. Dir. Mktg.: Toni Risely; Prodn. Head: Enoch Nondala; Vice Pres. A&R: Danny Antill.
Label(s): (Owned) Boots, Jaguar, Ream, Mamba, Int'l Reprs.: Rounder (U.S.A.).

Reveille Records (Pty) Ltd., PO Box 261141, Johannesburg, 2023, (011) 23-5276. (011) 23-1866. Managing Dir.: Audrey Smith.

Label(s): (Owned) Rev., One Way, Good As Gold.
Rob Roy Music, PO Box 28530, Sunnyside, Pretoria, TVL, 0132, 393-1211. Fax: 789-5237. Vice Pres.: Robert Schroder; Joint Vice Pres.: Roy Buckin; Dir.: Pat Schroder, Hewit Buckin.
Label(s): (Distributed) WEA.

Roots Record Co. (Pty.) Ltd., Box 700, Cramerview, 2060, 3 Main Rd., Guvon House, Bryanston, 2021, (2711)463-3939. Fax: (2711)706-7887. Managing Dir.: Robin C. Taylor.
Label(s): (Owned) ON, Roots, (Distributed) Stax, Original Jazz Classics, Pablo, riverside, Prestige, Landmark, Good Time Jazz, Milestone, Contemporary, Fantasy, Fantasy Group, Galaxy, G R P.

Shifty Records, PO Box 27513, Bertsam, 2013, 834-5356. Fax: 834-3468. Contact: Lukie Carleson.

Shisa Int'l (Pty) Ltd., PO Box 7473, Johannesburg, 2000, 29-3831, 28-2400. Fax: 29-8751. Contact: Peter Gallo; Ivor Haarburger.

Slave Record Prodn. (PTY) Ltd., 330 Albert St., Pretoria, TV 0181, Pres.: Robert Schroder; Dir.: Anthony Bock; Mervyn Mittel.

Storm Records, 4 Goudvis Rd., Melrose, North, Johannesburg, 2196, (011) 880-3757. Fax: (011) 880-6596. Pres.: Terry Dempsey; Gen. Mgr.: Carrie Dempsey.

Sunshine Records (Pty) Ltd., 480 Cork Ave., Ferndale, Randburg, 2194, (011) 793-2913. Managing Dir.: Grahame Beggs; Gen. Mgr.: Jenni Harris.

TNT, PO Box 89435, Lyndhurst, 14 Orange St., Sunnyside, Johannesburg, 2106, (011) 726-6311. Fax: (011) 726-5612. Mng. Dir.: Chris Kritzing; Dir.: Derek Hannan, Mike Oldfield.

Teal Trutone Music South Africa, PO Box 9299, Johannesburg, 2000, 2nd Floor, Gallo House, Hood Ave., Rosebank, Johannesburg, 2000, (011) 788 2114. Fax: (011) 788-8107. Teal Trutone Gen. Mgr.: Harry Voerman; Teal Music Gen. Mgr.: Gary Finch; Trutone Mktg/A & R Dir.: Steve Harris.
Label(s): (Owned) Trutone Music, Teal Music, (Distributed) Island, A&M, PolyGram Int'l.

Lee Thorp Entertainment, PO Box 70, Observatory, Cape Town, 7925, (21) 471358. Fax: (21) 471359. Managing Dir.: Patrick Lee Thorp.

Label(s): (Owned) Sea, Mountain, (Distributed) Claremont, EWM, AH.

Int'l Reprs.: EWM (Germany).

Transistor Music (Pty.) Ltd., PO Box 89435, Lyndhurst, 14 Orange St., Sunnyside, Johannesburg, 2106, (011) 726-6311. Fax: (011) 726-5612. Pres.: Chris Kritzing; Gen. Mgr.: Doug Goetsch; Promos. Mgr.: Jann Becker; Mktg. Mgr.: Ilona Salgado.
Label(s): (Owned) Transistor Music, Graffiti, (Distributed) Toco Int'l, TNT.

Trio Records (Pty) Ltd., PO Box 33283, Kimberley Rd., Bertrams, Jeppestown, 2043, (011)618-1470. Fax: (011) 618-2921. Mng. Dir.: Gavin Gibb; Vice Pres. A&R: Gavin Gibb.

Tusk Music Co. (Pty) Ltd., PO Box 156, Press Ave., Crown Mines, Johannesburg, 2025, (27-11)839-2211. Fax: (27-11)837-9113. Chrmn.: Derek Hannan; Managing Dir.: Michael Oldfield; Mktg/A & R Dir.: Benjy Mudie; Dir. Diamond Music/Sales: Phil Leach; Domestic A&R Dir.: Paul Tsotetsi; Financial Dir.: Bobby Hodgson; Int'l Label Mgr.: Edith Magnussen; Classical Mktg. Mgr.: Michael Lettelier.
Label(s): (Owned) Africa Music, Diamond Music, (Distributed) Elektra, WEA Int'l, MCA, Atlantic, Warner Bros.

Umusa Music, PO Box 997, 130 Goldman St., Florida, 1710, 027 11 672-887. Fax: 02711 472-1660. Pres.: J. Crickmore-Thompson; Vice Pres. A&R: Johannes Ntombini.

Vision Records, PO Box 10560, Lenasia, 155 Gemsbor St. Lenasia, Johannesburg, 1820, (011) 852-5040. Fax: (011) 852-5040. Managing Dir.: A. A. Haffjee.

Dick Voorendyk & Assoc. (Orange Records C.C.), PO Box 16592, Doornfontein, 2028, 402 5860. Fax: 402 5860.

THE

Gallo GROUP OF COMPANIES

REPRESENTING AFRICA'S
GREATEST
ARTISTS AND COMPOSERS
AS WELL AS MAJOR LICENCEES IN
SOUTHERN AFRICA.

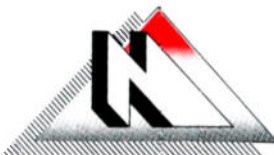
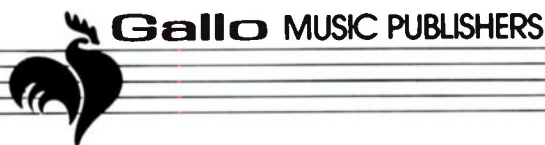
**RPM RECORD COMPANY**

THEATRES
VIDEO DISTRIBUTION
FILM PRODUCTION

GALLO
INTERNATIONAL

Contact Ivor Haarburger
Gallo (Africa) Ltd
Box 6216, Johannesburg 2000
South Africa
Telephone: 27 11 788-1900
Fax: 27 11 788-0043
Telex: 4-26091

World of Music, PO Box 1194, Northlands, Johannesburg, 2116, 642-7236. Fax: 642-1425. Contact: Peter Cooke; Robbie Mann.

MUSIC PUBLISHERS

A G Music, PO Box 6216, c/o MPA (Pty) Ltd., Johannesburg, 2000.

A.V.T. Music Group. (See April Music Publishing Co. (Pty) Ltd.).

Acts Music. (SAMRO) (See EMI Music Publishing).

Acuff Rose/Opryland Music. (See Gallo Music Publishers).

Alfred Publishers. (See Tradelius & Co.).

All Boys Music (UK). (See Little Monster Music).

All Nations Music (USA). (ASCAP) (See Little Monster Music).

Ampelos Music. (SAMRO) (See EMI Music Publishing).

Angela Music Publishing Co. (Pty) Ltd., PO Box 55325, Northlands, Johannesburg, 2116, 4 Goodvuid Rd., Melrose North, Johannesburg, 2196, (011) 880-3757. Fax: (011) 880-6596. Pres.: Terry Dempsey; Gen. Mgr.: Carrie Dempsey.

April Music Publishing Co. (Pty) Ltd., PO Box 6216, c/o Gallo/GRC Music Publishing (Pty) Ltd, Johannesburg, 2000.

Attic Music Ltd. (Canada). (See Little Monster Music).

BMG/Arista Music. (See Gallo Music Publishers).

Bandstand Publications (Pty) Ltd., PO Box 1234, c/o Worldwide Music Group of Companies, Highlands North, 2037.

Be+El Publishers, PO Box 23227, Innesdale, Pretoria, 0031, (012) 215 655. Fax: (012) 325 6517. Pres.: Robbie Engelbrecht; Gen. Mgr.: Dicky Thomas.

Black Talent Music, PO Box 2310, Joubertpark, 2044.

Blackwood Music. (See April Music Publishing Co. (Pty) Ltd.).

Blik Music. (SAMRO) (See EMI Music Publishing).

Blondie's Music Co., PO Box 1194, Kelvin, 2054.

Blue Bull Music, PO Box 6216, c/o MPA (Pty) Ltd., Johannesburg, 2000.

Blue Tree Music, PO Box 6857, c/o Tusk Music Publishing Co. (Pty) Ltd., Johannesburg, 2000.

Bop Music, PO Box 6857, c/o Tusk Music Publishing Co. (Pty) Ltd., Johannesburg, 2000.

Breakaway Music Co. (Pty) Ltd., PO Box 21, Cramerville, 2060.

Breve (Edms) Bpk, Posbus 56151, Pinegowrie, 2123.

Buza Music, PO Box 786305, Sandton, 2146.

Buffalo Songs, PO Box 6216, c/o MPA (Pty) Ltd., Johannesburg, 2000.

Bulk Music Ltd., (See Roan Antelope Music).

CA Music USA, (See Charis Music).

C and G Music, PO Box 6216, c/o Clan Music Publishing Co. (Pty) Ltd., Johannesburg, 2000.

C. Publishing. (SAMRO) (See EMI Music Publishing).

California Phase Music. (See Roan Antelope Music).

Carlin Music Library (United Kingdom). (See Worldwide Music Publishing (Pty) Ltd.).

Carstens-De Waal Music. (See Gallo Music Publishers).

Cavendish Music (United Kingdom). (See Worldwide Music Publishing (Pty) Ltd.).

Chappell Music (Africa) (Pty) Ltd., PO Box 6857, Johannesburg, 2000.

Charis Music. PO Box 90, 130 Goldman St., Florida, 1710, 027 11 4721660. Fax: 027 11 4721660. Pres.: Jenny Crickmore-Thompson; Gen. Mgr.: S. Du Plessis.

Chelsea Music (UK). (See Little Monster Music).

Clan Music. (See Gallo Music Publishers).

Clear Music Pub., (SAMRO) (See EMI Music Publishing).

Contemporary Sounds, PO Box 1510, c/o Musicpiece Publishers (Pty) Ltd., Johannesburg, 2000.

Cool Spot Prodn., PO Box 23980, 25 Koch St., Joubert Park, Contact: Ken Haycock.

De La Music c.c., PO Box 80101, Ridgeview, Johannesburg, 1701, One 11th St., Delarey, Johannesburg, 1700, (011) 673-3012, (011) 673-3013. Fax: (011) 673-7873. Gen. Mgr.: Yvonne Pretorius.

Deep South Music (Pty) Ltd., PO Box 41114, Craighall, Johannesburg, 2024.

Dephon Promos. & Publishing (Pty) Ltd., PO Box 3164, Johannesburg, 2000.

Designer Music Co. (UK). (See Little Monster Music).

EMI Brigadiers Music (PTY) Ltd., (SAMRO) PO Box 79551, Senderwood, 32 Steele St., Steeledale, Johannesburg, 2145, (011) 453-3463. Fax: (011) 453-1012. Dir/Gen. Mgr.: Robie Kallenbach.

EMI Music Publishing. (SAMRO) PO Box 79551, Senderwood, Riverwoods Office Park, Johnson Rd., Johannesburg, 2145, (11) 453-3463. Fax: (011) 453-1012. Mng. Dir.: R. Kallenbach; Creative Dir.: Vic Ellis.

E. Z. Music, CC, PO Box 754, Crown Mines, Johannesburg, TUL, 2025, 51, Eighth Ave., Mayfair, Johannesburg, TUL, 2092, (011) 837-9344. Fax: (011) 839-3810. Gen. Mgr.: Emil Zoghy.

Eaton Music Ltd., (See Roan Antelope Music).

Essex Music Group (Pty) Ltd., PO Box 6857, CNR Press Ave. & Main Reef Rd., Johannesburg, 2000, (011) 839-2211. Pres.: Kevin O'Hara; Gen. Mgr.: Kay Pillay.

Fairhill Music USA. (See Charis Music).

Filmsuk (Pty) Ltd., PO Box 11254, c/o Plymouth Music (Pty) Ltd., Johannesburg, 2000.

Flying Dutchman Music Publishing (Pty) Ltd., 17 Pretoria St., Oaklands, Johannesburg, 2192.

Eric Frish Prodn., PO Box 626, 177 Louis Botha Ave., Orange Grove, Johannesburg, 2009, 728-7145. Fax: 728-1979. Contact: Eric Frish.

Fuller Music (Pty) Ltd., PO Box 648, Johannesburg, 2192.

Gallo Music Publishers

PO Box 6216, Johannesburg, 2000, Gallo House, Hood Ave., Rosebank, 2196, (011) 788-0400. Fax: (011) 788-8702. Mng. Dir.: Geoff Paynter; Gen. Mgr.: Gill Rule; Prof./Creative Mgr.: Albert Ralulimi.

Garden Rake Music. (See April Music Publishing Co. (Pty) Ltd.).

Gold Music Co., PO Box 6216, c/o Gallo/GRC Music Publishing (Pty) Ltd, Johannesburg, 2192.

Gold Record Music, PO Box 5070, 782 Prince George Ave., Brenthurst, TVL, 1542, (011) 813-3418. Fax: (011) 813-1936. Pres.: Phyllis De Gouveia; Gen. Mgr.: Teresa Malone; Prof./Creative Mgr.: Myrie Grove.

Goldrush Music. (See Angela Music Publishing Co. (Pty) Ltd.).

Harrison Music Corp., (See Roan Antelope Music).

Headache Music, 8 Van Wyk Louw Dr., Parkrand, Boksburg, 1460.

Heads Music Ents. (Pty) Ltd., PO Box 754, Crown Mines, 2025.

Dennis Heaney Music. (See Gold Record Music).

Hit City Music, PO Box 2116, Johannesburg, 2000, 6th/F, Loutan House, 141 Pritchard St., Johannesburg, 2001, (011) 402-3209. Fax: (011) 402-7314. Pres./Prof.-Creative Mgr.: John Galanakis; Gen. Mgr.: Jill Galanakis.

Hitchhikes Music (USA). (See Little Monster Music).

Hub Music, PO Box 1269, Randburg, 2125.

ICBM Music, PO Box 2888, Benoni, 1500, 018-3-2274. Professional/Creative Mgr: Jonathan Handley.

Iciline Home Music Publishers, PO Box 70076, Bryanston, 2021.

Intersong (Pty) Ltd., PO Box 6857, Johannesburg, 2000.

Island Music. (See Gallo Music Publishers).

Jan De Wet Music. (SAMRO) (See EMI Music Publishing).

Jill Music Publishing. (See Gold Record Music).

Jobette Music Co., (See April Music Publishing Co. (Pty) Ltd.).

Jo'burg Music, PO Box 93005, Yeoville, Johannesburg, 2143, (011) 728-4715. Pres.: S. M. Cohen.

Jonathan Music (South Africa) (Pty) Ltd., PO Box 6857, CNR Press Ave. & Main Reef Rd., Johannesburg, 2000, (011) 839-2211. Pres.: Kevin O'Hara; Gen. Mgr.: Kay Pillay.

KIR Publishing Switzerland. (See Charis Music).

Edward Kassner Music Co. (Sa) (Pty) Ltd., PO Box 10274, Johannesburg, 2000.

Kaya Music c/o Jo'burg Records & Music Publishers, PO Box 93005, Yeoville, Johannesburg, 2000.

Khayyam Music (Pty) Ltd., PO Box 10013, Johannesburg, 2000.

Kings Music (Pty) Ltd., PO Box 1194, c/o World of Music, Parklands, 2121.

Krystal Music (sa), PO Box 110, Kliptown, 1812.

LVR Music, PO Box 29386, Melville, 2109.

Lazer Songs. (See Angela Music Publishing Co. (Pty) Ltd.).

Hal Leonard. (See Tradelius & Co.).

Linhlim Music c/o April Music Publishing Co. (Pty) Ltd., PO Box 2445, Johannesburg, 2000.

Lion's Head Music Co. (Pty) Ltd. c/o Clan Music Pub. Co. Ltd., PO Box 2807, Johannesburg, 2000.

Lister Publications, 17 Roderick Way, Constantia, 7800, (021) 794-2031. Pres.: Richard Oxtoby.

Lita Music USA. (See Charis Music).

Little Monster Music. (SAMRO) PO Box 46020, Orange Grove, 2119, (2711)444 2630. Fax: (2711)444 1932. Pres.: David Gresham; Gen. Mgr.: Nick Birkby; Prof./Mgr.: Dorothy Roberts.

Little Paul Music c/o April Music Publishing Co. (Pty) Ltd., PO Box 2445, Johannesburg, 2000.

Lulima Music. (See Gold Record Music).

MCA Music (South Africa). (SAMRO) PO Box 1510, Johannesburg, 2000, (011) 402-5700. Fax: (011) 402-6576. Gen. Mgr.: William Brooks; Professional Mgr.: Janet Scott.

MMA Music (Australia). (See Little Monster Music).

M M E Publishing CC, PO Box 525, kwaXUMA, 1868.

MNR Music. (SAMRO) (See EMI Music Publishing).

MOB Music. (SAMRO) (See Yackamo Music).

MPI/Jomlco Music. (See Roan Antelope Music).

Mac-Villa Music (Pty) Ltd., (SAMRO) PO Box 65, Honeydew, 2040, (011) 795-3781. Fax: (011) 795-2603. Gen. Mgr.: Andre' Viljoen.

Mailbox Music. (See Gold Record Music).

Mamba Music c/o EMI Music Publishing (Sa) (Pty) Ltd., PO Box 11254, Johannesburg, 2000.

Manhattan Prodn. Music (USA). (See Worldwide Music Publishing (Pty) Ltd.).

Maranatha! Music USA. (See Charis Music).

Mavuthela Music. (See Gallo Music Publishers).

Meloding Music Publishing Co. c/o MPA (Pty) Ltd., PO Box 6216, Johannesburg, 2000.

Melody Music (Pty) Ltd. c/o Gallo/GRC Music Pub. (Pty) Ltd., PO Box 6216, Johannesburg, 2000.

Melotoongolwe Musiekuitgewers, p/a Mv Marthas Andresen, Posbus 3302, Kempton Park, 1620.

Meritone Music c/o MPA (Pty) Ltd., PO Box 6216, Johannesburg, 2000.

Mhara Record Edizioni. (See Roan Antelope Music).

Mix Music, 86 Observatory Ave., Observatory Ext., Johannesburg, 2109.

Ivan Mogull (SA) (Pty) Ltd., PO Box 6857, CNR Press Ave. & Main Reef Rd., Johannesburg, 2000, (011) 839-2211. Pres.:

Kevin O'Hara; Gen. Mgr.: Kay Pillay.
Montparnasse Music, PO Box 6216, c/o M P A (Pty) Ltd., Johannesburg, 2000.

Moonlight Music, PO Box 11254, c/o EMI Music Publishers (SA) Pty Ltd., Johannesburg, 2000.

Movie Music, PO Box 6216, c/o Clan Music Publishing Co. Pty. Ltd., Johannesburg, 2000.

Music House Int'l (United Kingdom). (See Worldwide Music Publishing (Pty) Ltd.).

Music Publishing Co. of Africa (M.P.A.). (See Gallo Music Publishers).

Music Sales. (See Tradelius & Co.).

Music Unlimited (South Africa), PO Box 47508, Greyville, Durban, 4023.

Musicpiece Pub., (SAMRO) (See EMI Music Publishing).

Nataniel House of Music, 15 Jonkershoek Ann St., Cresta, Randburg, 2194.

Neil Music. (See Roan Antelope Music).

Noel Gay Music Ltd., (See Roan Antelope Music).

On Record C.C. c/o Tusk Music Publishing (Pty) Ltd., PO Box 6857, Johannesburg, 2000.

Orchestral Music. (See Roan Antelope Music).

P De C Songs c/o Clan Music Publishing Co. (Pty) Ltd., PO Box 6216, Johannesburg, 2000.

Panorama Songs c/o April Music Publishing Co. (Pty) Ltd., PO Box 6216, Johannesburg, 2000.

Parry Music (Canada). (See Worldwide Music Publishing (Pty) Ltd.).

Passage One. (SAMRO) (See EMI Music Publishing).

Peermusic. (See Southern Music Publishing Co. (South Africa) Pty. Ltd.).

Pelvic Music (Pty) Ltd., PO Box 89505, Lyndhurst, Johannesburg, 2106.

Justin Peters USA. (See Charis Music).

Phoenix Record Publishers CC, PO Box 6975, Johannesburg, 2000, 23-5992. Contact: Stan Nkosi.

Pink Floyd Music. (See April Music Publishing Co. (Pty) Ltd.).

Planetary-Nom (Africa) (Pty) Ltd., PO Box 6216, Johannesburg, 2000.

David Platz Music (Sa) (Pty) Ltd., PO Box 6857, CNR Press Ave. & Main Reef Rd., Johannesburg, 2000, (011) 839-2211. Pres.: Kevin O'Hara; Gen. Mgr.: Kay Pillay.

Plymouth Music (Pty) Ltd., (SAMRO) (See EMI Brigadiers Music (PTY) Ltd.).

Polygram Music International. (See Gallo Music Publishers).

Progressive Africa Music (Pty) Ltd. c/o Intersong (Pty) Ltd., PO Box 10678, Johannesburg, 2000.

Promise Publishing House, PO Box 64146, Highlands North, Johannesburg, 2037.

Protea Film Prodn. (Pty) Ltd., c/o 03 Groenkloof Gardens, Steger St., Groenkloof, Pretoria, 0181, Contact: W. Grunbauer.

Protea Music (Pty) Ltd., PO Box 35705, Northcliff, Johannesburg, 2115.

Reamusic Publishers, PO Box 96395, Brixton, Johannesburg, TVL, 2019, 4 Wordsworth Ave., Senderwood, Bedfordview, Johannesburg, TVL, 2008, (011) 453-1432, (011) 453-1433. Fax: (011) 453-2577. Pres.: Clive Risko; Gen. Mgr.: Toni Risely; Prof./Creative Mgr.: Enoch Nondaia.

Redfish Music. (SAMRO) (See Yackamo Music).

Reformation/KGB Music (U.K.). (See Little Monster Music).

Rella Music. (See April Music Publishing Co. (Pty) Ltd.).

Ricardo's Music Publishers, PO Box 1760, Krugersdorp, 1740, (011) 952-1828. Pres.: Ricardo Bornman.

Roan Antelope Music, PO Box 641, 30 Church St., Halfway House, 1685, (011) 805-1251. Fax: (011) 315-0599. Pres.: John Edmond; Gen. Mgr.: Teresa Edmond; Prof./Creative Mgr.: Boudine Hametner.

Robroy Music, 330 Albert St., Waterloof, Pretoria, TVL, 0181, (011) 886-4141. Fax: (11) 789-5237. Pres.: Robert Schroder; Gen. Mgr.: Pat Schroder.

Roi Music, PO Box 23535, Joubertpark, 2044.

Rondor Music International. (See Gallo Music Publishers).

Ryanstel Music Publishers c/o B & S Music Publishers (Pty) Ltd., PO Box 86175, City Deep, Johannesburg, 2049.

SMC Music. (See Gold Record Music).

Sad Music Co. (Pty) Ltd., 13 Kent Rd., Dunkeld W., Johannesburg, 2196.

Sapphire Music c/o April Music Publishing Co. (Pty) Ltd., PO Box 6216, Johannesburg, 2000.

Saxonrand Music c/o Mr. Michael Pam, 31 Kenmain Gardens, Main Rd., Kenilworth, 7700.

Shandel Music, 219 Hyde Gate, Hyde Park, 2196, Contact: Selwyn Shandel.

Sigude Music c/o Gallo (Africa) Ltd., PO Box 6216, Johannesburg, 2000.

Silversongs (Pty) Ltd., 19 Pretoria St., Oaklands, Johannesburg, 2192.

Soltone Records C.C., PO Box 1674, Parklands, 2121.

Sonet Music (U.K.). (PRS) (See Little Monster Music).

Songs of Bandler-Koppelman. (See April Music Publishing Co. (Pty) Ltd.).

Songwrights Publishers, PO Box 70, Observatory, Cape Town, 7935, 9 Clifton Terrace, Observatory, Cape Town, 7925, (21) 471358. Fax: (21) 471359. Pres.: Patrick Lee-Thorp.

Southern Music Publishing Co. (South Africa) Pty. Ltd.
PO Box 10274, Johannesburg, 2000, 62 St. Patrick Rd., Houghton, Johannesburg, 2198, (2711)648-5404. Fax: (2711)648-1902. Mgr.: Vera Taylor.

Southern Sky Music c/o Contagious Music (Pty) Ltd., PO Box 6216, Johannesburg, 2000.

Stab Music, 9 Menin Gradens, Menin Sq., Delville, Germiston, 1401, (011) 873-1285. Pres./Prof./Creative Mgr.: Barry E. Jarman.

Steve Music Publishing, 330 Albert St., Waterkloof, Pretoria, TVL, 0181, (011) 886-4141. Fax: (11) 789-5237. Pres.: Robert Schroder; Gen. Mgr.: Pat Schroder.

Storm Music, (See Angela Music Publishing Co. Pty. Ltd.).
Strike Music (Pty) Ltd., PO Box 6216, c/o Gallo Africa Ltd., Johannesburg, 2000.

Studio G (United Kingdom), (See Worldwide Music Publishing (Pty) Ltd.).

Sweet Summer Music (USA), (ASCAP) (See Little Monster Music).

Sylvia Music, PO Box 40293, Cleveland, 2022.

Tammi Music Ltd., (See Roan Antelope Music).

Tan Music c/o EMI Music Publishing (Sa) (Pty) Ltd., PO Box 11254, Johannesburg, 2000.

Tourmaline Music USA, (See Charis Music).

Tradellus & Co., PO Box 3159, Durban, 4000, (31) 304-3978. Fax: (31) 304-2096. Pres.: H. Tradellus; Gen. Mgr./Prof./Cre. Mgr.: E. Rasch.

Transistor Music (Pty.) Ltd., PO Box 89435, Lyndhurst, 14 Orange St., Sunnyside, Johannesburg, 2106, (011) 726-6311. Fax: (011) 726-5612. Pres.: Chris Kritzingler; Gen. Mgr.: Heila MacMillan.

Tusk Music Publishing (Pty) Ltd., PO Box 6857, CNR Press Ave. & Main Reef Rd., Johannesburg, 2000, (011) 839-2211. Pres.: Kevin O'Hara; Gen. Mgr.: Kay Pillay.

Valentine Music (South Africa) Co., PO Box 46020, Orange Grove, 2119.

Virgin Music International, (See Gallo Music Publishers).
Wea Music (South Africa), PO Box 6857, Johannesburg, 2000.

Josef Weinberger Music (United Kingdom), (See Worldwide Music Publishing (Pty) Ltd.).

Wendy O Music, (SAMRO) (See EMI Music Publishing).

Word Inc., (See Charis Music).

Word UK, (See Charis Music).

Worldwide Music Publishing (Pty) Ltd., PO Box 1234, Highlands North, 33 The Valley Rd, Parktown, Johannesburg, 2037, (011) 646-6000. Fax: (011) 646-4616. Pres.: Ron Singer; Gen. Mgr.: Nico Lesch.

Yackamo Music, (SAMRO) PO Box 46020, Orange Grove, Johannesburg, 2119, (2711) 4831805. Fax: (2711) 7281979. Pres.: Eric Frisch; Dir.: D. Gresham/A. Goldswain.

Yackamo Music Pty. Ltd., PO Box 626, Johannesburg, 2000, (2711)4831805. Fax: (2711)7281979. Pres.: E. Frisch; Professional Mgr.: P. Hannay.

SHEET MUSIC & FOLIO SUPPLIERS

Tradellus & Co., PO Box 3159, 118 Poynton Hse., Cnr Gardiner & Pine, Durban, 4000, 27(31)304 3978. Telex: 620389. Fax: 27(31)304-2096. Pres.: H. Tradellus.

PERFORMING & MECHANICAL RIGHTS ORGANIZATIONS

DALRO, PO Box 9292 Johannesburg 2000, SAMRO House 73, Juta St. Braamfontein, Johannesburg, 2001, (011) 403-6635. Fax: (011) 403-1934. Managing Dir.: Gideon Roos.
SAMRO, PO Box 9292, Johannesburg 2000, SAMBRO House, 73 Juta St., Braamfontein, 2001, (011) 403-6635. Fax: 403-1934. Exec. Pres.: Gideon Roos.

BLANK & BULK TAPE MANUFACTURERS

3M South Africa (Pty), Ltd., PO Box 10465, 181 Barbara Rd., Johannesburg, 2000, South Africa, (27)11 9229111. Fax: (27)11 9745072. Contact: Peter Hickman.

RECORD LABELS

Teal Record Co. Zambia Ltd., PO Box 70280, Ndola, 6103137. Fax: 655585. Gen. Mgr.: Howard A. Gatchell; Mgr.: Faisal Nanavat.

Int'l Reprs.: Ace Records (London); Demon Records, W.O.M.A.D Records, (United Kingdom).

RECORD LABELS

Gramma Records, PO Box St. 21, Harare Dr., New Ardbenne, Southern, Harare, (263-4) 64581. Managing Dir.: Julian Howard; Label Mgr.: Brian Cader.

Zimbabwe Music Corp., PO Box 4824, 30 Forbes Ave., Harare, 724478. 724492. Chrmn.: A. Hageithungu; Mng. Dir.: B. Anandale; A & R Mgrs.: R. Glover & G. Manyeba; Local Music Dir.: T. Mabaleka.
Label(s): (Distributed) CBS, Epic.

BLANK & BULK TAPE MANUFACTURERS

3M Zimbabwe Ltd., PO Box AV 64, Amby, Harare, Zimbabwe, (263)4 46164. Fax: (263)4 46165. Contact: Kim Chittenden.

ASIA

INDONESIA

RECORD LABELS

Pt. Aquarius Musikindo, PO Box 2674, Jalan Batutulis XIII/17, Jakarta, 10120, (62-21)367-238, (62-21)3807236. Fax: (62-21)370-934. Managing Dir.: J. Soerjoko; WEA Label Mgr.: Iman Sastroatomo.

P.T. Indo Semar Sakti, 2 JLAM Jelambar Ilir, Jakarta Barat, (62) 21611748, (62) 21610037. Fax: 629 6156. Managing Dir.: Iwan Sutadi Sidarta; Gen. Mgr.: Tony Djauhari; Marketing Dir.: Mr. Wendy Aji Sutantio; Financial Dir.: Ribka Khoe.

P.T. Musica Studios, Glodok Plaza Blok F. 111-112, Jakarta Kota, (21) 649-1729, (21) 649-1798. Fax: (21) 649-7309. Managing Dir.: Sendjaja Widjaja.

P.T. Inmac, Selahtera, Mura Karan Raya. #175-177, Jakarta, 14440, Contact: J. Loekman.

BLANK & BULK TAPE MANUFACTURERS

P.T. 3M Indonesia, PO Box 12/KBYT, Graha Purna Yudha Bldg., 7th Floor, J.L.Jend.Sudirman, Jakarta, KVA, 50, Indonesia, (62)21-510809. Fax: (62)21-511905. Contact: Peter Rumanby.

TAPE CUSTOM DUPLICATORS

PT. Panggung Electronic Industries, Jl. Raya Waru No. 1, Surabaya, (031) 832570. Fax: (031) 814257. Pres.: Kindarto Kohar; Sales Mgr./Export: Santoso Setyadi; Mktg. Dir.: Ali Soebroto.

Audio: Cassette.
Audio Packaging Services: Inserting, Collating, Labeling, Mailing.

MASTERING FACILITIES

PT. Panggung Electronic Industries, Jl. Raya Waru No. 1, Surabaya, (031) 832570. Fax: (031) 814257. Pres.: Kindarto Kohar; Sales Mgr./Export: Santoso Setyadi; Mktg. Dir.: Ali Soebroto. (Audio)

PHILIPPINES

RECORD LABELS

Able Music Int'l, Inc., 4 Ilang-Ilang St., Stes. 202-204, Quezon City, MM, (63-2)721-2665, (63-2)721-2669. Fax: (63-2)721-3998. Pres.: Reynaldo O. De Vera; Finance Officer: Ramon Tan. (Distributor, Recording Co.)

Labels: (Distributed) Audio: Ranwood, Higher Octave Music, Laserlight, Pilz, Classic Digital, Starlite, CeDe, Maybelline, Koala, Music World.

Able Music Int'l Inc., 4 Ilang-Ilang St., #202-204, Quezon City, MM, 721-2665, 721-2669. Fax: 721-39-98. Pres.: Reynaldo O. De Vera; Finance Officer: Ramon Tan; Dirs.: Olive M. Gamboa; Lucy S. De Vera; Manny Tan; Clarita Tan; Exec. Asst.: Vicky Cruz; Accountant: Norie Jean Ferreira; Sales Mgrs.: Manny Gaspard; Melchor Balonzo; Cebu City Br. Mgr.: Didi M. Balonzo; Cebu City Br. Sales Mgr.: J. A. Balonzo; Davao City Br. Mgr.: Tony Lematera.

Labels: (Owned) AMII, AMS, Able, Kiddieland, CCS.
Alpha Records Corp., 1731 E. Rodriguez Ave., Cubao, Quezon City, 97-45-65, 78-23-11. Fax: 721-47-08. Pres., Gen. Mgr.: Buddy O. De Vera; Exec. Vice Pres.: Alvin F. De Vera; Vice Pres., Mktg.: Roger O. De Vera; Vice Pres./Opns.: Rey Cruz, Jr.; Vice Pres. A&R: Ben C. Balboa.

Labels: (Distributed) A & M, Factory, Virgin, MCA.
Bell Films, Inc., 135 P. Sevilla Cor. Third Ave., Grace Park, Caloocan, Metro-Manila, (632) 361-0248, (632) 361-0261. Fax: (632) 361-2995. Pres.: James G. Dy; Vice Pres. A & R: Peter Chan; Exec. Vice Pres.: Ramon Chuaying; Gen. Mgr.: Bella D. Tan; Label Mgr.: Jesmon Chua.

Labels: (Owned) Bell, Vision, (Distributed) Teldec, WEA Int'l, Warner Brothers, Erato, K-Tel, Reprise, Nonesuch, Atlantic, Elektra, Atco.

Dyna Products, Inc., PO Box 4591, 135 W. Second Ave., Caloocan City, (632) 362-0379. Fax: (632) 345271. Pres.:

Albert Tan; Exec. Vice Pres/Mng. Dir.: James G. Dy; Gen. Mgr.: Tan Huy Bin; Treas.: Gregorio Tan.

Labels: (Distributed) Toco, EMI, PolyGram.
Emerald Music Corp., Ste. 201, Delta Bldg., West Ave., Quezon City, 3008, 922-28-50. Fax: (632) 815-0756. Pres./Chrmn. of the Board: Jose Antonio N.S. Carrion; Prodn. Mgr.: Gregoria E. Garcia; Public Relations Dir.: Junne C. Quintana; Vice Pres./Sales & Mktg.: Maria Salud S. Santos; A & R Dir.: Ramon del Rosario.

Labels: (Owned) OPM Emerald, Touchtone, Sunflower.
Ivory Records Corp., 80 Quadstar Bldg., Ortigas Ave., Greenhills, San Juan, MM, 1502, (632) 721-6278, (632) 723-0763. Fax: (632) 722-7097. Pres. & Gen. Mgr.: Antonio M. Ocampo; Vice Pres.: John C. Tan; Sales Mgr.: Henry Sayas; Prodn. Mgr.: Kedy A. Sanchez; A & R Mgr.: Mg O. Mozo.

Labels: (Owned) Peace Music, Ivory, (Distributed) AVI, GRP, TBA, Telesis, Viva, Victor Musical Industries.

MARQFED Int'l Trading Corp., Fedman Bldg. #802, Salcedo St., Legaspi Village, Makati, MM, 819-056.

OctoArts Int'l, Inc., OctoArts Bldg., 108 Panay Ave., Quezon City, Manila, (2) 968-191, (2) 982-461. Fax: (2) 921-1339. Pres.: Orlando R. Ilacad; Exec. Vice Pres.: Ramoncito R. Ilacad; Int'l A & R Dir.: Ricky R. Ilacad.

Labels: (Owned) New York, April, Canary, (Distributed) CBS, Crespuscule, Energy, Bassment, Beggars Banquet, Epic, Hot Sounds, Nastymix, Music West, Nightmare, Pandisc, Nova.

Praise, Inc., 175 Sto. Domingo St., San Francisco Del Monte, Quezon City, 1115, 34-70-21, 34-70-22. Fax: 632-7124169. Pres.: Victor Sy; Gen. Mgr.: Johnny K. Sy; Sec.: Lolita Cham; Treas.: Rebecca Ann Sy Tan.

Labels: (Distributed) Star Song, Sparrow, Word, Benson, Myrr, Maranatha.

Telesis Recording & Entertainment Corp., 96 20th Ave., Cubao, Quezon City, Metro Manila, 791013, 721-5499. Chrmn./Pres.: Wilfrido B. Cruz; Exec. Vice Pres.A&R/Gen. Mgr.: Margot M. Gallardo; Adv. & Promos. Mgr.: Edith M. Gallardo; Dir.: Ryan P. Cayabyab.

Vicor Music Corp., PO Box A.C. 270, 782 Aurora Blvd., Cuabo, Quezon City, 1100, (632) 721-33-3. Fax: (632) 7218302. Pres.: Florendo R. Garcia, Jr.; Dir.: Maria Teresa Roxas; Sr. Vice Pres.: Atty. Claire D. Manuel; Asst. Vice Pres. Prodn.: Alfonso S. Ilagan.

Labels: (Owned) Sunshine, Blackgold, Bayanihan, Plaka Filipino, (Distributed) Vicor Int'l.

WEA Records, PO Box 2512, Manila, MM, 2805, 135 P. Sevilla St., Grace Park, Caloocan, MM, 2805, (63-2)362-2119, (63-2)362-4426. Fax: (63-2)361-2995. Chrmn. & Pres.: James G. Dy; Exec. Vice Pres.: Ramon Chuaying; Gen. Mgr.: Bella D. Tan; Label Mgr.: Jesmon Chua; A&R Mgr.: Peter Chan.

Labels: (Owned) Elektra, Elektra, WEA Int'l, Warner Bros., Warner Bros.

MUSIC PUBLISHERS

Almo Music Pub., (See Alpha Records Corp.).
Alpha Records Corp., 1731 E. Rodriguez Ave., Cubao, Quezon City, 78-52-53, 78-12-33. Fax: 721-47-08. Pres., Gen. Mgr.: Buddy O. De Vera.

Bayanihan Music Philippines Inc. (BAMI), 782 Aurora Blvd., Cubao, Quezon City, (63) 721-33-31.

Bell Films, Inc., 135 P. Sevilla Cor. Third Ave., Grace Park, Caloocan, Metro-Manila, (632) 361-0248, (632) 361-0261. Fax: (632) 361-2995. Pres.: James G. Dy; Gen. Mgr.: Bella D. Tan.

Black Ice Pub. Co., (See Alpha Records Corp.).
Irving Music, Inc., (See Alpha Records Corp.).

Jobete Music, (See Alpha Records Corp.).
MCA Music Pub., (See Alpha Records Corp.).

OctoArts Music Publishing, 108 Panay Ave., Quezon City, Metro Manila, (2) 968-191. Fax: (2) 921-1339. Pres.: Orlando R. Ilacad.

Rondor Music (London) Ltd., (See Alpha Records Corp.).
Ten Music Ltd., (See Alpha Records Corp.).

Vicor Music Corp., (BAMI) PO Box A.C. 270, 782 Aurora Blvd., Cubao, Quezon City, 1100, (632) 7213331, (632) 7213332. Fax: (632) 7218302. Pres.: Florendo R. Garcia, Jr.; Asst. Vice Pres.: Alfonso S. Ilagan.

Virgin Music (Pub.) Ltd., (See Alpha Records Corp.).
Warner Chappell Music, (See Alpha Records Corp.).

MUSIC LIBRARIES

League of Filipino Composers, c/o Cultural Center of the Philippines, Roxas Blvd., Manila, 2801, 832-3701. Fax: (632) 832-3686. Pres.: Lucrecia R. Kasilag.

Soundtrack Audio Video Ents., 7447 Santillan St., Makati, (632) 874734. Fax: (632) 866757. Pres.: Danee Samonte; Sales Mgr.: Ronelio De Asis; Mktg. Dir.: Yhul Orhaze; Product Mgr.: Gal Macasinag.

PUBLIC RELATIONS

League of Filipino Composers, c/o Cultural Center of the Philippines, Roxas Blvd., Manila, 2801, 832-3701. Fax: (632) 832-3686. Pres.: Lucrecia R. Kasilag.

RECORD PROMOTION

Soundtrack Audio Video Ents., 7447 Santillan St., Makati,

(632) 874734. Fax: (632) 866757. Pres.: Danee Samonte; Sales Mgr.: Ronelio De Asis; Mktg. Dir: Yhul Orhaze; Product Mgr.: Gal Macasinag.

BLANK & BULK TAPE MANUFACTURERS

BASF Philippines, Inc./Vitacolor Inds., Inc., 7/F Emerald Bldg., Emerald Ave., Pasig, Metro Manila, 1600, Philippines, (632) 631-1601. Fax: (632) 631-3002. Pres.: Jaime B. Mendoza; Sales Mgr.: Jessica S. Huang; Mktg. Mgr.: Manuel Chavez;
Dyna Products, Inc., PO Box 4591, 135 Second Ave./Aquino St., Manila, Philippines, (632) 362-1353, (632)345485. Fax: (632) 632-0936.

3M Philippines, Inc., PO Box 840, 3M House, E De Los Santos Av., Makati, Rizal D-708, Guadalupe, Philippines, (632) 871-7061. Fax: (632) 817-7509, Mktg./Sales Mgr.: Renato P. Batucan.

CARTRIDGES, CASSETTES, REELS & OTHER PARTS

BASF Philippines, Inc./Vitacolor Inds., Inc., 5/F Emerald Bldg., Emerald Ave., Ortigas Complex, Pasig, 1600, (632) 631-1601. Fax: (632) 631-3002. Pres.: Jaime B. Mendoza; Sales Mgr.: Jessica S. Huang.
Audio: BASF Cassettes C-0 & Snap Packs, Pancake.

Dyna Products, Inc., PO Box 4591, 135 Second Ave., Grace Park, Caloocan City, (632) 362-1353. Fax: (632) 632-0936. Pres.: Albert Tan; Sales Mgr.: Billy Ong Hua Chiong; Gen. Mgr.: Tan Huy Bin; Treasurer: Gregorio Tan.
Audio: C-0, Snap Pack.

RAW MATERIALS

Dyna Products, Inc., PO Box 4591, 135 Second Ave., Grace Park, Caloocan City, (632) 362-1353. Fax: (632) 632-0936. Pres.: Albert Tan; Sales Mgr.: Billy Ong Hua Chiong; Gen. Mgr.: Tan Huy Bin; Treasurer: Gregorio Tan.
Product(s): Record Compound Pellets.

ENVELOPES & MAILERS

OctoArts Int'l, Inc., 108 Panay Ave., OctoArts Bldg., Quezon City, (2) 968-191, (2) 982-461. Fax: (2) 921-1339. Pres.: Orlando R. Ilacad; Mktg. Dir: Ramoncito R. Ilacad.
Audio: (CD, Tape, LP)
Video: (Tape, Disc)

JACKETS & SLEEVES

L R McKels, Inc., (Records & Tapes Div.), 131 Del Monte Ave., Quezon City, 1105, 34-42-62, 34-62-93. Pres.: Louie R. Villar, Sr.; Sales Mgr.: Saripaz R. Villar.
Audio: (Tape, LP)

OctoArts Int'l, Inc., 108 Panay Ave., OctoArts Bldg., Quezon City, (2) 968-191, (2) 982-461. Fax: (2) 921-1339. Pres.: Orlando R. Ilacad; Mktg. Dir: Ramoncito R. Ilacad.
Audio: (CD, Tape, LP)
Video: (Tape, Disc)

Soundtrack Audio Video Ents., 7447 Santillan St., Makati, (632) 874734. Fax: (632) 866757. Pres.: Danee Samonte; Sales Mgr.: Ronelio De Asis; Mktg. Dir: Yhul Orhaze; Product Mgr.: Gal Macasinag.
Audio: (Tape, LP)
Video: (Tape)

LABELS

L R McKels, Inc., (Records & Tapes Div.), 131 Del Monte Ave., Quezon City, 1105, 34-42-62, 34-62-93. Pres.: Louie R. Villar, Sr.; Sales Mgr.: Saripaz R. Villar.
Audio: (Tape, LP)

OctoArts Int'l, Inc., 108 Panay Ave., OctoArts Bldg., Quezon City, (2) 968-191, (2) 982-461. Fax: (2) 921-1339. Pres.: Orlando R. Ilacad; Mktg. Dir: Ramoncito R. Ilacad.
Audio: (CD, Tape, LP)
Video: (Tape, Disc)

Soundtrack Audio Video Ents., 7447 Santillan St., Makati, (632)874734, Fax: (632)866757, Pres.: Danee Samonte; Sales Mgr.: Ronelio De Asis; Mktg. Dir: Yhul Orhaze; Product Mgr.: Gal Macasinag.
Audio: (Tape, LP)
Video: (Tape)

POLYBAGS & SHRINKWRAP

Dyna Products, Inc., PO Box 4591, 135 Second Ave., Grace Park, Caloocan City, (632) 362-1353. Fax: (632) 632-0936. Pres.: Albert Tan; Sales Mgr.: Billy Ong Hua Chiong; Gen. Mgr.: Tan Huy Bin; Treasurer: Gregorio Tan.
(Shrinkwrap)

TAPE CUSTOM DUPLICATORS

BASF Philippines, Inc./Vitacolor Inds., Inc., 5/F Emerald

Bldg., Emerald Ave., Ortigas Complex, Pasig, 1600, (632) 631-1601. Fax: (632) 631-3002. Pres.: Jaime B. Mendoza; Sales Mgr.: Jessica S. Huang.

Audio: Cassette.
Audio Packaging Services: Inserting.
Dyna Products, Inc., PO Box 4591, 135 Second Ave., Grace Park, Caloocan City, (632) 362-1353. Fax: (632) 632-0936. Pres.: Albert Tan; Sales Mgr.: Billy Ong Hua Chiong; Gen. Mgr.: Tan Huy Bin; Treasurer: Gregorio Tan.
Audio: Cassette.

Audio Packaging Services: Labeling, Shrinkwrapping.
L R McKels, Inc., (Records & Tapes Div.), 131 Del Monte Ave., Quezon City, 1105, 34-42-62, 34-62-93. Pres.: Louie R. Villar, Sr.; Sales Mgr.: Saripaz R. Villar.

OctoArts Int'l, Inc., 108 Panay Ave., OctoArts Bldg., Quezon City, (2) 968-191, (2) 982-461. Fax: (2) 921-1339. Pres.: Orlando R. Ilacad; Mktg. Dir: Ramoncito R. Ilacad.

Audio: Cassette.
Audio Packaging Services: Inserting, Collating, Labeling, Mailing.

Soundtrack Audio Video Ents., 7447 Santillan St., Makati, (632) 874734. Fax: (632) 866757. Pres.: Danee Samonte; Sales Mgr.: Ronelio De Asis; Mktg. Dir: Yhul Orhaze; Product Mgr.: Gal Macasinag.
Audio: Cassette, Real-time.

Video: ¼ U-Matic, ½ VHS Cassette, 8mm, S-VHS, Beta, Super Beta, 41-8.

Video Packaging Services: Inserting, Labeling.

Other Services: Warehouse, Freight.

PLATING & PRESSING PLANTS

Dyna Products, Inc., PO Box 4591, 135 Second Ave., Grace Park, Caloocan City, Philippines, (632) 362-1353. Fax: (632) 632-0936. Pres.: Albert Tan; Sales Mgr.: Billy Ong Hua Chiong; Gen. Mgr.: Tan Huy Bin; Treasurer: Gregorio Tan.
(LP's)

L R McKels, Inc., (Records & Tapes Div.), 131 Del Monte Ave., Quezon City, 1105, Philippines, 34-42-62, 34-62-93. Pres.: Louie R. Villar, Sr.; Sales Mgr.: Saripaz R. Villar.
(LP's)

MASTERING FACILITIES

BASF Philippines, Inc./Vitacolor Inds., Inc., 5/F Emerald Bldg., Emerald Ave., Ortigas Complex, Pasig, 1600, (632) 631-1601. Fax: (632) 631-3002. Pres.: Jaime B. Mendoza; Sales Mgr.: Jessica S. Huang.
(Audio)

Dyna Products, Inc., PO Box 4591, 135 Second Ave., Grace Park, Caloocan City, (632) 362-1353. Fax: (632) 632-0936. Pres.: Albert Tan; Sales Mgr.: Billy Ong Hua Chiong; Gen. Mgr.: Tan Huy Bin; Treasurer: Gregorio Tan.
(Audio)

Soundtrack Audio Video Ents., 7447 Santillan St., Makati, (632) 874734. Fax: (632) 866757. Pres.: Danee Samonte; Sales Mgr.: Ronelio De Asis; Mktg. Dir: Yhul Orhaze; Product Mgr.: Gal Macasinag.
(Audio & Video)

TAPE DUPLICATING & PROCESSING EQUIPMENT MANUFACTURERS

OctoArts Int'l, Inc., 108 Panay Ave., OctoArts Bldg., Quezon City, (2) 968-191, (2) 982-461. Fax: (2) 921-1339. Pres.: Orlando R. Ilacad; Mktg. Dir: Ramoncito R. Ilacad.
Product(s): Electro Sound.

AUSTRALIA— NEW ZEALAND

AUSTRALIA

RECORD LABELS

A T A Allstar, PO Box 196, 98 Glebe Point Rd., Glebe, Sydney, NSW, 2037, (02) 552-1299. Fax: (02) 552-3629. Pres.: Colin Jacobsen; Vice Pres.: Col Joye; Gen. Mgr./Vice Pres. A&R: David Jacobsen; Pub. Rel.: Denise Turra; Sec.: Claire Cowell.
Label(s): (Owned) Wheel, Southern Star.
Adrenalin Records, 23 Lambert St., Camperdown, NSW, 2050, (02) 517 2968. Mgrs.: John Hresc, Greg Black.

Agape Records, 10 Charles St., Redfern, NSW, 2016, (02) 698 7145. Fax: (02) 908 0666. Proprietor: Roger Langford.

AIM Records & Tapes, PO Box 287, 326 Whale Beach Rd., Palm Beach, Newport Beach, NSW, 2106, (612) 974-5107. Fax: (612) 974-1196. Pres.: Peter Noble; Dist. Mgr.: Liz Noble.
Label(s): (Owned) Kingbee, (Distributed) Magnum Force, SST, Meteor, Alligator, Alternative Tentacles, Blue Horizon, Big Beat, Blue Moon, Cascade, DRG, Charly, ED Label,

Globestyle, Kent, Impact, Ace, See For Miles, Southbound, Thunderbolt, Sundown, Westbound.

Int'l Reps.: Fringe Prod.(Canada); Musigise (France); Teldee (Germany); Multirock (Spain); Caroline Int'l (United Kingdom).

Albert Prodn.s., 9 Rangers Rd., Neutral Bay, Sydney, NSW, 2089, (02) 953-6038. Fax: (02) 953-1803. Managing Dir: Ted Albert; Gen. Mgr.: Peter Dawkins; A & R: Colleen Champ; Asst. A & R: Nicole Mitchell.

Label(s): (Owned) AMC, (Distributed) Giant.
Int'l Reps.: CBS (Australia).

Another Record Dist., GPO Box 236C, 88 Bathurst St., Hobart, Tasmanai, 7001, (002) 348566. Fax: (002) 311208. Managing Dir: Stefan Morkovitch.

Label(s): (Distributed) Roadrunner, See For Miles, Unicorn Kanchana, ACE, Arc Music, BGO, Arion, Etcetera, Globe, Hungaroton, Globestyle, J&O, Line, Red Lightnin', Lismor.

Au-go-go Records, GPO Box 542D, 349 Little Bourke St., Melbourne, VIC, 3001, (613) 602-0677. Fax: (613) 602-5899. Dir.: Greta Moon; Bruce Milne.

Aven Guard Music Pty. Ltd., PO Box 437, 70-74 Wilson St., Newton, NSW, 2042, (612) 550-3688. Fax: (612) 519-1401. Managing Dir: Judith Knoll; Sales/Promo: Patricia Collins; Admin. Mgr.: Ross Sheard.

Branch(es): PO Box 458, Elsternwick, VIC, 3185, (03) 528-5645, Fax: (03) 532-8213, Contact: Max Robenstone; 147 Robertson Rd., Fortitude Valley, Queensland, VIC, 4006, (07) 854-1441, Fax: (07) 252-5458, Contact: Glen Navratil; 3/3 Daphne St., Prospect, SA, 5082, (08) 344-7933, Fax: (08) 344-3393, Contact: Bob Wait; PO Box 21, St. Mary's, TAS, 7215, (003) 72-2404, Fax: (003) 72-2286, Contact: Ernie Summerfield; PO Box 325, Willetton, WTA, 6155, (09) 457-9350, Fax: (09) 457-9350, Contact: Dawson J. Wheatley.

Label(s): (Owned) Avan-Guard, Pepito, Tifton, (Distributed) Mardi Gras, Maison de Soul, Maxiplay, Cinedisc, Critics Choice, Goldband, Gimell, Great Southern, Jin, La Louisiane, Kom-A-Day, Chandos.

Int'l Reps.: Ode Record Co.(New Zealand).

BMG Arista Arloia Int'l, The Blvd., 9th Floor Strathfield Plaza, Strathfield, NSW, 2135, (612) 764 3888. Fax: (612) 763 118. Managing Dir.: Brian Smith; Financial Controller: Ewan Fraser; Bus. Affairs Mgr.: John Rossiter; Int'l A & R Mgr.: Stuart Rubin.

Branch(es): Ste. 4/5 Iloura Plaza, 424 St. Kilda Rd, Melbourne, VIC, 30048, (03) 267 65660, Fax: (03) 267-2207, State Mgr.: Peter Whelan; 10 Benson St., Ground Floor Coronation, Toowoong, QLD, 4066, (03) 267 65660, Fax: (07) 371 5958, State Mgr.: Mark Rhodes.

Label(s): (Owned) MSA, Motown, Polar, Mute, Possum, Powderworks, Rhino, QMI, Selection, Starway, Wheatley, Tembo, Big Time, Arista, Carrere, Cherry Pie, Curb, Dreamland, Cyress, Evasound, Filmtrax, Hansa, Hadley.

Bazaar Record Distribution, 152 Greville St., Prahan, VIC, 3181, (03) 51 1696, (03) 51 4331, Fax: (03) 525 1024, Mgr.: Gill Matthews. (Distributor)

Beat Street Records, 70 Judge St., Woolloomooloo, Sydney, NSW, 2011, (02) 698-9644. Fax: (02) 699-1537. Managing Dir.: Kim Frankiewicz; Label Mgr.: Rob Milton.

Big Time Records, 9th Floor Strathfield Plaza, The Blvd., Strathfield, NSW, 2135, (02) 764 3888. Fax: (02) 764-3128. Managing Dir.: Fred Bestall; Gen. Mgr.: Sandra Bestall.

Bunyip Records, 3 Hessel Pl., Emu Heights, NSW, 2750, (047) 35 4389. Fax: (047) 354389. Managing Dir.: Ian B. MacLeod; Producer: Terry Hearne; Sec.: Cheryl A. Jones.

Label(s): (Owned) Bunyip, Pinewood, Rockabilly.

CBS Records Australia Ltd. (IFPI), 11-19 Hargrave St., East Sydney, NSW, 2010, (02) 339-0255. Fax: (02) 331-1377. CEO/Managing Dir.: Denis Handlin; Finance Dir.: Alan Terrey; Gen. Mgr., Label Div: Gill Robert; Mktg. Dir. (Australian Artists): Chris Moss; Vice Pres. A&R: Peter Karpin.

Label(s): (Owned) Epic, CBS Assoc., (Distributed) Boulevard, Castle Communications, Both Barrells, Albert Prodn.s., D.A. Allstars, Giant, Survival, True Blue.

Captain Vinto Records, 1/99 Darlinghurst Rd., Kings Cross, Sydney, NSW, 2011, (02) 356-2511, (02) 357-7000. Fax: (02) 358-4357. Managing Dir.: Joe Ciersh; Int'l Product Mgr.: Chris Molloy.

Central Station Records & Tapes Pty. Ltd., 81 Market St., South Melbourne, VIC, 3205, (613)690-4177. Fax: (613)699-9522. CEO: Giuseppe Palumbo; Dir./Vice Pres. A&R: Morgan Williams; Dir.: Emilio Palumbo.

Label(s): (Owned) Dance Trax, Central Station, Metal for Melbourne.

Cherry Pie Records, 15 Beresford Rd., Thornleigh, NSW, 2120, (02) 484 5506. Managing Dir.: Graeme Rule.

Christian Mktg. pti, PO Box 154, 83 Dourso St., North Geelong, VIC, 3215, (61) 52-786100, Fax: (61) 51-779614, Mgr./Buyer: Alan Kennedy; Buyer: Denise Potter; (Compact Disc, Pre-Recorded Audio Tape, Accessories) (Distributor, Importer, Exporter)

Labels Distributed: Audio & Video: Benson, Vineyard Ministries Int'l, Integrity/Hosanna, Frontline Music, Warner Bros. Gospel, Tynedale House, Focus On The Family, Multnomah, Diadem Music, River Records, Kent Henry Music.

Colossal Records of Australia Pty. Ltd., 14-16 Wilson Ave., Brunswick, Melbourne, VIC, 3056, (03) 387 0555. Fax: (03) 387 6374. Pres.: Domenic Loprete; Managing Dir.: Salvatore Loprete; Int'l Import Buyer: Raffaele Sinopoli; Admin.: Rose Affilitto; Vice Pres. A & R: Gabby Colombi.

Colstal Records, 3 Allison St., 5th Floor Parkrise, Surfers Paradise, QLD, 4217, Dirs.: Bernie Stahl, Suzanne Stahl, Col Elliott, Karen Elliott.

- Concert Recording**, PO Box 108, 10 Caloola Rd., Wentworthville, NSW, 2145, (61-2) 631-6189. Gen. Mgr.: John Clancy; Sales Mgr.: Mary Clancy; Office Mgr.: Kevin Clancy. Label(s): (Owned) Caloola, Concert Recording, Moonlight. Copperfield Sound Prodn., Lot 36 Veronica Dr., Tallai, QLD, 4213, (075) 317152. Fax: (075) 317152. Managing Dir.: David Gibson; Sales Mgr.: Leif Gibson. Label(s): (Owned) Copperfield.
- Dino Music Pty. Ltd.**, PO Box 242, Ste. W2/4, 42 Wattle St., Pyrmont, NSW, 2009, (61-2) 660 3228. Fax: (61-2) 660 6776. Managing Dir.: John Harper; Gen. Mgr.: Gary Jones. Branch(es): 42 Wattle St., Ultimo NSW, 2007, (61-2) 660-3288, Mng. Dir.: John Harper.
- EMI Records Australia Pty. Ltd.**, PO Box 3111, 98-100 Glover St., Cremorne, NSW, 2090, (02) 908 0777. Fax: (61-2) 908-0666. Managing Dir.: David Snell; Gen. Mgr.: Brian Harris; Finance Dir.: Graham Harris; A & R: David Baxter. Branch(es): 7 Marie St., Milton, QLD, 4064, (61-2) 690 3022, Fax: (61-2) 368-3013, State Mgr.: Kerry Byrne; 117 York St., South Melbourne, VIC, 3205, (61-2) 690-3022, Fax: (61-2) 690-7325, State Mgr.: Paul Martinovich. Label(s): (Owned) Angel, Apple, Axis, Blue Note, Chrysalis, Capitol, EMI, Columbia, EMI Int'l, EMI USA, Electrola, Ted Egan Ents., Envoy, Evasound, Fly, Fable, Harvest, His Master's Voice, Imperial, Image, Regal, Regal Zonophone, Rhino, T. Rex, Ritz, Roulette, Stateside, Seraphim, Studio 301, Sun, Toshiba, Supertunes, True Tone, United Artists, Wizard, Voix De L'Orient, Liberty, Listen For Pleasure, MPL, Little Mate, Manhattan, Mint, Nulla, Noeland, Odeon, OZ, Parlophone, PDU, Pathe, Pathe Marconi, Rak, Purple, (Distributed) Col Elliott Ents., Cube, Buddha, Artful Balance, Avenue.
- East Coast Traders**, PO Box 21, Saint Marys, TAS, 7215, (003) 72 2404, Managing Dir.: Ernie Summerfield. (Distributor)
- Eastern Amber Pty. Ltd.**, PO Box 433, Carlton South, Melbourne, VIC, 3053, (613) 348-1300. Fax: (613) 348-1649. Pres.: Neil Barnes; A&R Dir./Producer: George Ooi; Producer: Sam Melamed; Promos: Jan Barnes. Label(s): (Owned) J.N.S., Rumor.
- Enrec Records**, PO Box 1200, 15 Currew Crescent, Tamworth, NSW, 2340, (067) 66 3566. Fax: (067) 66 3566. Chairman: Steve Newton; Gen. Mgr.: Ed Matzenik; Financial Controller: Janet Planet; Vice Pres. A & R: Ed Matzenik. Label(s): (Owned) Enrec. Int'l Reps.: Larrikin (Australia).
- Evasound Record & Tapes Pty. Ltd.**, 28 Cross St., Sydney, NSW, 2100, (612) 9382200. Fax: (612) 938-2573. Gen. Mgr.: John Evans; A & R Mgr.: Dan Hennesy; Int'l Mgr.: Chris Evans. Label(s): (Owned) D for Dance, Jade, Junction.
- Eve Records**, 42 New St., 1st Floor, Ringwood, VIC, 3134, (03) 870 5124. Fax: (03) 879 3849. Contact: Matt Kilpatrick; Shayne Harris; Dirs.: Peter Dwyer; A & R Mgr.: Denis Franks. Label(s): (Owned) Glass.
- Factory Records**, 38 Thomson St., East Sydney, NSW, 2010, (02) 332 2270. Fax: (02) 361 1785. Managing Dir.: Andrew Penhallow; Prodn. Asst.: Chris Reed.
- Festival Records Pty. Ltd.**, Box 16, 63-79 Miller St., Pyrmont, Sydney, NSW, 2009, (02) 660-4022. Fax: (02) 692-8058. Managing Dir.: William Eeg; A & R Dir.: Kerry Fitzgerald. Label(s): (Owned) AGF, Blue Mosque, Concord Jazz, Collins Classics, Crescendo, Fantasy, Horatio Nelson, GWR, Infinity, Legacy, Onj Prodn., Mushroom, Parole, Project 3, Ranwood.
- Fiddling Fool Prodn.**, 1 Rosen St., Epping, NSW, 2121, (02) 862191. Contact: Gus McNeil.
- Flith Continent Music Corp.**, 3/1 Park St., Clovelly, NSW, 2031, (518) 453-2203, Fax: 011612-3157170, Pres.: John Lasher; Sales: Jim Orchison. (Compact Disc) (Distributor, Importer, Exporter) Labels Distributed: Audio: Celluloid Fanfare, Entr'acte, Label "X", Preamble, Southern Cross (CDs only). Labels Imported/Exported: ABC Classics, ABW, Move, One-M-One, Oz Music (Australia); Ode/New Zealand (New Zealand).
- Fission Chips Electroacoustics**, 150 Rathmines Rd., Hawthorn, VIC, 3122, (03) 882-8267. Managing Dir.: David Mow.
- Global Music**, PO Box 134, Ascot Vale, Melbourne, VIC, 3032, (03) 370 9666. Fax: (03) 375-2740. Gen. Mgr.: Sam Gervasi. Label(s): (Owned) Magnetic Records.
- Greasy Pop Records**, PO Box 136, Rundle Mall, Adelaide, SA, 5000, (08) 297 0218. Fax: (08) 239-0994. Proprietor: Doug Thomas.
- Grevillea Records**, PO Box 312, 26 Wallace St., Albion, QLD, 4010, (07) 262 8422. Fax: (07) 862 1422. Managing Dir.: Rodney Jacobson; Prodn. & Sales Mgr.: Malcolm Jacobson. Label(s): (Owned) Grevillea. Int'l Reps.: Larrikin Records (Australia).
- Group Leisure Dist.**, 79-81 Buckland St., Chippendale, Sydney, NSW, 2008, (612) 310-1866. Fax: (612) 319-0097. Dir.: Grant Calton; Moira Bennett; Sales: Matt Dixon; Dist. Mgr.: Karen Wehbe. Branch(es): 174 Robertson St., Fortitude Valley, Brisbane, QLD, 4006, (07) 854-1441; 263 Glenhuntingly Rd., Elsternwick, VIC, 3185, (03) 528-5645, Fax: (03) 532-8213; Tasman Hwy., Gray, TAS, 7215, (003) 72-2404, Fax: (003) 72-2286; 4 Braceby Close, Willetton, WA, 6155, (09) 457-9350, Fax: (09) 457-9350. Label(s): (Distributed) Demon, Audio Archives, Double Play, Edsel, Intercord, Symphonia.
- Grown Up Wrong**, GPO Box 2366V, Melbourne, VIC, 3001, (03) 670 0677. Mgr.: David Laing.
- Hadley Records**, 5 Egret Pl., Tamworth, NSW, 2340, (67) 65 7813. Managing Partner: Eric W. Scott; Partner: Hilary Scott. Label(s): (Owned) Hadley.
- Hammar TV Prodn. (Aust.) Pty. Ltd.**, 8 River St., Richmond, Victoria, 3121, (03) 428 5799. Fax: (03) 429 5918. Managing Dir.: Sino Guzzardi; Nat'l Sales Mgr.: Vin Forbes; A & R: Suzee Robin. Label(s): (Owned) Roxon.
- Hot Records**, PO Box 326, Spit Junction, Sydney, NSW, 2088, Dir.: Martin Jennings; Graeme Regan; Asst. Dir./A&R: Lynlea McIntyre. Label(s): (Owned) Hot, (Distributed) Mace, F.O.O.D. Int'l Reps.: U.F.O. (England); Normal (Germany); Shack (Australia).
- Hughes Leisure Group**, PO Box 148, Harbord, Sydney, NSW, 2096, 10 Sydenham Rd., Brookvale, Sydney, NSW, 2100, (02) 939-2433. Fax: (02) 905-0181. Managing Dir.: Hoghton Hughes; Sales & Mktg. Mgr.: Roger Curry; Stock Controller/Asst. A & R: Anton Hughes. Label(s): (Owned) Compact Hour, Golden Editions, Listen Easy, Koala, Music World, Starburst.
- The Image Music Group Pty. Ltd.**, 19 Johnston St., Port Melbourne, VIC, 3207, (03) 646-8888. Fax: (03) 646-8430. Mng. Dir.: John McDonald; Dir.: Kay McDonald; A&R Mgr.: Steve Chavez. Label(s): (Owned) Avenue, Fable, Harbour.
- Immedia!** P.R. p/l trading as Aural Sect Records, GPO Box 2977, 3 Rose St., Chippendale, Sydney, NSW, 2001, (612)212-6677. Fax: (612)211 5938. Managing Partner: Phil Tripp; A & R Mgr.: Aki Sakura. Label(s): (Owned) Aural Sect, (Distributed) Fflat, Jigil.
- Imparja Recordings**, PO Box 3669, Alice Springs, NT, 5750, (089) 52 5943. Contact: Rodney Gooch; Contacts: Edwina Shannon.
- Bruce Ingram & Assoc.**, 211 Hay St., Subiaco, WTA, 6008, (09) 381 7777. Fax: (09) 382 3539. Managing Dir.: David Davies; Buyer (Record/Tape): Cole Patterson; Buyer (Videos): Cole Patterson; Buyers (Accessories): Bevis Standen, David Davies. (Compact Disc, Pre-Recorded Audio Tape, Video (Cassette & Disc), Accessories) (Distributor, One-Stop) Labels Distributed: Audio: CBS, EMI, BMG, PolyGram, WEA, Festival, AIM, Alligator, Noise, Music For Nations, Relativity, Combat, Rhoni, Demon Bridge, Highgrade, Viola Classics; Video: (All PAL Format) EMI Music Video, CBS Music Video, Hoyts, PolyGram Music Video, Festival Music Video. Products/Accessories: CD, Tape & Record Products: Lift, Fischer, Goldring, Arista; Blank Tape: TDK; Head Phones: Goldring, Arista; Batteries: Duracell, Artec; Diamond Needles: Goldring.
- J & B Records**, Ltd., 39 Whiting St., Artarmon, Sydney, NSW, 2064, (02) 439-4377. Fax: (02) 438-5314. Managing Dir.: Brian Nicholls; Mktg. Dir.: Tony Paris; A & R Dir.: Barry Board; Managing Dir.: Theo Tambakis. Label(s): (Owned) Concept, Filmtrax, Hitsbound.
- Jazz Import Services**, PO Box 1160, City Rd., South Melbourne, VIC, 3205, (61-3)543-0071, Fax: (61-3)529-2663, Proprietor/Buyer: Graeme Osborne. (Distributor) Labels Distributed: Audio: Mole, Seabreeze, Steam, Black Saint-Soul Note, Dormouse, Hot House, Red, Harlequin, Crazy Kat, MG MOIR, ESP, Philology, Dawn Club, Calligrapher Esquire, LGO (VIC), Ogun, Cadillac, Emangn, Blues Club.
- Juniorville Records**, 114 Myrtle St., Chippendale, NSW, 2008, (02) 699 4827. Contact: Michael Roth.
- Kavern 7**, PO Box 1005, Geelong, VIC, 3220, (052) 9 4381. Managing Dir.: Dean Mittlehauser.
- Larrikin Records Pty. Ltd.**, PO Box 162, 282 Oxford St., Paddington, Sydney, NSW, 2021, (02) 3321944. Fax: (02) 360-2217. Managing Dir.: W. Fahey; Gen. Mgr.: F. Trimboli; Prodn. Mgr.: R. Orman; Dist. Mgr.: T. Taylor. Label(s): (Owned) Larrikin, Jarra Hill, (Distributed) Holborne, Monitor, Bellaphon, Black Lion Jazz, Celestial Harmonies, Fonitcetra, EG Editions, Real World, Recorded Book Corp., Shanachie, Rounder, Virgin Venture, Yazoo. Int'l Reps.: Metro Mktg. (New Zealand); Holborn (Canada); Silo (England); Topic (England); Greentrax (Scotland).
- Liberation**, 9 Dundas Ln., Albert Park, VIC, 3206, (61)3/690-5413. A&R: Scott Murphy.
- Mushroom Distribution Services**, 150 Ferrars St., South Melbourne, VIC, 3205, (61)3/696-7533. Fax: (61)3/690-5413.
- M. R. Acoustics**, PO Box 703, 211378 Logan Rd., Mount Gravatt, QLD, 4122, (617) 849-6020. Fax: (617) 349-8806. Managing Dir.: Ray Hartley; Sales Mgr.: Pam Chapman. Label(s): (Distributed) Canadian Broadcasting, American Gramophone, Denon, JVC, Sunset France, Nimbus.
- Major Music**, PO Box 458, 263 Glenhuntingly Rd., Elsternwick, VIC, 3185, (03) 528 5645, Managing Dir.: Max Robenstone. (Distributor)
- Makeshift Records**, PO Box 557, 13 Nowra St., Marayong, NSW, 2148, (02) 626 8991. Mgr.: Peter Bales.
- Matthews Music Pty. Ltd.**, 75 Denison St., Rozelle, NSW, 2039, (02) 555-1066. Fax: (02) 555-1301. Owner: Phil & Chris Matthews. Label(s): (Distributed) Emusic Pty Ltd.
- Midnight Records PTY. Ltd.**, PO Box 144, Bratton Hall, 38 Pitt St., Kirribilli, Milsons Point, NSW, 2061, (02) 922 6077. Fax: (02) 922 6603. Managing Dir.: Peter Rix; Dir.: Philip Walker; Label Mgr.: Sally Collins; Vice Pres. A & R: Barry M. Coram. Label(s): (Owned) Midnight, (Distributed) Paris Recording Partnership.
- Mighty Boy Music Pty Ltd.**, 79-81 Buckland St., Chippendale, Sydney, NSW, 2008, Managing Dir.: Grant Calton; Dir.: Moira Bennett.
- Missing Link Records**, PO Box 5159 AA GPO, 263 Glenhuntingly Rd., Melbourne, VIC, 3001, (03) 523 8309. Fax: (03) 532 8213. Managing Dir.: Keith Glass. Label(s): (Owned) Missig Link. Int'l Reps.: Virgin Records (Australia); YAD Records (London).
- Monash Records (Australia)**, 305 Swanston St., Melbourne, VIC, 3000, (61-3) 663-5255. Fax: (61-3) 663-4520. Pres.: Peter Snow; Exports Mgr./A & R: Robert Oertel; Mktg. Promo: Doug Thorp. Label(s): (Owned) Crash.
- Monkey Music**, PO Box 8327, Sterling St., Perth, WTA, 6000, (09) 227 9449, Fax: (09) 227 8236, Gen. Mgr.: Steve Tallis. (Distributor)
- Moonlight Label**, PO Box 148, 59 Langdon Crescent, Craigieburn, VIC, 3064, (03) 308-3836. Dir.: Michael Charles; Vice Pres. A&R: Debra Van Praagh.
- Move Records**, Box 266, Carlton South, VIC, 3053, 10 Glen Dr., Eaglemont, VIC, 3084, (61-3) 497-3105. Fax: (61-3) 497-4426. Dir.: Martin Wright. Label(s): (Owned) Move.
- Mushroom Records Pty. Ltd.**, PO Box 158, 9 Dundas Ln., Albert Park, Melbourne, VIC, 3206, (3) 690-3399. Fax: (3) 695-7819. Managing Dir.: Michael Gudinski; Dir./Gen. Mgr.: Gary Ashley; Dir. Business Affairs: Simon Young; Mktg. Mgr.: Warren Costello; A&R Rep.: Bill Page. Label(s): (Owned) Aurora, Mushroom, White Label, (Distributed) Picture This, True Tone, Razor, Big Stars, Flying Nun, Melodian, Liberation.
- Musicland Independent Distributors**, PO Box 121, 5-7 Gordon St., Richmond, Elsternwick, VIC, 3185, (03) 427-9066, Fax: (03) 427-0648, Dir.: Jeremy Fiebigler; Mgr.: Bill Tolson; Buyer (Record/Tape): Adam Boyle. (Distributor) Labels Distributed: Audio: Cleopatra, Musicland, Rampant, 3333.
- Nude Records**, PO Box 460, Kings Cross, Sydney, NSW, 2011, (02) 357 2350. Fax: (02) 36017858. Managing Dir.: Christopher Read.
- P.C. Stereo Pty Ltd.**, PO Box 282, Mt. Gravatt, Brisbane, QLD, 4122, 14/547 Kessels Rd., MacGregor, Brisbane, QLD, 4109, (617) 343-1612. Fax: (617) 8494697. Managing Dir.: Clive A. Purcell; Co. Dir.: N. J. Purcell; Sales Mgr.: T. Hicking. Label(s): (Distributed) Laudis, Refquenz, Bainbridge, Bandleader, Bridge, Capriccio, CNC, Chesky, DMP, Delta, Delos, Divox, Eian, Laserlight, Innovo.
- Phantom Records Pty. Ltd.**, PO Box A566, Sydney South, NSW, 2000, (02) 264-8992. Fax: (02) 267-5242. Managing Dir./A & R: Jules R.B. Normington. Label(s): (Owned) Messiah Complex.
- Phonogram Records Australia**, PO Box 112, 122 McEvoy St., Alexandria, NSW, 2015, (02) 699-1399. Managing Dir.: Tim Read; Nat'l Mktg. Mgr.: Steve Cartes; Nat'l Promos. Mgr.: Roland McAdam. Label(s): (Owned) Mercury, Island, Vertigo, (Distributed) RooArt, ABC.
- Platypus Records**, 61 Wellington St., Longford, TAS, 730, (003) 91 2277. Mgr.: Douglas Kelly. Label(s): (Owned) Platypus.
- Polydor Records Australia, Ltd.**, 111 Queenbridge St., First Floor, South Melbourne, VIC, 3205, (03) 686-1122. Mng. Dir.: Paul Dickson; Nat'l Promotions Mgr.: Sandra Robertson; A&M Label Mgr.: Bob Croucher; Polydor/London Label Mgr.: David James; Vice Pres. A&R: Paul Dickson. Branch(es): 1/122 McEvoy St., Alexandria, NSW, 2015, Contact: Melissa Temple; Taringa Centre, Ste. 1; CNR Moggi/Moor, Taringa, QLD, 4068, Australia, Contact: John Zucco. Label(s): (Owned) London, A & M, (Distributed) Redeye.
- Polyester Records**, 330 Brunswick St., Fitzroy, Melbourne, VIC, 3065, (03) 419-5137. Fax: (03) 419-4961. Contact: Paul Elliott. Label(s): (Owned) Polyester. Int'l Reps.: M.D.S. (Melbourne).
- Possum Records**, 28 Ferrans St., Northmead, NSW, 2152, (02) 683 4499. Fax: (02) 683 1254. Managing Dir.: Philip Isreal. Label(s): (Owned) Al, Astrophone, Creole, Fanfare, Deutsche Wag, Guardwise, Hard Back, King, Immediate, Logo, MBS NBR, Mute, Outlet, Record Shack, Satrii, Rhythm, Scotdisc, Sonet, Transatlantic, Splash.
- Rainbow Products Ltd. 1/2 Rainbow Music Group**, Unit 4, 19 Rodborough Rd., Frenchs Forest, NSW, 2086, (02) 451 7577. Fax: (02) 452 1233. Managing Dir.: John Avakian; Mktg. Dir.: Ara Avakian; Fin. Controller/Sec: Bruce Henry; Product Mgr.: Andy Yavasis. Label(s): (Owned) Summit, Rainbow, (Distributed) Peter Pan, Astor, Disney.
- Raven Records**, PO Box 92, Camberwell, VIC, 3124, Fax: (02) 639 1441. Contact: Glenn A. Baker; Kevin Mueller; Dirs. Peter Shillito.
- Reactor Records**, PO Box 623, Camberwell, VIC, 3124, (03) 882 8528. Gen. Mgr.: Philip MacDougall.
- Record Clubs of Australia Pty. Ltd.**, 8 Parramatta Rd., Homebush, NSW, 2140, (61-2) 764-2888. Fax: (61-2) 763-1878. Chrmn.: Bonita L. Boezeman; Gen. Mgr.: Aub Hogno; Mktg. Mgr.: Ivor Watkiss; Financial Dir.: Graham Sinden. Label(s): (Distributed) BMG, CBS, PolyGram, EMI, RCA, WEA.
- Recycled Records**, 37 Glebe Point Rd., Glebe, NSW, 2037, (02) 660 1416, Mgr.: Vera Ross. (Distributor)
- Red Eye Record Label**, GPO Box 211, Sydney, NSW, 2001, (02) 326 2021. Fax: (02) 327 8184. Pres.: John Foy; Label Mgr.: Therese Pye; Art Dir.: Jim Paton.
- Regular Records PTY Ltd.**, PO Box 141, 249 Darlinghurst Rd., Potts Point, Sydney, NSW, 2011, (02) 360-2511. Fax: (02)

332-4339. Managing Dir.: Martin Fabinyi; A & R Dir.: Vera Rizzo; Nat'l Promo. Mgr.: Lorraine Barr; Office Mgr.: Catherine McNamara.
Label(s): (Owned) HEX. Hoyden, Hyperreal, Regular.
Revolution Records, 15A Wahroonga Ave., Wahroonga, NSW, 2076, (02) 489 2203. Managing Dir.: Alan Thorn.
Rockable Records, 166 Centre Rd., Bentleigh, VIC, 3204, (03) 557 3667. Managing Dir.: Paul Breckenridge; Mgr.: Rick Baker.
rooArt Australia, 70 Judge St., Woolloo Mooloo, Sydney, NSW, 2011, (02) 357 1599. Fax: (02) 357 1841. CEO: C. M. Murphy; Gen. Mgr.: David Loiterton; Int'l Mktg. Dir.: Sebastian Chase; Nat'l Promo/Sales/Mktg.: Fleur Sarfaty; Vice Pres. A&R: Justin Van Stom.
Sandstock Music, PO Box 557, Charlestown, NSW, 2290, 10 Ance St., Cardiff, NSW, 2285, (61-49) 548379. Fax: (61-49) 565849. Prop.: Jill Gartrell; (Compact Disc, Pre-Recorded Audio Tape, Video (Cassette & Disc), Records (LP's)) (Distributor, Importer)
Labels Distributed: Audio: Crafty Maid, Flying Fish, Blind Pig, JSP, Topic, World Circuit, Sterns, Triple Earth, Green-trax, Dunkeld, Special Delivery, Rogue, Fellside, Green Linnet, Temple, Tara, Claddagh, Dara, Gaellinn, Redwood, Olivia, Kaleidoscope, Greenhays, Rooster, Standstock. Labels Imported/Exported: Kaleidoscope, Green Linnet, Green Hays, Flying Fish, Blind Pig, Redwood, Rooster, Olivia (U.S.); Dunkeld, Greentax, JSP, Topic, Rogue, World Circuit, Sterns, Triple Earth, Fellside, Temple, Special Delivery (Britain); Claddagh, Dara, Tara, Gael Linn (Ireland); Crafty Maid, Sandstock (Australia).
Session Records, PO Box 328, 68 Campbell Parade, Bondi Beach, NSW, 2026, (02) 309 1248. Managing Dir.: Graharr Mandroules.
Sonart Mecca Music & Vision, PO Box 400, Killara, Sydney, NSW, 2071, 4B/3-9 Kenneth Rd., Manly Vale, Sydney, NSW, 2093, (02) 948 1811. Fax: (02) 948-5085. CEO: Les Hodge; Mgr./Buyer: J.B. Hodge; (Compact Disc, Pre-Recorded Audio Tape, Video (Cassette & Disc)) (Distributor, Importer) Labels Distributed: Audio: ECM, Hyperion, Harmonia Mundi (France), BIS, Naxos, Claves, Virgin Classics, TER, Pearl, Unicorn, Olympia, Melodiya, Conifer, Marco Polo, Supraphon, Astree, Accent, Orfeo; Video: Naxos.
Glenakama Pty Ltd., dba Sound Jays, PO Box 840, 147 Robertson St., Fortitude Valley, Brisbane, QLD, 4006, (07) 854 1441. Fax: (07) 252 5458. Managing Dir.: Emile Theebom; Mgr.: John O'Neill; Buyer (Record/Tape): Glen Navratil; Buyer (Accessories): Emile & Yvonne Theebom; (Distributor, Importer)
Labels Distributed: Audio: Larrikin, Avian-Gard, Sandstock, Denon, Telark, Numbus, JVC, Fresh Aire, DMP, Boonaroo Music, Janda, E.P.S.
Products Imported: Accessories.
Products/Accessories: CD, Tape & Record Products: Allsop, Arista, Miltly; Storage & Carrying Cases: Sound Jays, Laserline, Flexoplast, Mayer, Lift; Blank Tape: TDK; Head Phones: Koss, Arista; Batteries: Arista; Diamond Needles: Arista; Other: Lift Racking Systems, Fischer Plastic Products, Phoenix Gold Cable.
Starlite Records, PO Box 374, 3 Taloma Ave., Liverpool, NSW, 2170, (02) 607-7088. Fax: (02) 607-4405. Managing Dir./A & R: David Rix; Mktg./Promo.: Suzanne Aufder-Heide; Mktg.: Georgy Lee Thomas; Music Prodn.: Adrian Munn.
Label(s): (Owned) Spottlite, (Distributed) Little Darlin's, US Reps.: Little Darlin's (FL).
Sundown Records, PO Box 107, 44 Paisley Dr., Lawnton, Aspley, QLD, 4034, (07) 285-2008. Fax: (07) 285-2922. Gen. Mgr.: Eleanor Briskey.
Survival Music, 61 Marlborough St., Ste. 53, Surry Hills, NSW, 2010, (61-2) 698-8133. Fax: (61-2) 698-5647. Managing Dir.: Alex Geshos; Label Mgr.: Dan Hennessy.
Label(s): (Owned) Survival.
Int'l Reps.: Sony Music, M.D.S. (Australia).
Swaggle Records, PO Box 125, South Yarra, VIC, 3141, (03) 808-6280. Exec. Dir.: Nevill L. Sherburn.
Label(s): (Owned) The Jazz Makers, Swaggle.
US Reps.: Bay Side Record Dist., Arhoolie Records (CA).
Tempo Communications Pty Ltd., PO Box 46, Doubleview, WTA, 6018, 2 Burgay Ct., Osborne Park, WTA, 6017, (61-9) 445-2966. Fax: (61-9) 446-5337. Mgr.: Joe Karam; Buyer: Peter Budgen; (Compact Disc, Pre-Recorded Audio Tape, Video (Cassette & Disc), Records (LP's, 12-inch, Singles), Accessories) (Distributor, Importer, Exporter)
Labels Distributed: Audio: Arhoolie, Blues Encore, Blues Classics, Blues & Rock Project, Cosmos, Double Play, Entertainers, Giants of Jazz, Joker, Lotus, President, Tempo, Boulevards, Sculptured Environments, Josie Boyle, Trojan, Warwick, Dutchesse; Video: Tempo, Similar.
Labels Imported: Arhoolie (USA); Blues Encore, Blues Classics, Blues & Rock Project, Entertainers, Giants of Jazz, Joker, Lotus (Italy); Cosmos (Germany); President, Trojan, Warwick (U.K.); Dutchesse (Denmark).
Products/Accessories: CD, Tape & Record Products: Whitner, Nakabayashi Co.; Video Cassette Recorder: SKC, Konica.
Time Life Music (Time Life Books Australia) Pty. Ltd., 61 Lavender St., Milsons Point, NSW, 2061, (612) 929-0933. Fax: (612) 956-6184. Chrmn./Managing Dir.: Bonita L. Boezman; Mktg. Dir.: Jenny Steigenberger; Financial Dir.: Andrew Williams; Prodn. Mgr.: Ken Hiley.
Trafalgar Records Pty. Ltd., PO Box 598, 25 Byron St., Coogee, Sydney, NSW, 2034, (61-2) 315-702. Fax: (61-2) 664-162. Gen. Mgr./Dir.: Michael McMartin; A & R/Dir.:

Charles Fischer; David Faulkner; Fin. Controller/Dir.: Liz McMartin.
True Tone Records, 98-100 Glover St., Cremorne, NSW, 2090, (02) 908 0777. Fax: (02) 908 0666. Chrmn.: Michael Crawley; Gen. Mgr.: David Jarrett.
Virgin Records Australia Pty Ltd., PO Box 902, 14 Hayberry St., Crows Nest, NSW, 2065, (02) 923-1844. Fax: (02) 929-8878. Managing Dir.: Laurie Dunn; Mktg. & Promo. Dir.: Michael Manos; A & R Dir.: Sophie Sadowska; A & R Mgr.: Paul Baylis.
Branch(es): 102 York St., South Melbourne, VIC, 3205, (03) 690-3105. Fax: (03) 690-7325. Victoria Promo. Mgr.: Byron Smith.
Vollition Records, 38 Thomson St., East Sydney, NSW, 2010, (02) 332 2270. Fax: (02) 360 1785. Managing Dir.: Andrew Penhallow; Gen. Mgr.: Chris Read.
Warner Music Australia Pty Ltd., PO Box 500, 39-47 Albany St., Crows Nest, Sydney, NSW, 2065, (61-2)950-1500. Fax: (61-2) 950-1510. Chrmn.: Paul M. Turner; Managing Dir.: Warner Group: Peter Ikin; Managing Dir. East West Records: Phil Mortlock; Financial Dir.: Steve Wagner; Classical Mgr.: Robert Rigby; MIS Mgr.: Steve Wright.
Label(s): (Owned) Asylum, Atlantic, Elektra, Nonesuch, Reprise, Sire, WEA, Warner Bros., (Distributed) Trafalgar, Geffen, MCA.
Warrior Records, 63 William St., 3rd Floor, East Sydney, NSW, 2011, (02) 332 2411. Fax: (02) 331 2296. Chrmn.: Hugh Lynn; Gen. Mgr.: Michael Chugg.
Waterfront Records, PO Box A 537, 770 George St., Sydney, NSW, 2000, (61-2) 211-0073. Fax: (61-2) 281-5939. Chrmn.: Frank Cotterell; Business Affairs Mgr.: Steven Stavrakis; Label A&R Mgr.: Christopher Dunn.
Label(s): (Owned) Seaside, Waterfront.
The Wheatley Organisation p/l, 111 Queensbridge St., 1st Floor, South Melbourne, VIC, 3205, (03) 686-9155. Fax: (03) 686-9205. Managing Dir.: Glenn Wheatley; A&R Mgr.: Ross Fraser.
Word Australia, 142 Canterbury Rd., Kilsyth, VIC, 3137, (613) 729-3777. Fax: (613) 720-1004. Joint Managing Dir.: Stan Moulton; Norm Moulton.
Label(s): (Owned) Triune, (Distributed) Starsong, Word, Dayspring, Myrrn.

HOME VIDEO COMPANIES (Theatrical, Music & Special Interest)

Dino Video Pty Ltd., PO Box 242, Pyrmont, NSW, 2009, 42 Wattle St., Ste. W-24, Ultimo, NSW, 2007, (61-2)660-3288, Fax: (61-2)660-6776. Managing Dir.: John Harper; Mktg. Mgr.: Lorraine Drennan.

MUSIC PUBLISHERS

AIM, 36 Beauty Dr., Whale Beach, NSW, 2107, (02) 919 5107. Fax: (02) 919 4742. Contact: Peter Noble.
J. Albert & Son Pty. Ltd., 9 Rangers Rd., Neutral Bay, Sydney, NSW, 2089, (02) 909-3111. Fax: (02) 909-3035. Pres.: Ted Albert; Gen. Mgr.: Peter Dawkins; Professional Mgr.: Karyn Wells.
Alfred Publishing (Australia), Ltd., PO Box 476, 5/44-61 Kingswood Rd., Engadine, NSW, 2233, (02) 520-5033. Fax: (02) 520-8063. Pres.: Morton Manus; Gen. Mgr.: Dave Bolden.
Allans Publishing, PO Box 364, 165 Gladstone St., South Melbourne, VIC, 3205, (03) 654 8444. Fax: (03) 696 1181. Chrmn.: CM Brash.
Almo Irving Music, (See Rondor Music Australia Pty. Ltd.).
Another State Music, PO Box A566, Sydney South, NSW, 2000, (02) 264-8992. Fax: (02) 267-5242. Gen. Mgr.: Jules R.B. Normington; Professional Mgr.: Annelise Pedersen; Prof. Mgr.: B. B. Bocksdogg.
Anton's Songs, PO Box 199, Darra, Brisbane, QLD, 4076, 42 Scenic Rd., Kenmore, Brisbane, QLD, 4069, (07) 378-6880. Fax: (07) 378-4810. Pres.: Houghton Hughes.
Arwin Music of Australia Pty. Ltd., (TRO) (See Essex Music Group).
BMG Music Pty. Ltd., 194 Miller St., North Sydney, NSW, 2060, (61-2)900-7888. Fax: (61-2)955-5014. Managing Dir.: Jim Shipstone.
Irving Berlin Music Corp., (See J. Albert & Son Pty. Ltd.).
Shapiro Bernstein & Co., Inc., (See J. Albert & Son Pty. Ltd.).
Big Stars Music, (See Mushroom Music Pty. Ltd.).
Blue Hill, (BMI) (See Music City Music).
Boosey & Hawkes (Australia), PO Box 188, 12/6 Campbell St., Artarmon, NSW, 2064, (02) 439 4144. Fax: (02) 439-2912. Managing Dir.: Richard D. Mackie.
Bright Spark Songs Pty. Ltd., (APRA) PO Box 342, 209 Toorak Rd., Ste. 31, South Yarra, VIC, 3141, (03) 827-6377. Fax: (03) 827-5165. Pres.: Richard East; Gen. Mgr.: John McDonald.
Steven Brookes, (See Two/PolyGram Music Publishing).
Buckwood Music of Australia Pty. Ltd., (TRO) (See Essex Music Group).
Allan Caswell Music, PO Box 66, Baglowah, NSW, 2093, (02) 94 1757. Dirs.: Allan Caswell, G. Caswell.
Cellar Music, (APRA) 1 Rosen St., Epping, NSW, 2121, (02) 876-2191. Pres.: Gus McNeil.
Central Station Publishing, 81 Market St., South Melbourne, VIC, 3205, (61-3) 690-4177. Fax: (61-3) 699-9522. Pres.: Giuseppe Palumbo; Gen. Mgr.: Morgan Williams; Prof./Creative Mgr.: Emilio Palumbo.
Chappell & Intersong Music Group (Australia) Ltd., (See

Warner/Chappell Music).
Coathanger Music, 1 Rosen St., Epping, NSW, 2121, (02) 86 2191. Managing Dir.: Ross Ryan.
Colstal Music, 3 Alison St., Parkrise, 5th Floor, Surfers Paradise, QLD, 4217, (075) 388-911. Fax: (075) 703-434. Dirs.: Bernie Stahl, Suzanne Stahl, Col. Elliott, Karen Elliott.
Complete Festivals Pty Ltd., 61 Wellington St., Longford, TAS, 7301, (003) 912277, (081) 132085. Pres.: Dougal Kelly.
Cromwell Music of Australia Pty. Ltd., (TRO) (See Essex Music Group).
Francis Day & Hunter Ltd., (See J. Albert & Son Pty. Ltd.).
Deerfield, (See Two/PolyGram Music Publishing).
Dennis Music, (APRA) (See Fable Music Pty. Ltd.).
Doo Dah Music, (See Mushroom Music Pty. Ltd.).
EMI Music Publishing Australia Pty Ltd., PO Box C-156, 100 Glover St., Cremorne, Cremorne Junction, NSW, 2090, (61-2) 953-0433. Fax: (61-2) 953-9163. Managing Dir.: John Anderson; Prof. Mgr.: Paul Nearhos.
Eaton Music (Australia) Pty. Ltd., (See Festival Music Pty. Ltd.).
Edible Music, PO Box 433 Carlton, 22 Little Cardigan St., Carlton S., Melbourne, VIC, 3053, (61-3) 348 1300. Fax: (61-3) 348 1649. Pres./Gen. Mgr.: Neil Barnes.
Elbow Room Music, 1 Rosen St., Epping, NSW, 2121, (02) 86 2191. Chrmn.: Gus McNeil.
Essex Music Group, (TRO) Uniline House, 5 Northcliff St., Milsons Point, Sydney, NSW, 2061, (02) 922-4100. Fax: (02) 923-2148. Pres.: Bruce Powell; Gen. Mgr.: Margaret Camenzul; Professional Mgr.: Annelise Pederson.
Eve Publishers, PO Box 811, 42 New St., 1st Floor, Ringwood, VIC, 3134, (03) 870 5124. Fax: (03) 879 3849. Dir.: Matt Kilpatrick.
Fable Music Pty. Ltd., (APRA) 19 Johnston St., Port Melbourne, VIC, 3207, (03) 646-1888. Fax: (03) 646-8430. Pres.: Gary Mac; Gen. Mgr.: Bella Keightley; Prof./Creative Mgr.: John McDonald.
Fairhill Music, (See Word Publishing Australia).
Leo Feist, Inc., (See J. Albert & Son Pty. Ltd.).
Festival Music Pty. Ltd., PO Box 141, 63-79 Miller St., Pyrmont, NSW, 2009, (02) 660-5218. Fax: (02) 6928058. Managing Dir.: Peter Hebbes.
Fifth Continent Music Publishing, (APRA/AMCOS) 3/1 Park St., Clovelly, NSW, 2031, (02) 315 7170. Fax: (02) 315 7170. Pres.: John Steven Lasher.
Filmtrax Pty. Sydney, PO Box 35, 67-69 Regent St., 4th Floor, Chippendale, NSW, 2008, Pres.: Philip C. Walker.
Five Star Publishing, PO Box 196, Glebe, Sydney, NSW, 2037, (02) 660-6881. Fax: (02) 522-1312. Pres.: Keith Jacobsen; Gen. Mgr.: Vicki Newman; Prof./Creative Mgr.: John Frohlich.
Flying Nun Music, (See Mushroom Music Pty. Ltd.).
Frankdon Music, PO Box 708, 10-12 Clarke St., Crows Nest, NSW, 2065, (02) 436-0799. Fax: (02) 437-5980. Managing Dir.: Matthew Donlevy.
Ross Fraser, (See Two/PolyGram Music Publishing).
Galther Music, (See Word Publishing Australia).
Gear Music Publishing, (See Two/PolyGram Music Publishing).
Genesis Music, 2/41 Maple St., Greystanes, NSW, 2145, (02) 636 3451. Managing Dir.: Bob Goodfellow.
Global Music, PO Box 134, Ascot Vale, Melbourne, VIC, 3032, (03) 370-9666. Fax: (03) 375-2740. Gen. Mgr.: Sam Gervasi.
Greasy Pop Songs, PO Box 136, Rundle Mall, Adelaide, SA, 5000, (08) 297 0218. Dir.: Doug Thomas.
Grundy Music, PO Box 2808, Sydney, NSW, 2001, (02) 428 0666. Fax: (02) 428 4887. Managing Dir.: Ian Holmes.
Halford Music Enters. Pty. Ltd., (APRA) 7 Langdale Pl., Wheeler Heights, Sydney, NSW, 2098, (02) 982-3867. Pres.: Joe Halford; Gen. Mgr.: Barbara Halford.
Happy Valley Music, USA, (See Larrikin Music Publishing Pty. Ltd.).
Haven Music Pty. Ltd., (APRA) (See The Image Music Group Pty. Ltd.).
Hot Music Publishing, PO Box 326, Spit Junction, Sydney, NSW, 2088, (612) 969-3194, (612) 960-3882. Fax: (612) 968-1707. Pres.: Martin Jennings; Gen. Mgr.: Graeme Regan; Prof./Creative Mgr.: Lynlea McIntyre.
Hudmar, (See Two/PolyGram Music Publishing).
Image Library, (APRA) (See Fable Music Pty. Ltd.).
The Image Music Group Pty. Ltd., (APRA) 19 Johnston St., Port Melbourne, VIC, 3207, (03) 646-1888. Fax: (03) 646-8430. Pres.: John McDonald; Gen. Mgr.: Bella Keightley; Prof./Creative Mgr.: Steve Chavez.
Irving Music, Inc., (See J. Albert & Son Pty. Ltd.).
Jackdor Music, (TRO) (See Essex Music Group).
Jansongs Pty. Limited, (APRA) PO Box 198, Bexley, NSW, 2207, 122 McEvoy St., Alexandria, NSW, 2015, (61-2) 580 8975. Fax: (612) 698 9969. Pres.: Peter Jansson; Copyright Mgr.: Yvonne Koolis.
Joye Publishing Co., 98 Glebe Pt. Rd., Glebe, Sydney, NSW, 2037, (02) 692-9399. Fax: (02) 552-1312. Pres.: Col. Joye; Gen. Mgr.: David Jacobsen; Prof./Creative Mgr.: Barry Newman.
July Music, (APRA) (See The Image Music Group Pty. Ltd.).
Killer Tracks, (APRA) (See Fable Music Pty. Ltd.).
Larrikin Music Publishing Pty. Ltd., PO Box 078, 4/72 Bathurst St., Queen Victoria Bldg., Sydney, NSW, 2000, (02) 267-7433. Fax: (02) 267-1328. Pres.: Norm Lurie; Prof. Mgr.: John Boughtwood; Copyright Mgr.: Richard Paine.
Laser Music, PO Box 36, 55 Grove St., Birchgrove, NSW, 2041, (02) 818 2590. Fax: (02) 818 5974. Pres.: G. Pierson; Gen. Mgr.: AM Davidson.
Leosong Copyright Service, GPO Box 196, 379 Kent St., 1st Floor, Sydney, NSW, 2000, (02) 29 4972. Fax: (02) 29 7696. Managing Dir.: John Hopkins.

Leosong Music Pty. Ltd., PO Box 35, Railway Sq., Sydney, NSW, 2001, 67-69 Regent St., Chippendale, NSW, 2008, (612) 698-4799. Fax: (612) 281-1778. Pres.: Phillip C. Walker; Gen. Mgr.: Susan L. Boylan.

Lexicon Music/Lexicon Spectra, (See Word Publishing Australia).

MCA Music (Australia) Pty. Ltd./Chris Gilbey Pty. Ltd.

23 Pilican St., Darlinghurst, NSW, 2010, (612) 267-6088. Fax: (612) 264-6543. Managing Dir.: Chris Gilbey; Prof./Creative Mgr.: Joanne Petersen.

MMA Music, 70 Judge St., Woolloomooloo, NSW, 2011, (612) 357-1599. Fax: (612) 357-1841. Pres.: C.M. Murphy; Gen. Mgr.: Kim Frankiewicz; Prof./Creative Mgr.: Andrew Valder.

Magnetic, (See Global Music).

Marble Music Publishing Pty. Ltd., (AMCOS) 240 Exhibition St., Melbourne, VIC, 3000, (03) 662 2222. Fax: (03) 663 5195. Dir.: Paul Dainty; Gen. Mgr.: Paul O'Gorman.

Edward B. Marks Music Corp., (See J. Albert & Son Pty. Ltd.).

Matthews Music Pty. Ltd., 75 Denison St., Rozelle, NSW, 2039, Managing Dir.: Chris Matthews.

Peter Maurice Music Co., Ltd., (See J. Albert & Son Pty. Ltd.).

Maverick Music, GPO Box 211, Sydney, NSW, 2001, (02) 326 2021. Gen. Mgr.: John Foy.

Melodian Music, (See Mushroom Music Pty. Ltd.).

Memory Lane Music (Australia) Pty. Ltd., (TRO) (See Essex Music Group).

Memory Lane Music (Australia) Pty. Ltd., (APRA) PO Box 1126, 27 Oaks Ave., 1st Floor, Dee Why, NSW, 2099, (02) 971-2700. Fax: (02) 971-2878. Pres.: Larry Spier; Gen. Mgr.: Paul Jaques; Dir.: Dorothy Spier.

Midnight Music Pty. Ltd., PO Box 144, Milsons Point, NSW, 2061, 38 Pitt St., "Bratton Hall", Kirribilli, NSW, 2061, (02) 922-6077. Fax: (02) 922-6603. Pres.: Peter Rix; Gen. Mgr.: Amelia George; Prof./Creative Mgr.: Victoria Archer.

Mighty Boy Music, (APRA) 59 Abercrombie St., Chippendale, Sydney, NSW, 2008, (02) 699-8377. Fax: (02) 698-7889. Pres.: Grant Carlton; Gen. Mgr.: Moira Bennett.

Miller Music Corp., (See J. Albert & Son Pty. Ltd.).

Mushroom Music Pty. Ltd., PO Box 158, 9 Dundas Ln., Albert Park, Melbourne, VIC, 3206, (03) 695-7832. Fax: (03) 695-7819. Gen. Mgr.: Ian James; Prof. Mgr.: Norman Parkhill; Royalty Mgr.: Laurel Shipley; Copyright Mgr.: Mary Georgiou.

Music City Music, (APRA) PO Box 1200, 15 Curlew Crescent, Tamworth, NSW, 2340, (067) 86 3566. Fax: (067) 86 2595. Managing Dir./Prof. Mgr.: Ed Matzenik.

Music Sales, PO Box Q78, Queen Victoria Bldg., Sydney, NSW, 2000, Managing Dir.: Norm Lurie.

Nicholls & Dimes Music, (TRO) (See Essex Music Group).

Off-Key, (See Two/PolyGram Music Publishing).

Paris Music, (See Midnight Music Pty. Ltd.).

Peermusic, (See Southern Music Publishing Co. (Australasia) Pty. Ltd.).

Peermusic Pty. Ltd., (See Southern Music Publishing Co. (Australasia) Pty. Ltd.).

Picture This Music, (See Mushroom Music Pty. Ltd.).

Possum Music, PO Box 50, Eastwood, NSW, 2122, (02) 683 4499. Fax: (02) 683-1254. Managing Dir.: Phillip Israel.

Production Music Services Pty. Ltd., PO Box 669, 717 Ramsey Rd., Pennant Hills, NSW, 2120, (02) 484 2321. Fax: (02) 484-7316. Managing Dir.: Peter Baker.

Rainbird Music, (APRA) (See The Image Music Group Pty. Ltd.).

Rango Music Pty. Ltd., (See Festival Music Pty. Ltd.).

Redwood Music, Ltd., (See J. Albert & Son Pty. Ltd.).

Regency Music, (See Word Publishing Australia).

Regular Music, PO Box 141, Potts Point, Sydney, NSW, 2011, 249 Darlinghurst Rd., Sydney, NSW, 2010, (02) 360 2511. Fax: (02) 332 4339. Pres.: Martin Fabinyi; Prof./Creative Mgr.: Vera Rizzo.

Ring Music, (APRA) (See Fable Music Pty. Ltd.).

Robins Music Corp., (See J. Albert & Son Pty. Ltd.).

Rondor Music Australia Pty. Ltd., 570 Military Rd. Mosman, Sydney, NSW, 2088, (02) 969-6366. Fax: (02) 960-3141. Pres.: Bob Aird; Prof./Creative Mgr.: Graham Thompson.

Rosco Prodn., (See Two/PolyGram Music Publishing).

Savage Music, (See Midnight Music Pty. Ltd.).

Sleeping Giant Music Int'l Ltd., (See Larrikin Music Publishing Pty. Ltd.).

Solid Music, (See Mushroom Music Pty. Ltd.).

Sony Music Publishing Australia, 11-19 Hargrave St., East Sydney, NSW, 2010, (02) 339-0255. Fax: (612) 331-1377. Gen. Mgr.: Mike Edwards; Prof. Mgr.: Paul Buchanan.

Sound Counsel, 324 St. Kilda Rd., 1st Floor, Melbourne, VIC, 3205, (03) 690 9537. Fax: (03) 696 3873. Managing Dir.: Gretchen Woodley.

Southern Music Publishing Co. (Australasia) Pty. Ltd.

(APRA) PO Box 708, Lawson House, Ste. 304, 10-12 Clarke St., Crows Nest, Sydney, NSW, 2065, (612) 436-0799. Fax: (612) 437-5980. Managing Dir.: Matthew Donlevy.

Star Song, (See Word Publishing Australia).

Starlite Publishing, PO Box 374, 3 Taloma Ave., Liverpool, NSW, 2170, (02) 607-7088. Fax: (02) 607-4405. Pres.: David L. Rix; Gen. Mgr.: Suzanne Aufder-Heide; Professional Mgr.: Lee Thomas.

Step Seven Music Pty. Ltd., (APRA) (See The Image Music Group Pty. Ltd.).

Mark Stevens, (See Two/PolyGram Music Publishing).

Sundown Publishers, PO Box 107, 44 Paisley Dr., Aspley, QLD, 4034, (07) 285 2008. Fax: (07) 285-2922. Gen. Mgr.: Eleanor Briskey.

Survival Music, 61 Marlborough St., Ste. 53, Surry Hills, NSW, 2010, (61-2)698-8133. Fax: (61-2)698-5647. Pres.: Alex Geshos; Gen. Mgr.: Dan Hennessy.

Sweet 16 Publishing, 70 Sylvan Rd., Toowong, QLD, 4066, (07) 371 6822. Fax: (07) 870 9224. Managing Dir.: Murray Lyons.

Syray Music, 79-81 Old S. Head Rd., Ste. 16, Bondi Junction, NSW, 2022, (612) 369-2118. Pres.: Jeremy Fabinyi.

Trafalgar Music Pty. Ltd., PO Box 598, 25 Byron St., Coogee, Sydney, NSW, 2034, (612)315-7022. Fax: (612)2664-1623. Gen. Mgr.: Michael McMartin; Prof. Mgr.: Neil Thompson; Fin. Controller: Liz McMartin.

Two/PolyGram Music Publishing, 122 McEvoy St., Alexandria, NSW, 2015, (02) 318-8800. Fax: (02) 698-9969. Pres.: Glenn Wheatley; Colin Cornish; Prof./Creative Mgr.: Kim Green.

Virgin Music Australia Pty. Ltd., PO Box 902, 14 Hayberry St., Crows Nest, NSW, 2065, (02) 956-8366. Fax: (02) 956-6091. Managing Dir.: Judi Moore.

Warner Bros. Music Australia Pty Ltd., (See Warner/Chappell Music).

Warner/Chappell Music, PO Box KK250 Kings Cross, 99 Forbes St., Woolloomooloo, Sydney, NSW, 2011, (02) 356-3322. Fax: (02) 357-2610. Managing Dir.: John Bromell.

Wit's End, (See Two/PolyGram Music Publishing).

Word Lik/Word Music, (See Word Publishing Australia).

Word Publishing Australia, (APRA) 142 Canterbury Rd., Kilsyth, VIC, 3137, (03) 729-3777. Fax: (03) 720-1004. Pres.: Stan Moulton.

Writers of Pseudo Echo, (See Two/PolyGram Music Publishing).

Yeldah Music, (APRA/AMCOS) 5 Egret Pl., Tamworth, NSW, 2340, (067) 657813. Managing Partner: Eric W. Scott.

SHEET MUSIC & FOLIO SUPPLIERS

Chappell Intersong Pty Ltd., (Sydney), 145 Brougham St., Kings Cross, Sydney, NSW, 2011, Australia

MANUFACTURERS: RETAIL MERCHANDISING PRODUCTS

Australian Tour Merchandising (A.T.M.), 9 Dundas Ln., Albert Park, VIC, 3206, (613) 699-7844. Fax: (613) 696-7982. Gen. Mgr.: Ros Braham. Product(s): Bell Buckles, Buttons/Badges, Hats/Caps, Posters, T-shirts.

ASSOCIATIONS & PROFESSIONAL ORGANIZATIONS

Actors Equity Assn. of Australia, 240 Currie St., 1st Floor, Adelaide, SA, 5000, (08) 231-9359. Fax: (08) 410-1964. Pres.: Patrick Frost; State Organiser: Sue Ridgway; Sec.: Stephen Spence; Office Supervisor: Robyn King.

Australia Council, PO Box 74, Chippendale, Sydney, NSW, 2008, 181 Lawson St., Redfern, Sydney, NSW, 2016, 61-2-950-9000. Fax: 61-2-950-9111. Dir. Performing Arts: Chris J. Mangin.

Australian Copyright Council, 3/245 Chalmers St., Redfern, NSW, 2016, (02) 318 1788. Fax: (02) 698 3536. Chrmn.: Peter Banki; Exec. Officer: Libby Baulich.

Australian Entertainment Industry Assn. Ltd., PO Box 423, Crows Nest, NSW, 2065, (02) 439 2322. Fax: (02) 439 2944. Pres.: Peter Rix; Vice Pres.: Gillian Levell.

Australian Guild of Screen Composers, PO Box 42, Potts Point, NSW, 2011, (02) 356-3529. Fax: (02) 357-7776. Pres.: Bob Young; Administrator: Marianne Bryant.

Australian Music Centre (Sounds Australian), PO Box 49, Grosvenor Pl., 201 Argyle Centre, The Rocks, 2nd Floor, Sydney, NSW, 2000, (02) 247 1611. Fax: (02) 241 2873. Pres.: Richard Letts; Sales Mgr.: Lorna Lander.

Australian Record Industry Assn., Ltd., PO Box 020 Queen Victoria Bldg., 263 Clarence St., 9th Floor, Sydney, NSW, 2000, (02) 267 7996. Fax: (02) 264 5589. Exec. Dir.: Emmanuel Candi; Gen. Mgr.: Jim White; Admin. Mgr.: Lionel Banbury.

Australian Theatrical & Amusement Employees Assn./Queensland Branch, GPO Box 2794, Brisbane, QLD, 4001, 236 Elizabeth St., Rm. 1E, Duncan B-se, Brisbane, QLD, 4000, (07) 221-8150, (07) 221-8310. Fax: (07) 221-9710. Pres.: Hec White.

Musica Viva Australia, PO Box 49 Railway Sq., 120 Chalmers St., Surry Hills, NSW, 2000, (02) 698-1711. Fax: (02) 698-3878. Chrmn.: Anthony R. Berg; Mktg. Dir.: Marian Vickery; Gen. Mgr.: Phillip Henry.

Phonographic Performance Co. of Australia Ltd., PO Box 020, Queen Victoria Bldg., 263 Clarence St., 9th Floor, Sydney, NSW, 2000, (02) 267 7877. Fax: (02) 264 5589. Exec. Dir.: Emmanuel Candi; Gen. Mgr.: Jim White; Admin. Mgr.: Lionel Banbury.

Public Broadcasting Assn. of Australia, 645 Harris St., Ultimo, NSW, 2007, (02) 211 3288. Fax: (02) 281 3370. Pres.: Brett Gleeson; Mktg. Dir.: Lee Hubber; Exec. Dir.: Ada Hulshoff.

Public Broadcasting Assn. of Australia, 44-54 Botany Rd., Suite One, Level Three, Alexandria, NSW, 2015, (02) 310 2999. Fax: (02) 319 4545. Pres.: Jeff Langdon; Exec. Dir.: Ada Hulshoff; Mktg. Dir.: Lee Hubber.

Victorian Rock Foundation, PO Box 297, Port Melbourne, VIC, 3207, 62-74 Pickles St., South Melbourne, VIC, 3205, (03) 696-2022. Fax: (03) 696-2879. Pres.: Ian Smith; Programs Mgr.: Michele Taylor; Projects Mgr.: Robert Walker.

ENTERTAINMENT ATTORNEYS

Arts Law Centre of Australia, 11 Randle St., Surry Hills, NSW, 2010, (02) 211-4033. Fax: (02) 281-1570. Dir.: Michael McMahon; Coord.: Lee Paterson; Admin.: Kerrie Cheers.

Australian Copyright Council, 3/245 Chalmers St., Redfern, NSW, 2016, (02) 318 1788. Fax: (02) 698 3536. Chrmn.: Peter Banki; Exec. Officer: Libby Baulich.

Martin Cooper & Co., 180 Victoria St., Potts Point, NSW, 2011, (02) 357-1522. Fax: (02) 357-1248. Contact: Martin Cooper.

Corrs Chambers Westgarth, 39 Martin Pl., Level 10, Sydney, NSW, 2000, (02) 210-6367. Fax: (02) 223-3022. Property Partner: Carmen Champion.

Cowley, Heame Solicitors, Attorneys & Notaries, PO Box 587, North Sydney, NSW, 2059, 80 Mount St., North Sydney, NSW, 2060, (02) 956-2100. Fax: (02) 959-3614. Partners: Michael H. McMichael, Jay Cassells; Associate: Leah Kennedy.

Craddock Murray & Neuman, 405-411 Sussex St., 3rd Floor, Sydney, NSW, 2000, (02) 211-5471. Fax: (02) 281-3361. Partner: Eddy Neumann.

Dobes & Andrews, Solicitors & Attorneys, PO Box 60, East-point Tower, Edgecliff, Sydney, NSW, 2027, (02) 328-1499. Fax: (02) 326-2912. Principal: Stephen Andrews.

Dwyer & Co., 334 St. Kilda Rd., Melbourne, VIC, 3004, (03) 696-4822. Fax: (03) 696-3832. Principal: Phil Dwyer.

Dwyer Durack, GPO Box M931, Perth, WTA, 6001, 40 St. George's Terr., Level 10, Perth, WTA, 6000, (619) 325 9277. Fax: (619) 221 1773. Partner: Brian Joseph Pass.

P.J. English, 483 Riley St., Surry Hills, Sydney, NSW, 2010, (02) 699-1722. Fax: (02) 699-9430. Partner: Peter English.

Gadens Ridgeway, 575 Bourke St., 4th Floor, Melbourne, VIC, 3000, (613) 614 4844. Fax: (613) 614 3770. Partner: Neil Anderson.

Gadens Ridgeway, 175 Pitt St., Sydney, NSW, 2000, (02) 232 5566. Fax: (02) 23 1727. Partner: Warren Cross.

Garland Seaborn, 25 Bligh St., Sydney, NSW, 2000, (02) 232 7388. Fax: (02) 221 4192.

Gilbert & Tobin, 30 Carrington St., Level 1, Sydney, NSW, 2000. (612) 262 1799. Fax: (612) 262 2783. Solicitor: Stephen Peach.

Lee, Hourigan & Brooks, 135 MacQuarie St., Ste. 802, Sydney, NSW, 2000, (02) 247 2113. Fax: (02) 251 4327. Sr. Partner: Mark Hourigan.

Lakos & Co., 352 Kent St., 3rd Floor, Sydney, NSW, 2000, (02) 262-6677. Fax: (02) 290-1884. Sr. Partner: John Lakos.

Lilley Brereton Lawyers, 114 William St., 13th Floor, Melbourne, VIC, 3000, (03) 670 2344. Fax: (03) 670 2302. Partner: Michael Brereton.

MacPhillamy Cummins & Gibson, GPO Box 628, Nat'l Mutual Ctr., 15 London Circuit, Canberra, ACT, 2601, (06) 2740777. Fax: (06) 2740666. Pres.: Peter Hohnen; Partner: Richard Refshaug.

Marshalls & Dent Lawyers, GPO Box 1645N, Level 12, 459 Little Collins St., Melbourne, VIC, 3000, (03) 670 5000. Fax: (03) 642 0409. Partner: Michael Dent.

Roth, Warren & Menzies, 121 Flinders Ln., Melbourne, VIC, 3000, (613) 650-5888. Fax: (613) 650-9440. Partner: Bryce Menzies.

Simpson Solicitors, 44 Kellett St., Potts Point, Sydney, NSW, 2011, (02) 358 2464. Fax: (02) 357 3112. Contact: Shane Simpson.

Tress, Cocks & Maddox, Level 20, 135 King St., Sydney, NSW, 2000, (612) 221 2744. Fax: (612) 221 4988. Partner: Peter Thompson.

Henry Davis York, Solicitors, Level 25, 135 King St., Sydney, NSW, 2000, (612) 232 2733. Fax: (612) 235 1244. Partner: Mark Allen; Contact: Geoff Hilton.

PERFORMING & MECHANICAL RIGHTS ORGANIZATIONS

Australasian Performing Right Assn. (APRA), PO Box 567, 1A Eden St., Crows Nest, NSW, 2065, (02) 922 6422. Fax: (02) 925 0314. Chief Exec.: Brett Cottle; Co. Sec.: Nick Hampton.

MUSIC LIBRARIES

Australian Music Centre (Sounds Australian), PO Box 49, Grosvenor Pl., 201 Argyle Centre, The Rocks, 2nd Floor, Sydney, NSW, 2000, (02) 247 1611. Fax: (02) 241 2873. Pres.: Richard Letts; Sales Mgr.: Lorna Lander.

Nat'l Film & Sound Archive, GPO Box 2202, McCoy Circuit, Acton, Canberra, ACT, 2601, (06) 287 1711. Fax: (06) 247 4651. Dir.: Graham Gilmour; Mktg. Head: Dr. Ann Villiers; Publ. Rel. Officer: Michele Parsons.

PUBLIC RELATIONS

Ingrid Berg & Assoc., PO Box 285, 85E Wigram Rd., Glebe,

NSW, 2037, 61-2-660-1433, Fax: 61-2-552-2868, Pres.: Ingrid Berg; Sales Mgr.: Lydia Grozdanovic.

Gaynor Crawford Publicity, PO Box 669, Glebe, NSW, 2037, (612) 552 1788, Fax: (612) 660 7822, Dir.: Gaynor Crawford; Dir.: Rob Goldstone.

Immedia! P. R. Pty. Ltd., GPO Box 2977, Sydney, NSW, 2001, 3 Rose St., Chippendale, NSW, 2008, (612) 212-6677, Fax: (612) 211-5938, Managing Partner: Phil Tripp.

Showbiz Mktg. Int'l, 170 Walker St., North Sydney, NSW, 2060, (02) 925 0044, Fax: (02) 925 0650, Pres.: Linda Monmouth.

Sydney Posters, PO Box 323, Kings Cross, NSW, 2011, 60 Stanley St., East Sydney, NSW, 2010, (02) 360-1714, Fax: (02) 360-5624, Pres./Mktg. Dir.: Adrian Tourie; Sales Mgr.: Nicole Hanna.

Watts Happening Pty. Ltd., PO Box 803, Potts Point, NSW, 2011, 54 Thorne St., Edgecliff, NSW, 2027, (02) 9635808, Fax: (02) 3632705, Pres.: Michele Watts.

Annie Wright Publicity, 5 Queens Ave., Avalon, NSW, 2107, (02) 918-3082, Fax: (02) 973-1181, Dir.: Annie Wright.

RECORD PROMOTION

Australian Music Centre (Sounds Australian), PO Box 49, Grosvenor Pl., 201 Argyle Centre, The Rocks, 2nd Floor, Sydney, NSW, 2000, (02) 247 1611, Fax: (02) 241 2873, Pres.: Richard Lettis; Sales Mgr.: Lorna Lander.

Sydney Posters, PO Box 323, Kings Cross, NSW, 2011, 60 Stanley St., East Sydney, NSW, 2010, (02) 360-1714, Fax: (02) 360-5624, Pres./Mktg. Dir.: Adrian Tourie; Sales Mgr.: Nicole Hanna.

Annie Wright Publicity, 5 Queens Ave., Avalon, NSW, 2107, (02) 918-3082, Fax: (02) 973-1181, Dir.: Annie Wright.

BLANK & BULK TAPE MANUFACTURERS

Ampex Australia Pty. Ltd., 21 Terra Cotta Dr., Blackburn, VIC, Australia, (61)3/877-6222, Sr. Sales Rep.: David Stafford;

Ampex Australia Pty. Ltd., PO Box 199, Unit A, 61 Talavera Rd., North Ryde, NSW, 2113, Australia, (61)2/887-3333, Fax: (61)2/887-3150, Managing Dir.: Richard Blackett; Sales/Mktg. Mgr.: Greg Martin;

Greencorp Magnetics Pty. Ltd., 80 Perry St., Matraville, NSW, 2036, Australia, (02) 661-6511, Fax: (02) 661-6997, Pres.: Stephen L. Green;

3M Australia Pty. Ltd., PO Box 99, 950 Pacific Hwy., Pymble, NSW, 2073, Australia, (61)2 498-9363, Fax: (61)2 499-2818, Contact: Geoff Hannigan;

CARTRIDGES, CASSETTES, REELS & OTHER PARTS

Ampex Australia Pty. Ltd., PO Box 199, 61 Talavera Rd., Unit A, North Ryde, NSW, 2113, (02) 887-3333, Fax: (02) 887-3150, Managing Dir.: Richard Blackett; Sales/Mktg. Dir.: Greg Martin.

Audio: Ampex Audio Prods., all formats.
Video: All Professional Formats.

W. H. Brady Pty. Ltd., PO Box 199, 2 Pat Devlin Close, Revesby, NSW, 2212, (61)2/602-5822, Fax: (61)2/601-6048, Mng. Dir.: C.R. Stevens; Sales Mgr.: J.A. Dullow.
Audio & Video: Brady Splicing Tape.

Evasound Records & Tapes, PO Box 156, 28 Cross St., Sydney, NSW, 2100, (02) 938 3440, Fax: (02) 905 4655, Pres.: G. R. Evens; Sales Mgr.: Glen Palmer; Mktg. Dir.: Anne Kennedy; Opns. Dir.: Jason Kennedy.

Greencorp Magnetics Pty. Ltd., 80 Perry St., Matraville, NSW, 2036, (02) 661-6511, Fax: (02) 661-6997, Pres.: Stephen Green.
Audio: C-0s.
Video: V-0s.

ENVELOPES & MAILERS

Evasound Records & Tapes, PO Box 156, 28 Cross St., Sydney, NSW, 2100, (02) 938 3440, Fax: (02) 905 4655, Pres.: G. R. Evens; Sales Mgr.: Glen Palmer; Mktg. Dir.: Anne Kennedy; Opns. Dir.: Jason Kennedy.
Audio—CD, Tape, LP)

JACKETS & SLEEVES

Dex Audio Pty. Ltd., 87-91 Arden St., North Melbourne, VIC, 3051, (03) 329-2877, Fax: (03) 326-5282, Pres.: Daniel Desiere; Pres.: Greg Williams; Mktg. Mgr.: John Durr.
(Jackets/Sleeves—Audio: CD, Tape)

Evasound Records & Tapes, PO Box 156, 28 Cross St., Sydney, NSW, 2100, (02) 938 3440, Fax: (02) 905 4655, Pres.: G. R. Evens; Sales Mgr.: Glen Palmer; Mktg. Dir.: Anne Kennedy; Opns. Dir.: Jason Kennedy.
(Jackets/Sleeves—Audio: CD, Tape, LP)

LABELS

Evasound Records & Tapes, PO Box 156, 28 Cross St., Sydney, NSW, 2100, (02) 938 3440, Fax: (02) 905 4655, Pres.: G. R. Evens; Sales Mgr.: Glen Palmer; Mktg. Dir.: Anne Ken-

ned; Opns. Dir.: Jason Kennedy.

(Audio—CD, Tape, LP)

Modern Records Pty. Ltd., Unit A, 100 May St., Saint Peters, NSW, 2044, (02) 550-6434, Fax: (02) 550-6432, Pres.: Mike Papas.
(Audio—LP).

TAPE CUSTOM DUPLICATORS

W. H. Brady Pty. Ltd., PO Box 199, 2 Pat Devlin Close, Revesby, NSW, 2212, (61)2/602-5822, Fax: (61)2/601-6048, Mng. Dir.: C.R. Stevens; Sales Mgr.: J.A. Dullow.

Dex Audio Pty. Ltd., 87-91 Arden St., North Melbourne, VIC, 3051, (03) 329-2877, Fax: (03) 326-5282, Pres.: Daniel Desiere; Pres.: Greg Williams; Mktg. Mgr.: John Durr.
Audio: Cassette, Open Reel, DAT.

Audio Packaging Services: Inserting, Collating, Labeling, Mailing.
Other Services: Freight.

EMI Records Australia Pty. Ltd., Rocked Bag No. 22 PO, Unit 28, Slough Bus. Park, Ermington, NSW, 2115, (02) 748-3144, Fax: (02) 748-4096, Gen. Mgr. Mfg.: Ken Harding; Prodn. Mgr.: Vin Forbes.

Audio: Cassette.
Audio Packaging Services: Inserting, Collating, Labeling.

Evasound Records & Tapes, PO Box 156, 28 Cross St., Sydney, NSW, 2100, (02) 938 3440, Fax: (02) 905 4655, Pres.: G. R. Evens; Sales Mgr.: Glen Palmer; Mktg. Dir.: Anne Kennedy; Opns. Dir.: Jason Kennedy.

Audio: Cassette, Open Reel, DAT.
Other Services: Warehouse, Freight, Direct Response—800 services.

Festival Records P/L, PO Box 16, Pymont, 63-79 Miller St., Pymont, Sydney, NSW, 2009, (02) 660 4022, Fax: (02) 692 8058, Managing Dir.: William Eeg; ADR Dir.: Kerry Fitzgerald.

Audio: Cassette.
Audio Packaging Services: Inserting, Collating, Labeling, Mailing.

Other Services: Warehouse, Freight, Credit Card Clearance Services.

Greenville Records, PO Box 312, 26 Wallace St., Albion, QLD, 4010, (07) 262-8422, Fax: (07) 862-1422, Pres.: Rodney Jacobson; Sales Mgr./Mktg. Dir.: Malcolm Jacobson.

Audio: Cassette.
Audio Packaging Services: Inserting, Labeling.
Other Services: Freight.

KGC Magnetic Tapes, PO Box 118, 122 Euston Rd., Alexandria, Saint Peters, NSW, 2015, (02) 519-2677, Fax: (02) 517-2530, Sales Mgr.: Steve Jennings; Pres./Gen. Mgr.: Nigel Price.

Audio: Cassette.
Video: ¼ U-Matic, ½ VHS Cassette, S-VHS.
Audio & Video Packaging Services: Inserting, Collating, Labeling, Mailing.
Other Services: Warehouse, Freight, Australia

COMPACT DISC MANUFACTURERS & VIDEODISC MANUFACTURERS

Disctronics Australia Pacific, 60-64 Bay St., Broadway, NSW, 2007, Australia, (02) 281-6535, Fax: (02) 281-6542, Sales Mgr./Mktg. Dir.: Doug Bell. Type: CD

PLATING & PRESSING PLANTS

Evasound Records & Tapes, PO Box 156, 28 Cross St., Sydney, NSW, 2100, Australia, (02) 938 3440, Fax: (02) 905 4655, Pres.: G. R. Evens; Sales Mgr.: Glen Palmer; Mktg. Dir.: Anne Kennedy; Opns. Dir.: Jason Kennedy. (LP's)

Festival Records P/L, PO Box 16, Pymont, 63-79 Miller St., Pymont, Sydney, NSW, 2009, Australia, (02) 660 4022, Fax: (02) 692 8058, Managing Dir.: William Eeg; ADR Dir.: Kerry Fitzgerald. (LP's)

Modern Records Pty. Ltd., Unit A, 100 May St., Saint Peters, NSW, 2044, Australia, (02) 550-6434, Fax: (02) 550-6432, Pres.: Mike Papas. (LP's)

Sundown Records, PO Box 107, 44 Paisley Dr., Lawnton, Aspley, QLD, 4034, Australia, (07) 285 2008, Fax: (07) 285 2922, Pres.: John Briskey; Sales/Mktg. Mgr.: Eleanor Briskey. (LP's)

MASTERING FACILITIES

Dex Audio Pty. Ltd., 87-91 Arden St., North Melbourne, VIC, 3051, (03) 329-2877, Fax: (03) 326-5282, Pres.: Daniel Desiere; Pres.: Greg Williams; Mktg. Mgr.: John Durr. (Audio)

EMI Records Australia Pty. Ltd., Rocked Bag No. 22 PO, Unit 28, Slough Bus. Park, Ermington, NSW, 2115, (02) 748-3144, Fax: (02) 748-4096, Gen. Mgr. Mfg.: Ken Harding; Prodn. Mgr.: Vin Forbes. (Audio)

Evasound Records & Tapes, PO Box 156, 28 Cross St., Sydney, NSW, 2100, (02) 938 3440, Fax: (02) 905 4655, Pres.: G. R. Evens; Sales Mgr.: Glen Palmer; Mktg. Dir.: Anne Kennedy; Opns. Dir.: Jason Kennedy. (Audio)

Festival Records P/L, PO Box 16, Pymont, 63-79 Miller St., Pymont, Sydney, NSW, 2009, (02) 660 4022, Fax: (02) 692 8058, Managing Dir.: William Eeg; ADR Dir.: Kerry Fitzgerald. (Audio)

Modern Records Pty. Ltd., Unit A, 100 May St., Saint Peters, NSW, 2044, (02) 550-6434, Fax: (02) 550-6432, Pres.: Mike Papas. (Audio)

PACKAGING & LABELING SERVICES

Sundown Records, PO Box 107, 44 Paisley Dr., Lawnton, Aspley, QLD, 4034, (07) 285 2008, Fax: (07) 285 2922, Pres.: John Briskey; Sales/Mktg. Mgr.: Eleanor Briskey.
(Inserting, Collating, Labeling, Mailing)

NEW ZEALAND

RECORD LABELS

BMG Arista/Ariola Ltd., 3rd Fl. Altos House, Newton Rd., Newton, Auckland, (9) 780-491. Fax: (9) 780-496. Managing Dir.: Morris Smith; Financial Controller: Stephen Green; Nat'l Sales Mgr.: George Spence; Nat'l Promos. Mgr.: David Jordan.

Label(s): (Owned) Bluebird, Novus, RCA, Arista, Ariola, (Distributed) Anxious, Beggars Banquet, Private Music, Reunion, Possum, MCA, Jive, Motown, Castle, Dino, Dedicated, Ear Candy, GRP, Imago, Geffen, Windham Hill, Silvertone, Zoo.

Christian Mktg. (New Zealand) Ltd., Private Bag, Cooper St., Havelock North, (070) 778-161. Fax: (070) 777-348. Chrmn.: L.M. Robertson; Vice Pres. A&R: J. McKenzie; Gen. Mgr.: A.M. Anyan; Dirs.: G.J. Muys, D.Osborn; C. Osborn, J. Paynter.

Hughes Leisure Group, Ltd., PO Box 71-164, 560 Rosebank Rd., Avondale, Auckland, (09) 882-096. Fax: (09) 885-633. Managing Dir.: Houghton Hughes; Gen. Mgr.: Ross Donohue; Sales Mgr.: Rod Biffin.

Label(s): (Owned) Compact Hour, Golden Editions, Koala, Listen Easy, Starburst, Music World.

Jayrem Records Ltd., PO Box 38-558, Petone, (04)5661-811. Fax: (04)5692-984. Managing Dir.: James Moss.
Label(s): (Owned) Blues, Fari, Reggae Rhythm, Jayrem, Rimu.

Int'l Reps.: Festival Records Dist. (Australia).
Kiwi-Pacific Records Int'l, Ltd., PO Box 826, 6 Broomhedge St., Wellington, Chrmn.: John Ruffell; Dir.: D. Park; A. Vercoe.

Label(s): (Owned) Hibiscus, Kiwi, Tartar.

Metro Marketing, 45 MacKelvie St., Auckland, (09) 764-628.

Ode Record Co. Ltd., PO Box 37-331, Parnell, 19 Earl St., Auckland, (09) 790-007. Fax: (09) 395-132. Managing Dir.: Terence O'Neill-Joyce; Sales/Finance: Kerry Jackson; Nat'l Sales: Steve Priest.

Label(s): (Owned) Voyager, Five Star, Manu Classic, Manu, Ode, (Distributed) Hyperion, Gimell, Hungaroton, Harmonia Muni, ASV, Auidis, Chandos, Bis, Supraphon, Unicorn. US Reps.: Allegro Imports (OR).

Reaction Records Ltd., PO Box 3924, 11 York St., Parnell, Auckland, (64-9) 793-222. Fax: (64-9) 795-236. Managing Dir.: Glyn Tucker.
Label(s): (Owned) Reaction.

Sacred Records Ltd., 176 Queen St. W., Levin, PM, 5500, (06) 368-4403. Managing Dir.: Peter R. Harris.

Sony Music Entertainment Ltd., PO Box 37-277, Parnell, 21 Falcon St., Parnell, Auckland, 1, (09) 797508. Fax: (09) 3031515. Vice Pres. A & R: Mike Chunn; Managing Dir.: Michael Glading; Finance Mgr.: Andy Arcus; Sales Mgr.: Mike Bradshaw; Promo. Mgr.: Paul Ellis.

Label(s): (Owned) Columbia, Def Jam, Definitive, WTG, Epic, (Distributed) Word.

Triton Securities Ltd., CPO Box 577, Level 16, 44-48 Emily Pl., Auckland, (64)09 3092090. Fax: (64)09 3779940. Dir./Buyer: John Bishop; Mgr.: Roger Herrick; (Compact Disc, Video (Cassette & Disc), Accessories) (Importer).
Labels Distributed: Audio: Naxos, LRC, Donau, Marco Polo; Video: Naxos.

Labels Imported: Naxos-Germany, LRC-USA, Donau-Singapore, Marco Polo-Germany.

Warner Music New Zealand Ltd., PO Box 2915, 15 Hopetown St., 7th Level Babbage Bldg., Ponsonby, Auckland, (64-9) 771-699. Fax: (64-9)307-0917. Managing Dir.: Tim Murdoch; Financial Dir.: Geoff Sherring; Classical Mgr.: Peter Andrews; Promo Mgr. Int'l Div.: Jeremy Freeman; Promo Mgr. U.S. Div.: Lisa Williams.

Label(s): (Owned) Atlantic, Elektra, Wea International, Warner Bros., (Distributed) Geffen, MCA, Sonet, Mute, Fiction, Delphine.

Word Database Ltd., 176 Queen St. W., Levin, PM, 5500, (06) 368-4403. Vice Ptes. A&R/Managing Dir.: Peter R. Harris.
Label(s): (Owned) Biletone, Sacred, Destiny.

MUSIC PUBLISHERS

Anton's Songs, PO Box 71-164, Auckland, 560 Rosebank Rd., Avondale, (09) 882-096. Fax: (09) 885-633. Pres.: Houghton Hughes; Gen. Mgr.: Ross Donohue.

Jayrem Records Limited, PO Box 38-558, Petone, (04) 5661-811. Fax: (04) 5692-984. Pres.: James Moss.

Kiwi Music, PO Box 826, 6 Broomhedge St., Wellington, Pres.: John Ruffell.

Mandrill Music, (APRA) PO Box 3924, 11 York St., Parnell, Auckland, (649) 793-222. Fax: (649) 795-236. Pres./Prof. Creative Mgr.: Glyn Tucker.

Sony Music Publishing—New Zealand, PO Box 37-277, 21 Falcon St., Auckland, (09) 797-508. Fax: (09) 303-1515. Gen. Mgr./Prof.-Crea.Mgr.: Mike Chunn.

Tafari Music. (See Jayrem Records Limited).

Word/Lexicon Music Group, 176 Queen St. W., Levin, PM, 5500, (06) 368-4403. Pres.: Peter R. Harris.

Word (South East Asia) Ltd., 119 Oxford St., The Mall, Levin, PM, 5500, (06) 368-1230. Pres.: Peter R. Harris.

COMPUTER SYSTEMS & SERVICES

Word (NZ) Ltd., 176 Queen St. W., Levin, PM 5500, (06) 368-4403. Pres.: Peter R. Harris; Sales Mgr.: John Dorland.

ASSOCIATIONS & PROFESSIONAL ORGANIZATIONS

Recording Industry Assn. of New Zealand, Inc., PO Box 9241, 15 Courtenay Pl., 6th Floor, Wellington, (64) 4 843 523. Fax: (64) 4 845 060. Pres.: Brian Pitts; Chief Exec./Sec.: Tony Chance.

PERFORMING & MECHANICAL RIGHTS ORGANIZATIONS

Phonographic Performances (New Zealand) Ltd., PO Box 9241, 15 Courtenay Pl., 6th Floor, Wellington, (64) 4 843 523. Fax: (64) 4 845 060. Pres.: Brian Pitts; Gen. Mgr.: Tony Chance; Co. Sec.: Sheran Ashley.

Word (NZ) Ltd., 176 Queen St. W., Levin, PM 5500, (06) 368-4403. Pres.: Peter R. Harris; Sales Mgr.: John Dorland.

RECORD PROMOTION

Record Publications Ltd., PO Box 9241, 15 Courtenay Pl., 6th Floor, Wellington, (64) 4 843 523. Fax: (64) 4 845 060. Contact: Sheran Ashley.

Word (NZ) Ltd., 176 Queen St. W., Levin, PM 5500, (06) 368-4403. Pres.: Peter R. Harris; Sales Mgr.: John Dorland.

BLANK & BULK TAPE MANUFACTURERS

Ampex Recording Media, MSAS House, 7 Freight Pl., Mangere, Auckland, New Zealand, (64) 9-2753085.

3M New Zealand Ltd., Box 33-246 Takapuna, 250 Archers Rd., Auckland, 9, New Zealand, (64)9 444-4760. Fax: (64)9 444-2773. Contact: J. M. Novak.

POLYBAGS & SHRINKWRAP

Danaflex Packaging Corp. Ltd., PO Box 56-089, Wellington, (4) 325-204. Fax: (4) 327-547. Mktg. Dir: Gragme Fairlie. (Polybags & Shrinkwrap).

CENTRAL AMERICA

COSTA RICA

RECORD LABELS

Sony Music Entertainment (Central America), S.A., PO Box 4093-1000, San Jose, San Vicente de Moravia, (506) 35-9322. Fax: (506) 35-9314. Vice Pres./Managing Dir.: Edward C. Lavish; Dir., Finance & Admin.: Andres Marten B.; Mgr., Sales & Promo.: William Mendez P.; Mgr., Opns.: Ronald Montagne S.

MUSIC PUBLISHERS

INDICA, S.A./Ediciones, PO Box 109, San Vicente de Moravia, San Jose, Moravia, (506) 359322. Fax: (506) 359314. Pres./Gen. Mgr.: Edward C. Lavish, Jr.; Professional Mgr.: Maria Eugenia Vindas.

Sony Music Publishing-Costa Rica, PO Box 4093, San Vicente de Moravia, San Jose, Contiguo a Pegaso Internacional, San Vicente de Moravia, (506) 35-9322. Fax: (506) 35-9314. Gen. Mgr.: Edward C. Lavish, Jr.

BLANK & BULK TAPE MANUFACTURERS

3M Costa Rica, SA, Apdo. 10119, San Jose, Costa Rica, (506) 37 5033. Fax: (506) 38 0935. Contact: Glauco Rivera.

JACKETS & SLEEVES

Sony Music Entertainment (Central America), S.A., PO Box 4093-1000, San Jose, (506) 35-9322. Fax: (506) 35-9314. Vice Pres./Managing Dir.: Edward C. Lavish, Jr.; Sales/Promotion Mgr.: William Mendez P. (Jackets/Sleeves-Audio: Tape, LP)

LABELS

Sony Music Entertainment (Central America), S.A., PO Box 4093-1000, San Jose, (506) 35-9322. Fax: (506) 35-9314. Vice Pres./Managing Dir.: Edward C. Lavish, Jr.; Sales/Promotion Mgr.: William Mendez P. (Audio—Tape, LP)

PLATING & PRESSING PLANTS

Sony Music Entertainment (Central America), S.A., PO Box 4093-1000, San Jose, Costa Rica, (506) 35-9322. Fax: (506) 35-9314. Vice Pres./Managing Dir.: Edward C. Lavish, Jr.; Sales/Promotion Mgr.: William Mendez P. (LP's)

MASTERING FACILITIES

Sony Music Entertainment (Central America), S.A., PO Box 4093-1000, San Jose, (506) 35-9322. Fax: (506) 35-9314. Vice Pres./Managing Dir.: Edward C. Lavish, Jr.; Sales/Promotion Mgr.: William Mendez P. (Audio)

EL SALVADOR

RECORD LABELS

Compania Salvadorena De Discos, S.A., PO Box 847, San Salvador, (503) 211858. Fax: (503) 266036. Gen. Mgr.: Edwar-do Hitt; Mktg. Mgr.: Carlos Hitt.

Label(s): (Owned) Dicesa, (Distributed) Discos Gas, RCA Records, Velvet, TH Records and Tapes, Walt Disney Company.

Distribuidora Salvadorena de Discos S.A., PO Box 960, San Salvador, (503) 23-97-92. Sales Mgr.: Ana Lillian Rodriguez; (Distributor)

Distribuidora Salvadorena de Discos, S.A., PO Box 960, San Salvador, (503) 243-846. Gen. Dir.: Guillermo Lopez Rojas.

BLANK & BULK TAPE MANUFACTURERS

3M El Salvador, Apdo. Postal 681, KM 5, Carretera/Panamerica Teciá, San Salvador, El Salvador, (503) 242 444. Fax: (503) 23 4285. Contact: Jose Claudio Diaz.

GUATEMALA

RECORD LABELS

Discos De Centroamerica, S.A., PO Box 1792, 12 Calle 3-27 Zona 1, Guatemala City, 01901, (502-2) 533695, (502-2) 516907. Fax: (502-2) 465841. Pres.: Byron Galvez Thompson. Label(s): (Owned) Dideca, (Distributed) Codiscos (Colombia), Discos Y Cintas Melody, EMI Ltd. (United Kingdom), A & M, Fuentes, Peerless (Mexico), Sono Rodven, PolyGram (Holand-Germany), Sonografica (Venezuela), Velvet, WEA Int'l (USA).

Distribuidora Guatemalteca de Discos S.A., 4a. Avenida 13-25, Zona 9, Guatemala City, (502) 35-93-22. Sales Mgr.: Ernesto Barrios; (Distributor)

PLATING & PRESSING PLANTS

Discos De Centroamerica, S.A., PO Box 1792, 12 Calle 3-27, Zona 1, Guatemala City, 01901, Guatemala, (519)602, 537565. Fax: 537457. Pres.: Byron Galvez Thompson; Mktg. Dir: Mauricio Henriquez; Int'l Mgr.: Bianca Avila. (LP's)

PANAMA

RECORD LABELS

Distribuidora Panamena de Discos S.A., PO Box 9614, Panama, 4, (507) 64-58-03. Sales Mgr.: Javier Correa.

(Distributor)

Maduro Electronica, S.A., PO Box 42-37 Free Zone, 17th St., Colon, 507-41-4566. Fax: 507-41-4980. Pres.: Ernesto J. Maduro; (Compact Disc, Video (Cassette & Disc)) (Importer, Exporter).

Labels Distributed: Audio: CDs, Sony/CBS, Karen, T-1 Rodven, Kubaney, Capitol/EMI, WEA, Sonotone; Video: Laserdiscs.

Products/Accessories: CD Players: Sony, Toshiba, Sansui, Gemini, Philips.

Panafoto Zona Libre, S.A., AP 2130, Calle "E" Paseo Gorgas, Zona Libre De Colon, Colon, (507) 45-3014, (507) 45-3600. Fax: (507) 41-5209. Pres.: N.H. Nandwani; Vice Pres. A&R: Peter R. Chatlani; Mgr.: George F. Goldson; Dir., Int'l Sales: Michael R. Thompson; Dan-el Vega Armoettes; Sec.: Pritam G. Tewanes; (Compact Disc, Video (Cassette & Disc), Computer Games, Accessories) (Distributor, Importer, Exporter).

Labels Distributed: Audio: Telarc, Delos, Delta, PolyGram, CBS, Concord Jazz, Nimbus, Reference Recording, Capitol, Chandos, Sonotone, Th-Rodven, Top Ten Hits (TTH), GRP, Intersound, MPI, Fantasy, Chesky and others; Video: Pioneer, Image Entertainment.

Products/Accessories: CD Players: Sony, JVC, Pioneer, Alpine; Audio & Video Playback Equipment: JVC, Sony, Pioneer; CD, Tape & Record Products: Recoton, Audio Quest; Storage & Carrying Cases: JVC, Sony, Lift Discplay; Video Cassette Recorder: JVC, Sony, Pioneer; Blank Tape: JVC, Sony, Samsung, SKC, etc.; Head Phones: JVC, Sony, Pioneer; Batteries: JVC, Sony, Kodak.

Sony Music Entertainment (Panama), S.A., PO Box 87-1994, Zona 7, Panama City, (507) 64-5803. Fax: (507) 23-8918, Chief Exec.: Edward Lavish Jr.; Manager/Lic.: Javier Correa Chiu. (Distributor)

Labels Distributed: Audio: Sony Music Entertainment, BMG Music, MCA Int'l, Geffen, GRP, Arista, Musical Prodn.

BLANK & BULK TAPE MANUFACTURERS

3M Panama SA, Apartado Postal 4454, Calle D Y Alberto Navarro, Edif Raquel, Panama, 5, Panama, (507)63-5244. Fax: (507)63-5434. Contact: Aldo Lancini.

INDIAN SUBCONTINENT

INDIA

RECORD LABELS

Bremen Music, 42, Pravasi Indus. Estates, Corecaon (East), Bombay, (91)22/6887423. Fax: (91) 22-954321. Pres.: Shashi Gopal; Gen. Mgr.: Bashir Sheikh; Finance Mgr.: L.V. Shankaran.

Label(s): (Distributed) All BMG Int'l Labels.

CBS Gramophone Records & Tapes (India) Ltd., #1110/1112 Dalamal Towers, Nariman Point, Bombay, 400 021, (91) 22/243016, (91) 22/243069. Gen. Mgr.: Shashi Gopal; Sec., Finance Mgr.: P. R. Mama; Mgr. Int'l Music Div.: Atul Churamani; A & R Mgr.: Irshwin Balwani.

The Gramophone Co. of India Ltd., PO Box 699, Calcutta, 1, 33 Jessora Rd., Dum Dum, Calcutta, 700028, (91)33-572431, (91)33-57-2433. Pres.: Pradip Chanda; Gen. Mgr./Sales & Mktg.: Sujit Kumar; Vice Pres. A & R: V. K. Dubei; Product Mgr.: V. T. Ravi.

Branch(es): 1-3, Uxbridge Rd., Hayes, Middlesex, UB4 0SY, United Kingdom, (01) 5615922, Fax: (01) 561 3692. Gen. Mgr.: Sanjeev Kohli.

Label(s): (Distributed) CNR, Blue Note, Capitol, EMI, HMV, EMI Records Ltd.

Magnasound (India) Pvt. Ltd., Lorette Ville, 25/E Main Ave., Maharashtra, Santacruz (West), Bombay, 400054, (91)22/6497620, (91)22/6497404. Fax: (91) 22/954321. Managing Dir.: Shashi Gopal; Financial Controller: Sanjay Bakadere; Gen. Mgr.: Atul Churamani.

Label(s): (Distributed) All Warner Music Lables.

Music India Ltd., Sterling Centre, 2nd Fl., Dr. Annie Besant Rd., Worli, Bombay, 400 018, 493 5981, 493 5993. Fax: (0022) 4932826. Vice Pres.: V.J. Lazarus.

Label(s): (Distributed) Verve, Polydor, RSO, Vertigo, Rocket, A & M, Casablanca, Decca, Fontana, London, Island, MPS, Mercury, PolyGram, Philips,

BLANK & BULK TAPE MANUFACTURERS

Hindustan Magnetics, 6-2-913/914 Progressive Towers/6th Floor, Khairatabad, Hyderabad, AP, 500 004, India, 2293470, 228173. Fax: 0842-6327. Gen. Mgr./Mktg.: A. K. Pandey; Managing Dir.: Srinivas Koneru.

Birla 3M Ltd., Jubilee Bldg., 45 Museum Rd., Bangalore, Karnataka, 560 001, India, (91)812-567348. Fax: (91)812-578681. Contact: Ram Sharma.

CARTRIDGES, CASSETTES, REELS & OTHER PARTS

Garware Plastics & Polyester Ltd., 50 A Swamy Nityanand Marg., Vile Parle, Bombay, 400057, 091-22-6340941, 091-22-6346381. Fax: 091-22-6348686. Video: V-0s.

TAPE CUSTOM DUPLICATORS

Garware Plastics & Polyester Ltd., 50 A Swamy Nityanand Marg., Vile Parle, Bombay, 400057, 091-22-6340941, 091-22-6346381. Fax: 091-22-6348686. Video.

PAKISTAN

BLANK & BULK TAPE MANUFACTURERS

Agfa-Gevaert Pakistan (Private), Ltd., 133, 12th East St., Karachi, 46, Pakistan, Fax: 54603110546035. Contacts: A.M. Carim, A. Farooqui.

CARTRIDGES, CASSETTES, REELS & OTHER PARTS

Auvitronics Ltd., I.I. Chundrigar Rd., Hirani Ctr., 8th Fl, Karachi, (92) 21/217182, (92) 21/210531. Fax: (92) 21/737865. Managing Dir.: Wazir Ali Mohamed; Tech. Dir.: Mansoor A. Bhatti. Audio: C-0s & finished cassettes. Video: V-0s & "Video King" cassettes.

TAPE CUSTOM DUPLICATORS

Auvitronics Ltd., I.I. Chundrigar Rd., Hirani Ctr., 8th Fl, Karachi, (92) 21/217182, (92) 21/210531. Fax: (92) 21/737865. Managing Dir.: Wazir Ali Mohamed; Tech. Dir.: Mansoor A. Bhatti. Branch(es): Audio: Cassette.

MIDDLE EAST

ISRAEL

RECORD LABELS

B.N.E. Records, 5 Hamerkava St., Ind. Zone B, Holon, 58851, (972-3)5562212. Fax: (972-3)5560938. Managing Dir.: Avi Brand. (Compact Disc, Pre-Recorded Audio Tape, Video (Cassette & Disc), Records) (Distributor, Importer, Exporter) Labels Distributed: Audio: Island, HNH Int'l, Naxos, LRC, Music Club, Mango; Video: HNH Video, Castle Music Video.

Ecco Record Company, 58 Sokolov Street, 46497 Herzlia, PO Box 5499, 46150, 052540 173, Fax: 052.542 642, Tlx: 361749, MD: Benny Reis. Labels (Owned): Ecco.

Gal-Ron, Ltd., 10 Sheinkin Str., Tel Aviv, 65231, (03) 528-0739, (03) 528-8901. Fax: 972-3-204081. Gen. Mgr.: Abraham Zborowski; Deputy Gen. Mgr.: Arie Almog; Sales Mgr.: Ilana Almog. Label(s): (Owned) Gal Ton, Gloria, Studio, O.S.I., Dzigan.

Gong Music Ltd., 2 Kaplan St., Tel Aviv, 64734, (03) 268211. Fax: (03) 268210. Buyer (Record/Tape): Jacob Ashkenazy; Buyer (Video, Access.): Allan Phillips; (Compact Disc, Pre-Recorded Audio Tape, Video (Cassette & Disc), Records (LP's), Accessories) (One-Stop, Importer)

Hed Arzi (1973) Ltd., 3 Hilazon St., Ramat Gan, 52522, (972)3/5752020. Fax: (972)3/7525906. Managing Dir.: Michael Tunis; Gen. Mgr.: Samuel Sachar; Mktg. Mgr.: Naftali Godesh; Head of Int'l: Charlie Solomon; WEA Label Mgr.: Caryn Rose; Royalties Accts.: Esther Lixenberg; Export Mgr.: Suzy Kahati; Import Sales Mgr.: Yoram Tam; Classical Mgr.: Ophir Segal; Head of Int'l Promo & Pub. Rel.: Pablo Weschler; Publicist: Uri Feldman. Label(s): (Owned) Arton, (Distributed) Arista, Atlantic, B M G, Warner Bros., Elektra, Geffen, WMI, MCA.

Helicon Records Ltd., PO Box 487, 7, Hamerkava St., Holon, 58851, (03) 556-2212. Fax: (03) 556-0938. Managing Dirs.: Ronnie Braun, Itzhak Alshech; Mktg.: Yossi Levanon; Int'l Mgr.: Guy Aylon. Label(s): (Owned) Canaan, Helicon, (Distributed) A & M,

Chrysalis, Virgin, Windham Hill, Island, Milan.

MCI Records, 16 Edward Bernstein St., Tel Aviv, 63408, (03) 229-1023. Fax: (02) 235-755. Pres./Managing Dir.: Ben Dror; Mktg. & Promo. Mgr.: Dirit Aviyam; Sales Mgr.: Ron Parnass; Label Mgr.: Tom Bellman.

Label(s): (Distributed) ECM, Fantasy, GRP, Hyperion, Harmonia Mundi.

NMC Music Ltd., PO Box 14, 50 Thon St., Holon, 58100, (03) 800 191. Fax: (03) 800 195. Managing Dir.: Daniel Yadin; Int'l Dir. Mktg./A & R: Moshe Morad; Bus Affairs Dir.: Sharon Dery.

Label(s): (Owned) NMC, (Distributed) 4AD, Beggars Banquet, Angel, Cooking Vinyl, Crammed Discs, Capitol, Creation, Delphine, Ghetto, Hungaroton, KLF, Les Disques du Crepuscule, Melodiya, Minos Matsas, Musikvertrieb, Mute, Play It Again Sam, Rough Trade, Sonet, Sony, Supraphon, Telarc, Trema, ZYX, Tring.

Phonokol Ltd., 14 Esset Tahanot St., Tel-Aviv, 69719, (03) 498 169-70. Fax: (03) 483 165. Managing Dirs.: Avi Ben-Natan, Dov Fuchs; A & R (Int'l): Oren Kristal.

Label represented: PolyGram group.

Picadilly Music Distribution, 4 Shatz Street, 94267 Jerusalem, 02.247 983. Fax: 02.247 983. Gen. Mgr.: Avi Braun.

Play Records, Hovevi Zion 53, Tel Aviv, 64336, 97235272815. Fax: 97235272815. Pres.: Yair Nitzani; Gen. Mgr.: Izhar Ashdot.

Unatex Import Export Ltd., PO Box 2467, 29 Lilienblum St. (65133), Tel-Aviv, 64024, (972) 3/655776. Fax: (972) 3/659841. Pres.: Jerry Janowski; Mktg. Dir.: Oded Janowski; (Importer, Exporter)

Products/Accessories: CD, Tape & Record Products: imports; Storage & Carrying Cases: imports.

HOME VIDEO COMPANIES

Ad Matalon & Co., 15 Hess Street, 61043 Tel Aviv, 03.296 251. Fax: 03.292 977. Contact: Ammon Matalon.

Argo Films, 43 Ben Yehuda Street, 63341 Tel Aviv, 03.228 251. Fax: 03.246 910.

Forum Film, 11 Pinsker Street, PO Box 2478, 63421 Tel Aviv, 03.293 105. Contact: Sammy Beracha.

Seven Stars, 8 Pinsker Street, 61047 Tel Aviv, 03.296 6314. Fax: 03.281 397. Contact: Isaac Chuwes.

MUSIC PUBLISHERS

BMG Music International, (See Music Unlimited).

Warner Chappell Music, (See Phonokol, Ltd.).

D.B. Productions, 1 Daniel Frisch Street, 64735 Tel Aviv, 03.267 076. Managing Dirs.: Ronen Ben-Tal, Uri First, Contact: Gil Toren.

Da'omonim, (ACUM) (See Subar Music Publishing Co. Ltd.).

EMI Music, (See Subar Music Publishing).

EMI Songs (SBK), (BMI) (See NMC Music Publishing).

Gogly Music, 7 Aharonovitch Street, 63566 Tel Aviv, 03.290 235. Fax: 03.292 735. Managing Dir.: Schlomo Zach.

Ilanot Music, PO Box 4292, 31003 Haifa, 04.645 521. Managing Dir.: Dov Zeira.

Intersong/Artemis, (See Phonokol, Ltd.).

Israel Music Institute, 144 Hayarkon Street, 63451 Tel Aviv, 03.544 0219. Gen. Mgr.: Paul Landau.

Israeli Music Publishing (IMP), 25 Keren Hayesod, 91488 Jerusalem, 02.241 377. Managing Dir.: Mandy Feingers.

Mifalei Tarbut Ve'Hinuch, 53 Weitzman Street, 62091 Tel Aviv, 03.216 577.

Music Unlimited, PO Box 1171, 44111 Kfar Sava, 0052.952 418. Fax: 0052.20968. Gen. Mgr.: Ronald Cole. (Sub-pub): BMG Music International.

NMC Music Publishing, PO Box 14, 50 Thon St., Holon, 58100, (972) 3 800191. Fax: (972) 3 800195. Professional Mgr.: Yaron Kedar; Managing Dir.: Danny Yadin.

Negen Edition, 63 Allenby Street, 65171 Tel Aviv, 03.291 457. Managing Dir.: Tova Schreiber.

Or-Tav Music, PO Box 3200, Tel Aviv, 03.624 902. Managing Dir.: Bruno Reinhardt.

Osnat Publishing, 3 Hilazon St., Ramat Gan, 52522, (03) 575 2020. Fax: (03) 752 5906. Managing Dir.: Michael Tunis.

Phonokol, Ltd., 14, Fesser Tahanot St., Tel-Aviv, 69719, (03) 498 16970. Fax: (03) 483 165. Copyright Mgr.: Merle Fuchs, Managing Dir.: Dov Fuchs.

PolyGram Int'l Music Publishing, (See Phonokol, Ltd.).

Rondor, (See Tapuz Music).

Screen Gems, (See Subar Music Publishing).

Sharon, (ACUM) (See Subar Music Publishing Co. Ltd.).

Subar Music Publishing Co. Ltd., (ACUM) 21 Any Ma'amim St., Ramat-Hasharon, 47212, (03) 5491323. Fax: (3) 5403490. Gen. Mgr.: Ophira Bar-Elan.

Sugar, (See Subar Music Publishing).

Tapuz Music, PO Box 8478, 91083 Jerusalem, 02.660 906. Gen. Mgr.: Dabid Gebler. (Sup-pub): Rondor.

Warner-Chappell Music, (See Phonokol).

Willshine Publishing, Hovevi Zion 53, Tel-Aviv, 64336, 972-3-299060. Fax: 972-3-299060. Pres.: Izhar Ashdot; Gen. Mgr.: Yair Nitzani; Professional/Creative Mgr.: Osi Shiloch.

Zomba Music, (See Phonokol, Ltd.).

MUSIC & VIDEO ACCESSORY MANUFACTURERS

PLC Ltd., PO Box 36572, 38 Yavne St., Tel-Aviv, 61364, (972)

3/612610, (972) 3/612567, Pres.: Yakov Bensinyor; Sales Mgr.: Yakov Bensinyor.

CD—Carrying & Storage Cases, Care Products. Tape—Audio/Video: Head Cleaners, Carrying & Storage Cases, Care Products.

Palatchi (Israel) Ltd., PO Box 1198, 9 Shamgar St., Ramat-Hasharon, 47210, (3) 615673, (3) 5404411. Fax: (3) 615725. Pres.: I. Edward Palatchi.

CD—Carrying & Storage Cases, Care Products. Tape—Audio/Video: Head Cleaners, Carrying & Storage Cases, Care Products.

AUDIO ACCESSORIES MANUFACTURERS

Adar Audio Agencies, Hachashmonaim Street 105, 67001 Tel Aviv, PO Box 20384, 67001, 03.561 0663/1943. Fax: 03.561 1942. Contacts: E. Mor, E. Danino. Agent of Frejo/Lift display systems.

STORE FIXTURE MANUFACTURERS

PLC Ltd., PO Box 36572, 38 Yavne St., Tel-Aviv, 61364, (972) 3/612610, (972) 3/612567, Pres.: Yakov Bensinyor; Sales Mgr.: Yakov Bensinyor.

Display Racks—(CD, Record, Tape, Video).

Palatchi (Israel) Ltd., PO Box 1198, 9 Shamgar St., Ramat-Hasharon, 47210, (3) 615673, (3) 5404411. Fax: (3) 615725. Pres.: I. Edward Palatchi.

Display Racks—(CD, Record, Tape, Video).

ASSOCIATIONS & PROFESSIONAL ORGANIZATIONS

Acum, Rothschild Boulevard 118, 61140 Tel Aviv, 03.562 0115. Fax: 03.562 0119. Chrmn.: Shlomo Tanny, Gen. Mgr.: Ran Kedar, Lic. Mgr.: Nilli Werker. Society of authors, composers & music publishers in Israel. Activities include collective administration of copyright (musical & literary works), public performing rights, mechanical rights, synchronization rights, reprint rights.

Hed Arzi, The General Music Co., 3 Hilazon St., Ramat-Gan, 52522, (972)3/575 2020. Fax: (972)3/752 5906. Pres.: Michael Tunis; Sales Mgr.: Avi Lamdan; Mktg. Dir.: Charlie Solomon; Gen. Mgr.: Samuel Sachar.

IFPI Israel, 4 Bnei Moshe St., 62308 Tel Aviv, 03.546 0952. Fax: 03.546 5732. Chrmn.: Daniel Yadin, Gen. Sec.: Yitchak Shefer. Israeli branch of the International Federation of the Phonographic Industry. Coordinates actions against copyright violations.

IUPA, 30 Dizengoff St., 64332 Tel Aviv, 03.297 671/282 922. Fax: 03.284 134. Contact: Moscu Alcalay. Israeli Union of Performing Artists.

Israel Music Institute, 144 Hayarkon St., Tel Aviv, 63451, (03) 5246475. Dir.: Paul Landau.

INTERNATIONAL BUSINESS AGENTS OF MUSIC/VIDEO

Hed Arzi, The General Music Co., 3 Hilazon St., Ramat-Gan, 52522, (972)3/575 2020. Fax: (972)3/752 5906. Pres.: Michael Tunis; Sales Mgr.: Avi Lamdan; Mktg. Dir.: Charlie Solomon; Gen. Mgr.: Samuel Sachar.

PERFORMING & MECHANICAL RIGHTS ORGANIZATIONS

Hed Arzi, The General Music Co., 3 Hilazon St., Ramat-Gan, 52522, (972)3/575 2020. Fax: (972)3/752 5906. Pres.: Michael Tunis; Sales Mgr.: Avi Lamdan; Mktg. Dir.: Charlie Solomon; Gen. Mgr.: Samuel Sachar.

NMC Music Ltd., PO Box 14, 50 Tehon St., Holon, 58100, (972) 3 800191. Fax: (972) 3 800195. Mktg. Dir.: Sharon Dery; Managing Dir.: Danny Yadin; Sales Dir.: David Lifshitz.

PUBLIC RELATIONS

NMC Music Ltd., PO Box 14, 50 Tehon St., Holon, 58100, (972) 3 800191. Fax: (972) 3 800195. Mktg. Dir.: Sharon Dery; Managing Dir.: Danny Yadin; Sales Dir.: David Lifshitz.

RECORD PROMOTION

NMC Music Ltd., PO Box 14, 50 Tehon St., Holon, 58100, (972) 3 800191. Fax: (972) 3 800195. Mktg. Dir.: Sharon Dery; Managing Dir.: Danny Yadin; Sales Dir.: David Lifshitz.

BLANK & BULK TAPE MANUFACTURERS

PLC Limited, PO Box 36572, 38 Yavne St., Tel-Aviv, 65792,

Israel, (3) 612610, (3) 612567, Pres./Sales Mgr.: Yakov Bensinyor;

Palatchi (Israel) Ltd., PO Box 1198, 9 Shamgar St., Ramat-Hasharon, 47210, (3) 615673, (3) 5404411. Fax: (3) 615725. Pres.: I. Edward Palatchi.

CARTRIDGES, CASSETTES, REELS & OTHER PARTS

Arkal, 15135 Beit Zera, 06.755 331. Fax: 06.751 333. Consultants, Nachalat Itzhak Street 58, 61330 Tel Aviv, PO Box 33019, 61330, 03.251 612. Fax: 03.265 546.

PLC Ltd., PO Box 36572, 38 Yavne St., Tel-Aviv, 61364, (972) 3/612610, (972) 3/612567, Pres.: Yakov Bensinyor; Sales Mgr.: Yakov Bensinyor.

Audio: C-0.
Video: V-0.

Palatchi (Israel) Ltd., PO Box 1198, 9 Shamgar St., Ramat-Hasharon, 47210, (3) 615673, (3) 5404411. Fax: (3) 615725. Pres.: I. Edward Palatchi.

Audio: C-0.
Video: V-0.

RKL—ISTIM, Inc., Arkal Beit-Zera, D.N. Emek-Hayarden, 15135, 06-755331. Fax: 972 6-751333. Pres.: Nir Krongold; Export Mgr.: Yehuda Gershuni.

Audio: Library boxes cassettes.

JACKETS & SLEEVES

NMC Music Ltd., PO Box 14, 50 Tehon St., Holon, 56100, (972) 3 800191. Fax: (972) 3 800195. Mktg. Dir: Sharon Dery; Managing Dir: Danny Yadin; Sales Dir.: David Lifshitz. (Jackets/Sleeves-Audio: Tape, LP)

PLC Ltd., PO Box 36572, 38 Yavne St., Tel-Aviv, 61364, (972) 3/612610, (972) 3/612567, Pres.: Yakov Bensinyor; Sales Mgr.: Yakov Bensinyor. (Jackets/Sleeves-Audio: Tape)(Jackets/Sleeves-Video: Tape)

Palatchi (Israel) Ltd., PO Box 1198, 9 Shamgar St., Ramat-Hasharon, 47210, (3) 615673, (3) 5404411. Fax: (3) 615725. Pres.: I. Edward Palatchi. (Jackets/Sleeves-Audio: Tape)(Jackets/Sleeves-Video: Tape)

LABELS

NMC Music Ltd., PO Box 14, 50 Tehon St., Holon, 56100, (972) 3 800191. Fax: (972) 3 800195. Mktg. Dir: Sharon Dery; Managing Dir: Danny Yadin; Sales Dir.: David Lifshitz. (Audio—Tape, LP)

TAPE CUSTOM DUPLICATORS

Ispaphon LTD, 7 Hamerkava St., Holon, 58851, (03) 5562212. Fax: (02) 5560938. Pres.: Issac Alshech.

Audio: Cassette.

Audio Packaging Services: Inserting, Labeling.

NMC Music Ltd., PO Box 14, 50 Tehon St., Holon, 56100, (972) 3 800191. Fax: (972) 3 800195. Mktg. Dir: Sharon Dery; Managing Dir: Danny Yadin; Sales Dir.: David Lifshitz.

Audio: Cassette.

Other Services: Warehouse, Freight, Direct Response—800 services. Credit Card Clearance Services.

COMPACT DISC MANUFACTURERS & VIDEO DISC MANUFACTURERS

C.D.I. (Compact Disc Int'l Ltd.), PO Box 6, Gan Galram, Industrial Zone, Karmiel, 20101, Israel, (04) 983-121. Fax: (04) 983-124. Managing Dir: Moshe Shomer; Joint Managing Dir.: Nir Ashkenazy; Asst. Managing Dir.: Tal Barnoach. Type: CD.

PLATING & PRESSING PLANTS

Ispaphon LTD, 7 Hamerkava St., Holon, 58851, Israel, (03) 5562212. Fax: (02) 5560938. Pres.: Issac Alshech. (LP's).

NMC Music, 50 Thon Street, 58811 Holon, PO Box 14, 56100, 03.800 191. Fax: 03.800 195. Managing Dir.: Daniel Yadin, Opons. Dir: Gabi Renitsky.

Tritone Studios, 15 Kinneret Street, Bnei Brak, 03.570 7545. Fax: 03.701 814. Studio Mgr: Guy Yaffe, Contact: Mark Rottwell. (Disc cutting).

PACKAGING & LABELING SERVICES

NMC Music, 50 Thon Street, 58811 Holon, PO Box 14, 56100, 03.800 191. Fax: 03.800 195. Managing Dir.: Daniel Yadin, Sales Dir: David Lifshitz.

CD REPLICATING SYSTEMS EQUIPMENT MANUFACTURERS

CDI Compact Disc Int'l, Gan Galram Industrial Zone, PO Box

6, 20101 Karmiel, 04.983 121. Fax: 04.983 124. Managing Dirs.: Moshe Shomer, Nir Ashkenazy.

CD Manufacturing; Annual capacity: 6 mil; Other: CD-ROM.

TAPE DUPLICATING & PROCESSING EQUIPMENT MANUFACTURERS

Ispaphon LTD, 7 Hamerkava St., Holon, 58851, (03) 5562212. Fax: (02) 5560938. Pres.: Issac Alshech.

Product(s): Gauss Duplicators & King Loaders.

TAPE EQUIPMENT MANUFACTURERS

Consultants, Nachalat Itzhak Street 58, 61330 Tel Aviv, PO Box 33019, 61330, 03.251 612. Fax: 03.265 546.

SAUDI ARABIA

RECORD LABELS

Music Master—Gassan S. El Ajou Trading Corp., PO Box 6675, Jeddah, 21452, (966-2)6607020. Fax: (966-2)6657515. Pres.: Ghassan S. El-Ajou; WEA Mgr.: Nicolas Alexandrou.

TURKEY

RECORD LABELS

Ahmet San Production, Cengiz Topel Cad. Bebek Yolu sok 17/1, Etiler, Istanbul, 01.165 5240/157 1062, Fax: 01.157 1062, Chmn: Ahmet San. Labels (lic): Carrere, Sherman Records (Ger), Five Records (Ita).

Alfa Kasetcilik Ve Muzik Production, Selanik Caddesi, 26/13 Kizilay, 06650 Ankara, 04.133 3302, Fax: 04.135 2824, Tlx: 46961, GM: Murat Kogoglu.

Balet Plak Ve Muzikkaset, IMC 6, Blok 6437, Unkapani, Istanbul, 01.522 7585/526 4169, Fax: 01.519 2996, Tlx: 22033 pop, Dir-Gen: Kadir Mertbasoglu, Chmn: Yesil Giresuntu, Sales Mgr: Adem Oner. Labels (lic): Delphine (Fra); production and distribution.

Gunes Plak Ve Kaset Yapimcilik, IMC 6, Blok 6408-6413, 34470 Unkapani, Istanbul, 01.512 3335/528 3888, Fax: 01.513 1828, President: Mustafa Gunes, Int'l Mgr: Volkan Olgun. Labels (owned): Gunes; (Lic): Roadrunner; Main product: Adult Contemporary, Jazz, Reggae, Classical, Dance, Album Rock, Black (R&B), New Age.

Kent Elektronik Sanayi Ve Ticaret, IMC 6 Blok 6302, 34470 Unkapani, Istanbul, 01.527 9518/526 3465, Fax: 01.519 1065, Tlx: 23217 plak, Dir-Gen: Mustafa Umit Guner, MD: Ali Riza Guner, Sales Mgr: Omer Cemal Borazanci, Int'l Mgr: Ayse Birkan. Labels (owned): Kent, Yenigun; (Dist): EMI, Capitol, Pathe-EMI, EMI-Electrola, EMI Italiana, EMI Bovema, Hispavox, IRS.

Milletlerarasi Muzik Yayinlari (MMY), IMC 6, Blok 6437, Unkapani, Istanbul, 01.522 7585/526 4169, Fax: 01.519 2996, Tlx: 22033 pop, President: Yesil Giresunlu, Chmn: Yasar Kekeva, MD: Kadir Mertbasoglu, Mktg Mgr: Haluk Atinc, Promo Mgr: Goksan Ozulu. Labels (lic): WEA Int'l, BMG Music Int'l, MCA, Teldec, RCA, Ariola, Arista, Motown.

Mix Records (Turkey), IMC 5, Blok 5649, 34470 Unkapani, Istanbul, 01.512 6717, Fax: 01.512 3329, President: Sahin Ozer.

Plaksan Plak Sanayi, Isiklar Caddesi Haramidere, 34010 Avclar, Istanbul, 01.591 2488, Fax: 01.590 0179, Tlx: 23185 ppas, MD: Engin Tunasar. Labels: (Lic): CGD, Polar, PolyGram.

Pop Muzik Dagitum, IMC 6, Blok 6635, 34470 Unkapani, Istanbul, 01.513 0380, Fax: 01.513 2318, Tlx: 38181 jazz, Dir: Mehmet Arman (Int'l), Ali Unal Tunali, Ergin Bener. Labels (dist): Topkapi, Yonca, Polygram, A&M, Virgin, Chrysalis, Trema, Windham Hill, Tommy Boy, JVC Japan; Main product: Jazz, Country, Reggae, Classical, Dance, Album Rock, Gold/Oldies, Black (R&B), New Age.

Topkapi Music & Video, Mesrutiyet Caddesi 113, Ece Han Kat 2, 80050 Tepebasi, Istanbul, 01.152 4235, Fax: 01.152 6274/513 2318, Tlx: 38181 jazz, Dirs: Mehmet Arman (Int'l), Ali Unal Tunali. Labels (owned): Topkapi; (Lic): A&M Records, Virgin Records, Chrysalis, Trema, Windham Hall, Tommy Boy, JVC Japan; Main product: Adult Contemporary, Jazz, Reggae, Classical, Dance, Album Rock, Gold/Oldies, New Age.

Uzelli Kaset, IMC 6, Blok 6325, 34470 Unkapani, Istanbul, 01.513 4303, Fax: 01.519 2005, Tlx: 30306 uks, President: Muammer Uzelli, Dir & Gen Mgr: Emre Ergor, Int'l Product Mgr: Elizabet Yorunk, A&R/Promo: Metin Uzelli, Mktg Mgr: Ismail Uzelli. Labels (lic): Sony Music.

Yasar Kekeva Plakcilik Sanayi, IMC 6, Blok 6439, Unkapani, Istanbul, 01.511 8271, Fax: 01.519 2996, Tlx: 22033 pop, Dir-Gen: Mustafa Kekeva, Chmn: Yasar Kekeva, MD: Selim Ataselim, Sales Mgr: Ahmet Iskenderoglu. Labels (lic): BMG, WEA; production and distribution.

Yonca Music International, Uzuncarsi Milas Han 182 Mercan, 34460 Istanbul, 01.513 3400, Fax: 01.513 302, CEO: Ergin Bener, Operations Mgr: Engin Tunasar, Label Mgr: Fatih Yildiz, Fin Mgr: Yavuz Salar. Labels (owned): Yonca, Odeon; (Lic): PolyGram, Toco Int'l.

MUSIC PUBLISHERS

Kent Muzik, IMC 6 Blok 6302, 34470 Unkapani, Istanbul, 01.527 9518/526 3465, Fax: 01.519 1065, Tlx: 23217 plak, President: Umit Guner, GM: Ali Riza Guner, Prof Mgr: Ayse Birkan.

Topkapi Music & Video, Mesrutiyet Caddesi 113, Ece Han Kat 2, 80050 Tepebasi, Istanbul, 01.152 4235, Fax: 01.152 6274/513 2318, Tlx: 38181 jazz, Dir: Mehmet Arman, Dir: Ali Unal Tunali. (Owned): Topkapi; Main product: Jazz, Reggae, Dance, Album Rock, New Age.

VIDEO PROGRAM SUPPLIERS & BUYERS

Ulusal Video Film, Kodaman sok. No. 106/107/108, Nisantasi, Istanbul, 01.141 7312/141 1356, Fax: 01.147 4740, Tlx: 26269 erk tr, GM: Turker Inanoglu, Int'l Relations: Ilker Inanoglu, Int'l TV Co-ord: Atif Ates Dagli. Film and video production and distribution network. Labels licensed: Vestron, Mega-Sat, Anderson.

RETAIL ACCESSORY SUPPLIERS

Pop Servis Muzik Sistemleri, IMC 6, Blok 6635, 34470 Unkapani, Istanbul, 01.513 0380, Fax: 01.513 2318, Tlx: 38181 jazz, Dir: Mehmet Arman (Int'l), Ali Unal Tunali, Sales Dir: Leyla Erol. Agent of Lift display/storage systems.

ASSOCIATIONS & PROFESSIONAL ORGANIZATIONS

Mesam, Kuyulu Bostan Sokak Kristal Plas Apt, Nisantasi, Istanbul, 01.132 7700. Mechanical and performing right society.

Milletlerarasi Muzik Yayinlari (MMY), Imc 6.Blok 6437 Unkapani, Istanbul, 01.519 2997/522 7585, Fax: 01.519 2996, President: Yesil Giresunlu.

Mu-Yap, IMC 5 Blok 5321, Unkapani, Istanbul. 01.528 3181 Music producers association; IFPI group.

TAPE CUSTOM DUPLICATORS

BASF Turkey, Ishan Deftardar Yokuse 3, Tophane, Istanbul 01.151 6500/12, Fax: 01.144 1673, Dir: Ernst Kappel.

Plaksan Plak Sanayi, Isiklar Caddesi Haramidere, 34010 Avclar, Istanbul, 01.591 2488, Fax: 01.590 0179, Tlx: 23185 ppas, MD: Engin Tunasar. Audio cassette duplications; Annual cap: 10 mil.

Raks Elektronik Sanayi, Cumhuriyet Bul. 69/4, 35210 Izmir. 051.122 210, Fax: 051.142 512, Tlx: 953019, President: Aslan Onel, Sales Mgr: Teoman Yurgan. Audio/video blank cassettes, duplication.

BLANK & BULK RAW TAPE

Bayer Tarim/AGFA Gevaert, PO Box 277, 80300 Mecidiyekoye, Istanbul, 01.174 2050, Fax: 01.172 7376, Tlx: 26985 bay.

UNITED ARAB EMIRATES

RECORD LABELS

Music Box, PO Box 51100, Jamal Abdul Nasser Sq., Dubai, (971) 4-233611. Fax: (971) 4-239896. Managing Partner: Mohd Ali Abou Odeh.

Music Master—Ghassan S. El-Ajou Trading Corp., PO Box 23076, Dubai, (971-4) 219080. Fax: (971-4) 277665. Pres. Ghassan S. El-Ajou; WEA Mgr.: Nicolas Alexandrou.

BLANK & BULK TAPE MANUFACTURERS

3M Gulf Ltd., PO Box 6903, Al Wahda St., Sharjah, U.A.E., (971) 6 594533, Fax: (44) 344-58730, Contact: Peter Sahyoun.

The listings contained in this publication are based solely upon information supplied to Billboard as of presstime. All information is checked for accuracy as of that time. However, Billboard is not responsible for changes in management or any other related business associations that may supersede the listings contained herein.

NORTH AMERICA**CANADA****RECORD LABELS**

AMS Records & Tapes, 635 Main St. E., Milton, ON, L9T 3J2, (416) 878-8803. Fax: (416) 878-8805. Pres./Mgr/Buyer: Thomas Baldock; Vice Pres.: Yolanda Baldock; Sales Sup.: Paul Griswold.
Branch(es): PO Box 63017, Dundas, ON, L9H 6Y3, (416) 628-1272. Fax: (416) 627-5468. (Distributor)
Label(s): (Owned) Prelude, Nautillus (Distributed); Audio: Pro-Arte, Pro-Jazz, Maxiplay, Quintessence, Cinedisc, Critic's Choice, Fanfare, Nova, Maximus, Arc Music.

Alta Record Dist. Ltd., 5326 -1A St. SE, Calgary, AB, T2H 1J2, (403) 252-7322. Fax: (403) 255-5611. Pres.: John S. Hardy; (Distributor)
Labels Distributed: Audio: Brownrigg Prods., Country Records, Emeralta (The Emeralds), Era Int'l, Haney Old Time Fiddlers, Valerie Ents. (Stan & Garnet Rogers); Video: Kd, Nova Entertainment.

Artiste Records, 154 Grande Cote, Rosemere, PQ, J7A 1H3, (514) 437-7625. Fax: (514) 430-9751. Pres.: Paul Levesque; Product Mgr.: Michael Todd; Mktg./Promo.: Lynn Barrette. Int'l Reprs.: MCA Records (Canada); Select Dist. (Canada).

Attic Records Ltd., 102 Atlantic Ave., Toronto, ON, M6K 1X9, (416) 532-4487. Fax: (416) 532-9545. Pres.: Alexander Mair; Sr. Vice Pres./Sales & Mkt.: Lindsey Gillespie; Vice Pres. Finance: Mukesh Sachdeva; Vice Pres. Promo.: Steve Waxman; Vice Pres. A & R: Brian Allon.
Label(s): (Owned) Attic Records Ltd., Attic World, (Distributed) Bandleader, Malaco, Music West, Scotti Bros.

Axe Records, 70 Craighurst Ave., Toronto, ON, M4R 1J8, (416) 487-8557. Fax: (416) 487-8557. Pres.: Greg Hambleton.

BMG Music Canada, Inc., 151 John St., Ste. 309, Toronto, ON, M5V 2T2, (416) 586-0022. Fax: (416) 586-0454. Pres./Gen. Mgr.: Don Kollar; Vice Pres. Finance: Liew Wong; Dir. Artist Mktg.: Carol Wright; Dir. Nat'l Sales: Tim Williams; Vice Pres. A & R: David Bendeth; Dir. Nat'l Promos: Larry MacRae; Dir. Special Mktg.: Norman Miller.
Branch(es): #145-2880 Glenmore Trail SE, Calgary, AB, T2C 2E7, Canada, (403) 236-2415. Fax: (403) 236-7375. Branch Mgr. Alta/Sask.: Doug Kinaschuk; 10215 178 St., Edmonton, AB, T5S 1M3, Canada, (403) 489-1059. Fax: (403) 484-7103. Sales & Promo Rep.: Michelle Smith; #207-1050 Kingsway, Vancouver, BC, V5V 3C7, Canada, (604) 872-5471. Fax: (604) 874-6825. B.C. Branch Mgr.: Bryan Boyce, Promo Rep.: Ray Ramsay; 1625 Dublin Ave., Ste. 120, Winnipeg, MB, R3H 0W3, Canada, (204) 774-4812. Fax: (204) 772-4041. Mgr. Reg'l Sales & Promos: Robert Tait; 1535 Birmingham St., 3rd Floor, Halifax, NS, B3J 2J6, Canada, (902) 455-0409. Fax: (902) 422-0748. Mgr. Reg'l Sales & Promo: Chris Jangaard; 4285 rue St-Denis, Montreal, PQ, H2J 2K9, Canada, (514) 499-9780. Fax: (514) 499-9106. Pres.: Ian Tremblay, Mktg. Coord.: Caroline Lagueux; 5500 Royalmount Ave., Ste. 330, Montreal, PQ, H4P 1H7, Canada, (514) 735-6523. Fax: (514) 735-5061. Branch Mgr.: Michel Turcot.
Label(s): (Distributed) Anxious, Arista, BMG Classics, Imago, Dedicated, Jive, RCA, Zoo Entertainment.

Beacon Distributing, PO Box 2000, Paris, ON, N3L 3X5, (519) 442-7853.

Bellevue Home Entertainment, 7215 TransCanada Hwy., St-Laurent, PQ, H4T 1A2, (514) 333-7555. (800) 361-3320. Fax: (514) 333-7309. Pres.: Sidney Greenberg; Mgr.: J'Opns.: Harry Kravitz; Buyer (Record/Tape): Ben Saragosa; Buyer (Videos): Ben Saragosa; Buyer (Accessories): Ben Saragosa; Nat'l Sales Mgr.: Barry Brooker; Finance Dir.: Mark Pereira; (Video (Cassette & Disc)) (Distributor, Importer)
Branch(es): 201 Brownslow Ave., Ste. 15, Dartmouth, NS, B3B-1W2, (902) 468-3393. (800) 565-1681. Fax: (902) 468-3197.

Branch Mgr.: Barbara Sullivan; Sales Mgr.: Brian Williams; 98 Orfus Rd., North York, Toronto, ON, M6A 1L9, (416) 785-5580. (800) 263-2974. Fax: (416) 785-1219. Branch Mgr.: Ron Brooker; 76-1313 Border St., Winnipeg, MB, R3H-0X4, (204) 694-4421. (800) 665-8012. Fax: (204) 694-7177. Sales Mgr.: Linda Morris; Sales Reprs.: Inez Tataryn, D. Laroque; 6143 Fourth St. SE, #9, Calgary, AB, T2H 2H9, (403) 258-2131. (800) 352-8296. Fax: (403) 253-3455. Branch Mgr.: Ted Rock; 11472 149th St., Edmonton, AB, T5M 1W8, (403) 453-3007. (800) 252-7907. Fax: (403) 452-8026. Sales Supervisor: Brandon Whyte; Sales Reprs.: Leslie Turner, H. Kadach; 2058 Alpha St., Burnaby, BC, V5C 5K7, (604) 299-8484. (800) 663-4559. Fax: (604) 299-8494. Western Regional Mgr.: David Veller; Sales Mgr.: Kevin Hawkin.
Labels Distributed: Video: Academy, Disney, Touchstone, Hollywood, Cinema Plus, Cineglobe, Vidmark, Celebrity, C/FP, Warren Miller, FoxVideo, Key, Playhouse, Media, Astral, Hi-Tops, Forum, RCA/Columbia, Tri-Star, Orion, World Vision, Maloffim, MCA, Alliance, IVE, F.H.E., Cineplex Odeon, Rhino, Carolco, LIVE, Virgin Vision, United, VCI, UAV, V.I.E.W., Nova, Lifestyle, Junior, Republic, Hemdale, Hanna Barbera, Sony and others.

Berandol Music, 2600 John St., Markham, ON, L3R 3W3, (416) 475-1848. Fax: (416) 474-9870. Pres.: Ralph Cruickshank.

CBC Ents., PO Box 6000, Sta. A, Montreal, PQ, H3C 3A8, (514) 597-7848. Fax: (514) 597-7862. Gen. Mgr.: Lyse Larouche; Dir. Consumer Products: Paul Gallant; Mgr. Audio Products: Jana Gonda; Coord., Publicity, Promo.: Joelle Turgeon.
Branch(es): PO Box 500, Sta. A, Toronto, ON, M5W 1E6, Canada, (416) 975-3500. Mgr., Audio Products: Jana Gonda. Label(s): (Owned) Jazzimage, Musica Viva, Passionata, SM5000.
US Reprs.: Allegro Imports (OR).
Int'l Reprs.: Olga Musik (Denmark).

CBS Records Canada Ltd., 1121 Leslie St., Don Mills, ON, M3C 2J9, (416) 447-3311, (416) 447-7196. Fax: (416) 447-6973. Pres.: Bernard DiMatteo; Sr. Vice Pres. Opns.: Jack Robertson; Vice Pres. Sales/Mktg.: Don Oates; Vice Pres. Finance: Alan Dyer. Label(s): (Owned) Epic Portrait.

Capitol Records-EMI of Canada, 3109 American Dr., Mississauga, ON, L4V 1B2, (416) 677-5050. Fax: (416) 677-1651. Pres.: Deane Cameron; Vice Pres. Sales: Al Andruschuk; Vice Pres. Mktg.: Peter Gourley; Dir. Talent/Artist: Tim Trombley.
Branch(es): 103-7180 11th St., S.E., Calgary, AB, T2H 2S9, Canada, (514) 631-9072, Contact: Danny Bertsch; 9924 Cote de Liesse, Lachine, PQ, H8T 1A1, Canada, (514) 631-9072, Contact: Val D'Amico.
Label(s): (Owned) Seraphim, Angel, Blue Note, EMI-Manhattan, Harvest, Odeon, Parlophone, Pathe-Marconi, (Distributed) Rhino, Nettwerk, Enigma, Anthem, Aquarius.

Chess Records Co MCA Records Canada, 2450 Victoria Park Ave., Willowdale, ON, M4J 4A2, (416) 491-3000. Fax: (416) 490-8206. Contact: Ross B. Reynolds.

The Children's Group, Inc., 561 Bloor St. W., Ste. 300, Toronto, ON, M5S 1Y6, (416) 538-7339. Fax: (416) 538-6042. Pres.: E.L. Gliner; Managing Dir.: Michelle Henderson; Sales & Mktg. Coord.: Carrie Beech; Opns. & Communication Coord.: Lorna Bourke.
US Reprs.: BMG Distr., Children's Book Store Distr. (NY).
Int'l Reprs.: A & M Records (Ontario, Canada).

Christian Marketing Canada, PO Box 7000, Niagara On The Lake, ON, L0S 1J0, (416) 641-0631.

Current Musical Ents., Inc., 418 Ontario St., Toronto, ON, M5A 2W1, Fax: (416) 921-7793. Pres.: Gerry Young; A & R: Trevor G. Shelton; Prod. Mgr.: Shelley-Lynn Pybus; Publicity/Promo Rep.: Angie Fyke.
Label(s): (Owned) Rammit, Current.
Int'l Reprs.: Line Music GmbH (West Germany).

D A Music, 47 Racine Rd., Rexdale, Toronto, ONT, M9W6B2, (416) 749-6601. Fax: (416) 749-3918. Pres.: Achim Neumann; CEO: Herb Heldt; Dir. Pub.: Susan Swain.

Dance Plant Records, 1492 Place Victor Hugo, Montreal, PQ, H3Y 3J2, Fax: (514) 842-7762. Pres.: Elliot Mechanic; A & R/Producer/Promo.: C. Cussy Nicodemo; Producer: John Brenner.

Destiny Records, 358 Dunlop Cres., Burlington, ON, L7L 3N7, (416) 634-2941. Contact: Jeff Johnstone.

Distribution Fusion III, Inc., 5455 Rue Pare', Ste. 101, Montreal, PQ, H4P 1P7, (514) 738-4600, Fax: (514) 737-9780, Pres.: Jim West; Gen. Mgr./Administrator: Nancy Marley; Buyer/Warehouse Mgr.: John Blazes; (Compact Disc, Pre-Recorded Audio Tape, Records (LP's)) (Distributor, Importer) Labels Distributed: Audio: Justin Time, Unity, Sea Jam, Tandem, CMC.
Labels Imported: Arhoolie, Celestial Harmonies, DRG, Conversaphone, Fortuna, King, Kuckuck, Lyrichord, Tomato, New Albion, Maze, Gramvision, Enemy, American Clave, Landmark (U.S.); Ace, Affinity, Charly, Demon, Trojan (U.K.); Enja, Wergo, Vera Bra (Germany); Atoll, Owl, OMD, Pierre, Verany, Disques Montagnes (France); Koch (Austria); Soul-Note, Black Saint Italy).

Distribution Select, 500 E. Ste-Catherine, Montreal, PQ, H2L 2C6, (514) 849-6201, Fax: (514) 849-0764, Mgr.: Aomar Dahman; (Compact Disc, Video (Cassette & Disc)) (Importer)
Labels Imported: JMS, Accord, America, Musidisc, Milan, Club du disque, Arabe, Ades, Buda, Zeta, Assimil, EPM (France); Hungaroton, White Label (Hungary); Novalis, Viola, Tuxedo (Switzerland); Master's (The Netherlands).

Distribution Trans-Canada, 2620 Transcanadienne, Pointe-Claire, PQ, H9R 1B1, (514) 336-7151. Fax: (514) 336-2095. Pres.:

Andre Gourd; Sales Dir.: Robert Lemay. Prodn./Distribution: Pierre Rodrigue, Jr.; Admin. Dir.: Chantale Reid.
Label(s): (Owned) Kebec-Disc, Saisons, (Distributed) Trema.

Distributions Madacy, 1865 Trans Canada Hwy., Montreal, PQ, H9P 1J1, (514) 683-9320. Fax: (514) 683-7848. Contact: Ron Brasseur; (Distributor).

EBS Recording & Mgmt., Inc., 2 Ruskin Ct., London, ON, N6G 1S8, (519) 473-0849, (Distributor)

Elephant Records, Inc., 24 Ryerson Ave., 4th Floor, Toronto, ON, M5T 2P3, (416) 364-3387. Fax: (416) 364-1326. Gen. Mgr.: Bob Roper.
US Reprs.: A & M (CA).

Exile Int'l, 451062 Ontario Ltd., 166 Norseman St., Toronto, ON, M8Z 2R4, (416) 234-9199, Fax: (416) 234-9197, Contact: Adrian or Ronnie; (Pre-Recorded Audio Tape, Records) (Exporter).

Fanfare Records Ltd., 467 Church St., Toronto, ON, M4Y 2C5, (416) 966-5107. Fax: (416) 966-5106. Pres.: Julian Rice; Sec.: Larry Trudel; Partner: Abe Cooper.
Label(s): (Owned) Mastersound, Fanfare.
US Reprs.: Intersound Int'l (GA); Allegro Imports (OR).

Festival Records, 3271 Main St., Vancouver, BC, V5N 1H2, (604) 879-2931, Fax: (604) 879-2931. Chief Exec.: Gay Cristall; Mgr.: Jack Schulla; Buyer (Record/Tape): Jack Schulla; (Distributor)
Labels Distributed: Audio: Aural Tradition, Flying Fish, Fogerty's Cove, Green Linnet, Kaleidoscope, Quinlar Rd., Rounder, Stash.
Pay-Per Transaction.

First Int'l Records, 11602-75 Ave., Edmonton, AB, T6G 0J2, (403) 435-2650. Gen. Mgr.: R. N. Maciver.

Fringe Product, Inc., PO Box 670, Sta. A, 12 Brant St., Toronto, ON, M5W 1G2, (416) 365-7878. Fax: (416) 869-0017. Pres.: Ben Hoffman; Gen. Mgr.: Angus Mackay.
Label(s): (Distributed) Diabolic Force, Lone Wolf, Int'l Reprs.: Electric Dist., Record Peddler (Canada).

Gamelon Music, PO Box 525, Sta. P, Toronto, ON, M5S 2T1, Gen. Mgr.: Michael Kleniec.

Gross Nat'l Product, 3625 Weston Rd., Unit #20, Weston, ON, M9L4V9, (416) 977-8777. Pres.: Johnathan Gross.
Int'l Reprs.: Somersault Records Ltd.

Handlemans Co., 10 Newgate Gate, #1-3, Scarborough, ON, M1X 1C5, (416) 298-0411. Vice Pres.: Dan Whitt; Mgr.: Craig Fukioka; Purchasing Dir.: Jane Bell; Nat'l Sales Mgr.: Keijo Puusa.
Branch(es): 7408 40th St., SE, #5, Calgary, AB, T2C 2H5, (403) 236-3868. Branch Mgr.: Georgena LeBlanc; Sales Mgr.: Joe Siegers; Sales Coord.: Sandy Townshend; 140 Barr St., Saint Laurent, PQ, H7W 1W6, (514) 341-1822. Fax: (514) 735-4003. Branch Mgr.: Mark Mariano; Opns. Mgr.: Sandra Paradis; Sales Mgr.: Pierre Bergeron; (Compact Disc, Pre-Recorded Audio Tape, Video (Cassette & Disc), Records, Computer Games) (Rackjobber).

Hoborne Distr. Co., PO Box 309, Mt. Albert, ON, L0G 1M0, (416) 841-1254. Fax: (416) 853-2955. Pres./Buyer: Frank P. Swain; Mgr.: David Giroux.
Branch(es): PO Box 309, Mount Albert, ON, L0G 1M0, (416) 841-1254. Fax: (416) 853-2955. Pres.: Frank P. Swain; PO Box 309, 120 Harry Walker Pkwy., Mount Albert, ON, L0G 1M0, (416) 841-1254. Fax: (416) 853-2955. Pres.: Frank P. Swain. (Compact Disc, Pre-Recorded Audio Tape, Video (Cassette & Disc)) (Distributor, Importer, Exporter)
Label(s): (Owned) Rodeo/Banff, Sounds of Nature, Labels Distributed: Audio: Solitudes, Rodeo, Banff, Total, Chakra, Nature Recordings, Peter Roberts, Lismore, Springhill, Transitions, Sounds Of Nature; Video: Peter Roberts, Solitudes, NSN, PONV, BBV, Invincible, World Disc, Northtrack, Namaste, Earthwoods, Kappa, Water Music.
Labels Imported: Lismor, BGS, (Scotland); Living Music, Springhill, Scarlett, Nature Recordings, Northwood, Peter Roberts, NSN (U.S.A.); ARC, Blue Flame (Germany); Larriken, Ken Davis (Australia); Edmar (Bermuda).

ISBA Records, Inc., 1327 St. Joseph E., Ste. 1, Montreal, PQ, H2J 1M1, (514) 522-4722. Fax: (514) 525-7550. Pres.: Maurice Velenosi; Label Mgr.: Steve Sechi; Sales Mgr.: Jean-Claude Aubin; Vice Pres. A & R: Larry Mancini.
Branch(es): 18 The Donway East, Ste. 607, Don Mills, ON, M3C 1X9, Canada, (416) 443-8756.
Label(s): (Owned) ISBA.

Image 7 Music, Inc., 607 W. 57th Ave., Vancouver, BC, V6P 1R8, (604) 327-7740. Fax: (604) 327-7785. Pres.: Gerry Scott; Pub. Repr.: Loretta Bonkowski; Vice Pres. A & R: Grant Saip. US Reprs.: Word (TX).
Int'l Reprs.: Word (Australia); Word Communications Ltd. (Canada).

Intersound Entertainment Canada, 1 Select Ave., Unit 10, Scarborough, ON, M1V 5J3, (416) 882-1212. Fax: (416) 609-9718.

Intrepid Records, 205/65 Jefferson Ave., Toronto, ON, M6K 1Y3, (416) 588-8962. Fax: (416) 588-4752. Pres.: Stuart Raven Hill; Vice Pres. Mktg.: Ashley Hillman; Promo.: Stephanie Heynes.

Johnny Jet Records, 1120 Hamilton St., Ste. 301, Vancouver, BC, V6B 2S2, (604) 685-2002. Fax: (604) 685-2021. Managing Dir.: John Livingston.

Justin Time Records, Inc., 5455 Rue Pare', Ste. 101, Montreal, PQ, H4P 1P7, (514) 738-9533. Fax: (514) 737-9780. Pres.: Jim West; Gen. Mgr.: Nancy Marley; Asst. A & R: Denis Barnabe; Vice Pres. A & R: Jean Pierre Leduc.
Label(s): (Owned) Just A Memory, Justin Time.
US Reprs.: Mesa, Blue Moon, Rhino (USA).
Int'l Reprs.: OMD (France); IRD (Italy); Majors Corp. (Japan); Planisphere (Switzerland); Moken Music (United Kingdom);



**DISTRIBUTION
SELECT**

**EXCLUSIVE DISTRIBUTOR
ACROSS CANADA OF THESE LABELS:**

NOVALIS-JMS-ACCORD-AMERICA
MUSIDISC-MILAN-MASTERS
CLUB DU DISQUE ARABE-ADÈS
BUDA-ZETA-ASSIMIL-TUXEDO
VIOLA-HUNGAROTON
WHITE LABEL-EPM

500, EAST STE-CATHERINE
MONTREAL, QUEBEC, CANADA, H2L 2C6
TEL: 514. 849. 6201 FAX: 514. 849. 0764

Three Little Pigs (Taiwan).
KOPS Records, 436 Queen St. W., Toronto, ON, M5V 2A8, (416) 363-3844, Chief Exec.: M. Koppel; Buyer (Record/Tape): M. Koppel, R. Bowman; Record/Tape Buyer: K. Wilson; (Records) (One-Stop).
Kids' Records, 87 Dearbourne Ave., Toronto, ON, M4K 1H6, (416) 461-0268. Fax: (416) 461-0810. Pres.: Bill Usher; Gen. Mgr./A & R: Maggie Calladine; Mktg. Mgr./Sales: Bruce Frazer; Promo. Mgr.: David Bray.
 Label(s): (Owned) Bamboo.
 Int'l Reps.: Waterlily Music (Canada).
Link Int'l, 2350 Halpern St., Ville St. Laurent, PQ, H4S 1N7, (514) 339-2732, Fax: (514) 339-2737, Pres.: Miles Flood; (Distributor, Licensing).
Liss Int'l, 65 Plage Riviera, Sainte Genevieve, PQ, H9H 4P6, (514) 696-5065, Fax: (514) 332-6720, Chief Exec.: Diane Liss; Mgr.: Ivor Liss; (Compact Disc, Video (Cassette & Disc), Records) (One-Stop, Rackjobber, Importer, Exporter).
Love Prods. Ltd., PO Box 615, Don Mills, ON, M3C 2T6, (416) 922-2909, Fax: (416) 923-4821. Chrmn.: William O. S. Ballard; Vice Chrmn.: Myron J. Wolfe; Pres./CEO: Frank Davies; Vice Pres. A & R: Frank Davies.
 Label(s): (Owned) Daffodil.
MCA Records Canada, 2450 Victoria Park Ave., Willowdale, ON, M2J 4A2, (416) 491-3000, Fax: (416) 490-8206, Pres.: Ross B. Reynolds; Vice Pres. Sales: Randy Lennox; Vice Pres. Mktg.: Stephen Tennant; Vice Pres. Opns.: Les Houston; Vice Pres. A & R: Cameron Carpenter.
 Label(s): (Owned) Chess, GRP, Geffen, MCA, (Distributed) Mechanic, Narada, Motown, Impact, Justin, Chrysalis, Duke St., Disques Traffic, Radio Active, Roadracer, TVT.

MaGaDa Int'l

5655 Terrasse Morency, St. Hubert, PQ J3Y 6Y4, (514) 678-9980. Fax: (514) 676-4174. Pres.: Robert LeMay; (Records) (Exporter).

Madacy/DMI Dist., 1865 Trans Canada Hwy., Dorval, PQ, H9P 1J1, (514) 683-9320, Fax: (514) 683-7848. Pres.: Amos Alter; Mgr.: Ronald Brasseur; Buyer (Record/Tape): Ronald Brasseur; (Distributor)
 Labels Distributed: Audio: Analekta, Canabel, DMI, EGBR, Spotlight, Sound Sensation, Sound Effects, Collection Souvenir, Classical Masterpieces, CDFX, Kiddie Collection.
Magnum Music Corp. Ltd., 8607 128 Ave., Edmonton, AB, T5E 0G3, (403) 476-8230, Fax: (403) 472-2584. Pres./Gen. Mgr.: Bill Maxim.
 Label(s): (Owned) Magnum.
The Master's Collection, 960 The Gateway, Burlington, ON, L7L 5K7, (416) 681-2760, Fax: (416) 333-6684. Pres.: Paul Young.
 Label(s): (Owned) Sharon, Pilgrim, TMC.
Merlin Records of Canada, PO Box 5087 VMPO, Vancouver, BC, V6B 4A9, (604) 525-9194. Pres.: Wilfred R. Hamann; Vice Pres. A & R: Marty Hamann.
Micah Records, 43 Applemore Rd., Scarborough, ON, M1B 1R7, (416) 298-3108. Pres.: Oswald L. Burke; Exec. Vice Pres.: Karen M. Burke; Promos. Dir.: Courtney Williams.
Midsummer Music Co., Inc., 1508 W. Second Ave., Ste. 270, Vancouver, BC, V6J 1H2, (604) 737-2347, Fax: (604) 737-2395. Pres./Buyer: Graham Way; Mgr./Music Buyer: Greg Joy; (Distributor)
 Labels Distributed: Audio: Ray Lynch Prods., Heavenly Music, Flying Fish, Midsummer, Silver Wave, Invincible, Hearts of Space, Nichols-Wright, Gourd, Northern Lights, Lumina, Miramar, Mike Strikland Prods., Oasis, Revere, Regina Musical, Moose, Jet City, Radhika Miller Music, Magic Wing, Thistlegate, Sounds of Nature.
 Pay-Per Transaction.
Music Connection, Box 270, Bentley, AB, T0C 0J0, (403) 748-2673. Pres./Mgr.: Dick Damron; Creative Dir.: Dean Preston.
 Label(s): (Owned) The Music Connection.
Music Machine Records, Box 541, Regina, SK, S4P 3A2, Branch(es):
 Label(s): (Owned) Music Machine, US Reps.: Don Le Blanc Ent's. (TN).
MusInfo Publishing Group, Inc., 2504 Mayfair St., Montreal, PQ, H4B 2C8, (514) 484-5419, Fax: (514) 484-9948. Gen. Mgr.: Jehan V. Valiquet; Mktg. Dir.: Pierre Bellini.
 Label(s): (Owned) So Far Away Music, Viceroy, Int'l Reps.: Hebra Music (Belgium).
Nettwerk Productions, 1717 W. 4th Ave., Vancouver, BC, V6J 1M2, (604) 654-2929, Fax: (604) 654-1993. Pres.: Terry McBride; Vice Pres.: Ric Arboit; Vice Pres. A & R/Publishing: Mark Jowett; Dir. Mktg.: Tonni Muruyama.
 Label(s): (Owned) Nettwerk US, US Reps.: Arista, Important (NY).
 Int'l Reps.: Capitol, I.R.S. (Canada); Play It Again Sam (Belgium).
Oak Street Music, 108-93 Lombard Ave., Winnipeg, MB, B3B 3B1, (204) 957-0085, Fax: (204) 943-3588. Pres.: Gilles Paquin; Gen. Mgr.: Ken Hiebert; Mktg. & Promos. Mgr.: Lisanne Ballantyne.
 Label(s): (Distributed) Sony Music, Int'l Reps.: Sony Music (Canada).
"ONE-STOP" Music Dists., PO Box 523, Kentville, NS, B4N 3X3, (902) 678-4201, Fax: (902) 678-4205, Mgr.: David Morse; Buyer (Record/Tape): David Morse, David Beach; Buyer (Accessories): Kevin Johnstone; Buyer: Darrell Peterson; Buyer: Loretta Reid; (Distributor)

Labels Distributed: Audio: A & M, CBS, Capitol, MCA, PolyGram, Quality, BMG, WEA, Fringe.
 Products/Accessories: CD Players: General Electric.
Plum Music, 23 Red Maple Way, Willowdale, ON, M2K 2T4, (416) 222-8845, Fax: (416) 733-2247, Owners: John & Dan Sack; Mgr.: John Sack; Buyer (Record/Tape): Fred De Luca; (Compact Disc, Pre-Recorded Audio Tape, Video (Cassette & Disc), Records) (Distributor, Importer, Exporter)
 Labels Distributed: Audio: Christophorous. Fonitcetra, Claque, Legato, Saphir, Intercord, Foyer, Laudis, Tudor, Concerto, Audite, Delfon, Mode, Herald, Urania, Attacca, Gop, Bridge, Gothic, Standing Room Only, Excelsia Musica, Royal Classics, Biographies in Music, Grammont, Bay Cities, Capstone.
 Labels Imported: Labels from Italy, Germany, USA, Austria, Switzerland & Belgium.
PolyGram, Inc./PolyGram Dist., Inc., PO Box 3040, 6000 Cote de Liesse, Saint Laurent, PQ, H4T 1E3, (514) 739-2701, Fax: (514) 739-4556. Pres.: Peter Erdmann; Exec. Vice Pres./F & A: Herbert Perera; Vice Pres. Promo./Media: Bob Ansell; Vice Pres. Product/Mktg.: Michael Theriault; Vice Pres. A & R: Corky Laing.
Praise Sound Prods. Ltd., 7802 Express St., Burnaby, BC, V5A 1T4, (604) 420-4227. Pres.: Willy Yaroshuk; Vice Pres.: Jerry Yaroshuk; Prodn. Mgr.: Metro Yaroshuk.
 Label(s): (Owned) Country Oak, Little People, Newborn, Quest, Praise, Tunesmith.
Quality Special Products, 1-480 Tapscott Rd., Scarborough, ON, M1B 1W3, (416) 420-4227. Pres.: Willy Yaroshuk; Vice Pres.: Bernie Wilcock; Dir. Sales/Opns.: Ned Talmeij; Gen. Mgr.: Steven Hecht; Mktg. Mgr.: Jennifer Baldock; A & R Mgr.: Markus Klinke.
R M P Record Sales Co. Ltd., 300 Bates Rd., Montreal, PQ, H3S 1A3, (514) 739-5662, (514) 739-8988, Fax: (514) 735-9252. Pres.: L. Faludi; Mgr./Buyer: C. Faludi; (Compact Disc, Pre-Recorded Audio Tape, Video (Cassette & Disc), Records) (One-Stop, Rackjobber).
Record Peddler, 12 Brant St., Toronto, ON, M5V 2M1, (416) 364-5507, Fax: (416) 869-0017, Pres.: Ben Hoffman; Sales Mgr.: David Raeder; Small Labels Buyers: B.Hoffman, Jack Freimanis; (Compact Disc, Pre-Recorded Audio Tape, Records (LP's, 12-Inch)) (Importer)
 Labels Imported: Alternative Tentacles, Carthage, Dischord, Mordam, Restless, R.O.I.R., Skyklad, S.S.T., Touch & Go, Cunieform, Rough Trade, Wax Trax, Taang, Buy Our Records (U.S.); B.G.O., Southern, Revolver (U.K.); Play It Again Sam (Belgium).
Records on Wheels Ltd., 255 Shields Ct., Markham, ON, L3R 8V2, (416) 475-3550, Fax: (416) 475-4163, Pres.: Vito Ierullo; Mgr.: Don Ierullo; Buyer (Record/Tape): Ron Abercrombie; Buyer (Videos): Sandra Bianchi; Buyer (Accessories): Rose

Knapp; (Compact Disc, Pre-Recorded Audio Tape, Video (Cassette & Disc), Cutouts, Overstock, Computer Games, Accessories) (Distributor, One-Stop)
 Labels Distributed: Audio: WEA, Sony, A&M, Poly, Quality, Capitol, BMG, MCA, all other majors; Video: WH, Fox, MCA, Orion, Nova, IVE, Alliance, Vestron, Media and several others.
 Labels Imported: Attick, Anthem, Quality, True North, Fringe, Network, Intrepid, Stony Plain, Star, Select, T.E. Rectrack (Canada), Inc., 2350 rue Halpern, Saint-Laurent, PQ, H4S 1N7, (514) 339-2732, Fax: (514) 339-2737. President: Miles Flood; Mgr.: Bill Lutterman; Sales & Mktg. Dir.: Alain Gamache; Nat'l Sales Mgr.: Dave Lowthian; (Distributor)
 Labels Distributed: Audio: Castle, Communications, D.C.C., Magnum Music, See For Miles, Point Prodn's, Jazz Life, Golden Hour, Onyx, Cirrus, M.C.R., Knight Riding, Blue City, Trojan, Sequel, and others.
Savannah Music, Inc., #104-5409 Eglinton Ave. W., Etobicoke, ON, M9C 5K6, (416) 620-0396, Fax: (416) 620-0398. Pres.: Brian Ferriman; Sec. Treas.: Sue Ferriman; Exec. Asst.: Sylvia Witkowski.
 Int'l Reps.: WEA (Canada).
Select Distribution, 500 East St-Catherine St., 5th Floor, Montreal, PQ, H2L 2C6.
Seventh Son Records, 41 Monkland Ave. #1, Ottawa, ON, K1S 1Y8, Contact: Stephen M. Groves.
Shannock Corp., 4222 Manor St., Burnaby, BC, V5G 1B2, (604) 433-3331, Fax: (604) 433-4815, Pres.: W.G. McCartney; Buyer (Record/Tape): Diane Chan; Buyer (Videos): Carol Martin; Sr. Vice Pres./Accy.Buyer: Uwe Schnack.
 Branch(es): 6120 Third St., SE, #8, Calgary, AB, T2H 1K4, (403) 253-2113, Fax: (403) 255-3359. Branch Mgr.: Bill Bouvette; 109 Ilsley Ave., Unit 15, Dartmouth, NS, B3B 1S8, (902) 468-2868, Fax: (902) 468-2814. Branch Mgr.: Al Caschera; 155 Duncan Mills Rd., #23, Don Mills, ON, M3B 3N2, (416) 445-3906, Fax: (416) 445-3982. Branch Mgr.: Richard Fyler; Nat'l Sales Mgr.: Ted Pierrepont; 2228 Ave. C, N., Bay D, Saskatoon, SK, S7L 6C4, Branch Mgr.: Stan Digneau; 1692 Dublin Ave., Unit 2, Winnipeg, MB, R3H 0H1, Branch Mgr.: Rafe Vogel.
 (Compact Disc, Pre-Recorded Audio Tape, Video (Cassette & Disc), Accessories) (Distributor, Rackjobber)
 Labels Distributed: Audio: A & M, BMG, CBS, Capitol/EMI, MCA, Mobile Fidelity, Pilz, PolyGram, Rectrack, Disney, WEA; Video: Academy, BMG, CBS/Fox, CineGlobe, Cinema Plus, Coliseum, HBO, HGV, Astral, RCA/Columbia, Orion, Nelson, MGM, Vestron, MCA, MPI, I.V.E., Nova, Paramount, CMV, PolyGram, Prism, Disney, Warner, Image, Pioneer LDCA.
 Labels Imported: USA: MPI, Image, Pioneer LDCA.
 Products/Accessories: CD, Tape & Record Products: Pro-

YOUR KEY TO THE CANADIAN MARKETPLACE



MAGADA



THE ONLY PROFESSIONAL ONE-STOP SPECIALIZING IN EXPORTS
 FULL SELECTION OF INDEPENDENT & MAJOR LABELS
 AVAILABLE AT ALL TIMES • COMPETITIVE PRICING,
 WE SERVICE IMPORTERS ONLY • NO DOMESTIC CUSTOMERS
 NEW RELEASE INFORMATION REGULARLY.
 C.M.P. MAGADA INT'L., 5655 TERRASSE MORENCY, ST-HUBERT, QC, CANADA J3Y 6Y4
 TELEPHONE 514-678-9980/FAXCOM 514-676-4174
 MAKE US YOUR CANADIAN PARTNER

tec; Storage & Carrying Cases: Casemakers, Satin; Blank Tape: TDK, Scotch.

Shar-V Imports Ltd., 411 Bradwick Dr., #9-10, Concord, ON, L4K 2P4, (416) 738-4666, Fax: (416) 738-4135, Pres./Buyer: Harvey Bean; (Distributor, Importer)
Products/Accessories: Blank Tape: Sunkyong; Other: C-0s & Norelco Boxes.

Signature Record & Tapes, 500 Newbold St., London, ON, N6E 1K6, (519) 686-5060. Dir.: Geoff Kaymer; Paul Steennuis.

Sizzle Records, 362 du Cheminot, Rosemere, PQ, J7A 4B2, (514) 437-8993, (514) 344-2343. Fax: (514) 437-9586. Pres.: Tee-noon Ali; Int'l Coord.: Mona Landry.

Small Horse Big Apple Records, #1, 521 21st Ave., S.W., Calgary, AB, T2S 0G9, (403) 229-0074. Pres./A&R & Promos Dir.: Mike Bezzag, Jr.; Communications: Lauren Yeung; Art, Photo, Graphics Dir.: Grant Hutchinson; Film & Video Dir.: Marino Dinapoli.

Sounds Alive, PO Box 152, West Hill Station, ON, M1E 4R5, (416) 284-7577. Owner: Michael R. Lee Shue.

Spindle Records, PO Box 559, Sta. A, Ottawa, ON, K1N 9H1, (613) 228-0001. Fax: (613) 228-1092. Owner: Peter Burnside; (Compact Disc, Pre-Recorded Audio Tape) (Exporter)
Labels Imported: Exports: All Canadian Labels; No Parallel Exports.

Starsound Ltd., 427 Yonge St., Toronto, ON, M5B 1T1, (416) 480-1267, (416) 470-7730, Fax: (416) 470-7739, Pres.: Sopher Azari; Buyer (Record/Tape): E. Stepowski, P. Sayer; Buyer (Accessories): Ahmad Azari; Dir.: Ahmad Azari; Buyer: Paul Grace; (Compact Disc, Pre-Recorded Audio Tape, Records (LP's, 12-Inch), Accessories) (Distributor, One-Stop, Importer, Exporter)
Labels Distributed: Audio: All Canadian Major & Independent Labels.
Labels Imported: Labels From Europe, North America.
Products/Accessories: Blank Tape: Maxell, TDK; Batteries: Duracell.

Stony Plain Recording Co., Ltd., PO Box 861, 9963-83 St., Edmonton, AB, T5J 2L8, (403) 468-6423. Fax: (403) 465-8941. Managing Dir.: Holger Petersen; Sec.: Alvin Jahns; Acctg./Royalties Mgr.: Linda Nichols; Export/Prodn. Mgr.: Louise McKay.
Label(s): (Distributed) Warner.
US Reps.: Bayside (CA); Rounder (MA); Sugar Hill (NC).
Int'l Reps.: Avan-Guard (Australia); Didie Frog (France); Pony Canyon (Japan); Amigo Musik (Sweden).

Total Sound, 10333 174th St., Edmonton, AB, T5S 1H1, (403) 483-3217, Fax: (403) 486-0589, Chief Exec.: Ray Vallee, Ken Jordan; Buyer (Record/Tape): T. Byers, T. Hyska; Buyer (Videos): T. Byers, T. Hyska; Buyer (Accessories): T. Byers, T. Hyska; Chief Exec.: Al Herfst; Opns. Mgr.: Aria Horn; (Distributor)
Labels Distributed: Audio/Video: All Major & Minor Labels. Products/Accessories: CD Players: Sanyo, G.E., Denon; Audio & Video Playback Equipment: G.E., Sanyo; CD, Tape & Record Products: General Films, Proturn, Allsop, Recoton; Storage & Carrying Cases: Labo, General Films, Savoy, Sotto, Ringo; Video Cassette Recorder: Sanyo, G.E.; Blank Tape: TDK, Maxell, Sony, Denon, SKC; Head Phones: General Films, SKC; Batteries: Eveready; Diamond Needles: General Films.

Trend Music Group, Inc., 47 Racine Rd., Unit 6, Rexdale, ON, M9W 6B2, (416) 749-6601, Fax: (416) 749-3918, Pres.: Jack Inhaber; Mgr.: Jerry Hochman; Buyer (Record/Tape): Jeff Bolter; Buyer (Videos): Neil Inhaber; Buyer (Accessories): Tyrone Biljan; Buyer (Other): Abbey Sholzberg; (Compact Disc, Pre-Recorded Audio Tape, Video (Cassette & Disc), Records (LP's, 12-Inch, Singles)) (Distributor, Importer)
Labels Distributed: Audio: Acoustic Disc, Adelphi, Bescol, Capriccio, Carlton Showband, Castle, CBS (Sony) Special Products, Celluloid, Chiaroscuro, CMG, Collegium, Compose, D.A. Music, Delmark, Everest, Fiesta, Fifth Continent, Flat Town, Flying Fish, Gecko, GNP Crescendo, Higher Octave, Hindsight, Innovative Communication, Jackal, Jewel/Ronn/Paula, Laserlight, Little Major, Living Language, Merymen, Monitor, Muse, others; Video: Parade, Triloka, Stash, America Powersport.
Products/Accessories: CD, Tape & Record Products: Pro Wipes;

Underground Records, 2938 Bayview Ave., North York, ON, M2N 5K5, Pres.: Craig Coyle; (Compact Disc, Records (Singles)) (Distributor, Importer, Exporter)
Labels Distributed: Audio: Underground, Laurie, Stardust, Ripete, Eric, American Pie.
Labels Imported: Import: Eric, American Pie, Laurie, Repete (USA); Export: Underground, Stardust.
Products/Accessories: Other: The Chum Chart Book.

Venutian Records, 436 Queen St. W., Toronto, ON, M5V 2A8, (416) 363-3844, Fax: (416) 360-6787, CEO/Buyer (Music): R. Bowman; Mgr./Buyer (Other): M. Koppel; Buyer (Other): K. Wilson; (Records) (Wholesaler/Retailer)

Video Globe 1, 398 Isabey St., Ville St. Laurent, PQ, H4T 1V3, (514) 738-6665, (800) 361-7151, Fax: (514) 738-3923, Vice Pres./Gen. Mgr.: Jean Trudel; Sales Mgr.: J. Berard; (Video (Cassette & Disc)) (Distributor)
Labels Distributed: Video: See "Video One Canada" Ontario Listing For Product Line.

Video One Canada Ltd., 93 Skyway Ave., Unit 101, Etobicoke, ON, M9W 6C7, (416) 674-0192. Fax: (416) 674-8725. Pres./CEO: R. J. McCloskey; Buyer (Videos): Barb Estey; Buyer (Accessories): Lisa Dyble.
Branch(es): 105-2550 Boundary Rd., Burnaby, BC, V5M 3Z3, (604) 437-4473, (800) 242-0648. Fax: (604) 432-6926. Vice

Pres./Gen. Mgr.: Andy Skerratt; Sales Mgr.: W. Froese; 11133 156th St., Edmonton, AB, T5M 1X9, (403) 451-9060. (800) 661-9635. Fax: (403) 452-1783. Gen. Mgr.: Sue McArthur; 6023 Fourth St., S.E., Calgary, AB, T2H 2A5, (403) 258-3880. Fax: (403) 252-3176, 10 Morris Dr., Unit 40, Dartmouth, NS, B3B 1K8, (902) 466-0661. Fax: (902) 468-2260. Gen. Mgr.: Kathy Day; 520 Edinburgh Dr., Moncton, NB, E1E 4C6, (506) 857-2917. Fax: (506) 857-1700. Gen. Mgr.: Gerry Boulay; 7-130 Robin Crescent, Saskatoon, SK, S7L 6M7, (306) 933-4930. Fax: (306) 933-4139. Gen. Mgr.: Tara Rose; Stn. A, Box 13010, 21 Mews Pl., Saint John's, NF, A1B 3V8, (709) 754-3437. Fax: (709) 754-3230. Sales Mgr.: Barry James; 1832 King Edward St., #12, Winnipeg, MB, R2R 0N1, (204) 694-6007. Fax: (204) 694-0928. Gen. Mgr.: Gerry Ward; 640 Wilton Grove Rd. W., Units 1-2, London, ON, N6A 4C2, (519) 685-1502. (800) 265-6054. Fax: (519) 668-2059. Gen. Mgr.: Rudy Eysens; 105 Scarsdale Rd., Toronto, ON, B3B 2R2, (416) 447-9600. (800) 387-0184. Fax: (416) 447-7775. Gen. Mgr.: Rick McCloskey; Sales Mgr.: Scott McGregor; 2285 St. Laurent Blvd., #A-11 & 13, Ottawa, ON, K1G 4Z4, (613) 521-1202. Fax: (613) 521-8385. Gen. Mgr.: Howie McCann; 450 Matheson Blvd. E., #48-49, Mississauga, ON, L4Z 1R5. (Video (Cassette & Disc)) (Distributor)
Labels Distributed: Video: Academy, Astral, HBO, CBS/FOX, Disney, CBS Canada, Touchstone, Media, RCA, Hi-Tops, Republic, Trylon, Celebrity, Vidmark, C.F.P., Xenon, Coliseum, Southgate, MGM, Nelson, Orion, F.H.E., IVE, Alliance, Malo Film, Norstar, Junior, Lifestyle, Nova, Paramount, Prism, Warner, Vestron, Forum, MCA.
Products/Accessories: CD, Tape & Record Products: Scotch brand video cassette head cleaners; Storage & Carrying Cases: Video Storage Cases, VCR Carrying Cases; Blank Tape: Scotch (Audio & Video), Casin (Video).
VidPro U.S.A., 991 Matheson Blvd., Unit 2, Mississauga, ON, L4W 2V3, (416) 624-5202. Fax: (416) 624-5046. Pres.: Willem Bake; Mgr.: Joe Crayhon.

W.E.A. Music of Canada, 1810 Birchmount Rd., Scarborough, ON, M1P 2J1, (416) 291-2515.

Warner Music Canada Ltd., 1810 Birchmount Rd., Scarborough, ON, M1P 2J1, (416) 291-2515. Fax: (416) 291-9253. Pres.: Stan Kulin; Sr. Vice Pres./Managing Dir. U.S. Div.: Garry Newman; Sr. Vice Pres./Managing Dir. Int'l Div.: Dave Tollington; Mktg. Mgr.-Domestic: Karen Shook; Mktg. Mgr.-Int'l: Bruce MacFavish; Vice Pres. Nat'l Promo/Special Proj.: Kim Cooke; Nat'l Publicity Mgr.: Jan Crabtree; Nat'l Artist Rel. Mgr.: Roger Desjardins; Mktg. Mgr.-Elektra: Doug Raafaub; Sr. Vice Pres./CFO: Claude Sasson; Mktg. Mgr.-Atlantic: Randy Sharrard; Vice Pres. Nat'l Promo-Dom/Int'l: Randy Stark; A & R Mgr.: Greg Torrington.
Branch(es): 75 Ontario Ave., Hamilton, ON, L8N 2X1, (416) 522-3663. Fax: (416) 522-6433. Sales: Ken Green; 6325 12th St. E., Unit 12, Calgary, AB, T2H 2K1, (403) 259-3000. Fax: (403) 255-3992. Sales: Alex Clark, Sandy Gottwald; 10215 178th St., Edmonton, AB, T5S 1M3, Fax: (403) 484-0524. Sales (403) 489-0240: Lina Botto, Sales (403) 489-0024: Marilyn Brodeur; 68 Water St., #400, Vancouver, BC, V6B 1A4, (604) 684-7417. Fax: (604) 684-2839. Sales: Peter Moser, Gail Basaraba; 1625 Dublin Ave., Winnipeg, MB, R3H 0W3, (204) 783-2346. Fax: (204) 788-0242. Sales: Jeff Story; 24 Northview Ave., Moncton, NB, E1C 8Z1, (506) 389-2538. Fax: (506) 389-9141. Sales: John Poirier; 6301 Quinpool Rd., Halifax, NS, B3L 1A4, (902) 852-4278. Fax: (902) 852-3739. Sales: Wendy Salsman; 465 Castlegrove Blvd., #402, London, ON, N6G 3R8, (519) 473-1456. Fax: (519) 473-2189. Sales: Ken Berry; 111 Colonnade Rd., Ste. 205, Nepean, ON, K2E 7M3, (613) 723-8201. Fax: (613) 723-7984. Sales: Mary Armstrong; 11 Robinson Crescent, Regina, SK, S4R 3R1 (306) 545-5905. Fax: (306) 775-3315. Sales: Kevin Korchinski; 7272 Rue des Grebes, Charny, PQ, G6X 2B9, (418) 832-7011. Fax: (418) 832-7028. Sales: Luc Laroche; 145 Rue Barr #1, St. Laurent, PQ, H4T 1W6, (514) 731-6401. Fax: (514) 738-3051. Sales: Ken Dion, Lisa Melanson.
Label(s): (Owned) Atco, Atlantic, East West Records America, Elektra Entertainment, Erato, Teldec, Warner Bros., Nonesuch, Reprise, Sire, (Distributed) Select, Slash, Savannah, Qwest, Risque Disque, Ruthless, Opal, Pendulum, PWL, Megaforce, Metal Blade, Mute, Modern, WEA, Worldwide, ZTT, Swan Song, Tommy Boy, Stony Plain, Es Paranza, Elektra/Musician, Duck, Dark Horse, East West, Eternal, First Priority, Great Pacific, Giant, Hollywood, In-Effect, Luke, Interscope, Cold Chillin', Cotillion, Alligator, Asylum.
Int'l Reps.: Sunrise, Saturn, ROW, SIL, Handelman, HMV, Pindoff, Roblan's (Ontario, Canada).

Word Communications, Ltd., PO Box 6900, 7720 Alderbridge Way, Vancouver, BC, V6B 4B5, (604) 270-7231. Fax: (604) 270-0821. Pres.: Terry Dawes; Vice Pres. Finance: Egon Dickau; Nat'l Sales Mgr.: Wayne Zeitner; Nat'l Sales Mgr.: Publish: Lana Bills.
Label(s): (Owned) Canaan, Dayspring, Myrrh, Word, Inc., (Distributed) Soulkeeper, Meadowgreen, Maranatha, Micah, Pakaderm, Pan-Trax, Reunion, Rejoice, Diadem, Command, Broken, Fingerprint, Good News, Home Sweet Home, Harvest, Image 7, King Communications, Live Oak, Light.

Buyer: Patricia DiGiovanni, Nat'l Acct. Mgr.: Julian Grant. Supplies: Exercise, Feature Films, Instructional, Special Interest Only, Sports.
Formats: VHS.
Seeking: Exercise, Feature Films, Instructional, Special Interest Only, Sports.

MCA HOME VIDEO CANADA, 2450 Victoria Park Ave., Willowdale, ON, M2J 4A2, (416) 491-3000. Fax: (416) 494-3990. Pres.: Eric W. Pertsch, Sales Mgr.: Steve Dorman. Supplies: Exercise, Feature Films, Instructional, Music Long Form, Sports.
Formats: VHS, Beta, LaserVision.

PATHWAY PRODNs., INC., 406-360 Bloor St. W., Toronto, ON, M5S 1X1, (416) 922-4506. Fax: (416) 922-7335. Pres.: Dr. F.G. Sommers.
Supplies: Instructional, Special Interest Only.
Formats: VHS, Beta.

PRISM ENTERTAINMENT, 401 Richmond St. W., Ste. 385, Toronto, ON, M5V 1X3, (416) 340-1735. Fax: (416) 340-6309. Gen. Mgr.: Don Rankin.
Supplies: Feature Films.
Formats: VHS, Beta.
Seeking: Feature Films.

SARI COLT MUSIC TALK, 151 Sterling Rd., Toronto, ON, M6R 2B2, (416) 535-7234.
Supplies: Music Long Form.
Formats: VHS, Beta.

MUSIC PUBLISHERS

AboveWater Music, (SOCAN) (See Attic Music, Ltd.).
Agincourt Music, (SOCAN) (See W/A Music Corp.).
Alfred (Canada) Ltd., 487 Westney Rd., South #1, Ajax, ON, L1S 6W7, (416) 428-7790. (800) 263-3131. Gen. Mgr.: Allan Ward.

Angebec Music, (SOCAN) (See Halben Music Publishing, Inc.).

Attic Music, Ltd., 102 Atlantic Ave., Toronto, ON, M6K 1X9, (416) 532-4487. Fax: (416) 532-9545. Pres.: Alexander Mair; Vice Pres.: Brian Allen; Prof./Creative Mgr.: Joe Frey.

Gene Autry Music Group, (BMI/ASCAP) (See BMG Music Publishing Canada, Inc.).

Axe Music, (SOCAN) 70 Craighurst Ave., Toronto, ON, M4R 1J8, (416) 487-8557. Fax: (416) 487-8557. Pres.: Greg Hambleton.

BMG Music Publishing Canada, Inc., (SOCAN) 151 John St., #309, Toronto, ON, M5V 2T2, (416) 586-0022. Fax: (416) 586-0454. Gen. Mgr.: Dianna Rybak; Prof. Mgr.: Terry O'Brien.

Banff Music, (SOCAN) PO Box 309, Mount Albert, ON, L0G 1M0, (416) 841-1254. Fax: (416) 853-2955. Pres.: Frank P. Swain.

Beggars Banquet/Momentum, (CAPAC) (See PolyGram Music Publishing, Inc.).

Belsize Park Music, (See Axe Music).

Berandol Music Ltd., 2600 John St., Markham, ON, L3R 3W3, (416) 475-1848. Fax: (416) 474-9870. Pres.: Ralph Crmikishank.

Betanne Music, (SOCAN) (See Halben Music Publishing, Inc.).

Betty Songs, (PROCAN) (See PolyGram Songs, Inc.).

Big Bay Music, (PROCAN) (See TMP: The Music Publisher).

Blackwing Music, (CAPAC) (See TMP: The Music Publisher).

Blue Vision Music, (PROCAN) (See PolyGram Songs, Inc.).

Bon Jovi Publishing, (CAPAC) (See PolyGram Music Publishing, Inc.).

Branch Group Publishing, #108-93 Lombard Ave., Winnipeg, MB, R3B 3B1, (204) 957-5663. Fax: (204) 943-3588. Pres.: Gilles Paquin; Gen. Mgr.: Ken Hiebert; Mgr. Mktg. & Promos: Lisanne Ballantyne.

Brand New Sounds Music, (PROCAN) (See Current Musical Ents. Inc., Current Sounds).

Bright Music, (See Attic Music, Ltd.).

Cabot Trail Music, (SOCAN) (See Morning Music Ltd.).

Cameo Catalogue, (CAPAC) (See PolyGram Music Publishing, Inc.).

Cancon Music, (SOCAN) 23 Lascelles Blvd., Ste. 1802, Toronto, ON, M4V 2B9, (416) 483-4473. Pres.: Robert H. Hahn.

Carisse Music, (PROCAN) (See Savannah Music Group).

Carisse & Rawlins Publishing Co., (PROCAN) (See Savannah Music Group).

Cedarwood Publishing Co., (PROCAN) (See PolyGram Songs, Inc.).

Cee & Cee Music, (CAPAC) (See Plumetree Music).

Certain Image Publishing, (CAPAC) (See Image 7 Music, Inc.).

Chinook Music, (SOCAN) (See Sparwood Music).

Collins Music, (BMI/ASCAP) (See BMG Music Publishing Canada, Inc.).

Complete Music, (See Nettowboard Publishing/TWK Publishing, Attic Music, Ltd.).

Coopro Music, (BMI) (See Cancon Music).

Corp. Rock Music, Inc., (SOCAN) 154 Grande Cote, Rosemere, PQ, J4A 1H3, (514) 437-7625. Fax: (514) 430-9751. Pres.: Paul Levesque; Prof./Creative Mgr.: Michael Todd.

Coup D'Etat Music, (BMI) (See Cancon Music).

Crown-Vetch Music, (SOCAN) (See Morning Music Ltd.).

Current Musical Ents. Inc., 418 Ontario St., Toronto, ON, M5A 2W1, Pres.: Gerry Young; A&R: Trevor G. Shelton; Product Mgr.: Shelley-Lynn Pybus; Publicity/Promo. Rep.: Angie Fyke.

Current Sounds, (CAPAC) 366 Adelaide St. E., #437, Toronto, ON, M5H 3X9, (416) 361-1101. Fax: (416) 867-9501. Pres.: Gerry Young.

HOME VIDEO COMPANIES (Theatrical, Music & Special Interest)

BFS LTD.— BFS VIDEO, 350 Newkirk Rd., Richmond Hill, ON, L4C 3G7, (416) 884-2323. Fax: (416) 884-8292. Pres.: Denis B.E. Donnelly, Sales Mgr.: Julian Grant, Program

Willin David Music/Blue Skyriider Music, (BMI) (See BMG Music Publishing Canada, Inc.).
Downchild Music, (See Attic Music, Ltd.).
EMI April Music (Canada) Ltd., (CAPAC) (See EMI Music Publishing Canada).
EMI Blackwood Music (Canada) Ltd., (PROCAN) (See EMI Music Publishing Canada).
EMI Music Publishing Canada, (SOCAN) 300 Richmond St. W., 2nd Floor, Toronto, ON, M5V1X2, (416) 345-9277. Fax: (416) 345-9284. Pres.: Hank Medress; Prof./Creative Mgr.: Raine Munro.
Ellymax Music, (BMI) (See TMP-The Music Publisher).
Eyeball Wine, (See Stony Plain Music).
Fairplay, (See Nettoverboard Publishing/NTWK Publishing).
Fat Brothers Music, (PROCAN) (See PolyGram Songs, Inc.).
Filmtrax PLC, (PRS) (See BMG Music Publishing Canada, Inc.).
Freewheeled Music, (CAPAC) (See Partisan Music Prods., Inc.).
GABRO Publishing, (SOCAN) (See ISBA Music Publishing, Inc.).
Gamelon Music, (SOCAN) PO Box 525, Sta. P, Toronto, ON, M5S 2T1, Gen. Mgr.: Michael Kleniec.
Gibb Bros. Music, (BMI) (See BMG Music Publishing Canada, Inc.).
Go! Discs Music, (CAPAC) (See PolyGram Music Publishing, Inc.).
Gone Fishin' Music Ltd., (BMI) RR #1, Madeira Park, BC, V0N 2H0, (604) 883-2120. Pres./Prof. Mgr.: Terry Jacks; Gen. Mgr.: Maggi Jacks.
Gralto Music, Ltd., (PROCAN) (See PolyGram Songs, Inc.).
Gullwing Music, (CAPAC) (See TMP-The Music Publisher).
Gwyneth Music, Ltd., (PROCAN) (See PolyGram Songs, Inc.).
Halben Music Publishing, Inc., (SOCAN) PO Box 4985, Saint Laurent, PQ, H4L 4Z6, (514) 744-3277. Fax: (514) 935-6098. Pres.: Ben Kaye.
Hannah's Eyes/Straight Lace Music, (BMI/ASCAP) (See BMG Music Publishing Canada, Inc.).
Happy Valley Music, (See Attic Music, Ltd.).
Hat Trick Music, (CAPAC) (See Savannah Music Group).
High River Music Publishing, (ASCAP) (See Ramblin' Man Music Publishing).
Home Cooked, (SOCAN) (See Don Valley Music/Home Cooked Music).
ISBA Music Publishing, Inc., (SOCAN) 1327 Blvd. St. Joseph E., Ste. 1, Montreal, PQ, H2J 1M1, (514) 522-4722. Fax: (514) 525-7550. Pres.: Larry Mancini; Gen. Mgr.: Maurice Velenosi.
Image 7 Music, Inc., 10551 Shellbridge Way, Ste. 35, Richmond, BC, V6X 2W9, (604) 270-2707. Fax: (604) 270-2773. Pres.: Gerry Scott; Vice Pres.: Grant Saip.
In-Tranzit Music, (SOCAN) (See Halben Music Publishing, Inc.).
Incubus Music, (BMI) (See Cancon Music).
Interlude Music Int'l, (PRO/SDE) (See Intermede Publishing, Inc.).
Intermede Publishing, Inc., 285, Place d'Youville, Ste.3, Montreal, PQ, H2Y 2A4, (514) 842-8661. Fax: (514) 843-8278. Pres.: Christopher J. Reed.
Intrepid Music Publishing, (SOCAN) 205/65 Jefferson Ave., Toronto, ON, M5K1Y3, (416) 588-8962. Fax: (416) 588-4752. Pres.: Stuart Raven-Hill; Gen. Mgr.: Graham Stairs.
Island Music, (CAPAC) (See PolyGram Music Publishing, Inc.).
Ivan, Ltd., (PROCAN) (See PolyGram Songs, Inc.).
Jah Music Co., (SOCAN) (See Morning Music Ltd.).
Dick James Music, Ltd., (PROCAN) (See PolyGram Songs, Inc.).
JaniJam Music, (SOCAN) (See Justin Time Publishing).
Jenimar Music, (SOCAN) (See Morning Music Ltd.).
Job Music, (PROCAN) (See Micah Music).
Justin Time Publishing, (SOCAN) 5455 rue Pare, Ste. 101, Montreal, PQ, H4P 1P7, (514) 738-9533. Fax: (514) 737-9780. Pres.: Jim West; Gen. Mgr. Publishing: Denis Barnabe'.
Ben Kaye Music, (SOCAN) (See Halben Music Publishing, Inc.).
Kayjam Music, (SOCAN) (See Halben Music Publishing, Inc.).
Kimbleco West Music, (See Stony Plain Music).
Kitchen Table Music, (See Stony Plain Music).
L&N Music, (BMI/SODRA) (See P & N Publishing).
Don Leblanc Ent's., PO Box 516, Sta. T, Toronto, ON, M6B 4C2, Branch(es): PO Box 41214, Nashville, TN, 37204; PO Box 541, Regina, SK, S4P 3A2, Canada.
Legit Music, (CAPAC) (See TMP-The Music Publisher).
Les Editions Confidentielle, (See Nettoverboard Publishing/NTWK Publishing).
Lido Music, (See Attic Music, Ltd.).
Lilbec Music, (SOCAN) (See Halben Music Publishing, Inc.).
Lilly Music, (SODRAC) (See P & N Publishing).
Little Big Town Music Group, (BMI/ASCAP) (See BMG Music Publishing Canada, Inc.).
Lobstick Music, (See Stony Plain Music).
Love-Lies-Bleeding, (PROCAN) (See Partisan Music Prods., Inc.).
MCA Music, (See Nettoverboard Publishing/NTWK Publishing).
Magnetic Movements, (CAPAC) (See Partisan Music Prods., Inc.).
Malaco Music, (See Attic Music, Ltd.).
Manhole Music, (SOCAN) 11602-75 Ave., Edmonton, AB, T6G 0J2, (403) 435-2650. Pres.: Neil MacIver; Gen. Mgr.: Frank Phillet.
McLauchlan Music, (CAPAC) (See TMP-The Music Publisher).
Medmenham Abbey Music, (CAPAC) (See Partisan Music

Prods., Inc.).
Megemikate Music, (ASCAP) (See Partisan Music Prods., Inc.).
Melbourne Music, (SOCAN) (See Banff Music).
Micah Music, (CAPAC) 43 Applemore Rd., Scarborough, ON, M1B 1R7, (416) 298-3108. Pres.: Oswald Burke; Gen. Mgr.: Karen Burke.
Middle Age Music, (ASCAP) (See Cancon Music).
Mind & Body, (CAPAC) (See PolyGram Music Publishing, Inc.).
Misty Music, (See Nettoverboard Publishing/NTWK Publishing).
Morning Music Ltd., (SOCAN) 5200 Dixie Rd., Ste. 203, Mississauga, ON, L4W 1E4, (416) 625-2676. Fax: (416) 625-2092. Pres.: Mark Altman.
Mt. Albert Music, (SOCAN) (See Banff Music).
NV Publishing, (CAPAC) (See Intrepid Music Publishing).
Nettverboard Publishing/NTWK Publishing, (SOCAN/BMI/ASCAP) 1717 W. Fourth Ave., Vancouver, BC, V6J 1M2, (604) 654-2929. Fax: (604) 654-1993. Pres.: Terry McBride; Gen. Mgr.: Ric Arboit; Prof./Creative Mgr.: Mark Jowell.
New Jersey Underground Music, (CAPAC) (See PolyGram Music Publishing, Inc.).
Oak Street Music, (See Branch Group Publishing).
P & N Publishing, (ASCAP) 61 Euphrasia Dr., Toronto, ON, M6B 3V8, (416) 782-5768. Pres.: Nicola DiMatteo; Gen. Mgr.: Panfilo Dimatteo; Prof./Creative Mgr.: Panfilo Dimatteo.

Partisan Music Prods., Inc., 1670 Bayview Dr., Toronto, ON, M4G 3C2, (416) 932-0244. Fax: (416) 932-0248. Pres.: Francis Davies; Gen. Mgr.: Vicki Walters; Prof./Creative Mgr.: William Skinny Tenn.
Peer Int'l (Canada) Ltd., (SOCAN) 180 Bloor St. W., Ste. 300, Toronto, ON, M5S 2V6, (416) 924-5781. Fax: (416) 924-9966. Managing Dir.: Greg Hambleton.
Peer Int'l, (PROCAN) (See Southern Music Publishing Co. (Canada) Ltd.).
Peermusic, (See Southern Music Publishing Co. (Canada) Ltd.).
Plumtree Music, (PROCAN/BM) 110A Sackville St., Toronto, ON, M5A 3E7, (416) 869-1872. Fax: (416) 869-1873.
PolyGram Music Publishing, Inc., (CAPAC) 939 Warden Ave., Scarborough, ON, M1L 4C5, (514) 842-8663. Fax: (514) 843-8278. Pres.: Peter Erdmann; Gen. Mgr.: Christopher J. Reed; Professional Mgr.: Celine Prevost.
PolyGram Songs, Inc., (PROCAN) 939 Warden Ave., Scarborough, ON, M1L 4C5, (514) 842-8663. Fax: (514) 843-8278. Pres.: Peter Erdmann; Gen. Mgr.: Christopher J. Reed; Professional Mgr.: Celine Prevost.
Branch(es): 810 Seventh Ave., New York, NY, 10019, (212) 333-8528.

Pondwater Music, (SOCAN) (See Attic Music, Ltd.).
Prehensile Publishing Co., (PROCAN) (See Savannah Music Group).
Rainy River Music Ltd., (SOCAN) (See Halben Music Publishing, Inc.).
Ramblin' Man Music Publishing, (SOCAN/BMI) 8607-128th Ave., Edmonton, AB, T5E 0G3, (403) 476-8230. Fax: (403) 472-2584. Pres./Gen. Mgr.: Bill Maxim; Professional Mgr.: Colleen Maxim.
Rammit Noise, (SOCAN) (See Current Musical Ent's, Inc.).
Reels of Rhyme, (PROCAN) (See Partisan Music Prods., Inc.).
Robco Music, (ASCAP) (See Cancon Music).
Rockfish Music, (BMI) (See Gone Fishin' Music Ltd.).
Rodeo Music, (SOCAN) (See Banff Music).
Sabal Music, Inc., (CAPAC) (See PolyGram Music Publishing, Inc.).
Savannah Music Group, (PROCAN) 5409 Eglinton Ave., #104, W., Etobicoke, ON, M9C 5K6, (416) 620-0396. Fax: (416) 620-0398. Pres.: Brian Ferriman.
Savoir Faire Music, (SOCAN) (See Corp. Rock Music, Inc.).
Sawgrass Music Publishing, Inc., (PROCAN) (See PolyGram Songs, Inc.).
Silversongs, (PROCAN) (See Savannah Music Group).
Skinner's Pond Music, (SOCAN) (See Morning Music Ltd.).
Small Horse Big Apple Music, (PROCAN) #1, 521 21st Ave., SW, Calgary, AB, T2S 0G9, (403) 229-0074. Pres.: Mike Bezzeg, Jr.; Gen. Mgr.: Frank Lockwood.
Al Snug Music, (PROCAN) (See PolyGram Songs, Inc.).
Sold For A Song, (CAPAC) (See Partisan Music Prods., Inc., TMP-The Music Publisher).
A Song For You, (PROCAN) (See Partisan Music Prods., Inc., TMP-The Music Publisher).
Sony Songs, (See Nettoverboard Publishing/NTWK Publishing).
Soul Survivor, 436 Queen St. W., Toronto, ON, M5V 2A8, (416) 363-3844. Pres.: M. Koppel; Gen. Mgr.: M. Koppel.
South Harbour Music, (PROCAN) (See Savannah Music Group).

Southern Music Publishing Co. (Canada) Ltd. (CAPAC) 180 Bloor St. W., Ste. 300, Toronto, ON, M5S 2V6, (416) 924-5781. Fax: (416) 924-9966. Mgr.: David Baxter.

Southern Music (South Africa), (See Peer Int'l (Canada) Ltd.).
Sparwood Music, (SOCAN) PO Box 270, Bentley, AB, T0C 0J0, (403) 748-2673. Pres./Gen. Mgr.: Dick Damron; Prof./Creative Mgr.: Dean Preston.
Special Songs, (CAPAC) (See Savannah Music Group).
Speckled Bird Music, (SOCAN) (See Morning Music Ltd.).

Stony Plain Music, PO Box 861, Edmonton, AB, T5J 2L8, 9963-83 St., Edmonton, AB, T6A 3N3, (403) 468-6423. Fax: (403) 465-8941. Managing Dir.: Holger Petersen.
Sunfish Music, (SOCAN) (See Gone Fishin' Music Ltd.).
Sunshot Music, (SOCAN) (See Halben Music Publishing, Inc.).
Frank Swain Music, (SOCAN) (See Banff Music).
TMP-The Music Publisher, 29 Birch Ave., Toronto, ON, M4V 1E2, (416) 922-2909. Fax: (416) 923-4821. Pres.: Frank Davies; Gen. Mgr.: Vicki Walters; Professional Mgr.: Michelle Nagel.
Teo & Teo Music, (SOCAN) (See Halben Music Publishing, Inc.).
Today's Tunes Music, (PROCAN) (See Current Musical Ent's, Inc.).
Topi-Tambo Music, (SOCAN) (See Banff Music).
Transfer Music, (SOCAN) (See Corp. Rock Music, Inc.).
Tranzit Music, (SOCAN) (See Halben Music Publishing, Inc.).
Don Valley Music/Home Cooked Music, (SOCAN) 1810 Birchmount Rd., Scarborough, ON, M1P 2J1, (416) 291-2515. Fax: (416) 291-9253. Pres.: Stan S. Kulin; Gen. Mgr.: David Tollington; Prof. Mgr./Creative Mgr.: Greg Torrington.
W/A Music Corp., (SOCAN) PO Box 9, Sta. O, Toronto, ON, M4A 2M9, (416) 299-2222. Fax: (416) 299-2232. Gen. Mgr.: Joyce Matheson.
Warner-Chapel, (See Nettoverboard Publishing/NTWK Publishing).
Web IV, (CAPAC) (See PolyGram Music Publishing, Inc.).
Welk Music Group, (CAPAC) (See PolyGram Music Publishing, Inc.).
West Hill Music, (SOCAN) (See W/A Music Corp.).
Whitewing Music, (CAPAC) (See TMP-The Music Publisher).
Wintrup Musik, (See Nettoverboard Publishing/NTWK Publishing).
Wood Monkey Music, (ASCAP) (See TMP-The Music Publisher).
Wrensong/Reynsong Music, (BMI/ASCAP) (See BMG Music Publishing Canada, Inc.).
Zauber Music Publishing, (SOCAN) PO Box 5087, VMPQ, Vancouver, BC, V6B 4A9, (604) 525-9194. Pres.: Wilfred R. Hamann; Prof./Creative Mgr.: Marty Hamann.

SHEET MUSIC & FOLIO SUPPLIERS

Music Box Dancer Pub., 2600 St., #220, Markham, ON, L3R 3W3, (416) 475-1848. Pres./Prof. Mgr.: John Loweth; Gen. Mgr.: Ken Stuart.
Musinfo Publishing Group, 2504 Mayfair Ave., Montreal, PQ, H4B 2C8, (514) 484-5419. Fax: (514) 484-9948. Pres.: Jehan V. Valiquet.

MUSIC & VIDEO ACCESSORY MANUFACTURERS

BASF Canada, Inc., 5850 Cote de Liesse Rd., Montreal, PQ, H4T 1C1, (514) 341-5411. Pres.: Joachim Tiarks; Retail Mgr.: Dan Kirby; Professional: Jobst W. Leichsenring. Tape—Audio: Head Cleaners.
Hergott Plastics Ltd., 642 Colby Dr., Waterloo, ON, N2V 1A2, (519) 886-4631. Fax: (519) 886-4820. Pres.: Robert MacNeil; Sales Mgr.: Hector MacNeil. CD—Safety lock long box.
Summit Magnetics (Canada) Ltd., 8828 Osler St., Vancouver, BC, V6P 4G2, (604) 266-3520. Fax: (604) 921-8873. Sales Mgr.: Elina Lam; Dir.: L. S. Lam. Branch(es): 140 Advance Blvd., Unit 11, Brampton, ON, L6T 4J4, (416) 791-6271. Fax: (416) 791-8757. Pres.: Lam Lugh Sung; Mktg. Dir.: Grace Siu. CD—Carrying & Storage Cases. Tape—Audio: Carrying & Storage Cases, Cassettes Magnetics.

AUDIO ACCESSORY MANUFACTURERS

BASF Canada, Inc., 5850 Cote de Liesse Rd., Montreal, PQ, H4T 1C1, (514) 341-5411. Pres.: Joachim Tiarks; Retail Mgr.: Dan Kirby; Professional: Jobst W. Leichsenring. Audio: Leader Tape, Splicing Tape & Equipment.
Summit Magnetics (Canada) Ltd., 8828 Osler St., Vancouver, BC, V6P 4G2, (604) 266-3520. Fax: (604) 921-8873. Sales Mgr.: Elina Lam; Dir.: L. S. Lam. Audio: Bulk Erasers, Demagnetizers, Leader Tape

STORE FIXTURE MANUFACTURERS

Summit Magnetics (Canada) Ltd., 8828 Osler St., Vancouver, BC, V6P 4G2, (604) 266-3520. Fax: (604) 921-8873. Sales Mgr.: Elina Lam; Dir.: L. S. Lam. Browser Boxes—(Tape).

SECURITY & SURVEILLANCE SYSTEMS MANUFACTURERS

Hergott Plastics Ltd., 642 Colby Dr., Waterloo, ON, N2V 1A2,

(519) 886-4631. Fax: (519) 886-4820. Pres.: Robert MacNeil; Sales Mgr.: Hector MacNeil.
Reusabre Security Packaging: Safety lockbox for CD's.

COMPUTER SYSTEMS & SERVICES

Electrohome Ltd., 809 Wellington St. N., Kitchener, ON, N2G 4J6, (519) 744-7111. Fax: (519) 749-3139. Pres.: J. A. Pollock; P.R. Mgr.: R. Lovellm.

ASSOCIATIONS & PROFESSIONAL ORGANIZATIONS

Alliance of Canadian Cinema, Television & Radio Artists (ACTRA), 2239 Yonge St., Toronto, ON, M4S 2B5, (416) 489-1311. Fax: (416) 489-1435. Pres.: Meg Hogarth.

Assn. of Canadian Orchestras, 56 The Esplanade, Ste. 311, Toronto, ON, M5E 1A7, (416) 366-8834. Fax: (416) 366-1780. Exec. Dir.: Betty Webster; Communications Coord.: Madeline Fiola.

Canadian Academy of Recording Arts & Sciences (CARAS), 124 Merton St., 3rd Floor, Toronto, ON, M4X 2Z2, (416) 485 3135. Fax: (416) 485 4978. Pres.: Peter E. Steinmetz; Exec. Dir.: Daisy Falle.

CIRPA (Canadian Independent Record Prodn. Assoc.), 144 Front St. W., Ste. 202, Toronto, ON, M5J 2L7, (416) 593-1865. Fax: (416) 593-7563. Pres.: Alexander Malr; Exec. Dir.: Brian Chater.

Canadian Music Publishers Assoc., 56 Wellesley St. W., Ste. 320, Toronto, ON, M5S 2S3, (416) 926-1966. Fax: (416) 926-7521. Pres.: John C. Bird.

Canadian Recording Industry Assn., 1255 Yonge St., Ste. 300, Toronto, ON, M4T 1W6, (416) 967-7272. Fax: (416) 967-9415. Pres.: Brian Robertson.

RSB Records Inc., 8420 Cote De Liesse, Saint Laurent, PQ, H4T 1G7, (514) 342-8511. Fax: (514) 342-0401. Pres./Mktg. Dir.: Richard Belanger.

ENTERTAINMENT ATTORNEYS

Cassels, Brock & Blackwell, 40 King St. W., Scotia Plaza Ste. 2100, Toronto, ON, M5H 1B5, Partner: Peter E. Steinmetz.
Farano Green, 22 St. Clair Ave. E., #1100, Toronto, ON, M4T 2Z6, (416) 961-2344. Fax: (416) 961-0585. Partner: Edmund L. Glinert.

McCarthy Tetrault, Ste. 4700 Toronto Dominion Bank Tower, Toronto, ON, M5K 1E6, (416) 362-1812. Fax: (416) 868-1790. Partner: J. Stephen Stohn.

Schiffier & Co., Mezzanine, 626 W. Pender St., Vancouver, BC, V6B 1V9, (604) 681-1171. Fax: (604) 681-1329. Contact: Roger C. Schiffier.

PERFORMING & MECHANICAL RIGHTS ORGANIZATIONS

Canadian Musical Reproduction Rights Agency, Ltd., 56 Wellesley St. W., Ste. 320, Toronto, ON, M5S 2S4, (416) 926-1966. Fax: (416) 926-7521. Gen. Mgr.: David Basskin.

Praise Sound Prodn. Ltd., 7802 Express St., Burnaby, BC, V5A 1T4, (604) 420-4227. Pres.: Willy Yaroshuk; Sales Mgr.: Metro Yaroshuk; Mktg. Dir.: Willy Yaroshuk.

Society of Composers Authors & Music Publishers of Canada, 41 Valleybrook Dr., Don Mills, ON, M3B 2S6, (416) 445-8700. Fax: (416) 445-7108. CEO: Jan V. Matejcek; Pres.: Louis Applebaum; Pub. Rel. Dir.: Nancy Gyokeres.

Society of Composers, Authors & Music Publishers of Canada (SOCAM), 41 Valleybrook Dr., Don Mills, ON, M3B 2S6, (416) 445-8700. Fax: (416) 445-7108. Pres.: Jan V. Matejcek.

MUSIC LIBRARIES

Intermede Communications, 285 Place d'Youville, Ste. 3, Montreal, PQ, H2Y 2A4, (514) 842-8661. Fax: (514) 843-8278. Pres.: Christopher J. Reed.

Sound Ideas, 105 W. Beaver Creek Rd., Ste. 4, Richmond Hill, ON, L4B 1C6, (416) 886-5000. Fax: (416) 886-6800. Pres.: Brian Nimens; Sales Mgr.: Mike Bell.

RECORD PROMOTION

Sheldon Kagan Prodn., Ltd., 1020 Fifth Ave., Dorval, PQ, H9S 1J2, (514) 631-2160. Fax: (514) 631-4430. Pres.: Sheldon Kagan; Sales Mgr.: Lucie Burdett; Mktg. Dir.: Muriel E. Nicholson.

Metro Sound Record Promotions, PO Box 1213, Station Q, Toronto, ON, M4T 2P4, (416) 483-8829. Fax: (416) 483-8703. Pres.: Craig R. Evans; Mktg. Dir.: Andrew Homorodean.

Praise Sound Prodn. Ltd., 7802 Express St., Burnaby, BC, V5A 1T4, (604) 420-4227. Pres.: Willy Yaroshuk; Sales Mgr.: Metro Yaroshuk; Mktg. Dir.: Willy Yaroshuk.

BLANK & BULK TAPE MANUFACTURERS

Ampex Canada, Inc., 1116-55 Avenue NE, Calgary, AB, T2E

6Y4, (403) 275-3444.

Branch(es): 729 Meloche Ave., Dorval, PQ, H9P 2S4, (514) 636-4840, Sales Rep.: Martine Louvet; 1770 Argenta Rd., Mississauga, ON, L5N 3S7, (416) 821-8840. Fax: (416) 821-8849. Pres.: J. L. Major; Mktg. Dir.: J. R. Pariselli.

BASF Canada, Inc., 345 Carlingview Dr., Toronto, ON, M9W 6N9, (416) 674-2562. Fax: (416) 674-2536. Pres.: C.H. von Krafft; Sales Mgr.: Paul Souliere; Mktg. Dir.: John Clarry; Nat'l Sales Mgr.-Pro: Joe Caco.

Casin Investment Corp. of Canada, Unit 5-3331 Viking Way, Richmond, BC, V4E 2P4, (604) 278-3996. Fax: (604) 278-3783.

Lee & Man Mfg. Ltd., 900 Granville St., 3rd Floor, Vancouver, BC, V6Z 1L3, Canada, (604) 688-4011. Fax: (604) 688-3499. Pres.: Patrick Lee Wan-Keung; Sales Mgr.: K.K. Wong.

Lee & Man Ontario Ltd., 980 Pacific Gate, Unit 13, Mississauga, ON, L5T 1Y1, (416) 870-8235. Fax: (416) 542-0482. M. Dir.: Patrick Lee Wan-Keung; Dir.: W.C. Wong.

Les Industries Magra Ltee, 5722 St-Andre, Montreal, PQ, H2S 2K1, Canada, (514) 272-8224. Fax: (514) 272-9785. Pres.: Mario Paquet; Sales Mgr.: Francois Godard.

Sony of Canada, Ltd., 411 Gordon Baker Rd., Willowdale, ON, M2H 2S6, Canada, (416) 499-1414. Sales Mgr.: Keith Usugui.

Summit Magnetics (Canada) Ltd., 8828 Osler St., Vancouver, BC, V6P4G2, Canada, (604) 286-3520. Fax: (604) 921-8873. Branch(es): No. 11, 140 Advance Blvd., Brampton, ON, L6T 4J4, Canada, (416) 791-6271. Fax: (416) 791-8757.

3M Canada, Inc., PO Box 5757, 1840 Oxford St. E., London, ON, N6A 4T1, (519) 451-2500. Fax: (519) 452-6262. Contact: Doug Fraser.

BLANK TAPE LOADERS

Analogue Industries, 6902 Park Ave., Montreal, PQ, H3N 1W9, Canada, (514) 278-8273. Fax: (514) 273-8883. Pres.: George Frehner; Sales/Mktg. Dir.: Rick Dexter. (Audio)

Les Industries Magra, 5722 St-Andre, Montreal, PQ, H2S 2K1, Canada, (514) 272-8224. Fax: (514) 272-9785. Pres.: Mario Paquet; Sales Mgr.: Francois Godard. (Audio)

CARTRIDGES, CASSETTES, REELS & OTHER PARTS

BASF Canada Inc., 345 Carlingview Dr., Toronto, ON, M9W 6N9, (416) 675-3611. Fax: (416) 674-2536. Pres.: Christoph von Krafft; Sales Mgr. (Professional): Joe Caco; Sales Mgr. (Retail): Paul Souliere; Mktg. Mgr.: John Clarry; Product Mgr.: Jobst W. Leichsenring.

Cinram Ltd., 2255 Markham Rd., Scarborough, ON, M1B 2W3, (416) 298-8190. Fax: (416) 298-0612. Pres.: Isidore Philosophie; Dir., Mktg. & Sales-Video: Anne Brown.

Audio: C-O's, Noreico Boxes.
Golden Musicassette, 510 Coronation Dr., Unit 20, West Hill, ON, M1E 4X6, (416) 284-9927. Fax: (416) 281-8579. Pres.: Ron Gardner.

Lee & Man Mfg., Ltd., 900 Granville St., Vancouver, BC, V6Z 1L3, (604) 688-4011. Fax: (604) 688-3499. Pres.: Patrick Lee; Sales Mgr.: K.K. Wong.

Audio: C-Os.
Lee & Man Ontario Ltd., 980 Pacific Gate, Unit 13, Mississauga, ON, L5T 1Y1, (416) 870-8235. Fax: (416) 542-0482. Pres.: Patrick Lee; Sales Mgr.: Joseph Wong;

Mktg. Dir.: Christina Wong.
Audio: Cassette housing, outer boxes, tape.

Summit Magnetics (Canada) Ltd., 8828 Osler St., Vancouver, BC, V6P 4G2, (604) 266-3520. Fax: (604) 921-8873. Sales Mgr.: Elina Lam; Dir.: L. S. Lam.

Branch(es): 140 Advance Blvd., Unit 11, Brampton, ON, L6T 4J4, (416) 791-6271, Fax: (416) 791-8757, Pres.: Lam Luk Sung; Mktg. Dir.: Grace Siu

Audio: C-O, Library & Dbl. Flat Cassette.
Tri-Tec Industries, Ltd., 130 Matheson Blvd. E., Unit 7/8, Mississauga, ON, L4Z 1Y6, (416) 890-0201. Fax: (416) 890-8477. Pres.: Simon Lee.

Audio: C-O.
Video: V-O.

JEWEL BOX MANUFACTURERS

Cinram Ltd., 2255 Markham Rd., Scarborough, ON, M1B 2W3, (416) 298-8190. Fax: (416) 298-0612. Pres.: Isidore Philosophie; Dir., Mktg. & Sales-Video: Anne Brown.

Summit Magnetics (Canada) Ltd., 8828 Osler St., Vancouver, BC, V6P 4G2, (604) 266-3520. Fax: (604) 921-8873. Sales Mgr.: Elina Lam; Dir.: L. S. Lam.

Branch(es): 140 Advance Blvd., Unit 11, Brampton, ON, L6T 4J4, (416) 791-6271, Fax: (416) 791-8757, Pres.: Lam Luk Sung; Mktg. Dir.: Grace Siu.

Tri-Tec Industries, Ltd., 130 Matheson Blvd. E., Unit 7/8, Mississauga, ON, L4Z 1Y6, (416) 890-0201. Fax: (416) 890-8477. Pres.: Simon Lee.

ENVELOPES & MAILERS

Agincourt Prodn., Ltd., 20 Kinnear Ct., Richmond Hill, ON, L4B 1K8, (416) 886-8273. Fax: (416) 886-5386. Pres.: C. William French; Vice Pres., Gen. Mgr.: Peter Bradley; Mktg. Dir.: Ken MacFarlane. (Video—Tape)

Lee & Man Ontario Ltd., 980 Pacific Gate, Unit 13, Mississauga, ON, L5T 1Y1, (416) 870-8235. Fax: (416) 542-0482. Pres.: Patrick Lee; Sales Mgr.: Joseph Wong; Mktg. Dir.: Christina Wong. (Audio—Tape)

Les Industries Magra Ltee, 5722 St. Andre St., Montreal, PQ, H2S 2K1, (514) 272-8224. Fax: (514) 272-9785. Pres.: Mario Paquet; Sales Mgr.: Francois Godard. (Audio—Tape)

Metro Graphic Corp., 2800 Francis Hughes Ave., Laval, PQ, H7L 3M4, (514) 863-0370. Fax: (514) 3850486. Pres.: Paul Kizner; Sales Mgr.: I. Engel; Mktg. Dir.: D. Engel. (Audio—CD, Tape, LP)

JACKETS & SLEEVES

Lee & Man Ontario Ltd., 980 Pacific Gate, Unit 13, Mississauga, ON, L5T 1Y1, (416) 870-8235. Fax: (416) 542-0482. Pres.: Patrick Lee; Sales Mgr.: Joseph Wong; Mktg. Dir.: Christina Wong. (Jackets/Sleeves-Audio: Tape)

Les Industries Magra Ltee, 5722 St. Andre St., Montreal, PQ, H2S 2K1, (514) 272-8224. Fax: (514) 272-9785. Pres.: Mario Paquet; Sales Mgr.: Francois Godard. (Jackets/Sleeves-Audio: Tape)

Metro Graphic Corp., 2800 Francis Hughes Ave., Laval, PQ, H7L 3M4, (514) 863-0370. Fax: (514) 3850486. Pres.: Paul Kizner; Sales Mgr.: I. Engel; Mktg. Dir.: D. Engel. (Jackets/Sleeves-Audio: CD, Tape, LP)

Ross-Ellis Ltd., 300 Ann St., Montreal, PQ, H3C 2K2, (514) 861-2411. Fax: (514) 861-7610. Contact: Peter Kerr. (Jackets/Sleeves-Audio: LP)

Summit Sound, Inc., PO Box 333, Westport, ON, KOG 1X0, (613) 273-2815. Fax: (613) 273-7325. Pres.: David Daw; Prodn. Coord.: Kathy Daw. (Jackets/Sleeves-Audio: CD, Tape)

LABELS

Agincourt Prodn., Ltd., 20 Kinnear Ct., Richmond Hill, ON, L4B 1K8, (416) 886-8273. Fax: (416) 886-5386. Pres.: C. William French; Vice Pres., Gen. Mgr.: Peter Bradley; Mktg. Dir.: Ken MacFarlane. (Video—Tape)

Lee & Man Ontario Ltd., 980 Pacific Gate, Unit 13, Mississauga, ON, L5T 1Y1, (416) 870-8235. Fax: (416) 542-0482. Pres.: Patrick Lee; Sales Mgr.: Joseph Wong; Mktg. Dir.: Christina Wong. (Audio—Tape)

Les Industries Magra Ltee, 5722 St. Andre St., Montreal, PQ, H2S 2K1, (514) 272-8224. Fax: (514) 272-9785. Pres.: Mario Paquet; Sales Mgr.: Francois Godard. (Audio—Tape)

Metro Graphic Corp., 2800 Francis Hughes Ave., Laval, PQ, H7L 3M4, (514) 863-0370. Fax: (514) 3850486. Pres.: Paul Kizner; Sales Mgr.: I. Engel; Mktg. Dir.: D. Engel. (Audio—LP)

Summit Sound, Inc., PO Box 333, Westport, ON, KOG 1X0, (613) 273-2815. Fax: (613) 273-7325. Pres.: David Daw; Prodn. Coord.: Kathy Daw. (Audio—Tape)

POLYBAGS & SHRINKWRAP

Agincourt Prodn., Ltd., 20 Kinnear Ct., Richmond Hill, ON, L4B 1K8, (416) 886-8273. Fax: (416) 886-5386. Pres.: C. William French; Vice Pres., Gen. Mgr.: Peter Bradley; Mktg. Dir.: Ken MacFarlane. (Shrinkwrap)

Golden Musicassette, 510 Coronation Dr., Unit 20, West Hill, ON, M1E 4X6, (416) 284-9927. Fax: (416) 281-8579. Pres.: Ron Gardner. (Shrinkwrap)

Lee & Man Ontario Ltd., 980 Pacific Gate, Unit 13, Mississauga, ON, L5T 1Y1, (416) 870-8235. Fax: (416) 542-0482. Pres.: Patrick Lee; Sales Mgr.: Joseph Wong; Mktg. Dir.: Christina Wong. (Polybags & Shrinkwrap)

Les Industries Magra Ltee, 5722 St. Andre St., Montreal, PQ, H2S 2K1, (514) 272-8224. Fax: (514) 272-9785. Pres.: Mario Paquet; Sales Mgr.: Francois Godard. (Shrinkwrap)

TAPE CUSTOM DUPLICATORS

Agincourt Prodn., Ltd., 20 Kinnear Ct., Richmond Hill, ON, L4B 1K8, (416) 886-8273. Fax: (416) 886-5386. Pres.: C. William French; Vice Pres., Gen. Mgr.: Peter Bradley; Mktg. Dir.: Ken MacFarlane.

Video: ¼ U-Matic, ½ VHS Cassette, 8mm, S-VHS, M-2, D-2, D-3, 1", Hi 8mm.

Video Packaging Services: Inserting, Collating, Labeling, Mailing.

Other Services: Warehouse, Freight, Direct Response—800 services, Credit Card Clearance Services, Silkscreening, Macrovision, Closed Cap.

Analogue Industries, 6902 Park Ave., Montreal, PQ, H3N 1W9, (514) 278-8273. Fax: (514) 273-8883. Pres.: George Frehner; Mktg. Dir.: Rick Dexter.

Audio: Cassette, Open Reel, DAT, Real-time, 16x video duplication.

Audio Packaging Services: Inserting, Collating, Labeling, Mailing, Shrink-wrap, graphic design.

Other Services: Freight, Direct Response—800 services.
Audiolec Recording Canada, Inc., 600 Ouest Port Royal, Montreal, PQ, H3L 2C5, (514) 384-6667. Fax: (514) 388-1488. Pres.: T. Tubie; Sales Mgr.: J. Desrosiers; Controller: M. Tubie.

Audio: Cassette.
Audio Packaging Services: Inserting.
B.W.M. Ents., Ltd., 91 Montclair Ave., Toronto, ON, M5P 1P5, (416) 488-0603. Pres.: B. McVicker; Sales Mgr.: K. Plerling.

Audio: Cassette, Open Reel, DAT, Real-time.
Video: ¾ U-Matic, ½ VHS Cassette.

Bellevue Pathe Quebec Video Duplication Centre, 8625
Chemin Devonshire, Montreal, PQ, H4P 2L3, (514) 737-2777.
Fax: (514) 737-1427. Vice Pres./Gen. Mgr.: Armand
Cournoyer.
Video: ¾ U-Matic, ½ VHS Cassette.

Cinram Ltd.

2255 Markham Rd., Scarborough, ON, M1B 2W3, (416)
298-8190. Fax: (416) 298-0612. Pres.: Isidore Philosophe; Dir.,
Mktg. & Sales-Video: Anne Brown.
Audio/Video: Cassette.
Audio Packaging Services: Inserting, Collating.
Other Services: Warehouse, Freight, Direct Response—800
services.

Eastern Sound Co. Ltd., 47 Scollard St., Toronto, ON, M5R
1G1, (416) 968-1855. Fax: (416) 924-9973. Pres.: Allan Slaight.
Audio: Cassette, Open Reel.

Video: ¾ U-Matic, ½ VHS Cassette, 2" quad.

Edelstein Diversified, 21 Mt. Vernon, Ville St. Pierre, Montre-
al, PQ, H8R 1J9, (514) 489-8689. Contact: Richard
Edelstein.

Audio: Cassette.

Audio Packaging Services: Tear Tapes for cassette/disc
film.

Evergreen Audio Limited, 7170 Warden Ave., Unit 3, Union-
ville, ON, L3R 8B2, (416) 477-6322. Fax: (416) 477-9299. Pres.:
L. S. Green; Sales Mgr.: J. Gamble.

Audio: Cassette, Blank cassettes, custom loading.

Audio Packaging Services: Inserting, Collating, Labeling,
Mailing.

Other Services: Warehouse.

Golden Musicassette, 510 Coronation Dr., Unit 20, West Hill,
ON, M1E 4X6, (416) 284-9927. Fax: (416) 281-8579. Pres.: Ron
Gardner.

Audio: Cassette, Open Reel, DAT, Real-time.

Audio Packaging Services: Inserting, Collating.

Other Services: Warehouse.

Lee & Man Mfg., Ltd., 900 Granville St., Vancouver, BC, V6Z
1L3, (604) 688-4011. Fax: (604) 688-3499. Pres.: Patrick Lee;
Sales Mgr.: K.K. Wong.

Audio: Cassette.

Les Industries Magra Ltee, 5722 St. Andre St., Montreal, PQ,
H2S 2K1, (514) 272-8224. Fax: (514) 272-9785. Pres.: Mario
Paquet; Sales Mgr.: Francois Godard.

Audio: Cassette, Open Reel, DAT, Real-time.

Audio/Video Packaging Services: Inserting, Collating,
Labeling, Imprinting.

Marc Prodn. (1986) Ltd., 1163 Parisien St., Ottawa, ON, K1B
4W4, (613) 741-9851. Fax: (613) 748-0981. Pres.: Gilles Poulin;
Sales Mgr.: Gaston Lavoie.

Audio: Cassette.

Video: ½ VHS Cassette.

Pathe Video, 720 King St. W., #1002, Toronto, ON, M5V 2T3,
(416) 364-6720. Fax: (416) 364-7757. Pres.: Sidney Greenberg;
Mktg./Sales Dir.: Anne Brown.

Video: ¾ U-Matic, ½ VHS Cassette, 1", 2", Betacam,
Betacam/SP.

Video Packaging Services: Inserting, Collating, Labeling,
Mailing, Point of Purchase Materials/Promo.

Other Services: Warehouse, Freight, Credit Card Clearance
Services, Silkscreen labeling on cassettes.

Praise Sound Prodn. Ltd., 7802 Express St., Burnaby, BC,
V5A 1T4, (604) 420-4227. Pres.: Willy Yaroshuk; Sales Mgr.:
Metro Yaroshuk; Mktg. Dir.: Willy Yaroshuk.

Audio: Cassette, Open Reel, Real-time.

Audio Packaging Services: Inserting, Collating, Labeling,
Mailing, Shrinkwrap.

Other Services: Warehouse, Freight.

RSB Records Inc., 8420 Cote De Liesse, Saint Laurent, PQ,
H4T 1G7, (514) 342-8511. Fax: (514) 342-0401. Pres./Mktg. Dir.:
Richard Belanger.

Audio: Cassette, Open Reel.

Stereodyne Ltd., 3121 Universal Dr., Mississauga, ON, L4X
2E2, (416) 625-8311. Fax: (416) 625-5209. Custom Orders Con-
tact: Brad Kerr; Mastering Contact: Mary Koswan.

Audio: Cassette.

Summit Magnetics (Canada) Ltd., 8828 Osler St., Vancouver,
BC, V6P 4G2, (604) 266-3520. Fax: (604) 921-8873. Sales Mgr.:
Elina Lam; Dir.: L. S. Lam.

Branch(es): 140 Advance Blvd., Unit 11, Brampton, ON, L6T
4J4, (416) 791-6271, Fax: (416) 791-8757. Pres.: Lam Luk Sung;
Mktg. Dir.: Grace Siu.

Audio: Cassette.

Other Services: Freight.

Summit Sound, Inc., PO Box 333, Westport, ON, KOG 1X0,
(613) 273-2815. Fax: (613) 273-7325. Pres.: David Daw; Prodn.
Coord.: Kathy Daw.

Audio: Cassette, Open Reel, DAT.

Audio Packaging Services: Inserting, Collating, Labeling,
Complete design svcs. for inserts.

Other Services: Warehouse, Freight, Credit Card Clearance
Services.

VTR Video, 34 Kern Rd., Don Mills, ON, M3B 1T1, (416)
443-0440. Fax: (416) 443-0466. Pres.: H. C. Coppen; Sales
Mgr.: A. Basian; Mktg. Dir.: A. Sydenham.

Video: ¾ U-Matic, ½ VHS Cassette, 8mm, S-VHS, Betacam
SP, 1/2" Beta, D2. High Speed Capability—TMD: SP, EP.

Video Packaging Services: Inserting, Collating, Labeling,
Mailing.

Other Services: Warehouse, Freight.

COMPACT DISC MANUFACTURERS & VIDEODISC MANUFACTURERS

Americ Disc, Inc., 2 Sheppard Ave. E., Ste. 900, Willowdale,
ON, M2N 5Y7, (416) 512-7001. Fax: (416) 512-6996. Pres.:
Pierre-A. Deschenes; Sales Dir.: Frank Johansen.

Type: CD.

Cinram Ltd., 2255 Markham Rd., Scarborough, ON, M1B 2W3,
Canada, (416) 298-8190. Fax: (416) 298-0612. Pres.: Isidore
Philosophe; Dir., Mktg. & Sales-Video: Anne Brown.

Type: CD.

PLATING & PRESSING PLANTS

Cinram Ltd., 2255 Markham Rd., Scarborough, ON, M1B 2W3,
Canada, (416) 298-8190. Fax: (416) 298-0612. Pres.: Isidore
Philosophe; Dir., Mktg. & Sales-Video: Anne Brown.

(LP's)

Praise Sound Prodn. Ltd., 7802 Express St., Burnaby, BC,
V5A 1T4, Canada, (604) 420-4227. Pres.: Willy Yaroshuk;
Sales Mgr.: Metro Yaroshuk; Mktg. Dir.: Willy Yaroshuk.

(LP's)

MASTERING FACILITIES

Agincourt Prodn., Ltd., 20 Kinnear Ct., Richmond Hill, ON,
L4B 1K8, (416) 886-8273. Fax: (416) 886-5386. Pres.: C.
William French; Vice Pres., Gen. Mgr.: Peter Bradley; Mktg.
Dir.: Ken MacFarlane.

(Video)

Audiobec Recording Canada, Inc., 600 Ouest Port Royal,
Montreal, PQ, H3L 2C5, (514) 384-6667. Fax: (514) 388-1488.
Pres.: T. Tubie; Sales Mgr.: J. Desrosiers; Controller: M.
Tubie.

(Audio)

Evergreen Audio Limited, 7170 Warden Ave., Unit 3, Union-
ville, ON, L3R 8B2, (416) 477-6322. Fax: (416) 477-9299. Pres.:
L. S. Green; Sales Mgr.: J. Gamble.

(Audio)

McClear Place Recording & Mastering Studios, 225 Mutual
St., Toronto, ON, M5B 2B4, (416) 977-9740. Fax: (416)
977-7147. Pres.: Bob Richards; Sales Mgr.: Jane Rowan;
Mktg. Dir.: Nathan Rappoport; Sr. Mastering Engineer: Pete
Norman.

(Audio)

RSB Records Inc., 8420 Cote De Liesse, Saint Laurent, PQ,
H4T 1G7, (514) 342-8511. Fax: (514) 342-0401. Pres./Mktg. Dir.:
Richard Belanger.

(Audio)

Summit Sound, Inc., PO Box 333, Westport, ON, KOG 1X0,
(613) 273-2815. Fax: (613) 273-7325. Pres.: David Daw; Prodn.
Coord.: Kathy Daw.

(Audio)

VTR Video, 34 Kern Rd., Don Mills, ON, M3B 1T1, (416)
443-0440. Fax: (416) 443-0466. Pres.: H.C. Coppen; Sales Mgr.:
A. Basian; Mktg. Dir.: A. Sydenham.

(Video)

PACKAGING & LABELING SERVICES

Edelstein Diversified

21 Mt. Vernon, Montreal, Canada, H8R 1J9. (514) 489-8689.

Contact: Richard Edelstein.

U.S. Toll Free 1-800-461-8273.

Branch Office: Chino, CA

Easy opening pressure sensitive tear tapes for overwrap-
ped cassettes, CD's, DAT's, video, data storage, etc.

Lee & Man Ontario Ltd., 980 Pacific Gate, Unit 13,
Mississauga, ON, L5T 1Y1, (416) 870-8235. Fax: (416)
542-0482. Pres.: Patrick Lee; Sales Mgr.: Joseph Wong;
Mktg. Dir.: Christina Wong.

(Inserting, Collating, Labeling)

TAPE EQUIPMENT MANUFACTURERS

Husky Injection Molding Systems, Inc., PO Box 1000, 530
Queen St. S., Bolton, ON, L7E 5S5, (416) 857-3240. Fax: (416)
857-6074. Prod. Mgr.: Brian Glutek.

Audio: Injection molding machines, molds & systems.

TAPE PACKAGING & LABELING EQUIPMENT MANUFACTURERS

Graham Fraser Packaging Machinery Ltd., 50 Don Park Rd.,
Unit 5, Markham, ON, L3R 1J3, (416) 475-6944. Fax: (416)
479-8320. Engineering Mgr.: Thomas Varghese; Pres./Gen.
Mgr.: H. Woertche.

Product(s): Cassette, cartons, labellers, conveyors.

MEXICO

RECORD LABELS

Bertlesmann de Mexico, S.A. de C.V. div. BMG/Ariola, PO Bx
17-570, CP, Mexico, DF, 02870, 527-6020. Fax: 527-5857.
Managing Dir.: Enrique de Noriega.

CBS/Columbia Int'l SA, Av. 16 de Septiembre/84, Naucaplan,
(905) 576-0333.

Label(s): (Owned) Epic, Harmony, Okeh, Sultana.
(Distributed) Philadelphia Int'l, Portrait, Jet, Nemporer, Kir-
shner, Caribou, GDE, GTO, TK, T-Neck, Tappan Zee, Tabu,
A & M, Bang, Calla, Buena Vista, Unlimited Gold.

Coro S.A. De C.V., Sierra Vertientes 870, Mexico, DF, 11000,
011525961435. Fax: 011525968220. Pres.: Federico E. Rio-
jas R.; Mktg.: Benjamin Herrera; Promo.: Jaime Sanchez.

(Compact Disc, Records (LP's, 12-Inch) (Distributor)
Label(s): (Owned) Coro, Accion.

Int'l Reprs.: Discos Fuentes (Colombia); Discorona
(Venezuela).

D A Music, Inc., Herra Y Cairo No. 542, Guadalajara, 44200,
(36) 58-08-85. Fax: (36) 58-00-13. Pres.: Achim Neumann;
CEO: Herb Heldt; Dir. Pub.: Susan Swain.

Discos GAS, S.A. de C.V., 1201 Eje Central, 100 mts., Mex-
ico, DF, 07700, (525) 754-3055. Fax: (525) 586-0796. Pres.:
Guillermo Acosta, Sr.; Vice Pres.: Jesus Acosta; Gen. Mgr.:
Alberto Arosta; Plant Mgr.: Guillermo Acosta, Jr.

Label(s): (Owned) Flama, GAS, Intergas, Orbe.

Discos Musart, S.A. De C.V., Av. Cuiclahuac 2335, Mexico,
DF, 02870, (341)99-55. Fax: (341)19-60. Pres.: Eduardo L. Bap-
tista; Gen. Dir.: Eduardo A. Baptista; Vice Pres.: Andres Bap-
tista; Manuel Baptista; Gen. Mgr.: Jose Luis Estrada.

Label(s): (Distributed) Baby, Ars Benelux, FBI, Serdisco,
Zyx, Toco Int'l.

US Reprs.: Balboa Records Co. (CA).

Discos Tequila/Musica De Mexico, Ignacio Esteva 26A, Mex-
ico, DF, 11850, 515-64-84, 515-35-90. Owner/Mgr.: Dario A.
Zorzanu.

EMI-Capitol de Mexico SA de CV (IFPI), Rio Balsas 49, Mex-
ico City, DF, 06500, (52-5)525-1700. Pres.: Eduardo L. Bap-
tista; Gen. Dir.: Eduardo A. Baptista; Vice Pres.: Andres Bap-
tista; Manuel Baptista; Gen. Mgr.: Jose Luis Estrada.

Label(s): (Distributed) Baby, Ars Benelux, FBI, Serdisco,
Zyx, Toco Int'l.

US Reprs.: Balboa Records Co. (CA).

EDIMUSA PUBLISHING GROUP

- EDIMUSA, S.A. de C.V.
- BRAMBILA MUSICAL MEXICO, S.A. de C.V.
- ACAPULCO MUSIC, S.A. de C.V.
- HERMANOS MARQUEZ
- DISCORAMA MEXICO, S.A.
- IVAN MOGULL LATINA, S. de R.L.

THE MOST PROFESSIONAL MUSIC PUBLISHER IN MEXICO

WE REPRESENT FOR LATINAMERICA
THE MOST IMPORTANT PUBLISHERS

CONTACT US

EDMUNDO MONROY — GENERAL MANAGER

EDIMUSA, S.A. de C.V.

AV. CUILAHUAC 2309 02870 MEXICO, D.F.

TELS.: 341-57-78 341-58-98

341-57-26 341-58-52 FAX: 341-51-65

US Reps.: Warner Chappell Music Group (CA); Coronet Delphine Inc. (NY).

Int'l Reps.: WEA Discos LTDA (Brazil).

Fabrica De Discos Peerless S.A. De C.V., Calz. Mariano Escobedo No. 201, Col. Anahuac, Mexico, DF, CP11320, (5) 531-3320. Fax: (5) 254-7540. Managing Dir: Jurgen Ulrich Klinckwort; Int'l Mgr: Carlos Gomez; Sales Gen. Mgr: Javier Ramirez; Promo. Mgr: Martha P. Blanco.

Label(s): (Owned) Eco, Peerless, Maxi.

US Reps.: Th-Records (FL).

Int'l Reps.: Dideca (Central America); FCA. Discos Fuentes (Colombia); Feraud (Ecuador); Virrey (Peru); El Palacio De La Musica (Venezuela).

Multimusic, S.A. de C.V., Sur 128 No. 12, Mexico, DF, 11820, (5) 2719438, (5) 2719590. Fax: (5) 2719580. Pres.: Luis Alberto San Martin; Vice Pres.: Olga de San Martin; Sales Mgr: Julio Lerma.

US Reps.: Southeast (FL).

Int'l Reps.: Dial Discosstar Soun (Chile).

Producciones Lubata, S.A.

PO Box 22-316, Mexico, DF, 14000, 12 Cuesta St., Mexico, DF, 04500, (525) 6064468. Fax: (525) 6064802. Owner/Pres./A&R Rep.: Luis Baston T.; Vice Pres. Admin.: Consuelo Baston; Sales Mgr.: Eduardo Ramos; Vice Pres. A&R: Luis T. Baston.

Label(s): (Owned) Talento, Lubata, Jazz Unlimited, Swing Time, Sol, (Distributed) Narada, TBA, Global Pacific, Miramar, Blue Moon, Celestial Harmonies, Denon, Concord Jazz, American Gramophone.

Promotora Fonografica S.A. (Promofon), Sahuayo No. 82 Gol. Janitzio, Mexico City, DF, 15200, 789-23-37, 795-36-78. Gen. Mgr: Gabriel Gonzalez De La O; Prodn. Mgr: Gabriel Gonzalez Lozano; Admin.: Olga Lozano Sanchez.

Label(s): (Owned) Promofon.

Warner Music Mexico S.A. de C.V., PO Box 7-1238, Mexico City, 7, Acapulco 37 Colonia Condesa, Mexico City, 06140, (52-5)553-6688. Fax: (52-5)286-5695. Managing Dir: Julio Saenz; Financial Dir.: Enrique Gomez; Head of Int'l: Marcel Toffel.

Label(s): (Owned) Atlantic, Elektra, Warner Bros., Sire, (Distributed) Geffen, MCA, Delphine.

US Reps.: WEA Latina (CA).

MUSIC PUBLISHERS

Alma Musical, (See Warner Chappell Music Mexico, S.A. De C.V.).

Artex, (See Warner Chappell Music Mexico, S.A. De C.V.).

BMG Edim, S.A. de C.V. and BMG Arabella Mexico, S.A., PO Box 17-570, Av. Cuilahuac No. 2519, Mexico City, 02870, 52-5-341-7092. Fax: 52-5-341-5572. Gen. Mgr: Rembero Cruz Amescua; Asst. Gen. Mgr: Sylvia Dominguez.

Begonia Melodies, (BMI) (See Galaxia Musical S.A. DE CV).

Blue Danube Music, (See Warner Music Mexico, S.A. DE CV).

Boosey & Hawkes, (ASCAP) (See Galaxia Musical S.A. DE CV).

Brambila Musical Mexico, S.A. de C.V., (See Edimusa Publishing Group).

Bug Music Group, (ASCAP) (See Galaxia Musical S.A. DE CV).

Catalogo Acapulco Music, (See Edimusa Publishing Group).

Catalogo Alex Music, (See Edimusa Publishing Group).

Catalogo Felinos Musical, (See Edimusa Publishing Group).

Catalogo Hermanos Marquez, (See Edimusa Publishing Group).

Catalogo Laramie/Monje Musical, (See Edimusa Publishing Group).

Catalogo Rio Musical, (See Edimusa Publishing Group).

Chufa Ediciones Musicales, (See Warner Music Mexico, S.A. DE CV).

Coronet Delphine E, Inc., (See Warner Music Mexico, S.A. DE CV).

Cottillion Music, Inc., (See Warner Music Mexico, S.A. DE CV).

DIMASI, (See Warner Music Mexico, S.A. DE CV).

Discorama Mexico, (See Edimusa Publishing Group).

Discos Tequila, Ignacio Esteva, #26-A, Mexico, 11850, (515) 35-90. Owner: Dario A. Zorzano.

EMI Music Publishing Mexico, Rio Balsas 49, Co. Cuauhtemoc, Mexico City, DF, 06500, (52-5)511-3742. Fax: (52-5)511-3935.

Ediciones Musicales Duher, (See Warner Music Mexico, S.A. DE CV).

Edimusa Publishing Group

Av. Cuilahuac 2309, Col San Salvador Xochimanca, Azapotalco, Mexico, DF, 02870, (525) 341-5778, (525) 341-5726. Fax: (525) 341-5165. Gen. Mgr: Edmundo Monroy; Copyright Mgr: Claudia Cilia; Royalties Dept.: Silvia Neri; Promo. Dept.: Julio Herrera.

Edimusa S.A. DE C.V., (See Edimusa Publishing Group).

Edimusic, (See Warner Chappell Music Mexico, S.A. DE CV).

Elvis Presley Music/Gladys Music, (BMI) (See Galaxia Musical S.A. DE CV).

Emly Music, (See Warner Chappell Music Mexico, S.A. DE CV).

Galaxia Musical S.A. DE C.V., (SACM) Leibnitz 130, Mexico City, DF, 11590, (525) 254-5790, (525) 250-0378. Fax: (525) 254-5790. Pres.: Arq. Jose G. Cruz Ayala.

Gas Musical, (See Warner Chappell Music Mexico, S.A. DE CV).

The Goodman Group, (ASCAP) (See Galaxia Musical S.A. DE CV).

Ivan Mogull Latina, S. de R.L., (See Edimusa Publishing Group).

Love Music, S.A., (See Warner Music Mexico, S.A. DE CV).

Melodias Universales, S.A. (MUSA)

Dr. Barragan, No 740/Bajos 1, Colonia Narvarte, Mexico City, 03020, (905) 696-5815, (52-5)696-5815. Fax: (905) 579-0017. Managing Dir.: Antonio Buquer.

Music Sales Corp., (ASCAP) (See Galaxia Musical S.A. DE CV).

Musica de Mexico/Editorial Musical Juventa, Ignacio Esteva, #26-A, Mexico, DF, 11850.

Ollantay Music, (See Promociones Y Ediciones Internacionales, SA (Predisa).

Pedrosillo Music, (See Warner Music Mexico, S.A. DE CV).

Peermusic, (See Melodias Universales, S.A. (MUSA)).

Promociones Y Ediciones Internacionales, SA (Predisa), Mariano Escobedo 201, Altos, Mexico, DF, 11320, (525) 351-3320. Fax: (525) 254-7540. Pres.: Ing. Jurgen Ulrich; Gen. Mgr.: Jose Luis Vela Z.

Rampel, (See Warner Chappell Music Mexico, S.A. DE CV).

Ricam, (See Warner Chappell Music Mexico, S.A. DE CV).

Rondor Music Int'l, Inc., (ASCAP) (See Galaxia Musical S.A. DE CV).

Carole Bayer Sager Music, (BMI) (See Galaxia Musical S.A. DE CV).

G. Schirmer, (ASCAP) (See Galaxia Musical S.A. DE CV).

Shenandoah Music, (See Promociones Y Ediciones Internacionales, SA (Predisa).

Sonoeditora, (See Warner Chappell Music Mexico, S.A. DE CV).

Supertype Publishing, (See Warner Music Mexico, S.A. DE CV).

Tannen Music Co., (ASCAP) (See Galaxia Musical S.A. DE CV).

Telearte, (See Warner Chappell Music Mexico, S.A. DE CV).

Warner Chappell Music Mexico, S.A. DE C.V., Ave. Ejercito Nacional 209-3er. Piso, Col. Veronica Anzures, Mexico, DF, 11300, 531-7030. Fax: 254-3095. Gen. Mgr: Hector Navarro Villegas; Prof./Creative Mgr: Sergio Ruiz Zapata.

Warner Music Mexico, S.A. DE C.V., Acapulco #37 Col. Condesa, Mexico, DF, 06140, (5) 286-1915. Fax: (2) 86-56-95.

ASSOCIATIONS & PROFESSIONAL ORGANIZATIONS

Camara Nacional De La Industria De Radio Y TV, Horacio 1013 Polanco, Mexico, DF, 11550, (905) 250-2577. Fax: (905) 545-6767. Pres.: Casio Carlos Narvaez; Gen. Mgr: Cesar Hernandez

PERFORMING & MECHANICAL RIGHTS ORGANIZATIONS

Fabrica De Discos Peerless, S.A. De C.V., Mariano Escobedo #201, Col. Anahuac, DF, 17, 531-3320. Fax: 254-7540.

BLANK & BULK TAPE MANUFACTURERS

Ampex de Mexico S.A. de C.V., A.P. 13-615, Cerro del Otate 133, Delegacion Coyoacan, DF, 04320, Mexico, 554-9255, 658-0071. Fax: 658-1799.

CintasVAC, S.A. de C.V., Netzahualpilli No. 77, Col. Tlaxpana, DF, 11370, Mexico, (905) 566-8380, (905) 535-1721. Fax: (905) 703-3902. Pres.: Ron Schneider; Gen. Dir./Sales Mgr: Ing. Jorge Vargas; Mktg. Dir: Robert L. Piselli.

Delta Magnetics, S.A. de C.V., Insurgentes #45, Tepotzotlan, 54600, Mexico, (525) 876-0242. Fax: (525) 876-0008. Pres.: Manuel Baptista Lucio; Gen. Mgr.: Oscar F. Aguilar.

3M Mexico, SA de CV, Apartado Postal 14-139, Calz. San Juan de Aragon 516, Mexico, DF, 07070, Mexico, (525)577-2100. Fax: (525)757-5576. Contact: Hector Contreras.

CARTRIDGES, CASSETTES, REELS & OTHER PARTS

Aurex, S. A. de C. V., Av. Tlahuac 6710, San FCO Tlaltenco, DF, 13400, (525) 841-2003. Fax: (525) 841-2044. Pres.: Federico Valdes Krieg; Sales Mgr: Jerry Bronaugh; Mktg. Dir: Ramiro Gamboa.

Audio: C-0'S & Norelco Boxes.

Video: V-0'S.

Auriga Plasticos, S.A. de C.V., Av. Tlahuac 5502, Ex-Hda, San Nicolas Tolentino, DF, 09850, (905) 656-3756. Fax: (905) 656-1404. Pres.: Federico Valdes K.; Sales Mgr: Jerry Bronaugh; Mktg. Dir: Ramiro Gamboa.

Audio: C-0'S

Video: V-0'S

JEWEL BOX MANUFACTURERS

Poliproductos Plasticos, S.A. de C.V., PO Box 1736, Av. Ing. Eduardo Molina #6688, Mexico, DF, CP07820, (525) 781-0601, (525) 781-0698. Pres.: Esteban PoliduraCervantes; Mktg. Dir: Ing. Arturo Garcia Solis; Supervisor: Felipe Loyo Rosas.

RAW MATERIALS

Aurex, S.A. de C. V., Av. Tlahuac 6710, San FCO Tlaltenco, DF, 13400, (525) 841-2003. Fax: (525) 841-2044. Pres.: Federico Valdes Krieg; Sales Mgr: Jerry Bronaugh; Mktg. Dir: Ramiro Gamboa.

Product(s): C-60 & C90 Ferric, chrome & cobalt tape.

JACKETS & SLEEVES

Fabrica De Discos Peerless, S.A. De C.V., Mariano Escobedo #201, Col. Anahuac, DF, 17, 531-3320. Fax: 254-7540.

Audio: Tape, LP

LABELS

Fabrica De Discos Peerless, S.A. De C.V., Mariano Escobedo #201, Col. Anahuac, DF, 17, 531-3320. Fax: 254-7540.

Audio: Tape, LP

TAPE CUSTOM DUPLICATORS

Fabrica De Discos Peerless, S.A. De C.V., Mariano Escobedo #201, Col. Anahuac, DF, 17, 531-3320. Fax: 254-7540.

Audio: Cassette

Promotora Fonografica S.A. (Promofon), Sahuayo 82, Col. Janitzio, Mexico, DF, 15200, (905) 789-2337, (905) 795-3678.

Pres.: Gabriel Gonzalez De Lao.

Audio: Cassette

Sonopress/Div. De Bertelsmann de Mexico, S.A. de C.V., Av. Cuilahuac #2519, Mexico, DF, 02070, 341 79 27. Fax: 396 73 92. Pres.: Luis Arias Barrera; Sales Mgr: Nelya Ordaz; Sub-Dir: Jesus Marcen Del Cos.

Audio: Cassette, DAT

Video: High Speed Capability—LP

Audio & Video Packaging Services: Inserting, Labeling.

Other Services: Warehouse, Freight.

Warner Music Mexico, Poniente 122, #667, Col. Industrial Vallejo, DF, 02300, (52-5)567-2881, (52-5)567-2662. Operating Dir: Arturo Valdes; Warehouse Mgr: Roberto Gaytan; Duplicating Mgr: Victor Vieyra.

Duplicating Mgr: Victor Vieyra.

COMPACT DISC MANUFACTURERS & VIDEODISC MANUFACTURERS

Ameritrade Optical Disc, Alcanfores # 27, Colonia Las

Aguilas C.P., Mexico City, DF, 01710, Mexico, (525) 593-1382.

Fax: (525) 680-1996. Pres.: Carlos Ramirez.

Type: CD

Poliproductos Plasticos, S.A. de C.V., PO Box 1736, Av. Ing. Eduardo Molina #6688, Mexico, DF, CP07820, Mexico, (525) 781-0601, (525) 781-0698. Pres.: Esteban PoliduraCervantes;

Mktg. Dir: Ing. Arturo Garcia Solis; Supervisor: Felipe Loyo Rosas.

Type: CD

Sonopress/Div. De Bertelsmann de Mexico, S.A. de C.V., Av. Cuilahuac #2519, Mexico, DF, 02070, Mexico, 341-79-27.

Fax: 396 73 92. Pres.: Luis Arias Barrera; Sales Mgr: Nelya Ordaz; Sub-Dir: Jesus Marcen Del Cos.

Type: CD

Fabrica De Discos Peerless, S.A. De C.V., Mariano Escobedo #201, Col. Anahuac, DF, 17, 531-3320. Fax: 254-7540.

(LP's)

Sonopress/Div. De Bertelsmann de Mexico, S.A. de C.V., Av. Cuilahuac #2519, Mexico, DF, 02070, Mexico, 341-79-27.

Fax: 396 73 92. Pres.: Luis Arias Barrera; Sales Mgr: Nelya Ordaz; Sub-Dir: Jesus Marcen Del Cos.

Type: CD

PLATING & PRESSING PLANTS

Fabrica De Discos Peerless, S.A. De C.V., Mariano Escobedo #201, Col. Anahuac, DF, 17, Mexico, 531-3320. Fax: 254-7540.

(LP's)

Sonopress/Div. De Bertelsmann de Mexico, S.A. de C.V., Av. Cuilahuac #2519, Mexico, DF, 02070, Mexico, 341-79-27.

Fax: 396 73 92. Pres.: Luis Arias Barrera; Sales Mgr: Nelya Ordaz; Sub-Dir: Jesus Marcen Del Cos.

(LP's)

MASTERING FACILITIES

Fabrica De Discos Peerless, S.A. De C.V., Mariano Escobedo #201, Col. Anahuac, DF, 17, 531-3320. Fax: 254-7540.

(Audio)

Promotora Fonografica S.A. (Promofon), Sahuayo 82, Col. Janitzio, Mexico, DF, 15200, (905) 789-2337, (905) 795-3678.

Pres.: Gabriel Gonzalez De Lao.

(Audio)

Sonopress/Div. De Bertelsmann de Mexico, S.A. de C.V., Av. Cuilahuac #2519, Mexico, DF, 02070, 341-79-27. Fax: 396 73 92. Pres.: Luis Arias Barrera; Sales Mgr: Nelya Ordaz; Sub-Dir: Jesus Marcen Del Cos.

(Audio)

TAPE DUPLICATING & PROCESSING EQUIPMENT MANUFACTURERS

Audio Consultores, Av. Matamoros 1319 Pet Col. Ma. Luisa, Monterrey, N.L., (83) 44-52-70. Contact: Santiago Salinas.

Product(s): Lyrec Cassette Duplicatin & Loading Equipment.

PACIFIC RIM CHINA

RECORD LABELS

Taiwan Electric Development Corp., 25 Chung Shan N. Rd., Sec. 2, Taipei 104-19, Taiwan/Formosa, 104, (02) 541 3525, (02) 551 2525. Fax: (02) 561 7803. Pres.: Cheng-Chih Chen; Exec. Dir.: Chen Chiang Yu-Nu; Gen. Mgr.: Wei-Yow Chen; Opns. Mgr.: Mei Chih Liu.
Label(s): (Distributed) Capitol, Polydor, WEA, RCA.

RAW MATERIALS

Shantou Ocean Audio-Video General Corp., 11 Shanzhang Rd., Shantou City, Guangdong, (0754) 31567. Fax: (0743) 51131. Product(s): Polyester base film.

HONG KONG

RECORD LABELS

Amo Record Corp., PO Box 95170 Tsim Sha Tsui PO, Kowloon, (852) 710-8811. Fax: (852) 710-7668. Gen. Mgr.: Paul Leung.

Label(s): (Owned) Musa, Amo, Sing Song Learn.
Art-Tune Records Co., Rm 1802, 1065 King's Rd. Eastern Centre, Hong Kong, (852) 880-0278. Fax: (852) 880-0304.
Label(s): (Owned) Art-Tune, Oriental, Rose.

BMG Pacific Ltd., 9/F Kai It Bldg., 58 Pak Tai St., Kowloon, (852) 712-5251. Fax: (852) 7610733. Mng., Dir.: Anders Nelsson; Dir., A&R/Mktg.: Sam Ho; Gen. Mgr., Int'l Mktg.: Levin Lo.

Label(s): (Owned) Ariola, Arista, Hansa, RCA, (Distributed) Play It Again Sam, Sonet, Delphine, Curb, Fantasy, Jive, Motown, PWL, Mute, Beaver, Carrere, Beggars Banquet. US Reps.: BMG Music Int'l (NY).

Int'l Reps.: PT Musica Studios (Indonesia); BMG Pacific Sdn. Bhd. (Malaysia); BMG Philippina (Philippines); BMG Pte. Ltd. (Singapore); BMG Pacific (Thailand).

Wing Cheung Records Co., Ltd., Flat A, 2/F Wing Cheung Mansion, 78 Morrison Hill Rd., Hong Kong, (5) 724657, (5) 728852. Fax: (5) 838-2272. Chrmn.: Mrs. Tang Wing Cheung; Gen. Mgr.: Raymond Hung; Mktg. Mgr.: Peter Hung; Opns. Mgr.: Winson Tong.

Shun Cheung Record Co., Room 802-4 Bank Centre, 636 Nathan Rd., Kowloon, Fax: 852 3 88 40 70. Contact: Raymond Ng.

Cross (HK) Co., GPO Box 4559, Hong Kong, (852) 3840880. Fax: (852) 7708282. CEO: Alexander Y.C. Lee; Buyer (Record/Tape): A. Lee; Buyer (Videos): A. Lee; Buyer (Accessories): A. Lee; Buyer (Other): Pauline Lu; (Compact Disc, Pre-Recorded Audio Tape, Video (Cassette & Disc)) (Distributor, Importer).

Labels Distributed: Audio: Sparrow Distribution, Kingsway Music; Video: Sparrow Distribution, (Owned): Tao's Foundation, The Witness, Amazing Grace.
Pay-Per Transaction.

EMI (Hong Kong) Ltd. (IFPI), 11 Fa Po St., Yau Yat Chuen, Kowloon, (852-3)810-321. Fax: (852-3)970-213. Managing Dir.: K. K. Wong.

HNH Int'l Ltd., 58 Pak Tai St., Eighth Floor, Tokawan, Kowloon, (852) 7606818. Fax: (852) 7601962. Managing Dir.: Klaus Heymann; Gen. Mgr.: Anthony Anderson; Mktg. Mgr.: Jenny Chung; Sales Mgr.: Joe Wong.

Label(s): (Owned) Donau, Naxos, Marco Polo, Naxos Int'l, (Distributed) LRC, Celestial Harmonies.

US Reps.: Naxos Of America (NJ).
Int'l Reps.: Naxos Singapore (Singapore); Naxos Malaysia (Malaysia); Naxos Japan (Japan); Select (England); Olga Musik (Denmark); Sonart Meca (Australia); MVD (Germany).

Hong Kong King Yoko Ltd., 5-6 Middle Rd/Far E. Mansion, 17/F, Flat K, Kowloon, (3) 668934, (3) 666949. Fax: (852) 3-721718. Chrmn./Gen. Mgr.: C.H. Koh; Mgr.: Kenny Mok.
Label(s): (Distributed) Apollon, Denon, Crown, Watanabe, Victor-JVC, GML, Invitation, Kolin, King, Landmark, Lodia, Melodiya, Meldac, Nippon Columbia, SMS, Tokuma, Teichiku.

Hugo Prodn. Ltd., PO Box 764, No.1-2,5/F Kinglet Ind. Bldg., Shatin, New Territories, (852) 602-4066. Fax: (852) 602-4078. Dir.: Aik Yew Goh.

Branch(es): #13-212 Block 67 Marine Dr., Singapore, 1544, Singapore, (65)5334466. Fax: (65)5333504. Mgr.: Tham Chak Kong; #569 Pai An Rd., Taipei, 10494, Taiwan, 8862-5031828. Fax: 8862-5099276. Mgr.: Lin Ming Chi.

Label(s): (Owned) Lotus, Hugo, Kiigo.
KUMA Music Int'l (HK), Ltd., #14D Sutton Ct., Harbor City, Kowloon, (852) 736-8452. Fax: (852) 730-3747. Pres.: Lance N.R. Robinson; Vice Pres.: John G. Schultz; Exec. Sales: Jordan.

Label(s): (Distributed) KUMA.
Int'l Reps.: BMG Music Int'l (Hong Kong).

Million Direction Plastic Ltd., 16a Yally Bldg., 6 Yip Fat St., Wong Chuk Hang, (05) 873-2318. Fax: (05) 873-6004. Pres.: Amond K.Y. Leung; Mgr.: Johnny Tsang. (Exporter)

Pacific Music Co. Ltd., PO Box 71017, Kowloon Central Post Office, Kowloon, (3) 712-5251. Fax: (3) 761-0759. Managing Dir.: Klaus Heymann.

Label(s): (Owned) Tao, Current, Golden Gate, Golden Fidelity, HK, Marco Polo, Naxos, (Distributed) Motown, Milestone, Mute, Jive, Hansa, K-Tel, Galaxy, PWL, Prestige, Riverside, RCA, Chrysalis, Delphine, Charisma, 21 records, Ariola, Carrere, Arista, Engi, Erato, Fantasy, Eurodisc, Stax, Solar/Constellation, Stiff, Virgin and others.

PolyGram Records, Ltd., Rm 1503, Garley Bldg., 233-239 Nathan Rd, Kowloon, (852) 7354138. Fax: (852) 7355345.

Regional Dir.: Norman Cheng; Mng. Dir.: Douglas Chan; Financial Controller: Caston Lee; Regional Mktg. Mgr.: Alex Chan; Nat'l A & R Dir.: William Kwan.

Label(s): (Distributed) A & M, Amadeo, Antilles, Archive, Archiv Prodn., Argo, BBC, Barclay, BCC, Big Life, Brian, Casablanca, Capricorn, China, Coda.

Popmen, Ltd., No. 2 Magazine Gap Rd., 9th Floor, Kwun Tong, Kowloon, (5) 9877155. Pres.: Melvin Lee; Dir.: Melina Ellison.

Rock In Records, Haven Comm. Bldg. 24/F-A, Tsing Fung St., Hong Kong, (852) 571-8227. Fax: (852) 806-3204. Gen. Mgr.: Keith Yip; Asst. to Gen. Mgr.: Lorraine Chan; Promo. Exec.: Rita Tung; Prodn. Exec.: Lennon Li.

Label(s): (Distributed) 4 A.D., Rough Trade.

Shun Cheung Record Co., Ltd.

Rm#802-4 Bank Centre, 636 Nathan Rd., Kowloon, (852) 3322397, (852) 3322398. Fax: (852) 3884070. Managing Dir.: Raymond K.P. Ng.

Label(s): (Distributed) Concord Jazz, Gecko, K-Tel, Sheffield Lab, Music & Arts, V. Sarabande.

Sony Music Entertainment (H.K.) Ltd., 4/F Acme Bldg., 22-28 Nanking St., Yaumati, Kowloon, (852) 771-4391. Fax: (852) 780-3152. Managing Dir.: Peter C.H. Chiu; Sr. Gen. Mgr.: Tony Lee; Gen. Mgr.: Angela Hon.

Warner Music Hong Kong Ltd., 118-120 Austin Rd., 2/F Landwide Bldg., Kowloon, (852-3) 697421, (852-3)7244610. Fax: (852-3)7243256. Managing Dir.: Paco Wong; Financial Controller: Stephen Cheng; Gen. Mgr.: Gordon Cheng, Herman Ho.

Branch(es): 33 Canton Rd., 904-5, 9/F, Tower One, China Hong Kong City, Kowloon, Hong Kong, (852) 766608. Fax: (852) 7366173. Vice Pres. & Reg'l Dir. S.E. Asia: Paul Ewing. Label(s): (Owned) Asylum, Atco, Atlantic, Finnadar, Elektra, Paisley Park, Nonesuch, Reprise, Sire, WEA Int'l, Warner Bros., (Distributed) Studio A (restr), Island (restr), MCA, Dino Music (restr), Geffen, CIM (restr).

Wing Hang Record Trading Co., Ltd., Winner Mansn, 695-697 Nathan Rd, 2nd Fl., Kowloon, (852) 391 8118, (852)394 6406. Fax: (852) 789 4801. Dir.: Tang Ping Hang; Sze Min Min.

MUSIC PUBLISHERS

BMG Pacific Music Pub. Ltd., 9/F Kai It Bldg., 58 Pak Tai St., Tokawan, Kowloon, (852) 712-5251. Fax: (852) 761-0733. Managing Dir.: Anders Nelsson; Gen. Mgr.: Irene Padilla Ho; Prof. Mgr.: Ritchie Lo.

Canworld Ltd., No. 2, Magazine Gap Rd., 9th Floor, Kowloon, (5) 9877155. Pres.: Melina Ellison.

Cosima Music Co., See PolyGram Int'l Music Publishing Ltd.).

Cross (H.K.) Co., G.P.O. Box 4559, Hong Kong, (852) 384-0880. Fax: (852) 770-8282. Gen. Mgr.: Alexander Y.C. Lee.

Cross Keys Publishing Co., Inc., (See Sony Music Publishing).

Dejamas Music, (See PolyGram Int'l Music Publishing Ltd.).

Discovering Music Ltd., Haven Bldg. 20/F, Rm. A, Tsing Fung St., Hong Kong, (852) 807-1297. Fax: (852) 806-3204. Pres./Gen. Mgr.: Keith Yip.

EMI Music Publishing Hong Kong, PO Box 95263 Tsimshat-sui, 11 Fa Po St., Yau Yat Chuen, Kowloon, (852) 3-810321. Fax: (852) 3-970213.

Epic/Solar Songs Inc., (See Sony Music Publishing).
Wing Hang Record Trading Co., Ltd., Winner Mansn, 695-697 Nathan Rd., 2nd Fl, Kowloon, (852) 3918118. Fax: (852) 7894801. Pres.: P. H. Tang; Gen. Mgr.: Sze Min Min.

Dick James Music, Inc., (See PolyGram Int'l Music Publishing Ltd.).

KUMA Music Int'l (HK), Ltd., (CASH) Sutton Ct., 14D, Harbour City, Kowloon, (852) 736-8452. Fax: (852) 730-3747. Pres.: Lance N. R. Robinson; Gen. Mgr.: Jordan.

Kaku-Sui Publishing Ltd., 5-6 Middle Rd., 17/F, Flat K, Far East Mansion, Kowloon, (3) 668934, (3) 666949. Fax: (852) 7217188. Pres.: C. H. Koh; Professional Mgr.: Kenny Mok.

London Music, (See PolyGram Int'l Music Publishing Ltd.).

PRI Music, Inc., (See PolyGram Int'l Music Publishing Ltd.).

PRI Songs, Inc., (See PolyGram Int'l Music Publishing Ltd.).
PRI Tunes, Inc., (See PolyGram Int'l Music Publishing Ltd.).

PolyGram Int'l Music Publishing Ltd., 233-239 Nathan Rd., Garley Bldg. Rm. 1001, Kowloon, (852) 37354138. Fax: (852) 37352050. Pres.: Norman Cheng; Gen. Mgr.: Jannifer Chan.

Portrait Solar Songs Inc., (See Sony Music Publishing).

Radio Tele Music, (See PolyGram Int'l Music Publishing Ltd.).

Song Power Limited, PO Box 95170 Tsim Sha Tsui, Kowloon, (852) 7108811. Fax: (852) 7107668. Gen. Mgr.: Paul Leung.

Songmatic Music Pub., (PRS) (See KUMA Music Int'l (HK), Ltd.).

Sony Music Publishing, 4/F, Acme Bldg., 22-28, Nanking St., Yaumati, Kowloon, (852) 771 4391. Fax: (852) 780 3152. Pres.: Peter C. H. Chiu; Prof./Creative Mgr.: Angela Hon.

Sony Songs Inc., (See Sony Music Publishing).

Sony Tunes Inc., (See Sony Music Publishing).

Sweden Music, (See PolyGram Int'l Music Publishing Ltd.).

Timber Publishing Co. Inc., (See Sony Music Publishing).

Tree Publishing Co. Inc., (See Sony Music Publishing).

MUSIC & VIDEO ACCESSORY MANUFACTURERS

Discos Tropical Limitada, PO Box 53-226, Calle 68-b No. 68-73, Barranquilla, (958) 325-362, (958) 316-509. Fax: (958) 560-977. Pres.: Emilio Fortou P.; Gen. Mgr./Sales Mgr.: Tony Fortou E.

Tape—Audio: Head Cleaners, Carrying & Storage Cases, Hong Kong.

MUSIC & VIDEO ACCESSORY MANUFACTURERS

Inter-Cassette (Hong Kong) Ltd., 7 Cheung Lee St., 13/F, Man Foong In. Bldg, Chaiwan, (852) 558-2121, Fax: (852) 897-0010. Managing Dir.: Terrance Ma.

CD—Carrying & Storage Cases, Care Products.
Tape—Audio: Head Cleaners, Carrying & Storage Cases, Care Products, Video: Head Cleaners, Carrying & Storage Cases, Care Products.

Summit Magnetics Ltd., 21/F, E Tat Fty. Bldg., 4, Heung Yip Rd., Wong Chuk Hang, Aberdeen, (852) 5535223. Fax: (852) 8735049. Pres.: Lam Luk Sung; Mktg. Dir.: Betty Hung; CD—Carrying & Storage Cases, Care Products, Jewel box.

Tape—Audio: Head Cleaners, Carrying & Storage Cases, Care Products.

Viva Magnetics Ltd., 14 Wong Chuk Hang Rd., 16/F, E On Fty. Bldg., (852) 870-0119. Fax: (852) 873-1041.

CD—Carrying & Storage Cases, Care Products, Cleaning Aids, Racks.
Record—CD Storage Box.

Wing Shing Cassette Mfg. Ltd., 7 Cheung Lee St., 19/F Man Foong Bldg., Chaiwan, (852) 557-0297. Fax: (852) 897-0020.

Tape—Audio: Head Cleaners, Video: Head Cleaners.
Yat Lung Industrial Ltd., 10 Hon Man St., 9/F, Flat A, Chaiwan, (852) 558-4203, (852) 558-5601. Fax: (852) 897-2041. Tape—Audio: Head Cleaners Hong Kong.

Celebrate our 25th year of
Import & Representation of all kinds of Worldwide
Labels and continuation of our service to
another 25 years

One of the leading independent record company in
the South-East Asia



Shun Cheung Record Co., Ltd.
Room 802-4 Bank Centre, 636 Nathan Road, Kowloon, Hong Kong
Tel: (852) 332-2397, 385-3007. Fax: (852) 388-4070

**AUDIO ACCESSORY
MANUFACTURERS**

Inter-Cassette (Hong Kong) Ltd., 7 Cheung Lee St., 13/F, Man Foong In Bldg., Chaiwan, (852) 558-2121. Fax: (852) 897-0010. Managing Dir.: Terrance Ma.
Audio: Bulk Erasers, Demagnetizers, Leader Tape, Splicing Tape & Equipment.
Video: Bulk Erasers, Demagnetizers, Leader Tape, Splicing Tape & Equipment.

Summit Magnetics Ltd., 21/F, E Tat Fty. Bldg., 4, Heung Yip Rd., Wong Chuk Hang, Aberdeen, (852) 5535223. Fax: (852) 8735049. Pres.: Lam Luk Sung; Mktg. Dir.: Betty Hung.
Audio: Bulk Erasers, Demagnetizers, Leader Tape, Splicing Tape & Equipment.

Tecko Screws Ind. Co. Ltd., 5/F "D" Koon Wah, Ind. Bldg., 4 Sun On St., Chai Wan, (852) 5586313. Fax: (852) 8973989. Pres.: J.C. Chung; Sales Mgr.: Penny Law; Mktg. Dir.: C.K. Chew; Screws & Metal Components.

**STORE FIXTURE
MANUFACTURERS**

Summit Magnetics Ltd., 21/F, E Tat Fty. Bldg., 4, Heung Yip

**C-ZEROS • DOUBLE NORELCOS
JEWEL BOXES • POLY BOXES**
ANWELL INDUSTRIAL LTD.
STATE-OF-THE-ART PERFECTION
(800) 800-4769

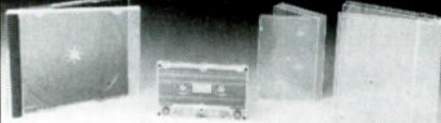

USA & CANADA SALES
(714) 920-1065 Fax (714) 920-1099
EUROPEAN (UK) SALES
(081) 560-6082 Fax (081) 560-9939

Rd., Wong Chuk Hang, Aberdeen, (852) 5535223. Fax: (852) 8735049. Pres.: Lam Luk Sung; Mktg. Dir.: Betty Hung.
Browser Boxes—(CD, Tape).

**PERFORMING & MECHANICAL
RIGHTS ORGANIZATIONS**

Sony Music Entertainment (Hong Kong) Ltd., 4/F, Acme Bldg., 22-28 Nanking St., Yaumati, Kowloon, (852) 7714391. Fax: (852) 7803152. Sales Mgr.: Jimmy Chan; Sr. Gen. Mgr.: Tony Lee; Mng. Dir.: Peter C. H. Chiu.

RECORD PROMOTION

Sony Music Entertainment (Hong Kong) Ltd., 4/F, Acme Bldg., 22-28 Nanking St., Yaumati, Kowloon, (852) 7714391. Fax: (852) 7803152. Sales Mgr.: Jimmy Chan; Sr. Gen. Mgr.: Tony Lee; Mng. Dir.: Peter C. H. Chiu.

**BLANK & BULK TAPE
MANUFACTURERS**

Allen Industries Ltd., 11 Sun Yip St., 4/F, Chaiwan, Hong Kong, (852) 557-0107, Telex: 65911. Fax: (852) 897-0297. Pres.: T. L. Liu; Mktg. Dir.: Simon Wu; Sales Mgr.: Joyce Tam

Alliance Creation Industrial, Ltd., 6 Hong Man St., 4/F Block A, Kam Man Fung, Chai Wan, Hong Kong, (852) 889-1217. Fax: (852) 889-1956.

Ampex Recording Media Corp., 709-711 W.F.C., Canton Rd., Tsim Sha Tsui, Kowloon, Hong Kong, (852) 736-1866. Fax: (852) 736-9834. Mktg. Mgr.: Freddie Wong.

Casin Video Cassette, Ltd., Unit G, 1/F Freder Centre 3 Mok Cheong, Tokwawan, Kowloon, Hong Kong, (852) 774-3996, (852) 558-63514. Fax: (852) 363-3356.

Honest Concept Industrial, Ltd., 10 Fung Yip St., Unit J, 6th Flr., YCheung, Chai Wan, Hong Kong, (852) 558-7008, (852) 558-4064. Fax: (852) 889-3141.

Jackin Video Cassette Co., Ltd., 21-23 Tai Lin Pai Rd., Unit 14, 6/F Vanta, Kwai Chung, NT, Hong Kong, (852) 480-1398. Fax: (852) 480-4295.

Lee & Man Magnetic Tapes (USA) Ltd., 8/F, Liven House, 61-3 King Yip St., Kowloon, Hong Kong, (852) 369-5299. Fax: (852) 341-7360. Pres.: Patrick Lee Wan-Keung; Sales Mgr.: Tung Cheung Kong.

Yat Lung Industrial, Ltd., 10 Hon Man St., 9/F, Flat A&5/F,

Sunrise, Chaiwan, Hong Kong, Hong Kong, (852) 558-42034, (852) 558-5601. Fax: (852) 897-2041.

Man Lin E & E Automation Engineering Co., Unit A, 14F, Block 1, 7-9 Ho Tin St., Tuen Mun, NT, Hong Kong, (852) 4637813. Fax: (852) 4563343.

Quali-Source Ltd., 15/F, Unit 8, 52-54 Hoi Yuen Rd., Kwun Tong, Kowloon, Hong Kong, (852) 797 2881. Fax: (852) 790-8703. Pres.: Billy Leung; Sales Mgr.: Francis Leung; Mktg. Dir.: Carina Leung.

Wai Shing Cassette Tape Mfg., Ltd., 14 Westland Rd., 6/F Bk. B&D, Aik San, Quarry Bay, Hong Kong, (852) 564-75614, (852) 561-2793. Fax: (852) 565-9518.

Silver Star Magnetic Co., 40 Lee Chung St., 20/F, Bk. A, Rm. A-1, Chaiwan, Hong Kong, (852) 889-7782. Fax: (852) 889-6778.

Silitech Ltd., Yip St., Block C, 8/F Sun View Ind. Bldg., Chai Wan, Hong Kong, (852) 558-8323, (852) 558-8324. Fax: (852) 558-9116.

Summit Magnetics, Ltd., 4 Heung Yip Rd., E Tat Fty. Bldg., 21/F, Wong Chuk Hang, Aberdeen, Hong Kong, (852) 553-5223. Fax: (852) 873-5049.

3M Hong Kong Ltd., GPO Box 270, 5/F Victoria Ctr., 15 Watson Rd., Causeway Bay, Hong Kong, (852) 806-6111. Fax: (852) 807-1308. Sales Mgr.: Ken Ho.

Vinco Plastic Industrial Co., Ltd.

7/F, Unit A-4, Fortune Factory Bldg., 40 Lee Chung St., Chai Wan, (852) 5580115-8. Fax: (852) 8973900. Pres.: David Kwok; Dir.: Laraine Chan; Sales Mgr.: Christopher Lee.

Wing Shing Cassette Mfg. Ltd., 7 Cheung Lee St., 19/F Man Foong Bldg., Chaiwan, Hong Kong, (852) 557-0297. Fax: (852) 897-0020.

**CARTRIDGES, CASSETTES,
REELS & OTHER PARTS****Allen Industries Ltd.**

11 Sun Yip St., 4/F, Chaiwan, 852-5570107. Fax: 852-8970297. Pres.: T. L. Liu; Sales Mgr.: Joyce Tam; Mktg. Mgr.: Simon Wu.

Anwell Industrial Ltd., 7/F Success Industrial Bldg., 7 Kin Fat St., Tuen Mun NT, (852) 463-1551. Fax: (852) 456-3259. Contact: Thomas Pereira.
Audio: C-0s, Norelco, Jewel Boxes, Polyboxes.
Video: V-Zeros.

Benelux Mfg. Ltd., 29 Cheung Lee St., 12/F, Benelux Center, Chaiwan, (852) 558-0258. Fax: (852) 897-0003. Pres.: Gary Chow; Sales Mgr.: Kenny Wu; Gen. Mgr.: Dick Chow.
Audio: C-0 and components.
Video: V-0 and Components.

Cheong Wing Electric Ltd., 16 Westlands Rd., 8/F, Ind. Bldg., Quarry Bay, (852) 562-6117. Fax: (852) 811-0699. Pres.: C. M. Lee; Sales Mgr./Mktg. Dir.: Chito Lee.
Audio: C-0s, pancakes, loaded cassettes.
Video: V-0s, loaded cassettes, video case.

Golden Age Industrial Co., 7 Wang Kong Rd., Flat 3, 4/F, Kowloon Bay, Kowloon, (852) 795-2886, (852) 795-2943. Fax: (852) 796-4682.
Audio: C-0s, Norelco Boxes.
Video: V-0s, Library Cases.

Lee & Man Mfg. Co., Ltd., 8/F, Liven House, 61-63 King Yip St., Kwun Tong, Kowloon, (852) 369-5299. Fax: (852) 341-9401. Pres.: Patrick Lee Wan-Keung; Sales Mgr.: Tun Cheung Kong.
Audio: C-0s.

Million Direction Plastic Ltd., 16A Yally Industrial Bldg., No. 6 Yip Fat St., Wong Chuk Hang, (852) 8732318. Fax: (852) 8736004. Pres.: Admond K Y leung; Mktg. Dir.: Maggie M Y Leung; Pres.: Admond K Y Leung.
Audio: Audio Cassette Housing C-0.

Quali-Source Ltd.

15/F, Unit 8, Hewlett Centre, 52-54 Hoi Yuen Rd., Kwun Tong, (852) 797-2881, (800) 888-3808. Fax: (852) 790-8703. Pres.: Billy Leung; Mktg. Mgr.: Cynthia Wong.
Audio: C-0, C-0 to C-122, Norelco Boxes.
Video: V-0, E-0 to E-240, T-0 to T-160, Library.

Silver Star Magnetic Co., 40 Lee Chung St., 20/F, Bk. A, Rm. A-1, Chaiwan, (852) 889-7782. Fax: (852) 889-6778.
Audio: C-0s.
Video: V-0s.

Summit Magnetics Ltd., 21/F, E Tat Fty. Bldg., 4, Heung Yip Rd., Wong Chuk Hang, Aberdeen, (852) 5535223. Fax: (852) 8735049. Pres.: Lam Luk Sung; Mktg. Dir.: Betty Hung.
Audio: C-0, Library & Dbl. Flat Cassette.
Video: box, back to back box, blank tape.

Vinco Plastic Industrial Co. Ltd., 7/F, A-4, 40 Lee Chung St., Fortune Factory Bldg., Chai Wan, (852) 558-0115, (852) 558-0118. Fax: (852) 897-3900. Pres.: David Kwok; Dir.: Laraine Chan; Sales Mgr.: Christopher Lee.
Audio: C-0s, Norelcos.

Viva Magnetics Ltd., 14 Wong Chuk Hang Rd., 16/F, E On Fty. Bldg., (852) 870-0119. Fax: (852) 873-1041.

**ALMAG
C-O
V-O
CD BOXES**

To get a leading edge over the competition you have installed the most sophisticated duplication equipment.

But a recording is only as good as the materials you use. To produce the best sound and picture possible, you need "ALMAG" C-O and V-O.

The C-O, V-O that enables recorded tape to perform best with minimum distortion. Your customer will love the superb quality of "ALMAG" C-O and V-O, and you'll find the trouble-free loading increases your productivity. Also for your trouble-free packaging of CD, please use our CD Jewel Box, Multi CD Box, Maxi Single CD Box and CD Twin Box.



Allen Industries Ltd.
4/F, Sum Lung Ind. Bldg.,
11 Sun Yip St.,
Chaiwan, Hong Kong

Tel.: (852) 5570107
Fax: (852) 8970297

North American Office
130 Matheson Blvd., E., Units 7/8
Mississauga, Ontario L4Z 1Y6,
Canada

Tel.: (1) 416-890-0201
Fax: (1) 416-890-8477

Video: V-0s.
Waitex Industries Ltd., 10 Hong Man St., 14/F, #C, Chaiwan, (852) 558-0821, (852) 558-7718. Fax: (852) 558-4902.
 Audio: Components.
 Video: Components.
Wing Shing Cassette Mfg. Ltd., 7 Cheung Lee St., 19/F Man Foong Bldg., Chaiwan, (852) 557-0297. Fax: (852) 897-0020.
 Audio: C-0s, C-10 to C-120.
 Video: V-0s, E-30 to E-240 & T-30 to T-160.
Yat Lung Industrial Ltd., 10 Hon Man St., 9/F, Flat A, Chaiwan, (852) 558-4203, (852) 558-5601. Fax: (852) 897-2041.
 Audio: C-0s, C-10 to C-120, Moldings.

JEWEL BOX MANUFACTURERS

Allen Industries Ltd., 11 Sun Yip St., 4/F, Chaiwan, 5570107. Fax: 8970297. Pres.: T. L. Liu; Sales Mgr.: Joyce Tam; Mktg. Dir.: Simon Wu.
Benelux Mfg. Ltd., 29 Cheung Lee St., 12/F, Benelux Center, Chiwan, (852) 558-0258. Fax: (852) 897-0003. Pres.: Gary Chow; Sales Mgr.: Kenny Wu; Gen. Mgr.: Dick Chow.
Cheong Wing Electric Ltd., 16 Westlands Rd., 8/F, Ind. Bldg., Quarry Bay, (852) 562-6117. Fax: (852) 811-0699. Pres.: C. M. Lee; Sales Mgr./Mktg. Dir.: Chito Lee.
Golden Age Industrial Co., 7 Wang Kong Rd., Flat 3, 4/F, Kowloon Bay, Kowloon, (852) 795-2886, (852) 795-2943. Fax: (852) 796-4682.
Million Direction Plastic Ltd., 16A Yally Industrial Bldg., No. 6 Yip Fat St., Wong Chuk Hang, (852) 8732318. Fax: (852) 8736004. Pres.: Admond K Y leung; Mktg. Dir.: Maggie M Y Leung; Pres.: Admond K Y Leung.
Quali-Source Ltd., 15/F, Unit 8, Hewlett Centre, 52-54 Hoi Yuen Rd., Kwun Tong, (852) 797-2881, (800) 888-3808. Fax: (852) 790-8703. Pres.: Billy Leung; Mktg. Mgr.: Cynthia Wong.
Summit Magnetics Ltd., 21/F, E Tat Fty. Bldg., 4, Heung Yip Rd., Wong Chuk Hang, Aberdeen, (852) 5535223. Fax: (852) 8735049. Pres.: Lam Luk Sung; Mktg. Dir.: Betty Hung.
Viva Magnetics Ltd., 14 Wong Chuk Hang Rd., 16/F, E On Fty. Bldg., (852) 870-0119. Fax: (852) 873-1041.
Wing Shing Cassette Mfg. Ltd., 7 Cheung Lee St., 19/F Man Foong Bldg., Chaiwan, (852) 557-0297. Fax: (852) 897-0020.

RAW MATERIALS

SKC Ltd., Hong Kong Office, #1604, 18 Harcourt Rd., Tower II, Hong Kong, (852) 5286369. Fax: (815) 5/8660019. Contact, Polyester Film: C.Y. Jung; Contact, Magnetic Media: Y.J. Park.
 Product(s): Polyester Film, Magnetic Media.

TAPE CUSTOM DUPLICATORS

Harmonic Hall Co., Room 302, Join-In Hang Sing Centre, 71 Container Port Rd., Kwai Chung, (852) 422-2772. Fax: (852) 480-4697. Contact: Thomas Pereira.
Lee & Man Mfg. Co., Ltd., 8/F, Liven House, 61-63 King Yip St., Kwun Tong, Kowloon, (852) 389-5299. Fax: (852) 341-9401. Pres.: Patrick Lee Wan-Keung; Sales Mgr.: Tun Cheung Kong.
 Audio: Cassette.
Sony Music Entertainment (Hong Kong) Ltd., 4/F, Acme Bldg., 22-28 Nanking St., Yaumati, Kowloon, (852) 7714391. Fax: (852) 7803152. Sales Mgr.: Jimmy Chan; Sr. Gen. Mgr.: Tony Lee; Mng. Dir.: Peter C. H. Chiu.
 Audio: Cassette.
 Audio Packaging Services: Inserting, Labeling, Mailing.
Summit Magnetics Ltd., 21/F, E Tat Fty. Bldg., 4, Heung Yip Rd., Wong Chuk Hang, Aberdeen, (852) 5535223. Fax: (852) 8735049. Pres.: Lam Luk Sung; Mktg. Dir.: Betty Hung.
 Audio: Cassette.

COMPACT DISC MANUFACTURERS & VIDEO DISC MANUFACTURERS

Harmonic Hall Co., Room 302, Join-In Hang Sing Centre, 71 Container Port Rd., Kwai Chung, Hong Kong, (852) 422-2772. Fax: (852) 480-4697. Contact: Thomas Pereira.
 Type: CD, Videodisk.
Sony Music Entertainment (Hong Kong) Ltd., 4/F, Acme Bldg., 22-28 Nanking St., Yaumati, Kowloon, Hong Kong, (852) 7714391. Fax: (852) 7803152. Sales Mgr.: Jimmy Chan; Sr. Gen. Mgr.: Tony Lee; Managing Dir.: Peter C. H. Chiu.
 Type: CD.

MASTERING FACILITIES

Sony Music Entertainment (Hong Kong) Ltd., 4/F, Acme Bldg., 22-28 Nanking St., Yaumati, Kowloon, (852) 7714391. Fax: (852) 7803152. Sales Mgr.: Jimmy Chan; Sr. Gen. Mgr.: Tony Lee; Managing Dir.: Peter C. H. Chiu. (Audio)

TAPE EQUIPMENT MANUFACTURERS

Benelux Mfg. Ltd., 29 Cheung Lee St., 12/F, Benelux Center, Chiwan, (852) 558-0258. Fax: (852) 897-0003. Pres.: Gary

Chow; Sales Mgr.: Kenny Wu; Gen. Mgr.: Dick Chow.
Inter-Cassette (Hong Kong) Ltd., 7 Cheung Lee St., 13/F, Man Foong In. Bldg., Chaiwan, (852) 558-2121. Fax: (852) 897-0010.
 Managing Dir.: Terrance Ma.
 Audio: C60, C90, any length.
 Video: E60/E90/E120/E180/E195/T60/T90/T120/V-0's.

JAPAN

RECORD LABELS

Alfa Moon, Inc., Gyoen Takagi Bldg. 7F, 1-1-8 Shinjuku, Shinjuku-ku, Tokyo, 160, 81 03-225-7271. Fax: 81 03-225-726. Pres.: Ryuzo Kosugi.
Alfa Records, Inc., 3-5-39, Shibaura, Minato-ku, Tokyo, 108, (03) 3455-1791. Fax: (03) 3452-5763. Pres.: Chuichi Kaneko; Gen. Mgr. (Int.): Ken Kambai; Gen. Mgr. (Jazz): Makoto Kimata; Gen. Mgr. (Domestic): Akihiro Akiya.
 Label(s): (Owned) Mute, PWL, Attic, Beggars Banquet, Jive, Curb Music.
 Int'l Reps.: Nippon Columbia Co. (Japan).

Americana Records, Inc.

PO Box 15 Kasai, Edogawa-Ku, Tokyo, 134, (03)3878-6041. Fax: (03)3878-6578. Pres.: Tom Kawai; Vice Pres.: Terry Kuroda; Sales Mgr.: Tadao Shimo.
 Branch(es): 1315 Bowdoin St., San Francisco, CA, 94134, (415) 587-1375. Fax: (415) 337-8991. Branch Mgr.: Jack Walker; 300 Linfield Dr., Vallejo, CA, 94590, (707) 645-1615. Fax: (707) 553-7773. Branch Mgr.: Jack Walker.
 Label(s): (Owned) Americana, (Distributed) Alshire Int'l, Autograph/BMG, Cexton, Advantage/Compeat, Charta, Dixie Frog, Flying Fish, Erdenklang, Int'l Mktg. Group, NSD, Step One, Rounder, Sugar Hill.

Apollon Inc., 3-8 Yochomachi, Shinjuku-ku, Tokyo, 162, (81)3/53793525. Fax: (81)3/35348711. Pres.: Hideki Hayashi; Gen. Mgr.: Satoshi Tsuchiya.
 Label(s): (Owned) Alty, Radio City, (Distributed) VariBari, Morning, Adam.
Art Union Corp., 18 Kyutei Mansion 2-B, 28-8, Maruyama-cho, Shibuya-ku, Tokyo, 150, (03) 3770-2371. Fax: (03) 3770-7612. Pres.: Taizo Fujii; Dir.: Yoichi Maeda; A & R Mgr.: Yasuaki Sawai; Int'l Rel.: Sohrab Saadat.
 Label(s): (Owned) Art Union, Showboat, Pass, (Distributed) Howards Int'l, Interplay, Stash, Spicewood, Xanadu.
BMG Victor, Japan, Inc., 1-7-8, Shibuya, Shibuya-ku, Tokyo, 150, (81)0337972001. Fax: (81)0334993475. Pres.: Osamu Sato; Gen. Mgr., Dir of Classic: Hiromasa Shimada; Dir./Int'l: Ikuma Murata; Deputy Dir./Int'l: Fumimaru Kawashima.
 Label(s): (Distributed) RCA, Arista, Ariola, Motown.

Blues Interactions, Inc.

2-41-10 Tomigaya, Shibuya-ku, Tokyo, 150, (03) 3460-8611. Fax: (03) 3460-8618. Managing Dir.: Yasufumi Higurashi; A & R Dir.: Akira Kochi.
 Label(s): (Owned) Modern/Kent, P-Vine, (Distributed) Arhoolie, Antone's, Armada & Fernandez, Acoustic Archives.

Bomba Records, Inc., 2-25-5 Shiroganedai, Arai Bldg. 2F, Minato-ku, Tokyo, 108, (81) 3-3444-55. Fax: (81) 3-3444590. Pres.: Naoto Kanazawa; Mgr. (Import, Licensing): Kumiko Sasaki.
 Label(s): (Distributed) Ansonia, Jap, Dureco, Musica, Seeco, Sonolux, Sonografica, TH, Tanaka, WS Latino, Tropical.
CBS/Sony Group, Inc., 1-4 Ichigaya-tamachi, Shinjuku-ku, Tokyo, 162, 81 03-266-5805. Fax: 81 03-235-2908. Pres.: Toshio Ozawa; Deputy Pres.: Shugo Matsu; Div. Pres. CBS/Sony: Hiroshi Inagaki; Div. Pres. Epic/Sony: Shigeo Maruyama.

Label(s): (Owned) Epic/Sony, Fitzbeat, Trefort, Life Size, US Reps.: CBS Records (NY).
CTA Co., Ltd., #53-5, Nagota 1-chome, Nakano-ku, Tokyo, 165, (03) 388-9111. Fax: (03) 388-7778. Pres.: Atsushi Katsumata; Managing Dir., Foreign: Ichiro Saito; Mktg. Dir.: Kazuhide Mitsuyama.
 Label(s): (Owned) Task Force, Starpak.
Caufuh, 7-7-7 Nishi-Shinjuku, High-Life #211, Shinjuku-ku, Tokyo, 160, (03) 369-4737. Fax: (03) 365-4494. Pres.: Shigeru Igari.
DIW Records (Disk Union Co., Ltd.), 213-1 Iidabashi, Chiyoda-ku, Tokyo, 102, (03)3234-5513. Fax: (03)3262-9724. Pres.: Teruichi Hirohata; Mgr.: Yuichi Kikuta; A & R/Promo: Isamu Suzuki; Import & Export Mgr.: Seiichi Kunishi.
 Label(s): (Owned) DIW.
Disc Center Co., Ltd., CPO Box 874, Osaka, 530-91, 1-20-14-303 Higashinakajima, Higashiyodogawa-ku, Osaka, 533, (06) 323-6350. Fax: (06) 323-0249. Pres.: Yasutoshi Gotoh; Exec. Vice Pres.: Nobuo Mekata; Sales Mgr.: Kimiko Ohmae.
 Label(s): (Owned) Admedia, Annesy, Dodejau.
Disc Prelude, Yodoyabashi White Bldg. 712, 3-5-19 Kitahama Chuo-ku, Osaka, 541, (6) 266-0688, Fax: (6) 201-4828, Pres.: Yoshihiro Asada; (Compact Disc, Records (LP's)) (Distributor, Importer).
Edison Records, Inc., Hongo 3-Chome 5-5, Bunkyo-ku, 113,



AMERICANA
RECORDS, INC.

CD & TAPE
MANUFACTURER
AND DISTRIBUTOR

MASTER LICENSING
ORGANIZATION
WORLDWIDE

RECORD COMPANY OR
PUBLISHER INTERESTED IN
THE JAPANESE MARKET
PLEASE CONTACT US.

MAIN OFFICE
P.O. Box 15 Kasai
Edogawa-Ku, Tokyo 134, Japan
(03) 3878-6041
Fax: (03) 3878-6578

US OFFICE
300 Linfield Dr.
Vallejo, CA 94590 USA
(707) 645-1615
Fax: (707) 553-7773



Japan's Most Experienced Label
for Black/Latin Sound

**African-American,
Caribbean, African & Asian Music**

Licensed distribution, purchasing and import export:
BLUES INTERACTIONS, INC.
 Tomigaya 2-41-10, Shibuya-ku, Tokyo 151, Japan
 Phone: 3-3460-8611 Telex: J33622 (Peavine) Fax: 3-3460-8618

R & B, Blues, Gospel,
Salsa, Soca, Dangdut
—We've got it!

P-VINE

DO YOU KNOW US?

PLEASE CONTACT US
IF YOU LOOK FOR A
RELIABLE BUSINESS PARTNER.

ELMO LIMITED

4-9-2 Nishifuna

Kasuga Sou

Funabashi-shi Chiba 273

TEL: (0474)31-0400 FAX: (0474)31-0402



81 3 818 7888. Fax: 81 3473 26 655. Contact: Katsuhiko Murakoshi.

Elmo Ltd., Kasuga Sou, 4-9-2, Nishifuna, Funabashi-Shi, Chiba-Ken, 273, 0474-31-0400, Fax: 0474-31-0402, Pres.: Hiromitsu Wada.

Labels Distributed: Audio: Major & Independent Label's CD, LP & Video.

Elmo Ltd., Kasuga Sou 4-9-2, Nishifuna, Funabashi-shi, Chiba-Ken, 273, 0474-31-0400, Fax: 0474-31-0402, Pres.: Hiromitsu Wada.

Label(s) (Distributed): Major & Independent Label's CD, LP, & Video.

Epic/Sony Records (Div. of CBS/Sony Group, Inc.), PO Box 5208, Plaza Mikado Bldg., 2-14-5 Akasaka, Tokyo, 107, 81 03-5563-603. Fax: 81 03-5563 810. Pres.: Shigeo Maruyama; Sr. Gen. Mgr.: Ryuzo Shirakawa; Assoc. Gen. Mgr./Int'l A&R: Masami Yamamoto; Dir. Int'l Mktg.: Aki Tanaka. Label(s) (Owned) A Touch, Escalier, Jungle Wave, Life Size, (Distributed) WTG, Epic, Epic Int'l.

Fun House, Inc., 1-9-1, Shinjuku, Shinjuku-ku, Tokyo, 160, (03) 3350-8698. Fax: (03) 3350-8827. Pres.: Kazunaga Nitta; Gen. Mgr. Int'l Div.: Hideo Takeyama.

Label(s) (Owned) Fun House.

Interplay, 18 Kyutei Mansion 2-B, 28-8, Maruyama-cho, Shibuya-ku, Tokyo, 150, (03) 770-2371. Fax: (03) 770-7612. Pres.: Taizo Fujii; Dir. Int'l: Yoichi Maeda; A & R Int'l: Yasuaki Sawai.

JVC/Victor Musical Ind., 2618 Jingu-mae, 4-Chome, Shibuya-ku, Tokyo, 150, (Distributor).

Japan All Round Music Co., Inc., 2F Maison De Simon, 1-2-10, Shibuya-ku, Tokyo, 150, (03) 408-6711. Fax: (03) 408-6745. Sales Mgr.: Koji Suganuma; (Compact Disc, Records) (Importer).

Japan Publications Trading Co., Ltd., PO Box 5030 Tokyo Int'l, 2-1, 1-chome, Sarugaku-cho, Chiyodaku, Tokyo, (03) 3292-3757. Fax: (03) 3292-0410. Export: Hirobumi Annoshita; Import: Yoh Kohno; (Compact Disc, Video (Cassette & Disc)) (Importer, Exporter).

Jimco Japan Corp., Jimco House, 4-7-7 Kachidoki, Chuo-ku, Tokyo, 104, (03) 3534-8771. Fax: (03) 3534-8200. A&R Dir.: Ken Nagai; A&R Mgr.: Eugene Otsuka; Prodn. Mgr.: Kenichi Yonezawa; Promo: Tomo Hasizume.

Label(s) (Owned) College Music, Heavy Metal Industry, Mad About Dance, Jimco. (Distributed) Motor City, Nightmare,

Int'l Reps.: Seoul Records, Inc. (South Korea).

Kikka Trading Co.

12-5, Hongo 3-Chome, Bunkyo-ku, Tokyo, 113, (81-3)38139346. Fax: (81-3)38131696. Managing Dir.: Ryusuke

Tanigawa; Mgr.: Masahiro Okaguchi; (Importer, Exporter) Labels Imported: Imports all labels; exports all Japanese label compact discs, laser discs and other software.

King Record Co. Ltd., 12-13, Otowa 2-Chome, Bunkyo-ku, Tokyo, 112, (03) 3945-2134. Fax: (03) 3945-1366. Pres.: Nobuo Ikeguchi; Managing Dir.: Tomohiro Kobayashi; Hironosuke Ikeda; Dir. A & R: Takekatsu Akama; Mgr. Int'l Dept.: Sumio Amamama.

Label(s) (Owned) Big Box, Crazy Rider, Crystal Bird, Electric Bird, Fruitgum Company, Flash, Grotesque New Pop, King, Nexus, Nadear, Paddle Wheel, 2nd Ave., Star Child, Seven Seas, Windmill.

Kitty Record, Inc., 1-8-4 Ohashi, Meguro-ku, Tokyo, 153, (03) 780-8646. Fax: (03) 780-8621. Pres.: Hidenori Taga; Managing Dir.: Yoshihiro Kanda; Int'l Div.: Kazuo Munakata. Label(s) (Owned) Mju.

MMG Inc., 1-1-8 Shinjuku, 5/F, Shinju-ku, Tokyo, 160, (81-3)32257271. Fax: (81-3)32251430. Pres.: Ryuzo Kosugi; Asst. Mgr. Int'l: Yumi Tabata; Dir. Mktg. Atlantic/ATCO: Takashi Ishihara; Deputy Gen. Mgr. ATL/ATCO: Sam Nagashima; Mgr. A*Vision: Kimisada Katoh; Dir. Admin.: Takashi Kamiide; Deputy Gen. Mgr./Acct.: Masaji Nakajima; Mgr. Acct.: Eiichi Kodaira.

Branch(es): 4-28 Yotsuya, 3/F, Gyoen Takagi Bldg., Shinjuku-ku, Tokyo, 160, Japan, (81-3)32252361, Fax: (81-3)32252360, V.P. A&R/Promo. Depts.: Sekiji Murata.

Marlux Int'l Corp., 2-5 Roppongi, 5-chome, Minato-ku, Tokyo, 106, (03) 404-6646. Fax: (03) 404-6649. Gen. Mgr.: Susan Harii; Sales Dept.: Yuko Takahashi.

Branch(es): Savannahweg 70, 3542 AW Utrecht, Holland, The Netherlands, (030) 436-157, Fax: (030) 4336-207.

Meta Co., Ltd., No. 501, Kagawa Bldg., 27-6, 7-Chome, Shinjuku-ku, Tokyo, 160, (03) 5273-2821. Fax: (03) 5273-2831. Pres.: Aki Takasawa; Import Mgr.: Masahiko Ebihara; Yoshiaki Fukazawa.

Muse Trading Co., Inc., New Atago Bldg., 2-4-9 Atago, Minato-ku, Tokyo, 105, (03) 438-2525. Telex: 27353. Fax: (03) 438-2529. Gen. Mgr.: Kazuo Kumagai; Sales Mgr.: Michinori Takahashi; (Distributor, Importer).

Music Tokyo Co., 8-5 Roppongi 4-Chome, Wako Bldg., Minato-ku, Tokyo, 106, (03) 403-7555. Fax: (03) 403-7550. Managing Dir.: Tsutomu Miyazawa; Mktg. Dir.: Tetsuya Maruyama; Classics Mgr.: Haruichi Nakamura.

Nippon Columbia Co., Ltd., 14-14, Akasaka, 4-Chrome, Minato-ku, Tokyo, 10711, (03)3584-8111. Fax: (03) 3584-8135. Pres.: Kazuo Mochizuki; Sen. Exec. Dir.: Jyoji Miyakawa; Dir.: Hidetoshi Kimura; Gen. Mgr.: Toshibumi Ohno.

Label(s) (Owned) Denon, (Distributed) Factory, Int'l, Hansler, Muza, One Little Indian, Supraphon, Reeves, 4 AD, Borenreiter, Bethlehem,

RELIABLE IMPORT PROFESSIONALS WITH OVER 20 YEARS EXPERIENCE

**PHENIX TRADING CO., LTD.**

Central Post Office Box 631, Osaka, 530-91 Japan

Tel. 06-363-7106

Tlx. 64219(PHXTRDG)

Fax. 06-365-9636

US Reprs.: A & M (CA).

Int'l Reprs.: Denon Canada, Inc. (Canada); Ades SA (France); NOWO srl (Italy); Hayden Laboratories (United Kingdom); Denon Electronic GmbH (West Germany).

Nippon Crown Co., Ltd., 2-10-8 Akasaka, Minato-ku, Tokyo, 107, (03) 582-4747. Fax: (03) 583-6176. Pres.: Noboru Saito; Overseas Div. Dir.: Tokukazu Sonoyama.

Branch(es): 345 N. Maple Dr., Ste. 284, Beverly Hills, CA, 90210, (213) 273-8812. Fax: (213) 273-7487. Vice Pres.: Tokukazu Sonoyama.

Label(s): (Owned) ABC Video Ents., Inc., ASV, Break Time, Audio Lab, Crown, Crown Classics, Granada Video, Enja, Tutu, Vice, Xanadu, Worldvision Ents., Inc., Hathut, Hi Blite, Koh Hak, J.A.P., LWT Int'l RPTA, Meldac, Ninety-One, Muse, Novalis, Palette Acanta, Arthur Rank, Panam, Sacis Int'l Dist., Suncrown, Theresa, Terminal.

Nippon Phonogram Co., Wako Bldg. 8-5, Roppongi 4-Chome, Minato-ku, Tokyo, 106.

Nippon Columbia Co. Ltd. (Denon), 4-14-14 Akasaka, Minato-ku, Tokyo, 107-11, (03) 351-8208.

PSP Co. Ltd., 2-20-7 Misaki-Cho, Chiyoda-ku, Tokyo, (3) 5275-0978. Fax: (3) 5275-0976. Dir.: Masuo Kokubo; Int'l Mgr.: Eltee Ogata; (Compact Disc, Video (Cassette & Disc), Records) (Exporter)

Labels Imported: Japanese nation-wide labels.

Pass, 18 Kyutei Mansion 2-B, 28-8, Maruyama-cho, Shibuya-ku, Tokyo, 150, (03) 770-2371. Fax: (03) 770-7612. Pres.: Taizo Fujii; Dir. Int'l: Yoichi Maeda; A & R Int'l: Yasuaki Sawai.

Phenix Trading Co., Ltd.

Central PO Box 631, Kita-ku, Osaka, 530-91, (06) 363-7106. Fax: (06) 365-9636. Pres.: Kikuo Tarumoto; Managing Dir.: Morio Nakatsu; (Compact Disc, Pre-Recorded Audio Tape, Video (Cassette & Disc), Records, Cutouts, Overstock) (Importer)

Labels Imported: Labels from USA, UK, Germany, Holland, France, Italy, Norway, Denmark, Sweden, Australia.

Polydor K. K., 8-4 Ohashi, 1-Chome, Meguro-Ku, Tokyo, 152, 81 03-496 8074. Pres./Nat'l A & R: Terumi Mizuta; Dir./Int'l Repertoire Mgr: Hiroyuki Takei; Dir./Special Project Mgr.: Yasuo Fujisawa; Dir./Admin. Mgr.: Takafumi Yamanaka. Label(s): (Owned) Archiv, Barclay, Deutsche Grammophon, Verve, London, RSO, (Distributed) Polystar, Sound Design, Pablo, Kitty, MPS, ECM, Sound World, Casablanca, DG.

Pony Canon, Inc., 3-3-5 Kudan Kita, Chiyoda-Ku, Tokyo, 102, (03) 221-3221. Fax: (03) 221-3229. Gen. Mgr./Int'l A & R: Harry Kaneko.

Label(s): (Owned) Windham Hill, Agartha, Face Int'l, (Distributed) Coda, Grammavision, Hi-Tension, A & M, Scotti Bros.

Pooh Yokochi, Inc., Pettitor Bldg. 4F, Sanj-kawaramachi, Nakagyo-ku, Kyoto, 604, (075) 256-2856. Fax: (075) 255-3293. Pres.: Hideaki Matsuoka; Mgr./Buyer: Kenji Matsuoka; (Compact Disc, Pre-Recorded Audio Tape, Video (Cassette & Disc), Records, Cutouts, Overstock) (Distributor, Importer, Exporter)

Labels Distributed: Audio: CMH, Country, Flying Fish, Kaleidoscope, Rebel, Rounder, Shanachie, Sugar Hill, Yazoo and all major Japanese labels; Video: Central Sun, Homespun Tapes.

Ratspack Records Co., Ltd., Soft Town Aoyama 515, Jingumae, 3-1-24, Shibuya-ku, Tokyo, 150, (03) 470-2179. Fax: (03) 470-2196. Pres.: Makito Tanahashi; Gen. Import Mgr.: Hideyuki Yamatake; Mgr. & Cut-out Buyer: Jun'ichi Iizuka. Label(s): (Distributed) Kanikapila.

Shinjuku Record Co. Inc., 7-5-6 Nishi-Shinjuku, Shinjuku-ku, Tokyo, 160, (03) 3363-3369. Fax: (03) 3365-4823.

Sound Trading Co. Ltd., 8-13, 2-Chome, Azabu Juban, Minato-Ku, Tokyo, 106, (03) 3457-0461. Fax: (03) 3457-0465. Pres.: Masao Yorozu; Mgr.: Hitoshi Wada; Managing Dir.: Hisaichi Urushiyama; Gen. Mgr.: Hitoshi Iijima; (Compact Disc, Pre-Recorded Audio Tape, Video (Cassette & Disc), Records (LP's, 12-inch, Singles), Cutouts, Accessories) (Distributor, Importer, Exporter).

Spicewood, 18 Kyutei Mansion 2-B, 28-8, Maruyama-cho, Shibuya-ku, Tokyo, 150, (03) 770-2371. Fax: (03) 770-7612. Pres.: Taizo Fujii; Dir. Int'l: Yoichi Maeda; A & R Int'l: Yasuaki Sawai.

Sunray Yamakou, Inc., 2-4-6, Kamiji Higashinari-ku, Osaka, 0118169727621. (Importer).

Super Stop, Inc.

Minoo Sound Hills, 1-15-6, Sembahigashi, Minoo, Osaka, 562, (0727) 28-2351. Fax: (0727) 28-2358. Pres.: Hirakazu Sasabe; Export Rep.: Tsuneo Fujisawa; Import Rep.: Chizuru Mizuta; Rep. Service: Toshiya Uratani.

Label(s): (Distributed) DIW, Avant, Fresh Sound, GBW, IRD, Heart Note, Moon, Palladium, Red, Philology, US Reprs.: MJU, Inc. (NJ).

Int'l Reprs.: Harmonia Mundi (UK & France): Bellahon Int'l (Germany); Be-Bop Records (Switzerland); I.R.D. (Italy); Dureco BV. (Holland); Musikk Distribution AS (Norway); Bar-na Records Lab. (Spain); Birdland Records (Australia).

Tower Records K.K., 2-15-9 Minami Shinagawa, Shinagawa-ku, Tokyo, 140, (03) 5479-8620. Fax: (03) 5479-8625. Far East Managing Dir.: Keith Cahoon; Sales Mgr.: Manabu Sano; Buyer: Takeshi Imaizumi; (Compact Disc, Pre-Recorded Audio Tape, Video (Cassette & Disc), Records (12-inch), Cutouts, Overstock, Accessories) (Distributor).

Victor Musical Industries, Inc., 26-18 Jingumae, 4-Chome, Shibuya-ku, Tokyo, 150, (03) 3497-1814. Fax: (03) 3408-1761.

我々から
最上級の
サービス及び
品質

**Kaleidoscopic
Music**

KALEIDOSCOPIC MUSIC srl

Viale Manzoni 52-00052

Cerveteri Rome-Italy

Tel: (39) 06/9941925

Fax: (39) 06/9943040

12" Singles, CD, LP,
20 years old Live, MC,
Licensing Deals.

BRINGING JAPAN CLOSER EXPORT, IMPORT & DISTRIBUTION OF CD RECORD BOOK VIDEO LD

FOR THE MOST EFFICIENT WAY TO CAPTURE
THE JAPANESE MARKET CONTACT :

PHONE: (0727) 28 - 2351 ~ 3

FAX:

(0727) 28 - 2358 MAIN

(0727) 27 - 2423 EXPORT

(0727) 28 - 8871 REP. SERVICE

(0727) 27 - 0059 DISTRIBUTE / IMPORT



1 - 15 - 6 SEMBAHIGASHI, MINOO, OSAKA 562 JAPAN
(MINOO SOUND HILLS)

BREAKING



NEW RECORDS EVERY YEAR!!!

FUJIPACIFIC MUSIC INC.
13-2 Rokubancho Chiyoda-ku Tokyo 102, Japan
TELEPHONE (81)3-3288-5435
FAX (81)3-3288-5440

THE MOST PROFESSIONAL IMPORTER IN JAPAN



**WOODYLAND
TRADING CO., LTD.**
TOKYO OFFICE: 5-5-11-102, HIGASHI-OHI,
SHINAGAWA, TOKYO 140 JAPAN
PHONE 03-3458-9220
FACSIMILE: 03-3458-9441

POP.
CLASSICAL.
JAZZ AND SO ON...

CREAV INC., U.S.A.

Producing musical pieces
Marketing foreign-label musical pieces and video movies
Producing and marketing CDs, analog discs, music tapes, video discs and videotapes
Discovering new talents; singers, artists, song writers and composers
Doing agent business for singers, artists, song writers and composers
Copyrighting and publishing musical pieces

<p style="text-align: center;">HEAD OFFICE 2-10-8 Akasaka, Minato-ku Tokyo 107 Japan Phone 03-3582-4747 Fax 03-3583-6176</p>	<p style="text-align: center;">LOS ANGELES OFFICE CROWN AUDIO VISUAL LOS ANGELES 345 North Maple Drive, Suite 284 Beverly Hills, CA 90210 Phone (213)273-8812/3 Fax (213)273-7487</p>
---	---

Pres.: Noboru Takayama; Managing Dir. (Finance): Jun Deguchi; Managing Dir. (Sales): Hideaki Suda; Int'l Dir.: Yoshihisa Honda. Label(s): (Owned) Victor, Taishita, Invitation, JVC, Roux, Globe, (Distributed) GMP, Gold Mountain, IRS, Callope, Contemporary, Curepuscule, Delphine, Fantasy, Eldorado, Rough Trade, Solar, River Side, Landmark, Malaco, Milan, Milestone, Noise, No Remorse, Pabro, Pierre Verany, RGE, Prestige, Stax, Waylo,
US Reps.: JVC Musical Industries, Inc. (CA).
Int'l Reps.: Kakusui Victor Records, Ltd. (Japan).
Voice, Inc., GS Akasaka 4/F, 8-6-28 Akasaka, Minato-ku, Tokyo, 135, 81 03-54745777. Fax: 81 03-54745808. Dir.: Masumi Hori; (Compact Disc, Pre-Recorded Audio Tape, Video (Cassette & Disc)) (Distributor, Importer)
Labels Imported: Canyon Records Prodn., Sound Currents, Emerald Green Sound, Helios Music Ent., Lazaris (USA).
WEA Music K.K., 3-8, Sanbancho, 3/F, Izumikan Sanbacho Bldg., Chiyoda-ku, Tokyo, 102, (81-3)32218555. Fax: (81-3)32218545. Pres.: Ikuo Orita; Label Mgr. WEA Int'l: Kei Hayashi; Label Mgr. MCA: Aiichiro Kiyohara; Int'l Liaison: Kanae Sumiya.
Warner Music Japan, Inc., 1-1-1 Minami-Aoyama, E-14F, Minato-ku, Tokyo, 107, (81-3)34752111. Fax: (81-3)34791138. Pres.: Tokugen Yamamoto; Sr. Vice Pres.: Shojiro Namba; Kiyoshi Hachiya; Dir./Gen. Mgr. Sales Dept.: Noboru Kanoda; Dir. & Gen. Mgr. Finance: Hiroshi Miyazawa; Asst. Gen. Mgr. Int'l A&R: Toshi Tanaka; Mgr. Liaison, Int'l A&R: Shintaro So; Gen. Mgr. Classical: Isamu Tama; Asst. G.M. Video Dept.: Yoshio Niwano; Gen. Mgr. Special Mktg.: Hiroki Imao; Mgr. Int'l Sales Dept.: Toshio Mori; Gen. Mgr. Bus. Affairs: Masao Yamada; Mgr. Systems: Hiroki Nagara; G.M. Stock Control/Distr.: Jiro Masuda; Gen. Mgr. Domestic A&R: Akihiro Mino.
Warner-Pioneer Corp., 1-1-1 Minami-Aoyama, East 14F, Minato-ku, Tokyo, 107, (81-3)475-2111. Fax: (81-3)479-1138. Pres.: Tokugen Yamamoto; Mng. Dir.: S. Namba/K. Hachiya; Mgr. Sales: Shin Kanoda; Mgr. Accts.: Hiroshi Miyazawa. Label(s): (Owned) Asylum, Elektra, Erato, Reprise, Nonesuch, Sire, Teldec, Westminster, Warner Bros., US Reps.: WEA Int'l (NY).

Woodyland Trading Co., Ltd.

5-5-11-102, Higashi-Ohi, Shinagawa, Tokyo, 140, (03) 3458-9220. Fax: (03) 3458-9441. Pres.: Masataka Matsuyama; Import Mgr.: Masayasu Kurimoto; Sales Mgr.: Hiroshi Futamura; Classical Mgr.: Tomohiko Furuichi. (Distributor, Importer, Exporter)
Cutouts/Overstocks: Record, CD, Video, Cassette, 12" s.

Xanadu, 18 Kyutei Mansion 2-B, 28-8, Maruyama-cho, Shibuya-ku, Tokyo, 150, (03) 770-2371. Fax: (03) 770-7612. Pres.: Taizo Fujii; Dir. Int'l: Yoichi Maeda; A & R Int'l: Yasuaki Sawai.

Zero Communications, 1-4-2 Yariya-machi, 4/F, Chuo-ku, Osaka, 540.

MUSIC PUBLISHERS

Alfa Publishing, Inc., 3-5-39 Shibaura, Menato-ku, Tokyo, 108, (03) 3455-1746. Fax: (03) 3452-5763. Pres.: Chuichi Kaneko; Gen. Mgr.: Ken Kambai; Prof./Creative Mgr.: Hircmasa Onaka.

Alshire Music Pub., (BMI) (See Americana Songs, Inc.).
Americana Music Publishing, Inc., (JASRAC) PO Box 15 Kasai, Edogawa-Ku, Tokyo, 134, (03)3878-6041. Fax: (03)3878-6578. Pres.: Tom Kawai; Gen. Mgr.: Kaz Watanabe; Prof./Creative Mgr.: Terry Kuroda.

Americana Songs, Inc., 5-3-11 Naka Kasai, Edogawa-Ku, Tokyo, 134, (03) 878-6041. Fax: (03) 878-6578. Pres.: Terry Kuroda; Gen. Mgr.: Tom Kawai; Professional Mgr.: Tadao Shimo.

Arrow Music Corp., (JASRAC) 1-1-1 Minami-Aoyama, Minato-ku, Tokyo, 107, (03) 475-2020. Fax: (03) 479-1139. Pres.: Tokugen Yamamoto; Gen. Mgr.: Shojiro Namba; Professional Mgr.: Masao Yamada.

Art Ensemble of Chicago Publishing Co., (See DIW Music Publishing Co.).

Baby Love Music, (ASCAP) (See 'Hara Int'l Inc.).

Black Bull Music, (See Taiyo Music, Inc.).

Buena Vista Music Co., (BMI) (See Yamaha Music Foundation).

CBS Sony/Songs, (JASRAC) PO Box 5208, Tokyo Int'l Airport, 2-4-12, Jingumae, Shibuya-ku, Tokyo, 10031, (03) 5474-9516. Fax: (03) 5474-9527. Pres.: Muneo Wakamatsu; Gen. Mgr.: Namihiko Sasaki; Professional Mgr.: Ken-ichi Watanabe.

Canbass Mattress Music, (See Yamaha Music Foundation).

Cerry Island, Inc., (JASRAC) (See Toshiba EMI Music Publishing Co., Ltd.).

Chappell/Intersong K.K., 8th Fl., Horaiya Bldg., Roppongi 5-2-1, Minato-ku, Tokyo, 106, (03) 405-5531. Fax: (03) 405-5570. Pres.: Leslie E. Bider; Gen. Mgr.: Michi Arai; Professional Mgr.: Michi Arai.

Chu Teh Music, Inc., (See Jimco Music, Inc.).

Columbia Music Publishing Co., Ltd., 4-10-21 Akasaka, Minato-ku, Tokyo, 107, (03) 3584-8111. Fax: (03) 3582-9857. Pres.: Hajime Ogura; Gen. Mgr.: Kotaro Mesaki; Prof. Mgr.: Minoru Sakurada.

Controversy Music, (See Taiyo Music, Inc.).

Copyright Mgmt., Inc., (See 'Hara Int'l Inc.).

Cram Renraif Co., (BMI) (See 'Hara Int'l Inc.).

DIW Music Publishing Co., 2-13-1 Iidabashi, Chiyoda-ku, Tokyo, 102, (03) 3234-5513. Fax: (03) 3262-9724. Pres.: Teruichi Hirohata; Gen. Mgr.: Yuichi Kikuta.

DeMurray Music. (See DIW Music Publishing Co.)

Delsound. (BMI) (See Americana Songs, Inc.)

Walt Disney Music Co., (ASCAP) (See Yamaha Music Foundation).

EMI Music Publishing Japan, 6-B Alcasaka 1-Chome, Minato-ku, Tokyo, 107, (81-3)224-0591. Fax: (81-3)224-0597.

Ecnirp Music. (See Taiyo Music, Inc.)

Edition Swington. (GEMA) (See 'Hara Int'l Inc.)

Emmylou Songs. (ASCAP) (See 'Hara Int'l Inc.)

Erdenklang Music. (GEMA) (See Americana Songs, Inc.)

Etc., Etc., (GEMA) (See 'Hara Int'l Inc.)

Fujipacific Music, Inc.

(JASRAC) 13-2 Rokubancho, Chiyoda-ku, Tokyo, 102, (03) 3288-5435. Fax: (03) 3288-5440. Pres.: Ichiro Asatsuma; Chief, Int'l: Taku Kitazawa; Int'l Mgr.: Dan Russon.

Fun House Music Publishers, Inc., 1-9-1, Shinjuku, Shinjuku-ku, Tokyo, 160, (03) 3350-8700. Fax: (03) 3350-8827. Pres.: Kazunaga Nitta; Managing Dir.: Hideo Takeyama.

Ganga. (See Taiyo Music, Inc.)

Edward Grant, Inc., (ASCAP) (See 'Hara Int'l Inc.)

Happy Valley Music. (BMI) (See Americana Songs, Inc.)

'Hara Int'l Inc., (JASRAC) 3-7-21 Higashi Gotanda, Shinagawa-ku, Tokyo, 141, (03) 3445-4545. Fax: (803) 34457474. Chrmn.: Richard Noboru Uehara; Gen. Mgr.: N. Yunoki.

Harrisongs. (See Taiyo Music, Inc.)

Hollywood Pictures Music. (ASCAP) (See Yamaha Music Foundation).

Holpic Music, Inc., (BMI) (See Yamaha Music Foundation).

HoriPro, Inc., (JASRAC) 1-2-5 Shimomeguro, Meguro-ku, Tokyo, 153, (03) 3490-8411. Fax: (03) 3490-4646. Chrmn./CEO: Tadeo Hori; Vice Pres. Int'l: Kaz Hori; Copyright Mgr.: Seiji Feuki.

Interplay Music. (See Pumpkin Music Ltd.)

Ital Music Ltd., 18 Kyutei Mansion 2-B, 28-8, Maruyama-cho, Shibuya-ku, Tokyo, 150, (03) 3770-2371. Fax: (03) 3770-7612. Pres.: Hidemaro Okumura; Prof./Creative Mgr.: Yoichi Maeda.

J-Land Music, Inc., (JASRAC) (See CBS Sony/Songs)

J-Wave Music Inc., Farm Bldg. 3F, 4-26-35, Jingumae, Shibuya-ku, Tokyo, 150, (03) 3796-0813. Fax: (03) 3796-2813. Pres.: Tamotsu Yamamoto; Gen. Mgr.: Katsumi Nishimura.

Jade Music Co. Ltd., 2-3-5 Kami-Ohsaki, #101-102, Sinagawa-ku, Tokyo, (03) 3442-3451. Fax: (03) 3442-3453. Pres.: Kazue Daido; Gen. Mgr.: Caruzo Fuller; Prof./Creative Mgr.: Michael Duer.



**THE MUSIC PUBLISHER.
THE SKILLS & EXPERTISE
YOU'VE BEEN WAITING FOR.**

—Hong Kong Office—

NTV MUSIC (HONG KONG)LTD.
11 Fa Po Street, Yau Yat Chuen,
Tel: 3-810321 Fax: 3-970213
Cable: EMIMUS Hong Kong
Telex: 33512 EMSEA HX

—London Office—

NTV MUSIC (U.K.)LTD.
159 Broadhurst Gardens,
London NW6 3AU England
Tel: (071)372-3966
Fax: (071)624-6384



NIPPON TELEVISION MUSIC CORPORATION

NTV Yonbancho Annex, 5-6 Yonbancho, Chiyoda-ku, Tokyo 102 Japan
Tel. (03)5275-1113 Fax: (03)5275-4059 Cable: NTVM Telex: J29410NTVMUSIC
A MEMBER OF NIPPON TELEVISION NETWORK GROUP

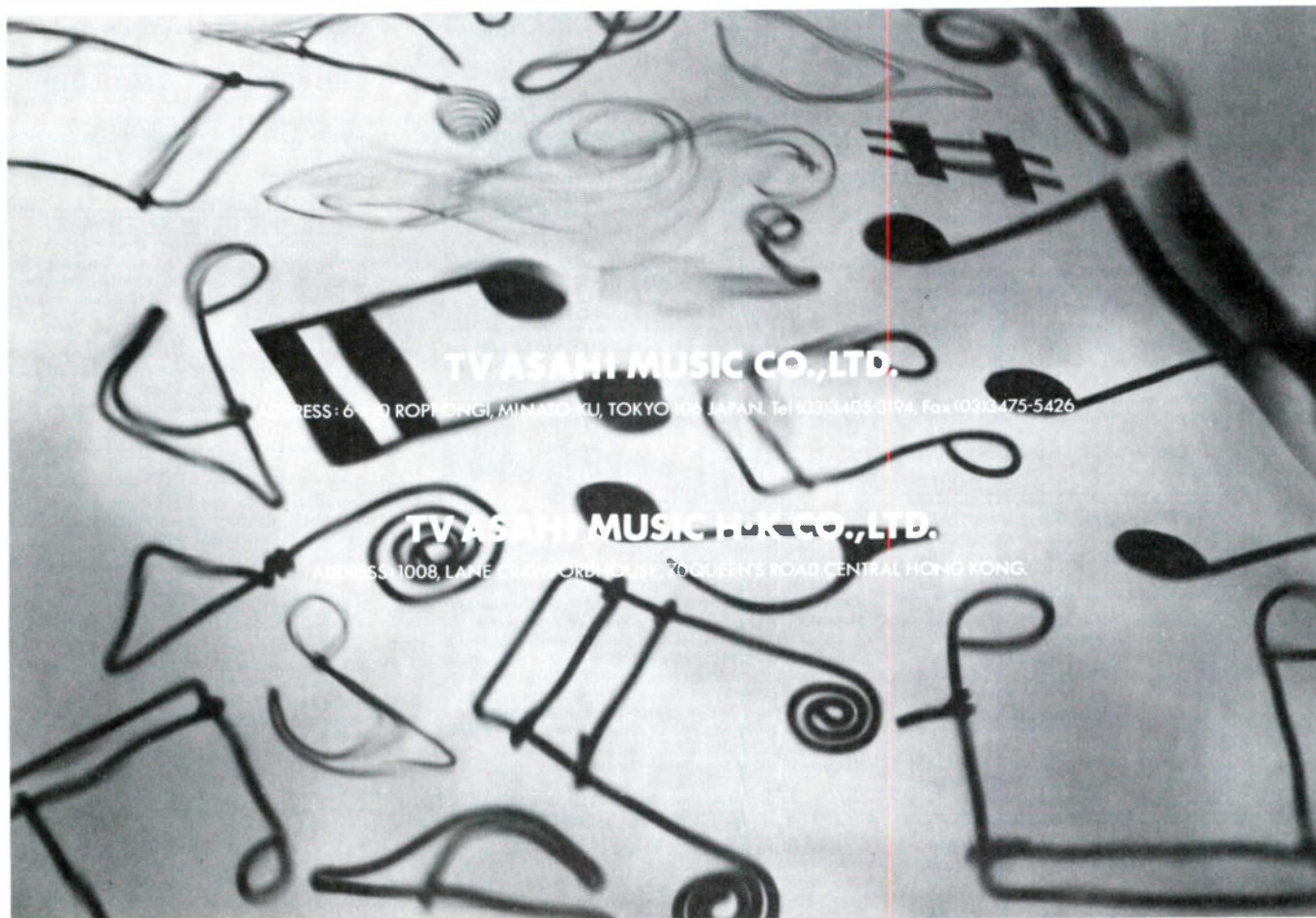

TV ASahi MUSIC CO., LTD.

ADDRESS: 6-1-10 ROPPONGI, MINATO-KU, TOKYO 106 JAPAN. Tel: 03-3405-3194. Fax: 03-3475-5426

TV ASahi MUSIC H.K. CO., LTD.

ADDRESS: 1008, LANE 4, MIDDLE HONG KONG, 70 QUEEN'S ROAD CENTRAL HONG KONG.

Japan All Round Music Co., Inc., 2F Maison De Simon, 1-2-10, Shibuya-ku, Tokyo, 150, (03) 408-6711. Fax: (03) 408-6745. Sales Mgr: Koji Suganuma.

Jimco Music, Inc., 4-7-7 Kachidoki, Jimco House, Chuou-ku, Tokyo, 104, (03) 3534-8771. Fax: (03) 3534-8200. Pres.: Mana Takekawa; Prof./Creative Mgr.: Eugene Otsuka.

Ju-Bop Music Div., (See Pumpkin Music Ltd.).

KAB Music, Inc., (JASRAC) (See CBS Sony/Songs).

Kenroad Music Ltd., 18 Kyutel Mansion 2-B, 28-8 Maruyama-cho, Shibuya-ku, Tokyo, 150, (03) 3770-2371. Fax: (03) 3770-7612. Pres.: Taizo Fujii; Gen. Mgr./Prof./Crea. Mgr.: Yoichi Maeda.

Kidada, (See Taiyo Music, Inc.).

Kitty Music Corp., 1-8-4 Ohachi, Meguro-ku, Tokyo, 153, (03) 780-8646. Fax: (03) 780-8669. Pres.: Hidenori Taga; Gen. Mgr.: Harumi Ogawa; Professional Mgr.: Kazuyasu Honma.

Laffia Music, (See DIW Music Publishing Co.).

Lamhill Music Ltd., (See Jimco Music, Inc.).

Lanikai Sound, (See DIW Music Publishing Co.).

Liberation Music, (See DIW Music Publishing Co.).

M.P.N. Prodn., (See Jimco Music, Inc.).

Marionette Music, (JASRAC) (See CBS Sony/Songs).

Mariux International Corp., 5-2-5, Roppongi, Minato-ku, Tokyo, (03) 404-6646. Fax: (03) 404-6649. Pres.: Taka Harii; Gen. Mgr.: Susan Harii.

Meshugah Music, (See Pumpkin Music Ltd.).

Metal Box, (JASRAC) (See CBS Sony/Songs).

Minas, (See Taiyo Music, Inc.).

Miracle Master Co., Ltd., (JASRAC) (See CBS Sony/Songs).

Morning Music, (CAPAC) (See Yamaha Music Foundation).

Munich Music, (See Jimco Music, Inc.).

Najamia Publishing, (See DIW Music Publishing Co.).

Nichon, Inc., 12-4, Nagatacho 2-Chome, Sanno Kowa Bldg., 8F, Chiyoda-ku, Tokyo, 100, (03) 3595-3883. Fax: (03) 3595-2772. Pres.: Mamoru Murakami; Prof./Creative Mgr.: Carol Naomi Abe.

Nippon BMG Music Pub., c/o Japan Central Music Ltd., 1-5 Wakaba, Shinjuku-ku, Tokyo, 81-3-358-1615. Fax: 81-3-358-2817. Gen. Mgr.: Keiko Hida.

Nippon Television Music Corp.

NTV Yonbancho Annex, 5-6 Yonbancho, Chiyoda-ku, Tokyo, 102, (03) 5275-1113. Fax: (03) 5275-4059. Pres.: Koichi Nakamura; Gen. Mgr.: Atsushi Kitamura; Prof./Creative Mgr.: Hiroji Eshima.

Novello & Co., (PRS) (See 'Hara Int'l Inc.).

Mark O'Connor Musik, (BMI) (See 'Hara Int'l Inc.).

Overheat Music, Inc., (JASRAC) (See CBS Sony/Songs).

Pablo Music, (See Yamaha Music Foundation).

Peermusic, (See Southern Music Publishing Co. (Japan) Ltd.).

Peermusic K.K., (JASRAC) Sanno Kowa Bldg., 12-4, Nagatacho, 2 Chome, Chiyoda-ku, Tokyo, 100, (03) 3595-3883. Fax: (03) 3595-2772. Gen. Mgr.: Tsugi Sakagami; Prof./Creative Mgr.: Carol Abe.

Dan Penn Music, (BMI) (See 'Hara Int'l Inc.).

Prime Music Publishing, Inc., 6F Kinoshita Bldg., 1-17-3 Shibuya, Shibuya-ku, Tokyo, 150, (03) 797-0870. Fax: (03) 797-1330. Pres.: Shinji Nakada; Gen. Mgr.: Shushoh Kobata; Professional Mgr.: Kaoru Maeda.

Pumpkin Music Ltd., 3-28-8 Koenji-Minami, Suginami-ku, Tokyo, 166, (03) 311-8945. Pres.: Yoichi Maeda.

Queen Music Office, (JASRAC) (See CBS Sony/Songs).

Rondor Music Int'l, Inc., (See Taiyo Music, Inc.).

Service Winner Music, (BMI) (See Americana Songs, Inc.).

Seven Seas Music Co. Ltd., 12-13, Otowa 2-chome, Bunkyo-ku, Tokyo, 112, (03) 3945-2135. Fax: (03) 3945-1366. Pres.: Tsunehiro Motoyoshi; Prof./Creative Mgr.: Koji Saito.

Shinjuku Record Co., Inc., 7-5-6 Nishi-Shinjuku, Shinjuku, Tokyo, 160, (03) 363-3669. Fax: (03) 365-4823. Pres.: Masaburo Fujiwara; Gen. Mgr.: Kunyio Fujiwara.

Shinko Music Publishing Co., Ltd., (JASRAC) 2-1 Ogawa-Machi, Kanda, Chiyoda-ku, Tokyo, 101, (03) 3292-2861. Fax: (03) 3295-5135. Pres.: Shooichi Kusano; Gen. Mgr. Int'l: Joe Miyasaki.

Shoko Music Co., (JASRAC) (See Toshiba EMI Music Publishing Co., Ltd.).

Southern Music Publishing Co. (Japan) Ltd.

Sanno Kowa Bldg., 12-4 Nagatacho, 2-Chome, Chiyoda-Ku, Tokyo, 100, (813) 595-3883. Fax: (813) 595-2772. Tlx: 26610. Mgr.: Tsugi Sakagami.

State of the Arts, (See Taiyo Music, Inc.).

Stuck On Music, (See Taiyo Music, Inc.).

Sunkyo Music Co., Ltd., TRS Princess 302, 2-716-5, Higashi-Onari, Omiya City, 330, (48) 667-2075. Fax: (48) 667-2076. Pres.: Ichiro Takeuchi; Gen. Mgr.: Youichi Takeuchi.

TV Asahi Music Co., Ltd.

6-4-10 Roppongi, Minato-ku, Tokyo, 150, (03) 3405-3194. Fax: (03) 3475-5426. Pres.: Hiroo Hirai; Gen. Mgr.: Ryuichi Hatanaka; Professional Mgr.: Kazuya Matsuzaki.

Taiyo Music, Inc., Akasaka PO Box 30, Tokyo, 107, 3-5-15 Kita-Aoyama, Minato-ku, 107, (03) 3470-2751. Fax: (03) 3470-2864. Pres.: Tatsuji Nagashima.

Top Music Publishing Co., Ltd., 1-2-5 Shimomeguro, Meguro-ku, Tokyo, 153, (03) 490-4635. Fax: (03) 490-4638. Pres.: Takeo

Hori; Professional Mgr.: Seiji Fueki; Contact: Nozomu Ito. **Toshiba EMI Music Publishing Co., Ltd.**, (JASRAC) Inoue Akasaka Bldg. 6-8, Akasaka 1-chome, Minato-ku, Tokyo, 107, (03) 3224-0591. Fax: (03) 3224-0597. Pres.: Isao Atsumi; Mng. Dir.: Mak Hirai; Prof./Creative Mgr.: Shig Yutani.

Touchstone Pictures Music & Songs, Inc., (ASCAP) (See Yamaha Music Foundation).

UPS, (JASRAC) (See CBS Sony/Songs).

Uncle-F Music Publishing, Inc., (JASRAC) (See CBS Sony/Songs).

Warne Marsh Music, (See Pumpkin Music Ltd.).

Watanabe Music Pub. Co., Ltd., 1-8-10, Azabudai, Minato-ku, Tokyo, 106, (03) 3585-1531. Fax: (03) 3586-4533. Chairperson: Misa Watanabe; Pres.: Hideki Hayashi; Gen. Mgr.: Nichiroku Nakajima; Int'l Dept.: Hiroshi Kuwashima; Harry Takeuchi; Tatsu Hirano.

Williamson Music Co., (See Yamaha Music Foundation).

Wonderland Music Co., Inc., (BMI) (See Yamaha Music Foundation).

Yamaha Music Foundation, (JASRAC) 3-24-22, Shim-Meguro, Meguro-ku, Tokyo, 153, (03) 3719-3109. Fax: (03) 3794-1654. Pres.: Gen'ichi Kawakami; Gen. Mgr.: Tsutomu Sakai; Int'l Affairs: Hiro Murakami.

Yellow Cab Music, (JASRAC) (See CBS Sony/Songs).

MUSIC & VIDEO ACCESSORY MANUFACTURERS

Yamagata Nagaoka Co., Ltd., 3-16-3 Kita-Ohtsuka, Toshima-ku, Tokyo, 170, (813)-3949-9497. Fax: (813)-3949-2104. Pres.: Eiichi Nagaoka; Sales Mgr.: Hiroshi Teramura; Mktg. Dir.: Yoshimi Sakamoto.

CD—Carrying & Storage Cases, Care Products. Record—Carrying & Storage Cases, Care Products (Record cleaner, anti-static sleeve) Replacement Styli, Audio cable. Tape—Audio: Head Cleaners, Carrying & Storage Cases, Care Products, Video: Head Cleaners, Carrying & Storage Cases, Care Products.

Victor Co. of Japan, Ltd., 8-14, Nihonbashi-Honcho 4-Chome, Chuo-ku, Tokyo, 103, 0462 75-1111. Fax: 0462 76-0333. Pres.: Takuro Bojo; Tape Div.: 0292-47-3111. Fax: 47-1570.

Record—Care Products (Cleaning cloth) Replacement Styli.

Tape—Audio: Head Cleaners, Video: Head Cleaners.

AUDIO ACCESSORY MANUFACTURERS

Yamagata Nagaoka Co., Ltd., 3-16-3 Kita-Ohtsuka, Toshima-ku, Tokyo, 170, (813)-3949-9497. Fax: (813)-3949-2104. Pres.: Eiichi Nagaoka; Sales Mgr.: Hiroshi Teramura; Mktg. Dir.: Yoshimi Sakamoto. Video: Demagnetizers.

MANUFACTURERS: RETAIL MERCHANDISING PRODUCTS

Victor Co. of Japan, Ltd., 8-14, Nihonbashi-Honcho 4-Chome, Chuo-ku, Tokyo, 103, 0462 75-1111. Fax: 0462 76-0333. Pres.: Takuro Bojo; Tape Div.: 0292-47-3111. Fax: 47-1570. Product(s): Posters.

STORE FIXTURE MANUFACTURERS

Victor Co. of Japan, Ltd., 8-14, Nihonbashi-Honcho 4-Chome, Chuo-ku, Tokyo, 103, 0462 75-1111. Fax: 0462 76-0333. Pres.: Takuro Bojo; Tape Div.: 0292-47-3111. Fax: 47-1570. Browser Boxes—(CD, Record, Tape, Video). Display Racks—(CD, Record, Tape, Video).

ASSOCIATIONS & PROFESSIONAL ORGANIZATIONS

The Federation Of Music Producers Japan, Sanwa Aoyama Bldg., 7F 2-22-19 Minami, Aoyama, Minato-ku, Tokyo, 107, (3)03-423-1621. Fax: (3)03-423-3022. Pres.: Ken Hosokawa; Mgr. Int'l Dept.: Shisaka Kimura; Sec. Gen.: Akira Murakami. **Japan Council Of Performers' Organization (Gaidankyo)**, Koyanagi Bldg., 1-7 Ginza, Chuo-ku, Tokyo, 104, 81 03-567-8748. Fax: 81 03-567-8714. Pres.: Utaemon Nakamura; Managing Dir.: Hiroshi Koizumi; Sec. Gen.: Masashi Tanano. **Japan Phonograph Record Assn.**, 2-8-9 Tuskiji, Chuo-ku, Tokyo, 104, (03) 541-4411. Fax: (03) 541-4460. Pres.: Noboru Takayama; Exec. Dir.: Ikuo Kato; Dir. Gen.: Saburo Kimura. **Min-On Concert Assn.**, 1-32-13 Kita-Shinjuku, Shinjuku-ku, Tokyo, 169, (813)3/33715103. Fax: (813)3/33619477. Pres.: Kaname Yoshida; Vice Pres.: Kazuaki Matsumura.

INTERNATIONAL BUSINESS AGENTS OF MUSIC/VIDEO

Jimco Music, Inc., Jimco House, 4-7-7 Kachidoki, Chuo-ku, Tokyo, 104, 03-3534-8771. Fax: 03-3534-8200. Pres.: Mana Takekawa.

PERFORMING & MECHANICAL RIGHTS ORGANIZATIONS

Japanese Society for Rights of Authors, Composers, & Publishers (JASRAC), 1-7-13 Nishishimbashi, Minato-ku, Tokyo, 105, (03)3502-6551. Fax: (03)3503-3444. Pres.: Miuki Ishimoto.

MUSIC LIBRARIES

Min-On Concert Assn., 1-32-13 Kita-Shinjuku, Shinjuku-ku, Tokyo, 169, (813)3/33715103. Fax: (813)3/33619477. Pres.: Kaname Yoshida; Vice Pres.: Kazuaki Matsumura.

BLANK & BULK TAPE MANUFACTURERS

Ampex Japan Ltd., PO Box 15, 6-1-1 Heiwajima, Ota-ku, Tokyo, 143, Japan, (813)767-4521. Regional Mgr.: Hiro Okochi.

MDC Limited, Kami Fukuoka PO Box 14, 1-10-5 Moto Fukuoka Kami-Fukuoka-Shi, Saitami-Ken, 356, Japan, (03) 3555-1405. Fax: (03) 3552-8791. Pres./Sales Mgr.: T. Tsuzuki.

Sumitomo 3M Ltd., Central PO Box 490, 33-1, Tamagawadai 2-Chome, Setagaya-ku, Tokyo, 158, Japan, (813) 709-8111. Fax: (813) 709-8752. Contact: Wataru Satoh.

Victor Co. of Japan, Ltd., 8-14, Nihonbashi-Honcho 4-chome, Chuo-ku, Tokyo, 103, Japan, (0292) 47-3111. Fax: (0292) 47-1570. Pres.: Takuro Bojo.

JEWEL BOX MANUFACTURERS

Yamagata Nagaoka Co., Ltd., 3-16-3 Kita-Ohtsuka, Toshima-ku, Tokyo, 170, (813)-3949-9497. Fax: (813)-3949-2104. Pres.: Eiichi Nagaoka; Sales Mgr.: Hiroshi Teramura; Mktg. Dir.: Yoshimi Sakamoto.

RAW MATERIALS

Bayer Japan Ltd., Plastics Div., 10-8, Takanawa 4-chome, Minato-Ku, Tokyo, 108, (03) 280-9761. Fax: (03) 280-9769. Pres.: Mr. Heinrichsohn; Sales Mgr.: Mr. Nakajima; Mktg. Dir.: Mr. Gattineau.

Product(s): Makrolon CD 2001.

SKC Ltd., Tokyo Office, 8/F 10th Mori Bldg., 1-18-1, Toranomon, Minato-ku, Tokyo, 81-3-591-6325. Fax: 81-3-591-6340. Contact, Polyester Film: J.W. Choi; Contact, Magnetic Media: C.Y. Jung.

Product(s): Polyester Film, Magnetic Media.

ENVELOPES & MAILERS

Victor Co. of Japan, Ltd., 8-14, Nihonbashi-Honcho 4-Chome, Chuo-ku, Tokyo, 103, 0462 75-1111. Fax: 0462 76-0333. Pres.: Takuro Bojo; Tape Div.: 0292-47-3111. Fax: 47-1570. (Audio—CD, Tape).

JACKETS & SLEEVES

Yamagata Nagaoka Co., Ltd., 3-16-3 Kita-Ohtsuka, Toshima-ku, Tokyo, 170, (813)-3949-9497. Fax: (813)-3949-2104. Pres.: Eiichi Nagaoka; Sales Mgr.: Hiroshi Teramura; Mktg. Dir.: Yoshimi Sakamoto. (Jackets/Sleeves-Audio: CD, LP).

Victor Co. of Japan, Ltd., 8-14, Nihonbashi-Honcho 4-Chome, Chuo-ku, Tokyo, 103, 0462 75-1111. Fax: 0462 76-0333. Pres.: Takuro Bojo; Tape Div.: 0292-47-3111. Fax: 47-1570. Branch(es): (Jackets/Sleeves-Audio: CD, Tape).

LABELS

Victor Co. of Japan, Ltd., 8-14, Nihonbashi-Honcho 4-Chome, Chuo-ku, Tokyo, 103, 0462 75-1111. Fax: 0462 76-0333. Pres.: Takuro Bojo; Tape Div.: 0292-47-3111. Fax: 47-1570. (Audio—CD, Tape).

TAPE CUSTOM DUPLICATORS

CTA Co., Ltd., #53-5, Nogata 1-chome, Nakano-ku, Tokyo, 165, (03) 388-9111. Fax: (03)3388-7778. Pres.: Atsushi Katsumata; Mktg./Managing Dir.: Ichiro Saito. Audio: Cassette.

Litton-Westrex Co., Japan, Chiyoda Bldg., 2-1-2, Marunouchi, Chiyoda-ku, Tokyo, 100, (03) 211-6791. Fax: (03) 211-6797. Vice Pres.: Y. Kawashima; Sales Mgr.: S. Fujita; Mktg. Dir.: Y. Kawashima. Audio: Cassette.

Victor Co. of Japan, Ltd., 8-14, Nihonbashi-Honcho 4-Chome, Chuo-ku, Tokyo, 103, 0462 75-1111. Fax: 0462 76-0333. Pres.: Takuro Bojo; Tape Div.: 0292-47-3111. Fax: 47-1570. Audio: Cassette, DAT.

Video: ¾ U-Matic, ½ VHS Cassette, SVHS. Audio Packaging Services: Inserting, Collating, Labeling, Mailing.

Video Packaging Services: Inserting, Collating, Labeling, Mailing.
Other Services: Warehouse, Freight.

COMPACT DISC MANUFACTURERS & VIDEO DISC MANUFACTURERS

CTA Co., Ltd., #53-5, Nogata 1-chome, Nakano-ku, Tokyo, 165, Japan, (03) 388-9111. Fax: (03)3388-7778. Pres.: Atsushi Katsumata; Mktg./Managing Dir.: Ichiro Saito.
Type: CD, Videodisk.

ELMO Ltd., Kasuga-Sou, 4-9-2 Nishifuna, Funabashi-Shi, Chiba, 273, Japan, (0474) 31-0400. Fax: (0474) 31-0402. Pres.: Hiromitsu Wada; Sales Mgr.: Hiroyuki Kimura; Licensee Admin.: Masako Omuro.
Type: CD.

Japan Publications Trading Co., Ltd., 1-2-1 Sarugaku-cho, Chiyoda-ku, Tokyo, 101, Japan, 81-3-3292-3751, 81-3-3292-3757. Fax: 81-3-3292-0410. Pres.: Satomi Nakabayashi; Gen. Mgr.: Masaaki Isozaki; Sales & Export Mgr.: Hirobumi Annoshita; Import Mgr.: Yoh Kohno.
Type: CD, Videodisk.

Nippon Columbia Co., Ltd., 4-14-14 Akasaka, Minato-ku, Tokyo, 107-11, Japan, (03) 584-8271. Fax: (03) 584-8135. Pres.: Kazuo Mochizuki; Mktg. Dir.: Toshi Hirahara; Int'l Sales & Mktg. Mgr.: Tom Ueno.
Type: CD, Videodisk, CDV.

Sony Music Entertainment (Japan) Inc., 1-4, Ichigaya-Tamachi, Shinjuku-Ku, Tokyo, 162, Japan, (81)3-3266-5830. Fax: (81)3-3235-2908. Pres.: Toshio Ozawa; Sales Mgr.: Tetsuo Mori.
Type: CD, Videodisk.

Victor Co. of Japan, Ltd., 8-14, Nihonbashi-Honcho 4-Chome, Chuo-ku, Tokyo, 103, Japan, 0462 75-1111. Fax: 0462 76-0333. Pres.: Takuro Bojo; Tape Div.: 0292-47-3111. Fax: 47-1570.
Type: CD, Videodisk, CDV.

PLATING & PRESSING PLANTS

CTA Co., Ltd., #53-5, Nogata 1-chome, Nakano-ku, Tokyo, 165, Japan, (03) 388-9111. Fax: (03)3388-7778. Pres.: Atsushi Katsumata; Mktg./Managing Dir.: Ichiro Saito.
(Videodisk)
Type: LV.

ELMO Ltd., Kasuga-Sou, 4-9-2 Nishifuna, Funabashi-Shi, Chiba, 273, Japan, (0474) 31-0400. Fax: (0474) 31-0402. Pres.: Hiromitsu Wada; Sales Mgr.: Hiroyuki Kimura; Licensee Admin.: Masako Omuro.
(LP's)

Japan Publications Trading Co., Ltd.

1-2-1 Sarugaku-cho, Chiyoda-ku, Tokyo, 101, Japan, 81-3-3292-3751. Fax: 81-3-3292-0410. Export Mgr.: Hirobumi Annoshita; Import Mgr.: Yoosuke Shiomi. (Videodisk).

Nippon Columbia Co., Ltd., 4-14-14 Akasaka, Minato-ku, Tokyo, 107-11, Japan, (03) 584-8271. Fax: (03) 584-8135. Pres.: Kazuo Mochizuki; Mktg. Dir.: Toshi Hirahara; Int'l Sales & Mktg. Mgr.: Tom Ueno.
(Videodisk)
Type: LV.

Sony Music Entertainment (Japan) Inc., 1-4, Ichigaya-Tamachi, Shinjuku-Ku, Tokyo, 162, Japan, (81)3-3266-5830. Fax: (81)3-3235-2908. Pres.: Toshio Ozawa; Sales Mgr.: Tetsuo Mori.
(Videodisk)
Type: LV.

Victor Co. of Japan, Ltd., 8-14, Nihonbashi-Honcho 4-Chome, Chuo-ku, Tokyo, 103, Japan, 0462 75-1111. Fax: 0462 76-0333. Pres.: Takuro Bojo; Tape Div.: 0292-47-3111. Fax: 47-1570.
(Videodisk)
Type: VHD.

MASTERING FACILITIES

CTA Co., Ltd., #53-5, Nogata 1-chome, Nakano-ku, Tokyo, 165, (03) 388-9111. Fax: (03)3388-7778. Pres.: Atsushi Katsumata; Mktg./Managing Dir.: Ichiro Saito.
(Audio & Video).

Nippon Columbia Co., Ltd., 4-14-14 Akasaka, Minato-ku, Tokyo, 107-11, (03) 584-8271. Fax: (03) 584-8135. Pres.: Kazuo Mochizuki; Mktg. Dir.: Toshi Hirahara; Int'l Sales & Mktg. Mgr.: Tom Ueno.
(Audio & Video).

Sony Music Entertainment (Japan) Inc., 1-4, Ichigaya-Tamachi, Shinjuku-Ku, Tokyo, 162, (81)3-3266-5830. Fax: (81)3-3235-2908. Pres.: Toshio Ozawa; Sales Mgr.: Tetsuo Mori.
(Audio & Video).

Victor Co. of Japan, Ltd., 8-14, Nihonbashi-Honcho 4-Chome, Chuo-ku, Tokyo, 103, 0462 75-1111. Fax: 0462 76-0333. Pres.: Takuro Bojo; Tape Div.: 0292-47-3111. Fax: 47-1570.
Branch(es):
(Audio & Video).

MALAYSIA

RECORD LABELS

BMG Pacific Sdn Bhd, 133-1 Jalan Segambut, Kuala Lumpur, 51200, (03) 621 0218. Fax: (03) 621 3944. Managing Dir.: Frankie Cheah; Int'l A & R: Raymond Hon; Sales Dir.: Lim Yee Hwa; Prodn. Dir.: Harry Wong.

EMI (Malaysia) Sdn. Bhd., Ste. 10.01, 10th Floor, Exchange Square, Off Jalan Semantan, Damansara Heights, Kuala Lumpur, 50490, (603) 254-3311. Fax: (603) 254-4928. Managing Dir.: Mrs. Beh Suat Pheng; Int'l Label Mgr.: Calvin Wong.
Label(s): (Distributed) Capitol, EMI, Liberty, Harvest, Manhattan, Parlophone, RAK.

Hup Hup Sdn Bhd, 66-68 Jalan Raja Chulan, Kuala Lumpur, 50200, Managing Dir.: Ng Cheong Hock; Dir.: Ng Ay Na.
Label(s): (Owned) Lerk Foong, Life, Li Foong, Music City.

Naxos (Malaysia) Sdn Bhd, 1030 Third Floor, Sg. Wang Plaza, Kuala Lumpur, WP, 50250, (603) 2444010, (603) 2444013. Fax: (603) 2488263. Managing Dir.: Mavis C.W. Wong; A & R Dir.: Andrew S.P. Yong; Dir.: Alan Loke; George Lim; Shareholder: Klaus Heymann.

Label(s): (Distributed) Black Sun, Donau, Celestiel Harmony, Fortuna, Gold Fedelity, Kuckuck, Heart Of Space, Marco Polo, Naxos, Pickwick, Oreade.

Pacific Music Corp. (M) SDN BHD, 149-1-2 Jalan Segambut, Kuala Lumpur, 51200, (3) 621-0218. Fax: (3) 621-3944. Managing Dir.: Frankie Cheah.

PolyGram Records SDN BHD, No. 20, Jalan Bukit Bintang, 1 & 2 Floor, Kuala Lumpur, 55100, (603) 242-9633. Fax: (603) 248-1319. Gen. Mgr.: Eric Yeo; Product Mgr.: T. Renganathan.

Label(s): (Owned) Mango, Mercury, Phillips, Metronome, Polydor, Rocket, Vertigo, Verve, Verve Forecast, Antilles, A & M, Archive, Decca, DGG, Delicious Vinyl, FFRR, 4th & Broadway, Fontana, London, Island, (Distributed) Hot Line, Jaws, Bite, CNR, Telarc.

Sony Music Entertainment (M) Sdn. Bhd., PO Box 6101, Pudu, Kuala Lumpur, 55910, 97 Jalan Jejaka 9, Taman Maluri, Cheras, Kuala Lumpur, 55100, (03) 9852541, (03) 9852340. Fax: (03) 9845769. Managing Dir.: Rick Loh; Sales Mgr.: Peter Wong; Int'l A&R Mgr.: Ben Teoh.

Label(s): (Owned) CBS Masterworks, Columbia, Epic, Def Jam, Epic/Associated, Portrait, Sony Classical, WGT, (Distributed) Tabu, Roadracer, Roadrunner.

Valentine Sound Prodn. SDN. BHD., Lot 336, 3/F, Jalan Dang Wangi, Kuala Lumpur, 50100, (603) 292-7546. Fax: (603) 292-7527. Dir.: Francis Lee; A & R Mktg. Dir.: Richard Chong; Label & Promo. Mgr.: Joe Siva.

Label(s): (Distributed) ZYX, Combat, Discomag, K-Tel Int'l, SPV, Noise Int'l.

Warner Music Malaysia Sdn. Bhd., 9th Floor, MUI Plaza (Box #18), Jalan P. Ramlee, Kuala Lumpur, 50250, (60-3) 2435611. Fax: (60-3) 2480861. Managing Dir.: Gunther Zitta; Sales Mgr.: Eddie Goh; Controller: Miss Siew Been Chang; Int'l A&R Mgr.: Cheah Mun Kit.

Label(s): (Owned) Nonesuch, Paisley Park, Sire, Reprise, Warner Bros., Atco, Asylum, Atlantic, Elektra, Finnadar, (Distributed) Geffen, MCA.

MUSIC PUBLISHERS

BMG-Pacific Music Publishing SDN.BHD., 133-1 Jalan Segambut, Kuala Lumpur, 51200, 60-3-621-0218. Fax: 60-3-621-3944. Publishing Mgr.: Suzanne Kwong.

EMI Music Publishing Malaysia, 8 Jalan Murai Dua, Komplek Batu, Kuala Lumpur, 51000, (60-3)6277511. Fax: (60-3)6271163.

Goodsound Sdn Bhd., No. 66-68 Jalan Raja Chulan, Kuala Lumpur, 50200, (03) 230-7524. Fax: (03) 238-3213. Pres.: Ng Ay Na (Ms.); Gen. Mgr.: Ng Cheong Hock (Mr.).

Pustaka Muzik EMI (Malaysia) SDN. BHD., Ste. 10.01, 10th Floor, Exchange Square, Off Jalan Semantan, Damansara

Heights, Kuala Lumpur, 50490, (603) 2543311. Fax: (603) 2544928.

Sony Music Publishing Sdn. Bhd., PO Box 6101 Pudu, Kuala Lumpur, 55910, 97 Jalan Jejaka 9, Taman Maluri, Cheras, Kuala Lumpur, 55100, (603) 985-3875. Fax: (603) 984-5769. Managing Dir.: Rick Loh.

BLANK & BULK TAPE MANUFACTURERS

3M Malaysia SDN.Berhad, PO Box 1115, Jalan Semangat 46870, Lot 16, Jalan 225, Section 51A, Petaling Jaya, Malaysia, (603) 775-7555. Fax: (603) 775-7269. Contact: Allan Lim;

CARTRIDGES, CASSETTES, REELS & OTHER PARTS

V.S. Industries Pte Ltd., Plot 7, Senai Industrial Estate, Johor, 81400, (60) 7/595-050. Fax: (60) 7/591-752. Pres.: Beh Kim Ling.

Audio: C0s, snap packs.
Video: V0s, snap packs.

JEWEL BOX MANUFACTURERS

V.S. Industries Pte Ltd., Plot 7, Senai Industrial Estate, Johor, 81400, (60) 7/595-050. Fax: (60) 7/591-752. Pres.: Beh Kim Ling.

TAPE CUSTOM DUPLICATORS

EMI Tape (Malaysia) Sdn. Bhd., Suite 10.01, 10th Floor, Exchange Bldg., Off Jalan Semantan, Damansara Hts., Kuala Lumpur, 50490, (03) 2543311. Fax: (03) 2544928. Managing Dir.: Beh Suat Pheng; Factory Mgr.: Jenny Thong.

Audio: Cassette.
Audio Packaging Services: Inserting, Collating, Labeling.

SINGAPORE

RECORD LABELS

Alshire (S) Pte Ltd., 1 Maritime Sq., #02-78, World Trade Center, 0409, (65) 2744567. Fax: (65) 2735444. Managing Dir.: T.T. Quek; Mgr.: Billy Kuek; (Compact Disc, Pre-Recorded Audio Tape, Accessories) (Distributor, Importer, Exporter) Labels Distributed: Audio: Alshire, AIM, Peter Rabbit.

Asia Music Distribution Pte. Ltd., Block 3006 Ubi Rd. 1, #02-366, Singapore, 1440, (65) 7490618. Fax: (65) 7490971. Gen. Mgr.: Steven Ng. Boon Tee; (Compact Disc, Pre-Recorded Audio Tape) (Distributor, Importer, Exporter). Labels Distributed: Audio: LS, Brentwood, Sparrow, Lillenas, Pathway; Video: LS Records.

BMG Pte. Ltd., Bldk 2, #11-01/04 Alexandra Distripark, Pasir Panjang Rd., Singapore, 0511, (65) 278-8388. Fax: (65) 273-6855. Managing Dir.: Steven Tan Song Chiang; Financial Controller: Edmund Lim Teck Foon; Prod. Exploitation Mgr.: Gary See Poh Lam; Sales Supervisor: Jimmy Wong Ming Jin.

Label(s): (Owned) RCA, Arista, Hansa, Ariola, (Distributed) MCA, Geffen.

Chiang Haut Co. Pte. Ltd./Around the World Music Co., Bldk. 20, Outram Park, #01-195, Singapore, 0316, 65-220-3444. Fax: 65-224-7805. Pres.: Robert B. Weiss; Managing Dir.: Piellak Chang, M.D.

Int'l Reps.: Musico (Malaysia); Celeste Int'l (Thailand),(Hong Kong),(Taiwan),(Indonesia),(Philippines).

J.P.T.

Since 1942

WANTED GOOD PARTNERS!

EXPORT AND IMPORT (COMPACT DISCS, LASER DISCS)

General Manager: Masaaki Isozaki
Export Manager: Hirobumi Annoshita
Import Manager: Yoh Kohno

JAPAN PUBLICATIONS TRADING CO., LTD.

1-2-1, SARUGAKU-CHO, CHIYODA-KU

TOKYO, JAPAN

PHONE: 81-3-3292-3757 FAX: 81-3-3292-0410,8542 TELEX: J27161 JPTCO

Eastland Trading (S) Pte. Ltd., 257 Selegie Rd., #02-283, Selegie Complex, Singapore, 0718, 337-1021. Fax: 3383883. Exec. Dir.: S. F. Quek; Managing Dir.: S. G. Quek.

Joyworld Music Pte Ltd.

30 Kallang Place #07-16/17, Singapore, 2057, (065) 2911122, Fax: (065) 2980478, Pres.: Steven Lim; Gen. Mgr.: Elian Ho; (Compact Disc, Pre-Recorded Audio Tape) (Distributor).

Joyworld Overseas Auvl Pte Ltd., Blk 30 Kallang Pl. #07-16/17, Singapore, 1233, (065) 2911122. Fax: (065) 2980478. Dir.: Elian Ho.

Kwang Sia Pte. Ltd., 750-E Chai Chee Rd. #08-03/04, Singapore, 1025, (065) 4412988. Fax: (065) 4410911. Dir.: Ricky Ang.

Life Records Industries (Pte) Ltd., 232 Serangoon Rd., Singapore, 0821, (02) 2933404. Fax: (02) 2930129. Mng. Dir.: Ng Cheong Hock; Dir.: Ng Ay Na.

Label(s): (Owned) Life, Li Foong, Music City, Lerk Foong.
Meilleur Electronics, 111 N. Bridge Rd., #03-26 Peninsula Plaza, 0617, (65) 3394920. Fax: (65) 3384280. Managing Dir.: Steven Wong; Mgr./Buyer: Grace Pey; (Compact Disc, Pre-Recorded Audio Tape, Records, Accessories) (Distributor, One-Stop, Importer, Exporter).



YOUR ASIA MUSIC PARTNER

Tap into our Asian-wide distribution network. We have over ten years of experience working with music specialists, music suppliers and music retailers.

- Manage all your recording needs - dance labels, master deals, publishing
- Provide licensing arrangements
- Import and export of CD's, records, tapes

VALENTINE MUSIC CENTRE

Contact Steven C. H. Goh at:
No 1 Selegie Road 01-30/31 Parodiz Centre
Singapore 0718 Tel: (65) 3387890, (65) 3391232
Telex: RS 42304 VMC. Fax: (65) 3381605,
(65) 3393084 (65) 3394558.
Raffles City P.O. Box 1506 Singapore 9117

Labels Distributed: Audio: Imports/distributes ATR, Audio, (Germany); Pierre Verany (France); Cardas, Klavier, Audiofon, DCC (USA); JAS, TBM (Japan); Southern Cross (Australia).

Products/Accessories: Audio & Video Playback Equipment: CD Accessories.

Naxos (Singapore) Pte Ltd., No.3 Irving Rd., No.3-4 Irving Industrial Bldg., Singapore, (65) 288 8984, (65) 288 7998. Fax: (65) 288 9997. Managing Dir.: George Lim.
Label(s): (Distributed) Oreade, Sitella, Celestial Harmonies, Donau, Hearts Of Space, Gold Fidelity, LRC, Marco Polo, Naxos Int'l, Naxos.

PolyGram Records Pte Ltd, 6 Joo Koon Cir., Jurong, 2262, (65) 8611255. Fax: (65) 8612729. Gen. Mgr.: Jimmy Lim Yan Teck.

Label(s): (Owned) A & M, Archive, Argo, DGG, Fontana, Deca, Island, L'oiseau-Lyre, Mercury, London, Metronome, Philips, Rocket, Polydor, Verve, Vertigo, (Distributed) Telarc, Toco Int'l.

Sony Music Entertainment (Singapore) PTE Ltd., 601 Sims Dr., #02-07, Pan-I Complex, Singapore, 1438, (65) 7453355. Fax: (65) 745-7752. Managing Dir.: Terence Phung; Acct. & Admin Mgr.: Yee Cheau Wen; Senior Promo. Exec.: Joseph Leo.

Label(s): (Distributed) Columbia, Epic Assoc., Epic.
Sound Technic, Pte. Ltd., 60 Kallang Pudding Rd., #06-00, Tan Jin Chwee, Industrial Bldg., Singapore, 1334, 747 4722. Fax: 745 2522. Managing Dir.: Joe Chen.

Supreme Record Centre, 2 Jalan Rajah, Unit 03-14, Singapore, 1232, (65) 255-5288. Fax: (65) 250-7459. Managing Dirs.: John Aw, Ricky Aw; Partners: Helen Aw, J.W. Aw; Gen. Mgr.: Roger Hui; (Compact Disc, Video (Cassette & Disc)) (Distributor, Importer).

Labels Distributed: Audio: Sonia, Black Lion, Selected Sound, Beautiful Music, DA, Candid, Freedom, Frudence, Elite Special.

Labels Imported: Thailand, Malaysia, Indonesian & Brunei.
Swissteo Holding (S) Pte Ltd., Blk. 37 #03-45 Defu Lane 10, Singapore, 1953, (65) 280-9033. Fax: (65) 382-1733. Managing Dir.: Swiss Teo S.K.; Mgr.: Edna Teo Ai Ling; Buyer (Record/Tape): (Export): Jolene Teo S.N.; Buyer (Videos): Francis Teo S.H.; Buyer (Accessories): Steven Teo S.H.; Buyer (Music): (Import): Alice Teo L.N.; Dir.: Nelson Teo S.T.;

(Compact Disc, Pre-Recorded Audio Tape, Video (Cassette & Disc), Records (LP's, 12-Inch, Singles), Cutouts, Overstock, Accessories) (Distributor, Importer, Exporter).
Labels Distributed: Audio: Castle Communication, New World Prodn., Collin Classic, Metal Blade, Relativity, In Effect, Combat, Rock Hard, Backstage Prodn., Ken Davis Music, Placenta Music, Pickwick plus all Major Labels (WEA, EMI, Sony Music, BMG, PolyGram) and other independents.

Labels Imported: Telstar, K-Tel Music Product, Double Play, Symphonia Digital Classics and other independents from U.S.A., Europe and the Far East.

Unisong Private Ltd., 24, Kingswear Ave., Singapore, 1955, 2800909, 2765208. Fax: (65) 2735444. Managing Dir.: T. T. Quek; Mktg. Mgr.: Billy Kuek.

Valentine Music Centre

No. 1, Selegie Rd., #01-30/31, Parodiz Center, 0718, (65) 338 7890. Fax: (65) 339 3084. CEO: Steven C.H. Goh; Mgr.: Annie Teo; (Compact Disc, Records) (Distributor, Importer, Exporter).

Labels Distributed: Audio: ZYX, Disco Magic, Passion, Relativity, K-Tel/Dimenion, A.J.K. Music, Arrival, Crush Music, Head-First, Pickwick, Old Gold, Tring Int'l.
Labels Imported: Exports to Indonesia, Philippines, Malaysia, Thailand, Korea, Taiwan.

Warner Music Singapore Pte Ltd., 10 Anson Rd., 15-07/08 Int'l Plaza, Singapore, 0207, (65) 2231688. Fax: (65) 2257830. Financial Controller: Yuen Han Yip; Sales Mgr.: Peter Lau. Label(s): (Owned) Asylum, Atco, Atlantic, Finnadar, Elektra, Paisley Park, Nonesuch, Sire, Reprise, Warner Bros., (Distributed) Geffen, MCA, Crown.

MUSIC PUBLISHERS

BMG Music Publishing Pte. Ltd., Blk. 2, #11-01/04, Pasir Panjang Rd., Alexandra Distripark, Singapore, 0511, (65) 278-8388, (65) 274-5888. Fax: (65) 273-6855. Managing Dir.: Steven Tan; Financial Controller: Edmund Lim; Publishing Asst.: Aishah Akil.

Sony Music Publishing Singapore Pte. Ltd., 601 Sims Dr., #02-07, Pan-I Complex, Singapore, 1438, (65) 745-3355. Fax: (65) 745-7752. Pres.: Terence Phung; Prof./Creative Mgr.: Yee Chean Wen.

Valentine Music Centre, No. 1 Selegie Rd., Parodiz Centre, Singapore, 01 30/31, 0718, (65) 3387890, (65) 3391232. Fax: (65) 3393084. Pres.: Steven Goh Chin Heng; Gen. Mgr.: Annie Teo.

MUSIC & VIDEO ACCESSORY MANUFACTURERS

Sound Technic Private Ltd., 60 Kallang Pudding Rd., Hex 07-00, Tan Jin Chwee Bldg., Singapore, 1334, (65) 7474722. Fax: (65) 7452522. Pres.: Ng Cheow Chye; Mktg. Dir.: Roland Tan Gek Seng.
CD—Mfg. micro floppies. [XX]Tape—Audio: Head Cleaners, Video: Head Cleaners.

AUDIO ACCESSORY MANUFACTURERS

Sound Technic Private Ltd., 60 Kallang Pudding Rd., Hex 07-00, Tan Jin Chwee Bldg., Singapore, 1334, (65) 7474722. Fax: (65) 7452522. Pres.: Ng Cheow Chye; Mktg. Dir.: Roland Tan Gek Seng.
Video: Leader Tape, Splicing Tape & Equipment.

MANUFACTURERS: RETAIL MERCHANDISING PRODUCTS

Sound Technic Private Ltd., 60 Kallang Pudding Rd., Hex 07-00, Tan Jin Chwee Bldg., Singapore, 1334, (65) 7474722. Fax: (65) 7452522. Pres.: Ng Cheow Chye; Mktg. Dir.: Roland Tan Gek Seng.
Product(s): Key Chains, T-shirts, Clocks.

COMPUTER SYSTEMS & SERVICES

Sound Technic Private Ltd., 60 Kallang Pudding Rd., Hex 07-00, Tan Jin Chwee Bldg., Singapore, 1334, (65) 7474722. Fax: (65) 7452522. Pres.: Ng Cheow Chye; Mktg. Dir.: Roland Tan Gek Seng.

BLANK & BULK TAPE MANUFACTURERS

General Magnetics Ltd., 625 Lorong 4, Toa Payoh, 1231, Singapore, (065) 259-5511. Fax: (065) 259-3723. Chrmn./Managing Dir.: Oh Loon Lian; Sales Mgr.: Gerald Tan; Sales Exec.: Susan Lee.

Sound Technic Private Ltd., 60 Kallang Pudding Hex 07-00, Tan Jin Chwee Industrial Bldg., Singapore, 1334, Singapore. (65) 7474722. Fax: (65) 7452522.

3M Singapore PTE. Ltd., 9 Tagore Ln., Singapore, 2678, Singapore, (65) 4548611. Fax: (65) 4568953. Contact: Alvin Lam.

Unimagnetic Pte. Ltd., #7, 4th Chin Bee Rd., Jurong Town, Singapore, (65) 268-5166. Fax: (65) 265-0739. Gen. Mgr.: Bay Yew Chuan; Sales Mgr.: Alex Tan; Sales Exec.: Andrew Koh.

BLANK TAPE LOADERS

Sound Technic Private Ltd., 60 Kallang Pudding Hex 07-00, Tan Jin Chwee Industrial Bldg., Singapore, 1334, Singapore, (65) 7474722. Fax: (65) 7452522.

Unimagnetic Pte. Ltd., #7, 4th Chin Bee Rd., Jurong Town, Singapore, (65) 268-5166. Fax: (65) 265-0739. Gen. Mgr.: Bay Yew Chuan; Sales Mgr.: Alex Tan; Sales Exec.: Andrew Koh. (Audio)

CARTRIDGES, CASSETTES, REELS & OTHER PARTS

General Magnetics Limited, 625, Lorong 4, Toa Payoh, Singapore, 1231, (65) 259-5511. Fax: (65) 259-3723. Chairman/Managing Dir.: Oh Loon Lian; Sales Mgr.: Gerald Tan; Sales Exec.: Susan Lee.

Audio: C-zero & blank cassettes including OEM.
Sound Technic Private Ltd., 60 Kallang Pudding Rd., Hex 07-00, Tan Jin Chwee Bldg., Singapore, 1334, (65) 7474722. Fax: (65) 7452522. Pres.: Ng Cheow Chye; Mktg. Dir.: Roland Tan Gek Seng.

Unimagnetic Pte. Ltd., No. 7, Fourth Chin Bee Rd., Jurong Town, 2261, (65) 2685166. Fax: (65) 2650739. Gen. Mgr.: Bay Yew Chuan; Sales Mgr.: Alex Tan; Mktg. Exec.: Andrew Koh;

**EXPORTER & IMPORTER OF
MUSIC CASSETTES • KARAOKE LASER DISC
COMPACT DISC • AUDIO & VIDEO ACCESSORIES**



JOYWORLD MUSIC PTE LTD

LICENSING • MANAGEMENT • PUBLICATION IN SINGAPORE, THAILAND, INDONESIA, MALAYSIA, TAIWAN, HONG KONG, CHINA.

BLK 30, #07-16/17, KALLANG PLACE, SINGAPORE 1233.

TEL: (065) 2911122 FAX: (065) 2980478

CONTACT: MR. STEVEN T. C. LIM (IMPORT) MISS ELIAN HO (EXPORT)



GENERAL MAGNETICS LIMITED
 625 LORONG 4 TOA PAYOH
 SINGAPORE 1231
 TEL: (65) 2595511
 TLX: RS 23252 GENMAG
 FAX: (65) 2593732

MAYRON UK LTD
 63 WHITTON AVE EAST
 GREENFORD, MIDDLESEX
 UB6-0QD
 LONDON
 UNITED KINGDOM
 FAX: 81-9032052
 TEL: 81-9032725

EACH A MASTERPIECE!

US Customer Service Exec.: Thierry Follonier.
Audio: C-0s, Norelco Boxes.

JEWEL BOX MANUFACTURERS

General Magnetics Limited, 625, Lorong 4, Toa Payoh, Singapore, 1231, (65) 259-5511. Fax: (65) 259-3723. Chairman/Managing Dir.: Oh Loon Lian; Sales Mgr.: Gerald Tan; Sales Exec.: Susan Lee.

Sound Technic Private Ltd., 60 Kallang Pudding Rd., Hex 07-00, Tan Jin Chwee Bldg., Singapore, 1334, (65) 7474722. Fax: (65) 7452522. Pres.: Ng Cheow Chye; Mktg. Dir.: Roland Tan Gek Seng.

RAW MATERIALS

Sound Technic Private Ltd., 60 Kallang Pudding Rd., Hex 07-00, Tan Jin Chwee Bldg., Singapore, 1334, (65) 7474722. Fax: (65) 7452522. Pres.: Ng Cheow Chye; Mktg. Dir.: Roland Tan Gek Seng.
Product(s): Audio Jumbo Web & Pancake.

ENVELOPES & MAILERS

Craft Print Pte Ltd., 06-13-17, Pasir Panjang Rd., Blk 1, Alexandra Distripark, Singapore, 0511, 2785816. Fax: 2722398. Sales Mgr.: Allan Yeo/Ong Teck Beng; Mktg. Dir.: Charlie Chan; Chairman: Dora Chan. (Audio—LP)

Sound Technic Private Ltd., 60 Kallang Pudding Rd., Hex 07-00, Tan Jin Chwee Bldg., Singapore, 1334, (65) 7474722. Fax: (65) 7452522. Pres.: Ng Cheow Chye; Mktg. Dir.: Roland Tan Gek Seng. (Audio—Tape)

JACKETS & SLEEVES

Craft Print Pte Ltd., 06-13-17, Pasir Panjang Rd., Blk 1, Alexandra Distripark, Singapore, 0511, 2785816. Fax: 2722398. Sales Mgr.: Allan Yeo/Ong Teck Beng; Mktg. Dir.: Charlie Chan; Chairman: Dora Chan. (Jackets/Sleeves-Audio: LP)

Sound Technic Private Ltd., 60 Kallang Pudding Rd., Hex 07-00, Tan Jin Chwee Bldg., Singapore, 1334, (65) 7474722. Fax: (65) 7452522. Pres.: Ng Cheow Chye; Mktg. Dir.: Roland Tan Gek Seng. (Jackets/Sleeves-Audio: Tape)

LABELS

Sound Technic Private Ltd., 60 Kallang Pudding Rd., Hex 07-00, Tan Jin Chwee Bldg., Singapore, 1334, (65) 7474722. Fax: (65) 7452522. Pres.: Ng Cheow Chye; Mktg. Dir.: Roland Tan Gek Seng. (Audio—Tape)

POLYBAGS & SHRINKWRAP

Craft Print Pte Ltd., 06-13-17, Pasir Panjang Rd., Blk 1, Alexandra Distripark, Singapore, 0511, 2785816. Fax: 2722398. Chairman: Dora Chan; Sales Mgr.: Allan Yeo/Ong Teck Beng; Mktg. Dir.: Charlie Chan. (Shrinkwrap)

Sound Technic Private Ltd., 60 Kallang Pudding Rd., Hex 07-00, Tan Jin Chwee Bldg., Singapore, 1334, (65) 7474722. Fax: (65) 7452522. Pres.: Ng Cheow Chye; Mktg. Dir.: Roland Tan Gek Seng. (Shrinkwrap)

TAPE CUSTOM DUPLICATORS

General Magnetics Limited

625, Lorong 4, Toa Payoh, Singapore, 1231, (65) 259-5511. Fax: (65) 259-3723. Chairman/Managing Dir.: Oh Loon Lian; Sales Mgr.: Gerald Tan; Sales Exec.: Susan Lee.
Audio: Cassette, Open Reel, DAT.
Audio Packaging Services.
Other Services: Freight.

Rediffusion Pte Ltd, One Jalan Selanting, Singapore, 2159, 4671144. Fax: 4663888. Adv. Mgr.: Eric Low; Mktg. Mgr.: Chan Suan Liang.
Audio: Open Reel.

Sound Technic Private Ltd., 60 Kallang Pudding Rd., Hex 07-00, Tan Jin Chwee Bldg., Singapore, 1334, (65) 7474722. Fax: (65) 7452522. Pres.: Ng Cheow Chye; Mktg. Dir.: Roland Tan Gek Seng.
Audio: Cassette, Open Reel, DAT, Real-time.
Audio Packaging Services: Inserting, Collating, Labeling, Mailing.
Other Services: Warehouse, Freight.

Swissteo Holdings (S) Pte. Ltd., Block 37, #03-45, Defu Lane 10, 1953, (65) 280-9033. Fax: (65) 382-1733. Pres.: Swiss Teo; Dir.: Nelson Teo; Sales Mgr.: Edna Teo.
Audio: Cassette, DAT.
Audio Packaging Services: Inserting.
Other Services: Warehouse, Freight.

Unimagnetic Pte. Ltd., No. 7, Fourth Chin Bee Rd., Jurong Town, 2261, (65) 2685166. Fax: (65) 2650739. Gen. Mgr.: Bey Yew Chuan; Sales Mgr.: Alex Tan; Mktg. Exec.: Andrew Koh;

US Customer Service Exec.: Thierry Follonier.
Audio: Cassette, Open Reel, DAT.
Other Services: Warehouse, Freight, Direct Response—800 services.

COMPACT DISC MANUFACTURERS & VIDEODISC MANUFACTURERS

General Magnetics Limited, 625, Lorong 4, Toa Payoh, Singapore, 1231, Singapore, (65) 259-5511. Fax: (65) 259-3723. Chairman/Managing Dir.: Oh Loon Lian; Sales Mgr.: Gerald Tan; Sales Exec.: Susan Lee.
Type: CD.

Swissteo Holdings (S) Pte. Ltd., Block 37, #03-45, Defu Lane 10, 1953, Singapore, (65) 280-9033. Fax: (65) 382-1733. Pres.: Swiss Teo; Dir.: Nelson Teo; Sales Mgr.: Edna Teo.
Type: CD.

MASTERING FACILITIES

Sound Technic Private Ltd., 60 Kallang Pudding Rd., Hex 07-00, Tan Jin Chwee Bldg., Singapore, 1334, (65) 7474722. Fax: (65) 7452522. Pres.: Ng Cheow Chye; Mktg. Dir.: Roland Tan Gek Seng. (Audio)

Swissteo Holdings (S) Pte. Ltd., Block 37, #03-45, Defu Lane 10, 1953, (65) 280-9033. Fax: (65) 382-1733. Pres.: Swiss Teo; Dir.: Nelson Teo; Sales Mgr.: Edna Teo. (Audio)

SOUTH KOREA

RECORD LABELS

C & L Records

#202 Yungkyung Bld., 1560-1 Seocho-Gu, Seocho-Dong, Seoul, (02) 522-1886, (02) 583-2731. Fax: (02) 522-5626. MD (Jazz, Pop): S.G. Choi; MD (Classic): Tai Lee.
Label(s): (Owned) C & L, (Distributed) Bayer, Calig, Channel Classics, Amati, Accent, Christophorus, Thorofon, ENJA, Timeless.

Dongwon Merchandise, Inc., Yeouido P.O. Box 1199, Youngdeungpo-Ku, Seoul, 150-010, 1-2 Eunha Bldg., 53-3 Yeouido-dong, Youngdeungpo-Ku, Seoul, 50-010, (02) 784-6819, (02) 784-1152. Fax: (02) 784-0630. Mgr./Buyer: Y.A. Kwon; (Compact Disc, Pre-Recorded Audio Tape, Video (Cassette & Disc), Records (LP's), Accessories) (Importer, Retailer).

Labels Imported: Delos, Reference (U.S.A.); DI. Music (U.K.); NTI Music (France).
Products/Accessories: CD Players: Chuo Denki Co. (Japan); Storage & Carrying Cases: EPPCO Ent. Inc. (USA); Diamond Needles: Sumiko Inc. (USA); Other: Kimber Kable (USA), The Tonearm of Sumiko Inc. (USA).

Han Yang Records Co., Ltd., 950-1 Bangbae-Dong, Seocho-Ku, Seoul, (02) 521-6141, (02) 521-6143. Fax: (02) 521-6144. Sales & Mktg. Dir.: D.K. Lee.

Hee Jee Record Co., Hyo Dong Bldg., Seoul, 723-1981-2.
Hyundai Records Mfg., Co. Ltd., CPO Box 988, 44-15 Chungdam-dong Kangnam-Ku, Seoul, (02) 546-5071. Fax: (02) 542-1026. Pres.: Suh Yun-Sik; Managing Dir.: Bang Won-Sub; Sales Mgr.: Yoo Sung-Sun.

US Reps.: Moss Music Group (NJ); GRP (NY).
Int'l Reps.: Countdown Music (Germany); Charly (United Kingdom).

Jigu Records Corp., 233 Daeja-ri, Byokje-eup, Koyang-kun, Kyunggi-do, 411-830, (822) 353-3151. Fax: (82)344-639261. Exec. Vice Pres.: Jae Woo Lim; Senior Mgr. Int'l A&R: Chi Kwan Chng; Mgr. Int'l Dept.: David P. Kim; Int'l A&R/Promos: Nam Suk Park.

Label(s): (Owned) Jigu, (Distributed) Innovative Communication, Living Music, Medical & Sports Music Institut, DCC Compact Classics, Enja, Hearts Of Space, Global Pacific, Nuovi Autori Riuniti, Optimism Inc., Sugo, Roadrunner Prods. BV, Beaver, Contempo, Blue Flame.

SKC Ltd., SKC Bldg., 199-15, 2-GA, ULJI-ro Chung-Gu, Seoul, 100-192, (02) 756-5151, (02) 756-6161. Fax: (02) 752-9088. Pres.: Chun-Sik Choi; Exec. Dir.: Sun-Gon Kim; Dir.: Jae-Ho Koh; Sales Mgr.: Hun-Kil Lee; A&R Mgr.: Myoun-In Lee.

Label(s): (Owned) SKC, (Distributed) Saydisc, Teldec, Sony Classical, KEM, Laudis, Pro-Art, Outlet-Book, ASV, Acanta, Claves, Bis, Columbia, Everest, Forlane, Fonit-Cetra.

Sangji Int'l, Inc., #505 Kwangjin Bldg., 83-4 Guro 2-Dong, Seoul, 152-052, 82-2-867-4544. Fax: 82-2-868-5179. Pres.: Allen Saejeeb Oh; Managing Dir.: Sae-Hoon Oh.

Seoul Records, Inc., 2/F Hankuk Glass B/D, 45-1, Yoido-Dong, Youngdeungpo-Gu, Seoul, 150-010, (822) 786-4521. Fax: (82) 786-4923. Pres.: Hong-Kyun Shin; Sr. Exec. Dir.: Eui-Jong Lee; Mktg. Mgr.: Sung-Hun Song; Mgr. A&R Dept./Classical: B.C. Soh; Acting Mgr. A&R Dept. Pop: Hee-Seung Yang.
Label(s): (Owned) Cantabile, (Distributed) Bond, Chandos, Beaver, Ranwood, Noise, Sound Design, Delphine, Hungaroton, Jimco, JVC/Victor, Melodiya, Narada, Nightingale, Naxos.

Sung Eum Ltd., 300-14, 2-Ka Sungsoo, Sungdong-Ku, Seoul, 133-123, (02) 463-0141. Fax: (02) 467-2844. Exec. Pres.: Sung

Hee, Lee; Int'l Dir.: Ho Bum, Lee; Int'l Mgr.: Hyun Sik, Shin. Label(s): (Owned) SEM, (Distributed) Polydor, Verve, PolyGram, A & M, Deutsche Gramophone, Decca, Island, Mercury, Philips, Metronome.

Warner Music Korea Ltd., 265-21 Yangjae-Dong, 1-2/F, Youngdong Bldg., Seocho-Ku, Seoul, 137-130, (82-2)577-7670. Fax: (82-2)576-2419. Managing Dir.: Inchung Khang; Financial Controller: S.H. Shin; Domestic Mgr.: W.B. Choi; Int'l Label Mgr.: Jin Huh.

Label(s): (Owned) Warner Music Korea, (Distributed) Erato, Giant, Reprise, Nonesuch, Sire, Teldec, Warner Bros., WEA, Asylum, Atco, Atlantic, CGD, Elektra, EastWest.

Yeh Eum Records Co., Ltd., 226/Nokbon-dong/Eunpyong-Ku, Seoul, 122-020, (822)356-33413. Fax: (822)354-1541. Pres.: Wha-Yeon Won; Exec. Dir.: Ju-Tack Kang; Dir., A & R Dept.: Doo Sik Kim; Int'l A & R Mgr.: Se Whan Lee.
Label(s): (Owned) Yeh Eum, (Distributed) HNH Int'l Ltd., FM-Revolver.

MUSIC PUBLISHERS

Alfred Publishing Co., Inc., (See Sangji Int'l, Inc.).

Almo Irving Music, (See Sangji Music Publishing Co., Ltd.).
CPP Belwin, Inc., (See Sangji Music Publishing Co., Ltd.).
EMI-Kemongsa Music Ltd., 772 Yoksam-Dong, 9/F, Kangnam-Gu, Seoul, 135-080, (82-2)5553488. Fax: (82-2)5550196.

Hal Leonard Publishing Corp., (See Sangji Int'l, Inc.).
Music Sales Corp., (See Sangji Music Publishing Co., Ltd.).
Peer Southern, (See Sangji Music Publishing Co., Ltd.).

Sam Ho Music Publishing Co., 95-1 2-GA Wonhyo-Ro Yongsan-Gu, Seoul, 140-112, (02) 718-4171. Fax: (02) 701-9535. Pres.: Kim Jung Tae.

Sangji Int'l, Inc., 505 Kwangjin Bldg., 83-4 Guro 2-Dong, Guro-Ku, Seoul, 152-052, (822) 867-4544. Fax: (822) 868-5179. Pres.: Allen Saejeeb Oh; Prof./Creative Mgr.: Sae-Hoon Oh.

Sangji Music Publishing Co., Ltd., 83-4 Guro 2-Dong, Guro-Ku, Seoul, 82-2-867-4544. Fax: 82-2-868-5179. Pres.: Allen S. Oh; Gen. Mgr.: Sae-Hoon Oh.

BLANK & BULK TAPE MANUFACTURERS

Sorex Co., Ltd., CPO Box 8595, Seoul, South Korea, (02) 267-11915. Fax: (02) 275-3227.

3M Korea, Ltd., Yoido P.O. Box 93, 11th Floor, Life Bldg., No. 61 Yoido-Dong, Yongsungpo-Gu, Seoul, 150, South Korea, (822) 765-4567. Fax: (822) 784-3908. Contact: Jay W. Lee.

JEWEL BOX MANUFACTURERS

Dongwon Merchandise, Inc., Yeouido P.O. Box 1199, Seoul, 150-611, 53-3 Yeouido-Dong, Eunha Bldg., Rm. 1-2, Youngdeungpo-Ku, Seoul, 150-010, (02) 784-6819, (02) 784-1152. Fax: (02) 784-0630. Pres./Sales Mgr.: Y.A. Kwon.
SKC Ltd., CPO 8783, SKC Bldg., 199-15, 2-GA, ULJI-ro, Chung-Gu, Seoul, 100-192, 82-2-756-5151, 82-2-756-6161. Fax: 82-2-752-9008. Pres.: Jun-Sik Choi; Sales Mgr.: Hyun-Kil Lee; Mktg. Dir.: Jae-Ho Koh; Asst. Mgr.: Tae-Jong Lee.

RAW MATERIALS

SKC Ltd.—Polyester Film Div., SKC Bldg., 199-15, 2-GA, ULJI-ro, Chung-Gu, Seoul, 100-192, 82-2-756-5151, 82-2-756-6161. Fax: 82-2-752-9008. Pres.: J.S. Choi; Magnetic Media Contact: J.H. Cha; Polyester Film Contact: Y.W. Kim.
Product(s): Polyester film, magnetic media.

ENVELOPES & MAILERS

SKC Ltd., CPO 8783, SKC Bldg., 199-15, 2-GA, ULJI-ro, Chung-Gu, Seoul, 100-192, 82-2-756-5151, 82-2-756-6161. Fax: 82-2-752-9008. Pres.: Jun-Sik Choi; Sales Mgr.: Hyun-Kil Lee; Mktg. Dir.: Jae-Ho Koh; Asst. Mgr.: Tae-Jong Lee. (Audio—CD)(Video—Tape)

Seoul Records, Inc., 2/F Hankuk Glass B/D, 45-1, Yoido-Dong, Youngdeungpo-Gu, Seoul, 150-010, (822) 786-4521. Fax: (822) 786-4923. Pres.: Hong-Kyun Shin; Sales Mgr.: Han-Ho Woo; Mktg. Dir.: Sung-Hun Song; Mgr./Classical, A&R: B.C. Soh. (Audio—CD, Tape, LP)(Video—Tape).

JACKETS & SLEEVES

Dongwon Merchandise, Inc., Yeouido P.O. Box 1199, Seoul, 150-611, 53-3 Yeouido-Dong, Eunha Bldg., Rm. 1-2, Youngdeungpo-Ku, Seoul, 150-010, (02) 784-6819, (02) 784-1152. Fax: (02) 784-0630. Pres./Sales Mgr.: Y.A. Kwon. (Jackets/Sleeves-Audio: CD, Tape, LP).

SKC Ltd., CPO 8783, SKC Bldg., 199-15, 2-GA, ULJI-ro, Chung-Gu, Seoul, 100-192, 82-2-756-5151, 82-2-756-6161. Fax: 82-2-752-9008. Pres.: Jun-Sik Choi; Sales Mgr.: Hyun-Kil Lee; Mktg. Dir.: Jae-Ho Koh; Asst. Mgr.: Tae-Jong Lee.

Branch(es): (Jackets/Sleeves-Audio: CD)(Jackets/Sleeves-Video: Tape).

Seoul Records, Inc., 2/F Hankuk Glass B/D, 45-1, Yoido-Dong, Youngdeungpo-Gu, Seoul, 150-010, (822) 786-4521. Fax: (822) 786-4923. Pres.: Hong-Kyun Shin; Sales Mgr.: Han-Ho Woo;

Mktg. Dir: Sung-Hun Song; Mgr./Classical, A&R: B.C. Soh. (Jackets/Sleeves-Audio: CD, Tape, LP)(Jackets/Sleeves-Video: Tape).

LABELS

Dongwon Merchandise, Inc., Yeoeuido P.O. Box 1199, Seoul, 150-611, 53-3 Yeoeuido-Dong, Eunha Bldg., Rm. 1-2, Youngdeungpo-Ku, Seoul, 150-010, (02) 784-6819, (02) 784-1152. Fax: (02) 784-0630. Pres./Sales Mgr.: Y.A. Kwon. (Audio—CD, Tape, LP).

Hyundai Records Mfg., Co. Ltd., 44-15 Chungdam-dong Kangnam-ku, Seoul, (02)546-5071, (02)546-5072. Fax: (02) 542-1026. Pres.: Suh Yun-Sik; Mktg. Dir: Bang Won-Sub; A&R Dept.: Kim Hyun-Soo. (Audio—CD, Tape, LP)(Video—Tape, Disk).

SKC Ltd., CPO 8783, SKC Bldg., 199-15, 2-GA, ULJI-RO, Chung-Gu, Seoul, 100-192, 82-2-756-5151, 82-2-756-6161. Fax: 82-2-752-9008. Pres.: Jun-Sik Choi; Sales Mgr.: Hyun-Kil Lee; Mktg. Dir: Jae-Ho Ko; Asst. Mgr.: Tae-Jong Lee. (Audio—CD)(Video—Tape).

Seoul Records, Inc., 2/F Hankuk Glass B/D, 45-1, Yoido-Dong, Yongdeungpo-Gu, Seoul, 150-010, (822) 786-4521. Fax: (822) 786-4923. Pres.: Hong-Kyun Shin; Sales Mgr.: Han-Ho Woo; Mktg. Dir: Sung-Hun Song; Mgr./Classical, A&R: B.C. Soh. (Audio—CD, Tape, LP)(Video—Tape)

POLYBAGS & SHRINKWRAP

Seoul Records, Inc., 2/F Hankuk Glass B/D, 45-1, Yoido-Dong, Yongdeungpo-Gu, Seoul, 150-010, (822) 786-4521. Fax: (822) 786-4923. Pres.: Hong-Kyun Shin; Sales Mgr.: Han-Ho Woo; Mktg. Dir: Sung-Hun Song; Mgr./Classical, A&R: B.C. Soh. (Polybags & Shrinkwrap)

TAPE CUSTOM DUPLICATORS

Hyundai Records Mfg., Co. Ltd., 44-15 Chungdam-dong Kangnam-ku, Seoul, (02)546-5071, (02)546-5072. Fax: (02) 542-1026. Pres.: Suh Yun-Sik; Mktg. Dir: Bang Won-Sub; A&R Dept.: Kim Hyun-Soo. Audio: Cassette. Other Services: Warehouse.

Seoul Records, Inc., 2/F Hankuk Glass B/D, 45-1, Yoido-Dong, Yongdeungpo-Gu, Seoul, 150-010, (822) 786-4521. Fax: (822) 786-4923. Pres.: Hong-Kyun Shin; Sales Mgr.: Han-Ho Woo; Mktg. Dir: Sung-Hun Song; Mgr./Classical, A&R: B.C. Soh. Audio: Cassette, DAT, Real-time, LP. Video: ¼ U-Matic, ½ VHS Cassette, S-VHS. Audio Packaging Services: Inserting, Labeling, Mailing. Video Packaging Services: Inserting, Labeling. Other Services: Direct Response—800 services.

COMPACT DISC MANUFACTURERS & VIDEO DISC MANUFACTURERS

Hyundai Records Mfg., Co. Ltd., 44-15 Chungdam-dong Kangnam-ku, Seoul, South Korea, (02)546-5071, (02)546-5072. Fax: (02) 542-1026. Pres.: Suh Yun-Sik; Mktg. Dir: Bang Won-Sub; A&R Dept.: Kim Hyun-Soo. Type: CD, Videodisk.

SKC Ltd., CPO 8783, SKC Bldg., 199-15, 2-GA, ULJI-RO, Chung-Gu, Seoul, 100-192, South Korea, 82-2-756-5151, 82-2-756-6161. Fax: 82-2-752-9008. Pres.: Jun-Sik Choi; Sales Mgr.: Hyun-Kil Lee; Mktg. Dir: Jae-Ho Ko; Asst. Mgr.: Tae-Jong Lee. Type: CD.

PLATING & PRESSING PLANTS

SKC Ltd., CPO 8783, SKC Bldg., 199-15, 2-GA, ULJI-RO, Chung-Gu, Seoul, 100-192, South Korea, 82-2-756-5151, 82-2-756-6161. Fax: 82-2-752-9008. Pres.: Jun-Sik Choi; Sales Mgr.: Hyun-Kil Lee; Mktg. Dir: Jae-Ho Ko; Asst. Mgr.: Tae-Jong Lee.

Seoul Records, Inc., 2/F Hankuk Glass B/D, 45-1, Yoido-Dong, Yongdeungpo-Gu, Seoul, 150-010, South Korea, (822) 786-4521. Fax: (822) 786-4923. Pres.: Hong-Kyun Shin; Sales Mgr.: Han-Ho Woo; Mktg. Dir: Sung-Hun Song; Mgr./Classical, A&R: B.C. Soh. (LP's)

MASTERING FACILITIES

Hyundai Records Mfg., Co. Ltd., 44-15 Chungdam-dong Kangnam-ku, Seoul, (02)546-5071, (02)546-5072. Fax: (02) 542-1026. Pres.: Suh Yun-Sik; Mktg. Dir: Bang Won-Sub; A&R Dept.: Kim Hyun-Soo. (Audio & Video)

SKC Ltd., CPO 8783, SKC Bldg., 199-15, 2-GA, ULJI-RO, Chung-Gu, Seoul, 100-192, 82-2-756-5151, 82-2-756-6161. Fax: 82-2-752-9008. Pres.: Jun-Sik Choi; Sales Mgr.: Hyun-Kil Lee; Mktg. Dir: Jae-Ho Ko; Asst. Mgr.: Tae-Jong Lee. (Audio)

Seoul Records, Inc., 2/F Hankuk Glass B/D, 45-1, Yoido-Dong, Yongdeungpo-Gu, Seoul, 150-010, (822) 786-4521. Fax: (822) 786-4923. Pres.: Hong-Kyun Shin; Sales Mgr.: Han-Ho Woo; Mktg. Dir: Sung-Hun Song; Mgr./Classical, A&R: B.C. Soh. (Audio & Video)

TAPE DUPLICATING & PROCESSING EQUIPMENT MANUFACTURERS

Seoul Records, Inc., 2/F Hankuk Glass B/D, 45-1, Yoido-Dong, Yongdeungpo-Gu, Seoul, 150-010, (822) 786-4521. Fax: (822) 786-4923. Pres.: Hong-Kyun Shin; Sales Mgr.: Han-Ho Woo; Mktg. Dir: Sung-Hun Song; Mgr./Classical, A&R: B.C. Soh. Product(s): Studer 1/2, 1/4, Studer Mixer.

TAPE EQUIPMENT MANUFACTURERS

Seoul Records, Inc., 2/F Hankuk Glass B/D, 45-1, Yoido-Dong, Yongdeungpo-Gu, Seoul, 150-010, (822) 786-4521. Fax: (822) 786-4923. Pres.: Hong-Kyun Shin; Sales Mgr.: Han-Ho Woo; Mktg. Dir: Sung-Hun Song; Mgr./Classical, A&R: B.C. Soh. Audio: ElectroSound, Gauss, Lyrec. Video: BVH-3100; Panasonic AG-6820/6840, SP U-Matic: BVU950.

TAPE PACKAGING & LABELING EQUIPMENT MANUFACTURERS

Dongwon Merchandise, Inc., Yeoeuido P.O. Box 1199, Seoul, 150-611, 53-3 Yeoeuido-Dong, Eunha Bldg., Rm. 1-2, Youngdeungpo-Ku, Seoul, 150-010, (02) 784-6819, (02) 784-1152. Fax: (02) 784-0630. Pres./Sales Mgr.: Y.A. Kwon. Product(s): All kinds of phonograph LP & CD.

Seoul Records, Inc., 2/F Hankuk Glass B/D, 45-1, Yoido-Dong, Yongdeungpo-Gu, Seoul, 150-010, (822) 786-4521. Fax: (822) 786-4923. Pres.: Hong-Kyun Shin; Sales Mgr.: Han-Ho Woo; Mktg. Dir: Sung-Hun Song; Mgr./Classical, A&R: B.C. Soh. Product(s): Marden Edward (Pkg.), Koyo, Viva (Label).

TAIWAN

RECORD LABELS

Himalaya Records Corp., 11th Floor, 180 Sec. 4, Nanking E. Rd., Taipei, (02) 731-3560. Fax: (02) 721-4900. Chrmn.: Harold Han; Pres.: S.K. Wang; Gen. Mgr.: Karl Yu; Vice Gen. Mgr.: Jesse Hung. Label(s): (Distributed) CBS, CBS Assoc., Rolling Stone, Epic, Sony Classical.

PolyGram Records Ltd., 2F-1, 25 Nanking E. Rd., Sec 4, Taipei, 105, +88627168214/5. Fax: +88627162228. Pres.: Mark Huang; Managing Dir.: Michael Hwang; Dir. of Int'l Dept.: Simon Hsin.

Label(s): (Owned) A & M, Island, Mercury, London, Philips Classics, Polydor. **Siegfried Ent's., Ltd.**, 3F, 25 Nanking East Rd., Sect. 4, Taipei, (02) 717-2686. Fax: (02) 716-2228. Pres.: Mark Huang. Label(s): (Distributed) A & M, Casablanca, Archiv, RSO, Polydor, Vertigo, DG, London, Philips, Mercury.

Simpson Music Co., Ltd., PO Box 7-857, No. 100, Sec. 1, Hsin-Hai Rd., Taipei, 10610, 886-2-3632500. Fax: 886-2-3633424. Pres.: Victor Chen; Exec. Mgr.: Nicolai Wang. Label(s): (Distributed) Valois, TM (Taylor Made), Tempo, Unidisc, Unesco, Arabesque, Artemis, BNL, Astree, Caprice, Dragon, Phone Suecia, Musica Sueciae, Pierre Verany, Playa Sound, Swedish Society, Playa Sound.

Sunrise Records Ltd., 7-7-4 Chung Shan N. Rd., #2, Taipei, 10419, (02) 511-8595. Fax: (02) 581-5849. Pres.: M.S. Lin; Managing Dir.: Pearl Lin; Gen. Mgr.: Elise Lin. Label(s): (Owned) Firebird, Runrice, (Distributed) SteepleChase, Supraphon, Telarc, Intersound, K-Tel, Musik, Milan, New World, Newport, Pickwick, Orfeo, Qari, Saydisc, Sittelle, Scotdisc, Fone, Hyperion, Harmonia Mundi, Ades, American Gramophone, Chandos, Bis, Coda, Delos, Enja, Durlum, Wergo.

UFO Group Co. Ltd., 9F, No. 52, Sec. 3, Nan King Rd., Taipei, (886-2)7881598. Fax: (886-2)7882195. Vice Pres.: Daniel Chen; Dir. of Int'l: Michael Chang.

MUSIC PUBLISHERS

Simpson Music Co. Ltd., PO Box 7-857, No. 100, Sec. 1, Hsin-Hai Rd., Taipei, 10718, (886) 23632500. Fax: 997-23733424. Pres.: Victor Chen; Gen. Mgr.: Nicolai Wang.

BLANK & BULK TAPE MANUFACTURERS

Barma Corp., 248 Hsin Shu Rd., Hsin Chuang, Taipei Hsin, Taiwan, 886-2-90354968. Fax: 886-2-9041812.

Forming Co., Ltd., 112 Lucky Star Bldg./5th Floor Chung-Shan, Sec. 2, Taipei, Taiwan, (886)2-5523288. Fax: (886)2-5435644.

3M Taiwan Ltd., PO Box 1653, 136, SEC 3, JEN Ai Rd., 13th Floor, Lotus Bldg., Taipei, 10628, Taiwan, (886)2 7049011. Fax: (886)2 7040551. Contact: Steve Lin.

CARTRIDGES, CASSETTES, REELS & OTHER PARTS

Vanda Union Industrial Co., Ltd., PO Box 206 NEI-HU, Taipei, (886) 27064842. Pres.: Allen Shih; Sales Mgr.: Tony Shih. Video: V-0, L-0.

TAPE EQUIPMENT MANUFACTURERS

Vanda Union Industrial Co., Ltd., PO Box 206 NEI-HU, Taipei, (886) 27064842. Pres.: Allen Shih; Sales Mgr.: Tony Shih.

THAILAND

RECORD LABELS

CBS Epic Thailand Ltd., 1091/184-5 New Petchburi Rd., Pyathai, Bangkok 10400, (66) 2/251-365, (66) 2/253-454. Fax: (66) 2/253-201. Chrmn.: Itthivat Bhiralues; Gen. Mgr.: Peter Mary Gan; Financial Controller: Premon Pinksul; Opns. Mgr.: Nit Sitheeamorn.

Label(s): (Owned) CBS Epic Portrait, (Distributed) BMG, Chrysalis, Arista, Ariola, Delphine, Hansa, K-tel, Jive, Motown, Mute, Virgin, RCA.

EMI (Thailand) Ltd., 1091/183 New Petchburi Rd., Makkasan, Phayathai, Bangkok, 10400, Fax: (66)2-254-2788.

KUMA Music Int'l Co., Ltd., 14 Soi Somkid, Ploenchit Rd., Pratunwan, Bangkok, 10330, (66-2) 254-746. Fax: (66-2) 255-347. Pres.: John G. Schultz; Mng. Dir.: Lance N.R. Robinson; Exec. Asst.: Siripen Muengsuang.

Int'l Reps.: BMG Pacific (Thailand). **MGA Records Co. Ltd.**, Sukumvit 69, 38 Chavanich Bldg., Prakanhong, Bangkok, 10110, (66-2)392-2023. Fax: (66-2)391-0452. Gen. Mgr.: Savasdi Navavongs.

MUSIC PUBLISHERS

KUMA Music Int'l Co., Ltd., (ASCAP) 14 Soi Somkid, Ploenchit Rd., Bangkok, 10330, (02) 254-7462. Fax: (02) 255-3473. Pres.: John G. Schultz; Gen. Mgr.: Sirpen Muengsuang.

BLANK & BULK TAPE MANUFACTURERS

3M Thailand Ltd., 41/16 Group 7, Vipavadee-Rangsit Rd., Bangkheng, Bangkok, 10210, Thailand, (66)2 5790023. Fax: (66)2 579940. Contact: Pichai Thamromdee.

COMPACT DISC MANUFACTURERS & VIDEO DISC MANUFACTURERS

KUMA Int'l Limited, 14 Soi Somkid, Ploenchit Rd., Patumwan, Bangkok, 10330, Thailand, 66-2-254-7462. Fax: 66-2-255-3473. Pres.: John G. Schultz; Sales Mgr.: Lance N.R. Robinson. Type: CD.

MASTERING FACILITIES

KUMA Int'l Limited, 14 Soi Somkid, Ploenchit Rd., Patumwan, Bangkok, 10330, 66-2-254-7462. Fax: 66-2-255-3473. Pres.: John G. Schultz; Sales Mgr.: Lance N.R. Robinson.

SOUTH AMERICA

ARGENTINA

RECORD LABELS

EMI-Odeon SAIC, Avda San Martin 3590, Florida, PCIA BS.AS., 1602, (54)11760-0081. Fax: (54)11760-0080. Pres.: Roberto Play; Sales Mgr.: Julio Dominguez; Adv. & Promos Mgr.: Julio Quinteros; Int'l Mgr.: Ernie Raid; A&R Dir.: Rolando Hernandez. Label(s): (Owned) Capitol, Chrysalis, I.R.S., EMI Music, SBK, (Distributed) Virgin.

EPSA Music, Mexico 2835, Capital Federal, 1223, (0541) 93-8316, (0541) 97-4609. Fax: (0541) 97-3872. Pres.: Laura Casella; Mktg. Dir.: Jose Orona; Sales Mgr.: Norma Fabris. A&R Rep.: Jorge Alloggio; Contact: Laura Tesariero. Label(s): (Distributed) AKG, Jose Luis Barros, Clan Dilo, CHM Discos, FDIPO, Musica Vision, Profon-AMBAP, Pepe Ureta, Sondor S.A.

Magnatec S.A., Vidal 3850, Buenos Aires, 1429, (541) 70-8014. (541) 70-6838. Fax: (541) 70-6535. Pres.: Alfredo Farhi; Vice

Pres.: Carlos Farhi; Vice Pres. A&R: Liliana Iaffe.
Label(s): (Owned) Magnatape, (Distributed) Melodia, Supraphon.

Microfon Argentina S.A., Riobamba 286, Capitol Federal, Buenos Aires, 48-7180/7181. Fax: 953-6759. Pres.: Mario Ruben Kaminsky.

Label(s): (Distributed) Can't Stop Prodn., Audiofidelity, Discos Y Cintas Melody, Music Shop, Solar, Orfeon, Vanguard.

US Reprs.: Astral Records (Hialeah Gardens, FL).
Int'l Reprs.: Edisa (Uruguay), Ifesa (Ecuador), FM Discos Y Cintas (Columbia), RCA Chile (Sgo. De Chile, Chile).

Milan Sur, Avenida Cordoba 827, Buenos Aires, 9901, (541) 313-7692. Fax: (541) 312-5172. Pres.: Fernando E. Solanas; Vice Pres.: Emmanuel Chamboredon; Gen. Mgr.: Envar El Kadri; A&R Mgr.: Litto Nebbia.
Label(s): (Distributed) Milan.

Musidisc Europe Sudamericana S.A.I.C. y F., Goemes 4418, 1er. "A", Buenos Aires, 1425, (541) 765-7625. Fax: (541) 804-6104.

Label(s): (Owned) Musicdisc, New Music, New Definitions, (Distributed) Musicola, Musidisc (France), Energy, Discomagic, Full Time (Italy), Tommy Boy, ZYX (Germany).

PolyGram Discos S.A., Belgrano 1670, Piso 7, Buenos Aires, 1093, (54) 138-0569. Fax: (54) 1953-3667. Mng. Dir.: Alberto C. Dieguez; Controller: Raul Salgado Dominguez; Mktg. Mgr.: Horacio Serto; Int'l Product Mgr.: Liliana Mammana.

Sony Music Entertainment (Argentina) S.A., Bartolome Mitre 1986, Buenos Aires, 1039, (541) 953-2500. Fax: (541) 953-2030. Managing Dir.: Alberto Fidel Caldeiro; Admin. & Finance Dir.: Jorge Oscar Schutt; A & R Dir.: Sergio Garcia; Mktg. Dir.: Hugo Piombi; Vice Pres. A & R: Luana Paganl.

Label(s): (Owned) Epic, Columbia, Orfeo, Sony Classical.

Warner Music Argentina SRL, Castro Barros 848, Buenos Aires, 1217, (54-1) 97-0326, (54-1) 97-3227. Fax: (54-1) 93-2449. Managing Dir.: Roberto "Chacho" Ruiz; Financial Controller: Mario Cairella.

Label(s): (Owned) Sire, Warner Bros., Asylum, Atco, Elektra, Atlantic, Finnadar, Paisley Park, Nonesuch, Reprise. (Distributed) MCA, Fusion, I.M. Discos (restr), Geffen.

MUSIC PUBLISHERS

All Boys Music Int'l, (SUISA) (See Organizacion Musical Sud Americana S.A. (OMSA)).

BMG Relay Ediciones Musicales, S.A., Talcahuano 750, 7th Floor, Buenos Aires, 1013, (54-1) 49-4051. Fax: (54-1) 814-2415. Mgr.: Roberto Hernandez.

Cutting Records Music, (ASCAP) (See Organizacion Musical Sud Americana S.A. (OMSA)).

EDAMI (Editorial Argentina de Musica Internacional) S.A.

Rivadavia 5012, Buenos Aires, 1424, (54-1) 903-3664. Fax: (54-1) 903-4139. Pres.: Edward Villar. Gen. Mgr.: Elsa N. Villar.

EMI Music Publishing Argentina—Melograf S.A., Montevideo 643, Lar. Piso, Buenos Aires, CF, 1019, (54-1) 409277. Fax: (54-1) 3221163.

EMI Odeon S.A.I.C., Avda. San Martin 3590, Florida, PCTA Buenos Aires, 1602, (54-1) 760-0081, (54-1) 760-0088. Fax: (54-1) 760-0080. Pres./Gen. Mgr.: Roberto Play.

Ediciones Internacionales Fermata, Parana 851, Buenos Aires 1017, 49-0884, 41-6632. Contact: M. S. Brenner.

Ediciones Musicales Relay, S.A., Talcahuano 750, Seventh Floor, Buenos Aires, 1013, 54-1-40-1680. Fax: 54-1-322-7947. Mgr.: Ana de Visaggio.

Ediciones Musicales Phonogram, Av. Belgrano 1670—Piso 6, Buenos Aires, 1093, (54-1) 38-0569, (54-1) 38-6508. Fax: (54-1) 953-3667. Gen. Mgr.: Andrea Vardakas.

Edifon S.R.L., Riobamba 286, Cap. Fed., Buenos Aires, 1025, 953-1063. Fax: 953-6759. Pres.: Beatriz Kaminsky; Gen. Mgr.: Elena Barreiro; Professional Mgr.: Raquel de Matteis.

Gallo Music Publishers, (SAMRO) (See Organizacion Musical Sud Americana S.A. (OMSA)).

Jeruvian Music Co., (ASCAP) (See Organizacion Musical Sud Americana S.A. (OMSA)).

Lido Music, (See EDAMI (Editorial Argentina de Musica Internacional) S.A.).

Livi Music, (ASCAP) (See Organizacion Musical Sud Americana S.A. (OMSA)).

MCA/ATV Music, (See EDAMI (Editorial Argentina de Musica Internacional) S.A.).

Melody Lane Publishing, Inc., (See EDAMI (Editorial Argentina de Musica Internacional) S.A.).

Music Sales Corp., (ASCAP) (See Organizacion Musical Sud Americana S.A. (OMSA)).

Jaime Olszewicki, Guemes 4418, 1er. piso, Buenos Aires, 1425, (541) 41-0464, (541) 41-7091. Fax: (541) 804-6104. Pres.: J. Olszewicki; Gen. Mgr.: A. M. Hernandez; Professional Mgr.: Nadina & Ivan Olszewicki.

Organizacion Musical Sud Americana S.A. (OMSA), (SADAIC) Lavalle 1145 (4A), Buenos Aires, 1048, Talcahuano 860, Buenos Aires, 1013, (541) 35-7132. Fax: (541) 35-7132. Pres.: Fernando Ferrari; Gen. Mgr.: Claudia Polito.

PSO Ltd., (See EDAMI (Editorial Argentina de Musica Internacional) S.A.).

Panther Music Corp., (See EDAMI (Editorial Argentina de Musica Internacional) S.A.).

Peer Int'l Corp., (See EDAMI (Editorial Argentina de Musica

International) S.A.).

Peer Southern Prodn., (See EDAMI (Editorial Argentina de Musica Internacional) S.A.).

Peermusic Ltd., (See EDAMI (Editorial Argentina de Musica Internacional) S.A.).

G. Schirmer, Inc., (ASCAP) (See Organizacion Musical Sud Americana S.A. (OMSA)).

Silivet Corp., (ASCAP) (See Organizacion Musical Sud Americana S.A. (OMSA)).

Sonet Publishing Ltd., (PRS) (See Organizacion Musical Sud Americana S.A. (OMSA)).

Sony Music Publishing (Argentina), Bartolome Mitre 1986, Buenos Aires, 1039, (541) 953-2328, (541) 953-9607. Fax: (541) 953-2030. Pres./Gen. Mgr.: Alberto Fidel Caldeiro; Prof./Creative Mgr.: Olinda Pascuali De Romera.

Thorn EMI Co., Montevideo 643-Piso 1, Cap. Federal/Buenos Aires, 1019, 40 9277, 40-9762. Fax: (541) 3221163. Professional Mgr.: Adrian Posse; Pres./Gen. Mgr.: Jorge Carlos Fortunato.

Virgin/Hit & Run/Charisma, (See EDAMI (Editorial Argentina de Musica Internacional) S.A.).

Walt Disney Music Co., (ASCAP) (See Organizacion Musical Sud Americana S.A. (OMSA)).

Warner Music Argentina SRL, Castro Barros 848, Buenos Aires, 1217, (54) 1-97-5666. Fax: (54) 1-93-2449. Gen. Mgr.: Roberto Ruiz; Prof./Creative Mgr.: Beatriz Musco.

ASSOCIATIONS & PROFESSIONAL ORGANIZATIONS

Mozarteum Argentino, Rodriguez Pena 1882, P. B., Buenos Aires, 1021, 41 0854. Fax: 11 2707. Pres.: Jeannette A.de Erez; Sales Mgr.: Gisela Timmermann.

Sociedad Argentina de Autores Y Compositores de Musica (SADAIC), Apartado 11-Sucursal 44 (B), Buenos Aires, 1444, Lavalle 1547, Buenos Aires, 1048, (541) 11 9895. Pres.: Atilio Stampone.

Sony Music Entertainment (Argentina) S.A., Bartolome Mitre 1986, Buenos Aires, 1039, (541) 953-2500. Fax: (541) 953-2030. Pres.: Alberto Fidel Caldeiro; Sales Mgr.: Ricardo Taverna; Mktg. Dir.: Hugo Piombi; Exec. Sec.: Andrea De Marco.

PERFORMING & MECHANICAL RIGHTS ORGANIZATIONS

Sony Music Entertainment (Argentina) S.A., Bartolome Mitre 1986, Buenos Aires, 1039, (541) 953-2500. Fax: (541) 953-2030. Pres.: Alberto Fidel Caldeiro; Sales Mgr.: Ricardo Taverna; Mktg. Dir.: Hugo Piombi; Exec. Sec.: Andrea De Marco.

Sony Music Entertainment (Argentina) S.A., Bartolome Mitre 1986, Buenos Aires, 1039, (541) 953-2500. Fax: (541) 953-2030. Pres.: Alberto Fidel Caldeiro; Sales Mgr.: Ricardo Taverna; Mktg. Dir.: Hugo Piombi; Exec. Sec.: Andrea De Marco.

MUSIC LIBRARIES

Sociedad Argentina de Autores Y Compositores de Musica (SADAIC), Apartado 11-Sucursal 44 (B), Buenos Aires, 1444, Lavalle 1547, Buenos Aires, 1048, (541) 11 9895. Pres.: Atilio Stampone.

PUBLIC RELATIONS

Sony Music Entertainment (Argentina) S.A., Bartolome Mitre 1986, Buenos Aires, 1039, (541) 953-2500. Fax: (541) 953-2030. Pres.: Alberto Fidel Caldeiro; Sales Mgr.: Ricardo Taverna; Mktg. Dir.: Hugo Piombi; Exec. Sec.: Andrea De Marco.

RECORD PROMOTION

Sony Music Entertainment (Argentina) S.A., Bartolome Mitre 1986, Buenos Aires, 1039, (541) 953-2500. Fax: (541) 953-2030. Pres.: Alberto Fidel Caldeiro; Sales Mgr.: Ricardo Taverna; Mktg. Dir.: Hugo Piombi; Exec. Sec.: Andrea De Marco.

BLANK & BULK TAPE MANUFACTURERS

3M Argentina SACIFIA, Los Arboles 842, 1686 Hurlingham, Buenos Aires, Argentina, (541) 865-0661. Fax: (541) 665-4071. Contact: Daniel Blanco.

CARTRIDGES, CASSETTES, REELS & OTHER PARTS

Magnatec S.A., Vidal 3850, Buenos Aires, 1429, (541) 70 8014, (541) 70 6838. Fax: (541) 70 6535. Pres.: Alfredo Farhi; Sales Mgr.: Liliana Iaffe; Mktg. Dir.: Carlos Farhi.
Audio: Cassettes, C-0, Norelco boxes.

TAPE CUSTOM DUPLICATORS

EPSA Electrical Products S.A., Mexico 2835, Capital Federal, Buenos Aires, 1223, (0541) 97-7185. Fax: (0541) 97-3872. Pres.: Laura Casella; Sales Mgr.: Alba Casella; Mktg. Dir.: Elba Casella; Contact: Laura Tesoriero.

Audio: Cassette.

Audio Packaging Services: Inserting, Labeling.
Magnatec S.A., Vidal 3850, Buenos Aires, 1429, (541) 70 8014, (541) 70 6838. Fax: (541) 70 6535. Pres.: Alfredo Farhi; Sales Mgr.: Liliana Iaffe; Mktg. Dir.: Carlos Farhi.
Audio: Cassette.

Sony Music Entertainment (Argentina) S.A., Bartolome Mitre 1986, Buenos Aires, 1039, (541) 953-2500. Fax: (541) 953-2030. Pres.: Alberto Fidel Caldeiro; Sales Mgr.: Ricardo Taverna; Mktg. Dir.: Hugo Piombi; Exec. Sec.: Andrea De Marco.
Audio: Cassette, Open Reel, DAT.

Audio Packaging Services: Inserting, Labeling, Mailing. Other Services: Warehouse, Freight.

COMPACT DISC MANUFACTURERS & VIDEODISC MANUFACTURERS

EPSA Electrical Products S.A., Mexico 2835, Capital Federal, Buenos Aires, 1223, Argentina, (0541) 97-7185. Fax: (0541) 97-3872. Pres.: Laura Casella; Sales Mgr.: Alba Casella; Mktg. Dir.: Elba Casella; Contact: Laura Tesoriero.
Type: CD

MASTERING FACILITIES

EPSA Electrical Products S.A., Mexico 2835, Capital Federal, Buenos Aires, 1223, (0541) 97-7185. Fax: (0541) 97-3872. Pres.: Laura Casella; Sales Mgr.: Alba Casella; Mktg. Dir.: Elba Casella; Contact: Laura Tesoriero.
(Audio)

Sony Music Entertainment (Argentina) S.A., Bartolome Mitre 1986, Buenos Aires, 1039, (541) 953-2500. Fax: (541) 953-2030. Pres.: Alberto Fidel Caldeiro; Sales Mgr.: Ricardo Taverna; Mktg. Dir.: Hugo Piombi; Exec. Sec.: Andrea De Marco.
(Audio)

TAPE DUPLICATING & PROCESSING EQUIPMENT MANUFACTURERS

Sony Music Entertainment (Argentina) S.A., Bartolome Mitre 1986, Buenos Aires, 1039, (541) 953-2500. Fax: (541) 953-2030. Pres.: Alberto Fidel Caldeiro; Sales Mgr.: Ricardo Taverna; Mktg. Dir.: Hugo Piombi; Exec. Sec.: Andrea De Marco.
Product(s): Sony.

TAPE EQUIPMENT MANUFACTURERS

Sony Music Entertainment (Argentina) S.A., Bartolome Mitre 1986, Buenos Aires, 1039, (541) 953-2500. Fax: (541) 953-2030. Pres.: Alberto Fidel Caldeiro; Sales Mgr.: Ricardo Taverna; Mktg. Dir.: Hugo Piombi; Exec. Sec.: Andrea De Marco.
Audio: Gauss Slaves.

BOLIVIA

RECORD LABELS

Columbians Ltda., Casilla 3051, La Paz, 591-2 352238. Fax: 591-2 391279. Gen. Mgr.: Wilfred Ocampo; Commercial Mgr.: Teresa Torres De Ocampo; Imports Dir.: Wilter Ocampo.
Label(s): (Owned) Campo.

Discolandia Dueri y Cia Ltda., PO Box Casilla No. 422, Calle Potosi 920, La Paz, (591-2) 356656, (591-2) 328513. Fax: (591-2) 355015. Pres.: Miguel Dueri; Mgr.: Henry Dueri.
Label(s): (Distributed) Warner Music Int'l.

Discos Jallalla, Figueroa 788 20 Piso Depto. 1, La Paz, 366514. **Heriba Ltda.**, Calle Abdon Saavedra 2190, Casilla 3120, La Paz, 351744-379141. Fax: 591-2-391333. Gerente Gen.: Eduardo Ibanez Wigger; Gerente Produccion: Dora Ibanez.
Label(s): (Distributed) EMI Int'l Ltd., Discos Fuentes Ltda., Sony Music Int'l, Velvet De Venezuela.

Industria Bolivina Del Fonograma S.R.L., PO Box 6001, La Paz, (2) 328-513, (2) 359-395. Fax: (2) 355-015. Pres.: Johnny Dueri.

MUSIC PUBLISHERS

Ediciones Musicales Kollasuyo, Figueroa 788 20 Piso Depto. 1, La Paz, 366514. Pres./Gen. Mgr.: Julio Martinez Artega.

ASSOCIATIONS & PROFESSIONAL ORGANIZATIONS

Sobodaycom-Sociedad Boliviana de Autores y Compositores de Musica, Figueroa 788-20 piso Depto. 1, La Paz, 366514, Dir. Gen.: Julio Martinez Artega; Mktg./Sec.: Victor Campos Ramos.

BRAZIL**RECORD LABELS**

Alldisc Consultoria E Comercial Fonografica Ltda., PO Box 54.192, Rua Haddock Lobo 151, Sao Paulo, SP, 01296, 55-11 258-8733. Fax: 55-11 258-8063. Chrmn./Pres.: Geraldo L. Loewenberg; Gen. Mgr.: Odair Corona; A & R Mgr.: Roberto A. Loewenberg.

Label(s): (Owned) Nostalgia, Scala, Alldisquihno, Alldisc, (Distributed) San Juan, Tabak, ZYX, The Long Island Music Co., Rounder, Energy, Black & Blue, Countdown, Discmagic, Curb.

BMG Ariola Discos Limitada, Rua Santa Clara-50 Cobertura, Rio De Janeiro, 22041, (021) 255-7225. Fax: (021) 255-0742. Pres.: Manuel Camero; Finance & Admin. Dir.: Juan Carlos Bernardes; Sales Mgr.: Marco Antonio Altafini; Int'l: Cecilia MacDowell.

Label(s): (Owned) RCA, Arista, Ariola, (Distributed) Motown, Jive, Private.

US Reps.: BMG Music Int'l (NY).

Comercial Fonografica Rge Ltda., 1584 Rua Marques de Sao Vicente, Sao Paulo, 01139, 005511 8269377. Fax: 005521 2863569. Pres.: Joao Araujo; Gen. Mgr.: Wilson Rodrigues Pozo; A & R Mgr.: Vasco Borges; Sales & Mktg. Mgr.: Jose Marcio Pelens.

Label(s): (Owned) Peralta, RGE, Young, (Distributed) Sigem, Xuxa Discos, Carrere.

Companhia Industrial De Discos, Rua Sete De Marco, 331-Bonsucesso, Rio De Janeiro, RJ, 21-040, (021) 280 3838. Fax: (021) 270-2786. Pres.: Hermann Zuckermann; Vice Pres.: Rodolfo Zuckermann, Harry Zuckermann; Int'l: Betina Zuckermann.

Label(s): (Owned) Alshire, Count Down, CID, Fama, Square, US Reps.: Alshire (CA); K-Tel (MN). Int'l Reps.: ARC Music (Germany); Vidisco (Portugal); Open Records (Spain).

Discos Presenca Ltda., C. Postal 2525 Centro, Rio de Janeiro, 20001, (021) 295-9081. Pres.: Wilson F. Falcao; Sales Dir.: Gilda C. Falcao; Int'l Dir.: Solange C. Falcao; Promo. Mgr.: Maria Helena C. Falcao.

EMI-Odeon Fonografica Industrial & Electronica Ltda., Rua Mena Barreto 151, Rio de Janeiro, 22271, (021) 286 1212. Fax: (021) 286-9023. Managing Dir.: Jo Goavaerts; Mktg. Dir.: Jorge Davidson; Mktg. Mgr.: Carolos Townsend; Promo. Mgr.: Luis Carlos de Carvalho; Sales Mgr.: Alberto Runkel.

Label(s): (Owned) E M I, Capitol, (Distributed) Virgin.

Editora E Produtora Fonografica Som Da Gente Ltda., Rua Bocaina, 61, Perdizes, Sao Paulo, SP, 05013, (5511) 65.5282. Fax: (5511) 62.2771. Pres.: Tereza Souza; Vice Pres./A&R Rep.: Walter Santos; Opns. Exec. & Int'l Dir.: Rifka Souza.

Label(s): (Owned) Somda, Somda Discos E Edicoes Ltda., Som Da Gente, SDG, (Distributed) DSDG.

US Reps.: Happy Hour (CA).

Fermata Industria Fonografica Ltda., Avenida Ipiranga, 1123, 10o Andar, Cjto 1001, Sao Paulo, 01039, (011) 229-3411. Fax: 0055-11-229361. Pres.: Enrique Lebendiger. Gen. Mgr.: Aldo E. Guimaraes.

Gravacoes Eletricas SA, Av. do Estado 4667, Sao Paulo, SP, 01515, (055)112796811, (055)11-270818. Fax: (055)112705703. Pres.: Alberto J. Byington Neto; Gen. Mgr.: Matheus Amaro Nazareth; Opns. Dir.: Ansano Baccelli; Admin. Mgr. Int'l Dept.: Mario do Carmo G. A. Botelho.

Musisom Empreendimentos Musicais Ltda., Av. Paulo de Frontim, 745, Rio De Janeiro, RJ, 20260, (021) 273-0497. Fax: (021) 293-9686. Pres.: Jonas Silva; Sales: Sergio Guedes Silva; Int'l Dept.: Ademir Williams; Mktg.: Sheila Leida.

Label(s): (Owned) Musisom, Imagem, (Distributed) Everest, Hungaroton, RPTV Communications.

RKR Import-Export e Com. Ltda., Rua Luiz Gies 616, Sao Paulo, SP, 04043, (011) 581-1871. Fax: (11) 581-1871. Chief Exec.: Hamilton Ruggiero; Mgr.: Lembit Karouk; Buyer (Record/Tape)/(Videos): Ricardo Ruggiero; Buyers (Other): H. Ruggiero & L. Karouk; (Compact Disc, Video (Cassette & Disc)) (Distributor, Importer)

Labels Distributed: Audio: Gimell & Pickwick (U.K.); Audvidis (France); Claves (Swiss); Orfeo, Haenssler & Thoron (Germany); Ars Nova, GDS, GOP, Laudis & Meliodram (Italy); Marco Polo, Naxos, LRC, Donau (Hong Kong); Music & Arts Programs of America (USA); Video: Naxos (Hong Kong).

Labels Imported: See Distributed.

Sigem-Sistema Globo De Edicoes Musicais Ltda., 411, Rua Assuncao, Rio de Janeiro, 22250, 005521 2863846. Fax: 005521 2863569. Pres.: Joao Araujo; Gen. Mgr.: Bruno Quaino.

Sigla-Sistema Globo De Audio-Visuals Ltda., 443, Rua Assuncao, Rio de Janeiro, 22250, 005521 2866482. Fax: 005521 2863569. Pres.: Joao Araujo; A & R Mgr.: Max-Pierre de Almeida; Sales & Mktg. Mgr.: Helene de Oliveira.

Label(s): (Owned) Globo, Som Livre, Soma TV.

Sony Music Entertainment Ind. E Comercio Ltda., Praia do Flamengo, 200/15th Floor, Rio de Janeiro, RJ, 22210, (021) 205-1112. Fax: (021) 285-1097. Pres.: Roberto Augusto; Mktg. Dir.: Jose Antonio Eboli; Int'l A & R Dir.: Sergio Lopes; Local A & D Dir.: Marcos Kilzer.

Label(s): (Owned) Columbia, Epic, (Distributed) Copacabana, Stiletto.

Tradisco Ltda., Av. Araugo Pinho, 159, Salvador, 40 130 Bahia, Contact: A. S. De Souza.

W.E.A. Discos LTDA, Rua Itaipava # 44Cep. 22461, Rio De Janeiro, 31314 286-3332.

Warner Music Brasil Ltda., PO Box 34.022, Rua Itaipava No. 44, Rio de Janeiro, RJ, 22461, (55-21)2863332, (55-21)2863202. Fax: (55-21)2263888. Managing Dir.: Luiz Roberto Boaventura; Financial Dir.: Joao Rossini Neto; Mktg. Dir.: Deborah Lise Cohen; Commercial Dir.: Aloysio Motta; Contact: Paulo Debetio, Nelson Motta.

Branch(es): Rua Do Rocio, 313-1st Fl., Vila Olimpia, Sao Paulo, SP, 04552, Brazil, (55-11)8252155.

Label(s): (Owned) Alligator, Beggar's Banquet, Atlantic, Elektra/Asylum, Factory, Mute, Warner Bros., Teldec*, Wea Int'l, Wea United Kingdom, (Distributed) One Little Indian, Sonet, Four A.D.

MUSIC PUBLISHERS

Alldisc Consultoria E Comercial Fonografica Ltda., (SICAM) PO Box 54.192, Sao Paulo, 01296, (5511)258-8733. Fax: (5511)258-8063. Pres.: Geraldo L. Loewenberg; Gen. Mgr.: Odair Corona; Prof./Creative Mgr.: Roberto A. Loewenberg.

Anjo Edicoes Musicais, (See Sony Music Edicoes Musicais Ltda.).

CID, (CID) Rua & de Marco, 331, Rio, 21041, (021) 280-3838. Fax: (021) 270-2786. Pres.: Harry Zuckermann; Professional Mgr.: Antonio Aguiro.

CMP-CBS Music Publishing (CBS Sons Edicoes Musicais Ltda.), (CMP) Praia do Flamengo, 200, 15th Floor, Rio de Janeiro, RJ, 22210, (021) 205-1112. Fax: (021) 285-1097. Pres.: Hans P. Beugger; Gen. Mgr.: Maria Creusa Meza.

Cia. Das Indias Prod. Art. Ltda., (See Sony Music Edicoes Musicais Ltda.).

Coracoes Perfeitos Edicoes Musicais Ltda., (See Sony Music Edicoes Musicais Ltda.).

EMBI (Editora de Musical Brasileira e Internacional), Av. Angelica 501, 2 Andar Conjunto 206, CEP, Sao Paulo, 01227, (5511)825-5533, (5511)825-5182. Fax: (5511)825-0810. Managing Dir.: Manoel Pinto.

Branch(es): Rua Teofilo Otoni, 135/3 Andar, CEP, Rio De Janeiro, GB, 20090, Brazil, (5521)233-3046. Managing Dir.: Manoel Pinto.

EMI Music Publishing Brazil, Rue da Gloria, 290/70 Andar, Gloria, Rio De Janeiro, RJ, 20241, (21) 221-4168. Fax: (21) 232-9460. Gen. Mgr.: Aileen Schneider, Managing Dir.: Jose Antonio Perdomo.

Ecra Realizacoes Artisticas, (See Sony Music Edicoes Musicais Ltda.).

Betina Edicoes, (SICAM) (See CID).

Editora E Produtora Fonografica Som Da Gente Ltda/Som-DaGenteRecln, (BMI) Rua Bocaina, 61-Perdizes, Sao Paulo, SP, 05103, (5511) 65-5282. Fax: (5511) 62-2771. Pres.: Tereza Souza; Gen. Mgr.: Rifka Souza; Prof./Creative Mgr.: Walter Santos.

Editora Musical Amigos Ltda., (See Sony Music Edicoes Musicais Ltda.).

Editora Musical BMG Arabella Ltda, Rua Barata Ribeiro, 181 Loja 1, Rio de Janeiro, CEP, 22011, 55-21-295-8197. Fax: 55-21-255-0742. Publishing Supervisor: Iris Maria Gamenha.

Editora Musical BMG Arabella Ltda., Rua Dona Veridiana, 203, Higienopolis, Sao Paulo, CEP, 01238, 55-11-221-9155. Fax: 55-11-223-9874. Finance Dir.: Juan Carlo Hernandez.

Editora de Musica Brasileira e Internacional s/a EMBI

Rua Visconde de Piraja 608 Conjunto 501, Impanema, Rio de Janeiro, RJ, 55-21 511-4495. Fax: 55-21-511-4542. Mgr.: Manoel Pinto.

Branch(es): Av. Angelica 501-2 Andar Conjunto 206, Santa Cecilia-Sao Paulo-SP-Brasil CEP 01227. 55-11 825-5533, 55-11 825-5182. Fax: 55-11 825-0810. Mgr.: Manoel Pinto.

Fermata Do Brasil Ltd., Av. Ipiranga, 1123, Sao Paulo, SP, 01039, 0055112293411. Fax: 0055112293612. Pres.: Enrique Lebendiger; Gen. Mgr.: Irene D.K. Lebendiger; Prof./Creative Mgr.: Lena D.K. Lebendiger.

Fermata Industria Fonografica, Av. Ipiranga, 1123, Sao Paulo, SP, 01039, 0055112293411. Fax: 0055112293612. Pres.: Enrique Lebendiger; Gen. Mgr.: Aldo Elias Guimaraes.

Latino Editora Musical, Av. do Estado, 4667, Sao Paulo, SP, 01515, (055)112796811. Fax: (055)112705703. Pres.: A. Jackson Byington Neto; Gen. Mgr.: Matheus Amaro Nazareth.

Neisjons-Nelson C. Motta Filho Ed. Mus., (See Sony Music Edicoes Musicais Ltda.).

Pao E Poesia Edicoes Musicais Ltda., (See Sony Music Edicoes Musicais Ltda.).

Peermusic, (See EMBI (Editora de Musical Brasileira e Internacional)).

Sigem-Sistema Globo De Edicoes Musicais Ltda., (UBC) 411, Rua Assuncao, Rio de Janeiro, 22250, 005521 2863846. Fax: 005521 2863569. Pres.: Bruno Quaino.

Sony Music Edicoes Musicais Ltda., Praia Do Flamengo, 200/15 Andar, Rio De Janeiro, 22210, (021) 205-1112. Fax: (021) 285-1097. Pres.: Roberto Augusto; Gen. Mgr.: Roberto Karam; Prof./Creative Mgr.: Eliane Azevedo.

Spell Promocoes Producoes Artisticas E Edicoes Musicais Ltda., (See Sony Music Edicoes Musicais Ltda.).

Verde Edicoes Musicais Ltda., (See Sony Music Edicoes Musicais Ltda.).

Zumbido Edicoes Musicais Ltda., (See Sony Music Edicoes Musicais Ltda.).

SHEET MUSIC & FOLIO SUPPLIERS

Fermata Do Brasil Ltda., Caixa Postal 6549, 1123 Av. Ipiranga, Sao Paulo, 01039, (011) 229-3612. Pres.: Enrique Lebendiger; Vice Pres.: Irene D.K. Lebendiger.

Bruno Quaino Material Cultural Ltda., 30 Rua Senador Feijó, Sao Paulo, 01006, 05511 360918. Fax: 05521 2863569. Pres.: Bruno Quaino;Brazil.

MUSIC & VIDEO ACCESSORY MANUFACTURERS

Som Industria & Comercio S/A, Rua Bento Freitas, 362-50 and, 01220, Sao Paulo, SP, 01220, (011) 259-3696. Fax: (011) 258-9456. Pres.: Adiel Macedo de Carvalho; Sales Mgr.: Enoch Gomes; Int'l Adv.: O. Bianco.

Tape—Audio: Head Cleaners.

BLANK & BULK TAPE MANUFACTURERS

3M DO Brazil, CP 123, Via Anhanguera, Km 110 Sumare, 13.100, Campinas, Sao Paulo, Brazil, (55)11 64-7000. Fax: (55) 1926411206. Contact: Helio Marinéz.

CARTRIDGES, CASSETTES, REELS & OTHER PARTS

Som Industria & Comercio S/A, Rua Bento Freitas, 362-50 and, 01220, Sao Paulo, SP, 01220, (011) 259-3696. Fax: (011) 258-9456. Pres.: Adiel Macedo de Carvalho; Sales Mgr.: Enoch Gomes; Int'l Adv.: O. Bianco.

JACKETS & SLEEVES

Gravacoes Eletricas S.A./Continental Records, Avenida Do Estado, 4667, Sao Paulo, 01515, 055-11-2796811, 055-11-2700818. Fax: 055-11-2705703. Pres.: Alberto J. Byington Neto; Mktg. Dir.: Matheus Amaro Nazareth; Int'l Admin. Mgr.: Maria Do Carmo Botelho; (Jackets/Sleeves-Audio: CD, Tape, LP)

Som Industria & Comercio S/A, Rua Bento Freitas, 362-50 and, 01220, Sao Paulo, SP, 01220, (011) 259-3696. Fax: (011) 258-9456. Pres.: Adiel Macedo de Carvalho; Sales Mgr.: Enoch Gomes; Int'l Adv.: O. Bianco; (Jackets/Sleeves-Audio: LP)

LABELS

Gravacoes Eletricas S.A./Continental Records, Avenida Do Estado, 4667, Sao Paulo, 01515, 055-11-2796811, 055-11-2700818. Fax: 055-11-2705703. Pres.: Alberto J. Byington Neto; Mktg. Dir.: Matheus Amaro Nazareth; Int'l Admin. Mgr.: Maria Do Carmo Botelho. (Audio—CD, Tape, LP)

TAPE CUSTOM DUPLICATORS

Companhia Industrial De Discos, Rua 7 De Marco, 331, Rio, 21040, (021) 280-3838. Fax: (021) 270-2786. Pres.: Hermann Zuckermann; Sales Mgr.: Harry Zuckermann; Mktg. Dir.: Rodolfo Zuckermann.

Audio: Cassette.

Gravacoes Eletricas S.A./Continental Records, Avenida Do Estado, 4667, Sao Paulo, 01515, 055-11-2796811, 055-11-2700818. Fax: 055-11-2705703. Pres.: Alberto J. Byington Neto; Mktg. Dir.: Matheus Amaro Nazareth; Int'l Admin. Mgr.: Maria Do Carmo Botelho.

Audio: Cassette, Open Reel, DAT.

Audio Packaging Services: Inserting, Collating, Labeling, Mailing.

New Vision Som E Imagem, 507 Irma Carolina St., Sao Paulo, SP, 03058, 55-11-292-6045. Fax: 55-11-92-1319. Pres.: Alex Pimentel; Mktg. Dir.: Domingos Orlando.

Video: ¾ U-Matic, ½ VHS Cassette.

Som Industria & Comercio S/A, Rua Bento Freitas, 362-50 and, 01220, Sao Paulo, SP, 01220, (011) 259-3696. Fax: (011) 258-9456. Pres.: Adiel Macedo de Carvalho; Sales Mgr.: Enoch Gomes; Int'l Adv.: O. Bianco.

Audio: Cassette.

PLATING & PRESSING PLANTS

Companhia Industrial De Discos, Rua 7 De Marco, 331, Rio, 21040, Brazil, (021) 280-3838. Fax: (021) 270-2786. Pres.: Hermann Zuckermann; Sales Mgr.: Harry Zuckermann; Mktg. Dir.: Rodolfo Zuckermann. (LP's)

Gravacoes Eletricas S.A./Continental Records, Avenida Do Estado, 4667, Sao Paulo, 01515, Brazil, 055-11-2796811, 055-11-2700818. Fax: 055-11-2705703. Pres.: Alberto J. Byington Neto; Mktg. Dir.: Matheus Amaro Nazareth; Int'l Admin. Mgr.: Maria Do Carmo Botelho. (LP's)

Som Indústria & Comercio S/A, Rua Bento Freitas, 362-50 and. 01220, Sao Paulo, SP, 01220, Brazil, (011) 259-3696. Fax: (011) 258-9456. Pres.: Adiel Macedo de Carvalho; Sales Mgr.: Enoch Gomes; Int'l Adv.: O. Bianco. (LP's)

MASTERING FACILITIES

Companhia Industrial De Discos, Rua 7 De Marco, 331, Rio, 21040, (021) 280-3838. Fax: (021) 270-2786. Pres.: Hermann Zuckermann; Sales Mgr.: Harry Zuckermann; Mktg. Dir.: Rodolfo Zuckermann.

Gravacoes Eletricas S.A./Continental Records, Avenida Do Estado, 4667, Sao Paulo, 01515, 055-11-2796811, 055-11-2700818. Fax: 055-11-2705703. Pres.: Alberto J. Byington Neto; Mktg. Dir.: Matheus Amaro Nazareth; Int'l Admin. Mgr.: Maria Do Carmo Botelho. (Audio)

CHILE

RECORD LABELS

Comercial Euromusic Ltda., PO Box 13462, Isidora Goyenechea, 2901, Santiago, 2312(800)233-5. Fax: (056) 2-231280. Admin. Exec. Mgr.: Antonio Azcona Romano; Import Dir.: Benedicto Azcona Virrueta; Gen. Mgr.: Odette Virrueta Pedraza; Exec. Sec.: Marietta Moraga; Vice Pres. A&R: Francisco Javier Virrueta.

Int'l Reps.: Commercial Rupayao (Chile).

EMI Odeon Chilena S. A., PO Box 186-D, Mujica 0344, Nunc-a, Santiago, (56)222-4565. Fax: (56)2465-841. Managing Dir.: Jozef Govaerts; Finance Dir.: Gabriel Troncoso Carrasco; Opns. & Planning Dir.: Julio Guzman Zamora; Int'l Repertoire Dir.: Ricardo Mundaca Izquierdo.

Label(s): (Owned) SBK, Capitol, Chrysalis, Enigma, EMI. Electrosonora Manufacturas Saavedra S.A., Francisco Noguera 217, Oficina No. 20, Santiago, (2) 251-2538, (2) 251-2276. Gen. Mgr.: Guillermo Vera.

SRC Ediciones Ltda., Nueva Providencia 2239, #62-A, Santiago, (56) 251-4352. Fax: (56) 22318946. Gen. Mgr.: Sergio Roman Canales; Admin. Mgr.: Elisa Badiellas; Promo Mgr.: Yuvisa Alvarez.

Label(s): (Owned) SRC, (Distributed) Mystic Music (USA), Discos Melopea (Argentina), Proel (Argentina), Discos Y Cintas Magnetofonicas, Ultrason (Argentina).

Sony Music Entertainment Chile Ltda., California 2370, Providencia, Santiago, Managing Dir.: Jorge Undurraga; Finance Dir.: Ramon Munoz; Sales Mgr.: Fernando Saavedra; A&R Mgr.: Andres Carrasco.

MUSIC PUBLISHERS

Augusta, (See Ediciones Musicales Fermata Ltda.).

Bandelirante, (See Ediciones Musicales Fermata Ltda.).

Cian Dilo Editorial Musical, (See Ediciones Musicales Fermata Ltda.).

Ediciones Musicales Baell Ltda., (See Ediciones Musicales Fermata Ltda.).

Ediciones Musicales Fermata Ltda., Carmen Silva 2857 Depto. 54, Casilla 1591-Centro De Castillas, Santiago, (56)2321623. Fax: (56)2 2319108. Gen. Mgr.: Eliana C. Cisternas.

Fermata Do Brasil, (See Ediciones Musicales Fermata Ltda.).

Arthur Napoleao, (See Ediciones Musicales Fermata Ltda.).

Nossa Terra, (See Ediciones Musicales Fermata Ltda.).

Peermusic, (See Southern Music Internacional).

SOCHEM/Sociedad Chilena De Ediciones Musicales Ltda., Casilla 186-D, Mujica 0344 Nunoa, Santiago, (2) 2224565. Fax: (2) 465841. Gen. Mgr.: Jozef Govaerts.

Seresta, (See Ediciones Musicales Fermata Ltda.).

Sonata, (See Ediciones Musicales Fermata Ltda.).

Sony Music Entertainment Chile, Ltda., California 2370, Providencia, Santiago, (562) 204-9044. Fax: (562) 225-9237. Gen. Mgr.: Jorge Undurraga.

Southern Music Internacional

San Antonio 527, 4 Piso, Dto. 42, Santiago, (562) 632-1160. Fax: (562) 632-1160. Rep.: Silvia Ramirez.

PERFORMING & MECHANICAL RIGHTS ORGANIZATIONS

EMI Odeon Chilena S.A., Mujica 0344-Nunoa, Santiago, (562) 222-4565, Fax: (562) 465-841, Pres.: Jozef Govaerts; Sales Mgr.: Edmundo Guerrero; Mktg. Dir.: Jorge Saint-Jean.

Sociedad Chilena del Derecho de Autor (SCD), PO Box: Casilla 51270 Correo Central, San Antonio 427, 2 Piso, Santiago, (56)2-393326, (56)2-384694. Fax: (56)2-397868. Gen. Dir.: Santiago Schuster V.; Opns. Dir.: Tatiana Urrutia.

PUBLIC RELATIONS

EMI Odeon Chilena S.A., Mujica 0344-Nunoa, Santiago, (562)

222-4565. Fax: (562) 465-841. Pres.: Jozef Govaerts; Sales Mgr.: Edmundo Guerrero; Mktg. Dir.: Jorge Saint-Jean.

RECORD PROMOTION

EMI Odeon Chilena S.A., Mujica 0344-Nunoa, Santiago, (562) 222-4565. Fax: (562) 465-841. Pres.: Jozef Govaerts; Sales Mgr.: Edmundo Guerrero; Mktg. Dir.: Jorge Saint-Jean.

BLANK & BULK TAPE MANUFACTURERS

3M Chile, SA, Casilla 3068, Las Hortensias 650-Maipu, Santiago, Chile, (56)2 557-6876. Fax: (56)2 557-1863. Contact: Patricio Lira.

TAPE CUSTOM DUPLICATORS

EMI Odeon Chilena S.A., Mujica 0344-Nunoa, Santiago, (562) 222-4565. Fax: (562) 465-841. Pres.: Jozef Govaerts; Sales Mgr.: Edmundo Guerrero; Mktg. Dir.: Jorge Saint-Jean. Audio: Open Reel

TAPE DUPLICATING & PROCESSING EQUIPMENT MANUFACTURERS

EMI Odeon Chilena S.A., Mujica 0344-Nunoa, Santiago, (562) 222-4565. Fax: (562) 465-841. Pres.: Jozef Govaerts; Sales Mgr.: Edmundo Guerrero; Mktg. Dir.: Jorge Saint-Jean. Product(s): ElectroSound Mod. 6000

COLOMBIA

RECORD LABELS

Compania Colombiana de Discos S.A. "Codiscos", PO Box 1428, Carrera 67 N#1 Sur 92, Medellin, Antioquia, (574) 255 7011, (574) 255 7074. Fax: (574) 285 2621. Pres.: Luciano Elejalde; Vice Pres. A&R: Alvaro Arango; A & R Mgr.: Fernando Lopez; Sales Mgr.: Alejandro Diez.

Label(s): (Owned) Costeno, De Oro, Famoso, Zeida, (Distributed) La Discoteca, Musart, US Reps.: Balboa Records (CA).

Int'l Reps.: Discos Musart (Mexico); La Discoteca (Venezuela); Famoso (Ecuador).

Discos Tropical Ltda., PO Box 53226, Calle 68-b, No. 68-73, Barranquilla, (958) 316-509, (958) 325-362. Fax: (958) 580-977. Pres.: Emilio Fortou P.; Int'l Dept.: Tony Fortou E.; Promo. Dept.: Adelaida Reyes; Vice Pres. A&R: Jorge Fortou E. Label(s): (Owned) Tropical, (Distributed) Swing, Ideal, Antillano, AVA, Extra.

Fabrica De Discos Fuentes Limitada, Carrera 51 #13-223, 1960 Apartado Aereo, Medellin, Antioquia, 1960, (574) 265-7000. Fax: (574) 265-2772. Gen. Mgr.: Conrado Dominguez; Int'l Mgr.: Javier Garcia M.; Sales & Promo. Mgr.: Rafael Velasquez.

Label(s): (Owned) Folclor, Fuentes, Juvenil, Tropical, (Distributed) Som Copacabana, Velvet Venezuela, Orfeon, Musical Production, Onix, Bronco, Fonodisco, Fonomusic, Virrey, US Reps.: Sonotone (FL).

Int'l Reps.: Heriba (Bolivia); Fedisco (Ecuador); Mango (England); Sonodisc (France); Dideca (Guatemala); Fabrica de Discos Peerless (Mexico); Sonomundi (Panama); El Virrey Industrias (Peru); Vidisco (Portugal); Fonomusic (Spain); Palacio de la Musica (Uruguay); Grupo Velvet (Venezuela).

Industrias Philipps De Colombia S. A., PO Box 4282-6393, Calle 13 #51-39, Bogota, Cundinamarca, (571) 260-0600. Fax: (571) 261-0139. Mng. Dir. Bus. Unit: Alfonso Escolar N.; Financial/Admin. Mgr.: Mauricio Garzon; Sales Mgr.: Luis Agarcia; Int'l/Modern Repertoire: William Escobar. Label(s): (Owned) Perla, (Distributed) Mercury, Philips, M.G.M., Zafiro, Polydor, Rocket, Verve, Vertigo, Barclay, A & M, D.G.G., Decca, London, Fontana.

US Reps.: PolyGram Records, Inc. (NY). Int'l Reps.: PolyGram Int'l Ltd. (London).

Instrumentaria Ltda., PO Box 89393, K11 #85-26, Bogota, (571) 218-9928. Fax: (571) 218-8565. Pres.: Alberto Burzstyn; Contact: Manolo Ballon; (Distributor, Importer)

Rodven Colombia, C. 57, Nr. 6-35, Piso 9, Bogota, DF, 248-5736. Fax: 248-7609. Pres.: Rodolfo Rodriguez M.; Gen. Mgr.: Humberto Moreno.

Label(s): (Distributed) TH-Rodven, Sono-Rodven, Carrera. Sonolux Industria Electro Sonora S.A., Ap. Aereo 640, Calle 29 Nro. 43A-5, Medellin, (57-4)232-0999. Fax: (57-4)2322086. Managing Dir.: Oscar Bravo; Dir. Mktg. & Sales: Fidel Jaramillo; A&R Dir.: Rafael Mejias.

Sony Music Entertainment (Colombia) S.A., Apartado Aereo No. 9240, Santa Fe De Bogota, 2 702200. Fax: 2 7104210. Gen. Mgr.: Carlos A. Gutierrez; Finance Dir.: Alvaro R. Martinez; A & R Dir.: Gabriel M. Cuartas; Opns. Dir.: Gustavo Lopez. Label(s): (Owned) Sony, Columbia, Epic, (Distributed) EMI,

Walt Disney, Melody. US Reps.: Sony Music Int'l Dist. (NY).

MUSIC PUBLISHERS

Beechwood, (See Promotora Colombiana De Musica Ltda.). Dimasi, (See Editora Internacional de Musica Edimusic Ltda.).

Discos Tropical Limitada, PO Box 53226, Calle 68-b no. 68-73, Barranquilla, (958) 316-509, (958) 325-362. Fax: (958) 580-977. Pres.: Emilio Fortou P.; Gen. Mgr.: Tony Fortou E.

EMI Music Publishing, (See Promotora Colombiana De Musica Ltda.).

Ediciones Musicales Hispavox, (See Promotora Colombiana De Musica Ltda.).

Ediciones Quiroga, (See Promotora Colombiana De Musica Ltda.).

Edimusa, (See Promotora Colombiana De Musica Ltda.).

Editora Intemational de Musica Edimusic Ltda., Carrera 51 Numero 13-223, Medellin, Antioquia, 1960, (574) 265-7000. Fax: (574)265-2772. Pres.: Conrado Dominguez H.; Gen. Mgr.: Gonzalo Pelaez C.; Professional Mgr.: Rosa Gaviria G.

Editora Velvet, (See Editora Intemational de Musica Edimusic Ltda.).

Editorial Colombiana E Internacional De Musica Ltd. "Ecomus", Apartado Aerea 14-28, Carrera 67 N sur 92, Medellin, Antioquia, (94) 255-7074. Fax: (94) 285-2621. Gen. Mgr.: Sylvia N. Arango D.

Editorial Union, (See Editora Intemational de Musica Edimusic Ltda.).

Egrem, (See Editora Intemational de Musica Edimusic Ltda.).

Emilasa, (See Promotora Colombiana De Musica Ltda.).

Esperance, (See Editora Intemational de Musica Edimusic Ltda.).

Hollywood Pictures Music, (See Sony Music Entertainment (Colombia) S.A.).

Intersong, (See Editora Intemational de Musica Edimusic Ltda.).

M.R.T., (See Promotora Colombiana De Musica Ltda.).

Pentamusic, (See Editora Intemational de Musica Edimusic Ltda.).

Philcolon, PO Box 4282 A/O 6393, Calle 13 #51-39, Santa Fe De Bogota, 571 2600600. Fax: 2610139. Managing Dir.: Alfonso Escolar N.; Financial/Administrative: Mauricio Garzon; Royalties: Lucia Rubiano.

Predisa, (See Editora Intemational de Musica Edimusic Ltda.).

Promotora Colombiana De Musica Ltda., Apartado Aereo 14-28, Carrera 67 N 1 sur 92, Medellin, Antioquia, (94) 255-7074. Fax: (94) 285-2621. Gen. Mgr.: Sylvia N. Arango D.

Rimo, (See Promotora Colombiana De Musica Ltda.).

Sadram, (See Promotora Colombiana De Musica Ltda. & Editora Int'l de Musica Edimusic Ltda.).

Sochem, (See Promotora Colombiana De Musica Ltda.).

Sonoeditora, (See Editora Intemational de Musica Edimusic Ltda.).

Sony Music Entertainment (Colombia) S.A., Apartado Aereo no. 9240, Autopista Sur No. 61-40, Santa Fe De Bogota, DC, 270-2200. Fax: 710-4210. Prof/Creative Mgr.: Miguel Angel Valenzuela.

Touchtone Pictures Music, (See Sony Music Entertainment (Colombia) S.A.).

Wonderland Music Co., Inc., (See Sony Music Entertainment (Colombia) S.A.).

MUSIC & VIDEO ACCESSORY MANUFACTURERS

Discos Tropical Limitada, PO Box 53-226, Calle 68-b No. 68-73, Barranquilla, (958) 325-362, (958) 316-509. Fax: (958) 580-977. Pres.: Emilio Fortou P.; Gen. Mgr./Sales Mgr.: Tony Fortou E.; [XX]Tape—Audio: Head Cleaners, Carrying & Storage Cases.

AUDIO ACCESSORY MANUFACTURERS

Discos Tropical Limitada, PO Box 53-226, Calle 68-b No. 68-73, Barranquilla, (958) 325-362, (958) 316-509. Fax: (958) 580-977. Pres.: Emilio Fortou P.; Gen. Mgr./Sales Mgr.: Tony Fortou E.; [XX]Audio: Bulk Erasers, Demagnetizers.

STORE FIXTURE MANUFACTURERS

Discos Tropical Limitada, PO Box 53-226, Calle 68-b No. 68-73, Barranquilla, (958) 325-362, (958) 316-509. Fax: (958) 580-977. Pres.: Emilio Fortou P.; Gen. Mgr./Sales Mgr.: Tony Fortou E. Browser Boxes, Display Racks, Divider Cards-(CD, Tape).

PERFORMING & MECHANICAL RIGHTS ORGANIZATIONS

Codiscos, PO Box 1428, Carrera 67 #1 Sur 92., Medellin, ANT,

(01574)2557011. Fax: (01574)2852621. Pres.: Dr. Luciano Elejalde; Sales Mgr.: Dr. Alejandro Diez; Mktg. Dir.: Guillermo Salazar.

Industrias Philips de Colombia S.A./Business Unit Music. PO Box 6393 A/O 4282, Calle 13, No. 51-39, Santafe de Bogota, CUN, (571) 260-0600. Fax: (571) 261-0139. Managing Dir.: Alfonso Escobar N.; Sales Mgr.: Luis Garcia; Financial/Admin. Mgr.: Maricio Garzon; Modern Rep. Mgr. (Int'l): William Escobar.

MUSIC LIBRARIES

Audiovisuales America Ltda., PO Box 50-804, Carrera 54 #75-45, Ste. 10-A, Barranquilla, (958) 325-362. Fax: (958) 560-977. Pres./Gen. Mgr.: Tony Fortou E.; Sales Mgr.: Adelaida Reyes.

Discos Tropical Limitada, PO Box 53-226, Calle 68-b No. 68-73, Barranquilla, (958) 325-362, (958) 316-509. Fax: (958) 560-977. Pres.: Emilio Fortou P.; Gen. Mgr./Sales Mgr.: Tony Fortou E.

PUBLIC RELATIONS

Audiovisuales America Ltda., PO Box 50-804, Carrera 54 #75-45, Ste. 10-A, Barranquilla, (958) 325-362. Fax: (958) 560-977. Pres./Gen. Mgr.: Tony Fortou E.; Sales Mgr.: Adelaida Reyes.

Codiscos, PO Box 1428, Carrera 67 #1 Sur 92., Medellin, ANT, (01574)2557011. Fax: (01574)2852621. Pres.: Dr. Luciano Elejalde; Sales Mgr.: Dr. Alejandro Diez; Mktg. Dir.: Guillermo Salazar.

Discos Tropical Limitada, PO Box 53-226, Calle 68-b No. 68-73, Barranquilla, (958) 325-362, (958) 316-509. Fax: (958) 560-977. Pres.: Emilio Fortou P.; Gen. Mgr./Sales Mgr.: Tony Fortou E.

RECORD PROMOTION

Audiovisuales America Ltda., PO Box 50-804, Carrera 54 #75-45, Ste. 10-A, Barranquilla, (958) 325-362. Fax: (958) 560-977. Pres./Gen. Mgr.: Tony Fortou E.; Sales Mgr.: Adelaida Reyes.

Codiscos, PO Box 1428, Carrera 67 #1 Sur 92., Medellin, ANT, (01574)2557011. Fax: (01574)2852621. Pres.: Dr. Luciano Elejalde; Sales Mgr.: Dr. Alejandro Diez; Mktg. Dir.: Guillermo Salazar.

Discos Tropical Limitada, PO Box 53-226, Calle 68-b No. 68-73, Barranquilla, (958) 325-362, (958) 316-509. Fax: (958) 560-977. Pres.: Emilio Fortou P.; Gen. Mgr./Sales Mgr.: Tony Fortou E.

Industrias Philips de Colombia S.A./Business Unit Music, PO Box 6393 A/O 4282, Calle 13, No. 51-39, Santafe de Bogota, CUN, (571) 260-0600. Fax: (571) 261-0139. Managing Dir.: Alfonso Escobar N.; Sales Mgr.: Luis Garcia; Financial/Admin. Mgr.: Maricio Garzon; Modern Rep. Mgr. (Int'l): William Escobar.

BLANK & BULK TAPE MANUFACTURERS

Ampex Recording Media Corp., Apartado Aereo 29613, Bogota, (57) 1-2567982.

3M Colombia, SA, Carrera 18 93A-57, Bogota, (57)1 218 8755. Fax: (57)1 610 2357. Contact: Ricardo Mejia Villa.

CARTRIDGES, CASSETTES, REELS & OTHER PARTS

Sonex Ltd., Apartado 4007, Calle 99 N 8-47, Bogota, (57) 257-20147. Fax: (57) 201-8492. Pres.: Manuel Drezner; Sales Mgr.: David Drezner. Audio: Cassettes

JEWEL BOX MANUFACTURERS

Sonex Ltd., Apartado 4007, Calle 99 N 8-47, Bogota, (57) 257-20147. Fax: (57) 201-8492. Pres.: Manuel Drezner; Sales Mgr.: David Drezner.

ENVELOPES & MAILERS

Audiovisuales America Ltda., PO Box 50-804, Carrera 54 #75-45, Ste. 10-A, Barranquilla, (958) 325-362. Fax: (958) 560-977. Pres./Gen. Mgr.: Tony Fortou E.; Sales Mgr.: Adelaida Reyes. Audio:(Tape, LP) Video:(Tape)

Discos Tropical Limitada, PO Box 53-226, Calle 68-b No. 68-73, Barranquilla, (958) 325-362, (958) 316-509. Fax: (958) 560-977. Pres.: Emilio Fortou P.; Gen. Mgr./Sales Mgr.: Tony Fortou E.

Sonolux-Industria Electrosonora S.A., Calle 29 #43A-5, Medellin, (57-4) 2320999. Fax: (57-4) 2322086. Pres.: Oscar Bravo P.; Sales Mgr./Mktg. Dir.: Fidel Jaramillo V. Audio:(Tape, LP)

JACKETS & SLEEVES

Audiovisuales America Ltda., PO Box 50-804, Carrera 54 #75-45, Ste. 10-A, Barranquilla, (958) 325-362. Fax: (958) 560-977. Pres./Gen. Mgr.: Tony Fortou E.; Sales Mgr.: Adelaida Reyes.

Discos Tropical Limitada, PO Box 53-226, Calle 68-b No. 68-73, Barranquilla, (958) 325-362, (958) 316-509. Fax: (958) 560-977. Pres.: Emilio Fortou P.; Gen. Mgr./Sales Mgr.: Tony Fortou E.

FM Discos & Cintas Ltda., Calle 16A, No. 13-78, Bogota, D.E., (571) 3343180. Fax: (571) 2832116. Pres.: Francisco Montoya; Sales Mgr.: Juan Diego Montoya; Mktg. Dir.: Carlos Eduardo Hernandez.

Sonex Ltd., Apartado 4007, Calle 99 N 8-47, Bogota, (57) 257-20147. Fax: (57) 201-8492. Pres.: Manuel Drezner; Sales Mgr.: David Drezner. Audio:(CD, Tape, LP)

Sonolux-Industria Electrosonora S.A., Calle 29 #43A-5, Medellin, (57-4) 2320999. Fax: (57-4) 2322086. Pres.: Oscar Bravo P.; Sales Mgr./Mktg. Dir.: Fidel Jaramillo V. Audio:(Tape, LP)

LABELS

Audiovisuales America Ltda., PO Box 50-804, Carrera 54 #75-45, Ste. 10-A, Barranquilla, (958) 325-362. Fax: (958) 560-977. Pres./Gen. Mgr.: Tony Fortou E.; Sales Mgr.: Adelaida Reyes. Audio:(Tape, LP) Video:(Tape)

Discos Tropical Limitada, PO Box 53-226, Calle 68-b No. 68-73, Barranquilla, (958) 325-362, (958) 316-509. Fax: (958) 560-977. Pres.: Emilio Fortou P.; Gen. Mgr./Sales Mgr.: Tony Fortou E.

Sonex Ltd., Apartado 4007, Calle 99 N 8-47, Bogota, (57) 257-20147. Fax: (57) 201-8492. Pres.: Manuel Drezner; Sales Mgr.: David Drezner. Audio:(CD, Tape, LP)

Sonolux-Industria Electrosonora S.A., Calle 29 #43A-5, Medellin, (57-4) 2320999. Fax: (57-4) 2322086. Pres.: Oscar Bravo P.; Sales Mgr./Mktg. Dir.: Fidel Jaramillo V. Audio:(Tape, LP)

POLYBAGS & SHRINKWRAP

Sonolux-Industria Electrosonora S.A., Calle 29 #43A-5, Medellin, (57-4) 2320999. Fax: (57-4) 2322086. Pres.: Oscar Bravo P.; Sales Mgr./Mktg. Dir.: Fidel Jaramillo V. (Polybags)

TAPE CUSTOM DUPLICATORS

Audiovisuales America Ltda., PO Box 50-804, Carrera 54 #75-45, Ste. 10-A, Barranquilla, (958) 325-362. Fax: (958) 560-977. Pres./Gen. Mgr.: Tony Fortou E.; Sales Mgr.: Adelaida Reyes.

Audio: Cassette, Open Reel, DAT, Real-time. **Video:** ¼ U-Matic, ½ VHS Cassette, 8mm, 1/2" Beta cassette.

Audio Packaging Services: Inserting, Labeling, Mailing, Artwork. **Video Packaging Services:** Inserting, Labeling, Mailing, Warehouse.

Codiscos, PO Box 1428, Carrera 67 #1 Sur 92., Medellin, ANT, (01574)2557011. Fax: (01574)2852621. Pres.: Dr. Luciano Elejalde; Sales Mgr.: Dr. Alejandro Diez; Mktg. Dir.: Guillermo Salazar.

Discos Tropical Limitada, PO Box 53-226, Calle 68-b No. 68-73, Barranquilla, (958) 325-362, (958) 316-509. Fax: (958) 560-977. Pres.: Emilio Fortou P.; Gen. Mgr./Sales Mgr.: Tony Fortou E.

Audio: Cassette, Open Reel, Real-time. **Audio Packaging Services:** Inserting, Labeling, Mailing. **Other Services:** Warehouse, Freight.

FM Discos & Cintas Ltda., Calle 16A, No. 13-78, Bogota, D.E., (571) 3343180. Fax: (571) 2832116. Pres.: Francisco Montoya; Sales Mgr.: Juan Diego Montoya; Mktg. Dir.: Carlos Eduardo Hernandez.

Industrias Philips de Colombia S.A./Business Unit Music, PO Box 6393 A/O 4282, Calle 13, No. 51-39, Santafe de Bogota, CUN, (571) 260-0600. Fax: (571) 261-0139. Managing Dir.: Alfonso Escobar N.; Sales Mgr.: Luis Garcia; Financial/Admin. Mgr.: Maricio Garzon; Modern Rep. Mgr. (Int'l): William Escobar.

Sonex Ltd., Apartado 4007, Calle 99 N 8-47, Bogota, (57) 257-20147. Fax: (57) 201-8492. Pres.: Manuel Drezner; Sales Mgr.: David Drezner. Audio: Cassette.

Audio Packaging Services: Inserting, Labeling. **Other Services:** Warehouse, Freight. **Sonolux-Industria Electrosonora S.A.,** Calle 29 #43A-5, Medellin, (57-4) 2320999. Fax: (57-4) 2322086. Pres.: Oscar Bravo P.; Sales Mgr./Mktg. Dir.: Fidel Jaramillo V. **Audio:** Cassette **Audio Packaging Services:** Inserting, Collating, Labeling, Mailing.

PLATING & PRESSING PLANTS

Codiscos, PO Box 1428, Carrera 67 #1 Sur 92., Medellin, ANT, (01574)2557011. Fax: (01574)2852621. Pres.: Dr. Luciano Elejalde; Sales Mgr.: Dr. Alejandro Diez; Mktg. Dir.: Guillermo Salazar. (LP's)

Discos Tropical Limitada, PO Box 53-226, Calle 68-b No. 68-73, Barranquilla, (958) 325-362, (958) 316-509. Fax: (958) 560-977. Pres.: Emilio Fortou P.; Gen. Mgr./Sales Mgr.: Tony Fortou E. (LP's)

FM Discos & Cintas Ltda., Calle 16A, No. 13-78, Bogota, D.E., (571) 3343180. Fax: (571) 2832116. Pres.: Francisco Montoya; Sales Mgr.: Juan Diego Montoya; Mktg. Dir.: Carlos Eduardo Hernandez. (LP's)

Sonex Ltd., Apartado 4007, Calle 99 N 8-47, Bogota, (57) 257-20147. Fax: (57) 201-8492. Pres.: Manuel Drezner; Sales Mgr.: David Drezner. (LP's)

Sonolux-Industria Electrosonora S.A., Calle 29 #43A-5, Medellin, (57-4) 2320999. Fax: (57-4) 2322086. Pres.: Oscar Bravo P.; Sales Mgr./Mktg. Dir.: Fidel Jaramillo V. (LP's)

MASTERING FACILITIES

Audiovisuales America Ltda., PO Box 50-804, Carrera 54 #75-45, Ste. 10-A, Barranquilla, (958) 325-362. Fax: (958) 560-977. Pres./Gen. Mgr.: Tony Fortou E.; Sales Mgr.: Adelaida Reyes. (Audio & Video)

Codiscos, PO Box 1428, Carrera 67 #1 Sur 92., Medellin, ANT, (01574)2557011. Fax: (01574)2852621. Pres.: Dr. Luciano Elejalde; Sales Mgr.: Dr. Alejandro Diez; Mktg. Dir.: Guillermo Salazar. (Audio)

Discos Tropical Limitada, PO Box 53-226, Calle 68-b No. 68-73, Barranquilla, (958) 325-362, (958) 316-509. Fax: (958) 560-977. Pres.: Emilio Fortou P.; Gen. Mgr./Sales Mgr.: Tony Fortou E. (Audio)

FM Discos & Cintas Ltda., Calle 16A, No. 13-78, Bogota, D.E., (571) 3343180. Fax: (571) 2832116. Pres.: Francisco Montoya; Sales Mgr.: Juan Diego Montoya; Mktg. Dir.: Carlos Eduardo Hernandez. (Audio)

Sonex Ltd., Apartado 4007, Calle 99 N 8-47, Bogota, (57) 257-20147. Fax: (57) 201-8492. Pres.: Manuel Drezner; Sales Mgr.: David Drezner. (Audio)

Sonolux-Industria Electrosonora S.A., Calle 29 #43A-5, Medellin, (57-4) 2320999. Fax: (57-4) 2322086. Pres.: Oscar Bravo P.; Sales Mgr./Mktg. Dir.: Fidel Jaramillo V. (Audio)

TAPE DUPLICATING & PROCESSING EQUIPMENT MANUFACTURERS

Codiscos, PO Box 1428, Carrera 67 #1 Sur 92., Medellin, ANT, (01574)2557011. Fax: (01574)2852621. Pres.: Dr. Luciano Elejalde; Sales Mgr.: Dr. Alejandro Diez; Mktg. Dir.: Guillermo Salazar. **Product(s):** Ampex, ElectroSound.

ECUADOR

RECORD LABELS

Compania Procesadora De Discos S.A., PO Box 5188, COPRODISA, Guayaquil, (4) 405-827, (4) 403-799. Fax: (4) 440-952. Mgr.: Heriberto Ortega Garcia.

Emporio Musical S.A., Av. Plaza Danin 101, Casilla 1276, Guayaquil, 98-593-4281745. Gen. Mgr.: Carlos Pino Plaza. (Distributor)

Labels Distributed: Audio: CBS, Orion, Kubaney, TH. **Fabrica Ecuatoriana De Discos S.A.,** PO Box N 856, KM. 7 ½ via a la costa, Guayaquil, (593) 4-352025. Fax: (593) 4-353930. Pres.: Francisco Feraud Aroca; Mgr.: Fausto Feraud Manssur; Int'l Dept.: Patricia Feraud de Silva. **Label(s):** (Owned) Onix, Teen, (Distributed) Prima, Toco Int', Velvet, J & N, Polygram, Fuentes, WEA.

Industria Fonografica Ecuatoriana S.A., PO Box 3885, Guayaquil, (5934) 400 700. Fax: (5934) 440 952. Pres.: Luis Pino Yerovi; Gen. Mgr.: Leticia Pino De Ortega.

Label(s): (Owned) Estelar, Sona, (Distributed) Sonografica.

Interdisc, Sonorodven, Dideca, EMI-Hispavox.
Industrias Famoso C.A., PO Box 3514, Capitan Ramos No. 623 Y Bethoven, Quito, 593-2-404332. Fax: 593-2-401845. Gen. Mgr.: Gonzalo Jimenez P.; Mktg. Mgr.: Rafael Arcos; Int'l Mgr.: Edgar Rodriguez.
 Label(s): (Owned) Industrias Famoso C.A., (Distributed) Codiscos (Colombia), Discos Musart (Mexico), Sonolux, Sony Music Entertainment.

PERFORMING & MECHANICAL RIGHTS ORGANIZATIONS

Fabrica Ecuatoriana de Discos S.A., PO Box 856, KM 7 1/2 via A La Costa, Guayaquil, (593) 4-352025. Fax: (593) 4-353930. Pres.: Francisco Feraud Aroca; Sales Mgr.: Fausto Feraud Manssur; Int'l: Patricia Feraud de Silva.

BLANK & BULK TAPE MANUFACTURERS

3M Ecuador CA, PO Box 6137, KM 1.5 Via Duran Tambo, Guayaquil, (593)4 800 777, (593)4 800 051. Fax: (593)4 802 254. Contact: Priscilla A. de Aviles.

CARTRIDGES, CASSETTES, REELS & OTHER PARTS

Fabrica Ecuatoriana de Discos S.A., PO Box 856, KM 7 1/2 via A La Costa, Guayaquil, (593) 4-352025. Fax: (593) 4-353930. Pres.: Francisco Feraud Aroca; Sales Mgr.: Fausto Feraud Manssur; Int'l: Patricia Feraud de Silva.

LABELS

Fabrica Ecuatoriana de Discos S.A., PO Box 856, KM 7 1/2 via A La Costa, Guayaquil, (593) 4-352025. Fax: (593) 4-353930. Pres.: Francisco Feraud Aroca; Sales Mgr.: Fausto Feraud Manssur; Int'l: Patricia Feraud de Silva. (Audio—Tape, LP).

TAPE CUSTOM DUPLICATORS

Fabrica Ecuatoriana de Discos S.A., PO Box 856, KM 7 1/2 via A La Costa, Guayaquil, (593) 4-352025. Fax: (593) 4-353930. Pres.: Francisco Feraud Aroca; Sales Mgr.: Fausto Feraud Manssur; Int'l: Patricia Feraud de Silva.

PLATING & PRESSING PLANTS

Fabrica Ecuatoriana de Discos S.A., PO Box 856, KM 7 1/2 via A La Costa, Guayaquil, (593) 4-352025. Fax: (593) 4-353930. Pres.: Francisco Feraud Aroca; Sales Mgr.: Fausto Feraud Manssur; Int'l: Patricia Feraud de Silva. (LP's)

MASTERING FACILITIES

Fabrica Ecuatoriana de Discos S.A., PO Box 856, KM 7 1/2 via A La Costa, Guayaquil, (593) 4-352025. Fax: (593) 4-353930. Pres.: Francisco Feraud Aroca; Sales Mgr.: Fausto Feraud Manssur; Int'l: Patricia Feraud de Silva. (Audio)

PERU

RECORD LABELS

CBS Discos Del Peru S.A., PO Box 76, Avenida Arenales 2586, Lima, 14, (51) 1440-33. Managing Dir.: Augusto Sarría; Mgr. Admin. & Finance: Mario Leon Z.; A & R Mgr. Int'l: German Gonzales G.; Promo Dept. Chief: Matias Jimenez.
 Label(s): (Distributed) Broadwalk, DRO, CBS, Twins, Potrait, Enigma, Epic, Jet, Geffen.

Delta Discos S.A., Esquilache 179, Lima, 27, (51) 14-226531. Fax: (51) 14-416279. Managing Dir.: Wieland Kafka.
 Label(s): (Distributed) Fania, Heriba, FTA.

Discos Hispanos Del Peru S.A., Esquilache 179-San Isidro, Lima, 32, (51-14) 225331, (51-14) 226531. Fax: (51-14)416279. Managing Dir.: Wieland Kafka Kiener; A & R Int'l Mgr.: Antonio Reyes L.; Admin. Mgr.: Martene Sanchez G.
 Label(s): (Owned) Hispanos, (Distributed) EMI/Capitol, IRS, Delta, Virgin, Chrysalis.

"El Virrey" Industrias Musicales S.A., PO Box 6191, Av. Republica de Panama, #3551, San Isidro, Lima, 227360, (51-14)40-4600. Fax: (51-14)40-8370. Vice Pres. A&R: Fernando Casas; Gen. Mgr.: Monica Brenner C.; Admin. Mgr.: Myrna Li; Oper. Mgr.: Juan Nunez; WEA Label Mgr.: Andres Rojas.
 Label(s): (Owned) Virrey, OHM, Nube Blanca, Candela, Colibri, (Distributed) DGG, Casablanca, Ansonia, Ariola, Atco, Ariola, Atlantic, Barclay, CNR, Bite, Delphine, Disneyland, Elektra, ECO, Musical Prods., Onix, Fantasy, Fontana, Gefen, Fuentes, Hot Line, Island, Jive, Jaws, London, MCA,

Motown, Mercury, Tamborito, Teen, Palacio, Peerless, Polystar, Polydor, RCA, RSO, Salsón, Rocket, Silvertone, Sire, Sonotone, Sonográfica, A&M.

Sono-Radio, Pasaje Los Pinos 165-Mezzanine, Lima 18, (14) 459745. Fax: (14) 457766. Gen. Dir.: Enrique Biez Canseco.

MUSIC PUBLISHERS

Ediciones Musicales Hispanas S.A., (EMI) Esquilache 179—San Isidro, Lima, 32, (5114) 225331. Fax: (5114) 416279. Pres.: Wieland Kafka Kiener; Gen. Mgr.: Carlos Renjifo. Edimusic, (See Editorial "Luz" S.A.).

Editorial "Luz" S.A., PO Box 6191, Lima 100, Av. Republica de Panama #3551, San Isidro, Lima, 27, (5114) 404800, (5114) 404750. Fax: (5114) 408370. Pres.: Monica Brenner; Prof./Creative Mgr.: Myrna Li.

Indochine Musique, (See Editorial "Luz" S.A.).

Julio Kron, (See Editorial "Luz" S.A.).

Muziekuitgeverij Artemis B.V., (See Editorial "Luz" S.A.).

Sadram, (See Editorial "Luz" S.A.).

Sonoeditora, (See Editorial "Luz" S.A.).

Warner Bros. Music, (See Editorial "Luz" S.A.).

Zomba Music, (See Editorial "Luz" S.A.).

BLANK & BULK TAPE MANUFACTURERS

3M Peru, PO Box 1897, Av. Canaval y Moreyra #641, Lima, 100, Peru, (51)14-416848. Fax: (51)14-418176. Contact: Victor Gargurevich.

CARTRIDGES, CASSETTES, REELS & OTHER PARTS

"El Virrey" Industrias Musicales S.A., PO Box 6191 Lima 100, Lima, Av. Republica de Panama No. 3551, San Isidro, Lima 27, (5114) 40-4600, (5114) 40-4750. Fax: (5114) 40-8370. Pres.: Monica Brenner C.; Sales Mgr.: Myrna Li; Mktg. Dir.: Juan Nunez.

Sica Peruana S.A. (Discos M.A.G.), Jiron Oroya 224, Lima, 3102, 22-94-32, 23-63-71. Pres. & Gen. Mgr.: Manuel A. Guerrero S.; Sales Mgr.: Carlos Guerrero. Audio: Cassette tape.

JEWEL BOX MANUFACTURERS

"El Virrey" Industrias Musicales S.A., PO Box 6191 Lima 100, Lima, Av. Republica de Panama No. 3551, San Isidro, Lima 27, (5114) 40-4600, (5114) 40-4750. Fax: (5114) 40-8370. Pres.: Monica Brenner C.; Sales Mgr.: Myrna Li; Mktg. Dir.: Juan Nunez.

RAW MATERIALS

Sica Peruana S.A. (Discos M.A.G.), Jiron Oroya 224, Lima, 3102, 22-94-32, 23-63-71. Pres. & Gen. Mgr.: Manuel A. Guerrero S.; Sales Mgr.: Carlos Guerrero. Product(s): Compound for records of LP & 45 RPM.

ENVELOPES & MAILERS

RPM Estudios, Manco Capac 495, Miraflores-Lima, 18, (5114) 450126. Fax: (5114) 450126. Pres.: Richardo Palma Michelsen; Sales Mgr.: Renzo Palma; Mktg. Dir.: Maria Fe Palma. (Audio—Tape)

Sica Peruana S.A. (Discos M.A.G.), Jiron Oroya 224, Lima, 3102, 22-94-32, 23-63-71. Pres. & Gen. Mgr.: Manuel A. Guerrero S.; Sales Mgr.: Carlos Guerrero. (Audio—Tape, LP)

JACKETS & SLEEVES

"El Virrey" Industrias Musicales S.A., PO Box 6191 Lima 100, Lima, Av. Republica de Panama No. 3551, San Isidro, Lima 27, (5114) 40-4600, (5114) 40-4750. Fax: (5114) 40-8370. Pres.: Monica Brenner C.; Sales Mgr.: Myrna Li; Mktg. Dir.: Juan Nunez.
 (Jackets/Sleeves-Audio: Tape, LP)

Sica Peruana S.A. (Discos M.A.G.), Jiron Oroya 224, Lima, 3102, 22-94-32, 23-63-71. Pres. & Gen. Mgr.: Manuel A. Guerrero S.; Sales Mgr.: Carlos Guerrero. (Jackets/Sleeves-Audio: Tape, LP)

LABELS

"El Virrey" Industrias Musicales S.A., PO Box 6191 Lima 100, Lima, Av. Republica de Panama No. 3551, San Isidro, Lima 27, (5114) 40-4600, (5114) 40-4750. Fax: (5114) 40-8370. Pres.: Monica Brenner C.; Sales Mgr.: Myrna Li; Mktg. Dir.: Juan Nunez. (Audio—Tape, LP)

Sica Peruana S.A. (Discos M.A.G.), Jiron Oroya 224, Lima, 3102, 22-94-32, 23-63-71. Pres. & Gen. Mgr.: Manuel A. Guerrero S.; Sales Mgr.: Carlos Guerrero. (Audio—Tape, LP)

TAPE CUSTOM DUPLICATORS

"El Virrey" Industrias Musicales S.A., PO Box 6191 Lima 100, Lima, Av. Republica de Panama No. 3551, San Isidro, Lima 27, (5114) 40-4600, (5114) 40-4750. Fax: (5114) 40-8370. Pres.: Monica Brenner C.; Sales Mgr.: Myrna Li; Mktg. Dir.: Juan Nunez.

Audio: Cassette.

Audio Packaging Services: Inserting, Labeling.

RPM Estudios, Manco Capac 495, Miraflores-Lima, 18, (5114) 450126. Fax: (5114) 450126. Pres.: Richardo Palma Michelsen; Sales Mgr.: Renzo Palma; Mktg. Dir.: Maria Fe Palma.

Audio: Cassette.

Other Services: Warehouse.

Sica Peruana S.A. (Discos M.A.G.), Jiron Oroya 224, Lima, 3102, 22-94-32, 23-63-71. Pres. & Gen. Mgr.: Manuel A. Guerrero S.; Sales Mgr.: Carlos Guerrero.

Audio: Cassette, Open Reel, DAT, Real-time.

PLATING & PRESSING PLANTS

"El Virrey" Industrias Musicales S.A., PO Box 6191 Lima 100, Lima, Peru, Av. Republica de Panama No. 3551, San Isidro, Lima 27, Peru, (5114) 40-4600, (5114) 40-4750. Fax: (5114) 40-8370. Pres.: Monica Brenner C.; Sales Mgr.: Myrna Li; Mktg. Dir.: Juan Nunez. (LP's)

Sica Peruana S.A. (Discos M.A.G.), Jiron Oroya 224, Lima, 3102, Peru, 22-94-32, 23-63-71. Pres. & Gen. Mgr.: Manuel A. Guerrero S.; Sales Mgr.: Carlos Guerrero. (LP's)

MASTERING FACILITIES

"El Virrey" Industrias Musicales S.A., PO Box 6191 Lima 100, Lima, Av. Republica de Panama No. 3551, San Isidro, Lima 27, (5114) 40-4600, (5114) 40-4750. Fax: (5114) 40-8370. Pres.: Monica Brenner C.; Sales Mgr.: Myrna Li; Mktg. Dir.: Juan Nunez. (Audio)

RPM Estudios, Manco Capac 495, Miraflores-Lima, 18, (5114) 450126. Fax: (5114) 450126. Pres.: Richardo Palma Michelsen; Sales Mgr.: Renzo Palma; Mktg. Dir.: Maria Fe Palma. (Audio)

Sica Peruana S.A. (Discos M.A.G.), Jiron Oroya 224, Lima, 3102, 22-94-32, 23-63-71. Pres. & Gen. Mgr.: Manuel A. Guerrero S.; Sales Mgr.: Carlos Guerrero. (Audio & Video)

URUGUAY

RECORD LABELS

WEL S.A., Andes 1179, Montevideo, 11100, (598)2-907-662. Fax: (598)2-921-015. Pres./Managing Dir.: Juan Carlos Garcia; Mgr.: Alfonso Carbone; (Compact Disc, Pre-Recorded Audio Tape, Records (LP's), Cutouts, Accessories) (Distributor, Importer)

Labels Distributed: Audio: Sony Music (Columbia, Epic); BMG Ariola (RCA, Motown, Arista, Ariola, Geffen, MCA); Warner Music (Atlantic, Asylum, Warner Bros., Sire, Elektra, Teldec, Delphine); Exclusive Representatives for Xuxa (GloBo Records' Artist).

Products/Accessories: Audio & Video Playback Equipment: Tape Recorders, Radios, Headphones; Storage & Carrying Cases: Cassette & Video Racks; Other: Synthesizers, Organs (Exclusive Rep. for Kawai in Uruguay).

STORE FIXTURE MANUFACTURERS

Sondor S. A., Rio Branco 1530, Montevideo, 11100, (5982) 912670. Fax: (5982) 913252. Pres.: Enrique Abal Salvo; Sales Mktg.: Omar Montano; Ingeniero: Rafael Abal. Browser Boxes—(Tape).

ASSOCIATIONS & PROFESSIONAL ORGANIZATIONS

Sociedad Uruguaya de Musica Contemporanea (SUMC), Casilla de Correo 1328, Montevideo, 11000, (598) 2/361513. Pres.: Diego Legrand; Sec.: Graciela Paraskevaidis.

PERFORMING & MECHANICAL RIGHTS ORGANIZATIONS

Sociedad Uruguaya de Interpretes, Canales 1090, C.P. 1100, Montevideo, 90 24 64. Pres.: Jose Maria Lorenzo; Sales Mgr./Mktg. Dir.: Guillermo Mario Cresci.

Sondor S. A., Rio Branco 1530, Montevideo, 11100, (5982) 912670. Fax: (5982) 913252. Pres.: Enrique Abal Salvo; Sales Mktg.: Omar Montano; Ingeniero: Rafael Abal.

RECORD PROMOTION

Sondor S. A., Rio Branco 1530, Montevideo, 11100, (5982) 912670. Fax: (5982) 913252. Pres.: Enrique Abal Salvo; Sales Mktg.: Omar Montano; Ingeniero: Rafael Abal.

ENVELOPES & MAILERS

Taguara, Ltda., Rio Branco 1530, Montevideo, 11100, (5982) 912670, (5982) 902896. Fax: (5982) 913252. Pres.: Enrique Abal Oliu. (Audio—CD, Tape).

POLYBAGS & SHRINKWRAP

Taguara, Ltda., Rio Branco 1530, Montevideo, 11100, (5982) 912670, (5982) 902896. Fax: (5982) 913252. Pres.: Enrique Abal Oliu. (Polybags).

TAPE CUSTOM DUPLICATORS

Sondor S. A., Rio Branco 1530, Montevideo, 11100, (5982) 912670. Fax: (5982) 913252. Pres.: Enrique Abal Salvo; Sales Mktg.: Omar Montano; Ingeniero: Rafael Abal. Audio: Cassette. Audio Packaging Services: Inserting, Collating, Labeling, Mailing.

PLATING & PRESSING PLANTS

Sondor S. A., Rio Branco 1530, Montevideo, 11100, Uruguay, (5982) 912670. Fax: (5982) 913252. Pres.: Enrique Abal Salvo; Sales Mktg.: Omar Montano; Ingeniero: Rafael Abal. (LP's)

PACKAGING & LABELING SERVICES

Taguara, Ltda., Rio Branco 1530, Montevideo, 11100, (5982) 912670, (5982) 902896. Fax: (5982) 913252. Pres.: Enrique Abal Oliu. (Mailing, Put in Blister, CDs, Cassettes).

VENEZUELA**RECORD LABELS**

Ardica Discos Armonia Digital C.A., Apartado 14819 Candelaria, Caracas, 1011-A, 979-1844. Fax: 979-1844. Pres.: Juan C. Perez. Label(s): (Owned) Lyric.

CBS Columbia CA, Av. PPAL, Los Cortijos De Lourdes, EDF., Industrial Los Hermanos, 3er Piso, Caracas, 70169, (02) 239-1385, (02) 239-6106. Fax: (582) 239-2996. Gen. Mgr.: Helcio Do Carmo; Dir. of Mktg.: Jose Antonio Asuaje; Sales: Rafael Vergel; Promo: Tito Correa.

Discomoda/Fabrica Venezolana De Discos (FAVDICA), A.P. 3402, 4ta. Calle Ind. Zone, Caracas, DF, 02, (58) 2/497492. Fax: (58) 2/492065. Pres.: Wolfgang Roldan; Sales Mgr.: Gladys Hernandez; Mktg. Dir.: Clementa Pena; Factory Dir.: Luisa Pinto; Publicity: Ruben Ferrer. Label(s): (Owned) Mucer, Orbe, (Distributed) Supraphon, Top Ten Hits, Memory.

Discos Top Hits C.A., PO Box 70498, Calle Milan #402, Ed. La Discoteca Po 1, Caracas, 1071-A, (02) 226422. Fax: (02) 2266033. Pres.: Wilhelm Ricken; Int'l Vice Pres.: Helga Moslener.

Label(s): (Owned) Araguaney, Color, LAD, Top Hits, Sonus, (Distributed) Musart, Nimbus, Costeno, Egrem, Artex, Auidis, Zeida.

Distribuidora Sonografica, Dolores a Pte. Soublette Sur 4, Piso 1, Aptdo. de Correos 19347, Caracas, 1014-A, (58-2)483-8633, (58-2)483-6922. Fax: (58-2)483-3394. Gen. Mgr.: Guillermo Urbano; Artistic Int'l Dir.: Carlos Espinoza Raybans; Mktg.: Fernando Ces; Label Mgr.: Robert Inman, Alexander Moreno; Promos.: Florencio Martinez; Royalties: Izaenico Blanco; Sales: Luis Redondo.

Label(s): (Owned) Sonografica, (Distributed) WEA, PolyGram, Palma Pro. US Reps.: Sonotone (FL). Int'l Reps.: Discos Fuentes (Colombia); El Virrey (Peru); Discos Lauro (Bolivia).

El Palacio de la Musica, S.A., Apartado 3637, Caracas, DF, 1010-A, (02) 934311. Fax: (02) 938756. Pres.: Ernesto Aue; Vice Pres.: Miguel A. Pina, Carlos von Einem; Gen. Mgr.: Nelida Pietri.

Label(s): (Owned) HB, Gramsa, Palacio, Televen, Solex, (Distributed) Peerless, Seeco, International, Inca, Musica Latina, Delphine, Fania, Vaya, Tico, Zafiro. US Reps.: West Side Latino Records (US).

Int'l Reps.: Fabrica de Discos Peerless (Mexico); Rodven (Colombia).

Gran Video, A.P. 80296, Of. 422, P2, CC. Concrea, P. Del Este, Caracas, Miranda, DF, 1080, (58)2/979-2122. Fax: (02) 979-3590. Pres.: Rodolfo Rodriguez M.; Managing Dir.: Peter Cernik; Sales Mgr.: Enrique Esponzoa. (Video (Cassette & Disc)) (Distributor) Labels Distributed: Video: RCA/Columbia Int'l Video, Media Home Entertainment.

Intervideo (subsidiary of Gran Video), A.P. 80296, Of. 422, P2, P. De. Esta, C.C. Concrea, Caracas, Miranda, DF, 1080, (58)2/979-2122. Fax: (58)2/979-3590. Pres.: Rodolfo Rodriguez; Managing Dir./Video Buyer: Peter Cernik. (Distributor) Labels Distributed: Video: Tri-Star (through RCA/Columbia), Turner Home Entertainment.

Love Records, AP 67203, P. Las Americas, Of 422, P2 C. C. Concrea, PDOS, Caracas, 1080, (582)979-2944. Fax: (582) 979-3590. Pres.: Rodolfo Rodriguez M.; Gen. Mgr.: Gloria Osorio; A & R Mgr.: Guillermo Zambrano. Label(s): (Distributed) Carrere, Virgin, Toco Int'l.

Sonorodven, AP 67203, P. Las Americas, Of. 422, Piso 2, C. C. Concrea, Caracas, Miranda, 1080, (582) 9798446. Fax: (582) 9793590. Pres.: Rodolfo Rodriguez M.; Gen. Mgr.: Gloria Osorio; A&R Mgr.: Carlos Sanchez. Label(s): (Distributed) Karen, BMG-Ariola, TH-Rodven. US Reps.: TH-Rodven (FL). Int'l Reps.: Rodven (Columbia).

Velvet de Venezuela, S.A., PO Box 19134, Barceñas Ario-Edificio Velvet, Caracas, 1010-A, (582) 41 8231. Fax: (582) 41 2623. Pres.: Jose Page Barrios; Vice Pres.: Jose H. Page; Vice Pres & Int'l: Guillermo Page Hernandez; Label Mgr.: Jesus Risco; Vice Pres. A & R: Alejandro Ortiz. Label(s): (Owned) Disqueras Unidas, (Distributed) Fuentus, Orfeon, Victoria. US Reps.: TH Rodven, Velvet Int'l (FL).

Venevista, A.P. 80296, Of. 422, Piso 2, C.C. Concrea, P. Del Este, Caracas, 1080, (02) 979-6111, (02) 979-2122. Fax: (02) 979-3580. Pres.: Rodolfo Rodriguez M.; Mgr.: Juan C. Rosales. (Video (Cassette & Disc)) (Distributor) Labels Distributed: Video: Buena Vista Home Video (Walt Disney, Touchstone, Hollywood Pictures).

Video Rodven, Of. 422, P2, C.C. Concrea, P. Del Este, Caracas, Miranda, 1080, (58)2/979-5556. Fax: (58)2/979-3590. Pres.: Rodolfo Rodriguez M.; Mgr.: Sonia Martinez. (Video (Cassette & Disc)) (Distributor) Labels Distributed: Video: Warner Home Video.

Venevista, A.P. 80296, Of. 422, Piso 2, C.C. Concrea, P. Del Este, Caracas, 1080, (582) 976-0286. Fax: (582) 979-3590. Pres.: Rodolfo Rodriguez M.; Managing Dir.: Peter Cernik; Sales Mgr.: Julio Cesar Moreno. (Distributor) Labels Distributed: Video: CBS/Fox Int'l Video, Rank Film Dists.

Videos De Venezuela, Centro Comercial Concrea, Piso 2, Of. 422, Prados Del Este, Caracas, Miranda, 1080, (02) 979-6111, (02) 979-2122. Fax: (02) 979-3580. Pres.: Rodolfo R. Miranda; Managing Dir.: Peter Cernik; Sales Mgr.: Carols Little. Branch(es): PO Box 02-5255, Miami, FL, 33102.

MUSIC PUBLISHERS

America Musical S.A. de C.V. (Mexico), (See Love Music C.A.).

Arpa Music, (LICENSE) (See Sonoeditora).

BMG Ariola-Arabella, (See Love Music C.A.).

Beechwood de Mexico, (See EMI-Rodven).

Black Bull, (See Sonoeditora).

Brambila, (See Sonoeditora).

Chappell, (LICENSE) (See Sonoeditora).

EMI Music Publishing-London, (See EMI-Rodven).

EMI Odeon, (See EMI-Rodven).

EMI-Rodven, (SACVEN) A.P. 67203, Prados del Este, Of. 422, Piso 2, C.C. Concrea, Caracas, DF, 1080, 58-2 979-8679. Fax: 58-2 979-3590. Pres.: Rodolfo Rodriguez Miranda; Gen. Mgr.: Ciro Vega Aguilera.

EMLASA, (See ORBE Ediciones Musicales, S.A. (ORBEMUSA)).

Edim (Mexico), (See Love Music C.A.).

Edimusic, (LICENSE) (See Sonoeditora).

Editora Musical Rodven, (SACVEN) A.P. 80296, Prados del Este, Of. 422, Piso 2, C.C. Concrea, Caracas, DF, 1080, 58-2 979-9164, 58-2 979-2122. Fax: 58-2 979-3590. Pres.: Rodolfo Rodriguez Miranda; Gen. Mgr.: Ciro Vega Aguilera.

Editorial Luz, (LICENSE) (See Sonoeditora).

Ermi Mexico, (See Love Music C.A.).

Escorpion, (See Sonoeditora).

Intersong S.A., (See Sonoeditora).

Iza Music, (See Sonoeditora).

Iza Music, (LICENSE) (See Sonoeditora).

Kubaney, (See Sonoeditora).

Kubaney—Carimusic, (LICENSE) (See Sonoeditora).

Love Music C.A., (SACVEN) A.P. 80296, Prados del Este, Of. 422, Piso 2, C.C. Concrea, Caracas, DF, 1080, 58-2 979-9164, 58-2 979-2122. Fax: 58-2 979-3590. Pres.: Rodolfo Rodriguez Miranda; Gen. Mgr.: Ciro Vega Aguilera.

Mai-Argentina, (See EMI-Rodven).

ORBE Ediciones Musicales, S.A. (ORBEMUSA), Cuarta Calle Ind. Carapa #40, Caracas, DF, 02, 02-497491, 02-497492. Fax: 02-492065. Pres.: Elena De Roldan; Gen. Mgr.: Ligia Garcia; International/Creative Mgr.: Alberto Ortiz Arismendi.

Peer Int'l, (See Love Music C.A.).

Pegasus Music (USA), (See Editora Musical Rodven).

Pham Mexico, (See Love Music C.A.).

Relay-Argentina, (See Love Music C.A.).

Rodven-Colombia, (See Love Music C.A.).

Rondor Music, (See Sonoeditora).

S.P.I. Venezolana, (See Love Music C.A.).

Screen Gens-EMI Music, Inc., (See EMI-Rodven).

Selemusica, C.A., Apartado 3637, Calle El Arenal, Urbanizacion Industrial La Trinidad, Caracas, DF, 1010-A, (02) 939767. Fax: (02) 938756. Pres.: Ernesto Aue; Gen. Mgr.: Nelida Pietri.

Sochen Chile, (See EMI-Rodven).

Sonoeditora, Dolores A Pte. Soublette Av. Sur 4-Edif, Centro Empresarial Sur 4, Caracas, 483-8633. Fax: 483-3354.

Pres.: Gabriel Rakower; Gen. Mgr.: Luisa Flores.

Sonoeditora, (See ORBE Ediciones Musicales, S.A. (ORBEMUSA)).

Telearte, (See ORBE Ediciones Musicales, S.A. (ORBEMUSA)).

Telearte Florida, (See Sonoeditora).

Universal Music Pub. C.A. (Unimusic), PO Box 70419, Caracas, 1071-A, Calle Milan #402, Ed. La Discoteca, P2, Los Ruices Sur, 1071-A, (2) 226422, (2) 226611. Fax: (2) 226033. Pres.: Wilhelm Ricken; Gen. Mgr.: Helga Moslener.

Warner Bros, (See Sonoeditora).

PERFORMING & MECHANICAL RIGHTS ORGANIZATIONS

S A C V E N (Sociedad de Autores & Compositores de Venezuela), Av. Andres Bello, Edif. Vam, Torre Oeste, Piso, 90, 41-01-23. Contact: Olga Urbina Pernia.

PUBLIC RELATIONS

Discomoda/Fabrica Venezolana De Discos (FAVEDICA), Apto. Postal 3402, 4ta. Calle Zona Industrial, Caracas, DF, (58) 2/497-492. Fax: (58) 2-492065. Pres.: Wolfgang Roldan; Sales Mgr.: Gladys Hernandez; Mktg. Dir.: Clementa Pena; Factory Dir.: Luisa Pinto; Publicity: Ruben Ferrer.

RECORD PROMOTION

Discomoda/Fabrica Venezolana De Discos (FAVEDICA), Apto. Postal 3402, 4ta. Calle Zona Industrial, Caracas, DF, (58) 2/497-492. Fax: (58) 2-492065. Pres.: Wolfgang Roldan; Sales Mgr.: Gladys Hernandez; Mktg. Dir.: Clementa Pena; Factory Dir.: Luisa Pinto; Publicity: Ruben Ferrer.

BLANK & BULK TAPE MANUFACTURERS

3M Venezuela SA, Apartado 2083, Caracas, 1010A, Venezuela, (58)2 572 8211. Fax: (58)2 572 9276. Contact: Emilio Maitin.

CARTRIDGES, CASSETTES, REELS & OTHER PARTS

Discomoda/Fabrica Venezolana De Discos (FAVEDICA), Apto. Postal 3402, 4ta. Calle Zona Industrial, Caracas, DF, (58) 2/497-492. Fax: (58) 2-492065. Pres.: Wolfgang Roldan; Sales Mgr.: Gladys Hernandez; Mktg. Dir.: Clementa Pena; Factory Dir.: Luisa Pinto; Publicity: Ruben Ferrer. Audio: 1/4", 2" & Cassette tapes.

Rodven Discos, C. A., Av. 1, Parcela E 12, Parcelamiento, Sta. Cruz, Aragua, 232, (043)61-9929. Fax: (043) 61-9681. Pres.: Rodolfo Miranda; Sales Mgr.: Eduardo Martirene; Mktg. Dir.: Corina de Martinez; Prodn. Mgr.: Jose V. Sanchez. Audio: C-0.

JEWEL BOX MANUFACTURERS

Rodven Discos, C. A., Av. 1, Parcela E 12, Parcelamiento, Sta. Cruz, Aragua, 232, (043)61-9929. Fax: (043) 61-9681. Pres.: Rodolfo Miranda; Sales Mgr.: Eduardo Martirene; Mktg. Dir.: Corina de Martinez; Prodn. Mgr.: Jose V. Sanchez.

ENVELOPES & MAILERS

Discomoda/Fabrica Venezolana De Discos (FAVEDICA), Apto. Postal 3402, 4ta. Calle Zona Industrial, Caracas, DF, (58) 2/497-492. Fax: (58) 2-492065. Pres.: Wolfgang Roldan; Sales Mgr.: Gladys Hernandez; Mktg. Dir.: Clementa Pena; Factory Dir.: Luisa Pinto; Publicity: Ruben Ferrer. (Audio—LP) Distribuidora Sonografica, Apartado de Correos No. 19.347, Caracas, 1014-A, (02) 483.86.33, (02) 483.87.39. Fax: (02) 483.33.94. Pres.: Gabriel Rakower; Sales Mgr.: Guillermo Urbano; Mktg. Dir.: Carlos Espinoza Raybans. (Audio—Tape, LP)(Video—Tape)

JACKETS & SLEEVES

Discomoda/Fabrica Venezolana De Discos (FAVEDICA), Apto. Postal 3402, 4ta. Calle Zona Industrial, Caracas, DF, (58) 2/497-492. Fax: (58) 2-492065. Pres.: Wolfgang Roldan; Sales Mgr.: Gladys Hernandez; Mktg. Dir.: Clementa Pena; Fac-

tory Dir.: Luisa Pinto; Publicity: Ruben Ferrer. (Jackets/Sleeves-Audio: LP)

Distribuidora Sonografica, Apartado de Correos No. 19.347, Caracas, 1014-A, (02) 483.86.33, (02) 483.87.39. Fax: (02) 483.33.94. Pres.: Gabriel Rakower; Sales Mgr.: Guillermo Urbano; Mktg. Dir.: Carlos Espinoza Raybans. (Jackets/Sleeves-Audio: Tape, LP)(Jackets/Sleeves-Video: Tape)

LABELS

Discomodal/Fabrica Venezolana De Discos (FAVEDICA), Apto. Postal 3402, 4ta. Calle Zona Industrial, Caracas, DF, (58) 2/497-492. Fax: (58) 2-492065. Pres.: Wolfgang Roldan; Sales Mgr.: Gladys Hernandez; Mktg. Dir.: Clementa Pena; Factory Dir.: Luisa Pinto; Publicity: Ruben Ferrer. (Audio—LP)

Distribuidora Sonografica, Apartado de Correos No. 19.347, Caracas, 1014-A, (02) 483.86.33, (02) 483.87.39. Fax: (02) 483.33.94. Pres.: Gabriel Rakower; Sales Mgr.: Guillermo Urbano; Mktg. Dir.: Carlos Espinoza Raybans. (Audio—Tape, LP)(Video—Tape)

"GRAMSA" Grabaciones de America, S.A., Apartado 3837, Piedras a Puente Restaurador, Caracas, DF, 1010-A, (02) 415422. Fax: (02) 938756. Pres.: Gladys de Aponte; Sales Mgr.: Jose Luis Aponte; Mktg. Dir.: Yomaira de Borrás; Vice Pres.: Ernesto Aue. (Audio—LP)

TAPE CUSTOM DUPLICATORS

Discomodal/Fabrica Venezolana De Discos (FAVEDICA), Apto. Postal 3402, 4ta. Calle Zona Industrial, Caracas, DF, (58) 2/497-492. Fax: (58) 2-492065. Pres.: Wolfgang Roldan; Sales Mgr.: Gladys Hernandez; Mktg. Dir.: Clementa Pena; Factory Dir.: Luisa Pinto; Publicity: Ruben Ferrer. (Audio: Cassette, Open Reel, DAT, Real-time. Audio Packaging Services: Inserting, Collating, Labeling, Mailing. Other Services: Warehouse, Freight, Credit Card Clearance Services.)

Distribuidora Sonografica, Apartado de Correos No. 19.347, Caracas, 1014-A, (02) 483.86.33, (02) 483.87.39. Fax: (02) 483.33.94. Pres.: Gabriel Rakower; Sales Mgr.: Guillermo Urbano; Mktg. Dir.: Carlos Espinoza Raybans. (Audio & Video)

"GRAMSA" Grabaciones de America, S.A., Apartado 3837, Piedras a Puente Restaurador, Caracas, DF, 1010-A, (02) 415422. Fax: (02) 938756. Pres.: Gladys de Aponte; Sales Mgr.: Jose Luis Aponte; Mktg. Dir.: Yomaira de Borrás; Vice Pres.: Ernesto Aue. (Audio—LP)

TAPE CUSTOM DUPLICATORS

Discomodal/Fabrica Venezolana De Discos (FAVEDICA), Apto. Postal 3402, 4ta. Calle Zona Industrial, Caracas, DF, (58) 2/497-492. Fax: (58) 2-492065. Pres.: Wolfgang Roldan; Sales Mgr.: Gladys Hernandez; Mktg. Dir.: Clementa Pena; Factory Dir.: Luisa Pinto; Publicity: Ruben Ferrer. (Audio: Cassette, Open Reel, DAT, Real-time. Audio Packaging Services: Inserting, Collating, Labeling, Mailing. Other Services: Warehouse, Freight, Credit Card Clearance Services.)

Distribuidora Sonografica, Apartado de Correos No. 19.347, Caracas, 1014-A, (02) 483.86.33, (02) 483.87.39. Fax: (02) 483.33.94. Pres.: Gabriel Rakower; Sales Mgr.: Guillermo Urbano; Mktg. Dir.: Carlos Espinoza Raybans. (Audio—Tape, LP)(Video—Tape)

"GRAMSA" Grabaciones de America, S.A., Apartado 3837, Piedras a Puente Restaurador, Caracas, DF, 1010-A, (02) 415422. Fax: (02) 938756. Pres.: Gladys de Aponte; Sales Mgr.: Jose Luis Aponte; Mktg. Dir.: Yomaira de Borrás; Vice Pres.: Ernesto Aue. (Audio—LP)

TAPE CUSTOM DUPLICATORS

Discomodal/Fabrica Venezolana De Discos (FAVEDICA), Apto. Postal 3402, 4ta. Calle Zona Industrial, Caracas, DF, (58) 2/497-492. Fax: (58) 2-492065. Pres.: Wolfgang Roldan; Sales Mgr.: Gladys Hernandez; Mktg. Dir.: Clementa Pena; Factory Dir.: Luisa Pinto; Publicity: Ruben Ferrer. (Audio: Cassette, Open Reel, DAT, Real-time. Audio Packaging Services: Inserting, Collating, Labeling, Mailing. Other Services: Warehouse, Freight, Direct Response—800 services.)

Distribuidora Sonografica, Apartado de Correos No. 19.347, Caracas, 1014-A, (02) 483.86.33, (02) 483.87.39. Fax: (02) 483.33.94. Pres.: Gabriel Rakower; Sales Mgr.: Guillermo Urbano; Mktg. Dir.: Carlos Espinoza Raybans. (Audio: Cassette. Other Services: Warehouse, Freight, Direct Response—800 services.)

"GRAMSA" Grabaciones de America, S.A., Apartado 3837, Piedras a Puente Restaurador, Caracas, DF, 1010-A, (02) 415422. Fax: (02) 938756. Pres.: Gladys de Aponte; Sales Mgr.: Jose Luis Aponte; Mktg. Dir.: Yomaira de Borrás; Vice Pres.: Ernesto Aue. (Audio: Cassette. Audio Packaging Services: Inserting, Collating, Labeling, Mailing. Other Services: Warehouse, Freight.)

Productora Criolla de Discos C.A. "Criodisca", Ed. La Discoteca, Calle Milan 402, Apartado 70498 Caracas 1071-A, Caracas, 70498, (582) 22-64-22. Fax: (582) 22-60-33. Pres.: Wilhelm Ricken. (Audio: Cassette. Audio Packaging Services: Inserting, Collating, Labeling, Mailing. Other Services: Warehouse, Freight.)

Rodven Discos, C. A., Av. 1, Parcela E 12, Parcelamiento, Sta. Cruz, Aragua, 232, (043)61-9929. Fax: (043) 61-9681. Pres.: Rodolfo Miranda; Sales Mgr.: Eduardo Martirene; Mktg. Dir.: Corina de Martinez; Prodn. Mgr.: Jose V. Sanchez. (Audio: Cassette. Video: ¼ U-Matic, ½ VHS Cassette, 1/2" Beta. Audio Packaging Services: Inserting. Other Services: Warehouse, Freight.)

Productora Criolla de Discos C.A. "Criodisca", Ed. La Discoteca, Calle Milan 402, Apartado 70498 Caracas 1071-A, Caracas, 70498, (582) 22-64-22. Fax: (582) 22-60-33. Pres.: Wilhelm Ricken. (Audio: Cassette. Audio Packaging Services: Inserting, Collating, Labeling, Mailing. Other Services: Warehouse, Freight.)

Rodven Discos, C. A., Av. 1, Parcela E 12, Parcelamiento, Sta. Cruz, Aragua, 232, (043)61-9929. Fax: (043) 61-9681. Pres.: Rodolfo Miranda; Sales Mgr.: Eduardo Martirene; Mktg. Dir.: Corina de Martinez; Prodn. Mgr.: Jose V. Sanchez. (Audio: Cassette. Video: ¼ U-Matic, ½ VHS Cassette, 1/2" Beta. Audio Packaging Services: Inserting. Other Services: Warehouse, Freight.)

"GRAMSA" Grabaciones de America, S.A., Apartado 3837, Piedras a Puente Restaurador, Caracas, DF, 1010-A, (02) 415422. Fax: (02) 938756. Pres.: Gladys de Aponte; Sales Mgr.: Jose Luis Aponte; Mktg. Dir.: Yomaira de Borrás; Vice Pres.: Ernesto Aue. (Audio: Cassette. Audio Packaging Services: Inserting, Collating, Labeling, Mailing. Other Services: Warehouse, Freight.)

Productora Criolla de Discos C.A. "Criodisca", Ed. La Discoteca, Calle Milan 402, Apartado 70498 Caracas 1071-A, Caracas, 70498, (582) 22-64-22. Fax: (582) 22-60-33. Pres.: Wilhelm Ricken. (Audio: Cassette. Audio Packaging Services: Inserting, Collating, Labeling, Mailing. Other Services: Warehouse, Freight.)

Rodven Discos, C. A., Av. 1, Parcela E 12, Parcelamiento, Sta. Cruz, Aragua, 232, (043)61-9929. Fax: (043) 61-9681. Pres.: Rodolfo Miranda; Sales Mgr.: Eduardo Martirene; Mktg. Dir.: Corina de Martinez; Prodn. Mgr.: Jose V. Sanchez. (Audio: Cassette. Video: ¼ U-Matic, ½ VHS Cassette, 1/2" Beta. Audio Packaging Services: Inserting. Other Services: Warehouse, Freight.)

"GRAMSA" Grabaciones de America, S.A., Apartado 3837, Piedras a Puente Restaurador, Caracas, DF, 1010-A, (02) 415422. Fax: (02) 938756. Pres.: Gladys de Aponte; Sales Mgr.: Jose Luis Aponte; Mktg. Dir.: Yomaira de Borrás; Vice Pres.: Ernesto Aue. (Audio: Cassette. Audio Packaging Services: Inserting, Collating, Labeling, Mailing. Other Services: Warehouse, Freight.)

Productora Criolla de Discos C.A. "Criodisca", Ed. La Discoteca, Calle Milan 402, Apartado 70498 Caracas 1071-A, Caracas, 70498, (582) 22-64-22. Fax: (582) 22-60-33. Pres.: Wilhelm Ricken. (Audio: Cassette. Audio Packaging Services: Inserting, Collating, Labeling, Mailing. Other Services: Warehouse, Freight.)

Rodven Discos, C. A., Av. 1, Parcela E 12, Parcelamiento, Sta. Cruz, Aragua, 232, (043)61-9929. Fax: (043) 61-9681. Pres.: Rodolfo Miranda; Sales Mgr.: Eduardo Martirene; Mktg. Dir.: Corina de Martinez; Prodn. Mgr.: Jose V. Sanchez. (Audio: Cassette. Video: ¼ U-Matic, ½ VHS Cassette, 1/2" Beta. Audio Packaging Services: Inserting. Other Services: Warehouse, Freight.)

"GRAMSA" Grabaciones de America, S.A., Apartado 3837, Piedras a Puente Restaurador, Caracas, DF, 1010-A, (02) 415422. Fax: (02) 938756. Pres.: Gladys de Aponte; Sales Mgr.: Jose Luis Aponte; Mktg. Dir.: Yomaira de Borrás; Vice Pres.: Ernesto Aue. (Audio: Cassette. Audio Packaging Services: Inserting, Collating, Labeling, Mailing. Other Services: Warehouse, Freight.)

Productora Criolla de Discos C.A. "Criodisca", Ed. La Discoteca, Calle Milan 402, Apartado 70498 Caracas 1071-A, Caracas, 70498, (582) 22-64-22. Fax: (582) 22-60-33. Pres.: Wilhelm Ricken. (Audio: Cassette. Audio Packaging Services: Inserting, Collating, Labeling, Mailing. Other Services: Warehouse, Freight.)

Postal 3402, 4ta. Calle Zona Industrial, Caracas, DF, Venezuela, (58) 2/497-492. Fax: (58) 2-492065. Pres.: Wolfgang Roldan; Sales Mgr.: Gladys Hernandez; Mktg. Dir.: Clementa Pena; Factory Dir.: Luisa Pinto; Publicity: Ruben Ferrer. (LP's)

Distribuidora Sonografica, Apartado de Correos No. 19.347, Caracas, 1014-A, Venezuela, (02) 483.86.33, (02) 483.87.39. Fax: (02) 483.33.94. Pres.: Gabriel Rakower; Sales Mgr.: Guillermo Urbano; Mktg. Dir.: Carlos Espinoza Raybans. (LP's)

"GRAMSA" Grabaciones de America, S.A., Apartado 3837, Piedras a Puente Restaurador, Caracas, DF, 1010-A, Venezuela, (02) 415422. Fax: (02) 938756. Pres.: Gladys de Aponte; Sales Mgr.: Jose Luis Aponte; Mktg. Dir.: Yomaira de Borrás; Vice Pres.: Ernesto Aue. (LP's)

Productora Criolla de Discos C.A. "Criodisca", Ed. La Discoteca, Calle Milan 402, Apartado 70498 Caracas 1071-A, Caracas, 70498, Venezuela, (582) 22-64-22. Fax: (582) 22-60-33. Pres.: Wilhelm Ricken. (LP's)

Rodven Discos, C. A., Av. 1, Parcela E 12, Parcelamiento, Sta. Cruz, Aragua, 232, Venezuela, (043)61-9929. Fax: (043) 61-9681. Pres.: Rodolfo Miranda; Sales Mgr.: Eduardo Martirene; Mktg. Dir.: Corina de Martinez; Prodn. Mgr.: Jose V. Sanchez. (LP's)

MASTERING FACILITIES

Discomodal/Fabrica Venezolana De Discos (FAVEDICA), Apto. Postal 3402, 4ta. Calle Zona Industrial, Caracas, DF, (58) 2/497-492. Fax: (58) 2-492065. Pres.: Wolfgang Roldan; Sales Mgr.: Gladys Hernandez; Mktg. Dir.: Clementa Pena; Factory Dir.: Luisa Pinto; Publicity: Ruben Ferrer. (Audio)

Distribuidora Sonografica, Apartado de Correos No. 19.347, Caracas, 1014-A, (02) 483.86.33, (02) 483.87.39. Fax: (02) 483.33.94. Pres.: Gabriel Rakower; Sales Mgr.: Guillermo Urbano; Mktg. Dir.: Carlos Espinoza Raybans. (Audio & Video)

"GRAMSA" Grabaciones de America, S.A., Apartado 3837, Piedras a Puente Restaurador, Caracas, DF, 1010-A, (02) 415422. Fax: (02) 938756. Pres.: Gladys de Aponte; Sales Mgr.: Jose Luis Aponte; Mktg. Dir.: Yomaira de Borrás; Vice Pres.: Ernesto Aue. (Audio)

Productora Criolla de Discos C.A. "Criodisca", Ed. La Discoteca, Calle Milan 402, Apartado 70498 Caracas 1071-A, Caracas, 70498, (582) 22-64-22. Fax: (582) 22-60-33. Pres.: Wilhelm Ricken. (Audio)

Rodven Discos, C. A., Av. 1, Parcela E 12, Parcelamiento, Sta. Cruz, Aragua, 232, (043)61-9929. Fax: (043) 61-9681. Pres.: Rodolfo Miranda; Sales Mgr.: Eduardo Martirene; Mktg. Dir.: Corina de Martinez; Prodn. Mgr.: Jose V. Sanchez. (Audio)

WEST INDIES

BAHAMAS

RECORD LABELS

House of Music, Ltd., PO Box 9226, Nassau, (809) 325-0331, (809) 325-3264. Fax: (809) 328-2828. CEO/Pres.: Bradley B. Roberts; Vice Pres.: Hartlyn M. Roberts; (Compact Disc, Video (Cassette & Disc), Records)

Intercity Records & Tapes, Inc., PO Box F-4008, #6 Hong Kong St., Int'l Bazaar, Freeport, (809) 352-6820. Pres.: Don Martin; Vice Pres./Buyer: Vanceta Martin; (Distributor) Labels Distributed: Audio: Cicada, D.D.V., GBI, Intercity, Junka, Paradise, Sheriff, 69.

BARBADOS

RECORD LABELS

West Indies Records (B'Dos) Ltd., Applewhaites Estate, (809) 425-0200. Fax: (809) 425-3384. Managing Dir.: Colin H. Wilke; Gen. Mgr.: D. Winston Leach; Sales Mgr.: E.A. "Bunny" Best; Cassette Plant Mgr.: Derek Wilkie. Label(s): (Distributed) Ranwood, Ariola, Arista, Capitol, BMG, Durium, EMI, Hansa, Enigma, Jive, London, PRT, Motown, A & M.

BERMUDA

RECORD LABELS

Edmar Records, PO Box 204 HMAX, Hamilton, (809) 295-4839. Fax: (809) 292-3357. Pres.: Eddy DeMeillo. Label(s): (Owned) Edmar, Duane, Int'l Reprs.: Holborne Records (Canada).

JAMAICA

RECORD LABELS

Dynamic Sounds Recording Co. Ltd., PO Box 137, 15 Bell Rd., Kingston, KGN 11, (809) 923-9168, (809) 923-9138. Fax: (809) 923-9130. Pres.: Byron A. Lee; Managing Dir.: Edward J. Lee; Financial: Byron A. Lee Jr. Label(s): (Owned) Dynamic, (Distributed) CBS, GRP, Gefen, MCA, Toco Int'l, Sony, WEA.

Dynamic Sounds Record Co. Ltd., PO Box 137, 15 Bell Rd., Kingston, 11, (809) 923-9168, (809) 923-9138. Fax: (809) 923-9130. Pres.: Byron A. Lee Sr.; Managing Dir.: Edward J. Lee; Vice Pres. Finance: Byron Lee Jr.; Vice Pres. A&R/Sales Mgr.: Delroy Morrison. Label(s): (Owned) Nura, (Distributed) CBS, MCA, WEA, Toco, Int'l Reprs.: V. P. Records (Jamaica).

Sonic Sounds Record Mfg. Co. Ltd., 25 Retirement Rd., Kingston 5, (809) 926-1204, (809) 926-2038. Fax: (809) 926-9243. Pres.: Neville Lee; Dir.: Winnifred Lee; Gen. Mgr.: Minah Ramarrack; Prodn. & Mktg. Mgr.: Stephen Lee. Label(s): (Owned) Gorgon, Mr. Tippy, Observer, Penthouse, Sonic, Taxi, Striker, Lee, Volcano, (Distributed) RCA, Jive, La Face, BMG, Arista, US Reprs.: V.P. Records (NY). Int'l Reprs.: Jet Star Records (England).

MUSIC PUBLISHERS

Charmaine Phang, (See Sonic Sounds-Jamaica). Sonic Sounds-Jamaica, 25 Retirement Rd., Kingston, W.I., 5, (809) 92-61204, (809) 92-62038. Fax: (809) 92-69243. Pres.: Neville Lee; Gen. Mgr.: Minah Ramarrack; Prof./Creative Mgr.: Stephen Lee.

PERFORMING & MECHANICAL RIGHTS ORGANIZATIONS

Multi Tape Ltd., PO Box 137, 15 Bell Rd., Kingston 11, Kingston, (809) 923-9168, (809) 923-9138. Fax: (809) 923-9130. Pres.: Byron A. Lee; Mktg. Dir.: D. Morrison; Managing & Sales Dir.: Edward Lee.

RECORD PROMOTION

Dynamic Sounds Recording Co., LTD., 15 Bell Rd., Kingston, KGN 11, (809) 923-9168, (809) 923-9138. Fax: (809) 923-9130. Pres.: Byron A. Lee; Sales/Mktg. Dir.: Edward Lee.

Multi Tape Ltd., PO Box 137, 15 Bell Rd., Kingston 11, Kingston, (809) 923-9168, (809) 923-9138. Fax: (809) 923-9130. Pres.: Byron A. Lee; Mktg. Dir.: D. Morrison; Managing & Sales Dir.: Edward Lee.

TAPE CUSTOM DUPLICATORS

Dynamic Sounds Recording Co., LTD., 15 Bell Rd., Kingston, KGN 11, (809) 923-9168, (809) 923-9138. Fax: (809) 923-9130. Pres.: Byron A. Lee; Sales/Mktg. Dir.: Edward Lee. Audio: Cassette.

Multi Tape Ltd., PO Box 137, 15 Bell Rd., Kingston 11, Kingston, (809) 923-9168, (809) 923-9138. Fax: (809) 923-9130. Pres.: Byron A. Lee; Mktg. Dir.: D. Morrison; Managing & Sales Dir.: Edward Lee. Audio: Cassette.

PLATING & PRESSING PLANTS

Dynamic Sounds Recording Co., LTD., 15 Bell Rd., Kingston, KGN 11, Jamaica, (809) 923-9168, (809) 923-9138. Fax: (809) 923-9130. Pres.: Byron A. Lee; Sales/Mktg. Dir.: Edward Lee. (LP's)

Multi Tape Ltd., PO Box 137, 15 Bell Rd., Kingston 11, Kingston, Jamaica, (809) 923-9168, (809) 923-9138. Fax: (809) 923-9130. Pres.: Byron A. Lee; Mktg. Dir.: D. Morrison; Managing & Sales Dir.: Edward Lee. (LP's)

MASTERING FACILITIES

Dynamic Sounds Recording Co., LTD., 15 Bell Rd., Kingston, KGN 11, (809) 923-9168, (809) 923-9138. Fax: (809) 923-9130. Pres.: Byron A. Lee; Sales/Mktg. Dir.: Edward Lee. (Audio)

Multi Tape Ltd., PO Box 137, 15 Bell Rd., Kingston 11, Kingston, (809) 923-9168, (809) 923-9138. Fax: (809) 923-9130. Pres.: Byron A. Lee; Mktg. Dir.: D. Morrison; Managing & Sales Dir.: Edward Lee. (Audio)

TRINIDAD & TOBAGO

RECORD LABELS

Trini-T Records, PO Box 3290, Diego Martin, (809) 628-8637,

(809) 622-6774. Fax: (809) 628-1903. Managing Dir.: Kevin C. Scoon; Technical Dir.: Peter R. Scoon. Label(s): (Owned) Trini-T. Int'l Reps.: Tropical (Germany).

MUSIC PUBLISHERS

Studio V Prods., PO Box 3290, Diego Martin, (809) 628-9637, (809) 622-6774. Fax: (809) 628-1903. Managing Dir.: Kelvin Scoon.

PERFORMING & MECHANICAL RIGHTS ORGANIZATIONS

Copyright Orngnization of Trinidad & Tobago, 45 C Jernigham Ave. Belmont, Port of Spain, (809) 62-36101, (809) 62-34755. Fax: (809) 62-34755. Chairman: Ronald V. Pollard; Chief Exec. Officer: Lennox Straker.

Labels...

(Continued from page 180)

SSDigital, PO Box 43551, 809 Echo Bridge, Louisville, KY, 40253, (502) 473-0068, Pres.: Jesus Rosebud; Sales Mgr.: Nohpar King; Mktg. Dir.: Vernon T. McEnos; Project Coord.: K. Scott Ritcher. (Audio—Tape)

Jasper Samuel Advertising & Printing, 406 W. 31st St., New York, NY, 10001, (212) 239-9544, Fax: (212) 594-0931, Pres.: Jasper Samuel; Sales Mgr.: Claude Chamlee; Mktg. Dir.: Courtland White. (Audio—CD, Tape, LP)(Video—Disc)

Shorewood Packaging of Georgia, 1707 Shorewood Dr., LaGrange, GA, 30240, (404) 884-3036, Gen. Mgr.: Charles Wardlaw. (Audio—CD, LP)

Sound Recorders, Inc., 4031 Guadalupe, Austin, TX, 78751, (512) 454-8324, (800) 880-0270, Fax: (512) 454-5594, Pres.: Miles Muller; Sales Mgr.: Basil Thomas; Mktg. Dir.: Matt Wiedemann. (Audio—Tape)(Video—Tape)

SoundSpace, Inc., 126 Dayton St., Yellow Springs, OH, 45387, (513) 767-7353, Pres.: Chris Hertzler. (Audio—CD, Tape)

Specialty Paper Products, 307 S. White Horse Pk., Audubon, NJ, 08106, (609) 547-5681, Pres.: Joseph A. Pauli; Sales/Mktg. Dir.: B. J. Pauli. (Audio—LP)(Video—Tape)

Studio Magnetics Co., Inc., 12 Long Island Ave., Holtsville, NY, 11742, (516) 289-3400, (800) 874-2202, Fax: (516) 289-1604, Pres.: George Clahane; Sales Mgr.: Craig Balaban; Mktg. Dir.: Doug Young. (Audio—Tape)(Video—Tape)

Sun Plastics Co., Inc./Dynamic LP Stereo Record Pressing Co., Inc., 534 Passaic Ave., East Newark, NJ, 07029, (201) 482-6749, (212) 349-0977, Fax: (201) 483-0031, Pres.: Jerry Salerno; Sales Mgr.: Vicky Salerno; Mktg. Dir.: Jerry R. Salerno. (Audio—LP)

Suttman Prods., PO Box 72, Dayton, OH, 45409, (513) 278-4601, Pres.: Eric J. Suttman. (Audio—CD, Tape)(Video—Tape)

United Ad Label Co., Inc., 650 Columbia St., Brea, CA, 92621, (714) 990-2700, (800) 992-5755, Fax: (800) 423-8488, Pres.: Patrick Burns; Sales Mgr.: Denis Walp; Mktg. Dir.: Gary Harmon. (Audio—Tape)(Video—Tape, Disc)

United Audio Video Group, Inc., 6855 Vineland Ave., North Hollywood, CA, 91605, (818) 980-6700, Fax: (818) 508-8273, Pres.: Miriam Newman; Vice Pres.: Steve Newman; Sales Mgr.: Larry Schwartz; Mktg. Dir.: Laurie Newman. (Audio—Tape)(Video—Tape)

Video Media Prods., 2727 W. Southern Ave., Tempe, AZ, 85282, (602) 966-6545, Fax: (602) 438-2238, Pres.: Jim Rinkenberger; Mktg. Dir.: Jim Pangborn. (Video—Tape)

Ville Platte Record Mfg. Co., PO Drawer 10, 120 E. Cypress St., Ville Platte, LA, 70586, (318) 363-2104, Fax: (318) 363-5622, Pres./Sales Mgr.: James Floyd Soileau; Sales Mgr.: Peggy Fontenot. (Audio—LP)

Virtue Recording & Video & Disc Mastering, 8809-11 Rising Sun Ave., Philadelphia, PA, 19115, (215) 763-2825, Pres.: Frank Virtue; Sales Mgr.: Mary Bozzi; Mktg. Dir.: Linda Vitacolonia. (Audio—CD, Tape, LP)

West & Co., Inc., PO Box 24281, Nashville, TN, 37202, 1726-C General George Patton Dr., Brentwood, TN, 37027, (615) 661-5808, Fax: (615) 661-5905, Pres.: Jerry West; Sales Mgr.: Mike Young; Mktg. Dir.: Gary Campbell. (Audio—CD, Tape)

Williams Printing Co., 811 Cowan St., Nashville, TN, 37207, (615) 256-7125. (Audio—LP)

POLYBAGS & SHRINKWRAP

AJM Inc., 1600 Wyatt Dr., Ste. 12, Santa Clara, CA, 95054, (408) 980-8631, Fax: (408) 980-0281, Sales Mgr.: Mike Frug. (Polybags & Shrinkwrap)

APS Packaging, PO Box 712, 1275 Bloomfield Ave., Fairfield, NJ, 07004, (201) 575-1040, Fax: (201) 575-6540, Pres.: Henry Verbeke; Sales Mgr.: Eric Verbeke. (Shrinkwrap)

A + R Record & Tape Mfg. Co., 902 N. Industrial Blvd., Dallas, TX, 75207, (214) 741-2027, Fax: (214) 638-6801, Pres.: Richard Sobel; Sales Mgr.: Stan Getz II; Mktg. Dir.: Maxine Sobel. (Polybags & Shrinkwrap)

ASR Recording Services of California, 8960 Eton Ave.,

Canoga Park, CA, 91304, (818) 341-1124, Fax: (818) 341-9131, Pres. (Mfg.): Allen Weintraub; Vice Pres./Sales: Lester P. Edwards. (Polybags & Shrinkwrap)

ATW Mfg. Co., Inc., PO Box 7755, 4065 W. 11th Ave., Bldg. 5, Eugene, OR, 97401, (503) 484-2111, Fax: (503) 484-1493, Pres.: Tom Drew; Sales Mgr.: Jeff Spencer; Mktg. Dir.: Janie Wilson. (Polybags & Shrinkwrap)

A to Z Audio Services, Inc., PO Box 26087, 21929 Lorain Rd., Fairview Park, OH, 44126, (216) 333-0040, Fax: (216) 333-0104, Pres.: Duane Abarca; Vice Pres.: Greg Zarnoski; Sales Mgr.: Jean Rust. (Shrinkwrap)

All American Records, div. All American Record Mfg. Inc., 4380 NW 128th St., Opa Locka, FL, 33054, (305) 688-7475, Fax: (305) 685-5697, Pres.: Peter Botome; Exec. Dir.: Jorge A. Jure; Sales Mgr.: Marilyn Moreno; Mktg. Dir.: Bertilda Torres. (Shrinkwrap)

At The Top Duplicators, 3330 Earhart, Carrollton, TX, 75006, (214) 980-7671, (214) 233-9191, Fax: (214) 991-1853, Prodn. Mgr.: Bert Newmeyer. (Shrinkwrap)

Audio Cassette Duplicator Co., 12426-1/2 Ventura Blvd., Studio City, CA, 91604, (818) 762-2232, Fax: (818) 508-8077, Owners: Steve Katz, Steve Mitchell. (Shrinkwrap)

Audiophile Realtime Cassette Duplication, 13801 E. 35 St., Independence, MO, 64055, (800) 322-2832, Fax: (816) 254-0045, Pres.: G.W. Riegler; Sales/Mktg. Dir.: Tom Stack. (Shrinkwrap)

Cassette Technologies, 5722 Swan Crk. Dr., E., Tacoma, WA, 98404, (206) 474-9835, Sales Mgr.: Dean K. Hart. (Shrinkwrap)

Crown Magnetics, Inc., 1223 Bittner Blvd., Lebanon, PA, 17042, (717) 274-2812, (800) 736-9001, Fax: (717) 274-3615, Pres.: Chuck Musser; Mktg. Dir.: Bob Turner; Sales: Judy Musser. (Polybags & Shrinkwrap)

Davkore Co., 1300-A Spacepark Way, Mountain View, CA, 94043, (415) 969-3030, Fax: (415) 969-0140, Pres.: C.W. Webber; Sales Mgr./Mktg. Dir.: Tom Sherry/Jeanne Horan. (Polybags & Shrinkwrap)

Dow Chemical USA, 2020 Dow Center, Midland, MI, 48640, (800) 441-4369, Listing Editor: Shirley Clark. (Shrinkwrap)

Fastrax, Inc., 4033 Aurora Ave. N., Seattle, WA, 98103, (206) 632-8300, Pres.: Miriam Hamilton; Sales Mgr.: Candace Williams. (Shrinkwrap)

Grenadier, 10 Parkwood Ave., Rochester, NY, 14620, (716) 442-6209, (716) 275-2942, Pres.: T. Greene; Sales/Mktg. Dir.: P. Greene. (Shrinkwrap)

HCV, Inc., 12229 Montague, Arleta, CA, 91331, (818) 896-4321, Pres.: Ed De Roo; Mktg. Dir.: Chuck Arnone. (Shrinkwrap)

Houston Records, Ltd., 3300 Jensen Dr., Houston, TX, 77026, (713) 223-5971, Pres.: Chris Puccio; Sales Mgr.: Steve Puccio. (Shrinkwrap)

Keall Real Time Tape Duplicators, 77 Bay Shore Rd., Bay Shore, NY, 11706, (516) 586-2486, Fax: (516) 586-2486, Pres.: Keith A. Gutschwager; Sales Mgr.: Larry Andrews; Contact: Dorothy E. Gutschwager. (Polybags)

M. Latter Mfg., Inc., 3669 Seventh Ave., Los Angeles, CA, 90018, (213) 737-0440, Fax: (213) 737-4867, Pres.: Mel Latter; Sales Mgr.: Neal Taiiki. (Shrinkwrap)

Lion Recording Services, 7532 Fullerton Ct., Springfield, VA, 22153, (703) 569-3200, Fax: (703) 455-5600, Pres.: Harold Lion; Mktg. Dir.: Karen Blackhall; Vice Pres./Sales Mgr.: Richard Lion. (Shrinkwrap)

Majestic Duplicating Service, 1208 W. Isabel St., Burbank, CA, 91506, (818) 843-1806, Fax: (818) 954-0770, Pres.: Leslie Sawyer; Sales Mgr.: John Northrop; Mktg. Dir.: Chris Saver. (Shrinkwrap)

Mark Custom Recording Service, 10815 Bodine Rd., Clarence, NY, 14031, (716) 759-2600, Pres./Owner: Mark J. Morette. (Shrinkwrap)

Marvel Pharmaceutical & Packaging Co., 490 Rt. 46 E., Fairfield, NJ, 07004, (201) 882-9339, Fax: (201) 575-6637, Pres.: R. Teich; Sales Mgr.: B. Berman; Mktg. Dir.: Scott Trich. (Polybags & Shrinkwrap)

Matchbook Albums (Sub. of Beach West Designs), 711 John St., Secaucus, NJ, 07094, (215) 478-1585, Pres.: Walt Henkel. (Polybags)

Musicol, Inc., 780 Oakland Park Ave., Columbus, OH, 43224, (614) 267-3133, Pres.: John W. Hull; Sales Mgr.: Warren Hull; Mktg. Dir.: Charlene Hull. (Shrinkwrap)

New Age Video, PO Box 68, 3480 So. Clinton Ave., South Plainfield, NJ, 07080, (201) 756-7500, Fax: (201) 757-1991, Pres.: Steven Nasar; Sales Mgr.: Jack Nasar; Vice Pres.: Joey Nasar. (Shrinkwrap)

Packaging Supplies, Inc., 1259-B Rand Rd., Des Plaines, IL, 60016, (708) 390-7770, Fax: (708) 390-7781, Pres.: Abe Cohen; Exec. Vice Pres.: Fred Cohen. (Polybags)

Poly Plastic Packaging Co., Inc., 36-36 36th St., Long Island City, NY, 11101, (718) 392-8670, Pres.: Herbert Rothchild; Sales Mgr.: Sheldon Rothchild. (Polybags)

Quality Cassette Services, 403 S. Woodlawn St., Wheaton, IL, 60187, (708) 668-2787, Pres.: Mary M. Newitt. (Shrinkwrap)

Queens Group, Inc., 52-35 Barnett Ave., Long Island City, NY, 11104, (718) 457-7700, Fax: (718) 457-9285, Pres.: Len Verebay; Vice Pres./Nat'l Sales Mgr.: Keith Kiedinger; Exec. Vice Pres.: Richard Roth; Sr. Vice Pres.: Jack Sims. (Polybags)

R.P. Products, Inc., 1618 Waxwing Ct., Schaumburg, IL, 60173, (708) 397-4575, Fax: (708) 397-4576, Pres.: Roy Pinks; Sales Mgr.: Dick Hirtz; Mktg. Dir.: Sent Fien. (Polybags & Shrinkwrap)

RTI, Record Technology, Inc., 486 Dawson Dr., Camarillo, CA, 93012, (805) 484-2747, Fax: (805) 987-0508, Pres.: William Bauer; Sales Mgr.: Don MacInnis. (Polybags)

Rainbo Records & Cassettes, 1738 Berkeley St., Santa

Monica, CA, 90404, (213) 829-0355, Fax: (213) 828-8765, Pres.: Jack G. Brown; Gen. Mgr.: Steve Sheldon. (Polybags & Shrinkwrap)

Regal, A Poly-Pak Industries Co., 125 Spagnoli Rd., Melville, NY, 11747, (516) 293-6767, Fax: (516) 454-6366, Pres.: Peter Levy; Sales Mgr.: Ken Trotter; Mktg. Dir.: Juliette H. McKenna. (Polybags)

Rexham Packaging, PO Box 240007, 1700 Industrial Dr., Charlotte, NC, 28224, (704) 88972621, Fax: (704) 889-4680, Mktg. Comm. Admn.: Julie Lampe. (Polybags & Shrinkwrap)

Romaba Record Pressing Corp. of America, 33-34th St., Brooklyn, NY, 11232, (718) 499-3060, Fax: (718) 499-3061, Pres.: Theodore E. Kolsky; Vice Pres.: Dara Kolsky; Sales Mgr.: Vicki M. Guerra; Mktg. Dir.: Jennifer Kolsky. (Shrinkwrap)

SSDigital, PO Box 43551, 809 Echo Bridge, Louisville, KY, 40253, (502) 473-0068, Pres.: Jesus Rosebud; Sales Mgr.: Nohpar King; Mktg. Dir.: Vernon T. McEnos; Project Coord.: K. Scott Ritcher. (Shrinkwrap)

Seal-O-Matic Co., 900 Passaic Ave., East Newark, NJ, 07029, (201) 481-6500, (800) 631-2072, Pres.: Samuel Orner; Sales Mgr.: Lee Chesin; Mktg. Dir.: Tom Eaton. (Polybags & Shrinkwrap)

SoundSpace, Inc., 126 Dayton St., Yellow Springs, OH, 45387, (513) 767-7353, Pres.: Chris Hertzler. (Shrinkwrap)

Sun Plastics Co., Inc./Dynamic LP Stereo Record Pressing Co., Inc., 534 Passaic Ave., East Newark, NJ, 07029, (201) 482-6749, (212) 349-0977, Fax: (201) 483-0031, Pres.: Jerry Salerno; Sales Mgr.: Vicky Salerno; Mktg. Dir.: Jerry R. Salerno. (Shrinkwrap)

Suttman Prods., PO Box 72, Dayton, OH, 45409, (513) 278-4601, Pres.: Eric J. Suttman. (Polybags & Shrinkwrap)

Tapecom, Inc., 1095 South Ave., Bridgeport, CT, 06604, (203) 579-7666, Contact: Ed L. Harm. (Polybags & Shrinkwrap)

Tapeponents Co., PO Box 236, 60 Midvale Rd., Mountain Lakes, NJ, 07046, (201) 263-1442, (201) 263-1443, Fax: (201) 263-8640, Pres.: J. Clifford Anglum; Sales Mgr.: Robert Pitcher; Office Mgr.: Colleen Koch. (Polybags)

Tri-Plex Packaging Corp., 267 Fifth Ave., 10th Floor, Ste. 1010, New York, NY, 10016, (212) 481-6070, Fax: (212) 481-1550, Pres.: Ken Golden; Sales Mgr.: Andy Napolitano; Mktg. Dir.: Jerry DeLuise. (Polybags)

United Audio Video Group, Inc., 6855 Vineland Ave., North Hollywood, CA, 91605, (818) 980-6700, Fax: (818) 508-8273, Pres.: Miriam Newman; Vice Pres.: Steve Newman; Sales Mgr.: Larry Schwartz; Mktg. Dir.: Laurie Newman. (Shrinkwrap)

Ville Platte Record Mfg. Co., PO Drawer 10, 120 E. Cypress St., Ville Platte, LA, 70586, (318) 363-2104, Fax: (318) 363-5622, Pres./Sales Mgr.: James Floyd Soileau; Sales Mgr.: Peggy Fontenot. (Shrinkwrap)

Virtue Recording & Video & Disc Mastering, 8809-11 Rising Sun Ave., Philadelphia, PA, 19115, (215) 763-2825, Pres.: Frank Virtue; Sales Mgr.: Mary Bozzi; Mktg. Dir.: Linda Vitacolonia. (Polybags & Shrinkwrap)

WMG, Inc. (World Media Group), 8472 Brookville Rd., Indianapolis, IN, 46239, (317) 353-1113, Fax: (317) 353-0750, Pres.: J.A. Mellentine; Sales Mgr.: Curt Albright. (Polybags)

Edward R. White Co., 190 Morgan Ave., Brooklyn, NY, 11237, (718) 366-3400, Pres.: Brian E. Sadowsky; Sales Mgr.: Morris Sadowsky. (Polybags)

World Class Tapes, PO Box 7611, Ann Arbor, MI, 48107, 670 Airport Blvd., Ann Arbor, MI, 48108, (313) 769-7575, Fax: (313) 662-0997, Pres.: R.G. Martens; Vice Pres.: J.W. Spencer; Sales Mgr.: Sue Gillis. (Shrinkwrap)

Yugoslavia...

(Continued from page 271)

MUSIC INFORMATION CENTRE (SOKOJ), Misarska 12-14, PO Box 213, 11000 Belgrade, Serbia, 011.338 761, Fax: 011.338 168, Tlx: 72655 sokoj, President: Dimitrije Buzarovski, Sec. Gen.: Ivan Kovac, GM: Vesna Koric, Acct. Dir.: Ruzica Sretenovic +, SOKOJ protects performing and mechanical copyrights for Yugoslav composers, and for composers in 54 other countries; Also promotes Yugoslav music and is active in various international music organizations. Provides a library service and music scores, and promotional literature.

UNION OF YUGOSLAV COMPOSERS, Misarska 12-14, 11000 Belgrade, Serbia, 011.334 771, Fax: 011.336 168, Dir: Ivan Kovac.

YUGOSLAV CONCERT ARTISTS UNION, Terazije 41, 11000 Belgrade, Serbia, 011.322 732, Fax: 011.340 478, Dir: Eduard Ilie.

PLATING, MASTERING & PRESSING PLANTS

AUDIO VIDEO STUDIO, Stularjeva 5, 61000 Ljubljana, Slovenia, 061.50774, Fax: 061.327 187, Tlx: 31660, MD: Joe Racman. Tape duplication.

CROATIA RECORDS, Niska Ulica bb, 41040 Zagreb, Croatia, 041.266 622/264 309, Fax: 041.264 309, Tlx: 21857 jugoton, Dir. Gen.: Mirko Bosnjak. Vinyl pressing.

HELIDON TOVARNA GRAMOFONSKIH PLOSC, Cyelovska 142, 61000 Ljubljana, Slovenia, 061.551 379/559 047/557 842, Fax: 061.551 047, MD: Frank Filipic, GM: Jose Kosar. CD, vinyl and tape manufacture; Parent company in Maribor; Fax: 062.26696, Tlx: 332555 yuzamb.



International Buyer's Guide

1992 Edition. The Worldwide Music and Video Business to Business Directory. Listings include name, key people, address, phone number and marketing information of record and video companies, music publishers, distributors, accessory manufacturers and suppliers. Also manufacturers and wholesalers of hardware, software and accessories for Compact Disc, Video Disc, and Video Cassettes. \$75.00

International Talent & Touring Directory

1992 Edition. The source for U.S. and international talent, booking agencies, facilities, services and products. Used by everyone who buys and books talent—promotes and manages tours. \$67.00

Record Retailing Directory

1991 Edition. The industry's first and only comprehensive directory of independent music stores and chain operations across the USA. \$85
To order call (800) 344-7119, in NJ (201) 363-4156

International Tape/Disc Directory

for the CD, Record and Audio/Video Tape Industries. 1992 Edition. Professional services and supplies for record and video manufacturers, audio and video manufacturers, audio and video tape manufacturers, video program suppliers and buyers, video music producers and production facilities. \$32.00

Country Music Sourcebook

1991 Edition. Personal managers, booking agents, performing artists, radio stations—everyone involved in Country Music. \$33.00

International Recording Equipment and Studio Directory

1992 Edition. All the information you need on professional recording equipment, recording studios and recording studio equipment usage. \$37.00

Billboard Directories are indispensable reference sources. They are, in fact, the main sources of vital information for the entire Music/Record/Tape and Video Industries.

Directory Order Form

Return this coupon to: BILLBOARD Directories, P.O. Box 2016, Lakewood, NJ 08701
Please add \$3 per directory for shipping & handling. For international orders please add \$8.

- | | | |
|-------|--------|--|
| # | Copies | Amount |
| _____ | _____ | International Buyer's Guide—\$75.00 (8230-8044-7) |
| _____ | _____ | International Talent & Touring Directory—\$67.00 (8230-8042-0) |
| _____ | _____ | Record Retailing Directory—\$85.00 (8230-7595-8) |
| _____ | _____ | International Tape/Disc Directory—\$32.00 (8230-8040-4) |
| _____ | _____ | Country Music Sourcebook—\$33.00 (8230-8041-2) |
| _____ | _____ | International Recording Equipment and Studio Directory—\$37.00 (8230-8043-9) |

NAME _____

COMPANY NAME _____

ADDRESS _____

CITY _____ STATE _____ ZIP _____

TELEPHONE _____

Check or money order enclosed \$ _____

charge to American Express MasterCard VISA

Card # _____ Exp. Date _____

Signature _____

Add appropriate sales tax in NY, NJ, CA, TN, MA, IL and DC. Foreign and Canadian orders payable in U.S. Funds only. Please add an additional \$5.00 per directory for foreign orders.

For the fastest service, call Toll Free:

1-800-223-7524 (outside NY), 212-536-5174 OR 1-800-344-7119 (OUTSIDE NJ), IN NJ 908-363-4156
(These numbers for directory orders only.)

Advertisers Index

- A**
- ALPHA Enterprises, Inc. 5
A.T.B. spa 227
Abbey Road Distributors 72
Accurate Sound Corporation 175
Ala Bianca Group s.r.l. 219
All Service One Stop Inc. 90
Allen Industries Ltd. 292
American Helix 163
American Record Sales, Inc. 104
Americana Records, Inc. 293
Analogue Industries 160
Andol Audio Products Inc. 139
Anwell Industrial Ltd. 292
Apex Machine Company 178
Audio One 70
AudioFile 116
Automatic Inspection Devices, Inc. 174
- B**
- BASF 135
Balboa Records, Co. 72
Bassin Distributors 79
Bayside Record Distributing Company 73
Beres Industries Inc. 141
Blues Interactions, Inc. 293
W.H. Brady Co. 125
- C**
- CD One Stop 95
C.M.P. MaGaDa International 285
California Record Distributors 73
Campus Records 95
Campus Records Inc. 101
Canyon Records 70
Cleveland 1 Stop Inc. 101
Coast Manufacturing Company 109
Cosmo 144
Creav Inc., U.S.A. 296
- D**
- DIC Digital Supply Corporation 133
Digital Audio Disc Corporation Cover III
Disc Makers 158
Disc Manufacturing, Inc. 161
Dischi Ricordi 221
Disctronics 9
Distribution Select 284
Dunn Industries, Inc. 140
Dutch East India Trading 93
- E**
- EAM Packaging 176
East Europe Records & Music 11
East Side Digital 89
Edelstein Diversified 173
Edimusa, S.A. de C.V. 289
El Mar Plastics, Inc. 139
The Electric Fetus 87
Elmo Limited 294
Encore Distributors, Inc. 66
Europadisk, Ltd. 162
- F**
- Fiebre Latina 74
Fiesta Record Company Inc. 94
Filam National Plastics, Inc. 142
- Forge Recording Studios Inc. 158
Fujipacific Music Inc. 296
Future Duplicators 155
- G**
- The Gallo Group of Companies 273
General Magnetics Limited 301
Golden Circle Inc. 78
Gopher Products 114
Gotham Distributing Corporation 103
The David Gresham Entertainment Group 272
- I**
- International Packaging Corporation 144
- J**
- Jacobson & Colfin, P.C. 119
Japan Publications Trading Co., Ltd. 299
Jewel Records 45
Jimco Japan Corporation 294
Joyworld Music Pte Ltd. 300
- K**
- KABA Research & Development 177
Kaleidoscopic Music srl 295
- L**
- Lenco 141
The Little Warehouse, Inc. 102
The Lowery Group 55
Lyrec/Media Technologies Ltd. 153
- M**
- Malverne Distributors, Inc. 97
Margold 115
Melody Mates, Inc. 111
Met Richmond Record Sales, Inc. 80
Michelex Industrial Group 143
Midnight Records 94
Motor City Music Distributing, Inc. 87
Music City Record Distributors, Inc. 105
The Music Connection 164, 172
- N**
- Navarre Corporation 74, 88, 94
Netstal 147
Nimbus Records 167
Nippon Television Music Corporation 297
North Country Distributors 94
Northeast One Stop Inc. 94
Nova Distributing Corp. 81
- O**
- OD&ME 182
Ocean Development America, Inc. 145
Off-Beat Records 87
Olamon Industries 140
One World Records 90
Overland Products Co. 142
- P**
- Pacific Coast One-Stop 76
Paulstarr Distributing 88
Peer Music 57
Performance Record & Tape Distributors 90
Phenix Trading Co., Ltd. 294
Pocket Songs 96

Advertisers Index

Poly-Matrix	142		
Polyform, Inc.	173		
Polyline Corp.	144		
Precision Sound Marketing, Ltd.	75		
Pricerite Entertainment Corp.	93		
Q			
QCA	157		
Quali-Source Limited	143		
R			
RCI Records Inc.	121		
RM Distributing	83		
RTI	89		
Rainbo Records & Cassettes	151		
Reliance Plastics & Packaging	172		
Reyes Records Inc.	80		
Ross-Ellis Ltd.	174		
Royalty Participation Management	116		
Ruby Sales Company, Inc.	83		
S			
Scandia Packaging	173		
Schwartz Brothers, Inc.	78		
Scorpio Music, Inc.	91		
Scotts One Stop	85		
Shape, Inc.	Cover II, 110		
Shun Cheong Record Co., Ltd.	291		
Sony Professional Tape	137		
Sound Impressions	159		
Sound Solutions	93		
Southwest Wholesale Records & Tapes	69		
Sun Plastics Company, Inc.	168		
Sunkyong Magnetic/America Inc.	131		
Super Stop, Inc.	295		
T			
TDK	Cover IV		
T-Shirt Distribution & Merchandising Co.	112		
TV Asahi Music Co., Ltd.	297		
Tapecom Inc.	150		
Truetone Inc.	171		
Ernest Tubb Record Dist.	105		
Twinbrook Music, Inc.	100		
U			
U.S. Optical Disc Inc.	165		
Unique Music Corp.	97		
Universal One Stop	71		
V			
Valentine Music Centre	300		
Valley Record Distributors	75		
Venus Records & Music Distribution Inc.	99		
Vintage Distributing, Inc.	77, 85, 100		
Vinyl Vendors	86		
Vista Sounds International, Inc.	92		
W			
WEA Manufacturing, Inc.	169		
Western Merchandisers One-Stop	107		
Wilmi Sales Corp.	98		
Win Records & Video, Inc.	99		
Woodruff Corp.	115		
Woodyland Trading Co., Ltd.	296		
World Trading Center, Inc.	96		
Z			
Zim Records	98		

**To Order Additional Copies
of the 1992
International Buyer's Guide
or other Billboard Directories**

**Call Toll Free: 1-800-344-7119
In New Jersey: 1-908-363-4156**

Perfect Impressions



Digital Audio Disc Corporation

COMPACT DISC, LASERDISC, CD-ROM, DAT: Editing, duplication, packaging and fulfillment.
1800 N. Fruitridge Ave., Terre Haute, Indiana 47804 • 812-462-8100 • A Subsidiary of SONY USA, INC.